

SOME ASPECTS OF THE STRUCTURAL DESIGN OF
SEGMENTAL BLOCK PAVEMENTS IN SOUTHERN AFRICA

by

JOHN MICHAEL CLIFFORD

PROMOTER : Professor P F Savage

This Thesis is submitted to the University of Pretoria in partial fulfilment of the requirements for the degree D.Ing. and has not been submitted either in whole or in part to any other university.

OCTOBER 1984

SOME ASPECTS OF THE STRUCTURAL DESIGN OF SEGMENTAL
BLOCK PAVEMENTS IN SOUTHERN AFRICA

TABLE OF CONTENTS

	PAGE
TABLE OF CONTENTS	(i)
SUMMARY	(v)
OPSOMMING	(x)
ACKNOWLEDGEMENTS	(xv)
FOREWORD	(xvi)
CHAPTER 1 - MOTIVATION FOR THE RESEARCH	
1.1 Introduction	1
1.2 Historical Review	4
1.3 Developments leading to modern block paving design	6
1.4 Reasons for the present study	10
1.5 Form of the study	11
CHAPTER 2 - TESTS TO DETERMINE WATERPROOF CHARACTERISTICS OF SEGMENTAL BLOCK PAVEMENTS	
2.1 Introduction	14
2.2 Factors considered	14
2.3 Simple repeatable test procedures	17
2.4 Discussion of results of tests	31
2.5 Conclusions	33
2.6 Transferability of experimental conclusions to the other forms of block pavements	34
CHAPTER 3 - ASPECTS OF "INTERLOCK" AND "LOCK-UP" IN BLOCK PAVEMENTS	
3.1 Introduction	36
3.2 Definition of terminology	36
3.3 Performance of pavements with time	37
3.4 The settling-in of block pavements	39
3.5 Lateral support requirements of block pavements	42
3.6 Structural and architectural use of blocks	43
3.7 Conclusions	45
CHAPTER 4 - MECHANISMS OCCURRING WITHIN THE BEDDING AND THE JOINTS OF SEGMENTAL BLOCK PAVEMENTS	
4.1 Introduction	50
4.2 Relevant aspects of the installation procedure	51
4.3 Functions of the bedding and jointing material	52
4.4 Mechanisms of response	56
4.5 Tests to study jointing and bedding of segments	61
4.6 Preconceived notions and results of tests	64
4.7 Results of extraction tests	65
4.8 Conclusions	68

CHAPTER 5 - SEGMENTAL BLOCK PAVEMENTS - OPTIMIZING JOINT
WIDTH AND JOINT MATERIAL

5.1	Introduction	71
5.2	Purpose	72
5.3	Considerations	72
5.4	Field measurement of joint width	75
5.5	Discussion of field joint widths	77
5.6	Extraction tests	81
5.7	Results and discussion of extraction tests	81
5.8	Laboratory tests with extraction instrument	84
5.9	Relating the tray tests to site construction methods	96

CHAPTER 6 - HEAVY VEHICLE SIMULATOR TESTING ON SOME
SEGMENTAL CONCRETE PAVING BLOCKS

6.1	Introduction	99
6.2	Repeated and step loading on block pavement layers with the HVS	100
6.3	Wheel load equivalency factors	101
6.4	Previous experience of testing deflections of segmental block pavements	103
6.5	Design of experimental pavements for evaluation with the HVS	105
6.6	Analysis of tests on segmental block pavements	109
6.7	Conclusions	116
6.8	Discussion	117

CHAPTER 7 - AN EVALUATION OF MORTAR-JOINTED SEGMENTAL BLOCKS

7.1	Introduction	123
7.2	Segments with mortared joints	123
7.3	Design of the experiments	124
7.4	Construction of the test areas	126
7.5	Heavy Vehicle Simulator testing	128
7.6	Expanded testing of circular units	133
7.7	Evaluation of circular segments 100 mm thick using the HVS	133
7.8	Evaluation of 37,5 mm thick segments using the HVS	136
7.9	Evaluation of 50 mm thick segments using the HVS	136
7.10	Evaluation of 75 mm thick segments using the HVS	139
7.11	Conclusions and Recommendations	139
7.12	Selected results and data obtained from HVS testing	140

CHAPTER 8 - SKID-RESISTANCE MEASUREMENTS MADE ON SEVERAL
SEGMENTAL BLOCK PAVEMENTS

8.1	Introduction	149
8.2	Methods of evaluating skid-resistance of segmental block pavements	151
8.3	The skid resistance experiments	153
8.4	Discussion of Botanical garden results	160
8.5	Analysis of results with respect to rating scales	163
8.6	Recommendations	167

CHAPTER 9 - MODELLING OF SEGMENTAL BLOCK PAVEMENTS FOR INDUSTRIAL APPLICATIONS

9.1	Purpose of modelling	169
9.2	Method of modelling	169
9.3	Requirements of modelling	170
9.4	Philosophy of modelling	170
9.5	Mechanistic input	171
9.6	Stress dependency	171
9.8	Results of the example of modelling	172

CHAPTER 10 - STRUCTURAL DESIGN PROCEDURES FOR SEGMENTAL BLOCK PAVEMENTS

10.1	Introduction	183
10.2	The design process	184
10.3	Design Step 1 - Select category	184
10.4	Design Step 2 - Design strategy	188
10.5	Design Step 3 - Design loads	188
10.6	Design Step 4 - Materials	191
10.7	Design Step 5 - Environment	191
10.8	Design Step 6 - Structural design and block pavement	194
10.9	Design Step 7 - Practical considerations	198
10.10	Design Step 8 - Cost analysis	205
10.11	Comparison of costs	206
10.12	Catalogue of designs for the various categories of segmental block pavements	211

CHAPTER 11 - EXPERIENCE OF SEGMENTAL BLOCK PAVING IN AUSTRALIA, BRITAIN, ISRAEL AND EUROPE; POSSIBLE APPLICATIONS IN SOUTH AFRICA

11.1	Introduction	219
11.2	Principal findings	219
11.3	Paving in urban areas ie category S2	220
11.4	Joint width	221
11.5	Blocks laid directly on desert sands	221
11.6	Use of blocks on airports - Luton Airport U K	222
11.7	What wet compressing strength (MPa) is desirable	222
11.8	Recommendations	223

CHAPTER 12 - CONCLUDING REVIEW AND RECOMMENDATIONS FOR FURTHER WORK

12.1	Concluding review	226
12.2	Recommendations for further work	236

REFERENCES	244
APPENDIX A. Philosophy for modelling segmental block pavements	253
APPENDIX B. Behaviour and distress criteria	259
APPENDIX C. Block paving in Australia, Israel, Britain and Europe	277
APPENDIX D. Four practical tests for measuring joint strength	291
APPENDIX E. Data of modelling	309

SUMMARY

SOME ASPECTS OF THE STRUCTURAL DESIGN OF SEGMENTAL
BLOCK PAVEMENTS IN SOUTHERN AFRICA

by

John Michael Clifford

Thesis for the degree : D.Ing.
Department of Civil Engineering
University of Pretoria 1984

Promoter : Professor P F Savage

This thesis presents a catalogue of designs for segmental block pavements for use in Southern Africa. It develops a basis for the designs by identifying and quantifying those parameters which affect the design. The evolution of the designs and the experimentation promoting their formulation are described.

Chapter one details the motivation for the thesis. Here it is initially established that there has been little research done around the world in substantiating the design guides published principally by manufacturers. A brief historical review shows that types of segmental block paving such as setts and stone blocks have been used for many hundreds of years but no scientific basis for their design was found. The fundamental design of all pavements requires effective compaction of the various layers and adequate drainage.

Pioneers in the development of materials suitable for pavement construction used tars and bitumens to seal the structural layers of a pavement from the ingress of moisture to ensure optimum performance, whilst construction techniques demanded drainage around the pavement to keep it substantially dry.

Engineers initially confronted with a block-pavement remember this and are often concerned with the possibility of weak or even saturated foundations under the blocks. Such a condition could seriously affect the performance of the pavement especially under heavy axle-load trafficking. Manufacturers and others experienced with block pavements, however, assure designers that block pavements are waterproof and that the ingress of water into the foundations is very limited indeed.

A series of experiments are described in *Chapter two* which studies the waterproofing aspects of blocks by means of laboratory tests and a portable, yet simple, instrument for site use.

In many parts of the world segmental block paving is rapidly gaining popularity in applications as divergent as the heaviest industrial use to light paving for footpaths. Designers who are familiar with pavement engineering terminology are often introduced to the possibilities of segmental blocks by non-technical sales promotional literature. Considerable variations in the meaning of the widely used terms 'Interlock' and 'Lock-up' exists and misunderstandings have occurred. *Chapter three* describes some of the problems the misapplied terminology has produced and defines 'Interlock' and 'Lock-up' in a manner consistent with established pavement engineering terminology. A conclusion is reached which suggests dropping the term 'lock-up' and using the term 'settled-in' which more aptly described what occurs.

Considerable experience in testing a wide variety of block pavements by Heavy Vehicle Simulators (HVS) has been gained in South Africa. The pavements tested included those which had just been laid and where environmental effects had not yet occurred, and those which had been in-service for some considerable time and subjected to both traffic and environmental effects. Typical curves of rutting plotted against time were derived from this work and tend to confirm these definitions given. The improvements in the performance of block pavements that

occur with time are also discussed. The inter-relationship of individual blocks within their matrix by the jointing material is shown to be very important and this is further shown to provide the flexible response of the block pavement as a whole, to induced loading.

Chapter four studies the mechanisms of the joints between individual blocks in a segmental block pavement. The effects of loading which induces resilient deformation in the pavement, and overloading where permanent (or non-resilient) deformation occurs in the pavement are investigated. Torsional, shear, compressive and tension effects are also investigated. A block extraction instrument was developed and is described. Its purpose is to pull individual blocks from their matrix to quantify the stresses induced and provide data for the optimization of the joints in a structural block pavement.

Following the study of the mechanisms occurring within the bedding and the joints of segmental block pavements, it was realized that further work was needed to study the effects of various jointing materials and the effect of varying the joint width between individual blocks. *Chapter five* describes a method of evaluating the interface strength of the joints by extracting individual blocks. A range of optimum widths and materials for the joints was identified. A site survey of precise joint widths was made to relate the optimum conditions determined by the experiments to the practical conditions achieved during construction.

A large number of experimental sections was constructed and tested with a HVS. These tests allowed rapid evaluation of various subgrade, subbase and loading conditions. *Chapter six* describes the tests and discusses the results. An economical design method using various equivalency factors is suggested. Equivalency factors are necessary for rapid HVS evaluation of pavements subjected to standard axle-loads or for extending the range of current pavement designs.

Segmental block pavements as defined in this thesis comprise hand-sized blocks bedded and jointed in sand. *Chapter seven* however describes an evaluation of mortar jointed segmental blocks. Mortar jointing is popular with some users but this method of jointing

produces a semi-rigid pavement where the flexible design concept is not valid. With mortar jointing there is a need for the construction, of construction, expansion and contraction joints. Comparisons between the two systems are made and a list of the various advantages and limitations is given. An HVS was used as part of the evaluation technique and it rapidly induced the equivalent of many years of use under industrial loading conditions. Conclusions reached show that the 2-5 mm wide joints desirable with interlocking units are not suitable for mortaring.

Since little work had been done to determine the skid resistance of segmental block pavements, seven sites were chosen for study, to represent as wide a cross section of pavements as possible. Sites chosen for evaluation included the 20 year old pavements in Chatsworth Natal and some newer pavements in the Cape and the Transvaal.

A Pendulum device and the SCRIM apparatus were used and *Chapter 8* details the skid-resistance results obtained and compares them with rating scales developed for other South African pavements. The results have shown that the block pavement tested were satisfactory for use by high speed vehicles when angular aggregates were used in the manufacture of the blocks. Changes in manufacturing procedures are recommended for the use of blocks in pavements for speeds in excess of 50 km/h.

Soil mechanics and pavement engineering evaluation techniques were developed from what may be described as 'normal' load applications. The Heavy Vehicle Simulators have enabled considerable extensions to this range but the design of pavements for industrial loading still requires special consideration. Modelling techniques for segmental pavements are discussed in *Chapter nine*. Modelling provides a means of rapidly evaluating changes in materials, layer thicknesses, density and loading for example. Mathematical and laboratory analysis techniques were examined and a full-scale HVS test was designed. Comparisons of these various techniques suggested a method whereby modulus values for the block layer could be determined.

Chapter ten summarizes the individual aspects discussed in the earlier chapters and provides guidelines for the design of segmental block pavements for Southern African conditions. The structural design method developed is applicable to both concrete and fired-clay units. A catalogue of designs is provided with various designs suitable for six categories of use. The chapter also includes a discussion of aspects related to materials, design loads, environment, drainage and compaction.

Australia is a country of similar climate and stage of industrial development to Southern Africa. It has also a fairly long history of using segmental block pavements in a variety of applications. *Chapter eleven* reviews their experience and examples of both good and bad practice are discussed with particular reference to any benefits which could be derived for Southern Africa. The findings discussed in Chapter eleven are expected to benefit Southern Africa economically and have led to improved knowledge and practice.

Specific conclusions reached in the thesis are reviewed and discussed in *Chapter twelve*. Areas where further work would be beneficial are also mentioned.

OPSOMMING

ENKELE ASPEKTE VAN STRUKTUURONTWERP VAN
STEENPLAVEISELS IN SUID-AFRIKA

deur

John Michael Clifford

Proefskrif vir die Graad D.Ing
Departement vir Siviele Ingenieurswese
Universiteit van Pretoria
Promoter : Professor P F Savage

Hierdie proefskrif bevat 'n katalogus van ontwerpe vir Steenplaveisels vir gebruik in Suider-Afrika. Hierin word 'n basis vir die ontwerpe, deur die hoeveelheid parameters wat die ontwerp beïnvloed te identifiseer en te bepaal, ontwikkel. Die ontwikkeling en die eksperimente wat die formulering van die ontwerpe bewerkstellig het, word beskryf.

In *Hoofstuk een* word die motivering vir die proefskrif gegee. Daar is vasgestel dat daar in die wêreld weinig navorsing gedoen is om die riglyne vir ontwerpe wat hoofsaaklik deur Vervaardigers gepubliseer is te staaf. Met 'n kort historiese oorsig is gevind dat sekere steenplaveisels soos "Selfts" en "Stene" al vir honderde jare gebruik word maar geen wetenskaplike basis vir hulle ontwerp kon gevind word nie. Die grondontwerp van alle plaveisels vereis effektiewe kompaksie en dreinerings van al die lae.

Pioniers in die ontwikkeling van geskikte materiale vir padkonstruksie het tere en bitumens gebruik om die struktuurlae van 'n plaveisel teen die indringing van nattigheid te seël, om sodoende optimum werkverrigting te verseker, terwyl konstruksie tegnieke gesorg het vir doeltreffende dreinerings langs die plaveisel om dit in 'n aansienlike mate droog te hou.

Wanneer 'n Ingenieur vir die eerste keer met 'n steenplaveisel te kampe het mag hy hiervan bewus wees en bekommerd wees oor die moontlikheid van 'n deurweekte fondasie onder die stene. So 'n toestand sal die werkverrigting van die plaveisel, veral onder verkeer met swaar aslaste, ernstig beïnvloed. Vervaardigers en ander ervare met steenplaveisels verseker ontwerpers egter dat steenplaveisels waterdig is en dat indringing van groot hoeveelhede water in die fondasie nie voorkom nie.

In *Hoofstuk twee* word 'n reeks eksperimente waarin die waterdigting van die stene deur middel van laboratoriumtoetse en 'n eenvoudige draagbare apparaat wat vir terreingebruik ontwikkel is, beskrywe.

In baie dele van die wêreld is steenplaveisels besig om gewildheid te verwerf in uiteenlopende gebruike soos in plaveisels by groot industrië tot in ligte voetpaadjies. Steenplaveisels word dikwels aan ontwerpers wat vertrou is met die terminologie van plaveiselsingeniërsweese deur nie-tegniese reklame bekend gestel.

Daar bestaan aansienlike variasies van die betekenis van die algemene gebruik van die terme "tussensluiting" en "sluiting" wat misverstande veroorsaak.

In *Hoofstuk drie* word sommige van die probleme wat as gevolg van die wangebruik van die terminologie ontstaan het, beskrywe en word "tussensluiting" en "sluiting" in terme van bestaande terminologie vir plaveiselsingeniërsweese gedefinieer.

In Suid-Afrika is aansienlike ondervinding in die toetsing van 'n verskeidenheid steenplaveisels met Swaarvoertuignabootsers (SVN) opgedoen. Die toetse het plaveisels wat pas gebou is waar geen omgewingsbeïnvloeding plaasgevind het nie en plaveisels wat al lank bestaan en reeds aan omgewingsinvloede en verkeer blootgestel is, ingesluit.

Tipiese grafieke van spoorvervorming teenoor tyd het uit hierdie werk voortgespruit en word getoon om die gegewe definisies te staaf. Die verbetering van die werkverrigting van steenplaveisels wat met tyd plaasvind word ook bespreek. Die tussenaksie van blokke in die lasdigtingsmateriaal in 'n matriks toon baie belangrik te wees en is ook verantwoordelik vir 'n buigsame reaksie van 'n steenplaveisel onder geïnduseerde belading.

In *Hoofstuk vier* word die meganisme in die lasse tussen afsonderlike stene in 'n steenplaveisel bestudeer.

Die effek van veerkragtige belading en nie-veerkragtige oorbelading wat permanente deformatsie veroorsaak word ondersoek. Die gevolge van wringings-, skuif-, druk- en trekspannings word ook ondersoek. 'n Steenuittrekkapparaat, met die doel om stene uit 'n matriks te trek om die geïnduseerde spannings te bepaal en data vir die vasstelling van die beste lasdigting vir 'n steenplaveiselstruktuur te verskaf, is ontwikkel en word beskryf.

Tydens die studie van die meganismes in die bedding en lasse van 'n steenplaveisel is besef dat verdere werk nodig is om die effek van verskillende lasdigtingsmateriale en 'n variasie in lasbreedtes tussen stene in die plaveisel te bestudeer.

In *Hoofstuk vyf* word 'n metode om die sterkte van die laskeidingsvlak te evalueer deur stene uit die plaveisel te trek, beskrywe. 'n Reeks van gunstige lasbreedtes en lasdigtingsmateriale is geïdentifiseer. 'n Terreinopname van die eksakte lasbreedte is gemaak om die optimum kondisies wat deur die eksperimente bepaal is, in verband met praktiese toestande wat deur konstruksie verkry is, te bring.

'n Groot hoeveelheid eksperimentele seksies is gebou en met die SVN getoets. Met hierdie toetse kon 'n snel-evaluering van verskeie grondlae, stutlae en beladingtoestande gemaak word. *Hoofstuk ses* beskryf en bespreek hierdie toetse en resultate. 'n Ekonomiese ontwerpmetode met verskeie ekwivalente faktore word voorgestel. Ekwivalente faktore is noodsaaklik vir snel-SVN-evaluering van plaveisels wat aan stan-

daardaslaste blootgestel word of om die huidige plaveiselontwerpmetodes uit te brei.

Steenplaveisels wat in hierdie proefskrif gedefinieer word bestaan uit handgrootte stene wat in sand gelê en gevoeg word. *Hoofstuk sewe* beskryf egter gemesselde stene. Gemesselde lasse is by sommige gebruikers gewild maar hierdie tipe van lasdigting gee 'n halfstye plaveisel wat gebruik word waar 'n buigsame plaveisel nie van toepassing is nie. In die geval van gemesselde lasse bestaan daar die nodigheid van rek en krimp in die konstruksie. Die twee sisteme word vergelyk en 'n lys van die verskillende voordele en beperkings word gegee. 'n SVN is gebruik as deel van die evalueringstegniek om baie jare van gebruik onder beladings by industriële te induseer. Gevolgtrekkings wat gemaak is toon dat die 2-5 mm wye lasse wat tussen tussensluitende stene wenslik is, nie geskik vir messel is nie.

Aangesien weinig navorsing om die glyweerstand van steenplaveisels te bepaal, gedoen is, is sewe terreine om so 'n groot deursnee van plaveisels as moontlik te verteenwoordig, gekies. Terreine wat vir die evaluering gekies is, sluit plaveisels in Chatsworth, Natal wat 20 jaar oud is en sommige nuwer plaveisels in die Kaapprovinsie en Transvaal, in.

Die Pendulum toetsapparaat en die SCRIM-apparaat was ook gebruik. Die glyweerstandresultate wat verkry is word in *Hoofstuk agt* opgesom en met waardebepalingsstelsels wat vir ander Suid-Afrikaanse plaveisels ontwikkel is, vergelyk.

Die resultate het getoon dat die steenplaveisels geskik is vir gebruik onder snelbewegende verkeer mits hoekige aggremaat in die vervaardiging gebruik word.

Veranderings in vervaardigingsmetodes vir stene wat in plaveisels gebruik word waar verkeer teen snelhede hoër as 50 km/h beweeg, word aanbeveel.

Huidige siviele- meganiese- en plaveiselingeniërs-evalueringstegnieke is geskik vir "normale" beladings maar die ontwerp van 'n plaveisel vir beladings by industriële verg. spesiale oorwegings. Modeltegnieke vir steenplaveisels word in *Hoofstuk nege* bespreek. Modellerings is 'n wyse van snel-evaluering van veranderings in byvoorbeeld materiale, laagdiktes, digtheid en beladings. Wiskundige en laboratorium analiese-tegnieke was ondersoek en 'n volskaalse SVN toets was ontwerp. Vergelykings tussen hierdie verskillende tegnieke het 'n metode waarby moduluswaardes vir die steenlaag vasgestel kon word, aangedui.

In *Hoofstuk tien* word die afsonderlike aspekte wat in die vorige hoofstukke bespreek word, saamgevat en riglyne vir die ontwerp van steenplaveisels vir Suider-Afrikaanse toestande word bepaal. Die struktuurontwerpmetode wat ontwikkel is, is toepaslik vir beide beton- en vuurvaste kleistene. 'n Katalogus met ontwerpe wat vir 6 kategorieë van gebruik geskik is, word voorsien. Hierdie hoofstuk sluit ook bespreking van aspekte verwant aan materiale, ontwerpbeladings, omgewing, dreinerings en verdigting in.

Australië is 'n land met soorgelyke klimaat en is in dieselfde ontwikkelings stadium as Suider-Afrika. Sy het ook 'n taamlike lang geskiedenis in die gebruik en verskeie toepassings van steenplaveisels. *Hoofstuk elf* hersien hulle ondervinding en voorbeelde van goeie sowel as slegte toepassing word bespreek met spesiale verwysing na enige voordele wat vir Suider-Afrika daaruit kan ontstaan. Suider-Afrika kan verwag om finansiële baat te vind by die bevindings in hoofstuk elf.

Spesifieke gevolgtrekkings wat in hierdie proefskrif bereik is, word hersien en in *Hoofstuk twaalf* bespreek. Areas waar verdere navorsing voordelig mag wees word ook genoem.

ACKNOWLEDGEMENTS

I should like to express my sincere thanks to Dr S H Kühn, Director of the National Institute for Transport and Road Research, for his permission to submit the findings of my research carried out at the Institute. I acknowledge also the general support of the Institute for this study.

To my promoter Professor P F Savage, I express my sincere appreciation of his interest, direction, encouragement, and also for his time and invaluable assistance in the preparation of this document.

My gratitude goes also to my colleagues of the Roads Branch; Mr Walker and Dr Freeme for their encouragement; Mr Marks and Mr Skultety for their technical assistance; and the ladies of the Editing and Word-Processing services and the drawing office.

I express my appreciation to the Concrete Masonry Association and the Brick Development Association of South Africa and the Portland Cement Institute for their help and encouragement.

I also acknowledge CONCOR Ltd and GRINAKER Ltd for permission to use some of material included in Chapter 12.

Lastly I should like to acknowledge my appreciation of the many types of support given by my family.

FOREWORD

This thesis comprises 12 Chapters most of which have been published over the past few years as papers for various conferences. Each chapter is therefore substantially complete in itself and a minimum amount of repetition occurs.

Chapter 10 details a structural design procedure for segmental block pavements and follows the style and format of TRH4 (Technical recommendation for highways "Structural design of inter urban and rural road pavements"). Much of the work for TRH4 was done by Dr Hoffman Maree who was then employed by the National Institute for Transport and Road Research, CSIR, Pretoria.

Little had been written and published in the world on segmental block pavements prior to the work reported in this thesis. The earliest work of relevance was done by Mr L R Marais of the South African Portland Cement Institute who is acknowledged for the work he did some years ago. More recently Dr B Shackel worked in South Africa whilst on a sabbatical leave from the University of New South Wales in Australia. He had carried out some research on segmental block paving which was continued whilst he was in South Africa. This work was continued after he left and formed the starting point of the work reported in this thesis. A brief review of work done and reported by Dr Shackel follows.

In an early review of the technology of interlocking concrete block paving for roads and industrial pavements (Shackel 1980 No. 2) the worldwide state of the art was detailed. Such things as advantages and disadvantages of the various block paving systems were given. Manufacturing methods and specifications were compared and an introduction to the mechanical laying of blocks was made. A summary of the then current design methods for block pavements from various countries of the world showed the limited approach that was then possible.

A subsequent evaluation of the design of block pavements subjected to road traffic critically reviewed the state of knowledge of the performance of block pavements under traffic. Shackel concluded that it would be possible to develop a hierarchy of design methods based on economic considerations and other factors. It was recognised that the design procedures then available were adequately conservative for their immediate application to practical block paving situations. These subsequently formed the basis of design charts used in the earlier days of block paving design in South Africa. (Shackel 1980 No. 3).

A small number of specialized investigations were carved out by Shackel using the Heavy Vehicle Simulator (HVS) and other specialist equipment. The design of a pilot study of HVS testing on blocks included experience over one and a half years prior to that time in Australia. The early work of Marais of PCI and others were also used to ensure continuation of developments in the block paving field. These studies were in part funded by industry. The outcome of these tests were reported both locally and internationally. (Shackel 1979 No. 2 and, 1980 No. 4, 1980 No. 5).

During 1980 the research programme included the optimization of bedding sands and the effect that different materials had on the surface deflections under traffic. (Shackel 1980, 1980 No. 6). Studies of supporting layers from pavement sections from around the world were also included. The use of large cranes at the South African electrical supply commission's power stations supported research into designs and testing of a suitable industrial block-pavement to carry the vehicle.

A large range of test sections including clay-brick and concrete-block pavements was designed and installed prior to Shackel's return to Australia. These test sections were subsequently evaluated as part of the work reported in this thesis by the author.

CHAPTER 1

MOTIVATION FOR THE RESEARCH

CHAPTER 1

MOTIVATION FOR THE RESEARCH

1.1 INTRODUCTION

The use of segmental block paving is relatively new to Southern Africa. The name derives from the individual segments, i.e. the bricks or blocks used to form both the surfacing and base of such pavements. They have a number of uses, both structural and architectural.

Figure 1.1 shows two segmental block pavements during construction. Segmental block paving was originally used in domestic applications, and for light pavements, such as footpaths. Their applications, however, are potentially much wider and in other countries they have long been used for housing estate roads and for secondary roads. In Southern Africa, experience in the use of such paving is limited, but has included pavements for heavily loaded industrial stacking and servicing yards. This heavy application is possible because the segments are typically 60 to 120 mm thick and therefore provide some stress-dissipation properties to the pavement as a whole. The use of segmental block paving is expected to increase in many areas, particularly for industrial access roads.

The blocks also find architectural application since they are aesthetically pleasing for areas such as pedestrian shopping malls and open city squares. A variety of patterns and colours is possible as is shown in an attractive advertisement by a company operating in the Netherlands (Figure 1.2).

At present two principal materials are used for making segments, namely brick and concrete, but it is expected that with the increased use of waste materials in road construction, new materials such as mine-sands and fuel ash may be employed.

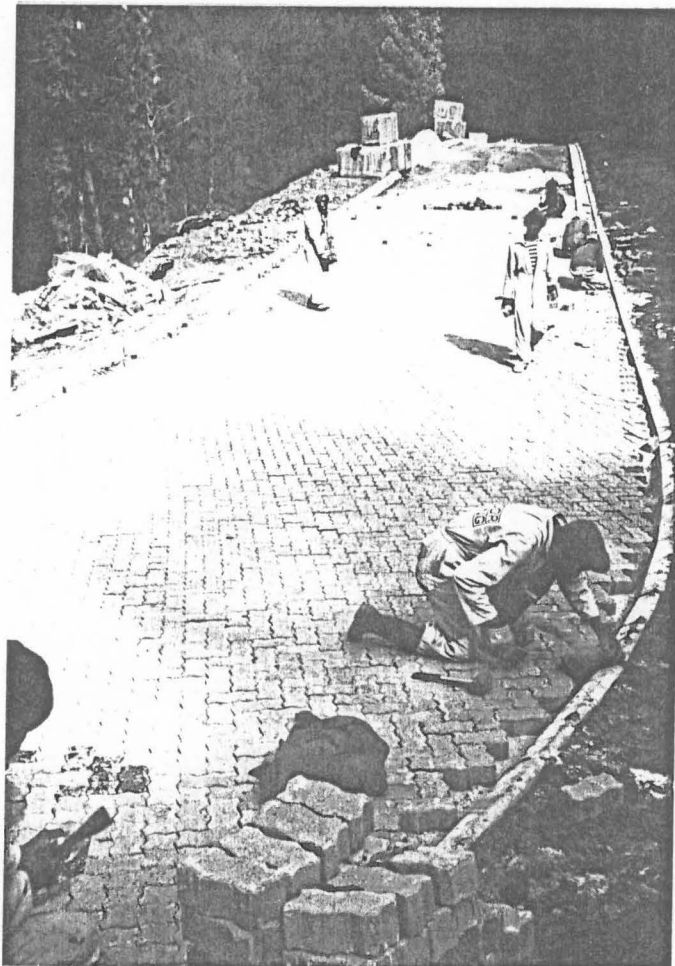
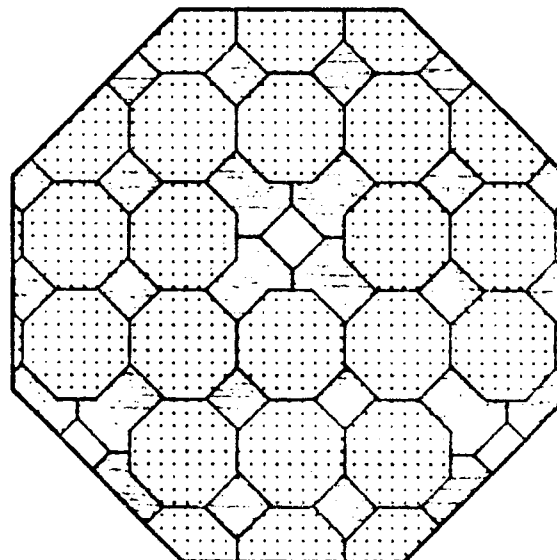
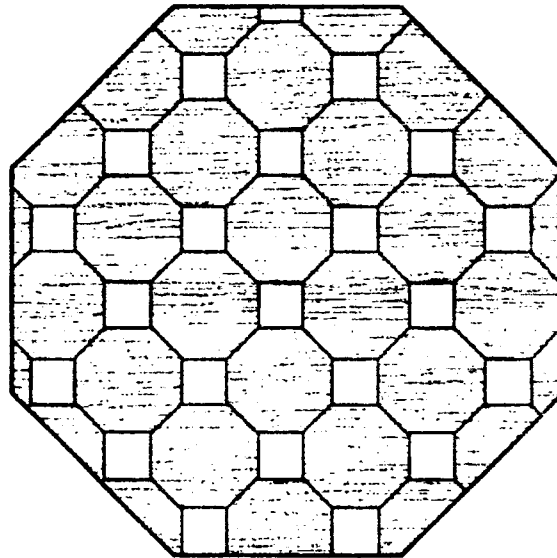
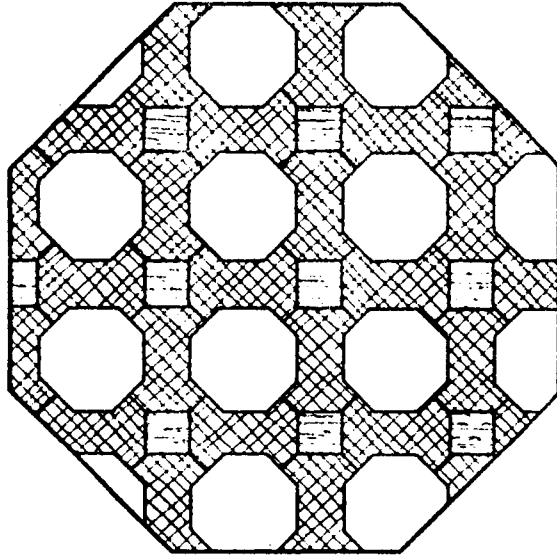


FIGURE 1.1

TYPICAL SEGMENTAL BLOCK PAVING DURING CONSTRUCTION



COMBINATION OF VARIOUS SHAPES SHOWN IN PLAN

NOTE :
VARIOUS COLOUR SHADES CAN BE USED

FIGURE 1.2

*AN INDICATION OF THE AESTHETIC POTENTIAL OF SEGMENTAL BLOCK PAVING
(TAKEN FROM A DUTCH BROCHURE)*

Segmental blocks are set on a layer of non-cohesive bedding sand and jointed together with another type of sand of finer grain size and containing some cohesive material. Specifications for these materials have been defined by Shackle (1980). Because of their size, individual segments are easy to handle and can therefore be placed by hand within their matrix. Subsequent maintenance is also easy because areas of blocks can be removed using handtools.

In summary, the advantages of segmental block paving are as follows :

- (i) they are manufactured from local materials;
- (ii) they can provide either a labour-intensive operation or can be machine manufactured and laid;
- (iii) they are aesthetically acceptable in a wide range of applications, and can be used for odd-shaped areas;
- (iv) they are versatile as they have some of the advantages of both flexible and rigid pavements.

1.2 HISTORICAL REVIEW

Segmental blocks have been used for surfacing roads from the earliest times. Examples still exist from ancient Rome, Greece and India. The segments used then were of hand-chiseled stone; stones were selected at random and chiseled to fit into neighbouring stones. The spaces between the stones were then filled with sand.

In more recent times (i.e. the 19th century) stone setts were prepared. These conformed to more exact dimensional tolerances so that the pavements could be laid in regular patterns. The stones were generally of uniform size and could be easily handled. Non-skid felspathic granite was specified for stone setts both in the United States and in Europe. According to Spielman and Elford (1934), rocks with a uniform grain were preferred to a porphyry in which crystals up to 3,5 mm are set

in a matrix of fine material, and to materials containing much hornblende or mica. These specifications were aimed at overcoming the problems experienced with the irregularly shaped and larger stone blocks used previously on which old-fashioned steel-tyred wheels caused spalling of the arrises and uneven wear on the stone setts. In time individual stones became dome shaped producing a very uneven surface, such as in the common European cobblestoned streets.

During the 19th century new ideas for urban street paving design were introduced. These included the use of triangular cast-iron road blocks. (Described in the book "Iron Roads", 1938). It is interesting from a historical point of view to note that they were hollow and about 50 mm thick, designed to be laid on bitumen over concrete with a bitumen filler between each block. Woodblock roads enjoyed a long and varied history according to Fowler (1935). They were first used experimentally in cities of New York and Philadelphia (USA) in 1835. The first roads paved in wood blocks were in Whitehall and the Old Bailey (London UK) in 1839. The problems in woodblock paving was to obtain suitable wood for trafficking requirements, and to preserve the block immovably in position and in a watertight condition under traffic. Some types of Pine, Deal, Jarrah and Karri wood provided the best blocks. Woodblocks varied in size but generally were about 200 mm x 75 mm x 100 mm thick. In the search for the way to convert a collection of wood blocks into a coherent and water tight pavement, various forms evolved. The most suitable seemed to have been a block with permanently attached splines on the edges for preserving accurate spacing. Joints were bitumen grouted and adequate water proofing was achieved. The life of a well-chosen and well-laid wood block pavement was reported by Greenhill and Elsdon (1901) to be about 20-30 years even under heavy urban trafficking.

Bricks have been used for segmental-block paving for several hundred years. After the 1930 International Road Congress in Washington (USA) at which experience of brick roads laid in

America, Britain and Holland was discussed, brick roads became popular, but because of the demand for fired-clay brick products for housing, this trend was short-lived. The Netherlands was the only country regularly constructing brick roads during the 1940s and later.

In the 1950s precast concrete blocks were produced as an alternative material to brick. Concrete blocks gradually became more popular and by 1978, according to Lilley (1981), nearly 16 million square metres of paving had been produced in the UK alone. One of the new towns in the UK, Milton Keynes, built to house a quarter of a million people, had most of its streets paved with concrete blocks (Knapton and Barber (1980)). Similar examples can be found in Germany and the Netherlands. By the end of the 1970s, in some countries up to 1,0 m²/capita of concrete blocks were manufactured. (The somewhat curious ratio "area/capita" is commonly accepted within the segmental paving block industry)

Modern segmental block pavements are manufactured to close dimensional tolerances and are laid on sublayers where modern compaction and quality control methods assume suitable support. The segmental block layer therefore forms an integral part of the structure of the pavement and if properly constructed should not be subject to environmentally induced differential settlements which seemed to have been a feature of 19th century segmental block pavements (eg Spielman and Elford (1934)).

1.3 DEVELOPMENTS LEADING TO MODERN BLOCK PAVING DESIGN

The cross-sections of pavements used in the ancient empires to carry relatively light traffic are very substantial, often comprising several layers of stone blocks dressed to fit together, and various gravel layers. Over the years the design thickness of pavements has been reduced considerably. Specifications for segmental block pavements have also changed. These changes are illustrated in Figures 1.3 and 1.4.

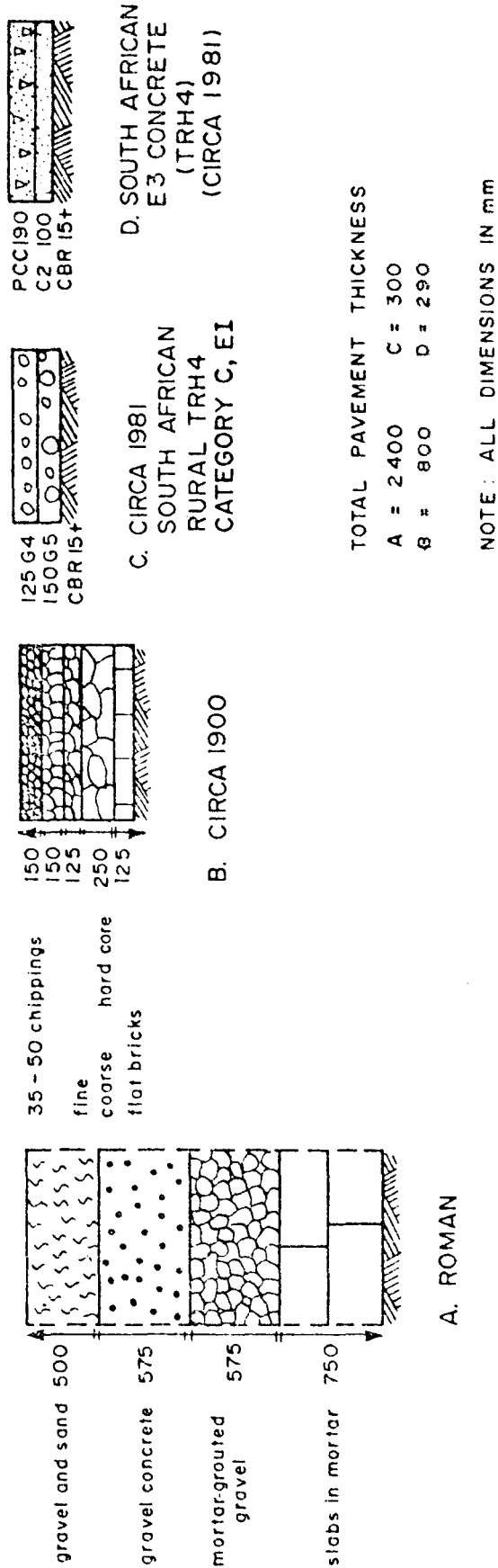


FIGURE 1.3
EXAMPLES OF ROMAN, RECENT AND MODERN PAVEMENT CROSS-SECTIONS

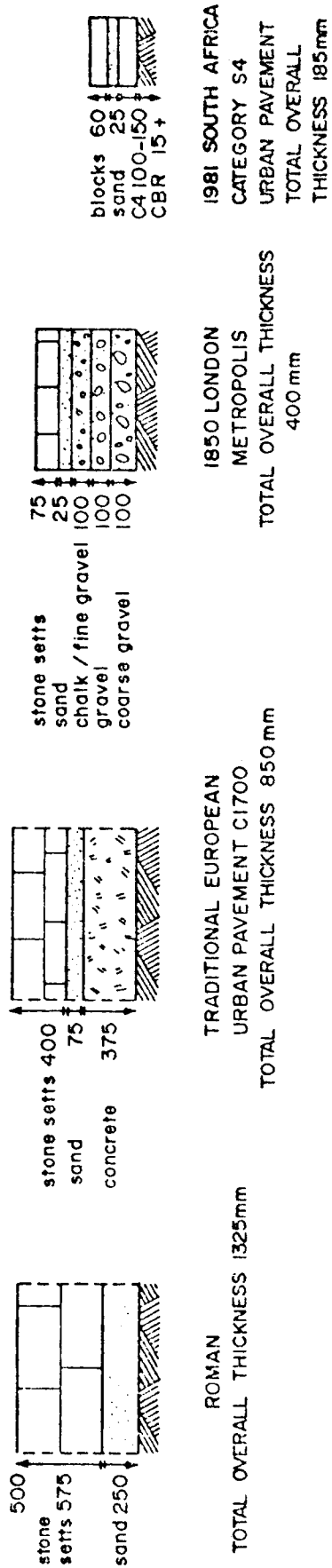


FIGURE 1.4

CROSS-SECTIONS OF SEGMENTAL BLOCK PAVEMENT DESIGN THROUGH THE YEARS

One can conclude that the earlier pavements were considerably overdesigned and unnecessarily expensive. New techniques are now available to monitor the strength of all parts of a pavement as constructed, rather than by random checking, and this has allowed reductions in the factors of safety included in designs to overcome inconsistencies of construction. These techniques include, the Southern African-developed Heavy Vehicle Simulator and its associated technology. (Freeme 1984)

The present method of construction of segmental block paving using sand-bedded and jointed blocks dates, according to Taylor (1850) from the mid-nineteenth century with the design of a pavement for central London, although it has been reported by Lilley (1981) that pavements of sand-bedded bricks have been in used in the Netherlands for some 600 years. Radford (1924) reported that in the United States of America, around the turn of the century when travel speeds were still relatively slow, sand bedding was being replaced by mortar bedding. The reason for this change was the tendency for the bedding sand to shift under the segmental unit under traffic loading. The bricks or blocks settled unevenly, causing water to pond on the surface, some of which subsequently entered the bedding and supporting layers. Mortar bedding was preferred because of its ability to keep the blocks in place and to reduce the ingress of rain water into the pavement.

During the 1920s stabilized bedding sand was introduced. Radford (1924) reported that it was stabilized with bituminous mastic (by adding 6 per cent of light tar or asphaltic oil), and laid hot. Various examples of sand and mortar-bedded segmental block pavements can be seen in Europe, especially in the Netherlands. During the last 10 to 15 years however the specification of sand bedding has been predominant.

1.4 REASONS FOR THE PRESENT STUDY

Surprisingly little has been written about segmental block pavements, although research has recently been undertaken, notably in Australia and South Africa.

1.4.1 Water resistance

The keys to successful pavement designs can be simply stated as effective compaction, and good drainage. If water is allowed to enter through the joints between the blocks and saturate the underlying foundation, the pavement's performance will obviously be adversely affected. Although manufacturers and others experienced with block pavements assure designers that block pavements are waterproof and that ingress of substantial quantities of water into the foundations does not occur, investigations showed that there was no easily repeatable procedure for testing the waterproof characteristics of segmental block pavements. A series of experiments was therefore designed for this purpose.

1.4.2 Pavement mechanisms

Segmental block pavements are a composite structure of blocks, bedding and jointing sand. They combine some of the benefits of rigid pavements (represented by the blocks) and flexible pavements (represented by the sand). Terms such as "interlock" and "lock-up" cause misunderstanding. A study of the mechanisms occurring within these pavements, for example, the part played by the joints, therefore formed part of this work.

1.4.3 Standard design procedures

Owing to the lack of formal research results and published data on this area, it was felt that there was a definite need in South Africa for a design guide for segmental block pavements. Modern analysis techniques, mathematical models

and instrumentation were used for these designs which were then constructed and tested at the NITRR's (National Institute for Transport and Road Research) Silverton test site, using the Heavy Vehicle Simulator. (Shackel (1979 No. 2)(1980 No.2). The information obtained was used to compile a catalogue of designs for segmental block pavements.

The designs produced cover numerous uses, from light civic to heavy industrial, for all the traffic conditions likely to be encountered, with the exception of high-speed freeways. The structural design method used is that explained in detail in TRH4 (1980).

1.5 Form of the study

For the reasons outlined above, this study was planned and carried out in the following way :

- Tests to determine the waterproof characteristics of segmental block pavements.
- A description of "interlock" and "lock-up" in block pavements.
- Mechanisms occurring within the bedding and the joints of segmental block pavements.
- Optimizing the joint width and the joint material.
- Heavy Vehicle Simulator testing on some segmental block paving.
- An Evaluation of mortar-jointed segmental blocks.
- Skid-resistance measurements made on several segmental block paving.
- Modelling of segmental block pavements for industrial application.
- Structural design procedures for segmental block pavements.

A review of Australian and European practice is included with some recommendations of ideas which could be incorporated into Southern African practice to our benefit.

The research work reported in this study is not expected to answer completely every possible question which may be asked, but to provide a foundation of knowledge to allow the designer and engineer to choose and construct suitable segmental block pavements with reasonable confidence.

C H A P T E R 2

TESTS TO DETERMINE WATERPROOF CHARACTERISTICS OF SEGMENTAL BLOCK PAVEMENTS

CHAPTER 2

TESTS TO DETERMINE WATERPROOF CHARACTERISTICS OF SEGMENTAL BLOCK PAVEMENTS

2.1 INTRODUCTION

It has been stated in Chapter 1 that the design concepts of road pavements were developed over a number of years. Early practical experience was later justified empirically and by mathematical calculation. A factor of this early work showed the need for sealing the surface from the ingress of moisture.

A series of experiments was designed to study the waterproof aspects of blocks by both laboratory tests and a portable yet simple repeatable procedure for site use.

2.2 FACTORS CONSIDERED

2.2.1 Rainfall patterns in Southern Africa

A large part of Southern Africa has a dry climate but a small section of the southern coast from Mossel Bay to Port Elizabeth, together with parts of Natal, south eastern Cape and the lowveld area of the Transvaal have been classified in TRH4 (1980) as having wet climates. Areas described as having a moderate rainfall are found in the east and extreme south of the country and also include the greater part of the Transvaal highveld. See Figure 2.1.

The waterproof characteristics of block pavements therefore rank differently in different parts of the country. As with other pavement types blocks should be laid to the recommended

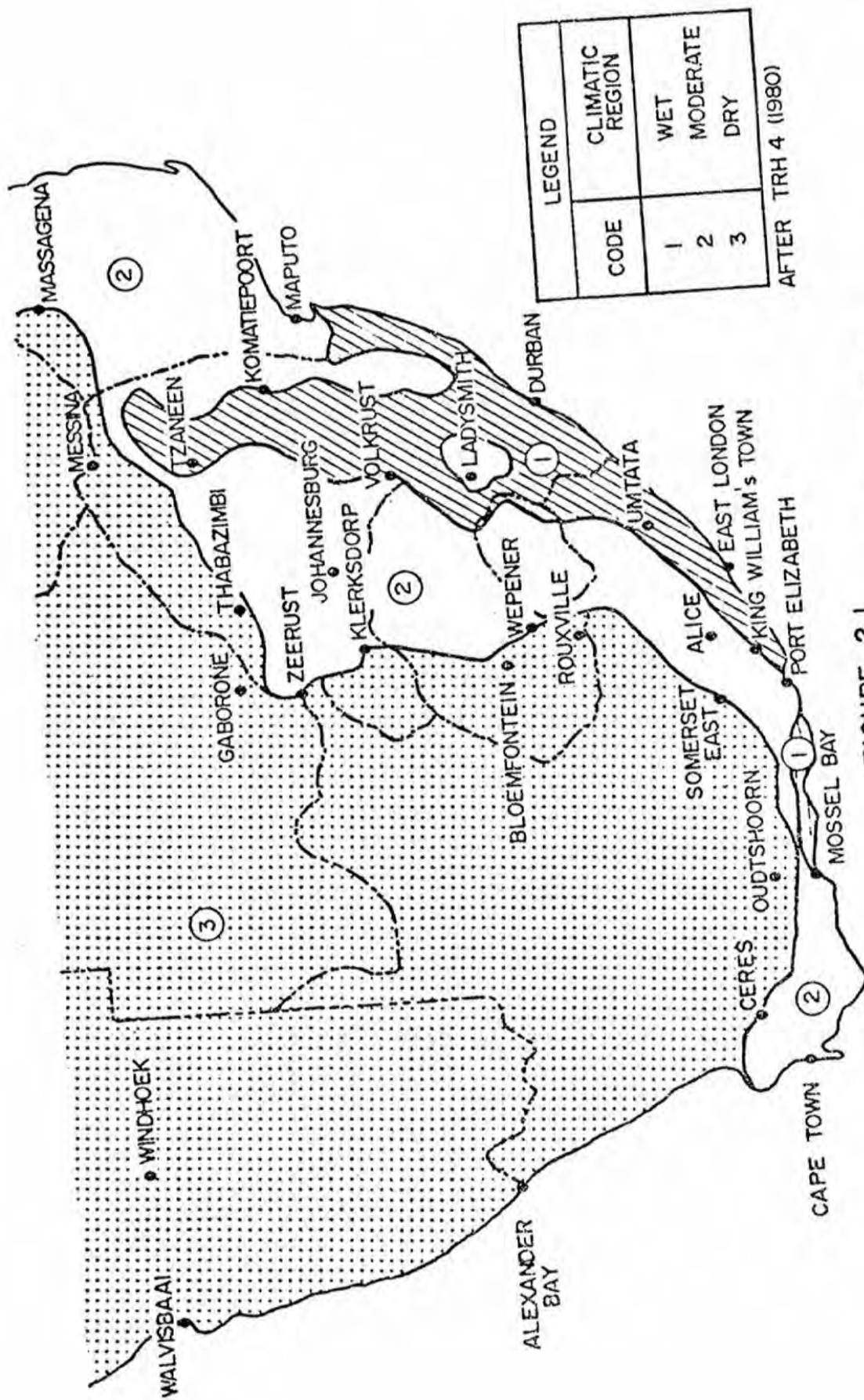


FIGURE 2.1
MACRO-CLIMATIC REGIONS FOR SOUTHERN AFRICA

minimum of one per cent cross or longitudinal fall. In large areas of paving or elsewhere where drainage is difficult an absolute minimum of one per cent fall can be accommodated with blocks. By these means a substantial runoff of surface water should take place. Another factor to be considered is the absorption characteristics of the blocks themselves. The tests described in this Chapter were designed to study inter alia these absorption characteristics. In many parts of southern Africa much of the rainfall occurs in light showers and most of the water falling on the pavement surface may be absorbed by the blocks themselves with little effect on the layers beneath the blocks. The tests were intended to determine a cut-off point between levels of rainfall which affect the lower layers (defined as "storm" conditions) and rainfall levels that can easily be accommodated in the wetting and drying cycles of the blocks themselves (defined as "shower" conditions). Since blocks are manufactured from different materials and by different techniques the cut-off point was suspected and later found to be substantially different from one material to another.

2.2.2 Block laying practice and sealing of joints

To ensure the optimum use of blocks for pavement construction the subbase layer upon which the blocks are to be laid should be levelled to within tolerances of ± 5 mm. A thin layer (typically about 25 mm) of bedding sand is screeded over the subbase and the blocks placed into this uncompacted sand bedding. When the blocks have been laid the completed area is compacted by one or two passes with a small vibrating plate compactor. The effect of this compaction not only beds the blocks into the sand but also compacts the sand layer and causes some of the bedding-sand to rise up the joints between the blocks by between 2 mm and 10 mm depending on sand type and compactive energy. Following this compaction procedure, sand which may be different from the bedding sand, is swept into the joints to fill them to the surface. A second pass with the plate vibrator compacts this sand within the joints.

The essential difference of this jointing sand from the bedding sand is its generally greater content of particles smaller than 75 μm which were found by Shackel (1980) to be desirable to cause a seal to develop within the joints.

2.2.3 Time effects of sealing of joints

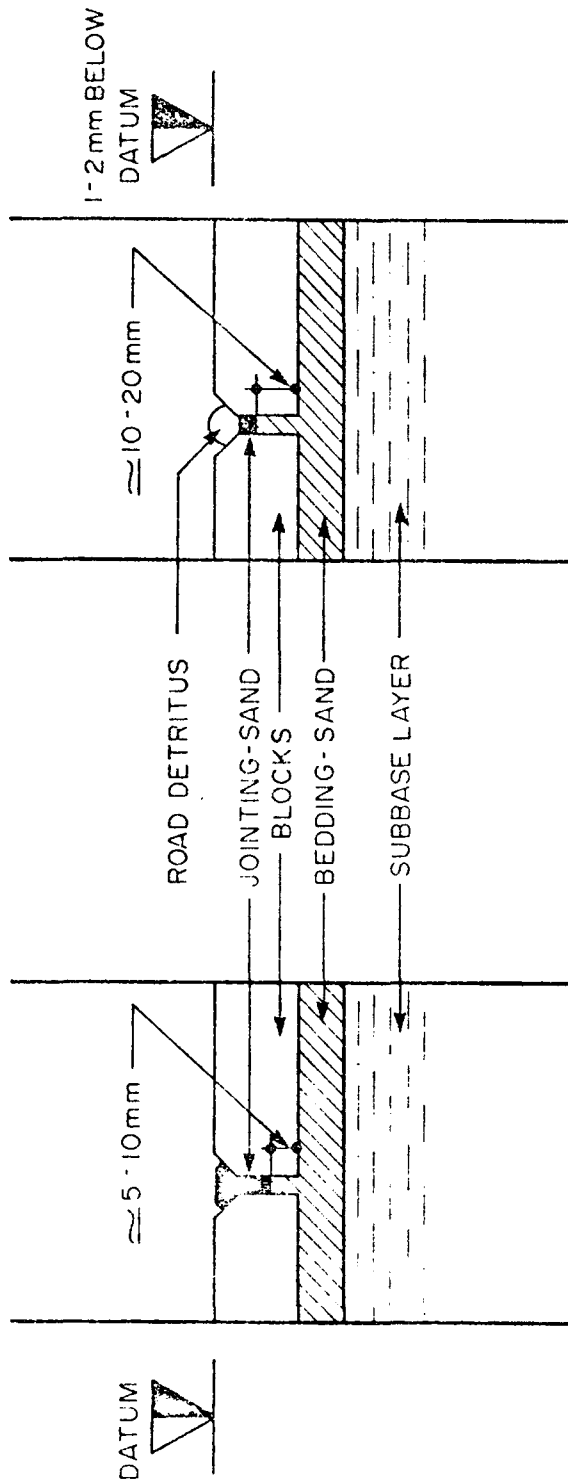
Following the completion of a block pavement, i.e. at the time when it is opened to traffic, the joint sealing would be as shown in Figure 2.2(A). With the passage of time and the additional compaction caused by trafficking the joints would be as shown in Figure 2.2(B). The cumulative compactive effect of traffic causes the blocks to bed further into the bedding-sand and displace some of the jointing sand vertically upwards. The action of passing vehicles removes some of the jointing sand and forms part of the road detritus. This detritus, which includes dust, particles of rubber from tyres and other particles re-enters the joints and forms an upper plug over the jointing sand assisting the sealing of the joints.

In the course of time the pavement may be overloaded or otherwise damaged causing the blocks to displace either laterally, vertically or as a combination of both. The blocks may also rotate in a horizontal plane. Such movement in the joints would break the seal caused by both the jointing sand and the road detritus. The seal would, however, re-form rapidly in most cases since additional material would fill the joints and the action of applied wheel or other loads with any moisture present would cause material in the joint to compact and reseal.

2.3 SIMPLE REPEATABLE TEST PROCEDURES

2.3.1 Absorption properties of blocks

A simple laboratory test to determine the absorption properties of blocks involved drying the blocks in a laboratory oven



A) JOINTS BETWEEN BLOCKS AS CONSTRUCTED B) JOINTS BETWEEN BLOCKS AFTER SOME TIME

FIGURE 2.2
CHANGES OCCURRING WITH THE MATERIAL IN THE JOINTS OF SEGMENTAL PAVING AS CONSTRUCTED AND AFTER SOME TIME

and recording their dry mass. The blocks were then placed in water for a period of time during which their increase in mass was recorded at specific increments of time. When no further increase was noted the saturated mass of the blocks was recorded.

A measure of the effect of the wetting/drying cycle was established by placing the saturated block in the open air under "natural conditions" (see Figure 2.3). The blocks were placed in a tight fitting polystyrene surround. By this means the drying-out of the saturated blocks was timed and studied. The weighing of the blocks was done without removing them from the polystyrene surround since the weight of the surround of each block was easily deducted from the total leaving the actual weight of the block and the water it contained.

The laboratory soaking test was an extreme indicator since, under actual site conditions, the blocks present only their upper surface for the absorption of rain water, whereas in the tests the blocks were allowed to absorb water from all sides. Providing water is not allowed to pond on top of the blocks the run-off of water would considerably reduce the "storm" and "shower" effects.

2.3.2 Sealing of joints between blocks

It is difficult to determine the amount of water entering the joints of a block pavement because of the absorption of some of that water into the blocks themselves. Initial suggestions during the planning of a simple, repeatable experiment to measure both the water ingress into the joints and any sealing included the design of a water-flow test. Such a test sought to relate the inflow of water at the surface in a given test area with that out-flowing at the bottom. The absorptive properties of the blocks however would attract water laterally from the joints by capillary action thus negating the value of measurements taken. A second suggestion was to install paint-treated blocks to almost eliminate the absorption

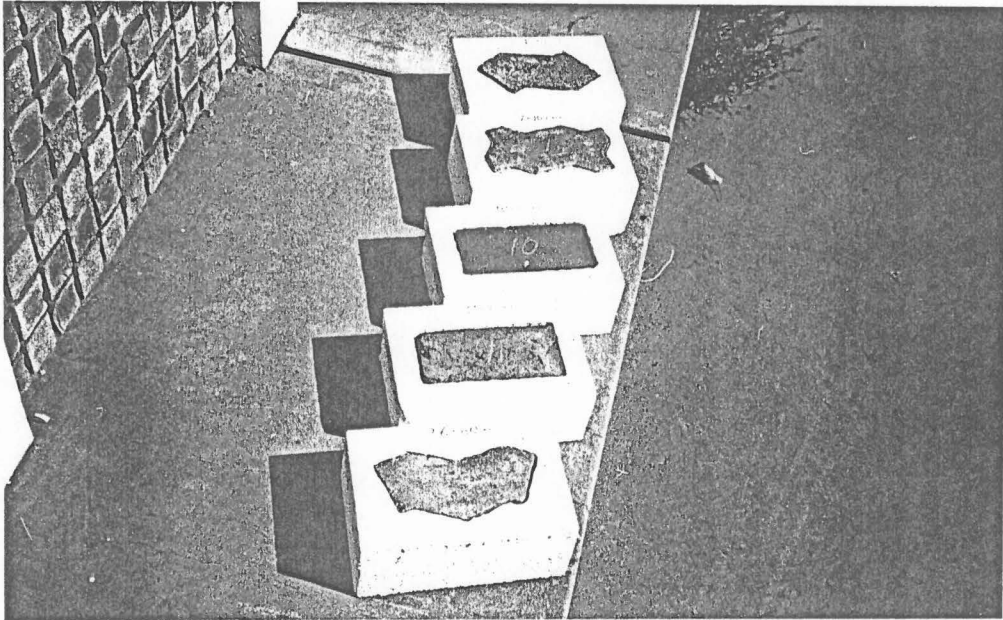


FIGURE 2.3
SATURATED BLOCKS DRYING UNDER "NATURAL CONDITIONS"

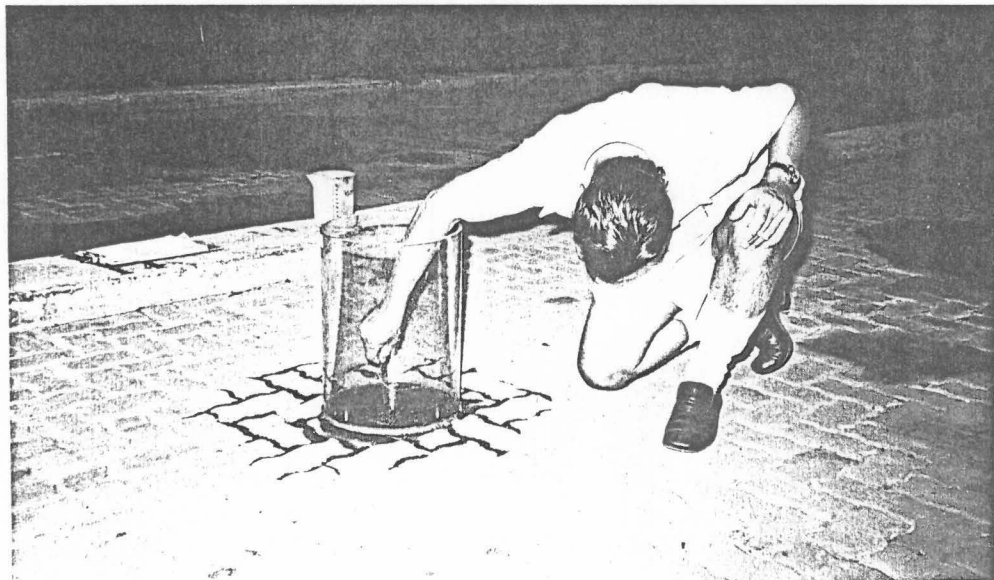


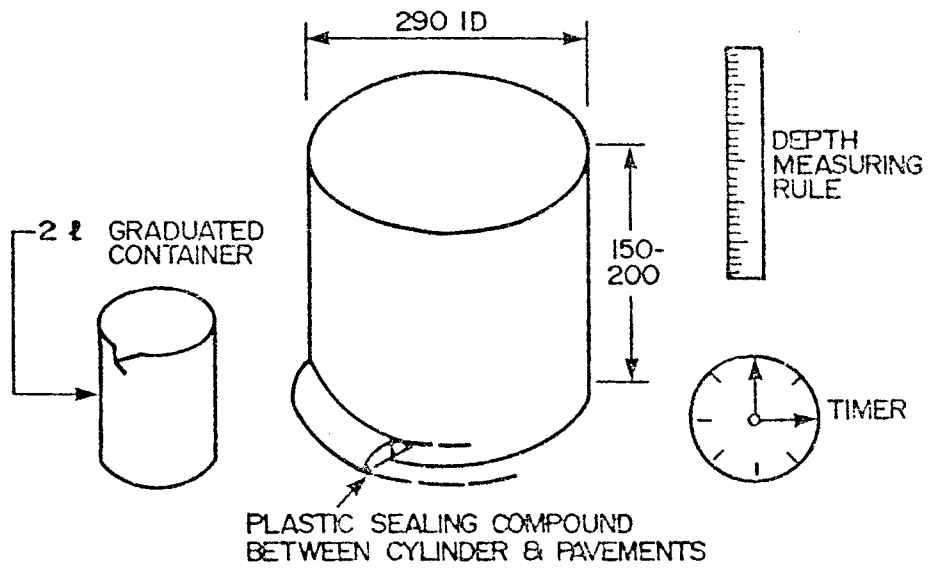
FIGURE 2.4
MEASURING HEAD OF WATER IN PORTABLE WATER INGRESS TESTING APPARATUS NOTE FLOW OF WATER ALONG JOINT

problem but this was rejected since the test was not repeatable on block pavements as laid. A compromise test was ultimately reached where an area of blocks was considered and the blocks and joints investigated as a composite whole. The test relied heavily on observation and an assumption of the absorptive properties of the individual blocks themselves.

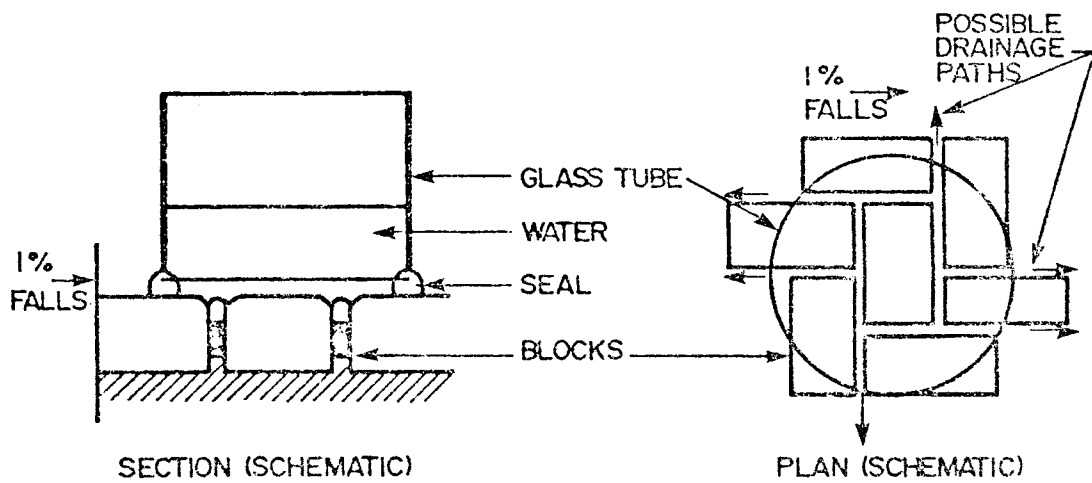
Figure 2.5 shows a glass tube used for the simple repeatable test. It is fitted with a sealer over the lower end and is large enough to cover one complete block. Water was carefully poured into the tube and the flow of water through the joint paths was observed. The absorption through the pavement was monitored by taking regular measurements of the water depth within the tube. The bulk of the tests were done on well jointed pavements to obviate loss of water by flow along the joints. See Figure 2.4. Rainfall occurs over a given time whereas the application of water to the pavement by this test is virtually instantaneous. In an attempt to simulate rainfall conditions only small amounts of water were put into the tube at any one application. It was thought that a head of not more than 10 mm water should be in the tube at any one time and after the dissipation of the first 10 mm a further 10 mm head of water was added and so forth. Alternatively a head of approximately 30 mm tends to induce a limited means of pressurizing weaker spots, which is an action thought to be similar to that which may be expected from trafficking. Both conditions are easily studied with the same apparatus.

Repeating the test on blocks which were saturated showed an improvement in measuring the sealing of the joints. This was seen either by observing water flow along joints (rather than its absorption into the pavement) or by considering the extensive time taken for water in the tube to enter the pavement.

The repeatability of the test relies to some extent on the observer's judgement. The results so obtained could therefore only provide an indicator of joint sealing.



SITE EVALUATION APPARATUS



MEANS OF ESTIMATING SEALING PROPERTIES OF JOINTS

FIGURE 2.5

SIMPLE PORTABLE REPEATABLE WATER INGRESS TESTING APPARATUS

Examples of results generated from a variety of tests are given in Figures 2.6, 2.7, 2.8, 2.9 and 2.10.

2.3.3 Test sites for portable apparatus

Three basic block shapes can be identified as follows :-

"S-A", blocks with geometric interlock on all vertical faces.

"S-B", blocks with geometric interlock on some vertical faces.

"S-C", blocks with no geometric interlock.

The following test sites were selected to study various block shapes and siting conditions.

Site A - This was in the Pretoria Botanical Gardens on the main access road. This road is lightly trafficked and the joints were well filled. The road had a one per cent horizontal crossfall. The test was done following soaking rains. The blocks were of S-B type.

Site B - This was also in Pretoria Botanical Gardens on the main access road where the joints were washed out. The test was carried out after soaking rains and on a one per cent horizontal crossfall. The blocks were of S-B type.

Site C - This site was on a recently constructed and untrafficked pavement inside a shed at NITRR Silverton test site. The joints were well filled. The blocks were of type S-A.

Site D - This site was on a non-trafficked experimental pavement outdoors at NITRR Silverton test site with rectangular blocks and joints well filled. The blocks were of S-C type.

Site E - This site was similar to site D, but with fully interlocking blocks (ie S-A)

Site F - This was at the NITRR Silverton test site where fully interlocking shaped blocks (ie S-A) were laid on bedding sand directly on top of a concrete pavement being an experimental site used to study bedding sands. The joints were well filled.

BLOCK No.	THICKNESS mm	TYPE	TEXTURE APPLIANCE	MATERIAL	COLOUR	SURFACE AREA cm ²
1	80	S - B	ROUGH	CONCRETE	CEMENT	184
2	78	S - C	MEDIUM	CONCRETE	CEMENT	220
3	60	S - C	MEDIUM	CONCRETE	RED	200
4	62	S - B	MEDIUM	CONCRETE	CEMENT	214
5	80	S - A	MEDIUM	CONCRETE	CEMENT	220
6	61	S - A	MEDIUM	CONCRETE	CEMENT	220
7	80	S - A	Smooth/Medium	CONCRETE	CEMENT	220
8	65	S - B	MEDIUM	CONCRETE	CEMENT	214
9	60	S - C	MEDIUM	CONCRETE	CEMENT	197
10	72	S - C	SMOOTH	BRICK	BLUE	227
11	72	S - C	MEDIUM	BRICK	RED/BLUE	227
12	60	S - B	MEDIUM	CONCRETE	CEMENT	214
13	60	S - B	MEDIUM	CONCRETE	CEMENT	214
14	60	S - B	MEDIUM	CONCRETE	CEMENT	214
15	100	S - B	MEDIUM	CONCRETE	CEMENT	200
16	60	S - A	ROUGH	CONCRETE	CEMENT	220
17	100	S - B	MEDIUM	CONCRETE	CEMENT	200
18	100	S - B	MEDIUM	CONCRETE	CEMENT	200
19	60	S - A	MEDIUM	CONCRETE	CEMENT	236
20	60	S - A	MEDIUM	CONCRETE	CEMENT	210
21	56	S - A	MEDIUM	CONCRETE	CEMENT	210
22	80	S - A	MEDIUM	CONCRETE	CEMENT	240
23	80	S - A	MEDIUM	CONCRETE	CEMENT	240
24	75	S - B	MEDIUM	CONCRETE	CEMENT	200
25	60	S - B	MEDIUM	CONCRETE	CEMENT	188
26	60	S - B	MEDIUM	CONCRETE	RED	188
27	55	S - B	MEDIUM	CONCRETE	CEMENT	188

FIGURE 2.6

TYPES AND DIMENSIONS OF BLOCKS USED IN POROSITY TESTS

BLOCK NUMBER	1	2	3	4	5	6	7	8	9	10	11	12	13	14	15	16	17	18	19	20	21	22	23	24	25	26	27	
Mass of dry block at 0 mins in grams	3455	4002	2802	2998	3603	3221	4154	3105	2985	3653	3028	2801	2726	2710	4642	733	4611	4431	3117	2756	2510	3662	4068	343	42633	2774	2333	
	1	157		68							33										105							
	2	150		78							40										113							
	3	164		84							46										115							
	4	167		89							51										121							
NOTE:- Absorption of water given in ml read at junction of frame & block number	5	169		93							55										124							
	6	170		96							60										126							
	7	171		99							63										127							
	8	172		101							66										128							
	9	173		104							69										129							
	10	175		106							72										126							
	11	174		107							75										123							
	12	174		110							78										129							
	13	174		111							81										130							
	14	175		113							83										130							
	15	176	27	22	113	42	32	16	74	37	21	86	8	19	51	14	126	16	21	17	12	130	86	60	9	32	6	11
Days																												
1/2	180	29	27	120	59	39	19	82	46	31	108	10	28	55	19	141	19	23	29	16	132	108	78	11	39	8	14	
1	184	31	31	127	79	47	24	88	55	48	136	13	40	60	25	161	22	27	39	21	132	125	99	14	47	11	16	
4	189	37	43	133	125	63	41	99	75	127	200	23	65	71	47	193	29	37	61	37	134	156	151	21	68	23	27	
Surface area cm ²																												
Surface absorption rate initial ml/cm ² /min from 0-15 mins	1	191	56	62	138	191	94	96	116	117	192	245	45	103	97	51	207	48	83	125	72	139	195	211	42	95	52	66
Surface absorption rate b) longer term ml/cm ² /h from 5-20 h	2	201	90	84	151	232	123	187	151	135	193	275	69	139	109	130	225	89	139	178	99	141	232	227	80	121	86	103
	3	184	220	200	214	220	220	220	214	197	227	227	214	214	214	200	220	200	200	236	210	210	220	240	200	188	188	188
				352							25,3										41,3							
	0,94	4,52	4,75	1,16	15	7,05	12,5	3,97	10,66	14,3	8,15	5,14	6,88	6,07	11	3,18	4,25	11,9	15,568	33	1,19	6,86	12,5	3,25	7,71	7,71	0,37	

FIGURE 2.7
DETAILS OF ABSORPTION OF INDIVIDUAL BLOCKS

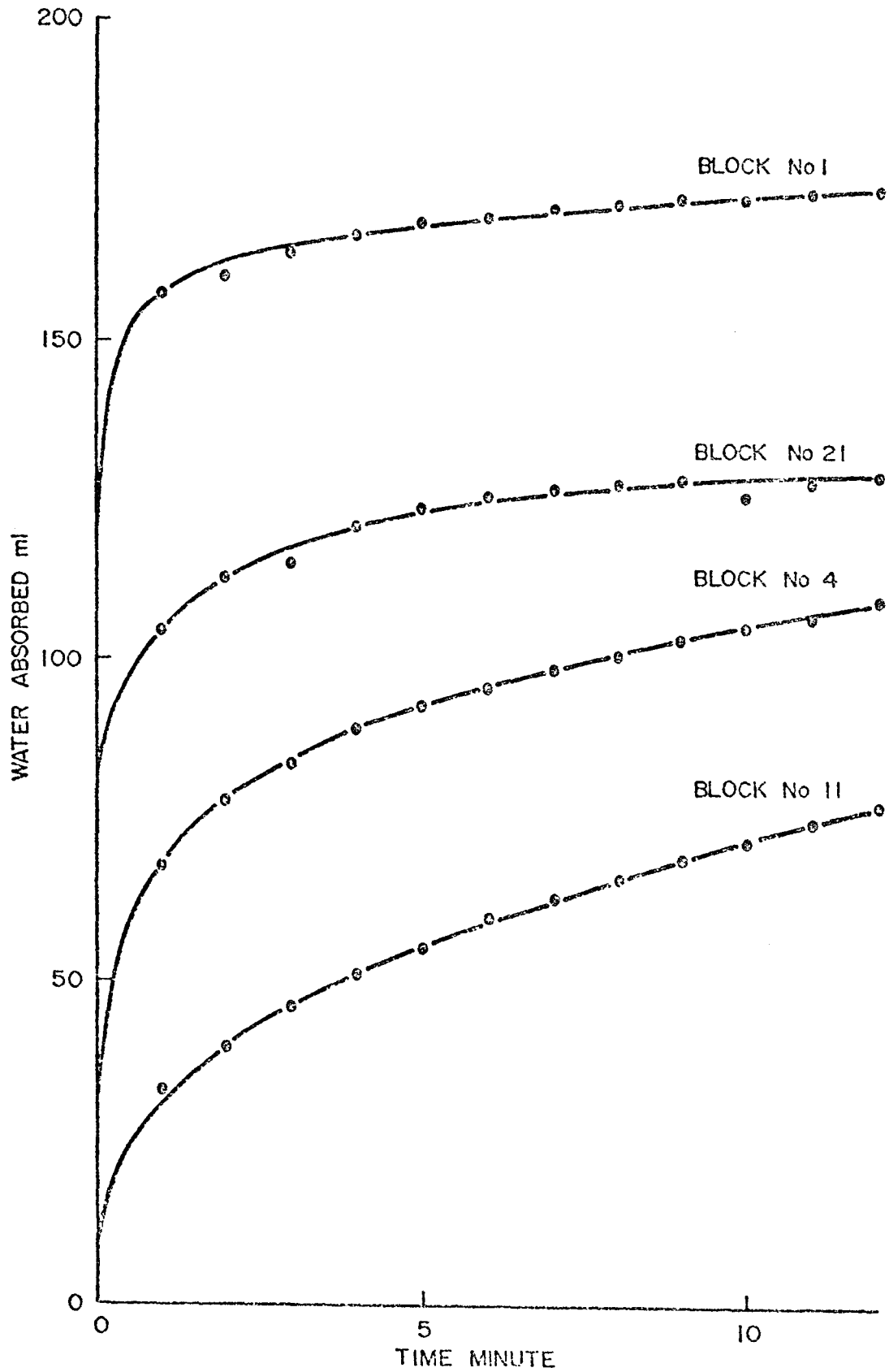


FIGURE 2.8

TYPICAL PLOT OF INITIAL WATER ABSORPTION INTO MORE POROUS BLOCKS

TEST No	DETAILS & DESCRIPTIONS	WATER ADDED	TIME TO FIRST DRIP THROUGH DRAINAGE HOLE	WATER MEASUREMENTS THROUGH DRAINAGE HOLE TIME QUANTITY
1	30mm Honeydew bedding sand 80mm CMA type interlocking concrete blocks Doman sand jointing	10	22 mins	32 mins — 37 ml 42 mins — 81 ml 52 mins — 118 ml 62 mins — 155 ml Rate \approx constant 3,9 ml/min Total water through = 3005ml ie pavement retained 6995ml
2	Repeat immediately after test 1	10	immediately	10 mins — 65 ml 20 mins — 140 ml 30 mins — 200 ml 40 mins — 270 ml Rate \approx constant 6,7 ml/min 3 hrs — 1170 ml 7 hrs — 2719 ml Rate \approx constant 6,48 ml/min
3	30 mm Honeydew bedding sand Engineering bricks 75 mm Doman sand jointing	10	10 mins 35 sec	20 mins — 100 ml 30 mins — 287 ml 40 mins — 418 ml 50 mins — 565 ml Rate \approx constant 14,1 ml — min 3 hrs — 2736 ml Rate \approx constant 15,2 ml/min
4	Repeat immediately after test 3	10	2 mins	12 mins — 243 ml 22 mins — 455 ml 32 mins — 665 ml 42 mins — 887 ml Rate \approx constant 22,2 ml/min

NOTE - Area of test tray = 0,5 m²

\approx means approximately

FIGURE 2.9
DETAILED FLOW RESULTS OF VARIOUS TRAY TESTS

Site G - This was another test section located inside a shed at NITRR Silverton test site with fully interlocking shaped concrete blocks (ie S-A) and joints well filled. The pavement was untrafficked at the time of the tests.

On all these sites the portable apparatus was used to measure the time taken for some of the water to penetrate the pavement and to flow along the joints.

Details of the water level measurements within the tube with respect to time recorded during these tests are given in Figure 2.10.

From the data it was concluded in a discussion given in appendix D that the target values should apply.

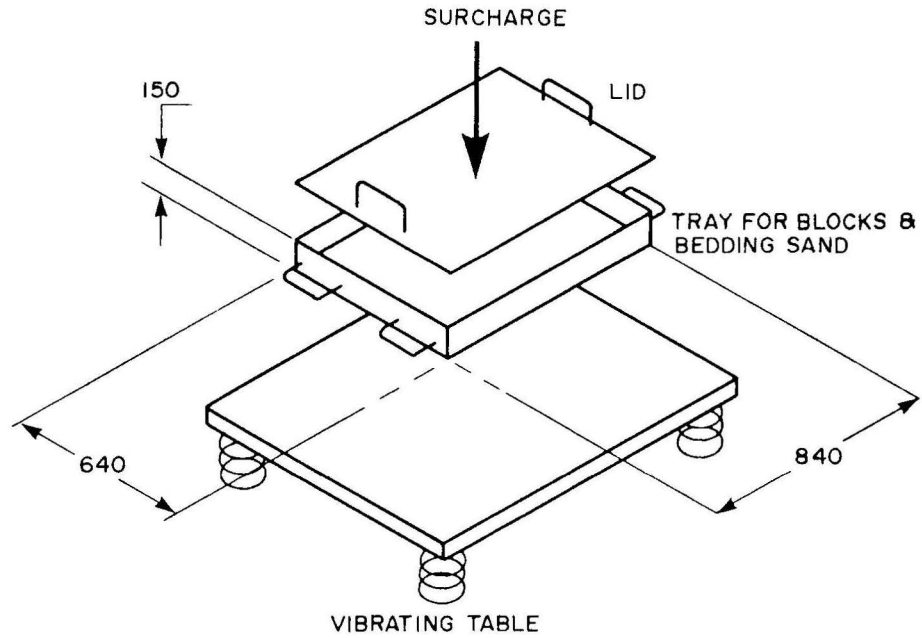
- (i) A maximum absorption rate of 20 mm head of water during a period of 2 hours for block paving not subjected to severe environmental effects (e.g. paving indoors)
- (ii) A maximum absorption rate of 5 mm head of water during 2 hours for block paving subjected to severe environmental effects.

2.3.4 Laboratory study on joint-sealing

Due to the difficulties in obtaining accurate readings of drainage and permeability through the block pavements as a whole in the field, a simple laboratory test was designed to measure the flow of water through the block layer into the supporting structural layers. A tray large enough to lay and joint a number of oven-dried blocks was provided with a drainage hole in its base (see Figure 2.11). The blocks were laid by hand on the specified thickness (ie 25 mm) of uncompacted sand. Compaction was provided to the blocks and sand by covering and preloading the blocks with kentledge and vibrating the whole on a vibrating table. By this means the

SITE	INITIAL WATER DEPTH mm	MEASURED DEPTH mm OF WATER AFTER TIME (h)	OBSERVATIONS	NOTES
A	28	28 - 0 26,5 - 0,5 25 - 1,0 24 - 1,5	blocks absorbed water flow laterally in joints Capillary soaking after heavy rains	test discontinued as little change seen
B	29	29 - 0 0 - 0,5	joints washed out, extensive lateral flow in joints	
C	30	30 - 0 25 - 0,5 18 - 2,0 13 - 2,5 9 - 4,0 5 - 2,0	joints well filled, slight lateral flow in joints	
D	31	31 - 0 29,5 - 0,25 25 - 2,5 12,5 - 21,0 9 - 25,0 4 - 28,0	joints well filled, very slight lateral flow in joints	test discontinued before all the water in the cylinder was absorbed
E	30	30 - 0 28,5 - 0,25 26 - 1,5 24 - 2,5 22 - 3,5 5 - 26,0 3,5 - 28,5	joints well filled, slight lateral flow in joints	
F	31	31 - 0 29 - 1,0 25 - 3,5 24 - 4,5 21 - 5,5 19 - 6,5 0 - 30,0	joints well filled, very slight lateral flow in joints	blocks laid on concrete pavement
G	29	29 - 0 25 - 0,25 13 - 1,25 10 - 2,0 5 - 2,5 0 - 3,0	joints well filled slight lateral flow in joints	inside test shed

FIGURE 2.10
 DETAILS OF WATER LEVEL IN SITE-TEST CYLINDER IN A
 VARIETY OF TESTS ON BLOCKS PAVEMENTS



APPARATUS FOR LABORATORY TESTING OF WATER-INGRESS INTO BLOCK PAVEMENTS

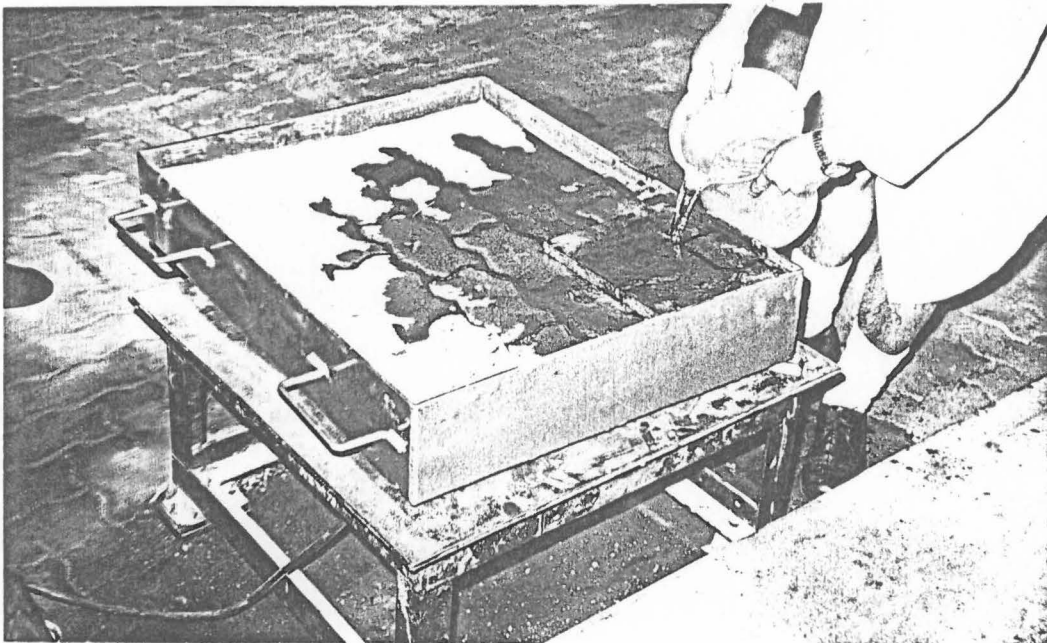


FIGURE 2.11
LABORATORY TEST EQUIPMENT FOR THE TRAY TEST

blocks were bedded into the sand and some of the sand was displaced vertically upwards into the joints in a similar way to that found in the site construction of a block pavement. The joints were sealed with jointing-sand by hand-brushing into the joints. A second series of vibrations by the vibrating table caused the jointing sand to penetrate and fill the joints.

The ingress of water through the pavement was measured simply by slowly applying a given amount of water to the surface and measuring the water draining through the hole in the base of the tray. Ingress was calculated from the flow divided by the surface area with respect to time. In a similar way to that described for block permeability a cut-off point between shower and saturation (i.e. storm) rainfall was determined.

2.4. DISCUSSION OF RESULTS OF TESTS

Three tests are described above namely :-

- (i) absorption and porosity tests on individual blocks
- (ii) Portable water ingress tester
- (iii) The Traytest which studied ingress of water through a section of block pavement.

These three tests provided a simple, yet repeatable, procedure for evaluating all aspects of the ingress of water through segmental block pavements.

The portable water ingress tests showed a difference between the waterproof characteristics of a newly constructed pavement and one which had been allowed to settle-in by time and trafficking. The rates of flow through the joints varied. In some cases the joints were almost completely sealed and in other cases a minimum amount of water ingressed through washed out joints. The test involved various depths of water (from 10 mm to 30 mm) to be ponded on a small section of block pavement for long time periods which were measured in hours. Such a condition is

unlikely in practise if proper cross-falls and drainage are provided. However in areas of poor construction the tests showed that water would need to pond for several hours before ingressing through open joints.

The porosity of the blocks themselves is of significance in acting as a soaking and drying layer for water on a pavement. The recommended (Clifford (1982)) 25 mPa strength concrete blocks provide a balance between porosity and strength. The open surface texture of these blocks allows sand and detritus to adhere more readily to the sides of the blocks (i.e. within the joints) thus ensuring a better bond and waterproofing of the joints. Various calculations of surface absorption rate for the short term and for the longer term were made (see Figure 2.7). These calculations showed that only the large amounts of water, possibly from heavy storms, would cause ponding and allow small amounts of water through the surface if the joints were properly sealed. This does not, of course, reduce any possible saturation of the sublayers by water flowing into the pavement structure by bad drainage or from ponding in surrounding material. The rate of water absorbed into the blocks by soaking has shown that for some blocks considerable amounts of water can be absorbed in the first five minutes of soaking (eg blocks No 1 & 21 in Figure 2.8).

The results of the laboratory tray test (Figure 2.9) showed that only after ten minutes of ponding in the poorest case studied did a few drops of moisture reach the subbase layer (ie test 2 in Figure 2.9). Thereafter a constant rate of 13,2 ml/m² per minute was received by the subbase with the blocks and bedding sand in a soaked condition. In practise if the blocks are laid to even a minimum of falls insufficient water to produce these conditions would be available. The ingress of such a minimal quantity of water into the subbase is not considered detrimental.

2.5 CONCLUSIONS

The following conclusions were reached from the above study of the passage of water through the surface of block pavements:

- 1) The tests were simple to set up and allowed easy repeatability with minimum cost and effort.
- 2) Block pavements which are built with a minimum of surface falls and are well jointed between blocks, allow most of the surface water to flow laterally across the pavement. This flow normally occurs in the gap formed above the jointing material and between individual blocks (ie within the joints themselves).
- 3) The blocks have some degree of absorption producing a "sponge" or "blotting paper" effect. In times of rainfall the blocks become saturated and more water runs off.
- 4) As a result of these tests block pavements can be considered substantially waterproof if the blocks are firmly bedded into the sand and the joints are not washed out.
- 5) A significant improvement in the waterproofing characteristics appears after an initial settling-in period.
- 6) A maximum absorption rate of 20 mm head of water during a period of 2 hours for block paving not subjected to severe environmental effects as measured by the portable instrument.
- 7) A maximum absorption rate of 5 mm head of water during 2 hours for block paving not subjected to severe environmental effects as measured by the portable instrument.

2.6 TRANSFERABILITY OF EXPERIMENTAL CONCLUSIONS TO OTHER MORE TRADITIONAL FORMS OF BLOCK PAVEMENTS

From early times block paving has been a traditional constructional medium for urban pavements. Familiar forms of this being stone setts, paving flag stones, and cobble-stones. The speed of vehicles and their load carrying capacity in earlier times was limited by the ability of the horses used for traction. Furthermore, the traditional construction techniques rarely permitted the blocks to rest on unbound materials. Indeed the norm according to Radford (1924) was to intimately bond them to the base layers by bitumen, tar, lime or cement.

The recent re-introduction and refinement of block paving which could be described as traditional road building material has many marked differences namely:

- (a) Paving blocks are now manufactured by using steel moulds which produce dimensionally accurate units as compared with the hand-cut stone blocks or slabs produced in the past;
- (b) Flexible segmental block pavements are sand bedded as compared with the more intimate bonding of cement or bitumen;
- (c) Modern technology provides precise compaction methods of the composite block and bedding sand as compared with hand-stamped compaction methods;
- (d) Paving blocks can now be accurately levelled on density controlled sub-base layers as compared with infill and hand compacted material;
- (e) Vehicles with rubber tyres or tracks spread the applied loads over greater areas than with iron tyred wooden wheels and horses hooves;

- (f) Modern vehicles induce high wheel and axle loads as compared with low wheel and axle loads of horse drawn vehicles;
- (g) The potentially high speed of modern transportation as compared with the speed limitations of the horse;
- (h) The great variety of speeds as compared with the close range of speeds with horse transport.

It can be seen therefore that the modern block pavement is in fact not really comparable with the traditional urban pavement made with stone blocks or slabs. The transferability of conclusions reached in research on the modern block pavement to the traditional urban street is therefore very limited. Interestingly according to the Oxford English Dictionary (1964) the term "street" traces its origin to "paved with stones" but the requirements of modern streets are quite different to those of the past.

CHAPTER 3

ASPECTS OF "INTERLOCK" AND "LOCK-UP" IN BLOCK PAVEMENTS

CHAPTER 3

ASPECTS OF "INTERLOCK" AND "LOCK-UP" IN BLOCK PAVEMENTS

3.1 INTRODUCTION

Two terms, "interlock" and "lock-up", are commonly used in connection with segmental block pavements. From discussions with both manufacturers and specifiers of blocks and paving bricks, there appears to be some misunderstanding as to the meaning of these terms. This chapter attempts to clarify and define current usage of the two terms. It also describes an anomaly with respect to "lock-up", offers an explanation in terms of other pavement behaviour and then suggests a redefinition of the two terms.

3.2 DEFINITION OF TERMINOLOGY

Modern blocks and paving bricks are manufactured with vertical side faces and may be shaped (in plan) to allow them to interlock with adjacent blocks. Many types of block are manufactured, but the two main types are those with interlocking shaped sides in plan, and those with non-interlocking shapes. The second type are commonly either paving bricks made of fired clay (of similar dimensions and shape to wall-bricks) or concrete bricks which abut with no interlocking effect. Blocks interlock due to compressive forces which keep individual blocks in place. Some shear interlock also occurs, but there is little tension interlock as with a piece in a jig-saw puzzle, for example. Any vertical interlock is restricted to forces within the joints. Interlocking blocks can be said to be geometrically interlocking in the horizontal plane provided that they are contained within kerbing or some similar means of restraint. Fully interlocking (ie S-A) and rectangular (ie S-C) blocks can be laid in a variety of bonds. The most usual are herringbone, stretcher or basket weave. The principle advantage of one bond over the other is aesthetic, although by laying the bonds where joints are at 45° to the direction of trafficking the blocks are less subject to the effects induced by

the wheels of vehicles.

"Interlock" therefore refers to the geometric relationship between one block and its neighbour, and in this regard it can be said that a particular block type is either interlocking or non-interlocking.

"Lock-up" has been described by Marais and Lane (1981) the Cement and Concrete Association of Australia (1980) and Shackel (1980 No 2) as a phenomenon which develops in block pavements after a certain amount of time has elapsed after construction. The construction of sand-bedded block pavements normally involves two passes of a small vibrating roller to bed the blocks into the bedding sand and to vibrate material into the joints between the blocks. After construction, owing to the action of traffic and weathering, the blocks are said to "lock-up". In this condition the blocks are thought to act as a composite whole rather than as individual units. It is interesting to note that areas which are not trafficked are also said to lock-up with time. (Shackel 1980 No.2)

3.3 PERFORMANCE OF PAVEMENTS WITH TIME

The National Institute for Transport and Road Research has carried out many specialized tests, including Heavy Vehicle Simulator tests on many pavement types. (ATC/1984), Clifford (1978), Maree and Van Zyl (1980), Shackel 1979 No. 2). These tests have shown that all pavement types, whether concrete, asphalt, tar or earth, behave similarly during what might be described as a settling-in period when pavements are subjected to environmental and/or trafficking stresses. Figure 3.1 shows an example of a graph of a type of surface deformation known as rut depth plotted against time for bituminous bases. The point at which the curve flattens (shown after time A on Figure 3.1) will vary according to the intensity and frequency of the applied loads and due to environmental factors including the density of the in situ material. The final shape of the curve (at time C on Figure 3.1)

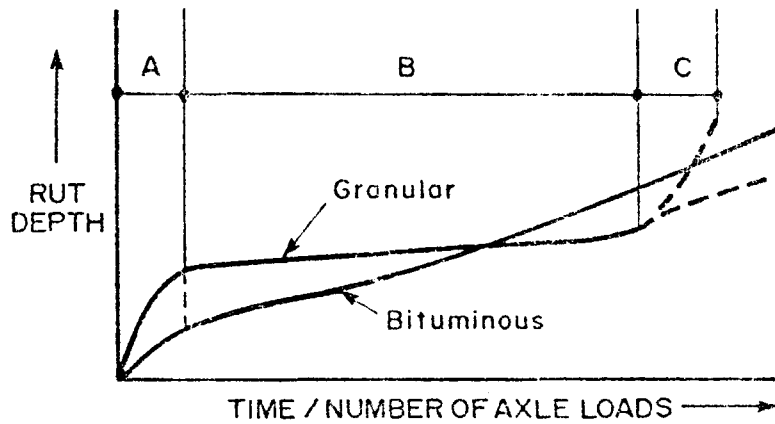


FIGURE 3.1
RUT DEPTH DEVELOPMENT WITH TIME IN
BITUMINOUS AND GRANULAR BASES

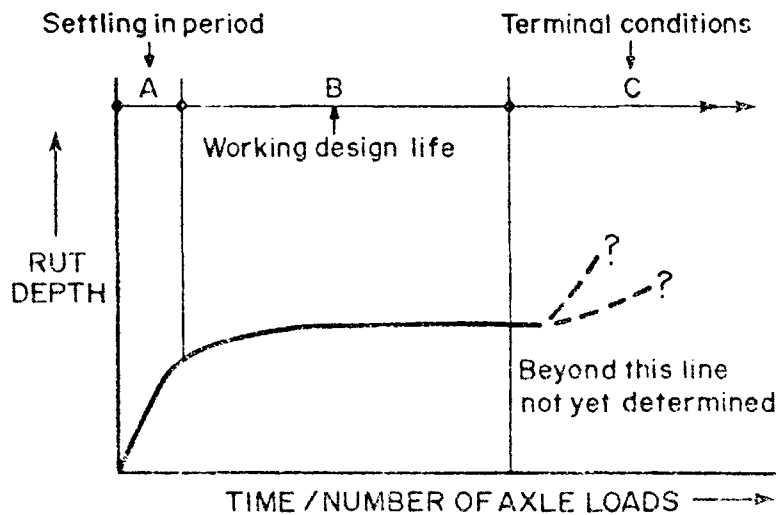


FIGURE 3.2
TYPICAL CURVE OF RUT-DEPTH WITH
TIME MEASURED AT THE SURFACE OF
A BLOCK PAVEMENT

will also vary and deterioration may be rapid or gradual. However, the shape is typical and shows that after a settling-in period when initial rutting is more pronounced, a more stable condition is reached and maintained for a large part of the life of the pavement providing the pavement is not subjected to overstressing. Similar curves have been obtained for block pavements (Shackel (1980 No 2) and Clifford and Savage (1982)) by Heavy Vehicle Simulator testing. Figure 3.2 shows a typical curve of rut depth against time for any pavement type. The flattening out of the curves on Figures 3.1 and 3.2 is a function of several factors such as density of subbase pavement thickness, but the pavement can support loads with little or no further rutting taking place during the working part of its design life, i.e. after the initial settling-in period and before the terminal conditions start to develop.

The term settling-in of a pavement, which has been shown to be applicable in some degree to all pavement types, may therefore be a more suitable description for lock-up which is used only for block pavements.

Some degree of settling-in is attributed to environmental factors - in earthworks technology the term environment refers not only to the climatic parameters, but also to parameters of the subgrade upon which the pavement is constructed. The drainage and thermal properties of the subgrade are modified by the pavement overlying it.

3.4 THE SETTLING-IN OF BLOCK PAVEMENTS

The flattening of the curve of rut depth against time (Figures 3.1 and 3.2) shows that improvements in the structural properties occur after the initial settling-in period. This is not peculiar to block pavements, as mentioned before. The settling-in of a pavement structure can be explained with reference to a number of factors. Block pavements consist of blocks (whether interlocking or not) bedded into a thin (typically 20-25 mm in South Africa) sand layer with jointing sand between the joints of the blocks.

The sand bedding layer lies on a subbase which in turn may lie on selected granular layers which overlay the subgrade.

The blocks should be laid in the bedding sand and vibrated into place with a small plate or wheeled roller. A second pass vibrates sand into the joints between the blocks. The climatic and environmental factors begin to affect the pavement immediately. The variation of daytime and night-time temperatures together with rainfall modifies both the moisture content and density of the sand in the joints. Some effect is also seen in the blocks themselves. Passing traffic changes the quantity and density of sand in the joints either by wheel action or by the effect of wind generated by the moving vehicles. Any sand thus removed adds to the deposits of detritus lying on the surface of the pavement.

Detritus comprises particles of rubber, dust, organic matter and so forth. In time the detritus settles into the joints between the blocks and forms an upper plug over the jointing sand. Because of the complex nature of the detritus the plug formed helps to seal the joints thereby improving their waterproofing characteristics. An example of a jointing plug is given in Figure 3.3. In time a firm bond develops between the blocks and the jointing sand. The blocks themselves bed a little further into the bedding sand, which is also affected by its environment and absorb moisture, if present. The combined effect of all this is to compact the bedding sand and the jointing material to a somewhat higher density than that achieved immediately after construction. In this way the bonding of block, bedding sand and jointing sand is improved. This is the condition of the block pavement after the initial settling-in period.

In the settled-in condition the pavement is capable of supporting design loads with less accumulative rutting than immediately after construction, as is shown by the flattening of the rut depth time curves in Figure 3.2. A gradual deterioration of the pavement takes place during its working life - the curve is not flat during time B in Figure 3.2. The stage in which much more rapid rutting takes place is often due to degradation of the subbase and lower

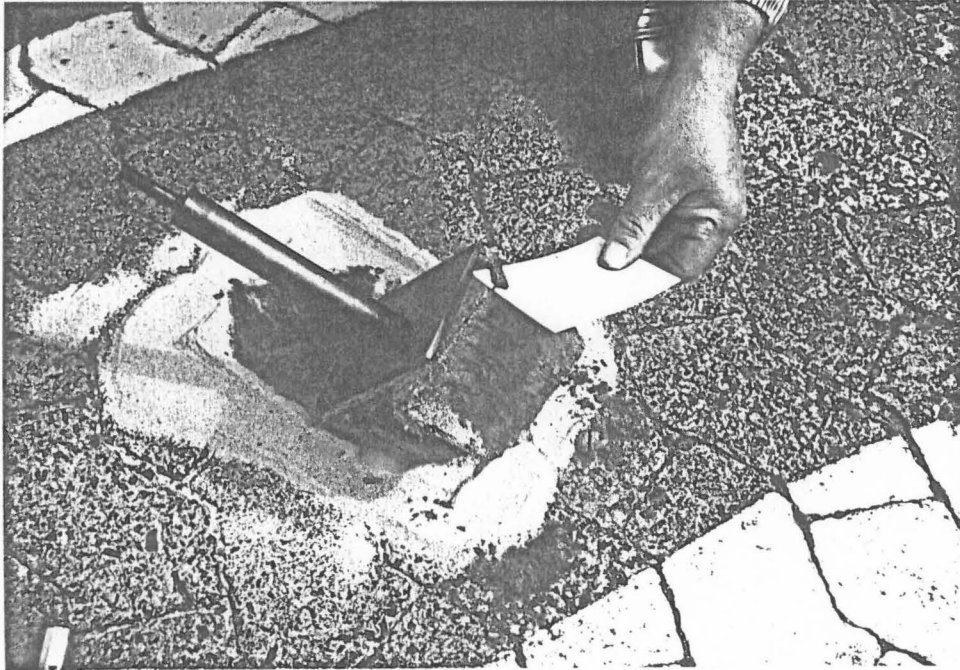


FIGURE 3.3

EXAMPLE OF JOINTING-PLUG WHICH FORMS OVER JOINTING SAND WITH TIME TO IMPROVE WATERPROOFING CHARACTERISTICS OF JOINTS

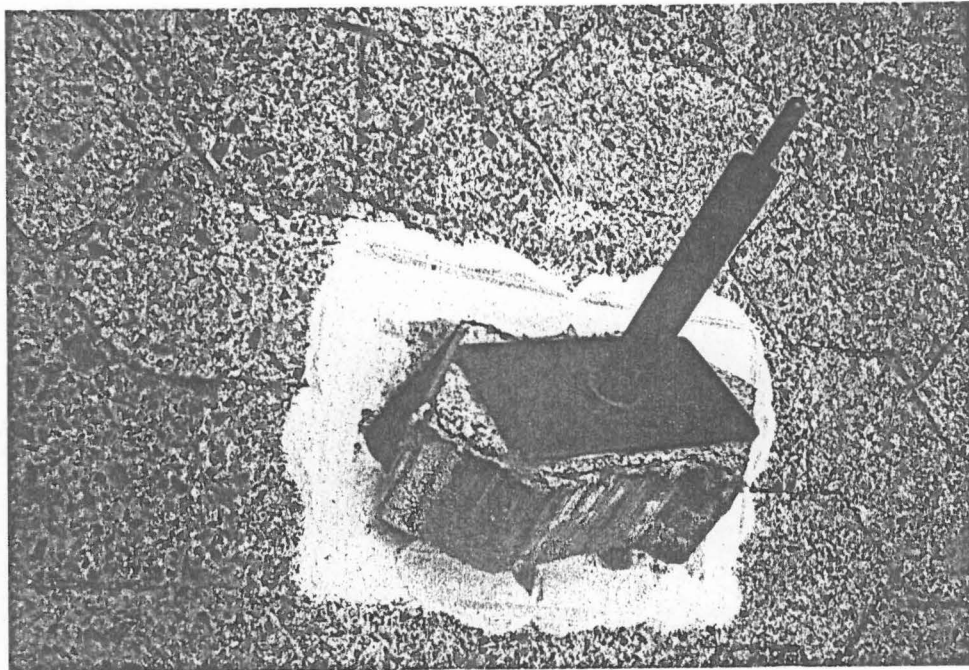


FIGURE 3.4

BONDING OF JOINTING SAND TO INDIVIDUAL BLOCKS

layers. This terminal behaviour of the pavement can cause excessive movement of individual blocks. Excessive deformation may also be caused by overstressing due to a very heavy load, causing differential settlement and rutting. Severe loads cause the bond between individual blocks in the jointing sand to be broken and the pavement becomes considerably more subject to water ingress and therefore rapid deterioration. A feature of segmental block paving is that the joints around the blocks can easily be re-established and the plug of detritus rapidly reformed to provide waterproof joints once more. Apart from the actual permanent deformation of the surface which may be unsightly, the pavement's strength remains unimpaired and it continues to be capable of supporting design loads.

3.5 LATERAL SUPPORT REQUIREMENTS OF BLOCK PAVEMENTS

It has been stated in a number of reports on block pavements that the area must be "contained" within kerbs or by other means to stop lateral spread of the blocks (Clifford (1981), Shackel (1980 No 2) and the Cement and Concrete Association of Australia (1980)). One of the reasons for containing an area of block paving within kerbs is to stop lateral movement of the blocks which may be caused by trafficking, since lateral movement of the blocks would cause the joints to open out.

It is difficult to make an opening in a block pavement, particularly if the pavement is made of interlocking blocks (S-A). Invariably the first unit must be broken to remove it. Thereafter removal of single blocks is easier. Interlocking blocks are more difficult to remove than non-interlocking blocks since their shape allows little sideways movement and they must be removed by lifting them vertically, which requires the bond on the sides of the blocks in the jointing sand to be broken at the same time.

Non-interlocking blocks can be raised more easily by a combination of vertical and rotational movements. Once an opening has been formed in an area of block pavement, the blocks whether interlocking or non-interlocking, must be kept apart by timbering or a

similar method. If this is not done the blocks creep slowly towards the opening even if they are not subjected to trafficking. This slow movement of the blocks towards the opening is an indication of the forces built up in the jointing material, which becomes pressurized due to the action of trafficking and environmental stresses. This pressurization is desirable because it helps to secure individual blocks within the matrix and assists local transfer and dissipation of stresses. As the blocks creep slowly towards an opening the forces within the joints are dissipated thereby reducing the bond generated in the joints. The reduction of the jointing stress also reduces the ability of the joint to resist the ingress of water.

3.6 STRUCTURAL AND ARCHITECTURAL USE OF BLOCKS

Where areas of block paving are built for trafficking purposes, whether for light traffic, as in the case of car parks, or for heavy industrial applications such as container stacking areas or factory yards, the function of the blocks together with the sub-layers is structural. However, in applications such as the paving of embankments where curved surfaces are required, the blocks are used not only to support light loads occasionally, but to stabilize the embankment and protect it from environmental distress. An impressive example of such work, which can best be described as architectural applications, is given in Figure 3.5. In such cases interlocking units have a definite advantage over non-interlocking units because the interlocking action, especially in three-dimensionally curved paving, assists in locating the blocks in their bonding pattern. The possibility of differential settlement in such embankment work is much greater since the densities of the embankment fill are often specified to a lower standard than those of trafficked pavements. Interlocking blocks are allowed greater individual movement and are kept in place by bearing on neighbouring blocks even if parts of the subbase or the jointing are washed away.

An improvement can be made in the current practice of using interlocking blocks for architectural purposes to bridge weak or eroded



FIGURE 3.5

*EXAMPLE OF CIVIC AND ARCHITECTURAL USE OF DOUBLE
INTERLOCKING PAVING BLOCKS*

areas: blocks designed to provide a three-dimensional geometric interlock can be used, which should have the advantage of more effectively bridging voids. Such blocks would also keep jointing sands in the joints for a longer period. Ingress of water into sublayers would also be reduced. Figure 3.6 shows a subbase wash-away bridged by three-dimensionally interlocking blocks. The suggested three-dimensional interlocking block is shown in Figure 3.7. However, the additional effort and care needed to manufacture a more complex block shape, together with the possibility of spalling of some of the corners, may negate any advantage such a shape may have for architectural applications.

A recently patented block system known as the G-block system is described as being truly interlocking in three-dimensions. The manufacturer claims that all other block shapes in the S-A, S-B & S-C shapes only inter-relate. The G-block shown in Figure 3.8 is based on solid packing geometry rather than edge connection details, and is a simple solid which relies on its sloping sides. The G-block is therefore a double wedge which on one axis resists downwards pressure while resisting upward pressure on the other. One disadvantage to the G-block system is that the removal of individual blocks for maintenance to sublayers or for the installation of service cables or ducts is impossible.

3.7 CONCLUSIONS

The term interlocking describes the process by which certain types of paving block became bonded within the pavement matrix according to their physical shape. Some blocks interlock in one direction only (S-B blocks), and others interlock in two directions (S-A blocks). The latter are also known as double interlocking blocks. A structurally fully interlocking block has been proposed, for civic and architectural uses where block-paved areas are not really flat, which would interact three-dimensionally.

Lateral support along the edges of block pavements is necessary to prevent opening of joints under traffic. Certain changes take place in a block pavement in time. Environmental aspects affect

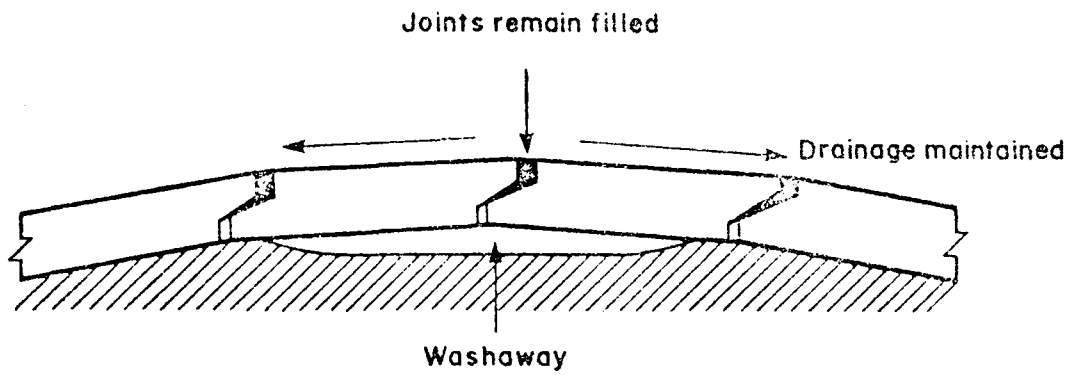


FIGURE 3.6

INTERLOCKING BLOCKS OVER WASHAWAY

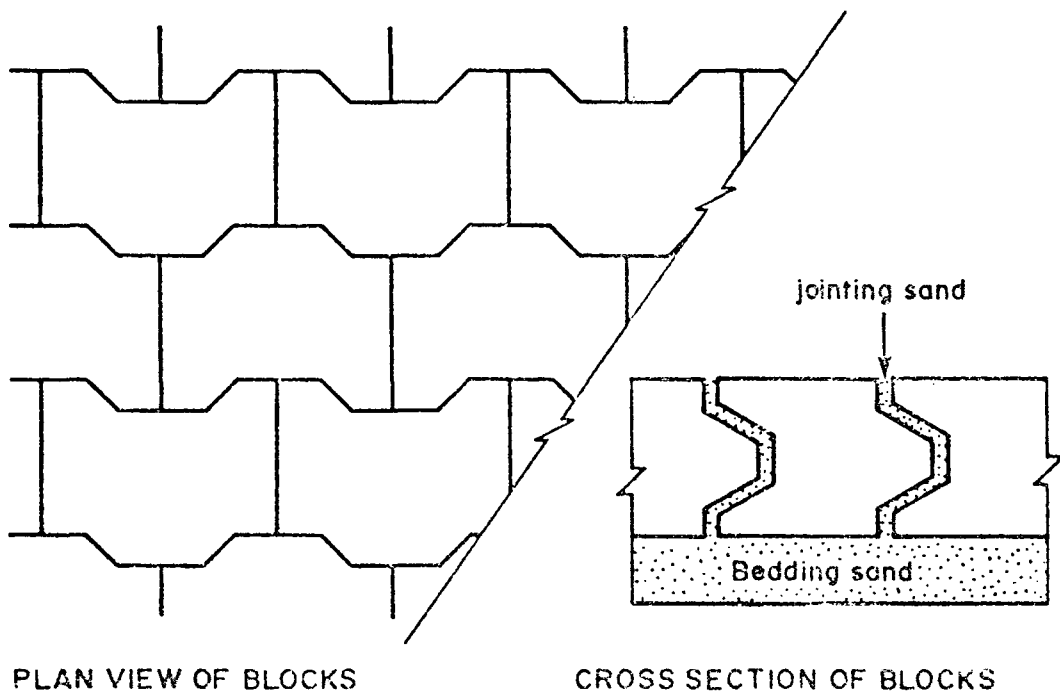
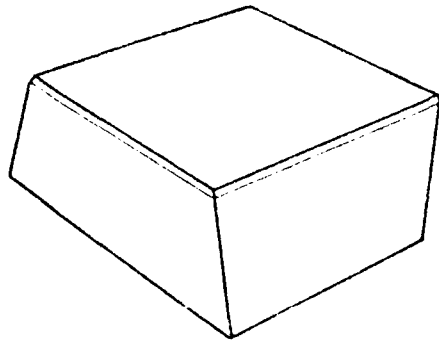
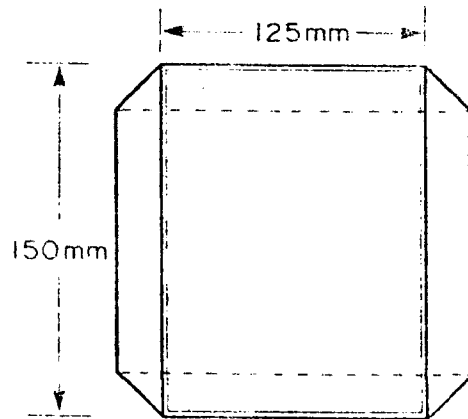


FIGURE 3.7

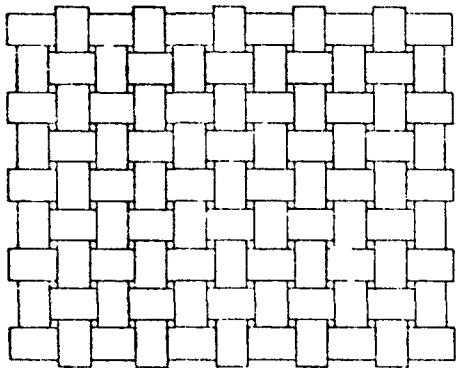
*SUGGESTED THREE DIMENSIONAL INTERLOCKING
BLOCK*



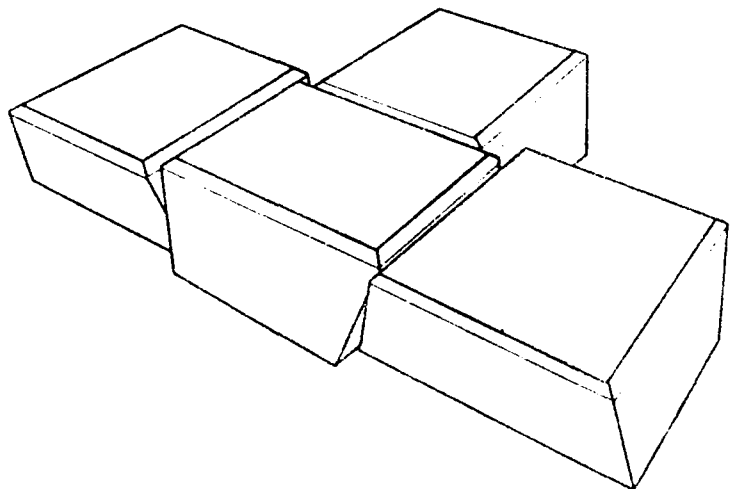
SINGLE G-BLOCK



DIMENSIONED PLAN OF G-BLOCK



PLAN OF G-BLOCKS



INTERLOCKING OF G-BLOCKS

FIGURE 3.8

THREE DIMENSIONALLY INTERLOCKING G-BLOCK SYSTEM

block pavements soon after construction and with the action of trafficking a plug of road detritus forms over the jointing sand thereby giving the joints themselves better waterproofing characteristics. The sand in the joints also adheres closely to the sides of the blocks. The blocks themselves bed further into the bedding sand during this settling-in period, effecting additional compaction of the bedding sand. These developments, which occur during the settling-in period, have been described as lock-up. It has, however, been shown in this chapter that all pavements undergo a similar settling-in period during which the rutting caused by applied loads is more significant. The term lock-up refers to a phenomenon held to occur in block pavements, but since this phenomenon is not unique, the term lock-up should be dropped and the block pavement should be described as settled-in. This term also refers to other pavement types.

Before settling-in occurs, the blocks are not closely joined to one another and firmly embedded in the bedding sand. During heavy rains it is possible that water could enter the subbase layers and cause saturation. If such a saturated state is related, rapid distress as shown in the 'C' phase in Figure 3.1 may be caused by trafficking. Care should therefore be exercised during the settling-in phase of block pavements to limit trafficking should heavy rains occur.

CHAPTER 4

MECHANISMS OCCURRING WITHIN THE BEDDING AND THE JOINTS OF SEGMENTAL BLOCK PAVEMENTS

CHAPTER 4

MECHANISMS OCCURRING WITHIN THE BEDDING AND THE JOINTS OF SEGEMENTAL BLOCK PAVEMENTS

4.1 INTRODUCTION

Segemental block pavements comprise individual, regularly shaped paving units (such as bricks and blocks) which are bedded on a relatively thin layer of bedding sand and are jointed together with fine-grained sand. The technology applying to the behaviour of this type of segmental block pavement will be shown to be different to that of segments which are mortared together, since such a system causes the mortared segments to act more like a rigid slab rather than have the flexible response of a sand-bedded and jointed segmental block pavement.

The pavements comprising mortared segments act as a semi-rigid slab and could be described as being bound together, whereas the technology of sand-bedded and jointed segments can be described in terms of a composite system involving aspects of both rigid and flexible mechanisms. The individual segments themselves are substantially inert from the effects of loading since they are relatively dense and hard in comparison with the bedding and jointing materials.

These individual segments therefore respond in some respects to the rigid component of the composite system. Their response to loading is substantially controlled by the bedding and jointing material which allows dissipation of stresses by a flexible mechanism. The composite segmental block pavement system as a whole therefore acts as a flexible pavement and it is more relevant to analyse it in terms of flexibility rather than rigidity. The mechanisms occurring in the bedding and jointing material are therefore the keys to understanding both the elastic and plastic response of this flexible composite pavement.

The purpose of this chapter is to analyse the functions of, and mechanisms occurring within the bedding and jointing of segmental block pavements.

4.2 RELEVANT ASPECTS OF THE INSTALLATION PROCEDURE

Segmental blocks used in pavement construction comprise both the surfacing and base of a pavement as described in Chapter 1. Subbase and subgrade as required beneath the blocks are constructed according to established practices. The bedding sand is placed directly on top of the sub-layers and levelled to the required thickness (which according to Shackle (1980) should be about 20 - 25 mm) without compaction. The bedding layer has been described by Shackel (1980) as a construction expedient necessary to level the sub-layer and to bed the segments. This description is, however, not complete since a function of the bedding layer is to provide material in which significant stress dissipation can occur, and which can in addition be remoulded in the event of serious overloading. The bedding layer may therefore be better described in terms of its structural requirements as part of the composite structural system.

Segments are either laid individually by hand or in groups by simple machines. Work continues from completed parts of the pavement so that there is no walking or riding over the uncompacted exposed bedding sand. A small plate vibrator is used to vibrate and compact the bedding sand through the segments, which not only gives the surface its final level, but also densifies the bedding sand. Some bedding sand is displaced vertically within the joints by this action. Jointing sand is then swept into the joints and the composite pavement is completed by a second pass of the small plate vibrator which fills the joints and compacts the jointing material. In this condition, and after some initial use, the segmental block pavement settles-in as described in Chapter 3. The bedding and jointing material to some extent resists the deformation of individually loaded segments due to the generation of shear and other forces.

Individual particles of sand are held together due to interparticle friction, which has substantially an elastic response to applied stress. Figure 4.1 shows the various stress transfers taking place in the jointing and bedding material due to an applied vertical load.

The compaction of the bedding sand (which is a thin layer) by vibration through the segments is a valuable method of ensuring that no "over-compaction" or de-densification occurs due to a lack of containment of the upper surface of the sand bedding, which would cause individual sand particles to separate rather than compact together. Such a condition would occur if the layer was vibrated before the segments were laid. The sand bedding is normally laid and compacted at low moisture content. It has been shown by Forssblad (1965) that this method of compaction produces high density and this procedure is therefore recommended for use in segmental block pavements. There is another state which produces high density by compaction in non-cohesive sands, namely when the non-cohesive sand is in the saturated state. However, saturation cannot be recommended in this application since the saturation procedure could cause ingress of water into the sub-layers, which may be detrimental and could cause rapid deterioration of the pavement when subjected to loading (Figure 4.2).

4.3 FUNCTIONS OF THE BEDDING AND JOINTING MATERIAL

The function of the bedding material is to respond to compressive forces induced by vertically applied loading through individual segments. In addition, the bedding material transmits forces laterally to some extent by means of shear stresses. It has been shown by a number of tests (eg Shackel 1980) that the optimum material for bedding is a non-cohesive sand complying with a particular specification shown in Figure 4.3.

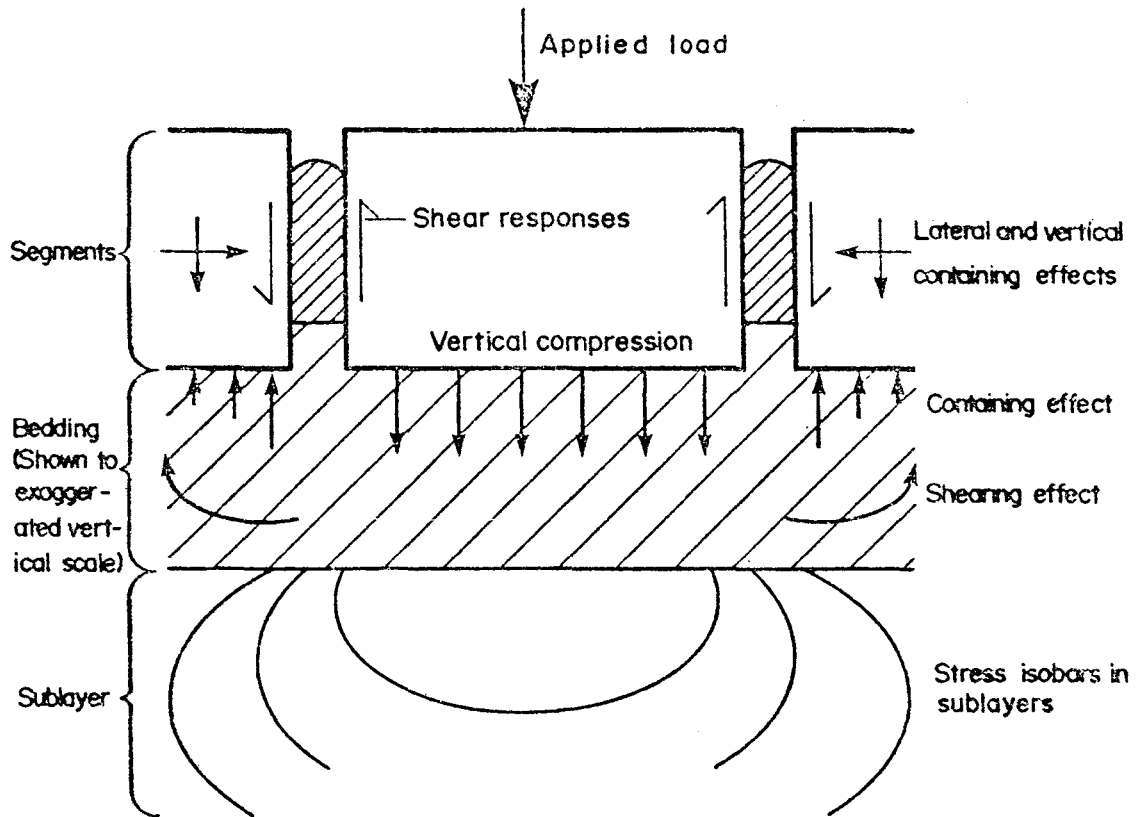


FIGURE 4.1

STRESS TRANSFER IN BEDDING AND JOINTING DUE TO APPLIED LOAD

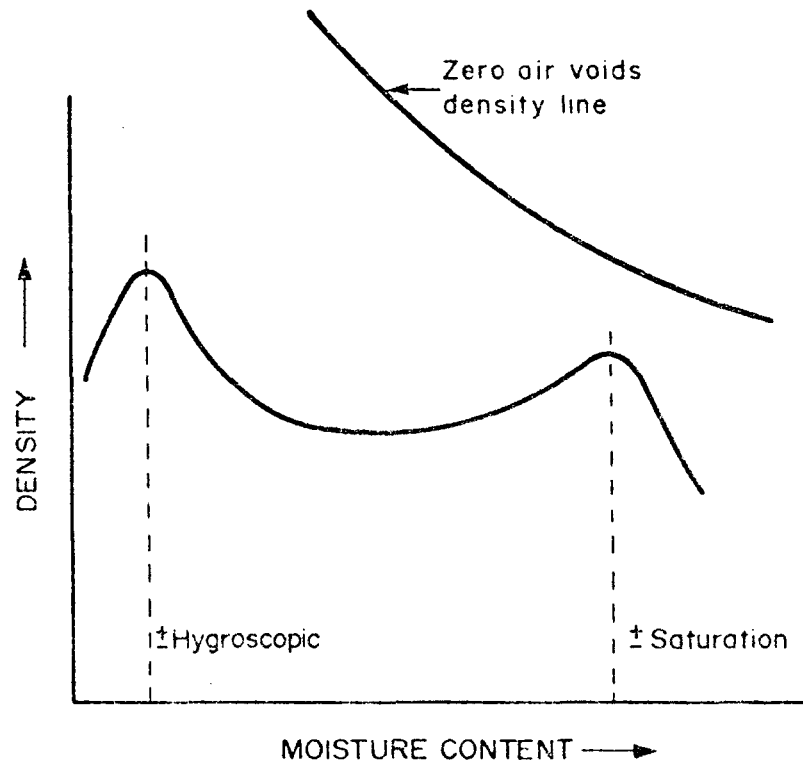


FIGURE 4.2

OPTIMUM DENSIFICATION CONDITIONS IN NON-COHESIVE MATERIAL USED IN BEDDING after FORSSBLAD (1965)

SIEVE SIZE	% PASSING
9,52 mm	0
4,75 mm	95 - 100
2,36 mm	80 - 100
1,18 mm	50 - 85
600 μm	25 - 60
300 μm	10 - 30
150 μm	5 - 15
75 μm	0 - 10

FIGURE 4.3

***RECOMMENDED GRADING FOR THE BEDDING SAND
after SHACKEL (1979 No 2)***

NOTE: EXPERIENCE HAS SHOWN THAT CERTAIN MINESANDS WHICH
DO NOT COMPLY WITH THIS GRADING ARE SATISFACTORY

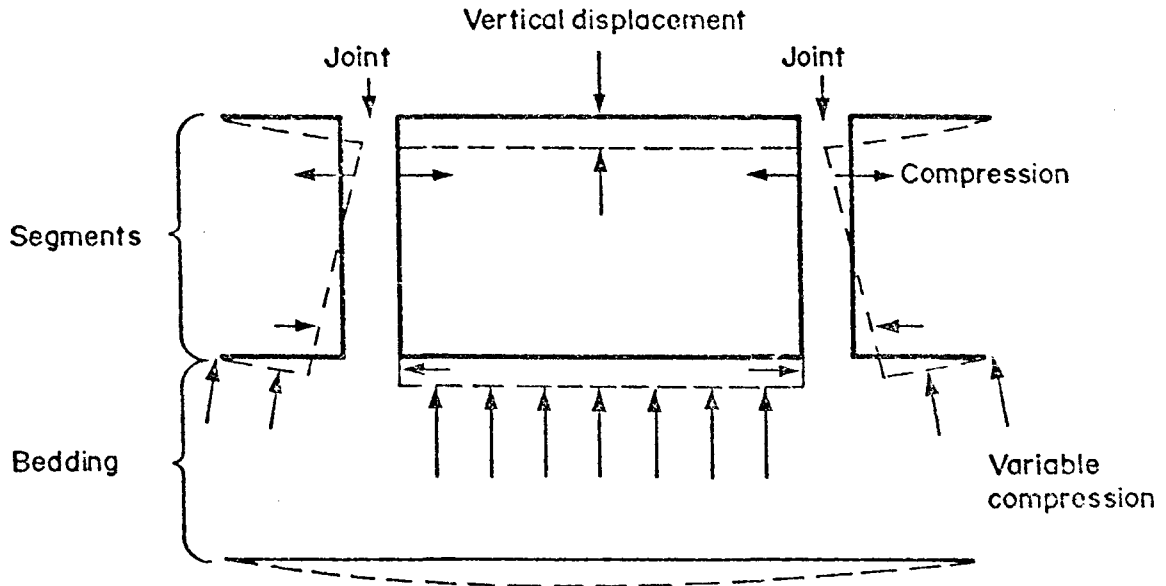
The functions of the jointing sand are different from those of the bedding sand since both tension and compression forces are exerted in the joints. The joints are also subject to shear responses induced when individual segments are loaded. The material most suitable for jointing has been found by Shackel (1980), to be a fine-grained sand containing a percentage of cohesive material which allows both tensile and compressive forces to be accommodated. An additional requirement of the jointing sand is that it should be readily remoulded both to fill and re-waterproof the joint if severe overloading of the segmental block pavement occurs, which would cause permanent deformation to take place. Jointing sand is studied in Chapter 5 and a specification is proposed.

4.4 MECHANISMS OF RESPONSE

The composite pavement layer comprising the blocks, their joints and the bedding material undergoes a substantially resilient deformation under applied loads. The mechanisms of the resilient response are shown in Figure 4.4.

In the event of overloading the forces induced may exceed the maximum elastic response thereby causing permanent or non-resilient deformation. The mechanisms of permanent deformation are shown in Figure 4.5. Permanent deformation requires the jointing material to be remoulded within the re-shaped joint profile. Sealing is effected by additional trafficking and by environmental effects which cause the somewhat cohesive material to adhere to the side faces of adjacent segments and any less dense jointing material to be additionally densified.

In some industrial applications individual segments are subject to torsional loading caused by large-tyred or tracked vehicles slewing around. In this condition both the resilient effects of torsion or permanent relocation of segments within the segmental pavement matrix can occur. The mechanisms of these conditions are shown in Figures 4.6 and 4.7.



Note :

- Initial and final position
- - - Temporary elastic response positions

FIGURE 4.4

LIMITED MECHANISMS OF RESILIENT RESPONSE (EXAGGERATED)

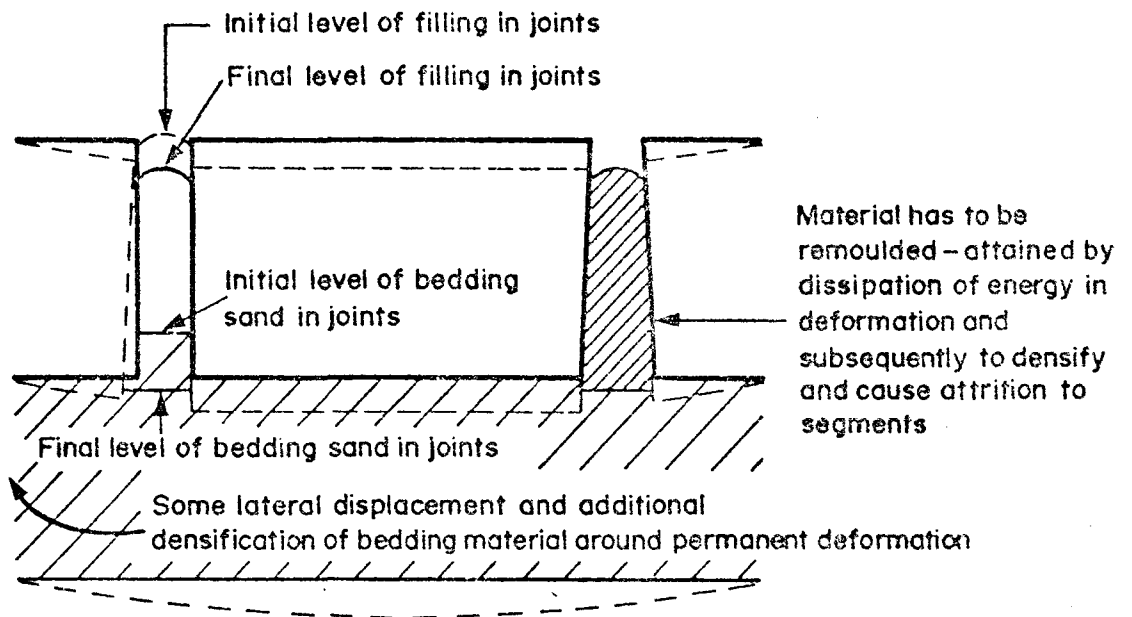
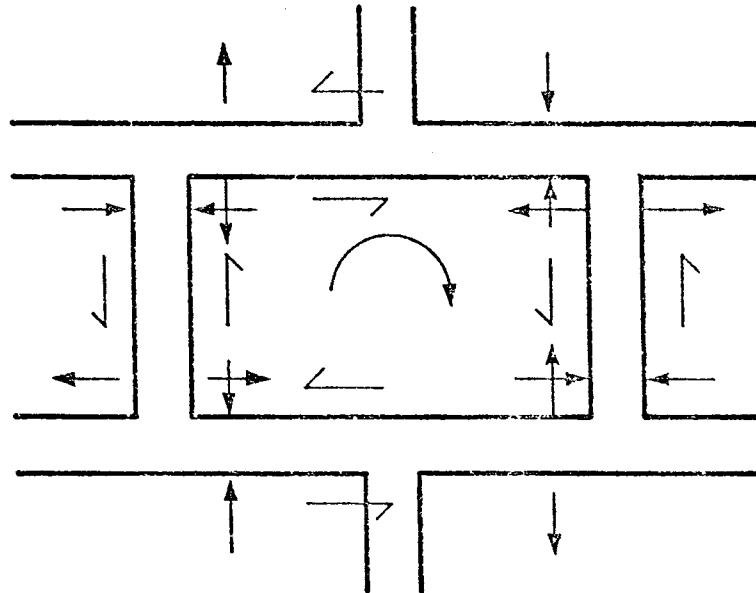


FIGURE 4.5
*PERMANENT DEFORMATION DUE TO OVERLOADING-WITH
ASSOCIATED MECHANISMS*

Plan of individual segment (within its matrix)



Modes:

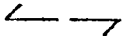

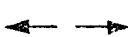

-  Shear response
-  Tension response
-  Compression response
-  Torsional response

FIGURE 4.6

*MECHANISMS OF RESILIENT RESPONSE TO TORSIONAL
LOADING*

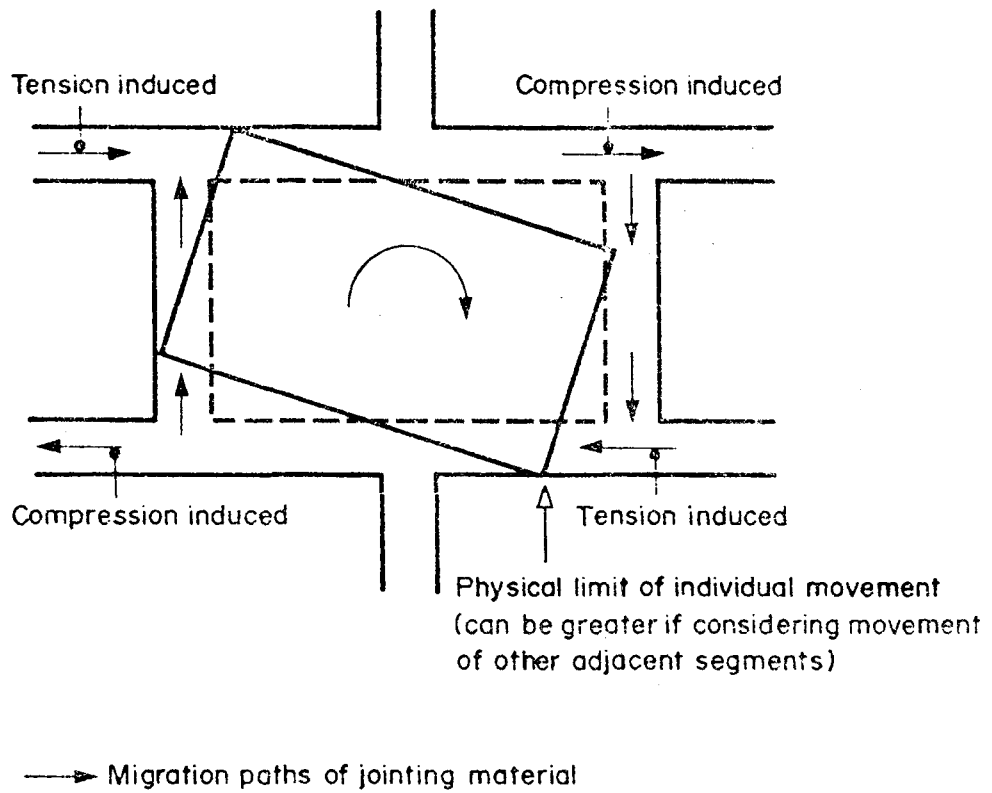


FIGURE 4.7

MECHANISM OF PERMANENT RELOCATION OF SEGMENT WITHIN ITS MATRIX DUE TO TORSIONAL OVERLOADING

4.5 TESTS TO STUDY JOINTING AND BEDDING OF SEGMENTS

A series of tests was designed for studying the behaviour of joints and the bedding material in a number of segmental block pavements at the Silverton test site. Two main test sections were prepared. The first was prepared with no jointing material between the blocks which were laid directly on the bedding sand. The sand was raked to loosen it prior to trafficking. The second was prepared with two types of block, namely fully interlocking blocks (ie type S-A as defined in Chapter 2) and rectangular blocks (type S-C). These tests were designed to study the possible effects of rocking of the segments under HVS loading when there was no lateral restraint afforded by the jointing sand.

The bedding of individual segments within the bedding sand and any resistance to lateral sliding caused by bedding sand displaced vertically into the joints were also studied. Prior to HVS trafficking the segments were subjected to a single pass of a light vibrating plate in accordance with the now established practice in block laying, but without the jointing procedure which would normally follow this.

A Heavy Vehicle Simulator (HVS) was used to cause rapid trafficking of the sections constructed. The HVS was used to apply several hundred load applications of the current legal axle load (80 kN) until the pavements established a condition where little increase in deformation with 80 kN axle loading occurred. This condition has been described by Clifford and Savage (1982) as the settled-in condition. Once the settled-in condition of the pavement had been reached the blocks from 50 per cent of the area trafficked by the HVS were removed and then replaced in a variety of ways. These included laying the blocks without filling the joints and laying the blocks with partly filled joints. An evaluation of the effects of trafficking the pavement as originally laid was easily compared to the trafficking on the relaid halves of the test section since the HVS then trafficked the two halves.

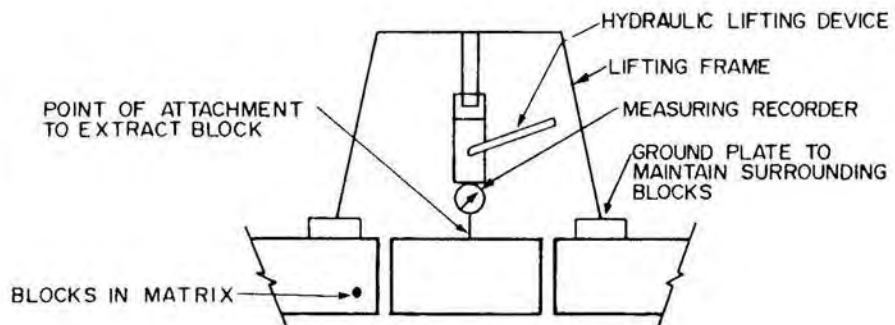
In association with the full-, partly- and open-joint tests, numerous blocks were pulled out of their matrix by a specially designed instrument equipped with a measuring device to record the resistance of the joints to the extraction forces induced.

The instrument shown in Figure 4.8 comprises a containing ring within which the vertically applied lifting device can be positioned. A hand-operated hydraulic jack provides the steady force needed to extract a single selected block whilst restraining the adjacent ones. As the test had to be non-destructive, a steel plate with a welded-on threaded-rut was first glued onto the upper surface of each block to be extracted. The extraction jack was then screwed onto this plate. After the block has been extracted the plate is easily removed by means of a chisel. This instrument is simple and portable thereby allowing a variety of block pavements to be evaluated in situ.

In order to eliminate the effects of the bedding sand and the sublayers under the blocks, the instrument was designed to pull an individual block from its matrix without affecting the surrounding blocks. In this way the resistance to extraction would apply to the joints only. It is appreciated that in practise a load applied to the pavement would induce stresses principally in a downwards direction but no means of measuring the effect on the joints only could be devised. The extraction force measured by the instrument in lifting the block was considered to be identical in magnitude to a downwards load (except for the effects of gravity). The instrument therefore provides an effective yet simple means of identifying actual stress within the joints occurring under a variety of simulated loading conditions. It was subsequently discovered that this approach had been adopted in Australian block pavement research by Mavin (1984).



PHOTOGRAPH OF EXTRACTION INSTRUMENT



SCHEMATIC DETAILS OF EXTRACTION INSTRUMENT (SECTIONAL)

FIGURE 4.8
*INSTRUMENT DEvised TO EXTRACT INDIVIDUAL UNITS FROM
THEIR MATRIX*

Extraction forces were measured on full tightly-jointed segments, segments with poorer joints, and where the bedding sand had been removed to study the shearing effects of the joints only. From these tests it was possible to rate a measure of the effect of the jointing and bedding material of a segmental pavement. A measure of the degree to which individual segments are locked into the matrix was found.

4.6 PRECONCEIVED NOTIONS AND RESULTS OF TESTS

It was expected that the blocks would rock under the action of the passing loaded HVS wheel and that in time this would cause the blocks to displace by an associated reworking of the bedding sand. It was expected that the finish of the pavement would soon become rough. It was also expected that bedding sand would rise within the joints until the pavement would achieve some degree of settling-in.

A further notion was that the edges of the blocks would spall and break due to the interaction and direct contact of one block with another.

The tests actually did not substantiate these ideas. It was observed that some of the bedding sand rose up into the joints and this was measured and found to vary from 1 to 6 mm. Individual blocks showed only slight movement under the applied load since the bedding sand was compacted to its optimum by both the plate vibrator and the subsequent loading applied by the test wheel. The small amount of sand which rose within the joints acted as a limited shear wedge and had the effect of position-fixing individual blocks. For the blocks to rock, additional compaction of the subbase would be required together with a lateral displacement of some of the bedding sand. Since the blocks were much thicker than the bedding sand they appeared to be suitably settled-in to the bedding sand and able to function in a load-carrying capacity. The blocks were able to support the applied HVS load with only little more deformation than was

recorded on the part of the test pavement which was constructed with jointing material. The HVS test wheel applied a fairly slow (0-10 km/h) moving wheel and applied the load vertically with no slewing action. Considerable differences in the response of the pavement to industrial loading where such torsionally applied loads are common could be expected.

Whilst the unjointed pavement performed well under the HVS load a serious disadvantage of an unjointed pavement however is the poor waterproof characteristics of the joints. Considerable ingress of water is possible during rainy weather which could cause damage to sub-layers. Another disadvantage of an unjointed pavement is that torsional loading would cause the unjointed blocks to displace rapidly.

4.7 RESULTS OF EXTRACTION TESTS

Numerous extraction tests were made on as wide a variety of blocks as it was possible to find. The tests were done on newly constructed pavements and on pavements which had already carried considerable traffic. The blocks extracted were not only rectangular (ie S-C) but also consisted of a variety of shaped units (S-A & S-B). The thickness of the blocks also varied. The results (summarized in Figure 4.9) included measurements of the thickness of the joints around the blocks.

Typical calculations made from extraction tests are as shown in the following example.

In location 1 (Figure 4.9) several blocks were chosen at random from an area of interlocking (i.e. S-A) units which had been trafficked by a Heavy Vehicle Simulator. They were labelled as "T, C, S-A" in Figure 4.9 a system of reference representing blocks which had been trafficked, (ie "T") made of concrete (ie "C") and of fully interlocking shape (ie "S-A") respectively. The thickness of the blocks was measured and was found to

LOCATION NO	TRAFFICKED T UNTRAFFICKED U	BLOCK SHAPE & MATERIAL RECTANGULAR S-C CONCRETE C BRICK B FULLY INTERLOCKING S-A PARTLY INTERLOCKING S-B	THICKNESS OF BLOCK mm	CHAMFER mm	LENGTH OF JOINT mm	MEAN JOINT WIDTH mm	CALCULATED VOLUME OF MATERIAL IN JOINT mm ³	AVERAGE INITIAL EXTRACTION FORCE kN	CALCULATED JOINT FACTORS mm ³ /N	NOTES
1	T	C,S-A	80	5	630	1,8	85050	3,5	24,30	
2	U	C,S-C	55	5	580	2,1	60900	3,7	16,46	
3	T	C,S-A	65	5	630	2,7	102060	2,8	36,45	
4	T	B,S-C	75	0	640	2,5	120000	1,3	92,31	SOFT BRICK
5	U	B,S-C	75	0	640	3,7	177600	1,3	136,62	SOFT BRICK
6	T	B,S-C	73	0	640	1,7	79424	1,3	61,10	HARD BRICK
7	U	B,S-C	73	0	640	2,2	102784	1,1	93,44	HARD BRICK
8	U	C,S-B	60	5	550	2,1	63525	0,5	127,05	
9	U	C,S-B	60	5	550	2,7	81675	0,4	204,19	
10	T	C,S-A	80	5	630	2,1	99225	2,7	36,75	
11	U	C,S-A	80	5	630	3,3	155925	1,0	155,93	
12	T	C,S-A	85	5	630	3,1	156240	2,5	62,50	SOAKED BLOCKS
13	U	C,S-A	85	5	630	3,3	166320	3,4	48,92	
14	T	C,S-A	80	5	630	3,0	141750	1,0	74,61	
15	T	C,S-A	80	5	630	2,9	137025	2,4	57,10	
16	T	C,S-C	65	5	580	2,1	73080	1,8	40,60	
17	T	C,S-C	65	5	580	2,2	76560	1,5	51,04	
18	U	C,S-B	75	5	550	2,5	96250	2,6	37,02	OLD PAVEMENT
19	U	C,S-B	75	5	550	1,7	65450	4,9	13,36	OLD PAVEMENT

Note

Joint factor is large for weak joints and joint factor is small for strong joints

FIGURE 4.9
 ANALYSIS OF RESULTS OF EXTRACTION TESTS

average 80 mm. The chamfer on the upper vertical to horizontal angles was 5 mm on average. The maximum thickness of the joints was therefore $80 - 5 = 75$ mm.

Numerous measurements of the circumference of various block shapes were made to establish the length of joints around the individual units. These were found to be 640 mm for the type of rectangular brick units (S-C) used in the tests, 630 mm for the fully interlocking units (S-A) used in the tests, 580 mm for the rectangular concrete blocks (S-C) used and 550 mm for the partly interlocking (S-B) blocks used. Average joint widths were calculated from at least six readings around individual blocks.

The maximum possible volume of material in the joints was calculated by multiplying the thickness of the joint by its average width and by the circumference of the block. In this example 75 mm (the maximum joint thickness) x 630 mm (the distance around the type S-A block) x 1,8 mm (average joint width from Figure 4.9) gives $85\ 050\ \text{mm}^3$ as the maximum possible volume of jointing material around one block. Because some of this material affects blocks on each side of the joint, it was decided that the volume around each block should be considered when calculating a "joint-factor", rather than trying to analyse individual units in the matrix.

The joint factor was calculated by dividing the volume of material in the joints around the block under consideration by the extraction force measured with the extraction instrument. Special care was taken to choose blocks for study which were representative of typical conditions. The joint factor calculated could therefore be used for direct comparison with joint factors calculated from other pavements. In this example the average initial extraction force was measured at 3,5 kN. The joint factor in this case is calculated as $85\ 050\ \text{mm}^3$ divided by 3,5 kN = $24,3\ \text{mm}^3\ \text{N}^{-1}$. In the same way other joint

factors were calculated for a variety of blocks extracted from trafficked and untrafficked areas and with different block shapes. The joint factors are shown in Figure 4.9. In some cases the segmental units were soaked for some time before they were extracted. There was considerable scatter of the results obtained for the calculated joint factors, and seemed to indicate that there was no obvious pattern. Since larger joint factors indicate weaker joints, it can be seen that some of the joints were particularly weak (where the factor is greater than say $60 \text{ mm}^3 \text{ N}^{-1}$). Examples of this condition were found with all types of block (ie S-A, S-B & S-C). Similarly the strongest joints were also found with all types of block.

What may, however, be deduced from the results is that the older pavements and those that had been subjected to environmental conditions including their saturation were "settled-in" and that some improvement in the jointing takes place over a period of time.

The joint factor takes into consideration the effects of partly filled joints since they would offer less resistance to the extraction of a block. The scatter of results could also be attributed to various conditions of joint filling.

Other tests were done with the extraction instrument on pavements where the joints were unfilled, and the readings, as expected, represented only a little more than the weight of individual units extracted. From this it may be concluded that the attrition of the bedding sand is negligible, which confirms the importance of the jointing sand to the structural performance of the segmental block pavement.

4.8 CONCLUSIONS

The studies of the mechanisms of the bedding sand and the joints showed that they are of considerable importance. However, within each pavement the containing forces exerted on individual blocks

were found to vary quite considerably. A measure of the variability can be attributed to reasons such as (a) moisture content of the sand; (b) densification of material within the joints; (c) amount of detritus within the joints; (d) thickness of joints, etc. A further series of tests to optimize the jointing material, joint width and the moisture content of material in the joints was seen to be necessary before reliable modulus of elasticity values for structural analysis purposes can be determined.

It was however shown that the joints resist torsional and shear forces and provide waterproofing to protect the sublayers. The bedding sand was also seen to offer some torsional resistance, and its function is to both levels the subbase and attenuate some of the applied stresses.

C H A P T E R 5

SEGMENTAL BLOCK PAVEMENTS - OPTIMIZING JOINT WIDTH AND JOINT MATERIAL

CHAPTER 5

SEGMENTAL BLOCK PAVEMENTS - OPTIMIZING JOINT WIDTH AND JOINT MATERIAL

5.1 INTRODUCTION

The individual blocks are rigid, yet the pavement as a whole responds in an elastic manner. It has been shown that the flexible response is accommodated by the material in the joints between individual blocks (Clifford, 1981 & 1983). Detailed studies (Clifford 1983) have identified flexible response in the joints as a mechanism to accommodate the interface stress, strain, shear and friction forces induced by loads applied either vertically or torsionally. In discussions of such concepts as "lock-up" - the development of the jointing material with weathering and application of loads (Clifford 1983, Shackel (1980 No 2) Sharp et al 1982) - it is recognized that if there is an improvement of the material in the joints around the blocks themselves then the pavement as a whole is more capable of supporting applied loads with less deformation. Reduced deformation results in either longer pavement life before the surface deformation becomes unacceptable and exceeds defined limits for materials used (Chapter 9 and Clifford 1981), or in the pavement structure being capable of supporting greater applied loads.

Attempts have been made to model segmental block pavements (Clifford 1982 No 2) and to study the effect of the improvements in the jointing material during a period of settling-in. The effective moduli of the support layers under the segmental blocks were determined by numerous Heavy Vehicle Simulator tests and other tests to obtain values with a high level of confidence (Clifford 1982 No 2). It has not yet been possible to use moduli with the same confidence level for the block layer because of the difficulty of determining the response value of the joints relative to the segmental-block paving-layer as a whole. Wide ranges of moduli values were used for the modelling (Clifford 1982 No 2) - to date these values were used in prediction modelling where the

results could not be easily related to existing pavements.

The determination of usable effective moduli for the composite structure forming the block layer required a series of interrelated tests incorporating many techniques available at the National Institute for Transport and Road Research (NITRR). These techniques included a Heavy Vehicle Simulator, multidepth deflectometers, INSTRON tri-axial apparatus with a purpose-designed tray, specially developed extraction equipment and other instruments designed for studying the block layer under both laboratory and field conditions. The instruments and the methodology used are described and the data obtained are discussed.

5.2 PURPOSE

Since the joints around the blocks are so important to the pavement as a whole, the maximum and minimum joint width required study. It was also necessary to determine and define the range of ideal jointing material and any restraints imposed upon it, such as moisture content and the required compaction technique. The study further sought to provide a simple method of evaluating both new and older existing block pavements with respect to the strength of the joints. The purpose of the evaluation method was to provide accurate input data for a prediction model for determining the effective field moduli of the insitu pavement.

5.3 CONSIDERATIONS

Various relationships for determining effective field moduli of the segmental block layer were first considered. These hypotheses included:

- i) Practical limits of joint width with respect to manufacturing tolerance, specified jointing sand particle size and site procedure.

- ii) Mean joint widths, determined by measurement, around individual blocks: standard deviations of individual joint widths, range of joint widths in a specified part of the pavement surface.

- iii) Consideration of the face of the blocks where joint width measurements are made since there was thought to be some variability in joint strength due to the physical shape of the block. For example, the response of the joint of the long face of a block may be different to that of the short face. In fully interlocking blocks (Clifford (1981)) (S-A) different responses can be expected if measured either at the convex or concave tip of the plan geometry of the faces.

- iv) A relationship of joint strength to joint width irrespective of material used (Figure 5.1). Physical restrictions on the ingress of jointing material in tight joints reduce their effectiveness, and in the wide joints the moduli would apply to the jointing material rather than the composite layer.

- v) The relationship of the extraction force needed to pull an individual block out of its matrix to the vertical distance moved. In such a relationship a practical limit for this can be established, based either on the acceptable step between individual adjacent blocks, or on the allowable resilient deformation of an individual block relative to neighbouring blocks. This type of relationship is shown in Figure 5.2.

- vi) Figure 5.2 also shows a variable relationship of the frictional resistance within a joint as a function of the stress or density of the jointing material.

- vii) A relationship between the following and the increase in joint strength :

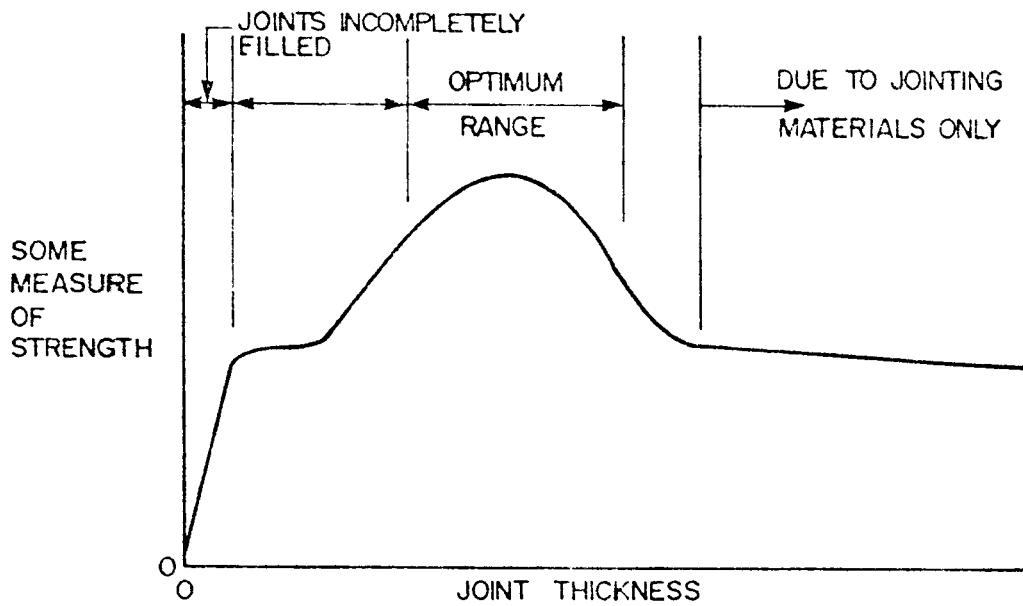


FIGURE 5.1
GENERAL HYPOTHETICAL RELATIONSHIP OF STRENGTH OF JOINTS WITH RESPECT TO THICKNESS

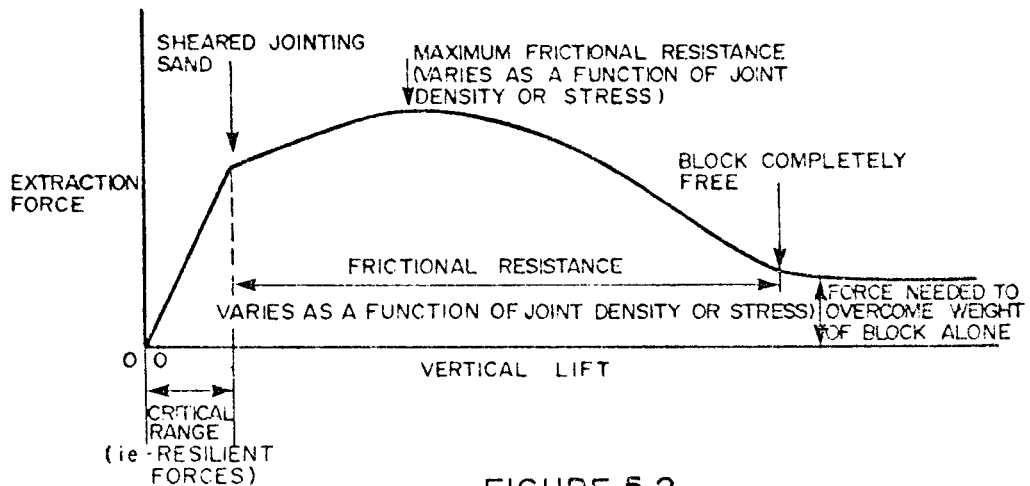


FIGURE 5.2
GENERAL HYPOTHETICAL RELATIONSHIP OF EXTRACTION FORCE TO THE VERTICAL LIFT

940-4-4273/3 HD (JC)

- a) deflection; or
- b) extraction force required to pull out a block; or
- c) density of material in the joints; or
- d) increase in pavement strength;

Such hypothetical relationships are suggested in Figure 5.3, which shows that the relationships are also affected by three moisture content conditions:

- a) optimum moisture content
- b) at wet of optimum and
- c) at dry of optimum.

Various rates of increases in joint strength are suggested in Figure 5.3 depending on the moisture content of the jointing material.

5.4 FIELD MEASUREMENT OF JOINT WIDTH

Blocks are laid by a variety of methods to ensure their alignment and to provide a particular joint width.

Some contractors use rubber hammers to position the blocks as tightly as possible and others place them by hand thereby achieving more open joints.

An instrument was devised some years ago by a visiting scientist to the NITRR (Dr Shackel) which was used in a survey of joint width. The instrument, called a "Shackelometer" after him consists of a simple graduated sharply pointed cone which is pushed into the joints. Its simplicity and accuracy of measurements allow a great number of joint widths to be measured rapidly.

Pavements with blocks of various shapes (S-A, S-B and S-C (Clifford 1981)) were selected at random for surveys. Where units had a rectangular shape (S-C), measurements at the centre of each of the four faces were made and averaged. With the more complex shapes found in S-A and S-B blocks, measurements were made on the

940-4-4273/16 HD (JC)

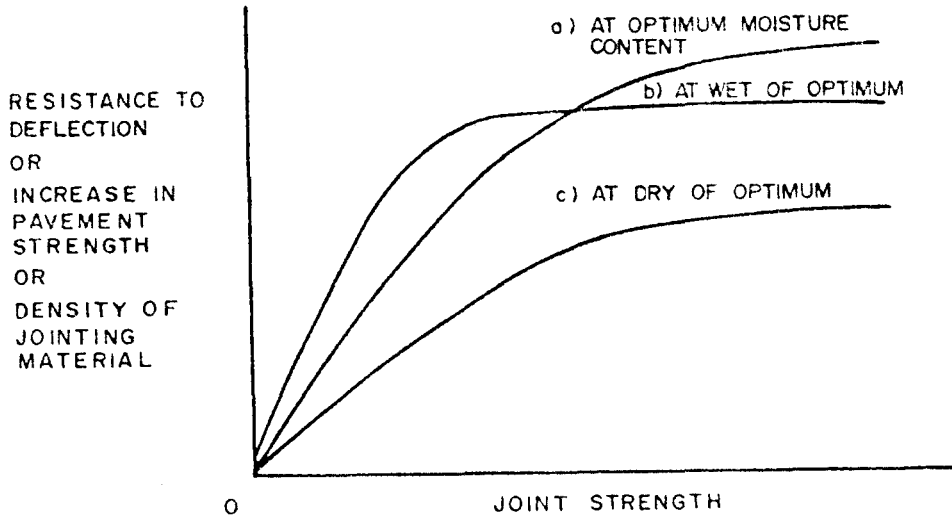


FIGURE 5.3
VARIOUS HYPOTHETICAL RELATIONSHIPS WITH RESPECT
TO JOINT STRENGTH

940-4-4273/22 HD (JC)

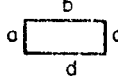
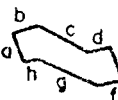
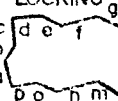
BLOCK TYPE	JOINT WIDTHS a,b,c, etc mm	AVERAGE JOINT WIDTH mm	AVERAGE OF 5 UNITS mm	RANGE OF WIDTHS mm
BRICK S-C RECTANGULAR 	1) .2,2,10,3	1) 4,25	} 3,15	} 1-10
	2) 4,3,8,2	2) 4,25		
	3) 2,4,2,1	3) 2,25		
	4) 1,2,3,2	4) 2		
	5) 6,3,2,1	5) 3		
CONCRETE S-B "SF" SHAPE 	1) 2,5/4/2/12/0,5/2/1,5/10	1) 4,3	} 3,15	} 1-12
	2) 2/2,5/3/11/1/2,5/2/14	2) 4,75		
	3) 1,5/2/1,5/4,5/2/2,5/4	3) 2,25		
	4) 2/2/2/3/2,5/1,5/3,5/1,5	4) 2,25		
	5) 2,5/4/2/1,5/2/1,5/2/2	5) 2,18		
CONCRETE S.A. FULLY INTER- LOCKING 	1) 2/1/3/4/3,5/5/2,5/1/1/1,5/1/5/2/2	1) 2,18	} 2,35	} 0,5-10
	2) 2/3/3/4/1/5/1,5/2/2/3/2/10/1/8/2/3	2) 3,28		
	3) 1/1,5/1/3/1/3/1,5/2/2/1/3/1/5/1,5	3) 1,68		
	4) 1/1/4/0,5/3/2/3/2/2,5/3/3/4/4/1	4) 2,5		
	5) 1/3/2/4/1/1/2/2,5/2/2/1/3/2/4/2/1	5) 2,09		

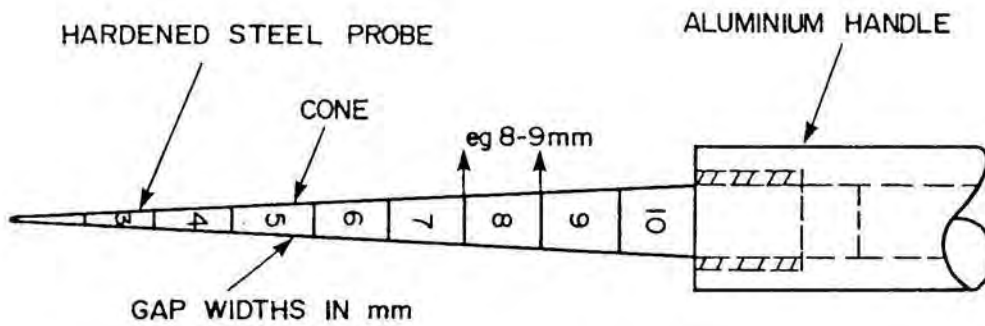
FIGURE 5.4
JOINT WIDTH SURVEY DATA FROM VARIOUS SEGMENTAL
BLOCK PAVEMENTS

centre of each of face for averaging. Blocks were chosen in accordance with the established random selection procedure (Technical Methods for Highways 1981) (TRH5) and at least 5 blocks were measured before an average joint width was established for a particular pavement. The scatter of results obtained was surprising, and on a typical pavement laid to the best standards, joint widths were found to vary from 1 to 5 mm. This can be explained by the manufacturer's tolerances and the need to correctly align the blocks by varying the joint widths. The specifications of the Concrete Masonry Association (CMA) and the Brick Development Association of South Africa (BDA), together with the draft manufacturing specifications produced by the Bureau of Standards provide guideline specifications (Concrete Masonry Association 1982 & 1982 No 2, Brick Development Association of South Africa 1983). These specifications allow that the width and length of concrete units to vary by ± 2 mm. The maximum variation between individual units can therefore be 4 mm, assuming adjacent blocks with these extreme dimensions. With fired clay units the specifications allow a wider tolerance since the manufacturing technique is currently less precise. For this product the length can vary by $\pm 3 - 4$ mm. Hence in extreme cases adjacent units could be 8 mm apart. The joint width in a pavement, calculated by the average measurements of the faces of at least 5 blocks chosen at random, is therefore not likely to be less than, say, 2 mm for any particular pavement to allow true alignment from end to end.

Typical results of the joint width surveys are shown in Figure 5.4. A photograph of the Shackelometer in use is shown in Figure 5.5.

5.5 DISCUSSION ON FIELD JOINT WIDTHS

Results of field joint width measurements showed that even in a pavement constructed to provide the tightest joints there was a typical scatter of results from 1 - 4 mm. By averaging all the results obtained in the manner described above an average joint width of 2,35 mm was calculated. In typical pavements laid by hand packing the blocks the average joint width was 3,15 mm, and



NOTE :- PROBE UNSCREWS FROM HANDLE AND
SCREWS BACK WITH THE POINT INTO
THE HANDLE FOR STORAGE

WORKING DETAILS OF SHACKELOMETER



PHOTOGRAPH OF SHACKELOMETER

FIGURE 5.5

THE SHACKELOMETER

in both brick and concrete pavements laid with widely varying joint widths the average width was also 3,15 mm.

The above data suggest that an average joint width specification of less than 2,35 mm is impractical.

Since the joints have such an important stress-transfer function in the pavement, properly constructed joints are essential. It should be possible to fill the joints with jointing material and compact it by suitable techniques such as vibration. The practical minimum average joint width is therefore 2,35 mm as measured by the above method.

With a minimum specified joint width of 2,35 mm, the joints should become adequately filled with sand should suitable material be used. Figure 5.6 shows the grading envelope of a jointing material I recommend. The largest particles allowed are 1,18 mm. 1,18 mm is the nearest standard sieve size to permit maximum sized particles to be not greater than two thirds of the joint width. This maximum limit is a common practise in earthwork specification. In order to permit such material to enter the joints an individual absolute minimum joint width of 1,25 mm is required.

The oldest known extensive areas of segmental block paving in South Africa are the Chatsworth residential streets in Natal. The blocks have been used by normal street traffic, including trucks and busses, for over 20 years. Apart from surface deformations occurring in some areas due to poor construction of the subbase and settlement of the subgrade, the pavement is performing very satisfactorily. There was no cracking of the blocks which would result if the joints were very tight as this would force adjacent units to come into physical contact with each other and so induce spalling. The average joint width was 4,5 mm and a sample of the jointing material was found to comply with the grading envelope specified in RP/9/81(Clifford 1981) and shown in Figure 5.6. Figure 5.6 also shows an Australian bedding and jointing sand grading envelope and a recommended improved grading envelope (discussed below).

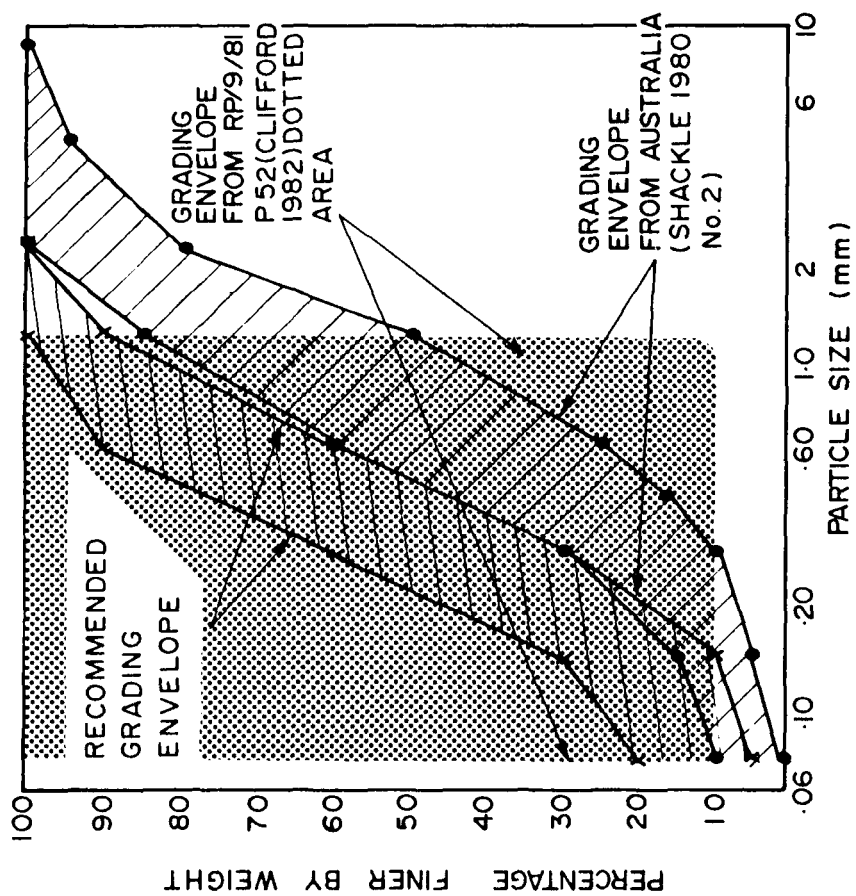


FIGURE 5.6
ENVELOPES OF JOINTING SAND

5.6 EXTRACTION TESTS

The extraction instrument described in Chapter 4 was used to evaluate the interface stresses, shear and strain within the joints only.

Figure 5,7 shows an extracted block still attached to the extractor.

Figure 5.8 shows the block replaced together with the surface plate chiseled off. This non-destructive test leaves only some scarring of the surface from the glue used. It soon weathers so that the block looks similar to the rest.

5.7 RESULTS AND DISCUSSION OF EXTRACTION TESTS

Numerous extraction tests were carried out on a variety of pavements with various block thicknesses and joint widths. Figure 5.9 shows the results of these tests. It was found that for individual pavements there is considerable scatter of the results. With some pavements, especially where the extraction force was low, the extraction results were similar for several blocks removed. The oldest pavements tested were at Chatsworth, Natal, where the main estate roads have served their purpose for more than 20 years. Whereas the extraction forces varied considerably from block to block, the lowest extraction force recorded was considerably higher than that found at any other place. It is therefore concluded that if jointing material is used which contains some material less than 0,15 mm in size as recommended ((Clifford 1981) and Figure 5.6), and as found in the Chatsworth pavements (where 100 per cent finer by weight, passed the 0,600 mm sieve, 96 per cent passed the 0,300 mm sieve, 91 per cent the 0,15 mm sieve and 90 per cent the 0,075 mm sieve), there will be a long-term improvement in extraction resistance. Jointing material used in pavements where the lowest extraction forces were recorded contained no cohesive material and often consisted of sand of a single particle size.

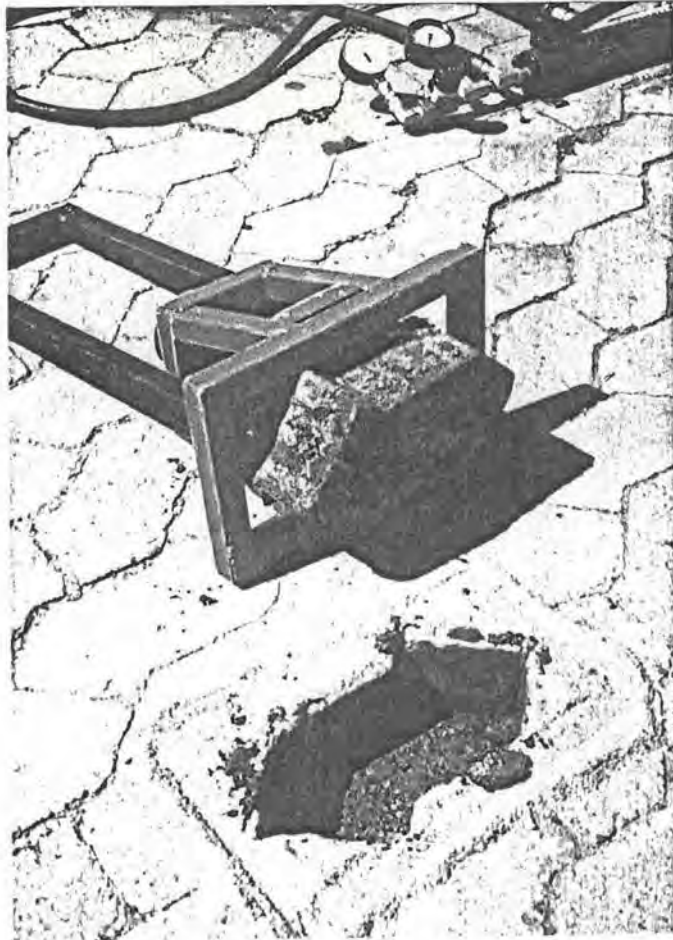


FIGURE 5.7 *BLOCK EXTRACTED BY EXTRACTION INSTRUMENT*

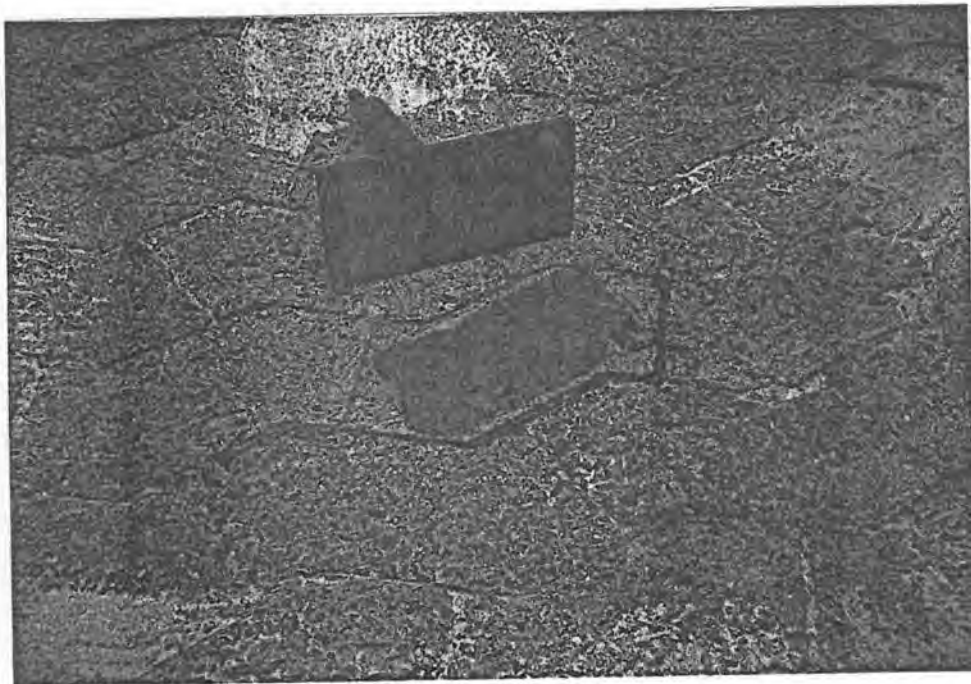


FIGURE 5.8 *BLOCK REINSTATED. ALSO SHOWN IS A SURFACE PLATE WHICH HAS BEEN CHISELLED FREE FROM THE BLOCK*

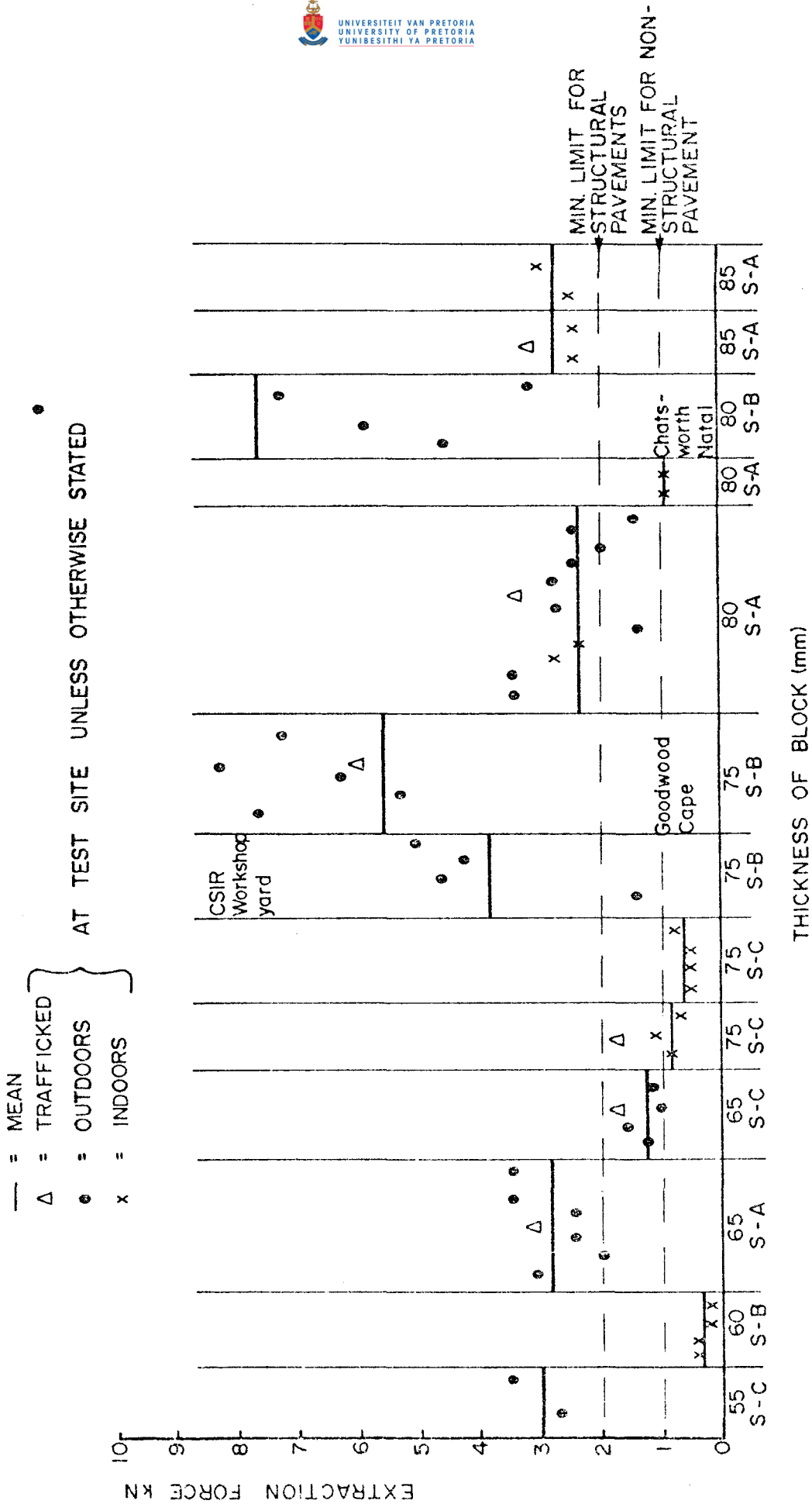
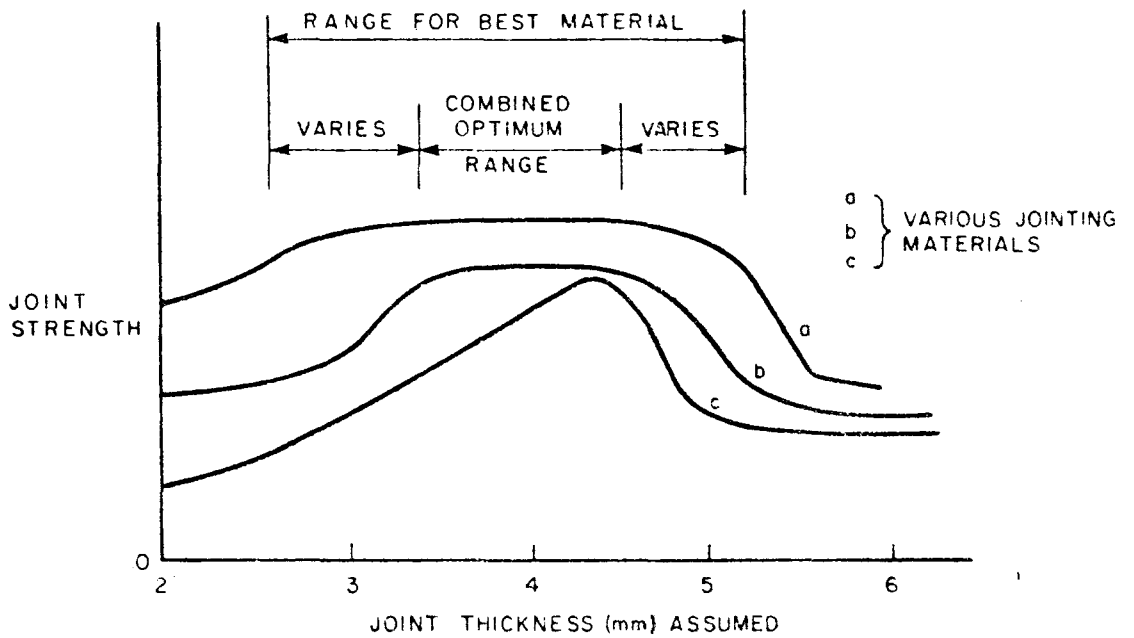


FIGURE 5.9
EXTRACTION FORCE MONITORED IN VARIOUS BLOCK PAVINGS

The results suggest the specification of a minimum extraction force for a structural pavement where the joints have the important function of stress transfer. From the results obtained so far with the extraction instrument a minimum acceptable extraction force of 1 kN is proposed. It is hoped that by laboratory experiments with the extraction instrument on a variety of jointing methods and materials, this minimum extraction force can be increased above 1 kN to a minimum of 3 kN, if possible. The tests are described below. An increase in extraction force also increases the field elastic modulus of the block layer, thereby requiring lesser quality material in the sublayers to support the same load. By this means a proper jointing material significantly improves the performance of a block pavement. Since the jointing sand represents a very small part of a block pavement structure, a better quality could be used without unduly increasing the cost.

5.8 LABORATORY TESTS WITH EXTRACTION INSTRUMENT

There were many stages involved in determining the effective elastic moduli of block pavements. One stage was to simulate construction with a variety of joint widths and jointing material in a laboratory. In order to study joints, a tray was designed and constructed into which a few blocks bedded on bedding sand and jointed with jointing material could be placed. The tray was mounted on a vibrating table and, by various methods of kentledge loading, construction techniques were simulated. The instrument is described in Chapter 2. Two relationships were considered to have bearing on the investigations. The first relationship is shown in Figure 5.11, where some optimum joint width for the type of jointing material could be determined. Where joints were tighter than suggested by the relationship, insufficient jointing material was introduced into the joints and effectively compacted to enable the full stress potential of the jointing material to be achieved. Where the joints were wider than the optimum range, the jointing material sheared more readily since the interface friction (i.e. the friction between the jointing material and the vertical face of the block in the joint) was not utilized as effectively as possible. An aspect of this relationship is also shown in general terms in Figure 5.1.



NOTE :
MANY OTHER RELATIONSHIPS ARE POSSIBLE

FIGURE 5.11
HYPOTHETICAL RELATIONSHIP OF JOINT
WIDTH/JOINTING MATERIAL/ JOINT STRENGTH

The other relationship considers the amount of jointing material around an individual block. Since there is an optimum joint width for a particular material, and the material is needed to provide the flexible response of the block layer of a segmental block pavement, it follows that the greater the amount of jointing material used effectively, the greater will be its stress-potential. Assuming that the joint filling material always completely fills the joints the quantity of material in the joints can be increased (without increasing the joint width beyond its optimum range) by

- (a) choosing a joint width at the widest end of the optimum range;
- (b) increasing the thickness of the block to provide a deeper joint;
- (c) taking away any surface chamfer to allow the joint to be as full as possible;
- (d) using a geometric shape (plan view) which provides the longest edge profile of the blocks (such as an S-A shape).

It is not practical, however, to use all these four methods to provide the maximum effective jointing material. It is obviously possible to lay blocks with the widest joint possible (ie (a) above) within the optimum range for the jointing material used, but this may not be readily adopted by site staff laying the blocks. The increase in block thickness proposed in (b) above is obviously not a cheap solution since with proper structural balance (Clifford 1982 No 2) in the total pavement design a small improvement in the strength (or possibly thickness) of supporting material under the blocks would be as effective as thicker blocks. Handling thicker and hence heavier blocks is more difficult and could affect the costs of the completed pavement. In some cases blocks are made without surface chamfers, but most units have them to allow easier handling. (Units without chamfers tend to cut the hands, especially when many units are laid in each shift.) Chamfers allow surface levels to be less precise and can easily accommodate up to 2 mm difference between one block and the next. The chamfers tend to hide these differences in levels from the naked eye. They also add to the overall aesthetic appearance of

the pavement. Since chamfers are typically only 3 mm deep the loss of jointing material by chamfering the units is minimal. An easy way of increasing jointing material in structural pavements is to choose a fully interlocking unit of the most complex shape possible (as suggested in (d) above).

Various tray tests were done in the laboratory. Six types of jointing sand were chosen from those currently used by contractors when laying blocks. The grading analysis of these sands is shown in Figure 5.12. Several other jointing materials were immediately rejected since they were either :

- (a) of too great a particle size to enter and effectively fill the joint, or
- (b) they contained no material less than 0,15 mm size needed to allow the joints to become pressurized (i.e. internally stressed). The jointing materials that provided the greatest extraction forces fell within the recommended grading envelope shown in Figure 5.6.

Many tests were conducted with acceptable jointing materials. Figures 5.13 - 5.18 inclusive plot the effect of the joint width on the extraction force needed to lift the block by the extraction instrument. Figures 5.19 and 5.20 show the relationship of each of the six sands used for given joint widths with different vibration times. For the sands numbered 1, 3, 4 & 5 a range of joint widths showed a greater resistance to extraction than sands numbered 2 and 6.

An important relationship was discovered when the effect of moisture content on the extraction force was studied. It can be seen in Figure 5.21 that it is critical to keep the moisture content of the jointing material to 2 % or less since above 2% the extraction force was almost zero. The sand types 4 & 5 used in the study were found to provide the best resistance to extraction and hence the best improvement in the strength of the block layer.

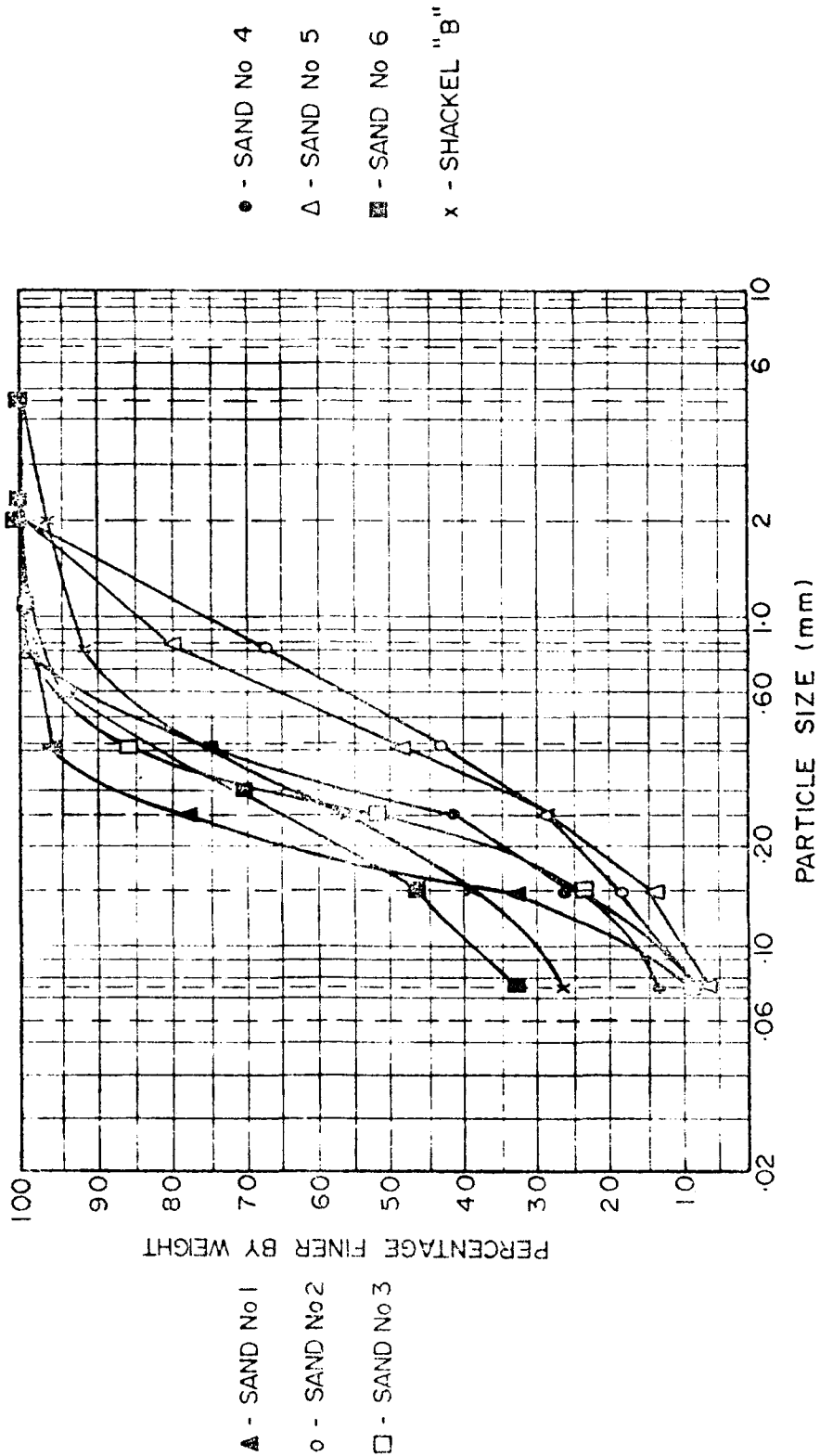


FIGURE 5.12
 PARTICLE SIZE DISTRIBUTION OF SIX SANDS USED FOR JOINTING TESTS TOGETHER WITH SAND SHACKEL "B"

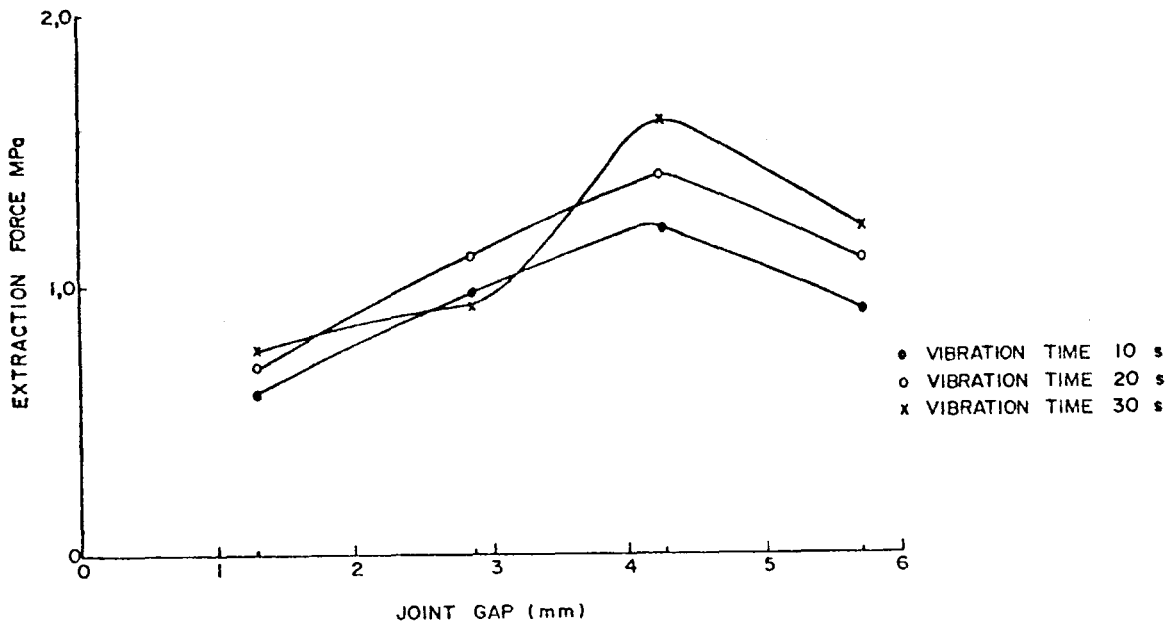


FIGURE 5.13
EXTRACTION FORCES REQUIRED FOR GIVEN VIBRATION TIME
AT VARIOUS JOINT GAPS FOR SAND NO 1

4-4216/II H.D.

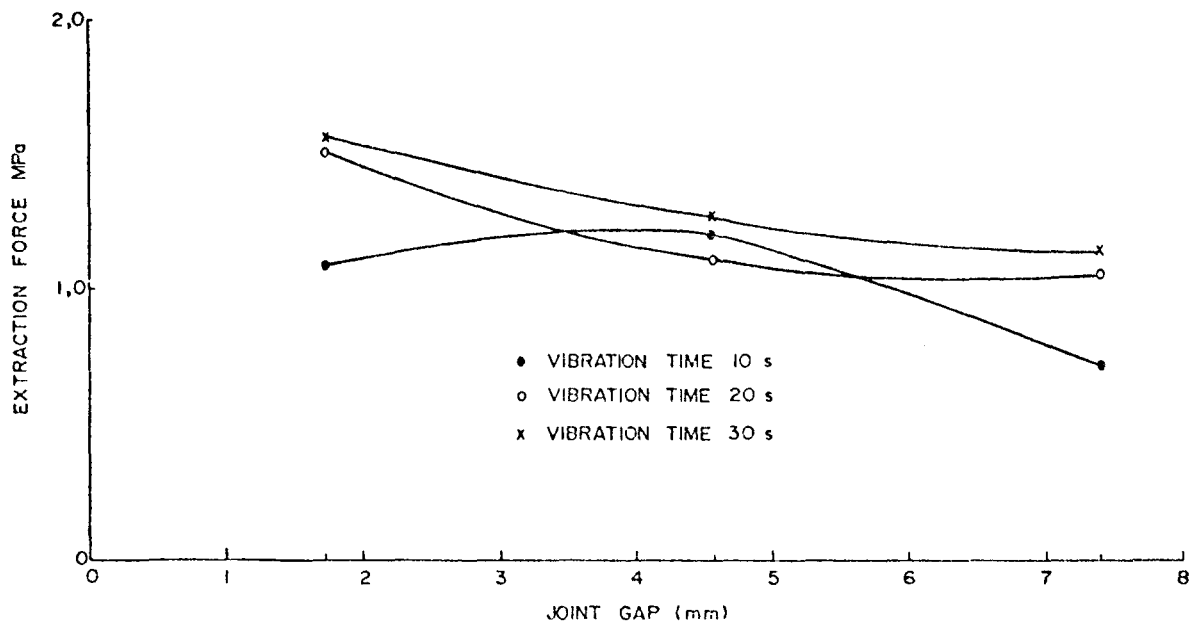


FIGURE 5.14
EXTRACTION FORCES REQUIRED FOR GIVEN VIBRATION TIME AT VARIOUS JOINT
GAPS FOR SAND NO 2

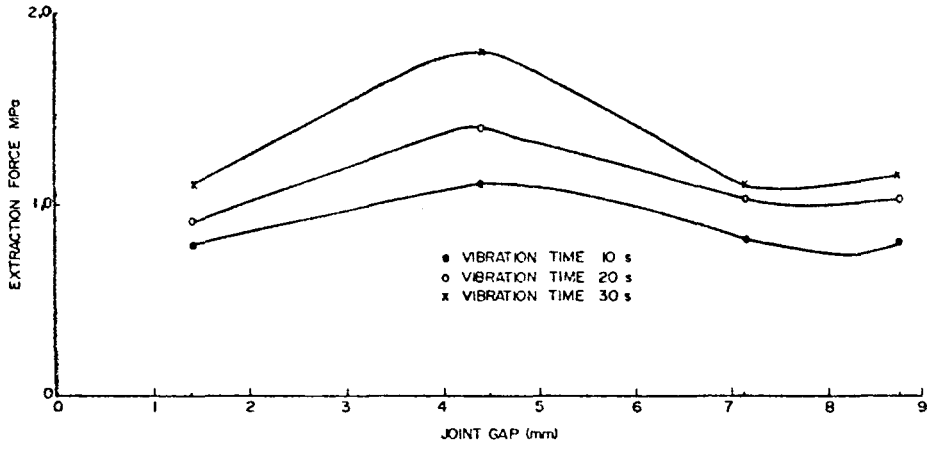


FIGURE 5.15
EXTRACTION FORCES REQUIRED FOR GIVEN VIBRATION TIME AT VARIOUS JOINT GAPS FOR SAND NO 3

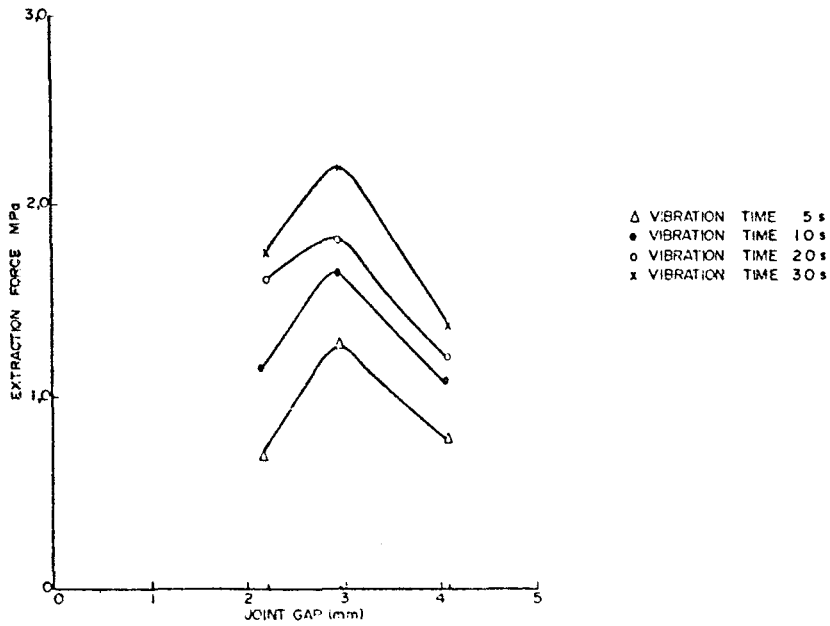
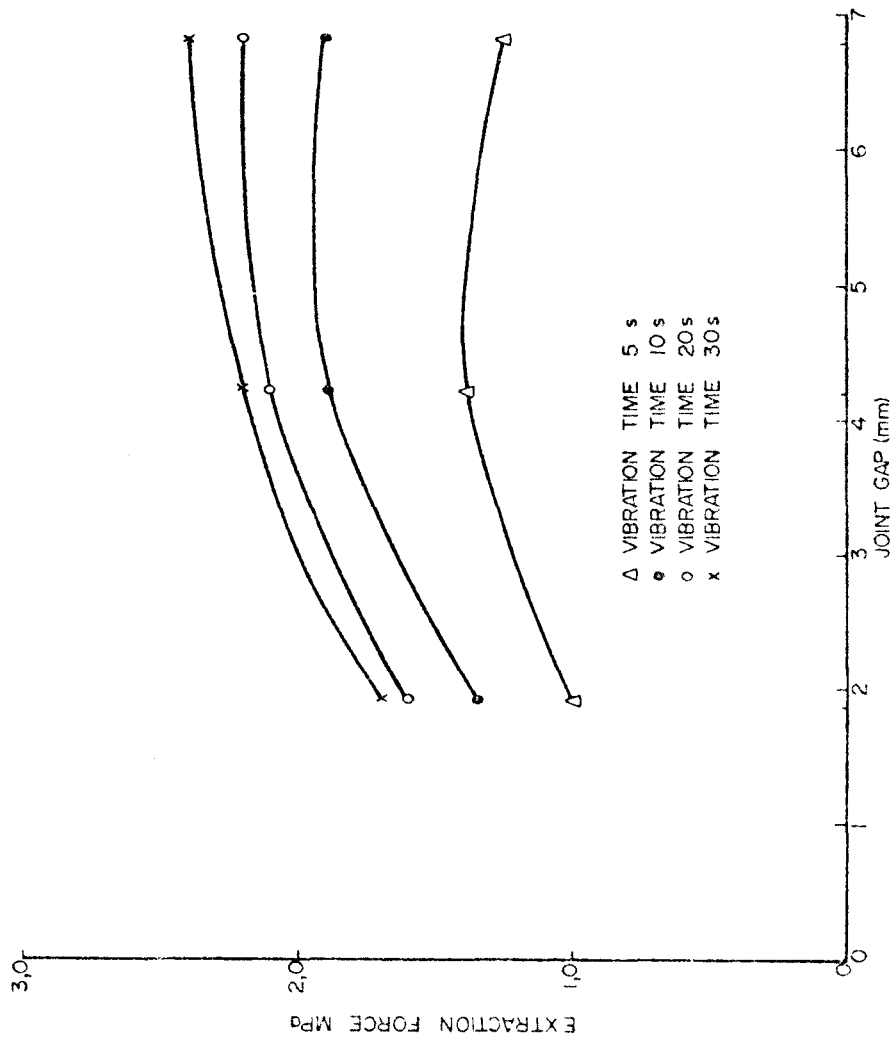


FIGURE 5.16
EXTRACTION FORCES REQUIRED FOR GIVEN VIBRATION TIME AT VARIOUS JOINT GAPS FOR SAND NO 4



EXTRACTION FORCES REQUIRED FOR GIVEN VIBRATION TIME AT VARIOUS JOINT GAPS
FOR SAND NO 5

- Δ VIBRATION TIME 5 s
- VIBRATION TIME 10 s
- VIBRATION TIME 20 s
- x VIBRATION TIME 30 s

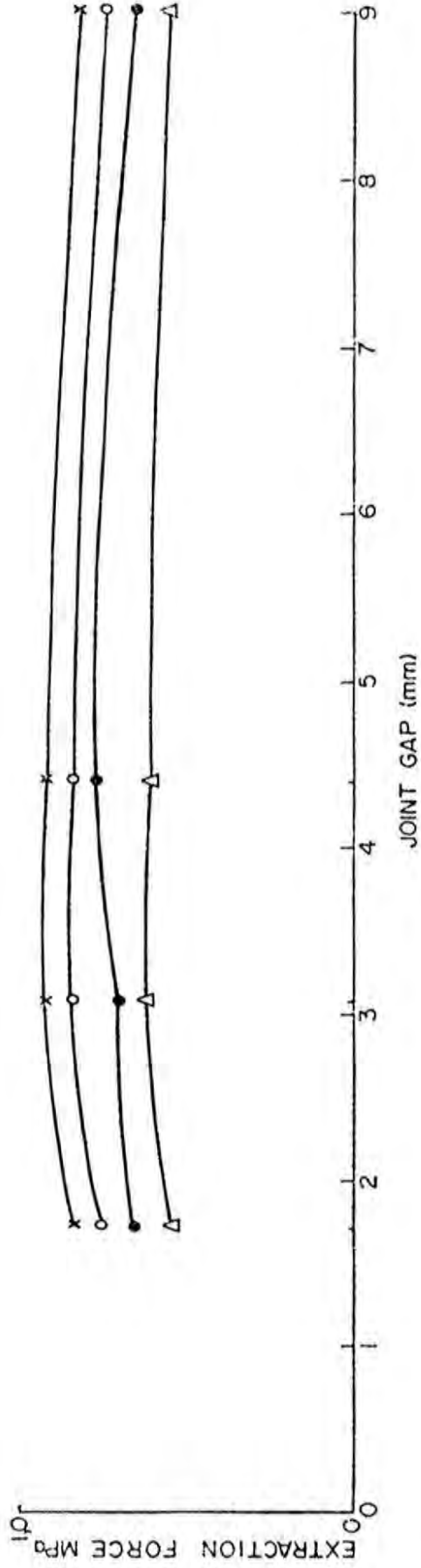


FIGURE 5.18

EXTRACTION FORCES REQUIRED FOR GIVEN VIBRATION TIME AT VARIOUS JOINT GAPS FOR SAND
 NO 6

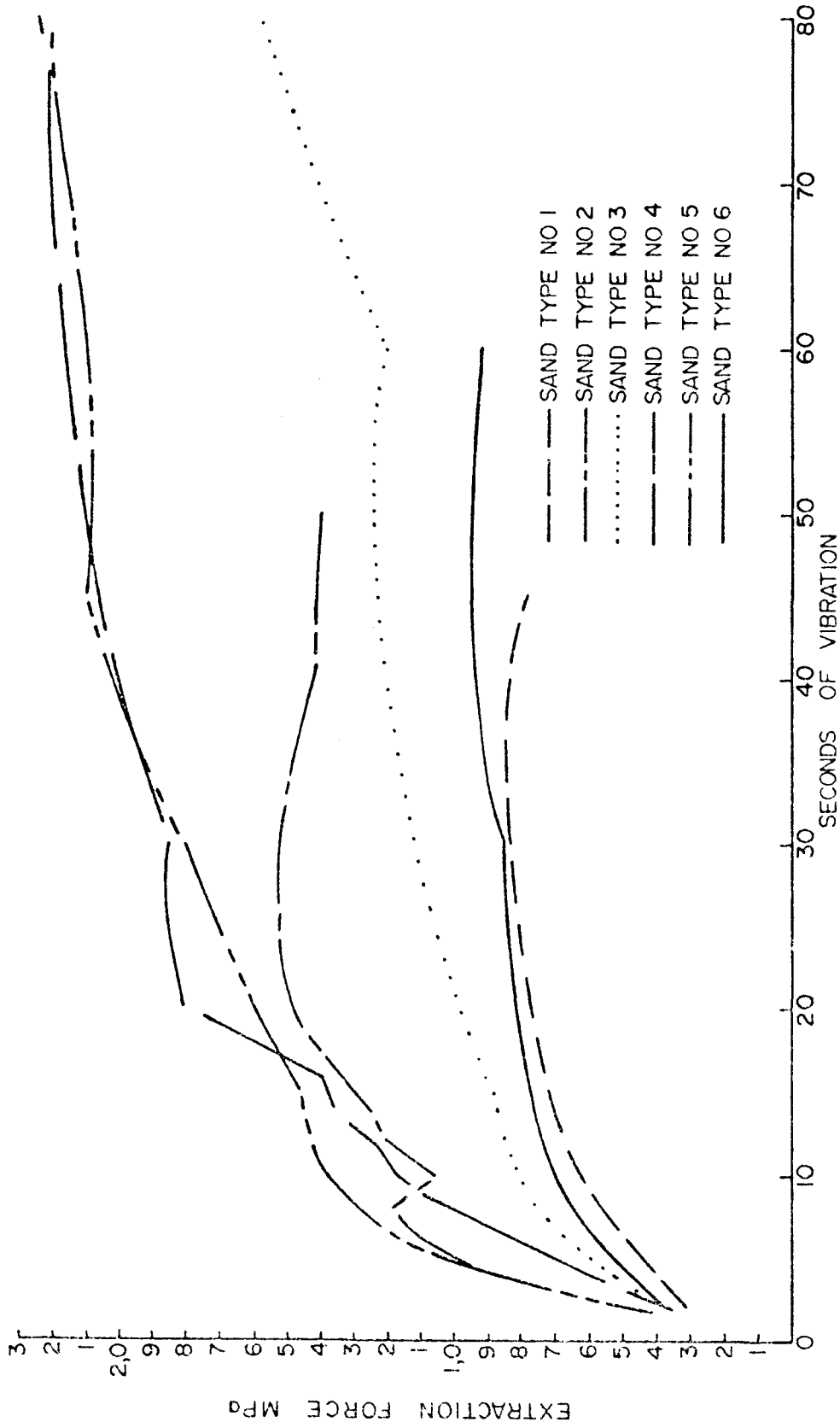


FIGURE 5.19

SANDS 1-6 (JOINT SPACING 1-2mm) THE INFLUENCE OF SAND TYPE ON FORCE REQUIRED TO VERTICALLY MOVE AN INDIVIDUAL BLOCK

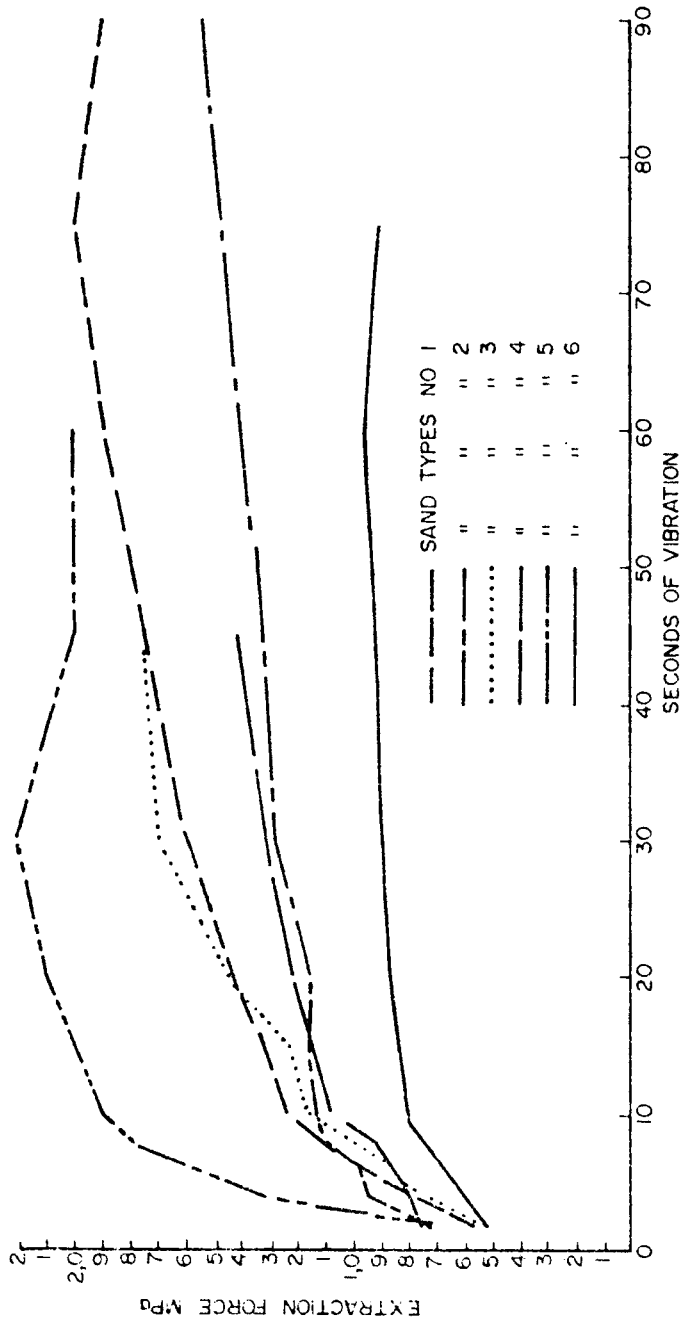
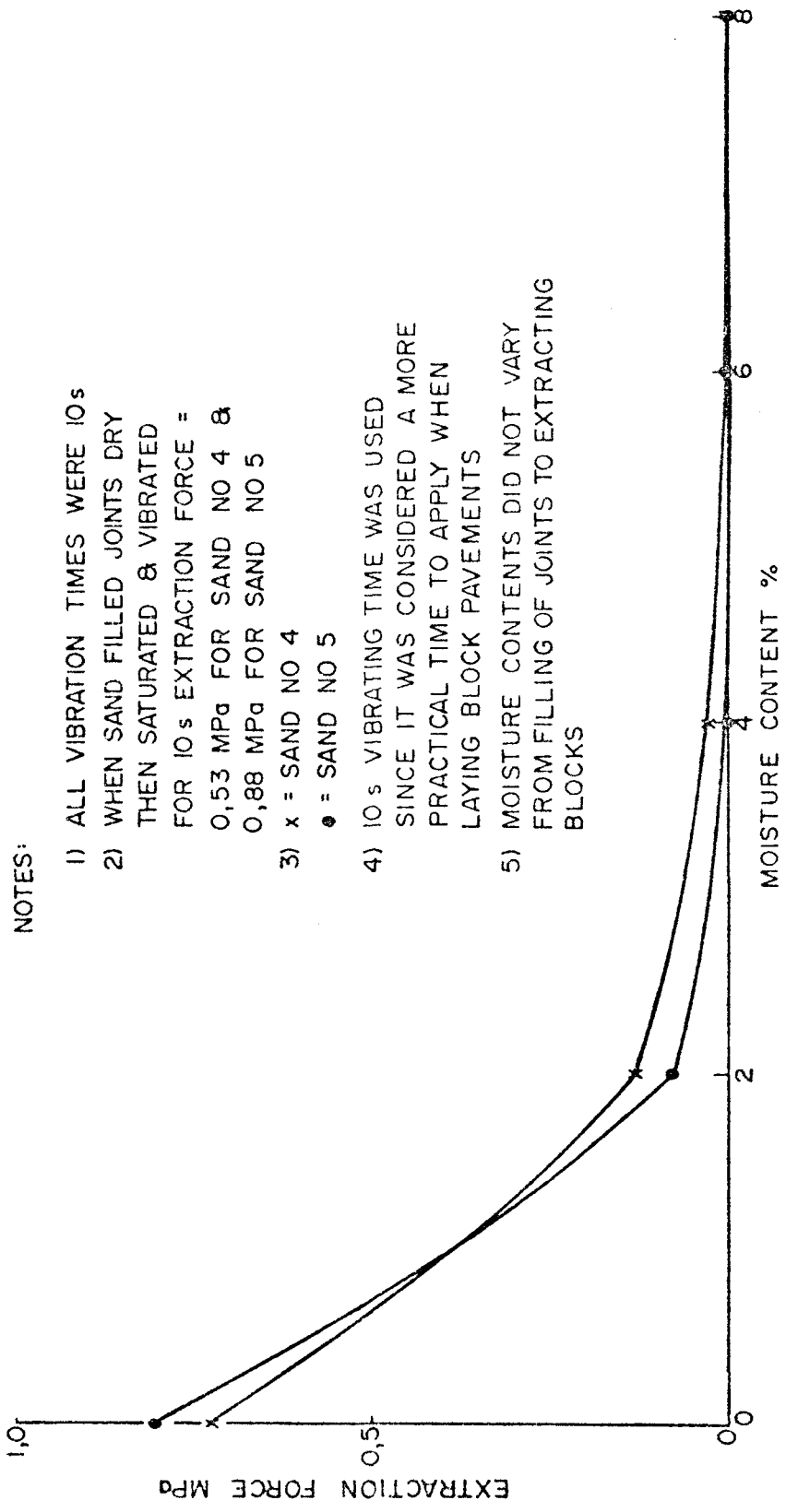


FIGURE 5.20

SANDS 1-6 (JOINT SPACING 4-5mm) THE INFLUENCE OF SAND TYPE ON FORCE REQUIRED TO VERTICALLY MOVE AN INDIVIDUAL BLOCK



NOTES:

- 1) ALL VIBRATION TIMES WERE 10s
- 2) WHEN SAND FILLED JOINTS DRY THEN SATURATED & VIBRATED FOR 10s EXTRACTION FORCE = 0,53 MPa FOR SAND NO 4 & 0,88 MPa FOR SAND NO 5
- 3) x = SAND NO 4
• = SAND NO 5
- 4) 10s VIBRATING TIME WAS USED SINCE IT WAS CONSIDERED A MORE PRACTICAL TIME TO APPLY WHEN LAYING BLOCK PAVEMENTS
- 5) MOISTURE CONTENTS DID NOT VARY FROM FILLING OF JOINTS TO EXTRACTING BLOCKS

FIGURE 5.21
EFFECT OF MOISTURE CONTENT ON EXTRACTION FORCE

From the data obtained, it was found that the optimum range of joint widths was 2 mm - 5 mm. (This confirms the general joint widths suggested by manufactures and by previous research). Figure 5.6 gives recommendations for an improved jointing material.

5.9 RELATING THE TRAY TESTS TO SITE CONSTRUCTION METHODS

The method of compacting the blocks into the bedding sand and vibrating and compacting the jointing material between the blocks in the tray test involved the use of a vibrating table. Two arbitrary vibration times were initially chosen, namely 6 seconds and 20 seconds. The 6-second period was thought to represent a well constructed pavement where several passes would have been made by a plate vibrator. The 20-second period was thought to provide a very well compacted segmental block layer. As the tests progressed it became obvious that the 6-second period made little improvement to the compaction of joint material, although it did allow the joint to fill. After 20 seconds of vibration some significant increases in extraction forces were noted. The tray tests were initially carried out with substantially dry jointing material whose moisture content was similar to that of material used in full-scale construction of segmental block pavements.

A relationship therefore exists between joint strength and vibration time (also shown in Figures 5.19 and 5.20). When the most suitable jointing material was found in accordance with the requirements described above an ideal method was sought to compact it within the joints.

To relate the vibration needed to compact jointing material to its maximum resistance to extraction as discovered in the tray tests to that required by the plate vibrators used in pavement construction, involved using the extraction instrument on a site. Several blocks were extracted after various numbers of passes with the type of plate vibrator used for construction. It was found that a minimum of 3 passes with a typical operating speed of 3 - 4 km/h were required. The usual one or two passes currently made on site gave a lower extraction force than desirable. Vibrations caused by trafficking in time help to produce the optimum conditions.

This is part of the reason for the improvement in carrying capacity that occurs with time in segmental block pavements. This is known as either the settling-in period (Clifford 1982 No 2 & 1983) or the "lock-up" (Shackel (1980 No 2) Sharp et al (1982)).

The tray tests therefore provided information to define the following with a high degree of confidence, which can be immediately applied in practice :

- (a) The grading envelope for jointing materials within which the ideal materials would be acceptable (Figure 5.6).
- (b) The range of joint widths within which the full structural response of the composite components of the segmental block layer are at an optimum of 2 - 5 mm.
- (c) A moisture content of not more than 2 per cent or preferably as dry as possible in the jointing material during construction.
- (d) The best compaction method for developing maximum joint strength : a minimum of 3 passes with the small plate vibrators used on site.

C H A P T E R 6

HEAVY VEHICLE SIMULATOR TESTING ON SOME SEGMENTAL CONCRETE PAVING BLOCKS

CHAPTER 6

HEAVY VEHICLE SIMULATOR TESTING ON SOME SEGMENTAL CONCRETE PAVING BLOCKS

6.1 INTRODUCTION

The Heavy Vehicle Simulator (HVS) was developed by the NITRR to enable many years of normal trafficking to be simulated on a test section of pavement within a period of weeks.

The HVS operates together with a wide range of ancillary equipment to measure transient deflection and permanent deformation of the surface. In addition vertical deformations, profile changes, layer interface movements, stress values and strain values can be measured to provide data for calculating the resilient modulus at any pre-determined depth within the pavement by means of multi-depth deflectometers, buried gauge sheets, pressure cells and strain gauges. The mobility of the HVS and its ancillary equipment permits pavements to be tested in situ. The HVS is therefore a highly sophisticated mobile testing laboratory. The equipment has been effectively used in the past and is currently being used for tests on new and older pavements. Numerous reports describe the HVS and its ancillary equipment, and results of pavement tested show the value of this unique facility. Examples of such reports are by Van Vuuren (1973), Paterson (1976), Richards et al (1977) and Basson et al (1981). Freeme (1984) ATC (1984). These tests can lead to savings by more accurately defining the material properties, pavement life and degradation cycles, and thus permitting the more exact design of pavements which are not over-conservative in their design and therefore needlessly expensive.

The availability of an HVS at the NITRR presented an opportunity to study the behaviour of a large variety of segmental block pavements under repeated load applications. A programme of tests with several segmental block pavement types on various supporting layers was planned and conducted at the NITRR's test

site at Silverton. Several of the sections chosen were similar to the sections used in the modelling studies and the results allowed comparisons between these testing techniques to be made. It was felt that HVS tests might assist in the study of some of the following aspects of block pavement design :

- (a) The effect of wheel loading repetitions and load increases on the underlying pavement layers and the effects of strengthened subgrade layers on the pavement performance.
- (b) The establishment of a realistic wheel-load equivalency factor for the block pavements, where high wheel loads could be related to the effects of an equivalent number of standard 40 kN wheel loads.
- (c) The relationship between rut depth (plastic deformation) and pavement thickness and type, for pavement design purposes.

What follows is a short discussion of these three facets of pavement design with reference to the HVS, and a description of the preparation of the test sections and the results achieved during the tests performed to date.

6.2 REPEATED AND STEP LOADING ON BLOCK PAVEMENT LAYERS WITH THE HVS

A segmental block pavement (like any other pavement) relies on its various supporting layers to reduce the stresses applied by trafficking on the surface to levels which can be accommodated in each structural layer. The effect of the stabilized subbases in block pavements is not fully known and a series of test sections with cement-treated subbases or natural gravel subbases was planned. The use of the HVS to test segmental block pavements would enable, inter alia, a study to be made of the effects of repeated loads and increases in loading (i.e. step loading) on all layers, including the subbase and underlying layers. Experience has shown that step loading often densifies the material below the blocks in stages, partly by compaction (i.e. rapid changes in density) and partly by consolidation (i.e. changes taking a longer time where pore pressure dissi-

pation is more significant). The loads applied with the HVS on a single wheel were accordingly selected as follows : 25, 40, 50, 60 and 70 kN. These are equivalent to axle loadings of 50, 80, 100, 120 and 140 kN respectively.

6.3 WHEEL LOAD EQUIVALENCY FACTORS

The current maximum axle load permitted on South African road networks is 80 kN. This was therefore the standard load used for evaluating segmental block pavements belonging to category S-4 for use on urban roads. The axle-loading in industrial use is often considerably higher than the 80 kN maximum allowed on the road networks. From experience gained with the HVS, which is capable of applying loads considerably higher than the legal maximum, the following equivalency factors which can be used for industrial pavement design are suggested. Equivalency factors (F_A or F_W) are based on calculations from

$$F_A = \left(\frac{P}{80}\right)^x \text{ or } F_W = \left(\frac{W}{40}\right)^x$$

where F_A or F_W are the load equivalency factors to express any wheel load W or axle load P in terms of the standard axle or wheel load of 80 or 40 kN respectively. In South Africa a commonly accepted value of x is 4,0, but experience has shown that x can vary quite considerably depending on the pavement layers and environmental conditions. TRH4 (1984) ATC (1984). Some suggestions by Grieve (1983) for values of $\frac{P}{80} > 1$ are as follows :

$x = 2$ can be used for granular materials,

$x = 3$ for crushed stone,

$x = 4$ for a bituminous base,

$x = 6$ for a cement-treated base.

Figure 6.1 shows the equivalency factors F_A for these various values of x , and the wide range of F_A illustrates how significant the selection of x can be.

SINGLE AXLE LOAD P (kN)	80 kN EQUIVALENCY FACTOR F FROM $F_A = \left(\frac{p}{80}\right)^x$ WHERE :-				
	x = 4,2	x = 2	x = 3	x = 4	x = 6
75 - 84	1,00	1,00	1,00	1,00	1,00
85 - 94	1,6	1,3	1,4	1,6	2,0
95 - 104	2,6	1,6	1,9	2,4	3,0
105 - 114	3,8	1,9	2,6	3,6	6,8
115 - 124	5,5	2,2	3,4	5,0	11,4
125 - 134	7,7	2,6	4,3	7,0	18,4
135 - 144	10	3,1	5,4	9,4	28,7
145 - 154	14	3,5	6,6	12,4	43,4
155 - 164	18	4	8	16	64
165 - 174	24	4,5	9,6	20,4	92
175 - 184	30	5,1	11,4	25,6	130
185 - 194	38	5,6	13,4	31,8	180
195 - 204	47	6,3	15,6	39	244
> 205	60	7,6	20,8	57	435

FIGURE 6.1

*80 kN SINGLE AXLE EQUIVALENCY FACTORS FOR
VARIOUS VALUES OF X*

WHERE:- F_A = LOAD EQUIVALENCY FACTORS (AXLE LOADS)
 p = SINGLE AXLE LOAD
 x = SEE TEXT

Industrial loading, although it is within the range of suggested equivalency factors given in Figure 6.1, is generally applied at slow speed. The HVS applies loads similarly to the way in which industrial loads are applied in practice, since HVS loads move in a backwards and forwards direction. The loading wheel stops at each end of its run, which is about 8 m in length, accelerating to a maximum of 10 km/h and decelerating to stop at the other end. A test width of about 1 m is trafficked by lateral movements of the beam carrying the loading wheel. Tests on segmental paving with the HVS could help to determine the choice of x for block paving designs.

6.4 PREVIOUS EXPERIENCE OF TESTING DEFLECTIONS OF SEGMENTAL BLOCK PAVEMENTS

Surprisingly few tests have been done on block pavements. The bulk of the work reported has been done in Australia and Europe. Whilst studies have been made on segmental block pavement structures as a whole, it seems that the areas of particular interest have been the shape and interlocking characteristics of the blocks themselves. It has been established by Shackel (1979) that segmental block pavements perform in a manner similar to conventional flexible pavements. No changes in the segments themselves take place as a result of trafficking but changes do occur in their relationship with neighbouring blocks and through wear of the surface as discussed in Chapter 4. The segments are affected by some lateral transfer of stresses which is inevitably caused by friction with the material in the joints. As loading continues, the blocks become closely bonded in the bedding sand and this increases their resistance to sliding. The jointing material between the blocks therefore makes it possible for an area of pavement to move slightly under traffic loads. Figure 6.2 shows an exaggerated loading displacement where a surface deflection of 5 mm results in short-term densification of the bedding sand, the subbase layers and the subgrade. This figure shows the compression and tension changes in the joints required to accommodate the displacement. Each pass of a wheel results in a small measure of permanent

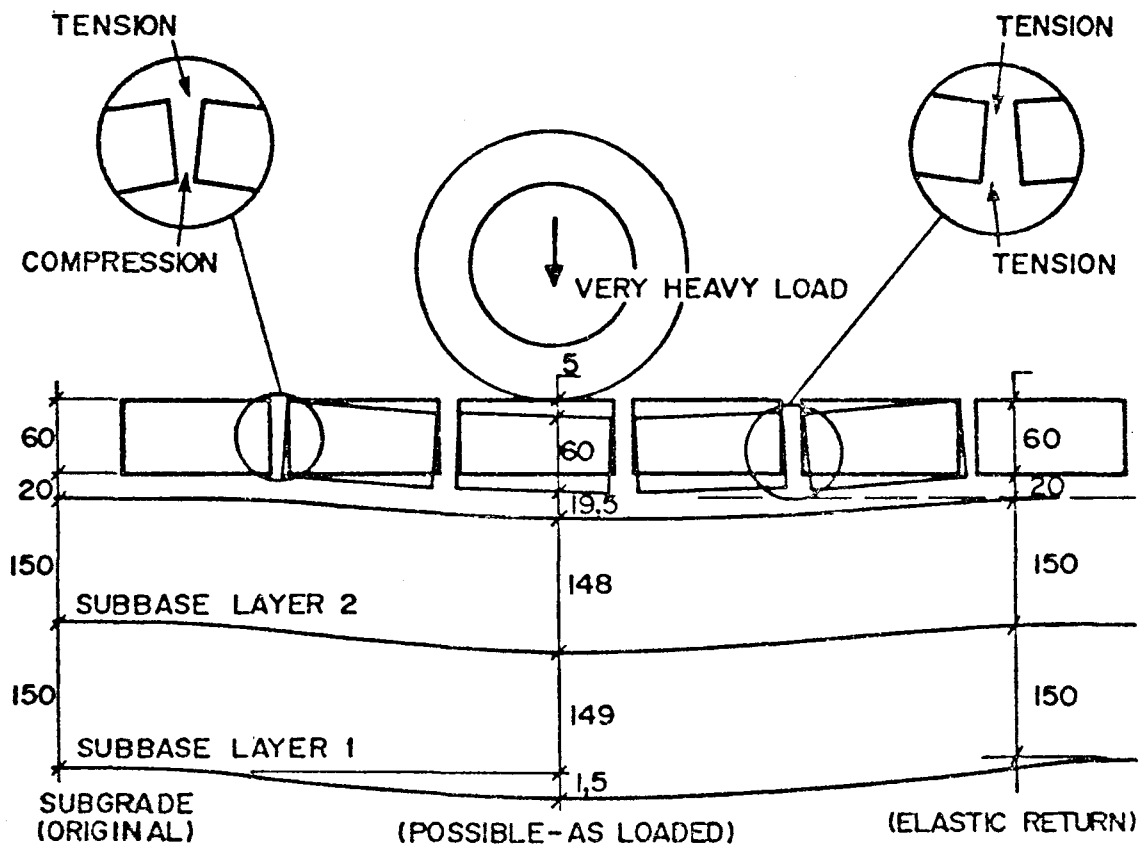


FIGURE 6.2

EXAGGERATED FLEXIBLE DISPLACEMENT OF A SEGMENTAL BLOCK PAVEMENT UNDER HEAVY LOADING.

deformation which accumulates and is measured as rut depth. The rut depth that can be tolerated will depend upon the purpose for which a particular segmental block pavement is built and would then dictate the pavement layer thicknesses. The maximum permissible rut depth is generally 25 mm (Clifford 1982).

6.5 DESIGN OF EXPERIMENTAL PAVEMENTS FOR EVALUATION WITH THE HVS

Six categories of segmental block pavement have been described in Chapter 1 which differentiates between the various uses to which this type of pavement may be put.

Briefly, these six categories were given as follows :

- S1 For light axle loads, low speeds <30 km/h such as parking areas.
- S2 For civic uses such as footpaths and cycleways.
- S3 For highly loaded working areas, low speeds <30 km/h.
- S4 For urban roads and industrial roads, speeds < 60 km/h.
- S5 For higher-speed pavements such as inter-urban collectors.
- S6 For special pavements, innovations, overlays and cost-saving ideas.

Categories S1 and S2 were not considered in this investigation as they are essentially only used for low speed and light axle load traffic in parking lots (S1) and for civic uses (S2). The experimental pavements were also not designed for Category S5 (higher speed) or Category S6 (special pavements, innovations and cost-saving ideas), although certain findings from the tests could allow some of the designs to be used in Category S6. The experimental sections were intended primarily to relate to Categories S3 and S4, which cover industrial pavements and urban roads respectively, on which speeds of less than 60 km per hour can generally be expected. Figures 6.3 and 6.4 show typical examples of S3 and S4 segmental block pavements respectively.

Design catalogues have been developed by Clifford (1982), Brick Development Association of South Africa (1983) and others, for



FIGURE 6.3

USE OF SEGMENTAL BLOCK PAVEMENTS FOR HIGHLY LOADED WORKING AREAS WHERE SPEEDS ARE GENERALLY LESS THAN 30 km/h



FIGURE 6.4

THE AESTHETICALLY ATTRACTIVE USE OF SEGMENTAL BLOCK PAVEMENTS FOR URBAN ROADS WHERE MANDATORY SPEED RESTRICTIONS OF 60 km HOUR APPLY

categories S3 and S4 segmental block pavements allow a choice of block and layer thicknesses. However, the minimum block and layer thicknesses possible were used in the experimental pavements to provide the most economical design conditions. Altogether 40 different test sections were planned and built at the NITRR Silverton test site near Pretoria, with a variety of block shapes including interlocking units and rectangular blocks (see Figure 6.5). The construction of a large number of pavements of different design was exacting for the contractor and it was later discovered that the pavement materials after construction were not in accordance with the specification given in Figure 6.5. In some respects this was an advantage since in the case of at least three test panels the results produced at the ends of each panel differed substantially although each panel had been subjected to the same loading. Detailed analysis later showed that the differences resulted from subgrade and subbase variability. By this means some of the test panels were able to yield more than one result.

The testing programme was scheduled for a time of year when maximum ingress of moisture from the surface of the test pavements and from surrounding areas could be expected, that is between October and April.

However, owing to the number of tests required to complete a full evaluation on all panels and to unforeseen mechanical problems with the HVS, only the first few panels tested had naturally-saturated sub-layers.

In accordance with established practice, the blocks were contained within kerbs. Experience has shown that containment is necessary because the blocks, irrespective of shape, tend to move outwards causing an opening of the joints if their lateral movement is not restricted. Interlocking blocks which are manufactured to close tolerances and laid with suitably spaced joints do, however, resist lateral movement to some extent. In practice, numerous examples can be seen where opening out occurs

PANEL	SHAPE	UPPER SUBBASE & THICKNESS mm	LOWER SUBBASE & THICKNESS mm	NOTES
1	S - A	NG+6% x 75	NG+1,5% x 100	NG=NATURAL GRAVEL + 6% INDICATED 6% OPC 1 - 40 LAID IN HERRINGBONE BOND
2	S - C	NG+6% x 75	NG+1,5% x 100	
3	S - A	NG+3% x 75	NG+1,5% x 100	
4	S - C	NG+3% x 75	NG+1,5% x 100	
5	S - A	NG+1,5% x 75	NG+1,5% x 100	
6	S - C	NG+1,5% x 75	NG+1,5% x 100	
7	S - A	NG x 75	NG+1,5% x 100	
8	S - C	NG x 75	NG+1,5% x 100	
9	S - A	SLAG x 75	NG+1,5% x 100	
10	S - C	SLAG x 75	NG+1,5% x 100	
11	S - A	NG+6% x 75	NG x 100	AREA PANEL 22,5m ²
12	S - C	NG+6% x 75	NG x 100	
13	S - A	NG+3% x 75	NG x 100	
14	S - C	NG+3% x 75	NG x 100	
15	S - A	NG+1,5% x 75	NG x 100	
16	S - C	NG+1,5% x 75	NG x 100	
17	S - A	NG x 75	NG x 100	
18	S - C	NG x 75	NG x 100	
19	S - A	SLAG x 75	NG x 100	
20	S - C	SLAG x 75	NG x 100	
21	S - A	NG+6% x 150	NG x 100	SEGMENTS ALL MADE FROM CONCRETE
22	S - C	NG+6% x 150	NG x 100	
23	S - A	NG+3% x 150	NG x 100	
24	S - C	NG+3% x 150	NG x 100	
25	S - A	NG+1,5% x 150	NG x 100	
26	S - C	NG+1,5% x 150	NG x 100	
27	S - A	NG x 150	NG x 100	
28	S - C	NG x 150	NG x 100	
29	S - A	SLAG x 150	NG x 100	
30	S - C	SLAG x 150	NG x 100	
31	S - A	NG+6% x 150	NG+1,5% x 100	THICKNESS OF ALL SEGMENTS 60 mm
32	S - C	NG+6% x 150	NG+1,5% x 100	
33	S - A	NG+3% x 150	NG+1,5% x 100	
34	S - C	NG+3% x 150	NG+1,5% x 100	
35	S - A	NG+1,5% x 150	NG+1,5% x 100	
36	S - C	NG+1,5% x 150	NG+1,5% x 100	
37	S - A	NG x 150	NG+1,5% x 100	
38	S - C	NG x 150	NG+1,5% x 100	
39	S - A	SLAG x 150	NG+1,5% x 100	
40	S - C	SLAG x 150	NG+1,5% x 100	

FIGURE 6.5
 DETAILS OF TEST PANELS CONSTRUCTED AT SILVERTON TEST SITE

and this is especially true where blocks are laid on slopes (see Figure 6.6).

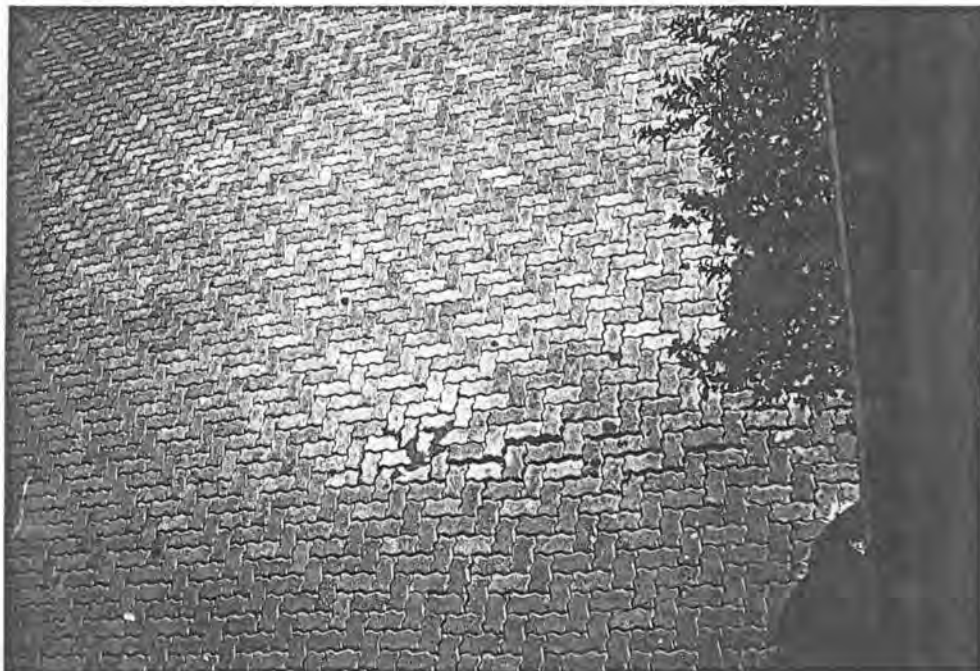
The subgrade under the test sections was chosen to provide as low a soaked CBR strength as possible. In practice the soaked CBR condition is unlikely to occur (as discussed in Chapter 2) and the use of in situ CBR values at the natural moisture content may be more realistic for design purposes.

6.6 ANALYSIS OF TESTS ON SEGMENTAL BLOCK PAVEMENTS

The HVS was installed on the test pavements and a standardized pattern of reference points was painted on their surface. These points were made both within and well outside the trafficked area. After a predetermined number of load repetitions various measurements were taken to enable plots of surface and layer interface movements to be made. Typical plots of the change in rut depth against the number of repetitions of a 40 kN single wheel load (relating to a 80 kN single axle load (ie E80) - the current legal maximum on South African roads) were made and are shown in Figure 6.7. Test panel 31 was tested first with saturated sub-layer (i.e. subbase and subgrade) conditions. The panel deteriorated rapidly at one end only. Further investigations revealed that the subbase in this panel, which should have been cement-stabilized was in fact not cement-stabilized. The subgrade was saturated and had a soaked CBR strength of less than eight. It is surprising therefore that concrete blocks laid on untreated gravel over a poor saturated-subgrade were able to support several hundred 80 kN axle loads before the rut depth reached the predetermined 25 mm rut-depth and the test was stopped. Segmental block pavements with unstabilized subbases with poor CBRs can therefore be categorized as special pavements and placed in segmental block category S6. The saturated sub-layer conditions which prevailed at the Silverton test site during the test are, however, unlikely to continue long enough for several hundred E80s to be applied in a properly designed pavement. Loading will probably be applied over the full pavement width, rather than over the small area trafficked



THESE BLOCKS HAVE MOVED LATERALLY BECAUSE OF A LACK OF KERBING TO CONTAIN THE BLOCKS



THESE BLOCKS HAVE SLID DOWN A SLOPE

FIGURE 6.6
EXAMPLES OF BLOCKS WHERE JOINTS
HAVE OPENED

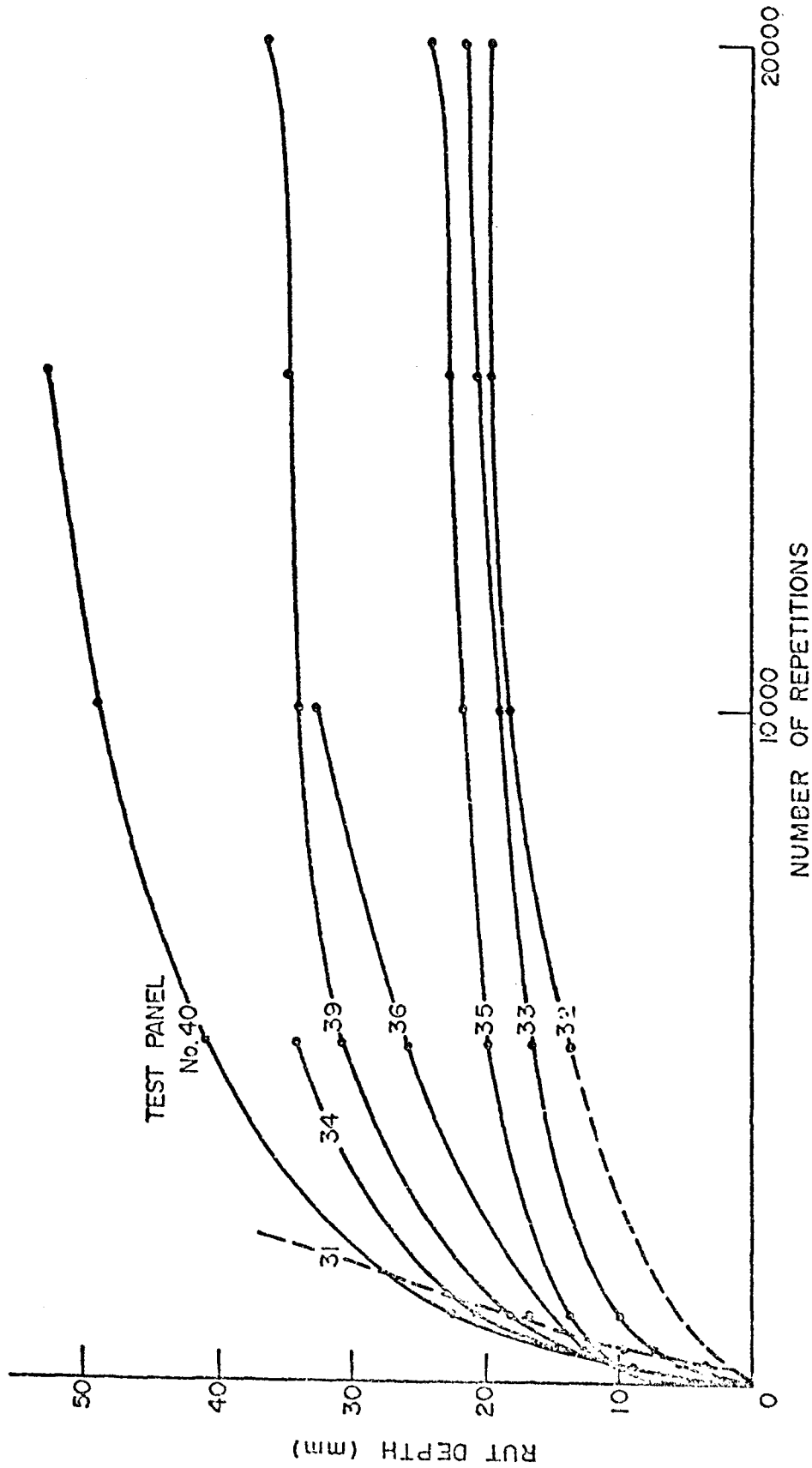


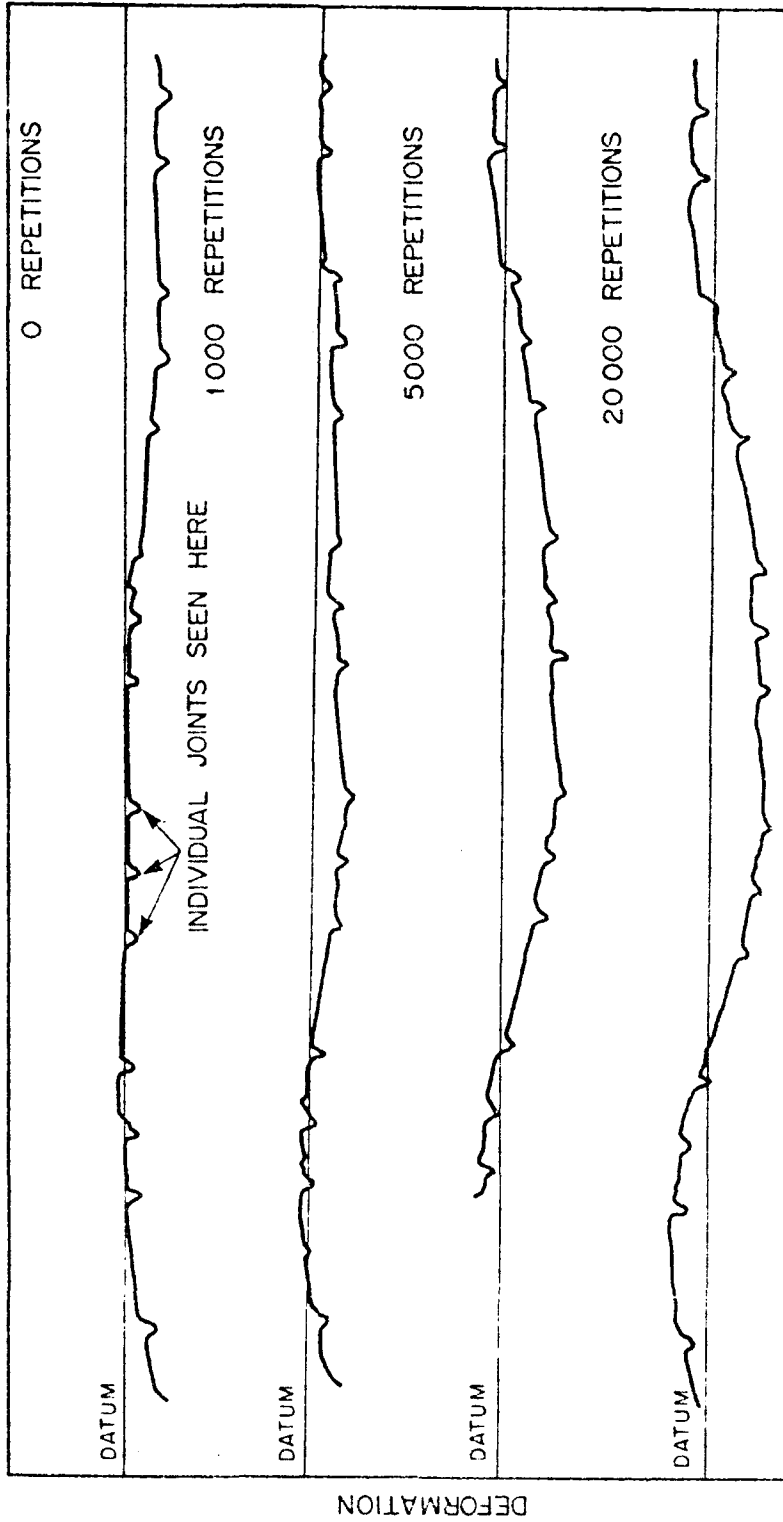
FIGURE 6.7
TYPICAL RESULTS OF RUT DEPTH AGAINST NUMBER OF REPETITIONS

with the HVS. The resulting substantially similar settlement over the whole area may still be acceptable.

Figure 6.8 shows a composite graph of a typical profile across a test section from the initial reading to the final reading at 20 000 repetitions. Individual blocks and joints are shown, thus affirming the sensitivity of the profiling apparatus. Similar results are available for all reference points on all the panels tested.

The results from all of the panels tested were similar, irrespective of the type of segmental block used and the sub-layers.

From Figure 6.7, it is observed that the test panels "settled-in" after about 5 000 repetitions during which the rate of rut depth formation was relatively rapid. Thereafter the deflection curves level off for the remaining working life of the pavement, i.e. the rate of increase of rut depth with load repetitions is substantially reduced. Differences in settling-in deflections are shown for the results given in Figure 6.7. A photograph of one of the panels after testing (Figure 6.9) shows the area tested and the permanent deformation achieved under the test wheel of the HVS. In practice the pavement would be trafficked over a greater width, and settlement would not generally be limited to a narrow section. Figure 6.10 shows the influence of excessive deformation in the wheel paths of an HVS on the untrafficked blocks on either side of the test section. It must be noted that the deformation is a result of sub-layer consolidation and densification since the blocks themselves are not affected significantly by the loading in terms of compressibility. The pavement can be seen to have long since failed if it reaches the condition shown in Figure 6.10 and the failure can be accounted for in terms of insufficient densification with an associated poor bearing capacity in the sub-layers. The failure of the structure can also be ascribed to the lack of adequate shear restraint around the trafficked area owing to the inability of the sub-layers to contain the lateral thrust effects of surface trafficking.



DISTANCE ACROSS WHEEL TRACK →

FIGURE 6.8

TYPICAL CROSS-SECTION PROFILES AT A SPECIFIC POINT UNDER HVS TESTING



FIGURE 6.9

*PHOTOGRAPH OF TYPICAL TEST PANEL - AFTER
TESTING WITH HEAVY VEHICLE SIMULATOR*

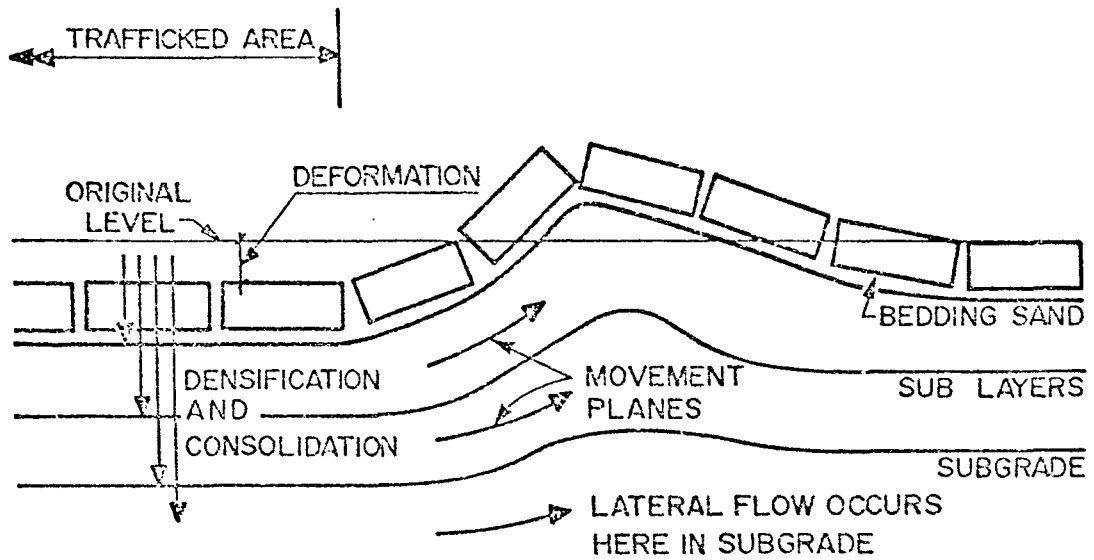


FIGURE 6.10

EFFECT OF EXCESSIVE DEFORMATION ADJACENT TO TRAFFICKED AREA. THE FAILURE CAN BE ATTRIBUTED TO INSUFFICIENT ORIGINAL DENSIFICATION OF SUB LAYERS AND LACK OF 'CONTAINMENT'.

6.7 CONCLUSIONS

The use of the HVS to test a large number of segmental block pavements has been limited to categories S3 and S4 pavements. The basic requirements for containment to arrest the lateral spread of the blocks were met by providing kerbing around the test panels.

A response measured in terms of rut-depth was seen to be similar to other pavement types which showed a "settling-in" period in the initial stages of trafficking prior to its attaining the conditions reached for the working life of the pavement (as seen in Figure 6.7).

The saturation of foundations under a block pavement (i.e. the subgrade) affected the performance significantly. In Figure 6.7, for example, test section 31 deformed rapidly due to low soaked CBR values and poor quality control during the construction of the test sections. No cement stabilization in the subbase was found, but despite this the pavement performed considerably better than was expected.

If poor ground conditions are experienced the use of a cemented subbase is recommended to assist the transmission of induced stresses to the structural layers. The cement-treated layers also reduce any ingress of water into structural support layers that could affect a segmental-block pavement before the formation of a plug of road detritus in the joints as discussed in Chapter 2, caused by environmental and load-associated factors. The benefit of the cement treatment of the subbase can be demonstrated by comparing test section 31 which was found to be unstabilized, with any of the sections with cement-treated layers (eg sections 32, 33 and 35) which showed gradual surface deformation.

Trafficking segmental block pavements causes settlement and subsequent additional compaction and an associated improvement

in the support available from the sub-layers.

Trafficking of the pavement also causes elastic movements in the supporting structural layers as shown in Figure 6.2 predominantly in the bedding-sand, subbase and subgrade.

Differences in initial settling-in can be seen in Figure 6.7 to be approximately 15-20 mm of vertical displacement. In the case of a pavement trafficked by industrial or urban vehicles, most of the pavement would be subject to loading and the vertical displacement of one point relative to another may not be significant.

The heavy vehicle simulator tests confirmed the general rut-depth/time relationships shown in Figures 3.1 and 3.2 where three specific phases are identified. The initial rutting when subjected to load relates to a settling-in period; the stable conditions during the working life of the pavement followed by some failure mode. The failure mode shown in Figure 6.10 as excessive lateral movement by shearing or lack of 'containment' caused excessive rutting - a condition considered to be distressed. In this failed state the block pavements were still capable of carrying applied load and had not therefore failed structurally.

6.8 Discussion

The tests made with the HVS on block pavements were in retrospect not of a sufficiently long time scale to enable a full behavioural pattern to be developed. Numerous tests on road pavements with the HVS could be cited where the number of repetitions of the wheel was in excess of 100 000. It may be beneficial to compare the tests reported with two typical HVS tests done at Bapsfontein and Hekpoort in the Transvaal in 1980. The pavement structures tested were light comprising 40 mm ST on top of 200 mm G5. The Bapsfontein pavement had an additional 100 mm of G7 between the subgrade and the subbase. In both

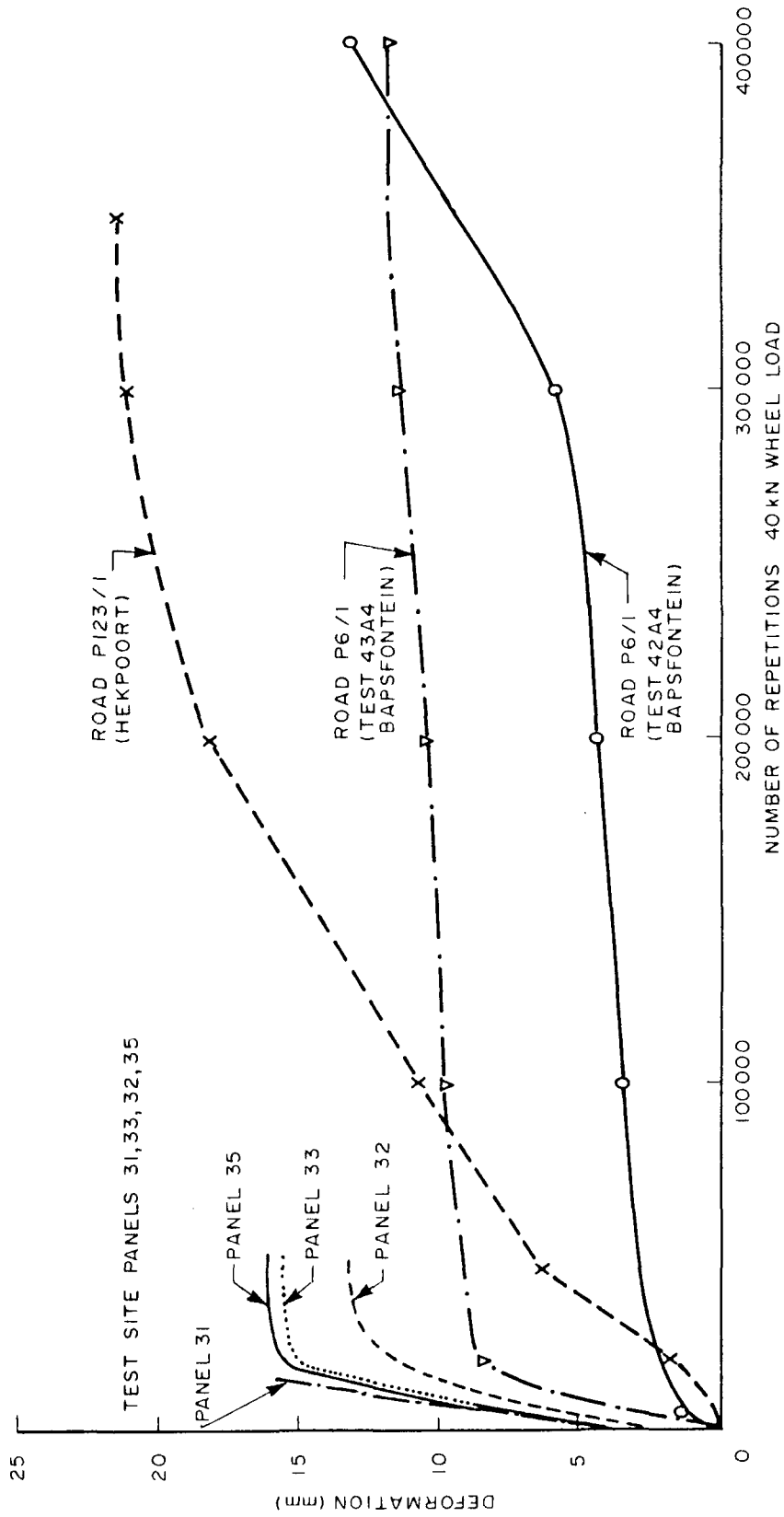
cases the subbases were of in situ CBR value 15% and greater. A composite plot of rut depth and deformation with time for three of the test sections at the test site (Sections 23, 31 and 33) and for the two HVS sites is given in Figure 6.11.

It will be obvious from a comparison of figures 6.7 and 6.11 that the settling-in phase of the block pavements shows greater initial deformation. The graphs of the three test panels (chosen as typical of the bulk of the results obtained) flatten out into the second stage, i.e. after the settling-in phase. This second phase could be described as the "life-stage" of the pavement. Figure 6.11 postulates the graphs for comparison with those generated from work at Bapsfontein and Hekpoort. (ATC (1984) and NITRR/HVS files.)

It is not possible to suggest a failure criterion from the postulated extensions to the graphs produced. A detailed discussion of the behavioural patterns of block pavements and aspects of distress are given in Appendix B. This appendix discusses all layers comprising the block pavement and suggests design parameters such as modulus values for the various states through which each of the layers progress during the phases of their life.

Behaviour is time dependant. The first time dependant change that was seen from the HVS tests was the change from the as constructed state (through the settling-in state) to the life state of the pavement. Block pavements have been shown to substantially reduce the potential ingress of water through the surface. This is due to the waterproofing characteristics of the joints with suitable properly compacted jointing material is used. The detritus plug which forms within the upper part of the joints aids the water resistance. (Chapter 2.)

Any crack-propagation from lower cemented layers will have little effect during the life of a block pavement. The typical reflection cracks from lower layers through the surface of black-top flexible pavements and associated distress by



PERMANENT DEFORMATION / REPETITIONS PLOTS - VARIOUS HVS SITES
FIGURE 6.11

moisture-ingress into susceptible lower layers does not occur with block pavements. The life plot of the block pavements shown in Figure 6.11 is therefore flatter than that for the other pavements.

Once the settling-in phase of a block pavement has occurred it is mooted that the life will be comparatively longer than for other pavements subjected to similar loads. The higher settling-in deformations for block-pavements is discussed in the appendix and shown in Figures B.2 and B.3. The greater initial deformation is caused in part by additional compaction of the bedding sand and by in-service densification of lower layers of a block pavement. (Chapters 1 and 2). Construction practices involve one or two passes with a light vibrator over the completed pavement to bed the blocks into the bedding sand and to fill the joints. This practice has little structural densification potential.

Appendix B explains the distress criteria of block-pavements in detail and the mechanisms of failure can be briefly explained by the following statements:

- (i) Even with the most severe loading the blocks themselves are rarely damaged other than some corners spalling and occasionally some thin units or some shaped units break in half. Figures 6.2, 6.9 and 6.10.
- (ii) Distress of the bedding sand can be caused by:-

lateral movement, loss into voids in lower layers, and loss into joints which have opened out as a result of substantial movement of the blocks. Figure 6.10.
- (iii) Lower layers fail in shear and in deformation due to compaction and densification. Figure 6.10. These effects cause excessive deformation or movements in the surface.

If the above is described as failure by the more traditional pavement terminology, the block pavement has still not failed in terms of its structural ability to carry traffic.

The failures can be repaired by what may be described as "cosmetic maintenance" requiring the removal of the blocks, reinstatement of the lower layers either by levelling or the introduction of a correction course and relaying the same blocks. A block-top pavement is considered to have failed when 20 mm of differential surface settlement occurs but 50 mm is still considered acceptable for block pavements. (Figure 10.6).

Block pavements are more "forgiving" than other pavements since they allow greater surface deformation and because of their waterproofing ability protect the lower layers from possible damage due to saturation. The load equivalency for a block pavement (i.e. factor x shown in Figure 6.1) may be less than two. The unique joints in block pavements have the ability to remould when subjected to overloading. The joints may be described as self-sealing due to their being filled by road detritus. (Chapters 4 and 5.)

Appendix B also shows the various moduli recommended for use with the design of block pavements. It discusses the time related changes in materials and suggests equivalent material states where applicable. Behavioural graphs of various parameters such as deformation, modulus and strength and developed with respect to time for all the layers within a block pavement (including the block layer itself). A relatively new technique for evaluation, known as the "factor of safety method", is included and appropriate values for blocks have been estimated. These values are used in the modelling exercises discussed in Chapter 9.

CHAPTER 7

AN EVALUATION OF MORTAR-JOINTED SEGMENTAL BLOCKS

CHAPTER 7

AN EVALUATION OF MORTAR-JOINTED SEGMENTAL BLOCKS

7.1 INTRODUCTION

Current studies on segmental block paving have all investigated house-brick-sized units which are sand-bedded and sand-jointed into place. The bedding and jointing technique applies to both rectangular and interlocking units. The sand-bedding and jointing is the major difference between the traditional stone or wooden setts and blocks which were mortar bedded, used for several hundred years to pave urban streets. (As discussed in Chapter 1)

The sand-bedded and jointed block pavements produced today have many advantages over the traditional mortared units used in the past. Some of the advantages are due to modern manufacturing techniques which allow accurate dimensional tolerances to be obtained, and other advantages are due to the quality of block pavements laid with machines such as plate vibrators. Some units manufactured today, however, require wide joints when laid due to their shape or design, and in such cases the use of sand jointing is not satisfactory. Wide joints are affected by weathering and traffic, both of which remove sand from the joints to a considerable degree. The undesirable growth of weeds in wide jointed segments is also more rapid than with block pavement with narrower joints.

7.2 SEGMENTS WITH MORTARED JOINTS

Part of an NITRR study (discussed in Chapter 4) into the mechanisms occurring in, and the behaviour of, the jointing material from a structural point of view included mortared joints. This chapter reviews the tests undertaken and discusses the results, and then makes recommendations concerning the use of mortared joints.

7.3 DESIGN OF THE EXPERIMENTS

Several small areas of segmental block pavements were laid on a subgrade and subbase with known properties, at the NITRR's Silverton test site. These sections were subjected to rapid loading by a HVS and various parameters were measured during the tests. The rates of surface movement, joint variation, lateral movements of individual blocks and other significant factors were studied.

The several small areas prepared for this test included :

- (a) a section of fully interlocking blocks (S-A) laid with joint widths varying between 2 - 5 mm;
- (b) a section of fully interlocking blocks (S-A) laid with wide joints to allow more mortar to fill the joints;
- (c) a section of fired-clay brick paving (S-C) with variable joint widths; and
- (d) a section of circular blocks (S-C) with infinitely varied joints, where individual units touched each other at their closest positions.

The HVS was used to test the sections as rapidly as possible since a failure condition was sought at which the upper limit of serviceability could be defined. The HVS programme of testing including stepping-up the loading by increasing the wheel load when the settled-in condition described in chapter 4 had been established. The sections were rapidly yet meaningfully evaluated in a way that allowed comparisons between results to be made. The HVS and its test wheel bogie are seen in Figures 7.1 and 7.2 respectively.

Characterization of the response of a pavement to accelerated trafficking typically involves the gathering of data in three main areas. These are :

- (a) details of traffic loads applied to the pavements,

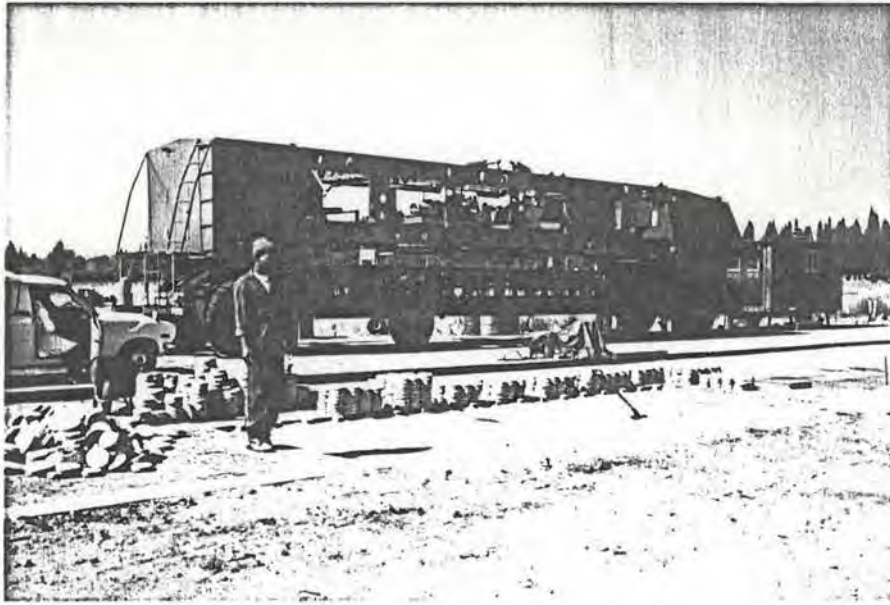


FIGURE 7.1
GENERAL VIEW OF HEAVY VEHICLE SIMULATOR

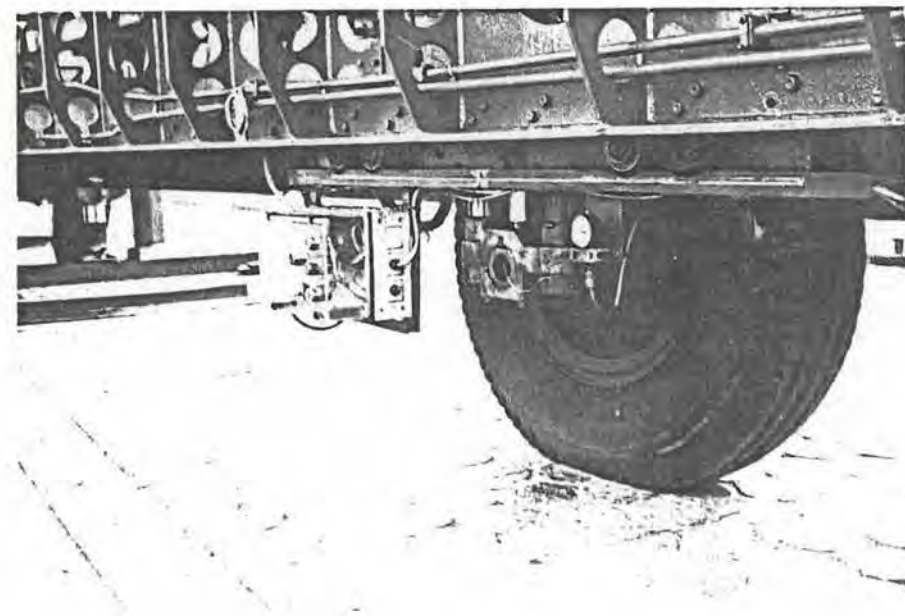


FIGURE 7.2
TEST WHEEL AND CARRIAGE ON HEAVY VEHICLE SIMULATOR

- (b) measurements of the permanent and resilient deformations within the various pavement layers; and
- (c) the collection of relevant environmental data such as temperature and moisture.

Many instruments have been specifically developed for rapid evaluation of HVS data, such as:

- (i) Instruments attached to the HVS itself, (e.g. load cells to measure applied wheel loads, sensors to measure the speed and position of the wheel on the pavement, and counters to determine the accumulated number of wheel passes over the test section.
- (ii) Instruments that measure the surface behaviour of the pavement, e.g. profile measuring instruments.
- (iii) Other instruments that can be buried within the pavement structure, such as multi-depth deflectometers and strain gauges.

None of the instruments in this third category were used, however, or were required for the evaluation of the mortared blocks.

7.4 CONSTRUCTION OF THE TEST AREAS

The sites for the various tests were chosen after studying previous tests which were done on sand jointed and sand bedded blocks. The subbases and subgrades of these areas were restrained from lateral movement by kerbing and were used to form the sub-layers for the cemented block test sections. The sites selected represented average conditions. They were neither particularly strong nor weak in terms of CBR as established by Dynamic Cone Penetrometer tests, so that testing could be done under what was considered typical field conditions. Previous segments were removed from the subbase (an advantage of sand-jointed segments). The subbase was fine-levelled where necessary and the new test sections laid thereon. The fully

interlocking units, were laid with joint widths varying between 2 - 5 mm as for a normally sand jointed block pavement. The laying procedure adopted was one in which a single pass with a plate vibrator settled the units into the bedding sand and which by this action compacted the bedding sand by means of the vibrations transmitted through the blocks. Part of the compaction and levelling of the blocks into the sand was made by a second pass of the vibrating plate after the dry jointing material had been brushed in. Pre-mixed mortar was at first tipped onto the surface of the pavement but brooming this material into the joints was almost impossible because of their small openings. The mortar mix was a 1:6 cement:sand mix with a high slump. The joints were thus not completely filled and it was not possible to vibrate the mortar into the joints due to segregation and splashing of the fines. The final levels of the surface were poor because it was not possible to make a second pass with the vibrating plate. The surface of the blocks was also stained and coloured by the brooming action when trying to fill the joints. Dry filling was then resorted to which permitted a second pass of the vibrating plate before applying a wash of water.

In a second area blocks were laid with a wider joint spacing of 6 mm minimum between individual units. In this case it was possible to fill the joints with mortar by brushing, but the material could still not be vibrated into the joints. Staining and colouring of the surface due to brooming the material into the joints still occurred which was aesthetically undesirable.

A third area was constructed with fired-clay bricks whose dimensional tolerances were less precise than those of the concrete units. Because of the experience gained in trying to mortar-joint the interlocking units and to allow comparisons to be made, the joints around the bricks were also made a minimum of 6 mm in width. In the same way jointing mortar was introduced into the pavement and brushed into the joints. Use of the vibrating plate was still impossible and staining and colouring of the surface of the bricks again occurred.

Circular blocks have been used particularly in Zimbabwe (Figures 7.3 and 7.4) where the practice has been to bed them on a thin layer of sand or mortar. These blocks were chosen for a mortar-jointing study of non-interlocking units. The method of installation in Zimbabwe was used. (Clifford and Marks 1981.) The joints were much easier to fill with mortar owing to the variable joint width and the wide wedge-shaped areas forming the joints between the circular units themselves. The procedure is shown in Figures 7.5 - 7.10 inclusive. Figure 7.5 shows a stack of units tipped adjacent to the test location. Figure 7.6 shows the site prepared and the units stacked awaiting their installation into the pavement. The blocks laid on a thin bed of sand are shown in Figure 7.7. What may be described as a "spread and shovel" technique for filling the joints was used and is shown in Figure 7.8. Brooming was also used when the bulk of the jointing material had been placed by the shovels. A plate vibrator was used successfully as seen in Figure 7.9 since the surface areas of the circular blocks are larger than with interlocking blocks (S-A) and this allows the machine to work without excessive splashing. The completed pavement is seen in Figure 7.10.

7.5 HEAVY VEHICLE SIMULATOR TESTING

The HVS machine was driven in place over the test areas and a single wheel loaded to 40 kN applied. The load was increased to 50 kN then 60 kN and 70 kN at intervals of 10 000 repetitions. Various measurements of deformation were made at set intervals.

Deformations of the same magnitude to that occurring in sand-filled joints was noted in the first three tests, (ie (i) the fully-interlocking with 2 - 5 mm joints, (ii) the fully interlocking with under filled joints and (iii) the bricks with wider joints), but severe cracking of the jointing material was observed in all cases. Jointing mortar was lost and in time the pavement, although it could still carry the load applied by the HVS, became very rough. As there was no lateral containment around individual blocks they began to rock slightly causing differential compaction of the bedding sand. Increased deformation occurred when joint deterioration was advanced.



FIGURE 7.3
CIRCULAR MORTAR - JOINTED SEGMENTS IN ZIMBABWE



FIGURE 7.4
CLOSER DETAILS OF SEGMENTS IN ZIMBABWE



FIGURE 7.5
CIRCULAR UNITS AS DELIVERED TO THE TEST SITE

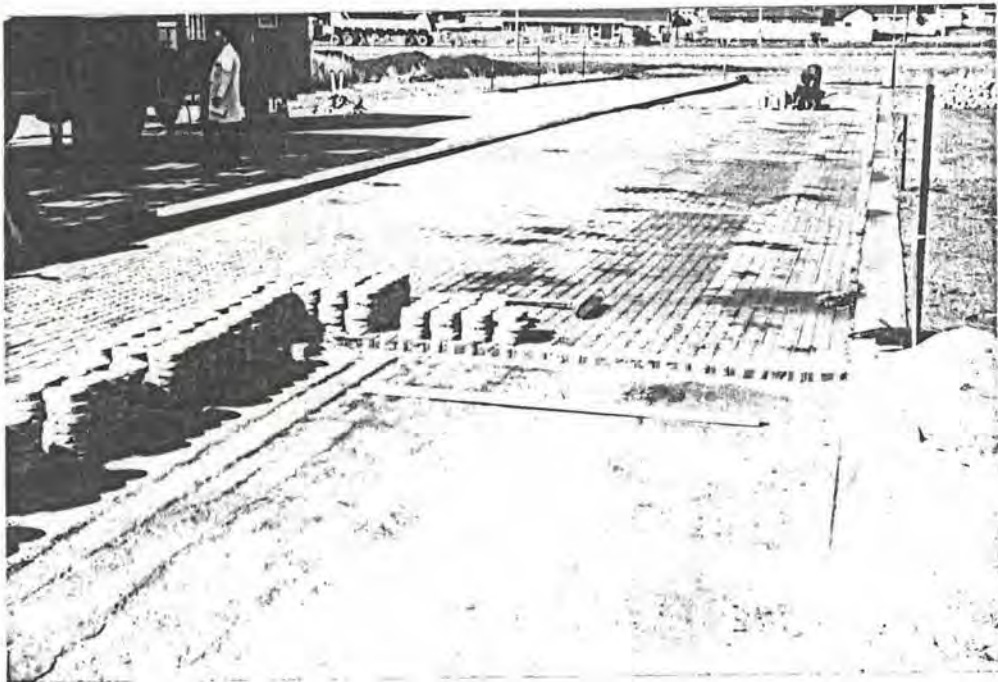


FIGURE 7.6
*PREPARATION OF TEST AREA PRIOR TO FINE LEVELING
AND LAYING CIRCULAR UNITS*

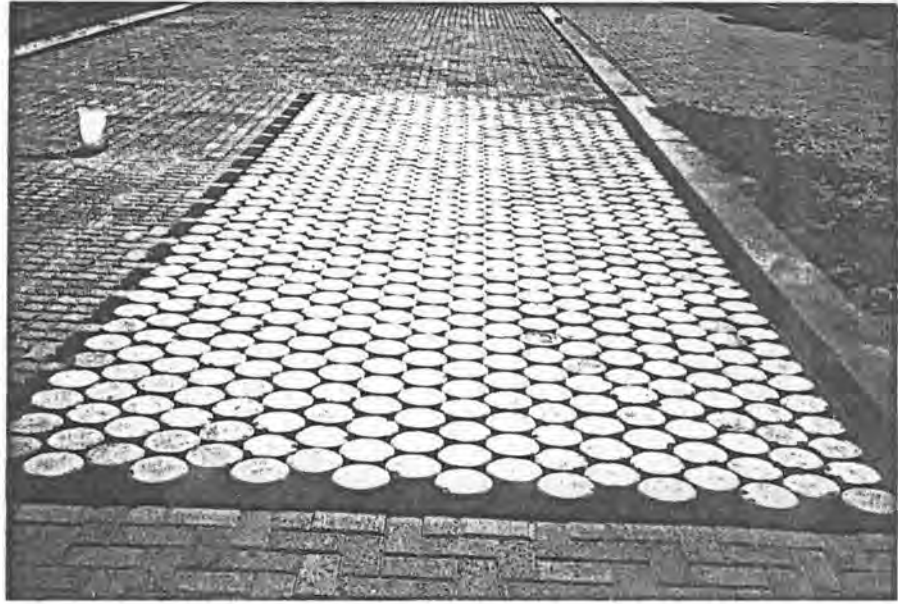


FIGURE 7.7
COMPLETED SECTION OF 100 mm SEGMENTS AWAITING
JOINTING PROCEDURE



FIGURE 7.8
SPREADING MORTAR JOINTING MATERIAL



FIGURE 7.9
LIGHT VIBRATION TO INDUCE MORTAR FILLING TO COMPLETELY FILL INTERSTICES



FIGURE 7.10
SECTION OF COMPLETED CIRCULAR SEGMENTAL PAVEMENT

In the case of the circular units little break-up of the mortar occurred and the pavement carried the applied loads adequately. Some cracks occurred around the units and a few units cracked under the applied load. The pavement was, however, still able to carry the applied load satisfactorily and there was no significant loss of jointing material. The cracking which occurred is seen in Figures 7.11 and 7.12.

7.6 EXPANDED TESTING OF CIRCULAR UNITS

The tests showed that it was impractical to mortar-joint interlocking or rectangular units unless the joints were much wider than normal. There is no advantage in mortar-jointing units which fit closely together; on the contrary, there are many disadvantages which were shown by the test. With the circular units and other shapes such as perhaps rejected tunnel linings used as a pavement as seen in Figure 7.13 and 7.14, where large joint widths are found there is some advantage of mortared joints because the pavement is locked together with the mortar. Since various thicknesses of circular units were available, it was decided to subject them to full-scale field tests as representative of non-interlocking blocks where individual units do not locate tightly and where mortaring of the joints is possible.

7.7 EVALUATION OF CIRCULAR SEGMENTS 100 mm THICK USING THE HVS

In the first of these additional tests, a section of 100 mm thick blocks was cement-mortared together and laid on a thin bed of sand or at times due to subbase levels, without a bed of sand (i.e. 5 to 0 mm). The completed section of blocks was subjected to a HVS loading programme. The blocks were contained within kerbs and between other sections of blocks which were to be tested later. The subbase had been prepared and used previously in other segmental block tests where HVS trafficking had been done.

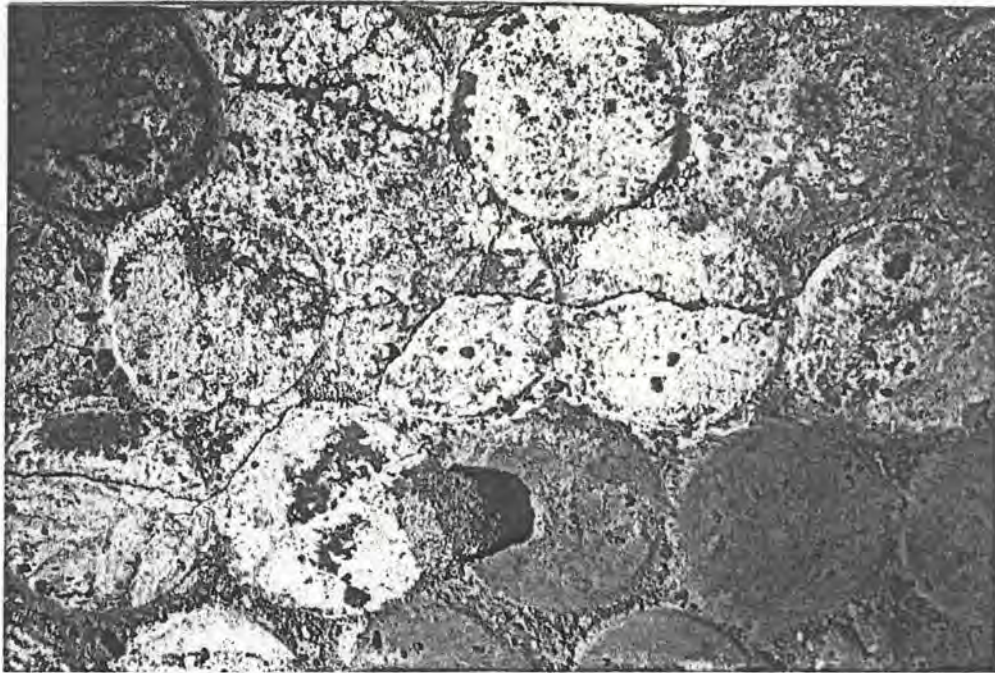


FIGURE 7.11
CRACKING OF CIRCULAR UNITS DURING HVS TESTING

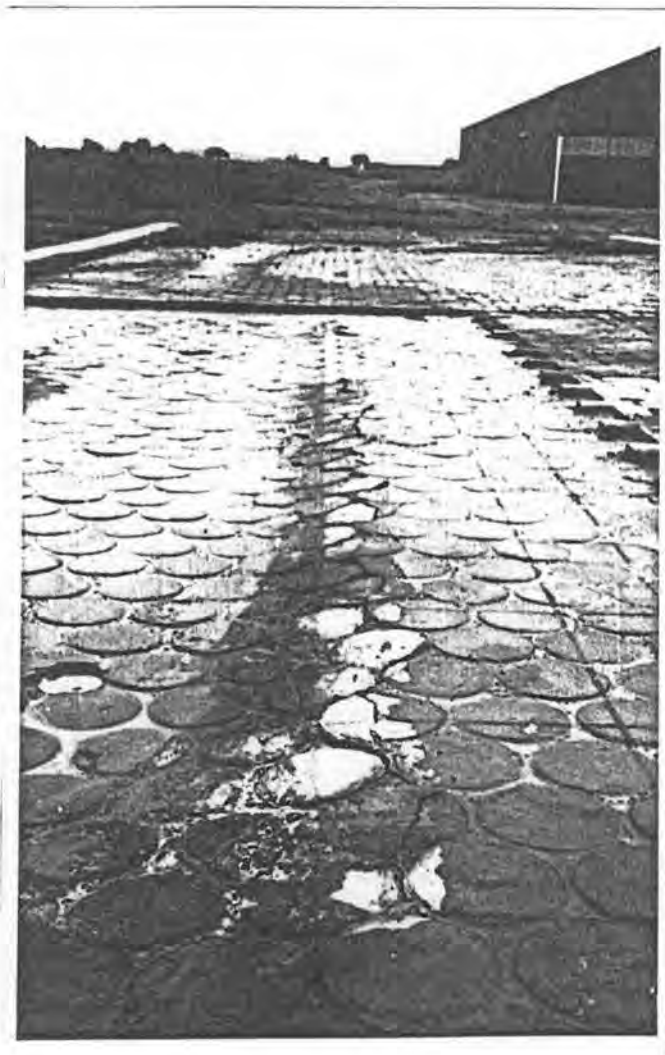


FIGURE 7.12
*LONGITUDINAL
CRACKING IN JOINTS
AND ACROSS UNITS
ADJACENT TO HVS
TRAFFICKED AREA*



FIGURE 7.13

*REJECTED CONCRETE TUNNEL LINING UNITS
USED AS S - C BLOCKS MORTAR - JOINTED TOGETHER*

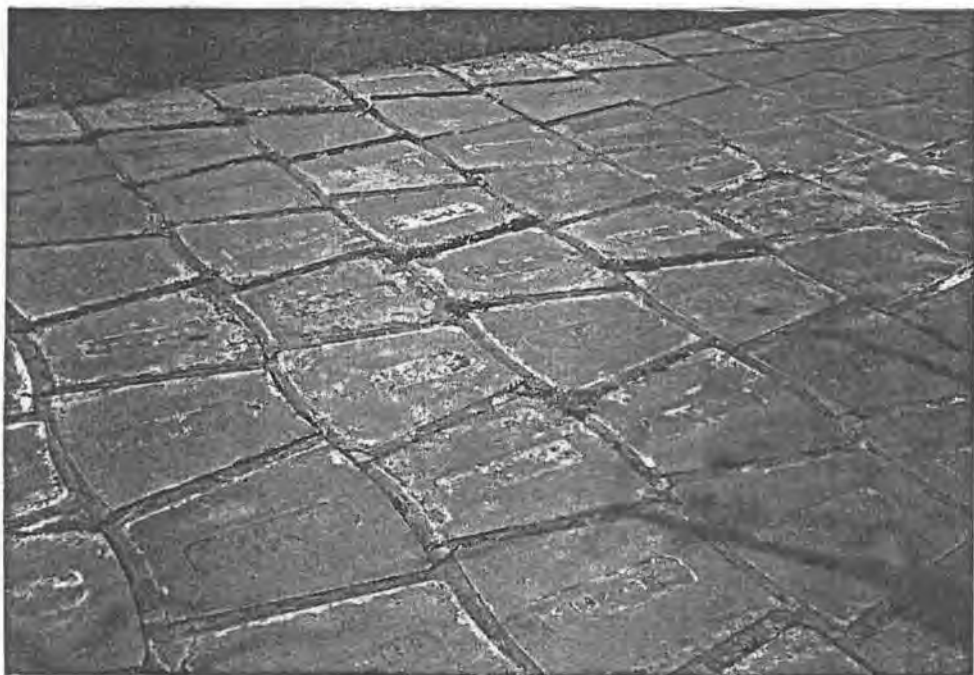


FIGURE 7.14

*SHRINKAGE CRACKING IN MORTAR JOINTING ALLOWING
WEEDS TO GERMINATE*

Initially, 20 000 repetitions of a 40 kN wheel load were applied. Various measurements of deformation along the test section were made at set intervals. Some cracking between individual segments and across one or two segments themselves (similar to those seen in Figure 7.8) was found on inspection after 20 000 repetitions. They can be described as minor, being to some extent load-associated and also caused by shrinkage within the pavement. Since no dramatic deformation or cracking had occurred, it was decided to flood the section and test at 40 kN for a further 1 000 repetitions. Thereafter the wheel load was applied to its maximum of 70 kN (i.e. 140 kN axle load) and flooding of the pavement with water was continued. Figure 7.15 shows the HVS trafficking the flooded section and Figure 7.16 shows the effect of trafficking on the pavement at the end of the test. After a further 1 000 repetitions of this 70 kN load, the pavement deformed further and the surface of some of the blocks had broken free as seen in Figures 7.17 and 7.18.

The testing under flooded conditions was intended to cause rapid failure. Heavy vehicle trafficking under flooding is a condition which is unlikely in practice. However, even with the high load and the flooded condition, the pavement was still able to support the test wheel.

7.8 EVALUATION OF CIRCULAR SEGMENTS 37,5 mm THICK USING THE HVS

The method described for the 100 mm blocks (except for the flooding) was used for an HVS test on a section of 37,5 mm thick circular blocks laid on a particularly strong subgrade (CBR approximately 50%). HVS testing showed the pavement easily capable of supporting applied loads.

7.9 EVALUATION OF CIRCULAR SEGMENTS 50 mm THICK USING THE HVS

Following the procedure established for the 100 and 37,5 mm circular block tests, the 50 mm circular segments were similarly

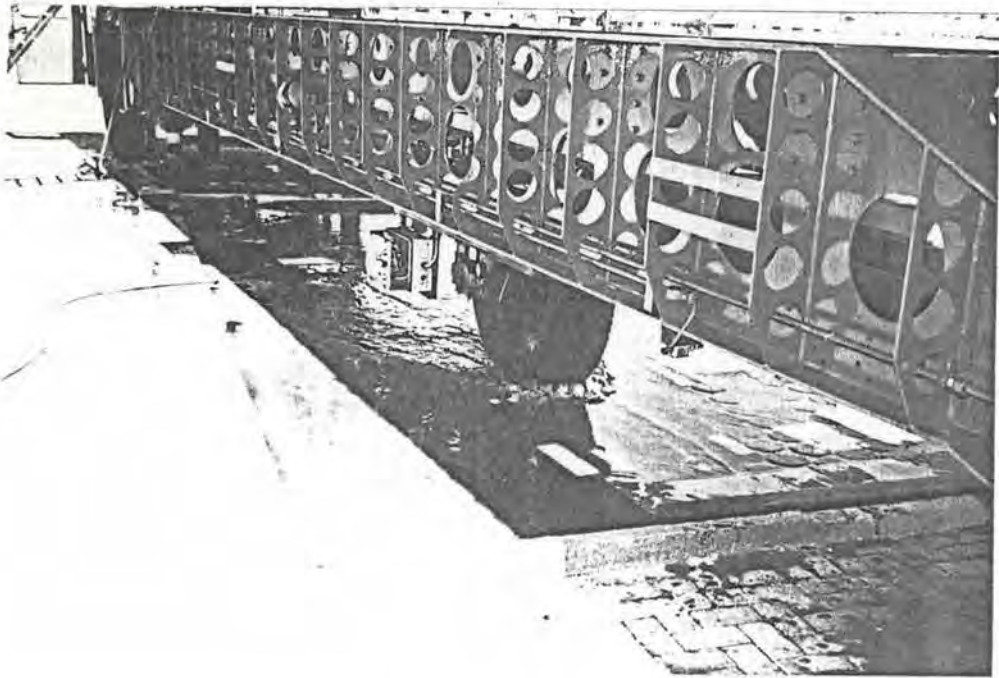


FIGURE 7.15
*FLOODED SECTION OF CIRCULAR BLOCKS UNDER
HVS TEST*



FIGURE 7.16
*TEST COMPLETED SHOWING DEFORMATION AND SHEAR
CRACKING ADJACENT TO TRAFFICKED AREA*

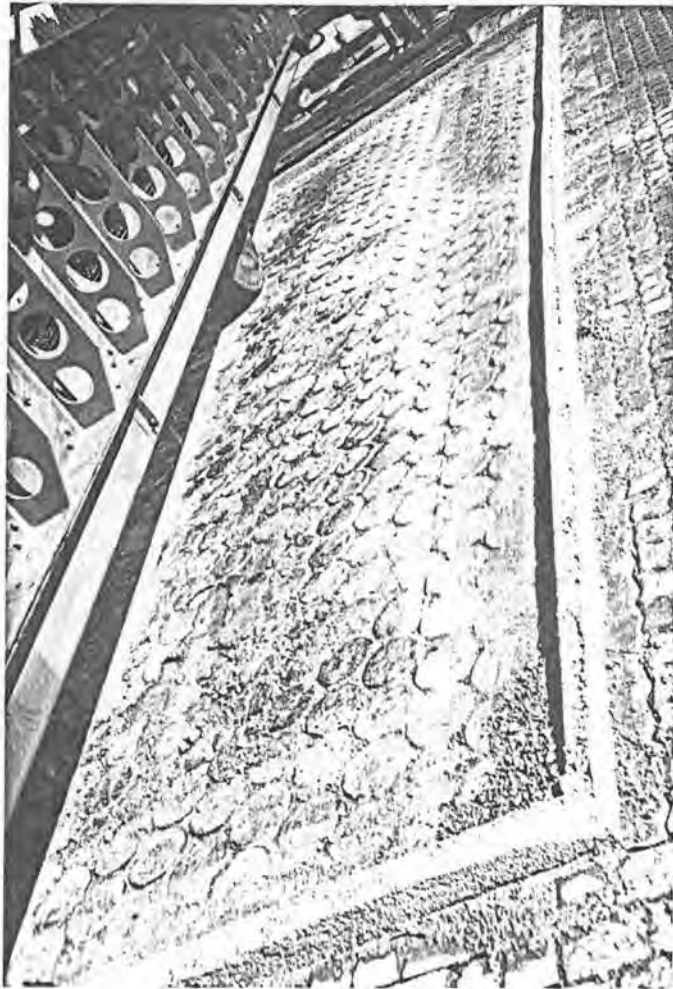


FIGURE 7.17

*TEST AREA FOLLOWING DRAINING OF FLOOD WATER
SHOWING SURFACE DAMAGE TO BLOCKS*

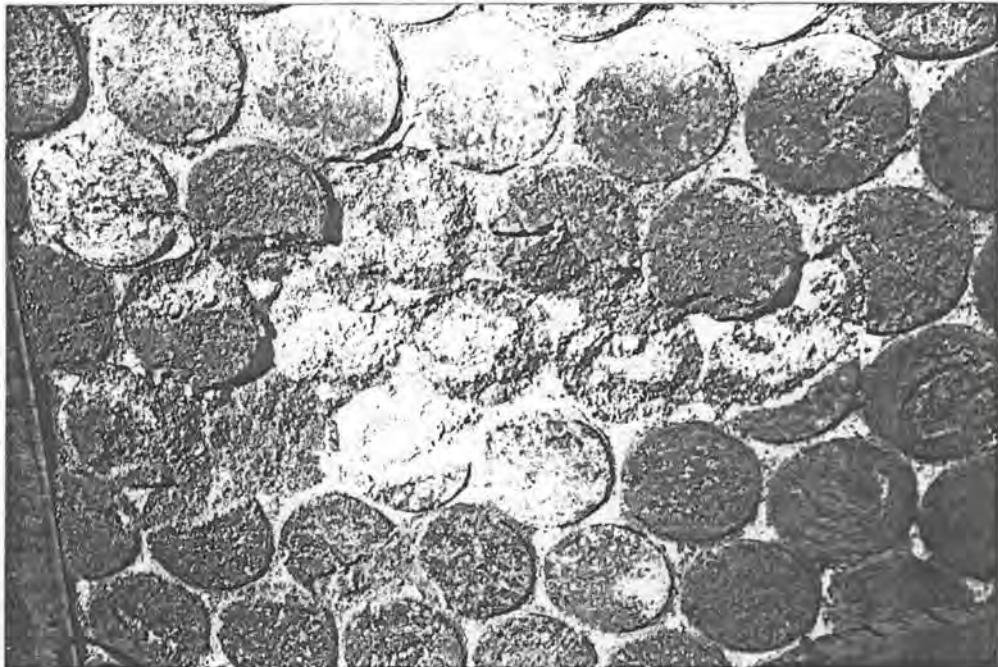


FIGURE 7.18

DETAIL OF SURFACE DAMAGED UNITS

tested and evaluated. Results again showed the pavement capable of carrying HVS loading. Subgrade CBR was similar to that under the 37,5 mm circular segments.

7.10 EVALUATION OF CIRCULAR SEGMENTS 75 mm THICK USING THE HVS

A site was selected for evaluating 75 mm thick segments laid directly on virtually unimproved subgrade (CBR 4,5%). Topsoil and grass were removed and the blocks laid directly on top of the handlevelled area. Few passes with the HVS were possible owing to rapid deformation over the softer parts of the subbase.

7.11 CONCLUSIONS AND RECOMMENDATIONS

From the tests undertaken and the data collected the following conclusions and recommendations can be made :

- (a) The tight joints (ie 2 - 5 mm) common to interlocking concrete units are not suitable for filling with wet mortar and are more suitable for sand filling (or a dry mixture of sand and cement or sand and lime).
- (b) The absolute minimum joint width that can be considered for wet mortar filling is 6 mm. The spading and brushing method used in the jointing of circular units is not suitable for use with units with parallel joints. (such as the rectangular or interlocking shaped units).
- (c) Compaction of the bedding sand and fine levelling to finishing levels require two passes (as a minimum) with a light plate vibrator, but this may not always be possible when mortared joints are used. For the variable joint-widths with circular units, a vibrating plate compactor may be used.
- (d) There is no advantage in mortar-jointing interlocking units when their flexible response to loading is satisfied by sand-bedding and sand-jointing. With block-shapes which fit

together in such a way that joint widths are variable, mortar filling is an advantage since it locks the pavement units together so that they act like a weak slab. In fact, sufficient mortaring material is required within the joints to satisfy some structural requirements.

- (e) Cracking from either expansion or contraction will be a feature of mortared joints. To contain the cracking within the joints, the mortar used should be weaker than the segmental units themselves. If the strength of the unit and the joint is similar, cracking will take place across the units and this is less aesthetically pleasing than if the cracks occur within the joints.
- (f) With mortared-joints a weak slab is formed and contraction cracking will occur. The design and installation of movement joints is therefore necessary or excessive weed growth in the joints will result of the type shown in Figure 7.14.
- (g) The circular segmental block paving which was mortar-jointed and founded on adequate support performed well under the HVS testing.
- (h) HVS testing was limited to the following categories of use :
 - category S3 for highly loaded working areas;
 - category S4 for urban roads where speeds are not greater than 60 km/h;
 - category S6 for special pavements where innovations and cost-saving measures may be introduced.
- (i) Should cracking occur in the joints around individual segments, the cracks will fill with road detritus in the same way as sand-filled blocks and respond to some degree in an elastic manner.

7.12 SELECTED RESULTS AND DATA OBTAINED FROM HVS TESTING

Examples of the type of data obtained during the tests are given in Figures 7.19 to 7.24. These include :

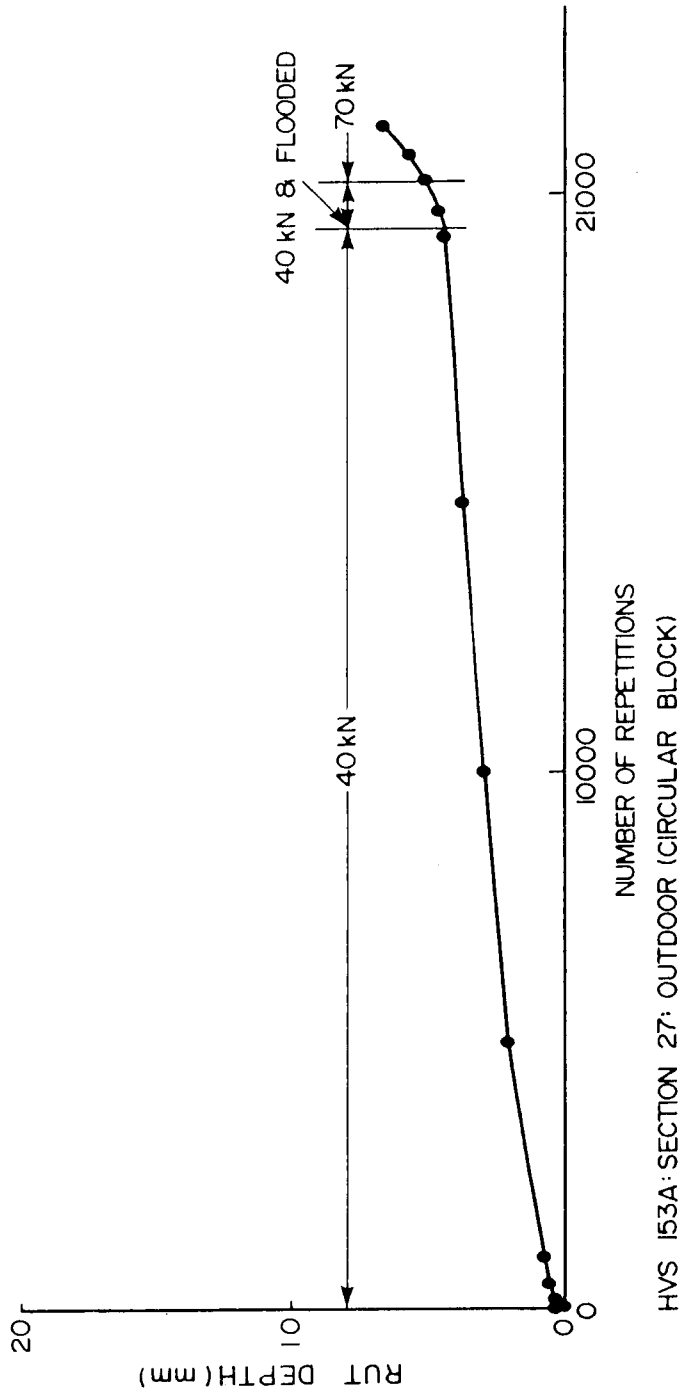


FIGURE 7.19
 NUMBER OF REPETITIONS VERSUS CHANGE IN RUT DEPTH

HVS1 - BLOCK PAVING

SECTION NUMBER:- 27 CIRCULAR BLOCKS

TYRE PRESSURE:- 600 kPa

LOAD: 40 kN

REPEATITIONS	1	2	3	4	5	6	7	8	9	10	11	12	13	MEAN CHANGE	NOTES
DATE															
0	10	8	12	18	17	20	13	14	16	18	17	19	19	15,5	LONGITUDINAL CRACKING, TWO BLOCKS
100	10	8	12	18	18	21	13	14	17	18	17	20	19	15,8	REMOVED FROM TRAFFICKED PATH ON
250	10	8	12	18	19	21	13	14	17	18	17	20	20	15,9	BOTH SIDES, FIRST NOTICED AT 5000
500	10	8	13	19	19	21	13	14	17	18	17	20	20	16,1	REPETITIONS 3-4 BLOCKS HAVE CRACKS
1000	10	9	13	19	19	21	14	14	17	19	17	20	20	16,3	ACROSS THEM
5000	12	12	14	20	21	22	15	15	18	19	19	21	21	17,6	AFTER 20000 REPETT. MANY BLOCKS
10 000	13	13	16	20	21	23	16	16	19	20	20	22	21	18,5	HAVE CRACKS AT WEAKER END OF SECT.
15 000	14	14	17	23	22	24	16	17	19	20	21	23	22	19,4	ie POINTS 1 TO 5
20 000	14	16	18	24	24	25	16	17	20	20	21	23	22	20,0	

GO TO 40 kN WITH SECTION FLOODED

FIGURE 7.20
CROSS-SECTIONAL PROFILE MEASUREMENTS AT SPECIFIC POINTS

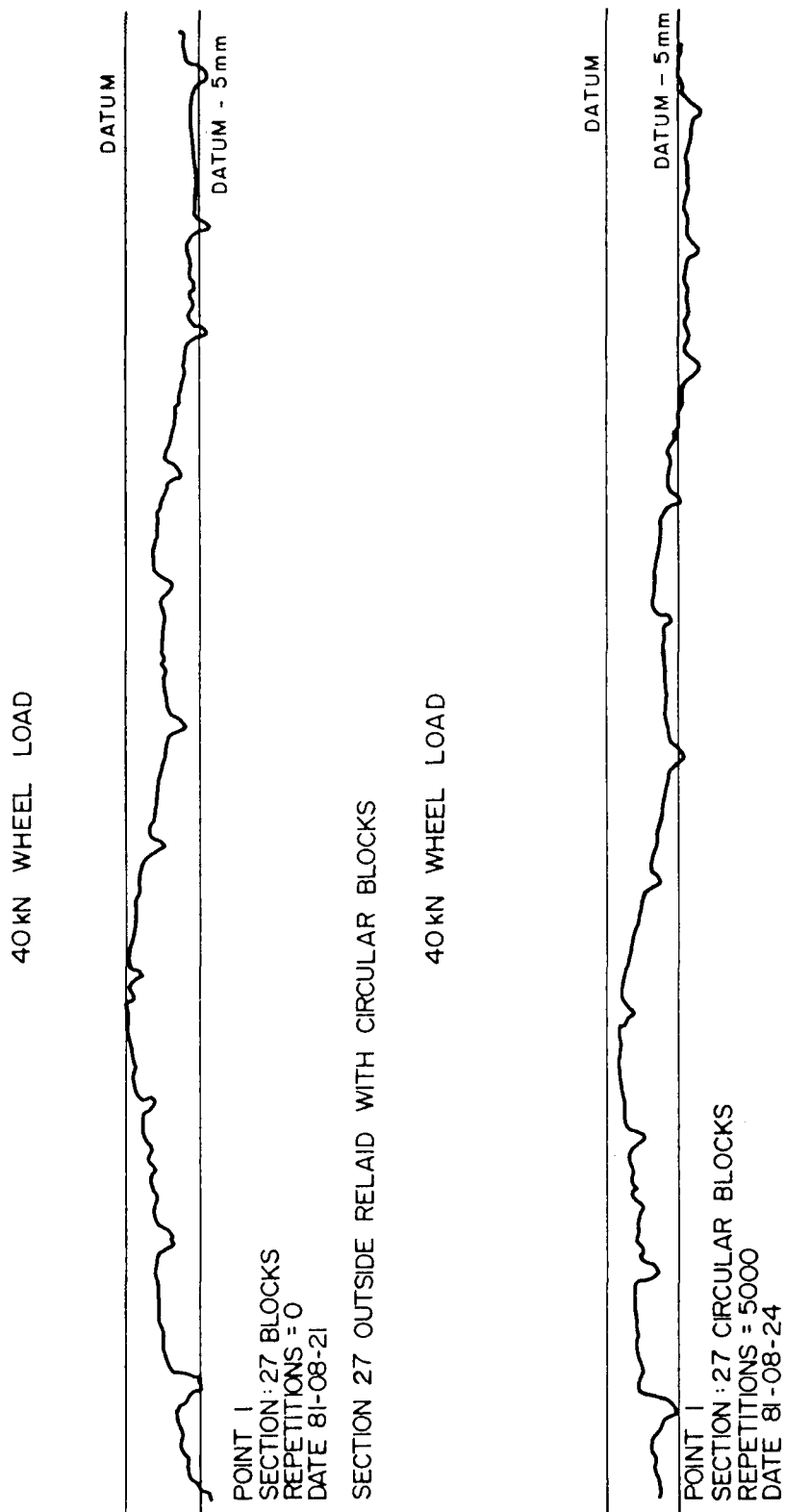
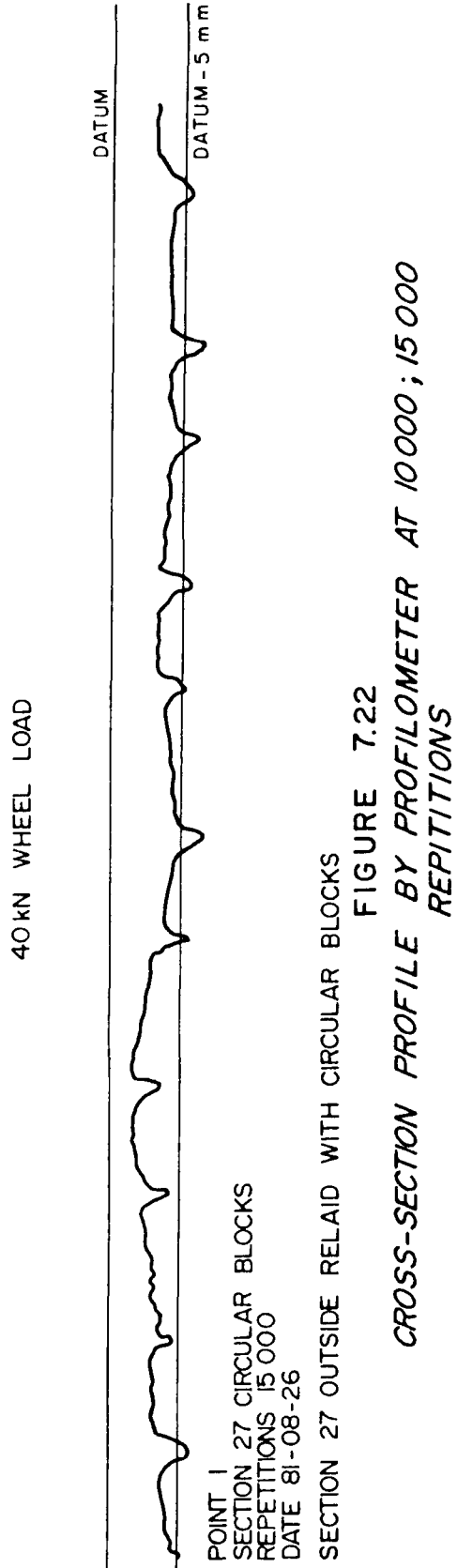
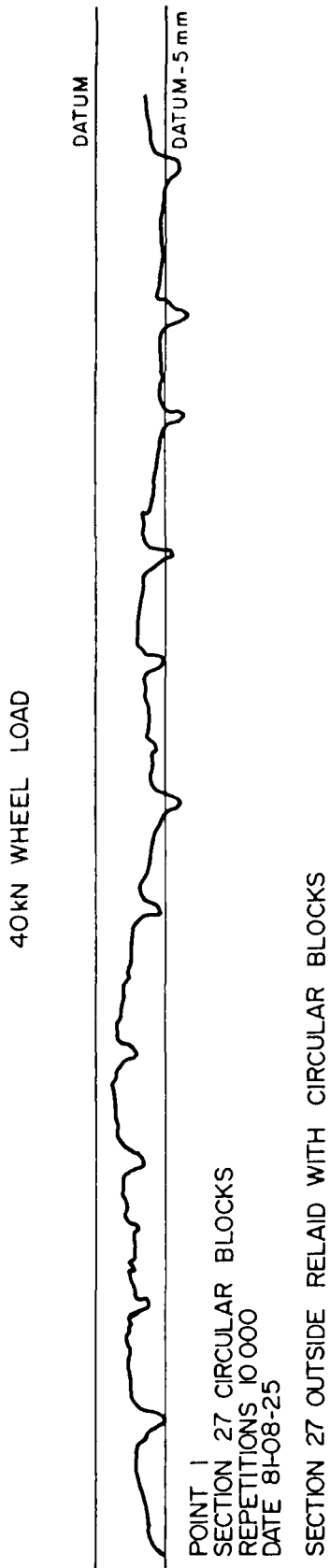


FIGURE 7.2I
CROSS-SECTION PROFILE BY PROFILOMETER AT 0;5000 REPETITIONS



40kN WHEEL LOAD

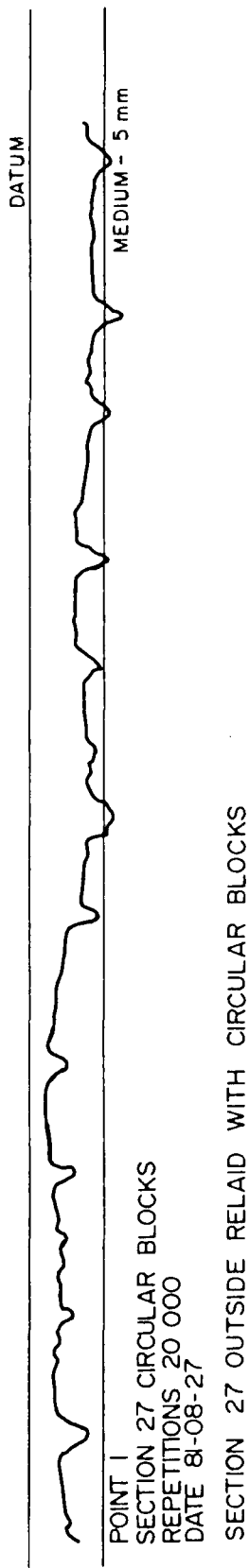


FIGURE 7.23
CROSS-SECTION PROFILE BY PROFILOMETER 20 000 REPETITIONS

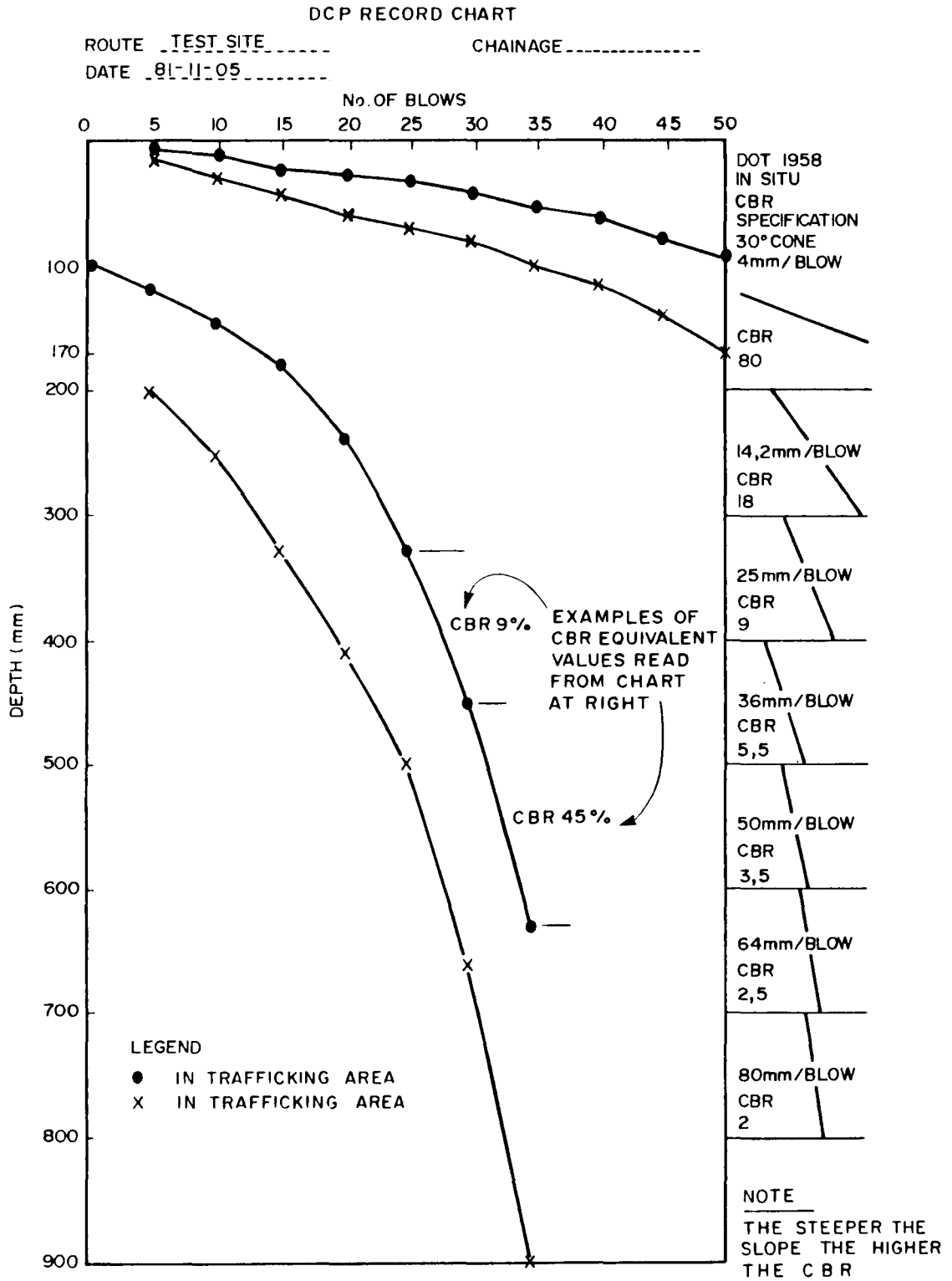


FIGURE 7.24
DCP PROFILE TAKEN UNDER 37,5 mm BLOCKS

- (a) Typical progression of deformation shown by cross-sectional profile at point 1 at 0, 5 000, 10 000, 15 000 and 20 000 repetitions of 40 kN wheel load.
- (b) Dynamic Cone Penetrometer (DCP) Kleyn (1983) profiles of several points showing the in situ Californian Bearing Ratio (CBR) at specific points within the subgrade.
- (c) Plot of average change of rut depth with number of repetitions at 40 and 70 kN wheel loads (equivalent to 80 and 140 kN axle loads respectively).
- (d) Measurement of cross sectional profiles at specific points throughout the test.

Full details of all measurements made and data collected are on NITRR files. (Clifford and Marks 1981.)

C H A P T E R 8

SKID-RESISTANCE MEASUREMENTS MADE ON SEVERAL
SEGMENTAL BLOCK PAVEMENTS

CHAPTER 8

SKID-RESISTANCE MEASUREMENTS MADE ON SEVERAL SEGMENTAL BLOCK PAVEMENTS

8.1 INTRODUCTION

Segmental block paving in Southern Africa has been used extensively for pavements subjected to slow speed traffic. The versatility and aesthetic appearance of block paving suggest that they could be specified for higher speed roads such as inter-urban collectors. However, there is a large segment of opinion which considers the surface roughness of a segmental block paved road to be unsuitable for use by vehicles at speeds in excess of 60 km/h which is the mandatory urban speed limit. A search of available literature showed that very few measurements of surface texture and skid resistance have been made especially on block pavements which have been in service for sometime. Seven study sites were therefore chosen to represent as wide a range as possible of pavements in use. To allow a rapid yet meaningful evaluation of the skid resistance of these pavements to be done use of the SCRIM apparatus and the Pendulum Device was made.

SCRIM is an acronym for the Sideways-force Coefficient Routine Investigation Machine and was developed by the British Transport and Road Research Laboratory (TRRL) (the apparatus is shown in Figure 8.1). It has been used for the routine measurement of skid resistance by NITRR in South Africa since 1975. A smooth-treaded measuring wheel is mounted on the side of a truck at an angle of 20° to the line of travel of the vehicle (as seen in Figure 8.2). Water is hosed onto the surface of the pavement just in front of the test wheel. The wetted surface imparts a sideways force to the wheel proportional to the skid resistance. A paper tape readout of the average values of the sideways force at 20 m intervals is provided.

The Pendulum Device is a portable skid-resistance tester also developed by TRRL for measuring the skid resistance of a wet



FIGURE 8.1 *THE SCRIM APPARATUS*

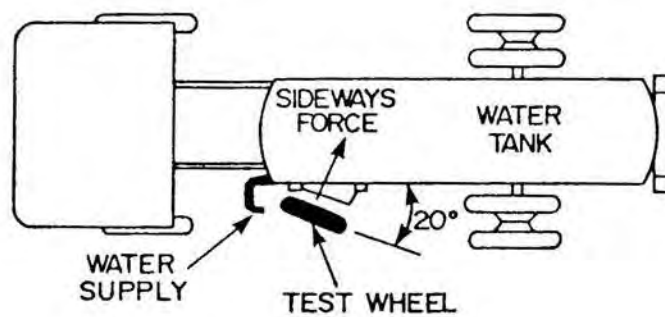


FIGURE 8.2 *SCRIM APPARATUS (PLAN SCHEMATIC)*

pavement surface and it is shown in Figure 8.3. The apparatus measures the frictional resistance between a rubber slider and the pavement surface. The rubber slider is mounted on the end of a pendulum arm. The skid-resistance measured by the pendulum has been calculated by Road Note No 27 (1960) to correlate with the performance of a vehicle with patterned tyres braking with locked wheels on a wet pavement surface. A rating scale of the standards of skid resistance is provided with the instrument and is shown in Figure 8.4. TRRL have found and reported in Road Note No 27 (1960) that the instrument correlates the skid-resistance which is available to a vehicle with patterned tyres stopping from 50 km/h. The instrument can therefore only be used to obtain an indication of the slow-speed (i.e. 50 km and less) skid resistance of a pavement surface.

8.2 METHODS OF EVALUATING SKID-RESISTANCE OF SEGMENTAL BLOCK PAVEMENTS

Since SCRIM is the most widely used technique for measuring skid-resistance in Southern Africa (with a unit provided by NITRR as a service to both rural and urban road authorities) its use on block pavements provides an acceptable form of evaluation.

It is not always possible or desirable to run a truck such as SCRIM at 50 km/h or greater across a pavement surface. Measurements were made with the pendulum tester on pavements tested by SCRIM in an attempt to determine a relationship between these methods which could be used when testing other pavements with the much simpler pendulum tester.

Several sites were chosen to determine the skid-resistance of types S-A, S-B and S-C segmental block pavements.

Site 1 with S-A (fully interlocking blocks) at the container terminal (City Deep) Johannesburg where examples of oil spillage, heavy cornering and parking use can be found. The pavement was constructed about one year prior to the tests.

Site 2 with S-A Blocks located in the CSIR Campus Pretoria. This was a lightly trafficked access road where the pavement was about 5 years old when tested.

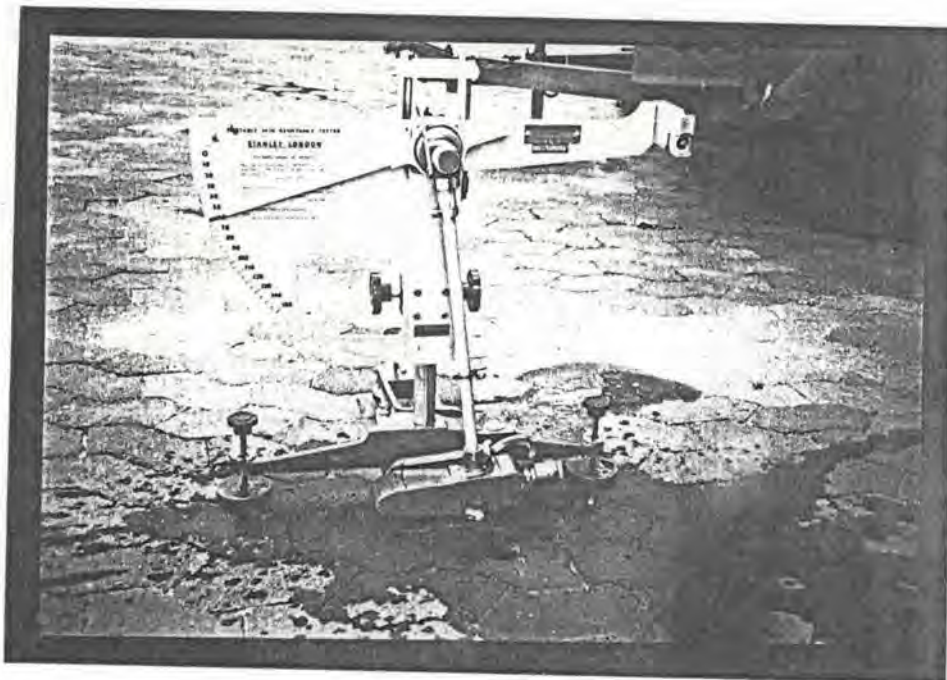


FIGURE 8.3 THE PENDULUM TESTER

SKID RESISTANCE MEASURED BY PENDULUM ON WET SURFACE	CATEGORY AND TYPE OF SITE	STANDARD OF SKID RESISTANCE REPRESENTED
ABOVE 65	APPROACH TO ROBOT OR STOP SIGN A. GRADIENTS 1 IN 20 OR MORE ON SHARP BENDS	GOOD FULFILLING THE REQUIREMENTS OF EVEN FAST TRAFFIC
ABOVE 55	B. GENERAL ROAD PAVEMENT REQUIREMENTS	GENERALLY SATISFACTORY, MEETING ALL BUT THE MOST DIFFICULT CONDITIONS ENCOUNTERED
ABOVE 45	"LONG SITES" E.G. STRAIGHT ROADS C. ON OPEN COUNTRY	SATISFACTORY ONLY IN FAVOURABLE CIRCUMSTANCES
BELOW 45	D. ALL SITES	POTENTIALLY SLIPPERY

FIGURE 8.4 ABBREVIATED RATING SCALE OF SKID RESISTANCE FOR USE WITH PENDULUM APPARATUS

Site 3 S-B Blocks (Partly interlocking). Located in the Pretoria National Botanical Gardens where access roads, footpaths and steep grades are found. The age of the pavement varied from 3 - 8 years at the time of testing.

Site 4 S-B Blocks in a loading and servicing area adjacent to the NITRR building in the CSIR Campus, Pretoria. The pavement was laid about 3 years prior to tests.

Site 5 S-B Blocks in a housing estate in Goodwood, Cape Town. The pavement was about 8 years old at the time of testing.

Site 6 S-B Blocks in a housing estate in Chatsworth, Natal. The pavement was about 20 years old at the time of testing.

Site 7 S-C (non interlocking) a Brick pavement at the Rank Xerox offices at Kempton Park where examples of a parking area, access road, footway and servicing area were found. The pavement was about 2 years old at the time of testing.

8.3 THE SKID RESISTANCE EXPERIMENTS

- i) Site 1 where S-A blocks were used. (City Deep Container Terminal, Johannesburg).

A simplified plan of the site is shown in Figure 8.5. The runs of the SCRIM are shown and these included runs along the main perimeter road, around heavily trafficked corners, adjacent to the wash areas where vehicles are pressure cleaned and on an oily area near the fuel pumps. The pendulum tests were made on each of these areas and were made on the centre of a block and across several joints.

The SCRIM tests showed a very large amount of scatter of results and a typical run is shown in Figure 8.6. This was made in the perimeter road where position 4 as shown in Figure 8.5 for the pendulum tests was sited.

The reason for the scatter is explained by the joints between the blocks which offer a considerably different resistance to skidding than the block itself. Even greater variation can be seen when considering the skid-resistance measured along a joint or across a joint.

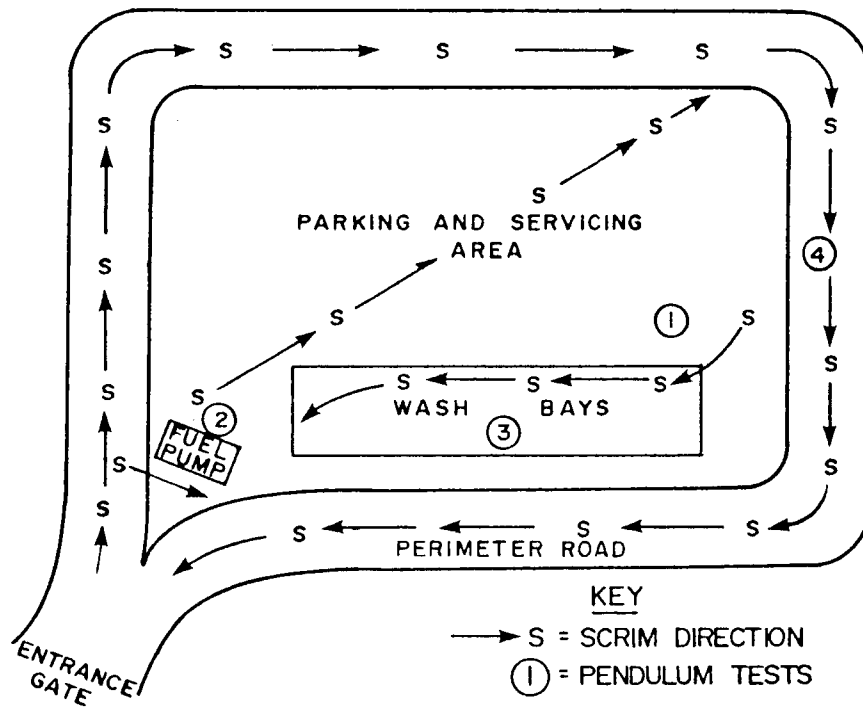


FIGURE 8.5 PLAN OF CITY DEEP AREA OF BLOCK PAVING SHOWING LOCATION OF PENDULUM TESTING AND RUNS OF SCRIM

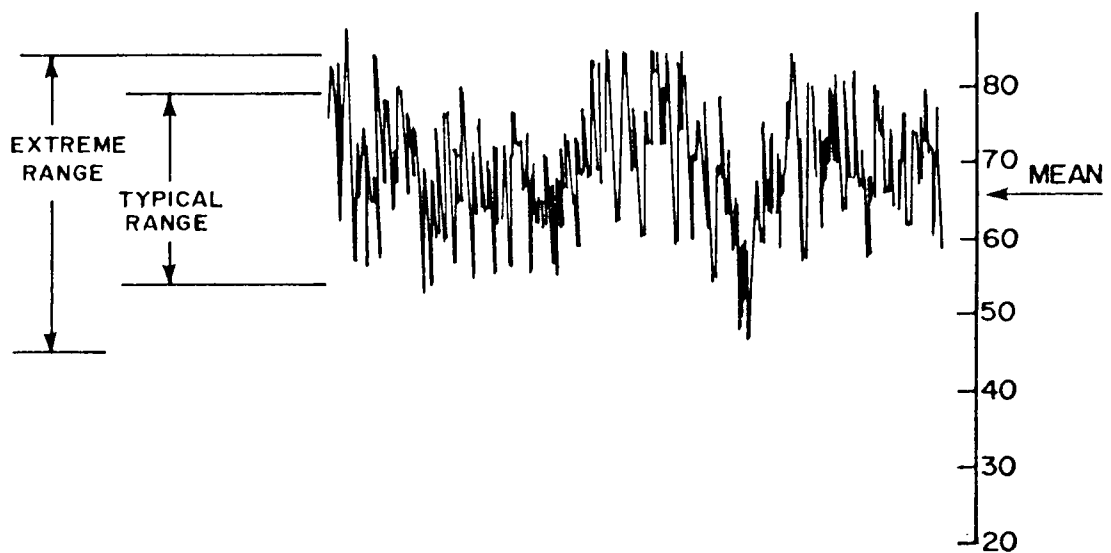


FIGURE 8.6 TYPICAL SCRIM PRINT OUT SHOWING WIDE SCATTER OF RESULTS

The SCRIM readings have been averaged and presented in tabular form below (Table 8.1). The range of the readings is also shown as one means of indicating this variation. A range was considered more meaningful in this case than the standard deviation.

TABLE 8.1 - SCRIM readings at City Deep (Taken at 50 km/h)

Site or run	Skid-resistance average	Range
1. Perimeter Road	71	25-85
2. Parking and Servicing area	69	45-85
3. Wash bays	75	52-85
4. By fuel pump (where much oil spillage)	63	38-80

The Pendulum readings made at the locations shown in Figure 8.5 were more consistent. In accordance with the recommended proceedings given in Road Note No 27 (1960) the average of 4 readings was calculated. The four readings taken at this site were practically the same in each case. Additional pendulum measurements were taken across the joints to study the effect of the joints on skid-resistance. The results of the tests made at City Deep are given in Table 8.2 below.

The skid-resistance measured across the joint is seen to be higher than that measured on the centre of the blocks. This may be explained by examining surface levels of adjacent blocks. Some variation of levels between adjacent blocks is inevitable and would cause differential resistance to the skid-resistance measuring instruments.

TABLE 8.2 - Pendulum skid-resistance tests at City Deep

Location from Figure 8.5	Description	Skid-resistance (wet)
1	Untrafficked block (a)	60
1	Untrafficked block (b)	61
2	Oily surface	50
3	Washing area joints partly washed out	45
4	On perimeter road	48
4	On a long joint rear Joints partly washed out	50
4	Across an end joint Joints partly washed out	56

The resistance of the joint can be seen to have a small effect on skid-resistance.

- ii) Site 2 where S-A Blocks were used in an access road to the wind tunnel on the CSIR Campus, Pretoria. This pavement was about 5 years old at the time of the tests.

Skid resistance results by SCRIM and the pendulum test are given in the same way as for Site 1 above in Table 8.3 below.

It will be noticed from the results tabulated (Table 8.3) that the skid-resistance on a corner in the roadway where some polishing of the surface would take place, was lower than on a straight section of the roadway. The effect of the impact of vehicles mounting the beginning of the block pavement (Reading No. 7) was also seen to reduce the skid-resistance. A similar increase is noticed when readings were made across the joints as seen in Site 1. The skid-resistance measured by SCRIM (Reading No. 1) showed a high value with a small range of variability for the level section of pavement. Skid-resistance was found to be lower with a much wider range on the slope (Reading No. 2).

TABLE 8.3 - Skid-resistance results from access road to wind tunnel CSIR, Pretoria

No.	Location	Description	Skid-resistance (wet)	Range
1	on wheel path	level access road	77	65-85
2	on wheel path	slope access road	62	45-85
3	unused area at end of road	Pendulum - centre block	64	-
4	on a bend in the wheel path	Pendulum - centre block	58	-
5	on a straight in the wheel path	Pendulum - centre block	62	-
6	on another bend on a slight grade in the wheel path	Pendulum - centre block	54	-
7	at the end of the pavement where some impact applied by vehicle as they drive onto the blocks	Pendulum - centre block	48	-
8	near 3 in the wheel path joints partly washed out	Pendulum - across an end	72	-
9	near 3 in the wheel path joints partly washed out	Pendulum - along a	71	-

- iii) Site 3 where partly interlocking blocks (S-B) were used. Figure 8.7 shows a plan of the National Botanical Gardens where extensive use of S-B blocks is made. The directions of travel of SCRIM and the location of pendulum results obtained are shown. The results are tabulated in the manner described above and are given in Table 8.4.

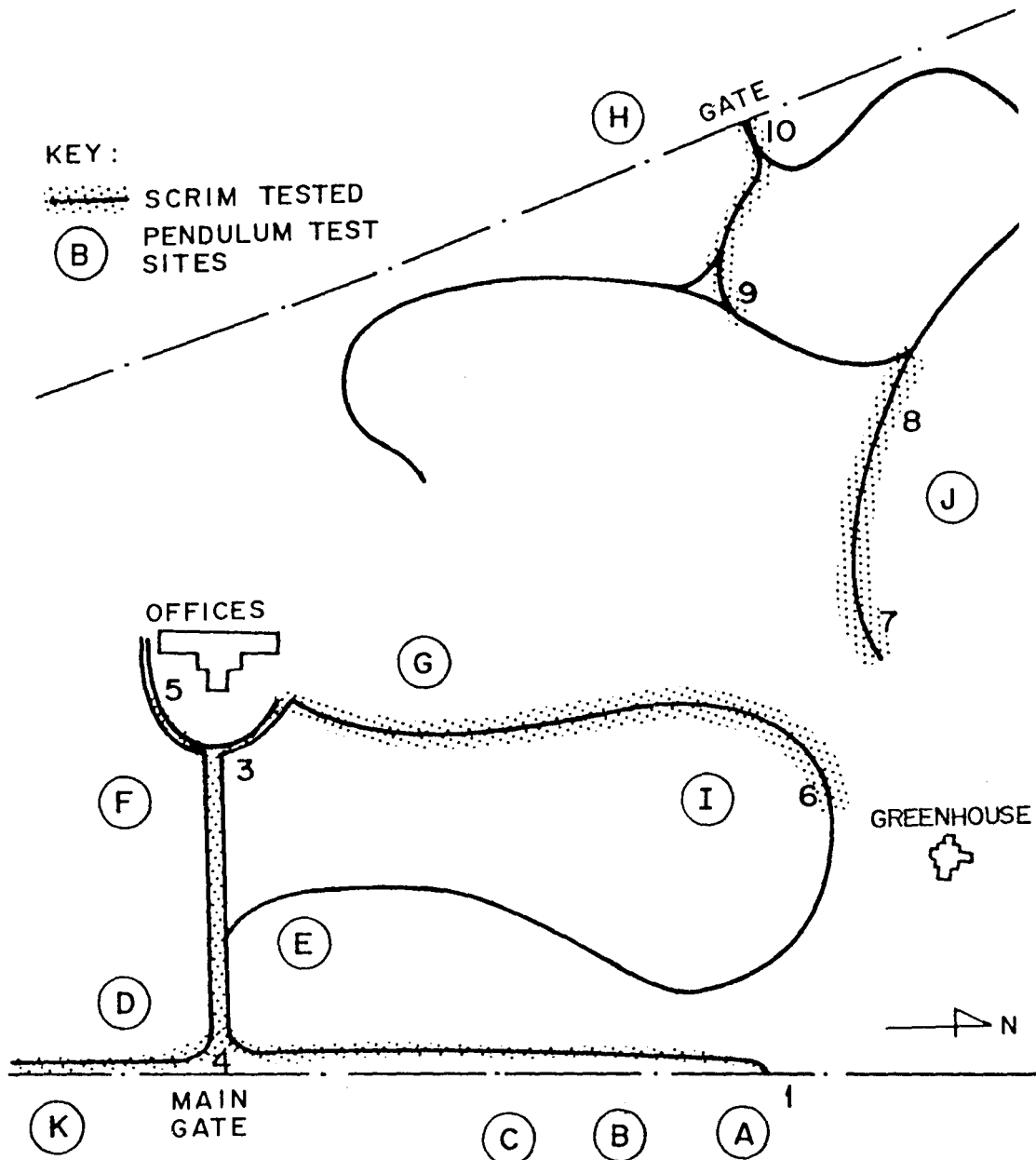


FIGURE 8.7

*PART PLAN OF NATIONAL BOTANICAL GARDENS PRETORIA
SHOWING PAVEMENTS SUBJECTED TO SCRIM AND SITES OF
PENDULUM TESTS*

TABLE 8.4 - Data of skid-resistance tests done at National Botanical Gardens, Pretoria

No.	Location	Description	Skid-resistance (wet)	Range
1	1-2 on Figure 8.7	SCRIM on Main access road	68	45-85
2	3-4 on Figure 8.7	SCRIM on Main access road	70	47-85
3	5-6 on Figure 8.7	SCRIM on secondary road	72	35-85
4	7-8 on Figure 8.7	SCRIM on secondary road	70	50-85
5	9-10 on Figure 8.7	SCRIM on secondary road	70	50-85
6	A on Figure 8.7	Pendulum-main access road in wheel path	51	-
7	A on Figure 8.7	Pendulum-main access road out of wheel path	72	-
8	B on Figure 8.7	Pendulum-main access road in wheel path	62	-
9	B on Figure 8.7	Pendulum-main access road out of wheel path	70	-
10	C on Figure 8.7	Pendulum-main access road in wheel path	57	-
11	C on Figure 8.7	Pendulum-main access road out of wheel path	64	-
12	C on Figure 8.7	Pendulum-main access road in wheel path across an end joint	61	-
13	C on Figure 8.7	Pendulum-main access road out of wheel path across an end joint	60	-
14	C on Figure 8.7	Pendulum-main access road in wheel path across long joint	64	-
15	C on Figure 8.7	Pendulum-main access road out of wheel path across long joint	64	-
16	D on Figure 8.7	Ditto on main access road	45	-
17	E on Figure 8.7	Ditto last	46	-
18	F on Figure 8.7	Ditto last	46	-
19	G on Figure 8.7	Ditto on secondary	54	-
20	H on Figure 8.7	Ditto last	54	-

8.4 DISCUSSION OF BOTANICAL GARDEN RESULTS

The SCRIM readings generally show a great similarity to each other. However, the range of readings on the highly trafficked main access road was less than on the other roads where the wide scatter of results described above was displayed.

The pendulum tests showed that where the pavement had been trafficked the skid-resistance was lower than where no trafficking had occurred. The main roads which had been subjected to more trafficking than the secondary roads showed a lower skid-resistance. This is to be expected since the polishing of the surface by vehicle wheels reduces the roughness and its associated resistance to skidding.

Site 4 S-B segmental blocks in a loading and servicing area adjacent to the NITRR headquarters building, Pretoria.

It was not possible to take SCRIM readings at this location due to the congestion of the site. Pendulum results obtained are given as described above in Table 8.5.

TABLE 8.5 - Skid-resistance details in yard adjacent to NITRR building

No.	Location	Description	Skid-resistance (wet)
1	Seldom used area	Pendulum centre block	52
2	Centred yard - Normal use	Pendulum centre block	54
3	By access - well used	Pendulum centre block	56
4	By access - well used	Pendulum - Across end joint	57
5	By access - well used	Pendulum - Along side joint	55

In this particular area it was noticed that the skid-resistance improved with use. This may seem to be anomalous but can be

explained after a detailed visual examination of the surface of the blocks. In the little used state the surface is seen to be smooth but with some wear the units become rougher on their surface due to the removal of the very fine sand particles with trafficking. With additional use the now exposed larger particles polish and the skid-resistance measurements are therefore expected to reduce. The reason for this unusual condition can be traced to the manufacture of the blocks which were over-vibrated causing fine sand particles and laitance to migrate vertically upwards to the surface leaving a more open textured block-surface on its lower face.

Site 5. This was a housing estate in Goodwood, Cape Town where pavements used for access and service roads are of S-B shape and were approximately 8 years old when tested.

As with site 5 it was not practical to do SCRIM tests on these pavements and Table 8.6 shows details of the Pendulum tests made.

TABLE 8.6 - Summary of skid-resistance readings in Goodwood, Cape Town

No.	Location	Description	Skid-resistance (wet)
1	Wallace St. - typical	Pendulum - Centre block	59
2	Wallace St. - Cornering	Pendulum - Centre block	56
3	Near Holland St typical	Pendulum - Centre block	57
4	Smartt Road - typical	Pendulum - Centre block	54

Numerous tests were done around the estate (summarized only in Table 8.6) and a close range of readings were obtained. The blocks used in this area were seen to be very consistent and therefore represent a good example of segmental block paving in terms of their wear and skid-resistance.

Site 6. S-B blocks in an extensive housing estate in Chatsworth, Natal. These pavements were about 20 years old when tested and in some cases were highly trafficked causing the blocks to become highly polished. SCRIM tests were not possible and Table 8.7 shows the pendulum skid-resistance tests made.

TABLE 8.7 - Skid-resistance values taken in Chatsworth housing estate, Natal.

No.	Location	Description	Skid-resistance (wet)
1	Silverglen Drive	Well polished - Centre Block	41
2	Silverglen Drive	Well polished - Centre Block and on a corner	44
3	Silverglen Drive	Well polished - Centre Block and with a Camber	40
4	Berryfield Place	Unpolished - Centre Block - lightly trafficked	49
5	Berryfield Place	Unpolished - Centre Block and on a corner	55
6	Berryfield Place	Unpolished - Centre Block and across end joint	53
7	Near Bulbul (Silverglen)	In wheel path semi-polished	49
8	Near Bulbul (Silverglen)	In wheel path semi-polished and on a corner	52
9	Near Bulbul (Silverglen)	In wheel path semi-polished and on a Camber	53
10	Near Bulbul (Silverglen)	In wheel path semi-polished near a junction	54

The results taken in Chatsworth show that the highly polished blocks in the heavily trafficked areas had a skid-resistance after almost 20 years of use about 10 units less than in the lightly trafficked areas.

Site 7. A S-C (rectangular brick) pavement at the Rank Xerox office complex in Kempton Park, Transvaal - in service for about 2 years when tested.

Table 8.8 shows details of SCRIM and Pendulum tests made.

The S-C pavement was made of rectangular fired clay bricks whose surface texture is smoother than the concrete units found at the other sites. The SCRIM readings were seen to be somewhat lower than for the concrete pavements.

TABLE 8.8 - SCRIM and pendulum skid-resistance results from Rank Xerox offices, Kempton Park, Transvaal.

No.	Location	Description	Skid-resistance (wet)	Range
1	In parking area	SCRIM at 50 km/h	50	30-70
2	Main access Road	SCRIM at 50 km/h	35	23-50
3	On delivery Road	SCRIM at 50 km/h	42	27-62
4	In parking area	Pendulum - Centre brick	39	-
5	In parking area	Pendulum - along long joint	42	-
6	In parking area	Pendulum - across end joint	44	-

8.5 ANALYSIS OF RESULTS WITH RESPECT TO RATING SCALES

The results of SCRIM and the pendulum tester can be individually evaluated and compared with recommended target values for particular road or pavement classification. It has not been possible to provide a relationship between SCRIM and the pendulum tester to allow the simple, easily portable pendulum to be used as an evaluation guide for all block pavements because:-

- i) The pendulum in essence measures the micro texture of the surface of the pavement.
- ii) The pendulum measures the slow speed effect of that small part of the surface used in the test and according to Road Note No 27 (1960) and Gordon (1978) relates to a skidding wheel of 50 km/h and less.

- iii) SCRIM is fitted with a smooth wheel and monitors some combination of the micro and macro textures of the surface. This is clearly evidenced with the wide range of readings from which an average was calculated.
- iv) SCRIM is designed to evaluate pavements at speeds of either 50 km/h or 80 km/h.
- v) SCRIM measures skid-resistance which is affected by some aspects of the drainage of the water applied in front of the test wheel since different macro textures of the surface and gradients will affect the quantity of water under the test wheel.

The pendulum test results can only be used as a slow speed (i.e. 50 km/h and less) evaluation of the surface of a block pavement. The rating scale suggested in Road Note No. 27 (1960) has been used for this exercise and the results of all 7 sites were plotted to enable a simple rating to be made. These are shown in Figure 8.8 together with the results of earlier pendulum testing by SHACKEL (1980 No 2), LESKO (1980), MAVIN (1980) and SHARP ET AL (1982). The majority of the pavements tested were below the pendulum value of 55 which indicates there are potential problems with skid-resistance. However, the micro texture ratings made in Figure 8.8 must be qualified by the macro texture rating and the other factors discussed above made with the SCRIM test.

A rating scale for the SCRIM results has been proposed by GORDON (1978) for South African conditions. Target levels of SCRIM at 50 km/h are proposed for various categories of road and for a specified accident risk. Figure 8.9 summarizes these target levels and Figure 8.10 compares the SCRIM results of the sites tested with these target values. It can be seen in Figure 8.10 that the results from Sites 1 - 3 inclusive are suitable for use in the road categories given in Figure 8.9. The range of results however, would suggest caution in the use of blocks in such pavements.

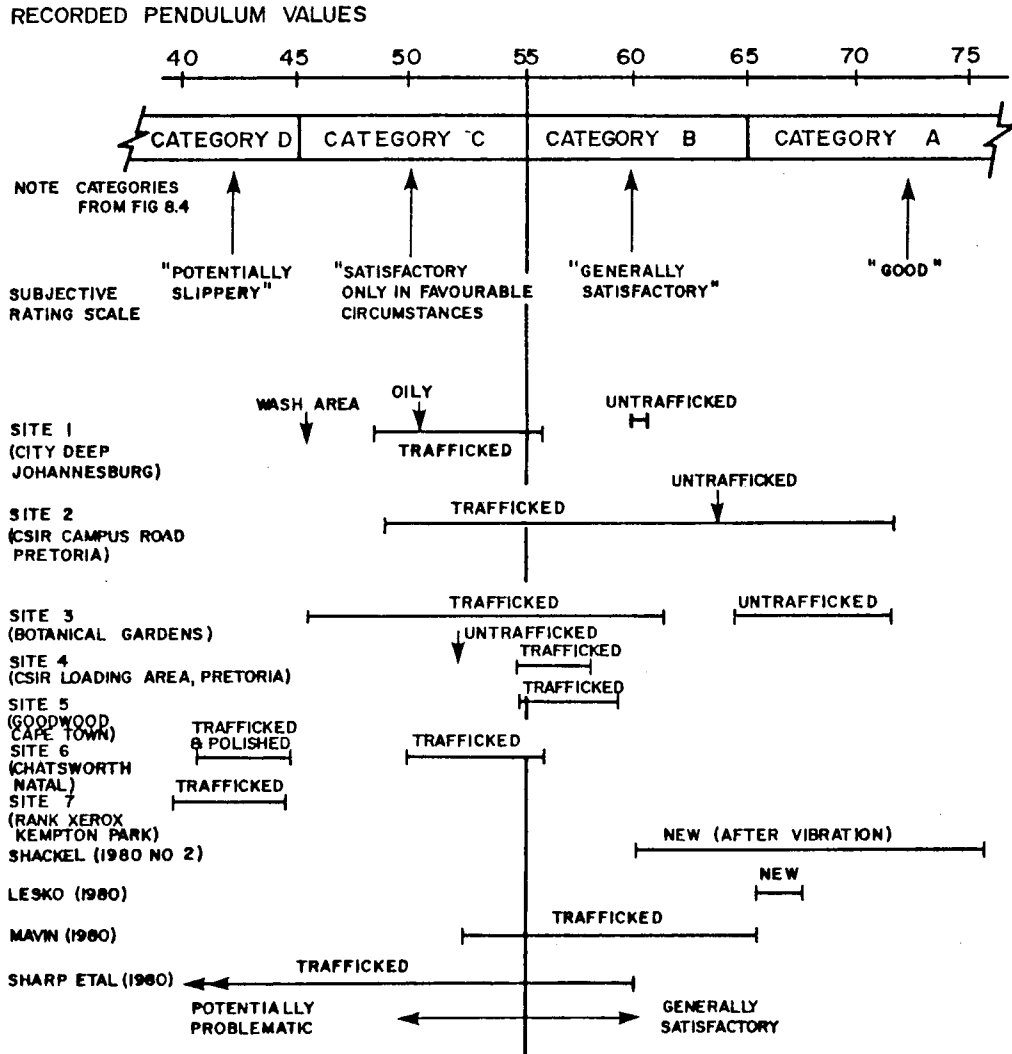


FIGURE 8.8

MICRO-SKID RESISTANCE OF BLOCKS AT VARIOUS SITES - COMPARED WITH A RATING SCALE PROPOSED BY ROAD NOTE No 27 (1960)

ACCIDENT RISK	TOTAL NUMBER OF ACCIDENTS PER INTERSECTION	FUNCTIONAL CLASSIFICATION	TARGET LEVEL
Moderate ie	5 - 10 / Year	Collector road	0,45
High ie	11 - 50 / Year	Arterial road	0,50
Severe ie	50 / Year	Main business road	0,55

FIGURE 8.9 TARGET SCRIM (AT 50 km/h) VALUES FOR VARIOUS CATEGORIES OF ROAD. AFTER GORDON (1978)

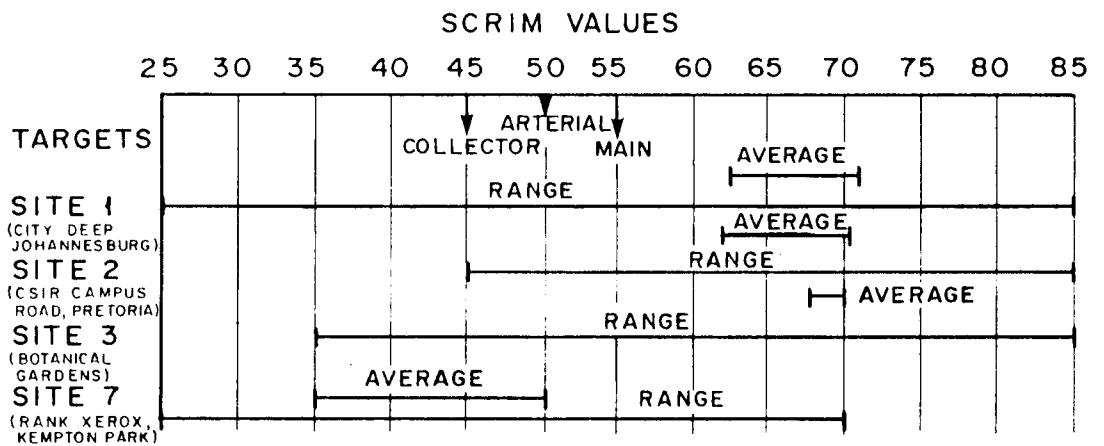


FIGURE 8.10 COMPARISON OF SCRIM RESULTS OF SITES TESTED WITH TARGET VALUES

8.6 RECOMMENDATIONS

If segmental block pavements are to be considered for higher speed roads some degree of surface roughness is necessary. In the case of the fired clay bricks tested, and the concrete units manufactured with too much vibration which provided a smooth surface, the pendulum skid-resistance was seen to be low and potentially dangerous when wet. In most of the other cases the rougher surface texture could be seen to be adequate in most cases. The manufacturing technique should therefore be such to ensure suitable surfaces for adequate skid-resistance.

After considerable trafficking where the larger aggregates became exposed by the removal of fine particles these aggregates may polish under trafficking. The skid-resistance of the units at Chatsworth, where almost 20 years of trafficking had taken place, was unacceptably low and could cause problems in wet weather. Care is therefore needed to select angular aggregates not subject to excessive polishing for use in blocks incorporated in higher speed roads.

The SCRIM test results whilst made at 50 km/h were found to be generally above the target values recommended for particular classes of road. However, the range of readings included results well below these target levels stressing again that care should be exercised before specifying blocks for higher speed roads.

Other factors which have not been considered here could also affect the specification of segmental blocks for higher speed roads. These include the noise level generated by traffic riding over a block road and the riding comfort of a block pavement which is designed to accommodate differences in finished level of up to 2 mm between individual segmental blocks.

C H A P T E R 9

MODELLING OF SEGMENTAL BLOCK PAVEMENTS FOR
INDUSTRIAL APPLICATIONS

CHAPTER 9

MODELLING OF SEGMENTAL BLOCK PAVEMENTS FOR INDUSTRIAL APPLICATIONS

9.1 PURPOSE OF MODELLING

Segmental block pavements are being used increasingly in industrial applications. This is one of the greatest potential uses of segmental blocks especially for heavy and very heavy industrial use where point loads for stacking and high wheel loads are encountered (defined as category S3 in Chapter 1). Present soil mechanics and pavement engineering evaluation techniques are suitable for 'normal' load applications, such as S1, S2, S4 and S5 categories. The extension of the 'normal' ranges to the spectrum of loads common in industrial pavements requires a means of relating known parameters such as strain, effective and resilient modulus and stress distribution characteristics under 'normal' road pavement conditions, to those which occur in industrial loading.

9.2 METHOD OF MODELLING

Modelling of segmental pavements by a variety of methods permits rapid evaluation of changes in materials, layer thickness, density, moisture content and applied loads. Modelling can be done in several ways, e.g. mathematical model analysis and small-scale laboratory model studies. In order to use currently available modelling methods most effectively, a combination of mathematical and laboratory methods has been chosen. The National Institute for Transport and Road Research (NITRR) has a number of computer programs on file which have been developed for layered pavement analysis (e.g. MECDE1 (1977) and MECDE3 (1983), CHEV4 (1977), ELSYM5 (1983) and others which relate to linear elastic layered theory, and FEPAVE (1983) and MAPS (1983) which are based on non-linear finite element methods).

For physical modelling of segmental block pavements, a unique evaluation machine developed by the NITRR, the Heavy Vehicle Simulator (HVS), and its associated instrumentation, are used. This equipment measures the various soil parameters during simulated trafficking, equivalent to many years of use, so that comparisons with mathematical predictions can be made.

A combination of techniques permits a study to be made of the effects of various applied loads, layer thickness and strengths, relative layer positions and different material types. Characterization of the blocks, their joints and the bedding sand in combination as a composite structural layer is also possible.

9.3 REQUIREMENTS OF MODELLING

Effective modelling requires the input of response parameters which have been either measured or predicted to a reasonable degree of accuracy from previous work. In order to include more accurate input data in the model, a rapid and effective evaluation technique is needed. Since many of the parameters will be interdependent, single response modification and changes should be possible at any stage and a simple yet meaningful means of analysis should be adopted.

9.4 PHILOSOPHY OF MODELLING

There are many aspects to modelling, especially where the highly complex characteristics of soil is concerned. Many assumptions must be made to reduce the number of variables and specific values for these variables must be chosen for input into mathematical models.

Results generated by model analysis techniques therefore, must be compared with those achieved from field tests and a process of reiteration of amended, specific input values may be necessary for realistic data to be attained. Since the importance of all the various parameters are not yet fully appreciated a rating to second or third order of importance of some of these parameters

may be necessary. The high degree of accuracy of output data by computer analysis is often very undesirable and of no benefit when considering the assumptions made in choosing input data.

Complete optimization by modelling must be a blend of theoretical and practical studies where adequate factors of safety are included in specifications for marking pavements.

The philosophy of modelling is studied in more detail in appendix A.

9.5 MECHANISTIC INPUT

The recent development of theoretical methods for the complex analysis of a pavement structure by layers permits evaluation of the pavement as a total mechanism. This is simply known as mechanistic design, a term introduced by Paterson and Maree (1978) and Maree and Freeme (1981). Freeme (1982) ATC (1984). The modelling technique allows the stresses, strains and displacement at various points within a particular layer and at the layer interfaces to be computed. Mechanistic input data of the various criteria required for layers used in the catalogue of category S3 designs are given in Figure 9.1

9.6 STRESS DEPENDENCY

It is known that granular materials show stress-stiffening behaviour which is a function of the sum of the principal stresses and constants derived from laboratory regressions (Maree et al (1980)). Following a series of experiments, typical stress-dependent behaviour of a granular base for example is shown (Figure 9.2). In the design of heavily and very heavily loaded segmental block pavements whose base and subbase are granular, improvements in carrying and support capacity with increased load can be expected.

These findings are consistent with the findings of Figueroa (1976) who, after extensive investigation produced a comparison of the

MATERIAL CLASSIFICATION	RESILIENT MODULUS (MPa)		POISSONS RATIO	
	POSSIBLE RANGE	MEAN	RANGE	RECOMMEND.
C 2	4000 - 14000	475	0,1-0,5	0,35
C 3	3000 - 10000			
C 4	2000 - 7000			
G 2	150 - 800			
G 4	100 - 600			
G 5	75 - 450			
G 6	50 - 300			
SUBGRADE G7	UNCERTAIN			

FIGURE 9.1

INPUT VALUES FOR MECHANISTIC MODELLING OF TYPE S3 PAVEMENTS

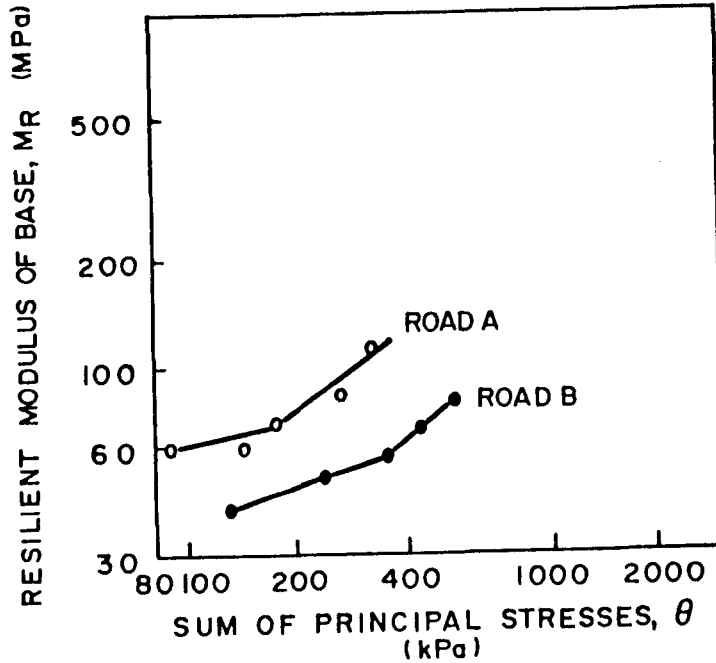


FIGURE 9.2

THE STRESS-DEPENDENCE OF A GRANULAR BASE RESILIENT MODULUS AS MEASURED IN THE HVS TEST

AFTER MAREE ET AL (1980)

940-4 - 3850 / 4 HD

normal strain criteria in subgrades of a variety of material types. Although some variability of magnitude occurs, there is consensus as to the reduction of subgrade normal strain with repetitions (Figure 9.3).

9.7 EXAMPLE OF MATHEMATICAL MODELLING

Several designs from the catalogue of designs were chosen for analysis. (Figures 10.11 and 12.8.) The industrial designs were considered the most demanding for modelling. A comparison of predicted behaviour with that measured at the test site by Heavy Vehicle Simulator Tests enables iteration of input values to fit the model to measurable parameters. Figure 6.5 details panels constructed at the test site and tested with the HVS.

Panels 23, 31 and 33 were selected from the panels in Figure 6.5. Pavement section S3d from Figure 10.11 was chosen to compare with Section E4R Category B from Figure 12.8. Section S3c from Figure 10.11 was chosen to compare with Section I(ii) from Figure 12.8.

The Sections of pavement were constructed at the Silverton test site to the particular specifications shown in figure 6.5. Multi-depth deflectometers were installed in three locations so that they were directly under the centre of a block in both the longitudinal direction and the latitudinal direction and at the edge of two adjacent blocks as shown in Figure 9.4.

The HVS was used to traffic the pavement with sufficient passes to enable it to settle in. At this initial stage the joints between the blocks were not filled. The joints between the blocks were later filled using the specified sand (Figure 9.5) and a small plate vibrator was used to compact the sand into the joints.

The HVS was again used to traffic the now jointed pavement until a settled-in condition had again occurred. Strain measurements were then taken under the loaded wheel at three depths below the

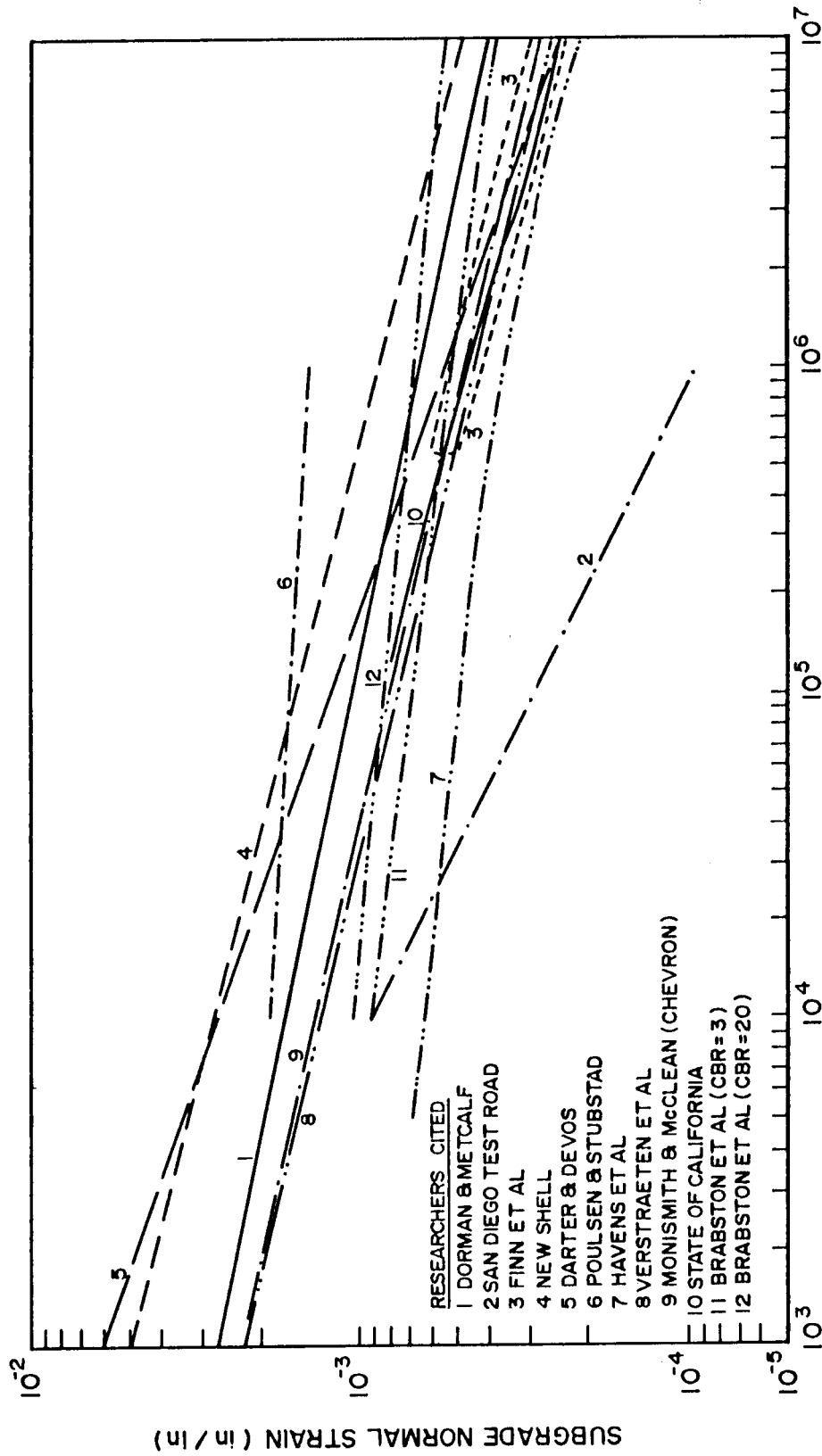


FIGURE 9.3
COMPARISON OF SUBGRADE NORMAL STRAIN CRITERIA
AFTER FIGUEROA (1976)

surface of the pavement at which the MDD modules had been placed. The results showed that in each case an improvement in total pavement strength occurred when the joints were properly filled. (Figure 9.6.)

Initial mathematical modelling required the input data given in Figure 9.1 which was the most recent available from extensive research carried out in the HVS testing programme. Reiterating the computer programs from site input data required the introduction of effective moduli (as determined from the field data). The effective moduli are determined by fitting the site-generated data to the mathematical model. The output of the computer analysis was then compared with the results from HVS tests and found to be reasonably comparable with predictions. It is known that granular materials show stress-stiffening behaviour which is a function of the sum of the principal stresses and constants derived from laboratory regressions (Maree et al (1980)). Following a series of experiments conducted by Maree et al using an HVS, typical stress-dependent behaviour of a granular base was determined and is shown in Figure 9.2. In the design of heavily and very heavily loaded segmental block pavements whose base and subbase are granular, improvements in carrying and support capacity with increased load can be expected because of this stress-stiffening behaviour.

These findings are consistent with the findings of Figueroa (1976) who, after extensive investigation produced a comparison of the normal strain criteria in subgrades of a variety of material types. Although some variability of magnitude occurs, there is consensus as to the reduction of subgrade normal strain with repetitions (Figure 9.3).

The modulus values listed in Table 9.1 which incorporate these aspects were therefore used as input in the mathematical modelling.

Computer Run No.	Pavement Structure	Modulus Values				
		Blocks	Bedding Sand	1st Sub-layer	2nd Sub-layer	3rd Sub-layer
1	Panel 23	1000		6000		
		1500		2200		
		2000	200	350	225	50
2	S3d	1000		8000		
		1500		2400		
		2000	200	450	225	100
3	S3d	1000		8000		
		1500		2400		
		2000	200	450	225	100
4	Panel 33	1500		6000	3500	
		2000		2200	1500	
			200	350	250	50
5	E4RCatB	1000		4000		
		1500		2000	2000	
		2000	200	300	300	50
6	E4RCatB	1000		4000		
		1500		2000	2000	
		2000	200	300	300	50
7	Panel 31	1000		8000	2500	
		1500		2400	1000	
		2000	200	450	200	100
8	S3c	1000		4000	2500	
		1500		2000	1000	
		2000	200	300	200	100

TABLE 9.1 INPUT DATA FOR ELSYM 5 MODELLING

9.8 RESULTS OF THE EXAMPLES OF MODELLING AND DISCUSSION

The programs were run and critical parameters extracted. These have been collected on standard pro forma and are given in Appendix E.

A study of the data generated must be qualified since many variables and unknowns cannot be effectively modelled. Generally the output is consistent with the considerable HVS experience reported in ATC 1984 and elsewhere.

The designs chosen were deliberately the lighter structures to allow some distress to occur on site. In this way cut off points between

the various phases of the pavement's life could be identified. The modelling included various development phases (discussed in Chapter 6 and Appendix B) where certain materials change with time. The modulus values for the last phase of cemented materials were chosen to represent the equivalent granular state to which the material will change with time. Blocks settle-in and seem to increase somewhat in strength with time and are accordingly modelled with appropriate modulus values. However in each case the lowest values were chosen to enable the ultimate choice of pavement to be conservative, or to include a hidden factor of safety. In time and with more experience it will be possible to input higher values of modulus to effect savings in layer thickness or reductions in material quality in the design of pavement sections to carry similar loading.

ELSYM5 and other programs have been developed to use the E80 concept (Chapter 6) and the site HVS testing was done with these standard axle loads to allow the best comparison of modelling-prediction with site data to be made.

Critical pavements identified in the modelling are often taken in the centre of a layer under consideration and some modification to these values must be made for the upper and lower fibres of the layer, when interpreting results. In the case of the subbase the parameters were calculated at 200 mm below the interface with the overlying layer.

In the first case modelled (No. 1 on Table 9.1 and in Appendix E) the critical layer is seen to be No. 3. Here the strain value of 117 indicates a short life in the first phase of the cemented material. However rapid breakdown into the equivalent granular state is not a problem with block pavements since there is no problem with reflective cracking.

The factor of safety value of 0,37 in the final phase shows that a short life may be indicated - although this might be 100 000 repetitions of an E80 axle before terminal conditions would apply. The terminal conditions as compared with black top pavements can be

more severe with block pavements since surface deformations can be easily reinstated during the life of the pavement if necessary. Figure 10.6 gives a working-committee's recommendation of terminal conditions for various block paving use.

In all calculations a dry state was assumed for the materials because of the protection characteristics of block pavements from the ingress of water through the surface (Chapter 2). Pavement design (for all types of pavement) additionally assumes that adequate drainage is provided (Chapter 10).

In a similar examination of critical parameters for the other calculations it can be seen from data presented in Appendix E that the block layer is never shown as critical. In most cases the cemented layers show rapid break down into the equivalent granular state during which the main part of the life of the pavement occurs.

These data were shown to some of the engineers who have considerable experience in interpretation of such results. They were asked to predict a realistic life of the pavements modelled. These NITRR Pavement Engineering staff have worked with HVS modelling and know from experience the effect of critical parameters on the overall life of the pavement. Predicted structural lives were given to the designs and are given on the pro forma in the appendix. In general they show a sufficiently long life for the use of the structures for industrial paving.

A comparison of field data from panels 23, 31 and 33 with the modelling data shows some discrepancy. Panel 23 was found by DCP tests to be built to a much lower standard than what was specified (Figure E 15 (Appendix E)).

In the HVS testing it showed early distress. Panels 33 settled in after some 10 000 repetitions of the standard axle load whereafter small deformations occurred (shown in Appendix E Figure E 16). This suggests that the blocks should be credited with a greater modulus value which implies they would transfer applied stress over a greater area thereby reducing stresses in the lower layers.

The modulus value for the blocks as modelled may be a measure of the resistance of the blocks to flexure which would be low because of the sand jointing. The compressive (i.e. vertical) resistance of blocks is high especially when supported over a granular subbase. Realistic modelling of blocks should therefore be a measure of the compressive rather than flexural strength.

It was decided to rerun the final modelled pavements with what was considered more realistic modulus values. (Computer Run No. 8 from Table 9.1).

Details of these analyses are also given in Appendix E and are referenced 9a, 9b, 10a and 10b.

The effect of the bedding sand was thought to be negligible and this is confirmed by comparison of critical parameters output in evaluations 8a and 9a. The bedding sand is a thin layer and if a modulus of 0 were given to it it would serve as a slip layer. Such a slip-layer is an unrealistic condition. In the final modelling it was decided to add the thickness of the blocks to the sand and compute critical parameters accordingly. A value of 8000 for the modulus of the blocks was chosen by considering the blocks as being the equivalent of a cemented state of a C2 pavement.

The analysis in 9 and 10 in Appendix E (Figures E11 - E14 inclusive) show the pavements to rapidly establish the post cracked and subsequent equivalent granular state in the sublayers. In this state they are shown to have a long life.

The factor of safety calculations which were made and given in Appendix E seem to be too stringent for block construction.

The above analyses suggests the modulus values for blocks may be between 2000 and 8000. Both these figures were used but did not model the pavements effectively to the state measured in the field. A realistic modulus for the block layer may be between 1000 and 5000 depending on the state of the joints. More work is needed in this field and for the present state of the art a modulus range of 400 to 2000 would suggest a conservative recommendation.

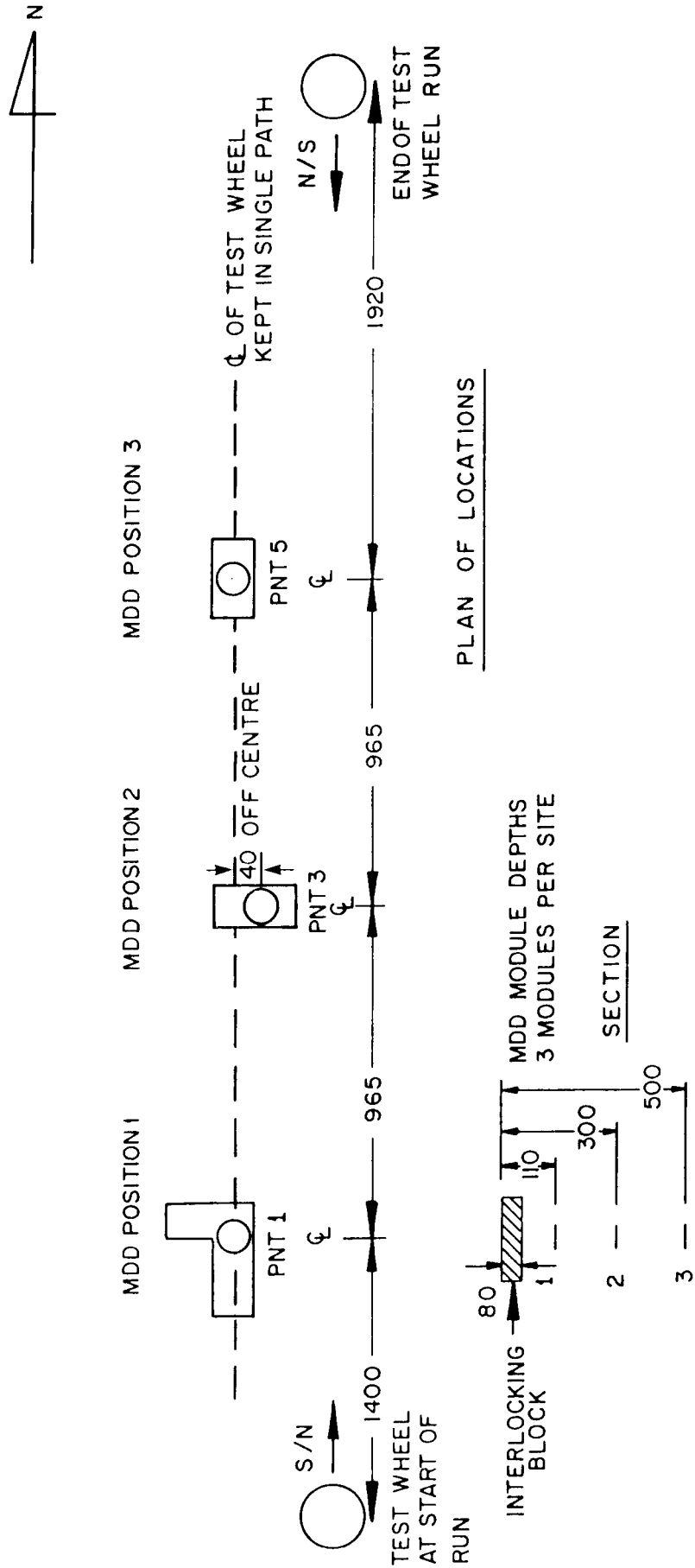


FIGURE 9.4

MDD INSTALLATION LAYOUT

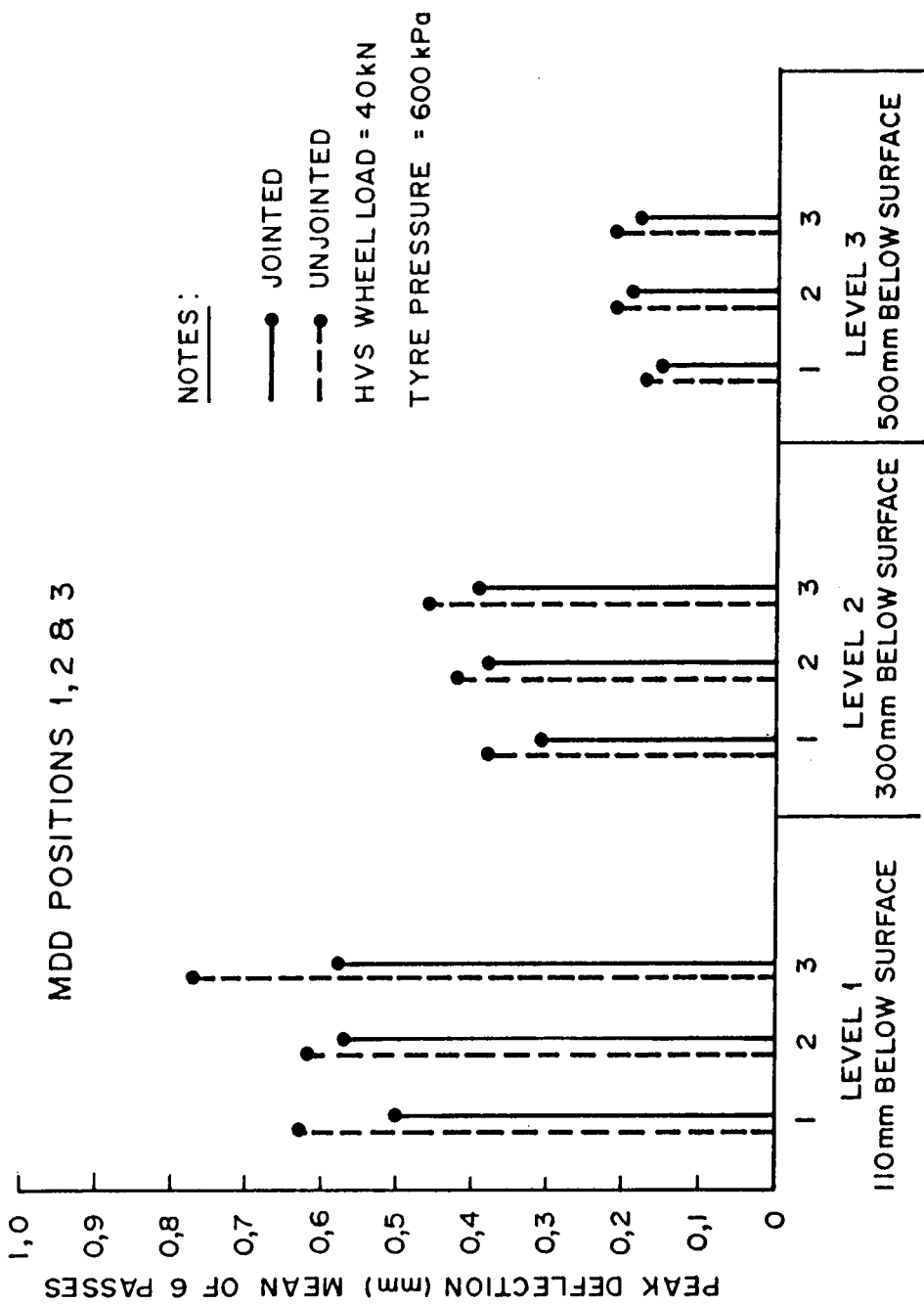


FIGURE 9.5
MULTI DEPTH DEFLECTOMETER - DEFLECTIONS MEASURED UNDER HVS
TRAFFICKING

C H A P T E R 10

STRUCTURAL DESIGN PROCEDURES FOR SEGMENTAL
BLOCK PAVEMENTS

CHAPTER 10

STRUCTURAL DESIGN PROCEDURES FOR SEGMENTAL
BLOCK PAVEMENTS

10.1 INTRODUCTION

The procedures for the structural design of block pavements are applicable for both industrial and normal road use. Industrial pavements can be for light, medium or heavy duty use which includes special applications such as container stacking areas. The design procedure includes the use of block paving for lightly trafficked or even non-trafficked areas such as in non-structural architectural use. Their use for footpaths, cycle tracks and civic uses can be cited as examples of this. The procedures developed in this chapter are based on a combination of existing methods, experience and the fundamental theories of structural design and material characteristics and behaviour. They do not necessarily exclude other design methods, indeed it is expected that as the technology and the use of block pavements increase many new procedures will come into being.

The structural design of pavements is concerned with the protection of the subgrade through the provision of pavement layers in order to achieve a chosen level of service, with rehabilitation, if necessary over an analysis period. This should be provided at an acceptable cost. Such factors as time, traffic, materials, subgrade soils, environmental conditions and economics are included. The design procedures follow the logic of those already adopted for both urban and rural road design in South Africa (viz. TRH4 (1980) and National norms for township services by Maree (1982)). An equivalent design guide for blocks has been prepared for use in Southern Africa. (Clifford, (1982))

10.2 THE DESIGN PROCESS

10.2.1 Philosophy

The design objective is to produce a structurally balanced pavement which, at minimum present worth of cost, will carry the traffic and other applied loads with high confidence for the structural design period in the prevailing environment at an acceptable level of service without major structural distress.

10.2.2 The design procedure

Figure 10.1 shows a flow diagram of the design process. Each of its eight steps will be treated separately but all steps must be considered in order to produce a proper design.

A catalogue of designs based on both design and current experience of block pavement construction and behaviour throughout Southern Africa has been developed. The use of the catalogue approach is considered as adequate in itself for providing the basic design but cognisance of special conditions may require a more detailed design by other methods to be undertaken.

10.3 DESIGN STEP 1 - SELECT CATEGORY

10.3.1 Six segmental pavement categories

In the use of segmental pavements six categories are considered for specific applications. These are re-stated from Chapter 1.

- S1 For low speed pavements where wheel- and axle-loads are light (for example parking areas) where low speed is defined as less than 30 km/h.

- S2 For civic uses such as footpaths, cycleways, around public buildings and for paving city squares.

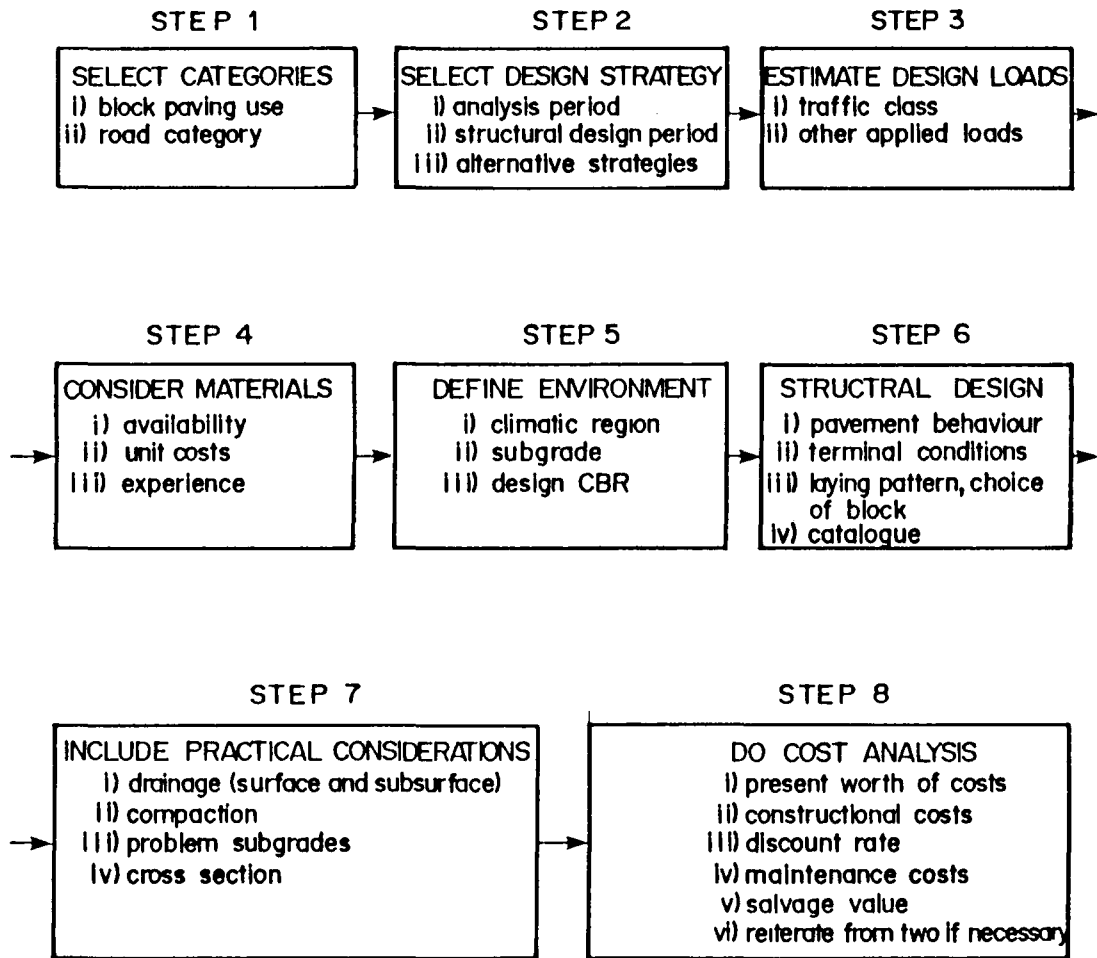


FIGURE 10.1

STRUCTURAL DESIGN OF SEGMENTAL BLOCK PAVEMENTS FLOW DIAGRAM

- S3 For highly-loaded working areas where speeds are generally less than 30 km per hour. Tracked vehicles or vehicles with a slewing action may be used. Point loads from stacking trailer landing legs and dolly wheels may be expected.
- S4 For urban roads and access roads to industrial areas with speeds not greater than 60 km per hour. Providing the conclusions of Chapter 8 in terms of micro and macro skid resistance are considered the removal of this speed restriction could be considered.
- S5 For higher-speed pavements such as inter-urban collectors.
- S6 Special pavements, innovations, overlays and cost saving ideas.

10.3.2 Subdivision of segmental pavement categories S4 and S5

The design of segmental pavements for categories S4 and S5 above can be further categorized into three categories used for the design of inter-urban and rural pavements and detailed in TRH4 (1980), given in Figure 10.2.

The design categories A through C are made on a number of parameters such as the importance of the road, service level, traffic and constructional standards.

10.3.3 Inclusion of the importance, service level, traffic and pavement standard

The client or authority will usually specify the required category of pavement. However, the designer should ascertain the traffic volume, present and future wheel and axle loadings and other factors.

The level of service which a user expects from a pavement is related to its function, to the general standard of the faci-

	ROAD CATEGORY		
	A	B	C
DESCRIPTION	eg. interurban freeways, major interurban roads	eg. interurban collectors, major rural roads, major industrial roads	Lightly trafficked rural roads, strategic roads
IMPORTANCE AND SERVICE LEVEL	Very important Very high level of service	Important High level of service	Less important Moderate level of service
TOTAL EQUIVALENT TRAFFIC OVER STRUCTURAL DESIGN PERIOD	3-50 x 10 ⁶ E80/lane** over 20yrs design strategy	0,2 - 12 x 10 ⁶ E80/lane depending on design strategy	<3 x 10 ⁶ E80/lane depending on design strategy
APPROXIMATE DAILY TRAFFIC	> 4000 e.v.u.*	400 - 10000 e.v.u.	<600 e.v.u.
STANDARD : Constructed riding quality	3,5 - 4,5	3,0 - 4,5	2,5 - 4,0
Terminal riding quality (P.S.I.)***	2,5	2,0	1,5

FIGURE 10.2

DEFINITION OF THREE ROAD CATEGORIES OF DRAFT TRH 4 (1980) FOR SUBDIVISION OF SEGMENTAL BLOCK PAVING CATEGORIES S4 & S5

NOTE: * e.v.u. = equivalent vehicle unit

**E80, according to standard procedure it is assumed that 1E80 ≡ 3 e.v.u

***p.s.i. = pavement serviceability Index - a subjective rating scale 0 to 5. See draft TRH (1980)
(a suggested improvement to "present" serviceability index)

lity and partly to the volume and type of traffic carried. For example, the user will expect a better riding quality on an access road to a similar complex than on a stacking area.

10.3.4 Category S6

Categories S4 and S5 cover a wide range of pavement structures normally encountered in practice. Special ideas on cost-saving, overlays to existing pavements, labour-intensive methods and the fact that the designer is sometimes confronted by very special conditions, necessitated the introduction of an extra category which can be substituted for either Category S3, S4 or S5 pavements. If the client agrees, the designer can produce innovations or special pavements under this category. Once these structures have been proved in practice, they may be included in the normal categories. Therefore Category S6 acts as a catalyst for encouraging new designs in the future.

10.4 DESIGN STEP 2 - DESIGN STRATEGY

10.4.1 Analysis period and structural design period

The analysis period is a convenient planning period during which full reconstruction of the pavement is undesirable. The structural design period is defined as the period during which it is predicted with a high degree of confidence that no structural maintenance will be required. In the case of a block pavement the occasional lifting of small areas of blocks to provide minor reinstatement is not considered as structural maintenance.

10.5 DESIGN STEP 3 - DESIGN LOADS

In the design of road and other pavements the cumulative damaging effect of all individually applied loads is expressed as the number of equivalent 80 kN single axle loads (E80).

This is the number of 80 kN single-axle loads that would cause the same damage to the pavement as the actual spectrum of applied loads. For structural design, an estimate of the cumulative equivalent traffic over the structural design period is required. This cumulative equivalent traffic can be determined in two different ways:

- (i) By estimation based on experience and expected future growth.
- (ii) Through detailed computation by estimation of initial and mean daily traffic, growth rates and lane or area distribution factors.

Estimation of the cumulative equivalent traffic over the structural design period from tabulated values is recommended, unless more specific information is available.

The cumulative equivalent traffic (total E80 over the design period) is grouped into five traffic classes, varying from E0 for very light traffic to E4 for very heavy traffic. The class of equivalent traffic is a major factor in the selection of the actual pavement structure obtained from the CATALOGUE of designs. The traffic classes are defined in Figure 10.3.

The equivalent traffic can be determined by multiplying the axle loads in each load group of the entire load spectrum by the relevant equivalency factor read from Figure 6.1. The choice of value of the x factor can be made to allow more accurate equivalency ratings but the South African commonly accepted value is 4.0 and may be used where no adverse conditions are likely.

TRAFFIC CLASS	CUMULATIVE EQUIVALENT TRAFFIC E 80/LANE OR \pm AREA	DESCRIPTION	BLOCK PAVING CATEGORY
E 0	$0,2 \times 10^6$	Very lightly trafficked few heavy vehicles	S 1 S 2
E 1	$0,2-0,8 \times 10^6$	Lightly trafficked few heavy vehicles	S 1 S 4 (in some cases)
E 2	$0,8-3 \times 10^6$	Medium traffic volume few heavy vehicles	S 4 S 5 S 6 (in some cases)
E 3	$3-12 \times 10^6$	High volume many heavy vehicles	S 3 S 4 S 6
E 4	$12-50 \times 10^6$	Very high volume or many very heavy vehicles	S 3 S 4 S 6

FIGURE 10.3
CLASSIFICATION OF TRAFFIC FOR STRUCTURAL DESIGN PURPOSES

10.6 DESIGN STEP 4 - MATERIALS

The selection of materials for the pavement design is based on a combination of availability, economics and previous experience. These factors need to be evaluated during the design in order to select the materials that best suit the requirements.

Generally the design procedure uses the standard material specifications defined in Draft TRH14 (1980). The classification of the materials is given in Figure 10.4. The material codes listed in this figure are used extensively in the catalogue of designs. Only abbreviated specifications are given and Draft TRH14 (1980) should be used for more details. Waste materials (e.g. blast furnace slags) and pedogenic materials have not been classified because of their varying quality. If these materials are to be used they should be classified under the appropriate material codes again given in Draft TRH 14 (1980). The three segmental block types are included. These are S-A which are the fully interlocking paving blocks, S-B the partly interlocking paving blocks and S-C the non interlocking blocks, a type which may include either rectangular or circular blocks.

The materials are classified according to their fundamental behaviour into various categories with different classes according to their strength characteristics.

10.7 DESIGN STEP 5 -ENVIRONMENT

The climatic conditions, particularly moisture and temperature, under which the pavement will function as well as the underlying subgrade conditions, define the environment. The environment must be taken into account in the design of pavement structures.

10.7.1 Climatic regions and the design of pavements

The climate will largely determine the weathering of natural rocks, the durability of weathered, natural road building materials and, depending on drainage conditions, also the

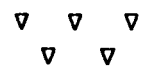
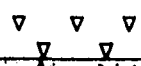
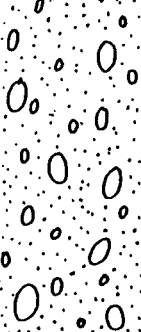




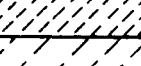




Symbol	Code	Material	Abbreviated Specifications
	G2	Graded crushed stone	Dense-graded unweathered crushed stone; Max. size 37,5 mm; 100-102% mod. AASHTO.
	G3	Graded crushed stone	Dense-graded stone + soil binder; Max. size 37,5 mm; Minimum 98% mod. AASHTO.
	G4	Natural gravel	CBR \leq 80; PI \geq 6
	G5	Natural gravel	CBR \leq 45; PI \geq 10 to 15 depending on grading; Max size 63 mm
	G6	Natural gravel	CBR \leq 25; Max size $\geq \frac{2}{3}$ layer thickness
	G7	Gravel-soil	CBR \leq 15; Max size $\geq \frac{2}{3}$ layer thickness
	G8	Gravel-soil	CBR \leq 10; at in situ density
	G9	Gravel-soil	CBR \leq 7 at in situ density
	G10	Gravel-soil	CBR \leq 3 at in situ density
	C1	Cemented crushed stone or gravel	UCS 6 to 12 MPa at 100% mod. AASHTO; Spec at least G2 before treatment; Dense-graded
	C2	Cemented crushed stone or gravel	UCS 3 to 6 MPa at 100% mod. AASHTO; Spec generally G2 or G4 before treatment; Dense-graded
	C3	Cemented natural gravel	UCS 1,5 to 3,0 MPa at 100% mod. AASHTO; Max size 63 mm
	C4	Cemented natural gravel	UCS 0,75 to 1,5 MPa at 100% mod. AASHTO; Max size 63 mm
	C5	Treated natural gravel	Modified mainly for Atterberg limits
	S-A	Interlocking paving blocks (type S-A)	Geometrical interlock on all vertical faces [possible to lay in herringbone bond]
	S-B	Interlocking paving blocks (type S-B)	Geometrical interlock on some vertical faces [not possible to lay in herringbone bond]
	S-C	Non-interlocking paving blocks (type S-C)	No geometrical interlock.
	BS	Bedding sand	For use with concrete, clay or other blocks CB and BS

FIGURE 10.4

DEFINITION OF MATERIAL SYMBOLS USED IN THE CATALOGUE

Note : Code S-C refers to all non-interlocking blocks whether made from fired clay, concrete or another material. S-C would include square, rectangular, circular or other non-interlocking shapes.

stability of untreated materials in the pavement. The climate may also influence the equilibrium moisture content. The designer should always consider the climatic conditions and avoid using materials known locally to display excessive water-susceptibility or temperature-sensitivity. It is also possible to accommodate climatic conditions by either adjusting CBR-values or weighting the equivalent traffic, but not both. A suggested weighting system for equivalent traffic is given in Draft TRH4 (1980).

Southern Africa can be divided into three climatic regions:

- (i) A large dry region
- (ii) A moderate region
- (iii) A small wet region

Figure 2.1 shows a map of southern Africa with the different climatic regions indicated. These are macroclimates and it should be noted that different microclimates could exist within these regions.

10.7.2 Climate and subgrade CBR

The current design parameters for the subgrade is the soaked California Bearing Ratio (CBR) at a representative expected final insitu density for structural design purposes. When a material is classified according to CBR, this implies that not more than 10 per cent of measured values of such a material will fall below the classified value. Research is being conducted on subgrade CBR and means of reducing its variability to enable a greater confidence level to be incorporated in its part in the pavement design. It is expected that reduction in base and subbase thicknesses will result, when the studies to more accurately define the subgrade's potential are completed.

10.7.3 Material Depth

The term 'material depth' is used to denote the depth below the

finished level of the pavement to which soil characteristics have a significant effect on pavement behaviour. Below this depth the strength and density of the soils are assumed to have a negligible effect on the pavement. The depth approximates the cover for a soil with a CBR of 1 or 2%.

Figure 10.5 specifies the material depths used for determining the design CBR of the subgrade for the different block paving and road categories.

10.7.4 Design CBR of Subgrade

For construction purposes the design subgrade CBR is limited to four groups in the structural design method. These are :

- (i) less than CBR 3%;
- (ii) 3 - 7%;
- (iii) 7 - 15% and
- (iv) greater than 15%.

The CBR is normally determined after samples have been soaked for four days and may be adjusted according to climate and subgrade considerations. Special measures are necessary if a material with a CBR of 3 or less is encountered within the material depth. These include treatment (chemical or mechanical), stabilization, modification (chemical), removal and replacement with a better material or the addition of extra cover. After the special treatment, the material will be classified under one of the remaining three subgrade groups.

10.8 DESIGN STEP 6 - STRUCTURAL DESIGN AND BLOCK PAVEMENT CATALOGUE

A number of design procedures may be used, such as the mechanistic design method described by Paterson and Maree (1978) and Walker et al (1977), the AASHTO structural number method described by Yoder and Witczak (1975) (Freeme (1982), or the catalogue of designs given in this Chapter. Whatever the method used, factors such as segmental block pavement category, design

SEGMENTAL BLOCK PAVING CATEGORY		ROAD CATEGORY	MATERIAL DEPTH (mm)
Low speed	S1	-	300 - 600
Civic uses	S2	-	300 - 600
Highly loaded	S3	-	800 - 2 500
Urban roads	S4	-	800 - 1 000
Higher speed	S5	-	800 - 1 200
-	-	A	1 000 - 1 200
-	-	B	800 - 1 000
-	-	C	800
Special pavements	S6	-	INVESTIGATE

FIGURE 10.5
MATERIAL DEPTHS TO BE USED FOR DETERMINING THE DESIGN CBR OF THE SUBGRADE .

strategy, applied loads, materials available, and environment must be taken into account.

10.8.1 Possible conditions at the end of the structural design period

There is no design method available to predict the exact condition of a segmental block pavement 10 to 20 years in the future. Figure 10.6 shows terminal conditions of rut depth and cracking considered acceptable for the various categories.

10.8.2 The catalogue design method

Before the catalogue is used, all the factors noted in design steps 1 through 5 should be considered. By making sure of the segmental block paving category, design strategy, design equivalent traffic and material availability the designer can choose a segmental block pavement structure. It should be noted that these designs are considered to be of adequate capacity to carry the total design equivalent traffic over the structural design period. Construction constraints on practical layer thicknesses and increments in thicknesses must be met. It is also assumed that the requirements of the material standards are met.

The catalogue may not be applicable when special conditions arise; other methods should then be used, but the catalogue can still act as a guide. The catalogue does not necessarily exclude other possible segmental block pavement structures.

10.8.3 Selected layers below the segmental block paving

The catalogue assumes that all subgrades are brought to equal support standards. Design step 5 limits the design CBR of the subgrade to four groups. For block pavements the in situ subgrade soil should be prepared, and ripped and recompacted for categories S3, S4 and S5 to a depth of 150 mm. On top of this prepared layer, one or two selected layers may be required. The required selected subgrade layers will vary

POSSIBLE CONDITION AT END OF STRUCTURAL DESIGN PERIOD	SEGMENTAL BLOCK - PAVING CATEGORY					
	S1	S2	S3	S4	S5 *	S6
Rut depth (mm)	50	30	40	30	20	?
Length or area of pavement exceeding stated rut depth (%)	60	50	50	15 - 30	20	?
Type of distress Granular subbase	Deformation by shear or densification excessive rutting, longitudinal roughness					
Type of distress Cemented subbase	Breaking up of subbase, rocking of subbase blocks pumping of fines					

FIGURE 10.6

POSSIBLE CONDITION AT END OF STRUCTURAL DESIGN PERIOD FOR THE SEGMENTAL BLOCK-PAVING CATEGORIES

* A COMMITTEE WAS RESPONSIBLE FOR SETTING THESE CRITERIA. THEY DID NOT CONSIDER IT OF MERIT TO SET DIFFERENT CRITERIA FOR THE SUBDIVISION OF CATEGORY S5 INTO ROAD CATEGORIES A, B & C.

according to the design CBR of the subgrade. Figure 10.7 shows the preparation of the subgrade and required selected layers for the different subgrade design CBRs.

10.8.4 Definition of terms used in block pavements

Figure 10.8 shows the various layers possible in a block pavement and defines the terms used. It must be noted that whilst the blocks themselves form the surfacing of the road their structural properties are similar to a road base - hence they are known as the base layer.

10.9 DESIGN STEP 7 - PRACTICAL CONSIDERATIONS

10.9.1 Drainage and compaction

Experience has shown that inadequate drainage is probably responsible for more pavement distress in Southern Africa than inadequate structural or material design. Consequently, effective drainage is essential to good pavement performance, and it is pre-supposed in the structural design procedure.

Drainage design is an extensive subject and detailed discussion of it is beyond the scope of this thesis. However the basic philosophy is to provide effective drainage at least to material depth so that the pavement structure is prevented from becoming saturated.

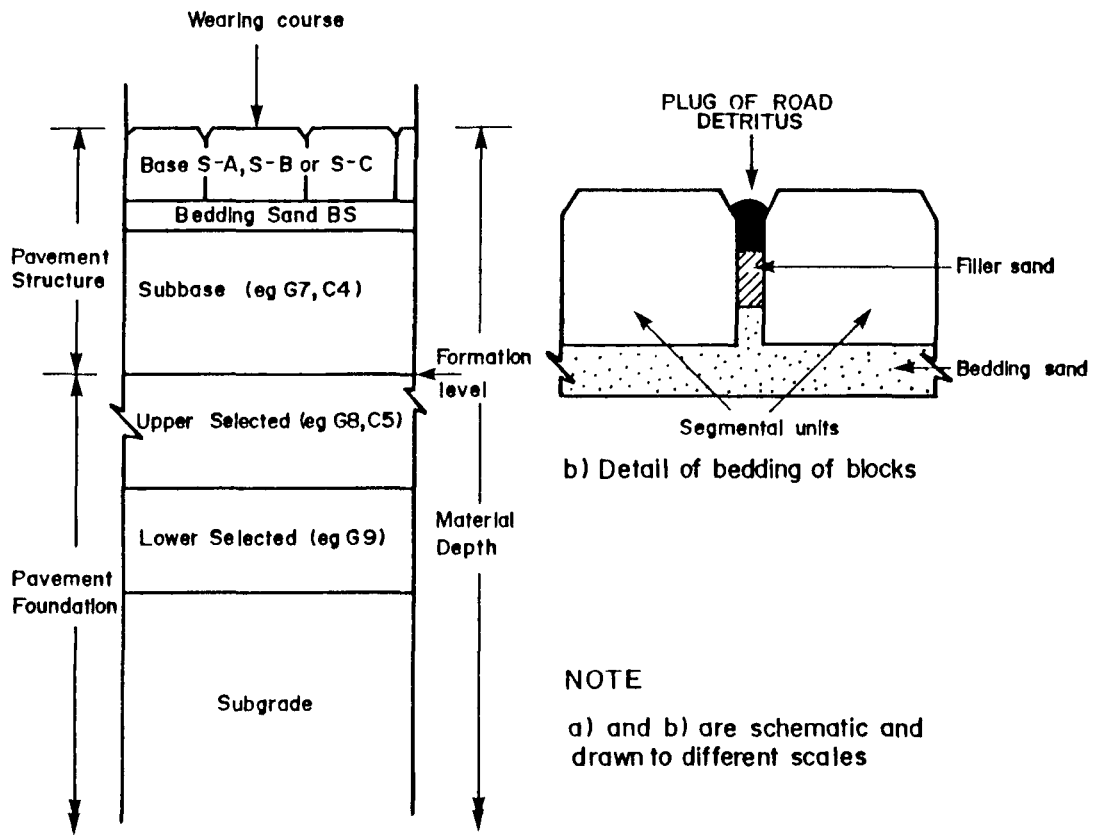
Both the discharge of surface run-off and the control of sub-surface water need to be considered. Surface run-off is generally readily controlled, but sub-surface drainage is important and must also be controlled. Certain in situ materials that are highly permeable, e.g. some Kalahari sands and Cape Flats sands, are free draining and little extra drainage is required. Impermeable materials may trap moisture and cause the pavement layers to become saturated, with an associated loss in strength. These will require deeper sub-surface drainage. Particular attention needs to be paid

Design CBR of Subgrade (%)	< 3	3 - 7	7 - 15	>15
Add selected layers upper lower	not applicable	150 mm G7 150 mm, G9 *	150 mm G7 -	- -
Treatment of in situ subgrade	special treatment required	proof roll	proof roll	proof roll

FIGURE 10.7

PREPARATION OF SUBGRADE AND REQUIRED SELECTED LAYERS FOR THE DIFFERENT SUBGRADE DESIGN CBS's (See figure 10.4 for material symbol eg G7)

* If the in situ subgrade is expected to be very wet or in wet climatic regions (Figure 2.1) an additional 150mm layer of G9 may be required.



a) Layers of pavement

FIGURE 10.8

TERMINOLOGY USED WITH SEGMENTAL BLOCK PAVING

to cuttings, high perched water tables, vlei's, etc.

The design procedures assume that the material properties specified are achieved in the field.

10.9.2 Subgrade below material depth

Certain special problems may arise in the subgrade which require individual treatment. The design procedure assumes that these have been taken into account separately.

10.9.3 Block laying tolerances and geometrics

Geometric design should follow practices for other pavements. Variable road widths, curves and junctions do not present problems in practice, since the blocks are small and can easily be cut and placed to suit the geometry of the pavement. Specially shaped blocks are also available in some cases.

10.9.4 Edge restraint

Edge restraint is required along the edges of a block pavement to prevent the outward migration of blocks, which would result in the opening of joints and loss of bond between the blocks. Edge restraint can be provided by conventional kerbing and may add to the aesthetics with precast or natural stone kerbing to contrast with the blocks themselves.

In large industrial or civic areas intermediate restraint measures may sometimes be necessary.

10.9.5 The bedding sand layer

The bedding sand is only included in block paving as a construction expedient. Although a substantial attenuation of the stresses applied to a block pavement occurs within the sand, much of the deformation in a pavement has been shown by

Shackel (1979) and (1979 No 2) to originate in the bedding layer. Three factors have been determined to have an important influence on the response of block pavements to traffic. These are:

- (a) the thickness of the sand layer;
- (b) the grading and angularity of the sand; and
- (c) the moisture content of the sand during compaction and in service.

A recommended grading for bedding sand complying with the above requirements is given in Figure 4.3. The thickness of the sand bedding layer has been found to fulfil the specified requirements providing it is kept within 25-30 mm range.

10.9.6 Compaction of blocks into bedding sand and sealing of joints

After the blocks are layed it is necessary to compact them into the bedding sand. Normally two cycles of compaction are applied. The first compactor-pass compacts the bedding sand and causes this material to rise up the joints by amounts of between 5 mm and 25 mm (see Figure 2.2). A finer jointing sand is then brushed into the joints.

The jointing sand should pass a 1,18 mm sieve and have at least 10 per cent (but preferably 15 per cent) of material smaller than 75 μm . A suitable grading envelope for jointing sand is given in Figure 5.6. Once the joints are filled a second compactor-pass is applied to bring the pavement to its final state. Each compaction cycle should involve at least two passes of the compactor.

10.9.7 Time effects of sealing of joints

Following the completion of a segmental block pavement, i.e. at the time when it is opened to traffic, the joint sealing would be as shown in Figure 2.2A. With the passage of time and the additional compaction caused by trafficking the joints

will be as shown in Figure 2.2B. The cumulative compactive effect of traffic will cause the blocks to bed further into the bedding-sand and displace some of the jointing sand vertically upwards. The action of passing vehicles removes some of the jointing sand which forms part of the road detritus. This detritus, which includes dust, particles of rubber from tyres and other particles, forms an upper plug over the jointing sand assisting the sealing of the blocks.

10.9.8 Steep grades

The minimal falls (in any direction) to the surface of block pavements should be 1% which allows water to drain across the pavement thereby reducing ingress by absorption or through the joints and eliminating ponding. Due to the ease of laying blocks especially by hand their use on steep grades is anticipated where only occasional vehicular access may be required. A word of warning however in respect of facilities sited on a hillside: the joints between the blocks on steep grades could become the drainage paths for stormwater. In such cases the pattern of the blocks is important since long joints in the direction of the grade could cause the joints to wash out rapidly. In such cases joints must be formed at an angle across the slope.

10.9.9 Re-use of blocks

An advantage of blocks is that they can be re-used. They can be lifted to effect repairs to failed areas of subbase or for the installation of services and relaid afterwards. As far as the structural design of segmental block pavements is concerned this aspect of the re-use of the blocks has no disadvantage provided that the established principles of laying are followed. Creep of the blocks can however take place on either side of the opening from which blocks are removed requiring the opening to be jacked apart or the blocks restrained from creep by other means. Failure to do this could result in difficulty in replacing blocks on

completion of the repair or if slightly smaller blocks were used the joints around the original opening would now be wider and could allow water ingress and subsequent saturation of subbase material.

10.9.10 Maintenance

Little maintenance work is normally required with segmental block paving except that of ensuring that joints are kept full of sand, the treatment of weeds and the correcting of levels of surfacing perhaps resulting from poor initial construction.

Various measures to deal with weeds growing within the joints of lightly trafficked areas are in current use. These include spraying with weedkiller at regular intervals or in providing a polyethylene sheet below the bedding sand during construction. This latter measure is not thought to be too effective since seeds could still germinate in the road detritus within the joints. Mine sand which is high in cyanide content to repel weed-growth can be used as bedding sand provided that its presence is not an environmental problem.

The correction of poor surface levels is effected by removing the area of blocks and bedding sand affected, levelling, and compacting the existing subbase (often with hand rammers) and replacing the blocks on the required thickness of replaced bedding sand.

Fired clay or concrete paving blocks meeting the specification appropriate to the intended usage, or in the absence of a suitable specification, products recommended by the manufacturer ought to be used to ensure that products of adequate durability and abrasion resistant characteristics are used. If the recommended Clifford (1982) minimum strength parameter of 25 MPa is achieved bricks may compare favourably with blocks in the long term.

10.10 DESIGN STEP 8 - COST ANALYSIS

Alternative pavement designs should be compared on a cost basis. The cost analysis should be regarded as an aid to decision-making. Although it is a very important factor, it does not necessarily include all the factors leading to a decision and should therefore not override all other considerations. The main economic factors which determine the cost of a facility are the analysis period, the structural design period, the construction cost, the maintenance costs, the salvage value at the end of the analysis period and the real discount rate. The cost analysis for segmental block pavements follows the method and principles expounded in TRH4 (1980), where the present worth of costs are calculated based on:

$$PWOC = C + M_1(1+r)^{-x_1} + \dots + M_i(1+r)^{-x_j} + \dots - S(1+r)^{-z}$$

where

PWOC = present worth of costs

C = present cost of initial construction.

M = cost of the i^{th} maintenance measure expressed in terms of current costs

r = real discount rate (expressed as a fraction)

x_j = number of years from the present to the i^{th} maintenance measure, within the analysis period (where $x_j = x_1$ years to the first maintenance measure to z)

z = analysis period

S = salvage value of pavement at the end of the analysis period expressed in terms of present values

Present worth of costs. This has limited applicability to block pavements. Initial costs are often somewhat higher than might be expected from a cursory investigation. The recovery rate of blocks is high and maintenance costs relatively low. However a comparison of initial costs was made which puts the value of blocks at the construction phase somewhat more into prospective.

10.11 COMPARISON OF COSTS

It is always difficult to give meaningful relative costs of various forms of construction as they depend on many factors such as the design and specification of the job, on the type of equipment used by the contractor, the efficiency of his work force, labour rates, the quality and price of materials and economic analysis method used in cost comparison.

However, in private discussions with several major Transvaal based block paving contractors (during May 1983) the following relative costs of precast segmental block pavements against premix bituminous paving (for use in three specific and different situations) were suggested. Figure 10.9 shows details of the paving sections used in the comparison. These data were subsequently presented in NITRR's hosted segmental block paving seminars held at various locations in South Africa during 1983.

1. a residential road approximately 1 km long by 6m wide
2. hardstanding around an industrial factory (+ 1 000 m²)
3. parking lot around shopping centre.

A summary of returns follows:

 1. RESIDENTIAL ROAD

(a)	Premix	R7,50 to R8,50/m ²
	Paving block (80 mm blocks on 150 mm crusher base)	R8,50 to R10,50/m ²
(b)	Paving block (costs include everything above subbase i.e. 80 mm block, bedding sand, compaction, edge filling)	R12,50 to R13,50/m ²
	Extra costs are the supply and lay of heavy or light duty kerbing at	R8,50 to R10,50/m ²
	Premix is R1,50 to R2,00/m ² cheaper	

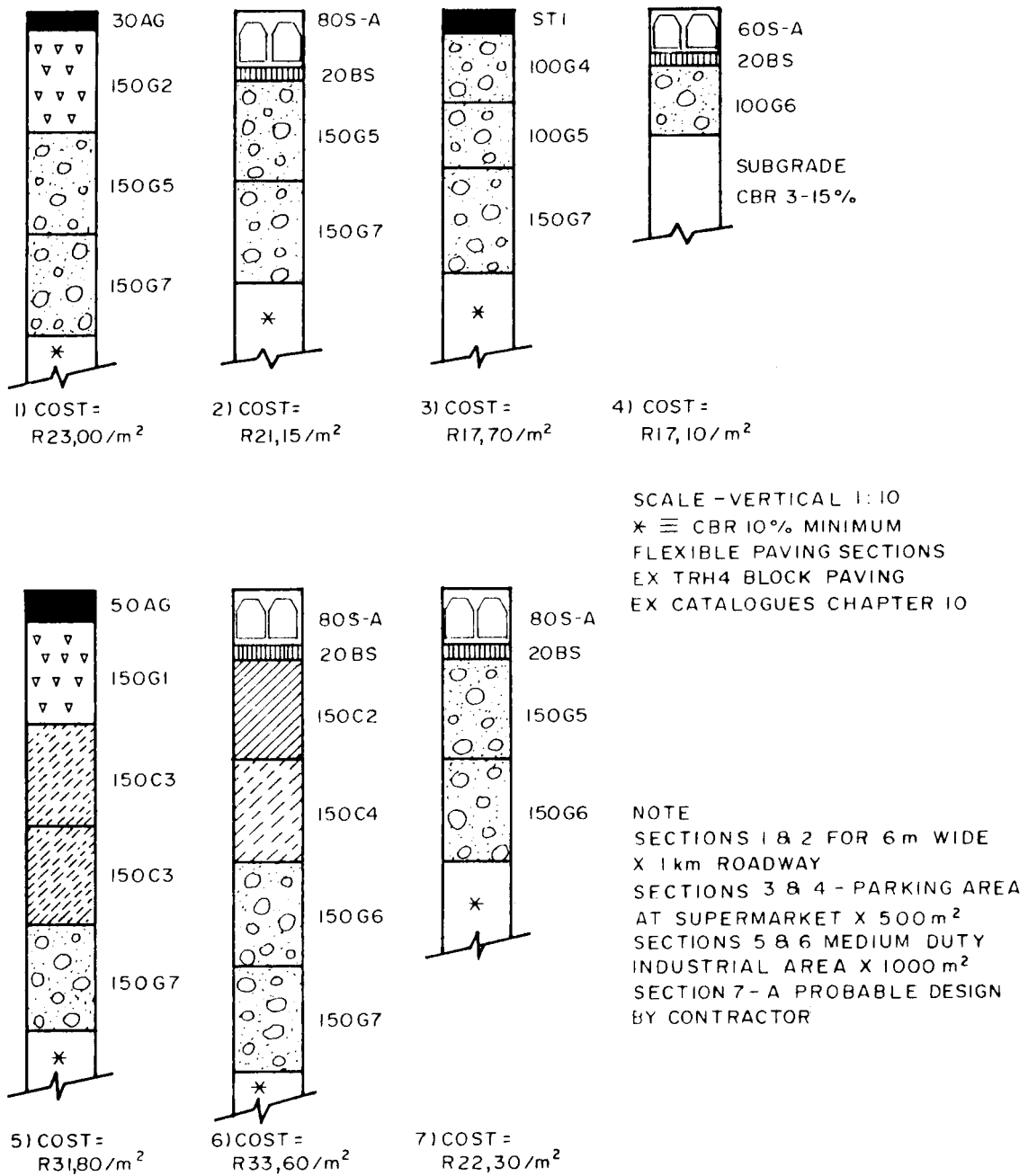


FIGURE 10.9
PAVEMENT SECTIONS USED FOR COST COMPARISONS

- (c) Prices from a recent tender for residential roads
- Premix: 40 mm premix, 100 mm treated base, 150 mm selected layer R13,00/m²
- Paving block: 80 mm blocks, 150 mm stabilised subbase 150 mm selected layer, proofrolling subgrade R15,26/m²
- (d) Premix: 30 mm, 150 mm graded crushed stone, 150 mm natural gravel, 150 mm gravel soil R23,00/m²
- Paving block: 80 mm blocks, 150 mm natural gravel (CBR † 45) 150 mm gravel soil R21,15/m²

2. HARDSTANDING AROUND AN INDUSTRIAL FACTORY

- (a) Paving block (costs include 60 mm block and everything above subbase) R9,00 to R10,50/m²
- Premix is R1,50 to R2,00/m² cheaper
- (b) Bituminous premix paving R7,50 to R8,50/m²
- Concrete paving block (80 mm thickness on 150 mm crusher run base) R8,50 to R10,50/m²
- (c) Very little premix is used for this application and competition is between concrete paving block and case in situ paving
- Paving block: 80 mm blocks, 2 layers 125 mm stabilised material R16,00/m²
- In situ concrete: 150 mm concrete slab lightly reinforced, 150 mm stabilised subbase R21,00/m²
- (d) Premix: 50 mm premix, 150 mm graded crushed stone 150 mm dumprock, 150 mm dumprock, 150 mm gravel soil (CBR † 15) R31,80/m²

Paving block (as per NITRR Technical Report RP/9/81): 80 mm block, 150 mm treated crushed stone (C2) 150 mm natural gravel (G4 - CBR $\nless 80$) 150 mm gravel soil (G7 - CBE $\nless 15$)	R33,60/m ²
Paving block (as designed by contractor): 80 mm block, 150 mm natural gravel (CBR $\nless 25$)	R22,30/m ²

3. PARKING LOT - SHOPPING CENTRE

- | | | |
|-----|---|-----------------------|
| (a) | Paving block using 80 mm blocks
R1,00 to R1,50 more expensive
than premix. If paving block
thicknesses reduced to 60 mm
then price differential reduced
by 50 cents. | |
| (b) | Premix: 40 mm, 100 mm stabilised
base, 150 mm selected layer,
proofroll | R7,00/m ² |
| | Paving block: 60 mm blocks, 100 mm
treated subbase, proofroll | R12,50/m ² |
| (c) | Premix: Premix, 100 mm
natural gravel (CBR < 80) 100 mm
natural gravel (CBR < 45)
150 mm gravel - soil (CBR < 45) | R17,70/m ² |
| | Paving block: 60 mm block, 100 mm
natural gravel (CBR < 25) on
sub-grade CBR - 3 -15%) | R17,10/m ² |

Though the initial cost of concrete block pavings is generally higher, as seen from the cost comparison presented it must be stressed that realistic "life cost" costing would show segmental block paving to be cheaper than black top pavements.

At the Cape Town symposium the following extract from an internal South African Transport Services (SATS) internal technical report dated January 1983 was presented:

"SUMMARY (Present prices)

	<u>Premix</u>	<u>Blocks</u>	<u>%</u>
Initial cost	R11,40	R14,00	+ 23
Maintenance	4,97	0,80	
Salvage	0	-1,02	
Total	<u>R16,37</u>	<u>R13,78</u>	- 16

Although initial construction cost of blocks is R2,60 (R14,00 - R11,40) or 13% more expensive than premix, blocks are in the order of R2,60 (R16,37 - R13,78) or 16% cheaper during a lifespan of 25 years when rehabilitation and maintenance is taken into account.

Further, blocks have many additional advantages i.e. less load sensitive, easy access to services, less sensitive to fuel spillage and impact loading. It is therefore felt that the benefit gained by higher initial cost can be justified.

A senior representative of the National Transport Commission (NTC) reported at one of a series of segmental block symposiums during 1983 (Pretoria, Pietermaritzburg and Cape Town) that NTC are proposing to the Road Authorities that in the economic analysis of various pavement types the discount rate will be reduced from 10 to 5%. This proposal favours concrete paving block pavements in relation to black top pavements which generally require more maintenance during their service life.

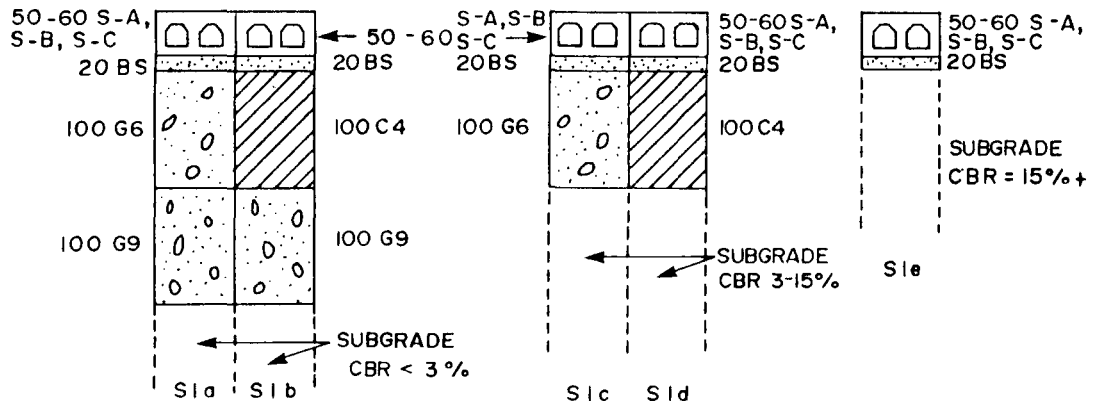
These findings of SATS which were for a specific pavement type could be extended to relate to other pavements where blocks can be considered. Even with the favourable long-term cost effectiveness of block pavements the real cost effectiveness must include some financial benefit for the additional advantages listed above.

In the case of abnormally heavy industrial stacking areas (Figure 10.12 (D)) there is some doubt, due to the very limited experience, as to the applicability of the equivalency concept. The design of pavements to support heavy industrial traffic should, with current limited knowledge of testing and modelling of

such pavements, be made for actual numbers of specific vehicles whose axle loads are known. The heavier pavements categorised within the (D) subdivision of Figure 10:12 and within E4 traffic in Figures 12.8 and 12.9 are designed for limited numbers of heavy industrial vehicles. It must be appreciated that a single very heavy load could cause severe deformation or advanced distress where special investigation as to the adequacy of a particular pavement for carrying specific industrial loads has not been made. For these reasons warning notes are given in the figures to prevent the misuse of some of the designs when used in industrial applications.

10.12 CATALOGUE OF DESIGNS FOR THE VARIOUS CATEGORIES OF SEGMENTAL
BLOCK PAVEMENTS

These are given in Figures 10.10 to 10.15 inclusive.



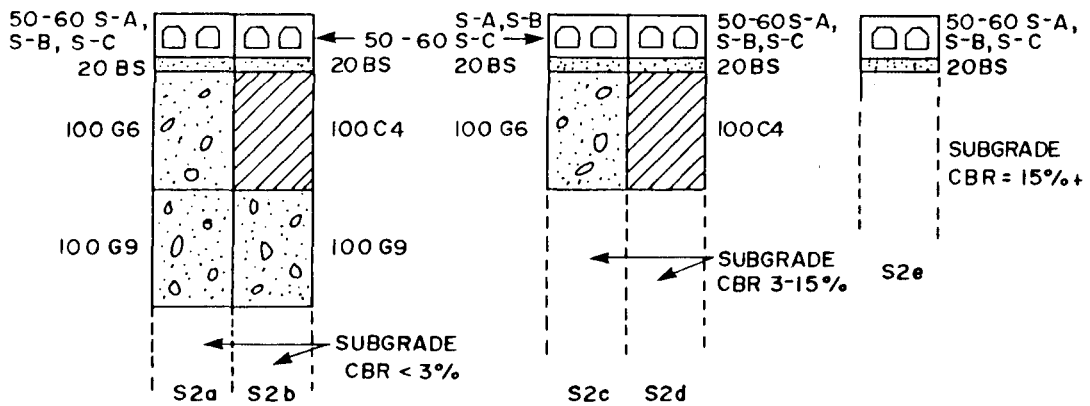
Traffic class	Cumulative equivalent traffic E80 / lane or area
E0	$< 0,2 \times 10^6$

NOTE: See figure 10.4 for explanation of material codes (eg BS, G 10)

FIGURE 10.10 (JULY 1982)

**CATALOGUE OF DESIGNS FOR SEGMENTAL BLOCK PAVING
CATEGORY SI**

(For low speed pavements where wheel and axle loads are light (eg parking areas) where low speed is defined as < 30 km/h)



Traffic class	Cumulative equivalent traffic E80 / lane or area
E 0	$< 0,2 \times 10^6$

NOTE: See figure 10.4 for explanation of material codes (eg BS, G10)

FIGURE 10.11 (JULY 1982)

*CATALOGUE OF DESIGNS FOR SEGMENTAL BLOCK PAVING
CATEGORY S2*

(For civic uses such as footpaths, cycleways, around public buildings and for paving city squares)

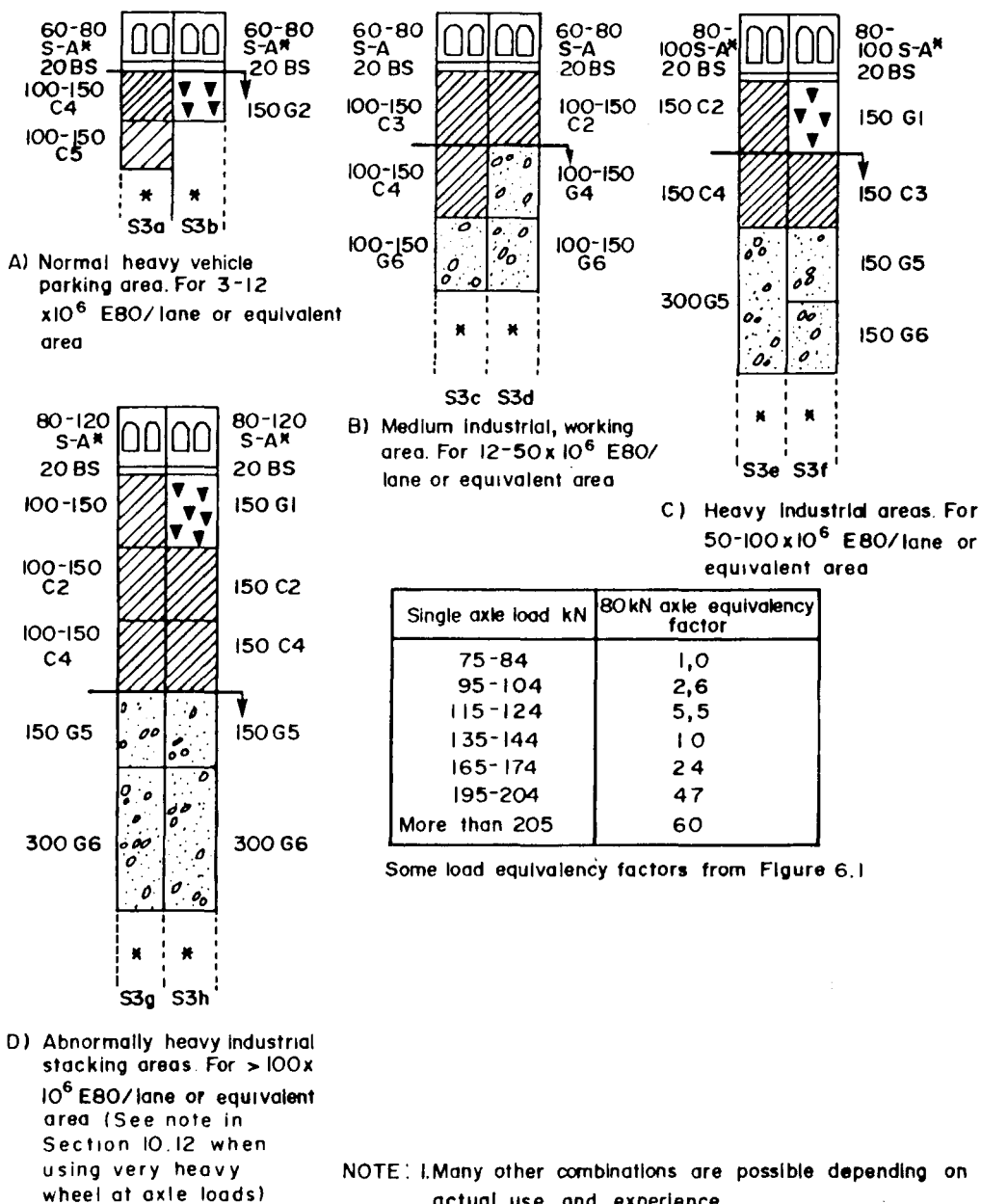
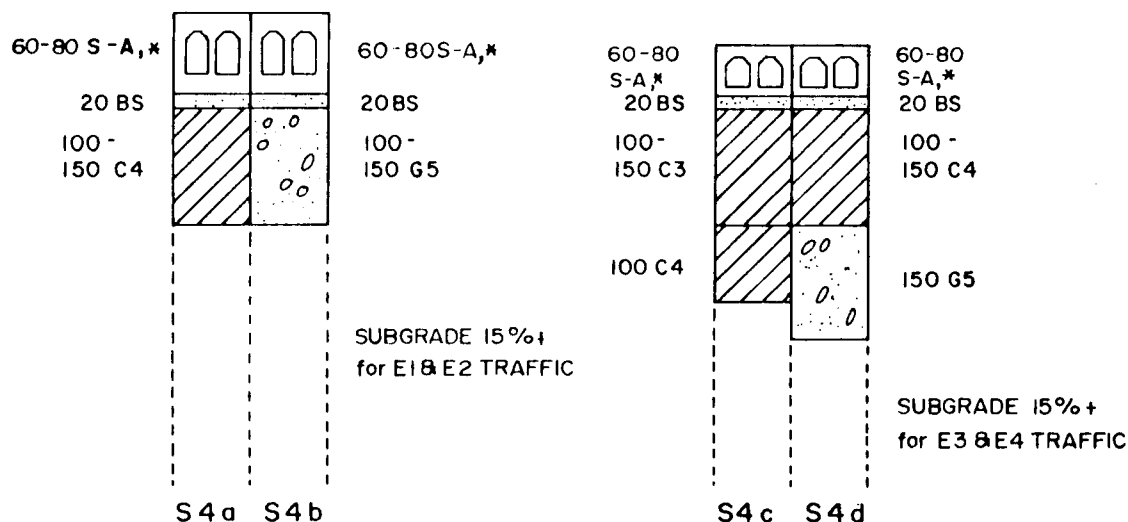


FIGURE 10.12 (JULY 1982)

CATALOGUE OF DESIGNS FOR SEGMENTAL BLOCK PAVING CATEGORY S3

(For highly-loaded working areas where speeds are generally less than 30 km/h. Tracked vehicles or vehicles with a slewing action may be used. Point loads from stacking, trailer feet and dolly wheels may be expected)



*(S-B, & C could be used where experience has shown them to be satisfactory)

NOTE : 1. See figure 10.4 for explanation on material codes (eg G5, BS)

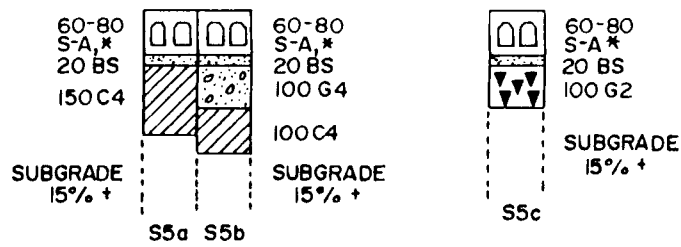
2. If CBR of insitu material is = or > than the recommended layers, the layer/s may be omitted

Traffic Class	Cumulative equivalent traffic E80/ lane or area
E0	See category S1 and S2
E1	0,2 - 0,8 x 10 ⁶
E2	0,8 - 3 x 10 ⁶
E3	3 - 12 x 10 ⁶
E4	12 - 50 x 10 ⁶

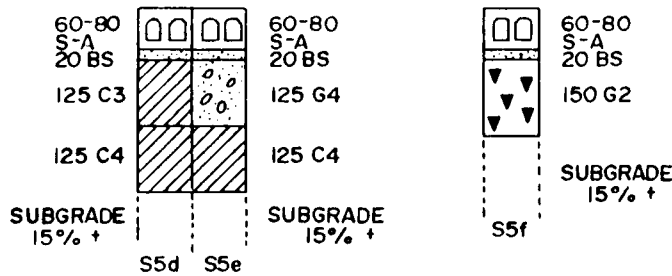
FIGURE 10.13 (JULY 1980)

**CATALOGUE OF DESIGNS FOR SEGMENTAL
BLOCK PAVING CATEGORY S4**

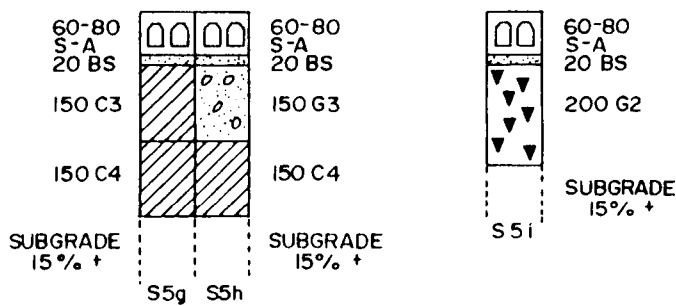
(For urban roads and access roads to industrial areas with speeds not greater than 60 km/hr - providing skid resistance conclusions from Chapter 8 are applied, this speed restriction could be removed)



A) For traffic class EO ($< 0,2 \times 10^6$ E80/lane or area)



B) For traffic class EI ($0,2 - 0,8 \times 10^6$ E80/lane or area)



C) For traffic class E2 ($0,8 - 3 \times 10^6$ E80/lane or area)

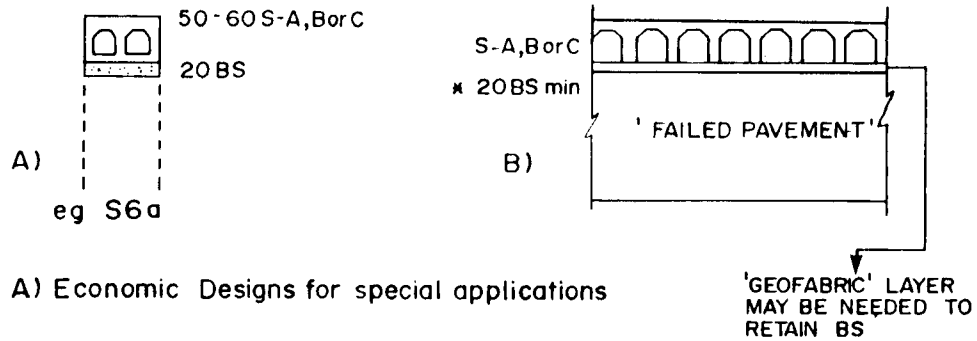
* S-B and C could be used where experience has shown them to be satisfactory

FIGURE 10.14 (JULY 1982)

CATALOGUE OF DESIGNS FOR SEGMENTAL BLOCK PAVING CATEGORY S5

(For higher speed pavements such as inter urban collectors and urban roads)

- NB 1. These are research designs which limit the extent of permanent deformation under traffic and as yet not proven in practise - see Chapter 10 for limitations
2. See figure 10.4 for explanation of material codes (eg G2, C4)
3. If CBR of in situ material is = or > than recommended layers, the layer(s) may be omitted



- A) Economic Designs for special applications
- B) Overlaying a 'failed pavement'
- C) Designs from Catalogue from S1 – S5 where waste materials are used to replace designed layers

* BS should maintain an even thickness, to correct levels it is recommended a weak mix of concrete is used. See Figure 10.4 for explanation of material codes (eg BS)

FIGURE 10.15 (JULY 1982)

CATALOGUE OF DESIGNS FOR SEGMENTAL BLOCK PAVING CATEGORY S6

(For special pavements, innovations, overlays and cost saving ideas)

CHAPTER 11

EXPERIENCE OF SEGMENTAL BLOCK PAVING IN AUSTRALIA, BRITAIN, ISRAEL AND EUROPE: POSSIBLE APPLICATIONS IN SOUTH AFRICA

CHAPTER 11

EXPERIENCE OF SEGMENTAL BLOCK PAVING IN AUSTRALIA, BRITAIN
ISRAEL AND EUROPE: POSSIBLE APPLICATIONS IN SOUTH AFRICA

11.1 INTRODUCTION

Educational study visits were made to Australia, Britain, Israel and Europe to compare developments of block paving with South African practice. These visits were of great significance to this thesis since they added considerable bearing on aspects of the structural design of segmental pavements.

Current research and application in the field of segmental paving blocks in South Africa benefitted considerably from discussions with Dr B Shackel of the School of Civil Engineering, University of New South Wales (Australia), who introduced and pioneered research in South Africa. Since the time of Dr Shackel's involvement in South Africa research much new work had been done which has culminated in the design document Clifford (1982) in which the procedures for the design of block pavements for a variety of uses are detailed. A catalogue design approach was chosen since this represents the same style as used for other pavement types in South Africa.

In the Netherlands the use of blocks (more particularly bricks) has enjoyed a long history. Bricks have been used extensively for paving because they can be easily taken up and relaid. In many parts of the Netherlands, settlements of paving is a problem and segmental block roads have for hundreds of years proved suitable. Over such a long period of time much experience has been gained.

11.2 PRINCIPAL FINDINGS

This chapter details some of the principal findings of these visits. More details of a nature which is not directly applicable to structural design are given in Appendix C. As a

result of the visits, the design document which is now the South African design guide for segmental paving, is considered suitable and complies not only with local but also with international practice. (Clifford 1984 No. 4.) There are still some minor differences of opinion (e.g. the use of catalogues or design curves) but they are minor points when seen within the overall context.

It is hoped that the findings discussed in this chapter will benefit South Africa financially and lead to improved knowledge and practice. Recommendations of possible changes in South African practice which could be introduced are given at the end of the chapter.

11.3 PAVING IN URBAN AREAS - i.e. Category S2

A significant practice in Australia and parts of Europe is to lay block paving in urban areas, especially around public buildings, on a substantial subbase. The subbase, which in several cases is considerably more substantial than either that recommended by the design curves used in Australia or that given in our own catalogue of designs, is often either of concrete or bituminized material. The reason for this is to ensure that in public areas the initial levels are maintained. This is more important than in other areas where some differential settlement is allowable. In order to use blocks in areas in which the considerations are more aesthetic than structural, accurate levels are attained in the subbase layer by using either 100 - 150 mm of weak-mix unreinforced concrete or by surfacing the subbase with 30 - 50 mm of bitumen. Required falls to the surface by this means can be readily and accurately accommodated prior to the laying of the blocks themselves. In at least two cases a bituminized sub-layer was used to isolate the blocks from water movements in the lower layers of the pavement owing either to high water tables or to fluctuating ground water levels.

11.4 JOINT WIDTH

The width of joints in block paving is more important than has perhaps been realised in the past. There are many examples of what is considered in Australia to be a high standard of block laying where the joints are as small as possible. A serious disadvantage of pavements laid in this way is that joints of less than 2 mm in width often contain little or no jointing sand. This would obviously reduce the contribution of individual blocks to the structural properties of the pavement. With use the individual blocks move in relation to one another which results in spalling of the edges. Although this is not structurally damaging, the overall appearance of the pavement is less desirable and the small pieces of broken corners could cause problems if not swept away. Spalling due to tight joints is more pronounced on S-A type blocks since the angles of the corners are more acute and there are more corners per block than with other shapes.

Blocks laid to a poor standard were seen where joint widths of more than 5 mm were common, especially in the Netherlands. The amount of sand required to fill the joints was too great to allow intimacy between the blocks forming the joint to develop. The shear strength of the jointing sand would be the limiting factor in the structure of the pavement.

From the observations made at a number of sites at various locations, and from discussions with both specifiers and users of block pavements, and for the design reasons enumerated in Chapter 5, joint widths for structural pavements should be within the range of 2 to 5 mm.

11.5 BLOCKS LAID DIRECTLY ON DESERT SANDS

An interesting use of blocks in Israel is for tracked vehicles. In the south of Israel in areas of desert, blocks have been placed directly on compacted sand to provide satisfactory roads. The tracked vehicles caused some spalling to the corners and an idea of reducing or even eliminating the chamfers on the blocks

was reported to be a satisfactory way of overcoming this. The wet compressive strength specifications for the blocks was typically 65 MPa.

11.6 USE OF BLOCKS ON AIRPORTS. LUTON AIRPORT UK

Segmental blocks have been used in an experimental capacity at the Luton International airport in the UK for hard-standing and maintenance areas. The choice of blocks was made because of their durability, ability to transmit typical $1,4 \text{ MN/m}^2$ tyre pressures of aircraft using the airport, good skid resistance, resistance to fuel and oil spillages and their resistance to high jet-engine exhaust velocities. The first areas were laid in 1981 and have performed markedly better than adjacent asphalt areas where surfacing loss due to oil spillage was seen.

The authorities are satisfied that blocks are an ideal material for hardstanding areas at airports. More recently a second experimental area was laid. Blocks were used to pave the blast-pads on either end of the runway. These large areas receive full jet-blast and some heavy braking.

11.7 WHAT WET COMPRESSIVE STRENGTH (MPa) IS DESIRABLE?

Concern was expressed by several people during discussions about the desirable and attainable wet compressive strengths for concrete blocks. Several opinions were put forward suggesting a wide range of strengths. Some manufacturers with the most modern equipment have a capability of producing various wet compressive strengths from 25 MPa to more than 60 MPa. Architects and landscape gardeners would like blocks of less than 15 MPa for non structural use. In order to obtain 60 MPa and greater, one company said that they used 12 per cent cement content with a moisture content just adequate to hydrate the cement. There was almost no slump for such a mix and the finished products looked and felt very smooth due to the long time during which they were subjected to vibration in the manufacturing process. The blocks were then steam-cured.

Fear was expressed by users that such a hard product would also be undesirably brittle. Examples were seen where these blocks, especially when laid close together, had spalled and cracked at the corners. To achieve such a high strength specification the most modern high-compaction manufacturing machinery must be used.

The range of blocks preferred by Australian specifiers and users appeared to be 25 - 45 MPa. In Europe where low temperatures are experienced a typical specification is 55 MPa. This is not a wet compressive strength but can be attained by any method as a dry compressive strength. The range recommended in the South African design guide (Clifford 1984) of 25 to 35 MPa for normal use and 40 MPa for special industrial applications appears suitable.

11.8 RECOMMENDATIONS

- (a) It is recommended that consideration be given to laying blocks directly on compacted desert sand in desert areas of southern Africa.
- (b) It is recommended that blocks be considered for hard standing areas at airports.
- (c) It is recommended that for South Africa the wet compressive strength for blocks should be 25 and 35 MPa for normal use, and 40 MPa for particular industrial areas.

Other recommendations extracted from Appendix C "Block Paving in Australia, Israel, Britain and Europe"

- (d) It is recommended that investigations into the use of blocks in factories and other buildings should be intensified.
- (e) It is not recommended that concrete or bituminized subbases be used under segmental paving as described in Section 11.3 in this chapter. This recommendation does not refer to the stabilization of sublayers as required in the structural design

- (f) It is not recommended that large rubber bands be used to maintain a 2 mm minimum joint width
- (g) It is recommended that trials be undertaken to study the architectural use in South Africa of the thinner blocks used in the Netherlands
- (h) It is recommended that a part-block measuring device like the Anderson meter be introduced into South Africa.

CHAPTER 12

CONCLUDING REVIEW AND RECOMMENDATIONS FOR FURTHER WORK

CHAPTER 12

CONCLUDING REVIEW AND RECOMMENDATIONS FOR FURTHER WORK

12.1 CONCLUDING REVIEW

The studies reported in this thesis are of necessity limited in scope because the subject is vast. Segmental block paving has been shown to be extremely versatile satisfying the needs of both engineers and architects for a wide variety of uses, from the lightest applications where aesthetic values are of prime importance, to the heaviest industrial pavements. The use of segmental block pavings in southern Africa continues to increase and the need for the design guidelines given in Chapter 10 is even more significant now than when the studies reported in this thesis started a few years ago.

This thesis has developed and produced a suitable basis for design for use in southern Africa identifying the parameters which affect design, such as skid resistance, drainage, tolerances and so forth. This design base is therefore a service tool to both manufacturers and specifiers of segmental blocks. As the experience of using blocks increases the potential for new shapes, styles and designs is exciting, and the design of pavement structures using such new ideas is a simple development on what is presented in this thesis.

It is surprising that little other research has been done elsewhere in the world especially when various types of blocks were used from earliest times. The economics of these ancient pavements was seen to be questionable when considering their great thickness and the relatively light applied loading of foot and horse cart traffic. The real advantages of modern technology can be recognized when a comparison of the designs given in the catalogue in Chapter 10 is made with the Roman pavements for example. The confidence levels and attained with today's designs includes strict dimensional tolerances and quality-control techniques which produce blocks with a close range of specifications. Such measures were not available before the machine-age.

Segmental block pavements are flexible in their response to applied loads. It would be impractical to consider an equivalent thickness of reinforced concrete supported on a CBR 15 per cent material as being suitable for carrying the particular loading as specified in the catalogue for block paving. Block pavements were seen to require properly designed joints where the correct range of joint-width and materials used to fill the joint add significantly to the structural strength of the pavement.

Properly constructed joints are important in waterproofing the pavement by stopping the ingress of water into the supporting layers. A simple easily-repeatable test for evaluating the waterproof characteristics of a block pavement was designed. Its use as a quality-control test for new and older block pavements has been recently proposed and accepted in principle by the industry. In studying the waterproofing of block pavements the existence of some degree of porosity in the blocks themselves was identified and the terms "storm" and "shower" were used as a measure of its importance. Other aspects of the waterproofing included the formation of a detritus plug as an additional seal in the joints and the need to recognise the micro and macro climatic regions which affect drainage.

Some manufacturers are under the misapprehension that a phenomenon occurs with block pavements where after some time and use the pavement is said to "lock-up". The heavy vehicle simulator (HVS) tests showed that a reduction of deformation occurs under particular applied loads after the pavement settles-in. This settling-in was shown to be similar for all pavements and involves the dissipation of pore pressures and the unification of density profiles by trafficking and environmental factors. Uninformed salesmen have, perhaps unknowingly, tried to use the settling-in conditions to advantage by claiming it as an additional benefit of block pavements. The real benefits of properly designed and

constructed block pavements have been shown.

The HVS and its ancilliary instrumentation were used to prove the findings of mathematical modelling. The tests were designed to traffic some of the pavements to failure thereby enabling the modes of failure to be studied. Modulus values thus attained were used in checking the structural adequacy of the catalogued pavement designs given in Chapter 10.

An aspect of the study of the joints around individual blocks led to the development of an instrument for extracting individual blocks by lifting them from their matrix. The resistance of the joints to this extraction is therefore an indication of their structural strength. This instrument, which is also simple to operate and easy to transport, was also recommended and approved by industry for use in quality-control.

There is some reluctance, by architects particularly, in specifying sand bedded and jointed blocks, which they term dry-paving where some doubt exists with regard to waterproofing. The traditional method is to mortar joint paving blocks and provide expansion, contraction and construction joints at required intervals. Mortar-jointed paving is termed wet-paving by architects. By comparison with the methodology for dry-paving the mortaring of joints is expensive and a more complex operation requiring additional staff, materials and expertise. A conclusion reached in the HVS studies on mortar jointed S-B blocks was that if joints are to be mortared than the minimum width of joints should be 6 mm. The pavement thereby is no longer flexible and the movements under load produce cracking in the joints, or in the blocks in the event of jointing mortar being stronger than the blocks.

Blocks and setts have been used as a paving for city streets for hundreds of years. The speed restrictions imposed on city streets of 50 or 60 km/h has suggested the imposition of a speed restriction on traffic over blocks. Skid resistance tests were

done on a variety of block pavements and with certain restrictions their use in higher speed facilities, where design for skid resistance is important, can be recommended. Other factors such as noise generation by high speed or riding quality may be limiting criteria.

The structural design of segmental block paving follows a logical appreciation of the various factors that need to be considered. The design strategy includes practical aspects such as material availability, environmental factors and the improvement of in situ material. It is hoped the current design methodology which involves soaked CBR values will be replaced with insitu CBR values especially when one considers the substantial areas of southern Africa which are classified as dry. By this means reductions in thicknesses of subbase material with the resultant savings in cost will be possible. Other practical considerations are enumerated and these include the containment by kerbing, use of herringbone bond and techniques for paving on steep grades. The catalogue designs given are in a similar form to those given in TRH 4 thereby allowing easy comparisons to be made by a designer. Modulus values for blocks were found to be within the range 400-2 000 MPa with a design target value of 1 000 MPa. At this stage insufficient experience has been gained in designing block pavements and it may be possible to raise the target level in the future.

The structural design catalogues show block pavements which are in some cases thinner than an equivalent design using bitumen or tar layers. The thesis has shown the waterproofing capabilities of the blocks which form not only the surface of the pavement but are the base layer as well. The improved waterproofing characteristics reduces the pavement's susceptibility to ingress of water with any subsequent effects on the sublayers.

In southern Africa failures to pavements normally occur within the base and subbase layers. It is rare that subgrades cause failure. Since the blocks are a good base layer to the pavement it follows that a block pavement should be less susceptible to failure within the base.

Black-top flexible pavements often reflect cracks in cemented lower layers through to the surface. These cracks allow water to ingress with possible effect on sublayers. The blocks are a pre-cracked and pre-sealed pavement and effectively eliminate any reflective cracking thus better protecting the sublayers.

For the above reasons it is possible to reduce the overall thickness of block pavements and this compares favourably with other pavement designs for similar traffic.

Some interesting ideas which can be used in southern Africa were found during visits to Australia, the Middle East and Europe. Interest in block paving was stimulated in southern Africa by Dr Shackel during a sabbatical at the CSIR. Work done by him in Australia over several years prior to his sabbatical put the Australian practise in the forefront. However, the unique facilities of the CSIR and the research effort started during the sabbatical has, in the opinion of many in the block paving industry, put South Africa in the forefront. The South African designs are now more economical and provide a greater degree of confidence than those seen elsewhere.

Several symposia have been hosted by CSIR to introduce the design guide and the block paving catalogue into practice. These have been held at Pretoria, at Pietermaritzburg and at Cape Town. Several hundred consulting engineers, provincial road engineers, central government engineers and those from the industry have attended. These symposia generated considerable interest in blocks and have provided additional areas for use.

Following a request by a consulting engineer to consider blocks for heavy duty mine roads the proposals given in Figure 12.1 were drawn up. At a later date it was discovered that blocks had been used experimentally for some time in a diamond mine. The problems experienced by the mine which led them to consider blocks were the excess tyre wear on the unimproved mine floor, the expense in closing sections of the mine whilst concrete flooring was curing and the heavy loads induced by the machinery. Tyres for the 25 tonne vehicle and its 6 tonne load were worn out in as

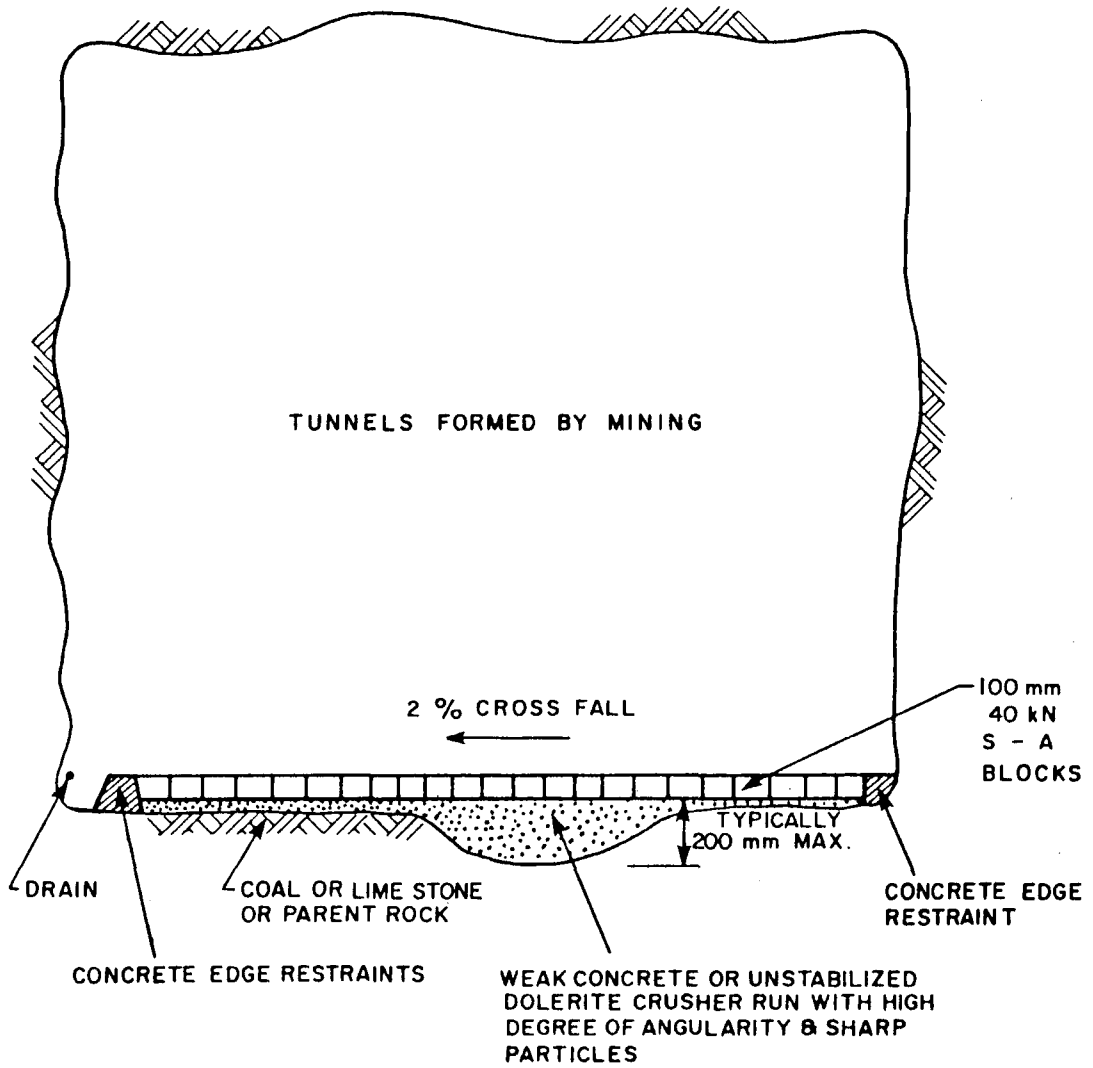


FIGURE 12.1

*CROSS SECTION OF PROPOSED SEGMENTAL
BLOCK MINE ROAD*

little as 100 hours of use when driving and cornering on an unimproved mine tunnel. Concrete flooring had been laid in places but the quality was poor. The tyres lasted for about 500 hours on the concrete flooring but potholes soon formed in the concrete, especially when cornering where the heavy vehicles induced torsional loads on the tyres. The potholes were difficult to repair and required pneumatic breakers to open out the pothole prior to filling with rapid curing concrete. Blocks were used in a similar way to those drawn on Figure 12.1 and areas of excessive wear easily reinstated. The tyres were found to last for an average of 2 000 hours when trafficking on the blocks. The driver comfort, engine wear and fuel economy all improved with the use of blocks.

An interesting use of blocks was made at the loading face of the mine. It was found that the wear on the surface of the blocks was excessive because of the scraping of the bucket of a loading shovel across the floor. Mine engineers installed a steel channel in the centre of the road along which the loading bucket would run and to either side of the channel blocks were used. In order to provide a thicker pavement the blocks were laid on their side or on end depending on the severity of loads induced by the wheels of the loading shovel. In this case S-A blocks were used but by placing them in this fashion they became S-C blocks since there was now no interlocking effect. Even with those measures the blocks had to be replaced every few months due to the severe conditions induced by loading at the face where loading continues 23 hours per day. The mine authorities appreciate the properties of the high-quality factory produced blocks with the ease and minimum time taken to lay the blocks. The savings in machine wear and down-time justified replacing blocks at the relatively short intervals of several months.

The advantages of using segmental blocks within factory buildings include the ease of taking up blocks to allow the installation of services within trenches or for building foundations for machinery. The disadvantages of using blocks for this purpose is that the pavement surface is not smooth because of the joints, and vehicles or trolleys with iron wheels are difficult to use. Also if nuts, bolts, pins or other small items are dropped they could be lost in the joints.

Dusting of concrete floors in factories also has many disadvantages. A delegate at one of the introductory symposia on blocks conceived an idea of overlaying segmental blocks with a thin wearing surface to utilize the benefits of blocks, i.e. flexible design, ease of removal, maintenance etc with the advantages of a smooth wearing surface. The HVS was used to induce industrial loading onto several trial sections of suitable types and thicknesses of topping laid over blocks. Figure 12.2 shows the application of Latexfalt surfacing to an area of blocks. Latexfalt is manufactured from an asphaltic mixture and a special additive made by a closely guarded method. It provides a flexible, hard wearing, mildly-acid resistant surface without the need for construction, expansion or contraction joints and seemed to complement the blocks ideally for this type of use. Figure 12.4 shows details of this composite flooring system.

The manufacturing process of segmental blocks to provide high quality-control units with strict dimensional and material specifications requires little machinery. Paddle mixers, delivery chutes and stockpiles of materials for mixing do not require much sophistication and these can be sited almost anywhere including some of the most remote parts of the subcontinent. The machine used to make the blocks together with the moulds and vibration equipment must, however, be made to the highest standards. This is a small unit and is shown in Figure 12.3. The machine requires very little in the way of foundations and protection from the weather. This unit can also be transported to remote areas. It is therefore possible to produce units to the highest standards at sites convenient to the location of the block paving projects thereby using local labour and materials in the production of a high quality product.

A recent development has taken place in the manufacturing process of blocks. This involves the wrapping of palletized blocks with heat sensitive "shrink-plastic" wrappings. The blocks can be packaged twenty four hours after their manufacture at the laying-head of the block making machine. Initial one day air-curing on pallets is shown in Figure 12.5. As the blocks are within the plastic wrapping any water given off remains as vapour within the packages and

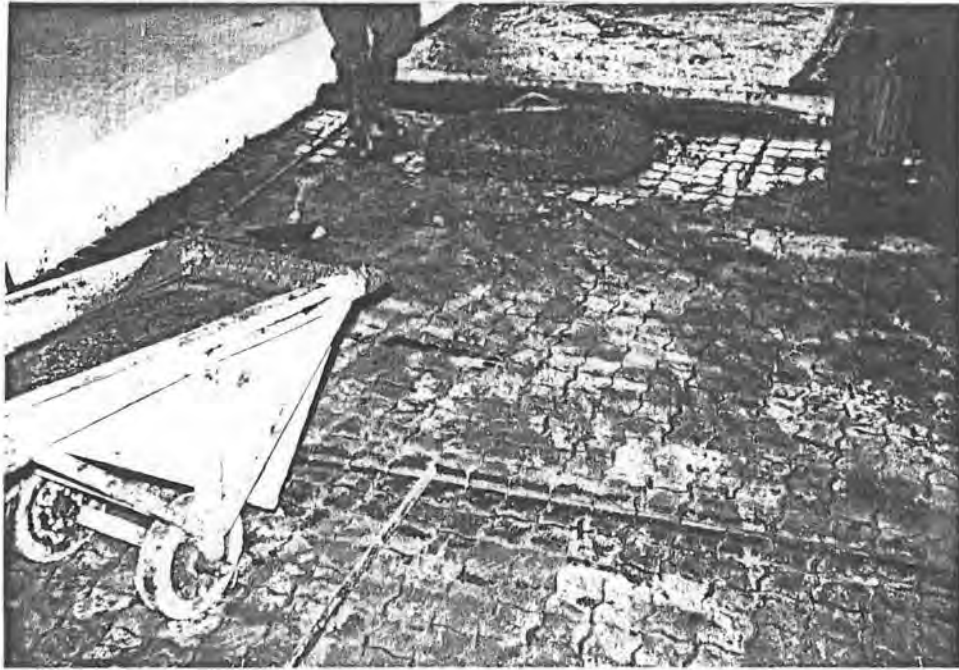
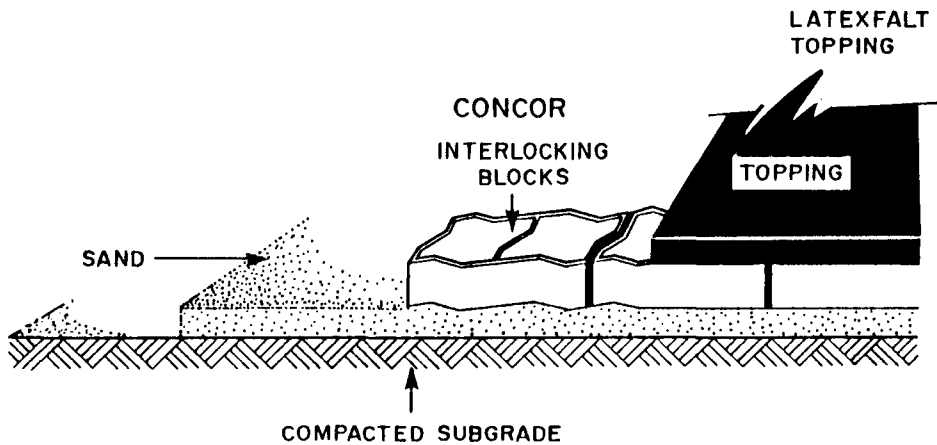


FIGURE 12.2
APPLICATION OF LATEXFALT OVER BLOCKS FOR FACTORY FLOORING



FIGURE 12.3
"LAYING HEAD" OF BLOCK MAKING MACHINE



TYPE	TOPPING THICKNESS mm	COMPRESSIVE STRENGTH MPa	APPLICATION
A	25-35	25-30	DOMESTIC AND COMMERCIAL
B	25-35	30-40	LIGHT INDUSTRIAL
C	30-40	40-50	MEDIUM INDUSTRIAL AND FACTORY FLOORS
D	30-50	50-70	HEAVY INDUSTRIAL AND HARD-WEARING SURFACES
E	40-50	70+	EXTREMELY HARD WEARING SURFACES

NOTE :

1. THICKNESS OF INTERLOCKING FOUNDATION BLOCKS CAN VARY FROM 60mm to 100mm
2. JOINTS IN TOPPING SLABS VARY BETWEEN 3,00 and 4,50 m CENTRE TO CENTRE

THESE COMPOSITE FACTORY FLOORS ARE :-

- EASY AND QUICK TO LAY
- HIGH QUALITY CONTROL ON MATERIALS AND WORKMANSHIP
- ECONOMICAL
- REDUCES SHRINKAGE, EXPANSION AND CONTRACTION PROBLEMS
- SMOOTH STEEL FLOAT FINISH
- EASY TO CLEAN
- HYGIENIC
- HIGH BOND BETWEEN FOUNDATION AND TOPPING
- CAPABLE OF CARRYING INDUSTRIAL TRAFFIC FOR MANY YEARS

FIGURE 12.4

A COMPOSITE FACTORY FLOORING SYSTEM

provides an ideal humid curing environment. The loading and delivery of the packages is simplified and is seen in Figure 12.6. Another advantage of packaging is that quantities of blocks delivered to a site can be easily checked by both manufacturer and purchaser.

TRH4 (1980) is currently being updated prior to its reissue in a final form. The design guide introduced in Chapter 10 is developed from the principles and strategy of TRH4. A new method of presentation of the catalogue of designs in TRH4 has been adopted and the catalogue now includes segmental block pavements. Figures 12.7, 8 and 9 are proposals for inclusion in TRH4 and show the catalogue of designs for block pavements. Three categories are covered namely Architectural, Industrial and Roads. The Industrial and Roads categories are subdivided into various design classes. It will be noted that the designs are more economical than those cataloged in Chapter 10. The developments have been made possible because of greater experience by contractors providing better quality-controlled materials in the support layers. The designs have been checked for strength and balance using the modulus values determined by HVS and modelling tests.

12.2 RECOMMENDATIONS FOR FURTHER WORK

1. Development of aesthetic standards for use by architects in designing block pavements for industrial yards. Figure 12.10 shows an example of the potential of this in an industrial yard being laid in Hobart, Tasmania.
2. Determination of the riding quality by a subjective rating scale for higher speed block pavements.
3. Studies into the factors which need to be specified for the use of blocks for roads for tracked vehicles.
4. Consideration of the use of blocks laid and jointed with Kalahari sands for helicopter landing platforms and other facilities sited in the Kalahari desert.

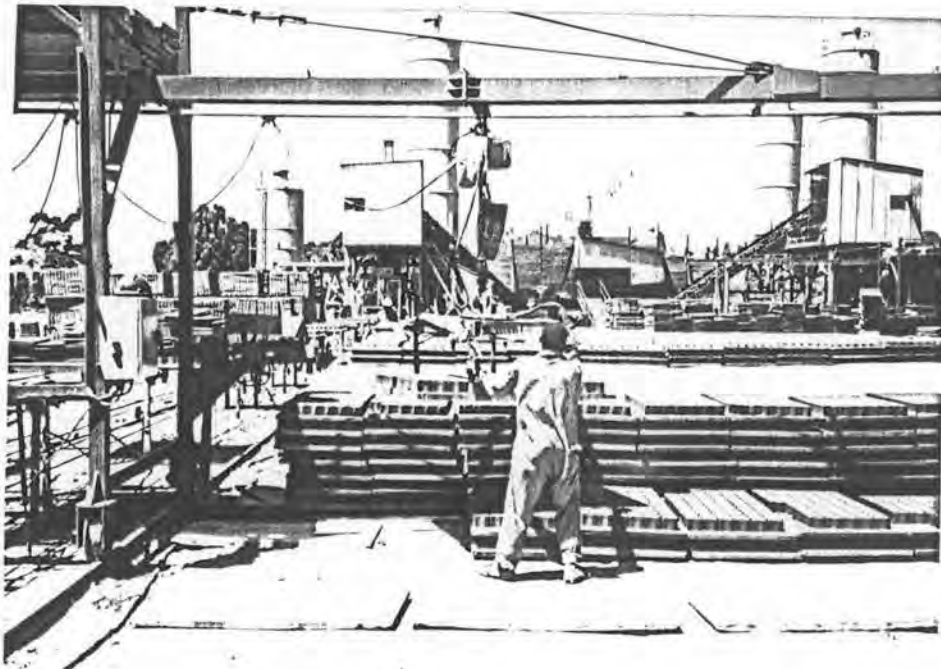
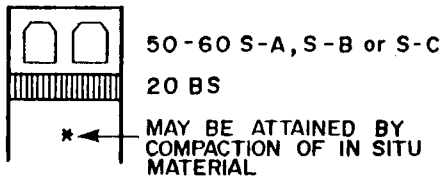


FIGURE 12.5
PALLETS OF BLOCKS FROM THE LAYING HEAD TO THE CURING PILES



FIGURE 12.6
SHRINK-WRAPPED PALLETED BLOCKS LOADING FOR DELIVERY

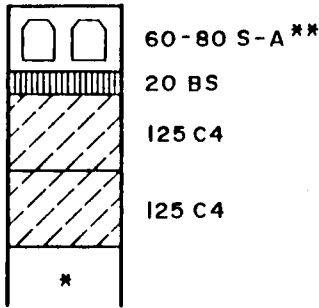
A- ARCHITECTURAL (NON VEHICLE ASSOCIATED)



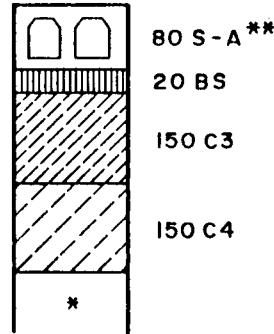
- SUBDIVISIONS
- I) FOOTPATH
 - II) SLOPE PROTECTION
 - III) UTILITY (eg SWIMMING POOL SURROUNDS)

I - INDUSTRIAL

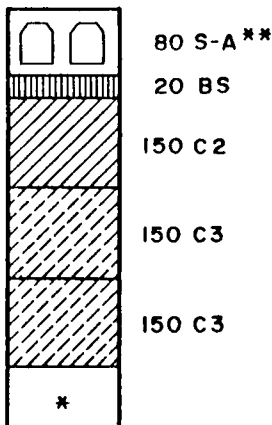
I) 3 - 12 x 10⁶ E80 / LANE OR ≡ AREA



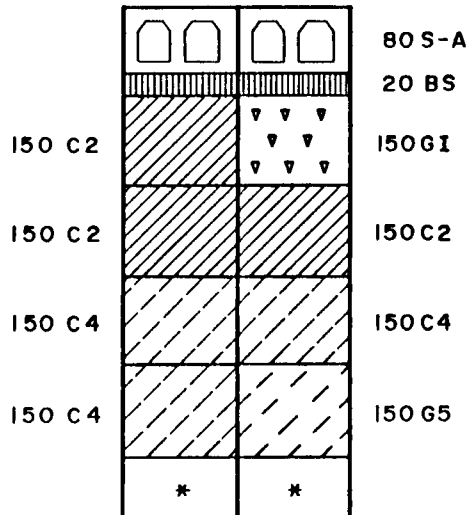
II) 12 - 50 x 10⁶ E80 / LANE OR ≡ AREA



iii) 50 - 100 x 10⁶ E80 / LANE OR ≡ AREA



iv) >100 x 10⁶ E80 / LANE OR ≡ AREA



NOTE :

* CBR MINIMUM 15 %

**S-B or S-C MAY BE SUITABLE IN SOME CASES

FIGURE 12.7

CATALOGUE OF BLOCK PAVING DESIGNS FOR TRH 4
FOR "A" AND "I" DESIGN CLASS

R-ROADS

CLIMATIC REGION		MODERATE OR DRY CONDITIONS				
DESIGN TRAFFIC CLASS E80 / LANE OVER STRUCTURAL DESIGN PERIOD						
ROAD CATEGORY	ER	E0	E1	E2	E3	E4 ****
		< 0,2 x 10 ⁶	0,2 - 0,8 x 10 ⁶	0,8 - 3 x 10 ⁶	3 - 12 x 10 ⁶	12 - 50 x 10 ⁶
B	—	—				
C						

* CBR MINIMUM 15% ** S-Bor S-C MAY BE USED IN SOME CASES *** CBR MINIMUM 10% **** NOT SUITABLE FOR VERY HEAVY INDUSTRIAL WHEEL LOADS SEE FIGURE 10.12. FOR SELECTED LAYERS REFER TO FIGURE 10.7

FIGURE 12.8

STANDARD DESIGNS FOR BLOCK PAVEMENTS FOR TRH 4
FOR "R" DESIGN CLASS IN MODERATE OR DRY CONDITIONS

R-ROADS

		CLIMATIC REGION		WET		
DESIGN TRAFFIC CLASS E80 / LANE OVER STRUCTURAL DESIGN PERIOD						
ROAD CATEGORY	ER	E0 < 0,2 x 10 ⁶	E1 0,2 - 0,8 x 10 ⁶	E2 0,8 - 3 x 10 ⁶	E3 3 - 12 x 10 ⁶	E4 *** 12 - 50 x 10 ⁶
B	—	—				
C					—	—

* CBR MINIMUM 15% ** S-B or S-C MAY BE USED IN SOME CASES *** CBR MINIMUM 10% **** NOT SUITABLE FOR VERY HEAVY INDUSTRIAL WHEEL LOADS, SEE FIGURE 10.12. FOR SELECTED LAYERS REFER TO FIGURE 10.7

FIGURE 12.9

STANDARD DESIGNS FOR BLOCK PAVEMENTS FOR TRH4 FOR "R" DESIGN CLASS IN WET CONDITIONS

5. Noise emission studies of block pavements under high speed truck trafficking.

6. Some skidding tests with a loaded vehicle were done at the NITRR's Silverton test site and are shown in Figure 12.11 but due to the short section of pavement the results, which showed the blocks were unaffected by the skidding wheels, were rated as inconclusive. Further work in this field may be needed.

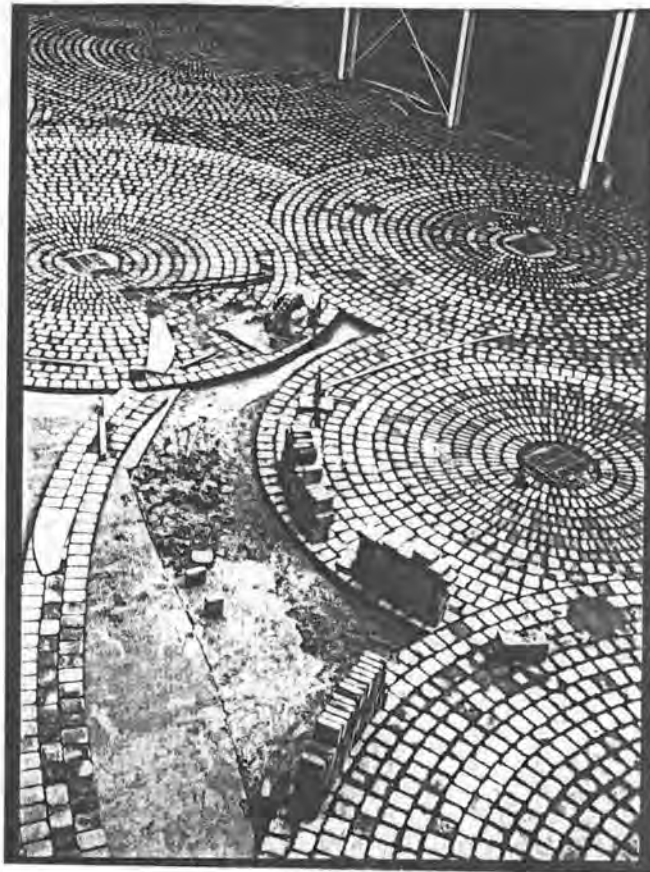


FIGURE 12.10
COMBINING THE AESTHETICS OF BLOCKS WITH THE DESIGN PRINCIPLES DEVELOPED IN THIS THESIS FOR INDUSTRIAL USE

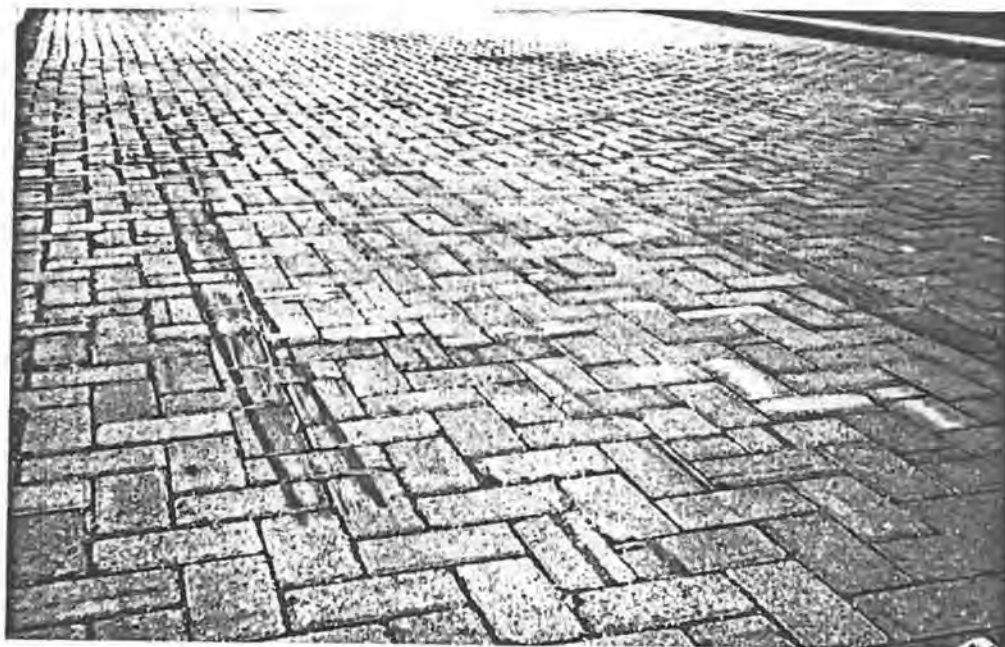


FIGURE 12.11
BLOCK PAVEMENT SUBJECTED TO LIMITED TRUCK SKIDDING TESTS

REFERENCES

REFERENCES

ATC (1984) Symposium on: Recent findings of Heavy Vehicle Simulator testing. Chapters by various authors. CSIR 1984 Pretoria.

BASSON, J E B et al (1981). The multi-depth deflectometer : A multi-stage sensor for the measurement of resilient deflections and permanent deformation at various depths in road pavements. NITRR Technical Report RP/3/81, Pretoria, CSIR, 1981.

BRICK DEVELOPMENT ASSOCIATION OF SOUTH AFRICA (1983). Flexible clay paving - trafficked and pedestrian pavements. BDA of SA Technical Guide, 1983.

CEMENT AND CONCRETE ASSOCIATION OF AUSTRALIA (1980). Technical Note TN34 : Interim guide to the design of interlocking concrete pavements for vehicular traffic. March 1980.

CONCRETE MASONRY ASSOCIATION (1982). Precast concrete paving blocks laying manual. CMA Portland Park RSA, ISBN 0-620-06407-2, 1982.

CONCRETE MASONRY ASSOCIATION (1982 No 2). Precast concrete block paving construction - Guidelines. CMA Portland Place RSA, ISBN 0-620-05720-3, 1982.

CHEV 4 (1977). Computer Information Centre for Transportation. Stresses and Strains in layered systems (Chev 4 1977, Manual P4 NITRR, Pretoria, CSIR, 1977.

CLIFFORD, J M (1978). Evaluation of compaction plant and methods for the construction of earthworks in southern Africa. M.Sc Thesis University of Natal, 1978.

CLIFFORD, J M (1981). Structural design of segmental block pavements in southern Africa. RP/9/81, NITRR, 1982.

CLIFFORD, J M and SAVAGE, P F (1982). Heavy Vehicle Simulator testing of some segmental concrete block pavements. Proceedings of the Annual Transportation Convention 1982, Pretoria, CSIR, 1982.

CLIFFORD, J M and MARKS, L T B (1981) Heavy Vehicle Simulator Evaluation of circular segmented paving at NITRR's Silverton test site. Technical Note TP/107/81 NITRR CSIR 1981

CLIFFORD, J M (1982 No 2). Modelling of segmental block pavements for industrial applications. NITRR Technical Report RP/34/82, CSIR, Pretoria, 1982.

CLIFFORD, J M (1982 No 3). Report on overseas trip to Australia in March 1982 to study segmental blocks. NITRR Technical Report RP/30/82, CSIR, Pretoria, 1982.

CLIFFORD, J M (1982 No 4). Tests to determine waterproof characteristics of segmental block pavements. Technical report presented at Biennial Conference (1982) Perth, Concrete Masonry Association of Australia Co-op Limited. (Design for the environment and the eighties). Perth Western Australia, March 1982.

CLIFFORD, J M (1982 No 5). Recent research in segmental block pavements. Spoken and written presentation for Cement and Concrete Association of Australia Symposium Interlocking Concrete Paving Update. Perth, Western Australia, March 1982.

CLIFFORD, J M (1983). Mechanisms occurring within the bedding and the joints of segmental block pavements. NITRR Technical Report RP/2/83, CSIR, Pretoria, 1983.

CLIFFORD, J M (1984 No 1) A description of "interlock" and "lock-up" in block pavements. Proceedings of the second international Conference on Concrete Block Paving. University of Technology Delft. The Netherlands April, 1984.

CLIFFORD, J M (1984 No 2) Segmental block pavements-optimizing the joint width and joint material. Proceedings of the second international Conference on Concrete block Paving. University of Technology. Delft. The Netherlands April 1984.

CLIFFORD, J M (1984 No 3) Structural design Procedures for segmental block Pavements in South Africa. Proceedings of the International meeting on permanent Concrete Block Paving. University of Trieste March 1984.

CLIFFORD, J M (1984 No. 4) Structural design of segmental block pavements in southern Africa. RP/9/84 NITRR 1984 CSIR Pretoria.

DRAFT TRH4 (1980) Draft Technical Recommendation for highways. National Institute for Transport and Road Research. Structural design of inter urban and rural road pavements. Draft TRH4, Pretoria, CSIR, 1980. TRH4 (1984) final edition (not draft) in print 1984.

DRAFT TRH5 (1977) Technical recommendations for highways. Statistical concepts of quality assurance and their application in road constructions. Draft TRH5, Pretoria, CSIR 1977.

DRAFT TRH6 (1980) Draft Technical Recommendation for highways. National Institute for Transport and Road Research. Standard nomenclature and methods for describing the condition of asphalt pavements. Draft TRH6, Pretoria, CSIR, May 1980.

DRAFT TRH14 (1980) Draft Technical recommendation for highways. National Institute for Transport and Road Research. Standards for road construction materials. Draft TRH14, Pretoria, CSIR 1980.

ELSYM5 (1983) Personal Communication with Computer Information Centre for Transportation NITRR CSIR Pretoria 1983.

FEPV'3 (1983) Available from University of Stellenbosch (1983).

FIGUEROA, J L (1976). Resilient Based Flexible Pavement Design Procedures for Secondary Roads. M.Sc Thesis University of Illinois, USA 1976.

FORBES, R J (1964). Notes on the history of ancient roads and their construction. Hakkert, Amsterdam 1964.

FORSSBLAD, L (1965). Investigations of soil compaction by vibration. Acta Polytechnica Scandinavica. Civil Engineering and Building Construction Series No 34, Stockholm, Sweden, 1965 and Personal Communications.

FOWLER T B (1935) Highways and Bridges. 9 October 1935 London UK

FREEME et al (1982) FREEME, C R; MAREE, J H; VILJOEN, A W. Mechanistic design of asphalt pavements and verification using the Heavy Vehicle Simulator. Proc. 5th Int. Conf. on the Structural Design of Asphalt Pavements Vol. 1. Delft Netherlands

FREEME, C R (1984) The HVS system in 1984 and economic implications - Symposium on: recent findings of Heavy Vehicle Simulator Testing Annual Transportation Convention 1984. CSIR, Pretoria.

GREENHILL A & EISDEN V (1901). Roads, Their construction and Maintenance, Whittaker and Co. 1901.

GORDON, R G (1978). Minimum skid-resistance requirements for Road Pavements in South Africa. NITRR Technical Report RC/3/78, CSIR, Pretoria.

GRIEVE, G (1983) M.Eng. Thesis in preparation. Pretoria University.

IRON ROADS (Great Britain) Ltd (1938). Marble Hall lane, Albert Embankment London SE 11. UK.

KLEYN, E.G. Aspekte van plaveiselevaluering en -ontwerp soos bepaal met behulp van die dinamiese kegelpenetro-meter. M.Ing verhandeling, Universiteit van Pretoria, Mei 1984 (in preparasie)

KNAPTON, J & BARBER S D (1980). Concrete Block Paving in UK. First International Precast Concrete Paving Block Symposium. Newcastle upon Tyne UK 1980.

LESKO, S (1980). The use of concrete block pavements for highways. Proc. 1st Int Conf on Concrete block paving, Newcastle, 1980. UK.

LILLEY, A A (1980). Concrete block paving, a review. The Highway Engineer, June 1981, London.

MAPS (1983) available at University of Stellenbosch.

MARAIS, L R and LANE J W (1980). Pavement and construction specifications. Seminar on interlocking concrete blocks for roads at the National Institute for Transport and Road Research, CSIR, Pretoria, 1980.

MAREE et al (1980) MAREE, J H, VAN ZYL, N J W and FREEME, C R. The effective moduli and the stress dependence of pavement materials as measured in some Heavy Vehicle Simulator tests. Transportation Research Board, USA, 1980.

MAREE, J H and VAN ZYL, N J W (1980). The heavy vehicle simulator test on freeway P157/1 near Jan Smuts Airport. NITRR Technical Report RP/11/80.

MAREE, J H & FREEME, C R (1981). The mechanistic design method used to evaluate the pavement structures in the catalogue of the draft TRH4 1980. Technical Report RP/2/81, Pretoria, NITRR, CSIR, 1978.

MAREE, J H (1982). Extract from Structural Design of Urban Roads, National Norms for Township Services (part 7). Department of Community Development. Supplement to Municipal Engineering March/April 1982.

MAVIN, K C (1980). Interlocking Block Paving in Australian Residential Streets. Proc. 1st Int. Conf on Concrete Paving, Newcastle, 1980, UK.

MAVIN, K C (1984) Site and laboratory testing of interlocking concrete block pavements. Proceedings of the second international Conference on Concrete block Paving. University of Technology Delft. the Netherlands April 1984.

MECDE 1 (1977) COMPUTER INFORMATION CENTRE FOR TRANSPORTATION. Stresses and strains in layered pavements under dual wheel load MECDE 1. Manual P5, NITRR, Pretoria, CSIR 1977.

MECDE 3 (1983). Personal Communication with the manager of the Computer information Centre for Transportation at NITRR. CSIR, Pretoria.

PATERSON, W D O (1976). An evaluation of the heavy vehicle simulator as a tool for measuring pavement behaviour. NITRR Internal Report, RP/5/76, Pretoria, CSIR, 1976.

PATERSON, W D O and MAREE, J H. An interim mechanistic procedure for the structural design of asphalt pavements. Technical Report RP/5/78, Pretoria, NITRR CSIR, 1978.

RADFORD, T (1924). The construction of roads and pavements. McGraw Hill Book Company New York 1924.

RICHARDS, R G et al (1977). The NITRR Heavy Vehicle Simulator : description and operational logistics. NITRR Internal Report RP/9/77, Pretoria, CSIR, 1977.

ROAD NOTE No 27 (1960). Department of Scientific and Industrial Research. Road Research Laboratory. Road Note No 27. Instructions for using the portable skid-resistance tester. HMSO 1960. London.

SHACKEL, B (1979). An experimental investigation of the response of interlocking block pavements to simulate traffic loading. Aust. Road Res. Bd Res. PRT ARR90, 1979.

SHACKEL, B (1979 No 2). A pilot study of the performance of block paving under traffic using a Heavy Vehicle Simulator. Proc. Symp. on Precast Concrete Paving Blocks, Johannesburg, 1979.

SHACKEL, B (1980). An experimental investigation of the roles of the bedding and jointing sand in the performance of interlocking block pavements subjected to traffic. Concrete Society of southern Africa Journal. September 1980 Halfway House Transvaal. RSA.

SHACKEL, B (1980 No 2). A review of the technology of interlocking block paving for roads and industrial pavements. NITRR Technical Report, RP/8/80, Pretoria, CSIR, October 1980.

SHACKEL, B (1980 No.3). The evaluation and design of interlocking concrete block pavements subjected to road traffic. NITRR Technical Report RP/9/80, Pretoria, CSIR 1980

SHACKEL, B (1980 No. 4) The performance of interlocking block pavements under accelerated trafficking. First International Conference on concrete block paving, Newcastle Upon Tyne, September 1980

SHACKEL, B (1980 No. 5). The construction and accelerated trafficking evaluation of interlocking concrete block pavements laid on sand subgrades. Zimbabwean Engineer, December 1980

SHACKEL, B (1980 No 6). Interlocking Block Paving. Materials and Design Course : August 1980, NITRR, Pretoria 1980.

SHARP et al (1982) SHARP, K G, ARMSTRONG, P J, MORRIS, P O. The performance of two interlocking concrete block pavements. ARRB Proceedings Volume 11 Part 2, 1982, Australia.

Shorter Oxford English Dictionary (1964) on historical principles. Clarendon Press, Oxford, 1964.

SPIELMAN & ELFORD (1934). Roadmaking and administration. Edward Arnold and Co London 1934.

TAYLOR, W (1850). Observations on the street paving of the metropolis London. Minutes of Institution of Civil Engineers, February 1850, London.

TECHNICAL METHODS FOR HIGHWAYS (1981). Sampling methods for road construction materials. ISBN 0-7988-20578 CSIR Pretoria.

VAN VUUREN, D J (1973). The Heavy Vehicle Simulator. Shell bitumen review 41, 1973.

WALKER et al (1977). WALKER, R N, PATERSON W D O, FREEME C R AND MARAIS C P. The South African mechanistic design procedure. Proc 4th Int Conf on the Structural Design of Asphalt pavements Vol 2 1977, RSA.

YODER & WITCZAK (1975). YODER E V & WITCZAK, M W. Principles of pavement design. Second Ed Wiley, Interscience Publication, 1975.

APPENDIX A

PHILOSOPHY FOR MODELLING SEGMENTAL BLOCK PAVEMENTS

APPENDIX A

PHILOSOPHY FOR MODELLING SEGMENTAL BLOCK PAVEMENTS

REQUIREMENTS OF MODELLING

Effective modelling requires the input of response parameters which have been either measured or predicted to a reasonable degree of accuracy from previous work. In order to include more accurate input data in the model, a rapid and effective evaluation technique is needed. Since many of the parameters will be inter-dependent, single response modification and changes should be possible at any stage and a simple yet meaningful means of analysis should be adopted.

LIMITATIONS AND ASSUMPTIONS OF MODELLING

Soil as a structural medium is very much more variable than a material such as steel. The variability of apparently similar materials constructed to the same specification is considerable. The variability can be ascribed inter alia to variable quantities of solids, fluids and gases within a soil matrix; variable angularity and size of individual solid soil particles; percentage of granular and cohesive components of the material, etc. Material variability results in different response modes under applied loading. The gradual dissipation of pore pressures within cohesive materials under statically applied loads causes consolidation in cohesive materials, whereas substantially resilient deformations are experienced, under the short-term of travelling loads. Repeated loading causes a variety of response modes within a soil matrix and causes visible differential settlement or rutting in an inadequately supported surfacing layer due to a combination of the above effects. Material variability has always been a problem in mathematical evaluation methods. It has been catered for in a variety of ways such as the inclusion of various constants in mathematical formulas and the use of average or typical values of resilient or effective modulus. None of these methods is completely satisfactory, and even detailed

evaluation to accuracies of several decimal places, which is, in many cases, possible in computer program analysis, is often not required and can be unnecessary or even misleading. These highly exacting analyses, which are based on assumptions and input values with large factors of safety do not indicate the true potential of the design. As a consequence, there is a demand by specifiers for better materials than should be required in actual practice.

Assumptions concerning linear elastic response, homogeneity, isotropic behaviour and constant stress-strain relationships are made in mathematical evaluations. In many cases, overdesign occurs or errors in evaluation are made because little or no structural value is given to the subgrade. However, when a subgrade is considered, either its soaked Californian Bearing Ratio (CBR) is used, and in many cases such a condition is unlikely for most of its life, or the subgrade is considered as a semi-infinite layer of assumed properties. Under heavy and very heavy loading conditions (which are becoming more common in industrial and other applications), surface loading, whether transitory or static, is likely to affect material to a depth of at least 3 m below the surface, therefore including the subgrade.

Computer programs adopt uniform loading conditions (often the maximum legal allowable) and the HVS applies dual-directional uniform loading over a test area. Both mathematical and physical models therefore do not allow for a variable load spectrum which would be the normal loading expected on a real pavement. Repeated loading by either uniform application or variable intensity causing consolidation or densification often changes the modulus of a material. Such materials are therefore stress-dependent, and variable modulus values must therefore be input into programs to accommodate this.

Since soils are highly complex, characterization of materials is not a simple exercise. Many assumptions clearly need to be made in modelling. Appreciation of these limitations is especially important for the optimization of designs at an acceptable degree of confidence. Modelling can then on the one hand be seen only as

a guide to optimization. Complete optimization, on the other hand, must include a careful blend of theory and experience; moreover, both these aspects need to be qualified with a practical safety factor to account for material variability and other non-constants, for example the effects of differences in density and material in subgrades with depth.

OTHER FACTORS IN MODELLING

There are several other factors in modelling segmental block pavements which may lead to an optimum design : environmental factors; reflection of pulses generated by applied loads on relatively hard layers within structural supporting layers; the containing and screening effect of any fabrics and geotechnical materials used; the use of very open-graded materials which may provide an extremely elastic material of low density and high void ratio.

Environmental factors include not only climate but also the location of the material in relation to other materials surrounding it. Climatic effects are difficult to model realistically but their importance can be seen in sections of disused pavements which deteriorate in time even with no applied loading. Environmental factors that act on block pavements during the settling-in time can cause, for example, the development of a plug of detritus in the joints between the blocks, which would be difficult to simulate.

Stress dissipation in soils is a complex subject and can be influenced by : the moisture content, pockets of fairly dense buried material within a less dense layer and the cohesive and granular content of the soil matrix. In laboratory modelling, stress dissipation can be unrealistic due to the effects of moulds and other containing devices which are necessary for the tests.

CHOICE OF MODELLING METHODS

The principle modelling techniques are: i) mathematical models, including the use of computer programs specifically designed to analyse the input data provided; ii) laboratory models specially prepared to evaluate data from triaxial and other repeated loading operations, where many variables such as climatic effects are eliminated; iii) site evaluation and modelling of sections of actual pavement or evaluation of a limited sample section constructed under actual site conditions and where individual loads or repeated loading representing many years of use can be modelled. In addition, the response of individual layers, interfaces between layers and surface conditions can be measured to verify the modelling technique. The HVS system is an ideal tool for this type of site evaluation.

There are various advantages and disadvantages to each of the above techniques. Mathematical modelling requires various known input parameters and assumes the pavement structure to consist of uniform horizontal layers which rest on a semi-infinite subgrade. The layers themselves are assumed to be uniform in thickness and to consist of a homogeneous, isotropic, linear elastic material (or material consisting of finite elements with an elastic linear response). Only the modulus, Poisson's ratio and thickness need to be entered. The applied loads are assumed to act vertically and make contact with the pavement over a circular area. Laboratory modelling makes many of the same assumptions that are used in mathematical modelling and some effect of the container within which the model is made must be assumed. Short term site modelling requires assumptions of climatic effects, future growth and hence expected numbers of applied loads together with the effect of variable time-spacing between individually applied loads which are clearly too large to model effectively.

Because of the limitations of the various modelling techniques, a combination of some of the advantages of the three techniques is considered the most effective way of modelling segmental block

pavements. Modelling of category S3 segmental block pavements by these means will therefore translate existing performance criteria for heavy and very heavy loading applications more readily. Initial modelling by mathematical analysis methods using existing linear elastic and finite element programs produces curves of various data generated, from the pavement profile. The curves generated by the mathematical model can be 'tried' by either laboratory or site modelling using levels of actual applied loads and their associated responses within the structure. New data curves are thus obtained by plotting similar data on the same axes.

The laboratory or site curves must now be 'fitted' to the mathematical model which can be re-run (or reiterated) to obtain more accurate data for input either with the applied load initially used or by extending the model to include other loads or other variables. Subsequent checking under conditions readily repeatable on site (or in the laboratory) provides the mathematical model with input data chosen and confirmed by both theory and experience. By using this technique one can accept the output data of the mathematical model with a high degree of confidence.

Considerable experience with load equivalency factors established by HVS work enables the applied loads in the model to be stepped up rapidly and with a reasonable degree of initial accuracy.

MECHANISTIC INPUT

The recent development of theoretical methods for the complex analysis of a pavement structure by layers permits evaluation of the pavement as a total mechanism. This is simply known as mechanistic design, a term introduced by Paterson and Maree (1978) and Maree and Freeme (1981). The modelling technique allows the stresses, strains and displacement at various points within a particular layer and at the layer interfaces to be computed.

APPENDIX B

BEHAVIOUR AND DISTRESS CRITERIA

APPENDIX B

BEHAVIOUR AND DISTRESS CRITERIA

BEHAVIOUR PHILOSOPHY

The behaviour of segmental block pavements have been shown in Chapters 3, 5, 6 and 10 to be similar to other pavement types. The primary behavioural pattern has been shown to be flexible and relates directly to granular materials. The behaviour of different parts of a segmented block pavement is a function of the time-dependent nature of each part. By analysis or design it is possible to predict future behaviour. It is accepted that different pavement layers behave differently. Different analysis methods have evolved with time. Unfortunately no method can be accepted as universally applicable for all pavement layers but the major advantages of each should be used where appropriate.

At the time of construction, the pavement layer may start its life in any one of these states and generally with time moves to the more flexible state. Different pavements which may have nominally identical materials can move through these states at different rates depending on the balance of the pavement and the ease with which water or temperature has an effect on the layers. The general tendency to become more flexible with time is valid for the majority of pavement layers. This grouping of pavement behaviour forms a very convenient platform on which to assess not only the original state of the pavement but also its present state and likely future condition. However, some pavements, such as those with self-stabilizing materials, can move from the flexible state through the stiff to the very stiff state. The use of the correct jointing material in block pavements causes the block layer to stiffen by this method during the settling-in stage. Table B.1 gives details of the changes which will occur with time and shows the equivalent material states.

EQUIVALENT MATERIAL STATE

The state of a material after some time in the field is often different from that after construction. This is because the state of the material can change with time and the material can behave structurally in a manner similar to another material type. This is termed equivalent material state. For example, a material can start in a cemented state and act as a slab but because of extensive cracking, exhibits the characteristics of a granular material. This would then be termed equivalent granular state. In this equivalent state the material will not normally meet all the specifications for the granular material (e.g. grading) but its bearing capacity, elastic modulus and water susceptibility characteristics are similar. The material can then be classified using the basic codes adopted for TRH14(1983).

GRANULAR LAYERS

The basic pavement behaviour of granular layers is illustrated in Figure B.1 in terms of the change of deformation, deflection, modulus and DCP strength with time or traffic.

Initially (Phase 1) there can be a rapid increase in permanent deformation because of an increase in densification of the material. The relative behaviour of different material standards is illustrated diagrammatically in Figure B.2. A segmented block pavement has been included and the deformation with time deduced from HVS tests.

Referring to Figure B.2, Phase 2 occurs if the material quality is adequate for the purpose and it is in a fairly dry state.

Phase 3 occurs when some change occurs in the balance of the structure or a change in moisture state.

The behaviour is also reflected in the resilient deflection between the top and bottom of the layer and is directly a reflection of the effective modulus of the material.

CEMENTED LAYERS

The behaviour of the cemented layers may be explained by showing the changes in its effective modulus which occur with time as seen in Figure 3.5.

In general the deflection is a good indicator of the state of the cemented material; low deflections indicate high moduli and vice versa. However, in Phase 3 the resilient deflection will not necessarily be a good indicator of large deformation, since this depends on the moisture condition of the material.

The relative behaviour of cemented materials of different qualities and strengths is indicated in Figure B.4. Generally high strength materials (such as a C1) will start off with a high modulus compared with that of a lower strength material (e.g. a C4 material). Initially the cemented material will crack because of shrinkage and these cracks may or may not be detrimental to the pavement. However, when further cracking occurs, the rate of decrease of modulus is generally very rapid.

It is interesting to reflect that a segmented block layer is built with many joints (relating to the cracks and therefore no reduction in modulus will occur. As the joints become more effective following settling-in in the modulus in the increases.

COMPOSITE PAVEMENTS

The behaviour of different pavement types is controlled by the behaviour of the individual layers and by the interaction between the layers forming the structure. Observations of the indicators of pavement behaviour reflect the cumulative effect of these interactions. Often ostensibly similar observations can be constituted in markedly different ways. It is this difficulty that makes evaluation of the behaviour of pavements so complex. Often it is only possible to establish the dominant behavioural characteristics and from these to establish the most likely future behaviour.

The concept of balance within the pavement aids the understanding of the interaction between layers and whether the pavement structure is likely to change its state rapidly or remain in a stable state in the future. Balance is defined as the state of the pavement in which none of the layers are overstressed and, because of this, each layer can cope adequately with the imposed loads. The pavement can become unbalanced because of the ingress of water into particular layers or changes in material state through the action of aggressive environment or abnormally large loads.

MODULI FOR GRANULAR MATERIALS

Generally the strength of granular materials are dependent on their state of stress and the effective modulus can change with wheel load, depth below the surface and support of the underlying layers. In the case of blocks, considered as granular materials for this study of moduli the modulus will vary a direct relationship with the strength and effectiveness of the joints. Table B.2 gives approximate values of the effective elastic moduli for four main conditions. These are:

- (a) The average modulus of the material in its optimum state, the moisture state is dry and the material is well supported by cemented layers with high moduli (>500 MPa).
- (b) The average moduli of the material in the same state as in (a) but with lower support in terms of moduli i.e. granular layers of lower quality or a cracked cemented material which is broken down into small blocks
- (c) The effective modulus of the material after the ingress of water. The ingress of water in this case is not taken to imply that an excess of water is present so that high pore water pressures develop with subsequent rapid shearing of the material under loading. If this occurs the pore pressures can usually be reduced, resulting in the moduli given in the table.

- (d) The effective moduli after the ingress of water but with relatively poor support conditions.

MODULI FOR CEMENTED MATERIALS

The effective moduli of cement or lime-stabilized materials are defined for four states : that is

- (a) Before extensive cracking (pre-cracked phase)
- (b) Loading or the environment, or both, have started to break down the block size, but the behaviour is still predominantly controlled by the large blocks of material relative to layer thickness;
- (c) The block size has decreased to blocks small in relation to layer thickness, and the material is equivalent to that of a granular material
- (d) The cemented material has broken down into a granular state.

These moduli are given in Table B.3.

MODULI FOR SUBGRADE SOILS

The elastic modulus of a granular soil is stress-dependent and its behaviour is similar to that of granular materials. Clayey soils differ from granular soils in that their effective modulus decreases with increasing vertical stress. Table B.4 gives approximate values of effective elastic moduli for subgrade and selected subgrade materials. Increases in moisture content will lower the modulus, with a larger relative effect on clayey soils.

DISTRESS CRITERIA FOR MATERIALS FOR REHABILITATION

The information given here is relatively new and was gleaned from HVS test results (ATC 1984) The necessity for these criteria cannot, however, be underestimated and considerable research effort

will no doubt be expended over the next few years to achieve a high degree of confidence in these values.

An important concept used in this section is that if a material is in an equivalent material state, then the criteria for that state apply, i.e. if a cemented material is in the granular state, say EG4 state, then the approach is to use safety factors to control deformation of the material (e.g. safety factors and Mōhr-Coulomb strength parameters of cohesion, c , and angle of internal friction, ϕ , for a G4 material apply).

GRANULAR MATERIALS

Granular materials exhibit distress in the form of cumulative permanent deformation or inadequate stability. Both distress modes are related to its shear strength which is expressed in terms of the Mōhr-Coulomb strength parameters of cohesion, c , and angle of internal friction, ϕ .

The use of the safety factor, F , as defined in the equation¹ below, safeguards the layer against shear failure or gradual shear deformation by limiting the shear stresses to a safe level.

$$F = \frac{\sigma_3 \left[K \left(\tan^2 \left(45 + \frac{\phi}{2} \right) - 1 \right) + 2Kc \tan \left(45 + \frac{\phi}{2} \right) \right]}{(\sigma_1 - \sigma_3)} \quad \dots\dots\dots (1)$$

where σ_1 and σ_3 = calculated major and minor principal stresses acting at a point in the layer. (Compressive stresses are positive while tensile stresses are negative.)

- c = cohesion
- ϕ = angle of internal friction
- K = constant = 0,65 for saturated conditions
= 0,95 for normal conditions

The values of c and ϕ and the c term and ϕ term in equation (1) are given in Table B.5. Values are given for the material in the dry state (~ 45 per cent of saturation) and the wet state (~ 90 per cent of saturation).

The safety factor depends more on the contact pressure and contact area than on the wheel load. The safety factors may be calculated at the mid-depth of the layer, under one of the wheels and at the centre of the dual wheel. At the current state of the ? inclusion of the safety fact may be suitable for the evaluation of block pavements.

The allowable safety factor varies according to the road category and the design traffic. Table B.6 gives the recommended safety factors for the design traffic classes (also shown in Figure B.4).

Fatigue properties : The fatigue life of cemented materials under repeated flexure can be expressed by the following

$$N_f = 10^{9,1(1-\epsilon_s/\epsilon_b)}$$

where N_f = number of repetitions at strain ϵ_s to crack initiation.

A shift factor is applied to cemented materials to account for the time between initiation of cracking and cracks appearing at the surface. Table B.7 shows the applicable shift factors for the different road categories and for different layer thicknesses.

At present, values for c and \emptyset for materials of this standard have not been determined but estimates are given in Table B.8.

TABLE B.1

Examples of equivalent material states

CODE	STATE	RANGE OF MODULI	STRENGTH PARAMETER	WATER SENSITIVITY
S-A	Equivalent to block cracked concrete		Jointing	Not sensitive to water ingress after "settling-in"
S-B	cracked concrete	400 - 2 000	sand	
S-C	pavement			
EG1	Equivalent high quality crushed stone	200 - 1 000	High particle interlock/ high density/ high strength aggregate	Not sensitive to water - generally impermeable (rate of deformation < 1 mm/yr)
EG2	Equivalent to crushed stone/natural gravel	200 - 900	Good particle interlock	Sensitive to the ingress of water (rate of deformation 0,5 - 2 mm/yr)
EG3	Equivalent to crusher run	200 - 500	Reasonable particle interlock	More sensitive to the ingress of water/rate of deformation up to 3 mm/yr.
EG4	Equivalent gravel base	175-700	CBR < 80 PI > 6	Sensitive to ingress of water; deformation can be very high if layer very wet
EG5	Equivalent natural gravel	150 - 450	CBR < 45 PI > 10	Sensitive to ingress of water; deformation depends on structure and moisture state
EG6	Equivalent natural gravel	50 - 300	CBR < 25	Sensitive to ingress of water; deformation depends on particle structure and moisture state
EG7	Equivalent gravel soil	50 - 250	CBR < 15	Sensitive to ingress of water; deformation depends on particle structure and moisture state
EG8	Equivalent gravel soil	40 - 200	CBR < 10	Sensitive to ingress of water; deformation depends on particle structure and moisture state
EG9	Equivalent gravel soil	30 - 150	CBR < 7	Sensitive to ingress of water; deformation depends on particle structure and moisture state
EG10	Equivalent gravel soil	30 - 100	CBR < 3	Very sensitive to the ingress of water

TABLE B.2

Moduli of granular materials for block pavement design

CODE	MATERIAL DESCRIPTION	ABBREVIATED SPECIFICATION	OVER CEMENTED LAYER SLAB STATE	OVER GRANULAR LAYER OR EQUIVALENT (GOOD SUPPORT)	WET STATE (POOR SUPPORT)
S-A					
S-B	Segmented blocks	Blocks	1 000 (400 - 2 000)	1 000 (400 - 2 000)	400
S-C					
G1	High quality crushed stone	86 - 88 % ARD impermeable	450 (250 - 1 000)	300 (175 - 600)	240
G2	Crushed stone	100 to 102 % Mod AASHTO	400 (200 - 800)	250 (150 - 450)	220
G3	Crushed stone	98 - 100 % Mod AASHTO	350 (200 - 800)	250 (125 - 400)	200
G4	Gravel base quality	CBR \geq 80 PI \leq 6	300 (175 - 600)	225 (100 - 375)	180
G5	Gravel	CBR \geq 45 PI \leq 10 - 15	250 (150 - 450)	200 (75 - 350)	160
G6	Gravel low quality subbase	CBR \geq 25	225 (100 - 400)	200 (50 - 300)	140
Poisson's ratio 0,35					

TABLE B.3

Moduli of cemented materials for block pavement design

ORIGINAL CODE	UCS (MPa) PRE-CRACKED STATE	PARENT MATERIAL	PRE-CRACKED STATE Gpa (range)	POST-CRACKED STATE (MPa)			
				LARGE BLOCKS	SMALL BLOCKS	WET STATE EQUIV. CODE	
				DRY STATE EQUIV. CODE	WET STATE EQUIV. CODE		
C1	6-12	Crushed stone G2	14 (7-30)	3 000	600 EG1	500 EG1	
		Crushed stone G3	12 (6-30)	2 800	600 EG1	400 EG2	
C2	3-6	Crushed stone G2	10 (4-14)	2 500	500 EG1	300 EG2	
		G3	8 (14-14)	2 400	450 EG2	250 EG3	
		G4	6 (3-12)	2 200	450 EG2	200 EG3	
C3	1,5-3	Gravel					
		Gravel					
		G4	5 (3-10)	2 000	400 EG3	180 EG4	
		G5	4,5 (3-9)	2 000	350 EG4	160 EG5	
		G6	4 (2-8)	2 000	300 EG4	140 EG6	
		G7	3,5 (2-7)	1 500	250 EG5	120 EG7	
		G8	3 (2-6)	1 200	200 EG5	90 EG8	
C4	0,75-1,5	G4	4 (2-7)	2 000	350 EG3	180 EG4	
		G5	3,5 (2-6)	2 000	300 EG4	160 EG5	
		G6	3 (2-6)	2 000	250 EG4	140 EG6	
		G7	2,5 (1-5)	1 000	200 EG5	120 EG7	
		G8	2 (1-4)	1 000	170 EG5	90 EG8	
		G9	1,5 (0,5-3)	500	150 EG6	70 EG9	
		G10	1 (0,5-2)	500	125 EG6	45 EG10	

Poisson's ratio 0,35

TABLE B.4

Moduli of subgrade materials

CODE	SOAKED	MATERIAL	RESILIENT MODULUS		EQUIV. CODE
			WET STATE	DRY STATE	
G7	‡ 15	Gravel-soil	120	240	EG5
G8	‡ 10	Gravel-soil	90	180	EG6
G9	‡ 7	Gravel-soil	70	140	EG7
G10	‡ 3	Gravel-soil	45	90	EG8

TABLE B.5

The shear properties of granular materials

MATERIAL, CODE	MOISTURE STATE	COHESION cm (kPa)	INTERNAL FRICTION, ϕ ($^{\circ}$)	ϕ term	c term
Segmented blocks	dry				
	wet	50	50	7,00	280
High density crushed stone, G1	dry	65	55	8,61	392
	wet	45	55	5,44	171
Moderate density crushed stone, G2	dry	55	52	7,06	303
	wet	40	52	4,46	139
Crushed stone and soil binder, G3	dry	50	50	6,22	261
	wet	35	50	3,93	115
Base quality gravel, G4	dry	45	48	5,50	223
	wet	35	48	3,47	109
Subbase quality gravel, G5	Moderate (K = 0,8)	40	43	3,43	147
	wet	30	43	3,17	83
Low quality subbase gravel, G6	Moderate (K = 0,8)	30	40	2,88	103
	wet	25	40	1,76	64

TABLE B.6

The safety factor recommended for granular material

ROAD CATEGORY	DESIGN TRAFFIC CLASS	MINIMUM ALLOWABLE SAFETY FACTOR
A	E4	1,60
	E3	1,40
B	E3	1,30
	E2	1,05
	E1	0,85
C	E2	0,95
	E1	0,75
	E0	0,50

TABLE B.7

Shift factors* for cemented layers

LAYER THICKNESS (mm)	ROAD CATEGORY		
	A	B	C
Bases and subbases			
100 - 200	1,2	2,0	3,0
Subbases >200	3,0	5,0	7,5

*The calculated fatigue life is multiplied by the appropriate shift factor. Segmented blocks would be considered as bases for these calculations.

TABLE B.8

Estimates of values of c and ϕ for soils

MATERIAL CODE	MOISTURE STATE	COHESION c, kPa	INTERNAL ($^{\circ}$) ϕ	ϕ TERM	c TERM
G7	dry	25	35	2,51	86
	wet	20	35	1,21	46
G8	dry	30	30	1,85	93
	wet	20	30	0,8	41
G9	dry	30	28	1,63	90
	wet	20	28	0,66	40
G10	dry	35	25	1,34	99
	wet	30	25	1,48	37

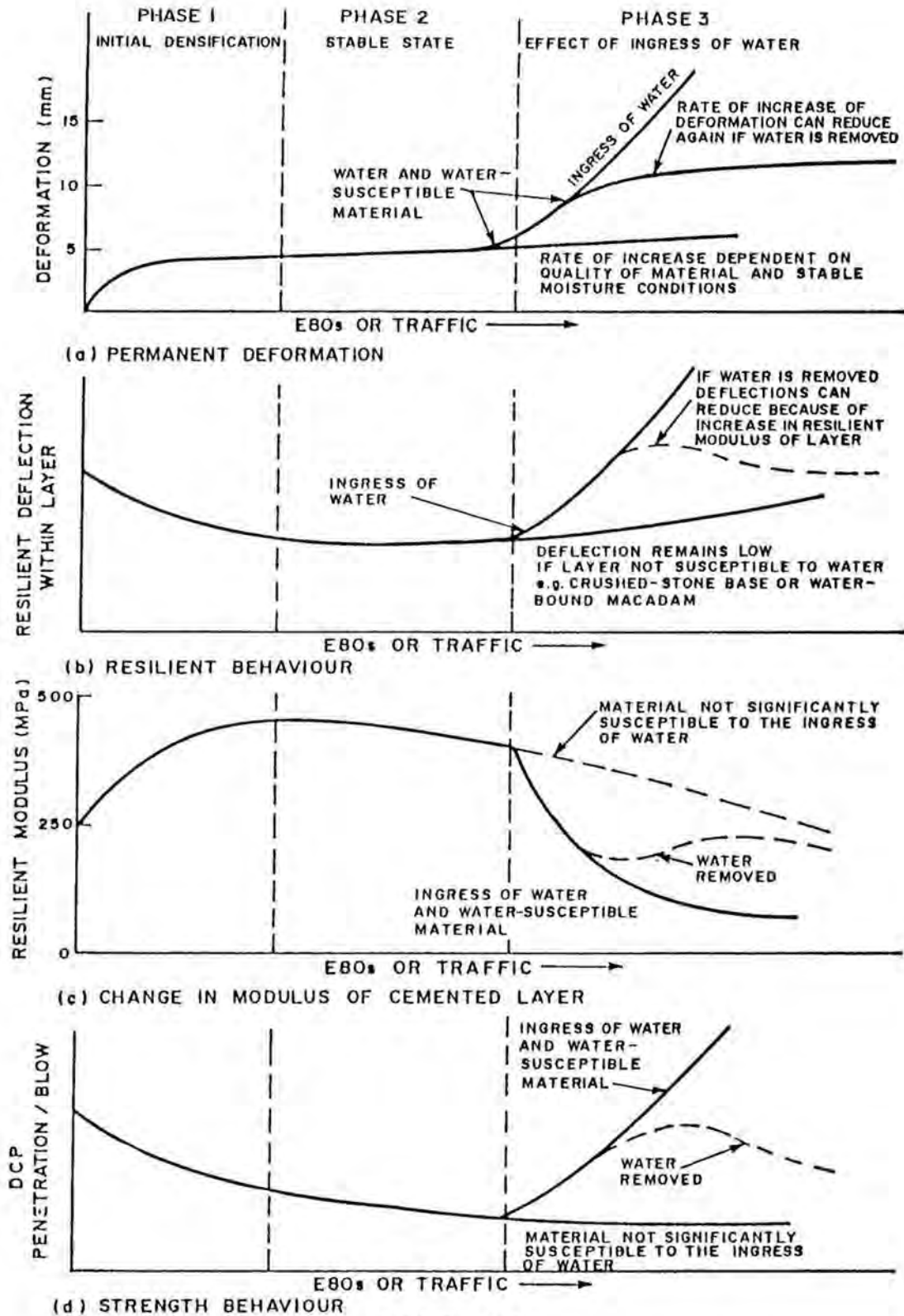


FIGURE B.1
INDICATORS OF THE BEHAVIOUR OF GRANULAR LAYERS

940-4-4748/B B.D.

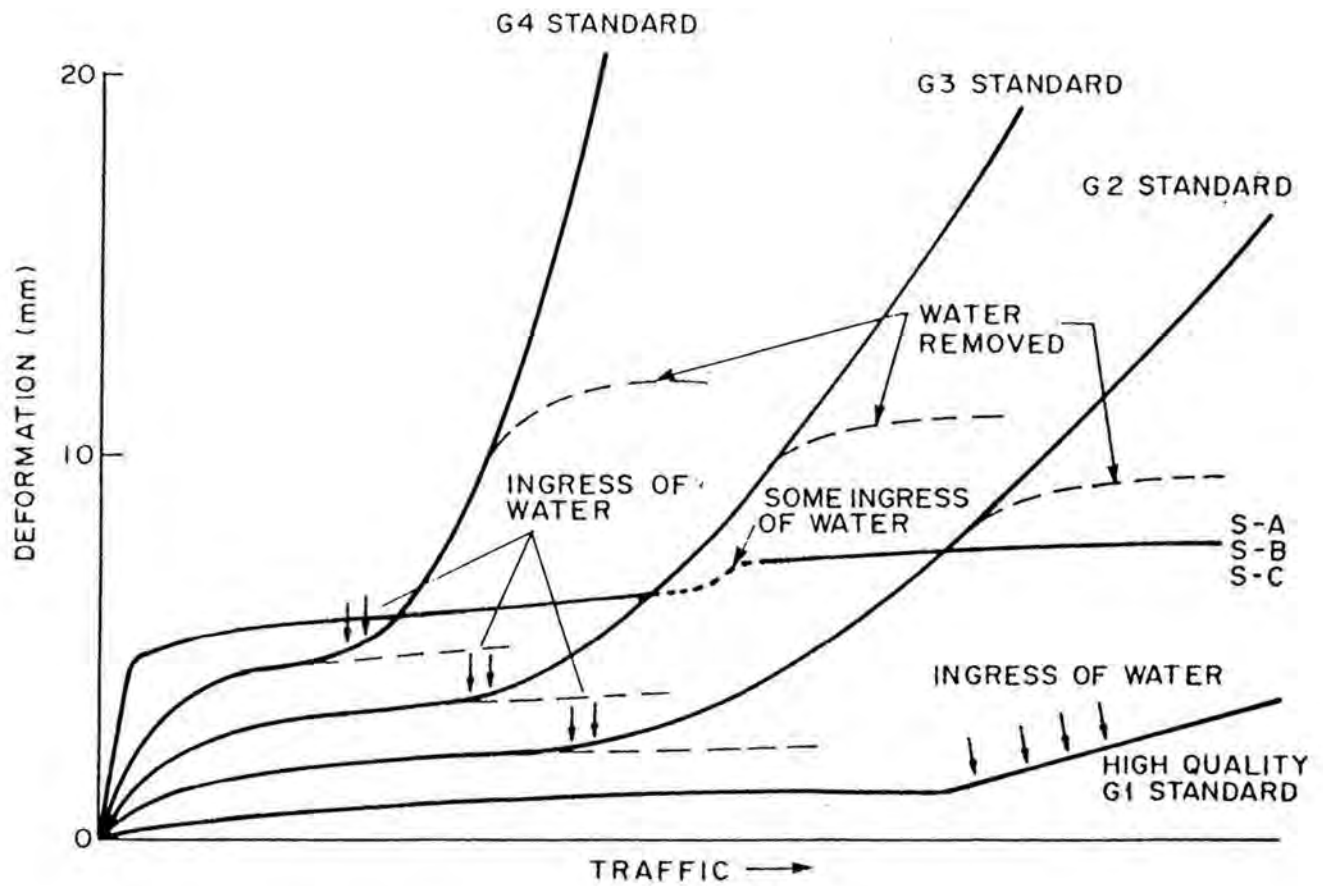


FIGURE B.2

SCHEMATIC DIAGRAM OF THE RELATIVE BEHAVIOUR OF GRANULAR MATERIAL OF DIFFERENT QUALITIES

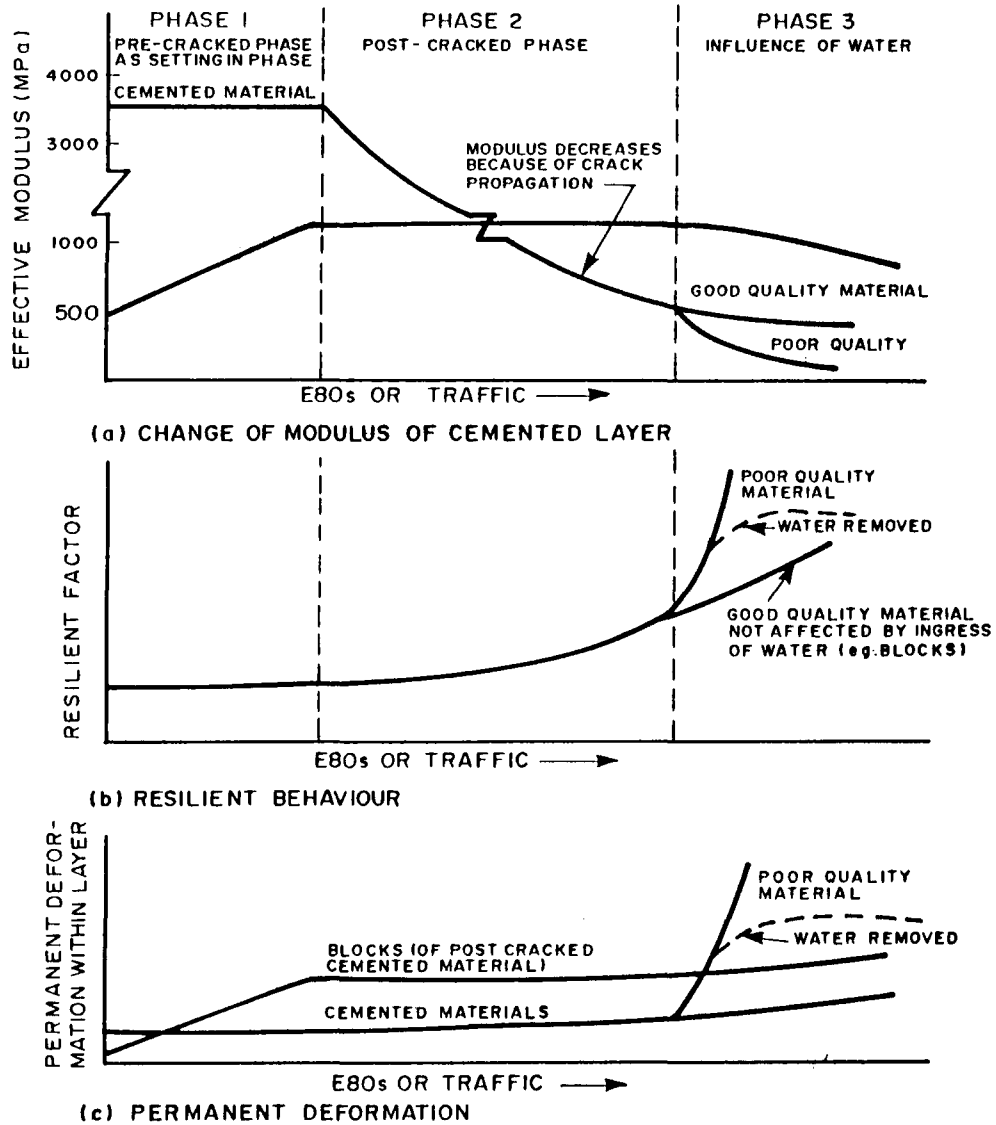
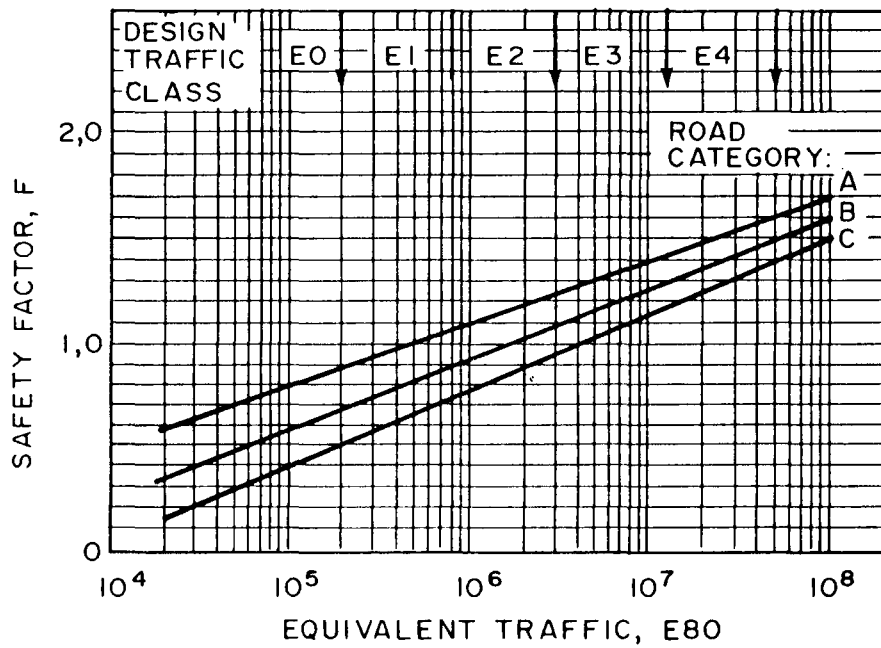


FIGURE B.3
INDICATORS OF THE BEHAVIOUR OF "CEMENTED" LAYERS



RECOMMENDED VALUES OF EQUIVALENCY COEFFICIENT
TO COMPUTE EQUIVALENT TRAFFIC

- n = 4 FOR A CATEGORY ROAD
- n = 3 FOR B CATEGORY ROAD
- n = 2 FOR C CATEGORY ROAD

FIGURE B4

RECOMMENDED SAFETY FACTORS FOR GRANULAR
MATERIALS (G1 TO G6)

APPENDIX C

BLOCK PAVING IN AUSTRALIA, ISRAEL, BRITAIN AND EUROPE

APPENDIX C

BLOCK PAVING IN AUSTRALIA, ISRAEL, BRITAIN AND EUROPE

INTRODUCTION

During the preparation of this thesis visits were made to Australia, Israel, Britain and Europe where numerous people were interviewed and sites visited. Several papers were presented at conferences. This appendix details personal impressions which may have a bearing on the use of blocks in southern Africa.

My visit to Australia in 1982 was timed to coincide with two conferences on segmental blocks in Perth to which my papers (Clifford 1982 Nos. 4 and 5) had been submitted and accepted. The visit also provided an opportunity to become familiar with the considerable experience gained over many years in Australia.

In 1984 I presented papers at the second International Conference on Blocks in the Netherlands and at an International meeting on Permanent Concrete Block Paving in Italy. (Clifford 1984 Nos. 1, 2 and 3.) This gave me the opportunity to exchange views with others in the field and to see blocks in Europe.

The opportunity to give lectures and present papers to a technical and often critical audience always helps to substantiate the findings of particular research work.

DIFFICULTIES IN MONITORING JOINT WIDTHS WITH TYPE S-C BLOCKS

Where non-interlocking units (S-C blocks) were used extensively, difficulties were experienced with accurate maintenance of joint widths. Joint widths of 2 - 5 mm are fairly easy to maintain with some types of fired-clay products since their dimensional tolerance is much more variable than that of concrete products. The accuracy attainable with concrete units makes tight jointing spacing possible, and where this is less than 2 mm, spalling of the corners of individual units often occurs.

To overcome the problems of tight joints with S-C units large rubber bands were used in some cases. The rubber bands were placed around individual units so that when they were laid the bands provided the 2 mm minimum jointing required. In discussions with those who used this method of spacing I was assured that they were very satisfied with this simple means of ensuring joint width, but there are several problems and this practice is not recommended for South Africa. The first objection is the cost of obtaining sufficient quantities of large, thick rubber bands and the time required for putting them around the blocks. It would only be necessary in practice to band every other unit to maintain joints, but it appeared that every unit was banded. Even if only 50 per cent of the Units were banded the expense and effort involved would be greater than the effort of training teams to ensure that their joints are not too tight. Another objection to such a practice concerns the filling of the joints with jointing sand. It can be appreciated that for practical purposes the rubber bands would be placed within the central third of the thickness of the blocks. Because of this the vertical movements of the jointing sand would be seriously restricted either by material introduced from the surface during the jointing procedure or by material rising in the joints during the compaction process. In these cases the joints would not be filled and intimacy of the units within their matrix would be seriously reduced. A third objection to this practice is that in time the rubber would perish and the bands would break. The joints would then contain lengths of perished rubber which may affect their ability to transmit stresses within the pavement and to resist the ingress of moisture.

BLOCKS LAID DIRECTLY ON DESERT SANDS

An interesting use of blocks in Israel is for tracked vehicles. In the south of Israel in areas of desert, blocks have been placed directly on compacted sand to provide satisfactory roads. The tracked vehicles caused some spalling to the corners and an idea of reducing or even eliminating the chamfers on the blocks was typically 65 MPa. It was not possible to visit the areas laid in the south, but I was taken to Yavneh, a new town near Ashdod built

on sands where the blocks were also laid directly on compacted sand as seen in Figure C.1. The pavements in Yavneh were not expected to be subject to tracked vehicle loading but the principle could be of great interest in building inexpensive roads in desert areas in southern Africa.

ANCIENT ROMAN BLOCK PAVED ROADS

A number of examples of ancient Roman block paved roads have been preserved in the Forum museum and in the Palatine. It was obviously not possible to discuss their construction with the contractors but a visual inspection revealed that they would prove to be most unsuitable for to-day's traffic. Indeed the large stones used and the wide joints between the stones would cause problems with pedestrian and horse traffic. I can only conclude that over the centuries some differential settlement has taken place. Figure C.2 shows a section of Roman Road with a small modern car and the sizes of the joints can clearly be seen. These wide joints would in no way stop the ingress of water into sublayers. The completely random placing of the blocks and various sizes of blocks used show that whilst these pavements can be described as "block-pavements" their design and service to traffic is different to modern block paving.

THE "ANDERSONMETER"

One team of very experienced freelance pavers in Australia attribute their rate of paving and the finished achieved against kerbing and around obstructions (such as gulleys) to the instrument invented by them which I dubbed the "Andersonmeter" after the inventor, Mr Slan Anderson. This is a simple measuring device which in one easy movement determines the size of block needed to fill a space, even if splay cutting is necessary. It allows the full block to be accurately marked so that when cut it will fill the space exactly. The device comprises three pieces of purpose-made aluminium which are infinitely variable in relation to each other and are locked together with wing nuts.

The Andersonmeter is placed in the space to be filled with a part block and quickly wing-nut tightened into position. The instrument is then laid onto the block to be cut and marked with a pencil against one of its aluminium edges. Once the block has been cut with the usual hydraulic shears, it fits perfectly into the space. Attention to such detail provided a very high quality of finish typical of the jobs done by this team. A photograph (Figure C.3) shows the instruments in use. By providing exchangeable end pieces the instrument can be used for either interlocking blocks for rectangular units (details for manufacturing the instrument are given in Figure C.4). The adoption of this instrument by contractors in South Africa could improve laying practice considerably. As a result of my report (Clifford 1982 No. 3) to the Concrete Masonry Association of South Africa, the instrument will be made available to their members at reasonable cost. Extensive use of such an instrument will considerably improve the finish of block paving in South Africa.

AN UNUSUAL ARCHITECTURAL USE WITH POSSIBLE LOCAL APPLICATION

Early Australian history was greatly shaped by the original "assisted migrants", namely convicts deported from England.

The arrows often seen on convict clothing indicated Government ownership, and on many of the oldest buildings constructed by government labour some of the paving bricks were marked with arrows. One company in Hobart, Tasmania, manufactures bricks and blocks to dimensions common to those used in the earliest construction and marked them with similar arrows on their faces. When repair work was carried out on buildings and pavements the new units had to match the original units. Part of the sales of such arrowed products was for new work where the historical construction could be duplicated.

SMALLER SIZED BLOCKS USED IN THE NETHERLANDS

Over the considerable history of the use of blocks in the Netherlands public reaction has demanded personalization wherever possible. The sizes of Dutch bricks are generally smaller than

in South Africa being about half as thick as the traditions 9" x 4½ x 3" brick made here (i.e. 9" x 4½ x 1½"). This smaller size provides a better human scale when bricks are used for pedestrian areas.

Several manufacturers in the Netherlands have capitalized on this and make concrete blocks, in a variety of colours, to the same size as the bricks, for paving (figure C.5). Figure C.6 shows the potential of these blocks where a map of the Netherlands has been made in a school playground. The larger blocks (the size that is traditional in South Africa) can be seen in the foreground. I propose we seriously consider using these thinner units in South Africa allowing architects free reign with pedestrian malls and domestic driveways.

ARCHITECTURAL BLOCKS

Architects and other users would like blocks that will wear with use to give a rough surface where stone aggregates are exposed. They suggested a MPa specification as low as 15 to achieve this. I suggested that, as with exposed aggregate panels made for vertical use in pre-formed concrete buildings, the moulds could be painted with an acid which would prevent cement, adjacent to the walls of the mould, from hydrating. By this method, when the blocks are cured the cement and fine particles at the surface of the block would fall away, leaving a finish which would be acceptable for architectural use. I did not consider that such a low strength was acceptable since the strength, and hence the structural capacity, durability and porosity of the block would be below the minimum required. Consideration should therefore be given to the manufacture and use in South Africa of exposed aggregate blocks of 25 MPa, especially for architectural and other applications in which aesthetics are important. The choice of suitable aggregates would be dictated by colour, angularity, size or shape, and a wide range of such blocks would probably find a ready market for use in S1 and S12 specification pavements. Their use for S4 may also be considered since the skid resistance of such exposed aggregate units would be greater than that of the normal units manufactured by the usual methods and which may be more desirable in certain cases.

USE OF SEGMENTAL BLOCKS IN BUILDINGS

Segmental block paving in South Africa has mainly been used for external paving where environmental conditions vary considerably. I have for some time considered their use in industrial and commercial flooring within buildings to be desirable. I was therefore very pleased to learn of several examples of such use in Tasmania, Israel and Germany. I was shown a car showroom in Tasmania where 60 mm thick S-A blocks had been used to pave over an existing suspended timber floor. Adjacent to this the blocks were used to pave over a concrete floor originally forming a verandah and over an area of concrete surfacing to finish an area of infilling and rubble subbase. The floors were laid in the usual way with sand bedding and sand jointing. A small hand-held plate vibrator was also used. One precaution was, however, taken prior to placing the bedding sand - some cracks in the timber-suspended floor were sealed with a plastic solution to prevent any loss of bedding sand. After approximately one year's use the floor still appeared to be sound. One part of the showroom was subjected to quite heavy loading where engines are stored on frames.

POSSIBLE USE OF MOSS AS AN UPPER SEAL IN JOINTS

Roadways in paths in the Perth botanical gardens are being professionally paved in S-A and S-C blocks and have been favourably commented upon by many local residents who wish to use similar materials in their own driveways. In one area it was noticed that a type of moss was growing in the road detritus and was not worn away by the action of passing vehicles since it was protected by the chamfers of adjacent blocks. I asked the superintendent if he had considered planting a variety of mosses in the joints to stop weed growth and to provide an aesthetic seal between the blocks. He said he had not considered such a possibility but would discuss it with his staff. He hoped to plant mosses in trial areas. I followed this up with the Pretoria-based National Herbarium, which is a division of the National Botanical Gardens. It seems that mosses are difficult to grow in large exposed areas such as the joints in S1 and S2

paving. Only one type of moss available in South Africa may be suitable, namely Bryum Argenium Hediv, which may, however, prove too soft for use in paving. Moss will not stop other plants like grasses from growing in the joints. Some moss might be lost when other plants are removed.

PRECOMPACTION OF BEDDING SAND - BRITISH PRACTICE

In discussions with two British experts on block paving, Mr Alan Lilley of the British Cement and Concrete Association, Dr John Knapton one time with the University of Newcastle and now in consulting engineering, the argument for precompaction of bedding sand was given. There seems to be some merit in the argument and it should not be discounted in South Africa. The British have a target thickness of 30 mm of compacted bedding sand, although this is not specified. The finished levels of the subbase may realistically be ± 20 mm, a specification which is difficult to attain. Block thicknesses may be ± 3 mm and these tolerances must be made up in the bedding sand layer. In calculating extreme cases, say blocks -3 mm, subbase -20 mm = -23 mm + sand layer target 30 mm = 53 sand thickness. In the other extreme blocks $+3$ mm, subbase $+20$ mm, from target 30 mm = 7 mm of sand bedding. Assuming a bulk factor of 30% in the sand, the compaction procedure would produce surface level differences of 15 mm in a perfectly constructed pavement as specified. It would therefore be impossible to achieve the required tolerances under a 3 m straight edge, the traditional South African specification, a condition which has happened several times in South Africa already. The British practice is therefore to precompact the bedding sand achieving the required levels and lightly raking the surface to allow variations in the thicknesses of blocks to be accommodated. I suggest we consider reviewing the specification and procedure of bedding sand in South Africa.

SIGNWRITING WITH BLOCK PAVING

Several poor attempts at writing with different colour blocks were seen in various countries. This led me to consider the advantages of developing a suitable system for use either industrially or domestically. Company names, house, names, street

signs and other writing could therefore be included in the pavement. The architectural possibilities of such a system could rapidly develop. Figure C.7 shows a lettering and a numbering system using rectangular units, half rectangular units (i.e. square) and the purpose-made lettering unit.

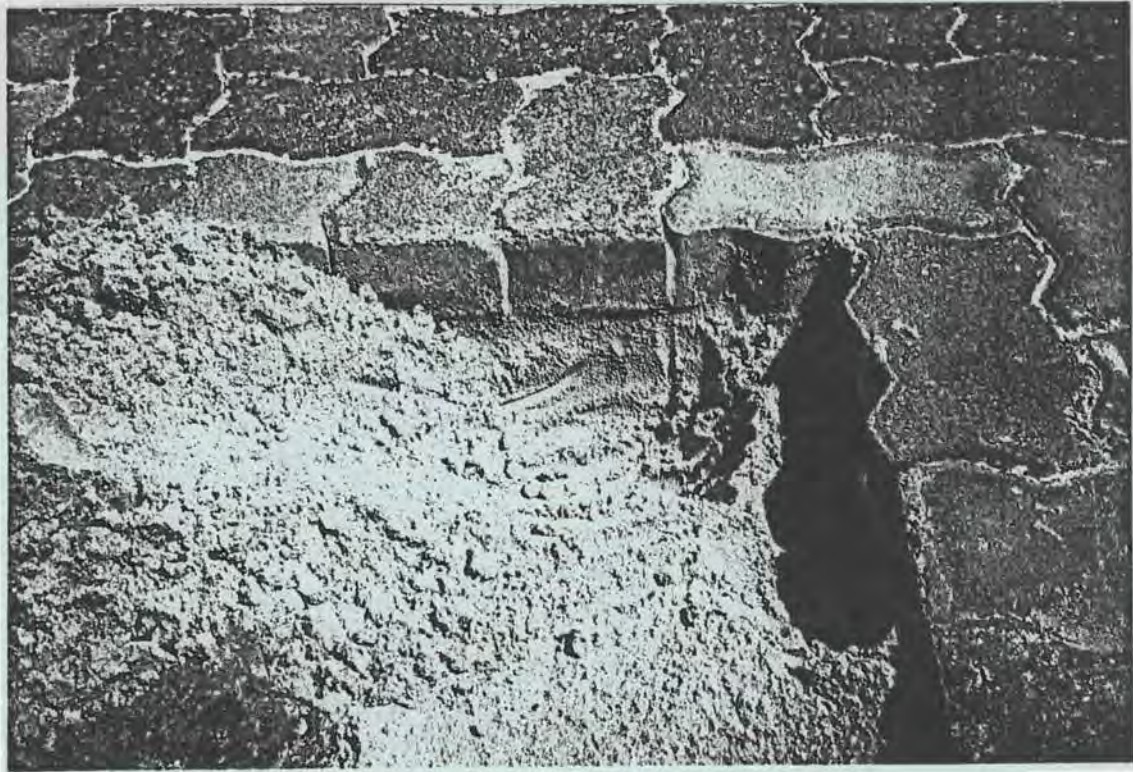


FIGURE C.1
*BLOCKS LAID DIRECTLY ON DESERT SANDS
ISRAEL*



FIGURE C.2
*ANCIENT ROMAN. BLOCK PAVED ROAD AND SMALL MODERN
CAR*

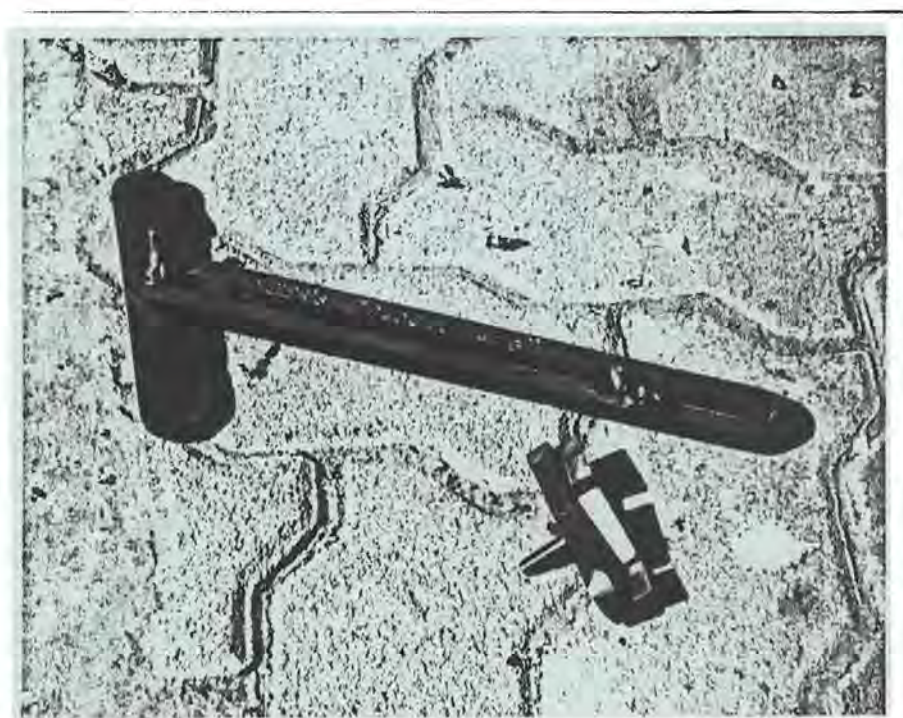
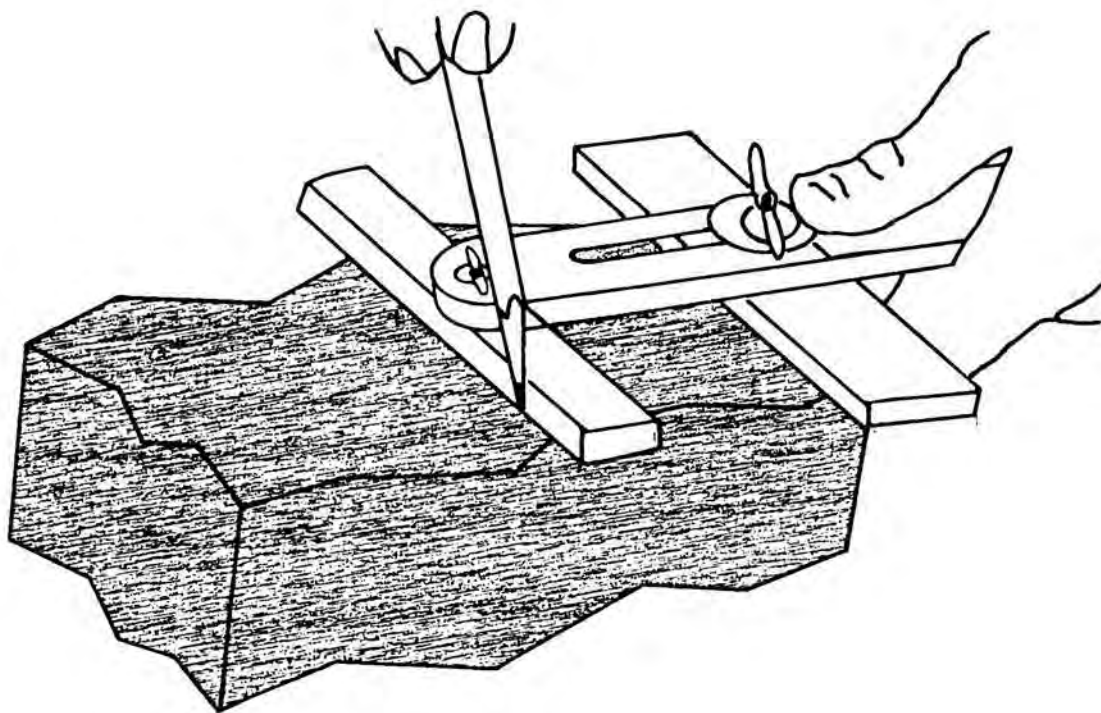
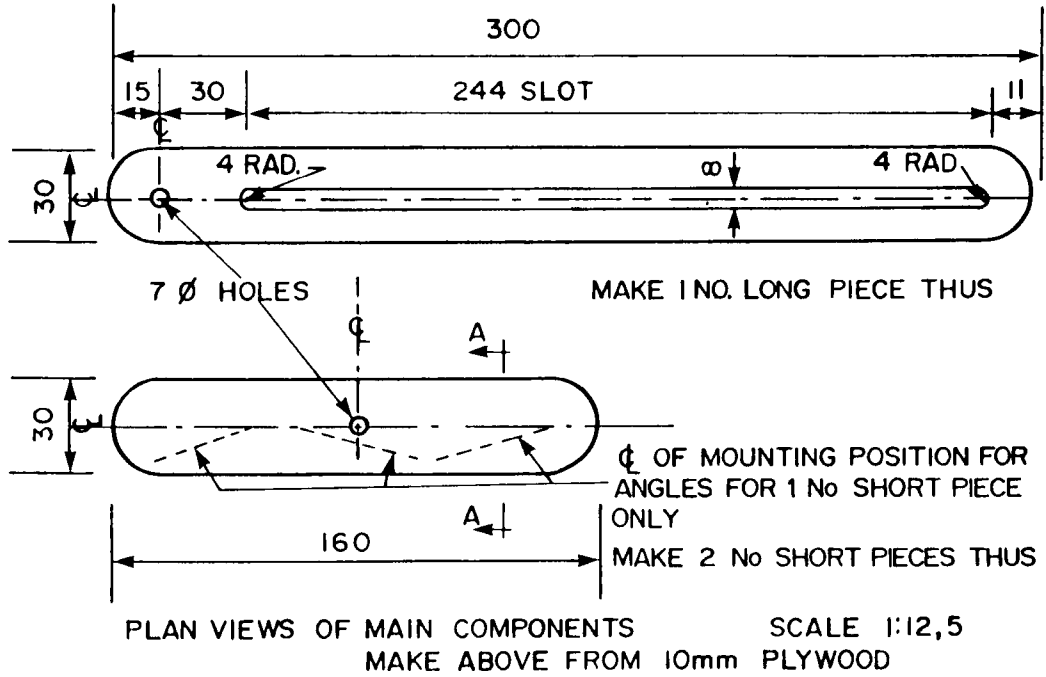


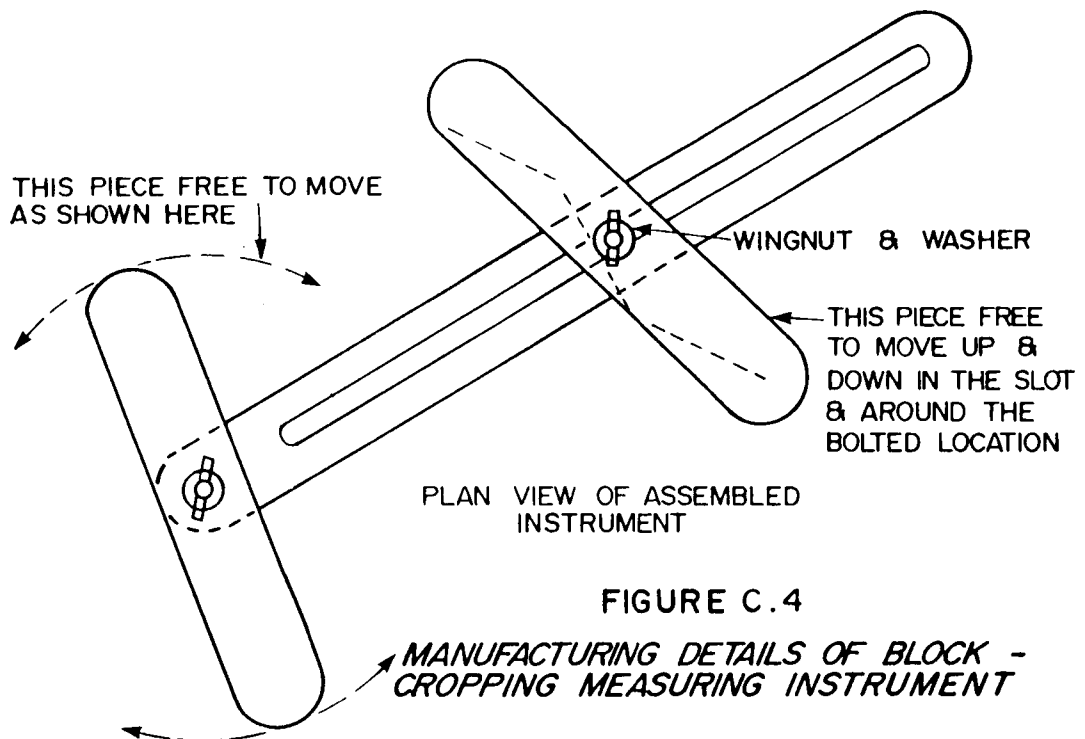
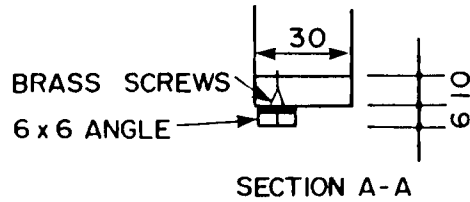
FIGURE C.3

*THE "ANDERSONMETER" USED FOR ACCURATELY
MEASURING PART BLOCKS*



PARTS LIST PER INSTRUMENT

- | |
|--------------------------------------|
| 1 NO. LONG PIECE AS ABOVE |
| 1 NO. SHORT PIECE WITH ANGLES |
| 1 NO. SHORT PIECE WITHOUT ANGLES |
| 2 NO. 7 ϕ BOLTS & WINGNUTS x 35 |
| 2 NO. WASHERS FOR ABOVE |
| 3 NO. 40x6x6 AL ANGLES |



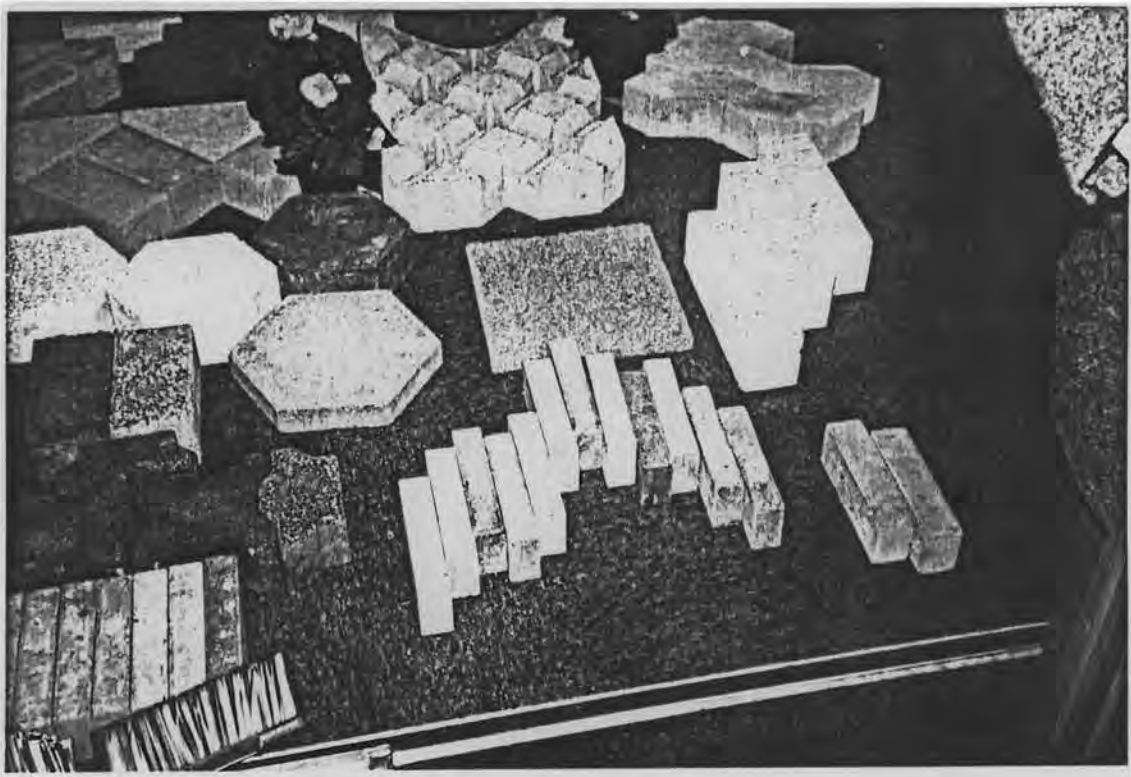


FIGURE C.5

*RANGE OF PRODUCTS BY ONE DUTCH MANUFACTURER,
NOTE THINNER CONCRETE UNITS IN FOREGROUND*

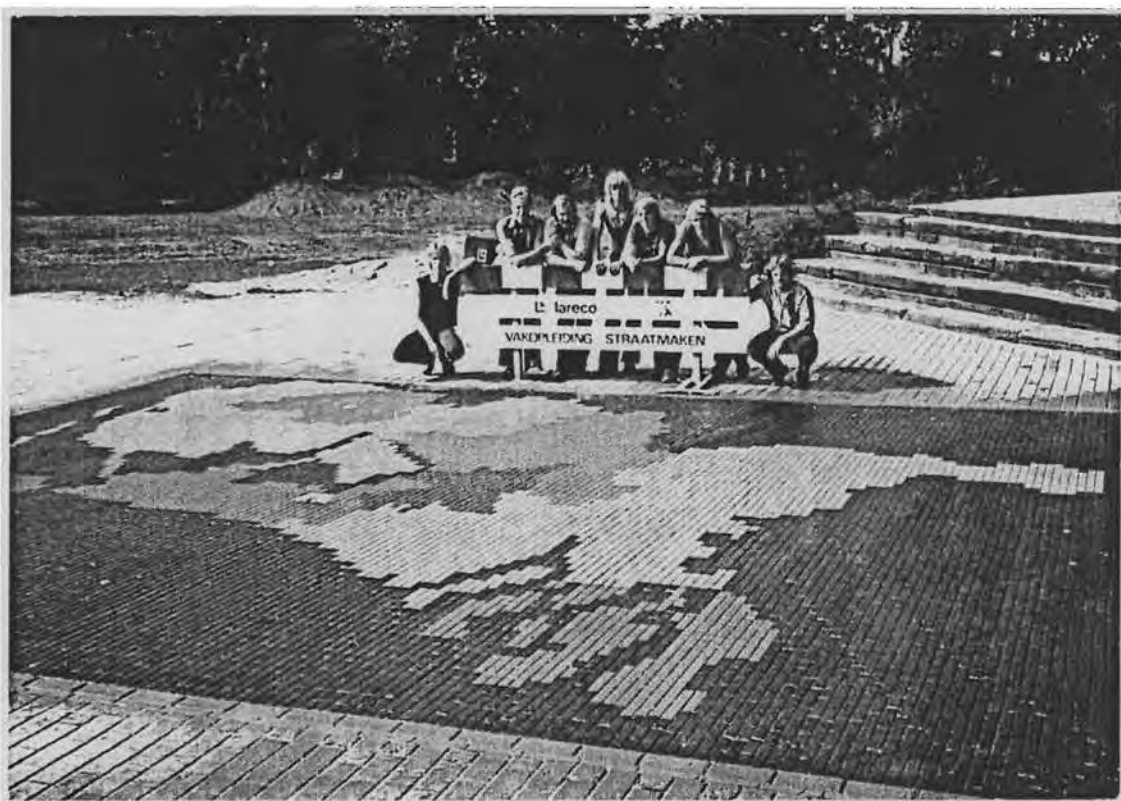


FIGURE C.6

MAP OF NETHERLANDS IN SCHOOL YARD USING THINNER UNITS

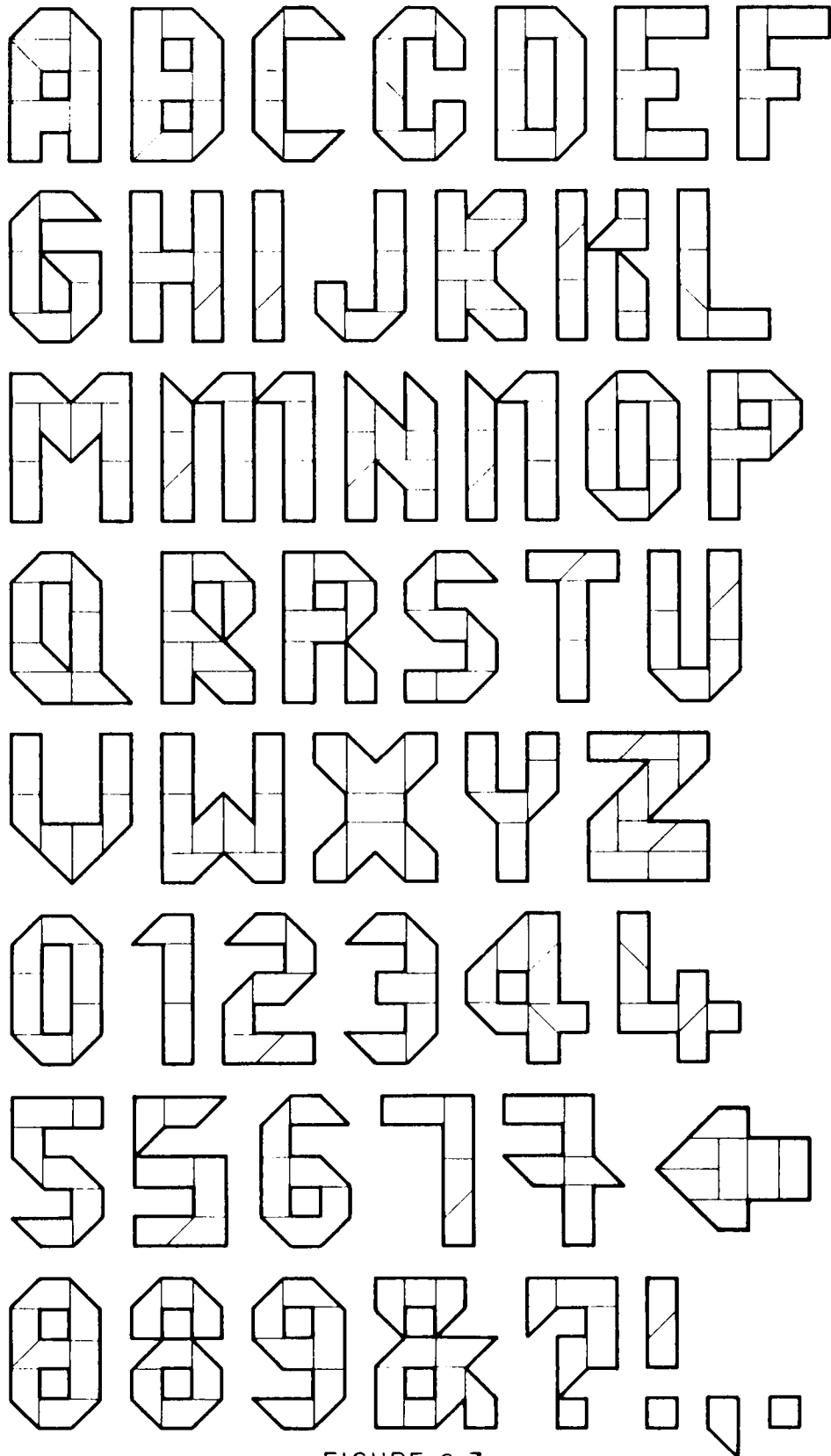


FIGURE C.7

*A LETTERING AND NUMBERING SYSTEM WITH SEGMENTAL
BLOCK PAVING*

APPENDIX D

FOUR PRACTICAL TESTS FOR MEASURING JOINT STRENGTH

FOUR PRACTICAL TESTS FOR MEASURING JOINT STRENGTH

INTRODUCTION

Specifications for segmental-block pavements usually include manufacturing limits for the blocks in terms of thickness, size (length and breadth) and aggregate choice and mix. The specifications may require particular thicknesses and types of bedding sand and grading for jointing sand. The pavement when completed is normally subjected to 3 m straight-edge measurements where limits of tolerance are given.

The segmental-block pavement when subjected to trafficking develops some measure of improvement in terms of "settling-in" which is seen particularly with respect to the joints. The flexible response of a segmental-block pavement as a whole required suitable jointing material where stresses, flexure and other forces can develop.

FOUR PRACTICAL TESTS

Four practical tests for measuring aspects of the strength of the joints at any time during the life of a segmental-block pavement have been used and are proposed.

Test 1

A measure of the force required to extract an individual block from within a matrix of blocks.

Test 2

Measurement of the sealing properties of joints.

Test 3

Alternative method for measurement of the sealing properties of joints.

Test 4

Measurement of the average joint-width.

Test 1. A method to monitor extraction force

The apparatus required comprises a hydraulic jack fitted with a pressure gauge mounted on a simple frame allowing an adaptor which is stuck to a selected block to be pulled vertically upwards from its matrix. The apparatus is shown in Figure D.1.

Procedure

1. Wire-brush the surface of block to be extracted.
2. Mix half the contents of a 40 ml pack of "Pratley quickset glue" (a clear epoxy) (or something similar) on a suitable palette using a putty knife or spatula.
Spread half the mix onto surface of block and half onto extraction adaptor. (On a hot day (i.e. $\pm 30^\circ$) the epoxy may become unworkable within ± 5 minutes after mixing.)
3. Place the adaptor onto the surface of a pre-selected block (as shown in figure D.2).
4. Place template over adaptor (as shown in Figure D.3 and pour fine grained sand to form a thin level bedding for the base of the extractor. The template is then removed.
5. Position the extractor over the adaptor and engage the stirrup of the extractor with the stem of the adaptor, then secure it with a nut.
6. Apply vertical force slowly with the hydraulic jack and record the highest reading obtained on pressure gauge.

Test 2. Sealing properties of joints

The apparatus required is simple and is shown in figure 2.5. It comprises:

1. Perspex cylinder (290 mm internal diameter by 100 mm high)
2. "Prestik" (or similar) sealing compound
3. Ruler
4. Two litres of water
5. Timer
6. Wire brush.

Method

1. Place the perspex cylinder to completely encircle one paving block and mark its position on the paving. Remove the cylinder.
2. Wire brush around the marked area of the pavement to ensure good surface adhesion and apply a small quantity of Prestik (or similar) to this area.
3. Roll a quantity of Prestik between hands to form a continuous bead approximately 5 mm thick and lay this bead on the end of the cylinder around the circumference applying sufficient pressure to make it adhere.
4. Place this end of cylinder onto the Prestik and apply sufficient pressure to ensure the cylinder is stuck onto the pavement. Use extra Prestik to form a good seal, both inside and outside the cylinder wall, and especially in those areas where there are joints passing beneath the edge of the cylinder
5. Note the time and pour the two litres of water into the cylinder. Record the head of water at the same pre-determined position.
6. Take periodic measurements to enable a time/head plot to be drawn.

Figure 2.5 also shows details of this test.

Test 3. An alternative method for studying sealing properties of joints

The apparatus required is shown in Figure D.4 and comprises:

1. Special perspex cylinder
2. Water
3. Tape measure
4. Chalk.

Method

1. Close off aperture in the special perspex cylinder with the finger of one hand and completely fill the cylinder with water.
2. Hold the cylinder as near to the pavement surface as possible, then remove the finger from the aperture and place the cylinder on top of a pre-selected block. Remove the cylinder when all the water has been discharged.
3. Mark the wetted area with chalk and count the number of blocks. Where water has followed a more direct route (e.g. on a slope) measure the distance which the water has flowed and relate this by calculation to number of blocks.

For example:

$$\begin{array}{rcl}
 \text{Rectangular unit 200 long a 100 wide} & = & 600 \text{ circumference} \\
 \text{Distance of water flow} & = & 2\ 640 \\
 \text{Therefore number of full blocks} = \frac{2640}{600} & = & 4
 \end{array}$$

Typical details of tests done and measurements made with the apparatus are given in Table D.1

Block type	Full blocks		Repeat after rain	
	Indoor	Outdoor		
S-A	15			Well jointed - minimal slope - dust on surface tension on water and inhibits flow
S-A	11			
S-A	18			
S-A		20	26	Well jointed - minimal slope
S-C		33	38	Well jointed - Minimal slope
S-C			32	
S-B		27		Well jointed with river sand - pronounced slope
S-B		28		
S-B		19		Poor jointing with river sand - pronounced slope
S-B		15		

Test 4. Measurement of joint spacings

The apparatus required is known as a "Shackelometer" and comprises a graduated cone as shown in figure 5.5

Method

(a) Rectangular blocks

Insert the cone between adjacent blocks at the approximate centre of each face (two long and two short faces) until the sides of the cone touch both faces. Record the joint width. Calculate the means of values recorded.

(b) Non-rectangular blocks

Insert the cone between adjacent blocks at the approximate centre of each of the many faces until the sides of the cone touch both faces. Record the joint width. Calculate the mean of values recorded.

NOTE: The spacing of all faces around a block must be measured. Several blocks (a minimum of 10) should be chosen at random to provide sufficient data for a realistic average joint width to be determined.

TARGET VALUES TO BE ACHIEVED BY THE TESTS

For Test 1

Figure 5.11 shows various extraction force measurements from a wide variety of block pavements. Two target values are suggested and are shown:

- (i) the extraction force of 2 kN representing an absolute minimum for non-structural pavements and
- (ii) the extraction force of 2 kN representing the minimum extraction force for structural block pavements (i.e. pavements subjected to heavy traffic or industrial loading).

For Test 2

Figure 2.10 shows typical details of tests made with the portable cylinder. Two target values for site evaluation are proposed.

- (i) In no case should the water in the cylinder dissipate in less than three hours
- (ii) For a structural block pavement some water must remain in the base of the cylinder after 24 hours.

For Test 3

Figures D.5 and D.6 show details of macro and micro scale plots respectively of various tests done with the equipment on a variety of pavements at the Silverton test site. Reference numbers refer to panels of blocks constructed for extensive structural evaluation tests made by heavy vehicle simulators and other means (as shown in Figure 6.5). Details of water absorption are given in Table D.2. Two limits are proposed.

- (i) A maximum absorption rate of 20 mm head of water in a period of 2 hours for block paving work not subjected to severe environmental effects. (Such as paving indoors.)
- (ii) A maximum absorption rate of 5 mm head of water in two hours for block paving subjected to severe environmental effects.

For Test 4

Figure 5.4 shows typical results of joint width surveys made. A Range of 2 - 5 mm is proposed as an acceptable target value.

Jointing sand used for this range should comply with the recommended grading envelope (Figure 5.6) to allow full strength of jointing material to be attained.

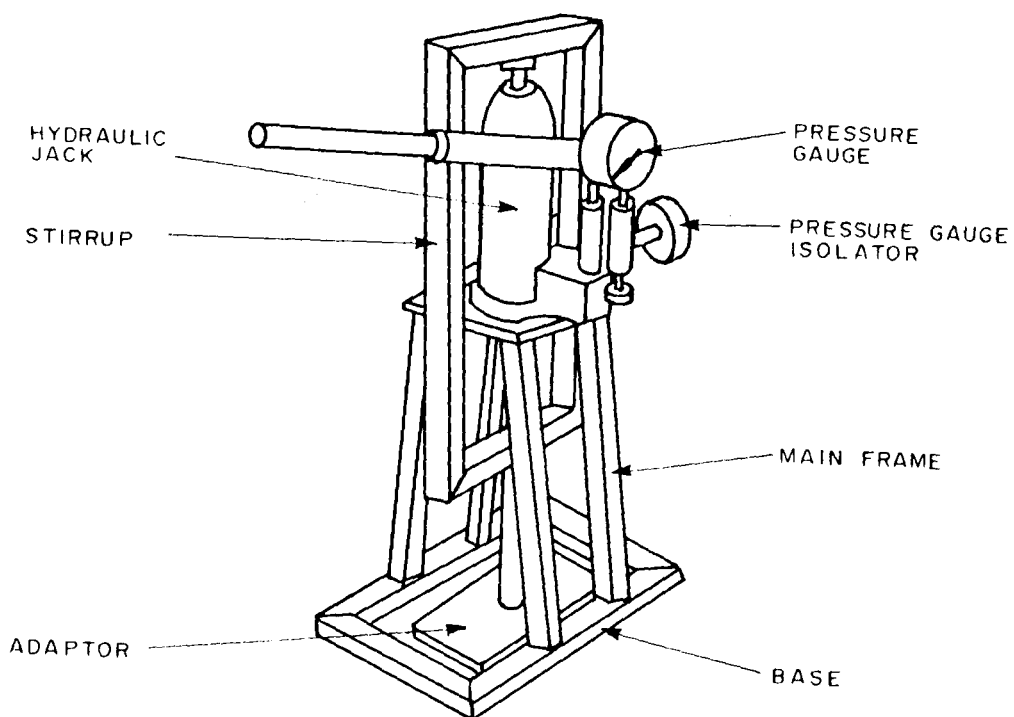


FIGURE D.1
BLOCK EXTRACTOR ASSEMBLY



FIGURE D.2 *PLACING ADAPTOR*



FIGURE D.3 *USING TEMPLATE*

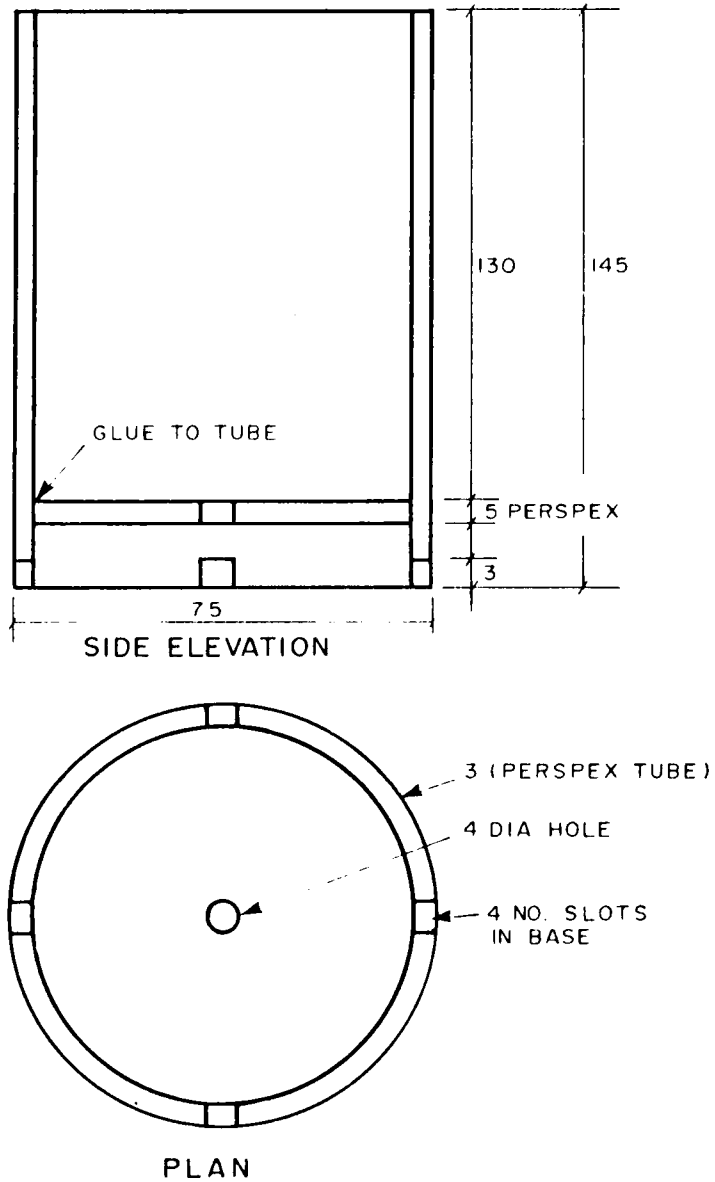


FIGURE D.4

WORKING DETAILS OF INSTRUMENT FOR ESTIMATING SEALING PROPERTIES OF JOINTS

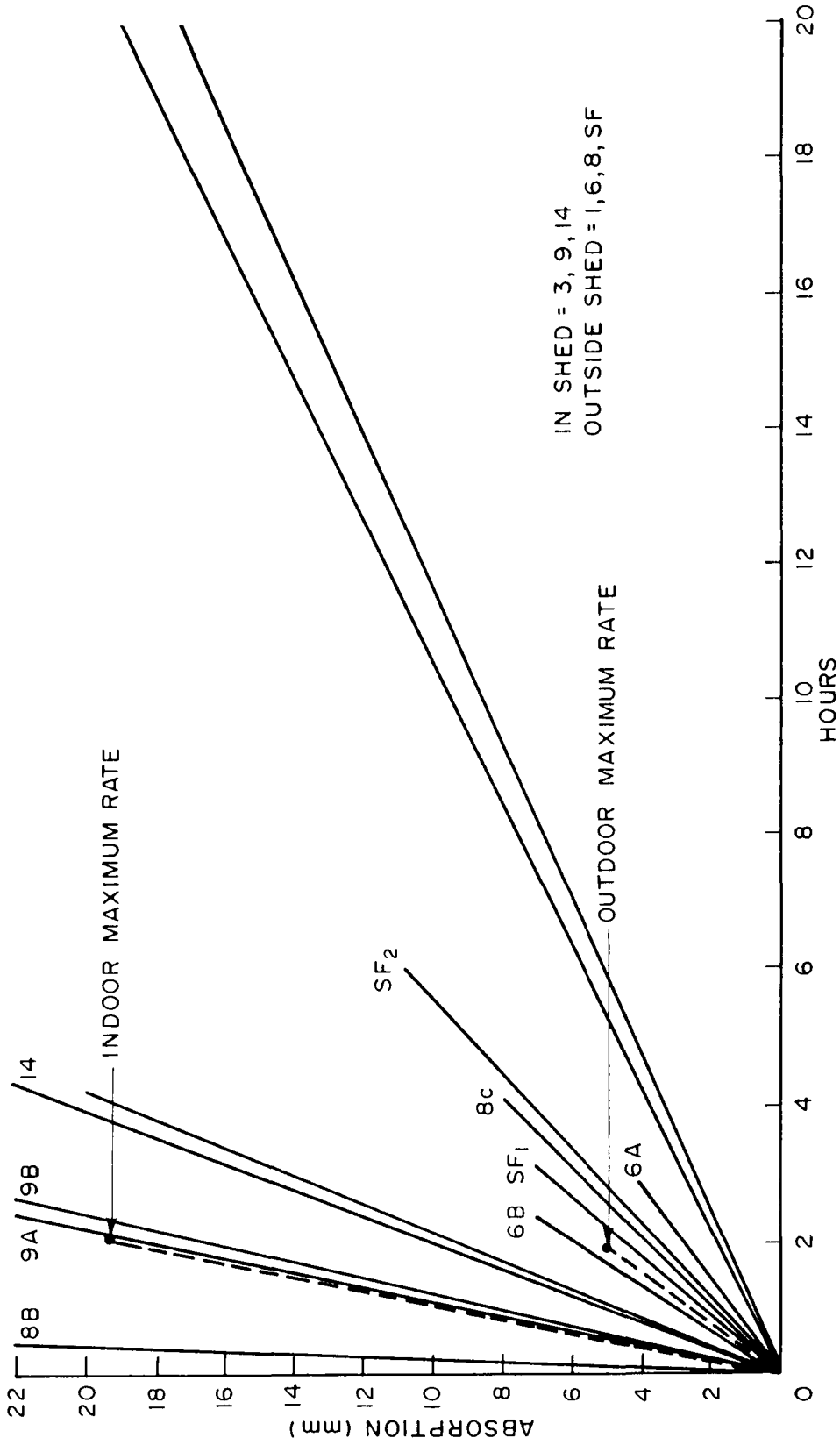


FIGURE D.5
 MACRO SCALE OF ABSORPTION RATE

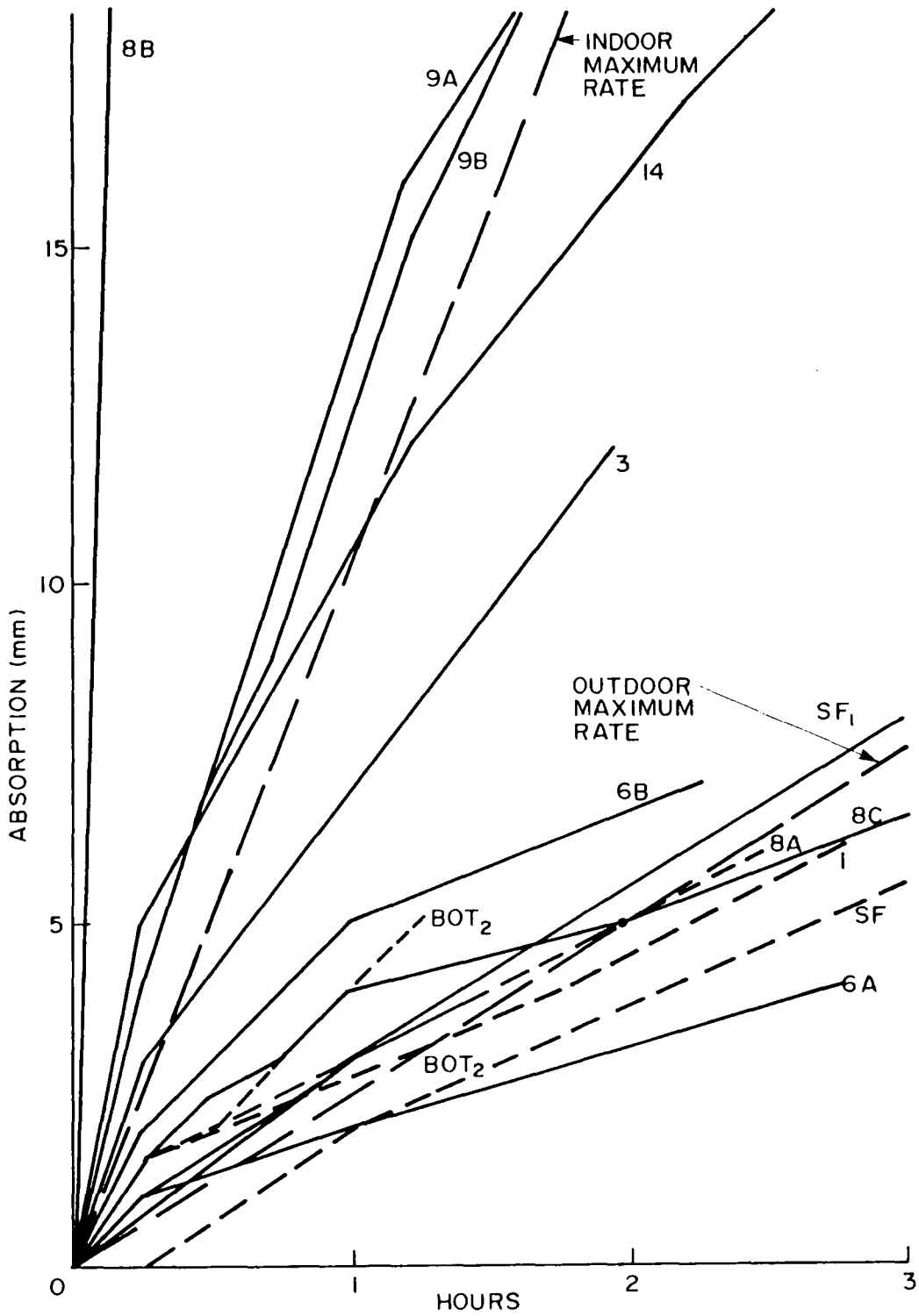


FIGURE D.6
 MICRO SCALE OF ABSORPTION RATE

TABLE D.1 TYPICAL MEASUREMENTS MADE FROM TEST 3

BLOCK TYPE	FULL BLOCKS		REPEAT AFTER RAIN	
	INDOOR	OUTDOOR		
S-A	15		}	Well jointed - minimal slope - dust on surface causes surface tension on water and inhibits flow.
S-A	11			
S-A	18			
S-A		20	26	Well jointed - minimal slope.
S-C		33	38 } 32 }	Well jointed - minimal slope.
S-C				
S-B		27	}	Well jointed with river sand - pronounced slope.
S-B		28		
S-B		19	}	Poor jointing with river sand - pronounced slope.
S-B		15		

TABLE D2 BLOCK PAVING WATER ABSORPTION

Date	Panel	Location	Time Hours	Interval Minutes	Absorb (mm)	
11/3/81		Botanical Garden	-	30	1,5	Minimal joint flow. Shaped concrete blocks. (Test done just after wet period) i e from 11/3/81 -
			1	00	3,0	
			1	30	4,0	
17/3/81	6	CMA Outdoor	1	15	1,0	No joint flow. Rectangular concrete blocks.
			2	00	2,0	
				45	4,0	
23/3/81	1	CMA Outdoor	-	15	1,5	Slight joint flow. Shaped concrete blocks.
			1	40	4,0	
			2	40	6,0	
			3	40	8,0	
			26	10	25,0	
			28	40	26,5	
			44	40	30,0	
25/3/81	SF blocks on concrete road		-	15	1,0	Slight joint flow.
			1	00	3,0	
			2	00	5,5	
			3	00	8,0	
26/3/81	Same As 25/3		-	15	0,0	Repeat test without disturbing vessel.
			1	00	2,0	
			3	00	5,5	
			4	00	6,5	
			5	00	10,0	
			6	00	12,0	

TABLE D2 (continued)

Date	Panel	Location	Time Hours	Interval Minutes	Absorb (mm)	
2/4/81	9	CMA Indoors	-	15	4,0	Slight joint flow. Shaped concrete blocks.
			1	15	16,0	
			1	45	19,0	
			2	15	24,0	
			2	45	28,0	
3	10	29,0				
7/4/81	14	CMA Indoors	-	15	5,0	Slight joint flow. Shaped concrete blocks.
			1	15	12,0	
			2	15	17,0	
			3	15	21,0	
			4	15	25,0	
5	15	28,0				
7/4/81	8A	CMA Outdoor	-	15	1,5	Slight joint flow. Rectangular concrete blocks.
			2	30	6,0	
			21	30	18,5	
			24	55	22,0	
			27	30	27,0	
29/4/81	3	CMA Indoors	-	15	3,0	Slight joint flow. Shaped concrete blocks. North end of panel.
			1	00	7,0	
			2	00	12,0	
			4	00	21,0	

TABLE D2 (continued)

Date	Panel	Location	Time Hours	Interval Minutes	Absorb (mm)					
25/5/81	8B	CMA Outdoor	-	15	22,0	Slight joint flow.* Test done on same position as 7/4/81 (8A) 2 ℓ water added after each time water was fully absorbed.				
			-	25	30,0					
			-	15	12,5					
			-	30	22,0					
			-	45	29,5					
			-	52	31,5					
			-	15	7,5					
			1	00	26,5					
			1	15	30,5					
			-	15	6,5					
			1	00	26,5					
1	20	31,0								
12/6/81	8C	CMA Outdoor	-	15	1,5	No joint flow.* Test done on different position to previous tests.				
			-	30	2,5					
			-	45	3,0					
			1	00	4,0					
			2	00	5,0					
			3	00	6,5					
			4	00	8,0					
			8/6/81	9	CMA Indoors		-	15	4,0	Slight joint flow.* Test done on same position as 2/4/81.
							-	30	7,0	
							-	45	9,0	
1	00	12,0								
1	15	15,0								
1	30	17,0								
1	45	19,0								
2	00	21,0								
2	30	25,0								
3	00	28,0								
3	15	29,5								

TABLE D2 (continued)

Date	Panel	Location	Time Hours	Interval Minutes	Absorb (mm)	
11/6/81	6	CWA Outdoor	-	15	2,0	Repeat test on different position.
			-	30	3,0	
			-	45	4,0	
			1	00	5,0	
			2	15	7,0	
26/6/81		Botanical Garden	-	15	1,5	Repeat test on same area but probably different position. Minimal joint flow.
			-	30	2,0	
			-	45	3,0	
			1	00	4,0	
			1	15	5,0	

APPENDIX E

DATA OF MODELLING

PAVEMENT STRUCTURE		ROAD CATEGORY	
60 20 150 100	BLOCKS SAND C2/3	DESIGN TRAFFIC CLASS	
100	G4	PAVEMENT TYPE	BLOCK PAVING (PANEL 23)
SEMI ∞			

INPUT VALUES		CRITICAL PARAMETERS			
LAYER NUMBER	THICKNESS (mm)	POISSON RATIO	E - VALUE (MPa)		
			PHASE 1	PHASE 2	PHASE 3
1	60	0,35	1000	1500	2000
2	20	0,35	200	200	200
3	150	0,35	6000	2200	350
4	100	0,35	225	225	225
5	SEMI-∞	0,35	50	50	50

STRESSES (σ, kPa); STRAINS (ε)	
PHASE 1	PHASE 2
Max. σ _v 520,3	
NO CHECKS MADE ON SAND LAYER	
117 με	188 με
σ _v = 27,6 (c) σ _m = 27,7 (t)	σ _v = 36,2 (c) σ _m = 43,8 (t)
ε _v = 320 με	ε _v = 164,9 (c) ε _v = 27,6 (t)
	524 με

INTERPRETATION AND EVALUATION			
LAYER NUMBER	LAYER LIFE (E80)		STRUCTURE LIFE (E80)
	PHASE 1	PHASE 2	PHASE 3
1			LAYER 3 CRITICAL
2			EG4, F.S = 0,37
3	VERY SHORT		~10 ⁵ (CCLAY)
4			LAYER 4 -ve FOS
5			

DEFLECTION (mm)	
INITIAL	FINAL
0,52	0,72

FIGURE E.1
PROFORMA DETAILS OF ELSYM 5 MODELLING

PAVEMENT STRUCTURE		ROAD CATEGORY	
60 20 150 100	BLOCKS SAND C2	DESIGN TRAFFIC CLASS	
100	G4	PAVEMENT TYPE	BLOCK PAVING S3d WORST CASE
G6 OR WORSE			

INPUT VALUES		CRITICAL PARAMETERS			
LAYER NUMBER	THICKNESS (mm)	POISSON RATIO	E - VALUE (MPa)		
			PHASE 1	PHASE 2	PHASE 3
1	60	0,35	1000	1500	2000
2	20	0,35	200	200	200
3	150	0,35	8000	2200	350
4	100	0,35	225	225	225
5	SEMI-∞	0,35	50	50	50

STRESSES (σ, kPa); STRAINS (ε)	
PHASE 1	PHASE 2
APPLIED σ _v = 520	
NO CHECKS MADE ON SAND INTERLAYER	
123 με	204 με
σ _v = 54,4 (c) σ _m = 12,3 (t)	σ _v = 71,6 (c) σ _m = 23,7 (t)
ε _v = 296 με	ε _v = 205,0 (c) ε _v = 28,6 (t)
	394 με

INTERPRETATION AND EVALUATION			
LAYER NUMBER	LAYER LIFE (E80)		STRUCTURE LIFE (E80)
	PHASE 1	PHASE 2	PHASE 3
1			LAYER 3 CRITICAL
2			EG2, F.S = 0,43
3	VERY SHORT		1,5 x 10 ⁵ (C)
4			F.S ~ 0 LAYER 4
5			

DEFLECTION (mm)	
INITIAL	FINAL
0,40	0,50

FIGURE E.2
PROFORMA DETAILS OF ELSYM 5 MODELLING






PAVEMENT STRUCTURE		ROAD CATEGORY				
60  BLOCKS 20  SAND 150  C2/3 100  C3/C4  G7 OR WORSE		DESIGN TRAFFIC CLASS PAVEMENT TYPE BLOCK PAVING (PANEL 33)				
INPUT VALUES		CRITICAL PARAMETERS				
LAYER NUMBER	THICKNESS (mm)	POISSON RATIO	E - VALUE (MPa)		STRESSES (σ , kPa); STRAINS (ϵ)	
			PHASE 1	PHASE 2	PHASE 1	PHASE 2
1	60	0,35	1500	1500	2000	APPLIED $\epsilon_v = 520$ kPa
2	20	0,35	200	200	200	NO CHECKS MADE ON SAND INTERLAYER
3	150	0,35	6000	2200	350	$\epsilon_H = 38 \mu\epsilon$ $\epsilon_v = 166,9$ (c) $\sigma_H = 23,6$ (t)
4	100	0,35	3500	1500	250	$\epsilon_H = 89 \mu\epsilon$ $\epsilon_v = 55,2$ (c) $\sigma_H = 72,1$ (t)
5	SEMI- ∞	0,35	50	50	50	$\epsilon_v = 199 \mu\epsilon$ $\epsilon_v = 294$ $\epsilon_v = 518$
INTERPRETATION AND EVALUATION						
LAYER NUMBER	LAYER LIFE (E80)			STRUCTURE LIFE (E80)		
	PHASE 1	PHASE 2	PHASE 3			
1				0,5 - 2 x 10 ⁶		
2			LAYER 3, EG 4	DEFLECTION (mm)		
3	VERY SHORT		FS = 0,49 2 x 10 ⁵ (c)	INITIAL	FINAL	
4	SHORT	VERY SHORT	FS = v ₆ EG 5	0,41		0,71
5						

FIGURE E.4
PROFORMA DETAILS OF ELSYM 5 MODELLING







PAVEMENT STRUCTURE		ROAD CATEGORY				
60  BLOCKS 20  SAND 150  C2 150  G4  G6 OR WORSE		DESIGN TRAFFIC CLASS PAVEMENT TYPE BLOCK PAVING S3d				
INPUT VALUES		CRITICAL PARAMETERS				
LAYER NUMBER	THICKNESS (mm)	POISSON RATIO	E - VALUE (MPa)		STRESSES (σ , kPa); STRAINS (ϵ)	
			PHASE 1	PHASE 2	PHASE 1	PHASE 2
1	60	0,35	1000	1500	2000	APPLIED $\epsilon_v = 520$ kPa
2	20	0,35	200	200	200	NO CHECKS MADE ON SAND INTERLAYER
3	150	0,35	8000	2400	450	$\epsilon_H = 82 \mu\epsilon$ $\epsilon_v = 182,1$ (c) $\sigma_H = 16,4$ (t)
4	150	0,35	225	225	225	$\sigma_v = 33,6$ (c) $\sigma_v = 46,6$ (c) $\sigma_v = 63,0$ (c) $\sigma_H = 8,7$ (t) $\sigma_H = 17,0$ (t) $\sigma_H = 25,4$ (t)
5	SEMI- ∞	0,35	100	100	100	$\epsilon_v = 185 \mu\epsilon$ $234 \mu\epsilon$ $289 \mu\epsilon$
INTERPRETATION AND EVALUATION						
LAYER NUMBER	LAYER LIFE (E80)			STRUCTURE LIFE (E80)		
	PHASE 1	PHASE 2	PHASE 3			
1				2 - 5 x 10 ⁶		
2			LAYER 3, EG 2	DEFLECTION (mm)		
3	VERY SHORT		FS = 0,95 ~ 3 x 10 ⁶ (c)	INITIAL	FINAL	
4		G4	FS = 0,94	0,32		0,45
5						

FIGURE E.3
PROFORMA DETAILS OF ELSYM 5 MODELLING

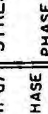
PAVEMENT STRUCTURE		ROAD CATEGORY	
60	BLOCKS	DESIGN TRAFFIC CLASS	
20	SAND		
125	C3		
125	C3	PAVEMENT TYPE	BLOCK PAVING (E4R) 60 mm BLOCKS
 G7 OR WORSE			

INPUT VALUES		CRITICAL PARAMETERS	
LAYER NUMBER	THICKNESS (mm)	E - VALUE (MPa)	
		PHASE 1	PHASE 2
1	60	0,35	1000
2	20	0,35	200
3	125	0,35	4000
4	125	0,35	2000
5	SEMI-∞	0,35	50

INTERPRETATION AND EVALUATION	
LAYER NUMBER	LAYER LIFE (E80)
	PHASE 1
1	
2	
3	LAYER 3, EG 4
4	VERY SHORT
5	VERY SHORT

CRITICAL PARAMETERS	
STRESSES (σ, kPa); STRAINS (ε)	PHASE 3
APPLIED $\sigma_v = 520$ kPa	
NO CHECKS MADE ON SAND INTERLAYER	
$\epsilon_H = 51 \mu\epsilon$	
$\sigma_v = 185,0$ (c)	
$\sigma_H = 4,8$ (t)	
$\sigma_v = 32,9$ (c)	
$\sigma_H = 99,6$ (t)	
$\epsilon_v = 265 \mu\epsilon$	
$\epsilon_v = 420 \mu\epsilon$	
$\epsilon_v = 521 \mu\epsilon$	

FIGURE E.5
 PROFORMA DETAILS OF ELSYM 5 MODELLING

PAVEMENT STRUCTURE		ROAD CATEGORY	
80	BLOCKS	DESIGN TRAFFIC CLASS	
20	SAND		
125	C3		
125	C3	PAVEMENT TYPE	BLOCK PAVING (E4R) 80 mm BLOCKS
 G7 OR WORSE			

INPUT VALUES		CRITICAL PARAMETERS	
LAYER NUMBER	THICKNESS (mm)	E - VALUE (MPa)	
		PHASE 1	PHASE 2
1	80	0,35	1000
2	20	0,35	200
3	125	0,35	4000
4	125	0,35	2000
5	SEMI-∞	0,35	50

INTERPRETATION AND EVALUATION	
LAYER NUMBER	LAYER LIFE (E80)
	PHASE 1
1	
2	
3	LAYER 3, EG 4
4	VERY SHORT
5	VERY SHORT

CRITICAL PARAMETERS	
STRESSES (σ, kPa); STRAINS (ε)	PHASE 3
APPLIED $\sigma_v = 520$ kPa	
NO CHECKS MADE ON SAND INTERLAYER	
$\epsilon_H = 48 \mu\epsilon$	
$\sigma_v = 143,2$ (c)	
$\sigma_H = 12,3$ (t)	
$\sigma_v = 40,9$ (c)	
$\sigma_H = 53,7$ (t)	
$\epsilon_v = 250 \mu\epsilon$	
$\epsilon_v = 384 \mu\epsilon$	
$\epsilon_v = 475 \mu\epsilon$	

FIGURE E.6
 PROFORMA DETAILS OF ELSYM 5 MODELLING


PAVEMENT STRUCTURE		ROAD CATEGORY			
60 BLOCKS 20 SAND 150 C2 100 C4  G6 OR WORSE		DESIGN TRAFFIC CLASS			
		PAVEMENT TYPE			
		BLOCK PAVING (PANEL 31)			
INPUT VALUES		CRITICAL PARAMETERS			
LAYER NUMBER	THICKNESS (mm)	POISSON RATIO	E - VALUE (MPa)		
			PHASE 1	PHASE 2	PHASE 3
1	60	0,35	2000	-	-
2	20	0,35	200	-	-
3	150	0,35	450	$\epsilon_v = 176,5(c)$ $\epsilon_H = 25,5(t)$	
4	100	0,35	200	$\epsilon_v = 68,2(c)$ $\epsilon_H = 28,3(t)$	
5	SEMI- ∞	0,35	100	$\epsilon_v = 332 \mu\epsilon$	
INTERPRETATION AND EVALUATION					
LAYER NUMBER	LAYER LIFE (E80)			STRUCTURE LIFE (E80)	
	PHASE 1	PHASE 2	PHASE 3	INITIAL	FINAL
1					
2	LAYER 3, EG 2				
3	FS = 0,61 ~ 4 x 10 ⁵				
4	LAYER 4, EG 5 FS = 0,52				
5				0,28	0,47

FIGURE E.8
PROFORMA DETAILS OF ELSYM 5 MODELLING


PAVEMENT STRUCTURE		ROAD CATEGORY			
60 BLOCKS 20 SAND 150 C2 100 C4  G6 OR WORSE		DESIGN TRAFFIC CLASS			
		PAVEMENT TYPE			
		BLOCK PAVING (PANEL 31)			
INPUT VALUES		CRITICAL PARAMETERS			
LAYER NUMBER	THICKNESS (mm)	POISSON RATIO	E - VALUE (MPa)		
			PHASE 1	PHASE 2	PHASE 3
1	60	0,35	1000	1500	1500
2	20	0,35	200	200	200
3	150	0,35	8000	2400	2400
4	100	0,35	2500	1000	1000
5	SEMI- ∞	0,35	100	100	100
INTERPRETATION AND EVALUATION					
LAYER NUMBER	LAYER LIFE (E80)			STRUCTURE LIFE (E80)	
	PHASE 1	PHASE 2	PHASE 3	INITIAL	FINAL
1					
2					
3					
4	SHORT	VERY SHORT			
5				0,28	0,47 (PHASE 4 OVER)

FIGURE E.7
PROFORMA DETAILS OF ELSYM 5 MODELLING

PAVEMENT STRUCTURE		ROAD CATEGORY	
100	BLOCKS + SAND	DESIGN TRAFFIC CLASS	
150	C3		
150	C4	PAVEMENT TYPE	BLOCK PAVING CASE 8 WITH SAND IGNORED
	gg.g WORSE		

INPUT VALUES				CRITICAL PARAMETERS		
LAYER NUMBER	THICKNESS (mm)	POISSON RATIO	E - VALUE (MPa)			STRESSES (σ , kPa); STRAINS (ϵ)
			PHASE 1	PHASE 2	PHASE 3	
1	100	0,35	1000	1500	1500	NO CHECKS MADE ON BLOCKS
2	150	0,35	4000	2000	2000	$\epsilon_n = 29 \mu\epsilon$ $\epsilon_n = 64 \mu\epsilon$ $\epsilon_n = 137 \mu\epsilon$
3	150	0,35	2500	1000	200	$\epsilon_n = 69 \mu\epsilon$ $\epsilon_n = 105 \mu\epsilon$ $\epsilon_n = 39,7 (c)$ $\epsilon_n = 12,7 (t)$
4	SEMI- ∞	0,35	100	100	100	$\epsilon_n = 130 \mu\epsilon$ $\epsilon_n = 168 \mu\epsilon$ $\epsilon_n = 209 \mu\epsilon$

INTERPRETATION AND EVALUATION					
LAYER NUMBER	LAYER LIFE (E80)			STRUCTURE LIFE (E80)	
	PHASE 1	PHASE 2	PHASE 3	INITIAL	FINAL
1					
2			VERY SHORT		
3	SHORT				
4				0,25	0,42

DEFLECTION (mm)	
INITIAL	FINAL
	0,42

FIGURE E.11

PROFORMA DETAILS OF ELSYM 5 MODELLING

PAVEMENT STRUCTURE		ROAD CATEGORY	
		DESIGN TRAFFIC CLASS	
		PAVEMENT TYPE	

INPUT VALUES				CRITICAL PARAMETERS		
LAYER NUMBER	THICKNESS (mm)	POISSON RATIO	E - VALUE (MPa)			STRESSES (σ , kPa); STRAINS (ϵ)
			PHASE 4	PHASE 2	PHASE 3	
1	100	0,35	2000			
2	150	0,35	300			$\sigma_v = 124,0 (c)$ $\sigma_n = 16,6 (t)$
3	150	0,35	200			$\sigma_v = 57,1 (c)$ $\sigma_n = 21,2 (t)$
4	SEMI- ∞	0,35	100			$\epsilon_v = 273 \mu\epsilon$

INTERPRETATION AND EVALUATION					
LAYER NUMBER	LAYER LIFE (E80)			STRUCTURE LIFE (E80)	
	PHASE 1	PHASE 2	PHASE 3	INITIAL	FINAL
1					
2			LAYER 2, E84 F.S = 6,94		
3			LAYER 3, E85 F.S = 0,95		
4					

DEFLECTION (mm)	
INITIAL	FINAL

FIGURE E.12

PROFORMA DETAILS OF ELSYM 5 MODELLING


PAVEMENT STRUCTURE		ROAD CATEGORY						
100 _____ BLOCKS + SAND 150 _____ C3 150 _____ C4  G6a WORSE	DESIGN TRAFFIC CLASS PAVEMENT TYPE BLOCK PAVING CASE 8 WITH SAND IGNORED AND HIGH MODULUS FOR BLOCKS							
INPUT VALUES		CRITICAL PARAMETERS						
LAYER NUMBER	THICKNESS (mm)	POISSON RATIO	E - VALUE (MPa)			STRESSES (σ , kPa); STRAINS (ϵ)		
			PHASE 1	PHASE 2	PHASE 3	PHASE 1	PHASE 2	PHASE 3
1	100	0,35	8000	8000	8000			
2	150	0,35	4000	2000	2000	$\epsilon_n = 29 \mu\epsilon$	$\epsilon_n = 59 \mu\epsilon$	$\epsilon_n = 109 \mu\epsilon$
3	150	0,35	2500	1000	200	$\epsilon_n = 51 \mu\epsilon$	$\epsilon_n = 83 \mu\epsilon$	$\epsilon_n = 28,3 (c)$ $\sigma_n = 11,8 (t)$
4	SEMI- ∞	0,35	100	100	100	$\epsilon_v = 91 \mu\epsilon$	$\epsilon_v = 128 \mu\epsilon$	$\epsilon_v = 157 \mu\epsilon$
INTERPRETATION AND EVALUATION								
LAYER NUMBER	LAYER LIFE (E80)			STRUCTURE LIFE (E80)				
	PHASE 1	PHASE 2	PHASE 3					
1				$>> 10^7$				
2			VERY SHORT					
3	$\sim 10^6$	SHORT		DEFLECTION (mm)				
4				INITIAL	FINAL			
				0,18	0,34			

FIGURE E.13

PROFORMA DETAILS OF ELSYM 5 MODELLING

PAVEMENT STRUCTURE		ROAD CATEGORY						
		DESIGN TRAFFIC CLASS						
		PAVEMENT TYPE						
INPUT VALUES		CRITICAL PARAMETERS						
LAYER NUMBER	THICKNESS (mm)	POISSON RATIO	E - VALUE (MPa)			STRESSES (σ , kPa); STRAINS (ϵ)		
			PHASE 4	PHASE 2	PHASE 3	PHASE 1	PHASE 2	PHASE 3
1	100	0,35	8000					
2	150	0,35	300			$\sigma_v = 76,4 (c)$ $\sigma_n = 11,3 (t)$		
3	150	0,35	200			$\sigma_v = 43,0 (c)$ $\sigma_n = 15,6 (t)$		
4	SEMI- ∞	0,35	100			$\epsilon_v = 225 \mu\epsilon$		
INTERPRETATION AND EVALUATION								
LAYER NUMBER	LAYER LIFE (E80)			STRUCTURE LIFE (E80)				
	PHASE 1	PHASE 2	PHASE 3					
1								
2	LAYER 2, E80 F.S = 1,83		LONG LIVES,					
3	LAYER 3, E80 F.S = 1,59		$>> 10^7$	DEFLECTION (mm)				
4				INITIAL	FINAL			
					0,34			

FIGURE E.14

PROFORMA DETAILS OF ELSYM 5 MODELLING

D C P RECORD CHART

ROUTE: CMA OUTDOOR

CHAINAGE: SECTION 23

DATE: 82/04/23

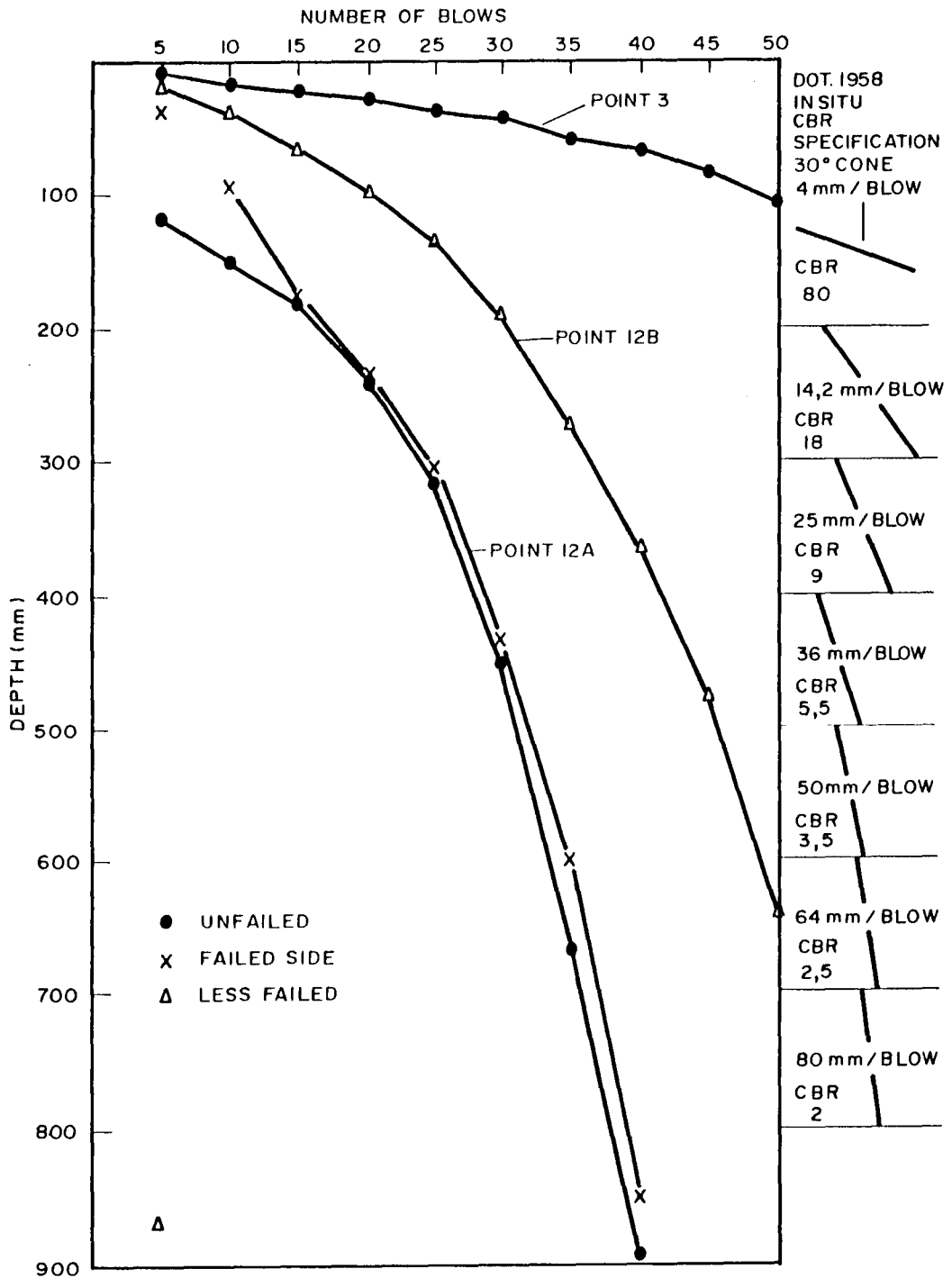
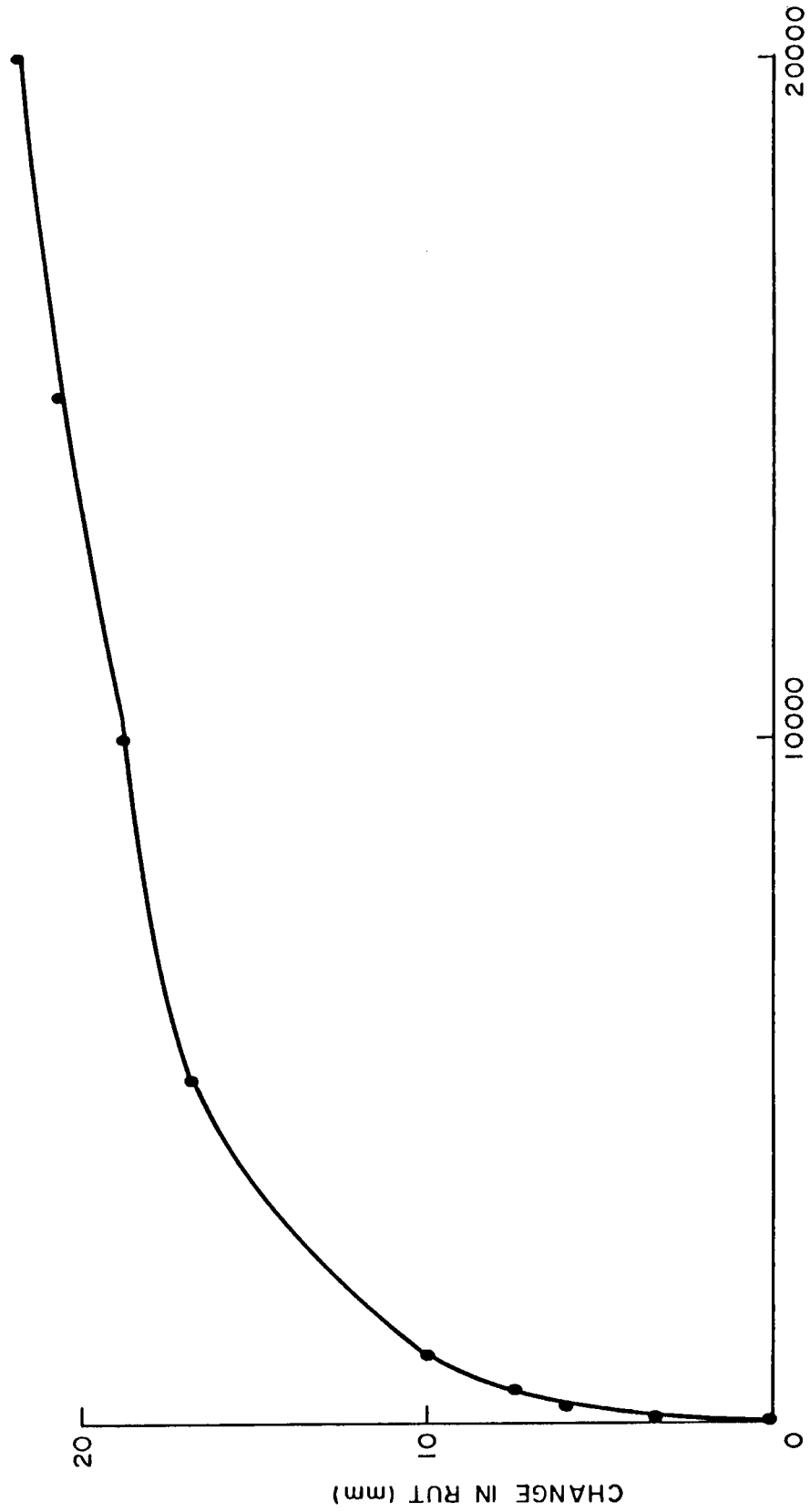


FIGURE E.15

DCP PROFILE , SECTION 23



NUMBER OF REPETITIONS

FIGURE E.16

HVS 145A1 : CMA OUTDOOR - SECTION 33