

AN APPLICATION OF THE HUB LOCATION PROBLEM
IN THE SOUTH AFRICAN
COAL TRANSPORTATION SECTOR

by

HEIDI BARENDIS
U11302594

Submitted in partial fulfillment of the requirements for the degree of

BACHELORS OF INDUSTRIAL AND SYSTEMS ENGINEERING

in the

FACULTY OF ENGINEERING, BUILT ENVIRONMENT AND INFORMATION
TECHNOLOGY

UNIVERSITY OF PRETORIA

October 2014

Executive Summary

The South African inland logistic systems are heavily reliant on existing road networks. The bulk transportation of goods, such as coal, increases the loads the roads currently have to carry and lead to damaged roads that in turn increase logistic costs. For these and other socio-economic reasons the strategic decision has been made by one of the major coal transportation companies in South Africa to migrate the transportation of coal as far as possible from road to rail. To support this strategy, coal consolidation centres are to be optimally located, whereby road-based coal will be diverted to the hubs and transported by rail to the demand point.

The purpose of this project is to develop and evaluate mathematical models that could be used by decision makers to determine optimal locations of coal consolidation centres. To fulfill this aim two mathematical models are developed: a network-based model in which a limited number of predefined nodes along the existing rail network can be chosen as hub locations, and the continuous model in which all points on the plane are considered. The two main objectives are to decrease total operational cost and to migrate the transportation as far as possible off road and onto rail.

A test case is used to highlight strengths, weaknesses and underlying behaviours of the models. The most noteworthy findings involve the major weaknesses of both models. The greatest weakness experienced by the network-based model is the limitation of the possible hub locations; improved locations not on the rail network are excluded and could yield improved results. The continuous model eliminates this weakness, however, it does not consider the distance along the rail network in calculating optimal locations. This chosen locations the continuous model yields are numerically inferior to the network-based counterparts. For these reasons the decision is taken to use both models in order to achieve optimal results; the continuous model is used to determine additional hub locations, while the network-based model is used to determine final results.

In the procedure described above, mathematical models are developed with the capability to guide decision makers in determining optimal coal consolidation centres. The results with regard to the case study are analysed to give recommendations to guide the decision-making process.

Contents

0.1	Acronyms	vi
1	Introduction	1
1.1	Problem Description	1
1.2	Research Design	3
1.3	Research Methodology	3
1.4	Document Structure	4
2	Literature Review	5
2.1	The Hub Location Problem on a Network	6
2.2	Solution Approaches for the Network-Based Hub Location Problem	8
2.2.1	Aykin's suggested heuristic solution approach for the NS-HLP	9
2.2.2	Heuristics Available for Other Hub Location Problems	10
2.3	The Hub Location Problem in Continuous Space	11
2.3.1	The Fermat-Weber Location Problem	11
2.3.2	The Multi-Facility Location Problem	12
2.4	Conclusion	14
3	Conceptual Solutions	15
3.1	The Network-Based LMA-NS-HLP	15
3.1.1	The NS-HLP	15
3.1.2	The Network-Based LMA-NS-HLP	16
3.2	The LMA-NS-HLP on Continuous Space	18
3.2.1	Terminology	18
3.2.2	General Approach	19
3.2.3	Weight Considerations	19
3.2.4	Centre Update	20
3.2.5	Direct Route Enabler	23
3.2.6	Multi-Allocation	23
3.2.7	Multi-Start Heuristic	25
3.2.8	Distance Calculation	25
3.2.9	Objective Function Calculation	25
3.3	Conclusion	26
4	Model Validation and Comparison	27
4.1	Test Case	27
4.1.1	Results for Test Case using the Network-Based LMA-NS-HLP	27
4.1.2	Results for Test Case using the Continuous LMA-NS-HLP	29
4.1.3	Comparison of the Models	30
5	Computational Results and Sensitivity Analysis	31
5.1	Case Study	31
5.1.1	General Approach	32
5.1.2	Results for the Case Study using the Network-Based LMA-NS-HLP	32
5.1.3	Results for the Case Study using the Continuous LMA-NS-HLP	33

5.1.4	Results for the case study using the network-based LMA-NS-HLP with additional nodes	34
5.1.5	Comparison of Results	35
6	Conclusion and Future Work	41
6.1	Future Research Opportunities	41
	Appendix A	45
	Appendix B	47
	Appendix C	49

List of Figures

1.1	(a) Current Transportation Network (b) Proposed Transportation Network	2
1.2	Possible Hub Locations on the (a) Continuous Domain (b) Network Domain	2
1.3	Operations Research Process	3
2.1	Distribution Networks: (a) Without Hubs (b) With Hubs	5
2.2	(a) Single-HLP and (b) p-HLP	6
2.3	(a) Single Allocation HLP and (b) Multiple Allocation HLP	6
2.4	Types of Hubbing Policies: (a) Strict Hubbing Policy and (b) Non-Strict Hubbing Policy	7
2.5	(a) NS-HLP and (b) LMA-NS-HLP	8
2.6	(a) Greedy-Drop Heuristic (b) Interchange Heuristic	9
2.7	Multistart Heuristics	10
2.8	Fermat-Weber Problem in Terms of (a) Customer Locations (b) Origin & Destination Points	11
2.9	A demonstration of the iterative procedure of the <i>Weiszfeld iteration</i> for a test case.	12
2.10	(a) Probability of customer 1 being allocated to hubs 1, 2, and 3 (b) Chosen allocation following principle of single allocation	13
2.11	Multi-facility location problem in terms of (a) customer locations Iyigun and Ben-Israel (2010) (b) origin & destination points (LMA-NS-HLP)	14
3.1	Weight Variable Explained	18
4.1	Test Case Study Area	27
4.2	Possible hub locations along rail network	28
4.3	Multi-allocation of d_3 for $k = 2$	28
4.4	Results for test case using the network-based LMS-NS-HLP	28
4.5	Results for test case using the continuous LMS-NS-HLP	29
4.6	Objective function value for each iteration for $k \in [1, 3]$	30
5.1	Rail Network	31
5.2	Chosen hub locations for Case 1	32
5.3	Chosen hub locations for Case 2	33
5.4	(a) Chosen hub locations for $k \in [1, 5]$ relating to Case 2 (b) Corresponding possible hub nodes with additional possible hub locations	34
5.5	Chosen hub locations for Case 3	35
5.6	Total operational costs	36
5.7	Percentage of road based coal diverted to rail in ntk for varying number of hubs	37
5.8	Operational Cost Savings	38
5.9	Current Transportation Network	40
5.10	Proposed transportation Network for $k = 2$	40
5.11	Proposed transportation Network for $k = 2$	40
C.1	Solutions for Case 1 with $k \in [0, 5]$ using the network-based LMA-NS-HLP with weighted flows	50
C.2	Solutions for Case 2 with $k \in [0, 5]$ using the continuous LMA-NS-HLP with weighted flows	51

C.3 Solutions for Case 2 with $k \in [0, 5]$ using the continuous LMA-NS-HLP with weighted flows 52

List of Tables

2.1	Path-Scanning tie-break rules	7
3.1	Terminology	18
4.1	Flow Between Points	27
5.1	Total operational costs for Case 1, 2 and 3 in millions of Rands	35
5.2	Upper Bound Limits for the Cost of Facilities	39
5.3	Upper Bound Limits for the Cost of Facilities	39
B.1	Network Distances	48

List of Algorithms

1	GENERAL APPROACH WITHOUT MULTISTART	19
2	WEIGHT CONVERTER	19
3	WEIGHT EDITOR	20
4	CENTRE UPDATE	21
5	WEISZFIELD ITERATION	22
6	DIRECT ROUTE ENABLER	24
7	OBJECTIVE FUNCTION CALCULATOR	25
8	COMPLETE ALGORITHM WITH MULTISTART	26

0.1 Acronyms

- HLP** Hub Location Problem
- NS-HLP** Non-Strict Hub Location Problem
- LMA-NS-HLP** Limited Multiple-Allocation Non-Strict Hub Location Problem

Chapter 1

Introduction

Facility location decisions greatly impact the strategic planning of transportation intensive companies. As major capital expenditure is linked to facility location and relocation projects, these are deemed to be long-term investments. Therefore, the challenge exists in locating facilities that will be profitable throughout their lifetime (Owen and Daskin, 1998). A relatively novel extension of the classical facilities location problem is the hub location problem. Hubs operate as facilities that consolidate and connect pre-determined origin and destination points in order to satisfy demand. A strategically chosen hub location can result in a more efficient use of limited resources or a decrease in the overall transportation costs (Farahani et al., 2013).

South African inland logistic systems are heavily reliant on road networks. As much as 70.1% of South Africa's inland freight (in tonne-*km*) is transported on roads (Viljoen et al., 2013). This places a massive burden on the road infrastructure and has led to damaged roads that, in turn, increase logistic and transportation costs (Steyn et al., 2011).

Taking these and other socio-economic reasons into consideration, a strategic decision has been taken by one of the main coal transporters in South Africa to migrate the transportation of coal from road to rail. To support this strategy, coal consolidation centres (hubs) are to be optimally located to reduce the overall cost of the transportation system. In order to reduce the load placed on the road network, road based coal will be diverted to the hubs and transported by rail to the demand point. The aim of this project is to develop and evaluate optimisation models that can be used by decision makers to determine the best locations for these consolidation centres, taking the above mentioned factors into account.

1.1 Problem Description

Two mathematical models have been developed, their objectives being to reduce transportation costs and to migrate the transportation of coal as far as possible from road to rail. These are used to answer two questions for a major coal transportation company in South Africa:

1. *Where are the best possible hub locations?*
2. *How many hub facilities should be built?*

The two optimisation models were developed to conform to a transportation network with certain distinct characteristics, as seen in Figure 1.1b. All supply points (mines) are allocated to exactly one consolidation centre (hub). Direct links between supply and demand points are possible, should this be a more cost effective alternative. Demand points and hubs are interconnected through a rail network, allowing demand points to be directly connected to multiple hubs. Two transportation modes between mines and consolidation centres are considered as seen in Figure 1.1b and include road or rail. The cost associated with the different transportation modes is included in calculating the total transportation costs. The flow between mines and demand points are set as inputs into the model; and the hubs are viewed as uncapacitated for the duration of this study.

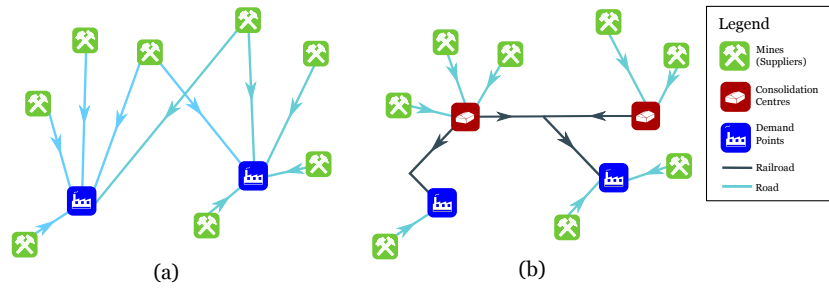

Figure 1.1: (a) Current Transportation Network (b) Proposed Transportation Network

As the problem is set in support of a strategic decision, the static demand of multiple time periods is included in the problem analysis. The assumption is made that all consolidation centres will come online in the first time period and stay online for the duration of the planning horizon. The number of hubs to be located, specified as inputs into the model, vary between one and five. The models are therefore capable of solving the problem for multiple consolidation centres.

In conclusion, this problem could be termed a limited multi-allocation, non-strict hub location problem and is formally defined as follows:

The LMA-NS-HLP consists of finding the optimal locations that results in the lowest transportation cost of multiple uncapacitated hubs in which a limited number of predefined nodes may be connected to multiple hubs and direct links between nodes are allowed following a non-strict hubbing policy.

Hub facilities could be sited in continuous space, meaning that the hubs may be located anywhere in a predefined area. They could also be sited on a network, limiting possible facility locations to the nodes of the transportation network as seen in Figure 1.2. An advantage of the latter is that it is more likely to yield geographically feasible locations along the existing rail network. However, a clear disadvantage lies in the limitation of the possible hub locations. In contrast, the continuous model overcomes this limitation, but could lead to geographically infeasible results. In certain instances it may be economically feasible to extend the rail network to accommodate locations identified through the continuous model. As it was unclear which model would yield the best solution, a model for each domain was developed following the Operations Research process, as described in the next section.

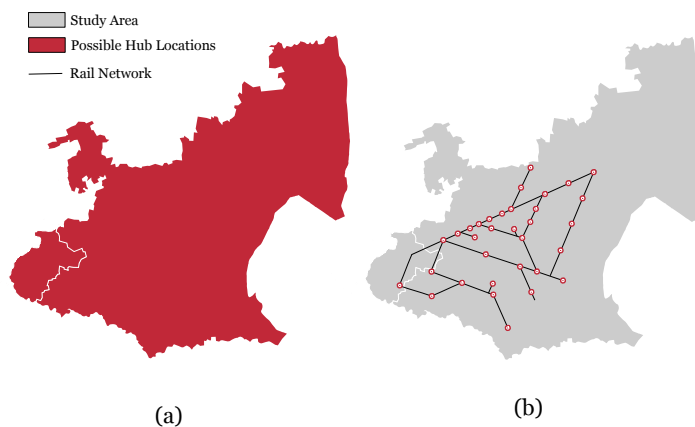

Figure 1.2: Possible Hub Locations on the (a) Continuous Domain (b) Network Domain

1.2 Research Design

Operations Research deals with decision problems and “*the study of how to form mathematical models of complex engineering and management problems and how to analyze them to gain insight about possible solutions*” (Rardin, 1997). Considering Operations Research is applicable to the problem at hand, the Operations Research process, as adapted by Rardin (1997) (Figure 1.3), was followed.

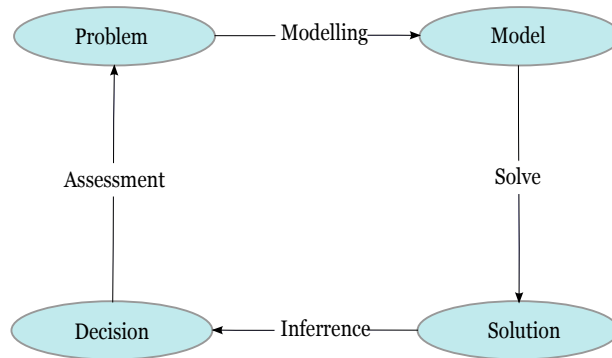

Figure 1.3: Operations Research Process

The process begins with formulating and modeling the problem. In this phase the objective, the constraints and the variables that will represent the decision choices are defined. The created model is an abstraction of the real-world problem, as solving it in its entirety is near impossible. In the second phase, the problem is solved using the developed mathematical model. These numerical results are then analysed to determine conclusions (a solution) that can be drawn from the model. These conclusions are inferred in the third phase, meaning that they are analysed to determine whether the solutions are applicable to the original problem, and solve it satisfactorily. An assessment phase loops back to the original problem that determines if the solution can be practically implemented. As this is a closed loop process, should any of the phases need revisiting, this solution approach can be repeated.

For the problem at hand this process was followed for both the continuous as well as the network-based LMA-NS-HLP. The two models were drawn together in the assessment and evaluation phase.

1.3 Research Methodology

For the successful completion of the project a systematic procedure was followed. The process began with Phase 1 that involved gaining a thorough understanding of the problem. The second phase included a comprehensive literature study of previous work to identify mathematical formulations and solution approaches that relate to the problem at hand. These formulations and solution approaches were then adapted for the development of the two mathematical models.

The third phase can be described as data capturing and analysis. In this phase, all the relevant information and data necessary to complete the project was gathered. This data included: the locations of all recorded demand and supply points, the expected demand for each demand point and the amount of coal that is expected to be extracted from the various mines. Since the routing of coal was defined as an input to the models, this set of data had to be created in this phase. For the network-based model, data on South African rail network had to be collected.

Phase 4 involved developing and solving the models with the input data collected in Phase 3. The models were subsequently validated by applying them to the given case study and evaluating whether they were capable of solving the actual problem satisfactorily. The study was concluded with a sensitivity analysis and a comparison of the developed models. The strengths and weaknesses of each model were weighed to form, and present, final conclusions.

1.4 Document Structure

An in-depth literature review is presented in Chapter 2. It includes existing formulations of both the discreet and the planar hub location problem as well as corresponding solution approaches. Chapter 3 expands on suitable formulations found in literature, and presents the adapted formulations and solution approaches for both the network and the continuous models. The computational results of a limited test case for both models are presented in Chapter 4 with the purpose of verifying the two models and illuminating the two models strengths, weaknesses and underlying behaviours. In Chapter 5 computational results of the case study are presented with a discussion and sensitivity analysis to determine the optimal number of hubs. The report is concluded with a short discussion on future work in Chapter 6.

Chapter 2

Literature Review

Finding optimal facility locations, in order to satisfy demand under certain constraints, has occupied the minds of an extensive variety of academics for many years. These problems date back as far as the 17th century; arguably the first location problem was captured by Torricelli (1608-1647) (ReVelle and Eiselt, 2005). Today it is a well established study area within the field of Operations Research (Melo et al., 2009). In this section we review an extension of the facility location problem, the hub location problem, and focus on two of its variants relevant to the case study.

The hub location problem attempts to locate consolidation centres (hubs). These are transshipment facilities that are located in many-to-many distribution networks to decrease the number of links needed between origin and destination points as seen in Figure 2.1. The use of hub facilities enable centralized product handling and can reduce transportation costs by allowing carriers to take advantage of economies of scale (O’Kelly and Miller, 1994). In the last 25 years this field of research has flourished, resulting in many proposed models and solution approaches.

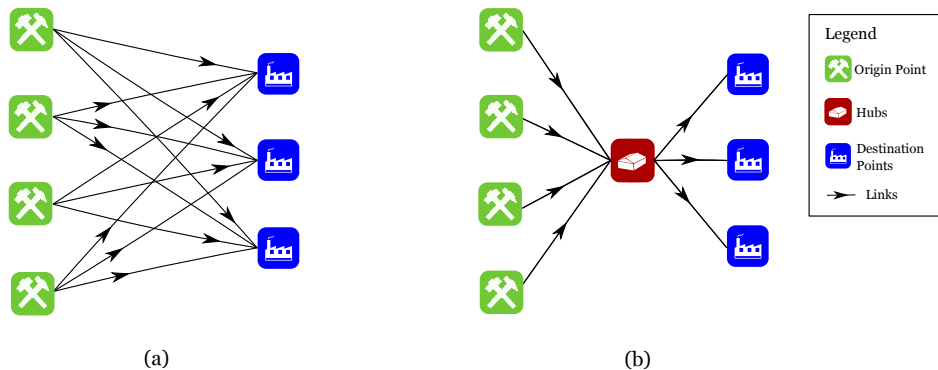

Figure 2.1: Distribution Networks: (a) Without Hubs (b) With Hubs

The greatest distinction between different models is the domain in which facilities may be located: either a continuous or network domain. Within the continuous domain, hubs may be placed on any point in a predefined area, whereas in the network domain, hubs can be located on a discrete number of possible locations, namely the nodes of the transportation network. The latter has received considerable attention in literature resulting in multiple surveys that classify existing hub location models.

In the next section, existing work on the network-based hub location problem is evaluated, including a review of mathematical models and solution approaches. This is followed by a similar evaluation of the continuous problem. The objective is to identify relevant models and solution approaches that are adapted for the full problem.

2.1 The Hub Location Problem on a Network

A multitude of network-based hub location problems exist, these will be reviewed and elements applicable to the study extracted. Firstly, a Hub Location Problem (HLP) with a simplified network design is defined utilising three assumptions: each node is connected to exactly one hub, all hubs are interconnected and no internodal (non-hub to non-hub) connections are allowed. If only one hub is located this problem is termed as the *Single-HLP* by Farahani et al. (2013).

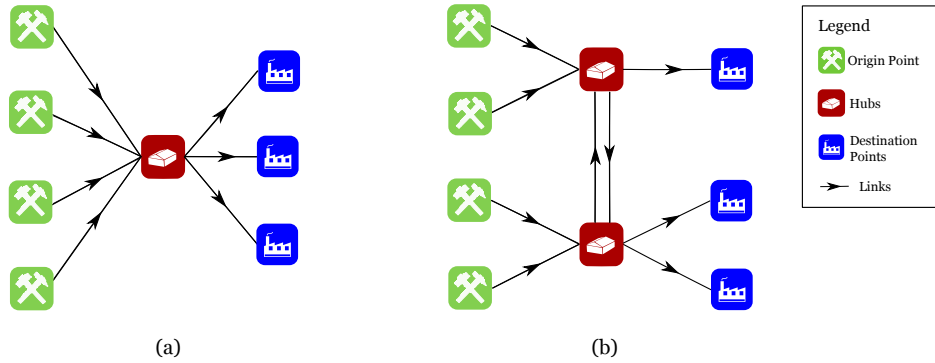

Figure 2.2: (a) Single-HLP and (b) p -HLP

Farahani et al. (2013) referred to the hub location problem with the same assumptions but multiple hubs as the p -HLP¹ (Figure 2.2b). If a non-hub node is connected to only one hub, this is termed as *single allocation*, the opposite is known as *multiple allocation*. The single-allocation p -HLP is a problem with uncapacitated hubs and a Mini-Sum objective function - which minimises the total transportation cost. Similarly, the *multiple allocation p-HLP* allows multiple allocations, whereby a non-hub node may be connected to several hubs (Figure 2.3b) (Farahani et al., 2013).

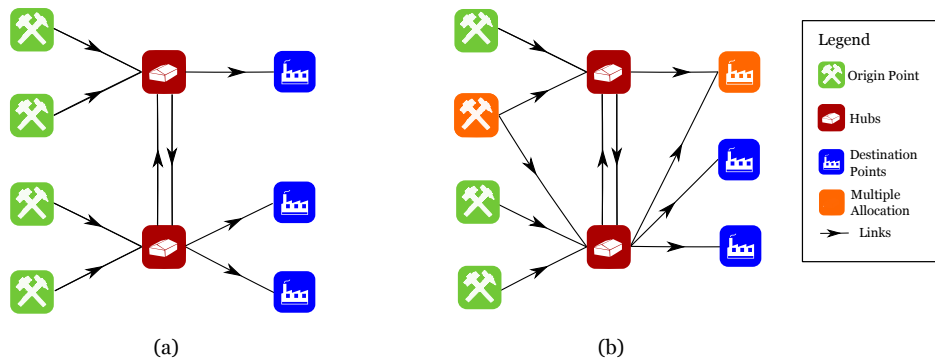

Figure 2.3: (a) Single Allocation HLP and (b) Multiple Allocation HLP

A further problem resembling the p -HLP is the p -Hub centre location problem. The notable difference between the two formulations lies within their objective functions. The p -HLP is characterized by a Mini-Sum objective function, while the p -Hub centre location problem is characterized by a Mini-Max objective function. This criterion minimises the maximum cost of transportation between origin and destination pairs (Farahani et al., 2013). The *Hub covering problem* is also characterised by its unique objective. These types of problems are used in cases where both the p -HLP and the p -centre do not entirely define the problem, as in the instance of finding locations for emergency facilities. Here the objective is to “cover” customers, meaning that demand points are only covered if hubs are located within a specified radius of the customer. In the case of finding

¹described as the p -median problem by ReVelle and Eiselt (2005)

locations for firefighting units, this specific radius may be $5km$, therefore all houses located within a $5km$ radius of the facility would be “covered”. The *Maximal hub-covering problem* attempts to satisfy (“cover”) a maximum demand, given a set amount of hubs (ReVelle and Eiselt, 2005).

In all the previously discussed problems, the number of hubs are defined externally as inputs to the model (exogenous source). In contrast to this, the number of hubs could be determined as part of the solutions (endogenous source), examples include: *Hub set covering problems* (Farahani et al., 2013) and *the hub location problem with fixed costs* as classified by Alumur and Kara (2008). A further similarity between all previously mentioned models, is the fact that optimal facilities are found using a static planning horizon. Alternately, the *dynamic* or *multi-period hub location problem* considers a finite planning horizon in which sited facilities can be re-located, shut-down or opened in each period of the planning horizon (Horhammer, 2014; Torres-Soto and Uster, 2011).

Increasingly complex models exist in which some of the simplifying assumptions used to defined the *p-HLP* are removed. An applicable example is a Mixed Integer Linear Program (MILP) proposed by Aykin (1995) that allows for multiple allocation as well as internodal (direct) routes . In this formulation direct routes are allowed, but will only be chosen if they prove to be more cost effective which Aykin (1995) referred to as a non-strict hubbing policy (Figure 2.4). Within this policy, the transport between origin and destination pairs can be routed in three different ways:

1. Nonstop
2. One-hub-stop
3. Two-hub-stop

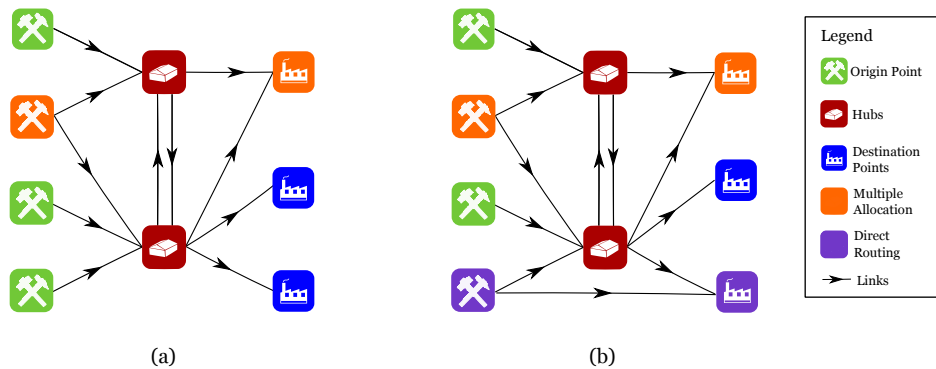

Figure 2.4: Types of Hubbing Policies: (a) Strict Hubbing Policy and (b) Non-Strict Hubbing Policy

Many existing formulations for the network-based hub location problem are discussed above. A summary of these formulations and their main differentiating characteristics can be seen in Table 2.1. This was used to identify the most suitable formulation that could be used as a starting point to develop the network-based LMA-NS-HLP.

Table 2.1: Summary of Network-Based Hub Location Problems

Problem	Objective Function	No. of Hubs	Source determining No. of Hubs	Multiple Allocation allowed	Direct Routes allowed	Time Consideration
<i>Single-HLP</i>	Mini-Sum	1	exogenous	no	no	static
<i>p-HLP</i>	Mini-Sum	p	exogenous	no	no	static
<i>multiple allocation p-HLP</i>	Mini-Sum	p	exogenous	yes	no	static
<i>p-Hub centre location problem</i>	Mini-Max	p	exogenous	no	no	static
<i>Maximum hub covering problem</i>	Max-Covering	p	exogenous	no	no	static
<i>Hub set covering problems</i>	Mini-Sum	p	endogenous	yes	no	static
<i>The hub location problem with fixed costs</i>	Mini-Sum	p	endogenous	no	no	static
<i>multi-period hub location problems</i>	Mini-Sum	p	exogenous	no	no	dynamic
<i>Aykin's Non-Strict HLP</i>	Mini-Sum	p	exogenous	yes	yes	static

Revisiting the definition of the LMA-NS-HLP it is clear that the requirements include:

- a Mini-Sum objective function
- direct routing
- multiple allocation
- an exogenous source determining number of hubs
- static time considerations
- the capability to solve for p hubs

Examining Table 2.1 closely it is clear that the Non-Strict Hub Location Problem (NS-HLP) formulation proposed by Aykin (1995) is the most suitable. The only major difference between the two formulations is the fact that multiple-allocation is limited to only destination points in the LMS-NS-HLP as seen in Figure 2.5. This formulation was therefore used as a starting point in developing the network-based LMA-NS-HLP and will be expanded on in Chapter 3. The next section will discuss possible solution approaches that could be used to gain numerical results and are discussed below.

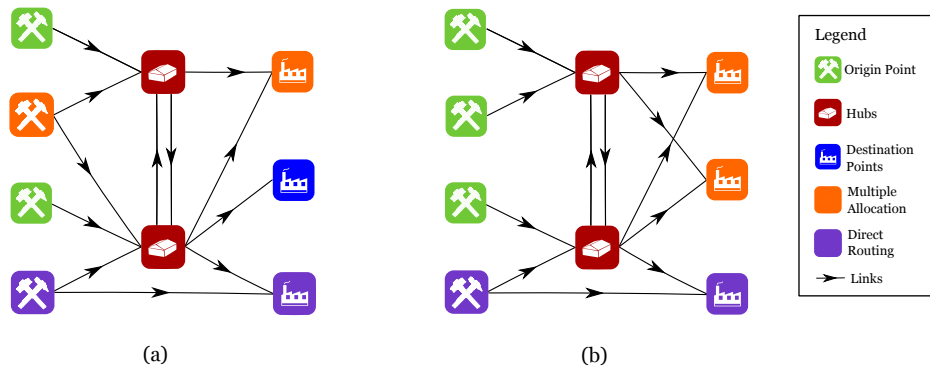

Figure 2.5: (a) NS-HLP and (b) LMA-NS-HLP

2.2 Solution Approaches for the Network-Based Hub Location Problem

Overall three different types of solution approaches can be defined: complete enumeration, heuristics and the use of Linear Programming Solvers. In the case of complete enumeration, every possible node in a set H is evaluated, and the associated cost of locating the hub at that node is calculated. The node resulting in the lowest cost is then chosen. This alternative is feasible for a limited problem size. An increase in the number of feasible nodes would exponentially increase the time to solve, limiting the usability of the enumeration method.

Heuristic solution approaches are simple procedures that can quickly and easily provide good but not necessarily optimal solutions to difficult problems (Zanakis and Evans, 1981). A weakness of pure heuristic solution methods is that they can become trapped within local optima, yielding inferior results. To overcome this weakness, metaheuristic methods have been developed. These are higher-level strategies that aim to make intelligent decisions that can escape local optima (Winston and Venkataramanan, 2003).

An alternative to heuristic solution methods is the use of a Linear Programming Solver such as Lingo or CPLEX. Linear Programming Solvers have become increasingly popular, most probably due to the fact that computational speed, as well as solver capability, have expanded rapidly in the last years. Bixby (2012) states that Linear Programming code alone has improved by a factor as large as 3300 in the period between 1988 and 2004.

As the NS-HLP formulation suggested by Aykin (1995) is used in developing the network-based LMA-NS-HLP, the heuristics suggested by him to solve the NS-HLP, as well as additional heuristics, will be discussed below.

2.2.1 Aykin's suggested heuristic solution approach for the NS-HLP

Aykin (1995) suggests a heuristic in two parts: a greedy and interchange part. The greedy part falls under a *constructive method* as described by Silver (2004). This means a step-by-step procedure is followed to construct a feasible solution. The method presented involves a *drop* strategy, in which a hub is initially placed at each node, one hub is then removed for each step until p hubs remain. To determine which hub is to be removed or *dropped*, the net increase in the objective function when each hub is removed is evaluated. The hub inducing the smallest effect on the objective value is removed and the process repeated. This is demonstrated in Figure 2.6 in which the straight-line distances between the various points is one and $W_{ij} = [1, 2; 2, 4]$. The network characteristics defined above will be used throughout this section for various explanations.

Once the greedy heuristic method has yielded an initial feasible solution, this solution is iteratively improved through the application of the interchange heuristic. Here, a non-hub node t is chosen and all possible interchanges between the non-hub node t and the current hub-nodes are evaluated. Should the best interchange yield an improved objective value compared to the current solution, the solution is updated and the hub is moved to node t (Figure ??). The hub locations, otherwise, remain the same. This process is repeated until the specified amount of iterations have been reached, or until no further interchanges improve the objective function. Aykin (1995) used this method to solve the NS-HLP, however other heuristics are available and are discussed below.

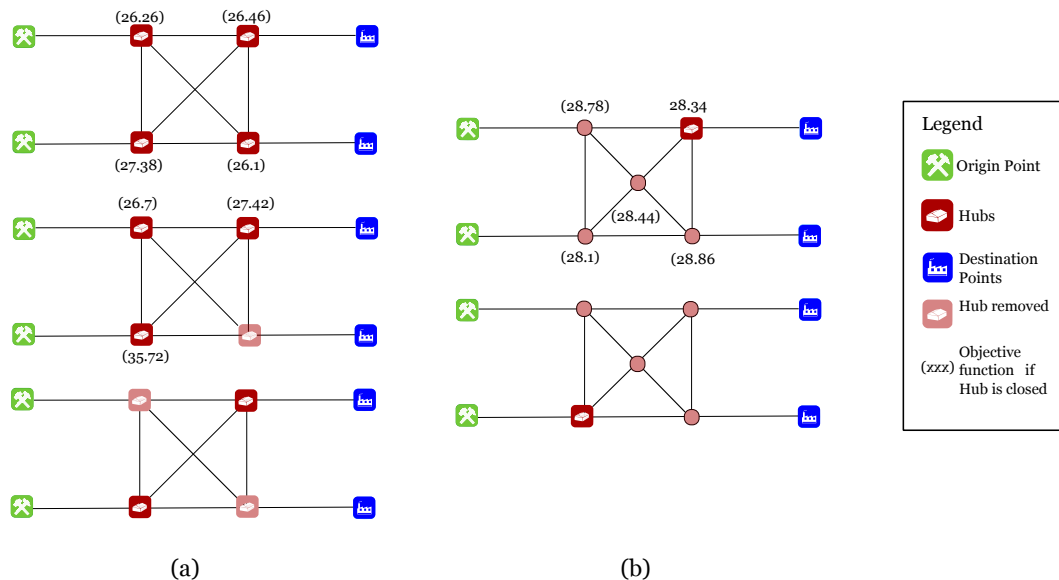

Figure 2.6: (a) Greedy-Drop Heuristic (b) Interchange Heuristic

2.2.2 Heuristics Available for Other Hub Location Problems

Further heuristics are presented by Silva and Cunha (2009) and are based on a multi-start tabu search heuristic. *Multi-start* heuristics are based on generating many initial solutions and are normally coupled to another heuristic that improve the initial solutions. Multi-start heuristics are compatible for problems in which initial solutions can easily be generated and the search algorithms are not capable of exploring a wide range of the feasible search space effectively.

The *tabu search* method stems from the *local improvement method* that begins with a feasible solution to the problem and considers feasible solutions in the neighbourhood of the current solution. If any neighbouring solution yields improved results, the neighbouring solution is chosen as the new solution. This process is continued until no further improvements are found. This often ends in local optima solutions. To overcome this, *tabu search* can accept results that lead to inferior solutions and makes use of a *tabu list* to prevent cycling. The *tabu list* disallows certain movements for a specified amount of iterations (Silver, 2004).

The three alternatives of the *multi-start tabu search* proposed by Silva and Cunha (2009) are based on these two principles. The difference lies in how the initial solutions are generated. To generate the initial solution for the first heuristic, equal probabilities are assigned to each possible hub node and random numbers are generated for each of these nodes. Should the random number be below the probability, the node will be chosen as a hub (Figure 2.7a). For the generation of initial solutions in the second heuristic, the assumption is made that the probabilities depend on the amount of flow to and from each node (Figure 2.7b). For the third heuristic the probabilities depend on the in and outbound flows, as well as a penalty factor that depends on the location of the node in respect to all other nodes.

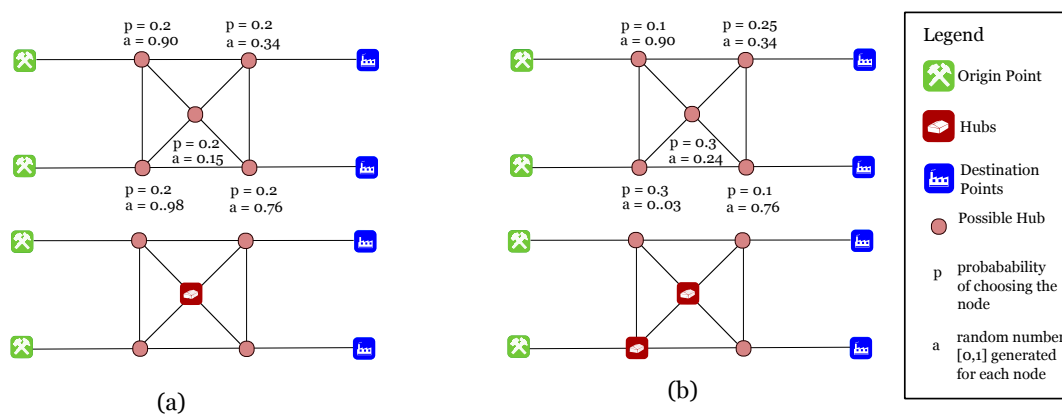

Figure 2.7: Multistart Heuristics

The *tabu search* coupled to the *multi-start* focuses on the allocation of non-hub nodes to hubs. It switches the allocation of one origin or destination point from one hub to another. A tabu list prevents short term cycling. In respect to this case study these heuristics are not easily transferable as some adaptation would be necessary. This heuristic, however could be very useful in reassigning mines to hubs, should Aykins's (1995) proposed heuristics not be flexible enough for this hub assignment.

Linear Programming Solvers are preferred compared to heuristics due to the fact that they are capable of obtaining exact global optimal solutions. Ultimately, the Lingo solver was used to solve this case study, as it was capable of solving the formulation in reasonable time and because it was freely accessible through a student licence. Besides the discussion on solution approaches, the network-based HLP has been reviewed in this section and a formulation applicable to the case study has been identified. This formulation, as well as an adapted model, will be presented in Chapter 3.

2.3 The Hub Location Problem in Continuous Space

Moving away from the network-based HLP, we now investigate the HLP on continuous space in which all the points in a plane are possible hub locations. The hub location problem on continuous space was originally formulated by O’Kelly in 1987, with the objective of locating k facilities in a plane that minimises the total logistic cost of the transportation network (Mini-Sum). The corresponding network design assumes that all nodes are linked to exactly one hub (single allocation) and no direct origin-destination links are allowed (Iyigun, 2013). A special case of this problem is the *Fermat-Weber location problem* where $k = 1$.

2.3.1 The Fermat-Weber Location Problem

Iyigun and Ben-Israel (2010) describe the *Fermat-Weber location problem* in terms of customers; given their location and weight find a location that optimally serves them (Figure 2.8a). This can easily be transferred to an origin-destination problem if the weights between origin and destination points are converted to weights to and from each origin and destination point (Figure 2.8b).

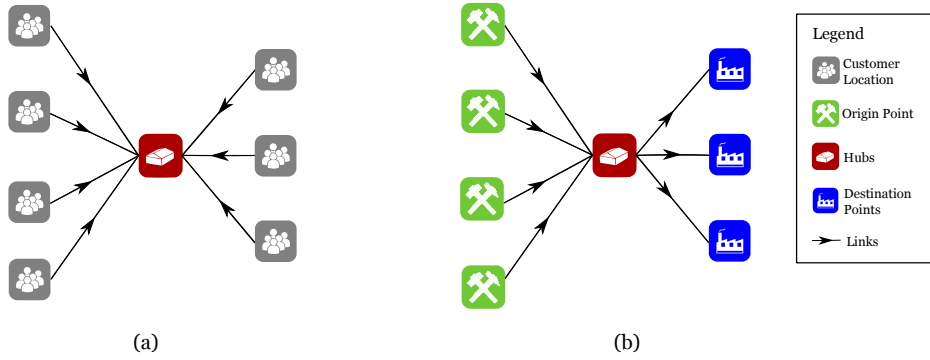

Figure 2.8: Fermat-Weber Problem in Terms of (a) Customer Locations (b) Origin & Destination Points

For the *Fermat-Weber location problem* no assignment is present as all the flows are automatically routed through the only possible hub, and consist of finding a point c in \mathbb{R}^n that solves the problem

$$\min_c = \sum_{i=1}^m w_i \|c - \mathbf{a}_i\| \quad (2.1)$$

where a_i with $i \in [1, m]$ are distinct points in \mathbb{R}^n with weights (flows) w_i and $\|x\|$ describes the Euclidean norm (2.2). For this problem a special solution method, the *Weiszfeld iteration* (2.4), has been developed (Chandrasekaran and Tamir, 1989). It is capable of efficiently obtaining exact results, eliminating the need to make use of heuristic solution methods. The *Weiszfeld iteration* uses the current centre location to calculate an updated centre location until it converges to the optimal location (Figure 2.9).

$$\|\mathbf{x}\| = \sqrt{\sum_j |x_j|^2} \quad (2.2)$$

$$(2.3)$$

$$T(x) = \begin{cases} \frac{\sum_i \frac{w_i a_i}{\|c - \mathbf{a}_i\|}}{\sum_i \frac{w_i}{\|c - \mathbf{a}_i\|}} & \text{if } x \neq a_i \{i \in [1, M]\} \\ a_i & \text{if } x = a_i \{i \in [i, M]\} \end{cases} \quad (2.4)$$

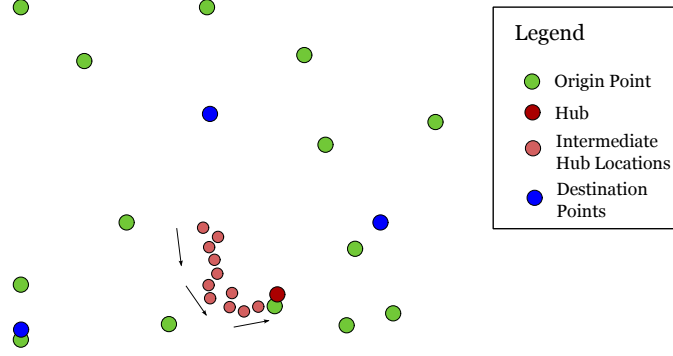

Figure 2.9: A demonstration of the iterative procedure of the *Weiszfeld iteration* for a test case.

For \mathbb{R}^2 the problem consist of finding $x, y \in \mathbb{R}$ that solve the problem

$$\text{Minimize } z = \sum_i d_i w_i \quad (2.5)$$

$$= w_i \sqrt{(a_i - x)^2 + (b_i - y)^2} \quad (2.6)$$

where the location of i -cities is given by (a_i, b_i) and w_i describes the flow to or from each city. For \mathbb{R}^2 the *Weiszfeld iteration* can be termed as (2.7) for x and (2.8) for y .

$$x_{k+1} = \frac{\sum_i \frac{w_i a_i}{\sqrt{(a_i - x_k)^2 + (b_i - y_k)^2}}}{\sum_i \frac{w_i}{\sqrt{(a_i - x_k)^2 + (b_i - y_k)^2}}} \quad (2.7)$$

$$y_{k+1} = \frac{\sum_i \frac{w_i b_i}{\sqrt{(a_i - x_k)^2 + (b_i - y_k)^2}}}{\sum_i \frac{w_i}{\sqrt{(a_i - x_k)^2 + (b_i - y_k)^2}}} \quad (2.8)$$

It should be noted that the above terms are derived by differentiating the objective function and then setting it equal to zero. The differentiated objective function is not defined for $(x, y) = (a_i, b_i) \forall i$, hence the second part of Equation (2.4) is included. To evaluate locations that coincide with customer points Kuhn (1973) introduced two additional Equations (2.9 , 2.10), that are derived from the negative of the gradient, where h is the data point that coincides with an optimal location.

$$R_h(\mathbf{x}_j) = \max \{ \|R_h\| - w_j, 0 \} \frac{R_h}{\|R_h\|} \quad (2.9)$$

$$R_h = \sum_{i \neq j} \frac{w_i}{\|\mathbf{x}_i - \mathbf{x}_j\|} (\mathbf{x}_i - \mathbf{x}_j) \quad (2.10)$$

In the case that $\|R_h\| < w_h$ the location will remain on the data point and will move towards a different point if $\|R_h\| > w_h$.

2.3.2 The Multi-Facility Location Problem

The problem for $1 < k < N$ is a *multi-facility location problem* that attempts to locate K facilities described by the variable c_k with $k \in [1, K]$. Iyigun and Ben-Israel (2010) once again define this problem in terms of customers: given the customer locations, weights and number of facilities K determine the best locations as well as the best assignment of customers to hub facilities to minimize overall transportation cost. It is described by

$$\min_{c_1, c_2, \dots, c_k} \sum_{k=1}^K \sum_{x_i \in X_k} w_i d(x_i, c_k) \quad (2.11)$$

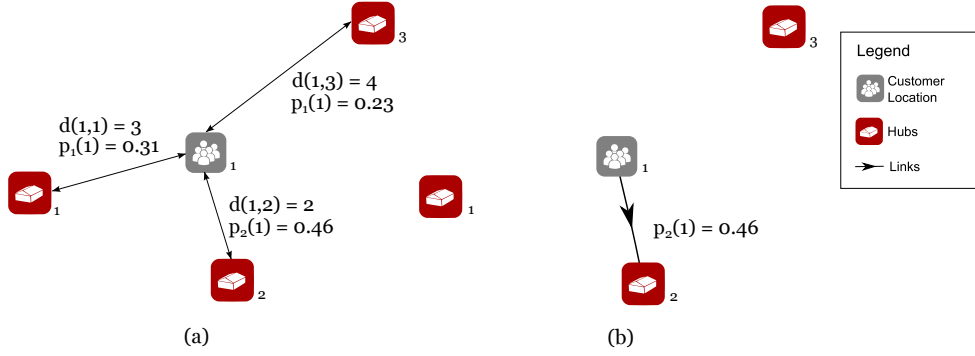

Figure 2.10: (a) Probability of customer 1 being allocated to hubs 1, 2, and 3 (b) Chosen allocation following principle of single allocation

where the customers assigned to the k^{th} facility are \mathbf{X}_k . This problem is NP hard. NP is defined as *nondeterministic polynomial time hard*; this means that an optimal solution can not be verified in polynomial time (Winston and Venkataramanan, 2003). Therefore, it is proposed to substitute the rigid assignments of points with probabilities. These probabilities depend only on the distances between the point \mathbf{x} and the centre k - the closer the two points the higher the probability (Figure 2.10a). Using this and the fact that probabilities add to one, the probabilities that a point \mathbf{x} is assigned to the k^{th} facility is given by

$$p_k(\mathbf{x}) = \frac{\prod_{t \neq k} d(\mathbf{x}, \mathbf{c}_j)}{\sum_{l=0}^K \prod_{m \neq l} d(\mathbf{x}, \mathbf{c}_m)} \quad (2.12)$$

The *multi-facility location problem* can thus be approximated by the minimization problem

$$\min \sum_{k=1}^K \sum_{i=1}^N p_k(\mathbf{x}_i) w_i d(\mathbf{x}_i, \mathbf{c}_k) \quad (2.13)$$

$$\text{s.t.} \quad \sum_{k=1}^K p_k(\mathbf{x}_i) = 1, \quad i \in (1, N) \quad (2.14)$$

$$p_k(\mathbf{x}_i) \geq 0 \quad k \in (1, K), i \in (1, N) \quad (2.15)$$

with two sets of variables: the probabilities $p_k(\mathbf{x})$ and the centres \mathbf{c}_k . This problem is then solved by fixing one set of variables and minimizing with respect to the other variable; the fixed property is then alternated between the two variables, following an iterative procedure. With fixed probabilities, Equation (2.13) becomes a separable function that can be derived. Similar to the *Weiszfeld iteration* the centres are then calculated by

$$T_k(\mathbf{c}) = \begin{cases} \sum_{i=1}^N \left(\frac{p_k^2(\mathbf{x}) w_i / \|\mathbf{x}_i - \mathbf{c}\|}{\sum_{j=1}^N p_k^2(\mathbf{x}) w_j / \|\mathbf{x}_j - \mathbf{c}\|} \right) \mathbf{x}_i & \text{if } \mathbf{c} \neq \mathbf{x}_i \{i \in [1, N]\} \\ \mathbf{x}_i & \text{if } \mathbf{c} = \mathbf{x}_i \{i \in [1, N]\} \end{cases} \quad (2.16)$$

The *generalized Weiszfeld method for the multi facility location problem* (2.16) will iterate towards an optimal solution if the hub locations do not coincide with any of the customer locations. Iyigun and Ben-Israel (2010) modify the formulation for continuity. As in the instance of a hub location coinciding with a customer point it needs to be determined if that customer point is an optimal location. In the case that it is not, the optimal hub location should iterate towards a different point.

For the case that a centre location coincides with a customer point, the probabilities for that customer location change as follows

$$p_k(\mathbf{x}_j) = 1 \quad (2.17)$$

$$p_m(\mathbf{x}_j) = 0 \quad \forall m \neq k \quad (2.18)$$

as the data point is then assigned to the hub with complete certainty, then the value $\mathbf{R}_h^j(\mathbf{x}_j)$ is calculated as in 2.19 with \mathbf{R}_h^j as in 3.32. This means that in the case that $\|\mathbf{R}_h^j\| \leq w_j$ the hub location will remain on the data point and in the case that $\|\mathbf{R}_h^j\| \geq w_j$ it will move towards a different point.

$$\mathbf{R}_h^j(\mathbf{x}_j) = \max \{ \|\mathbf{R}_h^j\| - w_j, 0 \} \frac{\mathbf{R}_h^j}{\|\mathbf{R}_h^j\|} \quad (2.19)$$

$$\mathbf{R}_h^j = \sum_{i \neq j} \frac{p_h^2(\mathbf{x}_i) w_i}{\|\mathbf{x}_i - \mathbf{x}_j\|} (\mathbf{x}_i - \mathbf{x}_j) \quad (2.20)$$

The method proposed by Iyigun and Ben-Israel (2010) for the multi-facility location problem has been presented above. It describes a solution approach to solve the multi-facility location problem in terms of customer locations (Figure 2.11a). In the case that the highest probability is used to determine allocation of customers to hub facility as seen in Figure 2.10b, the problem falls under the category of single allocation. This problem was used as the starting point to develop the continuous LMA-NS-HLP, some fundamental differences are that the problem is described in terms of origin and destination points, not in terms of customer locations; and that the single allocation will only be applied to origin points (Figure 2.11b). Further alterations to this formulation that allow for direct routing as well as the different cost implications are presented in Chapter 3.

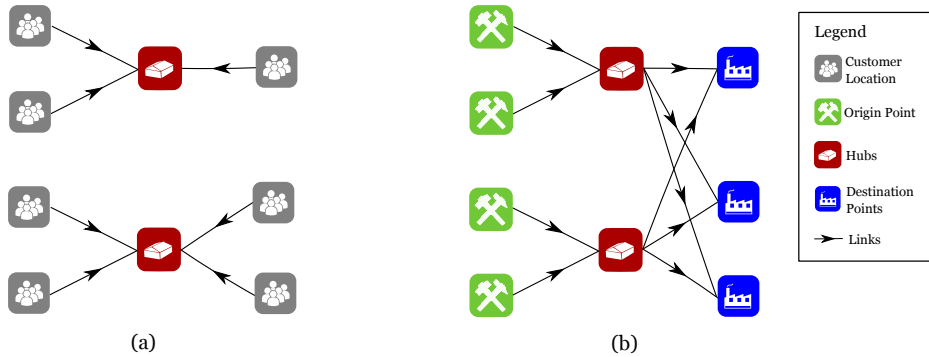

Figure 2.11: Multi-facility location problem in terms of (a) customer locations Iyigun and Ben-Israel (2010) (b) origin & destination points (LMA-NS-HLP)

2.4 Conclusion

The literature review revealed existing formulations and solution approaches applicable to both the continuous and the network-based LMA-NS-HLP. These findings were indispensable for the continuation of this case study. The formulation presented by Aykin (1995) for a hub location problem on a network will be expanded on in Chapter 3.1 before the adapted model is presented. The *generalised Weiszfeld Method for the multi-facility location problem* was used as a starting point in developing the continuous LMA-NS-HLP model that is presented in Chapter 3.2.

Chapter 3

Conceptual Solutions

The literature review was valuable in finding applicable formulations and solution approaches that could be adapted to suit the case study. The two models developed for the network and continuous domains will be presented in this chapter.

3.1 The Network-Based LMA-NS-HLP

Aykin's (1995) formulation was used as a starting point to develop the network-based LMA-NS-HLP model and will be referred to as the non-strict hub location problem (NS-HLP) for the remainder of this paper. In this section the formulation for the NS-HLP will be presented followed by the formulation for the network-based LMA-NS-HLP, highlighting the differences between the two formulations. Solution approaches available for the NS-HLP as well as other Hub Location Problems will be expanded on, and the section will be rounded off by the chosen solution approach.

3.1.1 The NS-HLP

The NS-HLP as presented by Aykin (1995) allows for direct routing and multi-allocation and considers a system with n nodes where a_1 , a_2 and a_3 are the scale economies due to hub operations. We begin by defining the decision variables as follows:

$$Y_k \triangleq \begin{cases} 1 & \text{if a hub is located at node } k, \\ 0 & \text{otherwise } x = 0, \end{cases} \quad (3.1)$$

$$X_{ij} \triangleq \begin{cases} 1 & \text{if nonstop service is provided from node } i \text{ to node } j, \\ 0 & \text{otherwise,} \end{cases} \quad (3.2)$$

$$X_{iktj} \triangleq \begin{cases} 1 & \text{if hub connected service is provided from node } i \text{ to node } j \\ & \text{with the routing } i \rightarrow k \rightarrow t \rightarrow j, \\ 0 & \text{otherwise,} \end{cases} \quad (3.3)$$

$$W_{ij} \triangleq \text{Flow between node } i \text{ and } j, \quad (3.4)$$

$$S_{ij} \triangleq \text{The cost per kilometer of transporting} \quad (3.5)$$

$$\text{one unit of flow directly from node } i \text{ to node } j, \quad (3.6)$$

$$d_{ij} \triangleq \text{The distance between node } i \text{ and node } j, \quad (3.7)$$

$$F_k \triangleq \text{The cost of locating a hub at node } k. \quad (3.8)$$

The objective is:

$$\begin{aligned} \min z = & \sum_i \sum_j W_{ij}(S_{ij}d_{ij})X_{ij} + \sum_k F_k Y_k + \\ & \sum_i \sum_k \sum_t \sum_j W_{ij}(a_1 S_{ik} d_{ik} + a_3 S_{kt} d_{kt} + a_2 S_{tj} d_{tj}) X_{iktj} \end{aligned} \quad (3.9)$$

Subject to

$$X_{ij} + \sum_k \sum_t X_{iktj} = 1 \quad \forall i \forall j \quad (3.10)$$

$$\sum_i \sum_t \sum_j (X_{iktj} + X_{itkj}) \leq MY_k \quad \forall k \quad (3.11)$$

$$\sum_k Y_k = p \quad (3.12)$$

$$\sum_{i \neq k} \sum_{l \neq k} (X_{ilhk} + X_{itjk}) + \sum_i (X_{ik} + X_{kt}) \leq M(1 - Y_k) \quad \forall k \quad (3.13)$$

$$\sum_{h \neq k \neq t} (X_{kkht} + X_{thkk} + X_{tthk} + X_{khtt}) + \sum_h (X_{khht} + X_{thhk}) \leq M(2 - Y_k - Y_t) \quad \forall k \quad (3.14)$$

$$X_{ij}, X_{iktj}, Y_k \in \{0, 1\} \quad (3.15)$$

In this formulation the objective function (3.9) minimizes the total cost of the transportation network that includes travel and set-up costs. The first term calculates the transport cost for non-stop routes, the second term calculates the setup cost and the last term calculates the travel cost of one-hub- and two-hub-stop trips.

Throughout the formulation the indices i and j refer to the origin and destination nodes where $i, j = \{1, 2, \dots, n\}, i \neq j$ and the indices k and t refer to all potential hub nodes where $k, t = \{1, \dots, n\}$. This formulation is used to solve a case study involving an air transportation system. The objective is to determine which cities should be chosen as hubs in an air transportation hub-and-spoke system in the United States of America. This means that all origin points are simultaneously destination points, as well as possible hub locations, indicating that i, j, k and t all refer to the same set. No additional nodes are included for evaluation, and the euclidean distance between nodes are applied as the used distances.

The variables X_{iktj} and X_{ij} are used to determine what type of trip is used. If $X_{ij} = 1$ a nonstop trip is used between node i and j . For $X_{iktj} = 1$ and $k = t$ the trip between node i and j is first routed through hub k . Lastly for $X_{iktj} = 1$ and $k \neq j$ a two-hub-stop trip is chosen, with routing $i \rightarrow k \rightarrow t \rightarrow j$. Constraints (3.10) ensure that a route is specified for each origin-destination pair.

In this system the number of hubs to be specified is described by p , constraint (3.12) ensures that p nodes are selected as hubs. If $Y_k = 0$ routing through node k is not possible. The relevant decision variables are set to zero with constraints (3.11). This system is defined for one-hub- or two-hub-stops. If a destination or origin node is selected as a hub two-, three- of even four-hub-stop services are possible when $X_{iktj} i \neq k \neq t \neq j$. Constraints (3.13) and (3.14) are included to set these variables to zero.

Many of the desired network characteristics are met by Aykin's (1995) formulation. However, the cost implications of different transporting modes is not included, and the limitation that all mines may only be linked to one hub is not specified (Figure 2.5). These and other modifications are presented below.

3.1.2 The Network-Based LMA-NS-HLP

For the LMA-NS-HLP the indices are defined differently because origin and destination points are clearly distinguished and additional points are included along the rail network as potential hub locations. Then, the mines are captured in the set \mathbf{I} with $i \in \mathbf{I}$ and the demand points are captured in the set \mathbf{J} with $j \in \mathbf{J}$. Potential hub nodes will be captured in the set \mathbf{K} that includes the demand points and the additional nodes, that are all placed along the rail network, with $k \in \mathbf{K}$.

For the network-based LMA-NS-HLP we evaluate the distances between hubs and destination points along the actual rail network and use euclidean distances for both origin-hub pairs and origin-destination pairs that are routed directly. The euclidean distances are captured in d_{ij} and the distances along the network in n_{ij} .

We begin by defining the decision variables as follows:

$$Y_k \triangleq \begin{cases} 1 & \text{if a hub is located at node } k, \\ 0 & \text{otherwise } x = 0, \end{cases} \quad (3.16)$$

$$X_{ij} \triangleq \begin{cases} 1 & \text{if nonstop service is provided from node } i \text{ to node } j, \\ 0 & \text{otherwise,} \end{cases} \quad (3.17)$$

$$X_{iktj} \triangleq \begin{cases} 1 & \text{if hub connected service is provided from node } i \text{ to node } j \\ & \text{with the routing } i \rightarrow k \rightarrow t \rightarrow j, \\ 0 & \text{otherwise,} \end{cases} \quad (3.18)$$

$$P_{ik} \triangleq \begin{cases} 1 & \text{if mine } i \text{ is allocated to consolidation centre } k, \\ 0 & \text{otherwise.} \end{cases} \quad (3.19)$$

The objective is:

$$\begin{aligned} \min z = & \sum_i \sum_j W_{ij}(d_{ij}c_1)X_{ij} + \\ & \sum_i \sum_k \sum_t \sum_j W_{ij}(d_{ik}c_1 + n_{kt}c_2 + n_{tj}c_2)X_{iktj} \end{aligned} \quad (3.20)$$

Subject to

$$X_{ij} + \sum_k \sum_t X_{iktj} = 1 \quad \forall i \forall j \quad (3.21)$$

$$\sum_k Y_k = p \quad (3.22)$$

$$\sum_k P_{ik} = 1 \quad \forall i \quad (3.23)$$

$$\sum_i P_{ik} \leq MY_k \quad \forall k \quad (3.24)$$

$$\sum_t \sum_j X_{iktj} + X_{itkj} \leq MP_{ik} \quad \forall i \forall k \quad (3.25)$$

$$\sum_i X_{ijjj} + \sum_i \sum_k X_{ikjj} = 0 \quad \forall j \quad (3.26)$$

Analogue to the NS-HLP constraints (3.21) and (3.22) ensure a trip type between each origin and destination pair and that p nodes are chosen as hubs.

Constraints (3.13) and (3.14) are removed, as it is not a requirement to inhibit three-hub-stops. Four-hub-stops are no longer possible due to the fact that origin points are no longer potential hub locations. Constraints (3.26) replace these with a different purpose, namely to make output data more manageable. For example X_{1222} is the same as X_{12} as well as X_{1233} resulting in the same as X_{1223} .

Constraints (3.23), (3.24) and (3.25) are included to enforce single allocation of origin points. The fact that origin points are only allocated to nodes which have been chosen as hubs is enforced by constraints (3.24) and constraints (3.25) set all variables that are routed from the origin point to any non-allocated hub to zero. Constraints (3.11) are removed; as routing through nodes, which are hubs, is already ensured by (3.25).

The cost of opening and building a facility is not included in the objective function as these costs will be discussed in the sensitivity analysis in Chapter 5. Furthermore, the values for c_1 and c_2 will be set to the cost per kilometer of moving one ton of coal on road and rail respectively, eliminating the need for the variable S_{ij} . This formulation satisfies all the design requirements specified in the problem description. The Lingo Linear Programming Solver was used to obtain numerical results. These results as well as the model validation and verification are presented in Chapter 4. Moving away from the network-based LMS-NS-HLP, the developed continuous model is now presented for the remainder of this chapter.

3.2 The LMA-NS-HLP on Continuous Space

For the development of the LMA-NS-HLP on continuous space the *multi-facility location problem* presented by Iyigun and Ben-Israel (2010) was used as a starting point. The formulation presented by Iyigun and Ben-Israel (2010) does not allow for direct trips or multi-allocation, leading to the adaptations presented below.

3.2.1 Terminology

To illustrate the LMA-NS-HLP more clearly the terminology used throughout this section is summarized in Table 3.1. Input data for the LMA-NS-HLP includes the locations \mathbf{L} , the flows between each origin and destination point \mathbf{W} , the number of hubs K , as well as the number of origin and destination points, \mathcal{O} and \mathcal{D} .

Table 3.1: Terminology

Term	Description
\mathbf{L}	A matrix of size $2 \times N$ that capture the locations of all origin and destination nodes
\mathcal{O}	Number of origin points
\mathcal{D}	Number of destination points, where $\mathcal{O} + \mathcal{D} = N$
K	The number of hub facilities
\mathbf{W}	A matrix of size $N \times N$ where $\mathbf{W} = \{w_{ij}\}$, w_{ij} describing the flow between point i and point j
\mathbf{H}	A matrix of size $N \times N$ where $\mathbf{H} = \{h_{ij}\}$, h_{ij} describing the flow between point i and point j that is routed through at least one hub
\mathbf{F}	A set $\mathbf{F} = \{f_i\}$ that captures the flow from or to each point through at least one hub
\mathbf{A}	A set $\mathbf{A} = \{a_i\}$ that captures the adapted flow from or to each point through at least one hub
\mathbf{C}	The set of centre locations $\mathbf{C} = \{c_k\}$ where $k \in K$

The flow variable plays an important role in enabling direct routing, therefore three further variables related to flow are introduced; \mathbf{H} , \mathbf{F} and \mathbf{A} . This variable can be saved in two different types of variables; a matrix or a set. A matrix variable such as \mathbf{H} specifies the amount of travel that is required from origin point i to destination point j , whereas a set variable \mathbf{F} specifies the amount of travel required from or to each origin and destination point. In the below example the weight associated with destination point 3 could be captured as $h_{13} = 10, h_{23} = 20$ or as $f_3 = 30$ as seen in figure 3.1.

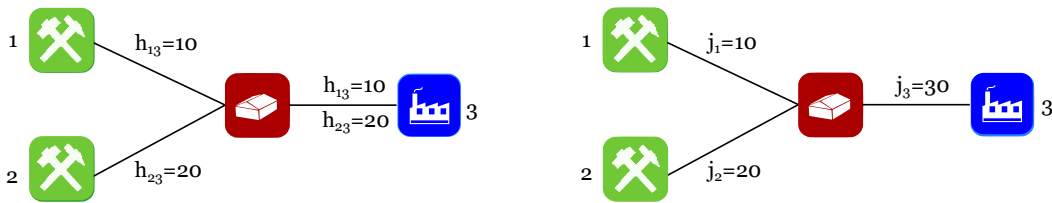

Figure 3.1: Weight Variable Explained

\mathbf{H} is the flow between an origin and destination pair that is routed through at least one hub. This means that all direct routing would be set to zero in this variable. The purpose of differentiating between variables \mathbf{F} and \mathbf{A} will be expanded on shortly - a brief explanation of their purpose is that they serve as inputs to the *generalized Weizfield method for the multi-facility location problem*.

The variable \mathbf{C} captures the centre locations, and is updated in each iteration. The output of the LMA-NS-HLP would be the optimal hub locations \mathbf{C} .

3.2.2 General Approach

To enable direct routes, an iterative algorithm is introduced that allows one added direct route per iteration: the direct route that resulted in the highest cost savings. The LMA-NS-HLP is a method that iterates between two logical sequences

1. The *generalised Weiszfeld method for the multi-facility location problem*, and
2. the direct route-enabler.

The algorithm is initiated, whereby the flow through hubs \mathbf{H} is set equal to the original flow \mathbf{W} , and then converted first to \mathbf{F} and then to \mathbf{A} . Centres are then calculated using a *generalised Weiszfeld method for the multi-facility location*. Based on these centre locations the direct-route enabler evaluates which one flow should be routed directly. This flow is removed from \mathbf{H} and steps 1 through 5 are repeated as seen in Algorithm 1.

Algorithm 1: GENERAL APPROACH WITHOUT MULTISTART

- Step 0: Initialization** The Matrix \mathbf{H} is set equal to matrix \mathbf{W} for initialization
- Step 1: Convert Weight** The matrix \mathbf{H} is converted to the set \mathbf{F}
- Step 2: Adapt Weight** The set \mathbf{F} is adapted to set \mathbf{A} using factors o and d
- Step 3: Centre Update** The generalized Weiszfeld method, in combination with $\mathbf{C}^{(t)}$ and \mathbf{A} is used to calculate new centre locations $\mathbf{C}^{(t+1)}$
- Step 4: Direct route enabler** The direct route enabler is run, using \mathbf{W} and $\mathbf{C}^{(t+1)}$ to determine which flow must be routed directly and \mathbf{H} is updated
- Step 5: Repeat** Repeat from Step 1 onwards using the updated \mathbf{H}
-

3.2.3 Weight Considerations

The flow variable is initially captured in a matrix and converted into a set so that it can be used as an input into the *multi-facility location problem*. Therefore a weight converter was implemented as seen in Algorithm 2, which corresponds to Step 1 above.

Algorithm 2: WEIGHT CONVERTER

Input: $\mathbf{H} = \{h_{ij}\}$ The flow routed through at least on hub
 \mathcal{O} The number of origin points
 \mathcal{D} The number of destination points

Output: $\mathbf{F} = \{f_i\}$ The flow to or from a point

```

for  $i \leftarrow 1$  to  $\mathcal{O}$  do
   $w \leftarrow 0$ 
  for  $j \leftarrow 1$  to  $\mathcal{D}$  do
     $w \leftarrow w + h_{ij}$ 
  end
   $f_i \leftarrow w$ 
end
for  $j \leftarrow 1$  to  $\mathcal{D}$  do
   $w \leftarrow 0$ 
  for  $i \leftarrow 1$  to  $\mathcal{O}$  do
     $w \leftarrow w + h_{ij+\mathcal{O}}$ 
  end
   $f_{j+\mathcal{O}} \leftarrow w$ 
end

```

Step 2 is included in the overall algorithm as the objective of finding the hub facility locations is to minimize overall travel cost and migrate the transportation of coal as far a possible off road and onto rail. In the case study the number of origin points is far greater than the number of destination points. As more volume travels to the destination points, the optimal locations naturally converge to the destination points, if this step is not included. Therefore a weights-editor algorithm is introduced and implemented as seen in Algorithm 3.

Algorithm 3: WEIGHT EDITOR

Input: F The flow to or from a point
 R Origin factor
 T Destination factor
 \mathcal{O} The number of origin points
 \mathcal{D} The number of destination points

Output: $A = \{f_i\}$ The adapted flow to or from a point

```

for  $i \leftarrow 1$  to total number of points do
  if  $i < \mathcal{O}$  then
    |  $a_i \leftarrow f_i R$ 
  else
    |  $a_i \leftarrow f_i T$ 
  end
end
end

```

This algorithm takes the updated weights F and multiplies them by two factors. The first factor, R , is for all the origin points and second, T , for all the destination points where $R > T$. The ratio of these two factors corresponds to the ratio between the cost associated with travel via rail and road, as the desired transportation mode between hubs and destination points is rail. By including these considerations the hub locations no longer converge toward destination points.

3.2.4 Centre Update

The purpose of this case study is to determine how many hub facilities would be optimal, as well as where these facilities should be optimally placed. The formulation must therefore be able to locate $k \in [1, 5]$ facilities. For a single facility the *Weiszfeld iteration* is implemented and for multiple facilities the *generalized Weiszfeld method for the multi facility location problem* is used as seen in Algorithm 4. This is an iterative approach that alternates between updating probabilities and centres until a stopping criterion has been reached. The probabilities are calculated using Equation (3.27), while the centre locations are updated using Equations (3.29), (3.30) and (3.28)

$$p_{jc} = \frac{\prod_{t \neq c} d(\mathbf{L}_j, \mathbf{L}_{b+t})}{\sum_{l=0}^K \prod_{m \neq l} d(\mathbf{L}_j, \mathbf{L}_{b+m})} \quad (3.27)$$

$$V_c = \sum_{j=1}^b \frac{p_{jc}^2 w_j}{\|\mathbf{L}_j - \mathbf{L}_{c+b}\|} \quad (3.28)$$

$$C_{c,x} = \sum_{i=1}^b \left(\frac{p_{ic}^2 w_i / \|\mathbf{L}_i - \mathbf{L}_{c+b}\|}{V_c} \right) L_{i0} \quad (3.29)$$

$$C_{c,y} = \sum_{i=1}^b \left(\frac{p_{ic}^2 w_i / \|\mathbf{L}_i - \mathbf{L}_{c+b}\|}{V_c} \right) L_{i1} \quad (3.30)$$

For the case in which a centre location is located on a origin or destination node, Equations (3.31), (3.32) and (3.33) are used to determine if the location is optimal or if it should iterate towards a different point.

Algorithm 4: CENTRE UPDATE

Input: L The locations of origin and destination points
 $C_i^{(t)}$ The current Centre Locations
 A The adapted weights/flows
Output: $C_i^{(t+1)}$

```

if  $k > 1$  then
   $b \leftarrow \text{length}(L)$ 
  append starting centre locations  $C_i^{(t)}$  to location matrix  $L$ 
  while  $\text{Criterion} < \text{checker}$  do
    calculate matrix  $\mathbf{d}$  in which the distance between all points in  $L$  are saved
    create empty matrix  $\mathbf{p}$  with the size  $b \times k$ , this is the matrix in which the
    probabilities will be saved.
    create a set  $m$  with size  $k$ 
    for  $j \leftarrow 0$  to  $b$  do
      for  $c \leftarrow 0$  to  $k$  do
        calculate  $p_{jc}$  using (3.27)
        calculate distance  $l$  between point  $j$  and and hub  $k$ 
        if  $l = 0$  then
           $p_{jc} \leftarrow 1$ 
           $m_c \leftarrow 1$ 
          for  $kh \leftarrow 0$  to  $k$  do
            if  $kh \neq c$  then
               $p_{jc} \leftarrow 0$ 
            end
          end
        end
      end
    end
    create empty set  $V$  with size  $k$ 
    for  $c \leftarrow 0$  to  $k$  do
      if  $m_c \neq 1$  then
        calculate  $V_c$  using (3.28)
        calculate  $C_{c,x}$  using (3.29)
        calculate  $C_{c,y}$  using (3.30)
        calculate the difference between the new and old location, if it is the largest
        change in centre locations, save it in the  $\text{checker}$  variable
         $L_{b+c,0} \leftarrow C_{c,x}$ 
         $L_{b+c,1} \leftarrow C_{c,y}$ 
      else
        determine the point with which the centre location coincides and save it in
        the variable  $e$ 
        calculate  $R$  using (3.32)
        if  $R - w_e < 0$  then
          calculate  $(C_{c,x}, C_{c,y}) \leftarrow (L_{e0}, L_{w1})$ 
        else
          calculate  $C_{c,x}$  and  $C_{c,y}$  using (3.31)
        end
      end
    end
  end
else
   $(C_{1,x}, C_{1,y}) \leftarrow \text{WEISZFIELD ITERATION}$ 
end

```

Similarly the *Weiszfeld iteration* is implemented as seen in Algorithm 5.

$$\mathbf{R}_e^j(\mathbf{x}_j) = \max \{ \|\mathbf{R}_e^j\| - w_j, 0 \} \frac{\mathbf{R}_e^j}{\|\mathbf{R}_e^j\|} \quad (3.31)$$

$$\mathbf{R}_e^j = \sum_{i \neq j} \frac{p_{ie}^2 w_i}{\|\mathbf{L}_i - \mathbf{L}_j\|} (\mathbf{L}_i - \mathbf{L}_j) \quad (3.32)$$

$$\|\mathbf{R}_e^j\| = \sqrt{\left(\sum_{i \neq j} \frac{p_{ie}^2 w_i}{\|\mathbf{L}_i - \mathbf{L}_j\|} (L_{i0} - L_{j0}) \right)^2 + \left(\sum_{i \neq j} \frac{p_{ie}^2 w_i}{\|\mathbf{L}_i - \mathbf{L}_j\|} (L_{i1} - L_{j1}) \right)^2} \quad (3.33)$$

Algorithm 5: WEISZFIELD ITERATION

Input: \mathbf{L} The locations of origin and destination points
 $C_i^{(t)}$ The current Centre Locations
 \mathbf{A} The adapted weights/flows

Output: $C_i^{(t+1)}$

$b \leftarrow \text{length}(\mathbf{L})$

while *Criterion* < *checker* **do**

for $k \leftarrow 0$ **to** b **do**

 calculate the distance d between the point k and the hub

if $d = 0$ **then**

$e \leftarrow k$

$m \leftarrow 1$

end

end

if $m = 0$ **then**

 calculate $C_{1,x}$ using (3.34)

 calculate $C_{1,y}$ using (3.35)

 calculate the distance between old and new hub location and save in *checker*

else

 calculate R using (3.38)

if $R - a_e < 0$ **then**

 | centre location remains at the data point

else

 | calculate $C_{1,x}$ and $C_{1,y}$ using (3.36)

end

 calculate the distance between old and new hub location and save in *checker*

end

end

$$C_{1,x}^{(t+1)} = \frac{\sum_i \frac{a_i l_{i0}}{\sqrt{(l_{i0} - C_{1x}^{(t)})^2 + (l_{i1} - C_{1y}^{(t)})^2}}}{\sum_i \frac{a_i}{\sqrt{(l_{i0} - C_{1x}^{(t)})^2 + (l_{i1} - C_{1y}^{(t)})^2}}} \quad (3.34)$$

$$C_{1,y}^{(t+1)} = \frac{\sum_i \frac{a_i l_{i1}}{\sqrt{(l_{i0} - C_{1x}^{(t)})^2 + (l_{i1} - C_{1y}^{(t)})^2}}}{\sum_i \frac{a_i}{\sqrt{(l_{i0} - C_{1x}^{(t)})^2 + (l_{i1} - C_{1y}^{(t)})^2}}} \quad (3.35)$$

$$R_k(\mathbf{L}_e) = \max \{ \|R_k\| - a_e, 0 \} \frac{R_k}{\|R_k\|} \quad (3.36)$$

$$R_k = \sum_{i \neq e} \frac{w_e}{\|\mathbf{L}_i - \mathbf{L}_e\|} (\mathbf{L}_i - \mathbf{L}_e) \quad (3.37)$$

$$\|R_k\| = \sqrt{\left(\sum_{i \neq j} \frac{a_i}{\|\mathbf{L}_i - \mathbf{L}_e\|} (L_{i0} - L_{e0}) \right)^2 + \left(\sum_{i \neq j} \frac{a_i}{\|\mathbf{L}_i - \mathbf{L}_e\|} (L_{i1} - L_{e1}) \right)^2} \quad (3.38)$$

3.2.5 Direct Route Enabler

The direct route enabler runs through all origin and destination pairs and determines the possible cost saving of direct routing. The pair which results in the largest cost savings is chosen to be directly routed and its flow is removed from the flow matrix \mathbf{H} , as it is no longer routed through a hub. The direct route enabler also evaluates if the removed routes should be rerouted through the hubs, given the changes in centre locations (Algorithm 6).

3.2.6 Multi-Allocation

The *generalized Weiszfeld method for the multi-facility location problem* finds optimal hub locations that will satisfy a customer demand, and clusters these customer nodes around hubs. Flows from an origin point, via hubs, to a destination point are not considered. The strict allocation of customers to hub facilities is decomposed using probabilities. Iyigun and Ben-Israel (2010) state that assigning each customer node to the facilities with the given probabilities is no better than assigning the customers to the closest hubs, i.e. the one with the highest probability.

Given two hub facilities and a node with probabilities 0.7 and 0.3 and a required flow of 10, using the first framework the node would be allocated to both hub facilities, with 7 units of flow being routed to the first hub and 3 units of flow routed through the second. If the node was assigned only to one hub, all 10 units of flow would be routed to hub 1, as it has the highest probability.

The probabilistic assignment is therefore an upper bound for the strict assignment as seen in Equation (3.39).

$$\sum_{k=1}^K \sum_{i=10}^N p_k(\mathbf{x}_i) w_i d(\mathbf{x}_i, \mathbf{c}_k) \geq \sum_{i=1}^N \min_{k \in [1, K]} \{d(\mathbf{x}_i, \mathbf{c}_k)\} \quad (3.39)$$

In this case study, the objective is to divert road-based coal as far as possible into rail. This means that hub facilities that are located in the centre of a group of origin points should be found, as the travel via road between mines and hubs should be minimized to save costs. Therefore the locations and flows related to the origin points should influence the chosen hub location more heavily compared to its destination counterparts. As required in the scope of this study, the origin points should only be allocated to exactly one hub facility. Each origin point is therefore allocated to its closest facility, this being determined by the highest probability.

This strict allocation is not passed to the destination points, allowing multi-allocation. If the strict allocation were passed to the destination point, exactly one alternative for indirect travel would be possible; *origin* \rightarrow *hub*₁ \rightarrow *hub*₂ \rightarrow *destination*, where *hub*₁ and *hub*₂ are determined by the highest probability. By not passing this strict allocation *hub*₂ can be determined by the route that results in the lowest cost. This is always the hub that is assigned to the origin point for the origin destination pair as by the triangle inequality. The triangle equality states that the sum of the lengths of two sides must be greater or equal to the length of the remaining side (Stewart, 2008) - the shortest distance is the direct distance between the destination and the hub as the sum of the two lengths that would form a triangle with a second hub are always greater or equal to the remaining side, in this case the direct length.

This is included in the formulation within the direct route enabler and the objective value calculation.

Algorithm 6: DIRECT ROUTE ENABLER

Input: $C_i^{(t+1)}$ Updated centre locations
 W Original flows
 $H^{(t)}$ Flow routed through at least one hub
 L The locations of origin and destination points
 $N^{(t)}$ The matrix specifying which direct routes have been chosen
Output: M The matrix specifying which hub a destination point is assigned to for each origin destination points
 $H^{(t+1)}$
 $N^{(t+1)}$

$b \leftarrow \text{length}(L)$

create a variable $best_s$ which captures the largest saving and set it equal to zero

create a variable g and set it equal to 1000

create a matrix M with size $b \times b$ used to determine which hub the destination point is allocated to, as multi-allocation is possible

for $i \leftarrow 0$ **to** b **do**

for $j \leftarrow 0$ **to** b **do**

if $i \neq j$ **then**

if $W_{ij} \neq 0$ **then**

if $N_{ij} \neq 1$ **then**

$h_1 \leftarrow \max(p_i)$

$r_1 \leftarrow d_{ij}R$ Direct distance multiplied by origin factor

for $h_2 \leftarrow 0$ **to** k **do**

$r_t \leftarrow d_{ih_1}R + (d_{h_1h_2} + d_{h_2j})T$

end

$r_2 \leftarrow \min(r_t)$

 determine which hub t resulted in the lowest indirect cost and save the value in g

$M_{ij} \leftarrow g$

$s \leftarrow r_2 - r_1$

if $s > best_s$ **then**

$best_s \leftarrow s$

$save_i \leftarrow i$

$save_j \leftarrow j$

end

else

$h_1 \leftarrow \max(p_i)$

$r_1 \leftarrow d_{ij}R$

for $h_2 \leftarrow 0$ **to** k **do**

$r_t \leftarrow d_{ih_1}R + (d_{h_1h_2} + d_{h_2j})T$

end

$r_2 \leftarrow \min(r_t)$

$s \leftarrow r_2 - r_1$

if $s < 0$ **then**

$N_{ij} \leftarrow 0$

$H_{ij} \leftarrow W_{ij}$

end

end

end

end

end

end

if $g \neq 1000$ **then**

$N_{save_i save_j} \leftarrow 1$

$H_{save_i save_j} \leftarrow 0$

end

3.2.7 Multi-Start Heuristic

The algorithm always converged to specific points, however with different starting solutions these solutions differed. Therefore a multi-start heuristic is implemented, in which a specified number of initial centre locations are randomly generated. The above algorithm is then run for each of these starting solutions and the solution that results in the lowest objective value is saved and presented as an output image. The complete algorithm with multi-start can be seen in Algorithm 8.

3.2.8 Distance Calculation

The location of both origin and destination points are captured in terms of latitude and longitude, however the cost of travel via road, rail or conveyor belt is known per kilometer. The *Haversine formula* (3.40) is thus used to calculate the distances d between points. It assumes a spherical earth with radius $R = 6,371km$, ignoring all ellipsoidal effects, but is particularly useful for computing even small distances (Montavont and Noel, 2006) as is required in this case study. The latitude and longitude values must be converted to radians before using the below formula.

$$\text{haversin}\left(\frac{d}{R}\right) = \text{haversin}(\Delta_{lat}) + \cos(lat1) \times \cos(lat2) \times \text{haversin}(\Delta_{long}) \quad (3.40)$$

$$\text{haversin}(\delta) = \sin^2\left(\frac{\delta}{2}\right) \quad (3.41)$$

3.2.9 Objective Function Calculation

Many alterations were made between the solution approach presented by Iyigun (2013) and the continuous LMA-NS-HLP. Therefore the value of the objective function has to be calculated differently, incorporating the above changes. An adapted objective function calculator was implemented as seen in Algorithm 7. This calculator, unlike the original objective value function, takes the distances between hubs and destination points, as well as multi-allocation into consideration.

Algorithm 7: OBJECTIVE FUNCTION CALCULATOR

Input: W The original flow
 P The final probabilities from the Weiszfeld Iteration
 $C^{(t)}$ The hub facilities
 L The original locations
 N The matrix specifying which direct routes have been chosen
 M The matrix specifying which hub the destination point is allocated to for each origin-destination pair

Output: Cost
 $b \leftarrow \text{Length}(L)$
for $i \leftarrow 0$ **to** b **do**
 for $j \leftarrow 0$ **to** b **do**
 if $W_{ij} \neq 0$ **then**
 if N_{ij} **then**
 $cost \leftarrow cost + W_{ij}d_{ij}R$
 else
 $f \leftarrow \max(p_i)$
 $g \leftarrow M_{ij}$
 $cost \leftarrow cost + W_{ij}(d_{if}R + (d_{fh} + d_{hj})T)$
 end
 end
 end
end

Algorithm 8: COMPLETE ALGORITHM WITH MULTISTART

Data:

$L = \{l_i : i \in [1, N]\}$	locations of origin and destination points
$W = \{w_{ij} : i, j \in [1, N]\}$	weight transported from point i to point j
K	the number of hubs
ϵ	stopping criterion
\mathcal{O}	number of origin points
\mathcal{D}	number of destination points, where $\mathcal{O} + \mathcal{D} = N$
I	number of initial solutions
R	origin factor
T	destination factor

(3.42)

Result: Optimal locations $\{\hat{C}\}$

Initialization: GENERATE-INITIAL-SOLUTIONS($K; C_i^{(0)}$)

$Objv_{best} \leftarrow 100000$

while $i < I$ **do**

$H \leftarrow W$

$t \leftarrow 0$

while $change < \epsilon$ **do**

 1. WEIGHT CONVERTER ($(H, \mathcal{O}, \mathcal{D}); F$)

 2. WEIGHT EDITOR ($(F, R, T), \mathcal{O}, \mathcal{D}; A$)

 3. CENTRE UPDATE ($(L, C_i^{(t)}, A); C_i^{(t+1)}$)

 4. DIRECT ROUTE ENABLER ($(C_i^{(t+1)}, W, H^{(t)}, L, N^{(t)}); (H^{(t+1)}, N^{(t+1)}, M)$)

$change \leftarrow \|C_i^{(t+1)} - C_i^{(t)}\|$

$t \leftarrow t + 1$

end

$Objv_{current} \leftarrow$ OBJECTIVE FUNCTION CALCULATOR($W, P, C^{(t)}, L, N, M$)

if $Objv_{current} < Objv_{best}$ **then**

$Objv_{best} \leftarrow Objv_{current}$

$\hat{C} \leftarrow C_i^{(t+1)}$

end

$i \leftarrow i + 1$

end

3.3 Conclusion

Two adapted models for the LMA-NS-HLP have been successfully developed and implemented. Both the network-based as well as the continuous models have acquired the desired characteristics that include single-allocation of origin points, multi-allocation of destination points and the inclusion of direct routes. Computational results of these models for a limited test case with the purpose of validation and comparison are presented in Chapter 4.

Chapter 4

Model Validation and Comparison

In this chapter computational results for a test case, with the purpose of validating and comparing the two models presented in Chapter 3, are presented. The test case was used to validate the models as well as determine any underlying behaviours, before the models capabilities were compared.

4.1 Test Case

A limited test case was used to validate both the network as well as the continuous models. The test case incorporates 14 origin- and 3 demand points (Figure 4.1) with corresponding weights between origin destination pairs as seen in Table 4.1. The cost associated with road was chosen to be R 1,00/*km* whereas the travel along the network was specified to be R 0,1/*km*.

Table 4.1: Flow Between Points

Origin	Destination		
	d ₁	d ₂	d ₃
o ₁	29		
o ₂	35	8	
o ₃	10	10	
o ₄	10	25	
o ₅	25	14	
o ₆	25		8
o ₇		30	0
o ₈	14		14
o ₉		25	15
o ₁₀	30	15	
o ₁₁	22		10
o ₁₂	10	10	14
o ₁₃	3	12	12
o ₁₄		20	20

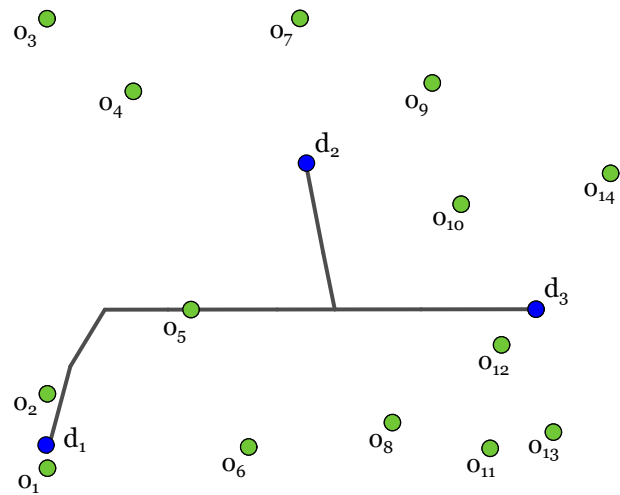

Figure 4.1: Test Case Study Area

4.1.1 Results for Test Case using the Network-Based LMA-NS-HLP

For the test case a rail network was defined through the study area, and a predefined number of possible hub locations along this network determined (Figure 4.2). Results for $k \in [0, 3]$ can be seen below in Figure 4.4. The sizes of the origin, destination and hub points are relative to the weighted flow traveling to or from each facility, while the width of the road and rail links also correspond to the weight traveling along them.

The results demonstrate the model's ability to allow for direct routes as seen in the the result for $k = 1$. The model, however, displays a tendency to prefer indirect routing, even if it passed the destination point en route to the hub, as displayed for $k = 3$. All results clearly demonstrate that the origin points are assigned to exactly one hub, as required. The multi-allocation of destination points is possible and highlighted in Figure 4.3.

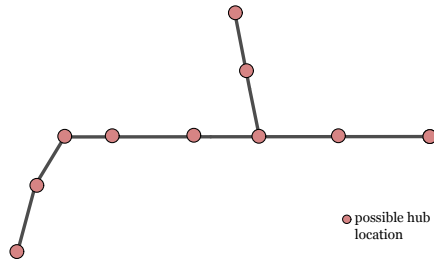

Figure 4.2: Possible hub locations along rail network

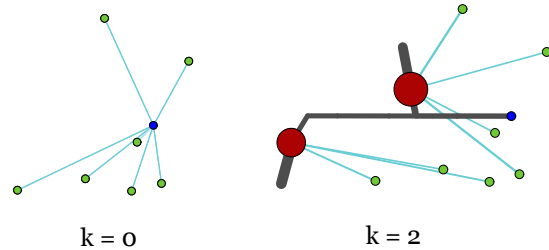

Figure 4.3: Multi-allocation of d_3 for $k = 2$

The chosen hub facilities for all solutions seem viable and logical; for $k = 1$ the node which is in the centre of the network is chosen, while two nodes positioned on opposite ends of the network are chosen for $k = 2$ and one additional node is added for $k = 3$. Noticeable is the fact that the nodes are chosen in such a manner that they cluster origin points together.

The results for the test case demonstrate that the network-based LMA-NS-HLP fulfills all the requirements. The results for the case study using the continuous LMA-NS-HLP will now be evaluated to determine if this is also the case for the second model.

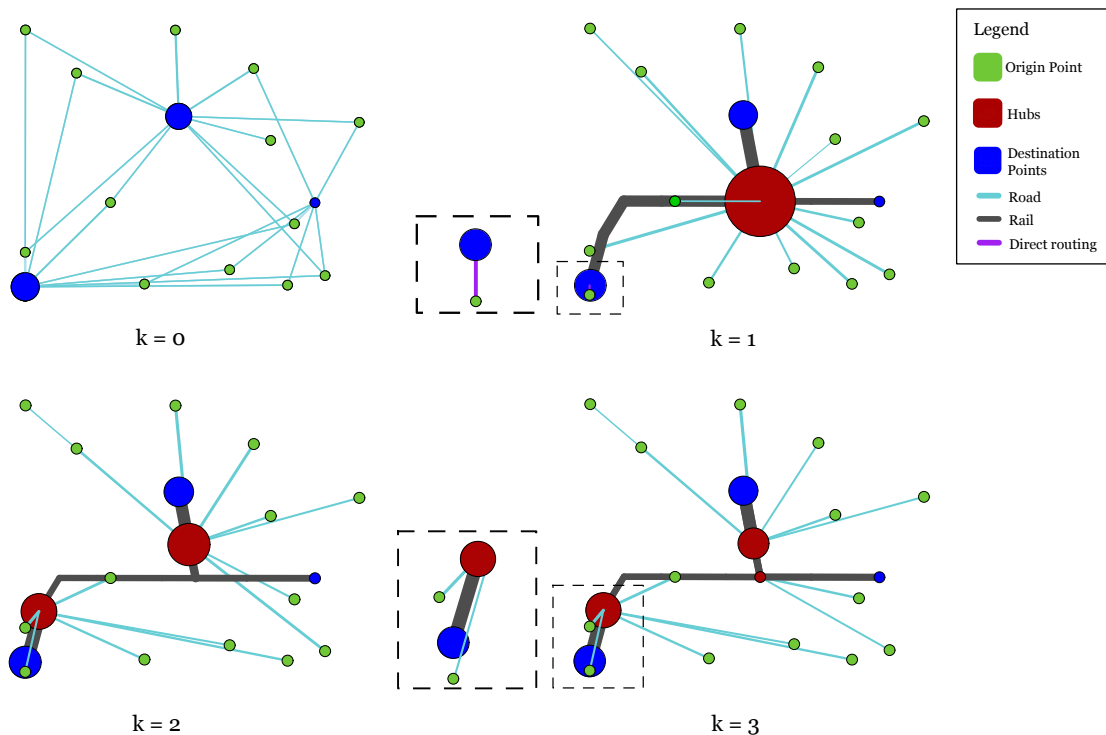

Figure 4.4: Results for test case using the network-based LMS-NS-HLP

4.1.2 Results for Test Case using the Continuous LMA-NS-HLP

The continuous model differs greatly from the network-based model in that it uses the straight-line euclidean distance between hubs and destination points instead of the distance between the points along the rail network. Therefore, the optimal outputs differ considerably. The results for the continuous model can be seen below for $k \in [0, 3]$ in Figure 4.5. Here, the weighted flows were once again used to determine relative sizes for facilities as well as links.

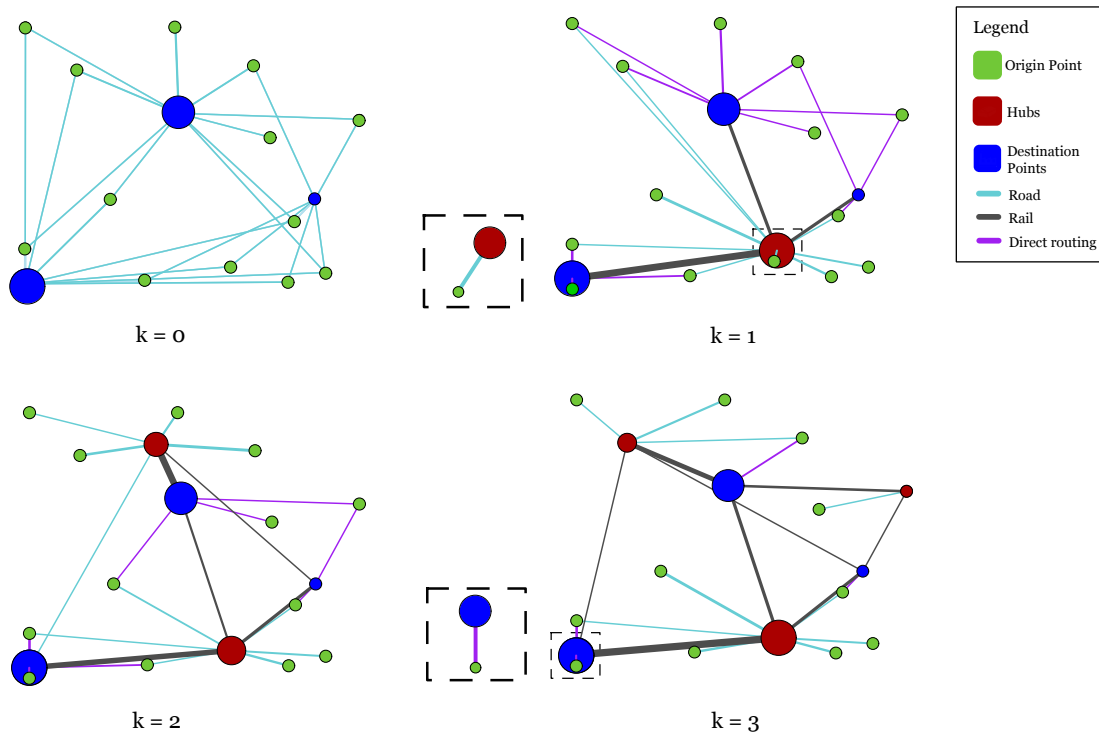

Figure 4.5: Results for test case using the continuous LMS-NS-HLP

The outputs demonstrate the extended capabilities of the model that include direct routing and limited multi-allocation. Direct routing is demonstrated for $k \in [1; 3]$ by the purple lines, origin points are allocated to exactly one hub facility while the destination points are allocated to multiple hub facilities. The multi-allocation is clearly demonstrated in the results for $k = 3$, where all three demand points are directly connected to two or more hubs.

During model development two aspects were used to validate the model; a decreasing objective function, to determine if the model is in fact iterating towards an optimum, and the results of various starting points to determine if the results were repeatable. The value resulting from the objective function calculator, as described in Chapter 3.2, for each iteration, was used to determine whether the locations iterate towards an optimum. The objective function of all the results below decrease steadily as depicted in Figure 4.6. Throughout development the model was repeatedly run with a predetermined number of starting solutions to determine if the results could repeatedly be obtained.

Applying this repeatability principle to the case study, underlying behaviour of the model was illuminated, such as the tendency of the continuous model to iterate towards points that have the greatest or very high flows compared to other points. For $k = 1$ the location of the hub facility does not coincide with an origin point, however, for $k \in [2, 3]$ this same hub's location coincides with the origin point o_8 . The summed weighted flow for origin point o_8 is 28, which is not the highest flow but as this particular point is relatively central, this is still a viable and logical solution. The third hub for $k = 3$ would appear to be an unexpected location, however, this location coincides with the origin point o_{14} , with the relatively high total summed weighted flow of 40.

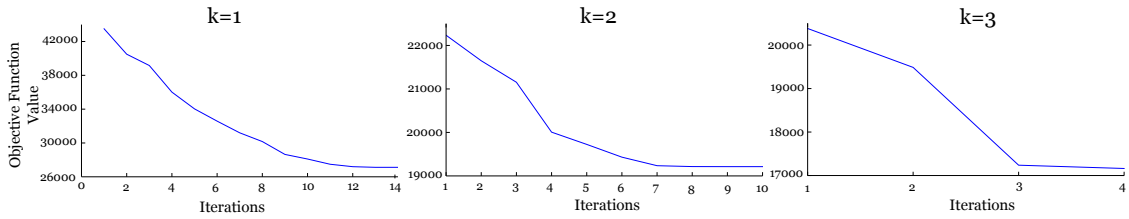

Figure 4.6: Objective function value for each iteration for $k \in [1, 3]$

By repeatedly evaluating the solutions, the effect the multi-start heuristic has on the model, could be evaluated. The solution for $k = 1$ is not affected by the multi-start in any way. For $k = 2$ the multi-start has a limited effect. The solutions always iterate towards the same two or three hub locations, resulting in very similar answers, where the optimal locations are just the correct combination of points. With an increase number of hubs, the multi-start has a growing effect. The underlying behaviour of the model to iterate towards points with high weights is the most prominent reason. For $k > 3$ the additional hubs tend to iterate towards one of the origin or destination points, the best solution resulting from the best combination. In conclusion the effect of the multi-start increases with the number of hub facilities.

Revisiting Figure 4.6 and focusing on the number of iterations needed for a varying number of hubs, it can be seen that the number of iterations decrease with a growing number of hubs. This is most probably due to the fact that with a growing number of hubs, the additional hubs quickly iterate towards origin or destination points and then do not change position for the remainder of the model run.

The results discussed above for the test case using the continuous LMA-NS-HLP clearly demonstrate that this model fulfills all specified requirements and highlights the underlying behaviour and tendencies of the model. Both the network-based, as well as the continuous model, have been validated. To verify that the models can solve the actual problem satisfactorily, computational results obtained for the case study are presented in the next chapter, after the strengths and weaknesses of the models have been discussed.

4.1.3 Comparison of the Models

The network model is superior to the continuous model in that it can obtain a global optimum. The continuous model falls under the heuristic category; no further improved solutions were found, however, there is no guarantee that no improved result exists. In this setting, the distance travelled along the rail network is important and influences the solution tremendously. The network-based model is capable of taking this fact into consideration, while the continuous model is only capable of taking the straight line distances into account.

A weakness of the network-based model is that it only considers a limited number of nodes, additional nodes may lead to an improved solution. The best case scenario would be to include every single point along the rail network, as this ensures that no optimal nodes are overlooked. However, as a Linear Programming Solver was used for the case study and additional nodes increase the time to solve exponentially, this is not a viable alternative. Here, the continuous model is useful, as it considers all points in a plane.

Taking these strengths and weaknesses into account, it was decided to use the models in combination in evaluating the case study. The network-based model yields superior results, as it incorporates the rail network into the calculation. To overcome the limitation of possible hub locations, the continuous model was used to identify additional possible nodes that should be included. This procedure, as well as the corresponding sensitivity analysis are presented in Chapter 5.

Chapter 5

Computational Results and Sensitivity Analysis

In this section the computational results obtained for the case study are presented. These are used to conduct a sensitivity analysis, with the purpose of answering the two questions for the major coal transportation company in South Africa:

1. *Where are the best possible hub locations?*
2. *How many hub facilities should be built?*

The findings and conclusions are presented and analysed to determine if they are capable of solving the actual problem satisfactorily.

5.1 Case Study

The case study incorporates 36 origin- and 10 demand points with predetermined flows between origin and destination pairs. A schematic depiction of the relevant rail lines and study area can be seen in Figure 5.1. This unscaled schematic will be used throughout to present results obtained for the case study, as the data used is confidential. The cost of moving one ton of coal along road was set to R 1.28/*km*, while R 0.39/*km* was used as the cost of moving one ton of coal along rail. The straight-line distances between points was used in calculating the road length for both models. To approximate a more accurate road length that incorporates curves, the euclidean distance was multiplied by the factor 1.3, a typically chosen factor for this application (Goodchild et al., 2007). Therefore the cost along road was ultimately set to R 1.664/*km*.

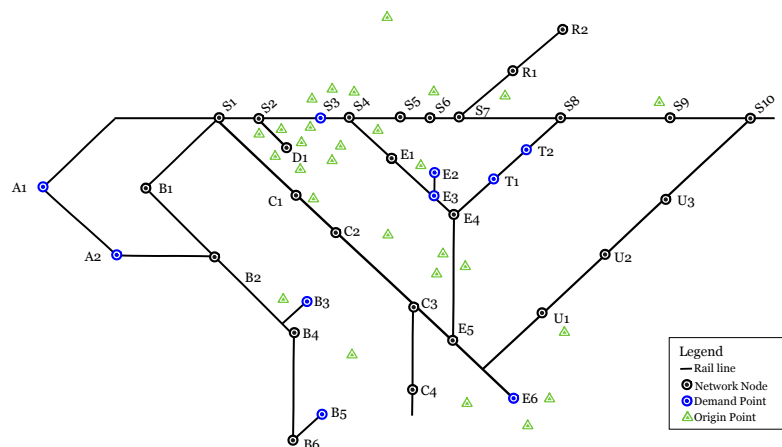

Figure 5.1: Rail Network

5.1.1 General Approach

For the evaluation of the case study, a systematic procedure that closely links to the strengths and weaknesses of the two developed models, was followed. Firstly, a predetermined number of possible hub locations along the existing rail network was chosen, and the network-based LMA-NS-HLP used to obtain results. In the next step, the continuous LMA-NS-HLP was used to determine which locations would be chosen considering continuous space. These results were superimposed onto the rail network, whereby outlying, previously excluded nodes, as well as required rail lines, were added. The three cases described above will be referred to Case 1, 2 and 3 for the remainder of this section. The results of the three cases were then compared focusing on two factors: total cost, and the percentage of road-based coal diverted to rail.

5.1.2 Results for the Case Study using the Network-Based LMA-NS-HLP

For Case 1 that describes the first iteration of the network-based model, a predefined number of possible nodes was defined as seen in Figure 5.2a. These all correspond to existing train stations. A distance matrix specifying the shortest path along the rail network between nodes, was developed from the table describing the distances between rail nodes presented in Appendix A. This distance matrix in combination with the other relevant input data, such as the locations of mines and destination points as well as flows, were then used to obtain results. The chosen hub locations for $k \in [0, 5]$ can be seen in Figure 5.2. A more detailed representation of the results, that include weighted flows as well as all origin and destination points with weighted sizes can be found in Appendix B (Figure C.1).

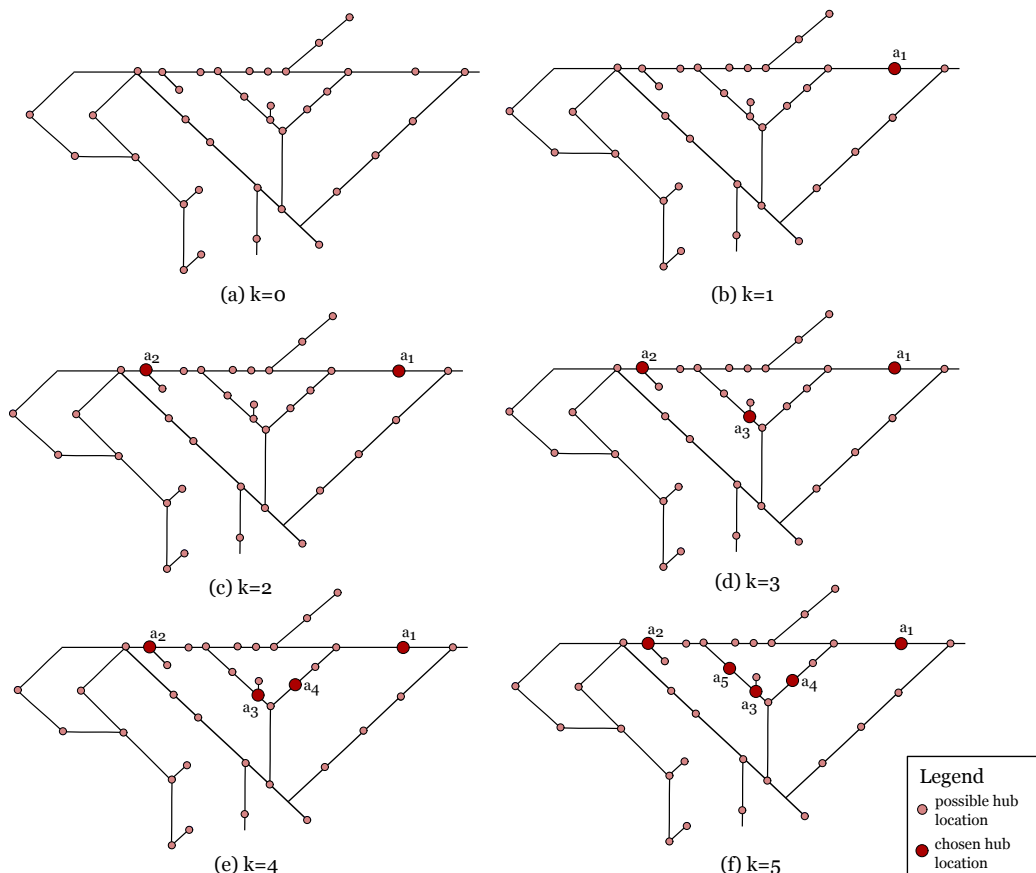

Figure 5.2: Chosen hub locations for Case 1

5.1.3 Results for the Case Study using the Continuous LMA-NS-HLP

For Case 2 the hub locations obtained using the continuous LMA-NS-HLP for $k \in [1, 5]$ relative to the rail network can be seen in Figure 5.3. A more detailed representation of the results, that include weighted flows as well as all origin and destination points with weighted sizes can be found in Appendix B (Figure C.2). The chosen hub locations for a varying number of hubs are often identical; the first chosen hub location features in the solutions for $k \in [1, 5]$. Comparing the results of the continuous and network-based LMA-NS-HLP various aspects were highlighted that guided the choice of additional possible hub nodes for Case 3.

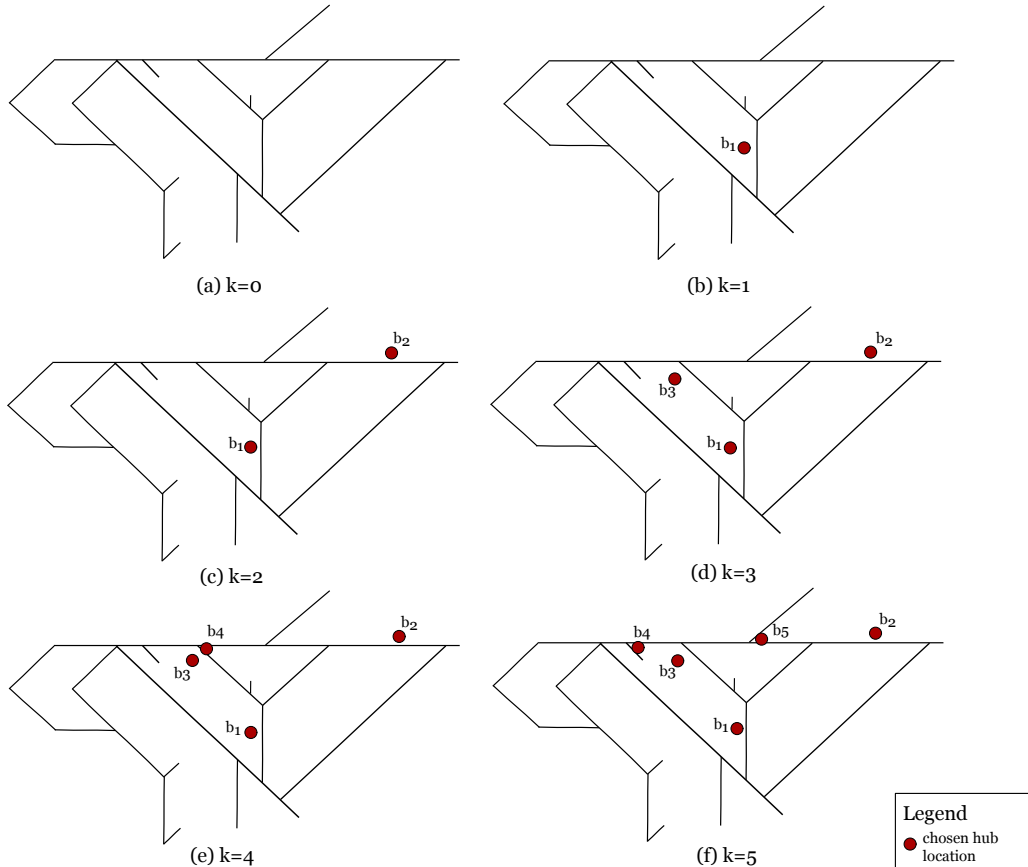

Figure 5.3: Chosen hub locations for Case 2

Firstly, the solutions for $k = 3$ of Case 1 and 2 are relatively similar; the locations of hubs a_1 and b_2 are almost identical, while the locations of a_2 and b_2 as well as the locations of a_3 and b_1 are relatively close together. In both cases the three chosen locations are placed in a triangle formation. The chosen location for b_1 is a lot further south compared to its network-based counterpart a_3 . There are no possible hub nodes in the network-based model for the exact point corresponding to this result, therefore, it was added as a possible hub location in Case 3. A 5km rail network is required to connect this point to the existing rail lines, therefore a second additional possible hub location was added to the point where the required rail line meets the existing rail line.

Furthermore, it is noticeable that one particular point is chosen throughout both results, namely the hub location on the north-easterly corner of the rail network (a_1 and b_2). This particular solution is chosen for $k \in [1, 5]$ in the network-based model, and for $k > 1$ in the continuous model. The major preference for this particular location can be explained by the fact that its closest mine has the highest flow compared to the other mines.

Evaluating the results of the continuous model for $k \geq 3$ it is noteworthy that the same three hub locations are chosen throughout, where one and two additional locations are chosen for $k = 4$

and $k = 5$ respectively. The north-westerly point b_2 , as well as central south point b_1 have been discussed above. The third point b_3 , located north-westerly on the rail network was chosen as another additional possible hub location for Case 3. The other hub locations chosen by the continuous model are not discussed at this point as they all fall within a $4km$ radius of already existing possible hub locations, and this degree of accuracy was deemed acceptable. The additional chosen hub locations discussed above for Case 3 are summarised in Figure 5.4 below.

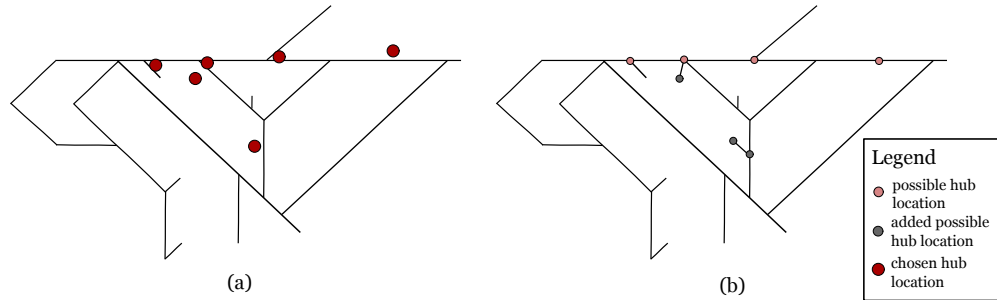

Figure 5.4: (a) Chosen hub locations for $k \in [1, 5]$ relating to Case 2 (b) Corresponding possible hub nodes with additional possible hub locations

5.1.4 Results for the case study using the network-based LMA-NS-HLP with additional nodes

Taking the three additional hub locations into account, the results for Case 3 using the network-based LMA-NS-HLP can be seen in Figure 5.5. A more detailed representation of the results can be found in Appendix B (Figure C.3). In evaluating this case, the most important factor to consider was whether the additional hub locations influence the result in any manner. For $k \in [1, 2]$ the chosen hub locations of Case 1 and 3 are identical. The influence of the additional hub locations is captured for $k \geq 3$, as one of the additional hub locations is chosen. This location corresponds to the point b_1 that is chosen for all solutions of Case 2. The triangular formation of Case 2 and 3 for $k = 3$ is even more similar than for Case 1 and 2. The difference in results of Case 1 and 3 is minimal; even though the third chosen hub location differs, the additional added locations for $k \geq 4$ are identical.

Evaluating the results of all three cases, one noteworthy aspect is captured in the fact that the solutions of many hubs are built upon the solutions of few hubs: The chosen location for $k = 1$ is featured in all further results, the second chosen hub location is featured for $k \geq 2$, and so is the location of the third hub for $k \geq 3$. From this information, it can be deduced that the solutions for $k \in [1, 3]$ are robust with regard to the changing number of hubs k . Hence, if the budget constraints allow for only one facility to be built, it is clear which point should be chosen. If at some point a further facility was possible, the first hub remains, while one additional hub would be built at the second point. The same principle applies for the third point.

Finally, a few observations for $k \geq 4$ of the three cases illuminate a certain aspect. For Case 2 with $k = 4$ and $k = 5$ the triangular formation is carried over from $k = 3$, with added locations b_4 and b_5 . These additional locations differ considerably for $k = 4$ and $k = 5$. For $k = 4$ the added hub location b_4 is placed westerly on the west-east link. This hub location is placed far more westerly for $k = 5$, while the fifth location b_5 is placed more easterly (Figure 5.4e and Figure 5.4f). Comparing the results for $k \geq 4$ of Case 2 and 3, differences are clear. Viewing Case 3 for $k = 5$ and highlighting the two nodes added to the triangular formation c_4 and c_5 , their locations correspond to more central points compared to the triangular formation, while the location of b_4 and b_5 for Case 2 lie on the boundary of the triangular formation. From the above discussion it is clear that the robustness discussed previously with regard to the changing number of hub facilities k does not apply for $k \geq 4$.

The results of the three cases have been thoroughly discussed in terms of chosen locations. The next section focuses on comparing the results in terms of the numerical factors.

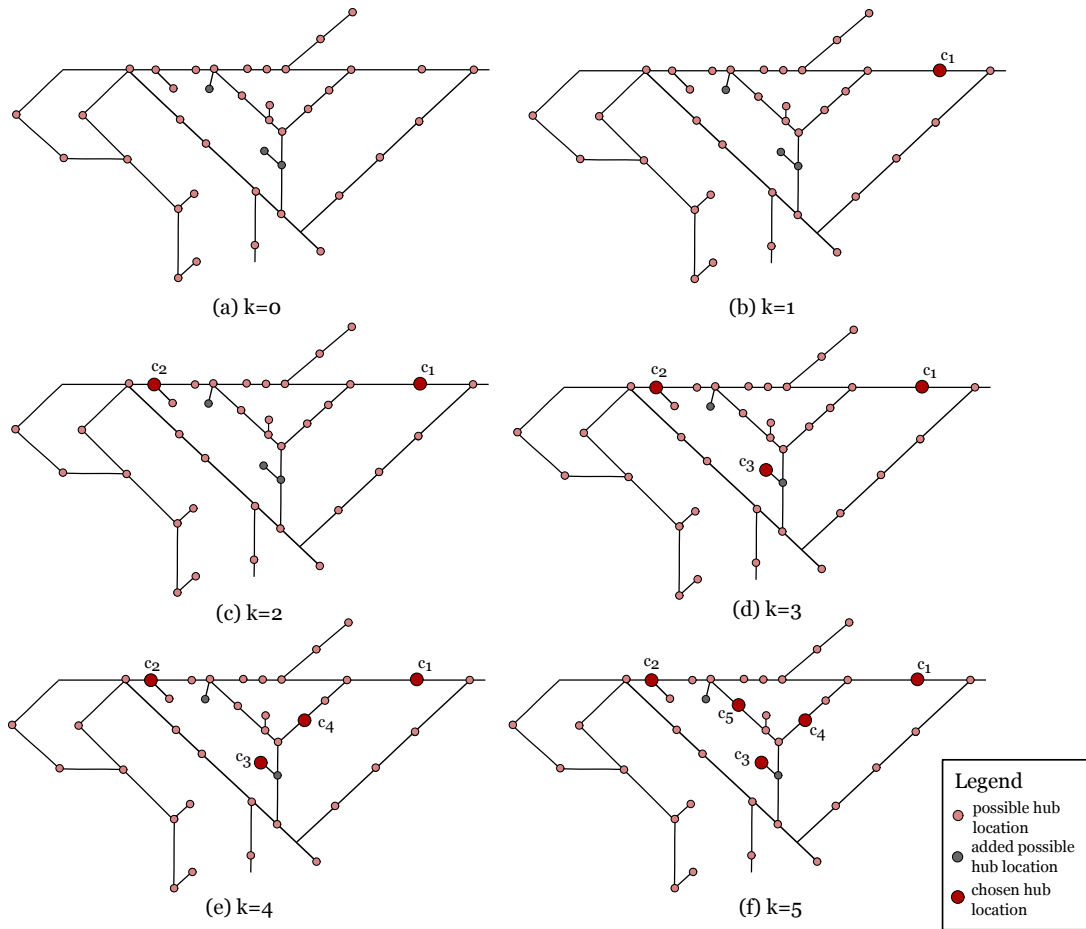

Figure 5.5: Chosen hub locations for Case 3

5.1.5 Comparison of Results

The two factors that were used to compare the three cases include total operational costs over the planning horizon, and the percentage of road-based coal diverted to rail. To ensure comparable results, the same calculation was used in calculating the total transportation costs for the three cases. The straight line distance between hubs and origin points, and direct origin destination links were used, while the distance along the existing rail network was used to calculate the distance between hubs and demand points, as this was the most realistic alternative. The total transportation cost over the planning horizon for a varying number of hubs can be seen in Table 5.1, with the corresponding graph as seen in Figure 5.6. The percentage of road-based coal that is diverted to rail was calculated using ntk - netto tons kilometre, calculated as the distance multiplied by volume. The resulting pie charts for $k \in [0, 5]$ for all three cases can be seen in Figure 5.7.

Table 5.1: Total operational costs for Case 1, 2 and 3 in millions of Rands

k	Case 1	Case 2	Case 3
0	R 153 479	R 153 479	R 153 479
1	R 128 969	R 159 684	R 128 969
2	R 110 761	R 136 913	R 110 761
3	R 105 680	R 113 029	R 99 359
4	R 103 382	R 112 475	R 96 890
5	R 101 834	R 108 788	R 95 398

These results illuminated and confirmed multiple aspects. The total transportation costs for Case 2, that resulted from the continuous model, are significantly higher throughout. For $k = 1$ the solution results in a higher total transportation cost than for $k = 0$. The weakness of the continuous model, namely the fact that the straight line distances between hubs and destination points are used to determine optimal locations, is the most probable cause of this unexpected result. For $k \leq 2$ the operational cost of Case 2 is a lot higher compared to Case 1 and 3; R 31 and R 27 billion respectively. The difference in total operational cost for Case 1 and 2 decreases significantly for $k \geq 3$ to an average of R 8 billion, and an average of R 14 billion comparing Case 2 and 3. By revisiting the chosen hub facilities relating to these results, this can easily be explained; for $k = 3$ similar hub locations are chosen, compared to the different results for $k \leq 2$. These differences arise as the preference of chosen hub locations differs. The preference of Case 1 and 3 should be followed for $k < 3$ as the total transportation cost are significantly lower. The difference in total operational cost between Case 2 and 3 for $k = 3$ can once more be explained by viewing the chosen hub locations: the most westerly point of the triangle formation differs - it is placed more westerly on the west-east link in Case 3. This small difference in chosen hub location increases cost savings by R 13 billion.

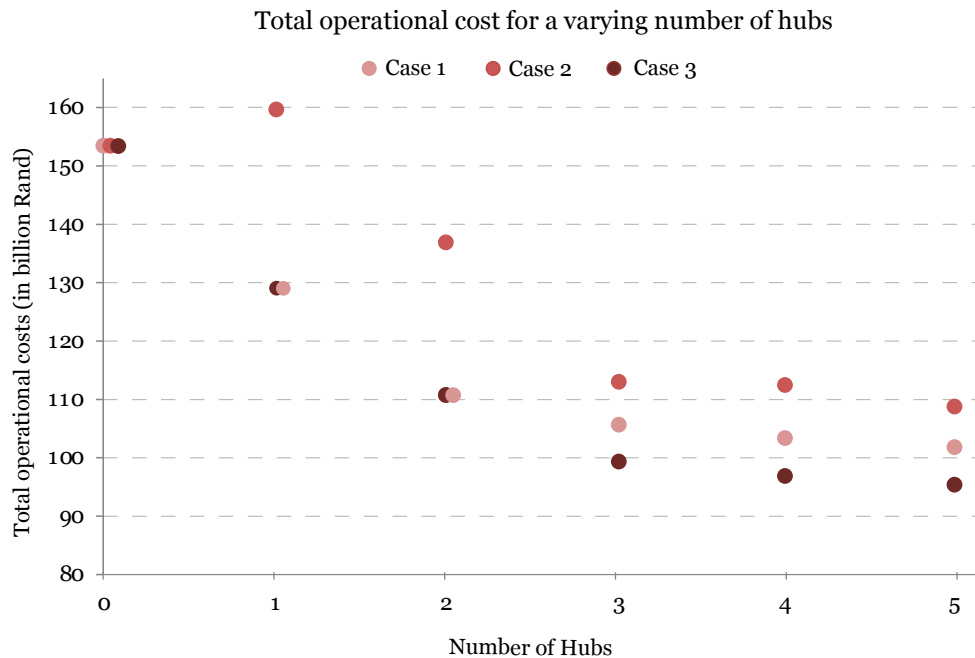

Figure 5.6: Total operational costs

Taking the total cost factor into account, it would appear that the network-based model is more suitable and applicable to the case study. However, analysing the percentage of diverted road-based coal, it is clear that the solutions obtained from the continuous model far surpass the network model in this aspect; for as little as one hub 65% of the coal in ntk is diverted to rail compared to the 13% for Case 1 and 3. For $k = 2$ the percentage of coal transported in rail is already as high as 80% compared to the 56% for Case 1 and 3. In the results for $k \geq 3$ this advantage decreases significantly; the percentage of diverted coal for $k = 3$ is 86% for Case 2 compared to 72% and 74% for Case 1 and 3 respectively.

As expected, the total operational costs for Case 1 and 3 are the same for $k \in [1, 2]$, as identical locations are chosen. However, for $k > 3$ the transportation costs differ, as the chosen hub locations differ. The lowest operational cost result from Case 3, in which additional possible nodes were placed, that were determined from results obtained in Case 2. This means the best possible results were obtained by using both mathematical models; the network-based model yielded better results, however the continuous model was useful in finding additional possible hub nodes. Adding these

possible hub locations to the network model resulted in the best solution.

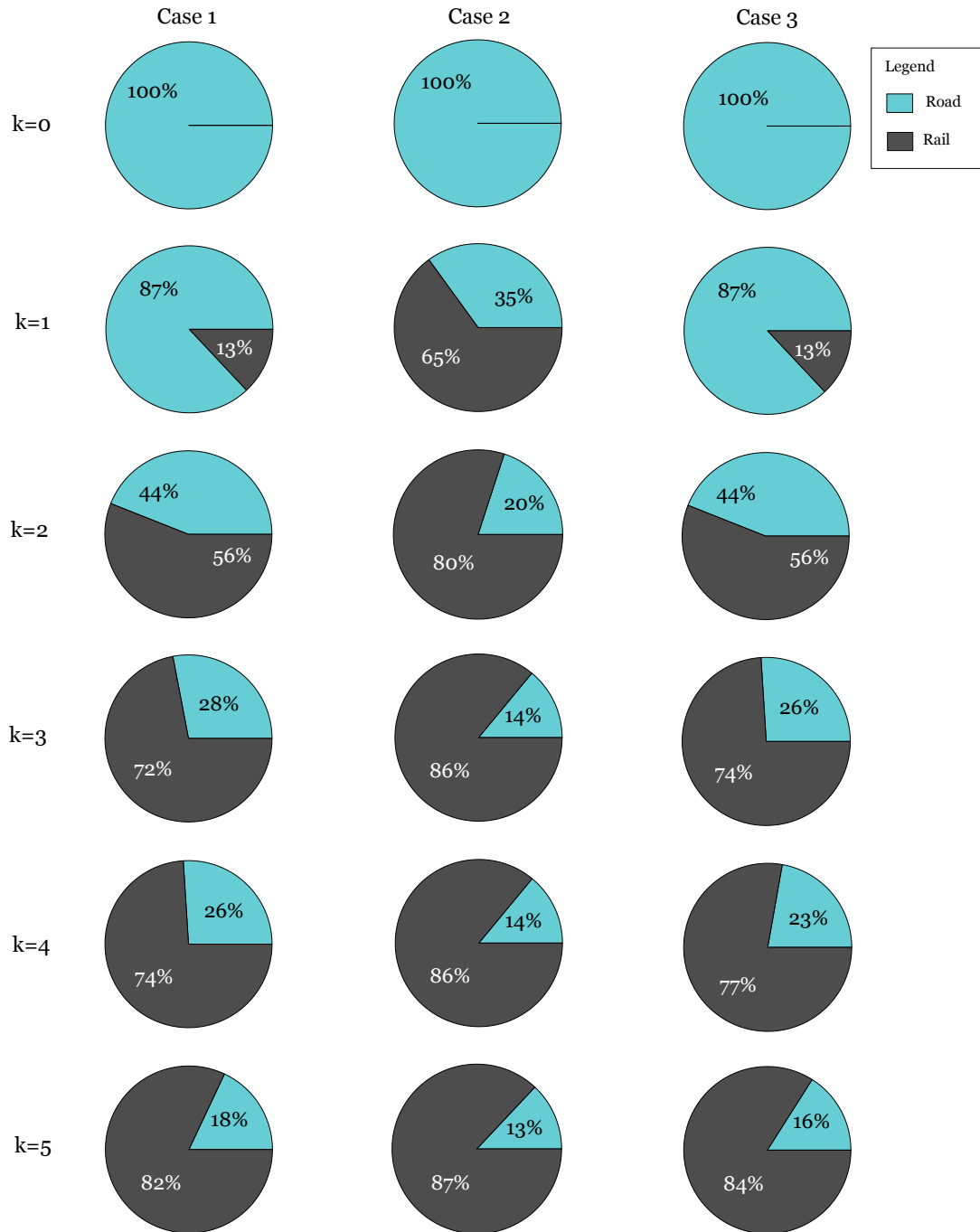

Figure 5.7: Percentage of road based coal diverted to rail in ntk for varying number of hubs

Having confirmed that the method used was suitable and yielded the best results, the total cost as well as the percentage of road-based coal diverted to road were used to determine the number of hubs that should be chosen and presented as final results. A bar graph depicting the operational cost saving of locating a varying number of hubs compared is shown in Figure 5.8.

Before discussing these aspects in detail, some remarks must be made. The cost saving of locating a varying number of hubs seems unrealistically high. The operational cost savings do not take the major cost of building the hub facilities into account. The equipment required such

as the trains and additional personnel is also not considered in this cost saving. Another major expense may arise in the need to upgrade and expand existing rail lines. The proposed changes may not be feasible for some of the existing rail lines as they have a capacity constraint and cannot carry the entire loads assigned to them. For the purpose of this discussion the limits of additional expenses are first elaborated, before assumptions with regard to these costs are made to form final conclusions.

Revisiting the pie graph depicting the percentage of diverted coal (Figure 5.7) the effect of a varying number of hubs on this factor are clearly displayed. For $k = 1$ the percentage relating to Case 1 and 3 is relatively low at 13% compared to the 65% relating to Case 2. Moving from $k = 1$ to $k = 2$, a major increase is visible: the percentage relating to Case 1 and 3 is 43% higher at 56%, while the percentage relating to Case 2 increases to 80%. A second hub, therefore, increases the percentage of road-based coal diverted to rail significantly, and should definitely be considered further, as this is one of the main objectives. Adding another hub, $k = 3$, the changes are still significant but not as large as previously. The percentage increases by 16, 8 and 18% for Case 1, 2 and 3 respectively, to 74, 86 and 76%. This increase is high enough for it to be considered further. The percentage relating to Case 3, that resulted in the best operational cost, for $k = 3$ is 74%. Close to $\frac{3}{4}$ of the road-based coal would be diverted following this solution. For an increase in hubs the percentage increase of diverted coal is relatively small.

The percentage increase of adding more hubs is comparatively small and relatively negligible. Considering these alternatives in the next step would require a significant further cost saving. For $k = 4$ the percentages increase by 2, 0 and 3%, resulting in 77, 86 and 77% for the three respective cases. If the cost saving do not significantly increase for this additional hub, it does not make sense to consider this alternative further. The percentage increase for $k = 5$ compared to the previous percentages is 8, 2, and 7% resulting in 83, 87 and 84% for the respective cases. This increase is larger than for the previous increment, however, the feasibility of building 5 hub facilities is questionable.

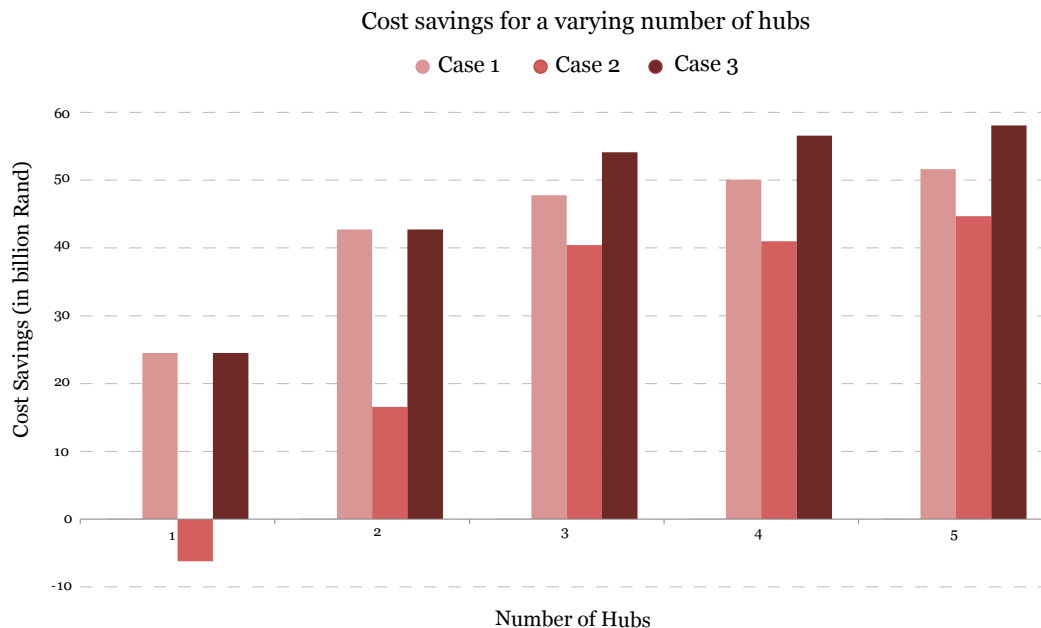

Figure 5.8: Operational Cost Savings

Moving on to the cost savings relating to the different alternatives, limits with regards to facility and additional cost can be determined in further guiding the decision process of how many hubs should be suggested and are summarised in Table 5.2. In reality there limits would be significantly lower, as additional cost would be considered and the company would specify a minimum total saving required to proceed with the project. In a hypothetical case the company

requires a minimum saving of R 20 billion and expects additional costs to amount to R 15 billion. The change in the upper bound limits can be seen in Table 5.3. In this hypothetical case the location of only one hub is not feasible.

Table 5.2: Upper Bound Limits for the Cost of Facilities

No of Hubs	Total Operational Savings (in million Rand)	Maximum Facility Cost
1	R 24 000	R 24 000
2	R 42 000	R 21 000
3	R 54 000	R 18 000
4	R 56 000	R 14 000
5	R 58 000	R 11 600

Table 5.3: Upper Bound Limits for the Cost of Facilities

No of Hubs	Available Funds for the Facility from surplus of cost savings (in million Rand)	Maximum Facility Cost
1	R-11 000	R -
2	R 7 000	R 3 500
3	R 19 000	R 6 300
4	R 21 000	R 5 200
5	R 23 000	R 4 600

The cost savings show a tapering increase for an growing number of hubs. Between one and two hubs the difference of operational cost savings is as high as R 18 billion, and between two and three hubs as high as R 12 billion. Between three, four and five hubs the increased cost saving is only R 2 billion. This is not significantly large enough to consider the placement of four and five hubs further and they are thus eliminated from further consideration.

The approximate cost per hub facility was discussed with the project sponsor to be between R 1 billion and R 2 billion. Revisiting the previous discussion of cost savings for a different number of hubs, it can be safely stated that two hub facilities would be the preferred alternative compared to one hub facility. The total cost saving with a R 2 billion hub facility for one hub is R 22 billion compared to the R 38 billion for two hub facilities. This incorporates a R 16 billion slack for additional cost in which two facilities would be preferred over one facility. At this, therefore, the location of only one hub facility is eliminated. The percentage of diverted coal for $k = 1$ is also too small to be feasible. The total cost savings for three facilities and R 2 billion facilities would be R 48 billion, R 10 billion more than in the placement of 2 facilities. This means there is a R 10 billion slack in which the placement of three facilities is preferred compared to the placement of 2 facilities. The hypothetical case also demonstrates the clear advantage of placing either 2 or three hubs.

In order to accurately advise the major coal transportation company in South Africa, a detailed facility design with appropriate life-cycle costing would be necessary. A detailed costing analysis would need to be conducted to illuminate any additional costs arising through the proposed changes in operations, such as maintenance and upgrade of lines, personnel and any other required equipment. In a discussion with the project sponsors, the required savings to accept the proposal, considering the above costing analysis, would need to be established to advise the coal transportation company with certainty.

At this point these factors are unknown and a recommendation can only be made under many assumptions. Therefore, the detailed results for both $k = 2$ and $k = 3$ are displayed compared to the current proposed transportation system as seen in Figure 5.10, 5.11 and 5.9 respectively. The size of the facility corresponds to the weighted sum flowing to or from the facilities. The size of the connection links also corresponds to the weighted sum traveling along them.

The discussion above answers the two questions for a major coal transportation company as they clearly demonstrate which hub locations should be chosen, and the amount of hubs has been

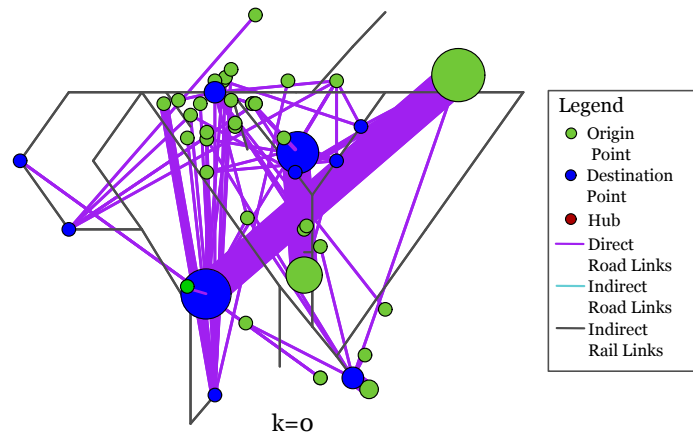

Figure 5.9: Current Transportation Network

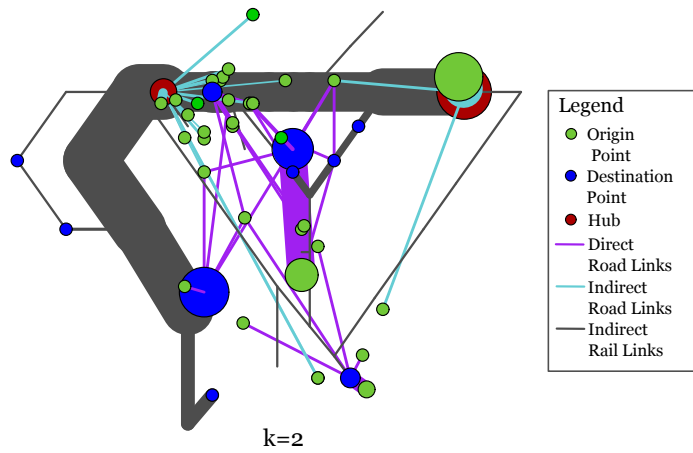

Figure 5.10: Proposed transportation Network for $k = 2$

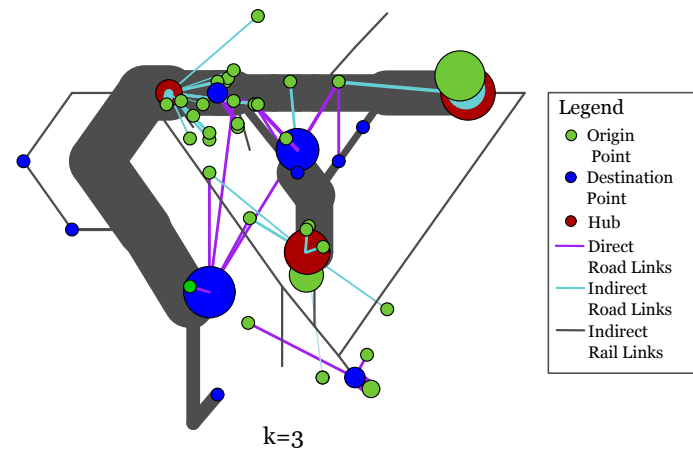

Figure 5.11: Proposed transportation Network for $k = 2$

narrowed down to a point in which a decision can be quickly made if more information is available. The objective of minimising the total operational cost, as well as diverting road based coal as far as possible off road and onto rail, have been met. In conclusion it is believed that the models and processes used were capable of solving the actual problem satisfactorily.

Chapter 6

Conclusion and Future Work

The aim of this project was to develop and evaluate optimisation models that can be used by decision makers to determine the best locations for coal consolidation centres in the South African coal transportation sector. Two models were developed to do so, the network-based LMA-NS-HLP and the continuous LMA-NS-HLP. The major difference between them being the domains in which hub locations may be sited. For the network-based LMA-NS-HLP, possible hub locations are limited to a predefined number of nodes along the rail network, while hubs may be located anywhere on the continuous plane with the continuous LMA-NS-HLP.

The two models were developed based on previous models and solution approaches found in literature. The formulation proposed by Aykin (1995) was used as a starting point in developing the network-based LMA-NS-HLP and solved using Lingo, a Linear Programming Solver. The solution approach suggested by Iyigun and Ben-Israel (2010) was selected as a starting point for the continuous LMA-NS-HLP. Modifications that allowed multi-allocation as well as direct routing, amongst others, were applied for the full problem. These models were then compared using a test case to determine strengths, weaknesses and any underlying behaviours. The most noteworthy findings are the major weaknesses of both models. The greatest weakness experienced by the network-based model is that the possible hub locations are limited; improved locations not on the rail network are excluded. The continuous model eliminates this weakness, however, it does not consider the distance along the rail network in calculating optimal locations and the results it yields are numerically inferior to the network-based counterparts. For these reasons it was decided to use both models in order to achieve optimal results; the continuous model was used to determine additional hub locations, while the network-based model was used to determine final results.

The two models were then applied to the case study and evaluated to determine if they solve the actual problem satisfactorily. The main objectives of determining the best locations for coal consolidation centres in this setting were to decrease the total transportation cost and to migrate the transportation of coal as far as possible off road and into rail. The recommended solutions for two and three hubs meet these requirements fully as cost savings are in the billions and the percentage of diverted coal is greater than 50%.

Further work in this case study is necessary to determine the life-cycle cost and design of coal consolidation centres, as well as to illuminate any additional cost such as rail maintenance and upgrades that would decrease the cost saving significantly. Once these aspects have been explored, the number of hub facilities to locate can be stated explicitly.

6.1 Future Research Opportunities

This research evaluated the application of the LMA-NS-HLP to one specific case study and evaluated whether the continuous or network-based model was more applicable in this setting. For further validation of these techniques, and a more thorough conclusion, benchmark problems would need to be developed and their results compared. As this stage, no benchmark problems were found for this specific problem. Through benchmark problems the effectiveness and efficiency of the techniques could be evaluated.

At this stage, the problem focused on a single objective, namely the minimization of total transportation costs. Models resembling the real-world case more closely would incorporate a multi-objective function, with the same first objective and the added objective of minimizing the maximum distance between origin points and hubs. This is included to equalize transportation costs between mines and hubs which will allow fair competition between mines.

A further research opportunity is attempting to combine the two developed models, as the possibility exists of eliminating the weaknesses found in both current models. In doing so, the focus would be to use a heuristic to determine locations, however, considering the rail-network distances in doing so. Another possible adaptation of the developed models involves including the constraints of the rail links into the calculation and evaluating how this effect the results.

Bibliography

- Alumur, S. and Kara, B. Y. (2008). Network hub location problems: The state of the art. *European Journal of Operational Research*, 190(1):1–21.
- Aykin, T. (1995). Networking policies for hub-and-spoke systems with application to the air transportation system. *Transportation Science*, 29(3):201–221.
- Chandrasekaran, R. and Tamir, A. (1989). Open questions concerning Weiszfeld’s algorithm for the Fermat-Weber location problem. *Mathematical Programming*, 44(1):293–295.
- Farahani, R. Z., Hekmatfar, M., Arabani, A. B., and Nikbakhsh, E. (2013). Hub location problems: A review of models, classification, solution techniques, and applications. *Computers & Industrial Engineering*, 64(4):1096–1109.
- Goodchild, M. F., De Smith, M. J., and Longley, P. (2007). *Geospatial Analysis - A Comprehensive Guide to Principles, Techniques and Software Tools*, volume 1. Matador, Leicester.
- Horhammer, A. M. (2014). Dynamic hub location problems with single allocation and multiple capacity levels. In *System Sciences (HICSS), 2014 47th Hawaii International Conference*, pages 994–1003. Hawaii. 6-9 January.
- Iyigun, C. (2013). The planar hub location problem: A probabilistic clustering approach. *Annals of Operations Research*, 211(1):193–207.
- Iyigun, C. and Ben-Israel, A. (2010). A generalized weiszfeld method for the multi-facility location problem. *Operations Research Letters*, 38(3):207–214.
- Kuhn, H. (1973). A note on fermat’s problem. *Mathematical Programming*, 4(1):98–107.
- Melo, M., Nickel, S., and Saldanha-da-Gama, F. (2009). Facility location and supply chain management-A review. *European Journal of Operational Research*, 196(2):401–412.
- Montavont, J. and Noel, T. (2006). IEEE 802.11 handovers assisted by GPS information. In *Wireless and Mobile Computing, Networking and Communications, 2006.(WiMob’2006). IEEE International Conference on*, pages 166–172. IEEE.
- O’Kelly, M. E. and Miller, H. J. (1994). The hub network design problem: A review and synthesis. *Journal of Transport Geography*, 2(1):31–40.
- Owen, S. H. and Daskin, M. S. (1998). Strategic facility location: A review. *European Journal of Operational Research*, 111(3):423–447.
- Rardin, R. L. (1997). *Optimization in Operations Research*, pages 1–8. Prentice-Hall.
- ReVelle, C. and Eiselt, H. (2005). Location analysis: A synthesis and survey. *European Journal of Operational Research*, 165(1):1–19.
- Silva, M. R. and Cunha, C. B. (2009). New simple and efficient heuristics for the uncapacitated single allocation hub location problem. *Computers & Operations Research*, 36(12):3152–3165.
- Silver, E. A. (2004). An overview of heuristic solution methods. *The Journal of the Operational Research Society*, 55(9):936–956.

- Stewart, J. (2008). *Calculus Early Transcendentals*, volume 6E. Brooks/Cole, Belmont, California.
- Steyn, W. J., Bean, W., King, D., and Komba, J. (2011). Evaluation of selected effects of pavement riding quality on logistics costs in South Africa. *Transportation Research Record: Journal of Transportation Research Board*, 2227(1):138–145.
- Torres-Soto, J. and Uster, H. (2011). Dynamic-demand capacitated facility location problems with and without relocation. *International Journal of Production Research*, 49(13):3979–4005.
- Viljoen, N., Steyn, W., Bean, W., Jankauskaite, Z., Gounder, S., Havenga, J., Simpson, Z., de Jonge, G., Sambandan, M., Laubscher, C., Ittmann, H., Luke, R., and Heyns, G. (2013). *9th Annual State of Logistics Survey for South Africa: Connecting Neighbours - Engaging the World*. CSIR, Imperial Logistics and Stellenbosch University, Pretoria, South Africa.
- Winston, W. L. and Venkataramanan, M. (2003). *Introduction to Mathematical Programming, fourth edition*, volume 1 of *Operations Research*. Brooks/Cole, Belmont, California.
- Zanakis, S. H. and Evans, J. R. (1981). Heuristic "optimization": Why , when, and how to use it. *Interfaces*, 11(5):84–91.

Appendix A

Department of Industrial & Systems Engineering Final Year Projects

Identification and Responsibility of Project Sponsors

All Final Year Projects are published by the University of Pretoria on *UPSpace* and thus freely available on the Internet. These publications portray the quality of education at the University and have the potential of exposing sensitive company information. It is important that both students and company representatives or sponsors are aware of such implications.

Key responsibilities of Project Sponsors:

A project sponsor is the key contact person within the company. This person should thus be able to provide the best guidance to the student on the project. The sponsor is also very likely to gain from the success of the project. The project sponsor has the following important responsibilities:

1. Confirm his/her role as project sponsor, duly authorised by the company. Multiple sponsors can be appointed, but this is not advised. The duly completed form will be considered as acceptance of sponsor role.
2. Review and approve the Project Proposal, ensuring that it clearly defines the problem to be investigated by the student and that the project aim, scope, deliverables and approach is acceptable from the company's perspective.
3. Review the Final Project Report (delivered during the second semester), ensuring that information is accurate and that the solution addresses the problems and/or design requirements of the defined project.
4. Acknowledges the intended publication of the Project Report on UP Space.
5. Ensures that any sensitive, confidential information or intellectual property of the company is not disclosed in the Final Project Report.

Project Sponsor Details:

Company:	University of Pretoria, Department of Industrial and Systems Engineering
Project Description:	Optimal location modelling of bulk-resource consolidation centers
Student Name:	Heidi Barends
Student number:	u11302594
Student Signature:	
Sponsor Name:	Elias Willemse
Designation:	Lecturer
E-mail:	elias.willemse@up.ac.za
Tel No:	012 420 3443
Cell No:	071 890 2714
Fax No:	012 362 5103
Sponsor Signature:	

Appendix B

Table B.1: Network Distances

Node 1	Node 2	Distance
A1	A2	76.754
A2	B2	20.505
S1	B1	37.866
B1	B2	30.822
B2	B4	75.679
B4	B3	35.492
B4	B6	54.922
B5	B6	17.280
S1	C1	80.771
C1	C2	17.104
C2	C3	33.601
C3	C4	44.501
S2	D1	22.095
S4	E1	10.432
E1	E3	31.112
E3	E2	12.922
E3	E4	9.660
E4	E5	49.952
E5	E6	46.335
A1	S1	81.727
S1	S2	32.154
S2	S3	35.518
S3	S4	10.330
S4	S5	27.419
S5	S6	34.262
S6	S7	9.181
S7	S8	36.748
S8	S9	20.756
S9	S10	29.691
S7	R1	59.339
R1	R2	36.542
E4	T1	9.188
T1	T2	30.328
T2	S8	19.584
E5	U1	58.089
E6	U1	39.456
U1	U2	39.850
U2	U3	22.607
U3	S10	28.552

Appendix C

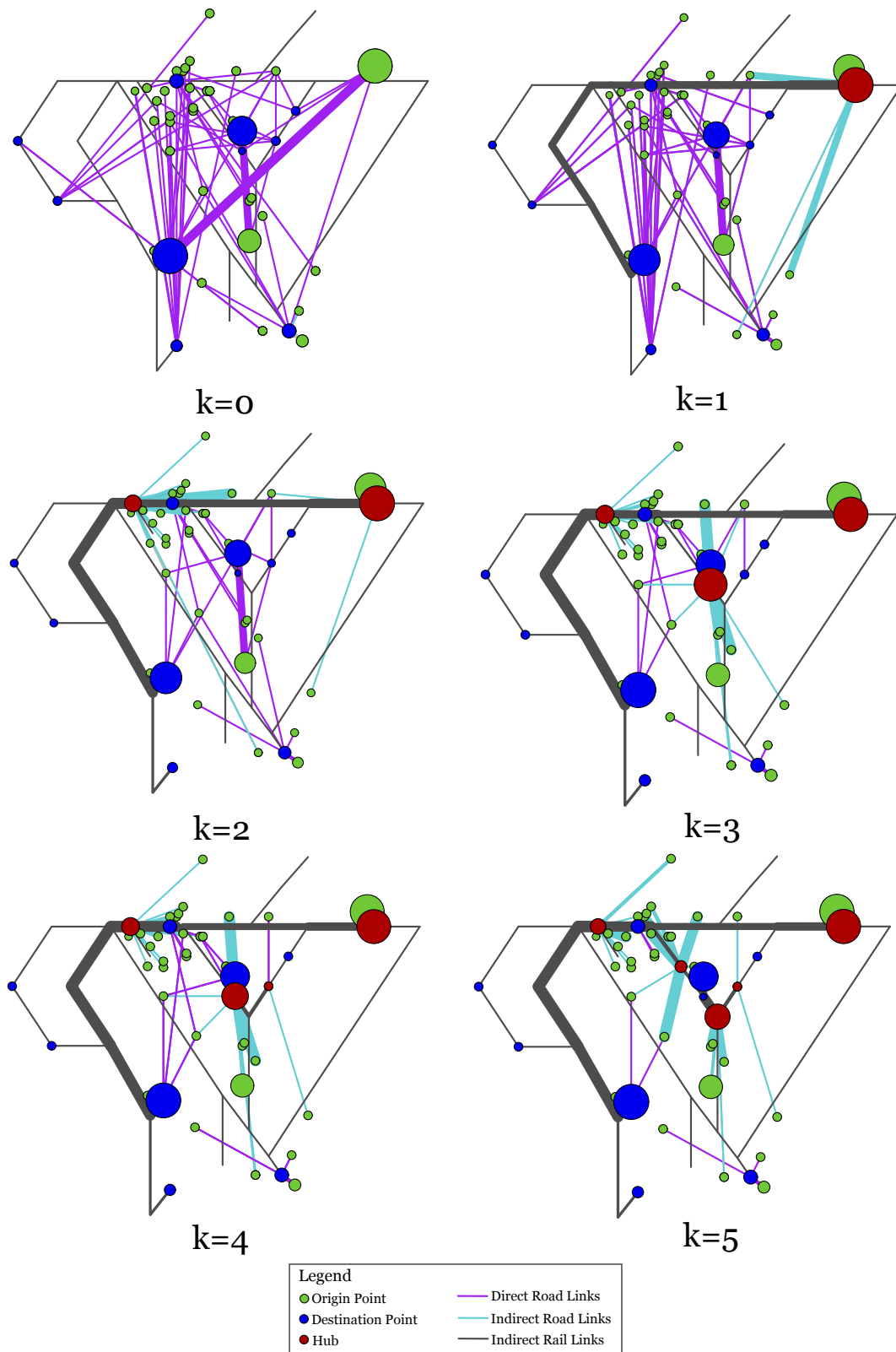

Figure C.1: Solutions for Case 1 with $k \in [0, 5]$ using the network-based LMA-NS-HLP with weighted flows

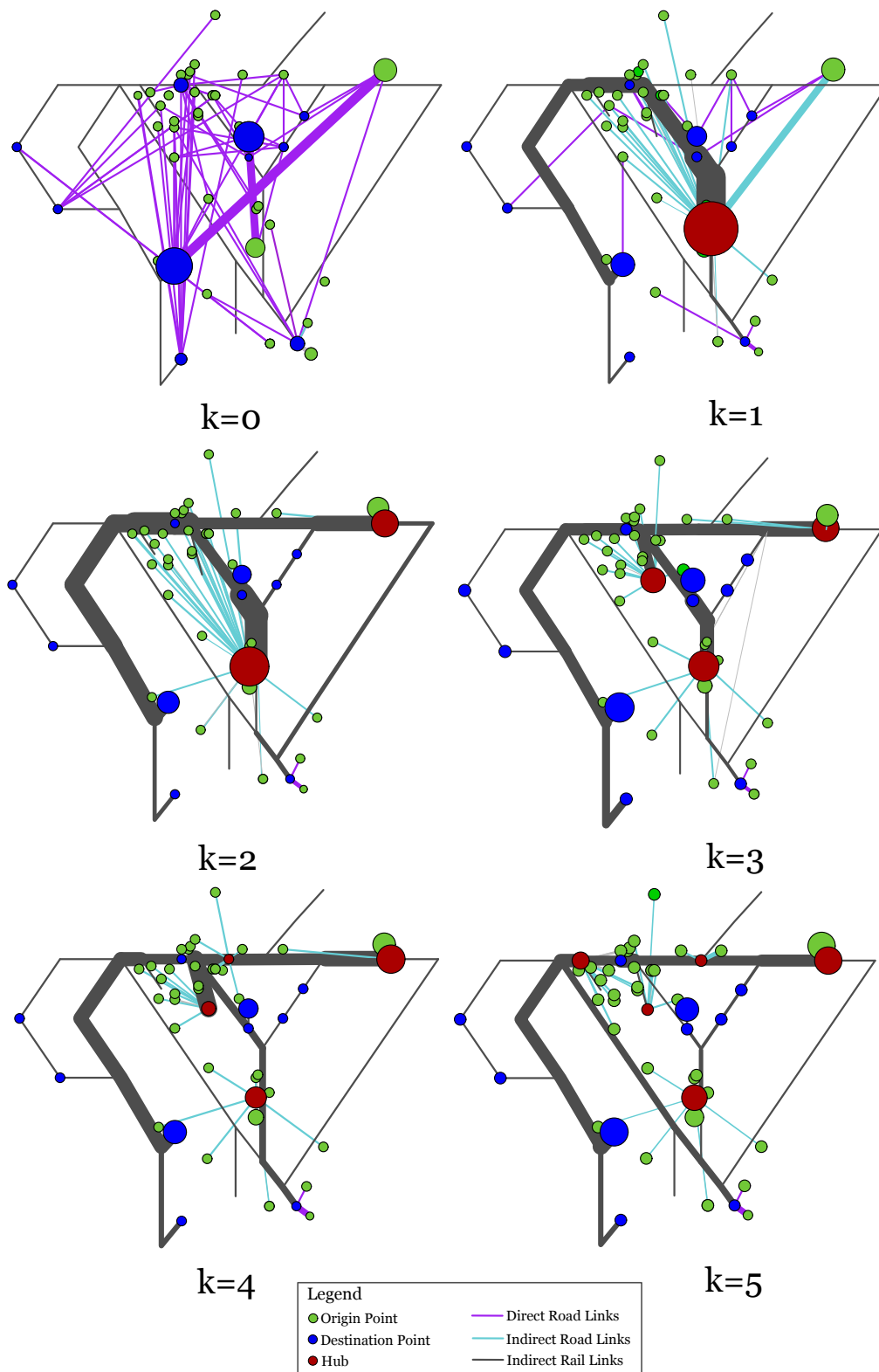

Figure C.2: Solutions for Case 2 with $k \in [0, 5]$ using the continuous LMA-NS-HLP with weighted flows

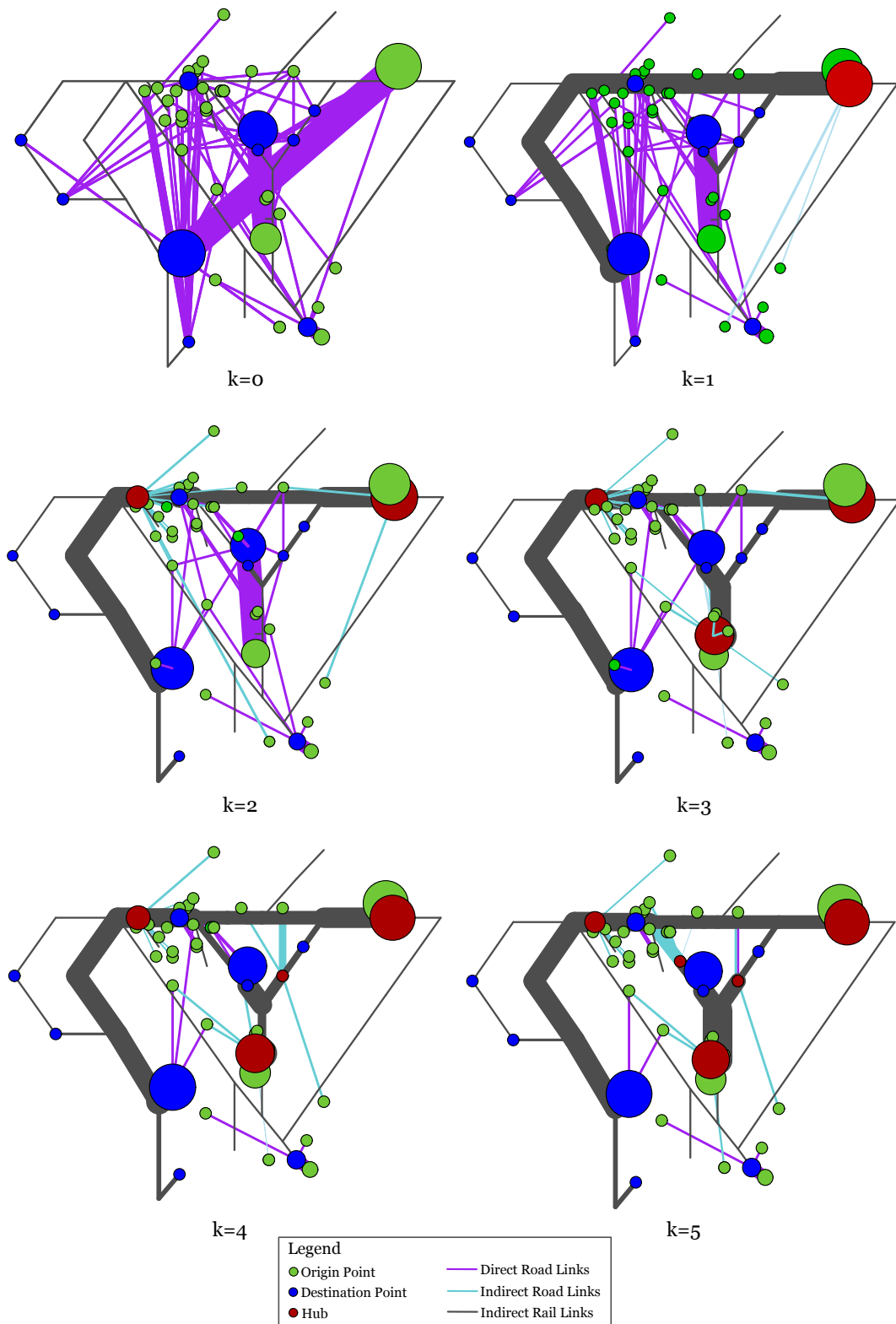

Figure C.3: Solutions for Case 2 with $k \in [0, 5]$ using the continuous LMA-NS-HLP with weighted flows