

HAMSTRING FLEXIBILITY: MEASUREMENT, STRETCHING AND INJURY SUSCEPTIBILITY

by

Sally Waterworth
Student number: 13218591

submitted in partial fulfillment of the requirements for the degree

DOCTOR PHILOSOPHIAE

in the

FACULTY OF HUMANITIES
(Department of Biokinetics, Sport and Leisure Science)
University of Pretoria

Promoter: Prof. P.E. Krüger
September 2013

C ONTENTS

	Page No.
ACKNOWLEDGEMENTS	vi
SYNOPSIS	vii
ABBREVIATIONS	xi
LIST OF TABLES	xii
LIST OF FIGURES	xiii
LIST OF EQUATIONS	xiv
CHAPTER 1	
INTRODUCTION	1
1. INTRODUCTION	2
1.1 FLEXIBILITY	3
1.2 INJURY RISK IN SPORT	5
1.3 HAMSTRING STRAIN MECHANISMS	8
1.4 STRETCHING	10
1.5 RATIONALE	11
1.6 STATEMENT OF THE PROBLEM	13
1.7 ORGANISATION OF THE THESIS	13
1.8 AIMS OF THE STUDY	14
CHAPTER 2	
LITERATURE REVIEW	15
2. LITERATURE REVIEW	16
2.1 MEASUREMENT OF STATIC FLEXIBILITY	16
2.2 STATIC FLEXIBILITY MEASURES	17
2.2.1 Reliability of static hamstring flexibility tests	17

2.2.2	Validity of static hamstring flexibility tests	19
2.3	MUSCLE AND JOINT STRUCTURE AND FLEXIBILITY	19
2.4	DYNAMIC HAMSTRING FLEXIBILITY	21
2.5	STRETCHING TECHNIQUES	23
2.6	STRETCHING AND FLEXIBILITY	25
2.7	STRETCHING AND PERFORMANCE	28
2.8	STRETCHING AND JOINT POSITION SENSE	29
2.9	STRETCHING AND INJURY PREVENTION	31
2.10	FATIGUE AND INJURY SUSCEPTIBILITY	33
2.11	SUMMARY	36
CHAPTER 3		
INTRA AND INTERDAY RELIABILITY OF HAMSTRING FLEXIBILITY MEASURES		38
3.1	INTRODUCTION	39
3.1.1	Methods for determining reliability	40
3.1.2	Reliability of flexibility measurements	43
3.1.3	Aims and hypotheses	44
3.2	PILOT STUDIES	45
3.2.1	Previous research procedures	45
3.2.2	Procedures	46
3.2.2.1	<i>Set-up</i>	46
3.2.2.2	<i>Passive straight leg raise approach</i>	46
3.2.2.3	<i>Passive knee extension approach</i>	47
3.2.2.4	<i>Warm-up</i>	48
3.2.2.5	<i>Data analysis</i>	49
3.2.2.6	<i>Sample size estimation</i>	50
3.3	METHODS	50
3.3.1	Participants	50
3.3.2	Study design	51
3.3.3	Procedures	51
3.3.3.1	<i>Passive properties</i>	51

3.3.3.2	<i>Static flexibility</i>	52
3.3.3.3	<i>Statistical analysis</i>	53
3.4	RESULTS	54
3.5	DISCUSSION	58
3.5.1	Static flexibility reliability	58
3.5.2	Dynamic flexibility reliability	60
3.5.3	Dynamometer comparison	61
3.5.4	Practical implications	63
3.5.5	Limitations	64
3.5.6	Reflections	63
3.6	CONCLUSIONS	65
CHAPTER 4		
COMPARISON BETWEEN DIFFERENT METHODS OF MEASURING STATIC AND DYNAMIC HAMSTRING FLEXIBILITY		66
4.1	INTRODUCTION	67
4.1.1	Aims and hypotheses	71
4.2	METHODS	72
4.2.1	Participants	72
4.2.2	Procedures	72
4.2.3	Statistical Analysis	73
4.3	RESULTS	73
4.3.1	Relationship between static flexibility measurements	73
4.3.2	Relationship between static and dynamic flexibility measurements	74
4.4	DISCUSSION	76
4.4.1	Static flexibility measurements	76
4.4.2	Static and dynamic flexibility measurements	79

4.4.3	Limitations	81
4.4.4	Reflections	82
4.5	CONCLUSIONS	83
CHAPTER 5		
IMPACT OF FATIGUE AND POST-EXERCISE STATIC HAMSTRING STRETCHING ON MEASURES OF STATIC AND DYNAMIC HAMSTRING FLEXIBILITY AND PERFORMANCE		
		84
5.1	INTRODUCTION	85
5.1.1	Injury prevention	86
5.1.2	Fatigue and injury risk	88
5.1.3	Stretching as part of recovery	90
5.1.4	Aims and hypotheses	92
5.2	METHODS	92
5.2.1	Participants	92
5.2.2	Study design	93
5.2.3	Sprint protocol	94
5.2.4	Post-exercise stretching intervention	95
5.2.5	Measurement procedures	97
5.2.5.1	<i>Eccentric torque</i>	97
5.2.5.2	<i>Perceived stiffness</i>	98
5.2.5.3	<i>Joint position sense</i>	98
5.2.6	Statistical analysis	98
5.3	RESULTS	99
5.4	DISCUSSION	109
5.4.1	Passive dynamic flexibility measurements to 0.99 rad	110
5.4.2	Final passive dynamic flexibility measurements	111
5.4.3	Active dynamic flexibility measurements	113
5.4.4	Static flexibility measurements	115
5.4.5	Perception of stiffness	116

5.4.6	Joint position sense	118
5.4.7	Practical implications	119
5.4.8	Limitations	120
5.4.9	General limitations	122
5.4.10	Reflections	124
5.4.11	Future directions of research	127
5.5	CONCLUSIONS	129
CHAPTER 6		
REFERENCES		130
CHAPTER 7		
APPENDIXES		189
7.1	APPENDIX 1	190
7.2	APPENDIX 2	194
7.3	APPENDIX 3	195
7.4	APPENDIX 4	196
7.5	APPENDIX 5	200
7.6	APPENDIX 6	202
7.7	APPENDIX 7	203
7.8	APPENDIX 8	204
7.9	APPENDIX 9	205
7.10	APPENDIX 10	206

ACKNOWLEDGEMENTS

To the Lord Almighty, without whom nothing is possible.

I wish to acknowledge the following persons and institutions for their assistance and support:

My parents, for the opportunities they awarded me.

Prof. P.E. Krüger - Promoter (Department of Biokinetics, Sport and Leisure Sciences, University of Pretoria), for his guidance and valuable time afforded to me.

Dr. M. Jones – (Head of Sports Science, Edge Hill University), for initial guidance, mentoring and time.

Mr Mark Leather – Head Physiotherapist Wigan Warriors RLFC, for his help in coordinating players and testing sessions.

Mr Andy Jones – Head Physiotherapist Widnes Vikings RLFC, for his help in coordinating players and testing sessions.

All the participants in the studies, for affording me their time and for their enthusiasm.

Titel: HAMPEES FLEKSITEIT: METINGE, STREKKING EN VATBAARHEID VIR BESERINGS

Kandidaat: Sally Waterworth

Promotor: Prof. P.E. Krüger

Graad: DPhil (MBK)

Dit het al tradisie geword om fleksiteit te beskou as 'n belangrike komponent van die mens se fisieke fiksheid, maar daar bestaan nie stawende empiriese bewyse vir hierdie veronderstelling nie. Hoewel uitgebreide gepubliseerde navorsing onderneem is oor die relatiewe belangrikheid van fleksiteit en die impak van verskillende strekmetodes op vlakke van fleksiteit, prestasie en beseringsrisiko, het die kwaliteit van die studies aansienlik gewissel; betroubaarheid en geldigheid van die metodologie is nie altyd bewys nie; en die rasionaal kon by tye bevraagteken word. Verder het baie literatuur gefokus op statiese lenigheid, wat nie noodwendig verband hou met eienskappe van die muskulotendon-eenheid en dus dinamiese lenigheid nie. Hierdie proefskrif is ontwerp om gapings in die bestaande literatuur te oorbrug met behulp van aanvaarbare metodes om die relatiewe en absolute betroubaarheid van fleksiteitstoetse vir die hampese vas te stel; die vergelykbaarheid van statiese en dinamiese komponente van die globale konsep van fleksiteit te oorweeg; en uit te vind hoe dinamiese fleksiteit beïnvloed word deur uitputtende oefening en daaropvolgende statiese strekking. Die eerste doelwit is bereik deur gebruik te maak van 'n herhaalde metingstudie, ontwerp om die geldigheid van die intradaaglikse en interdaaglikse intrakoersbepaler vas te stel, en die metingsfout van statiese en dinamiese metings van hampees fleksiteit vas te stel. Die beduidende relatiewe geldigheid van metings van statiese en dinamiese hampees fleksiteit is deur middel van interklas korrelasie gedemonstreer, maar limiete van ooreenkomsanalise het aangedui dat daar 'n graad van absolute metingsfout was wat in verhouding tot analitiese doelwitte geïnterpreteer moes word. Die tweede doelwit het evaluasie vereis van verhoudings wat gedeel word deur statiese en dinamiese metings van hampeesfleksiteit. Beduidende verhoudings tussen die verskillende

statische fleksiteitstoetse is vasgestel, maar die omvang van onverklaarde variansie het aangedui dat slegs metings van dieselfde toets direk met mekaar vergelyk behoort te word. Verhoudings tussen verskillende metings van dinamiese fleksiteit en statiese fleksiteit het gewissel van nie-beduidend tot redelik sterk, wat kon beteken dat metings van statiese en dinamiese fleksiteit nie identies is nie en dat resultate tussen die twee tipes toetse nie uitgewissel kon word nie. Weens 'n gebrek aan verklarende empiriese bewyse is die finale hoofstuk, wat ten doel gehad het om deur middel van 'n prospektiewe ewekansige herhaalde metingstudie om metings van dinamiese fleksiteit en prestasie te bepaal, nie voltooi nie. Uitputting het geen beduidende veranderings aan passiewe of aktiewe dinamiese fleksiteitsmetings meegebring nie, maar wel 'n beduidende verswakking van statiese fleksiteitsvlakke en waargenome styfheid getoon. Strekking na oefening het gelei tot beduidend verhoogde vlakke van aktiewe en passiewe energie-absorpsie onmiddellik na oefening en 18 uur daarna, en in beduidend verlaagde gewrigsposisie gewaarwording onmiddellik na oefening. Effekgroottes was klein, dus kan die kliniese beduidendheid van die uitvoering van statiese strekking na oefening bevraagteken word, veral as dit in plaas van ander, potensieel voordeliger praktyke uitgevoer word.

Lys van sleutel woorde: Muskulo-tendineus eenheid, Fleksiteit, Strekking, Passiewe fleksiteit, Aktiewe fleksiteit, Energie absorpsie, Uitputting, Beserings risikofaktore, Prestasie, Top sportlui

Title: HAMSTRING FLEXIBILITY: MEASUREMENT, STRETCHING AND INJURY SUSCEPTIBILITY

Candidate: Sally Waterworth

Promoter: Prof. P.E. Krüger

Degree: DPhil (HMS)

Flexibility has traditionally been considered an important component of human physical fitness but this conjecture lacks supporting empirical evidence. While there is extensive published research examining the relative importance of flexibility and the impact of various methods of stretching on levels of flexibility, performance and injury risk, the quality of studies has varied considerably, reliability and validity of methodology has not always been proven, and rationale has at times been questionable. Additionally, much literature has focused on static flexibility which is not necessarily related to properties of the musculotendinous unit and thus dynamic flexibility. This thesis was designed to fill gaps in the existing literature by using accepted methods to establish relative and absolute reliability of hamstring flexibility tests, consider the comparability of static and dynamic components of the global concept of flexibility and explore how dynamic flexibility and performance are influenced by fatiguing exercise and subsequent static stretching. The first aim was realised by a repeated measures study designed to establish the intraday and interday, intrarater reliability and measurement error of static and dynamic measures of hamstring flexibility. Significant relative reliability for measures of static and dynamic hamstring flexibility was demonstrated via intraclass correlation coefficient (3,1) but limits of agreement analysis indicated there was a degree of absolute measurement error that must be interpreted in relation to analytical goals. The second aim required evaluation of relationships shared by static and dynamic measures of hamstring flexibility. Significant relationships between the different static flexibility tests were established but the extent of unexplained variance indicated that only measurements from the same tests should be directly compared to each other. Relationships between different measures of dynamic flexibility and

static flexibility varied from non-significant to moderately strong, suggesting that measures of static and dynamic flexibility are not identical and results should not be interchanged between the two types of tests. Due to a lack of explanatory empirical evidence, the final chapter aimed via a prospective randomised repeated measures study to investigate the impact of fatigue and post-exercise static stretching on measures of dynamic flexibility and performance. Fatigue resulted in no significant changes to passive or active dynamic flexibility measures but a significant worsening of static flexibility levels and perceived stiffness. Post-exercise stretch resulted in significantly increased passive and active energy absorption immediately and 18 hours post-exercise and in significantly reduced joint position sense immediately post-exercise. Effect sizes were small so the clinical meaningfulness of performing post-exercise static stretching is questionable, particularly if performed in place of other, potentially more beneficial practices.

List of key words: Musculotendinous unit, Flexibility, Stretching, Passive stiffness, Active stiffness, Energy absorption, Fatigue, Injury risk factors, Performance, Elite athletes

LIST OF ABBREVIATIONS

AKE	-	Active knee extension
ANOVA	-	Analysis of variance
ASLR	-	Active straight leg raise
DOMS	-	Delayed onset muscle soreness
EDL	-	Extensor digitorum longus
EMG	-	Electromyography
ICC	-	Intraclass correlation
JPS	-	Joint position sense
KE	-	Knee extension
LOA	-	Limits of agreement
PKE	-	Passive knee extension
PNF	-	Proprioceptive neuromuscular facilitation
PSLR	-	Passive straight leg raise
PPM	-	Pearson product moment
ROM	-	Range of motion
SD	-	Standard deviation
SLR	-	Straight leg raise
<	-	Smaller than / Less than
>	-	Larger than / More than
≥	-	Larger than and equal to / More than and equal to
≤	-	Smaller than and equal to / Less than and equal to

LIST OF TABLES

Table		Page No.
3.1	One hour test-retest reliability values for measures of static and dynamic hamstring flexibility	55
3.2	Interday test-retest reliability values for measures of static and dynamic hamstring flexibility	57
3.3	Values of passive dynamic hamstring flexibility recorded on different models of Isokinetic dynamometer	58
4.1	Relationship between static and dynamic flexibility measures	75
4.2	Differences between dynamic flexibility of 'tight' and 'normal' participants	76
5.1	Impact of repeated sprint exercise and a 30 s post-exercise static stretch on passive dynamic hamstring flexibility measured at the highest common point	100
5.2	Impact of repeated sprint exercise and a 30 s post-exercise static stretch on peak passive dynamic hamstring flexibility	100
5.3	Impact of repeated sprint exercise and a 30 s post-exercise static stretch on active properties during eccentric hamstring contraction at $2.09 \text{ rad}\cdot\text{s}^{-1}$	102
5.4	Impact of a 30 s post-exercise static stretch on static hamstring flexibility levels	104
5.5	Impact of a 30 s post-exercise static stretch on perception of stiffness and JPS	106

LIST OF FIGURES

Figure	Page No.
1.1 Conceptual model of injury predisposition	7
2.1 A three-element model of a sarcomere	20
2.2 Example of a load-deformation (torque–angle) curve of a material with viscoelastic properties	21
3.1 Test position used for stretch manoeuvre by Magnusson <i>et al.</i> (1995)	45
3.2 Example of limits of agreement for PKE	56
4.1 Scatter plot of AKE against PKE	74
4.2 Scatter plot of total passive energy absorbed against PKE	75
5.1 Conceptual model of injury predisposition	85
5.2 Factors constraining flexibility	87
5.3 Flow diagram of testing procedure for Chapter 5	96
5.4 Mean sprint times for 20 maximal sprints performed during the repeated sprint protocol	99
5.5 Impact of a 30 s post-exercise static hamstring stretch on hamstring passive peak torque	101
5.6 Impact of a 30 s post-exercise static hamstring stretch on total passive energy absorbed by the hamstring muscle	102
5.7 Impact of a 30 s post-exercise static hamstring stretch on peak torque generated during maximal eccentric hamstring contraction	103
5.8 Impact of a 30 s post-exercise static hamstring stretch on total energy absorbed (work done) by the hamstring during a maximal eccentric contraction	104
5.9 Impact of a 30 s post-exercise static hamstring stretch on AKE	105
5.10 Impact of a 30 s post-exercise static hamstring stretch on perception of stiffness as measured on a visual analogue scale	107
5.11 Impact of a 30 s post-exercise static hamstring stretch on JPS	108
5.12 Scatter plot of passive peak torque against peak eccentric hamstring torque	108
5.13 Scatter plot of total passive against total active hamstring energy absorption	109

LIST OF EQUATIONS

Equation	Page No.
3.1 Theoretical formula for reliability	40
3.2 Generic reliability formula	40
3.3 Formula for ICCs	42

CHAPTER 1

INTRODUCTION

1 INTRODUCTION

Flexibility is considered to be a component of human physical fitness, ranking alongside others such as strength, stamina and speed (ACSM, 1998). Flexibility testing became of interest at the beginning of the 20th century when there was a need to assess disability, especially losses in range of motion (ROM), in response to two conditions; widespread poliomyelitis and injuries suffered by participants in World War 1 (Alquier, 1916; Albee & Gilliland, 1920). Cureton (1941) first presented flexibility as a component of physical fitness and suggested that flexibility had never been studied intensively because some of the necessary aspects are not measurable in human subjects and because of the joint specific nature of flexibility (Cureton, 1941). This suggestion still holds a degree of truth today. Corbin and Noble (1980) again highlighted flexibility testing as part of fitness in 1980 and in 1985, Corbin and Fox described flexibility as “*The forgotten part of fitness*” (Corbin & Fox, 1985: 191).

Anthropometric research has demonstrated differences in flexibility between athletes from various sports but the retrospective nature of most studies and varying measurement protocols limits understanding of these differences, and consequentially, the importance of flexibility for sports performance (Maud, 1983; Corbin & Fox, 1985; Gleim *et al.*, 1990; Roetert *et al.*, 1992; Roetert *et al.*, 1996; Wiesler *et al.*, 1996; Twellaar *et al.*, 1997; Tyler *et al.*, 2001; Watson, 2001; Beaudoin & Whatley Blum, 2005; Brooks *et al.*, 2006; Espana-Romero *et al.*, 2009; Platzer *et al.*, 2009; Singh *et al.*, 2011; Anloague *et al.*, 2012; Silva *et al.*, 2013). The early rationale for the inclusion of flexibility as a component of physical fitness was largely based on reason and belief that appropriate levels of flexibility are required for safe and effective movement (Clarke, 1975). While it is logical that flexibility below an acceptable threshold will more likely result in an overstretched muscle, the presumption that higher levels of flexibility will decrease injury risk is less plausible and lacks empirical support. Consensus that higher flexibility will lead to improved performance has also been common within coaching and teaching practice but experimental evidence to support this is lacking (Corbin & Noble, 1980; Gleim & McHugh, 1997; McHugh & Cosgrave, 2010; Kay & Blazevich, 2012; Stathokostas *et al.*, 2012).

The belief that flexibility is an important component of fitness has led to extensive research evaluating methods by which flexibility can be improved, usually through the use of a stretching regimes (Bandy & Irion, 1994; Bandy *et al.*, 1997; Bandy *et al.*, 1998; Roberts & Wilson, 1999;

Funk *et al.*, 2001; Zakas *et al.*, 2003; Nelson & Bandy, 2004; Young *et al.*, 2004; Davis *et al.*, 2005; Zakas *et al.*, 2006; O'Sullivan *et al.*, 2009; Marshall *et al.*, 2011; Maddigan *et al.*, 2012; Nakamura *et al.*, 2012; Ghanbari *et al.*, 2013; Matsuo *et al.*, 2013). The acute effects of stretching on flexibility and performance and the efficacy of longer-term stretching regimes have been widely researched but study designs have been of variable quality and often there is conflicting evidence (Shrier, 2004; McNeal & Sands, 2006; Behm & Chaouachi, 2011; Kay & Blazevich, 2012; Simic *et al.*, 2013). One of the key problems with literature surrounding flexibility and stretching is the inconsistent use of terminology and thus it is important to define key terms.

1.1 FLEXIBILITY

Flexibility comes from the Latin term *flexibilis*, which means to bend (Ingraham, 2003), and has technically been defined as the ability of matter to deform without breaking (Shewchuk & Moodie, 1998). A commonly accepted and widely utilised definition of human flexibility is the ROM at a joint or series of joints (Shellock & Prentice, 1985). This definition over simplifies a complex phenomenon because assessing only the ROM available at a joint does not give information about the properties of the musculotendinous unit, and joint ROM can be affected by neural, mechanical and anatomical constraints (Guissard & Duchateau, 2006). A more acceptable definition of flexibility is “...*the intrinsic property of body tissues, which determines the range of motion achievable without injury at a joint or group of joints*” (Holt *et al.*, 1996: 172). This definition better embraces the role of the musculotendinous units and also fits conceptually with early research that identified static and dynamic expressions of flexibility (Fleishman, 1963), giving rise to the commonly applied terms of static and dynamic flexibility (Anderson & Burke, 1991).

Static flexibility is a linear or angular measurement of the limits of motion in a joint or series of joints and thus defines the available range (Holt *et al.*, 1996). Static flexibility is generally assessed using ROM tests as a consequence them of being cheap, accessible and easy to administer (Armstrong *et al.*, 1998; Holm *et al.*, 2000; Gajdosik, 2001b; Sporis *et al.*, 2011; Ayala *et al.*, 2012a). There are inherent problems with static flexibility testing including the subjective nature of the end-point of the test and factors besides the musculotendinous unit influencing the measure, such as ligamentous constraints, neural tension and bony congruencies

(Armstrong *et al.*, 1998; Bierma-Zeinstra *et al.*, 1998). Furthermore, it has been suggested that some individuals have longer or shorter muscles as a result of the number of sarcomeres in series and therefore measures of static flexibility are not related to the actual stiffness of muscles (Gajdosik *et al.*, 1999). Despite the widespread application of static flexibility testing within fitness and rehabilitation settings, reports of reliability for different movements and at different joints are limited (Armstrong *et al.*, 1998; Awan *et al.*, 2002; Peeler & Anderson, 2008; Pua *et al.*, 2008; Bozic *et al.*, 2010; Shimon *et al.*, 2010; Sporis *et al.*, 2011; Ayala *et al.*, 2012b). The majority of existing research examining the reliability of static flexibility measures is typically confounded by poor statistical analysis of data with a focus on the relative relationship between repeated measures as opposed to consideration of the amount of error and its clinical meaningfulness (Atkinson & Nevill, 1998).

Because static flexibility tests do not give information on the resistance of the musculotendinous unit to motion, focus has begun to switch to consideration of dynamic measures of flexibility (Granata *et al.*, 2002; Blackburn *et al.*, 2004; Reid & McNair, 2004; Aquino *et al.*, 2006; Nordez *et al.*, 2006; Eiling *et al.*, 2007; Ryan *et al.*, 2008; Watsford *et al.*, 2010; Marshall *et al.*, 2011; Nakamura *et al.*, 2012; Pruyn *et al.*, 2012; Ditroilo *et al.*, 2013; Palmer *et al.*, 2013). Dynamic flexibility refers to the increase in resistance with muscle elongation and can be quantified in terms of stiffness (Gleim & McHugh, 1997). Studies have attempted to measure active dynamic flexibility using variations of a damped oscillation technique, which requires participants to maintain constant muscular activity while a perturbation is applied to the loaded musculotendinous unit and the damping response of the system is recorded (Wilson *et al.*, 1992; Wilson *et al.*, 1994; Walshe *et al.*, 1996; Hunter & Spriggs, 2000; Fukashiro *et al.*, 2001; Ditroilo *et al.*, 2011; Jarocka *et al.*, 2012; Faria *et al.*, 2013). This procedure has a degree of subjectivity in requiring participants to maintain constant muscle activity and consequently large variation in results has been found, even when the same muscle groups have been assessed (Aruin *et al.*, 1979; Greene & McMahon, 1979; Luhtanen & Komi, 1980). An alternative approach has made use of isokinetic dynamometers to measure passive responses to stretch, enabling evaluation of stiffness alongside appraisal of energy absorbing capabilities of musculotendinous units throughout their available range (Klinge *et al.*, 1997; Reid & McNair, 2004; Ryan *et al.*, 2008; McHugh *et al.*, 2012; Mizuno *et al.*, 2013). As it is difficult to separate the viscous and elastic properties of musculotendinous units as they are stretched from initial to

final length, these have generally been measured together and the terms passive viscoelastic stiffness, passive elastic stiffness and passive stiffness have been used interchangeably. Measurements of passive biomechanical responses to stretch on isokinetic dynamometers have been deemed reliable through the use of Pearson product moment (PPM) correlation coefficients (Magnusson *et al.*, 1995), but as these are interclass rather than intraclass coefficients, they are inappropriate for use in reliability studies (Nevill & Atkinson, 1997; Atkinson & Nevill, 1998; Weir, 2005).

1.2 INJURY RISK IN SPORT

Rugby League is a full contact team sport played internationally (Gabbett & Seibold, 2013). It is considered one of the toughest and most physically demanding team sports in the world and as such, participants have a relatively high risk of injury (Hodgson *et al.*, 2006; Gabbett *et al.*, 2008). Many studies have reported the injury incidence of rugby league participants in matches and training (Gibbs, 1993; Seward *et al.*, 1993; Estell *et al.*, 1995; Stephenson *et al.*, 1996; Gissane *et al.*, 2002; Orchard, 2002; Orchard & Seward, 2002; Orchard, 2004; Hodgson *et al.*, 2006; Gissane *et al.*, 2012) but comparison of these injury surveillance studies is difficult due to inconsistencies in injury definitions used (Ekstrand & Karlsson, 2003; Orchard *et al.*, 2005) and methodologies undertaken (van Mechelen *et al.*, 1992; Finch, 1997; Ekstrand & Karlsson, 2003; Brooks & Fuller, 2006). Conclusions have varied widely with reported injury rates ranging from 139 per 1000 playing hours to 346 per 1000 playing hours in professional rugby league players (Seward *et al.*, 1993; Hodgson *et al.*, 2006; Orchard & Hoskins, 2007; Gissane *et al.*, 2012; King *et al.*, 2012). Sixteen to 30% of all rugby league injuries have been reported as severe and resulted in players missing five or more matches (Gibbs, 1993; Gabbett, 2001; Gabbett, 2003; Gabbett, 2005; Gabbett & Domrow, 2005; Hodgson *et al.*, 2006; Gissane *et al.*, 2012; King *et al.*, 2012).

From a biomechanical perspective, injury is the failure of a structure due to the transfer of energy to that structure (Stauber, 2004). Muscle strains are among the most common injuries in sports involving high-speed movement and physical contact. They have been reported to account for 10 to 20% of injuries in American football (Meeuwisse *et al.*, 2000), 25% of injuries in Australian Rules football (Seward *et al.*, 1993), 13 to 41% of injuries in soccer (Hawkins & Fuller, 1999; Arnason *et al.*, 2004; Woods *et al.*, 2004; Cross *et al.*, 2013; Häggglund *et al.*, 2013) and 30% of

injuries in professional rugby league (Stephenson *et al.*, 1996), with 137 muscular strains being sustained per 1000 training hours (Gissane *et al.*, 1993; Gabbett, 2002). Most match injuries are sustained during tackles whilst during training sessions, injury incidence is more related to players rapidly accelerating, decelerating and changing direction (Meir, 1994; Gabbett, 2004; Gabbett *et al.*, 2008; Gabbett, 2008; King *et al.*, 2012). At elite levels, the hamstring is the most commonly strained muscle group and hamstring strains account for 5 to 16% of total injury occurrence in professional rugby and football, with 5 to 6 strains per club per season being reported and an average of 18 days and 3 to 3.5 matches missed per injury (Seward *et al.*, 1993; Woods *et al.*, 2004; Watsford *et al.*, 2010; Elliott *et al.*, 2011; Fousekis *et al.*, 2011). The re-injury rate is up to 31% (Hawkins *et al.*, 2001; Orchard & Best, 2002), possibly because the hamstring is a biarticular muscle group, subject to high strains and is disproportionately weak compared to the quadriceps (Costa *et al.*, 2009; Liu *et al.*, 2012). Inadequate flexibility is often cited as a risk factor for hamstring muscle strain injury (Gabbe *et al.*, 2005; Brooks & Fuller, 2006; Bradley & Portas, 2007; Fuller, 2007; Dallinga *et al.*, 2012).

Risk factors for injury are factors that do not seem to be a direct cause of the injury but seem to be associated in some way (Bahr & Holme, 2003; Hopkins *et al.*, 2007). Having a risk factor makes the chances of sustaining an injury higher but does not guarantee that the injury will occur (Fuller, 2007; Van Tiggelen *et al.*, 2008). The absence of any risk factors or having a protective factor does not necessarily guard against sustaining an injury (Hopkins *et al.*, 2007; Meeuwisse *et al.*, 2007). Risk factors can be extrinsic (from outside the body) or intrinsic (from within the body) and are multifactorial in nature (Arnason *et al.*, 2004; Gabbe *et al.*, 2004; Gabbett & Domrow, 2005; Liu *et al.*, 2012; Hägglund *et al.*, 2013). Extrinsic risk factors include skill level, use of protective equipment or braces, playing surface, level of competition and fatigue. Intrinsic risk factors include age, gender, previous injury, aerobic fitness, muscle strength, reaction time, muscle imbalances and flexibility (Hägglund *et al.*, 2006; Gabbett & Domrow, 2007; Arnason *et al.*, 2008; Alentorn-Geli *et al.*, 2009; Liu *et al.*, 2012). In order to examine the relative contribution of these, intrinsic predisposing factors as well as any interaction from extrinsic risk factors that might make an athlete susceptible to injury need to be examined before injury actually occurs (Brooks *et al.*, 2005; Willems *et al.*, 2005; Ekstrand *et al.*, 2006; Hägglund *et al.*, 2006).

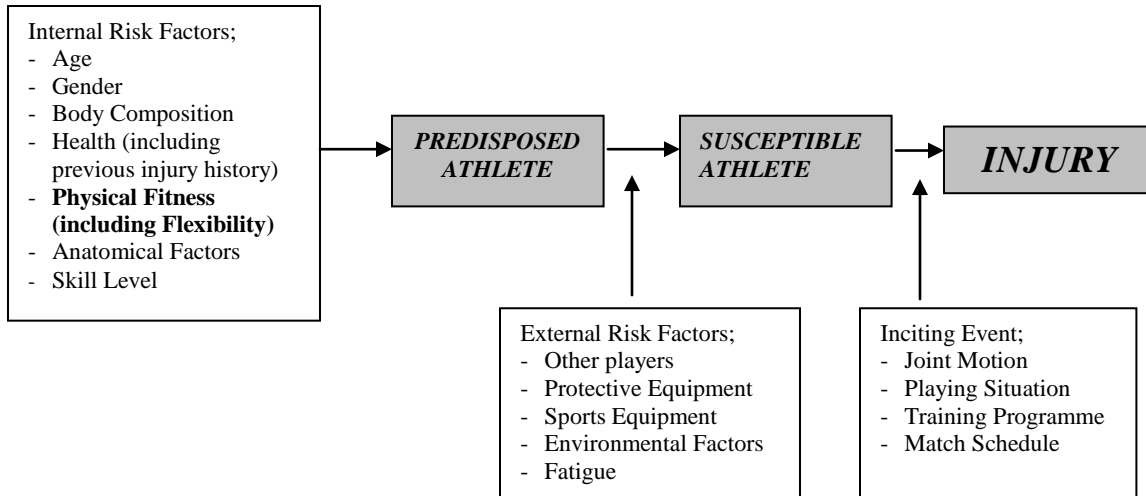

Figure 1.1 - Conceptual model of injury predisposition (Meeuwisse, 1994)

Flexibility is included as an intrinsic risk factor in most conceptual models of injury such as the one shown in Figure 1.1 (Meeuwisse, 1994) and is considered a primary aetiological factor associated with musculotendinous strain injuries (Agre, 1985; Worrell *et al.*, 1991; Jonhagen *et al.*, 1994; Kroll & Raya, 1997; Kujala *et al.*, 1997; Bennell *et al.*, 1999; Devlin, 2000; Hrysomallis, 2009; Engebretsen *et al.*, 2010; Beijsterveldt *et al.*, 2012). Many studies examining the relationship between flexibility and injury have been epidemiological and retrospective in nature (Worrell *et al.*, 1994; Krivickas, 1997; Orchard, 2001; Murphy *et al.*, 2003). Retrospective research designs fail to address whether theorised risk factors predisposed to, or were the result of injury (Bennell *et al.*, 1999). Results and conclusions from injury surveillance studies have varied widely as researchers have considered match hours, training hours, or combined match and training hours (King *et al.*, 2010), have used substantial differences in the definitions of injury (Ekstrand & Karlsson, 2003; Orchard *et al.*, 2005) and have generally focused only on static flexibility. Several studies have identified a relationship between flexibility levels and injury risk (Krivickas & Feinberg, 1996; Kaufman *et al.*, 1999; Beynnon *et al.*, 2001; Knapik *et al.*, 2001; McKay *et al.*, 2001; Soderman *et al.*, 2001; Bradley & Portas, 2007; Lowther *et al.*, 2012) while others have reported no association (Milgrom *et al.*, 1991; Arnason *et al.*, 1996; Wiesler *et al.*, 1996; Twellaar *et al.*, 1997; Engebretsen *et al.*, 2010). A more preferable study design is a prospective cohort study as these can provide more direct and accurate estimates of incidence and relative risk. The main disadvantage of such studies is that sample size is critical

and it may be necessary to include and monitor large numbers of athletes for long study periods (Bahr & Holme, 2003).

Eleven prospective cohort studies examining the relationship between flexibility and hamstring injury have been conducted. These studies used amateur (Bennell *et al.*, 1998; Gabbe *et al.*, 2005; Yeung *et al.*, 2009; Engebretsen *et al.*, 2010) and professional participants (Orchard *et al.*, 1997; Witvrouw *et al.*, 2003; Arnason *et al.*, 2004; Gabbe *et al.*, 2006; Bradley & Portas, 2007; Arnason *et al.*, 2008; Henderson *et al.*, 2010) and measurements were either ROM (Witvrouw *et al.*, 2003; Arnason *et al.*, 2004; Gabbe *et al.*, 2005; Gabbe *et al.*, 2006; Bradley & Portas, 2007; Engebretsen *et al.*, 2010) or sit and reach test scores (Orchard *et al.*, 1997). Eight of these studies demonstrated no significant association between flexibility and hamstring injury incidence via logistic regression analysis (Orchard *et al.*, 1997; Bennell *et al.*, 1998; Arnason *et al.*, 2004; Gabbe *et al.*, 2005; Gabbe *et al.*, 2006; Arnason *et al.*, 2008; Yeung *et al.*, 2009; Engebretsen *et al.*, 2010). Three studies involving professional footballers reported lower ROM of hip and knee flexors in players who subsequently sustained muscle strain injury (Witvrouw *et al.*, 2003; Bradley & Portas, 2007; Henderson *et al.*, 2010). The disparity in findings may be associated with the type of analysis applied and the inclusion or exclusion of participants with previous injury. Consistently it must be remembered that risk factors only lead to injury susceptibility and to provide a greater understanding of patterns leading up to an injury situation, the inciting event should also be described (Bahr & Holme, 2003).

1.3 HAMSTRING STRAIN MECHANISMS

During an eccentric contraction, when force exerted on a muscle exceeds the force developed by a muscle, work is done on the stretching muscle and in the process the muscle absorbs mechanical energy. The degree of energy that a muscle can absorb is thought to be related to injury risk (Noonan *et al.*, 1994; Garrett, 1996; Mair *et al.*, 1996; Magnusson *et al.*, 2000). Hamstring strain injuries usually occur near the musculotendinous junction (Proske *et al.*, 2004) and normally whilst an individual is accelerating or sprinting (Verrall *et al.*, 2003; Woods *et al.*, 2004), particularly if there is a degree of forward flexion (Verrall *et al.*, 2003). Conjecture exists regarding the precise point when hamstring strains occur; some researchers argue that initial stance is the critical point while others maintain that hamstrings are most biomechanically susceptible to injury during terminal swing (Stanton & Purdham, 1989; Thelen *et al.*, 2005;

Chumanov *et al.*, 2007; Chumanov *et al.*, 2012). Such conclusions have generally been based on theoretical rationale (Stanton & Purdham, 1989) or analysis of asymptomatic subjects (Mann & Sprague, 1980; Wood, 1987; Orchard & Seward, 2002); these approaches are unable to definitely establish when in the sprinting cycle the hamstrings fail.

While there are models to estimate the moments affecting individual joints during the human gait cycle (Mann & Hagy, 1980; Novacheck, 1995) as well as muscle length during sprinting (Hawkins & Hull, 1990; Gerritsen *et al.*, 1998), there is no model to determine the external force or stress that individual muscle or muscle groups are subject to at any given time of the gait cycle making it difficult to assess when and why strain injuries actually occur. The only two studies that have managed to capture data of a running athlete at the time of an actual hamstring strain occurring both identified terminal swing phase as the most likely time of injury (Heiderscheit *et al.*, 2005; Schache *et al.*, 2009). At this time the hamstrings demonstrate peak electromyographic activity as most of the inertial force acting about the knee joint is potentially imparted onto the hamstrings as they attempt to decelerate the swinging lower limb (Kryolainen *et al.*, 1999; Kuitunen *et al.*, 2002) with the gastrocnemius being the only other significant muscle capable of providing some assistance (Li *et al.*, 2002). In contrast, a number of large muscles are thought to contribute to the generation of hip extensor torque and control of trunk flexion during the initial stance (Waters *et al.*, 1974; Pandy & Zajac, 1991; Arnold *et al.*, 2005). Although the forces required to control upper body deflections and propel hip extension at initial stance would be overall greater than to control the relatively light weight of the lower limb at terminal swing, high tensile stress when the muscle is shortening is not thought a primary injury inducing mechanism (Moens *et al.*, 1993; Petrof *et al.*, 1993; Gao *et al.*, 2008). Conversely it is widely agreed that muscle strain injury is associated with exercise that involves eccentric contractions (Warren *et al.*, 1993; Morgan & Allen, 1999; Allen, 2001; Friden & Lieber, 2001), when extracellular matrix and lateral linkage is under large shear stress from the myofibrils (Petrof *et al.*, 1993). If this stress is sufficiently large, it can break the extracellular matrix linking adjacent fibres and peel off the basal lamina from the myofibrils (Stauber, 1989; Kääriäinen *et al.*, 2000) as well as causing sarcolemma damage (Friden & Lieber, 2001). The magnitude of this stress and resulting strain has been shown to relate to muscle damage (Talbot & Morgan, 1998).

1.4 STRETCHING

Practitioners have long advocated stretching before exercise as a method of achieving improved flexibility, enhanced performance and consequentially reduced injury risk. Epidemiological research examining the relationship between injury occurrence and stretching has yielded equivocal findings. The studies are frequently retrospective in nature, often fail to account for the array of other factors related to injury incidence and have included a range of athletic and non-athletic participants (Kerner & D'Amico, 1983; Jacobs & Berson, 1986; Blair *et al.*, 1987; Macera *et al.*, 1989; Brunet *et al.*, 1990; Wilber *et al.*, 1995). Experimental approaches have typically looked at the effect of pre-exercise stretching on static flexibility and various performance measures as opposed to injury risk, and this empirical evidence is equivocal in nature (Moller *et al.*, 1985; Wessling *et al.*, 1987; Godges *et al.*, 1989; Cornelius *et al.*, 1992; Clark *et al.*, 1999; Cornwell *et al.*, 2002; Gill *et al.*, 2002; Funk *et al.*, 2003; Zakas *et al.*, 2003; Bonnar *et al.*, 2004; Egan *et al.*, 2006). Published articles of an experimental or quasi-experimental nature have frequently lacked randomisation or have failed to include control measures and as such do not qualify for inclusion in meta-analyses or systematic reviews (Moller *et al.*, 1985; Wessling *et al.*, 1987; Godges *et al.*, 1989; Cornelius *et al.*, 1992; Clark *et al.*, 1999; Cornwell *et al.*, 2002; Gill *et al.*, 2002; Funk *et al.*, 2003; Zakas *et al.*, 2003; Bonnar *et al.*, 2004; Egan *et al.*, 2006). Furthermore, many studies which have suggested that static stretching prior to exercise might prevent injury have included co-interventions such as a warm-up and the use of braces in addition to stretching, thus making it impossible to identify the unique effect of the stretching (Ekstrand & Gillquist, 1983; Bixler & Jones, 1992; Amako *et al.*, 2003).

Systematic reviews considering the impact of stretching on injury risk are equivocal and collectively suggest that, based on the limited and low quality evidence available, stretching may or may not provide a meaningful decrease in the risk of injury but because appropriate evidence is lacking, that no definite recommendations should be made (Weldon & Hill, 2003; Thacker *et al.*, 2004; Small *et al.*, 2008). The most recent of these reviews identified 364 published peer-reviewed articles related to stretching and injury risk but only seven studies met inclusion and exclusion criteria (Small *et al.*, 2008). Of these, pre-exercise static stretching was considered ineffective in six studies (Bixler & Jones, 1992; van Mechelen *et al.*, 1993; Pope *et al.*, 1998; Amako *et al.*, 1999; Cross & Worrell, 1999; Pope *et al.*, 2000) while only one controlled clinical trial concluded that pre-exercise stretching had a positive impact on injury risk (Hartig &

Henderson, 1999). Other quasi-randomised (Amako *et al.*, 2003) or non-randomised (Hadala & Barrios, 2009) interventions have shown some beneficial effect of pre-exercise stretching. Yeung and Yeung (2001) in an investigation of experimental and quasi-experimental studies pertaining to the prevention of lower limb running injuries analysed the collective results of five studies with 1944 participants in stretch groups and 3159 participants in control groups and reported that there was no clear evidence to support the notion that pre-exercise static stretching exercises are effective in reducing lower limb injuries (Andrish *et al.*, 1974; van Mechelen *et al.*, 1993; Hartig & Henderson, 1999; Pope *et al.*, 2000). This conclusion needs to be treated with a degree of caution as it is not based on meta-analysis findings and the quality of the studies included was not evaluated. Reviews conducted into the relationship between stretching and injury risk have not always attempted to distinguish between pre-exercise, post-exercise or general stretching and furthermore stretching has been typically related to overall injury incidence. More recently Small *et al.* (2008) considered injuries to the musculotendinous unit independently of overall injury rate and suggested that there was some evidence to indicate that pre-exercise stretching might be beneficial in the prevention of musculotendinous strain injuries. Intuitively it is plausible that stretching is more likely to be linked to injuries of the musculotendinous unit rather than to joint, bone and vascular-related injuries but empirical evidence to substantiate this belief is lacking.

1.5 RATIONALE

Given the widespread application of flexibility testing there is a need to re-evaluate the reliability of static and dynamic flexibility measures using more acceptable statistical analysis procedures (Lamb, 1998). Reliability is the extent to which the measurements of a test remain constant over repeated tests of the same participants under identical conditions, and knowledge of the type and magnitude of error is important to determine whether a small but potentially meaningful effect would be detected (Nevill & Atkinson, 1997). Such analyses need to consider the population for which the measurement tool is intended, as reliability in one population does not necessarily infer reliability in a different population. Many previous studies considering the reliability of flexibility measures have used non-athletic convenience samples taken from University or general populations and used results to make assumptions about athletic individuals. Furthermore, applicability to the proposed testing schedule must be considered as conducting reliability studies on the same day is inappropriate if testing is to take place on different days, as

is common in flexibility and stretching studies, when between day (interday) reliability should be reported (Hopkins, 2000).

Some attempts have been made to consider the relationships shared between measures of static flexibility, passive dynamic flexibility and active dynamic flexibility (Cameron & Bohannon, 1993; Gajdosik *et al.*, 1993; Gleim & McHugh, 1997; McHugh *et al.*, 1998; Hunter & Spriggs, 2000; Gajdosik, 2002; Blackburn *et al.*, 2004; Rolls & George, 2004; Davis *et al.*, 2008; Ayala *et al.*, 2011; Ayala *et al.*, 2012a), although results have not been conclusive. Furthermore there is disparity among results of studies examining different aspects of the same type of flexibility measurement (Wilson *et al.*, 1991; Hunter & Spriggs, 2000; Bojsen-Moller *et al.*, 2007). As well as being highly specific to individual joints, it is possible that different tests which are attempting to investigate flexibility of the same muscle group (e.g. straight leg raise and knee extension tests for the hamstring) are examining, at least in part, different constraining factors (Gajdosik, 1987; Cameron & Bohannon, 1993; Gajdosik *et al.*, 1993; Rolls & George, 2004; Davis *et al.*, 2008). Examination of whether tests of static flexibility are related to each other and to the more complex dynamic flexibility tests is thus warranted.

While there is extensive published research examining the impact of stretching on levels of flexibility, performance and injury risk, the quality of studies has varied considerably. Reviewers have often failed to consider this, leading to inappropriate and unsubstantiated conclusions being drawn. Moreover, studies investigating stretching and injury risk have not always attempted to provide rationale for their findings and few studies examining flexibility or performance measures have been holistic in their approaches. An integrated review of available literature considering the impact of stretching on flexibility levels and performance measures would assist in better informing practitioners and sports personnel as to overall risks and benefits of this practice.

Existing research has almost exclusively focused on static flexibility as a potential risk factor for injury and there is clearly a need to examine whether dynamic flexibility, which provides a better indicator of the mechanical properties of the muscle, is related to injury risk. Understanding the mechanisms behind passive extensibility modifications that have been studied in animal models (Taylor *et al.*, 1993; Noonan *et al.*, 1994; Mair *et al.*, 1996) and considering how they apply to

interventions with human muscles is necessary to develop methods that promote favourable passive extensibility adaptations, functional activities and athletic performance (Gajdosik, 2001b). Given the conceptual model for injury development (Figure 1.1) and the number of and possible interactions between potential risk factors, it is unlikely that epidemiological approaches will be able to correctly identify the potential role of static and dynamic flexibility in predisposing injury. Experimental approaches might thus be better able to identify the potential theoretical framework through which flexibility may be a risk factor for injury.

1.6 STATEMENT OF THE PROBLEM

Existing literature related to both flexibility and stretching in humans has almost exclusively focused on static flexibility. Despite extensive published research, the evidence supporting static flexibility as an injury risk factor is equivocal and often poor quality. Static flexibility is not necessarily related to the mechanical properties of the musculotendinous unit and it is plausible that dynamic flexibility is better associated with injury risk and performance measures. Some research studies have explored dynamic flexibility in humans in terms of developing valid and reliable assessment techniques, comparing static and dynamic measures of flexibility and investigating factors influencing dynamic flexibility. Research exploring dynamic flexibility has tended to be experimental in nature to attempt to understand the mechanisms through which flexibility may be a risk factor for injury. Existing published research has tended to use heterogeneous groups of active adults, frequently has poorly described methodologies and lacks provision of reliability indices. Athletic populations consistently demonstrate a high incidence of strains to the musculotendinous unit, frequently located in the hamstring muscle group, and thus there is a need for research focusing on this subgroup of individuals. This thesis was designed to fill gaps in the existing literature by evaluating methods of assessing dynamic flexibility, considering the comparability of static and dynamic components of the global concept of flexibility and exploring how dynamic flexibility is influenced by exercise and stretching.

1.7 ORGANISATION OF THESIS

The central theme of this thesis is hamstring flexibility and the influence of fatiguing exercise and stretching on this. A review of the literature is provided in **Chapter 2**. The key topics addressed are the measurement of flexibility, reliability and validity of flexibility tests and the impact of exercise and post-exercise stretching on measures of flexibility and performance, with

consideration given to how these might influence injury risk. The review attempts to appraise current knowledge and suggest future directions in a critical manner. The reliability of different methods of measuring hamstring flexibility is evaluated in **Chapter 3**. To allow meaningful interpretation for a specific population, **Chapter 3** focuses on professional rugby league players. The same population takes part in subsequent studies. A comparison of static and dynamic hamstring flexibility measurements is reported in **Chapter 4**. Findings from previous Chapters are used to inform study design of **Chapter 5** which is a repeated measures randomised controlled study examining the consequence of fatiguing exercise and subsequent static stretching on measures of flexibility and performance and implications for injury risk. The thesis finishes with a critical review of the research and suggestions for future investigations.

1.8 AIMS OF THE STUDY

The aims of this thesis were to;

- 1) Establish the intraday and interday, relative and absolute reliability of static and dynamic measurements of hamstring flexibility;
- 2) Examine relationships shared by static and dynamic measurements of hamstring flexibility;
- 3) Investigate the impact of fatigue and post-exercise static stretching on measurements of static and dynamic flexibility and performance.

CHAPTER 2

LITERATURE REVIEW

2 LITERATURE REVIEW

Static flexibility testing has been commonplace since the beginning of the 1940s when flexibility was first identified as an important component of human physical fitness (Cureton, 1941). Substantial research using various approaches of evaluating the reliability and validity of static flexibility tests has been conducted and as these are essential to any measurement tool, it is important that their exploration and critical evaluation is always undertaken. Research pertaining to measures of dynamic flexibility is more limited and there is a need to understand the properties of the musculotendinous unit and investigate methods and applicability of dynamic flexibility testing. Various stretching techniques are used to improve levels of flexibility and it is necessary to explore reasons behind their possible effectiveness and consider the impact that stretching might have on injury mechanisms and recovery from exercise.

2.1 MEASUREMENT OF STATIC FLEXIBILITY

Static flexibility tests are based on linear or angular measurements of the motion of a joint or series of joints, and have been classified as single joint or compound (multiple joint) tests (Corbin & Noble, 1980). Single joint static flexibility tests are common clinical measures in sports medicine and typically involve angular (goniometers or inclinometers) measurements (Gajdosik, 2001a) rather than the linear measurements common in field tests of flexibility (Baltaci *et al.*, 2003). Single joint tests are considered better measures of static flexibility than compound tests because they are more specific but nonetheless are subject to testing limitations such as accurately identifying the centre of rotation for goniometry measurement, the influence of skin and fat movement and the difficulty in isolating the movement (Armstrong *et al.*, 1998; Peeler & Anderson, 2008; Pua *et al.*, 2008). Alongside the distinction between single and compound tests of static flexibility, there is a further division of common static flexibility tests into passive and active tests (Harvey *et al.*, 2002; Ylinen *et al.*, 2010). Passive static flexibility tests require the investigator or clinician to move the required joint to the end of its ROM without assistance from the participant. Participants are asked to indicate when they feel at their maximum range and the joint is held still and the angle measured (Maud & Cortez-Cooper, 1994). Active static flexibility tests require the participant to themselves move the required joint to end of its ROM themselves, using muscles surrounding the joint alone and then hold the joint still while the angle measured (Kim *et al.*, 2005). Passive static flexibility measurements may be influenced by factors such as the pain threshold of an individual, subject bias and application of

different levels of torque whilst differences in extent of muscle activation and stretch reflex might affect active measurements (Marshall *et al.*, 2011; Ayala *et al.*, 2012b).

2.2 STATIC HAMSTRING FLEXIBILITY MEASURES

Static flexibility of the hamstring muscle group has traditionally been measured using the straight leg raise (SLR) test (Gajdosik *et al.*, 1993; Halbertsma *et al.*, 2001), although movement of the pelvis means that the test is not necessarily specific to the hamstrings (Hu *et al.*, 2010). The SLR test can also be affected by deep fascia of the lower limb and neurological tissue (McHugh *et al.*, 2012) and has been described as a ‘key tension test’ of the lower limb and trunk (Boyd *et al.*, 2009), making it potentially more useful as a neurological test rather than a static flexibility test in the clinical setting. Other tests of static hamstring flexibility include active and passive knee extension (KE) tests which involve movement at the knee joint but not the hip making the joint movement easier to control and isolate (Gajdosik *et al.*, 1993). The most widely used compound and linear field based measurement of static hamstring flexibility is the sit and reach test (Sporis *et al.*, 2011; Ayala *et al.*, 2012b). This test is however only moderately related to hamstring flexibility, is influenced by anthropometric factors, e.g. leg length, adipose tissue, and as a compound movement includes a contribution from flexibility of the lower back (Ayala *et al.*, 2011).

2.2.1 Reliability of static hamstring flexibility tests

Before any useful information can be gleaned from flexibility assessment it is important to ensure that measurements are adequately valid and reliable. Validity is the ability of the measurement tool to reflect what it is designed to measure, while reliability is defined as the consistency of measurements or the absence of measurement error (Atkinson & Nevill, 1998). Intratester (intrarater) reliability reflects the consistency of repeated measurements taken by one tester over time while intertester reliability reflects the reproducibility of measurements taken by different individuals (Hopkins *et al.*, 2001). Some testers have found intratester reliability of the Active Knee Extension (AKE) test to be high ($r = 0.99$, $p < 0.05$) using a metal rig to assist in measurement and straps to limit pelvic and leg motion (Gajdosik & Lusin, 1983). Whilst this is likely to lead to improved isolation and therefore smaller measurement error, the applicability of this procedure has been questioned since these types of apparatus are rarely available clinically and the procedure therefore lacks ecological validity (Worrell *et al.*, 1991). The reliability of the

manual techniques and basic goniometry that are routinely used in clinical environments is variable with ICCs of 0.18 to 0.99 being reported for intratester (Rothstein *et al.*, 1983; Youdas *et al.*, 1993; Bierma-Zeinstra *et al.*, 1998; Pua *et al.*, 2008; Ayala *et al.*, 2011; Nunes *et al.*, 2012) and 0.28 to 0.97 being reported for intertester reliability (Rothstein *et al.*, 1983; Youdas *et al.*, 1993; Holm *et al.*, 2000; Gabbe *et al.*, 2004; Norris & Matthews, 2005; Bozic *et al.*, 2010; Nunes *et al.*, 2012; Poulsen *et al.*, 2012; Reurink *et al.*, 2013). Researchers generally interpret repeated measures of static flexibility exhibiting high correlation coefficients as being very reliable but these measure the strength of association rather than the agreement and if data is widely distributed, can exhibit poor intra-individual agreement but high correlations (Weir, 2005). Additionally, some studies inappropriately use the Pearson product moment correlation to assess reliability (Gajdosik & Lusin, 1983; Gajdosik & Bohannon, 1987). This is an interclass and bivariate statistic and thus should only be used to establish extent of relationships between different groups of variables and not to assess reliability, which involves repeated measurements within the same group (Weir, 2005). Little attempt has been made to establish the absolute reliability of static flexibility tests, for instance by reporting statistics such as SEM or Limits of Agreement (Bland & Altman, 1986). Studies that have reported absolute reliability identify that actual measurements can vary by as much as 6° to 20° between repeated measures (Hsieh *et al.*, 1983; Gajdosik *et al.*, 1993; Chow *et al.*, 1994; Mullaney *et al.*, 2010; Ayala *et al.*, 2011). Many reasons have been proposed for the presence of such measurement errors and include differing tolerance of participants to sensations of stretch and pain (Magnusson *et al.*, 1996), lack of stabilisation (Gajdosik & Lusin, 1983), influence from structures other than those being tested (Krabak *et al.*, 2001) and inconsistent force application on passive tests (Reid & McNair, 2004). It has been suggested that researchers should quantify force applied to passive movements in attempts to ensure better repeatability although the recent move toward post-positivism in orthopaedic and sports physical therapy research suggests that the tacit knowledge that forms parts of the skills of an experienced clinician is sufficient (Greenfield *et al.*, 2007). This inductive approach argues that although something cannot be empirically quantified, it should not be disregarded (Ferlie *et al.*, 1999). As clinicians are experienced in measuring static flexibility, they are therefore likely to apply similar levels of force and stabilisation thus giving high intrarater reliability of the tests.

2.2.2 Validity of static hamstring flexibility tests

Few studies have compared results obtained using different methods of assessing static hamstring flexibility (Hsieh *et al.*, 1983; Cameron & Bohannon, 1993; Gajdosik *et al.*, 1993; Hui & Yuen, 2000; Rolls & George, 2004; Davis *et al.*, 2008; Shimon *et al.*, 2010; Ayala *et al.*, 2011; Ayala *et al.*, 2012a). Many have considered common variance of tests as an indicator of validity (Hsieh *et al.*, 1983; Gajdosik *et al.*, 1993; Hui & Yuen, 2000; Gajdosik, 2001b; Awan *et al.*, 2002). Common variance, also called coefficient of determination, is in simple regression the proportion of the variance of the target or dependent variable that is accounted for by regression upon the regressor or independent variable and is given by the square of the PPM correlation (Kinnear & Gray, 2008). Gajdosik *et al.* (1993) reported Passive Knee Extension (PKE) and Passive Straight Leg Raise (PSLR) common variance of 43.5%, Active Knee Extension (AKE) and PKE common variance of 49 to 74% and ASLR and AKE common variance of only 4%. These common variances indicate that generally more than half of the available range is affected by different factors for each test. Linked to low shared common variances between active and passive knee extension tests, significant differences ($p < 0.05$) between joint angles achieved have also been identified (Gajdosik & Lusin, 1983; Cameron & Bohannon, 1993). Authors suggested that this might be because the AKE tests represent measurement of initial length of the hamstring and PKE tests represent a measurement of the final length. Initial length was described as the point where first passive resistance to stretch is detected, which is not identical to the resting length of the muscle (Gajdosik, 2001c). This suggests that active and passive static flexibility tests are not necessarily measuring the same constraints of static flexibility and these findings highlight the necessity to standardise between the use of active and passive tests.

2.3 MUSCLE AND JOINT STRUCTURE AND FLEXIBILITY

To understand the concept of dynamic flexibility it is important to consider the mechanical properties of muscle and factors that may influence quantification of resistance. The proposed mechanism through which changes in muscle length occur is through the sliding of thick and thin filaments past one another within the functional units of the muscle (Maganaris, 2001). Animal models have shown that muscles, like most biological materials, display viscoelastic properties (Taylor *et al.*, 1990) and thus demonstrate the characteristics of stress relaxation, creep and hysteresis (Magnusson *et al.*, 1997). These models have been extrapolated to explain the behaviour of human muscle *in vivo* and imply that muscles have both viscous (rate dependent)

and elastic (force dependent) properties (Fukashiro *et al.*, 2001). The mechanical characteristics of a sarcomere can be accounted for by a three-element model, which includes a parallel elastic component, series elastic component and contractile component (Figure 2.1). The parallel elastic component consists of the connective tissue sheath and cytoskeletal elements and is responsible for passive or resting tension in muscle. The contribution of the parallel elastic component to total muscle force increases with muscle length and is greatest at the longer muscle lengths (Cox *et al.*, 2000; Kubo *et al.*, 2002). The series elastic component is composed of the thick and thin filaments, cross-bridges and Z bands and has the role of smoothing rapid changes in muscle tension during active movements (Suzuki & Sugi, 1983). The contractile component consists of the actin and myosin filaments and represents the force-velocity capability of the sarcomere.

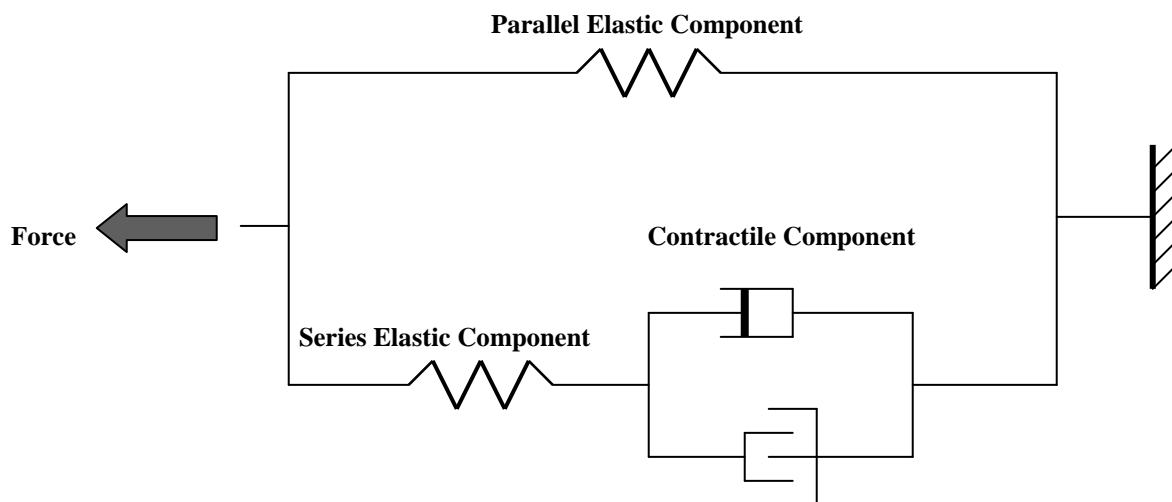

Figure 2.1 - A three-element model of a sarcomere (adapted from Enoka, 1994).

As a muscle is passively lengthened from a shortened position, it will reach a point where the first passive resistance to stretch can be measured. This has been termed the initial length (Gajdosik, 2001b). When the muscle is lengthened further, passive resistance will increase until a point of maximum passive resistance or maximum stretch tolerance is reached. This has been termed the final length by *in vivo* studies and is affected by perception of stretch as well as the properties of the musculotendinous unit (McHugh *et al.*, 1998; Magnusson *et al.*, 2000; Wepler & Magnusson, 2010). Stiffness is defined as the slope of the force-length or torque-angle relationship (Klinge *et al.*, 1997). The curvilinear force-length relationship of passive muscle

indicates that stiffness increases as a function of length, as is typical of most biological materials (Figure 2.2). The area enclosed by the torque-angle curve denotes the energy absorbed by the muscles (Noonan *et al.*, 1993). Although widely demonstrated through *in vitro* research using individual muscle fibres or muscle groups, little consideration has been given to whether human muscles display similar properties. Within *in vivo* situations there are additional complexities such as muscles with different architecture crossing sometimes multiple joints and multifaceted force patterns as opposed to simple linear force as utilised in animal models.

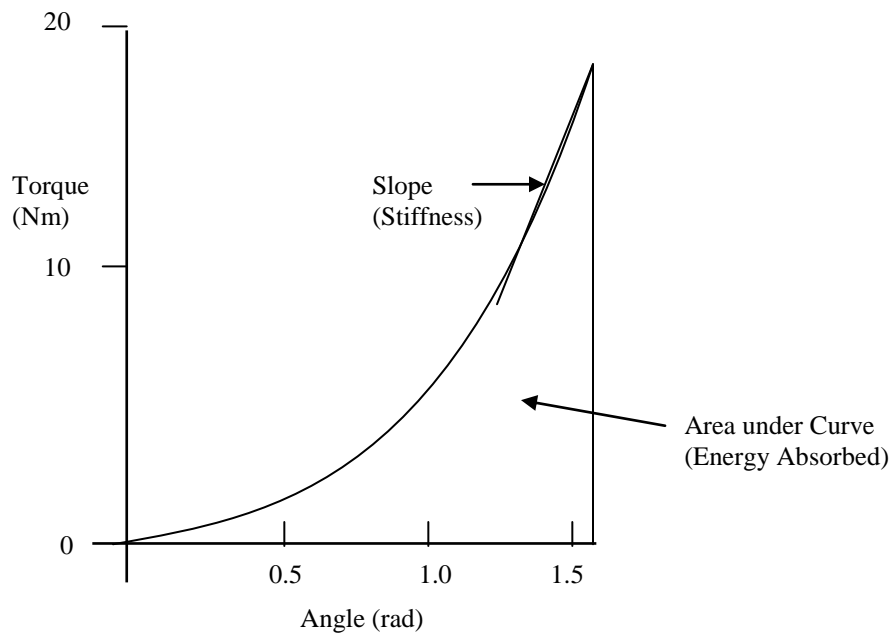

Figure 2.2 – Load-deformation (torque–angle) curve of a material with viscoelastic properties (adapted from Magnusson *et al.*, 1995).

2.4 DYNAMIC HAMSTRING FLEXIBILITY

Some studies have suggested that static flexibility tests of the hamstring muscle group are not limited by neural or biomechanical characteristics of muscle (Osternig *et al.*, 1990; Halbertsma *et al.*, 1996; McHugh *et al.*, 1998) and that the actual length of the hamstring muscle, determined by the number of sarcomeres in series, may be a factor (Gajdosik, 1995). Various models have been developed to investigate the contribution of biomechanical constraints to flexibility. An early attempt at measuring active dynamic flexibility utilised a damped oscillation technique, which involved gentle perturbation of a loaded musculotendinous system, during which the free response of the system was recorded and a second order linear equation applied to the resulting

damped oscillation to calculate the stiffness of the system (Bach *et al.*, 1983; Shorten, 1987). This technique has possible errors in that the downward force applied by the experimenter is generally described as a ‘downward gentle push’ in the region of 100-200N magnitude (Ditroilo *et al.*, 2011) and often estimated rather than being objectively measured. Differences in perturbation amplitude can influence stiffness assessment, particularly in terms of reflex contribution (Kearney *et al.*, 1999; Hunter & Spriggs, 2000). There is evidence that the damping response is somewhat curvilinear as opposed to completely linear (Watsford *et al.*, 2010). While Wilson *et al.* (1994) described reliability values for performance measures determined through the use of intraclass correlations (ICCs), they did not report any values for stiffness measures and two earlier studies failed to make any attempts at confirming reliability of the system (Wilson *et al.*, 1991; Wilson *et al.*, 1992). Other studies have reported ICCs of $r = 0.87$ to 0.94 ($p < 0.01$) but did not state which particular ICC was used (Walshe *et al.*, 1996; Murphy *et al.*, 2003). The choice of ICC test is not inherently obvious and different tests can yield different results, which should be considered when interpreting this value. Additionally, convenience samples of participants were used in all studies and as these can exhibit high inter-subject variability, artificially high reliability values can be obtained (Atkinson & Nevill, 1998).

In an attempt to improve objectivity and to allow further understanding of dynamic flexibility, Magnusson *et al.* (1995) developed a model which used an isokinetic dynamometer to examine the stiffness and energy in a dynamic phase, and viscoelastic response in a static phase of a standardised stretch manoeuvre of the human hamstring muscle group. Due to the insignificant differences between trials as measured by paired t-tests and having Pearson product moment correlation coefficients of $r = 0.91$ to 0.99 ($p < 0.05$), the method was considered highly reliable (Magnusson *et al.*, 1995). The use of PPM correlation coefficients in reliability studies is however inappropriate (Chen & Barnhart, 2008) as they are bivariate statistics and reliability measures are univariate in nature (Weir, 2005). Despite the challenges associated with the objective measurement of flexibility and the equivocal nature of the research considering the importance of flexibility for injury prevention, a variety of strategies aimed at improving flexibility and performance are utilised.

2.5 STRETCHING TECHNIQUES

Static stretching is generally the most widely used and recommended stretching technique because the exercises are relatively easy to perform and have little associated risk of injury (Kolber & Zepeda, 2004). These involve joints being placed in the outer limits of their ROM and then subjected to an elongation torque or force, which is maintained for a period ranging from a few seconds to minutes (Thacker *et al.*, 2004). The slow build-up of tension and the absence of pain involved with static stretching are believed to minimise stretch reflex responses thus inducing muscular relaxation and allowing further stretching (Guissard & Duchateau, 2006).

Ballistic stretching is a dynamic and fast movement in which a bouncing type of stretch torque is applied into the extreme ROM limits of the joints concerned (Covert *et al.*, 2010). This technique was thought a useful method of developing dynamic flexibility even though research often reports ballistic stretching to be less effective at improving flexibility than other types of stretching (Sady *et al.*, 1982; Wallin *et al.*, 1985; Bandy *et al.*, 1998; Bacurau *et al.*, 2009; Covert *et al.*, 2010). The inhibitory effect of the stretch reflex is thought to be one reason for the lower effectiveness of ballistic stretching for improving static flexibility (Guissard & Duchateau, 2006). Additionally, because higher forces are involved in ballistic stretching compared to other stretching methods, it is associated with increased potential of injury to the musculotendinous unit and thus has traditionally been avoided (Hartig & Henderson, 1999; Hedrick, 2000). While it is possible that the musculotendinous units of untrained and sedentary individuals may not be able to withstand this vigorous type of stretching without sustaining muscle damage, sports people often put their joints through large ranges while exerting considerable forces. It is therefore possible that ballistic-type stretching may be appropriate in these groups of people (Shrier, 2005). More recently, ballistic stretching procedures have been adapted to become more controlled, through range movements rather than end of range techniques, and these types of stretches have been termed dynamic stretching (Behm & Chaouachi, 2011).

Proprioceptive Neuromuscular Facilitation (PNF) is a collection of techniques for facilitating muscle contraction, strengthening and increasing flexibility. These techniques were originally formulated and developed as a physical therapy procedure for the rehabilitation of stroke patients (Knott & Voss, 1957; Kabat, 1958) and PNF stretching procedures were subsequently developed on the basis of several important neurophysiological mechanisms (Chalmers, 2004). Contract-

relax stretching involves an initial maximal isometric contraction of the muscle to be stretched (the antagonist) followed by the relaxation and passive stretch of the muscle to the limit of its ROM (Sharman *et al.*, 2006). The isometric contraction of the muscle to be stretched is followed by relaxation, thought to stem from autogenic inhibition by the Golgi tendon organs (Ferber *et al.*, 2002; Chalmers, 2004; Guissard & Duchateau, 2006). This suppresses the excitability of muscle spindles and thus allows the muscle to relax and stretch further (Bonnar *et al.*, 2004). Consequently, the intention of PNF stretching is to reduce reflex activity, thus diminishing resistance and thereby improving joint ROM (Etnyre & Abraham, 1986). Paradoxically, it has been found that PNF stretching techniques that were most effective in increasing static flexibility also produced the highest levels of EMG activity in the stretched muscles, indicating that full muscular relaxation is not necessary for elongation to take place (Sharman *et al.*, 2006; Mitchell *et al.*, 2009).

It has been suggested that PNF alters stretch perception, providing a stretch-induced analgesic effect and thus increasing the tolerance of an individual to stretch (Sharman *et al.*, 2006; Weppeler & Magnusson, 2010). There is little evidence for proposed mechanisms but this might be through activation of the descending pain suppression system. PNF techniques have been described as painful and painful stimuli cause the release of endorphins and enkephalins, which inhibit the release of Substance P, a neurotransmitter in the Lateral Spinothalamic Tract (the pathway in which pain signals travel from the receptor to the brain) (Piercey *et al.*, 1986; De Felipe *et al.*, 1998). Activation of the descending pain suppression system results in an individual becoming less sensitive to painful stimuli (i.e. maximal stretch) and thus is able to tolerate higher levels of this stimulus (i.e. greater degree of stretch resulting in higher achievable ROM) (Pert, 1982). Additionally it is accepted that pain perception can be affected by dynamic exercise (Sforzo, 1989), thus altered pain perception as a result of the isometric contraction could contribute to the mechanism of PNF stretching. Alternatively, there is a possibility that mechanoreceptors contribute to a decreased pain perception via gate control. This occurs when stimulation of these receptors by distortion, pressure or stretch causes presynaptic inhibition of nociceptive signals (Terman *et al.*, 1984).

2.6 STRETCHING AND FLEXIBILITY

Several studies have compared the effectiveness of different stretching techniques for improving static (Cornelius *et al.*, 1992; Bandy & Irion, 1994; Bandy *et al.*, 1997; Klinge *et al.*, 1997; Wiemann & Hahn, 1997; Bandy *et al.*, 1998; McHugh *et al.*, 1998; Roberts & Wilson, 1999; Depino *et al.*, 2000; Chan *et al.*, 2001; Funk *et al.*, 2001; Funk *et al.*, 2003; Zakas *et al.*, 2003; Nelson & Bandy, 2004; Young *et al.*, 2004; Davis *et al.*, 2005; Zakas *et al.*, 2006; Bacurau *et al.*, 2009; Fasen *et al.*, 2009; O'Sullivan *et al.*, 2009; Ayala & Sainz de Baranda Andújar, 2010; Covert *et al.*, 2010; O'Hora *et al.*, 2011; Maddigan *et al.*, 2012; Mizuno *et al.*, 2013; Place *et al.*, 2013) and dynamic flexibility (Mahieu *et al.*, 2007; Herda *et al.*, 2008; Jagggers *et al.*, 2008; Morse *et al.*, 2008; Hough *et al.*, 2009; Mahieu *et al.*, 2009; Herda *et al.*, 2010; Nakamura *et al.*, 2011; Matsuo *et al.*, 2013) with equivocal results. Many studies are of poor to moderate methodological quality (Moher *et al.*, 2009) and often fail to differentiate between an acute single stretch, series of stretches or a longer term stretching programme when setting up their rationale (Behm & Chaouachi, 2011). Additionally, some studies utilise an aerobic warm up before commencing the stretch intervention while others do not (Fradkin *et al.*, 2006). As well as different methods of stretching being used, stretches are held for differing amounts of time (Ryan *et al.*, 2008; Ayala & Sainz de Baranda Andújar, 2010; Matsuo *et al.*, 2013). Prospective randomised controlled trials or clinical controlled trials have shown that stretching increases static flexibility by between 5 and 30% (Wessling *et al.*, 1987; Halbertsma *et al.*, 1996; Wiemann & Hahn, 1997; Kokkonen *et al.*, 1998; Clark *et al.*, 1999; Depino *et al.*, 2000; Magnusson *et al.*, 2000; Church *et al.*, 2001; Draper *et al.*, 2002; de Weijer *et al.*, 2003; Power *et al.*, 2004; Bazett-Jones *et al.*, 2005; Young *et al.*, 2006; O'Hora *et al.*, 2011). The practical consequence of these findings is not always considered and differentiation should be made between stretching to restore normal osteokinematic movements in individuals with identifiable muscle tightness and stretching to produce hyperflexibility (beyond normal ROM) in athletes with otherwise functional movements (McCormack *et al.*, 2004).

Theoretical explanations of the effectiveness of stretching techniques in improving static flexibility have included overcoming the stretch reflex, reciprocal inhibition and autogenic inhibition (Hutton, 1992). Results of studies comparing PNF and static stretching techniques have been equivocal. Many researchers have found PNF to be the superior technique for improving static flexibility (Wallin *et al.*, 1985; Etnyre & Lee, 1988; Cornelius *et al.*, 1992;

Magnusson *et al.*, 1996; Funk *et al.*, 2003; Sharman *et al.*, 2006; O'Hora *et al.*, 2011) while others have concluded that PNF is equivalent to static stretching (Worrell *et al.*, 1994; Marek *et al.*, 2005; Maddigan *et al.*, 2012). Part of the disparity in such findings may be associated with the lack of distinction between short and long-term effects of stretching and a lack of uniformity among measurement procedures (McHugh & Cosgrave, 2010). Some studies through electromyography analysis have found excitability to be lower during PNF stretching than during static stretching which provided evidence for the rationale behind PNF techniques (Etnyre & Abraham, 1986). However, other studies contradict this and further question the mechanism through which PNF stretching is effective (Moore & Hutton, 1980; Hutton, 1992; Chalmers, 2004; Sharman *et al.*, 2006; Mitchell *et al.*, 2009). While there is evidence both static and PNF stretching result in improved flexibility, static stretching is generally performed before or after periods of exercise while PNF stretching is more often used as part of treatment or rehabilitation programmes (Westwater-Wood *et al.*, 2010).

While there is largely consensus that static stretching results in an improvement in static flexibility, no consistency is apparent with regard to how long stretches should be held to obtain optimum benefits. Recommendations for duration of stretching in flexibility training programmes range from 5 to 60 s yet justifications for these selections have largely been absent and the duration of the stretching protocols used in some studies do not always coincide with typical practice of athletes and fitness coaches (Behm & Chaouachi, 2011). A series of articles conducted in professional sport reported average stretch durations of 12 to 18 s (Ebben *et al.*, 2004; Ebben *et al.*, 2005; Simenz *et al.*, 2005; Duehring *et al.*, 2009). Madding *et al.* (1987) compared the effects of 15, 45 and 120s of stretching on hip abduction and reported that sustaining a stretch for 15s was as effective as 120s. Bandy and Irion (1994) found that a 30s stretch was more beneficial than a 15s stretch but there was no advantage to holding the stretch for 60s. Other authors have also concluded that 30s is the optimum duration to maintain a static stretch (Grady & Saxena, 1991; Walter *et al.*, 1994; Rubini *et al.*, 2007; Young, 2007). In the literature reviewed, no study investigating acute effects of stretching on flexibility indicated attempts to control for total amount of time spent stretching while manipulating stretch duration. Total time spent stretching may influence the improvements observed in static flexibility after a flexibility training programme as holding stretches for 60s would result in a much longer total time spent stretching compared to holding each stretch for 15s. The same duration of static

stretching completed either in multiple bouts of shorter durations or one single bout is thought to elicit similar gains in static flexibility (Roberts & Wilson, 1999).

Because of questions of applicability of improvements in static flexibility to measures of dynamic flexibility, research has considered the influence of stretching on viscoelastic properties of skeletal muscle (Halbertsma *et al.*, 1996; Magnusson *et al.*, 1996; Magnusson *et al.*, 1997; McHugh *et al.*, 1998; Magnusson *et al.*, 2000; Kubo *et al.*, 2001; Nordez *et al.*, 2006; Mahieu *et al.*, 2007; Morse *et al.*, 2008; Kay & Blazevich, 2009; Herda *et al.*, 2010; Kato *et al.*, 2010; Nakamura *et al.*, 2011). Results have indicated that while static stretching did increase static flexibility, there was generally no significant change in measures of passive torque, stiffness and energy absorbed during stretch to maximum pre-stretch angle achieved by each participant. Static stretching consistently increased the maximum angle and peak torque that a participant was able to achieve (McHugh *et al.*, 1992; Magnusson *et al.*, 1995; Magnusson *et al.*, 1996; Magnusson *et al.*, 1996; Magnusson *et al.*, 2000; Magnusson *et al.*, 2000). The increase in ROM and peak torque was attributed to stretch induced analgesia, as there were no apparent decreases in force at the same angle or greater joint angles for the same load, and therefore no visible effect on the tissue properties. Wiemann and Hahn (1997) agreed with this having found no change in the resting tension or resistance of muscle to a stretching procedure as a result of stretching exercises. In contrast, some authors reported a decreased passive tension in ankle dorsiflexion after short-term stretching of the soleus muscle (Toft *et al.*, 1989) and a reduced stretching resistance after 15s passive stretch of the thigh adductor muscle (Madding *et al.*, 1987; Ryan *et al.*, 2008). Prolonged static stretch (5 to 10 minutes) has been shown to decrease tendon and aponeurosis stiffness and hysteresis as measured passively by ultrasonography (Kubo *et al.*, 2002). It was suggested that the decrease in stiffness was possibly due to acute changes in the arrangement of collagen fibres in tendon but the stretch duration in these studies is considerably longer than the 30 to 60s more routinely used. In experiments with isolated muscle fibres, results showed that only stretches above 160% of the resting length reduced resting tension (Ramsey & Street, 1940; Higuchi *et al.*, 1988). Other studies utilising animal models have shown that stretching resulted in altered viscoelastic responses of rabbit extensor digitorum longus and tibialis anterior muscles (Taylor *et al.*, 1993) and canine medial collateral ligaments (Woo *et al.*, 1981).

2.7 STRETCHING AND PERFORMANCE

Stretching before exercise has traditionally been believed to enhance subsequent performance (McNeal & Sands, 2006). Given that pre-exercise routines usually consist of multiple interventions including cardiovascular work, progressively intense muscular contractions as well as stretching, it is impossible to ascertain the specific element of combination of elements responsible for altering performance or injury risk (Kay & Blazevich, 2012; Simic *et al.*, 2013). Additionally, as it is difficult to test actual competition performance with sufficient scientific rigour, various direct and indirect tests have been designed to provide reliable and valid objective measures. Numerous researchers have reported that acute static stretching can induce significant reductions in measures of performance indices including strength (Kokkonen *et al.*, 1998; Fowles *et al.*, 2000; Behm *et al.*, 2001; Nelson *et al.*, 2001; Nelson *et al.*, 2001; Knudson & Noffal, 2005; Brandenburg, 2006; Cramer *et al.*, 2006; Young *et al.*, 2006; Ogura *et al.*, 2007; Kay & Blazevich, 2008; McHugh & Nesse, 2008; Matsuo *et al.*, 2013), reaction or movement time (Behm *et al.*, 2004; McMillian *et al.*, 2006; Maddigan *et al.*, 2012), speed or efficiency (Little & Williams, 2006; Winchester *et al.*, 2008; Beckett *et al.*, 2009; Esposito *et al.*, 2012) and jump height (McNeal & Sands, 2006; Behm & Kibele, 2007; Bradley *et al.*, 2007; Holt & Lambourne, 2008; Jagers *et al.*, 2008; Robbins & Scheuermann, 2008; Gonzalez-Rave *et al.*, 2009; Hough *et al.*, 2009; Carvalho *et al.*, 2012; Fortier *et al.*, 2013). Conversely, others studies have reported no reduction in strength, power or explosive muscular performance (Bazett-Jones *et al.*, 2005; Burkett *et al.*, 2005; Unick *et al.*, 2005; Cramer *et al.*, 2007; Kinser *et al.*, 2008; Torres *et al.*, 2008; Wallmann *et al.*, 2008; Di Cagno *et al.*, 2010; Haag *et al.*, 2010; Handrakis *et al.*, 2010; Molacek *et al.*, 2010; Murphy *et al.*, 2010; Cannavan *et al.*, 2012; Fortier *et al.*, 2013; Gonçalves *et al.*, 2013; Morrin & Redding, 2013) or actual improvements in some measures of performance (O'connor *et al.*, 2006; Gonzalez-Rave *et al.*, 2009; Haag *et al.*, 2010).

These contradictory findings are likely to be due to a number of factors. Consideration is seldom given to study quality and many studies lacked randomisation, did not blind participants or investigators, did not have a control group and lacked homogeneity of participants at baseline. Additionally, as well as some studies using co-interventions other than acute static stretching, studies varied widely in the duration of stretch utilised. It has been suggested that the effect of acute static stretching on performance is dose-related, that is, studies utilising shorter durations of stretch are less likely to find pre-exercise stretching to be detrimental to performance. To date,

only ten studies have considered the effect of a ≤ 30 s acute static stretch on performance. Eight of these reported no significant reduction in performance measures of speed (Beckett *et al.*, 2009), strength (Knudson & Noffal, 2005; Kay & Blazevich, 2008; Siatras *et al.*, 2008), vertical jump (Church *et al.*, 2001; Holt & Lambourne, 2008; Murphy *et al.*, 2010) and medicine ball throw (McMillian *et al.*, 2006) while two reported significant increases in jump distance (McMillian *et al.*, 2006) and peak cycling power (O'connor *et al.*, 2006). Only one study utilising a stretch duration of ≤ 30 s reported a significant but small reduction in speed (Fletcher & Jones, 2004). Conversely, when stretch durations were greater than 60s, studies generally report significant reductions in measures of strength and performance which plateau when stretch duration exceeds 2 minutes (Simic *et al.*, 2012; Matsuo *et al.*, 2013). This finding is congruent with previous dose-response studies (Knudson & Noffal, 2005; Young *et al.*, 2006; Ogura *et al.*, 2007; Kay & Blazevich, 2008; Siatras *et al.*, 2008; Ayala & Sainz de Baranda Andújar, 2010; Cannavan *et al.*, 2012).

Contrary to the potentially detrimental effects of pre-exercise stretching on performance, stretching after exercise or outside of activity periods might contribute to improved performance as increased force production has been described after regular, long-term stretching programme in the elderly (Kerrigan *et al.*, 2003), and in athletes (Wilson *et al.*, 1992; Worrell *et al.*, 1994; Handel *et al.*, 1997; Kokkonen *et al.*, 2007). There is negligible evidence to suggest that regular stretching could decrease performance or be detrimental to performance when performed at times other than immediately before exercise.

2.8 STRETCHING AND JOINT POSITION SENSE

Joint position sense (JPS) is generally defined as the ability to assess the position of a limb without the assistance of vision (Ghaffarinejad *et al.*, 2007). Although not extensively studied in humans, JPS is considered important in musculotendinous function and performance (Herrington *et al.*, 2010), and is an accepted risk factor in injury occurrence and in higher re-injury rates, particularly in knee and ankle joints (Miura *et al.*, 2004; Givoni *et al.*, 2007; Ergen & Ulkar, 2008) and has been suggested as a risk factor for muscle strain injuries (Larsen *et al.*, 2005; Givoni *et al.*, 2007). JPS, also called proprioception, is the sense that indicates whether the body is moving with required effort, as well as where the various parts of the body are located in relation to each other. The integration of the information collected from various

mechanoreceptors, nociceptors and muscle afferents, allows feedback for motor control through position sense and movement sense (kinaesthesia) and provides dynamic joint stability (Proske, 2005). Motor control is accomplished through properly monitored feedback mechanisms realised during movement and the proper response to that feedback (Rahnama *et al.*, 2006; Walsh *et al.*, 2009). If the mechanoreceptors are unable to accurately report position in the outer range (stretch) position, then there is a potential for structures to become stressed before any compensatory muscle contraction can take place (Givoni *et al.*, 2007). Such alterations in JPS are commonly linked to either previous injury (Docherty *et al.*, 1998; Willems *et al.*, 2005; Ergen & Ulkar, 2008) or fatigue (Carpenter *et al.*, 1998; Walsh *et al.*, 2004; Givoni *et al.*, 2007; Walsh *et al.*, 2009). Several authors have demonstrated statistically significant deficits in JPS after localised fatigue protocols (Chappell *et al.*, 2005; Givoni *et al.*, 2007; Allen *et al.*, 2010; Mohammadi & Roozdar, 2010; Pinsault & Vuillerme, 2010; Gear, 2011). This is possibly due to decreased joint stability as a result of the body's intrinsic protective mechanisms being slowed or impaired. Different fatigue inducing exercise protocols have reduced electromechanical delay (Gleeson *et al.*, 1998; Cè *et al.*, 2013; Conchola *et al.*, 2013) and diminished coordination by affecting energy transfer between limb segments and thus timing (Melnyk & Gollhofer, 2007). If stress of sufficient magnitude is placed upon a structure it is possible that injury will occur and epidemiological studies have shown that JPS is different in injured compared to non-injured controls thus supporting this conjecture (Carter *et al.*, 1997; Herrington *et al.*, 2010; Yang *et al.*, 2010).

Little research has specifically considered the effect of static stretching on JPS. Ghaffarinejad *et al.* (2007) showed a significant improvement in knee JPS at 45° of flexion as a result of static stretching of the quadriceps, hamstring and adductors, suggesting that stretching may influence mechanoreceptors in muscles around the knee joint. Studies evaluating the effect of static stretching of quadriceps and hamstring muscles on knee JPS reported no significant difference between the stretching and control groups (Larsen *et al.*, 2005; Torres *et al.*, 2012). Other results indicated that after a 2-week stretching regime of the rectus femoris, stretch sensation was decreased in an experimental group and suggested that receptors were responsible for reduced stretch sensation (Bjorklund *et al.*, 2001). Muscle spindles have been shown to have a thixotropic property therefore if stretching breaks some of the stable bonds, proprioceptive input of muscular receptors may be improved and the positional sensitivity of the muscular receptors might be

adjusted (Proske *et al.*, 2003). The adjustment may begin early after stretching and involve recoil of the stretched elastic component of the tendon to a new equilibrium state and is a possible reason for altered JPS as a result of static stretching. This suggests that because the muscular receptors have an important role in the elaboration of limb positional sense, stretching may improve sensory and motor capabilities of perception of JPS. It has been hypothesised that the accuracy of JPS would improve as the muscles stretched and that this increase in accuracy might be responsible for the increase in motor capabilities after stretching (Bjorklund *et al.*, 2001). This theory is disputable because of the decrease in performance measures commonly seen after an acute bout of static stretching.

2.9 STRETCHING AND INJURY PREVENTION

Muscle strain injuries frequently occur in sport and can result in significant periods during which participants are unable to train or compete (Chan *et al.*, 2012). Epidemiological studies have estimated that hamstring strains in particular account for 5 to 16% of injuries in professional sport, which can have considerable financial effects on injured individuals and their clubs (Seward *et al.*, 1993; Orchard & Seward, 2002; Woods *et al.*, 2004; Brooks *et al.*, 2006; Ekstrand *et al.*, 2011; Elliott *et al.*, 2011). It has been estimated that English professional football players are absent through injury for an average of 39.6 days per year (Drawer & Fuller, 2002) and in 2011, players in the English Premiership were earning an average salary of £1.16million (Daily Mail, 2011), which equates to a financial loss of over £125,000 per player per season. Compared against criteria from the occupational health setting, this level of risk is defined as unacceptable (Drawer & Fuller, 2002). Studies and reviews have attempted to implicate individual or groups of risk factors in injury causation but there is little agreement with respect to the findings, which can in part be attributed to limitation in study design and the statistical methods used to assess the results (Reurink *et al.*, 2012). Poor flexibility is one of the more commonly cited of these risk factors (Orchard *et al.*, 1997; Witvrouw *et al.*, 2003; Gabbe *et al.*, 2006; Engebretsen *et al.*, 2010; Hägglund *et al.*, 2013) which has led to the rationale that stretching to improve flexibility is a necessary part of fitness regimes. This conjecture persists despite little supporting empirical evidence.

The only prospective studies that have suggested that stretching prior to exercise might prevent injury also included a warm-up and/or other co-interventions in addition to stretching (Ekstrand

et al., 1983; Bixler & Jones, 1992; Amako *et al.*, 2003; Hadala & Barrios, 2009). Warming up prior to activity has been reported to reduce the risk of injury in the subsequent activity session (Wedderkopp *et al.*, 1999; Olsen *et al.*, 2005) and the incorporation of a warm-up with static stretch has been shown to negate the detrimental effect of static stretching on ensuing exercise performance (Taylor *et al.*, 2009). The presence of such co-interventions therefore prevents any useful conclusions being drawn from these studies as to the effectiveness of stretching before exercise. Results of other studies have generally indicated that stretching before exercise is of no benefit to injury prevention (Jacobs & Berson, 1986; Macera *et al.*, 1989; Walter *et al.*, 1989; van Mechelen *et al.*, 1993; Pope *et al.*, 1998; Cross & Worrell, 1999; Pope *et al.*, 2000). Some of these studies have been epidemiological and retrospective rather than prospective in nature and most have not controlled for previous injury (McHugh & Cosgrave, 2010). This can confound cause and effect, i.e. an athlete may stretch more because of previous injury in an attempt to prevent injury recurrence (Meeuwisse & Hagel, 2009). For example, a retrospective case control study of sprinters found that those with hamstring injuries had weaker and less flexible hamstring muscles than did sprinters who had never experienced hamstring injury (Jonhagen *et al.*, 1994). This finding can be interpreted as the hamstring weakness and inflexibility being the cause of the injury when they might simply be the result of the injury. As muscle injuries heal by fibrosis and the laying down of relatively inelastic scar tissue, those who have been previously injured often exhibit reduced static flexibility levels (Toumi *et al.*, 2006), and thus strong correlations found between static flexibility measurements, stretching practice and injury occurrences may lead to incorrect assumptions as to the relationship between stretching and injury incidence.

Reasons for the apparent ineffectiveness of acute pre-exercise stretching in reducing injury risk have been suggested through the use of animal models. Because sarcomere length within a muscle is heterogeneous, some sarcomeres lengthen during a contraction at the same time as others are shortening (Horowitz & Podolsky, 1987). When sarcomeres are stretched until the actin and myosin filaments no longer overlap, the force is transmitted to the cytoskeleton of the muscle fibre and muscle fibre damage occurs. At this point the joint is often within a normal ROM (Shrier, 2008) suggesting that sarcomere length and not total muscle length might be more related to musculotendinous strain injury, and thus that stretching to increase static flexibility or decrease passive torque is irrelevant to likelihood of injury occurrence. It has been reported that pre-injury stretch protocols do not reduce force deficit or work deficit resulting from contraction-

induced injury in mouse Extensor Digitorum Longus (EDL) muscle (Black & Stevens, 2001). Additionally, stretching might produce small amounts of muscle damage and during subsequent exercise when far greater forces are applied to the muscles, any small tears might increase in size (Lieber & Friden, 2002). It is however plausible that stretching after exercise or outside of strenuous exercise periods might help adaptively lengthen shorter sarcomeres thus helping to reduce injury risk. Energy absorbed by a muscle is thought to be the most important variable with respect to musculotendinous strain injury occurrence (Macpherson *et al.*, 1996; Mair *et al.*, 1996). Active muscle has a lower compliance (higher stiffness) than resting muscle (Wilson *et al.*, 1991) but absorbs more energy (Garrett *et al.*, 1987; Brooks *et al.*, 1995). As most injuries are believed to occur when a muscle is active, the assessment of static flexibility may not provide sufficient information and that evaluation of the biomechanical properties of active muscle is necessary. Only one study has prospectively investigated the relationship between lower body stiffness and hamstring injury (Watsford *et al.*, 2010). Stiffness was assessed using a free oscillation technique. Results indicated that individuals who recorded higher lower leg stiffness values might be at higher risk of sustaining a hamstring strain injury. Interestingly, it also appeared that individuals with lowest recorded stiffness values were also at increased risk of injury, supporting the assumption that there is an optimum range of flexibility, above and below which predisposition to hamstring strain injury might be increased (Liu *et al.*, 2012). Further studies are needed to establish this, together with the effect of stretching on the properties of the musculotendinous system in an aim to identify the impact that any stretch-induced changes might have on injury risk.

2.10 FATIGUE AND INJURY SUSCEPTIBILITY

Fatigue is characterised by an inability to sustain the original work-rate (Robineau *et al.*, 2012). This can be through depletion of energy stores, thermal strain, failure of excitation-contraction at muscular level and effects of altered metabolic activity locally (peripheral fatigue) and on the central nervous system (central fatigue) (Rahnama *et al.*, 2003). Muscular fatigue is associated with altered JPS (Cote *et al.*, 2008; Allen *et al.*, 2010; Mohammadi & Roozdar, 2010; Gear, 2011) and impaired motor performance (Reilly *et al.*, 2008), and is a commonly proposed risk factor for injury (Gabbett & Domrow, 2005; Gabbe *et al.*, 2006; Alentorn-Geli *et al.*, 2009; Hägglund *et al.*, 2013). Epidemiological research that has reported that most hamstring strain injuries occur late in training sessions or matches thus leading to the conjecture that fatigue is a

predisposing factor to injury (Brockett *et al.*, 2004; Lattier *et al.*, 2004; Woods *et al.*, 2004; Engebretsen *et al.*, 2010; Small *et al.*, 2010; Liu *et al.*, 2012). In prospective cohort studies, Hawkins *et al.* (2001) identified the numbers of injuries recorded in the second half were greater than the first half in professional football, Pinto *et al.* (1999) reported 46% of injuries were sustained in the third period and 47% of injuries were sustained in the last 5 minutes of a match-play time in junior level ice hockey and Woods *et al.* (2004) stated that half of all hamstring injuries sustained during matches occurred in the last 15 min of each half.

Accepted conjecture is that muscle strain injuries occur when a muscle is stretched passively or activated during stretch (Garrett, 1996; Kirkendall & Garrett, 2002). This theoretical rationale has been deduced from laboratory studies of isolated animal muscle which have shown that strain (degree of lengthening expressed in SI units) has a higher degree of correlation with muscle damage than with muscle force (Lieber & Friden, 2002), velocity (Brooks & Faulkner, 2001), strain rate (Best *et al.*, 1995) and contraction status of the muscle (Garrett *et al.*, 1987). If extended to human running, this paradigm suggests that the hamstring muscles are prone to strain injury in the late swing phase (eccentric phase) rather than early ground contact when the hamstring contraction is concentric (Thelen *et al.*, 2006; Chumanov *et al.*, 2007; Yu *et al.*, 2008; Chumanov *et al.*, 2012). In such a situation, stretch and negative work requirements may couple together at high speeds to contribute to injury risk. For example, the cumulative negative work done over repeated maximal stretch-shortening contractions may predispose a muscle to injury (Butterfield & Herzog, 2005). Alternatively, injury can result from stride-to-stride variability in the peak stretch imposed, with an excessive stretch in a single stride leading to the onset of injury (Thelen *et al.*, 2006).

As well as increasing injury risk, exercising to fatigue, particularly when unaccustomed eccentric contractions are involved, can result in muscle damage that presents as soreness in the 24 to 48 hrs after exercise. This phenomenon is known as delayed onset muscle soreness (DOMS) (Tufano *et al.*, 2012). It is not known exactly what causes DOMS but theories include skeletal muscle damage, inflammatory responses and oxidising free radical damage (Barnett, 2006; Lewis *et al.*, 2012). Damage to skeletal muscle is thought to result from excessive or unaccustomed exercise causing disruption in some sarcomeres, resulting in the myosin and actin filaments no longer interdigitating properly (Armstrong *et al.*, 1991; Proske & Morgan, 2001)

thus potentially representing a weakness in the muscle. During repeated eccentric contractions, this area of disruption grows until the membranes are torn and the muscle fibre contracts uncontrollably, raising the passive tension of the whole muscle (Proske *et al.*, 2004). This also causes damage to the muscle cell membrane resulting in inflammatory response and leading to the formation of metabolic waste products, which act as a chemical stimulus to the nerve endings that directly cause a sensation of pain (MacIntyre *et al.*, 2001). These metabolic waste products also increase vascular permeability and attract neutrophils (a type of white blood cell) to the site of injury. Once at the site of injury, neutrophils generate free radicals (molecules with unshared electrons), which can further damage the cell membrane (Toumi & Best, 2003). Swelling is also a common occurrence at the site of membrane injury, and can lead to additional sensations of pain (Pyne, 1994).

Although empirical research has not established a sound and consistent treatment for DOMS, suggested interventions have included pharmaceuticals, pre-exercise warm-up, nutritional supplements, aerobic cool-down, massage and stretching (Connolly *et al.*, 2003; Barnett, 2006; Robey *et al.*, 2009; Henschke & Lin, 2011; Herbert *et al.*, 2011; Takizawa *et al.*, 2012; Tufano *et al.*, 2012). Studies considering the effect of pre-exercise stretching have found no significant effects on symptoms of DOMS (High *et al.*, 1989; Wessel & Wan, 1994; Johansson *et al.*, 1999). Of these studies, one randomised participants to stretch and control conditions (High *et al.*, 1989) and the others stratified by participants and randomised legs to stretch and control conditions (Wessel & Wan, 1994; Johansson *et al.*, 1999). These studies were quasi-experimental in design, consisted of 80 to 600s of stretch time per muscle group and used between 10 and 30 healthy adult participants. None of the studies concealed allocation, blinded participants or assessors or explicitly analysed by intention to treat and thus could not be considered of high methodological quality (De Morton, 2009). Pooled estimates showed that pre-exercise stretching reduced soreness one day after exercise by an average of 0.5 points on a 100 point scale (Herbert *et al.*, 2011) and thus the mean effect was too small to be of clinical relevance. Studies investigating the effect of stretching on DOMS have differed in the stretching techniques they have used, lengths of time stretches have been held for and when stretching has been performed in relation to the exercise bout (High *et al.*, 1989; Wessel & Wan, 1994; Johansson *et al.*, 1999). It is accepted that gentle exercise relieves the pain that is present in DOMS, even if only temporarily (Connolly *et al.*, 2003; Robey *et al.*, 2009), possibly because of a break up of adhesions in the

affected muscles, increased removal of noxious waste products due to the increased blood flow or endorphin release as a result of the activity (Cheung *et al.*, 2003). It is therefore possible that if static stretching is performed after exercise, lengthening the muscle through its full range, formation of adhesions may be limited. Studies that have investigated the effect of post-exercise stretching on other measures of exercise induced muscle damage have failed to find any significant effects (Buroker & Schwane, 1989; Dawson *et al.*, 2005; Weber, 2012; Torres *et al.*, 2013), possibly due to the heterogeneity of participants and low sample numbers. Johansson *et al.* (1999) found that pre and post-exercise stretching did not attenuate force loss following exercise in 10 female volunteers while Lund *et al.* (1998) showed that force loss was actually emphasised following pre and post-exercise stretching in 7 untrained women. It was interesting to note that the force loss in the stretching group continued for up to seven days post exercise (Lund *et al.*, 1998). Jamtvedt *et al.* (2010) conducted a 12 week program in which participants were asked to stretch major muscle groups for 30s before and after physical activity. This did not result in reduced injury risk but did reduce the risk of what was termed ‘*bothersome soreness*’ (Jamtvedt *et al.*, 2010). Because of the use of both pre- and post-exercise stretching, it is impossible to determine whether post-exercise stretching alone would have these effects. Some of the participants in the study reported a spontaneous relief in pain following the post-exercise stretching but the effect lasted only a few minutes. No attempts have yet been made to determine whether these feelings correlate to alterations in measures of dynamic flexibility.

2.11 SUMMARY

This review of literature highlights some common misconceptions and misunderstandings in the area of flexibility and stretching. The reliability of the techniques used to examine static and dynamic flexibility is questionable due to insufficient investigation, use of inappropriate statistical analysis and incorrect interpretation of results. Establishing reliability of static and dynamic measures of flexibility is paramount before it can be investigated whether any expected changes as a result of a stretching intervention would be detected or whether they would be disguised by random error (type II error). Studies comparing different measures of static and dynamic flexibility of the hamstring are necessary to consider the relationships shared by different tests and thus applicability of findings to clinical and field practice.

Conventional clinical practice suggests that stretching can enhance performance and reduce injury risk by increasing flexibility but current scientific research does not support this notion. Extensive quasi-experimental and experimental studies have been conducted to examine the effectiveness of different methods of stretching in improving static flexibility and whilst there are some equivocal findings, the general consensus is that stretching does increase static flexibility. There is less agreement on the impact of stretching on measures of dynamic flexibility, strength, performance and JPS with conclusions ranging from stretching negatively to positively affecting these measures. The disparity in findings is possibly in part caused by the use of differing methodologies and measurement techniques and furthermore, it is uncertain whether commonly used static flexibility tests give information about the mechanical properties of musculotendinous units.

As a consequence of findings that pre-exercise stretching can cause reductions in subsequent performance alongside having equivocal or no perceivable benefit to injury risk, suggestions have been made that static stretching should instead be performed after exercise sessions as part of the cool-down regime. Post-exercise stretching is believed to reduce the effect of DOMS through limitation of adhesion formation, dispersal of oedema and restoration of resting length and tension despite there being little supporting empirical evidence for this conjecture. Exercise of sufficient volume and intensity to induce fatigue is thought to increase risk of musculoskeletal injury occurrence. Proposed mechanisms for this include lowered energy absorbing capability of fatigued muscle, reduced proprioception, altered electromechanical delay, exercise induced microtrauma and increased resting tension and therefore stiffness of fatigued muscle. If stretching after exercise can positively affect any of these parameters, it is likely to be of benefit. These findings have generally been demonstrated though the use of isolated muscle in animal models. It remains to be established whether extrapolation of these to whole muscle groups in humans is appropriate and therefore further research into the effect of post-exercise stretching on the biomechanical characteristics of human muscle is warranted.

CHAPTER 3

**INTRA AND INTERDAY RELIABILITY
OF HAMSTRING FLEXIBILITY
MEASURES**

3.1 INTRODUCTION

Despite flexibility assessment being commonplace within sport medicine and sciences since Cureton's early work in the 1940's (Cureton, 1941), evidence of reliability is limited which may partially account for equivocal findings in the flexibility literature (Hopkins, 2000; Gabbe *et al.*, 2004; Weir, 2005; Janssen & Le-Ngoc, 2009; Bozic *et al.*, 2010; Ayala *et al.*, 2011; Sporis *et al.*, 2011; Ayala *et al.*, 2012; Frohm *et al.*, 2012; Nagai *et al.*, 2012; Nunes *et al.*, 2012; Reurink *et al.*, 2013). In order to make judgements about the effectiveness of stretching interventions it is essential that the extent of error in the assessment of stretching is known. Existing literature reporting reliability of flexibility measurements is based on relatively few studies that have used a range of different measurement tools and generally small and often heterogeneous samples. Furthermore, reflecting changes in clinical and medical research (Bland & Altman, 1986; Nevill & Atkinson, 1997; Atkinson & Nevill, 1998; Weir, 2005; Ayala *et al.*, 2012b), a movement in sport medicine and sciences has questioned the appropriateness of the statistical techniques (e.g. correlation) traditionally used to reflect measurement reliability. Consequently, this threatens the credibility of the findings of past studies that selected measures based on such statistics. This has crucial implications for current and future empirical investigations (Lamb & Rogers, 2007) and identifies the need for further research evaluating the reliability of flexibility measurements using contemporary statistical approaches.

One basic assumption of reliability is the repeatability of measurements, i.e. the extent to which the measurements of a test remain constant over repeated tests of the same participants under identical conditions. A measurement is deemed reliable if it yields consistent results, or unreliable if repeated measurements give different results (Reurink *et al.*, 2013). Reliability can thus be described as the absence of measurement error, although in reality some degree of measurement error is always present with continuous data (Costa-Santos *et al.*, 2011). For a group of measurements, the total variance in the data can be thought of as being due to true score variance and error variance and similarly, each observed score is composed of the true score and error (Equation 3.1).

$$\text{Reliability (R)} = \frac{\text{true score} - \text{error score}}{\text{true score}}$$

Equation 3.1 – Theoretical formula for reliability (adapted from Weir, 2005)

As the true score for each participant is not known in reliability studies, an index of true score variance based on between-participant variability is used (Equation 3.2).

$$R = \frac{\text{between participants variability} - \text{measurement error or residual variance}}{\text{between participants variability}}$$

Equation 3.2 – Generic reliability formula (adapted from Safrit & Wood, 1989)

Measurement error can be due to systematic bias (distorting the results in a specific direction, e.g. later scores worse due to fatigue) or random error (adds variability but not in a particular direction, e.g. biological variation or inconsistencies in measurement procedure). Systematic error can be a natural phenomenon and not necessarily a defect of the procedure but should be recognised and treated differently in different situations (Hopkins *et al.*, 2009). Although methodology should focus on equipment with small learning effects, or allow sufficient familiarisation to reduce learning effects, this is not always possible in a clinical setting where patient availability is limited and the extent of familiarisation that would be necessary is often unknown. Quantification of type and magnitude of error is important to determine whether a potentially small but meaningful effect would be detected (Dvir, 2003), although it is often impossible to separate the effects of different sorts of error (Weir, 2005).

3.1.1 Methods for determining reliability

Intratester or intrarater reliability reflects the consistency of repeated measurements taken by one tester over time (Rousson *et al.*, 2002). It is assessed by having one tester take measurements on one set of individuals on at least two separate occasions keeping all other testing conditions as constant as possible. Intratester reliability is demonstrated by the tester making repeated measurements and producing consistent scoring (Peeler & Anderson, 2008), and in relation to clinical practice, is important to detect small but possibly meaningful changes as a result of time or intervention. Intertester reliability is the reproducibility of measurements taken by different testers (Hopkins *et al.*, 2009). It is an assessment of a measurement situation rather than tool and

must be demonstrated if measures are to be taken by two or more individuals (Batterham & George, 2003).

Pearson Product Moment (PPM) correlation coefficients (r) are often used in sport medicine and sciences to quantify reliability (Weir, 2005) with the idea that if a high (> 0.80) and statistically significant coefficient is obtained, the measurement is adequately reliable (Atkinson & Nevill, 1998). PPM is calculated using standard deviations about the mean and works on the assumption that measures are bivariate in nature (Hopkins, 2000). As reliability studies involve repeats of the same measurement and are thus univariate, the use of PPM correlation coefficients is inappropriate and instead intraclass correlation coefficients (ICCs) should be reported (Chen & Barnhart, 2008). These have become a popular choice for reporting reliability in sport sciences and medicine, and have been utilised in some studies investigating the reliability of static measures of flexibility. A high correlation coefficient infers the participants will mostly keep their same places between tests, whereas a low correlation means they will be in a different order, thus the coefficient is a dimensionless index that provides some measure of relative reliability (Weir, 2005). A number of problems are evident with the use of correlation coefficients as indexes of reliability including that the magnitude of the coefficient is influenced by the heterogeneity (spread) of the values and is an indicator of relationship rather than agreement between measures and thus do not detect systematic bias (Bland & Altman, 1986; Nevill & Atkinson, 1997). Application of ICC is complex because there are six common methods of calculating the ICC (Shrout & Fleiss, 1979). The choice of ICC model relates to the number of testers and the extent of systematic error between measures and although there have been attempts to simplify selection with a model nomenclature approach, this is not intuitively obvious and thus there is confusion about both calculation and interpretation of ICCs.

ICCs are calculated from mean squares values derived from a within-subjects, single factor ANOVA (i.e., a repeated measures ANOVA) and can theoretically vary between 0 and 1.0, where a 0 indicates no reliability and 1.0 indicates perfect reliability, although with actual data the extremes rarely exist (Equation 3.3).

$$\text{ICC} = \frac{\text{Mean Square Variance between Participants} - \text{Mean Square Variance within Participants}}{\text{Mean Square Variance between Participants}}$$

Equation 3.3 – Formula for ICCs (adapted from Fleiss, 1986)

ICC model selection depends on the decision to consider between trial differences as random or systematic measurement error, whether or not error is considered a natural aspect of the variable being measured and the population from which the raters are drawn. Static flexibility studies have reported ICC models 1,1 [used when each subject is rated by multiple raters, raters assumed to be randomly assigned to subjects, all subjects have the same number of raters and there is some systematic difference between measurements (Pua *et al.*, 2008)] and 2,2 [used when all subjects are rated by the same raters who are assumed to be a random subset of all possible raters and there is no systematic difference between measurements (Janssen & Le-Ngoc, 2009)]. Researchers have often misapplied the ICC (2,1) to data from a single item of equipment. This is derived from the fully random model, where subjects and trials are considered as random effects and should be used when retesting subjects on different equipment, methods or installations. This makes the correct model for a simple test-retest study 3,1 (two way mixed model with absolute agreement; all subjects are rated by the same raters who are assumed to be the entire population of raters) providing one does not wish to generalise the ICCs beyond the confines of the study (Shrout & Fleiss, 1979). Furthermore the ICC (3,1) is unbiased for any sample size (McGraw & Wong, 1996) and can be calculated in such a way that it is sensitive to systematic bias within data but combines this to provide an index of total error as opposed to distinguishing between systematic and random error. The ICC nonetheless reflects relative reliability and whilst useful, it should not be used as the sole index of reliability but reported with other measures of error that can be more easily related to analytical goals (Weir, 2005).

Absolute reliability measures enable researchers to use their own judgement to assess the reliability of measurements in terms of clinical significance or meaningfulness, rather than accepting or rejecting a hypothesis on the basis of statistical significance (Ayala *et al.*, 2011). This involves knowing how much a dependent variable is expected to differ between defined groups or change following some controlled intervention and if the magnitude of measurement error is greater than the value of any expected change, considering that such a change might not be detected and thus the chance of a type II error occurring. To give an index of expected trial-

to-trial noise, it has been suggested that Bland and Altman's Limits of Agreement (LOA) technique should be used to assess reliability of data that is parametric in nature (Bland & Altman, 1986). LOA must only be performed if test-retest differences among subjects are normally distributed, if test and retest means are not significantly different and if there is no significant relationship between test-retest differences (expressed without sign) and test-retest means (Atkinson & Nevill, 1998). As these limits contain 95% of differences if data are normally distributed, researchers can use their own judgement to assess the suitability or reliability of a measurement in terms of clinical significance or meaningfulness (Costa-Santos *et al.*, 2011).

As well as the amount of measurement error, consideration should be given to the manner in which reliability studies are conducted. Reliability is frequently assessed by test and retest being administered in the same day (intraday), referred to as internal consistence reliability (Rousson *et al.*, 2002). Assessing intraday reliability is appropriate if the measurements, when applied to practice or research, are conducted in this manner, i.e. all testing of each participant completed within a single day, although care must be taken if there is a long period between initial and final testing sessions as results can be affected by circadian variation (Gribble *et al.*, 2007). If applied practice and/or research dictates participants are to be tested on different days, as is common in sport science and medicine, between day (interday) reliability also needs to be reported. This is known as stability reliability. Interday reliability values are generally lower than intraday reliability values because values can be affected by biological variations as well as measurement errors (Hopkins, 2000).

3.1.2 Reliability of flexibility measurements

Goniometric assessment of static flexibility is commonplace and allows the quantification of movement using angular units, usually degrees (Peeler & Anderson, 2008) and to date, reliability studies have tended to consider static flexibility measures as dependent variables (Watkins *et al.*, 1991; Holm *et al.*, 2000; Gabbe *et al.*, 2004; Norris & Matthews, 2005; Davis *et al.*, 2008; Peeler & Anderson, 2008; Pua *et al.*, 2008; Ayala *et al.*, 2012b). Different types of goniometer have demonstrated different readings for the same measurement (Bierma-Zeinstra *et al.*, 1998), which identifies a need for reliability indices unique to each type of goniometer. Previous reliability studies have reported ICCs ranging from 0.57 to 0.97 ($p \leq 0.05$) for static hamstring flexibility

measures (Bierma-Zeinstra *et al.*, 1998; Davis *et al.*, 2008; Pua *et al.*, 2008; Ayala *et al.*, 2011; Ayala *et al.*, 2012b; Reurink *et al.*, 2013). Despite coefficients of variation of between 5 and 28%, because of these moderate to high correlation coefficients and no significant differences between test and retest scores, measures were deemed reliable. Studies have also reported that static flexibility readings taken by experienced clinicians varied by 6 to 8° in the same testing session in healthy and previously injured individuals (ICC = 0.57 to 0.80, $p \leq 0.05$) (Rothstein *et al.*, 1983; Armstrong *et al.*, 1998; Reurink *et al.*, 2013). Additionally, many studies examining the reliability of static flexibility measures have attempted to control variables not ordinarily controlled in a clinical setting in an attempt to maximise internal validity (Gajdosik *et al.*, 1993; Bierma-Zeinstra *et al.*, 1998; Holm *et al.*, 2000) therefore results do not necessarily reflect the reliability of goniometry as it is used clinically and thus lack ecological validity (Riddle *et al.*, 1987).

There is very little published research reporting reliability data for measures of dynamic flexibility. In terms of passive dynamic hamstring flexibility, intrarater reliability with test and retest performed one hour apart produced PPM correlation coefficients in the range of $r = 0.91$ to 0.99 ($p \leq 0.05$) and thus the tests were interpreted as being reliable. As discussed previously, the use of PPM for reliability studies is inappropriate as they are bivariate statistics and additionally, same day reliability studies do not take into account any variability that might occur as a result of time (Lamb & Rogers, 2007) therefore there is no evidence that this methodology would be reproducible if measures were taken on separate days. Furthermore, as such studies utilised a convenience sample of healthy volunteers, results might not be applicable to a more specialised population (Morrow & Jackson, 1993).

3.1.3 Aims and hypotheses

The aim of this investigation was to establish the intraday and interday, intratester reliability of static flexibility measures (active and passive ROM) and passive dynamic flexibility measures (energy absorbed, peak torque and stiffness) of the hamstring muscle group. The relative reliability was examined via use of ICCs and it was hypothesised, on the basis of existing literature, that the measures would provide high (> 0.80) and statistically significant ICCs. The absolute reliability and thus degree of measurement error was examined to give a context for acceptable intervention change in future studies and was established by 95% LoA (Bland &

Altman, 1986). The 95% LoA are not hypothesis driven since researchers and clinicians should consider errors in relation to their analytical goals.

Summary aims of the chapter were to:

- Develop criteria to help justify an appropriateness of the test;
- Establish reliability between days;
- Define and measure variability within the outcome measures; and
- Acquire benchmark measurement error criteria to evaluate stretching in elite rugby players.

3.2 PILOT STUDIES

3.2.1 Previous research procedures

There is limited published methodological information related to the procedures to measure passive dynamic flexibility. The earliest method of using an isokinetic dynamometer to examine passive torque of the human hamstring muscle during controlled passive stretch was developed by Magnusson *et al.* (1995). Participants were seated in the chair of a KinCom dynamometer with the trunk perpendicular to the seat. The thigh was rested on what was described as a ‘specially constructed thigh pad’, elevating it 0.52 rad above the horizontal. The lower leg was moved at a speed of $0.087 \text{ rad}\cdot\text{s}^{-1}$ from a position of 0.85 rad below the horizontal to a predetermined final position that provoked a sensation similar to a static stretching manoeuvre but was below the level that would cause a painful response (Figure 3.1).

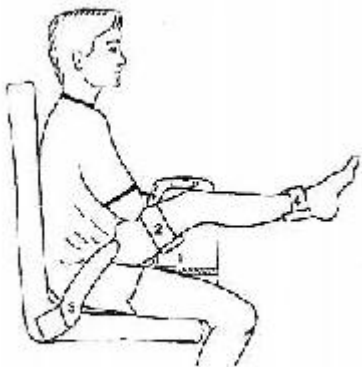

Figure 3.1 - Test position used for stretch manoeuvre by Magnusson et al. (1995)

Electromyographic (EMG) activity of the human hamstring group was measured and processed but as it was not significantly different in the initial compared to final five seconds of passive stretch manoeuvres, it was concluded that EMG was not a significant contributor during passive static stretch (Magnusson *et al.*, 1995).

3.2.2 Procedures

3.2.2.1 Set-up

Early pilot work for this study focused on attempting to replicate the method described by Magnusson *et al.* (1995). When replicating this procedure the participants (n = 8) found the positioning restrictive, uncomfortable and unfamiliar. It was therefore instead decided to utilise a method based on the universally used PSLR test.

3.2.2.2 Passive straight leg raise approach

Isokinetic dynamometers do not have adaptors for a SLR movement so these had to be designed and constructed. To ensure that any potential hypermobility at the knee did not influence testing, these comprised of two parts. The knee part was 25cm long so that the knee could be held in full extension without placing any stress on the posterior joint capsule, and thus preventing knee hyperextension influencing results. The ankle part was 12cm long and positioned just proximal to the medial malleolus so that the leg was comfortably supported but no pressure placed on the gastrocnemius muscle, which might have affected flexion of the ankle and thus influenced stretch of the sciatic nerve. Thick Velcro straps, positioned above and below the knee and above the ankle, were securely fastened to ensure there was no movement of the limb away from the adaptors. Participants lay supine in the dynamometer chair with their hip placed in line with the axis of rotation of the lever arm. EMG activity was recorded by electrodes placed on the posterior thigh midway between the gluteal fold and popliteal crease with a 3 cm inter-electrode distance. The root mean square of muscle activity was normalised to a maximum voluntary isometric contraction recorded at the completion of each test. EMG was expressed as a percentage of the activity recorded during maximum isometric voluntary contraction. If recorded EMG levels showed no visible change during the passive stretch manoeuvre, stretch reflex was not considered to have occurred. Increased EMG activity was not apparent during trials thus agreeing with previous studies (Magnusson *et al.*, 1995; Magnusson *et al.*, 1996; Klinge *et al.*, 1997; Magnusson *et al.*, 1997).

Although results appeared to be reliable with test and retest scores showing little variation, participants reported that the stretch was often limited by a burning sensation in their calf and foot rather than tension in the hamstring. As the SLR test is also used for neural tension testing (Guissard & Duchateau, 2006), it was considered possible that tests were placing stress on the sciatic nerve rather than the hamstring muscle in some participants, despite the absence of increased EMG activity. There was no way to alter the construction of the adaptors to minimise this potential stress further therefore, because the model was being developed to assess musculotendinous stiffness, the possible influence of neurological structures rendered it unsuitable and focus therefore returned to initial methodology.

3.2.2.3 Passive knee extension approach

In the first attempts to replicate the Magnusson procedure it had been necessary to incline the back of the dynamometer chair in front of the vertical to 80° to ensure that the more flexible participants could not reach full knee extension using the 0.52 rad wedge described by Magnusson *et al.* (1995). This led to participants reporting they felt '*nervous*', '*crunched up*' and '*uncomfortable*' which was reflected in curves that were non-uniform and with large peaks and troughs as participants shifted their positions. To reduce these negative sensations, a larger wedge was designed to raise the thigh to 0.79 rad above the horizontal so that the back of the dynamometer chair could remain vertical. The initial wedge was too short and placed painful levels of pressure on the posterior thigh so a longer model was constructed. Special straps were also developed to ensure that the thigh did not lift off this wedge during the terminal stages of knee extension and thus give artificially high results.

EMG analysis was conducted for early trials to confirm the absence of increased EMG activity at terminal ROM as described for the previous methodology. No increase in EMG activity at terminal stretch was apparent. In addition to these findings, it has previously been shown that EMG activity is unrelated to force decline or ROM (Moore & Hutton, 1980; Etnyre & Abraham, 1986; McHugh *et al.*, 1992; Mitchell *et al.*, 2009). Due to potential time constraints of using professional athletes and the lack of useful information gleaned from measurement of EMG, it was decided that this analysis would not be incorporated into the actual study.

Consideration was given to the use of the dominant compared to non-dominant limb. Early trials did not demonstrate noticeable differences in flexibility of right and left, and dominant and non-dominant legs, which is in agreement with previous reports of no significant differences between flexibility of preferred and non-preferred kicking legs in soccer players (Rahnama *et al.*, 2005). Further assessing any differences between the two legs was not a consideration of this study. Time restrictions also made it more favourable to keep the dynamometer chair in one position throughout testing sessions and this also helped eliminate any error that might occur through slight variations in chair positioning as a result of moving it.

Gravity correction was carried out with participants seated in the position to be used for the study and with the leg at the starting position for the passive stretch manoeuvre (0.26 rad). The weight of the limb in this position was recorded by the isokinetic dynamometer. It is necessary to subtract the weight of the limb segment that produces a moment (rotational force) from the force measurements obtained when the limb segment is moved against gravity (Nelson and Duncan, 1983; Winter *et al.*, 1981). Manufacturers instructions state that there should be no muscular tension when following gravity correction procedures as this can affect the gravity correction algorithms of the dynamometers (Finucane *et al.*, 1994). The position of 0.26 rad utilised for gravity correction in this study was chosen as subsequent to this, the passive tension recorded began to increase and it was thus deduced that passive tension of the hamstrings would affect the value. Calibration was carried out in various positions and through range by using a 98N load. This ensured that stress relaxation of the lead cell did not occur.

3.2.2.4 Warm-up

Prior to any flexibility testing, it is accepted that some warm-up is necessary to reduce thixotropic associated muscle stiffness (Proske *et al.*, 1993; Walsh *et al.*, 2009) but varying tissue temperature has been shown to affect stiffness (Strickler *et al.*, 1990; Noonan *et al.*, 1993). Because it was difficult to ensure that any aerobic warm-up would raise tissue temperature uniformly, it was decided to utilise cyclic warm-ups, similar to those performed in animal studies (Garrett *et al.*, 1987; Taylor *et al.*, 1993; Mair *et al.*, 1996) and to also use this as part of familiarisation with the protocol. As the club routinely performed isokinetic training and testing, participants were expected to be used to performing concentric, eccentric and isometric contractions but many had never experienced passive movements. Five passive movements with

visual feedback from the isokinetic dynamometer computer screen and verbal feedback from the tester were used to help ensure that participants were aware what was expected of them and they were able to relax fully during these manoeuvres.

3.2.2.5 Data analysis

Early results showed that although passive torque increased as angle increased, the load deformation plot was not always a uniform curve. Magnusson *et al.* (1995) considered the torque-angle curve obtained from the dynamometer to have three approximately even portions, an initial toe region, a transition period and a linear portion. Stiffness was calculated as the slope of the linear portion of the curve. Energy absorbed (work done) figures for each third of and the total curve were obtained from the dynamometer and used for subsequent analysis but authors did not provide a biomechanical or physiological rationale for dividing the curve into thirds and it may be that it was simply convenient as many isokinetic dynamometers provide data in this way. Additionally, there was no information given pertaining to the smoothing or data fitting of the described curves. Rather than following the methodology of these previous studies, gradient was calculated at specific points of the curve by differentiating the equation of the curve and substituting various values for x . After attempting to do this manually and using different software, it was determined that the mathematical package 'Derive' would be most appropriate. Initial tests found that results were more consistent if 3rd order rather than 4th order polynomial curves were fitted to the data. This software was also used to integrate the curves giving values for area under the curve (energy absorbed). This required identifying the most suitable limits and extracting the appropriate data set from the values provided by the dynamometer for each trial. As tests were performed to maximum achievable range, this was the upper limit and the lower limit of 0.26 rad was chosen as it was deemed the point that the dynamometer began to measure resistance to the passive movement. Because some studies have examined biomechanical characteristics of muscle to a common range, the ROM reached by the most inflexible participant was used as a measurement point to provide information on this.

When more than one trial is given, the reliability is often reported as the mean of all trials, yet practitioners typically administer a single trial. It has been suggested that an estimate of single trial reliability should be reported if one trial is typically used when determining the measure (Morrow and Jackson, 1993). Previous research into the reliability of instrumentation for

assessing flexibility has considered single (Watkins *et al.*, 1991; Youdas *et al.*, 1993; Norris & Matthews, 2005) or the mean (Gajdosik & Lusin, 1983; Cornbleet & Woolsey, 1996) of measurements. Although using the mean value of a raters repeated measurements to carry out ICC calculations is a statistically valid approach, ICC based on the mean of several measurements will be greater than the ICC of a single measurement (Eliasziw *et al.*, 1994). It was thus decided to use one measurement rather than mean of measurements and because participants generally obtained the larger flexibility scores on the final test, this value was used for subsequent analysis.

3.2.2.6 Sample size estimation

Sample size for reliability studies must be the same as would be used in an experiment to delimit the smallest worthwhile effect of a treatment but the difficulty lies in not being able to estimate the sample size without knowing the typical error (Hopkins, 2000). Estimation of sample size must instead be based on consideration of precision for the typical error. Sample size calculations indicated that 39 participants were necessary to detect greater than moderate reliability ($\alpha = 0.05$ and $\beta = 0.20$) (Walter *et al.*, 1998). This calculation is for samples from a general population and as the population used in this study was elite rugby league players and therefore more limited, it is likely that use of a smaller sample size would give an adequate refection of the population (Morrow & Jackson, 1993). Additionally, Hopkins (2000) stated that the likely range for typical error with 30 participants completing two trials is 0.77 to 1.30 whereas with 50 participants it is to 0.82 to 1.22, further supporting the use of 40 participants. Previous studies investigating reliability of isokinetic dynamometers in measuring dynamic flexibility have used only 8 to 15 participants from much larger populations composed of healthy individuals, recreationally active individuals or university and school students (Magnusson, 1998). Sample size of this study, as well as meeting criteria established in the literature, was therefore greater and more specialised than in previous studies.

3.3 METHODS

3.3.1 Participants

Forty rugby league players volunteered to participate in this study (age 19.72 years \pm 2.49, stature 1.78m \pm 0.06, mass 88.58kg \pm 9.84 [mean \pm SD]). Sample size calculations indicated that 39 participants were necessary to detect greater than moderate reliability ($\alpha = 0.05$ and $\beta = 0.20$)

(Walter *et al.*, 1998). All participants were part of a Great Britain Superleague Rugby League Club and familiar with the use of an isokinetic dynamometer. Testing was conducted in the first half of the season when participants were involved in training sessions four to five times a week and matches once or twice a week. For inclusion in the study, participants were certified free of lower limb injury by the club physiotherapist and considered to be in good physical condition. Because participants were all completing the same training programme and were tested within the season, they were considered to be of similar and close to peak fitness levels. Whilst fitness differences were likely between players, in part related to their position, this was not considered because a range of players from different positions (e.g. forwards and backs) were included within the sample. Participants were excluded if they had previously sustained any form of hamstring injury or were not currently participating fully in all training sessions scheduled by the club. Written informed consent was obtained prior to the study from the participants themselves if over the age of eighteen or via the club following letters being sent to parents or guardians if participants were u/18. In such situations club personnel acted in loco parentis during testing sessions. Ethical approval was obtained from the University of Pretoria's Post-graduate Committee and the Ethical Committee.

3.3.2 Study design

The study was of repeated measures design. One experienced experimenter took all measurements. There was a period of one hour between testing sessions for the intraday test-retest protocol and two weeks for the interday test-retest protocol, to fit in with the club training schedule. Participants were asked to refrain from any strenuous activity for at least three hours prior to testing to ensure that any influence from different levels of fatigue, tissue temperatures and thixotropic state of the muscle were minimal (Cornelius *et al.*, 1992; Noonan *et al.*, 1993; Proske & Morgan, 1999; Noakes, 2000).

3.3.3 Procedures

3.3.3.1 Passive properties

A Biodex system 2 isokinetic dynamometer and associated software (Biodex Medical Systems Inc., USA) (intraday protocol) and a Con-Trex MJ isokinetic dynamometer and associated software (Con-Trex Biomechanical Test and Training Systems, Switzerland) (interday protocol) were used to assess the biomechanical properties of the hamstring muscle during passive knee

extension (Nm). Both dynamometers have been shown to exhibit similar reliability for knee flexion and extension movements in healthy participants (Lund *et al.*, 2005; Maffiuletti *et al.*, 2007). Prior to testing the dynamometers were calibrated with a load cell to ensure that stress relaxation of the equipment was not occurring. All measurements were corrected for gravity. Participants were the same for the intraday and interday protocols. Because there can be some viscoelastic response to repeated stretch (Magnusson *et al.*, 1995), tests were performed in the same order. To minimise the effect of this, passive dynamic flexibility tests were conducted first so that participants could be taken through five controlled passive knee extension movements. Throughout testing, temperature of the lab remained constant.

Participants were seated in the chair of the dynamometer with the trunk perpendicular to the thighs. The right thigh was placed on a 0.79 rad specially constructed thigh pad. The lateral condyle of the femur was placed in line with the axis of rotation of the lever arm. The lower leg was secured to the dynamometer attachment 2 cm proximal to the medial malleolus of the ankle. The upper leg was fixed to the specially constructed thigh pad by a strap placed across the femur 5 cm proximal to the condyles. Additional straps were used to fix the upper body and contralateral limb to the chair. The starting position for the test was set at an angle of 0.26 rad of knee flexion. Prior to commencing testing, participants were taken through five passive knee extensions at a rate of 0.09 rad.s⁻¹ to a point where they experienced a feeling of stretch in their posterior thigh. During the test, participants were asked to relax fully while their knee was passively extended at 0.09 rad.s⁻¹ to a point when they felt a strong but not painful stretching sensation in their posterior thigh. At this point the test was immediately stopped and the leg quickly returned to the starting position. This was repeated three times, partly for comparability to other flexibility research (Gajdosik & Lusin, 1983; Magnusson *et al.*, 1995; Cornbleet & Woolsey, 1996) and partly to ensure participants were comfortable with the assessment procedure before the final measurement was taken. Torque during passive knee extension was recorded by the dynamometer. Data from the final test was exported for analysis.

3.3.3.2 Static flexibility

Static flexibility (ROM) measurements were taken using a clinical goniometer (MIE Medical Research Ltd, UK). This was zeroed to the horizontal prior to testing being commenced. For all measurements, participants lay supine on a treatment plinth with their legs fully supported and

were asked to try and keep their lower back and left limb flat on the table at all times. They were instructed to move as far as possible for active tests and to a point where they felt a strong stretching sensation similar to that experienced on the dynamometer for passive tests. Final positions were held for 3 s and ROM recorded. This timing was chosen as it provided sufficient time to ensure that the position was stable but would not have affected the viscoelastic properties of the muscle and thus subsequent measurements (Ford *et al.*, 2005; Brandenburg, 2006). As for passive dynamic flexibility, measurements were repeated three times with the final value being used for analysis. For AKE and PKE, participants were instructed to flex their right hip to 90°. The experimenter placed a hand on the thigh to help ensure that it stayed in the same position while the knee was extended. For ASLR and PSLR, participants were asked to keep their right knee fully extended while their right hip was flexed.

3.3.3.3 Statistical analysis

Data obtained from the isokinetic dynamometer were exported into Microsoft Excel 2000. 3rd Order Polynomial Curves were fitted and using Derive (version 7), equations of the fitted curves ($y = ax^3 \pm bx^2 \pm c \pm k$) were differentiated to find the gradient at the highest common point achieved by all participants (stiffness at 0.99 rad) in addition to the final position achieved by individual participants (final stiffness) and integrated to find the area under the curve (energy absorbed to 0.99 rad and total energy absorbed) during the passive knee extension manoeuvre. Measures of passive torque at 0.99 rad, maximum range achieved and passive peak torque were recorded.

The normality of the data sets was determined by a one-sample Kolmogorov-Smirnov test. Descriptive statistics, intraclass correlation coefficients (3,1) and 95% limits of agreement (Bland & Altman, 1986) were calculated using SPSS (Statistics Package for the Social Sciences, version 16.0) and Microsoft Excel 2000. The 95% limits of agreement included plotting a graph (Bland-Altman plot) of the mean for the participants test and retest results $[(\text{test} + \text{retest})/2]$ on the x axis corresponding to the difference between each participants test and retest results (test - retest) on the y axis. Heteroscedasticity occurs in test data when the amount of random error (test - retest) increases as the measured value increases (mean of test and retest). Heteroscedasticity is common in sports medicine-related variables as they are usually measured on a ratio scale (Nevill & Atkinson, 1997). ICC analysis was performed to check for heteroscedastic errors and

as no significant relationships were identified and correlation coefficients were all considered small ($r < 0.20$), absolute LoA were calculated (Bland & Altman, 1986). The 95% LoA were expressed as ± 1.96 multiplied by the mean of the differences between test and retest. Statistical significance was set at $p \leq 0.05$ for all hypothesis testing.

3.4 RESULTS

From Table 3.1 it can be seen that the mean values for test and retest were similar across all measurements. Intraclass correlation coefficients ranged from 0.85 to 0.98 ($p \leq 0.05$). These scores represent the proportion of variance that is attributable to between subjects variability (Weir, 2005) and indicate that 2 to 15% of the difference is attributable to measurement error (Traub & Rowley, 2005).

The LoA indicate that there was some degree of measurement error present across all measures in both test and retest. The first value of the limits of agreement is a measure of systematic bias and the second value of the random error. It appears that this was a small amount of systematic bias present in the measurements taken using the dynamometer and those with a goniometer. All measurements exhibited some degree of random error. The measurement error for energy absorbed indicated that, in 95% of the population, a typical measurement of 13 Nm for passive torque at 0.99 rad could range from 8.2 Nm to 16.9 Nm while a measurement of 30 Nm for passive peak torque could range from 21.5 Nm to 36.1 Nm. A maximum angle measurement of 1.4 rad could vary from 1.4 rad to 1.5 rad, for stiffness at 0.99 rad a gradient of 22 could range from 12.9 to 30.9 and for final stiffness 53 could range from 32.3 to 79.3. A usual measurement of 6 J for energy absorbed to 0.99 rad could range from 4.8 J to 6.8 J and for total energy absorbed 15 J could range from 9.5 J to 18.2 J. For the ROM measurements, angles of 69° for AKE could range from 62.6° to 74.9°, 78° for PKE could range from 72.7° to 85.3° (Figure 3.2), 71° for ASLR could range from 66.4° to 75.3° and 80° for PSLR could range from 74.3° to 86.8°.

Table 3.1 - One hour test-retest reliability values for measures of static and passive dynamic hamstring flexibility

Dynamometer	Test Mean (95% CI)	Retest Mean (95% CI)	ICC	95% LoA
Passive Torque @ 0.99 rad (Nm)	13.5 (11.7, 15.2)	13.9 (12.1, 15.7)	0.88*	-0.4 ± 4.34
Maximum Range (rad)	1.4 (1.4, 1.5)	1.5 (1.4, 1.5)	0.97*	-0.0 ± 0.1
Maximum Passive Torque (Nm)	30.6 (27.5, 33.8)	31.9 (28.7, 35.0)	0.90*	-1.2 ± 7.3
Gradient @ 0.99 rad	21.7 (18.1, 25.3)	21.8 (19.0, 24.6)	0.87*	-0.1 ± 9.0
Final Gradient	56.6 (48.0, 65.2)	53.8 (45.4, 62.2)	0.85*	2.8 ± 23.4
Energy Absorbed @ 0.99 rad (J)	6.1 (5.4, 6.8)	6.3 (5.5, 7.0)	0.96*	-0.2 ± 1.0
Maximum Energy Absorbed (J)	15.3 (13.3, 17.3)	16.2 (14.0, 18.4)	0.93*	-1.2 ± 4.4
ROM				
AKE (°)	68.3 (64.6, 71.9)	68.7 (64.8, 72.6)	0.95*	-0.3 ± 6.2
PKE (°)	77.5 (73.7, 81.3)	76.7 (72.5, 80.8)	0.95*	1.0 ± 6.3
ASLR (°)	70.5 (66.7, 74.4)	70.6 (66.4, 74.8)	0.97*	-0.2 ± 4.5
PSLR (°)	79.4 (75.0, 83.7)	78.5 (74.1, 98.0)	0.98*	0.6 ± 6.2

* denotes $p \leq 0.05$

An example of a LoA plot is shown in Figure 3.2, and illustrates that all measurements for PKE apart from one outlier, lie within the 95% LoA.

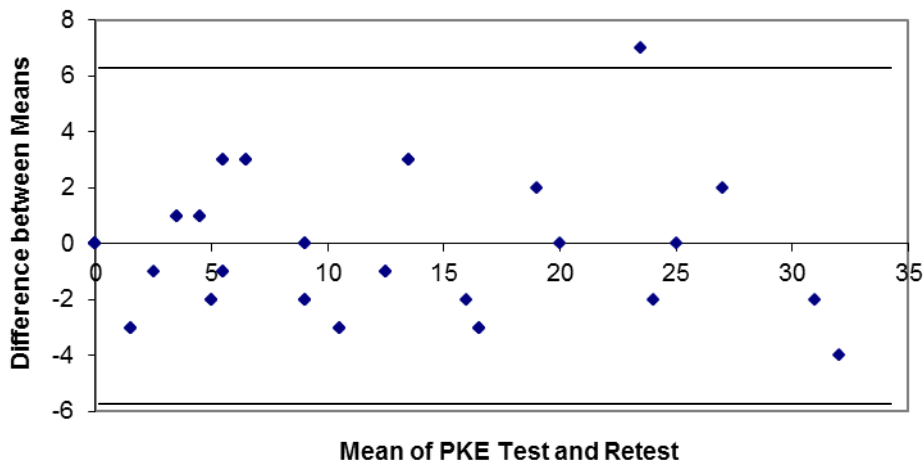

Figure 3.2 – Example of limits of agreement plot for PKE

ICCs (3,1) for one week test-retest ranged from $r = 0.86$ to 0.98 ($p \leq 0.05$). These scores represent the proportion of variance that is attributable to between subjects variability and indicate that 2 to 14% of the difference is attributable to measurement error.

The LoA indicate that there was some degree of measurement error present across all measures in both the test and retest (Table 3.2). There was a small amount of systematic bias present and some random error present in all measurements. The measurement error for energy absorbed indicated that, in 95% of the population, a typical measurement of 49 Nm for passive torque at 0.99 rad could range from 40.8 Nm to 56.6 Nm, maximum angle of 1.5 rad from 1.36 rad to 1.63 rad and maximum passive torque of 83 Nm from 70.5 Nm to 91.9 Nm. For stiffness at 0.99 rad, a typical gradient of 56 could range from 45.2 to 67.2 and final stiffness of 95 from 65.1 to 118.3. A typical measurement of 25 J for energy absorbed to 0.99 rad could range from 19.0 J to 30.0 J and total energy absorbed of 55 J from 46.8J to 61.0 J. True value for a ROM measurement for AKE of 68° lie in the range of 61.1° to 76.1° , PKE of 75° in the range of 69.7° to 80.6° , ASLR of 70° in the range of 74.1° to 76.7° and PSLR in the range of 61.7° to 87.4° .

Table 3.2 – Interday test-retest reliability values for measures of static and passive dynamic hamstring flexibility

Dynamometer	Test	Retest	ICC	95% LoA
	Mean (95% CI)	Mean (95% CI)		
Passive Torque @ 0.99 rad (Nm)	48.9 (39.7, 58.1)	49.2 (39.6, 58.8)	.97*	-0.3 ± 7.9
Maximum Range (rad)	1.5 (1.4, 1.6)	1.5 (1.4, 1.7)	.97*	-0.0 ± 0.1
Maximum Passive Torque (Nm)	83.6 (74.3, 92.8)	85.4 (76.5, 94.3)	.95*	-1.8 ± 10.7
Gradient @ 0.99 rad	56.3 (44.0, 68.6)	56.1 (43.8, 68.4)	0.97*	0.2 ± 11.0
Final Gradient	95.2 (82.7, 107.7)	98.5 (82.7, 114.3)	0.89*	-3.3 ± 26.6
Energy Absorbed @ 0.99 rad (J)	24.6 (19.4, 29.8)	25.1 (19.9, 30.4)	0.96*	-0.5 ± 5.5
Total Energy Absorbed (J)	56.2 (47.4, 64.9)	57.3 (49.2, 65.4)	0.98*	-1.1 ± 7.1
ROM				
AKE (°)	68.9 (63.9, 73.9)	68.3 (63.1, 73.5)	.92*	0.6 ± 7.5
PKE (°)	75.0 (70.2, 79.8)	74.8 (70.5, 79.1)	.95*	0.2 ± 5.4
ASLR (°)	70.0 (64.2, 75.8)	74.8 (70.5, 79.2)	.87*	-4.6 ± 9.3
PSLR (°)	76.9 (69.9, 83.8)	80.3 (74.3, 86.3)	.86*	-3.5 ± 10.8

* denotes $P \leq 0.05$

Substantially different absolute measures of peak torque, total energy absorption and stiffness were obtained depending on which isokinetic dynamometer was used (Table 3.3). Values of peak torque were 277% greater on the Contrex compared to the Biodex in this study and 260% greater on the KinCom in the study of Magnusson *et al.* (1996) compared to that of Reid and McNair (2004). Values of total energy absorbed were 379% and final stiffness 171% as great on the Contrex compared to the Biodex. Final stiffness values reported by Magnusson *et al.* (1996) were 1158% greater than those reported by Reid and McNair (2004).

Table 3.3 - Values of passive dynamic hamstring flexibility recorded on different models of isokinetic dynamometer

	Final ROM	Peak Torque	Total Energy Absorbed	Final Stiffness
Biodex	1.44	30.62	15.26	56.58
Contrex	1.53	85.03	57.86	96.85
KinCom (Reid and McNair, 2004)	1.29 to 1.47	72.7 to 114.4		3.31 to 4.18
KinCom (Magnusson <i>et al.</i> , 1996)		44.0	18.6	47.7

3.5 DISCUSSION

The aim of this investigation was to establish the intraday and interday, intratester reliability of static flexibility measures (active and passive ROM) and dynamic flexibility measures (passive energy absorbed, peak torque and stiffness) of the hamstring muscle group. Relative reliability was examined via use of ICC and absolute reliability and thus amount of measurement error was examined via establishing 95% limits of agreement (Bland & Altman, 1986).

3.5.1 Static flexibility reliability

Results showed that static flexibility measurements taken on the same day (intraday reliability, table 3.1) and on different days (interday reliability, Table 3.2) exhibited high ICCs (3,1) and thus a high relative reliability, supporting the hypothesis of the study. Reliability was higher for intraday static flexibility measurements ($r = 0.95$ to 0.98 , $p \leq 0.05$) than for interday static flexibility measurements ($r = 0.86$ to 0.95 , $p \leq 0.05$). Many studies considering the reliability of static flexibility measurement have considered only reliability of measurements taken in a single day (Gajdosik & Lusin, 1983; Riddle *et al.*, 1987; Armstrong *et al.*, 1998; Davis *et al.*, 2008; Peeler & Anderson, 2008; Ayala *et al.*, 2011; Ayala *et al.*, 2012b; Frohm *et al.*, 2012; Reurink *et al.*, 2013). As studies investigating the effect of stretch interventions on static flexibility measurements are often carried out across a number of days or weeks, considering only intraday reliability measurements is inappropriate (Morrow & Jackson, 1993) as interday measurements

may introduce different biological and procedural variations to those encountered within a day (Dixon & Keating, 2000). The results of this study are in agreement with previous studies in finding lower relative reliability of interday compared to intraday studies (DeVita & Bates, 1988; Hamill & McNiven, 1990) but as the values are greater than 0.8, the measurement can be deemed to demonstrate high interday relative reliability. Reliability of static flexibility measurements may be influenced by changes that result from repeated testing trials (Gajdosik & Bohannon, 1987) and researchers have reported that increases in static flexibility occur systematically over trials during a one to three day period (Cameron & Bohannon, 1993; Ghoncheh & Smith, 2004). This suggests that recording the average of several measurements might increase reliability of static flexibility tests in studies that have wide variations or systematic increases, but will have little effect in studies with more stable measurements. Additionally, it is known that an ICC based on the mean of several measurements will be greater than the ICC of a single measurement (Eliasziw *et al.*, 1994). The use of a single measurement in this study reduced the possibility of an artificially high relative reliability value and further confirms the high intra and interday reliability values obtained.

Although ICCs give accurate and easily interpreted measure of relative reliability or rank order within a sample, they give no information on absolute reliability. LoA analysis allows the reliability to be expressed in the units of measurement (Bland & Altman, 1986). Results showed that little systematic bias was indicated in the static flexibility measurements but there was a fairly large amount of random error. There are a number of possible reasons for this. All participants in the study would have been familiar with static flexibility measurements as these form part of many fitness assessments and thus there would be unlikely to be any learning effect present (Lund *et al.*, 2005). This is possibly the reason why there was little systematic bias present. The random error could be due to the fact that measurements were taken in a manner that would mimic a clinical setting, i.e. the pelvis and contralateral limb were not secured to the table and for the knee extension tests, no apparatus was used to ensure that the knee remained at 90°. The degree of random error in maximum ROM achieved on the dynamometer was less (0.10°) than that of PKE (5.4 to 6.3°), possibly because unlike during PKE measurement, participants were fully secured into the chair of the dynamometer which would have limited unwanted movement of other body parts. The use of highly stabilised movements, whilst seemingly reducing random error, has little application to applied practice and research since

clinically measures are not taken in this manner and thus the reliability findings cannot be applied to these settings. Additionally, it is possible that different amounts of pressure were applied to movements and that feedback from participants on what they felt was the end point varied (Gajdosik, 2001b). According to the inductive approach, this was unlikely to be a significant factor as the experimenter was experienced in taking measurements of passive static flexibility and consciously attempted to apply consistent force to the limb (Ferlie *et al.*, 1999; Greenfield *et al.*, 2007).

Magnitude of error is important when conducting longitudinal studies to determine the effects of various interventions such as stretching on static or dynamic flexibility levels of the hamstring muscle group (Jones *et al.*, 2002). As the amount of error is fairly large for the static flexibility measurements, it is possible that such tests, even though displaying high ICCs, are actually not sensitive enough to detect small but potentially clinically relevant changes in these variables. For example, as a result of a stretching programme, a participant might be expected to make gains of 8° in PKE (Harvey *et al.*, 2002). According to the limits of agreement, the true value for the measurement will lie in a range of approximately 13° and these gains of 8° may therefore not be detected. As static flexibility tests are commonly used, this is a potential reason for conflict in the literature examining effects of stretching for clinical and performance reasons. Re-examination of results with consideration given to absolute error of measurements is warranted to confirm or deny previous findings and try to reach some consensus as to the effect of stretching interventions on measures of static flexibility.

3.5.2 Dynamic flexibility reliability

Early studies investigating reliability of isokinetic dynamometers for measuring passive dynamic hamstring flexibility inappropriately calculated PPM (Magnusson *et al.*, 1995) and therefore although isokinetic dynamometers have become accepted methods of measuring passive dynamic flexibility, their reliability had not been correctly established. Shimon *et al.* (2010) reported intraday, interrater ICC of $r = 0.89$ but did not describe which ICC they had used (Shimon *et al.*, 2010). Results of this study demonstrated intraday ICCs (3,1) of $r = 0.85$ to 0.98 ($p \leq 0.05$) and interday ICCs (3,1) of $r = 0.89$ to 0.98 ($p \leq 0.05$). From these, it can be deemed that both dynamometers have good relative reliability in measuring the dynamic flexibility of the

hamstring muscle group during a controlled stretch manoeuvre thus supporting the hypothesis of this study.

As an index of absolute reliability LoA analysis showed that there was some systematic bias in the measurements taken on the dynamometer, with a small increase on the test compared to retest, and a larger amount of random error present. Most of the participants were familiar with the dynamometer but none had previously gone through passive movements to their maximum ROM. Participants completed five passive movements before testing commenced, partly as a warm-up to reduce thixotropic associated muscle stiffness (Proske *et al.*, 1993) and partly as a familiarisation session. It is possible that more familiarisation should be included prior to testing but this was not possible due to the time constraints of professional sport. A warm-up involving whole body physical activity was not undertaken to reduce any effects of altered muscle temperature, as this has been shown to affect muscle stiffness (Noonan *et al.*, 1993). Previous studies have shown that acute stretch induced increases in static (Duong *et al.*, 2001; Ryan *et al.*, 2008) and dynamic flexibility (Magnusson *et al.*, 1995; Matsuo *et al.*, 2013; Mizuno *et al.*, 2013) reset in under an hour. Based on these findings, the period between test and retest in intraday measures would have allowed any changes in flexibility as a result of the measurement procedures to have returned to baseline values. Although the passive manoeuvres on the dynamometers were well stabilised, some random error could be due to movement or muscle contraction during the test procedures, slight variations in participant positioning between tests or insufficient sensitivity of test instrumentation.

3.5.3 Dynamometer comparison

Results showed substantial differences between the absolute values obtained on the Biodex isokinetic dynamometer compared to those from the Contrex isokinetic dynamometer in this study (Table 3.3). Comparison of results from this study with those obtained in previous studies using KinCom isokinetic dynamometers also showed differences in absolute values achieved, both between different dynamometers and between different protocols on the same dynamometer. It has been suggested that there is a lack of comparability between separate makes of dynamometers for measures of peak torque (Greenberger *et al.*, 1994; Leggin *et al.*, 1996) and this difference is further increased if different subject positioning and protocols are used (Croisier *et al.*, 2002). Prior to this study, there has been no available data comparing values of

passive torque, stiffness and energy absorbed obtained from the same individuals on different makes of dynamometer. It is possible that companies manufacture dynamometers according to their own specifications, thus giving inconsistent results for the same measurement if different models of dynamometer are used. One of the major factors affecting isokinetic measurements is the moment of the gravitational forces of the involved segments and the dynamometer input arm (Kellis & Baltzopoulos, 1996). Mechanical work has been shown to vary by 26 to 43% for knee extensors and 55 to 510% for knee flexors in the absence of gravity correction (Winter *et al.*, 1981) and differences in participant positioning can affect gravitational moments. Some studies have estimated gravitational moments in a seated position (Feiring *et al.*, 1990; Griffin *et al.*, 1993; Tis *et al.*, 1993) whereas others have used a supine position (Worrell *et al.*, 1990; Fitzgerald *et al.*, 1991). Although some studies have found that measurements taken in a prone and supine position were not significantly different (Nelson & Duncan, 1983), others reported that gravitational moments were greater in a seated compared to supine position (Ford *et al.*, 1994). Furthermore, different gravity correction procedures are followed when using different dynamometers with some manufacturers recommending protocols that measure gravitational moments in a static position whereas others recommend a dynamic motion (Kellis & Baltzopoulos, 1996). Results from this and previous studies suggest that absolute data values, particularly those that are measured passively, should only be compared if collected from the same type of dynamometer. Further investigation into the role of gravity correction on different machines should be conducted using strain gauges or calculations based on anthropometric data. A standard protocol for measuring gravity correction should also be established to examine the extent that subject positioning and protocol affect the absolute measurements obtained from the dynamometers. Because of the differences in the absolute values obtained, it was decided to use only one dynamometer for further study. As the Contrex Isokinetic Dynamometer was more readily available, further studies were conducted on this alone.

3.5.4 Practical Implications

Flexibility assessment methods with minimal or acceptable measurement error are essential to monitor progression and effectiveness of injury prevention and recovery strategies (Atkinson & Nevill, 1998). Existing published research examining reliability of flexibility measurements has typically utilised highly stabilised static flexibility measures that are not consistent with practise, participants primarily from convenience samples of University students or active individuals, and

have focused on intraday reliability and thus do not take into account any variability that might occur as a result of time. Additionally, PPM correlations have been reported which is inappropriate for reliability studies because PPM is a bivariate statistic that measures strength of linear association, and reliability studies involve univariate measures (Maher, 1993). Chapter 3 utilised a homogenous sample from a specific athletic population in an endeavour to control for Type II errors and provide meaningful results that could be applied to a professional sport setting (Nevill & Atkinson, 1997). Significant interday static flexibility ICCs (3,1) suggested good relative reliability ($r = 0.86$ to 0.98 , $P \leq 0.05$) but LoA detected fairly large amounts of random error (5.4 to 10.8°). Few studies investigating the reliability of static flexibility measures have considered magnitude of error and those that have reported measurement errors of up to 36° despite correlations of 0.65 to 0.72 (Gabbe *et al.*, 2004; Peeler & Anderson, 2008; Peeler & Anderson, 2008). Stretching has been reported to increase static flexibility measures by a mean of 8° (Harvey *et al.*, 2002) thus static flexibility tests might not be sensitive enough to detect these potentially clinically relevant changes as a result of stretch interventions. The measurement error associated with static flexibility tests may partly account for inconsistencies in literature related to flexibility and injury risk.

3.5.5 Limitations

The intraday reliability part of the study utilised a one-hour period between test and retest. Previous studies have shown that any changes in static flexibility or mechanical properties of a muscle following a stretch reset to baseline in under an hour (Magnusson *et al.*, 1996; Ryan *et al.*, 2008), although other studies have indicated that the effects of stretching last much longer than this (de Weijer *et al.*, 2003). It is possible that a period of one hour between tests is insufficient for the hamstring to have returned to its baseline state. Studies have shown that time of day can affect flexibility, strength and postural control (Reilly *et al.*, 1984; Gifford, 1987; Coldwells *et al.*, 1994; Atkinson & Reilly, 1995; Michael *et al.*, 2003). If the period between test and retest had been too great, circadian variations in flexibility could potentially affect the results but further studies are needed to investigate this.

The limits of agreement presented here can only be applied to males playing rugby league at a semi-professional or professional level following the same procedures as the current study. Further studies using different populations of participants are warranted to establish reliability of

measurement procedure and allow further investigation of biomechanical factors that might influence static and dynamic flexibility.

3.5.6 Reflections

Previous studies using similar methodology have used small samples ($n = 8$ to 15) of school children, university students or recreational athletes to calculate reliability (McHugh *et al.*, 1992; Magnusson *et al.*, 1995; Magnusson *et al.*, 1996; Magnusson *et al.*, 1996; Shimon *et al.*, 2010). Convenience samples such as these can exhibit heteroscedascity as well as potentially large variations in fitness levels, which might impact on results of planned interventions, therefore this study utilised professional rugby league players. This provided some challenges in design and implementation of protocols. Testing sessions were severely constrained by time and had to be designed around participant availability. Additionally, there was no control over the activities that were performed on the day prior to testing. Through liaison with the coach and club physiotherapist, lists of players that were available to be tested on specific days were provided. To ensure that maximum numbers possible were tested, it was necessary to adhere to a strict testing timetable. Many pre-testing sessions on non-study participants were conducted to ensure that procedures were fine-tuned and that the testing routine was well practiced and would run smoothly. Later interventions also had to be designed around club requirements and player availability. Although the use of such participants placed restrictions on the testing protocol and procedures, it was felt that the opportunity of gaining access to such homogenous participants at an elite level of sport outweighed the disadvantages of this.

Due to lack of clarity in methodology described by Magnusson *et al.* (1995), extensive work was required to replicate the protocol. As isokinetic dynamometers are not generally used for passive movements to maximum ROM, instructions were not available in operational manuals and had to be determined from available functions. Furthermore, a number of wedges had to be designed and constructed to provide sufficient thigh elevation to prevent full knee extension while remaining comfortable for participants. This required a number of trials on non-athletic volunteers and adaptation of first the wedge and then the straps used to fix the thigh and other limb to the dynamometer chair. Challenges were also presented in determining the most appropriate way of analysing the data from the isokinetic dynamometer. It was felt that using the data directly as provided (split into thirds) as per previous methodology lacked theoretical

rationale and was thus not appropriate. Instead it was decided to use mathematical software to facilitate the differentiation and integration of curves, therefore allowing measurements at or to any points to be calculated. Learning to use the software proved challenging but was worthwhile due to the information provided, although on reflection, rather than differentiating the curve at specific points for measures of stiffness, it might have been more appropriate to consider a 1-2° portion of the curve to minimise potential inconsistencies due to momentary deflections of the curve as possibly helping to reduce the random error of stiffness measurements.

3.6 CONCLUSIONS

ICCs demonstrated high relative reliability for measures of static and dynamic hamstring flexibility, thus accepting the hypothesis. There was a degree of absolute measurement error, the magnitude of which must be interpreted in relation to analytical goals and the expected extent of change. There was a small amount of systematic bias present in static and dynamic flexibility measures and a larger amount of random error. The degree of random error in flexibility measurements means that care must be taken before categorising any interventions as effective or ineffective as the tests may not be sufficiently sensitive and thus type II errors might occur. Dynamic flexibility measures were specific to the model of isokinetic dynamometer and this should be taken into account when considering absolute reliability values.

CHAPTER 4

**COMPARISON BETWEEN DIFFERENT
METHODS
OF MEASURING STATIC AND
DYNAMIC HAMSTRING FLEXIBILITY**

4.1 INTRODUCTION

Flexibility measurements are commonly used by clinicians to evaluate the ability of the musculotendinous unit to lengthen, with the assumption that a more flexible muscle can be stretched further and to a higher ultimate strain and is therefore less susceptible to injury than a stiffer muscle (Blackburn *et al.*, 2004; Pruyn *et al.*, 2012). This conjecture lacks substantive supporting evidence and does not take into account that flexibility is constrained by a number of factors including neural, mechanical, joint and other constraints, e.g. skin, temperature, etc. (Bozic *et al.*, 2010; Ditroilo *et al.*, 2013). The passive stiffness of muscle has classically been regarded as being determined by connective tissue elements surrounding individual muscle fibres, bundles of fibres and whole muscles (Ramsey & Street, 1940). Later attempts to measure the contribution of connective tissue to stiffness have suggested that it contributes only at long sarcomere lengths (Casella, 1950; Rapoport, 1972; Tidball, 1986) and that structures within muscle fibres contribute to resting stiffness (Magid & Law, 1985). These include portions of the cytoskeletal network, especially connecting filaments composed of protein, titin (Horowitz *et al.*, 1989) and low level cross bridge interactions (Hill, 1968). These findings have been elicited using animal models and have often not included components of non-muscular origin.

Johns and Wright (1962) showed that in the cat wrist, the joint capsule actually contributed more to stiffness (47%) than the muscles (41%), tendons (10%) and skin (2%). *In vitro* experimental models have attempted to distinguish the mechanical consequences of reflex activity from those due to the intrinsic properties of the joint and muscle by comparing the behaviour of a joint under normal conditions with that observed after deafferentation, local contraction by artificial stimulation, immobilisation in a shortened position or a combination of these methods (Goldspink, 1976; Goldspink, 1977; Tardieu *et al.*, 1982; Jarvinen *et al.*, 1992; Herbert & Balnave, 1993; Herbert & Crosbie, 1997; Yang *et al.*, 1997; Joumaa *et al.*, 2008). These results have indicated that flexibility is primarily a result of myogenic rather than neurogenic mechanisms but it cannot be assumed that conditions would be the same for *in vivo* models. Flexibility is likely to be restricted to a greater extent at joints that have bi or multi-articular muscles as nervous structures might be stressed at the limits of the range (McHugh *et al.*, 2012). *In vivo* studies have suggested that among other things, flexibility is dependent on the viscoelasticity of the musculotendinous unit, ligaments and other connective tissues (Magnusson *et al.*, 2001; Sobolewski *et al.*, 2013). This is somewhat simplistic and previous research has

often has not taken into account that flexibility has both static and dynamic components (Bojsen-Moller *et al.*, 2007; Ditroilo *et al.*, 2011). Researchers and clinicians have measured static flexibility and used results to make assumptions about movement or injury kinematics that would be more related to dynamic flexibility (Bennell *et al.*, 1999; Tyler *et al.*, 2001; Witvrouw *et al.*, 2003; Rahnama *et al.*, 2005; Bradley & Portas, 2007; Hrysomallis, 2009) which could be one of the reasons for the disparity among researchers as to the effect of different levels of flexibility on injury risk and performance levels (Thacker *et al.*, 2004; Shrier, 2005; Foreman *et al.*, 2006; Small *et al.*, 2008; Kay & Blazevich, 2012; Simic *et al.*, 2013).

There is a lack of universally agreed definition as to what constitutes hamstring flexibility and therefore no agreed measurement procedure (Weppeler & Magnusson, 2010). Different methods of measuring hamstring flexibility have been shown to yield different results. Early research tended to consider only static hamstring flexibility measurements such as SLR and KE tests. Researchers considering the association between different methods of assessing active and passive static hamstring flexibility have shown relationships between tests of AKE and PKE ($r = 0.64$ to 0.87 , $p \leq 0.01$, common variance = 41% to 76%) but relationship between ASLR and PSLR has not been specifically examined (Cameron & Bohannon, 1993; Gajdosik *et al.*, 1993; Rolls & George, 2004; Davis *et al.*, 2008; Shimon *et al.*, 2010; Ayala *et al.*, 2011; Ayala *et al.*, 2012a). The unexplained variance of 24 to 59% between AKE and PKE tests suggests that there are different factors constraining these tests. In order to allow the hamstring to lengthen there is reciprocal inhibition from contraction of the quadriceps in the AKE as well as a force moment around the knee joint. It is known that muscles with greater moment arms undergo greater passive strain during joint motion (Magnusson *et al.*, 2000) and that for a given static situation the external moment about the knee joint is counterbalanced by the internal moment. As the results from PKE are generally greater than AKE tests, it is likely that the force applied externally by investigators is greater than that the body can generate through quadriceps contraction alone.

Studies investigating the relationship between different passive static hamstring flexibility tests have shown that PKE and PSLR ($r = 0.16$ to 0.66 , $p \leq 0.01$, common variance = 3% to 44%) share significant positive relationships (Cameron & Bohannon, 1993; Gajdosik *et al.*, 1993; Rolls & George, 2004; Davis *et al.*, 2008). Despite being significant, weak correlations in some instances

suggests that there are quite different factors influencing the result of each test. Similar to results for passive static flexibility tests, results for active static flexibility tests indicate that AKE and ASLR ($r = -0.72$, $p \leq 0.01$, common variance = 51%) are significantly positively related but nonetheless share little more than half their variance (Cameron & Bohannon, 1993; Gajdosik *et al.*, 1993; Rolls & George, 2004; Davis *et al.*, 2008). Consequently researchers have questioned the ability of SLR tests to assess static hamstring flexibility independently of other variables (McHugh *et al.*, 2012). It is possible that factors such as neural tension, movement of the pelvis and varying degrees of stabilization affect measures of static flexibility although little attempt has been made to quantify the extent of these potential influences (Davis *et al.*, 2008).

Some attempts have been made to study dynamic flexibility in both humans (Bach *et al.*, 1983; Wilson *et al.*, 1991; Wilson *et al.*, 1994; Halbertsma *et al.*, 1996; Walshe *et al.*, 1996; Magnusson, 1998; McHugh *et al.*, 1998; Hunter & Spriggs, 2000; Fukashiro *et al.*, 2001; Blackburn *et al.*, 2004; Reid & McNair, 2004; Owen *et al.*, 2005; Ryan *et al.*, 2008; Watsford *et al.*, 2010; Ditroilo *et al.*, 2011; Palmer *et al.*, 2013; Sobolewski *et al.*, 2013) and animals (Garrett *et al.*, 1987; Nikolaou *et al.*, 1987; Garrett *et al.*, 1988; Taylor *et al.*, 1993; Noonan *et al.*, 1994; Best *et al.*, 1995; Mair *et al.*, 1996; Taylor *et al.*, 1997; Yang *et al.*, 1997; Black & Stevens, 2001). Human models have used either damped oscillation techniques (Bach *et al.*, 1983; Wilson *et al.*, 1991; Wilson *et al.*, 1994; Walshe *et al.*, 1996; Hunter & Spriggs, 2000; Fukashiro *et al.*, 2001; Blackburn *et al.*, 2004; Owen *et al.*, 2005; Watsford *et al.*, 2010; Ditroilo *et al.*, 2011) or assessed load-deformation characteristics of muscle during passive movements (McNair & Stanley, 1996; Klinge *et al.*, 1997; Magnusson, 1998; Halbertsma *et al.*, 1999; Hunter & Spriggs, 2000; Magnusson *et al.*, 2000; Halbertsma *et al.*, 2001; McNair *et al.*, 2001; Gajdosik, 2002; Reid & McNair, 2004; Ryan *et al.*, 2008; Palmer *et al.*, 2013; Sobolewski *et al.*, 2013) while animal models have assessed stress-strain relationships of individual muscle fibres or muscle groups (Garrett *et al.*, 1987; Nikolaou *et al.*, 1987; Garrett *et al.*, 1988; Taylor *et al.*, 1990; Noonan *et al.*, 1994; Best *et al.*, 1995; Mair *et al.*, 1996; Taylor *et al.*, 1997; Yang *et al.*, 1997; Black & Stevens, 2001).

Studies investigating the viscoelastic characteristics of the hamstring muscle group in stiff (defined by not being able to extend hands past level of stool on toe touch test) compared to normal participants suggested that at a given angle, stiffer muscle absorbs a greater amount of

energy than does more flexible muscle (Magnusson *et al.*, 1997; Hobara *et al.*, 2010). Animal models have been used to examine factors that might contribute to muscle strain injury and have repeatedly shown that the energy absorbing capability of muscle is an important variable (Noonan *et al.*, 1994; Sun *et al.*, 1994; Garrett, 1996; Macpherson *et al.*, 1996; Lieber & Friden, 2002). These findings have been based on failure characteristics of stimulated and non-stimulated muscle and reported that muscle activation alone failed to result in strain injury, and that to obtain an injury, stretch was necessary. Furthermore, although total strain at failure was similar, force generated at failure was only 15% greater in the active muscles, but energy absorption was increased by 100% compared to the non-active muscle (Garrett, 1996). Basic science therefore suggests that in contrast to popular belief, it is possible that it is actually stiffer, rather than more flexible individuals who are at reduced risk of injury due to the higher energy absorbing capability of their muscles.

Few attempts have been made to compare values obtained from static hamstring flexibility tests to dynamic hamstring flexibility tests and available results are equivocal. In a series of studies, Magnusson *et al.* found that individuals with lower static flexibility exhibited lower passive peak torque and energy absorption than more flexible individuals, but that more flexible individuals demonstrated a higher stretch tolerance (Magnusson *et al.*, 1995; Magnusson *et al.*, 1996; Magnusson *et al.*, 1996; Magnusson *et al.*, 1996; Magnusson *et al.*, 1997; Magnusson *et al.*, 1998; Magnusson *et al.*, 2001). McHugh *et al.* (1998) found a significant relationship between energy absorbed by the hamstring, measured during an instrumented PSLR tests, and ROM on PSLR test as measured clinically using a goniometer ($r = 0.49$, $p \leq 0.05$; common variance = 25%). Common variance climbed to 79% when the increase in torque from 20 to 50° was also added into a stepwise multiple regression ($r = 0.89$, $p \leq 0.05$). Researchers suggested that static flexibility is predominantly limited by passive mechanical constraints and it was hypothesised that the remaining variance may have been due to an active contractile component at terminal ROM (McHugh *et al.*, 1998). This study did not take into account the possibility that the predictor variables were related to each other and thus the presence of multicollinearity (Lago *et al.*, 2010). Furthermore, McHugh *et al.* (1998) reported no significant relationship between passive peak torque and ROM that participants were able to achieve ($r = 0.09$, $p > 0.05$) which conflicts with Magnusson *et al.* (1997) who found a difference in passive peak torque in individuals exhibiting higher and lower levels of static flexibility.

Normally a high and statistically significant correlation coefficient is interpreted as a strong relationship between two variables (Hopkins *et al.*, 2009) but these coefficients can depend greatly on the range of values present in the sample (Janssen & Le-Ngoc, 2009). Most studies considering relationships between different measures of flexibility have used convenience samples, predominantly University students or active adults. Such participant groups can exhibit potentially a large range of measurements, which can result in artificially high relationships being found (Weir, 2005; Hopkins *et al.*, 2009). It remains to be established whether a homogenous sample of participants, such as athletes competing at professional level in the same sport, will share the same relationships between measures of flexibility as those found in more general samples (Hopkins, 2000). Additionally, because of the high incidence of hamstring injuries in sport, club physiotherapists routinely conduct testing of static hamstring flexibility (Pruyn *et al.*, 2012) and the applicability of these results to measures of dynamic flexibility should be considered. Because of the dearth of evidence empirically examining the validity of static flexibility tests for assessing dynamic properties of muscle, further research in this area is warranted to determine the extent of the relationship between the end point of goniometric measurements and the mechanical properties of the musculotendinous unit. Additionally, due to conflicting findings, the relationship between measures of dynamic and static hamstring flexibility needs further investigation.

4.1.1 Aims and hypotheses

The aim of this study was to evaluate the relationship shared by commonly used tests of static hamstring flexibility with measures of dynamic hamstring flexibility in professional rugby league players participating in the Great Britain Superleague.

Hypotheses were as follows;

- 1) There would be no significant positive relationship between KE and SLR tests;
- 2) AKE and PKE tests would share a significant positive relationship, as would ASLR and PSLR tests;
- 3) There would be a significant positive relationship between KE tests and energy absorbed by the hamstring during controlled KE on an isokinetic dynamometer;

- 4) Participants who were tight ($< 80^\circ$ on PSLR test) would have significantly greater stiffness than normal participants ($> 80^\circ$ on PSLR test); and
- 5) There would be no significant positive relationship between KE tests and level of passive peak torque and final stiffness.

4.2 METHODS

4.2.1 Participants

Twenty-five rugby league players volunteered to participate in this study (age $17.72 \text{ years} \pm 1.49$, stature $1.78\text{m} \pm 0.06$, mass $88.58\text{kg} \pm 9.84$ [mean \pm SD]). These were chosen from the sample that participated in the study reported in Chapter 3. The whole sample was not available due to National squad duties. SPSS sample power software indicated that this would give a sufficient power ($\alpha = 0.05$ and $\beta = 0.14$) by one-tailed correlation comparing values in the literature ($r = 0.49$, $p \leq 0.05$) (Blackburn *et al.*, 2004) against a theoretical value (constant) of 0.00. All participants were part of a Great Britain Super League rugby league club and testing was conducted mid-season when participants were involved in training sessions four to five times a week and matches once or twice a week. For inclusion in the study, participants were certified free of lower limb injury by the club physiotherapist and considered to be in good physical condition. Because participants were all participating in the same training programme and were tested within the season, they were considered to be of similar fitness levels close to their peak. Participants were excluded if they had previously sustained any form of hamstring injury or were not currently participating fully in all training sessions scheduled by the club. Written informed consent was obtained prior to the study from the participants themselves if over the age of eighteen years or via the club following letters being sent to parents or guardians if participants were under eighteen years, along with verbal assent from the participants themselves. In such situations club personnel acted in loco parentis during testing sessions. Ethical approval was obtained from the University of Pretoria's Post-graduate Committee and the Ethical Committee.

4.2.2 Procedures

Measurements were taken in a single testing session. Participants were asked to refrain from any strenuous activity for at least three hours prior to testing to ensure that effects from fatigue, different tissue temperatures and thixotropic state of the muscle were minimal (Cornelius *et al.*,

1992; Noonan *et al.*, 1993; Proske & Morgan, 1999; Noakes, 2000). The study followed assessment procedures described in Chapter 3.

4.2.3 Statistical analysis

Data obtained from the Isokinetic Dynamometer were exported into Microsoft Excel 2000. 3rd Order Polynomial Curves were fitted and using Derive (version 7), equations of the fitted curves ($y = ax^3 \pm bx^2 \pm c \pm k$) were differentiated to find the final stiffness (gradient) and integrated to find the energy absorbed (area under the curve) during the passive knee extension manoeuvre. To allow comparison with less stabilised static hamstring flexibility measurements, the maximum angle each participant achieved during passive knee extension on the dynamometer (MaxROM) was recorded.

Statistical analysis was performed using SPSS (Statistics Package for the Social Sciences, Version 16.0). The normality of the data sets was determined by one-sample Kolmogorov-Smirnov (K-S) test. Because data were not significantly different from normal distributions curve, parametric tests were used for analysis. Relationships between different hamstring flexibility measures were analysed by calculating PPM correlations and from the results, coefficients of determination (R^2) and common variances were calculated. Independent t-tests were performed to test for differences in dynamic flexibility measurements of participants who were tight ($< 80^\circ$) and normal ($> 80^\circ$) based on the results of the PSLR test (Göeken & Hof, 1993; Halbertsma *et al.*, 1999). Statistical significance was set at $p \leq 0.05$.

4.3 RESULTS

4.3.1 Relationship between static flexibility measurements

MaxROM on the dynamometer was significantly positively related to all static flexibility tests ($r = 0.52$ to 0.67 , $p \leq 0.05$, common variance = 27 to 45%). Significant positive relationships were identified between AKE and ASLR ($r = 0.91$, $p \leq 0.05$, common variance = 83%) and PKE and PSLR ($r = 0.86$, $p \leq 0.05$ common variance = 74%). The AKE and PKE ($r = 0.83$, $p \leq 0.05$, common variance = 69%) and ASLR and PSLR ($r = 0.79$, $p \leq 0.05$, common variance = 62%) also showed strong significant relationships. Scatter plots illustrated the strong positive relationships,

for instance Figure 4.1 shows data falling close to the line of best fit across the range of measures.

4.3.2 Relationship between static and dynamic flexibility measurements

Results were variable between measurements of dynamic flexibility and static flexibility. Torque at 0.99 rad showed a moderate negative relationship with all static flexibility measurements ($r = -0.35$ to -0.48 , $p \leq 0.05$, common variance = 12 to 23%). Energy absorbed to 0.99 rad showed a significant moderate negative relationship with all static flexibility measurements ($r = -0.39$ to -0.53 , $p \leq 0.05$, common variance = 15 to 28%) while total energy absorbed showed a moderate positive relationship with PKE ($r = 0.48$, $p \leq 0.05$, common variance = 23%) and PSLR ($r = 0.43$, $p \leq 0.05$, common variance = 18%). Scatter plots illustrated the moderate relationships, for example Figure 4.2 shows that data lies in the region of the line of best fit but there is a degree of spread.

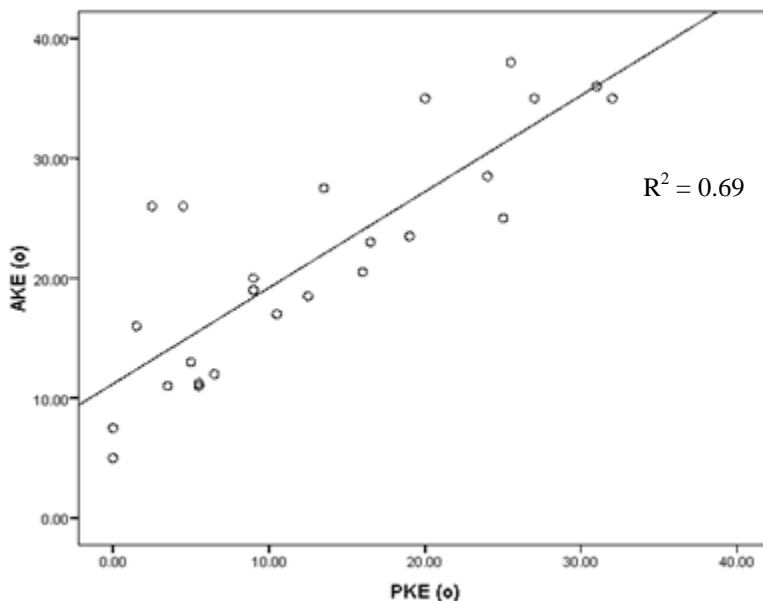

Figure 4.1 – Scatter plot of AKE against PKE ($n = 25$).

Table 4.1 - Relationship between static and dynamic flexibility measures

	Passive Torque at 0.99 rad	Max Rad	Passive peak Torque	Stiffness at 0.99 rad	Final Stiffness	Energy to 0.99 rad	Total Energy
AKE	-.46*	.52*	.45	-.56*	.08	-.49*	.21
PKE	-.48*	.58*	.08	-.55*	.04	-.53*	.48*
ASLR	-.35*	.62*	.29	-.53*	.28	-.39*	.26
PSLR	-.43*	.67*	.26	-.61*	.26	-.47*	.43*

* denotes $p \leq 0.05$

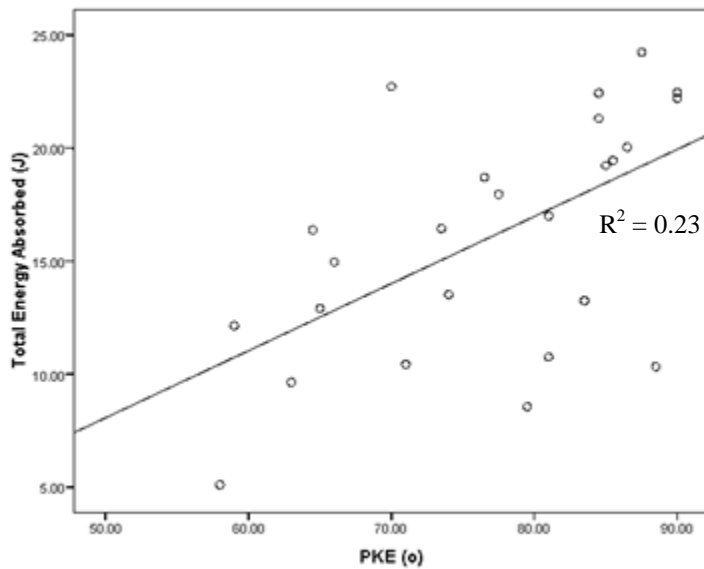

Figure 4.2 – Scatter plot of total passive energy absorbed against PKE ($n = 25$).

Independent t-tests (Table 4.2) showed that there was no significant difference in the dynamic flexibility results of stiffness or energy absorption at either a common measurement point or final measurement point for participants classified as ‘tight’ or ‘normal’, based on whether they scored below or above 80° on the PSLR test ($p > 0.05$).

Table 4.2 – Differences between dynamic flexibility of ‘tight’ and ‘normal’ participants

	Tight (< 80°) Participants	Normal (> 80°) Participants	t ₍₂₃₎	p
Energy Absorbed to 0.99 rad (J)	6.06 ± 1.94	6.51 ± 1.64	-0.60	0.55
Total Energy Absorbed (J)	14.24 ± 4.68	17.78 ± 5.31	-1.77	0.09
Stiffness at 0.99 rad	23.01 ± 9.57	19.85 ± 6.16	0.99	0.33
Final Stiffness	53.79 ± 16.01	52.41 ± 21.60	0.18	0.86

Regression analysis to predict energy absorbed from static hamstring flexibility tests was considered but due to the significant positive relationship between these predictor variables ($r = 0.79$ to 0.91 , $p \leq 0.05$) and because of the sample size, this analysis wasn't completed. Additionally due to the absence of theoretically driven understanding of the variables, stepwise regression would have been used. This is not hypothesis driven and does not require reasoned consideration of variables to include, yields R^2 values that are biased to be high, exhibits confidence intervals for effects and predicted values that are falsely narrow, biased regression coefficients that need shrinkage (the coefficients for remaining variables are too large) and severe problems in the presence of collinearity as it is based on methods (e.g., F tests for nested models) that were intended to be used for testing pre-specified hypotheses (Slinker & Glantz, 1985; Altman & Andersen, 1989; Tibshirani, 1996).

4.4 DISCUSSION

The aim of this study was to examine the relationship shared by static and dynamic measures of hamstring flexibility to evaluate the extent to which these tests are possibly examining the same phenomena.

4.4.1 Static hamstring flexibility measurements

Results showed strong significant positive relationships between the different static hamstring flexibility measures ($r = 0.75$ to 0.91 , $p \leq 0.05$; common variance = 57 to 82%) which were greater than previous studies that have shown moderate to strong negative but significant relationships between different static hamstring flexibility tests ($r = -0.16$ to -0.87 , $p \leq 0.05$; common variance = 3 to 76%) with the negative relationship being a result of hip angle being measured away from zero, i.e. full hip extension, and knee angle being measured towards zero,

i.e. full knee extension (Cameron & Bohannon, 1993; Gajdosik *et al.*, 1993; Rolls & George, 2004; Davis *et al.*, 2008). Participants in this study were screened for previous injury to avoid any potential effects of scar tissue from previous injury influencing level of static flexibility and impacting upon results (Toumi *et al.*, 2006) and were all familiar with the tests as they form part of screening and fitness testing programmes. Additionally, as participants were professional sportsmen, it is likely that they would have greater muscle strength than non-athletic populations and thus would be able to exert a greater force on the active tests, possibly resulting in the higher relationships seen between active and passive tests in this study compared to previous studies.

The two active and two passive static hamstring flexibility tests shared significant strong relationships with each other (AKE and ASLR $r = 0.91$, $p \leq 0.05$, common variance = 83%; PKE and PSLR $r = 0.86$, $p \leq 0.05$ common variance = 74%) thus rejecting hypothesis 1. Despite the strong relationships, the unexplained variance between the tests suggests that it is necessary to standardise tests of hamstring flexibility and the use of different tests can in part explain the disparity among researchers as to the implications of different levels of flexibility and stretching regimes (Bojsen-Moller *et al.*, 2007; Palmer *et al.*, 2013). The unexplained variance could be due to a number of factors including methodological issues and neural input. Both the ASLR and PSLR tests might be influenced by neural factors and the PSLR in particular, is a commonly used lower limb neural tension test (McHugh *et al.*, 2012). If this, rather than other neural or mechanical factors limited such tests, participants would be likely to score better on the knee extension tests. Care should be taken over subject positioning for these tests to attempt to limit effects from this (Shacklock, 2005). Congruency at the hip joint might affect the score on the SLR tests compared to KE tests in some populations (Holm *et al.*, 2000) but due to the utilisation of relatively young participants with no previous history of injury, would have been unlikely to have had significant effects in this study (Zakas *et al.*, 2006). The length of the moment arm differing between knee extension and straight leg raise tests might also have had an impact, particularly if one group of muscles was disproportionate in strength compared to another, i.e. participants with weaker hip flexor muscles might perform better on knee extension tests. This concept has been promoted in previous literature (Devlin, 2000; Ylinen *et al.*, 2010) but because this study did not measure baseline muscle strength, muscle balance and quadriceps:hamstring strength ratio it is not possible to directly support these findings.

ASLR and PSLR shared a significant strong positive relationship ($r = 0.79$, $p \leq 0.05$, common variance = 62%), as did AKE and PKE ($r = 0.83$, $p \leq 0.05$, common variance = 69%), thus accepting hypothesis 2. Despite strong relationships, there was 31 to 38% unexplained variance between active and passive SLR and KE tests. Methodological issues such as inability to apply consistent force to the limb or different interpretation of the end point of passive tests has been shown to affect results (Ylinen *et al.*, 2010). Identification of this can be difficult because it relies on psychophysiological phenomena, i.e. resistance of the muscle and a persons stretch tolerance (Marshall *et al.*, 2011; Sobolewski *et al.*, 2013). It is possible that active static hamstring flexibility tests might be influenced to a greater degree by the presence of a stretch reflex than passive tests (Stein & Kearney, 1995). Although participants were clearly instructed to move their limbs in a slow and controlled manner, due to the competitive nature of professional athletes, it is possible that some were trying to use momentum to achieve a better result thus triggering a stretch reflex. Conversely, had the tests been performed slowly, it is possible that activation of the agonist might have caused a degree of autogenic inhibition to the antagonist (Chalmers, 2004; Sharman *et al.*, 2006). This causes muscular relaxation and therefore could result in increased levels of static flexibility. EMG data from pilot and previously published studies suggest that the altered neural activity does not significantly affect static flexibility tests (Magnusson *et al.*, 1997; Wallmann *et al.*, 2008; Hough *et al.*, 2009) but such data would have been useful in eliminating this as a possible source of variance in this study.

The static flexibility measurements were taken in a manner that would mimic a clinical setting, i.e. the pelvis and contralateral limb were not secured to the table and for the knee extension tests, no apparatus was used to ensure that the knee remained at 90° . Previous studies have often used devices such as metal rigs to assist in measurement and straps to limit pelvic and leg motion (Rothstein *et al.*, 1983; McCombe *et al.*, 1989; Gajdosik *et al.*, 1993; Hall *et al.*, 1993; Li *et al.*, 1996; Armstrong *et al.*, 1998; Davis *et al.*, 2008). Whilst this is likely to lead to improved isolation and therefore better reliability, the applicability of this procedure is questionable since these types of apparatus are rarely available in the clinic and thus lack ecological validity. Previous studies have suggested that in order to achieve valid results in both a clinical and research setting the pelvis must be fully stabilised in order to prevent unwanted movement of the hamstring origin and involvement of gluteal or lower back muscles (Gajdosik *et al.*, 1993; Hall *et al.*, 1993; Li *et al.*, 1996; Mens *et al.*, 2010; Hu *et al.*, 2012). The strong relationships obtained

between static hamstring flexibility as measured clinically using a goniometer and the highly stabilised static flexibility measurements from the dynamometer dispute such findings and suggest good concurrent validity, although further research in other populations is warranted to confirm this.

Level of common variance between different static hamstring flexibility tests (57 to 82%) suggests that the tests are measuring the same basic phenomenon. Although this implies that it is not necessary to perform multiple static hamstring flexibility measurements clinically, the unexplained variance between tests (18 to 43%) suggests only measurements from the same tests should be directly compared to each other. Judgement of which test is most suitable should be made on an individual basis and may include physiological or clinical factors (Shacklock, 2005; Guissard & Duchateau, 2006). Consideration should also be given as to whether such measurements of static flexibility are relevant if an individual's sport is particularly dynamic or involves movements that take place in the middle rather than towards the outer part of the available range.

4.4.2 Static and dynamic hamstring flexibility measurements

Stiffness at 0.99 rad shared relationships of $r = -0.53$ to -0.61 ($p \leq 0.05$; common variance = 28 to 37%) and energy absorbed to 0.99 rad relationships of $r = -0.39$ to -0.53 ($p \leq 0.05$; common variance = 15 to 28%) with static hamstring flexibility tests (Table 4.1). The low common variance shared by energy absorbed to 0.99 rad and static flexibility levels is in disagreement with the findings of McHugh *et al.* (1998) who found a strong relationship and moderate common variance between PSLR ROM and energy absorbed from 20 to 50° in an instrumented PSLR ($r = -0.73$, $p \leq 0.001$, common variance 53%). Furthermore, results of this study demonstrated no significant relationship between active static flexibility tests and total energy absorbed and significant, but only moderately strong relationships, between passive static flexibility tests measured clinically ($r = 0.43$ to 0.48 , $p \leq 0.05$) and those measured on an isokinetic dynamometer ($r = 0.71$, $p \leq 0.05$) and total energy absorbed (Table 4.1) thus rejecting hypothesis 3. The lack of significant relationship between active static flexibility and dynamic flexibility tests and the unexplained variance between passive static flexibility and dynamic flexibility tests suggests that these variables are not identical. This may be a reason for the equivocal findings for the relationship between flexibility and injury risk in studies that have

utilised only static flexibility measures as their dependent variable and highlights the need to re-examine the injury risk literature using dynamic flexibility measures.

Results showed no significant differences between stiffness or energy absorption at either a common measurement point or final measurement point ($p>0.05$) in participants classified as 'tight' or 'normal' based on results of the PSLR test (Table 4.2), thus rejecting hypothesis 4. This disputes findings of previous studies which reported participants with lower levels of static hamstring flexibility and therefore classified as 'tight' exhibited greater stiffness and absorbed more energy for a given angle than those classed as 'normal' (Magnusson *et al.*, 1997). Previous *in vivo* studies have assessed stiffness in terms of viscoelastic stress relaxation of a muscle subjected to a stretch (McHugh *et al.*, 1998) and found a significant relationship between energy absorbed by the hamstring and maximum achievable ROM during passive SLR, as measured by goniometry ($r = 0.49, p \leq 0.05$). The current study calculated stiffness in terms of the gradient of a load-deformation curve and results indicated that there is no significant relationship between measurements of static flexibility and final stiffness of the muscle ($r = 0.04$ to $0.28, p > 0.05$), thus rejecting hypothesis 5. These findings further illustrate that the use of purely static flexibility measurements might be inappropriate and it is possible that global models of flexibility need to be specifically adapted for static flexibility measurements compared to dynamic flexibility measurements and should include factors related to the biomechanics and neurodynamics of skeletal muscle. Care must therefore be taken in extrapolating findings from *in vitro* research carried out on individual muscle fibres or groups of fibres, to the human *in vivo* environment. The controversial results regarding the effects of stretching on flexibility that have been reported may be linked to the unsubstantiated assumption of a relationship between stiffness and static flexibility levels.

The low to moderate relationships between measures of static and dynamic flexibility obtained in this and previous studies do not support the widely accepted view that static hamstring flexibility is limited by predominantly neural or biomechanical characteristics of muscle (Osternig *et al.*, 1987; Halbertsma *et al.*, 1996; McHugh *et al.*, 1998). Factors such as the joint structure, joint capsule, skin or neural tension might play a more major role in limiting static flexibility than previously believed. Genetic factors such as the actual length of the hamstring muscle, rather than its biomechanical characteristics may also be a limiting factor (Gajdosik, 2001b). Results of

this study suggest that extrapolation of findings from static flexibility tests to draw conclusions about factors more related to dynamic flexibility might be inappropriate. Research that directly assesses the dynamic flexibility of individual muscles or muscle groups rather than simply their available range is warranted, along with re-examination of some of the conjecture associated with flexibility, its assessment, relationships to factors such as injury risk and performance and influence of commonly used interventions such as stretching.

4.4.3 Limitations

Sample size was governed by number of squad players made available by the club. Although similar to previous studies ($n = 10$ to 30) that have attempted to compare different measures of static and dynamic flexibility (Cameron & Bohannon, 1993; Gajdosik *et al.*, 1993; Magnusson *et al.*, 1995; McHugh *et al.*, 1998; Hunter & Spriggs, 2000; Blackburn *et al.*, 2004), this was insufficient to perform multiple regression as this requires at least 10 participants per predictor variable. Most previous studies have used correlation to assess relationships between variables while only one has used stepwise multiple regression with appropriate number of participants per predictor variable (Blackburn *et al.*, 2004).

While isokinetic dynamometers as used in this and previous studies (Magnusson *et al.*, 1995; McNair *et al.*, 2001; Gajdosik, 2002; Reid & McNair, 2004; Ryan *et al.*, 2008) give information about the dynamic flexibility of passive muscles and therefore can be deemed more useful than purely static flexibility measures, it is questionable whether these are related to the dynamic flexibility of active muscles. Previous studies have reported significant weak to moderate positive relationships between measures of active static flexibility and passive and active stiffness of the knee flexors (Blackburn *et al.*, 2004). It would thus be useful in future studies to attempt to further examine the relationships shared by measures of passive and active dynamic flexibility.

Previous research and pilot studies did not show alterations in EMG activity at terminal static flexibility (Moore & Hutton, 1980; Etnyre & Abraham, 1986; McHugh *et al.*, 1992). Because of this and the extra time that would have been necessary to accurately record EMG, this was not performed in this study. It was therefore not possible to determine whether stretch reflex did contribute to limiting static flexibility, particularly in active tests. Participants were asked to

maintain their final position in active static flexibility tests for 3 s to try and reduce impact of this but the extent of any neurological responses is unknown.

4.4.4 Reflections

The *in vivo* approach used in this study limits understanding of which factors relate to common and which to unexplained variance of flexibility measurements. As no single research approach is adequate in terms of validity, accuracy, and completeness of information provided, it would necessary to combine different approaches such as human, cadaver, animal and computer simulation studies to provide results that are both valid and accurate in furthering awareness of constraints to dynamic flexibility. Combining evidence from studies using different approaches is valuable, but care must be taken as differences in experimental set up or study design impact on comparison of the findings from one study with those of another. Additionally, because of the different absolute values obtained for passive dynamic hamstring flexibility when the same protocols were performed on different types of isokinetic dynamometer, further research is needed to establish whether it is possible, via mathematical manipulation, regression equations or similar, to predict the absolute scores that individuals would achieve on different models of isokinetic dynamometer from those attained on one type of machine.

Order of testing was constrained by participant availability and thus it was necessary to measure static and dynamic flexibility in the same testing session. Although order of testing was kept the same to attempt to reduce any potential impact of this, had there been more time available it would possibly have been better to perform static flexibility testing on one day and dynamic flexibility testing the subsequent day.

Attempts were made to make this study theoretically driven but there was little literature on which to base the hypotheses. There is no conceptual model of factors constraining flexibility and researchers have seldom considered static and dynamic components of flexibility individually. To date, most studies have used a global model of flexibility, which needs to be developed and adapted to fit static and dynamic components of flexibility. Additionally, focusing on only passive dynamic flexibility meant that applicability of findings to dynamic flexibility of active muscle was limited. Attempts should be made to address this in future research.

4.5 CONCLUSIONS

In conclusion, the aim of this study was to examine relationships shared by static and dynamic measures of hamstring flexibility to evaluate the extent to which tests of these are possibly examining the same phenomena. Results showed significant relationships between different static flexibility tests but the strength of the relationships and extent of unexplained variance, particularly between active and passive static hamstring flexibility tests indicates that only measurements from the same tests should be directly compared to each other. Judgement of which test is most suitable should be made on an individual basis and may include physiological or clinical factors.

Results of passive dynamic flexibility tests at a common angle shared moderately strong relationships with results of static flexibility tests. There were no significant relationships found between measures of static flexibility and maximum peak torque and between active static flexibility tests and total energy absorbed and significant but only moderately strong relationships found between passive static flexibility tests and total energy absorbed. This suggests that measures of static and dynamic flexibility are not identical and that results should not be interchanged between the two types of test. This may be a reason for the equivocal findings for the relationship between flexibility, performance and injury risk in studies that have utilised only static flexibility measures as their dependent variable and highlights the need to re-examine the literature using prospective studies considering dynamic rather than static flexibility.

CHAPTER 5

**IMPACT OF FATIGUE AND POST-
EXERCISE**

**STATIC HAMSTRING STRETCHING ON
MEASURES OF STATIC AND DYNAMIC
HAMSTRING FLEXIBILITY AND
PERFORMANCE**

5.1 INTRODUCTION

Muscle strain injuries are prevalent in competitive and recreational athletes and have been reported to account for 10 to 41% of total injury occurrence (Verrall *et al.*, 2001; Arnason *et al.*, 2004; Brockett *et al.*, 2004; Croisier, 2004; Dadebo *et al.*, 2004; Proske *et al.*, 2004; Woods *et al.*, 2004; Gabbe *et al.*, 2005; Hagel, 2005; Gabbe *et al.*, 2006; Croisier *et al.*, 2008; Ekstrand *et al.*, 2011; Cross *et al.*, 2013; Hägglund *et al.*, 2013). A conceptual model of injury emphasising the multifactorial nature of injury risk was proposed by Meeuwisse (1994; Figure 5.1), detailing internal and external factors that predispose athletes to injury and highlighting that an inciting event must happen for injury to occur. Flexibility is typically cited as a risk factor for injury although the majority of research has been epidemiological and retrospectively evaluated flexibility of previously injured individuals (Worrell *et al.*, 1991; Krivickas, 1997; Orchard, 2001; Murphy *et al.*, 2003) or prospectively examined pre-season flexibility and injury occurrence (Orchard *et al.*, 1997; Witvrouw *et al.*, 2003; Arnason *et al.*, 2004; Gabbe *et al.*, 2006; Bradley & Portas, 2007; Engebretsen *et al.*, 2010; Watsford *et al.*, 2010; Fousekis *et al.*, 2011; Lowther *et al.*, 2012; Cross *et al.*, 2013; Hägglund *et al.*, 2013). Epidemiological approaches provide an overview and relative contribution of respective risk factors but are unable to separate the effects of various intervening factors or provide any understanding of the mechanism through which each risk factor might increase susceptibility to injury (Bahr & Krosshaug, 2005; Dallinga *et al.*, 2012). There has been limited empirical evidence examining proposed mechanisms through which flexibility might impact on injury risk and research has focused almost exclusively on static flexibility, which does not necessarily provide information on the biomechanical properties of a musculotendinous unit.

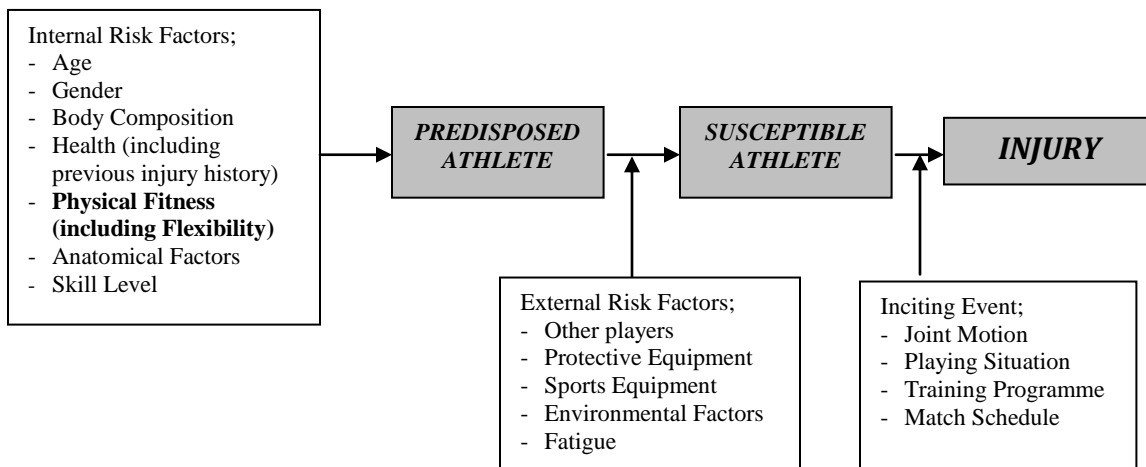

Figure 5.1 - Conceptual model of injury predisposition (Meeuwisse, 1994)

Flexibility is influenced by multiple factors and Figure 5.2 highlights the contribution from neural constraints, mechanical constraints, joint related constraints and other constraints (Johns & Wright, 1962; McHugh *et al.*, 1998; Magnusson *et al.*, 2001; Guissard & Duchateau, 2006; Bojsen-Moller *et al.*, 2007; Bozic *et al.*, 2010; Wepler & Magnusson, 2010; McHugh *et al.*, 2012). Of these constraints, some are active (e.g. musculotendinous unit) and some are passive (e.g. joint capsule). Empirical evidence detailing the relative roles played by these constraints is limited and tends to be provided by animal or cadaver studies (Ramsey & Street, 1940; Casella, 1950; Hill, 1968; Rapoport, 1972; Magid & Law, 1985; Tidball, 1986; Horowitz *et al.*, 1989), and findings are often extrapolated directly to humans without consideration of differences in tissue structures and properties (MacNaughton & MacIntosh, 2007). Additionally it has been suggested that there are static and dynamic expressions of flexibility (Gleim & McHugh, 1997) but researchers generally consider flexibility as a global concept. It is plausible that the constraints to flexibility differ in their relative contributions to static and dynamic flexibility, which makes interpretation and comparison of previous research investigating flexibility difficult because of differing dependent variables and methods of measurement used.

5.1.1 Injury prevention

Research on injury prevention is a step-by-step process in which information on causes of injury is systematically collected and used to develop potentially useful intervention methods (Van Tiggelen *et al.*, 2008). One important goal for effective injury prevention is to identify the multifactorial extrinsic and intrinsic risk factors that contribute to the susceptibility of an athlete to injury (Beijsterveldt *et al.*, 2012). A number of retrospective and prospective epidemiological studies have attempted to isolate risk factors related to hamstring strain injuries (Verrall *et al.*, 2001; Arnason *et al.*, 2004; Brockett *et al.*, 2004; Croisier, 2004; Dadebo *et al.*, 2004; Proske *et al.*, 2004; Woods *et al.*, 2004; Gabbe *et al.*, 2005; Hagel, 2005; Gabbe *et al.*, 2006; Croisier *et al.*, 2008; Engebretsen *et al.*, 2010; Henderson *et al.*, 2010; Watsford *et al.*, 2010; Ekstrand *et al.*, 2011; Fousekis *et al.*, 2011; Lowther *et al.*, 2012; Cross *et al.*, 2013; Hägglund *et al.*, 2013). Among other contributory factors, fatigue (Gabbett & Domrow, 2005; Gabbe *et al.*, 2006; Alentorn-Geli *et al.*, 2009; Small *et al.*, 2010) and inadequate flexibility (Agre, 1985; Jonhagen *et al.*, 1994; Worrell, 1994; Kroll & Raya, 1997; Kujala *et al.*, 1997; Bennell *et al.*, 1999; Devlin, 2000; Witvrouw *et al.*, 2003; Bradley & Portas, 2007; Watsford *et al.*, 2010) have been cited as risk factors for hamstring strain injury. Despite widespread acceptance of the conceptual model

for injury (Figure 5.1), approaches to evaluating injury risk often fail to consider the inciting event (Bahr & Krosshaug, 2005; Liu *et al.*, 2012). Appreciation of this is important to help understand the mechanism of a particular injury type in a given sport, accounting for the injury situation (player and opponent behaviour and playing situation) and whole body and joint biomechanics at time of injury.

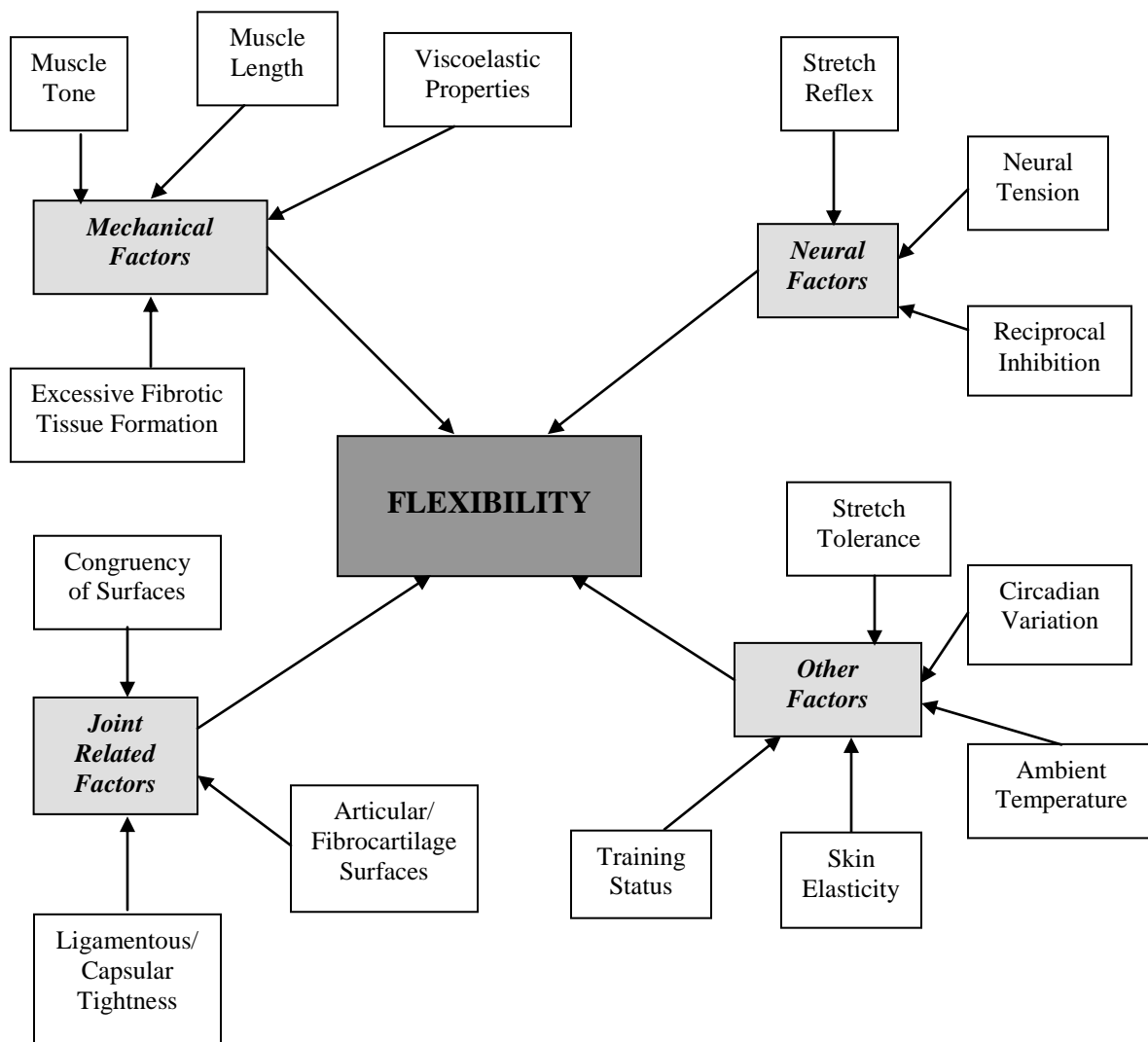

Figure 5.2 – Factors constraining flexibility

Controlled prospective epidemiological studies are well suited to identifying the potential contribution of a range of risk factors to injury but do not provide information about the possible mechanism through which they act and do not account for the inciting event. To develop better

understanding of injury prevention, a range of research approaches are needed including epidemiological studies exploring risk, athlete interviews, movement analysis of injury occurrence, cadaver studies, mathematical modelling and experimental approaches (Krosshaug *et al.*, 2005; Finch, 2011). Each method to understanding injury prevention has inherent limitations and no single research approach is adequate in terms of completeness of information provided. In terms of hamstring strain injury, there is a rationale for experimental approaches to facilitate examination and manipulation of recognised individual risk factors in a controlled manner thus providing further insight into how susceptibility to injury might be affected.

5.1.2 Fatigue and injury risk

Injury prevalence studies suggest injuries often occur towards the end of matches and training sessions and epidemiological approaches include fatigue as a risk factor for injury, but there is limited understanding about how fatigue might influence injury susceptibility. Few experimental studies in humans have considered the effect of fatigue on mechanical properties of human muscle (Garrandes *et al.*, 2007; Cote *et al.*, 2008; Timmins *et al.*, 2012; Semmler *et al.*, 2013), possibly because fatigue is difficult to quantify and not always synonymous with exposure time (Verrall *et al.*, 2001). Fatigue might be higher after shorter periods of time requiring repeated high-intensity efforts than at the end of competition if player involvement has been low (Robineau *et al.*, 2012). Human studies have shown that muscular fatigue (Melnik & Gollhofer, 2007; Gehring *et al.*, 2009; Cè *et al.*, 2013; Conchola *et al.*, 2013) and muscle damage (Davies & White, 1981; Kuipers, 1994; Hesselink *et al.*, 1996) induce neuromuscular control deficiencies, thereby influencing dynamic joint stability. Animal models have demonstrated that stimulated fatigued muscle undergoes a greater length change and absorbs less energy than non-fatigued muscle, and these models have been extrapolated to explain the increased predisposition to injury seen in fatigued individuals (Mair *et al.*, 1996; Gabbett & Domrow, 2005). Intense or sustained exercise induces microtrauma in muscle which can have a cumulative effect as the exercise bout progresses, causing micro-damage of the muscle fibres which could progress to more major muscle tears of involved muscle groups (Proske & Morgan, 2001). Rodent EDL and soleus muscle has demonstrated that fatigue increases resting tension because the muscles fail to relax properly between contractions (Matar *et al.*, 2000), and means that muscles will potentially exhibit greater stiffness. This has been a suggested mechanism by which fatigued human muscle

is at increased risk of injury (Aagaard *et al.*, 2000; Reilly *et al.*, 2008; Alentorn-Geli *et al.*, 2009) but there is little empirical evidence, particularly of an *in vivo* nature, to support this conjecture.

Muscle fatigue has been quantified by a reduction in maximum force that a muscle can generate compared to pre-exercise values (Cross *et al.*, 2013) and research has shown that concentric and, less frequently, eccentric strength of the knee flexors and extensors is impaired after exercise protocols comprising isokinetic maximal contractions (Sangnier & Tourny-Chollet, 2008), high-intensity cycling (Garrandes *et al.*, 2007) and prolonged intermittent running (Rahnama *et al.*, 2006; Small *et al.*, 2010). Different studies have found variations in magnitude of change with 8 to 15% of knee extensor and knee flexor peak torque being reported after a 90 minute fatiguing protocol set to simulate the work rate during a soccer game (Rahnama *et al.*, 2003), while reductions in peak torque of nearly 25% have been described after prolonged intermittent high intensity exercise (Mercer *et al.*, 2003). Alterations have also been seen in the dynamic control ratio of the leg (eccentric knee flexion:concentric knee extension) indicating a reduced ability to stabilise the knee (Rahnama *et al.*, 2003). Fatigue inducing exercise protocols have been shown to increase electromechanical delay (Gleeson *et al.*, 1998; Yavuz *et al.*, 2010; Cè *et al.*, 2013; Conchola *et al.*, 2013) and diminish coordination and timing by affecting energy transfer between limb segments (Rozzi *et al.*, 1999; Martin & Brown, 2009), thereby causing deficits in proprioception and JPS (Kaufman *et al.*, 2001; Givoni *et al.*, 2007). Alterations in JPS and neuromuscular function can cause an imbalance between afferent feedback and efferent responses (Herrington *et al.*, 2010) and such disruptions to the biological machinery for sensory-motor performance may elicit compromised self-perception of the capability for neuromuscular control. Imprecision of self-perception could contribute to a process by which injury becomes more likely (Noakes *et al.*, 2004); for instance, overestimation of performance capability may leave the participant partially unprotected during episodes of externally imposed mechanical stress. Skinner *et al.* (1986) studied knee proprioception performance in healthy young men and found a significant decrease in the ability to reproduce knee joint angles after a series of interval running sprints (3.75 miles in total), while in contrast, Marks and Quinney (1993) found that 20 maximal isokinetic quadriceps contractions did not significantly reduce knee proprioception performance in young sedentary women. The conflicting finding may be attributable to the type and duration of exercise protocol utilised and females being less likely to demonstrate significant changes in JPS after a fatigue inducing protocol (Lattanzio *et al.*, 1997; Yavuz *et al.*, 2010).

Research investigating the effect of static stretching on JPS has been equivocal with studies finding positive benefits (Ghaffarinejad *et al.*, 2007) and no measureable effects (Larsen *et al.*, 2005; Bjorklund *et al.*, 2006; Torres *et al.*, 2012) but a lack of high quality empirical evidence and differences in methodology and participant makes comparison of results difficult.

Through the use of animal models, it has been suggested that the most important factor in muscle strain occurrence is the amount of energy that the muscle can absorb before failure (Brooks *et al.*, 1995; Garrett, 1996; Mair *et al.*, 1996). Muscle strain injuries are thought to occur when muscles are stretched passively or activated during stretch (Garrett, 1996; Kirkendall & Garrett, 2002; Schache *et al.*, 2009; Chumanov *et al.*, 2012; Lowther *et al.*, 2012). Eccentric contractions are an important factor because muscle forces can be higher during lengthening than when shortening (Stauber, 2004), adding to the forces applied by passive connective tissue elements (Elftman, 1966). Animal studies have shown that maximally activated muscle absorbs significantly more energy before failure than less activated muscle, indicating that the passive elements of the muscle have the ability to absorb energy but the ability is enhanced when the muscle is active (Garrett *et al.*, 1987). Fatigue has been reported to reduce the energy absorbing capabilities of a muscle *in vitro* although failure was at the same length regardless of fatigue (Mair *et al.*, 1996). Fatigued muscle is less active than non-fatigued muscle, which might contribute to a reduced ability to absorb energy and thus increased level of injury predisposition (Garrandes *et al.*, 2007; Enoka, 2012).

5.1.3 Stretching as part of recovery

Pre-exercise stretching has traditionally been thought to play a role in reducing injury risk and subsequently, stretching has been an accepted and integral part of pre-exercise warm-up regimes (ACSM, 1998). While immediate increases in static flexibility as a result of an acute bout of stretching are well documented, little research has demonstrated benefits in terms of reduced injury risk (Andrish *et al.*, 1974; van Mechelen *et al.*, 1993; Pope *et al.*, 1998; Hartig & Henderson, 1999; Pope *et al.*, 2000; Amako *et al.*, 2003; Hadala & Barrios, 2009). Furthermore there is a growing body of evidence reporting concurrent decreases in measures of strength and performance (Kokkonen *et al.*, 1998; Avela *et al.*, 1999; Fowles *et al.*, 2000; Nelson *et al.*, 2001; Avela *et al.*, 2004; Behm *et al.*, 2004; Power *et al.*, 2004; Marek *et al.*, 2005; Nelson *et al.*, 2005; Cramer *et al.*, 2006; Egan *et al.*, 2006; Little & Williams, 2006; Yamaguchi *et al.*, 2006; Bradley

et al., 2007; Cramer *et al.*, 2007; Cramer *et al.*, 2007; McBride *et al.*, 2007; Stewart *et al.*, 2007; Herda *et al.*, 2008; McHugh & Nesse, 2008; Ryan *et al.*, 2008; Torres *et al.*, 2008; Winchester *et al.*, 2008; Costa *et al.*, 2009; Carvalho *et al.*, 2012; Esposito *et al.*, 2012; Maddigan *et al.*, 2012; Fortier *et al.*, 2013; Matsuo *et al.*, 2013). Stretch induced detriments in performance were generally smaller than decrements in strength measures (approx. 3% vs. 8% for clinically relevant stretch durations). In contrast to stretching before exercise, researchers have suggested that stretching after exercise might have positive benefits in improving recovery (Reilly & Ekblom, 2005; Shrier, 2008). Muscle recovery after physical activity is important because periods between games and training sessions have become shorter, with athletes often partaking in multiple training sessions per day on successive days of the week. It has been suggested that post-exercise static stretching could help fatigued muscles return to their normal resting lengths (Nelson & Hutton, 1985; Avela *et al.*, 1999), thus lessening symptoms of DOMS as well as decreasing subsequent risk of injury. This conjecture has not been supported empirically as no significant reductions in subjective measures of soreness on a visual analogue scale or palpation as a result of post-exercise static stretching have been demonstrated (McGlynn *et al.*, 1979; Buroker & Schwane, 1989; Dawson *et al.*, 2005; Kinugasa & Kilding, 2009; Robey *et al.*, 2009; Torres *et al.*, 2013). Studies examining the efficacy of post-exercise stretching have generally used relatively untrained convenience samples of participants and exposed participants to protocols designed to induce high levels of DOMS therefore it is not known whether the same responses would present in trained athletes exposed to protocols simulating normal strenuous training sessions. Furthermore, while most studies consider immediate effects of an intervention, in sports people impact at commencement of the subsequent training session is perhaps more important, as this would be when alterations in levels of performance and injury risk would be of greater relevance.

The impact of post-exercise stretching on ensuing performance and consequence on factors that might predispose injury remains to be firmly established and there is thus a need to examine possible modifiable risk factors in an experimental setting to evaluate their individual responses. It is difficult to directly measure the impact of post-exercise stretching on injury occurrence because of the number of confounding variables that can occur in longitudinal studies; for instance, alterations in training programmes, differences in fitness levels, use of braces or supports, changing weather conditions and different levels of opposition (Fuller, 2007). As all of

these factors are thought to influence injury predisposition, the impact of the post-exercise stretching alone cannot be isolated. To achieve sufficient scientific rigour to make any results meaningful, factors which themselves influence injury risk can be measured and the impact of post-exercise stretching on these established via experimental designs (Moher *et al.*, 2009). From results of such studies, inferences can be made as to the effect of post-exercise stretching on subsequent injury predisposition.

5.1.4 Aims and hypotheses

The aim of this study was to investigate the impact of fatigue and post-exercise static stretching on measures of static and dynamic flexibility and performance.

Hypotheses were as follows;

- 1) The fatigue inducing repeated spring protocol would lead to deterioration in measures of static and dynamic flexibility and performance immediately and 18 hours post-exercise;
- 2) A post-exercise static stretch would significantly improve measures of static and dynamic flexibility and performance in the stretch compared to the control condition immediately and 18 hours post-exercise;
- 3) The fatigue inducing repeated spring protocol would lead to deterioration in JPS immediately and 18 hours post-exercise; and
- 4) A post-exercise static stretch would significantly improve JPS in the stretch compared to the control condition immediately and 18 hours post-exercise.

5.2 METHODS

5.2.1 Participants

Fifteen rugby league players volunteered to participate in this study (age 21.20 years \pm 3.00, stature 180cm \pm 5.47, mass 92.64kg \pm 16.04 [mean \pm SD]). Sample size calculations indicated that 13 participants were needed for a repeated measures design to detect an expected change of 8° (Harvey *et al.*, 2002) as a result of a stretching program (α = 0.05 and β = 0.20). In case of any participants withdrawing from the study and to further increase power, two extra participants were recruited. All participants were part of a GB Super League rugby league club and so could be considered a homogenous sample. Testing was conducted pre-season when participants were involved in training sessions four to five times a week and training matches once a week. For

inclusion in the study, participants were certified free of lower limb injury by the club physiotherapist and considered to be in good physical condition. Because participants were all participating in the same training programme and were tested within the season, they were considered to be of similar fitness levels close to their peak. Whilst fitness differences were likely between players, in part related to their position, this was not considered because a range of players from different positions (e.g. forwards and backs) were included within the sample. Participants were excluded if they had previously sustained any form of hamstring injury or were not currently participating fully in all training sessions scheduled by the club. Written informed consent was obtained prior to the study from the participants themselves if over the age of eighteen or via the club following letters being sent to parents or guardians if participants were under eighteen. In such situations club personnel acted in loco parentis during testing sessions. Ethical approval was obtained from the University of Pretoria's Post-graduate Committee and the Ethical Committee.

5.2.2 Study design

The study was of randomised cross-over repeated measures design as indicated in Figure 5.3. Participants were asked to report to the lab on four occasions. The first and third occasions involved measurement of static hamstring flexibility, passive dynamic hamstring flexibility, eccentric peak torque, eccentric work done at $2.09 \text{ rad}\cdot\text{s}^{-1}$, JPS and perceived stiffness before and after a repeated sprint protocol. On one of these occasions the participant was randomly allocated to a hamstring stretch intervention condition and on the other occasion a no hamstring stretch (upper limb stretch) control condition. Immediately post-exercise measurements were taken one minute after participants had performed 30s static stretch of their hamstring or upper limb. The second and fourth occasions involved measurements of static and passive dynamic hamstring flexibility, eccentric force and work done at $2.09 \text{ rad}\cdot\text{s}^{-1}$, JPS and perceived stiffness. The second and fourth testing sessions took place 18 hours after the first and third sessions respectively. This timing was chosen partly to allow physiological recovery to have taken place (Noakes, 2000; Nédélec *et al.*, 2013) and partly because, following discussion with team coaches and medical team it was considered to mimic the normal club routine and training schedule and thus would have good ecological validity. Having undertaken the first testing session in an afternoon, participants were unlikely to have undertaken any further exercise by the following morning when the subsequent testing session took place. Participants were asked to undergo only

activities of normal daily living during this 18 hour period. One week separated the first and third testing sessions.

Allocation to control or stretch condition on the first occasion was randomised with seven and eight participants being allocated to each condition respectively. This allocation was reversed when participants presented for the third testing session so that all participants took part in both the intervention and control conditions. All participants received treatment and control conditions as allocated and none withdrew from the study. Allocation was concealed by the use of sealed envelopes. The assessor was not made aware of which condition the participant was allocated to until testing had been completed. A trained student who was not aware of the purpose of the study supervised the stretching intervention. Attempts were made to blind the participant by explaining that the purpose of the study was to examine the cross over effects of upper limb stretching on lower limb flexibility. A repeated measures design was considered optimal because differences between participants are removed as potential confounding variables and fewer participants are required, since data for all conditions derive from the same condition of participants (Hopkins *et al.*, 2009), and given that the study was to be carried out on elite rugby players, the available sample was smaller than if participants were from other, more general, populations. The potential disadvantage of repeated measures design is from order effects, which occur when people behave differently because of the order in which the conditions are performed. For example, the participant's performance may be enhanced because of a practice effect, or performance may be reduced because of a boredom or fatigue effect. Any order effects were counterbalanced and therefore limited in this study because participants were randomised to condition. Because participants were considered close to peak fitness levels and regularly carried out maximal sprint drills as part of their training, a wash out period of a week was considered sufficient to prevent any carry over effects from the sprint protocol. Additionally, the effects of an acute bout of static stretching are thought to return to baseline within one hour (Duong *et al.*, 2001; Ryan *et al.*, 2008) and as such, this was not considered to have an influence on the second set of testing.

5.2.3 Sprint protocol

Participants were asked to perform 30 x 20m sprints on an indoor track. This protocol was chosen following discussion with coaches as it has been shown to induce fatigue and relates to

what a player would perform during a match. Gabbett (2005) identified the importance of repeated sprinting in rugby league and suggested rugby league players are rarely required to sprint over 40 m, commonly sprint 10-20 m, and have work:rest ratios in the region of 1:6 to 1:12. Pilot study data and data based on fitness testing of comparable GB super league teams, led to the estimation the sprint time would be in the region of 3s, the recovery walk time in the region of 12 to 15s, with 3s to commence the next sprint and therefore an initial work:rest ratio in the region of 1:5/6. Previous research has tended to utilise single maximal efforts to induce fatigue rather than repeated dynamic sprint efforts which are more typical of team sports (Pinniger *et al.*, 2000), whereas with similar sprint distances and work:rest ratios the protocol was considered to have good ecological validity (Deutsch *et al.*, 1998). Sprints were performed from a standing start as and on completion of each sprint, the participant immediately turned and walked back to the start. The work to rest ratio was approximately 1:3. As soon as the starting position was reached, the next sprint was commenced. Electronic timing gates (Smart Speed, Fusion Sport) were used to measure the start and finish of the sprints. The first five sprints were conducted at 50% pace and the second five at 75% pace to ensure participants were sufficiently warmed-up before being asked to produce maximum effort. Percentage of maximal effort was determined by self-perception and these times did not count towards the study. The final twenty sprints were conducted at maximal effort.

5.2.4 Post-exercise stretching intervention

The hamstring stretch was performed in a standing position and took place five minutes after the repeated sprint protocol had been completed (Dorado *et al.*, 2004). This was to mimic field conditions where athletes usually perform an aerobic cool down prior to stretching. Few studies examining effects of post-exercise static stretching have explicitly described the time period between the completion of exercise and stretch intervention and those that have used times ranging between 5 and 15 to 20 minutes (Dawson *et al.*, 2005; Mika *et al.*, 2007). A period of 5 minutes was chosen for this study following discussion with coaches as it was believed to accurately reflect the time it would take for players to complete a training session and move to the cool-down area.

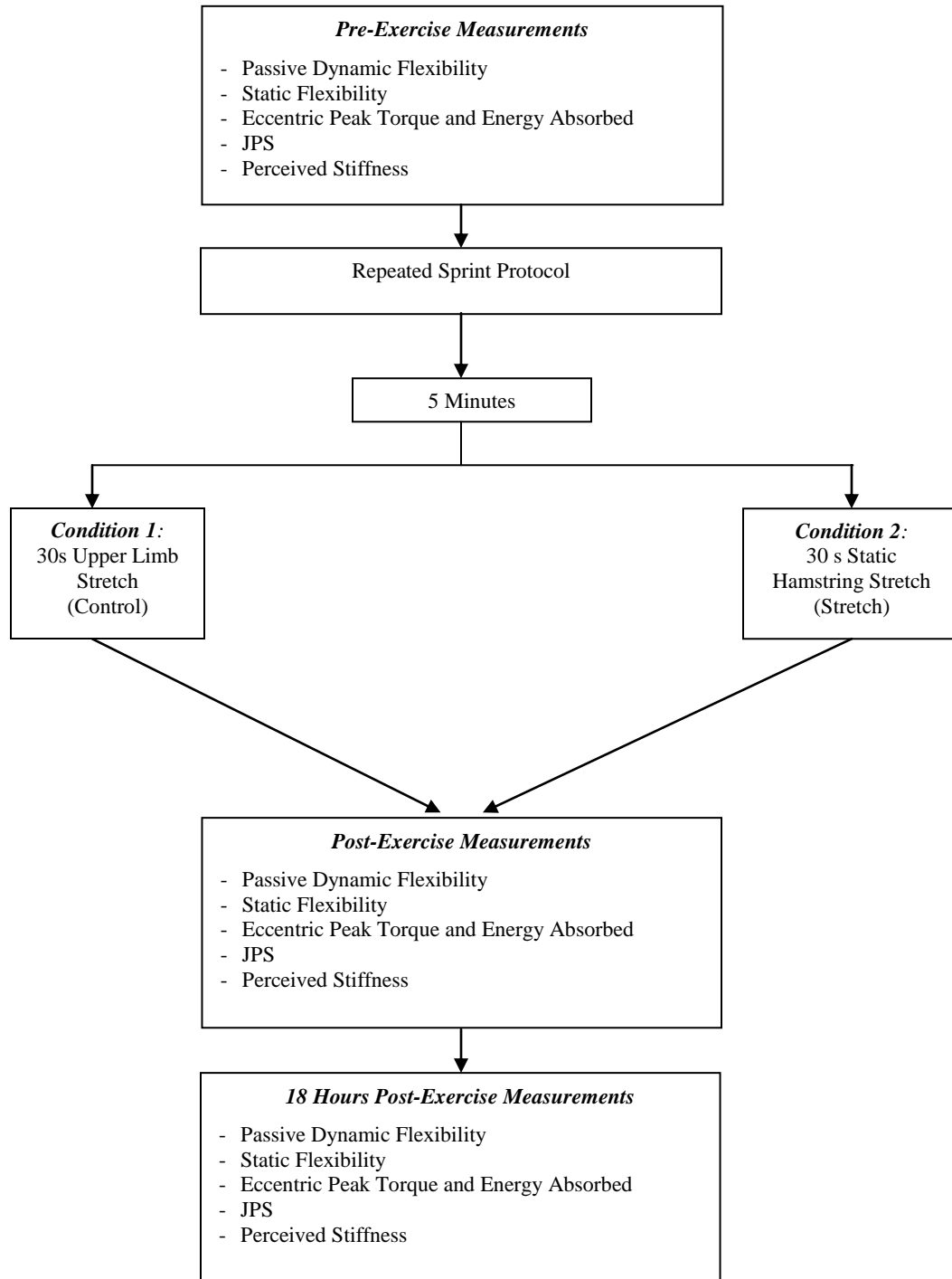

Figure 5.3 – Flow diagram of testing procedure for Chapter 5

This period consisted of the participant walking around the testing area at a self-selected pace. To perform the stretch, participants were asked to place the heel of the leg being stretched onto a raised surface, keeping the ankle in a neutral position. Whilst keeping the toe of the other foot

straight, the hips square and maintaining a lower lumbar lordosis, i.e. being instructed keep a curve in the lower back rather than slumping forwards, participants were asked to place their hands on the leg being stretched and move them forwards until a strong but not painful tension was felt in the posterior thigh. During the no hamstring stretch (control) condition, participants were asked to perform a posterior arm (tricep) stretch by raising one arm above their head, flexing the elbow and applying a downward pressure with their other hand.

Studies with longer stretching durations are more likely to reach significance with their results and many studies use durations of stretch far higher than is generally performed as part of a pre-exercise warm-up (McHugh & Cosgrave, 2010). For increases in static flexibility, a series of studies by Bandy and colleagues demonstrated significant improvements in the static flexibility of the hamstrings with a single static stretch lasting 30s performed 5 days per week for 6 weeks (Bandy & Irion, 1994; Bandy *et al.*, 1997; Bandy *et al.*, 1998). Other studies corroborated these results, reporting that 30 s of static stretching was optimal when compared with other durations for increasing static flexibility of the gastrocnemius (Grady & Saxena, 1991; Bandy & Irion, 1994) and hamstring muscles (Walter *et al.*, 1994). To ensure good ecological validity, stretches were maintained for 30s to mimic what is often practiced in a field setting.

5.2.5 Measurement procedures

Assessment of flexibility indices were taken according to the method described previously (Chapter 3).

5.2.5.1 Eccentric torque

Participants were seated in the chair of the isokinetic dynamometer with the trunk perpendicular to the thighs. The lateral condyle of the femur was placed in line with the axis of rotation of the lever arm. The lower leg was secured to a pad placed 2 cm proximal to the medial malleolus of the ankle. The upper leg was stabilised by a thigh strap placed across the femur 5 cm proximal to the condyles. Additional straps were used to fix the upper body and contralateral limb to the chair.

Speed for the test was set at $2.09 \text{ rad}\cdot\text{s}^{-1}$. Although optimum velocities remain uncertain, a relatively fast speed was required to attempt to mimic functional movements but if too great it

was anticipated that all participants would not be able to reach the speed of the dynamometer (Yen, 2005). Participants performed three maximal eccentric hamstring contractions against the dynamometer (Christou & Carlton, 2002). Data from all tests were exported. Final values obtained for gravity corrected peak torque, energy absorbed (work done) and position of peak torque were used for subsequent analysis.

5.2.5.2 Perceived stiffness

Participants were given a Visual Analogue Scale (10cm Line), with Absolutely No Stiffness marked on the left side of the scale and Worst Stiffness Ever marked on the right side of the scale. These scales have been shown to be reliable and valid (Mattacola *et al.*, 1997; McCormack *et al.*, 2009). Participants were asked to mark on the line where they felt that the stiffness they were currently experiencing fitted.

5.2.5.3 Joint position sense

JPS was measured using an accepted and deemed reliable method of testing the ability to reproduce specific knee joint angles in an open-kinetic sitting position (Skinner *et al.*, 1986; Marks & Quinney, 1993). Participants were seated on a treatment plinth that was of sufficient height that their feet did not touch the ground. With their eyes closed, the experimenter extended the participants knee to different angles to prevent a learning effect. The chosen angle was measured using a clinical goniometer (MIE Medical Research Ltd, UK) and the limb then lowered. The participant was asked to return the limb to the previous position and the angle measured. The difference between the first and second angles was used as a measure of JPS in subsequent analyses.

5.2.6 Statistical analysis

Data obtained from the Isokinetic Dynamometer were exported into Microsoft Excel 2000. 3rd Order Polynomial Curves were fitted, and using Derive (version 7), equations of the fitted curves ($y = ax^3 \pm bx^2 \pm c \pm k$) were differentiated to find gradient at the highest common point achieved by all participants (stiffness at 0.99 rad) as well the maximum position (final stiffness) and integrated to find the area under the curve (energy absorbed to 0.99 rad and total energy absorbed) during the passive knee extension manoeuvre. Measures of torque at 0.99 rad and passive peak torque were also recorded.

Data was tested for normality with a 1-sample Kolmogorov-Smirnov test. As the data did not significantly differ from a normal distribution, parametric statistical analysis was subsequently conducted. 2-way repeated measures ANOVAs (independent variables of condition [stretch vs control] and time [pre-exercise, immediately post-exercise, 18 hours post-exercise]) (SPSS Version 16.0) were used to determine the immediate and next day effect of a 30s static stretch on the dependent variables of ROM, energy absorbed (0.99 rad and final), stiffness (0.99 rad and final), passive torque (0.99 rad and peak), eccentric peak torque and work done, JPS and perceived stiffness. For all ANOVA models Mauchly’s test of sphericity was not significant and therefore the assumption of sphericity was met. For interaction effects, paired samples t-tests with Bonferroni adjustment for the number of comparisons were performed. PPM correlations were used to investigate relationships between passive and active measurements of peak torque and energy absorption and perceived stiffness to actual energy absorbing capabilities of the hamstring muscle condition. Statistical significance was set at $p \leq 0.05$ level.

5.3 RESULTS

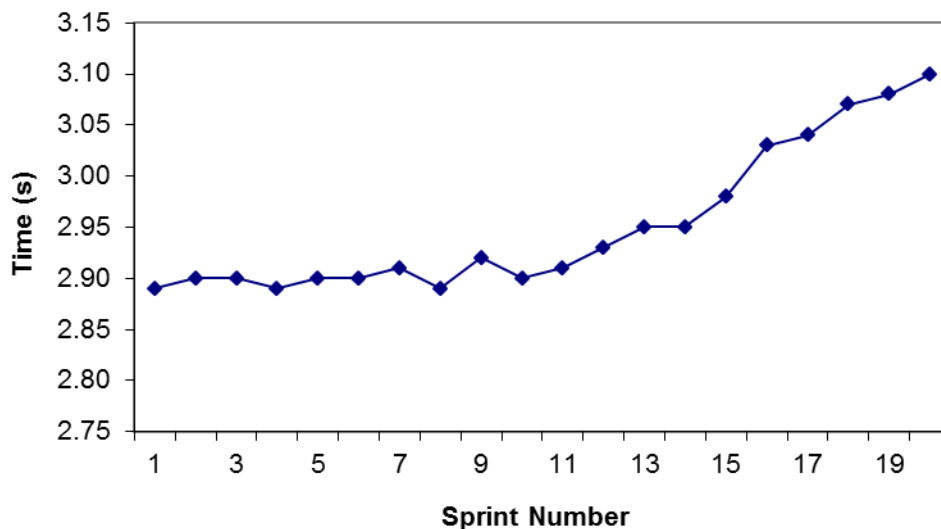

Figure 5.4 – Mean sprint times for 20 maximal sprints performed during the repeated sprint protocol.

Figure 5.4 shows the mean times for each of the final twenty maximal sprints in the repeated sprint protocol. There was an 8% increase in mean sprint time by the end of the protocol indicating that the protocol was of sufficient intensity to induce fatigue (Nédélec *et al.*, 2012). These times were faster than previously published data reporting 20m sprint times in first grade

amateur players (3.18 to 3.28s; Gabbett, 2002) and amateur players over a season (3.10 to 3.15s; Gabbett, 2005), which was expected as participants in this study were professional athletes and played at the elite level.

Table 5.1 – Impact of repeated sprint exercise and a 30 s post-exercise static stretch on passive dynamic hamstring flexibility measured at the highest common point

	Passive Torque at 0.99 rad (Nm)		Stiffness at 0.99 rad		Energy Absorbed to 0.99 rad (J)	
	Control	Stretch	Control	Stretch	Control	Stretch
Pre-Exercise	49.2 ± 17.2	48.9 ± 16.4	56.1 ± 22.2	56.3 ± 22.1	24.6 ± 9.2	25.2 ± 9.3
Immediately Post-Exercise	49.8 ± 16.5	49.9 ± 15.6	56.9 ± 26.8	53.8 ± 16.7	25.4 ± 7.7	25.2 ± 7.6
18h Post- Exercise	49.7 ± 16.9	50.0 ± 16.4	52.9 ± 18.1	53.9 ± 20.2	24.5 ± 9.4	26.7 ± 9.2

There was no significant effect of time [$F_{(2,28)} = 0.59, =0.55, p>0.05$] or of condition [$F_{(1,14)} = 1.01, p=0.72, p>0.05$] and no significant interaction between time and condition [$F_{(2,28)} = 0.73, =0.51, p>0.05$] on passive torque at 0.99 rad. There was no significant effect of time [$F_{(2,28)} = 1.37, =0.26, p>0.05$] or condition [$F_{(1,14)} = 0.77, p=0.39, p>0.05$] and no significant interaction between time and condition [$F_{(2,28)} = 2.471, p=0.91, p>0.05$] on stiffness at 0.99 rad. There was no significant effect of time [$F_{(2,28)} = 0.36, p=0.70, p>0.05$] or of condition [$F_{(1,14)} = 1.71, p=0.20, p>0.05$] and no significant interaction between time and condition [$F_{(2,28)} = 1.10, p=0.34, p>0.05$] on energy absorbed to 0.99 rad (Table 5.1).

Table 5.2 – Impact of repeated sprint exercise and a 30 s post-exercise static stretch on peak passive dynamic hamstring flexibility

	Passive Peak Torque (Nm)		Final Stiffness		Total Energy Absorbed (J)	
	Control	Stretch	Control	Stretch	Control	Stretch
Pre-Exercise	84.4 ± 16.0	83.4 ± 16.1	95.2 ± 22.5	98.5 ± 28.4	61.3 ± 14.5	58.2 ± 15.7
Immediately Post-Exercise	89.5 ± 20.5	85.4 ± 20.6	101.5 ± 26.6	100.1 ± 27.0	57.3 ± 14.6	60.6 ± 21.8
18h Post- Exercise	88.4 ± 19.0	86.2 ± 18.2	99.1 ± 27.9	96.5 ± 22.9	58.0 ± 18.0	61.3 ϕ ± 18.7

ϕ significantly different from pre-exercise values

There was no significant effect of time [$F_{(2,28)} = 2.68, p=0.08, p>0.05$] on passive peak hamstring torque and no significant interaction between time and condition [$F_{(2,28)} = 25.13, p=0.59, p>0.05$]. There was a significant effect of condition [$F_{(1,14)} = 8.38, p=0.01, p\leq 0.05$] on passive peak torque. Figure 5.5 illustrates that the control condition ($87.4\text{Nm} \pm 18.5$) appeared to have a higher passive peak torque than the stretch condition ($85.0\text{Nm} \pm 18.5$).

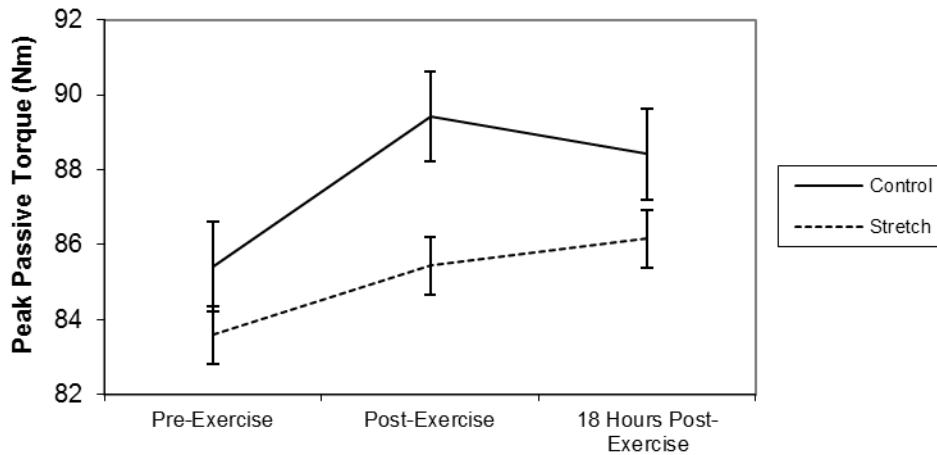

Figure 5.5 – Impact of a 30 s post-exercise static hamstring stretch on hamstring passive peak torque ($n = 15$).

There was no significant effect of time [$F_{(2,28)} = 0.47, p=0.63, p>0.05$] or condition [$F_{(1,14)} = 0.05, p=0.83, p>0.05$] and no significant interaction between time and condition [$F_{(2,28)} = 1.54, p=0.22, p>0.05$] on final stiffness (Table 5.2).

There was no significant effect of time [$F_{(2,28)} = 0.49, p=0.61, p>0.05$] or of condition [$F_{(1,14)} = 0.90, p=0.35, p>0.05$] on total energy absorbed by the hamstring during the passive stretching manoeuvre. There was a significant interaction between time and condition [$F_{(2,28)} = 6.84, p=0.001, p\leq 0.05$]. Paired samples t-tests with Bonferroni adjustment for number of comparisons indicated that there was no significant difference between stretch and control conditions pre-exercise [$t_{(14)} = 1.52, p=0.137, p>0.01$], post-exercise [$t_{(14)} = -2.10, p=0.04, p>0.01$] or 18 hours post-exercise [$t_{(14)} = -2.29, p=0.03, p>0.01$]. Figure 5.6 illustrates that total energy absorbed appears to decrease in the control condition post-exercise and remains lower than baseline values. In comparison in the stretch condition total energy absorbed appears to increase post-exercise although not significantly [$t_{(14)} = -1.47, p=0.15, p>0.01$], but there was a significant

increase in total energy absorbed between pre and 18 hours post-exercise [$t_{(14)} = -3.51, p=0.001, p \leq 0.01$].

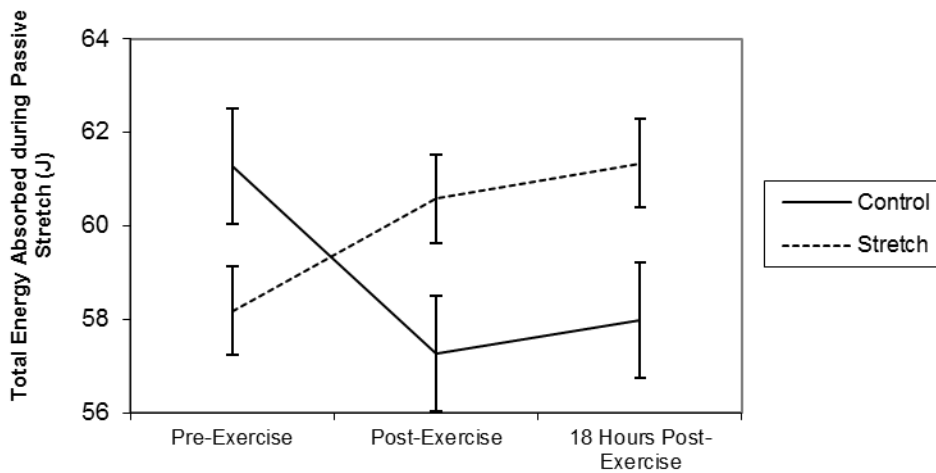

Figure 5.6 – Impact of a 30 s post-exercise static hamstring stretch on total passive energy absorbed by the hamstring muscle ($n = 15$).

Table 5.3 – Impact of repeated sprint exercise and a 30 s post-exercise static stretch on active properties during eccentric hamstring contraction at $2.09 \text{ rad}\cdot\text{s}^{-1}$

	Peak Torque (Nm)		Energy Absorbed (J)		Position of Peak Torque (rad)	
	Control	Stretch	Control	Stretch	Control	Stretch
Pre-Exercise	146.9 ± 34.3	149.9 ± 34.5	161.9 ± 44.5	164.8 ± 44.7	1.2 ± 0.3	1.2 ± 0.2
Immediately Post-Exercise	137.8 ± 26.7	148.9* ± 40.8	147.9 ± 39.9	162.4* ± 45.3	1.3 ± 0.2	1.3 ± 0.2
18h Post-Exercise	139.4 ± 38.2	150.4* ± 41.2	153.1 ± 42.9	164.9* ± 43.0	1.2 ± 0.2	1.2 ± 0.2

* significantly different from control condition

There was no significant effect of time on hamstring eccentric peak torque [$F_{(2,28)} = 1.13, p=0.33, p > 0.05$] and no significant interaction between time and condition [$F_{(2,28)} = 2.23, p=0.11, p > 0.05$]. There was a significant effect of condition on hamstring eccentric peak torque [$F_{(1,14)} = 12.39, p=0.00, p \leq 0.05$]. The control condition ($141.0 \text{ Nm} \pm 33.1$) appeared to produce a lower peak torque during eccentric contraction than the stretch condition ($149.7 \text{ Nm} \pm 38.8$), as illustrated in Figure 5.7.

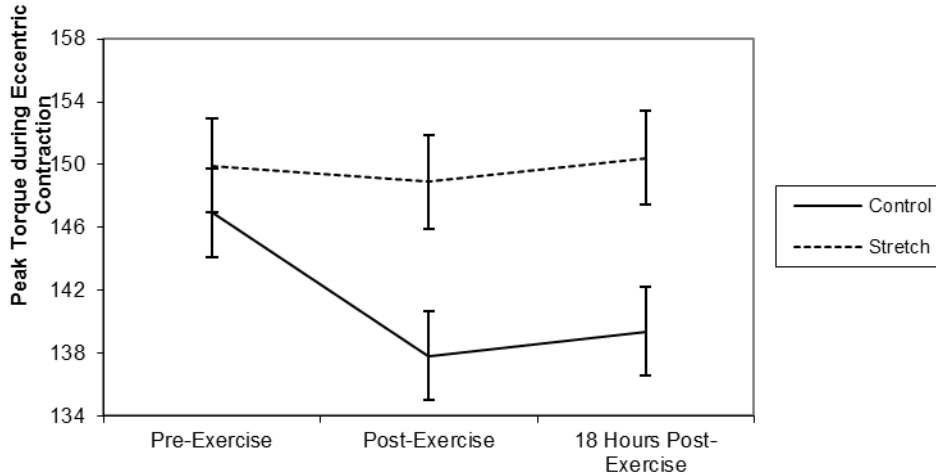

Figure 5.7 – Impact of a 30 s post-exercise static hamstring stretch on peak torque generated during maximal eccentric hamstring contraction (n = 15).

There was no significant effect of time on energy absorbed (work done) by the hamstring muscle group during an eccentric contraction [$F_{(2,28)} = 3.02, p=0.06, p>0.05$]. There was a significant effect of condition on work done (energy absorbed) by the hamstring muscle group during an eccentric contraction [$F_{(1,14)} = 8.62, p=0.01, p\leq 0.05$]. Overall the stretch condition (164.0 ± 44.3) produced a higher total energy absorbed compared to the control condition (154.3 ± 42.4) (mean values Table 5.3). There was a significant interaction between time and condition on energy absorbed (work done) by the hamstring muscle group [$F_{(2,28)} = 7.03, p=0.00, p\leq 0.05$]. Paired samples t-tests with Bonferroni adjustment for multiple comparisons showed no significant difference between control and stretch conditions pre-exercise [$t_{(14)} = -0.84, p=0.40, p>0.01$] whereas there was a significant difference both post-exercise [$t_{(14)} = -3.38, p=0.00, p\leq 0.01$] and 18 hours post-exercise [$t_{(14)} = -3.08, p=0.00, p\leq 0.01$]. Figure 5.8 illustrates that the total energy absorbed remains stable throughout the protocol in the stretch condition whereas it decreases post-exercise in the control condition.

There was no significant effect of time [$F_{(2,28)} = 0.26, p=0.77, p>0.05$] or condition [$F_{(1,14)} = 0.32, P=0.57, p>0.05$] and there was no significant interaction between time and condition [$F_{(1,14)} = 0.19, P=0.83, p>0.05$] on position of the torque-angle curve that peak torque was achieved during a maximal eccentric hamstring contraction at $2.09 \text{ rad}\cdot\text{s}^{-1}$ (Table 5.3).

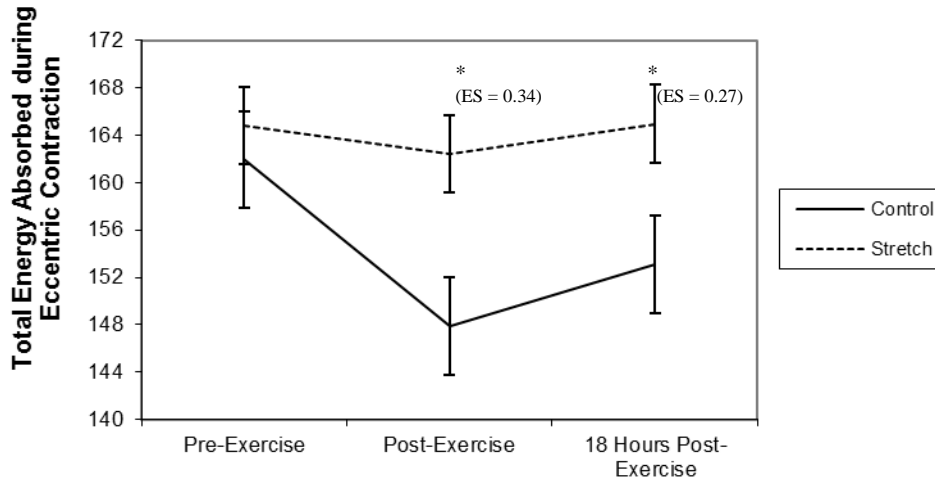

Figure 5.8 – Impact of a 30 s post-exercise static hamstring stretch on total energy absorbed (work done) by the hamstring during a maximal eccentric contraction (n = 15). * indicates significant difference between control and stretch conditions

Table 5.4 – Impact of a 30 s post-exercise static stretch on static hamstring flexibility levels

	AKE (°)		PKE (°)		ASLR (°)		PSLR (°)	
	Control	Stretch	Control	Stretch	Control	Stretch	Control	Stretch
Pre-Exercise	72.0±7.7	75.1±8.8	78.4±6.5	82.2±7.5	75.7±2.1	75.5±9.7	83.4±11.2	84.2±11.3
Immediately Post-Exercise	68.3±9.3	68.9 ϕ ±9.3	74.8±7.7	75.0 ϕ ±4.7	74.6±2.2	72.1* ϕ ±10.6	80.3* ϕ ±10.8	77.9±12.5
18h Post-Exercise	70.6±8.0	72.8* ϕ ±9.4	77.1±6.9	80.8* ϕ ±8.4	75.7±12.5	75.1±11.2	81.6±12.0	83.2±12.9

ϕ significantly different from pre-exercise values

* significantly different from control condition

There was a significant effect of time [$F_{(2,28)} = 12.72, p=0.00, p \leq 0.05$] on AKE. Paired samples t-tests with Bonferroni adjustment for number of comparisons indicated a significant difference between pre-exercise and immediate post-exercise [$t_{(29)} = -5.07, p=0.00, p \leq 0.025$] but no significant difference between pre-exercise and 18 hours post exercise measurements of AKE [$t_{(29)} = -0.31, p=0.76, p > 0.05$]. There was a significant effect of condition [$F_{(1,14)} = 20.11, p=0.00, p \leq 0.05$] with AKE in the stretch condition ($72.3^\circ \pm 9.2$) remaining higher than in the control condition ($70.3^\circ \pm 8.8$). There was also a significant interaction effect between time and condition [$F_{(2,28)} = 4.55, p=0.01, p \leq 0.05$] on AKE. Paired samples t-tests with Bonferroni adjustment for multiple comparisons showed that there was a significant differences between the

control and stretch conditions pre-exercise ($t_{(14)} = -4.43, p=0.00, p \leq 0.01$) and 18 hours post-exercise [$t_{(14)} = -2.83, p=0.01, p \leq 0.01$] but no significant difference between conditions immediately post-exercise [$t_{(14)} = -1.03, p=0.31, p > 0.01$]. Figure 5.9 illustrates that AKE in the stretch condition appears to return closer to baseline values 18 hours post-exercise than the control condition and there was no significant difference in AKE between pre and 18 hours post-exercise in the stretch condition [$t_{(14)} = 1.49, p=0.14, p > 0.01$].

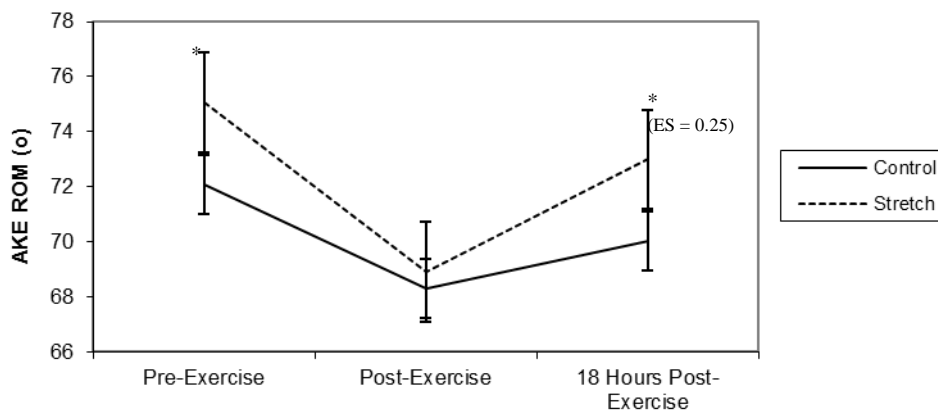

Figure 5.9 – Impact of a 30 s post-exercise static hamstring stretch on AKE (n=15).
 * indicates significant difference between control and stretch conditions

There was a significant effect of time [$F_{(2,28)} = 11.13, p=0.00, p \leq 0.05$] on PKE. Paired samples t-tests with Bonferroni adjustment for number of comparisons showed that there were significant differences in PKE between pre-exercise and immediate post-exercise measurements [$t_{(29)} = -6.61, p=0.00, p \leq 0.025$] but no significant difference between pre-exercise and 18 hours post-exercise [$t_{(29)} = 0.52, p=0.62, p > 0.025$]. There was a significant effect of condition [$F_{(1,14)} = 17.81, p=0.00, p \leq 0.05$] with PKE in the stretch condition ($79.3^\circ \pm 6.9$) remaining higher than in the control condition ($76.8^\circ \pm 7.0$) (mean values Table 5.4). There was also a significant interaction effect of time and condition [$F_{(2,28)} = 3.69, p=0.03, p \leq 0.05$] on PKE. Paired samples t-tests with Bonferroni adjustment for multiple comparisons indicated there was a significant differences between the control and stretch conditions pre-exercise [$t_{(14)} = -7.34, p=0.00, p \leq 0.01$] and 18 hours post-exercise [$t_{(14)} = -2.85, p=0.007, p \leq 0.01$] but no significant difference between conditions immediately post-exercise [$t_{(14)} = -0.36, p=0.72, p > 0.01$]. PKE in the stretch condition appears to return closer to baseline values 18 hours post-exercise than the control

condition and there was no significant difference in PKE between pre and 18 hours post-exercise in the stretch condition [$t_{(14)} = 2.74, p=0.009, p \leq 0.01$] (Table 5.4).

There was no significant effect of time [$F_{(2,28)} = 1.24, p=0.29, p > 0.05$] or condition [$F_{(1,14)} = 1.74, p=0.20, p > 0.05$] and no significant interaction between time and condition [$F_{(2,28)} = 5.70, p=0.57, p > 0.05$] on ASLR (Table 5.4).

There was a significant effect of time [$F_{(2,28)} = 8.19, p=0.001, p \leq 0.05$] on PSLR. Paired samples t-tests with Bonferroni adjustment for multiple comparisons indicated that there was a significant difference in PSLR between pre-exercise and post-exercise measurements [$t_{(29)} = 4.40, p=0.00, p \leq 0.025$] but no significant difference between pre and 18 hours post-exercise measurements [$t_{(29)} = 0.64, p=0.51, p > 0.025$]. There was no significant effect of condition [$F_{(1,14)} = 1.70, p=0.68, p > 0.05$] and no significant interaction between time and condition [$F_{(2,28)} = 2.24, p=0.11, p > 0.05$] on PSLR (Table 5.4).

Table 5.5 – Impact of a 30 s post-exercise static stretch on perception of stiffness and JPS

	Perceived Stiffness (mm)		Joint Position Sense (°)	
	Control	Stretch	Control	Stretch
Pre-Exercise	39.5 ± 12.2	38.2 ± 15.4	4.7 ± 1.7	3.9 ± 1.7
Immediately Post-Exercise	32.4 ± 21.1	29.9 ϕ ± 15.5	6.2 ± 1.1	7.2* ϕ ± 2.2
18h Post-Exercise	53.8 ± 19.1	42.0* ϕ ± 16.8	4.5 ± 2.0	4.8 ± 2.3

ϕ significantly different from pre-exercise values

* significantly different from control condition

There was a significant effect of time [$F_{(2,28)} = 30.65, p=0.001, p \leq 0.05$] on perceived stiffness. Paired sample t-tests with Bonferroni adjustment for multiple comparisons showed that there was a significant difference in perceived stiffness between pre-exercise and immediately post-exercise [$t_{(29)} = -2.74, p=0.00, p \leq 0.025$]. There was also a significant difference in perceived stiffness between pre-exercise and 18 hours post-exercise [$t_{(29)} = -3.80, p=0.00, p \leq 0.025$], illustrated in Figure 5.10 as an increase in perceived stiffness 18 hours post-exercise compared to pre-exercise. There was also a significant effect of condition [$F_{(1,14)} = 5.76, p=0.02, p \leq 0.05$] on perceived stiffness, with lower perceived stiffness in the stretch condition (34.7mm ± 15.9)

compared to the control condition ($41.9\text{mm} \pm 17.5$). There was also a significant interaction between time and condition [$F_{(2,28)} = 13.27, p=0.001, p \leq 0.05$] on perceived stiffness. Paired samples t-tests with Bonferroni adjustment for multiple comparisons indicated there was no significant differences between the control and stretch conditions pre-exercise [$t_{(14)} = 0.65, p=0.52, p > 0.01$] and immediately post-exercise [$t_{(14)} = 0.79, p=0.44, p > 0.01$] but there was a significant difference between conditions 18 hours post-exercise [$t_{(14)} = 5.19, p=0.00, p \leq 0.01$]. Figure 5.10 illustrates that perceived stiffness in the stretch condition is lower 18 hours post-exercise than the control condition.

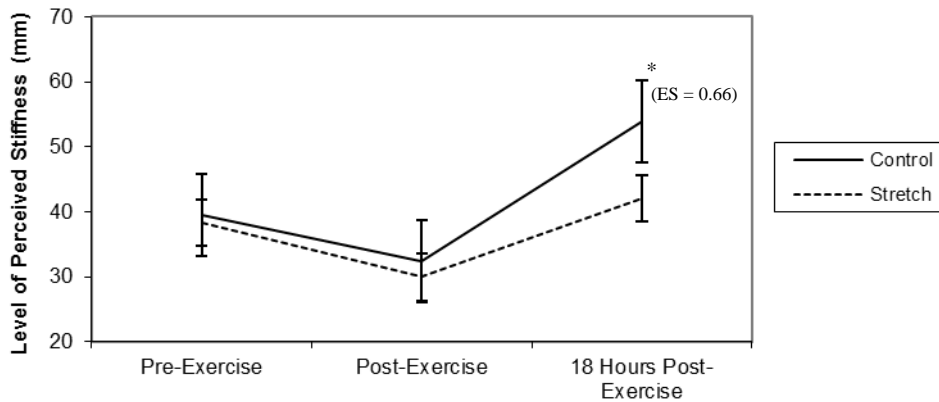
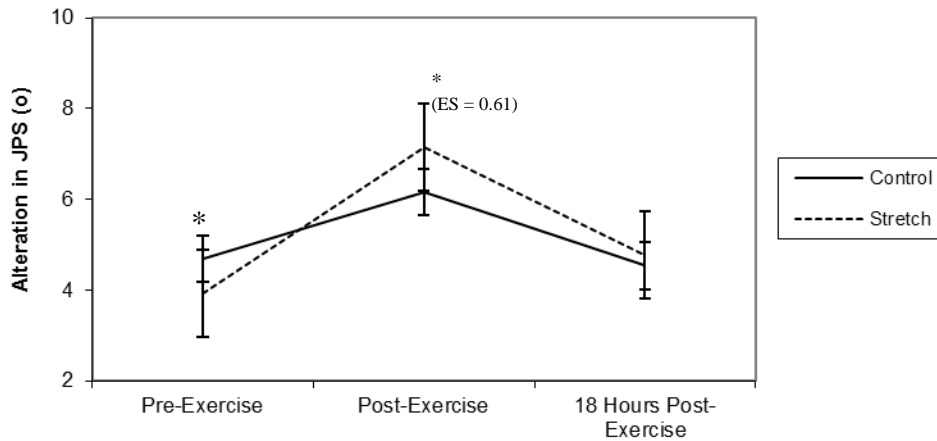

Figure 5.10 – Impact of a 30 s post-exercise static hamstring stretch on perception of stiffness as measured on a visual analogue scale ($n = 15$).

*** indicates significant difference between control and stretch conditions**

There was no significant effect of condition [$F_{(1,14)} = 0.77, p=0.39, p > 0.05$] on JPS but there was a significant effect of time [$F_{(2,28)} = 42.88, p=0.00, p \leq 0.05$]. Paired samples t-tests with Bonferroni adjustment for multiple comparisons showed there was a significant difference in JPS between pre and post exercise measurements [$t_{(29)} = -8.30, p=0.00, p \leq 0.025$]. Figure 5.11 illustrates JPS deteriorated post-exercise compared to pre-exercise. There was no significant difference in JPS between pre and 18 hours post exercise [$t_{(29)} = -1.06, p=0.30, p > 0.025$]. There was a significant interaction between time and condition [$F_{(2,28)} = 0.37, p=0.001, p \leq 0.05$] on JPS at the knee joint. Paired samples t-tests with Bonferroni adjustment for multiple comparisons indicated there was a significant difference between the control and stretch conditions pre-exercise [$t_{(14)} = 3.11, p=0.00, p \leq 0.01$] and immediately post-exercise [$t_{(14)} = 9.32, p=0.00, p \leq 0.01$] but there was no significant difference between conditions 18 hours post-exercise [$t_{(14)} = -0.70, P=0.49, p > 0.01$]. Figure 5.11 shows that the stretch condition exhibited greater

deterioration in JPS immediately post-exercise than did the control condition but these values had returned to near baseline by 18 hours post-exercise.



**Figure 5.11 – Impact of a 30 s post-exercise static hamstring stretch on JPS ($n = 15$).
* indicates significant difference between control and stretch conditions**

There was a strong significant positive relationship between passive peak torque during a controlled stretch manoeuvre of the hamstring muscle group and peak eccentric torque of the hamstring muscle group generated during a maximal eccentric contraction at $2.09 \text{ rad}\cdot\text{s}^{-1}$ ($r = 0.74, p \leq 0.05$; Figure 5.12).

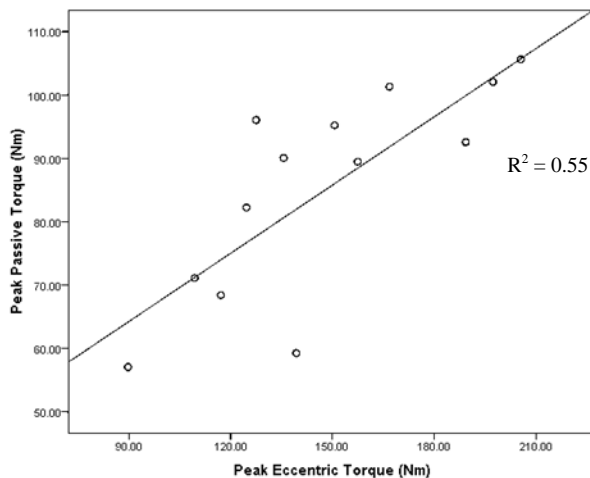

Figure 5.12 – Scatter plot of passive peak against peak eccentric hamstring torque ($n = 15$).

There was a significant positive relationship between total energy absorbed during passive stretch of the hamstring muscle group and total energy absorbed during a maximal eccentric contraction of the hamstring muscle group at 2.09 rad.s⁻¹ ($r = 0.61, p \leq 0.05$; Figure 5.13).

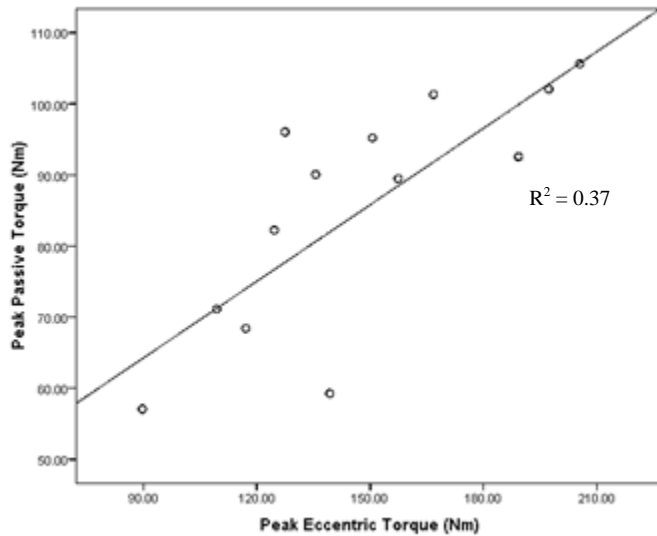

Figure 5.13 – Scatter plot of total passive against total active hamstring energy absorption ($n = 15$).

A significant relationship was found between immediate post-exercise passive energy absorption and perception of stiffness in the stretch condition ($r = 0.53, p \leq 0.05, R^2 = 0.28$). There was no significant relationship between the two variables in the control condition ($p > 0.05$). 18 hours post-exercise there was a significant negative relationship between passive energy absorption and perception of stiffness in the control condition ($r = -0.73, p \leq 0.05, R^2 = 0.53$) and a weaker but still significant relationship between the two variables in the stretch condition ($r = -0.32, p \leq 0.05, R^2 = 0.10$).

5.4 DISCUSSION

The aim of this study was to investigate the impact of fatigue and post-exercise static stretching on measures of static and dynamic hamstring flexibility and performance, and it was hypothesised that fatigue would have a negative influence and post-exercise static stretching a positive influence on these measures. Previous research has generally induced fatigue in single muscles or muscle groups rather than through repeated dynamic whole body efforts, which are more typical of team sports (Pinniger *et al.*, 2000; Enoka, 2012). The protocol used in this study

specifically related to what a player would perform during a match with comparable sprint distances and work:rest ratios (Deutsch *et al.*, 1998). The mean sprint time increased by 8% from the first to the final sprint and since fatigue has been characterised by an inability to sustain the original work rate (Reilly *et al.*, 2008) these results suggest the repeated sprint protocol employed in this study was of adequate duration and intensity to evoke fatigue.

5.4.1 Passive dynamic flexibility measurements to 0.99 rad

There was no significant main effect for time, condition or interaction effect between time and condition for passive torque, stiffness and energy absorbed to 0.99 rad. Fatigued muscles are thought to show increased resting tension (Gong *et al.*, 2000) and in animal models, fatigued muscles could absorb less energy than non-fatigued muscles with the differences being much more evident in the earlier part of the range (Mair *et al.*, 1996). Findings of this study did not support this in humans and therefore hypothesis 1 was rejected. The disagreement of results of this and previous research conducted *in vitro* could be due to a number of factors. Fatigue has multiple mechanical effects and it is possible that the contractile properties of muscle studied *in vitro* are not predominantly important and local muscle factors induced by altered energy supplies and metabolic changes are also critical (Rahnama *et al.*, 2006). The utilisation of whole body repeated dynamic efforts to induce fatigue rather than the cyclic stimulations of muscle used by Mair *et al.* (1996) might have influenced results and it is also possible that muscles would behave differently when purely longitudinal forces are applied *in vitro* than when the forces resulting from the mechanical output of the agonist as well as all synergists and antagonists crossing the joint are applied to multi-articular muscles (Maganaris, 2001).

Previous studies have attempted to identify the effect of stretching protocols on passive dynamic flexibility of the hamstring muscle group (Magnusson *et al.*, 1995; Magnusson *et al.*, 1996; Magnusson *et al.*, 2000; Reid & McNair, 2004; Nordez *et al.*, 2006; Whatman *et al.*, 2006; Marshall *et al.*, 2011; Matsuo *et al.*, 2013) and have shown that passive torque, stiffness and energy absorbed remain unchanged during stretch to a common angle. Results of this study agree with previous research in showing that stretching fatigued muscle appears to have no effect on the viscoelastic properties in this early part of the range and supports research which has considered the effect of stretch on non-fatigued human muscle (Magnusson *et al.*, 1997). These findings do not concur with those conducted on animal muscle fibres or individual muscles *in*

vitro (Brooks *et al.*, 1995; Mair *et al.*, 1996). As much *in vitro* research is conducted on single muscle fibres or individual fusiform muscles it is possible that these have a different response to multipennate muscle groups *in vivo*. Muscle fibres belonging to different motor unit types have been shown to have different lengths (Maganaris, 2003; Epstein *et al.*, 2006) and do not extend from one tendon plate to another but are arranged in series along the length of the muscle. This suggests that muscle deformation may be differentially distributed between muscle fibre types and therefore that strain experienced by fiber type is not equivalent (Lieber & Friden, 2002). *In vitro* models operate through the entire force-length relationship available while *in vivo* models may only operate in a part of the curve, because of anatomical and neural constraints (Maganaris, 2001). Although the mechanisms for the difference are not clear and require further research, the results of this study provide evidence that findings from *in vitro* investigations might not be directly related to human hamstring muscles.

5.4.2 Final passive dynamic flexibility measurements

There was no significant effect of time or interaction effect between time and condition on passive peak torque, suggesting that fatigue does not negatively influence this constraint of passive dynamic flexibility. There was a significant effect of condition on passive peak torque with the stretch condition having a lower mean throughout the protocol than the control condition and therefore partly rejecting hypotheses 1 and 2. Previous research has examined the effects of acute, cyclical or chronic stretch on passive dynamic flexibility and have repeatedly shown that following stretch protocols increases in torque about the joint occur, and these have been attributed to increases in muscle length (Gajdosik, 1991) or increased stretch tolerance through induced natural analgesic responses of the body (Magnusson, 1998; Ben & Harvey, 2010; Wepler & Magnusson, 2010; Marshall *et al.*, 2011). It is well accepted that exercise can alter pain perception in humans and animals (Koltyn, 2000) due to activation of the endogenous opioid system in which the release of endorphins and enkephalins blocks the productions of ‘Substance P’, a neurotransmitter in the pain circuit (Piercey *et al.*, 1986), but it is possible that as the participants used in this study were professional athletes and would thus be used to exercising at maximal levels, that the fatiguing effect of the repeated sprint protocol was not sufficient to activate this response.

There was no significant main effect of time or condition or interaction effect on final stiffness thus partly rejecting hypothesis 1. It is commonly assumed in the clinical and laboratory setting that stiffness and flexibility are synonymous concepts (Blackburn *et al.*, 2004). Flexibility gives an indication of the ability of the musculotendinous unit to elongate without consideration of the associated force response, and hence stiffness. The final stiffness is the gradient of the load-deformation curve at the maximal deformation (i.e. limit of flexibility). Because static stretching can increase levels of static flexibility (Cornelius *et al.*, 1992; Bandy & Irion, 1994; Bandy *et al.*, 1997; Klinge *et al.*, 1997; Wiemann & Hahn, 1997; Bandy *et al.*, 1998; McHugh *et al.*, 1998; Roberts & Wilson, 1999; Depino *et al.*, 2000; Chan *et al.*, 2001; Funk *et al.*, 2001; Funk *et al.*, 2003; Zakas *et al.*, 2003; Nelson & Bandy, 2004; Young *et al.*, 2004; Davis *et al.*, 2005; Zakas *et al.*, 2006; Bacurau *et al.*, 2009; Fasen *et al.*, 2009; O'Sullivan *et al.*, 2009; Ayala & Sainz de Baranda Andújar, 2010; Covert *et al.*, 2010; O'Hora *et al.*, 2011), it has been inferred to have concurrent effects in reducing stiffness. Results of this and other studies do not support that this conjecture is applicable to the hamstring muscle (Blackburn *et al.*, 2004; Aquino *et al.*, 2006). Other studies have shown that acute passive stretching of the plantar flexor muscle group reduces passive stiffness (Morse *et al.*, 2008; Ryan *et al.*, 2008; Herda *et al.*, 2010; Kato *et al.*, 2010; Nakamura *et al.*, 2011). LoA calculated in Chapter 3 showed a degree of random error in values of stiffness from the torque-angle curve obtained from passive stretch on an isokinetic dynamometer and it is possible this concealed a meaningful effect in this study (Bland & Altman, 1986). Alternatively, studies examining the plantar flexor muscle group used stretch durations of up to 20 minutes, unlike this study which used a clinically relevant stretch duration of 30 seconds. Studies using greater stretch durations are more likely to find statistical significance in their results, which may partly explain the conflicting findings (Behm & Chaouachi, 2011; Matsuo *et al.*, 2013).

There was no significant main effect of time or condition on total passive hamstring energy absorption but there was a significant interaction effect. Post-hoc analysis identified no significant difference between control and stretch conditions at any time interval but mean data demonstrated decreased energy absorption post-exercise in the control condition compared to increased energy absorption in the stretch condition, thus supporting hypothesis 2. Fatigue is an identified risk factor for injury and accepted conjecture is that fatigued muscles absorb less energy and are stiffer than non-fatigued muscles (Mair *et al.*, 1996; Verrall *et al.*, 2005; Gabbett

& Domrow, 2007; Alentorn-Geli *et al.*, 2009; Small *et al.*, 2010). Animal models have been used to demonstrate significantly less energy absorption in fatigued muscle compared to non-fatigued muscle, with the greatest loss occurring in the most fatigued muscle (Mair *et al.*, 1996). Prior to this study it remained to be established whether the energy absorbing capabilities of human muscle are affected by fatigue in the same way, and the current study offers tentative support for this. Performing a 30s static hamstring stretch post-exercise appears to negate the impact of fatigue on total passive energy absorption. It has been suggested that fatigued muscle ‘bunches’ and because of its supposed shorter length, would be at greater injury risk (Westerblad *et al.*, 1993). This idea has been supported by findings of reduced static flexibility in fatigued muscle (Cote *et al.*, 2008). Researchers have suggested that post-exercise stretching might help muscle return to its resting length and thus reduce likelihood of subsequent injury (Mika *et al.*, 2007; Robey *et al.*, 2009). The impact of post-exercise stretching in increasing the total passive energy absorption of the hamstring muscle 18 hours post-exercise provides a mechanism by which post-exercise static stretching may reduce susceptibility to injury in ensuing training sessions or games. The small effect size (0.18) between energy absorption of the hamstring muscle pre-exercise and 18 hours post-exercise suggests, that although there is a significant difference, its clinical meaningfulness is questionable.

5.4.3 Active dynamic flexibility measurements

There was no significant effect of time or interaction effect between time and condition on eccentric peak torque, thus disputing hypothesis 1. There was a significant effect of condition with the stretch condition overall resulting in higher eccentric peak torque than the control condition and therefore supporting hypothesis 2. Previous research has shown that concentric and less frequently, eccentric strength of the knee flexors and extensors is impaired after exercise protocols comprising isokinetic maximal contractions (Sangnier & Tourny-Chollet, 2008), high-intensity cycling (Garrandes *et al.*, 2007), and prolonged intermittent running (Rahnama *et al.*, 2006). This has been attributed to biomechanical factors such as decreased neural stimulation as measured by electromyographic activation of a muscle (Gleeson *et al.*, 1998) or increased muscle compliance (Wilson *et al.*, 1994). The 8% reduction in peak eccentric hamstring torque in the control condition in this study was similar to the 8 to 15% reduction of knee extensor and knee flexor peak torque reported after a 90 min fatiguing protocol set to simulate the work rate during a soccer game (Rahnama *et al.*, 2003) but the difference was not significant. Other studies

have reported greater reductions in peak torque of nearly 25% (Mercer *et al.*, 2003) and the conflicting findings may be due to the nature and duration of fatiguing exercise protocols using isokinetic dynamometers inducing more localised fatigue and maximal effort through full ROM (Enoka & Stuart, 1992; Kellis, 1999). Despite common assumptions on the effectiveness of static stretching as part of the recovery procedure, there is little research to indicate that this modality reduces the degree or course of post-exercise muscle soreness or force generation (Buroker & Schwane, 1989; Dawson *et al.*, 2005; Herbert & de Noronha, 2007; Kinugasa & Kilding, 2009; Robey *et al.*, 2009; Torres *et al.*, 2013). Prior to this study, no research has examined the effect of post-exercise static stretching on eccentric force generation either immediately or at the subsequent training session. Results provide some evidence that a post-exercise stretch might prevent reduction in eccentric peak torque but the small effect size (0.26) means that the clinical meaningfulness of this is questionable.

There was no significant effect of time but there was a significant effect of condition and a significant interaction between time and condition on active energy absorbed by the hamstring muscle group during eccentric contraction. The active energy absorbing capability of the control condition was significantly lower than the stretch condition both immediately and 18 hours post-exercise, thus supporting hypothesis 2. Effect sizes were small (0.34 immediately post-exercise and 0.27 18 hours post-exercise) despite a reduction of 9% in active energy absorption. Fatigue is an accepted risk factor for injury with most injuries occurring late in a training session or game when individuals are exhibiting signs of fatigue such as reduced work rate (Dadebo *et al.*, 2004; Woods *et al.*, 2004; Small *et al.*, 2010; Mooney *et al.*, 2013). Rabbit hind limb muscle has been shown to absorb 100% more energy when active compared to when passive, suggesting that passive elements of muscle have the ability to absorb energy but this ability is greatly enhanced when a muscle is active (Nikolaou *et al.*, 1987). Any condition that decreases the ability of a muscle to contract therefore decreases its ability to store energy and increases injury susceptibility (Kirkendall & Garrett, 2002). Results of this study provide evidence to support application of basic science findings to human hamstring muscle that fatigued muscle might be at increased predisposition to injury via the mechanism of its reduced active energy absorbing capability.

There was no significant time, condition or interaction effect in position of the torque-angle curve that peak torque was achieved, thus disputing the suggestion that fatigue alters the shape of this curve. Previous research into the force-length relationship has shown that the force depression of fatigued muscle correlates with a rightward shift in force-length characteristics of muscle (Whitehead *et al.*, 2001; Biewener *et al.*, 2004; MacIntosh & MacNaughton, 2005; MacNaughton & MacIntosh, 2007). This implies that fatigued muscles favour force generation at longer lengths, possibly due to stretch of series elastic elements resulting in sarcomeres contracting at a shorter length. Findings from this study do support those of a recent *in vitro* study which reported that when the series elastic compliance of whole muscle (rat medial gastrocnemius) and aponeurosis and/or tendon is taken into account, force depression resulting from fatigue via repetitive *in situ* muscle stimulation did not result in a substantial rightward shift in the muscle's force-length relationship. Researchers demonstrated this using sonomicrometry to measure directly muscle fascicle length, and reported no significant change in fascicle length before and after fatigue (MacNaughton & MacIntosh, 2006). Prior to this, the method of calculating active force used the passive force at the actual fascicle length during contraction, instead of the passive force at the length of the inactive muscle. The authors did note that this effect would be less important for muscles having less connective tissue and, as a result, less series elastic compliance. The gastrocnemius of rodents, like humans, is a muscle that has considerable passive stiffness (MacNaughton & MacIntosh, 2007) and the difference between results of this study and those that have previously demonstrated an *in vivo* shift in the force-length relationship is probably due to differences in measurement techniques affecting these factors.

5.4.4 Static flexibility measurements

There was a significant effect of time for all static hamstring flexibility measurements except ASLR, thus supporting hypothesis 1. Increases in static flexibility are commonly seen after a warm-up period (Murphy *et al.*, 2010) and while general non-fatiguing exercise results in increased static flexibility, probably due to the increased extensibility of warm tissues, (Noonan *et al.*, 1993; Magnusson *et al.*, 2000), the significant reduction in static flexibility measurements following the repeated sprint protocol performed in this study is likely to be due to a number of factors. Fatigue is associated with failure of the contractile capacity of the exercised muscles and as such, fatigued muscles are thought to exhibit greater stiffness and reduced tolerance to stretch

(Noakes, 2000; Ogai *et al.*, 2008). Fatiguing protocols have induced significant reductions in combined maximal hip flexion and knee extension angle during sprinting, which was attributed to reduced hamstring length (Moller *et al.*, 1985; Young *et al.*, 2004) and resulting in reduced stride length. Static flexibility measures in this study returned to values not significantly different from pre-exercise by 18 hours post-exercise, thus these findings have limited consequence to subsequent training sessions. There was a significant effect of condition and interaction between time and condition for AKE and PKE, with stretch conditions maintaining higher levels of AKE and PKE than control conditions, thus partly supporting hypothesis 2. The significant differences between control and stretch conditions 18 hours post-exercise in AKE and PKE suggest that performing a 30s static stretch post-exercise seems to negate the loss of static flexibility during AKE and PKE tests. This might be related to the increased passive and active energy absorption seen in the stretch condition 18 hours after exercise but further studies are needed to ascertain possible mechanisms for this.

5.4.5 Perception of stiffness

There was a significant time effect on perceived stiffness with significantly lower perceived stiffness immediately post-exercise and significantly higher perceived stiffness 18 hours post-exercise compared to pre-exercise, and a significant interaction between time and stretch condition. Mean data indicated that perceived stiffness was significantly greater in the control condition compared to the stretch condition 18 hours post-exercise. It is possible that the decrease in perception of stiffness following exercise can also be partly attributed to the increased tissue temperature reducing the viscoelasticity of the muscles thus allowing easier movements for a given force. Moreover, maximal sprinting will require relatively high levels of hip and knee flexion and extension therefore thixotropic associated stiffness will be minimised. In muscles, bonds between fibres become detached as a result of movement or stretch and gradually reform during rest (Proske & Morgan, 1999; Walsh *et al.*, 2009). Exercise is associated with a ‘loosening up’ of muscles and joints and as the participants had been using their joints through a relatively full part of their range, this would have ensured that most fibres had been recruited throughout their range. Exercise has also been shown to induce analgesia via alterations in the transmission of nociceptive (pain) fibres. This is caused by the endorphins and enkephalins released as a result of the exercise blocking the signal at synapses (Pert, 1982; Sforzo, 1989). This effect, in combination with the feelings of euphoria caused by the release of these

chemicals, might contribute to lessening in perception of stiffness. The first hint of fatigue in humans is often the sense that it is necessary to increase the effort associated with the task, rather than an inability to exert the necessary force (Gandevia *et al.*, 1981; Jones & Hunter, 1983; Ferrell *et al.*, 1987; Twist *et al.*, 2012). This suggests that individuals judgements are based on the effort required to generate a force, rather than the absolute magnitude of the force generated, and psychophysical experiments have demonstrated the independence of perceived effort and force failure during sustained activity (Psek & Cafarelli, 1993; Noakes *et al.*, 2004; Swart *et al.*, 2012). It has been proposed that these alterations in perception are due to the internal actions of motor commands or corollary discharge (McCloskey *et al.*, 1983; Cafarelli, 1988) and that the association is influenced by humoral factors circulating in the cerebrospinal fluid (Gerald, 1978; Heyes *et al.*, 1985). Although related to force production, it is possible that similar mechanisms influence perception of stiffness. Immediately post-exercise, there was decreased perceived stiffness despite reduced static and dynamic flexibility measures. A greater perception of capability relative to true capability may leave the individual partially unprotected during an episode of externally imposed mechanical stressors (Doyle *et al.*, 1998) and individuals may also choose actions in competitive situations that may have inherent extra risk when in conjunction with fatigue-related reduced neuromuscular performance capabilities (Gabbett, 2008; Cè *et al.*, 2013), for example stretching into a range that is no longer available and thus incurring a strain injury.

PPM correlations showed that perception of stiffness shared a significant positive relationship with passive energy absorption in the stretch condition immediately post-exercise ($r = 0.53$, $p \leq 0.05$, common variance 28%). Although this would be classed as a moderately strong relationship according to the correlation coefficient value (Atkinson & Nevill, 1998), these variables share a common variance of only 28% suggesting that there are other factors influencing level of perceived stiffness. These might include psychological factors such as motivation levels, anxiety, influence of peer group, and self-confidence (Smith, 2003; Tod *et al.*, 2003; McIntosh, 2005; Twist *et al.*, 2012). 18 hours post-exercise both the stretch and the control conditions shared significant negative relationships between passive energy absorption and perception of stiffness ($r = -0.32$ and $r = -0.71$, $p \leq 0.05$, common variance 10% and 50%). Although these common variances are low, it is possible that at this time the participants who felt looser had a reduced capacity for energy absorption and were thus at greater risk of sustaining a

muscle strain injury. Psychological factors play an important role in performance. The placebo effect is a psychological phenomenon where the measurable, observable, or felt improvement in health or behaviour is not attributable to a medication or invasive treatment that has been administered (Beedie & Foad, 2009). If athletes feel that post-exercise stretching makes them less stiff and better able to perform to their full capacity the following day, inclusion of these techniques in a cool-down regime might be useful if there were no apparent negative effects.

5.4.6 Joint position sense

Results of this study supported those of previous studies in finding a significant effect of time on JPS, with a significant deterioration in JPS immediately post-exercise in both control and stretch conditions (Skinner *et al.*, 1986; Walsh *et al.*, 2004; Walsh *et al.*, 2006; Givoni *et al.*, 2007) and supporting hypothesis 3. The magnitude of the change in the control condition in this study (1.5°) was similar to the 2.1° to 4.5° previously reported. While altered JPS has previously been considered an injury risk factor (Larsen *et al.*, 2005; Givoni *et al.*, 2007; Bonsfills *et al.*, 2008; Ergen & Ulkar, 2008), the influence of fatigue on JPS has received only limited scrutiny (Miura *et al.*, 2004; Mohammadi & Roozdar, 2010; Pinsault & Vuillerme, 2010; Vafadar *et al.*, 2012). Muscles subjected to an eccentric fatiguing protocol exhibit greater deterioration in JPS than those having undertaken a concentric fatiguing protocol, which might be as a result of the greater muscle damage induced by eccentric exercise (Aarimaa *et al.*, 2004).

There was a significant interaction between time and condition on JPS and post-hoc analysis indicated a significant difference between stretch and control conditions at baseline and immediately post-exercise, but not 18 hours post-exercise. Comparison of the means indicated the stretch condition (3.3°) led to a greater deterioration in JPS than the control condition (1.5°), therefore hypothesis 4 was rejected. It is likely that the increased deterioration in JPS in the stretch condition is due to altered muscle spindle activity as a result of the stretch. Muscle spindles provide information about limb position and velocity and the loading of the knee joint (Laskowski *et al.*, 2000). This assumption is supported by the observation that the muscle spindles are affected by a previous history of muscle stretching (Chalmers, 2004). It has also been suggested that static stretching may adjust the positional sensitivity of the muscular receptors by affecting the series elastic component of the muscles (Bjorklund *et al.*, 2001). The reduction in JPS was not evident 18 hours post-exercise but may be a consideration when

athletes are encouraged to stretch during breaks in play or training in attempts to minimise the effects of fatigue, although any possible detriments must be balanced against potential benefits.

5.4.7 Practical implications

Results of this study suggest mechanisms via which fatigue might increase injury predisposition and therefore can offer some tentative practical implications for sports science and medical practitioners:

- Although these data were gathered on an isokinetic dynamometer and therefore have limited applicability to real life sprinting situations where speed of movement is much greater as well as additional synergistic control being needed, it is possible that they provide more insightful information than purely static flexibility measures alone;
- Post-exercise static hamstring stretching reduced losses in active peak torque and increased active and passive energy absorption both immediately and 18 hours post-exercise, which might be beneficial to subsequent performance and level of injury predisposition;
- Post-exercise static hamstring stretching had a significant effect, with moderate to high effect size, on perception of stiffness with participants feeling that post-exercise stretching made them looser 18 hours later, when a subsequent training session might be likely to take place. Incorporation of post-exercise static stretching should not be at the exclusion of other factors which have more supporting empirical evidence, such as an aerobic cool-down (Montgomery *et al.*, 2008; Robey *et al.*, 2009);
- Recommendations about post-exercise static hamstring stretching should be made on an individual rather than general basis and take into account any prior injuries that the individual has sustained. For example, previous injuries to the ankle can affect proprioception (Alentorn-Geli *et al.*, 2009; Han *et al.*, 2009; Witchalls *et al.*, 2012) and in individuals such as these, altered JPS might be a more major factor than in those who have otherwise unaffected proprioceptive ability; and
- Because effect sizes were generally small, differences although significant have questionable clinical meaningfulness. A clinically meaningful implies a change that is both appreciably different, and of value to the participant (Atkinson & Nevill, 1998). Further research is needed using larger samples and more reliable methodology to determine whether this will increase the effect size of post-exercise static hamstring stretching.

5.4.8 Limitations

Fatigue was assumed in this study through the increase in sprint time seen between beginning and end of the repeated sprint protocol. This does not provide any markers of fatigue so it was not possible to determine whether fatigue was central or peripheral, and blood sampling and/or muscle biopsies would have been a useful inclusion to provide information on this. Given that much research has attributed improvements in static flexibility without concurrent changes in passive dynamic flexibility to stretch induced analgesia, termed increased stretch tolerance, measurement of pain or hormonal markers in participants undertaking stretching regimes would be valuable to investigate the extent that this proposed mechanism might contribute to increases in static flexibility seen following stretching interventions.

The repeated sprint protocol used in this study did not aim to specifically induce fatigue of the hamstring muscle group, as do protocols using specific concentric, eccentric or isometric movements, but rather a general fatigue similar to that experienced during matches and training sessions. Co-activation patterns during static contractions are different to those evaluated during a range of concentric and eccentric muscle contractions such as those performed repeatedly when sprinting (Psek & Cafarelli, 1993; Weir *et al.*, 1998) and significant differences have also been reported in muscle activation between isometric, eccentric and concentric contractions (Kellis, 1999). It is possible that although the fatiguing protocol utilised actions that would be performed regularly by participants, evaluation of the effect of fatigue through torque production on an isokinetic dynamometer did not provide a complete picture. Further research investigating the impact of fatigue on the biomechanical properties of the hamstring muscle group using functional movements should be considered. The practical nature of the fatiguing protocol is also likely to have induced fatigue in reciprocal muscle groups which may have affected static flexibility measures, particularly those involving an active component, e.g. quadriceps fatigue may have resulted in lesser achievements on AKE tests. Additionally, it is possible that participants experienced an inability to relax fatigued muscles completely and this might have further influenced some of the measurements. Replication of the experimental procedure with a protocol to induce localised hamstring fatigue would determine the extent of possible effects from these factors.

Attempts were made to control any effects of circadian variation for the studies in Chapters 3 and 4 by ensuring that testing sessions were held at similar times of the day. In order to mimic training schedules of clubs and limit the impact of participants undertaking different types and intensities of training sessions between the same day and next day post-exercise measurements being taken, testing sessions for the study in Chapter 5 were held on successive afternoons and mornings. As flexibility can be affected by circadian variation, this may have impacted on results. Further research, which utilises a 24-hour post-exercise, could be considered to minimise the potential impact of this. Additionally, the use of activity diaries in the periods between testing should be considered to ensure that differences in activities of daily living among participants did not influence results.

Because of the time constraints of the professional sportsmen used in this study and the necessity of conducting testing during the same period of the season to minimise any effects of varying levels of conditioning, it was necessary to employ an exercise protocol that related to a training situation as opposed to simulating a match. This was deemed appropriate as many injuries do occur in training situations and pre-season is a common injury point (Gabbett, 2004). Attempts were made to relate the protocol to typical play and training as far as possible by utilising sprints of a distance commonly seen in Rugby League and taking care that work:recovery intervals were comparable to those seen in training situations. Despite this, it is possible that the repeated sprint protocol used in this study induced fatigue via different mechanisms than would a longer exercise sessions and replication of the study using an exercise protocol simulating a game would be interesting to determine if the type of activity undertaken influences the effects of fatigue on active and passive mechanical characteristics of the hamstring muscle.

The static stretch used in this study was chosen to mimic protocols described in texts (Maud & Cortez-Cooper, 1994; Alter, 2004) and routinely used in coaching practice. Because time is often constrained in professional sport, it was decided to use a stretch that a participant could perform alone rather than an assisted stretch. As the participants assumed the stretch position, the hamstring muscle would have been working eccentrically in reverse action to control the lowering of the upper body and as such, the stretch was not purely a static one but had a contract component. Getting the participants to perform seated stretches might have lessened the effect of gravity on this but would still have had an impact. Additionally, although clear instructions were

given to keep the lower back curved, it was impossible to control for differences in lordosis. The use of assisted stretching with the lower back kept flat would help control for this. Future studies should consider using assisted stretches to determine if the effects are similar to those obtained from these unassisted stretches.

5.4.9 General limitations

Conclusions made in relation to this thesis need to be examined in light of the respective limitations, which can broadly be categorised in relation to threats to the internal and external validity of studies. Internal validity refers to the extent to which it can be accurately stated that the independent variable produced the observed effects, while external validity relates to the generalisability of findings across different populations, tasks or environments (Godwin *et al.*, 2003).

Many of the threats to internal validity have been separately addressed in the respective studies and are particular to the research approach undertaken. Specific aspects of the thesis that provided some uniqueness but nonetheless some threats to internal validity were the measurement of passive dynamic flexibility and the use of an elite athletic population. During passive dynamic flexibility tests, participants were asked to maintain full muscular relaxation while undergoing measurement procedures and because previous literature and pilot studies indicated unchanged EMG levels, these were not monitored. During testing it appeared that not all individuals were able to achieve the same levels of relaxation, as torque-angle curves of some participants were less smooth than others. Observation of any EMG changes would have been useful to ensure that results were not influenced by muscular resistance, but because of strict time constraints, it was not possible to adapt methodology to include this after testing had commenced. Although all passive measurements taken on isokinetic dynamometers were corrected for gravity, gravity correction equations are derived for active movements. The passive stretch protocol used in this study may have been influenced inappropriately by gravity correction, resulting in errors in values of absolute torque produced. Although these are likely to be constant and would therefore not affect relationship or comparison analyses, it is possible that to compare actual passive torque values is inappropriate. In relation to the elite athletic population, testing sessions had to be designed to fit around the club training schedule and it may have been that some of the participants had previously partaken in more intense training sessions

than other. Fatigue after a strenuous training session has a neural manifestation with some athletes unable to voluntarily fully activate muscle or experiencing stretch reflex inhibition after heavy training (Kirsch & Rymer, 1992; Melnyk & Gollhofer, 2007). Had participants been subjected to different intensities of training sessions in the days preceding testing sessions, this might have had an influence on the results. Training diaries would have been useful in quantifying any effect from this (Hartwig *et al.*, 2008) and should be incorporated into future studies of a similar nature.

Threats to external validity were related to the use of a specialised population, the specificity of the musculoskeletal region and the procedures utilised. To limit occurrence of type II errors, a homogenous sample of athletes (professional male rugby league players) participated in all studies. In each study the sample size was considered sufficient to have enough power to detect significant differences and/or relationships, as estimated by sample size calculations, but nonetheless the elite nature of the population presented challenges in terms of developing methodology with sufficient internal validity (see section 3.2.1) and recruiting sufficiently large sample sizes. Furthermore, findings are only applicable to highly trained rugby players and further research is needed before results can be extrapolated to other elite athletic populations and more general populations. It is possible that results would be different if the same protocols would be used on athletes with a greater than normal hamstring ROM (e.g. gymnasts) although the lack of significant difference found in dynamic flexibility measures of participants classified as ‘tight’ or ‘normal’ (Chapter 4) suggest that findings might be similar. Participants from a clinical population who had irregularities in joint congruency and possible mechanical blocks preventing them from reaching full passive knee extension warrant further investigation before extrapolation of results. A further threat to external validity is that focus was purely on the hamstring muscle group, the rationale for this relating to the high incidence and disability of hamstring strain injuries. Results can therefore not be translated to other musculature in the body as this will have different structural properties and will be subject to different magnitudes and directions of force. Research is needed to examine the effect of fatigue on the biomechanical properties of other muscle groups *in vivo*, particularly those that have a relatively high incidence of strain injury. The procedure and application of isokinetic testing to measure passive and active dynamic hamstring flexibility also threatened external validity as the protocols worked the muscle groups in an isokinetic passive or eccentric manner in highly stabilised, isolated and open

chained movements. In real-life situations, musculature stabilises and fixes other joints and movements are performed at much greater and variable velocities and involve multiple joints and multiple muscle actions. Although findings from this study attempt to partly bridge the difference between findings from animal models and human field-testing, a combination of research approaches might provide a more complete picture. The development of mathematical models to enable simulation of body kinematics and injury mechanisms in a computer environment would be useful and isokinetic measures could then be tested for validity against these.

Critical evaluation of the ethical approval procedures and governance associated with the research conducted as part of the PhD process is warranted. Testing procedures throughout the investigations conducted were considered to involve only activities that would be routinely undertaken as part of club testing or training programmes. In line with University of Pretoria ethics procedures, participants were required to provide written informed consent, and in the case of minors (< 18 years), written parental or guardian consent together with verbal participant assent. The informed consent adhered to the best practice principles established by the American College of Sports Medicine by including disclosure of the risks and control measures for these risks including specific risk assessment protocols (ACSM, 1998). Participants were informed verbally and in writing of their right not to participate in the study and withdraw at any time without needing to give a reason, nonetheless because coaches were involved in the testing and approval of the club for the testing was sought there was a degree of implicit coercion. This is an inherent challenge associated with any physical testing and research involving elite athletes where club approval is necessary to practically conduct the research. A further consideration is that of confidentiality in that research data collection was occasionally combined with fitness testing data collection required by the club and was therefore disclosed to the club. Participants did consent to this disclosure of information but nonetheless data is normally held confidentially unless disclosure is required by law or to prevent harm (Shephard, 2002).

5.4.10 Reflections

This study was designed to examine the impact of fatigue and post-exercise static stretching on measures of static and dynamic flexibility and performance. An experimental randomised cross-over repeated measures design was utilised because of a relatively small population of available

participants and to enable as much control as possible over extraneous variables (Hopkins *et al.*, 1999; Godwin *et al.*, 2003). The research study was designed with consideration to quality assessment of methodology and was deemed to be of good methodological quality (PEDro score 9); it was not possible to blind participants completely but attempts were made by describing the study as intending to assess the cross over effects of upper limb stretching (De Morton, 2009). Fatigue is considered to be a modifiable risk factor for injury via suggested mechanisms including reductions in energy absorption, force generation and proprioception (Moore *et al.*, 2002; Willems & Stauber, 2002; Miura *et al.*, 2004; Melnyk & Gollhofer, 2007) but there is little empirical *in vivo* evidence to substantiate these beliefs. Because of the intensity of sports training schedules, identification of mechanisms by which fatigue might affect the properties of a muscle to increase injury predisposition was considered important to aid in development of preventative strategies. Extrapolations from animal literature have led to speculation that the increased injury occurrence in fatigued muscle is due to the reduced ability of the muscle to absorb energy (Mair *et al.*, 1996; Lieber & Friden, 2002). Results from the control condition in Chapter 6 did not support previous *in vitro* research as fatigue caused no significant changes in measures of passive or active dynamic flexibility. Static flexibility generally significantly decreased immediately post-exercise but had returned to baseline by 18 hours post-exercise. The reduction in static flexibility might combine with the significantly lower perceived stiffness levels and decline in JPS seen immediately post-exercise to provide a tentative means by which fatigue might cause increased predisposition to hamstring injuries, although the mechanisms for this are not clear from this study and warrant further investigation.

To explore the impact of post-exercise static stretching, measurements were taken after exercise and 18 hours later to try and mimic normal club training schedules when individuals undertook training sessions during afternoons and then again on subsequent mornings. Results demonstrated significantly lower passive and active energy absorption post-exercise in the control condition compared to the stretch condition both immediately and 18 hours post-exercise, indicating that a 30 s post-exercise static hamstring stretch reduced fatigue-induced losses in the energy absorbing capability of the hamstring muscle. It is possible that this might in part account for the reduction in injury rate previously reported as a result of recovery interventions that included stretching (Verrall *et al.*, 2005), but further longitudinal research of experimental design is required to confirm this. In addition to improved energy absorption, perceived stiffness was

significantly higher in the control condition compared to the stretch condition 18 hours post-exercise. A detriment to post-exercise stretching was also revealed with the stretch condition exhibiting greater deterioration in JPS than the control condition immediately post-exercise. This is not likely to have major implications in subsequent exercise sessions but may be a consideration when athletes are encouraged to stretch during breaks in play or training in attempts to minimise the effects of fatigue (Verrall *et al.*, 2005). This novel finding suggests that care must be taken in prescribing stretching if individuals already have altered proprioceptive abilities due to prior injury. These results provide tentative support for suggestions that post-exercise static stretching could be beneficial to the recovery process but the small effect size means that clinical meaningfulness might be questionable.

Previous research has attempted to measure dynamic flexibility in humans through damped oscillation techniques (Wilson *et al.*, 1991; Wilson *et al.*, 1994; Walshe *et al.*, 1996; Fukashiro *et al.*, 2001) or isokinetic resistance to controlled stretch (Klinge *et al.*, 1997; Magnusson *et al.*, 1997; Reid & McNair, 2004; Ryan *et al.*, 2008; Weppeler & Magnusson, 2010). Controlled passive stretch using isokinetic dynamometers was deemed to be the better of the available methods because of the degree of subjectivity and lack of adequate reliability of damped oscillation techniques, but nonetheless, there is some lack of ecological validity in that manoeuvres are passive, slow, controlled and highly stabilised. Researchers have reported high same-day intrarater PPM correlation coefficients ($r = 0.91$ to 0.99 , $P \leq 0.05$) for passive dynamic hamstring flexibility measurements taken on a Biodex isokinetic dynamometer and interpreted these as indicating high reliability. This evidence is limited by the inappropriate use of bivariate correlations and same-day test and retest, and thus the reliability of these measures had not been appropriately established prior to this study. Results of Chapter 3 demonstrated high relative reliability with intraday ICCs (3,1) of $r = 0.85$ to 0.98 ($P \leq 0.05$) and interday ICCs (3,1) of $r = 0.89$ to 0.98 ($P \leq 0.05$). Absolute reliability values demonstrated random error of 7.3 to 10.7 Nm for passive peak torque and 4.4 to 7.1 J for passive energy absorption. Previous research has tended to consider decline in peak torque as a result of stretch rather than passive peak torque or energy absorption when investigating impact of interventions on passive dynamic flexibility (McHugh *et al.*, 1992; Magnusson *et al.*, 1996; LaRoche & Connolly, 2006; Marshall *et al.*, 2011). This study found non-significant changes in passive peak torque of 2.2 to 4.1 Nm and in passive energy absorption of 3.3 J as a result of post-exercise stretch, therefore it is possible that

as the degree of random error is larger than the observed changes, the measurement technique was not sufficiently sensitive and type II errors might have occurred (no impact of stretch was detected on passive and active dynamic hamstring flexibility but in actuality there was one). Procedures must be developed to reduce the extent of random error before future studies are conducted

This was an opportunistic study designed around the availability of professional rugby league players under the condition that testing would not adversely affect training or playing abilities. Opportunities to conduct research on such populations are rare and provide a homogenous sample but also present some difficulties. The testing battery took four hours on each of four afternoons and two hours on each of the subsequent mornings. These were the times made available by the coach and strict adherence to these was necessary. Because of this, there was no way the testing protocol could be adapted after testing commenced. Additionally, the variables selected, although providing more insight than has previously been gleaned into mechanisms by which fatigue and post-exercise static stretching might influence measures of static and dynamic flexibility, are insufficient to conclude on all aspects of movement science and further investigation using a combination of research methods is warranted.

5.4.11 Future directions of research

This thesis attempted to use a fairly novel and infrequently reported measure of passive dynamic flexibility to further understanding of flexibility, stretching and injury susceptibility. Despite establishing via pilot studies a workable protocol and providing evidence the measurement procedure had adequate relative reliability and acceptable measurement error, it nonetheless still lacked some ecological validity. To further understanding, more active measurements that mimic actions and speeds of real-life sport movements are required, and should also include consideration of the complex interaction of factors that constrain flexibility. For instance, fatiguing protocols have been reported to lead to significant reductions in combined maximal hip flexion and knee extension angle during sprinting, resulting in decreased stride length and attributed to reduced hamstring length (Moller *et al.*, 1985; Young *et al.*, 2004). Empirical evidence supporting such assumptions is lacking and measurement of force-deformation characteristics of muscle to establish active dynamic flexibility in a real life situation is warranted to further understanding. This would be complicated and require the use of complex

mathematical modelling of data from force plates, accelerometers and motion analysis software at the very least. A similar criticism can be made regarding the measure of JPS, which was assessed using a commonly described and accepted method (Givoni *et al.*, 2007; Walsh *et al.*, 2009; Gear, 2011). The movements involved were slow and controlled and performed in an open chain manner, whereas during locomotion the adaptation of movements by proprioceptive feedback is more dynamic and involves large forces which often need to be generated in split seconds. Future research would be useful to determine fatigue induced alterations in JPS in more real world situations using methodology that would mimic functional movements such as in closed kinetic chain movements at higher velocities. Development of procedures to enable data collection in more real-life scenarios and/or mathematical modelling of these situations is necessary to add to data measured in clinical or field settings.

An underlying aspiration within the thesis was to better understand why flexibility is cited as an injury risk factor, and how stretching might impact on flexibility, performance and susceptibility to injury. To fully understand injury, research approaches need to be combined in order to better understand relative risks of different internal and external factors, mechanisms of injury and inciting events. It was beyond the scope and aims of this thesis to include a range of research approaches, for instance athlete interviews to explore the inciting event or epidemiological approaches to evaluate relative risks of different levels of passive and active dynamic flexibility. The experimental approach taken in this study enabled investigation of the impact of post-exercise stretching immediately and 18 hours post-exercise, but it was not possible to take measurements between these two times and it would be interesting to observe the time course of any changes. This could have implications for tournament situations where many games take place in a relatively short period with little time for recovery in between, and would be of particular relevance to JPS, which significantly deteriorated immediately post-stretch but had returned to baseline 18 hours later. Prospective epidemiological investigations, ideally controlled clinical trials where teams are followed for two or more seasons prior to implementation of the intervention and two or more seasons after implementation of the intervention should be conducted to develop further understanding of the potential benefits of post-exercise static stretching. This research approach would limit influences of external variables such as weather conditions and levels of fitness but would require large study population numbers and resources to realise the research aims.

5.5 CONCLUSIONS

The purpose of this study was to investigate the impact of fatigue and post-exercise static stretching on measures of static and dynamic flexibility and performance. Fatigue resulted in no significant changes in passive dynamic flexibility to a common angle or final position, or to active dynamic flexibility. Static flexibility generally significantly decreased immediately post-exercise but had returned to baseline by 18 hours post-exercise. Perceived stiffness was significantly lower immediately post-exercise and significantly higher 18 hours post-exercise than pre-exercise. Post-exercise stretch resulted in significantly increased passive and active energy absorption immediately and 18 hours post-exercise compared to the control condition and in significantly reduced JPS in the stretch condition immediately post-exercise. Perceived stiffness was significantly greater in the control condition compared to the stretch condition 18 hours post-exercise. Effect sizes were generally small so the clinical meaningfulness of performing post-exercise static stretching is questionable, particularly as time constraints of professional sport might mean it would at the exclusion of other, potentially more beneficial practices.

CHAPTER 6

REFERENCES

AAGAARD, P. SIMONSEN, E.B. ANDERSEN, J.L. MAGNUSSON, S.P. HALKJAER-KRISTENSEN, J. & DYHRE-POULSEN, P. (2000). "Neural inhibition during maximal eccentric and concentric quadriceps contraction: effects of resistance training." *Journal of Applied Physiology*, 89(6): 2249-2257.

AARIMAA, V. RANTANEN, J. BEST, T. SCHULTZ, E. CORR, D. & KALIMO, H. (2004). "Mild eccentric stretch injury in skeletal muscle causes transient effects on tensile load and cell proliferation." *Scandinavian Journal of Medicine and Science in Sports*, 14(6): 367-372.

ACSM (1998). "American College of Sports Medicine Position Stand. The recommended quantity and quality of exercise for developing and maintaining cardiorespiratory and muscular fitness, and flexibility in healthy adults." *Medicine and Science in Sports and Exercise*, 30(6): 975-991.

AGRE, J.C. (1985). "Hamstring injuries. Proposed aetiological factors, prevention, and treatment." *Sports Medicine (Auckland, N.Z.)*, 2(1): 21-33.

ALBEE, F.H. & GILLILAND, A.R. (1920). "Metrotherapy, or the measure of voluntary movement." *Journal of the American Medical Association*, 75(15): 983-986.

ALENTORN-GELI, E. MYER, G.D. SILVERS, H.J. SAMITIER, G. ROMERO, D. LAZARO-HARO, C. & CUGAT, R. (2009). "Prevention of non-contact anterior cruciate ligament injuries in soccer players. Part 1: Mechanisms of injury and underlying risk factors." *Knee Surgery, Sports Traumatology Arthroscopy*, 17(7): 705-729.

ALLEN, D.G. (2001). "Eccentric muscle damage: mechanisms of early reduction of force." *Acta Physiologica Scandinavica*, 171(3): 311-319.

ALLEN, T.J. LEUNG, M. & PROSKE, U. (2010). "The effect of fatigue from exercise on human limb position sense." *The Journal of Physiology*, 588(8): 1369-1377.

ALQUIER, L. (1916). "Un goniometre precis." *Revue Neurologique*, 23(2): 515-519.

ALTER, M.J. (2004). *Science of Flexibility*. Europe, Human Kinetics Ltd.

ALTMAN, D.G. & ANDERSEN, P.K. (1989). "Bootstrap investigation of the stability of a Cox regression model." *Statistics in Medicine*, 8(7): 771-783.

AMAKO, M. ODA, T. MASUOKA, K. YOKOI, H. & CAMPISI, P. (2003). "Effect of static stretching on prevention of injuries for military recruits." *Military Medicine*, 168(6): 442-446.

AMAKO, M. TSUDA, K. OYAMA, E. MASUOKA, K. YOKOI, H. & OSADA, M. (1999). "Effect of Static Stretching on Muscle Flexibility of Military Recruits." *Japanese Journal of Orthopedic Sports Medicine*, 19(4): 411-416.

ANDERSON, B. & BURKE, E.R. (1991). "Scientific, medical, and practical aspects of stretching." *Clinics in Sports Medicine*, 10(1): 63-86.

ANDRISH, J.T. BERGFELD, J.A. & WALHEIM, J. (1974). "A prospective study on the management of shin splints." *The Journal of Bone and Joint Surgery*, 56(8): 1697-1700.

ANLOAGUE, P.A. SPEES, V. SMITH, J. HERBENICK, M.A. & RUBINO, L.J. (2012). "Glenohumeral range of motion and lower extremity flexibility in collegiate-level baseball players." *Sports Health: A Multidisciplinary Approach*, 4(1): 25-30.

AQUINO, C.F. GONÇALVES, G.G.P. FONSECA, S.T. & MANCINI, M.C. (2006). "Analysis of the relation between flexibility and passive stiffness of the hamstrings." *Revista Brasileira de Medicina do Esporte*, 12: 195-200.

ARMSTRONG, A.D. MACDERMID, J.C. CHINCHALKAR, S. STEVENS, R.S. & KING, G.J. (1998). "Reliability of range-of-motion measurement in the elbow and forearm." *Journal of Shoulder and Elbow Surgery*, 7(6): 573-580.

ARMSTRONG, R.B. WARREN, G.L. & WARREN, J.A. (1991). "Mechanisms of exercise-induced muscle fibre injury." *Sports Medicine (Auckland, N.Z.)*, 12(3): 184-207.

ARNASON, A. ANDERSEN, T.E. HOLME, I. ENGBRETSSEN, L. & BAHR, R. (2008). "Prevention of hamstring strains in elite soccer: an intervention study." *Scandinavian Journal of Medicine and Science in Sports*, 18(1): 40-48.

ARNASON, A. GUDMUNDSSON, A. DAHL, H.A. & JOHANNSSON, E. (1996). "Soccer injuries in Iceland." *Scandinavian Journal of Medicine and Science in Sports*, 6(1): 40-45.

ARNASON, A. SIGURDSSON, S.B. GUDMUNDSSON, A. HOLME, I. ENGBRETSSEN, L. & BAHR, R. (2004). "Risk factors for injuries in football." *The American Journal of Sports Medicine*, 32(1 Suppl): 5S-16S.

ARNOLD, A.S. ANDERSON, F.C. PANDY, M.G. & DELP, S.L. (2005). "Muscular contributions to hip and knee extension during the single limb stance phase of normal gait: a framework for investigating the causes of crouch gait." *Journal of Biomechanics*, 38(11): 2181-2189.

ARUIN, A.S. PRILUTSKII, B.I. RAITVIN, L.M. & SAVEL'EV, I.A. (1979). "Biomechanical properties of muscles and efficiency of movement." *Human Physiology*, 5(4): 426-434.

ATKINSON, G. & NEVILL, A.M. (1998). "Statistical methods for assessing measurement error (reliability) in variables relevant to sports medicine." *Sports Medicine (Auckland, N.Z.)*, 26(4): 217-238.

ATKINSON, G. & REILLY, T. (1995). "Effects of age and time of day on preferred work rates during prolonged exercise." *Chronobiology International*, 12(2): 121-134.

AVELA, J. FINNI, T. LIIKAVAINIO, T. NIEMELÄ, E. & KOMI, P.V. (2004). "Neural and mechanical responses of the triceps surae muscle group after 1 h of repeated fast passive stretches." *Journal of Applied Physiology*, 96(6): 2325-2332.

AVELA, J. KYROLAINEN, H. & KOMI, P.V. (1999). "Altered reflex sensitivity after repeated and prolonged passive muscle stretching." *Journal of Applied Physiology*, 86(4): 1283-1291.

AWAN, R. SMITH, J. & BOON, A.J. (2002). "Measuring shoulder internal rotation range of motion: a comparison of 3 techniques." *Archives of Physical Medicine and Rehabilitation*, 83(9): 1229-1234.

AYALA, F. DE BARANDA, P.S. CROIX, M.D.S. & SANTONJA, F. (2012a). "Reproducibility and Concurrent Validity of Hip Joint Angle Test for Estimating Hamstring Flexibility in Recreationally Active Young Men." *The Journal of Strength and Conditioning Research*, 26(9): 2372-2382.

AYALA, F. SAINZ, B.P. DE STE, C.M. & SANTONJA, F. (2012b). "Absolute reliability of five clinical tests for assessing hamstring flexibility in professional futsal players." *Journal of Science and Medicine in Sport*, 15(2): 142-147.

AYALA, F. & SAINZ DE BARANDA ANDÚJAR, P. (2010). "Effect of 3 different active stretch durations on hip flexion range of motion." *The Journal of Strength and Conditioning Research*, 24(2): 430-436.

AYALA, F. SAINZ DE BARANDA, P. DE STE CROIX, M. & SANTONJA, F. (2011). "Absolute reliability of five clinical tests for assessing hamstring flexibility in professional futsal players." *Journal of Science and Medicine in Sport*, 15(2): 142-147.

AYALA, F. SAINZ DE BARANDA, P. DE STE CROIX, M. & SANTONJA, F. (2011). "Criterion-related validity of four clinical tests used to measure hamstring flexibility in professional futsal players." *Physical Therapy in Sport*, 12(4): 175-181.

AYALA, F. SAINZ DE BARANDA, P. DE STE CROIX, M. & SANTONJA, F. (2012). "Reproducibility and criterion-related validity of the sit and reach test and toe touch test for estimating hamstring flexibility in recreationally active young adults." *Physical Therapy in Sport*, 13(4): 219-226.

BACH, T.M. CHAPMAN, A.E. & CALVERT, T.W. (1983). "Mechanical resonance of the human body during voluntary oscillations about the ankle joint." *Journal of Biomechanics*, 16(1): 85-90.

BACURAU, R.F.P. MONTEIRO, G.A. UGRINOWITSCH, C. TRICOLI, V. CABRAL, L.F. & AOKI, M.S. (2009). "Acute effect of a ballistic and a static stretching exercise bout on flexibility and maximal strength." *The Journal of Strength and Conditioning Research*, 23(1): 304-308.

BAHR, R. & HOLME, I. (2003). "Risk factors for sports injuries--a methodological approach." *British Journal of Sports Medicine*, 37(5): 384-392.

- BAHR, R. & KROSSHAUG, T. (2005). "Understanding injury mechanisms: a key component of preventing injuries in sport." *British Journal of Sports Medicine*, 39(6): 324-329.
- BALTACI, G. UN, N. TUNAY, V. BESLER, A. & GERCEKER, S. (2003). "Comparison of three different sit and reach tests for measurement of hamstring flexibility in female university students." *British Journal of Sports Medicine*, 37(1): 59-61.
- BANDY, W.D. & IRION, J.M. (1994). "The effect of time on static stretch on the flexibility of the hamstring muscles." *Physical Therapy*, 74(9): 845-850; discussion 850-842.
- BANDY, W.D. IRION, J.M. & BRIGGLER, M. (1997). "The effect of time and frequency of static stretching on flexibility of the hamstring muscles." *Physical Therapy*, 77(10): 1090-1096.
- BANDY, W.D. IRION, J.M. & BRIGGLER, M. (1998). "The effect of static stretch and dynamic range of motion training on the flexibility of the hamstring muscles." *The Journal of Orthopaedic and Sports Physical Therapy*, 27(4): 295-300.
- BARNETT, A. (2006). "Using recovery modalities between training sessions in elite athletes: does it help?" *Sports Medicine (Auckland, N.Z.)*, 36(9): 781-796.
- BATTERHAM, A.M. & GEORGE, K.P. (2003). "Reliability in evidence-based clinical practice: a primer for allied health professionals q." *Physical Therapy in Sport*, 4: 122-128.
- BAZETT-JONES, D.M. WINCHESTER, J.B. & MCBRIDE, J.M. (2005). "Effect of potentiation and stretching on maximal force, rate of force development, and range of motion." *Journal of Strength and Conditioning Research*, 19(2): 421-426.
- BEAUDOIN, C.M. & WHATLEY BLUM, J. (2005). "Flexibility and running economy in female collegiate track athletes." *The Journal of Sports Medicine and Physical Fitness*, 45(3): 295-300.
- BECKETT, J.R. SCHNEIKER, K.T. WALLMAN, K.E. DAWSON, B.T. & GUELFY, K.J. (2009). "Effects of static stretching on repeated sprint and change of direction performance." *Medicine and Science in Sports and Exercise*, 41(2): 444-450.
- BEEDIE, C.J. & FOAD, A.J. (2009). "The placebo effect in sports performance: a brief review." *Sports Medicine (Auckland, N.Z.)*, 39(4): 313-329.
- BEHM, D.G. BAMBURY, A. CAHILL, F. & POWER, K. (2004). "Effect of acute static stretching on force, balance, reaction time, and movement time." *Medicine and Science in Sports and Exercise*, 36(8): 1397-1402.
- BEHM, D.G. BUTTON, D.C. & BUTT, J.C. (2001). "Factors affecting force loss with prolonged stretching." *Canadian Journal of Applied Physiology*, 26(3): 261-272.

- BEHM, D.G. & CHAOUACHI, A. (2011). "A review of the acute effects of static and dynamic stretching on performance." *European Journal of Applied Physiology*, 111(11): 2633-2651.
- BEHM, D.G. & KIBELE, A. (2007). "Effects of differing intensities of static stretching on jump performance." *European Journal of Applied Physiology*, 101(5): 587-594.
- BEIJSTERVELDT, A. PORT, I. VEREIJKEN, A. & BACKX, F. (2012). "Risk Factors for Hamstring Injuries in Male Soccer Players: A Systematic Review of Prospective Studies." *Scandinavian Journal of Medicine & Science in Sports*, 23(3): 253-262.
- BEN, M. & HARVEY, L.A. (2010). "Regular stretch does not increase muscle extensibility: a randomized controlled trial." *Scandinavian Journal of Medicine and Science in Sports*, 20(1): 136-144.
- BENNELL, K. TULLY, E. & HARVEY, N. (1999). "Does the toe-touch test predict hamstring injury in Australian Rules footballers?" *The Australian Journal of Physiotherapy*, 45(2): 103-109.
- BENNELL, K. WAJSWELNER, H. LEW, P. SCHALL-RIAUCOUR, A. LESLIE, S. PLANT, D. & CIRONE, J. (1998). "Isokinetic strength testing does not predict hamstring injury in Australian Rules footballers." *British Journal of Sports Medicine*, 32(4): 309-314.
- BEST, T.M. MCELHANEY, J.H. GARRETT, W.E., JR. & MYERS, B.S. (1995). "Axial strain measurements in skeletal muscle at various strain rates." *Journal of Biomechanical Engineering*, 117(3): 262-265.
- BEYNNON, B.D. RENSTROM, P.A. ALOSA, D.M. BAUMHAUER, J.F. & VACEK, P.M. (2001). "Ankle ligament injury risk factors: a prospective study of college athletes." *Journal of Orthopaedic Research*, 19(2): 213-220.
- BIERMA-ZEINSTRA, S.M. BOHNEN, A.M. RAMLAL, R. RIDDERIKHOFF, J. VERHAAR, J.A. & PRINS, A. (1998). "Comparison between two devices for measuring hip joint motions." *Clinical Rehabilitation*, 12(6): 497-505.
- BIEWENER, A.A. MCGOWAN, C. CARD, G.M. & BAUDINETTE, R.V. (2004). "Dynamics of leg muscle function in tammar wallabies (*M. eugenii*) during level versus incline hopping." *The Journal of Experimental Biology*, 207(Pt 2): 211-223.
- BIXLER, B. & JONES, R.L. (1992). "High-school football injuries: effects of a post-halftime warm-up and stretching routine." *The Family Practice Research Journal*, 12(2): 131-139.
- BJORKLUND, M. DJUPSJOBACKA, M. & CRENSHAW, A.G. (2006). "Acute muscle stretching and shoulder position sense." *Journal of Athletic Training*, 41(3): 270-274.
- BJORKLUND, M. HAMBERG, J. & CRENSHAW, A.G. (2001). "Sensory adaptation after a 2-week stretching regimen of the rectus femoris muscle." *Archives of Physical Medicine and Rehabilitation*, 82(9): 1245-1250.

BLACK, J.D. & STEVENS, E.D. (2001). "Passive stretching does not protect against acute contraction-induced injury in mouse EDL muscle." *Journal of Muscle Research and Cell Motility*, 22(4): 301-310.

BLACKBURN, J.T. PADUA, D.A. RIEMANN, B.L. & GUSKIEWICZ, K.M. (2004). "The relationships between active extensibility, and passive and active stiffness of the knee flexors." *Journal of Electromyography and Kinesiology*, 14(6): 683-691.

BLAIR, S.N. KOHL, H.W. & GOODYEAR, N.N. (1987). "Relative risks for running and exercise injuries: Studies in three populations." *Research Quarterly*, 58: 221-228.

BLAND, J.M. & ALTMAN, D.G. (1986). "Statistical methods for assessing agreement between two methods of clinical measurement." *Lancet*, 1(8476): 307-310.

BOJSEN-MOLLER, J. BROGAARD, K. HAVE, M.J. STRYGER, H.P. KJAER, M. AAGAARD, P. & MAGNUSSON, S.P. (2007). "Passive knee joint range of motion is unrelated to the mechanical properties of the patellar tendon." *Scandinavian Journal of Medicine and Science in Sports*, 17(4): 415-421.

BONNAR, B.P. DEIVERT, R.G. & GOULD, T.E. (2004). "The relationship between isometric contraction durations during hold-relax stretching and improvement of hamstring flexibility." *The Journal of Sports Medicine and Physical Fitness*, 44(3): 258-261.

BONSFILLS, N. GOMEZ-BARRENA, E. RAYGOZA, J.J. & NUNEZ, A. (2008). "Loss of neuromuscular control related to motion in the acutely ACL-injured knee: an experimental study." *European Journal of Applied Physiology*, 104(3): 567-577.

BOYD, B.S. WANEK, L. GRAY, A.T. & TOPP, K.S. (2009). "Mechanosensitivity of the lower extremity nervous system during straight-leg raise neurodynamic testing in healthy individuals." *Journal of Orthopaedic and Sports Physical Therapy*, 39(11): 780-790.

BOZIC, P.R. PAZIN, N.R. BERJAN, B.B. PLANIC, N.M. & CUK, I.D. (2010). "Evaluation of the field tests of flexibility of the lower extremity: reliability and the concurrent and factorial validity." *The Journal of Strength and Conditioning Research*, 24(9): 2523-2531.

BRADLEY, P.S. OLSEN, P.D. & PORTAS, M.D. (2007). "The effect of static, ballistic, and proprioceptive neuromuscular facilitation stretching on vertical jump performance." *Journal of Strength and Conditioning Research*, 21(1): 223-226.

BRADLEY, P.S. & PORTAS, M.D. (2007). "The relationship between preseason range of motion and muscle strain injury in elite soccer players." *Journal of Strength and Conditioning Research*, 21(4): 1155-1159.

BRANDENBURG, J.P. (2006). "Duration of stretch does not influence the degree of force loss following static stretching." *The Journal of Sports Medicine and Physical Fitness*, 46(4): 526-534.

- BROCKETT, C.L. MORGAN, D.L. & PROSKE, U. (2004). "Predicting hamstring strain injury in elite athletes." *Medicine and Science in Sports and Exercise*, 36(3): 379-387.
- BROOKS, J.H. FULLER, C.W. KEMP, S.P. & REDDIN, D.B. (2005). "A prospective study of injuries and training amongst the England 2003 Rugby World Cup squad." *British Journal of Sports Medicine*, 39(5): 288-293.
- BROOKS, J.H. FULLER, C.W. KEMP, S.P. & REDDIN, D.B. (2006). "Incidence, risk, and prevention of hamstring muscle injuries in professional rugby union." *The American Journal of Sports Medicine*, 34(8): 1297-1306.
- BROOKS, J.H.M. & FULLER, C.W. (2006). "The influence of methodological issues on the results and conclusions from epidemiological studies of sports injuries: illustrative examples." *Sports Medicine*, 36(6): 459-472.
- BROOKS, S.V. & FAULKNER, J.A. (2001). "Severity of contraction-induced injury is affected by velocity only during stretches of large strain." *Journal of Applied Physiology*, 91(2): 661-666.
- BROOKS, S.V. ZERBA, E. & FAULKNER, J.A. (1995). "Injury to muscle fibres after single stretches of passive and maximally stimulated muscles in mice." *The Journal of Physiology*, 488(2): 459-469.
- BRUNET, M.E. COOK, S.D. BRINKER, M.R. & DICKINSON, J.A. (1990). "A survey of running injuries in 1505 competitive and recreational runners." *The Journal of Sports Medicine and Physical Fitness*, 30(3): 307-315.
- BURKETT, L.N. PHILLIPS, W.T. & ZIURAITIS, J. (2005). "The best warm-up for the vertical jump in college-age athletic men." *Journal of Strength and Conditioning Research*, 19(3): 673-676.
- BUROKER, K.C. & SCHWANE, J.A. (1989). "Does postexercise stretching alleviate delayed muscle soreness?" *The Physician and Sportsmedicine*, 17(6): 65-83.
- BUTTERFIELD, T.A. & HERZOG, W. (2005). "Quantification of muscle fiber strain during in vivo repetitive stretch-shortening cycles." *Journal of Applied Physiology*, 99(2): 593-602.
- CAFARELLI, E. (1988). "Force sensation in fresh and fatigued human skeletal muscle." *Exercise and Sport Sciences Reviews*, 16(1): 139-168.
- CAMERON, D.M. & BOHANNON, R.W. (1993). "Relationship between active knee extension and active straight leg raise test measurements." *The Journal of Orthopaedic and Sports Physical Therapy* 17(5): 257-260.

- CANNAVAN, D. COLEMAN, D.R. & BLAZEVIK, A.J. (2012). "Lack of effect of moderate-duration static stretching on plantar flexor force production and series compliance." *Clinical Biomechanics*, 27(3): 306-312.
- CARPENTER, J.E. BLASIER, R.B. & PELLIZZON, G.G. (1998). "The effects of muscle fatigue on shoulder joint position sense." *The American Journal of Sports Medicine*, 26(2): 262-265.
- CARTER, N.D. JENKINSON, T.R. WILSON, D. JONES, D.W. & TORODE, A.S. (1997). "Joint position sense and rehabilitation in the anterior cruciate ligament deficient knee." *British Journal of Sports Medicine*, 31(3): 209-212.
- CARVALHO, F.L. CARVALHO, M.C. SIMÃO, R. GOMES, T.M. COSTA, P.B. NETO, L.B. CARVALHO, R.L. & DANTAS, E.H. (2012). "Acute effects of a warm-up including active, passive, and dynamic stretching on vertical jump performance." *The Journal of Strength and Conditioning Research*, 26(9): 2447-2452.
- CASELLA, C. (1950). "Tensile force in total striated muscle, isolated fibre and sarcolemma." *Acta Physiologica Scandinavica*, 21(4): 380-401.
- CÈ, E. RAMPICHINI, S. AGNELLO, L. LIMONTA, E. VEICSTEINAS, A. & ESPOSITO, F. (2013). "Effects of temperature and fatigue on the electromechanical delay components." *Muscle and Nerve*, 47(4): 566-576.
- CHALMERS, G. (2004). "Re-examination of the possible role of Golgi tendon organ and muscle spindle reflexes in proprioceptive neuromuscular facilitation muscle stretching." *Sports Biomechanics*, 3(1): 159-183.
- CHAN, O. DEL BUONO, A. BEST, T.M. & MAFFULLI, N. (2012). "Acute muscle strain injuries: a proposed new classification system." *Knee Surgery, Sports Traumatology, Arthroscopy*, 20(11): 2356-2362.
- CHAN, S.P. HONG, Y. & ROBINSON, P.D. (2001). "Flexibility and passive resistance of the hamstrings of young adults using two different static stretching protocols." *Scandinavian Journal of Medicine and Science in Sports*, 11(2): 81-86.
- CHAPPELL, J.D. HERMAN, D.C. KNIGHT, B.S. KIRKENDALL, D.T. GARRETT, W.E. & YU, B. (2005). "Effect of fatigue on knee kinetics and kinematics in stop-jump tasks." *The American Journal of Sports Medicine*, 33(7): 1022-1029.
- CHEN, C.C. & BARNHART, H.X. (2008). "Comparison of ICC and CCC for assessing agreement for data without and with replications." *Computational Statistics and Data Analysis*, 53(2): 554-564.
- CHEUNG, K. HUME, P. & MAXWELL, L. (2003). "Delayed onset muscle soreness : treatment strategies and performance factors." *Sports Medicine (Auckland, N.Z.)*, 33(2): 145-164.

CHOW, R. ADAMS, R. & HERBERT, R. (1994). "Straight leg raise test high reliability is not a motor memory artefact." *Australian Journal of Physiotherapy*, 40: 107-107.

CHRISTOU, E.A. & CARLTON, L.G. (2002). "Motor output is more variable during eccentric compared with concentric contractions." *Medicine and Science in Sports and Exercise*, 34(11): 1773-1778.

CHUMANOV, E.S. HEIDERSCHEIT, B.C. & THELEN, D.G. (2007). "The effect of speed and influence of individual muscles on hamstring mechanics during the swing phase of sprinting." *Journal of Biomechanics*, 40(16): 3555-3562.

CHUMANOV, E.S. SCHACHE, A.G. HEIDERSCHEIT, B.C. & THELEN, D.G. (2012). "Hamstrings are most susceptible to injury during the late swing phase of sprinting." *British Journal of Sports Medicine*, 46(2): 90-90.

CHURCH, J.B. WIGGINS, M.S. MOODE, F.M. & CRIST, R. (2001). "Effect of warm-up and flexibility treatments on vertical jump performance." *Journal of Strength and Conditioning Research*, 15(3): 332-336.

CLARK, S. CHRISTIANSEN, A. HELLMAN, D.F. HUGUNIN, J.W. & HURST, K.M. (1999). "Effects of ipsilateral anterior thigh soft tissue stretching on passive unilateral straight-leg raise." *The Journal of Orthopaedic and Sports Physical Therapy*, 29(1): 4-9; discussion 10-12.

CLARKE, H.H. (1975). "Joint and body range of movement." *Physical Fitness Research Digest*, 5: 16-18.

COLDWELLS, A. ATKINSON, G. & REILLY, T. (1994). "Sources of variation in back and leg dynamometry." *Ergonomics*, 37(1): 79-86.

CONCHOLA, E. THOMPSON, B. & SMITH, D. (2013). "Effects of neuromuscular fatigue on the electromechanical delay of the leg extensors and flexors in young and old men." *European Journal of Applied Physiology*, 113(9): 2391-2399.

CONNOLLY, D.A. SAYERS, S.P. & MCHUGH, M.P. (2003). "Treatment and prevention of delayed onset muscle soreness." *Journal of Strength and Conditioning Research*, 17(1): 197-208.

CORBIN, C.B. & FOX, K. (1985). "Flexibility: The forgotten part of fitness." *Journal of Physical Education*, 16(6): 191-193.

CORBIN, C.B. & NOBLE, L. (1980). "Flexibility: A major component of physical fitness." *Journal of Physical Education and Recreation*, 6: 23-60.

CORNBLEET, S.L. & WOOLSEY, N.B. (1996). "Assessment of hamstring muscle length in school-aged children using the sit-and-reach test and the inclinometer measure of hip joint angle." *Physical Therapy*, 76(8): 850-855.

- CORNELIUS, W.L. EBRAHIM, K. WATSON, J. & HILL, D.W. (1992). "The effects of cold application and modified PNF stretching techniques on hip joint flexibility in college males." *Research Quarterly for Exercise and Sport*, 63(3): 311-314.
- CORNWELL, A. NELSON, A.G. & SIDAWAY, B. (2002). "Acute effects of stretching on the neuromechanical properties of the triceps surae muscle complex." *European Journal of Applied Physiology*, 86(5): 428-434.
- COSTA-SANTOS, C. BERNARDES, J. AYRES-DE-CAMPOS, D. COSTA, A. & COSTA, C. (2011). "The limits of agreement and the intraclass correlation coefficient may be inconsistent in the interpretation of agreement." *Journal of Clinical Epidemiology*, 64(3): 264-269.
- COSTA, P.B. RYAN, E.D. HERDA, T.J. DEFREITAS, J.M. BECK, T.W. & CRAMER, J.T. (2009). "Effects of stretching on peak torque and the H:Q ratio." *International Journal of Sports Medicine*, 30(1): 60-65.
- COTE, J.N. FELDMAN, A.G. MATHIEU, P.A. & LEVIN, M.F. (2008). "Effects of fatigue on intermuscular coordination during repetitive hammering." *Motor Control*, 12(2): 79-92.
- COVERT, C.A. ALEXANDER, M.P. PETRONIS, J.J. & DAVIS, D.S. (2010). "Comparison of ballistic and static stretching on hamstring muscle length using an equal stretching dose." *Journal of Strength and Conditioning Research*, 24(11): 3008-3014.
- COX, V.M. WILLIAMS, P.E. WRIGHT, H. JAMES, R.S. GILLOTT, K.L. YOUNG, I.S. & GOLDSPIK, D.F. (2000). "Growth induced by incremental static stretch in adult rabbit latissimus dorsi muscle." *Experimental Physiology*, 85(2): 193-202.
- CRAMER, J.T. BECK, T.W. HOUSH, T.J. MASSEY, L.L. MAREK, S.M. DANGLMEIER, S. PURKAYASTHA, S. CULBERTSON, J.Y. FITZ, K.A. & EGAN, A.D. (2007). "Acute effects of static stretching on characteristics of the isokinetic angle - torque relationship, surface electromyography, and mechanomyography." *Journal of Sports Sciences*, 25(6): 687-698.
- CRAMER, J.T. HOUSH, T.J. COBURN, J.W. BECK, T.W. & JOHNSON, G.O. (2006). "Acute effects of static stretching on maximal eccentric torque production in women." *Journal of Strength and Conditioning Research*, 20(2): 354-358.
- CRAMER, J.T. HOUSH, T.J. JOHNSON, G.O. WEIR, J.P. BECK, T.W. & COBURN, J.W. (2007). "An acute bout of static stretching does not affect maximal eccentric isokinetic peak torque, the joint angle at peak torque, mean power, electromyography, or mechanomyography." *The Journal of Orthopaedic and Sports Physical Therapy*, 37(3): 130-139.
- CROISIER, J. GANTEAUME, S. BINET, J. GENTY, M. & FERRET, J. (2008). "Strength imbalances and prevention of hamstring injury in professional soccer players: a prospective study." *The American Journal of Sports Medicine*, 36(8): 1469-1475.
- CROISIER, J.L. (2004). "Factors associated with recurrent hamstring injuries." *Sports Medicine (Auckland, N.Z.)*, 34(10): 681-695.

CROISIER, J.L. FORTHOMME, B. NAMUROIS, M.H. VANDERTHOMMEN, M. & CRIELAARD, J.M. (2002). "Hamstring muscle strain recurrence and strength performance disorders." *The American Journal of Sports Medicine*, 30(2): 199-203.

CROSS, K.M. GURKA, K.K. SALIBA, S. CONAWAY, M. & HERTEL, J. (2013). "Comparison of Hamstring Strain Injury Rates Between Male and Female Intercollegiate Soccer Athletes." *The American Journal of Sports Medicine*, 41(4): 742-748.

CROSS, K.M. & WORRELL, T.W. (1999). "Effects of a Static Stretching Program on the Incidence of Lower Extremity Musculotendinous Strains." *Journal of Athletic Training*, 34(1): 11-14.

CURETON, T.K. (1941). "Flexibility as an aspect of physical fitness." *Research Quarterly*, 12: 381-290.

DADEBO, B. WHITE, J. & GEORGE, K.P. (2004). "A survey of flexibility training protocols and hamstring strains in professional football clubs in England." *British Journal of Sports Medicine*, 38(4): 388-394.

DALLINGA, J. BENJAMINSE, A. & LEMMINK, K. (2012). "Which screening tools can predict injury to the lower extremities in team sports?: a systematic review." *Sports medicine (Auckland, NZ)*, 42(9): 791-815.

DAVIES, C.T.M. & WHITE, M.J. (1981). "Muscle weakness following eccentric work in man." *Pflügers Archiv European Journal of Physiology*, 392(2): 168-171.

DAVIS, D.S. ASHBY, P.E. MCCAULEY, K.L. MCQUAIN, J.A. & WINE, J.M. (2005). "The effectiveness of 3 stretching techniques on hamstring flexibility using consistent stretching parameters." *Journal of Strength and Conditioning Research*, 19(1): 27-32.

DAVIS, D.S. QUINN, R.O. WHITEMAN, C.T. WILLIAMS, J.D. & YOUNG, C.R. (2008). "Concurrent validity of four clinical tests used to measure hamstring flexibility." *Journal of Strength and Conditioning Research*, 22(2): 583-588.

DAWSON, B. COW, S. MODRA, S. BISHOP, D. & STEWART, G. (2005). "Effects of immediate post-game recovery procedures on muscle soreness, power and flexibility levels over the next 48 hours." *Journal of Science and Medicine in Sport*, 8(2): 210-221.

DE FELIPE, C. HERRERO, J.F. O'BRIEN, J.A. PALMER, J.A. DOYLE, C.A. SMITH, A.J.H. LAIRD, J.M.A. BELMONTE, C. CERVERO, F. & HUNT, S.P. (1998). "Altered nociception, analgesia and aggression in mice lacking the receptor for substance P." *Nature*, 392(6674): 394-397.

DE MORTON, N. (2009). "The PEDro scale is a valid measure of the methodological quality of clinical trials: a demographic study." *Australian Journal of Physiotherapy*, 55: 129-133.

- DE WEIJER, V.C. GORNIAC, G.C. & SHAMUS, E. (2003). "The effect of static stretch and warm-up exercise on hamstring length over the course of 24 hours." *The Journal of Orthopaedic and Sports Physical Therapy*, 33(12): 727-733.
- DEPINO, G.M. WEBRIGHT, W.G. & ARNOLD, B.L. (2000). "Duration of Maintained Hamstring Flexibility After Cessation of an Acute Static Stretching Protocol." *Journal of Athletic Training*, 35(1): 56-59.
- DEUTSCH, M.U. MAW, G.J. JENKINS, D. & REABURN, P. (1998). "Heart rate, blood lactate and kinematic data of elite colts (under-19) rugby union players during competition." *Journal of Sports Sciences*, 16(6): 561-570.
- DEVITA, P. & BATES, B.T. (1988). "Intraday reliability of ground reaction force data* 1." *Human Movement Science*, 7(1): 73-85.
- DEVLIN, L. (2000). "Recurrent posterior thigh symptoms detrimental to performance in rugby union." *Sports Medicine*, 29(4): 273-287.
- DI CAGNO, A. BALDARI, C. BATTAGLIA, C. GALLOTTA, M.C. VIDEIRA, M. PIAZZA, M. & GUIDETTI, L. (2010). "Preexercise static stretching effect on leaping performance in elite rhythmic gymnasts." *Journal of Strength and Conditioning Research*, 24(8): 1995-2000.
- DITROILO, M. WATSFORD, M. MURPHY, A. & DE VITO, G. (2011). "Assessing Musculo-Articular Stiffness Using Free Oscillations." *Sports Medicine*, 41(12): 1019-1032.
- DITROILO, M. WATSFORD, M. MURPHY, A. & DE VITO, G. (2011). "Assessing musculo-articular stiffness using free oscillations: theory, measurement and analysis." *Sports Medicine, (Auckland, NZ)* 41(12): 1019-1032.
- DITROILO, M. WATSFORD, M. MURPHY, A. & DE VITO, G. (2013). "Sources of Variability in Musculo-Articular Stiffness Measurement." *PloS one*, 8(5): e63719.
- DIXON, J.K. & KEATING, J.L. (2000). "Variability in Straight Leg Raise Measurements:: Review." *Physiotherapy*, 86(7): 361-370.
- DOCHERTY, C.L. MOORE, J.H. & ARNOLD, B.L. (1998). "Effects of Strength Training on Strength Development and Joint Position Sense in Functionally Unstable Ankles." *Journal of Athletic Training*, 33(4): 310-314.
- DORADO, C. SANCHIS-MOYSI, J. & CALBET, J.A. (2004). "Effects of recovery mode on performance, O₂ uptake, and O₂ deficit during high-intensity intermittent exercise." *Canadian Journal of Applied Physiology*, 29(3): 227-244.
- DOYLE, J. GLEESON, N.P. & REES, D. (1998). "Psychobiology and the athlete with anterior cruciate ligament (ACL) injury." *Sports Medicine (Auckland, N.Z.)*, 26(6): 379-393.

DRAPER, D.O. MINER, L. KNIGHT, K.L. & RICARD, M.D. (2002). "The Carry-Over Effects of Diathermy and Stretching in Developing Hamstring Flexibility." *Journal of Athletic Training*, 37(1): 37-42.

DRAWER, S. & FULLER, C.W. (2002). "Evaluating the level of injury in English professional football using a risk based assessment process." *British Journal of Sports Medicine*, 36(6): 446-451.

DUEHRING, M.D. FELDMANN, C.R. & EBBEN, W.P. (2009). "Strength and conditioning practices of United States high school strength and conditioning coaches." *Journal of Strength and Conditioning Research*, 23(8): 2188-2203.

DUONG, B. LOW, M. MOSELEY, A.M. LEE, R.Y. & HERBERT, R.D. (2001). "Time course of stress relaxation and recovery in human ankles." *Clinical Biomechanics (Bristol, Avon)*, 16(7): 601-607.

DVIR, Z. (2003). "How much is necessary to indicate a real improvement in muscle function? A review of modern methods of reproducibility analysis." *Isokinetics and Exercise Science*, 11(1): 49-52.

EBBEN, W.P. CARROLL, R.M. & SIMENZ, C.J. (2004). "Strength and conditioning practices of National Hockey League strength and conditioning coaches." *Journal of Strength and Conditioning Research*, 18(4): 889-897.

EBBEN, W.P. HINTZ, M.J. & SIMENZ, C.J. (2005). "Strength and conditioning practices of Major League Baseball strength and conditioning coaches." *Journal of Strength and Conditioning Research*, 19(3): 538-546.

EGAN, A.D. CRAMER, J.T. MASSEY, L.L. & MAREK, S.M. (2006). "Acute effects of static stretching on peak torque and mean power output in National Collegiate Athletic Association Division I women's basketball players." *Journal of Strength and Conditioning Research*, 20(4): 778-782.

EILING, E. BRYANT, A.L. PETERSEN, W. MURPHY, A. & HOHMANN, E. (2007). "Effects of menstrual-cycle hormone fluctuations on musculotendinous stiffness and knee joint laxity." *Knee Surgery, Sports Traumatology, Arthroscopy*, 15(2): 126-132.

EKSTRAND, J. & GILLQUIST, J. (1983). "Soccer injuries and their mechanisms: a prospective study." *Medicine and Science in Sports and Exercise*, 15(3): 267-270.

EKSTRAND, J. GILLQUIST, J. & LILJEDAHL, S.O. (1983). "Prevention of soccer injuries. Supervision by doctor and physiotherapist." *The American Journal of Sports Medicine*, 11(3): 116-120.

EKSTRAND, J. HÄGGLUND, M. & WALDÉN, M. (2011). "Epidemiology of muscle injuries in professional football (soccer)." *The American Journal of Sports Medicine*, 39(6): 1226-1232.

EKSTRAND, J. & KARLSSON, J. (2003). "The risk for injury in football. There is a need for a consensus about definition of the injury and the design of studies." *Scandinavian Journal of Medicine and Science in Sports*, 13(3): 147-149.

EKSTRAND, J. TIMPKA, T. & HAGGLUND, M. (2006). "Risk of injury in elite football played on artificial turf versus natural grass: a prospective two-cohort study." *British Journal of Sports Medicine*, 40(12): 975-980.

ELFTMAN, H. (1966). "Biomechanics of muscle with particular application to studies of gait." *The Journal of Bone and Joint Surgery*, 48(2): 363-377.

ELIASZIW, M. YOUNG, S.L. WOODBURY, M.G. & FRYDAY-FIELD, K. (1994). "Statistical methodology for the concurrent assessment of interrater and intrarater reliability: using goniometric measurements as an example." *Physical Therapy*, 74(8): 777-788.

ELLIOTT, M. ZARINS, B. POWELL, J. & KENYON, C. (2011). "Hamstring muscle strains in professional football players: a 10-year review." *The American Journal of Sports Medicine*, 39(4): 843-850.

ENGBRETSSEN, A.H. MYKLEBUST, G. HOLME, I. ENGBRETSSEN, L. & BAHR, R. (2010). "Intrinsic Risk Factors for Hamstring Injuries Among Male Soccer Players A Prospective Cohort Study." *The American Journal of Sports Medicine*, 38(6): 1147-1153.

ENOKA, R.M. (1994). Neuromechanical Basis of Kinesiology. Human Kinetics Ltd, Europe.

ENOKA, R.M. (2012). "Muscle fatigue—from motor units to clinical symptoms." *Journal of Biomechanics*, 45(3): 427-433.

ENOKA, R.M. & STUART, D.G. (1992). "Neurobiology of muscle fatigue." *Journal of Applied Physiology*, 72(5): 1631-1648.

EPSTEIN, M. WONG, M. & HERZOG, W. (2006). "Should tendon and aponeurosis be considered in series?" *Journal of Biomechanics*, 39(11): 2020-2025.

ERGEN, E. & ULKAR, B. (2008). "Proprioception and ankle injuries in soccer." *Clinics in Sports Medicine*, 27(1): 195-217.

ESPANA-ROMERO, V. ORTEGA PORCEL, F.B. ARTERO, E.G. JIMÉNEZ-PAVÓN, D. GUTIÉRREZ SAINZ, Á. CASTILLO GARZÓN, M.J. & RUIZ, J.R. (2009). "Climbing time to exhaustion is a determinant of climbing performance in high-level sport climbers." *European Journal of Applied Physiology*, 107(5): 517-525.

ESPOSITO, F. CÈ, E. & LIMONTA, E. (2012). "Cycling efficiency and time to exhaustion are reduced after acute passive stretching administration." *Scandinavian Journal of Medicine and Science in Sports*, 22(6): 737-745.

ESTELL, J. SHENSTONE, B. & BARNSELY, L. (1995). "Frequency of injuries in different age-groups in an elite rugby league club." *Australian Journal of Science and Medicine in Sport*, 27(4): 95-97.

ETNYRE, B.R. & ABRAHAM, L.D. (1986). "H-reflex changes during static stretching and two variations of proprioceptive neuromuscular facilitation techniques." *Electroencephalography and Clinical Neurophysiology*, 63(2): 174-179.

ETNYRE, B.R. & LEE, E.J. (1988). "Chronic and acute flexibility of men and women using three different stretching techniques." *Research Quarterly*, 59(5): 222-228.

FARIA, A. GABRIEL, R. ABRANTES, J. WOOD, P. & MOREIRA, H. (2013). "Mechanical properties of the triceps surae: Differences between football and non-football players." *Journal of Sports Sciences*, (in press).

FASEN, J.M. O'CONNOR, A.M. SCHWARTZ, S.L. WATSON, J.O. PLASTARAS, C.T. GARVAN, C.W. BULCAO, C. JOHNSON, S.C. & AKUTHOTA, V. (2009). "A randomized controlled trial of hamstring stretching: comparison of four techniques." *Journal of Strength and Conditioning Research*, 23(2): 660-667.

FEIRING, D.C. ELLENBECKER, T.S. & DERSCHEID, G.L. (1990). "Test-retest reliability of the biodex isokinetic dynamometer." *The Journal of Orthopaedic and Sports Physical Therapy* 11(7): 298-300.

FERBER, R. OSTERNIG, L.R. & GRAVELLE, D.C. (2002). "Effect of PNF stretch techniques on knee flexor muscle EMG activity in older adults." *Journal of Electromyography and Kinesiology*, 12(5): 391-398.

FERLIE, E. WOOD, M. & FITZGERALD, L. (1999). "Some limits to evidence-based medicine: a case study from elective orthopaedics." *British Medical Journal*, 8(2): 99-107.

FERRELL, W.R. GANDEVIA, S.C. & MCCLOSKEY, D.I. (1987). "The role of joint receptors in human kinaesthesia when intramuscular receptors cannot contribute." *The Journal of Physiology*, 386: 63-71.

FINCH, C.F. (1997). "An overview of some definitional issues for sports injury surveillance." *Sports Medicine (Auckland, N.Z.)*, 24(3): 157-163.

FINCH, C.F. (2011). "No longer lost in translation: the art and science of sports injury prevention implementation research." *British Journal of Sports Medicine*, 45(16): 1253-1257.

FINUCANE, S.D.G. MAYHEW, T.P. & ROTHSTEIN, J.M. (1994). "Evaluation of the Gravity-Correction Feature of a Kin-Com (R) Isokinetic Dynamometer." *Physical Therapy*, 74(12): 1125-1133.

FITZGERALD, G.K. ROTHSTEIN, J.M. MAYHEW, T.P. & LAMB, R.L. (1991). "Exercise-induced muscle soreness after concentric and eccentric isokinetic contractions." *Physical Therapy*, 71(7): 505-513.

FLEISHMAN, E.A. (1963). *The Structure and Measurement of Physical Fitness*. Englewood Cliffs NJ, Prentice Hall.

FLEISS, J.L. (1986). "Reliability of measurement." *The design and analysis of clinical experiments*: 1-32.

FLETCHER, I.M. & JONES, B. (2004). "The effect of different warm-up stretch protocols on 20 meter sprint performance in trained rugby union players." *Journal of Strength and Conditioning Research*, 18(4): 885-888.

FORD, G.S. MAZZONE, M.A. & TAYLOR, K. (2005). "The effect of 4 different durations of static hamstring stretching on passive knee-extension range of motion." *Journal of Sports Rehabilitation*, 14: 95-107.

FORD, W.J. BAILEY, S.D. BABICH, K. & WORRELL, T.W. (1994). "Effect of hip position on gravity effect torque." *Medicine and Science in Sports and Exercise*, 26(2): 230-234.

FOREMAN, T.K. ADDY, T. BAKER, S. BURNS, J. HILL, N. & MADDEN, T. (2006). "Prospective studies into the causation of hamstring injuries in sport: A systematic review." *Physical Therapy in Sport*, 7(2): 101-109.

FORTIER, J. LATTIER, G. & BABAULT, N. (2013). "Acute effects of short-duration isolated static stretching or combined with dynamic exercises on strength, jump and sprint performance." *Science and Sports*, (in press).

FOUSEKIS, K. TSEPIS, E. POULMEDIS, P. ATHANASOPOULOS, S. & VAGENAS, G. (2011). "Intrinsic risk factors of non-contact quadriceps and hamstring strains in soccer: a prospective study of 100 professional players." *British Journal of Sports Medicine*, 45(9): 709-714.

FOWLES, J.R. SALE, D.G. & MACDOUGALL, J.D. (2000). "Reduced strength after passive stretch of the human plantarflexors." *Journal of Applied Physiology*, 89(3): 1179-1188.

FRADKIN, A.J. GABBE, B.J. & CAMERON, P.A. (2006). "Does warming up prevent injury in sport? The evidence from randomised controlled trials?" *Journal of Science and Medicine in Sport*, 9(3): 214-220.

FRIDEN, J. & LIEBER, R.L. (2001). "Eccentric exercise-induced injuries to contractile and cytoskeletal muscle fibre components." *Acta Physiologica Scandinavica*, 171(3): 321-326.

FROHM, A. HEIJNE, A. KOWALSKI, J. SVENSSON, P. & MYKLEBUST, G. (2012). "A nine-test screening battery for athletes: a reliability study." *Scandinavian Journal of Medicine and Science in Sports*, 22(3): 306-315.

- FUKASHIRO, S. NODA, M. & SHIBAYAMA, A. (2001). "In vivo determination of muscle viscoelasticity in the human leg." *Acta Physiologica Scandinavica* 172(4): 241-248.
- FULLER, C.W. (2007). "Managing the risk of injury in sport." *Clinical Journal of Sport Medicine*, 17(3): 182-187.
- FUNK, D. SWANK, A.M. ADAMS, K.J. & TREOLO, D. (2001). "Efficacy of moist heat pack application over static stretching on hamstring flexibility." *Journal of Strength and Conditioning Research*, 15(1): 123-126.
- FUNK, D.C. SWANK, A.M. MIKLA, B.M. FAGAN, T.A. & FARR, B.K. (2003). "Impact of prior exercise on hamstring flexibility: a comparison of proprioceptive neuromuscular facilitation and static stretching." *Journal of Strength and Conditioning Research*, 17(3): 489-492.
- GABBE, B.J. BENNELL, K.L. FINCH, C.F. WAJSWELNER, H. & ORCHARD, J.W. (2006). "Predictors of hamstring injury at the elite level of Australian football." *Scandinavian Journal of Medicine and Science in Sports*, 16(1): 7-13.
- GABBE, B.J. BENNELL, K.L. WAJSWELNER, H. & FINCH, C.F. (2004). "Reliability of common lower extremity musculoskeletal screening tests." *Physical Therapy in Sport* 5(2): 90-97.
- GABBE, B.J. FINCH, C.F. BENNELL, K.L. & WAJSWELNER, H. (2005). "Risk factors for hamstring injuries in community level Australian football." *British Journal of Sports Medicine*, 39(2): 106-110.
- GABBE, B.J. FINCH, C.F. WAJSWELNER, H. & BENNELL, K.L. (2004). "Predictors of lower extremity injuries at the community level of Australian football." *Clinical Journal of Sport Medicine*, 14(2): 56-63.
- GABBETT, T. KING, T. & JENKINS, D. (2008). "Applied physiology of rugby league." *Sports Medicine (Auckland, N.Z.)* 38(2): 119-138.
- GABBETT, T.J. (2001). "Severity and cost of injuries in amateur rugby league: a case study." *Journal of Sports Sciences* 19(5): 341-347.
- GABBETT, T.J. (2002). "Training injuries in rugby league: an evaluation of skill-based conditioning games." *The Journal of Strength and Conditioning Research* 16(2): 236-241.
- GABBETT, T.J. (2003). "Incidence of injury in semi-professional rugby league players." *British Journal of Sports Medicine* 37(1): 36-44.
- GABBETT, T.J. (2004). "Incidence of injury in junior and senior rugby league players." *Sports Medicine (Auckland, N.Z.)* 34(12): 849-859.

- GABBETT, T.J. (2004). "Reductions in pre-season training loads reduce training injury rates in rugby league players." *British Journal of Sports Medicine*, 38(6): 743-749.
- GABBETT, T.J. (2005). "Influence of playing position on the site, nature, and cause of rugby league injuries." *Journal of Strength and Conditioning Research*, 19(4): 749-755.
- GABBETT, T.J. (2008). "Influence of fatigue on tackling technique in rugby league players." *Journal of Strength and Conditioning Research*, 22(2): 625-632.
- GABBETT, T.J. & DOMROW, N. (2005). "Risk factors for injury in subelite rugby league players." *The American Journal of Sports Medicine*, 33(3): 428-434.
- GABBETT, T.J. & DOMROW, N. (2007). "Relationships between training load, injury, and fitness in sub-elite collision sport athletes." *Journal of Sports Sciences*, 25(13): 1507-1519.
- GABBETT, T.J. & SEIBOLD, A. (2013). "Relationship Between Tests of Physical Qualities, Team Selection, and Physical Match Performance in Semi-Professional Rugby League Players." *Journal of Strength and Conditioning Research*, (in press).
- GAJDOSIK, R. & LUSIN, G. (1983). "Hamstring muscle tightness. Reliability of an active-knee-extension test." *Physical Therapy*, 63(7): 1085-1090.
- GAJDOSIK, R.L. (1987). "Goniometric measurements at the knee." *Physical Therapy*, 67(6): 979-980.
- GAJDOSIK, R.L. (1991). "Effects of static stretching on the maximal length and resistance to passive stretch of short hamstring muscles." *The Journal of Orthopaedic and Sports Physical Therapy*, 14(6): 250-255.
- GAJDOSIK, R.L. (1995). "Flexibility or muscle length?" *Physical Therapy*, 75(3): 238-239.
- GAJDOSIK, R.L. (2001a). "Comparison and reliability of three goniometric methods for measuring forearm supination and pronation." *Perceptual and Motor Skills*, 93(2): 353-355.
- GAJDOSIK, R.L. (2001b). "Passive extensibility of skeletal muscle: review of the literature with clinical implications." *Clinical Biomechanics (Bristol, Avon)*, 16(2): 87-101.
- GAJDOSIK, R.L. (2001c). "Was hamstring muscle stiffness measured?" *Archives of Physical Medicine and Rehabilitation*, 82(7): 1004-1005.
- GAJDOSIK, R.L. (2002). "Relationship between passive properties of the calf muscles and plantarflexion concentric isokinetic torque characteristics." *European Journal of Applied Physiology*, 87(3): 220-227.
- GAJDOSIK, R.L. & BOHANNON, R.W. (1987). "Clinical measurement of range of motion. Review of goniometry emphasizing reliability and validity." *Physical Therapy*, 67(12): 1867-1872.

GAJDOSIK, R.L. RIECK, M.A. SULLIVAN, D.K. & WIGHTMAN, S.E. (1993). "Comparison of four clinical tests for assessing hamstring muscle length." *The Journal of Orthopaedic and Sports Physical Therapy*, 18(5): 614-618.

GAJDOSIK, R.L. VANDER LINDEN, D.W. & WILLIAMS, A.K. (1999). "Influence of age on length and passive elastic stiffness characteristics of the calf muscle-tendon unit of women." *Physical Therapy*, 79(9): 827-838.

GANDEVIA, S.C. KILLIAN, K.J. & CAMPBELL, E.J.M. (1981). "The effect of respiratory muscle fatigue on respiratory sensations." *Clinical Science*, 60: 463-466.

GAO, Y. WINEMAN, A.S. & WAAS, A.M. (2008). "Mechanics of muscle injury induced by lengthening contraction." *Annals of Biomedical Engineering*, 36(10): 1615-1623.

GARRANDES, F. COLSON, S.S. PENSINI, M. & LEGROS, P. (2007). "Time course of mechanical and neuromuscular characteristics of cyclists and triathletes during a fatiguing exercise." *International Journal of Sports Medicine*, 28(2): 148-156.

GARRETT, W.E., JR. (1996). "Muscle strain injuries." *The American Journal of Sports Medicine*, 24(6 Suppl): S2-8.

GARRETT, W.E., JR. NIKOLAOU, P.K. RIBBECK, B.M. GLISSON, R.R. & SEABER, A.V. (1988). "The effect of muscle architecture on the biomechanical failure properties of skeletal muscle under passive extension." *The American Journal of Sports Medicine*, 16(1): 7-12.

GARRETT, W.E., JR. SAFRAN, M.R. SEABER, A.V. GLISSON, R.R. & RIBBECK, B.M. (1987). "Biomechanical comparison of stimulated and nonstimulated skeletal muscle pulled to failure." *The American Journal of Sports Medicine*, 15(5): 448-454.

GEAR, W.S. (2011). "Effect of different levels of localized muscle fatigue on knee position sense." *Journal of Sports Science and Medicine*, 10: 725-730.

GEHRING, D. MELNYK, M. & GOLLHOFER, A. (2009). "Gender and fatigue have influence on knee joint control strategies during landing." *Clinical Biomechanics (Bristol, Avon)*, 24(1): 82-87.

GERALD, M.C. (1978). "Effects of amphetamine on the treadmill endurance performance of rats." *Neuropharmacology*, 17(9): 703-704.

GERRITSEN, K.G. VAN DEN BOGERT, A.J. HULLIGER, M. & ZERNICKE, R.F. (1998). "Intrinsic muscle properties facilitate locomotor control - a computer simulation study." *Motor Control*, 2(3): 206-220.

GHAFFARINEJAD, F. TAGHIZADEH, S. & MOHAMMADI, F. (2007). "Effect of static stretching of muscles surrounding the knee on knee joint position sense." *British Journal of Sports Medicine*, 41(10): 684-687.

- GHANBARI, A. EBRAHIMIAN, M. MOHAMADI, M. & NAJJAR-HASANPOUR, A. (2013). "Comparing Hold Relax-Proprioceptive Neuromuscular Facilitation and Static Stretching Techniques in Management of Hamstring Tightness." *Indian Journal of Physiotherapy and Occupational Therapy*, 7(1): 126-130.
- GHONCHEH, S. & SMITH, J.C. (2004). "Progressive muscle relaxation, yoga stretching, and ABC relaxation theory." *Journal of Clinical Psychology*, 60(1): 131-136.
- GIBBS, N. (1993). "Injuries in professional rugby league: A three-year prospective study of the South Sydney Professional Rugby League Football Club." *The American Journal of Sports Medicine*, 21(5): 696-700.
- GIFFORD, L.S. (1987). "Circadian variation in human flexibility and grip strength." *Australian Journal of Physiotherapy*, 33: 3-9.
- GILL, T. WILKINSON, A. EDWARDS, E. & GRIMMER, K. (2002). "The effect of either a pre or post exercise stretch on straight leg raise range of motion (SLR-ROM) in females." *Journal of Science and Medicine in Sport*, 5(4): 281-290.
- GISSANE, C. HODGSON, L. & JENNINGS, D. (2012). "Time-Loss Injuries Versus Non-Time-Loss Injuries in the First Team Rugby League Football: A Pooled Data Analysis." *Clinical Journal of Sport Medicine*, 22(5): 414-417.
- GISSANE, C. JENNINGS, D. KERR, K. & WHITE, J.A. (2002). "A pooled data analysis of injury incidence in rugby league football." *Sports Medicine*, 32(3): 211-216.
- GISSANE, C. JENNINGS, D.C. & STANDING, P. (1993). "Incidence of injury in rugby league football." *Physiotherapy*, 79(5): 305-310.
- GIVONI, N.J. PHAM, T. ALLEN, T.J. & PROSKE, U. (2007). "The effect of quadriceps muscle fatigue on position matching at the knee." *The Journal of Physiology*, 584(Pt 1): 111-119.
- GLEESON, N.P. REILLY, T. MERCER, T.H. RAKOWSKI, S. & REES, D. (1998). "Influence of acute endurance activity on leg neuromuscular and musculoskeletal performance." *Medicine and Science in Sports and Exercise*, 30(4): 596-608.
- GLEIM, G.W. & MCHUGH, M.P. (1997). "Flexibility and its effects on sports injury and performance." *Sports Medicine (Auckland, N.Z.)*, 24(5): 289-299.
- GLEIM, G.W. STACHENFELD, N.S. & NICHOLAS, J.A. (1990). "The influence of flexibility on the economy of walking and jogging." *Journal of Orthopaedic Research*, 8(6): 814-823.
- GODGES, J.J. MACRAE, H. LONGDON, C. TINBERG, C. & MACRAE, P.G. (1989). "The effects of two stretching procedures on hip range of motion and gait economy." *The Journal of Orthopaedic and Sports Physical Therapy*, 10(9): 350-357.

- GODWIN, M. RUHLAND, L. CASSON, I. MACDONALD, S. DELVA, D. BIRTHWHISTLE, R. LAM, M. & SEGUIN, R. (2003). "Pragmatic controlled clinical trials in primary care: the struggle between external and internal validity." *BMC Medical Research Methodology*, 3: 28-34.
- GÖEKEN, L. & HOF, A.L. (1993). "Instrumental straight-leg raising: results in healthy subjects." *Archives of Physical Medicine and Rehabilitation*, 74(2): 194-203.
- GOLDSPINK, D.F. (1976). "The effects of denervation on protein turnover of rat skeletal muscle." *Biochemical Journal*, 156(1): 71-80.
- GOLDSPINK, D.F. (1977). "The influence of immobilization and stretch on protein turnover of rat skeletal muscle." *The Journal of Physiology*, 264(1): 267-282.
- GONÇALVES, R. GURJÃO, A.L.D. JAMBASSI FILHO, J.C. FARINATTI, P.D.T.V. GOBBI, L.T.B. & GOBBI, S. (2013). "The acute effects of static stretching on peak force, peak rate of force development and muscle activity during single-and multiple-joint actions in older women." *Journal of Sports Sciences*, 31(7): 690-698.
- GONG, B. MIKI, T. SEINO, S. & RENAUD, J.M. (2000). "A K(ATP) channel deficiency affects resting tension, not contractile force, during fatigue in skeletal muscle." *American Journal of Physiology : Cell physiology*, 279(5): C1351-1358.
- GONZALEZ-RAVE, J.M. MACHADO, L. NAVARRO-VALDIVIELSO, F. & VILAS-BOAS, J.P. (2009). "Acute effects of heavy-load exercises, stretching exercises, and heavy-load plus stretching exercises on squat jump and countermovement jump performance." *Journal of Strength and Conditioning Research*, 23(2): 472-479.
- GRADY, J.F. & SAXENA, A. (1991). "Effects of stretching the gastrocnemius muscle." *The Journal of Foot Surgery*, 30(5): 465-469.
- GRANATA, K.P. WILSON, S.E. & PADUA, D.A. (2002). "Gender differences in active musculoskeletal stiffness. Part I.: Quantification in controlled measurements of knee joint dynamics." *Journal of Electromyography and Kinesiology*, 12(2): 119-126.
- GREENBERGER, H. WILKOWSKI, T. & BELYEA, B. (1994). "Comparison of quadriceps peak torque using three different isokinetic dynamometers." *Isokinetics Exercise and Science*, 4: 70-75.
- GREENE, P.R. & MCMAHON, T.A. (1979). "Reflex stiffness of man's anti-gravity muscles during kneebends while carrying extra weights." *Journal of Biomechanics*, 12(12): 881-891.
- GREENFIELD, B.H. GREENE, B. & JOHANSON, M.A. (2007). "The use of qualitative research techniques in orthopedic and sports physical therapy: Moving toward postpositivism." *Physical Therapy in Sport*, 8(1): 44-54.

- GRIBBLE, P.A. TUCKER, W.S. & WHITE, P.A. (2007). "Time-of-day influences on static and dynamic postural control." *Journal of Athletic Training*, 42(1): 35-41.
- GRIFFIN, J.W. TOOMS, R.E. VANDER ZWAAG, R. BERTORINI, T.E. & O'TOOLE, M.L. (1993). "Eccentric muscle performance of elbow and knee muscle groups in untrained men and women." *Medicine and Science in Sports and Exercise*, 25(8): 936-944.
- GUISSARD, N. & DUCHATEAU, J. (2006). "Neural aspects of muscle stretching." *Exercise and Sport Sciences Reviews*, 34(4): 154-158.
- HAAG, S.J. WRIGHT, G.A. GILLETTE, C.M. & GREANY, J.F. (2010). "Effects of acute static stretching of the throwing shoulder on pitching performance of national collegiate athletic association division III baseball players." *Journal of Strength and Conditioning Research*, 24(2): 452-457.
- HADALA, M. & BARRIOS, C. (2009). "Different strategies for sports injury prevention in an America's Cup yachting crew." *Medicine and Science in Sports and Exercise*, 41(8): 1587-1596.
- HAGEL, B. (2005). "Hamstring injuries in Australian football." *Clinical Journal of Sport Medicine*, 15(5): 400.
- HAGGLUND, M. WALDEN, M. & EKSTRAND, J. (2006). "Previous injury as a risk factor for injury in elite football: a prospective study over two consecutive seasons." *British Journal of Sports Medicine*, 40(9): 767-772.
- HÄGGLUND, M. WALDÉN, M. & EKSTRAND, J. (2013). "Risk Factors for Lower Extremity Muscle Injury in Professional Soccer The UEFA Injury Study." *The American Journal of Sports Medicine*, 41(2): 327-335.
- HALBERTSMA, J.P. GOEKEN, L.N. HOF, A.L. GROOTHOFF, J.W. & EISMA, W.H. (2001). "Extensibility and stiffness of the hamstrings in patients with nonspecific low back pain." *Archives of Physical Medicine and Rehabilitation*, 82(2): 232-238.
- HALBERTSMA, J.P. MULDER, I. GOEKEN, L.N. & EISMA, W.H. (1999). "Repeated passive stretching: acute effect on the passive muscle moment and extensibility of short hamstrings." *Archives of Physical Medicine and Rehabilitation*, 80(4): 407-414.
- HALBERTSMA, J.P. VAN BOLHUIS, A.I. & GOEKEN, L.N. (1996). "Sport stretching: effect on passive muscle stiffness of short hamstrings." *Archives of Physical Medicine and Rehabilitation*, 77(7): 688-692.
- HALL, T. HEPBURN, M. & ELVEY, R.L. (1993). "The effect of lumbosacral posture on a modification of the straight leg raise test." *Physiotherapy*, 79(8): 566-570.
- HAMILL, J. & MCNIVEN, S.L. (1990). "Reliability of selected ground reaction force parameters during walking." *Human Movement Science* 9(2): 117-131.

- HAN, K. RICARD, M.D. & FELLINGHAM, G.W. (2009). "Effects of a 4-week exercise program on balance using elastic tubing as a perturbation force for individuals with a history of ankle sprains." *The Journal of Orthopaedic and Sports Physical Therapy*, 39(4): 246-255.
- HANDEL, M. HORSTMANN, T. DICKHUTH, H.H. & GULCH, R.W. (1997). "Effects of contract-relax stretching training on muscle performance in athletes." *European Journal of Applied Physiology and Occupational Physiology*, 76(5): 400-408.
- HANDRAKIS, J.P. SOUTHARD, V.N. ABREU, J.M. ALOISA, M. DOYEN, M.R. ECHEVARRIA, L.M. HWANG, H. SAMUELS, C. VENEGAS, S.A. & DOURIS, P.C. (2010). "Static stretching does not impair performance in active middle-aged adults." *Journal of Strength and Conditioning Research*, 24(3): 825-830.
- HARTIG, D.E. & HENDERSON, J.M. (1999). "Increasing hamstring flexibility decreases lower extremity overuse injuries in military basic trainees." *The American Journal of Sports Medicine*, 27(2): 173-176.
- HARTWIG, T.B. NAUGHTON, G. & SEARL, J. (2008). "Defining the volume and intensity of sport participation in adolescent rugby union players." *International Journal of Sports Physiology and Performance*, 3(1): 94-106.
- HARVEY, L. HERBERT, R. & CROSBIE, J. (2002). "Does stretching induce lasting increases in joint ROM? A systematic review." *Physiotherapy Research International*, 7(1): 1-13.
- HAWKINS, D. & HULL, M.L. (1990). "A method for determining lower extremity muscle-tendon lengths during flexion/extension movements." *Journal of Biomechanics*, 23(5): 487-494.
- HAWKINS, R.D. & FULLER, C.W. (1999). "A prospective epidemiological study of injuries in four English professional football clubs." *British Journal of Sports Medicine*, 33(3): 196-203.
- HAWKINS, R.D. HULSE, M.A. WILKINSON, C. HODSON, A. & GIBSON, M. (2001). "The association football medical research programme: an audit of injuries in professional football." *British Journal of Sports Medicine*, 35(1): 43-47.
- HEDRICK, A. (2000). "Dynamic flexibility training." *Journal of Strength and Conditioning Research*, 22(5): 33-38.
- HEIDERSCHEIT, B.C. HOERTH, D.M. CHUMANOV, E.S. SWANSON, S.C. THELEN, B.J. & THELEN, D.G. (2005). "Identifying the time of occurrence of a hamstring strain injury during treadmill running: a case study." *Clinical Biomechanics*, 20(10): 1072-1078.
- HENDERSON, G. BARNES, C. & PORTAS, M. (2010). "Factors associated with increased propensity for hamstring injury in English Premier League soccer players." *Journal of Science and Medicine in Sport*, 13(4): 397-402.

HENSCHKE, N. & LIN, C.C. (2011). "Stretching before or after exercise does not reduce delayed-onset muscle soreness." *British Journal of Sports Medicine*, 45(15): 1249-1250.

HERBERT, R.D. & BALNAVE, R.J. (1993). "The effect of position of immobilisation on resting length, resting stiffness, and weight of the soleus muscle of the rabbit." *Journal of Orthopaedic Research*, 11(3): 358-366.

HERBERT, R.D. & CROSBIE, J. (1997). "Rest length and compliance of non-immobilised and immobilised rabbit soleus muscle and tendon." *European Journal of Applied Physiology and Occupational Physiology*, 76(5): 472-479.

HERBERT, R.D. & DE NORONHA, M. (2007). "Stretching to prevent or reduce muscle soreness after exercise." *Cochrane Database of Systematic Reviews*, (4): CD004577.

HERBERT, R.D. DE NORONHA, M. & KAMPER, S.J. (2011). "Stretching to prevent or reduce muscle soreness after exercise." *Cochrane Database of Systematic Reviews*, 7: CD004577.

HERDA, T. RYAN, E. COSTA, P. WALTER, A. HOGE, K. URIBE, B. MCLAGAN, J. STOUT, J. & CRAMER, J. (2010). "Acute effects of passive stretching and vibration on the electromechanical delay and musculotendinous stiffness of the plantar flexors." *Electromyography and Clinical Neurophysiology*, 50(6): 277.

HERDA, T.J. CRAMER, J.T. RYAN, E.D. MCHUGH, M.P. & STOUT, J.R. (2008). "Acute effects of static versus dynamic stretching on isometric peak torque, electromyography, and mechanomyography of the biceps femoris muscle." *Journal of Strength and Conditioning Research*, 22(3): 809-817.

HERRINGTON, L. HORSLEY, I. & ROLF, C. (2010). "Evaluation of shoulder joint position sense in both asymptomatic and rehabilitated professional rugby players and matched controls." *Physical Therapy in Sport*, 11(1): 18-22.

HESSELINK, M.K.C. KUIPERS, H. GEURTEN, P. & STRAATEN, H. (1996). "Structural muscle damage and muscle strength after incremental number of isometric and forced lengthening contractions." *Journal of Muscle Research and Cell Motility*, 17(3): 335-341.

HEYES, M.P. GARNETT, E.S. & COATES, G. (1985). "Central dopaminergic activity influences rats ability to exercise." *Life Sciences*, 36(7): 671-677.

HIGH, D.M. HOWLEY, E.T. & FRANKS, B.D. (1989). "The effects of static stretching and warm-up on prevention of delayed-onset muscle soreness." *Research Quarterly for Exercise and Sport*, 60(4): 357-361.

HIGUCHI, H. YOSHIOKA, T. & MARUYAMA, K. (1988). "Positioning of actin filaments and tension generation in skinned muscle fibres released after stretch beyond overlap of the actin and myosin filaments." *Journal of Muscle Research and Cell Motility*, 9(6): 491-498.

HILL, T.L. (1968). "On the sliding-filament model of muscular contraction, II." *Proceedings of the National Academy of Sciences of the United States of America*, 61(1): 98.

HOBARA, H. KIMURA, K. OMURO, K. GOMI, K. MURAOKA, T. SAKAMOTO, M. & KANOSUE, K. (2010). "Differences in lower extremity stiffness between endurance-trained athletes and untrained subjects." *Journal of Science and Medicine in Sport*, 13(1): 106-111.

HODGSON, L. STANDEN, P.J. & BATT, M.E. (2006). "An analysis of injury rates after the seasonal change in rugby league." *Clinical Journal of Sport Medicine*, 16(4): 305-310.

HOLM, I. BOLSTAD, B. LUTKEN, T. ERVIK, A. ROKKUM, M. & STEEN, H. (2000). "Reliability of goniometric measurements and visual estimates of hip ROM in patients with osteoarthritis." *Physiotherapy Research International*, 5(4): 241-248.

HOLT, B.W. & LAMBOURNE, K. (2008). "The impact of different warm-up protocols on vertical jump performance in male collegiate athletes." *Journal of Strength and Conditioning Research*, 22(1): 226-229.

HOLT, J. HOLT, L.E. & PELHAN, T.W. (1996). Flexibility redefined. *XIIIth International Symposium for Biomechanics in Sport*, T. BAUER. Ontario, Lakehead University: 170-174.

HOPKINS, W.G. (2000). "Measures of reliability in sports medicine and science." *Sports Medicine (Auckland, N.Z.)*, 30(1): 1-15.

HOPKINS, W.G. HAWLEY, J.A. & BURKE, L.M. (1999). "Design and analysis of research on sport performance enhancement." *Medicine and Science in Sports and Exercise*, 31(3): 472-485.

HOPKINS, W.G. MARSHALL, S.W. BATTERHAM, A.M. & HANIN, J. (2009). "Progressive statistics for studies in sports medicine and exercise science." *Medicine and Science in Sports and Exercise*, 41(1): 3-13.

HOPKINS, W.G. MARSHALL, S.W. QUARRIE, K.L. & HUME, P.A. (2007). "Risk factors and risk statistics for sports injuries." *Clinical Journal of Sport Medicine*, 17(3): 208-210.

HOPKINS, W.G. SCHABORT, E.J. & HAWLEY, J.A. (2001). "Reliability of power in physical performance tests." *Sports Medicine (Auckland, N.Z.)*, 31(3): 211-234.

HOROWITS, R. MARUYAMA, K. & PODOLSKY, R.J. (1989). "Elastic behavior of connectin filaments during thick filament movement in activated skeletal muscle." *Journal of Cell Biology*, 109(5): 2169-2176.

HOROWITS, R. & PODOLSKY, R.J. (1987). "The positional stability of thick filaments in activated skeletal muscle depends on sarcomere length: evidence for the role of titin filaments." *The Journal of Cell Biology*, 105(5): 2217-2223.

- HOUGH, P.A. ROSS, E.Z. & HOWATSON, G. (2009). "Effects of dynamic and static stretching on vertical jump performance and electromyographic activity." *Journal of Strength and Conditioning Research*, 23(2): 507-512.
- HRYMOMALLIS, C. (2009). "Hip adductors' strength, flexibility, and injury risk." *Journal of Strength and Conditioning Research*, 23(5): 1514-1517.
- HSIEH, C.Y. WALKER, J.M. & GILLIS, K. (1983). "Straight-leg-raising test: Comparison of three instruments." *Physical Therapy*, 63(9): 1429-1433.
- HU, H. MEIJER, O.G. HODGES, P.W. BRUIJN, S.M. STRIJERS, R.L. NANAYAKKARA, P.W.B. VAN ROYEN, B.J. WU, W. XIA, C. & VAN DIEËN, J.H. (2012). "Understanding the Active Straight Leg Raise (ASLR): An electromyographic study in healthy subjects." *Manual therapy*, 17(6): 531-537.
- HU, H. MEIJER, O.G. VAN DIEËN, J.H. HODGES, P.W. BRUIJN, S.M. STRIJERS, R.L. NANAYAKKARA, P.W. VAN ROYEN, B.J. WU, W. & XIA, C. (2010). "Muscle activity during the active straight leg raise (ASLR), and the effects of a pelvic belt on the ASLR and on treadmill walking." *Journal of Biomechanics*, 43(3): 532-539.
- HUI, S.S. & YUEN, P.Y. (2000). "Validity of the modified back-saver sit-and-reach test: a comparison with other protocols." *Medicine and Science in Sports and Exercise*, 32(9): 1655-1659.
- HUNTER, D.G. & SPRIGGS, J. (2000). "Investigation into the relationship between the passive flexibility and active stiffness of the ankle plantar-flexor muscles." *Clinical Biomechanics (Bristol, Avon)*, 15(8): 600-606.
- HUTTON, R.S. (1992). Neuromuscular Basis of Stretching Exercises. *Strength and Power in Sport*. P. V. KOMI. Oxford, Blackwell Science Ltd.
- INGRAHAM, S.J. (2003). "The role of flexibility in injury prevention and athletic performance: have we stretched the truth?" *Minnesota Medicine*, 86(5): 58-61.
- JACOBS, S.J. & BERSON, B.L. (1986). "Injuries to runners: a study of entrants to a 10,000 meter race." *The American Journal of Sports Medicine*, 14(2): 151-155.
- JAGGERS, J.R. SWANK, A.M. FROST, K.L. & LEE, C.D. (2008). "The acute effects of dynamic and ballistic stretching on vertical jump height, force, and power." *Journal of Strength and Conditioning Research*, 22(6): 1844-1849.
- JAMTVEDT, G. HERBERT, R.D. FLOTTORP, S. ODGAARD-JENSEN, J. HÅVELSRUD, K. BARRATT, A. MATHIEU, E. BURLS, A. & OXMAN, A.D. (2010). "A pragmatic randomised trial of stretching before and after physical activity to prevent injury and soreness." *British Journal of Sports Medicine*, 44(14): 1002-1009.

- JANSSEN, J.C. & LE-NGOC, L. (2009). "Intratester reliability and validity of concentric measurements using a new hand-held dynamometer." *Archives of Physical Medicine and Rehabilitation*, 90(9): 1541-1547.
- JAROCKA, E. MARUSIAK, J. KUMOREK, M. JASKÓLSKA, A. & JASKÓLSKI, A. (2012). "Muscle stiffness at different force levels measured with two myotonometric devices." *Physiological Measurement*, 33(1): 65-78.
- JARVINEN, M.J. EINOLA, S.A. & VIRTANEN, E.O. (1992). "Effect of the position of immobilization upon the tensile properties of the rat gastrocnemius muscle." *Archives of Physical Medicine and Rehabilitation*, 73(3): 253-257.
- JOHANSSON, P.H. LINDSTROM, L. SUNDELIN, G. & LINDSTROM, B. (1999). "The effects of preexercise stretching on muscular soreness, tenderness and force loss following heavy eccentric exercise." *Scandinavian Journal of Medicine and Science in Sports*, 9(4): 219-225.
- JOHNS, R.J. & WRIGHT, V. (1962). "Relative importance of various tissues in joint stiffness." *Journal of Applied Physiology*, 17(5): 824-828.
- JONES, L.A. & HUNTER, I.W. (1983). "Effect of fatigue on force sensation." *Experimental Neurology*, 81(3): 640-650.
- JONES, M.A. STRATTON, G. REILLY, T. & UNNITHAN, V.B. (2002). "Measurement error associated with spinal mobility measures in children with and without low-back pain." *Acta Paediatrica (Oslo, Norway : 1992)*, 91(12): 1339-1343.
- JONHAGEN, S. NEMETH, G. & ERIKSSON, E. (1994). "Hamstring injuries in sprinters. The role of concentric and eccentric hamstring muscle strength and flexibility." *The American Journal of Sports Medicine*, 22(2): 262-266.
- JOUMAA, V. RASSIER, D.E. LEONARD, T.R. & HERZOG, W. (2008). "The origin of passive force enhancement in skeletal muscle." *American Journal of Physiology. Cell Physiology*, 294(1): C74-78.
- KÄÄRIÄINEN, M. JÄRVINEN, T. JÄRVINEN, M. RANTANEN, J. & KALIMO, H. (2000). "Relation between myofibers and connective tissue during muscle injury repair." *Scandinavian Journal of Medicine and Science in Sports*, 10(6): 332-337.
- KABAT, H. (1958). "Proprioceptive facilitation in therapeutic exercise." In LIGHT, S. (Editor) *Therapeutic exercise*. New Haven, Conn.
- KATO, E. KANEHISA, H. FUKUNAGA, T. & KAWAKAMI, Y. (2010). "Changes in ankle joint stiffness due to stretching: The role of tendon elongation of the gastrocnemius muscle." *European Journal of Sport Science*, 10(2): 111-119.

- KAUFMAN, K.R. BRODINE, S.K. SHAFFER, R.A. JOHNSON, C.W. & CULLISON, T.R. (1999). "The effect of foot structure and range of motion on musculoskeletal overuse injuries." *The American Journal of Sports Medicine*, 27(5): 585-593.
- KAUFMAN, T. BURKE, J.R. DAVIS, J.M. & DURSTINE, J.L. (2001). "Exercise-induced neuromuscular dysfunction under reflex conditions." *European Journal of Applied Physiology*, 84(6): 510-520.
- KAY, A.D. & BLAZEVIK, A.J. (2008). "Reductions in active plantarflexor moment are significantly correlated with static stretch duration." *European Journal of Sport Science*, 8(1): 41-46.
- KAY, A.D. & BLAZEVIK, A.J. (2009). "Moderate-duration static stretch reduces active and passive plantar flexor moment but not Achilles tendon stiffness or active muscle length." *Journal of Applied Physiology*, 106(4): 1249-1256.
- KAY, A.D. & BLAZEVIK, A.J. (2012). "Effect of acute static stretch on maximal muscle performance: a systematic review." *Medicine and Science in Sports and Exercise*, 44(1): 154-164.
- KEARNEY, R.E. LORTIE, M. & STEIN, R.B. (1999). "Modulation of stretch reflexes during imposed walking movements of the human ankle." *Journal of Neurophysiology*, 81(6): 2893-2902.
- KELLIS, E. (1999). "The effects of fatigue on the resultant joint moment, agonist and antagonist electromyographic activity at different angles during dynamic knee extension efforts." *Journal of Electromyography and Kinesiology*, 9(3): 191-199.
- KELLIS, E. & BALZOPoulos, V. (1996). "Gravitational moment correction in isokinetic dynamometry using anthropometric data." *Medicine and Science in Sports and Exercise*, 28(7): 900-907.
- KERNER, J.A. & D'AMICO, J.C. (1983). "A statistical analysis of a group of runners." *Journal of the American Podiatry Association*, 73(3): 160-164.
- KERRIGAN, D.C. XENOPOULOS-ODDSSON, A. SULLIVAN, M.J. LELAS, J.J. & RILEY, P.O. (2003). "Effect of a hip flexor-stretching program on gait in the elderly." *Archives of Physical Medicine and Rehabilitation*, 84(1): 1-6.
- KIM, Y.H. SOHN, K.S. & KIM, J.S. (2005). "Range of motion of standard and high-flexion posterior stabilized total knee prostheses. A prospective, randomized study." *The Journal of Bone and Joint Surgery*, 87(7): 1470-1475.
- KING, D. HUME, P.A. & CLARK, T. (2012). "Nature of tackles that result in injury in professional rugby league." *Research in Sports Medicine*, 20(2): 86-104.

KING, D.A. HUME, P.A. MILBURN, P.D. & GUTTENBEIL, D. (2010). "Match and training injuries in rugby league: a review of published studies." *Sports Medicine*, 40(2): 163-178.

KINNEAR, P.R. & GRAY, C.D. (2008). *SPSS 16 made simple*, Psychology Press.

KINSER, A.M. RAMSEY, M.W. O'BRYANT, H.S. AYRES, C.A. SANDS, W.A. & STONE, M.H. (2008). "Vibration and stretching effects on flexibility and explosive strength in young gymnasts." *Medicine and Science in Sports and Exercise*, 40(1): 133-140.

KINUGASA, T. & KILDING, A.E. (2009). "A comparison of post-match recovery strategies in youth soccer players." *Journal of Strength and Conditioning Research*, 23(5): 1402-1407.

KIRKENDALL, D.T. & GARRETT, W.E., JR. (2002). "Clinical perspectives regarding eccentric muscle injury." *Clinical Orthopaedics and Related Research*, (403 Suppl): S81-89.

KIRSCH, R.F. & RYMER, W.Z. (1992). "Neural compensation for fatigue-induced changes in muscle stiffness during perturbations of elbow angle in human." *Journal of Neurophysiology*, 68(2): 449-470.

KLINGE, K. MAGNUSSEN, S.P. SIMONSEN, E.B. AAGAARD, P. KLAUSEN, K. & KJAER, M. (1997). "The effect of strength and flexibility training on skeletal muscle electromyographic activity, stiffness, and viscoelastic stress relaxation response." *The American Journal of Sports Medicine*, 25(5): 710-716.

KNAPIK, J.J. SHARP, M.A. CANHAM-CHERVAK, M. HAURET, K. PATTON, J.F. & JONES, B.H. (2001). "Risk factors for training-related injuries among men and women in basic combat training." *Medicine and Science in Sports and Exercise*, 33(6): 946-954.

KNOTT, M. & VOSS, D.E. (1957). "Proprioceptive Neuromuscular Facilitation (Pattern and Techniques)." *The American Journal of the Medical Sciences*, 233(1): 490.

KNUDSON, D. & NOFFAL, G. (2005). "Time course of stretch-induced isometric strength deficits." *European Journal of Applied Physiology*, 94(3): 348-351.

KOKKONEN, J. NELSON, A.G. & CORNWELL, A. (1998). "Acute muscle stretching inhibits maximal strength performance." *Research Quarterly for Exercise and Sport*, 69(4): 411-415.

KOKKONEN, J. NELSON, A.G. ELDREDGE, C. & WINCHESTER, J.B. (2007). "Chronic static stretching improves exercise performance." *Medicine and Science in Sports and Exercise*, 39(10): 1825-1831.

KOLBER, M.J. & ZEPEDA, J. (2004). "Addressing hamstring flexibility in athletes with lower back pain: A discussion of commonly prescribed stretching exercises." *Strength and Conditioning Journal*, 26(1): 18-23.

KOLTYN, K.F. (2000). "Analgesia following exercise: a review." *Sports Medicine (Auckland, N.Z.)*, 29(2): 85-98.

- KRABAK, B.J. LASKOWSKI, E.R. SMITH, J. STUART, M.J. & WONG, G.Y. (2001). "Neurophysiologic influences on hamstring flexibility: a pilot study." *Clinical Journal of Sport Medicine*, 11(4): 241-246.
- KRIVICKAS, L.S. (1997). "Anatomical factors associated with overuse sports injuries." *Sports Medicine (Auckland, N.Z.)* 24(2): 132-146.
- KRIVICKAS, L.S. & FEINBERG, J.H. (1996). "Lower extremity injuries in college athletes: relation between ligamentous laxity and lower extremity muscle tightness." *Archives of Physical Medicine and Rehabilitation*, 77(11): 1139-1143.
- KROLL, P.G. & RAYA, M.A. (1997). "Hamstring Muscles: An Overview of Anatomy, Biomechanics and Function, Injury Etiology, Treatment, and Prevention." *Critical Reviews in Physical and Rehabilitation Medicine*, 9: 191-204.
- KROSSHAUG, T. ANDERSEN, T.E. OLSEN, O.E. MYKLEBUST, G. & BAHR, R. (2005). "Research approaches to describe the mechanisms of injuries in sport: limitations and possibilities." *British Journal of Sports Medicine*, 39(6): 330-339.
- KRYOLAINEN, H. KOMI, P.V. & BELLI, A. (1999). "Changes in muscle activity patterns and kinetics with increasing running speed." *Journal of Strength and Conditioning Research*, 13(4): 400-406.
- KUBO, K. KANEHISA, H. & FUKUNAGA, T. (2001). "Is passive stiffness in human muscles related to the elasticity of tendon structures?" *European Journal of Applied Physiology*, 85(3): 226-232.
- KUBO, K. KANEHISA, H. & FUKUNAGA, T. (2002). "Effects of resistance and stretching training programmes on the viscoelastic properties of human tendon structures in vivo." *The Journal of Physiology*, 538(Pt 1): 219-226.
- KUIPERS, H. (1994). "Exercise-induced muscle damage." *International Journal of Sports Medicine*, 15(3): 132-135.
- KUITUNEN, S. KOMI, P.V. & KRYOLAINEN, H. (2002). "Knee and ankle joint stiffness in sprint running." *Medicine and Science in Sports and Exercise*, 34(1): 166-173.
- KUJALA, U.M. ORAVA, S. & JARVINEN, M. (1997). "Hamstring injuries. Current trends in treatment and prevention." *Sports Medicine (Auckland, N.Z.)*, 23(6): 397-404.
- LAGO, C. CASAIS, L. DOMINGUEZ, E. & SAMPAIO, J. (2010). "The effects of situational variables on distance covered at various speeds in elite soccer." *European Journal of Sport Science*, 10(2): 103-109.
- LAMB, K. (1998). "Test-retest reliability in quantitative physical education research: a commentary." *European Physical Education Review*, 4(2): 145-152.

- LAMB, K.L. & ROGERS, L. (2007). "A re-appraisal of the reliability of the 20 m multi-stage shuttle run test." *European Journal of Applied Physiology*, 100(3): 287-292.
- LAROCHE, D.P. & CONNOLLY, D.A. (2006). "Effects of stretching on passive muscle tension and response to eccentric exercise." *The American Journal of Sports Medicine*, 34(6): 1000-1007.
- LARSEN, R. LUND, H. CHRISTENSEN, R. ROGIND, H. DANNESKIOLD-SAMSOE, B. & BLIDDAL, H. (2005). "Effect of static stretching of quadriceps and hamstring muscles on knee joint position sense." *British Journal of Sports Medicine*, 39(1): 43-46.
- LASKOWSKI, E.R. NEWCOMER-ANEY, K. & SMITH, J. (2000). "Proprioception." *Physical Medicine and Rehabilitation Clinics of North America*, 11(2): 323-340.
- LATTANIZIO, P.J. PETRELLA, R.J. SPROULE, J.R. & FOWLER, P.J. (1997). "Effects of fatigue on knee proprioception." *Clinical Journal of Sport Medicine*, 7(1): 22-27.
- LATTIER, G. MILLET, G.Y. MARTIN, A. & MARTIN, V. (2004). "Fatigue and recovery after high-intensity exercise part I: neuromuscular fatigue." *International Journal of Sports Medicine*, 25(6): 450-456.
- LEGGIN, B.G. NEUMAN, R.M. IANNOTTI, J.P. WILLIAMS, G.R. & THOMPSON, E.C. (1996). "Intrarater and interrater reliability of three isometric dynamometers in assessing shoulder strength." *Journal of Shoulder and Elbow Surgery*, 5(1): 18-24.
- LEWIS, P.B. RUBY, D. & BUSH-JOSEPH, C.A. (2012). "Muscle soreness and delayed-onset muscle soreness." *Clinics in Sports Medicine*, 31(2): 255-262.
- LI, L. LANDIN, D. GRODESKY, J. & MYERS, J. (2002). "The function of gastrocnemius as a knee flexor at selected knee and ankle angles." *Journal of Electromyography and Kinesiology*, 12(5): 385-390.
- LI, Y. MCCLURE, P.W. & PRATT, N. (1996). "The effect of hamstring muscle stretching on standing posture and on lumbar and hip motions during forward bending." *Physical Therapy*, 76(8): 836-849.
- LIEBER, R.L. & FRIDEN, J. (2002). "Mechanisms of muscle injury gleaned from animal models." *American Journal of Physical Medicine and Rehabilitation*, 81(11 Suppl): S70-79.
- LITTLE, T. & WILLIAMS, A.G. (2006). "Effects of differential stretching protocols during warm-ups on high-speed motor capacities in professional soccer players." *Journal of Strength and Conditioning Research*, 20(1): 203-207.
- LIU, H. GARRETT, W.E. MOORMAN, C.T. & YU, B. (2012). "Injury rate, mechanism, and risk factors of hamstring strain injuries in sports: A review of the literature." *Journal of Sport and Health Science*, 1(2): 92-101.

LOWTHER, D. O'CONNOR, A. CLIFFORD, A. & O'SULLIVAN, K. (2012). "The relationship between lower limb flexibility and hamstring injury in male Gaelic footballers." *Physiotherapy Practice and Research*, 33(1): 22-28.

LUHTANEN, P. & KOMI, P.V. (1980). "Force-, power-, and elasticity-velocity relationships in walking, running, and jumping." *European Journal of Applied Physiology and Occupational Physiology*, 44(3): 279-289.

LUND, H. SØNDERGAARD, K. ZACHARIASSEN, T. CHRISTENSEN, R. BÜLOW, P. HENRIKSEN, M. BARTELS, E.M. DANNESKIOLD-SAMSØE, B. & BLIDDAL, H. (2005). "Learning effect of isokinetic measurements in healthy subjects, and reliability and comparability of Biodex and Lido dynamometers." *Clinical Physiology and Functional Imaging*, 25(2): 75-82.

LUND, H. VESTERGAARD-POULSEN, P. KANSTRUP, I.L. & SEJRSEN, P. (1998). "The effect of passive stretching on delayed onset muscle soreness, and other detrimental effects following eccentric exercise." *Scandinavian Journal of Medicine and Science in Sports*, 8(4): 216-221.

MACERA, C.A. PATE, R.R. POWELL, K.E. JACKSON, K.L. KENDRICK, J.S. & CRAVEN, T.E. (1989). "Predicting lower-extremity injuries among habitual runners." *Archives of Internal Medicine*, 149(11): 2565-2568.

MACINTOSH, B.R. & MACNAUGHTON, M.B. (2005). "The length dependence of muscle active force: considerations for parallel elastic properties." *Journal of Applied Physiology*, 98(5): 1666-1673.

MACINTYRE, D.L. SORICHTER, S. MAIR, J. BERG, A. & MCKENZIE, D.C. (2001). "Markers of inflammation and myofibrillar proteins following eccentric exercise in humans." *European Journal of Applied Physiology*, 84(3): 180-186.

MACNAUGHTON, M.B. & MACINTOSH, B.R. (2006). "Reports of the length dependence of fatigue are greatly exaggerated." *Journal of Applied Physiology*, 101(1): 23-29.

MACNAUGHTON, M.B. & MACINTOSH, B.R. (2007). "Impact of length during repetitive contractions on fatigue in rat skeletal muscle." *Pflugers Archiv : European Journal of Physiology*, 455(2): 359-366.

MACPHERSON, P.C. SCHORK, M.A. & FAULKNER, J.A. (1996). "Contraction-induced injury to single fiber segments from fast and slow muscles of rats by single stretches." *The American Journal of Physiology*, 271(5 Pt 1): C1438-1446.

MADDIGAN, M.E. PEACH, A.A. & BEHM, D.G. (2012). "A Comparison of Assisted and Unassisted Proprioceptive Neuromuscular Facilitation Techniques and Static Stretching." *Journal of Strength and Conditioning Research*, 26(5): 1238-1244.

- MADDING, S.W. WONG, J.G. HALLUM, A. & MEDEIROS, J. (1987). "Effect of duration of passive stretch on hip abduction range of motion." *The Journal of Orthopaedic and Sports Physical Therapy*, 8(8): 409-416.
- MAFFIULETTI, N.A. BIZZINI, M. DESBROSSES, K. BABAULT, N. & MUNZINGER, U. (2007). "Reliability of knee extension and flexion measurements using the Con-Trex isokinetic dynamometer." *Clinical Physiology and Functional Imaging*, 27(6): 346-353.
- MAGANARIS, C.N. (2001). "Force-length characteristics of in vivo human skeletal muscle." *Acta Physiologica Scandinavica*, 172(4): 279-285.
- MAGANARIS, C.N. (2003). "Force-length characteristics of the in vivo human gastrocnemius muscle." *Clinical Anatomy*, 16(3): 215-223.
- MAGID, A. & LAW, D.J. (1985). "Myofibrils bear most of the resting tension in frog skeletal muscle." *Science*, 230(4731): 1280-1282.
- MAGNUSSON, S. SIMONSEN, E. AAGAARD, P. GLEIM, G. MCHUGH, M. & KJAER, M. (1995). "Viscoelastic response to repeated static stretching in the human hamstring muscle." *Scandinavian Journal of Medicine and Science in Sports*, 5(6): 342-347.
- MAGNUSSON, S.P. (1998). "Passive properties of human skeletal muscle during stretch maneuvers. A review." *Scandinavian Journal of Medicine and Science in Sports*, 8(2): 65-77.
- MAGNUSSON, S.P. AAGAARD, P. LARSSON, B. & KJAER, M. (2000). "Passive energy absorption by human muscle-tendon unit is unaffected by increase in intramuscular temperature." *Journal of Applied Physiology*, 88(4): 1215-1220.
- MAGNUSSON, S.P. AAGAARD, P. & NIELSON, J.J. (2000). "Passive energy return after repeated stretches of the hamstring muscle-tendon unit." *Medicine and Science in Sports and Exercise*, 32(6): 1160-1164.
- MAGNUSSON, S.P. AAGAARD, P. SIMONSEN, E.B. & BOJSEN-MOLLER, F. (2000). "Passive tensile stress and energy of the human hamstring muscles in vivo." *Scandinavian Journal of Medicine and Science in Sports*, 10(6): 351-359.
- MAGNUSSON, S.P. AAGARD, P. SIMONSEN, E. & BOJSEN-MOLLER, F. (1998). "A biomechanical evaluation of cyclic and static stretch in human skeletal muscle." *International Journal of Sports Medicine*, 19(5): 310-316.
- MAGNUSSON, S.P. JULSGAARD, C. AAGAARD, P. ZACHARIE, C. ULLMAN, S. KOBAYASI, T. & KJAER, M. (2001). "Viscoelastic properties and flexibility of the human muscle-tendon unit in benign joint hypermobility syndrome." *The Journal of Rheumatology*, 28(12): 2720-2725.
- MAGNUSSON, S.P. SIMONSEN, E.B. AAGAARD, P. BOESEN, J. JOHANNSEN, F. & KJAER, M. (1997). "Determinants of musculoskeletal flexibility: viscoelastic properties, cross-

sectional area, EMG and stretch tolerance." *Scandinavian Journal of Medicine and Science in Sports*, 7(4): 195-202.

MAGNUSSON, S.P. SIMONSEN, E.B. AAGAARD, P. DYHRE-POULSEN, P. MCHUGH, M.P. & KJAER, M. (1996). "Mechanical and physical responses to stretching with and without preisometric contraction in human skeletal muscle." *Archives of Physical Medicine and Rehabilitation*, 77(4): 373-378.

MAGNUSSON, S.P. SIMONSEN, E.B. AAGAARD, P. GLEIM, G.W. MCHUGH, M.P. & KJAER, M. (1995). "Viscoelastic response to repeated static stretching in the human hamstring muscle." *Scandinavian Journal of Medicine and Science in Sports*, 5(6): 342-347.

MAGNUSSON, S.P. SIMONSEN, E.B. AAGAARD, P. & KJAER, M. (1996). "Biomechanical responses to repeated stretches in human hamstring muscle in vivo." *The American Journal of Sports Medicine*, 24(5): 622-628.

MAGNUSSON, S.P. SIMONSEN, E.B. AAGAARD, P. SORENSEN, H. & KJAER, M. (1996). "A mechanism for altered flexibility in human skeletal muscle." *The Journal of Physiology*, 497 (Pt 1)(Pt 1): 291-298.

MAGNUSSON, S.P. SIMONSEN, E.B. DYHRE-POULSEN, P. AAGAARD, P. MOHR, T. & KJAER, M. (1996). "Viscoelastic stress relaxation during static stretch in human skeletal muscle in the absence of EMG activity." *Scandinavian Journal of Medicine and Science in Sports*, 6(6): 323-328.

MAHER, C. (1993). "Pitfalls in reliability studies: some suggestions for change." *Australian Journal of Physiotherapy*, 39: 5-7.

MAHIEU, N. COOLS, A. DE WILDE, B. BOON, M. & WITVROUW, E. (2009). "Effect of proprioceptive neuromuscular facilitation stretching on the plantar flexor muscle-tendon tissue properties." *Scandinavian Journal of Medicine and Science in Sports*, 19(4): 553-560.

MAHIEU, N.N. MCNAIR, P. DE MUYNCK, M. STEVENS, V. BLANCKAERT, I. SMITS, N. & WITVROUW, E. (2007). "Effect of static and ballistic stretching on the muscle-tendon tissue properties." *Medicine and Science in Sports and Exercise*, 39(3): 494-501.

MAIR, S.D. SEABER, A.V. GLISSON, R.R. & GARRETT, W.E., JR. (1996). "The role of fatigue in susceptibility to acute muscle strain injury." *The American Journal of Sports Medicine*, 24(2): 137-143.

MANN, R. & SPRAGUE, P. (1980). "A kinetic analysis of the ground leg during sprint running." *Research Quarterly for Exercise and Sport*, 51(2): 334-348.

MANN, R.A. & HAGY, J. (1980). "Biomechanics of walking, running, and sprinting." *The American Journal of Sports Medicine*, 8(5): 345-350.

- MAREK, S.M. CRAMER, J.T. FINCHER, A.L. MASSEY, L.L. DANGELMAIER, S.M. PURKAYASTHA, S. FITZ, K.A. & CULBERTSON, J.Y. (2005). "Acute Effects of Static and Proprioceptive Neuromuscular Facilitation Stretching on Muscle Strength and Power Output." *Journal of Athletic Training*, 40(2): 94-103.
- MARKS, R. & QUINNEY, A.H. (1993). "Reliability and validity of the measurement of position sense in women with osteoarthritis of the knee." *The Journal of Rheumatology*, 20(11): 1919-1924.
- MARSHALL, P.W.M. CASHMAN, A. & CHEEMA, B.S. (2011). "A randomized controlled trial for the effect of passive stretching on measures of hamstring extensibility, passive stiffness, strength, and stretch tolerance." *Journal of Science and Medicine in Sport*, 14(6): 535-540.
- MARTIN, J.C. & BROWN, N.A.T. (2009). "Joint-specific power production and fatigue during maximal cycling." *Journal of Biomechanics*, 42(4): 474-479.
- MATAR, W. NOSEK, T.M. WONG, D. & RENAUD, J.M. (2000). "Pinacidil suppresses contractility and preserves energy but glibenclamide has no effect during muscle fatigue." *American Journal of Physiology- Cell Physiology*, 278(2): C404-C416.
- MATSUO, S. SUZUKI, S. IWATA, M. BANNO, Y. ASAI, Y. TSUCHIDA, W. & INOUE, T. (2013). "Acute effects of different stretching durations on passive torque, mobility, and isometric muscle force." *Journal of Strength and Conditioning Research*, (in press)
- MATTACOLA, C.G. PERRIN, D.H. GANSNEDER, B.M. ALLEN, J.D. & MICKEY, C.A. (1997). "A comparison of visual analog and graphic rating scales for assessing pain following delayed onset muscle soreness." *Journal of Sport Rehabilitation*, 6: 38-46.
- MAUD, P.J. (1983). "Physiological and anthropometric parameters that describe a rugby union team." *British Journal of Sports Medicine*, 17(1): 16-23.
- MAUD, P.J. & CORTEZ-COOPER, M.Y. (1994). Static techniques for the evaluation of joint range of motion. in P.J. MAUD & C. FOSTER. *Physiological Assessment of Human Fitness*. Champaign USA, Human Kinetics.
- MCBRIDE, J.M. DEANE, R. & NIMPHIUS, S. (2007). "Effect of stretching on agonist-antagonist muscle activity and muscle force output during single and multiple joint isometric contractions." *Scandinavian Journal of Medicine and Science in Sports*, 17(1): 54-60.
- McCLOSKEY, D.I. GANDEVIA, S. POTTER, E.K. & COLEBATCH, J.G. (1983). "Muscle sense and effort: motor commands and judgments about muscular contractions." *Advances in Neurology*, 39: 151-167.
- McCOMBE, P.F. FAIRBANK, J.C.T. COCKERSOLE, B.C. & PYNSENT, P.B. (1989). "Reproducibility of physical signs in low-back pain." *Spine*, 14(9): 908-918.

- McCORMACK, H.M. DE L. HORNE, D.J. & SHEATHER, S. (2009). "Clinical applications of visual analogue scales: a critical review." *Psychological Medicine*, 18(04): 1007-1019.
- McCORMACK, M. BRIGGS, J. HAKIM, A. & GRAHAME, R. (2004). "Joint laxity and the benign joint hypermobility syndrome in student and professional ballet dancers." *Journal of Rheumatology*, 31(1): 173-178.
- McGLYNN, G.H. LAUGHLIN, N.T. & ROWE, V. (1979). "Effect of electromyographic feedback and static stretching on artificially induced muscle soreness." *American Journal of Physical Medicine*, 58(3): 139-148.
- McGRAW, K.O. & WONG, S.P. (1996). "Forming inferences about some intraclass correlation coefficients." *Psychological Methods*, 1(1): 30-46.
- McHUGH, M. JOHNSON, C. & MORRISON, R. (2012). "The role of neural tension in hamstring flexibility." *Scandinavian Journal of Medicine and Science in Sports*, 22(2): 164-169.
- McHUGH, M.P. & COSGRAVE, C. (2010). "To stretch or not to stretch: the role of stretching in injury prevention and performance." *Scandinavian Journal of Medicine and Science in Sports*, 20(2): 169-181.
- McHUGH, M.P. KREMENIC, I.J. FOX, M.B. & GLEIM, G.W. (1998). "The role of mechanical and neural restraints to joint range of motion during passive stretch." *Medicine and Science in Sports and Exercise*, 30(6): 928-932.
- McHUGH, M.P. MAGNUSSON, S.P. GLEIM, G.W. & NICHOLAS, J.A. (1992). "Viscoelastic stress relaxation in human skeletal muscle." *Medicine and Science in Sports and Exercise*, 24(12): 1375-1382.
- McHUGH, M.P. & NESSE, M. (2008). "Effect of stretching on strength loss and pain after eccentric exercise." *Medicine and Science in Sports and Exercise*, 40(3): 566-573.
- McINTOSH, A.S. (2005). "Risk compensation, motivation, injuries, and biomechanics in competitive sport." *British Journal of Sports Medicine*, 39(1): 2-3.
- McKAY, G.D. GOLDIE, P.A. PAYNE, W.R. & OAKES, B.W. (2001). "Ankle injuries in basketball: injury rate and risk factors." *British Journal of Sports Medicine*, 35(2): 103-108.
- McMILLIAN, D.J. MOORE, J.H. HATLER, B.S. & TAYLOR, D.C. (2006). "Dynamic vs. static-stretching warm up: the effect on power and agility performance." *Journal of Strength and Conditioning Research*, 20(3): 492-499.
- McNAIR, P.J. DOMBROSKI, E.W. HEWSON, D.J. & STANLEY, S.N. (2001). "Stretching at the ankle joint: viscoelastic responses to holds and continuous passive motion." *Medicine and Science in Sports and Exercise*, 33(3): 354-358.

- McNAIR, P.J. & STANLEY, S.N. (1996). "Effect of passive stretching and jogging on the series elastic muscle stiffness and range of motion of the ankle joint." *British Journal of Sports Medicine*, 30(4): 313-318.
- McNEAL, J.R. & SANDS, W.A. (2006). "Stretching for performance enhancement." *Current Sports Medicine Reports*, 5(3): 141-146.
- MEEUWISSE, W. (1994). "Athletic Injury Aetiology: Distinguishing between interaction and confounding." *Clinical Journal of Sport Medicine*, 4(3): 171-175.
- MEEUWISSE, W. & HAGEL, B. (2009). "The multi-causality of injury—current concepts." *Sports Injury Research*, 16(1): 99-105.
- MEEUWISSE, W.H. HAGEL, B.E. MOHTADI, N.G. BUTTERWICK, D.J. & FICK, G.H. (2000). "The distribution of injuries in men's Canada West university football. A 5-year analysis." *The American Journal of Sports Medicine*, 28(4): 516-523.
- MEEUWISSE, W.H. TYREMAN, H. HAGEL, B. & EMERY, C. (2007). "A dynamic model of etiology in sport injury: the recursive nature of risk and causation." *Clinical Journal of Sport Medicine*, 17(3): 215-219.
- MEIR, R.A. (1994). "Evaluating player fitness in professional rugby league: reducing subjectivity." *Strength and Conditioning Coach*, 1(4): 11-17.
- MELNYK, M. & GOLLHOFER, A. (2007). "Submaximal fatigue of the hamstrings impairs specific reflex components and knee stability." *Knee Surgery, Sports Traumatology, Arthroscopy*, 15(5): 525-532.
- MENS, J. POOL-GOUDZWAARD, A. BEEKMANS, R.E.P.M. & TIJHUIS, M.T.F. (2010). "Relation between subjective and objective scores on the active straight leg raising test." *Spine*, 35(3): 336.
- MERCER, T.H. GLEESON, N.P. & WREN, K. (2003). "Influence of prolonged intermittent high-intensity exercise on knee flexor strength in male and female soccer players." *European Journal of Applied Physiology*, 89(5): 506-508.
- MICHAEL, T.P. SALOME, P.A. YU, H.J. SPENCER, T.R. SHARP, E.L. MCPEEK, M.A. ALONSO, J.M. ECKER, J.R. & MCCLUNG, C.R. (2003). "Enhanced fitness conferred by naturally occurring variation in the circadian clock." *Science*, 302(5647): 1049-1053.
- MIKA, A. MIKA, P. FERNHALL, B. & UNNITHAN, V.B. (2007). "Comparison of recovery strategies on muscle performance after fatiguing exercise." *American Journal of Physical Medicine and Rehabilitation*, 86(6): 474-481.
- MILGROM, C. SHLAMKOVITCH, N. FINESTONE, A. ELDAD, A. LAOR, A. DANON, Y.L. LAVIE, O. WOSK, J. & SIMKIN, A. (1991). "Risk factors for lateral ankle sprain: a prospective study among military recruits." *Foot and Ankle*, 12(1): 26-30.

- MITCHELL, U.H. MYRER, J.W. HOPKINS, J.T. HUNTER, I. FELAND, J.B. & HILTON, S.C. (2009). "Neurophysiological reflex mechanisms' lack of contribution to the success of PNF stretches." *Journal of Sport Rehabilitation*, 18(3): 343-357.
- MIURA, K. ISHIBASHI, Y. TSUDA, E. OKAMURA, Y. OTSUKA, H. & TOH, S. (2004). "The effect of local and general fatigue on knee proprioception." *Arthroscopy : The Journal of Arthroscopic and Related Surgery*, 20(4): 414-418.
- MIZUNO, T. MATSUMOTO, M. & UMEMURA, Y. (2013). "Viscoelasticity of the muscle-tendon unit is returned more rapidly than range of motion after stretching." *Scandinavian Journal of Medicine and Science in Sports*, 23(1): 23-30.
- MOENS, P. BAATSEN, P. & MARECHAL, G. (1993). "Increased susceptibility of EDL muscles from mdx mice to damage induced by contractions with stretch." *Journal of Muscle Research and Cell Motility* 14(4): 446-451.
- MOHAMMADI, F. & ROOZDAR, A. (2010). "Effects of fatigue due to contraction of evertor muscles on the ankle joint position sense in male soccer players." *The American Journal of Sports Medicine*, 38(4): 824-828.
- MOHER, D. JADAD, A.R. & TUGWELL, P. (2009). "Assessing the quality of randomized controlled trials: current issues and future directions." *International Journal of Technology Assessment in Health Care*, 12(02): 195-208.
- MOLACEK, Z.D. CONLEY, D.S. EVETOVICH, T.K. & HINNERICHS, K.R. (2010). "Effects of low-and high-volume stretching on bench press performance in collegiate football players." *Journal of Strength and Conditioning Research*, 24(3): 711-716.
- MOLLER, M. EKSTRAND, J. OBERG, B. & GILLQUIST, J. (1985). "Duration of stretching effect on range of motion in lower extremities." *Archives of Physical Medicine and Rehabilitation*, 66(3): 171-173.
- MOLLER, M.H. OBERG, B.E. & GILLQUIST, J. (1985). "Stretching exercise and soccer: effect of stretching on range of motion in the lower extremity in connection with soccer training." *International Journal of Sports Medicine*, 6(1): 50-52.
- MONTGOMERY, P.G. PYNE, D.B. HOPKINS, W.G. DORMAN, J.C. COOK, K. & MINAHAN, C.L. (2008). "The effect of recovery strategies on physical performance and cumulative fatigue in competitive basketball." *Journal of Sports Sciences*, 26(11): 1135-1145.
- MOONEY, M.G. CORMACK, S. O'BRIEN, B.J. MORGAN, W.M. & MCGUIGAN, M. (2013). "Impact of neuromuscular fatigue on match exercise intensity and performance in elite Australian football." *Journal of Strength and Conditioning Research*, 27(1): 166-173.

- MOORE, B.D. DROUIN, J. GANSNEDER, B.M. & SHULTZ, S.J. (2002). "The differential effects of fatigue on reflex response timing and amplitude in males and females." *Journal of Electromyography and Kinesiology*, 12(5): 351-360.
- MOORE, M.A. & HUTTON, R.S. (1980). "Electromyographic investigation of muscle stretching techniques." *Medicine and Science in Sports and Exercise*, 12(5): 322-329.
- MORGAN, D.L. & ALLEN, D.G. (1999). "Early events in stretch-induced muscle damage." *Journal of Applied Physiology*, 87(6): 2007-2015.
- MORRIN, N. & REDDING, E. (2013). "Acute Effects of Warm-up Stretch Protocols on Balance, Vertical Jump Height, and Range of Motion in Dancers." *Journal of Dance Medicine and Science*, 17(1): 34-40.
- MORROW, J.R. & JACKSON, A.W. (1993). "How" Significant" Is Your Reliability?" *Research Quarterly for Exercise and Sport*, 64: 352-352.
- MORSE, C.I. DEGENS, H. SEYNNES, O.R. MAGANARIS, C.N. & JONES, D.A. (2008). "The acute effect of stretching on the passive stiffness of the human gastrocnemius muscle tendon unit." *The Journal of Physiology*, 586(1): 97-106.
- MULLANEY, M.J. MCHUGH, M.P. JOHNSON, C.P. & TYLER, T.F. (2010). "Reliability of shoulder range of motion comparing a goniometer to a digital level." *Physiotherapy Theory and Practice*, 26(5): 327-333.
- MURPHY, A.J. WATSFORD, M.L. COUTTS, A.J. & PINE, M.J. (2003). "Reliability of a test of musculotendinous stiffness for the triceps-surae." *Physical Therapy in Sport*, 4(4): 175-181.
- MURPHY, D.F. CONNOLLY, D.A. & BEYNNON, B.D. (2003). "Risk factors for lower extremity injury: a review of the literature." *British Journal of Sports Medicine*, 37(1): 13-29.
- MURPHY, J.C. NAGLE, E.F. ROBERT, J. & JEAN, L. (2010). "Effect of Single Set Dynamic and Static Stretching Exercise on Jump Height in College Age Recreational Athletes." *International Journal of Exercise Science*, 3(4): 8-13.
- MURPHY, J.R.M.J.R. DI, M.C.D.S.M.C. ALKANANI, T.A.T. & BEHM, D.G.B.D.G. (2010). "Aerobic activity before and following short-duration static stretching improves range of motion and performance vs. a traditional warm-up." *Applied Physiology, Nutrition, and Metabolism*, 35(5): 679-690.
- NAGAI, T. SELL, T.C. ABT, J.P. & LEPHART, S.M. (2012). "Reliability, precision, and gender differences in knee internal/external rotation proprioception measurements." *Physical Therapy in Sport* 13(4): 233-237.
- NAKAMURA, M. IKEZOE, T. TAKENO, Y. & ICHIHASHI, N. (2011). "Acute and prolonged effect of static stretching on the passive stiffness of the human gastrocnemius muscle tendon unit in vivo." *Journal of Orthopaedic Research* 29(11): 1759-1763.

- NAKAMURA, M. IKEZOE, T. TAKENO, Y. & ICHIHASHI, N. (2012). "Effects of a 4-week static stretch training program on passive stiffness of human gastrocnemius muscle-tendon unit in vivo." *European Journal of Applied Physiology and Occupational Physiology*, 112(7): 2749-2755.
- NÉDÉLEC, M. MCCALL, A. CARLING, C. LEGALL, F. BERTHOIN, S. & DUPONT, G. (2012). "Recovery in Soccer." *Sports Medicine*, 42(12): 997-1015.
- NÉDÉLEC, M. MCCALL, A. CARLING, C. LEGALL, F. BERTHOIN, S. & DUPONT, G. (2013). "Recovery in Soccer." *Sports Medicine*, 43(1): 9-22.
- NELSON, A.G. ALLEN, J.D. CORNWELL, A. & KOKKONEN, J. (2001). "Inhibition of maximal voluntary isometric torque production by acute stretching is joint-angle specific." *Research Quarterly for Exercise and Sport*, 72(1): 68-70.
- NELSON, A.G. GUILLORY, I.K. CORNWELL, C. & KOKKONEN, J. (2001). "Inhibition of maximal voluntary isokinetic torque production following stretching is velocity-specific." *Journal of Strength and Conditioning Research*, 15(2): 241-246.
- NELSON, A.G. KOKKONEN, J. & ARNALL, D.A. (2005). "Acute muscle stretching inhibits muscle strength endurance performance." *Journal of Strength and Conditioning Research*, 19(2): 338-343.
- NELSON, D.L. & HUTTON, R.S. (1985). "Dynamic and static stretch responses in muscle spindle receptors in fatigued muscle." *Medicine and Science in Sports and Exercise*, 17(4): 445-450.
- NELSON, R.T. & BANDY, W.D. (2004). "Eccentric Training and Static Stretching Improve Hamstring Flexibility of High School Males." *Journal of Athletic Training*, 39(3): 254-258.
- NELSON, S.G. & DUNCAN, P.W. (1983). "Correction of isokinetic and isometric torque recordings for the effects of gravity: A clinical report." *Physical Therapy*, 63(5): 674-676.
- NEVILL, A.M. & ATKINSON, G. (1997). "Assessing agreement between measurements recorded on a ratio scale in sports medicine and sports science." *British Journal of Sports Medicine*, 31(4): 314-318.
- NIKOLAOU, P.K. MACDONALD, B.L. GLISSON, R.R. SEABER, A.V. & GARRETT, W.E., JR. (1987). "Biomechanical and histological evaluation of muscle after controlled strain injury." *The American Journal of Sports Medicine*, 15(1): 9-14.
- NOAKES, T.D. (2000). "Physiological models to understand exercise fatigue and the adaptations that predict or enhance athletic performance." *Scandinavian Journal of Medicine and Science in Sports*, 10(3): 123-145.

- NOAKES, T.D. SNOW, R.J. & FEBBRAIO, M.A. (2004). "Linear relationship between the perception of effort and the duration of constant load exercise that remains." *Journal of Applied Physiology*, 96(4): 1571-1573.
- NOONAN, T.J. BEST, T.M. SEABER, A.V. & GARRETT, W.E., JR. (1993). "Thermal effects on skeletal muscle tensile behavior." *The American Journal of Sports Medicine*, 21(4): 517-522.
- NOONAN, T.J. BEST, T.M. SEABER, A.V. & GARRETT, W.E., JR. (1994). "Identification of a threshold for skeletal muscle injury." *The American Journal of Sports Medicine*, 22(2): 257-261.
- NORDEZ, A. CORNU, C. & MCNAIR, P. (2006). "Acute effects of static stretching on passive stiffness of the hamstring muscles calculated using different mathematical models." *Clinical biomechanics (Bristol, Avon)*, 21(7): 755-760.
- NORRIS, C.M. & MATTHEWS, M. (2005). "Inter-tester reliability of a self-monitored active knee extension test." *Journal of Bodywork and Movement Therapies*, 9(4): 256-259.
- NOVACHECK, T.F. (1995). "Walking, running, and sprinting: a three-dimensional analysis of kinematics and kinetics." *Instructional Course Lectures*, 44: 497-506.
- NUNES, G. BAYER, G. DA COSTA, L.M. & DE NORONHA, M. (2012). "Intra-and Inter-Observer Reliability of a Method to Measure Range of Motion of Ankle Plantar Flexion in the Hooklying Position." *Journal of Sport Rehabilitation*, (in press)
- O'CONNOR, D. CROWE, M.J. & SPINKS, W.L. (2006). "Effects of static stretching on leg power during cycling." *The Journal of Sports Medicine and Physical Fitness*, 46(1): 52-56.
- O'HORA, J. CARTWRIGHT, A. WADE, C.D. HOUGH, A.D. & SHUM, G.L.K. (2011). "Efficacy of static stretching and proprioceptive neuromuscular facilitation stretch on hamstrings length after a single session." *Journal of Strength and Conditioning Research*, 25(6): 1586-1591.
- O'SULLIVAN, K. MURRAY, E. & SAINSBURY, D. (2009). "The effect of warm-up, static stretching and dynamic stretching on hamstring flexibility in previously injured subjects." *BMC Musculoskeletal Disorders*, 10: 37-45.
- OGAI, R. YAMANE, M. MATSUMOTO, T. & KOSAKA, M. (2008). "Effects of petrissage massage on fatigue and exercise performance following intensive cycle pedalling." *British Journal of Sports Medicine*, 42(10): 534-538.
- OGURA, Y. MIYAHARA, Y. NAITO, H. KATAMOTO, S. & AOKI, J. (2007). "Duration of static stretching influences muscle force production in hamstring muscles." *Journal of Strength and Conditioning Research*, 21(3): 788-792.

- OLSEN, O.E. MYKLEBUST, G. ENGBRETSSEN, L. HOLME, I. & BAHR, R. (2005). "Exercises to prevent lower limb injuries in youth sports: cluster randomised controlled trial." *British Medical Journal*, 330(7489): 449-455.
- ORCHARD, J. (2002). "Is there a relationship between ground and climatic conditions and injuries in football?" *Sports Medicine*, 32(7): 419-432.
- ORCHARD, J. (2004). "Missed time through injury and injury management at an NRL club." *Sport Health*, 22(1): 11-20.
- ORCHARD, J. & BEST, T.M. (2002). "The management of muscle strain injuries: an early return versus the risk of recurrence." *Clinical Journal of Sport Medicine*, 12(1): 3-5.
- ORCHARD, J. BEST, T.M. & VERRALL, G.M. (2005). "Return to play following muscle strains." *Clinical Journal of Sport Medicine*, 15(6): 436-441.
- ORCHARD, J. & HOSKINS, W. (2007). "Rugby league injuries at State of Origin level." *Sport Health*, 25(2): 19-24.
- ORCHARD, J. MARSDEN, J. LORD, S. & GARLICK, D. (1997). "Preseason hamstring muscle weakness associated with hamstring muscle injury in Australian footballers." *The American Journal of Sports Medicine*, 25(1): 81-85.
- ORCHARD, J. & SEWARD, H. (2002). "Epidemiology of injuries in the Australian Football League, seasons 1997-2000." *British Journal of Sports Medicine*, 36(1): 39-44.
- ORCHARD, J.W. (2001). "Intrinsic and extrinsic risk factors for muscle strains in Australian football." *The American Journal of Sports Medicine*, 29(3): 300-303.
- OSTERNIG, L.R. ROBERTSON, R. TROXEL, R. & HANSEN, P. (1987). "Muscle activation during proprioceptive neuromuscular facilitation (PNF) stretching techniques." *American Journal of Physical Medicine*, 66(5): 298-307.
- OSTERNIG, L.R. ROBERTSON, R.N. TROXEL, R.K. & HANSEN, P. (1990). "Differential responses to proprioceptive neuromuscular facilitation (PNF) stretch techniques." *Medicine and Science in Sports and Exercise*, 22(1): 106-111.
- OWEN, G. CRONIN, J. GILL, N. & MCNAIR, P. (2005). "Knee extensor stiffness and functional performance." *Physical Therapy in Sport*, 6(1): 38-44.
- PALMER, T.B. JENKINS, N.D. THOMPSON, B.J. SMITH, D.B. & CRAMER, J.T. (2013). "The relationship between passive stiffness and muscle power output: Influence of muscle CSA normalization." *Muscle & nerve*, (in press).
- PANDY, M.G. & ZAJAC, F.E. (1991). "Optimal muscular coordination strategies for jumping." *Journal of Biomechanics*, 24(1): 1-10.

PEELER, J. & ANDERSON, J.E. (2008). "Reliability of the Ely's test for assessing rectus femoris muscle flexibility and joint range of motion." *Journal of Orthopaedic Research*, 26(6): 793-799.

PEELER, J.D. & ANDERSON, J.E. (2008). "Reliability limits of the modified Thomas test for assessing rectus femoris muscle flexibility about the knee joint." *Journal of Athletic Training*, 43(5): 470-476.

PERT, A. (1982). "Mechanisms of opiate analgesia and the role of endorphins in pain suppression." *Advances in Neurology*, 33: 107-122.

PETROF, B.J. SHRAGER, J.B. STEDMAN, H.H. KELLY, A.M. & SWEENEY, H.L. (1993). "Dystrophin protects the sarcolemma from stresses developed during muscle contraction." *Proceedings of the National Academy of Sciences of the United States of America* 90(8): 3710-3714.

PIERCEY, M.F. MOON, M.W. BLINN, J.R. & DOBRY-SCHREUR, P.J.K. (1986). "Analgesic activities of spinal cord substance P antagonists implicate substance P as a neurotransmitter of pain sensation." *Brain Research*, 385(1): 74-85.

PINNIGER, G.J. STEELE, J.R. & GROELLER, H. (2000). "Does fatigue induced by repeated dynamic efforts affect hamstring muscle function?" *Medicine and Science in Sports and Exercise*, 32(3): 647-653.

PINSAULT, N. & VUILLERME, N. (2010). "Degradation of cervical joint position sense following muscular fatigue in humans." *Spine*, 35(3): 294-297.

PINTO, M. KUHN, J. GREENFIELD, M. & HAWKINS, R. (1999). "Prospective analysis of ice hockey injuries at the Junior A level over the course of one season." *Clinical journal of sport medicine: official journal of the Canadian Academy of Sport Medicine* 9(2): 70-74.

PLACE, N. BLUM, Y. ARMAND, S. MAFFIULETTI, N.A. & BEHM, D.G. (2013). "Effects of a Short Proprioceptive Neuromuscular Facilitation Stretching Bout on Quadriceps Neuromuscular Function, Flexibility, and Vertical Jump Performance." *Journal of Strength and Conditioning Research*, 27(2): 463-470.

PLATZER, H.P. RASCHNER, C. & PATTERSON, C. (2009). "Performance-determining physiological factors in the luge start." *Journal of Sports Sciences*, 27(3): 221-226.

POPE, R. HERBERT, R. & KIRWAN, J. (1998). "Effects of ankle dorsiflexion range and pre-exercise calf muscle stretching on injury risk in Army recruits." *The Australian Journal of Physiotherapy*, 44(3): 165-172.

POPE, R.P. HERBERT, R.D. KIRWAN, J.D. & GRAHAM, B.J. (2000). "A randomized trial of preexercise stretching for prevention of lower-limb injury." *Medicine and Science in Sports and Exercise*, 32(2): 271-277.

POULSEN, E. CHRISTENSEN, H.W. PENNY, J.Ø. OVERGAARD, S. VACH, W. & HARTVIGSEN, J. (2012). "Reproducibility of range of motion and muscle strength measurements in patients with hip osteoarthritis—an inter-rater study." *BMC Musculoskeletal Disorders*, 13: 242-251.

POWER, K. BEHM, D. CAHILL, F. CARROLL, M. & YOUNG, W. (2004). "An acute bout of static stretching: effects on force and jumping performance." *Medicine and Science in Sports and Exercise*, 36(8): 1389-1396.

PROSKE, U. (2005). "What is the role of muscle receptors in proprioception?" *Muscle and Nerve*, 31(6): 780-787.

PROSKE, U. GREGORY, J.E. MORGAN, D.L. PERCIVAL, P. WEERAKKODY, N.S. & CANNY, B.J. (2004). "Force matching errors following eccentric exercise." *Human Movement Science*, 23(3-4): 365-378.

PROSKE, U. & MORGAN, D.L. (1999). "Do cross-bridges contribute to the tension during stretch of passive muscle?" *Journal of Muscle Research and Cell Motility*, 20(5-6): 433-442.

PROSKE, U. & MORGAN, D.L. (2001). "Muscle damage from eccentric exercise: mechanism, mechanical signs, adaptation and clinical applications." *The Journal of Physiology*, 537(Pt 2): 333-345.

PROSKE, U. MORGAN, D.L. BROCKETT, C.L. & PERCIVAL, P. (2004). "Identifying athletes at risk of hamstring strains and how to protect them." *Clinical and Experimental Pharmacology and Physiology*, 31(8): 546-550.

PROSKE, U. MORGAN, D.L. & GREGORY, J.E. (1993). "Thixotropy in skeletal muscle and in muscle spindles: a review." *Progress in Neurobiology*, 41(6): 705-721.

PROSKE, U. WEERAKKODY, N.S. PERCIVAL, P. MORGAN, D.L. GREGORY, J.E. & CANNY, B.J. (2003). "Force-matching errors after eccentric exercise attributed to muscle soreness." *Clinical and Experimental Pharmacology and Physiology*, 30(8): 576-579.

PRUYN, E.C. WATSFORD, M.L. MURPHY, A.J. PINE, M.J. SPURRS, R.W. CAMERON, M.L. & JOHNSTON, R.J. (2012). "Relationship between leg stiffness and lower body injuries in professional Australian football." *Journal of Sports Sciences*, 30(1): 71-78.

PSEK, J.A. & CAFARELLI, E. (1993). "Behavior of coactive muscles during fatigue." *Journal of Applied Physiology*, 74(1): 170-175.

PUA, Y.H. WRIGLEY, T.V. COWAN, S.M. & BENNELL, K.L. (2008). "Intrarater test-retest reliability of hip range of motion and hip muscle strength measurements in persons with hip osteoarthritis." *Archives of Physical Medicine and Rehabilitation*, 89(6): 1146-1154.

PYNE, D.B. (1994). "Exercise-induced muscle damage and inflammation: a review." *Australian Journal of Science and Medicine in Sport* 26(3-4): 49-58.

RAHNAMA, N. LEES, A. & BAMBACICHI, E. (2005). "Comparison of muscle strength and flexibility between the preferred and non-preferred leg in English soccer players." *Ergonomics*, 48(11-14): 1568-1575.

RAHNAMA, N. LEES, A. & REILLY, T. (2006). "Electromyography of selected lower-limb muscles fatigued by exercise at the intensity of soccer match-play." *Journal of Electromyography and Kinesiology*, 16(3): 257-263.

RAHNAMA, N. REILLY, T. LEES, A. & GRAHAM-SMITH, P. (2003). "Muscle fatigue induced by exercise simulating the work rate of competitive soccer." *Journal of Sports Sciences*, 21(11): 933-942.

RAMSEY, R.W. & STREET, S.F. (1940). "The isometric length-tension diagram of isolated skeletal muscle fibers of the frog." *Journal of Cellular and Comparative Physiology*, 15(1): 11-34.

RAPOPORT, S.I. (1972). "Mechanical properties of the sarcolemma and myoplasm in frog muscle as a function of sarcomere length." *The Journal of General Physiology*, 59(5): 559-585.

REID, D.A. & MCNAIR, P.J. (2004). "Passive force, angle, and stiffness changes after stretching of hamstring muscles." *Medicine and Science in Sports and Exercise*, 36(11): 1944-1948.

REILLY, T. DRUST, B. & CLARKE, N. (2008). "Muscle fatigue during football match-play." *Sports Medicine (Auckland, N.Z.)*, 38(5): 357-367.

REILLY, T. & EKBLUM, B. (2005). "The use of recovery methods post-exercise." *Journal of Sports Sciences*, 23(6): 619-627.

REILLY, T. TYRRELL, A. & TROUP, J.D. (1984). "Circadian variation in human stature." *Chronobiology International*, 1(2): 121-126.

REURINK, G. GOUDSWAARD, G.J. OOMEN, H.G. MOEN, M.H. TOL, J.L. VERHAAR, J.A. & WEIR, A. (2013). "Reliability of the Active and Passive Knee Extension Test in Acute Hamstring Injuries." *The American Journal of Sports Medicine*, 41(8): 1757-1761.

REURINK, G. GOUDSWAARD, G.J. TOL, J.L. VERHAAR, J.A.N. WEIR, A. & MOEN, M.H. (2012). "Therapeutic interventions for acute hamstring injuries: a systematic review." *British Journal of Sports Medicine*, 46(2): 103-109.

RIDDLE, D.L. ROTHSTEIN, J.M. & LAMB, R.L. (1987). "Goniometric reliability in a clinical setting: shoulder measurements." *Physical Therapy*, 67(5): 668-673.

- ROBBINS, J.W. & SCHEUERMANN, B.W. (2008). "Varying amounts of acute static stretching and its effect on vertical jump performance." *Journal of Strength and Conditioning Research*, 22(3): 781-786.
- ROBERTS, J.M. & WILSON, K. (1999). "Effect of stretching duration on active and passive range of motion in the lower extremity." *British Journal of Sports Medicine*, 33(4): 259-263.
- ROBEY, E. DAWSON, B. GOODMAN, C. & BEILBY, J. (2009). "Effect of postexercise recovery procedures following strenuous stair-climb running." *Research in Sports Medicine (Print)*, 17(4): 245-259.
- ROBINEAU, J. JOUAUX, T. LACROIX, M. & BABAULT, N. (2012). "Neuromuscular Fatigue Induced by a 90-Minute Soccer Game Modeling." *Journal of Strength and Conditioning Research*, 26(2): 555-562.
- ROETERT, E.P. BROWN, S.W. PIORKOWSKI, P.A. & WOODS, R.B. (1996). "Fitness comparisons among three different levels of elite tennis players." *Journal of Strength and Conditioning Research*, 10: 139-143.
- ROETERT, E.P. GARRETT, G.E. BROWN, S.W. & CAMAIONE, D.N. (1992). "Performance profiles of nationally ranked junior tennis players." *Journal of Strength and Conditioning Research*, 6(4): 225-231.
- ROLLS, A. & GEORGE, K. (2004). "The relationship between hamstring muscle injuries and hamstring muscle length in young elite footballers." *Physical Therapy in Sport*, 5(4): 179-187.
- ROTHSTEIN, J.M. MILLER, P.J. & ROETTGER, R.F. (1983). "Goniometric reliability in a clinical setting. Elbow and knee measurements." *Physical Therapy*, 63(10): 1611-1615.
- ROUSSON, V. GASSER, T. & SEIFERT, B. (2002). "Assessing intrarater, interrater and test-retest reliability of continuous measurements." *Statistics in Medicine*, 21(22): 3431-3446.
- ROZZI, S.L. LEPHART, S.M. & FU, F.H. (1999). "Effects of Muscular Fatigue on Knee Joint Laxity and Neuromuscular Characteristics of Male and Female Athletes." *Journal of Athletic Training*, 34(2): 106-114.
- RUBINI, E.C. COSTA, A.L.L. & GOMES, P.S.C. (2007). "The effects of stretching on strength performance." *Sports Medicine*, 37(3): 213-224.
- RYAN, E.D. BECK, T.W. HERDA, T.J. HULL, H.R. HARTMAN, M.J. COSTA, P.B. DEFREITAS, J.M. STOUT, J.R. & CRAMER, J.T. (2008). "The time course of musculotendinous stiffness responses following different durations of passive stretching." *The Journal of Orthopaedic and Sports Physical Therapy*, 38(10): 632-639.
- RYAN, E.D. BECK, T.W. HERDA, T.J. HULL, H.R. HARTMAN, M.J. STOUT, J.R. & CRAMER, J.T. (2008). "Do practical durations of stretching alter muscle strength? A dose-response study." *Medicine and Science in Sports and Exercise*, 40(8): 1529-1537.

SADY, S.P. WORTMAN, M. & BLANKE, D. (1982). "Flexibility training: ballistic, static or proprioceptive neuromuscular facilitation?" *Archives of Physical Medicine and Rehabilitation*, 63(6): 261-263.

SAFRIT, M.J. & WOOD, T.M. (1989). Measurement concepts in physical education and exercise science. Champaign (IL), Human Kinetics.

SANGNIER, S. & TOURNY-CHOLLET, C. (2008). "Study of the fatigue curve in quadriceps and hamstrings of soccer players during isokinetic endurance testing." *Journal of Strength and Conditioning Research*, 22(5): 1458-1467.

SCHACHE, A.G. WRIGLEY, T.V. BAKER, R. & PANDY, M.G. (2009). "Biomechanical response to hamstring muscle strain injury." *Gait and posture*, 29(2): 332-338.

SEMMLER, J.G. EBERT, S.A. & AMARASENA, J. (2013). "Eccentric muscle damage increases intermuscular coherence during a fatiguing isometric contraction." *Acta Physiologica*, 208(4): 362-375.

SEWARD, H. ORCHARD, J. HAZARD, H. & COLLINSON, D. (1993). "Football injuries in Australia at the elite level." *The Medical journal of Australia*, 159(5): 298-301.

SFORZO, G.A. (1989). "Opioids and exercise. An update." *Sports Medicine (Auckland, N.Z.)*, 7(2): 109-124.

SHACKLOCK, M. (2005). "Improving application of neurodynamic (neural tension) testing and treatments: a message to researchers and clinicians." *Manual Therapy*, 10(3): 175-179.

SHARMAN, M.J. CRESSWELL, A.G. & RIEK, S. (2006). "Proprioceptive neuromuscular facilitation stretching : mechanisms and clinical implications." *Sports Medicine (Auckland, N.Z.)*, 36(11): 929-939.

SHELLOCK, F.G. & PRENTICE, W.E. (1985). "Warming-up and stretching for improved physical performance and prevention of sports-related injuries." *Sports Medicine (Auckland, N.Z.)*, 2(4): 267-278.

SHEPHARD, R.J. (2002). "Ethics in exercise science research." *Sports Medicine (Auckland, N.Z.)*, 32(3): 169-183.

SHEWCHUK, J.P. & MOODIE, C.L. (1998). "Definition and classification of manufacturing flexibility types and measures." *International Journal of Flexible Manufacturing Systems*, 10(4): 325-349.

SHIMON, J.M. DARDEN, G.F. MARTINEZ, R. & CLOUSE-SNELL, J. (2010). "Initial reliability and validity of the lift-and-raise hamstring test." *Journal of Strength and Conditioning Research*, 24(2): 517-521.

- SHORTEN, M.R. (1987). "Muscle elasticity and human performance." *Medicine in Sport Science*, 25: 1-18.
- SHRIER, I. (2004). "Does stretching improve performance? A systematic and critical review of the literature." *Clinical Journal of Sport Medicine*, 14(5): 267-273.
- SHRIER, I. (2005). "Stretching perspectives." *Current Sports Medicine Reports*, 4(5): 237-238.
- SHRIER, I. (2008). "Warm-up and stretching in the prevention of muscular injury." *Sports Medicine (Auckland, N.Z.)*, 38(10): 879; author reply 879-880.
- SHROUT, P.E. & FLEISS, J.L. (1979). "Intraclass correlations: uses in assessing rater reliability." *Psychology Bulletin*, 86(2): 420-428.
- SIATRAS, T.A. MITTAS, V.P. MAMELETZI, D.N. & VAMVAKOUDIS, E.A. (2008). "The duration of the inhibitory effects with static stretching on quadriceps peak torque production." *Journal of Strength and Conditioning Research*, 22(1): 40-46.
- SILVA, D.A.S. PETROSKI, E.L. & ARAUJO GAYA, A.C. (2013). "Anthropometric and Physical Fitness Differences Among Brazilian Adolescents who Practise Different Team Court Sports." *Journal of Human Kinetics*, 36(1): 77-86.
- SIMENZ, C.J. DUGAN, C.A. & EBBEN, W.P. (2005). "Strength and conditioning practices of National Basketball Association strength and conditioning coaches." *Journal of Strength and Conditioning Research*, 19(3): 495-504.
- SIMIC, L. SARABON, N. & MARKOVIC, G. (2013). "Does pre-exercise static stretching inhibit maximal muscular performance? A meta-analytical review." *Scandinavian Journal of Medicine and Science in Sports*, 23(2): 131-148.
- SINGH, J. RAZA, S. & MOHAMMAD, A. (2011). "Physical Characteristics and Level of Performance in Badminton: A Relationship Study." *Journal of Education and Practice*, 2(5): 6-9.
- SKINNER, H.B. WYATT, M.P. HODGDON, J.A. CONARD, D.W. & BARRACK, R.L. (1986). "Effect of fatigue on joint position sense of the knee." *Journal of Orthopaedic Research*, 4(1): 112-118.
- SLINKER, B.K. & GLANTZ, S.A. (1985). "Multiple regression for physiological data analysis: the problem of multicollinearity." *American Journal of Physiology*, 249(1 Pt 2): R1-R12.
- SMALL, K. MC NAUGHTON, L. & MATTHEWS, M. (2008). "A systematic review into the efficacy of static stretching as part of a warm-up for the prevention of exercise-related injury." *Research in Sports Medicine (Print)*, 16(3): 213-231.

- SMALL, K. MCNAUGHTON, L. GREIG, M. & LOVELL, R. (2010). "The effects of multidirectional soccer-specific fatigue on markers of hamstring injury risk." *Journal of Science and Medicine in Sport*, 13(1): 120-125.
- SMITH, D.J. (2003). "A framework for understanding the training process leading to elite performance." *Sports Medicine*, 33(15): 1103-1126.
- SOBOLEWSKI, E.J. RYAN, E.D. & THOMPSON, B.J. (2013). "The influence of maximum range of motion and stiffness on the viscoelastic stretch response." *Muscle and Nerve*, (in press).
- SODERMAN, K. ALFREDSON, H. PIETILA, T. & WERNER, S. (2001). "Risk factors for leg injuries in female soccer players: a prospective investigation during one out-door season." *Knee Surgery, Sports Traumatology, Arthroscopy*, 9(5): 313-321.
- SPORIS, G. VUCETIC, V. JOVANOVIC, M. JUKIC, I. & OMRCEN, D. (2011). "Reliability and Factorial Validity of Flexibility Tests for Team Sports." *Journal of Strength and Conditioning Research*, 25(4): 1168-1176.
- STANTON, P. & PURDHAM, C. (1989). "Hamstring injuries in sprinting - the role of eccentric exercise." *The Journal of Orthopaedic and Sports Physical Therapy*, 10(9): 343-349.
- STATHOKOSTAS, L. LITTLE, R.M. VANDERVOORT, A. & PATERSON, D.H. (2012). "Flexibility Training and Functional Ability in Older Adults: A Systematic Review." *Journal of Aging Research*, (in press).
- STAUBER, W.T. (1989). "Eccentric action of muscles: physiology, injury, and adaptation." *Exercise and Sport Sciences Reviews*, 17: 157-185.
- STAUBER, W.T. (2004). "Factors involved in strain-induced injury in skeletal muscles and outcomes of prolonged exposures." *Journal of Electromyography and Kinesiology*, 14(1): 61-70.
- STEIN, R.B. & KEARNEY, R.E. (1995). "Nonlinear behavior of muscle reflexes at the human ankle joint." *Journal of Neurophysiology*, 73(1): 65-72.
- STEPHENSON, S. GISSANE, C. & JENNINGS, D. (1996). "Injury in rugby league: a four year prospective survey." *British Journal of Sports Medicine*, 30(4): 331-334.
- STEWART, M. ADAMS, R. ALONSO, A. VAN KOESVELD, B. & CAMPBELL, S. (2007). "Warm-up or stretch as preparation for sprint performance?" *Journal of Science and Medicine in Sport*, 10(6): 403-410.
- STRICKLER, T. MALONE, T. & GARRETT, W.E. (1990). "The effects of passive warming on muscle injury." *The American Journal of Sports Medicine*, 18(2): 141-145.

- SUN, J.S. TSUANG, Y.H. LIU, T.K. HANG, Y.S. & CHENG, C.K. (1994). "Failure sites and peak tensile forces of the composite triceps surae muscle by passive extension in the rabbit." *Clinical Biomechanics*, 9(5): 310-314.
- SUZUKI, S. & SUGI, H. (1983). "Extensibility of the myofilaments in vertebrate skeletal muscle as revealed by stretching rigor muscle fibers." *The Journal of General Physiology*, 81(4): 531-546.
- SWART, J. LINDSAY, T.R. LAMBERT, M.I. BROWN, J.C. & NOAKES, T.D. (2012). "Perceptual cues in the regulation of exercise performance—physical sensations of exercise and awareness of effort interact as separate cues." *British Journal of Sports Medicine*, 46(1): 42-48.
- TAKIZAWA, K. SOMA, T. NOSAKA, K. ISHIKAWA, T. & ISHII, K. (2012). "Effect of warm-up exercise on delayed-onset muscle soreness." *European Journal of Sport Science*, 12(6): 455-461.
- TALBOT, J.A. & MORGAN, D.L. (1998). "The effects of stretch parameters on eccentric exercise-induced damage to toad skeletal muscle." *Journal of Muscle Research and Cell Motility*, 19(3): 237-245.
- TARDIEU, C. TABARY, J.C. TABARY, C. & TARDIEU, G. (1982). "Adaptation of connective tissue length to immobilization in the lengthened and shortened positions in cat soleus muscle." *Journal de Physiologie*, 78(2): 214-220.
- TAYLOR, D.C. BROOKS, D.E. & RYAN, J.B. (1997). "Viscoelastic characteristics of muscle: passive stretching versus muscular contractions." *Medicine and Science in Sports and Exercise*, 29(12): 1619-1624.
- TAYLOR, D.C. DALTON, J.D., JR. SEABER, A.V. & GARRETT, W.E., JR. (1990). "Viscoelastic properties of muscle-tendon units. The biomechanical effects of stretching." *The American Journal of Sports Medicine*, 18(3): 300-309.
- TAYLOR, D.C. DALTON, J.D., JR. SEABER, A.V. & GARRETT, W.E., JR. (1993). "Experimental muscle strain injury. Early functional and structural deficits and the increased risk for reinjury." *The American Journal of Sports Medicine*, 21(2): 190-194.
- TAYLOR, K.L. SHEPPARD, J.M. LEE, H. & PLUMMER, N. (2009). "Negative effect of static stretching restored when combined with a sport specific warm-up component." *Journal of Science and Medicine in Sport*, 12(6): 657-661.
- TERMAN, G.W. SHAVIT, Y. LEWIS, J.W. CANNON, J.T. & LIEBESKIND, J.C. (1984). "Intrinsic mechanisms of pain inhibition: activation by stress." *Science*, 226(4680): 1270-1277.
- THACKER, S.B. GILCHRIST, J. STROUP, D.F. & KIMSEY, C.D., JR. (2004). "The impact of stretching on sports injury risk: a systematic review of the literature." *Medicine and Science in Sports and Exercise*, 36(3): 371-378.

- THELEN, D.G. CHUMANOV, E.S. HOERTH, D.M. BEST, T.M. SWANSON, S.C. LI, L. YOUNG, M. & HEIDERSCHEIT, B.C. (2005). "Hamstring muscle kinematics during treadmill sprinting." *Medicine and Science in Sports and Exercise*, 37(1): 108-114.
- THELEN, D.G. CHUMANOV, E.S. SHERRY, M.A. & HEIDERSCHEIT, B.C. (2006). "Neuromusculoskeletal models provide insights into the mechanisms and rehabilitation of hamstring strains." *Exercise and Sport Sciences Reviews*, 34(3): 135-141.
- TIBSHIRANI, R. (1996). "Regression shrinkage and selection via the lasso." *Journal of the Royal Statistical Society. Series B (Methodological)*, 58(1): 267-288.
- TIDBALL, J.G. (1986). "Energy stored and dissipated in skeletal muscle basement membranes during sinusoidal oscillations." *Biophysical Journal*, 50(6): 1127-1138.
- TIMMINS, R. DEAR, N. OPAR, D.A. WILLIAMS, M. & SHIELD, A. (2012). "**The impact of fatigue caused by sprint running on the median power frequency of the hamstring muscle group.**" Proceedings of the XIX Congress of the International Society of Electrophysiology and Kinesiology, 19-21 July 2012, Brisbane.
- TIS, L.L. PERRIN, D.H. WELTMAN, A. BALL, D.W. & GIECK, J.H. (1993). "Effect of preload and range of motion on isokinetic torque in women." *Medicine and Science in Sports and Exercise*, 25: 1038-1038.
- TOD, D. IREDALE, F. & GILL, N. (2003). "'Psyching-up' and muscular force production." *Sports Medicine (Auckland, N.Z.)*, 33(1): 47-58.
- TOFT, E. ESPERSEN, G.T. KÅLUND, S. SINKJÆR, T. & HORNEMANN, B.C. (1989). "Passive tension of the ankle before and after stretching." *The American Journal of Sports Medicine*, 17(4): 489-494.
- TORRES, E.M. KRAEMER, W.J. VINGREN, J.L. VOLEK, J.S. HATFIELD, D.L. SPIERING, B.A. HO, J.Y. FRAGALA, M.S. THOMAS, G.A. & ANDERSON, J.M. (2008). "Effects of stretching on upper-body muscular performance." *Journal of Strength and Conditioning Research*, 22(4): 1279-1285.
- TORRES, R. DUARTE, J.A. & CABRI, J.M.H. (2012). "An acute bout of quadriceps muscle stretching has no influence on knee joint proprioception." *Journal of Human Kinetics*, 34: 33-39
- TORRES, R. PINHO, F. DUARTE, J.A. & CABRI, J.M. (2013). "Effect of single bout versus repeated bouts of stretching on muscle recovery following eccentric exercise." *Journal of Science and Medicine in Sport*, (in press).
- TOUMI, H. & BEST, T.M. (2003). "The inflammatory response: friend or enemy for muscle injury?" *British Journal of Sports Medicine*, 37(4): 284-286.
- TOUMI, H. F'GUYER, S. & BEST, T.M. (2006). "The role of neutrophils in injury and repair following muscle stretch." *Journal of Anatomy*, 208(4): 459-470.

TRAUB, R.E. & ROWLEY, G.L. (2005). "Understanding Reliability." *Educational Measurement: Issues and Practice*, 10(1): 37-45.

TUFANO, J.J. BROWN, L.E. COBURN, J.W. TSANG, K.K. CAZAS, V.L. & LAPORTA, J.W. (2012). "Effect of Aerobic Recovery Intensity on Delayed-Onset Muscle Soreness and Strength." *Journal of Strength and Conditioning Research*, 26(10): 2777-2782.

TWELLAAR, M. VERSTAPPEN, F.T. HUSON, A. & VAN MECHELEN, W. (1997). "Physical characteristics as risk factors for sports injuries: a four year prospective study." *International Journal of Sports Medicine*, 18(1): 66-71.

TWIST, C. WALDRON, M. HIGHTON, J. BURT, D. & DANIELS, M. (2012). "Neuromuscular, biochemical and perceptual post-match fatigue in professional rugby league forwards and backs." *Journal of Sports Sciences*, 30(4): 359-367.

TYLER, T.F. NICHOLAS, S.J. CAMPBELL, R.J. & MCHUGH, M.P. (2001). "The association of hip strength and flexibility with the incidence of adductor muscle strains in professional ice hockey players." *The American Journal of Sports Medicine*, 29(2): 124-128.

UNICK, J. KIEFFER, H.S. CHEESMAN, W. & FEENEY, A. (2005). "The acute effects of static and ballistic stretching on vertical jump performance in trained women." *Journal of Strength and Conditioning Research*, 19(1): 206-212.

VAFADAR, A.K. CÔTÉ, J.N. & ARCHAMBAULT, P.S. (2012). "The effect of muscle fatigue on position sense in an upper limb multi-joint task." *Motor Control*, 16(2): 265-283.

VAN MECHELEN, W. HLOBIL, H. & KEMPER, H.C. (1992). "Incidence, severity, aetiology and prevention of sports injuries. A review of concepts." *Sports Medicine (Auckland, N.Z.)*, 14(2): 82-99.

VAN MECHELEN, W. HLOBIL, H. KEMPER, H.C. VOORN, W.J. & DE JONGH, H.R. (1993). "Prevention of running injuries by warm-up, cool-down, and stretching exercises." *The American Journal of Sports Medicine*, 21(5): 711-719.

VAN TIGGELEN, D. WICKES, S. STEVENS, V. ROOSEN, P. & WITVROUW, E. (2008). "Effective prevention of sports injuries: a model integrating efficacy, efficiency, compliance and risk-taking behaviour." *British Journal of Sports Medicine*, 42(8): 648-652.

VERRALL, G.M. SLAVOTINEK, J.P. & BARNES, P.G. (2005). "The effect of sports specific training on reducing the incidence of hamstring injuries in professional Australian Rules football players." *British Journal of Sports Medicine*, 39(6): 363-368.

VERRALL, G.M. SLAVOTINEK, J.P. BARNES, P.G. & FON, G.T. (2003). "Diagnostic and prognostic value of clinical findings in 83 athletes with posterior thigh injury: comparison of clinical findings with magnetic resonance imaging documentation of hamstring muscle strain." *The American Journal of Sports Medicine*, 31(6): 969-973.

- VERRALL, G.M. SLAVOTINEK, J.P. BARNES, P.G. FON, G.T. & SPRIGGINS, A.J. (2001). "Clinical risk factors for hamstring muscle strain injury: a prospective study with correlation of injury by magnetic resonance imaging." *British Journal of Sports Medicine*, 35(6): 435-440.
- WALLIN, D. EKBLUM, B. GRAHN, R. & NORDENBORG, T. (1985). "Improvement of muscle flexibility: a comparison between two techniques." *The American Journal of Sports Medicine*, 13(4): 263-268.
- WALLMANN, H.W. MERCER, J.A. & LANDERS, M.R. (2008). "Surface electromyographic assessment of the effect of dynamic activity and dynamic activity with static stretching of the gastrocnemius on vertical jump performance." *Journal of Strength and Conditioning Research*, 22(3): 787-793.
- WALSH, L.D. ALLEN, T.J. GANDEVIA, S.C. & PROSKE, U. (2006). "Effect of eccentric exercise on position sense at the human forearm in different postures." *Journal of Applied Physiology*, 100(4): 1109-1116.
- WALSH, L.D. HESSE, C.W. MORGAN, D.L. & PROSKE, U. (2004). "Human forearm position sense after fatigue of elbow flexor muscles." *The Journal of Physiology*, 558(Pt 2): 705-715.
- WALSH, L.D. SMITH, J.L. GANDEVIA, S.C. & TAYLOR, J.L. (2009). "The combined effect of muscle contraction history and motor commands on human position sense." *Experimental Brain Research*, 195(4): 603-610.
- WALSHE, A.D. WILSON, G.J. & MURPHY, A.J. (1996). "The validity and reliability of a test of lower body musculotendinous stiffness." *European Journal of Applied Physiology and Occupational Physiology*, 73(3-4): 332-339.
- WALTER, J. FIGONI, S.F. ANDRES, F.F. & BROWN, E. (1994). "Training intensity and duration in flexibility." *Clinical Kinesiology*, 50: 40-45.
- WALTER, S.D. ELIASZIW, M. & DONNER, A. (1998). "Sample size and optimal designs for reliability studies." *Statistics in Medicine*, 17(1): 101-110.
- WALTER, S.D. HART, L.E. MCINTOSH, J.M. & SUTTON, J.R. (1989). "The Ontario cohort study of running-related injuries." *Archives of Internal Medicine*, 149(11): 2561-2564.
- WARREN, G.L. HAYES, D.A. LOWE, D.A. PRIOR, B.M. & ARMSTRONG, R.B. (1993). "Materials fatigue initiates eccentric contraction-induced injury in rat soleus muscle." *The Journal of Physiology*, 464(1): 477-489.
- WATERS, R.L. PERRY, J. MCDANIELS, J.M. & HOUSE, K. (1974). "The relative strength of the hamstrings during hip extension." *The Journal of Bone and Joint Surgery*, 56(8): 1592-1597.

WATKINS, M.A. RIDDLE, D.L. LAMB, R.L. & PERSONIUS, W.J. (1991). "Reliability of goniometric measurements and visual estimates of knee range of motion obtained in a clinical setting." *Physical Therapy*, 71(2): 90-97.

WATSFORD, M. DITROILO, M. FERNÁNDEZ-PEÑA, E. D'AMEN, G. & LUCERTINI, F. (2010). "Muscle stiffness and rate of torque development during sprint cycling." *Medicine and Science in Sports and Exercise*, 42(7): 1324-1332.

WATSFORD, M.L. MURPHY, A.J. MCLACHLAN, K.A. BRYANT, A.L. CAMERON, M.L. CROSSLEY, K.M. & MAKDISSI, M. (2010). "A prospective study of the relationship between lower body stiffness and hamstring injury in professional Australian rules footballers." *The American Journal of Sports Medicine*, 38(10): 2058-2064.

WATSON, A.W. (2001). "Sports injuries related to flexibility, posture, acceleration, clinical defects, and previous injury, in high-level players of body contact sports." *International Journal of Sports Medicine*, 22(3): 222-225.

WEBER, D.W. (2012). **A comparison of the effects of a stretching and a cold before stretching treatment on the recovery of range of motion and perception of soreness following delayed muscle soreness.** Unpublished PhD Thesis, Emporia State University

WEDDERKOPP, N. KALTOFT, M. LUNDGAARD, B. ROSENDAHL, M. & FROBERG, K. (1999). "Prevention of injuries in young female players in European team handball. A prospective intervention study." *Scandinavian Journal of Medicine and Science in Sports*, 9: 41-47.

WEIR, J.P. (2005). "Quantifying test-retest reliability using the intraclass correlation coefficient and the SEM." *Journal of Strength and Conditioning Research*, 19(1): 231-240.

WEIR, J.P. KEEFE, D.A. EATON, J.F. AUGUSTINE, R.T. & TOBIN, D.M. (1998). "Effect of fatigue on hamstring coactivation during isokinetic knee extensions." *European Journal of Applied Physiology and Occupational Physiology*, 78(6): 555-559.

WELDON, S.M. & HILL, R.H. (2003). "The efficacy of stretching for prevention of exercise-related injury: a systematic review of the literature." *Manual Therapy*, 8(3): 141-150.

WEPPLER, C. & MAGNUSSON, S. (2010). "Increasing muscle extensibility: a matter of increasing length or modifying sensation?" *Physical Therapy* 90(3): 438-449.

WESSEL, J. & WAN, A. (1994). "Effect of stretching on the intensity of delayed-onset muscle soreness." *Clinical Journal of Sport Medicine*, 4: 83-87.

WESSLING, K.C. DEVANE, D.A. & HYLTON, C.R. (1987). "Effects of static stretch versus static stretch and ultrasound combined on triceps surae muscle extensibility in healthy women." *Physical Therapy*, 67(5): 674-679.

WESTERBLAD, H. DUTY, S. & ALLEN, D.G. (1993). "Intracellular calcium concentration during low-frequency fatigue in isolated single fibers of mouse skeletal muscle." *Journal of Applied Physiology*, 75(1): 382-388.

WESTWATER-WOOD, S. ADAMS, N. & KERRY, R. (2010). "The use of proprioceptive neuromuscular facilitation in physiotherapy practice." *Physical Therapy Reviews*, 15(1): 23-28.

WHATMAN, C. KNAPPSTEIN, A. & HUME, P. (2006). "Acute changes in passive stiffness and range of motion post-stretching." *Physical Therapy in Sport* 7(4): 195-200.

WHITEHEAD, N.P. GREGORY, J.E. MORGAN, D.L. & PROSKE, U. (2001). "Passive mechanical properties of the medial gastrocnemius muscle of the cat." *The Journal of Physiology*, 536(Pt 3): 893-903.

WIEMANN, K. & HAHN, K. (1997). "Influences of strength, stretching and circulatory exercises on flexibility parameters of the human hamstrings." *International Journal of Sports Medicine*, 18(5): 340-346.

WIESLER, E.R. HUNTER, D.M. MARTIN, D.F. CURL, W.W. & HOEN, H. (1996). "Ankle flexibility and injury patterns in dancers." *The American Journal of Sports Medicine*, 24(6): 754-757.

WILBER, C.A. HOLLAND, G.J. MADISON, R.E. & LOY, S.F. (1995). "An epidemiological analysis of overuse injuries among recreational cyclists." *International Journal of Sports Medicine*, 16(3): 201-206.

WILLEMS, M.E. & STAUBER, W.T. (2002). "Fatigue and recovery at long and short muscle lengths after eccentric training." *Medicine and Science in Sports and Exercise*, 34(11): 1738-1743.

WILLEMS, T.M. WITVROUW, E. DELBAERE, K. MAHIEU, N. DE BOURDEAUDHUIJ, I. & DE CLERCQ, D. (2005). "Intrinsic risk factors for inversion ankle sprains in male subjects: a prospective study." *The American Journal of Sports Medicine*, 33(3): 415-423.

WILSON, G.J. ELLIOTT, B.C. & WOOD, G.A. (1992). "Stretch shorten cycle performance enhancement through flexibility training." *Medicine and Science in Sports and Exercise*, 24(1): 116-123.

WILSON, G.J. MURPHY, A.J. & PRYOR, J.F. (1994). "Musculotendinous stiffness: its relationship to eccentric, isometric, and concentric performance." *Journal of Applied Physiology*, 76(6): 2714-2719.

WILSON, G.J. WOOD, G.A. & ELLIOTT, B.C. (1991). "The relationship between stiffness of the musculature and static flexibility: an alternative explanation for the occurrence of muscular injury." *International Journal of Sports Medicine*, 12(4): 403-407.

- WINCHESTER, J.B. NELSON, A.G. LANDIN, D. YOUNG, M.A. & SCHEXNAYDER, I.C. (2008). "Static stretching impairs sprint performance in collegiate track and field athletes." *Journal of Strength and Conditioning Research*, 22(1): 13-19.
- WINTER, D.A. WELLS, R.P. & ORR, G.W. (1981). "Errors in the use of isokinetic dynamometers." *European journal of applied physiology and occupational physiology* 46(4): 397-408.
- WITCHALLS, J. BLANCH, P. WADDINGTON, G. & ADAMS, R. (2012). "Intrinsic functional deficits associated with increased risk of ankle injuries: a systematic review with meta-analysis." *British Journal of Sports Medicine*, 46(7): 515-523.
- WITVROUW, E. DANNEELS, L. ASSELMAN, P. D'HAVE, T. & CAMBIER, D. (2003). "Muscle flexibility as a risk factor for developing muscle injuries in male professional soccer players. A prospective study." *The American Journal of Sports Medicine*, 31(1): 41-46.
- WOO, S.L. GOMEZ, M.A. & AKESON, W.H. (1981). "The time and history-dependent viscoelastic properties of the canine medical collateral ligament." *Journal of Biomechanical Engineering*, 103(4): 293-298.
- WOOD, G.A. (1987). "Biomechanical limitations to sprint running." *Medicine and Science in Sports and Exercise*, 25: 58-71
- WOODS, C. HAWKINS, R.D. MALTBY, S. HULSE, M. THOMAS, A. HODSON, A. & FOOTBALL ASSOCIATION MEDICAL RESEARCH, P. (2004). "The Football Association Medical Research Programme: an audit of injuries in professional football--analysis of hamstring injuries." *British Journal of Sports Medicine*, 38(1): 36-41.
- WORRELL, T.W. (1994). "Factors associated with hamstring injuries. An approach to treatment and preventative measures." *Sports Medicine (Auckland, N.Z.)*, 17(5): 338-345.
- WORRELL, T.W. DENEGAR, C.R. ARMSTRONG, S.L. & PERRIN, D.H. (1990). "Effect of body position on hamstring muscle group average torque." *The Journal of Orthopaedic and Sports Physical Therapy*, 11(10): 449-452.
- WORRELL, T.W. PERRIN, D.H. GANSNEDER, B.M. & GIECK, J.H. (1991). "Comparison of isokinetic strength and flexibility measures between hamstring injured and noninjured athletes." *The Journal of Orthopaedic and Sports Physical Therapy*, 13(3): 118-125.
- WORRELL, T.W. SMITH, T.L. & WINEGARDNER, J. (1994). "Effect of hamstring stretching on hamstring muscle performance." *The Journal of Orthopaedic and Sports Physical Therapy*, 20(3): 154-159.
- YAMAGUCHI, T. ISHII, K. YAMANAKA, M. & YASUDA, K. (2006). "Acute effect of static stretching on power output during concentric dynamic constant external resistance leg extension." *Journal of Strength and Conditioning Research*, 20(4): 804-810.

- YANG, H. ALNAQEEB, M. SIMPSON, H. & GOLDSPIK, G. (1997). "Changes in muscle fibre type, muscle mass and IGF-I gene expression in rabbit skeletal muscle subjected to stretch." *Journal of Anatomy*, 190 (Pt 4)(Pt 4): 613-622.
- YANG, J.L. JAN, M.H. HUNG, C.J. YANG, P.L. & LIN, J.J. (2010). "Reduced scapular muscle control and impaired shoulder joint position sense in subjects with chronic shoulder stiffness." *Journal of Electromyography and Kinesiology*, 20(2): 206-211.
- YAVUZ, Ş.U. ŞENDEMİR-ÜRKMEZ, A. & TÜRKER, K.S. (2010). "Effect of gender, age, fatigue and contraction level on electromechanical delay." *Clinical Neurophysiology*, 121(10): 1700-1706.
- YEN, D. (2005). "Limitations of isokinetic testing to determine shoulder strength after rotator cuff repair." *The Iowa Orthopaedic Journal*, 25: 141-144.
- YEUNG, S.S. SUEN, A.M.Y. & YEUNG, E.W. (2009). "A prospective cohort study of hamstring injuries in competitive sprinters: preseason muscle imbalance as a possible risk factor." *British Journal of Sports Medicine*, 43(8): 589-594.
- YEUNG, E.W. & YEUNG, S.S. (2001). "Interventions for preventing lower limb soft-tissue injuries in runners." *Cochrane database of systematic reviews*, (3): CD001256.
- YLINEN, J.J. KAUTIAINEN, H.J. & HÄKKINEN, A.H. (2010). "Comparison of active, manual, and instrumental straight leg raise in measuring hamstring extensibility." *Journal of Strength and Conditioning Research*, 24(4): 972-977.
- YOUDAS, J.W. BOGARD, C.L. & SUMAN, V.J. (1993). "Reliability of goniometric measurements and visual estimates of ankle joint active range of motion obtained in a clinical setting." *Archives of Physical Medicine and Rehabilitation*, 74(10): 1113-1118.
- YOUNG, W. CLOTHIER, P. OTAGO, L. BRUCE, L. & LIDDELL, D. (2004). "Acute effects of static stretching on hip flexor and quadriceps flexibility, range of motion and foot speed in kicking a football." *Journal of Science and Medicine in Sport*, 7(1): 23-31.
- YOUNG, W. ELIAS, G. & POWER, J. (2006). "Effects of static stretching volume and intensity on plantar flexor explosive force production and range of motion." *The Journal of Sports Medicine and Physical Fitness*, 46(3): 403-411.
- YOUNG, W.B. (2007). "The use of static stretching in warm-up for training and competition." *International Journal of Sports Physiology and Performance*, 2(2): 212-216.
- YU, B. QUEEN, R.M. ABBEY, A.N. LIU, Y. MOORMAN, C.T. & GARRETT, W.E. (2008). "Hamstring muscle kinematics and activation during overground sprinting." *Journal of Biomechanics*, 41(15): 3121-3126.

ZAKAS, A. GRAMMATIKOPOULOU, M.G. ZAKAS, N. ZAHARIADIS, P. & VAMVAKOUDIS, E. (2006). "The effect of active warm-up and stretching on the flexibility of adolescent soccer players." *The Journal of Sports Medicine and Physical Fitness*, 46(1): 57-61.

ZAKAS, A. VERGOU, A. GRAMMATIKOPOULOU, M.G. ZAKAS, N. SENTELIDIS, T. & VAMVAKOUDIS, S. (2003). "The effect of stretching during warming-up on the flexibility of junior handball players." *The Journal of Sports Medicine and Physical Fitness*, 43(2): 145-149.

CHAPTER 7

APPENDIXES

7.1 APPENDIX 1

20 March 2013

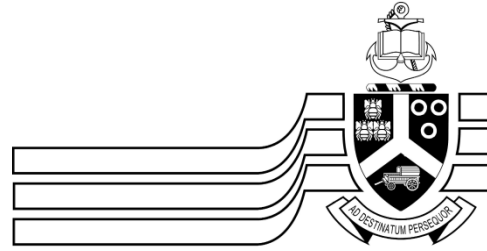

Universiteit van Pretoria

Pretoria 0002 Republiek van Suid Afrika
[Http://www.up.ac.za](http://www.up.ac.za)

FACULTY OF HUMANITIES

Dept Biokinetics, Sport & Leisure Sciences
Tel: 012-420-6040 Fax: 012-420-6099
www.bsl.up.ac.za

INFORMED CONSENT FORM AND INFORMATION SHEET : CHAPTERS 3 AND 4

Project title

The title of this project is **Flexibility; Passive Biomechanical Responses**

The student leading the project is Miss Sally Waterworth

The supervisor of the project is Prof PE Krüger

Thank you for showing an interest in this project. Please read all the information carefully. Think about whether or not you want to take part. If you decide to take part, you will be asked to sign this form. You do not have to take part. If you decide that you do not want to participate, there will be no disadvantage to you.

What are the aims of the project?

The main aims of the project are

- Determine the reliability of a Biodex Isokinetic Dynamometer for passive measurements of muscle stiffness
- Determine the reliability of the Active and Passive Knee Extension Tests, the Straight Leg Raise Test and the Sit and Reach Test

- Establish any relationships between the different tests of flexibility

Procedures

If you agree to take part, you will be asked to come for testing on two occasions in the same day. Each test will take approximately 20 minutes and you will be asked to come for the second test 1 hour after the first. On each occasion, you will be seated into the chair of the Isokinetic Dynamometer while it is adjusted to your measurements. Your leg will be raised to 45° through the use of a thigh pad. The Isokinetic Dynamometer will be set to take you through 5 movements of straightening and bending your knee. You will be asked to relax completely at this time and not provide any resistance to the movement of the Dynamometer. You will then go through a single passive knee extension to a point where you feel a strong tension in the back of your thigh, similar to the feeling you get when performing a normal hamstring stretch. You will then be moved onto a treatment table where a goniometer (device measuring joint angle) will be used to measure your maximum range for the Active Knee Extension (AKE), Passive Knee Extension (PKE) and Straight Leg Raise (SLR) tests. After these, you will be asked to perform a Sit and Reach Test.

Risks and discomfort

There are no risks in taking part in this study above what you expose yourself to in your daily training and playing. It is highly unlikely that you will experience any discomfort as a result of this testing. If you do experience pain or discomfort, please tell the researcher immediately.

Full details of the risks involved in the procedures are detailed in the risk assessments A19 and A36 in the department health and safety manual.

Safety

General health and safety procedures will be followed as detailed in the department health and safety manual. The researcher is a qualified First-Aider.

Benefits

You will not get any direct benefit from this study. However, by taking part, you will help us to increase knowledge of the area being studied.

Can you stop taking part?

You can change your mind and decide not to take part at any time. If you decide to stop, you do not have to give any reasons for your decision, and you will not be placed at any disadvantage whatsoever.

What information will be collected, and how will it be used?

Details of your height, weight, age and the results of your flexibility tests will be recorded. No-one other than the researcher will have access to your specific data. When testing is finished, data will be coded and grouped together for analysis. Data will be stored on a password-protected personal computer and any floppy disks in a locked drawer to which only the researcher has the key. Data will be destroyed on completion of the study.

The results of this project may be published, but the information will not be linked to any specific person. A copy of your results will be given to you if you ask for them. You can ask questions about the project at any time. Please contact Sally Waterworth at any of the testing sessions, by email sallywaterworth@hotmail.com or telephone 01695 584686 / 07814 106332.

Statement by subject

I have volunteered to take part in this project

I know I can stop taking part at any time without being disadvantaged

I am satisfied that the results will be stored securely

I know that the results may be published, but they will not be linked to me

I am aware of any possible risks and discomfort

I agree to inform the researcher immediately if I am in pain, or if I feel uncomfortable

I have had the chance to ask questions

I know that I will not receive any money for taking part

I have read this form and I understand it. I agree to take part in the project titled Flexibility; Passive Biomechanical Responses

Signed (Subject):

Date:

Signed (Witness):

Date:

7.2 APPENDIX 2

20 March 2013



Universiteit van Pretoria

Pretoria 0002 Republiek van Suid Afrika
[Http://www.up.ac.za](http://www.up.ac.za)

FACULTY OF HUMANITIES

Dept Biokinetics, Sport & Leisure Sciences
Tel: 012-420-6040 Fax: 012-420-6099
www.bsl.up.ac.za

PARENTAL CONSENT LETTER FOR UNDER 18 PARTICIPANTS: CHAPTERS 3 AND 4

Dear Parent/Guardian,

I am a Senior Lecturer at Edge Hill College of Higher Education in Ormskirk where I am also working towards my PhD. The aim of this is to determine whether stretching after exercise should be used to aid recovery and if so, what type of stretching should be performed.

The first part of this involves determining whether the tests that I'm planning on using to measure flexibility are reliable enough for the results to be meaningful. The procedures for this are outlined in the attached Informed Consent Form if you would like to read them in more detail. This study will be carried out in the Easter Holiday period so your child will not miss any classes at school.

As your child is under the age of 18, I will need your consent to allow him to participate. Should you have any more questions, please feel free to contact me by email: sallywaterworth@hotmail.com, tel: 01695 584686 or mob: 07814 106332.

If you are happy for your child to participate, please sign the attached form and give to your child to return to Andy Jones, the academy physio at the club.

Many thanks for your time.

Kind regards,

Sally Waterworth
BSc, MSST
Senior Lecturer in Sports Therapy

7.3 APPENDIX 3

Example of curve obtained from passive stretch on isokinetic dynamometer

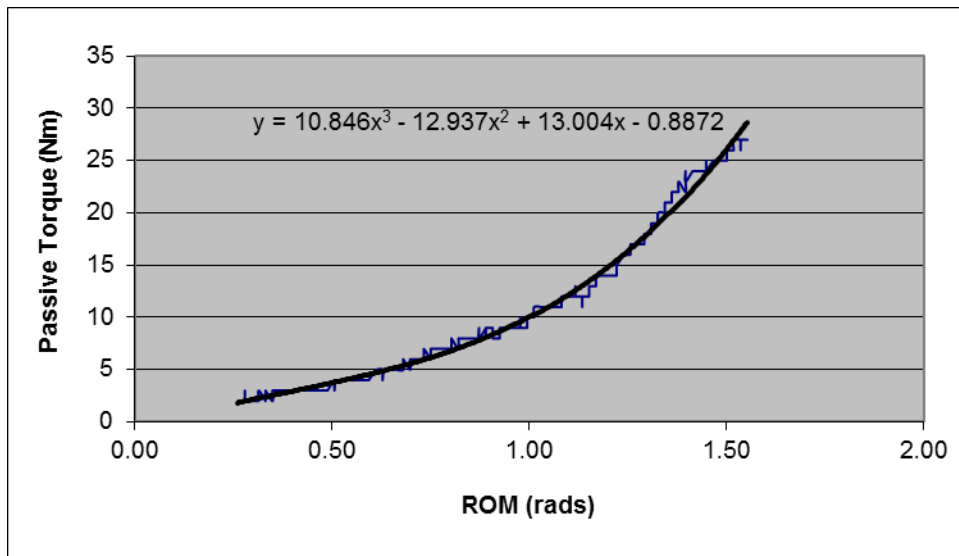

Differentiation (Stiffness):

$$y = d/dx (10.846 \cdot x^3 - 12.937 \cdot x^2 + 13.004 \cdot x - 0.8872)$$

Substituting $x = 1.55$

$$y = 10214369 / 200000$$

$$y = 51.07$$

Integrating (Energy Absorbed):

$$y = \int (10.846 \cdot x^3 - 12.937 \cdot x^2 + 13.004 \cdot x - 0.8872)$$

Limits – 0.26 to 1.55 rads

$$y = 2738527824327 / 2000000000$$

$$y = 13.70 \text{ J}$$

7.4 APPENDIX 4

20 March 2013



Universiteit van Pretoria

Pretoria 0002 Republiek van Suid Afrika
[Http://www.up.ac.za](http://www.up.ac.za)

FACULTY OF HUMANITIES

Dept Biokinetics, Sport & Leisure Sciences
Tel: 012-420-6040 Fax: 012-420-6099
www.bsl.up.ac.za

INFORMED CONSENT FORM AND INFORMATION SHEET CHAPTER 6

Project title

The title of this project is **Flexibility; Passive Biomechanical Responses and Recovery from Exercise**

The student leading the project is Miss Sally Waterworth

The supervisor of the project is Prof PE Krüger

Thank you for showing an interest in this project. Please read all the information carefully. Think about whether or not you want to take part. If you decide to take part, you will be asked to sign this form. You do not have to take part. If you decide that you do not want to participate, there will be no disadvantage to you.

What are the aims of the project?

The main aims of the project are

Determine the between day reliability of an Isokinetic Dynamometer for passive measurements of muscle stiffness

Establish the effect of an repeated sprint protocol on Perceived Stiffness, Knee Joint Position Sense, Biomechanical Properties of the Hamstring, Concentric and Eccentric Quadriceps and Hamstring Strength

Determine the effects of static stretching on the above factors

Procedures

If you agree to take part, you will be asked to come for testing on four occasions. The first and third tests will last for approximately one hour each and the second and fourth tests approximately 20mins each. On each occasion you will be asked to lie on a treatment table where a goniometer (device measuring joint angle) will be used to measure your maximum range for the Active Knee Extension (AKE), Passive Knee Extension (PKE) and Straight Leg Raise (SLR) tests. You will be seated into the chair of the Isokinetic Dynamometer while it is adjusted to your measurements. Your leg will be raised to 45° through the use of a thigh pad. You will be asked to relax completely at this time and not provide any resistance to the movement of the Dynamometer. You will then go through a single passive knee extension to a point where you feel a strong tension in the back of your thigh, similar to the feeling you get when performing a normal hamstring stretch. After this, the Dynamometer will be adjusted and you will then be asked to resist the machine in bending and straightening your knee while concentric and eccentric quadriceps and hamstrings strength is measured. On the first and third testing occasions you will then go through a multiple sprint protocol before repeating the above procedure. On the second and fourth testing occasions you will go through the above procedure alone. After one of the multi-sprint sessions, you will be asked to perform some static stretching of the lower limb and after the other some static stretching of the upper limb.

Risks and discomfort

There are no risks in taking part in this study above what you expose yourself to in your daily training and playing. It is highly unlikely that you will experience any discomfort as a result of this testing. If you do experience pain or discomfort, please tell the researcher immediately.

Full details of the risks involved in the procedures are detailed in the risk assessments A19 and A36 in the department health and safety manual.

Safety

General health and safety procedures will be followed as detailed in the department health and safety manual. The researcher is a qualified First-Aider.

Benefits

You will not get any direct benefit from this study. However, by taking part, you will help us to increase knowledge of the area being studied.

Can you stop taking part?

You can change your mind and decide not to take part at any time. If you decide to stop, you do not have to give any reasons for your decision, and you will not be placed at any disadvantage whatsoever.

What information will be collected, and how will it be used?

Details of your height, weight, age and the results of your flexibility tests will be recorded. No-one other than the researcher will have access to your specific data. When testing is finished, data will be coded and grouped together for analysis. Data will be stored on a password-protected personal computer.

The results of this project may be published, but the information will not be linked to any specific person. A copy of your results will be given to you if you ask for them. You can ask questions about the project at any time. Please contact Sally Waterworth at any of the testing sessions, by email sallywaterworth@hotmail.com or telephone 01695 584686 / 07814 106332.

Statement by subject

I have volunteered to take part in this project

I know I can stop taking part at any time without being disadvantaged

I am satisfied that the results will be stored securely

I know that the results may be published, but they will not be linked to me

I am aware of any possible risks and discomfort

I agree to inform the researcher immediately if I am in pain, or if I feel uncomfortable

I have had the chance to ask questions

I know that I will not receive any money for taking part

I have read this form and I understand it. I agree to take part in the project.

Name:

Signed (Subject):

Date:

Signed (Witness):

Date:

7.5 APPENDIX 5
Data Collection Sheet Chapter 5

Date:

Name	DOB
Position	
Height	Weight

Test No

One	Two	Three

Joint Position Sense

Actual	Perceived

Perceived Stiffness



ROM

AKE	PKE	ASLR	PSLR

IKD

Passive Stretch			
Eccentric 2.09rads ⁻¹			

Sprints

½ Speed x 5	¾ Speed x 5	<u>Full Speed x 20</u>	

Condition

Stretch	No Stretch

7.6 APPENDIX 6

Tests of Normality Chapter 4

Tests of Normality

	Kolmogorov-Smirnov ^a		
	Statistic	df	Sig.
Tor0.99	.168	25	.066
MaxTor	.122	25	.200 [*]
Grad0.99	.164	25	.083
FinalGrad	.102	25	.200 [*]
Energy0.99	.108	25	.200 [*]
TotalEnergy	.092	25	.200 [*]
AKE	.119	25	.200 [*]
PKE	.142	25	.200 [*]
ASLR	.139	25	.200 [*]
PSLR	.107	25	.200 [*]

a. Lilliefors Significance Correction

*. This is a lower bound of the true significance.

7.7 APPENDIX 7

Sample size calculation Chapter 4

SPSS Sample Power software

Power for a test of the null hypothesis

One goal of the proposed study is to test the null hypothesis that the correlation in the population is 0.00. The criterion for significance (alpha) has been set at 0.050. The test is 1-tailed, which means that only an effect in the expected direction will be interpreted.

With the proposed sample size of 25 the study will have power of 86.0% to yield a statistically significant result.

This computation assumes that the correlation in the population is 0.49. The observed value will be tested against a theoretical value (constant) of 0.00

This effect was selected as the smallest effect that would be important to detect, in the sense that any smaller effect would not be of clinical or substantive significance. It is also assumed that this effect size is reasonable, in the sense that an effect of this magnitude could be anticipated in this field of research.

Precision for estimating the effect size

A second goal of this study is to estimate the correlation in the population. Based on these same parameters and assumptions the study will enable us to report the this value with a precision (95.0% confidence level) of approximately plus/minus 0.26 points.

For example, an observed correlation of 0.49 would be reported with a 95.0% confidence interval of 0.18 to infinity, or (alternatively, per the a priori hypothesis) of minus infinity to 0.71. (Since the confidence interval has been defined as one tailed, only one boundary is meaningful).

The precision estimated here is the . Precision will vary as a function of the observed correlation (as well as sample size), and in any single study will be narrower or wider than this estimate.

Notes

Power computation: Fisher Z approximation (when null=0, exact formula is used)

Precision computation: Fisher Z approximation

7.8 APPENDIX 8

Descriptive statistics of participants Chapter 4

	Mean \pm SD
Passive Torque at 0.99 rads (Nm)	13.76 \pm 4.42
Stiffness at 0.99 rads	21.76 \pm 8.06
Energy Absorbed to 0.99 rads (J)	6.17 \pm 1.85
Peak Passive Torque (Nm)	31.23 \pm 7.99
Final Stiffness	55.20 \pm 21.33
Total Energy Absorbed (J)	15.85 \pm 5.26
AKE ($^{\circ}$)	68.4 \pm 9.5
PKE ($^{\circ}$)	77.0 \pm 10.0
ASLR ($^{\circ}$)	70.6 \pm 10.3
PSLR ($^{\circ}$)	79.6 \pm 11.4

7.9 APPENDIX 9

Tests of Normality Chapter 5

Tests of Normality

	Kolmogorov-Smirnov		
	Statistic	df	Sig.
MaxTorque	.202	15	.103
MaxTorque	.215	15	.093
FinGrad	.153	15	.200 ^a
FinGrad	.216	15	.097
TotalEnergy	.154	15	.200 ^a
TotalEnergy	.164	15	.200 ^a
Grad0.99	.231	15	.080
Grad0.99	.194	15	.134
Energy0.99	.250	15	.082
Energy0.99	.209	15	.076
Torque0.99	.280	15	.082
Torque0.99	.268	15	.125
AKE	.257	15	.069
AKE	.335	15	.289
PKE	.164	15	.200 ^a
PKE	.317	15	.127
ASLR	.251	15	.092
ASLR	.189	15	.154
PSLR	.259	15	.148
PSLR	.165	15	.200 ^a
a. Lilliefors Significance Correction			

7.10 APPENDIX 10

Bonferroni adjustment tables for post-hoc testing in Chapter 5

Peak Passive Torque

		t	Sig. (2-tailed)
Pair 1	Pre-Exercise - Pre-Exercise	2.161	.037
Pair 2	Post-Exercise - Post-Exercise	1.635	.110
Pair 3	18 Hours Post-Exercise - Post-Exercise	1.279	.209
Pair 4	Pre-Exercise - Post-Exercise	-.838	.407
Pair 5	Pre-Exercise - 18 Hours Post-Exercise	-1.812	.078

Passive Energy Absorbed

		t	Sig. (2-tailed)
Pair 1	Pre-Exercise - Pre-Exercise	1.520	.137
Pair 2	Post-Exercise - Post-Exercise	-2.099	.043
Pair 3	18 Hours Post-Exercise - 18 Hours Post-Exercise	-2.291	.028
Pair 4	Pre-Exercise - Post-Exercise	-1.467	.151
Pair 5	Pre-Exercise - 18 Hours Post-Exercise	-3.508	.001

Peak Torque during Eccentric Contraction

		t	Sig. (2-tailed)
Pair 1	Pre-Exercise - Pre-Exercise	-.992	.328
Pair 2	Post-Exercise - Post-Exercise	-2.761	.009
Pair 3	18 Hours Post-Exercise - 18 Hours Post-Exercise	-3.298	.002
Pair 4	Pre-Exercise - Post-Exercise	.208	.836
Pair 5	Pre-Exercise - 18 Hours Post-Exercise	-.152	.880

Eccentric Total Work Done

		t	Sig. (2-tailed)
Pair 1	Pre-Exercise - Pre-Exercise	-.845	.403
Pair 2	Post-Exercise - Post-Exercise	-3.478	.001
Pair 3	18 Hours Post-Exercise - 18 Hours Post-Exercise	-3.077	.004
Pair 4	Pre-Exercise - Post-Exercise	.454	.653
Pair 5	Pre-Exercise - 18 Hours Post-Exercise	-.052	.959

AKE

		t	Sig. (2-tailed)
Pair 1	Pre-Exercise - Pre-Exercise	-4.435	.000
Pair 2	Post-Exercise - Post-Exercise	-1.034	.308
Pair 3	18 Hours Post-Exercise - 18 Hours Post-Exercise	-2.825	.007
Pair 4	Pre-Exercise - Post-Exercise	7.797	.000
Pair 5	Pre-Exercise - 18 Hours Post-Exercise	1.492	.144

Perceived Stiffness

		t	Sig. (2-tailed)
Pair 1	Pre-Exercise - Pre-Exercise	.646	.522
Pair 2	Post-Exercise - Post-Exercise	.786	.437
Pair 3	18 Hours Post-Exercise - 18 Hours Post-Exercise	5.192	.000
Pair 4	Pre-Exercise - Post-Exercise	4.449	.000
Pair 5	Pre-Exercise - 18 Hours Post-Exercise	-2.636	.012

JPE

		t	Sig. (2-tailed)
Pair 1	Pre-Exercise - Pre-Exercise	3.106	.004
Pair 2	Post-Exercise - Pre-Exercise	9.319	.000
Pair 3	18 Hours Post-Exercise - 18 Hours Post-Exercise	-.696	.491
Pair 4	Pre-Exercise - Post-Exercise	-8.330	.000
Pair 5	Pre-Exercise - 18 Hours Post-Exercise	-2.286	.028

PKE

		t	Sig. (2-tailed)
Pair 1	Pre-Exercise - Pre-Exercise	-7.339	.000
Pair 2	Post-Exercise - Post-Exercise	-.357	.723
Pair 3	18 Hours Post-Exercise - 18 Hours Post-Exercise	-2.851	.007
Pair 4	Pre-Exercise - Post-Exercise	9.216	.000
Pair 5	Pre-Exercise - 18 Hours Post-Exercise	2.741	.009

ASLR

		t	Sig. (2-tailed)
Pair 1	Pre-Exercise - Pre-Exercise	.233	.817
Pair 2	Post-Exercise - Post-Exercise	2.881	.006
Pair 3	18 Hours Post-Exercise - 18 Hours Post-Exercise	.084	.934
Pair 4	Pre-Exercise - Post-Exercise	4.441	.000
Pair 5	Pre-Exercise - 18 Hours Post-Exercise	.018	.986

PSLR

		t	Sig. (2-tailed)
Pair 1	Pre-Exercise - Pre-Exercise	-.854	.399
Pair 2	Post-Exercise - Post-Exercise	2.549	.015
Pair 3	18 Hours Post-Exercise - 18 Hours Post-Exercise	-1.183	.244
Pair 4	Pre-Exercise - Post-Exercise	9.580	.000
Pair 5	Pre-Exercise - 18 Hours Post-Exercise	1.242	.222