

A comparison of the efficacy and cost of intravenous and oral formulations of ondansetron against chemotherapy-induced nausea

By

Gretta Cornelia MBITSI IBOUILY

BSc: Biomedicine (MGI)

BSc (Hons): Pharmacology (Pret.)

Dissertation submitted to the Department of Pharmacology, Faculty of Health Sciences at the University of Pretoria in partial fulfilment of the requirements for the degree of:

Magister Scientiae (Pharmacology)

April 2013

Supervisor: Prof OBW Greeff
Department of Pharmacology
Faculty of Health Sciences
University of Pretoria

Co-supervisor: Dr AD Cromarty
Department of Pharmacology
Faculty of Health Sciences
University of Pretoria

TABLE OF CONTENT

DECLARATION BY CANDIDATE	iv
ACKNOWLEDGMENTS	v
SUMMARY.....	vi
GLOSSARY OF ABBREVIATIONS.....	viii
LIST OF TABLES	x
LIST OF FIGURES.....	xi
CHAPTER 1: INTRODUCTION	1
1.1. Literature review.....	1
1.1.1. Cancer.....	2
1.1.2. Chemotherapy.....	3
1.1.3. Chemotherapy-induced nausea and vomiting (CINV)	11
1.1.4. Serotonin (5HT ₃) Receptor Antagonists	12
1.1.5. Analytical techniques	15
1.1.6. LC-MS/MS and Ondansetron.....	16
1.2. Summary	18
AIMS AND OBJECTIVES.....	20
CHAPTER 2: MATERIALS AND METHODS	21
2.1. Clinical trial	21
2.1.1. Primary outcomes	21
2.1.2. Secondary outcomes	21
2.1.3. Study design	21
2.1.4. Ethical considerations	22
2.1.5. Patient selection.....	22
2.1.5.1. Inclusion criteria.....	22
2.1.5.2. Exclusion criteria	23
2.1.6. Treatment assignments and randomization	23
2.1.6.1. Randomization.....	23
2.1.6.2. Treatment administration and storage	23
2.1.7. Study procedure.....	24
2.2. Measurements.....	28
2.2.1. Nausea and vomiting	28
2.2.2. Cost-effectiveness.....	30

2.3. Liquid Chromatography - Tandem Mass Spectrometry (LC-MS/MS).....	31
2.3.1. Principle of the method	31
2.3.2. Materials (chemicals and reagents)	32
2.3.3. Instrumentation	33
2.3.4. Calibration standards and quality control	33
2.3.5. Sample preparation	34
2.3.6. Chromatographic and mass spectrometric conditions.....	35
2.3.7. Calibration and recovery assessment	35
2.3.8. Data analysis.....	35
CHAPTER 3: RESULTS AND DISCUSSION	37
3.1. Clinical trial.....	37
3.1.1. Demographics and baseline vitals.....	37
3.1.2. Type of cancer and chemotherapy medications.....	39
3.1.3. VAS and questionnaires.....	43
3.1.3.1. Chemotherapy treatment period.....	43
3.1.3.2. Follow-up period	56
3.2. Patients' plasma concentrations of ondansetron.....	64
3.2.1. Oral ondansetron group.....	66
3.2.2. Intravenous (IV) ondansetron group.....	73
3.2.3. IV ondansetron group vs. OT ondansetron group	80
3.2.4. Pharmacokinetics (PK) parameters.....	82
3.3. Cost-effectiveness.....	82
CHAPTER 4: SUMMARY AND CONCLUSION	84
4.1. Summary	84
4.2. Conclusion	86
REFERENCES.....	89

DECLARATION BY CANDIDATE

I Gretta Cornelia MBITSI IBOUILY

Student number 29232253

Subject of the work: A comparison of the efficacy and cost of intravenous and oral formulations of ondansetron against chemotherapy-induced nausea

Declaration

1. I understand what plagiarism entails and am aware of the University's policy in this regard.
2. I declare that this dissertation is my own, original work. Where someone else's work was used (whether from a printed source, the internet or any other source) due acknowledgement was given and reference was made according to departmental requirements.
3. I did not make use of another student's previous work and submitted it as my own.
4. I did not allow and will not allow anyone to copy my work with the intention of presenting it as his or her own work.

Signature _____

Date _____

ACKNOWLEDGMENTS

“Whatever your hand finds to do, do it with all your might, for in the realm of the dead, where you are going, there is neither working nor planning nor knowledge nor wisdom.” Ecclesiastes 9:10 (New International version)

I wish to thank God for the constant blessings and guidance in everything I do.

My family has always believed in me in all my undertakings. A special thank you to my parents Béatrice Kantsou and PM Ibouily Nzamba, and my siblings, Nanice Tsigui, Alain G Robaky and Nelly Koumba Ibouily for the continued spiritual, emotional and material support.

My sincere gratitude goes to my husband, Stéphane J Soami Mabilia, for his love, motivation, support, patience and his never-failing faith in me. It also goes to my close friends for their constant encouragements.

I am grateful to the Gabonese Government for giving me a postgraduate bursary.

Prof Oppel BW Greeff, besides providing guidance and knowledge, has given me the opportunity to extend my knowledge of clinical trials by allowing me to be an intern at the Clinical Research Unit of the University of Pretoria. I thank him for that.

Dr A Duncan Cromarty has been an educator, especially in the laboratory. Thanks to him I acquired valuable knowledge of many laboratory techniques. Thanks for the availability, guidance, criticism and advice on all aspects of the project.

Many thanks to Dr David T Reynders, Dr Fareed Omar, Sr Cecilia Matome, Sr Fekile Ndlouvu and Sr Poppy Ncobe of the Paediatric Oncology Department at the Steve Biko Academic Hospital for their active participation in patient recruitment and blood sampling.

Thanks to Dr Steve Olorunju for his input with regards to the statistics.

SUMMARY

Introduction: Nausea and vomiting are the most common and distressing side effects of chemotherapy because they negatively impact on quality of life and treatment compliance. Adequate control of nausea and vomiting in children receiving chemotherapy is imperative. Currently, the first-line drug for the prophylaxis and treatment of chemotherapy-induced nausea and vomiting (CINV) in paediatric patients is the serotonin (5HT₃) receptor antagonist, ondansetron, administered intravenously. However, the parenteral route of administration of this drug is now being questioned as it is inconvenient for children and there is pressure to switch to an available oral formulation. The aim of this study was to evaluate the ease of administration, efficacy and cost-effectiveness of intravenous (IV) and oral tablet (OT) formulations of ondansetron in paediatric cancer patients receiving moderately emetogenic chemotherapy at the Steve Biko Academic Hospital in Pretoria, Gauteng (South Africa).

Methods: It was an open-label, parallel, randomized trial. Thirty (30) patients scheduled to receive moderately emetogenic chemotherapy were recruited from the paediatric oncology department of the hospital. These patients were randomized to receive the same dose of either IV or OT ondansetron for the prophylaxis of CINV for one chemotherapy cycle. The efficacy of the agents was determined using a visual analogue scale (VAS) completed by the paediatric patients, which was compared to a one page questionnaire completed by the parents of the patients. Both questionnaires were completed at the end of chemotherapy (treatment period) as well as after a week without chemotherapy treatment (follow-up period).

The patients' plasma concentrations of ondansetron at four different time points were quantified by liquid chromatography tandem mass spectrometry (LC-MS/MS). The ondansetron plasma concentrations obtained in the IV group were compared to those obtained in the OT group.

The cost-effectiveness calculations included the direct costs of antiemetic prophylaxis and treatment, the use of any rescue medication and the length of hospital stay.

Results: The VAS revealed that patients who were given antiemetic prophylaxis with OT ondansetron experienced less acute and delayed nausea than the patients in the IV ondansetron group; however, these differences were not statistically significant ($p=0.538$). Vomiting was similar in the two groups ($p=1$). There was a statistically significant difference between the patients and their parents in the perception of acute nausea ($p=0.018$), with parents overstating the level of acute nausea felt by their children.

The plasma concentrations of ondansetron in patients on the IV formulation were higher than the ones in patients on the OT formulation at all the time points investigated. At 30 minutes post-dosing the mean plasma concentration of ondansetron in the IV group was significantly higher than in the OT group ($p=0.0015$), but the differences in plasma concentrations between the two groups from 2 hours were fairly comparable.

The cost of antiemetic prophylaxis for IV ondansetron was significantly higher than the cost of antiemetic prophylaxis using the equivalent OT dose ($p=0.0351$).

Conclusion: For the prevention of CINV, OT ondansetron, a 5HT₃ receptor antagonist, proved to be an easy to use and cost-effective alternative to IV ondansetron in paediatric cancer patients receiving moderately emetogenic chemotherapy treatment.

Keywords: paediatric patients, chemotherapy, nausea, vomiting, ondansetron, antiemetic, LC-MS/MS.

GLOSSARY OF ABBREVIATIONS

ALL	Acute lymphocytic leukaemia
AML	Acute myeloid leukaemia
BMI	Body mass index
CE	Chiral capillary electrophoresis
CINV	Chemotherapy-induced nausea and vomiting
DNA	Deoxyribonucleic acid
eV	Electron volt
ESI	Electrospray ionisation
K_{el}	Elimination rate constant
GC/MS	Gas chromatography/Mass spectrometry
g	Gram
g	Gravitational acceleration
$t_{1/2}$	Half-life
HPLC	High-performance liquid chromatography
HPLC-ESI-MS/MS	High-performance liquid chromatography coupled to electrospray ionisation tandem mass spectrometry
h	Hour
IS	Internal standard
IV	Intravenous
Kg	Kilogram
LOD	Limit of detection
LC-ESI-MS/MS	Liquid chromatography coupled to electrospray ionisation tandem mass spectrometry
LC-MS/MS	Liquid chromatography tandem mass spectrometry
L	Litre
LLOQ	Lower limit of quantification
MS	Mass spectrometry
C_{max}	Maximum plasma concentration
m	Metre
m^2	Metre square
μg	Microgram



μL	Microlitre
μm	Micrometre
mg	Milligram
mL	Millilitre
mm	Millimetre
min	Minute
MRM	Multiple reaction monitoring
ng	Nanogram
ng/mL	Nanogram/millilitre
PO	Orally
ODT	Orally disintegrating tablet
OT	Oral tablet
pH	Negative logarithm of hydronium ion concentration
PK	Pharmacokinetics
RIA	Radioimmunoassay
s	Second
5HT ₃	Serotonin
SBAH	Steve Biko Academic Hospital
T _{max}	Time at which maximum plasma concentration is reached
vs.	Versus
VAS	Visual analogue scale
V _d	Volume of distribution

LIST OF TABLES

Table 1.1

Cancer types and antineoplastic medications used to treat the study participants (pg 5).

Table 1.2

Emetogenic levels of intravenously administered antineoplastic agents (pg 9).

Table 3.1

Patients' demographic and baseline vitals (pg 38).

Table 3.2

Cancer types and antineoplastic medications used to treat the study participants (pg 40).

LIST OF FIGURES

- Figure 2.1**
BMI chart for girls 2-20 years old (pg 25).
- Figure 2.2**
BMI chart for boys 2-20 years old (pg 25).
- Figure 2.3**
Visual analogue scale the patients needed to complete for the study (pg 28).
- Figure 2.4**
Questionnaire the parents/caregivers needed to fill for study purposes (pg 29).
- Figure 2.5**
Schematic of a simple HPLC system (pg 31).
- Figure 2.6**
Schematic of tandem mass spectrometry (pg 32).
- Figure 2.7**
Schematic of sample preparation before introduction into the LC-MS/MS system (pg 34).
- Figure 3.1**
Percentages of patients with nausea during the treatment period (VAS): oral vs. IV ondansetron (pg 43).
- Figure 3.2**
Percentages of patients with vomiting during the treatment period (VAS): oral vs. IV ondansetron (pg 44).
- Figure 3.3**
Percentages of patients with nausea during the treatment period: VAS (patients) vs. questionnaires (parents) (pg 48).

Figure 3.4

Percentages of patients with vomiting during the treatment period:
VAS (patients) vs. questionnaires (parents) (pg 50).

Figure 3.5

Percentages of patients with different levels of appetite during the
treatment period (VAS): oral vs. IV ondansetron (pg 51).

Figure 3.6

Percentages of patients with different levels of daily activities during
the treatment period (VAS): oral vs. IV ondansetron (pg 52).

Figure 3.7

Percentages of patients with different appetite levels during the
treatment period: VAS (patients) vs. questionnaires (parents) (pg 54).

Figure 3.8

Percentages of patients with different levels of daily activities during
the treatment period: VAS (patients) vs. questionnaires (parents) (pg 55).

Figure 3.9

Percentages of patients with delayed nausea (VAS): oral vs. IV
ondansetron (pg 56).

Figure 3.10

Percentages of patients with vomiting during the follow-up period
(VAS): oral vs. IV ondansetron (pg 57).

Figure 3.11

Percentages of patients with delayed nausea: VAS (patients)
vs. questionnaires (parents) (pg 58).

Figure 3.12

Percentages of patients with delayed vomiting: VAS (patients)
vs. questionnaires (parents) (pg 59).

Figure 3.13

Percentages of patients with different levels of appetite during the follow-up period (VAS): oral vs. IV ondansetron (pg 60).

Figure 3.14

Percentages of patients with different levels of daily activities during the follow-up period (VAS): oral vs. IV ondansetron (pg 61).

Figure 3.15

Percentages of patients with different appetite levels during the follow-up period: VAS (patients) vs. questionnaires (parents) (pg 62).

Figure 3.16

Percentages of patients with different levels of daily activities during the follow-up period: VAS (patients) vs. questionnaires (parents) (pg 63).

Figure 3.17

Ondansetron solvent-based and plasma-based calibration curves (quantification by LC-MS/MS) (pg 64).

Figure 3.18

Signal to noise ratio for ondansetron 0.5 ng/mL in water-methanol (pg 65).

Figure 3.19

Plasma concentrations of ondansetron over time for seven patients in the oral ondansetron group (pg 66).

Figure 3.20

Plasma concentrations of ondansetron over time for three patients in the oral ondansetron group (pg 69).

Figure 3.21

Plasma concentrations of ondansetron over time for patient 28 who received oral ondansetron dosing (pg 70).

Figure 3.22

Plasma concentrations of ondansetron over time for patient 17 who was given antiemetic prophylaxis with oral ondansetron (pg 71).

Figure 3.23

Plasma concentrations of ondansetron over time for ten patients in the IV ondansetron group (pg 73).

Figure 3.24

Plasma concentrations of ondansetron over time for four patients in the IV ondansetron group (pg 75).

Figure 3.25

Plasma concentrations of ondansetron over time for patient 15 in the IV ondansetron group (pg 77).

Figure 3.26

Plasma concentrations of ondansetron over time for two patients in the IV ondansetron group (pg 78)

Figure 3.27

Plasma concentrations of ondansetron over time for four patients in the IV ondansetron group (pg 79)

Figure 3.28

A comparison of the mean ondansetron plasma concentrations of patients administered ondansetron by the IV and oral route (pg 80).

CHAPTER 1: INTRODUCTION

1.1. Literature review

The most common and distressing side effects of chemotherapy are nausea and vomiting. This is a major problem in the treatment of cancer in children. Nausea and vomiting due to chemotherapy may cause electrolyte imbalance, dehydration, poor nutrition and prolonged hospitalizations, all of these leading to increased patient morbidity. Adequate control of nausea and vomiting in children receiving chemotherapy is imperative. Despite the importance of this problem, only a few studies have been done specifically on the prevention of chemotherapy-induced nausea and vomiting in children. Previously, phenothiazines and metoclopramide (dopamine receptor antagonist) were prescribed most commonly for the treatment of chemotherapy induced nausea and vomiting (CINV) in children. Due to their side effect profile, which is not outweighed by their moderate efficacy, these treatments were later replaced by 5-HT₃ receptor antagonists. The most observed side effects of phenothiazines and metoclopramide are marked sedation and extrapyramidal reactions.

Currently, the recommended drug for CINV prophylaxis and treatment in paediatric patients at the Steve Biko Academic Hospital is the 5-HT₃ receptor antagonist ondansetron, as an intravenous formulation. However, the parenteral route of administration of this drug is now being questioned. In fact, while having advantages such as permitting a rapid effect, intravenous administration can be painful and may introduce bacteria through contamination at the site of injection. This route of administration is not convenient for children, thus the aim of this study was to evaluate the ease, clinical efficacy and cost-effectiveness of oral tablet of ondansetron in comparison with intravenous ondansetron in children receiving moderately emetogenic chemotherapy at the Steve Biko Academic Hospital in Pretoria, Gauteng (South Africa) where only the intravenous formulation of ondansetron is currently used in children with cancer. What is more, the skilled personnel requirement and cost implications of administering an intravenous

ondansetron regime are usually higher than that of the equivalent oral tablet regime.

During this open label study, thirty patients scheduled to receive moderately emetogenic chemotherapy were recruited from the Paediatric Oncology Department at the Steve Biko Academic Hospital in Gauteng, South Africa. The patients were randomized to receive either intravenous ondansetron (as per current hospital protocol) or oral tablet of ondansetron for the prophylaxis of CINV for the duration of one cycle of chemotherapy. The efficacy of the agents was determined by a visual analogue scale (VAS) completed by the paediatric patients and a one page questionnaire completed by the parents/caregivers. These results were correlated with the patients' blood analyses used to determine the plasma concentrations of ondansetron (IV and OT) at selected time intervals. The direct cost of antiemetic prophylaxis and treatment, the use of any rescue medication and the length of hospital stay were included in the cost-effectiveness calculations.

1.1.1. Cancer

The human body is made up of billions of cells that grow, divide and then die in a predictable manner. Cancer occurs when there is uncontrolled cell division and growth, forming a tumour (Oxford Advanced Learner's Dictionary of Current English, 2000). Cancer is said to be "the failure of controls over cellular birth and death" (Frank, 2007). In fact, cancer cells have the ability to become independent of the different signals normally required by cells for division, differentiation and death resulting in disorderly cell growth and proliferation. Allowing proliferation to proceed unchecked and propagate results in metastasis, which can lead to fatal organ failure (Hejmadi, 2010).

Nowadays, cancer is the leading cause of death worldwide with approximately 13% of all deaths in 2008 (7,6 million deaths) and the number of victims of this disease is expected to continue rising to an estimated 13,1 million deaths in 2030 (GLOBOCAN 2008, IARC 2012). Although cancer may appear at any time in life, it is generally believed to be a disease of aging (Ruddon, 1995). However, in the United States of America, childhood cancers are the leading cause of death by disease in children between birth and the age of 15 years (Sandoval *et al.*, 2012; Williams *et al.*, 2012).

The worldwide incidence of childhood cancer is 150 in a million and in South Africa, one in 600 children is affected by cancer before reaching the age of 16. The most common childhood cancer is leukaemia, followed by brain tumours (CANSA, 2012). In the patients from the paediatric oncology ward of the Steve Biko Academic Hospital who participated in this study, the most prevalent cancer types, in descending order, were the following: acute lymphocytic leukaemia (ALL), nephroblastoma (Wilms Tumour), Hodgkin's lymphoma, rhabdomyosarcoma (embryonal), acute myeloid leukaemia (AML) and osteosarcoma. Leukaemia (ALL) was the most common cancer type among the study participants, which confirmed the statistics released by the CANSA in 2012. Fortunately, early diagnosis of childhood cancer results in 70-85% children being cured (Childhood Cancer Foundation South Africa, 2012). However, in South Africa, cancer in children is not diagnosed early enough in the majority of cases, leading to a late treatment or no treatment at all (Childhood Cancer Foundation South Africa, 2012). This situation results in the death of up to 700 South African children each year due to cancer (CANSA, 2012).

There are different approaches to treating cancer including surgery, radiation and chemotherapy. Cancer treatment involves the choice of one or more of these interventions combined in order to cure the disease or, if the disease has reached advanced stages and can no longer be cured, to substantially prolong life while ameliorating the quality of life of the patient in the process (WHO, 2012).

1.1.2. Chemotherapy

Chemotherapy is the treatment of cancer with antineoplastic agents which are drugs that can destroy rapidly dividing cells like cancer cells by stopping them from multiplying (Rang and Dale, 2007). Chemotherapy is the treatment most commonly used in people diagnosed with cancer and for the majority of them, this approach contributes to the effective treatment of their disease thereby helping them to continue living productive lives (Ignoffo and Rosenbaum, 2008). Because chemotherapy targets any rapidly dividing cell, healthy cells that normally divide quickly can also be harmed, causing various side effects (Rang and Dale, 2007;

Dewan *et al.*, 2010). This is the main reason why chemotherapy treatment is given in cycles; the body is given some time to heal between doses and an opportunity to build new healthy cells (National Cancer Institute, 2007). However, fatigue, hair loss, nausea and vomiting are still some of the common adverse effects of chemotherapy which are uncomfortable and can cause long-term complications (Miller *et al.*, 2011). For these reasons, novel approaches and modifications to chemotherapy are constantly being developed to help alleviate the previously mentioned side effects (National Cancer Institute, 2007).

Depending on the diagnosed cancer, the chemotherapy regimen administered to patients differs. Due to the different cancer types among the study participants, various chemotherapy regimens were administered, as summarised in Table 1.1:

Table 1.1: Cancer types and antineoplastic medications used to treat the study participants

Type of cancer: n (%)	Chemotherapy regimens
Leukaemia: 13 (44.83)	
Acute Lymphoblastic Leukaemia (ALL): 12 (41.38)	Vincristine + Daunorubicin Vincristine + Doxorubicin Vincristine + Methotrexate Vincristine + Ifosfamide + Methotrexate
Acute Myeloid Leukaemia (AML): 1 (3.45)	Idarubicin
Carcinoma: 6 (20.69)	
Nephroblastoma (Wilms tumour)	Vincristine + Dactinomycin + Doxorubicin Vincristine + Dactinomycin Cyclophosphamide + Doxorubicin
Lymphoma: 6 (20.69)	
Hodgkin's Lymphoma	Vinblastine + Bleomycin + Dacarbazine + Doxorubicin
Sarcoma: 4 (13.79)	
Rhabdomyosarcoma (embryonal): 3 (10.34)	Ifosfamide + Vincristine + Dactinomycin Vincristine + Dactinomycin
*Osteosarcoma: 1 (3.45)	

*The chemotherapy regimen for osteosarcoma was not obtained.

The anticancer medications that have been used to treat the study participants belong to different cytotoxic drug classes. The sixth edition of the Rang and Dale's Pharmacology (Rang, Dale *et al.*, 2007) contains a summary of chemotherapeutic agents that places the medications that the study participants received into the following drug classes:

- **Antibiotics:** bleomycin, dactinomycin, daunorubicin, doxorubicin and idarubicin

Antibiotics act as cytotoxic agents by interacting with DNA. They are cell-cycle specific and exert their action by disrupting DNA function.

Dactinomycin (also known as Actinomycin D) was the first antibiotic found to have anticancer activity. It is mostly given together with vincristine for the treatment of nephroblastoma, which was seen in this study. In fact, dactinomycin was indeed found in different combination regimens with vincristine and other anticancer drugs for the treatment of nephroblastoma in children (Table 1.1). This antibiotic was also used in chemotherapy regimens for the treatment of rhabdomyosarcoma.

Daunorubicin, doxorubicin and idarubicin are anthracycline antibiotics. Doxorubicin is obtained by hydroxylation of daunorubicin. Despite their apparent similarities in terms of structure and mechanism of action, the applications of anthracyclines in cancer therapy are varied.

The most widely used chemotherapeutic anthracycline drug is doxorubicin; it is used for the treatment of sarcomas, carcinomas, lymphocytic leukaemia and lymphomas. Doxorubicin was used in the treatment of most of the paediatric patients participating in this study in combination with other antineoplastic agents for ALL (leukaemia), nephroblastoma (carcinoma) and Hodgkin's lymphoma (Table 1.1).

For the treatment of acute leukaemias, daunorubicin and idarubicin are the anthracyclines mostly used in general as well as in this study. AML was treated with idarubicin only while daunorubicin was used in combination regimens to treat ALL (Table 1.1).

Bleomycin is a glycopeptide antibiotic. Like the anthracyclines, bleomycin causes disruptions in DNA function and is also cell-cycle specific. Its efficacy has been demonstrated in the treatment of testicular tumours, squamous cell carcinomas and lymphomas. Bleomycin was used in combination with other chemotherapy medications for the treatment of Hodgkin's lymphoma in this study, as recommended in its therapeutic uses (Table 1.1).

- **Alkylating agents:** cyclophosphamide, dacarbazine and ifosfamide

Alkylating agents add an alkyl group to the DNA of cell constituents and thereby prevent DNA replication; this results in apoptosis of rapidly dividing cells. These agents are used along with other chemotherapeutic agents for the treatment of some lymphatic and solid tumours. However, these agents are also mutagenic and carcinogenic. They can therefore cause a second malignancy like acute leukaemia. Cyclophosphamide and ifosfamide are both mustard agents that act in a similar way in the treatment of cancer. Unlike other anticancer drugs, they can also be taken

orally. These agents may be used singly or in combination with other drugs for different cancer types like breast cancer and Burkitt lymphoma. Cyclophosphamide, the most commonly used alkylating agent, is used in the treatment of nephroblastoma (Dome and Huff, 2011) and this was confirmed in this study (Table 1.1). It is also used in the treatment of non-neoplastic conditions such as rheumatoid arthritis.

Ifosfamide is also often used in the treatment of sarcomas, leukaemias and lymphomas (Mashhadi *et al.*, 2011), and it was the case in this study where it was present in the treatment regimens for ALL and rhabdomyosarcoma (Table 1.1).

Dacarbazine acts as an anticancer agent by the methylation of DNA, specifically on the O₆ position of guanine. It is used for the treatment of different cancers, including melanoma and Hodgkin's lymphoma. In this study dacarbazine was part of the chemotherapy regimen for the treatment of Hodgkin's lymphoma (Table 1.1).

- **Antimetabolites:** methotrexate

The structure of methotrexate is related to that of folic acid. Methotrexate antagonises folic acid via inhibition of the enzyme responsible for the conversion of folic acid to its active form (tetrahydrofolic acid). It is used therapeutically in the treatment of various cancers, including ALL and breast cancer, usually in combination with other antineoplastic drugs. In patients with ALL participating in this study, methotrexate was used with vincristine for the treatment of this cancer (Table 1.1). Methotrexate is also used as a single agent in the treatment of some inflammatory diseases, including rheumatoid arthritis and psoriasis.

- **Microtubule inhibitors:** vinblastine and vincristine

Microtubule inhibitors destabilize the function of microtubules during the late stages of cell division (metaphase) and initiate cell apoptosis due to incomplete cell division of cells with a double complement of DNA.

Vinblastine and vincristine are compounds derived from a plant called *Vinca rosea* and are also known as vinca alkaloids. They are often used in combination with other drugs in the treatment of different cancer types. Although they are similar in structure and act the same way, these two vinca alkaloids have different indications.

Vincristine is mainly used in the treatment of ALL, Wilms tumour, Ewing soft-tissue

sarcoma, Hodgkin and non-Hodgkin lymphomas. Vincristine was always used in combination with one or more other antineoplastic drugs in this study for the treatment of different cancers, namely ALL, nephroblastoma and rhabdomyosarcoma (Table 1.1). These therapeutic uses follow the recommendations documented in the literature and mentioned previously.

Vinblastine is used in the treatment of testicular carcinoma as well as Hodgkin and non-Hodgkin lymphomas. In the chemotherapy regimen used for the treatment of Hodgkin's lymphoma in the paediatric patients participating in this study, vinblastine was used along with other antineoplastic drugs (Table 1.1). This complies with the documented therapeutic uses for this vinca alkaloid.

As mentioned earlier, various types of malignancies were found in these paediatric patients and therefore different chemotherapy regimens were used for the treatment of different tumours. The antineoplastic agents included in the different chemotherapy regimens used in this study were used in accordance with the therapeutic uses recommended for them.

The different chemotherapy regimens administered to the study participants were all classified as having moderate emetogenic potential by the study doctor. However, the individual antineoplastic agents used in this study had different emetogenic potentials. For the definition of the emetogenic level of each anticancer drug used in this study, the guidelines and recommendations given by the 2004 Perugia Consensus Conference on antiemetics (MASCC, 2006) are followed. These guidelines classify the emetic risk of intravenous anticancer drugs used in this study as follows:

Table 1.2: Emetogenic levels of intravenously administered antineoplastic agents*

Level 1	Level 2	Level 3	Level 4
minimal risk	low risk	Moderate risk	High risk
<10%	10 – 30%	31 – 90%	>90%
Bleomycin	Methotrexate	Cyclophosphamide	Dacarbazine
Vinblastine		($\leq 1.5\text{g/m}^2$)	
Vincristine		Dactinomycin*	
		Daunorubicin	
		Doxorubicin	
		Idarubicin	
		Ifosfamide	

*Percentages indicate the risk of vomiting after intravenous administration in the absence of antiemetic prophylaxis (Hesketh, 2008).

*Dactinomycin was not included in the classification from which Table 1.2 is derived but was found in the literature to be a moderately emetogenic antineoplastic agent (Chandler Medical Center, 2002; Durand *et al.*, 2009).

It is to be noted that the classification in Table 1.2 is derived from an article published by Hesketh in 2008 and it only takes into account emesis. Nausea is not included in the data provided in this table and it is usually not classified because of its subjectivity. This is a problem because many patients experience severe nausea without vomiting following chemotherapy, some more than others, but classifications available in the literature only concentrate on emesis (Olver *et al.*, 2011).

As can be observed from Table 1.1 and Table 1.2, most chemotherapy regimens administered to the patients contained at least one drug of moderate emetogenic potential, given along with other medications of lower emetogenic risk (minimal or low). When medications of different emetogenic levels are combined, the combination therapy takes the emetogenic level of the agent with the highest emetogenic risk (MASCC, 2006). However, when a combination has more than one agent with a given emetogenic risk (e.g. moderate risk), the concomitant administration of these agents increases the emetogenic risk of the combination (i.e. moderate risk + moderate risk = high risk) (MASCC, 2006; Durand *et al.*, 2009; Olver

et al., 2011). The first example of the previously described combinations found in Table 1.1 is: vincristine + doxorubicin for the treatment of ALL, where vincristine has a minimal emetogenic level and doxorubicin a moderate emetogenic level (Table 1.2); the combination thus confers a moderate emetogenic risk. Most treatment regimens used in this study followed the trend shown in the previous example. The second example from Table 1.1 is the combination of cyclophosphamide and doxorubicin for the treatment of nephroblastoma. Both antineoplastic agents in this case have a moderate emetogenic risk and thus the combination becomes highly emetogenic. The combination vincristine + methotrexate for the treatment of ALL (Table 1.1) contains an agent of emetogenic level 1 (minimal risk) and a drug of emetogenic level 2 (low risk) (Table 1.2); thus this combination is classified as low risk in terms of emesis. Finally, the combination used in this study for the treatment of Hodgkin's lymphoma contained dacarbazine (Table 1.1), an agent with high emetogenic risk (Table 1.2), making the entire chemotherapy regimen highly emetogenic. However, despite the guidelines available, it is always easier to determine the emetogenicity of a single antineoplastic agent than that of combination chemotherapy (Olver *et al.*, 2011). Most patients receive combination chemotherapy (in this study, only one patient received a single agent for treatment as seen in Table 1.1), thus more research should be done in the area of emetogenic potential of combination therapy. Guidelines should be made available to health practitioners that will ameliorate the antiemetic prophylaxis treatments used in patients receiving multiple chemotherapy medications for their treatment.

This study was designed for patients receiving moderately emetogenic chemotherapy and, according to Hesketh (Table 1.2), it was generally the case, with a few patients receiving either low or highly emetogenic chemotherapy (Hesketh, 2008). According to the study doctor, however, all patients included in the study were administered moderately emetogenic chemotherapy. There were, thus, some discrepancies between the chemotherapy regimens' emetogenic classification by the study doctor and that published in the literature (Hesketh, 2008).

1.1.3. Chemotherapy-induced nausea and vomiting (CINV)

The most common and distressing side effects of chemotherapy are nausea and vomiting because they negatively influence on quality of life as well as treatment compliance (Armando *et al.*, 2009; Dewan *et al.*, 2010; Miller *et al.*, 2011). This is a major problem in the treatment of cancer in children. Nausea and vomiting due to chemotherapy may cause conditions such as electrolyte imbalance, dehydration, poor nutrition and prolonged hospitalizations, all leading to increased patient morbidity (Dewan *et al.*, 2010; Wood *et al.*, 2011). Furthermore, the intensification of antineoplastic regimens (especially combination chemotherapy), particularly with multi-day dosing regimens, exacerbates the nausea (Williams *et al.*, 2012). For these reasons, adequate control of nausea and vomiting in children receiving chemotherapy is mandatory (Roila *et al.*, 1998; Dewan *et al.*, 2010). Despite the importance of avoiding nausea, few studies have been done specifically on the prevention of chemotherapy-induced nausea and vomiting in children (Roila *et al.*, 2005; Williams *et al.*, 2012).

Depending on the time at which vomiting occurs after initiation of treatment, CINV may be classed as anticipatory, acute or delayed. Anticipatory CINV usually occurs 1 to 4 hours before chemotherapy; it is mainly psychological and its triggers include thoughts of chemotherapy and anxiety following a history of failed antiemetic prophylaxis. Acute CINV is experienced by patients in the first 24 hours of chemotherapy treatment; it is the most common form of CINV. If vomiting occurs more than 24 hours after chemotherapy, it is then classified as delayed CINV; the main issue with delayed CINV is that it is not as well controlled as acute CINV with currently available antiemetic medications (Dewan *et al.*, 2010; Miller *et al.*, 2011).

CINV is best avoided by prophylactic treatment to prevent it from occurring. Antiemetics are medications that block the signals in the brain and gut that causes nausea and vomiting (Howland and Mycek, 2006). There are a number of different antiemetic drugs available on the market.

The standard approach in paediatric oncology for a number of years has been phenothiazines and metoclopramide which have been the most commonly

prescribed antiemetics. However, it has been shown that these medications only have moderate efficacy coupled with significant side effects. The most observed side effects of these drugs are marked sedation and extrapyramidal reactions (Roila *et al.*, 1998; MASCC, 2006; Dewan *et al.*, 2010).

1.1.4. Serotonin (5HT₃) Receptor Antagonists

Due to the adverse effects of the older approach, researchers investigated serotonin receptor antagonists as an alternative to the standard treatment. Serotonin receptor antagonists act by blocking the action of serotonin, a natural substance released from the mucosal enterochromaffin cells that can cause nausea and vomiting although their precise mode of action is not fully understood (Martindale, 2008). Numerous studies have been done on serotonin receptor antagonists. In one study it has been found that ondansetron and granisetron are superior to chlorpromazine and to metoclopramide, even when these drugs are combined with a corticosteroid (Roila *et al.*, 1998). Furthermore, serotonin receptor antagonists are far less toxic than traditionally used drugs and thus have fewer side effects (Roila *et al.*, 1998; MASCC, 2006; Hesketh, 2008).

Other studies have shown that the combination of a serotonin receptor antagonist with a corticosteroid (dexamethasone) is more effective than a serotonin receptor antagonist alone. Therefore, the current guidelines recommend that all paediatric patients receiving chemotherapy of moderate emetogenic potential should receive antiemetic prophylaxis with a serotonin receptor antagonist alone (e.g. ondansetron), and a combination of a 5HT₃ receptor antagonist and a corticosteroid (dexamethasone) for severely emetogenic chemotherapy (Roila *et al.*, 2005; Kris *et al.*, 2006; Dewan *et al.*, 2010).

A study comparing the efficacy of ondansetron and tropisetron (both selective serotonin receptor antagonists) in the prevention of nausea and vomiting in paediatric patients receiving combined chemotherapy was conducted in Greece. Twenty-three (23) children from 20 months to 17 years old were studied during 205 chemotherapy courses (116 one-day regimens and 89 multiple-day regimens).

Ondansetron was given intravenously to the children at 5 mg/m² 30 minutes before initiating chemotherapy and then 4 mg/m² every 8 h in 102 chemotherapy cycles. Tropisetron was given in 103 cycles as 0.2 mg/kg single dose IV, the maximum dose being 5 mg, 30 minutes before initiating chemotherapy. The results showed that ondansetron is more effective than tropisetron in controlling acute nausea and vomiting in children receiving mildly to moderately emetogenic chemotherapy. However, there was no difference in the efficacy of the antiemetic agents when highly emetogenic drugs were administered (Stiakaki *et al.*, 1999). Ondansetron is currently available in different formulations, namely intravenous (IV), intramuscular, oral (tablets, syrup and ODT) and rectal (Martindale, 2008).

Another study looking at the safety and efficacy of two different formulations of ondansetron (oral syrup and IV) in combination with dexamethasone was performed to assess the efficacy of the two routes of administration (White *et al.*, 2000). During this study, on each day of chemotherapy, patients were administered either intravenous ondansetron at 5 mg/m² and placebo syrup orally (n=215) or ondansetron 8 mg orally and placebo IV (n=223) plus dexamethasone 2-4 mg orally. Ondansetron 4 mg syrup PO was administered twice daily for 2 days following the cessation of chemotherapy. It was concluded that IV and oral syrup ondansetron plus dexamethasone were well tolerated and effective in preventing chemotherapy-induced emesis in paediatric patients.

In Turkey in 2005, a study was conducted that compared the antiemetic efficacy and cost-effectiveness of intravenous and orally disintegrating tablet of ondansetron in children with cancer. Orally disintegrating tablet (ODT) of ondansetron is the latest formulation of this medication. ODT instantaneously disintegrates and disperses in the saliva without need for ingestion of a liquid. This characteristic makes this formulation suitable for administration in children but it does come at a higher cost than the other formulations. Twenty-two (22) children were enrolled in this study and they were administered study agents 30 minutes before initiation of chemotherapy and again 12 hours after chemotherapy. The dosages were as follows: 5 mg/m² intravenously and 4-8 mg orally according to body surface area in 56 and 39 treatment courses, respectively. The results of this study led to the conclusion that the oral disintegrating tablet formulation of ondansetron is a safe, well-tolerated, and

effective antiemetic for children with cancer. However, the sample size was too small to be definitely conclusive. The authors therefore recommended further studies be done as their study showed encouraging results (Çorapçıoğlu and Sarper, 2005).

A study comparing the safety and efficacy of ODT of ondansetron with conventional ondansetron tablet in cancer patients was conducted in the United Kingdom in 1999. A total of 427 adult cancer patients were included in this study. The study agents were administered just before chemotherapy and taken by the patients twice daily for three days. Both the ODT of ondansetron and the conventional ondansetron tablet were given at the same dose of 8 mg. It was concluded that 8 mg ODT given twice daily is equivalent to conventional ondansetron tablet 8 mg twice daily in terms of efficacy and tolerability (Davidson *et al.*, 1999).

The pharmacokinetics of ondansetron is well described in the prescribing information of the Zofran® medication provided by GlaxoSmithKline in 2010. This drug is adequately absorbed from the gastrointestinal tract and undergoes limited first-pass metabolism. Ingestion of an 8 mg Zofran® tablet by a healthy subject results in a mean bioavailability of approximately 60%. Some gender differences are observed in the extent and rate of ondansetron absorption with higher plasma levels of the drug in women, which may be explained by the differences in body weight between men and women. In healthy volunteers (age 18-40 years old), peak plasma concentration following a single 8 mg Zofran® tablet dose (26,2 ng/ml for male versus 42.7 ng/ml for females) were reached 2 hours after dosing and the mean elimination half-life was 3 hours (GlaxoSmithKline, 2010; Martindale, 2008).

As the safety and efficacy of ondansetron have been proven in numerous studies, this medication is now used in the standard care of children with cancer in many hospitals. This is the case at the Steve Biko Academic Hospital (SBAH) in Pretoria, Gauteng (South Africa), where ondansetron is the first line drug for the prophylaxis and treatment of nausea and vomiting in children receiving chemotherapy. Intravenous ondansetron is currently used but the parenteral route of administration of this drug is now being questioned. In fact, while having advantages such as permitting a rapid effect, intravenous administration needs to be performed by

trained medical personnel and even so, it is painful and may introduce bacteria through contamination at the site of injection (Howland and Mycek, 2006). Due to safety and available trained personnel concerns there is pressure to switch from IV to oral ondansetron in the paediatric oncology ward of the SBAH. What is more, for the same treatment regimen, oral tablet (OT) of ondansetron is less expensive than intravenous ondansetron on the South African market (Snyman, 2009; Snyman, 2012), which is a big advantage, especially for patients attending public hospitals. However, changing from IV to OT ondansetron at the SBAH cannot be done until a comparative study of the efficacy of these two formulations of ondansetron has been conducted in the paediatric oncology patients of the SBAH and has proven at least equivalent efficacy of the two formulations.

1.1.5. Analytical techniques

In order to determine the concentration of a chemical compound in a mixture, different analytical methods may be used. Chromatography is an analytical technique used in the laboratory for the efficient separation of mixtures of compounds which relies on the selective distribution of analytes between a mobile phase and a stationary phase. In this method, the various constituents to be separated are dissolved into a mobile phase, a fluid that flows through a stationary bed in a column format. The separation of the components of the mixture results from these components moving through the stationary phase at different rates due to the diversities in distribution coefficients of the individual components in the mixed sample (Niessen and van der Greef, 1992). There are different types of chromatography, including gas chromatography (the mobile phase is a gas) and liquid chromatography (the mobile phase is a liquid).

Mass spectrometry is an analytical identification technique. It can be used for both the detection and the determination (molecular weight and structure) of a particular analyte (Niessen and van der Greef, 1992; Watson and Sparkman, 2007). It is said to be “the most sensitive method of molecular analysis” (Niessen and van der Greef, 1992) because mass spectrometry has proven its superiority over any other analytical technique in providing information about the quantity and structure of a

given analyte (Watson and Sparkman, 2007). This technique works by producing ions which are then filtered according to their mass-to-charge (m/z) ratio and therefore produce a mass spectrum (a diagram representing the abundance of the ions produced according to their m/z ratio) on the mass spectrometer instrument (Niessen and van der Greef, 1992; Watson and Sparkman, 2007).

Chromatography and mass spectrometry are two analytical techniques that work differently; separation of mixtures into their individual constituents for chromatography and identification of the constituents of a mixture for mass spectrometry. Therefore, a combination of these two techniques provides the ability to both separate a mixture (chromatography) and then correctly identify and quantify the components of that mixture (mass spectrometry) (Niessen and van der Greef, 1992). Coupling high or ultra pressure liquid chromatography (LC) directly to tandem mass spectrometry (MS) to form a liquid chromatography tandem mass spectrometry (LC-MS/MS) system, is a perfect analytical method for the separation of a mixture and the identification of its components (McMaster, 2005). Gas Chromatography/Mass spectrometry (GC/MS) was a preferred technique to do such experiments, however it is limited by several factors including that the analytes need to be volatile and therefore require derivatisation, aqueous samples require extraction (which adds to the cost) and the heat of the GC oven degrades thermally labile samples (McMaster, 2005). LC-MS/MS has overcome these limitations and is nowadays the golden standard in terms of separation of a mixture and identification of polar compounds.

1.1.6. LC-MS/MS and Ondansetron

Radioimmunoassay (RIA) and chiral capillary electrophoresis (CE) are some of the diverse methods that have been used in the past for the quantification of ondansetron in human plasma (Moreira *et al.*, 2010). However, the most recent methods used to determine ondansetron in human plasma are chromatographic techniques, including LC-MS/MS (Armando *et al.*, 2009) and high-performance liquid chromatography coupled to electrospray ionisation tandem mass spectrometry (HPLC-ESI-MS/MS) (Moreira *et al.*, 2010). The majority of the published methods

have considerable run times and time-consuming, multi-step procedures for ondansetron extraction from biological samples (Armando *et al.*, 2009). For these reasons, research is ongoing in order to find better ways of quantifying ondansetron in human plasma.

In 2009, Armando *et al.* used HPLC and mass spectrometry to develop a method for ondansetron quantification in human plasma. The method described in this paper was suitable for ondansetron and was achieved with a simple liquid-liquid extraction procedure as well as a shorter run-time than the previous studies (6 minutes). However, it showed less sensitivity than the previously published similar methods. The developed method was validated and subsequently applied in a bioequivalence trial between orally disintegrating and conventional tablets of ondansetron formulations available in Brazil. It was an open, randomized, two-period crossover trial with a one week washout period conducted on twenty-three (23) mixed gender healthy volunteers of mean age 30 years. The participants were given the same dose (8 mg) of either ondansetron formulation; several blood samples were taken at different given times for bioequivalence determination. Although less sensitive than the LC-methods published in previous papers, the lower limit of quantification (LLOQ) in the reported method (2,5 ng/mL) was adequate for human pharmacokinetics and bioequivalence studies. Therefore, applying the newly developed LC-MS/MS method for ondansetron quantification in human plasma, Armando *et al.* found the two formulations of ondansetron tested to be bioequivalent in their rate and extent of absorption. Using orally disintegrating or conventional tablet of ondansetron interchangeably should therefore not alter the therapeutic effect. The analytical method developed and validated in this study was said to be “simple, rapid, sensitive and selective” (Armando *et al.*, 2009).

In 2010, a novel LC-ESI-MS/MS method for ondansetron quantification in human plasma was developed by Moreira *et al.* The authors claimed that there was still room for improvement on the previously published similar methods because very low concentration ranges were reached, the run times were still extensive and finally large volumes of plasma were used for drug extraction from biological samples. These are the reasons why they decided to develop and validate a LC-ESI-MS/MS method for the determination of ondansetron in a small volume of human plasma.

The analytical method was developed, validated and applied in healthy volunteers to compare the bioavailability of two ondansetron tablet formulations available in the Brazilian market. The study was a randomized two-period crossover trial. Twenty-five (25) volunteers of both genders (age 18 to 50 years) participated in the trial; they each received 8 mg of either ondansetron tablet formulations and blood sampling was done at given time points for the comparative pharmacokinetics study. This method showed many advantages over the previously published methods, namely a low validated LLOQ of 0.2 ng/mL (versus 2.5 ng/mL for Armando *et. al*, 2009), a short 2.5 minutes chromatographic run time (versus 6 min for Armando *et. al*, 2009) and a low human plasma volume for ondansetron extraction (50 μ L compared to 250 μ L for Armando *et. al*, 2009). The test and reference formulations of ondansetron in this study were found to be bioequivalent in both their rate and extent of absorption. This novel method was described as “fast, sensitive and robust” (Moreira *et al.*, 2010).

Different methods have been developed over the years for the quantification of ondansetron in human plasma and LC-MS/MS methods have been proven to be the most appropriate methods to use for the accurate determination of ondansetron in human plasma samples.

1.2. Summary

Cancer is a disease caused by uncontrolled cell division and growth that result in the formation of a tumour. This condition is currently one of the leading causes of death worldwide and the numbers are expected to continue increasing in the following years. Different approaches to treating cancer are currently available.

Chemotherapy is the treatment of cancer using cytotoxic medications that can stop cancer cells from growing and multiplying (antineoplastic agents). Chemotherapy is the most common form of treatment used in people diagnosed with cancer and its efficacy has been proven in many cases. However, since the treatment targets rapidly dividing cells (cancerous and healthy), many side effects are experienced by patients receiving chemotherapy treatment.

The two most common and distressing side effects of chemotherapy are nausea and vomiting and therefore, controlling these symptoms is indispensable for the success of the treatment, especially in children. Patients may experience chemotherapy-induced nausea and vomiting (CINV) at different stages. Anticipatory vomiting occurs before chemotherapy, acute CINV during the first 24 hours of chemotherapy and delayed vomiting later than 24 hours after chemotherapy.

There are different antiemetic medications available for the prevention and treatment CINV. The current guidelines recommend using a serotonin (5HT₃) receptor antagonist alone in mild to moderate emetogenic chemotherapy and a serotonin receptor antagonist plus dexamethasone for highly emetogenic chemotherapy. Ondansetron is the 5HT₃ receptor antagonist mostly used in the treatment of CINV in both adults and children because its safety, tolerability and efficacy have been established in many published studies. The intravenous (IV) formulation of ondansetron is at present the preferred formulation but there is a need to replace IV by oral tablet (OT) of ondansetron in children because IV administration is not suitable for them due to the pain associated with this administration and the possibility of infection at the site of injection.

LC-MS/MS is currently the best analytical technique to use for the separation of a mixture and the identification and quantitation of its components. Different LC-MS/MS methods have been developed for the quantification of ondansetron in human plasma samples and have been found to be useful in various ondansetron pharmacokinetics and bioequivalence studies.

AIMS AND OBJECTIVES

Aim

To evaluate the efficacy, ease of administration and cost-effectiveness of an oral tablet (OT) formulation of ondansetron in children with cancer receiving chemotherapeutic agents with moderately emetogenic potential.

Primary objectives

- A- To compare the antiemetic efficacy of intravenous ondansetron and oral tablet of ondansetron.
- B- To compare the cost-effectiveness of intravenous ondansetron and oral tablet of ondansetron.

Secondary objectives

- C- To compare the emetogenic status as reported by the treated children to the perceived emetogenic status as reported by the parents/guardians of the children.
- D- To determine descriptive pharmacokinetic parameters of oral tablet and intravenous ondansetron formulations.

CHAPTER 2: MATERIALS AND METHODS

2.1. Clinical trial

2.1.1. Primary outcomes

The primary outcomes of the clinical trial were:

- 1- To evaluate the antiemetic efficacy of the proposed oral tablet formulation of ondansetron versus intravenous ondansetron in children with cancer receiving moderately emetogenic chemotherapy by means of:
 - Visual analogues scales
 - Questionnaires
- 2- To determine the plasma concentrations of ondansetron in paediatric patients with cancer following OT and IV administration.
- 3- To evaluate the cost-effectiveness of OT ondansetron versus IV ondansetron in children with cancer receiving moderately emetogenic chemotherapy.

2.1.2. Secondary outcomes

- 1- Emetogenic status reported by the children (VAS).
- 2- Emetogenic status reported by the parents/caregivers (questionnaires).
- 3- To determine descriptive pharmacokinetic parameters of OT and IV ondansetron formulations.

2.1.3. Study design

An open-label, parallel, randomized trial was conducted.

2.1.4. Ethical considerations

Approval to conduct this study was obtained from the Research Ethics Committee of the University of Pretoria (Protocol 196/2010) and the study was conducted according to ICH Good Clinical Practice Guidelines and the World Medical Association Declaration of Helsinki Ethical Principles for Medical Research Involving Human Subjects.

2.1.5. Patient selection

Paediatric patients with cancer and scheduled to receive moderately emetogenic chemotherapy were recruited. In order to be enrolled in the study, the patients needed to meet all the inclusion and none of the exclusion criteria; to ensure the validity of the results.

2.1.5.1. Inclusion criteria

1. Male or female patients aged 4 - 17 years old;
2. Patients who were to be treated for cancer with moderately emetogenic chemotherapy*;
3. Patients starting a new chemotherapy cycle;
4. Patients with indwelling intravenous catheters;
5. Written informed consent from parent/legal guardian;
6. Assent from the child patient.

* Moderately emetogenic chemotherapy is defined as chemotherapy that carries a 31 to 90% risk of vomiting when no antiemetic prophylaxis is given to the patient (MASCC, 2006; Hesketh, 2008).

2.1.5.2. Exclusion criteria

1. Patients younger than 4 years and older than 17 years of age;
2. Any chronic disease other than the diagnosed cancer;
3. Other medication. e.g. antiemetics other than the study drugs, sedatives, drugs other than chemotherapeutic agents with the potential to cause emesis;
4. Any antiemetic rescue medication during the first 4 hours of chemotherapy.

2.1.6. Treatment assignments and randomization

2.1.6.1. Randomization

Randomization was done using randomization envelopes. These envelopes were prepared by associating a patient's number with either of the ondansetron formulations under study (e.g. Patient 001: oral ondansetron). Each patient participating in the study was randomly assigned an envelope which determined which ondansetron formulation he/she was to receive. The attending physician, the nurse on duty and the patient knew what medication the patient was to receive. The investigator, on the other hand, was blinded to the antiemetic treatment each patient received until the end of the trial.

2.1.6.2. Treatment administration and storage

The study drugs were administered in the following way depending on each patient's body weight:

Treatment group A: Intravenous infusion of 4 or 8 mg ondansetron (Zofran®) 30 minutes before chemotherapy initiation and every 12 hour during chemotherapy and at least 24 hours after chemotherapy.

Treatment group B: Oral tablet of ondansetron (Zofran®) 4 or 8 mg 30 minutes prior to chemotherapy and then every 12 hour during chemotherapy and at least 24 hours after chemotherapy.

At the Paediatric Oncology Department of the SBAH, the actual dose of ondansetron

administered to a patient is based on the body weight of the patient (< 30 kg = 4 mg dose oral or IV; ≥ 30 kg = 8 mg dose oral or IV).

The medications were kept at the hospital pharmacy and were dispensed according to hospital regulations and standard practice.

2.1.7. Study procedure

On the first day of the study, each patient and his/her parents were provided all the information about the study which was discussed with both the patient and the parents. The informed consent form (parents), the assent form (children) and the study implications were also discussed. If the parent accompanying the child was willing to let the child participate in the study and the child was also willing to participate, the parent signed both the informed consent and assent forms for younger patients (4-5 years old). For older patients (from 6 years old), the parents signed the consent form and the child signed the assent form. The inclusion and exclusion criteria were confirmed by collecting demographics, vitals and medical history from the patients. The Body Mass Index (BMI) of each patient was calculated. BMI in children, teenagers and adults is calculated the same way but interpreted differently because there is a difference in body fat between boys and girls and also because of the changes in body fat that occur with age (All Children's Hospital, 2012). Therefore, the interpretation of BMI values in children must take age and gender into account. The following charts were used in order to determine the BMI category of each study participant:

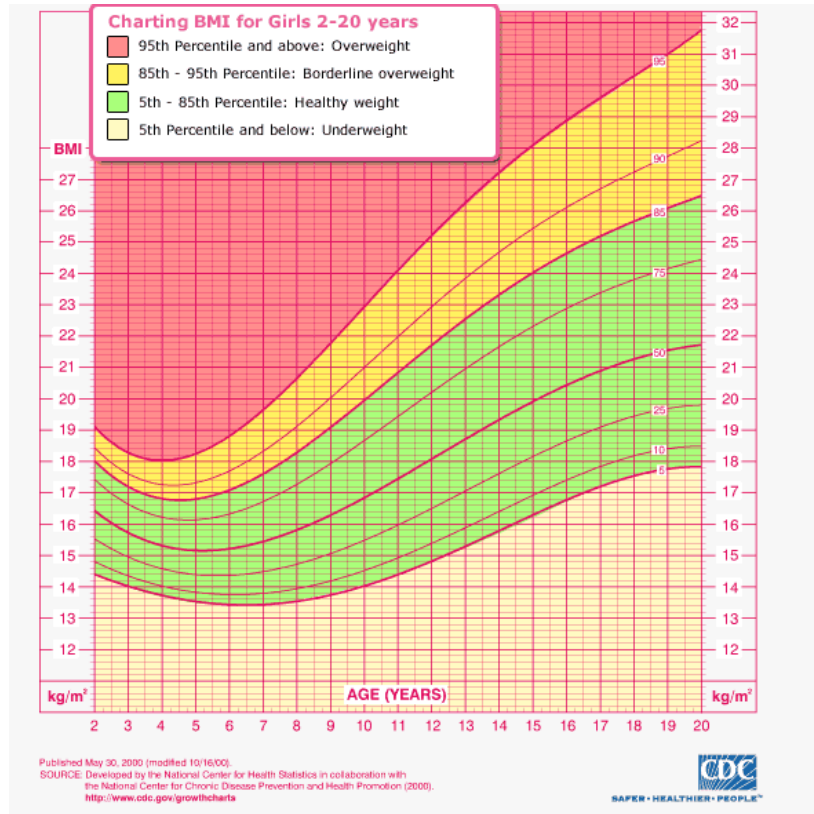

Figure 2.1: BMI chart for girls 2-20 years old (NCHS and NCCH, 2000)

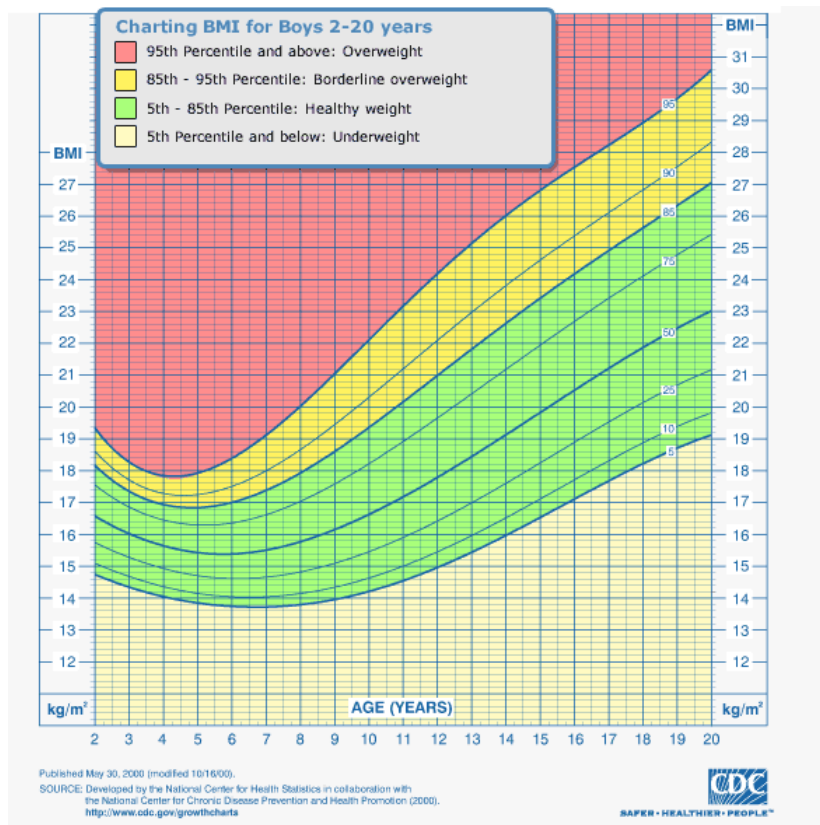

Figure 2.2: BMI chart for boys 2-20 years old (NCHS and NCCH, 2000)

The patients enrolled were those starting a cycle of moderately emetogenic chemotherapy and they were randomly assigned by the study doctor to one of the two ondansetron treatment groups. Following recommendations from the statistician, a total of thirty patients were recruited. All patients were undergoing treatment at the paediatric oncology ward of the Steve Biko Academic Hospital.

Blood was regularly drawn during chemotherapy cycles for routine analyses as part of the patients' standard care. An additional 12 mL of blood was taken for the determination of the patients' ondansetron plasma concentration in this study. A baseline blood sample of 3 mL was drawn from each patient before any medication was given; this blood draw was followed by the first dose of ondansetron. Just before the start of chemotherapy (30 minutes after the ondansetron dose), another 3 mL of blood was taken from the patient. The next 3 mL blood sample was drawn 90 minutes after the start of chemotherapy (which is when ondansetron is expected to reach its peak concentration in human plasma after an oral dose), and the last blood sample was taken 4 hours after the start of chemotherapy. The aim of this procedure was to determine and compare the plasma concentrations of the two different ondansetron formulations (OT and IV) in children receiving moderately emetogenic chemotherapy treatment. Blood sampling was done through the indwelling intravenous catheter (Portacath or Broviac line) to minimize discomfort to the children. No blood was drawn percutaneously. A total of 12 ml of additional blood was drawn per patient to accommodate this study. The tubes used to collect the blood from the patients were gold top gel serum separator BD (Becton Dickinson and Co.) vacutainers. Each blood sample was centrifuged within 1 hour of collection at 800 g for 15 minutes and the plasma samples were stored at - 80°C until analysis.

A chemotherapy cycle lasts for at least 2 hours and maximum one week. Daily chemotherapy cycles (less than 24 hours) were the most common dosing regimen administered to patients recruited into this study; 20% of patients (n=6) had a chemotherapy cycle longer than 24 hours.

At the end of the chemotherapy administration, the patients were asked questions about nausea, vomiting, appetite and daily activities using a visual analogue scale (VAS). The parents/caregivers of the children were asked the same questions but in

this case a one-page questionnaire was used.

A week after the end of chemotherapy, the patients were asked the same questions using the VAS for assessment and the parents/caregivers were given the same questionnaire to complete to gather follow-up information.

Each patient was monitored for a period of only one chemotherapy cycle. The trial ended when the last patient had completed his/her treatment and follow-up periods.

If at any stage of the evaluation period after initiation of chemotherapy treatment, a child vomited and the tablet was still identifiable in the vomitus, the dose of the tablet that was given would be repeated. If the tablet were not identifiable, the dose would not be repeated. If the patient were not able to tolerate oral medicines, it would be noted that oral had failed and the child would be offered second line therapy, which would be intravenous antiemetic (ondansetron or granisetron) and intravenous dexamethasone. This rescue medication protocol is the one currently applied by the Paediatric Oncology Department of the Steve Biko Academic Hospital.

2.2. Measurements

2.2.1. Nausea and vomiting

Nausea and vomiting were recorded by the paediatric patients on a validated visual analogue scale (VAS) (Wong *et al.*, 2001). This type of questionnaire included “smiley” and “sad” faces for easy interpretation by the children and required that the child chose the face that best described his/her feeling.

Patient's initials:

Patient's date of birth:

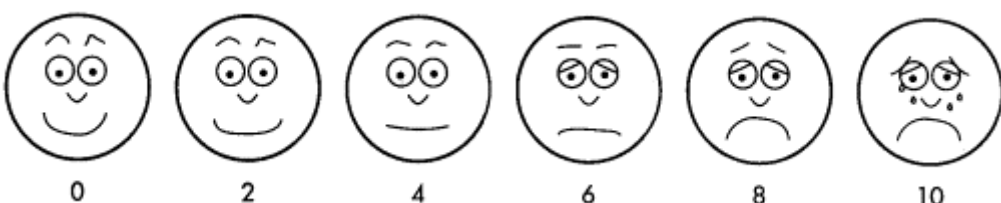

	Nausea	Vomiting	Daily activities	Appetite
0	None	None	High	High
2	Very little	Very little	Normal	Normal
4	Mild	Mild	Moderate	Moderate
6	Moderate	Moderate	Low	Low
8	Severe	Severe	Very low	Very low
10	Unbearable	Unbearable	Absent	Absent

Figure 2.3: Visual analogue scale the patients needed to complete for the study (Wong *et al.*, 2001)

Nausea and vomiting were recorded by the parent/caregiver on a validated one page questionnaire as illustrated in Figure 2.4 (Small *et al.*, 2000).

Patient study number		Date.....	
Age..... years		Weight.....Kg	
Antiemetic (first 24 hours):		(after 24 hours)	
.....		
.....		
Chemotherapy drugs	Dose	Frequency	
.....	
.....	
1. How much nausea did your child have from chemotherapy that he or she received?			
<u>None</u>	<u>Mild (a little bit)</u>	<u>Moderate (some)</u>	<u>Severe (a lot)</u>
0	1	2	3
How long did the nausea last?			
<u>0-12 hours</u>	<u>12-24 hours</u>	<u>> 24 hours</u>	
0	1	2	
If the nausea lasted for greater than 24 hours, how long did it last?			
2. How much vomiting or dry heaves did your child have following chemotherapy?			
<u>None</u>	<u>Mild (a little bit)</u>	<u>Moderate (some)</u>	<u>Severe (a lot)</u>
0	1	2	3
Approximately how many vomiting (or dry heaves*) episodes occurred?			
3. If your child had nausea and vomiting, how much did they affect his or her activities?			
<u>None</u>	<u>Mild (a little bit)</u>	<u>Moderate (some)</u>	<u>Severe (a lot)</u>
0	1	2	3
4. How would you describe your child's appetite following chemotherapy?			
<u>None</u>	<u>A little appetite</u>	<u>Some appetite</u>	<u>Good appetite</u>
0	1	2	3
5. Was any antiemetic other than the study drug given to your child during chemotherapy? If yes, please provide the following:			
Drug Name	Date when given	Dose	Frequency

Figure 2.4: Questionnaire the parents/caregivers needed to fill for study purposes (Small et al., 2000)

*A dry heave (Figure 2.4) is defined as a non-productive attempt at expulsion of stomach contents separated from another such episode by at least one minute (Small *et. al*, 2000).

Surveys were administered by the investigator twice during the study: firstly at the end of the chemotherapy cycle (treatment period) and secondly at the end of the week following chemotherapy; week without anticancer treatment (follow-up period).

For consistency between the children's VAS and the parents' questionnaire for analysis purposes, some categories in the VAS were grouped as follows: 0 and 2 corresponded to "none" and 8 and 10 were "severe" for nausea and vomiting; for appetite and daily activities, 0 and 2 were "normal" and 8 and 10 were "absent". This way both the VAS and questionnaires contained four categories.

Complete protection by the antiemetic regimen for a given chemotherapy protocol was defined as vomiting severity (V_{sev}) = 0, number of vomiting episodes ($V_{\#}$) = 0, and nausea severity (N_{sev}) = 0. Good protection was defined as $V_{sev} = 0-1$, $V_{\#} = 0-1$, and $N_{sev} = 0-1$. Moderate protection was defined as $V_{sev} > 1$, $V_{\#} = 2-4$, and $N_{sev} > 1$ and finally failure of the antiemetic regimen was considered to have occurred when $V_{sev} > 1$, $V_{\#} > 4$, and $N_{sev} > 1$ (Small *et. al*, 2000).

For statistical analysis of the questionnaires and VAS, comparison between OT and IV ondansetron was done using Kruskal-Wallis equality-of-population rank test and Fisher's Exact test. For both tests, a probability lower than 0.05 ($p < 0.05$) implied significance, otherwise it was deemed not significant. Comparison between emetogenic status reported by parents and children was assessed using Wilcoxon Signed-Rank test and Fisher's Exact test; $p < 0.05$ implied significance.

2.2.2. Cost-effectiveness

Included in the cost calculations were: the direct cost of antiemetic prophylaxis and treatment, the use of any rescue medications and the length of hospital stay. Comparison between the costs of IV ondansetron versus OT ondansetron was done statistically using the two-sample T-test; $p < 0.05$ represented significance.

2.3. Liquid Chromatography - Tandem Mass Spectrometry (LC-MS/MS)

2.3.1. Principle of the method

LC-MS/MS combines high-performance liquid chromatography (HPLC) separation of a mixture with mass spectrometric detection and quantitation of the different components of that mixture (McMaster, 2005).

Chromatography is an analytical technique used in the laboratory for the separation of mixtures which relies on the selective distribution of analytes between a mobile phase and a stationary phase. In this method, the various constituents to be separated are dissolved into a mobile phase, a fluid that flows through a stationary bed. The separation of the components of the mixture is caused by the fact that these components all travel through the stationary phase at different rates due to the differences in the distribution coefficients of the individual constituents in a mixed sample (Niessen and van der Greef, 1992).

HPLC works by applying pressure to the mobile phase (which is a liquid) to force it through the stationary phase bed. The diagram below illustrates the basic layout of the system and shows the function of each part.

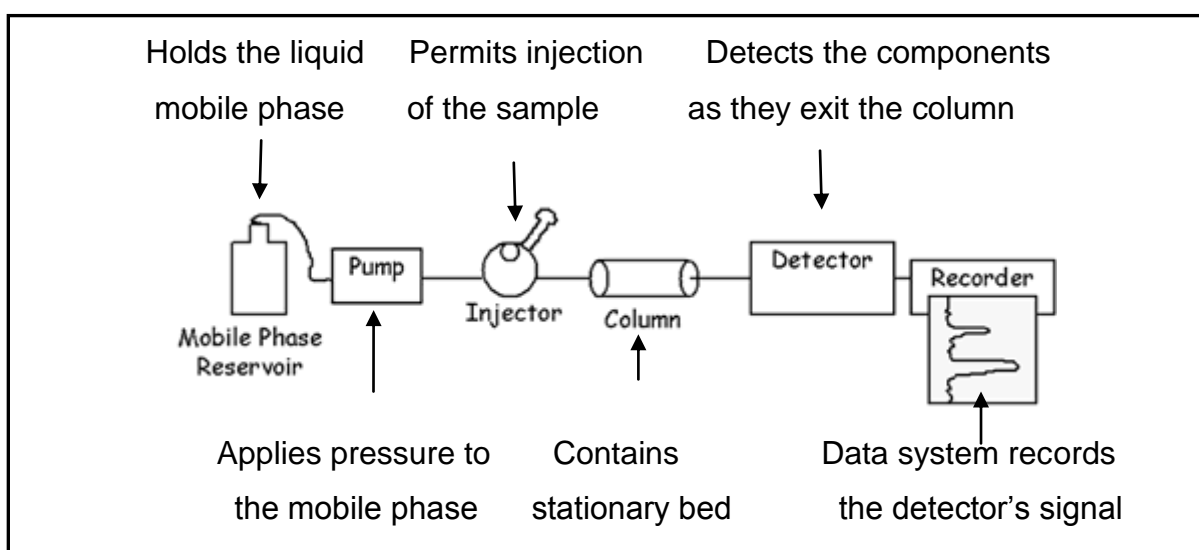

Figure 2.5: Schematic of a simple HPLC system (Kutztown University, 2011)

Mass spectrometry (MS) works by producing ions from the analytes eluting from the chromatography column which are then filtered according to their mass-to-charge (m/z) ratio and therefore produce a mass spectrum (a diagram representing the abundance of the ions produced according to their m/z ratio) on the mass spectrometer instrument (Niessen and van der Greef, 1992; Watson and Sparkman, 2007).

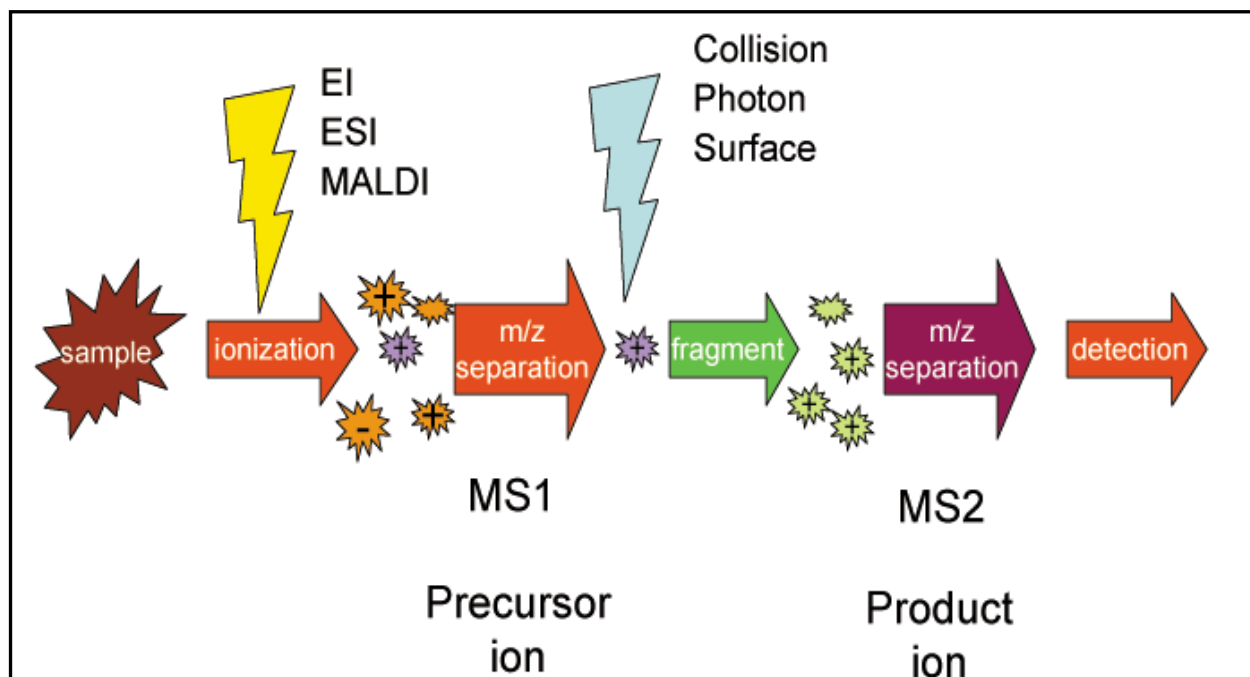

Figure 2.6: Schematic of tandem mass spectrometry (ent.wikibooks.org, 2011)

In LC-MS/MS, the complete system shown in Figure 2.6 represents the “detector” shown in Figure 2.5, thus combining HPLC separation and MS detection.

2.3.2. Materials (chemicals and reagents)

A European Pharmacopoeia standard of ondansetron was purchased from Sigma Aldrich (St Louis, USA). Imipramine powder, HPLC grade methanol and MS grade acetonitrile were used and purchased from Sigma. Formic acid was purchased from Fluka. All other reagents used were of analytical grade and were used without further purification. In-house prepared double deionised water was used throughout the study. Blank (drug-free) human plasma was obtained from healthy adult blood

donors from whom written consent was received. Blood was collected in coagulation tubes and centrifuged at 800 g for 15 minutes at room temperature. Pasteur pipettes were used to collect the plasma which was then frozen at -80°C for use in later experiments. The plasma was used as a model matrix for method development of a MRM (Multiple Reaction Monitoring) based quantitation for ondansetron. The harvested plasma samples of participating patients receiving ondansetron were also kept at -80°C until analysis.

2.3.3. Instrumentation

An Agilent 1100 Binary HPLC system with a well plate autosampler and column oven coupled to an Applied Biosystem 4000 QTRAP triple quadrupole mass spectrometer with a “Turbo V” ESI source was used to analyse the plasma samples.

2.3.4. Calibration standards and quality control

Stock solution of ondansetron (1 mg/mL) for the preparation of calibration standards was made up in methanol/water (50:50, v/v). The ondansetron 1 mg/mL stock solution was then serially diluted down to 1 $\mu\text{g/mL}$ in methanol/water (50:50, v/v). From ondansetron 1 $\mu\text{g/mL}$, serial dilutions were prepared to obtain the following concentrations: 0.5 ng/mL, 1 ng/mL, 2.5 ng/mL, 5 ng/mL, 10 ng/mL, 25 ng/mL, 50 ng/mL, 100 ng/mL. A set of these dilutions was done in methanol/water (50:50, v/v) and the second set of the same dilutions was done in drug-free plasma. Imipramine (internal standard (IS)) working solution (1 mg/mL) was prepared by dissolving 1 mg imipramine hydrochloride powder in 1 mL of water. Serial dilutions in acetonitrile were done from imipramine 1 mg/mL down to a concentration of 5 $\mu\text{g/mL}$ imipramine in acetonitrile. A volume of 25 μL of imipramine IS stock solution (concentration of 5 $\mu\text{g/mL}$) was added to each calibration and unknown sample.

The above concentrations were used to make the calibration curves for ondansetron. Analyses were done in triplicate for each concentration.

A separate set of control standards were made to check the slope and accuracy of the calibration curves by using different weightings of the ondansetron and diluting these to achieve concentrations of 30 ng/ml and 400 ng/ml.

2.3.5. Sample preparation

The patients' plasma samples previously frozen at - 80°C were thawed overnight in the fridge. The next day, the samples were prepared for analysis by the LC-MS/MS using the following procedure:

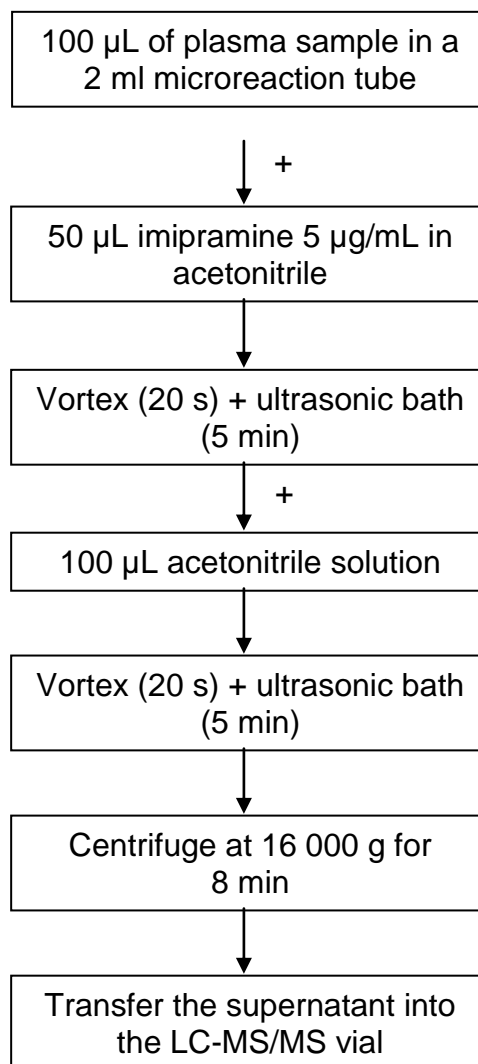

Figure 2.7: Schematic of sample preparation before introduction into the LC-MS/MS system

2.3.6. Chromatographic and mass spectrometric conditions

Following extraction, 3 μL of each sample was injected onto a Gemini C18, 3 μm (100 x 2 mm i.d.) column operated at 40°C. The mobile phases were A: 0.1% Acetic acid in water, pH was adjusted to 5.5 with ammonium hydroxide (1L); and B: Acetonitrile with 1 mL 25% Ammonium Hydroxide (1L). The flow rate was set to 250 $\mu\text{L}/\text{min}$. Under these chromatographic conditions, retention times for both ondansetron and imipramine were 6.0 ± 0.5 min. The total run time was 9 minutes. This method was developed and validated to ensure an interference-free and sensitive method for ondansetron. The electrospray ionisation (ESI) source was used in the positive mode at all times. Quantitation was done using multiple reaction monitoring (MRM) of the transitions m/z 294.4 > 170.2 for ondansetron and 281.4 > 86.3 for imipramine. The optimized collision energy of 35 eV was used for ondansetron and 25 eV was used for imipramine. Analyst Software (version 1.5.2) from Applied Biosystems was used to control the system as well as to collect and process data.

2.3.7. Calibration and recovery assessment

Calibration curves for ondansetron were established by injecting the different standards from lowest to highest concentration and the linear response curve determined by linear regression. The intra-day and interday precision and accuracy of the method were determined by injecting at least six repeats per day and over several days where fresh mobile phases and standards were prepared. The method was further validated to determine the LOD, LLOQ and that all samples from the patients fell within the range of concentrations tested.

By comparing the solvent based and the plasma based calibration curves, the recovery of ondansetron from plasma could be determined.

2.3.8. Data analysis

Despite the short period for which data was collected, XISimEst, a Microsoft Excel add-in for performing PK analysis, was used to attempt the calculation of some PK parameters. These included half-life ($t_{1/2}$), elimination rate constant (K_{el}) and volume

of distribution (V_d).

Patients' plasma concentrations of ondansetron were obtained, the plasma concentrations of the OT group were compared to that of the IV group using the Mann-Whitney test; $p < 0.05$ was an indication of significance.

CHAPTER 3: RESULTS AND DISCUSSION

3.1. Clinical trial

3.1.1. Demographics and baseline vitals

Demographics and baseline vitals were obtained from the patients on their first day of chemotherapy and are summarised in the Table 3.1. It should be noted that none of the participants in this study were chemotherapy-naïve at the time the study was conducted.

Patients from 4 to 16 years old participated in the study, with a mean age of 9.30 years. This wide age range confirms that although the risk of having cancer increases with age, cancers can also affect children at any age (Ruddon, 1995; Sandoval *et al.*, 2012). In developed countries, childhood cancer is the second most common cause of death in children (Kaatsch, 2010) and the leading cause of death due to disease in paediatric patients (Williams *et al.*, 2012).

Cancer has been shown in the literature to be more prevalent in males than in females, regardless of the age of the patients (Kaatsch, 2010). In fact, this gender difference is observed in both adult and childhood cancers. There are possible explanations as to why it is the case in adults, including hormonal and behavioural differences between the two genders. However, these differences do not apply in childhood, but boys still generally have a higher risk of cancer than girls (Dorak and Karpozoglu, 2012). The patient sample in this study followed the trend reported in the literature and more male than female cancer patients participated in the trial. There were 18 male patients (60%) and 12 female patients (40%).

Table 3.1: Patients' demographics and baseline vitals

Number of patients (n)	30.00
Age: years	
Mean	9.30
Range	4.00 – 16.00
Gender: n (%)	
Male	18.00 (60.00)
Female	12.00 (40.00)
Race: n (%)	
Black	28.00 (93.33)
Caucasian	2.00 (6.67)
Weight: kg	
Mean	26.32
Range	14.50 – 61.10
BMI: kg/m²	
Mean	15.7
Range	12 - 24
BMI categories*	
Underweight	3 females (10%); 4 males (13.33%)
Healthy	7 females (23.33%); 14 males (46.67%)
Borderline Overweight	2 females (6.67%)
Overweight	0

*Body Mass Index (BMI) in children, teenagers and adults is calculated the same way but interpreted differently because of the difference in body fat between boys and girls and also because there are changes in body fat that occur with age (All Children's Hospital, 2012). Therefore, the interpretation of BMI values in children must take age and gender into account (as discussed in the methods).

The demographic information collected from the patients at their first day of the study revealed that the majority of patients were Black 28 (93.33%) and the rest of them were Caucasian 2 (6.67%). No Coloured or Indian patients were recruited into this study although these two ethnicities are represented in the South African population. The patients that participated in this study were randomly selected and race was not one of the inclusion criteria. However, according to Statistics South Africa (2011), 79.5% of the South African population is Black, while 9% is White, 9% is Coloured

and 2.5% is Indian. Therefore this study's sample, which was predominantly Black, was a realistic representation of the South African population. Furthermore, the Cancer Association of South Africa (CANSA) published recent statistics stating that between 800 and 1500 South African children of all ethnicities are newly diagnosed with cancer each year (CANSA, 2012).

According to the BMI calculations and interpretation, seven (7) patients were underweight (23.33%), which can be explained by their poor state of health when they arrived at the hospital for cancer treatment. However, the majority of the patients included in the study were healthy ($n=21/70\%$), and two (2) patients were borderline overweight (6.67%).

3.1.2. Type of cancer and chemotherapy medications

The patients included in this study were all scheduled to receive moderately emetogenic chemotherapy although they had different types of cancer. The different cancer types diagnosed in the patient sample and the chemotherapeutic drugs used for the treatment of each of them are given in Table 3.2.

Table 3.2: Cancer types and antineoplastic medications used to treat the study participants*

Type of cancer: n (%)	Chemotherapy regimens
Leukaemia: 13 (44.83)	
Acute Lymphoblastic Leukaemia ALL: 12 (41.38)	Vincristine + Daunorubicin Vincristine + Doxorubicin Vincristine + Methotrexate Vincristine + Ifosfamide + Methotrexate
Acute Myeloid Leukaemia AML: 1 (3.45)	Idarubicin
Carcinoma: 6 (20.69)	
Nephroblastoma (Wilms tumour)	Vincristine + Dactinomycin + Doxorubicin Vincristine + Dactinomycin Cyclophosphamide + Doxorubicin
Lymphoma: 6 (20.69)	
Hodgkin's Lymphoma	Vinblastine + Bleomycin + Dacarbazine + Doxorubicin
Sarcoma: 4 (13.79)	
Rhabdomyosarcoma (embryonal): 3 (10.34)	Ifosfamide + Vincristine + Dactinomycin Vincristine + Dactinomycin
Osteosarcoma: 1 (3.45)	

*The diagnosis data shown in Table 3.2 above represents the cancer types confirmed for 29 of the 30 patients recruited into this study. For one patient, diagnosis could not be obtained from the patient's hospital file. This patient's previous treatment information was also unavailable. The chemotherapy regimen used for the patient with osteosarcoma was also not available in the patient file.

The most common cancer type in the study participants was ALL (41.38%), which represents approximately 80% of the leukaemias (cancers of the blood or blood-forming organs) diagnosed in children (Ruddon, 1995). This is in accordance with more recent information provided by the Childhood Cancer Foundation of South Africa in 2012 reporting that the most common cancer diagnosed in children is leukaemia. Likewise, a study conducted in Germany in 2010 demonstrated that ALL is the most common form of leukaemia and the largest proportion of malignancies diagnosed in German children, accounting for 26.8% of all childhood cancers between 1998 and 2007 (Kaatsch, 2010). Furthermore, previous studies in the United States of America have shown that the majority of newly diagnosed cancer in children is ALL, with males showing a higher incidence of this disease than females. White children have also been reported have twice the risk of Black children for developing ALL (Robinson, 2011). In this study, more girls were diagnosed with ALL (n=8/27.59%) compared to boys (n=4/13.79%). What is more, only two Caucasian (White) patients participated in the study (Table 3.1), they were two girls who both had ALL. In terms of gender and race, the patients in this study did not follow the worldwide trend. This can be explained by the small sample size in which this study was carried out and thus did not allow for such variables to be observed. As far as ethnicity is concerned, the fact that majority of the South African population is Black (Statistics South Africa, 2011) may also have influenced the sample demographics.

Nephroblastoma (Wilms tumour) and Hodgkin's lymphoma were the second most common types of cancer diagnosed in the study participants (20.69% each). Nephroblastoma is the predominant childhood kidney malignancy worldwide (Jain *et al.*, 2012), affecting 1 in 10,000 child (Scott *et al.*, 2012). It is considered to be a rare condition over the world and when found it usually presents during the first five years of life with no apparent gender difference (Stiller and Parkin, 1990). Two of the patients diagnosed with nephroblastoma were indeed less than five years old (both were 4 years of age), the remaining four were older (two were 6 and two were 10 years old). It is to be noted that the year the patients participated in the study was not the same year when they were diagnosed, thus the age of the patient at the time of diagnosis is unknown. Although no gender differences were observed in nephroblastoma, some race differences were reported, stating that higher prevalence rates of Wilms Tumour are found in Black children from sub-Saharan

Africa (Axt *et al.*, 2011). In this study, all patients with this condition were Black South Africans, confirming the statistics published by Axt *et al.* in 2011.

Six patients (20.69%) that participated in the study were suffering from Hodgkin's lymphoma which is defined as "a cancer of lymph tissue found in the lymph nodes, spleen, liver, bone marrow, and other sites" (A.D.A.M. Medical Encyclopedia, 2012). It occurs in both children and adults regardless of gender and race (Freed and Kelly, 2010). Hodgkin's lymphoma is known to be one of the most curable cancers, even at its late stages and especially in paediatric patients (A.D.A.M. Medical Encyclopedia, 2012; Freed and Kelly, 2010; Kelly *et al.*, 2011; Castellino *et al.*, 2011).

Embryonal rhabdomyosarcoma, the cancer of the muscles attached to the bones (Malempati *et al.*, 2011), was present in three (10.34%) of the paediatric patients included in this study. It is a soft tissue sarcoma, the most common found in children (Rodeberg *et al.*, 2011; Badr *et al.*, 2012). Boys seem to be slightly more at risk than girls to develop this condition with a ratio of 1.3:1 (Badr *et al.*, 2012). Two boys and one girl affected by embryonal rhabdomyosarcoma were included in this study, which is in accordance with the statistical prevalence reported in literature.

One participant in this study was diagnosed with osteosarcoma (3.45%). Osteosarcoma is a bone malignancy, prevalent in children and adolescents (Martin *et al.*, 2012; Savitskaya *et al.*, 2012). Although males are more affected by this cancer (Savitskaya *et al.*, 2012), the only patient with bone cancer included in this study was a female patient.

With reference to Table 1.1 (discussed in the introduction), according to the classification of Hesketh (2008), most patients were administered moderately emetogenic chemotherapy. However, low and highly emetogenic chemotherapy regimens were given to some paediatric patients, which may have influenced the results obtained.

3.1.3. VAS and questionnaires

3.1.3.1. Chemotherapy treatment period

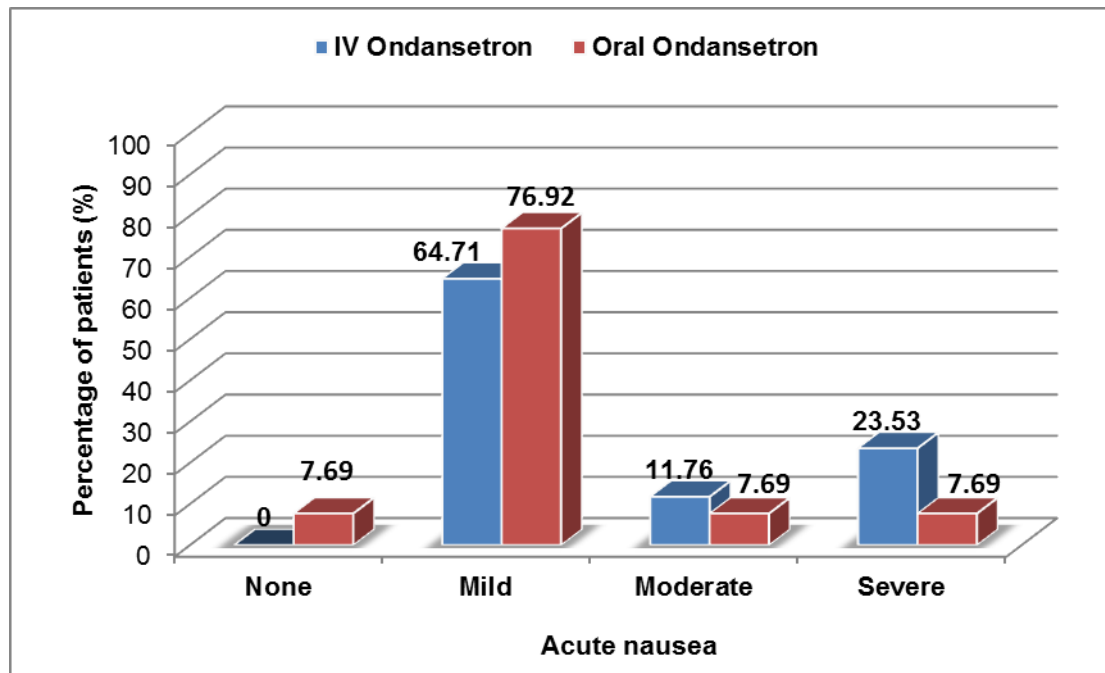

Figure 3.1: Percentages of patients with nausea during the treatment period (VAS): oral vs. IV ondansetron

No patient in the group pre-treated by IV ondansetron reported no nausea, versus 7.69% (n=1) of patients in the oral ondansetron treatment group. Whether the patients received IV or oral ondansetron, most of them reported mild nausea: 64.71% (n=10) in the IV group and 76.92% (n=11) in the oral group. In both groups, a few patients reported moderate nausea: 11.76% (n=2) of patients who received IV and 7.69% (n=1) of patients on oral ondansetron. More patients with IV ondansetron prophylaxis experienced severe nausea (23.53%/n=4) than the patients that were given oral ondansetron (7.69%/n=1).

Figure 3.1 shows differences in the levels of nausea between patients on oral and those on IV ondansetron during the chemotherapy treatment period. Overall, prophylaxis with oral ondansetron appeared to give better protection than that with IV ondansetron, with fewer patients in the oral ondansetron group experiencing severe nausea. However, none of the differences observed in Figure 3.1 were found to be statistically significant (p=0.538).

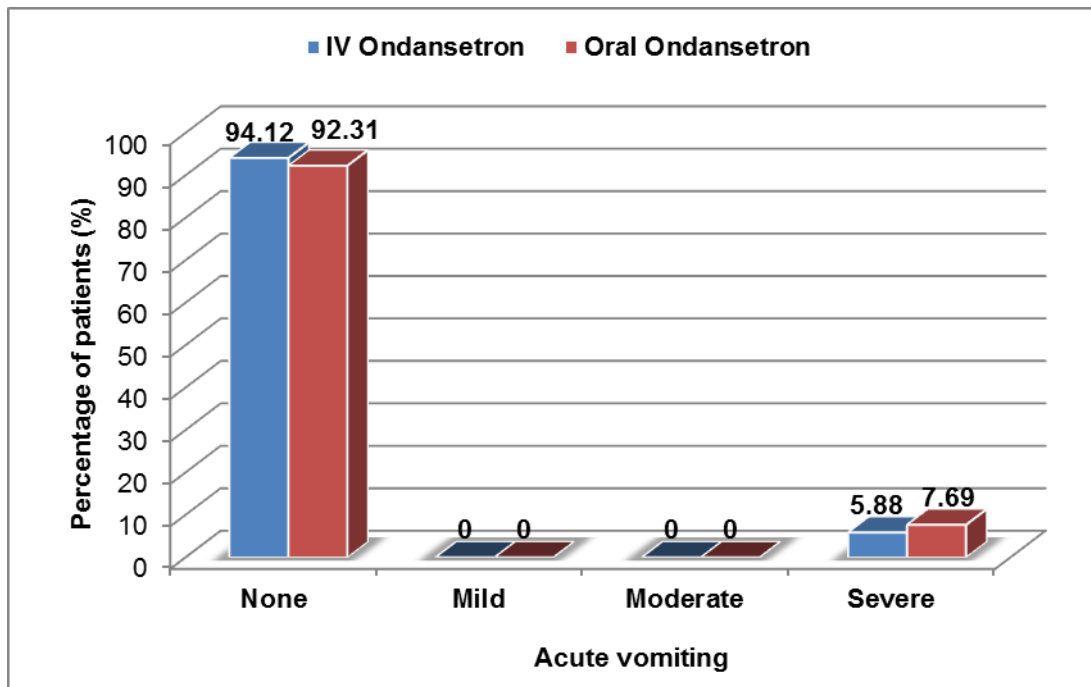

Figure 3.2: Percentages of patients with vomiting during the treatment period (VAS): oral vs. IV ondansetron

Vomiting in patients in the two groups was very similar, with most of them reporting no vomiting (94.12%/n=16 IV and 92.31%/n=12 oral) and very few patients who reported severe vomiting (5.88%/n=1 IV and 7.69%/n=1 oral). After statistical analysis of these results, no statistical difference for vomiting was demonstrated between the two groups, which was thus confirmed to be similar ($p=1$).

The incidence of nausea in patients following chemotherapy treatment was much higher than the incidence of vomiting (Figure 3.1 and Figure 3.2). Although nausea and vomiting are closely related, it has been observed that nausea is usually far more prevalent in patients on chemotherapy than vomiting (Kris *et al.*, 2006).

CINV experienced by patients following chemotherapy treatment depend on different variables. The emetogenicity of the antineoplastic agents used in the chemotherapy regimen received by the patient as well as the doses given are considered to be the main risk factor for CINV (Aapro *et al.*, 2006; Durand *et al.*, 2009; Olver *et al.*, 2011; Pirri *et al.*, 2012). In addition, some individual factors such as age (the younger the patient, the higher the risk of CINV), gender (females have a higher risk of experiencing CINV than males) and history of chemotherapy (patients who have had

chemotherapy before have a higher risk of experiencing CINV) may also influence the incidence of CINV in a patient (Jordan *et al.*, 2007; Durand *et al.*, 2009; Dewan *et al.*, 2010; Pirri *et al.*, 2012). Finally, the antiemetic prophylaxis given to patients prior to chemotherapy influences CINV; antiemetic prophylaxis aims at suppressing CINV completely but it usually manages to only reduce it (Komada *et al.*, 1999; Kris *et al.*, 2006; Jordan *et al.*, 2007; Dewan *et al.*, 2010). In this study, all patients received the same antiemetic prophylaxis with 4 mg ondansetron (Zofran®) either given IV or as an oral tablet.

Patients participating in this study suffered from different cancers and therefore received different chemotherapy regimens as shown in Table 3.2. A total number of five (5) patients reported severe nausea. Of these patients, 4 (23.53%) had received IV ondansetron and 1 (7.69%) had received oral ondansetron. When looking at the antineoplastic agents that these patients with severe nausea received, the following combinations were seen (emetogenic potential was determined using the classification published by Hesketh in 2008):

- Idarubicin (moderate emetogenic risk)
- Vincristine + doxorubicin (moderate emetogenic risk)
- Ifosfamide + vincristine + dactinomycin (high emetogenic risk)
- Vinblastine + bleomycin + dacarbazine + doxorubicin (high emetogenic risk)

Three (3) patients received the chemotherapy regimens with moderate emetogenic risk and experienced severe nausea. They were all given antiemetic prophylaxis with 4 mg Zofran® IV. These patients were amongst the youngest in the group (all of them were 4 years old), which may explain the severe nausea (Jordan *et al.*, 2007; Durand *et al.*, 2009; Dewan *et al.*, 2010). Two of the three patients were male patients and thus the gender component that places females at a higher risk for CINV was not seen here. None of these patients was chemotherapy-naive. In these cases, nausea was severe but it was not accompanied by vomiting and thus the antiemetic regimen given appeared to be effective (Small *et al.*, 2000).

The other two patients who had severe nausea were the ones who received the highly emetogenic chemotherapy regimens. One was in the oral ondansetron group and received a 4 mg oral tablet of Zofran® 30 minutes prior to chemotherapy and the other one, from the IV group, received 4 mg Zofran® IV 30 minutes prior to

chemotherapy. The same two patients were the only ones to report severe acute vomiting. The patient who received oral Zofran® was a 14 year-old boy (weight: 33.2 kg) who arrived at the hospital very sick and was already vomiting when he arrived (anticipatory vomiting). He had a total of three emetic episodes during his chemotherapy treatment. However, the tablet was not identified in the vomitus and thus the dose given was not repeated (as per hospital protocol). The patient who received IV Zofran® was a 12 year-old boy (weight: 33.3 kg). He experienced two emetic episodes during his chemotherapy treatment. Despite the hospital protocol prescribing an 8 mg dose of ondansetron for patients weighing more than 30 kg, these two patients received only 4 mg of the antiemetic drug for CINV prophylaxis and were given chemotherapy regimens with a high risk of emesis. There was a discrepancy between the hospital protocol and the Zofran® dose that was actually administered to the patient. Not only was 4 mg Zofran® a low dose according to hospital protocol, but it is also below the recommended IV dose when receiving highly emetogenic chemotherapy which is 0.15 mg/kg; thus a minimum 5 mg dose for a patient weighing 33.3 kg (Dewan *et al.*, 2010). Oral ondansetron tablet 4 mg or 8 mg is given to children depending on the body surface area (MASCC, 2006) or age with 4 mg up to 11 years and 8 mg from 12 years and above (GlaxoSmithKline, 2010). What is more, the published guidelines recommended the addition of a corticosteroid to the serotonin receptor antagonist for chemotherapies of high emetogenic risk (Roila *et al.*, 2005) and were later updated to a three-drug regimen by adding the NK1 antagonist aprepitant to the antiemetic regimen (Jordan *et al.*, 2007; Olver *et al.*, 2011). The antiemetic prophylaxis these patients received was below recommended protocols for the highly emetogenic chemotherapy regimens they were given and thus the nausea and vomiting they experienced were not unexpected. The antiemetic protection for these two patients was classified as moderate when looking at the severe nausea and the numbers of vomiting episodes (2-4) (Small *et. al*, 2000).

Three patients reported moderate nausea (n=2/11.76% in the IV group and n=1/7.69% in the oral group). When looking at the chemotherapy regimens they received, the following combined anticancer drugs were observed (the emetogenic risk of each chemotherapy regimen was determined using the publication by Hesketh in 2008):

- Vincristine + doxorubicin (moderate emetogenic risk)
- Vincristine + bleomycin + dacarbazine + doxorubicin (high emetogenic risk)

Two of the patients who reported moderate nausea received the highly emetogenic chemotherapy. The first one was a 15 year-old girl (61.1 kg) who was given antiemetic prophylaxis IV with 4 mg Zofran®. The second one was a 12 year-old boy (32 kg) who received a 4 mg Zofran® tablet for antiemetic prophylaxis. Based on the hospital protocol as well as the recommended IV Zofran® dose of 0.15 mg/kg, the girl weighing 61.1 kg should have received at least 8 mg IV Zofran® for her to be adequately protected against CINV. However, she only received 4 mg Zofran® IV, which was too low according to her weight. What is more, she was given highly emetogenic chemotherapy and, as mentioned previously, she should have been pre-treated with a two-drug antiemetic regimen (ondansetron and dexamethasone) for CINV prevention. The moderate nausea she experienced was thus predictable and even vomiting was expected but did not occur. This may be due to the antineoplastic doses that were given to her, which probably were low enough to prevent severe nausea and vomiting from occurring. The boy on oral ondansetron should have received a higher ondansetron dose than 4 mg according to his body weight. The chemotherapy treatment he received put him at high risk of emesis and yet the only antiemetic prophylaxis he received was Zofran® at a low dose. These two cases did not follow the hospital protocol or the guidelines for the management of CINV (Roila *et al.*, 2005; Jordan *et al.*, 2007; Olver *et al.*, 2011). However, the antiemetic regimen they received still gave them good protection, as they experienced moderate nausea but no vomiting (Small *et al.*, 2000).

The third patient with moderate nausea was an 8 year-old boy (25.2 kg). He received moderately emetogenic chemotherapy and adequate antiemetic prophylaxis IV with 4 mg Zofran® but still experienced moderate nausea. His young age and the fact that he had received chemotherapy before may have put him at a higher risk of CINV but the antiemetic regimen he was given did give adequate protection against CINV (Jordan *et al.*, 2007; Lohr, 2008; Durand *et al.*, 2009; Small *et al.*, 2000).

Only one patient in the entire study reported no nausea during the treatment period. Surprisingly enough, this patient was a young (4 years old), female patient weighing 14.5 kg. She received 4 mg Zofran® orally for antiemetic prophylaxis and a chemotherapy regimen consisting of vincristine + actinomycin, which has a moderate emetogenic risk. Considering the predisposing factors of CINV: young age, female gender and emetogenicity of the anticancer therapy (Jordan *et al.*, 2007; Lohr, 2008; Durand *et al.*, 2009), this patient would have been placed in the high risk group. However, she did not experience any nausea nor vomiting and thus was completely protected by the antiemetic prophylaxis she received (Small *et. al*, 2000).

For both antiemetic prophylaxis groups (oral and IV), the majority of the patients reported mild nausea and no vomiting (Figures 3.1 and 3.2). This shows an overall good protection from either of the ondansetron formulations (Small *et. al*, 2000).

The parents of the study participants were also asked about the nausea and vomiting experienced by their children during chemotherapy treatment using a questionnaire. This was done to compare the emetogenic status reported by the patients to that reported by their parents.

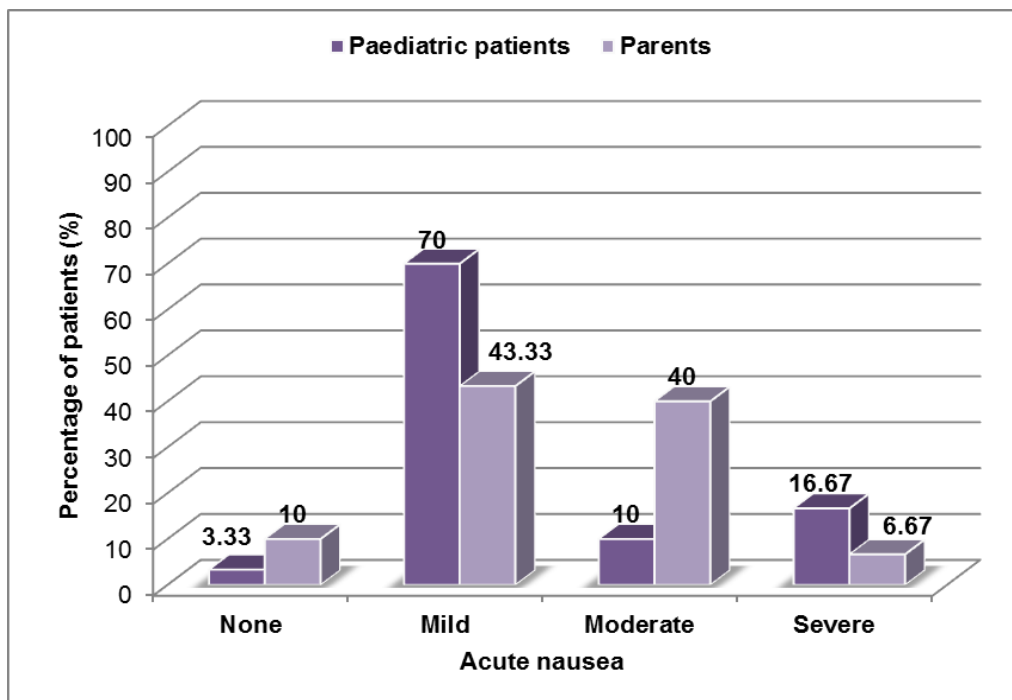

Figure 3.3: Percentages of patients with nausea during the treatment period: VAS (patients) vs. questionnaires (parents)

Some differences are observed in Figure 3.3. In fact, more parents reported children with no nausea (10%/n=3) than the patients reported themselves (3.33%/n=1). The parents reported less children in the mild nausea category (43.33%/n=13) than the patients did (70%/n=21). While only 10% (n=3) of patients reported having moderate nausea, the parents reported 40% (n=12) of patients in the moderate nausea category. For severe nausea, five cases were reported by the patients (16.67%) against only two cases by their parents (6.67%).

The biggest difference observed is for the moderate nausea where the parents reported four times more cases than the children. For many children who described their nausea as mild, the parents classified it as moderate. Likewise, some patients put their nausea in the mild category while their parents reported no nausea at all. Finally, parents only reported the two patients who had nausea and vomiting with severe nausea. On the other hand, some patients who did not vomit still reported severe nausea.

Reporting nausea is a challenge because it is less measurable than vomiting and thus it is very subjective. The person experiencing nausea feels the urge to vomit but does not do so and thus there are no visible signs (Miller *et. al*, 2011). That subjectivity explains why there are so many differences observed between the patients and their parents. The differences for nausea during the treatment period between children and their parents were found to be statistically significant ($p=0.018$).

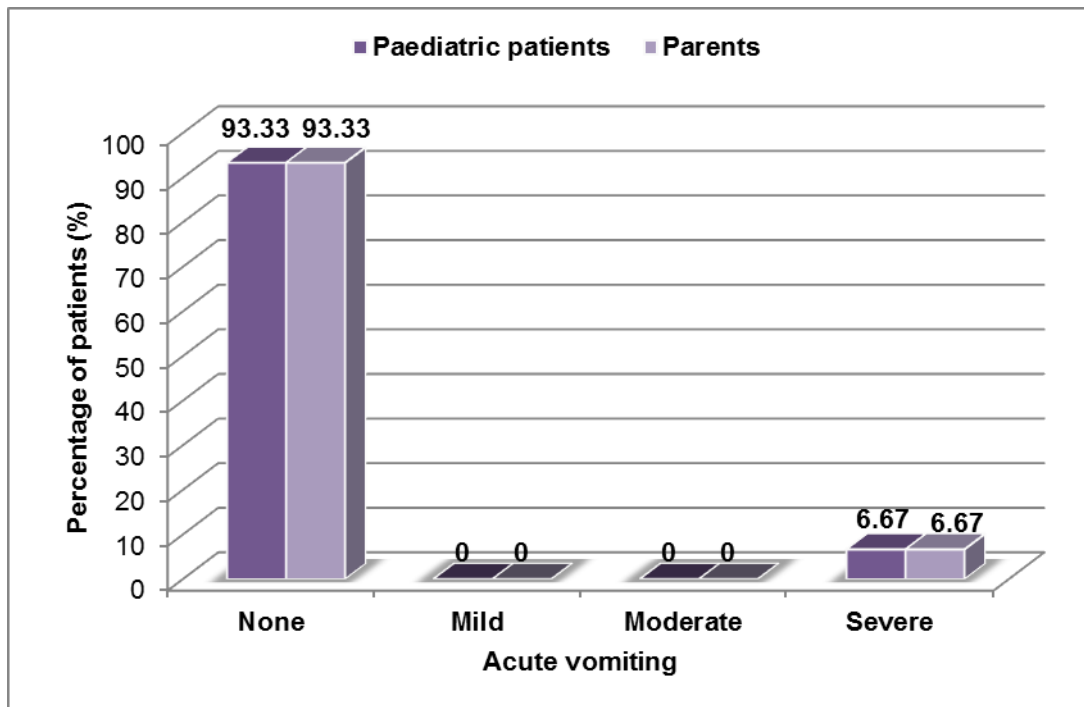

Figure 3.4: Percentages of patients with vomiting during the treatment period: VAS (patients) vs. questionnaires (parents)

As can be observed in Figure 3.4, vomiting reported by the paediatric patients and their parents was exactly the same ($p=1$). In both cases two patients experienced vomiting during the treatment period and the rest of the patients had no vomiting. Vomiting is very measurable and therefore easier to report than nausea and thus no difference was found between the patients and their parents in the way they perceived vomiting.

Because CINV has a negative impact on the patients' overall quality of life (Armando *et al.*, 2009; Wood *et al.*, 2011), it can also affect appetite and daily activities. Therefore, appetite and daily activities during chemotherapy treatment were investigated along with nausea and vomiting in the VAS and questionnaires.

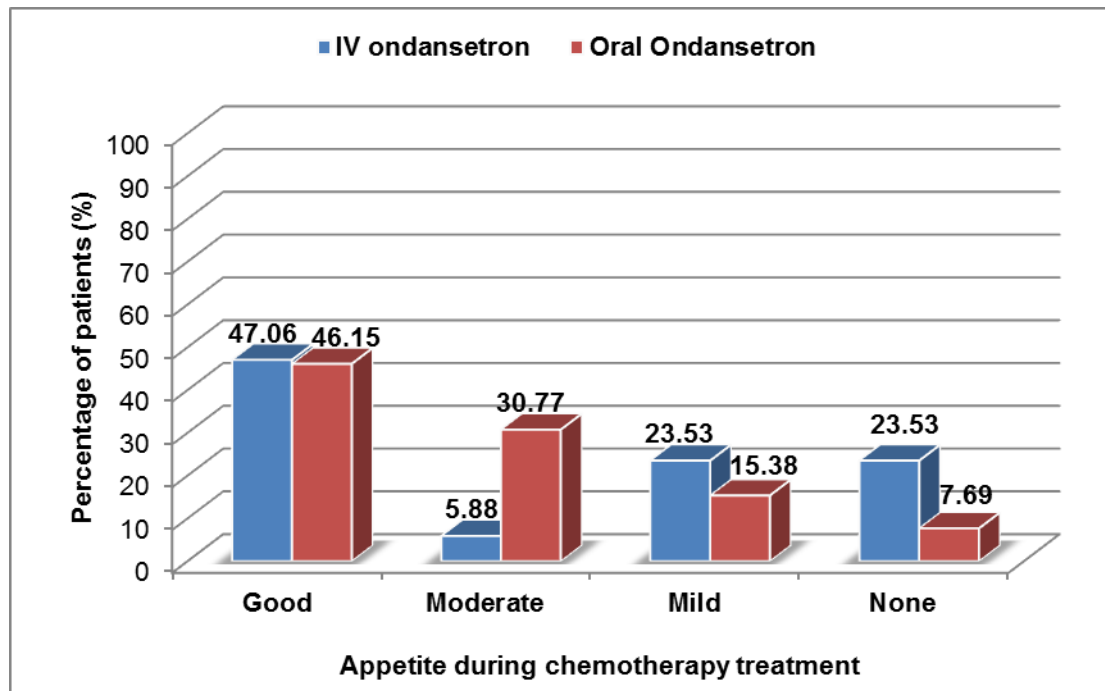

Figure 3.5: Percentages of patients with different levels of appetite during the treatment period (VAS): oral vs. IV ondansetron

A few patients experienced total loss of appetite during chemotherapy treatment, 7.69% (n=1) in the oral group and 23.53% (n=4) in the intravenous ondansetron group. Some patients had mild appetite, 15.38% (n=2) in the oral ondansetron group and 23.53% (n=4) in the IV group. Some other patients found themselves with moderate appetite, 30.77% (n=4) in the oral group versus 5.88% (n=1) in the IV ondansetron group. For both ondansetron formulations, majority of the patients had good appetite despite the chemotherapy they received; 46.15% (n=6) of patients in the oral group and 47.06% (n=8) of patients in the IV group had good appetite. After statistical analysis, the differences in terms of appetite between the oral and IV ondansetron groups were not found to be statistically significant (p=0.309) and thus the two groups were concluded to be similar for appetite. However, appetite for patients in the oral ondansetron group was generally less affected than for patients in the IV ondansetron group.

A study was conducted in 2011 that aimed at describing the prevalence, frequency, severity and distress of physical and psychological symptoms during hospitalizations of children and adolescents with cancer (Miller *et al.*, 2011). This study demonstrated that, in paediatric patients receiving chemotherapy for cancer, loss of

appetite usually co-occurs with nausea. Nausea and loss of appetite together are even more observed in patients receiving highly emetogenic chemotherapy. The present study was no exception to the rule, as many patients found their appetite influenced by chemotherapy treatment. In fact, of the total five (5) patients who experienced a total loss of appetite, four (4) of them had severe nausea along with the lack of appetite and the fifth one had moderate nausea; two of the four patients with severe nausea were treated with highly emetogenic chemotherapy and also had vomiting. These three symptoms (nausea, vomiting and appetite loss) combined have been described by Pirri *et al.* in 2012 as the “gastrointestinal symptom cluster” in a study they conducted on cancer patients. Data collected from 200 cancer patients was included in that study. The authors found that three quarters of the sample group they used had experienced co-occurrence of nausea, vomiting and appetite loss when receiving cancer chemotherapy or radiotherapy, despite prior antiemetic treatment. This is a major issue because this symptom cluster increases the impairment of patients’ quality of life (Pirri *et al.*, 2012). In the present study, patients with mild and moderate appetite were patients showing mild and moderate nausea as well. The only exception was the only patient who had no nausea but reported mild appetite. All patients with good appetite also had mild nausea.

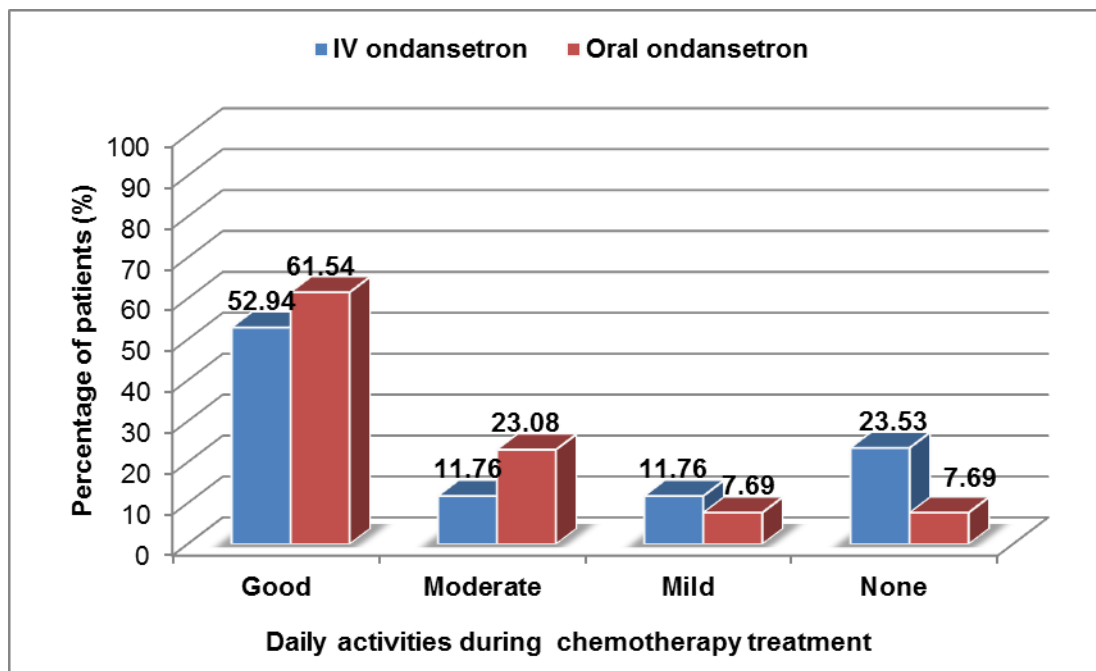

Figure 3.6: Percentages of patients with different levels of daily activities during the treatment period (VAS): oral vs. IV ondansetron

In both groups, the majority of the patients had good daily activities (61.54% /n=8 of patients in the oral ondansetron group and 52.94% /n=9 of patients in the IV group). The patients with moderate daily activities followed with 23.08% (n=3) of patients in the oral group and 11.76% (n=2) of patients in the IV ondansetron group. 7.69% (n=1) of patients who had oral ondansetron experienced mild daily activities versus 11.76% (n=2) of patients on IV ondansetron. The final five patients experienced absence of daily activities; one of them (7.69%) was in the oral ondansetron group and the other four (23.53%) in the IV ondansetron pre-treatment group. The differences observed in Figure 3.6 between the oral and IV ondansetron groups were not statistically significant ($p=0.7$). However, it is observed that the daily activities of the patients who received antiemetic prophylaxis with IV ondansetron were generally more affected than those of the patients in the oral ondansetron group.

Many different factors influence the level of activity of a cancer patient. The physical state of the patient is the first one, the weaker the patient the less activities he can perform. Secondly, the antineoplastic treatment the patient is given and its side effects: the more aggressive the treatment, the weaker the patient gets. Finally, the route of administration of the treatment, IV being more inconvenient in terms of movement than oral tablets, for example (Miller *et al.*, 2011; Pirri *et al.*, 2012).

All patients who could not carry out daily activities during chemotherapy treatment (n=5) experienced severe nausea; three of them had both severe nausea and loss of appetite; two of them had severe nausea, vomiting and loss of appetite. In a study that was conducted on children with cancer in 2011, Miller *et al.* stated that nausea, lack of energy, fatigue and loss of appetite are among the most frequently reported symptoms by children with cancer (Miller *et al.*, 2011). This statement was verified in some patients in this study, as a lack of daily activities implies lack of energy to carry out these activities. Another element that limited daily activities is the fact that all chemotherapy regimens in this study were administered IV and thus the children were confined in bed. However, many children still managed to be active during treatment by using the help of their parents to move around and go play with the other children in the ward. The fact that the majority of the chemotherapy regimens given in this study lasted for a maximum of 4 hours allowed them to remain active for the majority of the day.

The parents of the study participants were also asked about the appetite and daily activities of their children during chemotherapy treatment. This was done to compare the perception of parents to that of their children in terms of appetite and daily activities.

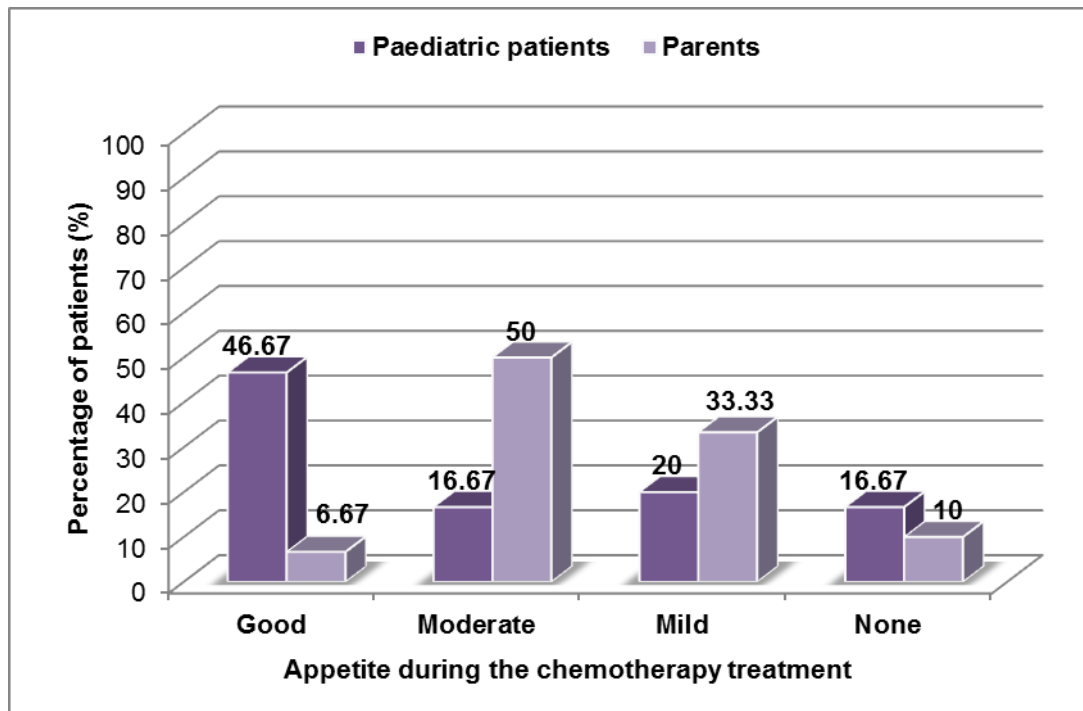

Figure 3.7: Percentages of patients with different appetite levels during the treatment period: VAS (patients) vs. questionnaires (parents)

While the majority of patients reported good appetite (46.67%/n=14), their parents put half of the patients in the moderate appetite category (50%/n=15). For many of the patients who reported good appetite, their parents actually reported moderate appetite. This shows a difference between children and parents in the way they perceive appetite. A total of 20% (n=6) of patients placed themselves in the mild appetite category while the parents reported 33.33% (n=10) of the patients with mild appetite in total. A few more patients reported having a total loss of appetite (16.67%/ n=5) than their parents did (10%/n=3).

Figure 3.7 shows differences in the way parents and their children perceived appetite. The differences observed in the good and moderate appetite category were found to be statistically significant ($p=0.001$). Therefore, evidence was provided that there was a real difference between paediatric patients and their

parents in reporting appetite during the treatment period, with parents being more pessimistic than the children and reporting lower levels of appetite.

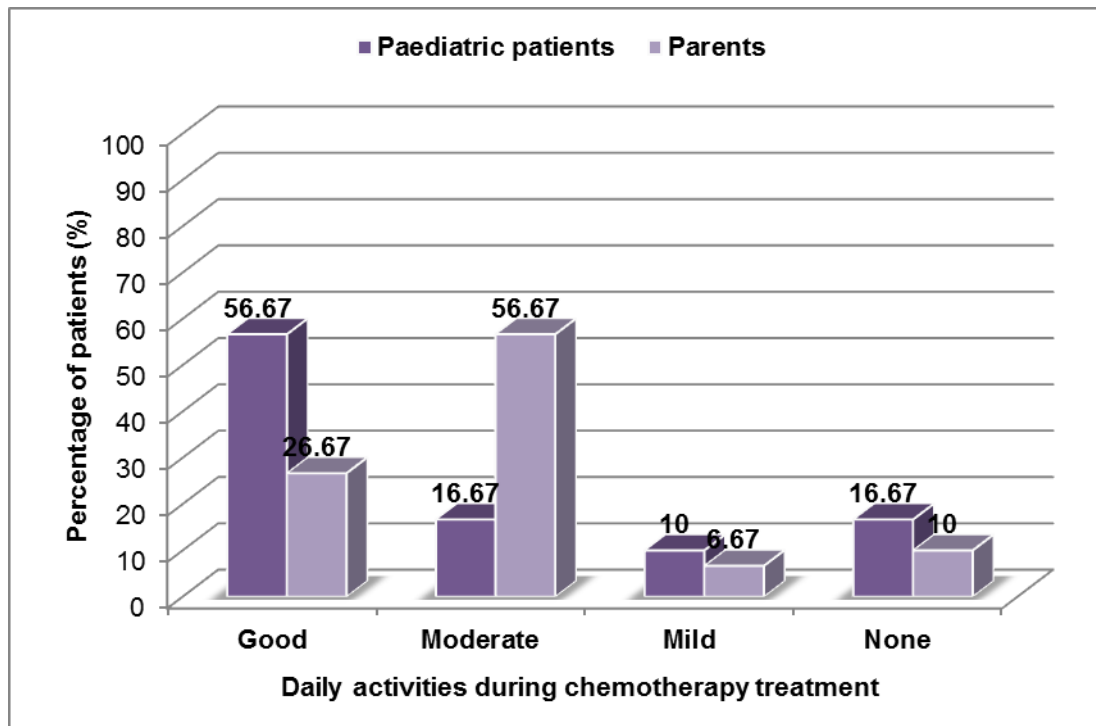

Figure 3.8: Percentages of patients with different levels of daily activities during the treatment period: VAS (patients) vs. questionnaires (parents)

The biggest differences are observed between the good and moderate daily activities. In fact, while the majority of patients placed themselves in the good daily activities category (56.67%/n=17), their parents reported the most patients as having moderate daily activities (56.67%/n=17). A few more patients (10%/n=3) than parents (6.67%/n=2) reported mild daily activities. Total lack of daily activities was reported by 16.67% (n=5) of patients versus 10% (n=3) of parents.

Many differences between daily activities reported by the patients and their parents during the treatment period are observed in Figure 3.8. The differences between patients and parents in reporting good and moderate daily activities were found to be statistically significant ($p=0.007$) and thus confirmed that there was a difference in the perception of daily activities between the two groups.

The differences between paediatric patients and their parents in perceived daily activities follow previous research where it has been demonstrated that fatigue can be perceived differently by parents and their children (Miller *et al.*, 2011). According

to Miller *et al.*, children associate fatigue with physical weakness, adolescents view fatigue as physical and mental exhaustion and finally parents see fatigue as a loss of energy. Since fatigue and daily activities are correlated, the differences in fatigue perception between different age groups described by Miller *et al.* can be used to justify the differences in reporting daily activities between the patients and their parents that were observed in this study.

3.1.3.2. Follow-up period

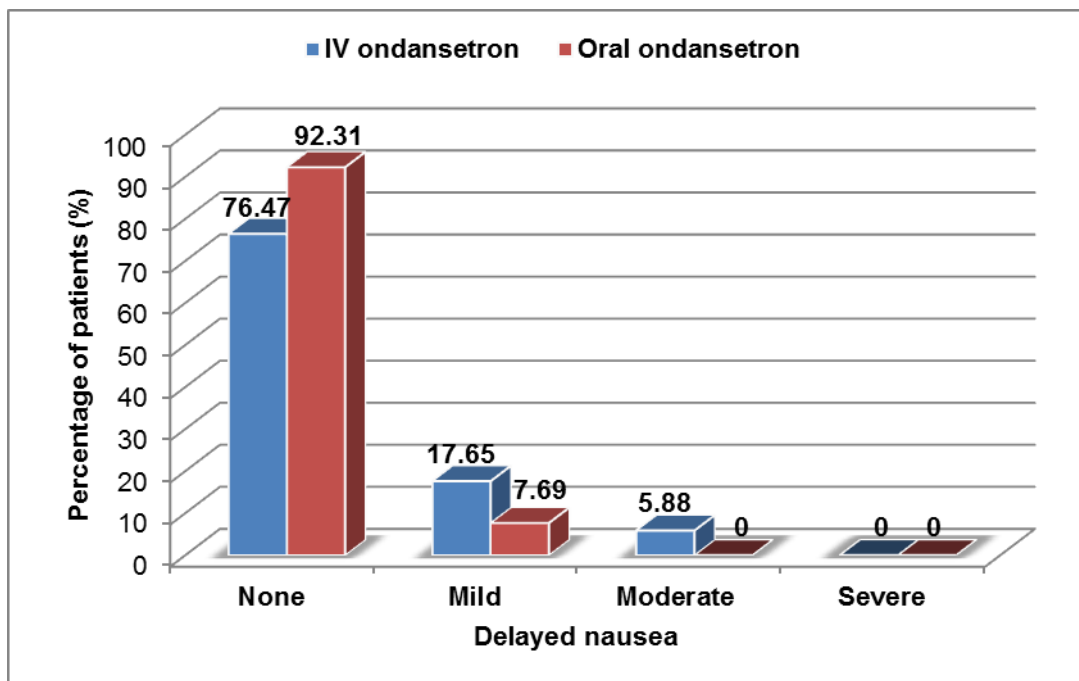

Figure 3.9: Percentages of patients with delayed nausea (VAS): oral vs. IV ondansetron

During the week following the end of chemotherapy, the majority of patients did not experience any nausea. The IV ondansetron group reported 76.47% of patients (n=13) without delayed nausea and the oral group reported 92.31% of patients (n=12) without delayed nausea. Some patients experienced mild delayed nausea, 17.65% (n=3) in the IV ondansetron group and 7.69% (n=1) in the oral ondansetron group. One patient in the IV ondansetron group (5.88%) had moderate nausea during the week following the end of chemotherapy.

There are small differences in delayed nausea between the oral and IV ondansetron

groups that are illustrated in Figure 3.9, but none of these differences were statistically significant ($p=0.777$) and the two groups were thus concluded to be similar in terms of delayed nausea.

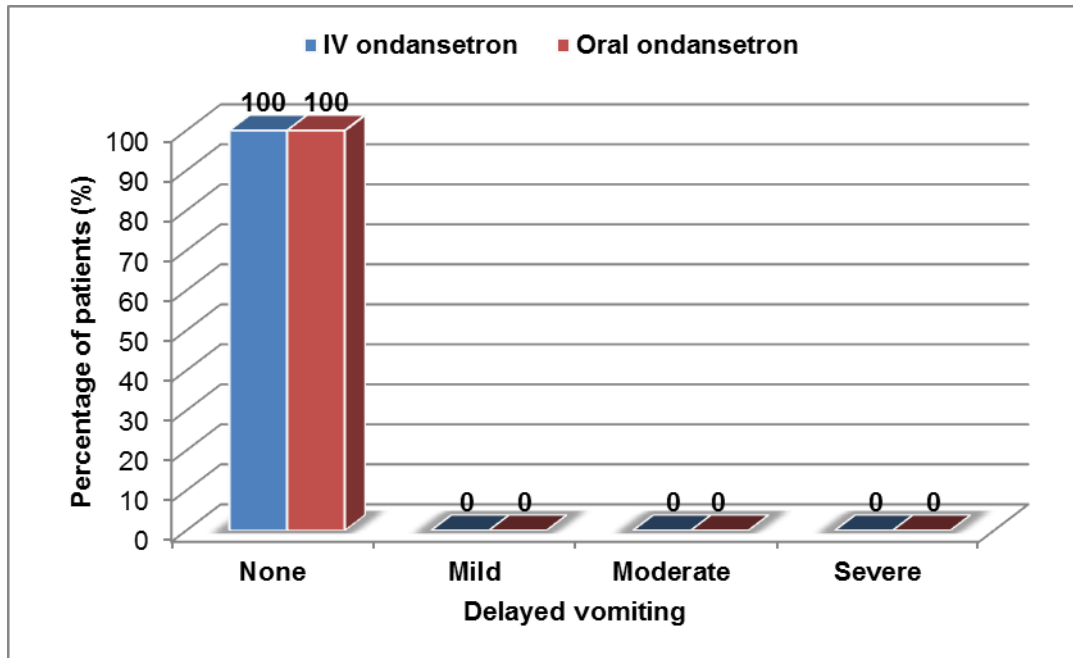

Figure 3.10: Percentages of patients with vomiting during the follow-up period (VAS): oral vs. IV ondansetron

The oral and IV ondansetron groups were identical with none of the patients in either group experiencing delayed vomiting ($p=1$).

All patients with mild delayed nausea ($n=4$) and the only patient with moderate delayed nausea were the patients who had experienced severe acute nausea during the treatment period. Two of these patients experienced severe acute nausea and emesis during the treatment period. Of the patients with mild delayed nausea, three (3) experienced the symptoms 12-24 hours after the end of chemotherapy and the fourth one had mild delayed nausea during the first 72 hours following chemotherapy. The patient with the longest time experiencing delayed nausea (72 hours) had also previously experienced severe acute nausea and vomiting during chemotherapy. The patient with moderate delayed nausea experienced symptoms for 48 hours after the end of chemotherapy.

Approximately a fourth of the patients who participated in this study experienced

delayed CINV (23.53%). It was noticed that the patients who reported delayed nausea had previously experienced either severe acute nausea only or severe acute nausea with vomiting. The severe acute nausea these patients felt during the chemotherapy treatment period was still present for a few days after chemotherapy but it decreased in intensity with time after chemotherapy. On the other hand, the severe acute vomiting experienced by two of the patients during the chemotherapy treatment period only lasted till the end of the treatment.

Delayed CINV affect many patients treated with highly and moderately emetogenic chemotherapy regimens but it is generally neglected and rarely attended to (Grunberg *et al.*, 2004). What is more, the currently available antiemetic regimens are reputed to be ineffective against delayed CINV (Dewan *et al.* 2010). There is therefore a need for a better understanding of the incidence of delayed CINV in patients receiving chemotherapy in order to achieve a better control of these symptoms and thereby to improve the quality of life of patients with delayed CINV after chemotherapeutic treatment.

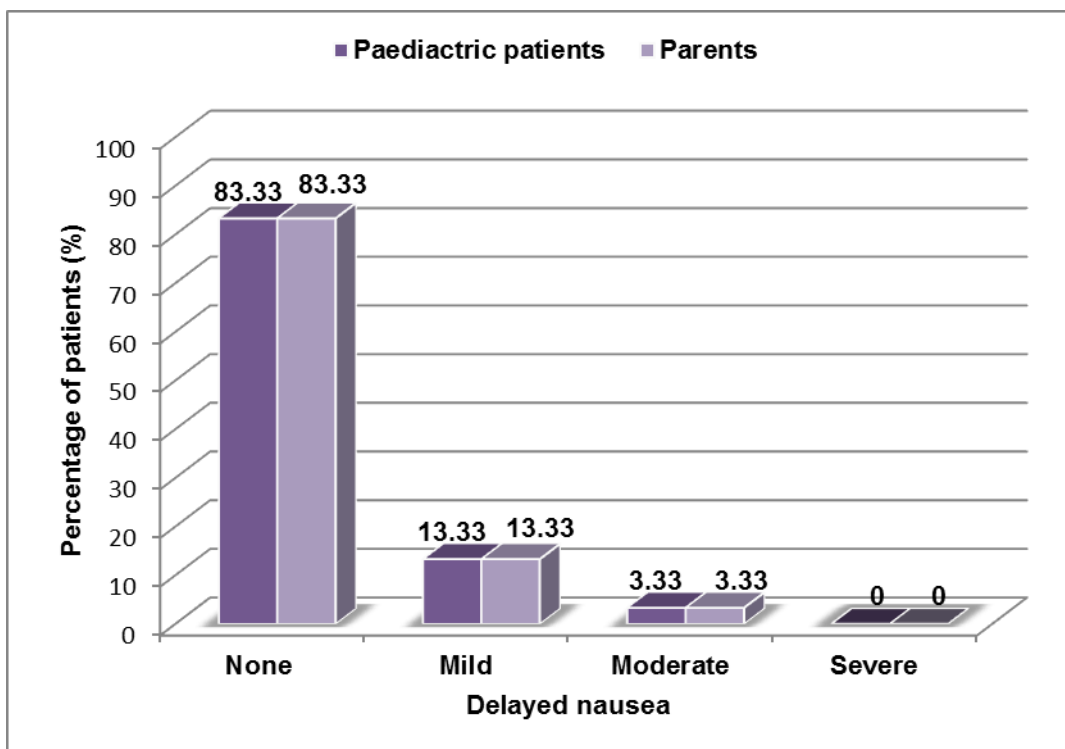

Figure 3.11: Percentages of patients with delayed nausea: VAS (patients) vs. questionnaires (parents)

The patients and their parents reported exactly the same numbers in the different delayed nausea categories. According to both the patients and their parents, majority of the patients had no delayed nausea (83.33%/n=25), a few experienced mild delayed nausea (13.33%/n=4) and one patient had moderate delayed nausea (3.33%).

The differences observed between the paediatric patients and their parents in reporting acute nausea were not seen when reporting delayed nausea. Despite the subjectivity of nausea, the perception of delayed nausea was identical in the patients and their parents ($p=1$).

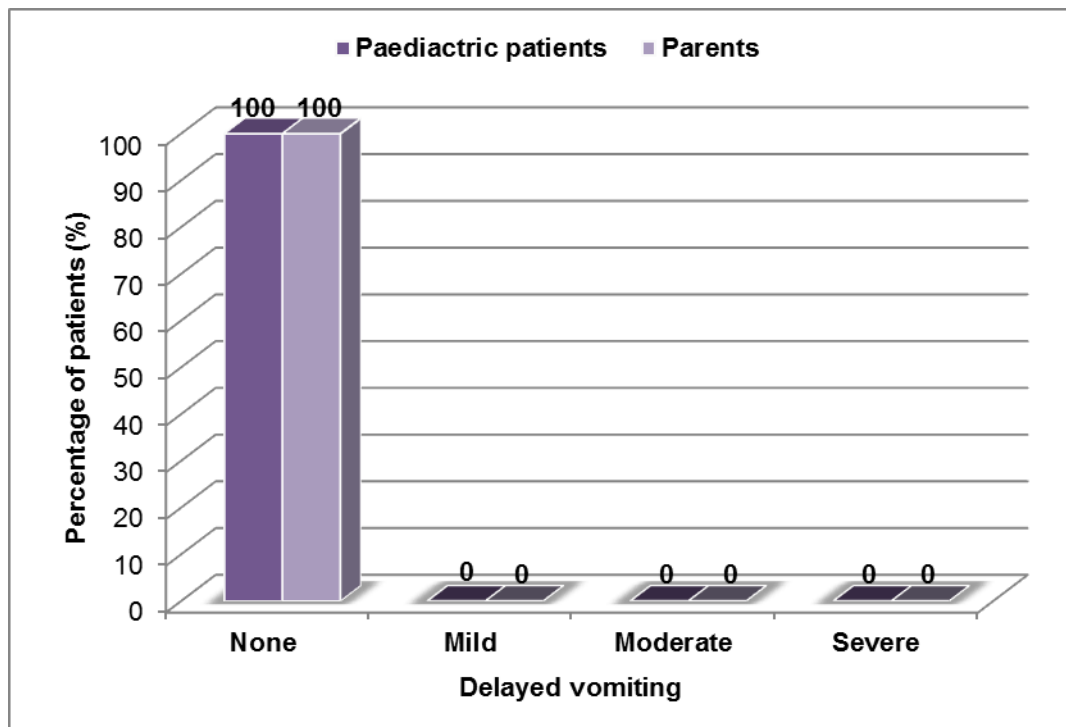

Figure 3.12: Percentages of patients with delayed vomiting: VAS (patients) vs. questionnaires (parents)

As can be seen in Figure 3.12, both the patients and their parents reported that none of the patients in the study had experienced delayed vomiting ($p=1$).

As can be seen in Figures 3.11 and 3.12, the perception of nausea and vomiting of the patients and their parents during the follow-up period was the same, contrary to the large differences that were observed between the patients and their parents in

reporting nausea during the treatment period.

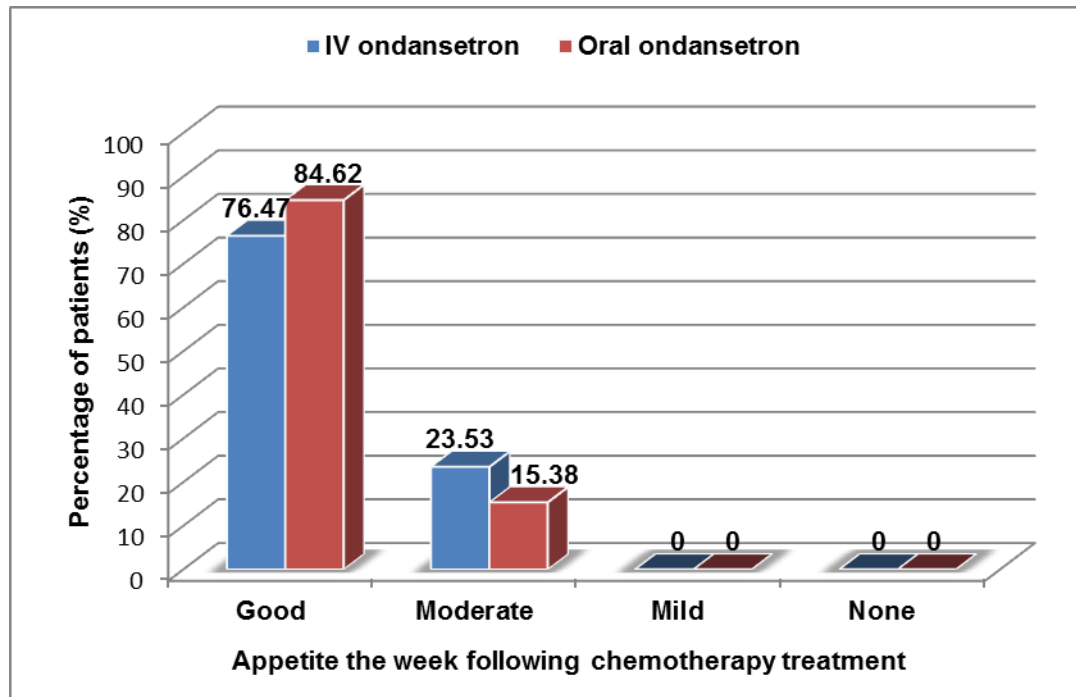

Figure 3.13: Percentages of patients with different levels of appetite during the follow-up period (VAS): oral vs. IV ondansetron

In both groups (IV and oral ondansetron), the majority of the patients recovered a good appetite during the week following the end of chemotherapy; 76.47% of patients (n=13) in the IV ondansetron group and 84.62% of patients (n=11) in the oral ondansetron group. The rest of the patients (23.53%/n=4 in the IV group and 15.38%/n=2 in the oral group) experienced moderate appetite the week following the end of chemotherapy treatment. The differences observed in Figure 3.13 between the oral and IV ondansetron groups were found not to be statistically significant ($p=0.672$) and thus the two groups were concluded to be similar in terms of appetite during the follow-up period.

Good appetite was the most prevalent category during the follow-up period. However, some patients still had moderate appetite. A total of six (6) patients experienced moderate appetite the week after chemotherapy was stopped. Five of the patients with moderate follow-up appetite also had mild delayed nausea and the sixth one also had moderate delayed nausea. The co-occurrence of nausea and

decrease in appetite in patients with cancer treated with chemotherapy has been demonstrated in previous studies (Miller *et al.*, 2011) and it was also observed in this study.

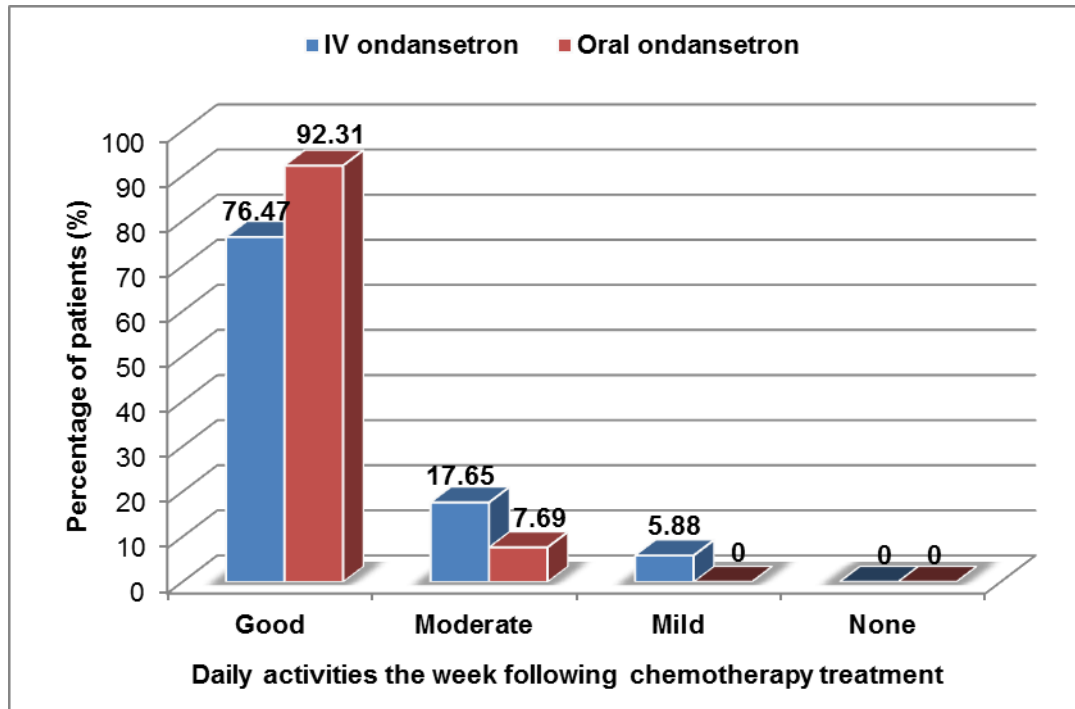

Figure 3.14: Percentages of patients with different levels of daily activities during the follow-up period (VAS): oral vs. IV ondansetron

Most of the patients had good daily activities the week following the end of chemotherapy, with 76.47% of patients (n=13) in the IV ondansetron group and 92.31% of patients (n=12) in the oral ondansetron group reporting good daily activities. In both groups there were some patients who had only moderate daily activities; 17.65% (n=3) in the IV ondansetron group and 7.69% (n=1) in the oral ondansetron group. One patient from the IV ondansetron group (5.88%) still had only mild daily activities during the follow-up period.

The differences observed in Figure 3.14 between the oral and IV ondansetron groups were not statistically significant (p=0.777) and thus the two groups were shown to be similar in follow-up daily activities.

During the week following the end of chemotherapy, most patients reported good daily activities. All patients (n=4) with only moderate daily activities during the follow-

up period had a co-occurrence of mild delayed nausea and only one patient with mild daily activities also had moderate delayed nausea. This shows that delayed nausea negatively impacts daily activities in children. In fact, lack of energy and fatigue are two of the most reported symptoms by children with cancer, along with nausea and loss of appetite (Miller *et al.*, 2011). The patients in this study were no exception to the trend reported in the literature.

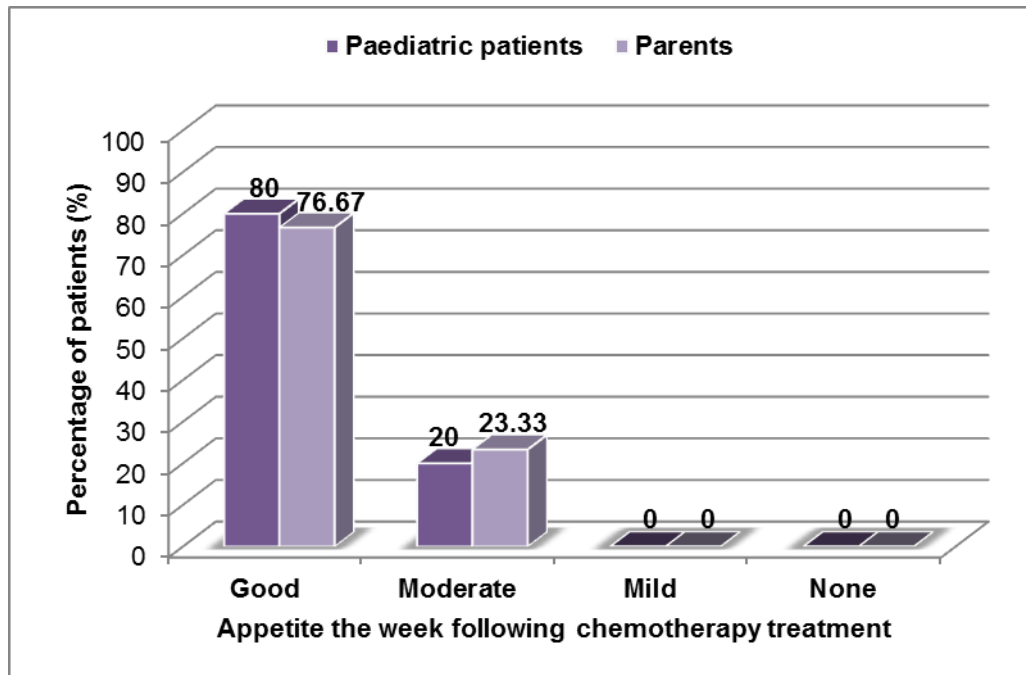

Figure 3.15: Percentages of patients with different appetite levels during the follow-up period: VAS (patients) vs. questionnaires (parents)

Figure 3.15 shows that appetite of the patients during the week following the end of chemotherapy was reported in a similar way by the patients and their parents ($p=1$). The differences observed in reporting appetite during the treatment period were not repeated during the follow-up period.

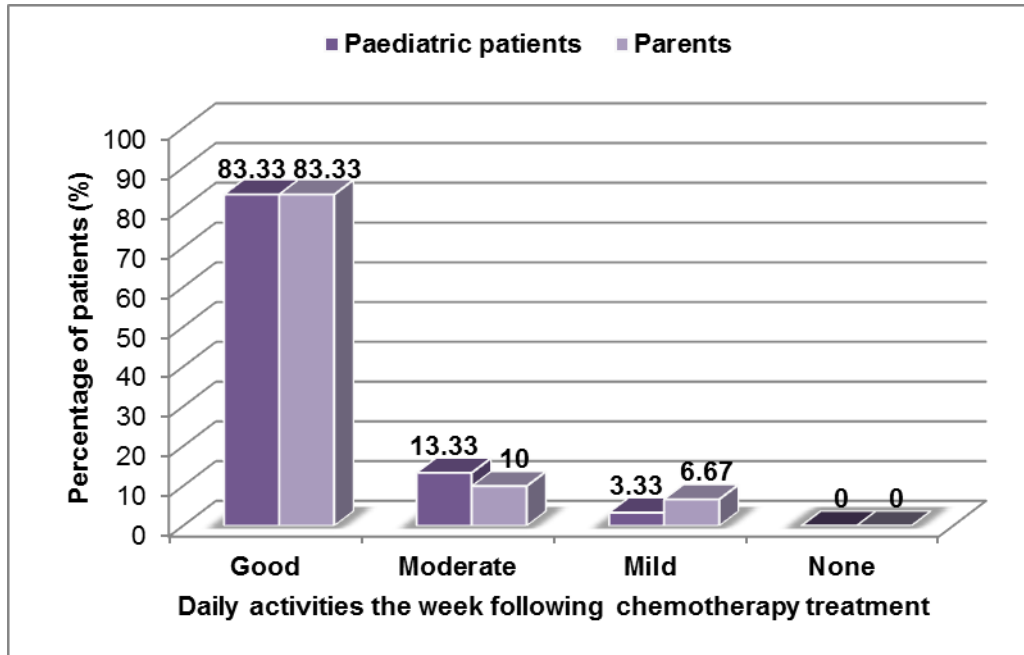

Figure 3.16: Percentages of patients with different levels of daily activities during the follow-up period: VAS (patients) vs. questionnaires (parents)

Figure 3.16 illustrates the similarities between the patients and their parents in reporting daily activities the week following chemotherapy treatment ($p=1$).

During the week following the end of chemotherapy treatment, the majority of the patients recovered good daily activities. However, some of them had only moderate and mild daily activities. The only patient who reported mild daily activities had a co-occurrence of moderate delayed nausea and moderate appetite during the follow-up period. The parent of that patient also reported mild daily activities. The second patient for whom the parent reported mild daily activities reported moderate daily activities for himself but also had mild delayed nausea and moderate appetite during the follow-up period. All patients with moderate daily activities also had mild delayed nausea and moderate appetite during the follow-up period. What comes out from these observations is that the presence of nausea and decreased appetite negatively impacts on daily activities because nausea is unpleasant and affects appetite; inadequate appetite, in turn, makes the patients weaker (Miller *et al.*, 2011, Pirri *et al.*, 2012).

3.2. Patients' plasma concentrations of ondansetron

The LC-MS/MS method that was developed for this study was able to quantitate ondansetron in the patients' plasma samples at the concentrations found for both the IV and OT administrations over time. Ondansetron was efficiently extracted from the patients' plasma samples.

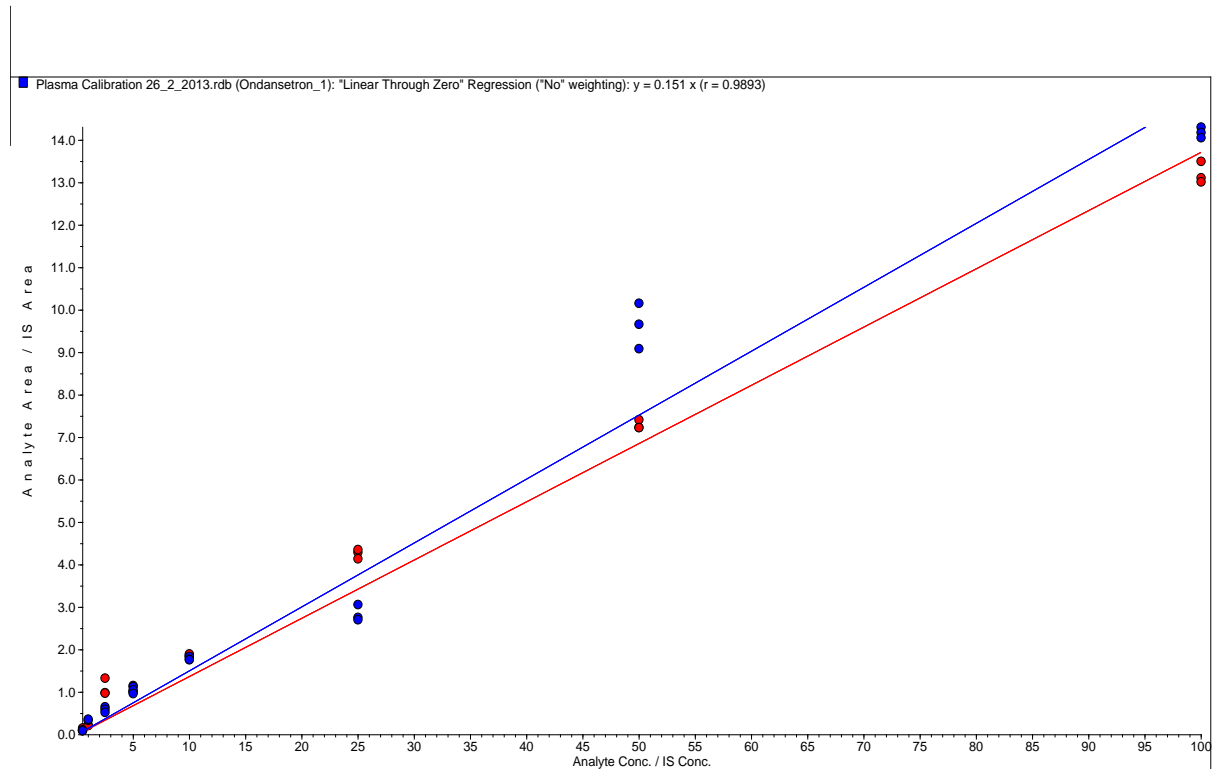

Figure 3.17: Ondansetron solvent-based and serum-based calibration curves (quantification by LC-MS/MS)

Figure 3.17 shows two calibration curves. The blue line is the ondansetron calibration curve when dilutions were made in 50/50 methanol-water ($y=0.137x$, $r^2=0.997$) and the red line represents the ondansetron calibration curve for dilutions made in drug-free human plasma ($y= 0.151x$, $r^2= 0.989$).

The mean recovery of ondansetron from human plasma was 110%.

The method was linear over the range 0.5-100 ng/mL and the combined calibration curve could be described by the equation $y=0,144 x$ ($r^2=0.991$). The lower limit of

quantification (LLOQ) was 0.5 ng/mL.

The ondansetron and imipramine (IS) retention times were both 6.0 ± 0.5 min and the signal-to-noise ratio was higher than 44 for the lowest ondansetron concentration (0.5 ng/mL) in methanol-water, as illustrated in the following figure:

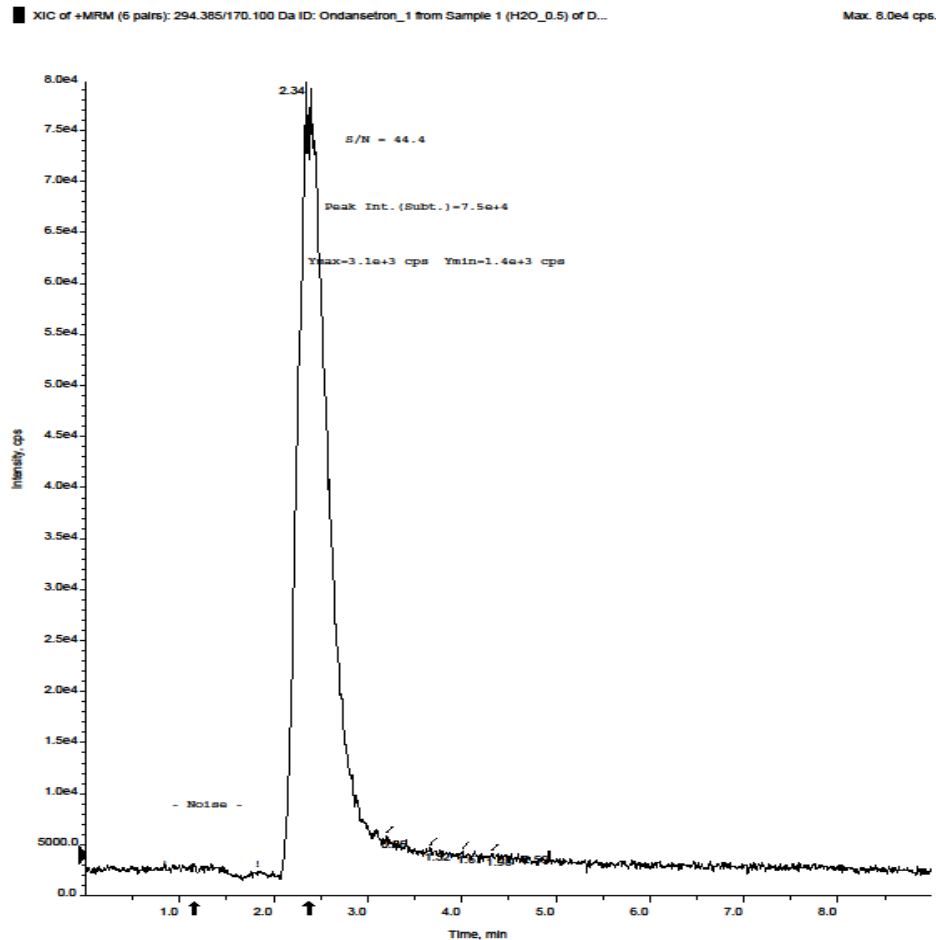

Figure 3.18: Signal to noise ratio for ondansetron 0.5 ng/mL in water-methanol

In the case of ondansetron and its internal standard imipramine, there was no significant ion suppression in the region where the analyte and internal standard were eluted.

The developed method was suitable for the purpose to quantitate the plasma ondansetron levels of the patients participating in the study.

3.2.1. Oral ondansetron group

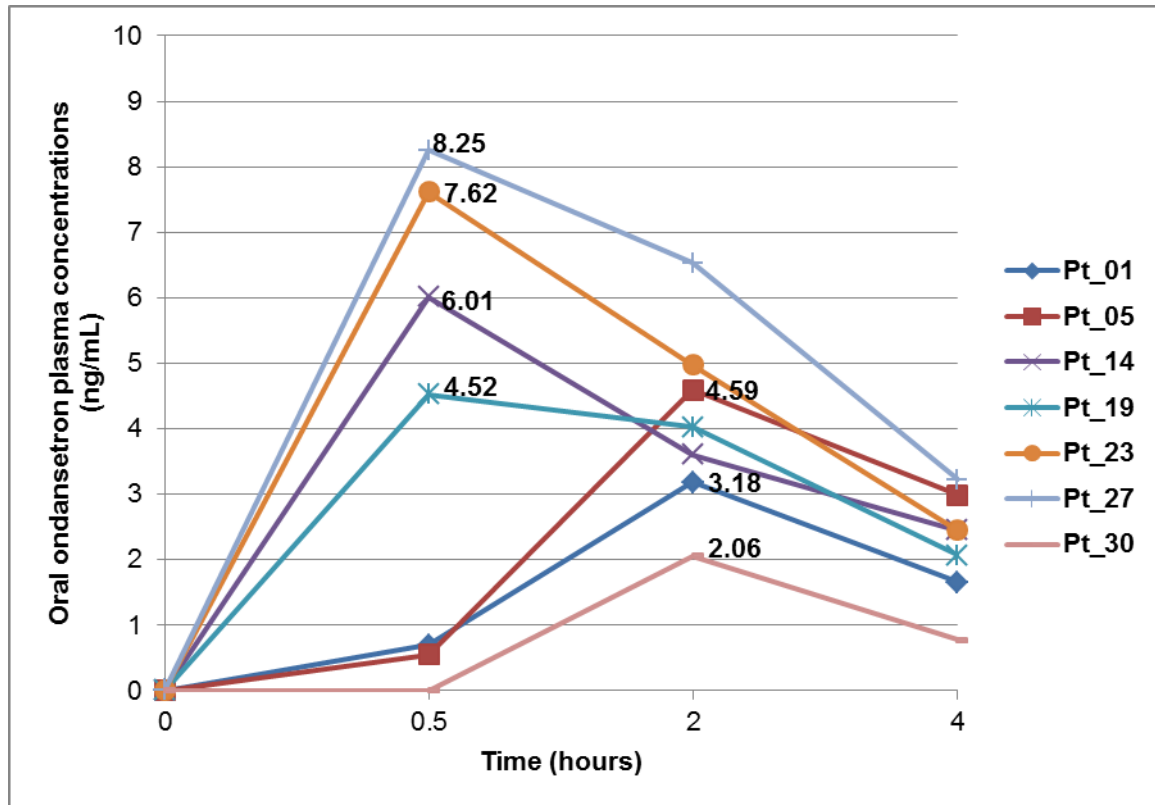

Figure 3.19: Plasma concentrations of ondansetron over time for seven patients in the oral ondansetron group

Figure 3.19 shows the different ondansetron plasma concentrations over time for 7 of the 13 patients who received oral antiemetic prophylaxis using ondansetron; with an emphasis on the different apparent maximum plasma concentrations (C_{max}) obtained from the LC-MS/MS analysis.

The apparent maximum plasma concentrations seen in Figure 3.19 varied from 2.06 ng/mL to 8.25 ng/mL and were reached between 0.5 hours (4 patients) and 2 hours (3 patients). This is confounded by the fact that these were the only times that were allowed for blood collection during the treatment period that was in progress during that time.

Different studies have been conducted on the pharmacokinetics of ondansetron and allowed for various population averaged pharmacokinetics parameters to be determined.

The mean bioavailability after ingestion of a single 8-mg ondansetron tablet in healthy adult volunteers is approximately 60% and the terminal half-life is approximately 3 to 4 hours (Roila and Del Favero, 1995; Simpson and Hicks, 1996; de Wit *et al.*, 1996; Martindale, 2008; GlaxoSmithKline, 2010). After a standard meal, this bioavailability is slightly increased (Roila and Del Favero, 1995; Simpson and Hicks, 1996; Martindale, 2008; GlaxoSmithKline, 2010). Age and gender may also influence the disposition of ondansetron with increased clearance in younger children (thus faster elimination) and slower clearance, resulting in higher bioavailability and C_{max} in adult females (de Alwis *et al.*, 1998; Simpson and Hicks, 1996; GlaxoSmithKline, 2010).

The time that oral ondansetron takes to reach maximum plasma concentration (T_{max}) has been shown to be between 0.5 hour and 2 hours (Roila and Del Favero, 1995; de Wit *et al.*, 1996). The data shown in Figure 3.19 falls in this range, with some patients' plasma concentrations peaking at 0.5 hour and others' at 2 hours.

C_{max} after a single 8 mg Zofran® tablet in adults (> 18 years old) has been reported to be in the following ranges in different sources: 25.6 - 38.1 ng/mL (Simpson and Hicks, 1996), 24.7 - 199.6 ng/mL (de Wit *et al.*, 1996) and 26.2 - 42.7 ng/mL (GlaxoSmithKline, 2010). When comparing the C_{max} range in Figure 3.19 (2.06 - 8.25 ng/mL) to the ones reported in literature, the values obtained in this study are much lower. The studies previously mentioned reporting C_{max} values for ondansetron tablets were conducted in adults using a single 8 mg tablet dose; in the data observed in Figure 3.19, the patients were children and they were each given a single 4 mg ondansetron tablet. However, although the plasma concentrations of ondansetron were low, it did not appear to negatively affect the efficacy of the antiemetic (de Wit *et al.*, 1996). In fact, none of the patients included in Figure 3.19 had acute vomiting during chemotherapy treatment; six of them had mild acute nausea and the seventh one had no acute nausea. Oral tablet administration of ondansetron therefore provided the six patients who experienced mild nausea and no vomiting with good antiemetic protection (Small *et al.*, 2000) and the patient who had no nausea nor vomiting with complete antiemetic protection (Small *et al.*, 2000).

It is to be noted that patient 12 (Pt_12) also received oral ondansetron but was not included in Figure 3.19 because the 0.5 hour post dosing blood sample was missed;

thus this patient only had three blood samples drawn instead of four. With the samples that were available, Pt_12 reached an apparent C_{max} of only 0.958 ng/mL at 2 hours after the 4 mg tablet was administered. This is, relative to the other patients, a very low plasma concentration. Pt_12 experienced severe nausea and vomiting during chemotherapy treatment; with severe nausea and two vomiting episodes. This could have resulted in emesis of the active pharmaceutical agent resulting, in turn, in the very low plasma concentration which still appeared to provide moderate nausea and emesis protection to this patient according to the scale of Small *et al.* (2000). In this case, contrary to what was reported by de Wit *et al.* in 2006, there seemed to be a proportional relationship between the low ondansetron plasma concentration and the decreased control of emesis during chemotherapy. However, the antiemetic prophylaxis given to a patient is not the only factor to consider when looking at the risk a patient has of experiencing CINV. Some other factors to consider include the emetogenicity of the chemotherapeutic treatment regimen and the doses of the antineoplastic agents that were given to him/her (Aapro *et al.*, 2006; Durand *et al.*, 2009; Olver *et al.*, 2011; Pirri *et al.*, 2012). Pt_12 was treated with highly emetogenic chemotherapy and received only one 4 mg oral Zofran® tablet, which was below the required dose for a 14 year-old boy weighing 33.2 kg (GlaxoSmithKline, 2010). The combination of all these factors put the patient at a higher risk of CINV. Another fact is that when this patient arrived in the paediatric oncology ward he was already very sick and he was vomiting before the start of chemotherapy.

Pharmacokinetics studies on oral tablet of ondansetron in paediatric patients belonging to the age group included in this study are very rare in literature and the few that were found did not include pharmacokinetics parameters such as C_{max} and T_{max} that could be used for comparison purposes with the findings in this study (Spahr-Schopfer *et al.*, 1995; de Alwis *et al.*, 1998). The lack of data on the pharmacokinetics of oral tablet of ondansetron in children is a problem because the adults' data is usually extrapolated to children, not taking into account the differences that result from different age groups (Spahr-Schopfer *et al.*, 1995). More research on the pharmacokinetics of oral ondansetron tablet in children is therefore imperative.

For most patients who were given oral tablet of ondansetron, the plasma

concentrations of the drug followed the trend observed in Figure 3.19, rising quickly to reach apparent C_{max} between 0.5 hour and 2 hours and then decreasing more slowly following typical first-order kinetics (Hsyu *et al.*, 1994). However, there were a few exceptions, as will be illustrated in the following figures.

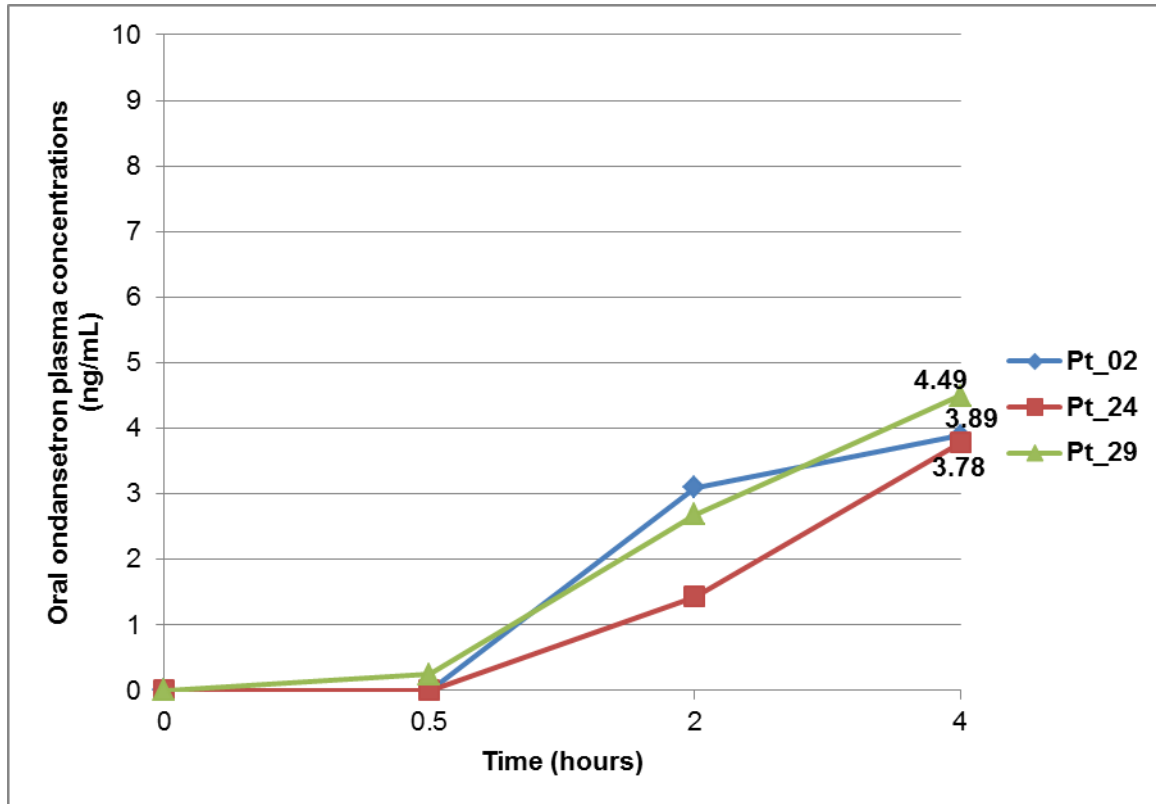

Figure 3.20: Plasma concentrations of ondansetron over time for three patients in the oral ondansetron group

Figure 3.20 shows the ondansetron plasma concentrations for 3 of the 13 patients in the oral ondansetron group that did not follow the more general absorption kinetics demonstrated by the majority of the patients.

In the three patients shown in Figure 3.20, the apparent maximum ondansetron plasma concentrations were reached much later than the ones shown in Figure 3.19. What is more, since the last blood was taken 4 hours after the ondansetron dose, it is not possible to know when C_{max} was in fact reached.

The data shown in Figure 3.20 does not follow any of the information given by various studies on the pharmacokinetics of oral ondansetron. In fact, C_{max} has been reported to be reached between 0.5 hour and 2 hours by several sources (Roila and

Del Favero, 1995; de Wit *et al.*, 1996) and between 1 and 1.5 hours by others (Hsyu *et al.*, 1994; Simpson and Hicks, 1996). In Figure 3.20, a clear lag time of at least 0.5 hour can be seen in the plasma concentrations increases; concentration which then continue to rise until the last sample at 4 hours.

The half-life of the drug is said to be 3 hours (de Alwis *et al.*, 1998; Martindale, 2008) but this was not verified in the plasma concentrations shown in Figure 3.20, as the highest concentrations were seen at 4 hours, when the final blood samples were taken.

The ondansetron plasma concentrations shown in Figure 3.20 were from patients that all had mild acute nausea but no acute vomiting. These patients thus received good prophylactic antiemetic protection (according to the classification of Small *et al.*, 2000) from a single 4 mg oral tablet of ondansetron despite the low ondansetron plasma concentrations during chemotherapy.

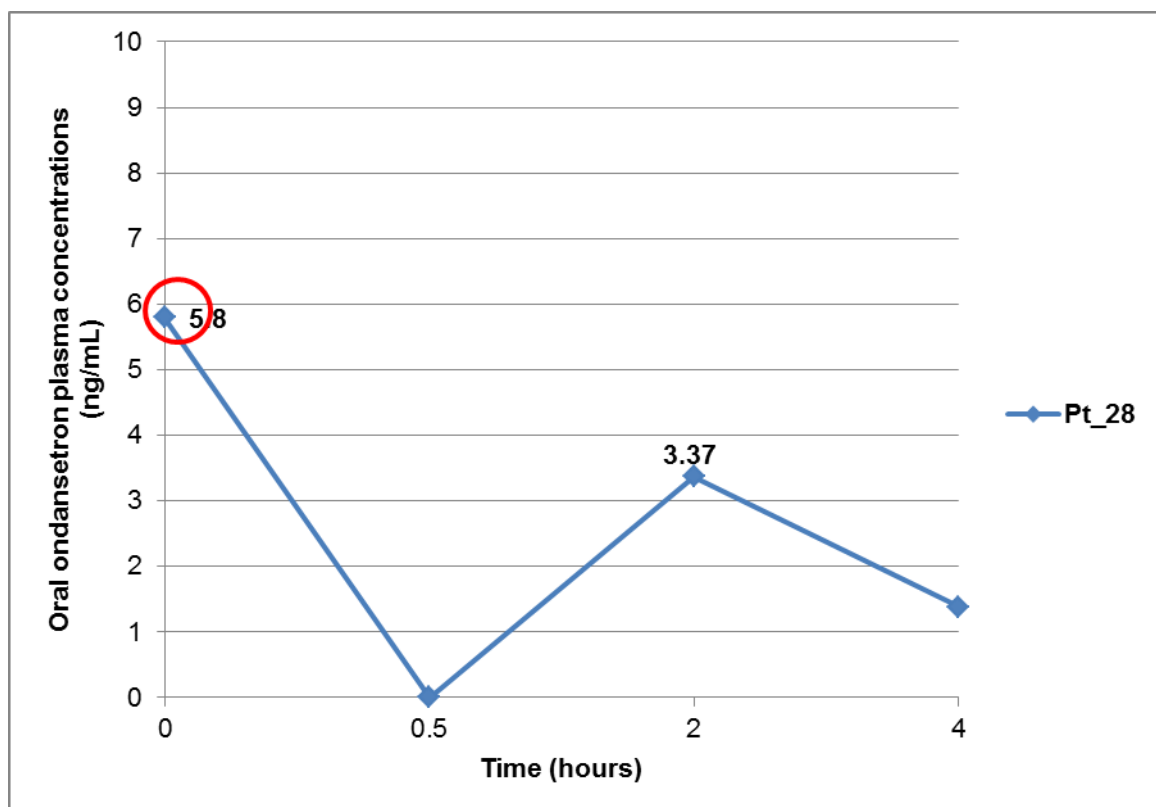

Figure 3.21: Plasma concentrations of ondansetron over time for patient 28 who received oral ondansetron dosing

The blood taken at 0 hour was the baseline blood (before any medication was given

to the patient), but patient 28 was found to have 5,8 ng/ml ondansetron in his/her plasma at this baseline time point, as can be observed in Figure 3.21. When looking at the patient's file to check whether any dose of ondansetron was given up to the week prior the day when the blood samples were taken, no record of administered ondansetron was found. It is possible that the blood collection tubes were switched at collection time or during plasma harvesting between the 0 and the 0.5 time points but these possibilities could not be confirmed.

This patient had no acute vomiting and mild acute nausea and therefore had good protection from antiemetic prophylaxis with oral tablet of ondansetron according to the classification of Small *et al.* (2000).

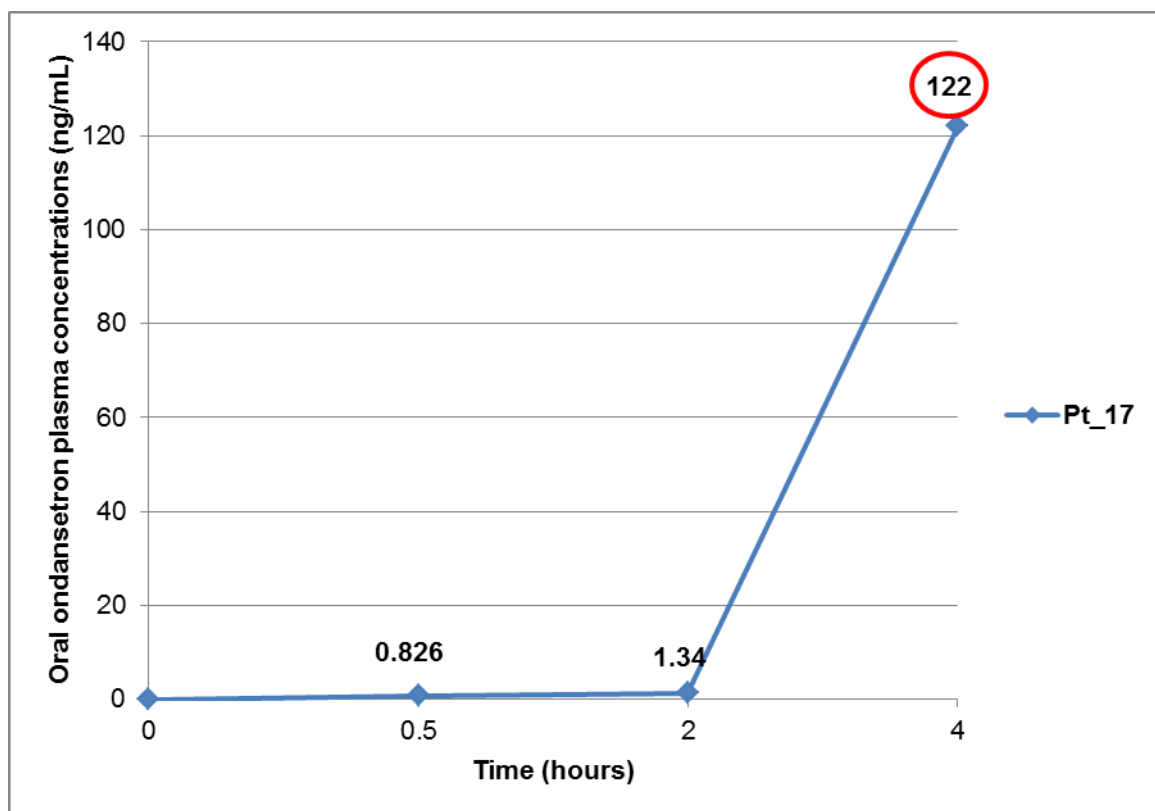

Figure 3.22: Plasma concentrations of ondansetron over time for patient 17 who was given antiemetic prophylaxis with oral ondansetron

The plasma concentrations of patient 17 illustrated in Figure 3.22 were very low up to 2 hours after the dose was given and then suddenly reached a very high concentration (122 ng/mL). Such a high plasma concentration was not seen in any other patient in the oral ondansetron group (the highest plasma concentration

observed in other patients was 8.25 ng/mL). The patient did not follow the standard dosing protocol and it appears that the patient was given an extra dose of ondansetron after 2 hours and probably by IV infusion because ondansetron systemic exposure does not rise proportionally to the administered dose, and thus, if the patient had received an extra oral dose there would not have been such a large increase in plasma concentration (GlaxoSmithKline, 2010). However, no additional ondansetron administrations were reported in the patient's file. In only one study, published in 1996, did the highest plasma concentrations reported exceed 100 ng/mL after oral administration of ondansetron but this level was detected early in the concentration-time curves (de Wit *et al.*, 1996). In Figure 3.22 it can be observed that the highest concentration was measured at 4 hours, although oral administration of ondansetron is expected to reach C_{max} between 0.5 and 2 hours post administration (Roila and Del Favero, 1995; de Wit *et al.*, 1996). As the blood sample taken 4 hours after the ondansetron dose was the last sampling time it is not possible to know when C_{max} was reached or whether this was a collection protocol problem.

Patient 17 (Figure 3.22) did not experience acute vomiting but did report moderate acute nausea; implying that the patient was provided with good antiemetic protection with oral tablet of ondansetron according to the classification of Small *et al.* (2000).

3.2.2. Intravenous (IV) ondansetron group

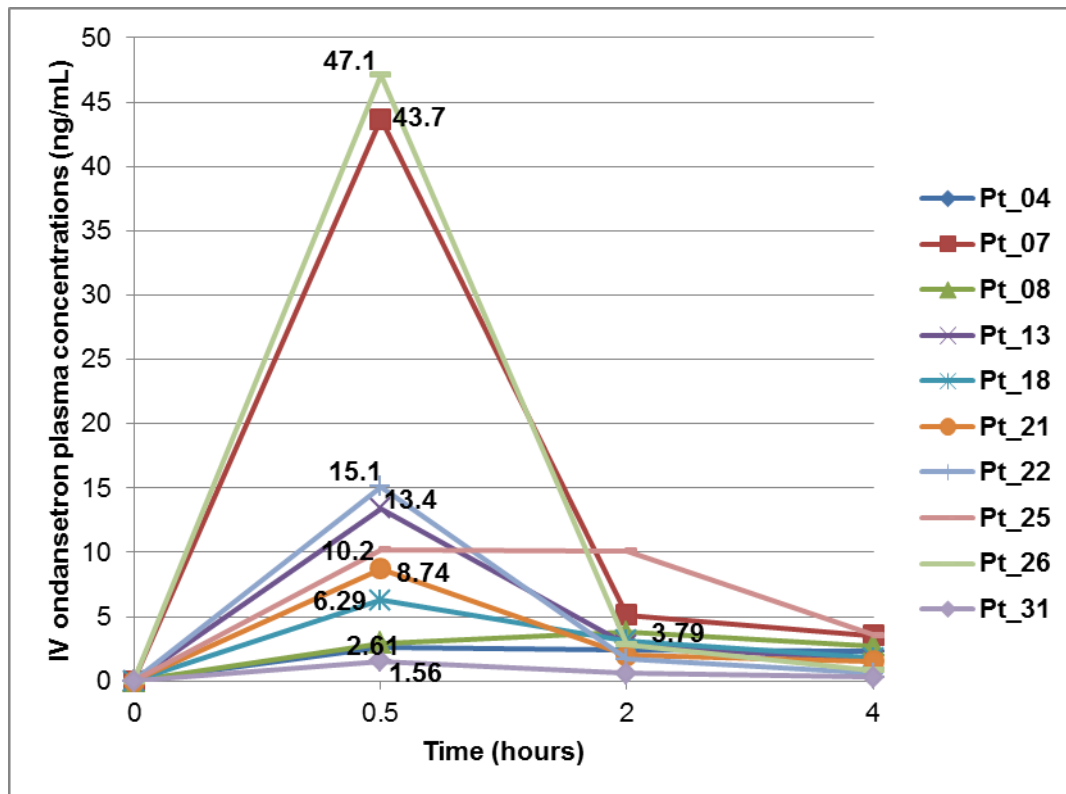

Figure 3.23: Plasma concentrations of ondansetron over time for ten patients in the IV ondansetron group

Figure 3.23 shows the plasma concentrations of 10 of the 17 patients in the IV ondansetron group obtained from the LC-MS/MS analysis and the C_{max} for each patient.

IV ondansetron reaches peak plasma concentrations seconds following the rapid infusion and should have a more rapid onset of antiemetic action than oral tablet of ondansetron (Simpson and Hicks, 2006; GlaxoSmithKline, 2010). However, for consistency in the study design during this investigation where limited sampling was permitted, the second blood samples were taken 30 minutes (0.5 hour) after the ondansetron dose was administered to the patient for both the oral and IV groups. The majority of the patients reached C_{max} at 0.5 hour (Figure 3.23). The only exception was patient 8 (Pt_08), who reached a very low C_{max} of 3,79 ng/ml 2 hours after the ondansetron dose; this matches the levels and kinetic profile of an oral administration despite the records showing that the patient received IV

administration of 4 mg ondansetron.

The highest plasma concentrations ranged from 1.56 to 47.1 ng/mL for the IV dosed participants. These C_{max} values appear to be very low compared to the mean C_{max} of 102 ng/mL reported by GlaxoSmithKline in 2010 for adult volunteers (19-40 years) after an 8 mg IV Zofran® dose. The reasons are that the values at 0.5 hour are not true C_{max} values due to the time between dosing and sampling and that the dose for these participants was only 4 mg. However, a study conducted in paediatric patients undergoing general anaesthesia (3-11 years old) showed that ondansetron plasma concentrations in children (after receiving IV ondansetron 2 or 4 mg) were similar to those in adults (Lerman *et al.*, 1993). Although the plasma concentrations were lower than expected, most patients shown in the IV dosing group were provided with good antiemetic protection as they had mild acute nausea and no acute vomiting according to the classification of Small *et al.* (2000). The low ondansetron plasma concentrations after IV administration did not result in a lowered antiemetic efficacy of the drug, as also seen in previous studies (de Wit *et al.*, 1996); this was true for all patients in Figure 3.23 except patient 31 (Pt_31) who was the patient with the lowest ondansetron plasma concentration of 1.56 ng/ml 30 minutes after dosing. This patient was the only one of the ten patients whose data is shown in Figure 3.23 to experience severe acute nausea and severe acute vomiting. In this case, the low concentration of ondansetron was inadequate to provide antiemetic efficacy. To aggravate the situation this patient received a highly emetogenic chemotherapy regimen (Aapro *et al.*, 2006; Durand *et al.*, 2009; Olver *et al.*, 2011; Pirri *et al.*, 2012), and, combined with the low dose of antiemetic prophylaxis administered (4 mg for a 12-year old boy weighing 33.3 kg when the dose recommended by the manufacturer is 0.15 mg/kg (GlaxoSmithKline, 2010)), therapeutic failure could have been expected.

The majority of the patients administered IV ondansetron had plasma concentrations of the antiemetic follow a typical trend as illustrated in Figure 3.23, with an apparent C_{max} at 0.5 hour post dosing, due to sampling time, followed by a steady decrease as would be expected from a drug following first order kinetics. However, some patients did not follow this rule, as will be seen in the following figures.

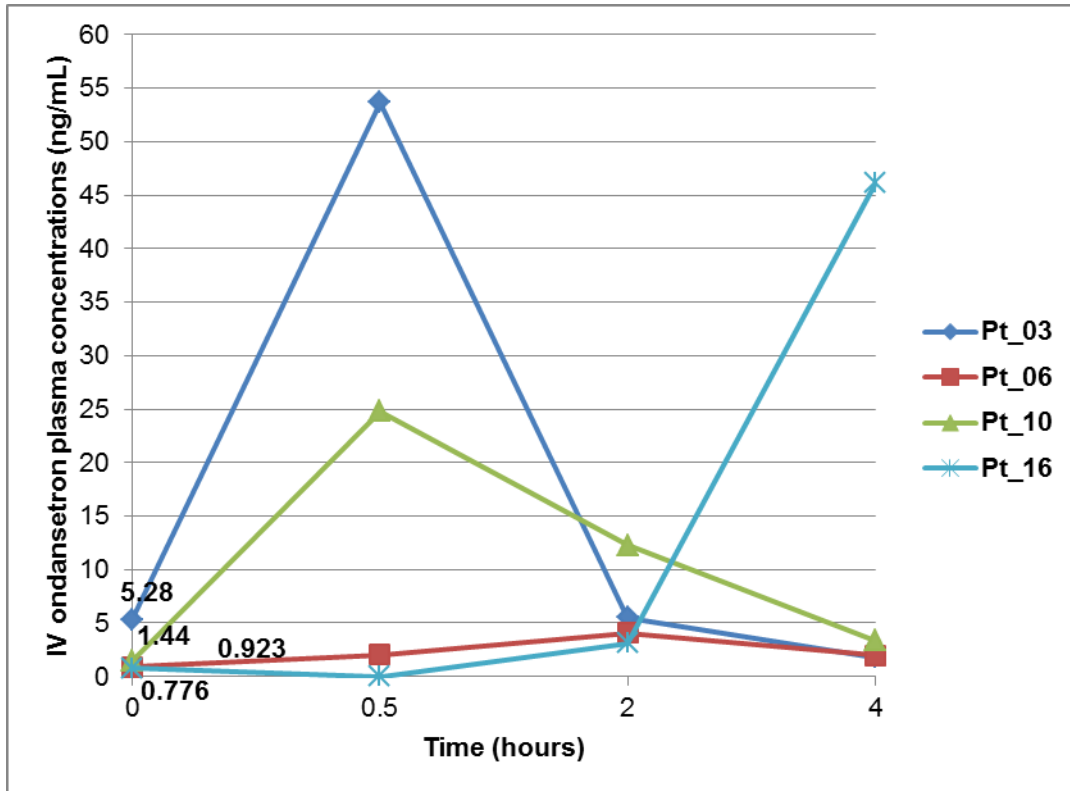

Figure 3.24: Plasma concentrations of ondansetron over time for four patients in the IV ondansetron group

The patients shown in Figure 3.24 had one thing in common: the presence of ondansetron in their baseline blood. The baseline blood was the blood sample taken before any medication was given to the patient and thus finding ondansetron in the plasma was unexpected. The patients' hospital files were reviewed to verify if any dose of ondansetron was given to these patients up to seven days prior to the day when the blood samples were taken but no record of previous ondansetron dosing was found. Some ondansetron was probably given to these patients the days before the day when the baseline blood sample was taken but since it was not documented in the patients' files, this conclusion cannot be made with certainty.

Patient 3 (Pt_03) had mild acute nausea and no acute vomiting and was thus well protected against CINV with 4 mg IV ondansetron according to the classification of Small *et al.* (2000).

Pt_16, who experienced moderate acute nausea but no acute vomiting, was a 8 year-old boy weighing 25.2 kg who was given moderately emetogenic chemotherapy

and adequate antiemetic prophylaxis IV with 4 mg Zofran® was achieved. This patient was young and had received chemotherapy before; factors which may have put him at a higher risk of having CINV (Jordan *et. al*, 2007; Lohr, 2008; Durand *et. al*, 2009). The plasma concentrations of ondansetron up to 2 hours after the dose were very low and there was a sudden surge in concentration similar to that of patient 17 in the oral treatment group with a peak concentration 4 hours after the ondansetron dose was reported to have been administered (Figure 3.24). Despite this abnormal disposition of drug that hints at a late administration of ondansetron, the antiemetic regimen gave the patient good protection against CINV according to the classification of Small *et al.* (2000).

Pt_06 and Pt_10 both had severe acute nausea but no acute vomiting. They achieved adequate antiemetic prophylaxis with a 4 mg Zofran® IV. Pt_06 and Pt_10 were both 4 years old and were the youngest in the group, which may explain the severe nausea (Jordan *et. al*, 2007; Durand *et. al*, 2009; Dewan *et. al*, 2010). Also Pt_06 had low plasma concentrations of ondansetron during the chemotherapy treatment (Figure 3.24) which would match that of an oral administration of the dose which is further confirmed by fact that the C_{max} was only achieved after 2 hour post dosing. However, since these patients had severe acute nausea but no acute vomiting, the antiemetic prophylaxis provided them with good protection against CINV according to the classification of Small *et al.* (2000).

Data from patient 11 (Pt_11) was not included in any of the figures above because only three blood samples were obtained from that patient. The critical sample that had to be taken at 0.5 hour was missed. In addition, this patient was found to have a very high baseline concentration of ondansetron (33.9 ng/mL). This patient was admitted to hospital early the day he received chemotherapy and it was later found in the patient's file that 4 mg of ondansetron was administered IV 1h30 minutes before the baseline blood sample was drawn. This explains why such a high ondansetron plasma concentration was found in this patient at baseline. The patient did not get a second dose of Zofran® during blood sampling.

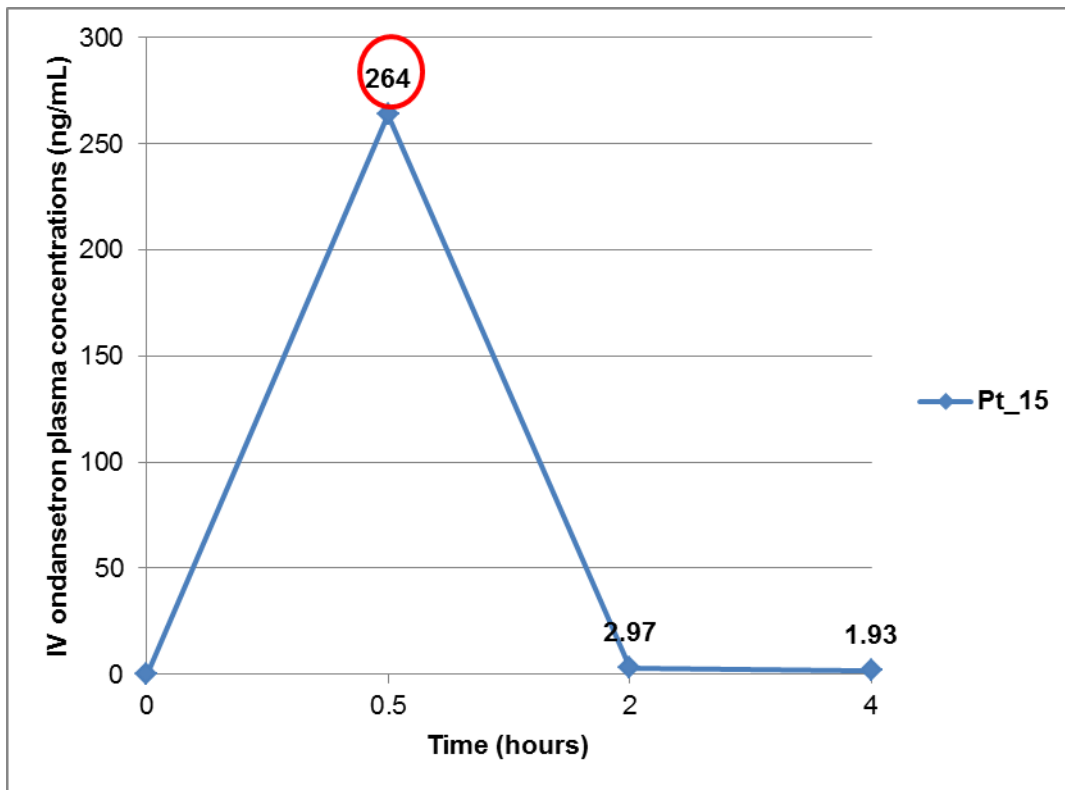

Figure 3.25: Plasma concentrations of ondansetron over time for patient 15 in the IV ondansetron group

In Figure 3.25, data for Pt_15 shows the extremely high plasma concentration of ondansetron 0.5 hour after the 4 mg IV dose of Zofran® was given (264 ng/mL). No such high plasma concentration was seen in any other patient in the IV ondansetron group, with the next highest plasma concentration being 53.7 ng/mL in Pt_03 (Figure 3.24).

Although Pt_15 was a 15-year-old girl with a weight of 61.1 kg, she was administered only a 4 mg IV Zofran® dose. It is suspected that the blood sample at 0.5 hour was drawn from the same Broviac line in which IV ondansetron was administered 30 minutes before and that some residual dose remained in the catheter. This would explain the high concentration (264 ng/ml) but also, the equally quick fall to 2.97 ng/mL. However, this could not be verified.

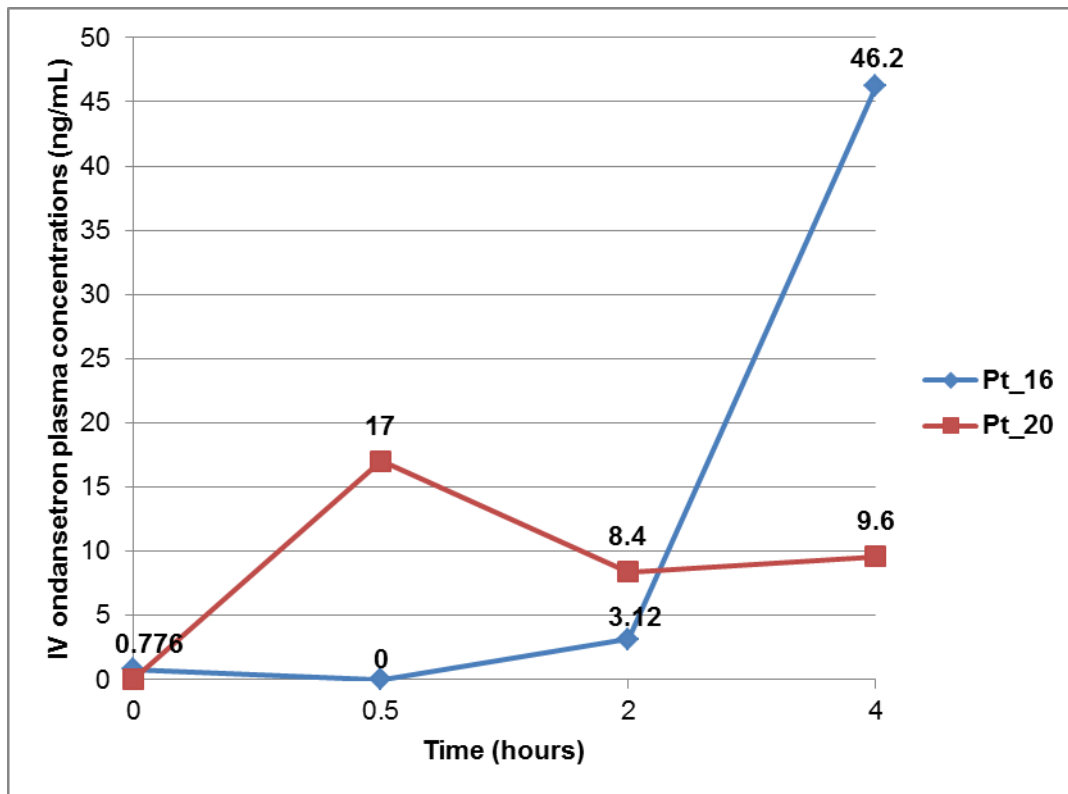

Figure 3.26: Plasma concentrations of ondansetron over time for two patients in the IV ondansetron group

Data for Pt_16 was already included in Figure 3.24 due to the presence of ondansetron in his/her baseline blood. What Pt_16 and Pt_20 have in common is a rise in ondansetron plasma concentration 4 hours after the ondansetron dose was administered, as can be seen in Figure 3.26. This is really surprising because IV ondansetron is known to reach peak plasma concentration within seconds after the infusion (GlaxoSmithKline, 2010) and to subsequently decrease in a first order kinetics fashion (Hsyu *et al.*, 1994). What is more, the terminal half-life of ondansetron is 3-4 hours (Martindale, 2008; GlaxoSmithKline, 2010).

Pt_16 had some ondansetron present in the baseline blood, then no ondansetron after 0.5 hour, some ondansetron after 2 hours and finally reached his/her peak plasma concentration 4 hours after the IV ondansetron dose (46.2 ng/mL). This plasma concentration trend is uncommon and was not seen in any other patient. It could be that the IV ondansetron dose was administered by the nurse later than the time it should have been given at for this study but no time was recorded in the patient's hospital file. It is also tempting to assume that Pt_16 received a second

Zofran® dose before the last blood sample was taken, but it was not recorded in the patient’s file and thus this assumption cannot be made.

Pt_20 had only a slight rise in plasma concentration between 2 and 4 hours (from 8.4 ng/mL to 9.6 ng/mL) that has no obvious explanation. Pt_20 had mild acute nausea and no acute vomiting and thus received good protection from the antiemetic prophylaxis with 4 mg Zofran® IV (Small *et al.*, 2000).

Furthermore, the last blood samples were taken 4 hours after the ondansetron dose and thus it is not possible to know what happened to the ondansetron plasma concentrations of these two patients after 4 hours, with no indication of the concentration rising or dropping.

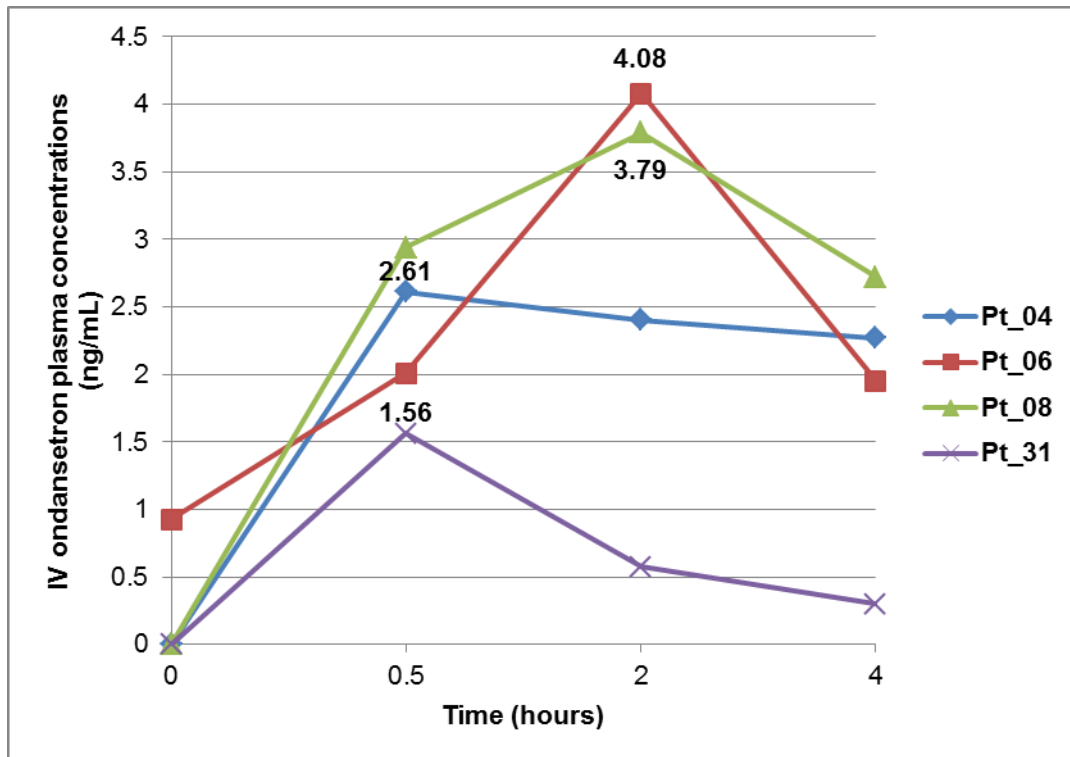

Figure 3.27: Plasma concentrations of ondansetron over time for four patients in the IV ondansetron group

All the data for the patients shown in Figure 3.27 were presented in previous figures on the IV ondansetron group’s result; however, Figure 3.27 focuses on the fact that the ondansetron plasma concentrations of these patients over time were very low for patients who were given IV ondansetron. In fact, although these patients were said

to be in the IV ondansetron group, the plasma concentrations they exhibited looked similar to those seen in the patients in the oral ondansetron group. What is more, Pt_06 and Pt_08 only reached peak plasma concentration 2 hours after the dose, which is not expected if an IV bolus was administered as this would exhibit more rapid plasma concentration rise than an oral tablet (Simpson and Hicks, 1996).

The study doctor, the nurses, the paediatric patients and their parents were all aware of the ondansetron formulation the patient was to be administered on the first day of the study. However, the principal investigator was blinded until the end of the clinical trial and thus relied on the information recorded by the study doctor and the nurses concerning the ondansetron formulation given to each patient.

3.2.3. IV ondansetron group vs. OT ondansetron group

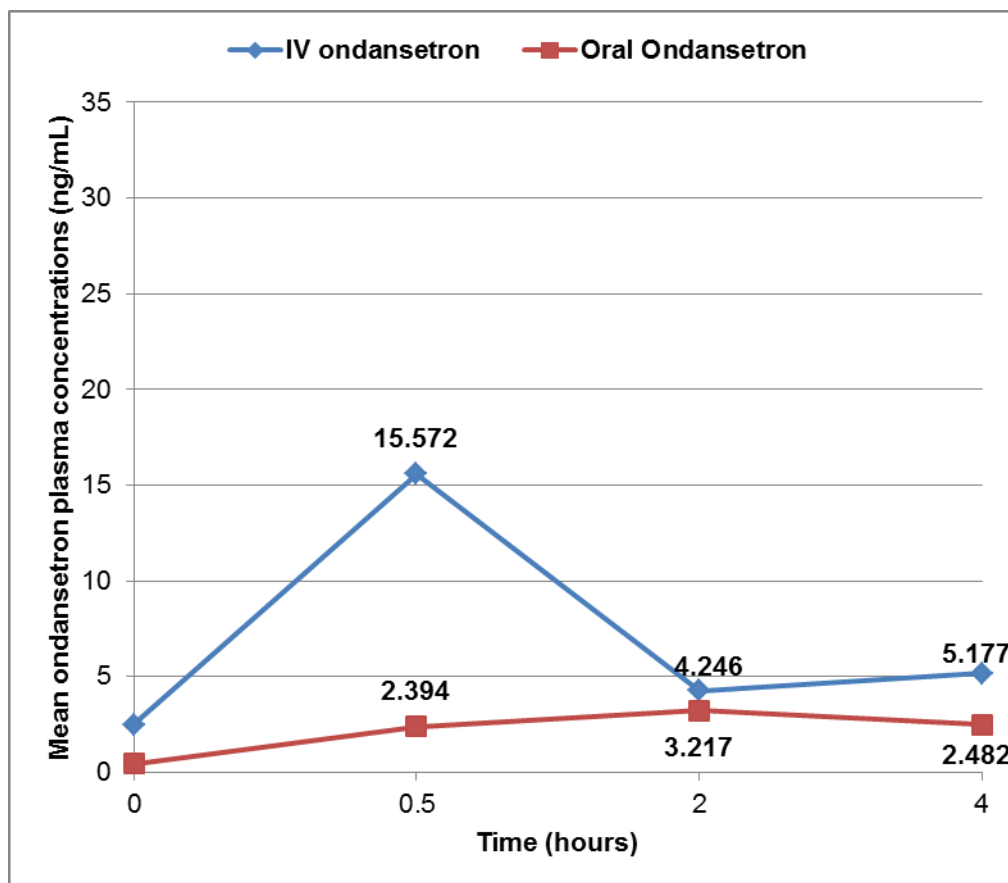

Figure 3.28: A comparison of the mean ondansetron plasma concentrations of patients administered ondansetron by the IV and oral route*

*The outliers were not included in the mean calculations, 122 ng/mL in the oral ondansetron group and 264 ng/mL in the IV ondansetron group.

Figure 3.28 shows the average plasma concentration versus time for the two groups receiving IV or oral administration of the antiemetic drug. The IV ondansetron group showed higher plasma concentrations than the oral ondansetron group. In fact, the mean plasma concentration 0.5 hour after the 4 mg Zofran® dose was much higher in the IV group (15.572 ng/mL) than in the oral group (2.394 ng/mL). The mean apparent C_{max} in the oral group (3.217 ng/mL) was reached 2 hours after the dose and was approximately 1/5 of the average apparent C_{max} at 0.5 hour for the IV group. However, by 2 hours post dosing, the IV group mean plasma concentration dropped to 4.246 ng/mL which was comparable to the plasma concentration of the orally dosed group's mean plasma concentration of 3.217 ng/mL at that time. At 4 hours post dosing, there was a slight increase in the mean ondansetron plasma concentration of the IV group (5.177 ng/mL) while the mean ondansetron plasma concentration of the oral group decreased (2.482 ng/mL).

There were differences in the mean ondansetron plasma concentrations in the IV and oral groups, the biggest one being observed 0.5 hour after the ondansetron dose was given (Figure 3.28). The mean plasma concentration at 0.5 hour post-dosing in the IV ondansetron group was significantly higher than in the oral ondansetron group ($p=0.0015$). It was observed that the plasma concentrations of ondansetron for patients in the IV group were higher than that of the oral group at all times, however, unexpectedly, antiemetic prophylaxis with oral ondansetron generally appeared to provide patients with a better protection from CINV than prophylaxis with IV ondansetron. In fact, during chemotherapy treatment, nausea was less present in the oral ondansetron group than in the IV group (Figure 3.1), vomiting was identical for the two groups (Figure 3.2) and both appetite and daily activities were better in the oral ondansetron group (Figures 3.5 and 3.6). While IV ondansetron administration results in a rapid rise in plasma concentration followed by an equally rapid drop in plasma concentration, administration of an oral tablet of ondansetron offers a consistent elevated plasma level. Although the ondansetron plasma concentrations achieved after administration of an oral tablet were generally much lower than the ones following IV administration, the consistency in the plasma concentration seen with the oral tablet of ondansetron seemed to lead to a better antiemetic efficacy than the rapid rise and fall observed with IV administration.

3.2.4. Pharmacokinetics (PK) parameters

Although it was an objective to calculate some pharmacokinetic parameters for each ondansetron formulation (half-life ($t_{1/2}$), elimination rate constant (K_{el}) and volume of distribution (V_d)) the limited number of blood samples for each patient (4), the different time intervals for blood sampling (baseline, 30 min, 120 min and 240 min) and the high variation in detected plasma concentrations at each time point rendered the calculation of these PK parameters using XISimEst unreliable with variance greater than the calculated values.

3.3. Cost-effectiveness

The direct costs of the antiemetic prophylactic drugs were calculated using the prices in the MIMS 2009 and the MIMS 2012 (Snyman, 2009; Snyman, 2012). The cost of oral tablet ondansetron treatment in patients staying in hospital for less than 24 hours was R36.13; when a patient was hospitalized for more than 24 hours but less than 48 hours, antiemetic prophylaxis with oral tablet of ondansetron cost R108.39. For IV ondansetron, on the other hand, the cost for less than 24 hours in hospital was R52.4 and R157.2 when a patient stayed in hospital for more than 24 hours but less than 48 hours.

To these costs should be added the cost of nursing time, the requirement of a trained nurse or doctor to administer the drug and the placement of a drip-line/catheter prior to administration, all of which carry further costs to the patient or health care system when IV formulation is used.

The majority of the patients in this study stayed in hospital for less than 24 hours. Four patients in the IV group and two patients in the OT group stayed in the hospital for more than 24 hours but less than 48 hours. None of the patients stayed in hospital to receive chemotherapy treatment for 48 hours or more.

In neither group did any of the patients make use of any rescue antiemetic medication.

The difference in cost of the medication only, when comparing the OT and IV

ondansetron prophylaxis and treatment, was found to be statistically significant ($p=0.0351$) with IV ondansetron administration being more expensive to use than OT ondansetron. This was true without the infrastructure and personnel requirements taken into account.

CHAPTER 4: SUMMARY AND CONCLUSION

4.1. Summary

The purpose of this study was to evaluate the ease, efficacy and cost-effectiveness of an oral tablet of ondansetron in paediatric patients with cancer receiving moderately emetogenic chemotherapy. The primary objectives of this study were to compare the efficacy and cost-effectiveness of the oral tablet of ondansetron to that of IV ondansetron in these children. The secondary objectives were the comparison of the emetogenic status perception between the paediatric patients and their parents as well as the determination of some pharmacokinetics parameters of OT and IV ondansetron formulations. To reach these goals, an open-label, parallel, randomized trial was conducted in the paediatric oncology ward of the Steve Biko Academic Hospital. Thirty patients scheduled to receive moderately emetogenic chemotherapy were included in the study. They were randomly divided into two groups that would receive either the oral tablet or IV ondansetron formulation prior to chemotherapy as antiemetic prophylaxis. Each patient received 4 mg of either IV or oral Zofran® 30 minutes prior to the initiation of the chemotherapy.

Oral ondansetron tablets were easy to administer to the paediatric patients who participated in this trial; there was no report of any complications associated with the administration of oral tablets of ondansetron. Furthermore, it was easier to administer than IV ondansetron because it did not require the expertise of a medical practitioner or a trained nurse.

A visual analogue scale (VAS) evaluating nausea, vomiting, appetite and daily activities was completed by each participant at the end of the chemotherapy treatment as well as a week after the chemotherapy treatment was ended. Likewise, the parents were asked the same questions their children had to answer, except that a one-page questionnaire was used, both at the end of the chemotherapy treatment and a week after the end of chemotherapy. The information provided by the visual analogue scale assessment was used to evaluate the efficacy of the two ondansetron formulations. After analysis of the results recorded by the VAS based

questionnaire and comparing the oral tablet and IV ondansetron groups, some differences in efficacy were evident, with the orally administered ondansetron seemingly providing patients with better CINV protection than the IV formulation. Although these differences were not statistically significant, the patients who received antiemetic prophylaxis with oral ondansetron experienced less nausea as well as better appetite and daily activities compared to the patients who were administered IV ondansetron.

The cost of the oral Zofran® tablet was lower than the cost of the IV Zofran® formulation used in this study. If the requirement for trained personnel and sterile syringes and swabs is taken into consideration, then the cost of the oral administration is significantly lower than that of the IV administration. This difference in cost was statistically significant. Since the oral and IV formulations were shown to have similar efficacy under the conditions used (the differences that were observed in the efficacy of the two formulations were not statistically significant), oral ondansetron tablets were more cost-effective than IV ondansetron.

Pertaining to the perception of nausea and vomiting by the paediatric patients and their parents, it was observed that parents had a tendency to overstate the level of acute nausea felt by the children. These differences were found to be statistically significant. The children and their parents perceived delayed nausea in the same way. The perception of acute vomiting as well as delayed vomiting was exactly the same in the children and their parents. It was noticed that the extent of nausea and vomiting had a negative effect on the patients' appetite and daily activities; and this effect was reported by both the parents and the children.

Although the pharmacokinetics of oral tablet and IV ondansetron was to be investigated, a total of only four blood samples were allowed to be drawn from each patient during the study; this is a limited number of samples and thus proper pharmacokinetics analysis could not be conducted. These blood samples were thus used only to estimate the patients' plasma ondansetron concentrations over time using a quantitative liquid chromatography tandem mass spectrometry (LC-MS/MS) method. LC-MS/MS was the appropriate analytical technique to use for this determination, as it is rapid and sensitive enough to detect low plasma

concentrations of an analyte. The developed LC-MS/MS method used in this study enabled the quantitation of ondansetron in the patients' plasma samples at the concentrations found for both the IV and oral formulations administrations over time. Ondansetron was efficiently recovered from the patients' plasma samples; the mean recovery of ondansetron from human plasma being 110%. The method was linear over the range 0.5-100 ng/mL. The lower limit of quantification (LLOQ) was 0.5 ng/mL and the signal-to-noise ratio was higher than 44 for the lowest ondansetron concentration (0.5 ng/mL) in methanol-water. Imipramine was an appropriate internal standard (IS) to use as it was extracted equally well with a similar recovery of approximately 104%. In fact, in the case of ondansetron and this IS, no significant ion suppression was noticed in the region where the analyte and its IS were eluted. What is more, no interfering peaks were present when performing the analysis.

Thirty minutes after the ondansetron dose, the mean plasma concentration of ondansetron was much higher in the IV group than in the oral group; this difference was found to be statistically significant ($p=0.0015$). However, during the following two collection times (2 hours and 4 hours after the ondansetron dose), the mean plasma concentrations of the oral and IV groups were fairly comparable. There were a few deviations from the known pharmacokinetics of ondansetron in some patients such as extended times to reach maximum plasma concentration and extended terminal half-life but for most of the patients, the pharmacokinetics of ondansetron followed published trends. As expected, the IV formulation of ondansetron resulted in a rapid rise in plasma concentration followed by a rapid decrease while the plasma concentration of the oral administration increased more slowly and then slowly decreased after reaching apparent C_{max} . Overall, the ondansetron plasma concentrations measured in this study (for both the oral tablet and IV groups) were lower than the values reported in literature (Simpson and Hicks, 1996; de Wit *et al.*, 1996; GlaxoSmithKline, 2010), but it did not seem to lower the efficacy of ondansetron.

4.2. Conclusion

For the prevention of chemotherapy-induced nausea and vomiting, oral tablet of ondansetron, a 5-hydroxytryptamine 3 receptor antagonist, proved to be an easy to

use and cost-effective alternative to IV administered ondansetron in paediatric cancer patients receiving moderately emetogenic chemotherapy treatment.

The combination of visual analogue scales completed from the paediatric cancer patients perspective and questionnaires completed by their parents gave a good indication of the extent of nausea and vomiting experienced by these paediatric patients during the treatment and the follow-up periods. It was observed that the parents had a tendency to report a more severe acute nausea than what the children themselves reported; these differences in acute nausea perception were statistically significant ($p=0.018$).

Antiemetic prophylaxis with ondansetron only (IV or OT) 30 minutes prior to initiation of moderately emetogenic chemotherapy treatment provided most patients with good protection against emesis. However, research on the prevention and treatment of chemotherapy-induced nausea and vomiting is on-going and the prophylactic regimens are being intensified to increase efficacy. The updated guidelines published by Olver *et al.* in 2011 now recommend the use of the combination of a 5-hydroxytryptamine 3 (5-HT₃) receptor antagonist (e.g. ondansetron), dexamethasone and a neurokinin 1 (NK1) antagonist (e.g. aprepitant) for adequate prophylaxis and treatment of chemotherapy-induced nausea and vomiting (Olver *et al.*, 2011) and thus ondansetron alone is no longer regarded as sufficient. The published guidelines take emesis into consideration but not nausea, which is a problem because patients in this study experienced nausea more often than vomiting during and after chemotherapy. Therefore, more research should be done to better understand nausea and find ways to appropriately control this side effect (Olver *et al.*, 2011).

The pharmacokinetics of ondansetron in the study participants generally followed the trend reported in the literature, although some exceptions were found and there are possible explanations due to treatment deviations from the trial protocol. In some patients, possible interactions between ondansetron and the antineoplastic drugs they received appeared to affect the pharmacokinetics of ondansetron. However, it has been reported that chemotherapy regimens generally do not affect the pharmacokinetics of ondansetron (Martindale, 2008; GlaxoSmithKline, 2010). Therefore, it is not possible to draw a conclusion on what happened in the patients

with unexpected ondansetron pharmacokinetics. Furthermore, proper determination of pharmacokinetics parameters such as $t_{1/2}$, K_{el} and V_d for each ondansetron formulation could not be done due to the limited number of blood samples that were obtained from the patients.

The sample size of thirty (30) patients was small, which is one of the limitations of this study. A further limitation is the fact that the patients received different chemotherapy regimens for their cancers; a comparison with identical chemotherapy regimens would be more accurate. Furthermore, the number of blood samples per patient used for the determination of ondansetron plasma concentrations and pharmacokinetics parameters in this study were very limited. Further studies that compare the efficacy of oral tablets of ondansetron to IV ondansetron in children should be conducted on larger numbers of participants in order to overcome the sample size limitation of this study and then if more samples were drawn, pharmacokinetics parameters could be properly determined.

As the oral tablet administration of ondansetron has shown equivalent or even slightly better efficacy at a significantly reduced cost (limited expenses), limited resources and time saving compared to the standard intravenous administration of ondansetron, it can be concluded that the oral tablet formulation could be used to replace the standard treatment used at present at the Steve Biko Academic Hospital in Pretoria, Gauteng (South Africa).

REFERENCES

- A.D.A.M. Medical Encyclopedia. Hodgkin's lymphoma. 7 February 2011. <http://www.ncbi.nlm.nih.gov/pubmedhealth/PMH0001606/>. Accessed on October 4, 2012.
- Apro MS, Grunberg SM, Manikhas GM, Olivares G, Suarez T, Tjulandin SA, Bertoli LF, Yunus F, Morrica B, Lordick F and Macciocchi A (2006). A phase III, double-blind, randomized trial of palonosetron compared with ondansetron in preventing chemotherapy-induced nausea and vomiting following highly emetogenic chemotherapy. *Annals of Oncology*; 17: 1441–1449.
- All Children's Hospital. BMI Calculator; Know your Body Mass Index. 2012. www.allkids.org/body.cfm?id=574. Accessed on October 17, 2012.
- Armando YP, Schramm SG, de Freitas Silva M, Kano EK, Koono EEM, Porta V and dos Reis Serra CH (2009). Bioequivalence assay between orally disintegrating and conventional tablet formulations in healthy volunteers. *International Journal of Pharmaceutics*; 366: 149–153.
- Axt J, Murphy AJ, Seeley EH, Martin CA, Taylor C, Pierce J, Caprioli RM, Whiteside M and Lovvorn HN (2011). Race Disparities in Wilms Tumor Incidence and Biology. *J Surg Res.*; 170 (1): 112–119. doi:10.1016/j.jss.2011.03.011.
- Badr MA, Al-Tonbary YA, Mansour AK, Hassan TH, Beshir MR, Darwish A and El-Ashry RA (2012). Epidemiological Characteristics and Survival Studies of Rhabdomyosarcoma in East Egypt: A Five-Year Multicenter Study. *ISRN Oncology*; 2012; Article ID 674523, 8 pages, doi:10.5402/2012/674523.
- Bayo J, Fonseca PJ, Hernando S, Servitja S, Calvo A, Falagan S, García E, González I, de Miguel MJ, Pérez Q, Milena A, Ruiz A and Barnadas A (2012). Chemotherapy-induced nausea and vomiting: pathophysiology and therapeutic principles. *Clin Transl Oncol*;14: 413-422.

- Cancer Association of South Africa (CANSA). TLC for Youth and Families Affected by Cancer. 26 May 2012. <http://www.cansa.org.za/tlc-for-youth-and-families-affected-by-cancer/>. Accessed on October 2, 2012.
- Castellino SM, Geiger AM, Mertens AC, Leisenring WM, Tooze JA, Goodman P, Stovall M, Robison LL, and Hudson MM (2011). Morbidity and mortality in long-term survivors of Hodgkin lymphoma: a report from the Childhood Cancer Survivor Study. *Blood* 117 (6):1806-1816.
- Chandler Medical Center, (859) 323-5320. Chemotherapy-Induced Nausea and Vomiting Guidelines for Adult and Pediatric Patients at UK Hospital. 2002. http://www.hosp.uky.edu/pharmacy/formulary/criteria/chemoinduced_N-V.pdf. Accessed on October 4, 2012.
- Childhood Cancer Foundation South Africa (CHOC). Cancer Facts.2012. http://www.choc.org.za/cancer_facts.html. Accessed on March 24, 2012.
- Çorapçıoğlu F and Sarper N (2005). A Prospective Randomized Trial of the antiemetic efficacy and cost-effectiveness of intravenous and orally disintegrating tablet of ondansetron children with cancer. *Pediatric Hematology and Oncology*; 22: 103-114.
- Davidson N, Rapoport B, Erikstein B, L'Esperance B, Ruff P, Paska W, Miller I and Curtis P (1999). Comparison of an Orally Disintegrating Ondansetron Tablet with the Conventional Ondansetron Tablet for Cyclophosphamide-Induced Emesis in Cancer Patients: A Multicenter, Double-Masked Study. *Clinical Therapeutics*; 21(3): 492-502.
- de Alwis DP, Aarons L and Palmer JL (1998). Population pharmacokinetics of ondansetron: a covariate analysis. *Br J Clin Pharmacol*; 46: 117-125.
- de Wit R, Beijnen JH, van Tellingen O, Schellens JHM, de Boer-Dennert M and Verweij J (1996). Pharmacokinetic profile and clinical efficacy of a once-daily ondansetron suppository in cyclophosphamide-induced emesis: a double blind comparative study with ondansetron tablets. *British Journal of Cancer*; 74: 323-326.

- Dewan P, Singhal S and Harit D (2010). Management of Chemotherapy-Induced Nausea and Vomiting. *Indian Pediatrics*; 47: 149-155.
- Dome Jeffrey S and Vicki Huff (2011). Wilms Tumor Overview. Pagon RA, Bird TD, Dolan CR, et al., editors. GeneReviews™ [Internet]. Seattle (WA): University of Washington, Seattle; 1993-2012. Bookshelf ID: NBK1294 PMID: 20301471.
- Dorak MT and Karpuzoglu E (2012). Gender Differences in Cancer Susceptibility: An Inadequately Addressed Issue. *Frontiers in Genetics* 3:268. doi:10.3389/fgene.2012.00268.
- Durand J-P, Madelaine I, Scotté F (2009). Guidelines for prophylaxis and treatment of chemotherapy-induced nausea and vomiting. *Bulletin du Cancer*; 96 (10): 951-960.
- En.wikibooks.org. Proteomics/Protein Sample Preparation/Sample Preparation for Mass Spectrometry. 02 October 2011. http://en.wikibooks.org/wiki/Proteomics/Protein_Sample_Preparation/Sample_Preparation_for_Mass_Spectrometry. Accessed on September 26, 2012.
- Frank SA. Dynamics of cancer: Incidence, Inheritance, and Evolution (2007). Published by Princeton University Press, Princeton and Oxford. Introduction (Page 1).
- Freed J and Kelly KM. (2010). Current approaches to the management of pediatric Hodgkin lymphoma. *Pediatric Drugs*; 12 (2): 85-98.
- GlaxoSmithKline. Prescribing information ZOFTRAN® (ondansetron hydrochloride) Tablets ZOFTRAN ODT® (ondansetron) Orally Disintegrating Tablets ZOFTRAN® (ondansetron hydrochloride) Oral Solution. 2011. http://us.gsk.com/products/assets/us_zofran_tablets.pdf. Accessed on June 17, 2012.
- GlaxoSmithKline. Prescribing information ZOFTRAN® (ondansetron hydrochloride) injection for intravenous use. 2012. http://us.gsk.com/products/assets/us_zofran_tablets.pdf. Accessed on June 17, 2012.

- Globocan 2008 (IARC). Fast Stats. IARC, 2010.
<http://globocan.iarc.fr/factsheets/populations/factsheet.asp?uno=900>.
Accessed on March 24, 2012.
- Grunberg SM, Deuson RR, Mavros P, Geling O, Hansen M, Cruciani G, Daniele B, De Pouvourville G, Rubenstein EB., Daugaard G (2004). Incidence of Chemotherapy-Induced Nausea and Emesis after Modern Antiemetics. Perception versus Reality. *Cancer* 2004; 100:2261–2268.
- Hejmadi Momna. Introduction to Cancer Biology (2010). Momna Hejmadi & Ventus Publishing ApS. Defining Cancer (Page 6).
- Hesketh PJ (2008). Chemotherapy-Induced Nausea and Vomiting. *N Engl J Med*; 358 (23): 2482-2494.
- Howland RD., Mycek MJ. Lippincott's illustrated reviews: Pharmacology (2006). Published by Lippincott William & Wilkins. Third Edition. Routes of drug administration (Pages 1-3).
- Hsyu P-H, Pritchard JF , Bozigian HP, Lloyd TL, Griffin RH , Shamburek R, Krishna G and Barr WH (1994). Comparison of the Pharmacokinetics of an Ondansetron Solution (8 mg) When Administered Intravenously, Orally, to the Colon, and to the Rectum. *Pharmaceutical Research*; 11 (1): 156-159.
DOI: 10.1023/A:1018974501232.
- Ignoffo RJ and Rosenbaum EH. What happens in chemotherapy (2008). In: Ko AH, Dollinger M, Rosenbaum EH, eds. *Everyone's Guide to Cancer Therapy, Revised 5th Edition*. Kansas City, MS: Andrew McMeel Publishing; 2008.
- Jain V, Mohta A, Sengar M, Khurana N (2011). Is antenatal detection of Wilms' tumor a bad prognostic marker? *Indian Journal of Medical and Pediatric Oncology* 32 (4): 214-216.
- Jordan K, Sippel C, Schmoll H-J (2007) Guidelines for Antiemetic Treatment of Chemotherapy-Induced Nausea and Vomiting: Past, Present, and Future Recommendations. *The Oncologist* ; 12:1143–1150.

- Kaatsch P (2010). Epidemiology of childhood cancer. *Cancer Treatment Reviews*; 36: 277–285.
- Kelly KM, Sposto R, Hutchinson R, Massey V, McCarten K, Perkins S, Lones M, Villaluna D and Weiner M (2011). BEACOPP chemotherapy is a highly effective regimen in children and adolescents with high-risk Hodgkin lymphoma: a report from the Children's Oncology Group. *Blood*; 117 (9): 2596-2603.
- Komada Y, Matsuyama T, Takao A, Hongo T, Nishimura Y, Horibe K and Sakurai M (1999). A Randomised Dose-comparison Trial of Granisetron in Preventing Emesis in Children with Leukaemia Receiving Emetogenic Chemotherapy. *European Journal of Cancer*, 35 (7): 1095-1101.
- Kris MG, Hesketh PJ, Somerfield MR, Feyer P, Clark-Snow R, Koeller JM, Morrow GR, Chinnery LW, Chesney MJ, Gralla RJ, and Grunberg SM (2006). American Society of Clinical Oncology Guideline for Antiemetics in Oncology: Update 2006. *J Clin Oncol*; 24:2932-2947.
- Kutztown University. Chemistry. High Performance Liquid Chromatography. 25 July 2011. http://www.kutztown.edu/acad/chem/instruments_html/hplc.htm. Accessed on September 26, 2012.
- Lerman J, Sphar-Schopfer A, Sikich N (1993) Pharmacokinetics of intravenous ondansetron in healthy children. *Can. J. Anaesthesiol.* A24.
- Lohr L (2008). Chemotherapy-Induced Nausea and Vomiting. *The Cancer Journal*; 14 (2).
- Malempati S, Rodeberg DA, Donaldson SS, Lyden ER, Anderson JR, Hawkins DS and Arndt CAS (2011). Rhabdomyosarcoma in Infants Younger Than 1 Year; A Report From the Children's Oncology Group. *Cancer*; 117 (15): 3493-3501.
- Martin JW, Squire JA and Zielenska M (2012). The Genetics of Osteosarcoma. *Sarcoma*; 2012, Article ID 627254, 11 pages, doi:10.1155/2012/627254.

- Martindale- The complete drug reference (2008). Sweetman. Published by Pharmaceutical Press. 2007. Thirty-fifth edition. Ondansetron (Part 1: gastrointestinal drugs).
- MASCC: The Antiemetic Subcommittee of the Multinational Association of Supportive Care in Cancer (2006). Prevention of chemotherapy- and radiotherapy-induced emesis: results of the 2004 Perugia International Antiemetic Consensus Conference. *Annals of Oncology*; 17: 20–28.
- Mashhadi MA, Sanadgol H, Keikhaei M (2011). Ifosfamide Nephropathy in Patients With Sarcoma. *Iranian Journal of Kidney Diseases*; 5 (4): 238-241.
- McMaster MC. LC/MS: a practical user's guide (2005). Published by John Wiley & Sons (Page 1).
- Miller E, Jacob E and Hockenberry MJ (2011). Nausea, Pain, Fatigue and Multiple Symptoms in Children Hospitalized with Cancer. *Oncology Nursing Forum*; 38 (5): E382-E393.
- Moreira RF, Salvadori MC, Azevedo CP, Oliveira-Silva D, Borges DC, Moreno RA, Sverdloff CE and Borges NC (2010). Development and validation of a rapid and sensitive LC-ESI-MS/MS method for ondansetron quantification in human plasma and its application in comparative bioavailability study. *Biomed. Chromatogr.*; 24: 1220–1227.
- National Center for Health Statistics (NCHS) in collaboration with the National Center for Chronic disease prevention and Health Promotion (NCCH). Growth charts – Clinical growth charts. May 30, 2000 (Modified October 16, 2000). <http://www.cdc.gov/growthcharts>. Accessed on October 17, 2012.
- National Cancer Institute. Chemotherapy and you. May 2007. <http://www.cancer.gov/cancertopics/coping/chemotherapy-and-you.pdf>. Accessed on February 28, 2012.
- Niessen W and van der Greef J. Liquid chromatography: mass spectrometry: principles and applications (1992). Published by Marcel Dekker, Inc. Introduction to liquid chromatography (Page 3), introduction to mass spectrometry (Pages 29, 45 and 57).

- Olver I, Molassiotis A, Aapro M, Herrstedt J, Grunberg S and Morrow G (2011). Antiemetic research: future directions. *Support Care Cancer*; 19 (Suppl 1):S49–S55.
- Oxford Advanced Learner’s Dictionary of Current English (2000). AS Hornby. Published by Oxford University Press. Sixth Edition. Cancer (Page 158).
- Pirri C, Bayliss E, Trotter J, Olver IN, Katris P, Drummond P and Bennett R (2012). Nausea still the poor relation in antiemetic therapy? The impact on cancer patients’ quality of life and psychological adjustment of nausea, vomiting and appetite loss, individually and concurrently as part of a symptom cluster. *Support Care Cancer* DOI 10.1007/s00520-012-1574-9 (Published online 12 September, 2012).
- Rang HP, Dale MM, Ritter JM and Flower RJ. Rang and Dale’s Pharmacology (2007). Published by Elsevier Limited. Sixth edition. Drugs used in the treatment of infections and cancer (pp. 718-735).
- Robinson LL (2011). Late Effects of Acute Lymphoblastic Leukemia Therapy in Patients Diagnosed at 0-20 Years of Age. *Hematology*; 2011 (1): 238-242.
- Rodeberg DA, Garcia-Henriquez N, Lyden ER, Davicioni E, Parham DM, Skapek SX, Hayes-Jordan AA, Donaldson SS, Brown KL, Triche TJ, Meyer WH, and Hawkins DS (2011). Prognostic Significance and Tumor Biology of Regional Lymph Node Disease in Patients With Rhabdomyosarcoma: A Report From the Children’s Oncology Group. *Journal of Clinical Oncology*; 29 (10): 1304-1311.
- Roila F, Aapro M, Stewart A (1998). Optimal selection of antiemetics in children receiving cancer chemotherapy. *Support Care Cancer*; 6:215–220.
- Roila F and Del Favero A (1995). Ondansetron Clinical Pharmacokinetics. *Clinical Pharmacokinetics*; 29 (2): 67-138.
- Roila F, Feyer P, Maranzano E, Olver I, Clarck-Snow R, Warr D and Molassiotos A (2005). Antiemetics in children receiving chemotherapy. *Support Care Cancer*; 13:129–131.

- Ruddon RW. Cancer Biology (1995) Third Edition. Oxford University Press. Basic facts about cancer (Page 3).
- Sandoval JA, Malkas LH and Hickey RJ (2012). Clinical Significance of Serum Biomarkers in Pediatric Solid Mediastinal and Abdominal Tumors. *Int. J. Mol. Sci.*; 13: 1126-1153; doi:10.3390/ijms13011126.
- Savitskaya YA, Rico-Martínez G, Linares-González LM, Delgado-Cedillo EA, Téllez-Gastelum R, Alfaro-Rodríguez AB, Redón-Tavera A and Ibarra-Ponce de León JC (2012). Serum tumor markers in pediatric osteosarcoma: a summary review. *Clinical Sarcoma Research* 2012 (2): 1-9.
- Scott RH, Murray A, Baskcomb L, Turnbull C, Loveday C, Al-Saadi R, Williams R, Breatnach F, Gerrard M, Hale J, Kohler J, Lapunzina P, Levitt GA, Picton S, Pize B, Ronghe MD, Traunecker H, Williams D, Kelsey A, Vujanic GM, Sebire NJ, Grundy P, Stiller CA, Pritchard-Jones K, Douglas J and Rahman N (2012). Stratification of Wilms tumor by genetic and epigenetic analysis. *Oncotarget*; 3: 327-335
- Simpson KH and Hicks FM (1996). Clinical Pharmacokinetics of Ondansetron. A Review. *J. Pharm. Pharmacol*; 48: 774-781.
- Small BE, Holdsworth MT, Raisch DW and Winter SS (2000). Survey Ranking of Emetogenic Control in Children Receiving Chemotherapy. *Journal of Paediatric Hematology/ Oncology*; 22(2): 125-132.
- Snyman JR. Monthly Index of Medical Specialties (MIMS), Volume 49 Number 5. May 2009. Serotonin Antagonists, Zofran, pp. 93-94.
- Snyman JR. Monthly Index of Medical Specialties (MIMS), Volume 52 Number 2. February 2012. Serotonin Antagonists, Zofran, p 103.
- Spahr-Schopfer IA, Lerman J, Sikich N, Palmer J and Jorch U (1995). Pharmacokinetics of intravenous ondansetron in healthy children undergoing ear, nose, and throat surgery. *Clinical Pharmacology & Therapeutics*; 58 (3): 316-321.

- Statistics South Africa. Statistical release P0302. 27 July 2011.
<http://www.statssa.gov.za/publications/P0302/P03022011.pdf>. Accessed on October 16, 2012.
- Stiakaki E, Savvas S, Lydaki E, Bolonaki I, Kouvidi E, Dimitriou H, Kambourakis A and Kalmanti M (1999). Ondansetron and tropisetron in the control of nausea and vomiting in children receiving combined cancer chemotherapy. *Paediatric Hematology and Oncology*; 16:101-108.
- Stiller CA and Parkin DM (1990). International variations in the incidence of childhood renal tumours. *Br. J. Cancer*; 62: 1026-1030.
- University of Iowa Healthcare. Guide to antiemetic use in adult oncology settings.
2011.<http://www.healthcare.uiowa.edu/pharmacy/formulary/Pocketguide/GuideToAntiemeticUseinAdultOncology.pdf>. Accessed on October 5, 2012.
- Watson JT and Sparkman OD .Introduction to mass spectrometry : instrumentation, applications and strategies for data interpretation (2007). Published by John Wiley & Sons. Fourth Edition (Pages 3-6).
- White L, Daly SA, McKenna CJ, Zhestkova N, Leal C, Breatnach F, Smelhaus V, Hung I-J, Kowalczyk J, Ninane J, Mitchell T and Haigh C (2000). A comparison of oral ondansetron syrup or intravenous ondansetron loading dose regimens given in combination with dexamethasone for the prevention of nausea and emesis in paediatric and adolescent patients receiving moderately/highly emetogenic chemotherapy. *Paediatric Hematology and Oncology*; 17:445 – 455.
- Williams PD, Williams AR, Kelly KP, Dobos C, Giesecking A, Connor R, Ridder L, Potter N and Del Favero D (2012). A Symptom Checklist for Children With Cancer. *Cancer NursingTM*;35(2): 89-98.
- Wong DL, Hockenberry-Eaton M, Wilson D, Winkelstein ML, Schwartz P. Wong's Essentials of Paediatric Nursing. Sixth Edition, St. Louis, 2001 Mosby. p. 1301.

- Wood JM., Chapman K, Eilers J (2011). Tools for Assessing Nausea, Vomiting, and Retching. *Cancer Nursing*TM; 34(1): E14-E24.
- World Health Organization (WHO). Cancer. Fact sheet N°297. February 2012. <http://www.who.int/mediacentre/factsheets/fs297/en/index.html>. Accessed on March 24, 2012.