



08. DESIGN & TECHNICAL RESOLUTION

Figure 172. Follow spot effect 2 kW
(McGill, 2007).

8.1 TYPICAL SET CONSTRUCTION

The list of materials used in the construction of scenery is endless. New innovations, materials and applications are constantly introduced to the theatre. There are however certain materials that are considered to be standard, widely used, traditional stage materials. Parker & Smith (1974, 164) classify these materials as follows.

8.1.1 Structural materials

Timber

Timber is the most common framing and structural material. Timber used for scenery must be lightweight, straight, strong and cheap. In South Africa clear pine provides the best combination. Clear SA pine is preferred because it has few knots that cause weak spots in the wood that tend to split. Wood is combustible and must be protected with paint, varnish or fire and water resistant agents. Timber is recyclable and reusable.

Metal

Hollow, square and angle iron sections are used for the structural frames of platforms and panel scenery and to support standing scenery. Malleable iron pipes is used for battens to support hanging scenery, as a weight or bottom batten for a drop; for lighting booms and as structural elements (Parker & Smith, 1974, 168).

8.1.2 Cover stock

The material used to cover the structural frame of scenery is called cover stock. Depending on the use fabric or a hard surface material can be used.

Covering Fabrics (soft Scenery)

Structural frames are traditionally covered with canvas although any fabric can be used as covering. Fabrics like gauzes (scrimps), vision, square or sharks tooth mesh, Holt (1988, 33) and Hessian are often used to create textured or lighting effects. In South Africa unbleached Calico is most often used as a substitute because it is lighter, cheaper and more readily available. Fabric covering is fireproofed and sewn to size. A thin mixture of water and PVA paint is used to prepare the surface before it gets painted.

Hard surfaces

If the surface is such that it has to be walked on or withstand active handling, the frame is covered with a harder surface. Plywood is most commonly used because it is lightweight yet strong enough to supply a hard surface with a minimum of framing. Laminated wood is sometimes used as a substitute. Masonite, a very hard surface of compressed wood pulp, is also commonly used as a floor covering. Thin plywood is mainly used for platform tops. Double faced corrugated cardboard is an inexpensive hard surface covering (Parker & Smith, 1974, 170).

8.1.3 Hardware

Joining hardware

Joining hardware includes nails, screws, tacks, staples, and bolts used for joining wood or metal.

Stage hardware

Stage hardware refer to hardware made especially for the stage and designed to brace, stiffen, rig flying scenery and temporarily join units of scenery (Parker & Smith, 1974, 172).

8.1.4 Rope, cable, and chains

Cotton braid rope

This type of rope is used for lightweight rigging and as a trick line to trigger a mechanical effect from an offstage position.

Manila rope

Stranded manila rope is used for heave rigging.

Cable

Cable is used to hang scenery when the supporting wire will be in view. Cables are very strong for its small diameter and can support a heavy piece of scenery without being too prominent.

Chain:

in theatre chains are used for special rigging and as weights for draperies.

8.1.5 Structural materials

Timber

Timber is the most common framing and structural material. Timber used for scenery must be lightweight, straight, strong and cheap. In South Africa clear pine provides the best combination. Clear SA pine is preferred because it has few knots that cause weak spots in the wood that tend to split. Wood is combustible and must be protected with paint, varnish or fire and water resistant agents. Timber is recyclable and reusable.

Metal

Hollow, square and angle iron sections are used for the structural frames of platforms and panel scenery and to support standing scenery. Malleable iron pipes is used for battens to support hanging scenery, as a weight or bottom batten for a drop; for lighting booms and as structural elements (Parker & Smith, 1974, 168).

Chain:

in theatre chains are used for special rigging and as weights for draperies.

8.1.6 Free forms

Depending on the form, irregular three-dimensional pieces of scenery are created by constructing a framework from a structural material such as timber or metal. Contour pieces are often cut across the shortest dimension, fixed to a base shape and stiffened with cross bracing. The frame is wrapped in chicken wire so that it adapts to the shape of the frame. The final surface is then applied to the chicken wire. Usually unbleached Calico is dyed with a base colour, dipped in a water-and-wood glue mixture, tacked to the frame and allowed to dry. Once dry effect painting and texturing (saw dust) are applied. Free forms are also frequently made from fibreglass, polystyrene or polyurethane which is undesirable unless reused, because they are environmentally unfriendly. These pieces are lightweight, inexpensive and sturdy (Parker & Smith, 1974, 204).



Figure 176. Construction of steel frame, Johannesburg Theatre (Author, 2010).



Figure 173. Construction of a rostra, Pretoria State Theatre (Author, 2010).



Figure 174. Frames used for the painting canvas backdrops, Pretoria State Theatre (Author, 2010).



Figure 175. Canvas cyclorama suspended with cables, Johannesburg Theatre (Author, 2010).

8.2 MATERIALS

8.2.1 Approach

“A seamless package is frustratingly daunting. However, a broken system is usually one that attracts the most attention... breaks enable one to understand better how something should or could work.”
 (Fuller & Haque, 2009)

When encouraging the reuse and re-purposing of buildings and materials Fuller & Haque, (2009) recommend the use of what they call “pre-broken” materials and buildings.

The fabric of the existing building could be considered as pre-broken. It is a utility industrial building that speaks of creating rather than an intimidating, pristine or precious building.

Pre-broken materials are materials that are discarded, unused, readily decomposed and are interrogate-able or hack-able. Because these materials aren't expected to last they encourage reuse and re-purposing and enable people to experiment and participate. Building with these materials requires constant innovation, replenishment and reconstruction and emphasises the ephemerality of architectural constructs, says Fuller & Haque, (2009).

8.2.2 Temporality

Materials chosen for this design were chosen based on their temporality or ephemeral feel. The inserted space is of a temporary nature and therefore the materials should speak of the transient nature of the design. Materials perceived as temporary materials will be easily distinguishable from the permanent fabric of the existing building and reinforce the concept of symbiosis between the temporary and permanent elements.

Materials already used in a temporary fashion in the Pretoria CBD were observed during the framework investigation and informed material choices.

Greef (2005, 3-6) is of opinion that South Africans reject the notion of temporary and reused materials mainly because of the perceived stigma of inferiority. By using these kind of materials in an innovative and fun way could greatly improve the public's perception and open them up to the idea. It also gives designers the opportunity to experiment with and test the use of these materials.

8.2.3 Availability & sustainability

Material was selected based on whether they could be sourced locally. Using available materials from the site and surrounding area are cheaper and faster. The embodied energy will also be less that if materials had to be transported over great distances. The local community could the also benefit and be involved in the collecting of materials.

8.2.4 Floor covering

Interlocking, recycled rubber floor tiles qualify as a green product.

Rubber tiles usually comes in square sizes from 300-500mm, it is a bit easier to install and can easily be mixed to create patterns. A tile can be replaced if needed.

Sheets: Rubber sheets are better protected against moisture and water damage due to less seams than tiles.

* Glued: The rubber tile or sheet gets glued to the sub-floor.

* Interlock: The rubber tiles are manufactured with a locking system.

Pattern Options

* Plain: Available in both tiles or sheets this floor has a smooth surface.

Recycled rubber flooring is suitable for indoor and outdoor use. It has outstanding slip-resistance, low VOC emissions, provides cushioned resilience and is very durable, stain resistant and has constant colour. (ECOsurfaces, 2005).

Installation and maintenance are relatively easy. Rubber flooring is generally considered a low-impact, environmentally friendly building material. Flooring that contains recycled rubber is a cheaper and more durable choice than synthetic or virgin rubber says TVE (2002). The energy required to process the used tyres and chemicals is lower than that used to produce other resilient flooring says ECOsurfaces (2005).

Additional recycling benefits can be realized if rubber flooring is installed without adhesive. The environmental impact of manufacturing the adhesive is eliminated and the air quality of the area where the adhesive would have been used is improved. Rubber tiles are flammable but they are 100% recyclable.

Carpet

Styles Loop Pile: The loop pile carpet is an great all rounder both for residential and commercial use. This is due to the fairly low pile and tight weave which makes for easy cleaning and is also available in a wide range of colour combinations.

Dark colours: Deep colours create a cosier feeling in rooms, as well as disguising dirt and stains better than lighter shades. Dust and lint will show up more on darker colours, making a darker palette ideal for rooms that have high use.

This is a crucial part of the installation and serves a variety of purposes. Underlay or under felt drastically lengthens the life of your carpet and serves as a shock absorber, reducing the strain of impact on your carpet, this will also reduce pile crushing. Protecting your carpets backing from rubbing on the sub-floor is also an important function while allowing for airflow beneath your carpet. Sound and heat insulation are also added benefits.

Always use a good quality underlay, in South Africa the most common and cost effective underlay is the fibre underfelts which are classified in ranges by the gram per m² of the underlay. The minimum recommended is the 800gsm but we recommend you ask your supplier

for the 1000gms under felt which is most commonly used.

Carpet Pile Fibres

Blends: It is a popular practice to blend the above fibre types in order to use the best properties from each and also to reduce the cost of the more expensive fibre types like wool.

Polyester: Polyester is available in vibrant colours and has similar properties to Nylon, non-allergenic, moisture and wear resistant properties, high resistance to staining, does not fade easily and is also permanently anti-static, but lacks the same degree of durability.

Wool: Unique, Natural, Soft, Luxurious and more, guarantees an exceptional experience. Wool also naturally has excellent properties like, water repellent, flame resistant, resistant to crushing, extremely durable and naturally antistatic, which improves soil resistance and ease of maintenance. Wool also has good sound and thermal insulation properties and gives unsurpassed comfort underfoot. This premium fibre is in a class of its own, as its price will reflect.

8.2.5 Temporary local materials

cardboard boxes



wood pallets



recycled wood



plastic cold drink crates



shopping centre trolleys



printed vinyl billboards



scaffolding & shade net



Figure 177. Local material inspiration (Author, 2010).

8.2.6 Temporary materials on site & application examples

cardboard tubes



Figure 178. Wooden pallets used for raked seating (Michler, 2010).



cardboard drums



Figure 179. Stacked cardboard tubes creating a wall (Heaney, 2005).

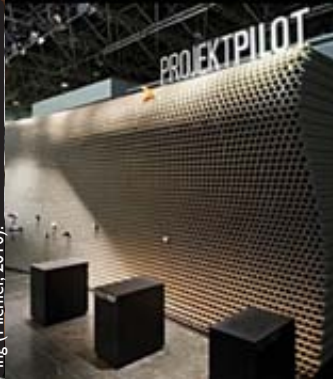

Figure 180. Stacked cardboard tubes creating a room (Ohrt, 2007).



wood crates



cardboard boxes



paper



wood pallets



cardboard sheets



Figure 181. Stacked cardboard boxes creating an entrance (Fairs, 2008).



Figure 182. Stacked cardboard sheets creating an enclosed sound box (The Cool Hunter, 2007).



8.3 FLOOR PLANS

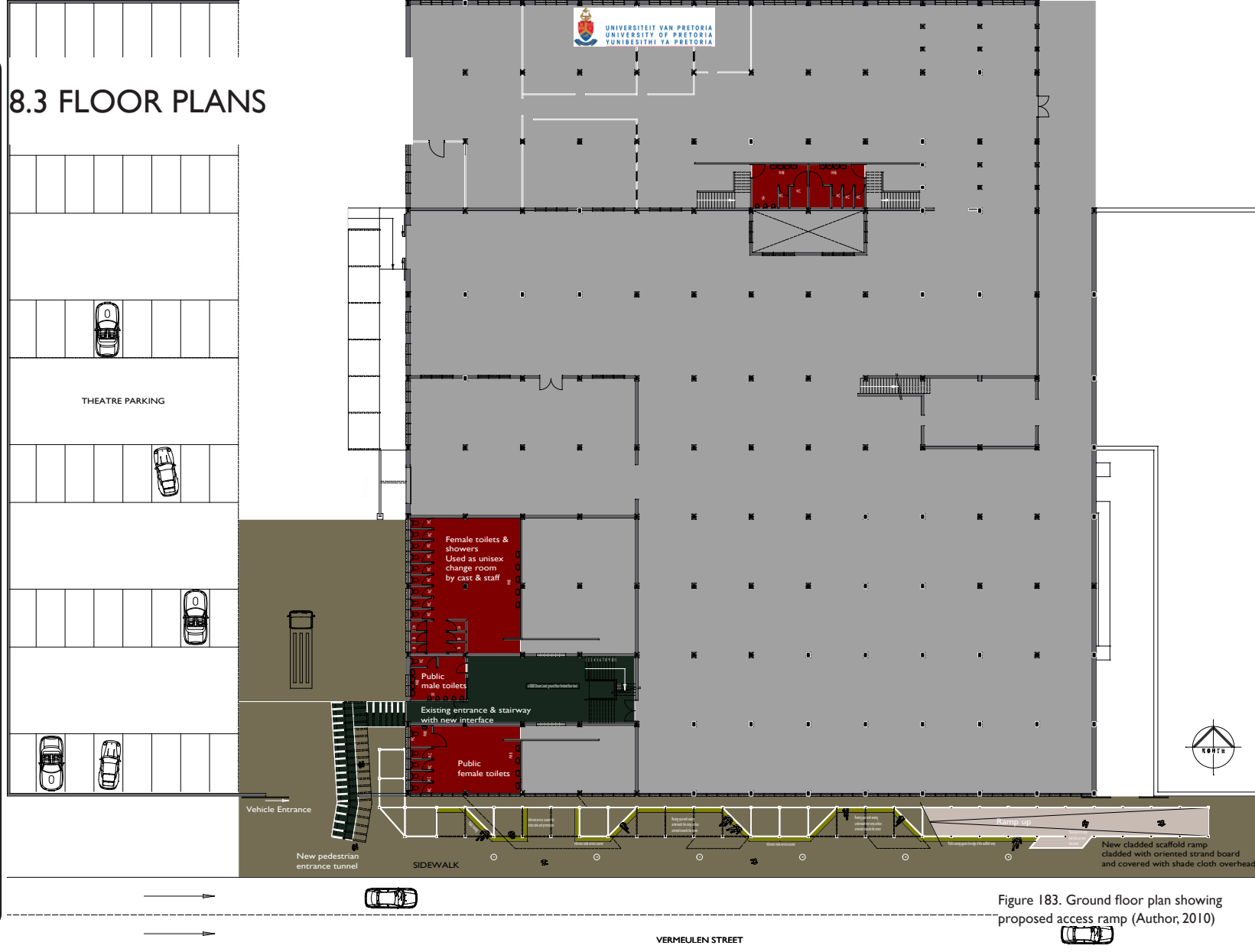

Figure 183. Ground floor plan showing proposed access ramp (Author, 2010)

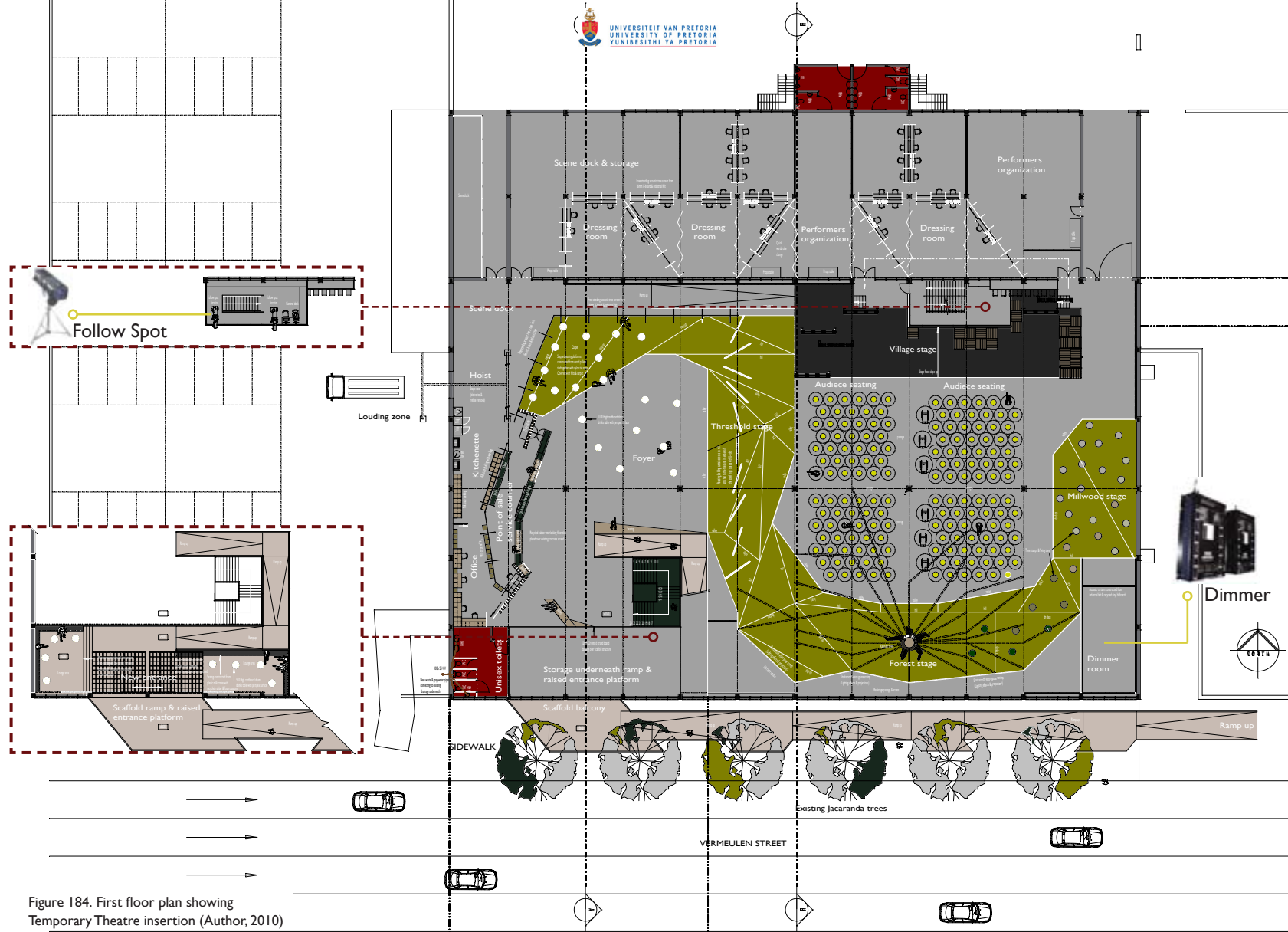
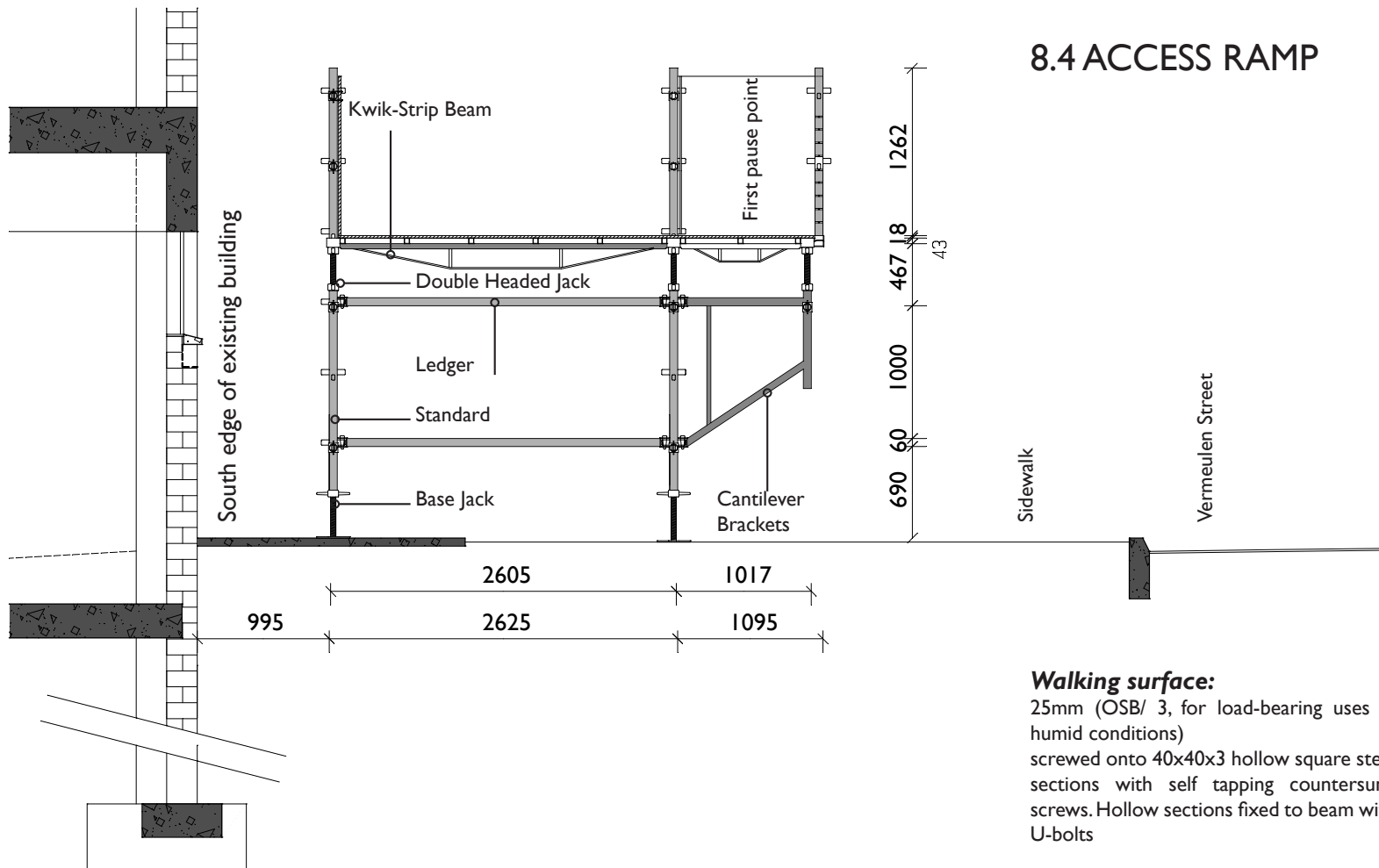

Figure 184. First floor plan showing Temporary Theatre insertion (Author, 2010)



8.4 ACCESS RAMP

Walking surface:
 25mm (OSB/ 3, for load-bearing uses in humid conditions)
 screwed onto 40x40x3 hollow square steel sections with self tapping countersunk screws. Hollow sections fixed to beam with U-bolts

8.4.1 SECTION THROUGH SCAFFOLD RAMP

1:50

Figure 185. Section through scaffold ramp
 (Author, 2010)

KwikAz clips

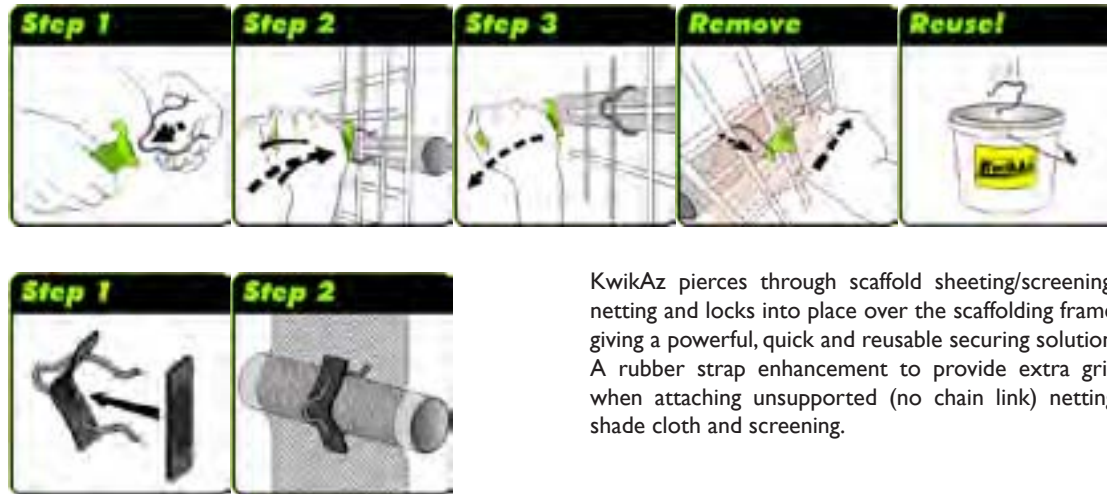

KwikAz pierces through scaffold sheeting/screening/netting and locks into place over the scaffolding frame, giving a powerful, quick and reusable securing solution. A rubber strap enhancement to provide extra grip when attaching unsupported (no chain link) netting, shade cloth and screening.



Figure 187. Example of new sliding door to be fitted in two existing window openings after windows have been removed (Marathondoors, 2010)

Figure 186. Diagrams illustrating how KwikAz clips work (Scaffold Industry Association, 2010)



Figure 188. South facade (Author, 2010)

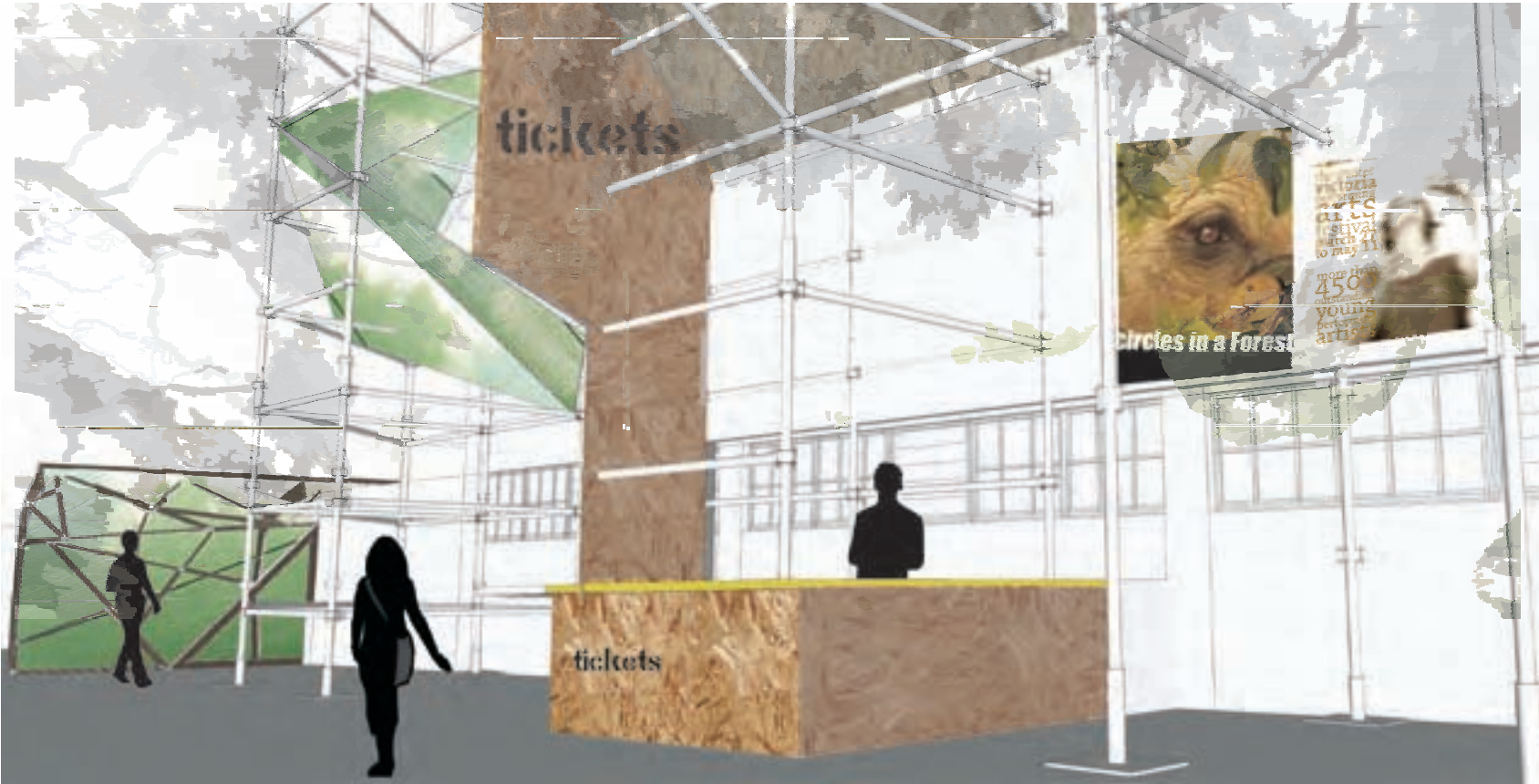

Figure 189. Perspective of space underneath the access ramp showing the secondary entrance, shade cloth wrapping & ticket sales counter (Author, 2010)

8.4.3 PERSPECTIVES OF STREET INTERFACE & RAMP



Figure 190. Perspective of access ramp showing the first pause point



Figure 191. Perspective showing seating underneath the ramp, advertisement boards & covered space to be appropriated by informal traders (Author ,2010)



Recycled plastic cold drink bottles strung together with wire rope and hung from the existing trusses.



Scaffold interior entrance ramp structure clad with 10mm oriented strand board, finished with clear varnish.



270x270x270 mm Building blocs constructed from nine pieces of 75ø cardboard tubes, cut to size and fixed together with clear silicon in 270x270x270 cubes. Cubes are fixed to each other with 4ø threaded rod through corresponding pre-drilled holes.



Lit lettering created by fixing a compact fluorescent lamp inside selected tubes. The open ends of the tube are covered with a disc of white translucent acrylic sheet cut to size. Different coloured lamps will provide additional possibilities.

8.5 FOYER, SCREEN & COUNTER

8.5.1 PERSPECTIVE VIEW AS SEEN BY VISITORS ENTERING THE FOYER SPACE FROM THE STAIRS OR THE RAMP



Recycled rubber interlocking floor tiles over the existing concrete floor.



75ø Cardboard tubes fixed together with clear silicon in 270x270x270 cubes. Cubes are fixed to each other with 4ø threaded rod.



16mm Thick layers of acrylic sheet inserted between layers of X-board to transmit light from mini fluorescent tubes fixed to the inside of the crates with cable ties.

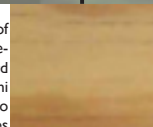

10 mm Plywood Curved over X-board at seating and service areas.

Figure 192. Interior perspective of foyer space (Author, 2010)

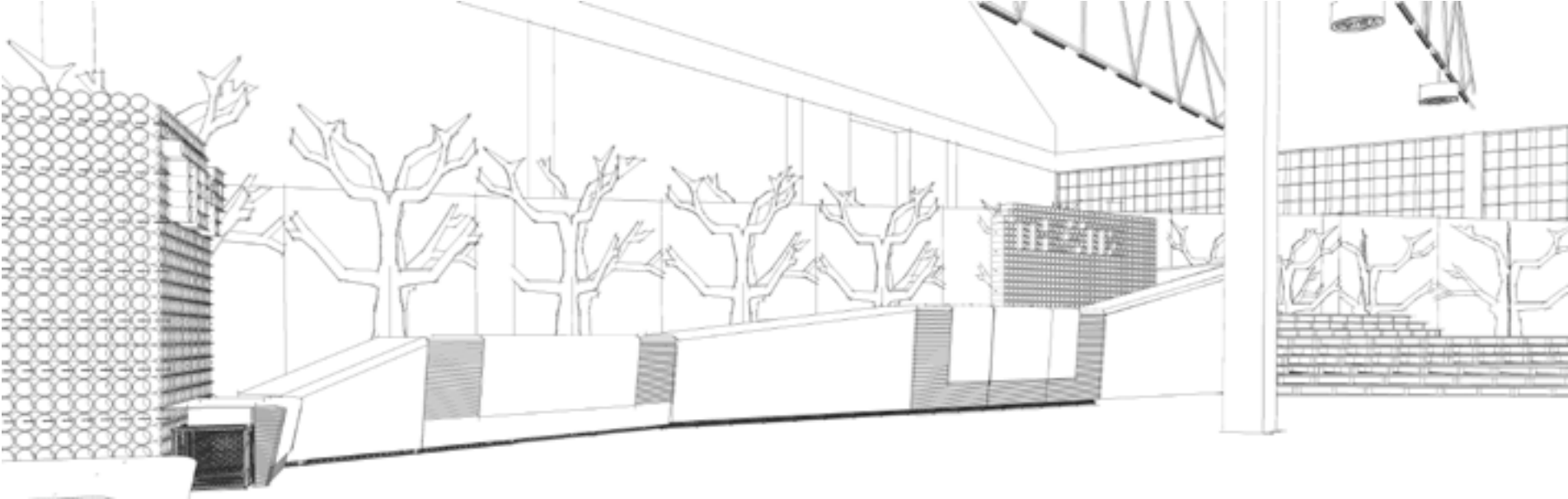

8.5.2 PERSPECTIVES OF TREE SCREEN, TERRACED PALLET SEATING & SERVICE COUNTER

8.5.3 DETAILING OF TICKET & INFO COUNTER

1:50

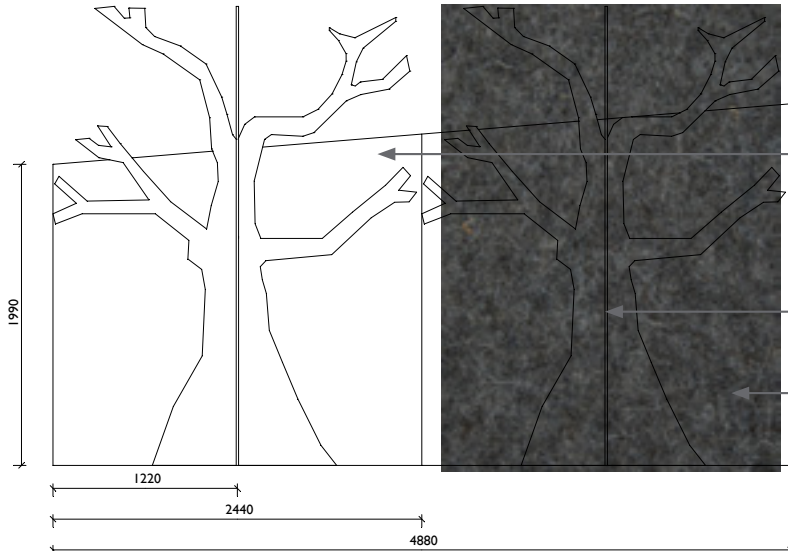

16 mm Closed cell X-Board screens, 2440mm wide each (standard sheet sizes)

16 mm Closed cell X-Board tree cut-outs to form perpendicular supports

Holes are drilled into the X-Board tree shapes. The perforated shapes are then covered with 10mm grey felt to increase sound absorption

Elevation of Tree screens separating service spaces from front of house 1:50

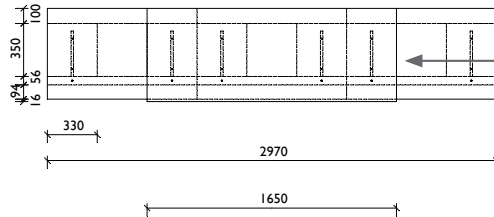

Segment of service counter consists of three 990mm long units

Plan of ticket & information counter 1:50



10 mm thick, curved plywood fixed to stack of X-board with 6ø threaded rod strung through corresponding pre-drilled holes in the plywood and layers of X-board. Rod secured with a 6ø nut & washer at the top & the bottom.

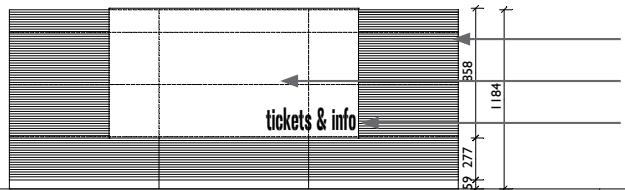

16 mm Open cell X-Board off-cuts stacked with edges exposed in elevation.
90 Degree curved plywood to be primed and painted. Lettering painted on with stencil

Front elevation of ticket & information counter 1:50

Figure 193. Details of ticket & information counter (Author; 2010)

8.5.4 SECTION THROUGH REFRESHMENT COUNTER 1:25

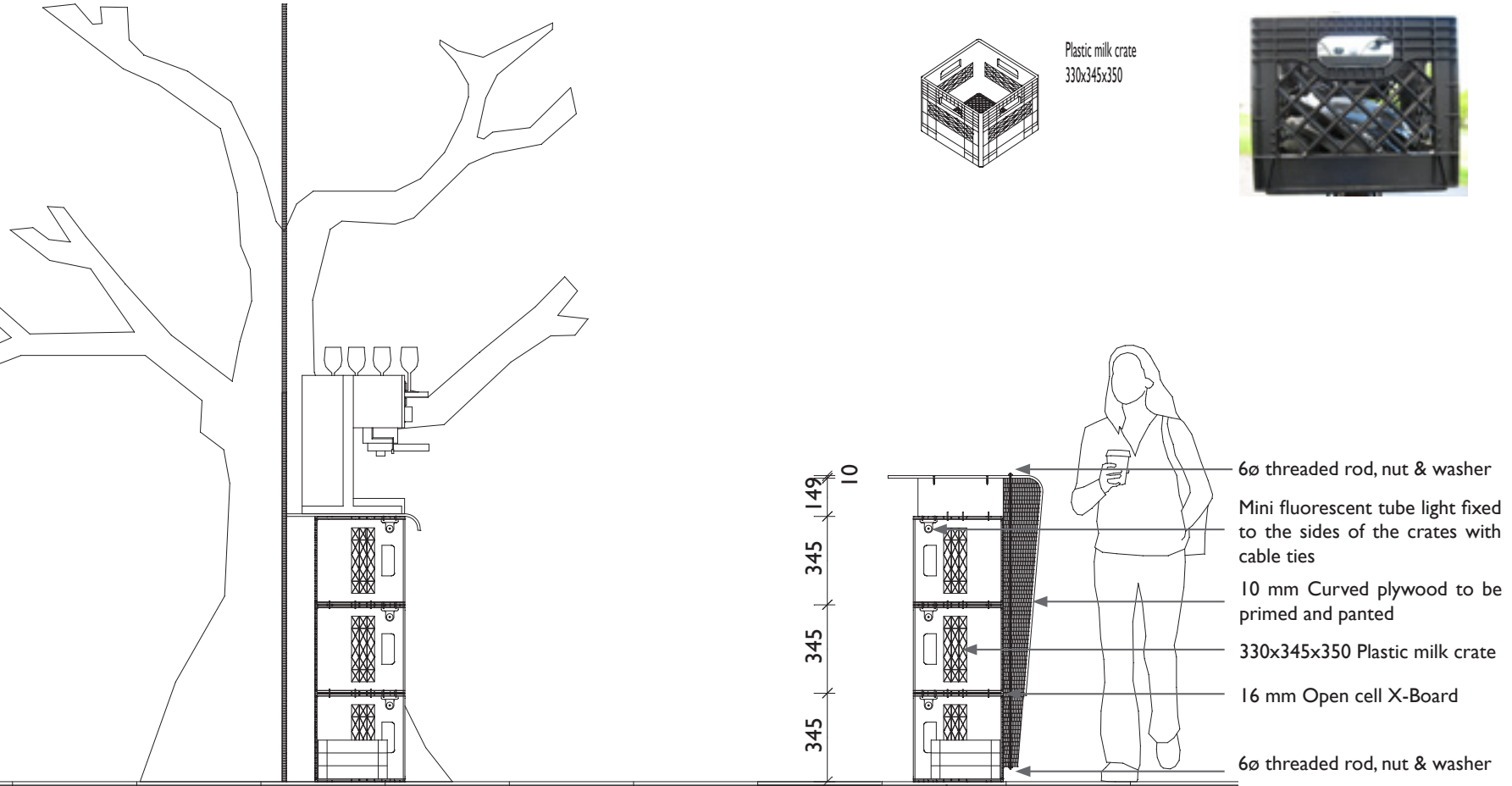

Figure 194. Section through refreshment counter (Author, 2010)

Figure 198. 1:20 model of tickets & info counter (Author, 2010).

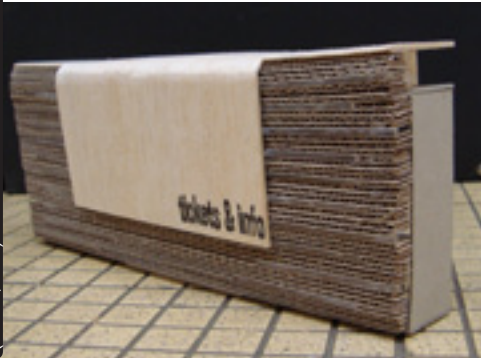

Figure 195. 1:20 Model illustrating tree shaped X-board screen supports, perforated & covered with grey felt (Author, 2010).



Figure 196. 1:1 Prototype of cardboard tube building blocks (Author, 2010)



The tube can be filled with fibre glass or any re-used material with good sound absorption qualities and the open ends covered with a disc made of metal mesh with a layer of felt glued to it.

4ø Threaded rod connector stretching the 74ø diameter of the tube and held in place by the thickness of the cardboard wall of the tube through two corresponding holes.



Figure 197. Prototype showing how tubes are joined to form a screen (Author, 2010).



The building blocks are modular, each with two rods, one to the top(bottom) and one to the side and two holes one to the top(bottom) and one to the side. This allows the blocks to be stacked and joined in various configurations



Figure 199. Prototype showing light application of blocks & examples of felt & acrylic disc covers (Author, 2010).



Figure 200. Model illustrating lighting effect of layers of open cell X-board & acrylic sheet lit from behind with a CFL (Author, 2010).



8.6 LIGHTING

8.6.1 Existing lighting

The existing building is currently provided with 220 luminaires each with two fluorescent tube lamps. In total there are 440 lamps. Assuming that these lamps are basic T8, 58W lamps they add up to 25.5 KW

Fluorescent tube lights are discharge lamps that produce light through electric discharge when a current passes through an inert gas. These lamps use 5 times less electricity than a tungsten lamp, produce less heat and have a longer life. The light quality of these lamps is generally harsh and flat. Softer colours are available; Neon for example produces a warm red colour. Fluorescent light is diffuse and cannot be directed. These lamps can only be dimmed with an electronic dimmer. Fluorescent tube lights are mainly used for general lighting.

8.6.2 Replacement lamps

Luminous intensity of source = candela (cd)

Luminous flux = lumen (lm)

Illuminance (Lux) = lumen/m² = lux (lx) lx = lm/m²

On April 13, 2010 as part of the implementation measure for EU ordinance 245/2009, there will be an incremental phasing-out of products used mainly in street, industry and office lighting, namely inefficient fluorescent lamps as well as control gear and luminaires for fluorescent lamps and high-intensity discharge lamps.

The Temporary Theatre will replace these lamps with **OSRAM LUMILUX® Cool Daylight** fluorescent

lamps that have a longer service life that allows longer replacement intervals and therefore lower maintenance costs. It is also more ecologically friendly as a result of greatly reduced mercury content and full recyclability (Osram, 2010, 3).

8.6.3 Calculations

The recommended value of 50 Lux for the new occupancy class (A2: Theatrical and indoor sport) is much less than the 700 Lux recommended for the current occupancy class (D1: High-risk industrial). This means that the replacement lamps can have a lower Watt value. Alternatively fewer lamps can be used to achieve the necessary Lux value. Using fewer lamps will be more cost effective and when the theatre is used for other purposes more lamps can be added to suit the specific lux requirements. As a result electricity will be saved (SANS 204-2:2008).

Luminous intensity of source = candela (cd)

Luminous flux = lumen (lm)

Illuminance (Lux) = lumen/m² = lux (lx) lx = lm/m²

Existing D1 occupancy

Lux = lm/m²

700Lux = lm/2124m²

lm = 700x2124 = 1486800 lm

Basic T8, 58W = 5200lm

1486800/5200 = 285.9

286 lamps needed

Even if calculated for occupancy D1 which has the highest Lux requirement the 420 lamps are excessive.

New A2 occupancy

50Lux = lm/2124m²

lm = 50x2124 = 106200 lm

OSRAM LUMILUX® T8 = 5200lm

106200lm/5200lm = 20.42

21 OSRAM LUMILUX® T8 lamps will be needed for the temporary theatre.

Other possible occupancies

A1: Entertainment and public assembly: 50 Lux

A3: Place of instruction: 100 Lux

A4: Worship: 100Lux

B3: Low-risk commercial:

C1: Exhibition Halls: 300 Lux

C2: Museums: 300Lux

300Lux = lm/2124m²

lm = 300x2124 = 637200 lm

637200/5200lm = 122.54

A maximum of 123 OSRAM LUMILUX® T8 lamps will be needed for alternative occupancies which is still less than the 440 fluorescent lamps currently in use.

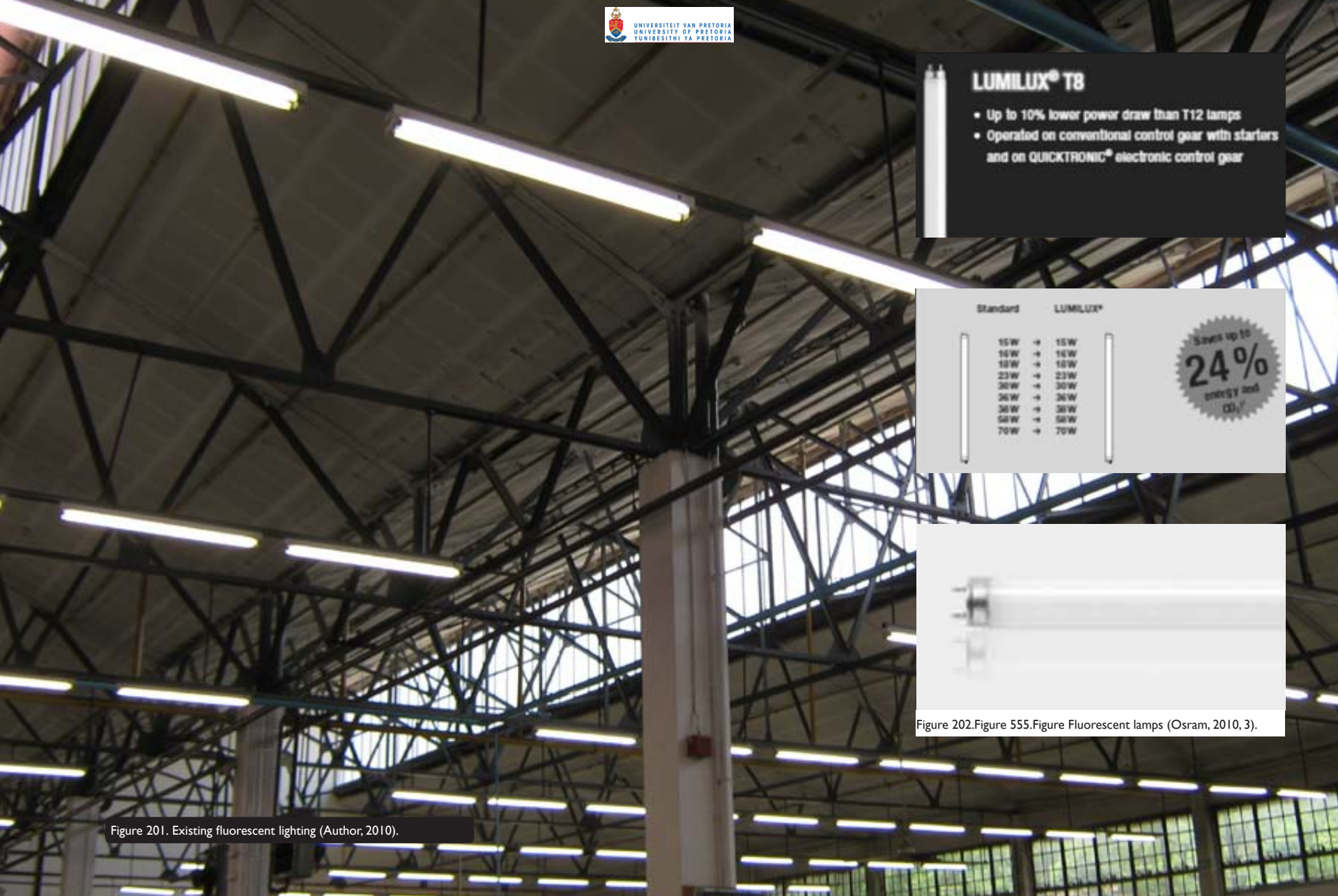

LUMILUX® T8

- Up to 10% lower power draw than T12 lamps
- Operated on conventional control gear with starters and on QUICKTRONIC® electronic control gear

Standard		LUMILUX®
15W	→	15W
16W	→	16W
18W	→	18W
23W	→	23W
30W	→	30W
36W	→	36W
36W	→	36W
54W	→	54W
70W	→	70W

Saves up to
24%
energy and
CO₂

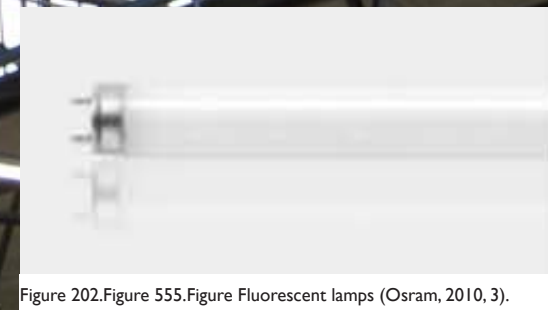

Figure 202. Figure 555. Figure Fluorescent lamps (Osram, 2010, 3).

Figure 201. Existing fluorescent lighting (Author, 2010).

8.6.4 Stage lighting Instruments

Dimmers

External dimmers are relied on to control the lighting level of lights that have no built-in electronics or dimming (Cadena, 2006, 49).



Figure 203. GM 48 x 2 kW Dimmer (Author, 2010).



Figure 204. 5m Z-Line truss (Dance South Florida, 2010).

Rigging Systems

A rigging system is used to provide a safe and convenient structure on which to hang production equipment such as lighting, sound, video, and scenic elements (Cadena, 2006, 36).

Floodlights

PAR lights (parabolic aluminized reflector) come in varying diameters and are used to light scenes, as top lights, and for special effects. The wide unfocused beam produces an intense oval pool of light with soft edges. An adjustable knob allows the lamp unit to be rotated within its casing, changing the orientation of the oval. The colour and intensity can be altered.

Profile Spot Fixtures

A profile spot luminaire is a hard-edge fixture that can project an image by using a gobo. The beam can be focused and controlled. It is used to light the faces of actors, to control light spill or to project scenery or graphic images (Cadena, 2006, 373).

Follow Spots

Follow spots are used to emphasize a moving actor by increasing the brightness of the light on him over the general intensity of the stage lights. The movement of the actor is followed by a single, freely mounted spotlight. In straight drama soft edge follow spots with reduced intensity are used so that the audience doesn't notice it and only feels the effect (Parker & Smith, 1974, 368).



Figure 208. Floodlight temporarily attached to Z-Line truss (Author, 2010).



Figure 205. Parcan (Par 64) 1 kW (Mellor, 2009).



Figure 206. Profile 1 kW (Livelite, 2010).

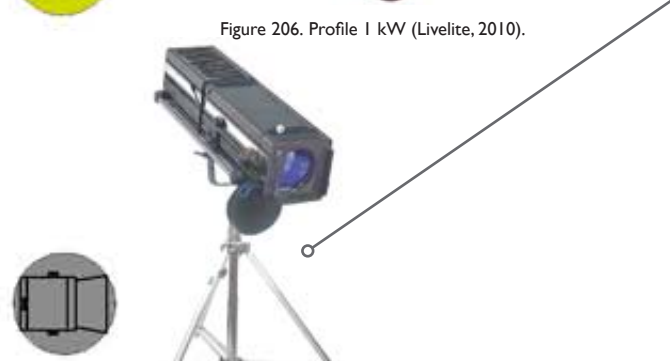

Figure 207. Follow spot 2 kW (Arts Council of Northern Ireland, 2010).

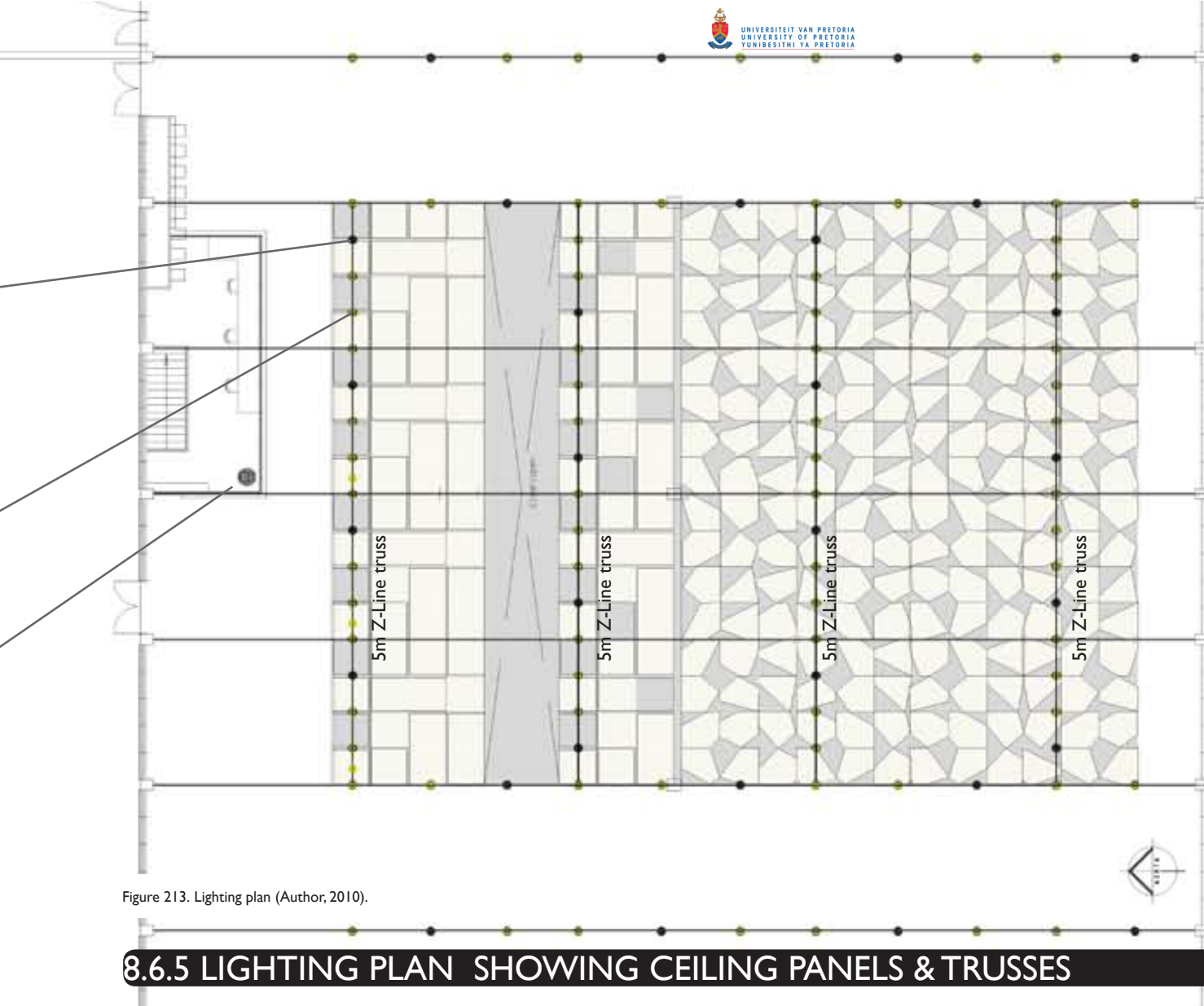

Figure 213. Lighting plan (Author, 2010).

8.6.5 LIGHTING PLAN SHOWING CEILING PANELS & TRUSSES



Figure 209. Floodlight effect 2 kW (Berne, 2010).



Figure 210. Follow spot effect 2 kW (McGill, 2007).



Figure 211. Gobo effect 2 kW (WeddingWire, 2010).



Figure 212. Profile spot effect 2 kW (Mellor, 2008).

NOT TO SCALE

8.6.6 Light & Colour

Colour experience

The expressive content of a colour can stimulate, relax or depress the feelings of the viewer. Reds quicken the heartbeat, greens are restful, and neutral hues can be depressing. The impression is registered in terms of colour and brightness. The experience of colour is a physiological, intellectual and emotional process. Tradition and personal frame of reference can also condition an emotional response (Parker & Smith,235).

The six basic spectrum hues can be described in terms of their emotional response:

Yellow: Radiant, light giving, golden, saintly; in light values near white, virginal.

Orange: Festive, earthly, peasant colours, warmth, neutral shades, nature in the fall.

Red: Danger, active, passionate, full of inner warmth, fiery, strong, forceful, anger war.

Violet: Royal, piety, deeper shades, shadows, terror, chaos, a reddening colour.

Blue: Passive, receding, restraint, detached, deep, cold, purity, icy tints.

Green: Tranquillity, compassion, restfulness, nature in the spring and summer.

Black: Evil, dominance

Coloured light and the actor

Startling colours will be avoided for the acting areas as it will adversely effect the faces and costumes of the actors. Often the acting area is lit with tints of pink and amber that is flattering to the faces of the actors but deadly to green materials. For the forest stage shades of green will be used in the scenery. These acting areas will be lit with clear light which appears warm when used in conjunction with cool colours on stage such as green.

Green light has limited use on the acting areas of the stage. Green adversely effects the human face; cheeks and lips appears muddy, blond and reddish hair look dead and any blemish becomes grotesque. Green light will only be used on the acting area of the destruction stage where a distorted effect is desired.

Green light will be used on the transitional scenery between the threshold and the forest and the forest and the destruction stage. On scenery green light is especially enriching (Parker & Smith,394).

Coloured light and the scenery

The lighting should enhance the scenery. Only tints of light will be used. Strong colours tire the audience and tend to distort the colours of the scenery. Light intensifies, brightens and makes the colour of paint appear lighter. The colour of scenery was chosen a shade or two darker than the desired colour.

On the background stronger colours can be used to

show the time of day, weather conditions and other effects. Delicate and precise shadings require different colours to be blended in stead of using a single colour medium (Parker & Smith,395).

Colour media

A gel or gelatin is the most typically used because the sheets are very thin, the colour range is extensive and it is the cheapest. The plastic like coloured sheet is bought and cut into the desired sizes and placed in the colour frame of a luminaire. They have to be replaced quite often but can last up to two years (Parker & Smith,395).

8.6.7 Light as scenery

The most familiar form of light as scenery is projected imagery and live footage. However curtains and columns of light are also included in this definition.

At this point in time the use of projections have developed past a sensational novelty and extreme experimentation. Now designers can draw from previous crude and successful examples and apply projections more effectively, economical and subtly in order for it to be a supporting element rather than overwhelming and distracting.

For the purpose of this study projections will be employed as it embodies the concept of symbiosis between the temporary (ephemeral projected light image) and the permanent (tangible object, surface or plane projected on).

Projections will be used to reinforce the setting or milieu and to incorporate the original culturally idiosyncratic text into the space.

Because of the temporality of light and projections it is more flexible, multi-functional and sustainable. Although the equipment necessary are currently expensive and rely on electricity creating and projecting an image is quicker and less resource and labour intensive.

Projections are usually applied to the background; not as a substitute realistic background but as a medium of its own and best expressed in abstract or thematic terms becoming an additional actor.

Projection= light source + medium (slide/electronic) +

image+surface (called the screen but can be anything)
Projection equipment can be placed in front of an opaque screen or behind a translucent screen normally used for shadow projection (Parker & Smith,440).

Tips for a clear image

- Use dark colours in your setting.
- Keep reflective surfaces on the floor to a minimum
- Baffle reflected light from the stage with a black gauze in front of the screen. This is especially useful in back projection.
- Light actors from the side reducing damaging front light.
- Give the screen a black border to sharpen the projected image by contrast.

8.6.8 New temporary diffusers

The thesis investigates the temporary reuse of an existing building by means of insertion. The intention is to avoid too much major permanent changes and to utilize as much of what is existing as possible. To support this intention the design decision was made to use the existing lighting fixtures. As mentioned fluorescent light is mainly used for functional lighting. To create a more intimate theatre atmosphere that is in keeping with the text new, designed temporary diffusers will be suspended from the horizontal members of the existing angle iron trusses so that it hangs underneath the fluorescent tubes at varying distances.

The design of the diffusers is inspired by the way gobos work. A gobo, also known as a break up pattern is a mask used to create patterns, shapes or dappled light effects on the stage. A shape is cut into a disc of aluminium, stainless steel, or glass that is inserted in the focal plane of a luminaire. Gobos come in many shapes, but often include leaves, waves, stars or similar patterns (Cadena, 2006, 254).

The diffusers will be made from cardboard drums cut across the width into two cylinders of varying length. A circular disc of translucent acrylic sheet, cut to size is then loosely placed inside the drum. The metal reinforced edges of the drum have a smaller diameter than the rest of the drum. After the drum is cut there will be two cylinder pieces with one metal edge each. The diffuser will be suspended with the metal edge to the bottom so that the acrylic sheet will be held by the smaller diameter of the drum. Before installation, twig and leaf shapes are laser cut out of the acrylic discs. Shades of green and yellow acrylic will be used for the discs.



Figure 214. Aluminium gobo (West Bay Opera, 2006).



Figure 217. Gobo inserted in the focal plane of a luminaire (GoboMan, 2010).



Figure 218. Gobo inserted in the focal plane of a luminaire (Merrell, 2009)



Figure 216. Acrylic disc with laser cut pattern (Author, 2010).



Figure 215. Cardboard drum found on site and cut into discs (Author, 2010).

*"Of the original phenomena, light is the most enthralling.
Leonardo da Vinci" (Cadena, 2006, 213)*

Green lights distorts the human face while warm yellow livens the face creating a visible duality and separation among the audience



Figure 219. Insert acrylic disc into the drum (Author, 2010).

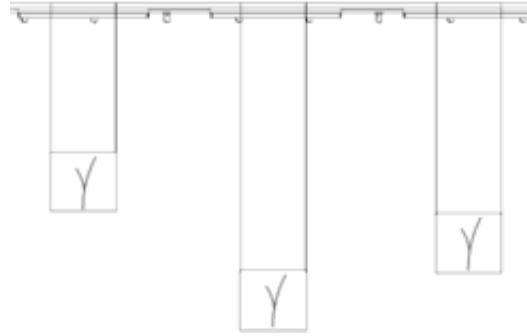

Figure 220. Elevation of hanging diffusers (Author, 2010).

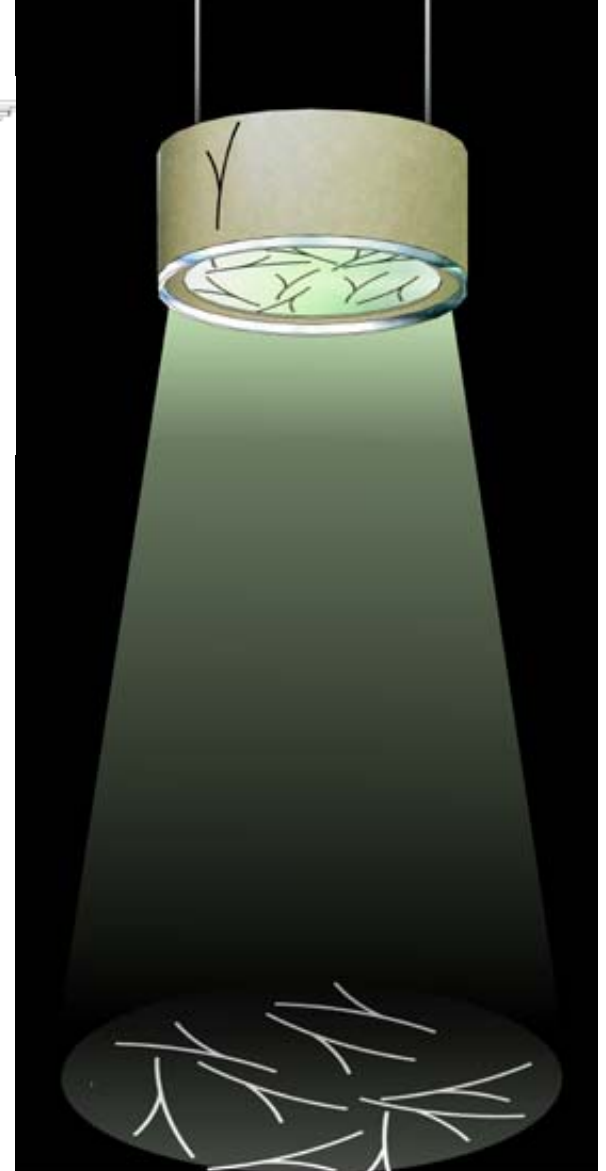

Figure 221. Lighting effect of diffusers (Author, 2010).

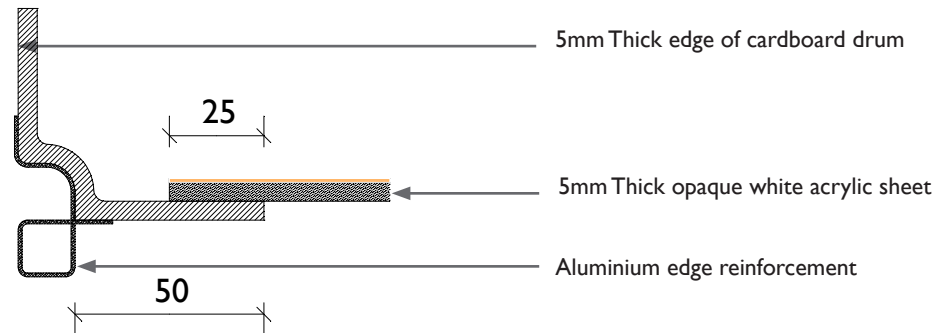
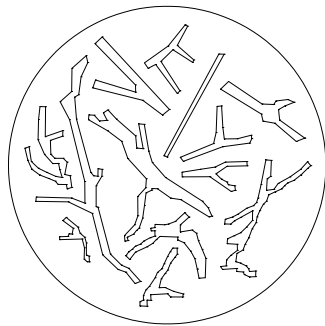
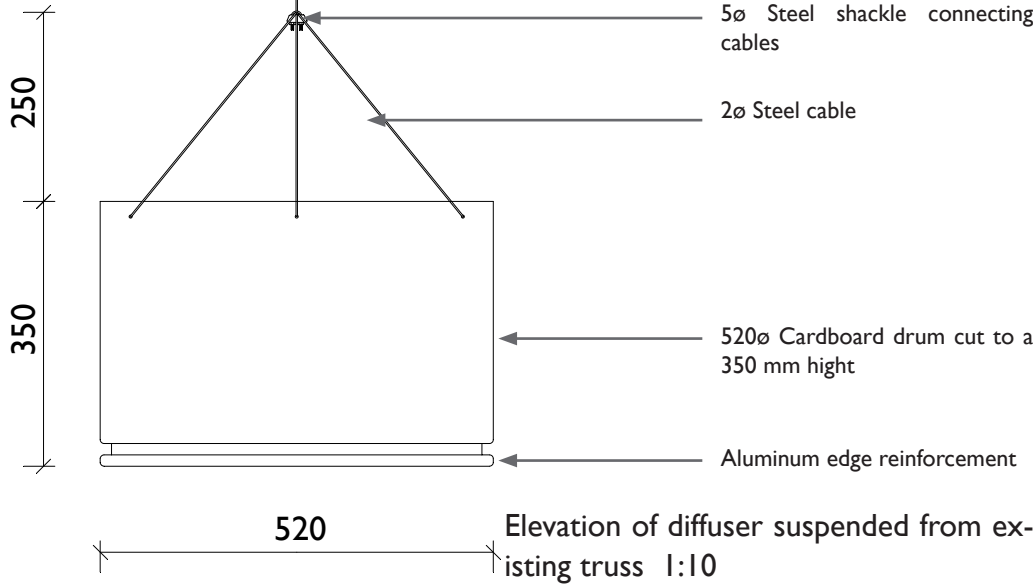

Figure 222. 1:1 Prototype of cardboard drum diffuser (Author, 2010)

Figure 223. Details of cardboard drum diffuser (Author, 2010)



Cables united and tied together with a 5ø steel shackle

Three 4ø holes drilled 20mm away from the edge of the drum
2ø Steel cable looped through

420ø round acrylic disk with twig pattern laser cut before assembly

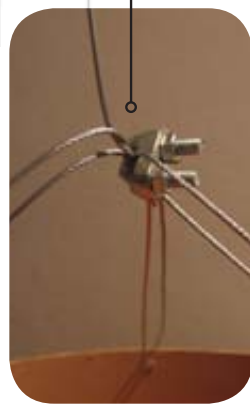
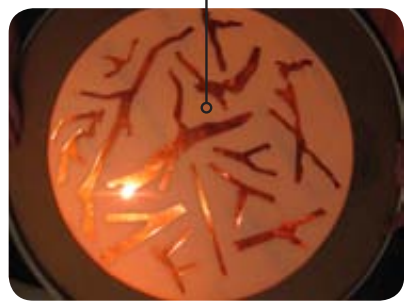

Figure 224. Interior perspective showing diffusers & drinks tables from cardboard drums (Author, 2010)

Figure 225. Photo's showing diffuser assembly (Author, 2010)



8.7 SECTIONS



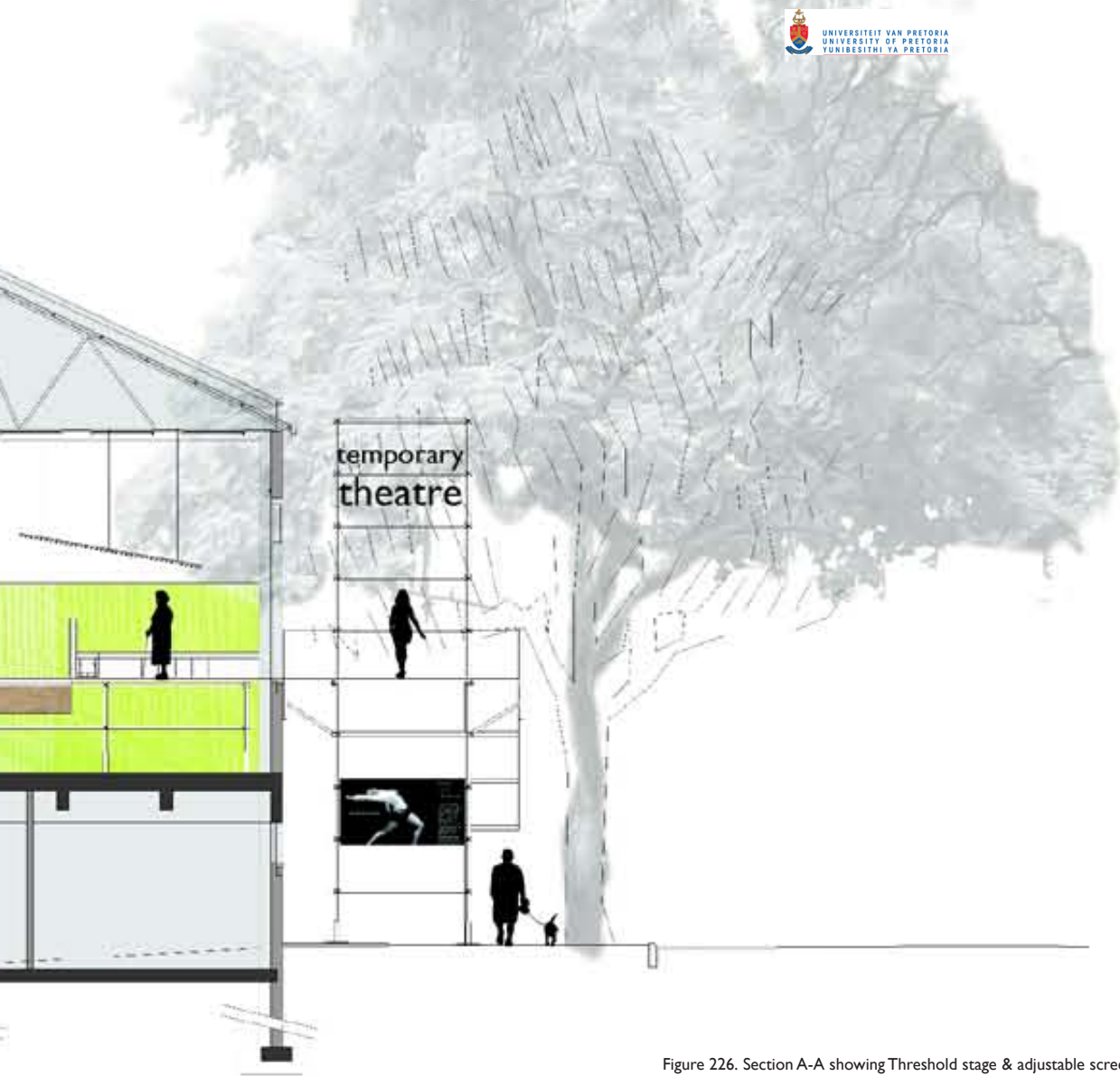

Figure 226. Section A-A showing Threshold stage & adjustable screens with forest projection (Author, 2010)

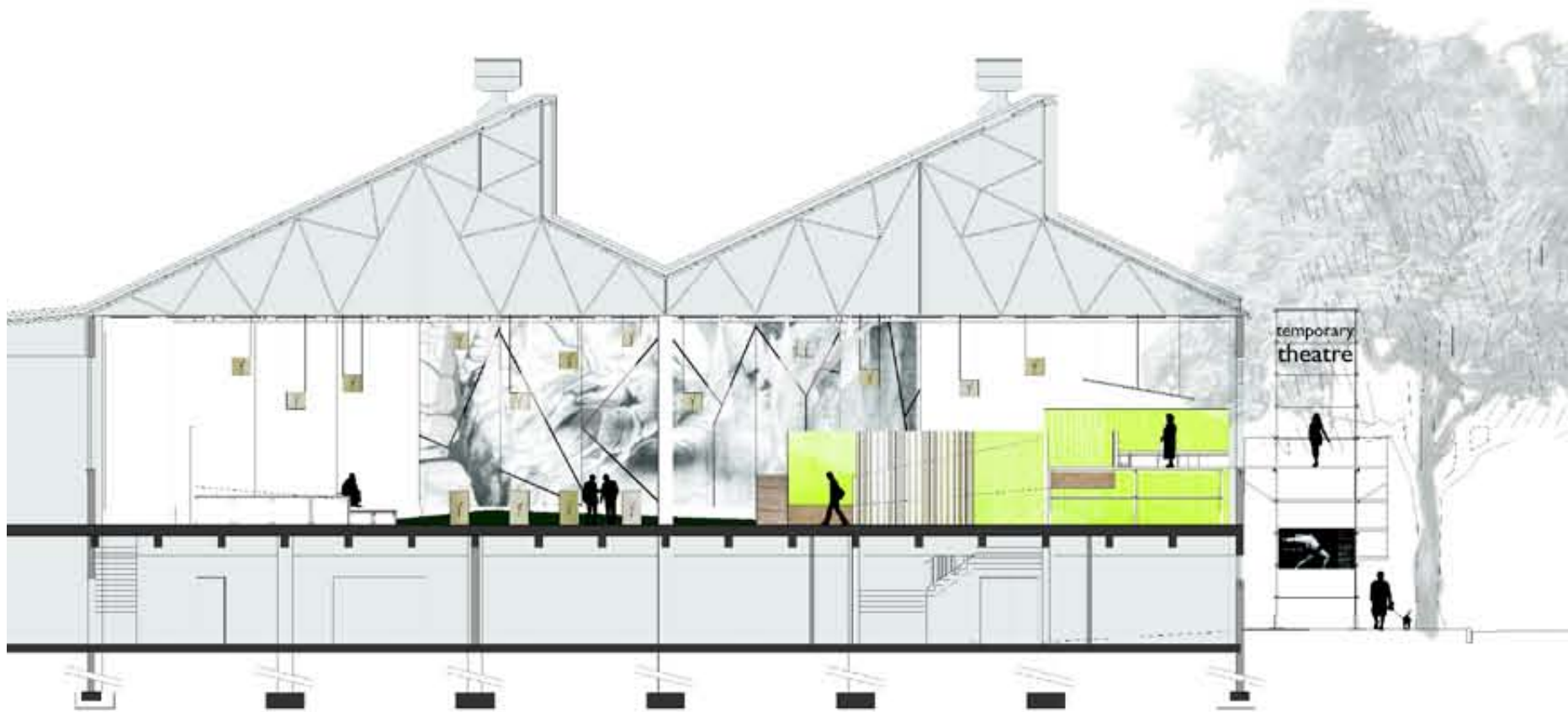

Figure 227. Section A-A showing Threshold stage with adjustable screens & changing projections to show destruction, 1:200 (Author, 2010)

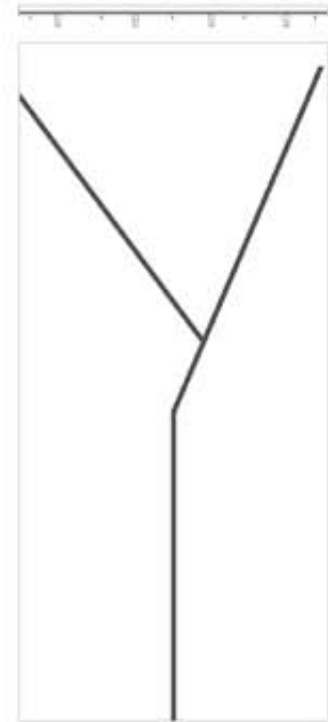
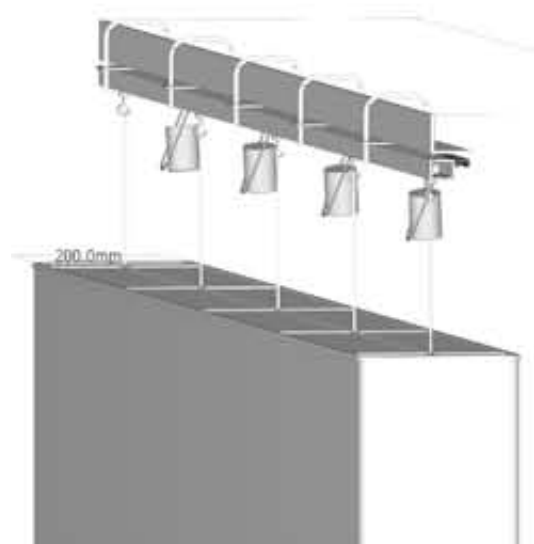

Figure 228. Curtain screens with lighting (Author, 2010)

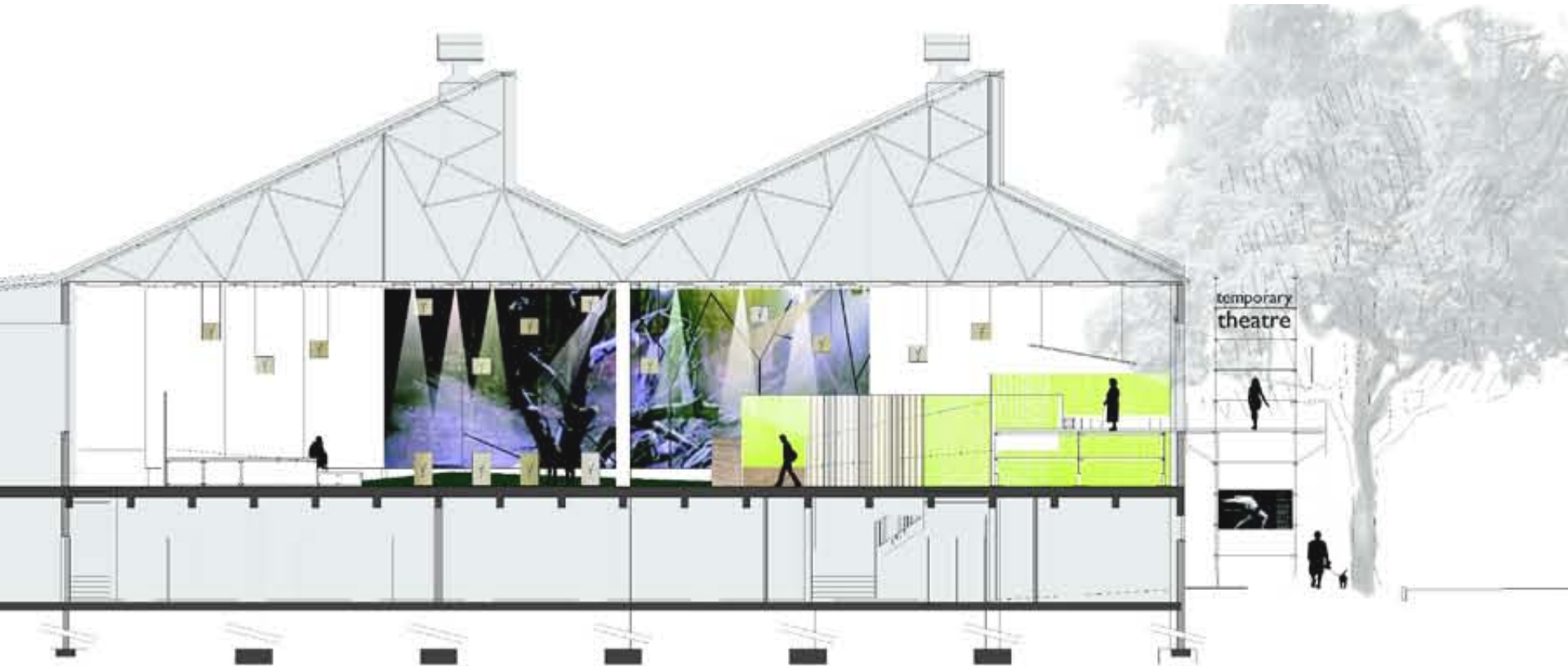

Figure 229. Section A-A projections depicting Maska's spiritual forest, 1:200 (Author, 2010)

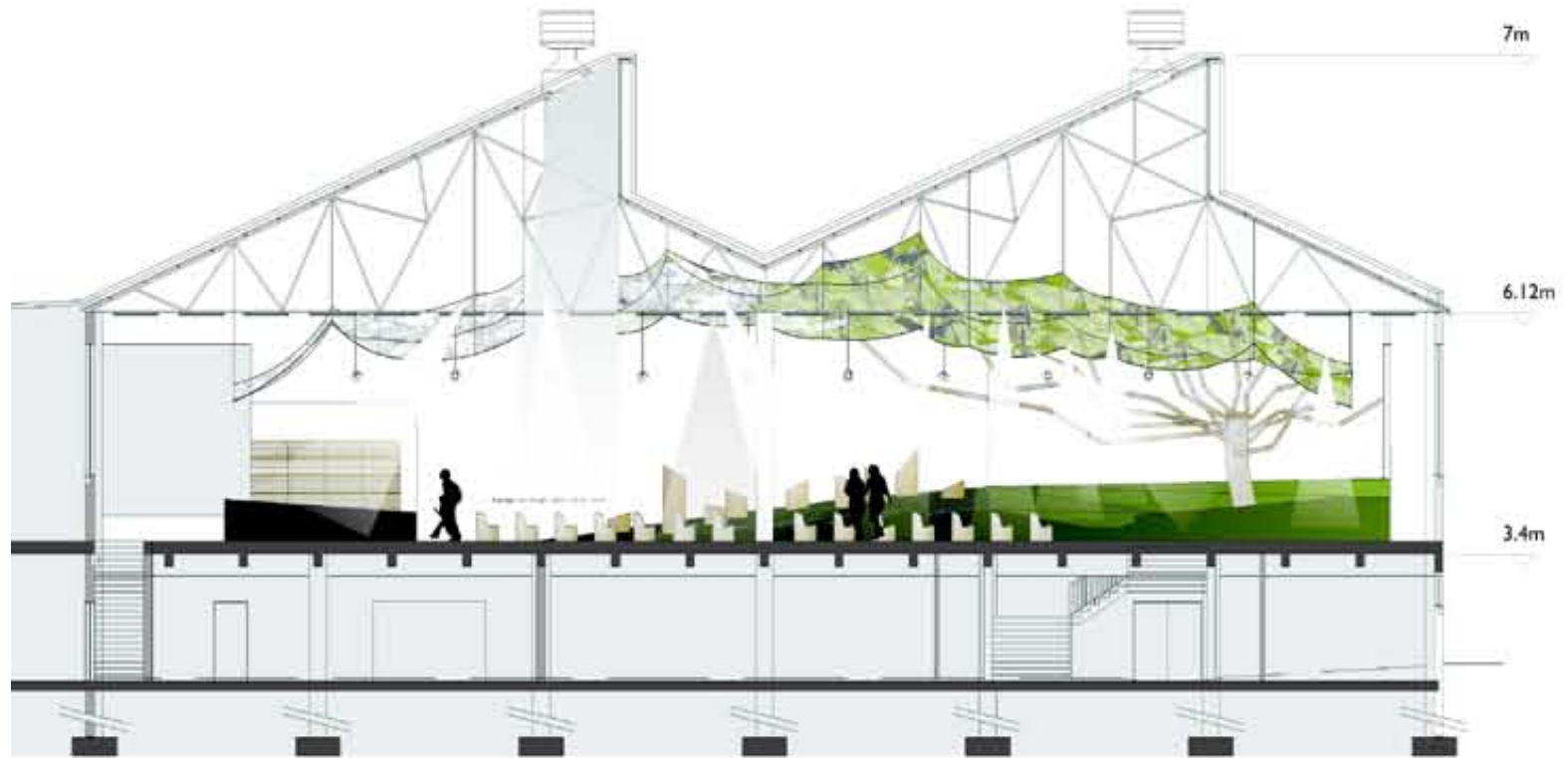

Figure 230. Section B-B showing the ceiling panels & the audience caught between the Forest & the Village stage (Author, 2010)

8.8 INTERIOR PERSPECTIVES

“Maska, you used to tell us that the spirits live in the trees” (1986, 240)

“He would hide in the forest so that nobody would ever find him. Surely God could not have seen down into the forest from up in the sky, even the sun has to struggle to shine to the ground. Only specks of sunlight got through that roof of the tree tops” (Mathee, 1984, 47)

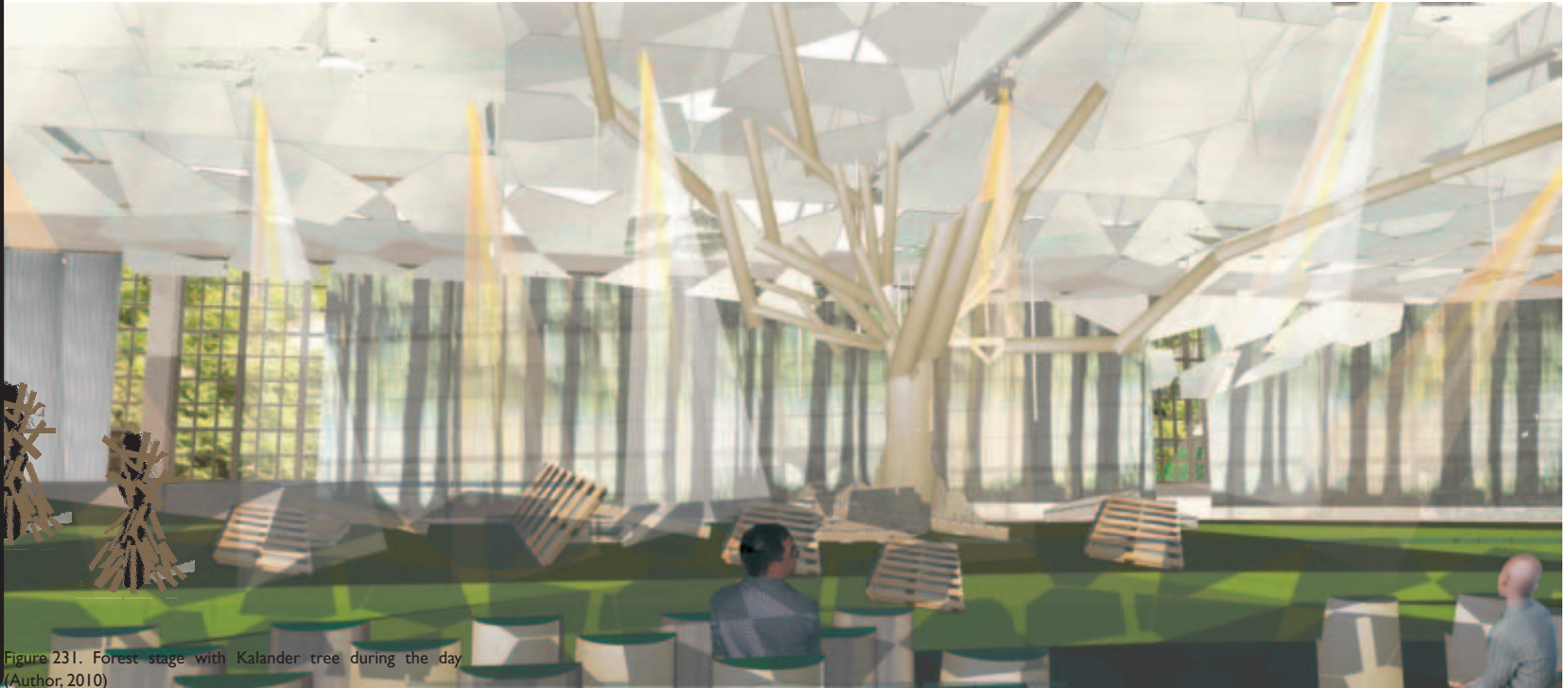

Figure 231. Forest stage with Kalandar tree during the day
(Author, 2010)

“By the time it was dark they were back in the forest. It was like a thick blanket closing around your body, warming you against the cold,” (Matthee, 1984, 61)

“They came to know the shrubs of the underbrush: which were medicine and which were not; which berries you could eat and which not.” (Matthee, 1984, 18)

8.8.2 FOREST STAGE AT NIGHT WITH ARTIFICIAL LIGHT

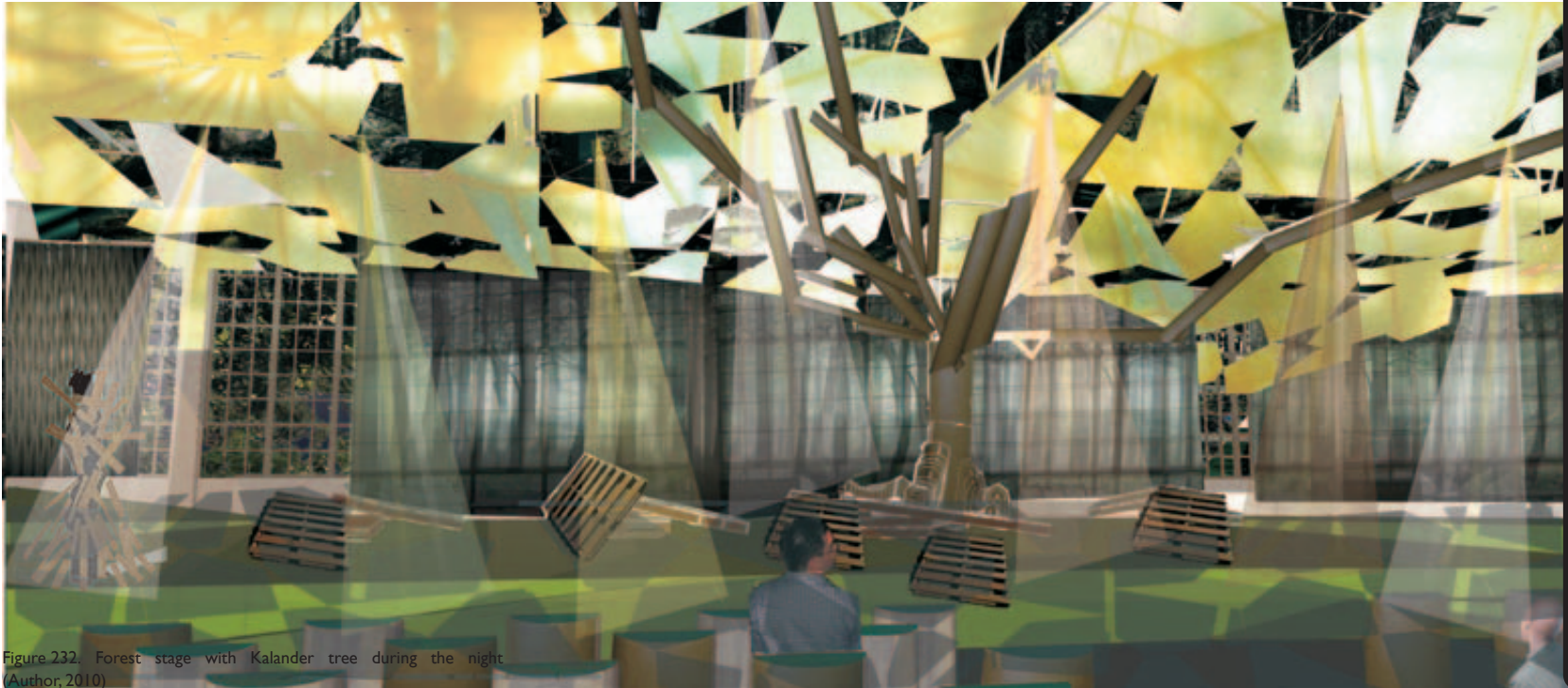

Figure 232. Forest stage with Kalander tree during the night
(Author, 2010)



At the beginning of the play 'living trees' (extra's in costume) are standing inside the cardboard drum tree stumps

As the play progress they gradually exit the stage leaving the red painted stumps exposed to depict the gradual destruction of the forest

"Where Harrison or his men stopped them today, they felled tomorrow because the Government were putting pressure from the west for more and more wood for railway lines, wood for jetties, wood for harbours, wood for the mines, wood for making wagons that had to take man and his possessions north! Wood for tables, wood for chairs and cupboards and beds! Wood! Wood! Wood!" (Matthee, 1984, 109).

*"...where diggers' axes had hacked out everything to make space for the tents and houses, and to provide firewood."
(Matthee, 1984, 109)*

Saul follows old foot in circles through the forest. Eventually Oldfoot leads him to Millwood to show him the destruction. This is also where Oldfoot gets shot by a gold prospector

Figure 233. Perspectives of the Threshold stage showing destruction (Author, 2010)



"Everybody was shooting, everybody was felling. Harrison's control was not strict enough; where he warned them off today, they cut open the roof of the forest that should have protected the seedlings tomorrow. Or they shot the cows that should have calved in the spring. Harrison says, the way they're felling now, there will be little more than fifty years left for the forest...How long for the elephants."(Matthee, 1984, 109).

Figure 234. Concept model for 'Living tree costume' (Author, 2010)

And nobody ever told him that the village was not in the forest.” (Mathee, 1984, 53)

“They came out of the forest on the eastern side of the town. One moment the forest was still around and above them, the next moment it started thinning out, getting lighter...more sun and then suddenly the world was lying open. Naked. Like someone without a hat. Without a roof. He wanted to turn round and run back to the shady shelter of the forest. The sun was hurting his eyes.” (Mathee, 1984, 54)

Villagers “traveling” through the audience from the Forest stage to the Village stage to sell the “chopped wood”



Figure 235. Interior perspective showing Millwood stage & audience seating between Forest & Village stage. (Author, 2010)

“He stayed behind the wagon when they came to the first houses. Far apart to start with. Then closer together. Square and white, their roofs neatly made of thatch. And the fear that was in him was not the same fear as for bigfeet, it was different, he was surrounded by it, he was in it.” (Matthee, 1984, 55)
“...enormous. Wood was stacked up everywhere, wood wherever you looked! Mountains of wood. Next to a large shed men were loading some of the wood on other wagons...” (Matthee, 1984, 56)



8.8.5 WOOD BEING PROCESSED IN THE VILLAGE



Figure 236. Interior elevation of the Village stage (Author, 2010)

8.9 KALANDER TREE DETAIL

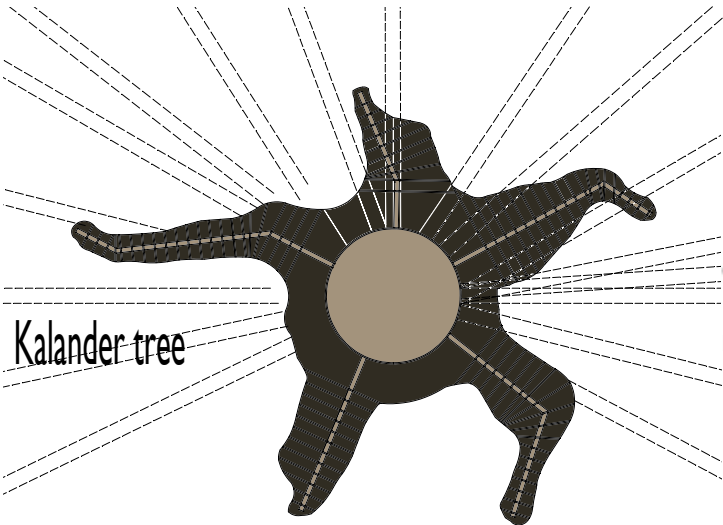

Kalander tree

Plan of Kalander tree 1:50



Base of Kalander tree cut from 16mm X-board



1100mm High, 590 ø,
cardboard drums placed
in the centre of the root
construction
1:50

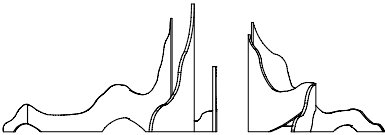
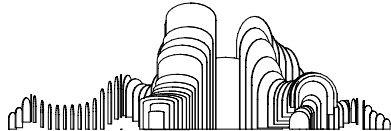

Vertical root profile shapes cut from 16mm X-board
and fixed perpendicular to the base with wood screws
,from underneath the base, in a radial fashion
1:50

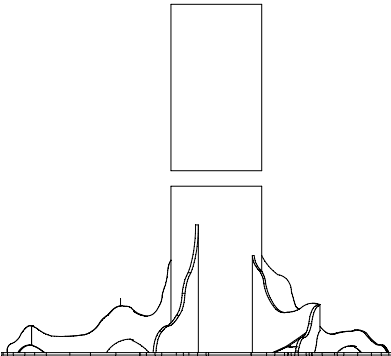
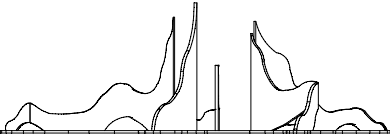

“...enormous”
 “Standing with his feet almost in the water of the Homtini...The most beautiful...Towering above all other trees. Giant roots anchored it to the ground like giant arms. Grey bark hung like dry strips of skin”
 “The old man’s beard, moss in its branches hung like thin green hair, waving eerily in the wind.” (Mathee, 1984, 74)
 ... something tells me that tree is alive! If he was dead he could not have grown and if you live, you can feel and if you feel you’ll be afraid to go dead”

Figure 237. Detailing & assembly of the Kalander tree (Author, 2010)

Perpendicular bracing from corrugated cardboard sheets cut to root section profiles and slotted over vertical element provide thickness to the roots
 1:50

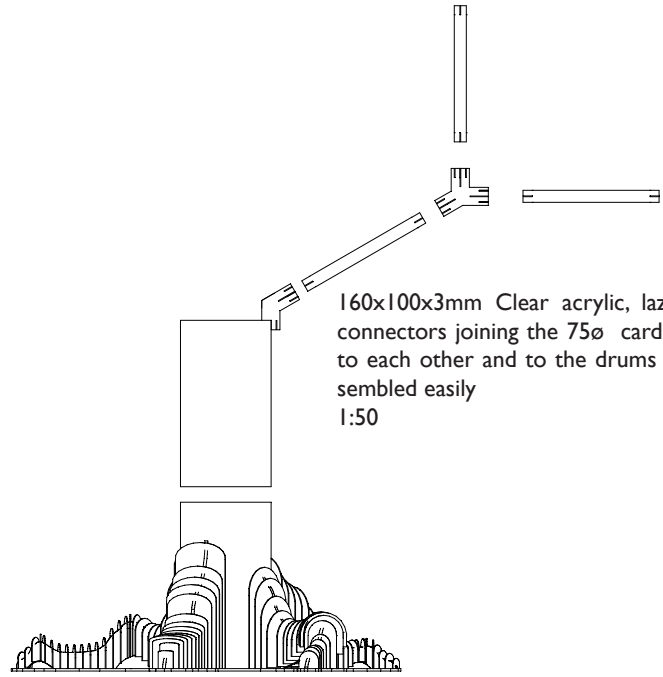
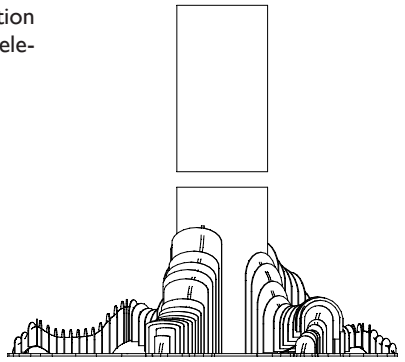
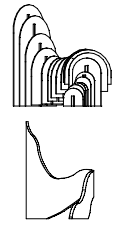

160x100x3mm Clear acrylic, lazer cut slot connectors joining the 75ø cardboard tubes to each other and to the drums to be disassembled easily
 1:50

160x100x3mm Clear acrylic connectors
 joining the 75 ϕ cardboard tubes together
 1:20

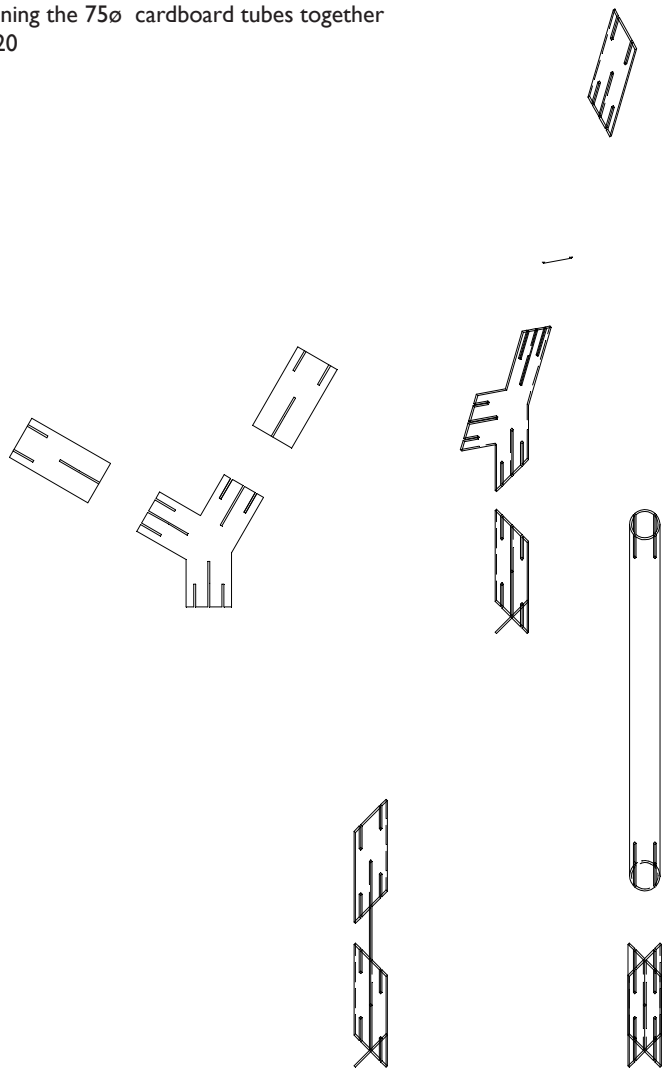

Figure 238. Joining of cardboard tubes to create branches (Author, 2010)

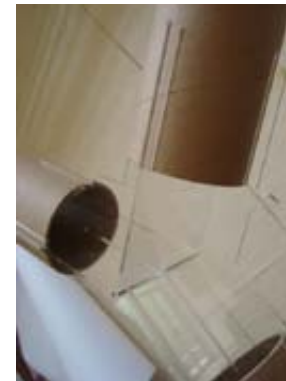

Figure 239. 1:1 Prototype to show assembly & disassembly of the Kalandar tree (Author, 2010)

When the Kalander tree is felled and during the course of the play the Kalander tree is disassembled and transported to the Village stage where the “wood” is sold

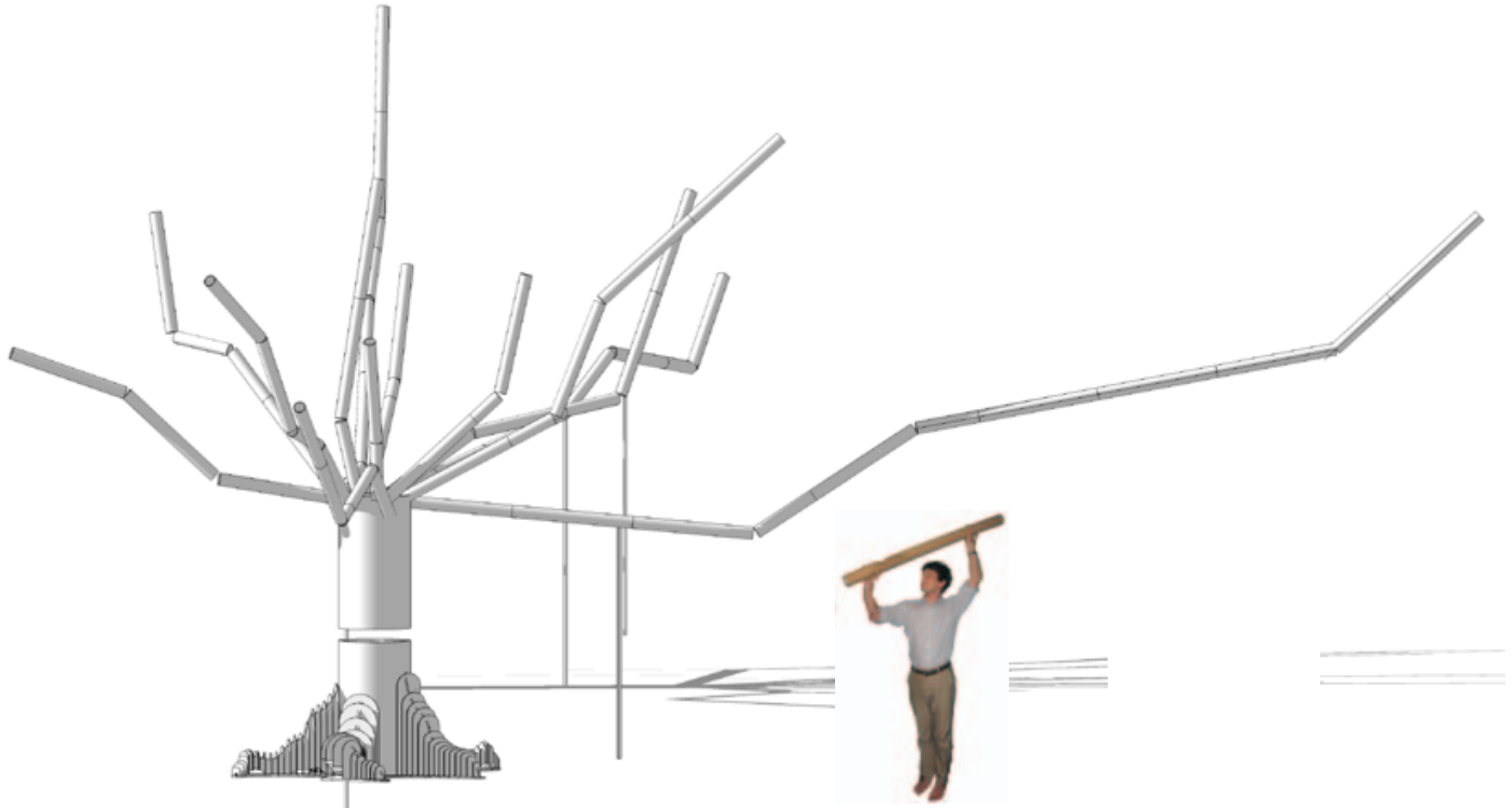

Figure 240. Felling of the Kalander tree (Author, 2010)



Figure 241. Live size model experimenting with the acoustic panel system
(Author,2010)

*“By the time it was dark they were back in the forest. It was like a thick blanket closing around your body, warming you against the cold,”
(Matthee, 1984, 61)*

8.10 ACOUSTICS

Theatres used for drama depend on good speech intelligibility and acoustic intimacy around the audience. The affects of sound occur in two ways; the quality of generated sound that the audience wants to hear and annoyance with unwanted sound (noise).

8.10.1 Existing building

When using an existing building not designed as a theatre there will be shortcomings regarding acoustics. Sensitive spaces may be located adjacent to a noise source for example a busy road, or the building might have poor sound insulation. The Temporary Theatre is located parallel to Vermeulen Street which is quite busy during the day but much quieter during the night. Some of the noise disturbance is alleviated by positioning the theatre space on the first floor and the useful mass provided by the heavy traditional brick construction (Lord & Templeton, 1986, 41).

“Subjectively people will be more tolerant of prevailing acoustical conditions in an existing building than in a new one, and there may be more tendencies to have to compromise standards where existing fabric is dealt with. It may be more cost effective to employ corrective measures like sound reinforcement rather than drastically modifying a sound fabric” (Lord & Templeton, 1986, 41).

This statement supports the intention of the study to utilize the existing and avoid drastic permanent changes.

8.10.2 Reverberation time

For the audibility of speech clarity is a prime requirement. To achieve this, the audience must receive strong sound reflections immediately after the direct sound. For clear speech in a theatre, the desired reverberation time is between 1.0 s and 1.5s (Spring, 1999, 2).

“The reverberation time is defined as the time taken for an interrupted sound to fall in level by 60 dB. The reverberation time is probably the most significant measurable factor determining the acoustical character of a room”

8.10.3 Existing acoustic character

Reverberation time calculations

Room dimensions: 59m x 36m x 9.17m = 19470m³

Wall surface area:

631 + 111.656(2) = 854.312m² (bricks - plastered)

197 + 164.22 + 413 = 774.22m² (windows)

108m² (concrete – plastered)

Floor surface area:

2124m²

Ceiling surface area:

885+767+236 +413 = 2300m²

Total absorption for 125Hz

=646.76 m²

With people = 946.76 m²

Reverberation time (RT60)

RT60=0.161(V/A)

RT60=0.161(19470 m³/646.76 m²)

RT60=4.84 sec. with people - 3.31sec

4.84=0.161(19470 m³/A)

4.848=3134.67

A must be 2089.78

Critical distance Dc

Dc = 0.057. √V/RT60

= 0.057. √ 19470 m³/ 3.31

= 0.057. √ 5882, 2

= 0.057x76.7

= 4.4m

Existing acoustics

Floors	125Hz	250Hz	500Hz	1000Hz	2000Hz	4000Hz
Concrete	.01	.01	.015	.02	.02	.02
2124m ²	21.24 m ²	21.24 m ²	31.86 m ²	42.48 m ²	42.48 m ²	42.48 m ²
Walls	125Hz	250Hz	500Hz	1000Hz	2000Hz	4000Hz
Plaster on masonry	0.01	0.02	0.02	0.03	0.04	0.05
854m ²	8.54 m ²	17.1 m ²	17.1 m ²	25.62 m ²	34.16 m ²	42.7 m ²
Concrete (sealed or painted)	0.01	0.01	0.02	0.02	0.02	0.02
108m ²	1.08 m ²	1.08 m ²	2.16 m ²	2.16 m ²	2.16 m ²	2.16 m ²
Windows	125Hz	250Hz	500Hz	1000Hz	2000Hz	4000Hz
Ordinary glass in steel frame	.35	.25	.18	.12	.07	.04
774m ²	270.9 m ²	193.5 m ²	139.32 m ²	92.88 m ²	54.18 m ²	30.96 m ²
Ceilings	125Hz	250Hz	500Hz	1000Hz	2000Hz	4000Hz
Plasterboard 12mm in suspended ceiling grid	0.15	0.11	0.04	0.04	0.07	0.08
2300m ²	345 m ²	253 m ²	92 m ²	92 m ²	161 m ²	184 m ²
People	125Hz	250Hz	500Hz	1000Hz	2000Hz	4000Hz
Highschool	2	3	4	5	5	4
150	300 m ²	450 m ²	600 m ²	750 m ²	750 m ²	600 m ²

Figure 243. Table showing the sound absorption coefficient values of existing materials (Author,2010)

Sound absorption coefficient values of existing materials

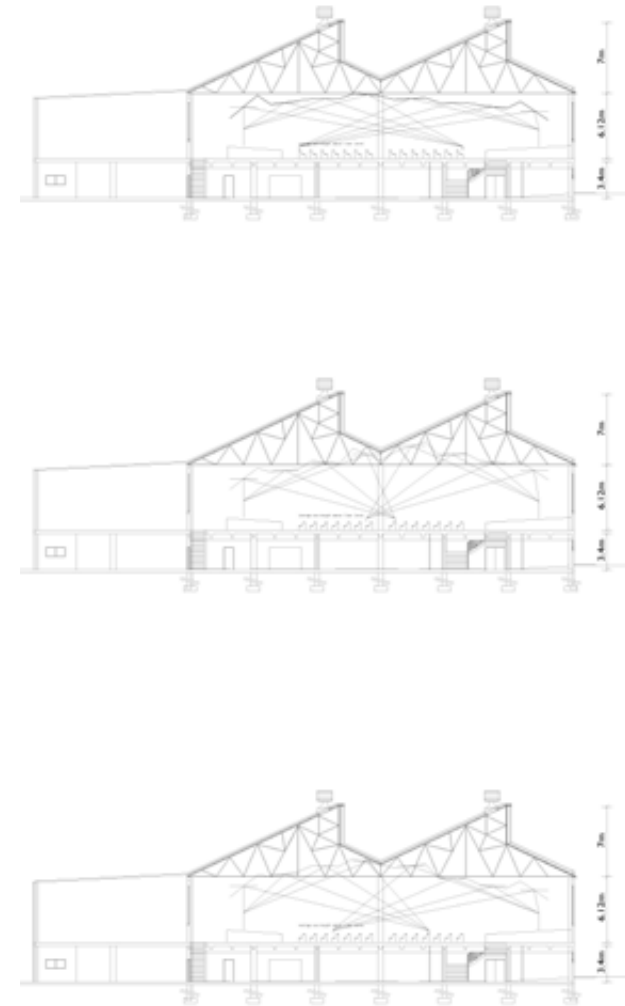

Figure 242. Determining the reflection angles of the acoustic panels (Author,2010)

Distributing sound; Angle of incidence = Angle of reflection

Problem: Noise

Possible cause

The most important kind of external noise affecting buildings is transport noise from road traffic, aircraft and railways (Appleton & Aveline, 1999, 4). The windows are usually the weakest part of the envelope where sound insulation is concerned.

Larger rooms with large reflective surfaces can cause echoes and excessive reverberation (Lord & Templeton, 1986, 42).

Possible solution

Screen or add absorption (Lord & Templeton, 1986, 43). Noise level can be reduced by lining the room surfaces with an efficient acoustical absorbent material (Spring, 1999, 3)

For speech the wall behind the audience must be absorptive and the surfaces behind the actors should be reflective (Appleton & Aveline, 1999, 4). In the case of the Temporary Theatre the walls behind the audience is also the wall behind the actors. From the calculations it is clear that more absorptive material is necessary. Absorptive material will be applied to available surfaces in the form of carpets felts and fabric. The largest floor surface will be covered in rubber tiles. Rubber is a resilient material which will act as an absorber because the interlocking tiles are placed on the concrete floor and not fixed to it with a rigid connection.

Because the theatre has large standard steel frame windows with opening sections it will be a futile exercise to try and insulate the space. The design will aim to

reduce the noise level by placing barriers that intercept the line-of-sight between a sound source (the street) and the audience. As a rough guide, screen-type barriers 1 to 4 m high and mass about 10 kg/m² can give transmission losses of 5 to 20 dB (Spring, 1999, 6).

Problem: Poor reception at rear

Possible cause

Lack of useful reinforcement of sound source (Lord & Templeton, 1986, 43).

Normal conversation is audible over a distance of up to 10m. Raised conversation is audible up to 24m (Lord & Templeton, 1986, 29).

The volume and quality of the unamplified sound is dependent on the volume, shape, size and internal finishes of the auditorium, and on its resultant reverberation time (Appleton & Aveline, 1999, 4).

Possible solution

Add reflective surfaces. Flat surfaces is effective in distributing sound but easily cause a “flutter echo” or “standing wave”. Reflective Concave surfaces concentrate sound in some places causing deficiencies of the reflected sound in certain places called dead spots (Lord & Templeton, 1986, 42). Convex surfaces are the best surfaces for distributing sound. They provide a wide-spread of reflected sound. Reflections can be controlled by irregularities such as columns and trusses or through the use of absorptive materials (Acoustics.com, 2004).

8.10.4 New temporary, sound reflective ceiling panels

The ceiling suspended at calculated angles will reflect and disperse sound into the audience to reinforce the sound and make sure that desired sound is audible. The reflective ceiling panels will be suspended from the existing steel trusses with adjustable cables at the corners. The panels will be made of white, translucent acrylic sheets cut into irregular (forest) and regular shapes (village) and tied together with cable ties through pre-drilled holes. The ceiling will cover the audience and progress from irregular to regular. Assemble will be done on the floor surface below and then hoisted into place. The resilience of the suspended acrylic sheets together with gravity will cause the sheets to sag in the middle forming convex surfaces that will reflect and disperse the sound. The resilience of the sheet is inhibited by the convex shape it takes on and thus loses its absorptive qualities.



Figure 244. Live size model installation testing the acoustic panel system (Author,2010)

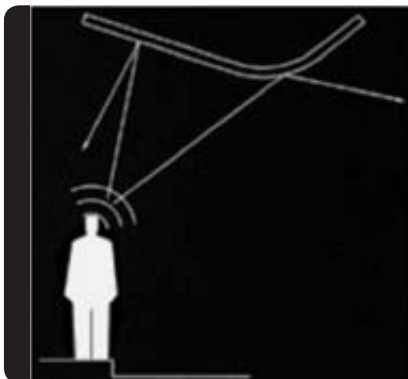

Figure 245. Figure Sound reflection of convex surfaces (Acoustics.com, 2004).

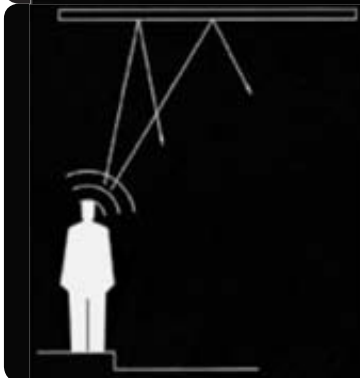

Figure 246. Figure Sound reflection of flat surfaces (Acoustics.com, 2004).

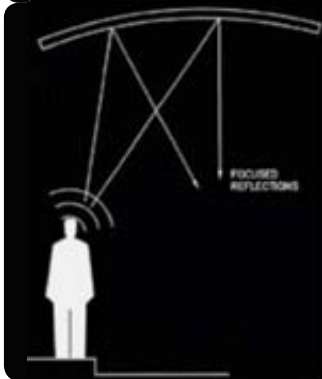

Figure 247. Figure Sound reflection of concave surfaces (Acoustics.com, 2004).

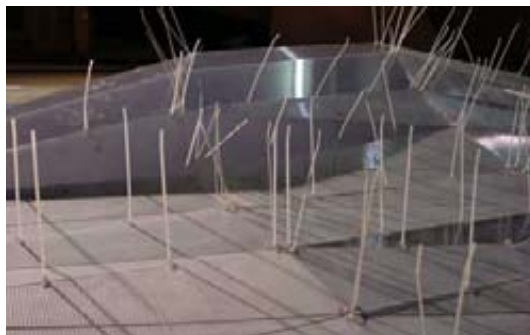

Figure 248. The set for a dance called "California." Polycarbonate panels are joined with plastic zip ties and suspended above the stage with cables (Cramer, 2004).



Figure 249. A focal point for Mash-Up!, an eight-week-long series of experimental events and performances (Ferrara, 2005).



Figure 250. Figure 1:20 Model illustrating acrylic materiality of ceiling panels (Author, 2010).

8.10.5 Configuration & assembly

Marking the dimensions of on the floor.

*Filling the marked area with cardboard.
Tracing and cutting out the shapes.*

*Marking holes in the corners.
Tying pieces together with cable ties.
Attaching strings of fishing line from the
cable ties to the outside.*

*Lifting and suspending the panel from
existing hooks and ballustrades.*

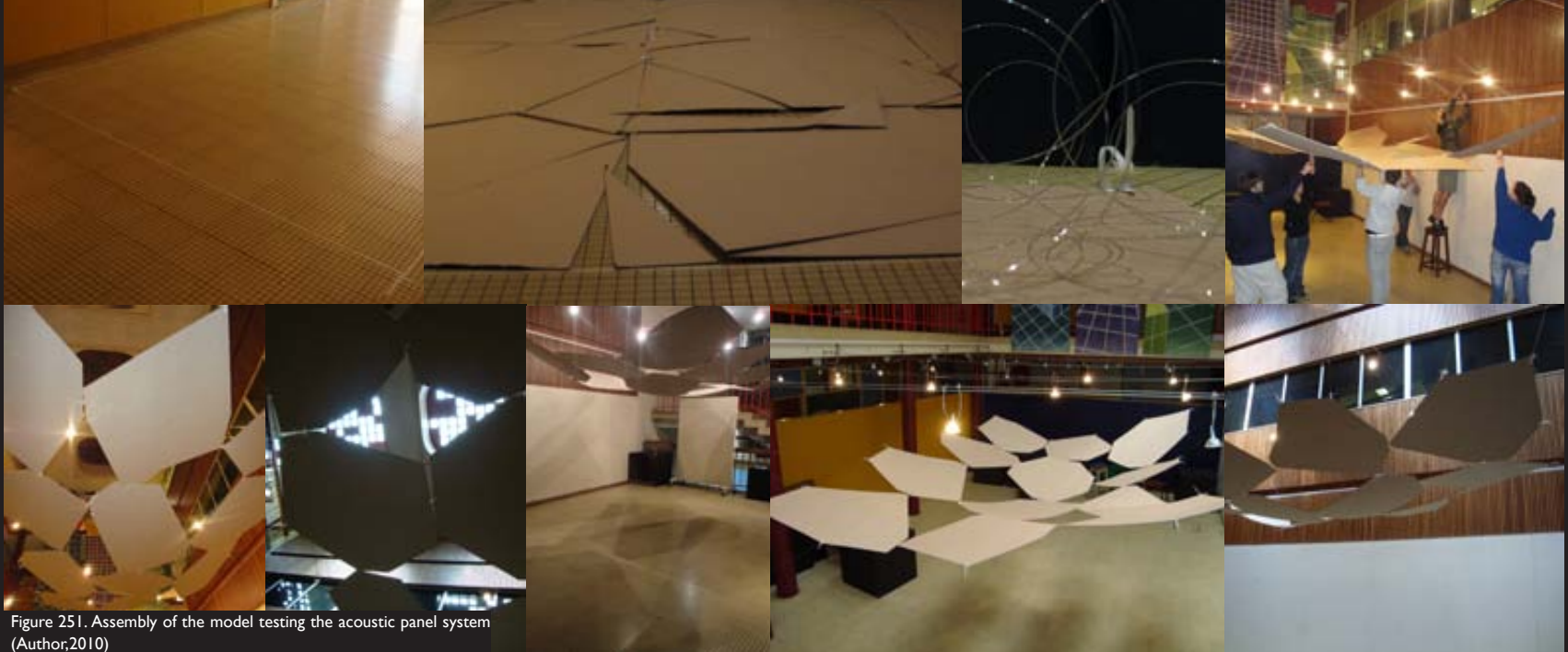

Figure 251. Assembly of the model testing the acoustic panel system
(Author,2010)



Figure Forest ceiling panel plan Village ceiling panel plan
(Author, 2010)

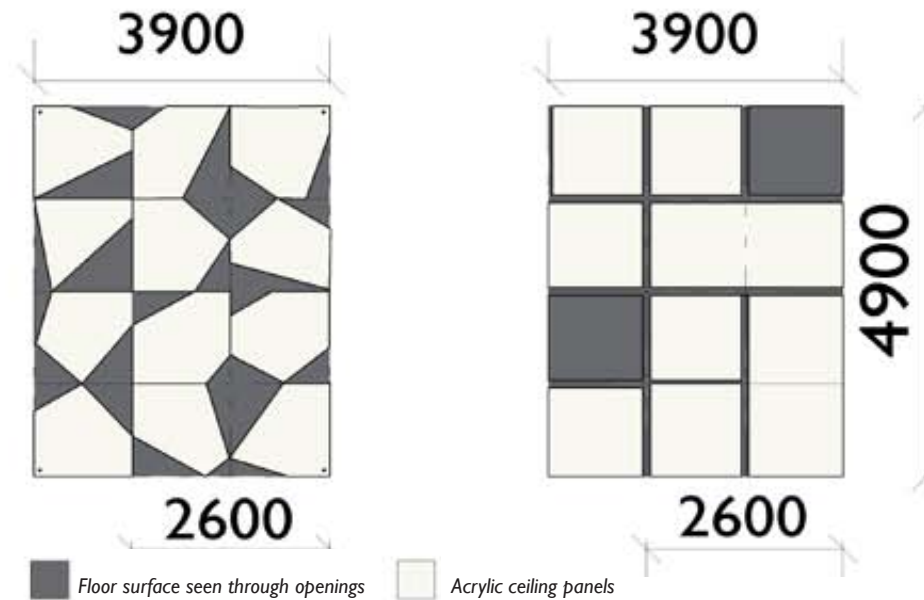
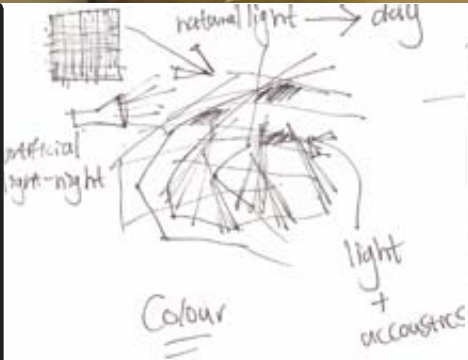
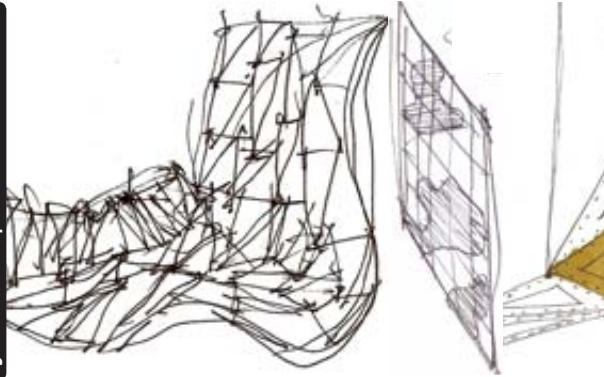

Figure 252. Plan view of acoustic panel model (Author,2010)

April concept sketches



June concept sketches



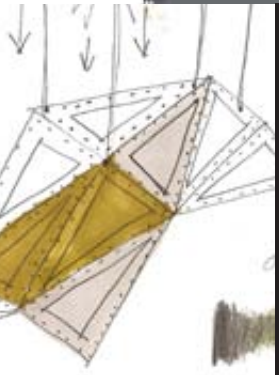

Figure 254. Concept sketches of acoustic panels (Author, 2010)

Figure 253. Ceiling plan showing sound reflecting acoustic panels (Author, 2010)



Adjustable suspension of the ceiling panels from the existing angle section steel trusses 1:10

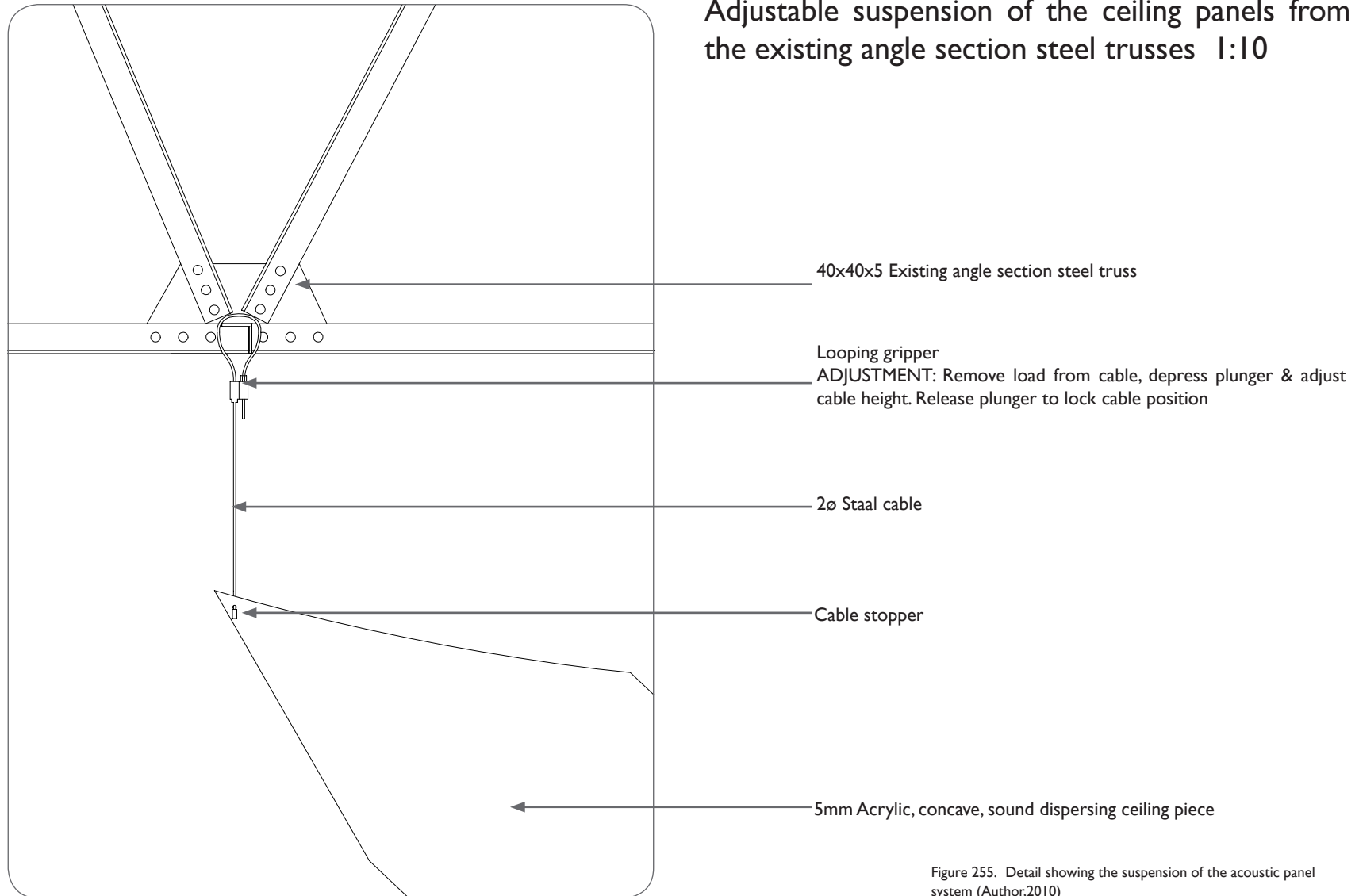
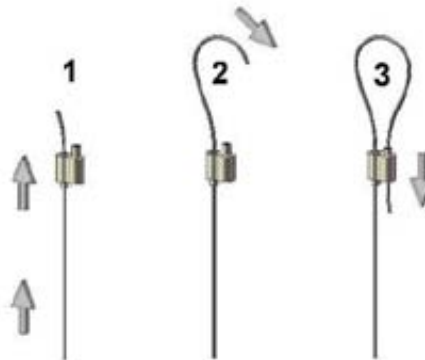

Figure 255. Detail showing the suspension of the acoustic panel system (Author,2010)



Cable ties used to join the 12 individual pieces of each panel

Figure 256. Cable ties (Author,2010)



STEP 1: Insert cable into looping gripper
STEP 2: Pass cable through or around anchor point
STEP 3: Insert cable back into

Figure 257. Diagram illustrating how a looping gripper works (Cable grippers,2010)

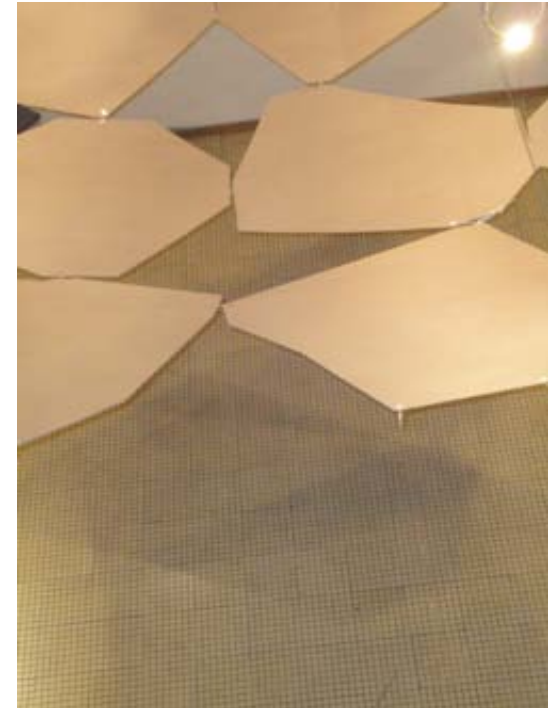
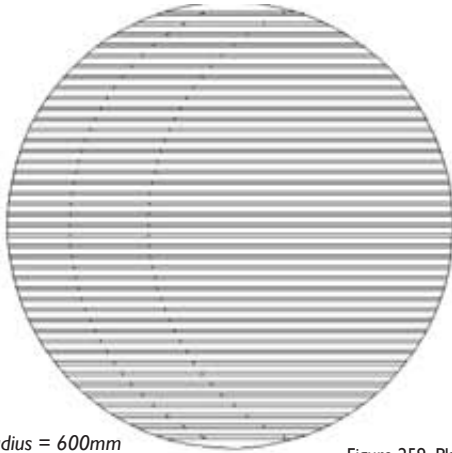

Figure 258. View from above ceiling model showing shadows created on the floor surface underneath (Cable grippers,2010)

8.1 | SEATING _ CARDBOARD DRUM SWIVEL CHAIR



Radius = 600mm

Figure 259. Plan of swivel chair (Author,2010)

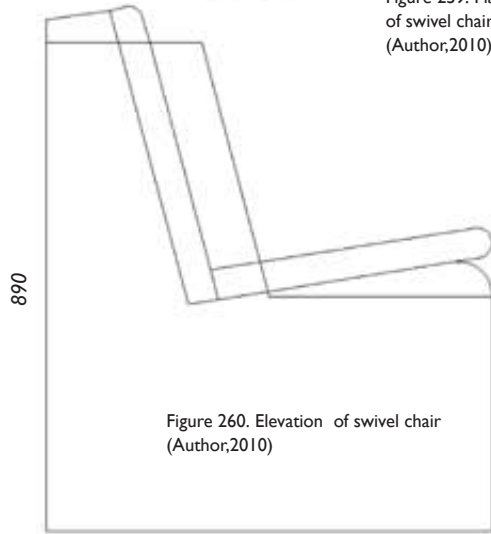

890

Figure 260. Elevation of swivel chair (Author,2010)

590

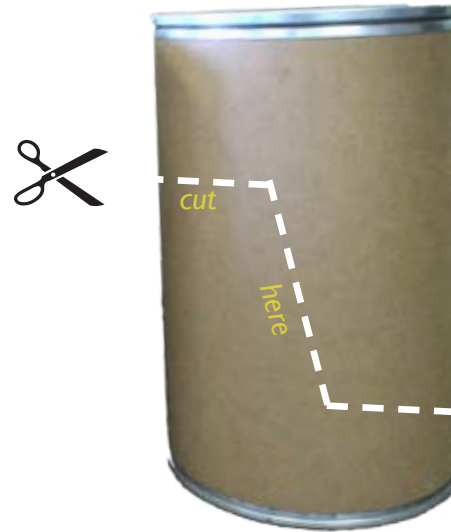
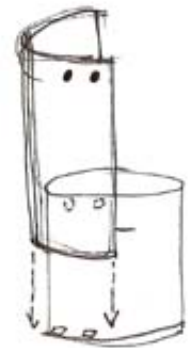
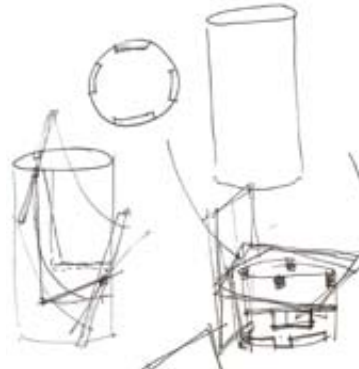

Figure 261. Cardboard drum available on the site (Author,2010)



Figure 262. Chair profile cut from tube resulting in two identical pieces that fit onto each other (Author,2010)

June concept sketches



360 degree rotating chair



Figure 263. Two 38x114mm pieces of timber are cut to 600mm lengths. The ends are rounded and a slot is cut in each end for a casters to fit through. The two pieces are fixed together with a shiplap joint and secured with wood-glue and wood-screws .A caster is placed in each slot and fixed to the wood with wood-screws. Matching holes are cut in the base of the drum to accommodate the casters. The assembly is placed in the bottom of the drum (Author,2010).

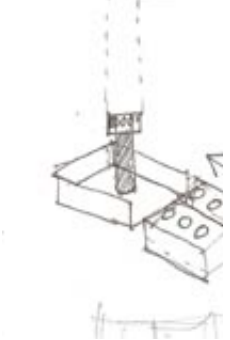
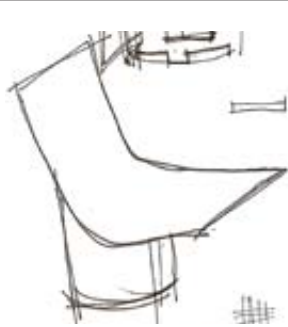

The chair will be manufactured on site from the cardboard drums in which printer toner is packaged and delivered. The profile that is being cut out will allow two chairs to be made from one 1100mm high, 600dia. drum. The sharp edged angular profile will also resemble the stumps of cut down trees. The casters that cant swivel themselves are attached in such a way that the chair can only rotate and not move back and forth easily to help keep the chairs in place and avoid distraction.

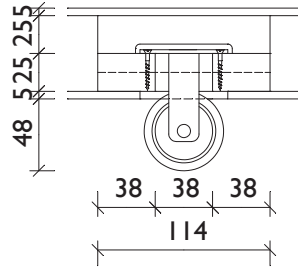

Figure 264. The wood members are fixed to the base of the drum with wood screws and washers. Four pieces of timber are cut to size and a groove is made in each, to fit over the connections of the casters. These pieces are then fixed over the casters and screwed to the wood underneath. This is done to secure the casters in place (Author,2010).



Figure 265. Sheets of cardboard was cut according to the chair profile and stacked next to each other inside the chair to create a seating surface. A 450 x 1000 mm rubber mat is woven from 40mm wide strips of the inner tube of a vehicle tyre. A 400 x 950 x 40 mm piece of foam is covered with a felt cover that can be removed and washed. The covered foam is attached to the rubber mat by pressed-it clips. The 'pillow' is then placed onto the seating surface of the chair to increase comfort & acoustic absorption. The pillow itself can also be used as temporary movable seating with the rubber mat as durable substrate providing a non-slip grip (Author,2010).





Caster screwed onto the 25mm x 14mm plywood cross support into which a slot is cut for the caster to fit through

Detail of caster connection 1:5

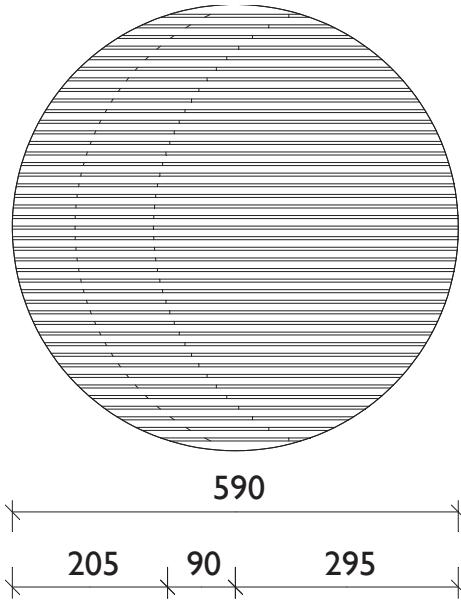

Plan of cardboard swivel chair 1:10

Figure 266. Detailing of cardboard swivel chair (Author, 2010)

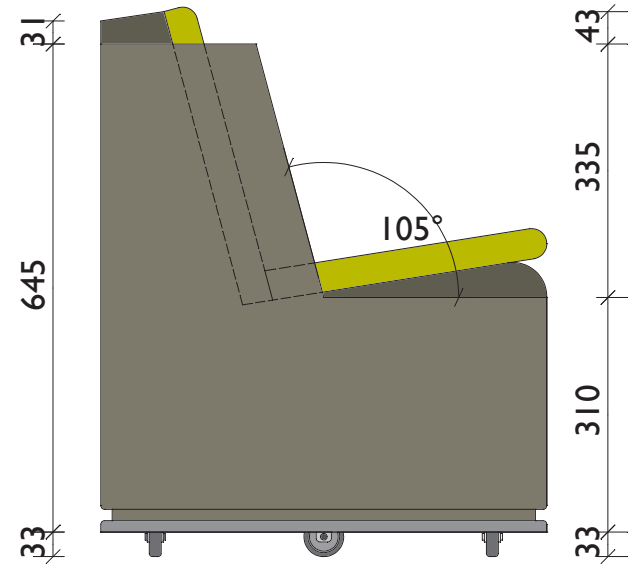

Elevation of cardboard swivel chair 1:10



Figure 267. 1:1 Prototype of cardboard swivel chair with upholstered covering (Author, 2010)

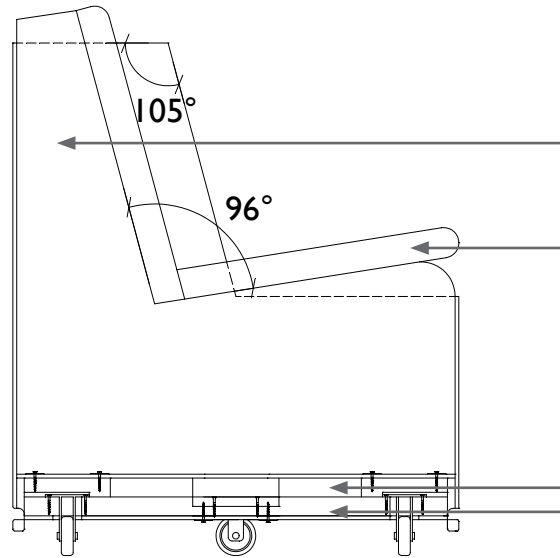

590ø Cardboard drum cut to specifications

1000mm x 400mm Upholstered covering made from recycled rubber, foam and felt

5mm Masonite coveringbase, screwed onto 25mm plywood over castor
Caster screwed onto a 25mmx14mm plywood cross support into which a slot is cut for the caster to fit through

Longitudinal section through cardboard swivel chair 1:10

8.12 FIRE SAFETY

General requirements according to SANS 0400 Part T

Compliance of the Temporary Theatre

Escape routes & doors	Escape routes & doors
<ul style="list-style-type: none"> 45 Maximum travel distances to nearest escape door 	<ul style="list-style-type: none"> The length of the building exceeds 45m and therefore a minimum of two escape routes have been provided in the initial design. The added ramp entrance will further ease evacuation.
<ul style="list-style-type: none"> Exit door shall open in the direction of travel along the escape route 	<ul style="list-style-type: none"> All of the existing exit doors already open in the direction of travel. The new door that exit to the ramp is a sliding door.
<ul style="list-style-type: none"> Walls of corridors forming part of an escape route must be constructed of non-combustible materials 	<ul style="list-style-type: none"> The existing walls of corridors forming part of an escape route are constructed of non-combustible materials
<ul style="list-style-type: none"> The floor of any escape route must have a slip resistant surface. 	<ul style="list-style-type: none"> The existing concrete floor screed will be covered in rubber tiles that increase the slip resistance of the interior floor surface and varnished OSB board will be used for the surface of the interior and exterior ramp.
<ul style="list-style-type: none"> The maximum number of people per escape route is 190. Escape routes for 190 people must have a minimum width of 1800mm. 	<ul style="list-style-type: none"> The existing escape routes are 2900mm (exit 6) and 2185mm (exit 4). The planned occupancy for the Temporary Theatre is 150 patrons and shouldn't exceed 200 including staff. The existing escape routes are thus sufficient. The new exit via a 2150mm wide scaffold ramp will provide an accessible fire escape.
<ul style="list-style-type: none"> Rooms with a population of more than 25 must have at least 2 exit doors opening in the direction of travel along the escape route and with an aggregate width not less than the required width for the escape route. 	<ul style="list-style-type: none"> There are two existing exit doors. A third one will be provided for the ramp exit.
<ul style="list-style-type: none"> Emergency routes shall discharge at ground level directly to a street or public place or to an approved open air space leading to a street or public place. 	<ul style="list-style-type: none"> The existing stairway forms part of an emergency route. It has handrails on each side throughout its length and discharge into a corridor that is part of the route and then into an open space. The ramp discharges into the street.



Figure 268. Existing fire escapes routes (Author, 2010).

General requirements according to SANS 0400 Part T

Compliance of the Temporary Theatre

Markings, signposting & Emergency lighting	Markings, signposting & Emergency lighting
<ul style="list-style-type: none"> Emergency routes shall be clearly marked and signposted to indicate the direction to be travelled in the case of emergency. 	<ul style="list-style-type: none"> The Temporary theatre will be entirely non-smoking and "No smoking" signs of approved size shall be prominently displayed.
<ul style="list-style-type: none"> Emergency routes must be provided with artificial lighting and when the building is occupied there must be a minimum illuminance of 50 lux on a horizontal plane 100 mm above the floor. 	<ul style="list-style-type: none"> The existing exit routes already comply. The new exit route will be provided with such lighting.



Figure 269. Signposting for escape routes & equipment (Author, 2010).



Figure 270. Discharge spaces emergency routes (Author, 2010).

Occupancy specific requirements requirements according to SANS 0400 Part T

Compliance of the Temporary Theatre

Escape routes	Escape routes
<ul style="list-style-type: none"> Aisles must have a minimum clear width of 1100mm and allow unobstructed movement to the escape routes. Distance from the front edge of any seat to the front edge of the seat immediately in front of, or behind must be a minimum of 675 mm. 	<ul style="list-style-type: none"> The width of the aisles between the chairs is 1800mm to allow actors to move and perform along them. To allow the chairs to rotate 360 degrees and for people to have enough legroom the seats are spaced 841mm away from each other which is further than in a typical theatre. As a result there is ample space between the seats.
Fire-fighting equipment	Fire-fighting equipment
<ul style="list-style-type: none"> Fire hydrants One per 1 000 m² or part thereof Portable extinguishers Occupation A2: 1 per 200m² Occupation D2: 1 per 100m² (Previous occupation: D2 Moderate risk industrial) Hose reels Any building of two or more storeys in height or in any single storey building of more than 250 m² in floor area must have hose reels at a rate of 1 for every 500 m² Sprinkler system 	<ul style="list-style-type: none"> For occupation A2 fire hydrants aren't required. The fire hydrants required for the previous occupation will be an added benefit. In accordance with its previous occupation the space has more portable extinguishers with bigger capacities than needed for the new occupation. There are already enough fire hydrants provided for the existing buildings floor area of 2972m² (3000m²/500m² =6) For occupation A2 without a fly tower a sprinkler system isn't required. The existing building does have a sprinkler system that will provide extra safety in the case of fire.



Figure 271. Fire-fighting equipment (Author, 2010).

Occupancy specific requirements according to SANS 0400 Part T

Compliance of the Temporary Theatre

Escape routes & doors	Markings, signposting & Emergency lighting
<ul style="list-style-type: none"> 45 Maximum travel distances to nearest escape door 	
<ul style="list-style-type: none"> Exit door shall open in the direction of travel along the escape route 	<ul style="list-style-type: none"> The Temporary theatre will be entirely non-smoking and "No smoking" signs of approved size shall be prominently displayed.
<ul style="list-style-type: none"> Walls of corridors forming part of an escape route must be constructed of non-combustible materials The floor of any escape route must have a slip resistant surface. 	<ul style="list-style-type: none"> Such signage is not provided in the existing building and will be added in order to comply with the requirements. The possibility of battery powered devices will be investigated.
<ul style="list-style-type: none"> The maximum number of people per escape route is 190. Escape routes for 190 people must have a minimum width of 1800mm. 	<ul style="list-style-type: none"> The existing building wasn't intended for use during the night and therefore new emergency lighting independent of the normal mains supply will be installed.

Rules that don't apply

Sub rules TT49.2, TT49.4, TT49.5 and TT49.6 don't apply in the case of places used solely for amateur productions or stages without a fly gallery. The Temporary theatre will mainly be used for amateur productions and won't have a fly tower. This provides certain design advantages: the existing separation or lack thereof between the audience and the stage and the stage and the dressing rooms is allowed. Fire shutters aren't required, the stage floor may be of timber, an automated roof ventilation system, communication and alarm systems aren't needed and the dressing rooms don't need direct access to an emergency route. Any Decorative material, wall, partition, horizontal slab and ceiling don't have to be of a non-combustible material.

- Rooms with a population of more than 25 must have at least 2 exit doors opening in the direction of travel along the escape route and with an aggregate width not less than the required width for the escape route.
- Emergency routes shall discharge at ground level directly to a street or public place or to an approved open air space leading to a street or public place.