



UNIVERSITEIT VAN PRETORIA  
UNIVERSITY OF PRETORIA  
YUNIBESITHI YA PRETORIA

# THE OBJECT OF EXPERIENCE



UNIVERSITEIT VAN PRETORIA  
UNIVERSITY OF PRETORIA  
YUNIBESITHI YA PRETORIA

# The object of experience

A phenomenological approach to exhibition space in the  
Ditsong: National Museum of Natural History

by Olga-Marie de Villiers

Study Leader: Raymund Konigk

Study Leader (co): Elana van der Watt

Studio Master: Arthur Barker

University of Pretoria, Department of Architecture

Submitted in fulfilment of part of the requirements for the  
degree of Magister of Interior Architecture (Professional) in  
the Faculty of Engineering, Built Environment and  
Information Technology.

2010

## THANK YOU

to God, my Deliverer

to those who believed in me even when I didn't

The financial assistance of the National Research Foundation (NRF) towards this research is hereby acknowledged.

Opinions expressed and conclusions arrived at, are those of the author and are not necessarily to be attributed to the NRF.

# Die objek van ervaring

deur Olga-Marie de Villiers

Studie Leier: Raymund König

Studie Leier (ko): Elana van der Watt

Studio Meester: Arthur Barker

## Ekserp

Hierdie studie ondersoek die skep en manipulasie van ervaring in die binneruim. Met fenomenologie as uitgangspunt word die objek sekondêr tot die ervaring.

Die perseel sal 'n ongebruikte gewelf struktuur op die Ditsong: Nasionale Museum van Natuurlike Geskiedenis se gronde in Pretoria wees. Om uitdrukking te gee aan ervaring is die gekose program 'n ervaring gebaseerde uitstalling wat toevoeg tot die huidige uitstalling by die museum. Die uitstalling sal jaarliks verander word om variasie te verseker vir gereelde besoekers.

Om de verandering van die uitstalling te vergemaklik, word die ruimtes ontwerp met die sintuie as basis laag. Elke ruimte sal primêr ervaar word deur een van die sintuie sodat die gebruiker bewus word van die spesifieke sintuig in daardie ruimte. Die uitstalling wat gebaseer is op die sintuigbasis kan fokus op daardie sintuig om feite oor die onderwerp oor te dra.

Keywords:

Phenomenology

Experience

Exhibition

Ditsong National Museum  
of Natural History

Die gekose onderwerp vir die uitstalling uiteengesit in die projek is die insekversameling. Die doel van die uitstalling sal wees om te wys hoe insekte gebruik maak van hulle sintuie. Die sintuie van die insek sal bo op die basis laag van menslike sintuie gevoeg word. Omdat alles wat ons ervaar deur ons eie sintuie geskied, kan ons slegs 'n idee kry van wat die insek sal ervaar. Daar sal altyd die tussenlaag van ons eie sintuie wees.

# The object of experience

by Olga-Marie de Villiers

Study Leader: Raymund König

Study Leader (co): Elana van der Watt

Studio Master: Arthur Barker

## Abstract

The study will investigate the creation and manipulation of experience in interior space. With phenomenology as the premise, the object becomes secondary to the experience.

The site will be an unutilized vault structure on the Ditsong: National Museum of Natural History grounds in Pretoria. To give expression to experience, the program chosen is an experience based exhibition that adds onto the current exhibition at the museum. The exhibition will change annually to ensure variation for yearly visitors.

To facilitate changing the exhibition, the spaces will be designed with the senses as base layers. Each space will be experienced primarily through one of the senses, so that the user becomes more aware of the specific sense in that space. The exhibition that layers onto the sense layer can focus on that sense to convey facts about the subject.

The chosen subject for the exhibition detailed in the project is the insect collection. The purpose of the exhibition will be to show how insects use their senses. The senses of the insect will layer onto the basis layer of human senses. Because everything we experience is through our own senses, we can only get an idea of what the insect would experience. There will always be the interlayer of our own senses.

# CONTENTS

List of figures	iv	06_Analysis	45
01_Introduction	3	6.1_Light	47
1.1_Problem Statement	3	6.2_Scale	52
1.2_Project Aims	5	6.3_Context	54
1.3_Research Methods	5	6.4_Materiality	55
02_Theoretical approach	7	6.5_Object in space	56
2.1_Phenomenology	9	6.6_Circulation through main building	59
2.2_Environmental Psychology	12	6.7_Extension of the intervention	62
03_Context, framework, site	15	07_Design discourse	65
3.1_Framework	19	7.1_Reaction to existing elements	67
3.2_Site	19	7.2_Exploration of form	70
3.2.1_Ditsong Museum History	19	7.3_Final proposal	76
3.2.2_Ditsong Museum at present	21	08_Technical investigation	91
3.2.3_The vault structure	23	8.1_Structure	93
04_The Museum	27	8.2_CLadding	93
4.1_Existing vs Experience	29	8.3_Floor finishes	94
4.2_The Insect	30	8.4_Materials	97
4.3_Future of Ditsong Museum	31	8.5_Lighting	98
05_Experience	35	8.6_Split unit air conditioning	100
5.1_What is experience?	37	8.7_Stair detail	101
5.2_Investigation of experience in	39	8.8_Seating detail	103
existing designed space		_Conclusion	105
5.2.1_The Church	39	_Appendix	107
5.2.2_Oceanarium	40	_List of references	113
5.2.3_Cour Puget, Louvre	41		
5.2.4_Restaurants	42		
5.2.4.1_Mugg&Bean	42		
5.2.4.2_Kream	42		
5.2.4.3_Primi Piatti	43		

# LIST OF FIGURES

2.1_Diagram explaining phenomenology	10	5.15_Interior of Primi Piatti Restaurant (Menlyn Park 2010)	43
2.2_Thermal Bath, Vals, 1996 (Galinsky 2006)	11	5.16_Interior of Primi Piatti Restaurant (Menlyn Park 2010)	43
2.3_Thermal Bath, Vals, 1996 (Galinsky 2006)	11	6.1_Diagram showing natural light entering the foyer, Genesis Hall 1, Geosciences Hall and offices to the east of the vault	47
2.4_The heated pools, Vals, 1996 (Picassa [sa])	11	6.2_Photo showing window above staircase and across from entrance into foyer	47
3.1_Aerial photo showing Ditsong: National Museum of Natural History in context, 2010	17	6.3_Exhibition panels cutting off natural light into the hall	48
3.2_View of main entrance of Ditsong National Museum of Natural History from Paul Kruger Street, 2010	18	6.4_Genesis Hall 1	49
3.3_View of City Hall from Ditsong National Museum of Natural History entrance, 2010	18	6.5_Genesis Hall 2	49
3.4_Framework; museum walk and city centre walk	19	6.6_Diagrams showing the shade in the vault in June	50
3.5_Map showing location of Ditsong: National Museum of Natural History	20	6.7_Diagrams showing the shade in the vault in December	51
3.6_Site plan	20	6.8_Figure showing scale and placement of interior spaces	52
3.7_Diagram showing development of the museum	21	6.9_Low volume followed by higher volume in Genesis 1	52
3.8_Diagram showing location of exhibition spaces	21	6.10_Diagram showing actual scale of interior spaces against the volume in the steel structure	53
3.9_Northern vault with museum building around it. Southern vault in background	21	6.11_Diagram showing the perceived scale of a volume in terms of context	54
3.10_Ground floor plan of museum and vault structure	22	6.12_Stairs and handrail at entrance of museum	55
3.11_Diagram illustrating entrances into vault structure	23	6.13_Floor finish in foyer	55
3.12_Photo showing ramp structure in Northern vault	23	6.14_Window above foyer	55
3.13_Photo showing interior of the structure	23	6.15_Sandstone staircase	55
3.14_Photo illustrating contrast between steel and plant	25	6.16_Floor finish from stairs to hall	55
3.15_Photo illustrating contrast between structure and building	25	6.17_Floor finish change between hall and Genesis 1	55
4.1_Diagram showing process followed for a new exhibition	31	6.18_Interior of Genesis 1	55
4.2_Focus Terra Exhibition by Holzer and Kolber Architects, 2009 (e-architect [sa])	32	6.19_Interior of Genesis 1	55
4.3_Focus Terra Exhibition by Holzer and Kolber Architects 2009 (e-architect [sa])	32	6.20_Building facade	55
5.1_Illustration of light as element of experience	38	6.21_Steel structure of Vault	55
5.2_Illustration of scale as element of experience	38	6.22_Service pipes on facade of building	55
5.3_Illustration of object as element of experience	38	6.23_Wild fig tree roots	55
5.4_Illustration of context as element of experience	38	6.24_Wild fig tree leaves	55
5.5_Illustration of material as element of experience	38	6.25_Entrance into vault	55
5.6_Church of the light, Tadao Ando, 2007 (Jodidio 2007:126)	39	6.26_Ramp on facade of building	55
5.7_Catholic Basilica, Bern, Switzerland (Chris Spracklen 2008:sp)	39	6.27_Ramp attached to building	55
5.8_Lisbon Oceanarium (Modernnomad 2010:sp)	40	6.28_Whale skeleton in front of museum	56
5.9_Lisbon Oceanarium (Modernnomad 2010:sp)	40	6.29_Elephant in the foyer of the museum	56
5.10_Cour Puget, Louvre, Paris, France	41	6.30_Smaller volume created by temporary structure in Genesis 1	56
5.11_Trees in planters in Cour Puget, Louvre	41	6.31_Wooden floor behind temporary structure and carpet in exhibition space	57
5.12_Interior of a Mugg & Bean Franchise (Top places 2008)	42	6.32_Unobstructed volume within vault	57
5.13_Interior of Kream Restaurant (Kream 2010)	42	6.33_Diagram showing existing public circulation through the museum on ground level	58
5.14_Interior of Kream Restaurant (Kream 2010)	42		

6.34_Diagram showing existing public circulation through the museum on first floor and mezzanine	59	7.35_Level 0 - Touch Plan	80
6.35_Entrance over ramp on ground level	60	7.36_Illustration of interpretation of texture for exhibition	81
6.36_Entrance on first floor onto ramp from Dinosaur Hall	60	7.37_Illustration of floor finishes creating texture	81
6.37_Entrance through office on mezzanine level onto ramp	60	7.38_Illustration of the tree touching the user, the user touching the tree	81
6.38_Entrance on second floor onto ramp from Genesis 1	60	7.39_Level 1 - Hear Plan	82
6.39_Drawing showing some possibilities in terms of what the user would see through the existing windows and how curiosity could be evoked	61	7.40_Illustration of connection between Level 1 - Hear and Genesis 1 - Section	83
6.40_Extention options indicated on aerial photo	62	7.41_Illustration of connection between Level 1 - Hear and Genesis 1 - Plan	83
6.41_Diagram showing possible extentions of the intervention	62	7.42_Illustration of sound refelctive space	83
6.42_The wall of the building behind the foyer can be seen through the windows above the stairs	63	7.43_Level 2 - See Plan	84
7.1_Window looking out on vault structure from Genesis 1	67	7.44_Illustration of view being revealed in Level 2 - See	85
7.2_Illustration of possible reactions to windows	67	7.45_View of building across Visagie Street	85
7.3_Entrance into vault structure from Genesis 1	68	7.46_Perspective painted on ground and facades of building (Dezeen 2009)	85
7.4_Illustration of possible reations to volume	68	7.47_Perspective painted on ground and facades of building (Dezeen 2009)	85
7.5_Illustration of possible reactions to tree	68	7.48_Level -1 - Taste and Smell Plan	86
7.6_Wild fig tree	68	7.49_Parabienta Green Wall, Toronto (Thegrowspot.com 2010)	87
7.7_Illustration of possible reactions to tree	68	7.50_Parabienta Green Wall, Toronto (Thegrowspot.com 2010)	87
7.8_Photo showing brick wall on northern facade	69	7.51_Blueberries (Blueberries for beauty and taste 2009)	87
7.9_Photo showing balcony on eastern facade	69	7.52_Goji berries (Tibet Advice 2007)	87
7.10_Illustration showing possible reactions to balcony	69	7.53_Strawberry blossom (Strawberry Plants.org 2010)	87
7.11_Photo showing ground level of volume	69	7.54_Strawberry plant (California Pacific Plant Exports 2010)	87
7.12_Models showing exploration of form	70	7.55_Garlic chives (Aiden brooks: Trainee chef [sa])	87
7.13_Models showing exploration of form	70	7.56_Apple mint herb (Free images [sa])	87
7.14_Models showing exploration of form	70	7.57_Illustration of experience created by vertical garden	87
7.15_Models showing exploration of form	70	7.58_Ground level plan	88
7.16_Models showing exploration of form	70	7.59_Illustration of plants forming basis for exhibition	88
7.17_New element wrapping around existing ramp structure	70	7.60_Illustration of trees forming specific view point of volume	88
7.18_New element wrapping around existing ramp structure	70	7.61_Illustration of experience created by long grass	88
7.19_Elements forming different interior spaces through different compositions	71	8.1_Diagram showing floor and roof structures for all levels	93
7.20_Wasp nest latching on to existing structure	71	8.2_Plan of sound pods showing linoleum used	94
7.21_Permanent structure with columns on grid to act as guide for temporary experience	72	8.3_Detail section of sound pod	94
7.22_Permanent stucture developed into platforms	72	8.4_Detail plan of sound pod	95
7.23_Wellcome Wing, blue lights create sense of mystery (Tim_d 2010)	72	8.5_Saligna solid wood decking	96
7.24_Entrance into Wellcome wing flooded with orange light (Mumphalee 2010)	72	8.6_Detail section through floor	96
7.25_Experience based exhibition in Wellcome Wing (Davepatten 2010)	72	8.7_Aluminium plate and Linouleum xf Etrusco Beige	96
7.26_Elements of experience and possible combinations thereof	73	8.8_Materials according to level	97
7.27_Different experiences created through different placements of planes	73	8.9_Representation of light progression on Level 2 - See	98
7.28_Model showing proposed ramp structure	74	8.10_Representation of progression from artificial to natural light	99
7.29_Model showing proposed ramp structure	74	8.11_Casette type outlet	100
7.30_Elevation of cladded ramp structure protruding through steel structure	75	8.12_Stair detail _ Section	101
7.31_Sketch illustrating change within interior space and response of exterior cladding	75	8.13_Fixing of glass balustrade to tread_Front view	102
7.32_Model of final proposal for intervention	77	8.14_Fixing of glass balustrade to tread_Bottom view	102
7.33_Elevation of intervention	78	8.15_Illustation of Printed vinyl stuck on balustrade glass	102
7.34_Section showing all levels of intervention	79	8.16_Detail of seating becoming exhibition	103
		8.17_Plan of seat	103
		8.18_Elevations of seat	103
		8.19_Stranded wire fittings	103



UNIVERSITEIT VAN PRETORIA  
UNIVERSITY OF PRETORIA  
YUNIBESITHI YA PRETORIA

# 1 introduction

general background information





A building creates images that are linked with emotions. If the basic conditions of phenomenological theory is not fulfilled by a building, in that it should be a symbol of human existence or presence in the world, it would be unable to influence these feelings. It is only when a building fulfils these conditions that it can become more than just a sculpture (Pallasmaa 1986:452).

Brand (1994:3) said “First we shape our buildings, then they shape us and then we shape them\_ *ad infinitum*.” Man transforms the environment in which he moves, but also adapts to and is influenced by physical environments. There exists a constant relationship and interaction between man and the physical context. Although the first contact we make with architecture is physical, the actual importance of architecture lies in the experience it creates and the influence it has on the behaviour of the user who occupies the space.

Sights, sounds, shapes, textures and smells all contribute to the experience of place. Pallasmaa (2005:11) stated that all the senses should be addressed simultaneously in ‘life-enhancing’ architecture.

Experience happens anywhere and everywhere, but the quality of experience can be manipulated, explored and applied to contribute to a specific feel and purpose of place.

The thesis will focus on how experience can become the basis for the design decision making process. The site and program, whilst important to any design, becomes the vehicle to be able to investigate and apply experience and therefore stands secondary to experience.

The study will investigate the regeneration of the existing steel vaults at the Ditsong: National Museum of Natural History, previously the Transvaal Museum of Natural History, in Paul Kruger Street, Pretoria. This will be done in conjunction with the exhibiting of natural history in order to revive interest in the museum as well as to assist the museum in the education of natural history. A secondary aim of the study is to give meaning to the field of interest beyond mere facts and change the perception of users in general about the subject of the programme.

### 1.1 Problem statement

Interior design plays an important role in how we experience space and what the lasting effect of the experience is on the user. Museum design, in general, is more concerned with portraying facts than what the experience of the user is within the exhibition space. Experience within built form easily becomes secondary to the objects and the aesthetics of a space.

Pallasmaa (1986:450) claims that planning has become a game of form.

To determine how specific programme related experience can be created through utilisation of the user's senses, the relationship between the human body, human behaviour and the physical environment will be investigated. The study will explore the creation of and experimentation with experience within a specific context and programme. The study will also look at the essential meaning of experience and the role interior design can play in this exploration.

The user of a building or space should not be seen as an observer in space, but as an active participant. A building can only be successful if the user can interact and feel comfortable and use the building as it was intended by the architect or designer. Tadao Ando said:

*"Architecture is deemed complete only upon the intervention of the human that experiences it. In other words, architectural space becomes alive only in correspondence with the human presence that perceives it in our contemporary culture"* (Ando in Jodidio 2007:13).

Pallasmaa (1986:454) states "An impressive architectural experience sensitizes our whole physical and mental receptivity."

Where human experience and consciousness take on material and spatial form, embodied space is located (Altman 1975:sp). The built environment is too easily limited to concrete physical space and objects. Human social behaviour in relation to the physical environment and the influence the environment has on the user are aspects of the profession that should be given the same weight as the physical and aesthetic. Interior architecture has so much more to offer

in terms of sensory engagement and quality of experience. The constant interaction between the user and architecture, between skin and material, allows for exploration and development. Because the user is a multi-sensory being, experience in architectural space should be a collaboration of all the senses fused into each other to create a heightened experience. Phenomenology and environmental psychology will be investigated in chapter 3 as theory of experience.

Space, light or the absence thereof, objects in space, materials used, sound, smell, context, scale and time are all different elements that influence experience. All these elements contribute to or demote the experience of place and have to be taken into account in the design of space. These elements influence each other and can be used together with a specific end goal in mind, to create a precise experience, quality or sense of place. Attention will be given to these elements individually as well as in conjunction with each other.

The aim of the study is to create an intervention that could enhance experience of place through specific investigation and implementation. In doing so, it will enrich the interior design field and inform it as to how experience can be created, enhanced and exploited. Even though the study will be specific to the programme and site, it will act as a case study and aid in creating awareness of the importance of quality of experience and the exploitation thereof.



## 1.2 Project aims

- Create spaces where quality of experience is the primary focus
- Enhance experience through stimulating the user's senses and encouraging interaction
- Create an experience that adds to the exhibition of natural history and give meaning beyond mere facts
- Instigate a change in perception of the museum as a whole and strengthen its identity

## 1.3 Research methods

Other than literature and precedent studies, the heuristic research method will be used as informant for design decisions. Experience will be investigated in terms of specific elements and how these elements were applied in existing buildings.

\*

The relationship and communication between the user and the physical environment, as well as the interaction of body and material, will be investigated and analysed and used to influence the design of experience. This will be applied to guide, educate and affect people within and through interior design. Experience will be created in interior space for the specific programme of exhibition beyond mere facts. Behaviour will be manipulated and influenced through interior design and the use and application of elements of experience such as light, material, object, time, space, sound and smell. User experience as driving force in the creation of interior space becomes the primary focus of the study.

# theoretical approach to space with relation to experience

investigation of theoretical influences



The influence the environment that we move in has on us can completely change the way we behave (Cave 1998:1). This influence, and the subsequent change in behaviour, can be on a subconscious level or very direct and clear to the user. Experience can have a very specific function and focus within architectural space. In this chapter two approaches to experience as program generator will be discussed namely phenomenology and environmental psychology.

## 2.1 Phenomenology

Phenomenology seeks to concentrate on the experience, rather than on what is experienced. The focus is not the objects in space, but the essential structure of the experience or the way in which these objects are manifest to us (Cerbone 2006:3,7). When an object is experienced, no one experience of that object can present or take in that object in its entirety. Only one side can be presented at once (Cerbone 2006:19). This implies that any perceptual experience will always be inadequate and the other sides of the object will only be hinted at by the experience but “is not part of the experience in the sense of being presented in that experience”. This implies that there does not exist complete certainty about what is being experienced or the

experience is not “apodictic”. Future experiences may show the falsity of the previous experience, but because it is not the object of the experience that matters but the experience itself, the falsity or truth of that experience is not of importance (Cerbone 2006:20).

Edmund Husserl (1859 – 1938), viewed as the father of phenomenology, delineated experience to the essential structure thereof. He identified the subject, which is the observer, and the object, that which is being experienced. To fully understand the object, for instance a pencil, different sides of the pencil have to be experienced. These different experiences accumulate as the “horizontal structure of experience”. The “just-experienced” and the “still-to-be-experienced” are parts of the horizon of experience (Cerbone 2006:27). All these horizons are fused together through “synthesis” and form the “adumbration” of the experience, which is all the experiences, of one side of the pencil at a time, put together. This gives rise to “fixed and abiding unities” (Cerbone 2006:28,29).

Two other terms that contribute to the understanding of the essential structure of experience are ‘noesis’ and ‘noema’. Noesis is the process of experiencing or the process of “synthesizing various moments of experience”.

Noema is the “sense” or “meaning” of the process, focused on the content of experience, regardless of whether or not the object exists. Although noema is directed at the object of the experience, there exists a sharp distinction between noema and the object itself (Cerbone 2006:29).

As can be seen here, the focus of phenomenology lies not on the content or object of experience, but on the experience itself. Therefore the space becomes secondary to experience and that which lingers in the mind of the user. The phenomenological approach to theory in architecture argues that the experience of architecture and building materials and their sensory properties become important. Pallasmaa (1986:451) states “[t]he phenomenology of architecture seeks the inner language of building”. He argues that planning became a game of form. The result was that the reality of the experience in the building was ignored. It is important to interpret user behaviour, not only to represent it. He states that it is time that we reconsider whether architectural feeling can be created through forms and geometry in general and that the only effect form has on our feelings is through that which it represents (Pallasmaa 1986:450). Benton McKaye said: “The job is not to plan, but to reveal” (Hiss 1990:200).

A building creates images that are linked with emotional feelings in our subconscious. If a building does not fulfil the basic conditions of phenomenological theory in that it should be a symbol of human existence or presence in the world, it would be unable to influence these feelings. It is only when it influences these feelings that a building can become more than a sculpture (Pallasmaa 1986:452).

\*

Applied in the field of interior design, phenomenology can change and enhance the manner in which we experience space. When thinking in terms of phenomenology, the designer is more aware of the effect or importance of specific experience within space, consciously and sub-consciously. The experience created should relate directly back to the programme, and therefore the space and programme, as well as the user, becomes closely connected.

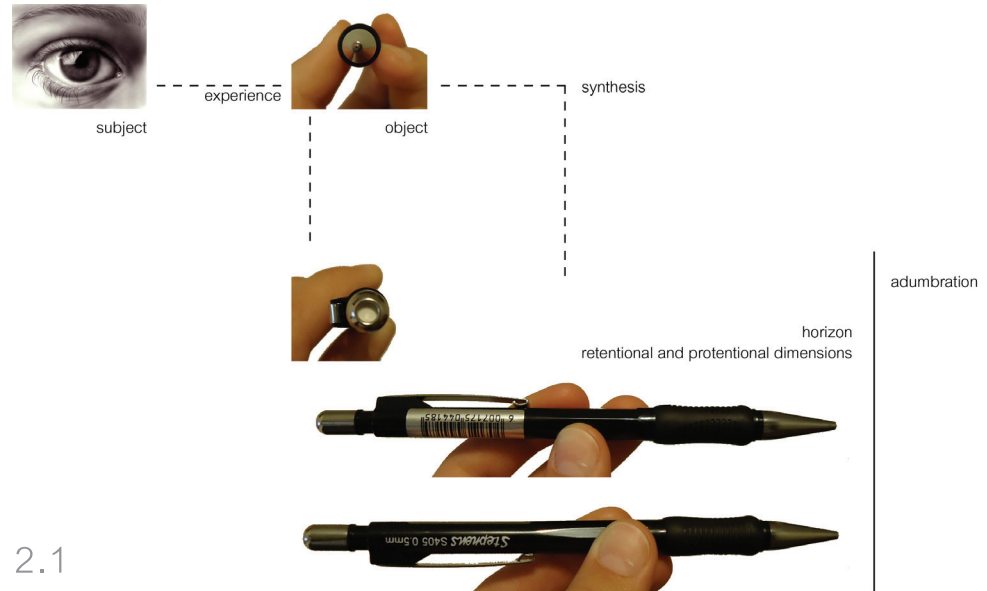

## 2.1

Figure 2.1: Diagram explaining phenomenology

Thermal Baths Vals  
Vals, Graubünden, Switzerland  
Peter Zumthor 1996



Figure 2.2 - 2.3: Thermal Bath Vals (Galinsky 2006)

Figure 2.4: The heated pool at Vals (Picassa [sa])

A contemporary architect who views himself as a phenomenologist and emphasises the sensory aspects of experience in architecture is Peter Zumthor. In his book *Thinking Architecture* (Zumthor 2006:9) he describes architecture that appeals to all the senses. He remembers specifically his aunt's house and describes the visual experience as well as sounds and smells. The thermal bath in Vals, Switzerland (1993-1996), designed by Zumthor, is an excellent example of a building where sense emerges through the materials used. He sees the tangibility, smell and acoustic qualities of materials as "elements of the language we are obliged to use" (Zumthor 2006:sp). This is what Pallasmaa (1986:454) refers to when talking about sound space and smell space.

## 2.2 Environmental psychology

Environmental psychology is the field of study relating to human behaviour and well-being in relation to the socio-physical environment. This refers to the relationship between user and environment. We influence the environment and the environment influences us (Cave 1998:2). Environmental psychology approaches people and the environment holistically, so that the reaction to the whole environment is of importance (Cave 1998:13). Aspects such as light, colour, texture, acoustic characteristics and context are taken into account (Popow 2000:1). There are several elements into which environmental psychology can be divided. Included in this are: Attention to understanding how the environment is noticed by the user; Perception or cognitive mapping or how users cognitively map their experience based on previous knowledge of the environment or how stimulation from the environment is received (Cave 1998:2); Preferred environmental psychology or motivations which illustrate that users choose places where the feelings of competence, confidence and comfort are created (Popow 2000:1).

It is important to note that behaviour is not only determined by the physical environment, but by cultural, social, personal and economic factors as well (Gifford 1997:319). Although all these factors play a big part in how the user experiences an environment, experience within the built environment itself is the focus of this study.

Ergonomics in its broadest sense is that which empirical studies tell us about the workability of environments. Environmental psychology and ergonomics feed into each other; with the difference being that environmental psychology is focused on behaviour where as ergonomics focuses on performance (Brebner 1982:1).

Images and symbols are stored in our long term memory in relation to other items. According to Brebner (1982:27) “these relationships are abstracted from our experiences and allow us to anticipate the next event.” This allows for anticipation which is a complex, complete and integrated perception because it covers all the sensory channels (Brebner 1982:28). Brebner (1982:28) also states: “missing or unexpected features of any kind can force reorganisation of a person’s perceptual and cognitive interpretation of the world at the expense of time. This is an important point since even one new element can lead to a total reorganisation of the perceived world.” A very interesting example is in the research of Ivo Kohler where the effects of wearing inverting lenses, which turns the visual world upside down, were studied. The auditory and tactual world was left as it was. Brebner (1982:28) writes: “A candle seen through the lenses was perceived as being upside down until the moment it was lit. Then, the heat from the flame and the stored information that candle flames burn upwards was sufficient to change the perceived orientation of the candle so that it then was seen the right way up.”

\*

In conclusion, if experience becomes the central focus of a design, the mind and perceptions of the user must be considered. Elements in space can so easily influence the user and change the experience from what was intended. The study of phenomenology and environmental psychology provides insight into the unconscious influences architecture might have on the user. These influences are difficult to anticipate without the knowledge provided by these fields of study.



# context, framework, site

investigation of site and surroundings





Figure 3.1: Aerial photo showing  
Ditsong: National Museum  
of Natural History in context

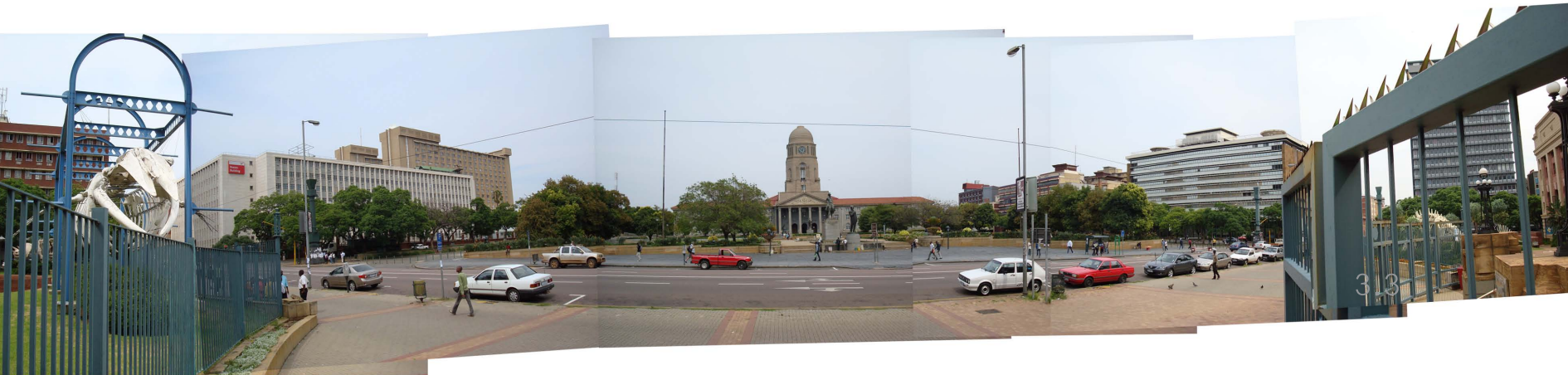
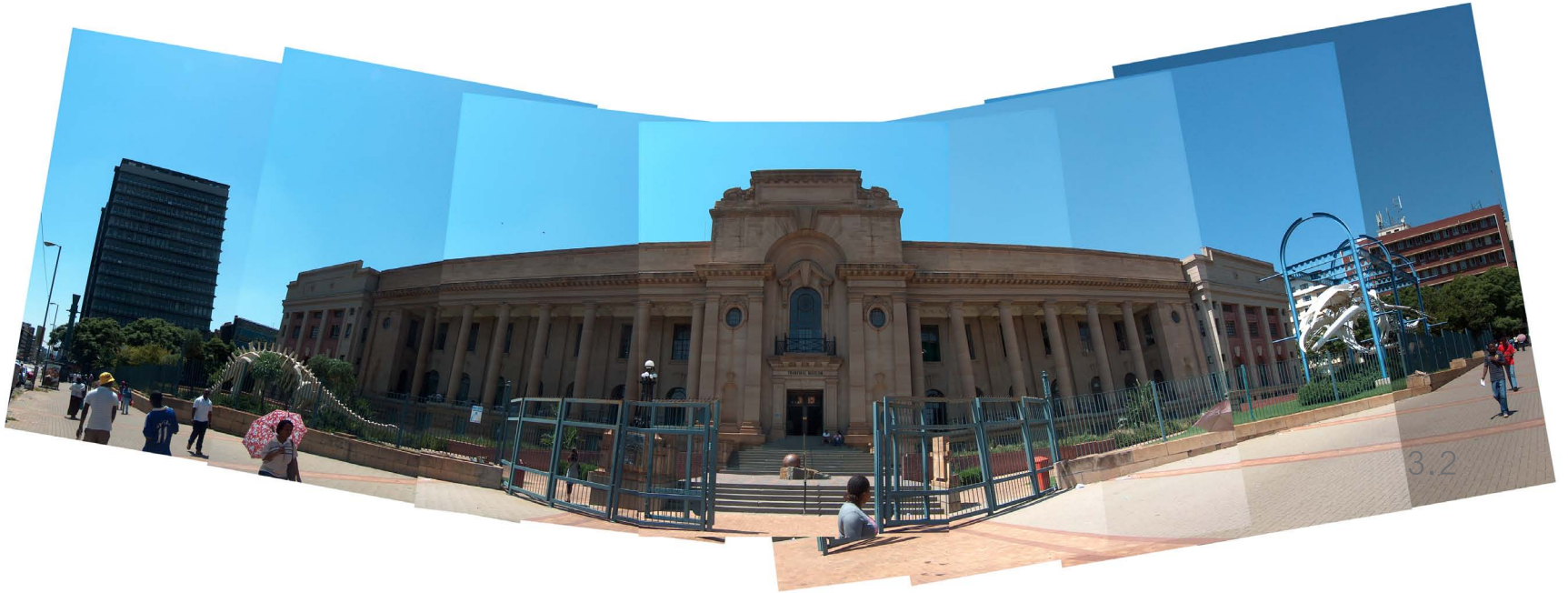

Figure 3.2: View of main entrance of Ditsong National Museum of Natural History from Paul Kruger Street  
Figure 3.3: View of City Hall from Ditsong National Museum of Natural History entrance

### 3.1 Framework

The scheme forms part of the Plug-in Festival framework and should be seen as part of the bigger framework. The framework is derived from the existing Jakaranda festival that is an annual cultural festival. Most of the venues however are situated to the east of Pretoria, and not in the inner city. The aim of the framework is to revive an interest in the inner city by bringing the festival into the city and to use its existing infrastructure and programme, to add to the festival.

The framework focuses on site specific interventions with common vision, where each intervention functions as a catalyst on its own, thus creating points of rejuvenation throughout the city. The Museum is an existing cultural node in the city and situated on the Museum walk<sup>1</sup>, but can benefit from an intervention within the existing building to act as site specific catalyst to revive interest in the museum. This, in turn, will aid the Museum Walk and larger framework.

Figure 3.4: Framework; museum walk and city centre walk



<sup>1</sup>The museum walk refers to the route connecting the National Museum of Natural history, National Museum of Cultural History and the Kruger Museum.

An annual festival such as this would change from year to year. This becomes an important consideration in terms of the museum intervention. To keep the interest of the users, the intervention in the museum would have to change and adapt with the festival. The required adaptability becomes a driving force in terms of concept for the intervention.

### 3.2 Site

The Ditsong: National Museum of Natural History (hereafter referred to as Ditsong Museum), previously known as the Transvaal Museum of Natural History, forms part of the Ditsong: Northern Flagship Institute, which develops, manages and administers eight museums in the Gauteng region under the fields of fauna, palaeontology, cultural history, military history, anthropology and archaeology (Ditsong: Northern Flagships Institutions: [sa]). Ditsong Museum is situated on Paul Kruger Street across from City Hall, between Visagie and Minnaar Streets.

#### 3.2.1 Ditsong Museum history

The museum was first situated in a building in Boom Street, Pretoria. It was officially opened on 15 December 1904. In 1912 some of the items were moved to the current site in Paul Kruger Street, although at that time only the centre portion of the building was built because of the outbreak of the First World War, even though the building was planned to be in the shape of an H (Grobler 2006:65). The museum needed more space and between 1995 and 1997 the northern and southern flanks were added. The two steel vaults (Highveld and Lowveld biodomes) were built in the same period.

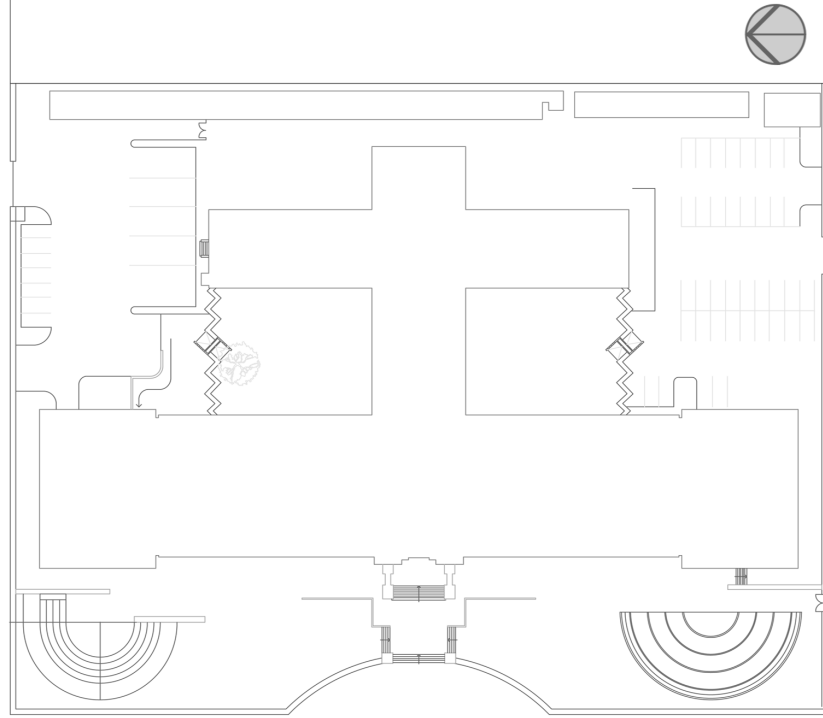

PAUL KRUGER STREET

3.6

Figure 3.5: Map showing location of Ditsong:  
 National Museum of Natural History  
 Figure 3.6: Site plan

The northern flank houses the Discovery Centre, storage space and the headquarters of the Ditsong Northern Flagships Institution. The southern flank houses storage and a restaurant. The Discovery Centre in the northern flank is aimed at creating a more experience based exhibition for children aged between three and eight. Older children do visit the centre, but is not the main focus group (Vermaak 2010). The centre includes amongst others a place for discussions or storytelling, a shadow puppet show, an insect collection that can be seen under microscopes and an exhibition of photosynthesis.

The original intention for the steel vaults was to create a Highveld and Lowveld 'biodome'. The northern vault was intended to be the Highveld biodome, where the plants still can be seen as typical of the Highveld region. In addition to the plants, the intention was to have live animals in cages to be observed by visitors of the museum, in both the Highveld and Lowveld biodome. The museum could not carry the cost implications this had, so the animals were sent to the Pretoria Zoo. The vaults are steel structures connected to the building that surrounds it on three sides. At the moment these vaults stand empty except for a small temporary building in the southern flank that serves as work space for a palaeontologist.

### 3.2.2 Ditsong Museum at present

The museum has different categories within its exhibition spaces (figure 3.8). Genesis 1 (Hall of Life) exhibits the animal kingdom starting from single cell organisms. This includes amongst others reptiles, fish, amphibians, insects and arthropods. Genesis 2 exhibits mammals. The Bird Hall houses an encompassing collection of the birds of southern Africa as set out by Austin Roberts. The Museum of Geosciences has an exhibition of minerals, crystals and precious stones. The dinosaur exhibition is due to open during 2010.

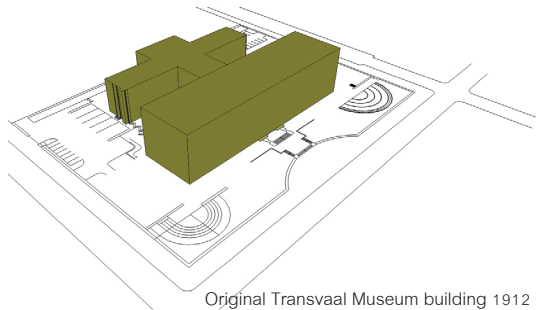

Original Transvaal Museum building 1912

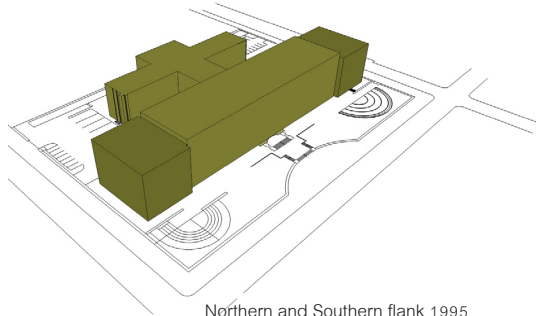

Northern and Southern flank 1995

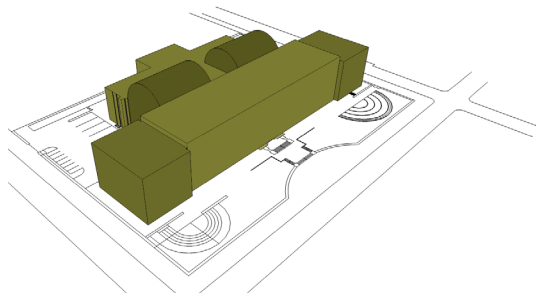

Highveld and Lowveld biodomes 1995

3.7

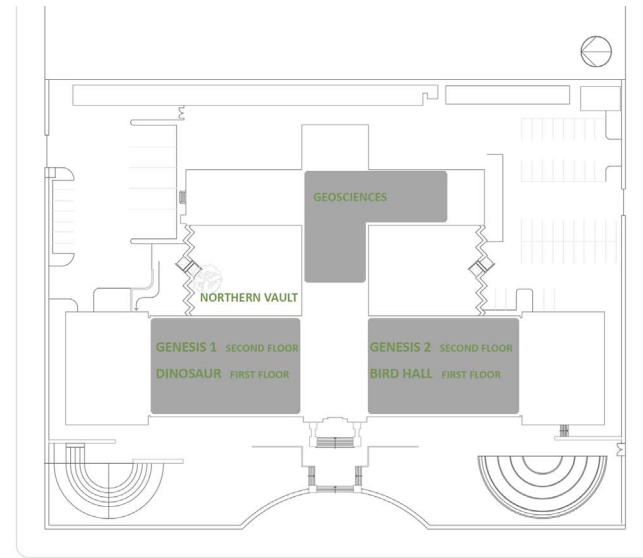

3.8



Figure 3.7: Diagram showing development of the museum  
Figure 3.8: Diagram showing location of exhibition spaces  
Figure 3.9: Northern vault with museum building around it.  
Southern vault in background

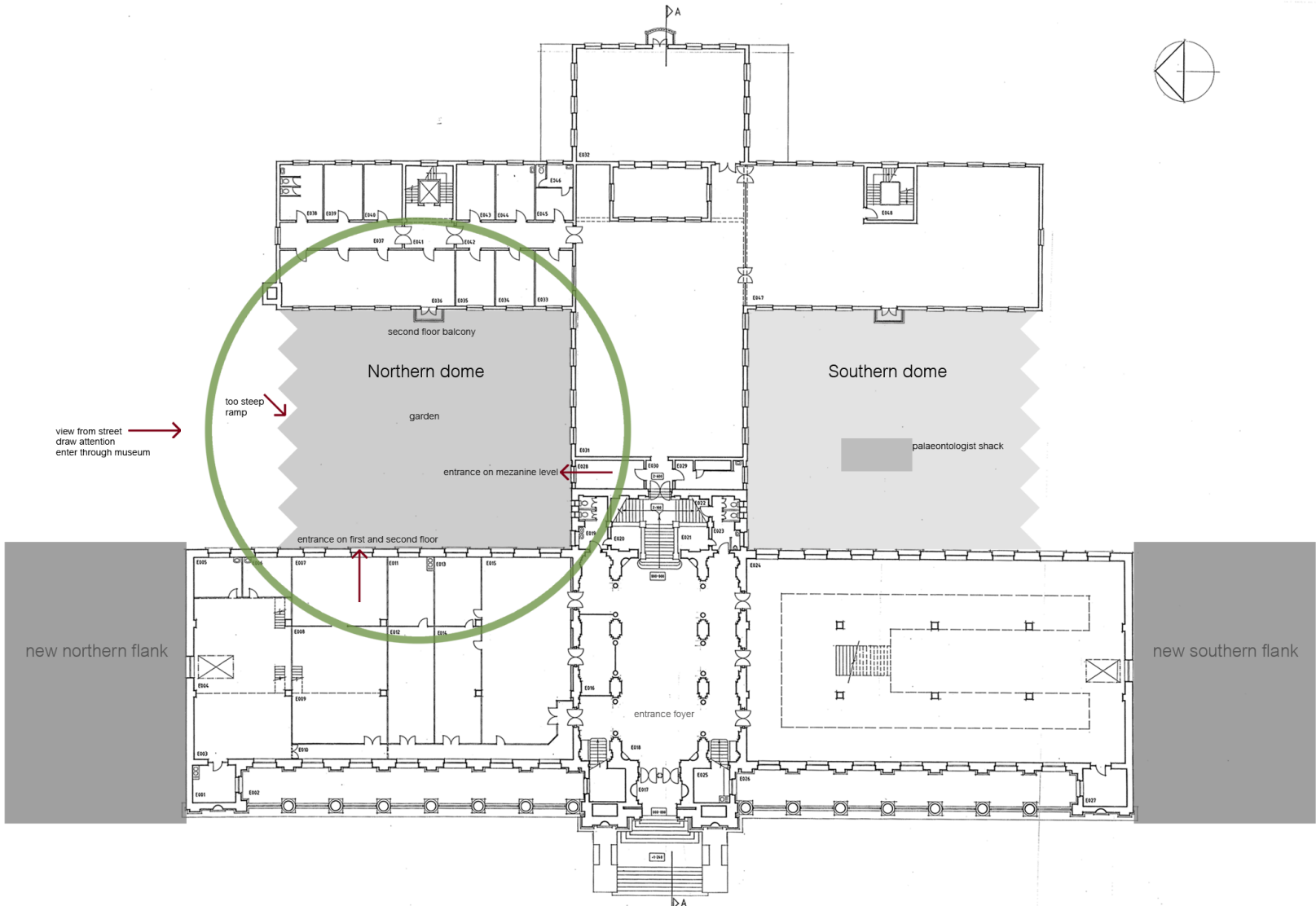

Figure 3.10: Ground floor plan of museum and vault structure

According to Erna Vermaak (2010), educational co-ordinator at the museum, the aim is to change the exhibitions during the next three to five years, to conform to contemporary and international standards. The story line for the new exhibitions is being written at present and would include other subjects that are not necessarily covered in the research done at the museum itself. This includes global warming, South African biomes and the plant and animal life in these biomes, evolution, extinction events etc. The collections on exhibition at the moment will be incorporated into the new story line and exhibitions as far as possible (Vermaak 2010).

### 3.2.3 The vault structure

The northern vault was chosen as space for the intervention, because of its visibility from Visagie Street which is much busier than Minnaar Street. The experience of a natural habitat is much more pronounced in the northern vault, because of the existing Highveld garden, which contributed to the choice of site as well.

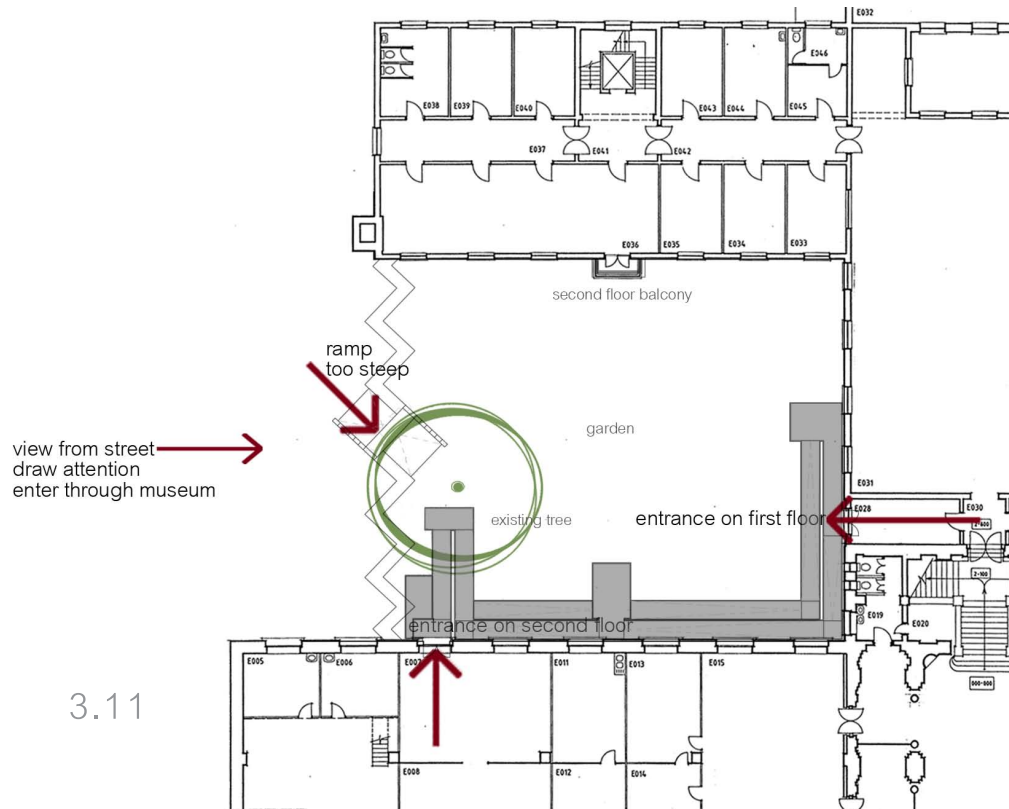
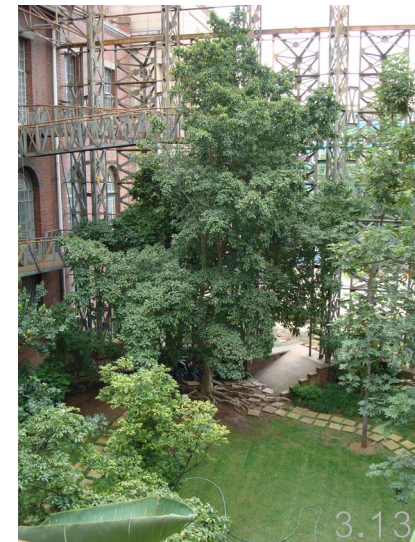

Figure 3.11: Diagram illustrating entrances into vault structure  
Figure 3.12: Photo showing ramp structure in Northern vault  
Figure 3.13: Photo showing interior of the structure



The building is linked to the interior space of the vault by a ramp structure that connects the mezzanine level on the centre flank of the main building with the first and second floor on the northern flank. The ramp is not connected with the ground level. The only access to the ground level is through the northern flank, around the older part of the building and out at ground level. Entrance into the structure on ground level is over a steep ramp.

When inside the structure calmness and a sense of silence are experienced, even though traffic from Visagie Street can clearly be heard. The volume within the structure is uninterrupted by any elements and has natural light flooding in through the mesh covered structure. This creates a contrast with the darker museum interior. The ramp is mostly confined to the edges of the space and therefore does not impinge on the volume. The occupant of the space constantly has a link with the sky through the steel mesh. This contributes to the sense of calmness and relief.

The connection of the steel structure with the museum building creates a contrast between materials. The contrast between the two spaces, interior of museum and interior of the structure, is enhanced by dark and light as well as the man made environment of the building against the natural environment within the structure created through plants. The structure itself creates a contrast between steel and plant.

The garden in the structure consists of a few established trees and shrubs, all indigenous to the Highveld. The *Ficus thonningii* (wild fig tree) seen in figure 2.9, will definitely be kept and reacted to in the intervention. The rest of the vegetation will be manipulated to influence the experience of the space. This will provide an opportunity to create experience

through plants that can contribute to the specific experience of the program.

Through the windows in the northern flank of the building the space in the vault can be seen. These windows are temporarily blocked out by the existing exhibition in Genesis 1, but if this link is re-established it could create curiosity towards the intervention in the vault. This will become an important consideration in the proposal and design for further development of the museum interior and exhibitions.

\*

At present, the space within the steel structure portrays the idea of a natural habitat within a man-made environment, because of the change from museum to vault, its isolation from the museum interior, the constant link with the sky and therefore natural light and the green of the garden on ground level.

Contrast exists between the structure and the museum building. This is created by the following aspects:

- Material of steel structure against brick of museum building.
- Natural light in structure against dark interior of museum.
- Natural environment within structure against man-made environment of museum.

This contrast might become integral in the design development along with other aspects like sensitivity towards the volume within the structure and the enhancement in the experience thereof, investigation of the threshold between museum and vault or man-made and natural and re-establishing the sense of habitat within the structure.



Figure 3.14: Photo illustrating contrast between steel and plant  
Figure 3.15: Photo illustrating contrast between structure and building

# 4 the museum

Investigation of museum typology in general  
and the Ditsong Museum specifically



Even though the Ditsong Museum and the insect collection were chosen only for the application of experience, the concerns existing in the museum at the moment become important for further motivation as to why experience within the museum, and museums in South Africa in general, are a relevant and important problem to be solved.

The exhibition in the Bird Hall dates from 1972, the Genesis 1 exhibition from 1978 and the Genesis 2 exhibition partly from 1987, with a newer addition added in 1998 (Vermaak 2010). The collections of the museum are old and outdated as far as the objects on display are concerned. The interactive displays are not up to date with technology and are broken in some cases. The displays are very repetitive and the user is often bombarded with too much information. The stagnation of the exhibition is problematic, because change and adaptation ensures that users return to the museum.

#### 4.1 Existing vs Experience

The international Council of Museums states that the definition of what a museum is has changed seven times since 1946 (Grobler 2006: 34). One would think that something as static, and almost straightforward, as a museum would stay constant in its goal and description. It is clear though that a

change in definition is needed for the Ditsong Museum.

Traditionally objects in museums are viewed from a distance with, in most cases, glass as a separation between object and observer. Hein (2000:80) calls it “distanced contemplation”. According to Hein (2000:5) the objects in museums, previously plain objects, are being reconstituted as “sites of experience” and that museums see it as their responsibility to deliver experience. These museums take authority to educate through stimulation and encouraged inquiry. This creates environments where the object appears less as an end, than the means to get to the end, which is to generate an illuminating and satisfying museum experience (Hein 2000:6). This, however, is not the case in the Ditsong Museum. There still exists the “static monumentality” (Hein 2000:8) facilitated by the repetition and permanence of the objects on display.

“Museums are places of inquiry and exploration” (Hein 2000:150). The meaning of “museum experience”, according to Hein (2000:7), is determined by the answer to the question: “Is the designated experience of the object exclusively for its own sake, or does the object serve as occasional stimulus for a broader, more encompassing experience?” She goes further to say that the answer deter-

mines our thinking about museums as “object centred” or “story centred”.

When the object becomes more the means to an end than the elevated object itself, experience can become the encompassing factor that ensures the stimulation and further inquiry of the user. The argument can then develop as to whether the experience is “real” enough. This is an important argument, because of the existing museum being object centred and set on the “realness” of the object. Phenomenology suggests that experience is genuine, even when, for example created through illusion. Hein (2000:8) states that “experiential reality is phenomenologically self-contained and divorced from both its causes and consequences.” This does not suggest that false representations are being made, but rather that the objective is not aimed exclusively at assembling collectables, but that the collections become the driving force behind the creation of authentic experience (Hein 2000:8). To create an authentic experience does not necessarily mean that the devices used must be authentic or real. The impact of the experience is real, even though it is manufactured and therefore artificial. Specific feelings are intentionally provoked and with those feelings comes a new dimension of authenticity (Hein 2000:84). The emphasis is shifting from product to process (Hein 2000:67). The “real thing” pinned to the wall behind glass, is substituted by real experience.

When a living organism is taken from its natural habitat, killed and preserved to become an exhibition, it becomes artificial. This implies that no matter how “real” the butterfly on the wall is, it is still out of place and artificial, and except for a closer look at its colour and patterns, cannot be experienced as a butterfly in its full glory. Now, the question is: “Can this ever happen in a restricted, structured museum

environment?” The answer would be no, but to create a more encompassing, stimulating experience that includes the user, his senses and mind would surely come closer. Interactivity and experience within exhibition space heighten and intensify the engagement of the user with the exhibition (Hein 2000:80). An important point to remember is that the experience should not happen at the expense of the object that makes it possible (Hein 2000:147).

The users of the space would be everyone and anyone that visits the museum, which means the age of users stretches from pre-school to adult. This complicates the program in terms of the perception and understanding of different age groups. Ideally the experiences created must communicate to both young and old. The young and pre-iterate are an audience of “doers” and not “viewers” (Hein 2000:34). This, fortunately, may apply to adults of this technologically driven, “button pressing” age as well. The part of the community that the contemporary museum has to address, according to Hein (2000:85), covers a broader social spectrum than was traditionally true for museum visitors. This means that where certain perceptual and behavioural characteristics could have been seen as general or uniform in the past, the enlargement of the user group today does not allow for such uniformities. The aim is to create an experience that is universal.

#### 4.2 The insect

The insect collection was chosen as the subject for the experience exhibition. This collection is only the vehicle to assist in the exploration of experience. The experience stays at the core of the investigation, with the collection secondary to that.



The intervention in the steel structure will be additional to the existing insect collection and not a repetition or replacement of the current exhibition.

The exhibition itself will be the third layer of the scheme. First is the intervention, its reaction to the exterior, to the existing space within the steel structure and facades of the existing building. Second is the interior space that forms the basis of the exhibition. These spaces will guide the curator in decision making for the exhibition that will change once a year. Every new exhibition will follow the guidelines formed by the interior in terms of human senses. To see how the exhibition will be supported and informed by the spaces, exhibition for parts of the insect collection will be designed.

Insects comprise an estimated 85% of all animals on earth and there are over a million known species (Prinsloo 2010). Hein (2000:85) states, "Some phenomena are too big, small, far away, fast, slow, complex, or incidental to be observed by normal perception or under normal conditions." In a lot of

ways, normal perception falls short in understanding insects because of their size and complexity. This adds to the interest, because by changing the perception of the user, the insect or its behaviour can be experienced, something that cannot be achieved only by looking at it through a microscope or glass partition.

### 4.3 Future of Ditsong Museum

Considering that the museum is planning on changing the current exhibitions, the process that is followed should be evaluated. According to Erna Vermaak, educational co-ordinator at the museum (2010), the museum employed five artists that worked on the exhibitions full time during the time of the assembly of the current exhibitions.

Currently there are no artists or curators employed at the museum, because of financial restrictions. Erna Vermaak is supplied with information about the subjects to be exhibited from scientists, after which she writes the story line of the exhibition. This is presented to a board of scientists who approves the story line and its content, before it goes out for tender to companies who handle everything regarding the exhibition (figure 4.1). Problems of this process include the fact that the educational co-ordinator, the scientists and the contractor all think differently and that there is no one party taking the exhibition from start to finish.

The intentions of the story and proper application of the facts would be clearer if someone with an exhibition or interior design background could assist throughout the process. Through collaboration and inter-disciplinary work, the future exhibitions of the Ditsong Museum can become more experience based with the spaces allocated to the exhibitions considered from the beginning.

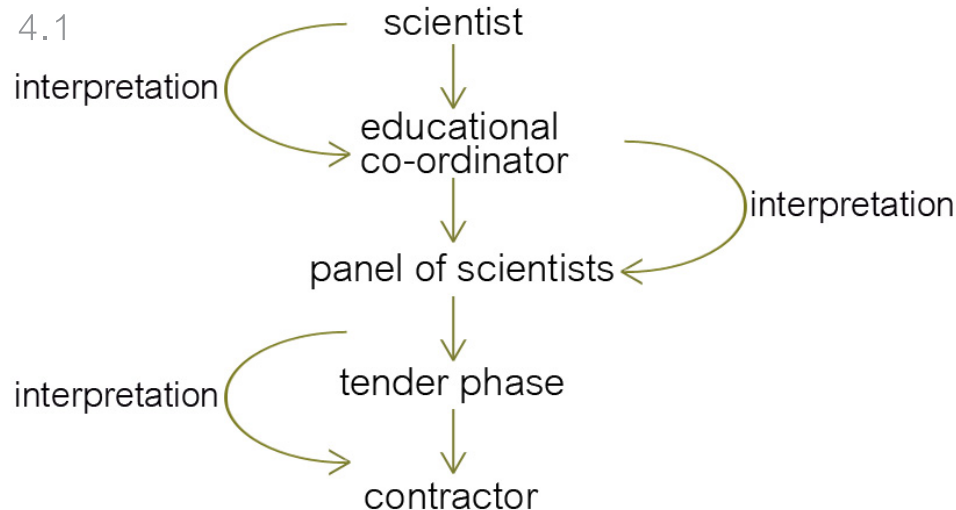

Figure 4.1: Diagram showing process followed for a new exhibition

Natural light, for example, can become a consideration in terms of the specific placement of certain subjects or artefacts, so that the building and existing spaces contributes to the exhibition and do not become a box inserted into the interior, as it is at present.

\*

Change in the museum in terms of interactive and experience based exhibition is desperately needed. Museums exist to promote and portray knowledge to the public, but if the user does not engage with the exhibition, stimulation, and therefore knowledge transfer, will not happen. It is crucial that the object of the collection evolves into experience so that the user becomes a participant in the space and not only a spectator. The objects should become collections of experience.

Focus Terra Exhibition  
Holzer Kobler Architects  
Zurich, Switzerland 2009



Figure 4.2 and 4.3: Focus Terra Exhibition by Holzer and Kolber Architects (e-architect [sa])

The Focus Terra exhibition in the Natural Sciences Building in Zurich, Switzerland is an example of an exhibition where the designers worked in close collaboration with the scientists from start to finish. Holzer Kobler Architects played the role of curator and designer, with an integrated, well-planned and executed exhibition as end result (e-architect [sa]).

# experience

investigation of the meaning and creation  
of experience in interior space

# 5





Experience is inherently emotional and subjective and therefore very difficult to judge in terms of quality. There is an inherent privacy to experience that makes it less accessible to evaluation than objects (Hein 2000:67). In this chapter the heuristic method was used to determine the elements of experience and precedent studies were looked at.

It is argued that original objects in museum collections cannot be replaced by simulated or artificial objects or experiences thereof, because the replicas are not the “real thing” and the real thing would evoke a greater thrill. Hein (2000:79) argues that both experiences are equally real. The difference does not lie in the degree of reality, but in the emotional intensity, quality and cognitive effect. Hein (2000:79) is of the opinion that for the public of today, what is known and what is felt becomes inter-woven without sharp distinction. By changing from an ‘object centred’ to ‘experience centred’ viewpoint, museums give emotive meaning priority over cognitive meaning. Experience orientated museums aim to construct realities that are cognitively and emotively totalizing (Hein 2000:80).

## 5.1 What is experience?

Experience is more than an observation, more than knowledge of a space or object and more than a feeling. It is a description of the complete, encompassing influence of a space, object or person on the user through mind, perception and senses. There are many influences on the experience of space, many elements that contribute to experience. Some elements are internal and impossible to anticipate for, but others are external and have more or less specific influences on the user in terms of experience. By looking at how these elements in design were applied and manipulated in existing designed space, clues can be derived as to what specific experiences or emotions these elements provoke. The elements to be investigated are light, scale, object, context and material.

Light

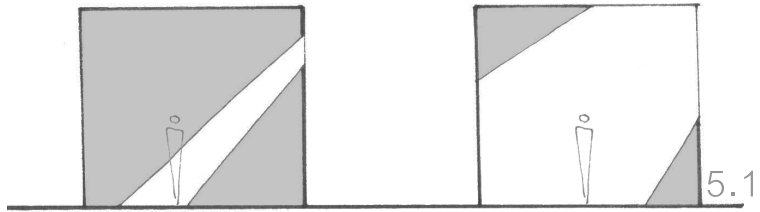

Scale

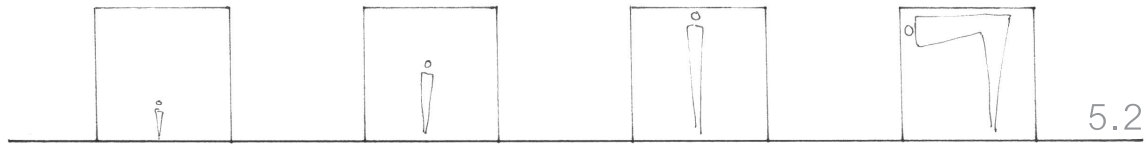

Object

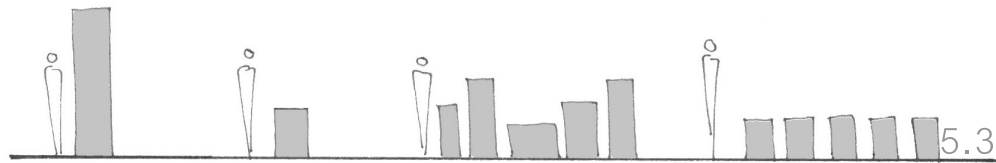

Context

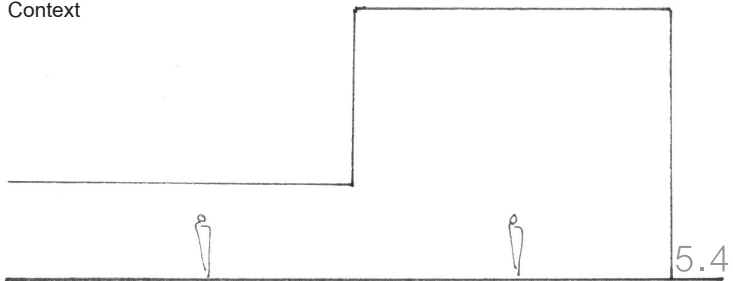

Material



Figure 5.1: Quality and quantity of light has an influence on experience within a space.

Figure 5.2: Scale of a space alters the experience

Figure 5.3: Object in space as element of experience

Figure 5.4: The context from which the user enter into another space has a great influence on how that space is experienced

Figure 5.5: Material, not only of floor finishes, but in general, can create a specific experience



5.6

## 5.2 Investigation of experience in existing designed space

### 5.2.1 The Church

In Church of The Light by Tadao Ando, the light source behind the preacher and in the direction the congregation are facing, is natural light through a cross shaped opening in the concrete wall. This accentuates the importance of God and puts the focus on Him rather than the preacher. Ando states that he would have wanted to keep the cross-shaped opening in the wall without glass so that wind can enter just as the light does. This was unfortunately not possible because of climatic reasons. Through the downward slope to the front of the church and the absence of objects except for the pews and the floor of blackened cedar wood, the church projects an image of simplicity (Jodidio 2007:127). Although not typical of church architecture, the simplicity in this building adds to the experience of humbleness, and focus on God.

Figure 5.6: Church of The Light, Tadao Ando (Jodidio 2007:126)

Figure 5.7: Catholic Basilica, Bern, Switzerland (Chris Spracklen 2008:sp).

Light becomes integral to the design in terms of symbols as well as experience. The use of natural light shows the time of day. Ando investigates the angles at which light enters space (Jodidio 2007:129). This influences the amount of light entering the space and the areas that will be cast in light, and is therefore a very important consideration. Church architecture aims to convey the importance and power of God through the monumentality of the building. High volumes within a church contribute to the feeling of awe and the rows of seats create a feeling of humbleness and smallness in front of God.

In the photo (figure 5.7) of a Catholic basilica in Bern, Switzerland, the scale of the interior can be seen with the focus on the pulpit to the front of the church. The focus is directed through the difference in scale as well as the colour added through stained glass windows. Light does not play such an integral part in this experience as it does in Church of the Light, although some of the same feelings are conveyed.



### 5.2.2. Aquariums

Aquariums are a form of exhibition. The difference between this and the insect collection in the Ditsong Museum, for instance, is the fact that the objects are alive and in their own context. The idea is created that they are not brought into our context, but that the building is punctured into their habitat. This adds to the authenticity of the experience.

Aquariums surround the user with ocean life so that the experience of walking under water is created, with the added benefits of not getting wet and breathing normally. The darkness within the passages puts the focus on the creatures in the water and the natural light seeping in from above the water enhances that focus and creates an almost mystical feeling. Although the environment in which the ocean life is placed is artificial, the animals are real, alive and flourishing in it so the animals can be observed in their 'natural' environment from a safe vantage point. The users are almost overwhelmed by the ocean surrounding them, which gives the impression of the vastness of the ocean and the life it contains. Even though the user feels completely safe within the glass surroundings, a big shark swimming close by will still create a feeling of fear.

Light and the absence thereof are integral to the experience created in this space. The feeling is created that this can be used as a space for contemplation and thinking, because of the anonymity given to the user through the darkness of the space and the shifted focus from the user to the exhibition.



Figure 5.8 - 5.9: Lisbon Oceanarium (Modernnomad 2010:sp)

### 5.2.3 Cour Puget, Louvre, Paris, France

The *Cour Puget*, designed by the architect Lefuel, forms part of the Louvre in Paris. A glass roof was added in 1872 to cover and protect the space (Thematic Trails: sp). When walking through the Louvre, the user looks at hundreds of paintings, one after the other. Then, without really expecting it, the user walks into the *Cour Puget*, which is an open space with a large volume and natural light flooding in through the glass roof above (figure 5.9). When the user walks into this space, a feeling of calmness and relaxation is experienced. The context contributes to the experience of relief, because of the contrast with the smaller scale of the darker passages that the user has become accustomed to throughout the museum. The natural light also plays an important role in the experience of relief. Although the space is frequented by many users, there still exists the feeling of rest which is enhanced by the trees in planters (figure 5.10).



Figure 5.10: Cour Puget, Louvre, Paris, France

Figure 5.11: Trees in planters in the Cour Puget, Louvre

## 5.2.4 Restaurants

Restaurant interiors immediately inform the user as to what might be expected from the prices, the food, as well as the service. Amongst other factors, materials used play a very important role in this split second summary of a space and the experience when dining there.

### 5.2.4.1 Mugg & Bean

Quick lunches, relatively priced food and bottomless coffees are expected from Mugg & Bean. The materials used are durable and easy to clean and replace. Chairs are relatively light, which does not give the impression of quality. The seats of the chairs can easily be replaced or re-upholstered without much cost. Exposed services create an informal, but also unfinished feeling and contribute to the experience of a less expensive environment. Most Mugg & Bean franchises are open to the walkways that surround it, so even if the user is seated inside, it doesn't offer much privacy.



### 5.2.4.2 Kream

Light colours, heavy, fully upholstered chairs, table cloths, curtains and reflective surfaces that are kept reflective, contribute to the feeling of luxury, comfort and quality. Excessive use of textile for the curtains, which hang from the high ceiling to the ground, creates the feeling of extravagance. A relaxed atmosphere with a feeling of importance and privacy is created through the light coloured materials and placement of the tables, separated at some places by planters and screens. The feeling that time can be spent here is generated. The different textures used contribute to the lavishness of the space.



Figure 5.12: Interior of a Mugg & Bean Franchise (Top places 2008)  
Figure 5.13 - 5.14: Interior of Kream Restaurant (Kream 2010)

#### 5.2.4.3 Primi Piatti

An informal setting is created in the interior of Primi Piatti. The durable materials, brick, steel, concrete, screed floor, the bright colours and use of graphics and exposed services generate an industrial feeling. Although the afore mentioned materials all contribute to a more informal interior, the use of light and exhibition of bottles of water, as well as the high ceiling and mezzanine floor contribute to a feeling of luxury, which enhances the overall experience. The exhibition of drinks shows availability and abundance.

\*

In conclusion, these five elements of experience contribute to the experience created within an interior space. It should be noted though that these five are only a few of the elements that can influence a user's experience, and it would be remiss to limit one's thinking of experiential influences to these five. Colour use, sound and temperature, for example, can be added to the list, but these are more specific. These elements will be held in mind when designing experience within interior space. It is important to realize the subconscious impact that elements, that might seem to be only of aesthetic value, can have on the user and influence how the space is approached and experienced.

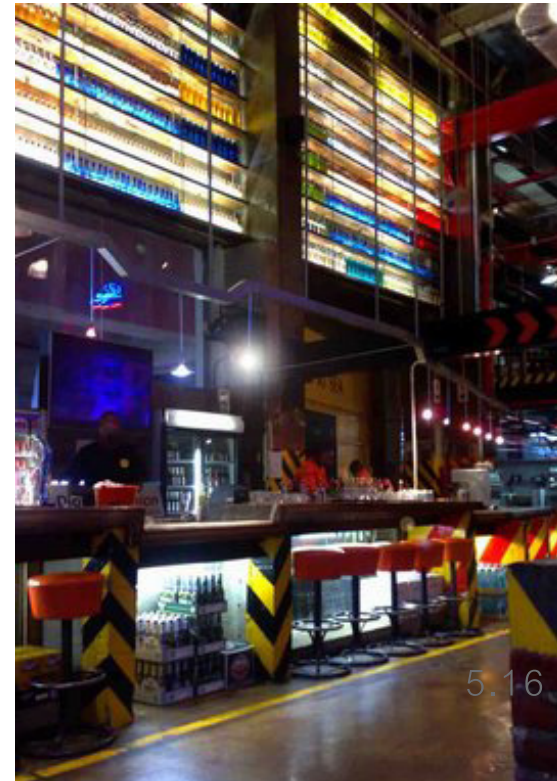

Figure 5.15 - 5.16: Interior of Primi Piatti Restaurant (Menlyn Park 2010)

# site analysis 6

detailed analysis of site in terms of elements of experience





The site, building and steel vaults will be analysed in terms of the elements of experience discussed in chapter 5, namely light, context, material, object and scale, as well as circulation through the existing building and limitations of the intervention. The existing building and steel structure, which is the context of the new intervention, become major informants for the design and therefore thorough analysis is required.

### 6.1 Light

The influence of natural light on the spatial experience should not be underestimated. Natural light does not always provide the desired effect for specific experiences, but it plays an important role in energy saving as well as the psy-

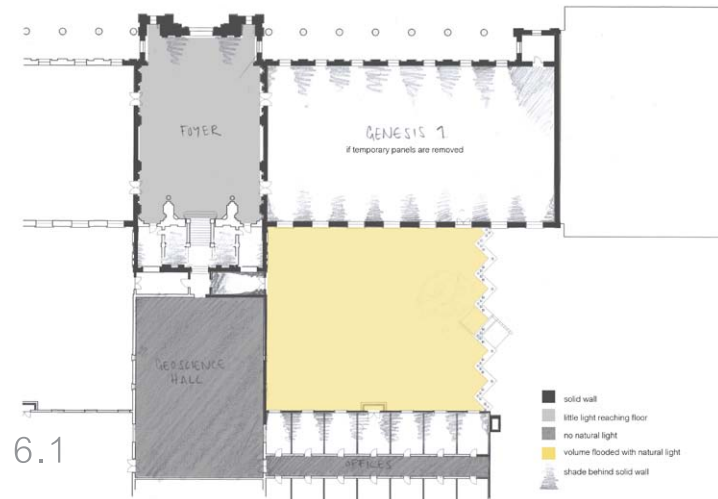

6.1

chology of the user (Edwards and Torcellini 2002:2).

The foyer of the museum, especially the staircase, is lit by windows on the eastern as well as western facade, as well as through the glass entrance. These windows are placed high in the double volume, so not much light reaches the ground. The windows, and the light that penetrates through

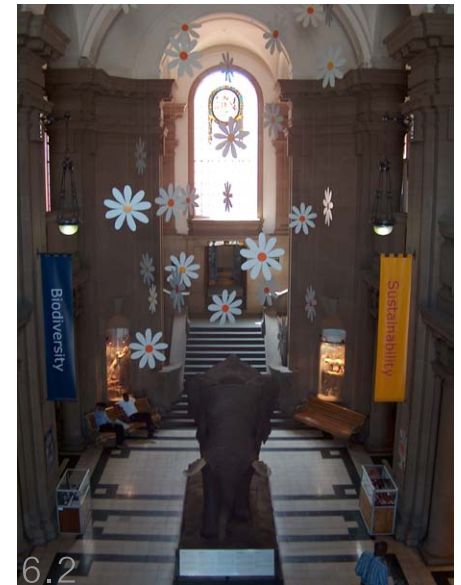

6.2

Figure 6.1: Diagram showing natural light entering the foyer, Genesis Hall 1, Geosciences Hall and offices to the east of the vault.  
Figure 6.2: Photo showing window above staircase and across from entrance into foyer.

them, across from the entrance into the foyer and above the staircase, lead the user to the stairs.

Natural light enters the exhibition halls through windows on the facades in the volume formed by the steel vault as well as on the western facade. At the moment the windows in Genesis Hall 1 are closed off by exhibition panels, which deprive the interior of natural light (figure 6.3). By removing these panels, the hall could be much lighter and a link can be established with the volume within the structure and the new intervention.

The effect of light in an interior space can be clearly seen in the experience of Genesis Halls 1 and 2. Genesis 1 is experienced first, where the natural light is completely blocked out by panelling for the exhibition. The space is lit by artificial light, but the absence of natural light is immediately felt. Mickenberg (2008) states that studies have shown that a view out a window can help the user to refocus attention. This might become important for the museum environment where the user focuses on one fact after the other. In Genesis 2, natural light floods the space. This has a tremendous impact on how the space is experienced and results in the user lingering longer.

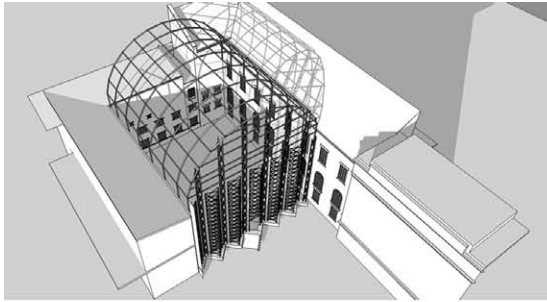

Figure 6.3: Exhibition panels blocking natural light from entering the hall

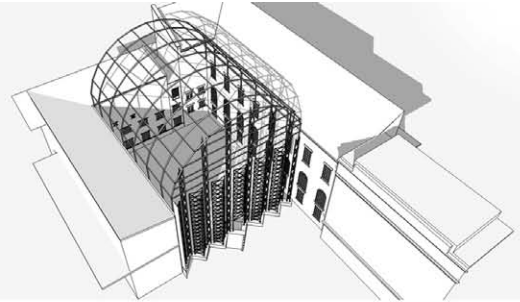

Figure 6.4: Genesis Hall 1

Figure 6.5: Genesis Hall 2



june 08:00 am



june 09:00 am

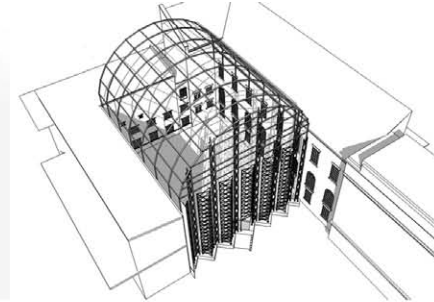

june 10:00 am

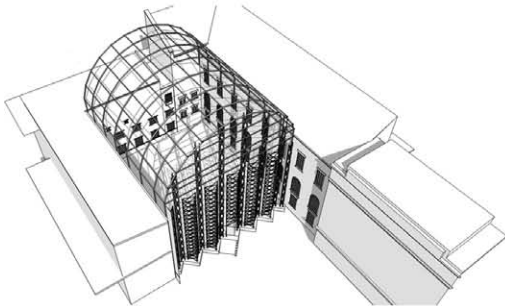

june 11:00 am

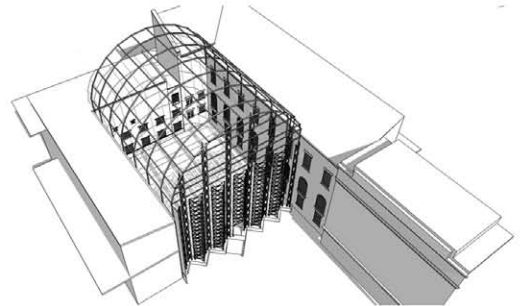

june 12:00 pm

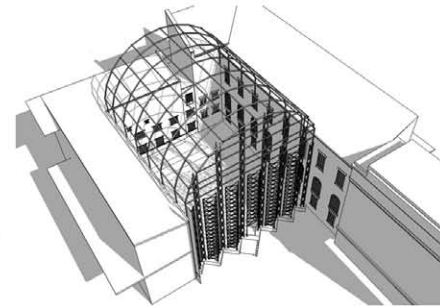

june 13:00 pm

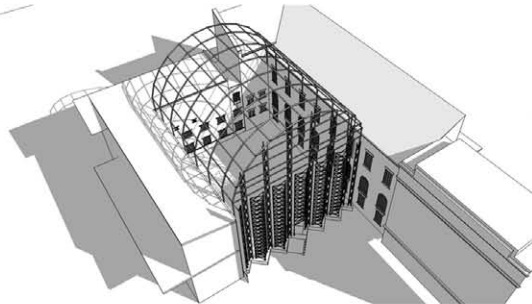

june 14:00 pm

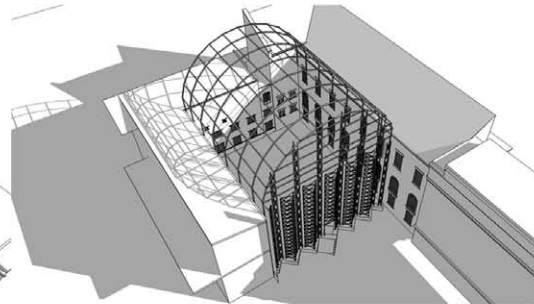

june 15:00 pm

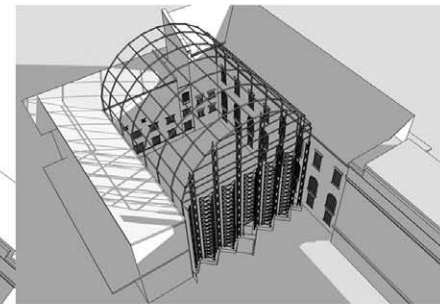

june 16:00 pm

Figure 6.6: Diagrams showing the shade in the vault in June

The vault volume is surrounded by the main building on three sides. This results in deep shadows in the morning and late afternoon. The following diagrams show shadows in the vault in June (winter) and December (summer).

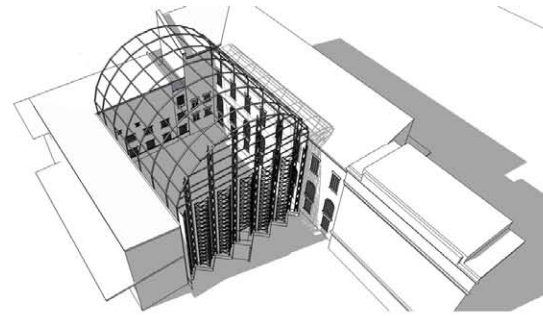

december 08:00 am

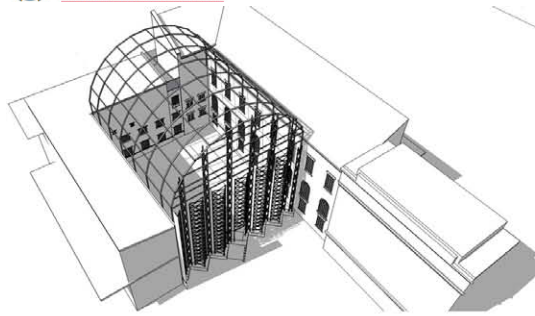

december 09:00 am

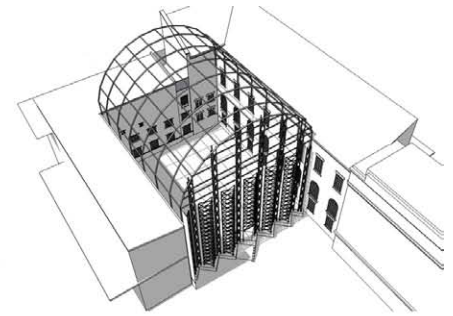

december 10:00 am

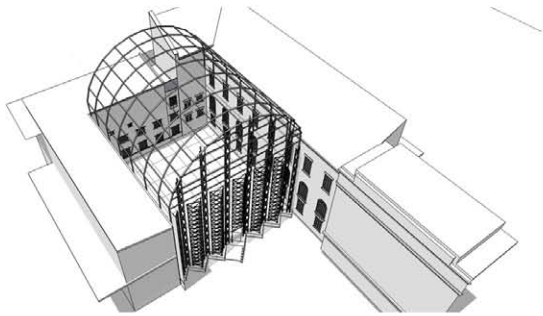

december 11:00 am

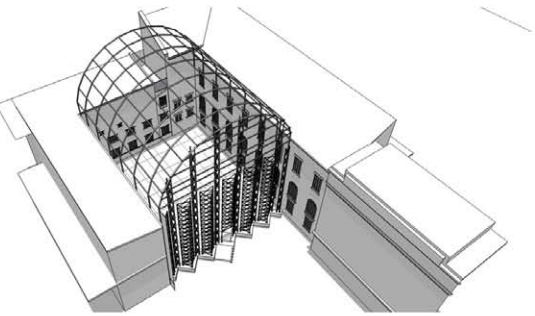

december 12:00 pm

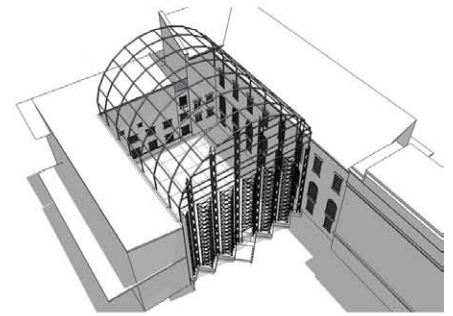

december 13:00 pm

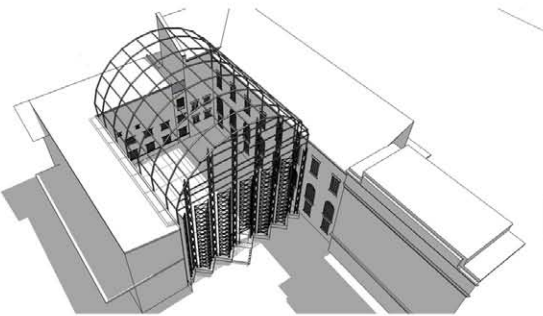

december 14:00 pm

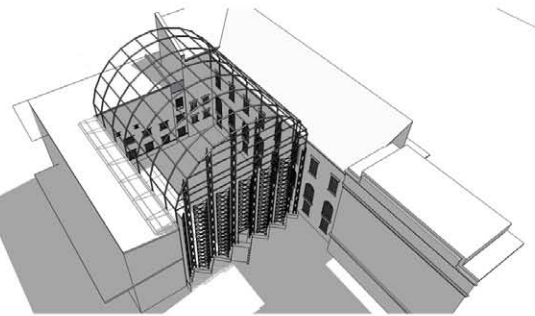

december 15:00 pm

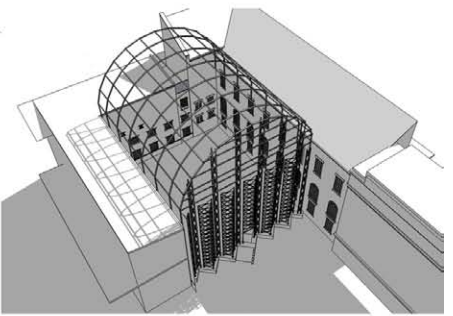

december 16:00 pm

Figure 6.7: Diagrams showing the shade in the vault in December

In the winter, the ground level has full sun only from around 11:30 am to 12:30 pm. In summer this is extended from 11:00 am to 13:00 pm, after which the shadows slowly starts to come over. The northern facade of the building is always in shade in December, but receives much more sunlight in June.

Morning and late afternoon might be cold in the space, because of the shade of the buildings. In summer it should be warm, but certain parts of the building are always in shade, which helps cool the space. The shade facilitates, along with the grass and plants, in the creation of an environment that does not feel harsh, despite the sunlight flooding the space.

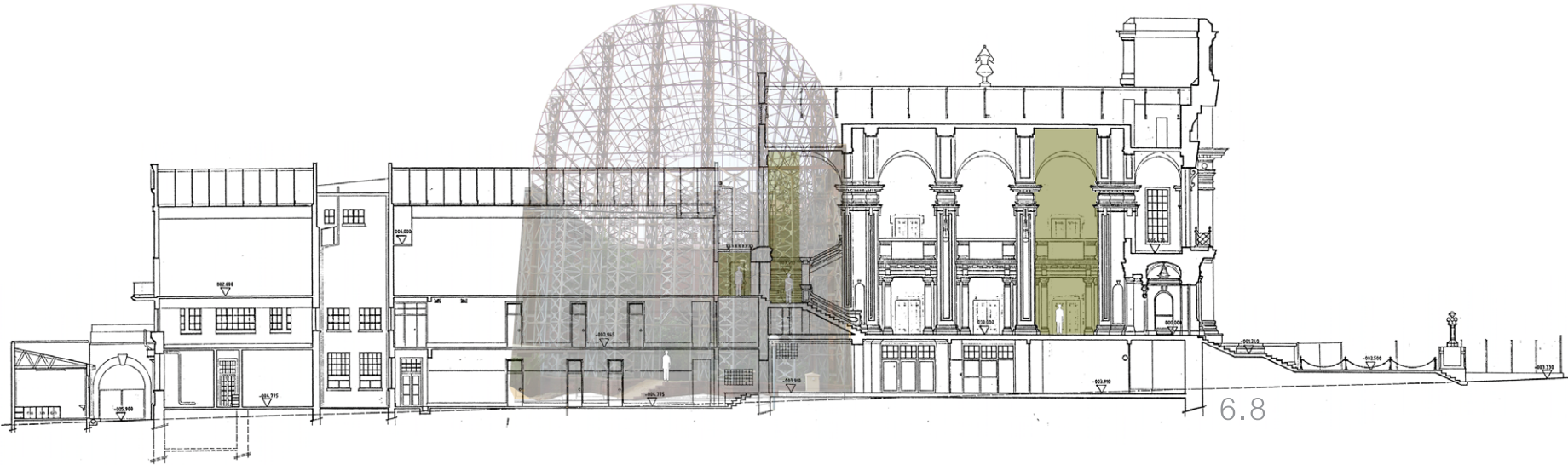

## 6.2 Scale

Light contributes to the effect of scale. In the foyer of the museum, the scale of the volume above the stairs feels bigger than that of the foyer itself, because of the intensity of the light directly above the user. The space in Genesis 1 feels much smaller than in Genesis 2, although the halls are exactly the same size. This is caused by the absence of sufficient natural light and because of objects in the space. The intention might have been that the volume would be experienced as higher if the user walks through a very low space before entering the double volume (figure 6.12). Experience is created by context, but because the volume and ceiling are dark, the volume is perceived as lower than it really is.



Figure 6.8: Figure showing scale and placement of interior spaces

Figure 6.9: Low volume followed by higher volume in Genesis 1

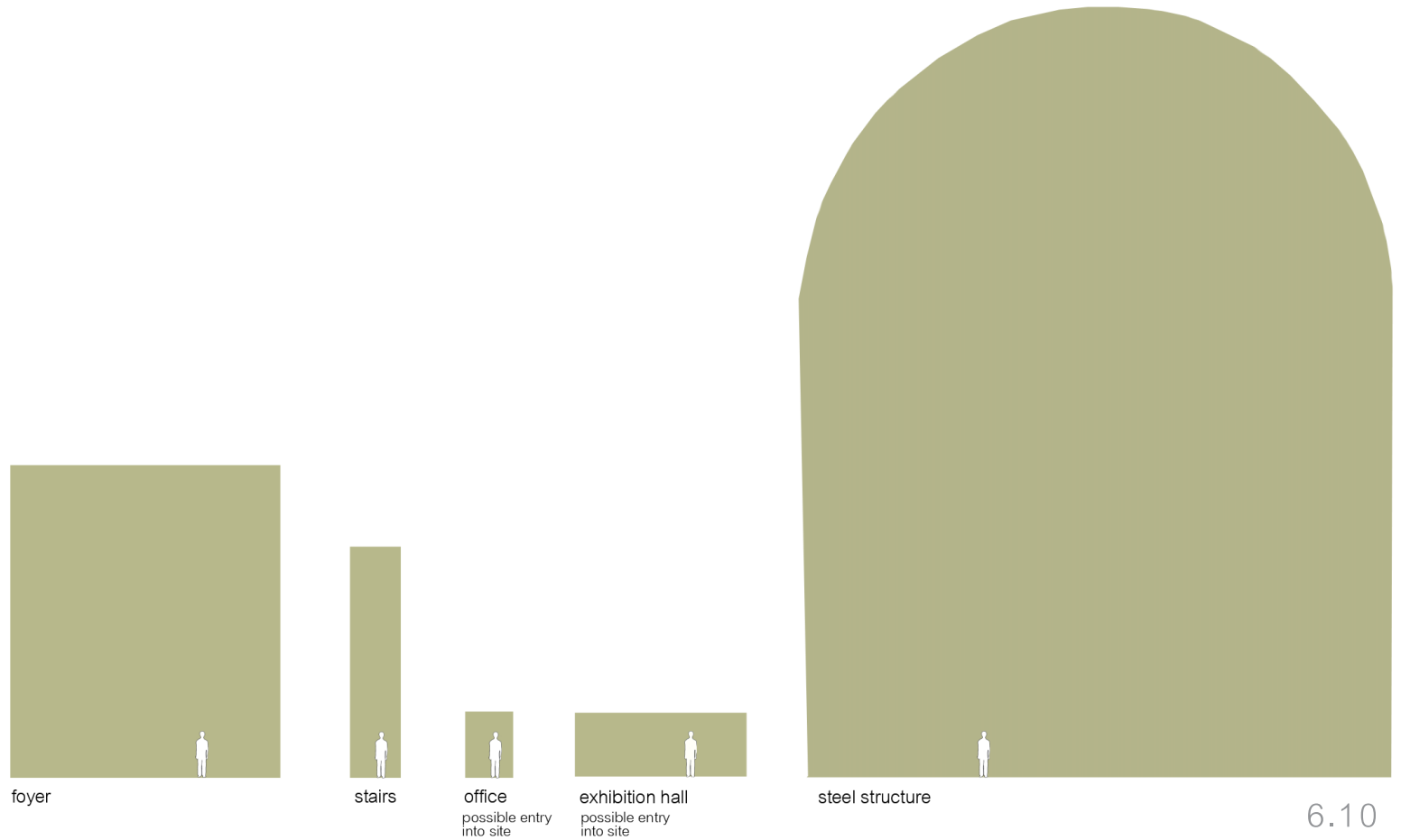
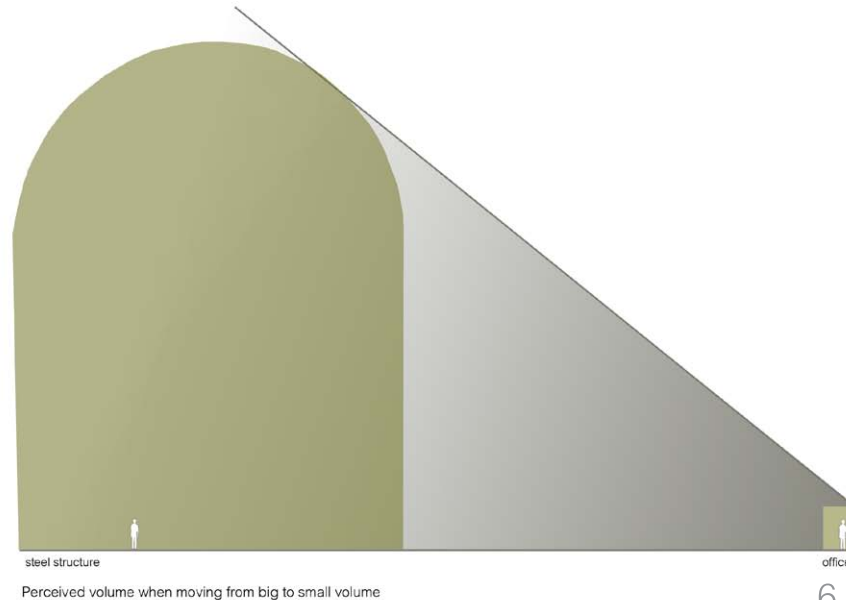
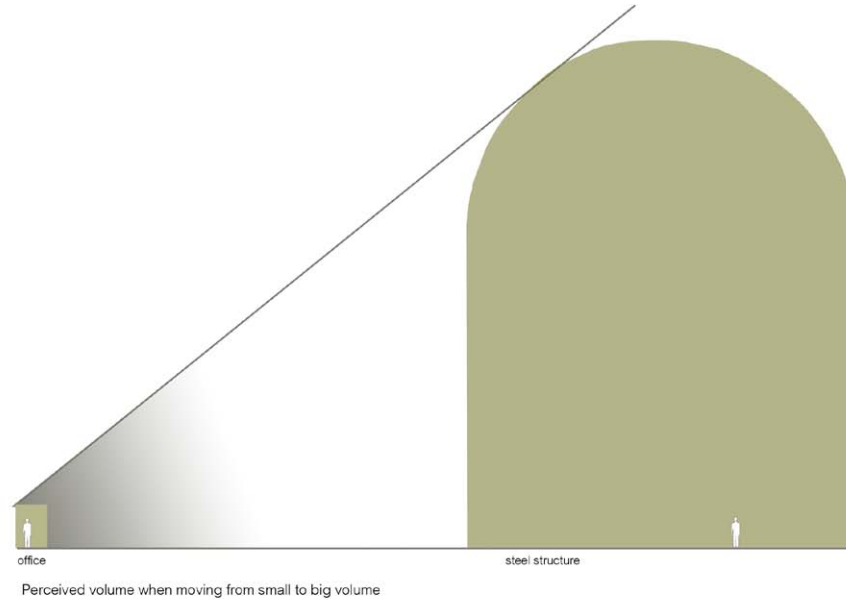

Figure 6.10: Diagram showing actual scale of interior spaces against the volume in the steel structure

### 6.3 Context

A space or volume must be seen in context to understand the possible experience within it. Space cannot be seen in isolation. The space, through which the user has moved to reach another volume, influences the experience of the following space. If a user walks through a space with a big volume or large perceived volume into a space with a low ceiling, the second space would be perceived as smaller than it would have been if the first space was dark and small. The office space might be experienced as being smaller than it really is, after coming through the foyer and volume above the stairs. The volume within the steel vault might be experienced as even bigger if it is entered through the museum spaces rather than when entering from the outside on ground level. The height of entry may also play a role in the perception of the volume being larger than it is, as the user is approximately ten meters lower on the ground than they would be at the entrance from Genesis 1.

The entrance to the site determines (to an extent) the experience within the space. The inherent scale of the volume is influenced by the placement of the entrance, as this determines the perception of the user. The perceived volume needs to be taken into consideration when looking into the spatial experience of a space.



6.11

Figure 6.11: Diagram showing the perceived scale of a volume in terms of context



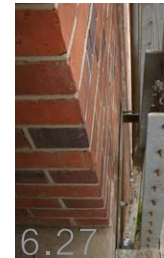
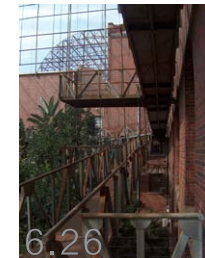
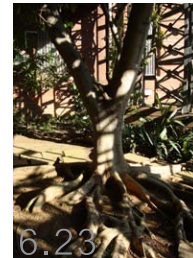
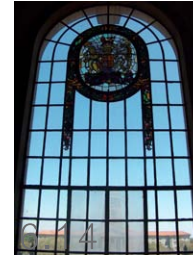

Figure 6.12: Stairs and handrail at entrance of museum  
 Figure 6.13: Floor finish in foyer  
 Figure 6.14: Window above foyer  
 Figure 6.15: Sandstone staircase  
 Figure 6.16: Floor finish from stairs to hall  
 Figure 6.17: Floor finish change between hall and Genesis 1  
 Figure 6.18: Interior of Genesis 1  
 Figure 6.19: Interior of Genesis 1  
 Figure 6.20: Building facade  
 Figure 6.21: Steel structure of Vault  
 Figure 6.22: Service pipes on facade of building  
 Figure 6.23: Wild fig tree roots  
 Figure 6.24: Wild fig tree leaves  
 Figure 6.25: Entrance into vault  
 Figure 6.26: Ramp on facade of building  
 Figure 6.27: Ramp attached to building

#### 6.4 Materiality

Materials can provide sub-conscious information to users that influence the experience of a place. The sandstone of the building immediately gives a historical status to the museum. The steel ramp and steel structure against the

brick of the building creates a contrast and confirms the difference in the volumes enclosed. The green of the wild fig tree implies a natural environment and the texture of its roots contrast with the solidity and geometric character of the concrete and steel structure, demonstrating the contrast between man-made and natural.

## 6.5 Objects in space

The Ditsong Museum is known for the whale skeleton in front of the building (figure 6:28). This object in space immediately stimulates a feeling of awe and curiosity. An interesting space underneath the structure and skeleton is created, where the user can move underneath it and experience the skeleton from different angles. This encourages closer investigation and stimulates knowledge transfer without forcing the user to engage in the activity. The object shows the monumentality of not only the whale, but of the museum as well.

When entering the foyer of the museum, the first thing the user sees is the elephant in the centre of the space (fig. 6.20). The scale of the foyer means that the size of the elephant is not overpowering in the space, but again shows monumentality and immediately introduces the user to the content of the museum.

Exhibitions are objects in space. It is not only the artefacts on exhibition that create experience within space, but also that on or through which the artefacts are exhibited that contribute to the experience of space. Genesis Halls 1 and 2 are exactly the same size, but the experience within Genesis 1 was drastically altered when temporary structures were erected within the hall to create more exhibition space (fig. 6.30). The result is that the volume is very small in some places, and the natural light is eliminated from the space.

Figure 6.28: Whale skeleton in front of Ditsong Museum

Figure 6.29: Elephant in the foyer of the museum

Figure 6.30: Smaller volume created by temporary structure in Genesis 1



The low structure creates spaces that become dark and enclosed. The original wood flooring can be seen between the panelling and the windows (Fig 6.31). It is uncertain what the state of the wooden floor will be if the temporary structures and carpet are removed. Even though the wooden floor might have to be replaced, it will be beneficial to take out the temporary structures, so that the volumes can be reconsidered for the new exhibition; the link re-established between the interior and the volume within the vault; and the placement of the exhibition could be designed around the entrance to the new intervention.

The experience of relief and calm within the vault structure is due to the lack of objects in space. The volume can be experienced as a whole and light can flood the space without obstruction (fig. 6:32). The objects that are present in the volume are the ramp that follows the facade of the building, which is sensitive to the volume, and plants on the ground. The plants add to the experience of calm and create a contrast between the volume and the building.



6.31



6.32

Figure 6.31: Wooden floor behind temporary structure and carpet in exhibition space.  
Figure 6.32: Unobstructed volume within vault

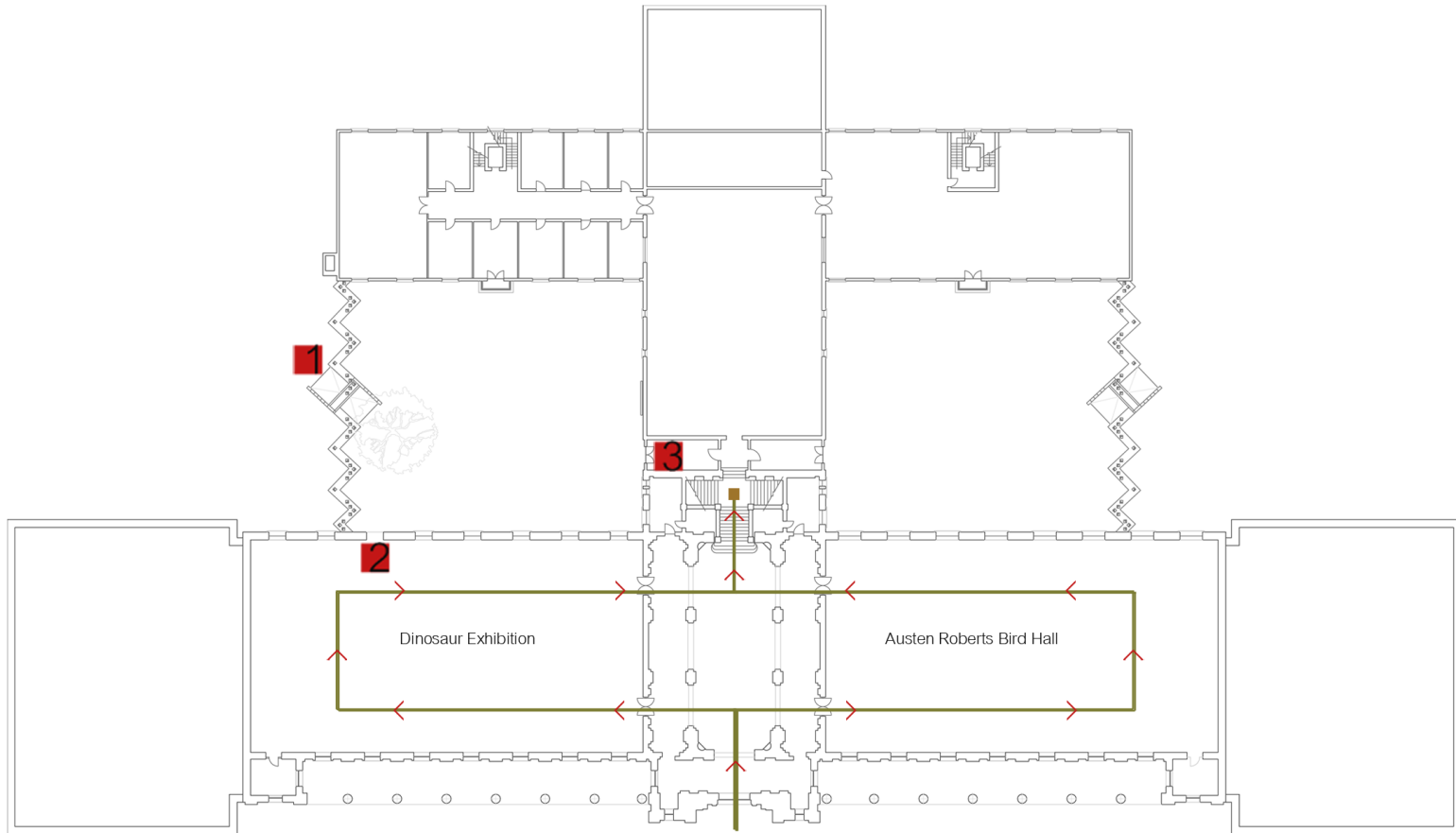

Circulation from entrance through Dinosaur and Bird Halls

■ Possible entrances into vault

6.33

Figure 6.33: Diagram showing existing public circulation through the museum on ground level

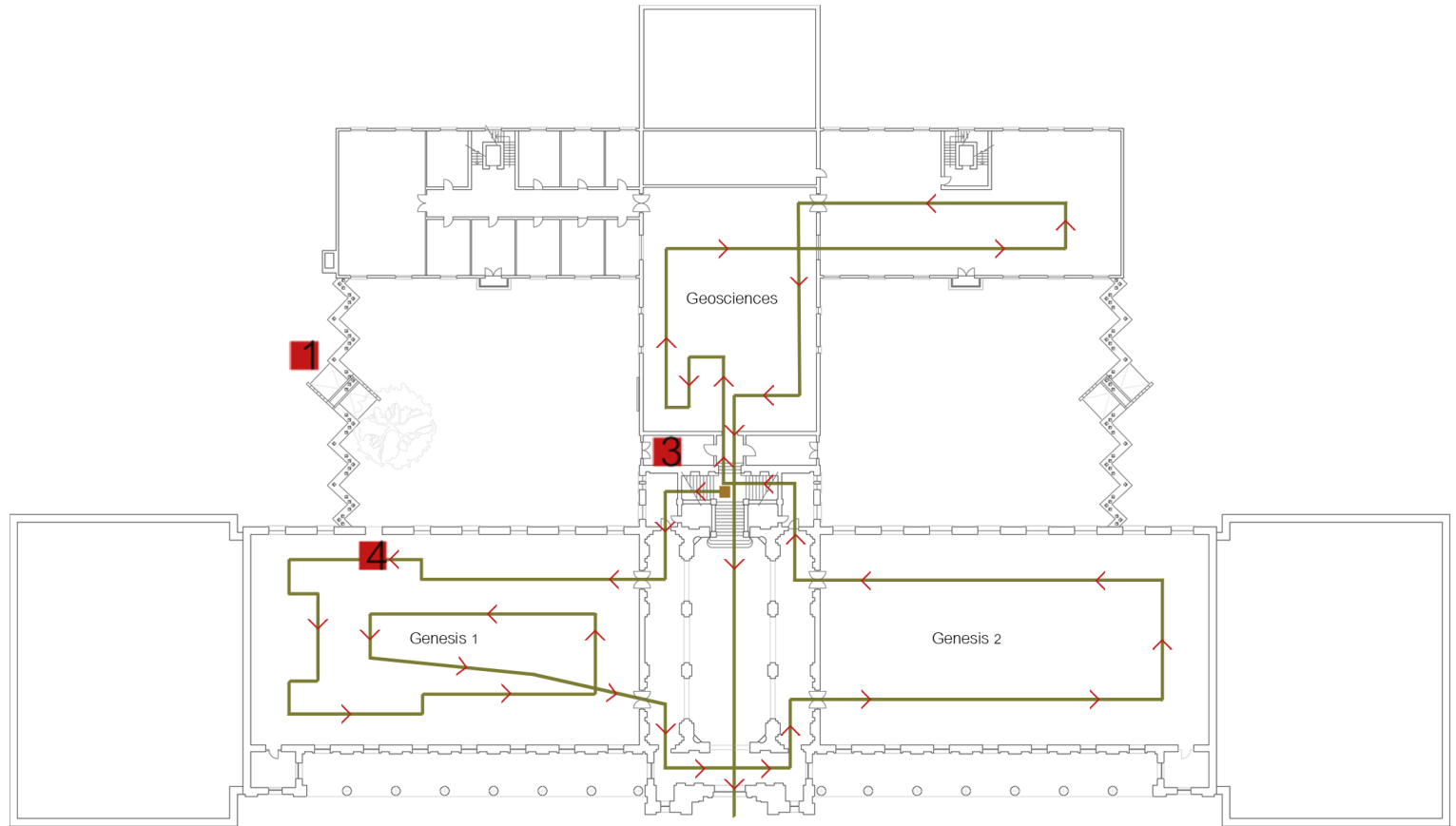

6.34 Circulation up the stairs through Genesis 1 and 2 and Geosciences Hall

■ Possible entrances into vault

### 6.6 Circulation through main building

To determine which entrance from the museum into the steel vault is most appropriate, the existing circulation through the exhibition spaces is considered.

Figure 6.34: Diagram showing existing public circulation through the museum on first floor and mezzanine

Four different entrances are considered:

1. Entrance over ramp on ground level. The existing concrete ramp over which the user enters the vault on ground level is too steep for public use so it will have to be adjusted. For the user to get to this entrance, he would have to walk out of the museum, and around the building or through the northern flank, down using a lift and out of the building. This completely separates the user from the museum experience.
2. Entrance on first floor level in Dinosaur Hall, which is on the same level as the foyer. This is an advantage in terms of inclusive design, for no stairs will have to be adapted. The existing door leads onto the ramp structure within the vault. A disadvantage of this option is that the dinosaur exhibition will be interrupted by the new insect exhibition.
3. Entrance through the office on the mezzanine level onto the ramp in the vault. The user can walk straight through the foyer, up the stairs and into the office. The stairs will have to be adapted for inclusive use. The office space becomes a threshold between the museum and vault, if used as entrance into the vault and intervention.
4. Entrance on second floor through an existing door that leads onto the ramp. The user will walk through the existing Genesis Hall 1 when going into the new intervention. The Genesis exhibition houses the insect collection, which becomes relevant for the present exhibition, but also covers a wide spectrum of other subjects regarding the development of life on earth.



GENESIS 1 EXHIBITION

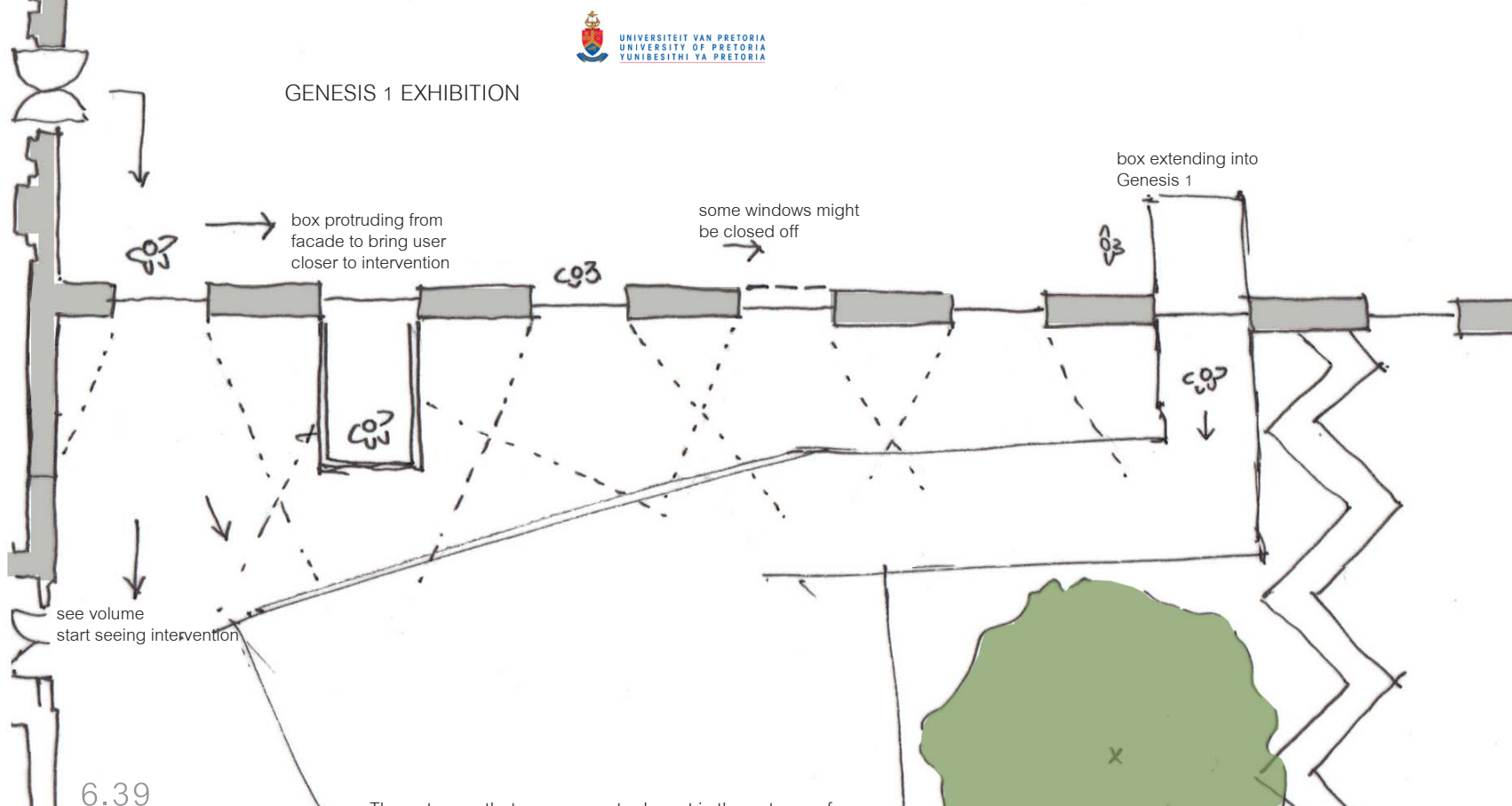

The entrance that seems most relevant is the entrance from Genesis 1. The user is not disconnected from the exhibition space before entering the intervention. The windows that the user passes whilst walking through the exhibition can be used to create a curiosity towards the intervention, and it is so close to the entrance into the vault structure that a build up towards the intervention can be created.

At the moment the museum is not fully accessible for the disabled. Most areas can be reached via lifts, but takes the user completely out of the regular circulation of the museum. The proposal is to install a platform lift in the foyer so that users can go directly to Genesis 1. The museum in general will benefit from this.

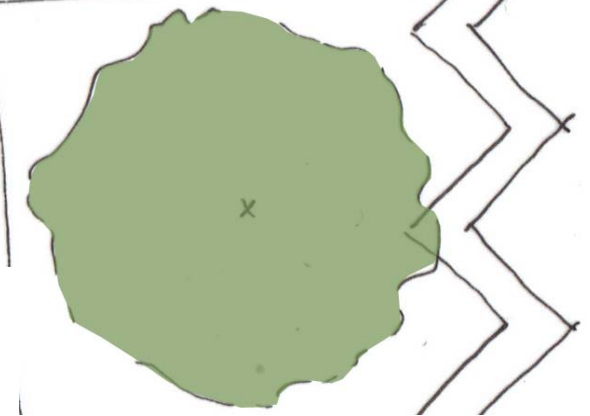

Figure 6.39: Drawing showing some possibilities in terms of what the user would see through the existing windows and how curiosity could be evoked

## 6.7 Extension of the intervention

Consideration needs to be given to the limitations of the new intervention. The intervention is bound to the museum process and procedures. The user will enter through the main entrance of the museum and pay a fee for the museum as a whole. It becomes difficult if the user wants to visit only the new intervention, because entry can only be gained through Genesis Hall 1.

Possible extensions of the intervention beyond the borders of the vault structure include:

1. Extension into Genesis 1.
2. To the sidewalk, out of the structure on the northern facade.
3. Into an office space over the balcony.
4. Over the northern facade of the building onto the roof.

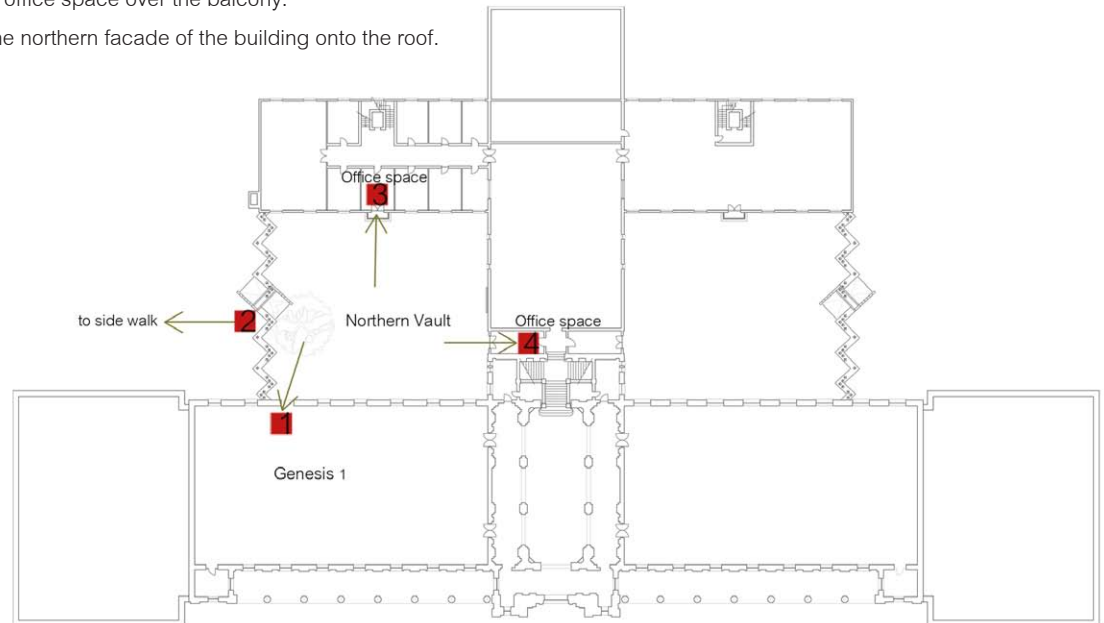

Figure 6.40: Extension options indicated on aerial photo  
Figure 6.41: Diagram showing possible extensions of the intervention

■ Possible extensions of intervention



1. The extension of the intervention into Genesis 1 is established through using the door from the hall as an entrance and exit to the vault. This can be emphasized by pulling the intervention structure into the hall to make users more aware of the intervention, and encourage them into the vault.
2. Extending the intervention to the side walk on Visagie Street becomes difficult because of the distance from the structure to the side walk (fig. 6:41). If the structure is extended in a straight line, the distance is 34 meters and it crosses the parking area. The advantage of extending the intervention in this manner would be that the public using Visagie Street become aware of the intervention and it would break the isolation of the museum. This cannot become a second entrance into the museum or intervention for practical reasons. It can become an extension of the experience within the vault, or a quick introduction to what may be expected, although the experience might be completely misinterpreted if experienced outside of the context of the museum. Alternatively the intervention can extend beyond the vault structure, but stay within the museum site. This will take the user through the structure and create a different experience or view, but will not have to extend all the way to the side walk.
3. Another option is to extend the intervention to the balcony, stopping at the balcony or entering the office space behind it. The office is separated from the exhibition halls which again disconnects the user from the museum experience. This separation eliminates this extension as an option, but a connection between the intervention and the balcony will have to be established without entering the building.

4. Windows above the main stairs in the foyer look onto the wall of the building extending to the east (fig. 6.41). This cannot be seen clearly because of the glare from the window, the darker interior, and because the wall is painted cream (fig. 6.42). If the intervention was to extend onto the roof dividing the foyer and the wall, and painted a bright colour or made from a contrasting material, the user would become aware of the intervention when walking towards the stairs. This again establishes a curiosity towards what the intervention might be. This might also be negative because the user might not realize that this is an extension of the intervention. So, instead of the curiosity being clearly directed at the intervention, the user wonders what it is. This link will be clearly made in Genesis 1 through the windows, where the user can see the intervention in its context.

\*

Through the site analysis, guidelines have been established that will support and direct the design process. These are guidelines regarding the entrance into the site and limitations of the intervention. The current contrasting materials become informant in terms of the use of contrasting materials in the intervention. Through the light study, and possible connections with the intervention, it was determined that it is important to open the windows in Genesis 1 to the vault structure to allow natural light into the hall, and re-establish the connection with the vault. The building surrounding the vault provides protection from extreme heat because of the ever present, moving shadows, with the advantage of never blocking out the natural light completely. This provides the opportunity to open up big parts of the structure of the intervention to make full advantage of the natural light.

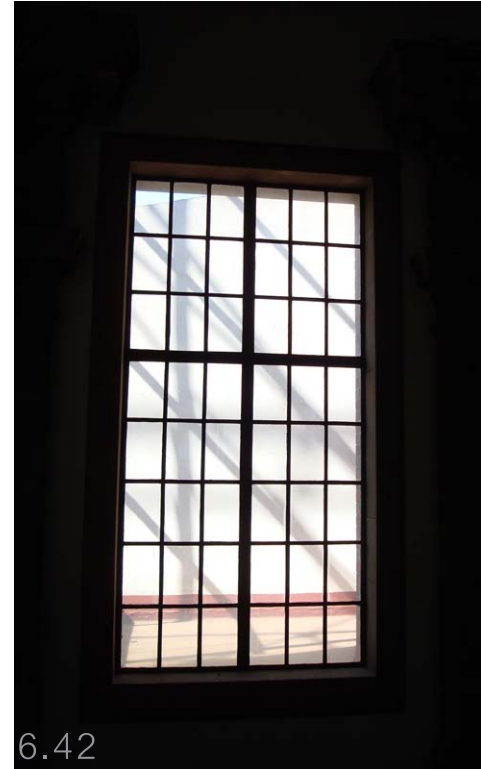

6.42  
Figure 6.42: The wall of the building behind the foyer can be seen through the windows above the stairs

# design discourse

concept and design development



The intervention aims to create an experience based exhibition, with the five senses as the basis for the exhibition spaces. The exhibition links to the museum to become an additional exhibition space. Although the insect was investigated as subject for the exhibition, the reality of the museum context caused this decision to be altered, so that the insect collection is still an influence in terms of design decisions and the thinking towards the general exhibition, but would not be detailed in the exhibition.

It is important for the user to have something in the experience to relate to, or that connects with his frame of reference. Experience is perceived through the senses. We know our senses, live with them, use them and know what the sensory organs look like. It might be expected that insects have senses more or less the same as human senses, but insects have very different and interesting ways of seeing, tasting, smelling, touching and hearing.

Human senses will be dealt with in the new exhibition in Genesis 1 (Vermaak 2010). The exhibition should be arranged in such a way that human senses are emphasised in advance of the user encountering the insect collection. This establishes a link, and contrast, between the human senses and those of the insect.

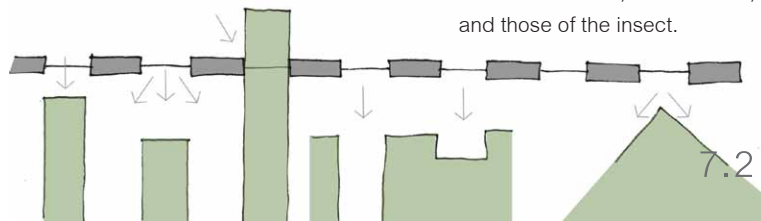

Figure 7.1: Window looking out on vault structure from Genesis 1  
Figure 7.2: Illustration of possible reactions to windows

### 7.1 Reaction to existing elements

Within the existing building and structure there are certain elements that need reaction from the intervention. These reactions should be specific to the existing elements and connect these elements with the intervention as well as the exhibition within the intervention.

In Genesis 1 the windows looking out onto the volume and intervention should look onto and react with parts of the intervention that will create curiosity in the user.





7.3

The entrance to the volume becomes the only direct connection between building and intervention. This becomes the user's first encounter with the space, and should be treated accordingly.

In certain areas the volume should be experienced without interruption, so that the height within the structure has a powerful impact on the user. The height of the volume gives the user the opportunity to go up from entrance level, so that a height can be reached from which the surrounding areas can be seen. Specific reaction to the surroundings will be necessary if the height is reached and a view point is established on the surrounding area (figure 7.4).

The wild fig tree is an important element in the space and reaction towards it is required. Specific reaction will show the existing habitat within the structure and the contrast between structure and tree (figure 7.5).

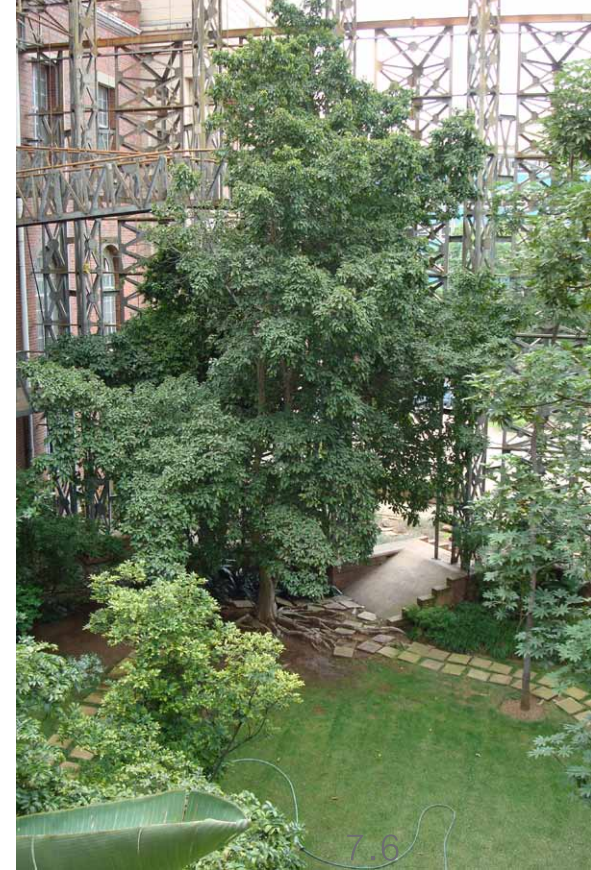

7.6

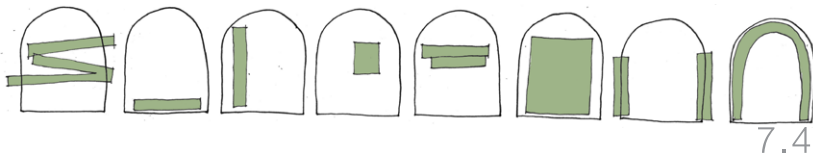

7.4

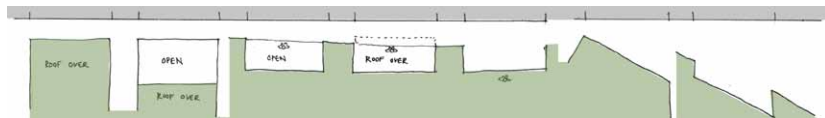

7.5

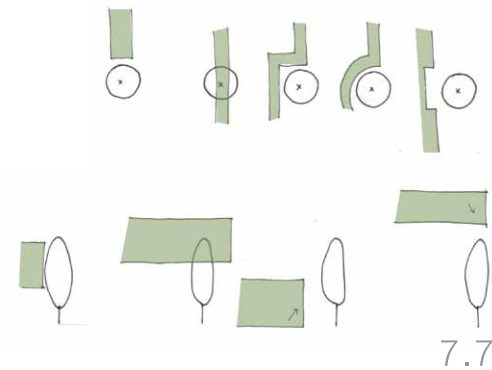

7.7

Figure 7.3: Entrance into vault structure from Genesis 1  
Figure 7.4: Illustration of possible reactions to volume  
Figure 7.5: Illustration of possible reactions to tree  
Figure 7.6: Wild fig tree  
Figure 7.7: Illustration of possible reactions to tree



On the northern facade of the building within the structure, there is a large wall without windows. The bricks form a harsh wall onto which, for example, a film can be projected. This will link the existing building strongly with the exhibition in the intervention to follow and eliminate the harshness of the wall to a certain extent.

To acknowledge the existing, a reaction to the balcony is required. The balcony overlooks the volume and is accessed from an office space in the eastern leg of the building.

For the user to be able to appreciate the volume from the ground, the intervention will have to connect with the ground. The ground plays an important role, along with the tree, in terms of the contrast between the building and the volume within the structure.

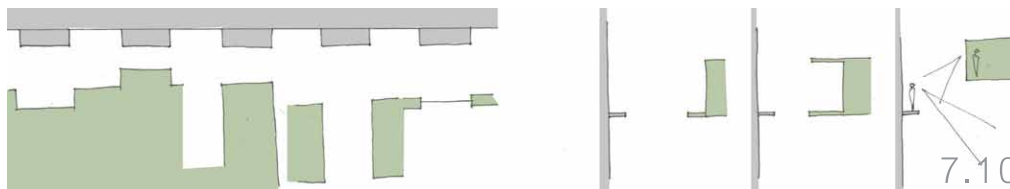
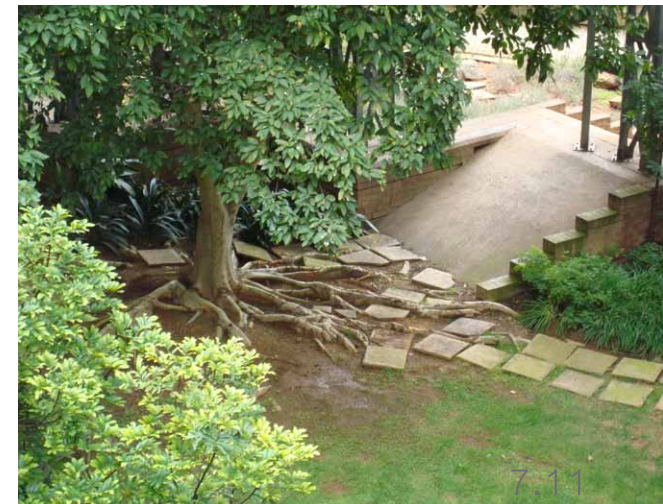
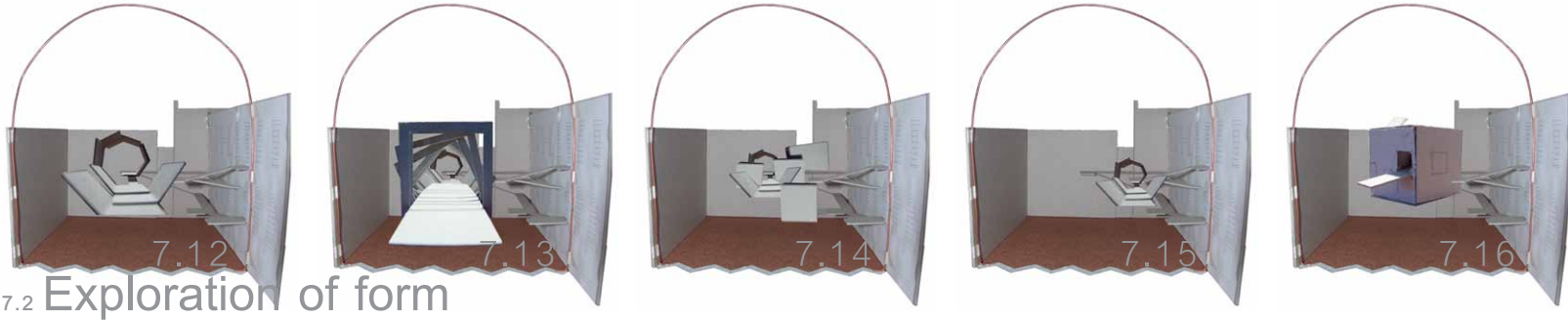

Figure 7.8: Photo showing brick wall on northern facade  
 Figure 7.9: Photo showing balcony on eastern facade  
 Figure 7.10: Illustration showing possible reactions to balcony  
 Figure 7.11: Photo showing ground level of volume



In the above models, size, placement and form of the intervention were explored. Two options for the exterior form of the intervention were considered. One option is a more permanent basic structure which forms a walkway onto which exhibition elements can be added. This would result in a changing interior and exterior environment.

The second option is to design a more enclosed structure and focus on the interior. It might be easier to change

the exhibition if the interior configurations are based on a system, which is an important consideration because of the hesitance of the museum to change exhibitions.

Option one was explored for quite some time, before option two was developed into the final design.

Figure 7.12-7.16: Models showing exploration of form  
Figure 7.17-7.18: New element wrapping around existing ramp structure  
Figure 7.19: Elements forming different interior spaces through different compositions  
Figure 7.20: Wasp nest latching on to existing structure

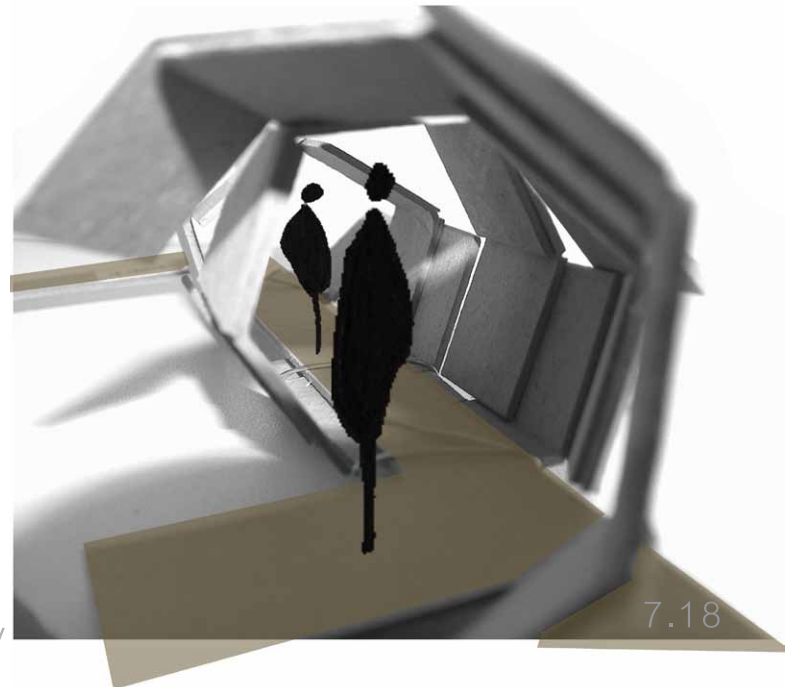
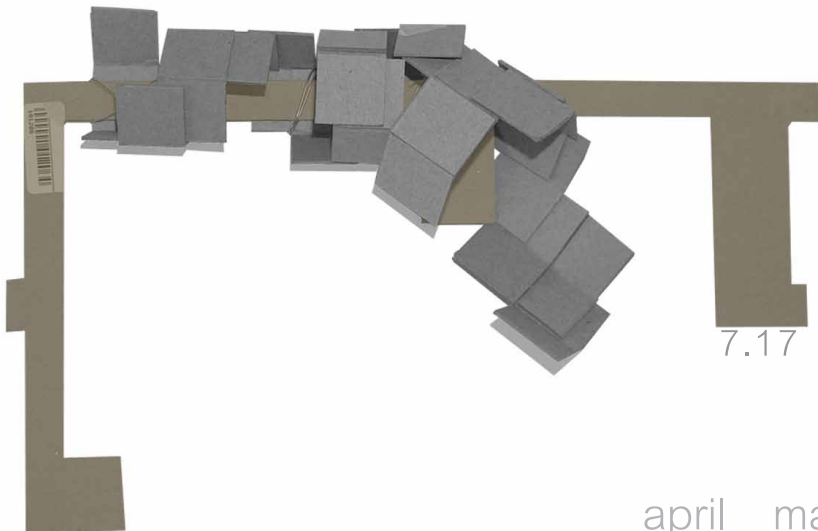

\_april \_ may

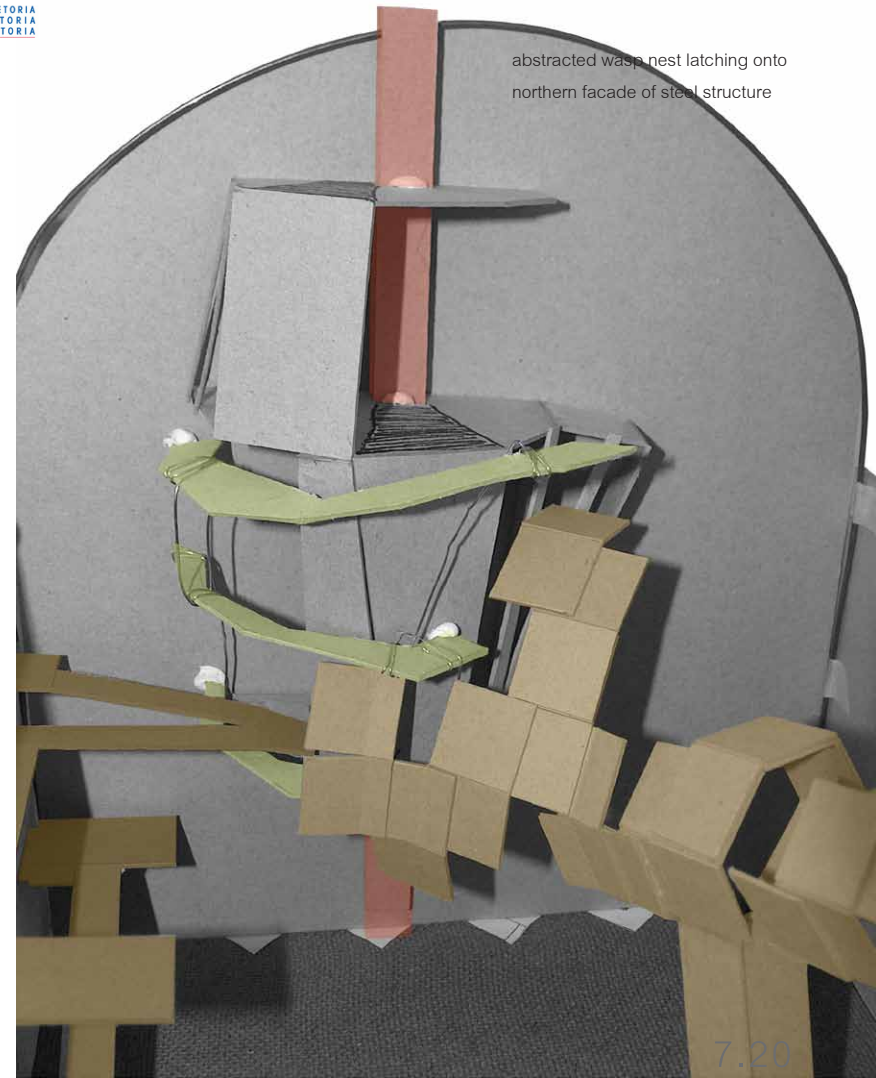
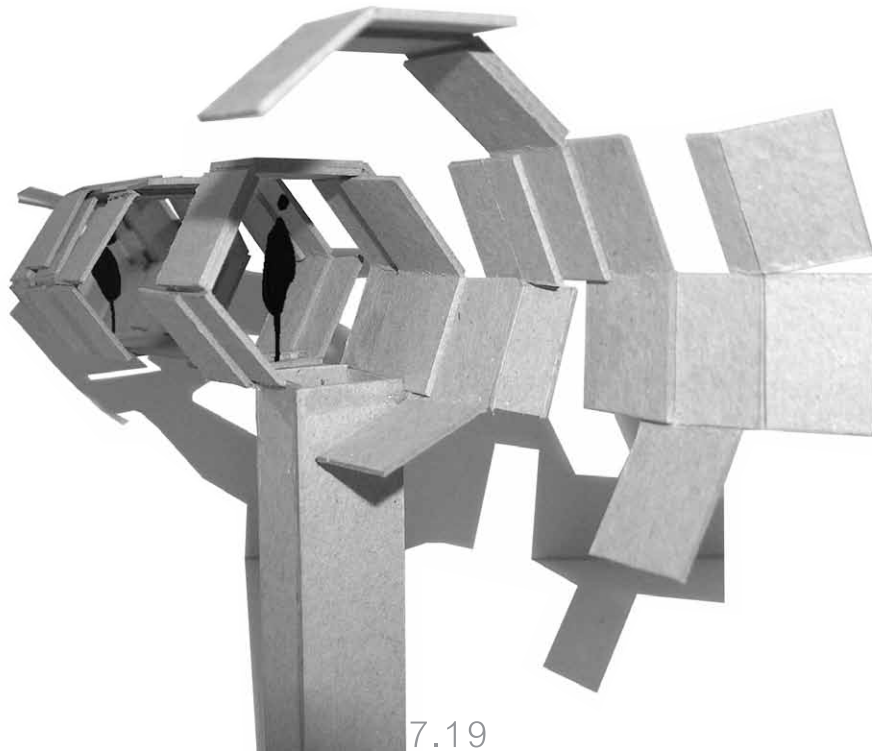

Option one, where the exterior and interior spaces change and therefore experience in both areas change drastically, had the following problems:

- clarity of form was lost
- difficulty in prescribing guidelines to which future exhibitions must adhere
- no basis space onto or into which exhibition can latch

Positive aspects of option one were:

- changing spaces and experiences result in more variation for frequent visitors
- the intervention becomes expressive of that which it exhibits

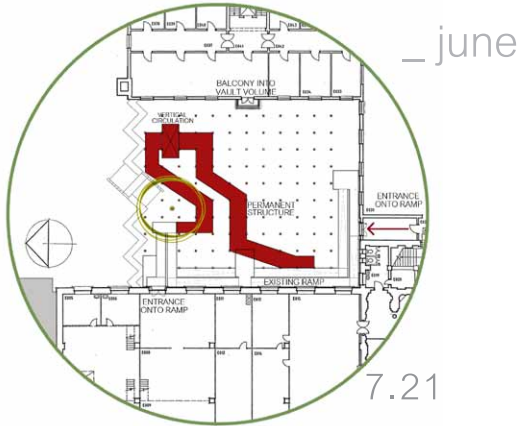

In the exploration of option one, the permanent structure formed a route through the volume to experience different aspects and parts of the volume, building and vault structure. The route started on the existing ramp. Columns formed a grid to guide the exhibitions to follow, and create structure for elements added onto the route.

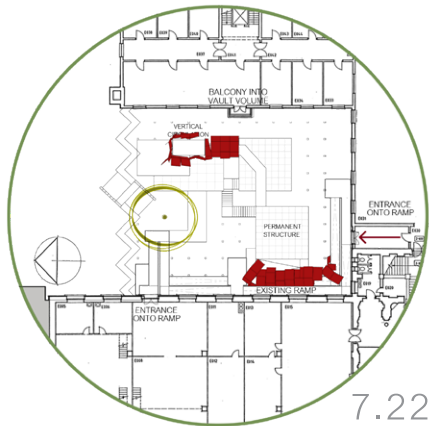

The permanent structure developed into platforms connected through walkways, and were handled in the same manner to form repetitive spaces throughout the intervention. The tectonic language of the intervention became different from platform to platform. The language of the intervention became unclear and the intervention became too much of an obstruction of the volume.

Wellcome Wing, The Science Museum  
MJP Architects  
London, England, 2003

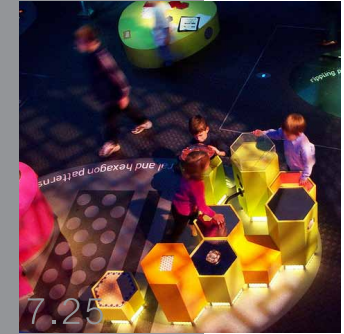

Figure 7.23: Wellcome Wing, blue lights create sense of mystery (Tim\_d 2010)

Figure 7.24: Entrance into Wellcome wing flooded with orange light (Mumphaee 2010)

Figure 7.25: Experience based exhibition (Davepatten 2010)

The Wellcome Wing is an addition to the science museum and contrasts with the Victorian buildings of the rest of the museum. The blue light contributes to this contrast and creates a completely different experience to the rest of the museum. This illustrates the element of context as discussed in chapter 5 and 6, especially where the user walks from a space flooded with light through orange panels into a space flooded with blue light (figure 7.10). The blue light suggests a sense of mystery, which hints at the infinite possibilities of science (MJP Architects:sp). This sub-consciously creates an experience which the user probably cannot pin point directly, but enhances the overall experience of the exhibition. The exhibition in the Wellcome Wing is experience based, and engages the user so that education can happen through experience (figure 7.11).

Figure 7.21: Permanent structure with columns on grid to act as guide for temporary experience

Figure 7.22: Permanent structure developed into platforms



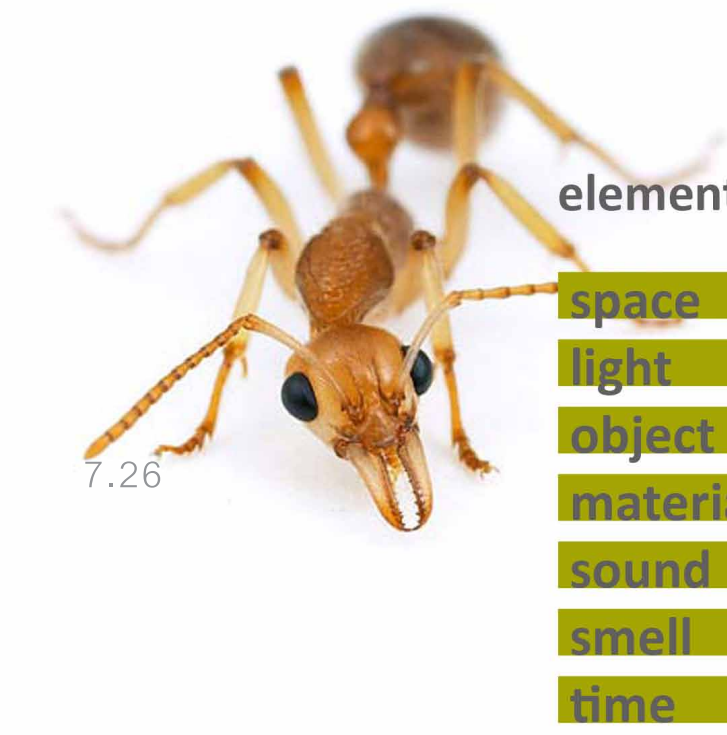

## elements of experience

- space
- light
- object
- material
- sound
- smell
- time

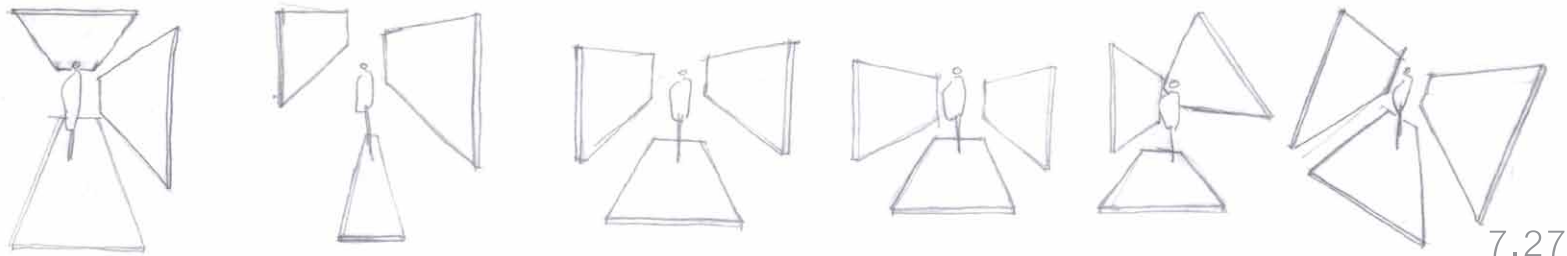
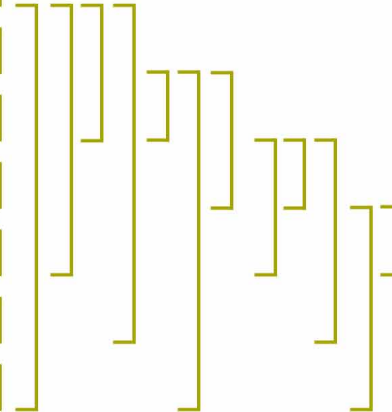
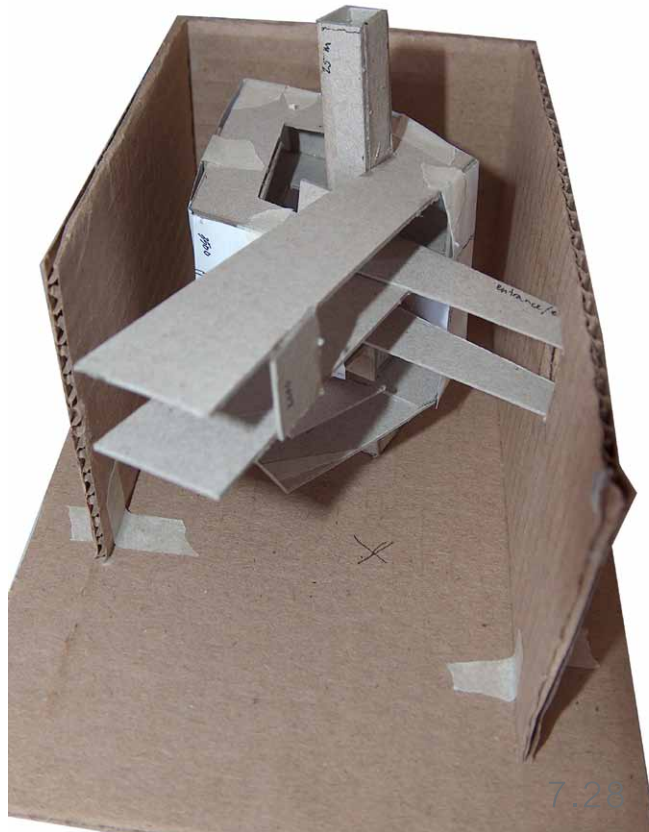

Figure 7.26: Elements of experience and possible combinations thereof  
Figure 7.27: Different experiences created through different placements of planes

The decision was made to remove the existing ramp structure so that the user can enter directly from the building into the intervention.

A new ramp structure was introduced for inclusive reasons as well as to facilitate flow of users through the exhibition spaces. The ramp connected the entrance level with the ground, as well as a higher level. The intervention protruded through the steel structure to

create a point at which the user can look out onto the surrounding area from a height above the roof of the eastern flank of the building. The ramp had to reach a minimum height of 15 meters to protrude through the steel structure at a point where the structural integrity of the structure would not be compromised. This, with the ramp connecting with ground level, resulted in a ramp of minimum 180 meters. The intervention filled the volume to such an extent that the volume could no longer be appreciated.



\_july

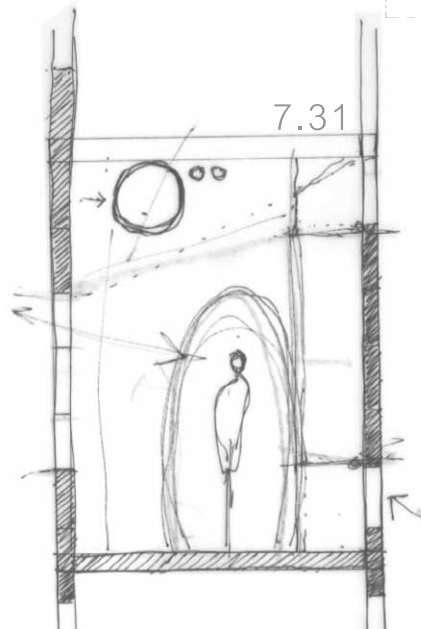
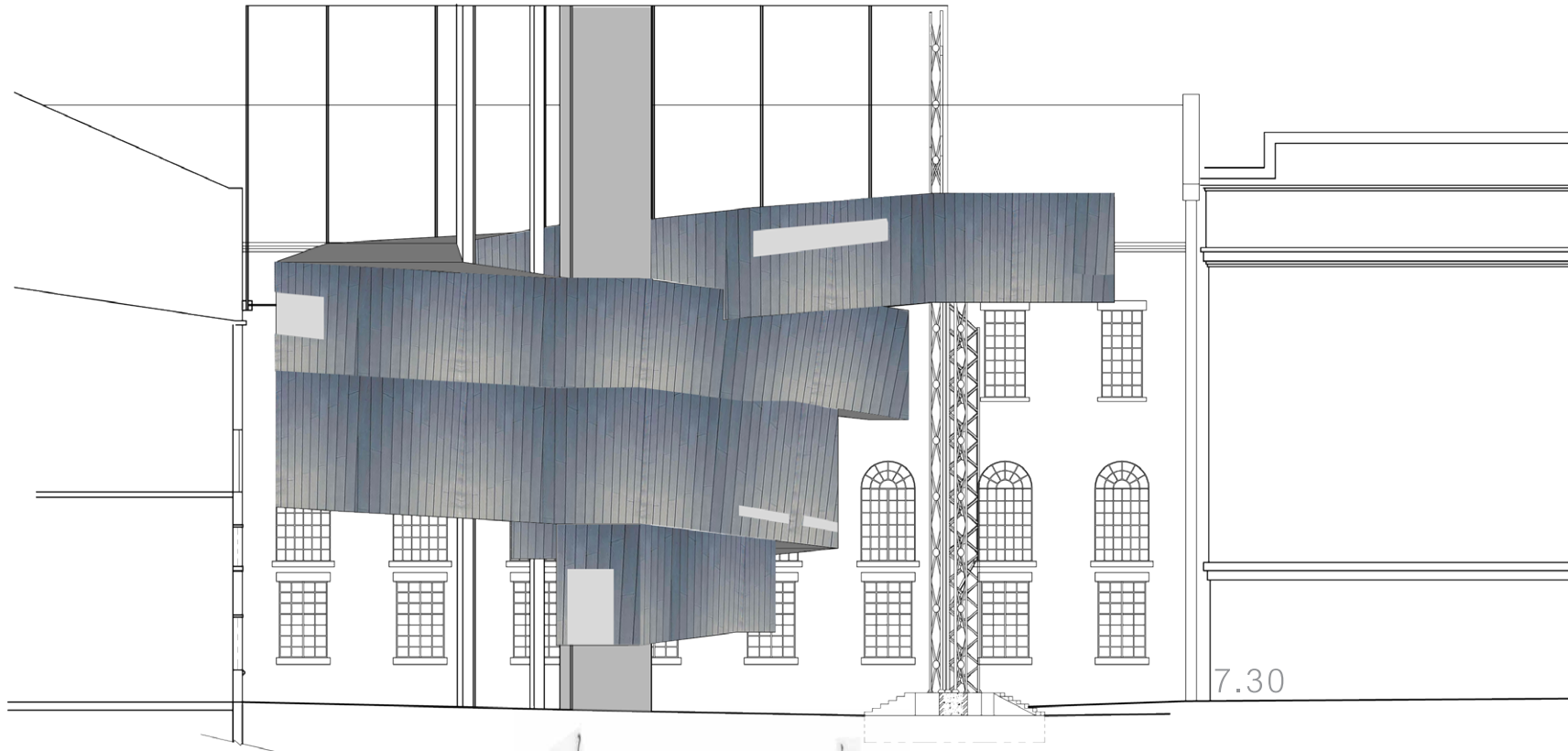

Figure 7.28-7.29: Model showing proposed ramp structure  
Figure 7.30: Elevation of cladged ramp structure protruding through steel structure  
Figure 7.31: Sketch illustrating change within interior space and exterior cladding responding to that.

The enclosed ramp formed interior spaces that were the same throughout the route. On the exterior the cladding system should have allowed for openings to change with any change in the interior. The exterior systems, although independent from the interior system, reflected the change on the interior. The intention was to have the interior space change completely from area to area and experience to experience.

The lack of connection with the existing building and volume resulted in a change of form and approach.

### 7.3 Final proposal

Taking the existing building and volume into account, the intervention became less enclosed, with openings placed specifically to react to the existing building and surroundings.

The structure of the intervention is supported by the lift that becomes the core structure. From the core, the rest of the intervention cantilevers, so that the only other support and therefore connection with the building, is the entrance into the volume. To keep damage to the building to a minimum the connection of the new structure happens where the old ramp structure connected to the building.

Entering from the museum building into the volume, the user experiences the volume for the first time. The walkway is therefore kept open on the sides, so that the user can start experiencing the space. The roof of the walkway should be solid roofing material, to provide cover from rain, and to house services that connects the main unit to the split units in the intervention.

The different spaces in the intervention are sense specific to create a base layer, which create guidelines for future exhibitions. The introduction to the exhibition and the 'touch' space is on the entry level. The lift at the core of the structure as well as stairs to either side of the lift, connect the different levels. One level up from Level 0 - Touch is Level 1 - Hear, with the highest level being Level 2 - See. One level down from the entry level is Level -1 - Taste and Smell. The interior of each of these spaces should be developed to make the user aware of the specific sense it focuses on. Figure 7.35 - 7.61 explain the various spaces in a bit more detail.

The structure form the basis of the exhibition and will remain sense specific for a longer period of time. The more temporary exhibition will fill the spaces to make them specific to the content for example insects. The exhibition will change annually and will always react to the basis space and specific experiential qualities embedded within each space.

Figure 7.32: Model of final proposal for intervention

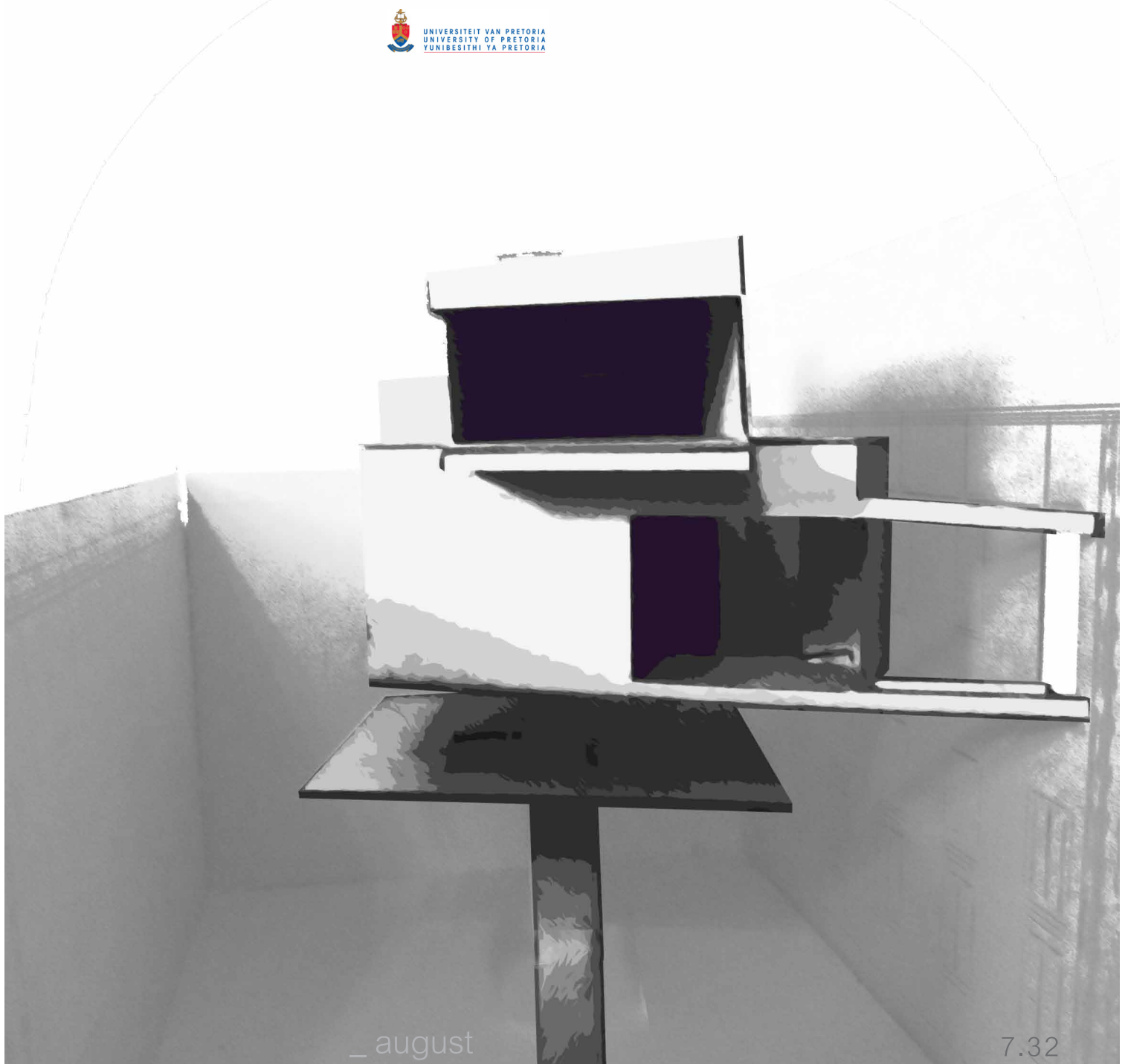

\_ august

7.32

1  
HEAR

2  
SEE

introduction  
to exhibition

entrance

0  
TOUCH

-1  
TASTE AND  
SMELL

7.33

GROUND



Figure 7.33: Eastern elevation of intervention

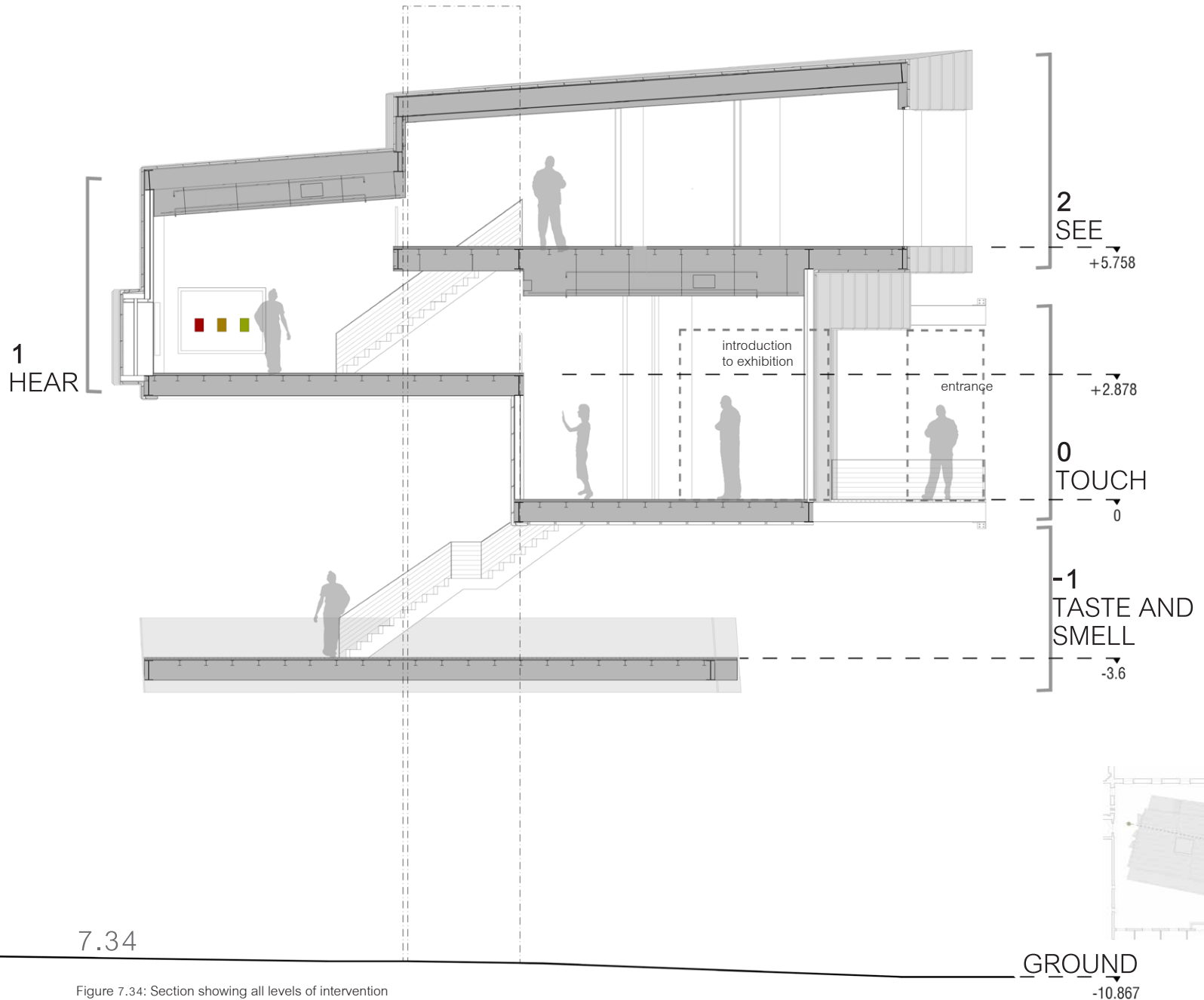
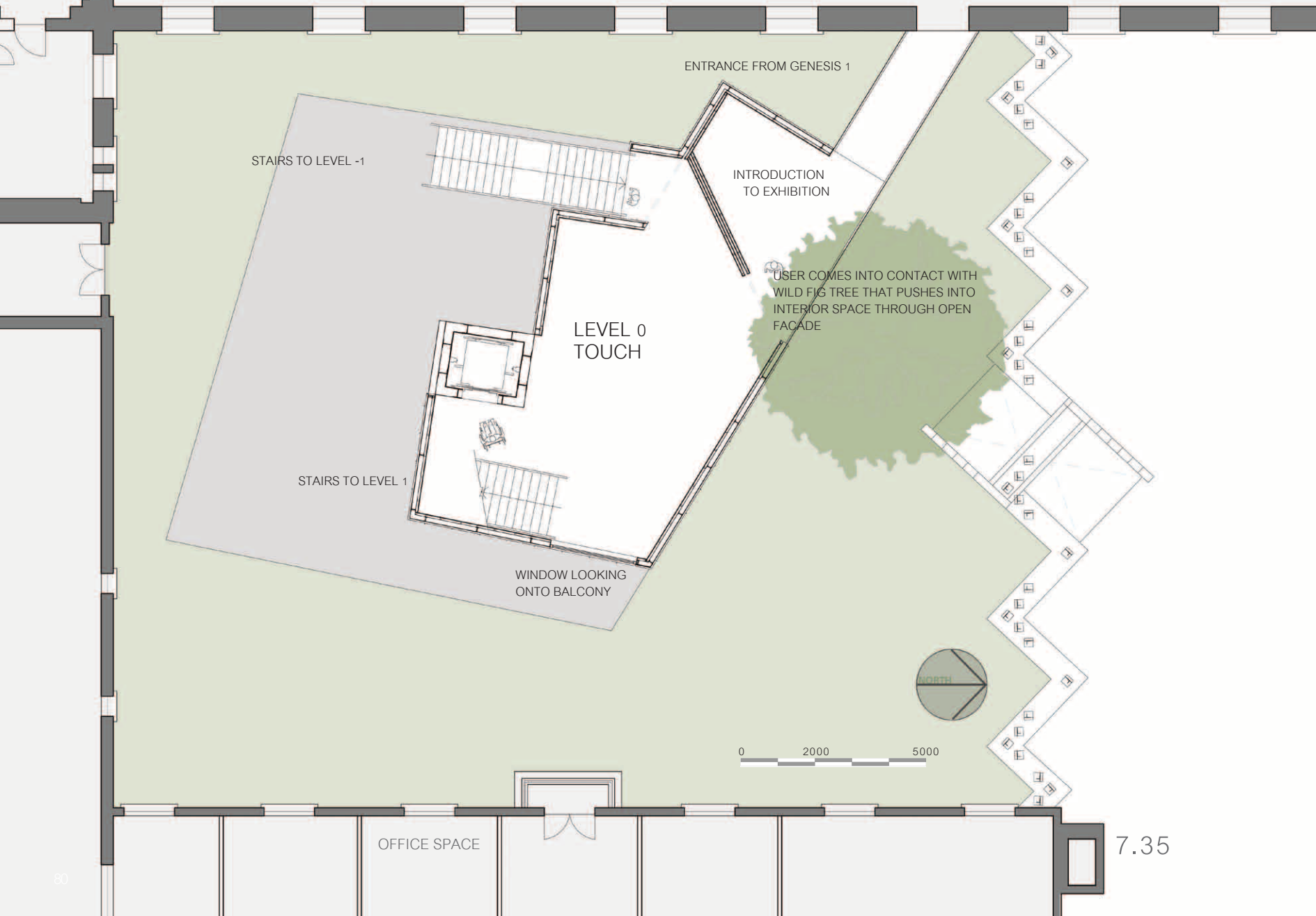
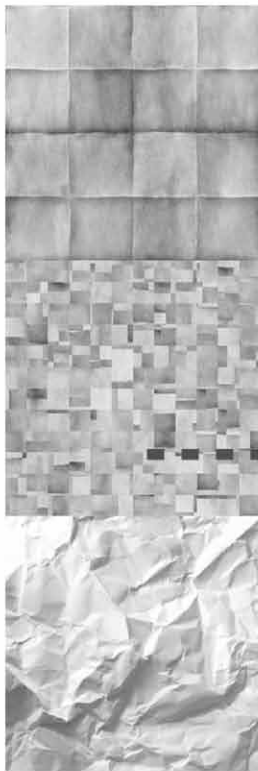

Figure 7.34: Section showing all levels of intervention

GENESIS 1







7.36

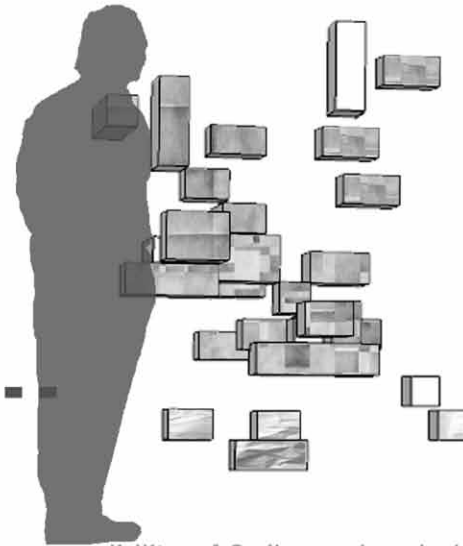
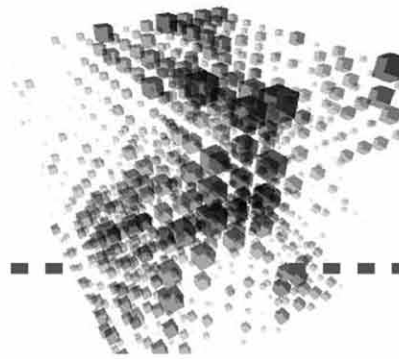

possibility of 3 dimensional object  
portraying texture in exhibition

touch and being touched

the tree and mist touching the user  
makes the user more aware of touch

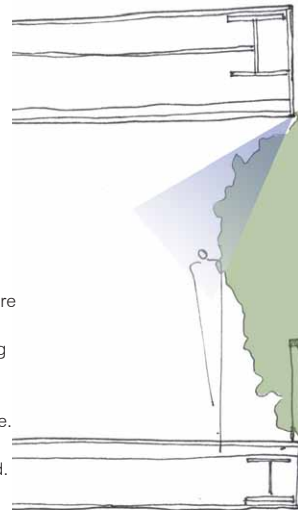

7.38

Figure 7.35: Plan of Level 0 - Touch

Figure 7.36: Illustration of interpretation of texture  
for exhibition

Figure 7.37: Illustration of floor finishes creating  
texture

Figure 7.38: Illustration of the tree touching  
the user, the user touching the tree.  
A light water spray will make the  
user more aware of being touched.



TOUCH

BOXES EXTRUDING FROM FACADE PROVIDING SPECIFIC SPACES FOR SOUND BASED EXHIBITION AND ESTABLISHING VISUAL LINK WITH EXISTING BUILDING

WINDOW AND SOUND BOXES TO ESTABLISH VISUAL AND SOUND CONNECTION BETWEEN EXISTING BUILDING AND INTERVENTION

LEVEL 1  
HEAR

SOUND REFLECTIVE SPACE

SPACE TO EXPERIENCE SOUND REFLECTION  
ALL FACES TO BE OF SOUND-REFLECTIVE MATERIAL.  
ALUMINIUM PLATE FLOOR COVERING

0 1000 2000 5000



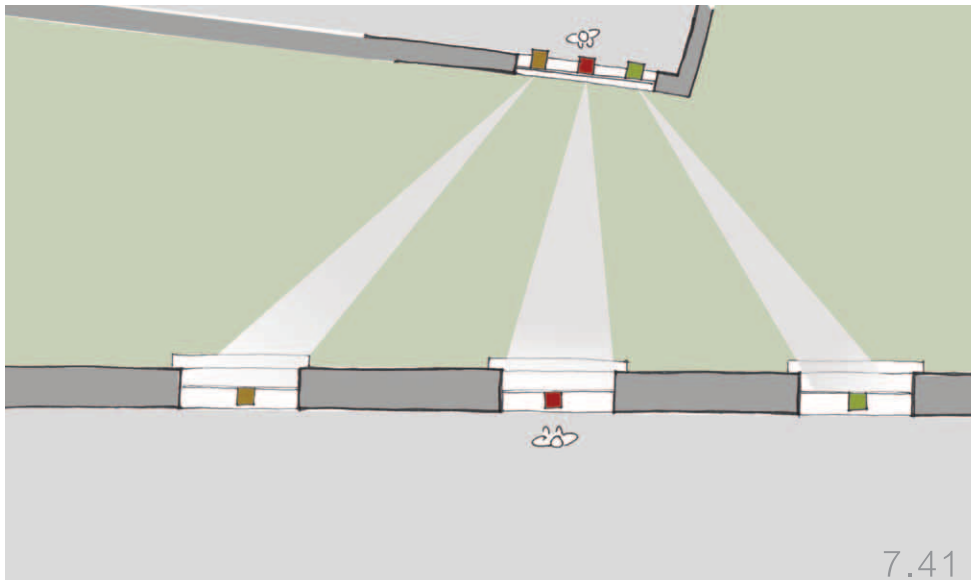
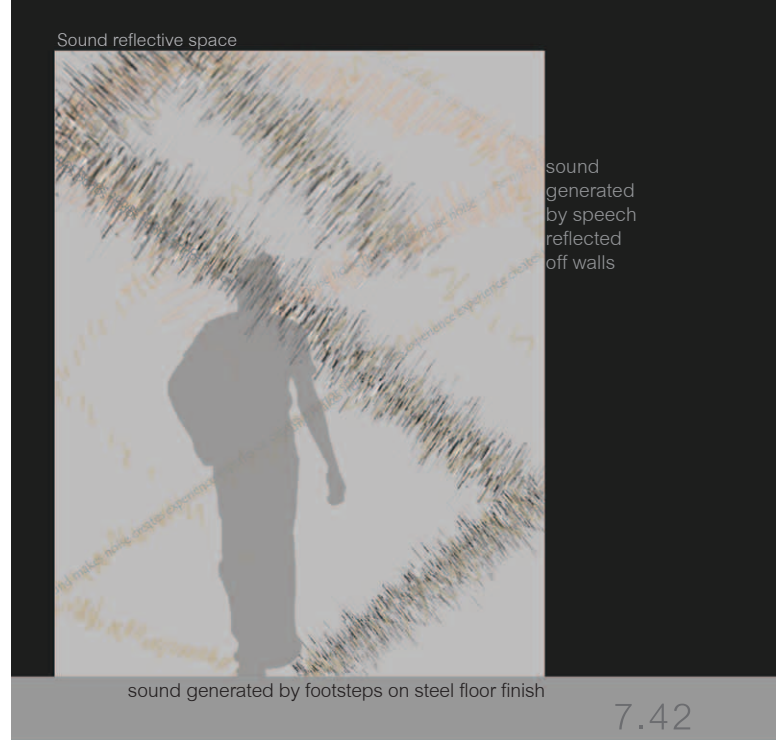
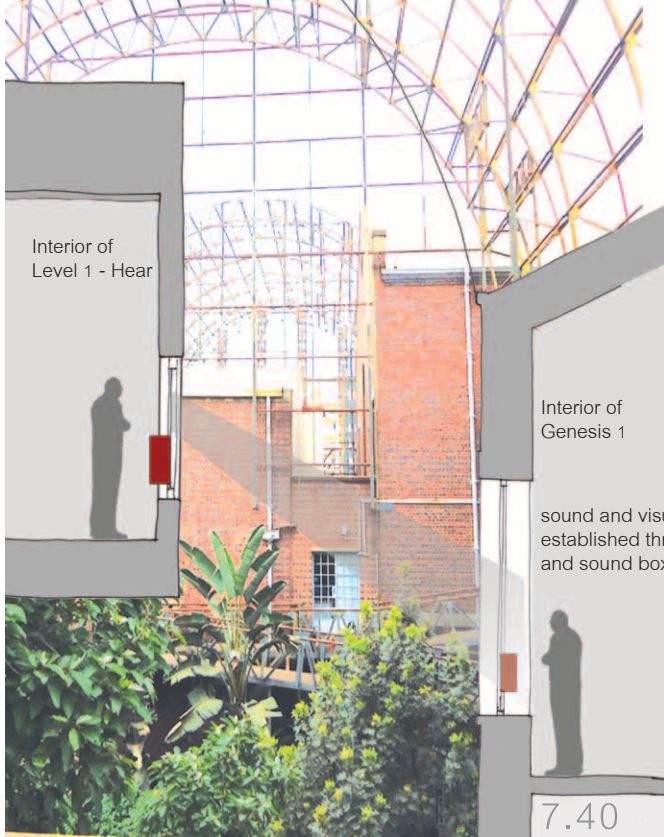

Figure 7.39: Plan of Level 1 - Hear

Figure 7.40: Illustration of connection between Level 1 - Hear and Genesis 1 - section

Figure 7.41: Illustration of connection between Level 1 - Hear and Genesis 1 - plan

Figure 7.42: Illustration of sound reflective space

HEAR



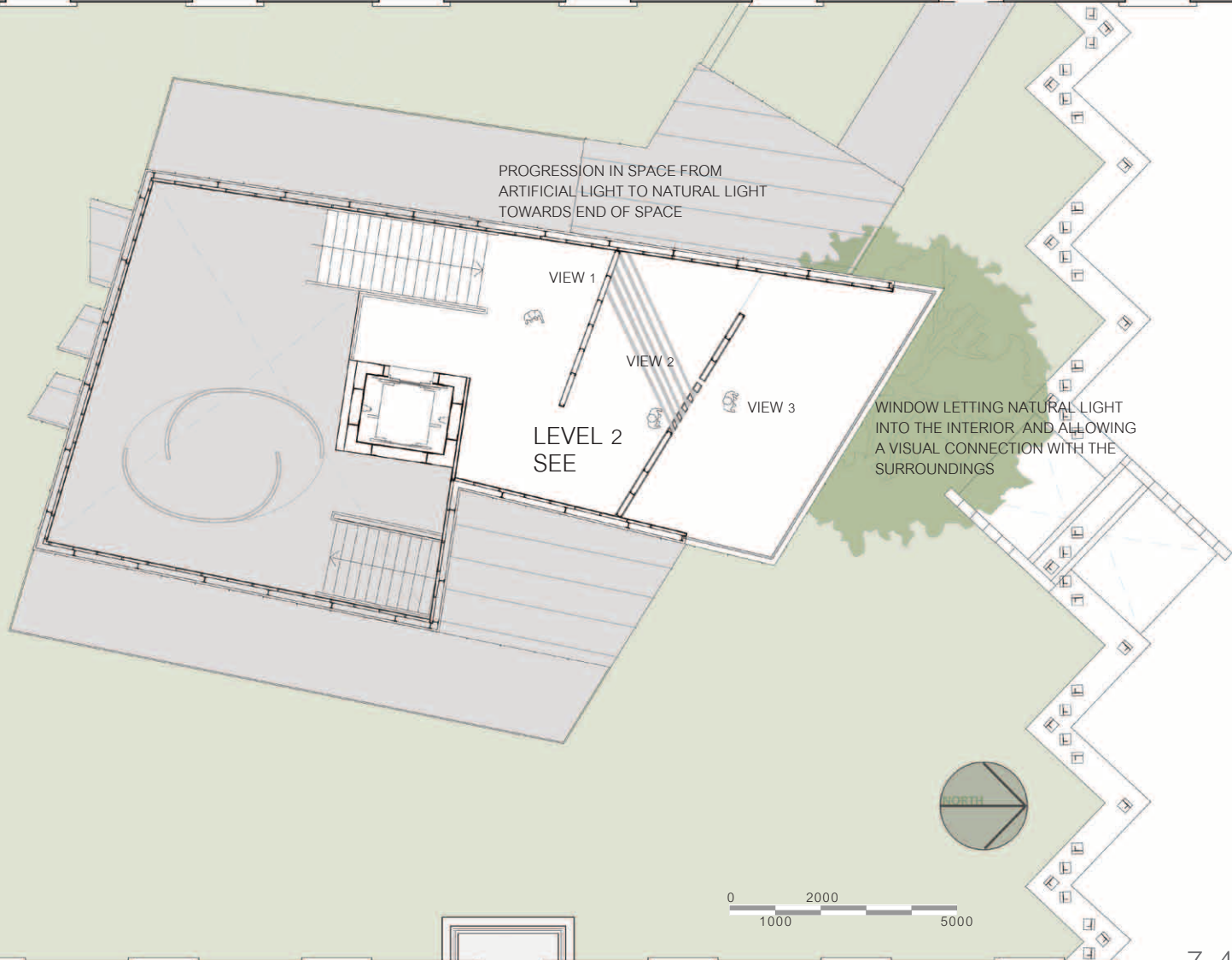

VIEW 1

VIEW 2

VIEW 3

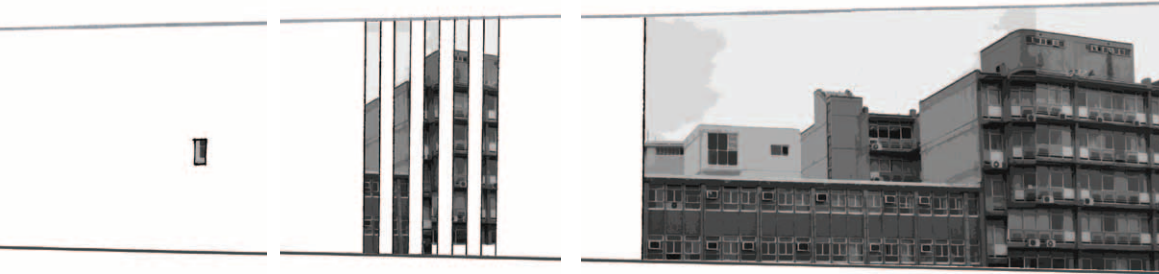

7.44

As the user progresses through the spaces of Level 2 - See, more of the view is revealed (figure 7.40). In the first space only a small hole in the wall will show the user what is to come (view 1). The wall in the second space has slits from floor to ceiling, which allow the user to see more of the view and let some natural into the space (view 2). In the third space natural light floods the space and the surroundings come into full view (view 3).

VIEW 3

view of building across Visagie Street



7.45

Figure 7.43: Plan of level 2 - See

Figure 7.44: Illustration of view being revealed in Level 2 - See

Figure 7.45: View of building across Visagie Street

Leo Bunett Office  
Ministry of Design  
Singapore, 2009



7.46

7.47

Figure 7.46 - 47: Perspective painted on ground and facades of building (Dezeen 2009).

Through projecting an image onto different planes and painting the exact forms onto those planes, an image can be created that becomes clear only from a specific view point.

By creating such an image on the building across the street, the image will only make sense from the view point of the user in the See Space. The image should relate to the exhibition and to sight. The specific view and connection with the building will make the user aware of the surroundings.

SEE  
S





Parabienta Green Wall  
Shimizu Corporation  
Toronto, 2009



Figure 7.49-50: Parabienta Green Wall, Toronto (Thegrowspot.com 2010)

The Parabienta system combines panel-type planting units in a green-  
ing system that is light weight and low cost. A variety of plants can  
be incorporated in the system which, along with the different panel  
combinations, allow for flexibility (Thegrowspot.com 2009).

The detailing and plant specification for the vertical garden  
does not form part of the project. This will be dealt with by a  
specialist in the field. Because of a lack of direct sunlight on  
most of the vertical garden, the proposed system incorpo-  
rates panels that can be exchanged with panels on a wall  
on ground level. This can be done approximately every two  
weeks and provides flexibility in terms of the placement of  
different plants and the experience it creates. Examples  
are given of proposed plants or types of plants that would  
stimulate the senses of the user.



\_Blueberries



\_Goji berries



\_Strawberry blossom



\_Strawberry plant



\_Garlic chives

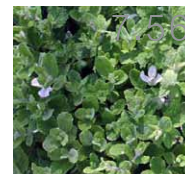

\_Apple mint herb

senses fuse into each other more  
clearly on taste and smell level

to be able to experience fully the  
senses are dependent on each other

see to touch  
touch to taste  
smell to taste

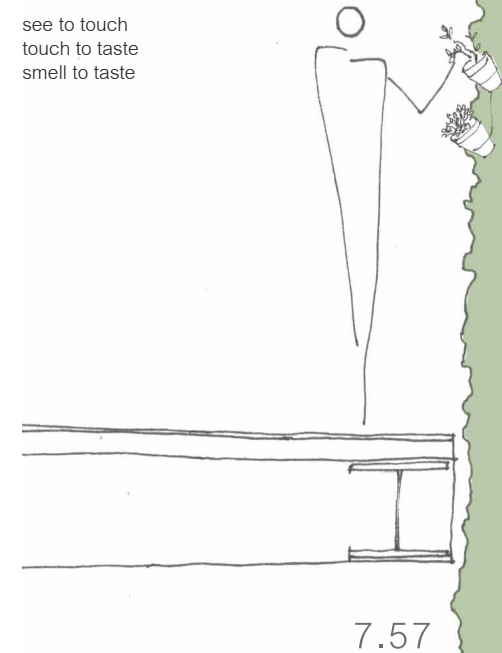

Figure 7.48: Plan of level -1 - Taste and Smell

Figure 7.51: Blueberries (Blueberries for beauty and taste 2009)

Figure 7.52: Goji berries (Tibet Advice 2007)

Figure 7.53: Strawberry blossom (Strawberry Plants.org 2010)

Figure 7.54: Strawberry plant (California Pacific Plant Exports 2010)

Figure 7.55: Garlic chives (Aiden brooks: Trainee chef [sa])

Figure 7.56: Apple mint herb (Free images [sa])

Figure 7.57: Illustration of experience created by vertical garden



TASTE AND SMELL

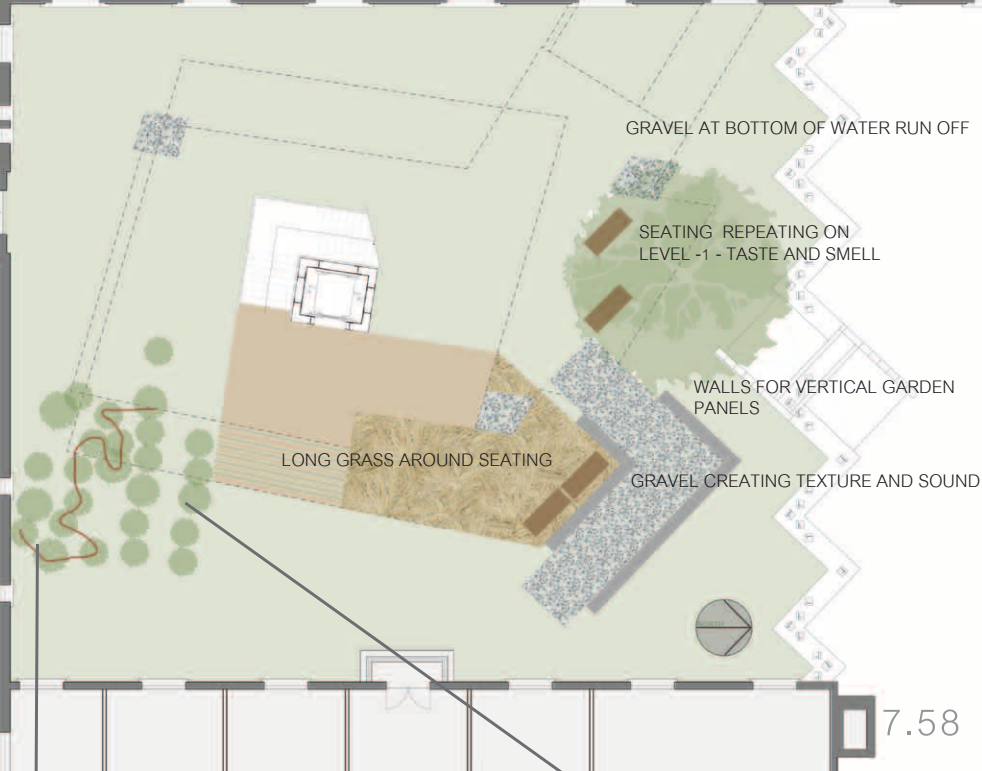

The exhibition can continue on ground level, where plants and ground coverings can assist in the experience of the exhibition as well as the volume.

On ground level, walls will provide surface for the panels of the vertical wall to be placed from time to time for sun exposure. This can form an opportunity for users to learn about hydroponics. Although this will probably not fall directly in the subject of the exhibition, it can provide interesting, optional information. Users can use the ground level as pick-nick spot as well, and to relax after the museum experience. The ground level should stimulate sight, taste, smell, touch and hearing.

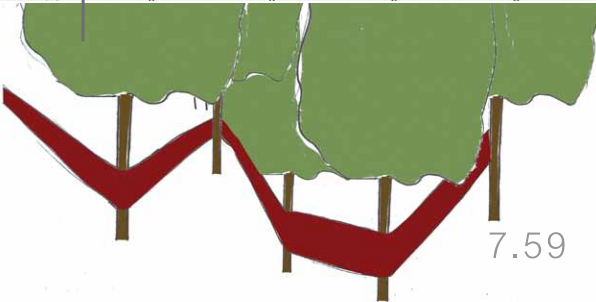

Some plants can create a high, narrow path from where the volume can be experienced only through the opening above (figure 7.44). This will create a completely different view and experience than an area with no high objects that allows for a 180 degree view of the volume (figure 7.44).

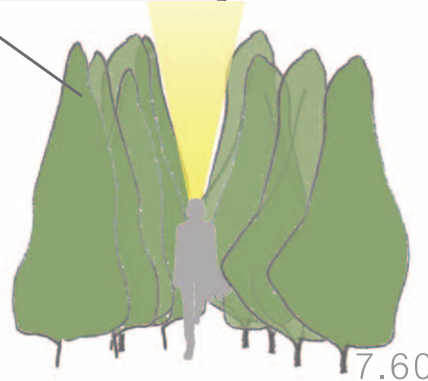

Figure 7.58: Ground level plan

Figure 7.59: Illustration of plants forming basis for exhibition

Figure 7.60: Illustration of trees forming specific view point of volume

Figure 7.61: Illustration of experience created by long grass



# GROUND



# technical investigation

technical realization of design



In the creation of experience, materials and their application plays a very important role. Every level has to be approached differently in terms of the sensory experience of the space. The lift, the structure and the cladding onto that is the most permanent elements of the intervention, with the infill of the spaces being semi permanent.

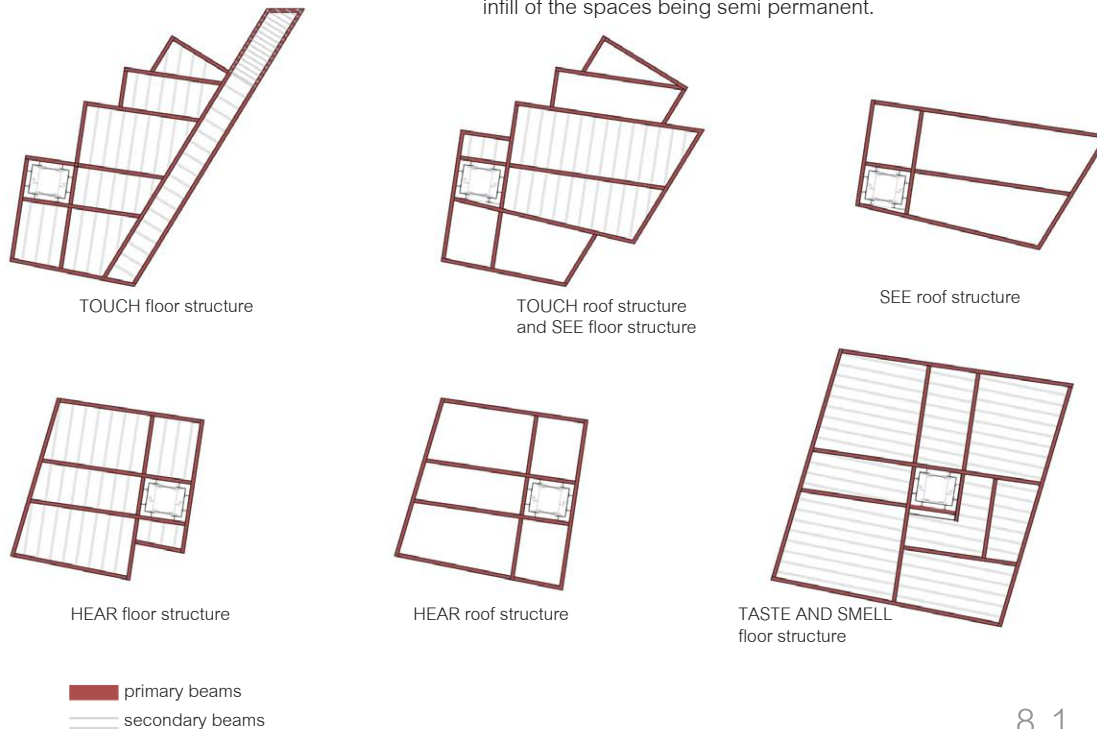

Figure 8.1: Diagram showing floor and roof structures for all levels

## 8.1 Structure

The structure of the intervention is cantilevered from the core structure. 457x191x 67 kg/m steel I-beams forms the primary structure, with 127x76x13 kg/m steel I-beams as secondary structure and support for the floor.

The Schindler 5400 motor-room-less lift, two sided entrance, forms the core of the structure. The shaft is formed by 254x254x16 kg/m I-columns that support the lift as well as the cantilevered structure.

## 8.2 Cladding

Aluminium sheet will be used for cladding of the exterior of the intervention with a standing seam fixing. Aluminium is a light weight material which is also corrosion-resistant and maintenance free. It can be recycled without any loss of properties and saves 95% of energy required to produce primary aluminium when recycled (Alu 2009).

There are different possible surface finishes available. To keep reflectivity of the exterior surface to a minimum, the 2 mm thick sheets will be anodized. A variety of colours are available, of which grey is the most suitable.

### 8.3 Floor finishes

Linoleum was chosen as floor finish for most of the areas, because of its durability, flexibility, low maintenance and sound absorption properties. For the Touch level, a combination of Tarkett linoleum xf Etrusco Beige and Quartz Carpet Slate will be used because of its texture. Etrusco has a thickness of 2.5 mm (Tarkett [sa]) and the Quartz Carpet is 6 mm thick (Bezuidenhout 2010). The Etrusco will have to be installed on an underlayer of 3.5 mm.

On the stairs to Level 1 - Hear, Etrusco Beige will continue, but with a 2 mm Elafono underlayer, to create an environment in which most sounds are absorbed. The Elafono underlayer reduces sound by 14 dB (Tarkett [sa]). The total thickness will be 4.5 mm. The other materials in this area should contribute to the sound absorption.

The Etrusco Beige and Elafono underlayer will continue into Level 1 - Hear, except for the sound reflective space, where steel flooring will ensure loud sounds from footsteps of the users. The other materials in this area should contribute to the sound reflection.

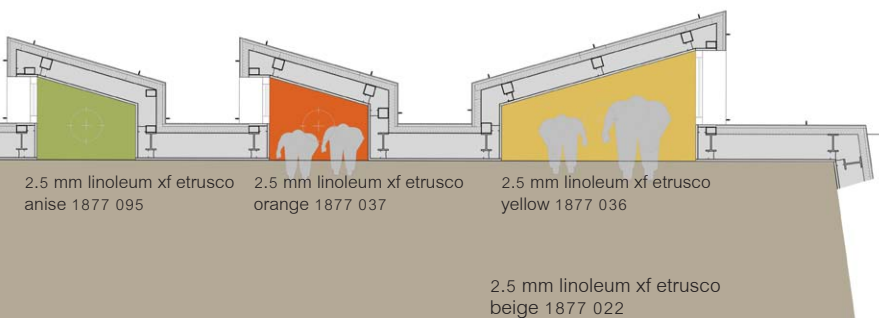
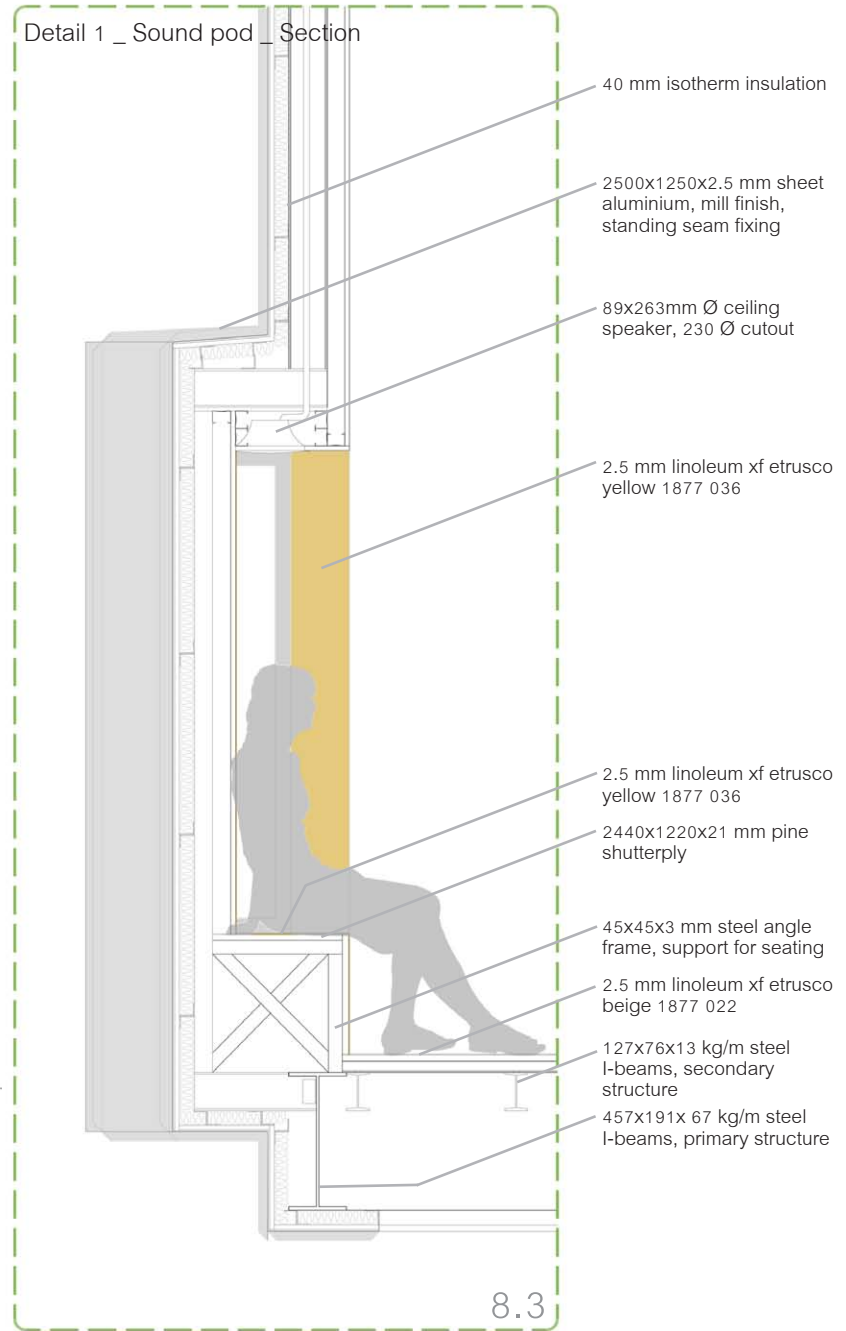

Figure 8.2: Plan of sound pods showing linoleum used  
Figure 8.3: Detail section of sound pod  
Figure 8.4: Detail plan of sound pod



8.2

8.3

The sound pods on the Level 1 - Hear, will be finished with linoleum as well (figure 8.2 and 8.3). Each pod will have a different colour. Although this will create a visual stimulation in the user, which is not the primary goal of this level, it will serve as attraction to the pods, where the exhibition is purely sound based.

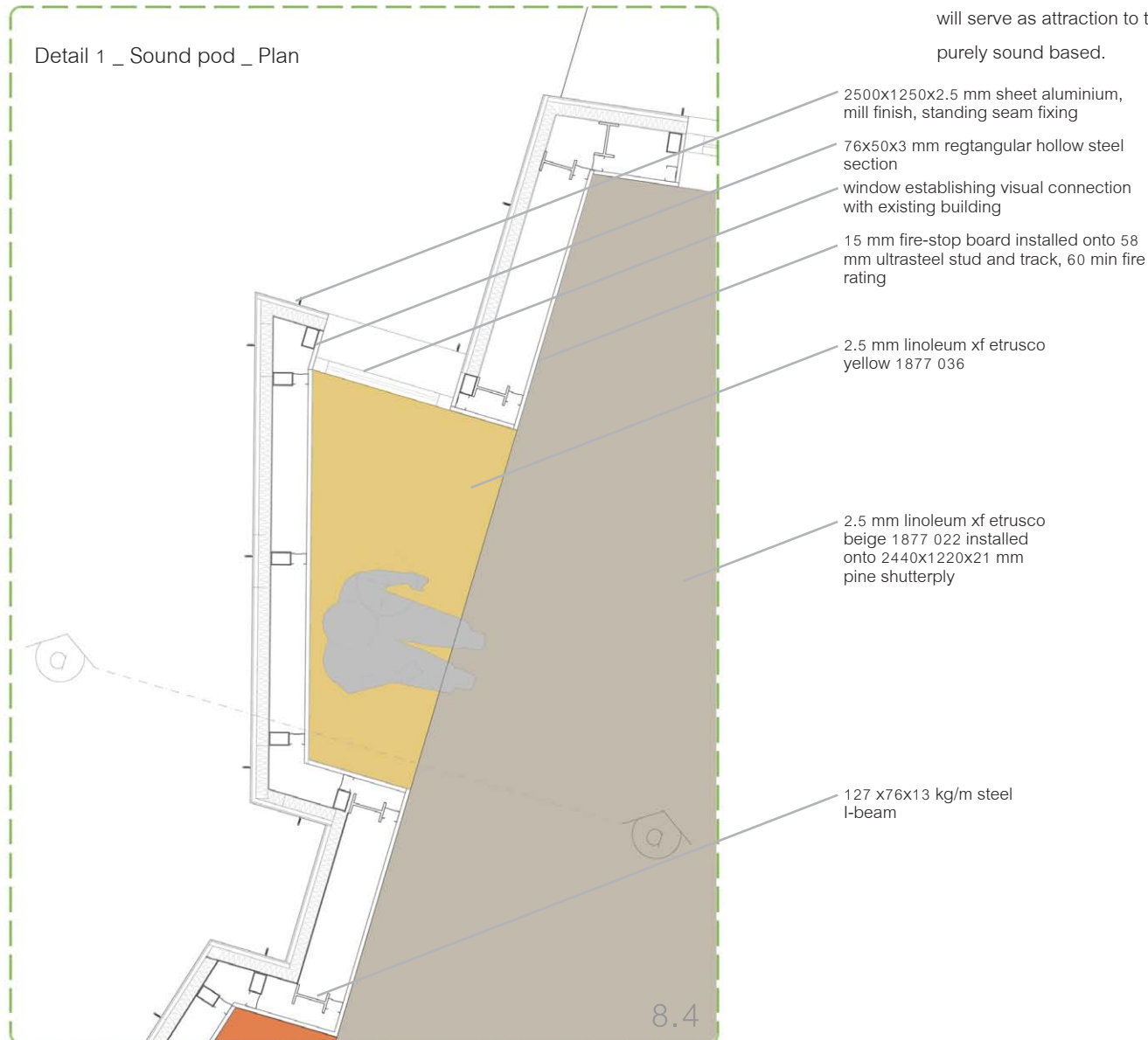

On the lowest level, Taste and Smell, Saligna solid wood flooring is specified (figure 8.5). It is suitable for exterior use, grown in south Africa, relatively cheap and contributes to the natural feeling of the level. The wood will be sealed with Woodoc Deck sealer which offers wind, water and pollution protection while nourishing the wood (Woodoc 2010).



Resolving the transition between the different floor finishes becomes important, because of the different thicknesses and danger it might hold if not finished off flush (figure 8.6). Different elements will be used to ensure that floor finishes line up.

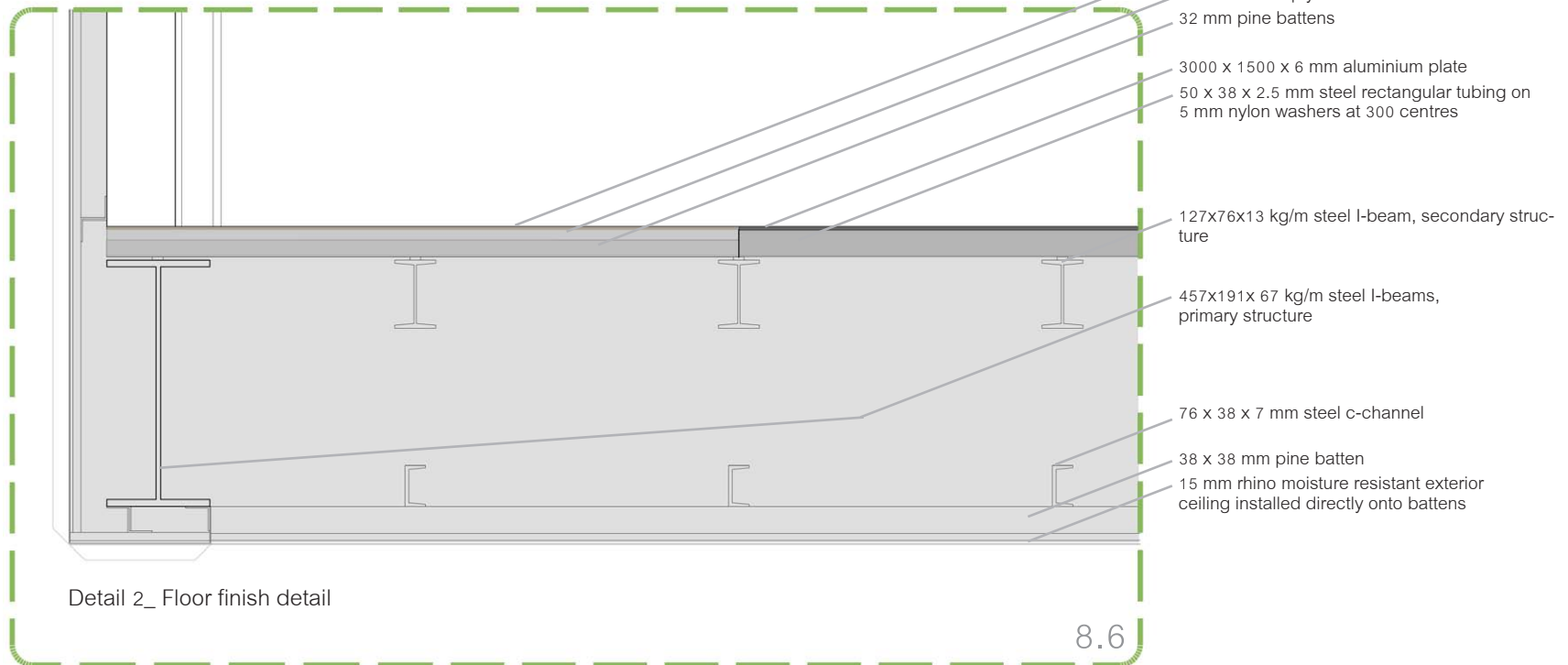

8.6

Figure 8.5: Saligna solid wood decking  
Figure 8.6: Detail section through floor  
Figure 8.7: Aluminium plate and Linoleum xf Etrusco Beige

8.4 Materials



1\_aluminium diamond plate\_



2\_wild fig leaves\_

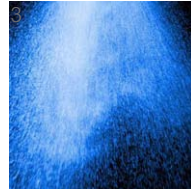

3\_water mist\_



4\_linoleum xf etrusco beige\_5\_etrusco metal welding rods\_



5\_quartz carpet slate\_

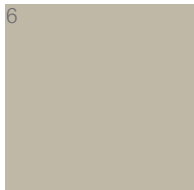

6\_linoleum xf etrusco beige\_7\_linoleum xf etrusco yellow\_8\_linoleum xf etrusco orange\_9\_linoleum xf etrusco anise\_

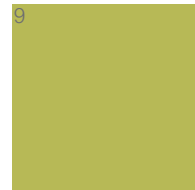
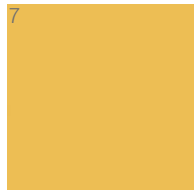

HEAR



10\_light and shade\_



11\_recessed fluorescent light fitting\_



12\_track lighting\_



13\_linoleum xf etrusco beige\_



14\_view onto building across from vault structure\_



SEE

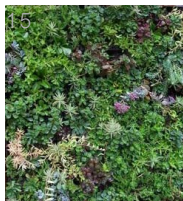

15\_vertical garden\_



16\_saligna solid wood flooring\_17\_perforated aluminium sheet\_

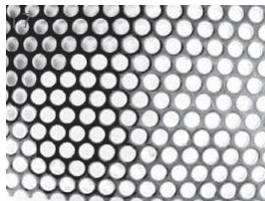

TASTE AND SMELL

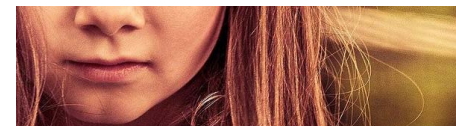

Figure 8.8: Materials according to level

## 8.5 Lighting

The quality, intensity and type of light play an important role in exhibition design. Light, as discussed in previous chapters, plays an important role in experience as well.

On Level 2 - See, a progression of light will be experienced as the light change from artificial to natural. To enhance the experience of progression and make the user aware of the changes in lighting condition, the extremes will be applied.

In the first space, when coming up with the stairs, a small hole in the wall will give the user a glimpse of the view through the window at the end of the level, as he comes up the stairs. Except for that opening, the whole space will be flooded with artificial light.

Sunlight has a colour temperature of 3000 K. To exaggerate the contrast between sunlight and artificial light, cool white fluorescent lights of 6500 K will be used (Osram [sa]). Spazio Duplo recessed light fittings will accommodate 20 S-Type T12 Tubular, G13 base lamps in total. Ten double luminaires will account for a total of 1020 lux (see appendix for details). This is higher than the recommended 500 lux for exhibition spaces as well as the 750 lux for supermarkets, workshops and kitchens for example (Architects' Data [sa]).

According to The Engineering Toolbox the lux level of direct sunlight is 107 527, while that of full daylight is 10 752 lux. This means that the contrast between the artificial light in the first space and the natural light in the third space will be approximately 9700 lux. Although this is still a very big difference, the lux levels of the artificial lights should be enough to make the user specifically aware of the lighting, because of the colour rendering as well as the contrast with the other

interior spaces.

Lighting in this space does not only assist in showing the exhibition, but becomes exhibition. The lamps will be dimmable to accommodate the possibility that, in the future, the space might be used at night. This will prevent a contrast from 1020 lux to darkness which might be a bit extreme.

Figure 8.9: Representation of light progression on Level 2 - See

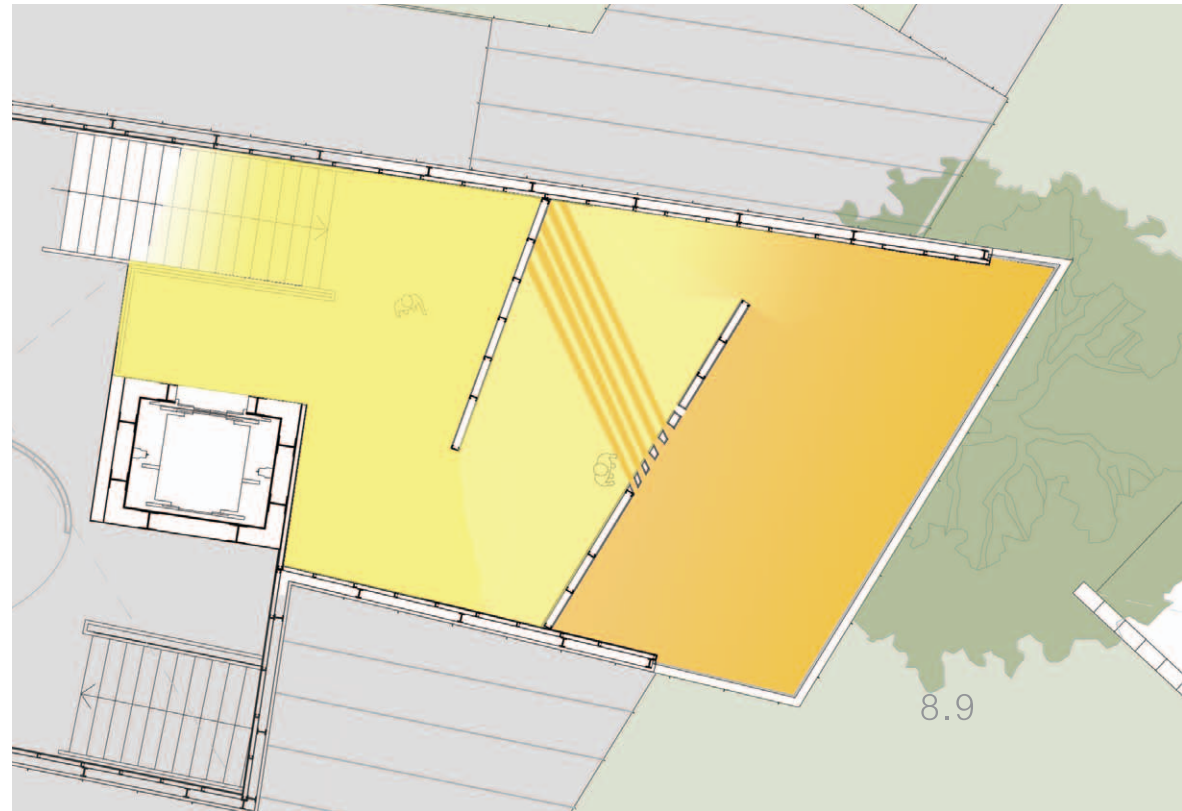

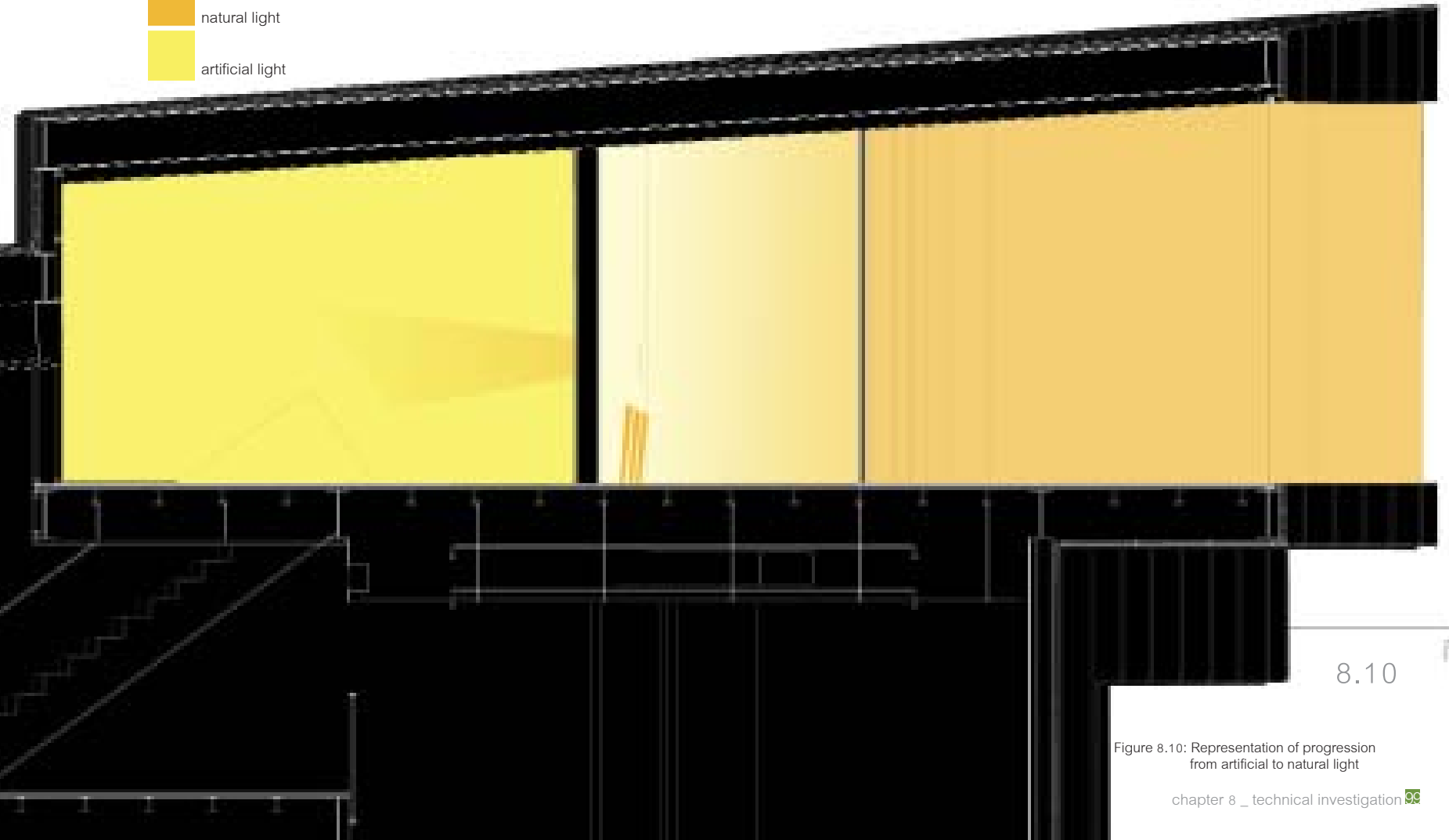

8.10

Figure 8.10: Representation of progression from artificial to natural light



In the space that follows on the first, natural light starts seeping through openings in the wall that separates the user from the window (figure 8.9). Here, a lamp type with a warmer colour temperature should be used and lower lux levels are required.

Spazio Profi track Control Spotlight 6713/00 will accommodate six Decostar 51 cool blue 50 W halogen lamps (Osram [sa]). These lamps have a colour temperature of 4500 K, which falls between the 6500 K fluorescents and 3000 K sunlight. In combination with the halogen lamps, which is specifically for illumination of the exhibition, two Osram Dulux D 18W/840 G24D-2 FS1 compact fluorescent, 18 W luminaires will assist in the general lighting (see appendix for details).

The window in the next space provides sufficient natural light so that no artificial light is necessary. The weather outside determines the quality of light coming into the space, which in turn determines the experience within the space. If the space is used at night in future, the artificial light from the spaces prior to this one, will enter through the openings in the wall, which will create the inverse of the experience in the day. The light in this space will probably not be enough to illuminate exhibition on the walls, but the exhibition of the surroundings becomes more pronounced.

## 8.5. Split unit air conditioning

Split unit air conditioning was chosen as system after a discussion with Mr. Pieter Joubert, a Mechanical Engineer (Joubert 2010). Evaporative cooling was suggested, but according to Mr. Joubert, this option is not viable in the Pretoria climate and the main cooling unit and outlets would have to be larger than what can be accommodated.

Cassette type outlets will be used in the interior spaces with the main unit on ground level against the main building. An advantage of using this system is that no ducting is required. It makes use of a 50 mm diameter connecting cable to connect the main unit with the outlet units. This cable will run underground from the main unit to the core structure of the intervention, from where it will go up to the different outlets.



8.11

Figure 8.11: Cassette type outlet

Detail 3\_Stair detail \_ Section

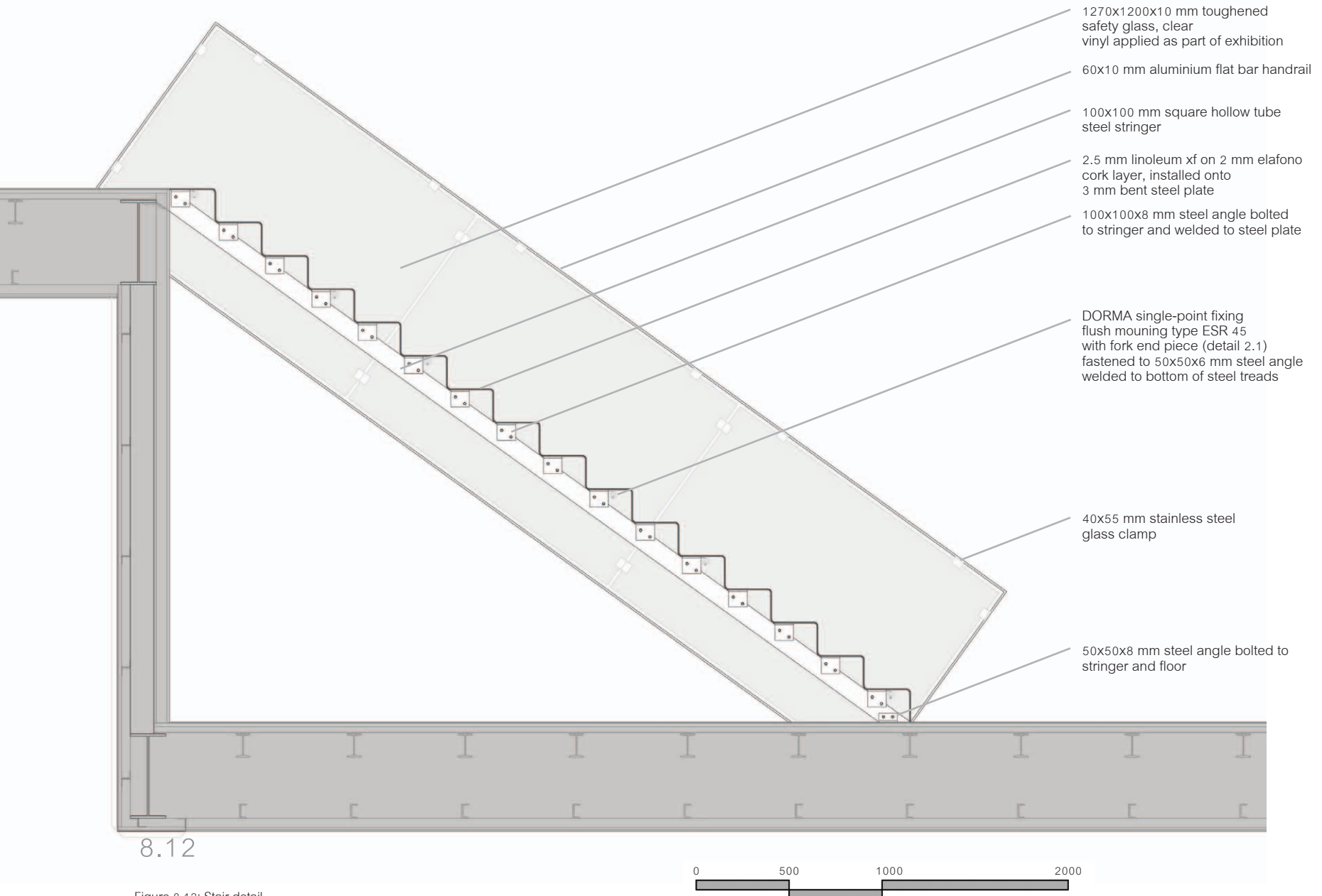
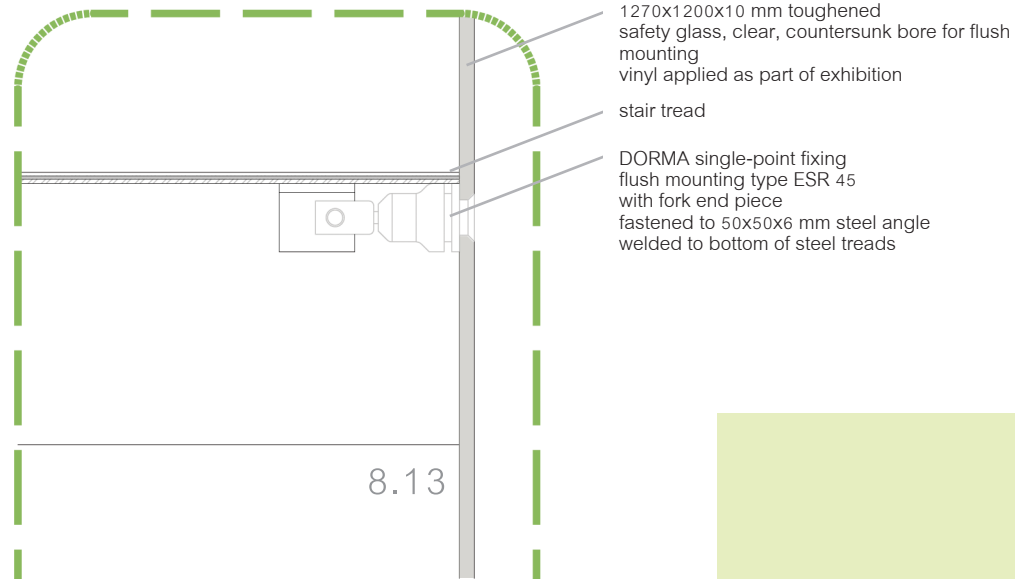

Figure 8.12: Stair detail

Detail 3.1\_Fixing of glass balustrade to tread  
\_Scale 1:10



8.13

- 1270x1200x10 mm toughened safety glass, clear, countersunk bore for flush mounting vinyl applied as part of exhibition
- stair tread
- DORMA single-point fixing flush mounting type ESR 45 with fork end piece fastened to 50x50x6 mm steel angle welded to bottom of steel treads

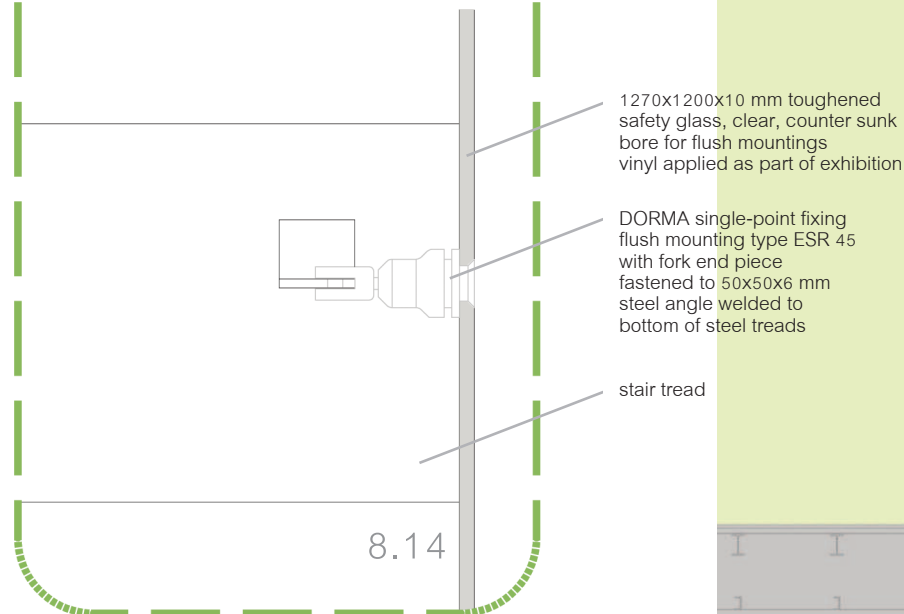

8.14

- 1270x1200x10 mm toughened safety glass, clear, counter sunk bore for flush mountings vinyl applied as part of exhibition
- DORMA single-point fixing flush mounting type ESR 45 with fork end piece fastened to 50x50x6 mm steel angle welded to bottom of steel treads
- stair tread

Figure 8.13: Front view of DORMA fixing detail  
Figure 8.14: Bottom view of DORMA fixing detail  
Figure 8.15: Illustration of printed vinyl stuck on balustrade glass

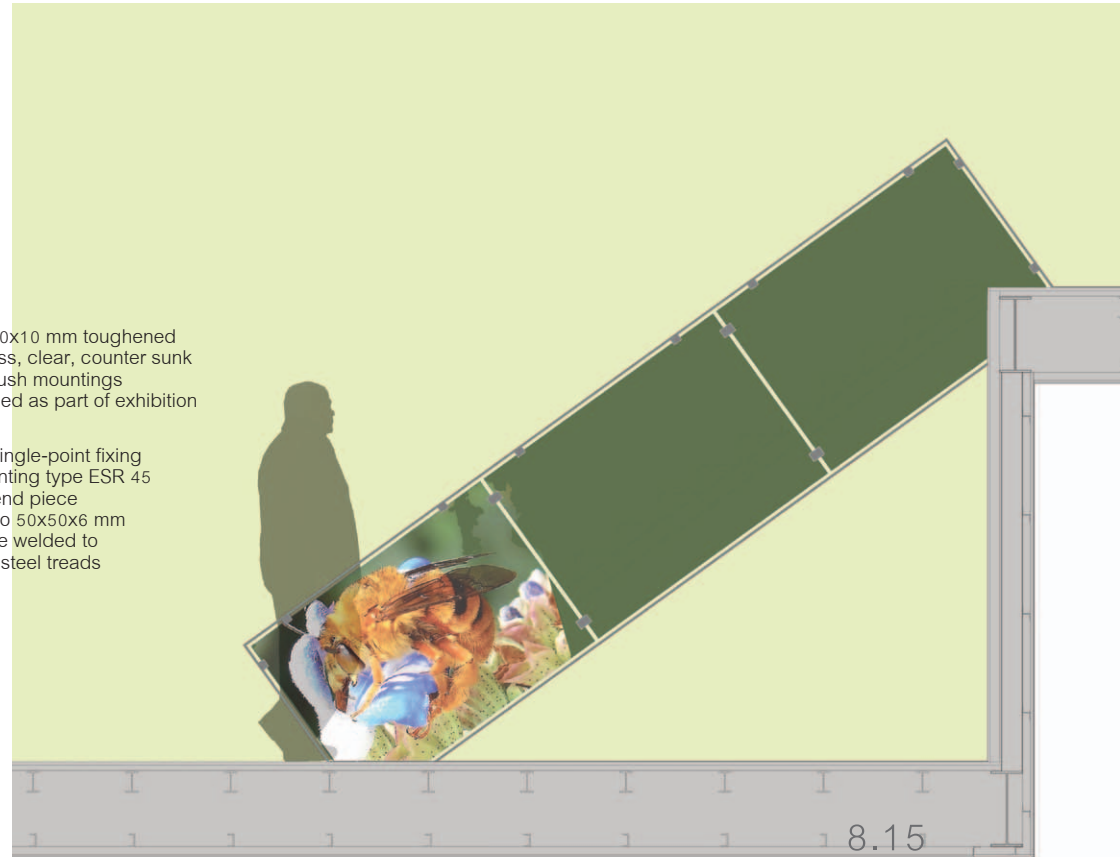

8.15

Detail 4\_Seating and exhibition

\_Scale 1:20

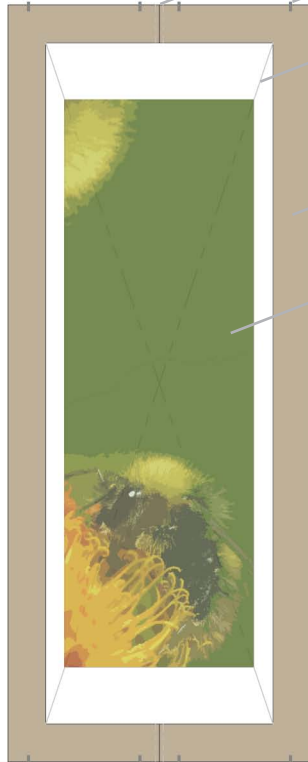

- male and female ends of feet
- 400x20x5 mm aluminium flat bar inlay
- 2 mm stainless steel stranded wire with clevis end connecting to eye bolts in corners Figure 8.19)
- 25 mm saligna wood on 50x50x3 mm steel angle frame
- 3 mm clear perspex fastened to stranded wire with rope clamp (figure 8.19)

8.16

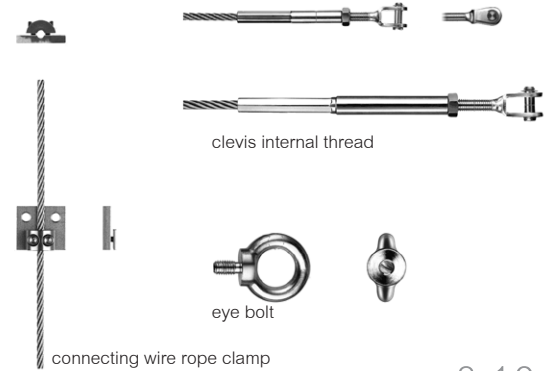
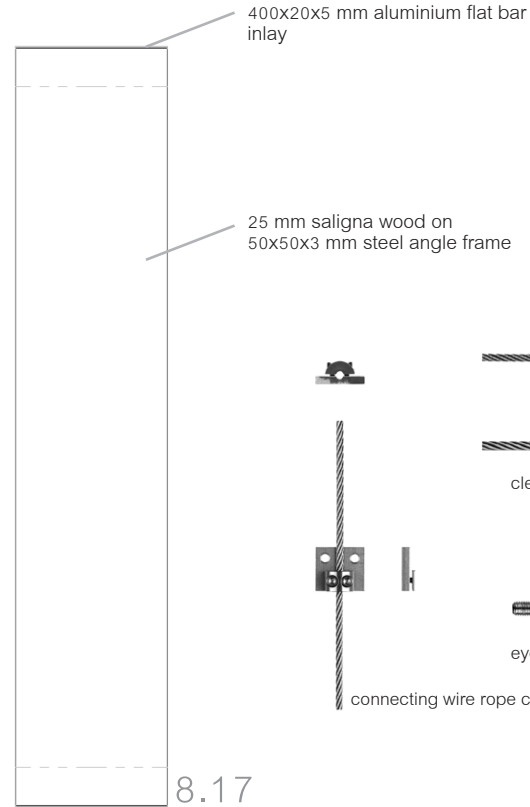

8.19

The seats provide seating on Level -1 - Taste and Smell and ground level, as well as exhibition surface by lifting two seats on their sides with the male and female ends of the opposite seats together. Stranded wire from corner to corner, keeps the seats together and provide opportunity for exhibition surface to attach.

Figure 8.16: Detail of seating becoming exhibition  
Figure 8.17: Plan of seat  
Figure 8.18: Elevations of seat  
Figure 8.19: Stranded wire fittings

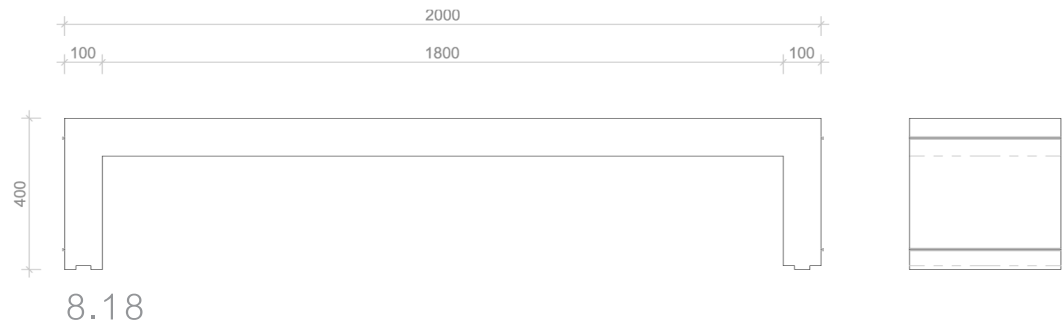

8.18



---

## Conclusion

Experience of interior architecture depends on a number of factors. These factors or elements cannot always be controlled or predicted. The subconscious mind contributes a great deal to experience, and should be taken into consideration. Through a phenomenological approach, the space is experienced not only in terms of the visual sense, but through touch, sound, taste and smell as well. Through stimulating the senses of the user and encouraging interaction, the elements in space become worth more than only their aesthetic or practical value. It's not only a means to a functional end, but a means to an experience.

The ideas and expectations that inspired this project were altered and developed into the final design. Because of guidelines set by the site and programme, the project developed slightly differently to what was anticipated at the start of the thesis. Starting out with a much more expressive approach in terms of the subject of the exhibition, the intervention evolved into a more generic envelope, with opportunity for the exhibition to change annually.

The envelope, became more responsive to the existing building and surroundings, which anchors it to the site and brings the user into contact with the existing. The intervention explores human senses and creates spaces specific to certain senses which inform the exhibition that layers onto that.

The vault volume, through the intervention, can now be experienced by users of the museum. The intervention will hopefully attract more users to the museum and strengthen the identity of the museum as a whole.

The experience within any space should be an important consideration in the design process. Experience may sometimes overpower the user, but should never overpower the programme or the site.

Interior space must be felt, heard, smelled, tasted and seen. It must be experienced.



# appendix

lighting study





Definitions according to Mains lighting definitions ([sa]):

**Colour rendering:**

A measure of the degree to which the appearance of a surface colour under a given light source compares to the same surface in sunlight. The index has a maximum value of 100.

**Lamp Lumen Maintenance Factor (LLMF):**

The proportion of light output of a lamp after a stated period, compared with initial lumen output.

**Lamp Survival Factor (LSF):**

The proportion of functioning lamps in an installation after a stated period.

**Lumen (lm):**

The unit of luminous flux used to describe the quantity of light emitted by a source or received by a surface.

Lux = lumens/m<sup>2</sup>

**Luminaire Maintenance Factor (LMF):**

The proportion of light output from a luminaire with dirt deposition after a stated period, compared with the initial light output when clean.

**Maintenance Factor (MF):**

The ratio of the illuminance provided by an installation at a stated period, compared to the installation when new. Calculated as a product of lamp lumen, lamp survival, luminaire and room surface maintenance factors.

**Room Index (K):**

Index defining the relationship between the height, length and width of a room. Used for illuminance calculations.

**Room Surface Maintenance Factor (RSMF):**

The proportion of illuminance provided by a lighting installation with dirt deposition on the room surfaces after a stated period, compared with the illuminance when the room was clean.

**Utilization Factor (UF):**

The proportion of luminous flux emitted by a lamp (or lamps) which reaches the working plane.

Lighting calculations will be done for the areas on level 2 - See.

AREA 1: Osram S-Type T12 Tubular lamps L65 W/765 S

Technical information (Osram [sa]):

Life span: 10 000 h

Luminous flux: 4200 lm

Colour temperature: 6500 K

Colour rendering: 70

LLMF at 4000h: 0.7

LSF at 4000h: 0.99

LMF: 0.82 (Table A 2.2 in Bean 2004)

RSMF: 0.94 (Table A 2.3 in Bean 2004)

With 20 lamps:

$$MF = \text{LLMF} \times \text{LSF} \times \text{LMF} \times \text{RSMF}$$

$$= 0.7 \times 0.99 \times 0.82 \times 0.94$$

$$= 0.61$$

$$RI = W/2H \text{ (width of room/height from 850 mm height to luminaire)}$$

$$= 3000/2(2240)$$

$$= 0.67$$

Reflectance of: Ceiling - 0.7 (white)

Walls - 0.3 (colours will differ)

Floor - 0.2 (beige)

UF = 0.3 - derived from Table A 3.2 which takes reflectances and RI into consideration (Bean 2004)

$$E_{av} = n \times F_L \times UF \times MF / A_{WP}$$

$$= 20 \times 4200 \times 0.3 \times 0.61 / 15$$

$$= 15372 / 15$$

$$= 1024 \text{ lux}$$



Condition	Illumination	
	(fcd)	(lux)
Sunlight	10,000	107,527
Full Daylight	1,000	10,752
Overcast Day	100	1,075
Very Dark Day	10	107
Twilight	1	10.8
Deep Twilight	.1	1.08
Full Moon	.01	.108
Quarter Moon	.001	.0108
Starlight	.0001	.0011
Overcast Night	.00001	.0001

Figure a-1: Table showing lux levels of outdoor conditions (The Engineering Toolbox [sa]).

AREA 2: Osram Dulux D 18W/840 G24D-2 FS1 compact fluorescent, 18 W, 2 lamps per luminaire

Technical information (Osram [sa]):

Life span: 10 000 h

Luminous flux: 1200 lm

Colour temperature: 4000 K

Colour rendering: 80

LLMF at 4000h: 0.78

LSF at 4000h: 0.99

LMF: 0.82 (Table A 2.2 in Bean 2004)

RSMF: 0.94 (Table A 2.3 in Bean 2004)

With 12 lamps:

$$\begin{aligned}
 MF &= \text{LLMF} \times \text{LSF} \times \text{LMF} \times \text{RSMF} \\
 &= 0.78 \times 0.99 \times 0.82 \times 0.94 \\
 &= 0.6
 \end{aligned}$$

$$\begin{aligned}
 RI &= W/2H \text{ (width of room)/height from 850 mm height to luminaire} \\
 &= 3000/2(2240) \\
 &= 0.67
 \end{aligned}$$

Reflectance of: Ceiling - 0.7 (white)

Walls - 0.3 (colours will differ)

Floor - 0.2 (beige)

UF = 0.3 - derived from Table A 3.2 which takes reflectances and RI into consideration (Bean 2004)

$$\begin{aligned} E_{av} &= n \times F_L \times UF \times MF / A_{WP} \\ &= 12 \times 1200 \times 0.3 \times 0.6 / 15 \\ &= 2592 / 15 \\ &= 170 \text{ lux} \end{aligned}$$

The 170 lux from the compact fluorescents in combination with the halogen spots will be sufficient to illuminate the space for exhibition purposes and create a transition between the spaces before and after it.

# final work

drawings not to scale

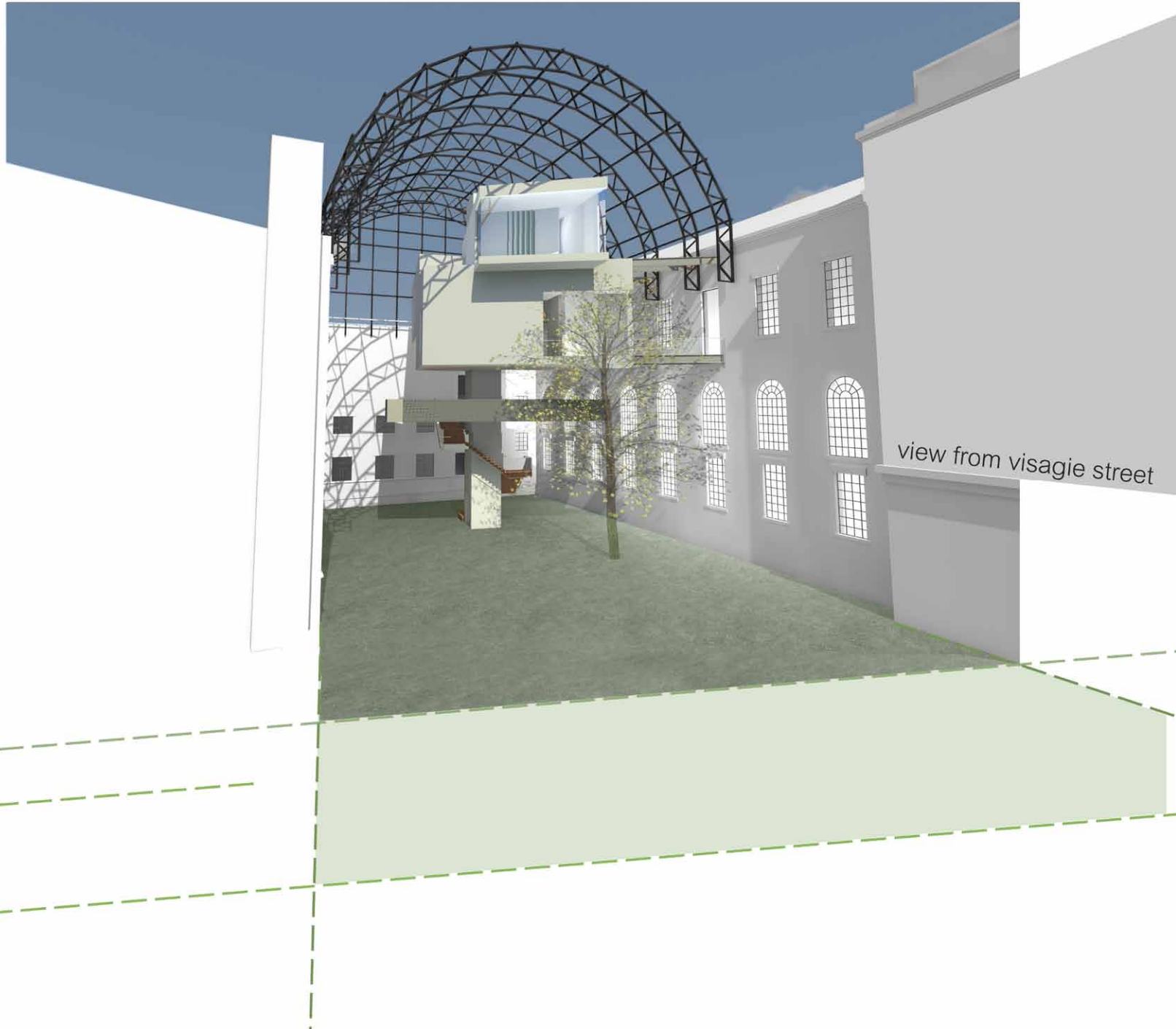

view from visagie street

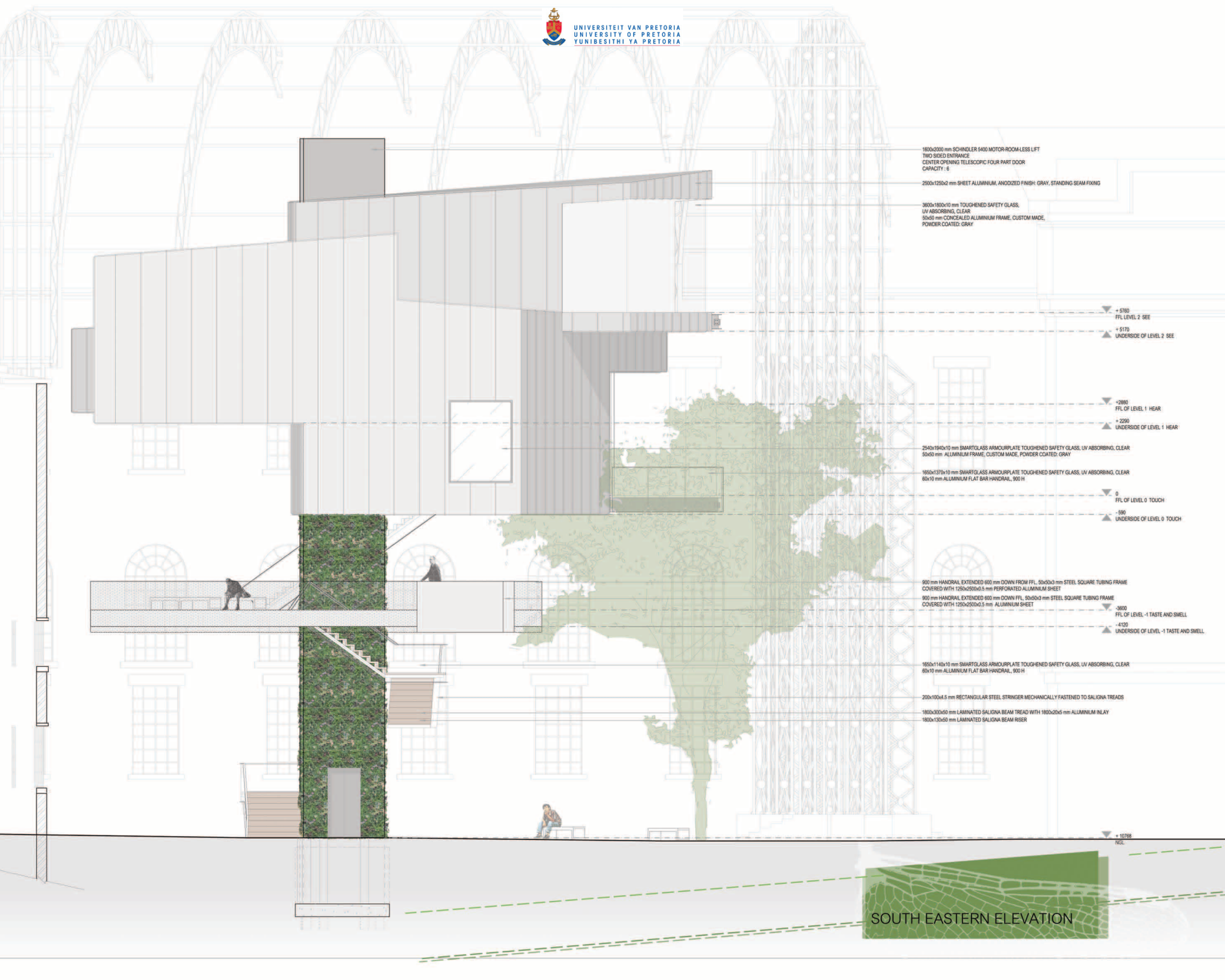

1600x2000 mm SCHINDLER 5400 MOTOR-ROOM-LESS LIFT  
 TWO SIDED ENTRANCE  
 CENTER OPENING TELESCOPIC FOUR PART DOOR  
 CAPACITY: 8

2500x1200x2 mm SHEET ALUMINUM, ANODIZED FINISH - GRAY, STANDING SEAM FIXING

3600x1800x10 mm TOUCHED SAFETY GLASS,  
 UV ABSORBING, CLEAR  
 50x50 mm CONCRETE ALUMINUM FRAME, CUSTOM MADE,  
 POWDER COATED GRAY

+ 5170  
FFL LEVEL 2 SEE

+ 5170  
UNDERSIDE OF LEVEL 2 SEE

+ 2880  
FFL OF LEVEL 1 HEAR

+ 2290  
UNDERSIDE OF LEVEL 1 HEAR

2540x1940x10 mm SMARTGLASS ARMOURPLATE TOUCHED SAFETY GLASS, UV ABSORBING, CLEAR  
 50x50 mm ALUMINUM FRAME, CUSTOM MADE, POWDER COATED GRAY

1650x1370x10 mm SMARTGLASS ARMOURPLATE TOUCHED SAFETY GLASS, UV ABSORBING, CLEAR  
 60x10 mm ALUMINUM FLAT BAR HORIZONTAL, 900 H

0  
FFL OF LEVEL 0 TOUCH

- 390  
UNDERSIDE OF LEVEL 0 TOUCH

900 mm HORIZONTAL EXTENDED 600 mm DOWN FROM FFL, 50x50x3 mm STEEL SQUARE TUBING FRAME  
 COVERED WITH 1250x2500x0.5 mm PERFORATED ALUMINUM SHEET

900 mm HORIZONTAL EXTENDED 600 mm DOWN FFL, 50x50x0 mm STEEL SQUARE TUBING FRAME  
 COVERED WITH 1250x2500x0.5 mm ALUMINUM SHEET

- 3670  
FFL OF LEVEL -1 TASTE AND SMELL

- 4120  
UNDERSIDE OF LEVEL -1 TASTE AND SMELL

1650x1140x10 mm SMARTGLASS ARMOURPLATE TOUCHED SAFETY GLASS, UV ABSORBING, CLEAR  
 60x10 mm ALUMINUM FLAT BAR HORIZONTAL, 900 H

200x100x4.5 mm RECTANGULAR STEEL STRINGER MECHANICALLY FASTENED TO SALIGNA TREADS

1800x300x60 mm LAMINATED SALIGNA BEAM TREAD WITH 1800x20x6 mm ALUMINUM INLAY  
 1800x120x50 mm LAMINATED SALIGNA BEAM RISER

+ 10788  
N/C

SOUTH EASTERN ELEVATION



NEW ALUMINIUM FRAME DOOR



A

B

LEVEL -1  
TASTE AND SMELL

1800x2000 mm SCHINDLER 6400 MOTOR-ROOM-LESS LIFT  
TWO SIDED ENTRANCE  
CENTER OPENING TELESCOPIC FOUR PART DOOR  
CAPACITY: 8

25x25x63 kg/m STEEL I-COLUMN CORE STRUCTURE

15 mm EXTERIOR GRADE  
PLYWOOD FOR EXPOSED APPLICATION  
INSTALLED ONTO 58 mm STUD AND TRACK  
6080

STAIRS TO LEVEL -1  
TASTE AND SMELL

INTRODUCTION  
TO EXHIBITION  
AREA: 27.47 m²

900 H HANDRAIL,  
60x10 mm EXTRUDED ALUMINIUM FLAT BAR  
SUPPORTED ON 10 mm TOUGHENED SAFETY GLASS  
2000x1780x6 mm ALUMINIUM  
CHECKERED PLATE ON 5 mm NYLON WASHERS  
AT 300 CENTERS

WATER MIST POINT

EXISTING TREE ENTERS INTO THE INTERIOR SPACE  
ENCOURAGING THE USER TO TOUCH AND FEEL

WIRE SYSTEM FOR EXHIBITION  
SEE DETAIL 1

TOUCH  
AREA: 62.7 m²

STAIRS TO LEVEL 1 HEAR  
SEE DETAIL 2

2500x1250x2 mm SHEET ALUMINIUM, ANODIZED FINISH: GRAY, STANDING SEAM FIXING

1950x2550x6 mm TOUGHENED SAFETY GLASS, CLEAR  
50x50 mm ALUMINIUM FRAME, CUSTOM MADE,  
POWDER COATED: GRAY  
ESTABLISHING CONNECTION WITH EXISTING GALCONY

LEVEL 0 - TOUCH PLAN

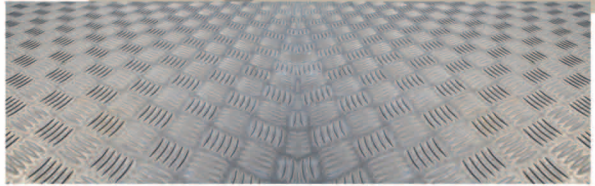

FLOOR FINISHES



FLEXI-TILE PVC INTERLOCKING TILES, COIN PATTERN, TAN

LINOLEUM XF ETRUSCO, BEIGE

ALUMINIUM CHECKERED PLATE



EXHIBITION POSSIBILITY 1 KIT-OF-PARTS

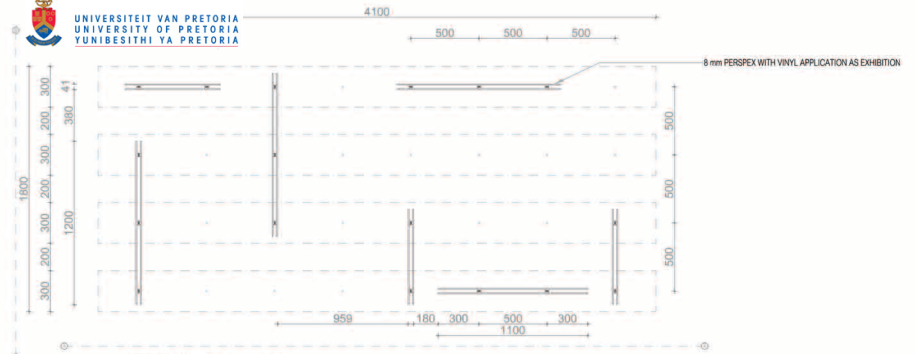

POSSIBILITY 1 PLAN SCALE 1:20

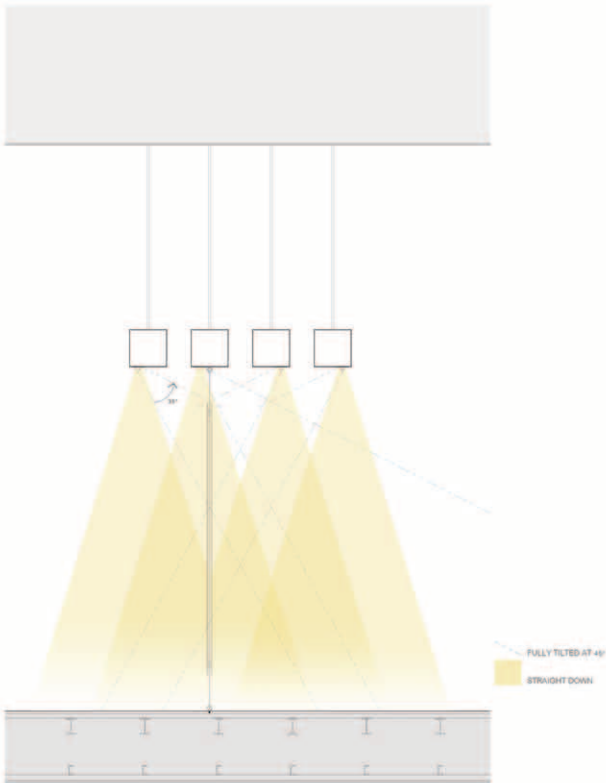

REPRESENTATION OF LIGHTING ON WIRE SYSTEM EXHIBITION



SPAZIO BASIC SQUARE TILTING DOWNLIGHT WITH BAYONET LOCK SYSTEM, 45° TILT, 78 Ø CUT OUT, OSRAM E12 HALOPAR GU10, 35°, 50 W, 230 V



ELEVATION AA SCALE 1:20

WIRE EXHIBITION SYSTEM

EXHIBITION POSSIBILITY 2 KI

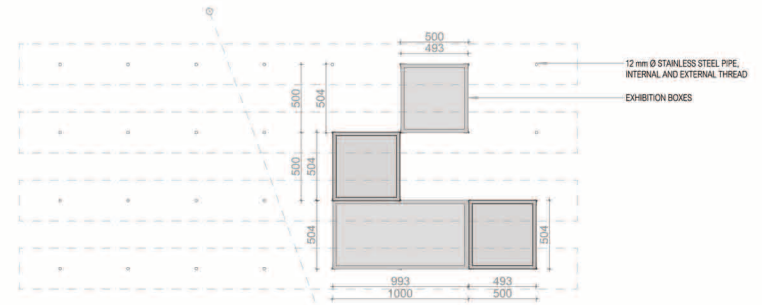
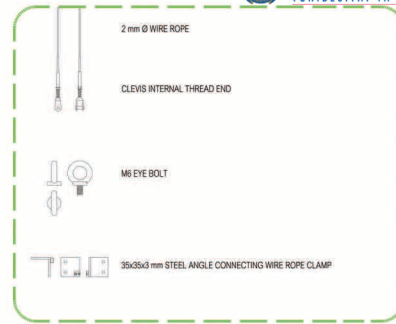

POSSIBILITY 2 PLAN SCALE 1:20

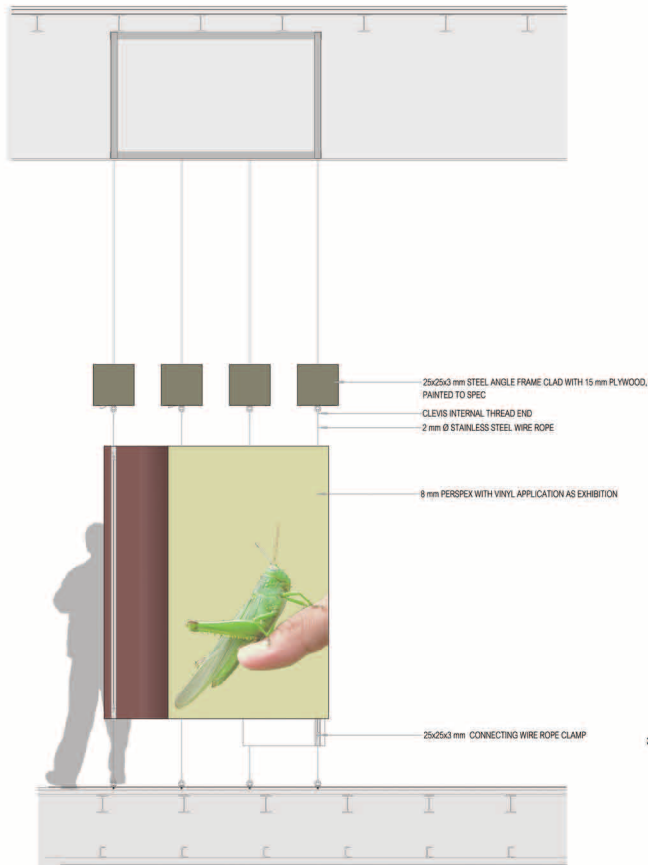

ELEVATION BB SCALE 1:20

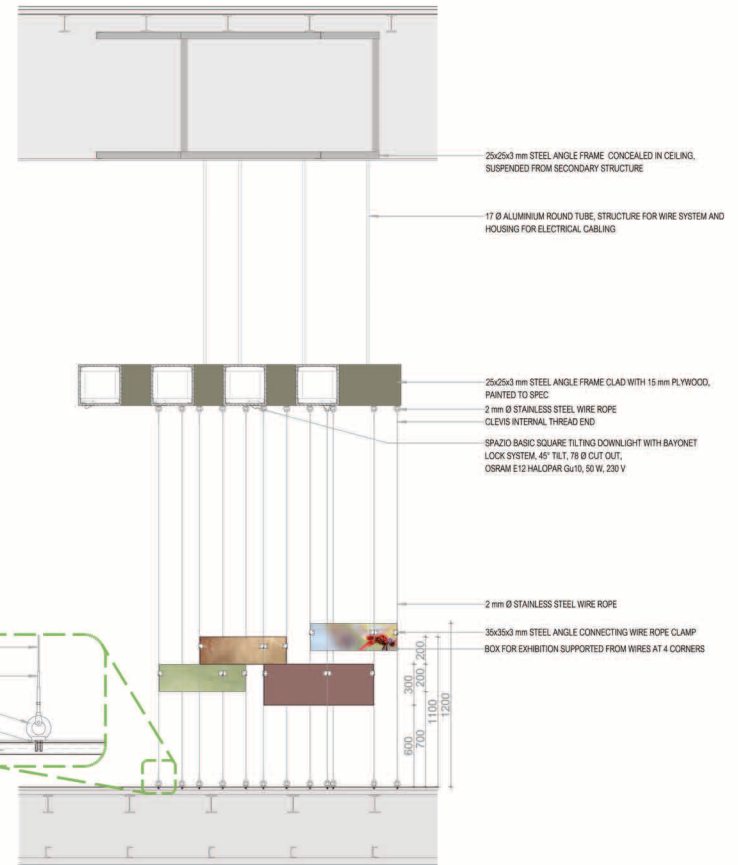

SECTION AA SCALE 1:20

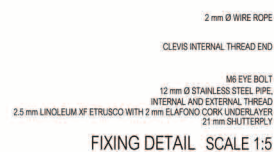



LEVEL 1 - HEAR PLAN

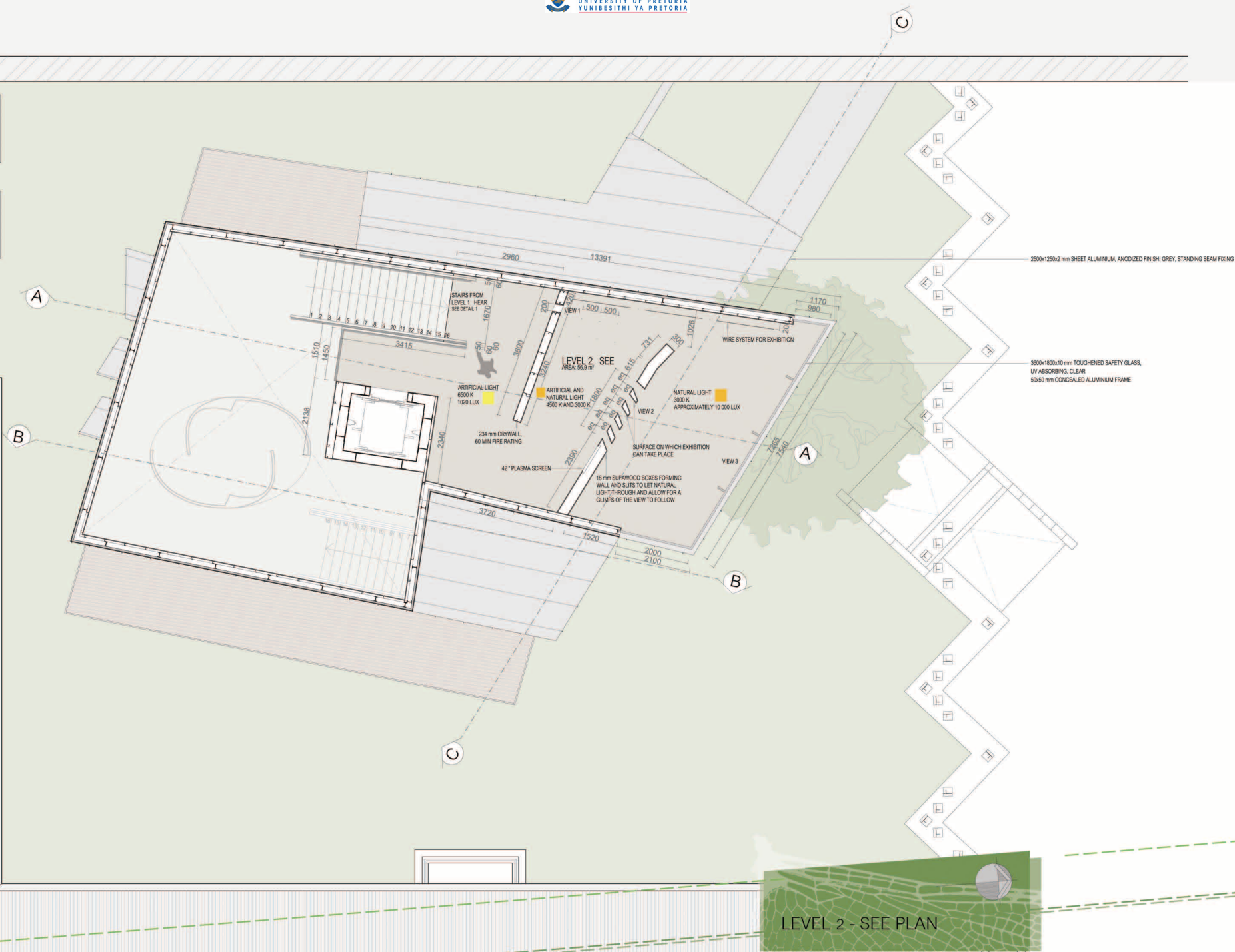

2500x1250x2 mm SHEET ALUMINIUM, ANODIZED FINISH: GREY, STANDING SEAM FIXING

3600x1800x10 mm TOUGHENED SAFETY GLASS,  
UV ABSORBING, CLEAR  
50/50 mm CONCEALED ALUMINIUM FRAME

STAIRS FROM LEVEL 1 HEAR SEE DETAIL 1

LEVEL 2 SEE AREA 903.9 m<sup>2</sup>

ARTIFICIAL LIGHT 6500 K 1000 LUX

ARTIFICIAL AND NATURAL LIGHT 4500 K AND 3000 K

NATURAL LIGHT 3000 K APPROXIMATELY 10 000 LUX

234 mm DRYWALL, 60 MIN FIRE RATING

42" PLASMA SCREEN

18 mm SUPAWOOD BOXES FORMING WALL AND SLITS TO LET NATURAL LIGHT THROUGH AND ALLOW FOR A GLIMPSE OF THE VIEW TO FOLLOW

WIRE SYSTEM FOR EXHIBITION

SURFACE ON WHICH EXHIBITION CAN TAKE PLACE

VIEW 1 500, 500

VIEW 2

VIEW 3

LEVEL 2 - SEE PLAN

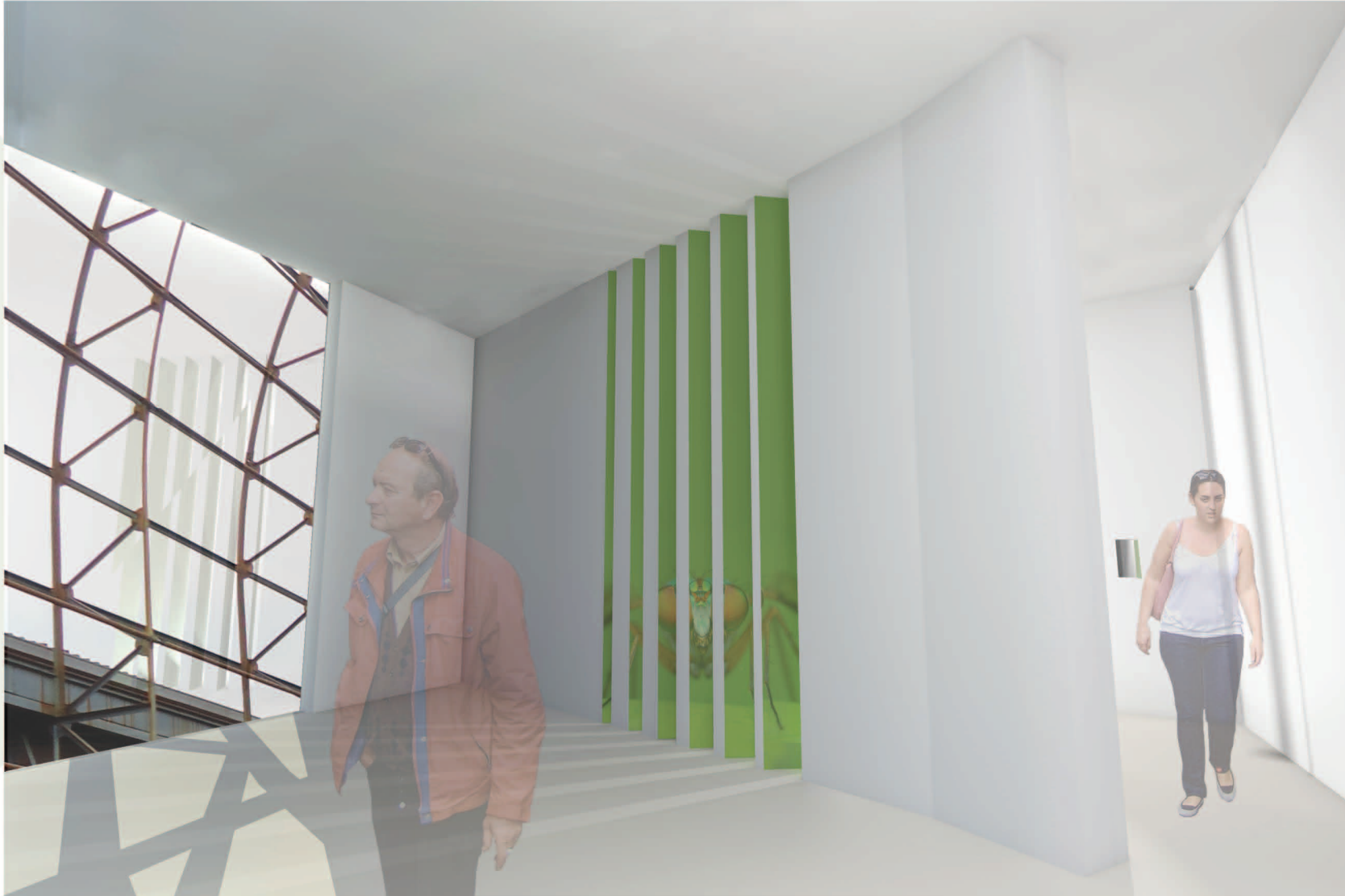

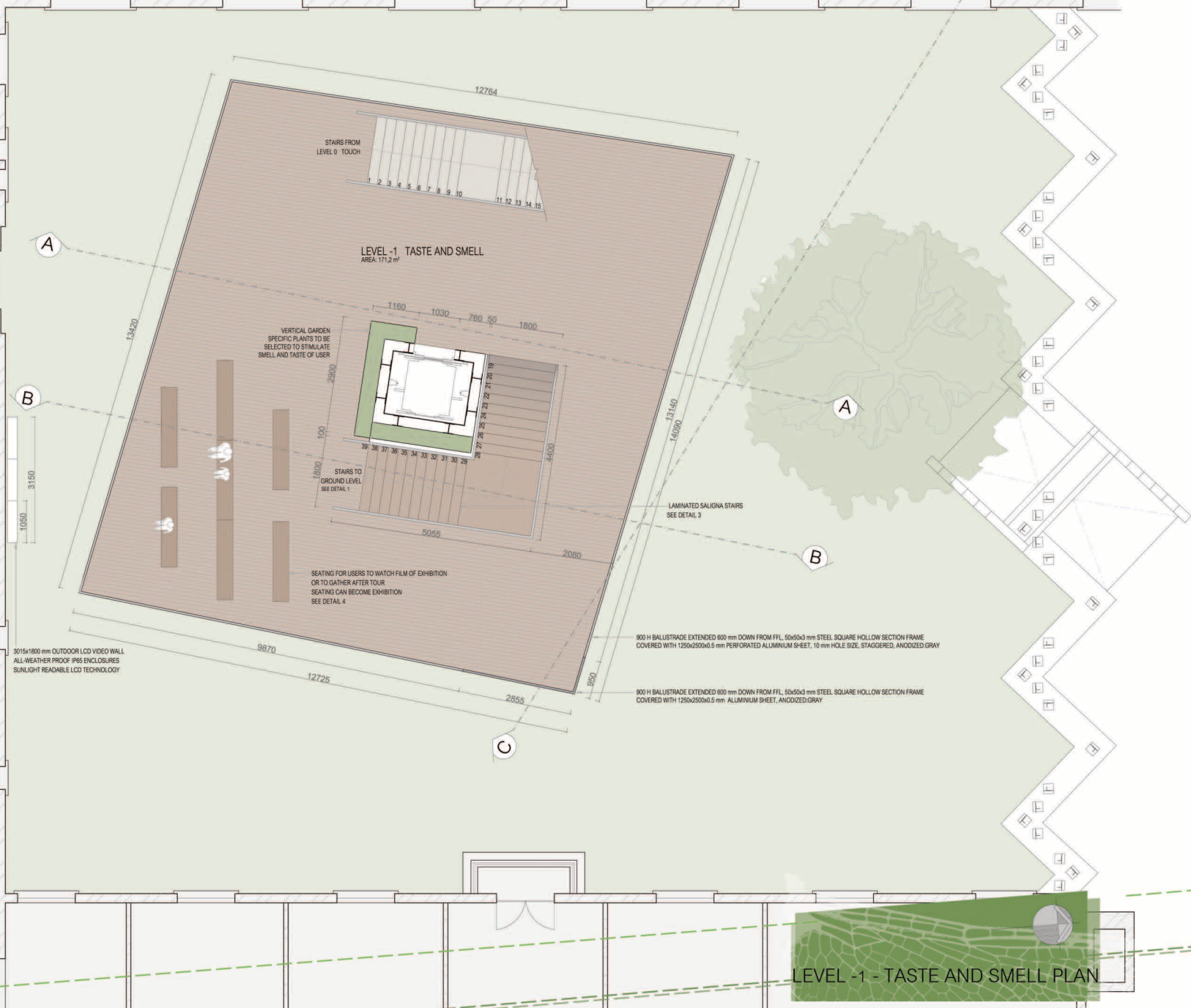

LEVEL -1 - TASTE AND SMELL PLAN



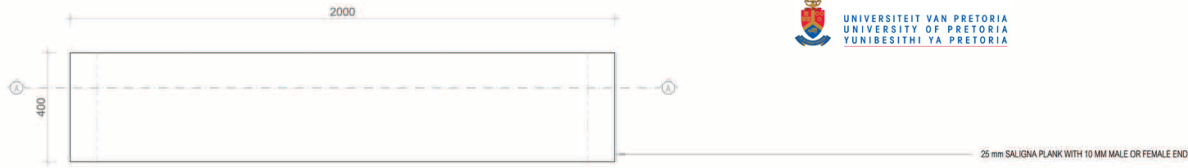

PLAN OF SEATING

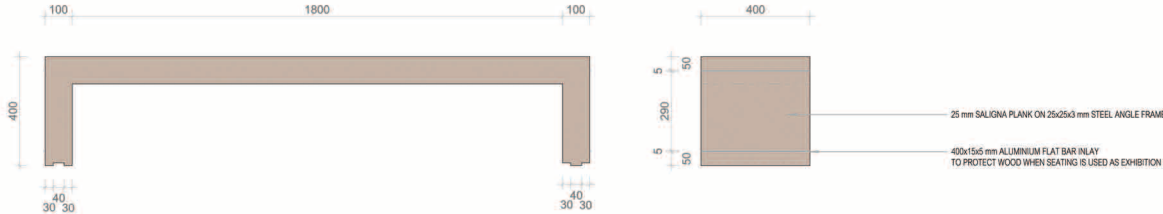

ELEVATION OF SEATING

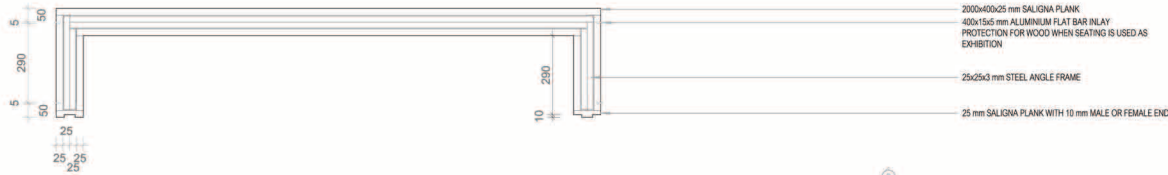

SECTION A-A  
SEATING

SEATING EXHIBITION KIT-OF-PARTS

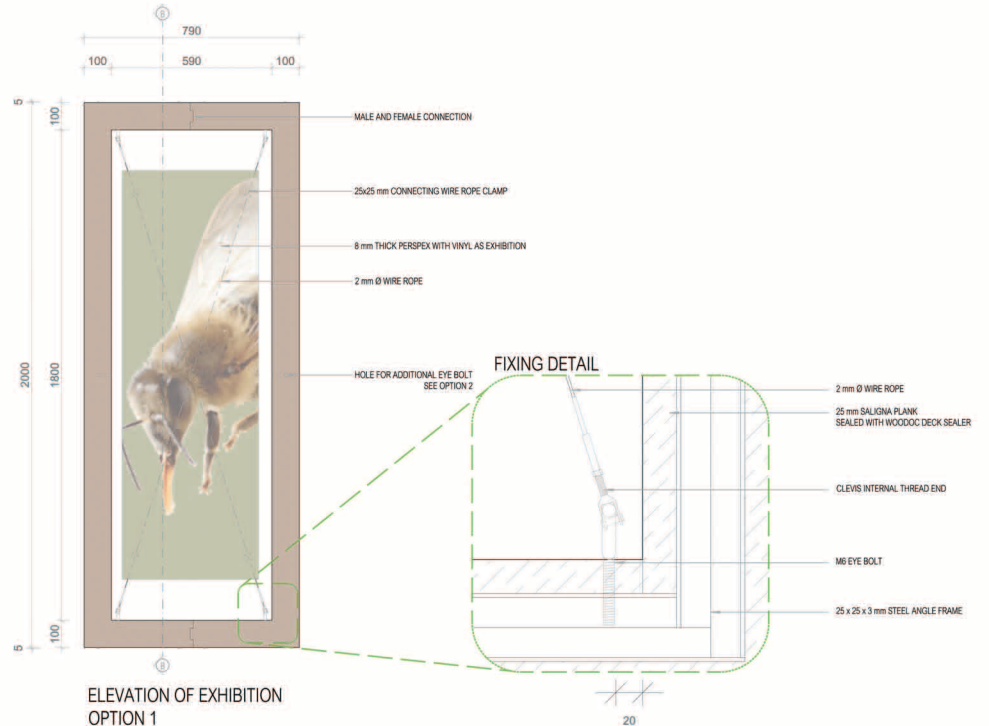
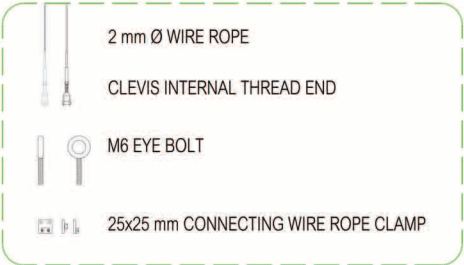

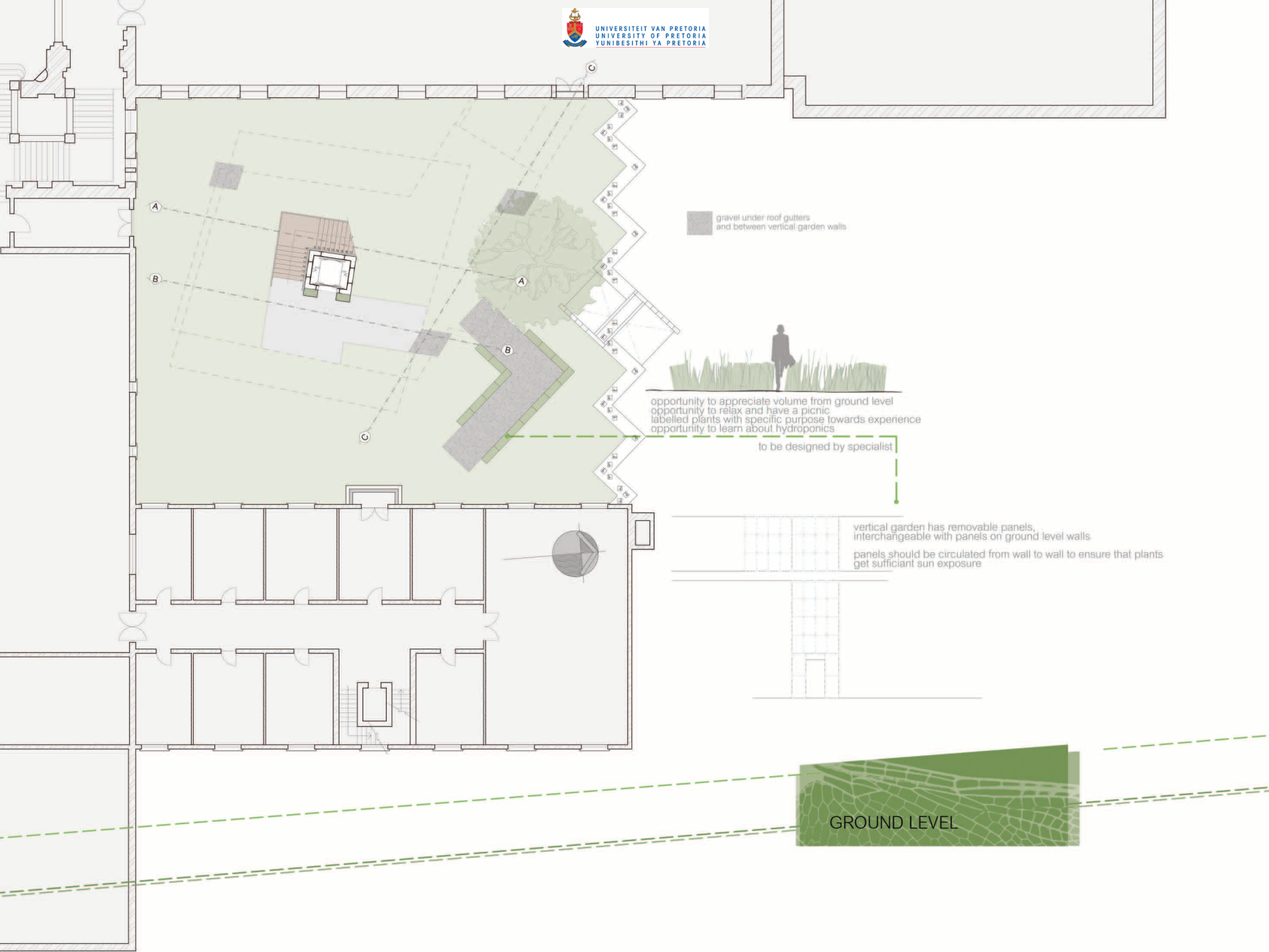



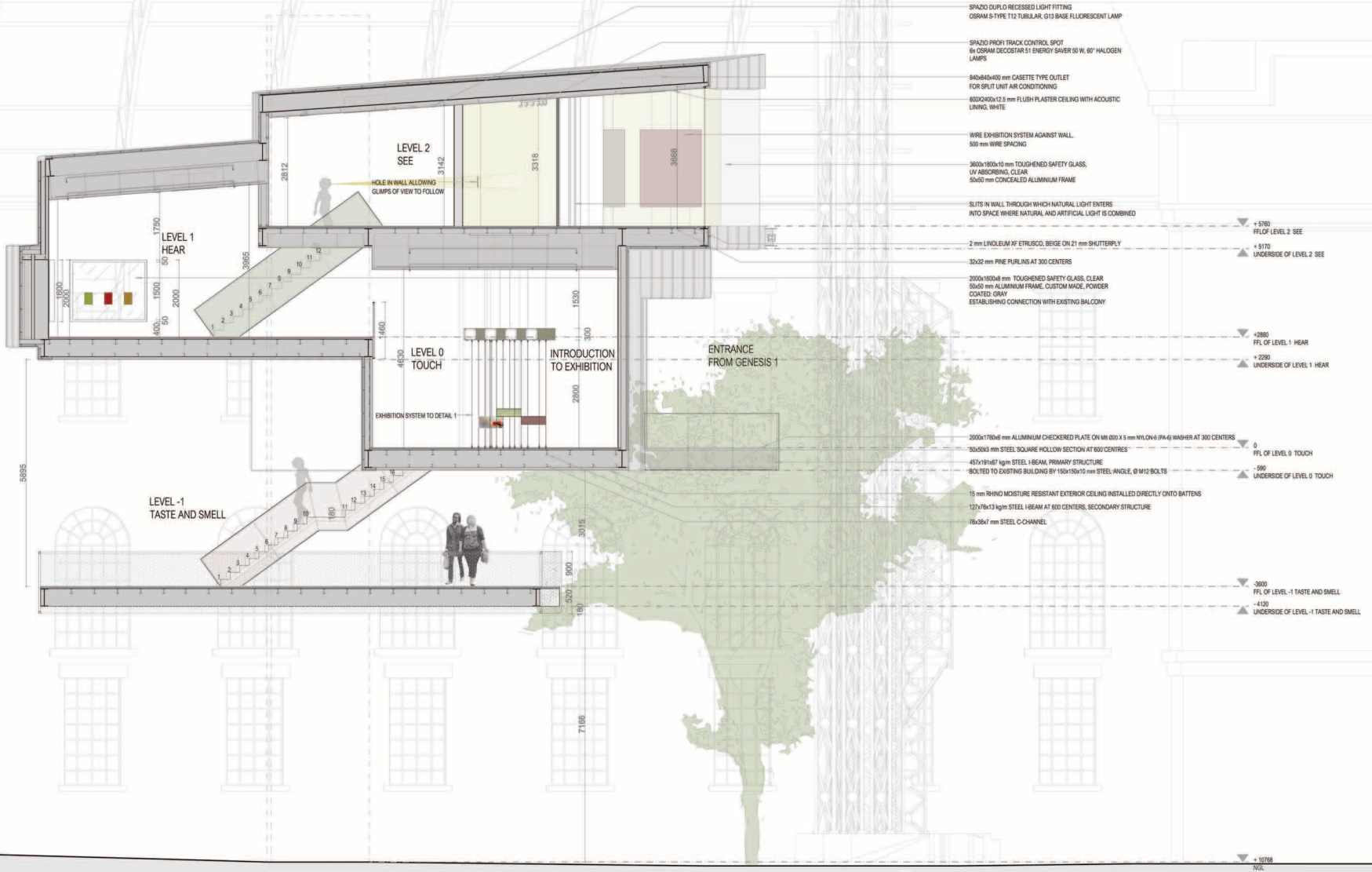

SECTION A-A

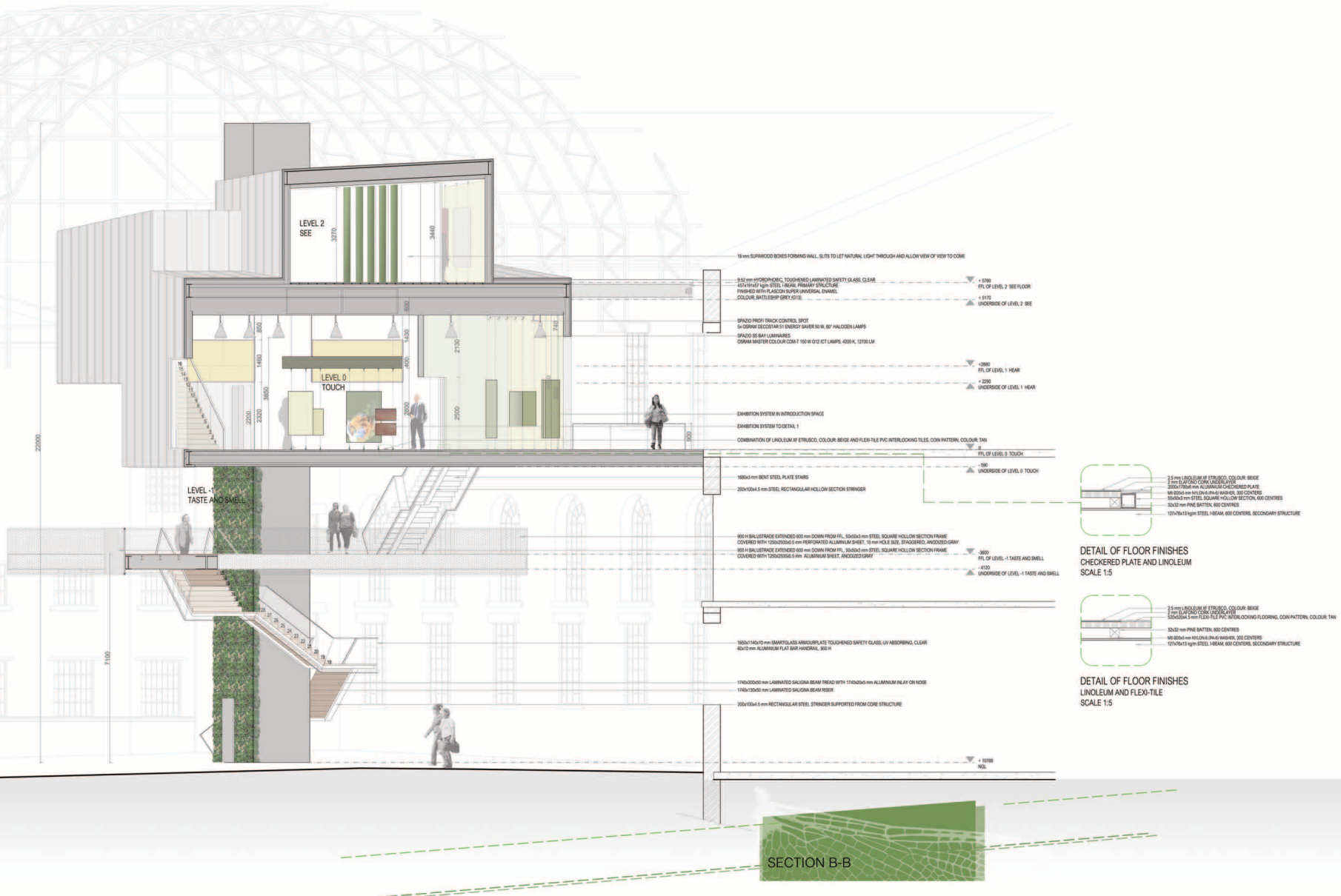

SECTION B-B



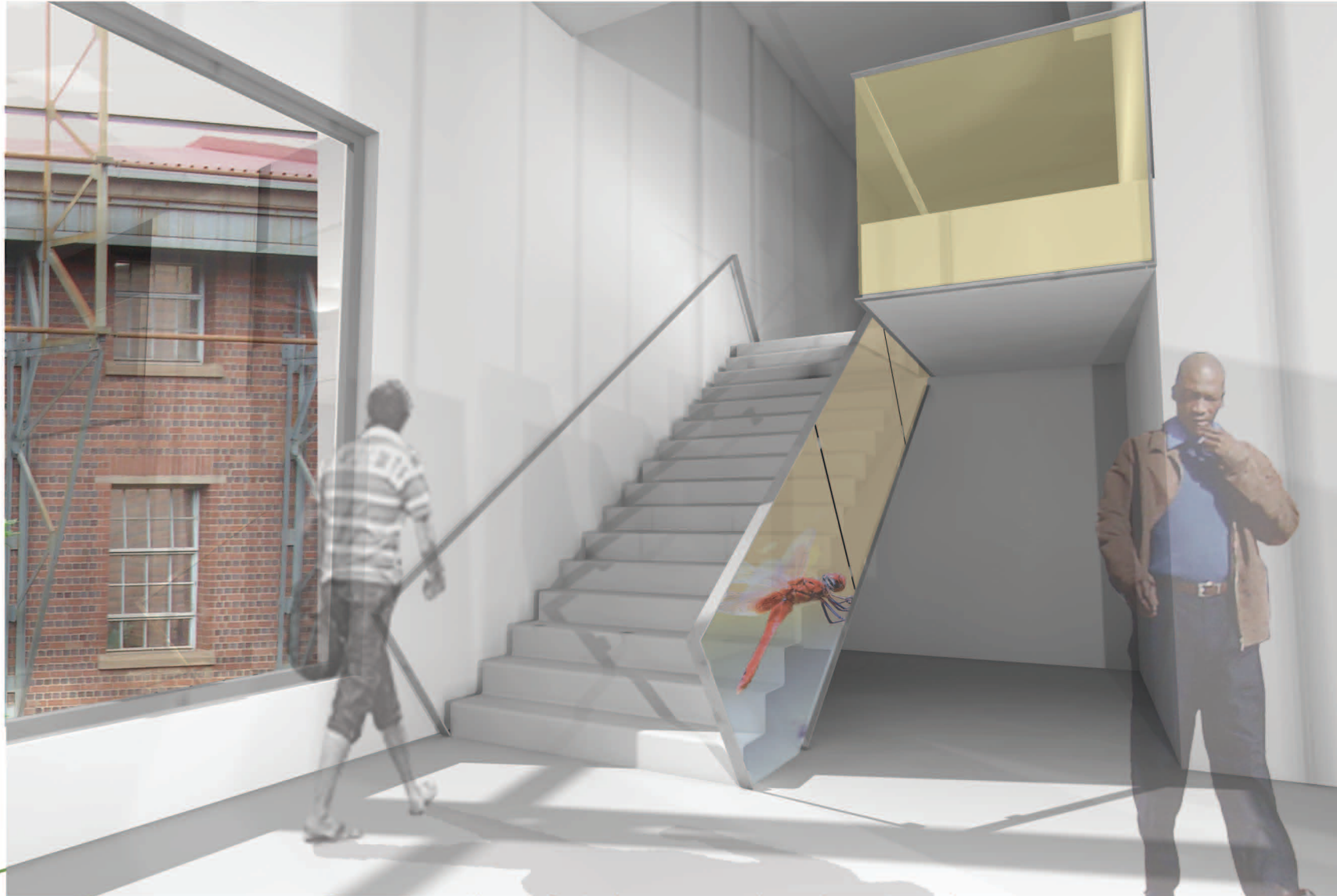

perspective of staircase on level 0 - touch

# LIST OF REFERENCES

- Adam. *The heated pool (36 degree C) door that lets you swim outside in the 0 degree weather*. [sa]. [O]. Available:  
<http://picasaweb.google.com/lh/photo/fVgTUDhl2awMbHba7BL1VQ>;  
Accessed 27 August 2010
- Aiden brooks: Trainee chef. [Sa]. [O]. Available:  
<http://aidanbrooksspices.blogspot.com/2007/10/chives.html>  
Accessed 23 October 2010
- Altman, I. 1975. *The Environment and Social behaviour*.  
California: Wadsworth Publishing Company Inc.
- Alu: The future builds on aluminium. 2009. [O]. Available:  
<http://greenbuilding.world.aluminium.org/facts/end-of-life-recycling/>  
Accessed 27 September 2010
- Bean, R. 2004. *Lighting: Interior and Exterior*. New York: Architectural Press
- Bezuidenhout, R. Quartz Carpet specialist applicator. 2010.  
Interview by author [Transcript]. 6 October 2010. Pretoria.
- Blueberries for beauty and taste. 2009. [O]. Available:  
<http://www.enflower.org/entry/blueberries-for-beauty-and-taste/>  
Accessed 23 October 2010
- Brand, S. 1994. *How buildings learn: What happens after their built?* New York:  
Penguin.
- Brebner, J. 1982. *Environmental Psychology in building design*. London: Applied  
Science Publishers Ltd.
- Cave, S. 1998. *Applying psychology to the Environment*. England: Hodder &  
Soughton Educational
- Cerbone, D.R. 2006. *Understanding Phenomenology*.  
Chesham: Acumen Publishing Limited.
- Chris Spracklen. 2008. [O]. Available:  
<http://www.pbase.com/moorlands/image/101000391>  
Accessed 24 April 2010
- Davepatten. *Children using texture pattern*. 2006. Available:  
<http://www.flickr.com/photos/davepatten/103969286/sizes/z/in/photostream/>  
Accessed 15 July 2010
- Dezeen. 2009. [O]. Available:  
<http://www.dezeen.com/2009/10/18/leo-burnett-office-by-ministry-of-design/>  
Accessed 8 July 2010
- Ditsong: Northern Flagships Institutions. [Sa]. [O]. Available:  
[http://www.dac.gov.za/publications/Guide/Gauteng/Ditsong\\_%20Northern%20Flagship%20Institutions.pdf](http://www.dac.gov.za/publications/Guide/Gauteng/Ditsong_%20Northern%20Flagship%20Institutions.pdf)  
Accessed 9 July 2010
- e-architect. Focus Terra Switzerland : Architecture Information. [sa]. [O]. Available:  
[http://www.e-architect.co.uk/switzerland/focus\\_terra\\_zurich.htm](http://www.e-architect.co.uk/switzerland/focus_terra_zurich.htm)  
Accessed 1 August 2010
- Edward, L & Torcellini, P. 2002. *National Renewable Energy Laboratory: A Literature Review of the Effects of Natural Light on Building Occupants*. Springfield:  
National Technical Information Services
- Neufert, E and Neufert, P. [Sa]. *Architects' Data*. Edited by Baiche, B and  
Walliman, N. Blackwell Science



Free images. [Sa]. [O]. Available:

<http://www.free-images.org.uk/herbs/03-applemint.htm>

Accessed 23 October 2010

Galinsky. 2006. [O]. Available:

<http://www.galinsky.com/buildings/baths/>

Accessed on 2 August 2010

Gifford, R. 1997. *Environmental Psychology: Principles and Practice*. 2nd ed.

Boston: Allyn & Bacon

Grobler, E. 2006. [O]. Collections Management practices at the Transvaal Museum, 1913 – 1964: Anthropological, Archaeological and Historical. Available:

<http://upetd.up.ac.za/thesis/available/etd-05112006-101101/unrestricted/01introduction.pdf>

Accessed 27 April 2010

Grow Wild. [Sa]. [O]. Available:

<http://www.growwild.co.za/retailisting.php?type=groundcover&alpha=K>

Accessed 23 October 2010

Hein, H.S. 2000. *The museum in transition: a philosophical perspective*. Washington: Smithsonian Institution.

Hiss, T. 1990. *The Experience of Place*. New York: Knopf.

Jodidio P. 2007. *Ando Complete Works*. London: Tachen

Joubert, P. Mechanical Engineer. 2010. Interview by author [Transcript].

7 October 2010. Pretoria

Kream. 2010. [O]. Available:

<http://www.kream.co.za/>

Accessed 27 September 2010

Mains lighting definitions [O]. [Sa]. Available:

[http://www.cooper-ls.com/dg\\_mainsdef.html](http://www.cooper-ls.com/dg_mainsdef.html)

Accessed 21 October 2010

Menlyn Park. 2010. [O]. Available:

<http://www.menlynpark.co.za/shop.htm?shopMGID=2719>

Accessed 28 September 2010

Mickenberg, K. 2008. *Behavioural Economics: A Room with a View*. [O]. Available:

<http://www.psychologytoday.com/articles/200807/natural-element-room-view>

Accessed 3 August 2010

MJP Architects. [Sa]. [O]. Available:

[http://www.mjparchitects.co.uk/Wellcome\\_Wolfson.php](http://www.mjparchitects.co.uk/Wellcome_Wolfson.php)

Accessed 5 Aug 2010

Modernnomad67. Travelpod. 2010. [O]. Available:

<http://www.travelpod.com/travel-blog-entries/modernnomad67/2/1200464520/tpod.html>

Accessed 16 April 2010

Mumphalee. *Red alert*. 2009. Available:

<http://www.flickr.com/photos/mumphalee/3733530566/sizes/l/in/photostream/>

Accessed 15 July 2010

O. Orkin Insect Zoo: Student Resource Page. 1997. [O]. Available:

<http://insectzoo.msstate.edu/Students/basic.numbers.html>

Accessed 7 July 2010

Osram. [O]. [Sa]. Available:

<http://catalog.myosram.com/zb2b/b2b/start.do?browsername=mozilla%2F4.0%2520%2528compatible%253B%2520msie%25208.0%253B%2520windows%2520nt%25206.1%253B%2520trident%2F4.0%253B%2520gtb6.5%253B%2520slcc2%253B%2520.net%2520clr%25202.0.50727%253B%2520.net%2520clr%25203.5.30729%253B%2520.net%2520clr%25203.0.30729%253B%2520media%2520center%2520pc%25206.0%253B%2520infopath.2%253B%2520tablet%2520pc%25202.0%2529&browsermajor=4&browserminor=4>

Accessed 15 October 2010

Pallasmaa J. 1986. *The Geometry of Feeling: A look at the phenomenology of Architecture. Theorizing a new agenda for architecture. An anthology of architectural theory 1965-199*, edited by Kate Nesbitt.

New York: Princeton Architectural Press: 447-454

Pallasmaa, J. 2005. *The Eyes of the Skin: Architecture and the senses*.

Great Britain: Wiley-Academy.

Powpow, V.G. 2000. [O]. A Report on Psychology & Architecture. Available:

[http://www.grandlodge.mb.ca/mrc\\_docs/Psychology%20of%20Architecture.pdf](http://www.grandlodge.mb.ca/mrc_docs/Psychology%20of%20Architecture.pdf)

Accessed 26 April 2010

Tarkett. The ultimate flooring experience. [Sa]. [O]. Available:

<http://professionals.tarkett.com/range/24072o.tktp>

Accessed 12 August 2010

Strawberry Plants.org. 2010. [O]. Available:

<http://strawberryplants.org/2010/05/the-mountain-strawberry/>

Accessed 23 October 2010

Tibet Advice. 2007. [O]. Accessed:  
<http://tibetadvice.com/product.htm>  
Accessed 23 October 2010

The Engineering Toolbox. [O]. [Sa]. Available:  
[http://www.engineeringtoolbox.com/light-level-rooms-d\\_708.html](http://www.engineeringtoolbox.com/light-level-rooms-d_708.html)  
Accessed 20 October 2010

Thegrowspot.com. 2009. [O]. Available:  
<http://www.thegrowspot.com/know/f5/vertical-gardens-living-walls-53838.html>  
Accessed 25 September 2010

Thematic Trails: From Palace to Museum: Eight Hundred Years of History. [Sa].  
[O]. Available:  
[http://www.louvre.fr/llv/activite/detail\\_parcours.jsp?CURRENT\\_LLV\\_PARCOURS%3C%3Ecnt\\_id=10134198673226919&CONTENT%3C%3Ecnt\\_id=10134198673226792&CURRENT\\_LLV\\_CHEMINEMENT%3C%3Ecnt\\_id=10134198673226792&bmLocale=en](http://www.louvre.fr/llv/activite/detail_parcours.jsp?CURRENT_LLV_PARCOURS%3C%3Ecnt_id=10134198673226919&CONTENT%3C%3Ecnt_id=10134198673226792&CURRENT_LLV_CHEMINEMENT%3C%3Ecnt_id=10134198673226792&bmLocale=en)  
Accessed 26 April 2010

Tim\_d. *Blue*. 2009. Available:  
[http://www.flickr.com/photos/tim\\_d/105563044/sizes/z/in/photostream/](http://www.flickr.com/photos/tim_d/105563044/sizes/z/in/photostream/)  
Accessed 15 July 2010

Top Places. 2008. [O]. Available:  
<http://topplaces.co.za/good-food/mugg-and-bean/>  
Accessed 27 September 2010

Vermaak, E. Educational Co-ordinator, Ditsong: National Museum of Natural History. 2010. Interview by author [Transcript]. 27 July 2010. Pretoria.

Woodoc: food for wood. 2010. [O]. Available:  
<http://www.woodoc.com/products.asp?id=fa7d982c1f7f001&p=ZGVjayBwcm9kdWN0cw==>  
Accessed: 30 September 2010

Zumthor, P. 2006. *Thinking Architecture*. Switzerland: Birkhauser Press.