

“How do we define and recognise the characteristics of buildings that are socially concerned and humanitarian in their objectives.”

## TECHNICAL INVESTIGATION

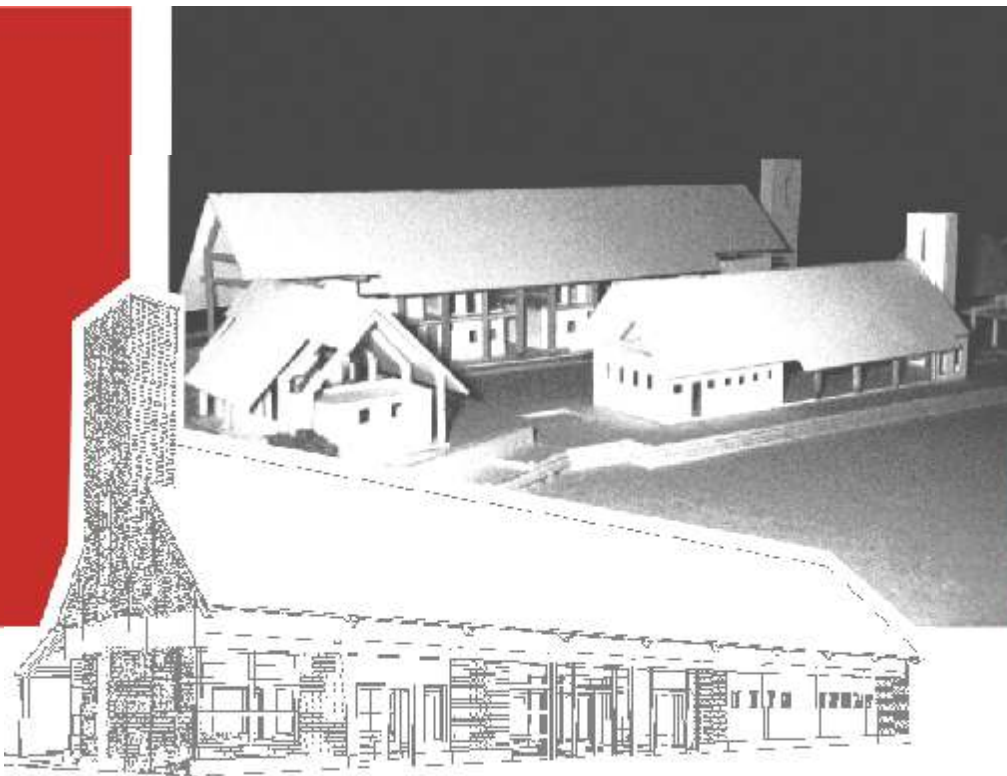

Figure B.1: Concept model  
Figure B.2: Perspective view of restaurant

## 7.1 Design Philosophy

As previously discussed, the design philosophy is built around the concept of the enclosed space accommodating the service or private functions and the defined space housing the served or public functions. This philosophy is based on the inherent characteristics of these space structuring systems.

By nature space enclosing systems are more private and conveys the perception of safety and security, while space defining systems seems to be more permeable, accessible and free.

This design philosophy will be extended beyond conceptualization and be utilized in the manifestation of the spaces. These two space structuring systems have technical characteristics that will be implemented in an attempt to produce buildings that communicate their functions and characters to the user.

### SPACE ENCLOSING

### SPACE DEFINING

### SPACE ENCLOSING

### SPACE DEFINING

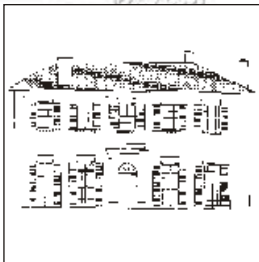

Figure 8.3: Light sources are visible and it has recognisable doors and windows.

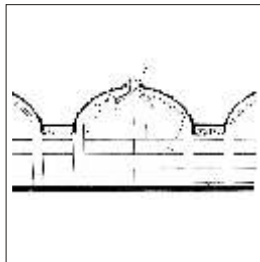

Figure 8.4: Has hidden light sources.



Figure 8.5: Has recognisable doors and windows, signs of 'human occupancy'.

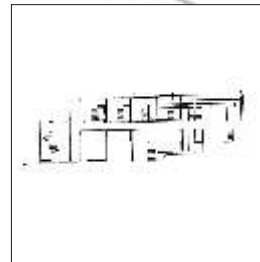

Figure 8.6: Openings are 'gaps' in the fabric of the assemblage - it gives few clues that the assemblage is occupied.

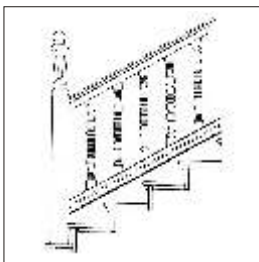

Figure 8.7: Components are 'joined'.

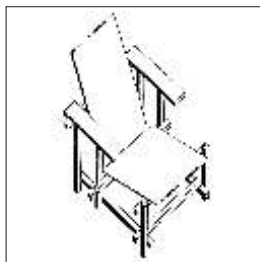

Figure 8.8: Components are visually distinct or separate.

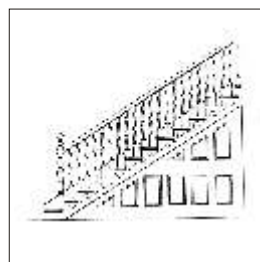

Figure 8.9: The articulation of the relationship between elements is positive.

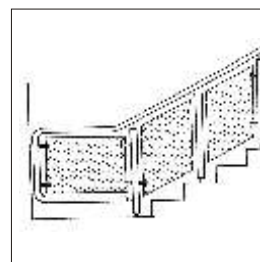

Figure 8.10: The articulation is not based on joining elements, but on maintaining a relationship between components. Surface is discontinuous.

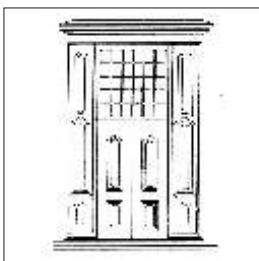

Figure 8.11: Components are framed and edged.

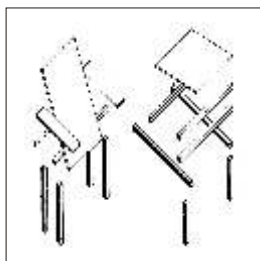

Figure 8.12: Components are spatially separate.



Figure 8.13: Openings are primary elements.

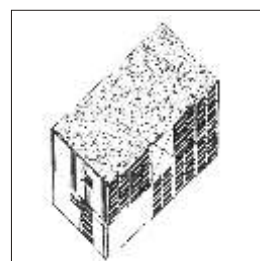

Figure 8.14: Frames or panels are primary.

Figure 8.3-14: Drawings (Righini 2000:145-146)

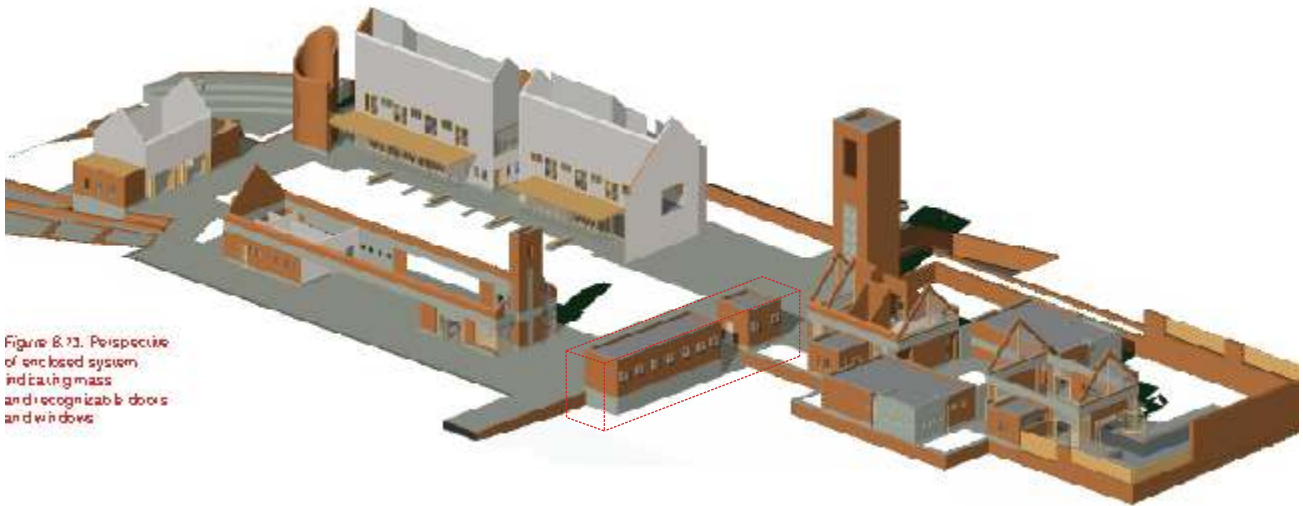

Figure 8.73. Perspective of enclosed system indicating mass and recognizable doors and windows

## 7.2 Space Enclosing System



Figure 8.16: Interior view of the courtyard of Säynätsalo Town Hall, Jyväskylä, Finland - Alvar Aalto  
Aalto's use of brick and timber has a cultural reference in that these materials are widely used in Finland. The massing quality of the brick produces strong and bold forms.

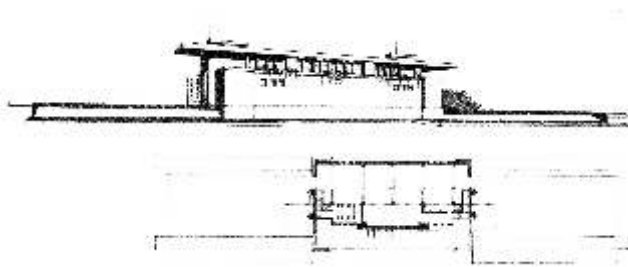

Figure 8.17: Yahara Boat Club, Madison, Wisconsin - Frank Lloyd Wright  
The plan reflects the use of brick in the massing of the material. A strong modular arrangement exist due to the manufacturing properties of brick.

Brick was chosen as enclosing system due to its reference to the historical context, local availability and low maintenance cost.

### 7.2.1 BRICK

Brick is often described as the poor man's stone (Righini, 2000: 25). The brick used in this project is 220 x 110 x 75 kiln fired, solid wirecut bricks. Common bricks are used for plastered walls and red bricks for face brick facades.

The red brick's appearance is caused by iron oxide. It will be specified to match the historical brick and applied in english bond with flush mortar joints.

#### Proportion

##### Material proportion

Masonry units are strong in compression and depend on their mass for strength.

##### Structural proportion

It is due to its compressive strength that the structural form of loadbearing walls are thicker. This will influence the design and appearance of the plan form.

##### Manufactured proportion

The process of forming and manufacturing the bricks gives them their size and proportion. Bricks are produced as modular building blocks and this should be considered in the design of the buildings.

##### Modular co-ordination and design

###### Grid

A grid of 1870mm x 1870mm have been used to co-ordinate brickwork with the dimensions of the building. This ensured the use of brick without modification.

###### Co-ordinating sizes

In the enclosed system custom made doors and window were used that complied with the modular sizes of bricks.

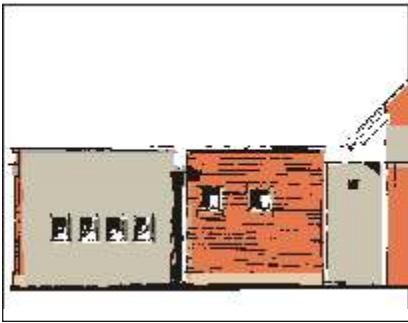

Figure 8.18: Exterior elevation of health hydro - the enclosed space seem to be framed and edged

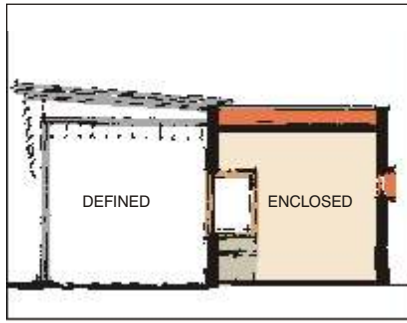

Figure 8.19: Section through information desk - the enclosed nature of the information desk is in clear contrast to the walkway roof structure

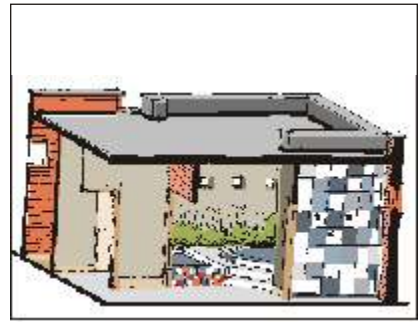

Figure 8.20: Interior perspective showing the jet bath and plunge pool in the health hydro - articulation between relationship of elements are positive and light sources are visible

The information desk and public ablution block was chosen as case study for the enclosing space system. The general construction components apply to all the enclosed spaces.



Figure 8.21: North elevation

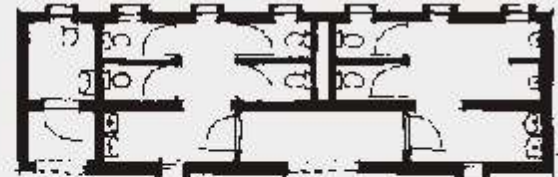
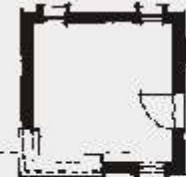

Figure 8.22: Ground floor plan

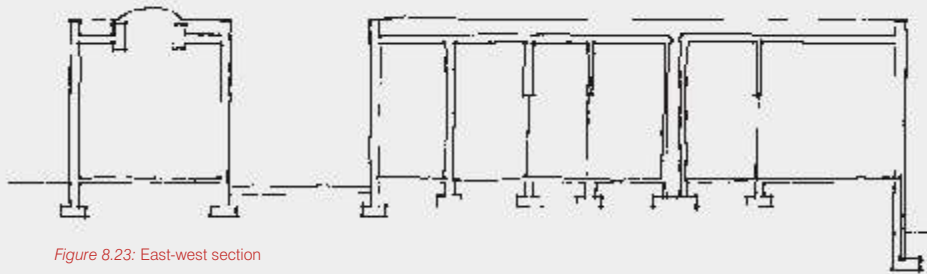

Figure 8.23: East-west section

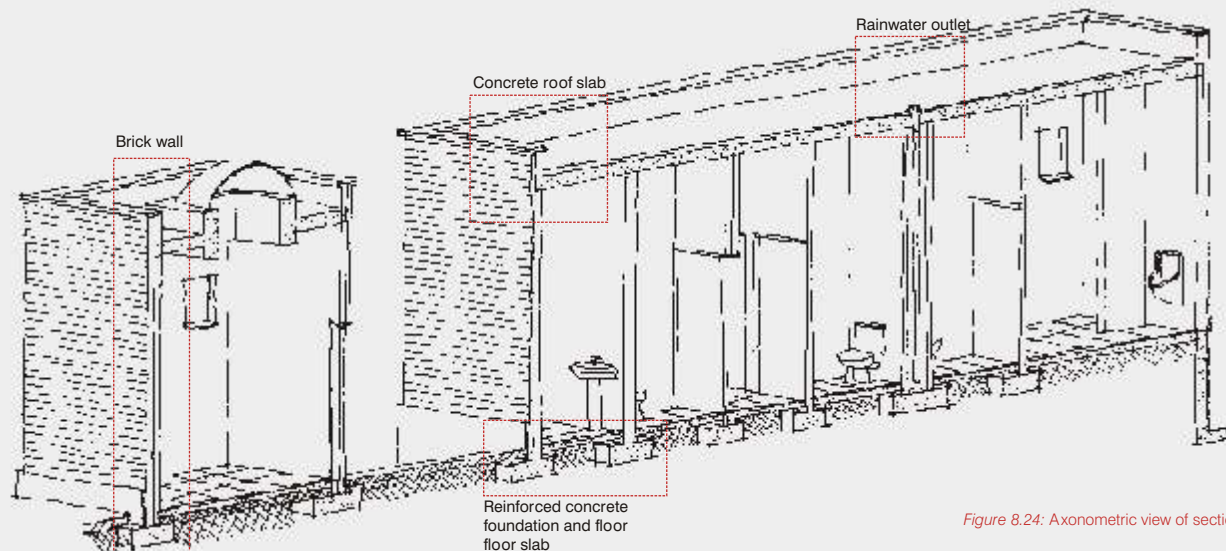

Figure 8.24: Axonometric view of section

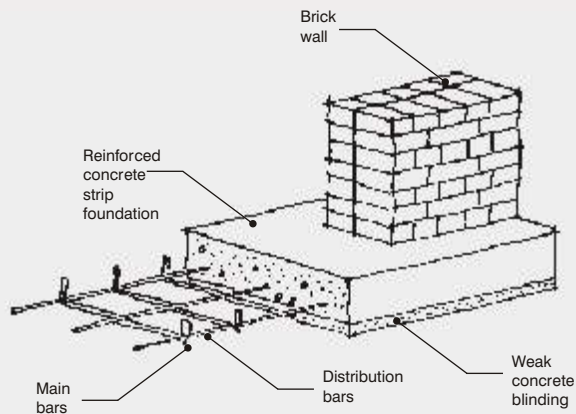

Figure 8.25: Reinforced concrete strip foundation

## 7.2.2 FOUNDATIONS

The load imposed on the soil due to the weight of the buildings can be compared to that of a house. Reinforced concrete footings will be sufficient. The depth of the footing will be at least equal to the overhang. The only foundations that will require additional design considerations are those of the landmark structures. Conventional strip foundations are used, as the prevailing soil conditions are not extreme.

“A room is an enclosed space; it reflects ‘here’ and ‘there’ as two distinct realms.”

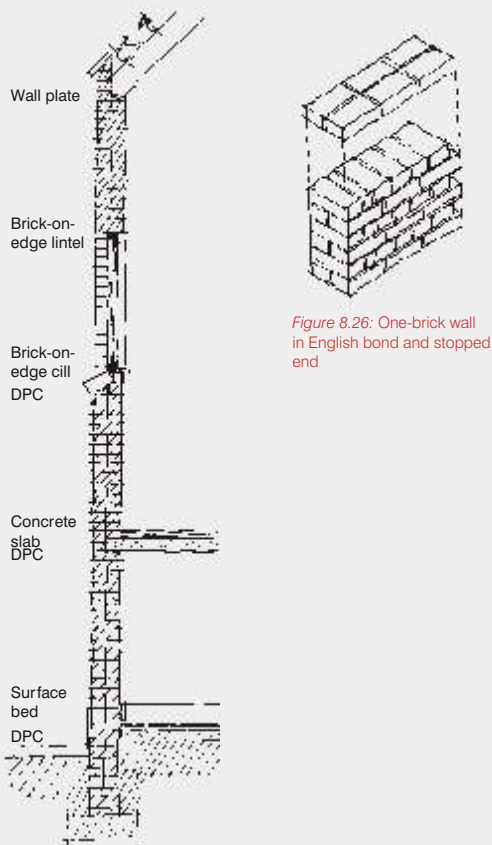

Figure 8.26: One-brick wall in English bond and stopped end

Figure 8.27: Brick wall

## 7.2.3 BRICK WALLS

### Structural strength and stability

Walls will have adequate strength and stability for their purpose.

### Durability

Masonry units shall be sufficiently durable to resist local exposure conditions for the intended life of the building.

### Accommodation of movement

Control joints will comply with SABS 0249 and reinforcement with SABS 0145

### Weatherproofness

Single brick exterior wall will be sufficient and shall comply with SABS 0249 and SABS 021

### Acoustic properties

Shall comply with minimal values of Agrément Board of South Africa

### Fire resistance

All brick walls shall comply with Section T of the National Building Regulations 0040

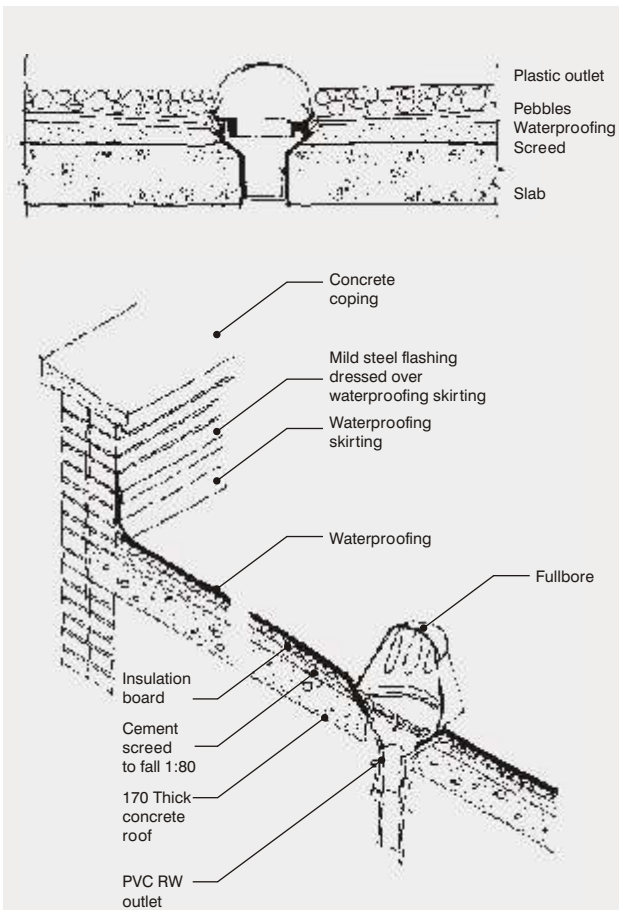

Figure 8.28: Rainwater outlet in concrete roof

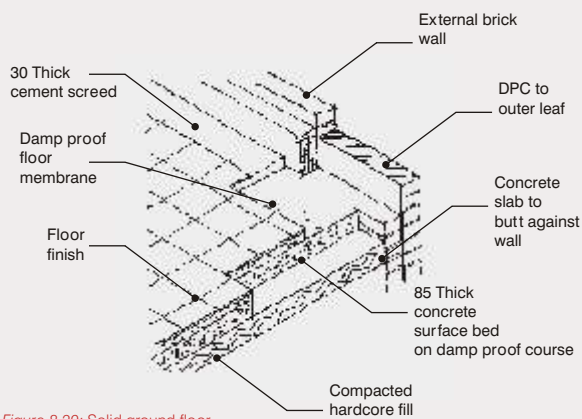

Figure 8.29: Solid ground floor

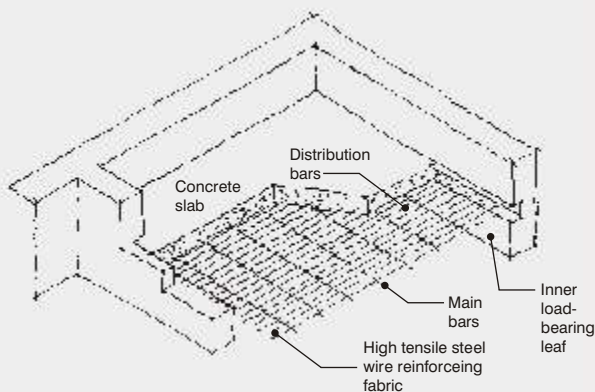

Figure 8.30: In-situ concrete floor slab

## 7.2.4 CONCRETE ROOF SLABS

### Roof slab

Concrete roof slabs will be used for the enclosed systems such as the information desk, public ablution block, spa area and landmark structures. 170mm Thick roof slab will be sufficient for all concrete roofs in this project.

The roof slab has to support

- The weight of the screeding placed on top of the structural slab and tapered in thickness to allow water to run off the roof into the outlets provided
- The weight of the asphalt required for waterproofing the roof
- The weight of the pebbles used on roofs that will be visible from the double storey training and therapy center
- The imposed loads
- The weight of the plaster on the underside of the slab
- The weight of the slab itself

### Rainwater outlet

The rainwater outlets in the concrete slabs are of cast iron, consisting of a funnel-shaped head. A plastic domical removable grating is secured by a single center hook bolt.

The rainwater outlet will be accommodated within the sanitary duct in the center of the slab.

## 7.2.5 CONCRETE FLOOR SLAB

### Ground floor slab

Hardcore is put down to reduce capillary rise of ground moisture, to act as a filling to provide a horizontal surface and to form a firm, dry working surface. The concrete slab is 85mm thick and the top surface is finished with a power float to take a 30mm thick cement screed. 30mm Thick sandstone tiles will mainly be used.

### Reinforced concrete floor

Reinforced concrete floor slabs will only be used for the first floors of the training and therapy center and the health hydro. The maximum clear span is 7480mm. Through consultation with an engineer, it was decided that 255mm thick slabs will be sufficient for both buildings.

The floor slabs will be in situ cast, one-way spanning slabs with the reinforcement acting in one direction only between two supports.

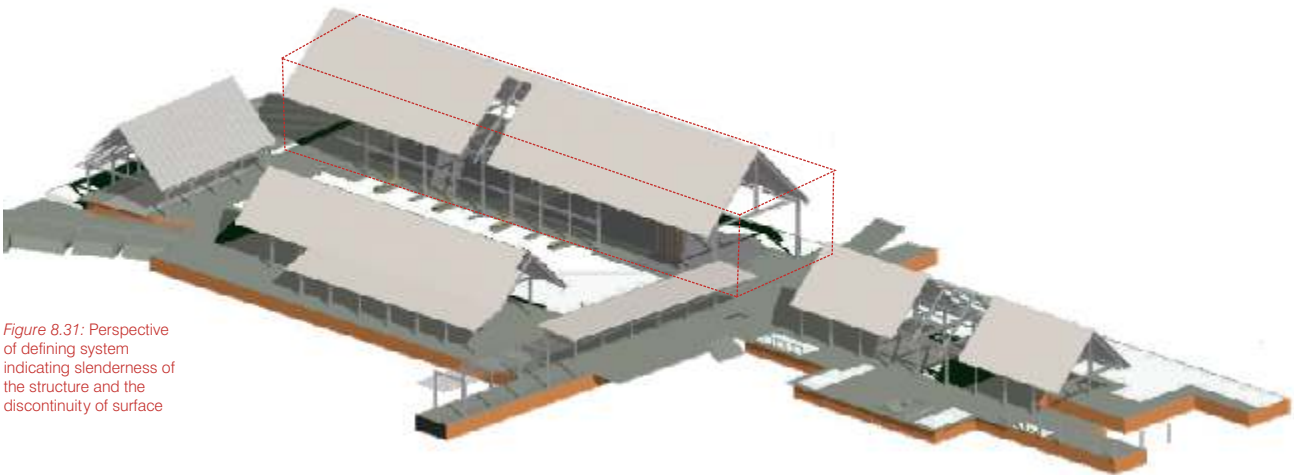

Figure 8.31: Perspective of defining system indicating slenderness of the structure and the discontinuity of surface

## 7.3 Space Defining System



Figure 8.32: Eames House - Charles and Ray Eames. This was an aesthetic based on technology. This building was one of the first 'patter-book' buildings, using components that could be ordered from catalogues.

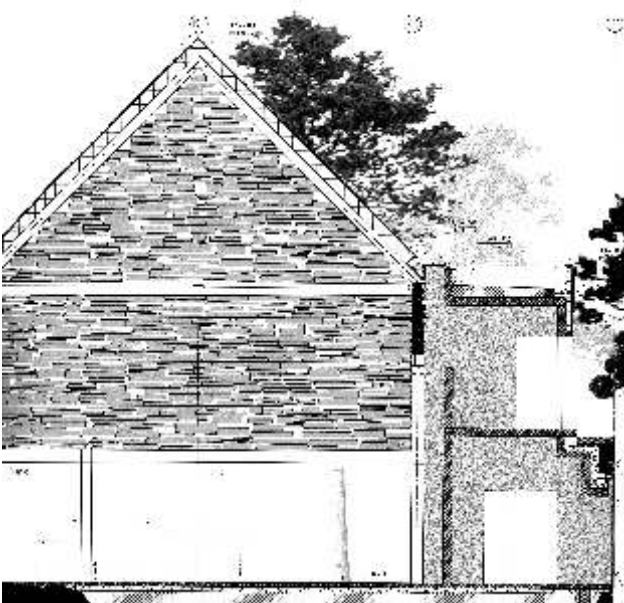

Figure 8.33: Mortensrud Church, Mortensrud, Oslo, Norway - Jensen & Skodvin. The main structure of this building is a steel frame, with a stone wall carrying the roof. The architects found that using basic techniques and methods, produced a cheaper building and afforded them greater architectural freedom.

Steel was chosen as structural material for the defining system as the members are smaller than aluminum, ensuring a lighter appearance. Steel would be easier to maintain than timber frames and cheaper than reinforced concrete frames.

### 7.3.1 STEEL CONSTRUCTION

Hot rolled structural steel is used for all components of the assemblage. Bolted connections will mainly be used as this is the most common connector, requiring little special equipment.

#### Proportion

##### Material proportion

Steel is the material that is used in the majority of framed structures because of its good compressive and tensile strength and favourable strength to weight ratio. Because of its strength in compression and tension, steel can be formed into linear columns and beams as well as planar sheet material.

##### Structural proportion

The skeletal structure defines modules of space. The spaces are articulated by the size and proportion of the components, giving the space scale and hierarchy. This is due to the increase in component size as loads and spans of buildings and spaces increases. This can clearly be seen in figure 8.25.

#### Modular co-ordination

##### Grid

The spacing for steel columns of a lattice truss construction is between 3 and 5 meters. The columns have been spaced at 3740mm centers which is double the spacing of the brick grid that is 1870mm.

#### Functional requirements

##### Strength and stability

The design of the structural system will be carried out in accordance with SABS 0160 (for loads) and SABS 0162.

##### Fire

Steel structure shall comply with section TT 7 of SABS 0040.

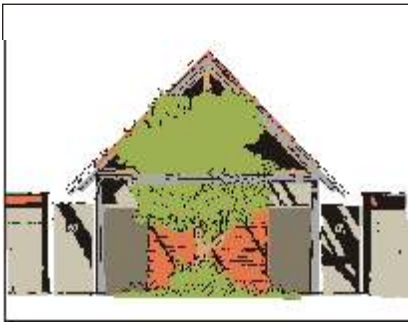

Figure 8.34: Internal view of inner courtyard of health hydro. Components are visibly distinct and light sources are not visible.



Figure 8.35: The articulation is not based on joining elements, but on maintaining a relationship between components. The lobby of the training and therapy center is a defined space, with the timber screen and steel columns giving definition. The stair, however, is placed in a brick box that suggest continuity with the enclosed structure as in the historic Edwardian tradition.

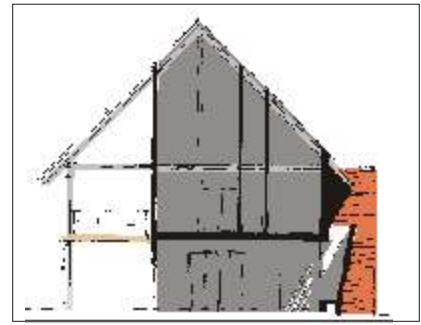

Figure 8.36: The concrete seats in the workshops are another type of defining structure. It has a hidden light source and causes discontinuity with the surface.

The training and therapy center was chosen as case study for the space defining system. The general construction components apply to all the defined spaces.



Figure 8.37: West elevation

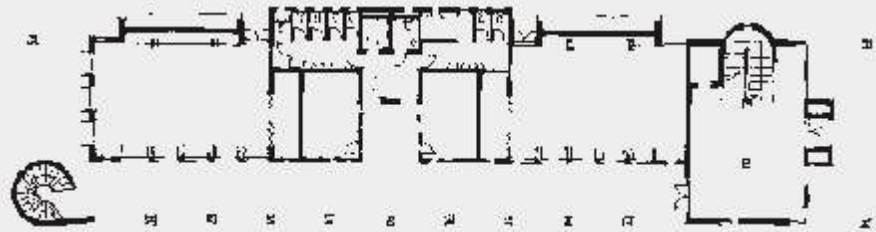

Figure 8.38: Ground floor plan

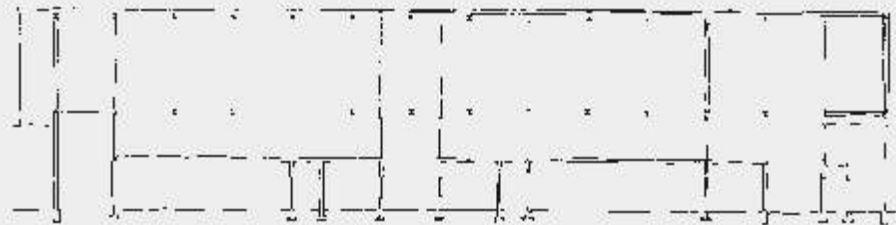

Figure 8.39: North-south section

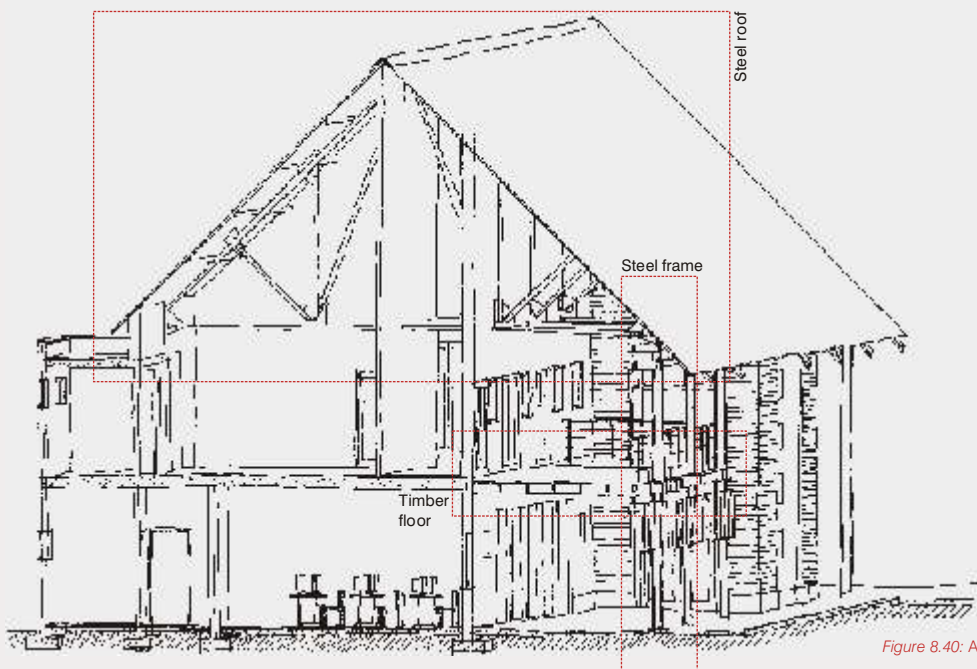

Figure 8.40: Axonometric view of section



### 7.3.2 STEEL CONSTRUCTION

#### Lattice truss construction

The lattice steel trusses are fabricated from small, mild steel sections bolted together to form a triangular symmetrical-pitch roof frame. The considerable depth of the roof frames at mid span provides adequate strength and rigidity in supporting dead and imposed roof loads. 203 x 203mm H-section steel columns spaced at 3740mm c-c will be used with 120 x 120mm steel angle purlins fixed across the trusses to support roof sheeting.

#### Steel connections

The system comprises of a lattice steel truss, a gusset plate joining the members of the steel truss, a cap on top of columns, steel columns and base plates fixed on a concrete base.

The structure will mainly be bolted as little special equipment is required and parts can be assembled on site.

#### Steel columns in brick walls

Where the steel columns are built into brick walls, they will be cast into concrete.

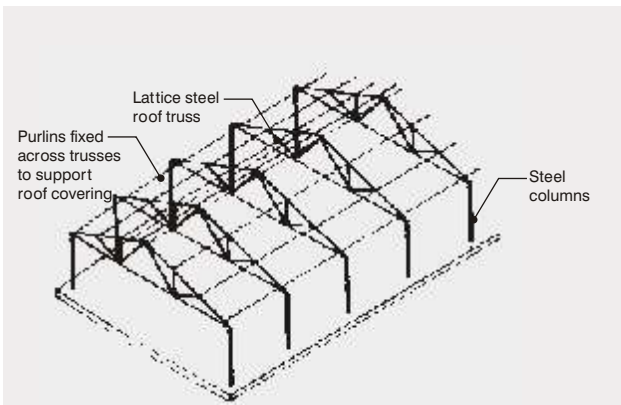

Figure 8.41: Symmetrical pitch lattice steel roof on columns

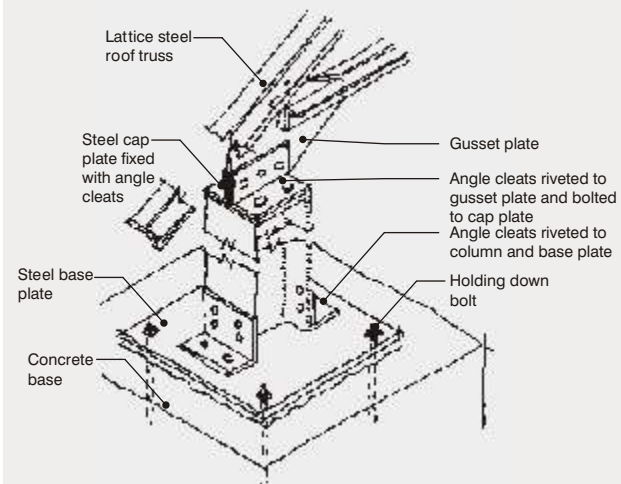

Figure 8.42: Cap and base of steel column support for lattice steel truss

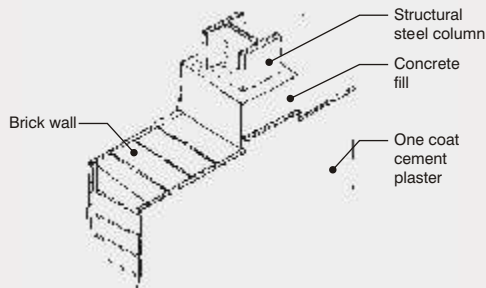

Figure 8.43: Steel frame in concrete column

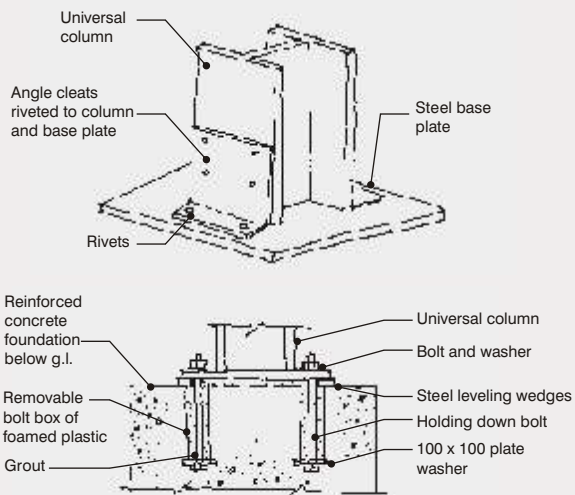

Figure 8.44: Steel slab base on concrete pad foundation

### 7.3.3 FOUNDATIONS

The simplest and most economical solution is to provide each column in the buildings with its own base. The size of the base depends on the bearing capacity of the soil and load on the column base.

The depth of the concrete is equal to the projection of the concrete beyond the base plate, assuming an angle of dispersion of load in concrete 45 degrees.

For heavier loads, reinforced-concrete bases will be used, since it requires less depth of concrete and less excavation.

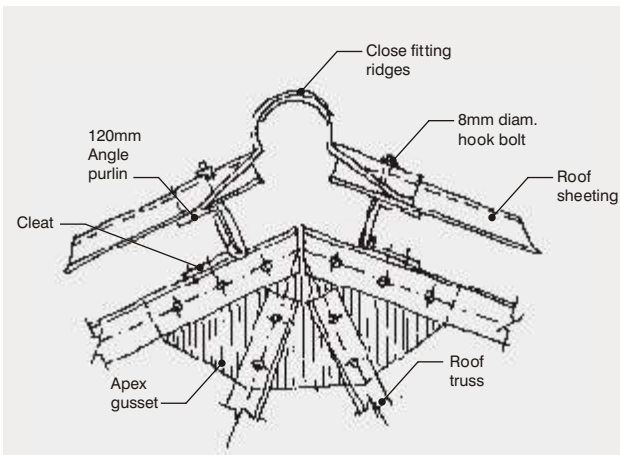

Figure 8.45: Corrugated sheet ridge detail

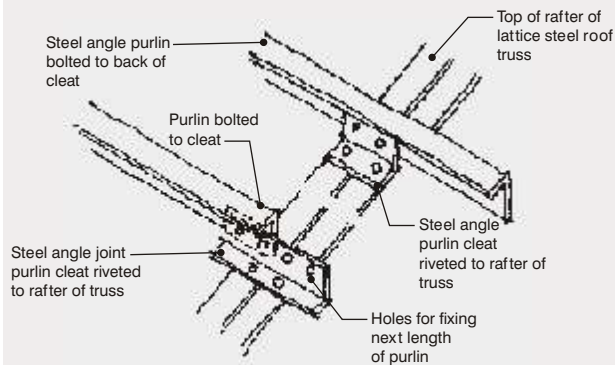

Figure 8.46: Connection of purlin to truss

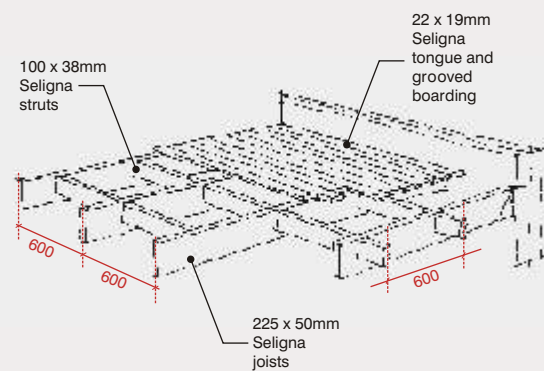

Figure 8.47: Timber balcony construction

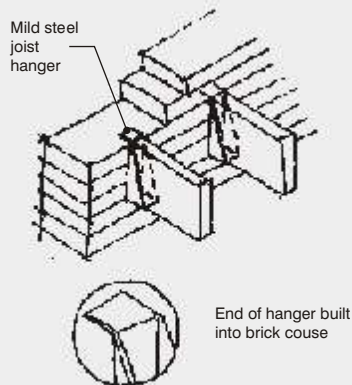

Figure 8.48: Support of joists

### 7.3.4 STEEL ROOF

Purlins are fixed across roof trusses to provide support and fixing for the roof and insulation. IBR roof sheeting will be used, requiring that purlins be spaced no more than 2 150mm c-c. Hot-dip galvanized steel sheets will be used for the roof coverings.

The composite roof system will comprise of cladding sheets and pre-formed insulation supported on profiled steel inner lining sheets which serve as a vapour check and provide a smooth, painted soffit. The roof is fixed to the purlins with self drilling, self tapping screws.

“Space is defined by placing of elements - it has a ‘loose’ quality, its dominant feature is about ‘connecting’ and maintaining continuity.”

### 7.3.5 TIMBER BALCONY

Timber balconies are used as first floors for the space defining system. The construction is appropriate for defining systems, since the components are spatially separate and visually distinct.

The decks have three components; the joists, the struts and the floor boarding. The joists are fixed across the shortest distance between the wall and the support. They are 225 x 50 thick Seligna boards spaced at 600 c-c.

Stiffening is required when joists are deep in order to avoid winding or buckling at the top of the joists. The struts give lateral support to the decks. They are 100 x 38 thick Seligna boards spaced at 600 c-c.

22 x 96 Thick Seligna tongue and groove boarding will be used for the flooring. Tongue and grooved boarding is preferable to plain-edge because it is able to transmit point loads on one board to adjacent boards. This reduces the intensity of load on individual boards.

Mild steel joist hangers will support the joist ends on the inner leaf of the walls.

## 7.4 Passive Systems

### 7.4.1 ORIENTATION

Due to the design intent the buildings were orientated predominantly north-south. This implies that the longer elevations of the buildings are exposed to early morning sun and late afternoon sun. The following guidelines apply:

- Avoid direct heat gain and solar radiation through overhangs and shading devices.
- Maintain views, natural light and natural ventilation regardless of shading devices.

The sun study is used to indicate seasonal sun exposure in order to assist in the design of windows, placing of patios, window shades, placing of trees etc. In summer one would want to shade the buildings, whereas in winter one would want to expose them to the sun for warmth.

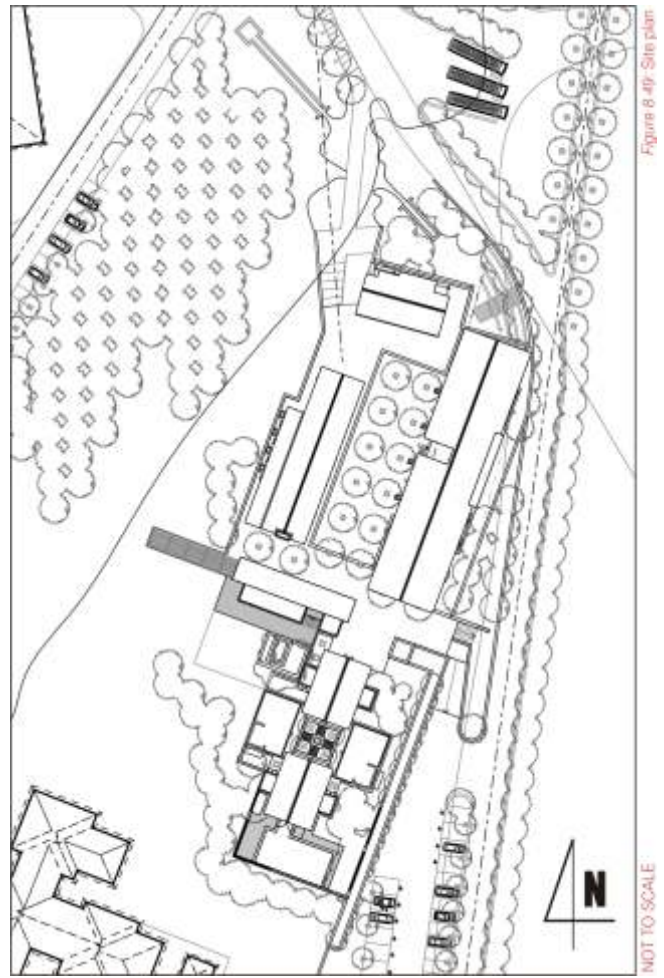

## SUN STUDY

### SUMMER: 21 DECEMBER

### WINTER: 21 JUNE



Figure 8.50: Time: 7:45 am



Figure 8.53: Time: 14:30 pm



Figure 8.56: Time: 7:05 am



Figure 8.59: Time: 13:20 pm



Figure 8.51: Time: 10:00 am



Figure 8.54: Time: 16:45 pm



Figure 8.57: Time: 9:10 am



Figure 8.60: Time: 15:25 pm



Figure 8.52: Time: 12:15 am



Figure 8.55: Time: 19:00 pm



Figure 8.58: Time: 11:15 am



Figure 8.61: Time: 17:30 pm

## 7.4.2 DAYLIGHTING

### Design strategy

The strategy selected for lighting the building interior is by predominant daylight, supplemented by artificial light where necessary.

The buildings layouts enable good natural lighting with no person being further than 3,5m away from natural daylight in any room. East, west and north facing windows are controlled for good daylighting and south facing windows provide uniform daylighting without control.

Daylighting strategies consider heat gain, glare, variation in light availability and solar penetration. These are addressed through opening size and spacing, shading devices, glazing materials and surface reflectance materials.

### Opening size and spacing

The opening size required for each room has been calculate in order to obtain the correct daylight factor (see appendix). Where the windows occur on the east or west facades they will be shaded to avoid heat gain.

Where possible windows will be provided in more than one wall in each room, so that brightness of framing wall-areas around windows are raised (by cross-lighting), thus reducing contrast between dark wall surface and bright sky.

High windows for daylighting are preferable because, if properly designed, they bring light deeper into the interior and eliminate glare.

### Shading devices

As illustrated in fig. 8.49 shading devices include: roof overhangs, external louvres and vegetation. These devices are used without compromising daylighting.

### Glazing materials

Double glazing is used on the western and eastern facades in order to minimize heat gain. Single glazing will be used on the northern facade to maximize heat gain in the winter.

### Surface reflectance materials

Once the daylight enters the room, the surrounding wall, ceiling, and floor surfaces are important light reflectors. Using high reflectance surfaces will better bounce the daylight around the room and it will reduce extreme brightness contrast.

Window frame materials will be light-colored to reduce contrast with the view and have a non-specular finish to eliminate glare spots.

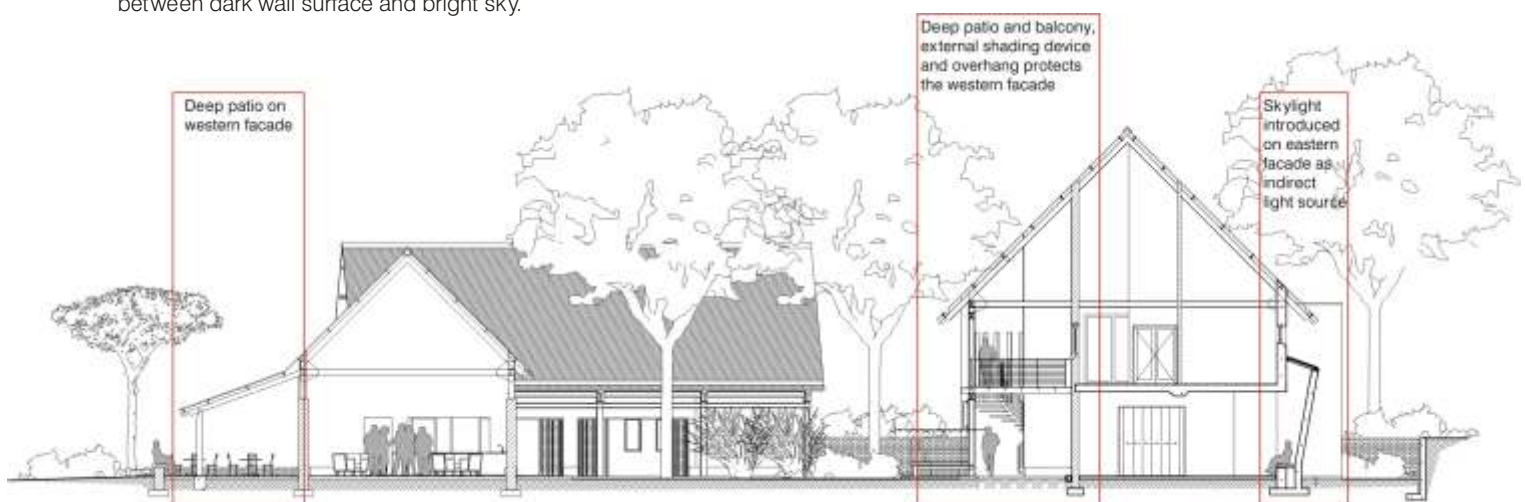

Figure 8.62: Shading devices

## 7.4 Passive Systems

### 7.4.3 PASSIVE HEATING

Passive heating is a heating system that collects solar heat, without the use of external mechanical power to distribute it. The building itself is designed as a solar collector with windows acting as the collection source. Solar collection may be either direct (solar radiation entering directly into a space) or indirect (solar radiation heats an area which then continues to heat the area when the solar exposure has passed).

Direct passive heating is used in the buildings, as they will be used during the day and therefore indirect systems will not be appropriate.

#### Direct gain

The overhangs are designed to allow winter sun to enter directly into the building, while keeping summer sun out. This causes the interior of the building to be heated in winter by the sun's energy, while remaining cool during the summer.

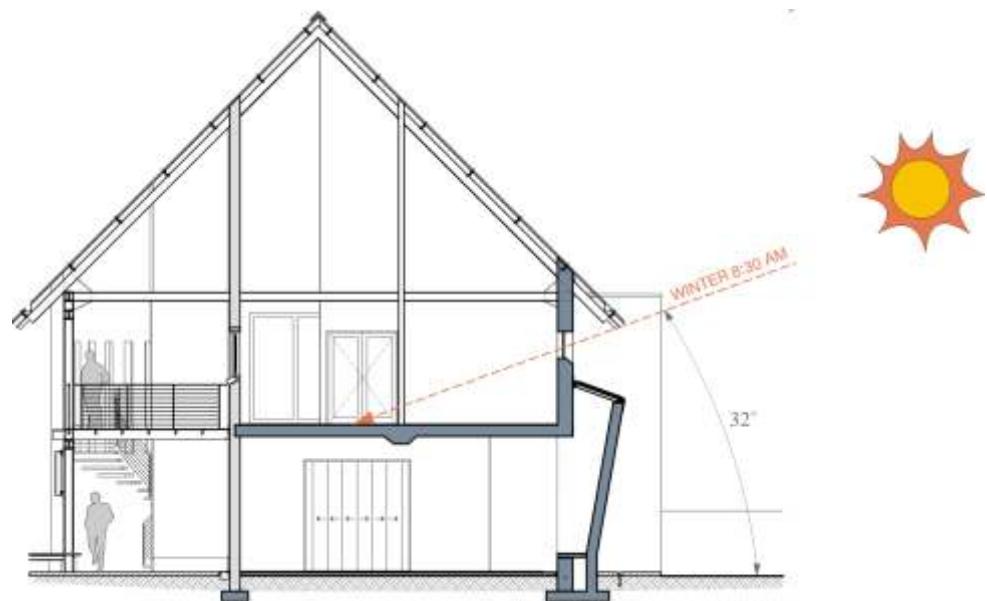

Figure 8.63: Direct solar heat gain during winter

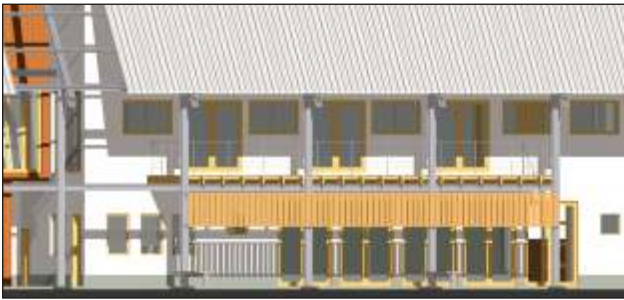

Figure 8.64: Vertical louvres and overhangs are designed as shading devices on the western facade of the training and therapy center.



Figure 8.65: Leafless trees admit sun in winter



Figure 8.66: Deciduous trees shade the building and garden in summer

## 7.4.4 PASSIVE COOLING

Passive cooling strategies include shading devices, thermal mass, overhangs, balconies and patios, high ceilings, applying the correct finishes and natural ventilation.

### Shading devices

#### Exterior louvres

Vertical adjustable louvres are applied to the western facade of the training and therapy center. They are distant from the windows, fixed to the steel structure, and therefore warmed air is prevented from entering the interior of the building. Figure 8.54 illustrates that the louvres are designed not to compromise the view from the interior spaces to the inner courtyard. Timber louvres will be used, treated with exterior wood stains and set in a steel frame.

#### Landscaping

Deciduous vegetation is an attractive and inexpensive form of shading, because it follows the local seasons. Trees are strategically planted on the east and west sides of the buildings to block the rising and setting sun. Bushes are also positioned to block undesirable low sun angles from the east or west.

### Thermal mass

The eastern wall of the training and therapy center consist of mass concrete which acts as a thermal wall. The cool structural mass will absorb heat from the interior during day time, provided that the thermal wall is shaded.

### Overhangs

Where possible, overhangs were designed to allow for maximum shading of opening without compromising view and natural ventilation.

### Natural ventilation

The buildings are orientated at roughly 45° angles to the prevailing summer and winter winds. Winter winds are blocked by vegetation, but summer prevailing winds are allowed to cross ventilate the buildings. Where possible open plans allow air movement. The area of operable windows have been calculated for each room (see appendix). Full height opening have been implemented where possible in order to provide maximum cooling. Multiple mullions in full height windows allow for the user to control the amount of natural ventilation in the interior spaces.

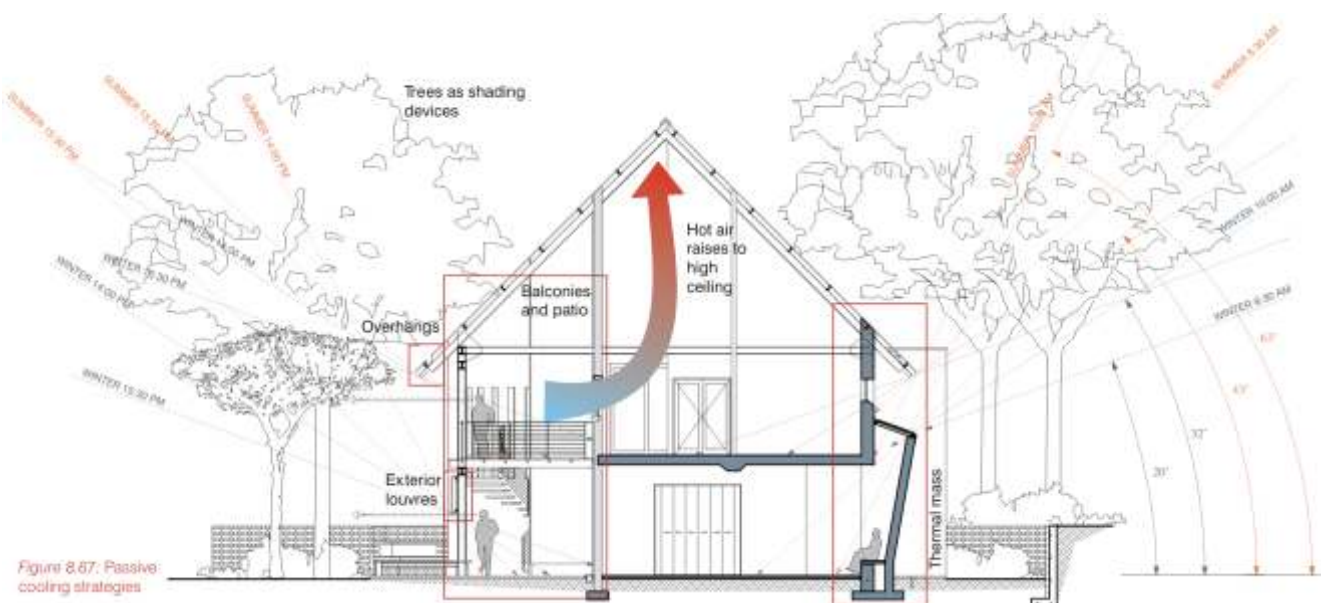

Figure 8.67: Passive cooling strategies



Figure 8.68: Perspective of west facade of training and therapy center indicating timber and steel composite seat and louvre system and timber balcony.



Figure 8.69: Use of galvanised corrugated steel sheeting for the roof.



Figure 8.70: South-west elevation of training and therapy center indicating the use of brick, off-shutter concrete and steel for the structural frame and roof.



Figure 8.71: An internal view of the training and therapy center lobby as seen from the stair. Timber is used internally to create warmth.

## 7.5 Material Use and Detailing

The training and therapy center was used as prototype of all the buildings.

Basic building materials such as wood, concrete, brick and steel are boldly used to create a lively, yet calm building. Traditional detailing was used throughout the building to accommodate the limited skills resources available to the construction industry in South Africa.

A corrugated steel roof is supported by a simple steel frame, enclosing brick and concrete walls. A great number of Bloekom trees are being uprooted on site and therefore Seligna is used for all timber components. Timber is used for window and door frames, balconies, louvres and seats as this adds warmth to the building.

203 x 203 x 12 thick hot rolled grade 300W structural steel frame, primed and cleaned according to SABS 064, and painted with two coats of zinc phosphate primer to comply with SABS 1319. Structural steel components designed in accordance with SABS 14713, and galvanised to comply with SABS ISO 1461.

Ordinary bolt assembly to comply with SABS 1700.

Composite louvre system comprising of 100 x 1000 x 25mm thick treated Seligna machined slabs sandpapered to smooth finish and painted with sealing coat and two coats of approved varnish and bolted to steel flats.

Composite seat comprising of 2670 x 100 x 25mm thick treated Seligna machined slabs sandpapered to smooth finish and painted with sealing coat and two coats of approved varnish and bolted to hot rolled structural steel 152 x 152 x 10mm frame.

1000 x 80 x 15mm Steel plate balustrade at 1000mm intervals with 21,4 daim. cold rolled steel tube horizontal balustrades

22 x 96mm Treated Seligna tongue and groove boarding sanded with a mechanical floor sander and painted with a sealing coat and two coats of approved varnish laid on 225 x 50mm thick treated Seligna joists and 100 x 38mm thick treated Seligna struts.

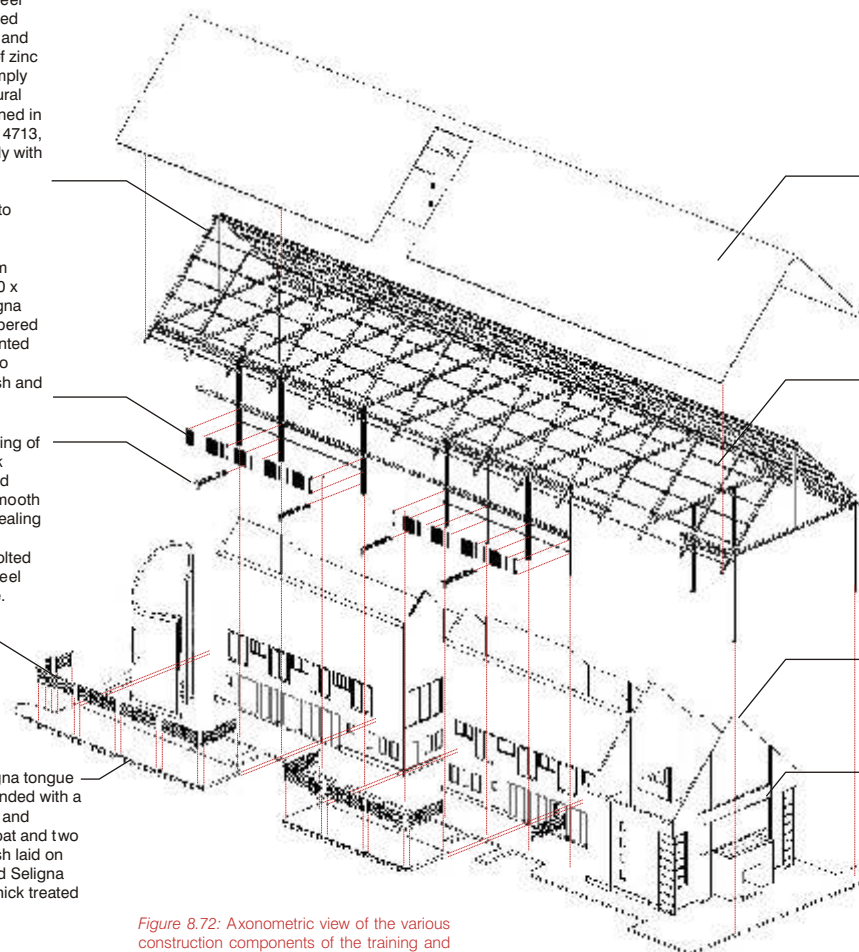

0,6mm thick mild steel sheet coated with class Z185 galvanising, primed with an epoxy-based primer, and painted with silicon polyester paint for normal exterior use, to 0,02mm thickness, on both sides.

120 x 120 x 8mm thick hot rolled structural steel angle iron purlin cleat riveted to rafter

12mm Thick normal strength laminated safety glass to comply with SABS 1263, set in treated Seligna frame with frame, subframe and glazing beads profiled and sized as specified.

850mm Deep off-shutter concrete beam. Smooth formwork with surface within degree of accuracy 2 to comply with SABS 0155.

Figure 8.72: Axonometric view of the various construction components of the training and therapy center. The other buildings will follow the same principles and use of materials.

## 7.6 Fire Strategy

### 7.6.1 FIRE RESISTANCE OF EXTERNAL WALLS

According to SABS 0040 TT2.1, structural elements are to have a fire resistance as follows:

Occupancy	Fire resistance, minutes
Workshops	120
Classrooms	90
Offices	60
Counselling rooms	90
Restaurant	120
Health hydro	120

#### Timber

As timber beneath the charred layer does not lose significant strength, with known rates of charring, initial size of structural members can be calculated which would continue to support design loads after various periods of exposure to fire. Metal fastenings must be within the residual section and be protected, eg. with timber of appropriate thickness, securely fixed.

#### Brick

The fire resistance ratings of loadbearing walls constructed of solid masonry units are as follows:

Thus, single leaf walls in the workshops, restaurant and health hydro, should be plastered, as this will improve the fire resistance rating.

Construction	Thickness (excluding plaster) in mm, min., for fire resistance rating in minutes of	
	220	110
Unplastered	190	150
Plastered	150	90

#### Concrete

In concrete's fire resistance of the elements of structure depends largely upon the properties of the aggregates. Light weight aggregates used in reinforced concrete elements would be appropriate for the fire resistance requirements. Light weight aggregates have a loose bulk density of not more than 1200kg/m<sup>3</sup> for fine aggregates and not more and not more than 1000kg/m<sup>3</sup> for coarse aggregates.

#### Steel

Structural steel will require a fire resistant coating. This will consist of a primer, the intumescent base coat, and a decorative top coat.

### 7.6.2 PROVISION OF ESCAPE ROUTES

According to SABS 0040 section TT16, emergency escape routes are not be required where the travel distance measured to the nearest escape door is not more than 45m, such building is not more than two storeys high. Therefore, no escape routes or exit door will be needed.

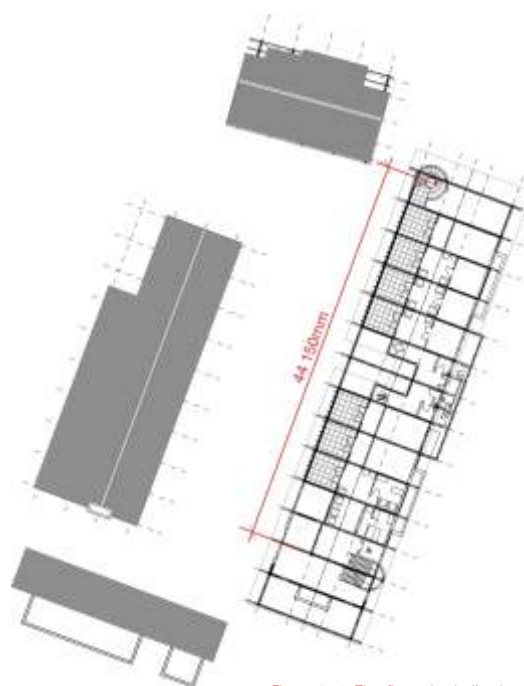

Figure 8.73: First floor plan indicating distance to nearest escape door.



## 7.7 Rainwater Harvesting

Rainwater harvesting will be feasible, due to the large roof area of the development. The water harvested will be used for irrigation purposes only and not for human consumption. This implies that there will be no need for water treatment. Rainwater can simply be stored for use when needed, or used directly for irrigation.

The financial gain brought about by the rainwater harvesting system in the long run, is its biggest advantage. In this case 1 276kl of water can be salvaged. At a cost of R3 per kl of water R3 828 can be saved annually.

### System components

- Catchment area/roof, the surface upon which the rain falls;
- Gutters and downspouts, the transport channels from catchment surface to storage;
- Leaf screens and roof washers, the systems that remove contaminants and debris;
- Cisterns or storage tanks, where collected rainwater

is stored;

- Conveying, the delivery system for the treated rainwater, either by gravity or pump

### Catchment area

Metal roofing is the preferred material because of its smooth surface and durability.

### Gutters and downspouts

Standard galvanised steel gutter will suffice. The only addition would be a continuous leaf screen to keep leaves and other debris from entering the system. The screen is made of 6mm wire mesh in a metal frame, installed along their entire length of the gutter.

### Storage tank

A 1000l standard reinforced fibreglass water tank will be used at the training and therapy center. Rainwater from the other roofs will be directly applied for irrigation purposes through soakage trenches.

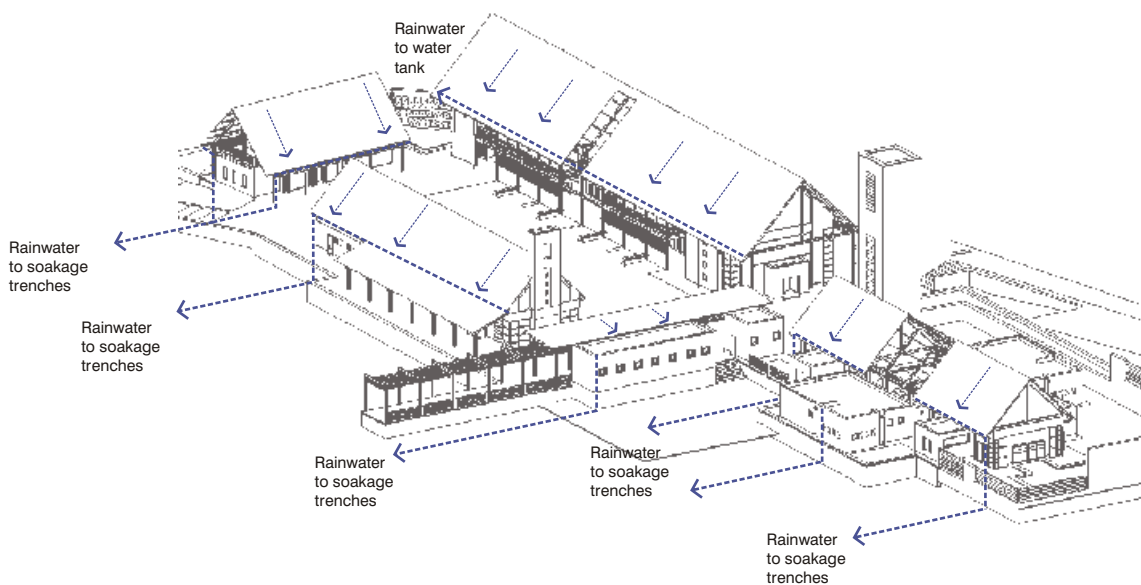

Figure 8.74: Rainwater harvesting strategy

Month	Aggregate rainfall in mm/month for Pretoria	Total water harvesting area = 1 717m <sup>2</sup> Total amount of water harvested (kl)
January	101.3	174
February	108.8	187
March	63.8	110
April	37.5	64
May	48.4	83
June	3.8	7
July	2.3	4
August	2.3	4
September	11.3	19
October	82.5	141
November	168.8	290
December	112.5	193
<b>Total</b>	<b>745.27mm</b>	<b>1276kl</b>

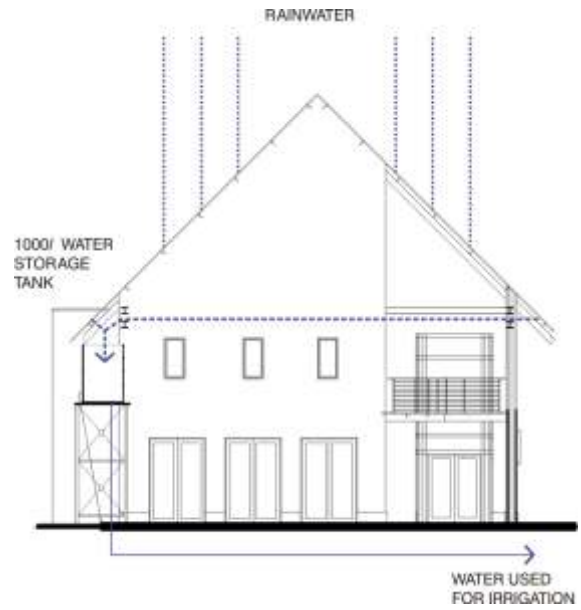

Figure 8.75: Rainwater stored from the training and therapy center roof

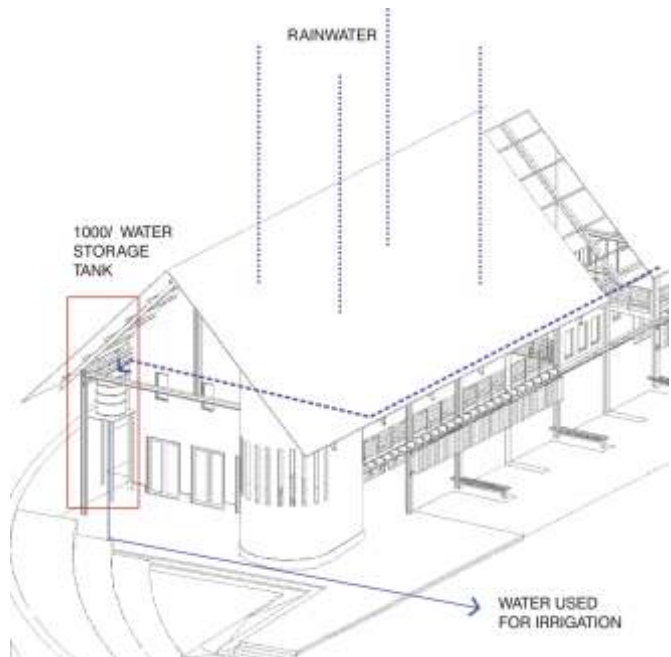

Figure 8.76: Rainwater stored from the training and therapy center roof