

4. DEVELOPMENT OF SUITABLE TRAPS

4.1 ABSTRACT

Sticky traps of various shapes and colours were tested and improved for the purpose of surveying the distribution of *Glossina austeni* and *G. brevipalpis* in South Africa. For *G. austeni* and *G. brevipalpis* the 3-dimensional shapes of the XT and 3DT in light blue (l.blue) and white were better than the RT. An electric blue (e.blue)/l.blue odour-baited XT was effective to apply in surveys to monitor the distribution of the two species in N.E. KwaZulu-Natal. This sticky trap was later replaced by an e.blue/black XT proven to be more effective for *G. austeni* and similarly effective for *G. brevipalpis*. An increased size of the trap increased the numbers of *G. brevipalpis* females and both sexes of *G. austeni* significantly. For both species larger monopanel traps (95 x 80 cm and 120 x 100 cm) of which each side was painted half e.blue and black (vertical) were found equally attractive to the standard size (70 x 60 cm) XT. A new trap, named the "H trap", was developed for the simultaneous collection of live *G. brevipalpis* and *G. austeni*. Its design followed an evaluation of the responses of the two species towards traps that are used elsewhere in Africa for the collection of other tsetse fly species. These traps were found at Hellsgate to be unsuitable for capturing both *G. brevipalpis* and *G. austeni*. Some new trap designs and many modifications of these were tested, most of which were unsuccessful. The odour-baited blue and black H trap represents a different approach for trapping tsetse flies as it is fitted with lateral cones of white netting which induce the flies to take a more horizontal flight path once they have entered the trap, instead of the vertical flight paths they are forced to assume in existing tsetse fly traps. A number of modifications of the prototype H trap were devised (H1-H5), before the final design was established. Catches of up to 76 *G. brevipalpis* and 37 *G. austeni* were obtained per trap on a single day with the H3 modification. Further modifications improved on the trap's efficiency to capture *G. brevipalpis* and *G. austeni*. The final modification caught a record number of 180 *G. brevipalpis* and 57 *G. austeni* on a single day.

4.2 INTRODUCTION

Hargrove (1998) has defined a tsetse fly 'trap' as a device designed to induce tsetse to enter a space from which they cannot escape. Harris (1931) developed the first trap used for tsetse flies and employed it to capture large numbers of *G. pallidipes* Austen in South Africa. Since then, many traps have been designed for other species of tsetse in other parts of Africa (Morris & Morris 1949; Challier & Laveissière 1973, cited in Hargrove 1998; Mooloo 1973; Hargrove 1977; Laveissière & Couret 1980; Vale 1982a; Flint 1985; Gouteux & Lancien 1986; Brightwell *et al.* 1987; Laveissière & Grébaud 1990; Brightwell *et al.* 1991; Gouteux 1991; FAO 1992; Kyorku *et al.* 1993; Mhindurwa 1994; Vreysen *et al.* 1996). Traps are, however, preferably used as monitoring tools but have shown to be very effective in control programmes.

4.2.1 Sticky traps

Initially sticky traps were developed in Zanzibar (Hall 1990; Schonefeld 1988, cited in Hall 1990) for the monitoring of *G. austeni*. These were light blue and white traps of the 3DT (3-dimensional trap), the XT (cross-shaped X target), and the RT (rectangular sticky screen) with 3-dimensional leg panels. The only traps earlier found to be effective for capturing *G. austeni* in KwaZulu-Natal have been these sticky panels of various shapes and colours. When baited with synthetic ox-odour, they also captured *G. brevipalpis* (Kappmeier, Venter & Nevill 1995). Since then more sticky traps have been developed, namely the Chuka trap by Madubunyi (1990) and the free rotating monopanel (MP) and legpanel (LP) by Vreysen *et al.* (1996).

Before the distribution of *G. austeni* and *G. brevipalpis* in northern KwaZulu-Natal could be surveyed, studies were needed to evaluate the sticky trap shapes and colours, so as to be able to select the best trap for these surveys. The three Zanzibar sticky traps available at that time (3DT, XT and RT) were, therefore, evaluated for their efficacy for the two tsetse species. Later, further studies were undertaken to improve on the design of the sticky traps used in initial surveys. The attractiveness of additional colours, colour combinations

and sizes were tested as well as simplifying the design for its manufacture and practical use in the field.

4.2.2 Cloth traps

Sticky traps proved to be useful tools for monitoring the relative distribution of both species in KwaZulu-Natal (Nevill *et al.* 1995; Nevill 1997), but, do not provide live flies suitable for mark-release-recapture studies. For this it is necessary to use a trap which catches live specimens in large enough numbers. No such trap exists for *G. austeni* as its behaviour is elusive and only low numbers are caught in existing tsetse fly traps elsewhere in Africa (Takken 1984; Hall 1986; Madubunyi 1990). The only trap available for this purpose for *G. brevipalpis* was the Siamese trap but it is only partially effective for this species in Kenya (Kyorku *et al.* 1993).

Preliminary studies in KwaZulu-Natal have indicated that, with the exception of sticky traps, most existing tsetse fly traps, which are effective for other species elsewhere in Africa, were not effective for the capture of *G. brevipalpis* and particularly not for *G. austeni* (Kappmeier, in press). Traps that have been tested in South Africa for capturing live *G. austeni* and *G. brevipalpis* include the Epsilon, Pyramidal, Biconical, Vavoua, Ngu (Ng2f) and Siamese (B) (Gouteux & Lancien 1986; Brightwell *et al.* 1987; Laveissière & Grébaud 1990; FAO 1992; Kyorku *et al.* 1993).

The best of these, namely the Ngu (Ng2f) and Siamese (B), caught mean daily numbers of 8,2 and 5,8 *G. brevipalpis* respectively (35 replicates) and 0,4 *G. austeni* (35 replicates) (Kappmeier, in press). In addition, the efficiencies of the Ngu and Siamese traps, as determined by comparing the results obtained with those when electrified nets were placed immediately adjacent to the traps, as suggested by Vale (1982a), were also found to be very low (Kappmeier, in press). The reason for the ineffectiveness of the traps for *G. brevipalpis* and *G. austeni* in KwaZulu-Natal was determined during further trap-orientated behavioural studies, as described by Vale (1982b), when, by the use of

electrified nets, it was shown that the upward flight responses of the flies were very low. Only 21-45 % of the *G. brevipalpis* that entered a Ngu and Siamese (B) trap, flew upwards towards the cone (Kappmeier, in press). The same basic trend also held true for *G. austeni*.

The poor vertical movement of these tsetse fly species led to the development of a prototype of a new trap using lateral or side-cones instead of vertical or top-cones so that the flies, once they had entered the trap, flew horizontally rather than upwards. In order to improve on the design, several modifications of this prototype trap, named the H trap, were assessed for trap-orientated responses of the flies as well as for efficiency.

Months of studies on numerous modifications of existing traps and on new designs preceded the development of the H trap. Because they were unsuccessful these efforts will only be referred to briefly and the main body of the chapter will concentrate on the evolution of the H trap.

4.3 MATERIALS AND METHODS

4.3.1 Sticky traps

Trap designs and tests

Three types of sticky traps were made for testing at Hellsgate according to the description of Hall (1990). These were the 3 DT, XT and RT (Fig. 4.1). The traps were made from 3 mm tempered hardboard panels, painted light blue (l.blue), electric blue (e.blue), white or black with gloss enamel. All traps were hung from trees and were allowed to rotate with their lowest part 10-20 cm above ground level. They were painted with polybutene so that the flies that landed on the traps could be retained on the sticky surface. The polybutene was diluted with hexane to facilitate easier application. Once applied, the hexane evaporates and the surface remains sticky. To collect flies lost from the lower edges due to dripping, especially during the first day when the polybutene is still quite fluid, a plastic sheet was placed underneath each trap.

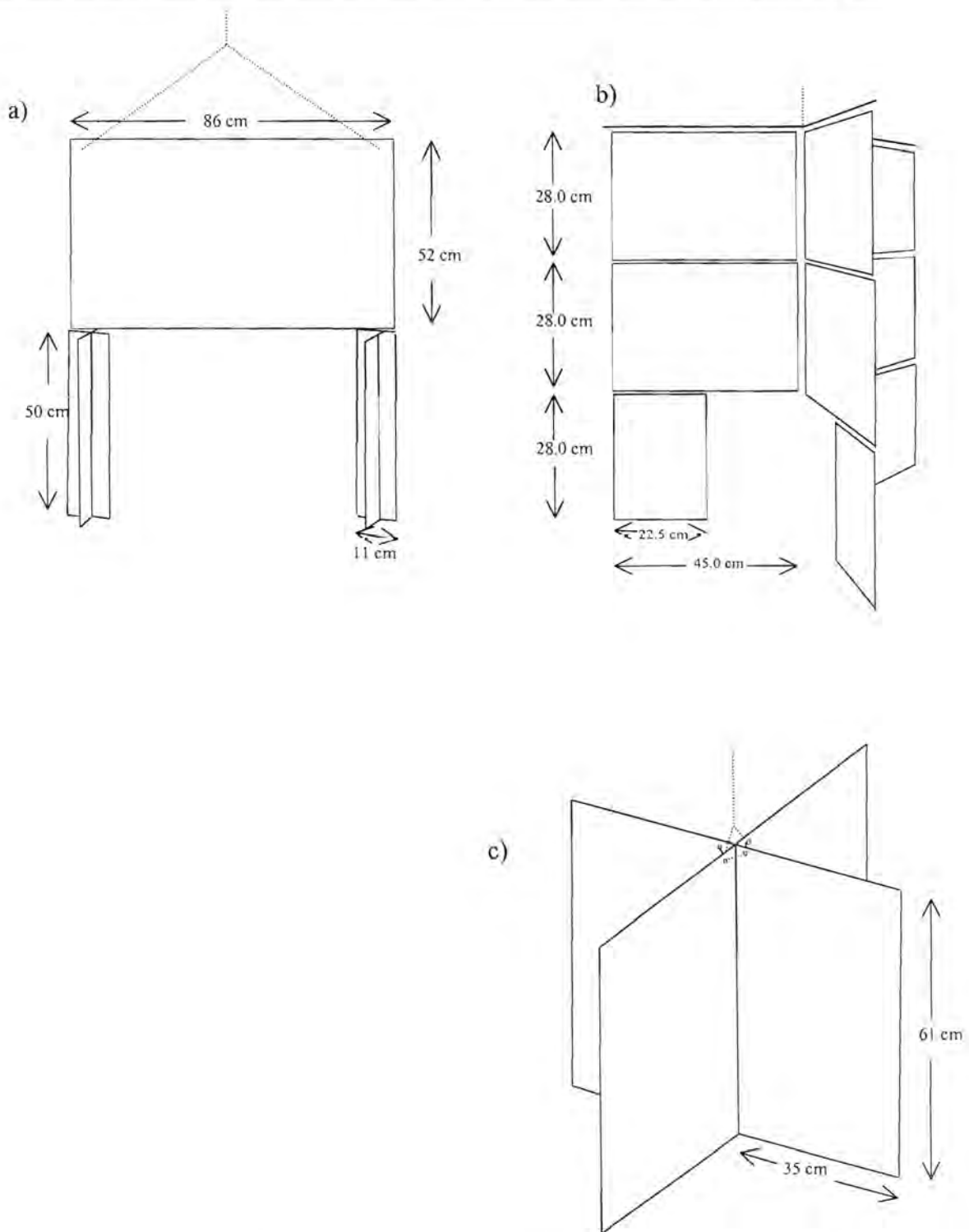

Fig. 4.1 Sticky traps for *G. austeni*: (a) Rectangular sticky screen (Hall 1986, cited in Hall 1990); (b) 3-DT (Schonefeld 1988, cited in Hall 1990); (c) cross-shaped target (XT) (Hall 1990)

This also reduced contamination of the trap with soil and leaves due to rain and wind. The polythene sheet was pinned down with 200 mm pegs made from heavy fencing wire.

A series of experiments were conducted between 1993 - 1996, firstly to evaluate the various sticky trap designs and compare black, white, l.blue and e.blue versions. Thereafter, the best design (XT) was improved and evaluated in single- and bicoloured combinations (i.e. one panel of the XT was painted a different colour to the second panel). It was then attempted to simplify the best colour combination of the XT in the form of monopanel (being a single panel of the XT) for more practical use in the field. These were also tested in various bicoloured combinations and sizes. The experiments will be described in more detail in the Experiments and Results section (4.4) below.

Sticky trap efficiencies

In order to determine the efficiency of traps, an electric net (1 x 1 m), was placed immediately adjacent to the trap. This electric net intercepted flies that were attracted to the trap, but which flew around it and which might never have landed on the trap. The number of flies captured by a trap (without an electric net) was expressed as a percentage of the total number of flies attracted to a trap (trap plus electric net), to give an estimate of trap efficiency (Vale 1982a; 1982b).

4.3.2 Cloth traps

Preceding trap tests and designs

Before the prototype of the H trap was designed, many modifications of existing traps were made and some other traps were originated at Hellsgate. The designs of all these traps took into account the flies' reluctance to fly upwards towards the cones. Some of these designs were also described in Kappmeier (in press).

The first designs consisted of modifications of the Ngu and Siamese traps where both were fitted with lowered or sunken cones so that the path towards the collecting devices was lower. Some of the latest tsetse traps were included in these tests, namely the M3 (Mhindurwa 1994) and the Nzi traps (Mihok 2001). The Nzi was also modified into what was referred to as the Nzi3 which consisted of three Nzi traps united back to back thus with three separate entrances. The Nzi was also further modified so that the rear netting part was incorporated into a horizontal and diagonally sloping cone plus collecting device, therefore doing away with the top/vertical cone. The Canopy trap used for Tabanidae (Catts 1970) was also tested and then modified, firstly by adding a pthalogen blue panel to the base (to enhance attraction), and later by providing openings in the blue pyramidal base, and simultaneously lowering the top cone part. Some new trap designs included what was referred to as the Monoscreen trap, which consisted of a blue and black cloth target with two thirds of the top part fixed with white mosquito netting which formed a "tent" over the target. A few modifications to the net part followed to encourage the horizontal movement of flies towards a collecting device. One of these modifications was further modified into what was called a 3-dimensional-screen trap (3DS), which, as seen from above, consisted of an X-shaped cloth target, also fixed with a tent-like cover of netting and collecting cages. The prototype H trap (with different modifications [H1-H5] as described below) was designed and developed together with a B trap (P.W. Trollip, personal communication, 1997) and its modifications B1-B5. The latter were similar to the H trap, but had only one horizontal cone.

Of all the above designs and modifications, other than the H trap modifications, only a few looked promising, namely the Nzi, Nzi3 and B1-B5 traps. Further experiments included the comparison of these traps with an e.blue/black XT sticky trap described in the previous section. These results will briefly be summarized in section 4.4.

The prototype H trap

The prototype design of the H trap (Fig. 4.2 a) consisted of a phthalogen blue cloth outer “box” (100 x 65 x 65 cm) with two opposite side entrances (40 x 45 cm), an inner black cloth X-target (which also acted as a baffle, attached to the centre of the roof), and then two “horizontal” cones of white mosquito netting extending laterally from the ends of the trap in opposite directions, therefore initially named the “Horizontal trap”. Although the “cone”-device used here, was a hollow four-sided pyramid-shaped structure with a square base and straight (not curved) sides, it will here and henceforth be referred to as a “cone”, which is an accepted term to use with tsetse fly traps (FAO 1992). The four corners of the trap body were fastened, with strings attached to the trap, to four poles pegged into the ground at the positions of the trap corners. The cones were held in position by attaching them each to a flexible rod which provided tension to keep them rigid (Fig. 4.2 a). The apex of each cone was fitted with the top third of a 750 ml polythene bottle on which a second bottle fitted as the collecting device (Fig. 4.2 e).

H trap modifications

Five modifications of the prototype trap (Fig. 4.2 a) were made, and referred to as the H1 – H5 traps/modifications. The following is a description of the modifications, also depicted in Figs. 4.2 b-d:

H1: The prototype H trap was modified by adding a black inner lining to the base of the cones to prevent flies from collecting at the corners at the cones' bases (Fig. 4.2 b).

H2: The H2 was made with an extension of the outer blue "body" over the cones of the prototype trap (Fig. 4.2 c) to attract the flies to the light and the trap cage (collecting device) at the apex of the cones.

H3: A third modification, the H3, was designed with diagonal or upward-sloping cones to eliminate the problem of flies collecting at the corners of the bases (Fig. 4.2 d).

H4: The H4 modification was as the H3 but with bigger entrances (65 x 45 cm) and therefore a bigger blue body (125 x 65 x 65 cm).

H5: The H5 modification was as the H4 but with bigger cones.

Final "H trap": See Fig. 4.3 and 4.4.

a) H trap (prototype)

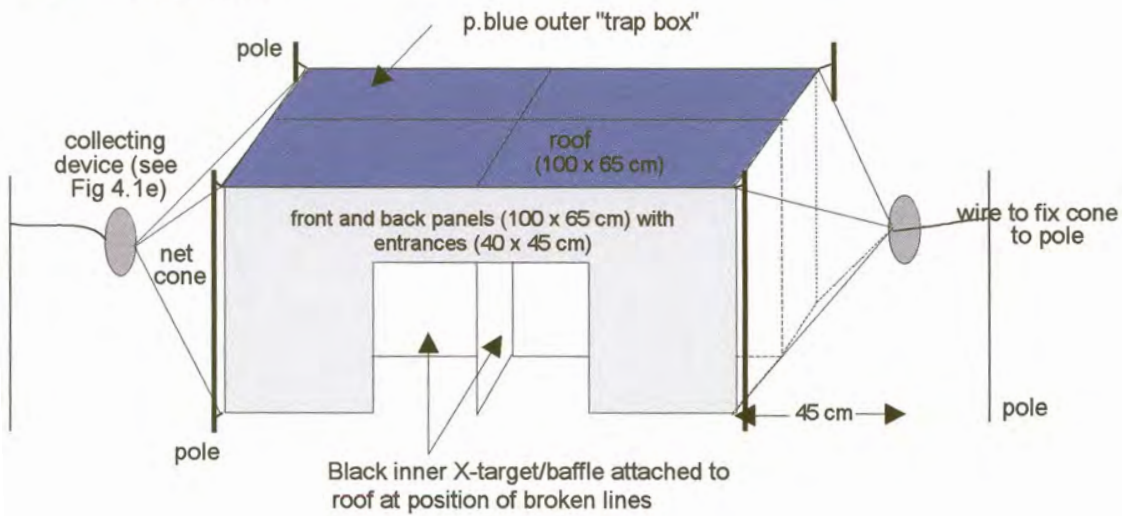

b) H1 with black lining added to inner bases of cones

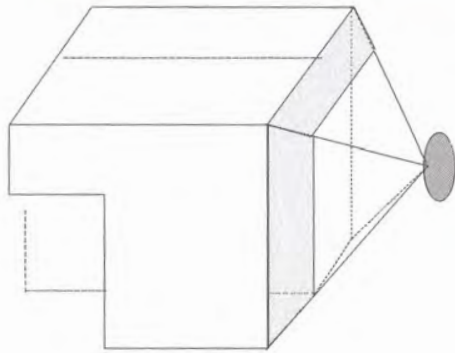

c) H2 with blue outer box extended over cones

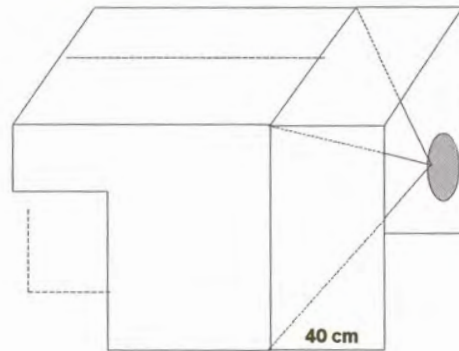

d) H3 with diagonal cones

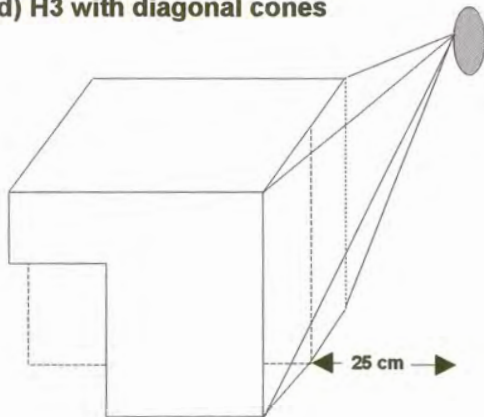

e) Details of collecting device

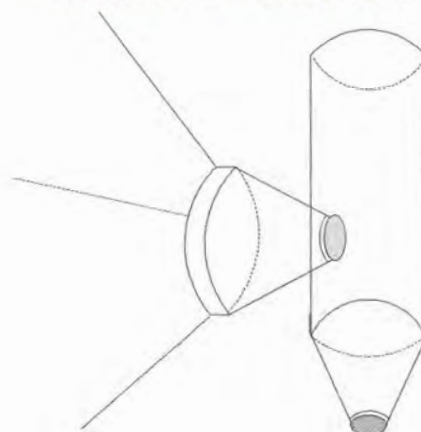

Fig. 4.2 Diagrammatic representations of the prototype H trap (a) with its H1, H2 and H3 modifications (b-d) and details of collecting device (e)

Trap efficiencies

The prototype H trap evolved from studying the behavioural responses of *G. brevipalpis* and *G. austeni* in and around the Siamese (B) and Ng2f traps (Kappmeier, in press). These behavioural studies were also conducted on later modifications of the H trap so as to be able to improve on its design. These trap-orientated responses and trap efficiencies of the H trap modification were evaluated by using electric nets (Vale 1974a) of various sizes and placements similar to those used by Vale (1982a; 1982b). All flies that were intercepted by the nets were electrocuted and retained on a tray painted sticky with polybutene so that they could be sexed and counted. In order to determine the efficiency of traps, an electric net (1 x 1 m), was placed immediately adjacent to the trap. This net intercepted flies that were attracted to the trap, but which flew around it, and which might never have been captured. The number of flies captured by the trap was expressed as a percentage of the total number of flies attracted to the trap, to give an estimate of trap efficiency. To determine the entering responses of flies, the trap's entrances were closed by means of smaller but similar electric nets, which were just large enough to fit into the trap entrances. All flies that attempted to enter the trap were therefore electrocuted and counted. The flies' horizontal flight responses were tested by placing small electric nets inside the traps, at the base of the cone, so that they intercepted all flies that flew horizontally towards the cone part of the trap. [These behavioural studies were also conducted with the Nzi and B3/B4 traps, the results of which are summarized in Kappmeier (in press)].

4.3.3 Odour baits

All treatments under comparison were baited either with the Zim-mix or the best SA blend as described in Chapter 2.2.2. The bait was placed about 20 cm away from the traps at ground level on the downwind side of sticky traps or in front of the downwind entrance of cloth traps.

4.3.4 Experimental design and analyses

All comparisons of traps as well as the efficiency and behavioural response tests with electric nets were tested by means of Latin squares. The comparisons of the traps and modifications were conducted over a 24-hour period, after which they were rotated between sites according to the Latin square design. The comparisons of trap efficiencies and trap-orientated behaviour of the flies, were determined from data collected from 10:00 until dark, the period of maximum activity of both species (Kappmeier 2000).

All data were analyzed, where numbers were adequate, by means of a statistical program for Latin squares, the details given in Chapter 2.3. Male and female catches were analyzed separately for *G. brevipalpis*, but numbers were usually too low for *G. austeni* to justify separate analyses according to the sex. Further details are given below in Experiments and Results.

4.4 EXPERIMENTS AND RESULTS

4.4.1 Sticky traps

Tables 4.1 and 4.2 are summaries of the results of the experiments on the various colours and types of sticky traps tested for *G. brevipalpis* and *G. austeni* baited with the Zim-mix. Where catches were too low for separate analyses of the sexes, the pooled total catches are reported on. The overall trap catch of each treatment is given as an index of increase relative to the control treatment. The detransformed mean catch of the control treatment is given in brackets. Treatments followed by the same symbol are not significantly different from the control in the same experiment. Table summaries will incorporate the number of replicates (n) for each treatment, the transformed standard errors (s.e.) as well as the levels of probability (P) that the means are different at $P < 0,05$ (*), $P < 0,01$ (**), $P < 0,001$ (***), or not significantly different (n.s.).

In Experiment 1 (Table 4.1) the 3DT, XT and RT traps were each tested in l.blue, white and black. Nine replicates were carried out. For *G. brevipalpis* no significant difference was found between any of the treatments. However, very low numbers of this species were collected. For *G. austeni* the l.blue 3DT (control) was the best trap, which was significantly greater than all the black traps and all the RTs.

In Experiment 2 (Table 4.1) the best traps of Exp. 1 (XT and 3DT) were tested again in l.blue, e.blue and white. (Black was not included due to its lesser performance in the previous experiment, while e.blue was the colour most closely resembling phthalogen blue, the attractive blue part of a target for these species (Kappmeier & Nevill 1999b). Six replicates were carried out. For *G. brevipalpis* and *G. austeni* no significant differences were obtained between any treatments, suggesting the 3-dimensional shapes to be equally effective. White seemed very effective for *G. brevipalpis* but not for *G. austeni*.

Since no differences were obtained between the 3DT and XT and between the colours in experiment 2, the XT was chosen for upgrading due to its practicality for use in the field, consisting only of two panels as opposed to the nine panels of the 3DT. In Experiment 3 (Table 4.1) uni- and bicoloured XTs were tested in combinations of white, e.blue and l.blue, to try to improve on its design. Single coloured monopanels of the same size as one panel of the XT, were included for comparison. Ten replicates were carried out. For both species the e.blue/l.blue XT performed best and was then selected as the trap to use in tsetse distribution surveys, which started in December 1993.

In Experiment 4 the XTs were evaluated with different combinations of colour panels as set out in Table 4.1 to incorporate more uni- and bicoloured traps to try and find a better combination for use in surveys. This time black, which was previously left out, was once again included due to strong settling responses obtained for *G. brevipalpis* and *G. austeni* on black when added to a blue target (Kappmeier & Nevill 1999b). The e.blue/l.blue XT, selected for

Table 4.1 Comparisons of various shapes and colours of sticky traps in four experiments [Indices of increase are given relative to the control treatment (index = 1) in each experiment. Detransformed means of the controls are indicated in brackets. The number of replicates (n), the transformed standard errors (s.e.) and the probability that the means are different at the $P < 0,05$ (*), $P < 0,001$ (***) levels of probability or not significantly different (n.s.) are given]

	Trap	Colour combination	<i>G. brevipalpis</i> totals			<i>G. austeni</i> totals			n					
			Index	P	s.e.	Index	P	s.e.						
Exp. 1	3DT	l.blue	1 (1,113)a	n.s.	0,158	1 (12,466)d	*	0,168	9					
		white	0,594a			0,684d								
		black	0,683a			0,049ab								
	XT	l.blue	0,422a			0,818d								
		white	0,734a			0,447cd								
		black	0,865a			0,112ab								
	RT	l.blue	0,324a			0,142abc								
		white	0,456a			0,144bc								
		black	0,117a			0,013a								
Exp. 2	3DT	l.blue	1 (0,414)a	n.s.	0,142	1 (11,462)a	n.s.	0,150	6					
		e.blue	1,000a			1,124a								
		white	1,565a			0,698a								
	XT	l.blue	0,841a			1,141a								
		e.blue	0,295a			0,858a								
		white	1,973a			0,658a								
Exp. 3	XT	l.blue	1 (0,625)abc	***	0,141	1 (4,760)bc	***	0,202	10					
		e.blue	2,274bc			0,739abc								
		white	0,512ab			0,187ab								
		e.blue/l.blue	2,918c			1,847c								
		l.blue/white	1,336abc			0,951bc								
		e.blue/white	2,770c			1,217bc								
	Mono	l.blue	0,115a			0,499abc								
		e.blue	0,314a			0,557abc								
		white	0,314a			0,046a								
		Exp. 4	XT	l.blue		1,090c	***			0,170	0,790bcd	***	0,166	40
				e.blue		1,165c					1,008cde			
white	0,608a				0,570ab									
black	0,667ab				0,383a									
e.blue/l.blue	1 (4,640)bc				1 (6,629)cde									
e.blue/white	1,114c				1,160def									
e.blue/black	1,080c				1,533f									
l.blue/white	0,687ab				0,729bc									
l.blue/black	1,076c		1,308ef											
white/black	0,937bc		1,203ef											

abcdef Treatments followed by the same symbol are not significantly different

surveys, acted as the control trap. Forty replicates were conducted. For *G. brevipalpis* the e.blue, l.blue, e.blue/white, e.blue/black and l.blue/black XTs all caught better than the control, but this was not significant. For *G. austeni* the e.blue/black XT was significantly better than the control (e.blue/l.blue) XT and increased the catches by *c.* 1,5 times. The e.blue/black XT therefore replaced the e.blue/l.blue XT in surveys conducted from May 1995 onwards.

The next experiment (Table 4.2) attempted to improve on the recommended XT of the previous experiment (i.e. e.blue/black XT) by finding an optimal size, or to simplify it by using a bicoloured monopanel (single panel of the XT), making it more practical to use in the field. Three sizes of the XT and monopanel were tested, namely one panel measuring 70 x 60 cm (as original XT panel size); 95 x 80 cm and 120 x 100 cm. Monopanel consisted of a single XT panel, measuring the same sizes as given for the XT above. Two types of bicoloured monopanel were tested. In the first, referred to as Mono I, each side of the panel was painted both e.blue and black (split vertically in the centre). In the second, referred to as Mono II, one side of the panel was e.blue and the other side black.

For *G. brevipalpis* the larger monopanel (i.e. 95 x 80 cm and 120 x 100 cm) were all equally effective as the control XT (70 x 60 cm). It was also shown for both sexes that the larger the trap the better its performance. This was especially the case for females, where previously the small-sized XT was ineffective, the bigger size would capture 2,4 – 4,2 x more. For *G. austeni* males and females the bigger sized Mono I panels (95 x 80 cm and 120 x 100 cm) were mostly significantly better than the control XT (especially for females). Similarly as for *G. brevipalpis*, an increased size of the control XT meant better performance for both sexes (especially for females).

The results for both species, therefore, suggested that a single Mono I (or Mono II for *G. brevipalpis*) panel of a larger size, which would be more practical to handle in the field and cheaper to make, could replace the XT used in distribution surveys.

Table 4.2 Comparisons of e.blue/black 3-dimensional XTs with 2-dimensional Monopanel traps of various sizes [Indices of increase are given relative to the control treatment (index = 1) in each experiment. Detransformed means of the controls are indicated in brackets. The number of replicates (*n*), the transformed standard errors (s.e.) and the probability that the means are different at the $P < 0,01$ (**) and $P < 0,001$ (***) levels of probability are given]

Species	Trap type	Size	Males			Females			<i>n</i>
			Index	<i>P</i>	s.e.	Index	<i>P</i>	s.e.	
<i>G. brevipalpis</i>	XT	70 x 60	1 (3,527)b	***	0,173	1 (0,655)abc	**	0,157	27
		95 x 80	1,435b			2,443cd			
		120 x 100	2,886c			4,246d			
	Mono I	70 x 60	0,347a			0,663ab			
		95 x 80	1,018b			1,641abc			
		120 x 100	1,178b			1,904bc			
	Mono II	70 x 60	0,430a			0,522a			
		95 x 80	1,232b			1,148abc			
		120 x 100	1,121b			1,321abc			
<i>G. austeni</i>	XT	70 x 60	1 (1,873)ab	***	0,105	1 (1,989)ab	***	0,165	27
		95 x 80	3,649d			5,884d			
		120 x 100	4,266d			10,595e			
	Mono I	70 x 60	0,820ab			1,338b			
		95 x 80	1,556bc			2,989c			
		120 x 100	1,954c			4,107cd			
	Mono II	70 x 60	0,442a			0,528a			
		95 x 80	1,009ab			2,708c			
		120 x 100	0,656a			1,165ab			

abcde Treatments followed by the same symbol are not significantly different

Estimates of trap efficiency

The efficiencies of the e.blue/l.blue and e.blue/black XTs were evaluated. Catches with and without a flanking net next to the trap for ten replicates were pooled. Trap efficiency is expressed as the proportion of flies of the pooled catch that were actually caught on the XTs (without flanking net) expressed as the percentage of flies that were caught by the traps with flanking nets (i.e. trap plus net). The overall trap efficiency of the e.blue/l.blue XT was 23 % for *G. brevipalpis* (33 % for males and 0 % for females) and 28 % for *G. austeni* (39 % for males and 24 % for females). The overall efficiency of the e.blue/black XT was 16 % for *G. brevipalpis* (22 % males, 2 % females) and 51 % for *G. austeni* (males 48 % and females 54 %). The low efficiencies of

the XTs for *G. brevipalpis* females explains the low catches obtained during preceding experiments.

4.4.2 Cloth traps

Results of the full series of Latin squares and comparisons with other designs and trap modifications are not given here. Apart from the H trap and its modifications, only a few traps and modifications, as described above, were worthwhile which included the Nzi, Nzi3 and B1-5 traps (Kappmeier, in press). Results, given below, are a summary of the work comparing only the H trap modifications and trap orientated behaviour around these modifications, which lead to the final design. Results of the final experiment comparing the H4 and H5 modifications with the Nzi, B4 and B5 traps are given.

Evaluation of initial H trap designs (H1 – H3)

It was observed with the prototype H trap that the flies tended to collect at the upper base corners of the cones (where they connect with the trap body). The prototype was then modified so that the H1, H2 and H3 modifications were developed as described earlier. The results of the H1-H3 modifications were originally compared with those of the Siamese trap, which acted as the control. All the results of the former were significantly ($p < 0,01$) better than those of the Siamese (i.e. 3,2 - 4,2 x for the total number of *G. brevipalpis* caught and at least 6,7 x for *G. austeni*). The H3 modification also consistently gave the best results when compared further with other promising traps, namely the XT, Nzi, Nzi3 and B3 traps (Kappmeier, in press) where it was found that the H3 caught twice as many *G. brevipalpis* as both the B3 and XT, and about three times more than the Nzi. The H3 caught significantly three times more *G. austeni* than the XT, while the remaining traps were ineffective for this species. The H3 caught mean daily catches of 12,0 *G. brevipalpis* (63 % females; 25 replicates), when baited with the Zimbabwe ox-odour blend, and was even more successful when baited with the best SA blend with mean daily numbers of 45,1 *G. brevipalpis* (64 % females; 12 replicates). The mean daily catches for *G. austeni* were 3,0 (82 % females, 25 replicates) when baited with

the Zimbabwe blend and 9,7 (64 % females; 12 replicates) when baited with the best SA blend. For *G. brevipalpis* the record catch in one day by an H3 trap was 76 flies and for *G. austeni* 37 flies.

Trap-orientated responses of tsetse in and around the H3 modification

In order to improve on the H3 design, the behavioural or trap-orientated responses of *G. brevipalpis* and *G. austeni* (Table 4.3 a & b) were determined by means of electric nets placed in and around the H3 trap, following the methods of Vale (1982a, 1982b). [Simultaneously this was done with the B3, B4 and Nzi traps, the results of which are given in Kappmeier (in press).] Only 16,8 % of the *G. brevipalpis* (total catches) that were initially attracted to the H3 trap actually attempted to enter them (Table 4.3 a). The lateral upward-sloping/diagonal cones were quite effective in inducing horizontally-directed flight responses, especially for *G. brevipalpis* for which it was found that all flies that found the entrances of the trap, thereafter flew in a horizontal direction and were captured. For *G. austeni* (Table 4.3 b) only 28,3 % of the flies that found the entrances flew towards the cones. Only four replicates (*n*) of this experiment were carried out. The statistical *P* and s.e. values are given in the Tables.

Table 4.3 Behavioural responses of a) *G. brevipalpis* and b) *G. austeni* in and around the H3, H4 and H5 trap modifications as determined with electric nets [The results are expressed as a percentage relative to the mean daily number of the flies attracted to the traps (indicated as 100 %). The detransformed mean number of flies that were attracted are given in brackets for the control treatment. The number of replicates (*n*), the transformed standard errors (s.e.) and the probability (*P*) that the means are different or not significantly different (n.s.) are given.]

a) *G. brevipalpis*

Trap type and treatment	Males		Females		Totals	
H3						<i>P</i> < 0,001
Flies attracted	100 (26,308)	<i>P</i> < 0,001	100 (27,112)	<i>P</i> < 0,01	100 (54,422)	s.e.= 0,066
Entrance response	18,4	s.e.= 0,055	15,8	s.e.= 0,098	16,8	<i>n</i> = 4
Sideways flight response	22,2	<i>n</i> = 4	16,2	<i>n</i> = 4	19,2 (100 % of tsetse that entered)	
Eventually caught (efficiency)	34,9		42,4		38,2	
H4						
Flies attracted	100 (15,827)	<i>P</i> < 0,001	100 (12,856)	<i>P</i> > 0,05 n.s.	100 (29,360)	<i>P</i> < 0,01
Entrance response	60,3	s.e.= 0,529	61,3	s.e.= 0,071	62,6	s.e.= 0,057
Sideways flight response	44,7	<i>n</i> = 14	56,5	<i>n</i> = 14	50,0 (79,9 % of tsetse that entered)	<i>n</i> = 14
Eventually caught (efficiency)	37,7		59,7		47,9	
H5						
Flies attracted	100 (30,299)	<i>P</i> < 0,001	100 (21,264)	<i>P</i> < 0,001	100 (51,870)	<i>P</i> < 0,001
Entrance response	49,5	s.e.= 0,070	54,4	s.e.= 0,069	51,6	s.e.= 0,068
Sideways flight response	19,7	<i>n</i> = 12	24,0	<i>n</i> = 12	21,9 (42,4 % of tsetse that entered)	<i>n</i> = 12
Eventually caught (efficiency)	30,5		32,6		31,9	

Table 4.3 (Cont.)

 b) *G. austeni*

Trap type and treatment	Males		Females		Totals	
H3						
Flies attracted	100 (8,836)	$P = 0,05$	100 (16,855)	$P < 0,01$	100 (26,964)	$P < 0,05$
Entrance response	36,5	s.e.= 0,140	20,3	s.e.= 0,1031	27,2	s.e.= 0,131
Sideways flight response	8,8	$n = 4$	5,9	$n = 4$	7,7 (28,3 % of tsetse that entered)	$n = 4$
Eventually caught (efficiency)	29,4		45,9		38,4	
H4						
Flies attracted	100 (6,920)	$P > 0,05$ n.s.	100 (14,983)	$P < 0,05$	100 (23,624)	$P > 0,05$ n.s.
Entrance response	57,8	s.e.= 0,148	43,6	s.e.= 0,110	44,4	s.e.= 0,122
Sideways flight response	58,8	$n = 8$	45,3	$n = 8$	44,3 (99,8 % of tsetse that entered)	$n = 8$
Eventually caught (efficiency)	31,6		26,9		29,0	
H5						
Flies attracted	100 (4,002)	$P > 0,05$ n.s.	100 (12,173)	$P < 0,01$	100 (16,819)	$P < 0,01$
Entrance response	60,1	s.e.= 0,105	66,6	s.e.= 0,077	69,4	s.e.= 0,0653
Sideways flight response	63,2	$n = 8$	33,8	$n = 8$	42,5 (61,2 % of tsetse that entered)	$n = 8$
Eventually caught (efficiency)	43,1		36,0		37,6	

Evaluation of H4 and H5 modifications

The H4 trap was a modification of the H3, and took into account its shortcomings as determined with electric nets. It, therefore, had bigger entrances (65 x 45 cm) and thus a slightly bigger body (125 x 65 x 65 cm) than the H3 to improve on the entrance responses of the flies. The H4 trap was further modified by providing it with somewhat larger cones to become the H5. The lower (bottom) side of each cone was at less of an acute angle (lower slope) to the body of the trap than the previous two modifications. This change was aimed at preventing flies from flying against the lower side and then bouncing off (especially in the case of the bigger *G. brevipalpis*), so that it was easier to progress to the trap collecting device.

The results for *G. brevipalpis* males, females and total catches and for *G. austeni* total catches as obtained with the H4 and H5 traps are compared in Table 4.4 with the B4 and B5 modifications (from Kappmeier, in press) and the Nzi. The results are given as indices of increase relative to the Nzi (with index = 1). The detransformed means of the catches obtained by the Nzi are given in brackets. Treatments' indices (for total catches) followed by the same symbols (a,b or c) are not significantly different.

The results showed the Nzi trap to be relatively effective for *G. brevipalpis* and although the H4 and H5 were better than the Nzi, this was not significant. The Nzi was poor for capturing *G. austeni* and the H4 and H5 increased catches significantly by c. 3,0 – 4,1 times respectively compared to the catches obtained with the Nzi. The larger cones of the H5 (compared to the H4) had no effect on the number of flies of either species captured. The mean daily catch for *G. brevipalpis* was 15,7 (69,5 % females) with the H4 trap and 16,9 (70,8 % females) with the H5 trap (28 replicates). For *G. austeni* the mean daily catch was 5,7 (99,0 % females) with the H4 trap and slightly better at 7,6 with the H5 trap (14 replicates).

Table 4.4 Final comparisons of the H4 and H5 modifications with the B4, B5 and Nzi traps [The results are expressed as the indices of increase relative to the Nzi trap (index = 1). The detransformed means of the Nzi are given in brackets. The number of replicates (n), the transformed standard errors (s.e.) and the probability (P) that the means are different are given]

Trap type	<i>G. brevipalpis</i>			<i>G. austeni</i>		
	Males	Females	Totals	Males	Females	Totals
Nzi	1,000ab (4,228)	1,000bc (9,610)	1,000bc (13,673)	1,000ab (1,379)		
B4	0,668a $P < 0,05$	0,554a $P < 0,05$	0,569a $P < 0,05$	0,685a $P < 0,001$		
B5	0,919ab s.e.=0,154	0,768ab s.e.=0,146	0,804ab s.e.=0,137	2,622bc s.e.=0,177		
H4	1,235b $n = 28$	1,132bc $n = 28$	1,145bc $n = 28$	4,102c $n = 14$		
H5	1,170b	1,245c	1,236c	5,487c		

abc Treatments' indices followed by the same symbol are not significantly different from each other

Trap-orientated responses of tsetse in and around the H4 and H5 modifications

The behavioural or trap-orientated responses of tsetse flies in and around the H4 and H5 traps were tested in a final attempt to confirm whether the modifications of the H3 that were made were worthwhile, and also to make a final decision as to which of the modifications should be employed for future use. The results are given in Table 4.3 a and b for *G. brevipalpis* and *G. austeni* respectively. The number of replicates performed is indicated in the Tables. The various responses and trap efficiencies are given as a percentage relative to the mean daily number of flies that were attracted to the traps (detransformed means of the control trap are given in brackets). The statistical P and s.e. values and the numbers of replicates (n) are given in the Table.

For *G. brevipalpis* it was clear that the bigger entrances of the H4 and H5 modifications were an advantage in that more flies (51,6-62,6 %) attempted to enter these traps than the number entering the H3 (16,8 %). On the other hand, all flies that entered the H3 trap flew in a horizontal direction to the cones,

while only 42,4 - 79,9 % of the flies entering the H5 and H4 traps respectively, flew horizontally. It may, therefore, be suggested that because of the bigger entrances, more flies could fly directly out of the trap again, i.e. fewer of them advanced towards the cones. Nevertheless, the overall efficiency of the H4 trap was still better than the H3 (47,9 % versus 38,2 %). The efficiency of the H5 (with larger cones) was lower (31,9 %) than the previous modifications which might indicate that the flies get disorientated towards the apex of the cones and fewer of them enter the collecting device.

For *G. austeni* the efficiencies of the H4 and H5 traps were determined respectively at 29,0 % and 37,6 %. For this species the bigger entrances of the H4 and H5 traps also prompted more flies to enter the traps (44,4 - 69,4 %) compared to the number of those entering the H3 (27,2 %). Between 61 % and nearly 100 % of the flies that entered the H4 and H5 traps also flew horizontally towards the cones, indicating that, unlike *G. brevipalpis*, they do not often immediately fly out, but, as was observed, tend to “linger” once at the entrance to or inside a trap.

The final design

In accordance with the trap-orientated responses, the final H trap design incorporated entrances of the same size as those of the H4 and H5 traps but the cone sizes were in-between those of the H4 and H5 traps. Further comparisons between the H4 and H5 and the final design were not conducted. This final H trap design (Fig. 4.3) caught a record catch of 180 *G. brevipalpis* and 57 *G. austeni* in one day. A schematic representation of the final design is given in Fig. 4.3 with material measurements and construction procedures. The same method of erection, i.e. with the use of poles, is employed as was described previously and as indicated in the Figures.



Fig. 4.3 Photograph of the final H trap design for the capture of *G. brevivalpis* and *G. austeni* (the trap is held upright by fastening the corners to four rigid metal poles (1,2 m long) and the cones are suspended from two flexible steel rods (1,4 m long))

Final H

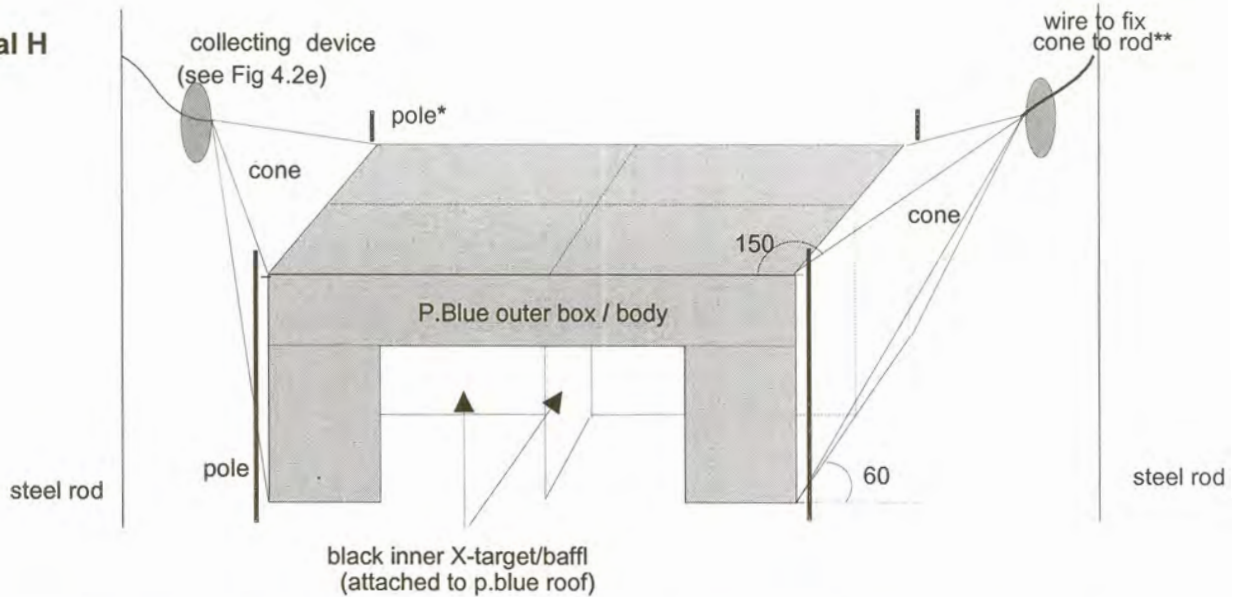

- * To erect the trap each corner of the trap is attached with string to a pole driven into the ground
- **To keep the cones rigid they are attached with wire at the apex to tops of flexible steel rods

Material requirements (measurements in cm) and steps necessary for making:

P.blue outer box / body:

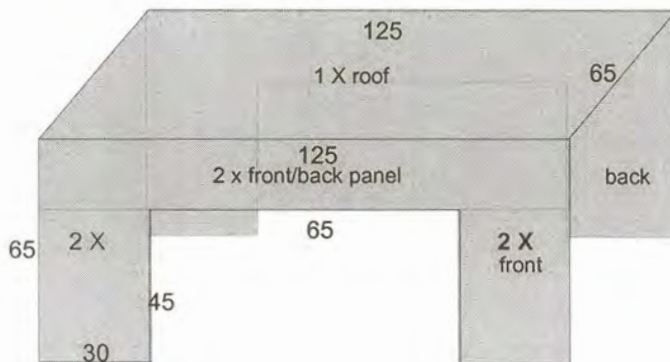

1. Sew the three blue pieces together (along the 125 cm sides) with roof panel between front and back panels

Black inner X-target:

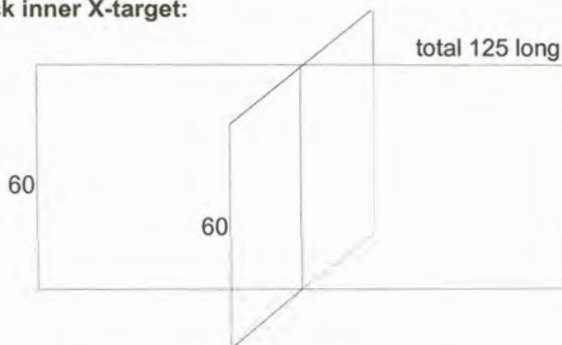

2. Sew black target/baffle pieces together (as indicated) and attach target to centre of blue roof (indicated with broken lines in drawing of final H trap)

Net cone (x 2):

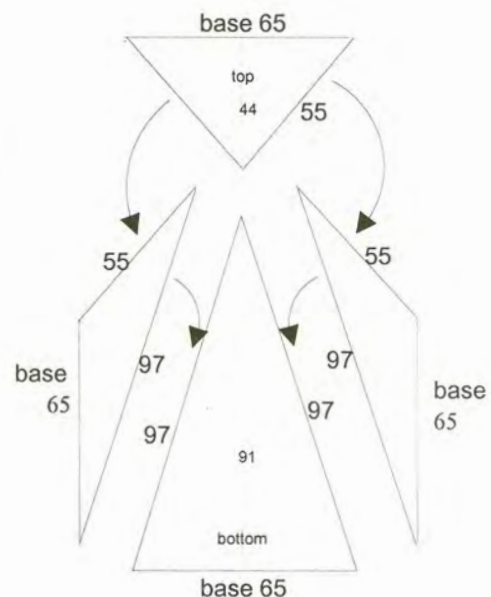

3. Sew pieces of netting together (as indicated) and then attach completed cone's top and side base to sides of blue outer box at the cones' positions
4. Cut apex of cone open to size of circumference of collecting system's base bottle (see Fig 4.2e) and attach reinforcing seam to prevent netting from tearing

Fig. 4.4 Diagrammatic representation of the final H trap with details of materials and measurements for trap construction

4.5 DISCUSSION

4.5.1 Sticky traps

Effect of colour and shape

For *G. brevipalpis* l.blue, white and black traps showed no significant difference in the catches during initial studies of the 3DT, XT and RT sticky traps. For *G. austeni*, l.blue and white were significantly better than black in initial studies with these traps. Later studies with the XT showed l.blue and e.blue to be superior over black and white traps for both species. Sticky traps tested concurrently by Vreysen *et al.* (1996) for the monitoring of *G. austeni* in Zanzibar showed, however, that sky blue, baby blue and white monopanel (MP) showed no significant difference in the catch size.

The 3-dimensional shapes of the 3DT and XT were more or less equally effective for *G. austeni* and *G. brevipalpis* and significantly more attractive than the RT for *G. austeni*. The main advantage from the 3-dimensional traps over the RT seems to be that the trap is visible from all directions all of the time and this could account, together with the bigger surface area, for the higher catches. The XT was chosen for further upgrading, being more practical to make and use in the field. Initial experiments showed that bicoloured XTs of white were less effective than single coloured e.blue and l.blue traps for both species. For *G. brevipalpis* single e.blue trap was very effective, together with an e.blue/white and e.blue/l.blue, the latter which was most effective. These bicoloured traps were also most effective for *G. austeni* of which the e.blue/l.blue XT was also best for this species. Early studies of Vreysen *et al.* (1996) showed that the only occasion where a combination of colours significantly affected the catch rate of *G. austeni* in Zanzibar, was with legpanels (LP) coloured white on one panel side and sky blue on the other side. In this study, however, l.blue/white XTs were the most ineffective bicoloured traps for *G. austeni* and also for *G. brevipalpis*.

From December 1993 the e.blue/l.blue, due to its best performance for both species, used to survey the distribution of the two species in Zululand (Nevill *et al.* 1995). More tests with single and bicoloured XTs showed e.blue XTs to be as effective as the e.blue/black XT for both species while a black (and white) XTs was very ineffective for *G. austeni*. This corresponds with previous studies on cloth targets where phthalogen blue (e.blue is the closest resemblance of phthalogen blue) was also attractive for both species but black was very unattractive for *G. austeni* (Kappmeier & Nevill 1999b). Low trap catches of *G. austeni* were also obtained with single coloured black XTs on Unguja Island (Vreysen *et al.* 1998).

For *G. austeni* only the bicoloured e.blue/black XT was significantly better than the e.blue/l.blue XT and increased catches by 1,5 times, while e.blue/white, white/black and l.blue black bicoloured XTs were also relatively effective. For *G. brevipalpis* the e.blue/black XT was also, together with e.blue/white and l.blue/ black XTs, found to be more or less equally effective to the l.blue/e.blue XT for *G. brevipalpis*. For this reason the e.blue/l.blue XTs used in surveys were replaced by the e.blue/black XTs from May 1995 (Nevill 1997; Nevill *et al.* 1999). Phthalogen blue/black cloth target combinations were also most effective for the two species (Kappmeier & Nevill 1999b). Targets designed in blue/black combinations are also highly attractive for *G. morsitans* and *G. palpalis* species (Green 1993; Vale 1993; Merot & Filledier 1985; Laveissiere *et al.* 1987 cited in Vreysen *et al.* 1998). For *G. austeni* in Zanzibar poor catch results were obtained when black was combined with royal blue both as XT and XLP (cross-shaped legpanel) while royal blue/white XTs were more effective (Vreysen *et al.* 1998). Vreysen *et al.* (1998) ascribed the possible difference in the two *G. austeni* populations' behaviour to the genetic variations between the two populations or in differences of the spectral reflectance of the paint material used.

Trap efficiencies

The efficiencies of the e.blue/l.blue and e.blue/black were relatively high 33 - 39 % for *G. brevipalpis* males and very low for females (0 - 2 %). The low

efficiency for females could probably be ascribed to the relatively small size of the trap, in that catches of females increased with the bigger sized traps, as will be explained below. For *G. austeni* the traps were similarly effective for both sexes, i.e. 28 - 51 % for males and 24 - 54 % for females.

Effect of size of XT and monopanel

For *G. brevipalpis* the catches of both sexes increased as the size of the XTs and Monopanel increased although this was not always significant. Where previously the standard sized (70 x 60 cm) XT was ineffective for females, the bigger sizes increased catches of females 2,4 - 4,2 x. The larger monopanel (95 x 80 cm and 120 x 100 cm), i.e. Mono I (e.blue/black painted on both sides) and Mono II (e.blue painted one side and black on the other side) were equally effective as the standard XT. For *G. austeni* males and females an increase in the catches was related to an increase in the size of the trap. This was especially so with the XT where the bigger sized XTs increased the catches significantly by 3,6 - 4,3 x for males and 5,9 - 10,6 x for females. The bigger sizes of Mono I also improved the catches compared to the original sized XT by 1,6 - 1,9 x for males and 3,0 - 4,1 x for females, which was significant for females. Increased catches of these species were also obtained with an increase in the size of cloth targets (Kappmeier & Nevill 1999b). Vreysen *et al.* (1998) found an increase in the width of a blue XT (from 70 - 120 cm) doubled the catch of *G. austeni* in Zanzibar as compared to a standard sized blue XT.

Because larger sizes of e.blue/black monopanel of (Mono I) proved to be equally or even more effective than the XT for both species, it could therefore in future surveys be used instead of the XT. These would be cheaper in terms of construction material, paint, sticky material and kerosene for removal of sticky material. They are also lighter and easier to manipulate in the field, especially in densely forested areas.

4.5.2 Cloth traps

Following the improvements of the XT sticky trap, the H trap was developed and described for the monitoring and live collection of *G. brevipalpis* and *G. austeni*. It was designed after evaluating the behaviour of *G. brevipalpis* and *G. austeni* in and around Ngu (Ng2f) and Siamese (B) traps (Brightwell *et al.* 1987; Kyorku *et al.* 1993) in which it was shown that the two species were reluctant to fly upwards towards the cones (Kappmeier, in press). The H trap was, therefore, designed to do away with a top cone system, so that a totally different approach was employed, namely that of a trap fitted with two lateral devices (cones). This approach made use of the flies' preference to fly in a horizontal instead of a vertical flight path which is required in existing tsetse fly traps. The angled cones of the final trap incorporated an element of the ramp trap principle used extensively by mosquito ecologists (Service 1976).

This new H trap design proved to be effective, when baited with synthetic odour, in catching *G. brevipalpis*, since it is known that this species is attracted by colour and odour (Kappmeier & Nevill 1999a, 1999b). It was, however, not as efficient in capturing *G. austeni*, probably because *G. austeni* is not attracted by the odours (Kappmeier & Nevill 1999a) although it responds strongly to colour (Kappmeier & Nevill 1999b). It may be that the odour does influence short-range trap entering behaviour (Vale & Hall 1985a) of *G. austeni*. The final version of the "horizontal" or H trap was developed after testing five modifications of the original prototype.

Some of the H trap modifications increased the sizes of the catches when compared to those of the XT sticky trap by up to 1,4 times (not significant) for *G. brevipalpis* and by up to 2,4 times (significantly) for *G. austeni* (Kappmeier, in press). The advantage of the H trap over the XT sticky trap, used in tsetse distribution surveys (Nevill 1997), is that flies are captured alive and can thus be used for studies on population dynamics. It can also be used for the automatic treatment of wild-caught flies with a variety of agents ranging from entomopathogenic fungi (Kaaya *et al.* 1991) to insect growth regulators (Hargrove & Langley 1990; Langley 1995, 1999).

Highest catches with the final H trap were 57 *G. austeni* and 180 *G. brevipalpis* in one day. Compared to the previous best live trap catches at Hellsgate with the Ng2f and Siamese traps, this new trap is a definite improvement. Although the Nzi also performs relatively well for capturing *G. brevipalpis*, the H trap is still better and it is significantly better for *G. austeni*. There is no doubt still room for improving the H trap, especially as far as *G. austeni* is concerned. The horizontally situated cones are, however, a major step forward for capturing both *G. brevipalpis* and *G. austeni* alive and facilitates studies, which require the use of live wild-caught *G. austeni* and *G. brevipalpis*. The H trap is certainly an advance for the trapping of these two previously “difficult” species of flies.

5. POPULATION DISPERSAL AND MOVEMENT

5.1 ABSTRACT

Mark-release-recapture studies were undertaken at Hellsgate Tsetse Research Station to determine the population density and dispersal rates of *Glossina brevipalpis* and *G. austeni* in order to estimate target densities suitable to control these species. The recommended target density, based on the assumption of killing 4 % of the female populations per day, was estimated first at nine and ten targets per square kilometer for *G. brevipalpis* and *G. austeni* females, respectively, but was then reconsidered and adjusted to four and seven targets/km² for the two species respectively. *Glossina brevipalpis* was by far the more mobile species while *G. austeni* appeared to be more static. The movement of flies over open areas of vleis and grassland was also investigated to determine their value as natural barriers in a strategy to protect controlled areas from reinvasion. From the results it is evident that both species do, to a certain extent, traverse open areas of “unsuitable” habitat.

5.2 INTRODUCTION

In 1990 a serious outbreak of nagana in N.E. KwaZulu-Natal Province, South Africa (Kappmeier *et al.* 1998), precipitated a need to develop a long-term control strategy for the two vector species *Glossina austeni* and *G. brevipalpis*. Studies on colour targets (Kappmeier & Nevill 1999b) and odours (Kappmeier & Nevill 1999a) have resulted in the development of an attractive odour-baited target (Kappmeier & Nevill 1999c) which, if treated with a suitable pyrethroid, could be used for the control of the two species in South Africa. No studies have, however, been conducted on the population dynamics of these species.

Rogers & Randolph (1985) pointed out the importance in understanding the population dynamics of tsetse flies in planning all types of tsetse control operations and also to assess tsetse control interventions. A precise knowledge of this subject is particularly important when the operation employs insecticide-treated targets. An optimal strategy in this type of operation would

involve the deployment of the smallest number of targets sufficient to eradicate the tsetse population in any desired time interval or rate of population reduction (Hargrove 1988).

A number of studies have been conducted on the movement or dispersal of tsetse flies as the distances they can travel will affect the success of tsetse control schemes (Leak 1999). For the successful target implementation to control or eradicate *G. brevipalpis* and *G. austeni*, base-line data on their movement and dispersal was, however, needed so that the targets could in future be sited successfully in optimal locations and densities in the field. Such studies would be critical for the planning of any future control operations in South Africa.

5.2.1 Estimates of dispersal rates and population size

The control of tsetse fly populations using traps or targets depends on the movement patterns of the flies, which determines how many flies find the targets, and on the efficiency of the targets, which determines the proportion of flies that are killed (Williams *et al.* 1992). It has been shown that traps or targets, used mainly for control rather than eradication, can reduce tsetse fly densities to acceptably low levels (Vale *et al.* 1988a; Dransfield *et al.* 1990). However, for such ongoing control strategies to be viable they must be cost-effective to livestock-producers in Africa and it is essential to make the most efficient use of targets. In order to reduce tsetse fly populations, targets must therefore kill the flies more rapidly than the flies can reproduce or invade the control area (Williams *et al.* 1992).

For the savannah species *G. m. morsitans*, *G. m. centralis* and *G. pallidipes* it appears that, with the attractive synthetic odours presently available (Vale 1993) a density of about four targets/km² is necessary and sufficient to eradicate a population in nine months to a year (Hargrove 1993). Because of their low natural birth rate, a population can be eradicated by superimposing and sustaining, on the natural death rate, a mortality of 4 % per day on any female tsetse population, for example through the use of targets or traps

(Hargrove 1981; Hargrove 1988). It seems likely that in most field conditions only an added 2–3 % is required (Hargrove 1988), which agrees with Williams *et al.* (1992) who stated that a population can be driven to extinction by imposing only an additional mortality rate greater than 2 % per day. This can easily be achieved with targets (Vale *et al.* 1988a).

Population studies often involve mark-release-recapture programmes, a technique that is potentially more promising by improved sampling devices. It raises the possibility that a high proportion of marked flies could be released into a small area to be recaptured (Hargrove & Vale 1979; Vale *et al.* 1984). Mark-release-recapture methods (Jolly 1965; Seber 1965) can be used to measure mortality for closed populations, but under more natural open conditions it is difficult to separate the effects of mortality and emigration, and the methods are generally complex and time consuming (Hargrove 1990, cited in Hargrove 1993). The recaptures obtained during mark-release-recapture operations, whilst providing an estimate of population size, also give some idea on the nature and extent of fly movement and dispersal (Rogers 1977; Hargrove & Lange 1989).

Many models concerning fly dispersal have been developed over the years by various authors. It was suggested that dispersal in tsetse flies could be viewed as a series of discrete daily steps each taken in a random direction (Bursell 1970). Although movement within a habitat appears to be random, Rogers (1977) assumed it to consist of fairly constant step lengths and that natural factors, e.g. humidity, availability of shade, host density and odour plumes, tend to limit movement to within the habitat and may reduce its randomness. He gave two methods for investigating the outcome of two-dimensional random movement appropriate to tsetse. The first model is a prediction of the mean distance d away from the starting point, assuming a constant step length s (the distance moved per unit time), and a variable number of steps x so that:

$$d \cong sx^{1/2}$$

Applying this to tsetse movement and defining a single step as the distance traversed in one day, Rogers (1977) proposed it is only necessary to know

accurately the mean population displacement over a period of time to calculate a value of s , the mean daily displacement. The second model is based on computer predictions of a series of random movements away from a release point. This involved the probability distributions for directions moved and distances covered per step. Hargrove (cited in Bursell & Taylor 1980) derived a more accurate definition of daily displacement d , based on modelled predictions of a series of random movements away from a release point, as:

$$d \cong 0,9sx^{1/2}$$

The predictions involved the probability distributions for the directions moved, and distances covered per step, but could be simplified by assuming that tsetse only fly for a few minutes per day and have a relatively constant step length. Hargrove (1981) further suggested the step length might vary and probably change with age and physiological stage of the fly. Hargrove & Lange (1989) suggested the 'rate' of dispersal to be simply defined as a diffusion coefficient rather than as a discrete step length. They therefore viewed tsetse dispersal as a diffusion process, with the position of a fly, relative to its origin, as a normally distributed random variable, i.e. the mean distance of a diffusing particle from the origin. Other models have estimated rates of advance of tsetse based on a root-mean-square displacement of 200 metres per day and a population growth rate of 1 % per day (Williams *et al.* 1992). Williams *et al.* (1992) implied that the dispersal of insects could be described by a Gaussian diffusion model with an exponential mortality term. The rate of diffusion (dispersal) was then defined by the root-mean-square displacement in one day (λ). If this is high, tsetse will disperse quickly into the vicinity of traps and there will be a rapid reduction of the population.

Bailey (1951) used simple recapture techniques to determine the maximum likelihood estimate of the population size P based on the number of flies marked and released M , the sample size recaptured N and the number of marked flies R in the sample N so that:

$$P = MN/R$$

However, he suggested that in certain ecological problems it may be more appropriate to use the reciprocal of the population size as the appropriate index, rather than the population size itself, so that:

$$1/P = R/MN$$

To improve the precision of mark-release-recapture technique it would be necessary to increase the expected number of recaptures, by increasing the number of marked flies released or increasing the expected recapture percentage (Vale *et al.* 1984).

In order to control tsetse flies successfully with targets and to ascertain the density of targets needed for the control of the two tsetse species in Zululand, it was necessary to initiate trials to evaluate the movement and dispersal rate of the two tsetse species. A good trap was, therefore, necessary to capture live *G. brevipalpis* and *G. austeni* in large enough numbers. The H trap described in the previous chapter was specifically developed for this purpose. Questions that needed to be answered were: At what rate does each of the species disperse? What is the population density at the research site? At what density should targets be placed in order to kill *c.* 3 - 4 % of the population per day?

The present study involved mark-release-recapture experiments to estimate the population size by determining the probability of recapture and then using the inverse of the population size as a population estimate as suggested by (Bailey 1951). Because the results were based on the degree of trapping efficiency of the H trap and the required levels of population control were based on this, it was essential to relate the results to the required effect to obtain control with targets. The relative performance of the H trap used in this study was, therefore, compared to the recommended control target. The target density required for certain levels of tsetse control based on the results obtained with the H trap could then be assessed.

5.2.2 Estimates of composition of natural barriers

As tsetse flies are relatively mobile, there is a constant reinvasion pressure against areas from which the flies have not been removed or controlled unless these measures are taken up to natural boundaries, or an effective barrier is maintained (Leak 1999).

Several methods of preventing reinvasion have been attempted over the years, often with little long-term success. In early days barriers of bush clearings to prevent reinvasion were used. The distance a fly could travel was, therefore, critical in determining the width for effective clearings. In Zambia, a bush clearing of one kilometer wide was standard for a 'holding line' (Wooff 1968, cited in Leak 1999) while Jackson (1954b, cited in Leak 1999) referred to the use of a 3,2 km wide clearing, which was necessary to stop the passage of flies. In Uganda, much wider clearings, up to 8 km wide, were used for tsetse (Wooff 1968, cited in Leak 1999).

Target barriers to prevent reinvasion or emigration into a controlled area could be used in control campaigns (Williams *et al.* 1992; Hargrove 1993). These barriers normally consist of stationary targets only but could also consist of a combination of stationary and mobile targets (i.e. cattle treated with deltamethrin) (Warnes *et al.* 1999). Use could also be made of natural barriers, e.g. large water masses, which tsetse could not traverse.

Tsetse flies do not normally venture far from trees during their daily activities as they seem to need to rest frequently and they also need cover to prevent exposure during flight. Therefore, it is unlikely that a tsetse fly would set off into a large open area such as an extensive body of water when there was no suitable object in sight to provide the next stopping point or, more important, shade. Barriers that have therefore been identified are higher ground and unsuitable temperature, natural and man-made bodies of water including large rivers, desert sands, natural treeless areas including grassland, flood plain and seasonal or permanent swamps, arid areas, mountains and expanding areas of

human settlement. The critical factor is the width of the particular body of water or natural treeless areas and lack of shade if it is to serve as a barrier to tsetse movement (Lovemore 1996).

In South Africa *G. brevipalpis* and *G. austeni* are confined to riverine, coastal, and low-lying forests and thickets of the N.E. KwaZulu-Natal area. The distribution of the two species is sometimes patchy, especially where forests are patchy and isolated. In this study it was proposed to establish the distance of apparently “unsuitable” habitat between pockets of forests and other suitable habitat. This could indicate whether such situations could in future act as a natural barrier between populations, or between controlled and infested areas. For *G. brevipalpis* it had already been recorded that they could roam out of these forested areas, especially during their times of main activity at dawn and dusk, and at night (Kappmeier 2000). However, it is not known what distance they will cross over these more open areas between forest pockets. For *G. austeni* the experience was that they are restricted to the pockets of suitable habitat, but whether they could cross small sections of unsuitable habitat, perhaps at night, was not known. This study was, therefore, designed to establish the distance that the two species may or may not cross between forest pockets over open areas of vlei and grassland at the Hellsgate research area.

5.3 MATERIALS AND METHODS

5.3.1 Relative efficiency of target vs. H trap

The relative performance (catch) of the H trap, compared to the recommended target, was established at Hellsgate Tsetse Research Station. This was needed because many experiments are done only with targets or only with traps and the question always arises as to how much better the target performs as they are generally more effective than traps. A comparative test was therefore necessary to establish the relative increase of catches obtained by the recommended SA target (Kappmeier & Nevill 1999c) vs. the H trap.

This comparison was also necessary for the present studies on population densities, with mark-release-recapture techniques. When the fly density in an area, and recapture rate of marked flies, are for example determined by traps (which they mostly are), it can be determined what number of traps will be needed per square kilometre to control the population at a certain rate (e.g. between 3 - 4 % female reduction per day). However, when targets are substituted for traps to conduct a control trial, it is necessary to adjust the calculations to determine what target density is required to have the same effect.

The performance of the H trap was compared with the recommended target to be used for control purposes, namely a 1,75 m black/blue/black target (Kappmeier & Nevill 1999b). Eighteen replicates were tested by means of a Latin Square design. The targets were tested by the use of electric grids, as described in Chapter 2. Targets and traps were baited with the best SA blend (see Chapter 2) placed \pm 30 cm downwind of the target or trap. Treatments were operated daily from about 09:00 until dark, and electric grids were supplied with fully charged replacement batteries, halfway during the daily trial to remain effective throughout.

Flies were sexed and recorded, and then analysed statistically. The catches (n) were normalized using a $\log_{10}(n+1)$ transformation and subjected to analysis of variance (Anova), using GLIM4.

5.3.2 Mark-release-recapture trials

Estimates of dispersal rates and population size

Based on the trials that were conducted on *G. pallidipes* and *G. m. morsitans* in Zimbabwe (G.A. Vale, pers. comm., 1998) a mark-release-recapture trial was conducted at Hellsgate. H traps, designed specifically for the purpose of capturing live flies for mark-release-recapture studies, were used. Traps were placed in 'concentric' squares around a central release point, following an example used in Zimbabwe where 'concentric' squares radiated out at 500 m

intervals from the centre and traps were sited 500 m apart to form a grid (G.A. Vale, pers. comm., 1998). However, since nothing was yet known of the dispersal of *G. brevipalpis* and *G. austeni*, a smaller grid lay-out was designed for the present study.

The initial design of the grid was established in a stretch of sand-forest with pockets of dense thickets during August - December 1998. Since the type of vegetation is not optimal for visibility and flight as in a savanna situation, a series of squares was cut through the bush at 'linear' distances of 200, 400 and 600 m from the point of marking and release, which thus became the centre of three 'concentric squares'. The three squares were each marked out with white sisal twine, which made it easier to follow and not lose track in the forest. Traps, on each concentric line, were initially placed at intervals of 400 m, but afterwards changed to 200 m (indicated in Fig. 5.1 Block A) to be sure of results, especially for *G. austeni* (since the feeling was that this species might not disperse very fast).

H traps were set up before commencement of the trial, which started on 13 January 1999. The approximate trap positions are indicated with dots (Fig. 5.1, Block A). One of the two openings of the traps faced the downwind side of the prevailing wind direction.

Marking of flies at the centre was carried out for a total of 24 consecutive days, starting at about 07:00 until 17:30. For this, a set of 10 traps, which were located separately (c. 3 km away) to provide freshly-caught flies, were emptied approximately 2-hourly. Flies were kept cool and dark during transportation to the release site. This was done to ensure that all flies that were released were as fresh and viable as possible with the greatest chance of survival. Each day's mark was coded differently with yellow spots of artist's oil paint, on various positions on the thorax (see Fig. 5.2 a & b), so that recaptures could be tracked back to the day they were released, and so determine the period from release to recapture and distance traveled during that period. Score was kept on the number of males and females of each species that were released each day.

The recapture traps in the grid were numbered 1 - 46 (according to distance from centre) to keep track of the position where flies were recaptured. The 'centre trap' (no. 1) was not placed directly at the marking site but 30 m from the site so that it would not directly interfere with the flies' release. The trap catches were collected daily (early morning during the same time) by a party of two catchers during the 24 days that flies were marked and released and for a further 28 consecutive days until no more marked flies were recaptured (last eight days for *G. brevipalpis* and last four days for *G. austeni*). Thus over the period of the experiment there was more than one daily opportunity to recapture flies marked at a certain day previously. Daily records were kept of the species, sex, total number of unmarked flies for each trap, and the number and code of marked flies for each trap position for that day. This enabled the calculation of dispersal rates and population density for each species and sex.

Dispersal over open areas

In order to determine various distances of open (supposedly unsuitable) habitat, mark-release-recapture trials were conducted. Initially three separate release blocks were used at Hellsgate between September and December 1998, named Block B, C and D where flies were marked on position 10 of the thorax (see Fig. 5.2 b) with blue, red and green artist's oil paint for the three release areas respectively. They were recaptured in H traps placed in certain positions surrounding the release sites and separated by various distances of open areas between the release and recapture sites. Ten independent traps at a separate location provided a daily (early mornings) supply of freshly-caught flies which were transported to one of the release points where they were marked and released.

Fig. 5.1 shows the layout of the positions of the release and recapture sites of Block B (in blue), Block C (in red) and Block D (in green). Each of the release points in the different blocks is indicated with an X and marked B, C and D respectively. The recapture sites of each block in the surrounding areas are marked in the respective block colours, i.e. recapture sites B1-9 in Block B (blue), sites C1-11 in Block C (red) and sites D1-8 in Block D (green). Flies at

Block B were released every second day for 17 days (between 3 Sep. - 2 Nov. 1998) and at block C for 5 days (between 4 Nov. - 16 Nov. 1998). On every alternative second day, flies were released at block D for 21 days (between 9 Sep. - 17 Nov. 1998). The recapture traps were checked every second and alternative second day for each of the blocks, from the time that flies were marked until 17 Dec. 1998. Record was kept of the number of flies released at each block and the number of marked and unmarked flies recaptured at the surrounding traps.

For Blocks B - D results could only be obtained for *G. brevipalpis*, probably due to open areas being too extensive for *G. austeni* to cross. Therefore, a new trial (Block E – indicated in Fig. 5.1 in orange/yellow) was planned, with the release site (indicated with xE) being an isolated small pocket of bush in grassland. This bush was also much closer to other patches of bush, so that the recapture traps were mainly placed within these surrounding patches of bush. The distances between the release site and the ten recapture sites were, therefore, much shorter than in previous trials (B, C and D). The trial started on 16 March 1999. Flies were marked and released until 27 March 1999. The recapture traps were checked during this period on a daily basis, and continued until 9 April 1999.

5.3.3 Odours

All traps and electrified targets in this study were baited with the best SA blend, as described in Chapter 2.

5.3.4 Marking techniques

Marking was done with artist's oil paint (Fig. 5.2 a) on different positions of the thorax (Fig. 5.2 b). For each trial (release points) different colours and coding were used. In the dispersal study (Trial E) positions of the markings were varied so that all flies released on a specific day were differently coded and records could be kept of the time it took a fly to reach a specific trap from the release point.



Fig. 5.1 Copy of airphoto of Ndlozi peninsula, Lake St. Lucia, showing the vegetation of the Hellsgate study area. The positions of various Blocks (A-E) used in mark-release-recapture trials are shown. [Release sites are indicated with x and trapping sites for the recapture of flies are numbered in different colours for each block as described in the text. The straight line distances are indicated between release and recapture sites that were crossed over open grassland and vlei areas, i.e. for *G. brevipalpis* males (green), *G. brevipalpis* females (blue), *G. austeni* males (black) and *G. austeni* females (red). Distances covered in block C are indicated as broken lines. (In Block E only *G. austeni* recaptures are indicated).]



Fig. 5.2 a Yellow artists' oilpaint was used to colour-code flies on positions of thorax as also indicated in Fig 5.2 b.

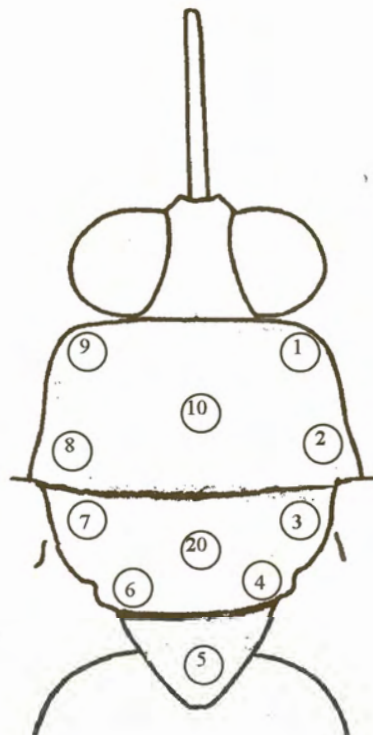

Fig 5.2 b Positions on thorax used for marking (e.g. for position 18, positions 10 + 8 are marked)

5.4 RESULTS

5.4.1 Relative efficiency of target vs. H trap

The results for the experiment, which compared the catches obtained by an H trap to a target, are given in Table 5.1. The results are expressed as an index of increase of the detransformed mean catches of the H trap (index = 1) relative to the mean target catches. Geometric means for the trap catches are given in brackets. The levels of probability (P) that the means are different at $P < 0,01$ (**) or $P < 0,001$ (***) are indicated in the Table as well as the number of replicates (n) for each treatment, the degrees of freedom (df) for error and the transformed standard errors (s.e.).

As expected, the recommended target increased catches significantly compared to the H trap for both *G. brevipalpis* and *G. austeni* males and females. For *G. brevipalpis* the target increased male and female catches, respectively, by *c.* 2,8 and 2,2 times compared to the H trap. For *G. austeni* the target increased catches of males and females by *c.* 33,4 and 6,8 times, respectively. These results can now be applied to determine target densities when making use of the results of a mark-release-recapture trial where H traps instead of targets were used to determine population density (see Table 5.3).

Table 5.1 Indices of increase of the recommended target¹ relative to the H trap [Geometric means of the H trap are given in brackets]

		Indices of increase		n	df	P	\pm s.e.
		H trap	Target ¹				
<i>G. brevipalpis</i>	Males	1 (23,140)	2,811	18	24	***	0,073
	Females	1 (29,690)	2,181	18	24	**	0,064
<i>G. austeni</i>	Males	1 (0,565)	33,445	18	24	***	0,066
	Females	1 (7,196)	6,815	18	24	***	0,053

¹ 1,75 m black/blue/black (50/75/50 cm) target (best SA target)

5.4.2 Mark-release-recapture trials

Estimates of dispersal rates

Table 5.2 is a summary of the total number of each species and sex released at the release site over the 24 mark-and-release days and the total number of flies captured and recaptured at traps number 1 - 46 over the 52 recapture days. The approximate linear distances of each trap (1 - 46) from the centre are also indicated in the Table. Recaptured flies are given as the total number of unmarked and marked flies captured over the period at each trap site. During the period of study a total of 2,683 male and 3,563 female *G. brevipalpis* and 1,518 male and 6,977 female *G. austeni* were marked and released at the centre. A total of 8,627 male and 13,697 female *G. brevipalpis* and 1,984 male and 9,436 female *G. austeni* were caught in the recapture traps (no. 1 - 46). Of these 159 male (1,8 %) and 112 female (0,8 %) *G. brevipalpis* and 21 male (1,1 %) and 291 female (3,1 %) *G. austeni* were marked. Most of the recaptures, 66 male and 29 female *G. brevipalpis* and 25 female *G. austeni*, were made at the 'centre trap' no.1. The direction of fly movement from the release point appeared to be random.

To investigate the movement of tsetse within the block, the recaptures made in the block were separated according to various distances from the centre of the block, at various times after release. Figs. 5.3a-d summarizes, for *G. brevipalpis* and *G. austeni* males and females, respectively, the concentration of flies expressed as the total number of recaptured flies, which dispersed over the various distances from the centre over the various number of days in time. This gives a clear 3-dimensional picture of dispersal rates of the flies.

Table 5.2 Summary of details on the number of flies released and recaptured at the various trap sites – 13 January to 5 March 1999

Total released		<i>G.b</i> males		<i>G.b</i> females		<i>G.a</i> males		<i>G.a</i> females	
		2683		3563		1518		6977	
Total (re)captured		Un-marked		Marked		Un-marked		Marked	
Trap no.	Distance from rel. site	Un-marked	Marked	Un-marked	Marked	Un-marked	Marked	Un-marked	Marked
1	30	241	66	377	29	42	0	254	25
2	200	128	3	213	6	84	2	395	21
3	200	126	7	164	3	50	1	253	6
4	200	111	3	225	2	53	3	276	17
5	200	245	10	277	3	74	0	289	5
6	283	99	6	172	3	73	1	245	10
7	283	136	0	229	8	23	0	120	2
8	283	154	3	237	2	55	1	194	6
9	283	171	4	282	2	45	1	215	11
10	400	160	0	172	0	28	0	180	9
11	400	128	1	241	3	35	0	200	6
12	400	144	0	296	3	43	1	221	4
13	400	184	2	283	2	29	0	120	5
14	447	123	1	248	1	59	0	373	9
15	447	31	1	122	1	18	0	86	4
16	447	69	0	115	1	40	0	127	2
17	447	127	1	222	2	46	0	223	2
18	447	112	3	226	1	26	0	185	8
19	447	353	5	455	1	40	3	234	12
20	447	504	3	788	3	61	2	234	9
21	447	241	1	350	0	25	0	209	4
22	566	78	1	149	0	56	0	376	12
23	566	89	1	153	0	24	0	73	0
24	566	229	3	386	0	49	1	154	6
25	566	711	5	1 088	2	78	0	243	9
26	600	130	2	202	1	59	0	327	6
27	600	55	2	86	0	9	0	31	1
28	600	155	0	279	1	34	0	137	4
29	600	744	1	1 112	4	83	0	364	3
30	632	291	2	563	3	60	0	388	12
31	632	177	4	324	3	15	0	39	2
32	632	79	2	161	1	28	0	88	4
33	632	203	2	295	3	46	0	209	3
34	632	160	1	311	0	54	2	419	15
35	632	219	0	243	0	28	1	135	3
36	632	173	1	267	3	48	0	163	1
37	721	130	2	282	1	59	0	298	3
38	721	72	1	83	1	16	0	35	0
39	721	64	2	112	3	29	0	54	2
40	721	89	2	116	1	42	0	111	2
41	721	169	0	232	3	38	1	260	3
42	721	221	0	357	3	39	1	196	4
43	721	364	2	513	0	42	0	149	10
44	849	94	0	214	2	23	0	48	4
45	849	64	2	172	1	25	0	70	4
46	849	121	1	191	0	30	0	145	1
TOT		8 468	159	13 585	112	1 963	21	9 145	291

The proportions of *G. brevipalpis* males and females recaptured at the traps most distant from the release point, that is recaptured at 600 - 849 m from the centre, increased soon after release. From this it seems that they reached the outer limits (600 - 849 m) of the recapture block within a short time (*c.* 1 - 7 days for males and *c.* 1 - 9 days for females), after which only a very few individual flies were recaptured within the block as time passed. One hypothesis to explain the recapture of *G. brevipalpis* later in the recapture period, is that many of the released flies rapidly diffused out of the area and some of these probably diffused back again later, so appearing in the traps. This is supported by the recapture of marked flies on occasions at the collection traps, placed at linear distances approximately 2,585 m from the centre release point of the block as well as further at two sites, i.e. 3,138 m and 3,310 m away.

For *G. austeni* not many males were recaptured, but the proportions of both males and females recaptured at the most distant traps from the release point, seemed to increase more or less with time. Although some specimens reached the outer limits of the block after only one or a few days, for most flies the distance dispersed depended on time. Some flies also remained close to the release point. It appears that this species dispersed much slower than *G. brevipalpis*. No significant data could be obtained for *G. austeni* males, since the H trap is biased for females and therefore very few males are captured in the first place (note the small number of males marked and released compared to females).

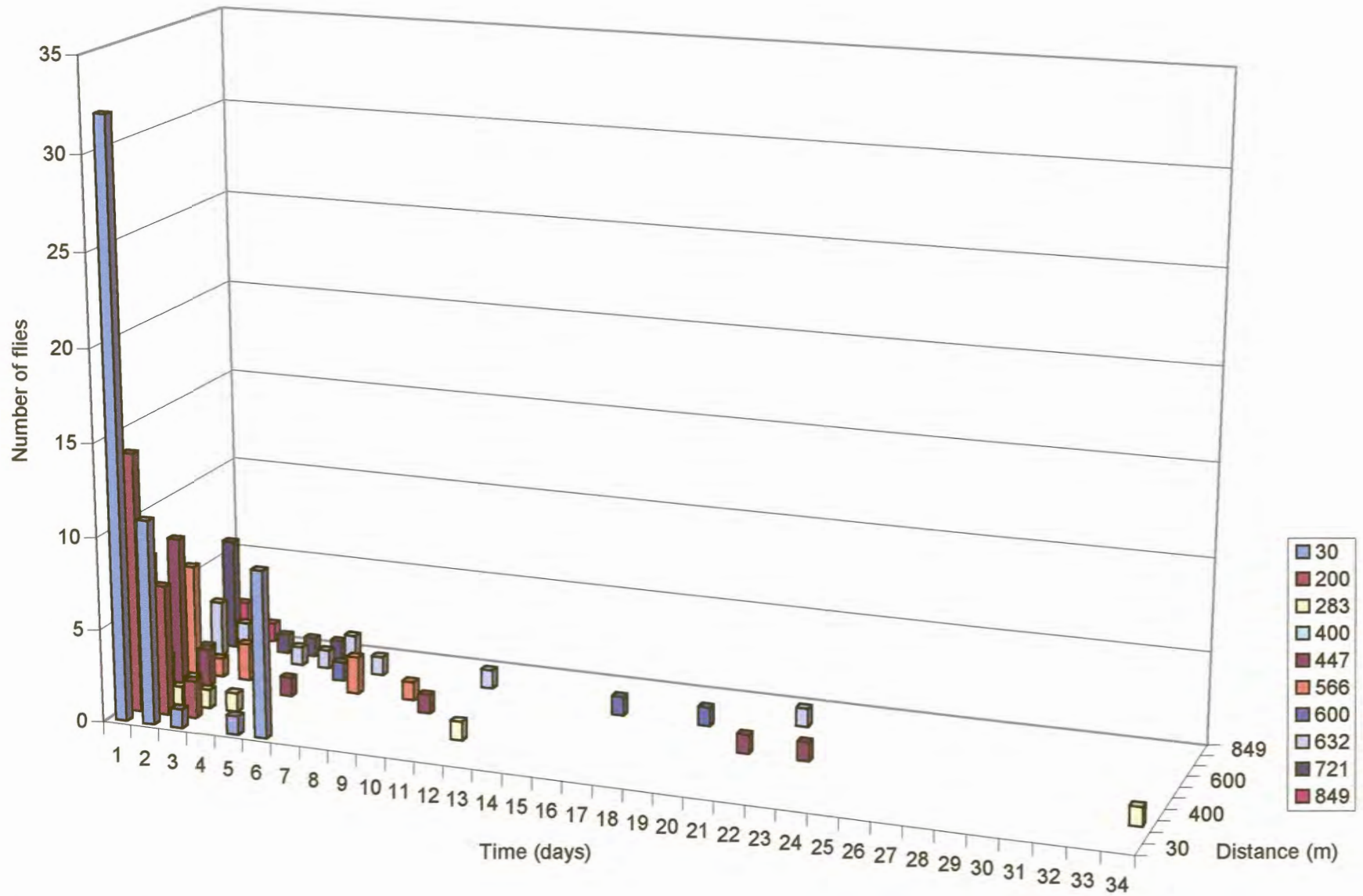
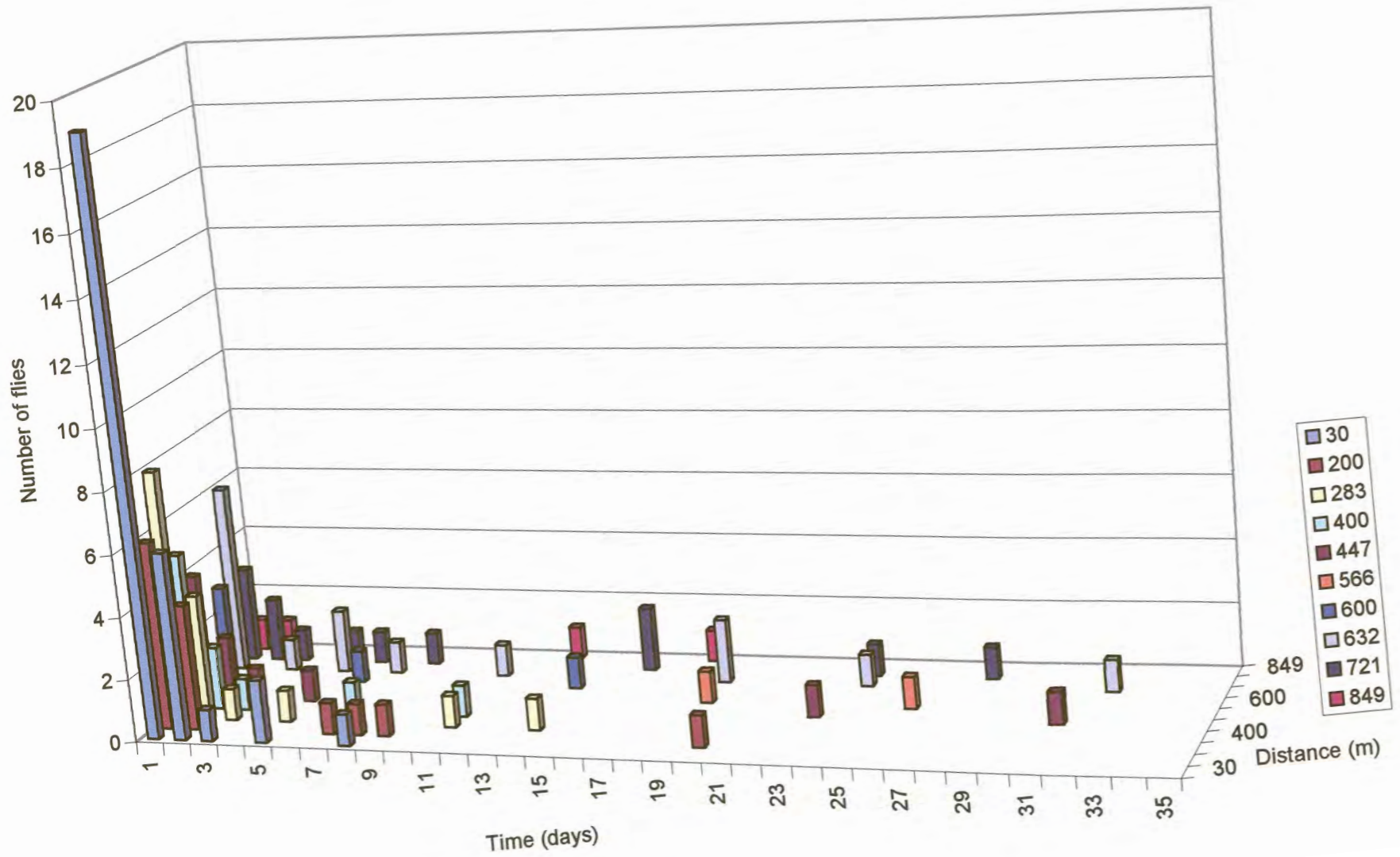

Fig. 5.3 a Summary of the dispersal rates for *G. brevipalpis* males



Population dispersal

Fig. 5.3 b Summary of the dispersal rates for *G. brevipalpis* females

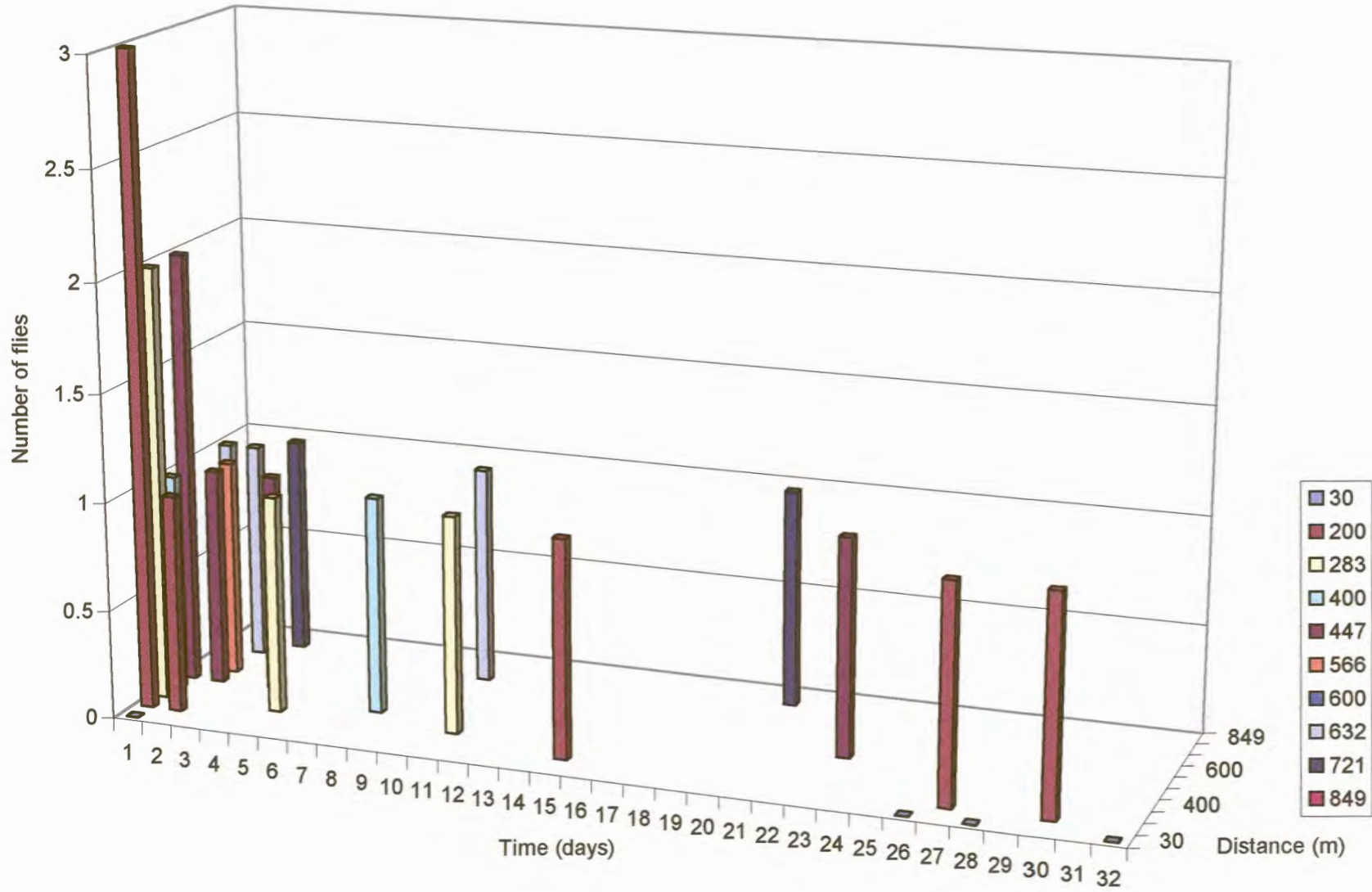
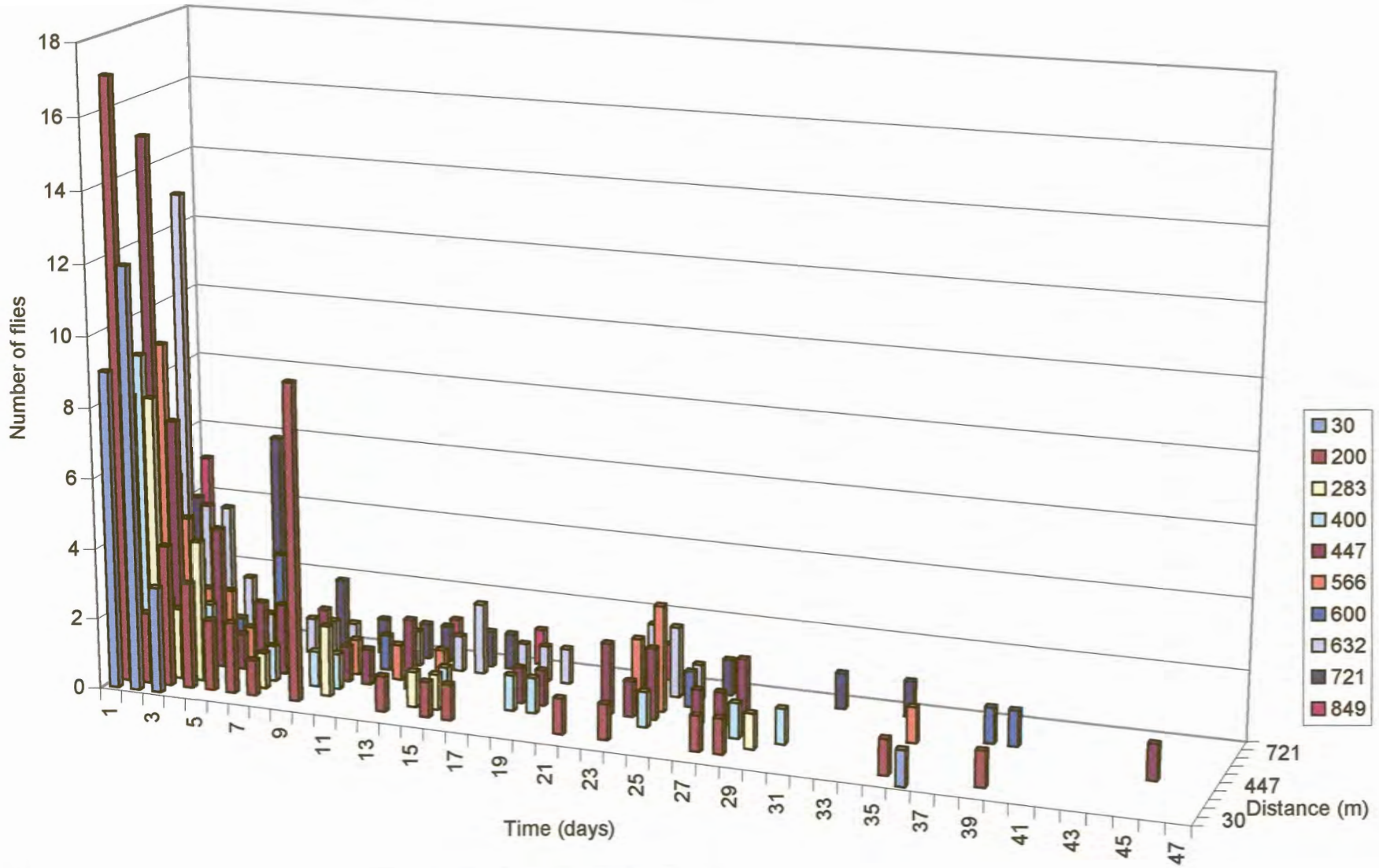

Fig. 5.3 c Summary of dispersal rates for *G. austeni* males



Population dispersal

Fig. 5.3 d Summary of the dispersal rates for *G. austeni* females

For both species it is, therefore, notable that the concentration of recaptures decreased with distance from the release point. Both the distribution of recaptures in the traps and the decrease in concentration with distance suggests that the movement of *G. brevipalpis* and *G. austeni* in this habitat is a simple diffusion from the point of release.

The data for *G. brevipalpis* and *G. austeni* is inappropriate to determine the exact rate of movement, since some flies moved fairly rapidly to the outermost concentric square traps and, presumably, beyond, so that the mean distance moved away from a starting point and the daily step length could not accurately be estimated in this study.

Estimates of population size

Further analyses, done to determine the population size, were based on estimates that were basically made on the way in which the capture probability (in all traps taken jointly) changed with time-since-release (see Fig. 5.4 for *G. brevipalpis* and Fig. 5.5 for *G. austeni*). Steps involved in the procedure are as follows (J.W. Hargrove, pers. comm., 1999):

1. Totals were obtained for marked releases, and unmarked and marked recaptures for each day of the trial.
2. A matrix of recaptures was then formed (using the daily totals as in point 1 above) by columnizing the daily total catches of unmarked flies and the sum of the daily marked and unmarked captures, together with the numbers of flies released on each day. The matrix further summarized the number of recaptures caught during each capture day after release (i.e. time after release).
3. In order to calculate the probability of recapture on each day after release, it was needed to know how many marked flies were released and were available for recapture. In doing this provision was made for the marked flies which were being removed from the population by means of trapping. Another matrix was designed to do this.

4. The population can be estimated by (Bailey 1951):

$$\text{Population} = MN / R$$

where M is the number of marked flies released and N is a random sample of flies taken some short time later, and R will be the sample of marked flies recaptured:

The probability of capture (p) is just the inverse of this and can be estimated by:

$$p = R / MN$$

One can then get estimates, and variances, of the probability as it changes with time after release. If n experiments were conducted and on the i th day there were M_i marked flies from that experiment in the population, a sample can then be taken on day i and in this sample there could be N_i flies, of which R_i were marked. Then as before:

$$p_i = R_i / M_i N_i$$

It can be shown that, if the data from all n experiments are used, the maximum likelihood estimate of p_i is given by:

$$p_i = \sum_{i=1}^{i=n} R_i / M_i N_i \quad \text{Equation 1.}$$

Equation 1 has been used to calculate the capture probabilities.

The probabilities of recapture are given in Fig 5.4 at various days after release for male and female *G. brevipalpis* and in Fig. 5.5 for *G. austeni*.

a) *G. brevivalpis* males

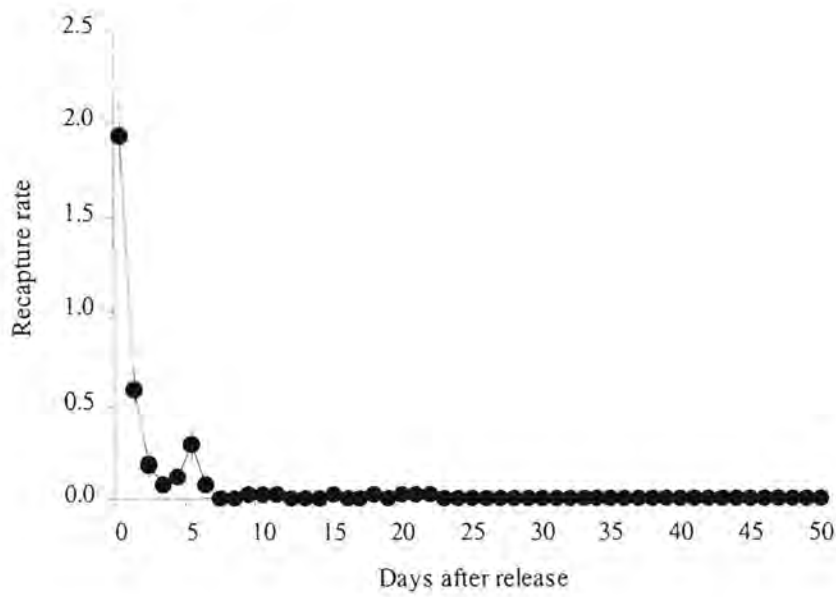

b) *G. brevivalpis* females

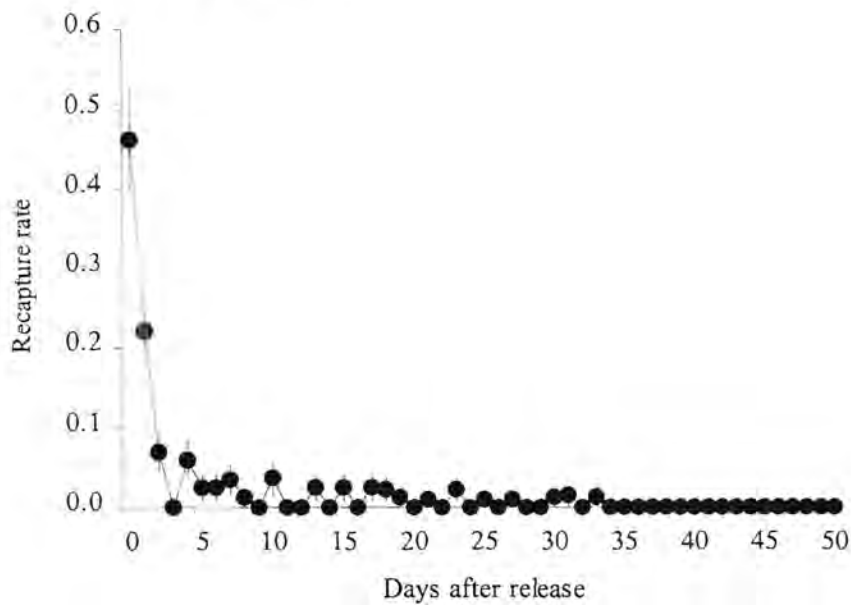
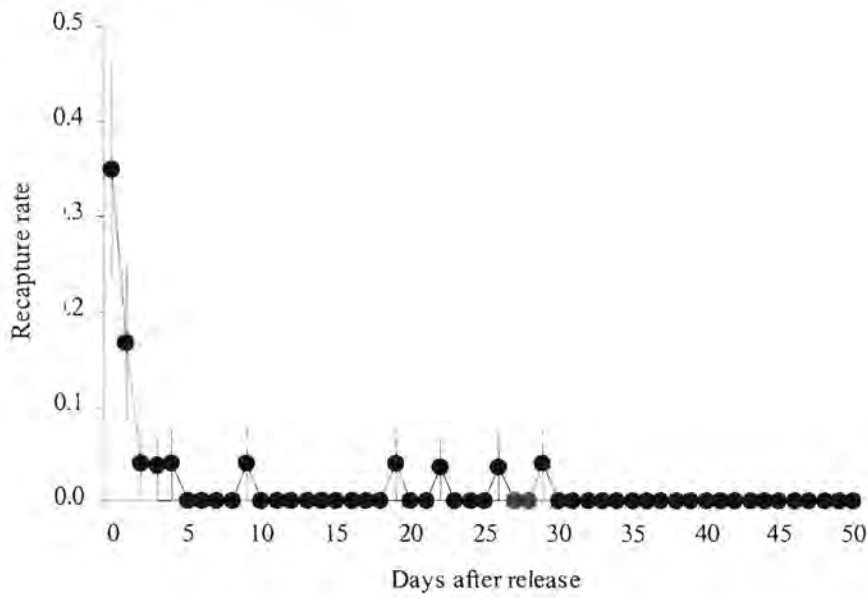

Fig. 5.4 Daily recapture rate at various days after release for *G. brevivalpis* a) males and b) females

a) *G. austeni* males



b) *G. austeni* females

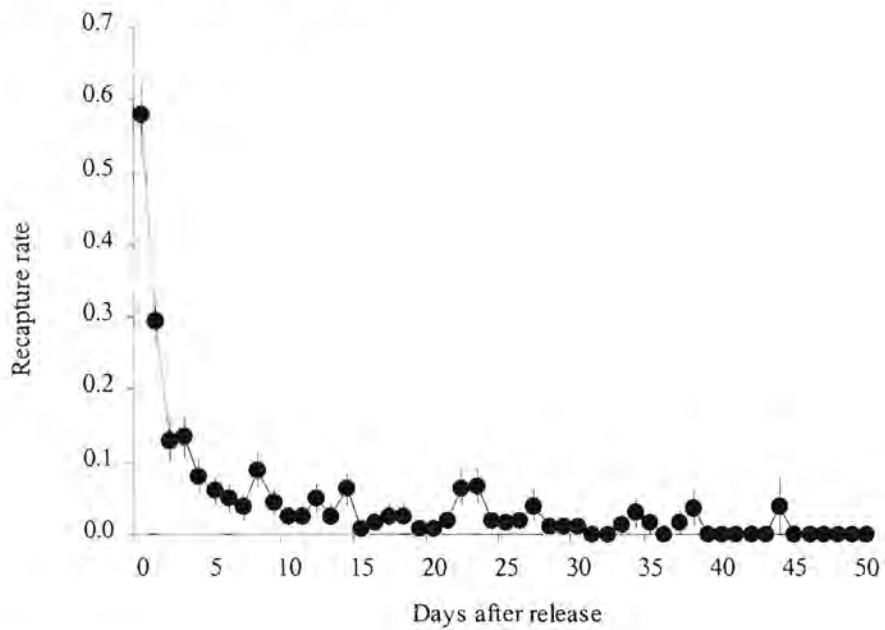

Fig. 5.5 Daily recapture rate at various days after release for *G. austeni* a) males and b) females

Once the probability of recapture had been calculated, the population in the mark-recapture area could be estimated from above indicated formula, using the day 1 recapture rates and probability of recapture (i.e. obtaining the reciprocal of the recapture rate of *G. austeni* of e.g. 0,5779 which then gives 1,7305 x 10 000 – see Table 5.3).

Table 5.3 is a summary of the probabilities of recapture (for day 1) and estimated population densities for each species and sex. The mean catch per trap as determined in Table 5.1 and the expected catch per target, are also indicated together with estimated target densities and options of killing percentages e.g. 1-10 % per day.

Table 5.3 Summary of estimates on population density and expected target densities needed for various options of killing percentages

	<i>G. brevipalpis</i>		<i>G. austeni</i>	
	Males	Females	Males	Females
Probability of recapture on day 1	1,9335	0,4618	0,3485	0,5779
Population in mark-release-recapture area	5172	21653	28691	17305
Area (sq.km)	1,44	1,44	1,44	1,44
Density per sq.km	3591,7	15037	19924	12017
Mean catch per H trap*	23	30	0,6	7
Increase per target*	2,8	2,2	33,4	6,8
Catch per target	64,4	66	20,04	47,6
Killing percentage:	Required target densities:			
1	0,6	2,3	9,9	2,5
2	1,1	4,6	19,9	5,0
3	1,7	6,8	29,8	7,6
4	2,2	9,1	39,8	10,1
5	2,8	11,4	49,7	12,6
6	3,3	13,7	59,7	15,1
7	3,9	15,9	69,6	17,7
9	5,0	20,5	89,5	22,7
10	5,6	22,8	99,4	25,2

* The mean catch per H trap and increase per targets indicated were obtained from the results of comparisons the effectiveness of the H trap vs. target (5.3.1)

Looking at females only, the above Table would then suggest the use of nine targets for the females of *G. brevipalpis* and 10 targets for *G. austeni*, at a 4 % killing rate (indicated in bold in Table 5.3).

It was, therefore, initially proposed that 9 targets/km² would work well for both species. However, it was decided that the population estimates as indicated in Table 5.3 were certainly far too high in that they are about an order of magnitude higher than the estimates for the tsetse population density in the Rifa Triangle (G.A. Vale & J.W. Hargrove, pers. comm. 1999). The population estimates are also a first approximation and the reasons for expecting that they are too high (J.W. Hargrove, pers. comm. 1999) are that:

- a) Only the day 1 recapture rates were used to estimate the population. Using the day 0 level will probably give a higher capture probability and hence a lower population estimate. A crude estimate indicates that the population may be 35 % lower than the figure in Table 5.3. For *G. austeni* one could therefore use 7 targets /km² where 10 were originally suggested and for *G. brevipalpis* 4 targets /km² instead of 9.
- b) It is assumed that there was no movement out of the study (mark-recapture) area. If there was such movement (of marked flies), which there definitely was, this will further inflate the population estimate. (If the marked flies leave the area one under-estimates the recapture probability and hence over-estimates the population.)

Dispersal over open areas of unsuitable habitat

Table 5.4 is a summary of the number of flies marked and released at the four different release sites (Blocks B, C, D and E). The total number of marked and unmarked flies captured at each recapture site is also given in the table. Approximate straight distances between each release site and the block's corresponding recapture sites, are also indicated (also refer to Fig. 5.1).

Table 5.4 Summary of mark-release-recapture results for Blocks B, C, D and E to investigate the use of open areas as natural barriers to the movement of *G. brevipalpis* and *G. austeni* – 3 September to 17 December 1998

Flies released		Gb males		Gb females		Ga males		Ga females	
Block	B	543		662		65		190	
	C	103		175		36		89	
	D	509		582		109		314	
	E	1806		1856		1399		2979	
Flies recaptured		Un-		Un-		Un-		Un-	
(m) from		marked		marked		marked		marked	
Trap									
release pt									
No.									
775	B1	39	0	73	0	0	0	0	0
520	B2	14	1	18	1	0	0	0	0
1120	B3	21	0	19	0	1	0	0	0
1085	B4	12	1	18	0	0	0	0	0
1190	B5	33	0	31	0	0	0	0	0
1105	B6	52	0	82	0	2	0	6	0
1155	B7	25	0	28	1	0	0	1	0
1225	B8	30	0	30	0	2	0	7	0
1345	B9	27	1	25	0	0	0	1	0
275	C1	40	0	88	0	0	0	0	0
85	C2	19	0	29	0	0	0	0	0
465	C3	87	2	121	0	0	0	0	0
500	C4	77	0	195	0	5	0	45	0
725	C5	42	1	51	0	0	0	0	0
605	C6	41	2	57	0	0	0	1	0
655	C7	23	0	28	0	0	0	0	0
725	C8	3	0	6	0	0	0	0	0
860	C9	50	1	63	0	0	0	0	1
690	C10	33	0	51	1	0	0	0	0
485	C11	123	0	237	0	11	0	68	0
725	D1	35	0	31	0	0	0	0	0
550	D2	105	2	157	0	1	0	4	0
550	D3	84	2	131	0	0	0	1	0
450	D4	91	0	132	0	2	0	11	0
515	D5	200	2	264	0	2	0	9	0
725	D6	119	1	246	2	9	0	35	0
400	D7	35	2	48	1	0	0	2	0
415	D8	59	0	91	2	0	0	4	0
345	E1	49	7	912	1	45	2	189	10
275	E2	479	5	760	3	35	0	158	7
310	E3	380	6	656	4	36	8	241	6
240	E4	328	5	506	4	26	2	198	20
240	E5	516	9	886	1	22	1	211	4
295	E6]	153	2	220	0	0	0	0	0
310	E7]**	147	2	168	0	0	0	1	1
205	E8]	45	1	64	0	0	0	1	1
85	E9*	205	33	301	23	11	27	16	34
140	E10	166	14	198	7	2	2	3	3

* Trap E9 was positioned inside the same patch where flies were marked and released.

** Traps E6, 7 and 8 were all small clusters of bush where ants removed many of the catches. Site 6 consisted of very dense thickets, so that the trap was hidden, therefore the low numbers. Note that trap E10 was located about 140 m from the release site under a copse of two *Syzygium* trees (note the high number of unmarked catches of *G. brevipalpis* and even the presence of *G. austeni* that were found at this unusual site).

The distances that were crossed over the unsuitable grass and vleis areas are also depicted in Fig. 5.1. Different colours are used for each species and sex, i.e. *G. brevipalpis* males (green), *G. brevipalpis* females (blue), *G. austeni* males (black) and *G. austeni* females (red). Although these flight distances are indicated as straight lines and as the shortest linear distances between the release and each recapture site, it is unlikely that it is a true representation of the actual path that was traversed. A fly may, for example, have crossed at a particular point (closer or further than the straight distance to the recapture sites), and then have followed the bush before it was attracted and captured by a particular trap. The flies released at point A of Block B, may have followed the bush to the recapture sites, since the release point of Block B is in actual fact indirectly connected to the bush where its recapture traps were set. However, the release points of Blocks C, D and E are totally separated from their respective recapture sites, and so give a truer reflection on what is happening.

From the recapture results obtained from Blocks C and D it is clear that *G. brevipalpis* males and females readily cross all distances of vleis and grassland to reach patches of bushed areas. It is probable that the *G. brevipalpis* males and females recaptured in Block B crossed the open section of grassland and did not follow the bush all the way round.

For *G. austeni* only one recaptured female was obtained in Block C. However, in this case it is more likely that it did not actually cross this distance, but followed the bush all the way round, since no flies were recaptured in Blocks B and D.

The final results for Block E showed that *G. brevipalpis* males and females crossed all distances of open areas, as was expected from the previous results. This time *G. austeni* was also found to cross various distances of open areas (up to 345 m). It seems that, due to a lower percentage of recaptured marked flies, *G. brevipalpis* moved out quicker from the isolated pockets (while unmarked flies move into the patches). *G. austeni*, on the other hand, showed a

greater percentage of recovered marked flies, which may suggest that this species is more static. This is especially supported by trap E9's results.

5.5 DISCUSSION

Attempts to control tsetse flies in much of Africa rely increasingly on the use of odour baited targets (Vale *et al.* 1986; Vale *et al.* 1988a; Willemse 1991; Knols *et al.* 1993; Van den Bossche 1997). In order to implement sustainable control of *G. brevipalpis* and *G. austeni* in South Africa by means of targets at the right density, the probability of recapture and population density of each species and sex was estimated. The re-adapted results suggested an estimated use of four targets per square kilometer to control *G. brevipalpis* females and seven targets per square kilometer for *G. austeni* females.

The recommended target density was based on the assumption of killing 4 % of the female population per day. Although ground and aerial spraying techniques produce much higher mortalities than this (Leak 1999), they may often not be sustained for sufficiently long enough periods to achieve eradication. When odour-baited targets are used the increased death rate is much smaller, but it can be sustained as required (Hargrove 1988). A number of four targets per square kilometer was suggested for *G. brevipalpis*. It compares with the defined absolute lower limit for target densities for the savanna species *G. m. morsitans* and *G. pallidipes* (Hargrove 1993), for which one cannot be sure of eradicating these tsetse populations with a target density lower than 4/km². For *G. austeni* the recommended seven targets per square kilometer is also significantly less and much more economical than the 70 blue targets per square kilometer that were used to suppress *G. austeni* numbers in the Jozani forest on the Unguja Island of Zanzibar prior to applying SIT (Tanzania Government/FAO/IAEA 1994).

Fly movement is important, at least in the short-term regulation of fly numbers, especially for particularly mobile species (Leak 1999). One of the factors responsible in the lack of success in sustaining control of tsetse is their high mobility resulting in continual invasion pressure into cleared areas. *G.*

brevipalpis proved to be very mobile in the forested areas, since it appeared to move out of the 850 m range (of this study) in a short period of time (1 - 7 days) (see Fig. 5.3 a-b). It is clear that this species should, therefore, be regarded and treated the same way as the mobile savanna species. *G. austeni*, however, shows a much slower rate of dispersal as seen in Fig. 5.3 c-d. Data for movement of marked *G. m. morsitans* and *G. pallidipes* suggested that the minimal daily rates of movement were about 700 m for *G. m. morsitans* males and 800 m for *G. m. morsitans* females and *G. pallidipes* (Vale *et al.* 1984). Their displacement averages up to 1 km/day in random steps (Laveissiere *et al.* 1990, cited in Leak 1999).

The pattern of movement of *G. brevipalpis* and *G. austeni* appears also to be random, suggested by the low recapture rates in Figs. 5.4 and 5.5. The decrease in recapture rates with time demonstrates how quickly the marked population is lost from the sampling area. Most of this loss is probably attributable to emigration rather than mortality. The decrease in the concentration of marked flies with distance from the point of marking and release is also similar to the diffusion patterns of other invertebrates (Southwood 1966).

As tsetse flies are relatively mobile, there is a constant reinvasion pressure into areas from which the fly has been removed or controlled (Leak 1999). The utilization of natural barriers to protect areas cleared of tsetse flies from reinvasion is a great advantage (Lovemore 1996) and was investigated for use against *G. brevipalpis* and *G. austeni*. At the Hellsgate study area *G. brevipalpis* readily crossed various distances of vlei and grassland between patches of bushed areas (up to 1,345 m or more). *G. austeni* were also found to cross distances of open areas (up to 345 m). In some situations the open grassveld areas had single standing shrubs or small trees (sometimes in very small clusters) which might have still given sufficient shade for protection. However, keeping in mind *G. brevipalpis*' times of peak activity, i.e. early morning and late afternoon until dark (Kappmeier 2000), the crossing of open areas of this species will most probably occur at these times, when the sun and heat factor is less, and when these distances of open areas, could easily be

bridged. It could also be at night, during which time *G. brevipalpis* was often found entering moving vehicles in open areas (Kappmeier 2000). Taking into account *G. austeni*'s activity times being mainly during the middle morning to late afternoon (Kappmeier 2000), it is questionable whether it traverses even the 345 m, shown during this study, in this warmest part of the day and probably rather does so at night. *G. swynnertoni* was able to cross a 800 m clearing, although flies crossing were mainly hungry and presumably in search of a blood-meal (Lloyd 1935, cited in Leak 1999).

Although the type of "unsuitable" habitat at Hellsgate, i.e. an open grassland situation with patches of small bushes situated between their preferred habitat of forests, would have no value as a natural barrier for *G. brevipalpis*, it may be more suitable for *G. austeni*. It is apparent that natural barriers could be effective, especially for the less mobile *G. austeni*, and should be adopted in the preparation of the comprehensive strategic plan. Many barriers could be identified in the N.E. KwaZulu-Natal region as suitable for this purpose, e.g. numerous lakes, a mountain range, reed and sedge swamps, and open grassland areas, and should be used to advantage. However, there is a need to conduct special studies of the various types of barrier identified to understand their mode of operation more fully and to confirm their effectiveness in limiting tsetse movement. It is also essential to identify any possible weaknesses in these natural barriers so that the necessary precautionary measures can be instituted from the outset. Passive movement of tsetse flies by human traffic, especially for *G. brevipalpis*, which enters vehicles easily, would have to be controlled and eliminated where possible.

Because these studies have revealed and proven that both species of tsetse do cross certain distances of these "unsuitable" open areas adjacent and between forests, and that they (especially *G. brevipalpis*) readily roam out of "suitable" habitat of dense bush, it is important not to ignore these "unsuitable" or open areas when setting traps/targets in a control campaign. This was also concluded in a separate study in which traps were placed along a 12 km transect through different vegetation types. Both *G. brevipalpis* and *G. austeni* were captured in open areas of shrubveld and grassland, although their

numbers were comparatively (but not significantly) lower than in forested areas (J.R. Esterhuizen, pers. comm., 2000). In a target control trial for *G. brevipalpis* in 1992 (Kappmeier *et al.* 1998), targets were only concentrated inside the forests, and not in adjacent open areas, and this could have been one of the reasons for the failure of this trial. It is, therefore, clear that control devices such as targets should also be placed strategically in open areas adjacent to dense bush. Whether the concentration of targets needs to be lower in open situations, should still be investigated.

Where natural barriers are unavailable the use of target barriers will have to be implemented. Efficiency of barriers constructed from lines of traps/targets depends on the width of the barrier, the mobility of the flies and the mortality rate within the barrier (Williams *et al.* 1992). Hargrove (1993) made estimates of the width of target barriers required to prevent reinvasion, and attempted to establish the relationship between barrier width, target density and economic costs (the widest barrier is cheapest and uses smallest number of targets). He suggested that targets should be deployed in barriers exactly as they are in normal control operations, when that density is chosen to provide local eradication in 9 - 12 months, while the width of such a barrier should be *c.* 8 times the daily step length of the tsetse species concerned. For the two Zululand species they should, therefore, consist of four targets per square kilometer and for *G. brevipalpis* and eight targets per square kilometer for *G. austeni*. Since the daily step length was not calculated in this study, the width of the barriers for each species could not be estimated. The presence of a target barrier has a marked depressing effect on tsetse populations outside its boundaries, and barriers will be most effective if they are positioned before the treatment of the areas they are meant to protect (Hargrove 1993).

In conclusion an estimate of four and seven targets/km² for *G. brevipalpis* and *G. austeni*, respectively, should be sufficient to control *c.* 4 % of the female populations per day. Eight instead of seven targets/km² would, however, be advisable for *G. austeni*, as this would make the lay-out of targets easier. It is, however, essential that a small-scale control trial be conducted first before implementing these results on a large-scale to make sure that the target density

estimates are correct and to refine the recommendations. Such a trial is currently underway in the Hellsgate area. This trial will simultaneously be used to evaluate the width of targets in a barrier for both *G. brevipalpis* and *G. austeni*.

Adjacent areas of open grassland next to forested tsetse infested areas should not be ignored when setting targets and traps in a control trial, although the target density would probably decrease in such areas. The distances between main pockets of tsetse distribution (suitable tsetse habitat), which will act as natural barriers between populations, should be reconsidered, especially for *G. brevipalpis*.