



TECHNICAL  
PLATFORM

↑ Exit

TECHNICAL INVESTIGATION

07:00

Concrete sub-structure

Concrete slab structure

Steel structure

Box

Screen

Circulation detail



07:01

The building has been grouped into the various structural components. Illustrated in this figure is the extrusion of these elements and in this chapter each component will be discussed



box offices

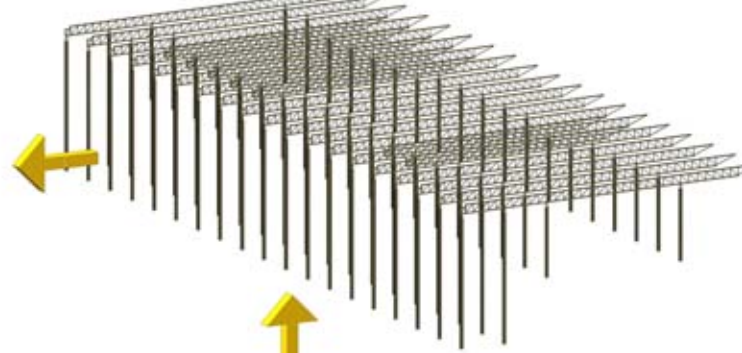

steel  
structure

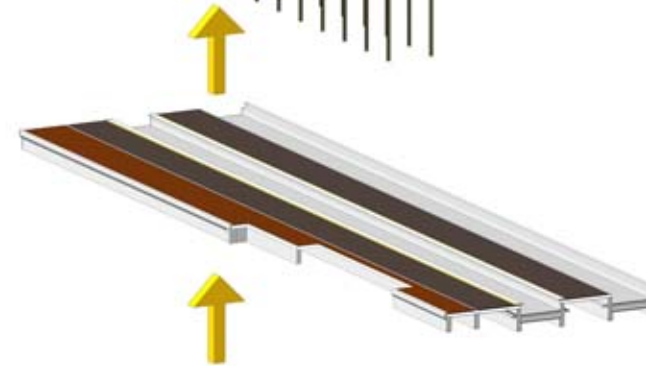

concrete  
slab structure

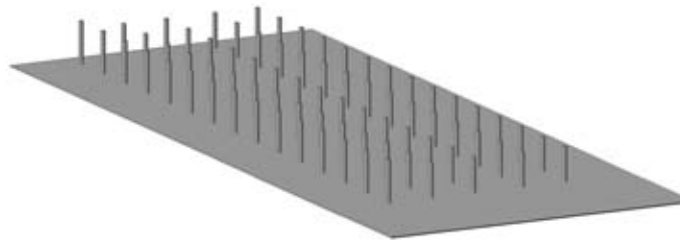

concrete  
sub-structure

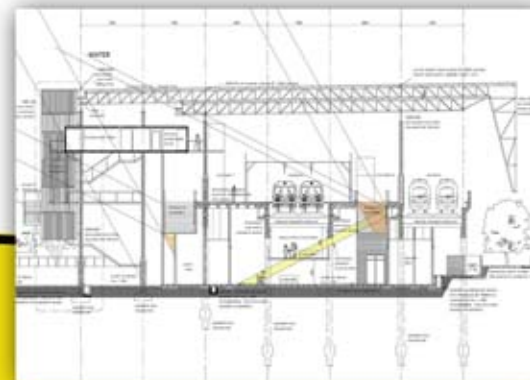

building



## concrete sub-structure

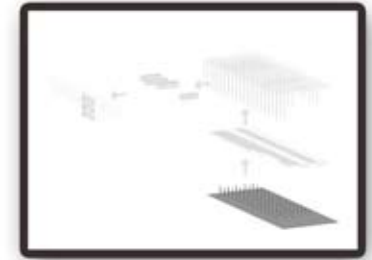

The train:

The train approaches the station at 60km/h and starts decreasing speed 400m away from the station, thus coming into the station at a relatively low speed, according to Mr. Richard Bercher (Chief Engineering Technician of Metrorail. Interview: 15.05.08)

The train weighs 16tons per axle thus at any point on the track the weight of 64ton (4axles) needs to be taken into account (fig. 7.1).

This means that the train requires a robust structure that is able to bear the high mass and movement of the train.

Thus a reinforced concrete base structure was chosen, because of concrete's compressive strength, robustness and resistance against fire.

The combined concrete base consists of concrete piles, precast concrete beams under the railway tracks and a two-way coffer slab carrying the platform area (fig. 7.6).

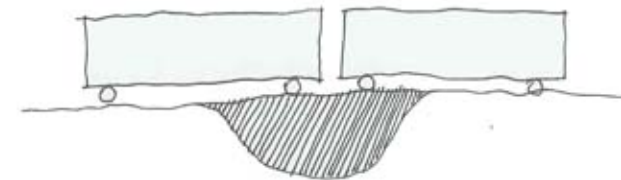

64 ton load

fig. 7.1



The concrete piles are driven into the ground on a 7x7m grid. This grid size is determined by the railway track's width in section (6.7m) and the space needed for the platform areas in between. Because the train has to remain operational throughout the project, piles were the best option. The choice being between piles and in-situ slabs.

Phase 1: drive piles in at night time to the desired depth (according to engineer Carl Von Geysso: approximately 23m)

Phase 2: Place scaffolding supports underneath the tracks

Phase 3: Dig away the mound of earth that the train rests on

Phase 4: Tank and cast the surface bed on the new ground level.

Phase 5: Place precast beams on top of the piles acting as pile caps.

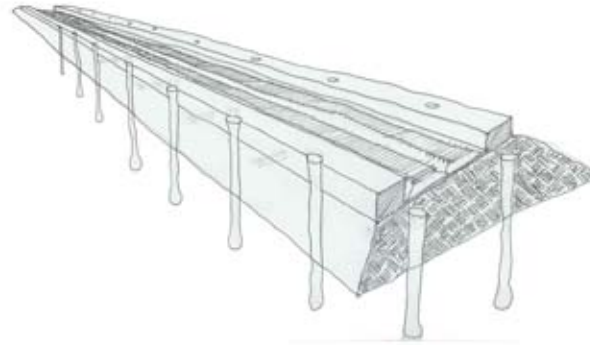

phase 1

fig. 7.3

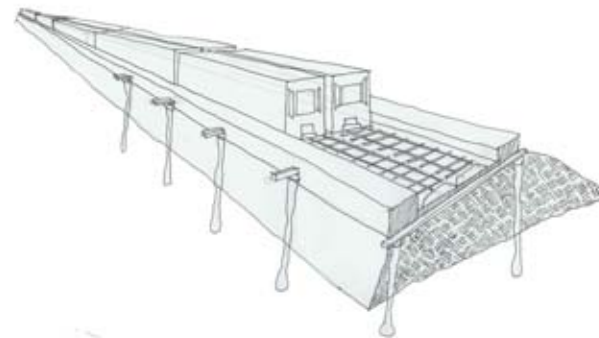

phase 2

fig. 7.4

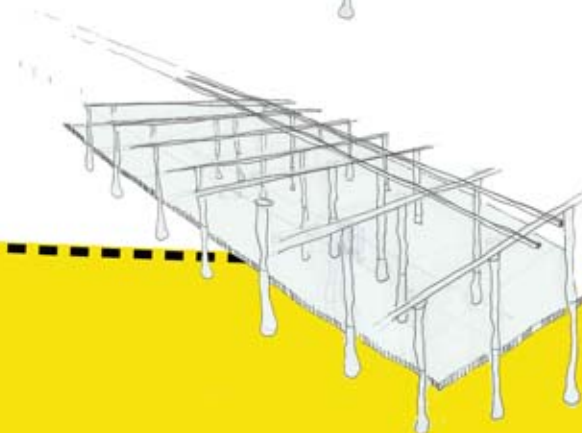

phase 3 & 4

fig. 7.5



## concrete slab structure

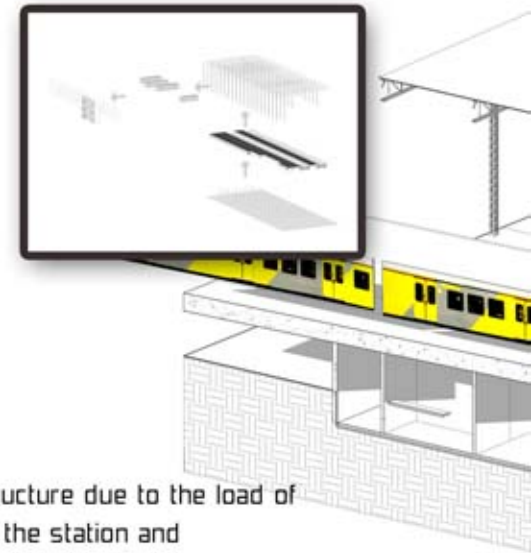

The profile of these beams are specially designed to form a foot on which the track beams rest (I-profile concrete sections which are perpendicularly placed at 700mm centres (accommodating movement of the train moving directly on the beams). These profiles 7m long precast beams (first mentioned) double up as enclosed maintenance 'trenches' where the cabling of the train is situated (fig. 7.6).

In a technical detail meeting with Metrorail (05.09.08) it was clear that precast beams are the best option to use underneath the tracks, since there is no curing waiting period (28days) necessary and quick erection is possible.

The platform area slab deals with much lower load factor and time isn't of the essence, thus a two-way coffer slab has been used in this area. This cast in-situ slab is much more adaptable to the spaces needed for staircases and lifts.

Because of the demand of such a robust structure due to the load of the train, the effect is seen in the columns in the station and commercial zone.

The 7x7m grid easily accommodates both shopping spaces between them as well as free movement of people through the building. This station and shopping area has been dropped down into the ground for maximum natural light to penetrate the building because of the now bigger openings, thus everything that belongs to the concrete structure in essence belongs to the ground, hence the platform edges becoming a grass embankment flowing into the ground.

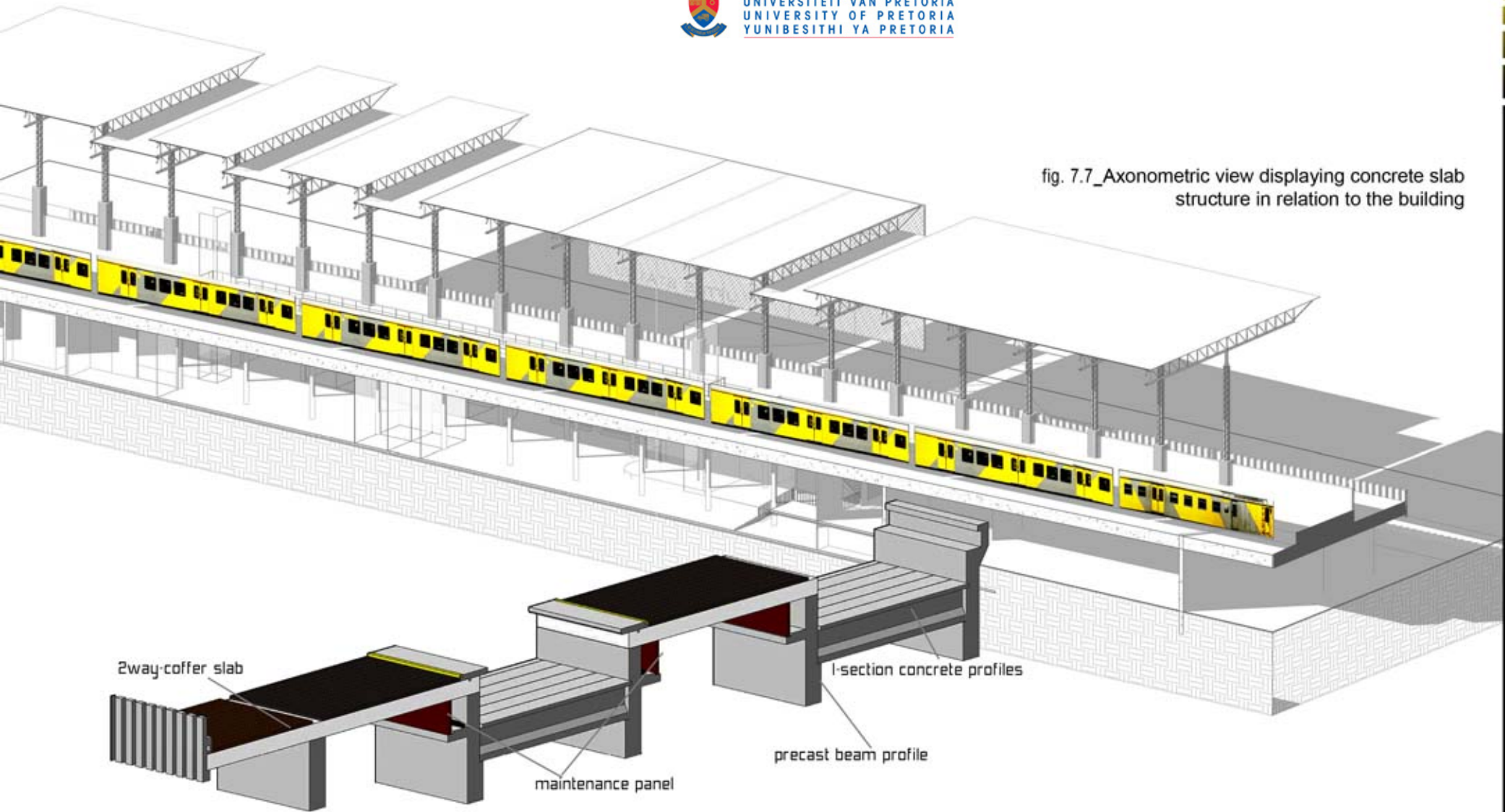
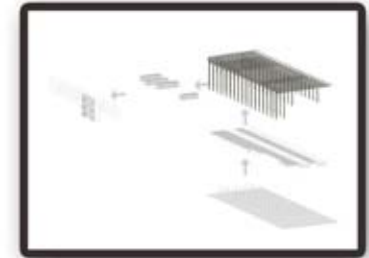
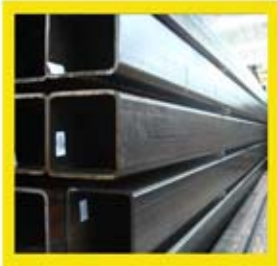

fig. 7.7\_Axonometric view displaying concrete slab structure in relation to the building

fig. 7.6\_Axonometric section illustrating concrete slab composition



# steel structure



Unlike the concrete structure that has to carry the train's load and spread it into the ground - there is a 'lighter' side to the train, and that is the area above it - the area that belongs to the sky. A structure is needed that can span a great length (cover 2 double tracks and platforms: approx. 30m), which seems light and open at the same time. Thus a steel structure is used that reaches up into the sky (columns) embracing and welcoming the arriving trains into space (roof). This steel structure also relates on a more human scale to the daily commuter and accommodates the different movement systems coinciding at this point. The structure is easily adaptable and open for visual linkage with the surroundings. The angled braced columns on the grid represent the high tensile electrical cable system on either side of the train dating back to the very beginning of the electric train.

The roof is designed to stagger in height according to function but mainly to allow natural light into the structure (fig. 7.8). The roof slopes to the West (where the park area is) making use of the rainwater - storing it in the underground tank - and using the water for irrigation. To accommodate the low pitch of 1degree, Klip-Lok 700 roof sheeting is used. In the event of fire on the platform the structure allows quick evacuation and once under the tracks (concrete slab); commuters will be safe and protected by the high mass concrete.

Storage tank calculation:

Avg daily rainfall: 36mm

Roof m2: 2405m2  
thus:  $2405 \times 0.036 = 86.6\text{m}^3$

Outside floor area: 903m2  
thus:  $903 \times 0.036 = 32.5\text{m}^3$   
= 119.1m3  
minus trench area: 30m3

tank size: 89.1m3  
Provide 100m3 tank

gutter calculation:  
140mm2 (summer/1m2)  
 $0.1\text{m} \times 0.14\text{m} = 0.014$   
Roof:  $1750\text{m}^2 \times 0.014 = 24.5$   
thus min gutter size: 495x495



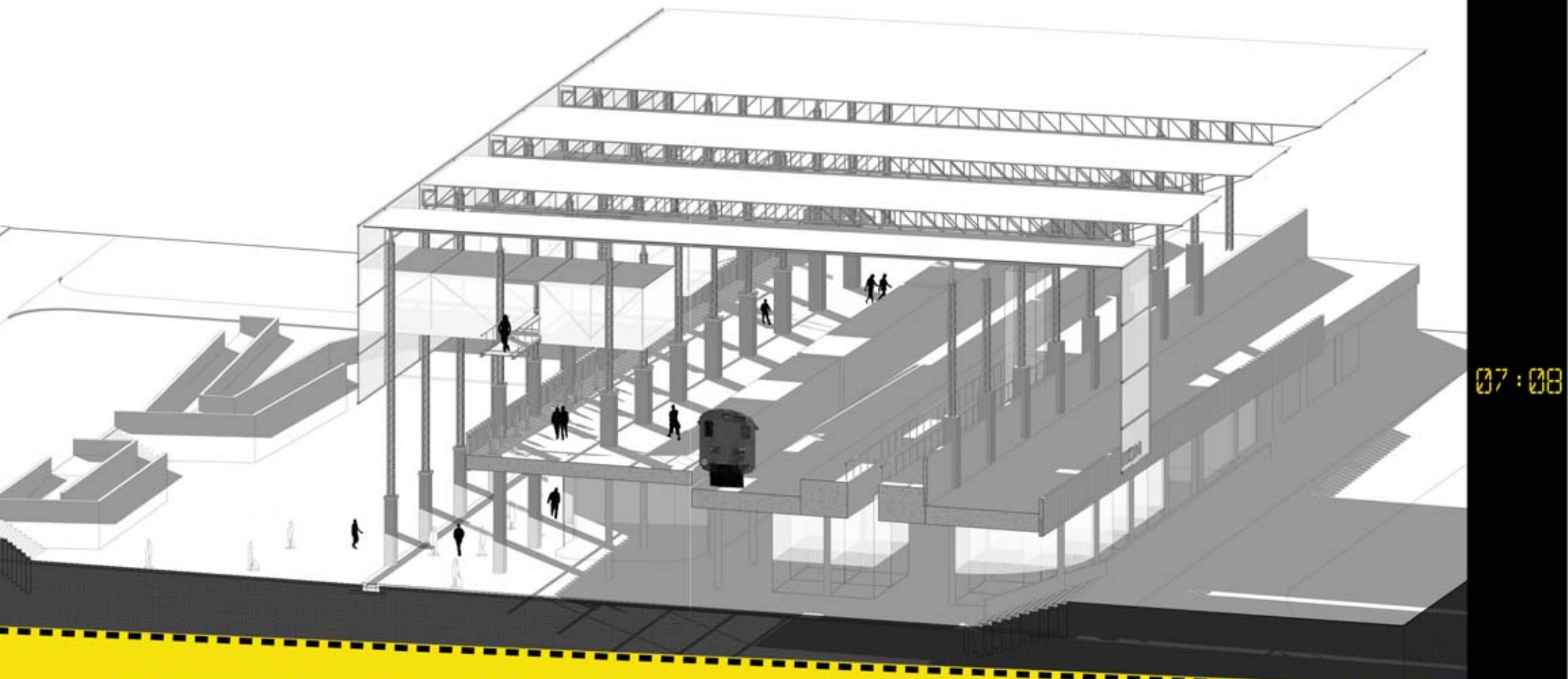

07:08

fig. 7.8\_Axonometric view of the steel structure in relation to the platform

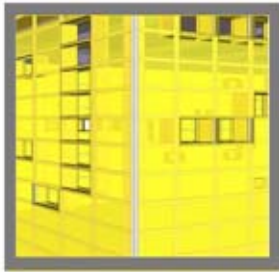

# box

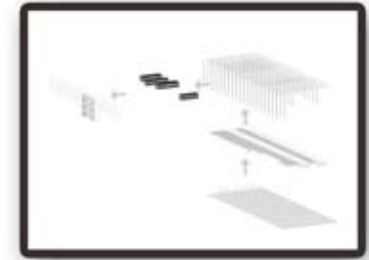

The office 'boxes' on the mezzanine level are constructed of a steel frame system clad with polycarbonate sheeting with a transparency of 70% (fig. 7.9). The choice was based on the need for these 'boxes' to glow at night. Thus becoming the trademark of Loftus Metrorail Station. The aim was to insulate these lightweight structures (while still glowing) since they face the direct SW sun. Although only a fraction of the 'boxes' are exposed to the harsh sunlight, appropriate insulation is needed.

For insulation, polystyrene balls weaved into bags and placed in the frame were used (fig. 7.14). This serves as an adequate insulator which also allows light to pass through (fig. 7.11).

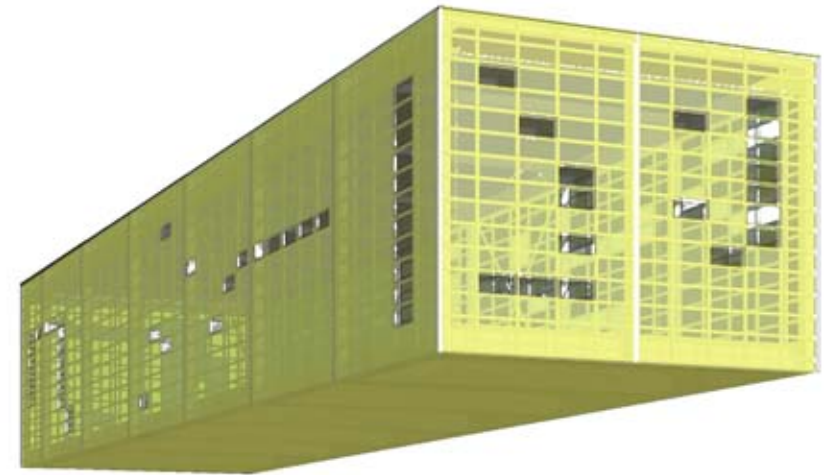

07:09

fig. 7.9\_Polycarbonate sheeting



fig. 7.10\_Double glazing panels

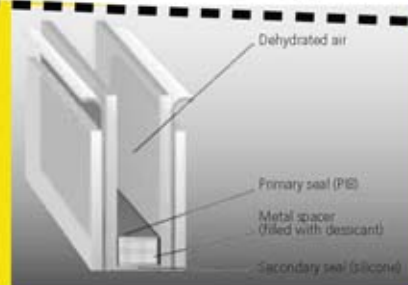

fig. 7.11\_Glowing effect



fig. 7.12\_Cabling suspension system



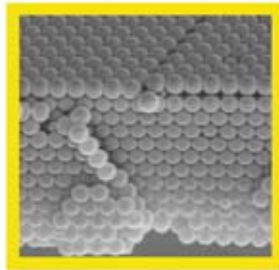

fig. 7.14\_Polystyrene

## insulation

The difficult placing of windows into the 'boxes' was accommodated by the intermediate frame structure holding the sheeting in place. This frame structure consists of tube steel sections at 210cm intervals and a light gauge steel section at 42cm centres with polycarbonate sheeting overlapping 1 cycle at the horizontal seams. This creates the perfect grid to insert windows in, according to the function on the inside. The window sizes are reduced as well as heat gain. Coolvue double glazing is used by Smartglass with a 12mm air gap to reduce unnecessary heat gain (fig. 7.10).

These 'boxes' are hung from a cable system welded to the steel braced column.

Clevis pins are welded to the column and a 31.75mm diameter galvanized steel wire rod (1.31kg/m, 58.1 ton strength) suspended and controlled by a turnbuckle for adjusting the cable (fig. 7.12). (Manufacturer: Anchor Industries, JHB). These cables are placed at each column at the top, the bottom and diagonally preventing movement to the sides and tilting of the cantilevers.

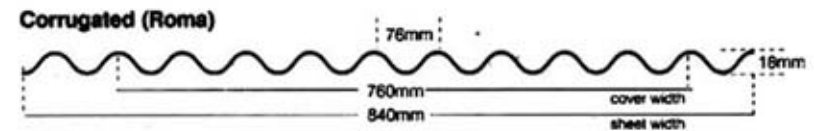

fig. 7.13\_Sheeting

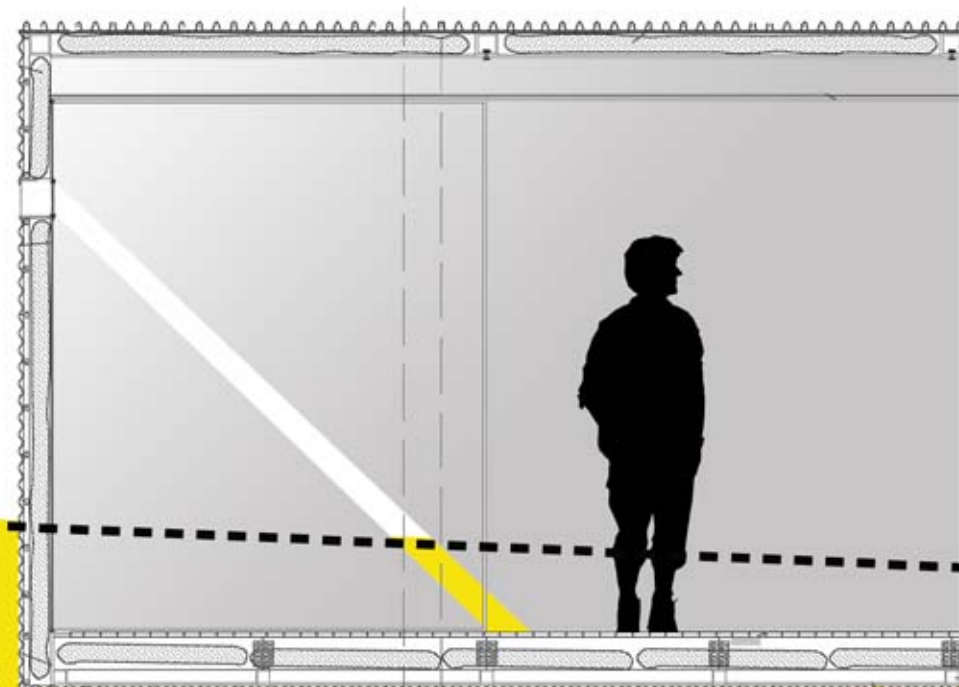
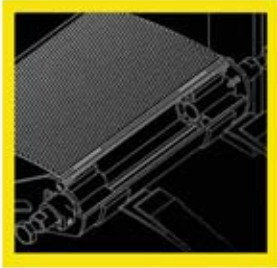

fig. 7.15\_Box with insulation, illustrating internal shadow from square windows



## screen

### Louvered screen

Because of the predominant NE-SW orientation of the building the longest and main facade is the West facade. Therefore a shading device was designed to cover the platforms from the harsh west afternoon sun. In order for the screen to be of any use, it has been placed on an offset of 7m from the platform to completely shade the platform whilst still being open for clear visual principals.

Kool Aluminium Louvre system is used (fig. 7.17). The louvers are vertically placed and adjustable, a varied facade is achieved when the louvers are rotated in different directions according to the wind direction, giving an ever-changing screen facade while still appearing transparent and exposing the structure and function within it.

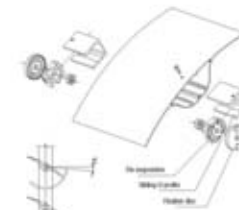
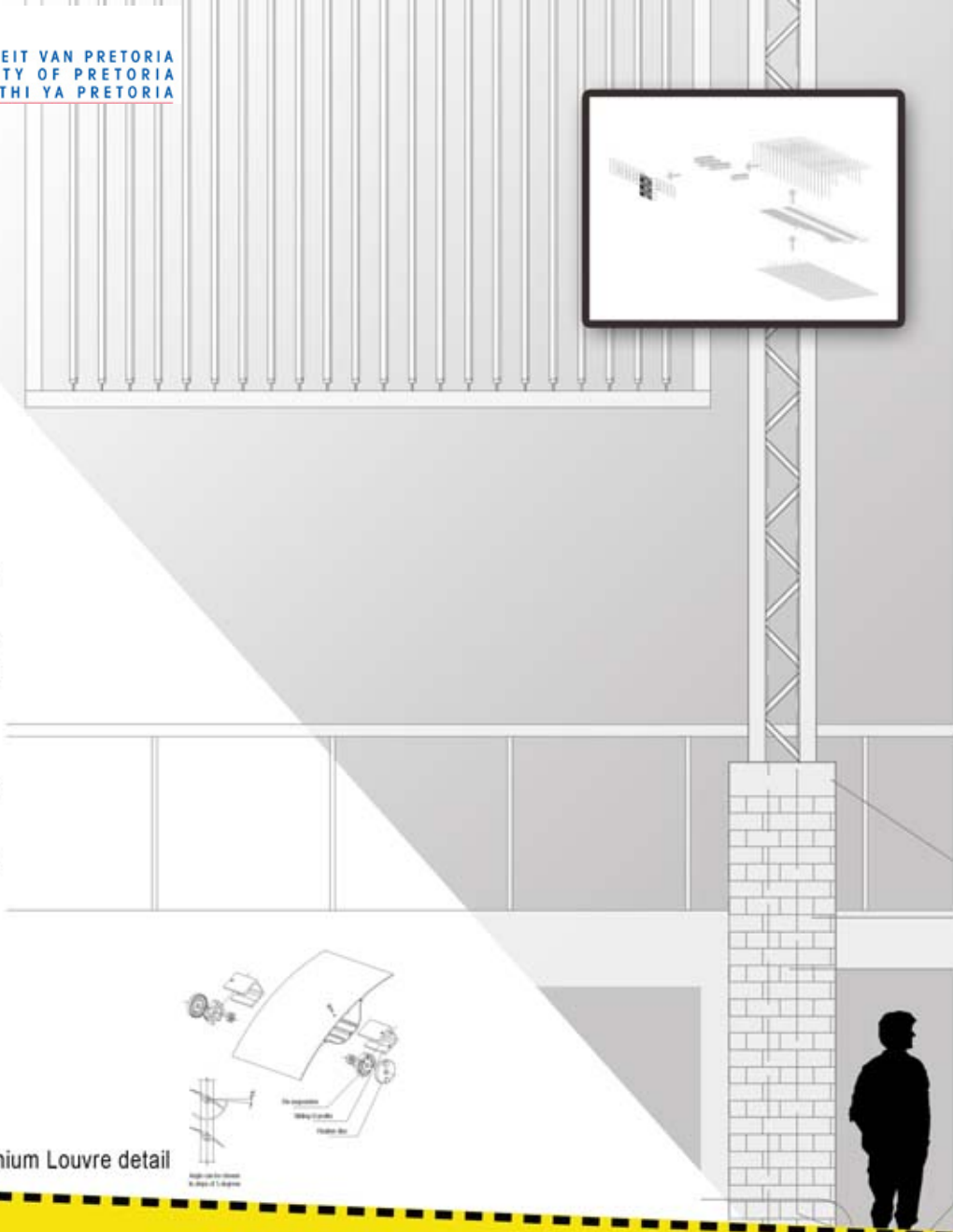
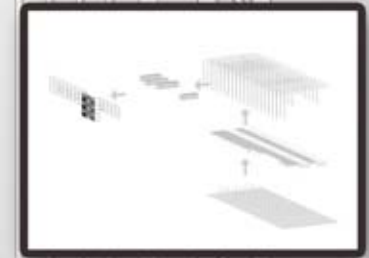

fig. 7.16\_Kool Aluminium Louvre detail



# gkd mediamesh



The screen is specially developed for architectural application. Constructed of stainless steel wire mesh with IT-based LED profiles, it provides a permanent, integrated and intelligent media-based facade system (fig. 7.20). The screen provides the necessary area for signage and displays required by the station and shopping centre. Live matches will be displayed when the stadium is in full capacity, hence the terraced seating in the landscape facing the screen (fig. 7.17). The screen achieves a transparency of 70% - once again exposing circulation routes placed behind the mesh. The system is water resistant, requires very little maintenance, has long life span and low power consumption.

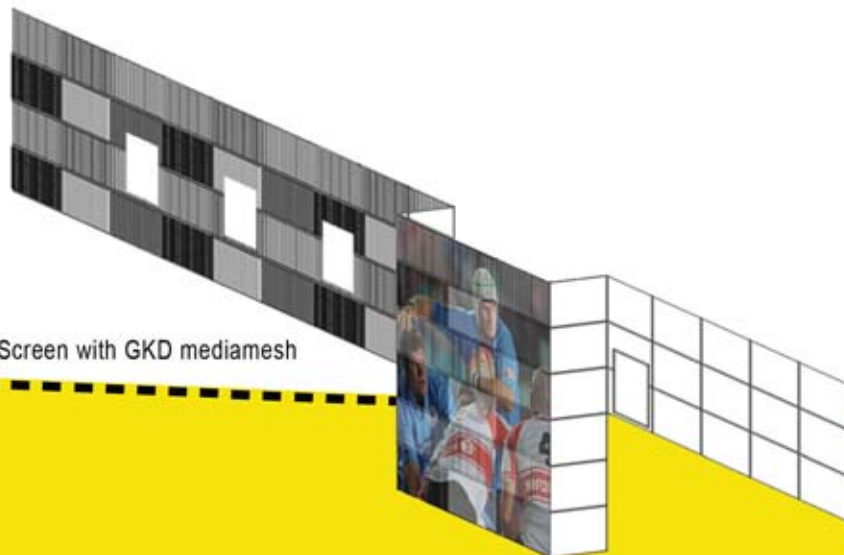

fig. 7.17\_Screen with GKD mediamesh



fig. 7.18\_GKD mediamesh



fig. 7.19\_GKD mediamesh



fig. 7.20\_Stainless steel wire mesh with LED's



## circulation walkway detail

### Circulation on Mezzanine level

The circulation route is constructed of steel H-sections and rest on a webbed frame system which is both bolted to a base plate and then again to the column (fig. 7.21). This structure choice is based on the structural support only available at 7m centres and needs to span the length in between (fig. 7.22).



fig. 7.21\_Detail Section of walkway



fig. 7.22\_Walkway detail illustrated