



PRESENTATION PRECINCT
MODIFICATION OF CONSCIOUSNESS

TSHWANE UNIVERSITY OF TECHNOLOGY;
ARTS CAMPUS

FOORD CERONIO
75 422 591



ABSTRACT

The proposed thesis project consists of an art presentation precinct where art works will be exhibited, presented and performed before being presented to under-exposed communities in outlying areas of Tshwane and beyond

The dissertation responds to certain identified requirements. Its approach will be preservation based, while being sensitive to the distinctiveness of the site. The aim is that the aesthetics will add to the character of the site and that, at completion, visual appropriateness will be prominent.

Keywords: Visual appropriateness,
Permeability,
Contextual dialogue,
Variety & Legibility.

The interweaving of public squares, interiors and walkways are proposed as a way to energise and densify the new areas for the display of art.

“Every act of construction and every increment of growth must work towards the goal of wholeness”.
(Alexander 1987: 22)

“Pragmatism is nothing more or less than a method for testing ideas by challenging them to make a difference in our experience of the world”.
(Nobel 2001: 2)

[01][00][00] INTRODUCTION

[01][01][00] CONTEXT

The campus of the arts faculty is the creative heartbeat of the Tshwane University of Technology.

The faculty's purpose lies not only in the creative practice and critical discourse of the visual and performing arts, but also in its particular relationship with the community and its involvement in social and economical development.

The site facilitates social interaction between various like-minded groups from different walks of life and from different areas in the community, as well as groups from the outlying regions.

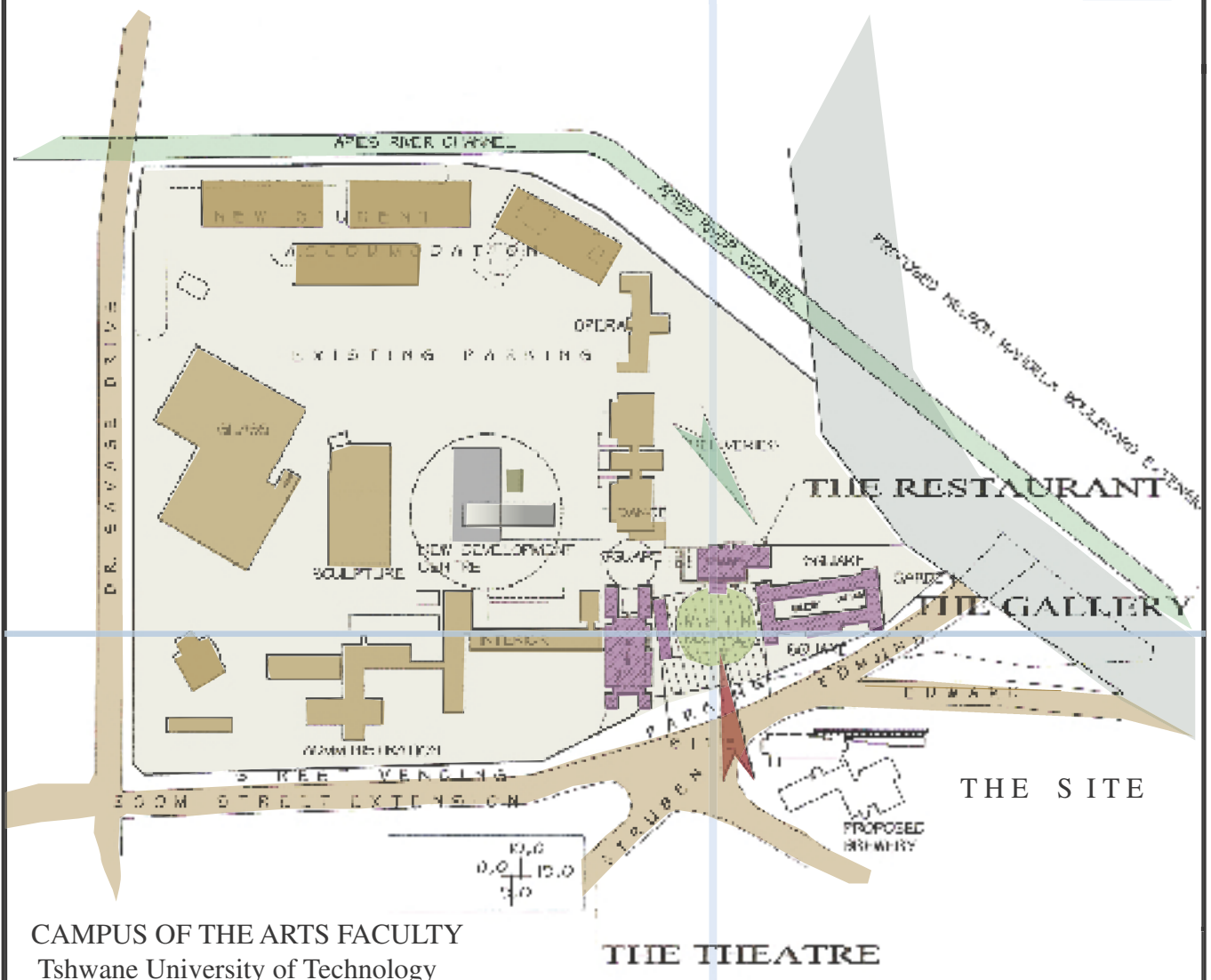

INTRODUCTION

[01][02][00] SUMMARY

The interplay between different factions from various backgrounds, each with their own set of references and artistic interests, talents and enthusiasms for the different study disciplines will promote the learning experience.

The arts campus promotes a wide range of creative disciplines, and thus facilitates the cross-pollination of a variety of multi-disciplinary creative endeavours that will contribute to the regeneration of this section of the central city district.

International trends indicate that artistic activities contribute to strategies aimed at social upliftment and economic growth.

The arts faculty wants to build on these trends by promoting facilities on the campus - artistic and academic, as well as commercial and social. The benefit of this revitalisation will filter through to local businesses, the metropolitan area and even more widely to the provincial economies.

The proposal aims to create opportunities for untrained artists and culturally inclined members of the community, to obtain the relevant training and formal development in their chosen artistic fields of interest. It will also allow the students to suggest the course and content of the artistic and cultural activities, according to the special needs of their communities.

The diversity, the richness of culture and the artistic traditions of the community will be developed into formal disciplines that will acknowledge its cultural endeavours, not only for their entertainment value, but also as

INTRODUCTION

[01][03][00] STRATEGY

In identifying the needs of the community and responding to these needs, the influence of the centre will increase. This effect will improve communication between various groups and thus promote the integration of the arts into the community. With this heightened awareness, the increase in the audience base for arts activities will improve the facilities for the arts, and this would in its turn lead to an increase in public and private funding.

The infusion and harnessing of cultures will anticipate a dynamic interaction among students and the facilities in the project will become stages for varied interchanges. The centre will largely be involved in outreach activities, training community members that will take completed projects back to their communities.

INTRODUCTION

[01][04][00] PROPOSAL

The proposed project will be in line with the Tshwane University of Technology's institutional operating plan, which aims to provide professional career education of an international standard that is relevant to the needs and aspirations of the community, and to continually produce projects that interpret contemporary society through public participation. Participants would express their ideas and suggestions as part of the program in the proposed gallery, theatre and restaurant. In effect, the project aims to be a fun place that will facilitate social interplay.

In this approach a response will be formulated to the challenges of the encountered conditions, as facilitated in the relationship between the three buildings and the landscape. Could a symbiosis of architecture and site be developed into a fusion of the elements in this composition?

The proposed project aims to demonstrate a unifying approach that will exploit every opportunity provided by the site to forge a successful spatial experience.



INDEX:

[01][00][00] INTRODUCTION

[01][01][00]	CONTEXT	page	1
[01][02][00]	SUMMARY		2
[01][03][00]	STRATEGY		3
[01][04][00]	PROPOSAL		4

[02][00][00] PROBLEM STATEMENT

[02][01][00]	THE NEED		5
[02][02][00]	INTRODUCTION		6
[02][03][00]	PRECEDENT		7
[02][03][01]	NEWTOWN CULTURAL PRECINCT JHB		7
[02][03][02]	THE BAT CENTRE; DURBAN		7
[02][04][00]	PROPOSAL		8

[03][00][00] CONTEXT ANALYSIS

[03][01][00]	INTERNATIONAL		9
[03][02][00]	NATIONAL		10
[03][03][00]	REGIONAL		11
[03][04][00]	CITY		12
[03][05][00]	SITE; AIRIAL VIEW		13
[03][06][00]	CONTOURS		14
[03][07][00]	SITE PROPOSAL		15
[03][08][00]	MAKRO SITE ANALYSIS		16
[03][09][00]	GEOGRAPHY AND CLIMATE		17
[03][09][01]	SUNRISE AND SUNSET DATA		17
[03][10][00]	DEMOGRAPHICS		18
[03][10][01]	LANGUAGES		18
[03][11][00]	CULTURAL AND ACADEMIC		18
[03][11][01]	CBD		18



INDEX:

[04][00][00] DESIGN PHILOSOPHY

[04][01][00]	A PRACTICAL ENVIRONMENT	page	19
[04][02][00]	THE SQUARE		20
[04][03][00]	SCALLOPED EDGE		21
[04][04][00]	TRANSITION		22
[04][05][00]	THRESHOLDS		23
[04][06][00]	SAFE SHIELD		24
[04][07][00]	INTERMEDIATE NODES		25
[04][08][00]	CONCLUSION		26

[05][00][00] ACCOMODATION SCHEDULE

[05][01][00]	GROUND FLOOR 'HEIDEHOF' GALLERY	28 & 29
[05][02][00]	FIRST FLOOR 'HEIDEHOF' GALLERY	30 & 31
[05][03][00]	GROUND FLOOR RESTAURANT	32 & 33
[05][04][00]	FIRST FLOOR RESTAURANT	34 & 35
[05][05][00]	GROUND FLOOR THEATRE	36 & 37
[05][06][00]	FIRST FLOOR THEATRE	38 & 39

[06][00][00] DESIGN STRATEGY

[06][01][00]	INTRODUCTION	40
[06][02][00]	THE SQUARE	41
[06][03][00]	SOUTH / NORTH AXIS	45
[06][04][00]	NEW GALLERY	46
[06][05][00]	PRECEDENT	50
[06][06][00]	THE RESTAURANT	54
[06][07][00]	THE THEATRE	57
[06][07][01]	MAIN ENTRANCE	59
[06][07][02]	STAGE	59
[06][08][00]	PRECEDENT STUDY	60
[06][08][01]	GALLERY	60
[06][08][02]	THEATRE	62
[06][09][00]	CONCLUSION	64



INDEX:

[07][00][00]	TECHNICAL NOTES	
[07][01][00]	INTRODUCTION	65
[07][01][01]	CONCRETE	65
[07][01][02]	BRICK	65
[07][01][03]	STEEL	66
[07][01][04]	GLASS	66
[07][02][00]	STRUCTURE	68
[07][02][01]	ROOF CONSTRUCTION	68
[07][03][00]	INCLUSIVITY	69
[07][04][00]	SUSTAINABLE FEATURES	69
[07][05][00]	ROOM ACOUSTICS	71
[07][06][00]	REVERBERATION TIME	71
[07][06][01]	FREQUENCY DEPENDENCE	71
[07][06][02]	TYPICAL REVERBERATION TIMES	72
[07][06][03]	SOUND ABSORBERS	73
[07][07][00]	FIRE MANAGEMENT	74
[07][08][00]	CLIMATE CONTROL	74
[07][09][00]	THERMAL MASS	75
[07][10][00]	VENTILATION	76
[07][11][00]	LIGHTING	76
[07][12][00]	THEATRE SIGHTLINE	79
<hr/>		
[08][00][00]	CONCLUSION	80

[02][00][00] PROBLEM STATEMENT

[02][01][00] THE NEED

The site is in need of urban regeneration and is located in an important education node, being part of the Tshwane University of Technology and the hospital / medical education centres, on the north-eastern outskirts of Tshwane's Central Business District.

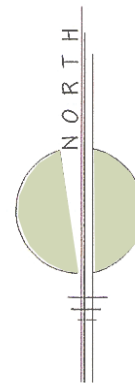

fig [02] EDUCATIONAL NODE

PROBLEM STATEMENT

[02][02][00] INTRODUCTION

The Witwatersrand region is home to a large group of registered artists in an area that includes Springs in the east, and stretches beyond Vereeniging in the south-west, with Johannesburg at its centre.

In northern Gauteng, on the Witbank/Rustenburg axis, with Tshwane as the centre point, the number of active members of the art associations, and professional and junior visual and performing art groups, compares favourably with such membership in the Johannesburg area. Add to this the areas to the north, including Limpopo and up to Polokwane and beyond, and it becomes clear that this is a region that enjoys very little professional support.

Taking the above factors into consideration, as well as the following:

- numerous requests for support and training,
- requests for the use of the TUT library and the library's media services,
- the need for advice and information,
- enquiries regarding the arts,
- requests regarding materials, products and methods,
- requests for involvement and help with community projects,
- and regular enquiries regarding short courses and workshops,

the necessity for a support and development centre for the arts becomes obvious.

The centre will largely be involved in outreach activities and the training of community members that will take prepared projects back to their communities.

The centre could easily become a catalyst for urban regeneration through the intervention of the creative industries, similar to the Newtown Precinct in Johannesburg and the BAT Centre in Durban.

[02][03][04]

PRECEDENT

PROBLEM STATEMENT

[02][03][04] 1] THE NEWTOWN CULTURAL PRECINCT has become Johannesburg’s tourist hot spot in recent years, attracting large numbers of local residents as well as travellers from far and wide. There is much to see and do in the renewed **Newtown Precinct** .

Some years ago, the Newtown area had degenerated into a slum overlooked by the derelict cooling towers and dark turbine hall of the first coal power station in Johannesburg. The main feature of the all new Newtown Precinct is the massive Victorian building which houses both the renowned Museum Africa as well as the Market Theatre.



fig. [03] Newtown Cultural Precinct; Jhb



fig. [04] The Bat Centre; Durban

Durban, KwaZulu-Natal and South Africa by promoting local talent and skills.

Celebrating their unique cultures and encouraging cross-fertilisation, it creates jobs for artists by sourcing talent, imparting skills and developing markets. It also acts as a community cultural centre for the city of Durban and the people of the harbour and Esplanade, and has become a resource to outlying arts and cultural centres and creative people.

Short courses, workshops & seminars take place at the BAT Centre on a continuous basis. Topics of discussion vary between the fields of the visual arts, music, acting, writing and literature.

The BAT Centre’s Visual Art Studio, galleries & BAT shops allows its patrons the advantages of being part of the art world by offering exhibition space where tourists and art lovers can select and purchase artworks.

02][03][02]

THE BAT CENTRE is an arts and culture community centre located in the small craft harbour off Durban’s Victoria Embankment. Its vision is to celebrate the arts and culture of

PROBLEM STATEMENT

[02][04][00] PROPOSAL

This proposed development will provide a facility for the presentation of completed projects from the development and training centre.

The presentation, performance and exhibition of art works will provide a final rehearsal for artists prior to presenting their works to their communities, in areas that previously had little exposure to the performing and visual arts.

A square will be provided, where like-minded members of the community can congregate and experience the arts and art environment. This ‘square’ will be formed by:

- the art ‘**gallery**’ in the readdressed existing “Heidehof” students’ residence,
- the ‘**theatre**’ in the altered and extended general utility hall,
- and a new building, which will house the ‘**restaurant**’.

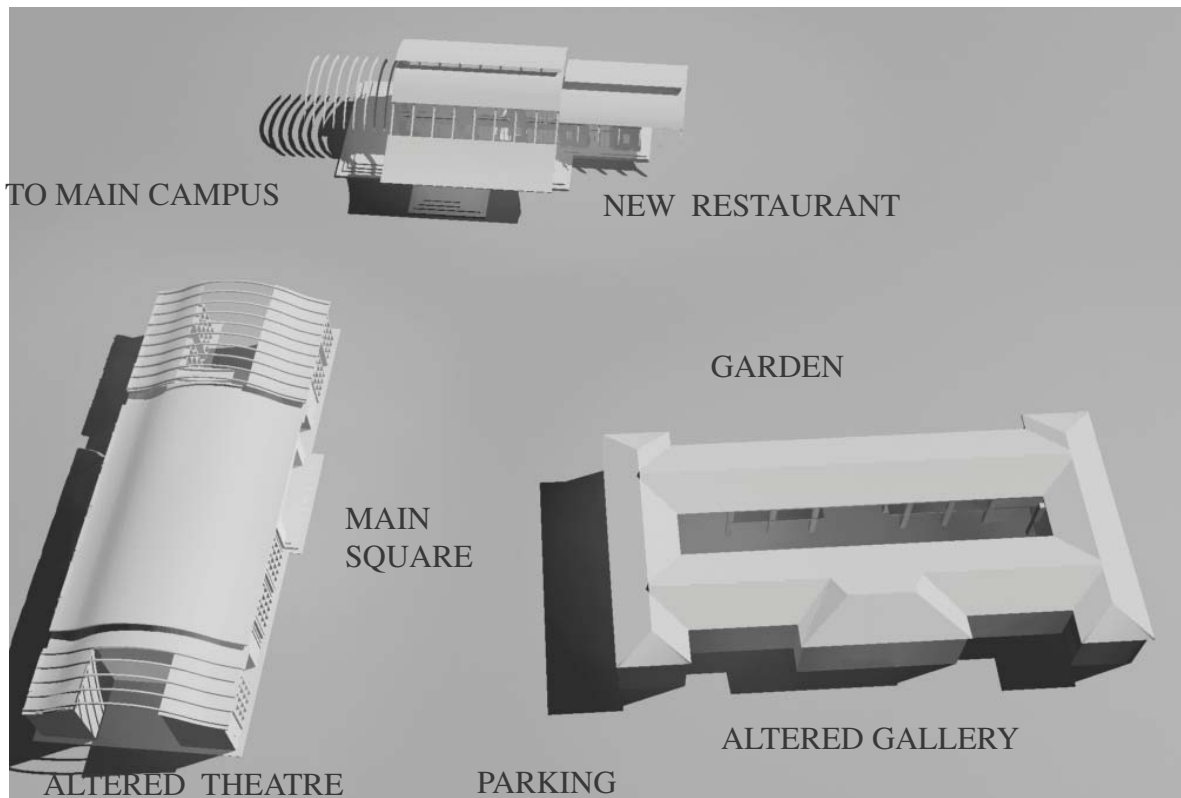

fig. [05] OVER VIEW: BUILDINGS OF THE PROJECT

[03][00][00] CONTEXT ANALYSIS

[03][01][00] INTERNATIONAL

The Republic of South Africa is a country located at the southern tip of Africa. The South African economy is the largest in Africa and 24th largest in the world. Due to this it is the most highly developed country on the continent - socially, economically, and where infrastructure is concerned.

South Africa is ethnically diverse, with the largest Caucasian, Indian and racially mixed communities in Africa.

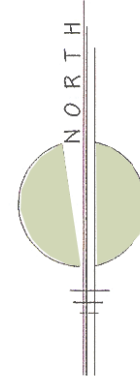

fig. [06] MAP: AFRICA

CONTEXT ANALYSIS

[03][02][00] NATIONAL

Tshwane, the administrative capital of South Africa, envisions becoming an internationally acclaimed African capital of excellence, a city that represents the nation and radiates a national identity to Africa and the world.

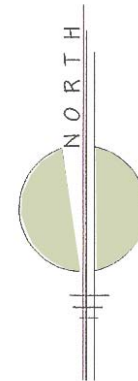

fig. [07] MAP: SOUTH AIR ICA

[03][03][00] REGIONAL

An important city in the **Gatag** province north of Johannesburg and the O.R. Thambo International airport

Tswane is the centre point in the northern Gauteng on the Witbank/Rustenburg axis, and in addition to this, the area to the north, the Limpopo province with the city of Polokwani and beyond see Tshwane as their main centre for all cultural support.

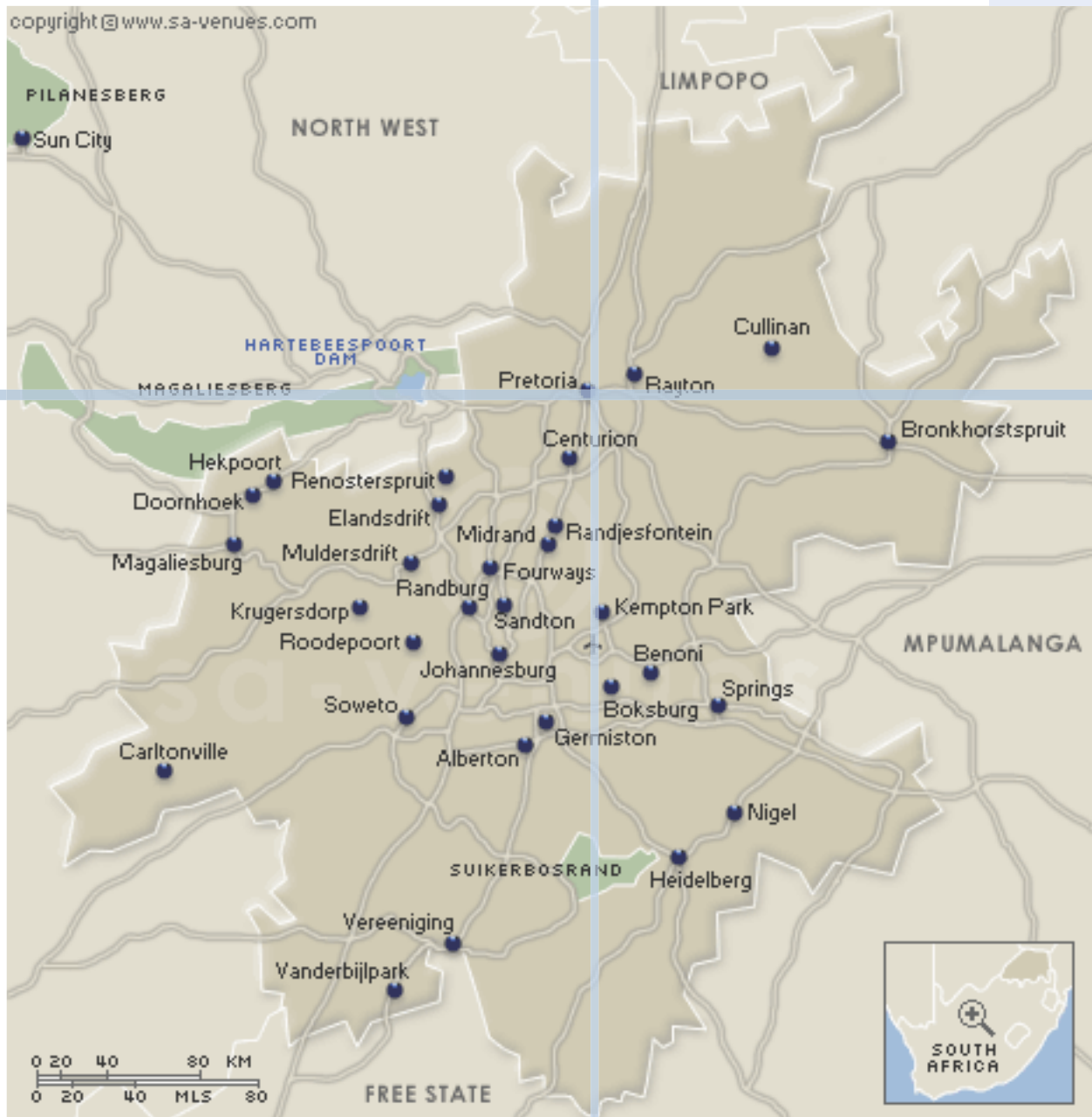
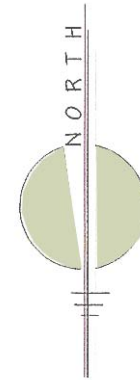

fig. [08] MAP: GAUTENG

CONTEXT ANALYSIS

[03][04][00] CITY

The Tshwane University of Technology's arts faculty is located in the north-eastern sector of the city centre, at the northern end of Nelson Mandela Boulevard. It is bordered by the Apies River canal to the east, Boom and Du Toit Streets to the west and Dr Savage Drive to the north.

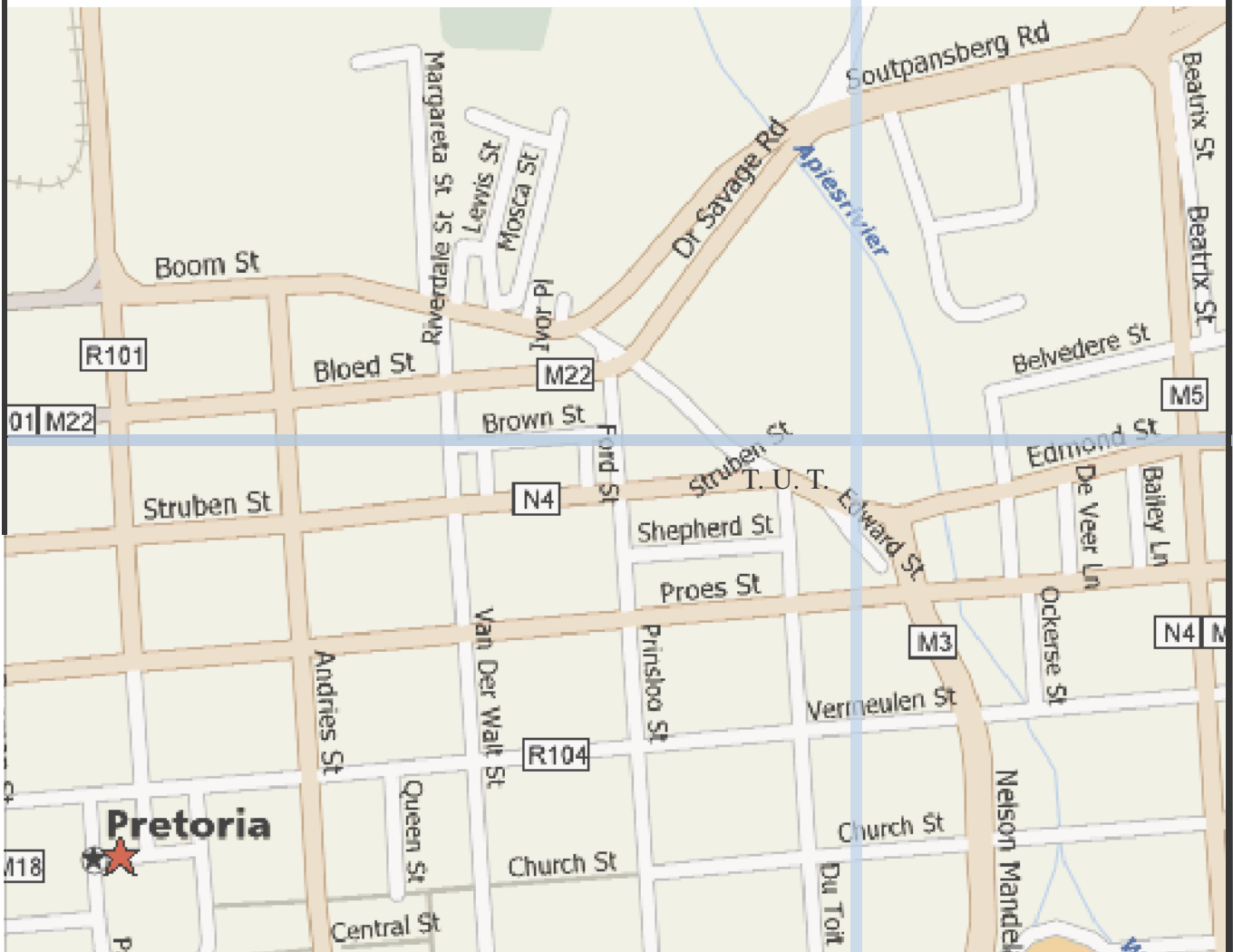
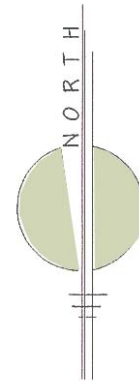

fig. [09] MAP CITY CBD

[03][05][00] THE SITE

AERIAL VIEW.

Aerial view of the urban context. The proposed project embedded in the landscape of this education node, with the medical educational facilities to the north. The Bosman street taxi transport node to the west and the central business district to the south.

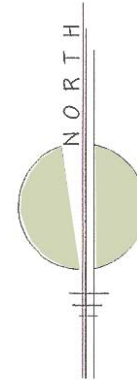

fig. [10] MAP: CITY CBD SITE; AERIAL VIEW

[03][06][00] CONTOURS

Enclosed by a gentle slope to the north and the Apies River, the site is an ideal, open space amongst the existing face-brick buildings. It is entered from the south and has a northern orientation. It lies in close proximity to the city centre and is bordered by the Nelson Mandela Corridor. It forms part of the Tshwane University of Technology's arts campus in the education node, with the medical training facilities to the north. An access route will be created across the square to the main campus.

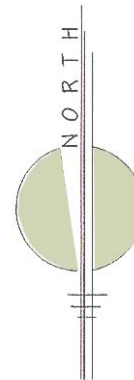

fig. [11] SITE; CONTOURS

CONTEXT ANALYSIS

[03][07][00] THE SITE

The alteration of this environment will be aesthetically appropriate and will add to the character of its surroundings. The design will be sensitive to the site and the existing structures where height and historic distinctiveness is concerned.

The continuity of the development process will manifest through the built form and in the intended pragmatist approach of the proposed project.

Pedestrianization of the site is a priority and access from Edmund Street to the south and the CBD is the link to community participation. Materials used will denote functions and movement routes through the site.

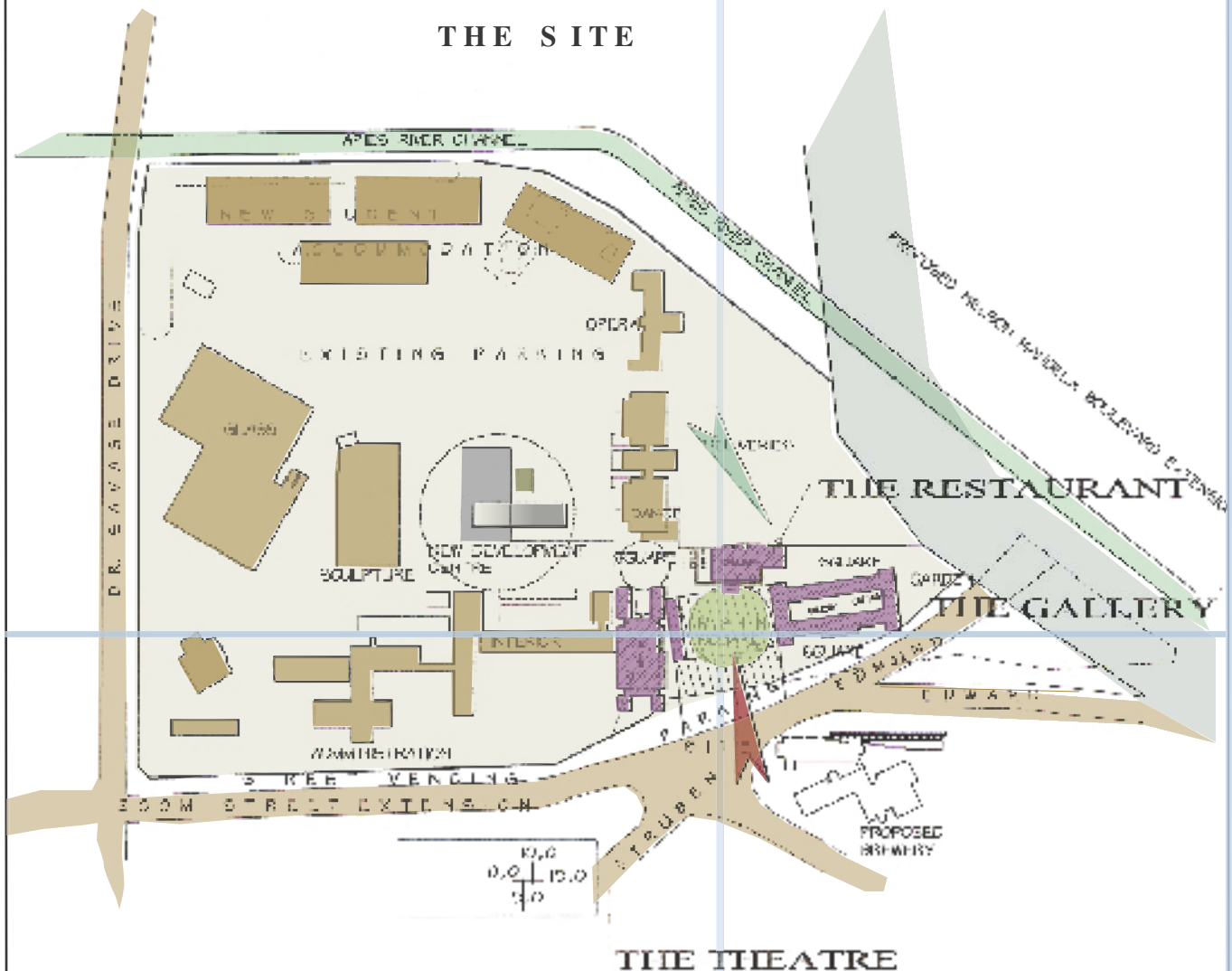
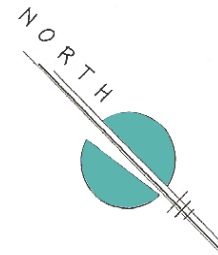
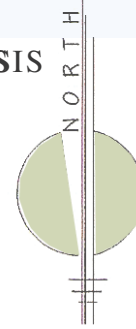

fig.[12] SE ; PROPCA

[03][08][00]MAKRO SITE ANALYSIS

Makroanalysis of the site reveals that the proposed project is located on its perimeter and is including the Site Development Framework of The Tshwane Inner City Project. Main roads and pedestrian routes analog to Stage Drive, Bond Street and the Nelson Mandela Corridor that frame the site. The site also lies in close proximity to the Church Street and Paul Kruger Street Development Corridors.



Private Vehicle and Parking

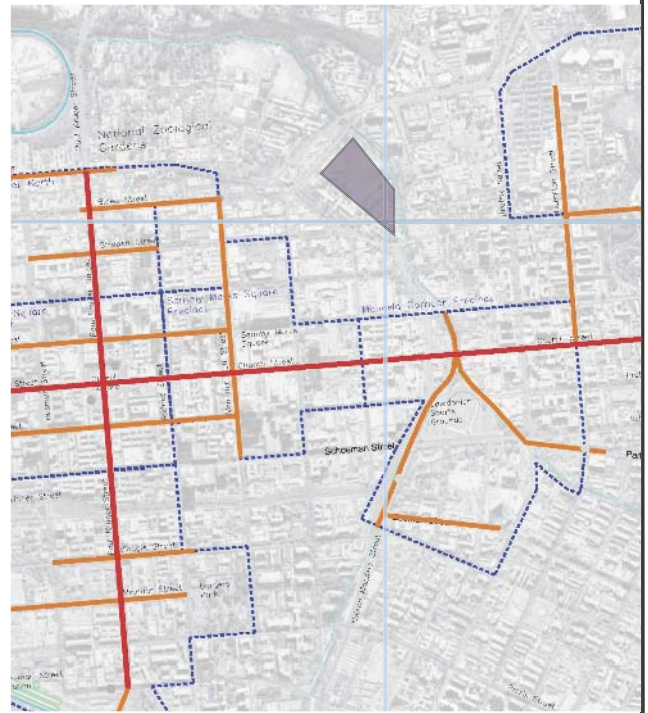

Minimum Secondary Pedestrian Routes

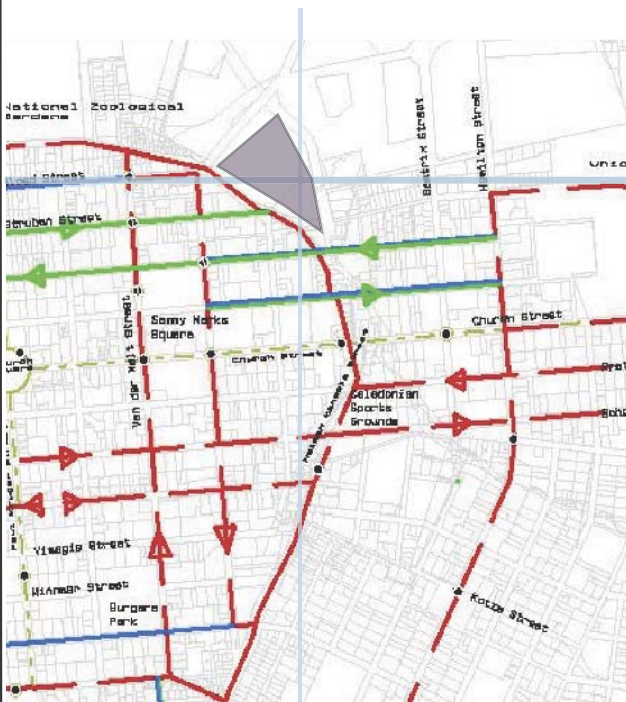
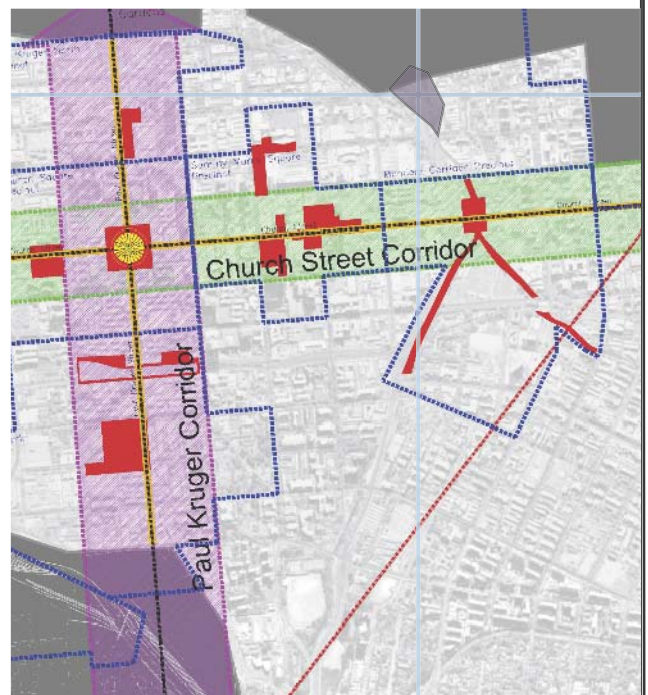

fig. [13] M A Y S
MRO AL YS



Overall Context

CONTEXT ANALYSIS

[03][09][00] GEOGRAPHY AND CLIMATE

Gauteng is said to offer one of the world's best climates: summer days are warm and wind free and winter days are crisp and clear. The rainy season occurs in summer. Rainstorms are often harsh, accompanied by thunder and lightning and occasional hail. Pretoria is situated in the transitional area between the highveld and the bushveld, approximately 50 km north of Johannesburg in the north-east of South Africa. Pretoria's climate is similar to that of Johannesburg, it lies at a lower altitude than its neighbour and its air temperatures are about two degrees higher.

The city lies in a warm, sheltered, fertile valley, surrounded by the hills of the Magaliesberg mountain range, 1,330 m above sea level. The city's coordinates are approximately 25° 44' S 28° 11' E. Snow is an extremely rare event, which may occur once or twice in a century, with the last recorded snowfall on 27 June 2007.

CLIMATE TABLE

	Jan	Feb	Mar	Apr	May	Jun	Jul	Aug	Sep	Oct	Nov	Dec	Year
Highest recorded temperature (°C)	36	36	35	33	29	25	26	31	34	36	36	35	36
Average daily maximum temperature (°C)	29	28	27	24	22	19	20	22	26	27	27	28	25
Average daily minimum temperature (°C)	18	17	16	12	8	5	5	8	12	14	16	17	12
Lowest recorded temperature (°C)	8	11	6	3	-1	-6	-4	-1	2	4	7	7	-6
Average monthly precipitation (mm)	136	75	82	51	13	7	3	6	22	71	98	110	674
Average number of rain days (>= 1 mm)	14	11	10	7	3	1	1	2	3	9	12	15	87
Source: South African Weather Services													

[03][09][01] SUNRISE AND SUNSET DATA

Use the time-of-day scales, on the left and right, and the month scale at the top and bottom, to tell approximately when sunrise and sunset occur. The sunrise and sunset times shown in the chart are approximate. They are accurate for the latitude, and show the precise amount of daylight. The charts are compiled assuming that the location is in the middle of an evenly spaced time zone. For Pretoria, South Africa, latitude 25°44'S and longitude 028°11'E are used.

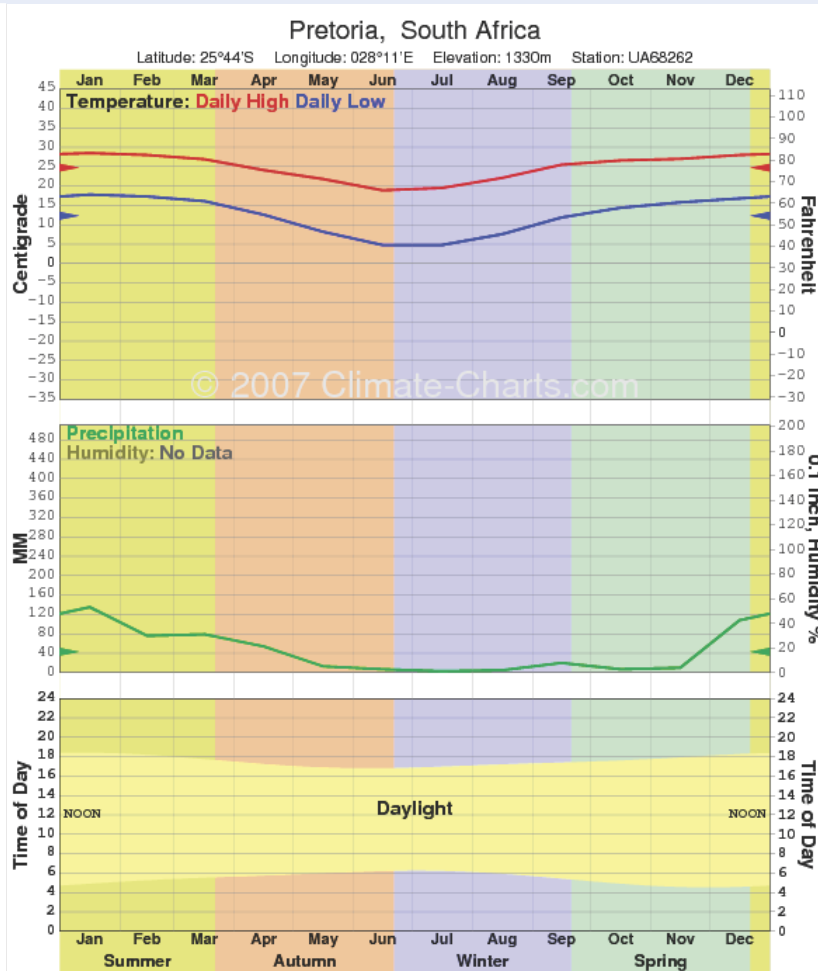

CONTEXT ANALYSIS

[03][10][00] DEMOGRAPHICS

[03][10][01] LANGUAGES

Geographical distribution of home languages in the Tshwane Metropolitan Municipality. The city has a population of approximately one million. The main languages spoken in Pretoria include Tswana, Afrikaans, Ndebele and English. The whole Tshwane Metropolitan Municipality had a population of 1 985 997 according to the 2001 census.

Language	Population	%
Pedi	439 732	22.14%
Afrikaans	422 866	21.29%
Tswana	339 719	17.11%
Tsonga	198 441	9.99%
Zulu	151 200	7.61%
English	129 923	6.54%
Ndebele	98 077	4.94%
Sotho	78 435	3.95%
Swati	37 963	1.91%
Xhosa	37 957	1.91%
Venda	35 242	1.77%
Other	16 425	0.83%

[03][11][00] CULTURAL AND ACADEMIC FACTORS

Pretoria is one of South Africa's leading academic cities, and it is home to the largest residential university in the country, the University of Pretoria, as well as the Tshwane University of Technology and the largest distance education university, the University of South Africa, more commonly known by its initials, UNISA. The South African Council for Scientific and Industrial Research (CSIR) is also located in this city.

[03][11][01] THE CENTRAL BUSINESS DISTRICT

The Pretoria central property market remains stable, primarily owing to attractive rentals and the fact that about 80% of buildings are occupied by government. The western side of the CBD is, however, becoming increasingly neglected and higher vacancies are occurring. Similar to Johannesburg, the conversion of office space to residential is taking place.

The office market is still centred in the CBD, the Eastern suburbs (Hatfield, Brooklyn and Menlyn) and Centurion, with very little activity in the north-west.

THE SITE AND ITS SURROUNDS

SITE LOCATION

The site is located in the north-eastern sector of the CBD, with the Nelson Mandela Corridor to the east, the Apies River framing the eastern and northern boundaries, the Boom Street extension to the west and Dr Savage Drive to the north.

SITE DESCRIPTION

The site lies on the south-east corner of the TUT campus. The student accommodation will be relocated to the north-eastern area of the campus. With the hospital and nurses training facilities to the north, it forms part of the educational node.



APIES RIVER CANAL



APIES RIVER CANAL; SITE - NORTH



SITE, CAMPUS; NORTH TO THE
MEDICAL TRAINING NODE



SITE, CAMPUS; SOUTH TO THE CBD

[04][00][00]

DESIGN PHILOSOPHY

[04][01][00] A PRACTICAL ENVIRONMENT

This proposed Art Precinct will attract like minded people to facilities where they can enjoy social interaction and a shared interest in the arts.

They will visit the square, to cross it but also to enjoy contact with people, to make music, and to enjoy the performances and exhibitions in the open air and the surrounding buildings.

In 1906 William James gave a lecture entitled “What Pragmatism Means.” There James returned to an idea he had first developed years earlier, Pragmatism is nothing more or less than a method for testing ideas by challenging them to make a difference in our experience of the world.

William James (1842–1910)

James became professor of psychology and later philosophy at Harvard, teaching full-time until 1907. He lectured widely in America and Europe until his death on 26 August 1910

(Nobel,2001:2)

Pragmatism is a major intellectual movement which started in America in the 1870s Pragmatists have impacted politics, law, education, religion, and every academic discipline.

“Each subculture needs a centre for its public life: a place where you can go to see people, and to be seen” (Alexander, 1977:169).

The success of this node depends on the grouping of its functions and their interdependence. The functions collaborate to attract people with the same interests, at the same time of day, and in this way the concentration of activities will increase.

“To James, ideas, however lofty, prove themselves to be true only when they are carried all the way back down to Earth, examined in the clear light of human doubt, and are shown to perform” (Nobel 2001:1).

To create an area that can function as a node, where people would want to congregate, it is best to group similar functions around a small square that can form the core. The square should be small enough to keep movement patterns well concentrated; if it is too large it feels deserted. It should be big enough for small gatherings, celebrations, festivals and performances. It should be a place where the community will feel safe and would like to visit, that would become their favourite place.

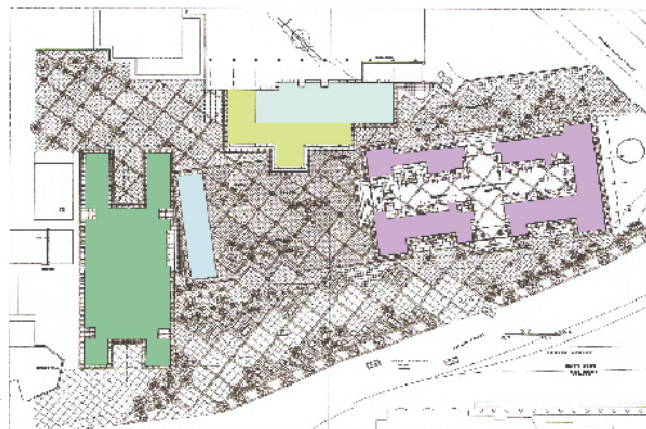

fig. [14] SITE: ORIENTATION

DESIGN PHILOSOPHY [04][02][00] THE SQUARE

‘Small squares forms the core which makes an activity node, it also help to generate a node, by its mere existence, provided that it is correctly placed along the intersection of the paths which people use most often’.
(Alexander,1977:311)

The flow of pedestrians is directed to move through the node and amongst the functions. The layout of paths and the main route through the square are not formal and structured; they are only generally indicated as routes and it is then left to pedestrians to create the crossroad and focal points. The paths should ideally pass through the centre of the site to intensify the life in the square.

The composition of the square and the relationship between the volumes of the different buildings form the basis of the project, and contained herein is the importance of the individual buildings.

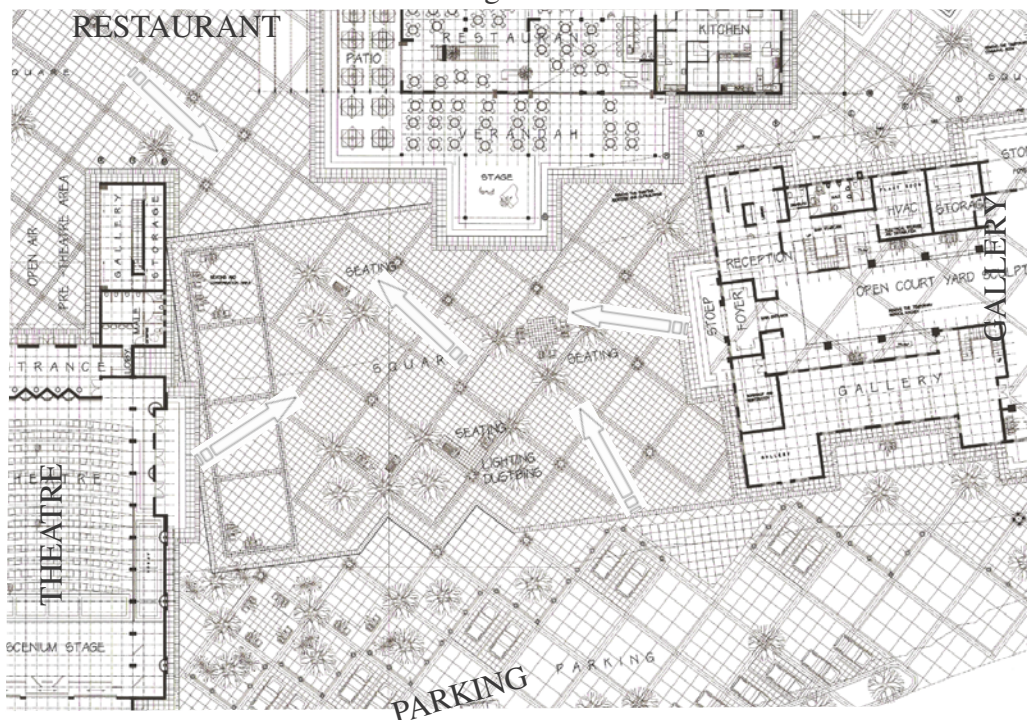

fig. [15] SITE: SQUARE The buildings will be linked through the treatment and finishes of the envelope - as a reaction to the design drivers of the existing buildings. The application of ornament will be more, not less, and in this the various aspects will tie in and melt into the buildings and create a wholeness.

The design approach will be holistic, in that each part forms a whole and that all parts work together, not only parts of the individual buildings but also the buildings as a group.

This composition, and the relationship between the buildings, forms the well organised exterior space.

The buildings surround space and every building creates a coherent and well shaped public space next to it.

The positions of the buildings dominate and define the pedestrian spaces.

DESIGN PHILOSOPHY

[04][03][00] CROSSOVERS

The buildings surround the square and form a defined space, with views onto the centre. The square is partly enclosed by the three buildings. The individual buildings then open onto secondary squares and courtyards that lead back to the main square.

The significance of links to the outside from each of the courtyards, together with the building's edge and its orientation towards the outside, is as important as the buildings' internal design. In consequence, the building edge remains a positive place, making it part of the social fabric, making it human. People placing themselves at the edge find themselves in a realm between realms, experiencing the ambiguity between outdoors and indoors, the crossover from the one to the other.

'Make all the outdoor spaces which surround and lie between your buildings positive. Give each one some degree of enclosure; surround each space with wings of buildings, trees, hedges, fences, arcades, and trellised walks, until it becomes an entity with a positive quality and does not spill out indefinitely around corners' (Alexander, 1977:522).

The scalloped edges of the facilities, with outcrops and extensions protruding into the square, will make it come alive with movement and conversation, making it natural for visitors to pause and get involved.

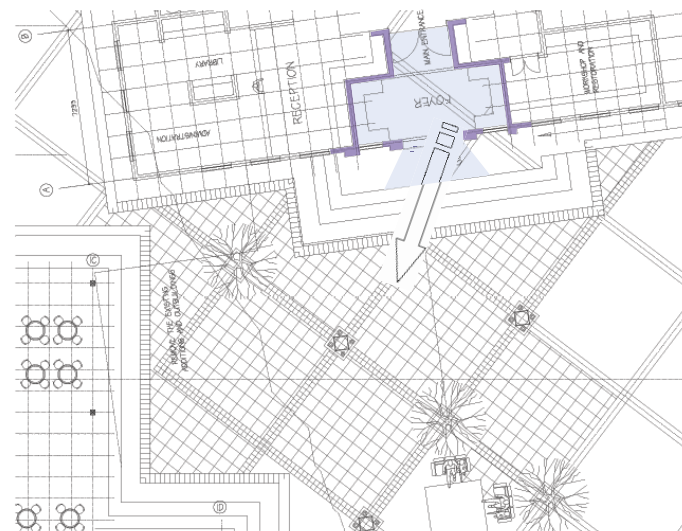

fig. [16] SCALLOPED EDGE

DESIGN PHILOSOPHY

[04][04][00] TRANSITIONS

The inside-outside connection and the activities in the zone are enhanced by the boundary itself. The edge is a place with volume, with depth. In the change-over from internal to external areas, the transition is achieved through a courtyard or foyer, or a roofed exit. Places to sit are provided, especially at points that overlook interesting and lively vistas.

The transitional (intermediate) areas underline the importance of the partial connectivity between the indoor and outdoor activities. This structured hierarchy, at access points to the squares and courtyards, will afford views and links to a larger open space.

People feel safer in areas that are partially enclosed.

The success of the square lies in the grouping of people and their activities, and in the quality of the presentations that will be on offer. The liveliness of the square is related to the quality of performances and visitors.

Pragmatism: the fruition of the idea.

How successful will the development be?

The outcome depends on the quality of the idea and its execution.

fig. [17] TRANSITION

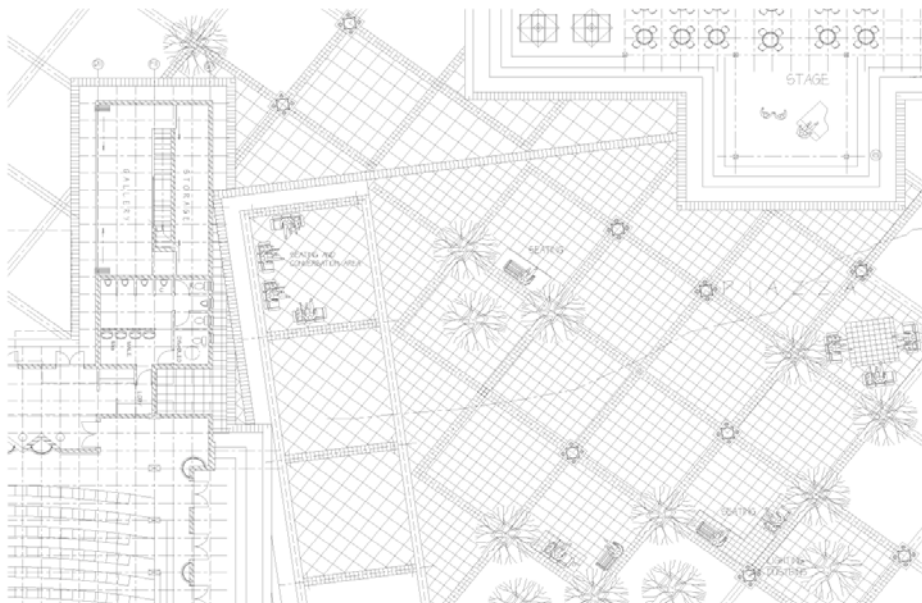

DESIGN PHILOSOPHY

[04][05][00] THRESHOLDS

A series of thresholds has been developed in layers between the street and the buildings. These are visually defined in a manner that is not physically obstructive. Bollards, changes in level, dwarf walls and elaborate patterns in the paving are used to differentiate between different thresholds.

Make a transition space..., and mark it with a change of light, a change of sound, a change of direction, a change of surface, a change of level, perhaps by a gateway which makes a change of enclosure, and above all with a change of view (Alexander, 1977:552).

The individual buildings will create a system of nodes and internal paths with small internal squares and lanes.

fig. [18]

THRESHOLDS

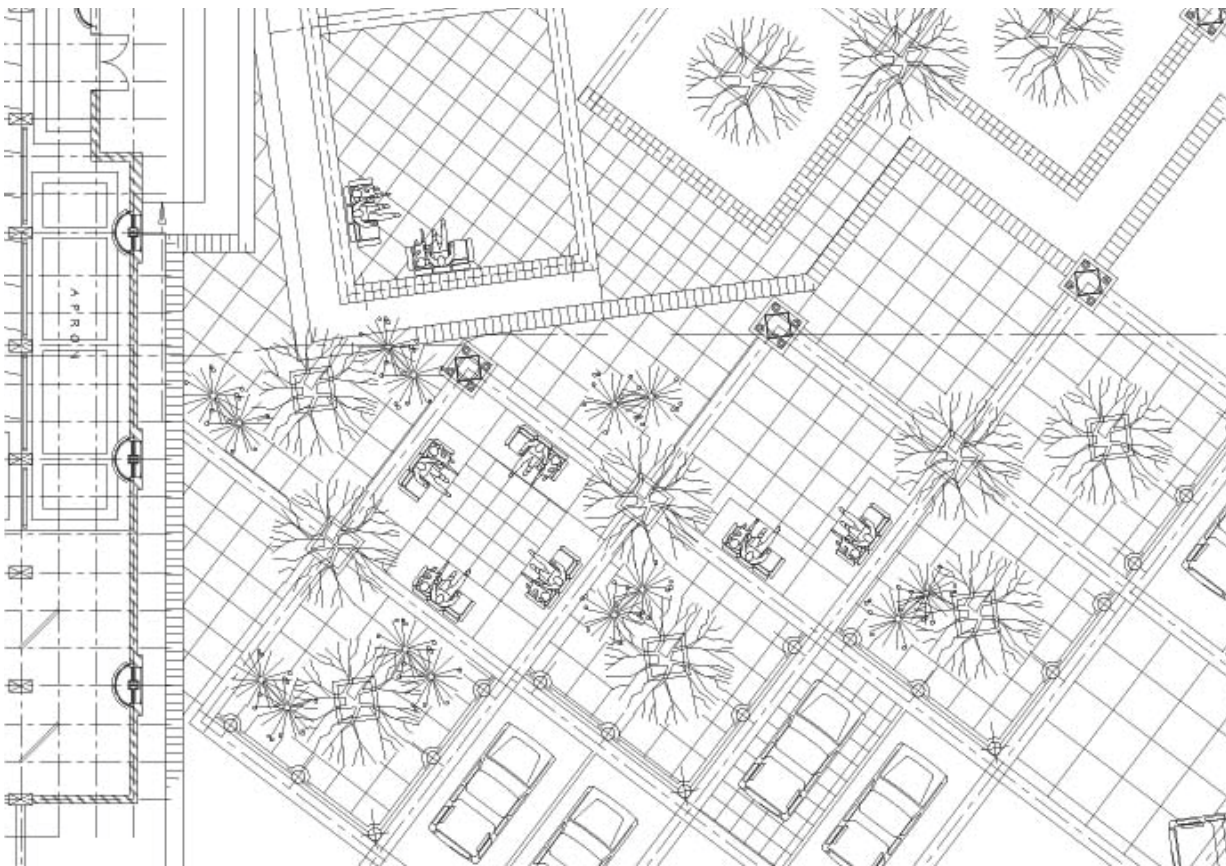

DESIGN PHILOSOPHY

[04][06][00] A SAFE SHIELD

..people always try to find a spot where they can have their backs protected, looking out toward some large opening, beyond the space immediately in front of them . (Alexander , 1977: 558)

Where outdoor seats are set down without regard for view and climate, they will almost certainly be useless.

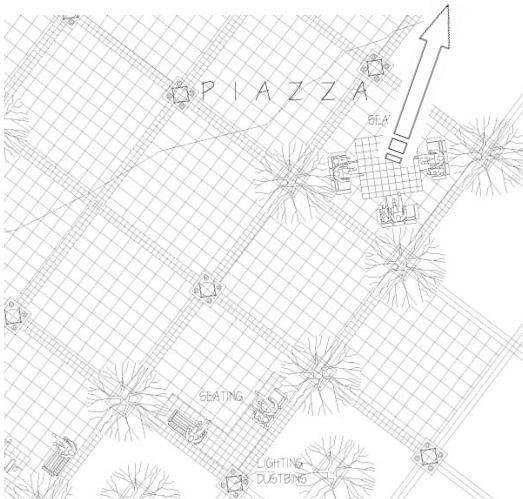

Make a quiet place..... a private enclosure with a comfortable seat, thick planting, sun. Pick the place for the seat carefully; pick the place that will give you the most intense kind of solitude.

(Alexander, 1977: 1119, 817)

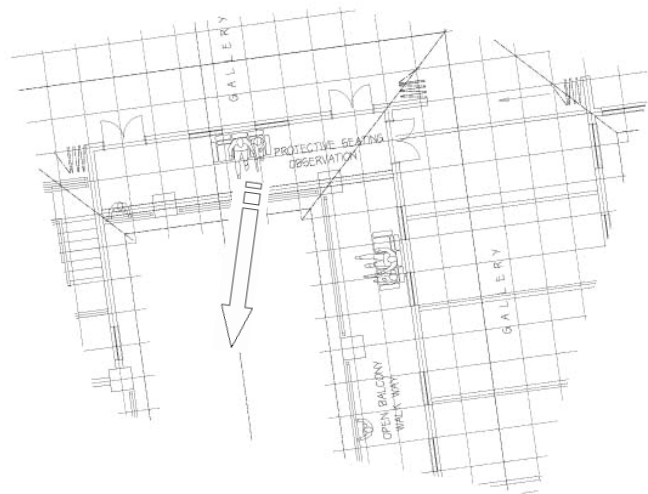

Contained and secure seating will be created in selected areas of the precinct, from the various conversation settings on the square, to the seating alcoves in the restaurant, and the walkway and observation promenades in the gallery.

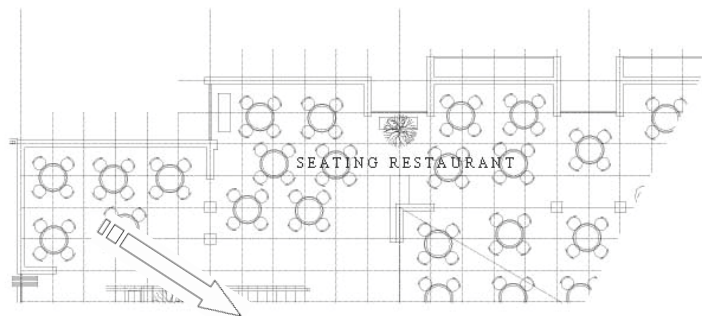

fig. [19] SAFE SHIELDS

DESIGN PHILOSOPHY

[04][07][00] INTERMEDIATE NODES

From the pre-concert courtyard at the theatre to the seating in the new auditorium, a feeling of well-being will be created, where people would like to congregate and enjoy the arts being performed and exhibited.

This will ensure that the space is alive with movement and conversation - activities that will help to make the theatre experience more than just a performance.

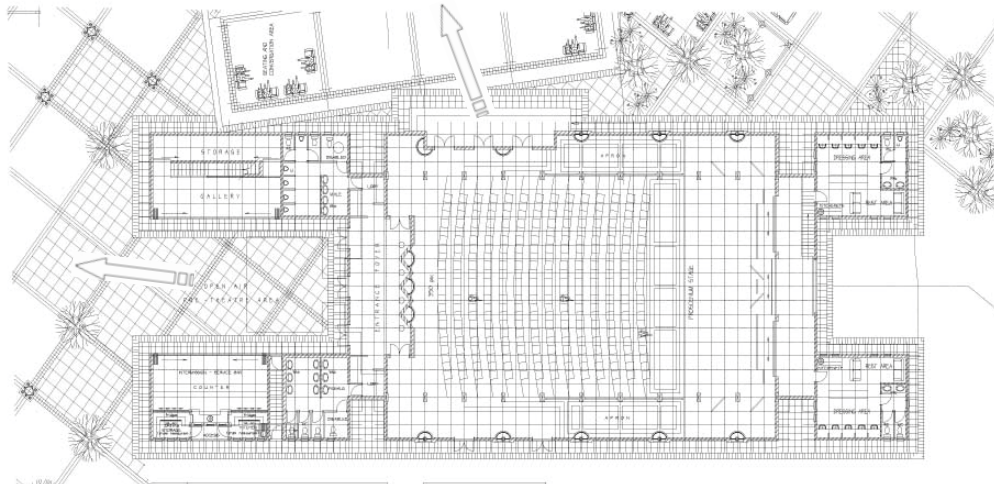

fig. [20] VIEW TO THE SQUARE

Place every courtyard in such a way that there is a view out of it to some larger open space; place it so that at least two or three doors open from the building into it and so that the natural path which connect these doors pass across the courtyard.

(Alexande,1977:564)

The threshold areas are structured to form important links and orientation points to the outside. The view from the courtyard will help to form a link to the larger open space.

The scalloped edge with interesting extensions will create a positive place, making it part of the social and educational functions of the facility.

The links between the inside and the outside, and the activities in these intermediate nodes of intensity, consist of the service bar and gallery, as well as the management areas of the theatre and administration of ces on the rst o or.

DESIGN PHILOSOPHY

[04][08][00] CONCLUSION

The basis of this design philosophy analysis is the pragmatism theory: the fruition of the idea.

The success of the development is dependent on the quality of the design idea and then on the execution of that design idea.

The project demands sensitivity towards its important environment, not only by preserving the buildings and clearing from insensitive additions, but through the re-modulation of space.

A keen responsibility was felt for creating a public urban space, particularly in terms of multi-functionality, people-friendliness and attractiveness, for creating a place where people would like to congregate and enjoy the arts being performed and exhibited, and for creating a development that would ensure that this space will be alive with movement and conversation.

The newly formed square and the relationship between the volumes of the different buildings form the basis of the project, and contained herein is the importance of the individual buildings. The placing of the buildings will ensure that the outdoor spaces which surround and lie between the buildings remain positive.

This small square will form the core of the new activity node. Naturally formed paths that pass across the courtyard connect the different facilities, and the movement they direct will indicate the interdependence of the functions. The fruition of the idea will be that the visitors enjoy social interaction, rooted in their shared interest in the arts.

fig. [21] Model
SOUTH ELEVATION
TO THE RESTAURANT



[05][00][00] ACCOMMODATION SCHEDULE

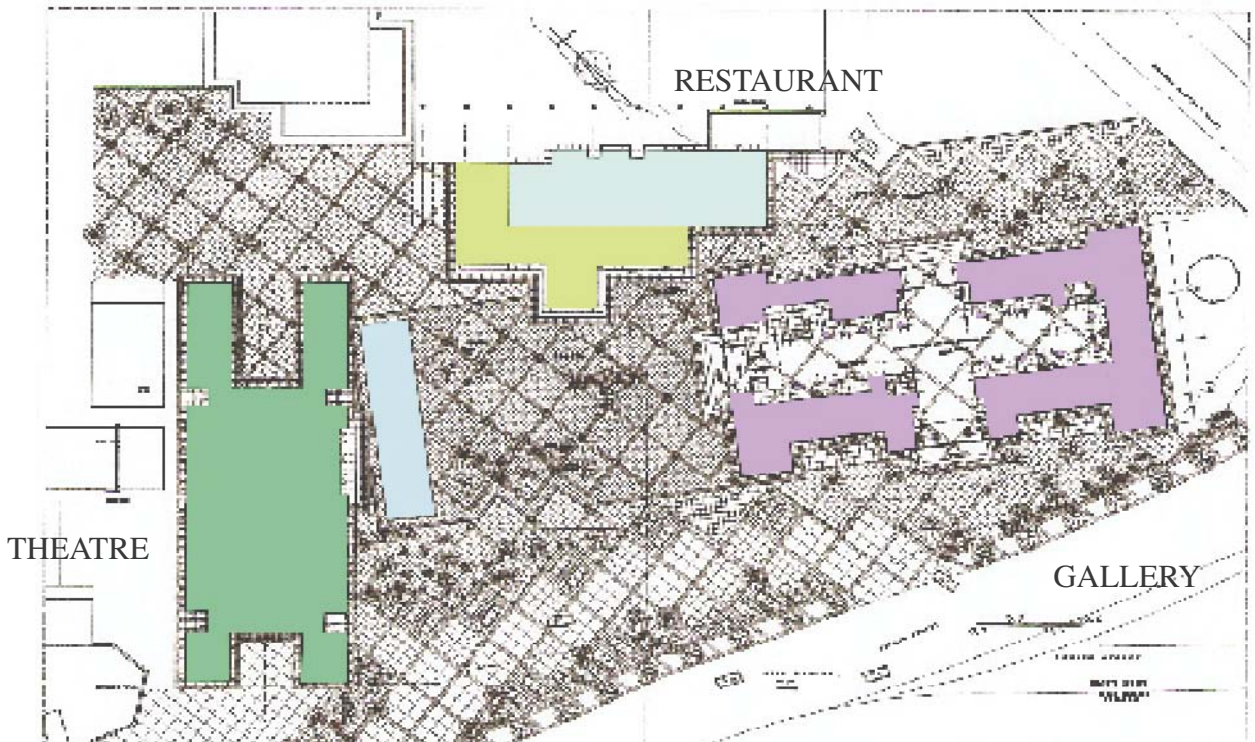
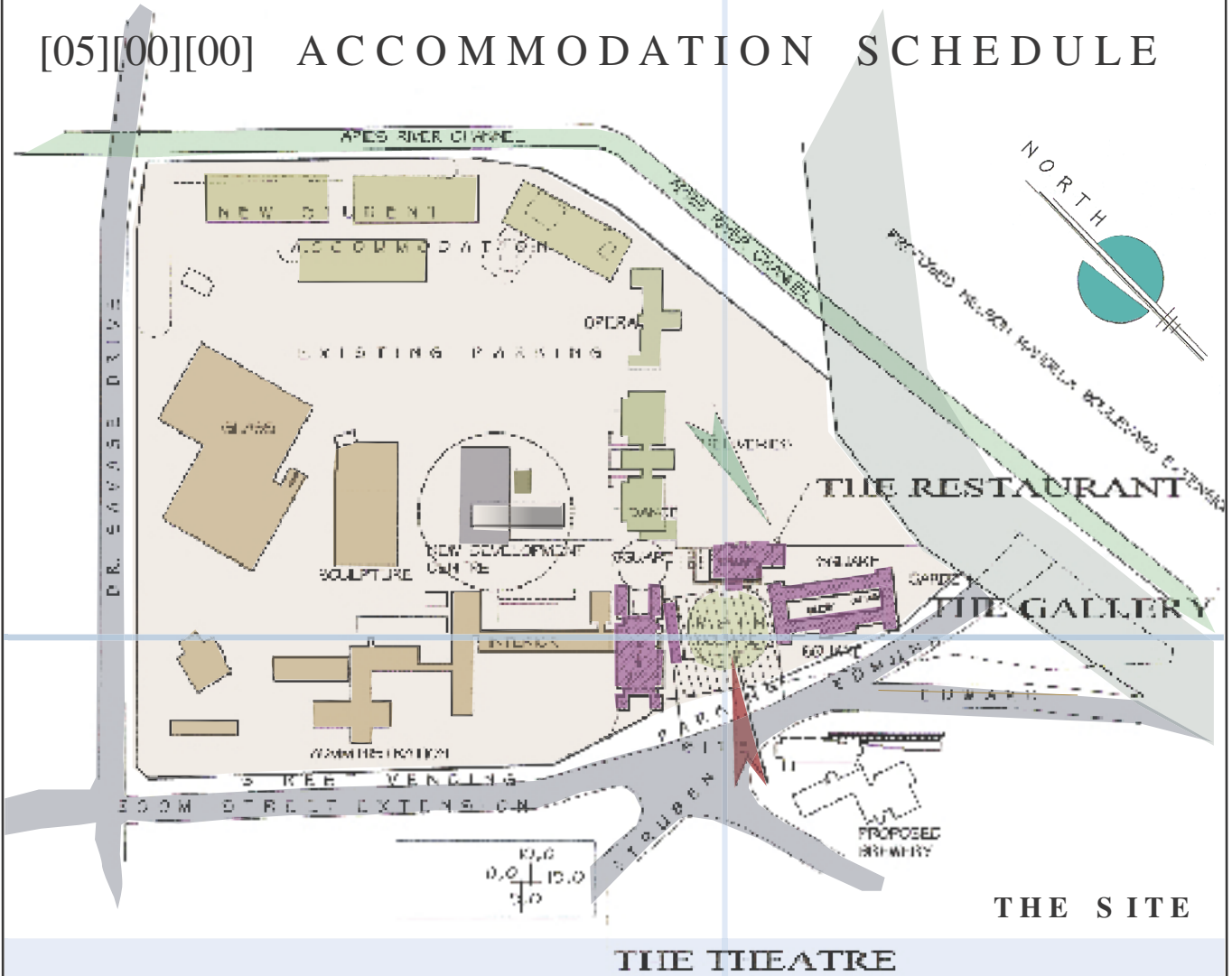

fig. [22] PROJECT EXTEND & SITE

ACCOMMODATION SCHEDULE

[05][01][00] GROUND FLOOR 'HEIDEHOF' GALLERY

DISCRIPTION & FUNCTIONS

1. ENTRANCE: Access to Gallery
2. GALLERIES: Exhibition and Promotions
3. RETAIL: Craft and artistic works
4. RECEPTION: and Administration
5. STORAGE: Art works and Retail
6. COURT YARD: Central open air exhibitions

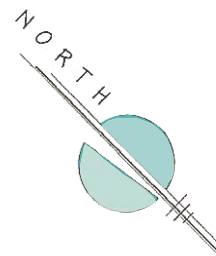

GROUND FLOOR

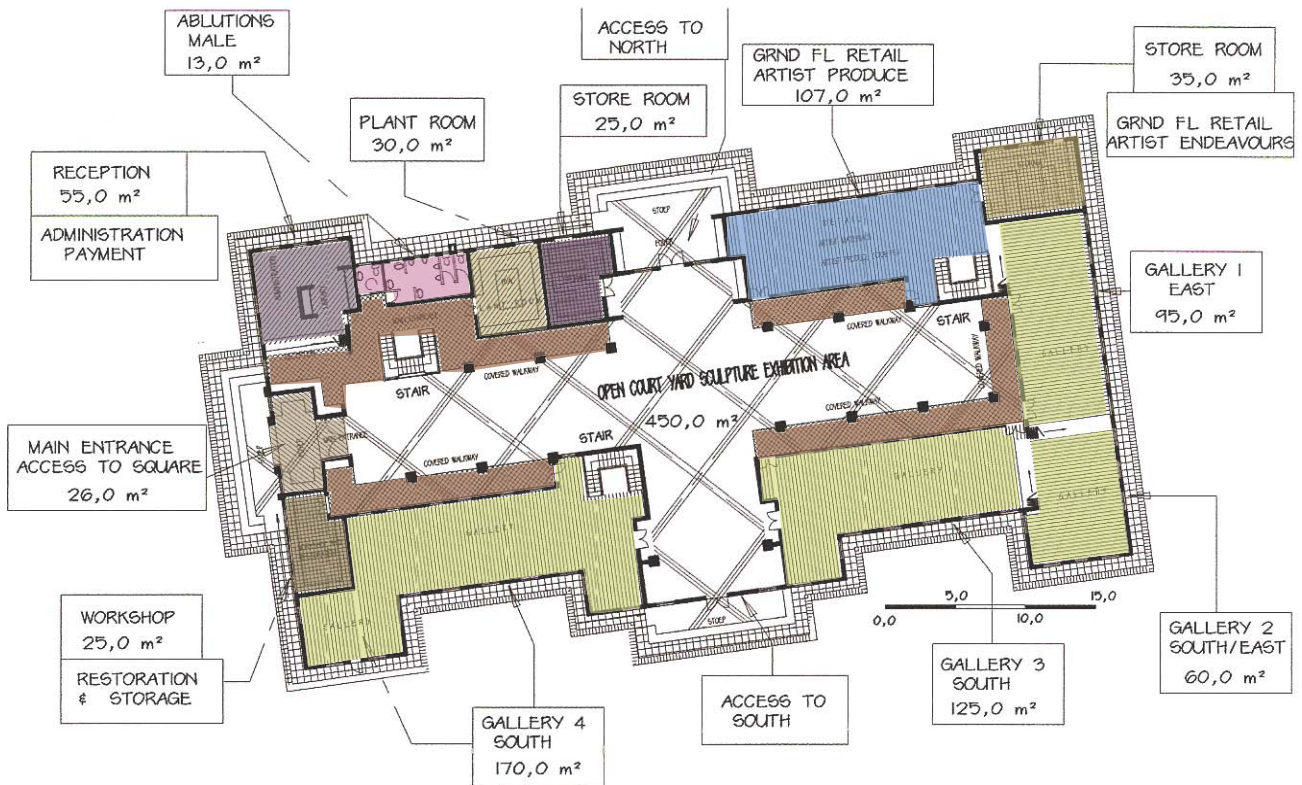

fig. [23] GROUND FLOOR 'HEIDEHOF' GALLERY



GROUND FLOOR 'HE DEHOF' GALLERY

DESCRIPTION: ENTRANCE, THE GALLERY AND RETAIL
FUNCTION: RECEPTION, EXHIBITING AND SHOPPING.

ROOM	SIZE	STANDARD
Main Entrance	26,0m ²	New access into the gallery, with sandstone surround.
Reception & Administration	55,0m ²	Gallery Administration and Information, Reception
Workshop, Restoration & Storage	25,0m ²	Minor restoration & maintenance to art works. Storage
Ablutions Male & Disabled	13,0m ²	Near gallery access and main staircase. Screenwalls
Plant Room & electrical d.b.	30,0m ²	HVAC plant, Electrical distribution and service, storage
Store Room	25,0m ²	smaller artworks and retail overflow storage
RETAIL NORTH		
Retail of crafts produced by artists	107,0m ²	Artistic produce in this northern wing. Natural light, from existing windows to the north Southern windows to court yard. Access near the northern entrance and stair, for students and professionals.
Store room	35,0m ²	Retail storage and replenishing for the ground floor.
GALLERIES GROUND FLOOR		
Softer eastern and southern natural light into the galleries from, existing windows. Natural light into the galleries also from new windows, onto the central court yard, screened by the overhang of the first floor balconies. Movable screens for exhibiting, and defusing direct light, at all windows in the galleries .		
Gallery #1 East	95,0m ²	
Gallery #2 South/East	60,0m ²	For very sensitive works - watercolours etc.
Gallery #3 South	125,0m ²	
Gallery #4 South	170,0m ²	
Central Court Yard	450,0m ²	Open air sculpture and installation exhibition area
Collonade walkway	185,0m ²	circulation, gallery bypass and rest area.

ACCOMMODATION SCHEDULE

[05][02][00] 1ST FLOOR HEIDEHOFF GALLERY

DESCRIPTION & FUNCTIONS

1. BALCONY ES: Observation and circulation
2. GALLERY ES: Exhibition and Promotions
3. RETAIL: Stationary and Art Materials
4. MANAGEMENT : and Administration
5. STORAGE: Art works and Retail
6. AVAILABLE VOLUME: Court Yard Below

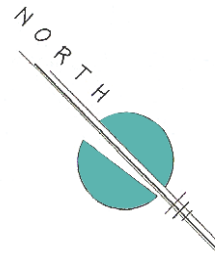

FIRST FLOOR GALLERY

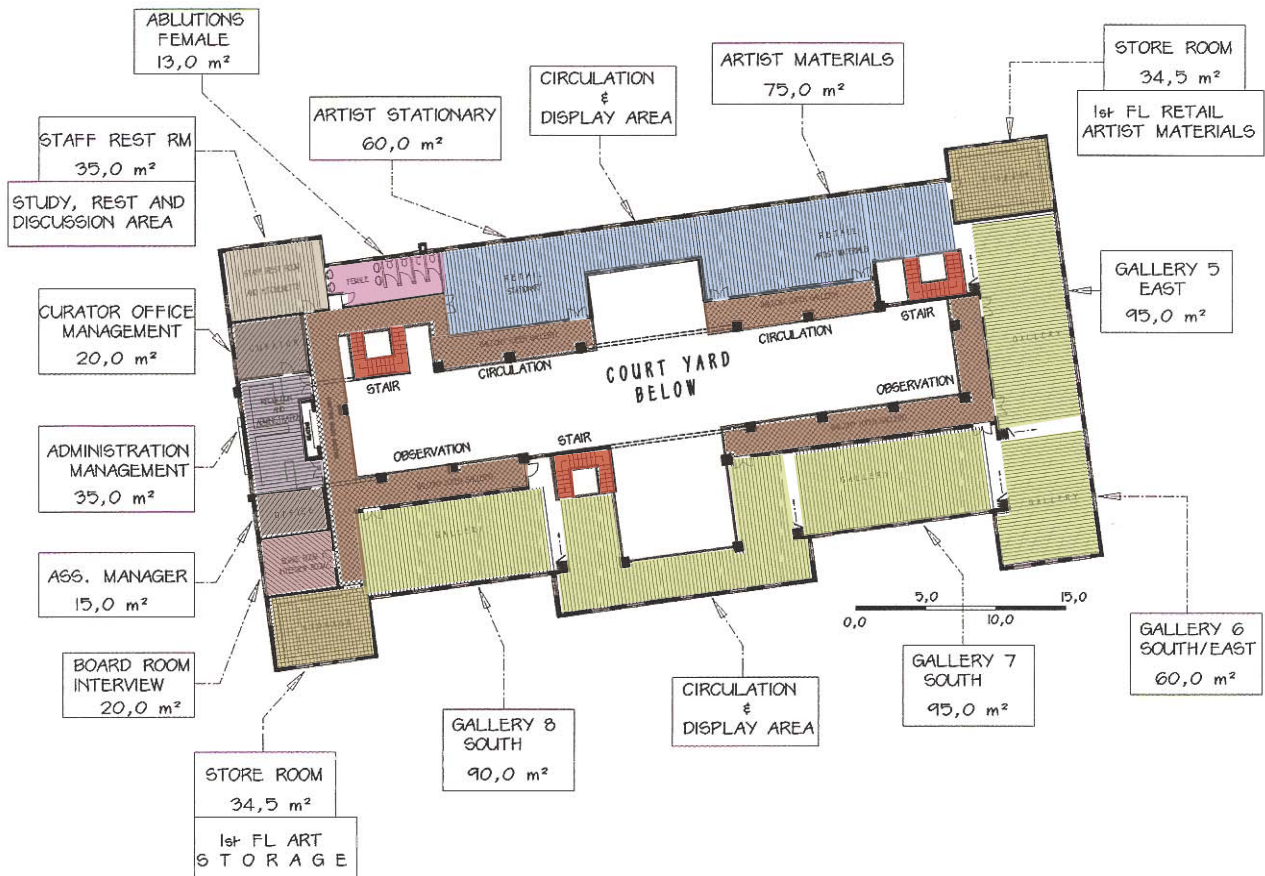

fig. [24] 1ST FLOOR HEIDEHOFF GALLERY



FIRST FLOOR 'HEIDEHOF' GALLERY

DESCRIPTION: ADMINISTRATION AND GALLERY

FUNCTION: ADMINISTRATING AND EXHIBITIONS

ROOM	SIZE	STANDARD
Reception & Administration	35,0m ²	Gallery Management Administration
Curator Office	20,0m ²	Gallery Executive Manager
Assistant Manager Office	15,0m ²	2 I C
Board & Interview Room	20,0m ²	Discussions and interviews with artists ; Staff meetings
Staff Rest Room	35,0m ²	Kitchenette and informal staff meetings
Ablutions ; Female	13,0m ²	Facilities for the gallery located in this area .
Store room	34,5m ²	Smaller artworks for the first floor galleries
RETAIL NORTH		
Artist Store	60,0m ²	Natural light is preferable, existing windows to the South and West to courtyard . Store retail, access to the main stairs , for student and professional .
Artist Materials	75,0m ²	Materials for the creative and for forming artist . Access through gallery #5 and the main stairs .
Store room	34,5m ²	Retail storage and display
GALLERIES FIRST FLOOR		
All galleries and retail areas to have white (reflective) ceilings and light coloured glazed tile floor finish. The main walls at the windows and display walls to be painted dark gray to contrast with the display works of art .		
Gallery #5 East	95,0m ²	
Gallery #6 South/East	60,0m ²	
Gallery #7 South	95,0m ²	
Circulation	100,m ²	Circulation and exhibition , courtyard below
Gallery #8 South	90,0m ²	
Balconies	195,m ²	Circulation , gallery bypass and rest area view to courtyard .

ACCOMMODATION SCHEDULE

[05][03][00] GROUND FLOOR RESTAURANT

DESCRIPTIONS

1. RECEPTION : Access to Restaurant
2. STAIRCASE: Circulation Detail
3. DINING AREA: Dining and entertain
4. DOUBLE VOLUME: Dining and entertain
5. BAR: Entertain
6. KITCHEN: Preparation and scullery

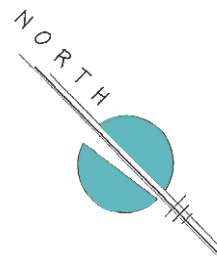

GROUND FLOOR RESTAURANT

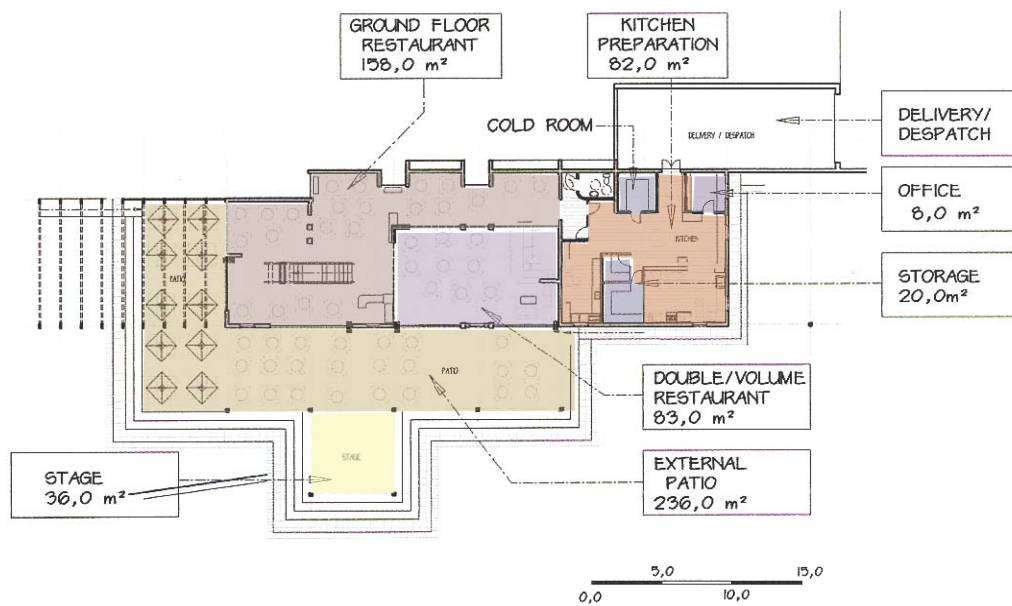

fig. [25] GROUND FLOOR RESTAURANT



GROUNDFLOOR RESTAURANT

DESCRIPTION: RESTAURANT, VERANDA AND KITCHEN
FUNCTION: PREPARATION AND ENTERTAINING

ROOM	SIZE	STANDARD
KITCHEN		
Preparation Area	82,0m ²	Heart of the kitchen; cooking, cold prep., scullery wash up.
Delivery/dispatch		External; open, screen walled area. Receiving and refuse.
Dry storage and coldroom	20,0m ²	Restaurant preparation provisions storage.
Office	8,0m ²	Restaurant and kitchen, management and control.
Disabled toilet & kitchen foyer		Wheelchair toilet. Kitchen foyer, double; egress & ingress.
RESTAURANT		
DINING AREA		
Including; Double Volume Area Bar - Entertaining Reception & control Waiting Area	240,m ²	The airy, open dining area the vertical circulation and planting display, with the double volume area, ensure visual contact with the first floor dining. Steel and glass front to the verandah allow ample softer southern light. the lighting The layout create a wholeness as discussed in text
Verandah	236,m ²	Raised, tiled, open air external dining area. with stair and ramp details
Stage	36,0m ²	At the same level as the verandah, roofed

ACCOMMODATION SCHEDULE

[05][04][00] FIRST FLOOR RESTAURANT

DESCRIPTION & FUNCTIONS

1. RECEPTION : first floor placing
2. STAIRCASE: Circulation Detail
3. DINING AREA: Dining and entertaining
4. BALCONY: Walkway
5. ABLUTIONS : Foyer, Male and Female

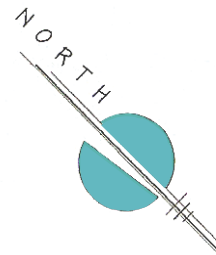

FIRST FLOOR RESTAURANT

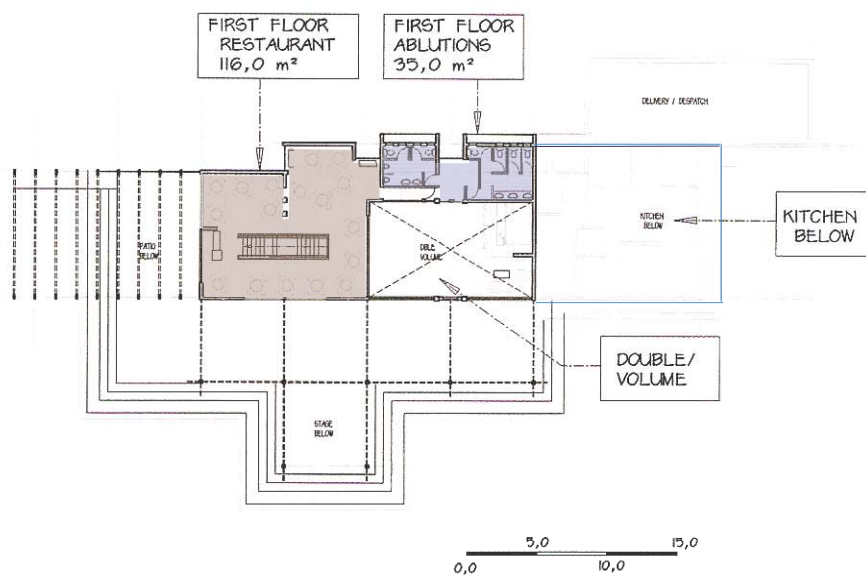

fig. [26] FIRST FLOOR RESTAURANT



FIRST FLOOR RESTAURANT

DESCRIPTION: RESTAURANT AND ACCOMMODATIONS
FUNCTION: ENTERTAINING AND DINING

ROOM	SIZE	STANDARD
Dining Area	11 6 m ²	With star vertical circulation detail, plating and detail detail.
Table dune		Natural light is preferred, windows to the north are deep recessed to diffuse the glare with the extend louvers to minimise the solar gain.
Sar		South windows to the verandahs square are double glazing to prevent (glass will).
		Table dune open into Restaurant below to bar area
First floor alterations with foyer	350 m ²	Ventilated by means of green walling at a recess

AC COMMOD AT ION SCHEDUL E

[05][05][00] GRONDHOOR THEATRE
DISKRIPTIE & FUNKTIES

1. RE -THEATRE ; Bar; Gallery
2. ERNE ; Theatre Patrons
3. THEATRE : Auditorium
4. STAGE; Apron
5. BAKSTAGE; Foyer; Actor Rest Area
6. ACESS ; Service Court Yard

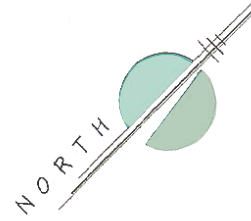

GROUND FLOOR THEATRE

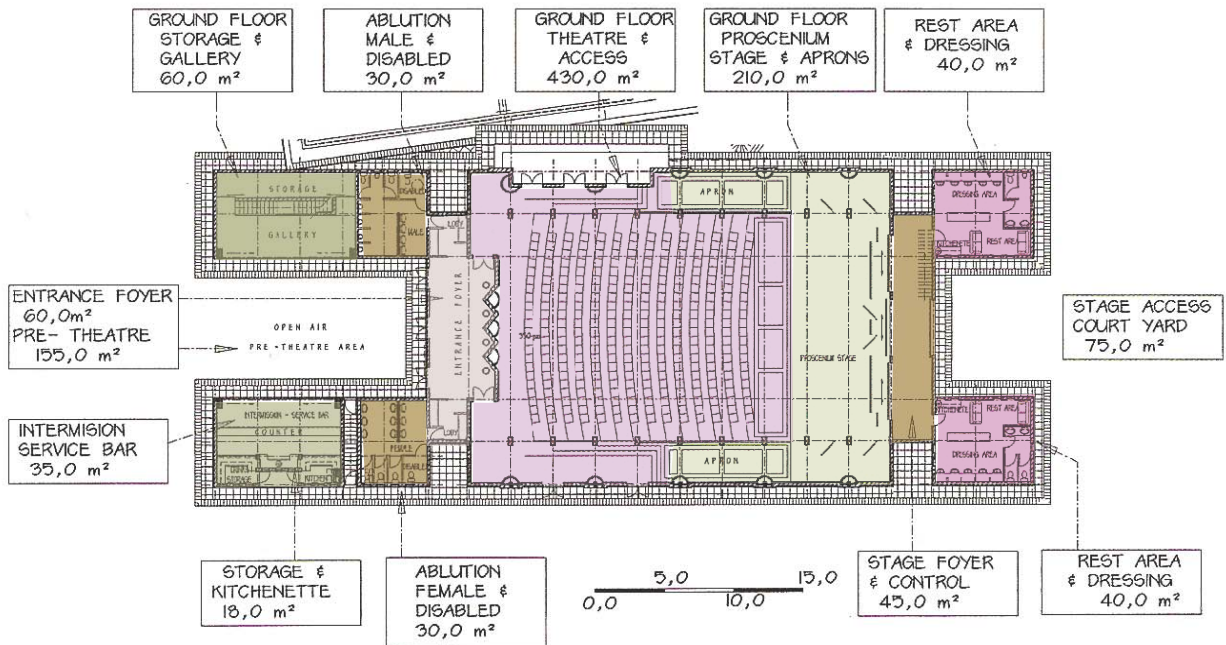

fig. [27]

GRONDHOOR THEATRE



GRO UND FLOOR THEATRE

DESCRIPTION: ENTRENCE, THEATRE AND STAGE

FUNCTION: APPOINTMENT, ENTERTAINMENT PERFORMANCE

ROOM

SIZE

STANDARD

REHEARSAL AREA

Galley

Store room
Stair to admin. 60,0m2 Exhibiting selected works from the main galley, with store and workshop area - to prepare work for showing

Intermission Bar. 35,0m2 Entertaining area at intermission and pre-theatre period.
Kitchenette & Preparation and heating light meals from Restaurant.
Store room 18,0m2 Cold storage, wine and prepared food.

Pre - Theatre; Open Court Yard 155,m2 Paved court yard, an open gathering area, during interval in theatre performances

ENTRANCE

Entrance Foyer 60,0m2 Reception and admission to the theatre, foyer to the ablution facilities

Ablutions; Female 30,0m2 Screened, ventilated lobby

Ablutions; Male 30,0m2 Screened, ventilated lobby

THEATRE

Auditorium 430,m2 Seating area : 290,0m2 - 265 seats 1,1m2 p/seat (1,22 x 0,9)
Note; Disabled access. Mechanically ventilated, inlet at floor level and extraction return at ceiling ducting.
Acoustic fabric covered panels at rear wall and 2/3 of back, to side walls. Vinyl covering to side walls 1/3 of front (from stage)

Stage and aprons 210,m2 Stage, restore and reuse the existing theatre's stage and pit as required by the setting. Movable and overhead sets.

BACKSTAGE

Stage Foyer 45,0m2 Movement of artists and sets, backstage to first floor.

Rest Area Female 40,0m2 Ablutions and change areas for artists and staff

Rest Area Male 40,0m2 Ablutions and change areas for artists and staff

SERVICE ENTRANCE

Access Court Yard 75,0m2 Deliveries and dispatch to the stage door. Access to street.

AC COMMOD AT ION SCHEDUL E
[05][06][00] HIST HCR THE TE

DISRPTIO&FUNCTIOS

1. ADMINISTRATION : Stair
2. CONTROL ; Office, Stair
3. GENERAL : Court Yard
4. DOUBLE VOLUME : Theatre & Stage
5. STAGESERVICERY ; Sets, Stair
6. SERVICE : Plant room, Workshop, Store

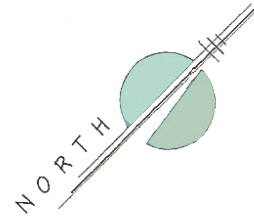

FIRST FLOOR THEATRE

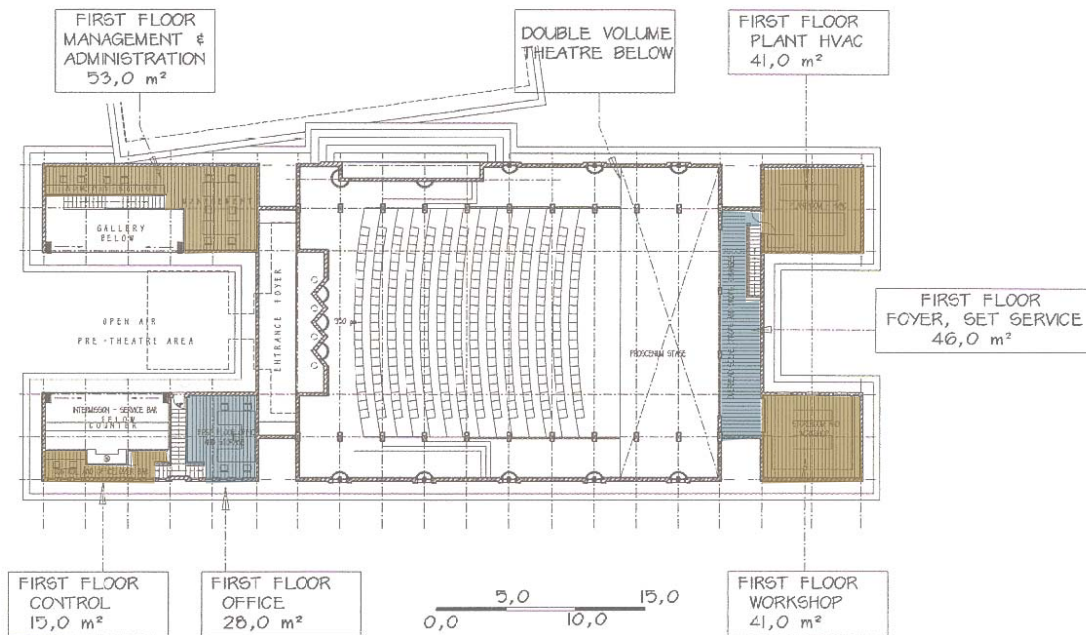

fig. [28] HIST HCR THE TE



FIRST FLOOR THEATRE

DESCRIPTION: SERVICES

FUNCTION: ADMINISTRATION, WORKSHOP AND PLAT ROOM

ROOM SIZE STANDARD

ADMINISTRATION

Theatre Administration

Management Office
Administration
Openair

53,0m²

Theatre Management Administration

Staff meetings, Invitations

Natural light through gallery below,

Small southern wind wsto courtyard, cross ventilation.

CONROL

Stock Management & Control

Office and Storage
Openair

15,0m²

Open to the bar below, control and stock management

Offices, storage for the theatre

kitchenette, sinks for sanitation

28,0m²

ADJUSTABLE VOLUME

Theatre & Stage

650,m²

Tea acoustic timber ceiling over existing concrete potal

also using the room ventilation and conditioning ducting

ducting

SERVICES

Foyer ; stage service area

46,0m²

Access from foyer to stage and service area

stair vertical circulation and service area

Workshop, Store room

41,0m²

Storage, storage and service

Plat room HVAC

41,0m²

HVAC Plat and electrical distribution and storage

[06][00][00]

DESIGN STRATEGY

[06][01][00] INTRODUCTION

The aim of the proposed project is to create a venue that promotes and exhibits a wide range of creative disciplines and in doing so, to facilitate the cross-pollination of a variety of multi-disciplinary creative endeavours.

The project will be an attempt to unite different mediums of expression.

The student will participate in the realisation of actual projects. This would entail applied creativity, where the various artistic disciplines and cultural identities blend.

To encourage projects that interpret contemporary society, public participation will be invited into the gallery, theatre and the restaurant, where participants can express their reaction to the displayed works.

In effect, the project will become a fun place to frequent in the CBD.

The project takes a holistic approach to design, in the appropriation of

- the existing students' residence as an ART GALLERY,
- the existing school hall as a THEATRE,
- and in the layout of the new RESTAURANT.

With the staged fusion of cultures and expressions, a dynamic and varied interaction among patrons is anticipated.

DESIGN STRATEGY

[06][02][00] THE SQUARE

'square', "... area planted with trees etc. or ornamentally laid out & surrounded with buildings" (Oxford 1964:1245)

"Use open public spaces such as courtyards, atriums to link semi-private and private spaces. The volumes of these open public spaces must be proportioned to suit their surrounding enclosed spaces so as to allow sufficient light and air circulation within the open public spaces."
(TICP 2005: principle 8)

"Each subculture needs a centre for its public life: a place where you can go to see people, and to be seen".
(Alexander 1977:169)

"Pragmatism is bound to reality and the success of the end product. To execute the thought". (Nobel 2001:2)

The square represents the backbone of the project and the points of interest along its edge will ensure constant movement across it.

The activity spines criss-cross between the theatre, gallery and restaurant, and onto the main campus. A facility will be provided for the artistic community to meet, exchange ideas and exhibit examples of their endeavours.

The movement routes will help to identify this activity node and the frequency of visits to the facilities. The natural development of crossroads will indicate spots where an activity could be generated: a reading corner or an area for a small discussion group, an exhibition area, a sculpture or installation.

These paths - 'promenades' - help to formulate the activity node, not only for visits to the facilities but also, as in the towns of Italy and Spain, for becoming places to stroll, meet friends, and observe people that one doesn't know, i.e. ideal places where people with like values can go to get in touch with each other.

With the square at the heart of this community and the public paths passing through it, the success of the precinct will depend on the people and the quality of art that they will be exposed to.

DESIGN STRATEGY

The various influences that interact in the space

“The layout of paths will seem right and comfortable only when it is compatible with the process of walking. And the process of walking is far more subtle than one might imagine.”

(Alexander 1977:586)

(Pragmatism)

Idea development and the method to test the idea, is when it need to hold its own in reality.

As mentioned previously, the criss-crossing paths will naturally form focal points in the squares and courtyards, shaped by the traffic between the various functions, and the irregularly distributed areas untouched by traffic.

These focal points are where the fountain or the stage or the monument will be placed - something ‘roughly in the middle’ (Alexander, 1977: 607) that gives a strong pulse to the square and so draws people to its centre.

In large-scale areas, as in this project, the edge is critical; if the edge is not successfully designed and interesting to people, then the space will never become lively. The importance of the edge is that people always gravitate towards it. There they will linger and stop, sit and converse, and if not, then the square will soon become merely a place to walk through.

If the square is to be surrounded by activity, the edge must be scalloped and interesting to the visitor. There has to be a process that creates possibilities for gradual involvement. Activities taking place next to the paths and the entrances will draw visitors to the facilities as they pass through the square. This goal-orientated activity will then become more relaxed and small groups will spill over into the centre to utilise the park and furniture, and socialise amongst the sculptures. To be successful, pockets of activity must alternate with access points.



fig. [29] THE MODEL;
PLAN VIEW OVER

DESIGN STRATEGY

'Maintain detailing that encourages inclusion at all times, including the choice of sculpture and object d'art.

Encourage, where possible, integration and mix of commercial/retail space with exhibition / performance space on the ground floor. This is to avoid edges from being 'lifeless'.

All long 'dead' edges are to be given commercial life at ground floor.

Where public/commercial space is introduced beyond the building's foot print, exterior treatment of such space is to be finished in a way to demarcate this function for the extent of the foot print.

Building interiors should have an extension to the exterior through communal spaces such as courtyards and atria.

Create internal and external courtyards and atria with indigenous planting and water features as well as furniture for sitting and eating".

(TICP 2005: principle 4 - 8)

The planting of trees and the landscaping, together with the external furniture and lighting details within the square, will soften the harshness of the paved area and help to create a park-like environment. The protrusion into the main square of the pent roof to the west, at the theatre, and the open-air stage at the restaurant ensures that the square is developed to be a positive space.

The abovementioned elements will result in a soft-edged, sensitive, and interesting open area, a restful space where students and lecturers can interact.

In many cases, squares that are intended for people to congregate in, are dead and deserted. The ratio (14m² p/p) people to the size of the square is an important factor, but it is not the most important one. The activities that the visitors partake in, the grouping of people and the nature of the edge-functions influence the liveliness of the square.

All distances across the square are limited to a maximum of approximately 45 m between activities, to avoid unused pockets and fatigue. There is variety in the walks, regular seating and rest areas. Trees and plants, shade at the seating (stairs, benches, low walls) and the plants function as points of interest and beauty.



FACEBRICK AND CONCRETE DETAILS



FACEBRICK AND SASH WINDOW
DESIGN DRIVERS

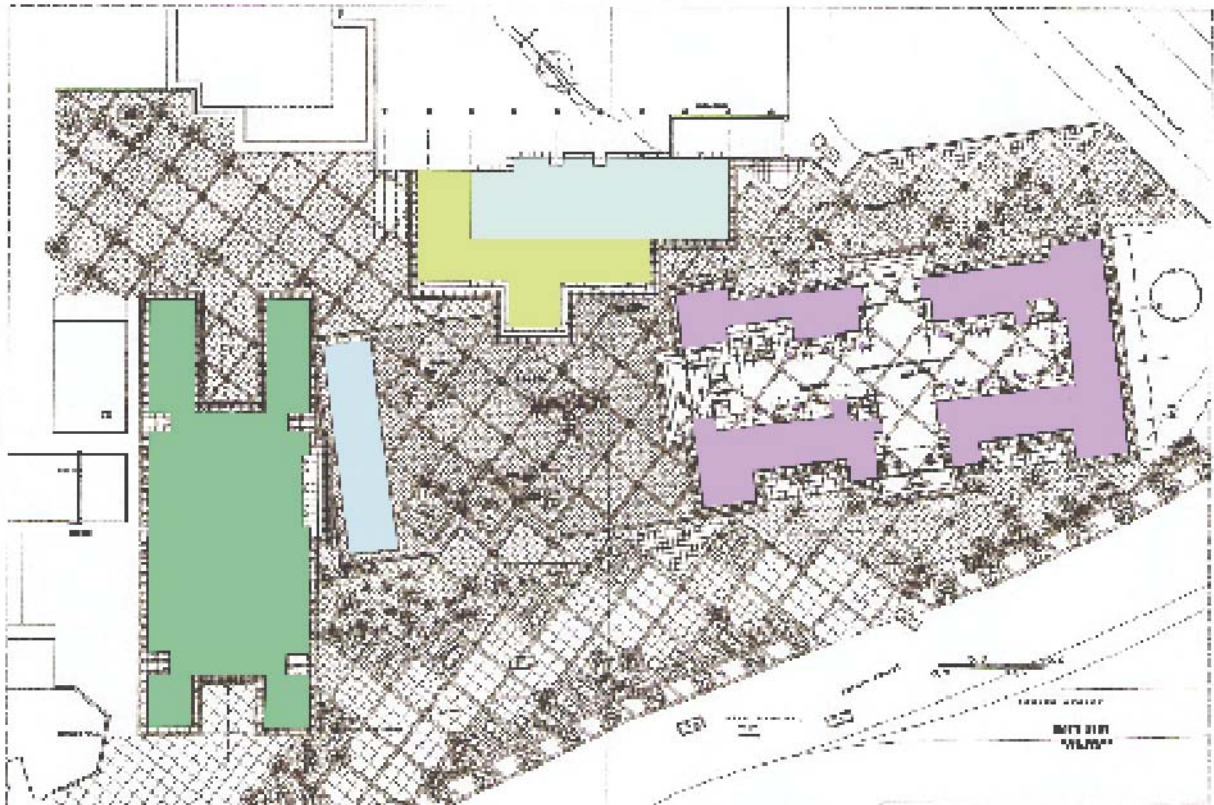
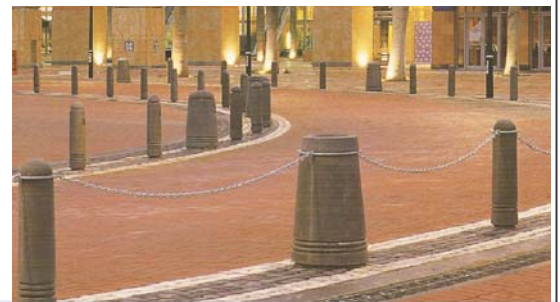

fig. [30] SITE & DESIGN DRIVERS



PAVING AND PARKING



PAVING AND BOLLARDS

DESIGN STRATEGY

[06][03][00] SOUTH / NORTH AXIS:

Currently the majority of the city's public urban spaces are regarded merely as road reserves, ie motor vehicle and service conduits.

Consequently, they are often designed in a way that other activities, such as strolling, sightseeing, enjoying refreshments, people watching, busking and trading, become unpleasant or, in extreme cases, even impossible.

The creating of the public urban environment has traditionally been unconstrained, uncoordinated, and often independently undertaken.

Public urban spaces are all external or internal spaces accessible to the general public without control or restriction, regardless of ownership. Examples include malls, arcades, streets, avenues, boulevards, squares, parks and promenades.

No one takes responsibility for the public urban space, particularly in terms of its multifunctionality, people-friendliness and attractiveness.

Streetscape elements are therefore often arbitrarily placed and bear no relationship to one another in terms of both their placing and design. All of this of course affects the city's image, its liveability, its tourism potential, investor confidence and the satisfaction of its residents .

(SDG 2005: 13 - 25)

The southern parking area off Edmund Street is the main point of access to the square.

The visitor is then directed towards the main campus to the north, along the diagonally paved and landscaped grid.

The landscaping and tree plantings to the west and the gallery to the east demarcate this main gateway onto the square. Here, the boundary is set by the low step of the kerb, and the style and colour treatment of the paving. The deterrent bollards bordering the parking area create the transition to the new precinct.

The parking area, as a screen to the square, has a number of functions at different times of day and on different days of the week.

The parking area will accommodate the Saturday market and special markets (fundraising occasions) and will thus become part of the square.

This parking area will contain the overrun from parking areas on the campus to alleviate the need on theatre evenings and gallery openings.

A maximum of six cars are grouped together with planting and trees to soften the harshness of the paving. The irregular layout of this landscaped area will link it visually to the square.

The small parking area forms a transition area from the commercial zone of the city to this section of the educational node.

DESIGN STRATEGY

[06][04][00] NEW GALLERY

The historic student residence is appropriated for the new gallery.

The gallery forms part of the public open space, and is the most prominent volume framing the eastern wing of the square.

The building has a wholeness (holism) about it, and this wholeness is experienced throughout its various parts. The introduction of the new architecture revitalises the hotel and accentuates its character. The building concept was to accentuate the spirit of the new program, providing creative energy from dialogue with the past and to realise the concept through an essential spatial program.

The strong volume of the central courtyard will be re-established with the removal of the existing temporary structures. This semi-public and semi-private space, with well-articulated wide walkways and junctions, is designed to facilitate meetings between participants and the public to provide an ideal open-air exhibition atrium.

In the atrium, discussion and seating areas are created at the crossing points of internal paths from the main square to the north garden, and from the sculpture garden to the south. The gardens will be an integral part of the gallery and the exhibition.

New galleries will be formed by the sensitive removal of parts of the internal structure. The soft indirect light through the atrium will create ideal exhibition conditions.

The new main entrance will be from the west, off the square, giving direct access into the central courtyard. The double-volume high arch and sculptural detail is inspired by the existing entrance to the building.

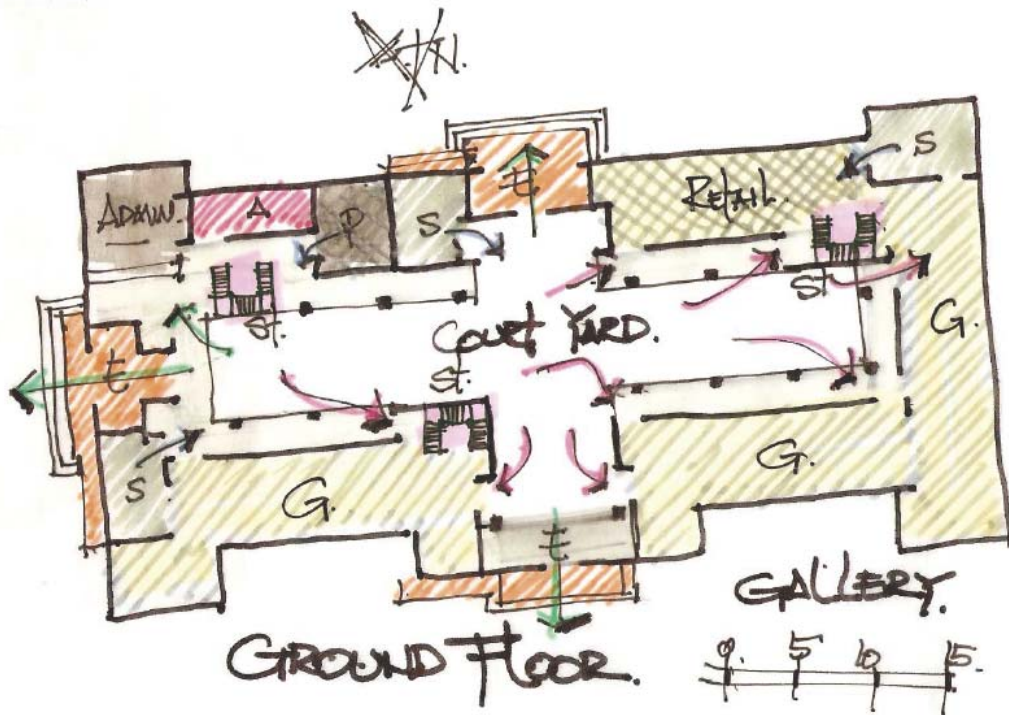

The recreating of the central court yard in the new gallery. Remove and make good all the temporary structures. the dining and rest area, the temporary kitchen.

Create the columns and walkways with the galleries set back as indicated with new internal doors and windows. This allow light and natural ventilation from different directions into the galleries.

Visitor flow through the galleries will be either continuous from display to the next, or a single exhibition can be enjoyed and then back to the central sculpture court yard and then to the external gardens.



fig. [31] PLAN & SECTION THE GALLERY; THE CENTRAL COURT YARD

DESIGN STRATEGY

Make all the outdoor spaces with
surround and lie between your buildings
positively. Give each room a degree
of enclosure; surround each space with
walls of buildings, trees, ledges, fountains,
arcades and trellised walkways, until it be-
comes an entity with a positive quality
and does not spill out into the night around
corners.
(Alexander, 1977: 52)

The importance of the outdoor spaces and
their design is that if the design is not
successful the area will not be used.
Pragmatically, that any design of
successful, value created, it will be
accepted and utilised.

The entrance will be a prominent feature, with its seating
foyer forming a waiting (rest) area and also a courtyard
the main square. The foyer leads to the central courtyard,
and the gallery's main reception. From the reception it
leads to recognise the various departments.

The upgrade of the existing staircases into strong
vertical voids will create interesting circulation solutions
tying the various departments (retail, galleries, reception
and administration) together, that will be in different circum-
stances be scattered and divorced from each other. Vertical
seams in the departments will allow the structural elements
to be visible and will be part of the architectural experience
in the gallery.

The retail area will complete the visit to the gallery,
where the visitor will be presented with work (crafts, design
etc.) that artists produce apart from their professional
endeavours. Artists' materials, stationery, instruments and
tools will also be available.



EXISTING FACADE SOUTH
ELEVATION



H / SOUTH

WEST ELEVATION GALLERY
NEW ENTRANCE

fig. [32] PROPOSED
SOUTH ELEVATION

WESTERN
MILITARY

TO GALLERY FROM SQUARE
EXISTING

DESIGN STRATEGY

[06][05][00] PRECEDENT

CASTELVECCHIO MUSEUM, VERONA

CARLO SCARPA
(1906-1978)

Carlo Scarpa grew up in Venice. He studied at the Venice University of Architecture, and he was professor there from 1964 to 1976 and Chancellor in the years 1972 to 1974.

He had a long association with the Venice Biennale that started in 1948 with his project for the Paul Klee retrospective.

Scarpa died in 1978 after a fall down a stairwell in a Japanese temple.

“... Castelvecchio marks a milestone in museum design ...It represents an attitude of very deliberate architectural intervention to create spaces and relationships that elevate the works on display and encourage the visitor in his journey through them to delight in their experience. Here Scarpa has fulfilled his aim: the experience of the Castelvecchio enhances both the uniqueness of and the interconnection between visitor, object and environment.” (Murphy, 1990:19)

The Castelvecchio is truly a monumental work in its sensitivity towards its important heritage environment, not only for preserving the building and clearing from insensitive additions, but for the excellent re-modulation of space.

Scarpa has enhanced the appearance of the building and exhibits. His unique architectural style is visible in the details from doorways and staircases, to bookcases and display cabinets.

Scarpa established this modern, uncluttered museum look and yet he could create focal areas, as well as a pattern of secure, private viewing where a single painting or sculpture could be studied.

DESIGN STRATEGY

Carlo Scarpa's architectural drawings in colour pencil on cardboard, are characterised by a unique free and schematic touch, for what are essentially working drawings.

Scarpa's fascination with textures and the mechanics of detail, make him an exponent of post-modern aesthetics. His investigations and solutions, documented by the many drawings and photographs, have an unusual relevance in an age concerned with the transformation of industrial buildings into post-industrial museums, commercial or living spaces.

(Mithy, 1993: 16)

In various areas Scarpa used polished cast concrete in contrast with natural stone and tiles. He made unique use of materials and colour in his work, characterised particularly by his mastery of the use of light.

Marble, wood, glass and iron were integrated in historical settings on their own modern terms.

Additional work includes diverse interventions, not only to openings in the elevations but also by creating sensitive exhibition volumes, and through the design of display furnishings and exquisitely crafted fixtures to hold specific pieces of artwork.

The museum displays a collection of sculpture (mostly from the Romanesque period), paintings, ancient weapons, ceramics, gold works, miniatures and some old bells.

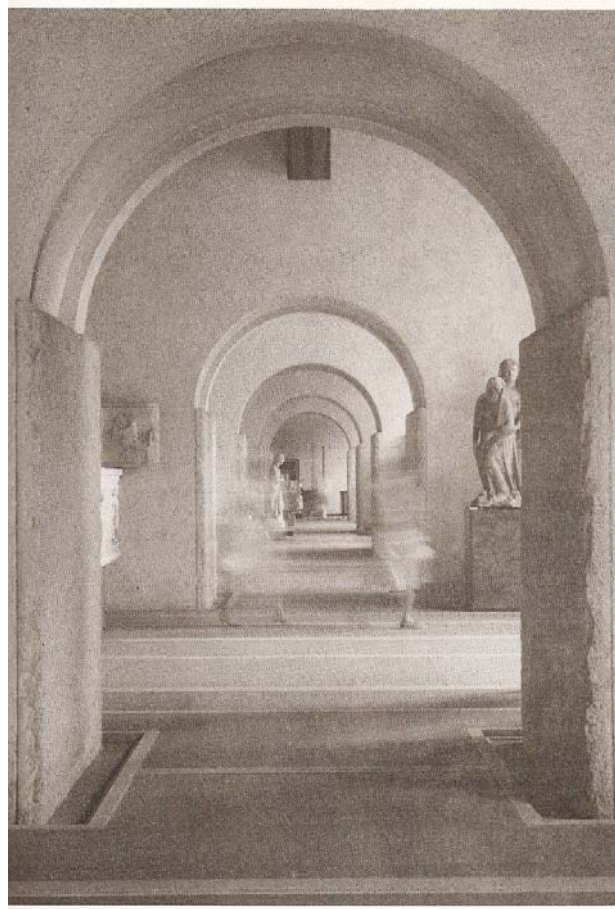

fig. [33] CASTELVECCHIO INTERIOR

DESIGN STRATEGY

The Castelvecchio museum, has as one of the focal displays, the equestrian sculpture *Giugale della Sala* (a member of a merchant family that were representatives of the emperors). Sapi placed the sculpture on a concrete base. An asymmetrical incision of the end of the wall were made to create an air exhibit of this remarkable work.

The full drama of the space created around the equestrian statue of *Giugale*. This whole space was originally inside the Napoleonic barack block. - The roof has been cut back - only the ridge beams now connect to the wall - .. (Milly, 1991: 1)

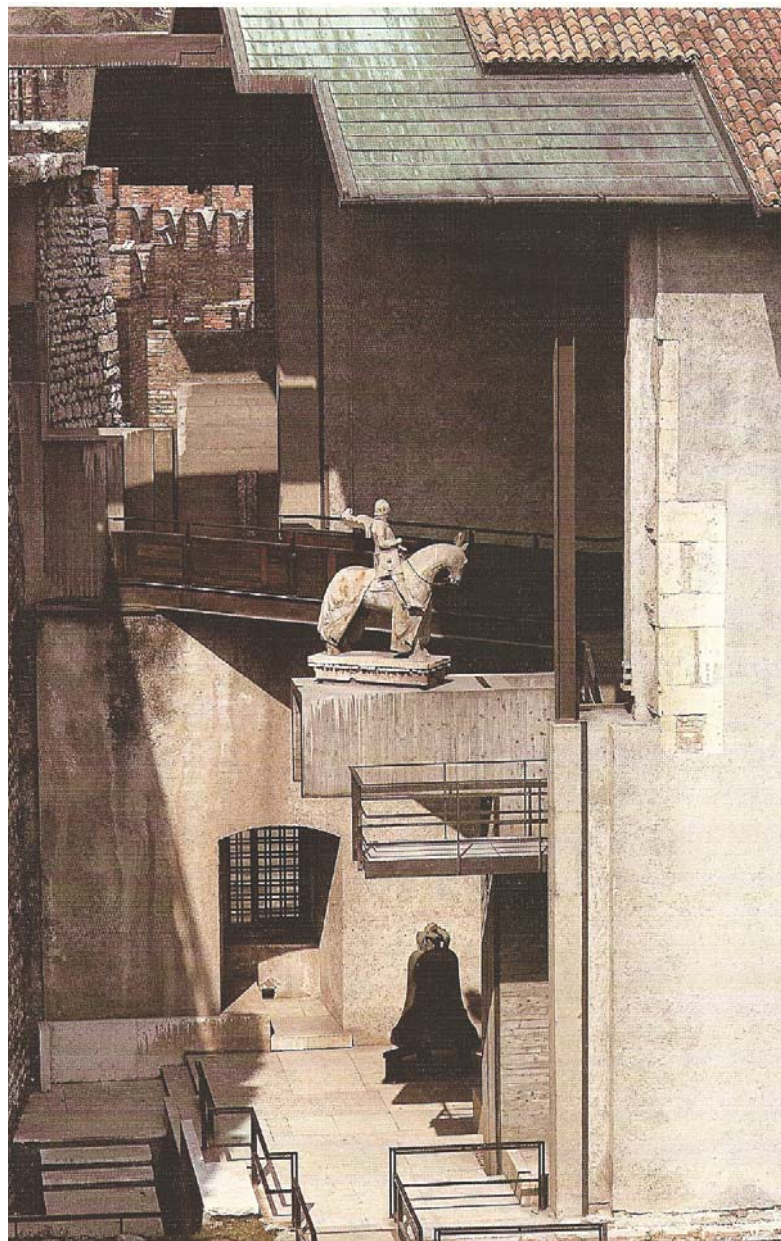

fig. [34] CARNE, SCULPTURE FORA

RINT

DESIGN STRATEGY

The design circulation has the effect that it allows the visitor to escape from a dogmatic sequential tour of the galleries. Sapa intended the southern openings to be for circulation between galleries while the northern route could be used to bypass rooms if desired. A number of free-standing screens are placed between this route and the galleries (Mphahlele, 1990: 14). The treatment of the northern aisle is repeated throughout the restoration and accentuates the format of the individual galleries.

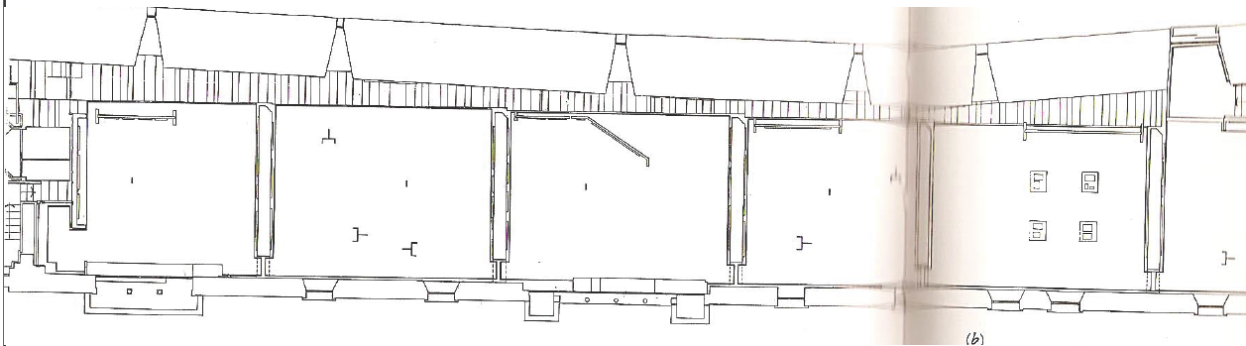

fig. [35] ORLA TONGA GALLERY



The building with generous circulation allows each person's instincts and intuitions full play. The generosity of movement depends on the overall arrangement of the movement in the building not on the detailed design of individual passages. (Alexander, 1977: 68)

DESIGN STRATEGY

[06][06][00] THEATRE

The restaurant forms the northern flank of the square. Its position, and its relationship with the other buildings, creates a well-defined exterior space. The buildings surround the square and every building creates a direct and well-shaped public area next to it. The position defines and defines the areas for pedestrian movement.

The restaurant is part of the public space, and is located off the main north-south axis across the square, en route to the main campus. The restaurant frontage with the open-air stage is a prominent feature of the square. The secondary point of access into the restaurant is from the west, on the same side as the theatre.

The restaurant will be crossed by busy paths from the theatre and the gallery, with both facilities making use of the restaurant as a rest area, and as an essential part of the visiting experience to the point. Although the building creates a system of rooms and internal paths with small internal squares and lanes, it is made up of simple volumes.

The circulation in the building, the division of the interior spaces, and the admission of daylight are consistent with the wholeness of the building and its position in the environment. The main entrance is from the south, across the verandah and past the stage, entering into the double volume with the main reception and waiting area at the threshold.

The double-volume dining area creates a sense of openness, a courtyard experience with an open walkway above. The subsidiary mass of the bar supports and leads into the main dining space adjacent to the entrance/reception.

The recessed narrow northern windows allow diffused light into the restaurant, ensuring a light and airy space.

DESIGN STRATEGY

At the entrance to the restaurant from the verandah, certain nodes of intensity will be created and identified, i.e. the bar, the reception area and the stairs. The ground-floor internal paths will either lead to the more private northern seating or to the social southern verandah and the open-air stage.

The major circulation arteries in the restaurant will consist of the restaurateur's route from the kitchen to the diners. All access and flow through the restaurant will be around or through the double-volume section, the heart of the restaurant.

The strong architectural statement of the prominent central stair in the dining area will accentuate the vertical circulation leading to the middle of the first-floor dining areas.

From the first-floor dining area the path to the ablutions runs along the northern gallery walkway, at the edge of the double-volume, with visual links to the ground-floor bar and dining areas. The first-floor views are predominantly to the south, the stage and the square.

The stepped roof allows soft southern light into the double volume and the first-floor dining area.

fig. [36] RESTAURANT ;
S / W SECTION

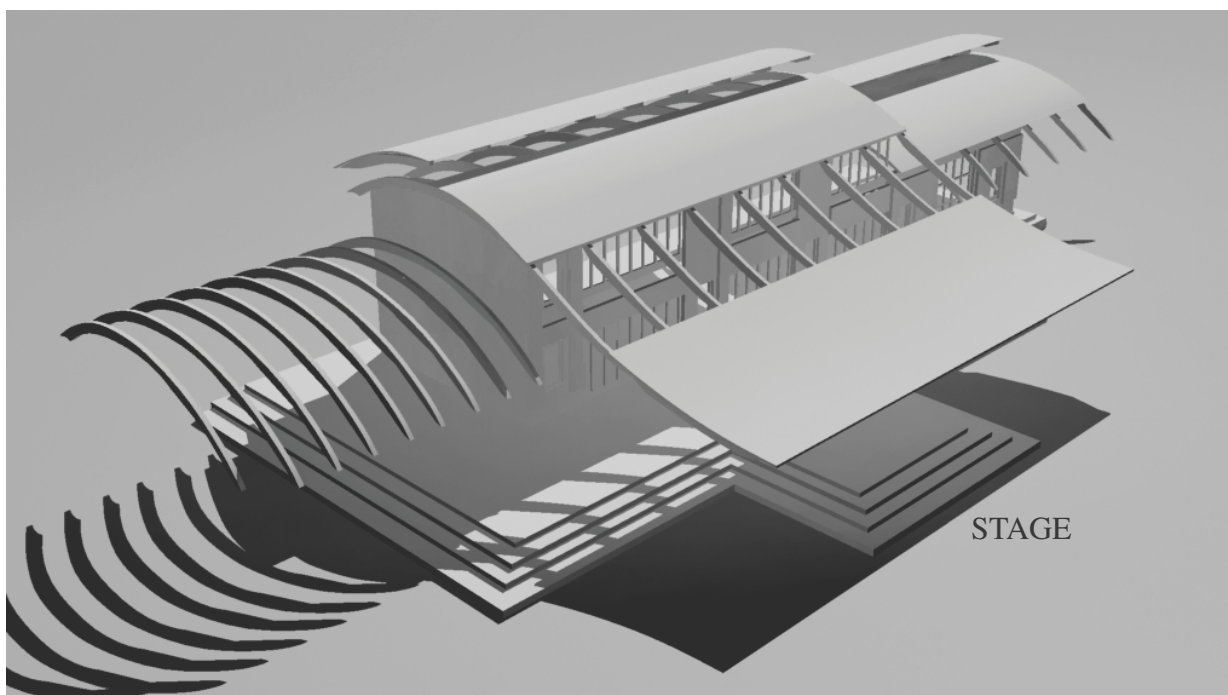

DESIGN STRATEGY

At the entrance to the restaurant from the verandah, it must be easy to identify the reception area. There must be no obstruction in the flow from the reception to the internal and external dining areas. A view onto the stage must be ensured from the verandah.

The raised ceiling of the main dining area and the discussed chain of importance of the areas in the layout will indicate the secondary passages leading to service areas, the ablutions and the kitchen – i.e. the interstitial structures - completing the process of wholeness in every part of the project.



fig. [37] PROPOSED NEW RESTAURANT; SOUTH ELEVATION
EXTERNAL FINISHES TO MATCH EXISTING AND
PROPOSED ALTERATIONS TO THE NEW THEATRE

DESIGN STRATEGY

[06][07][00] THE THEATRE

THE WESTERN HANK OF THE SQUARE

The existing school hall bordering the small stationery outlet and the stairwell/foyer has fallen into disuse. The hall is used as an examination venue and for the odd art exhibition. The stage is boarded up and blocked off to create a computer and media lecture room with access from the western stoep.

This building needs to be totally re-addressed and the altered theatre will respond to the design drivers and visually link with the gallery and restaurant in the newly created precinct. The concrete portal frames of the existing hall will be internal features of the new theatre.

The new theatre will be constructed to enclose the portals, accommodating the acoustic reflectors and ventilation installation overhead. This ribbed framework in the new enlarged space will demarcate the seating and patron area. The apron and circulation volumes leading from the entrance to the stage will surround the new sloped seating layout to ensure an undisturbed theatre experience - undisturbed by the movement of people and actors using the aprons and the access points.

fig. [38] THEATRE;
EAST ELEVATION

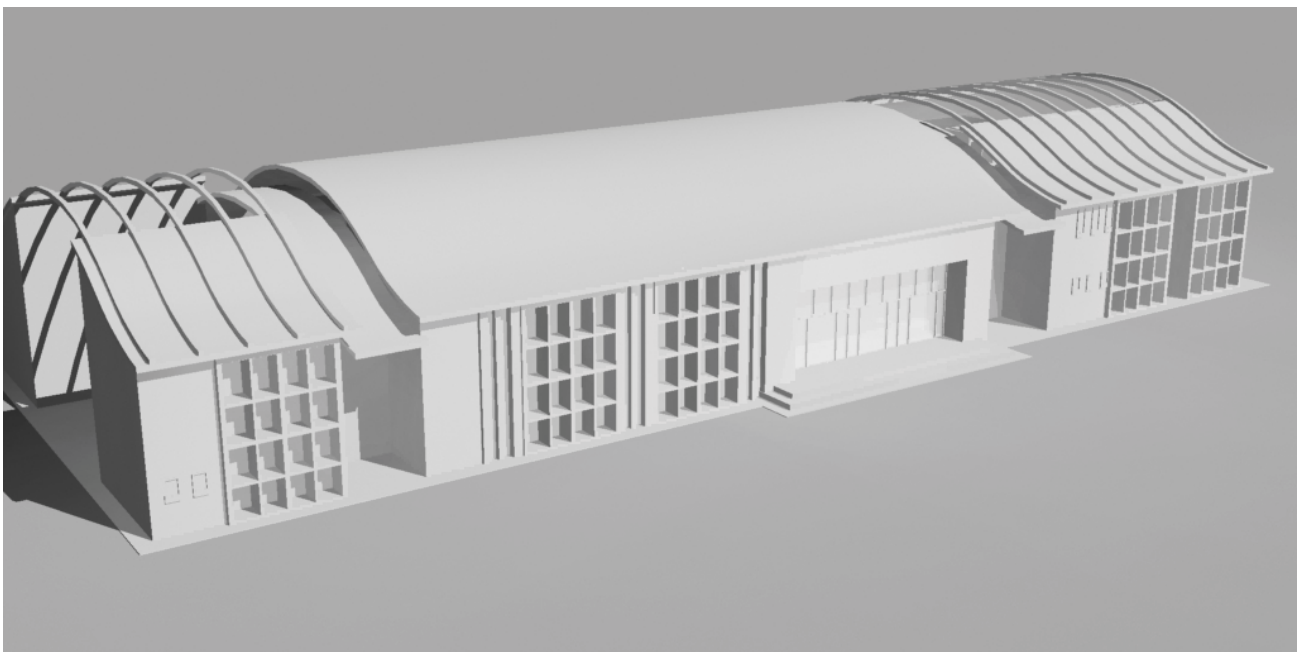



EAST ELEVATION: EXISTING HALL



NORTH ELEVATION: EXISTING HALL

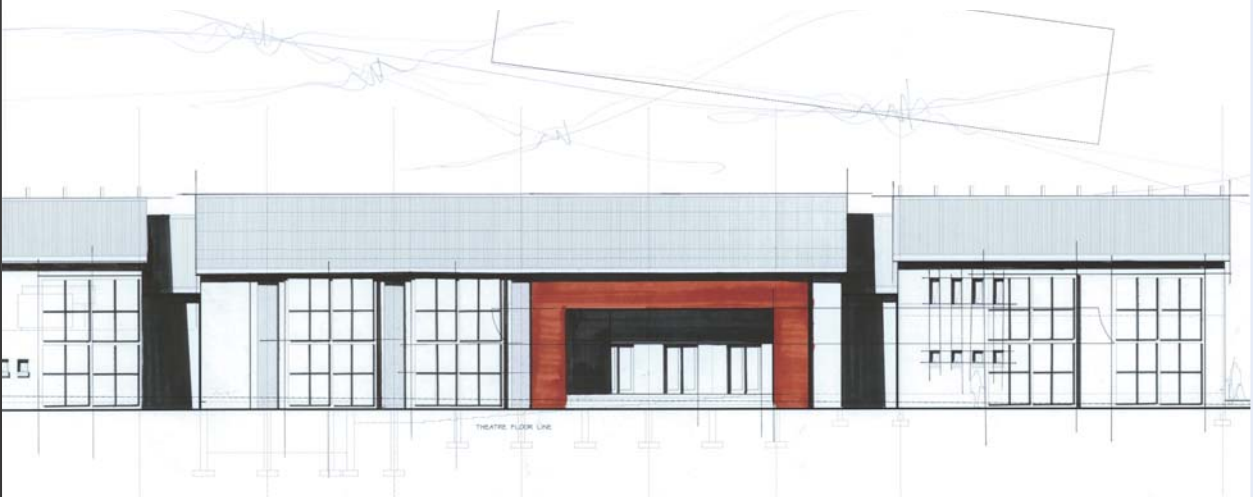

fig. [39] EAST ELEVATION: PROPOSED

DESIGN STRATEGY

[01] THE MIN ENTRANCE

The new main entrance to the theatre will be in the extended northern section of the theatre complex. Access to the theatre opens to the larger volume of the open-air pre-concert congenial area. This new courtyard will be enclosed and secure, with a view to the larger northern square. The existing dance department to the north and the restaurant to the north-east will establish this new secondary square as a gateway to the existing campus.

[02] THE STAGE

The northern alterations are aimed at entertaining visitors to the theatre, and fulfilling their needs. The extension to the south will house the stage and the workings of the theatre, including new change-rooms and facilities for the actors, the plant room, storage and workshop.

Large sliding doors to the intermediate foyer link the stage with the service courtyard. The foyer is a key point in the circulation system. Within this intermediate node of intense activity is contained the connectivity from indoors to outside, the partly connected threshold.

The service activities of the theatre, like delivery and dispatch, take place in the new partially enclosed courtyard, a space that is secure and forms part of the larger structure. From here the view is to the southern square, the parking and on towards the CBD.

The intermediate foyer is the main circulation route for the actors, between preparing, resting, rehearsing, waiting - and the stage. The maintenance and service of the décor, and the preparing and replacing of sets are major operations that flow through this vital activity knuckle.

The foyer's staircase leads to the all-important plant and service area on the first floor. The atmosphere, electricity, and lighting control for the theatre and auxiliary services are regulated from this position.

The storeroom and workshop are also on the first floor. The vertical sets can easily be serviced from the higher level, as well as the stage lighting and the manipulation of the set during performances.

DESIGN STRATEGY

[06][08][00] PRECEDENT STUDY

In contrast to Scarpa's Castelvechio restoration are the modern clean lines of the Johannesburg University's Art Centre. However, both display a sensitivity towards the artworks and the visitor with subdued attention to detail in construction and interior finishes.

The red face brick and off-shutter concrete envelope treatment that architect Jeremy Rose applied in this strong architectural statement is a welcome addition to the University of Johannesburg precinct.

The new art centre blends successfully with the well known architecture of the university and is located at the entrance to the new Main building. The new buildings have strong and innovative forms and are part of the new visual gateway to the city from the west.

[06][08][01] THE GALLERY

The pools of natural light streaming through the large aluminium windows create rest areas, and extend the interior/exterior experience, where contact with nature could counter gallery fatigue.

To avoid glare, the deeply recessed window is set in an oversized concrete frame to form a prominent bay window at the north-western end of the gallery.



fig. [40] BAY WINDOW ON NORTHERN ELEVATION
FACEBRICK AND CONCRETE ENVELOPE

DESIGN STRATEGY

Industrial services carriers at ceiling height accommodate adjustable spotlights, with extensions that adjust according to the size of the art work and the light requirements of the exhibition.

The circular HVAC outlets and the ceiling roof light openings are repetitive details along the length of the gallery that highlight the functionality of the interior, but do not detract from the art works.



fig. [41] Gallery, - looking west from the entrance

The concrete high-gloss industrial floor finish is a good reflector of light along with the white walls, and with the correct light intensity the art works are successfully displayed.

The prominent corner glazing detail with overhanging brickwork accentuates the entrance to the gallery. Access is gained directly to the reception and information area, leading to the curator's office and into the gallery. The wide exhibition foyer is part of the gallery, yet with its glazing detail it still forms part of the courtyard and garden.

The gallery widens beyond the store room (below the stair to the grass-covered roof), where the large picture window looks onto the southern square that links the theatre to the main campus, by way of the sculptured path and stair.

Beyond the service kitchen, ablutions, storage and office placed to the north-west, the gallery widens further, to end in the described concrete-framed bay window to the north, forming a prominent square exhibition area.

DESIGN STRATEGY

The theatre design complies with the requirements of the diet, providing 40 seats in the auditorium and 10 on the gallery, with administration and technical support functions and facilities.

The main access points lead from the square, and from the gallery in the west. The pre-theatre foyer and rest area form a double-volume area with polished granite and a drop-shutter concrete ceiling. A small raised exhibition area to the north links the foyer with the theatre gallery. A large bay window with detail similar to the one in the art gallery accentuates the wholeness of the art centre.

The theatre complex consists of three main function areas: administration, theatre and reception.

To the east are located the administration facilities (technical services, dress studios, ablutions, the stage and dressing rooms) with entrances from the north and south.

The stage is the heart of the theatre, together with the system (the first system designed and manufactured in South Africa), the stage set store room and back stage service area. The road trap is located below the stage (a lift still to be installed).



fig. [42] Theatre - looking north in the entrance

DESIGN STRATEGY



fig. [43] Façade : Square , west to the theatre

With the careful layout of the seating and the sloped floor in the theatre, the sight lines from each seat ensures an unobstructed view of the stage. The acoustic treatment is very successful in the theatre. The perforated timber panels against the side walls, the ceiling and the rear wall, the absorptive seating and the reflective concrete floor make for a pleasant theatrical experience.

With the glass balustrade along the balcony, a good sightline from the gallery to the stage is assured. The lighting bridges are well positioned and a common part of the acoustic ceiling treatment. The fly tower for set storage over the stage gives form to this prominent section of the theatre building complex.

The re-lighting equipment allows for a sprinkler system over the stage, and an under-air-conditioning system with smoke detection and extraction serves the rest of the theatre. Lighting and sound are controlled from the central technical control position, centrally located at the back of the auditorium.



fig. [44] Square , - north to the gallery

DESIGN STRATEGY

CONCLUSION

The design strategy reflects the influences of pragmatism and theories from *A Pattern Language* (Alexander, 1977), as discussed in the design philosophy.

The present studies concern the totality of design structure, the creation of a complete project, where design and fusion with the site are considered.

The facilities created in the project interpret contemporary society by encouraging public participation. The inclusion of cultural variety will be evident in the expression of patterns within this blend of various artistic disciplines and materials.

Reaction to the design and works can be expressed in the gallery, theatre and the restaurant, making it a rather lively point to frequent.

The project takes an holistic approach to the design, layout and relation between the different buildings and the site. Within this stage of fusion of cultures and expressions, a dynamic and varied interaction among patterns is anticipated.

[07][00][00] TECHNICAL NOTES

[07][01][00] INTRODUCTION

MATERIAL SELECTION

[07][01][01] CONCRETE

CONCRETE

The superstructure of the proposed development consists of a reinforced column and slab structure.

The alterations and extensions to the gallery will include the new balconies and walkways in the atrium. New openings will be formed in the gallery slabs, to create interesting access points from the north and south.

The reinforced concrete column and slab construction will also form the first floor dining area in the new restaurant.

This construction method will also be used for the altered theatre, especially in the additional areas of the pre theatre, which include the newly created entertainment area and the administration volumes, as well as in the southern service areas and the stage.

There are numerous advantages to using concrete construction, one of which is its good thermal mass due to its high density. It can achieve large spans and is easily moulded and cast in situ. Various finishes and textures can be achieved in concrete, depending on the formwork used and the addition of oxide pigments.

[07][01][02] BRICK

Many of the buildings at the arts campus are of concrete construction with brick infill, as are many examples in the CBD. This is the case with the design drivers at the proposed project, not only derived from the existing hostel and the school hall but also from the neighbouring buildings.

Brick has a low embodied energy and is produced locally. The erection of brick structures relies on intensive labour by local bricklayers, empowering the local labour force. Brick has good thermal mass and load bearing / structural properties. Brick is recyclable and easily reused. The proposed project requires two different types of bricks: stock bricks will be hidden by cladding and plaster and will serve as thermal mass. The face brick will tie in with the existing envelope and create the wholeness that the design strives for.



DANCE DEPARTMENT; SOUTH EAST



GALLERY; NORTH/ EAST
'HEIDEHOF'

DESIGN DRIVERS; THE TWO COLOURS RED FACE BRICK, THE SASH WINDOWS



EXISTING ENTRANCE; SOUTH
'HEIDEHOF'



SOUTH / WEST ELEVATION; NEW
MAIN ENTRANCE FROM THE SQUARE

THESE SANDSTONE SURROUND AT THE FRONT DOOR TO REPEAT AT THE NEW ACCESS



EAST ELEVATION EXISTING HALL

fig [45] DESIGN DRIVERS



SOUTH ELEVATION THEATRE
EXISTING HALL

THE FACE BRICK, THE LARGE FRAMED WINDOWS AND THE CONCRETE PORTAL FRAMES

TECHNICAL NOTES

[01] [01] [01] STEEL.

The proposed project uses steel sparingly, except in the restaurant where the effect of lightness is communicated, as demonstrated by the “shop front” of the support system to the glazed southern glass wall that opens onto the verandah and stage. Steel is utilised for its tensile qualities.

The advantages of steel include the following: it can be recycled and reused, has good structural properties and requires very little maintenance. Standard steel sections will be used in the project, the assembly of which will be executed on site. Steel is a non-renewable resource.

[01] [01] [0 4] GLASS

Glass introduce natural light into the buildings, merging interior and exterior space. At the restaurant, as discussed, a feeling of weightlessness, translucency and illuminating the verandah and the stage during the evening performances.

The advantages of glass is in the interior exterior visual link, and the natural day light penetration.

It can be recycled and reused, it ad to occupant comfort.

At the restaurant where larger areas of glass are a prominent envelope treatment it will be to minimum 19mm insullvue glass or similar as spesi ed by the manufacturer.

The glass must have a low emissivity outer layer in order to reduce heat loss at night, due to the low thermal insulation value of glass. The proposed project relies on shading devices on the northern and western facades of the restaurant, reducing the most disadvantages associated with glass

TENCA

NES

[0][0][0]

STRUCTURE

The off-shutter reinforced concrete columns are not only structural, but also provide volume in the composition of the elevations, as in the colonnade in the gallery atrium and in the treatment of the theatre auditorium. All the columns to have 20 mm chamfered edges and to be cast in single-storey heights.

Concrete to be cast with vertical movement joints at 10.0 m intervals, with expansion joints providing a complete break through the entire structure. Joints in the brickwork to be sealed with 12 mm bitumen-impregnated soft board. 340 mm concrete slab in the theatre service areas and in the restaurant. All reinforced concrete work, slabs, columns and beams to the specification of the structural engineer.

[0][0][0]

1]

ROOF

CONSTRUCTION

The roof construction of the proposed project will match the roof treatments of the existing buildings on campus.

Steel rafter construction to the design details of the roofing specialist and the structural engineers.

The curved design as indicated on the sections of the theatre and the restaurant roofs will bring a softer, more organic form to the precinct.

The stepped detail creating the skylight at the restaurant allows natural light to penetrate deep into the restaurant interior.

The theatre roof construction detail being similar to that of the restaurant, with the pre-theatre and stage service areas opening to central atriums, create the interesting curved roof volumes to the west of the proposed project.

Corrugated galvanised sheet roof finish, to match the existing roof finish.

~~RENCA~~

~~NES~~

~~[07][03][00]~~

~~IN~~ US VITY

The project allows for easy access by visitors with disabilities. The demarcated enlarged parking bays at the main access point onto the square lead to a ramp that avoids the threshold curb at the parking area.

There are access ramps at the entrances to all three the buildings. All ramps have a maximum gradient of 1:12. The paving layout and installations on the square will be easily manoeuvrable.

The disability toilets are part of the ablution facilities in the buildings, and comply with the requirements set by Section 8 of the National Building Regulations. These amenities are provided close to the entrances for easy access, near foyers or courtyards.

~~[07][04][00]~~

~~SUSTAIN~~ BIE FEATURIS

The new restaurant will be placed 26 degrees east to avoid the harsh and hot northern solar orientation. The orientation of the existing “heidehof” hostel is successful to the north. The enclosed design of the theatre will not be affected by the northern orientation.

The provision of a skylight in the split level, roof construction of the new restaurant, with the orientation of the building to the South and provision of ample glazing while blocking western sunlight with masonry walls, will effectively block unwanted solar gain.

The interiors are organised around a courtyard – atrium in the gallery and so receive abundant light, fresh air, and views to the outdoors.

TENCA

NES

The project's many **GREEN FEATURES** include:

- precise mapping and load separation of areas receiving outside air to **minimise the mechanical load** of the air-conditioning,
- deep **daylighting**, achieved by ceiling configurations,
- envelope upgrades that include **good insulation and overhangs**, resulting in a well-insulated and comfortable building.

SSI AIMS include:

- A **rain water** collection and filtration system for the ablution facilities and landscaped areas in and around the buildings.
- Optimal building **orientation** and the provision of **natural ventilation** with operable windows located to optimise exterior air currents, in order to deliver good indoor air quality.
- Energy systems such as a **photovoltaic** array, ground-source **heat pumps, daylighting, ceiling fans, and efficient lighting** integrated into the building. An interactive panel will show how these energy systems can be controlled to balance energy demands with incoming **solar power**.
- One of the design features of the restaurant is the prominent roof construction forming a **solar umbrella**, or shading solar canopy, that is passively adapted to the temperate-arid climate of Northern Gauteng. Rather than deflecting sunlight, this solar canopy will use amorphous **photovoltaic panels** to transform sunlight into usable energy, providing the building's electricity. At the same time, it will **screen** large portions of the structure from direct exposure to the intense sun, protecting the body of the building from **thermal heat gain**. A future net meter should be provided by the electricity distribution authorities that will connect the photovoltaic array to the municipal supply grid, eliminating both the need for a storage system and the time-of-use charges associated with traditional electricity use.
- **Solar hot-water panels** will preheat hot water.
- The **day-lit interior** requires no electric lighting on sunny days.
- Materials will be selected for their durability and **environmental responsibility**.

THEORY

NOTES

[07][05][00]

ROOM ACOUSTICS
THEORY

In the auditorium the control of background noise and optimisation of reverberation times are crucial requirements for attaining good speech intelligibility. One of the main parameters controlling reverberation is sound absorption.

[07][06][00] REVERBERATION TIME

Reverberation time entails the relation in sound power and in sound pressure levels after a number of reflections. The sound pressure level (db) of a sound wave undergoing reflections between the boundaries of a room decreases linearly with time, at a rate which is the function of the average absorption coefficient. The total reverberant sound pressure level will fall at a constant rate, if the source of the sound is stopped. The less absorption in the room, the smaller the rate of decay and the longer the time it will take for the sound pressure level to fall by a specified amount. Reverberation time is defined as the time that it takes for the sound pressure level to fall by 60db after the source has been switched off. Reverberation time is indicated by the symbol t_{60} and is calculated by the Norris-Eyring formula.

The Norris-Eyring Formula :

$$t_{60} = 0.161V$$

$$-2.3 \log(1-a)$$

$$v = \text{volume of the room (m}^3\text{)}$$

$$s = \text{total surface area (m}^2\text{)}$$

$$a = \text{average absorption coefficient}$$

sound absorption of auditorium is not homogeneous

the average absorption is ;

the amount of absorption in m^2 for each sub surface

The total amount of absorption

(sum absorption of all sub surfaces)

divide total absorption by total surface area of room.

$$a = \frac{\sum a_i s_i}{s}$$

$$a = \frac{(s_1 a_1 + s_2 a_2 + \dots + s_n a_n)}{s} = \sum_{i=1}^n \frac{s_i a_i}{s}$$

simple formula for reverberation time

a simplified formula for quick calculation of reverberation time

$$t_{60} = 0.161V$$

$$-2.3 \log(1-a)$$

this formula is accurate for $a = 0.25$

[07][06][01] FREQUENCY DEPENDENCE

The sound absorption of any material is frequency dependent, and the reverberation time of a room is also frequency dependent. Reverberation time is calculated at octave band or third-octave band centre frequencies.

TECHNICAL

NOTES

[07][06][02] TYPICAL REVERBERATION TIMES

The reverberation time is an important parameter in the design and performance assessment of the auditorium. There are no international standards for optimal reverberation times, and the task should be left to an acoustic specialist. In general, music requires relatively long reverberation times, but good speech intelligibility requires short reverberation times.

Examples of typical mid-frequency range (500hz) reverberation times are:

Auditorium 500 m ³	1.0
Auditorium 2500 m ³	1.2
Unisa Chapman hall with adjustable acoustics (set for speech)	1,90

T60 is directly proportional to volume V.

T60 is indirectly proportional to absorption.

For reverberation purposes, a certain minimum volume is required in a room.

It is dependent on the number of seats in the room, and the purpose of the room.

For speech: the volume increases from 4,5 m³ per person for 50 seats

to 6,5 m³ per person for 5,000 seats.

The contents of a room affect the amount of absorption and in turn the reverberation time.

The desired reverberation time may be designed for a room that is $\frac{3}{4}$ of its capacity. The desirable reverberation time is a function of the intended use of the space and room volume.

For speech; the ideal reverberation time increases from 0.7s for 300m³ to

1,0s for 3000m³

1,3s for 30,000m³

TECHNICAL

NOTES

[07][06][03]

SOUND ABSORBERS

Dissipative absorbers are employed in the acoustic design for the control of reverberation time and noise, and are used in conjunction with insulating materials for the cladding of walls, panels and ceilings. Materials to be used: glass wool, mineral wool, open-cell polyurethane foam and underfelt.

The porosity of the surface materials will allow sound penetration. The internal porosity will consist of elastic particles and thin fibres connected by small air passages or cavities, allowing sound to enter and set fibres in motion. Soft, resilient panels of materials as above will be provided.

These dissipative absorbers will allow sound energy to penetrate their surfaces and enter the small passages and air-filled cavities in the material.

Kinetic energy in the sound wave is transferred to the material and sets fibres, particles and cavity walls into vibration.

Due to friction and viscous losses, this energy is eventually transformed into heat.

Examples of acoustically translucent protective covers to be used: perforated vinyl, perforated steel, woven cloth, wooden slats with openings and expanded metal.

The acoustic finish to the ceiling:

A wooden slatted ceiling with openings and 100 mm glass wool insulation absorbers to be installed at the back and the front of the theatre (as against the back wall).

Seats: open weave upholstered
occupied/p.seat 0.42 @ 500hz/m²

Reflective non-absorptive finish to the
floor - ceramic or vinyl tiles
0.01 0.05
absorption at 500 hz

A lobby is to be created at the access to the theatre to serve as a sound absorber.

TECHNICAL

NOTES

[07][07][07]

FIRE MANAGEMENT

The National Building Regulations stipulate in Section TT 16.2 that a building with three storeys or less in height is not required to include an emergency escape route.

The NBR specifies that the distance to be travelled by those fleeing a fire, measured to the nearest escape door, must not exceed 45 m. The buildings in the project are double storeys and the distance from any point in the interior is close to an outside door.

In section TT7 the NBR requires structural elements to have the following fire resistance levels:

The restaurant: 60 minutes

Exhibition space: 90 minutes

Offices: 60 minutes

All exposed structural steel to be fire retardant treated with Fire Barrier Intumescent paint and a finishing coat of non-flammable acrylic paint. Matt finish, colour to match envelope treatment as indicated on the elevations and the finishing schedules.

Steel load-bearing elements must be cast in-situ, at connection points with concrete and masonry work.

All fire protection systems to comply with SA BS 0400, i.e. fire management, water sprinkler system, fire detectors, alarms, carbon dioxide fire extinguishers and fire escapes. See fire management drawings.

[07][08][00]

CLIMATE CONTROL

Climate control is achieved through orientation, solar control and natural lighting.

The site has a strong north / south orientation. As a result the design, being informed by the site and its context, has long north and south facades.

TENCA

NIS

Making use of natural daylight was an important objective during the design process and roof lights and atriums are incorporated to open up the design and let natural daylight into the buildings. On northern and western facades, preference was given to offices, administration and retail functions. Southern and eastern light was preferred for the galleries to facilitate the display of sensitive art works. Indirect northern light, provided by the atrium, enters the gallery. The extended roof overhangs over the balconies and walkways create further diffusers, and prevent direct solar radiation from entering the north-facing galleries in the south wing.

Similar to the treatment of the restaurant, the northern light is diffused by deeply recessed narrow windows. The southern facade with its bigger glazing opens to the view, the square and the outdoor stage. The stepped roof detail allows natural daylight deep into the restaurant through the double-volume central internal atrium.

[07][09][00]

THEMA

MAS

Thermal mass will be provided by the brick exterior of the western and the northern facades of the theatre, gallery and restaurant. It will contribute to the comfort of these spaces during evening performances and functions. The facades absorb direct and indirect solar radiation during the day and radiate the accumulated heat at night. This delay period is determined by the density and thickness of the materials used.

The thickness of the hard-baked face brick exterior finish provides a sufficient delay period to ensure that interior temperatures are effectively cool during the day and comfortable at night.

VENIA

TON

[07][10][00] VENIA TON

Passive ventilation is an important consideration in the design process, in order to reduce the amount of energy used. All windows can be manually opened and closed to maximise occupant comfort. The design incorporates internal open areas, such as the double-volume dining area in the restaurant, an atrium that is not roofed, and central internal courtyards in the gallery and the pre-theatre area.

Mechanical ventilation systems will be introduced in the auditorium and stage, for use during performances. These systems will also be provided for the western offices, the administration offices at the gallery, and for the kitchen and office at the restaurant.

[07][11][00] LIGHTING

Lighting Measurements

Lumen – denotes the measurement of the light output of a lamp.

Lux - denotes the measurement of the light intensity falling on a surface. One lux is equal to one lumen per square metre.

One of the factors used when designing architectural lighting systems is illuminance. One lux is the illuminance at the same point at a distance of 1 metre from the source. Good lighting depends on more than just illuminance levels. The direction, distribution, colour temperature and colour rendering index of the source all contribute to effective lighting (and visibility). The task reflectance and contrast also contribute greatly. Illumination levels are generally dictated by the needs of the visual task. Typically, the more light available, the easier it is to perform a specific task.

It is important today that the lighting designer provide appropriate lighting levels required by any task. In new constructions, energy restrictions and building codes often tend to limit lighting to the number of watts per meter. It must be remembered that these are average figures in that a storage room might require lower lighting levels and an office area might require higher lighting levels.

There is great value in the task/ambient approach to lighting. This method first provides general room illumination and then specific, brighter illumination - only where needed. In this way, ambient lighting levels may be reduced to save energy and task area lighting may be increased for optimum human performance.

TABLE 1**TABLE 1****TABLE 1**

The Illuminating Engineering Society has published illuminance recommendations in table form

ACTIVITY**CATEGORY****LUX**

Public spaces with dark surroundings	A	20-30-50
Simple orientation for short temporary visits	B	50-75-100
Working spaces where visual tasks are only occasionally performed	C	100-150-200
Performance of visual tasks of high contrast or large size	D	200-300-500
Performance of visual tasks of medium contrast or small size	E	500-750-1000
Performance of visual tasks of low contrast or very sm size	F	1000-1500-2000
Performance of visual tasks of low contrast or very sm size over a prolonged period	G	2000-3000-5000
Performance of very prolonged and exacting visual tasks	H	5000-7500-10000

TABLE 2**ILLUMINANCE CATEGORY****DIFFICULTY OF VISUAL TASK****IMPORTANCE OF SPEED & ACCURACY**

non critical / critical

A	MOVEMENT THROUGH PUBLIC SPACES	50 - LUX - 75
B	INFREQUENT READING OR WRITING; High contrast & large size	100 150
C	FREQUENT (& easy) READING OR WRITING; High contrast & large size	200 300
D	MODERATELY DIFFICULT READING OR WRITING; low contrast or small size	300 450 (e.g. penciled mechanical drawings)
E	DIFFICULT READING OR WRITING; low contrast & small size	500 750

TECHNICAL NOTES

PROPOSED LIGHTING AND CONTROL

THEATRE				
LOCATION	FITTING TYPE	QUANTITY	POWER	TOTAL POWER(W)
Intermission and service bar	35W IRC Low Voltage	20	35	700
Kitchen and Storage	2X36W, T8 Surface	4	72	288
Male and Female Toilets	18W CFL DOWNLIGHT	20	19	380
Storage	2X36W, T8 Surface	3	72	216
Gallery	LF UV STOP 1X58W DIM	20	58	1160
Gallery	Tube Light:LF UV STOP 1X58W DIM	10	58	580
Entrance Foyer and Lobby	35W IRC Low Voltage	18	35	630
Dressing Areas	18W CFL DOWNLIGHT	20	19	380
Theatre L Cove Surroundings	2 X 80W, T5	30	160	4800
Plant Room	2X36W, T8 Surface	4	72	288
Storeroom and workshop.	2X36W, T8 Surface	4	72	288
Management and Admin	2 X54W, T5 Pendant	6	56	336
First floor office and storage	2 X54W, T5 Pendant	6	56	336
Control and office over bar	2 X54W, T5 Pendant	2	56	112
DALI Control Solution with P/D and L/S	BECKHOFF	1	10	10
				10504

RESTAURANT				
LOCATION	FITTING TYPE	QUANTITY	POWER	TOTAL POWER(W)
Kitchen	2X36W, T8 Surface	4	72	288
Restaurant (Ground floor)	2 X54W, T5 Pendant	30	108	3240
Restaurant (1st floor)	2 X54W, T5 Pendant	15	108	1620
Bath Rooms	18W CFL DOWNLIGHT	10	19	190
DALI Control Solution with P/D and L/S	BECKHOFF	1	10	10
				5348

ART GALLERY				
LOCATION	FITTING TYPE	QUANTITY	POWER	TOTAL POWER(W)
Ground Floor Open Areas, L Cove Surroundings	LF UV STOP 1X58W DIM	175	58	10150
Ground Floor Open Areas	Tube Light:LF UV STOP 1X58W DIM	96	58	5568
Workshop and restoration	2X36W, T8 Surface	3	72	216
Admin and Library	2 X54W, T5 Pendant	6	56	336
Plant room	2X36W, T8 Surface	3	72	216
Toilets-male and disabled.	18W CFL DOWNLIGHT	5	19	95
Storage	2X36W, T8 Surface	3	72	216
DALI Control Solution with P/D and L/S	BECKHOFF	1	10	10
LOCATION	FITTING TYPE	QUANTITY	POWER	TOTAL POWER(W)
1st Floor Open Areas, L Cove Surroundings	LF UV STOP 1X58W DIM	145	58	8410
1st Floor Open Areas	Tube Light:LF UV STOP 1X58W DIM	96	58	5568
Staff Rest Room	2 X54W, T5 Pendant	3	108	324
Curator	2 X54W, T5 Pendant	2	108	216
Office	2 X54W, T5 Pendant	2	108	216
Toilets-female	18W CFL DOWNLIGHT	5	19	95
Board Room	2 X54W, T5 Pendant	3	108	324
Storage	2X36W, T8 Surface	3	72	216
				15369

info: Clarkson,M.2008. Osram Jhb.

TECHNICAL NOTES

[07][12][00] THEATRE SIGHTLINE

S=Floor to stage bottom	1000
H1=Height of seated front row viewers top of head	1300
E1=Height of seated rear row viewers eyes (no riser)	1200
D1=Stage to front row viewers eyes	3400
D2=Stage to back row viewers eyes	19000

Then, the calculations:

$H1 - S = V1$	300
$V1 / D1 = R$	0.09
$R * D2 = V2$	950
$V2 + S = E2$	1710
$E2 - E1 = \text{Riser height}$	510
V1=300, Vertical V2=950, Vertical E2=1710 Back row eye level (with riser).	

GROUND FLOOR THEATRE

THEATRE SIGHTLINES

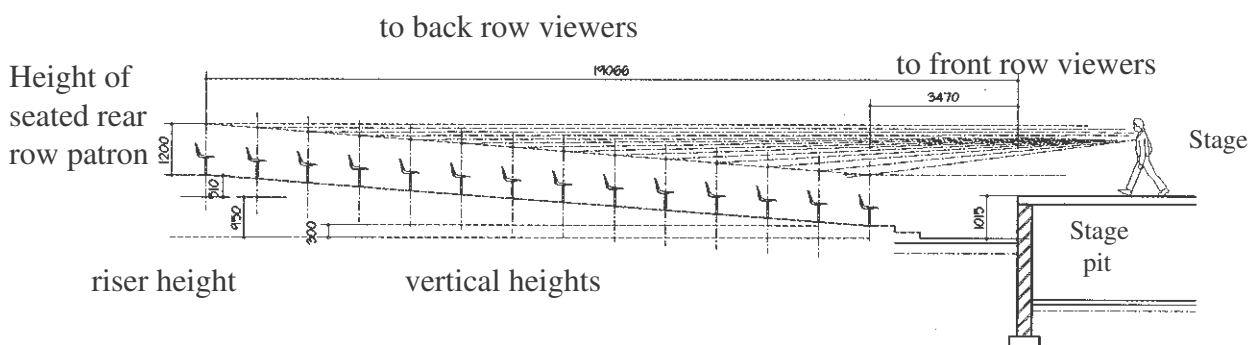

SECTION; SEATING AREA

[08][00][00] CONCLUSION

The aim of the proposed thesis project is to establish an art facility, where art works can be exhibited and performed in an environment that links the academic and the public realms. By taking a holistic approach in the appropriation of existing buildings as an art gallery and a theatre, and in the establishment of a new restaurant, the totality of this newly formed square is pertinent as a new cultural venue of significance in the CBD.

The orchestration of movement through the site to the main campus facilitates an appreciation of the spatial qualities and the relation between the three buildings. Could architecture and landscape of equal value, as alluded to in this essay, be pushed further to achieve a near fusion? And could they be seen as a single unified process?

In this approach the design response was formulated according to the changes and challenges of the encountered conditions.

The composition exploits every opportunity provided by the site and forges a successful spatial experience. The unique character of the relationship between the buildings, and the order and arrangement of spaces around the buildings, makes it a complex exercise to place forms that are valued for purposes other than their own intrinsic elegance, which is largely the case here. The differentiation in form arises as a result of an acute sensibility to the site forces and in the various scenarios of the superimposed assertive tectonic.

The development belongs so naturally to the site and forges such an exceptional spatial experience, that a sense of inclusive permanence is manifested.



IMAGES:

fig [01]	Drwg	Campus: T.U.T.	page 1
[02]	Phto: airial	Site; Education Node	5
[03]	Phto: p r o m o .	New town @ Itura l Precinct; Jhb	7
[04]	Phto: p r o m o .	The Bat @ ntre; D r b a n	7
[05]	Persp :3d irg	Buildings @ The Project	8
[06]	Map : iit & net	Africa	9
[07]	Map :	South Africa	10
[08]	Map :	Gai teng	11
[09]	Map :	City; CBD	12
[10]	Map : City; CBD	Site; Aer ial View	13
[11]	Drw: Site	Coto urs	14
[12]	Drw: Site	Proposal	15
[13]	Drw: TICP	Macro Analysis	16
[14]	Drw: Site	Orient ation	19
[15]	Drw: Site	SQUARE	20
[16]	Drw: Square	SCAIL OPED EDGE	21
[17]	Drw: Square	TRANS TION	22
[18]	Drw: Square	THRIS HOLDS	23
[19]	Drw: Square	SA FES HIELD	24
[20]	Drw: Theatre	VIEW TO THES QUARE	25
[21]	Md : Project	SOUT H ELEVATION TO THE RESTAURANT	26
[22]	Drw: Project	S I TE A ND EXTEND OF PROJECT	27
[23]	Drw: Gallery	GROUND EL @ R HE DEHOF @ IL ERY	28
[24]	Drw: Gallery	FIRST EL @ R HE DEHOF @ IL ERY	30
[25]	Drw: Restaurant	GROUND EL @ R RES TAURANT	32
[26]	Drw: Restaurant	FIRST EL @ R RES TAURANT	34
[27]	Drw: Theatre	GROUND EL @ R THEA TRE	36
[28]	Drw: Theatre	FIRST EL @ R THEA TRE	38
[29]	Md : Project	THE MODEL; PLAN VIEW OVER	42
[30]	Phto & D w	S I TE & DESIG N DRIVERS	44
[31]	Drw: Gallery	PLAN & SE CTION Court Yard	47
[32]	Phto & D w	@ IL ERY ENTRANCES andstone Surround	49
[33]	Phto: Precedent	C@ TELVECC HIO INTERIOR	51
[34]	Phto: Precedent	CANGRANDE; SCU LPTU RE FOCAL POINT	52
[35]	Drw: Gallery	CIRCULATION @ IL ERY	53
[36]	Persp :3d irg	RES TAURANT; S / W IMPRESS ION	55
[37]	Drw: Restaurant	SKETCH; SOUTH ELEVATION	56
[38]	Persp :3d irg	THEA TRE; ES T ELEVATION	57
[39]	Phto & D w	THEA TRE & DESIG N DRIVERS	58
[40]	Phto: Precedent	ENVELOPE; PRECEDENT	60
[41]	Phto: Precedent	@ IL ERY; INTERIOR	61
[42]	Phto: Precedent	THEA TRE; INTERIOR	62
[43]	Phto: Precedent	THEA TRE; WES T ELEVATION, EVENING	63
[44]	Phto: Precedent	@ IL ERY; SOUT H ELEVATION	63
[45]	Phto: Existing	DESIG N DRIVERS	65



BIBLIOGRAPHY

- Alexander, C. (ao) 1977. *A Pattern Language*.
Oxford University Press: New York.
- (TICP 2005) Tshwane Inner City Project . 2005 . *Architecture and principles*. Namibia architects.
- (SD G 2005:) City of Tshwane 2005. *Street scape design and principles*
City Planning Division.
- Nobel, P. 2011. *What Pragmatism Ain't: Architectural theorists do a number on William James's all American philosophy*. www.metropdismag.com
- James, W. 1906. *Lecture II: What Pragmatism Means*
(from) www.pragmatism.org
- Spektor, T. 2004. Pragmatism for Architects . *Contemporary Pragmatism*, June 2004, Vol.1, No.1.
- Murray, R. 1990. *Carlo Scarpa and the Castelvecchio*.
Butterworth London.
- Alexander, C. (ao) 1987. *A new theory of urban design*.
Oxford University Press: New York.
- Alexander, C. 1981. *The Lincoln Cafe*.
Oxford University Press: New York.
- Silverman, M. 1965. *Contemporary theatre architecture*.
New York.
- Holod, R & Kahn, H. 1997. *The Mosque and the Modern World*.
Thames & Hudson: London.
- Talaska, R. (ed.). 1986. *Halls for Music Performance*.
American Institute of Physics: New York.
- Sternberg, E & B. 1971. *Community centres and student unions* VNR: New York
- Nervi, P. 1963. *New Structures*
The Architectural Press: London
- Gil, B 1991 *Architectural Design*.
Van Nostrand Reinhold: New York.
- The Concise Oxford Dictionary. 1964. Oxford University Press: Oxford.

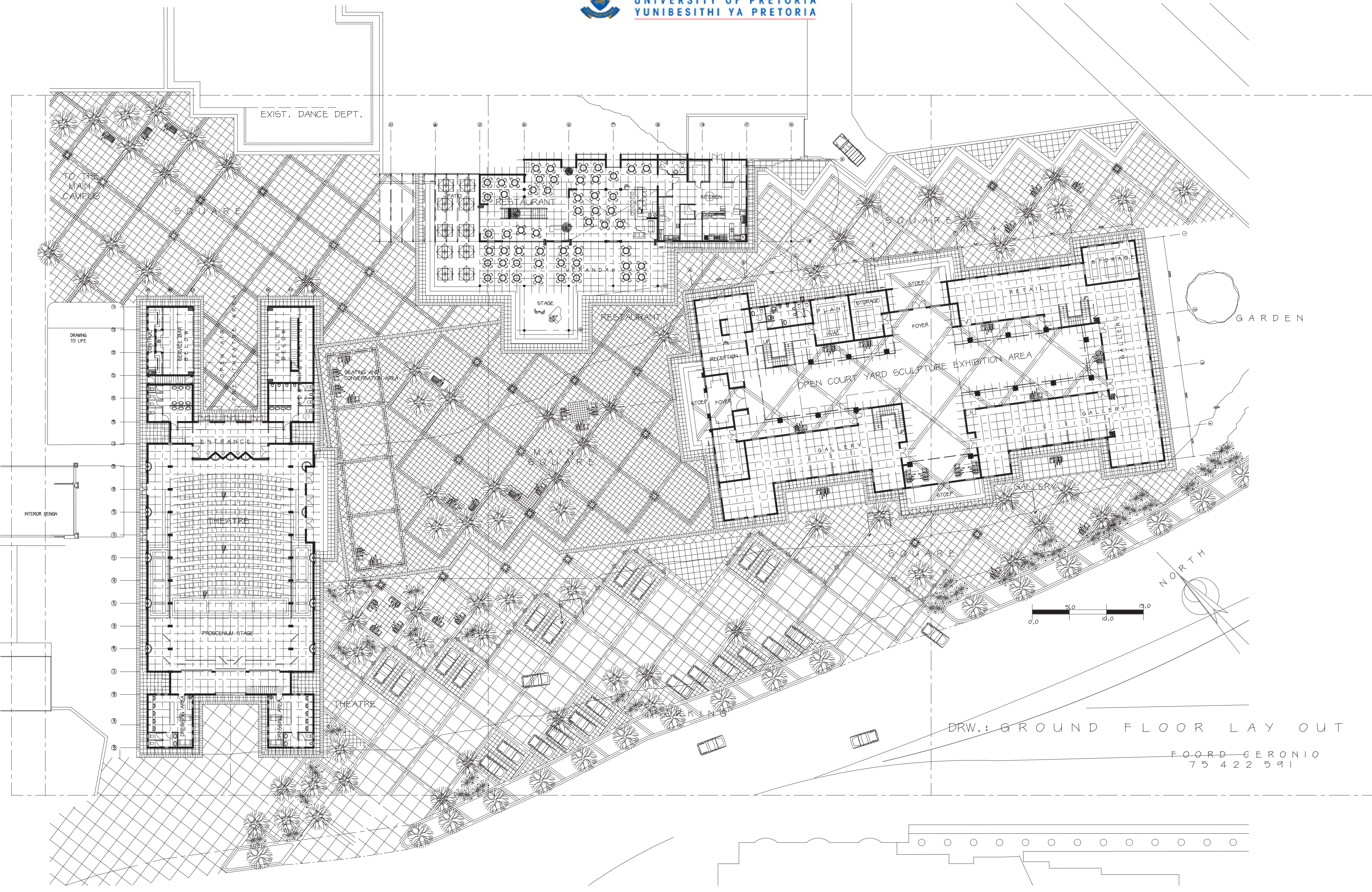

DRW.: GROUND FLOOR LAY OUT
 FOORD GERONIO
 75 422 591



TO THE
 MAIN
 CAMPUS

EXIST. DANCE DEPT.

SQUARE
 BELOW

PATIO
 BELOW

RESTAURANT

DOUBLE
 VOLUME

KITCHEN
 BELOW

SQUARE
 BELOW

VERANDAH
 BELOW

STAGE

FIRST FLOOR RESTAURANT

MAIN
 SQUARE
 BELOW

GARDEN

OPEN COURT YARD SCULPTURE EXHIBITION AREA
 BELOW

SQUARE
 BELOW

FIRST FLOOR GALLERY

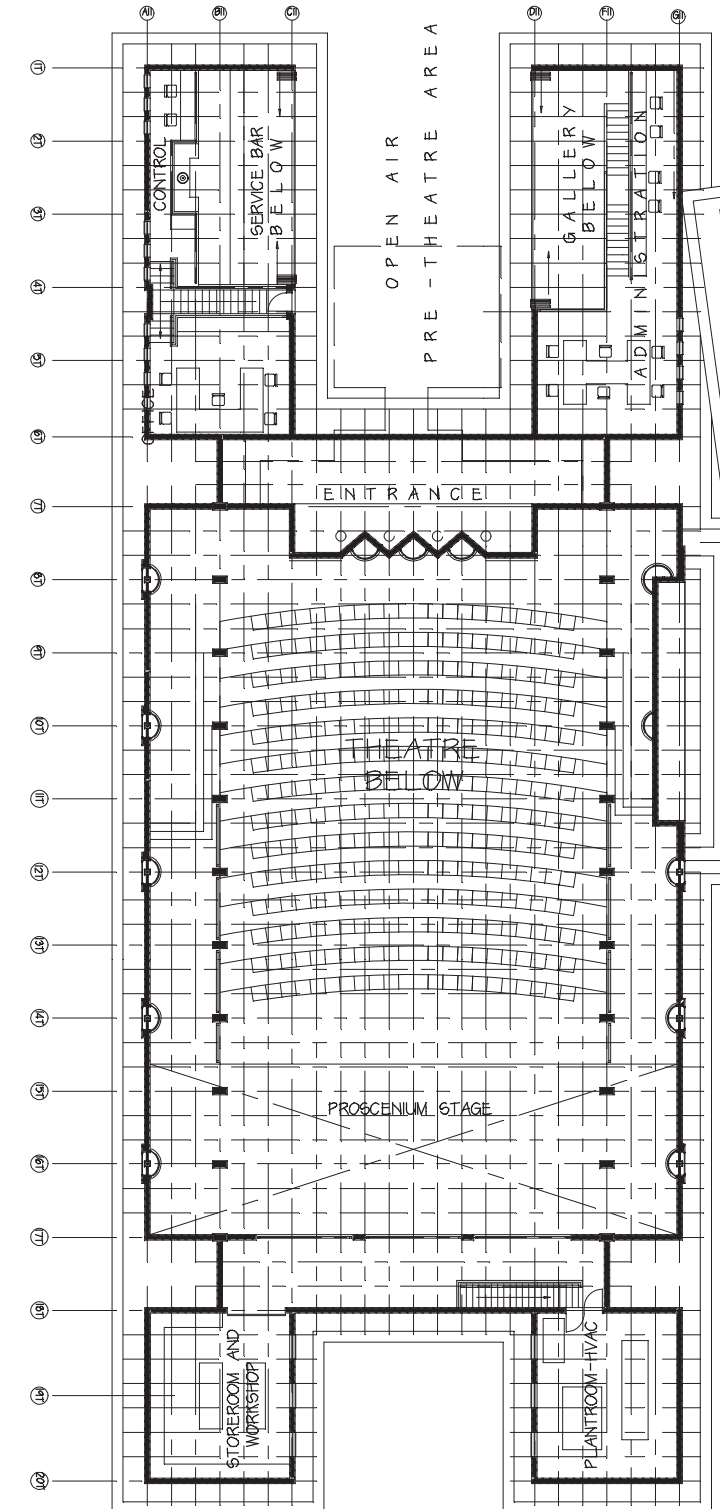
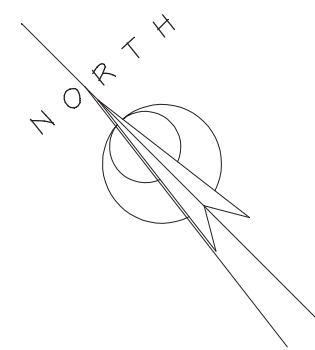
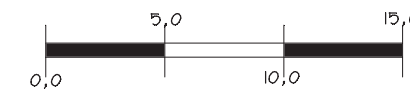

FIRST FLOOR THEATRE

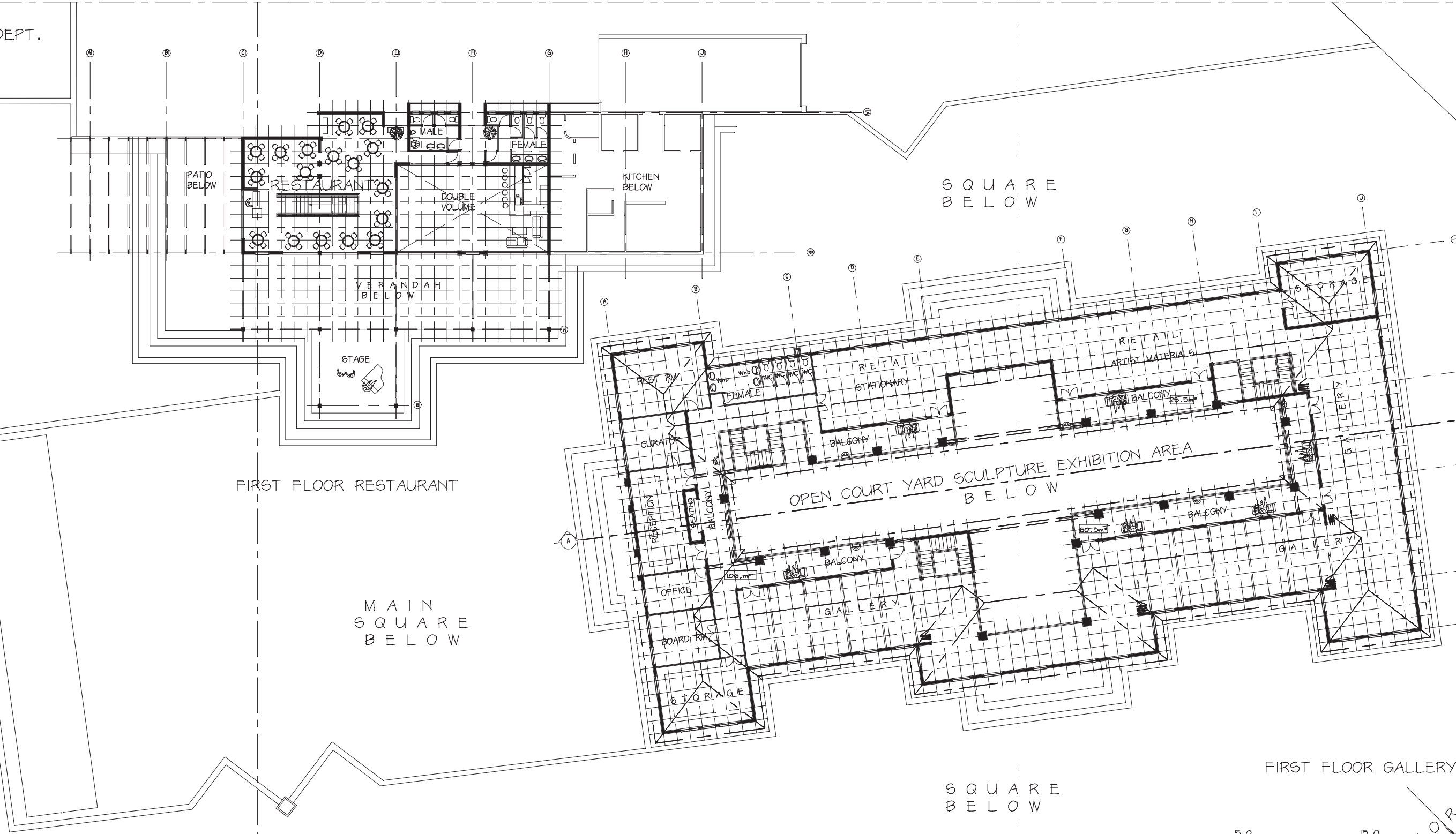

PARKING

DRW.: FIRST FLOOR LAY OUT

FOORD CERONIO
 75 422 591



MASONRY:

SANDSTONE DETAIL AT THE NEW MAIN WESTERN ENTRANCE TO MATCH THE DETAIL AT THE EXISTING NORTHERN ENTRANCE. THE APPLIED AND FORMED STONE TO BE LAID (AS A FACING) INTO THE BRICKWORK, SIMILAR TO 'ASHLAR' MASONRY FORMAT. ASHLAR FACING MUST MATCH THE EXISTING AND CAN BE CHAMFERED AND REBATED. THE BEDDING MUST MATCH THE BACKING BOND BEDDING TO ENSURE QUALITY OF SETTLEMENT.

GUTTERS:

EAVES GUTTERS MUST BE OF COMMERCIAL GRADE STEEL SHEET WITH CLASS 2275 GALVANISING TO COMPLY WITH SABS 934:1 WITH BEADED EDGES ANGLES STOPPED ENDS AND OUTLET NOZZLES TO THE SIZE: SQUARE 125 X 125 LAY GUTTERS IN GALVANISED MILD STEEL BRACKETS AS STATED IN ROOF NOTES. FIX DOWNPIPS AT LEAST TWICE TO COLLARS WITH BEAM AT THE BRICK AND 25mm FROM POST.

BARGE BOARDS AND FASCIAS MUST BE FIBRE CEMENT SHEETS; SCREW FASCIAS TO THE TILTING BATTENS OR THE VERGE BATTENS.

DAMP PROOF

0.25mm SMOOTH GREEN POLYOLEFIN DAMP-PROOF MEMBRANE TO COMPLY WITH SABS 9152 TYPE-C. LAY MEMBRANE UNDER SURFACE BED, AND FOLD IT UP AGAINST THE FOUNDATION WALL. LAY MEMBRANE IN LARGEST POSSIBLE SIZES WITH 200mm OVERLAPS. ANY JOINTS SHALL BE SEALED WITH PRESSURE SENSITIVE TAPE APPLIED OVER THE LEADING POINT.

POISON

IF THERE IS EVIDENCE OF TERMITES, THE SOIL SHALL BE POISONED WITH AN APPROVED REGISTERED POISON. A CLEARANCE CERTIFICATE IS TO BE SUBMITTED.

SMOOTH

USE SAND, FINE GRAVEL TO FILL VOIDS AND PROVIDE A CLOSE SMOOTH SURFACE.

FILLING

FILLING UNDER SURFACE BED OF CLEAN GRAVEL, EARTH AND SAND, FREE OF CLAY AND ORGANIC MATTER - WELL WATERED AND RAMMED IN LAYERS OF NOT MORE THAN 150MM.

FOUNDATIONS

FOUNDATION WALLS SHALL BE SOLID MASONRY, SOLID OR FILLED CONCRETE BLOCKS (OR HARD BURNT CLAY BRICKS). HEIGHT OF ANY FOUNDATION WALL NOT TO EXCEED 1.0 METER - TO BE DESIGNED BY THE ENGINEER.

ADMINISTRATION



ENTRANCE

SECTION

REINFORCED FOUNDATIONS TO THE ENGINEER'S DETAILS WITH ARTICULATION JOINTS AT ALL INTERNAL/EXTERNAL DOORS AND OPENINGS, LIGHT REINFORCEMENT IN MASONRY.

ENTRANCE AT THE GALLERY



ROOF NOTES:

COLOURED CHROMADEK CORRUGATED GALVANISED IRON, ROOF FINISH

PRE-PAINTED GALVANISED STEEL: COLOURED CHROMADEK 0.6MM THICK MILD STEEL WITH CLASS 2275 GALVANISING PRIMED WITH AN EPOXY-BASED PRIMER, AND PAINTED WITH SILICON POLYESTER PAINT.

ENSURE THAT GUTTER BRACKETS AND GUTTERS ARE INSTALLED BEFORE LAYING ROOF SHEETS.

METAL FLASHING MUST BE OF 0.6MM COMMERCIAL GRADE STEEL SHEET AND PRE-PAINTED TO MATCH THE ROOF SHEETS.

76x100MM S.A. PINE BATTENS @ 1000MM C/C PREFABRICATED TRUSSES AND BRACING MUST BE DESIGNED BY A COMPETENT PROFESSIONAL ENGINEER. RAFTER CONSTRUCTION FROM 192 X 38MM S.A. PINE WITH 14 X 38 STRUTTING @ 1000MM C/C OR AS SPECIFIED.

ON 228 X 76MM LAMINATED S.A. PINE BEARER BEAM FIXED TO COLUMNS - BEAM DESIGN BY THE ENGINEER. ALL TIMBER TO BE SABS GR 6.

(TIMBER RAFTERS TO BE FACTORY MANUFACTURED UNDER SUPERVISION OF THE ENGINEER)

MASONRY

CLAY BRICKS

CLAY BRICKS MUST CONFORM TO SABS 2271:1 FACE BRICKS MUST BE CLASS 195, FIX OR FBA AS SPECIFIED, OR TO MATCH EXISTING FACE BRICKS, WITH A MINIMUM COMPRESSIVE STRENGTH OF 17 MPA. COMMON BRICKS MUST BE CLASS NFP WITH A MINIMUM COMPRESSIVE STRENGTH OF 7 MPA FOR GENERAL SINGLE-STORY WORK; CLASS NFX WITH A MINIMUM COMPRESSIVE STRENGTH OF 10.5 MPA FOR DOUBLE STOREY STRUCTURAL WALLS, FREE-STANDING WALLS AND RETAINING WALLS. GRADE OF EFFLORESCENCE: STANDARD GRADE FOR INTERNAL WALLS THAT WILL NOT BECOME DAMP; SPECIAL GRADE FOR VISIBLE UNPLASTERED FOUNDATION WALLS.

PROOF OF QUALITY: DESPATCH OR CONSIGNMENT NOTES OF BRICKS AND BLOCKS DELIVERED TO SITE MUST STATE THE SPECIFIED REQUIREMENTS AND MUST BE KEPT OR SHOWN WHEN REQUESTED BY THE ARCHITECT/PRINCIPAL AGENT.

SAMPLES: SUPPLY A SAMPLE OF 20 CLAY FACE BRICKS AND SIX OF EVERY OTHER TYPE OF CLAY BRICK FOR APPROVAL. SUPPLY ONE SAMPLE OF EVERY TYPE OF CONCRETE BLOCK. KEEP THESE UNITS ON SITE FOR REFERENCE.

STORAGE: UNLOAD BRICKS AND BLOCKS CAREFULLY TO PREVENT CHIPPING AND BREAK-AGE. STACK ON PREPARED LEVEL AREAS AND PROTECT FROM STAINING OR MARKING.

0.375mm SABS 952 UNDER WINDOW SILLS IN THICKNES OF WALL AND UNDER FIRST FULL COURSE OF MASONRY. NOT JUST IN THE BEDDING MATERIAL DIRECTLY BELOW THE CILL. BRICK ON EDGE EXTERNAL WINDOW CILL.

FLOOR: FINISHES AS INDICATED ON PLAN. 25mm CEMENT SCREED 75mm THICK 13 MPA CONCRETE SURFACE BED, CAST IN 200 X 200 X 4 WELDED STEEL MESH PLACE NEAR TOP OF SURFACE (USE LARGE MATS WITH 300mm OVER LAPS).

DAMP-PROOF COURSE: DAMP PROOFING SHALL BE PLACED UNDER ALL WALLS AT A MIN HEIGHT OF 150MM ABOVE NATURAL GROUND LEVEL AND MUST COMPLY WITH SABS 9152 - B - POLYOLEFIN SHEET WATERPROOFING FOR STRUCTURE, 375 MICRONS EMBOSSED LAY IN UNJOINTED LENGTHS AND WITH FULL CORNER LAPS.

MACHINE MIX CONCRETE IN PROPORTIONS BY VOLUME, CONCRETE NO WEAKER THAN 1 PART 42.5 PORTLAND CEMENT TO 3 PARTS CLEAN DRY SAND TO 6 PARTS COARSE AGGREGATE, AGGREGATE FROM 140 TO 28.50 mm.

CONCRETE SHALL HAVE A COMPRESSIVE STRENGTH NO LESS THAN 10 MPA AT 28 DAYS.

SOIL TESTS AND DENSITY TEST WILL BE UNDER THE SUPERVISION OF THE ENGINEER.

ALL REINFORCED CONCRETE IN ACCORDANCE WITH DESIGN AND SPECIFICATION OF PROFESSIONAL ENGINEER.

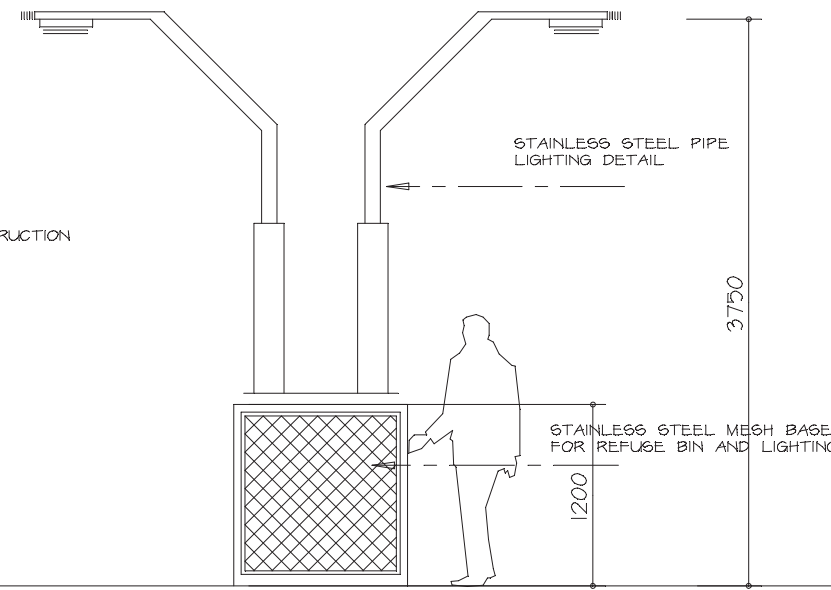

SQUARE LIGHTING

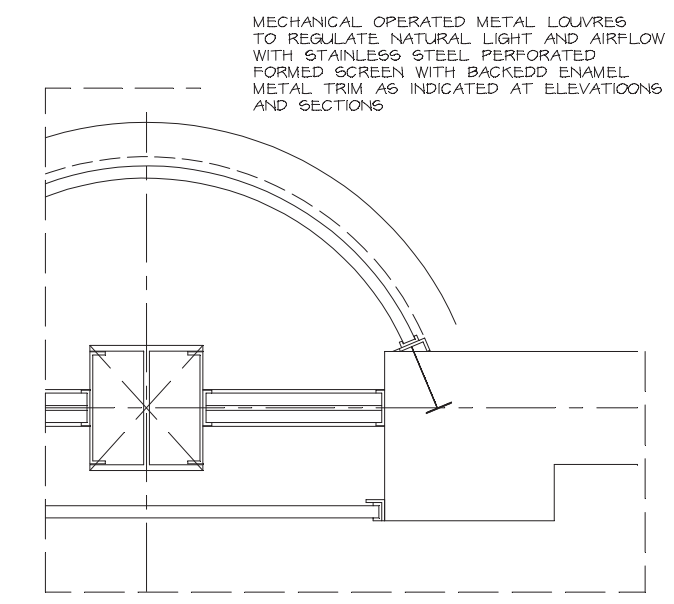

LOUVRE DETAIL: THEATRE

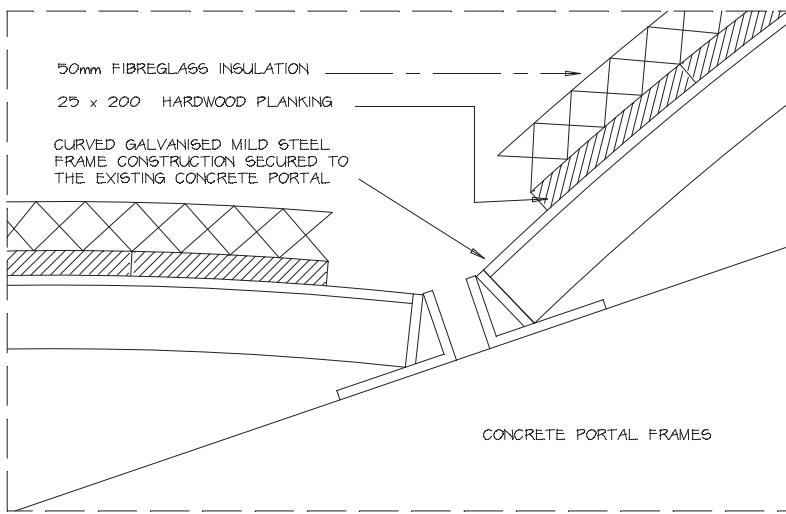

ACOUSTIC CEILING THEATRE

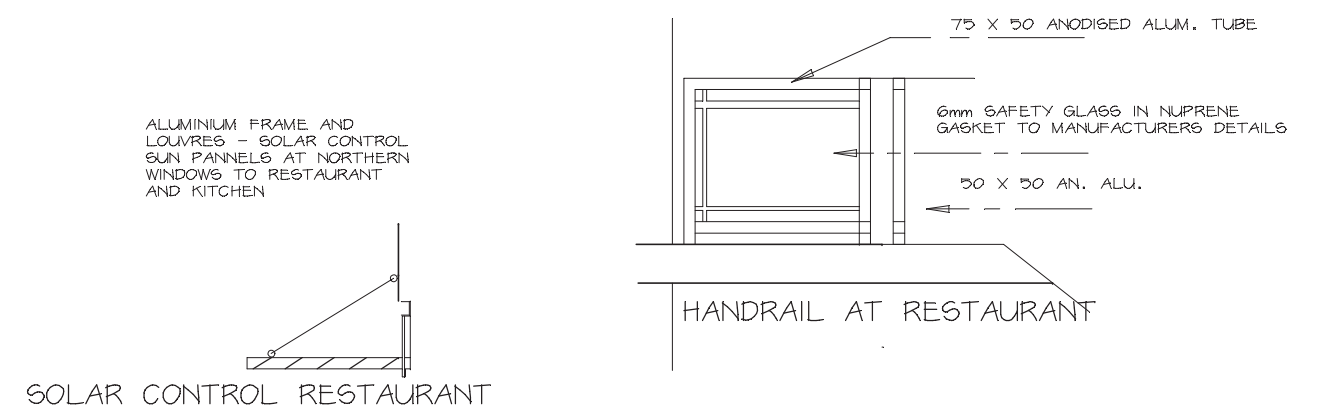

SOLAR CONTROL RESTAURANT

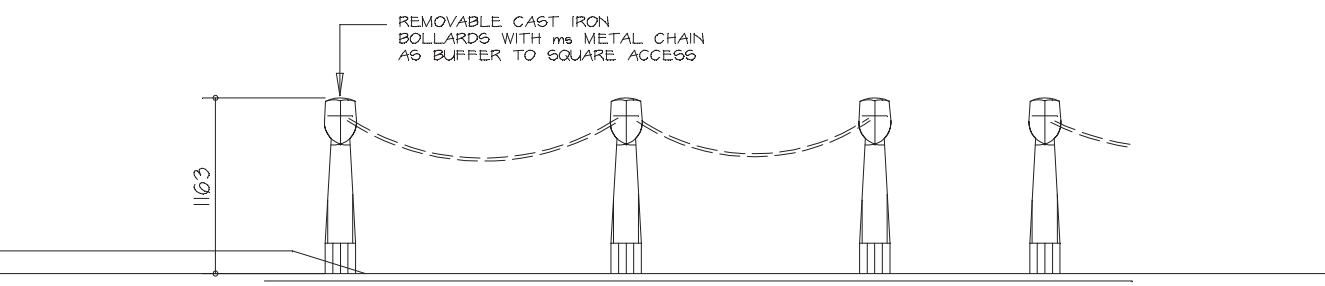

BOLLARDS

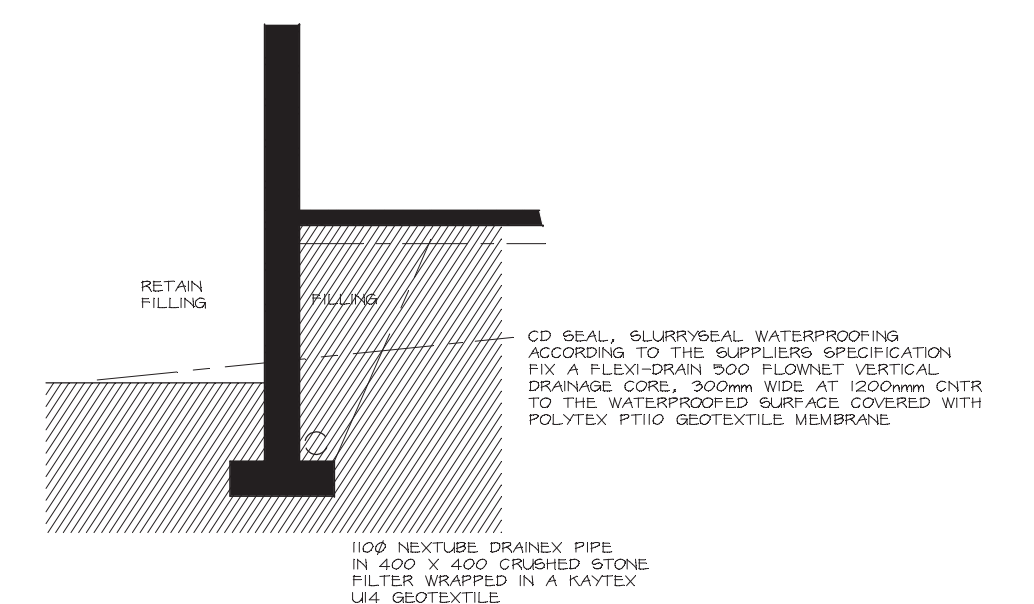

FILLING AT RESTAURANT

DRW.: DETAIL
SECTIONS
& ELEVATIONS

F O O R D C E R O N I O
7 5 4 2 2 5 9 1

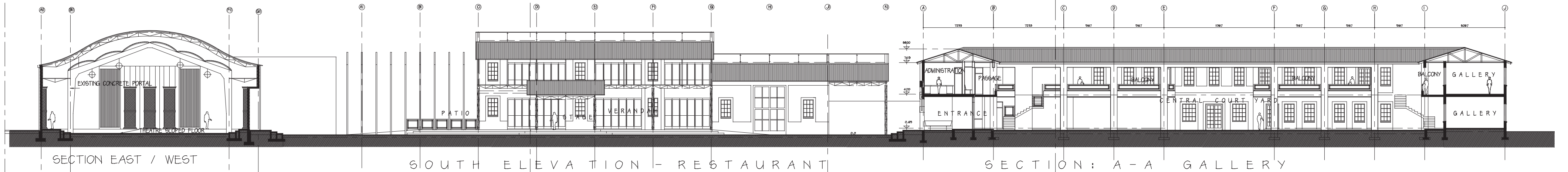

DRW.: SECTION EAST / WEST

FOORD CERONIO
75 422 591



DRW.: SECTION NORTH / SOUTH

FOORD CERONIO
 75 422 591

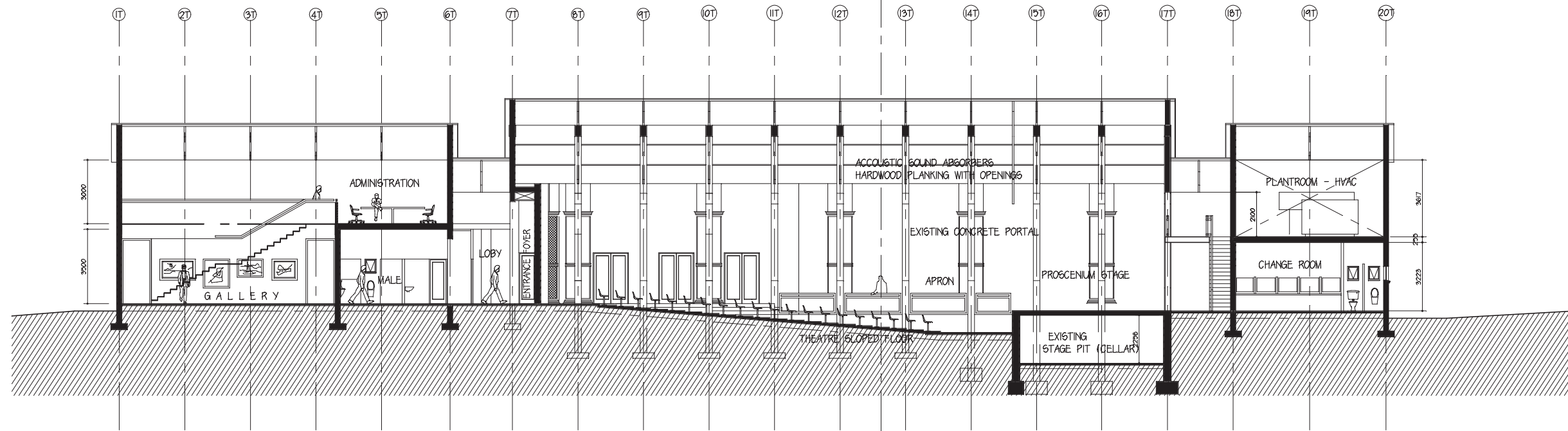

SECTION NORTH / SOUTH

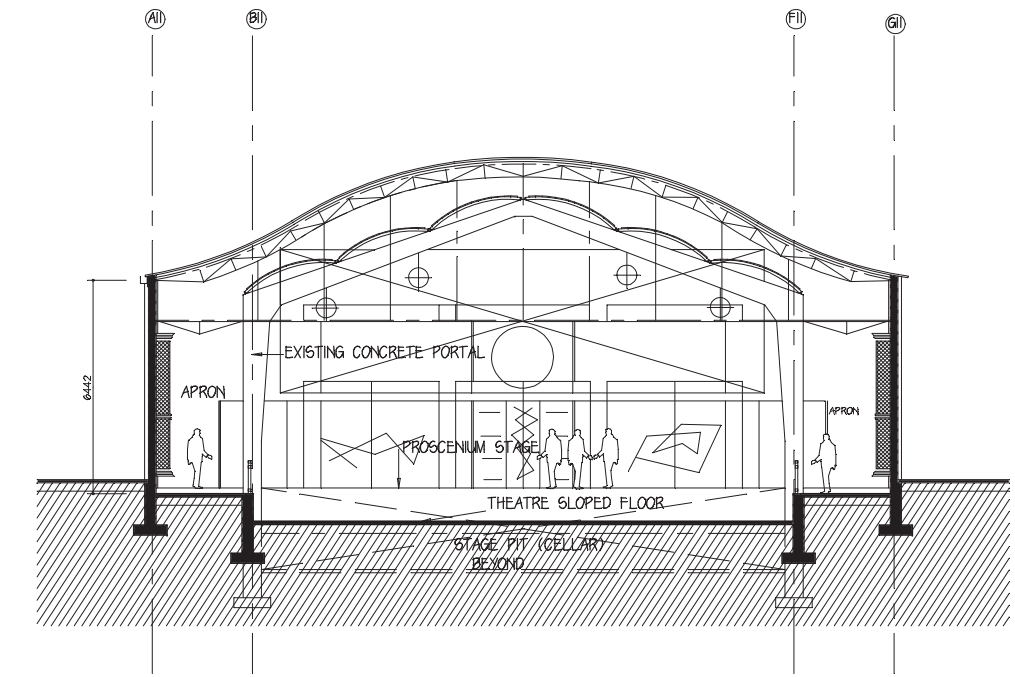

SECTION EAST / WEST

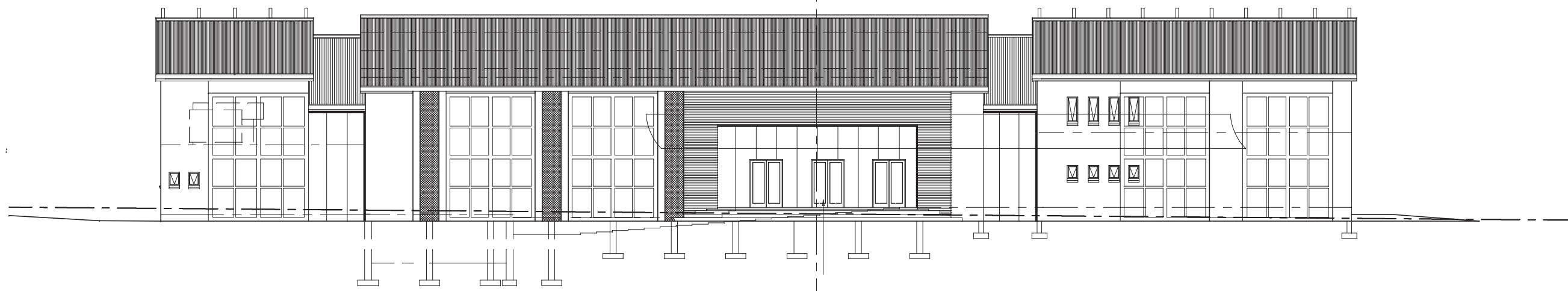

EAST ELEVATION THEATRE

DRW.: SECTIONS THEATRE

FOORD CERONIO
75 422 591