

*Immune responses against recombinant poxviruses expressing full-length lyssavirus glycoprotein genes*  
Jacqueline Weyer

**Part Two**

**PREPARATION OF RECOMBINANT LUMPY SKIN DISEASE VIRUS  
(NEETHLING STRAIN) EXPRESSING A FULL-LENGTH RABIES VIRUS  
GLYCOPROTEIN GENE AND EVALUATION OF IMMUNOGENICITY IN A  
MOUSE MODEL**

## CHAPTER III

### CONSTRUCTION AND ISOLATION OF RECOMBINANT LUMPY SKIN DISEASE VIRUS (NEETHLING STRAIN) EXPRESSING A FULL-LENGTH RABIES VIRUS GLYCOPROTEIN GENE

#### 3.1 Introduction

Attenuated vaccine strains of Lumpy Skin Disease virus (LSDV) have been investigated by several groups as carriers for foreign disease antigens. The Kenya sheep-1 strain, KS-1, has been used for the expression of antigens of rinderpest, bluetongue and peste-des-petits-ruminants viruses (Berhe *et al.*, 2003; Wade-Evans *et al.*, 1996; Romero *et al.*, 1994a; Romero *et al.*, 1993). The southern African vaccine strain of LSDV, the Neethling strain (LSDV-SA), has also been investigated as a vector for foreign disease genes. To this effect, genes of bovine ephemeral fever; rabies and rinderpest viruses have been expressed in this system (Wallace and Viljoen, 2005; Aspden *et al.*, 2003; Cohen *et al.*, 1997). In all of the before mentioned studies the foreign disease genes were immunogenically expressed in the LSDV system as shown in immunization studies in different animal models.

Essentially, the principles for the generation of vaccinia viruses are also applicable to the generation of recombinant LSDV (Smith and Mackett, 1992). Shortly, a recombinant transfer vector is transfected into cells that has been infected with wild type virus at a low multiplicity. With the recombinant plasmid DNA in close proximity of the viral genomic DNA, a double cross over event would allow the integration of the expression cassette of the transfer vector into the corresponding region of the viral genome. Recombination occurs at a relatively high rate in poxvirus infected-cells, but almost the entire population of progeny virus remains parental wild type virus (more than 99%) (Moss, 1992; Smith and Mackett, 1992). Once recombinants have been generated, it must then be purified from wild type viruses. The latter is accomplished by applying specific selective pressure *in vitro*, determined by the markers encoded on the recombinant virus. Some modifications to this standard protocol for the generation of

recombinant vaccinia viruses have already been investigated to optimize the generation of recombinant LSDV-SA, particularly because it grows comparatively slower in cell culture than the vaccinia virus (Fick, 1998).

Even though the principles for generation and isolation of these viruses remain the same, the isolation of homogenous recombinant LSDV isolates proves more challenging than with some of the other recombinant poxviruses in which case this has become a routine procedure (personal communication Dr. G.J. Viljoen, International Atomic Energy Agency, Austria and Mr. D.B Wallace, Agricultural Research Council-Onderstepoort Veterinary Institute, South Africa; Berhe *et al.*, 2003). First off, the selection of thymidine kinase (TK) negative phenotype, which is a convenient and efficient selectable marker often used for the purification of recombinant vaccinia viruses, and results in recombinants free from additional genetic selection markers, have proven problematic in the purification of recombinant LSDV-SA (Wallace and Viljoen, 2002). The insertional inactivation of the TK gene of LSDV-SA leads to the generation of unstable recombinant viruses (Fick, 1998, Wallace and Viljoen, 2002). It was, however, shown that the TK gene can be used as an insertion site of the LSDV-SA genome providing that the host cell complements the thymidine kinase deficiency (Wallace and Viljoen, 2002; Wallace and Viljoen, 2005). This anomaly is not unique and use of TK negative selection is conditional for the selection of other recombinant poxviruses such as modified vaccinia virus Ankara, fowlpoxvirus and pigeonpoxvirus (Scheiflinger *et al.*, 1996; Letellier, 1993; Nazerian and Dhawale, 1991). The use of a dominant positive selectable marker gene such as the *Escherichia coli* guanosine phosphoribosyl transferase (*Ecogpt*) gene, which encodes for mycophenolic acid (MPA) resistance, proves to be a viable alternative (Wallace and Viljoen, 2002). Another stumbling block in the isolation of homogenous recombinant LSDV-SA isolates is thought to be associated with the formation of intracytoplasmic clumps or inclusions (Thomas and Maré, 1945; De Lange, 1959; Prozesky and Barnard, 1982). This is postulated in observation of the relative difficulty of the purification of recombinant LSDV with respect to other recombinant poxviruses, especially compared to recombinant vaccinia viruses. It is postulated that these clumps can consist of recombinant and wild type viruses, which could infect the same cell. The recombinant virus, bearing selectable

marker gene or genes would then be able to rescue the wild type virus for replication. Various approaches have been explored to facilitate the elimination of this wild type virus background and therefore the isolation of pure recombinants. Breaking up of these virion clumps through sonication treatment is suggested in Berhe *et al.*, 2003. Another approach entails the filtration of viral supernatants through a 0.45 µm pore filter, in order to separate virions (Personal communication, Mr. D.B. Wallace).

One of the aims of this section of the study was to generate and isolate a homogenous recombinant LSDV-SA expressing a rabies virus glycoprotein gene. In addition different selection strategies (filtration, sonication and detergent treatment of viral lysates) were investigated with the intention to compare the methods and make suggestions towards a strategy for the convenient isolation of pure recombinants. Additionally, the vaccine viruses were prepared for immunization studies in animals.

## **3.2 Materials and methods**

### **3.2.1 Recombinant plasmids and viruses**

A recombinant LSDV transfer vector clone, pLSEG-RG was obtained from Prof. L.H. Nel (University of Pretoria, South Africa). The full length glycoprotein gene of a mongoose rabies virus isolate (Agricultural Research Council - Onderstepoort Veterinary Institute reference number: m710/90) was directionally inserted into the *Bam*H I and the *Sac* I sites of the pLSEG transfer vector. The pLSEG vector was constructed and originally obtained from Mr. D.B. Wallace (Agricultural Research Council - Onderstepoort Veterinary Institute, South Africa) (figure 3.1). Mr. D.B. Wallace also provided LSDV-SA stocks. The passage history of LSDV-SA is described in Wallace and Viljoen, 2005.

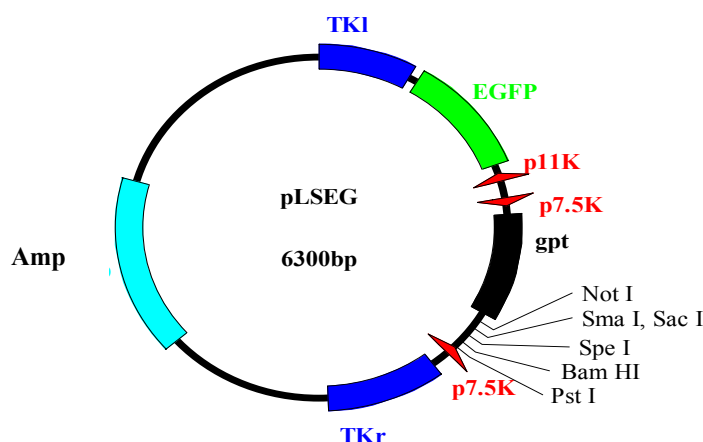

**Figure 3.1:** Circle map of the LSDV transfer vector, pLSEG, depicting the relevant features of the plasmid.

### 3.2.2 General cell culture procedures

#### 3.2.2.1 Maintenance of cell culture

Aseptic technique and other general procedures adopted for the maintenance of cell culture are described in Freshney, 1994 and Spector *et al.*, 1998.

Cell cultures were routinely examined with an inverted microscope for morphological deterioration. When the cultures reached 80-90% confluency the cultures were subcultured. Briefly, the spent medium was removed from the culture and discarded using a mechanical pipettor. The cell monolayer was then washed three times with 0.1% trypsin, using 40  $\mu$ l per  $\text{cm}^2$  of culture vessel. After the third wash, the trypsin was removed from the culture vessel and the culture incubated at 37 °C for 5-10 minutes or until the cells dislodged from the floor of the culture vessel. A rich culture medium was used, consisting of Dulbecco's Modified Eagle's Medium and Ham's F12 medium prepared in a 1:1 ratio, hereafter DMEM/F12 (Highveld Biologicals, South Africa). The trypsinized cells were then suspended in pre-warmed DMEM/F12 with 1X antibiotics (100  $\mu$ g/ml streptomycin, 100  $\mu$ g/ml penicillin and 250  $\mu$ g/ml amphotericin) (Highveld Biologicals, South Africa) and then subcultured at an appropriate split ratio. Primary

fetal bovine testis cells (FBT) were maintained in DMEM/F12 supplemented with 8% fetal calf serum (FCS) (Highveld Biologics, South Africa) and subcultured in a split ratio of 1:4. When required cells were counted after viable staining with 0.4% Tryphan Blue stain and counted with a hematocytometer. The cell culture was grown under standard growth conditions of 37 °C and an atmosphere of 4.5 % CO<sub>2</sub> in a water-jacketed incubator.

### **3.2.2.2 Preparation of primary fetal bovine testis cell culture**

The testes of calf fetuses were collected by abattoir personnel at Pyramid Abattoir (Pretoria North, South Africa). The testes were stored in phosphate buffered saline (PBS) (13.7 mM NaCl, 0.27 mM KCl, 0.43 mM Na<sub>2</sub>HPO<sub>4</sub>·2H<sub>2</sub>O, 0.14 mM KH<sub>2</sub>PO<sub>4</sub>, pH 7.3) with 3-4 % antibiotics (100 µg/ml streptomycin, 100 µg/ml penicillin and 250 µg/ml amphotericin) (Highveld Biologics, South Africa) until it could be processed. The primary culture was prepared according to the Warm Trypsin method as described in Freshney, 1994, but with modifications. The outer connective tissue of the testes was removed with a scalpel, and the tissue copiously washed with sterile PBS. The tissue was then macerated with a scalpel. The pulp was placed in a sterile Erlen Meyer flask with a magnetic stirrer. The pulp was covered with 0.25 % trypsin and stirred with a magnetic stirrer for 30 minutes at 200 rpm and 37 °C. The trypsinized material was then transferred to sterile centrifugation tubes and centrifuged at 200 g for five minutes. The resultant supernatant was discarded and the pellet resuspended in 10 ml of complete medium with 20 % FCS, and seeded into a 75 cm<sup>2</sup> flask. The cells were then incubated at 37 °C and 4.5 % CO<sub>2</sub>. The condition of the culture was monitored and once confluent, trypsinized and seeded into a 175 cm<sup>2</sup> flask. Once this culture become confluent, the cells were trypsinized and resuspended in complete DMEM/F12. The cells were counted with a hematocytometer and the cells/ml of the culture determined. The resuspended cells were then transferred to centrifugation tubes and collected by centrifugation at 200 g for five minutes. The supernatant was collected without disturbing the cell pellet. The pellet was then resuspended in a volume of freeze medium (8% DMSO, 15% FCS in DMEM/F12) so that the titer of the cells was approximately 5 X 10<sup>6</sup> cells/ml. The cells

in the freeze medium were then aliquoted in cryogenic freeze tubes (~5 X 10<sup>6</sup> cells/tube). The cells were frozen slowly by wrapping the tubes in cotton wool and then covering with aluminum foil. The cells were then frozen at – 70 °C overnight. The frozen cells were then transferred to a –180 °C liquid nitrogen freezer for long term storage. The cryogenic cultures were retrieved by the centrifugation method (Freshney, 1994).

### **3.2.3 Generation of recombinant LSDV-SA: transfection of infected cell culture with recombinant transfer vector**

Approximately 1X10<sup>5</sup> FBT cells were seeded per well on a six well plate (NUNC) in complete DMEM/F12. The following day the confluent FBT cells were infected with LSDV-SA at a MOI of 0.1. The virus was absorbed for five hours at 37 °C and 4.5 % CO<sub>2</sub>. During the virus absorption period, the transfection complexes were prepared. DNA that has been purified using spin columns (QIAquick® Gel extraction Kit, QIAGEN) according to manufacturer's instructions. The DNA was then analysed spectrophotometrically for purity and concentration determination. 400 ng of DNA with an A<sub>260</sub>/A<sub>280</sub> ratio of 1.8 were used for the preparation of the transfection complexes with the non-liposomal lipid transfection reagent, Effectene™ (QIAGEN) according to the manufacturer's suggestions, except that complex formation was allowed for 1 hour. After the 5 hours virus absorption period the inoculum was removed from the cells and washed with sterile PBS to remove unabsorbed virus. The cells were fed with fresh, complete medium and the transfection complexes added to the cells. The cells were incubated under standard growth condition for 48 hours. After 48 hours the cells were investigated microscopically and the transfection efficiency estimated.

### **3.2.4 Isolation of recombinant LSDV-SA: positive dominant selection for mycophenolic acid selection**

#### **3.2.4.1 Classic plaque purification protocol**

Recombinant LSDV-SA was selected as described in Romero *et al.*, 1993, but with some modifications as suggested by David B. Wallace (ARC-OVI, personal communication). Briefly, the supernatant of the transfected materials<sup>1</sup> were harvested by freeze thawing three times and a low speed centrifugation in a bench top microcentrifuge to pellet cellular debris. The supernatant of the harvested material was then titrated in a tenfold serial dilution ( $10^{-2}$  to  $10^{-4}$ ) on FBT monolayers in duplicate and under MPA selection. The MPA selection medium was prepared with DMEM/F12, 2.5 % FCS, 25 µg/ml MPA (Sigma), 250 µg/ml xanthine (Sigma) and 15 µg/ml hypoxanthine (Sigma) as suggested in Romero *et al.*, 1993. The confluent FBT monolayers were pre-incubated with MPA selection medium 20-24 hours before infection. The MPA medium was replaced with fresh MPA medium after 48 hours of incubation. The material from the highest dilution well, where recombinant foci could be visualized using a UV microscope, were harvested by freeze thawing three times and clarification by a low speed spin in a bench top centrifuge. The material was then diluted in a tenfold serial titration ( $10^{-1}$  to  $10^{-3}$ ) and absorbed overnight on FBT monolayers that have been pre-incubated with MPA selection medium, as before. The infected cells were incubated for eight days under normal growth conditions and the MPA medium changed 48 hours after infection. The medium was removed and the cells washed with sterile PBS to remove residual virus. 1 ml of sterile PBS was put in each well. Foci of virus infection that appeared homogenous for EGFP expression, and were distinctly single from other foci, were picked in 20 µl volumes with sterile, filter tips. The picked material was processed by freeze thawing three times and was inoculated on FBT monolayers under MPA selection, as before. After 8 days foci were picked, as before. All suitable foci were picked and analyzed for homogeneity by PCR analysis<sup>2</sup>. The virus samples that appeared

---

<sup>1</sup> Refer to section 3.2.3

<sup>2</sup> Refer to section 3.2.5



homogenous, judging from the PCR results, were chosen to be further processed. The picked material was freeze-thawed three times and sonicated for 60 seconds. Half of the remainder of picked material (not used to prepare template for PCR) was titrated to endpoint on FBT monolayers in the absence of MPA and the other half in the presence of the selection medium. The cell culture supernatants of the highest dilution infections presenting CPE (cytopathic effect) were freeze-thawed three times and titrated to endpoint both in the presence and in absence of selection. This cycle was repeated until homogenous recombinant virus isolates could be retrieved.

#### **3.2.4.2 Filtration and sonication treatment of virus lysates supernatants to facilitate selection**

Transfection material was processed as described in 3.2.4.1 and after the second passage under MPA selection; the cells and supernatants of the infections were harvested by freeze-thawing thrice. Samples were either subjected to sonication treatment for 2 minutes in an ice water-filled water bath sonicator (Sonorex TK 52, Bandelin, Germany) whilst others were filtered through a 0.45 µm pore filter (Millipore, USA). The resultant harvested material was then titrated in a tenfold serial dilution in the range  $10^0$  to  $10^{-2}$  on FBT monolayers under MPA selection. The infections were incubated for five to six days, as before. Thereafter, virus isolates were passaged in a series of endpoint dilutions, until homogeneity was reached, as follows. The supernatant from the highest dilution well presenting CPE was processed by freeze-thawing three times followed by a centrifugation step at 200 g to pellet cellular debris. The supernatant was then titrated to endpoint on FBT monolayers under MPA selection and incubated, as before. The purification of the recombinant viruses in successive rounds was monitored with PCR, as described in section 3.1.5 of this chapter. Samples that appeared homogenous judging by the PCR results were processed as follows. The remainder of the material (which was not used for the preparation of template for PCR) was harvested as previously described and titrated to endpoint in the presence and absence of MPA selection. Each successive round was monitored by PCR, as described later in this chapter<sup>3</sup>.

---

<sup>3</sup> Refer to section 3.2.5

### **3.2.4.3 Detergent treatment of recombinant LSDV-SA to facilitate selection of homogenous recombinant viruses**

10 % sodiumdodecylsulphate (SDS) and 100 mM CHAPS (Amersham) stock solutions were prepared in double distilled H<sub>2</sub>O and filter sterilized. Cell culture grade  $\beta$ -mercaptoethanol (Sigma) was also used. Firstly, the effect of the detergents at different concentrations on FBT monolayers, was investigated by setting up dilution series of the detergents in duplicate and transferring the dilution series on confluent FBT cultures seeded in six well plates. SDS was titrated in the range 0.000001% to 1%,  $\beta$ -mercaptoethanol in the range 0.01 mM – 10 mM and CHAPS in the range 0.1 mM to 10 mM. The cells were then returned to the 37 °C incubator with an atmosphere of 4.5% CO<sub>2</sub> and monitored daily under a light microscope. The concentrations at which the detergents were well tolerated by the FBT cultures were noted.

The effect of the detergents, at the determined concentrations, on the infectivity of wild type LSDV-SA was investigated. Wild type LSDV-SA infected cells were freeze thawed three times and sonicated for one minute. The lysate was briefly centrifuged at 200 g in a benchtop centrifuge to pellet the cellular debris. Tenfold dilution series of the supernatant was then prepared, in the range 10<sup>-4</sup> to 10<sup>-6</sup> (were distinct foci can be counted), against the pre-determined detergent concentration, and in duplicate. The reactions were vortexed briefly and incubated at room temperature for one minute. The detergent treated virus was then transferred to confluent monolayers of FBT cells. The infected cell cultures were returned to the CO<sub>2</sub> incubator and monitored until virus CPE became apparent. An untreated wild type LSDV-SA titration was also prepared in the same manner. The foci were counted and the reduction in infectivity calculated.

Transfection material was processed as described before<sup>4</sup> and after the second passage under MPA selection single plaques were harvested by freeze thawing three times. The lysates were then inoculated on a 25cm<sup>2</sup> flask of confluent FBT monolayer under MPA selection, as before. The MPA selection medium was changed after 48 hours and the infected cells incubated further until about 90 % cell death. The virus were harvested as before and infected unto a 175cm<sup>2</sup> flask of confluent FBT cells under MPA

---

<sup>4</sup> Refer to section 3.2.4.1

selection. The infection was monitored and when the CPE was almost complete, the virus harvested as before. Tenfold dilution series were setup with the harvested virus against the determined concentration of detergent, and transferred onto FBT monolayers under MPA selection. The medium was changed after 48 hours and incubated for another five days. The medium was removed from the infected wells, and washed with sterile PBS. One ml of sterile PBS was dropped onto the wells and foci picked with 20 µl filter tips (the volume was made up to 100 µl with MPA selection medium). The DNA of ½ of the foci material was extracted and analyzed with a PCR for homogeneity as described later in this chapter<sup>5</sup>.

### **3.2.5 PCR analysis of the recombinant LSDV-SA**

#### **3.2.5.1 Nucleic acid extraction**

50 µl of the harvested viruses, or 100 µl of the cells and supernatants of passaged virus isolates, were incubated with an equal volume poxvirus lysis buffer (1% SDS, 20mM β-mercaptoethanol, 20mM EDTA) (Esposito *et al.* 1981) and 100 µg/ml Proteinase K (Sigma Aldrich) for at least two hours at 56 °C.

#### **3.2.5.2 Phenol/chloroform extraction and precipitation of genomic virus DNA**

The protocol was adapted from Sambrook and Russel, 2001. An equal volume of phenol/chloroform/isoamylalcohol (25:24:1) was added to each sample and the mixture repeatedly inverted to mix. The samples were then centrifuged at maximum on a benchtop centrifuge at 4 °C for five minutes. The top aqueous layer of the samples was then removed and placed in a fresh microcentrifuge tube. Half volume of chloroform:isoamylalcohol (24:1) was added to each sample, and centrifuged again for five minutes at in a benchtop microcentrifuge at maximum speed and at 4 °C. Again, the top aqueous phase was removed and placed in a clean microcentrifuge tube. The DNA

---

<sup>5</sup> Refer to section 3.2.5

was then precipitated in two volumes of ice-cold absolute ethanol with one tenth of the volume 3 M NaOAc (pH 5.3) added. Calf liver tRNA (Boehringer Mannheim) was added to each preparation to a final concentration of 100 µg/ml to aid precipitation of the DNA. Precipitation was allowed overnight at -20 °C. The DNA was then pelleted by centrifugation in a benchtop centrifuge at maximum speed and 4 °C for 15 minutes. The supernatant was discarded and the DNA pellets air-dried. The dried pellets were suspended in 20 - 50 µl of nuclease free H<sub>2</sub>O. These samples were used as templates in PCR reactions to determine the homogeneity of the samples.

### 3.2.5.3 PCR analysis of homogeneity of recombinant LSDV-SA samples

The PCR analysis was carried out with a primer pair, OP3 and OP49 that binds in the LSDV TK gene (table 3.1). The primer pair was designed and provided by Mr. D.B Wallace, ARC-OVI. The PCR reactions were setup by preparing a master mix of (indicated quantities per reaction):

2.5 µl *Ex Taq*<sup>TM</sup> Buffer (10X)\*  
2µl dNTP mixture (10 mM, 2.5 mM of each dNTP)\*  
10 pmol OP3  
10 pmol OP49  
0.5 U *Ex Taq*<sup>TM</sup> Polymerase\*(5U/µl)  
Nuclease-free H<sub>2</sub>O to a final volume of 20 µl  
(\* All from TaKaRa Bio Inc, Amersham Biosciences)

5µl of the DNA extractions were used as templates per reaction<sup>6</sup>. A positive, using recombinant pLSEG plasmid, or wild type LSDV-SA genomic DNA and negative control reaction, without the addition of any additional template was also included. The PCRs was carried out in a Perkin-Elmer thermal cycler (model 2400) with the cycle as follows: an initial denaturation step at 94 °C for 90 seconds and 35 cycles of 94 °C for 30

---

<sup>6</sup> Refer to section 3.2.5.1 and 3.2.5.2

seconds, 53 °C for 45 seconds and 72 °C for 3 minutes. One additional elongation step at 72 °C for 7 minutes was also included after the 35 cycles.

**Table 3.1:** The nucleotide sequences and melting temperatures ( $T_m$ ) values of the primer pair, OP3 and OP49.

PRIMER	SEQUENCE (5' - 3')	$T_M$ $4(G+C) + 2(A+T)$
OP3	CACCAGAGCCGATAAC	50 °C
OP49	GTGCTATCTAGTGCAGCTAT	58 °C

#### 3.2.5.4 PCR verification of integration of the expression cassette on the LSDV-SA genome

The PCR was designed with primers binding within the G protein gene (designated RevG) and the TK region of the LSDV-SA genome (designated OP3) (table 3.2). The template was prepared as described before<sup>7</sup> and 5µl of the preparations used per PCR. A master mix was prepared to include the following for each reaction:

5µl *Ex Taq*<sup>TM</sup> Buffer (10X)\*  
 2µl dNTP mixture (10 mM, 2.5 mM of each dNTP)\*  
 10 pmol OP3  
 10 pmol RevG  
 0.5 U *Ex Taq*<sup>TM</sup> Polymerase\*(5U/µl)  
 Nuclease-free H<sub>2</sub>O to a final volume of 45µl  
 (\* All from Takara Biochemicals )

A negative control was included by substituting the DNA template with nuclease free H<sub>2</sub>O. A positive control PCR was prepared by using diluted pLSEG-RabG plasmid as template. The PCR was carried out in a Perkin-Elmer thermal cycler (model 2400) and the cycle that was used as follows: an initial denaturing step at 94 °C for 60 seconds

<sup>7</sup> Refer to section 3.2.5.1 and 3.2.5.2

followed by 30 cycles of 30 seconds at 94 °C, an annealing step of 50 seconds at 50 °C, and an elongation step of 90 seconds at 72 °C. A final elongation step of 7 minutes at 72 °C was also included. 5 µl of each PCR were subsequently resolved against a size marker on an agarose gel.

**Table 3.2:** The nucleotide sequences and melting temperatures ( $T_m$ ) of the primers, OP3 and RevG.

PRIMER	SEQUENCE (5' - 3')	$T_M$ $2(A+T) + 4(G+C)$
OP3	CACCAGAGCCGATAAC	50 °C
RevG	CCCCAGTTCGGGAGACCCAGGTC	78 °C

### 3.2.6. Analysis of stable expression of foreign genes from recombinant LSDV-SA: visualization of EGFP fluorescence and indirect immunofluorescence assay

Glass coverslips were sterilized in saturated Biocide D (Diversey Lever) solution, washed with sterile PBS and then aseptically placed in the wells of a six well cluster cell culture plate (NUNC). Approximately  $1 \times 10^5$  FBT cells were seeded per well of a six well cluster plate. Following overnight incubation under standard growth conditions, the monolayers were infected with the respective recombinant virus clones or wild type virus (as control). An additional well was kept uninfected, to serve as a background control in the assay. After 48 hours the wells were examined for EGFP fluorescence with a fluorescence microscope (Orthoplan, Leitz Weitzler). Photographs were taken with an Olympus C-35 AD camera and Fujichrome Sensia ASA 400 slide film (FujiFilm, South Africa). Hereafter the coverslips were removed from the six well plate using forceps and the cells fixed with ice-cold acetone for 10 minutes. In addition, as controls, coverslips with uninfected cells and untransfected, virus infected cells, were included in this assay. The coverslips were halved by cutting the glass with a diamond cutter so that one half could be used in the assay and the other stored as a backup. The coverslips were then washed with PBS and could be stored in the PBS until required for the analysis. The fixed cultures were flooded with primary antibody diluted in a 1:2 ratio (pre-determined value, results not shown) in blocking solution (2% low fat milk powder [Elite, South

Africa] diluted in PBS) and incubated at 37 °C for 30 minutes. The monoclonals M725 and M778 (respectively directed against antigenic site II and III) were used for the analysis of transient expression. Incubation was followed by four, ten minute washes in PBS with gentle rocking. Fluorescein isothiocyanate (FITC) labeled, anti-mouse IgG (Sigma Aldrich, Cat. No. F5897) was diluted 1:64 (as suggested by the manufacturer) in blocking solution with 0.01% Evan's Blue and was transferred to the fixed cells and incubated for 30 minutes at 37 °C. The incubation was followed by four, ten minute washes with PBS and a final ten-minute wash in distilled H<sub>2</sub>O. The coverslips were then air-dried and mounted on glass microscope slides in non-permanent mounting fluid (50% glycerol, 50% PBS, pH 7.4). The samples were then analyzed under a fluorescence microscope with a 50X lens (total of 500 times magnification) and photographed (Wild MP551, Heerbrugg Switzerland) on Fujichrome Sensia ASA 400 slide film (FujiFilm, South Africa).

### **3.2.7 Preparation of recombinant and parental virus for immunization of animals**

#### **3.2.7.1 Large scale growth of viruses from single foci isolates**

The protocol was adapted from Wallace, 1994. Viruses were cultured on monolayers of FBT under standard growth conditions as described before<sup>8</sup>. Single, foci isolates were harvested by freeze-thawing three times and a brief centrifugation at 200 g in a benchtop centrifuge to collect cellular debris. The supernatants were then inoculated on a 25 cm<sup>2</sup> cell culture flask. The infected cultures were harvested as before, after 2-3 days of incubation (until 90-100% cytopathic effect become apparent). The medium on the flask was reduced and the infected cells harvested as before<sup>9</sup>. The harvested virus lysates were then used as inoculum on a 75 cm<sup>2</sup> cell culture flask. The infected cultures were once again incubated for 2-3 days or until 90-100% cytopathic effect was observed. This culture was harvested and used as inoculum on 10 150 cm<sup>2</sup> cell culture flasks. The infected flasks are then incubated for 2-3 days and harvested as before.

---

<sup>8</sup> Refer to section 3.2.2

<sup>9</sup> Refer to section 3.2.4.1

The material was transferred to 50 ml centrifuge tubes and centrifuged for 5 minutes at 1800 g and 4 °C. The resultant supernatants were collected and the pellets were resuspended in cell culture medium, vortexed briefly and centrifuged as before. After the second centrifugation, the supernatants were pooled and transferred to polycarbonate Oakridge tubes. Sterile 36 % sucrose (36% sucrose in 1mM Tris, pH 9.0) cushions were injected into the bottom of the loaded Oakridge tubes. The tubes were centrifuged for 2 hours at 19 000 g and 4 °C. The supernatants were discarded and the pelleted virus material resuspended in 1 ml of MEM with 1% antibiotics but no FBS. The virus material was stored in aliquots at -80 °C.

### **3.2.7.2 Infectivity assay for LSDV-SA**

The stocks of the vaccine and parental virus were prepared by growing the virus in monolayers of primary FBT cells. The virus infected cells were freeze-thawed three times and sonicated for 60 seconds. A tenfold serial dilution of the sonicated virus material was prepared in duplicate in the range of  $10^{-2}$  to  $10^{-5}$ . The dilutions were then transferred unto confluent FBT monolayers, which were seeded the previous day on six well cluster plates. The infected cells were then incubated under standard growth conditions for three to four days, or until CPE became apparent. Foci were then counted under an inverted microscope. The titer in focus forming units per milliliter (ffu/ml) was then subsequently calculated.

## **3.3 Results**

### **3.3.1 Generation of recombinant LSDV-SA**

FBT monolayers that have been infected with LSDV-SA at a low MOI, were transfected with the recombinant pLSEG-RabG construct using the Effectene™ transfection reagent. A PCR was designed to indicate the integration of the expression cassette in the wild type virus genome. The primer pair binds, respectively, in the TK region of the virus genome and within the glycoprotein gene (figure 3.2). The PCRs



were performed on templates prepared from passaged recombinant viruses. The results of the PCRs are therefore less likely to be attributed to the amplification of transfer plasmid DNA carried over from the transfection well. An amplicon with an approximate size of 1 600 base pairs was amplified with the OP3/RevG primer pair, indicating the integration of the cassette in the LSDV-SA genome (figure 3.3).

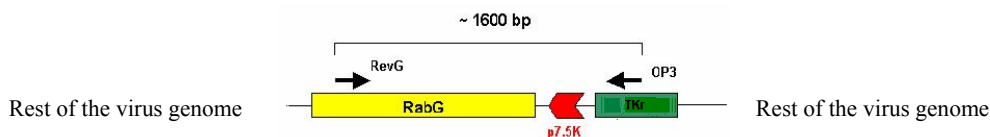

**Figure 3.2:** A diagram depicting the binding position of the primers, OP3 and RevG in the insertion region of the recombinant LSDV-SA genome.

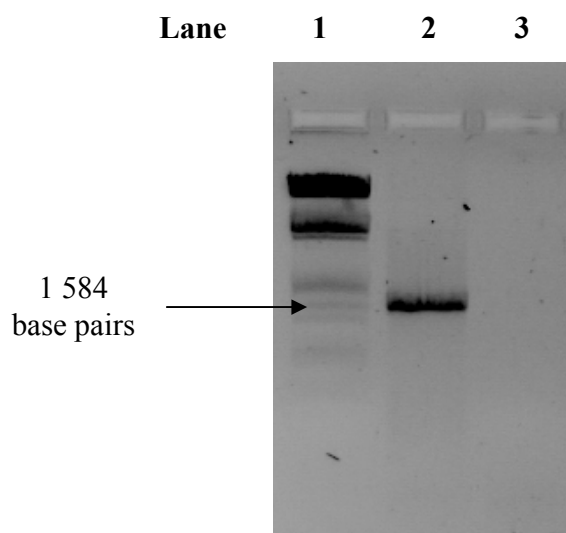
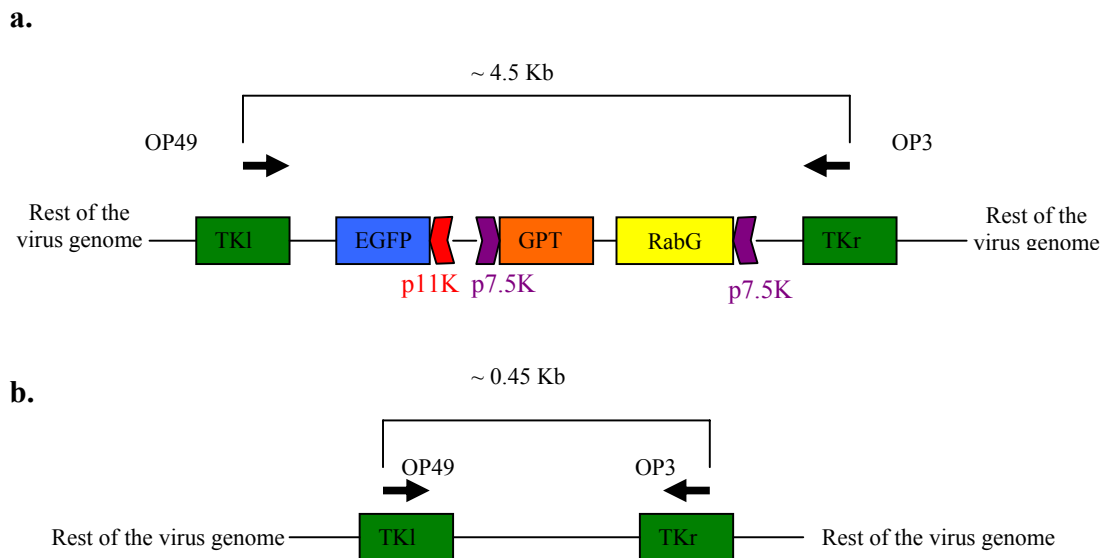

**Figure 3.3:** PCR verification of the integration of the expression cassette in the LSDV-SA genome. In lane (1) molecular weight marker (lambda DNA *EcoR* I and *Hin* dIII, Promega), and (figure 3.4, continued) PCR with the following templates (2) recombinant LSDV-SA, (3) LSDV-SA. The negative control PCR buffer control yielded no amplification but is not shown here.

### 3.3.2 Selection of recombinant LSDV-SA

#### 3.3.2.1 Classic plaque purification protocol

Recombinant foci were picked on the third round under MPA selection, as described in Romero *et al.*, 1993. The foci were picked from the well that was initially inoculated with the highest dilution of the previous passage virus material and where foci were still distinctly single. Nearly 300 foci were picked and screened by PCR for homogeneity using the OP3/OP49 primer pair (figure 3.4). The results of these PCRs are depicted in table 3.3 and figure 3.5.



**Figure 3.4:** A diagrammatic representation of the regions and the sizes of the amplicons that can be expected with the OP3/OP49 primer pair in the a) recombinant LSDV-SA genome and b) the wild type LSDV-SA genome.

**Table 3.3:** The outcome of the PCR to determine homogeneity of different recombinant LSDV-SA samples prepared according to Romero *et al.*, 1993. The total number of foci that was screened in this study is depicted below. The number of PCRs that yielded amplicons of size that indicated the presence of only wild type, recombinant, or both wild type and recombinant viruses in a sample, is given.

Number of picked foci	Wild type (% of total)	Recombinant (% of total)	Both (% of total)	Unresolved (% of total)
278	153 (55.0)	4 (1.43)	96 (34.5)	25 (8.99)

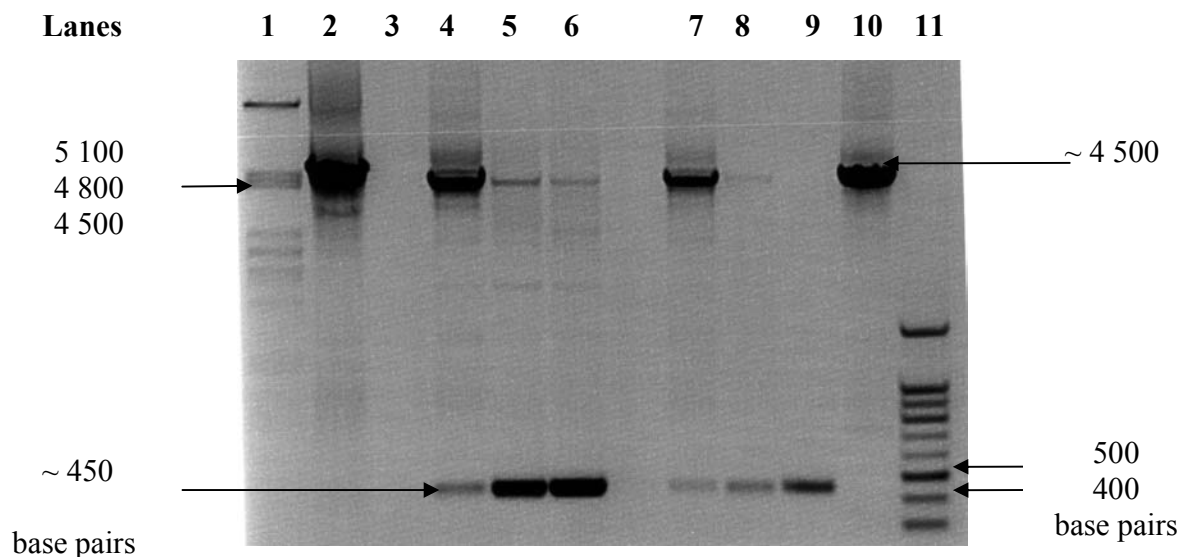

**Figure 3.5:** Electrophoretic profile of the representative results of the PCRs conducted on DNA templates prepared from recombinant LSDV-SA which was processed as described by Romero *et al.*, 1993. The sizes of the amplicons can be read from, in lane 1, the lambda DNA *Pst* I marker and, in lane 11, the 100 bp DNA ladder (Promega). In lane 2, the positive PCR control amplicon, and in lane 3, the contamination control PCR. In lanes 4 to 10 are the typical amplicons that were yielded from the different samples. Note the different ratios of amplicon of the recombinant viral DNA and wild type virus DNA in the different samples. Although no recombinant virus was picked up with PCR with some of the samples, such as in lane 9, it was present as could be deduced from the detection of EGFP from the particular focus. Few samples, such as in lane 10, appeared to be free from wild type background contamination.

**3.3.2.2 Filtration and sonication of virus lysates to facilitate selection**

The virus isolates were treated according to the same procedure as for the Romero *et al.*, 1993 protocol. After two rounds under selection, lysates were either filtered or sonicated. Filtering led to the decrease in recovery of virus in subsequent rounds which made this an impractical approach for screening of many foci. This approach did not enhance the recovery of homogenous virus samples in this study (table 3.4). Foci were also treated by sonication, and again did not appear to enhance the recovery of homogenous samples in this study (table 3.5).

**Table 3.4:** The outcome of the PCR to determine homogeneity of different recombinant LSDV-SA samples treated by filtration. The total number of foci that was screened in this study is depicted below. The number of PCRs that yielded amplicons of size that indicated the presence of only wild type, recombinant, or both wild type and recombinant viruses in a sample, is given.

Number of picked foci	Wild type (% of total)	Recombinant (% of total)	Both (% of total)	Unresolved (% of total)
150	75 (50.0)	2 (1.33)	62 (41.0)	11 (7.33)

**Table 3.5:** The outcome of the PCR to determine homogeneity of different recombinant LSDV-SA samples treated by sonication. The total number of foci that was screened in this study is depicted below. The number of PCRs that yielded amplicons of size that indicated the presence of only wild type, recombinant, or both wild type and recombinant viruses in a sample, is given.

Number of picked foci	Wild type (% of total)	Recombinant (% of total)	Both (% of total)	Unresolved (% of total)
195	101 (51.79)	1 (0.52)	88 (45.0)	5 (2.56)

**3.3.2.3 Detergent treatment of recombinant LSDV-SA to facilitate selection of homogenous recombinant viruses**

Firstly, the concentrations of the respective detergents that would be tolerated by the primary FBT cell cultures were determined (table 3.5). Thereafter LSDV-SA was titrated against these concentrations and the reduction in infectivity of the virus noted (results not shown). Concentrations of the detergents that did not cause observable damage to the cells and still allowed some infection of the virus were then deduced and were used in a subsequent experiment with the recombinant LSDV-SA. Foci were picked from the highest dilution wells, with distinctly single foci, of the control and the treated virus titration plates. PCR was performed on DNA template prepared from the respective foci to determine if there was enrichment for the recombinant viruses (table 3.6).

**Table 3.6:** The effect of detergent treatment on the isolation of homogenous isolates of recombinant LSDV-SA. The number of PCRs that yielded amplicons of size that indicated the presence of only wild type, recombinant, or both wild type and recombinant viruses in a sample, is given

DETERGENT	FINAL CONCENTRATION	NUMBER OF FOCI ANALYSED	WILD TYPE BAND ONLY (% OF TOTAL)	RECOMBINANT BAND ONLY (% OF TOTAL)	BOTH BANDS (% OF TOTAL)	UNRESOLVED (% OF TOTAL)
NONE	-	55	31 (56.64)	6 (3.30)	18 (32.72)	0
SDS	0.0000001%	62	32 (51.61)	3 (4.84)	25 (40.43)	2 (3.23)
SDS	0.000001%	65	36 (55.38)	3 (4.61)	26 (40.00)	0
CHAPS	0.1 MM	60	36 (60.00)	3 (5.00)	21 (35.00)	0
CHAPS	1MM	48	26 (54.12)	2 (4.17)	20 (41.67)	0
B-MERCAPTO ETHANOL	0.01 MM	57	36 (63.16)	4 (7.02)	17 (29.82)	0
B-MERCAPTO ETHANOL	0.1 MM	55	31 (56.36)	5 (9.09)	19 (34.54)	0

### 3.3.3 Stable expression of foreign genes from recombinant LSDV-SA

48 hours after infection of FBT monolayers with recombinant LSDV-SA, EGFP fluorescence was visualized under a fluorescence microscope (figure 3.6).

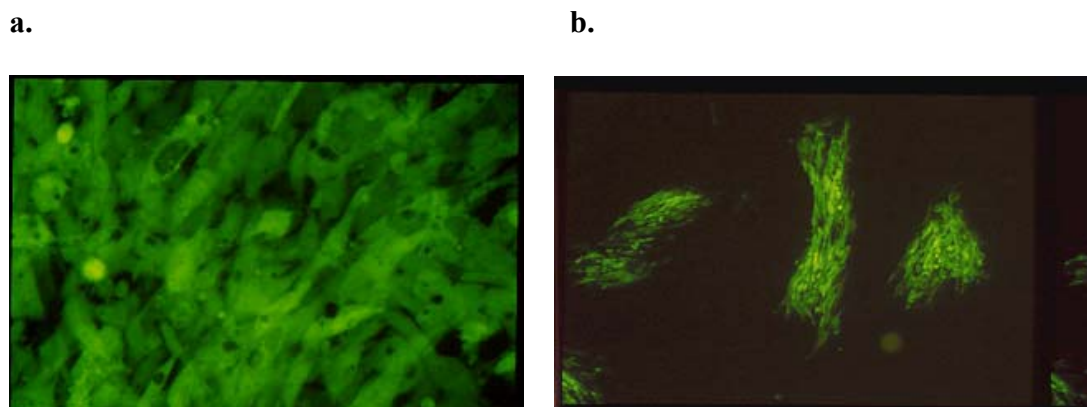

**Figure 3.6:** EGFP fluorescence recombinant LSDV-SA infected FBT cell culture. In (a) under 50 X objective where distinct fluorescing cells can be observed and in (b) under a 10X objective where clear foci can be distinguished. A further 10X magnification for the eyepiece of the microscope and 1.2 X automatic magnification of the camera should be taken into account.

The expression of rabies virus glycoprotein was analysed with an indirect immunofluorescence test. Primary antibodies that were directed to the antigenically important antigenic sites II and III was used. The recombinant viruses expressed the protein interpreted by the specific FITC fluorescence signals observed with these samples (figure 3.7). Uninfected and wild type virus infected controls exhibited minimal unspecific background signal.

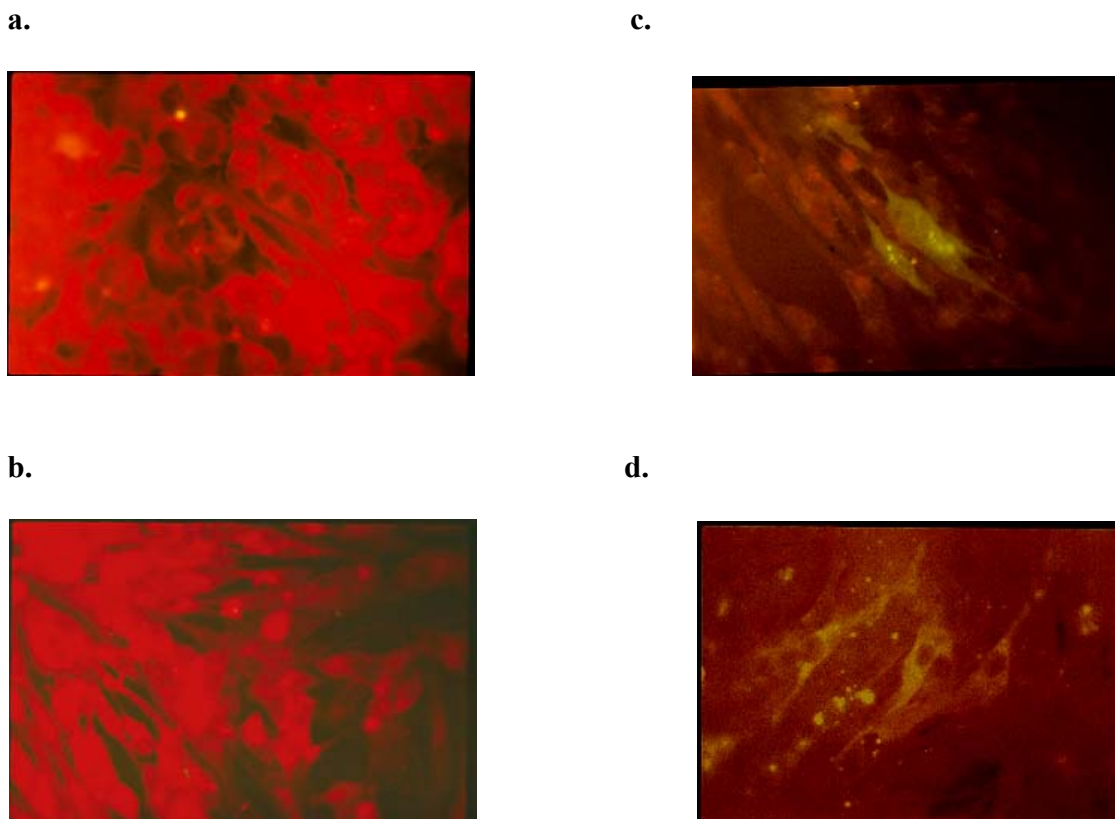

**Figure 3.7:** Indirect immunofluorescence analysis of rabies virus glycoprotein from LSDV-SA recombinants. In (a) uninfected FBT cell culture probed with M725, (b) LSDV-SA infected FBT cell culture probed with M725, and (c) rLSDV-SA infected FBT cell culture probed with M725 and (d) M778.

### 3.4 Discussion

The attenuated vaccine strain, LSDV-SA, holds the potential of becoming a valuable vaccine vector for recombinant veterinary vaccines with specific application in southern Africa. Various disease genes have been successfully expressed in the LSDV system.

Here the stable expression of a rabies virus glycoprotein gene from recombinant LSDV-SA was shown. The protein was antigenically expressed as indicated in an

indirect antibody test employing antibody directed toward antigenically important sites II and III. An EGFP gene was also stably expressed from the recombinant virus. The visualization of EGFP fluorescence was used to facilitate the isolation of recombinant foci as suggested in previous studies (Chen *et al.*, 1996; Wallace and Viljoen, 2005)

The obstacles in the convenient isolation of pure recombinant LSDV-SA have been discussed in the introduction to this chapter. Various approaches to purify recombinant LSDV have been described. In this study it was the intention to compare some of these methods. The information generated during this study may facilitate the process of purification of recombinant LSDV and be useful development of vaccines based on this vector.

Plaque purification is routinely used in the purification of various types of recombinant poxviruses and has also been described an attempt to purify recombinant LSDV-SA (Smith and Mackett, 1992; Aspden *et al.*, 2002). The protocol for the purification of recombinant LSDV, as described in Romero *et al.*, 1993, relies on picking homogenous recombinant plaques after only three rounds of selection, which included two plaque purification steps. Although the foci that were processed were similar in appearance and also appeared homogenous for EGFP expression, it was clear from the PCR results that the different plaques consisted of different ratios of wild type to recombinant virus. Some of the foci that clearly appeared recombinant, judging by the presence of EGFP expression, yielded only the amplicon representing wild type virus during PCR analysis. Although recombinant viruses are also undoubtedly present in these samples, the PCR bias may reflect more on the size of the amplicons than precise ratios of viruses present in the sample. The amplicon amplified from the wild type virus template is ten times smaller than the amplicon amplified from the recombinant virus template and may therefore be more abundantly amplified. In this study, the isolates that appeared homogenous for recombinant virus from the PCR results however had some residual wild type virus, which amplified readily when MPA selection was lifted as suggested in Romero *et al.*, 1993. In this study, it was determined that at least five more rounds under MPA selection was required to clean up the samples. It is recommended that this approach may be of value to single out the most homogenous virus samples for



further manipulation, as shown in this study. Such samples may be more easily and rapidly purified than less homogenous samples.

The value of incorporating steps of sonication and filtration of the viral supernatants were evaluated. The value of using sonication steps is underlined in Berhe *et al.*, 2003, and may be of value in breaking up of viral clumps. Filtration of viral supernatants was also employed in the protocol suggested in Wallace. Filtrations of these viral supernatants often led to a decrease in recovery of viruses in subsequent passages. It, however, does not seem that either sonication or filtration are essential steps in the purification of recombinant LSDV-SA, since recombinant viruses were also purified without making use of treatments and the treatments did not enhance the retrieval of homogenous samples in this particular study.

If LSDV virions stick together due to some protein-protein interactions, it was put forward that detergent treatment of virus samples might break up these so-called clumps and aid the purification of the recombinant viruses. Detergents are charged or uncharged, amphipathic structures and some detergents have the ability to break protein-protein interactions. Detergents can also be either denaturing or nondenaturing agents. It was decided to use sodium dodecyl sulphate (SDS), CHAPS (a sulfobetaine derivative of cholic acid) and  $\beta$ -mercaptoethanol in the experiment. SDS is an anionic denaturing detergent, and mode of action is based on the disruption of membranes and denaturing proteins by breaking up protein-protein interactions. CHAPS is a nondenaturing zwitterionic detergents and mode of action based on the neutralization of electric charges. CHAPS have disaggregating properties and solublize proteins without altering the function of the proteins. This is an important consideration to maintain infectivity of the virus by keeping receptors intact.  $\beta$ -mercaptoethanol has previously been described in the solubilization of surface tubules of vaccinia virions, and was therefore also included in the study (Stern and Dales, 1976). In this study there was no apparent increase in the isolation of homogenous recombinant isolates with the application of detergents. There was no substantial difference in untreated and treated groups in this study.

It is therefore suggested from this study that the classical plaque purification protocol should be sufficient enough to isolate homogenous recombinant isolates of LSDV-SA. The use of PCR to identify the more homogenous samples from isolates

*Immune responses against recombinant poxviruses expressing full-length lyssavirus glycoprotein genes*  
Jacqueline Weyer

contaminated with wild type virus is a useful tool in the purification of recombinant viruses.

## Chapter IV

### **IMMUNE RESPONSES TO RECOMBINANT LUMPY SKIN DISEASE VIRUS (NEETHLING STRAIN) EXPRESSING A FULL-LENGTH RABIES VIRUS GLYCOPROTEIN GENE IN A MOUSE MODEL**

#### **4.1 Introduction**

The attenuated vaccine strains of Lumpy Skin Disease virus (LSDV), Kenya sheep-1 strain (KS-1) and Neethling strain (LSDV-SA) have been investigated by several groups as recombinant vaccine carriers in different vaccine regimens and disease models. Recombinant vaccines based on KS-1 and expressing disease antigens of rinderpest, bluetongue and peste-des-petits-ruminants have been tested in several ruminant species (Berhe *et al.*, 2003; Wade-Evans *et al.*, 1996; Romero *et al.*, 1994a, b and c; Romero *et al.*, 1993). Recombinants expressing a rinderpest virus fusion or hemagglutinin protein genes protected cattle against lethal rinderpest virus challenge and also against lumpy skin disease (Romero *et al.*, 1994; Romero *et al.*, 1993). The hemagglutinin expressing recombinants also offered protection against lethal peste-des-petits-ruminants virus infection (Romero *et al.*, 1994b). In another study, recombinant KS-1 expressing a bluetongue virus structural protein protected sheep against lethal bluetongue virus challenge although clinical symptoms still appeared (Wade-Evans *et al.*, 1996). Recombinant KS-1 expressing peste-des-petits-ruminants glycoprotein also protected against lethal peste-des-petits-ruminant virus and lumpy skin disease (Berhe *et al.*, 2003). The use of the southern African LSDV vaccine, LSDV-SA has also been investigated as a recombinant vaccine vehicle. LSDV-SA recombinants have been tested in disease models for rinderpest, rabies and three day stiffness (Wallace and Viljoen, 2005; Aspden *et al.*, 2002 and 2003; Cohen *et al.*, 1997). In all of these studies the value of recombinant LSDV vaccine strains as dual vaccines against a disease of interest and capripoxvirus infections were investigated and shown.

The use of recombinant LSDV-SA as vaccine vector was approached from another angle in Aspden *et al.*, 2003. Recombinants expressing rabies virus glycoprotein

were shown to elicit immune responses in non-ruminant animal models. The study highlighted the potential of using LSDV-SA as a replication deficient, host restricted vaccine vehicle. The study in essence produced evidence for the expression of foreign genes in non-ruminant derived cell culture during early and late replicative stages of the virus. The efficacy of the recombinants was also indicated in laboratory mice and rabbits.

With this study the use of recombinant LSDV-SA vaccines is further explored in a non-ruminant small animal model. A recombinant LSDV-SA expressing the major rabies virus antigen, the glycoprotein, was tested in a mouse model.

## **4.2 Materials and methods**

### **4.2.1 Viruses and animals**

A recombinant LSDV-SA expressing a rabies virus glycoprotein gene (hereafter LSDV-RG) was constructed as previously described<sup>10</sup>. LSDV-SA was provided by Mr. D.B.Wallace (Agricultural Research Council – Onderstepoort Veterinary Institute, South Africa). The particulars of these viruses are fully described elsewhere<sup>10</sup>.

BALB/c mice were obtained from Onderstepoort Biological Products. Animals were housed and handled under supervision of veterinary staff at the Rabies Unit, Agricultural Research Council – Onderstepoort Veterinary Institute and under protocols and regulations advised by the Ethical Advisory Committee of Agricultural Research Council – Onderstepoort Veterinary Institute.

### **4.2.2 Immunization of animals**

Six week old, female BALB/c mice were grouped in groups of 10 mice each. Groups received  $10^7$  focus forming units (ffu) of recombinant LSDV-SA or the parent virus, LSDV-SA intramuscularly or *per os* in 50  $\mu$ l minimal essential medium (MEM) supplemented with 1 X antibiotic mixture (100  $\mu$ g/ml streptomycin, 100  $\mu$ g/ml penicillin

---

<sup>10</sup> Refer to Part Two, Chapter III

and 250 µg/ml amphotericin) (all from Highveld Biological Products, South Africa). The intramuscular administrations were made in the right quadriceps muscle using a 1cc tuberculin syringe with a 26-gauge needle (Becton Dickinson and Company, United States of America). Animals were fed vaccine *via* a filter tip and pipet for the *per os* administrations. Some groups of the animals received booster immunizations of  $10^5$  ffu through the same route as the primary inoculation and two weeks thereafter.

Blood was collected *via* the retro-orbital route on day 0, 7 and 21. Sera were separated in Microtainer® serum separation tubes with SST™ (Becton Dickinson and Company, United States of America) as suggested by the manufacturer, aliquoted and stored at  $-20\text{ }^{\circ}\text{C}$  until analysis.

#### **4.2.3 Rapid fluorescent focus inhibition test (RFFIT)**

The RFFIT protocol was adapted from Smith *et al.*, 1996.

##### **4.2.3.1 Preparation of the RFFIT**

The tests were prepared in Lab-Tek 8 well chamber slides with a coverslip (Nalge Nunc International). The sera for the test were heat inactivated at  $56\text{ }^{\circ}\text{C}$  for 30 minutes. The sera were set up in serum end-point dilutions of 8-serial, 10 fold dilutions (modification of standard protocol where 5 fold dilutions are prepared). Shortly, 100 µl MEM with 10% fetal bovine serum (FBS) was transferred into each well followed by the addition of 25 µl of serum which was added to the first well of each slide. 25 µl was serially carried over from the first well to the last well on the slide. Hereafter the challenge virus was added. The challenge virus, Challenge Virus Standard (CVS), was diluted appropriately in MEM with 10 % FBS to attain 50 50%-fluorescent foci doses (ff<sub>d50</sub>) per 100 µl. 100 µl of challenge virus preparation was then added to each well of the test. A control slide was prepared with 75 µl complete MEM in the first well of the slide and 100 µl in the remaining wells. The controls were prepared by setting up a back titration of the challenge virus in a 10 fold serial dilution (i.e. 50 ff<sub>d50</sub>/5 ff<sub>d50</sub> and 0.5 ff<sub>d50</sub>). One well was left uninfected to serve as a cell culture control in the test. 50 µl of

standard rabies immunoglobulin (Laboratory of Standards and Testing, Center for Biologics Evaluation and Research, Food and Drug Administration, United States of America) at 2 international units (IU) per ml was added to the first well of the control slide, and serially diluted by transferring 25 µl in four, five-fold dilutions (i.e. 1:5, 1:25, 1:125 en 1:625). The dilutions were incubated at 37 °C and 0.5 % CO<sub>2</sub> for 90 minutes. Following incubation mouse neuroblastoma cells were added to the reactions. A suspension of cells was prepared by trypsinizing 3-day old, confluent 75 cm<sup>2</sup> monolayers and adding 30 ml of complete MEM (should yield roughly 5.0 X 10<sup>5</sup> cells per ml). 200 µl of the cell suspension was added to each well of the tests. The preparations were returned to the incubator for another 20 hours.

#### **4.2.3.2 Fixation, staining and reading of the tests**

After the incubation the cell culture supernatants were decanted and the slides dip-rinsed in phosphate buffered saline (PBS) (13.7 mM NaCl, 0.27 mM KCl, 0.43 mM Na<sub>2</sub>HPO<sub>4</sub>.2H<sub>2</sub>O, 0.14 mM KH<sub>2</sub>PO<sub>4</sub>, pH 7.3). The slides were then transferred to ice-cold acetone for 30 minutes. After the incubation the slides were washed twice in PBS and air dried. Anti-rabies virus monoclonal conjugate was prepared as suggested by the manufacturer (Centocor, Inc. or Fujirebio Diagnostics Inc., United States of America). Approximately 100 µl of rabies conjugate was spot dropped onto each well. The slides were incubated at 37 °C for 30 minutes. Following the incubation the conjugate was washed from the wells with PBS. The slides were dip-rinsed in distilled water and air dried before reading.

The slides were read at 160 to 200 times magnification under a fluorescent microscope (Axioskop, Zeiss). 20 microscope fields per well were observed and noted.

#### **4.2.4 Cytokine assay**

Sera were tested with a multiplex, solid phase sandwich immunoassay (Biosource, United States of America, catalogue number LMC0002) measuring Th1/Th2 cytokine

responses using the Luminex 100™ system. The cytokine panel as follows: Interleukin (IL)-2; IL-4; IL-5, IL-10, IL-12 and interferon (IFN)- $\gamma$ .

Sera collected before vaccination and after the third bleed of the vaccinated animals (i.e. 7 days after booster inoculations) were used for the determinations. Only animals that received intramuscular administration of vaccine were included in this study. Serum samples representing the experimental groups were chosen randomly from the lots of sera with suitable volume for testing.

The test was performed as suggested by the manufacturer of the kit with no exceptions. The prepared plate was analyzed using standard settings on the Luminex 100™ instrument of the Biotechnology Core Division, Centers for Disease Control and Prevention (Atlanta, Georgia, United States of America). The results were analyzed using Bioplex® 4 software for the Luminex 100™ system.

### **4.3 Results**

#### **4.3.1 Rabies virus neutralizing responses to LSDV-RG**

No sero-conversion could be detected in any of the groups tested. Background levels (i.e. reciprocal titer of <10) of rabies virus neutralizing responses were measured in all the groups of animals.

#### **4.3.2 Cytokine responses to LSDV-RG**

The serum titers of different Th1 and Th2 cytokines were measured in an attempt to establish the inclination of immune responses induced by recombinant LSDV-SA. Serum titers for IL-2 and IL-10 could however not be determined in this study. The lack of results for these cytokines with the particular kit used could likely be attributed to intrinsic factors of the kit, particularly sensitivity, and or that the condition of the serum samples tested were not ideal for detecting the particular cytokine (Personal communication, Miss Aida Mahmutovic, Centers for Disease Control and Prevention, Biotechnology Core division, Atlanta Georgia, United States of America). The results

that were obtained with this test are summarized in tables 4.1 through 4.4. The relative increase in titers of the respective cytokines was noted. Notably, there was an increase in IFN- $\gamma$  levels, from background levels of 2.62 pg/ml to 26.00 pg/ml, for the animals that received the recombinant vaccine. This constitutes roughly a 9 times increase in titer of the interferon. The titer of the other Th1 cytokine, IL-12 also increased two fold. Two Th2 cytokines were also measured. The IL-5 levels increased 2 fold, and the IL-4 levels also increased markedly.

**Table 4.1:** Mouse IL-12 titers measured in pg/ml and n the number of serum samples tested per group that yielded titers within the standard range of the kit used

MOUSE GROUP (N)	MEAN TITER (PG/ML)
LSDV-RG (8)	393.98
LSDV-SA (4)	260.89
DMEM mock control (2)	191.485
Naïve control group (1)	107.14

**Table 4.2:** Mouse IL-5 titers measured in pg/ml and n the number of serum samples tested per group that yielded titers within the standard range of the kit used

MOUSE GROUP (N)	MEAN TITER (PG/ML)
LSDV-RG (6)	46.35
LSDV-SA (3)	21.45
DMEM mock control (2)	19.72
Naïve control group	NA <sup>a</sup>

<sup>a</sup>NA – Results not available



**Table 4.3:** Mouse IL-4 titers measured in pg/ml and n the number of serum samples tested per group that yielded titers within the standard range of the kit used

MOUSE GROUP (N)	MEAN TITER (PG/ML)
LSDV-RG (6)	355.41
LSDV-SA (3)	270.68
DMEM mock control (1)	19.45 <sup>b</sup>
Naïve control group	NA <sup>a</sup>

<sup>a</sup>NA – Results not available<sup>b</sup>Observed concentration lower than standard range of the kit used**Table 4.4:** Mouse IFN- $\gamma$  measured in pg/ml and n the number of serum samples tested per group that yielded titers within the standard range of the kit used

MOUSE GROUP (N)	MEAN TITER (PG/ML)
LSDV-RG (3)	26.00
LSDV-SA (4)	3.46 <sup>b</sup>
DMEM mock control (2)	2.62 <sup>b</sup>
Naïve control group	NA <sup>a</sup>

<sup>a</sup>NA – Results not available<sup>b</sup>Observed concentration lower than standard range of the kit used

#### 4.4 Discussion

The efficacy of LSDV-SA as a vaccine vector in ruminant species has been shown in numerous studies. Motivated by the development of safe and immunogenic vectors for vaccine delivery, LSDV-SA has also been suggested as a vaccine carrier in non-ruminants. An additional motivation for the testing of these recombinants in non-ruminants is the development of a small animal model to be used in the development of other recombinant LSDV-SA vaccines. This would be a particularly useful feature in the development of this type of vaccines for ruminants, where testing of the vaccines in a

smaller animal model may be used to substantiate testing in larger animals such as cattle. However, this theme has not been extensively investigated yet and, to this effect, only two studies have reported testing of such recombinants in non-ruminants (Aspden *et al.*, 2003; Wallace and Viljoen, 2005).

Aspden *et al.*, 2003 described the expression of cloned genes from recombinant LSDV-SA *in vitro* in early and late stages of virus replication in permissive, as well as non-permissive cell cultures. The disruption of replication of the virus in non-permissive cultures, judging from electronmicrographs, appeared to take place late during the replication cycle of the virus with no mature particles budding from infected cells. In this study the induction of protective immunity in mice upon immunization with recombinant LSDV-SA expressing a rabies virus glycoprotein gene was also described. This protection was afforded in the absence of measurable humoral responses. The protection was ascribed to the induction of cytotoxic T cell responses. Although cytotoxic responses play a role in the immunity against rabies virus infection, the all important role of virus neutralizing antibody responses is widely recognized.

Here the potency of recombinant LSDV-SA was further explored in the mouse model. Once again no measurable rabies virus neutralizing responses could be detected in the animals, even after receiving two doses of recombinant LSDV-SA. This data is therefore in accordance with what was found previously (Aspden *et al.*, 2003). It is believed that multiple booster doses might be required to obtain measurable serology in non-ruminants (Personal communication, Mr. D. B. Wallace, ARC-OVI). In Aspden *et al.*, 2003, multiple booster doses were required to obtain relatively low titers of neutralizing antibodies in rabbits. This phenomenon may be attributed to the lack of production of infectious progeny beyond the initial infection cycle of the virus. Another aspect that may have effect, and that has not been fully investigated yet, is the relative efficiency of infection of cells of non-ruminant origin against that of ruminant origin with these viruses. All these factors may attribute to the apparent lower efficacy of recombinant LSDV-SA vaccines in non-ruminants as in ruminants.

Immune responses induced by recombinant LSDV-SA in non-ruminants, further appears to be skewed towards cytotoxic T cell responses (Aspden *et al.*, 2003, Wallace and Viljoen, 2005). A clear induction of IFN- $\gamma$ , in animals that received LSDV-RG, in

this study, indirectly indicates an induction of cytotoxic responses. It would appear that the immune responses induced by recombinant LSDV-SA may be slightly skewed towards a Th1 response. This assumption is made in observation of the induction of the particular cytokines, but also the lack of measurable humoral responses. It is however, important to realize that the balance of Th1 and Th2 factors are dependant on features such as the amount and the affinity of the antigen. It is therefore likely that this balance may be altered in the event of multiple boosting doses administered. The stronger Th1 responses can nonetheless be explained by the low level of circulating antigens and lack of production of mature particles that would be present after immunization with a replication defective vaccine.

The advantages of developing LSDV-SA as a replication deficient vaccine vector are clear, but there is little evidence to support its efficacy in non-ruminants thus far. It appears that multiple doses might be required to induce humoral responses in non-ruminants, and although no conclusion can be made about the oral innocuity of these constructs from these studies done so far, it seems doubtful. The dynamics and efficacy of these recombinants however remains to be tested in target animals and should be tested in larger animals accordingly.