

healing space

“education, motivation, integration”

youth prison facility

Submitted as part of the requirement for the Degree of Magister in Architecture [Professional]
in the Faculty of Engineering, the Build Environment and Information Technology

University of Pretoria
Department of Architecture

November 2004

Marcelle Booyzen

Mentor: Gwen Breedlove
Study leader: Karel Bakker

contents

overview	zero_0
design philosophy	one_1
design development	two_13
context study	three_28
precedents studies	four_62
baseline studies	five_86
materials & technical studies	six_149
design product	seven_177

overview

Crime in South Africa today has become a subject that has invaded our conversations, the way we move about our environments, our recreation, our driving habits, the way we build, plan our cities or plan our routes home at night. In short, crime has permeated our society so profoundly that we have almost begun to accept that all the above violations of our civil liberties, are simply part and parcel of life in South Africa. This got me thinking about whom these criminals were, where do they come from and how can we, as future architects, contribute to putting a stop to this cycle of civil abuse? I thought of the countless young offenders who, when committed to an institution, instead of coming out rehabilitated, return to crime as blossoming criminals. With these thoughts in mind, I chose a Youth Holding Prison for my thesis study.

My main question is, how much can an architectural environment assist in the rehabilitation of socially dysfunctional people? Rehabilitation applies to criminals who were normal members of society before they snapped, committed a crime, were punished in prison whereupon they are released and return to society, and reformed. How often is this the case? Are we, contrary to this notion, not confronted with a scenario of criminals, who leave prison and re-enter society, unchanged by the prison environment and unable to interact normally with society, only to be labeled as habitual criminals? Here, the word rehabilitation does not apply. Here, we require healing. Can architecture help to heal? If so, we should apply these healing principles to those young, first-time offenders who still have a chance to change their values and alter their perceptions of life and their place in society, through education, new life experiences and above all, motivation.

The unofficial name of the ensuing proposal is, "Healing spaces; education, motivation, integration"

figure list

one design philosophy

- 1 _ 1 The Radial prison design. McShane, M & F Williams. (Eds.), 1996: 30
 - 1 _ 2 The Roundhouse design. McShane, M & F Williams. (Eds.), 1996: 30
 - 1 _ 3 The Reformatory design. McShane, M & F Williams. (Eds.), 1996: 30
 - 1 _ 4 The Courtyard design. McShane, M & F Williams. (Eds.), 1996: 30
 - 1 _ 5 The Campus design. McShane, M & F Williams. (Eds.), 1996: 30
 - 1 _ 6 The Telephone pole design. McShane, M & F Williams. (Eds.), 1996: 30
 - 1 _ 7 The Skyscraper design. McShane, M & F Williams. (Eds.), 1996: 30
 - 1 _ 8 The Modular design. McShane, M & F Williams. (Eds.), 1996: 30
 - 1 _ 9 The New Generation Prisons. Copad Engineers, 2002:19 - 22
-

two design development

- 2 _ 1 Conceptual plan of visitors centre. Author
- 2 _ 2 Conceptual plan of visitors centre. Author
- 2 _ 3 The "Security Loop" Road around the entire facility. Author
- 2 _ 4 The Staff zone of the Youth prison Facility. Author
- 2 _ 5 The Inmate/Youth prisoner zone. Author
- 2 _ 6 The Visitors zone. Author
- 2 _ 7 Space plan of visitors centre. Author
- 2 _ 8 Inmate movement plan. Author
- 2 _ 9 Staff movement plan. Author
- 2 _ 10 Visitors movement plan. Author
- 2 _ 11 Security points of facility. Author

three context study

- 3 _ 1 On the site looking North-West towards Sunninghill. Author
- 3 _ 2 On the site looking North-East towards the existing youth prison facility. Author
- 3 _ 3 On the site looking East. Author
- 3 _ 4 On the site looking North-North East towards the Kayalami reservoir. Author
- 3 _ 5 Map of Africa. Author
- 3 _ 6 Site map of the area. Author
- 3 _ 7 Figure ground of site. Author
- 3 _ 8 Ground figure of site. Author
- 3 _ 9 Contour map of site. Author
- 3 _ 10 Map showing surrounding suburbs. Author

cont. three context study

- 3 _ 11 Sunninghill suburb. Author
- 3 _ 12 The Leeuwkop reservoir. Author
- 3 _ 13 Paulshoff suburb. Author
- 3 _ 14 Kayalami. Author
- 3 _ 15 The entrance route into the site. Author
- 3 _ 16 List of land uses. Copad Engineers, 2002:25
- 3 _ 17 Leeuwkop Prison water supply layout. Copad Engineers, 2002:28
- 3 _ 18 Leeuwkop Prison sewer layout. Copad Engineers, 2002:29
- 3 _ 19 Water. Urban Green File, vol. 7, 2002: May/June
- 3 _ 20 Road. Visi vol. 18, 2004
- 3 _ 21 Recycling symbol. Author
- 3 _ 22 Contouring. Urban Green File vol. 7, 2002: May/June
- 3 _ 23 Biomes of South Africa. Rutherford, M and R, Westfall, 1986
- 3 _ 24 Map Illustrating grass types found in South Africa. van Oudtshoorn, 1991
- 3 _ 25 Map of site. Author
- 3 _ 26 ***Digitaria erianthia***. van Wyk, 2000
- 3 _ 27 ***Huparrhenia anamesa***. van Wyk, 2000
- 3 _ 28 ***Hyparrhenia hirta***. van Wyk, 2000
- 3 _ 29 ***Pennisetum clandestinum***. van Wyk, 2000
- 3 _ 30 ***Eragrotis curvula***. van Wyk, 2000
- 3 _ 31 ***Acacia karoo***, van Wyk, 2000
- 3 _ 32 ***Acacia mearnsii***. van Wyk, 2000
- 3 _ 33 ***Celtis africana***. van Wyk, 2000
- 3 _ 34 ***Eucalyptus grandis/globulus***. van Wyk, 2000
- 3 _ 35 ***Grewia spp.*** van Wyk, 2000
- 3 _ 36 Map of site. Author
- 3 _ 37 Climate. Wall Paper, 2002
- 3 _ 38 Climatic zone - northern stepped. Holm, 1996:64
- 3 _ 39 Wind rose for Johannesburg. Holm, 1996:66
- 3 _ 40 The arc of the sun in Johannesburg. Holm, 1996:66
- 3 _ 41 The vertical sun angles @ 12:00 noon. Holm, 1996:67
- 3 _ 42 Solar access for building spaces in Johannesburg. Holm, 1996:66
- 3 _ 43 Deciduous trees for 35% - 55% transmission in summer. Holm, 1996:68
- 3 _ 44 Allow for 65%-85% transmission of sun in winter. Holm, 1996:68
- 3 _ 45 Clouds. Wall Paper, 2002
- 3 _ 46 The characters of natural light. Tutt, Adler, 1998: 406

four precedents studies

- 4_1 Baviaanspoort Youth Prison Facility. Author
- 4_2 New Generation Medium Prison Facility. Sigodi Marah Martin, 2002: 10
- 4_3 Primary School de Vogles.
- 4_4 Ann Richards Middle school.
- 4_5 Elevation Of entrance staircase of P.S. 156, I.S. 293 School.
- 4_6 New Wesbank Primary school. Digest, 2004
- 4_7 Nyanga Multipurpose centre. Architecture South Africa, 2004
- 4_8 The Constitutional Court. Architecture South Africa, July/August 2004
- 4_9 The Apartheid Museum. Architecture South Africa, July/August 2004
- 4_10 Art and Architecture. Visi, vol. 18, 2004
- 4_11 Analysis sketch of Baviaanspoort Youth Prison Facility. Author
- 4_12 Images of Baviaanspoort Youth Prison Facility. Author
- 4_13 New Generation Medium Prison Facility. Copad Engineers. 2002
- 4_14 Primary School de Vogles. Elevation showing class rooms raised in the air.
- 4_15 Primary School de Vogles. Image of courtyard space.
- 4_16 Analysis sketch of Primary School de Vogles showing interconnection between spaces
- 4_17 Plan of school.
- 4_18 Image showing covered roof structure.
- 4_19 Analysis sketch of Ann Richards Middle school. Author
- 4_20 Image towards the entrance of the school.
- 4_21 Image showing corridors linking spaces.
- 4_22 Plan of school.
- 4_23 Staircase of school.
- 4_24 Elevation of the class rooms. Digest, 2004
- 4_25 Plan of Primary school. Digest, 2004
- 4_26 Digest, 2004
- 4_27 Digest, 2004
- 4_28 Plan of Multipurpose centre. Architecture South Africa, July/August 2003.
- 4_29 Seating areas @ Multipurpose centre. Architecture South Africa, July/August 2003.
- 4_30 Mosaic wall made by local community. Architecture South Africa, July/August 2003.
- 4_31 Entrance Foyer of Multipurpose centre. Architecture South Africa, July/August 2003.
- 4_32 Elevation of entrance to The Constitutional Court. Architecture South Africa, July/August 2003.
- 4_33 Plan of Constitutional Hill. Architecture South Africa, July/August 2003.
- 4_34 Images of the interior of The Constitutional Court. Architecture South Africa, July/August 2003.
- 4_35 Entrance to Apartheids Museum. Author
- 4_36 The collaboration of Art & Architecture. Visi, vol. 18, 2004

five baseline

- 5 _ 1 Natural processes, an organism. Author
- 5 _ 2 Construction hats. Abbitare, vol. 427, 2003: 184
- 5 _ 3 Water. Urban Green File, vol. 5, 2000
- 5 _ 4 Disabled images. Diffrient, N., Tilley, A.R., Bardagjy, J.C. 1974
- 5 _ 5 Floor grating specs. Diffrient, N., Tilley, A.R., Bardagjy, J.C. 1974
- 5 _ 6 Outdoor steps specs. Diffrient, N., Tilley, A.R., Bardagjy, J.C. 1974
- 5 _ 7 Indoor steps specs. Diffrient, N., Tilley, A.R., Bardagjy, J.C. 1974
- 5 _ 8 Handicapped and Elderly specs. Diffrient, N., Tilley, A.R., Bardagjy, J.C. 1974
- 5 _ 9 Single passage specs. Diffrient, N., Tilley, A.R., Bardagjy, J.C. 1974
- 5 _ 10 Ramp specs. Diffrient, N., Tilley, A.R., Bardagjy, J.C. 1974
- 5 _ 11 Two way passage specs. Diffrient, N., Tilley, A.R., Bardagjy, J.C. 1974
- 5 _ 12 Wheel chair moving space. Diffrient, N., Tilley, A.R., Bardagjy, J.C. 1974
- 5 _ 13 Minimum toilet room. Diffrient, N., Tilley, A.R., Bardagjy, J.C. 1974
- 5 _ 14 A Bathroom plan. Diffrient, N., Tilley, A.R., Bardagjy, J.C. 1974
- 5 _ 15 Floor plan of disabled prison cell design. Author
- 5 _ 16 Scale indication 400m in 5min and 800m in 10min. Author
- 5 _ 17 Information board @ baviaanspoort Youth prison facility. Author
- 5 _ 18 Sun light entering the building during the winter months. Author
- 5 _ 19 Sun light entering the building during the summer months. Shading created by the trees place specifically on the northern facade. Author
- 5 _ 20 Table showing luminance levels in different temperate climates. Holm, 1996:69
- 5 _ 21 Position of windows relative to ruling wind direction. Solar orientation is less forgiving than aeolic orientation. Induced ventilation achieved by additional windows and outdoor guides. Holm, 1996:6
- 5 _ 22 Rock bin systems diagram. Author
- 5 _ 23 Diagram showing stack ventilation in building. Author
- 5 _ 24 Diagram showing cross ventilation in building. Author
- 5 _ 25 Conceptual sketch of green roof. Author
- 5 _ 26 Conceptual sketch of green roof. Author
- 5 _ 27 Conceptual sketch of green roof. Author
- 5 _ 28 Diagrammatical representation of rainwater catchment and distribution. Author
- 5 _ 29 3Dimensional representation of rainwater catchment and distribution. Author
- 5 _ 30 Table showing Average rainwater in Johannesburg.

six materials & technical

- 6_ 1 Colour. Chiazzari, S. 1998
- 6_ 2 Interior of Villa Mairea. Millet, M. 1996: 9
- 6_ 3 The pines outside the Villa Mairea. Millet, M. 1996: 9
- 6_ 4 Colour Blue. Chiazzari, S. 1998
- 6_ 5 Concrete. Tadao Ando, 2002
- 6_ 6 Gabion wall @ The Fashion District (Ink) Johannesburg. Author
- 6_ 7 Timber. Wall Paper, 2003
- 6_ 8 Renzo Piano Building Workshop in Rome. Abitare, vol. 418,2002
- 6_ 9 Glass facade and details in Proposed youth prison visitors centre. Author



thank you

my whole family mamma, pappa, paul, mati

for all the love, support, encouragement & making it all possible

to ryan for true friendship, love & support, helping me cope

mentors & inspirers gwen, karel & paul

design philosophy

history one_1

design philosophy one_5

“Prison not only robs you of your freedom, it attempts to take away your identity...it is by definition a purely authoritarian state that tolerates no independence and individuality. As a freedom fighter and as a man, one must fight against the prison’s attempt to rob one of these qualities.”

The prison as an environment:
President Nelson Mandela commented during his incarceration:

(V Stern, A Sin Against the Future: Imprisonment in the World, Penguin Books, London, 1998, pg.107)

Types of prisons

During the 1500's and 1600's, prisons evolved around the practises of banishment (the exile into the wilderness) and transportation (sending offenders to other countries or colonies). Around the 1550, England started what was then called workhouses (London's Famous Bridewell workhouse as an example.) These became very unsanitary and overcrowded places. In 1790 the Walnut Street Jail in Philadelphia was converted from a jail to a prison this was known as America's first state prison.

In the late 1790's a group (Cesare Beccaria 1738-1794; John Howard 1726-1790; Jeremy Bentham 1748-1832) started the penitentiary movement, which lasted for a hundred years. The reformatory movement in the 1870's followed this. (Enoch Wines 1806-1879; Zebulon Brockway 1827-1920) this movement only lasted twenty years and by the end America was searching for a new way of making prison systems more industrial and punitive. During the great depression of the 1920's and 1930's the old penitentiaries and reformatories were converted and made bigger and were called big house prisons. These became the basis of various correctional centre designs through out the 20th century. During the 1940's was the rebirth of rehabilitation, but this also only lasted twenty years. Most prisons built since the 1980's are designed as warehousing or for custodial purposes, sometimes called the deserts model. (Which is a philosophy involving the multiple purposes of incapacitation, deterrence, and retribution). That which follows is just a brief visual history of prison architectural facilities.

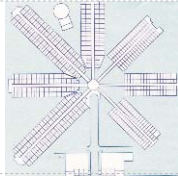

1_1



1_2



1_3



1_4

The 1790 penitentiary followed a hub and spokes pattern. This is also known as the radial design. The sub-type known as the Pennsylvania system placed the administration building in the center, and the Auburn (NY) system placed this building on the outer wall. The Pennsylvania system (pictured) was based on solitary and silent confinement, with the Auburn system based on congregate work and meals with silent confinement (but inmates developed hand signals).

The 1950 Panopticon, or roundhouse design, was a type of modern penitentiary advocated long ago by Jeremy Bentham. Only two were built in the world. The guard tower is a cylindrical structure going up the middle of the inside, hence the name, Panopticon, or all-seeing-eye.

The 1870 reformatory is a large structure like a penitentiary, but notice how the cell doors open inward into a mass hallway (like a hotel). Penitentiaries, by contrast, either have cells with windows on the back of them, or the cells are centered inside the cellblock so inmates can look out their cell doors to see the outside of the cellblock windows. Reformatories became used for special populations, like juveniles and women. If extra floors are added to the top of a reformatory or penitentiary, the design is called the big house prison design. The original reformatories were designed for rehabilitation, and inmates earned early release, or parole, based on how many points they accumulated for good behaviour.

The 1890 courtyard design is also known as a Taggart Fortress, named after an ex-civil war entrepreneur, Colonel Taggart, who bought up a few Army forts, and converted them into prison camps. Convicts were often leased out as labourers or on road crews, or made to exercise, drill, or become industrious.



1_5



1_6



1_7



1_8

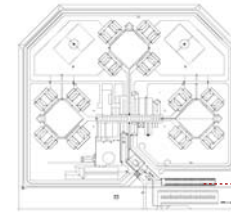

1_9

one_3

The 1945 campus design tried to blend in with the environment by allowing trees, rolling hills, etc., and the grounds aren't usually surrounded by a wall, but concertina razor wire instead. The outer perimeter is patrolled by guards on foot, vehicle, and sometimes by a mini-train. The educational center is usually the largest building on campus.

The 1950 telephone pole design, which was advocated by the federal government, is based on a long hallway with living or work quarters as add-on module units attached to the sides. Many federal BOP prisons are based on this model. A few states, like New Mexico, have experienced some terrible riots in them.

The 1980 skyscraper design, like the one shown here, which is the Piedmont Correctional facility in North Carolina, was designed for little more than warehousing offenders, although some of the floors may contain classrooms and/or work rooms. Exercise yards are usually located on the roof. Most major cities (and the federal penitentiaries) have what are called Metro prisons of this type, and often local jails are of this architectural design, as are many private prisons operated by corporations who contract with the government.

The 1990 modular design is also known as a pod prison, direct supervision jail, or new generation design, and like the TV show OZ, consists of living quarters with tall ceilings, mezzanine balconies, sharp architectural angles, Plexiglas panels, and hi-tech. environmental control equipment.

The 2002 New Generation Prisons

Prisons are operated on a basis of care, custody and control, of which control is the most important. The correctional enterprise is ultimately evaluated on how well all its activities, its treatment as well as security programs, come together and eventually allow for the replacement of correctional control with self-control. There is no simple way to do this. Laws, political appointments, judicial decisions, and demographics all affect corrections. It has no power to restrict the flood of people that enter its doors every day. Yet it must do something, anything, to treat, rehabilitate, and re-integrate its clientele.

In the past, prisons in South Africa were built as 'cattle housing' institutions. There were no facilities to alleviate boredom or programmes to help re-integrate the offender back into the society on his/her release. The militaristic and racist culture of prison officials, embedded not only in the law of apartheid, but also in the religion and politics of such officials, added to the harshness of the prison regime. The desperate environment, in which prisoners were housed, was often described in many books and articles written in particular by political prisoners.

"Prisons, even the most reformed ones produce damage and disease, in varied forms of intensity, they produce damaged and ill people"

(V. Ruggiro, *The Disrespect of Prisons*, Prison Reform Trust, London. 1991)

This suggests, that harm is evadable in the prison environment and that it is too extreme for any prisoner to deal with. Prisons are congested; life in prison is spartan and sterile and is becoming more so as all the time. Somewhere along the line the goal of rehabilitation was lost and this resulted in human warehouses. The idea around rehabilitation was the concern with a constructive impact on people, and a retreat from the concern meant that the impact was now left to chance. Such institutions are not the answers for dealing with criminals, but alternative forms of punishment are seldom seen as a priority by many governments.

Prisons are environments which contain people who have been removed from society. They are 24-hour-a-day, year-in-year-out environments in which people are sequestered with no contact with the outside world. A prison encompasses all the aspects of human life in one zone.

Stressful environments

The nature of a prison is self contained and precise and so the relationship between the individual and the environment, as a consumer of the environment, becomes the most important concern, for there are no external factors that influence the internal environment.

People are inextricably linked to their surroundings, but a person and his/her environment can be interdependently defined. The individual and his/her environment do lead independent existences, but in another sense they are linked. A library in a prison would evoke different connotations in a prisoner's mind than the segregation cells.

Dewey and Bentley (1949) coined the term "transaction" to describe the closeness or the relationship between a person and his environment. A given physical or social setting is a different psychological environment for everyone who operates in it; different people feel and act differently if they move from one setting to another. "Desirable" and "undesirable" features of the environment are "desirable" and "undesirable" for different people. One person's meat is another's poison. (Toch, H. Living in Prison. Washington, DC: American Psychologist Association. (Original work published 1977)

When designing a prison environment it is of great importance to create "transactional" spaces in which the prisoners can interact, related and feel comfortable in.

"Stressful environments are environments where the transactional junctures are of critical personal importance." (Lazarus & Folkman, 1984.)

The interrelation of a person and their environment marks the difference between psychological survival and non-survival, between growth and discomfort or maladaptation. Often we worry about the person who manages and overlook the people who suffer.

Stress stimuli are uninviting situations like hurricanes, thunderstorms, concentration camps, surgery, unemployment, isolation and waiting rooms; these stimuli have been seen to produce different impacts on people. Stress responses are "defensive" reactions to the stimuli or situation, such as emergency body changes ranging from perspiration and blood-pressure level to change in hormones found in the urine. The trouble is we do not know what the reaction is inspired by or what goes on in the persons mind at the time of the reaction.

In exploring the connotations of stress we begin to understand that the particular relationship between the person and their environment can endanger his or her well-being. That is why it is so important to prevent stress through ecological intervention. This is done by giving the user (of the environment) choice: to move his or her desk to a space, which is more private or safe. To give someone the option of choice permits him or her to shape their own environments in a way, which matters to them.

The stresses involved in being an inmate in prison are:

- Deprivation of liberty
- The absence of goods and services
- The loss of sexual/intimate companionship
- A decrease in autonomy
- Lessening of security

All of the above translates into self-doubts and reduced feelings of self-esteem. Most prisons are described as being congested, monotonous and lacking physical privacy. If one had to look at improving the person-environment interrelationship, could you alleviate these problems among inmates?

Possible solutions

Prisons are designed to discourage criminal misbehaviour; society has no regret for putting criminals in confined places with stultifying routines, away from their families and the ones they love. The milieu of prison is that of non-comfort and non-desirability however prisons should be humane and not psychologically harmful. They should be secure so as to keep the inmates dependently inside. This results in the location being isolated, quarantined insulation and the architecture being fortress-like. With stress as a built-in feature of prisons and the fact that we want prisons to be a “sane” environment for prisoners, how do you design a prison which combines all these concepts?

In order to maximise the congruence of people and environments we must use new options and use the old options in new ways. We need to look at new ways of defining environments. Prison should not only be a place where people are kept away from society and punished but should also be a place of therapy and rehabilitation. Prison spaces should be “unpredictable”. Unpredictable in a sense that space should be seen as having dual functions. Classrooms must also be seen as social mixers, a workshop as a source of loving supervision, a living space as a haven of privacy and areas of punishment as areas of therapy. (Toch, H. Living in Prison. Washington, DC: American Psychologist Association. (Original work published 1977))

Before we can realign environments we need to understand what transactional possibilities or the human attributes of our environments are. We need to understand how people, who operate and live in certain environments, perceive it and adjust accordingly.

The 9 concerns in the prison environments and an attempt to accommodate the concerns.

one_7

The following extracts are from Tochs' book Living in Prison.

privacy safety structure

A concern about social and physical over stimulation; a preference for isolation, peace and quite, absence of environmental irritants such as noise and crowding.

Inmate known as Au R Q: "well as far as – see, you got a different type of situation in every prison. Now, maybe one would have the type of peace and quite that I'm looking for, they might not have the work program that I'm looking for."

In the design of the facility the consumer of the environment will have a choice of space in which he or she want to move in.

A concern about one's physical safety; a preference for social and physical setting that provide protection and that minimize the chance of being attacked.

Inmate known as Att R P: "sure, there's always tension. You can be walk down the corridor and see electricity in the hall from the tension. It's only a figure of speech, but you know what I mean."

The design of the facility will aim towards achieving maximum safety and security through maximizing visual contact at all times and increase views in all directions.

A concern about the environment stability and predictability; a preference for consistency, clear-cut rules, orderly and scheduled events and impingements.

Inmate known as Att R P: "They're all brand new guards. It's not their fault, they just don't know nothing. You ask one of them a question, he knows less than me. To me this ain't no prison, it's a kindergarten."

support

A concern about reliable, tangible assistance from persons and settings, and about services that facilitate self-advancement and self-improvement.

emotional feedback

A concern about being loved, appreciated, and cared for; a desire for intimate relationships that provide emotional sustenance and empathy.

Inmate known as GH R U: "They calm me down at night; we get letters here at night... If I don't get a letter that night, I'm unbearable to live with all the next day."

social stimulation

A concern with congeniality, a preference for settings that provide an opportunity for social interaction, companionship, and gregariousness.

Inmate known as Att R H: "Like, when you do it in groups, they push you more, you get more out of it than when you do it by yourself. When you exercise by yourself, you're only going to do so much, and that's it. But, like, when you go in a group, they say, "let's do more than that." And then, let's do another one." But when you do it by yourself you only do ten and then stop. But you sometimes get in spirit when it's more than one, you enjoy it more."

education activity freedom

A concern about circumscription of one's autonomy; a need for minimal restriction and maximum opportunity to govern one's own conduct.

Inmate Cox S 13: "You feel like an adolescent, and it blows your mind. It is a bad feeling."

Skills development, academic training – something, which will give a future context to their place in society – something that will break the 'circle of crime.

A concern about under stimulation; a need for maximizing the opportunity to be occupied and to fill time; a need for distraction.

Inmate known as GH R V: "I'm on the go all day long. I don't stop for one minute. I don't stop to relax for a minute. I could never relax. In fact, when it's time to sleep I don't relax and I can never go to sleep."

The post-apartheid era has brought about many changes in legislation, but the implementation process has been very slow and painful. It was only in 2001 that many of the changes envisioned in the 1980's, started to transpire.

Looking at three youth centres in the Western Cape one can gain a better understanding of the educational opportunities of youth offenders in correctional institutions.

The Drakenstein Youth Centre

The youth centre holds 521 youth offenders and is the only centre which has a maximum-security facility in the Western Cape. Adult Basic Education and Training (ABET) framework is the curriculum, which is followed.

The facility has very few physical resources, the classrooms are small and the textbooks are shared among pupils, as there is a shortage. There is a lack of attendance, a lack of study space. The dominant languages spoken are English and Xhosa but Afrikaans is the medium of instruction.

The older prisoners lose their identification documents so the biggest problem is the inability of the prison in controlling the adult prisoners from living in the juvenile section. For there is no proof that they are too old to live in this section.

It must be noted that the quality of the lessons planning and the interaction between students and staff is of high quality.

The Hawaqua Youth Centre

This facility is completely dedicated to juvenile offenders. It now holds 390 inmates. The school has eight teachers and has enrolled 120 pupils.

The facility is divided into school cell, so the classes sleep in the same cell according to the ABET level. Majority of the inmates speak Xhosa and Afrikaans, and even so the medium of instruction is in English.

The facility works extensively with NGO's in the area. The initial plans for reform schools were to demolish the old reform schools and schools of industries, sell the properties and buy new land and facilities with that money. At the time that was not feasible so the present facilities were retained. They will be upgraded as the money becomes available. This process has begun and facilities are starting to change names and formally begin the process of retraining. The staff needs to be trained in psychology and social work, which emphasises the individual treatment and development of the youths in care.

The Eureka Youth Centre

This centre is the first of the reformed schools in the Western Cape to officially make a switch to a youth care and special education centre for boys. This is a centre only for boys under the age of 18. The boys are able to have much longer days of activities, spend more time with their family and have individual tailored development programmes which take into account their learning disabilities and previous educational history.

In conclusion looking at the various facilities we realise the vast limitations of correctional institutions for realising the goals “as promoting a child’s re-integration as assuming a constructive role in society,” as stated by the Correctional Service. Even with all the programmes, opportunities and the dedicated staff, the environment was one that cuts a youth inmate off from his community and makes him more knowledgeable in the world of crime.

When studying adolescent offenders, they have very different problems and concerns. For most adolescents, the imprisonment process is a very stressful experience, no matter where they are imprisoned. A juvenile inmate sees being institutionalised as being put in an environment where you are told when to wake up and when to go to bed, a place where you are escorted to all activities, made to eat institutional food and besupervised 24 hours a day by brutal staff, a place where religion is forced upon you and where you are to be rehabilitated and reformed.

The worst of all is that you are removed from your family. They feel they have to “make it through” and have huge confrontations with peer pressures, ‘Only the strong shall survive!’ Most juveniles choose to run away, withdraw in to their own world or ‘Hang it up’ (commit suicide). *“I was scared, because when I was at (another institution), everyone was telling me (present institution) was suppose to be a bad place. Everybody was getting pushed around, jumped on all the time, fighting all the time and all of this. Always being locked up, and they said (present institution) was underground.”* Quote from Juvenile inmate at the maximum-security training school for boys in Ohio. (Johnson, R and Toch, H. The Pains of Imprisonment. London: Sage publications, 1982.)

There is a growing tendency to imprison youth offenders. The media presents us with horrifying statistics on the number of aggressive offenders among youths; however large number have only committed minor crimes. Many of the children come from deprived backgrounds and commit the crimes in order to survive. If children are placed in an institution, which does not deal with the rehabilitation of these youths, they will re-enter the same community and continue committing crime.

In the words of one child:

“I know i will steal a car again when i get out of prison, where else can i earn so much money in a short time? What else is there for me to do?”

(Dissel, A. Children serving goal sentence. A profile on children sentenced to prison. Research paper written for the centre for the study of violence and reconciliation. August 1999)

design development

introduction two_13

conceptual design two_15

design objectives two_19

Aims toward a design concept

How to deal with juvenile delinquency is an issue on which there are diverging views. The restoration of law and order is a common political slogan, but at the same time many people who deal with youth offenders are coming to believe in a different philosophy, that youth offenders should not be seen as lawbreakers in need of punishment and deterrence, but as children with social and psychological problems in need of treatment by social workers and other professionals.

- The design will focus on the Functional Core of a youth prison facility.
- Designing an environment, which is “transactional” investigating the closeness or the relationship between a person and their prison environment.
- Designing to improve the lives of people (juveniles) in the prison environment.
- The facility is meant, not to necessarily to prevent crime but to create a place of holding for youth offenders, at the same time rehabilitating and educating the youth for the period which they are remanded.
- The design should be adaptable and seen a model for future youth correctional facilities.

“The children of now live in luxury, they have bad manners, contempt for authority, they show disrespect for adults and love to talk rather than work or exercise. They no longer rise when adults enter the room, they contradict their parents, chatter in front of company, gobble down food at the table and intimidate their teachers”

Socrates (469 - 399 BC)

The client

Key stockholders in the establishment of the facility would be:

- Integrated Justice System (IJS)
- Police Justice Correctional service
- Department of Correctional Services
- South Africa Government.

The client's requirement is to design a youth prison facility that focuses on rehabilitation of juvenile prisoners and the interrelationship between a prisoner and their environment. This facility must be self-sufficient, train prisoners in life (school education) and labour skills (vocational training), and at the same time create a prison that is self-sustainable.

The financing

South African Government under the management of the Department of Public Works and private organizations will sponsor the funding of the youth prison facility.

“Architecture is conceived, designed, realised and built in response to an existing set of conditions may be purely functional in nature, or may also reflect in varying degrees the social, political and economic climate. The act of creating architecture is a problem-solving or design process.”

(Ching, D.K. 1996.)

Any prison design has to accommodate certain pragmatic technical requirements that relate to a complex series of security issues and regulate every aspect of prison activity. These specifications form the basis for every prison design.

The project takes its ideological starting point from the hypothesis that the architectural environment can have a positive, stimulating influence upon inmates, by means of confronting them with environmental conditions that they may have never have experienced or been conscious of. This hypothesis supports the view that an architectural environment that stimulates, if you like, the higher senses, makes concepts such as education, motivation and integration easier to engender. A repressive environment kindles rebellion and stifles creativity. An awareness of nature and the discovery of new horizons, inspires hope and a desire for change. These positive stimulants are integrated into the scheme in the form of nature and light. The site and its topographical and botanical characteristics are assimilated into the language of the building so as to interface with its direct environment. Gabion walls provide security, dignity and authority and massing. The clear, highveld light is brought into the spaces to inspire positivity.

one_15

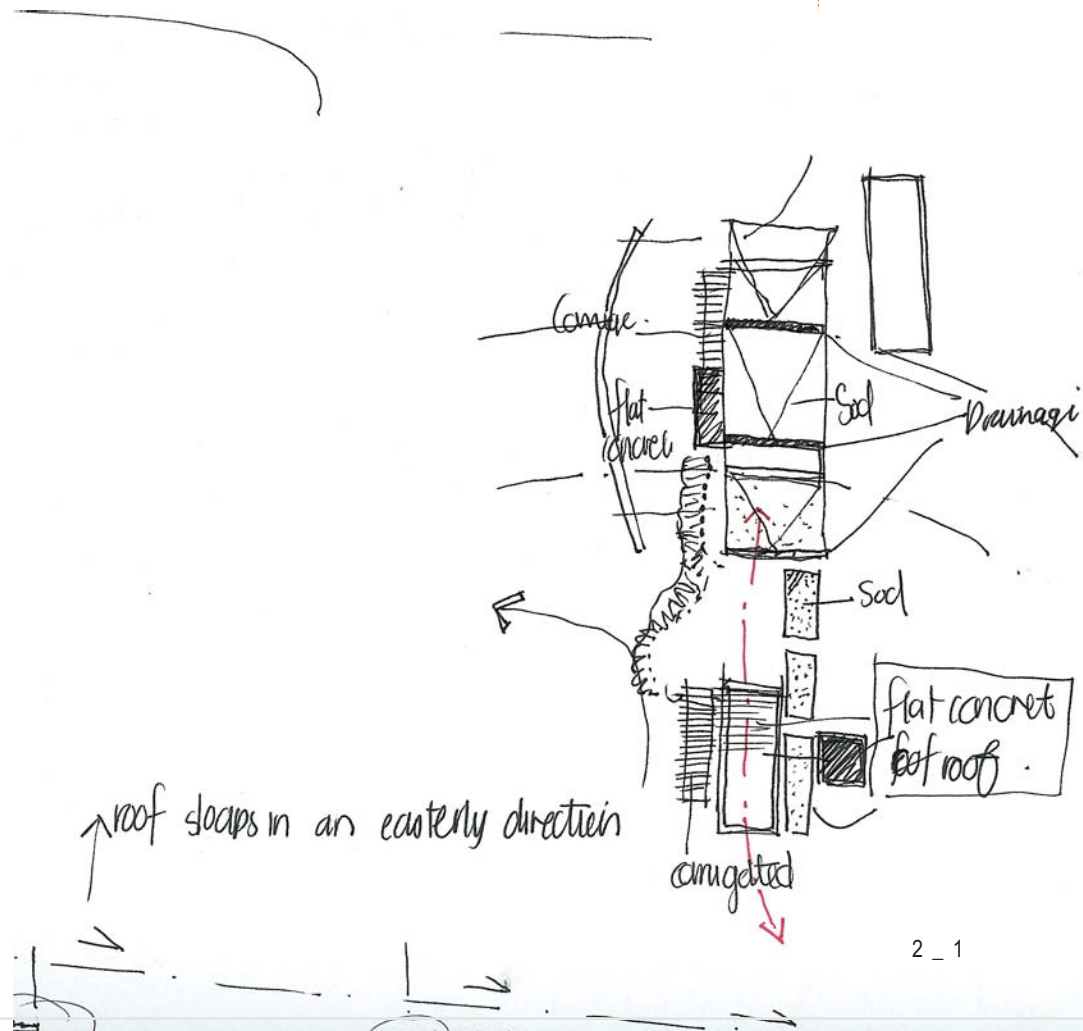

The structure and site are designed via an organic, hierarchical process, as follows:

- Security - focal advantage and lines of clear vision to all areas: linear, horizontal spaces.

- Movement- the hierarchical functions of movement through threshold and holding areas into communal spaces relating to:

- a) Inmates

- b) Visitors

- c) Staff

- d) Combination of all three

- Sustainability of services: heating, cooling & ventilation, lighting inspire the choice of materials and technical development. Good day lighting assists in security and lifts the spirits. Artificial light sources, low energy, high performance. Rock bins and a roof-stack ventilate and cool.

- Environmental interface - bringing the outside in, the application of natural daylight, allowing the exterior of the building to recede into the landscape. The traditional materials of prison security, bars and cages are substituted with stone and glass. This is a youth facility. Imprisonment without exclusion. Exclusion breeds revolt. Punched metal screen, articulated slot openings, glass screens.

- Site design - the organic relationship between different buildings, each characterized by its own function. The school stands in a central position at the top of the site. An ever-present symbol of hope; the key to a new life.

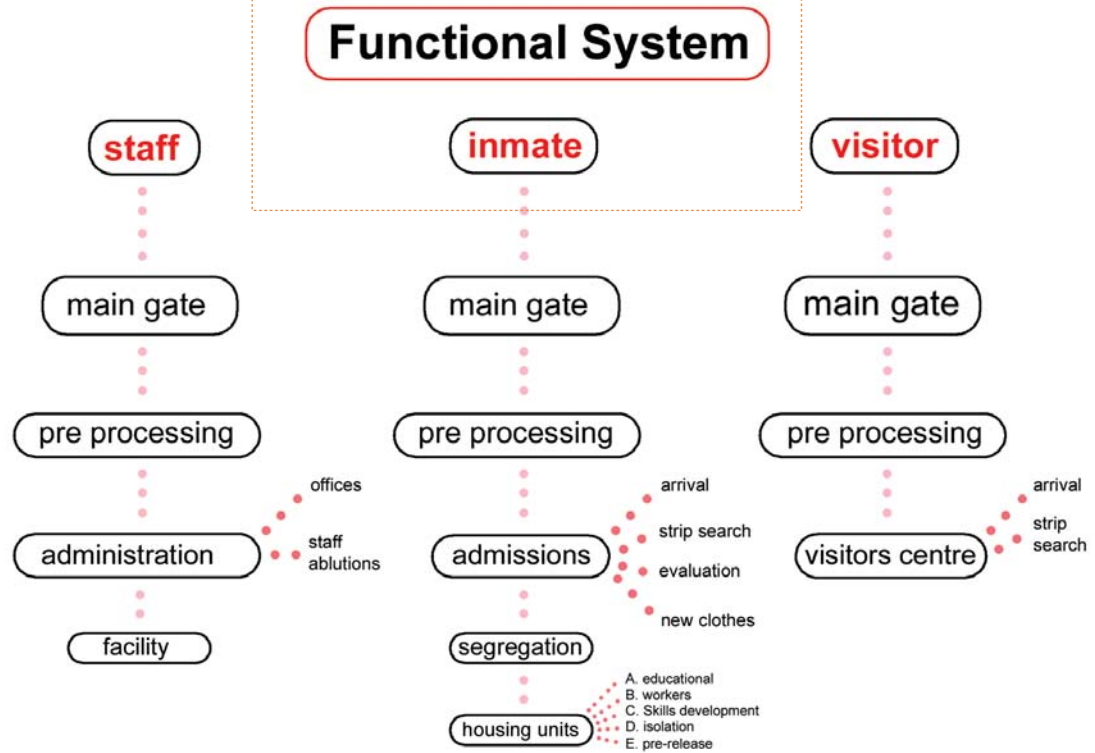

-
- 1 *To accommodate youth prison inmates already living in overcrowded conditions in the Leeuwkop youth prison facility.*
- a. It is expected that the facility will result in approximately 500 additional youths for which additional services capacity may be required.
 - b. Must be born in mind that further expansion of the facility may be required in the medium and long-term.
-
- 2 *To improve the effectiveness of rehabilitation and quality of live in a youth prison facility.*
- a. Provide spaces which are “transactional” and investigate the closeness or the relationship between a person and their environment.
 - b. Build the character and perceptions of the prison facility.
-
- 3 *To transfer the whole piece of existing correctional service owned land into functional peri-urban fabric which is sustainable and self-sufficient.*
- a. Integrate the landscape around the proposed designed facility. Do not just design only the buildings but the spaces in between.
 - b. Integrate all the services and generate a recycling system. Recycling rain water, grey water and organic waste.
 - c. Design the buildings, the landscape and in between spaces in such a way that it deals with and resolves the problems such as over heating, high energy consumption, erosion and rainwater drainage etc.

4 *Design the prison facility as a peri-urban island that is cut off and removed from the rest of society and its surroundings (as a security measure) yet once inside you feel the connection with the outside and strive towards freedom and the only way you can reach out is through self improvement and rehabilitation.*

- a. Establish a double security fence around the entire facility.
- b. Place the facility in an area which is removed physically by rivers, ridges or roads.
- c. Design the building in such a way that you are always reminded of your surrounding landscape. (Views out)
- d. Create spaces which investigate
- e.
 1. Physical orders of solids/voids, interior/exterior and the systems and organization of space, structure, enclosure and machines.
 2. Sensory perceptions and recognition of the physical elements by experiencing them sequential in time such as Approach/Departure, Entry/Egress, Movement through the order of spaces, functioning of and activities within spaces, qualities of light, colour, texture, views and sounds.
 3. Conceptual orders. The comprehension of the ordered or disordered relationships among a building's elements and their systems and responding to the meaning they evoke. Through images, patterns, signs, symbols and the context (form, space and functions) of the buildings.

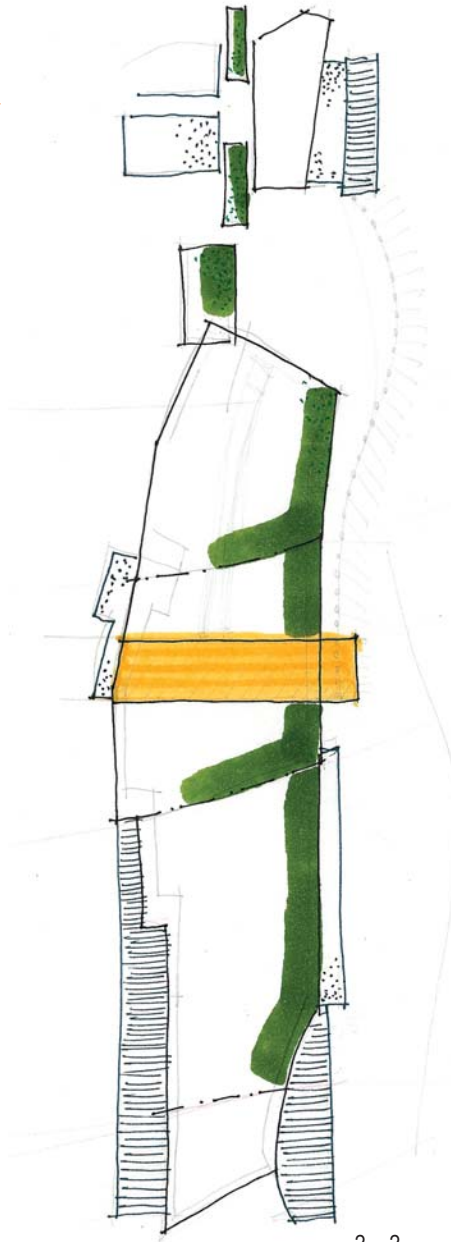

The proposed design can be divided into nine sub-areas:

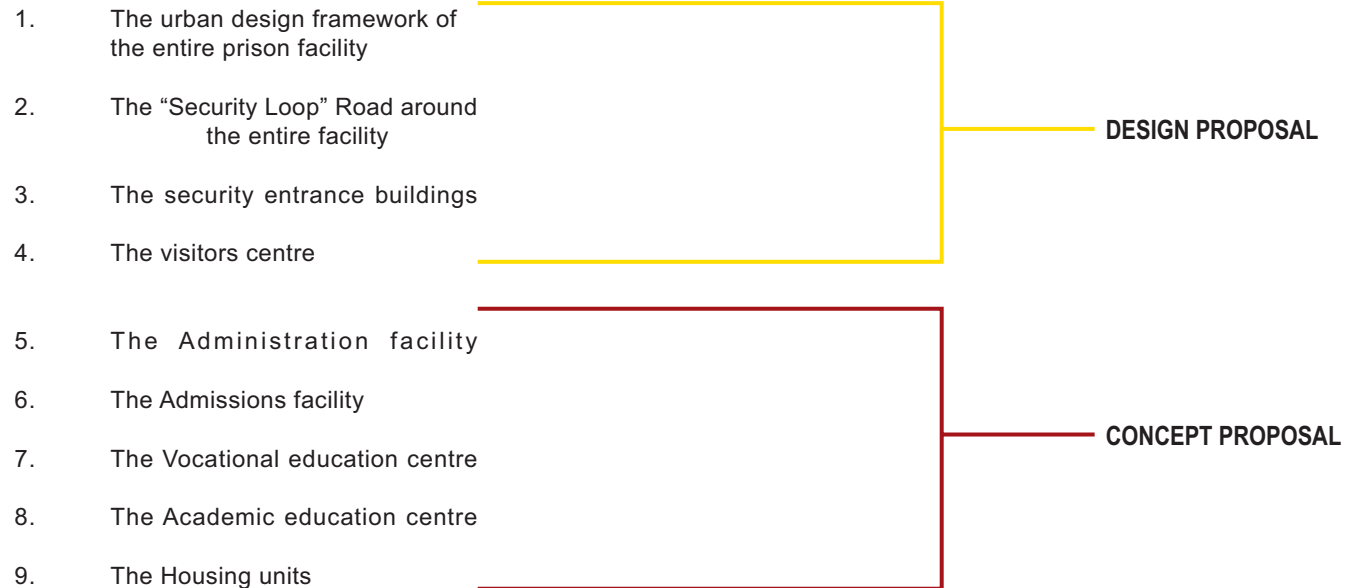

Although distinguishable, these areas interact and overlap in an attempt to achieve a "transactional" approach towards a site design. (Previously identified as one of the design objectives)

Illustration showing the relationship between these areas

The sub-areas one through to four combine to form the overall experience of the entire facility. All three groups of people interact in these areas; the staff, inmates and visitors.

The sub-areas five through to eight are a conceptual proposal for the rest of the youth prison facility.

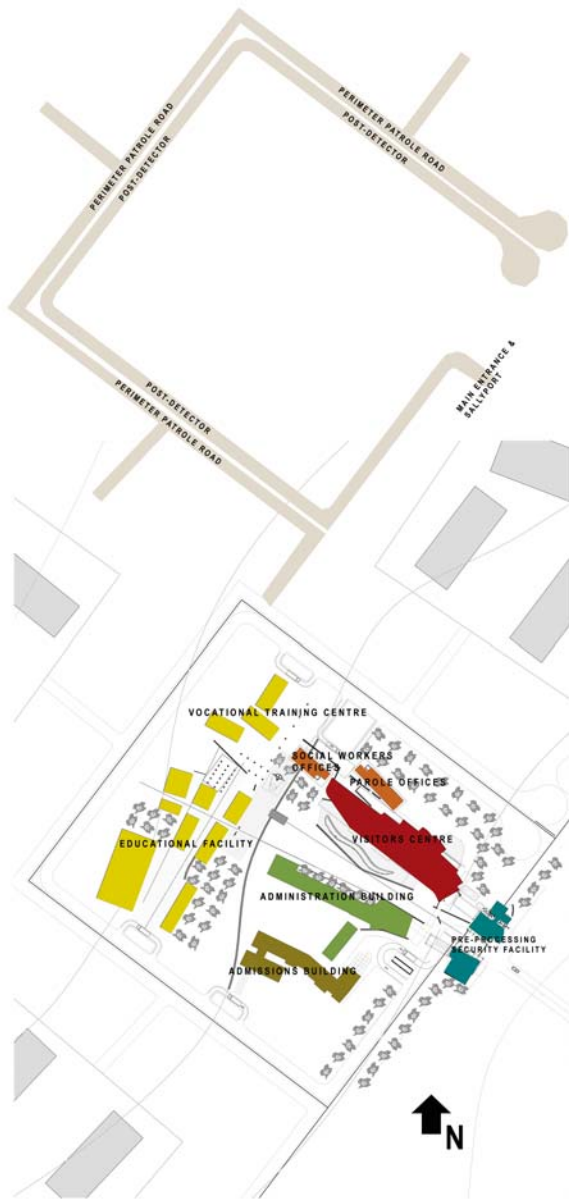

Approach

To achieve maximum security, the youth prison facility is sited in already existing prison grounds. The facility is surrounded by a double security fence and parole road, thereby creating free movement within the facility.

one_21

Approach

As security is so important, the need for separation of functional systems becomes the leading design tool. This resulted in dividing the entire facility in two four main zones.

1. The Staff zone
2. The Inmate/Youth prisoner zone
3. The Visitors zone
4. The Housing units zone

Through creating these different zones, movement and security is controlled and monitored in a successful, ordered manner.





Approach

Designing a visitors centre which provides spaces which can have a positive influence on its occupants, spaces which are able to stimulate as well as rehabilitate and space which are “transactional” and investigate the relationship between the occupants and their environment.

The design of the visitors centre has to be strongly influenced by security measures, this will be visible in layout of the plan, with strong linear and horizontal lines vision and movements, as well as the attention to vandal proof details.

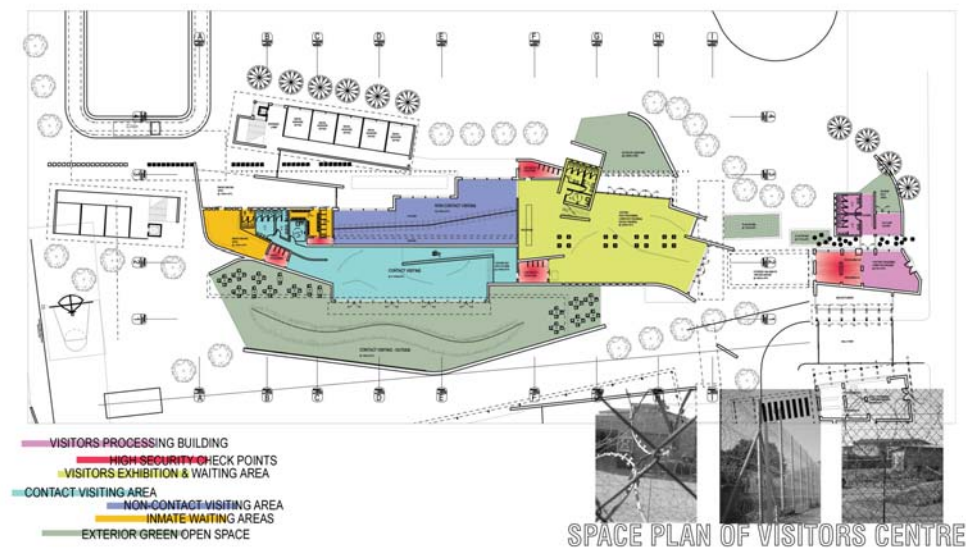

movement & views

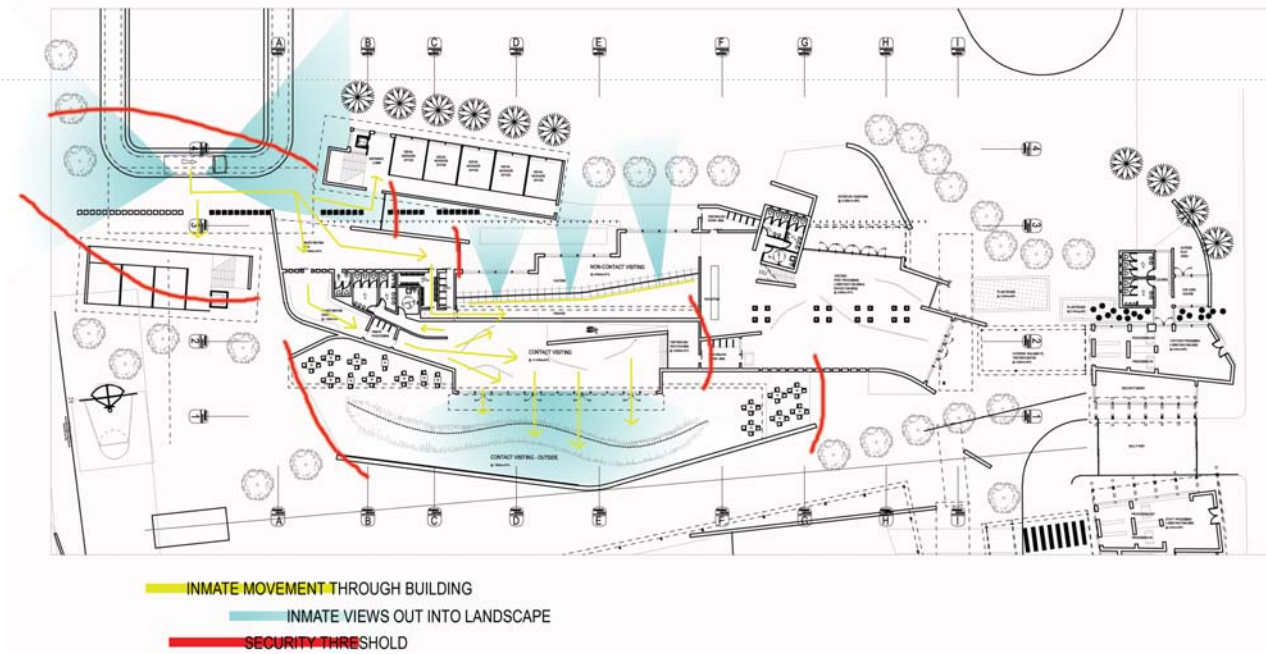

INMATE MOVEMENT

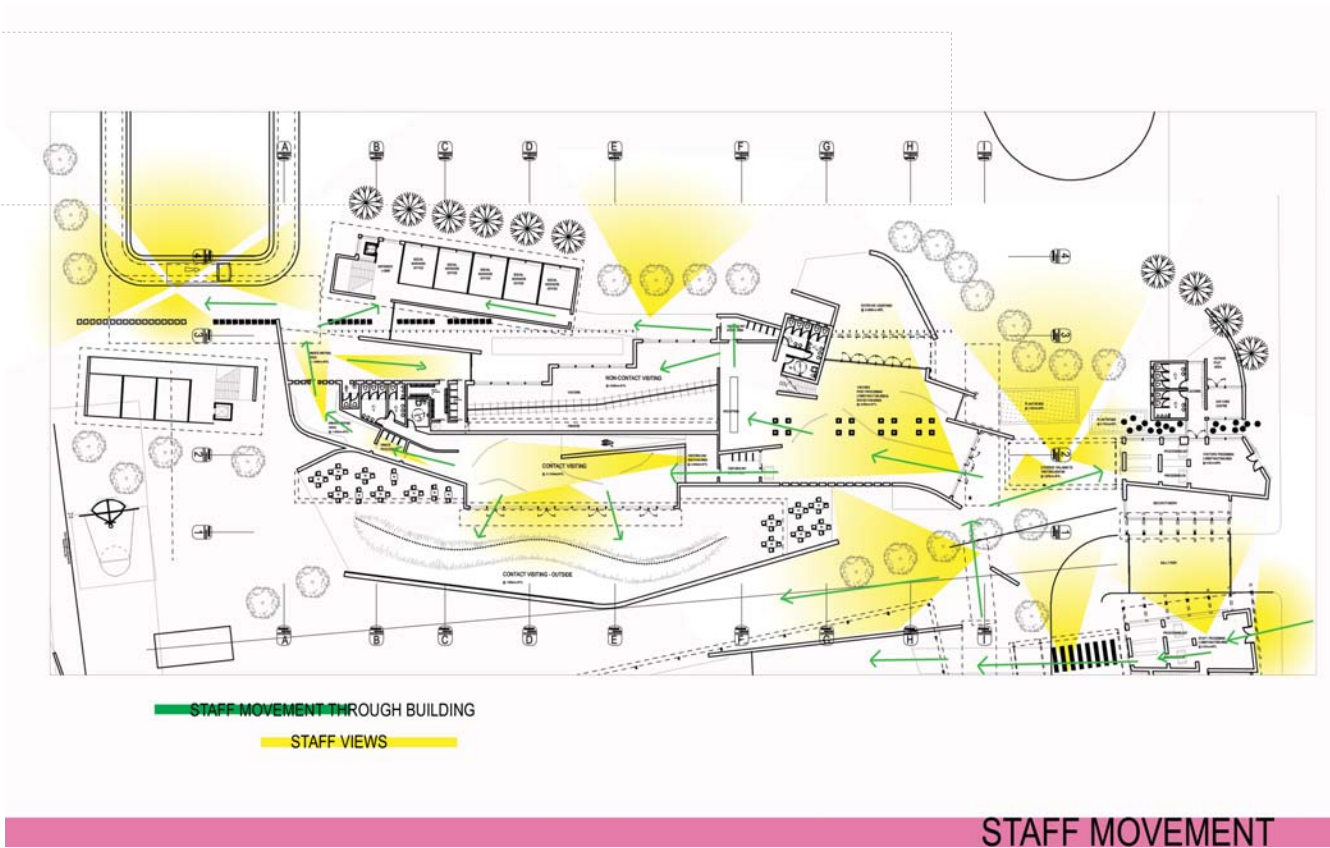

movement & views

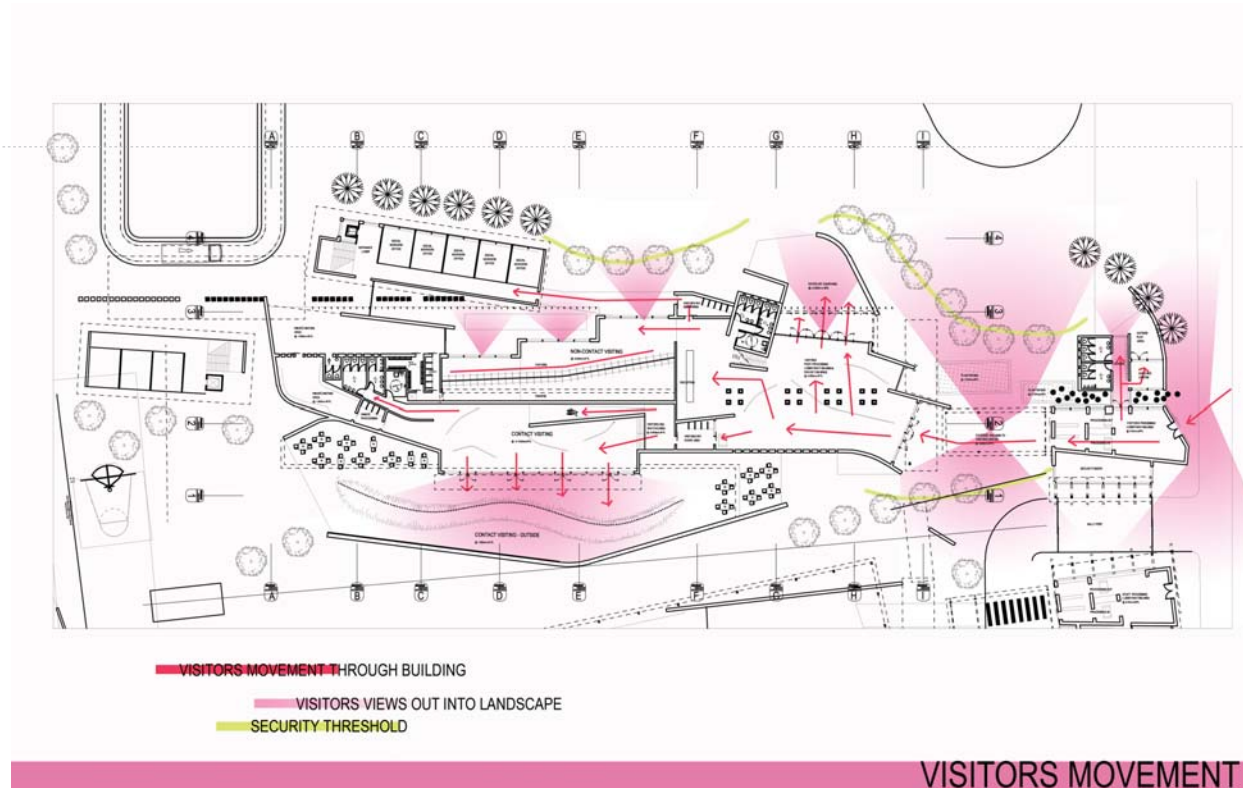

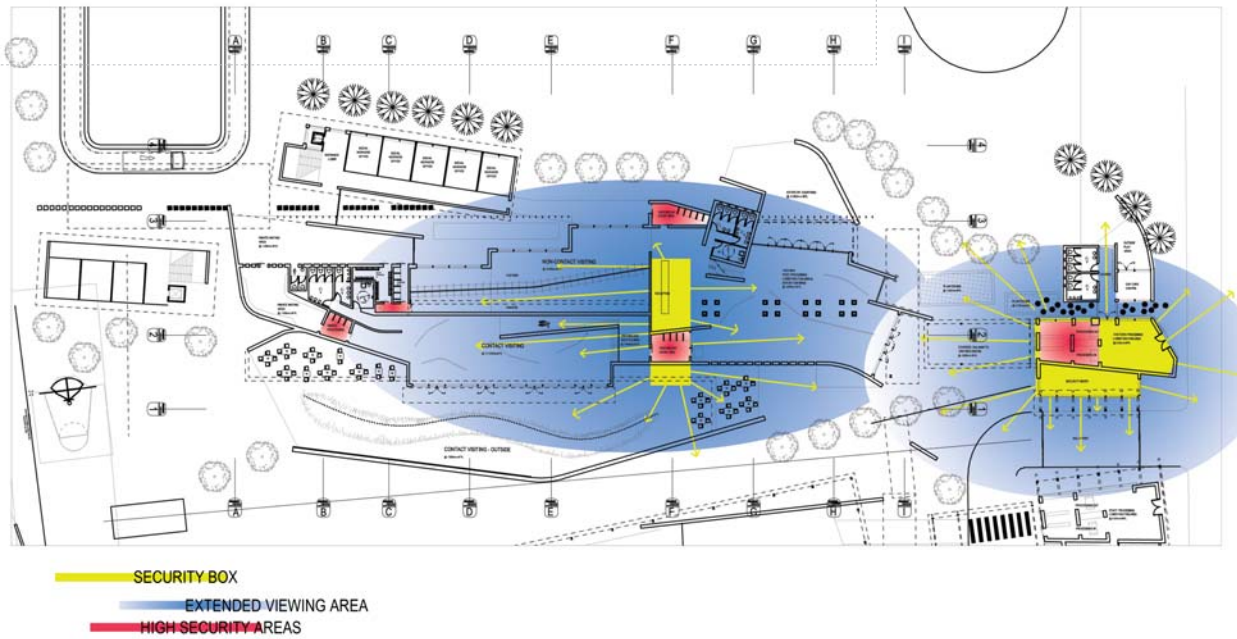

SECURITY POINTS AND VIEWS

context study

summary three_28

context study three_31



3_1



3_2



3_3



three_29

3_4

Description of the Site & Surrounding Land Uses

The site is approx. 870 hectares in extent. To the south of the site are the residential suburbs of Paulshof and Sunninghill (and its commercial centre).

Witkoppen road, and the almost parallel N1 Western Bypass Highway, lies to the south of these suburbs. Kyalami Agricultural holdings, Kyalami Business Park, and the Kyalami race track and the exhibition Centre lies to the north northwest

The site location

The Leeuwkop prison site lies approx. 20km (as the crow flies) to the north of Johannesburg CBD and lies 10km north of the decentralised business node of Sandton. The site is situated approx. 6km southwest of Midrand and the Ben Schoeman Highway.



3_5

three _31

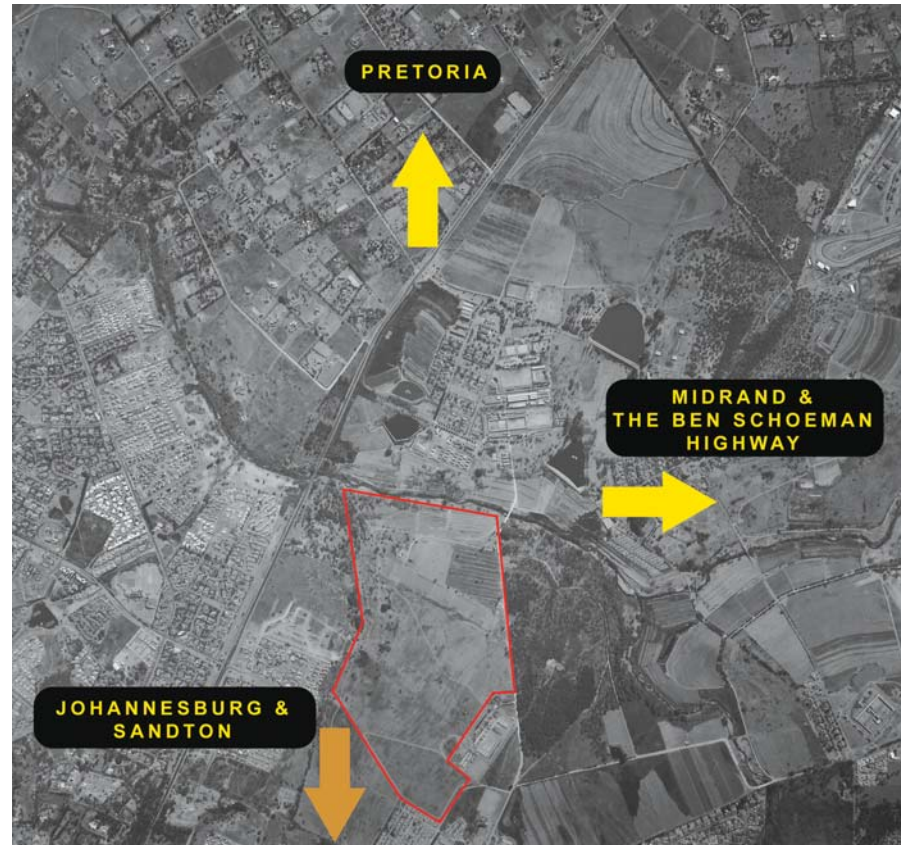

3_6

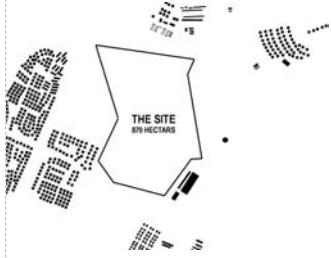

3_7

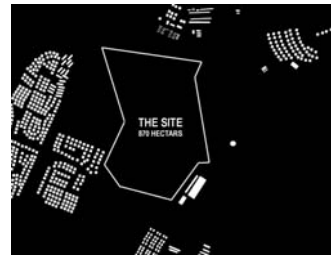

3_8

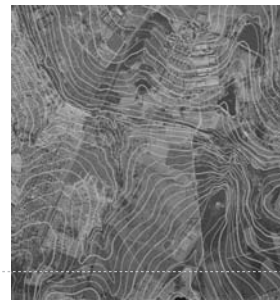

3_9

Description of the site and the surrounding land uses

The site is approx. 870 hectors in extent. To the south of the site are the residential suburbs of Paulshof and Sunninghill (and its commercial centre).

Witkoppen road, and the almost parallel N1 Western Bypass Highway, lies to the south of these suburbs. Kyalami Agricultural holdings, Kyalami Business Park, and the Kyalami race track and the exhibition Centre lies to the north northwest and the northwest of the site respectively.

Main Road forms the eastern border of the site. Beyond the main road in a northwesterly direction lies the Glenferness Agricultural Holdings while to the immediate west of the site lies the up market single residential and cluster housing suburbs of Lonehill and further a field, Fourways (and its commercial centre) and Dainfern.

Access to the site

The site is bordered on the western side by Main Road from which primary access to the site is gained and where the main entrance to the prison complex is located. A secondary entrance exists to the south where Leeuwkop road meets the prison site. The Local Integrated development Plan (LIDP), Region 3 seeks to promote the construction of the K60 as an alternative mobility corridor from Woodmead Drive to William Nicol Avenue. This may allow convenient access to the Leeuwkop site from the south.

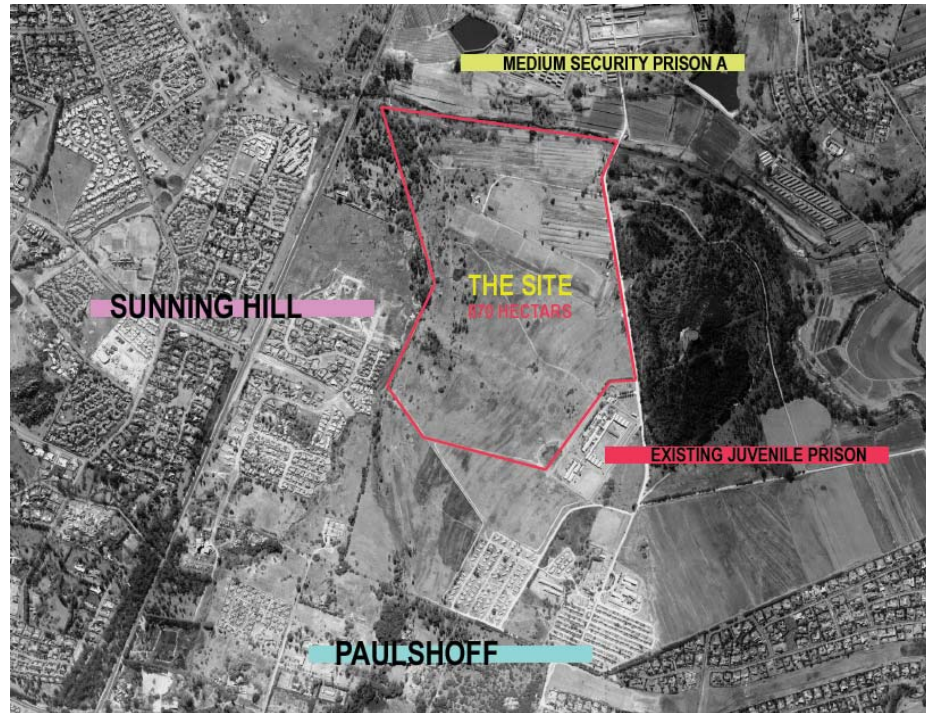

3_11



3_12



3_13



3_14



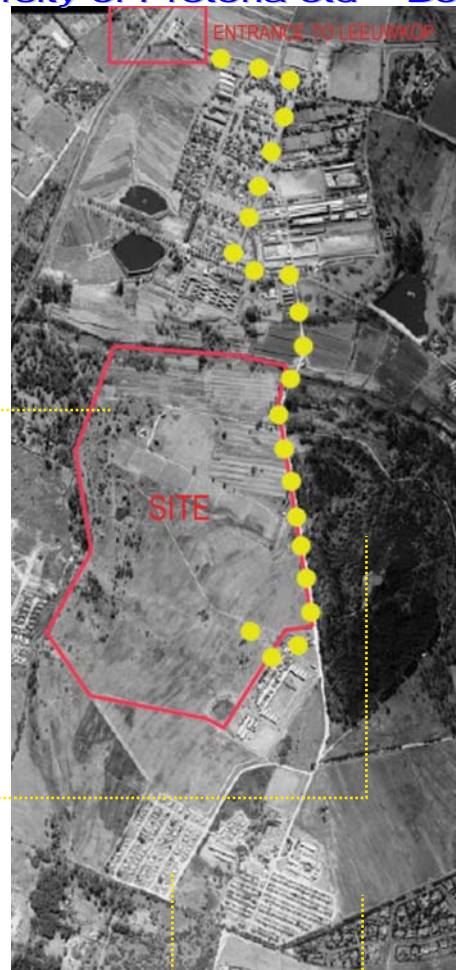

3 _ 15

three _ 35

- The site is located in the southwestern part of the Leeuwkop grounds, adjacent to the west of the existing medium B prison.
- An old shooting range borders the site from the north whilst the remaining boundaries consist of open veld.
- The site altitude varies from 1440 to 1415.
- The site slopes towards the northwest in the direction of the Jukskei river at an average gradient of 6.5%.
- The sites average altitude is about 40m higher and 700m away from the Jukskei River.
- The site consists of open veld with grass and wild vegetation covering the whole site.
- Very few rocky outcrops are visible from the surface.
- There are no agriculture structures on the site and there is no sign of standing water or dams formed on the surface.
- The site overlooks the residential area on the southern border of the Leeuwkop grounds

City wide principles guiding development

- No tolerance toward land invasion or doubling up of settlements

- Protect and enhance the role of open space within a metropolitan open space system (MOSS)

- Promote sustainable development-development that delivers basic environmental, social and economic service to all, without threatening the viability of the natural, built and social systems upon which these services depend.

- Preserve the semi-rural lifestyle northwest of the Urban development Boundary.

- Incorporate the role of urban agriculture and peripheral land uses as secondary economic activities.

- Protect public and private investment

- Contain urban development to prevent urban sprawl through:

- The promotion of nodal development

- Balancing the mobility and activity roles of the arterial road system

Land use management

To the west of the prison site are large undeveloped areas, making it subject to strong development pressures for the expansion of Diepsloot settlement, land invasion and illegal land uses. The development pressure is threatening the rural character and environmental quality of the area and is placing increasing pressure on bulk services and housing delivery.

Environmental management

The area is more rural in character and thus has higher environmental quality. Investigations are required to determine the status of the watercourses and wetlands, fauna and flora in order for informed decisions to be made regarding environmental management. Consideration should be given to the protection, conservation and management of areas such as the Jukskei & Klein Jukskei Rivers watercourses, koppies, the Rietfontein Ridge and the vegetation and how these integrate with the Metropolitan open space System (MOSS). The open space, rivers, wetlands should form part of the MOSS in city of Johannesburg. MOSS will fulfil the following purposes: protect sensitive environmental areas, provision of recreational spaces; and assist with storm water management. No proclaimed nature reserve exists in this region.

Future projects

The Intervention and Guidelines for Sub-area 3 (Kyalami Park, Leeuwkop prison), of the Local Integrated Development Plan (LIDP), Region 2, suggest that a Leeuwkop Precinct Plan is to be formulated.

The following projects have been identified for the region 3, which have an impact on the Leeuwkop Prison Site:

- The upgrade of Witkoppen road
- The promotion of the construction of the K60 as an alternative mobility corridor from Woodmead Drive to William Nicole Avenue.
- The protection and management of the Klein Jukskei as important links in the open space system.

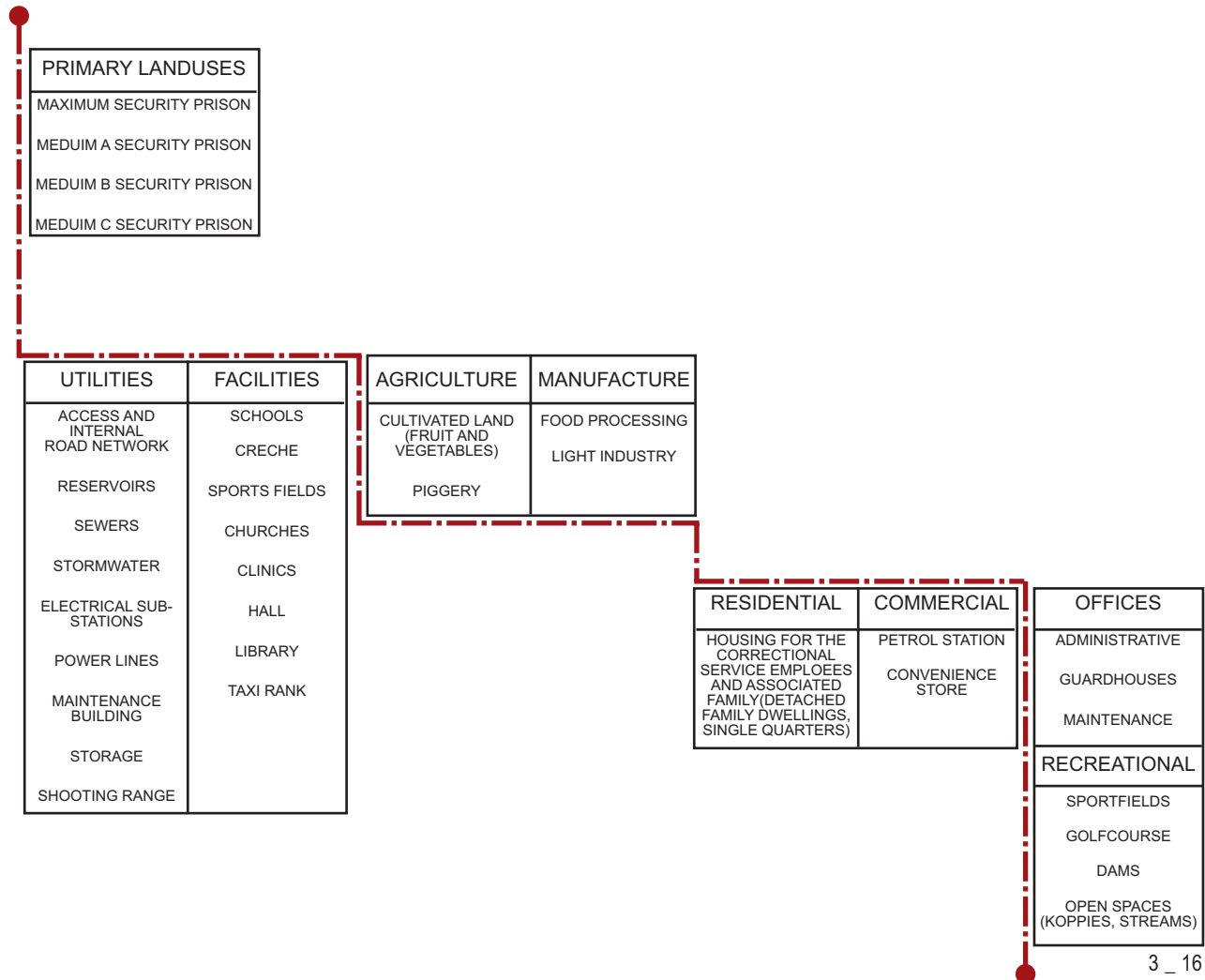

The LIPD's for the region 2 & 3 indicate that there is sufficient bulk service capacity to service development in the area.

Water

Water to the site if fed through two water mains to the south of the site:

- Sandton Municipal Water Main; to
- New Sandton Water Main

The Sandton Municipal Water Main supplies water to the Kyalami reservoir (Leeuwkop Reservoir) which has a capacity of 2275kl and is backed up by a stand-by reservoir with the same 2275kl capacity. A gravity fed reticulation system distributes water to the prison site. The New Sandton Water Main supplies the "New Reservoir", which has a capacity of 5170kl and at present is not fully drawn upon and thus has spare capacity. Water consumption has been reduced by means of pressure control on the water mains and leak detection of water mains. This system is implemented by Shared Energy Management and have recorded the following consumption figures. Further investigation are required to determine the adequacy of water supply and its reticulation for the new prison facility. A formal enquiry has been submitted to Johannesburg Water (see Appendix) regarding the water and sewer capacity requirement for the extension of the Leeuwkop prison

Sewerage

The LIPD's for the region 3 raises concern regarding the capacity of the sewerage system in the vicinity. The control factor in this catchment area in the Diepsloot Outflow, which can accommodate an approximate 1 000 000 persons. The catchment is divided into five sub-catchments, each having a bulk sewer line connecting into the major outflow sewer line, viz., the Diepsloot Outflow. The sub-catchment relevant to the Leeuwkop Prison site is the Western Klein Jukskei sub-catchment. Within this area a few of the smaller bulk sewers are already near and over capacity. (LIPD, region 2 & 3, CoJ, December 2001). Johannesburg Water also mentioned that the sewers were under strain in the Leeuwkop area and that there are plans to address these problems and upgrade the sewers in the area. (Mr. E Beddington, Johannesburg Water, personal communication, 19 June 2002)

future investigations are necessary into the capacity of the sewer system to avoid potential environmental damage to the natural system. Remedial measures will be required to ensure that the sewerage is disposed of in an environmentally sustainable manner. A formal enquiry has been submitted to Johannesburg Water regarding the water and sewer capacity requirements for the extension of the Leeuwkop Prison.

Electricity

Electricity is fed to the site via Eskom Supply Authority Substation, which lies to the North of the site. It has been mentioned, however, that Eskom seeks to upgrade this connection from the present 6600v main to a 11000v main. This may require upgrading of the present on-site system, alternatively, a transformer would be required to supply the site on the 600v system. (Rip Wyma, personal communication, 21 June 2002)

Electricity consumption has been reduced by means of load shifting from peak tariff period to off peak and standard period by means of load control geyser. This system is implemented by Shared Energy Management.

Roads

A further enquiry has been submitted to CoJ and the Johannesburg Roads Agency (see appendix) regarding the impact of the new facility on existing future roads in the area.

Town planning scheme

Property description:
Portion 2, farm Rietfontein 2-IR

TP Scheme:
Peri-urban Town Planning Scheme 1975 (previously Halfwayhouse en ClayvilleTown Planning Scheme)

Use zone:
Agricultural

Building line:
No standards

Parking:
As per Town Planning Scheme
restrictive conditions: None

Coverage:
5%

Density:
N/A

Floor area ratio:
N/A

Height zone:
Restricted to 2 storeys

Town planning procedures

Currently, the land is zoned agricultural and the council has given consent for the establishment of prisons and ancillary uses (places of institution, Special buildings) Investigations are under way as to when the consent was first granted by the council and what conditions and circumstances prevailed at the time under the Peri-urban Town Planning Scheme 1975, and prior to this, the Halfwayhouse en Clayville Town Planning Scheme.

Water

The Leeuwkop grounds are supplied from the Johannesburg water with two mains at the south borders of the site:

First point of supply:

Meinecke-1 (M1):
a 250mm concrete pipe

Second point of supply:

Meinecke-2 (M2):
a 200mm diameter steel pipe which
supplies the Kyalami reservoir.

The Leeuwkop site has 3 water
reservoirs in total.

- The Kyalami reservoir with
a capacity of 2275KL
- The Green reservoir with
a capacity of 5170KL
- The Stand-by reservoir to
the Kyalami reservoir with
a capacity of 2275KL

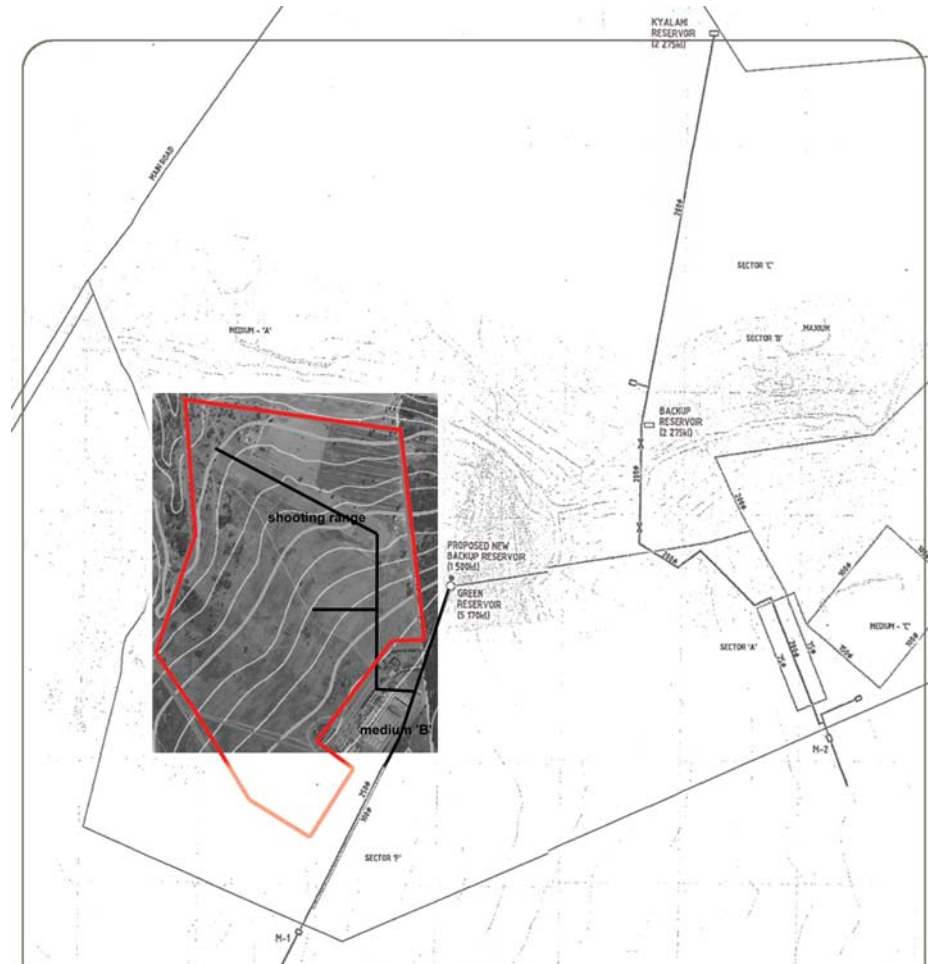

Sewerage

There are three sewerage lines entering the Leeuwkop grounds from different directions

- A bulk sewer which enters the grounds from the eastern border and run parallel to the Jukskei River.
- Another bulk sewer enters the grounds from the southern border in the south-northern direction and joins the first line in the vicinity of the centre of the site.
- Another outflow sewer pipe enters the site from the southern border in the east-south to north-west direction.

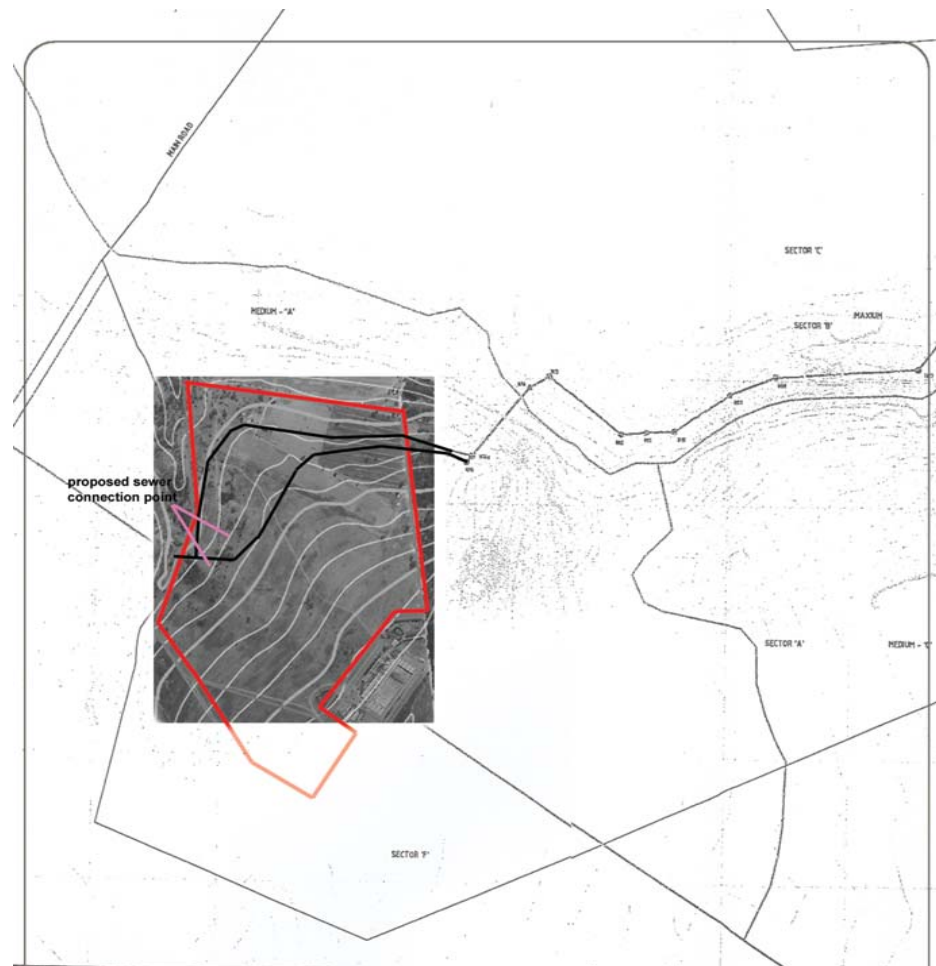



3 _ 20

Roads

- The site is located right next to Main Road.
- The main entrance is approx. 2000m from the site.
- There are speculations that new entrance might be built to replace the existing one. The new entrance is pointed out to be very close to the site, about 600m.

Storm water

The site has a gentle slope towards the Jukskei River as seen from the contour lines on the site.

The difference in level between the estimated lowest points of the prison to the river is about 30m over a distance of 500m, which gives the average slope of 6%.

Two options are considered

- The collection of the storm water

A proposed dam of a capacity up to 2000 cubic meters on the site, which is used for the supply of water for agriculture. But as the site investigation has pointed out several water pumps are installed directly to the main stream of the Jukskei River, making this option impractical. The expenses of building a dam while water is already available from different sources on the ground, can not be justified.

- Diverting the storm water to the Jukskei River

Concrete channels will collect the storm water from the site and discharge into the Jukskei River. This option is suitable option and relatively expensive.

3 _ 19

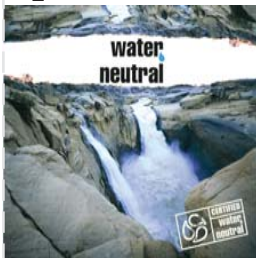

Existing service

Presently “inter waste” render the management of the waste at the Leeuwkop site. There would be no problem in accommodating any additional waste generated by the new prison. The initial estimate for waste management for the new prison would be R 5 500 per month.

three _ 47

Alternative waste management systems

- ‘Pikitup’ could be approached for their services.
- Waste management on the site.

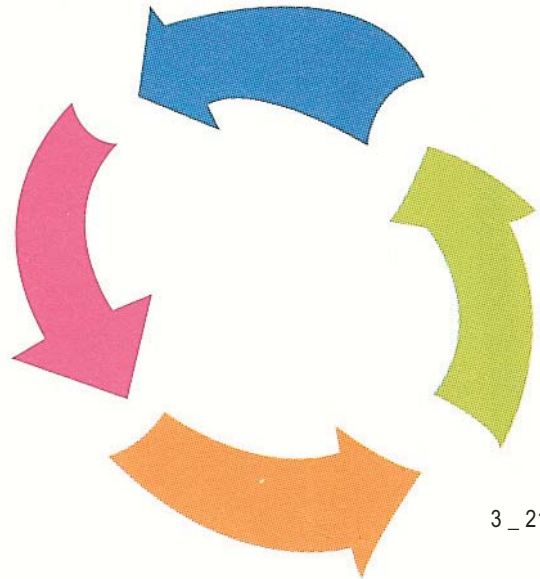

3_21

Geotechnical

Rocky outcrops on the south-western side of the site, and hard materials encountered from 1.8m below the surface.

Shallow seasonal perched water table occurring during summer time.
Granite occurs in scattered areas.

The presence of rocky outcrops and the underground water suggest that the prison should be build on different platforms as to minimize the need to deep cut of blast in rocky areas and to minimize the size of importing materials to site.



[URBAN GREEN FILE vol 7,2002.may/june]

Recommended foundations:

- Deeps trip footing
- Soil raft/ compaction of in-situ soils.

biophysical study

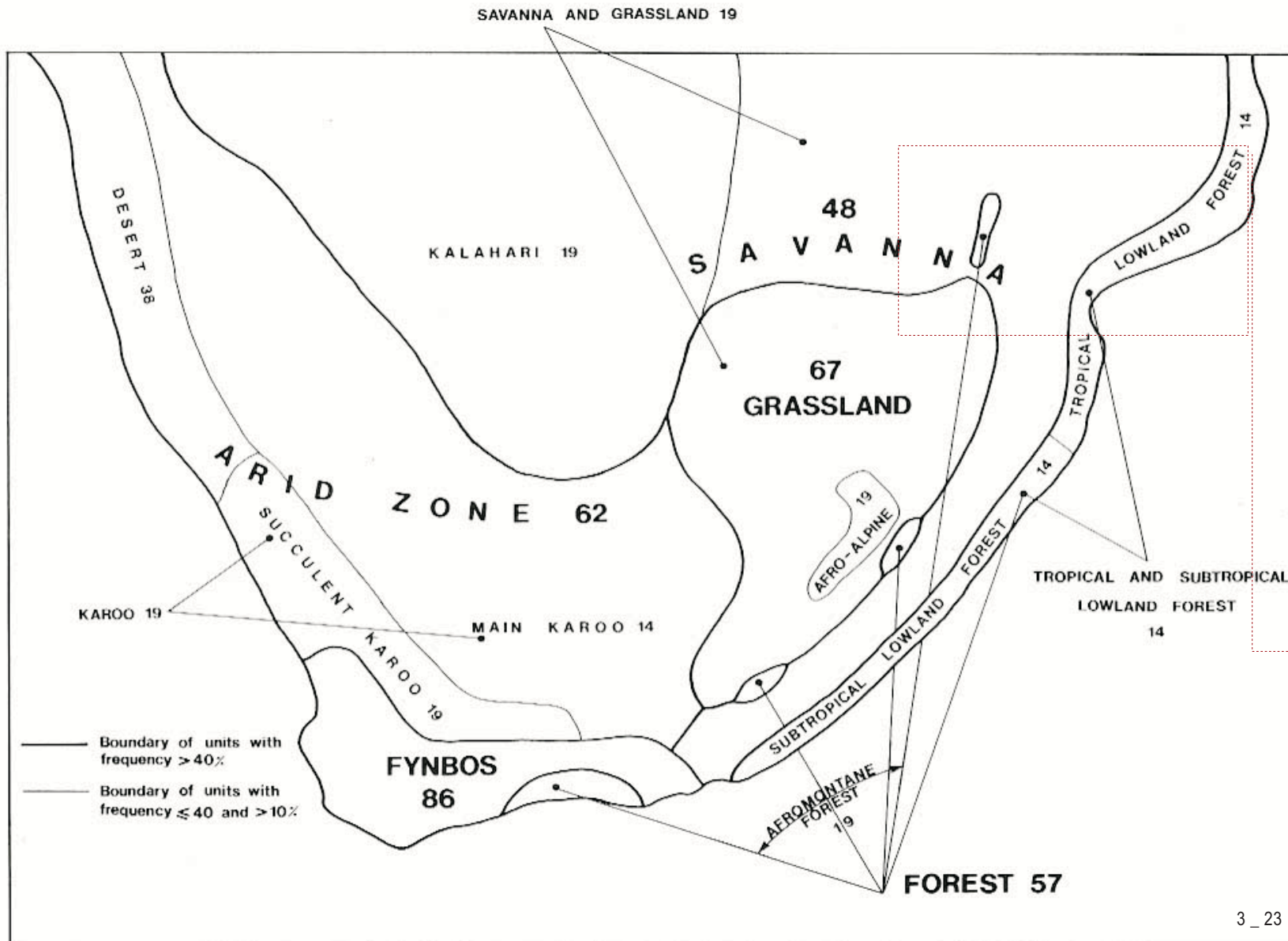

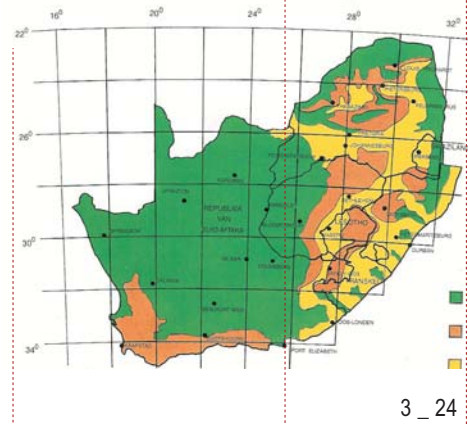

three_49

2 Major grass dominate:

- sweet grass: lower fibre content, maintain nutrients in leaves in winter palatable to stock
- sour grass: higher fibre content, withdraw nutrients in leaves in winter unpalatable to stock

biophysical study

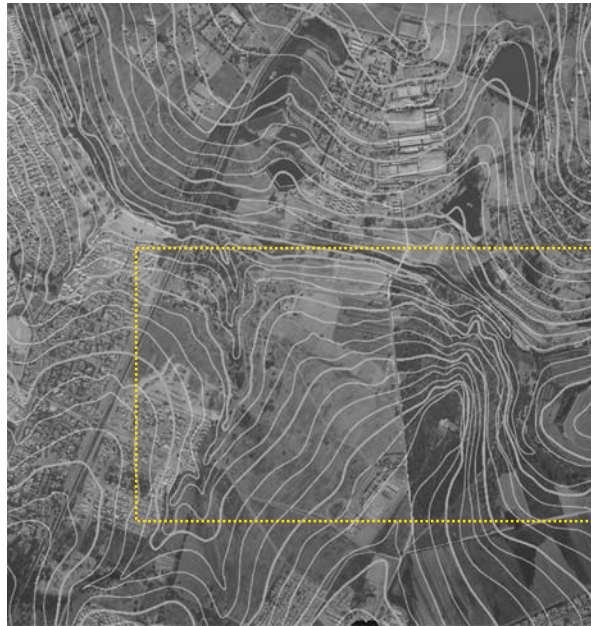

3_25

Digitaria eriantha
'Finger grass'

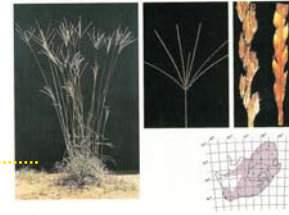

3_26

three_51

Hyparrhenia anamesa
'Bundle thatching grass'

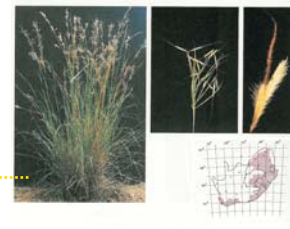

3_27

Hyparrhenia hirta
'Common thatching grass'

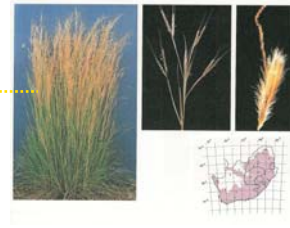

3_28

Pennisetum clandestinum
'Kikuyu'



3_29

Eragrotis curvula
'Weeping love grass'

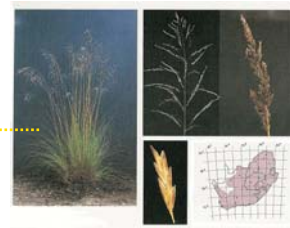

3_30

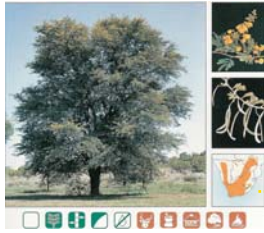

Acacia karoo

'Sweet thorn' [INDIGENOUS]

3_31



Acacia mearnsii

'Blackwattle' [EXOTIC]

3_32



Celtis africana

White Stinkwood [INDIGENOUS]

3_33

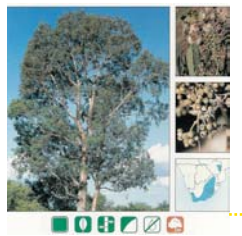

Eucalyptus grandis/globulus

Blue gum [EXOTIC]

3_34



Grewia spp.

Velvet rasin/ Cross-berry [INDIGENOUS]

3_35

biophysical study

three _ 53



3 _ 36



climatic analysis

This analysis is guided by Dieter Holm's manual for energy conscious design document. Holm 1996

Introduction

In order for the man-made environment to use the available natural energy to its optimum efficiency, it must be planned with consideration given to:

- Materials
- Micro climatic conditions
- Building orientation within the site
- Landscaping

An environmental responsive building should have:

- Minimal negative impact on its site
- Maximum human comfort

To economically incorporate alternative energy devices into buildings, energy conservation measures must be taken which diminish the total energy usage of the building and functions. Many different items relating to energy conservation should be considered and evaluated for possible use in buildings. Areas in which energy conservation practice can be employed, relative to the climatic zone, have been divided into the following categories.

- 1 Climate
- 2 Wind
- 3 Solar

The design considerations for Johannesburg:

- 4 Peri-urban
- 5 Plan form
- 6 Possible functions
- 7 Rain protection
- 8 Mass
- 9 Insulation
- 11 Properties of materials
- 12 Lighting
- 13 Ventilation

Every aspect of the building should be planned for its best utilization of all energy, including passive systems which use the natural energies from the sun, wind, water and earth.

2 WIND

Summer winds are predominantly east-north-easterly to east-south-easterly. Winter winds are predominantly south-westerly with a fair amount originating from the north-east.

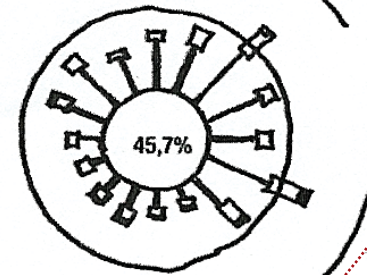

July

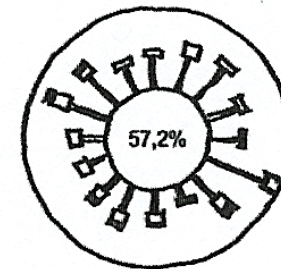

January

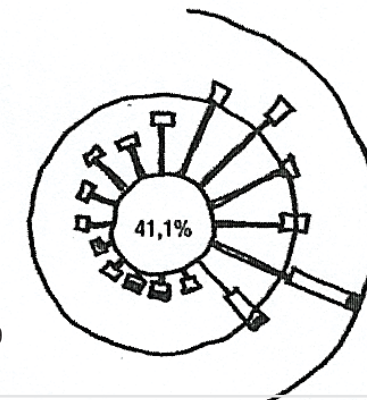

1 Climate

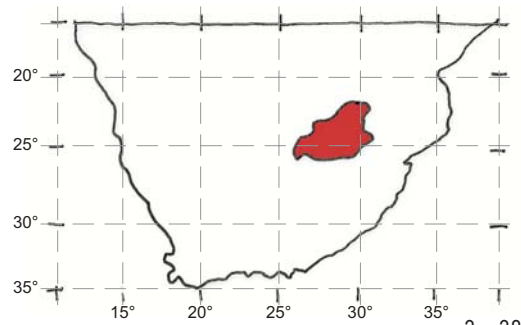

Location of climatic region: 3_38

25,8° TO 30,7° East and 22,0° to 25,9° South.

Description of zone climate:

Distinct rainy and dry seasons exist with a large daily temperature variation and strong solar radiation. Humidity levels are moderate.

Humidity:

The average monthly relative humidity level is 59%.

Temperatures:

The maximum diurnal variation occurs in July. The average monthly diurnal variation is 13K.

three_57

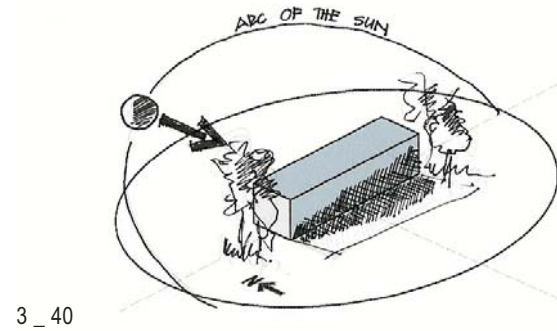

3_40

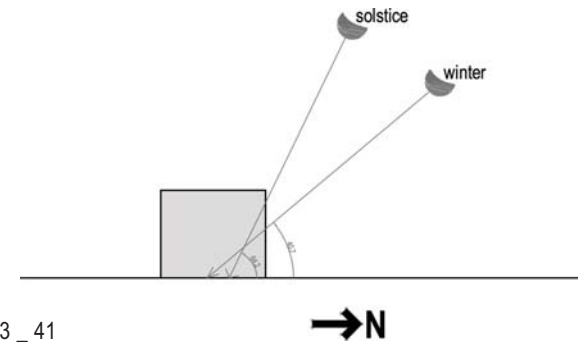

3_41

3 Solar

There is a greater chance of successfully integrating solar applications if they are taken into account from the initial conceptual design stages.

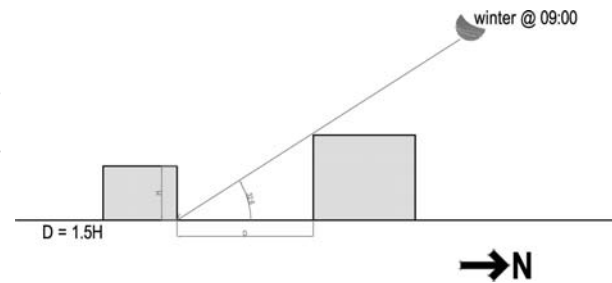

3_42

5 Plan form

The winter and summer requirements are different.

The winter demands:

A building which has a compact form, well insulated envelope and a need for great solar gain.

The summer demands:

A building with a free form which is well ventilated and has shading devices which control the penetration of the sun.

6 Possible functions

External spaces should be created forming courtyards. These spaces should provide shading for internal spaces. Louvres should be placed on the west and east facades.

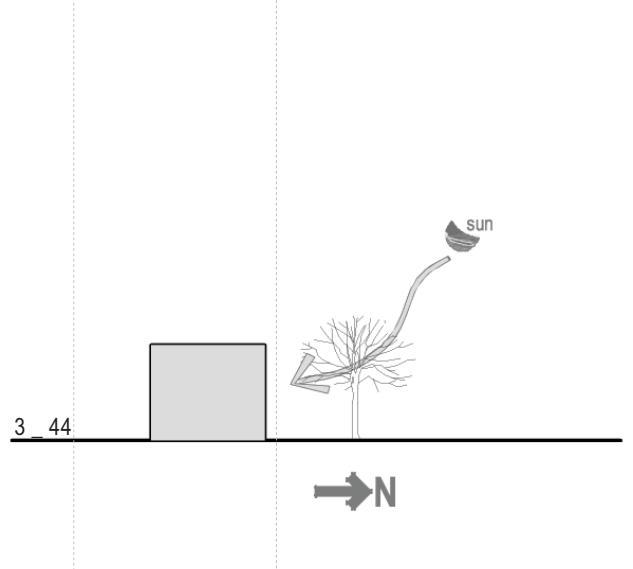
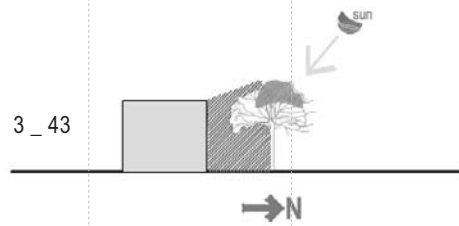

4 Peri-urban

The urban development structure determines the quality of the built environment and open space. It also creates the possibility to use solar energy in buildings. The most important elements for achieving the optimum energy levels in an urban development plan include:

- Orientation of the facades
- Directing parts of the roof towards the south

Protection of pedestrians by tree, covered walkways, or canopies. North facades of buildings receive high radiation during summer and should be tree lined. Insulation is enhanced by a small angle of obstruction of buildings and vegetation. A larger distance between buildings reduces the angle of obstruction thus offering the greatest possibility of utilising passive solar heat.

The position of vegetation also has an effect on exposure:

The active solar application, is greatly effected by the orientation of the roof. The maximum solar incidence for active utilisation is achieved by positioning the roof structure or parts of the facade between southeast and southwest.

three _ 59

7 Rain protection

All entrances should be protected from rain and sudden thunderstorms.

8 Mass

Thermal mass is effective for half of the under heating period of the day. In Johannesburg the thermal mass is required due to the large daily temperatures swings. It can be provided by floors, roofs, thick walls and internal partitions.

9 Insulation

Light insulated roofs are feasible in this climatic region provided that the walls and the floors give thermal mass. Heavy thermal roofs are also feasible if the walls and floors are light weight.

10 Lighting

The right application of natural and artificial lighting is vital for good task perception and comfort within a building.

The relationship between daylight and artificial light is of importance in terms of the controllability, uniformity and colour of the light.

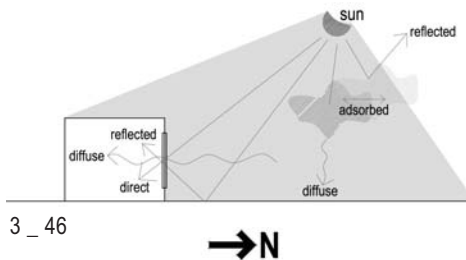

11 Ventilation

Ventilation is the provision of air to a building. One reason for ventilation is that the occupant needs oxygen to oxidize their food produce the energy in order to live. Ventilation is also required to remove pollutants, to minimize moisture, to reduce the risk of condensation and the most obvious task, to provide cooling, and is most likely to result from occupant action. For ventilation to result in useful heat loss, the ambient temperature must be lower than the maximum comfort temperatures indoors.

Different systems can be used to gain maximum ventilation levels:

- Evaporative cooling

Direct evaporative cooling is effective for most of the overheated periods of the day, but should not be used the whole time as it can add to humidity levels which could compromise human comfort levels.

- Active

air conditioning is not a necessity, but the building functions may require it.

- Mechanical

Mechanical ventilation may be necessary to achieve the required ventilation rates

precedent studies

Introduction

four_62

Prisons

- 1 Baviaanspoort Youth Development Centre
- 2 New Generation Prototype

four_67

Schools

- 1 Primary School Devogels, Oegstgeest, The Netherlands
By Herman Hertzberger
- 2 Ann Richards Middle School,
La Joya, Texas
By Kell Munoz Architects
- 3 P.S. 156, I.S. 293,
Brooklyn, New York
By Mitchell/Giurgola Architects
- 4 New Wesbank Primary School,
Kuilsriver, Capetown
By C S Studio Architects

four_71

Other Buildings

- 1 The Multi-purpose Centre,
Nyanga, Capetown
By C S Studio Architects
- 2 The Constitutional Court,
Johannesburg
By Omm Design Workshop & Urban Solutions
- 3 Apartheid Museum, Johannesburg
By Mashbane Rose, Sidney Abramovitch, Bannie Brits, Linda Mvusi and Gapp
- 4 Art And Architecture,
Andrew Makin And Andrew Vester

four_79

prisons

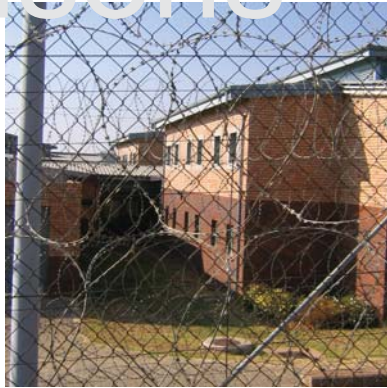

4_1

CASE STUDY (ONE)

BAVIAANSPOORT YOUTH DEVELOPMENT CENTRE

The prison was chosen as a case study for the reason that it is an existing youth prison facility located on the out skirts of Pretoria, models for housing juvenile offenders.

This is what a youth prison should not look like.

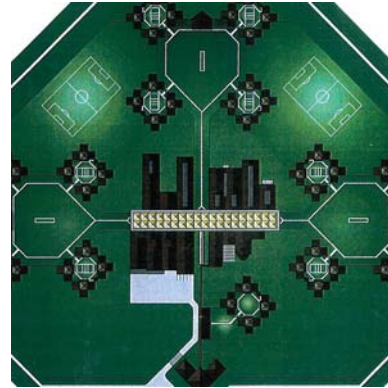

4_2

CASE STUDY (TWO)

NEW GENERATION PROTOTYPE PRISON FACILITY

This facility was studied in order to gain more information on the layout of a prison facility, the processes one needs to go through when entering a prison facility and the security aspect of such a facility.

schools

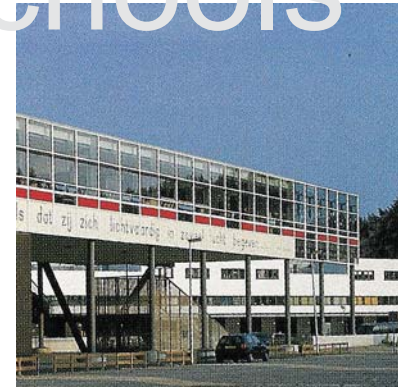

4_3

CASE STUDY (THREE)

PRIMARY SCHOOL DEVOGELS, OEGSTGEEST, THE NETHERLANDS

This facility was studied to understand the important balance between inside and outside spaces an how these inter link and at the same time trying to create a micro city, break down the rigidity of conventional school plans.

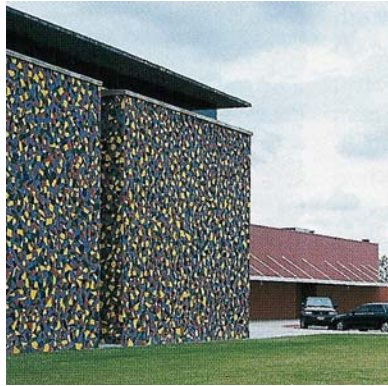

4_4

CASE STUDY (FOUR)

ANN RICHARDS MIDDLE
SCHOOL, LA JOYA, TEXAS

The school is used not only during the day but at night as well and over weekends, this is a very important in the design of a prison environment for prison operate for 24 hours.



4_5

CASE STUDY (FIVE)

P.S. 156, I.S. 293, BROOKLYN,
NEW YORK

The reason for choosing this facility was that the use of colour in this school dominates the design of the project.. Colour plays a large role in the design of the youth prison facility and the rehabilitation of the juveniles.

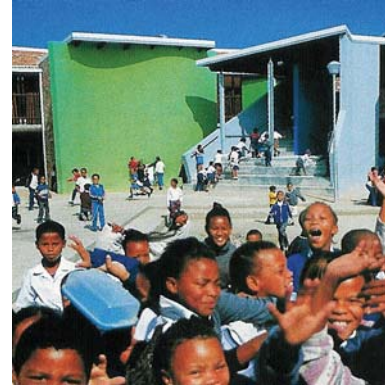

4_6

CASE STUDY (SIX)

NEW WESBANK PRIMARY
SCHOOL, KUILSRIVER,
CAPETOWN

This case study was chosen for its appropriate use on construction materials and colours. The design of the facility also facilitates the need to provide 24 hour security observance.



4_7

CASE STUDY (SEVEN)

THE MULTIPURPOSE CENTRE, NYANGA, CAPETOWN

This case study explored the notion of in-between spaces and the street in a township and the way these concepts interacted creating a special typology of community efficient design. The design places emphasis the balance between activities and the need to allow for spaces where these activities can take place. In the design of the youth prison facility space planning is one of the main design tools.



4_8

CASE STUDY (EIGHT)

THE CONSTITUTIONAL COURT, JOHANNESBURG

The design of the constitutional court is moulded by light. The materials used were all selected according to their appearance when exposed to light. Light and immateriality are two very important aspect in the design of the youth prison facility.



4_9

CASE STUDY (NINE)

APARTHEID MUSEUM, JOHANNESBURG

The notion of creating metaphorical spaces to evoke emotions, is one of the leading design criteria in the Apartheid Museum. How can one create spaces which do not only function as a control for people but rehabilitates and heals.

other buildings

other buildings

four_65

CASE STUDY (TEN) ART AND ARCHITECTURE

The two concepts are inextricably linked.

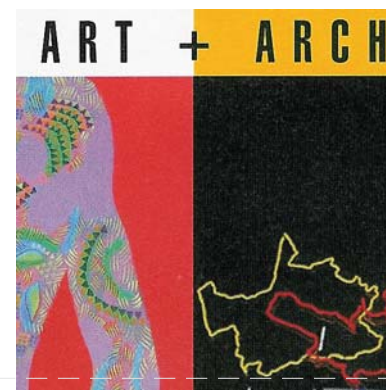

4_10

Baviaanspoort Youth Development Centre

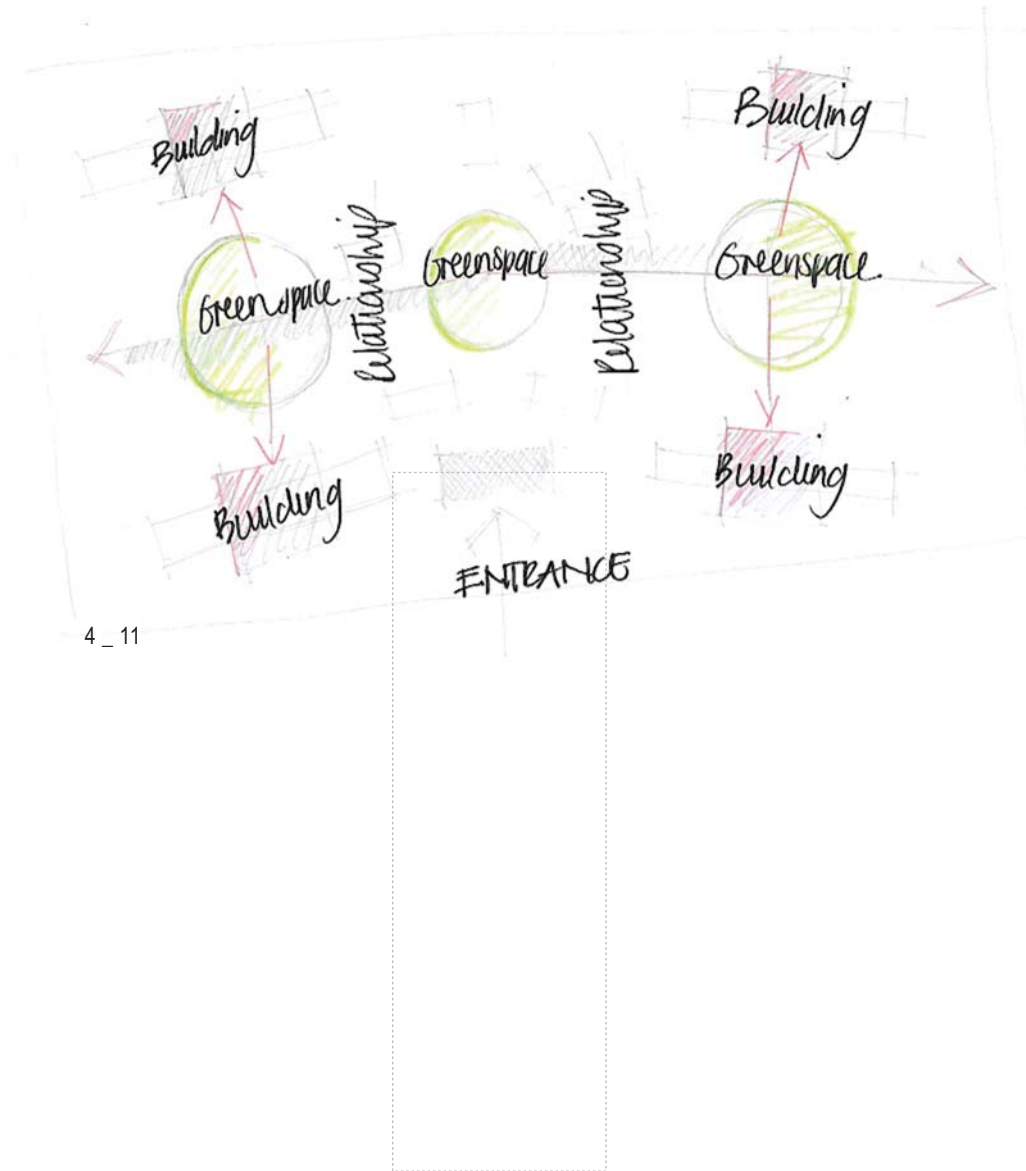



four _ 67

The Clients:

Department of Public Works Pretoria

The Facility:

Baviaanspoort youth prison centre is part of a much larger prison facility to the north of Pretoria. It holds 3000 youth prisoners between the age of 15 and 25 years.

The Design :

The centre is designed around green sports ground which connect the cellular units, creating an interconnection relationship between buildings and green exterior spaces. This in turn defines the human aspect of the design. Place is created through the interconnection between interior and exterior spaces.

New generation prison prototype

Purpose:

Accommodates 3000 prison inmates

Total Floor Area :

30 000m² comprising:

15 000m² for residential purposes (for inmates and support staff) 15 000m² for support facilities (Kitchens, Vocational Training Facilities, Libraries, Educational Facilities etc.)

The Site Area:

the facility is sited on a 400 x 500m piece of ground.

four_69

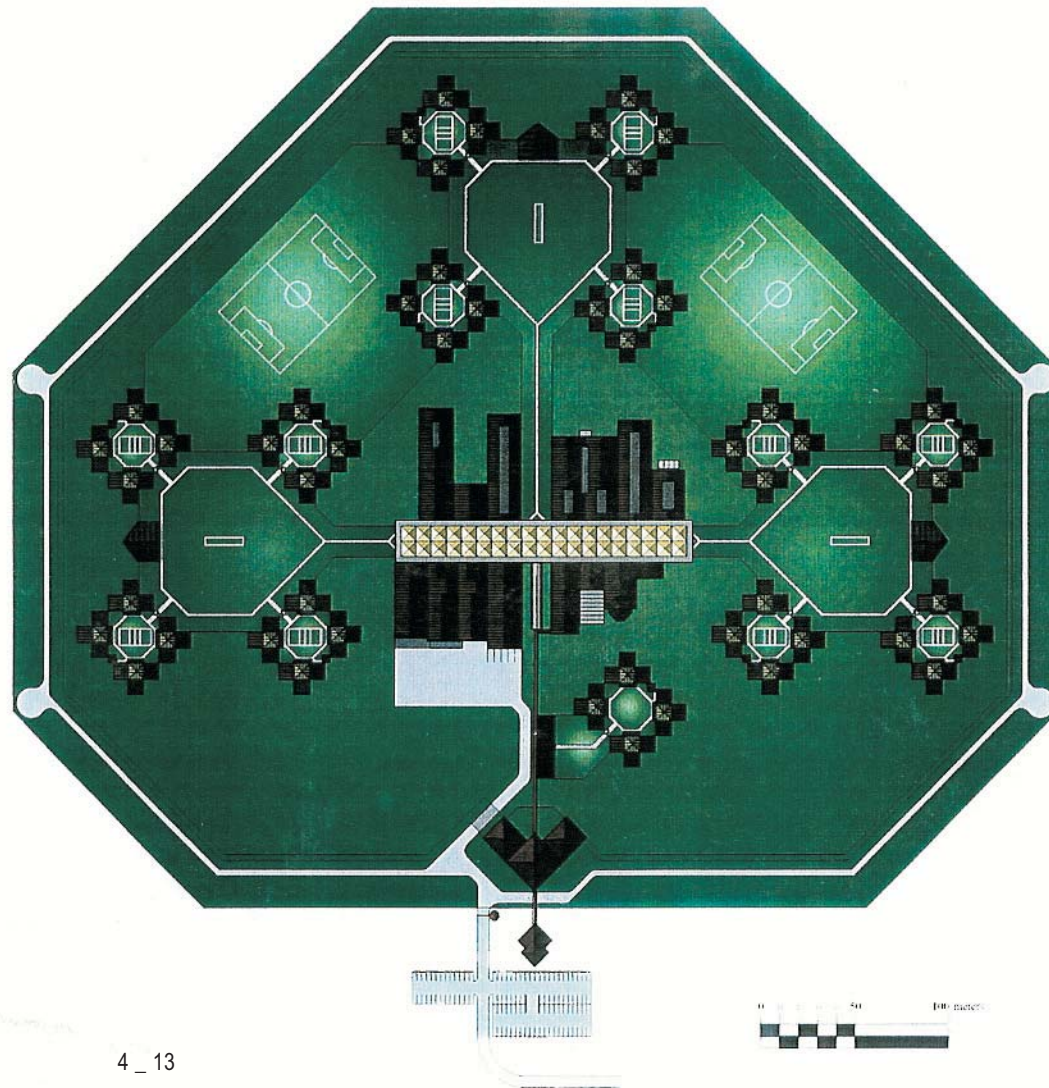

4_13



4_14



4_15

Primary school de Vogels, Oegstgeest, the Netherlands

By Herman Hertzberger

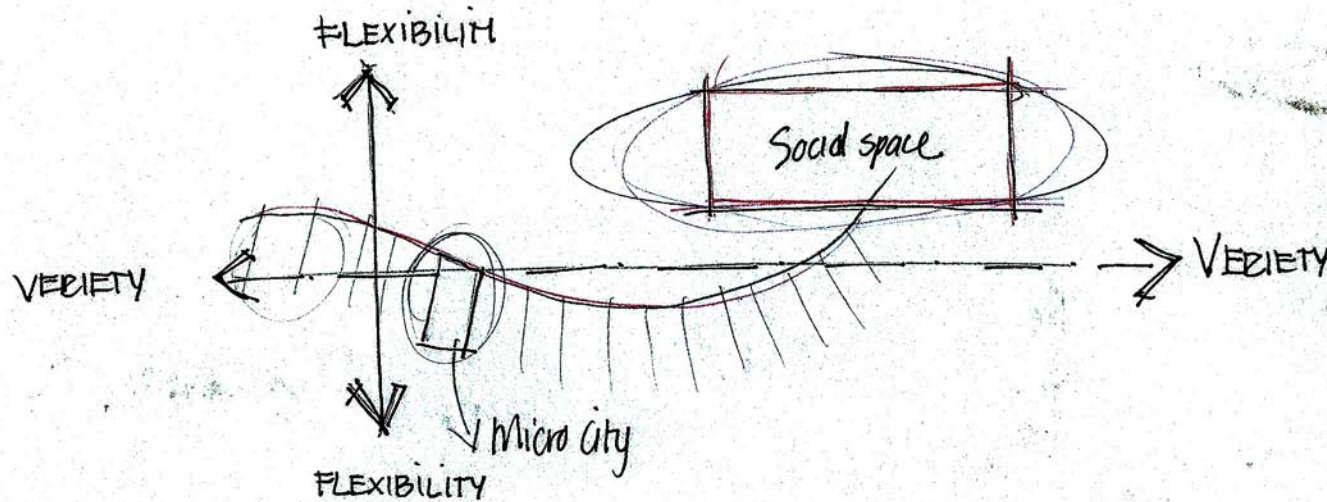

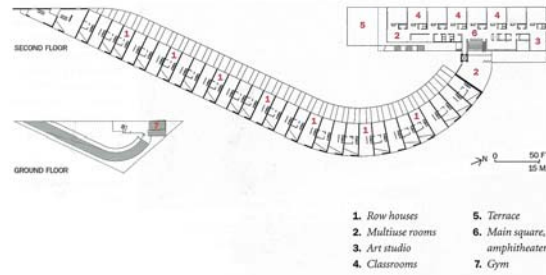

4 _ 17



4 _ 18

four _ 71

Defying conventional wisdom, Hertzberger raised the class rooms into the air “so that the houses have views uninterrupted by the school and the school looks out over the houses” The strategy also created needed outdoor play areas. The entire building was designed as to become a big social space.

The interiors are designed to breakdown the rigidity of a conventional school plan. He tried to make every classroom a micro-city. Hertzberger notes that the variety and flexibility of spaces is particularly important for the different learning needs of children from different backgrounds in the school.

Hertzberger is flexible in his approach to design. “I try to let the program develop possibilities for adjustment; to make a form like an umbrella, where different things can happen underneath.”

The building is not a monumental, finished object but the gesture of a roof under which there is more liberty and openness.

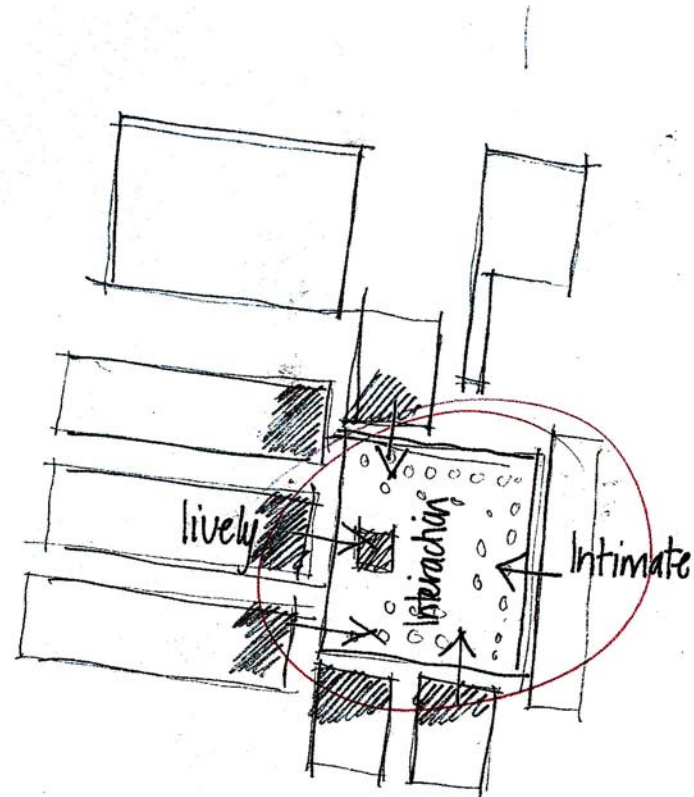

4_19

Ann Richards middle school,
La Joya, Texas



4_20



4_21



4_22

- | | |
|---------------|----------------------------|
| 1. Gym | 6. Library |
| 2. Classrooms | 7. Administration |
| 3. Music room | 8. Orchestra, choir, dance |
| 4. Cafeteria | 9. Computer, art, theater |

four_73

The heart of the school is a large open plaza, similar to those in the small Mexican towns from which many La Joya residents come. It is paved in concrete bricks, with a grid of live oak trees and a small pavilion or kiosk, for festivals and performances. The plaza is the social and cultural center of the school, where students mingle between classes and return in the evenings and on weekends for special events. The architectural showpiece is the library, with its cracked tile walls and 20-foot hyperbolic paraboloid roof that rests on a single Mayan-style column in the center of the room.

La Joya needed a place that was intimate, lively, and welcoming and the school is all of that a source of pride and pleasure along a shifting cultural fault line.

As the central theme of the school is art, it is resembled in the school's design. The most visibly compelling part of the building, a two story wall of glass tiles designed by noted sculptor Ned Smyth. It overlooks the prominent grand entrance.

Illuminated at night and prominently visible to the community through the glazed wall, it fronts Sutter avenue, one of the main arteries in Brownville. the playground and social areas of the school open onto the street bringing in more life into the school. The clients requirements were security screening over the windows at the first floor level.

P.S. 156, I.S. 293, Brooklyn, New York

By Mitchell/Giurgola Architects

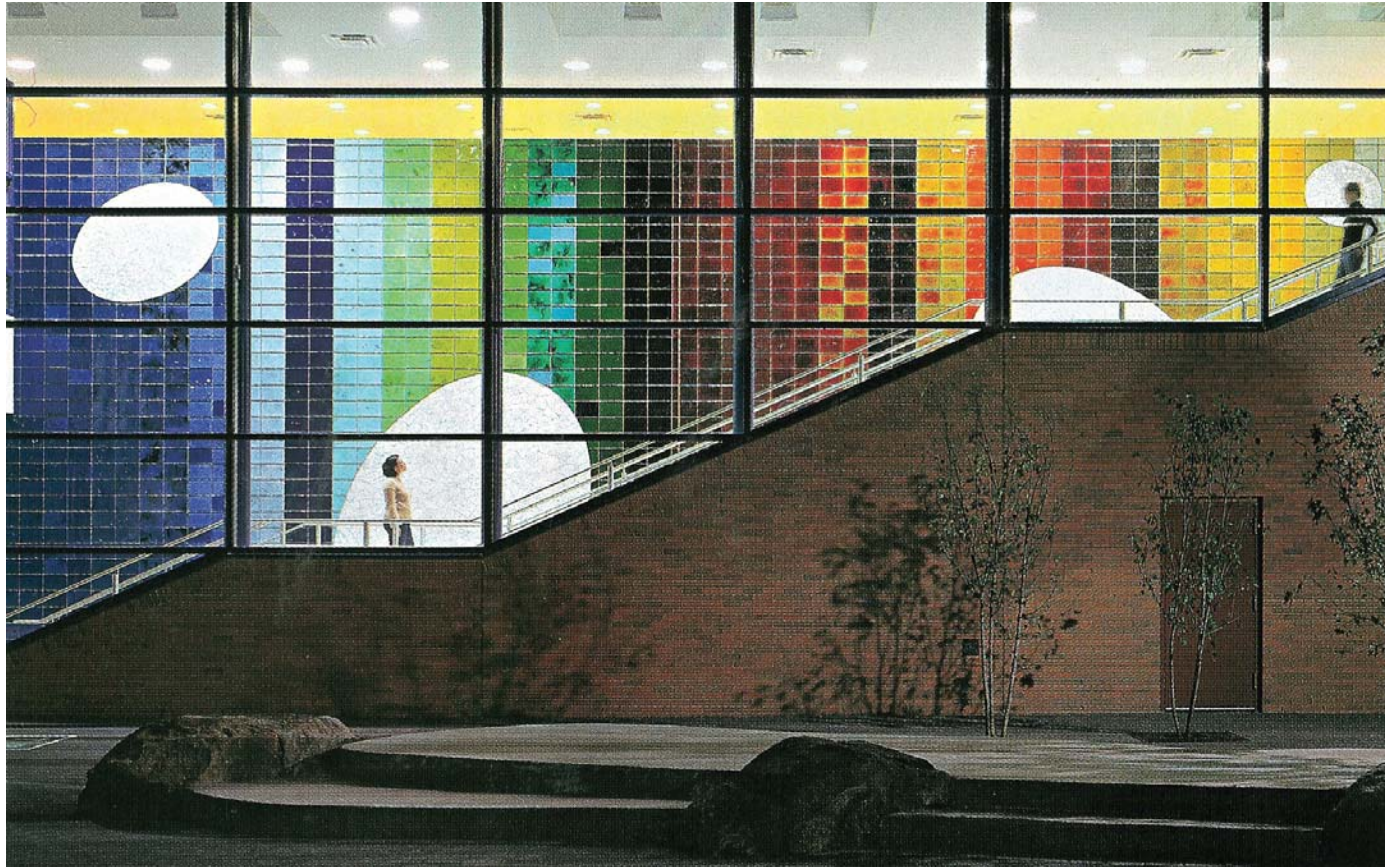

four _ 75

4 _ 23

“frequently other schools used expanded wire mesh, which has somewhat of a prisonlike association”

Wesbank is a RDP housing area developed five years ago to alleviate the proliferation of back yard shacks from communities all over Cape Town area. As a result, a totally new community – encompassing people from all walks of life – have taken up residence there.

The site is in Kuilsriver and is a square piece of reclaimed dune, situated along Wesbank road at the centre of the first phase of the building of 5000 RDP houses. The main access is from Wesbank road while the parking area and main entrance to the school form an urban presence on the road.

The school has been designed to provide public infrastructure as well as a learning environment. The environment copes with 1200 learners at a time as well as offering diversity in the space provided.

The overall concept of the facility is that of a medieval city, surrounded by a moat for defence. This has been the precise aim of the design to pull the buildings away from the edges of the site and establish a learning village. The public areas, namely the multipurpose hall, library, computer centre and kitchen can be totally isolated from the rest of the school. The external courtyards between the class rooms allow for external play areas during break. Five different outdoor activity areas were created.

New Wesbank Primary School, Kuilsriver, Capetown

By C S Studio Architects

Irregular walkways form undercover, screened play areas – a necessity for cold, rainy days and during the heat of the summer months. The walk ways become intermediate spaces, not only to facilitate circulation but to enhance interaction between students and create protective spaces during break periods.

The construction techniques and building materials were chosen to be labour-intensive, conventional, vandal-proof and low-maintenance. Face brick, aluminium sliding windows with galvanized metal screens for security and layers of fencing and walls have been introduced to make the school secure.

four_77



4_24

4_25

- A Classroom block
- B Classroom block
- C Classroom block
- D Classroom block
- E Classroom block
- F Classroom block
- G Classroom block
- H Classroom block
- J Classroom block
- K Multi-purpose hall
- L Admin block
- M Toilet block
- N Educational courtyard
- O Playground
- P Sports courts



4_26



4_27

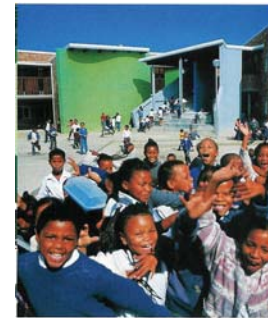

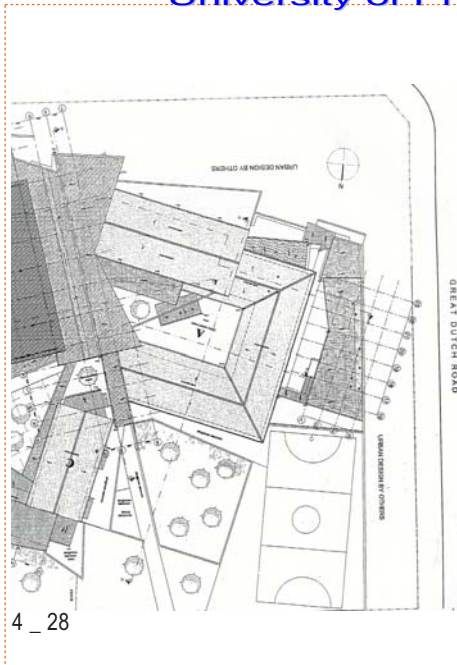

4_28

The aim of the project was to deconstruct an apartheid notion of a community centre – an old, rundown government facility- into a vibrant place with civic scale for multipurpose use. The building had to accommodate a range of different special requirements as the demand for space in Nyanga is great, space for recreation was minimal.

The notion of in-between space and the streets in the township provided a rich new architectural special typology, one that allows for space in which to circulate and where people do their domestic chores. There is a balance between coexistence of activities. Yet there is also a strong reminder of the harsh social conditions that lead to crime and violence. It is important to recognize this and not be naive about its existence. This facility provides spaces for sitting and chatting, places to have a bite to eat and spaces for children. It is the ability of space to accommodate diversity and allow coexistence that starts transforming the build environment.

The Multi-purpose Centre, Nyanga, Capetown

By C S Studio Architects

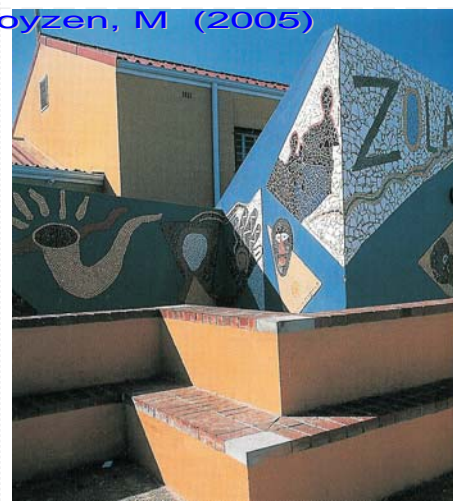

4 _ 29

four _ 79

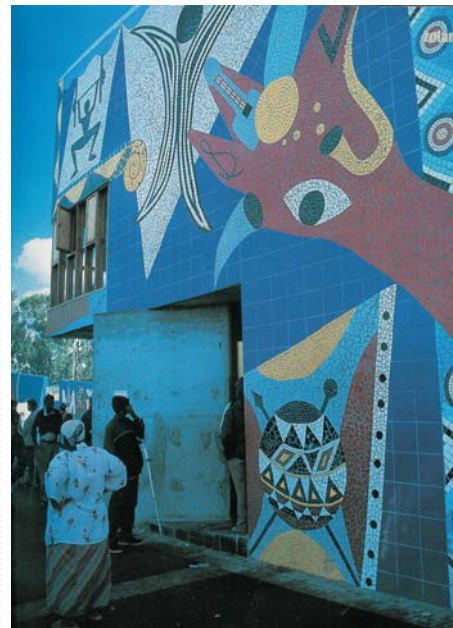

4 _ 30

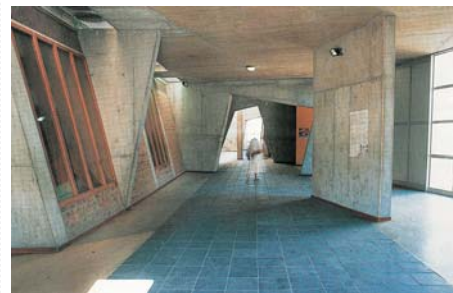

4 _ 31

The Constitutional Court, Johannesburg

By Omm Design Workshop & Urban Solutions



constitutional court

4_32

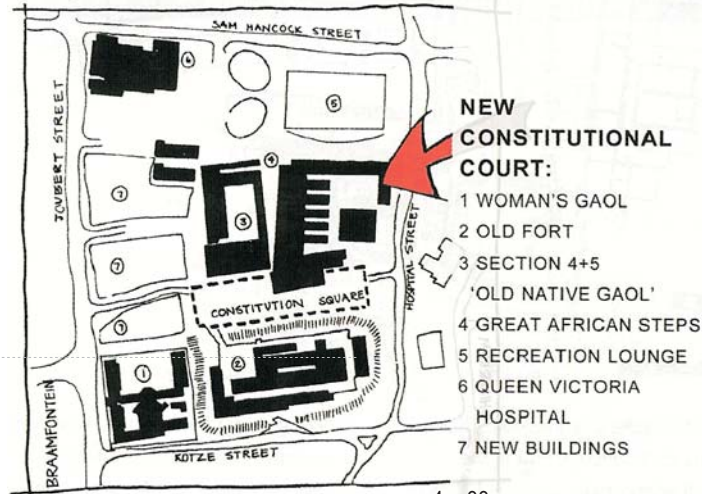

4_33

The gold reef apartheid museum is located on the outskirts of Johannesburg on land reclaimed from a played out gold mine. The museum shows how architectural language might be deployed to create metaphoric spaces of oppression. The notion is that architectural qualities of the spaces act in concert with the content to generate an almost visceral experience of events described in the displays. In the museum up and down movement is used metaphorically.

Ceiling heights is deployed strategically to compress and release the visitors' bodies as they move through. All these dramatic devices are effecting in evoking emotions.



four_81

4_34

Apartheid Museum, Johannesburg

By Mashebane Rose, Sidney Abramovitch, Bannie Brits, Linda Mvusi and Gapp

The aim was to design a building with a sense of heritage, the recognition that people aspire to a better future, and an optimistic view of a world free of oppression that nurtures a dignified human spirit.

The main idea was to re-integrate the previously isolated and impenetrable prison precinct into the Johannesburg city grid. What was closed by Apartheid should be opened. The two most workable north-south and east-west routes across the site were identified. The east-west ones connected Hillbrow to Braamfontein and the north-south ones connected Braamfontein across the site, but to the north.

The establishment of one of the east-west routes necessitated the demolition of the awaiting trial building, a historically important prison building close to the centre of the precinct. The access ways paths resulted in the definition of the site on which we decided to design the buildings.

Light is one of the most important materials used in construction. Concrete steel timber stone and glass are found all-over. They exist as solids and one places them in relation to one another and in space, but light cannot, in itself, be placed. It is there because of the placement of these solids within the context of the unchangeable movement of the sun. The spiritual component shifts like air and affects the way we feel. The materials of the building were chosen not only to do their textural, structural and mechanical jobs, but also to be surfaces onto which light would fall.

four_83



4_35

Art And Architecture,

Andrew Makin And Andrew Vester

It is only through collaboration that it is possible to make beautiful, meaning full things.

Architecture is constantly being influenced by art and artist and so the buildings become and art work in itself.

A building becomes alive with feeling and emotion when art is integrated into the very fabric of the building. In life everything is about memory and association and this needs to be brought into our buildings and spaces where we spend the most part of our day.



four_85

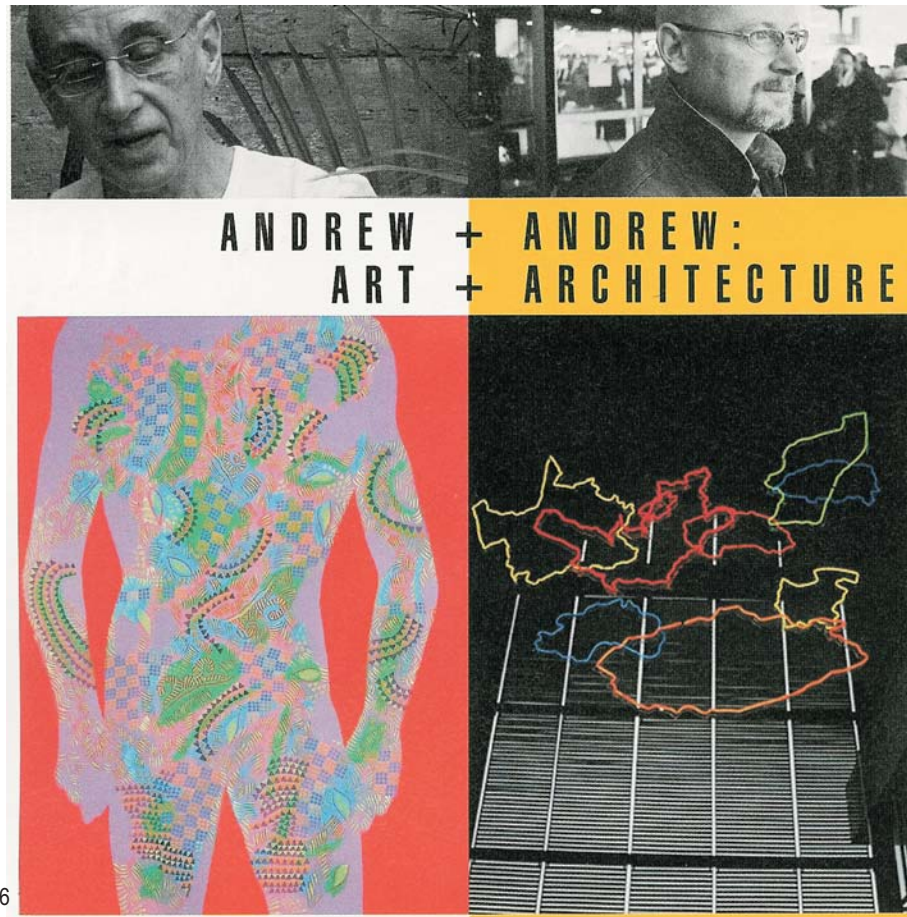

4_36

baseline study

baseline introduction five_86

sustainable site design five_91

sustainable building design five_101

“The biggest problem is that we architects have been using too narrow a balance sheet to evaluate our decisions. That sheet is not complete; it doesn’t include total efficiency and environmental costs. A building may be cheap and pretty, but will it go on to become an environmental and financial burden to those who occupy and maintain it?”

(Randolph Croxton, The Croxton Collaborative Architects)

A sustainable facility should do the following:

- Use land wisely
- Use energy water and materials efficiently
- Enhance human health and well-being
- Be economical to operate
- Promote recycling

Sustainable development is simply about ensuring a better quality of life for every one, now and for generations to come.

Sustainability:

“Development that meets the needs of the present without compromising the ability of future generations to meet their own needs.” (Brundland 1987)

The over arching goals of Sustainable Facility Design are to create buildings that are warm in winter, cool in summer, and comfortably illuminated; that promote the health and well being of occupants; and that are resource efficient to build and operate.

Sustainable (or green) buildings cost about the same as conventional buildings and reduce costs in the long run. For example, increased insulation can reduce the cost of mechanical systems. Smaller mechanical systems can use smaller ducts; smaller ducts can reduce the size of a ceiling cavity, thus reducing the overall size of a building.

The simple decision to increase insulation can have a significant impact on the overall cost of a building if the designer follows the implications of that decision. Another example is choosing energy efficient, high-quality lighting. If lighting quality is good, it requires less energy to provide the same level of visibility. Sustainable buildings are less expensive to heat, cool, and light. Because they use less energy, they produce less pollution. What is more important, sustainable buildings are healthier places in which to work and live.

Sustainable design is the thoughtful integration of architecture with electrical, mechanical, and structural engineering. In addition to concern for the traditional aesthetics of massing, proportion, scale, texture, shadow, and light, the facility design team needs to be concerned with long term costs: environmental, economic, and human.

Sustainable design requires an integrated-systems approach to creating the built environment. In addition to realizing the programmatic goals for the facility, the term A/E should coordinate siting and landscaping decisions; mechanical, electrical, and structural engineering; thermal envelop, daylighting, and fenestration design; materials selection; indoor air quality considerations; and life cycle costs to create a cost effective, energy efficient building.

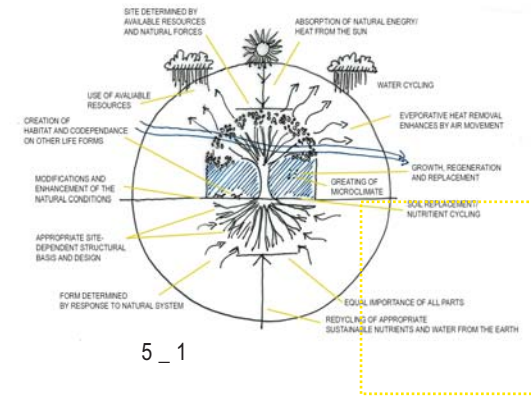

Understanding Place

Sustainable design begins with an intimate understanding of place. If we are sensitive to the nuances of place, we can inhabit without destroying it. Understanding place helps determine design practices such as solar orientation of a building on the site, preservation of the natural environment, and access to public transportation.

Connecting With Nature

Whether the design site is a building in the inner city or in a more natural setting, connecting with nature brings the designed environment back to life. Effective design helps inform us of our place within nature.

Understanding Natural Processes

In nature there is no waste. The by-product of one organism becomes the food for another. In other words, natural systems are made of closed loops. By working with living processes, we respect the needs of all species. Engaging processes that regenerate rather than deplete, we become more alive. Making natural cycles and processes visible this brings the designed environment back to life.

Understanding Environmental Impact

Sustainable design attempts to have an understanding of the environmental impact of the design by evaluating the site, the embodied energy and toxicity of the materials, and the energy efficiency of design, materials and construction techniques. Negative environmental impact can be mitigated through use of sustainably harvested building materials and finishes, materials with low toxicity in manufacturing and installation, and recycling building materials while on the job site.

Embracing Co-creative Design Processes

Sustainable designers are finding it is important to listen to every voice. Collaboration with systems consultants, engineers and other experts happens early in the design process, instead of an afterthought. Designers are also listening to the voices of local communities.

Understanding People

Sustainable design must take into consideration the wide range of cultures, races, religions and habits of the people who are going to be using and inhabiting the built environment. This requires sensitivity and empathy on the needs of the people and the community.

site design

General site design considerations

five_91

Specific site design

five_92

- considerations
- premises
- site access
- road design & construction
- utilities and waste systems
 - night lighting
 - storm drainage
- irrigation systems
- waste treatment

Site-adaptive design

five_97

- considerations
- natural characteristics
- construction process program

Site design is a process of intervention involving the location of circulation, structures, and utilities, and making natural and cultural values available to visitors. The process encompasses many steps from planning to construction, including initial inventory, assessment, alternative analysis, detailed design, and construction procedures and services. Site design requires holistic, ecological based strategies, these strategies should help to repair and restore existing systems.

Recognition of Context

A site cannot be understood and evaluated without looking outward to the site context. Before planning and designing a project, fundamental questions must be asked in light of its impact on the larger community.

Treatment of Landscapes as Interdependent and Interconnected

Typical development increases the fragmentation of the landscape. This results in islands of landscapes, which are surrounded by fabric of development. These landscapes are incapable of supporting a variety of plant communities and habitats. Reconnecting fragmented landscapes and establishing contiguous networks with other natural systems both within a site and beyond

The Integration of the Native Landscape with Development

Areas should be redesigned to support some component of the natural landscape to provide critical connections to adjacent habitats.

Promotion of Bio-diversity

Site design must be directed to protect local plant and animal communities, and new landscape plantings must deliberately re-establish diverse natural habitats in organic patterns that reflect the processes of the site.

Making a Habit of Restoration

As most of the ecosystems are increasingly disturbed, every development project should have a restoration component. When site disturbance is uncontrolled, ecological deterioration accelerates, and natural systems diminish in diversity and complexity. Effective restoration requires recognition of the interdependence of all site factors and must include repair of all site systems soil, water, vegetation, and wildlife.

The Following Considerations Apply to Sustainable Site Design:

- Promote spiritual harmony with, and embody an ethical responsibility to, the native landscape and its resources.
- Plan landscape development according to the surrounding context rather than by overlaying familiar patterns and solutions.
- Do not sacrifice ecological integrity or economic viability in a sustainable development; both are equally important factors in the development process.
- Understand the site as an integrated ecosystem with changes occurring over time in dynamic balance; the impacts of development must be confined within these natural changes.
- Allow simplicity of functions to prevail, while respecting basic human needs of comfort and safety.
- Recognize there is no such thing as waste, only resources out of place.
- Assess feasibility of development in long-term social and environmental costs, not just short-term construction costs.
- Analyse and model water and nutrient cycles prior to development intervention - "First, do no harm."
- Minimize areas of vegetation disturbance, earth grading, and water channel alternation.
- Locate structures to take maximum advantage of passive energy technologies to provide for human comfort.
- Provide space for processing all wastes created on site (collection/recycling facilities, digesters, lagoons, etc.) so that no hazardous or destructive wastes will be released into the environment.
- Determine environmentally safe means of on site energy production and storage in the early stages of site planning.
- Phase development to allow for the monitoring of cumulative environmental impacts of development.
- Allow the natural ecosystem to be self-maintaining to the greatest extent possible.
- Develop facilities to integrate selected maintenance functions such as energy conservation, waste reduction, recycling, and resource conservation into the visitor experience.
- Incorporate indigenous materials and crafts into structures, native plants into landscaping, and local customs into programs and operations.

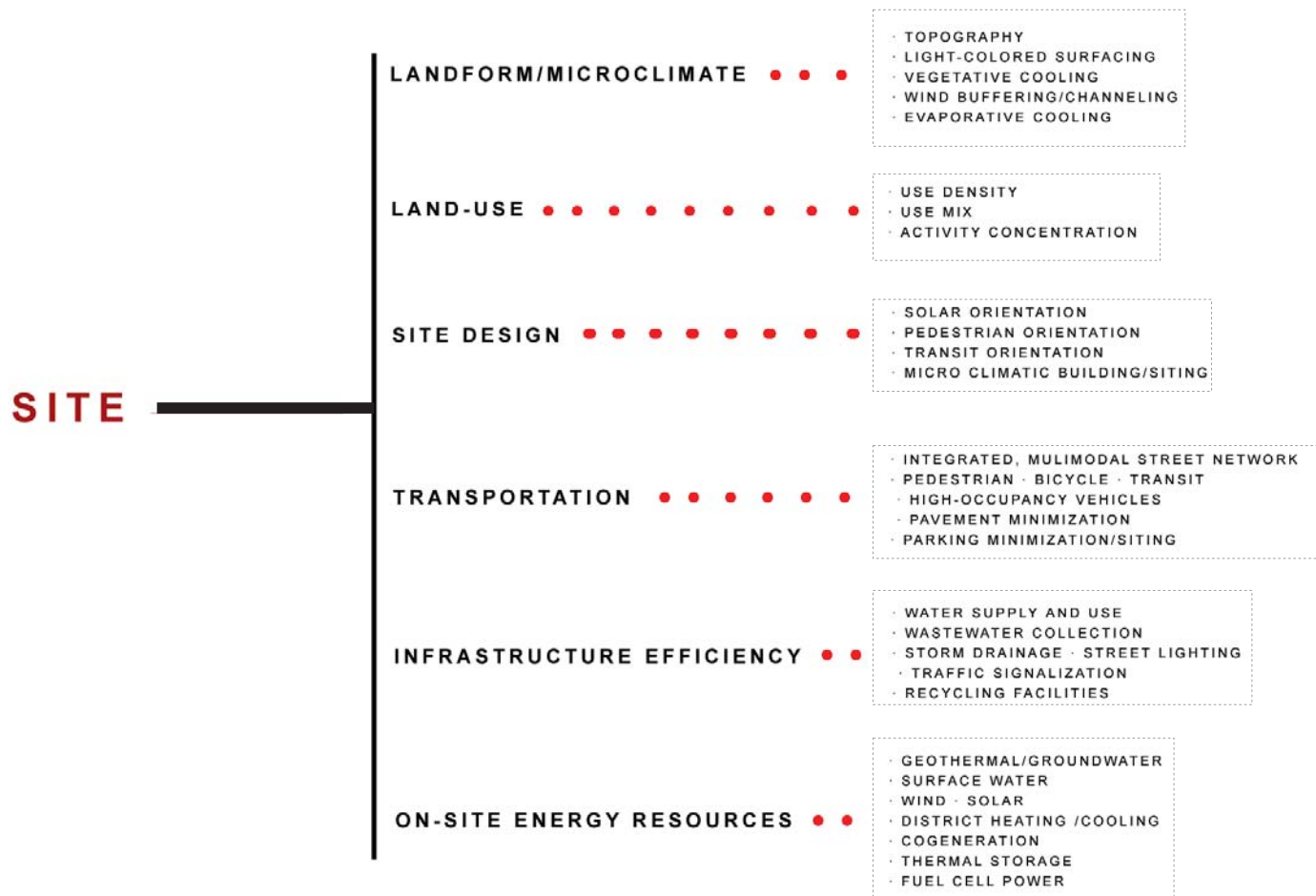

Premises

What makes the site suitable for a prison development? First and foremost, it must be in an area where the prison can draw prisoners. It must be located close to family and friends of the prisoners to enable easy visitation. The site needs to be secure

The site selection process asks a series of questions:

1. Can development impacts on a site be minimized?
2. What inputs (energy, material, labour, products) are necessary to support a development option, and are required inputs available?
3. Can waste outputs (solid waste, sewage effluent, exhaust emissions) be dealt with at acceptable environmental costs?

The programmatic requirements and environmental characteristics of sustainable development will vary greatly, but the following factors should be considered in site selection:

Capacity

Every site has a carrying capacity for structures and human activity. A detailed site analysis should determine this capacity based on the sensitivity of the site resources and the ability of the land to regenerate.

Density

Concentration of structure leaves more undisturbed natural areas.

Climate

The characteristics of certain climates should be considered.

Slopes

Building on steep slopes predominantly require special siting of structures and costly construction practices. Building on slopes can lead to soil erosion, loss of hillside vegetation and damage to fragile ecosystems.

Vegetation

It is important to maintain as much of the natural vegetation as possible to secure integrated site design.

Site Access

Site access refers to the means of physically entering a sustainable development.

Road design & Construction

A curvilinear alignment should be designed to flow with the topography and add visual interest; crossing unstable slopes should be avoided.

Steep grades should be used as needed to lay road lightly on the ground, and retaining walls should be included on cut slopes to ensure long-term slope stability. The road should have low design speeds (with more and tighter curves) and a narrower width to minimize cut-and-fill disturbance. Over engineering of roads should be avoided

Many soils are highly susceptible to erosion. Vegetation clearing on the road shoulders should be minimized to limit erosion impacts and retain the benefits of greenery. All fill slopes should be stabilized and walls provided in cut sections where needed. Exposed soils should be immediately replanted and mulched. Paved ditches are frequently used to stem erosion along steep road gradients.

Utilities and Waste Systems

With the development of a site comes the need for some level of utility systems. Even the smallest human habitat requires sanitary facilities for human waste and provisions for water. More elaborate developments have extensive systems to provide electricity, gas, heating, cooling, ventilation, and storm drainage. The provision of these services and the appurtenances associated with them sometimes create substantial impacts on the landscape and the functioning of the natural ecosystem. Sustainable site planning and design principles must be applied early in the planning process to assist in selecting systems that will not adversely affect the environment and will work within established natural systems.

Night Lighting

Night lighting should be efficient in accordance with the percentage of lux needed in a prison facility.

Storm Drainage

In undisturbed landscapes, storm drainage is typically handled by vegetation canopy, ground cover plants, soil absorption, and streams and waterways.

The main principles in storm drainage control are to regulate runoff to provide protection from soil erosion and avoid directing water into unmanageable volumes. Removal of natural vegetation, topsoil, and natural channels that provide natural drainage control should always be avoided. An alternative would be to try and stabilize soils, capture runoff in depressions (to help recharge ground water supply), and re-vegetate areas to replicate natural drainage systems.

Irrigation Systems

Low volume irrigation systems are appropriate in most areas as a temporary method to help restore previously disturbed areas or as a means to support local agriculture and native traditions. Captured rainwater, recycled grey water, or treated effluent could be used as irrigation water.

The concept of sustainability suggests an approach to the relationship of site components that is somewhat different from conventional site design. With a sustainable approach, site components defer to the character of the landscape they occupy so that the experience of the landscape will be paramount. More ecological knowledge is at the core of sustainable design. Instead of human functional needs driving the site design, site components respond to the indigenous spatial character, climate, topography, soils, and vegetation as well as compatibility with the existing cultural context. For example, all facilities would conform to constraints of existing land forms and tree locations, and the character of existing landscape will be largely maintained. Natural buffers and openings for privacy are used rather than artificially produced through planting and clearing.

Natural Characteristics

The greatest challenge in achieving sustainable site design is to realize that much can be learned from nature. When nature is incorporated into designs, spaces can be more comfortable, interesting, and efficient. It is important to understand natural systems and the way they interrelate in order to work within these constraints with the least amount of environmental impact. Like nature, design should not be static but always evolving and adapting to interact more intimately with its surroundings.

Wind

The major advantage of wind in development is its cooling aspect.

Sun

Where sun is abundant, it is imperative to provide shade for human comfort and safety in activity areas (e.g., pathways, patios). The most economical and practical way is to use natural vegetation, slope aspects, or introduced shade structures. The need for natural light in indoor spaces and solar energy are important considerations to save energy and showcase environmental responsive solutions.

Rainfall

Many settings must import water, which substantially increases energy use and operating costs, and makes conservation of water important. Rainfall should be captured for a variety of uses (e.g. drinking, bathing) and this water reused for secondary purposes (e.g., flushing toilets, washing clothes). Waste water or excess runoff from developed areas should be channelled and discharged in ways that allow for ground water recharge instead of soil erosion. Minimizing disturbance to soils and vegetation and keeping development away from natural drainage ways protect the environment as well as the structure.

Topography

In many areas, flatland is at a premium and should be set aside for agricultural uses. This leaves only slopes upon which to build. Slopes do not have to be an insurmountable site constraint if innovative design solutions and sound construction techniques are applied. Topography can potentially provide vertical separation and more privacy for individual structures. Changes in topography can also enhance and vary the way a visitor experiences the site by changing intimacy or familiarity

Geology and Soils

Designing with geologic features such as rock outcrops can enhance the sense of place. For example, integrating rocks into the design of a deck or boardwalk brings the visitor in direct contact with the resource and the uniqueness of a place. Soil disturbances should be kept to a minimum to avoid erosion of fragile tropical soils and discourage growth of exotic plants. If limited soil disturbance must take place, a continuous cover over disturbed soils with erosion control netting should always be maintained.

Construction Process Program

This required program will be a primer for developers, construction contractors, and maintenance workers. The plan covers materials, methods, testing, and options. A careful organization and sequencing of construction is emphasized. Examples include building walkways first, then using them as access to the site. Also it is important to plan material staging for areas in conjunction with future facilities. A knowledgeable construction supervisor must be involved, and all new construction methods should be tested in a prototypical first phase. Maintenance and operations staff should also be involved in this construction program and should participate in the development of an operations manual.

foto Alberto Menelli

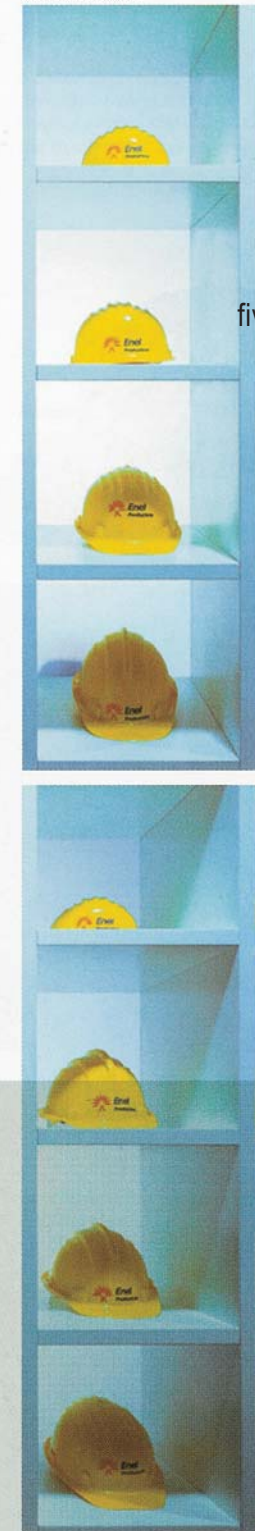

five _ 97

building design

schedule of accommodation

five_101

target setting

five_104

social issues

five_108

inclusive environments
access to facilities
participation,
control & occupant comfort
functions with in structure
education, health and safety

economic issues

five_126

local economy
efficiency of use
adaptability and flexibility
ongoing costs

environmental issues

five_130

water
energy
ventilation systems
lighting systems
cooling systems
heating systems
recycling and reuse
materials and components
site

accommodation shedule

ACCOMMODATION SCHEDULE	
FUNCTION	SPACE REQUIRED
PRE-PROCESSING	
WAITING AREA	40m ²
CONTROL ROOM	30m ²
FEMALE WC	15m ²
MALE WC	10m ²
PARAPLEGIC WC	5m ²
PROCESSING AREA & SECURE COUNTER	6m ²
PLAY AREA	20m ²
PUBLIC PARKING	
PARKING BAYS FOR VISITORS	3315m ²
PARKING BAYS FOR STAFF	2380m ²
ADMINISTRATION	
LOBBY AND WAITING AREA	35m ²
OFFICE: HEAD OF PRISON	24m ²
OFFICE: RECEPTIONIST - INCLUDING WAIT AREA	8m ²
OFFICE: ASSISTANT HEAD OF PRISON	15m ²
OFFICE: PERSONNEL MANAGEMENT	15m ²
OFFICE: PERSONNEL ADMIN & REGISTRATION	20m ²
MAIL ROOM	10m ²
OFFICE: HEAD OF PRISON MANAGEMENT	15m ²
OFFICE: PSYCHOLOGICAL/SOCIAL WORKER	12m ²
FINANCE ADMIN & SERVICES	30m ²
ADMIN SUPPORT AND TYPIST	20m ²
OFFICE: CHAIR OF INSTITUTIONAL COMMITTEE	15m ²
INVESTIGATIONS OFFICER	10m ²
STAFF ABLUTIONS	8m ²
STORE ROOM	6m ²
STAFF REST AND TEA	15m ²
ADMISSIONS	
VEHICULAR SALLY PORT	50m ²
GROUP HOLDINGS ROOM IN	24m ²
INDIVIDUAL HOLDING CELLS	6m ²
GROUP HOLDINGS ROOM OUT	22m ²
STRIP SEARCH ROOM	8m ²
CONTROL ROOM	8m ²
RECORDS ROOM	11m ²
STAFF WC	4m ²
NON-CONTACT VISITING BOOTHS	10m ²
ARCHIVE/DEAD RECORDS STORE ROOM	32m ²
PHOTO ID ROOM	8m ²
INTERVIEW ROOM	12m ²
MEDICAL EXAMINATION ROOM	5m ²
HEAD OF ADMISSIONS	8.5m ²
PRIVATE EFFECTS PROPERTY STORAGE	100m ²
CLOTHES ISSUE	73m ²
WAITING ROOM	23m ²
PROPERTY STORAGE ROOM & VAULT	44m ²
TUCK SHOP & SERVICE CENTRE	59m ²

CENTRAL VISITORS FACILITIES	
Control room	6
Visitors post processing lobby and waiting room	20
Outside visiting yard	15
2 Toilet facilities for visitors: Each 12m ²	24
Contact visiting room	120
30 Non contact visit cubicles: Each 6m ²	180
4 Inmates processing and strip search rooms: Each 3m ²	12
X-ray and metal detector area	8
EDUCATIONAL & VOCATIONAL FACILITY	
Office: Education Supervisor	15m ²
2 Offices: Staff: Each 12m ²	24m ²
Control office	10m ²
Workroom	20m ²
Conference room	30m ²
8 Classrooms: Each 40m ²	320m ²
Library W/Carrels	40m ²
Store room	30m ²
Chapel / multipurpose hall	180m ²
2 Offices: Chaplain: Each 12m ²	24m ²
2 Study rooms: Each 15m ²	30m ²
2 Store rooms: Each 5m ²	10m ²
Staff toilet	4m ²
Inmates toilets	4m ²
Toilet facilities: Inmates	8m ²
Toilet facilities: Personnel	4m ²
3 Shaded exercise areas: Each 280m ²	840m ²
3 Offices: Recr Supervisor: Each 10m ²	30m ²
3 Store rooms: Equipment: Each 6m ²	18m ²
2 Soccer play fields	NAA
3 Outdoor exercise areas	NAA
3 Toilet facilities for inmates: Each 4m ²	12m ²
8 Vocational training and handcraft development rooms: Each 40m ²	320m ²
Toilet facilities: Personnel	4m ²
Toilet facilities: Inmates	8m ²
Office: Voc Train Supervisor	15m ²
2 Offices: Staff: Each 12m ²	24m ²
Control office	10m ²
Work room	20m ²
Conference room	30m ²
Store room for item 14.16b	40m ²

Sense Of Place

The concept known as bioregionalism is based on the idea that all life is established and maintained on a functional community basis and that all of these distinctive communities (bioregions) have mutually supporting life systems that are generally self-sustaining. Human civilization is an integral part of the natural world and is dependent on the preservation of nature for its own perpetuation.

More specifically, sustainable development should have the absolute minimal impact on the local, regional, and global environments. Planners, designers, developers, and operators have an opportunity and a responsibility to protect the sanctity of a place, its people and its spirit

Sustainable design balances human needs (rather than human wants) with the carrying capacity of the natural and cultural environments. It minimizes environmental impacts, importation of goods and energy as well as the generation of waste.

The ideal situation would be that if development was necessary, it would be constructed from natural sustainable materials collected onsite, generate its own energy from renewable sources such as solar or wind, and manage its own waste.

Sustainable design is an ecosystematic approach that demands an understanding of the consequences of our actions. As a tool to understanding this principle, a metaphoric example is drawn using an organism to symbolize functional appropriateness, habitat harmony, and survival based on adaptation and cultivation

The organism makes use of immediately and locally available materials to construct itself, and does so with economy and efficiency. The same strategies when used in development can minimize global and local impacts on resources.

The organism maintains a harmonious relationship with its environment by establishing a balance between its needs and available resources. Similarly, the ecologically sensitive design adjusts demands, lifestyles, and

A Sustainable Building

five _ 103

- Use the building (or non-building) as an educational tool to demonstrate the importance of the environment in sustaining human life
- Reconnect humans with their environment for the spiritual, emotional, and therapeutic benefits that nature provides
- Promote new human values and lifestyles to achieve a more harmonious relationship with local, regional, and global resources and environments
- Increase public awareness about appropriate technologies and the cradle-to-grave energy and waste implications of various building and consumer materials
- Nurture living cultures to perpetuate indigenous responsiveness to, and harmony with, local environmental factors
- Relay cultural and historical understandings of the site with local, regional, and global relationships
- Be subordinate to the ecosystem and cultural context; respect the natural and cultural resources of the site and absolutely minimize the impacts of any development.
- Avoid use of energy intensive, environmentally damaging, waste producing, and/or hazardous materials. Use cradle-to-grave analysis in decision making for materials and construction techniques and renewable indigenous building materials to the greatest extent possible.
- Consider “constructability” . . striving for minimal environmental disruption, resource consumption, and material waste, and identifying opportunities for reuse/recycling of construction debris.
- Allow for future expansion and/or adaptive uses with a minimum of demolition and waste
- Materials and components should be chosen that could be easily reused or recycled.
- Make it easy for the occupants /operators to recycle waste.
- Interpret how development works within natural systems to effect resource protection and human comfort and foster less consumptive lifestyles
- Use the resource as the primary experience of the site and as the primary design determinant
- Enhance appreciation of natural environment and encourage/establish rules of conduct.
- Use the simplest technology appropriate to the functional need, and incorporate passive energy-conserving strategies responsive to the local climate.

target setting

1. Lighting

- Use special sun control devices
- Allow maximum daylight to penetrate the entire building
- Avoid glare
- Block direct sun rays into building
- Daylight - the coolest colour (Security entrances, Exhibition area, Canteen)
- White light - the intermediate colour (entrances, waiting areas)
- Warm light - the warmest colour (non-contact and contact areas to create moods)

2. Ventilation

- Cross ventilation
- Stack ventilation system (Stack-effect)
- Ventilation system (Rock bin-system)
- Flexibility, adaptability
- Openable windows on South facade
- Extractor fans at the top of the stack (Removes excess hot air & creates a negative pressure inside)
- Requires no maintenance and louvre can be closed in winter
- Allows for minimum fresh air supply of 4.72 litres/person

3. Noise & acoustics

- Minimize amount of openings leading from one area into another
- Cavity wall and isolation material, mineral wool
- Allow for acoustic control in visiting area (contact and non-contact) & security boxes



4. Disabled

- WC compartments for the disabled
- Requirements for handrailings and support
- Ramps and access to and from the building
- Ramps to fall @ 1:12 or lifts
- Edges - between walls and floors well defined

5. Security

- Highest possible level of security
- Security staff on site as well as in building
- Entrances and exist and control points all checked by electronic detection device
- External windows and doors are all protected from external and internal vandalism and illegal entry and exit
- “Camera eyes” 24 hour activated at all possible hiding places and movement areas
- Entire site is surrounded by a double fence, a 4.6 meter Bekaert Bastion high security fence and a taut wire detection system
- Only one vehicle entrance to entire site
- Vehicle control sally port system and security staff at the entrance
- Sufficient highting must be supplied at these points

6. Fire regulations

- No smoking inside the building
- Fire escapes according to SABS 0400
- Sufficient outside space provided
- Escape routs in case of fire will not exceed the maximum of 45m²
- 8 exits doors for the visitors centre the width of the door not beeing less than 800mm
- SABS 0400: TT16.2 & TT17.1
- Two escape routs minimum at a width not less than 800mm
- Stairs in canteen area will have a max rise of 200mm and tread minimum 250mm, hand railings 900mm high
- Fire extinguishers will be provided on every level and every excluded area. (exhibition area, canteen, contact visiting area, non-contact visiting inmate side and visitor side and security box (control facility)
- Smoke exhaust fans provided in the building.

target setting

7. Vertical dimension

- Main structural system are concrete walls, maximum span is 6m
- 170mm floor slab, the height varies according to different spaces from 3000mm to 7000mm (double volumes)
- 200mm concrete roof slab carrying a green roof system

8. Water

- 30% of the rainwater from the green roof system is harvested and stored and reused
- 53m³ water/month harvest (1230m²x0.65x0.9)
- Water for the usage of fire fighting is available from the Green reservoir @ a pressure of 500Kpa
- The Green reservoir has the capacity for storing 14 days of water requirements

The
Intelligent
Use of Water™

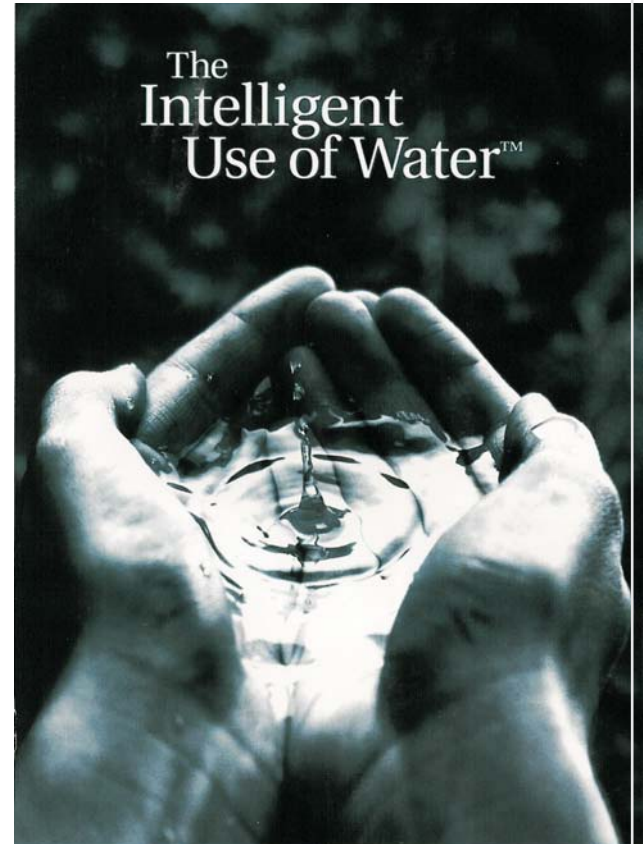

social issues - inclusive environments

An essential criterion for a sustainable development is that the building is designed to accommodate everyone otherwise specially designed buildings need to be provided. Ensuring that buildings are inclusive, supports sustainability as replication is avoided and “change of use” supported. (Gibberd, 2000: SBAT)

Criteria:

Approach

Distance from communities

Public transport

Public access

Youth prison facility

Routes

Edges

Change in levels

Ablutions

When the site for the youth prison facility was chosen it was clear that the public transport route (which carry mainly taxis and cars) to the northwest of the site was main connection to the site from the north as well as from the south.

The staff as well as the visitors to the facility rely dominantly on public transport (taxis) to and from the facility.

The taxis stop is at the main entrance of the main Leeuwkop Prison Facility. Pedestrians access at the main entrance from where they are then transported by shuttle to the youth prison facility which is 5Km away.

Private vehicle access to the main leeuwkop prison ground is allowed and parking is allocated outside the Youth Prison Facility for staff as well as visitors.

Disabled people are adaptable and often because of necessity extremely determined to manage for themselves in buildings for able-bodied people.

For ambulant disabled people, it is mostly easier to move around a building which does not have a disabled environment. For wheelchairs users it is a more serious problem for if areas are not accessible by a wheelchair, the user is prohibited from entering. Unlike other disabled people, who can make their way through existing architecture, wheelchair users need spacial environmental safety measures, and certain architectural elements have to be provided for them.

five _ 109



5_4

design requirements

Walls

1. Rough walls can cause hand abrasions
2. Textures are useful in identification and creating interest and can help with orientation.
3. Objects projecting from walls should be kept to a minimum.

Floors

1. Steps and curbs should be eliminated. Maximum threshold or curb height is 2.5cm.
2. No scatter rugs and mats.
3. Floor gratings may interfere with wheel travel.
4. Slippery floor should not be used.

Doors

1. Sliding doors are an obstacle to a wheelchair user unless they are automatic and have no obstructing track
2. Revolving doors may not be used.
3. A spacing of 198.1cm between two sets of doors (one set behind the other) avoids a wheelchair trap.
4. Doors must be easy to open. The maximum force is 3.6kg.
5. Lever handles on all doors and water facets are preferred.
6. Automatic doors are the preferable.
7. Kick plates must be 40.6cm high for wheelchair users; they are normally 33cm high.
8. Door widths must have a 81.cm minimum clear opening.
9. Bathroom doors must swing outwards but be placed so that they do not interfere with traffic

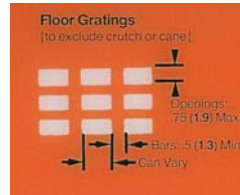

5_5



5_6

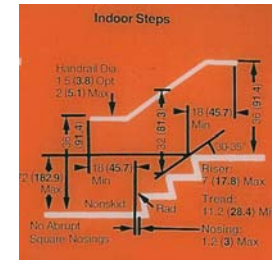

5_7

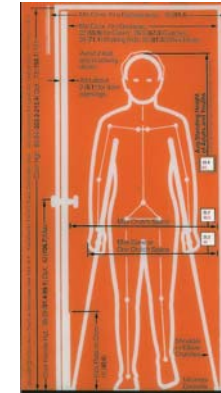

5_8

five_111

design requirements

Space

1. Wheelchair parking space is required in theatres, auditoriums, stadiums, prisons and other public gathering places.
2. Increased aisle space and parking space is required in cafeterias, restaurants, and libraries.
3. Public toilet stalls, and phone booths need to be large enough to accommodate a wheelchair.
4. For the blind brail can be used. But only 10% of blind people know brail.
5. Space should be uncluttered for the use of blind people, and should be organized in grid patterns.
6. Visual signals and displays can be used to reinforce audible signals red lights along with a fire alarm.
7. Good illumination facilitates lip reading.

Reach

1. Phones, drinking fountains, vending machines, light switches, and fire alarms must be within easy reach. The handy reach zone is 91.4 - 121.9cm, measured from the floor.

Walkways and ramps

1. The maximum recommended grade for walkways is 3%.
2. Walkways with a 3% grade requires rest areas. The minimum width is 121.9cm.
3. Ramps generally have a 5 - 8% grade. They require rest areas every 9.1m, restricting curbs 5.1cm high, and handrails on both sides.
4. The maximum grade for ramps is 8 - 10%. Such as ramps require rest areas every 4.6m restricting curbs 76.2cm apart, and handrails on both sides.
5. rest platforms have a minimum length of 137.2cm.
6. handrails on stairs should have horizontal extensions at the top and bottom or be knurled at the ends to indicate the last step.
7. ramps should be textured to provide a non skid surface.
8. Stairs are better for crutch users than long ramps

five _ 113

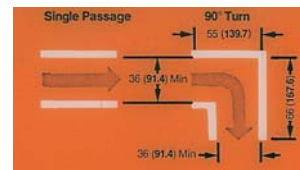

5_9

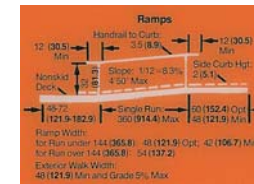

5_10

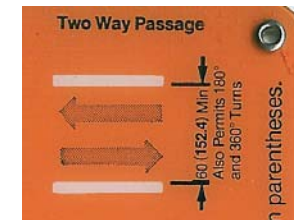

5_11

design requirements

Bathrooms

1. A 360deg turning circle is desirable in a bathroom; an 180deg turn is acceptable and requires a space of 152.4cm².
2. Lavatory height from the rim to the floor is 82.6cm maximum.
3. Lavatory bowl depth over 15.2cm interferes with leg room.
4. The maximum knee well width under the lavatory is 71.1cm.
5. Pedestals and leg supports on lavatories should be avoided. Counters or wall mountings are preferred.
6. Exposed drain and hot water pipes must be isolated.
7. Bath height is 40.6cm minimum, 48.3cm maximum.
8. An adjoining tub seat is 45.7cm wide, sloping to drain.
9. Nonskid material should be provided for the bath bottom.
10. No slip grab bars are necessary as assists near the bath and toilets.

Showers

1. Shower stalls are 91.4cm² for wheelchair users.
2. A folding seat should be hinged on the side wall opposite the shower head.
3. The seat size is 35.6 x 91.4cm and is 48.3cm high.
4. Horizontal grab bars are recommended along the three sides of the stall 83.8 cm above the floor.
5. Water controls and soap trays should be 106.7 cm above the floor.
6. Shower curd height is 5.1cm maximum.

Furniture

1. Surroundings should be pleasant, not institutional looking.
2. Special consideration should be given to shelves and storage areas to acknowledge the limited reach in all directions due to the wheelchair dimensions.
3. Tables must be clear armrests.
4. Clearance must be provided for the hand while operating the driving rims.
5. Increased toe space must be provided.
6. Access spaces are needed around the bed. Allow 137.2cm between bed and furniture and 121,9cm at the foot of the bed.
7. Furniture should be steady and sturdy with well rounded edges and corners.

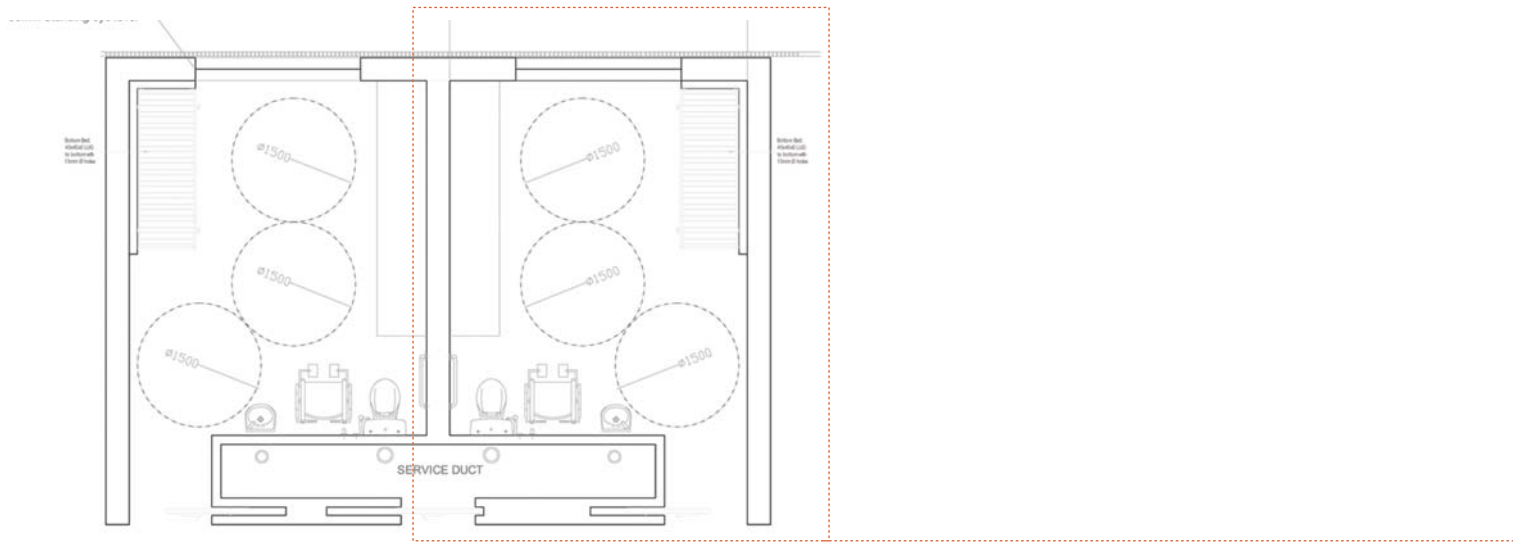

5_15

Accommodation units and Ablution facilities are designed according to SABS0400: Part S. There are very few steps in the Youth Prison Facility, where there are steps such as in the contact visiting area, there is a ramp which caters for the disabled with a 1:12 fall. Access to all facilities is easy, edges between walls and floors are well defined and clearly marked

The proposed conceptual youth prison facility, Convention living and working patterns of the average South African, It requires regular access to a range of services. Ensuring that these services can be accessed easily and in environmentally friendly ways, supports sustainability by increasing efficiency and reducing environmental impact.

(Gibberd, 2000: SBAT)

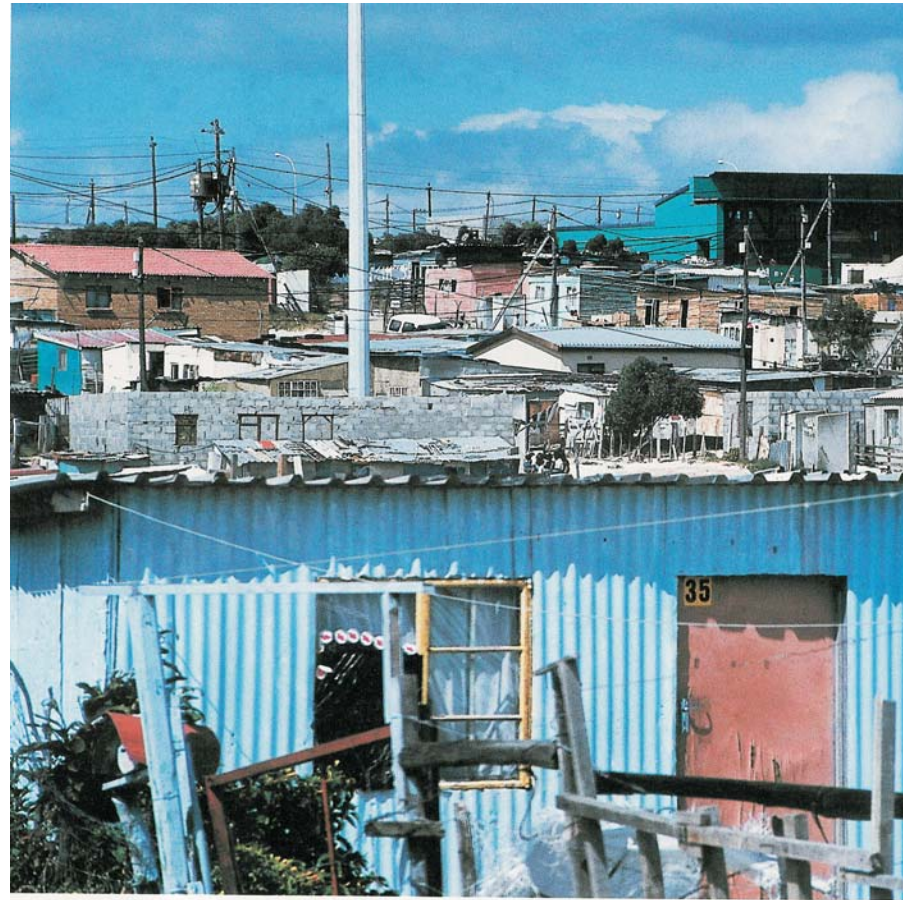

social issues - access to facilities

The proposed conceptual youth prison facility, Convention living and working patterns of the average South African, It requires regular access to a range of services. Ensuring that these services can be accessed easily and in environmentally friendly ways, supports sustainability by increasing efficiency and reducing environmental impact.

(Gibberd, 2000: SBAT)

Childcare

Childcare provided in building or close by (within 3km)

Banking

Banking services close by (within 3km)

Retail

Grocery, items required on a day to day basis available in building or close by (within 3km)

Communication

Postal, telephone or email facilities provided in the building or close by (within 3km)

Residential

Home, for occupants of the building is within 2km.

All of these facilities are located in the Leeuwkop residential village 2km in distance from the Youth Prison facility

five _ 121

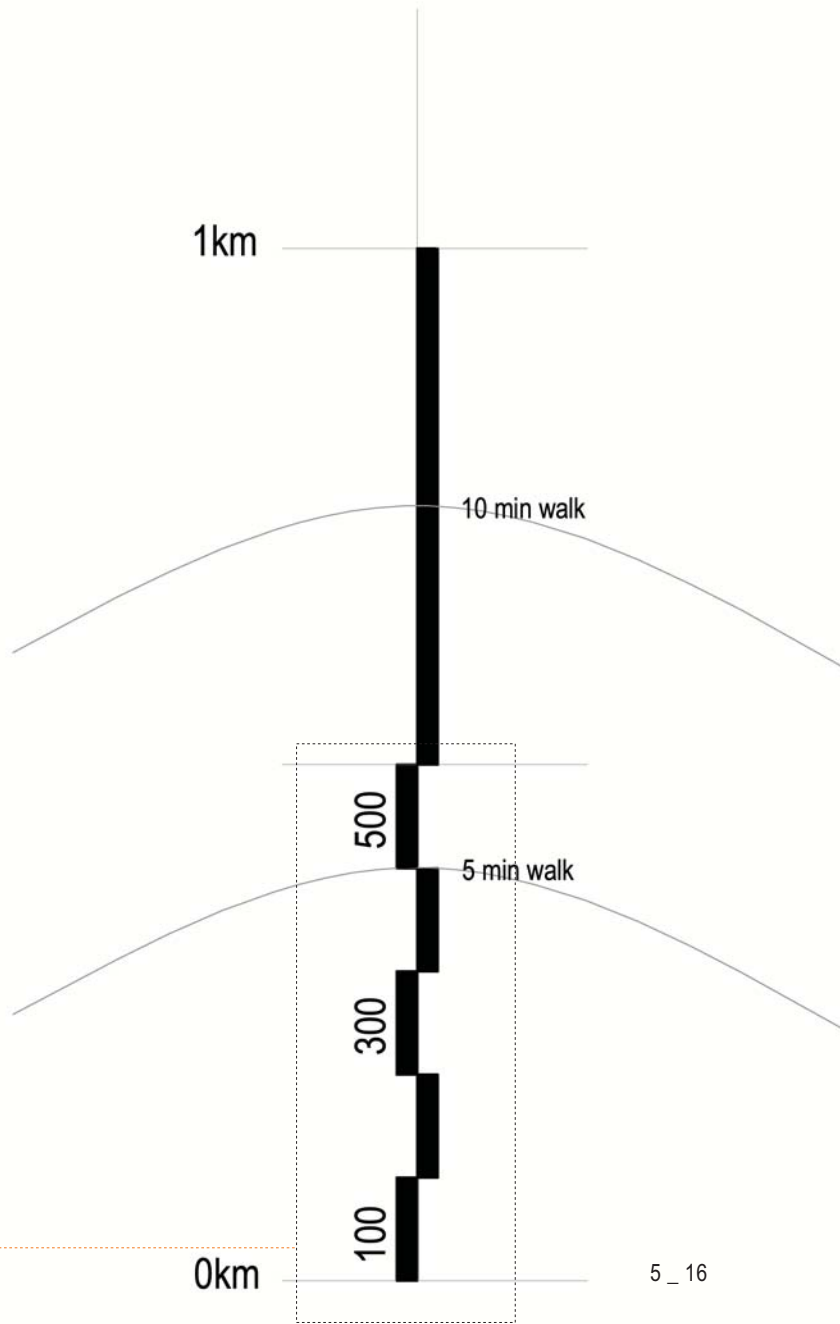

5 _ 16

Within the conceptual design of the Youth prison facility it is important to ensuring that users participate in decisions about their environment helps ensure that they care for and manage this properly. Control over aspects of their local environment enables personal satisfaction and comfort. Both of these support sustainability by promoting proper management of buildings and increasing productivity.

(Gibberd, 2000: SBAT)

social issues - participation & control

Within the conceptual design of the Youth prison facility it is important to ensuring that users participate in decisions about their environment helps ensure that they care for and manage this properly. Control over aspects of their local environment enables personal satisfaction and comfort. Both of these support sustainability by promoting proper management of buildings and increasing productivity.
(Gibberd, 2000: SBAT)

Environmental control

Users of building have reasonable control over their environmental conditions; this should include opening windows and adjustable blinds

User adaptation

Furniture and fittings i.e. tables, chairs, internal partitions designed or specified allow arrangement/rearrangement by user. Provision made for personalisation of spaces if desired. This may include provision for pin boards, choice of colours, places for plants and personal storage. In the areas where prison inmates are, furniture and fittings will be vandal proof and to a certain extent adaptable

Social spaces

Design for easy informal / formal social interaction. This could involve a tea room with comfortable seating. Seating provided along regularly used routes. Spaces shared between occupants/users (i.e. photocopying rooms etc.) large enough to allow for comfortable social interaction. These spaces will allow for interaction between staff, inmates and visitors. (i.e. contact visiting area and the exhibition area)

Amenity

Easy access to refreshment facilities (tea point, kitchen, vending machines, canteens), green spaces and WCs for all users of the building,

Community Involvement

The community should be involved to a certain extent with supporting the youth prison facility, by funding sport functions, exhibitions and concerts. A shop will be allocated in the Leeuwkop residential village where fresh produce and articles made by the prisoners will be sold to the community.

Education, Health and Safety

Buildings need to cater for the well being, development and safety of the people that use them. Awareness and environments that promote health can help reduce the incidence of diseases such as AIDS. Safe environments and first aid can help limit the incidence of accidents and where these occur, reduce the effect. Learning and access to information is increasingly seen as a requirement of a competitive work force. All of these factors contribute to sustainability by helping ensure that people remain healthy and economically active, thus reducing the 'costs' (to society, the environment and the economy) of unemployment and ill health. (Gibberd, 2000: SBAT)

social issues - participation & control

Education

The Youth prison facility assist in assuring that the environment in which the staff, inmates and visitors find themselves in offer support for learning, through the possibility of internet access, structured courses for the staff, inmates, visitors and the community, reading material such as books, journals and newspapers. (The Star newspaper delivers newspapers to the education centre every morning)

Health

First aid kit provided in a central location. Policy to ensure that this can be used effectively. Information readily available on health, education, and career development issues. This could be in the form of a well serviced notice boards located in a central position.

Smoking

No smoking in public spaces, Space allocated for smoking where it will not affect other users, i.e. away from air intakes etc.

Security/Safety

Building complies with all health and safety requirements. Policy/regular checks in place to ensure that these are complied with.

The security and the safety of the staff, inmates and visitors are of great importance. Measures are taken to ensure that the transition from one secure area in to another is well managed and supervised, walkways, corridors and rooms are well lit, the risk of illegally breaking in or out of a building is minimized through designing openings and details in such a way as to prevent it from occurring. Routes and spaces are always under surveillance by cameras and are also visually linked.



The construction and management of buildings can have a major impact on the economy of an area. The economy of an area can be stimulated and sustained by buildings that make use and develop local skills and resources. The conceptual Youth Prison facility is sited in the already existing Leeuwkop prison land parcel.

(Gibberd, 2000: SBAT)

economic issues - local economy

The construction and management of buildings can have a major impact on the economy of an area. The economy of an area can be stimulated and sustained by buildings that make use and develop local skills and resources. The conceptual Youth Prison facility is sited in the already existing Leeuwkop prison land parcel. (Gibberd, 2000: SBAT)

Local contractors

80% of the construction has been carried out by contractors based within 40km of the building/refurbishment

Local building material supply

80% of construction materials: cement, sand, bricks etc. produced within 200km of site

Local component manufacturer (Furniture?)

80% of building components i.e. windows and doors produced locally (within 200km)

economic issues - efficiency of use

Buildings cost money and make use of resources whether they are used or not. Effective and efficient use of buildings supports sustainability by reducing waste and the need for additional buildings. (Gibberd, 2000: SBAT)

Useable space

Non useable space such plant, WCs and circulation does not make up more than 20% of total area.

Occupancy

Building and all working/living spaces are occupied for an average equivalent minimum of 30 hours per week.

Space use

Use of space intensified through space management approach and policy such as shared work spaces i.e. 'hot-desking'.

Use of technology

Communications and information technologies used to reduce space requirements i.e. video conference, teleworking etc.

Space management

Policy to ensure that space is well used. This may include regular audits, or space management system that charges space to cost centres.

The high efficiency of use of the proposed work will ensure high performance of useable space according to the floor area provided. The buildings are designed for natural means of environmental control such as orientation for natural ventilation, lighting and thermal gains this all aids in allocating the unusable spaces as circulation routes and ablutions.

The occupancy of the Youth prison facility will stretch far beyond the benchmark of average equivalent minimum of 30 hours per week for the design houses mixed functions. The occupancy within the design concept will require an intensive design management approach to accommodate the mixed functions:

1. Access to the Youth prison facility by staff, inmates and visitors.
2. Security and control of access and movement
3. Ensure access, security and control to other functions of the concept.
4. Delivery access
5. Strict vehicular access

social issues - ongoing costs

Maintenance

Specification and material specification for low maintenance and or low cost maintenance. All plant and fabric have a maintenance cycle of at least 2 years. Low or no maintenance components (i.e. windows, doors, plant, ironmongery etc.) selected. Maintenance can be carried out cost effectively (i.e. replaceable items such as light bulbs can be easily reached and replaced). The most important consideration in this design is that the material has to be vandal proof i.e. light fitting, benches, windows and bathroom fittings

Cleaning

Measures taken to limit requirement for cleaning. Hard wearing solid flooring (limited or no carpeting) specified. Windows should be easily accessible for cleaning.

Security / Care taking

Security is most of the most important aspects in the design therefore it is important to design the facility in such a way that the means of escape is decreased.

Insurance / Water / Energy / Sewerage

Costs of insurance, water, energy and sewerage monitored. Consumption and costs regularly reported to management and users. Policy and management to reduce consumption (ie switching off lights on leaving building spaces) implemented.

Disruption and 'downtime'

Electrical and communication services, HVAC and plant located where they can be easily accessed with a minimum of disruption to occupants of building. This should maximising access to this from circulation areas (rather than work/living areas) and lift off panels at regular intervals to vertical and horizontal ducking.

“Qualities of light have profound responses within us: they are the wellsprings of feeling... with light as the palette, architecture can be supreme in the arts. It is a source of expression that we tend to ignore and the one aspect of architecture that we cannot divorce from meaning in our determined nihilism as long as night and day and the sun and moon work their pattern upon us. It is with light that we can bring soul and spirit back into architecture and perhaps find our own souls in the process.”

five _ 129

(Erickson, Arthur.1975: 33)

environmental issues - lighting

“Qualities of light have profound responses within us: they are the wellsprings of feeling... with light as the palette, architecture can be supreme in the arts. It is a source of expression that we tend to ignore and the one aspect of architecture that we cannot divorce from meaning in our determined nihilism as long as night and day and the sun and moon work their pattern upon us. It is with light that we can bring soul and spirit back into architecture and perhaps find our own souls in the process.”
(Erickson, Arthur.1975: 33)

Light is fundamental to our existence and to our perception of the world. Light is a life-giving force fuelling processes such as photosynthesis that allows flora and fauna to survive and thrive. It reveals our environment to us; it warms us; it affects our moods and senses of well-being. Light is the medium by which we directly experience our surroundings, without light it would be impossible to comprehend and appreciate colour, depth, space and volume.

Climate is also a very important aspect in the element of genius loci. The use of light in a building affects our feelings of comfort in relation to the thermal variables in each climatic zone. Light is connected to time in our experience and can express or stifle the expression of changing time in buildings. Light does not only provide us with illumination for visual activities, it also enriches our experiences.

There are thermal realities associated with the introduction of light into a building that cannot be avoided.

- The introduction of heat along with direct sunlight.
- Heat loss through glazing when the temperature outside is lower than the temperature inside.
- The addition of heat to the interiors when electric lighting fixtures are operating.

Any building that wants to provide both comfort and delight must respond to these realities.

The connection with light and heat is evident in small rooms with large windows that are facing south. The occupants are unable to escape neither the dazzling light nor the high temperatures produced by the trapped heat from sunlight.

Based on the basic requirements for lighting, conceptual details have been set-up to give a basic understanding of the design approach specific to the Youth prison facility concept.

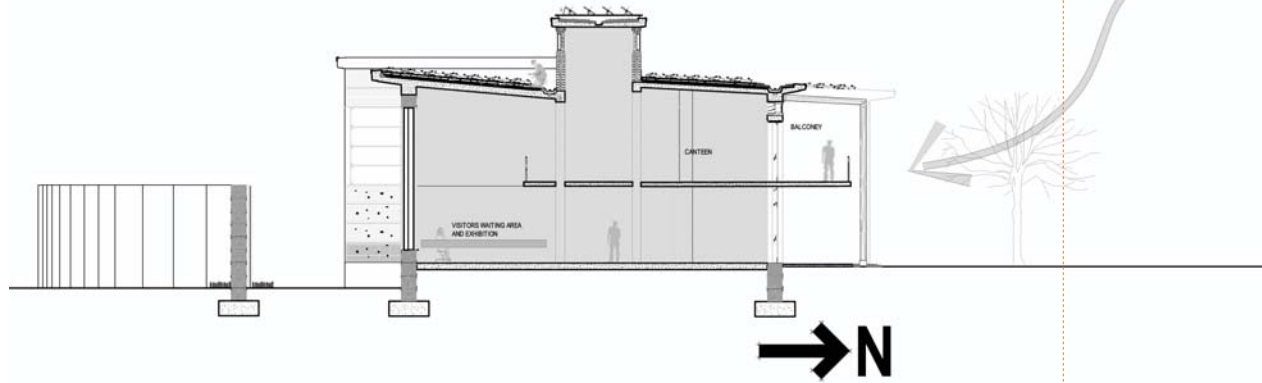

five _ 131

5 _ 18

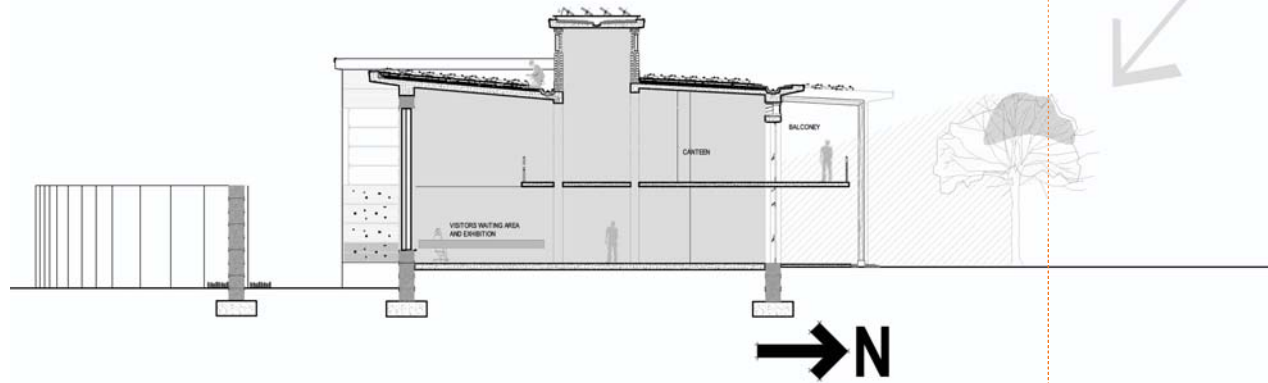

5 _ 19

environmental issues - lighting

Visual Comfort

Lighting is required for the functional purpose in the building to enable the completion of visual tasks and for human safety. The principles for satisfying these requirements are climate independent.

The climate dependant issues come from the quality and quantity of the day lighting found in different climates. This in turn is related to the sky conditions and the levels of solar radiation, which vary in the different types of warm climates. Hot humid climates are fairly cloudy during the year, with 60 – 90% cover. Luminance from the clear sky is high but is reduced with overcast conditions to approx. 12% of the clear sky conditions.

The clear sky conditions in both the moderate and hot dry climates give high levels of light and solar radiation. From the table it is evidently show that there is enough daylight for interior lighting, but the larger amounts of solar radiation admitted into the building is the main concern. Particularly in the moderate climates where there are long periods of clear sky conditions. this is a difficult problem for with the light there is also a release of heat, with a 1m² skylight 1000w heat is released this is the equivalent of to the sensible and latent heat load of 6 to 7 occupants. In moderate climates there is an abundance of natural light; the challenge for the designer it to utilize the natural light without the heat gain.

The climate responsive design issues concerned with day lighting are:

1. Diffuse light: the use on diffused light where possible, rather than direct sunlight, to avoid heat gain and ultraviolet degradation of the interior materials and furnishings.
2. Heat gain from glazing: the provision of external shading to reduce direct solar gain but allow sufficient lighting for natural lighting; optimize the glazing ratio to provide appropriate natural lighting conditions and provide ventilation to remove the heat gain associated with the glazed areas.
3. Glare: use of materials and colors to avoid high contrasts in the external and internal lighting conditions; elements such as landscaping, frosted or colored glass and screens are of use as buffers to moderate internal and external conditions
4. Light transmission and thresholds: in situations where contrasts occur, avoid sharp contrast in light levels to avoid disabling glare; set electrical lighting threshold to smooth transition from natural light.

Other consideration to take into account when designing:

- Provide environments that are visually stimulating. Humans respond well to variations in lighting levels, comfortable contrasts and pleasant changes in light and shadow.

- Provide as much natural light as possible. Coordinate supplemental light sources with available daylight.

- Consider creative integration of daylight, energy efficient lighting options and effective control strategies. Include daylight as a factor when trying to meet industry standards for lighting.

- Optimize the spaces being illuminated with the appropriate colors, surface treatments, room proportions and ceiling heights for the tasks involved.

	HOT HUMID	HOT DRY	MODERATE
TYPICAL SKY LUMINANCE, LUMENS			
Clear skies	7500	10800	100000
Overcast, obscured	9000	9000	20000
TYPICAL SOLAR RADIATION, Wm²			
Clear skies	750	1080	1000
Overcast	90	90	200

This ventilation system for the non-smoking/filtered building will be sufficient according to SABS 0400.

Lobbies - 5.0 litres/s Show room – 7.5 litres/s Cafeterias

– 5.0 litres/s The minimum air which needs to be supplied

is 5.8 litres/s Will have a maximum of 200 people in the

visitors' facility 5.8 litre/s x 200 people = 1160 litres/s of

fresh air required per person = 1.16 m³/s of fresh air

required per person (500 litre/s = 0.5 m³/s) The minimum

fresh air required in the building is 1.16 m³/s.

Calculations: Interior floor area of Lobby and Exhibition

space (double volume) = 1088 m² = 108.8 m² rock bin to

be provided = l x b x h = 22 x 2 x 2.5 = 110 m²

position of windows relative to ruling wind direction. solar orientation is less forgiving than aeolic orientation.

(Holm, 1996:6)

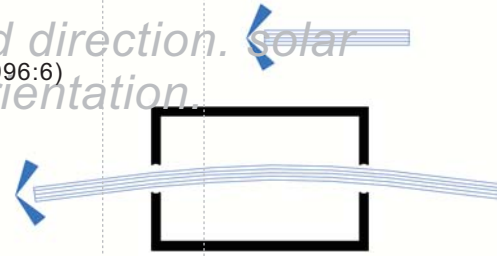

environmental issues - ventilation



Ventilation comes from the word 'ventus' in Latin, and means the movement of air.

The buildings envelope separates the indoor and outdoor environments.

In the winter ventilation should be minimized to prevent heat loss. In the summer the building can be cooled by the removal of heat by convection.

Air movement is especially important in climates which are hot and humid for occupants' comfort. The prevailing wind creates characteristic air flow patterns around buildings or obstructions in general. Positive pressure zones occur on the windward side and suction on the leeward side.

environmental issues - ventilation

Air movement through a building depends on difference in air pressure. The required changes in air will be achieved through different passive systems

Solar passive system

This system allows for the optimum design of the building envelope. In most climates the optimum design may still need an additional heating and cooling system, to keep an indoor environment with in the comfort zone. This can be achieved through passive solar collection and heat loss strategies.

Heat can be stored in elements with a high thermal mass like concrete, rock, brick and water. These devices are usually fixed and part of the building.

Rock bin

The rock bin system will be implemented to keep the building cool during the hot summer months.

A rock bin is a bin filled with rocks. The air is drawn through the openings between the rocks and cooled. The ground has a constant temperature of 15 – 20 deg Celsius therefore a good place for the rock bin would be under the building. There is a main gabion wall running along the south façade of the building and rock bin would run along the same line

The air reached the interior of the building at an average of 20 degrees Celsius therefore it is necessary to cool the air even further with the help of an air-conditioning system which will further cool the air another 5 degrees. Using this system will decrease the operating cost and size of the air-conditioning system.

For every 10m² of floor space you need 1m³ rock bin. The maximum flowing distance if the rock bin air is 2m. Airflow rate must be between 3 – 8 m/s otherwise it becomes too noisy.

Section area (m²)
Flow rate (m³/s)
Formula: Flow rate = Speed x area
Ventilation rate: 2 x volume of room m³/3600s

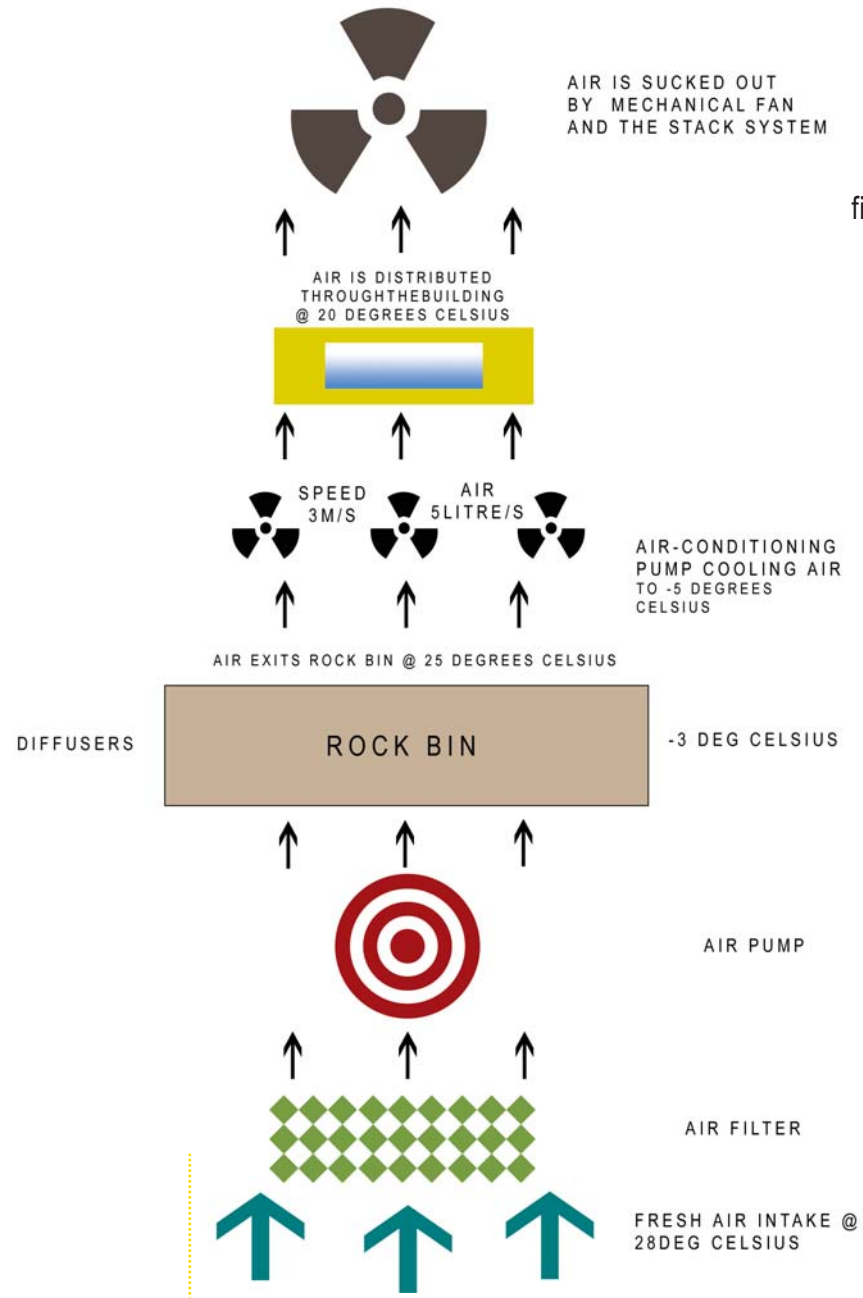

five _ 137

5 _ 22

environmental issues - ventilation

Cross ventilation

In this system openings are orientated directly towards the ruling wind direction will receive greater air speed than openings oblique to the direction of the wind. No air flows into the building through openings situated parallel to the direction of the wind.

Different types of window openings also affect the amount of air flow:

- Top hung windows direct air flow up.
- Horizontal pivot windows direct air stream downwards.
- Vertical pivots and casement windows catch wind blowing from other directions.

The building will be ventilated through cross ventilation, roof and the stack system. Spaces are designed to allow maximum cross ventilation and the atrium will act as a stack system to ensure that unwanted warm air during the summer will escape through windows at the top.

Stack effect (atriums)

Stack ventilation is achieved through the process of buoyant warm air rising upwards in a building and exiting through high-level openings. The air is replaced by cooler air drawn into the building through low-level openings such as louvres/doors. The main benefit of the stack effect is that the temperature between the indoor and the outdoor air is the driving force for the ventilation and will be effective on days when there is no or little wind.

The stack effect is particularly effective for night time cooling when there is the greatest difference between internal and external temperatures.

It is only effective when outside air is cooler than internal air and if the path is relatively clear from obstructions so that the air can travel from a low-level openings to high-level openings.

All rising air will be removed through the stack system; this system will be supported by an extractor fan mechanical system which will suck the hot air out.

These fans will be closed during the winter months and will require no maintenance; if maintenance is required they are easily accessible from the roof.

All cold air will move through the louvered floor gaps into the building, up through the stack and out through the clerestory louvers at the top.

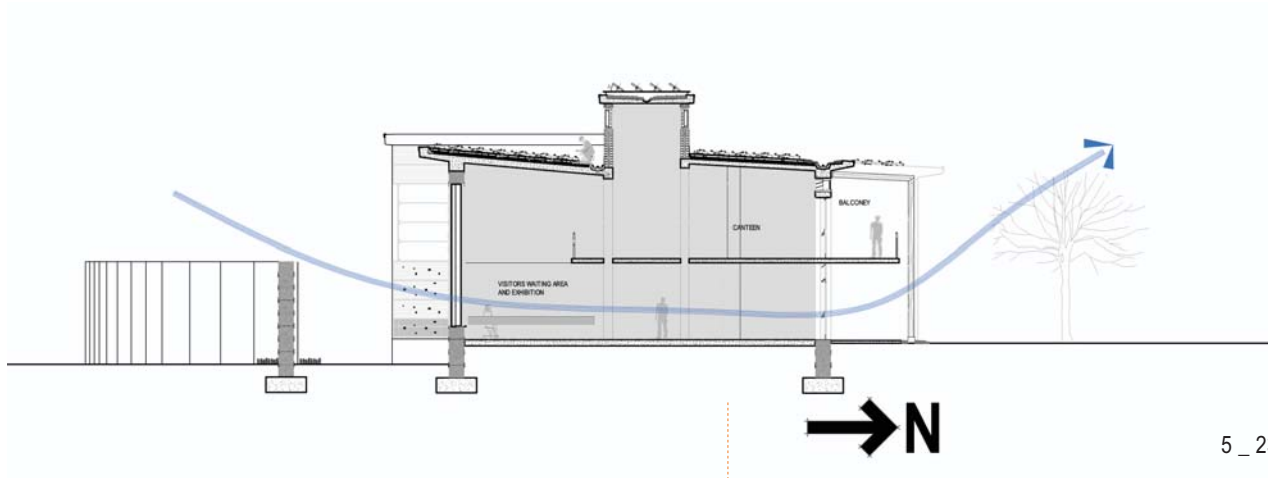

five_139

5_23

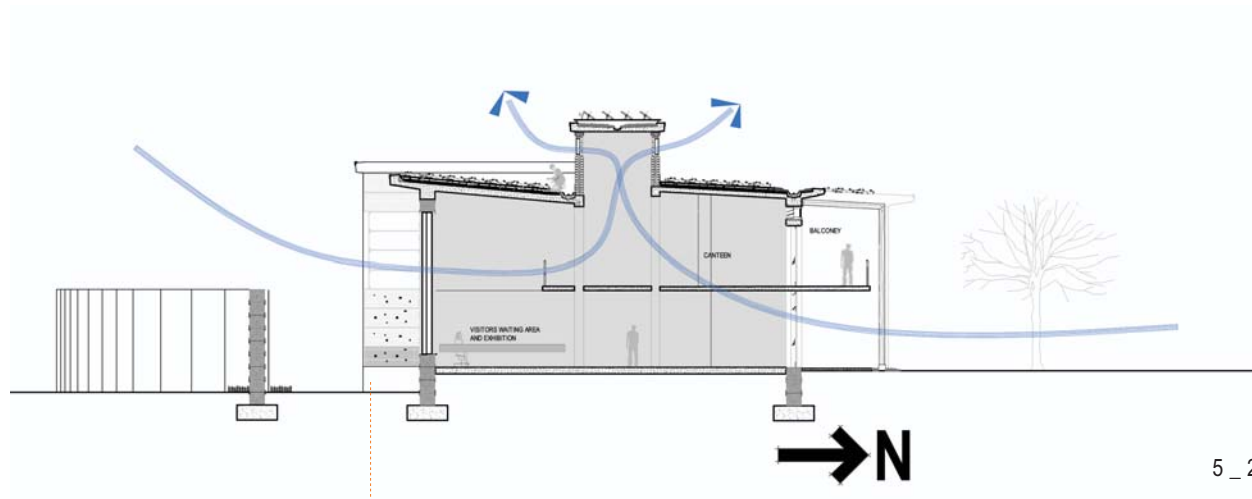

5_24

environmental issues - ventilation

Other consideration to take into account when designing:

-Evaluate the site and surrounding area for potential sources of interior air pollution. Carefully consider the impact of traffic, transit drop offs, parking lots, dumpsters and other pollutants that can readily enter a building.

-Avoid materials and furnishings comprised of petrochemicals and volatile organic compounds to reduce harmful off gassing.

-Give special attention to ventilation requirements and system configuration and controls.

-Perform cleaning and maintenance with nontoxic cleaning products and procedures.

-Pesticides and herbicides should be used sparingly and only when necessary. Benign, natural methods

·Optimize the thermal envelope before relying on building space conditioning systems for environment control

·Use available computer modeling whenever possible to investigate the performance of various thermal envelope materials and configurations.

·Understand the relationship between radiant surface temperatures and comfort. High performance glazing and enclosure systems that provide acceptable interior surface temperatures can reduce the need for expensive perimeter conditioning systems.

·Recognize the influence of site and building orientation when designing building enclosure systems. Select wall and glazing materials that respond to variations of wind and solar loads associated with orientation.

·Understand the role of building mass in controlling thermal comfort, especially in interiors. High mass buildings have an inherent ability to stabilize temperature swings and can contribute to cooling strategies using nighttime air.

·Bring the outdoor into the building. Designs that incorporate atriums, light wells or connections to patios and terraces can also integrate natural light and ventilation.

·Choose enclosure systems that perform well in varying seasonal conditions. Exterior rain screens with vented voids behind, such as brick cavity walls or pressurized curtain walls perform better than solid masonry or low quality window mullion and glazing combinations.

·Select enclosure materials and detail building assemblies to limit uncontrolled infiltration.

Thermal temperature for load calculations will be based on 24 deg Celsius in the summer and 20 deg Celsius in the winter months with a maximum humidity of 57%Rh. The required ventilation in a building should be provided by natural means. No mechanical ventilation should be used in the building other than in toilets and kitchens.

five _ 141

(Gibberd, 2000: SBAT)

·Depend on thermal envelope performance and natural space conditioning and ventilation strategies before engaging mechanical systems

·If outside conditions are acceptable, design the structure to take advantage of prevailing breezes to maximize natural ventilation.

The quality of environments in and around buildings has been shown to have a direct impact on health, happiness and productivity of people. When an environment is healthy it contributes to sustainability by being more efficient and therefore reducing resource consumption and waste. The quality of this environment needs to be achieved at minimal cost to the environment.

(Gibberd, 2000: SBAT)

environmental issues

- thermal comfort

“..... architecture, beyond providing physical forms for human activities, also interprets to human beings their place in nature and society ”

(Harries, Karten. 1984: 51)

The thermal performance of buildings is the process whereby design, layout and orientation as well as the construction materials of a building, adjust the existing outdoor climate to create the indoor climate. There is a need to account for the amount of heating and cooling required in creating thermal comfort of occupants.

When designing a building it is very important to take into consideration the two major influences of thermal performance:

- The buildings heat absorbing capacity.
- The thermal resistance of its shell.

Thermal performance is measured in degrees Celsius and the information evaluated can be used to establish the maximum indoor temperature in the summer and the amount of energy required to maintain a minimum temperature throughout the winter months. This is expressed in kWh/m².

The values of each of these vary according to their material usage and the way in which these materials are used. (Burnt clay bricks, timber, steel, concrete, and corrugated iron.) The heat absorbing capacity also depends on the building mass and the density of the materials, which it is constructed from. The greater the density and the mass of the external and internal walls, the more heat can be absorbed. The insulating properties of a material or building element depend on the extent to which it limits the transmission of heat through it. The ability of a building component such as a wall to transmit heat is expressed as the U-value of the component.

The U-value of building components is defined as the amount of heat transmitted in watts per square meter per degree Celsius difference in temperature between air on one side of the component and air on the other side of the component. The U-value, therefore, takes into consideration the thermal transmittance of both surfaces of the component as well as the thermal transmittance of individual layers and air spaces that may be contained within the component itself.

Each materials heat absorbing capacity and insulation property, determines the heat storage capacity of the building.

The siting of the building is very important when there is a need to create a comfortable thermal interior environment.

The youth prison facility is sited in a dry area with wide diurnal variations in outdoor temperatures, the buildings have a greater heat storage capacity and therefore will tend to even out the effect of the outdoor fluctuations in temperature by absorbing and storing heat during the day without passing much of the heat to the inside of the building, but gradually losing heat to the indoor and outdoor environment at night.

environmental issues

- thermal comfort

Roof tops have played a very unglamorous role in modern construction. The top surface of typical buildings is a very necessary component that is technically addressed in the design and construction of the building and then goes unnoticed by everyone except the maintenance crew. The horizontal surface that once defined the building site, which was full of life and rejuvenating processes is replaced by a single one-dimensional plane several stories in the air. The solution for this problem would be a green roof, a waterproof protection layer with a top layer of plants embedded in a growing medium. In this way the new vegetation replaces the ecology destroyed by the footprint of the new building the plants can be simple grass carpet or a lusciously elaborate garden.

The main benefit of a green roof is that it is environmentally beneficial and it helps with storm water management, a green roof slows down, reduces and even cleans storm water runoff. This permeable layer absorbs and retains water which allows a lot of evapotranspire and only a very slowly releasing the rest to the ground this gives chance of reaching an aquifer rather than simply disappearing down a pipe. A green roof with low-growing vegetation can absorb up to 70% of the rainwater it receives and air pollution that is swept up by precipitation like nitrogen and phosphorous are filtered out by the vegetation before they can pollute the ground water systems.

> HUMAN BEINGS

SHAPES
WHICH
EX ACTLY

five

1

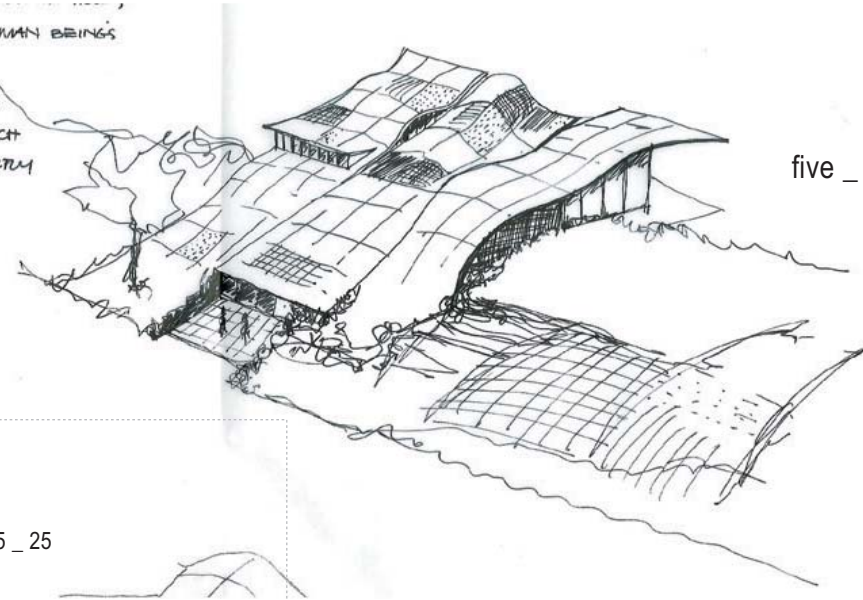

five_145

5_25

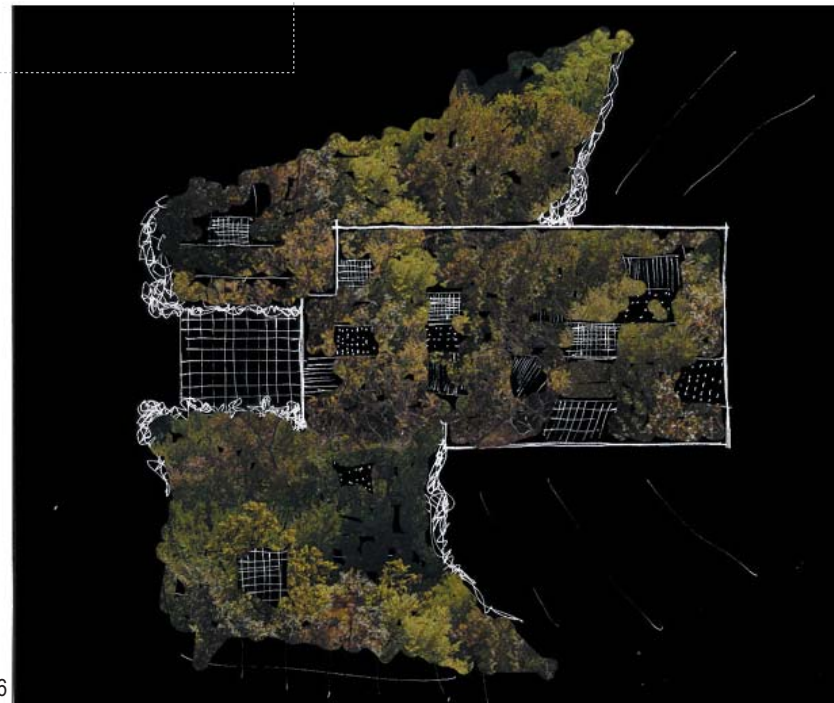

5_26

environmental issues

- thermal comfort

Although green roofs are upfront more expensive, in the long run the operational savings in terms of energy consumptions and the maintenance cost with off set the construction premium associates with a simple green roof with low-growing vegetation. In addition to all these benefits, the living roof provides aesthetic and psychological relief to a concrete and asphalt urban jungle.

There are three conditions which damage a typically black membrane roof; brittleness caused by the sun's UV radiation, thermal shock due to temperature differences between the top and the bottom layers and the punctures resulting from pedestrian traffic of dropping of tools. The vegetation and soil layers of a green roof protect the membrane against all three. Assuming that the membrane was installed properly the first time it should last far longer than a normal exposed roof membrane. The estimate life span is around 20 to 40 years.

The most important purpose of a green roof is to keep water out of the building it does this with several protective layers: waterproof membrane, drainage system, fabric filter, growing medium and vegetation. Depending on the system an insulation layer may be place below the membrane.

The waterproofing membrane is the most crucial; vegetation can be replanted. You do not want a leaking roof.

A drainage system is required below the soil layer to handle the excess water due to heavy rains. The system consists of elevated airspace through with the water can run once it reaches a certain level it flows off the roof through interior drains. The drains can be designed so that it collects water which can be saved and used in the dryer seasons. A very fine cloth filter is place between the growing medium and the drainage system so that only water can pass through.

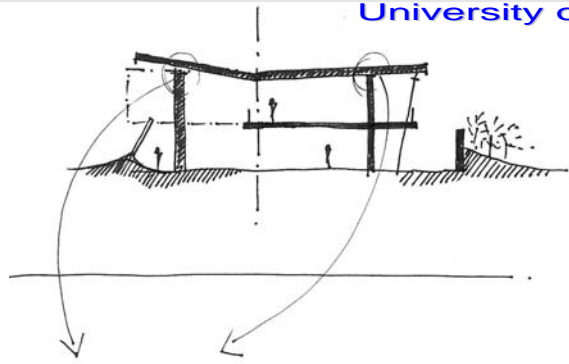

five _ 147

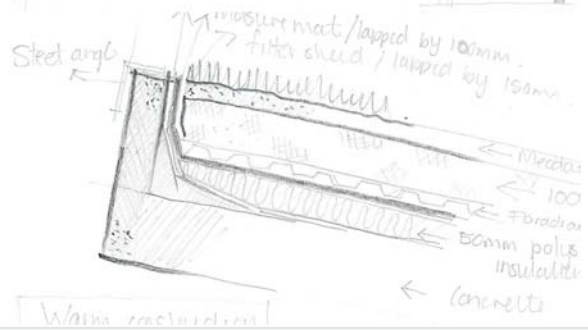
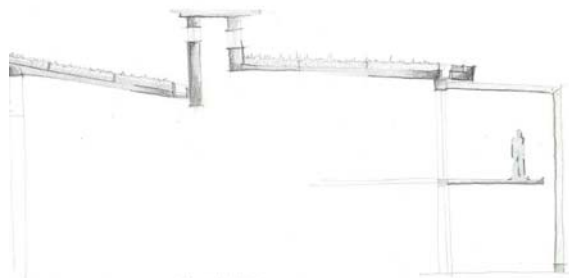
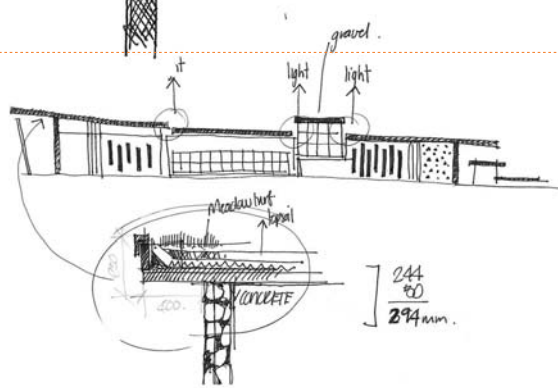
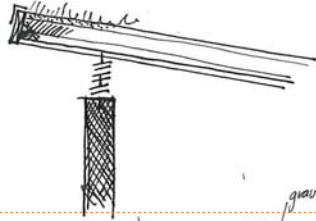

Water is required for many activities. However the large-scale provision of conventional water supply has many environmental implications. Water needs to be stored (sometimes taking up large areas of valuable land and disturbing natural drainage patterns with associated problems from erosion etc), it also needs to be pumped (using energy) through a large network of pipes (that need to be maintained and repaired). Having delivered the water, a parallel efforts is then required to dispose of this after it is used, i.e. sewerage systems. Reducing water consumption supports sustainability by reducing the environmental impact required to deliver water, and dispose of this after use in a conventional system.

(Gibberd, 2000: SBAT)

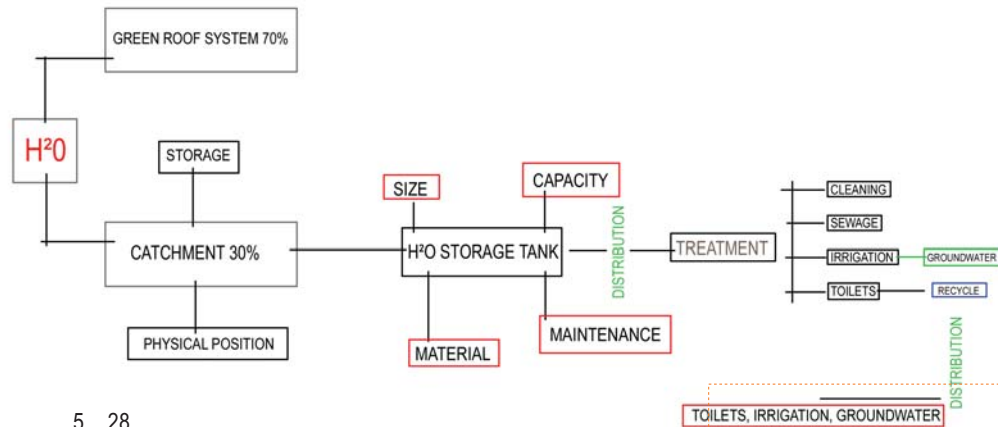

5_28

environmental issues - water

Rainwater

The roof is a green roof structure which absorbs 70% of the rain water the other 30% is gathered and stored in storage tanks below the building.

Water storage

Area of the roof = 1120m²
 Harvested rain water = 30% of 833.36kl = 250kl
 Current cost = R3/kl
 Possible annual savings on only the visitors centres roof = R750
 For storage only one 9000 litre tank will be necessary

Water use

All water devices should minimize water consumption and encourage efficiency of use. Use efficiency:
 Toilets - below 6 litre of water
 Taps – below 0.03 – 0.07 litres per second (specify low flow taps)

Grey water

Grey water (water from washing etc) recycled (to flush toilets or water plants)

Runoff

Run off reduced by using pervious or absorbent surfaces. Hard landscaping minimised, pervious surfaces specified for car parking and paths.

five_149

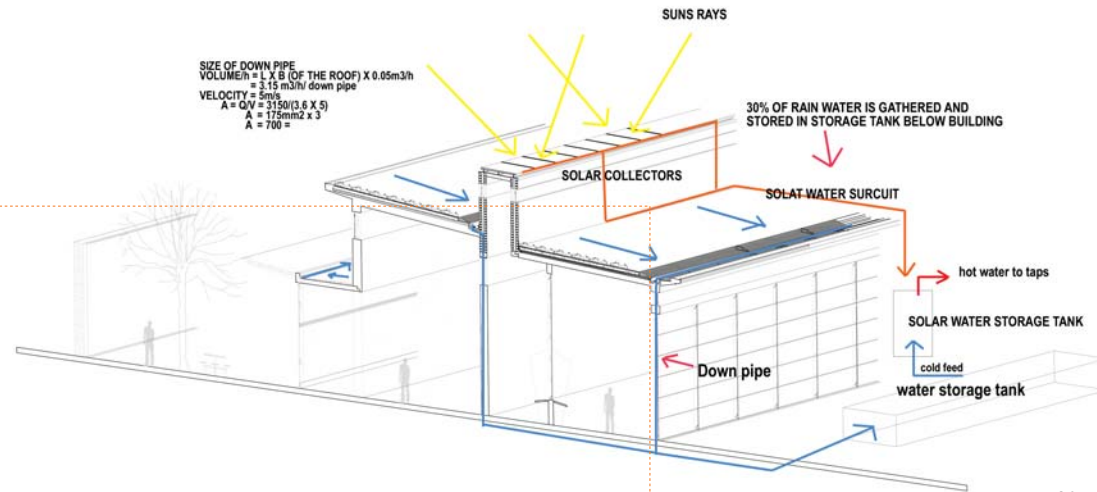

SIZE OF DOWN PIPE
 VOLUME/h = L X B (OF THE ROOF) X 0.05m³/h
 = 3.15 m³/h/ down pipe
 VELOCITY = 5m/s
 A = Q/V = 3150 (3.6 X 5)
 A = 175mm² x 3
 A = 700 =

5_29

	Average rainwater in mm/month for Johannesburg	Total amount of water falling visitors centre roof = 1000m ²
January	101mm	113.2kl
February	109mm	122.08kl
March	64mm	71.68kl
April	38mm	42.56kl
May	48mm	53.76kl
June	4mm	4.48kl
July	2mm	2.24kl
August	2mm	2.24kl
September	11mm	12.32kl
October	83mm	92.96kl
November	169mm	189.28kl
December	113mm	126.56kl
TOTAL	744mm	833.36kl

5_30

environmental issues - planting

PLANTING *All planting specified has a low water requirement. (Indigenous species) Hard surface paving will be restricted(even through the materials need to vandal proof and hardy); landscaping will aim towards water-permeable hardening for it enlarges the water collecting area, which favours micro-climates. Run-off will reduce when soft landscaping is used. Trees and lawn (soft landscape) will filter and absorb water.*



5_31

[Arcacia xanthophloea]

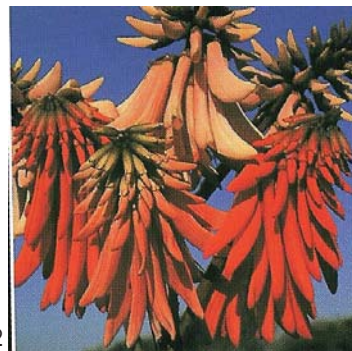

5_32

[Erythrina iysistemom]



5_33

[Arcacia erioloba]

THE INDIGENOUS PLANTING WILL INCLUDE: *Indigenous trees (planted on the northern side of the building for sun (winter) and shade (summer). All the trees are thorn trees as to prevent inmates from climbing and hiding in them: Erythrina iysistemon, Arcacia xanthophloea, Arcacia erioloba. Other plants will include: Aloe angelica, Aloe arborescenes, Aloe cryptopada, Aloe ferox. Roof planting will include: Aptenia cordifolia, Carpobrotus andulis.*



5 _ 34

[Flowers. Visi, 2002]



5 _ 35

[Aloe ferox]

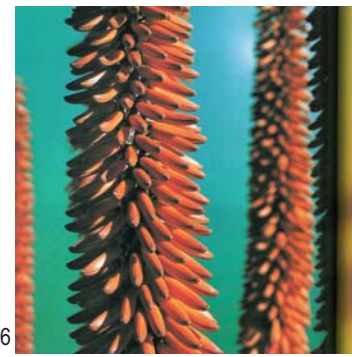

5 _ 36

[Aloe]

[Aptenia cordifolia]



5 _ 37



5 _ 38

[Carpobrotus andulis]

materials & technical studies

Light six_153

Concrete six_165

Stone [Gabion wall] six_169

Planting six_171

Timber six_173

Glass six_175



“Architecture is the masterly, correct and magnificent play of masses brought together in light. Our eyes are made to see forms in light; light and shade reveals these forms...”

Le Corbusier: Towards a New Architecture – 1927.

light as a material of architecture

“Qualities of light have profound responses within us: they are the wellsprings of feeling... with light as the palette, architecture can be supreme in the arts. It is a source of expression that we tend to ignore and the one aspect of architecture that we cannot divorce from meaning in our determined nihilism as long as night and day and the sun and moon work their pattern upon us. It is with light that we can bring soul and spirit back into architecture and perhaps find our own souls in the process.”

(Erickson, Arthur.1975: 33)

Light is fundamental to our existence and to our perception of the world. Light is a life-giving force fuelling processes such as photosynthesis that allows flora and fauna to survive and thrive. It reveals our environment to us; it warms us; it affects our moods and senses of well-being. Light is the medium by which we directly experience our surroundings, without light it would be impossible to comprehend and appreciate color, depth, space and volume.

The history of architecture is a story of the way light enters into buildings and reveals the spatial composition and the forms within. Sunlight and moonlight, artificial light and fire or candlelight has a great effect on our perception of space and surfaces. The materials of light; brightness, shadow, color whiteness, are also materials of architecture through which we can appreciate the nature of space, colors, textures and objects. Textures and objects are felt just as much through the eyes as through the skin. We experience light mainly because we work in it. We are very acutely aware of light when there is not enough of it, or too much, to be able to comfortably do what we want to

Incorporate high efficiency fixtures, lamps and controls. Strive to reduce watts-per-square-foot design targets and actual connected loads.

Enable occupant control of individual workstations or small work areas with task-ambient lighting systems, as opposed to large, uniformly lit interior areas.

Include lighting systems in regular maintenance procedures to ensure optimum light output and energy efficiency.

Begin with an effective day lighting scheme that optimizes the use of natural light.

Design controls to balance available daylight with the secondary need for electric light.

Create environments that are visually interesting or stimulating by integrating overall illumination, ambient and task lighting.

Design lighting to serve the needs of building occupants. Uniform lighting seldom serves well as both ambient and task lighting.

It is exactly this kind of metamorphic thinking about light that can make buildings the places that have special meaning for us, extending their value beyond functional use.

Interior of Villa Mairea.

The screens of poles that enclose the stairwell echoes the forms of the tall straight trunk of trees outside. They break up and filter the daylight and evoke the light quality of the Finnish woods inside the house.

(Millet, M. 1996: 9)



6_2



6_3

The pines outside the Villa Mairea.
(Alvar Aalto Architect, 1937-39)
in Noormarkku, Finland.

(Millet, M. 1996: 9)

Creating a certain setting in a particular place either inside or outside starts by fitting it gracefully to its location and providing comfort to the people, who inhabit the space. These intentions all fit under the same umbrella of experience: our experience of the world, and our culture and sensory associations. Our experience of light is connected to specific places where light contributes to the identification of genius loci: the peculiar character of a place as it is impressed upon our minds. By responding to the sensitivity of light one can also convey the spirit of a place.

Forests provide a complete pallet of colors and textures in light and each one is particular to its own part of the world.

“Our eyes are constructed to enable us to see form in Light”

(Le Corbusier.1974: 8)

Climate is also a very important aspect in the element of genius loci. The use of light in a building affects our feelings of comfort in relation to the thermal variables in each climatic zone. Light is connected to time in our experience and can express or stifle the expression of changing time in buildings. Light does not only provide us with illumination for visual activities, it also enriches our experiences.

There are also thermal realities associated with the introduction of light into a building that cannot be avoided.

- The introduction of heat along with direct sunlight
- Heat loss through glazing when the temperature outside is lower than the temperature inside
- The addition of heat to the interiors when electric lighting fixtures are operating.

Any building that wants to provide both comfort and delight must respond to these realities.

The connection with light and heat is evident in small rooms with large windows that are facing south. The occupants are unable to escape neither the dazzling light nor the high temperatures produced by the trapped heat from sunlight.

The definition of enclosure is the definition of architectural space in which light plays a major role. Our sense of space is dependant on the way light reveals an enclosed space to us. A white room with a mirror on one wall appears open and spacious when flooded with daylight; and mysterious at night with one candle burning, the corners and the edges of the room obscured, the image of the candle reflected in the glass, which appears to cover endless black space.

"When we manipulate light we are able to manipulate our perception of architectural space. Space, as we experience it in architectural settings, is the result of our entire perceptual system: "One sees the environment not with the eyes but with the eyes-in-the-head-on-the-body-resting-on-the-ground."
(Gibson, James. J. 1986: 205)

As we walk through a room our visual perceptual system tells us both about the invariant structure of the environment and also about our movement in relation to it. The light is structured according to its source and also by the surfaces of the environment, resulting in the illumination of the rooms' surfaces informing us about the room.

The definition of architectural space in light has many aspects. It is especially evident at exterior walls, where the inside and the outside meet, here light can be used to emphasize connection or separation between the two. Internally the way that light interacts with light can be unify of differentiate the space. Light is also capable of connecting interior spaces or separating them. Light is also a very powerful device in providing orientation in a building by providing focus or developing a hierarchy or suggesting movement.

Light contributes to the definition of space. The only clue that we have of the vastness of outer space is the perpetual presence of the stars in the galaxies. There may be much more beyond than which we can see, but we can only know what we can perceive. Starlight defines the extent of our perceptible habitat. In the same way in the desert, in the wood, in the countryside, in cities, and in buildings, light defines the space we inhabit.

"If architecture is the art in science of conceiving form, the architectural lighting is the art in science for revealing the form in light. Light directly influences on how we design interior and exterior realms. It influences the form of the spaces and the materials from which they are composed." Spiers and Major Buildings and landscape are not only to be enjoyed during the day but must also function after darkness therefore they should not only provide light but must also be seen in light.

six _ 159

"Space remains in oblivion without light. Light's shadow and shade, its different sources, its opacity, transparency, translucency, and conditions of reflection and refraction intertwine to define or redefine space. Light subjects space to uncertainty, forming a kind of tentative bridge through fields of experience."
(Holl, Steven. 1989: 11)

The effects of light and colour

The source of light is the sun. In plants the energy from natural daylight is captured by chlorophyll (the green pigment that gives most plants their colour) and is used to make up complex organic molecules within the plants cells. This process is commonly known as photosynthesis and emphasises the close links between light and life, since directly or indirectly it feeds us all. Without light plants turn yellow or whitish in colour and usually have underdeveloped leaves as a result of chlorophyll deficiency. In 1095 C. Flammarion discovered that red light offered the best effects for growth in plants. He noted that plants under red and orange light seemed to become taller plant with thinner leaves than those exposed to blue light, which causes them to grow relatively weak and underdeveloped in comparison. Just as insufficient light causes deficiencies in plants and humans, so too the over-exposure of intense light upon plants can cause adverse affects. The long wavelengths of the infrared and the short wavelengths of the ultraviolet have both been found to be detrimental to, and will eventually destroy, plant life. Yet these same rays have been accepted to be of therapeutical value to human beings.

One thing is for certain human bodies respond to light. Infrared light produces heat within the body, which is used for the treatment of neuralgia. Ultraviolet light also helps to keep the skin healthy and is recognised for the vital production of vitamin D in the body, and the destruction of germs. Too much exposure to ultraviolet light causes malignant skin tumours at worst and to a lesser degree encourages wrinkles and tends to quicken the aging process. Light and colour therefore seem to have 'nutritional' value providing us with vital elements to sustain and nourish our bodies, and they have the potential to effect subtle chemical changes within our bodies to help the healing processes of certain diseases.

Ordinary fluorescent lighting comes in basically two types: warm (red) biased and cool (blue) biased. The warm type give out a yellowish light, and the cool types a blue\white light. In recent years fluorescent lighting has been linked to various health disorders, especially where people are exposed to it over along period of time. Apart from the incorrect colour balance flickering effect, the sheer volume of artificial light to which it exposes us can promote stress, headaches, tiredness, irritability, an inability to concentrate and nausea. Their inventors never intended them to be used on the scale they are today. In fact he judged then unsafe for use over long periods. They spread largely because of the need for cheap electricity during the last world war. The ordinary house hold bulb has been improved to that of a daylight bulb, which is suppose to simulate natural light in artificial form. It consists of natural blue-coloured glass filters with excess red light to improve alertness and concentration, reduce eyestrain and to aid against stress, headaches and depression. People experience this type of lighting as being softer and more restful on the eyes. It also seems to have a great benefit to plants as well as humans.

Using coloured light is one of the most powerful ways of using colour as it works on the whole body through the entire nervous system. Robert Gerard, an American scientist, undertook one major research project in to effects of colour and light on humans. In 1932 he experimented on prisoners using coloured lights. First he exposed them to red light and found they became restless, agitated and even aggressive in behaviour. Red, he documented in his report, created feelings of anxiety and tended to stimulate the heartbeat and respiration rate as well as muscular activity. The prisoners generally experienced an increase in physiological activity and mental activity. Blue light on the other hand created calming and tranquillising effect. Blue had the reverse effects to those of red, creating feelings of sedation and relaxation. Physiologically the blood pressure was decreased, and respiratory and muscular activity were reduced compared with using red

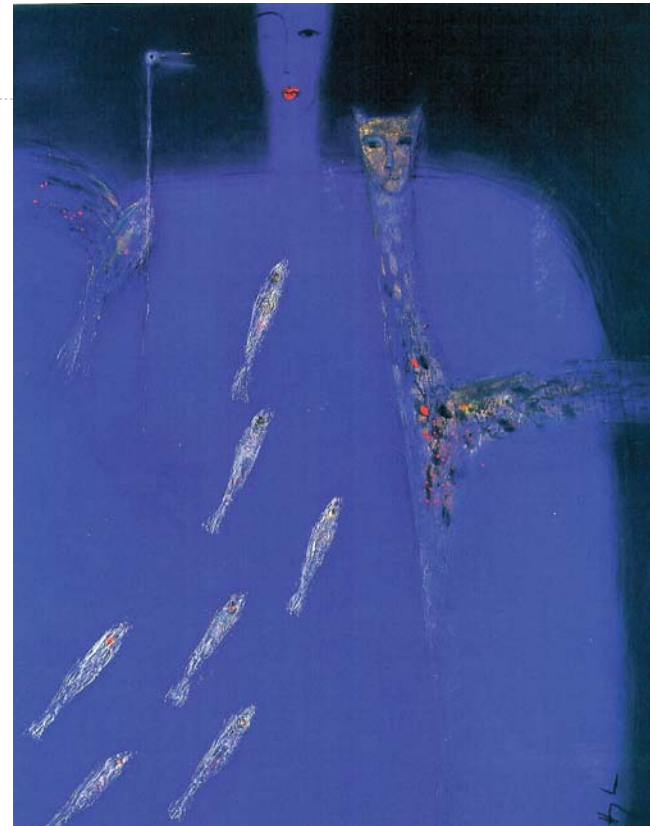

6_4

How coloured light effects our bodies

Red is the most physical of all colours and has the slowest vibratory rate and longest wavelength. It is the colour of blood and has stimulating action on our heart and circulation; red light will raise the blood pressure. Our body system is fortified by red, which helps build up the red blood cells. It also stimulates the adrenal glands, helping us become stronger and building up our stamina. Pink, which is a mixture of red and white, is gentler in its stimulation than red and helps muscles relax.

Orange stimulates the sexual organs and has a strong effect on the digestive system. It also strengthens the immune system, including the spleen, and the lungs and pancreas. It has a releasing action on the body fluids.

Yellow wavelengths of light stimulate the brain, making you alert, clear-headed and decisive. Yellow also strengthens the nervous system generally. It creates energy in the muscles by activating motor nerve. It also activates the lymph system and cleanses the digestive tract. It has a sympathetic resonance with the pancreas, the liver and the gall bladder.

Green is good for the heart on a physical and emotional level. It brings physical equilibrium and relaxation. It has a balancing quality and help regulate our circulation. It also stimulates the pituitary gland. It works through the sympathetic nervous system, relaxing the muscles in our chest to help us breath more deeply and slowly.

Blue is linked to the throat and the thyroid gland and is very soothing, cooling and calming. Blue light has been shown to lower blood pressure by calming the autonomic nervous system. It has a constricting action and is ant-inflammatory. Deep blue stimulates the pituitary gland, which regulates our sleep patterns. Dark blue has wonderful pain-healing properties. It also works on our skeleton, keeping the bone marrow healthy.

Turquoise has a sympathetic resonance with the thymus gland; this gland performs a major role in warding off infections. If you suffer from frayed nerves and a weakened immune system, turquoise acts like a refreshing tonic. It also stimulates the thyroid gland and lungs.

Indigo has been found to have narcotic qualities, and some doctors in Texas have used indigo light to induce anaesthesia for minor operations.

Violet affects the brain and nervous system and has a purification and antiseptic effect. It cools the system and alleviates "hot" conditions such as heat rash and sunburn. Violet also suppresses hunger and balances the body's metabolism

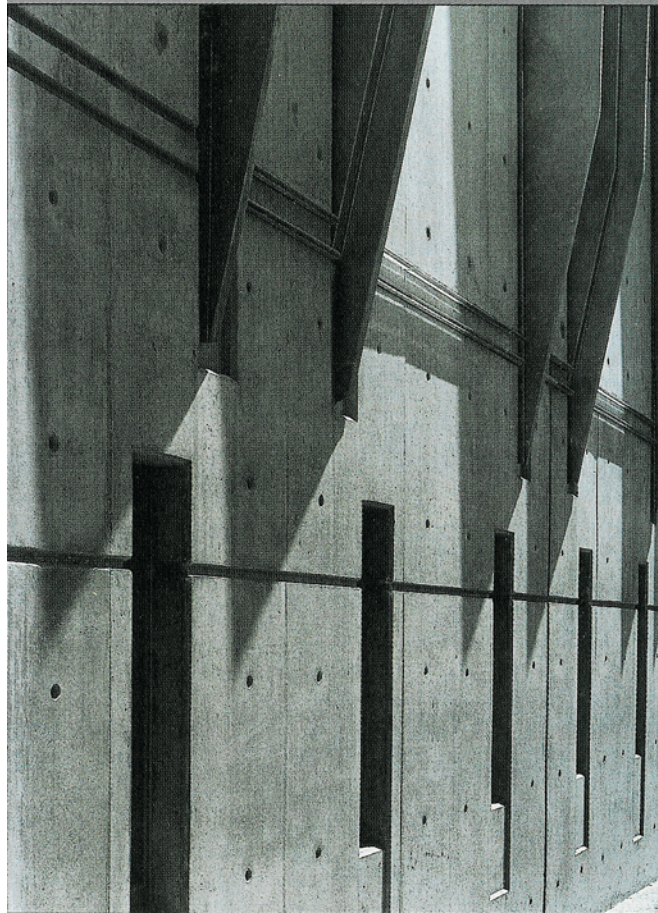

6_5

concrete *as a material of architecture*

EcoSmart™ Concrete

What makes EcoSmart concrete different from conventional concrete is that it uses a maximum percentage of supplementary cementing materials to replace cement in the mix. Depending on the application, from 30 to 60 % of cement can be replaced with supplementary cementing materials such as fly ash, blast-furnace slag, rice husk ash, and silica fume. These materials are industrial by-products, so EcoSmart concrete is generally cheaper and can lower construction costs. In laboratory tests and field applications, EcoSmart concrete often outperforms conventional concrete in strength development and durability. It also offers significant environmental benefits, since each tonne of cement replaced by a supplementary cementing material reduces CO₂ emissions by approximately one tonne.

When properly proportioned, and especially in applications where high early-age strength is not crucial, using EcoSmart concrete can reduce construction costs. Supplementary cementing materials are generally cheaper than cement, since they are industrial by-products. A lifetime cost analysis may show the financial advantages of using EcoSmart concrete since it becomes stronger and more impermeable with time compared to conventional concrete of similar 28-day strength.

Concrete is basically a mixture of two components: aggregates and paste. The paste is usually composed of Portland cement and water, and it binds together the fine and coarse aggregates. Supplementary cementing materials may also be included in the paste. A typical mix is about 10 to 15 % cement, 60 to 75 % sand/aggregate, 10 to 20 % water and 5 to 8 % air. When freshly mixed, it is plastic and malleable, allowing it to be poured into place and finished. Then, through a chemical reaction called hydration, the mixture hardens and gains strength to form the concrete we see in buildings, sidewalks, bridges and other structures. Concrete is the most commonly used construction material in the world.

Using EcoSmart concrete saves natural resources because fewer raw materials are extracted for cement production, reducing energy use and greenhouse gas emissions. Using industrial by-products such as fly ash reduces landfill costs.

Concrete is the most common construction material used in the world. Cement is the principal ingredient in concrete. Producing one tonne of cement results in the emission of approximately one tonne of CO₂, created by fuel combustion and the calcination of raw materials. Cement manufacturing is a source of greenhouse gas emissions, accounting for approximately 7% to 8% of CO₂ globally (1), and approximately 2.8% of CO₂ emissions in Canada (2). The cement industry has made significant progress in reducing CO₂ emissions through improvements in process and efficiency, but further improvements are limited because CO₂ production is inherent to the basic process of calcinating limestone. There is an increasing demand for concrete worldwide, estimated to double within the next 30 years. How can that demand be met without a corresponding increase in greenhouse gases? By using (SCMs) to replace a maximum amount of the cement in concrete, we can reduce energy and resource consumption, reduce CO₂ emissions, and lessen the negative environmental impact. There is a further environmental benefit in that most commonly used SCMs (such as fly ash) are waste products and would otherwise end up in landfills.

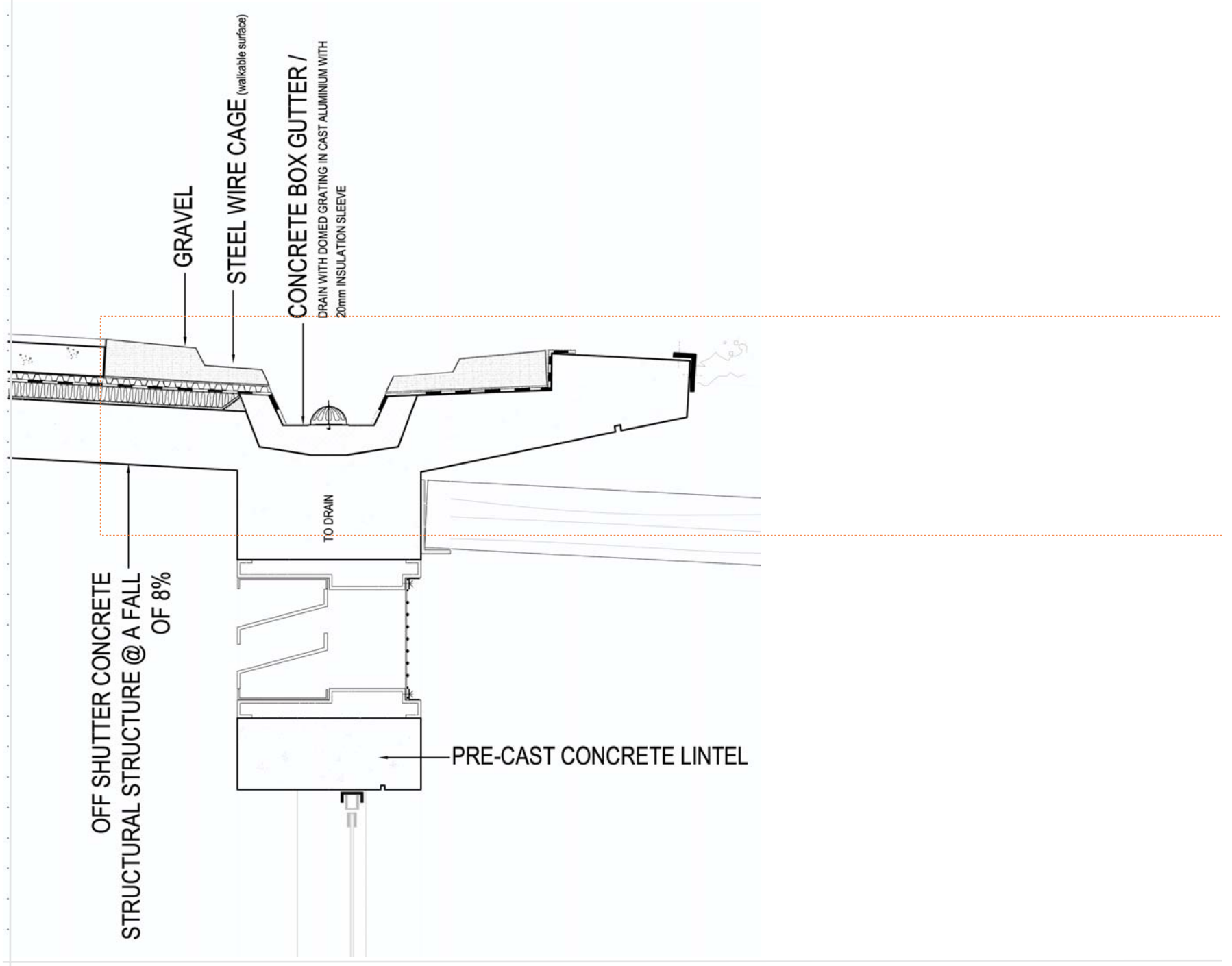



The fundamental qualities of concrete as a versatile, strong and easily applied building material make it the ideal basic structural element. Many of the walls are off-shuttered concrete structures, contrasted with stone gabion walling elements. The earth-topped roof is ideally supported by an in-situ concrete slab roof structure with provision for integrated drainage. The earth and planting structure completes the metaphor of the protected and secure role that natural elements play within the context of the scheme insofar as the earth embraces the structure integrating it with the landscape. What would ordinarily have been an aggressive concrete structure is clothed by nature, alive and ever changing. The juxtaposition of contrasting elements, stone, concrete, glass, timber and earth are played upon by the various permutations of sunlight throughout the day, creating visual and textural interest; a sense of optimism to young eyes.



stone (gabion wall) as a material of architecture

The gabion is rectangular basket stoutly made from steel wire strengthened by selvages of heavier wire. Supplied as a flat pack, it is assembled on site and normally filled in situ with quarried stone or large round shingles. The site has a few rocky outcrops which if they have to be removed the removed rocks can be used to fill the baskets. Sections of the gabion wall are securely wired together in position to form the required retaining and anti-erosion structure. In the case of the visitors centre the Gabion walls are there for structural support, retaining walls and security division.

The gabion wall also has high thermal qualities and retains heat during the winter days and releasing it at night.

Stone is applied in such a manner so as to establish a visual and textural contrast from the other principal materials, concrete and glass. The stone is applied in the form of gabion walls which define axial and dividing walls, inside and outside the scheme, thus creating a visual dialogue between interior and exterior. Stone, while adding natural color and warmth, thus creating a refreshing departure from the austerity of the concrete walls, also imparts a tone of strength, authority and dignity to the spaces. The innate qualities of this natural material, maintain constant metaphorical references to nature and its associations of purity and freedom. The gabion walls are also often utilized in combination with laminated glass screen, for security purposes. The use of stone is also present in the underground cooling troughs which form a fundamental part of the ventilation/cooling system. The stone walls, thus, in a sense, take root in these troughs.

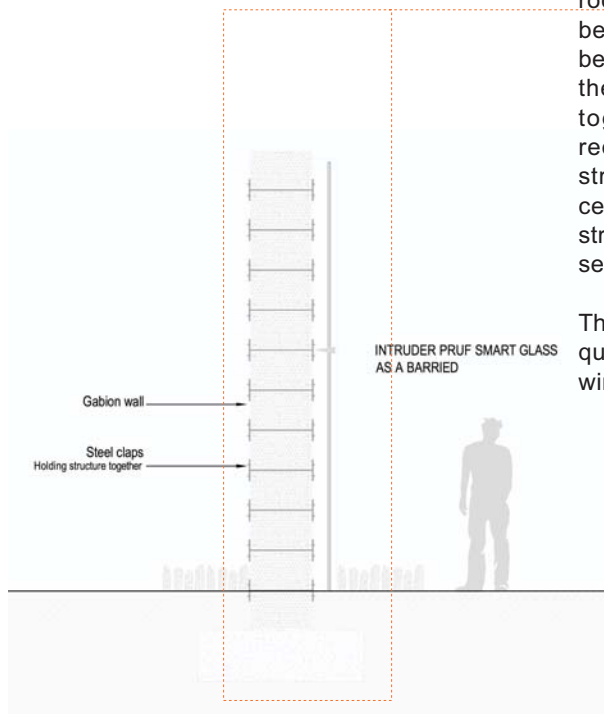



planting (green roof) as a material of architecture

The natural landscape is an integral part of the building design. The landscape is not only brought right into the building but actually passes over the building, forming a planting carpet on the roof. This landscaped roof structure does not only affect the visual effect of the building, it also assist in the thermal cooling if the building.

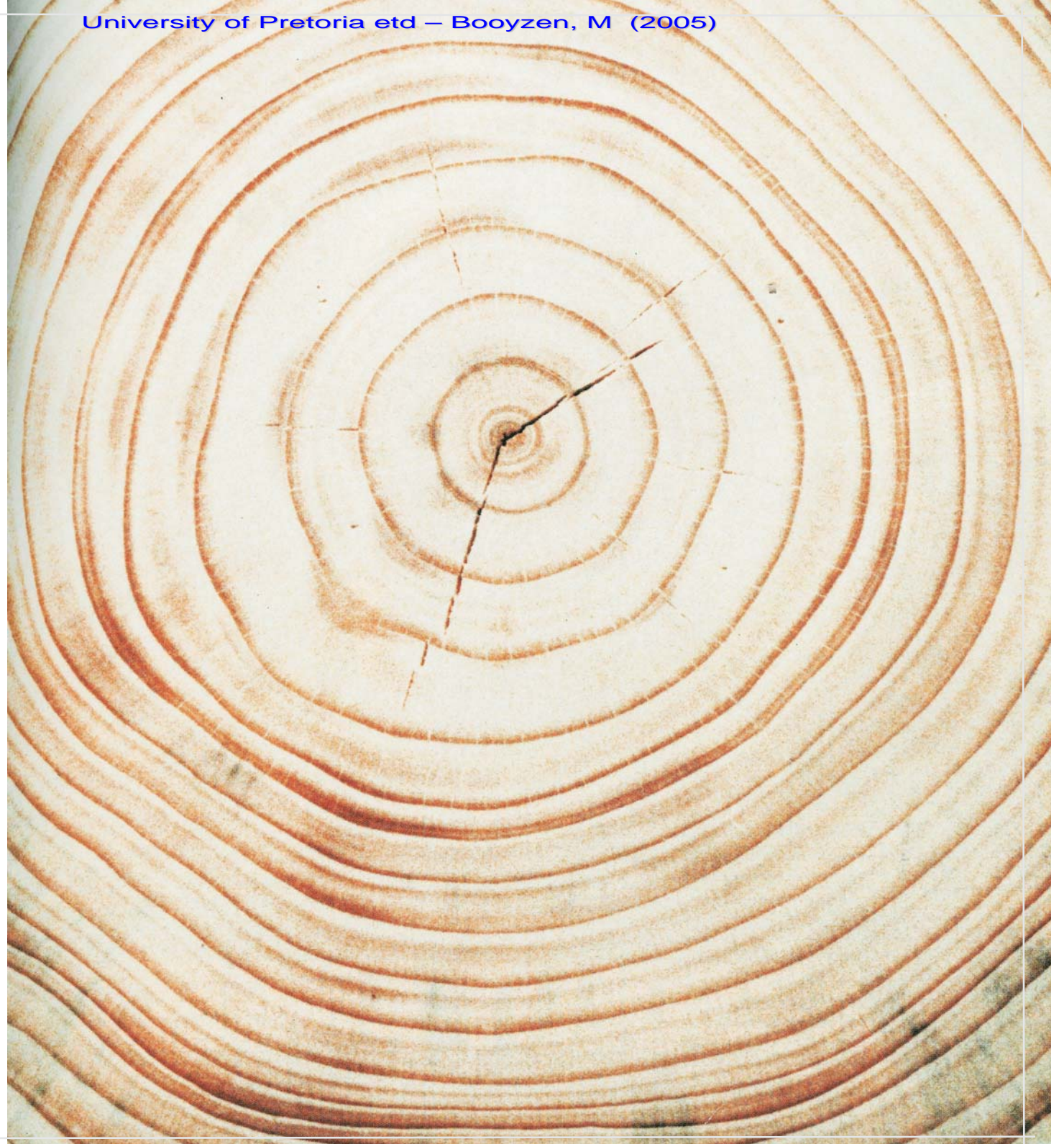

timber as a material of architecture

Large laminated timber lattices are applied to various large openings for the purpose of sun screening. These take the form of natural, sealed, laminated 280mmx75mm battens, arranged to form a lattice screens over large windows. These screens serve the dual purpose of controlling the penetration of excessive sunlight while creating diverse and interesting shadows on the respective interiors, once again adding interest. On the elevation, this new element accents and articulates the façade with forest-like configuration of vertical elements and completes the language of contrasting densities.

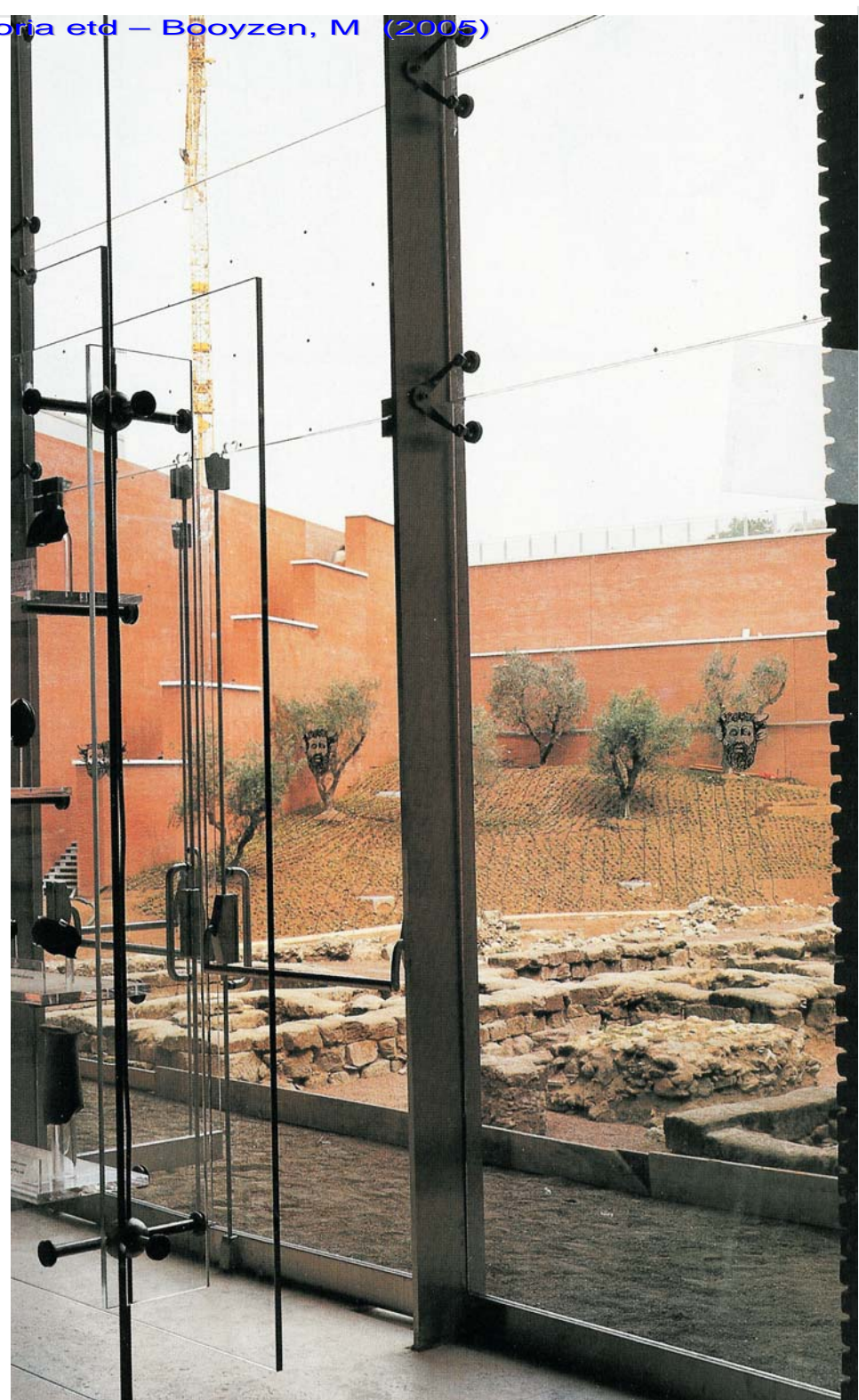

FLAT CONCRETE ROOF WITH GRAVEL ON TOP

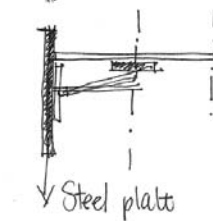
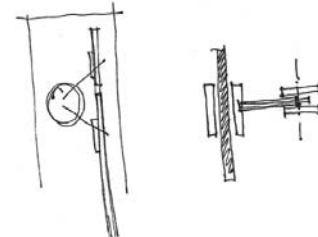
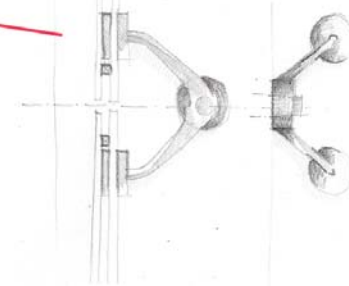
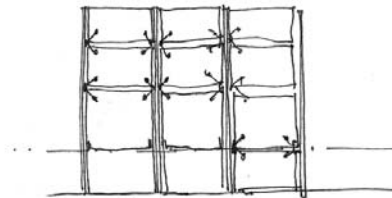
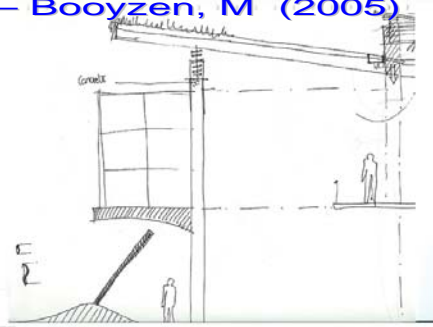
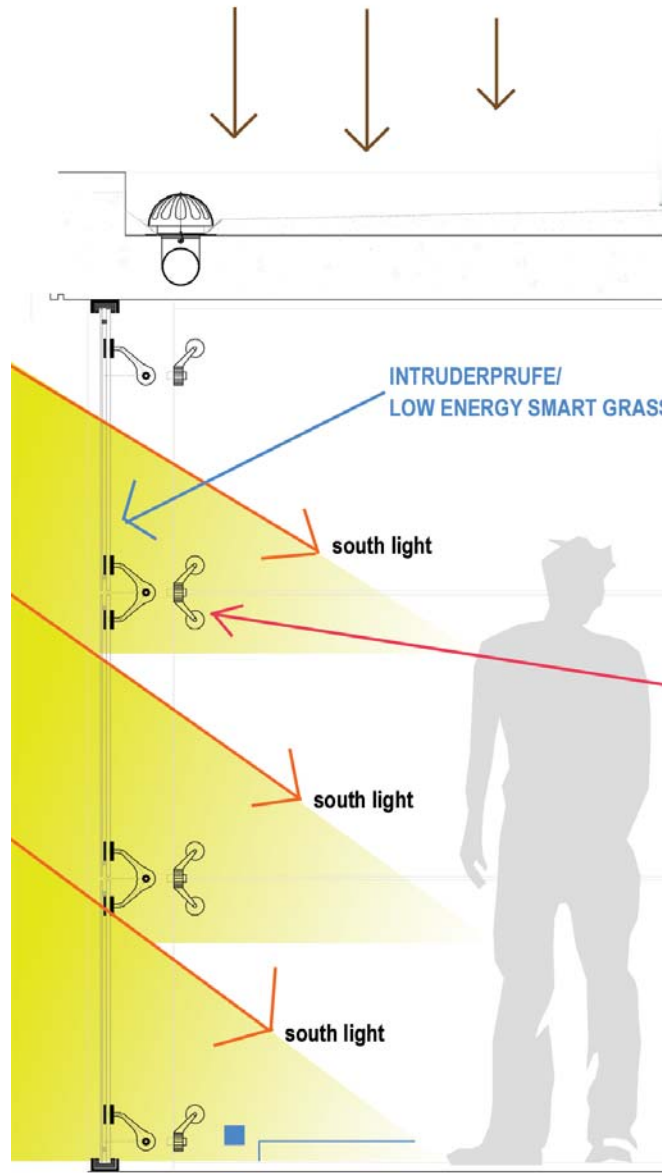

glass as a material of architecture

Intruderprufe Smart glass

Intruderprufe is a clear laminated glass, made from two layers of clear float glass, permanently bonded together by pressure and heat with one or more Polyvinyl Butyral (PVB) plastic interlayers.

Intruderprufe offers in blocking the intrusion of unwelcome noise and UV light. It also prevents a simple fall against a large window from turning into a tragic accident. The result is a SABS approved safety glass that can withstand many blows. High Penetration Resistant (HPR) for additional security - 0.76mm PVB

Laminated glass is used to open the interiors to the outside and allow the healing aspect of light to permeate the spaces. A pervasive and interesting application of light in an interior engenders an atmosphere of positivity and optimism. This is particularly pertinent to the application of a youth facility as the atmosphere influences, not only inmates, but staff, teachers and visitors. The fenestration thus plays an important role in the application of interesting and varied daylight penetration. Glazing is also utilized to screen gabion walls so as to prevent prisoners from concealing objects within the stone-work

performance data

solarshield + 12mm air gap +intruderprufe low-e

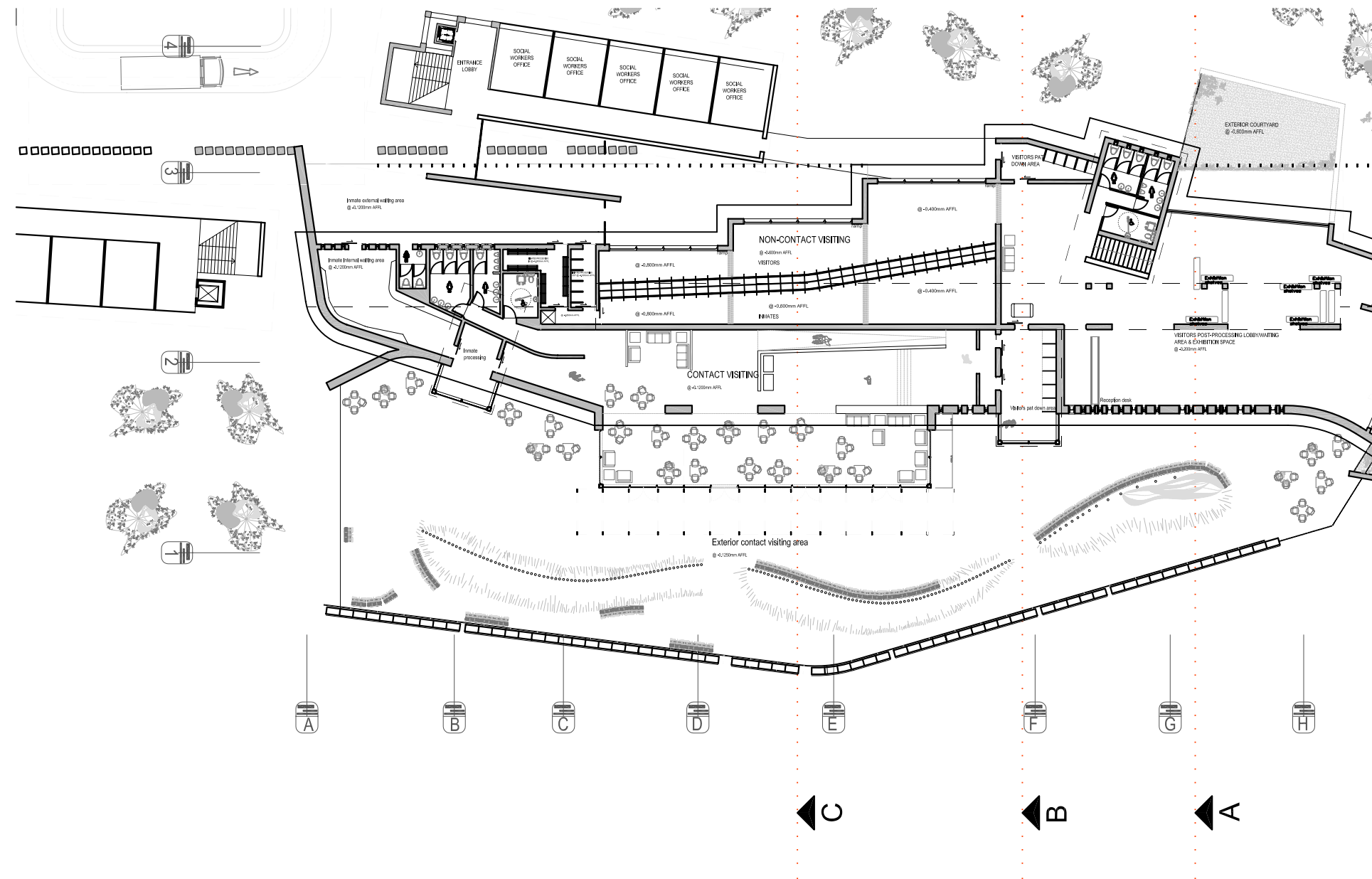

GROUND FLOOR OF VISITORS CENTRE *scale 1:400*

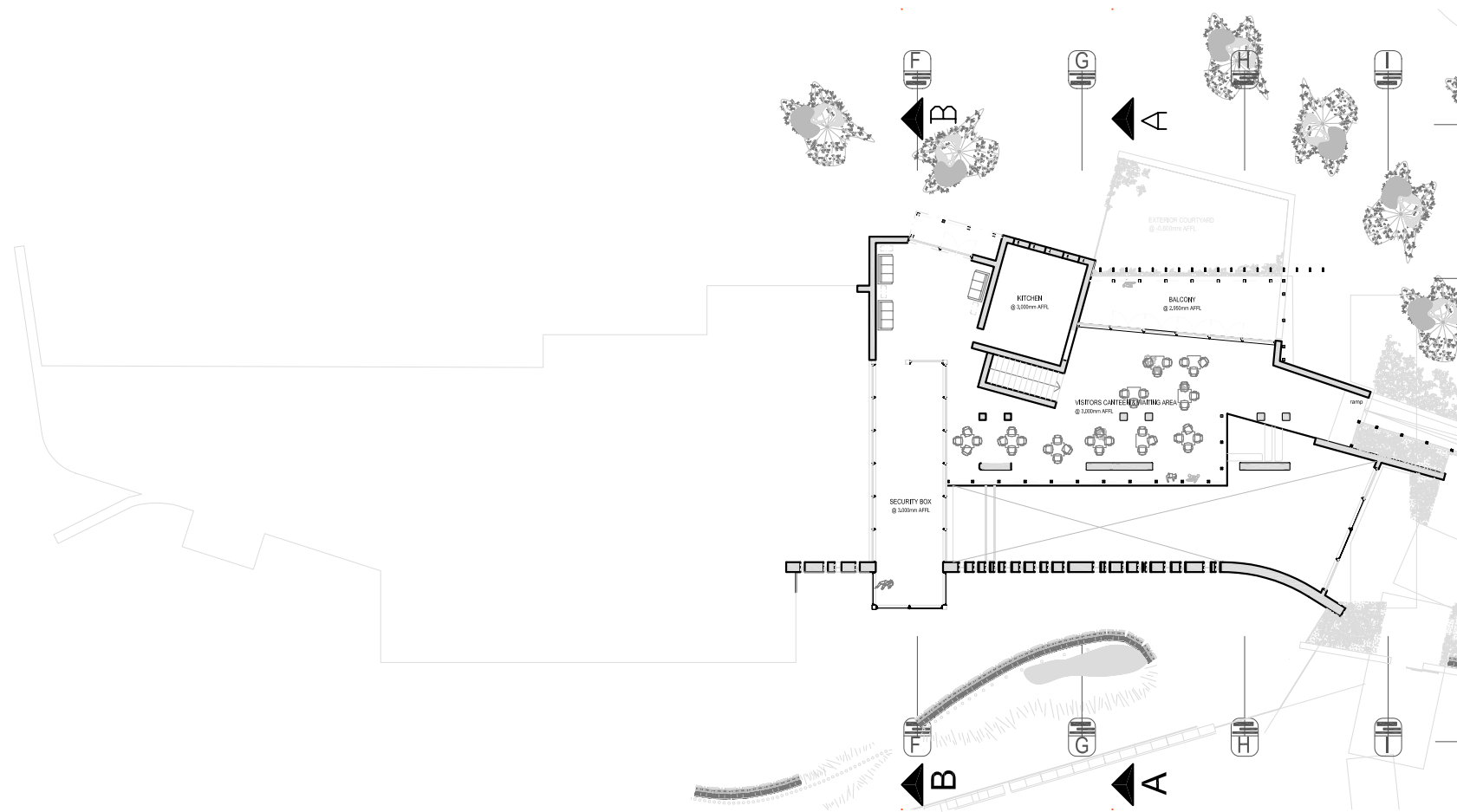

FIRST FLOOR OF VISITORS CENTRE *scale 1:100*

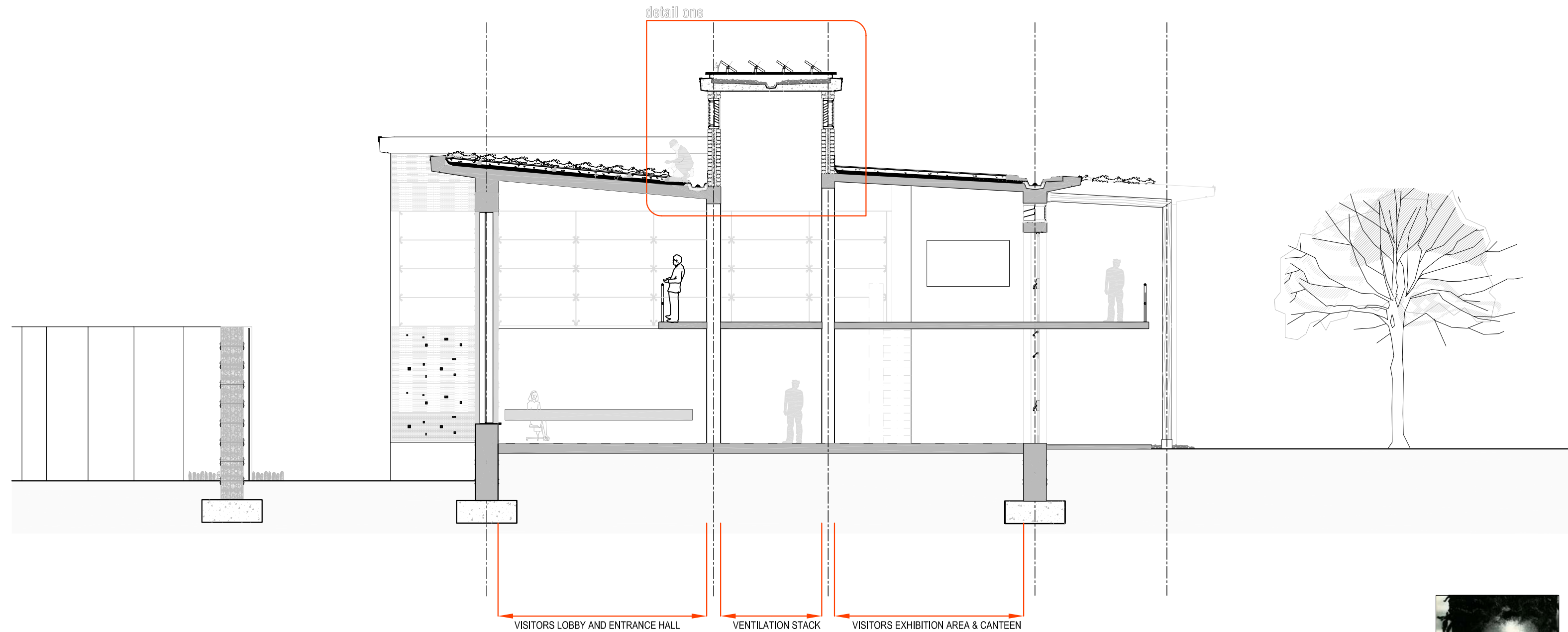

Section A:A scale 1:100

Leeuwkop youth prison
visitors centre



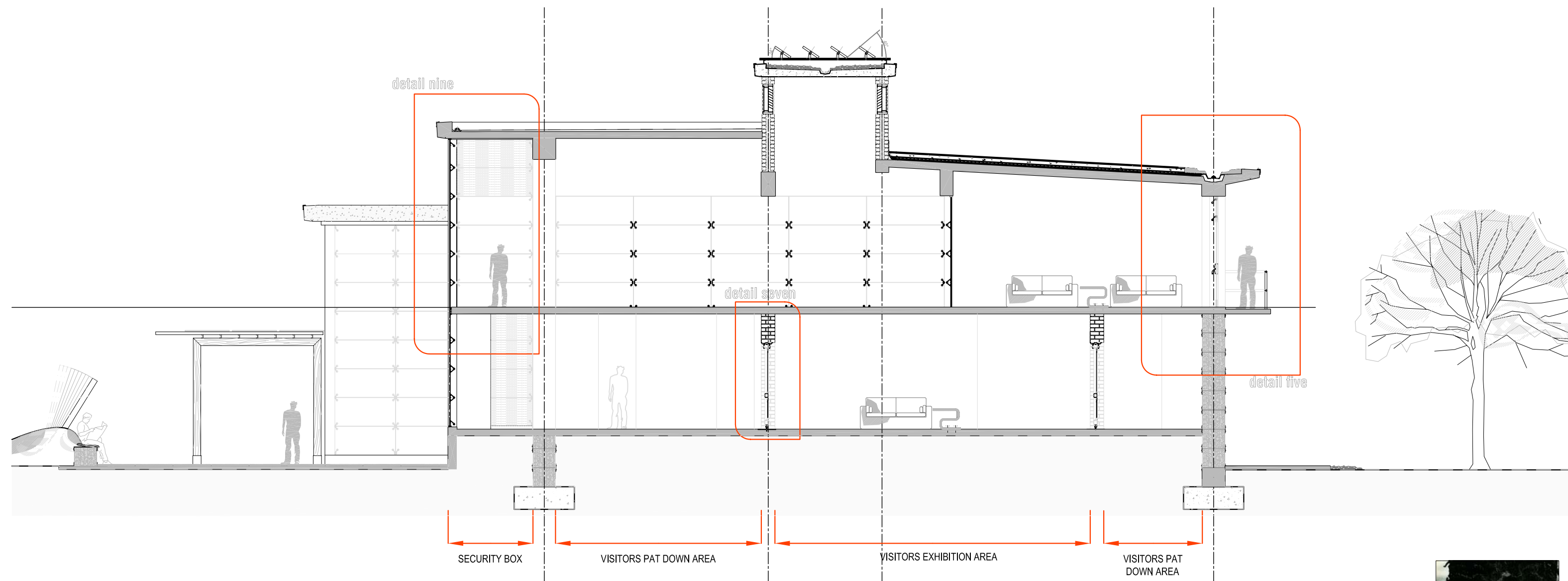

Section B:B scale 1:100

Leeuwkop youth prison
visitors centre



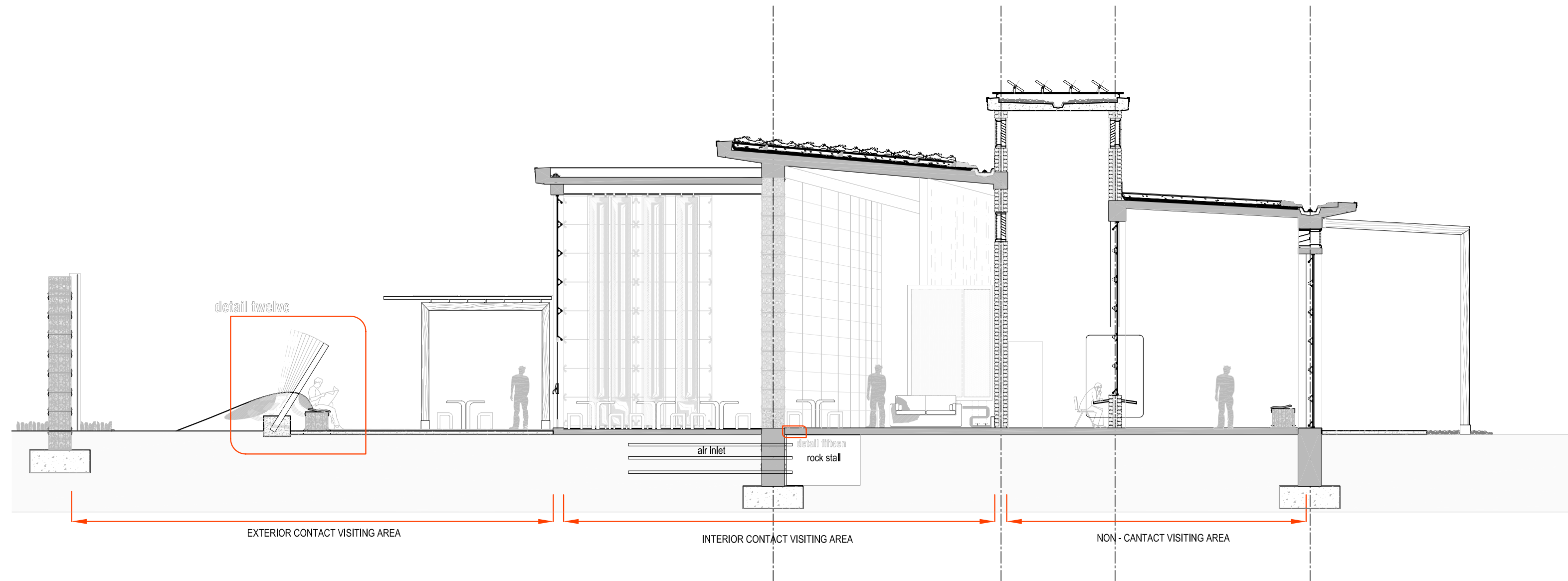

Section C:C scale 1:100

Leeuwkop youth prison
visitors centre



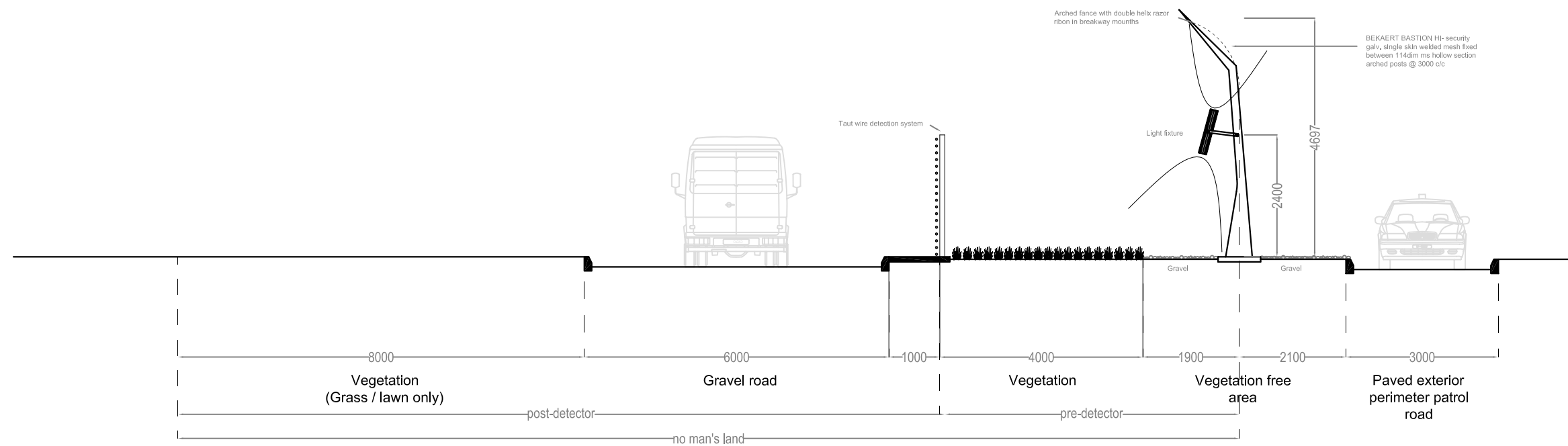

detail fourteen:
Bekaert Bastion hi-security fence
scale 1:100

Leeuwkop youth prison
visitors centre



Healing space:
education, motivation, intergration

- Photo voltaic panels @ 43deg facing North
- 100 x 50mm steel channel
- 100 x 60mm steel angle coaping
- gravel
- structural concrete roof slab
- drip
- concrete roof gutter
- 230mm secured louvered section

detail two

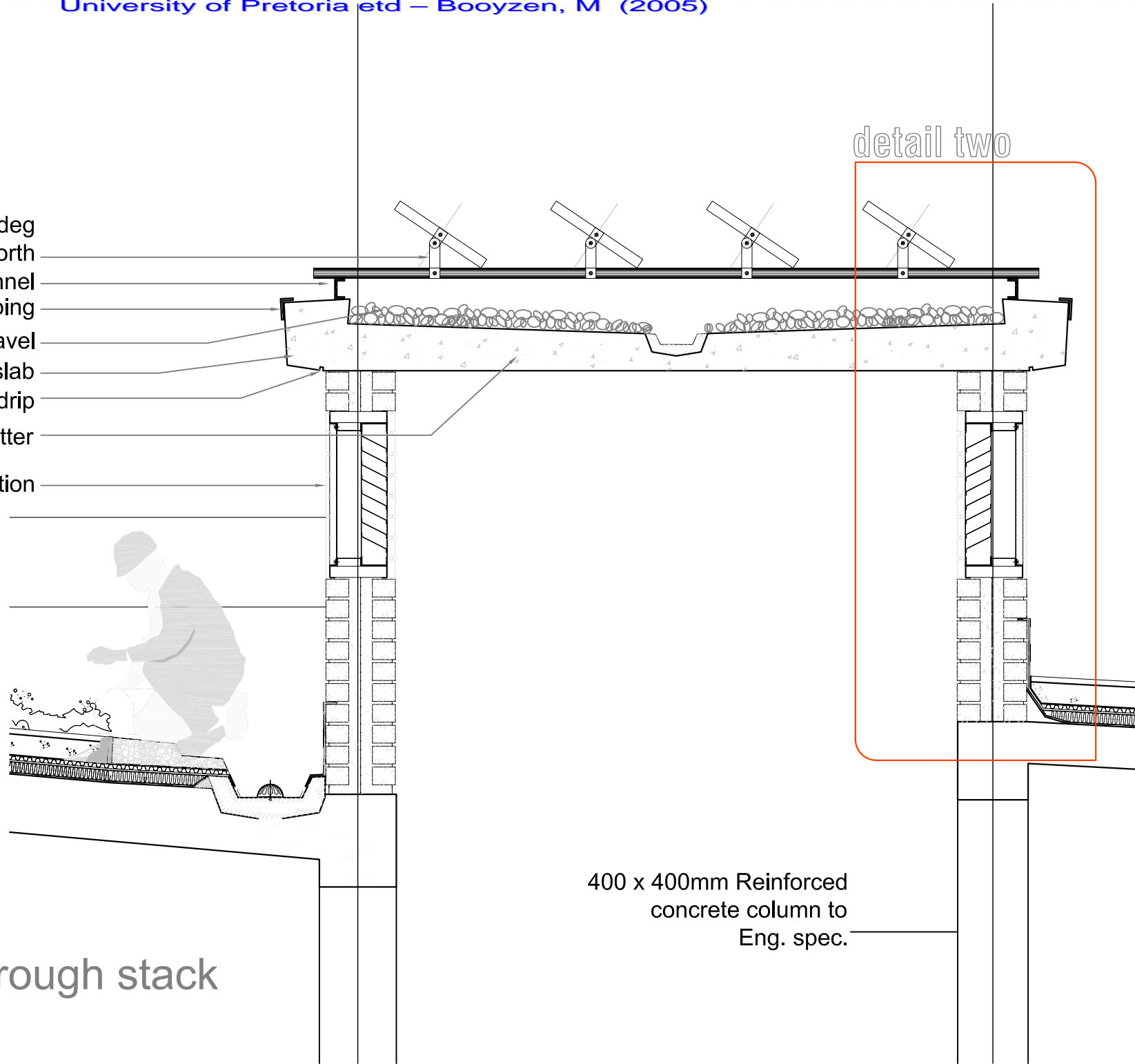

Detail one

detailed section through stack

scale 1:25

400 x 400mm Reinforced concrete column to Eng. spec.

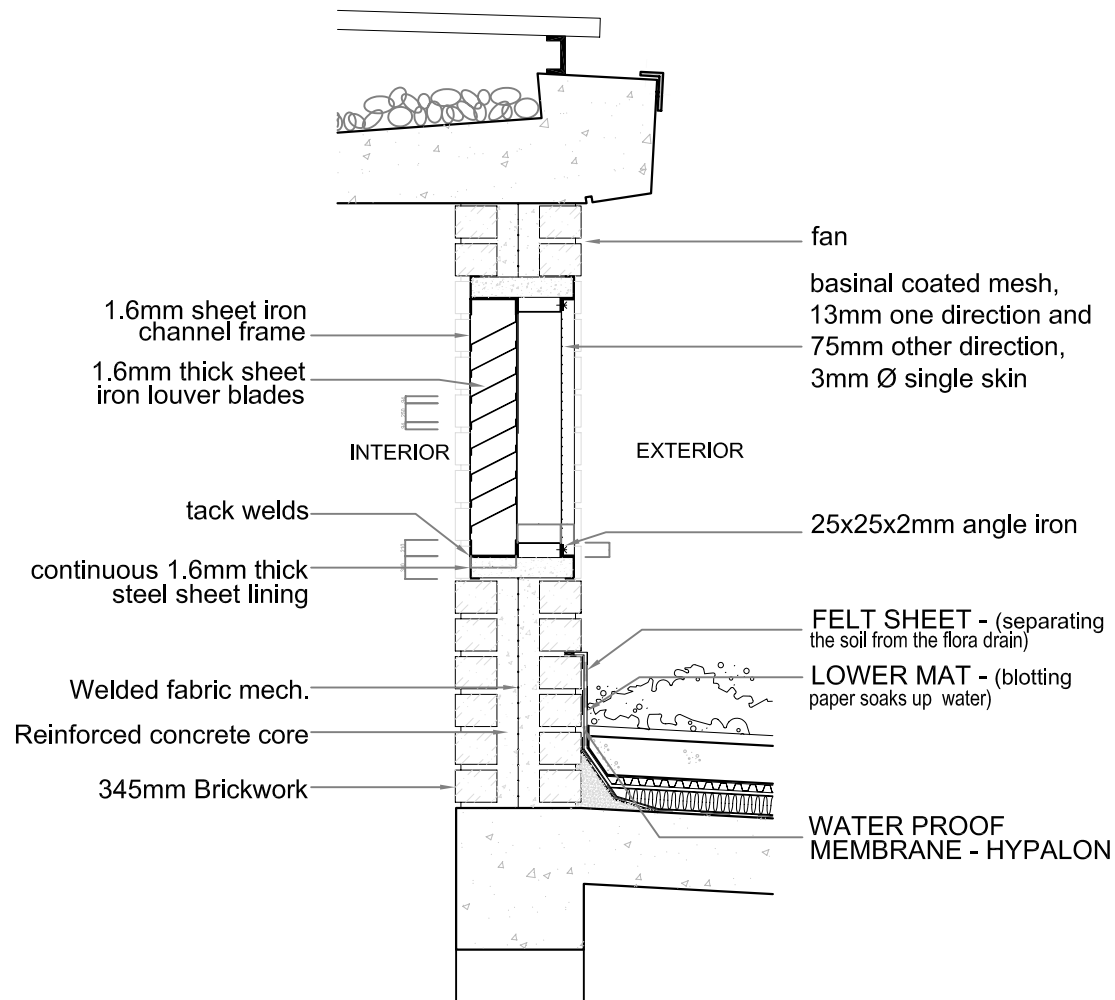

Detail two

230mm secured louver section

scale 1:20

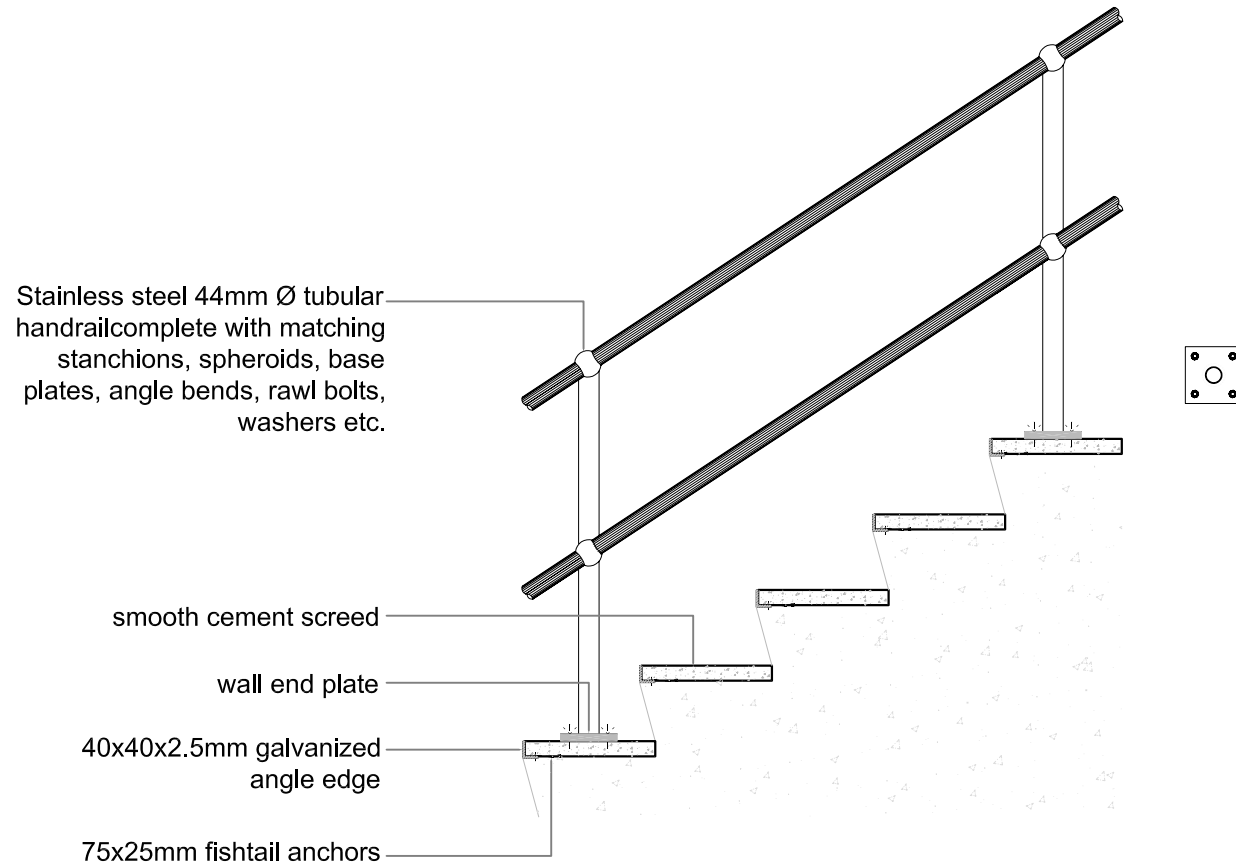

Detail three

staircase and rail detail

scale 1:20

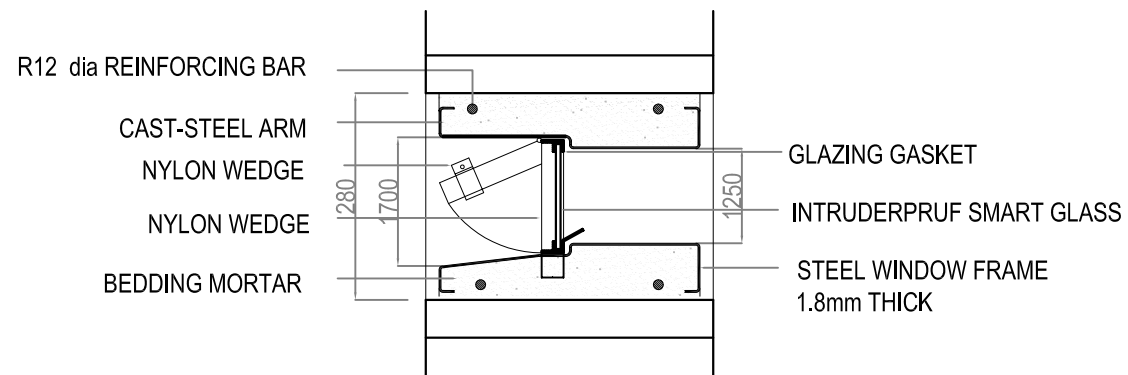

Detail four

tamper proof window and concrete frame

scale 1:10

detail six

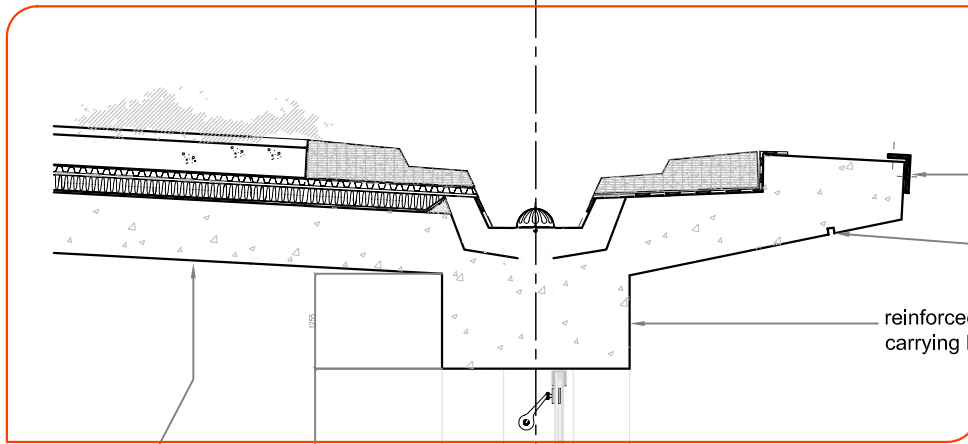

125x75x12mm steel angle iron

drip

reinforced pre-cast concrete beam carrying horizontal loading

Reinforced concrete coffer slab to Eng. spec with Green roof structure (THE ERISCO-BRAUDER 'GREEN' ROOF) on screed to fall @ 8%. Pre-cast concrete box gutter as storm water outlet.

Vandal proof cast-steel arm

Intruderpruf high penetration resistant smart glass (12.76mm thick)

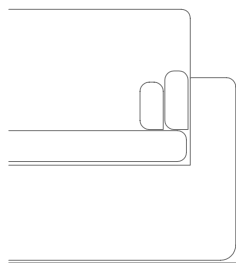

Stainless steel 44mm diameter tubular handrail complete with matching stanchions, spheroids, base plates, angle bends, rawl bolts, washers etc.

Reinforced concrete coffer slab to Eng. design and spec. with power-floated, tinted, hardened concrete.

Gabion wall structure

Detail five

scale 1:25

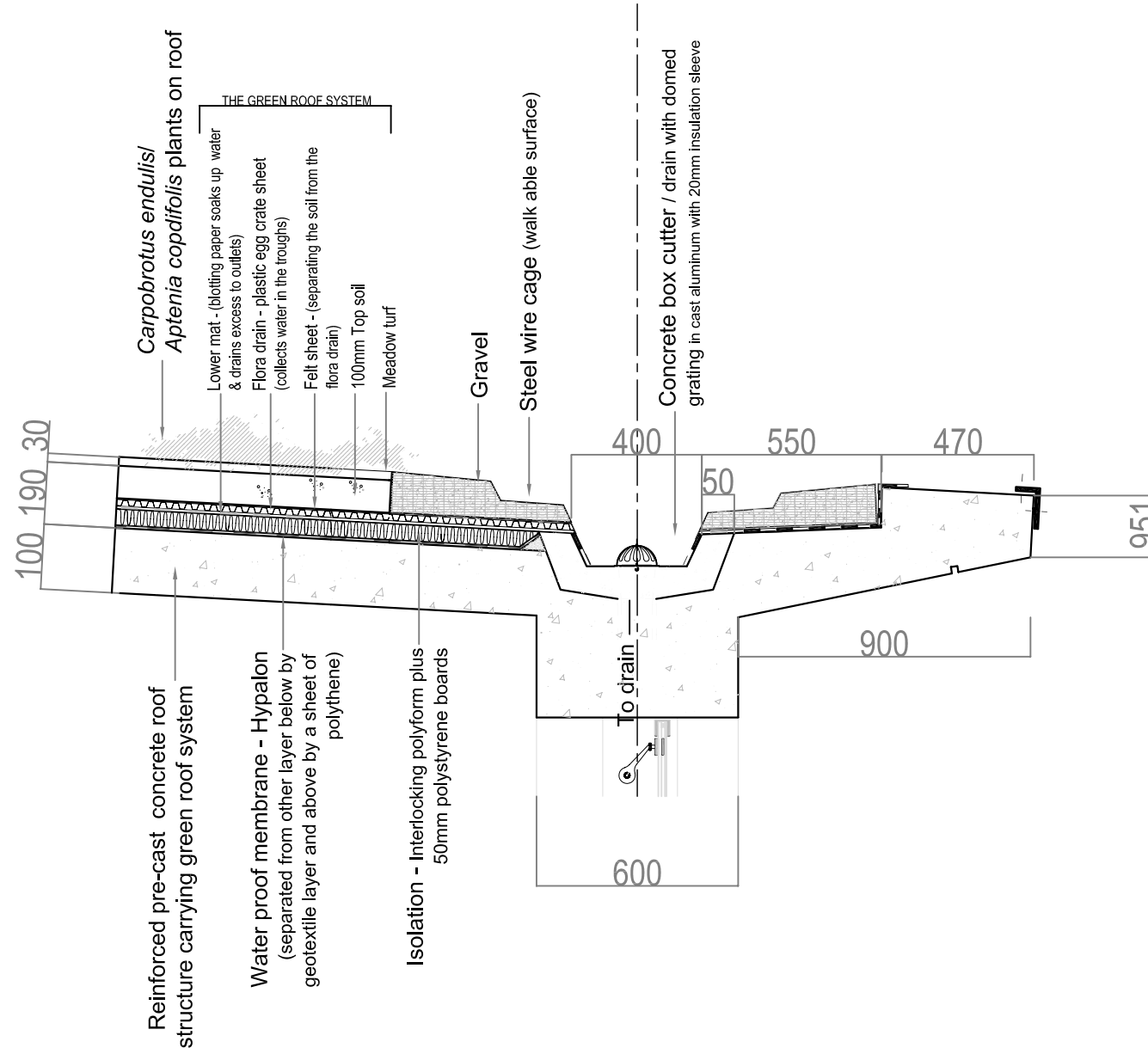

Detail six

Green roof structure

scale 1:20

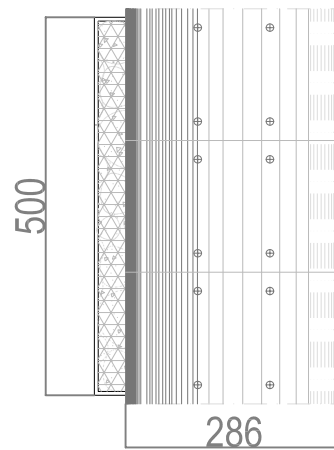
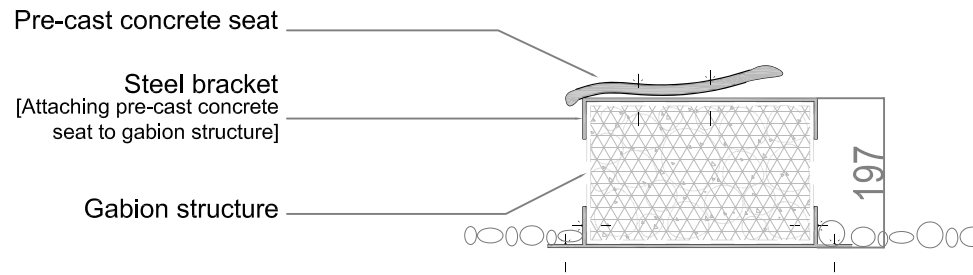

Detail ten

pre-cast concrete seat and gabion

scale 1:20

detail eight

M10 Galvanized bolts and nuts with galvanized 3mm steel washers at max. 400mm centers. Bolt ends are to be riveted on the safe side of the area.

75x75 5mm galvanized steel angle

75x8mm galvanized steel plate

M10 Galvanized bolts and nuts with galvanized 3mm steel washers at max. 400mm centers. Bolt ends are to be riveted on the safe side of the area.

Power-floated, tinted, hardened Concrete on 85mm concrete surface bed on damp proof membrane, on 150mm compacted hard-core filling

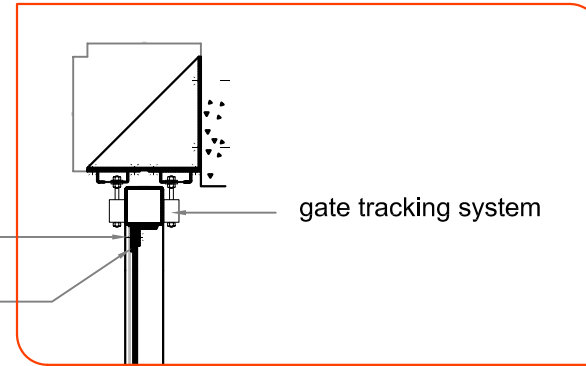

gate tracking system

welded fabric with 75 x 50 openings, galvanized 2mm wires both ways

100x85 5mm galvanized steel hollow square section for frame to gate

Intruderpruf smart glass (orange)

100x100 5mm galvanized steel hollow square section for frame to gate

guide wheel (to be designed by gate specialist)

75x75 6mm galvanized steel angle fishtail anchor welded to angle

Detail seven

Gate track and roller detail

scale 1:25

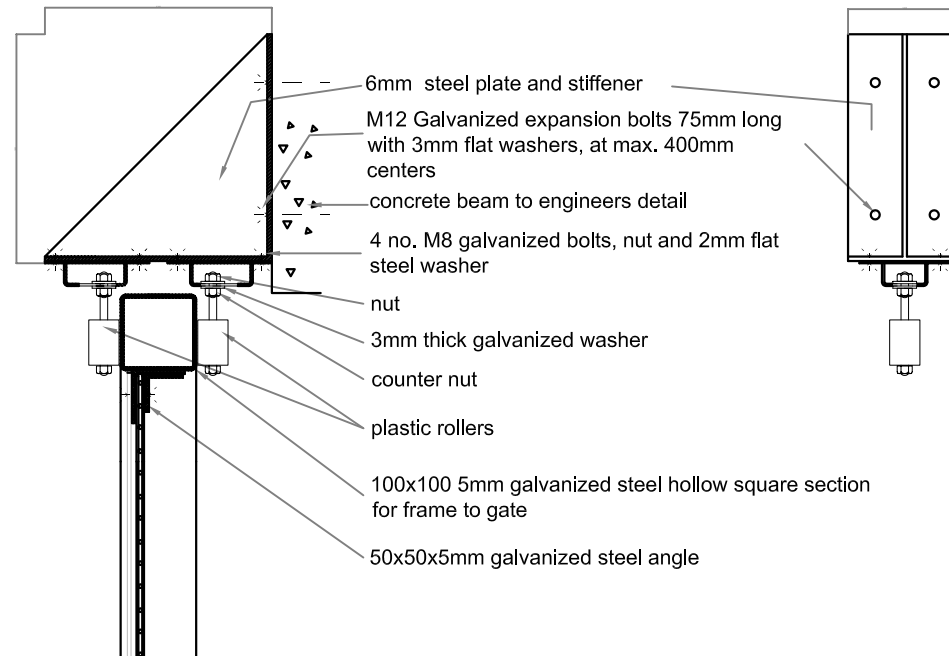

Detail eight

Gate track system

scale 1:10

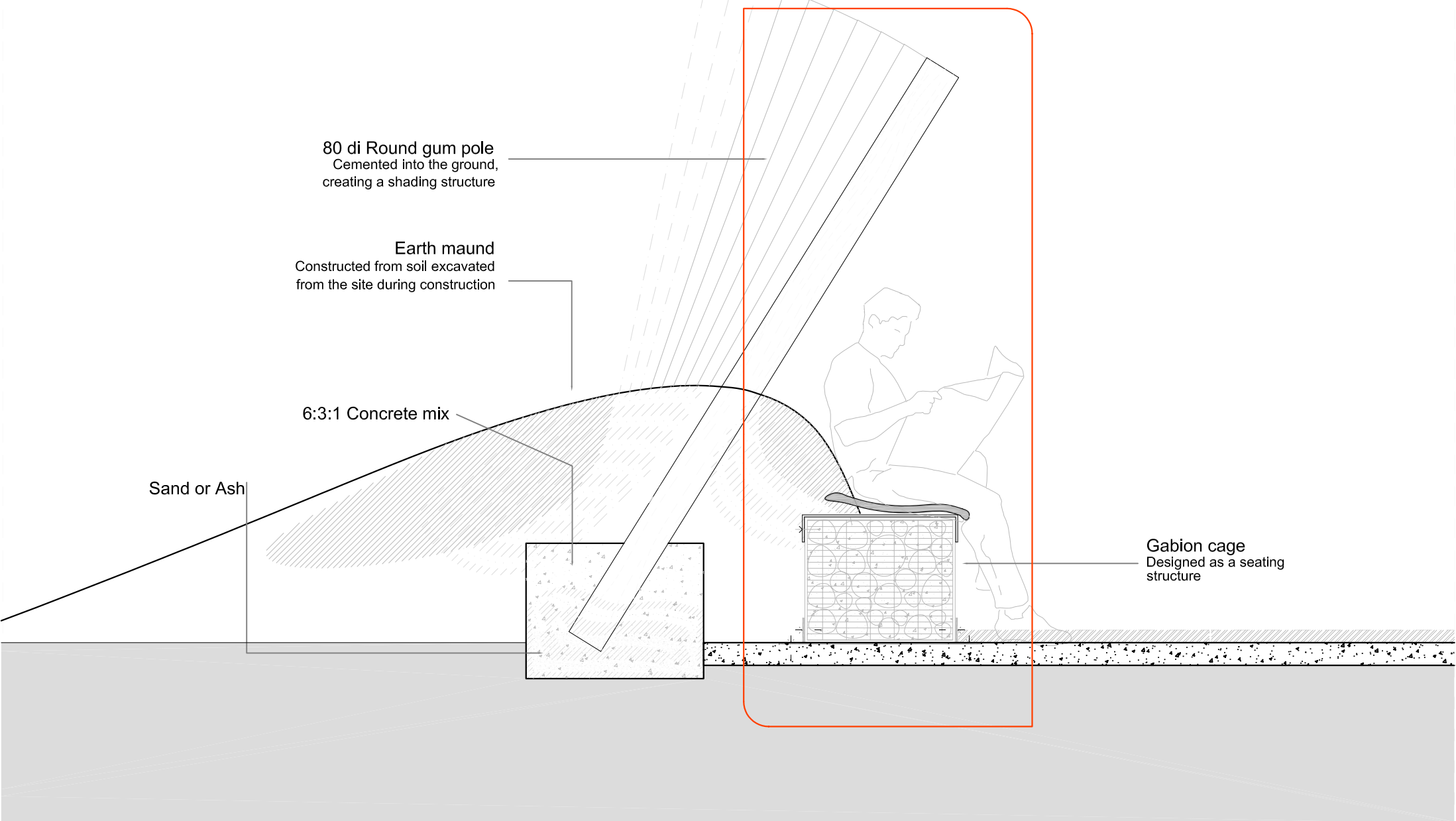

Detail nine

section through earth mound and gumpoleshading structure

scale 1:20

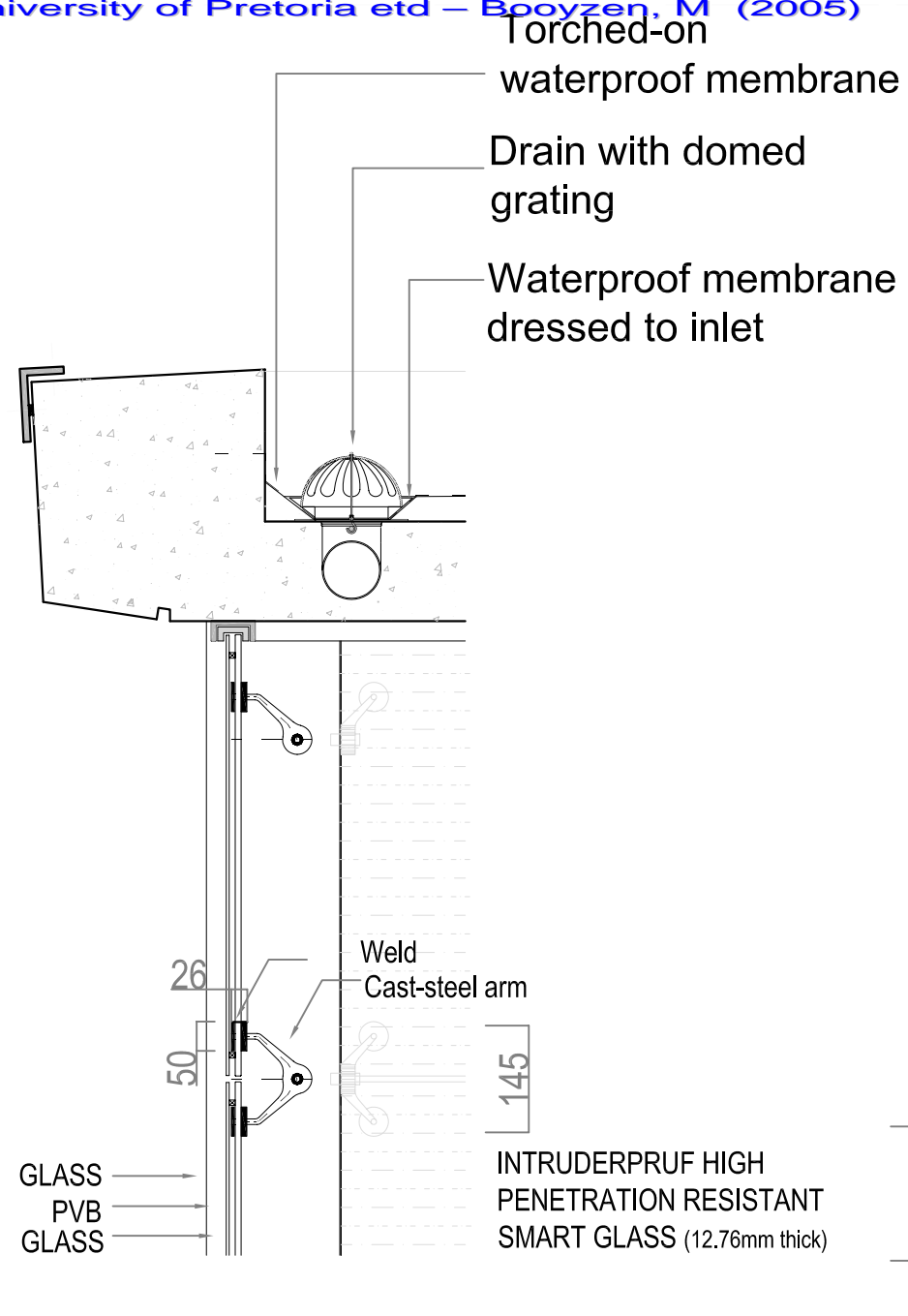

Detail eleven

Drain with domed grating

scale 1:20

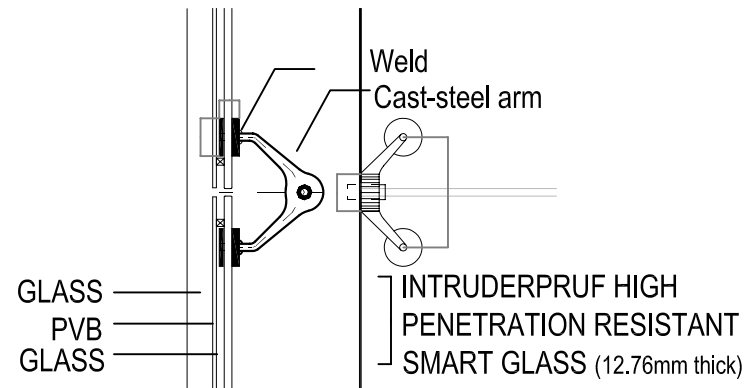

Detail twelve

Cats-steel arm connecting the panes of glass
to the lattice structure

scale 1:10

detail eleven

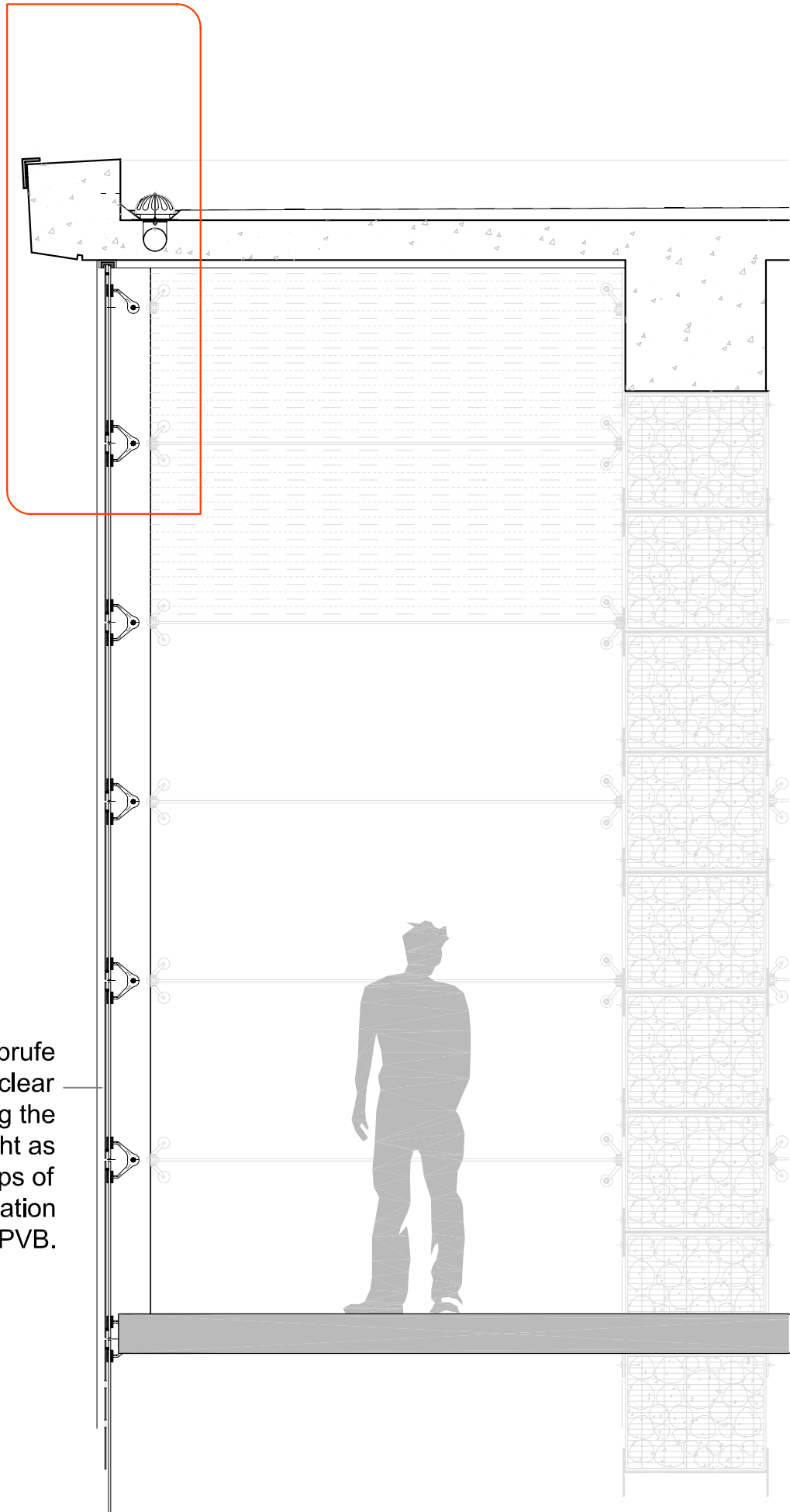

Glazing element - Intruderprufe Smart glass. Two layers of clear laminated glass blocking the intrusion of noise and UV light as well as preventing attempts of escape with high penetration resistance - 0.76mm PVB.

Detailed section through security box showing flat concrete roof & rainwater outlet

bibliography

- Brandi, U. and Brandi, C. (2001) Lightbook. Birkhauser, Switzerland.
- Bromilow, C. (1995). Problem Plants of South Africa. Briza Publications. Pretoria- South Africa.
- Carney, L. Introduction to correctional science. London: McGraw-Hill Book Company, 1974.
- Chiazzari, S. (1998) The complete book of colour. Element Books Limited, Britian.
- Chiazzari, S. (1998) The healing home. Ebury Press, London.
- Dal Co, F. (1995) Tadao Ando: Complete works. Phaidon Press Limited, London.
- Dissel, A. Children Serving Gaol Sentences: A profile on children sentenced to prison, Research paper written for the Centre for the Study of Violence and Reconciliation, August 1999.
- Donnelly, M.C. (1992) Architecture in Scandinavian Countries., DEKR Corporation, U.S.A.
- Entwistle, J. (1999). Designing with light: Bars and Restaurants. Watson-Guptill Publications, New York.
- Faber, T. (1968) New Danish Architectur., London Press, Germany.
- Gardner, C and Molony, R. (2001) Transformations Light. RotoVision SA, Switzerland.
- Gary, R, Steffy, Lies and Lald. (1990) Architectural Lighting Design. John Wiley & Sons. Inc, Canada.
- Gast, M. Education and the South African juvenile justice system. CYC online, issue 34 2001
- Hiort, E. (1958) Contemporary Danish Architecture. Arkitektens Forlag, Kopenhagen.
- Jencks, C. (1973). Le Corbusier and the tragic view of architecture. Penguin Books Ltd, London.
- Johnson, R and Toch, H. The Pains of Imprisonment. London: Sage publications, 1982.
- Longford, L. Young Offenders. London: Chapmans Publishers, 1993.
- Mehta, P.K. "Role of Pozzolanic & Cementitious By-Products in Sustainable Development of the Concrete Industry", in Sixth CANMET/ACI/JCI Conference: Fly Ash, Silica Fume, Slag & Natural Pozzolans in Concrete, 1998.
- Michel, L. (1996) Light: The Space of Space. Van Nostrand Runhold, New York.
- Millet, M. (1996). Light Revealing Architecture. International Thomson Publishing, Inc, U.S.A.
- Millham, S. and Bullock, R. and Hosie, K. Locking up Children. England: Saxon House, 1978.

Mokgohloa, T. Good Cop, Bad Cop, in the S'camto lovelife's uncut magazine, Issue 2. South Africa: Printability, 2004.

Moyer, I. L. Criminological Theories. London: Sage publications, 2001.

Neitzert, F. et al. Canada's Greenhouse Gas Inventory: 1997 Emissions and Removals with Trends. Environment Canada, 1999.

Oppler, S. Correcting Corrections - Prospect for South Africa's Prisons. South Africa: ISS Monograph series, 1998.

Oudtshoorn, F. (1991). Grasse van Suid-Afrika. Briza Publikasies. Pretoria- South Africa

Palmer, J. W. Constitutional Rights of Prisoners. Cincinnati: the W.H Anderson Company, 1973.

Sun, H and Sun, D. (1992) Colour your life. Judy Piatkus (Publishers) Ltd, London.

Thomas, V. and Grant, R.(1998). Sappi Tree Spotting - Highveld and the Drakensberg. Jacana-Durban. South Africa.

Toch, H. Living in Prison. Washington, DC: American Psychologist Association. (Original work published 1977)

Tregenza, P and Loe, D. (1998) The Design of Lighting. E & FN Spon, London and New York.

Van Wyk, B., Van Wyk, P., and Van Wyk, B.E. (2000). Photographic guide to Trees of Southern Africa. Briza Publications. Pretoria- South Africa

Walter, J. A. Sent away: a study of young offenders in care. England: Saxon House, 1977.

