

Chapter 8 - Technical Investigation

8.1 Structure

A concrete structure is selected for economic reasons, as well as being representative of the Pretoria heritage. Concrete columns are used throughout the design, with 85mm \varnothing rainwater down pipes cast into these columns, leading to underground storage tanks to maintain the public precinct.

Most of the slabs used in the building span 8m, and after discussions with an engineer, it was decided to introduce 340 mm coffer slabs at intervals of 600 mm into the design to ensure proper spans, eliminating deep concrete beams. The rest of the building uses conventional 255 mm slabs.

An exposed steel frame is used wherever Kor-ten cladding comes into play, producing a more lightweight appearance to a building that has a predominantly bulk mass. The cladding is an indicator of passive surveillance throughout the design.

8.2 Materials

To a great degree the materials of the building relate to the Pretoria vernacular. This necessitates the use of local materials, while concrete reflects the modernist principles, with a Brazilian influence. The public nature of the building necessitates the use of materials that weather well and are low-maintenance.

Brick

The use of red brick roots the building firmly in its context, as these bricks are a regular occurrence in Pretoria, especially in institutional facilities. Although face bricks come at a higher price than stock bricks the client will save in the long term with the low maintenance aspects of face brick. As a result walls on ground floor are in face brick.

Glazing

The concept of the building as a viewing station provided the opportunity of using ceiling-to floor glazing, to optimize interaction between the in- and outside of the building. This ideal, combined with the modernist rational of strip windows results in the extensive use of glass in the building. As a public building, the intervention is to appear open, transparent and inviting, thus the entrance of the building is portrayed as a glass box.

Timber

Balau timber is used for the dance floors and other mezzanine floors in the steel frames of the building. Aesthetically, the material adds to the warmth and comfort of the intervention. Use is limited to spaces that can be locked up, due to security reasons. The material is also used in the construction of the horizontal light box, as discussed above in chapter 7.11. Long-term advantages include low maintenance cost and Balau timber weathers to grey and does not need to be treated.

Steel

Steel is used in most door and window frames in the building. Steel components exposed to the elements are black powder-coated for protection. Where possible, galvanized mild steel is used for ease of maintenance. Perforated Kor-ten plates are used as a cladding material throughout the building.

Surfaces

Public spaces are defined with pre-cast concrete pavement blocks of exposed aggregate in a medium colour. On the roof garden the blocks are on adjustable spacers to level the roof surface. 10 mm open grooves are cast into the blocks to ensure sufficient drainage. Concrete blocks with a brush finish are used to allow easier movement for wheelchair users (Van den Heever, 71). The grass surfaces are irrigated by the underground water storage.

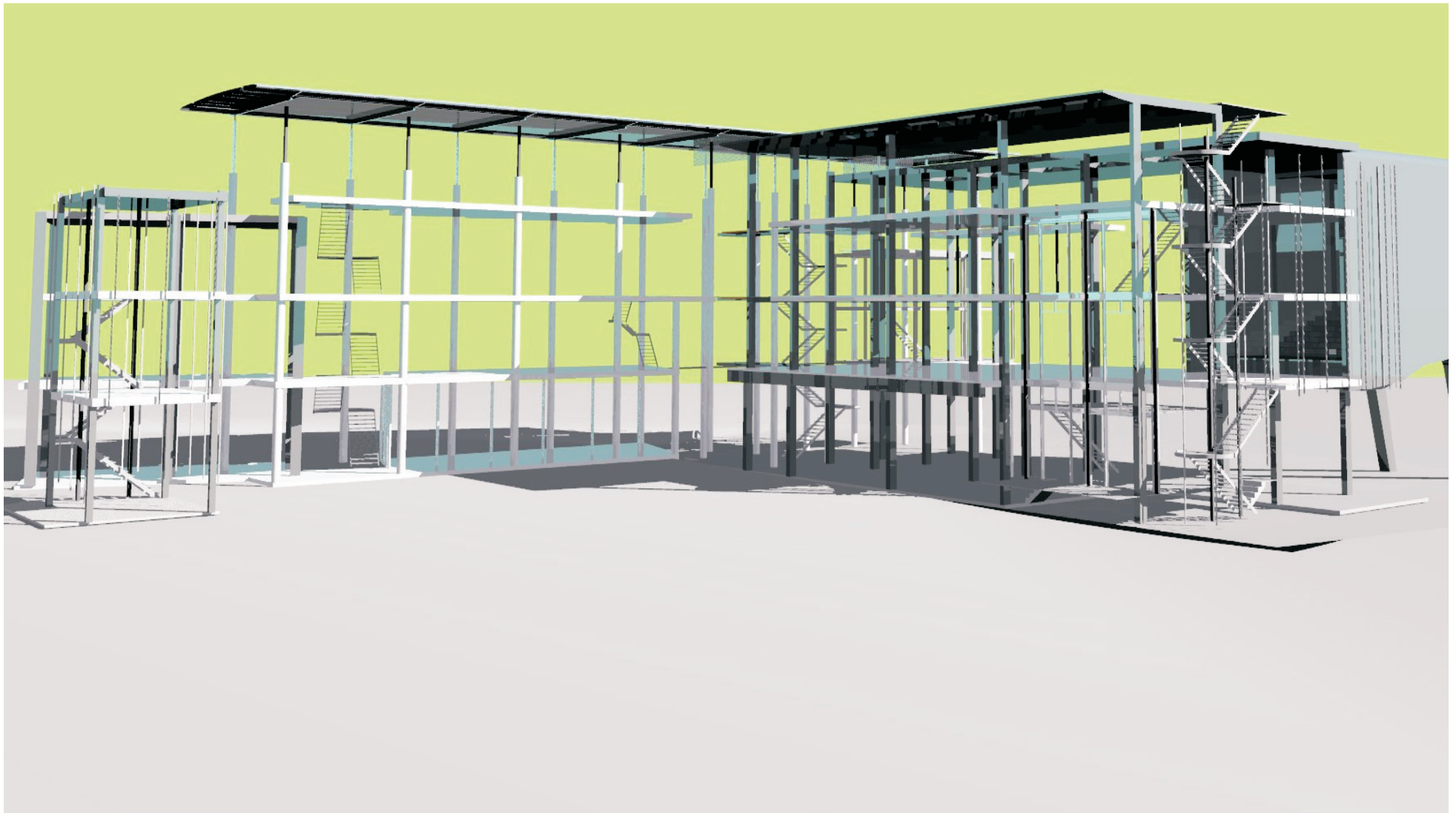

Fig 8.1 Diagram of the structural system of the building

8.3 Services

Multiple-service cores are integrated into the design to ensure longevity regarding future air-conditioning and cabling needs. Floors of the buildings are fitted with removable carpet and adjustable spacers to ensure ease of maintenance. Where possible, services are hidden behind a skin of kor-ten plates, providing the opportunity of placing generous openings into public restrooms. A plant room is located on the third floor of the building next to the auditorium to ensure effective air-conditioning. The plant room is accessible by two double doors from the outside, hidden by the Kor-ten skin but provided with a custom hinged door for ease of access.

The kitchen is located on the western side of the building with a service yard. Extraction ducts are fitted into exterior walls for fire regulations. Storm water is collected in channels throughout the site and channelled to the municipal storm water system.

A discussion with engineering experts resulted in the office floor being fitted with air-conditioning units in the removable floor panels. A single unit allows for 100 sq. meter ventilation. The gym is naturally ventilated through the skylight, while all spaces in the educational wing of the building are ventilated via cross-ventilation. The building is designed to allow for future air-conditioning needs if necessary.

8.4. Circulation

A disabled-friendly building was one of the main design initiatives. The presence of a lift in the building ensures the accessibility of all parts of the building to disabled users. All restrooms are wheelchair-friendly, including shower facilities. The lift is of adequate size to ensure the moving of gym equipment to the second floor. For ease of security, access to the building is limited to a single circulation space, while necessary fire escapes are provided throughout the building. All routes lead to a fire escape.

8.5. Lighting

Movement routes between the light boxes are illuminated by low-level lighting in the shape of bollards. Bollards are 350 mm high to double as seating space. The rugged appearance of these lights ensures easy maintenance and are theft-proof. Bollards that prevent vehicles from entering the public space are custom-made steel plates, removable if vehicles need to enter the spaces.

Spread lighting is placed around the soccer field and public space, yet will only be used during events.

8.5. Phases of construction

1. Construction of sports facility to define urban edge and frame public precinct. Add education facility to further define public precinct
2. Convert existing buildings into incubation stalls and community hall, introduce apartments onto incubator facilities and add soccer field.
3. Convert existing building into additional office space.



Fig 8.2 View from Struben street

main circulation

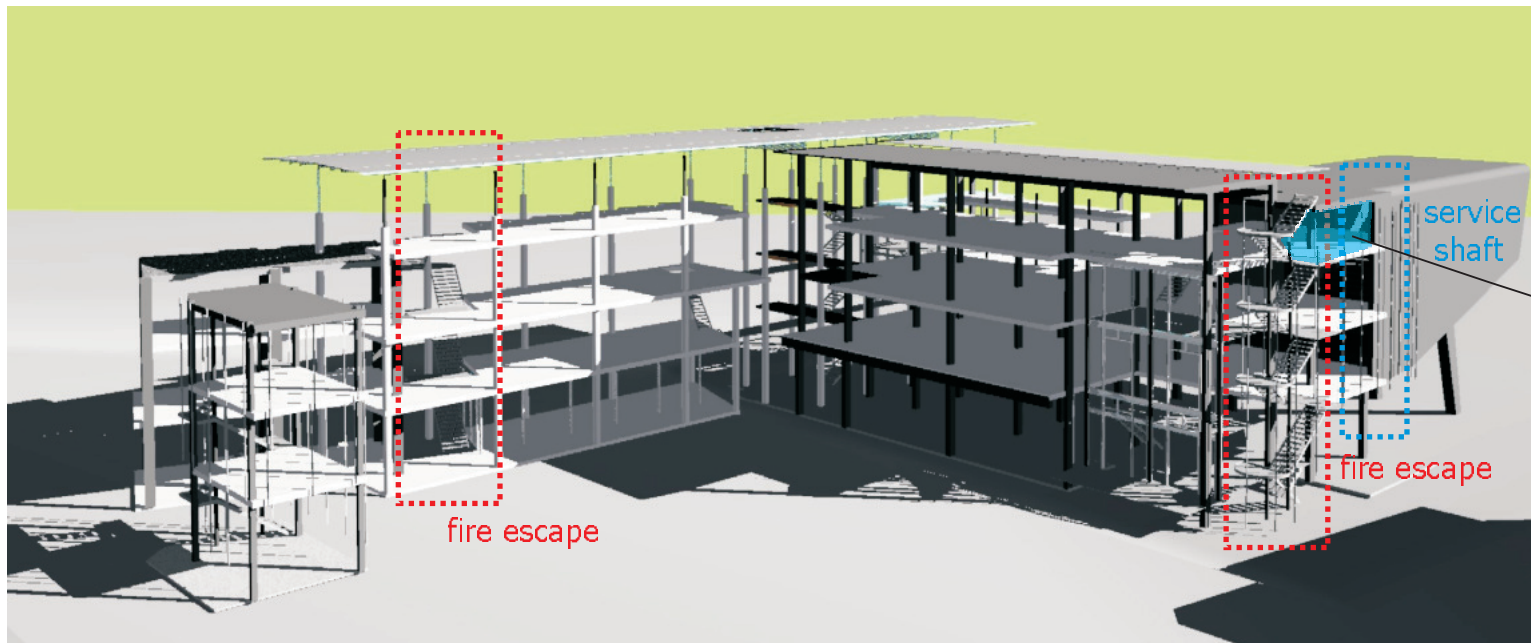
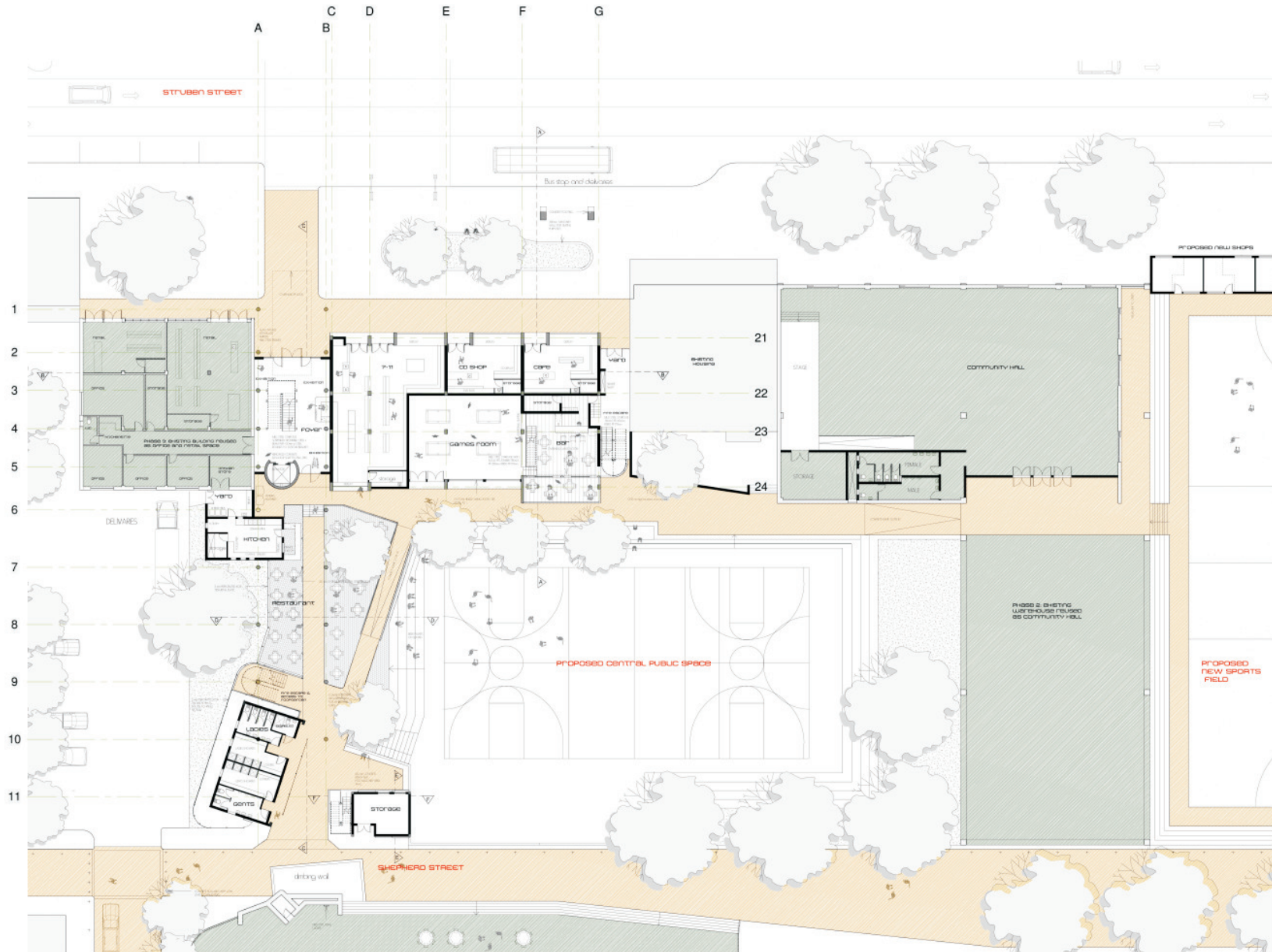

Fig 8.3 View from the public space

plant room

fire escape



GROUND FLOOR, NOT TO SCALE

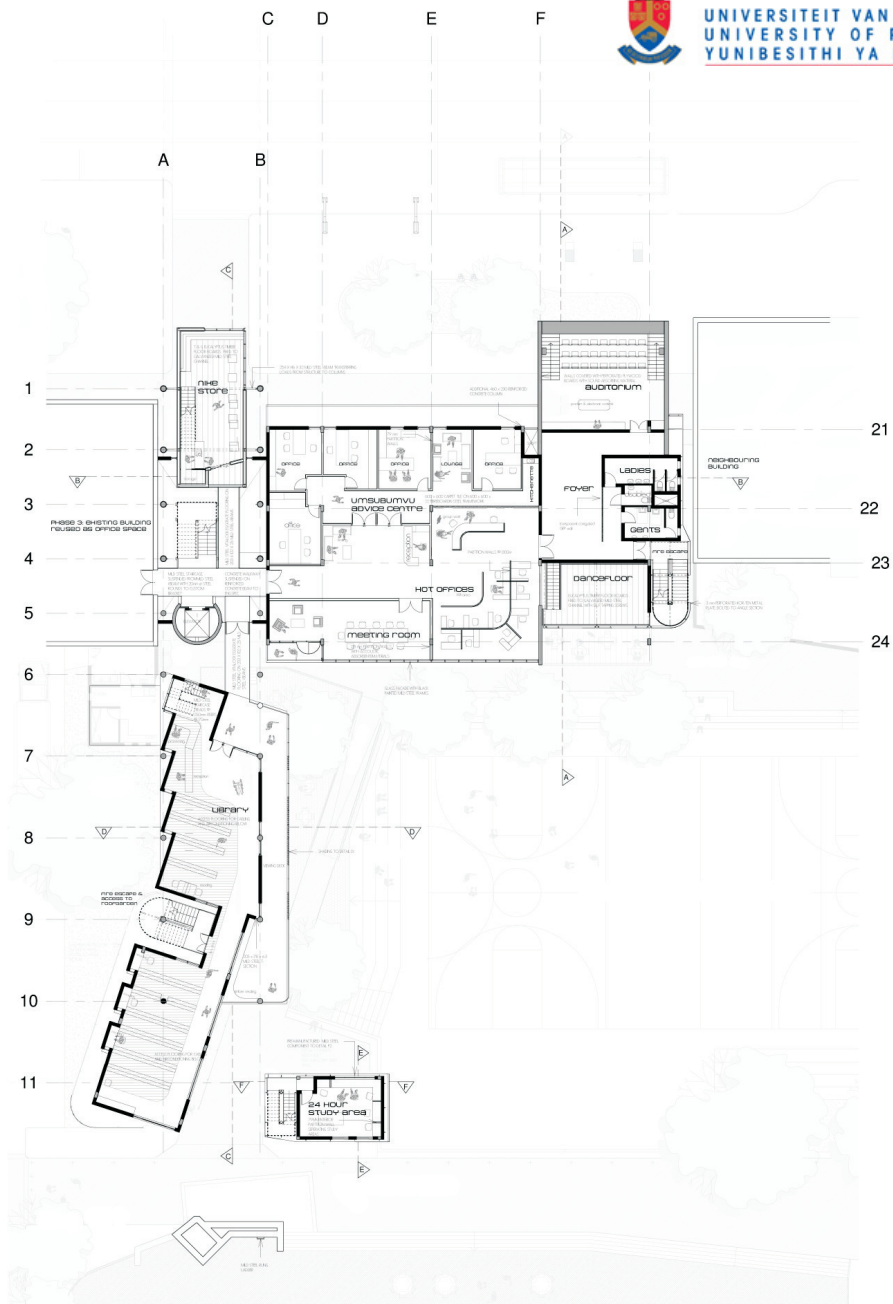

FIRST FLOOR, NOT TO SCALE

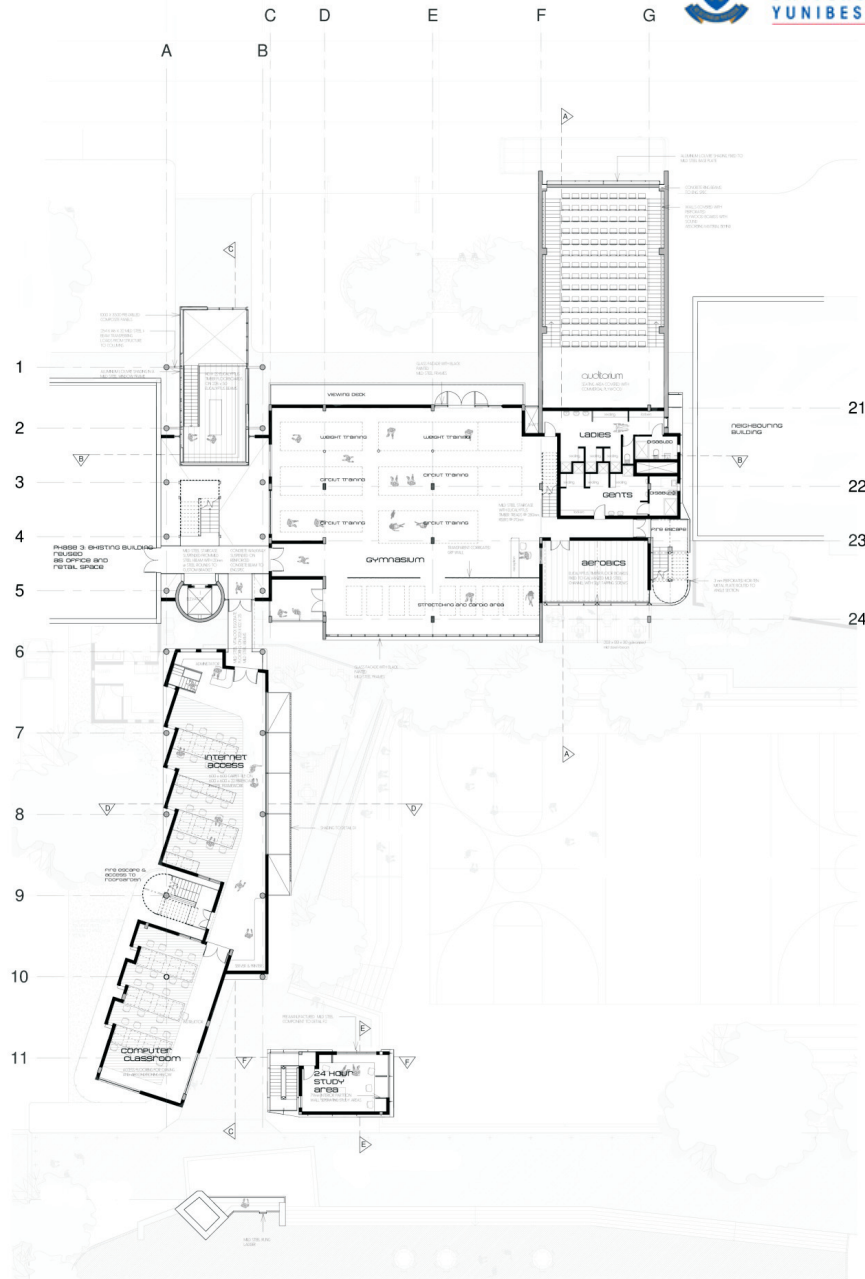

PHASE 2 PROPOSED NEW HOUSE

SECOND FLOOR, NOT TO SCALE

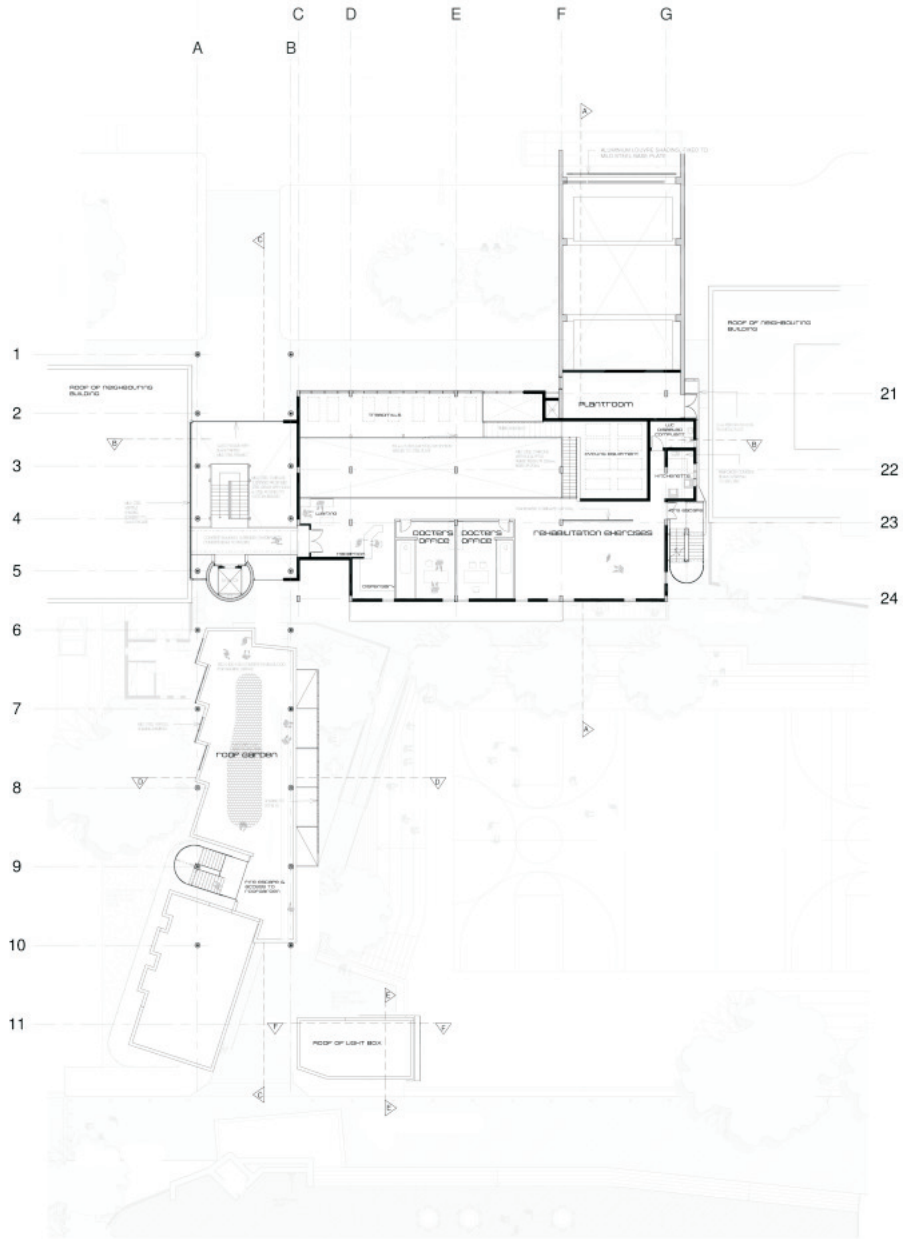

THIRD FLOOR, NOT TO SCALE



nORTH ELEVATION, NOT TO SCALE



WEST ELEVATION, NOT TO SCALE

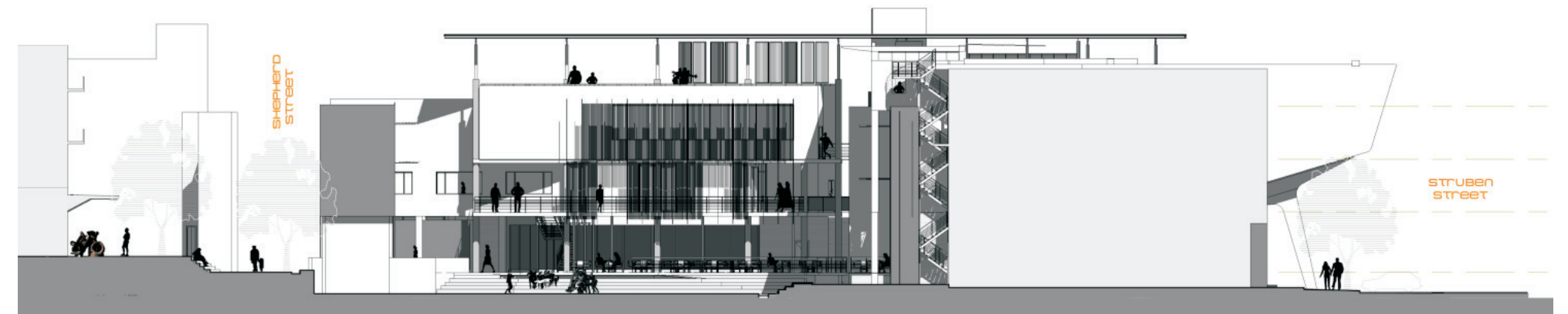

EAST ELEVATION, NOT TO SCALE

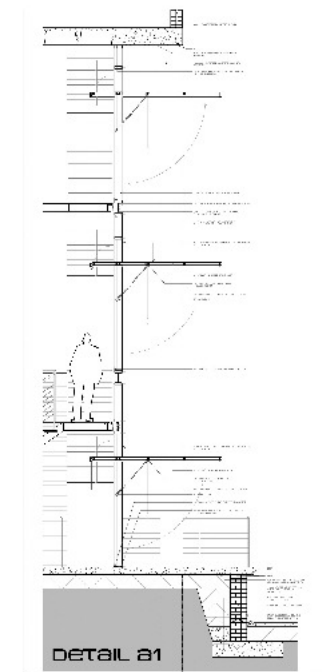
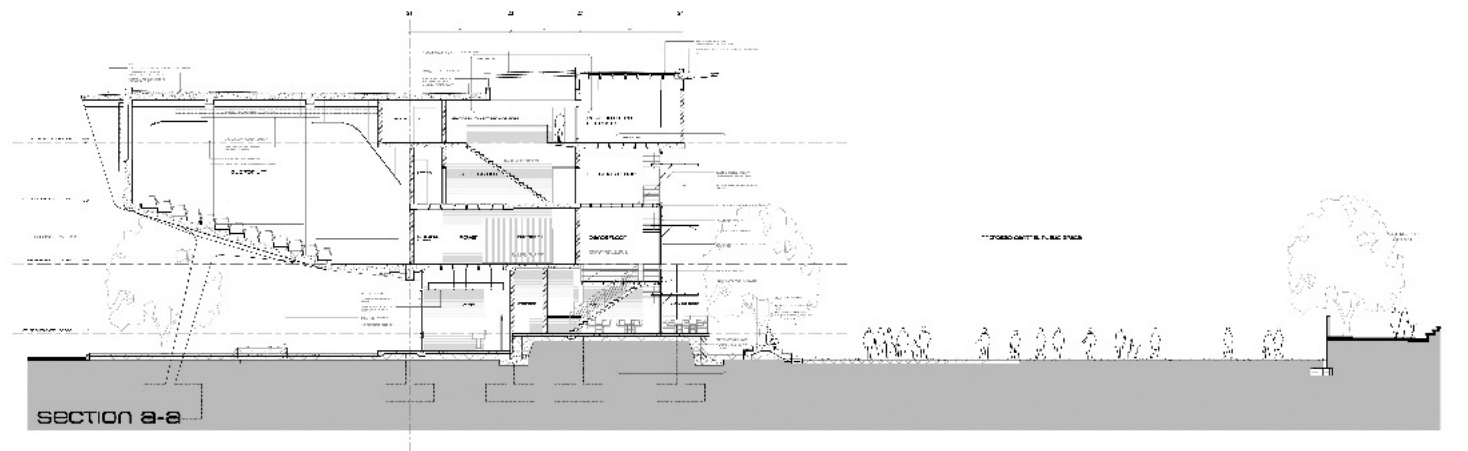
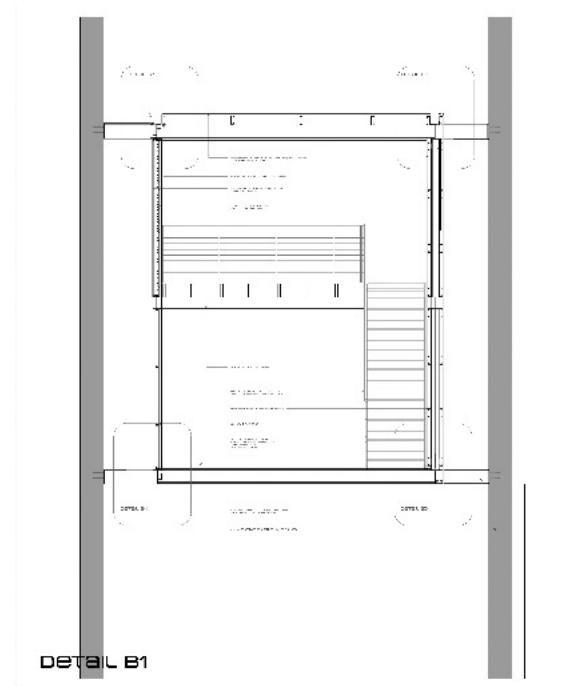
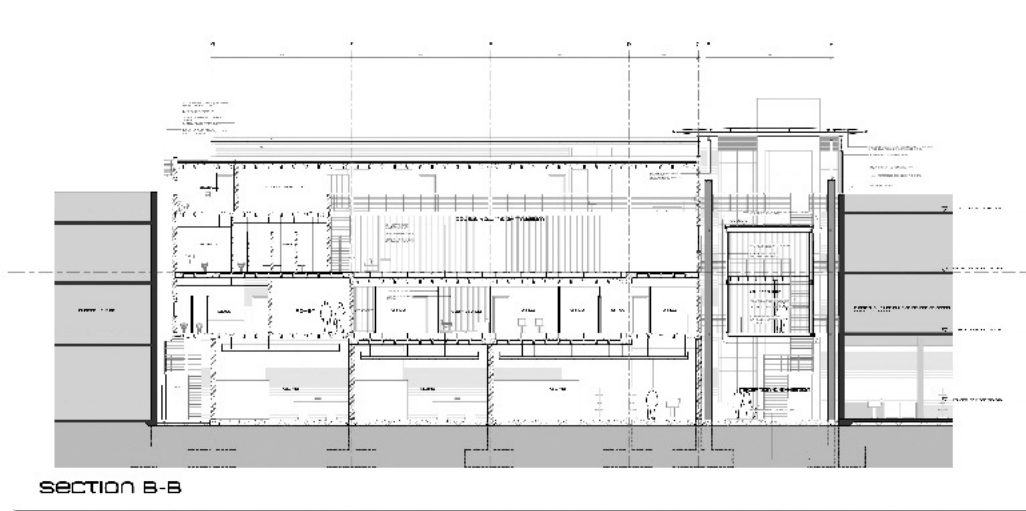

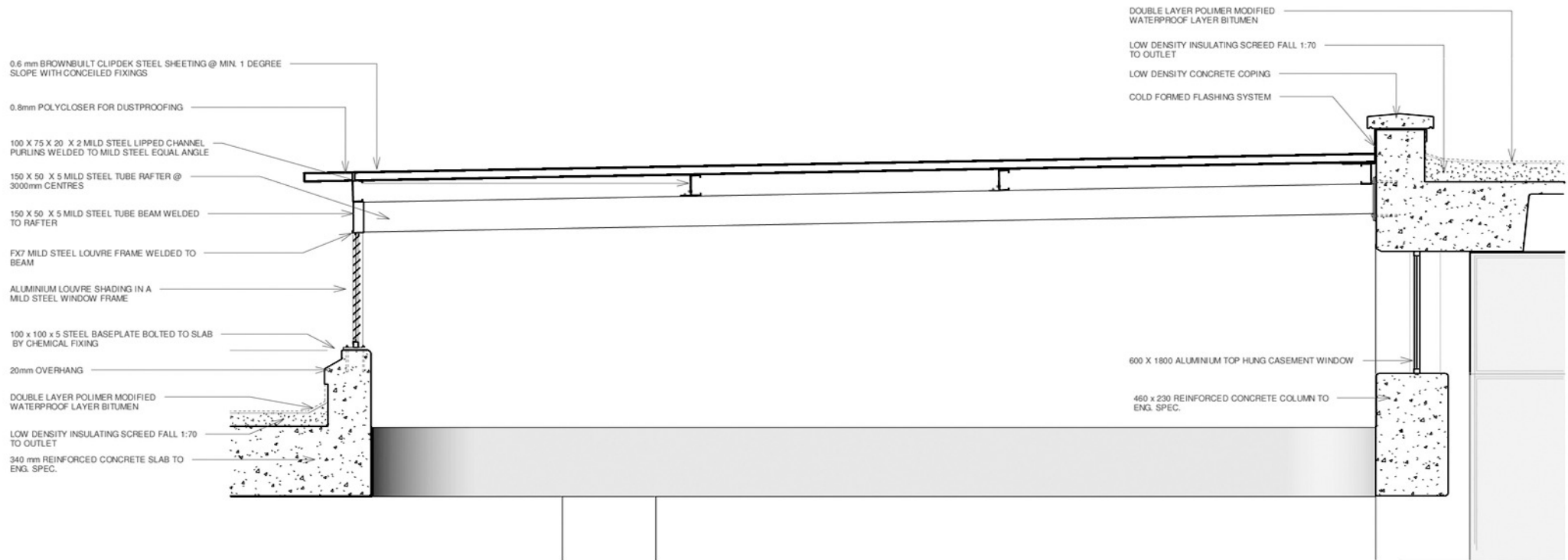

DETAIL A2, SCALE 1:20

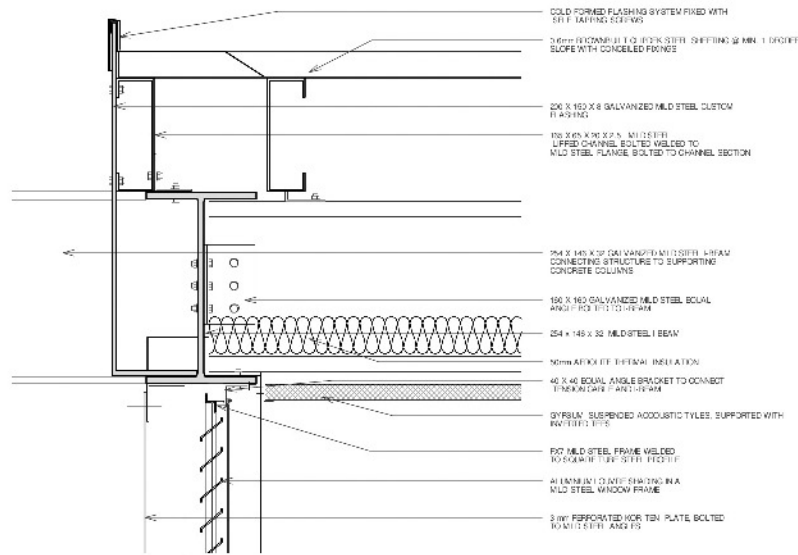

DETAIL B2

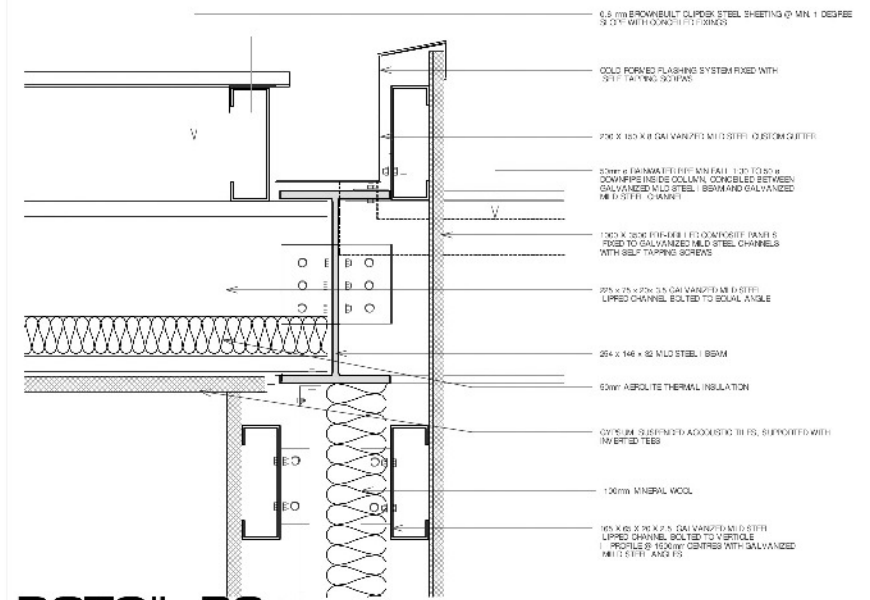

DETAIL B3

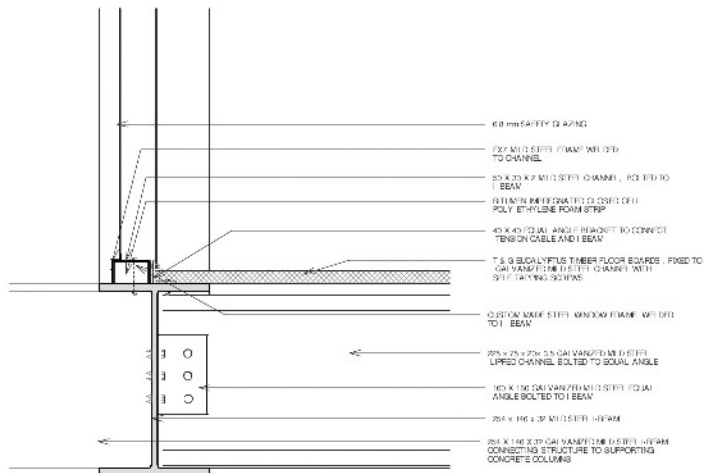

DETAIL B4

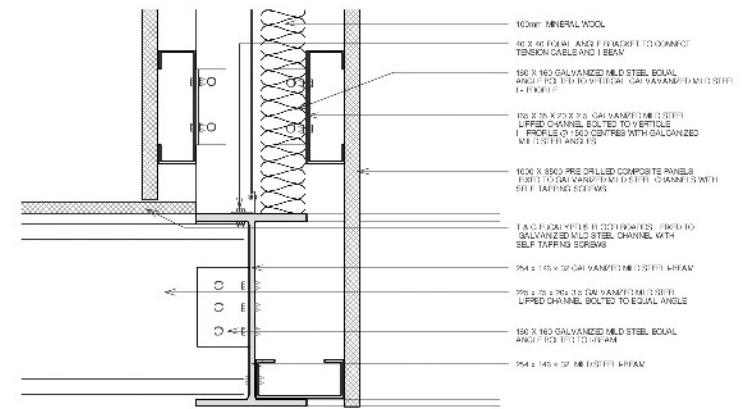

DETAIL B5

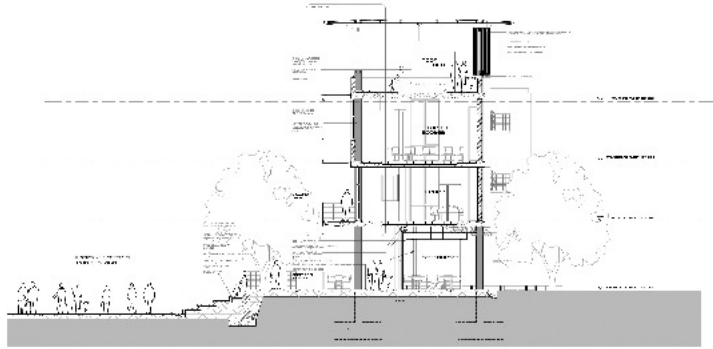

SECTION D-D

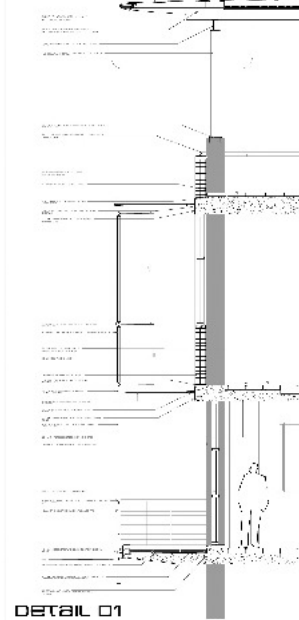

DETAIL D1

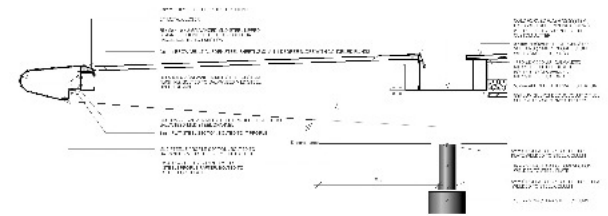

DETAIL D2

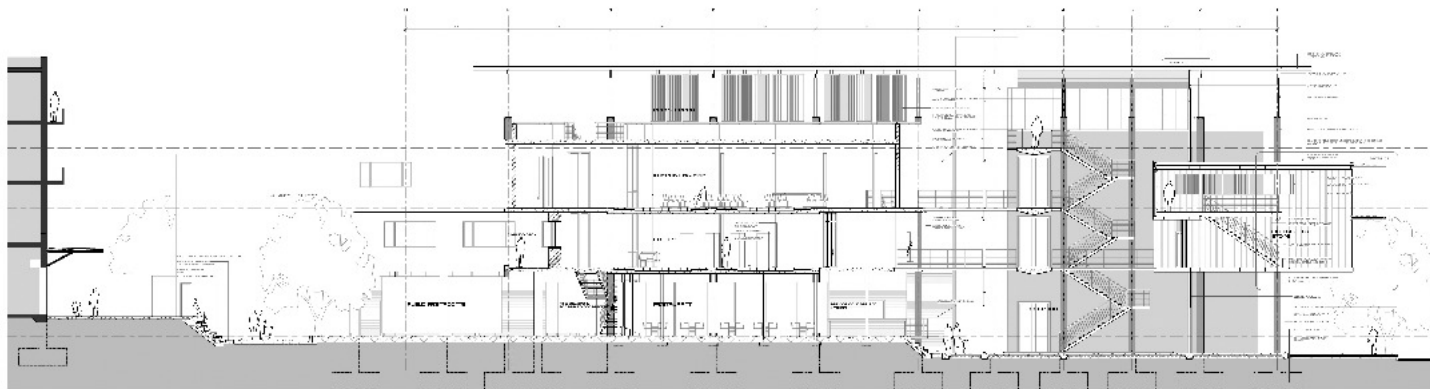

SECTION C-C

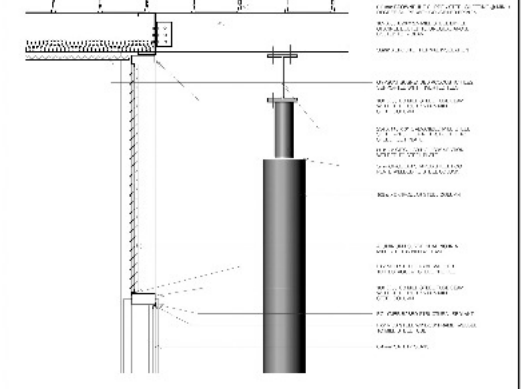

DETAIL C1

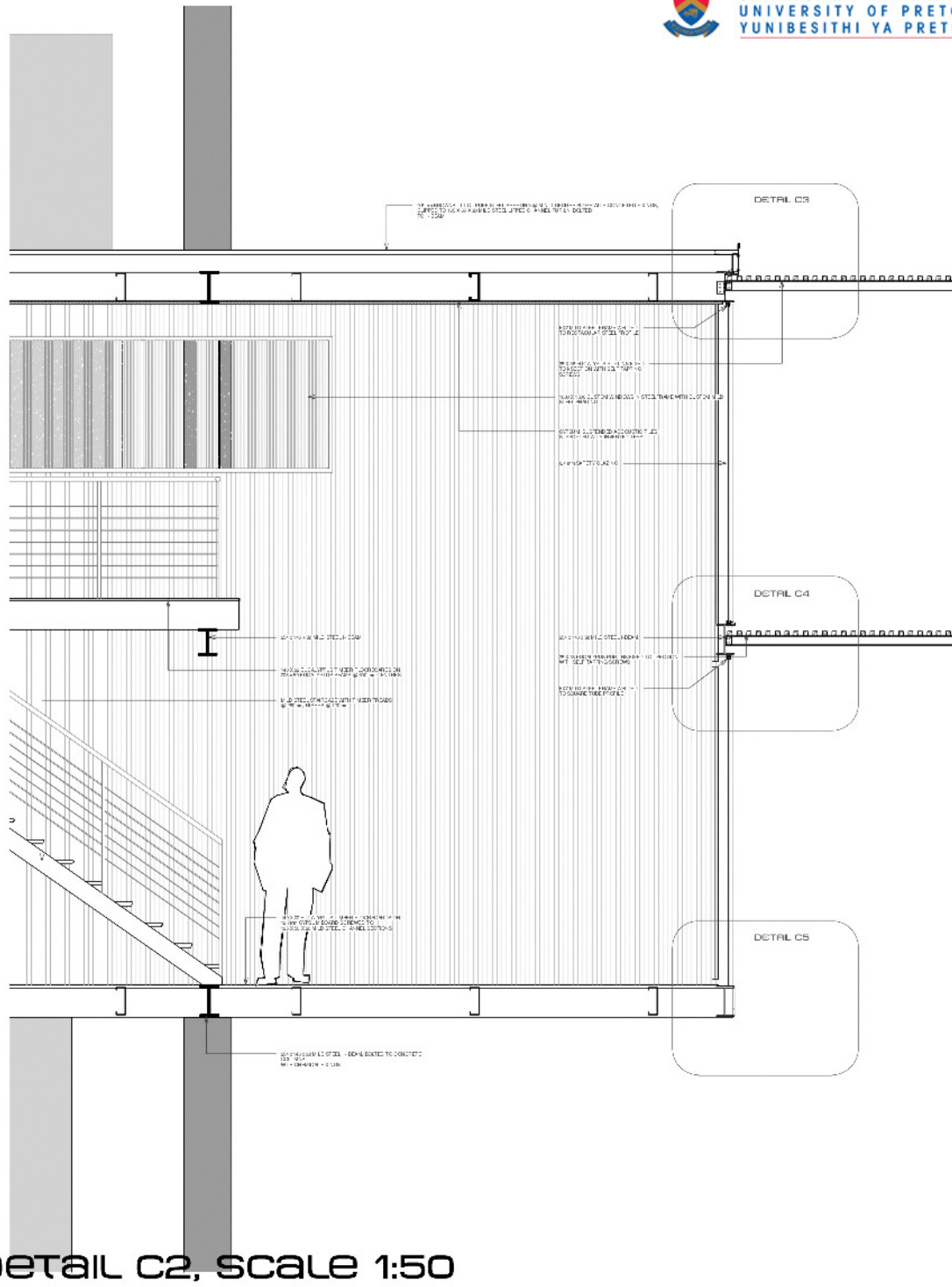

DETAIL C2, SCALE 1:50

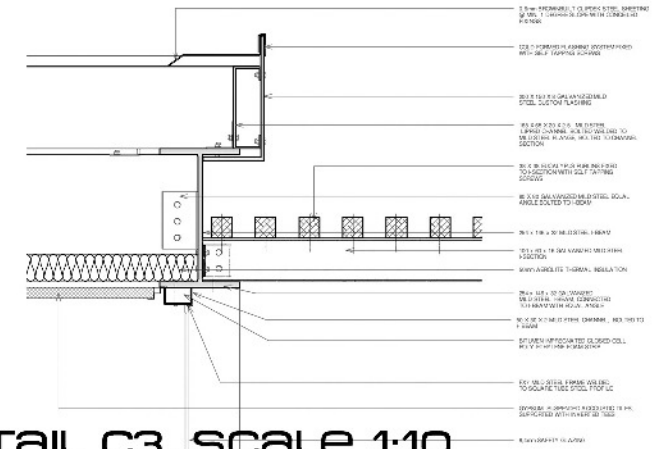

DETAIL C3, SCALE 1:10

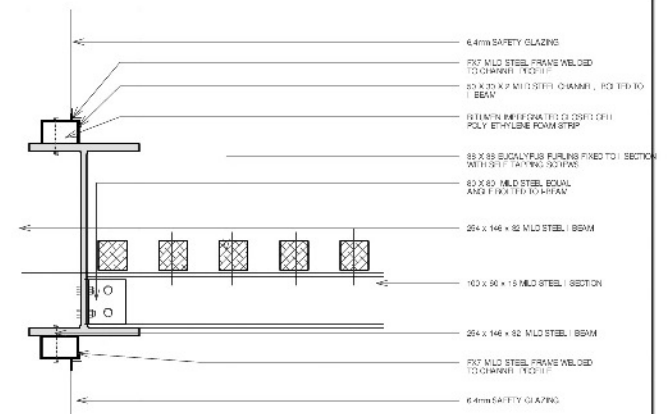

DETAIL C4, SCALE 1:10

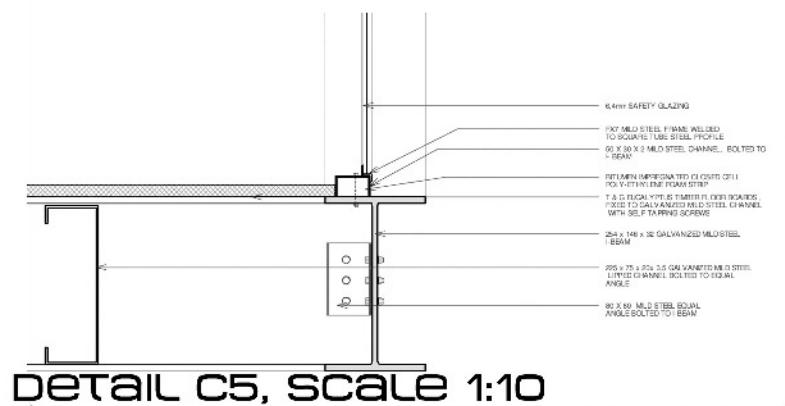

DETAIL C5, SCALE 1:10

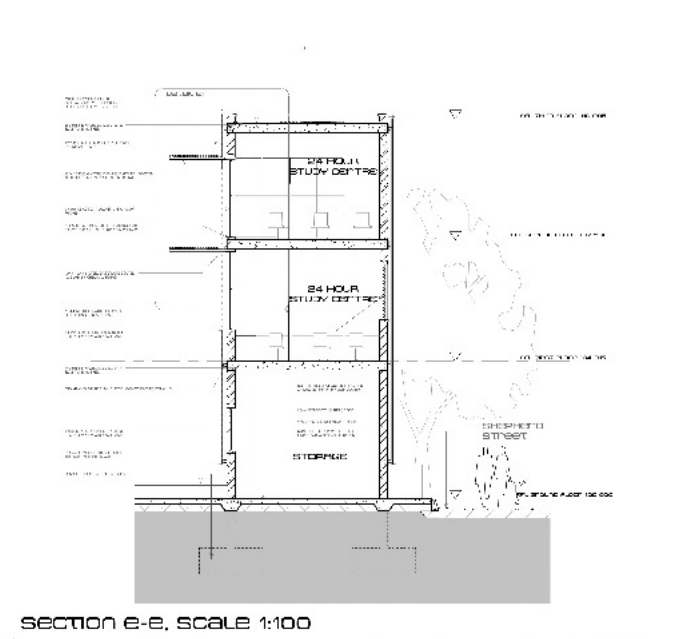
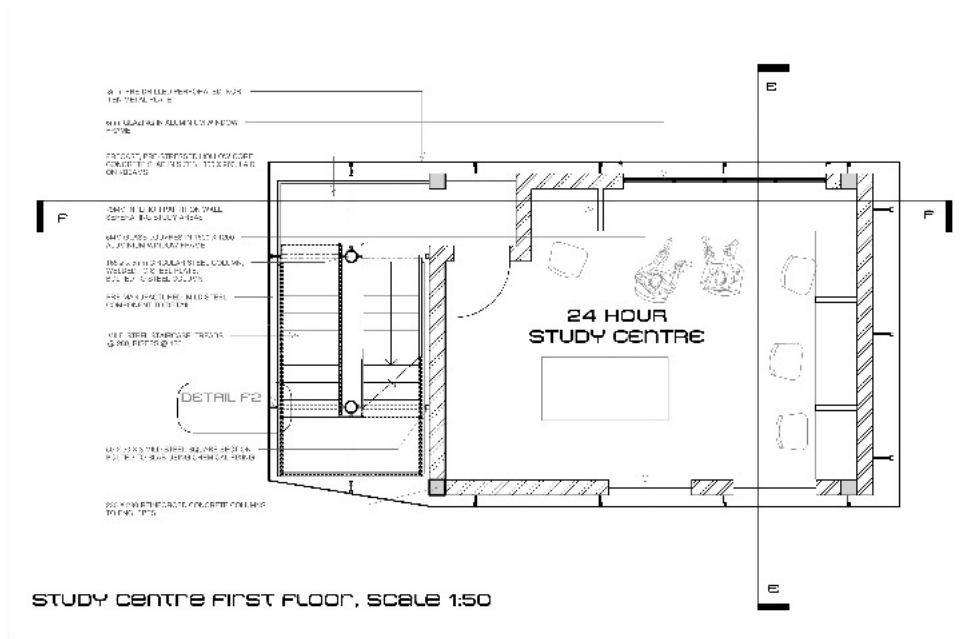
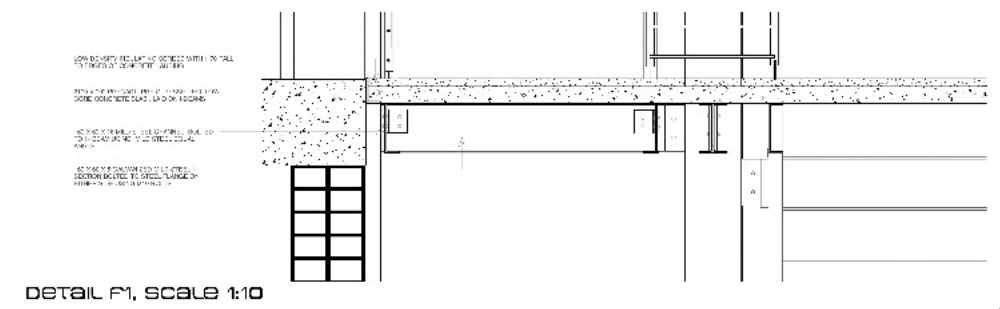
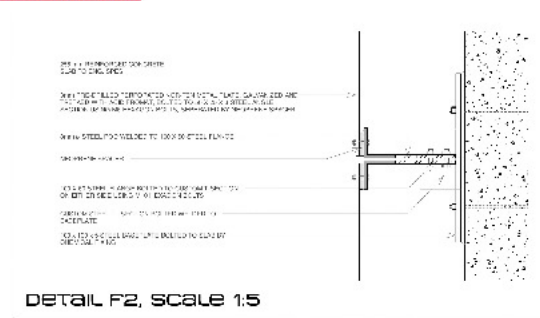
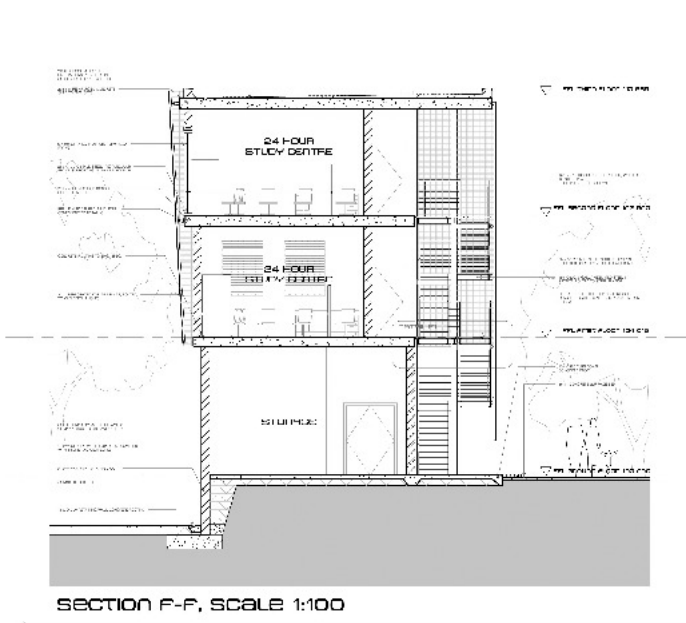

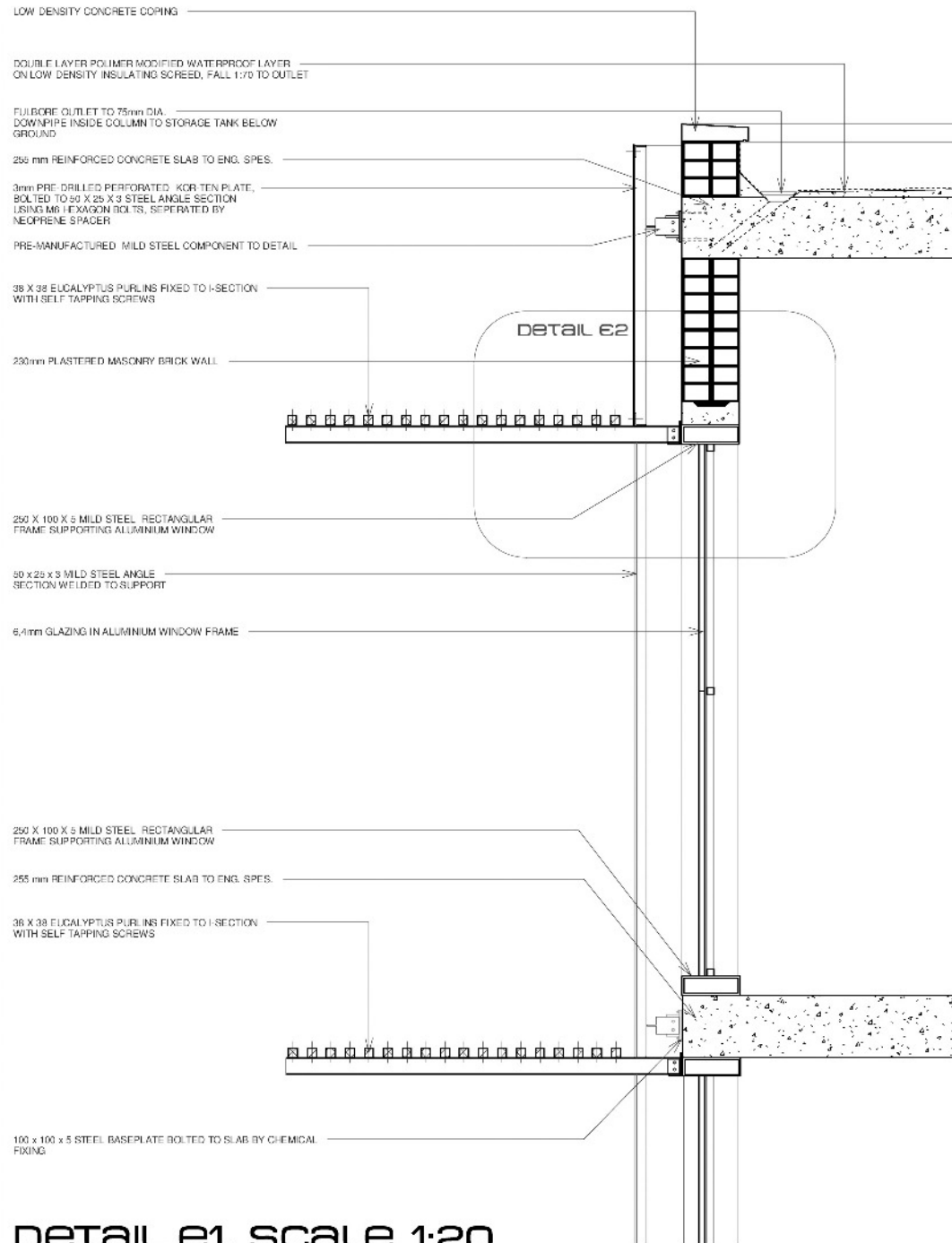

DETAIL e1, SCALE 1:20

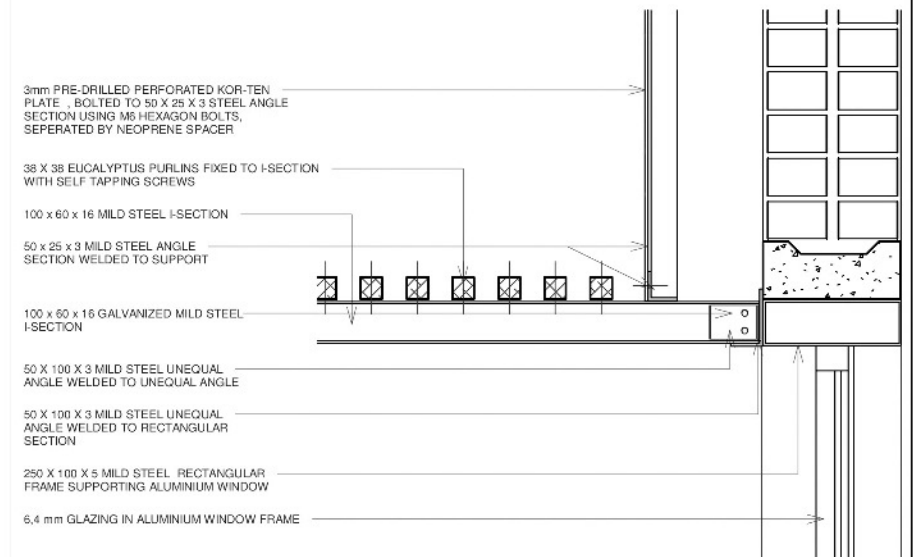

DETAIL e2, SCALE 1:10