



# contents

*contents*>>

*list of illustrations*>>

*list of abbreviations*>>

*context study*>>

*brief*>>

*theoretical investigation*>>

*normative position*>>

*design investigation*>>



*technical investigation*>>

*conclusion*>>

*drawings*>>

*addendum a: constitution hill*>>

*addendum b: historical context*>>

*addendum c: informal*>>

*addendum d: precedent study*>>

*addendum e: accommodation schedule*>>

*addendum f: baseline document*>>

*addendum g: funding*>>

*list of references*>>

structure_	86
roof construction_	87
curtain wall construction_	88
floor construction_	89
climate control_	90
acoustics_	92
inclusivity_	93
fire strategy	93

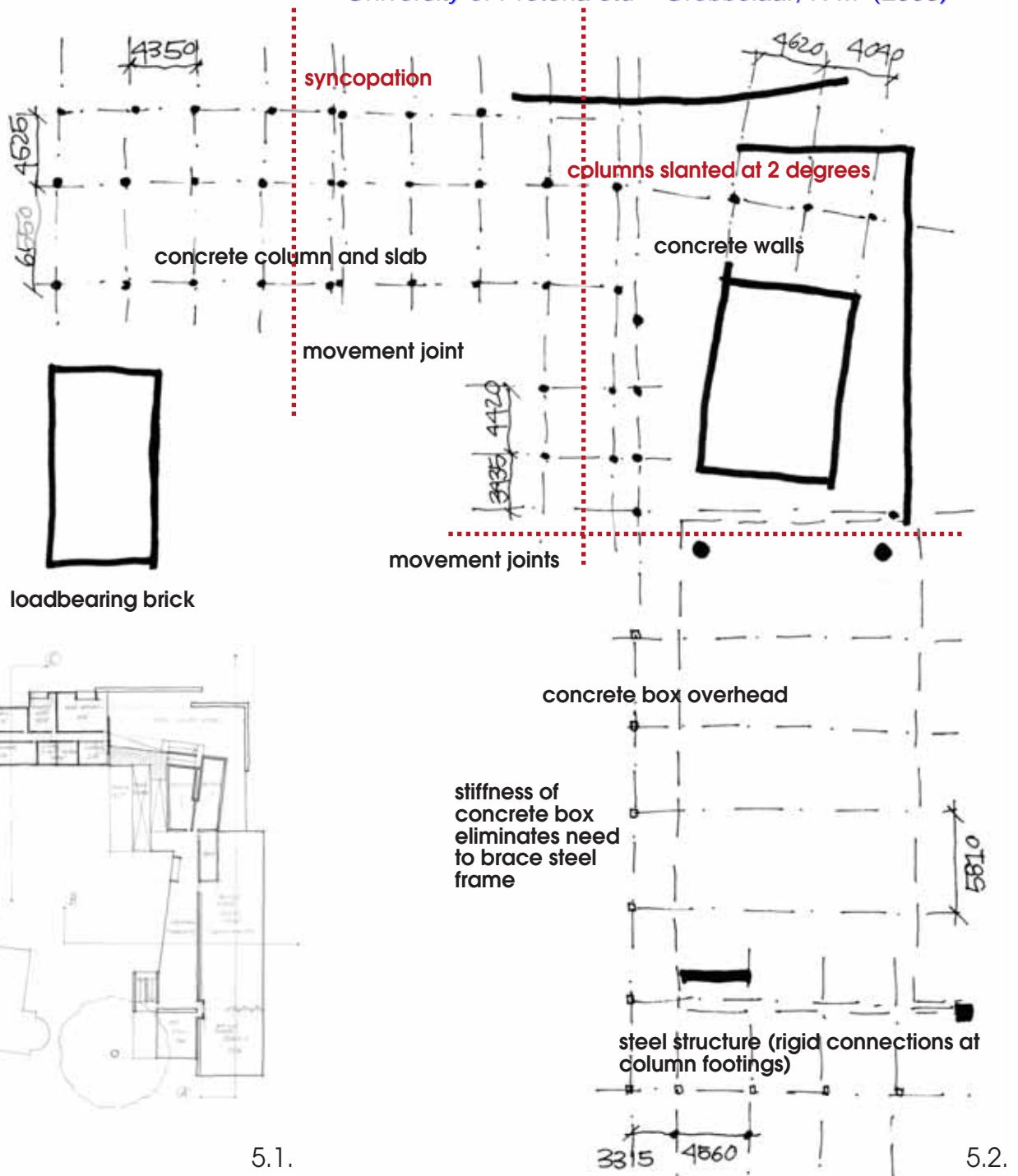

5.1. Second Floor Plan [23\_06].  
 5.2. Structural Layout and Materials.

While a simple flat concrete roof is provided for the northern wing, entrance foyer and restaurant, the articulation of the contrast between the concrete music box and the light steel structure of the dance studio above necessitates the use of a lighter roof construction over the dance studio. It is a further requirement of the roof construction that it provides effective sound dampening in the event of a rain -/ hail storm.

Composite roof panels (pre-coated internal and external metal facings bonded to rigid insulation core) are available in the UK for roof pitches down to  $1^\circ$  without end laps. The sound reduction index of typical composite roof panels is 26 dBA, which is around 11 dBA more than that of a normal steel roof. The South African counterpart of the product is manufactured in Germiston, but with a minimum roof slope of  $3^\circ$  without end laps, thus requiring a roof edge of almost 600 mm in this specific application.

It is thus proposed that composite roof panels are purpose-made on site. The panels consist of a patent steel roofing system (e.g. Clipdek, which can be specified for roof slopes down to  $1^\circ$ ) fixed by means of patent roofing clips to galvanised sheet metal trays manufactured on site to fit the profile of the roof sheets. Mineral wool blankets are laid inside the trays for acoustic insulation, and the roof panels are laid at  $1,5^\circ$  without end laps. An acoustic ceiling (mineral wool on perforated plywood) is installed below the roof panels for extra acoustic insulation.

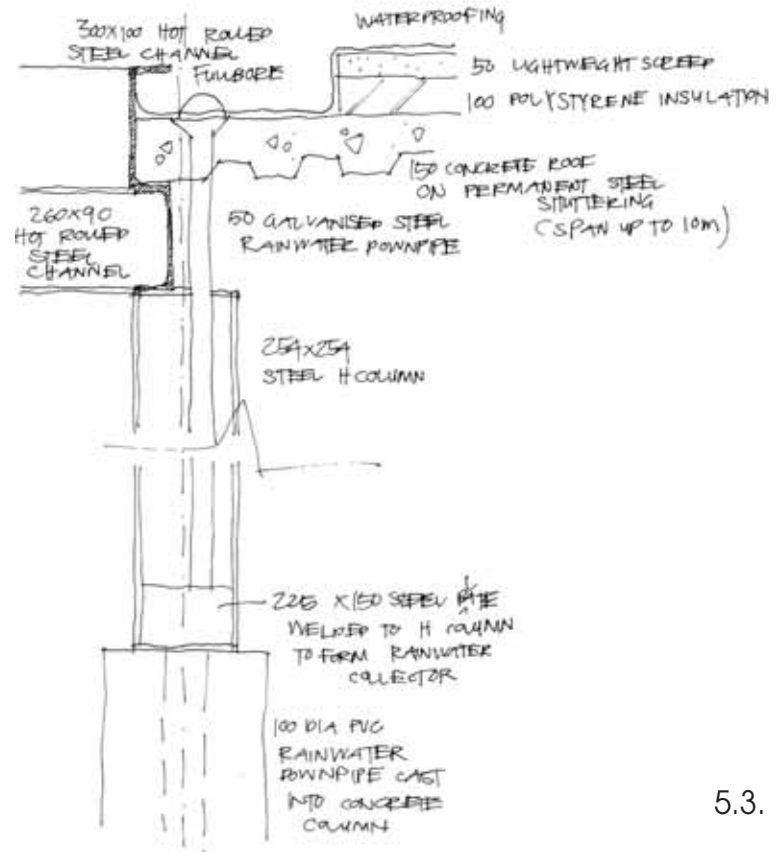

5.3.

mineral wool insulation or other recycled insulative material laid inside trays

clipdek roof sheet fixed to patent fixing clips over sheet metal trays

galvanised sheet metal trays purpose-made on site to fit profile of roof sheets

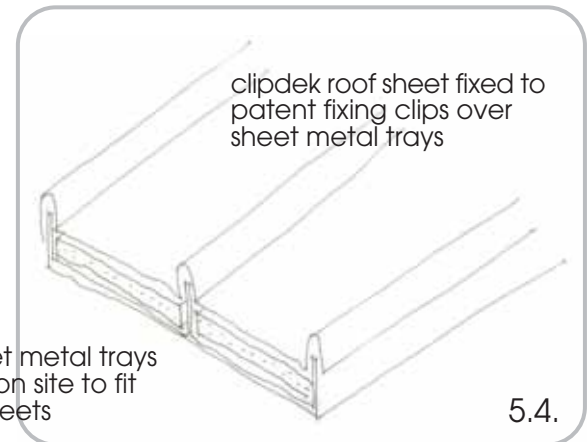

5.4.

A comparison between steel and aluminium as structural materials for curtain wall construction follows:

steel		aluminium
economy lower initial energy cost larger elements can be re-used	advantages	precision ease of construction durable and corrosion-resistant minimal maintenance recyclable without loss of quality
less precision heavier members, more difficult to handle more maintenance	disadvantages	high initial energy cost expensive

From a purely pragmatic point of view, aluminium would be the logical choice of structural material for curtain wall construction. The decision is however made to use steel as primary structural material for curtain walls in the southern wing; the semi-industrial quality of the southern wing being complimented by the use of numerous bolted connections and the degree of imperfection which is characteristic of steel construction and typical of workshop-type industrial buildings. Also, because steel structural members are somewhat smaller than their counterparts in aluminium, the use of steel instead of aluminium ensures a lighter appearance.

With the exception of the steel frames in the southern façade, which are factory-made and bolted in position to the main structural steel frame, the primary steel structure for curtain walling in the southern wing is constructed in situ. Glazed sections are factory-framed in aluminium and fixed in position to the steel frames with self-cutting screws. Polyethylene-taped between steel and aluminium frames prevent the occurrence of bio-metallic corrosion.

Although the language of the northern wing departs from the semi-industrial aesthetic of the studio spaces, the system of curtain wall construction is continued so as to provide a measure of continuity. Like the southern façade, the northern curtain walls are made up of steel frames which are factory-made and fixed in position to the concrete structure. Glazed window sections are fixed in the same manner as in the southern wing.

Timber-framed louvre panels and timber doors replace selected glazed sections in both wings for the sake of ventilation and providing escape areas, while adding a measure of warmth and variation to the curtain walls. Timber in the northern façade is protected against solar radiation by a 3,2 m overhang and a series of textile sunscreens, while its use is avoided in the eastern façade, which is less protected.

The glazed sections of the southern façade are silkscreened and together contain a single image which is interrupted by the steel structure framing the art studios beyond. Despite the façade's flush surface, depth is created by the superimposition of a two-dimensional graphic and three-dimensional framed views.

Concrete surface beds at ground level receive a concrete screed which is delayed trowelled, power floated and polyurethane sealed to produce an economical and hard-wearing floor finish which relates well with both the earthy character of the northern foyer and the semi-industrial character of the southern wing and the workshop. Where an alternative floor finish is required, the surface bed is receded to receive such finish - slate tiles in the restaurant and gallery and a sprung timber floor in the performance area. These floor coverings thus read as 'carpets' laid within the continuous grano floor surface.

Similarly, the shuttering patterns on vertical concrete surfaces are discontinued at some distance from the edges of the surface to create a series of vertical carpets rather than continuous floor to ceiling finishes.

The floor construction at first and second floor level consists of 12mm solid timber flooring boards laid directly over a vilt layer on the concrete slabs. Sprung timber flooring for the dance studio is constructed with 19mm polymer-treated plywood laid on a 30mm-thick layer of compressible foam providing the required sponginess.

External walkways consist of exterior - or marine grade plywood boards on a steel substructure spanning between the post-tensioned concrete structure and the exterior steel columns. Although a single sheet of plywood would be structurally sufficient, a second sheet is added and the two sheets countersunk-bolted together on either side of a 15mm-thick sound-dampening styrofoam layer to create composite floor panels which are visually less flimsy and therefore relate better to the scale of the overall construction. Since the styrofoam layer is cut back from the exterior edge of the panels, the two sheets of plywood read independently and add a measure of visual complexity which provides relief from the stark outline of the concrete music box.

The construction system of composite floor panels on a steel substructure is continued in the art studios, which - conceptually - provides a continuation of the steel cage wrapped around the western edge of the concrete music box.

The use of timber is repeated in stair treads (laminated saligna) and balustrade handrails throughout the building. Timber thus becomes a recurring element serving to provide a continuation between the three units (foyer and two wings) of the building.

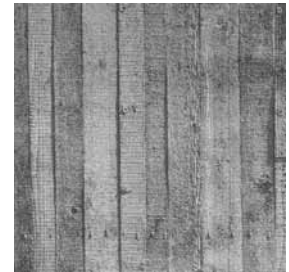

**\_ventilation**

Figures 5.5 and 5.6 indicate passive air flow through the building sections. The use of electronic systems is limited to two evaporative cooler units ventilating the 'music box'. The series of inset windows along the box's neutral axis are provided with double glazed opening sections which ensure acoustic insulation, but may be opened in the event of the cooler units malfunctioning. Console units may be installed in the northern façade of the offices and classrooms at a later stage should it prove a requirement.

**\_thermal mass**

Thermal mass - provided by flat concrete roofs, exterior concrete walls and the eastern wall of the music box - absorbs heat from direct and indirect solar radiation during the day, and after a delay period which is determined by the density and thickness of the absorbent surface, radiates the heat energy to internal spaces. With the thickness of the roof and wall surfaces ranging between 230 and 500 mm, a sufficient delay period is created to ensure that internal temperatures are effectively lowered during the day and raised during the night.

**\_orientation, solar control, natural light**

The orientation of built form on the site is determined by the Urban Design Framework, which considers the quality of the surrounding urban environment with little regard for the climatic effect of the constraints as set.

The designer's freedom is largely limited to the positioning of functions within the prescribed form.

Northern façade preference is given to the classrooms and offices, for which thermal comfort and sufficient lighting levels are a minimum requirement. The 3,2 meter overhang, mentis grid balconies and a series of textile sunscreens prevent direct solar radiation during summertime, while in wintertime allowing direct sunlight into the workshop at ground level, and a limited amount

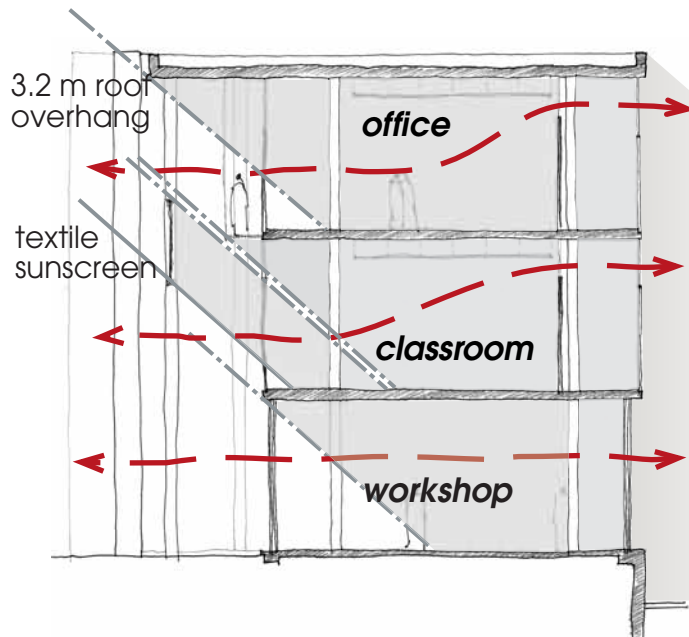
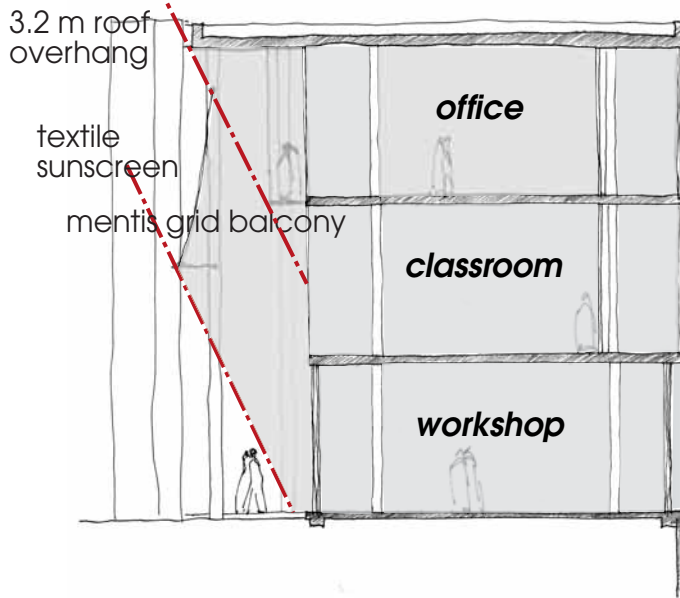

5.5. Northern Wing: Solar Control 21 December.

5.6. Northern Wing: Natural Ventilation; Solar Control 21 June.

of radiation into the offices and classrooms according to the position of the adjustable/removable textile sunscreens. The textile sunscreens also serve to diffuse light and prevent glare on visual media surfaces.

The gallery/foyer and art studios are positioned along the southern edge of the building and extensively glazed to make full use of the southern light.

As a result of the shadows cast by the high-rise buildings along the western edge of Hospital Street, the long western elevation presents little problems as regards solar heat gain (cf. shadow study p. 19-21). A 3,2 meter overhang contained in the colonnade provides effective protection against high-level western sun, while deciduous trees in the garden act as additional shading devices for low-level western sun during the hot summer months.

The ground- and first floor levels of the eastern elevation are protected against low level eastern sun by the bulk of the new building east of the Centre. A mentis grid shading structure and the overhang of the music box at first floor level protects against high-level eastern sun, while trees in the pedestrian street provide additional shade. The exposed polycarbonate screens at second floor level are protected from eastern sun by a series of perforated stainless steel sliding panels which are manually adjustable from inside the dance studio. Both the polycarbonate sliding panels and the sunscreens can be opened/closed in a number of different configurations, thereby lending the elevation a layered and highly varied composition. A freestanding perforated stainless steel screen shades the southern portion of the eastern façade.

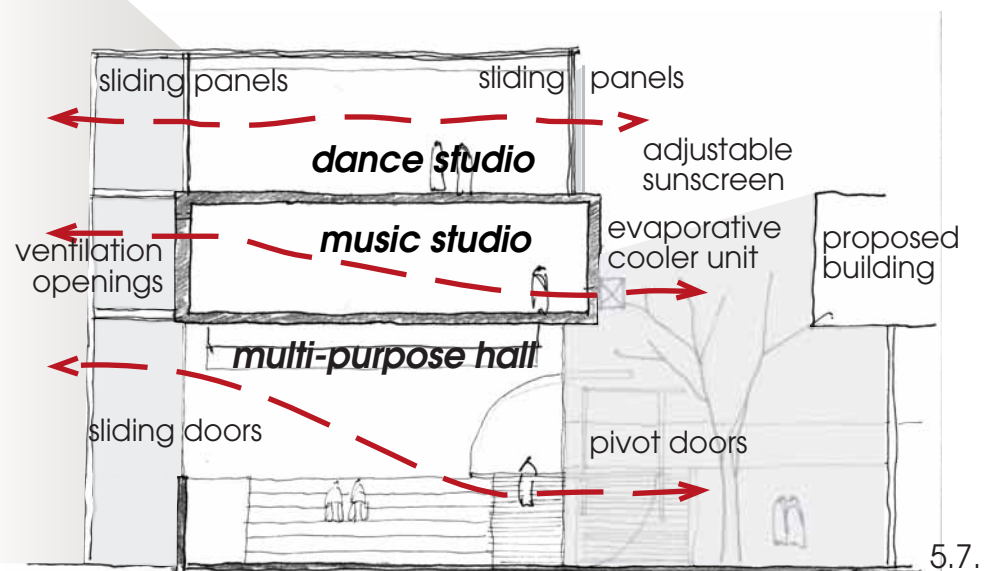

5.7. Southern Wing: Solar Control and Natural Ventilation.



### \_Offices, Classrooms

Lacking the acoustic insulation of the music studios, the classrooms and offices are the most noise-sensitive areas, and are therefore located as far away as possible from Smit Street, which is the source of the highest levels of ambient noise.

### \_Multi-Purpose Hall

A profiled plywood acoustic ceiling is installed in the multi-purpose hall to aid the acoustic performance of the raked mini-theatre. With a series of mobile acoustic panels in place, the mini-theatre functions as a separate unit within the larger multi-purpose hall. The profile is designed to reflect the majority of sound back into the pavilion area, with a smaller proportion being reflected towards the back of the multi-purpose hall to ensure satisfactory acoustic performance during larger public gatherings.

The ceiling is fixed to a number of flat steel bars which are bent in the profile of the ceiling and welded to a lightweight steel truss. The plywood itself provides a reflective surface. Where absorption is required, the plywood is perforated and mineral wool laid on top.

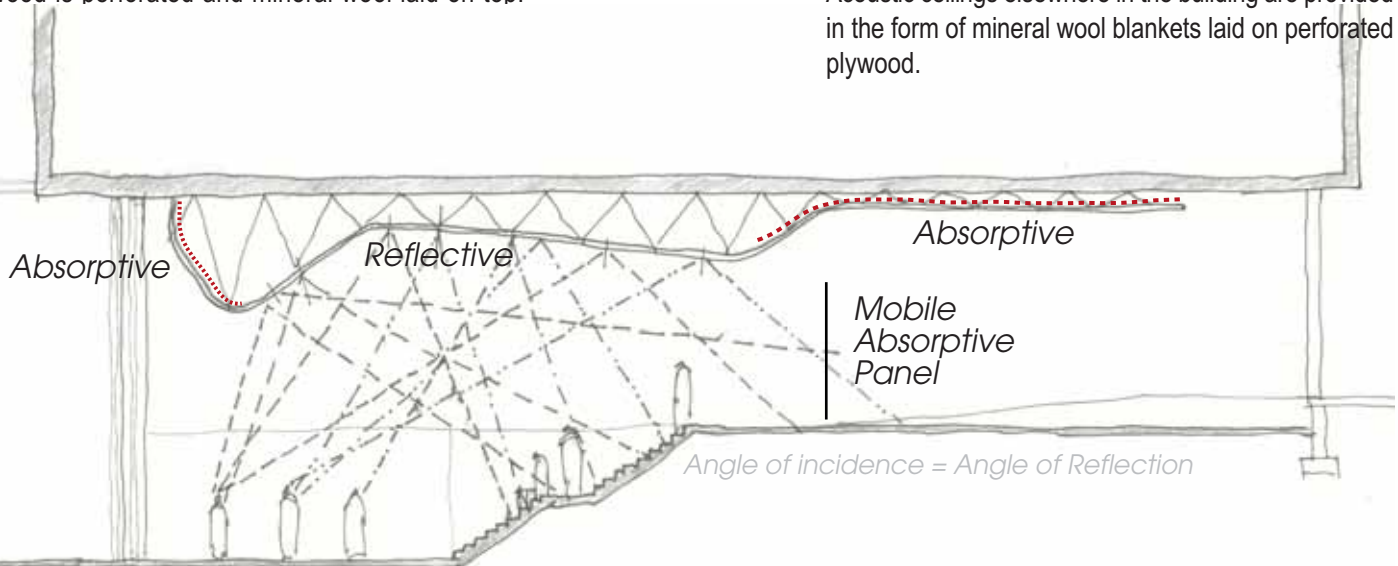

5.8.

### \_Music Studio

The music studios - located in the concrete tube structure at first floor level - benefit from the acoustic properties of the mass concrete structure. A sound-absorbent ceiling and sound absorbent wall panels - consisting of a 100 mm air gap, 50 mm mineral wool and 5 mm perforated hardboard nailed to timber battens - are added to absorb low frequencies and prevent the occurrence of flutter echoes between parallel surfaces. The windows are double-glazed for acoustic insulation. The cost of installing an acoustic sliding door to divide the large studio space into two music studios is around R10 000 per meter - certainly not a favourable option. Instead, an acoustic curtain can be provided instead at a much lower cost should the division be required.

### \_Dance Studio

The dance studio is not sound proof. Being located far enough from the offices and classrooms, and with the music studio being acoustically insulated, music from the dance studio is allowed to permeate the public foyer and spill into the pedestrian street and garden.

Acoustic ceilings elsewhere in the building are provided in the form of mineral wool blankets laid on perforated plywood.



by this type of system essentially resemble painted steel with a gloss finish. When exposed to fire, the base coat expands (intumesces), to form a thick layer of foam that protects the steel by thermally insulating it and shielding it against radiation. Once exposed to flame, the mastic char must be removed and a new layer of coating applied in order to maintain the fire-resistive rating required for protection of the structural member.

In practice, a rational design by a specialist will be required to ensure the integrity of structural steel members in case of fire. Probable measures include the choice of larger members than are required for mere structural purposes, and the use of members with a greater flange and web thickness than otherwise required.

### Norms and Standards

Addendum E.

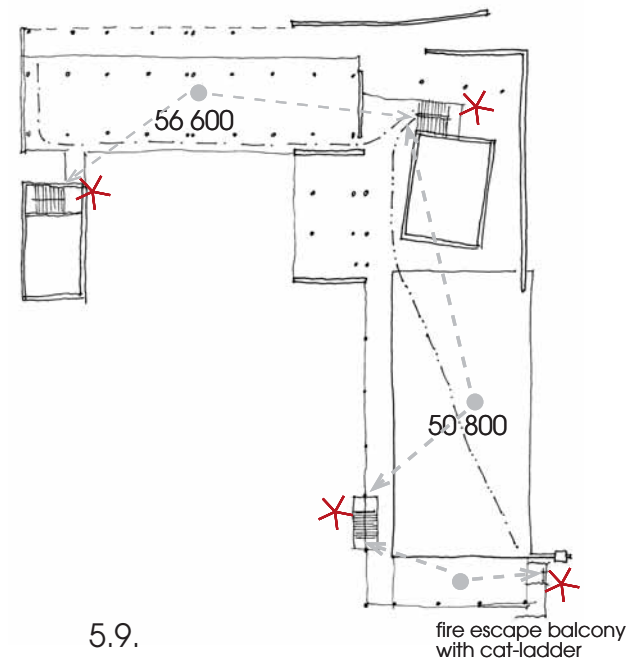

5.9.

fire escape balcony  
with cat-ladder

## Inclusivity

Considering the proximity of the various healthcare-related institutions to the Centre, it is essential that the Centre be accessible to pedestrians, including the old and infirm. A lift is provided in the foyer for access to the first and second floor levels, while access from the foyer to the multi-purpose hall and from the classroom - and office levels to the lower levels of the music- and dance studio is provided by ramps at a maximum gradient of 1:12. A purpose-made lift platform provides access from the stage level of the performance area to the multi-purpose level 3 meters above. Toilets for use by disabled persons are provided on ground - and first floor level according to the requirements of Section S of the National Building Regulations.

## Fire Strategy

According to NBR TT 16.2, where the travel distance to the nearest escape door is not more than 45m, a three storey building shall be provided with at least two escape routes, but shall not be required to have an emergency route.

According to NBR TT 7, structural elements are to have a fire resistance as follows:

Restaurant, Multi-Purpose Hall, Dance/Music Studios:  
120 minutes

Educational Facilities: 90 minutes

Workshops: 120 minutes

Offices, Art Studios, 60 minutes.

The concrete structure is deemed to provide sufficient fire resistance. Steel structural members however require a fire resistant coating.

Thin-film intumescent mastic coatings generally consist of a primer, the intumescent base coat, and some type of decorative topcoat. Structural steel shapes protected

5.9. Diagram indicating position of staircases; alternative escape routes; longest traveling distances.