



Chapter 5

The Engineering Geological Characteristics of the Asmari Formation Rock Mass at the Construction Sites of Five Large Dams

5.1. Introduction

In his chapter, the engineering geological characteristics of the Asmari Formation at the five dam sites are discussed.

The engineering geological parameters of the rock mass in this research were determined by using the results of rock mechanics laboratory tests in addition to Schmidt hammer field tests. The petrographic characteristics have been determined from thin section studies from the systematic sampling of outcrops and boreholes (Appendix 1 to 5). These samples were also subjected to Schmidt Hammer (Haramy and DeMarco, 1985) field tests to provide UCS values for index layers. Otherwise, the data are compared to mechanical laboratory test results which have been obtained from Mahab Ghodss Consulting Engineering Company-Ministry of Energy- Iran (MG co., 1984-2003).

All data, including rock quality designations (RQDs), core recovery, permeability and point load test results are based on MG co. (1984- 2003) geological reports and field data. The geotechnical information was collected during three periods, namely Feasibility Study, Complementary Study, and the ongoing Final Design investigations. The geotechnical investigation program was divided into two parts:

- 1) Laboratory tests; and
- 2) Site investigations consisting of the drilling investigation and test holes, excavation of adits, tunnels and field mapping.

The laboratory test program included determination of uniaxial compressive strength (UCS), triaxial strength, shear strength, poisson's ratio, modulus of elasticity, specific weight and suitability of the Asmari limestone for aggregate.

The rock mass classification and characteristics along tunnels and investigations of their stability have been carried out with ordinary experimental data methods using RQD, RMR, Q and GSI. The rock support and stand-up time of tunnels during excavation operations were calculated in accordance with the RMR system (Bieniawski, 1989).

The *Unwedge*©-(Rocscience) geotechnical software was used to determine rock instabilities in tunnels. The software is designed to be a quick, interactive and simple to use method to analyse the geometry and the stability of underground wedges defined by intersecting structural discontinuities in the rock mass surrounding an underground excavation (Rocscience Inc. 2004).

In this research, *RocLab*©-Rocscience software has been used to determine rock mass strength parameters (*C*- cohesion, *Phi*-friction angle, *sigc*- uniaxial rock mass compressive strength, *sigt*- rock mass tensile strength and *Em*- rock mass modulus of deformation).

RocLab is designed to aid engineers, especially at the preliminary stages of design and provides simple and intuitive implementation of the Generalized Hoek-Brown, Barton-Bandis, Power Curve and Mohr-Coulomb failure criteria. The program enables users to easily visualize the effect of changes in input parameters on rock and soil failure envelopes such as (Rocscience Inc. 2004):

- *sigci*- unconfined compressive strength of intact rock,
- *GSI*- Geological Strength Index
- *mi*- Intact rock parameter (rock type)
- *D*- Disturbance factor

5.2. Engineering Geological Characteristics of the Karun-3 Dam and Power plant (Engineering Rock Mass Classification of the Asmari Formation)

5.2.1. Diversion Tunnel

5.2.1.1. Lower Unit- As.1 (Lower Asmari Formation- 4a1, 4a2, 4a3)

The diversion system consists of upstream roller compacted concrete and downstream concrete cofferdams and 13 m final inside diameter (horse shoe) tunnel under the right flank. Geological data for the tunnel are derived from surface mapping and five boreholes, BH-106D, BH-107E, BH-110F, BH-114U and BH-115Z (Figure 5.2.1). The tunnel is constructed in the Pabdeh Formation (3b) from 0.0 (intake) to 265 m and in the Asmari Formation (4a1-4a2) from 250 m – 450 m (outlet). The Asmari Formation along the diversion tunnel axis is a fair to good quality limestone with RQDs generally ranging between 50% and 85%. The tunnel passes through subunits 4a1, 4a2 and 4a3 of the lower Asmari Formation. The permeabilities are fairly high and fall between 2×10^{-4} to 1×10^{-3} cm/s.

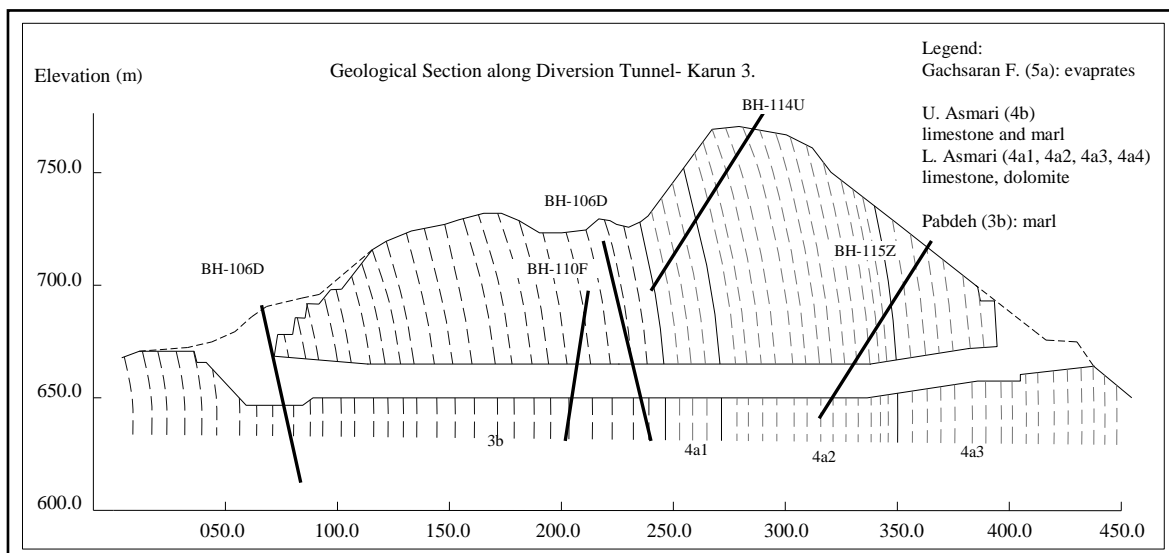

Figure 5.2.1. Geological section along the diversion tunnel at the Karun-3 Dam (after MG co., 1993).

Based on discontinuity surveys, which have been carried out along the tunnel route, the following discontinuity sets are present (Table 5.2.1 and Figure 5.2.2).

Table 5.2.1. Discontinuity sets in the diversion tunnel.

Discontinuity Set	Dip Direction (°)	Dip (°)
Bedding	47	80 - 90
Set A	135	81
Set B	180	08
Set C	149	49

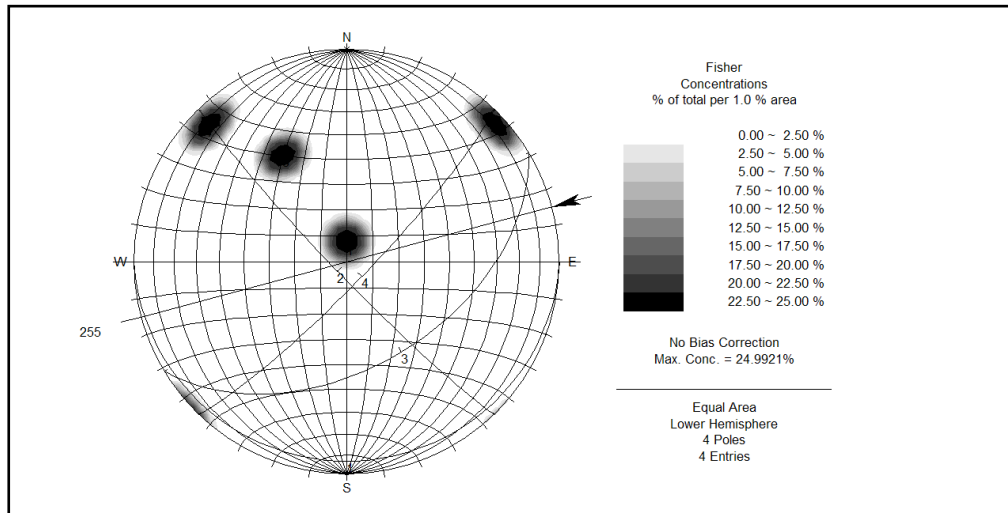

Figure 5.2.2. Contour plot and major plane plots of discontinuity sets in the diversion tunnel.

Spacing of the bedding discontinuities are extremely wide (7.6 m) and Joint set spacing is wide to extremely wide (0.6 to 6 m).

In the Karun-3 Dam project 48 boreholes with a total length of 6 688 m and another 3 635 m for the final design were drilled. All of them have been logged by the Mahab Ghodss Company and Acers International Ltd. staff. For each borehole the lithological and discontinuity logs have been compiled. Core recovery (CR) and RQD were measured on a run by run basis in every borehole. The mean weighted RQD were then calculated (Table 5.2.2).

Table 5.2.2. Rock Quality Designation (RQD) assessment of the Asmari Formation at the Karun-3 Dam.

	Unit	Subunit	Lithology	Thickness	RQD
	ASMARI FORMATION	As.2	4b	Thin to thickly bedded marlstone and shale	200 m
As.1		4a4	Medium to thickly bedded marly limestone and limestone	235 m	Fair- Good (51%- 82%)
		4a3	Thick to V.Thickly bedded limestone, interbedded marly limestone	95 m	Fair- Good (74%- 81%)
		4a2	Very Thickly bedded limestone	63 m	Fair- Good (70%- 85%)
		4a1	Thickly bedded limestone, marly limestone	22 m	Fair-Good (50%- 84%)

The **RMR** value for the Asmari Formation (units 4a1, 4a2, and 4a3) in the diversion tunnel based on Table 3.3. is assessed as follows:

Table 5.2.3. Assessment of Rock Mass Rating for the Asmari Formation (4a1, 4a2, 4a3).

	Property	Value	Rating
1	UCS (MPa)	116- 138	12 - 12
2	RQD	50%- 85%	13- 17
3	Spacing of discontinuities	0.6-2m, >2m	15- 20
4	Condition discontinuities	Slightly rough slightly weathered	25 - 25
5	Ground water	Dripping to Wet	4- 7
6	Adjustment for joint orientation	Fair	-5
Total : 64-76 (Good)			

From Table 3.4. the guidelines for excavation and support of a 15 m span rock tunnel for the above RMR values are as follows:

Table 5.2.4. Rock support types for units 4a1, 4a2, and 4a3 in the diversion tunnel.

Rock mass class	Excavation	Rock bolts (20 mm diameter, fully grouted)	Shotcrete	Steel sets
II – Good rock	Full face, 1- 1.5m advance. Complete support 20 m from face	Locally, bolts in crown 4.5 m long, spaced 2.5 m with occasional wire mesh	25 mm in crown and in sides if required	Non

The *Stand up Time* for the diversion tunnel is between 1×10^3 hours (41.6 days) and 1×10^4 hours (416.6 days) based on the Bieniawski (1989) stand up time graph for good quality rock mass.

The *Rock Tunneling Quality Index, Q* based on six parameters *RQD, Jn, Jr, Ja, Jw and SRF* (Table 3. 5) were calculated indirectly using equations 3.9 and 3.10 in section 3:

From these equations, the Q-values vary between **35.1** (Good Quality) and **268.6** (Extremely Good Quality)

The geological strength index (*GSI*) based on two simple equations of 3.11 and 3.12 which were introduced by Hoek and Brown (1997) was calculated for the Lower Asmari Formation as follows:

The *GSI* then falls between **59** and **71**

The rock mass strength with input data, UCS, GSI, mi and D (disturbance factor) for tunnel application was assessed using *RocLab*© software and Table 5.2.5 is a summary of the results:

Table 5.2.5. The rock mass strength in the Lower Asmari unit.

Hoek-Brown Classification	Hoek-Brown Classification
sigci 116 MPa	sigci 138 MPa
GSI 59	GSI 71
mi 9	mi 9
D 0	D 0
Hoek-Brown Criterion	Hoek-Brown Criterion
mb 2.1	mb 3.2
s 0.01	s 0.04
a 0.5	a 0.5
Failure Envelope Range	Failure Envelope Range
Application Tunnels	Application Tunnels
sig3max 0.7 MPa	sig3max 0.7 MPa
Unit Weight 0.03 MN/m ³	Unit Weight 0.03 MN/m ³
Tunnel Depth 50 m	Tunnel Depth 50 m
Mohr-Coulomb Fit	Mohr-Coulomb Fit
c 1.6 MPa	c 3.96 MPa
phi (φ) 57.5°	phi (φ) 57.6°
Rock Mass Parameters	Rock Mass Parameters
sigt -0.6 MPa	sigt -1.7 MPa
sigc 11.7 MPa	sigc 27.4 MPa
sigcm 23.6 MPa	sigcm 38.4 MPa
Em 16788 MPa	Em 33496.5 MPa

Figures 5.2.3 and 5.2.4 indicate the relationship between major and minor principal stresses also normal and shear stresses for the Hoek-Brown and equivalent Mohr-Coulomb criteria for GSI 59 and 71.

Structural Stability Control and Rock Support Arrangement elements were determined by using the RocScience Software UNWEDGE©.

Four major discontinuity planes (Table 5.2.1) control, shape and dimensions of the rock wedges in the diversion tunnel.

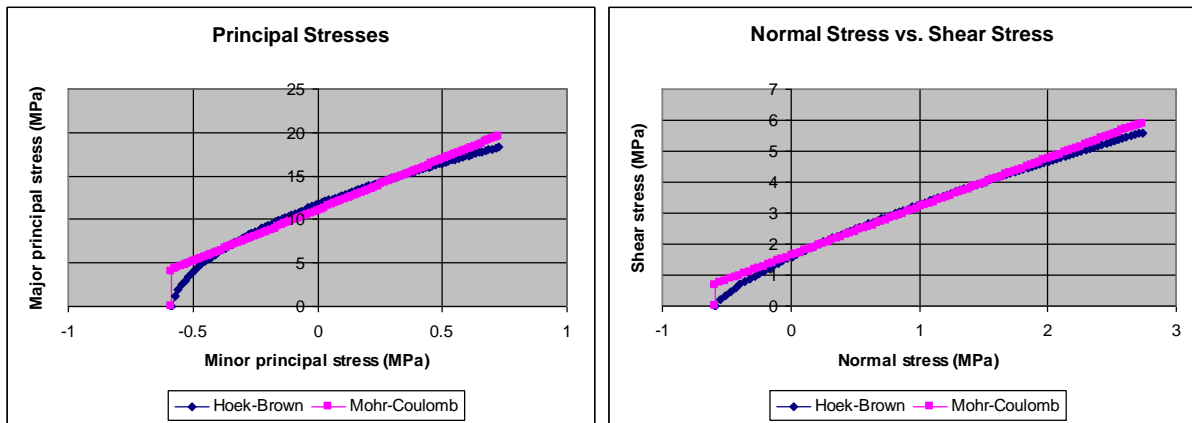

Figure 5.2.3. Relationship between major and minor principal stresses also normal and shear stresses for the Hoek-Brown and equivalent Mohr-Coulomb criteria for GSI 59 in the lower unit of the Asmari Formation.

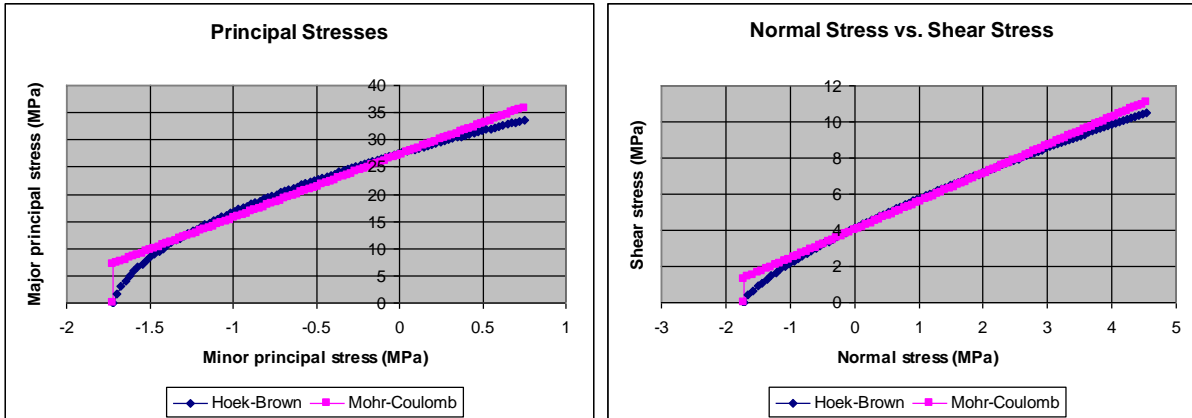

Figure 5.2.4. Relationship between major and minor principal stresses also normal and shear stresses for the Hoek-Brown and equivalent Mohr-Coulomb criteria for GSI 71 in the lower unit of the Asmari Formation.

Unwedge© program always initially calculates the maximum sized wedges which can form around an excavation (Figure 5.2.5). Wedges can scale down according to actual field observations (e.g. observed joint trace lengths, persistence and wedge volume). The Js1 (bedding planes), Js2, and Js3 intersecting discontinuities play a principal role in wedge failure in the diversion tunnel. The safety factor, volume, dimensions, wedge weight, wedge length, excavation face area and sliding direction of all wedges have been introduced in Table 5.2.6.

Figure 5.2.5 is a multi view of the Karun-3 dam diversion tunnel showing typical wedges which can be formed in the roof, sidewalls and floor by joint sets Js1 (bedding plane), Js2 and Js3. This figure represents approximately real possible sizes of wedges, which can be formed in the tunnel. Of course, during construction, decision on the sizes of wedges should be scaled and revised according to the real joint trace lengths measured during the excavation operation.

In Figure 5.2.5 it is evident that the two roof wedges (upper left and upper right) are relatively unstable and they need to be stabilized. The factor of safety is about 1.7 during excavation. The stabilization is achieved by the placement of 4.5 m length bolting system of 20 mm diameter, with 2.5 m spacing and 25 mm shotcrete layers in crown and sides.

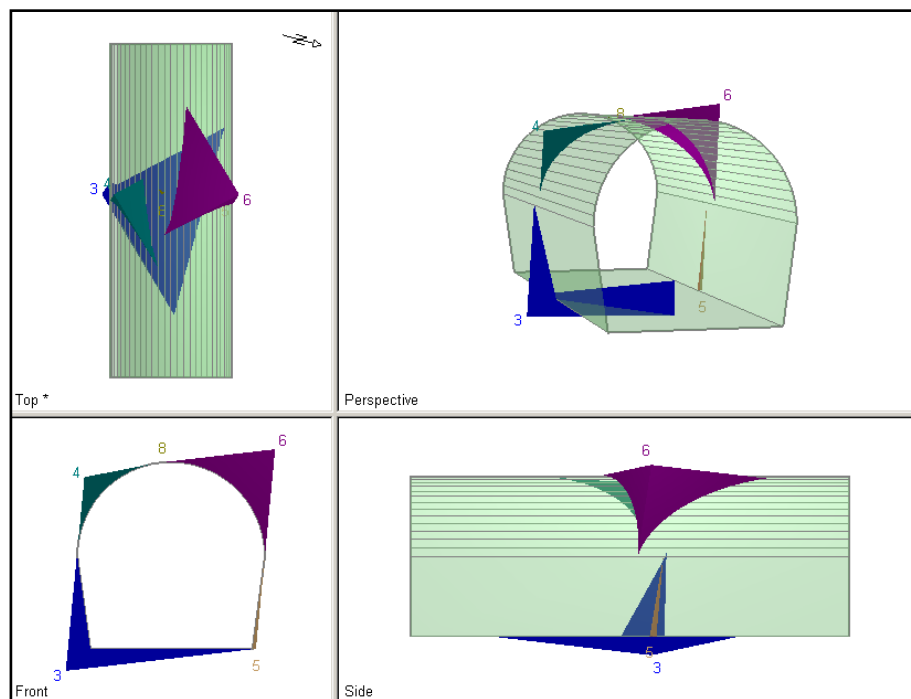

Figure 5.2.5. Multi view of the diversion tunnel. The shape, dimensions and specifications of wedges because of intersecting major discontinuity sets Js.1 (bedding planes), Js.2 and Js.3 in diversion tunnel at the Karun-3 Dam.

Dimensions on the number, length and capacity of the rock bolts are made by on-site geotechnical staff using equilibrium calculations based on the volume of the wedges defined by the measured trace lengths. For those wedges which involve sliding on one plane or along the line of intersection of two planes, rock bolts are installed across these planes to bring the sliding factor of safety of the wedge up to 1.5. For wedges which are free to fall from the roof, a factor of safety of 2 is used. This factor is calculated as the ratio of the total capacity of the bolts to the weight of wedge and is intended to account for uncertainties associated with the bolt installation. Early recognition of the potential instability problems, identification and visualization of the wedges which could be released and the installation of support at each stage of excavation, before the wedge bases are fully exposed, resulted in a very effective stabilization program (Unwedge©Rocscience Inc, 2004).

The factor of safety after installation of 4.5 m rock bolts and 25 mm shotcrete increased to 2.3 and 3.3 respectively (Figure 5.2.6).

Rock support arrangement in diversion tunnel, can be introduced according to Table 3.4. The support elements are converted for 15 m excavated span (Figure 5.2.6).

-Bolt length – 4.50 m in crown, and in sides if required
-Spacing – 2.50 m
-Shotcrete – 25.0 mm in crown, and in sides if required

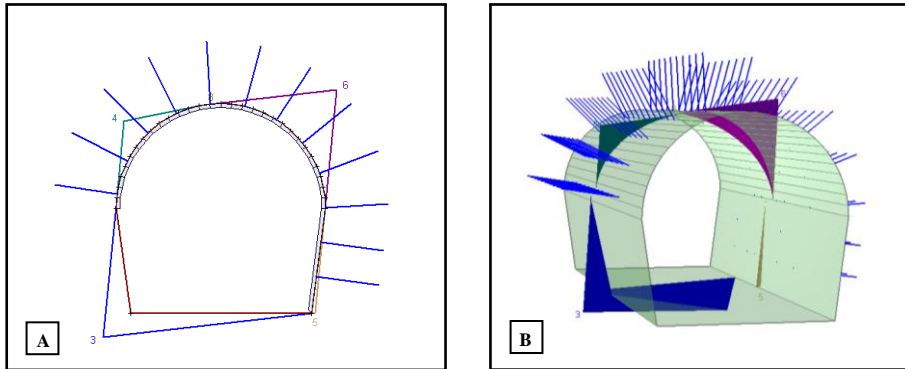

Figure 5.2.6. Rock support arrangement in good quality rock mass at 15 m excavated diameter of diversion tunnel (A- 2D and B- 3D views).

Table 5.2.6. The rock wedge specifications at the diversion tunnel resulted by Js.1, Js.2 and Js.4.

<p><u>Floor wedge [3]</u> Factor of Safety: stable Wedge Volume: 93.4 m³ Wedge Weight: 252.2 tones Wedge z-Length: 22.9 m Excavation Face Area: 157.3 m²</p>	<p>Wedge z-Length: 1.3 m Excavation Face Area: 2.4 m² Sliding Direction (trend, plunge): 180°, 8°</p>
<p><u>Upper Left wedge [4]</u> Factor of Safety: 1.8 Wedge Volume: 13.2 m³ Wedge Weight: 35.6 tones Wedge z-Length: 10.9 m Excavation Face Area: 26.7 m² Sliding Direction (trend, plunge): 47°, 85°</p>	<p><u>Upper Right wedge [6]</u> Factor of Safety: 1.8 Wedge Volume: 79 m³ Wedge Weight: 213.3 tones Wedge z-Length: 15.7 m Excavation Face Area: 67.6 m² Sliding Direction (trend, plunge): 135°, 81°</p>
<p><u>Lower Right wedge [5]</u> Factor of Safety: 15.9 Wedge Volume: 0.2 m³ Wedge Weight: 0.6 tones</p>	<p><u>Roof wedge [8]</u> Factor of Safety: 0.0 Wedge Volume: 0.001 m³ Wedge Weight: 0.002 tones Wedge z-Length: 0.7 m Excavation Face Area: 0.2 m² Sliding Direction (trend, plunge): 0°, 90°</p>

The finite element mesh shown in Figure 5.2.7 is constructed to simulate the loading conditions of normal and shear stress and their distribution on all wedge blocks. Except for (Js1, Js2, and Js3) other discontinuity sets have less influence on instability in the tunnel. All possible wedges are shown in Figure 5.2.7. The wedges shown in C-D, E-F and G-H are considered more stable than the case A-B because smaller blocks are involved, and light support such as primary reinforced shotcrete effectively limit failure.

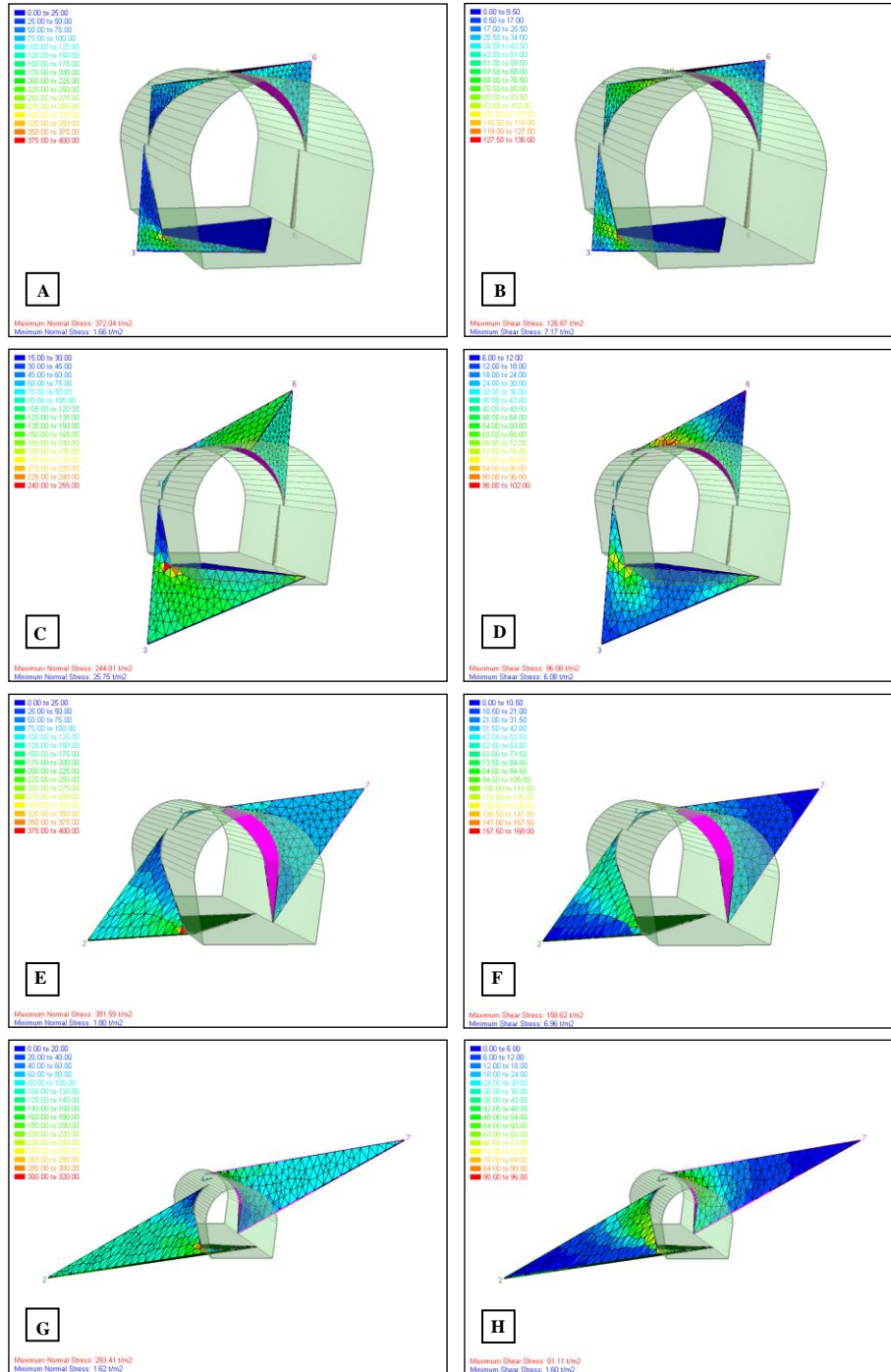

Figure 5.2.7. The finite element mesh of normal and shear stresses for all possible wedge because of intersection of discontinuities at diversion tunnel. The critical wedges based on distribution of shear stress and the shapes of wedges are A-B. In the other cases, the instabilities will be very small and local. A-B (Js.1, Js.2, Js.3), C-D (Js.1, Js.2, Js.4), E-F (Js.1, Js.3, Js.4), G-H (Js.2, Js.3, Js.4).

5.2.2. Hydropower Tunnels

5.2.2.1. Lower Asmari (4a1, 4a2, 4a3, 4a4)

Geological data for the tunnels were defined from surface mapping and four boreholes, namely, BH-108C, BH-111B, BH-118M, BH-120V and BH-107T. The detailed geology along the power tunnels are shown in Figure 5.2.8.

The tunnels are constructed from 0.0 m (intake) to 465 m in the Pabdeh Formation, and

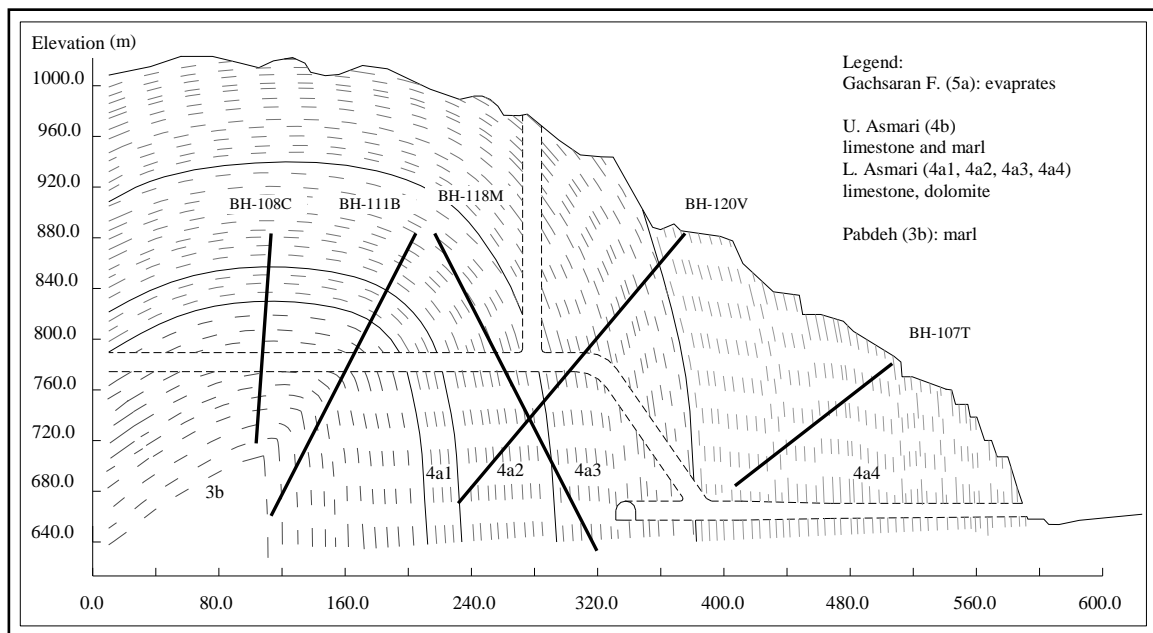

Figure 5.2.8. Geological section along the hydropower tunnels axis and gate shaft (after MG co., 1993).

from 465 m to 950 m (outlet) in the Asmari Formation. The Pabdeh Formation along the tunnel alignment comprises fair to good quality rock. Weighted mean RQDs range from 60% to 80%. The rock is generally moderately strong to strong and hydraulic conductivity is fairly low.

The downstream portion of the high pressure tunnels, the gate shafts and penstocks are excavated in the Asmari Formation. From 465 m to 695 m the underground works are predominantly limestone beds of subunits 4a1, 4a2 and 4a3. Between 695 m and 950 m (outlet), marly limestone and limestone with minor marlstone of subunit 4a4 is encountered. All the subunits are made up of strong to very strong rock which is of fair to good rock quality. Weighted RQDs generally ranged from 60% to 80%. A few zones of closely fractured to fragmented rock have noted, the most notable being the 10 to 20 m wide, so called vuggy zone at approximately St. 550 m. Rock mass hydraulic conductivities are high, generally ranging from 1×10^{-4} to 1×10^{-3} cm/s.

Based on discontinuity surveys (Figure 5.2.9) which have been taken along the tunnel route, the following significant discontinuity sets have been identified (Table 5.2.7). Spacing of bedding discontinuities and for the joint sets is wide to very wide (0.6 to 2 m). From 0.0 m to approximately 450 m, the tunnels pass through the dome of the Keyfe Malek Anticline. In this section the bedding dip is almost horizontal. Downstream from 450 m the tunnels are

located in the southwest flank of the anticline and the bedding is inclined at 70° to 85° toward the southwest.

Table 5.2.7. Summary of discontinuity data at the Hydropower tunnels.

Discontinuity Set	Dip Direction (°)	Dip (°)
Bedding	224	85
Set A	128	80
Set B	325	32

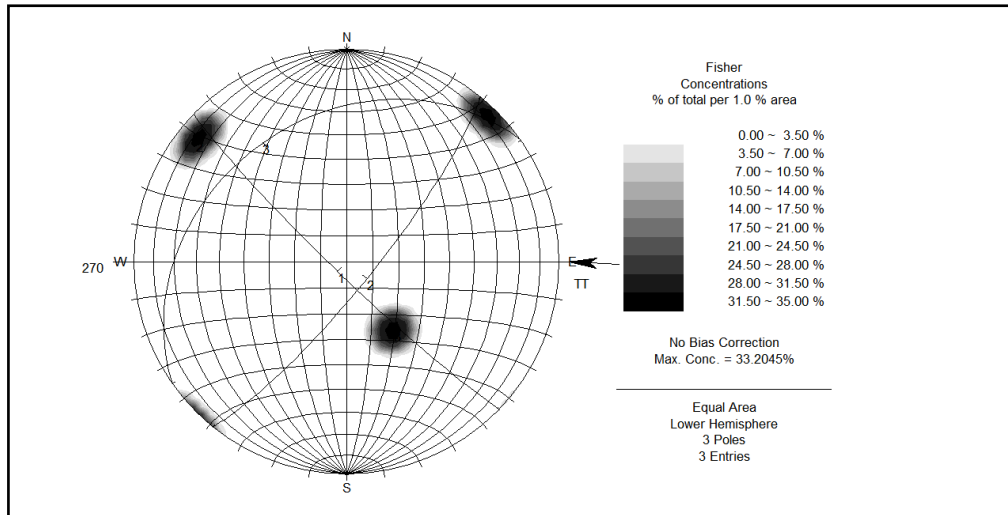

Figure 5.2.9. Contour plot and major plane plots of discontinuity sets at the hydropower tunnels (Dips©, equal area projection-Schmidt net, lower hemisphere).

The **RMR** value for the Lower Asmari (units 4a1, 4a2, 4a3, 4a4) based on Table 3.3 in hydropower tunnel are assessed as follows:

Table 5.2.8. Assessment of Rock Mass Rating for the Lower Asmari Formation (4a1, 4a2, 4a3, 4a4) in the hydropower tunnels.

	Property	Value	Rating
1	UCS (MPa)	138 - 116	12 - 12
2	RQD	80% - 60%	17 - 13
3	Spacing of discontinuities	B, 0.6-6.0m – j, 2- 0.6	15 - 15
4	Condition discontinuities	Slightly rough slightly weathered	25 - 25
5	Ground water	Wet to Dripping	7 - 4
6	Adjustment for joint orientation	Fair	-5
Total : 64 to 71 (Good)			

Based on Table 3.4 the guidelines for excavation and support of a 10 m span rock tunnel for the above RMR values are as follow:

Table 5.2.9. Rock support types for units 4a1, 4a2, 4a3 and 4a4 in the hydropower tunnels.

Rock mass class	Excavation	Rock bolts (20 mm diameter, fully grouted)	Shotcrete	Steel sets
II – Good rock	Full face, 1- 1.5 m advance. Complete support 20 m from face	Locally, bolts in crown 3 m long, spaced 2.5 m with occasional wire mesh	50 mm in crown where required	None

The *Stand up Time* for the hydropower tunnel with 15 m diameter was assessed based on the Bieniawski stand up time graph as 2×10^3 hours (83 days) for *RMR* (71) and 8×10^2 hours (33 days) for *RMR* (64).

The *Rock Tunneling Quality Index, Q* was determined as 35.1 (Good Quality) and 115.1 (Extremely Good Quality)

The *GSI* was determined from Hoek and Brown (1997) using equations 3.11, 3.12, and 3.13:

The *GSI* is then between 59 and 66.

Structural Stability Control and Rock Support Arrangement elements were determined by using the RocScience Software UNWEDGE©.

The three major discontinuity planes (Table 5.2.7) that control the shape and dimensions of wedges in the circular section of the power tunnels are presented in Figure 5.2.10.

The wedge information and specifications are summarized in Table 5.2.10. Rock support arrangement for good quality rock mass (4a1, 4a2, 4a3, 4a4) in the hydropower tunnel, can be introduced based on Table 3.4. Then the support elements are converted for a 15 m excavated span (Figure 5.2.11).

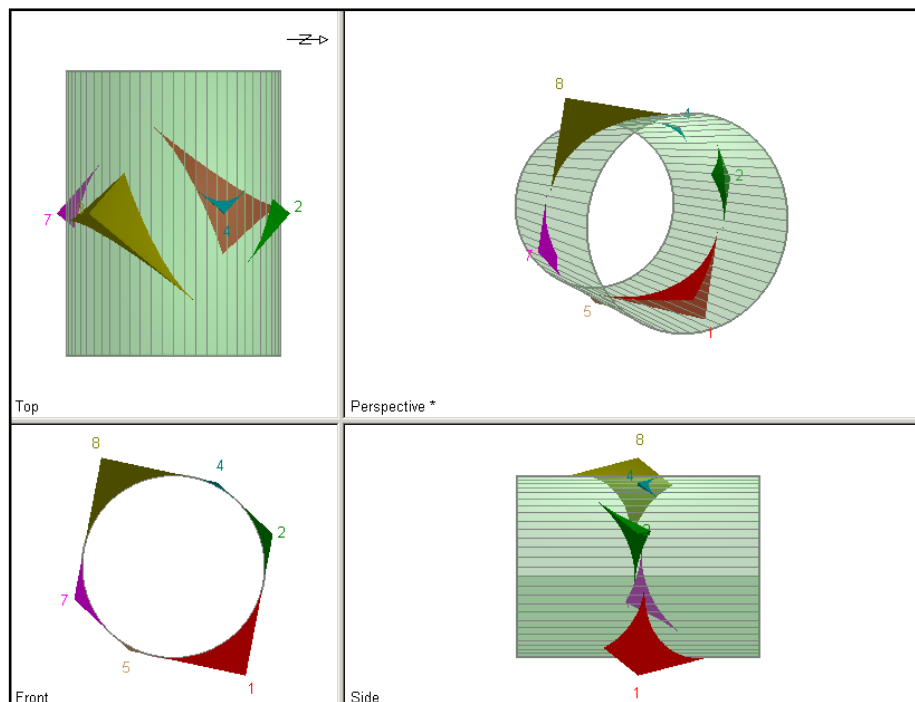

Figure 5.2.10. The shape dimensions and specifications of wedges because of intersecting major discontinuities in the hydropower tunnel at Karun-3 Dam (dia.15 m).

<p>-Bolt length – 4.50 m in crown, and in sides if required -Spacing – 2.5 m -Shotcrete – 25.0 mm in crown, and in sides if required</p>

Table 5.2.10. The rock wedge specifications in the hydropower tunnel resulting from three joint sets.

<p><u>Lower Right wedge [1]</u> Factor of Safety: stable Wedge Volume: 20.7 m³ Wedge Weight: 55.9 tonnes Wedge z-Length: 9.1 m Excavation Face Area: 21.7 m²</p> <p><u>Upper Right wedge [2]</u> Factor of Safety: 12.1 Wedge Volume: 2 m³ Wedge Weight: 5.4 tonnes Wedge z-Length: 4.7 m Excavation Face Area: 6.2 m² Sliding Direction (trend, plunge): 159°, 78°</p> <p><u>Roof wedge [4]</u> Factor of Safety: 9.3 Wedge Volume: 0.1 m³ Wedge Weight: 0.3 tonnes Wedge z-Length: 1.7 m Excavation Face Area: 1.3 m² Sliding Direction (trend, plunge): 224°, 85°</p>	<p><u>Floor wedge [5]</u> Factor of Safety: stable Wedge Volume: 0.1 m³ Wedge Weight: 0.3 tonnes Wedge z-Length: 1.7 m Excavation Face Area: 1.3 m² Sliding Direction (trend, plunge): 40°, 9°</p> <p><u>Lower Left wedge [7]</u> Factor of Safety: 13 Wedge Volume: 2 m³ Wedge Weight: 5.4 tonnes Wedge z-Length: 4.7 m Excavation Face Area: 6.2 m² Sliding Direction (trend, plunge): 325°, 32°</p> <p><u>Upper Left wedge [8]</u> Factor of Safety: 1.4 Wedge Volume: 21 m³ Wedge Weight: 55.9 tonnes Wedge z-Length: 9.1 m Excavation Face Area: 21.7 m² Sliding Direction (trend, plunge): 2°, 64°</p>
--	--

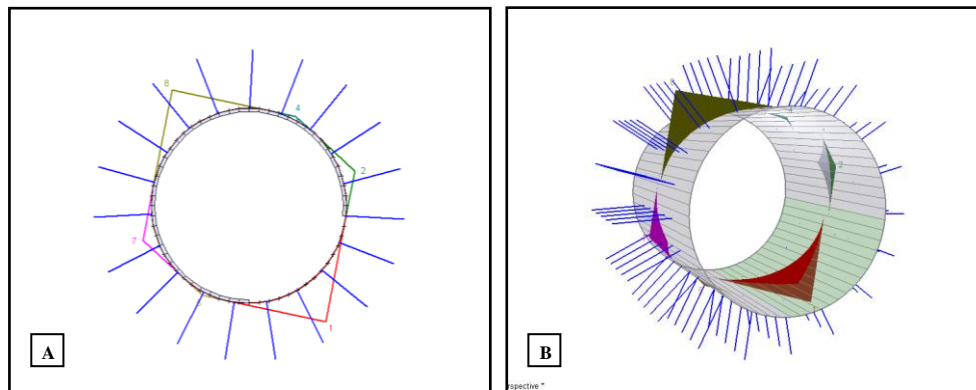

Figure 5.2.11. Rock support arrangement A (2D view) and B (3D view) of the Lower Asmari Formation (4a1, 4a2, 4a3, 4a4) in good quality rock mass in 15 m diameter at the power tunnel.

5.2.2.2. Unit- As.2 (Upper Asmari Formation- 4b)

Based on lithological column, the unit consists of 200 m thin to medium bedded marly limestone, marlstone, shale and limestone. The limestone and marly limestone are light grey to grey, fine to medium grained, crystalline, medium to thickly bedded and strong to very strong. The shale and marlstone are grey to dark grey, fine grained, thinly to thickly bedded and medium strong. Petrographical analysis indicated the limestone classified as Intrabiomicrite to Biomicrite- mudstone to wackestone. The bioclasts consist of mainly planktonic foraminifera such as *Globigerina* sp., some benthic species such as *Borelis* sp., *Dendritina* sp., *Miogyopsina* sp., and miliolides in addition Bivalves and Echinoid shell fragments. The porosity is mainly due to fractures and the values generally are between 1% to 13.8% which indicate medium to extremely high porosity.

The discontinuities are open at surface and have close to moderate spacing. Rock blocks are usually small to medium sized tabular fragments. Frequent calcite veins up to 10 mm

thick, are present in most locations. Rock quality is variable with the weighted mean RQD values ranging from 31% to 81% which indicates poor to good quality rock mass. If the discontinuity data from the dam in addition to the RMR parameters for the upper unit are taken into account the rock mass rating can be assessed as in Table 5.2.11.

Table 5.2.11. Assessment of Rock Mass Rating for the Upper Asmari (As.2).

	Property	Value	Rating
1	UCS (MPa)	15- 116	2 - 12
2	RQD	31% - 53%	8 - 13
3	Spacing of discontinuities	0.2- 0.6, 0.6- 2	10 - 15
4	Condition discontinuities	Slightly rough slightly weathered	25 - 25
5	Ground water	Wet to Dripping	4 - 7
6	Adjustment for joint orientation	Fair	-5
Total : 44 to 67 (Good)			

The Rock Quality Index, Q can then be calculated indirectly from equation 3.10 (Rutlege, Preston, 1978):

Then the Q values fall between **1.2 (Poor Quality)** and **58.4 (Very Good Quality)**.

The geological strength index (GSI) was calculated according to Hoek and Brown, 1997, (3.11 and 3.12):

The GSI values vary between **39** and **62**.

The rock mass strength with input data, UCS, GSI, mi and D for general application was assessed using **RocLab**© software and Table 5.2.12 is a summary of the results:

Table 5.2.12. The rock mass strength in the Upper Asmari unit.

Hoek-Brown Classification	Hoek-Brown Classification
sigci 15 MPa	sigci 116 MPa
GSI 39	GSI 62
mi 7	mi 8
D 0	D 0
Hoek-Brown Criterion	Hoek-Brown Criterion
mb 0.8	mb 2.1
s 0.001	s 0.01
a 0.5	a 0.50
Failure Envelope Range	Failure Envelope Range
Application General	Application General
sig3max 3.8 MPa	sig3max 29 MPa
Mohr-Coulomb Fit	Mohr-Coulomb Fit
c 0.6 MPa	c 6.7 MPa
phi (ϕ) 24.4°	phi (ϕ) 32.1°
Rock Mass Parameters	Rock Mass Parameters
sigt -0.02 MPa	sigt -0.8 MPa
sigc 0.5 MPa	sigc 13.9 MPa
sigcm 1.7 MPa	sigcm 24.7 MPa
Em 2056.1 MPa	Em 19952.6 MPa

Figures 5.2.12 and 5.2.13 show the relationship between major and minor principal stresses in addition to normal and shear stresses for Hoek- Brown and Mohr- Coulomb criteria for GSI 39 and GSI 62 in the upper unit of the Asmari Formation.

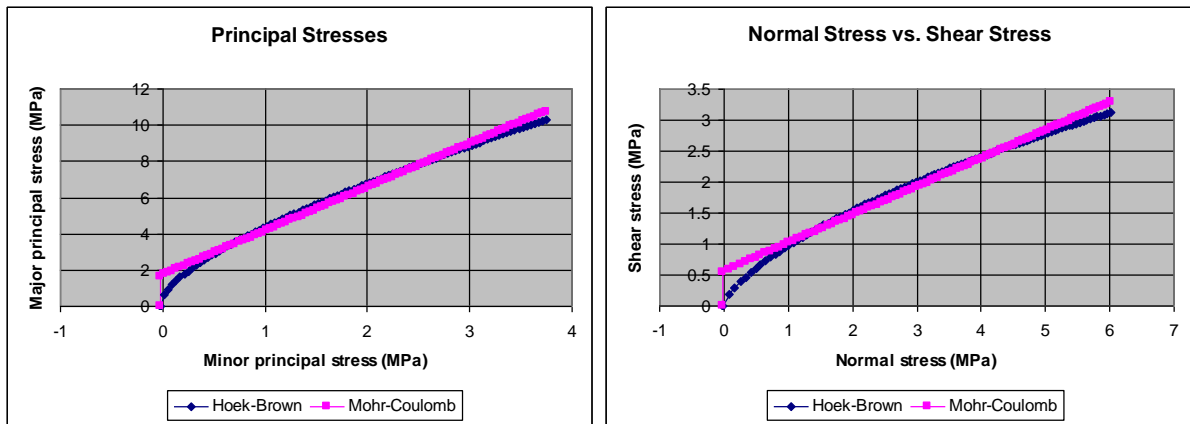

Figure 5.2.12. Relationship between major and minor principal stresses also normal and shear stresses for the Hoek-Brown and equivalent Mohr-Coulomb criteria for GSI 39 in the upper unit of the Asmari Formation.

With consideration of all geological strength index values (GSI) for the two rock units of the Asmari Formation, which resulted in the above calculations, the situation of rock mass strength at the Karun-3 dam can be plotted on Figure 5.2.14. Figure 5.2.14 has been used to estimate the value of GSI from field observations of blockiness and discontinuity surface conditions.

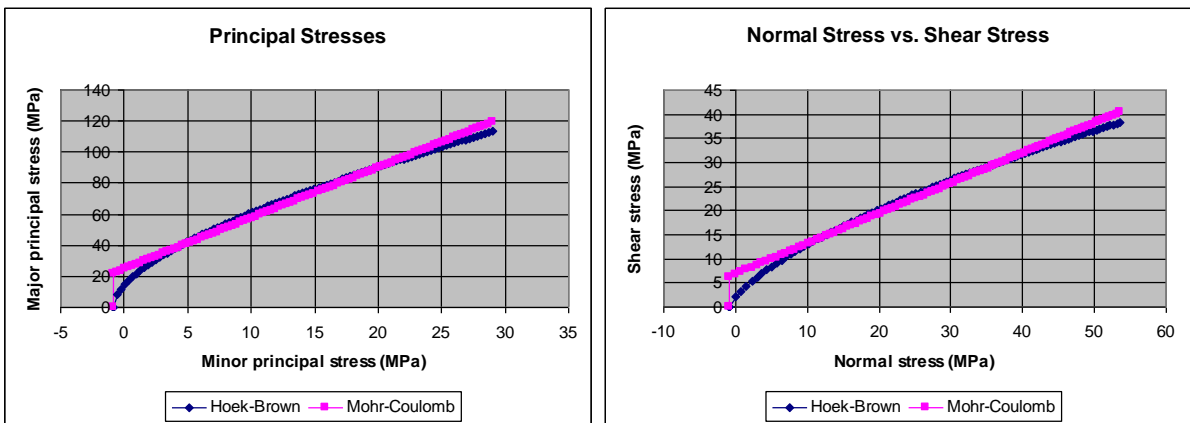

Figure 5.2.13. Relationship between major and minor principal stresses also normal and shear stresses for the Hoek-Brown and equivalent Mohr-Coulomb criteria for GSI 62 in the upper unit of the Asmari Formation.

Figures 5.2.14 and 5.2.15, based on the strength and other engineering rock mass properties for the Asmari Formation at the Karun-3 dam, show the rock mass quality variations are wide ranging from *Blocky-Very Well Interlocked* and *Good (B/G)* to *Blocky Disturbed /Seamy* and *Fair (BD/F)*.

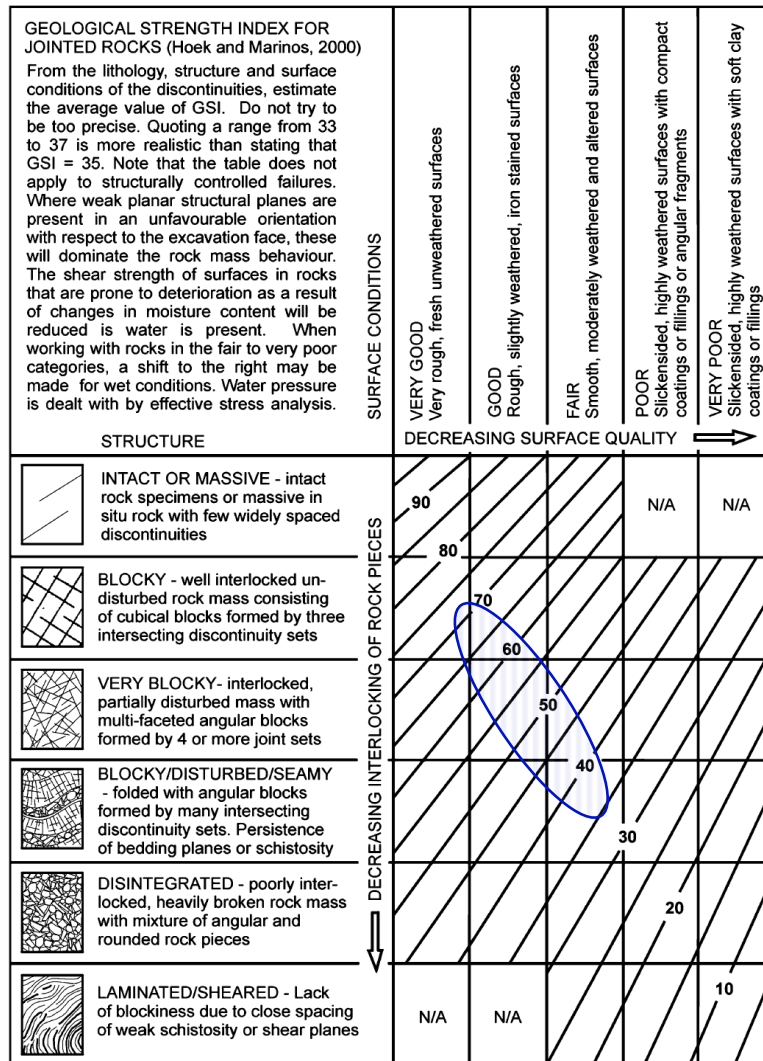

Figure 5.2.14. General Geological Strength Index (GSI) chart, for jointed rock masses (Hoek and Brown 1997, Hoek and Karzulovic, 2001). The shaded area is indicative of distribution of geological strength index of various rock mass units of the Asmari Formation at the Karun-3 dam.



Formation	Thickness	Unit no./subunit	Lithological column	Lithological description	Porosity%	Karst features	Permeability	UCS/Mpa	ROD %	RMR	Q	GSI	Mohr Coulumb Fit		Rock		Mass Parameters			
													C, Mpa	phi, deg	sigt, Mpa	sigc, Mpa	En, Mpa			
Gachsaran Fm.		5a		Alternating white, thin to very thickly bedded anhydrite and red and grey, very thickly bedded marl																
ASMARI FORMATION 615.0 m	2000 m	4b		Thin to thickly bedded marlstone with minor shale interbedded light grey to grey in color	1.30 0.75	Vuggy zones and solution cavities along discontinuities are common	Medium to High	15	Poor - Fair (31% - 53%)	44	1.2	39	0.55	24.4	-0.02	0.47	2056.1			
				Biostratigraphic, Mudstone to Wackestone Fracture and vuggy porosity, bioclasts elements are mainly planktonic Foraminifera such as Globigerina sp. and benthic species such as Dendritina sp., Mogyssina sp., Borelis sp., Miliolides, Echinoid, Bivalvia shell fragments and Calcareous Red Algae locally recrystallized	1.00 3.00 1.00 3.75 5.50 3.50															
	2350 m	404		Medium to thickly bedded limestone light brownish grey to light reddish grey colour, and thin to thickly bedded marly limestone, with occasional marlstone and shale beds	1.50 2.00 1.35 5.00	Open solution cavities 1-2 mm in diameter are common, they are partially filled with clay and are rarely interconnected, some solution enlargement of discontinuities	Low to High	116	Fair - Good (51% - 82%)	64	35.1	59	1.59	57	-0.58	11.72	16788			
				Intrabiostratigraphic, wackestone to packstone, vuggy and intraparticle porosity, bioclasts components are mainly planktonic Foraminifera such as Globigerina sp., Globorotalia sp. and benthic species such as Rotalia sp., Borelis sp., Elphidium sp. and Miliolides, Green Algae and Echinoid shell debris	2.00 15.70 3.50 2.60 4.50															
				Thick to very thickly bedded limestone light brownish grey in colour with interbedded of marly limestone, slightly dolomitic, several prominent slickensided bedding	5.30 14.60 10.70															
				Intrabiostratigraphic, dolomicrosparite - Wackestone, Vuggy, Fracture and intraparticle porosity,	4.20 2.00 1.50															
		950 m	403		Very thickly bedded limestone, grey to light brownish grey colour,	5.00 15.50	Vuggy zones are well developed, 1.9 m dia. solution cavities and several clay filled solution cavities up to 0.2 m in diameter			Fair - Good (74% - 81%)	76	268.6	71	3.97	57.4	-1.70	27.44	33496.5		
					Thickly bedded limestone, grey in colour and marly limestone	4.00 2.50														
		630 m	402		Marlstone, 40% grey to dark grey limestone, 25% light brownish grey marly limestone and shale															
					220 m	401														
Pabdeh Fm.-		3b																		

Figure 5.2.15. The lithological units and engineering rock mass characterization of the Asmari Formation at the Karun-3 dam.

5.2.3. Hydrogeology of Project Site

Records of river levels during the feasibility study period show that there is a close relationship between groundwater level fluctuations and seasonal changes in river level. Water level elevations in Boreholes BH-101A, BH106D, BH107E, BH110-F, BH114U and BH-116S are generally within 1 m of river elevation. These boreholes are all adjacent to the river. The abutments at the damsite are well drained which indicates that the local hydraulic conductivity is high. Borehole BH-108C was drilled in the Pabdeh Formation and is located 230 m away from the river. It has a water elevation that is 3 m to 5 m higher than the corresponding river elevation. The groundwater table was not encountered in boreholes BH-115Z and BH-119CA, both of which were terminated well above river level (MG.co. 1998).

5.2.3.1. Hydraulic Conductivity

Results of water pressure tests (lugeon test) in drill holes were evaluated in terms of coefficient of permeability (k). At later stages, the Lugeon criterion was introduced and the coefficient of infiltration was calculated. The coefficient of permeability (k) of the bedrock varies from 9×10^{-7} to 6×10^{-2} cm/s.

In the Asmari Formation, a large number of measurements indicate k values in the range from 2×10^{-3} to 4×10^{-4} cm/s and in the marlstone of the Pabdeh Formation between 3×10^{-5} to 8×10^{-5} cm/s (Table 5.2.13).

Table 5.2.13. Permeability (K) values classification.

Very Low K	< 10^{-5} cm/s (about 1 lugeon)
Low K	10^{-3} to 10^{-4} cm/s (about 1 to 10 lugeon)
Medium K	10^{-2} to 10^{-3} cm/s (about 10 to 100 lugeon)
High K	> 10^{-3} cm/s (about 100 lugeon)

In all studies, k values were related directly to permeability. Similarly, arbitrary subdivisions of calculated Lugeon values (coefficient of infiltration) were made to indicate zones of high and low permeability. The groupings given in Table 5.2.14 are used only for comparative descriptions.

Table 5.2.14. Hydraulic conductivity of the Asmari and Pabdeh formations in the Karun-3 Dam.

Hydraulic Conductivity (K) %				
Asmari F.	very Low	Low	Medium	High
Unit 4b (78 tests above 100m depth)	4	6	11	79
Unit 4a (556 tests above 100m depth)	9	13	23	55
Unit 4a (479 tests below 100m depth)	15	23	35	27
Pabdeh F.				
Unit 3 (226 tests from 0 to 250m depth)	26	18	19	37

The Lugeon values indicate great variation in hydraulic conductivity with depth and location. Generally in the Asmari Formation to a depth of 100 m from the surface, the hydraulic conductivity varies from very low to high with the majority of the results in the medium range. Below this depth, the measured conductivities are very low to medium.

5.2.3.2. Curtain Grouting

The extent of curtain grouting is indicated in Figure 5.2.16. Grout curtains are critical components of dams constructed on karstic bedrock foundations such as at Karun-3 damsite. In this geological environment, grout curtains are more extensive and require much higher volumes of cement than is normally the case in other rock types. The grout curtain should extend 150 m below the base of the dam and 200 m into each abutment.

A multiline curtain, comprising 2 to 3 rows of holes, was installed in the medium to high permeability limestone in each abutment and beneath the dam. High grout takes were anticipated in this part of the grout curtain. A single row curtain with relatively low grout take was extended through the slightly permeable rock units near the right abutment and below 100 m depth under the base and left abutment.

The grouting was performed mostly from tunnel galleries, the arrangement of which is shown on Figure 5.2.16. The grout galleries are 3.5 m high by 2.5 m wide, based on the anticipated size of drilling equipment. Grout holes should be approximately 50 mm in diameter and have an average spacing of 3 m, although spacings as low as 1.50 m can be expected at some locations.

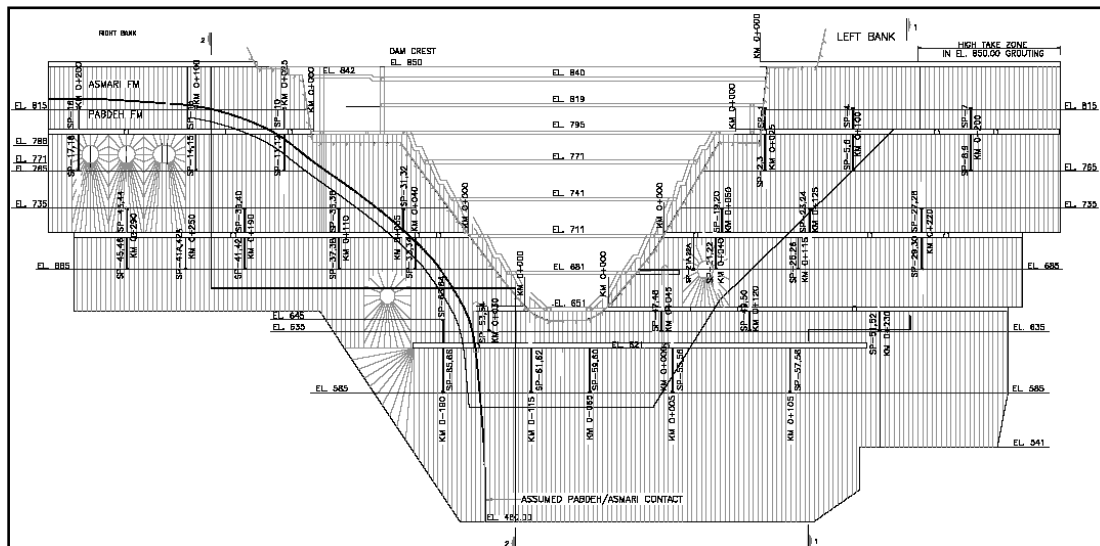

Figure 5.2.16. Developed section of the grout curtain at the Karun-3 dam (MG co. 1989).

5.2.4. Watertightness of Reservoir

The reservoir is aligned parallel to the bedrock structures. Seepage through the sides or bottom of the reservoir will be perpendicular or oblique to the bedding. In the northwestern end of the reservoir, seepage would be parallel to the bedding through rock formations running to either sides of the dam. These two cases of reservoir seepage are discussed separately in the following paragraphs.

The rocks of the Agha Jari and Gachsaran Formations, which make up most of both flanks and the bottom of the reservoir, have low to very low permeability. Boreholes BH-102K and BH-103J, which were drilled in the Gachsaran Formation, indicate that permeabilities of the

mudstones, marlstone and anhydrites are generally less than 1×10^{-5} cm/s. High hydraulic conductivities in the order of 2×10^{-4} cm/s to 1×10^{-3} cm/s were found in sandstone strata. As flow is mostly across strike, the less permeable argillaceous and anhydrite rocks will determine the overall mass hydraulic conductivity. Slightly southwest of the reservoir, the marlstone, shales and limestones of the Pabdeh Formation are warped up well above the reservoir elevation of 850 m. Testing at the dam site has shown that the hydraulic conductivity perpendicular to bedding in the Pabdeh Formation is low, and generally ranges between 1×10^{-5} cm/s - 1×10^{-4} cm/s.

Reservoir seepage through the low permeability rocks of the Gachsaran and Agha Jari Formations will be very slight. These rocks outcrop along the entire right bank and bottom of the reservoir upstream from Pole Shalu. It is possible that windows below elevation 850 m pass through the Gachsaran Formation beneath the displaced rock masses. If this is the case, the low permeability rocks of the nearby Pabdeh Formation will contain potential leakage from the left flank of the reservoir (MG. co, 1989).

5.3. Engineering Geological Characteristics of the Karun-4 Dam and Power plant (Engineering Rock Mass Classification of the Asmari Formation)

5.3.1. Diversion Tunnel

5.3.1.1. Lower Unit (Lower Asmari Formation- As.1)

In order to divert the Karun River during the dam construction, two tunnels in the right flank have been designed. The tunnels are excavated at a strike of S40°W with lengths of 610 m and 635 m respectively and diameter of 11.2 m. Almost 50% of the tunnel's length are excavated in the Pabdeh Formation and the rest pass through the Asmari Formation (As.1). The Asmari Formation (As.1), which forms the dam abutments, is considered here to be a part of the bedrock of this structure. This part is composed of thick limestone beds, porous limestone (karstified) with intercalations of marly limestone (Figures 5.3.1 and 5. 3.2).



Figure 5.3.1. The diversion tunnel at outlet and down stream coffer dam, during the heavy flood 2006 (left). Diversion tunnel with temporary support elements. The final reinforced concrete lining has been done in the lower part of tunnel (right).

The Asmari Formation (As.1) along the diversion tunnel is fair to good quality limestone with RQD generally ranging between 55% to 83%.

The **RMR** value for unit As.1 based on rock mass rating parameters in Table 3.3 can be assessed as in Table 5.3.1.

Table 5.3.1. Major discontinuity sets and their specifications.

Discontinuity Set	Dip direction (°)	Dip (°)	Spacing	Surface	Opening	Filling	Length
Set 1	55	42	0.6- 2 m	rough	2- 5 mm	calcite/clay	3- 15 m
Set 2	092	65	0.6- 2 m	rough	2- 4 mm	calcite/clay	5- 10 m
Set 3	126	85	0.6- 2 m	smooth	2- 5 mm	calcite/clay	3- 30 m
Bedding	230	49		smooth to rough	2- 100 mm	calcite/clay	>100 m

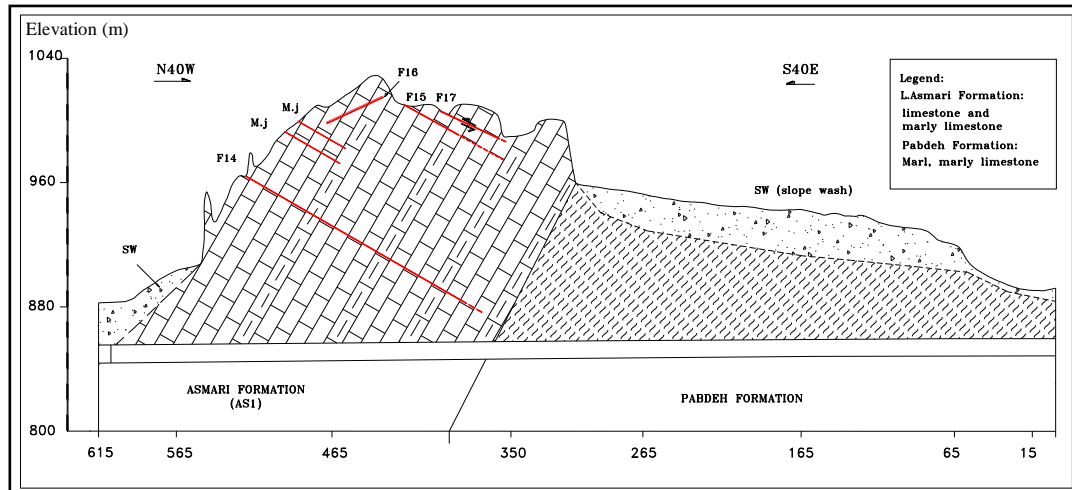

Figure 5.3.2. The engineering geological section along the diversion tunnel. This tunnel with over 600 m excavated in the Pabdeh and lower unit of Asmari Formations (after MG co., 1989).

Table 5.3.2. Assessment of Rock Mass Rating for the Asmari Formation (Lower unit).

	Property	Value	Rating
1	UCS (MPa)	48- 100	4- 7
2	RQD	55% - 83%	13- 17
3	Spacing of discontinuities	0.6- 2m	15
4	Condition of discontinuities	Rough to Smooth	25
5	Ground water	Wet to Dripping	4- 7
6	Adjustment for joint orientation	Very favorable	0
Total : 61– 71 (Good)			

In addition, based on Table 3.4, the guidelines for excavation and support of an 11.2 m diameter tunnel for relevant *RMR* values are as follows (Table 5.3.3):

Table 5.3.3. Rock support types in the diversion tunnel.

Rock mass class	Excavation	Rock bolts (20 mm diameter, fully grouted)	Shotcrete	Steel sets
II – Good rock	Full face, 1- 1.5 m advance. Complete support 20 m from face	Locally, bolts in crown 3m long, spaced 2.5m with occasional wire mesh	30 mm in crown where required	Non

The *Stand up Time* for the diversion tunnel is 2×10^3 hours (83 days) for a good quality rock mass based on the Bieniawski stand up time graph.

The *Rock Tunneling Quality Index, Q* considering the six parameters in Table 3.6, can be determined based on equation 3.4.

Or can be calculated by empirical equation 3.10 introduced by Rutlege and Preston (1978).

The *Q* values were determined as **21 (Good Quality)** and **151 (Extremely Good Quality)**.

Structural Stability Control and Rock Support Arrangement elements were determined by using the RocScience Software UNWEDGE©.

There are four major discontinuities (Table 5.3.1) which control the shape and dimensions of wedges in the diversion tunnel. Three of them have more influence on the instabilities and are, Js1, Js3 and bedding planes (Js.4).

Figure 5.3.3 and Table 5.3.4 show the safety factor, volume, dimensions, geometry, wedge weight, wedge z length, excavation face area and sliding direction of the rock wedges.

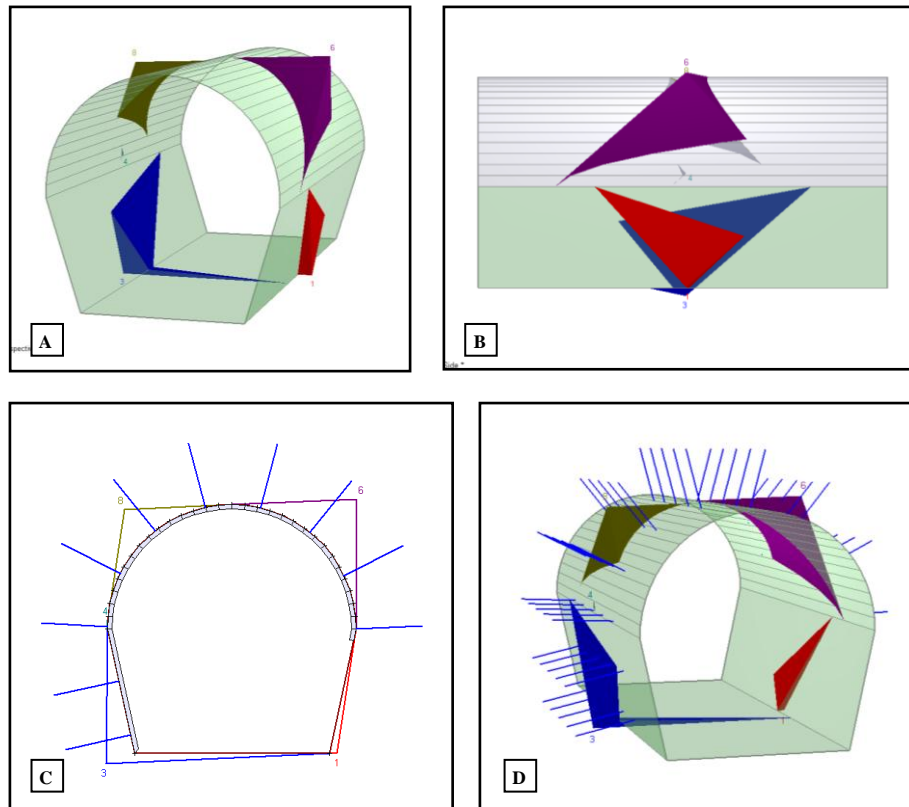

Figure 5.3.3. All possible rock wedges due to intersection of the major joint sets, Js.1, Js.3 and bedding planes in the diversion tunnel. A- Perspective view, B- Side view of tunnel showing unstable wedges, C- (2D view) and D (3D view) of the Rock support arrangement of the lower Asmari Formation in good quality rock mass.

Wedge 8 is the only unstable block of 6.6 m^3 with a factor of safety of 1.1. If wedge sliding takes place, the direction of sliding will be $330^\circ/ 55^\circ$. Other blocks are regarded as relatively stable during the excavation operation. After installation of support elements as stated below, the safety factor of wedge no. 8 increases to 3.14.

Figure 5.3.4 shows the finite elements mesh of normal and shear stresses for all possible wedges because of intersection of discontinuities in the diversion tunnel and Table 5.3.4 indicates wedges specifications. The critical wedges based on distribution of shear stress can be observed. Intersection of Js.1, Js.3 and bedding planes (A, B), intersection of Js.2, Js.3 and bedding planes (C, D), intersection of Js.1, Js.2 and Js.3 (E, F).

- Bolt length – 3.0 m $\Phi 20.0$ mm, in crown, and in sides locally if required
- Spacing – 2.5 m
- Shotcrete – 30.0 mm primary in crown, and in sides 20 mm if required

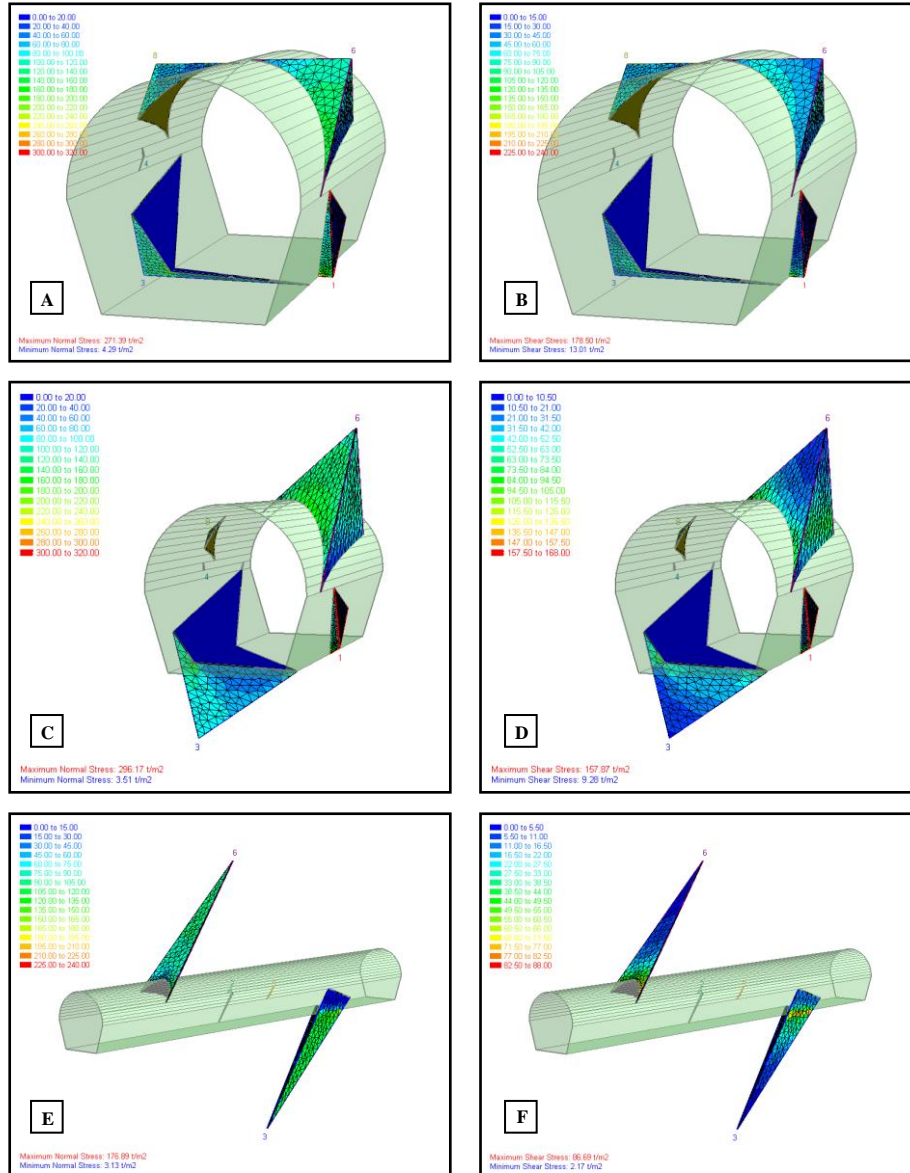

Figure 5.3.4. The finite elements mesh of normal and shear stresses for all possible wedges because of intersection of discontinuities in the diversion tunnel.

The geological strength index (*GSI*) based on two equations (3.11 and 3.12) which were introduced by Hoek and Brown (1997) was calculated as follows:

The *GSI* values vary between **56** and **66**.

The rock mass strength with input data, UCS, *GSI*, *m_i*, *D* and tunnel depth was assessed using *RocLab*© software and Table 5.3.5, Figures 5.3.5 and 5.3.6 are the summary of the results.

Table 5.3.4. The rock wedge specifications in the diversion tunnel.

<p><u>Lower Right wedge [1]</u> Factor of Safety: stable Wedge Volume: 4 m³ Wedge Weight: 10.8 tonnes Wedge z-Length: 8.0 m Excavation Face Area: 15.6 m² Shear Force: 0.5 tonnes Sliding Direction (trend, plunge): 142°, 3°</p> <p><u>Lower Left wedge [3]</u> Factor of Safety: stable Wedge Volume: 14.5 m³ Wedge Weight: 39.2 tonnes Wedge z-Length: 10.3 m Excavation Face Area: 27.1 m² Shear Force: 0.0 tonnes</p> <p><u>Upper Left wedge [4]</u> Factor of Safety: stable Wedge Volume: 0.0 m³ Wedge Weight: 0.001 tonnes Wedge z-Length: 0.8 m</p>	<p>Excavation Face Area: 0.1 m² Shear Force: 0.0 tonnes Sliding Direction (trend, plunge): 40°, 41°</p> <p><u>Upper Right wedge [6]</u> Factor of Safety: 4.4 Wedge Volume: 16.2 m³ Wedge Weight: 43.7 tonnes Wedge z-Length: 10.3 m Excavation Face Area: 23 m² Shear Force: 43.6 tonnes Sliding Direction (trend, plunge): 126°, 85°</p> <p><u>Upper Left wedge [8]</u> Factor of Safety: 1.1 Wedge Volume: 6.6 m³ Wedge Weight: 17.8 tonnes Wedge z-Length: 7.1 m Excavation Face Area: 14.3 m² Shear Force: 0.00 tonnes Sliding Direction (trend, plunge): 330°, 55°</p>
---	---

Table 5.3.5. The rock mass strength in the Lower Asmari unit.

<p>Hoek-Brown Classification sigci 48 MPa GSI 56 mi 8 D 0 Hoek-Brown Criterion mb 1.7 s 0.01 a 0.5 Failure Envelope Range Application Tunnels Unit Weight 0.02 MN/m³ Tunnel Depth 100 m Mohr-Coulomb Fit c 0.8 MPa phi (φ) 47.9° Rock Mass Parameters sigt -0.2 MPa sigc 4.1 MPa sigcm 8.6 MPa Em 9786.4 MPa</p>	<p>Hoek-Brown Classification sigci 100 MPa GSI 66 mi 8 D 0 Hoek-Brown Criterion mb 2.4 s 0.02 a 0.5 Failure Envelope Range Application Tunnels sig3max 1.4 MPa Unit Weight 0.03 MN/m³ Tunnel Depth 100 m Mohr-Coulomb Fit c 2.3 MPa phi (φ) 53.1° Rock Mass Parameters sigt -0.9 MPa sigc 15.02 MPa sigcm 23.1 MPa Em 25118.9 MPa</p>
---	--

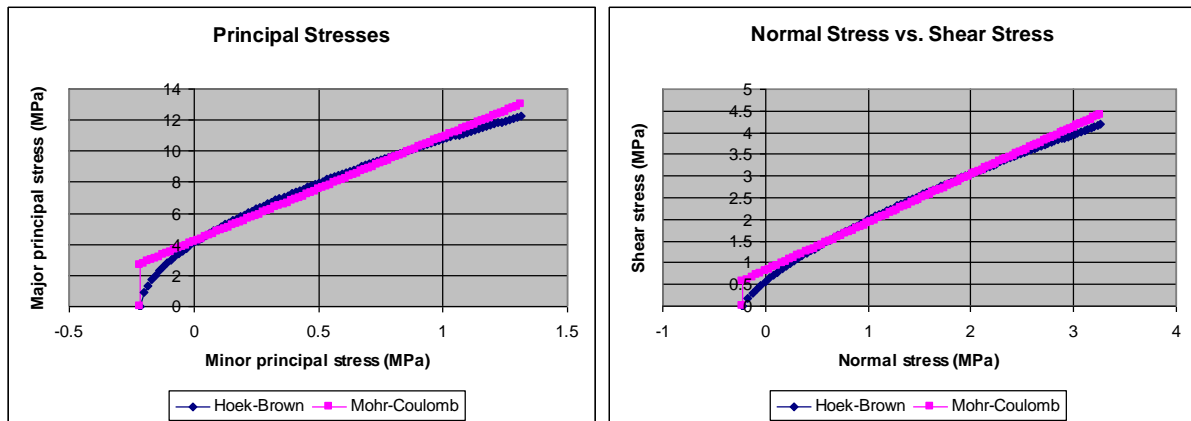

Figure 5.3.5. Relationship between major and minor principal stresses also normal and shear stresses for the Hoek-Brown and equivalent Mohr-Coulomb criteria for GSI 56 in the lower unit of the Asmari Formation.

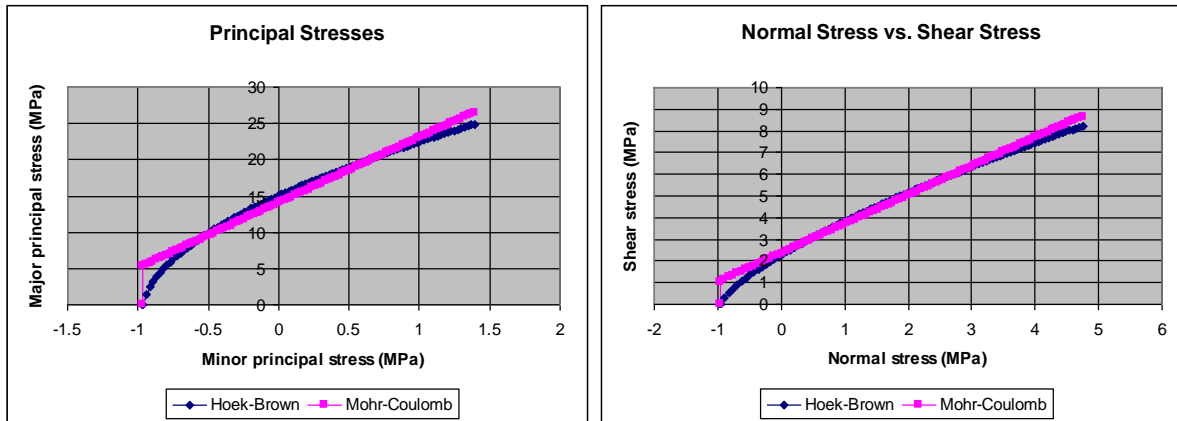

Figure 5.3.6. Relationship between major and minor principal stresses also normal and shear stresses for the Hoek-Brown and equivalent Mohr-Coulomb criteria for GSI 66 in the lower unit of the Asmari Formation.

5.3.1.2. Middle Unit (Middle Asmari Formation- As.2)

This unit lithologically comprise medium to thickly bedded limestone, marlylimestone and marlstone with, dolomitization well developed at the base slightly karstified with mostly fractured and vuggy porosity. The rock is impermeable but can be locally very high permeability.

The **RMR** value for unit As.2 based on rock mass rating parameters in Table 3.3 can be assessed as in Table 5.3.6.

Table 5.3.6. Assessment of Rock Mass Rating for the Middle Asmari Formation (Middle unit).

	Property	Value	Rating
1	UCS (MPa)	39- 116	4-12
2	RQD	53% - 84%	13- 17
3	Spacing of discontinuities	0.6- 2.0 m	10- 15
4	Condition discontinuities	Rough to Smooth, weathered	20
5	Ground water	Damp	10
6	Adjustment for joint orientation	Very unfavorable	-25
Total : 32- 49 (Weak to fair)			

The Rock Quality Index (Q) can be clarified by two empirical equations 3.9 (Bieniawski, 1989) and 3.10 (Rutlege, Preston, 1978).

Based on Rotelech-Preston equation the Q values were determined as **0.84 - 2.8 (Poor Quality)**.

The Geological Strength Index (**GSI**) was calculated using equations 3.11 and 3.12 (Hoek and Brown, 1997) and the **GSI** values fall between **27** and **44**.

The rock mass strength with input data, UCS, GSI, mi, D (disturbance factor) and tunnel depth was assessed using **RocLab**© software and Table 5.3.7, Figures 5.3.7 and 5.3.8 are the summary of the results.

Table 5.3.7. The rock mass strength in the Middle Asmari unit.

Hoek-Brown Classification		Hoek-Brown Classification	
sigci	116 MPa	sigci	39 MPa
GSI	44	GSI	27
mi	8	mi	8
D	0	D	0
Hoek-Brown Criterion		Hoek-Brown Criterion	
mb	1.1	mb	0.6
s	0.002	s	0.0003
a	0.5	a	0.5
Failure Envelope Range		Failure Envelope Range	
Application	General	Application	General
sig3max	29 MPa	sig3max	9.8 MPa
Mohr-Coulomb Fit		Mohr-Coulomb Fit	
c	4.9 MPa	c	1.2 MPa
phi (ϕ)	26.9°	phi (ϕ)	2°
Rock Mass Parameters		Rock Mass Parameters	
sigt	-0.2 MPa	sigt	-0.02 MPa
sigc	4.9 MPa	sigc	0.5 MPa
sigcm	15.9 MPa	sigcm	3.5 MPa
Em	079.5 MPa	Em	61.6 MPa

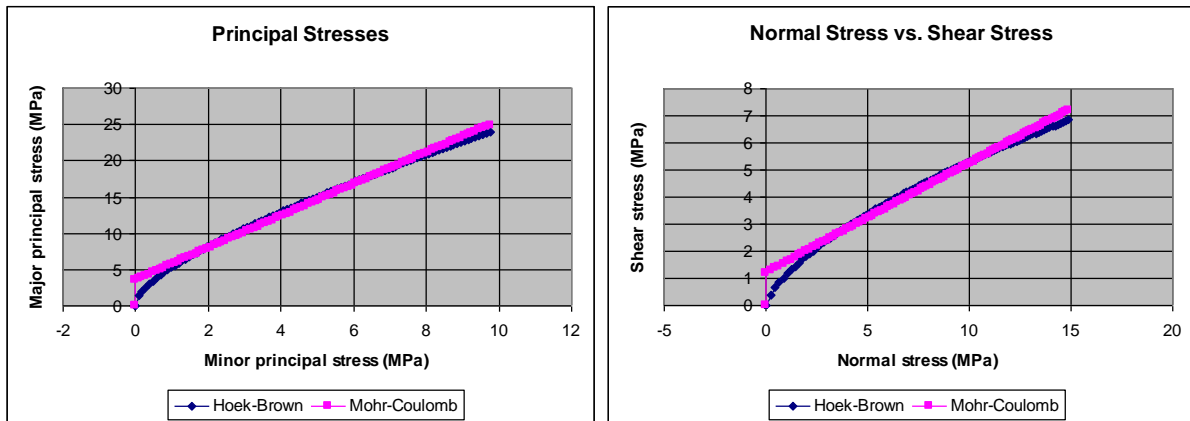

Figure 5.3.7. Relationship between major and minor principal stresses also normal and shear stresses for the Hoek-Brown and equivalent Mohr-Coulomb criteria for GSI 27 in the middle unit of the Asmari Formation.

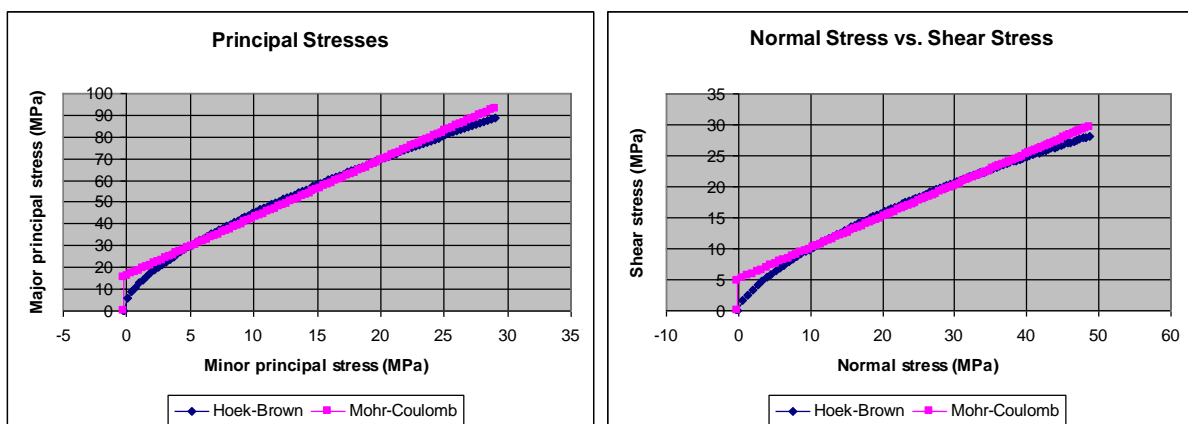

Figure 5.3.8. Relationship between major and minor principal stresses also normal and shear stresses for the Hoek-Brown and equivalent Mohr-Coulomb criteria for GSI 44 in the middle unit of the Asmari Formation.

5.3.1.3. Upper Unit (Upper Asmari Formation- As.3)

The upper Asmari Formation lithologically comprise marly limestone with marlstone and sometimes interbedded limestone, non karstic to slightly karstified and impermeable to locally very highly permeable.

Considering the discontinuity set specifications at the dam foundation, as well as the RMR parameters for the upper unit, the rock mass rating can be assessed as in Table 5.3.8.

Table 5.3.8. Assessment of Rock Mass Rating for the Asmari Formation (Upper unit).

	Property	Value	Rating
1	UCS (MPa)	39-48	4
2	RQD	45% - 78%	8-17
3	Spacing of discontinuities	0.6- 1.0 m	15
4	Condition discontinuities	Rough to Smooth, weathered	20
5	Ground water	Damp	10
6	Adjustment for joint orientation	Very unfavorable	-25
Total : 32 – 41 (Weak to Fair)			

The Rock Quality Index (Q) can be assessed by two empirical equations (3.9 and 3.10) which were introduced by (Bieniawski, 1989) and (Rutlege, Preston, 1978).

Based on Rotelech-Preston equation the Q values were determined as **0.15 to 0.7 (Very Poor Quality)**.

The Geological Strength Index (GSI) was estimated according to equations 3.11 and 3.12 (Hoek and Brown, 1997) and the values obtained vary between **27 and 36**.

The rock mass strength with input data, UCS, GSI , m_i , D (disturbance factor) and tunnel depth for general application was assessed using **RocLab**© software and Table 5.3.9, Figures 5.3.9 and 5.3.10 are the summary of the results.

Table 5.3.9. The rock mass strength in the Upper Asmari unit.

Hoek-Brown Classification		Hoek-Brown Classification	
sigci	39 MPa	sigci	48 MPa
GSI	27	GSI	36
m_i	8	m_i	8
D	0	D	0
Hoek-Brown Criterion		Hoek-Brown Criterion	
mb	0.6	mb	0.8
s	0.0003	s	0.001
a	0.5	a	0.5
Failure Envelope Range		Failure Envelope Range	
Application	General	Application	General
sig3max	9.8 Mpa	sig3max	12 MPa
Mohr-Coulomb Fit		Mohr-Coulomb Fit	
c	1.2 MPa	c	1.8 MPa
ϕ (ϕ)	21.9°	ϕ (ϕ)	24.6°
Rock Mass Parameters		Rock Mass Parameters	
sigt	-0.02 MPa	sigt	-0.04 MPa
sigc	0.5 MPa	sigc	1.2 MPa
sigcm	3.5 MPa	si	5.5 MPa
Em	1661.6 MPa	Em	094.7 MPa

Figures 5.3.9 and 5.3.10 show the relationships between the major and minor principal stresses and the normal and shear stresses for Hoek- Brown and Mohr- Coulomb criteria for GSI 27 and GSI 36 in the upper unit of the Asmari Formation.

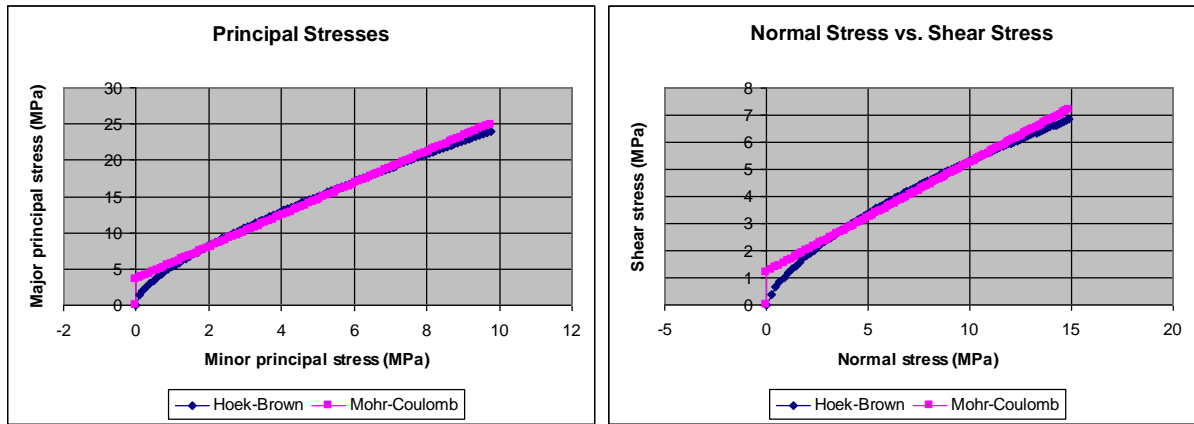

Figure 5.3.9. Relationship between major and minor principal stresses also normal and shear stresses for the Hoek-Brown and equivalent Mohr-Coulomb criteria for GSI 27 in the upper unit of the Asmari Formation.

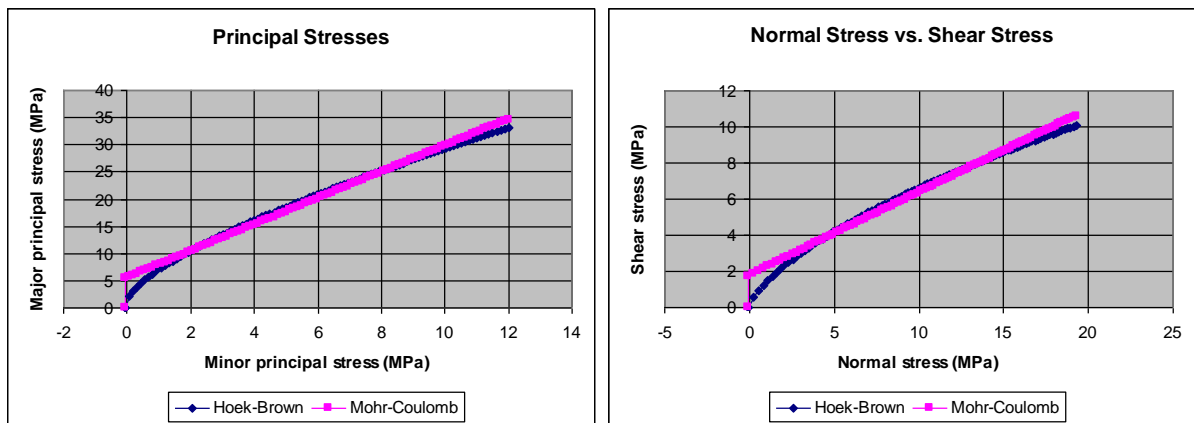

Figure 5.3.10. Relationship between major and minor principal stresses also normal and shear stresses for the Hoek-Brown and equivalent Mohr-Coulomb criteria for GSI 36 in the upper unit of the Asmari Formation.

Taking all geological strength index values (GSI) for the three rock units of the Asmari Formation into account the rock mass strength at the Karun-4 dam is plotted in Figure 5.3.11.

Figures 5.3.11 and 5.3.12 are based on the strength and other engineering rock mass properties for the Asmari Formation at the Karun-4 dam and show the rock mass quality variations are wide ranging from *Blocky- Very Well Interlocked and Good (B/G)* to *Blocky Disturbed/Seamy and Fair (BD/F)*.

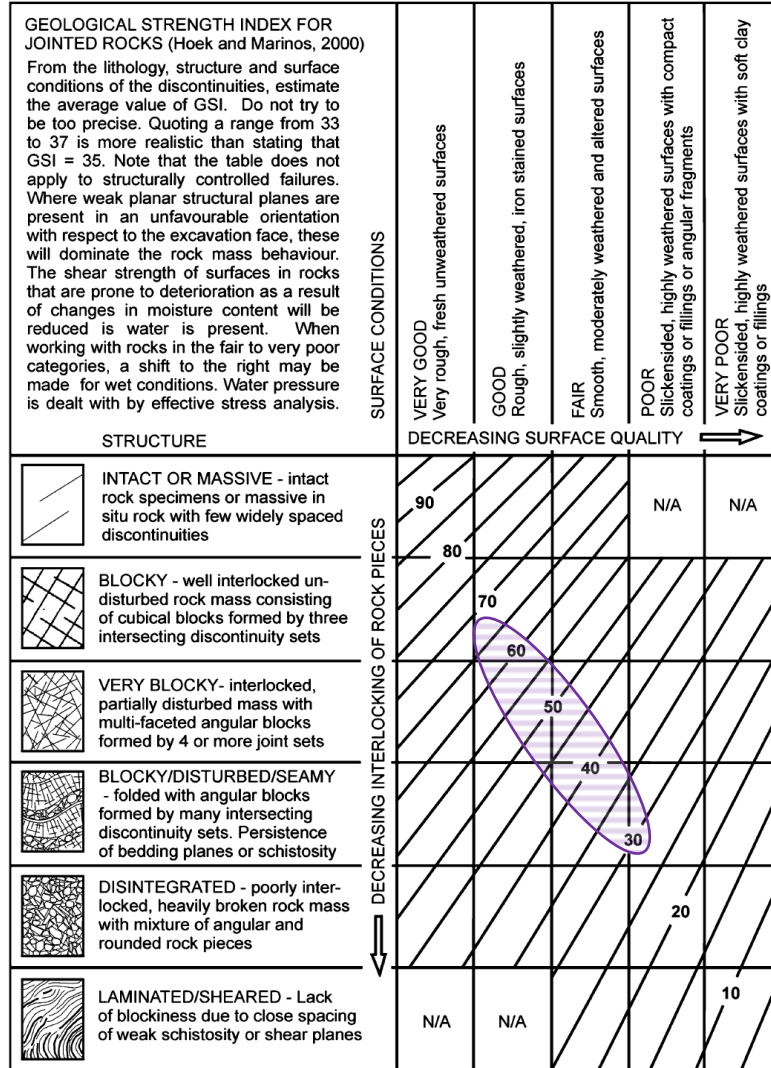

Figure 5.3.11. General Geological Strength Index (GSI) chart, for jointed rock masses (Hoek and Brown 1997, Hoek and Karzulovic, 2001). The shaded area is indicative of distribution of geological strength index of various rock mass units of the Asmari Formation at the Karun-4 dam.



Formation	Thickness	Unit no.	Lithological column	Lithological description	Porosity Z	Karst features	Permeability	UCS/Mpa	ROD %	RMR	Q	GSI	Mohr coulumb fit		Rock Mass Parameters																			
													C, Mpa	phi, deg	sig., Mpa	sig., Mpa	En, Mpa																	
Gochsaran Fm.				Alternation of salt hydrate, gypsum marl, marly limestone, limestone and shale																														
ASMARI FORMATION 5000.0 m	37.0 m	As.3		Marly limestone with Marlstone and some times Limestone interbedded	0.50	Non karstic	Impermeable locally Very High	39 to 48	Poor - Good (45% - 78%) Good (78%)	32 to 41	0.15 to 0.7	27 to 36	1.18 to 1.8	21.9 to 24.6	-0.019 to -0.048	0.54 to 1.23	1661.6 to 3094.7																	
	100.0 m			Medium to thick bedded limestone and Marly limestone, sporadically marlstone interbedded,	2.25																													
	63.0 m			Intrabioncritic, Mudstone to Wackestone Fracture/ vuggy porosity, bioclasts are Foraminifera such as Globigerina sp.	0.75															Slightly karstified	5.00													
	170.0 m	As.2		Medium to thick bedded limestone dolomitic limestone, marly limestone and marlstone frequency,	1.00	Slightly karstified	Impermeable locally Very High	39 to 116	Fair - Good (53% - 84%)	32 to 49	0.84 to 2.8	27 to 44	1.45 to 4.9	24.9 to 26.9	-0.042 to -0.21	1.07 to 4.9	2954.8 to 7079.5																	
				Biostraticrite, Wackestone - Packstone Fracture/vuggy porosity, Bioclasts are mainly Foraminifera such as Miliolides, Austrotrilina sp., Peneroplis sp., Bendritina sp., Echinoid shell fragments	7.00																													
					1.00																													
					1.50																													
					1.75																													
				Dolomitic sparite, Wackestone, Dolomitization relatively developed	1.50																													
					3.40																													
230.0 m	As.1		Thick to very thick bedded, porous Limestone, grey to light grey, fine to medium grained, weak to relatively strong, Fracture/ vuggy porosity	2.00	Generally Highly karstified 3 to 50 cm diameter	High to Very High	48 to 100	Fair - Good (55% - 83%)	61 to 71	21 to 151	56 to 66	0.80 to 2.3	47.8 to 53.13	-0.22 to -0.96	4.08 to 15.0	9786.35 to 25118.9																		
			Marly limestone, medium to thick bedded grey, grey greenish, weak to medium strength,	11.00																														
			Thick to very thick bedded Limestone grey to grey brownish, fine to medium grained, medium to high strength	5.00																														
			Intrabioncritic- Wackestone to Packstone Bioclastic elements are Foraminifera such as, Amphistegina sp., Rotalia sp., Heterostegina sp., Iperculina sp., Elphidium sp., Lepidocyclus sp., Ditrupa sp. Calcareous Red Algae, Echinoid shell Rudists shell fragments	3.35																														
				2.10																														
			Calcareous marls, grey to green, fine grained, weak to relatively weak, Biostraticrite- wackestone,	0.30																														
				15.2																														
				3.00																														
				0.75																														
				1.50																														
Pabdeh Fm.				Alternation of marlstone, marly limestone and shale																														

Figure 5.3.12. The lithological units and engineering rock mass characterization of the Asmari Formation at the Karun-4 dam.

5.4. Engineering Geological Characteristics of the Marun Dam and Power plant (Engineering Rock Mass Classification of the Asmari Formation)

5.4.1. Diversion Tunnels

5.4.1.1. Lower Unit (Lower Asmari Formation- As.1)

The diversion tunnels are designed to pass a 1: 100 year flood of 4 000 m³/sec and include a 45 m high upstream cofferdam with a volume of 42 1304 m³. The tunnel lengths are 505 m and 640 m with diameters of 10.7 m and 13 m. They are orientated along strike of S33°W, almost perpendicular to the bedding strike which passes through all three units of the Asmari succession.

The middle and upper Asmari units show some instability in the diversion tunnels due to the influence of joint sets of 030°- 035°/75° and 300°/70°- 80° and some thin shale and marls interbeds. The stabilization of these zones included rock bolts, wire mesh and shotcrete. In some places, due to the intersection of joint sets and bedding planes, high leakage was observed (Figure 5.4.1).

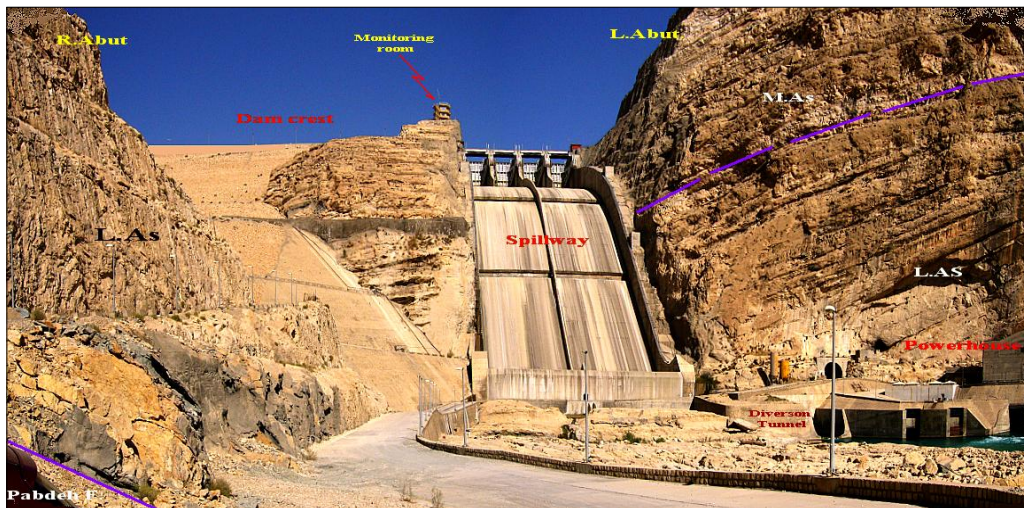

Figure 5.4.1. The Marun dam site and other accessory structures. The two diversion tunnels, power tunnels, spillway at the left flank and rock fill dam body can be observed. The diversion and power tunnels pass through all three units of the Asmari succession but the spillway structure is mainly located in the lower and middle units.

The Asmari Formation (As.1) forms the lowest part of the bedrock and is composed of grey to light grey massive to thickly bedded microcrystalline limestone and marly limestone with thin interbeds of marls and shale. This unit is relatively karstified with low to medium permeability. The porosity is 1.5% to 14.9 % indicating high to extremely high porosity for this unit.

The rock quality designation (RQD) of the lower unit (As.1) is 70% to 85% that shows fair to good quality rock mass. The uniaxial compressive strength tests and field tests (Schmidt hammer test) indicate values ranging between 60 to 84 MPa.

The major discontinuity sets and their specifications are listed in Table 5.4.1.

Table 5.4.1. Major discontinuity sets and their specifications at the Marun dam site.

Discontinuity Set	DD.	Dip	Spacing	Discon. surface	Opening	Filling	Length
Set 3	209	74	0.6- 2 m	rough	10- 20 mm	calcite/clay	5- 10 m
Set 4	296	88	0.6- 2 m	rough	2- 4 mm	calcite/clay	5- 10 m
Set 5	033	79	0.6- 2 m	smooth	2- 5 mm	calcite/clay	3- 30 m
Set 6	207	54	0.6- 2 m	rough	2- 5 mm	calcite/clay	5- 10 m
Set 1 (Bedding)	033	34	0.6-2, >2 m	Wavy , rough	2- 100	calcite/clay	>100 m

The **RMR** value for the As.1 unit based on the rock mass rating parameters in Table 3.3 are shown in Table 5.4.2.

Table 5.4.2. Assessment of Rock Mass Rating for the Asmari Formation (Lower unit).

	Property	Value	Rating
1	UCS (MPa)	60- 84	7
2	RQD	70% - 85%	13- 17
3	Spacing of discontinuities	0.6- 2m, > 2 m	15- 20
4	Condition of discontinuities	Rough to Smooth	20- 25
5	Ground water	Wet to Dripping	4- 7
6	Adjustment for joint orientation	Very favorable	0
Total : 59– 76 (Fair to Good)			

In addition, based on Table 3.4, the guidelines for excavation and support of a 13 m diameter tunnel for the relevant **RMR** values are as follows (Table 5.4.3):

Table 5.4.3. Rock support types for the middle unit in the diversion tunnel (Bieniawski, 1984)

Rock mass class	Excavation	Rock bolts (20 mm diameter, fully grouted)	Shotcrete	Steel sets
II – Good rock	Full face, 1- 1.5 m advance. Complete support 20 m from face	Locally, bolts in crown 3.5- 4 m long, spaced 2.5 m, with occasional wire mesh	20 mm in crown where required	Non
III – Fair rock	Top heading and bench 1.5- 3m advance in top heading. Commence support 10 m from face	Systematic bolts 3.5 – 4 m long, spaced 2.5m in crown with wire mesh, sides locally if needed	2X20mm in crown and 20 mm in sides	Non

The *Stand up Time* for the diversion tunnel is 2×10^3 hours (83 days) for fair quality rock mass and 1×10^4 hours (416 days) for good quality rock mass.

The *Rock Tunneling Quality Index*, **Q** can be determined from the parameters in Table 3.5 and equation 3.2 or experimentally can be calculated from the equations 3.9 or 3.10.

Based on the Rutledge-Preston (3.10) the **Q** values were determined as **15.1** (*Good Quality*) and **268.6** (*Extremely Good Quality*).

Structural Stability Control and Rock Support Arrangement elements were determine by using the RocScience Software UNWEDGE©.

Five major discontinuity planes (Table 5.4.1) control the shape and dimensions of wedges in the diversion tunnels, but only three of them (Js.3, Js.4 and bedding planes) control the instability (Figure 5.4.2).

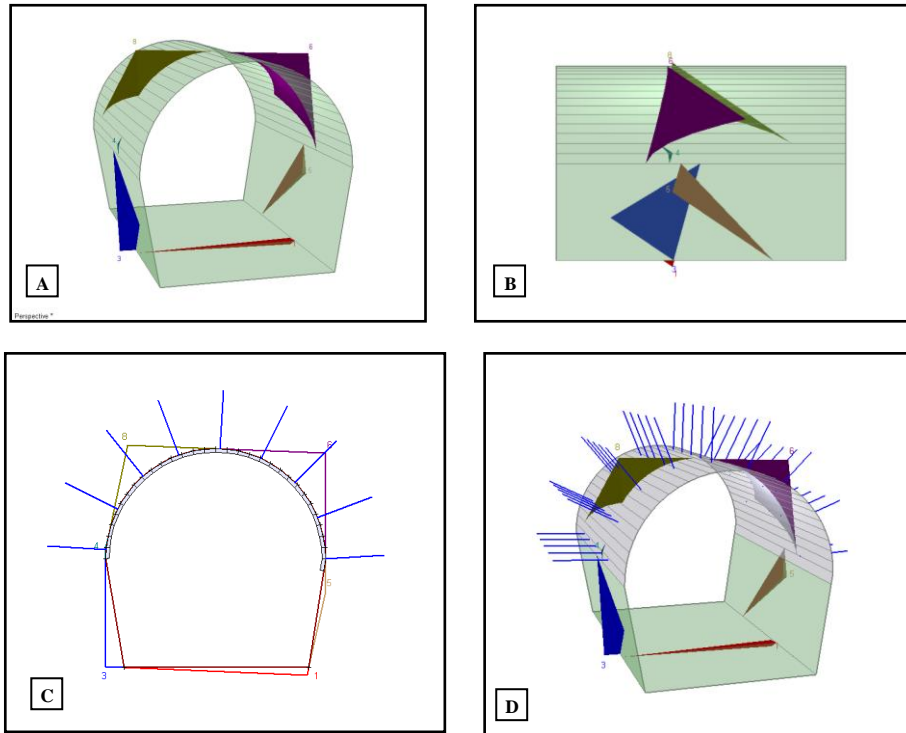

Figure 5.4.2. The dimensions, geometry and structural specifications of wedges because of intersecting major joint sets of Js.3, Js.4 and Js.1 (bedding planes) in the diversion tunnel at the Marun dam. A- Perspective view, B- Side view of tunnel, showing potentially unstable wedges and C- Rock support elements arrangement for the Asmari Formation limestone.

The safety factor, volume, dimensions, geometry and other specifications of all possible rock wedges in the diversion tunnels are listed in the wedge information and specifications in Table 5.4.4.

Wedge 8 (upper left) is the only unstable rock wedge of 8.9 m^3 with a factor of safety of about 1.0. If wedge sliding occurred, the direction of sliding will be 139/55. Other blocks are relatively stable during excavation operation. After installation of support elements (Table 5.4.4) the safety factor of wedge no. 8 increases to about 3.4.

The proposed stabilization elements are:

- Bolt length – 3.5 to 4 m, $\Phi 20.0\text{mm}$, in crown, and in sides locally if required
- Spacing – 2.5 m
- Shotcrete – 20.0mm primary in crown, and in sides 20 mm if required

The Geological Strength Index (*GSI*) was calculated based on equations 3.11 and 3.12.

The *GSI* values vary between 54 and 71.

Table 5.4.4. The rock wedge specification in the diversion tunnel

<p>Floor wedge [1] Factor of Safety: stable Wedge Volume: 0.6 m³ Wedge Weight: 1.6 tonnes Wedge z-Length: 0.8 m Excavation Face Area: 4.2 m²</p> <p>Lower Left wedge [3] Factor of Safety: stable Wedge Volume: 5.9 m³ Wedge Weight: 16.1 tonnes Wedge z-Length: 6.04 m Excavation Face Area: 16.6 m² Sliding Direction (trend, plunge): 120°, 2°</p> <p>Upper Left wedge [4] Factor of Safety: 19.8 Wedge Volume: 0.003 m³ Wedge Weight: 0.01 tonnes Wedge z-Length: 1 m Excavation Face Area: 0.2 m² Sliding Direction (trend, plunge): 209°, 74°</p>	<p>Lower Right wedge [5] Factor of Safety: 80 Wedge Volume: 0.8 m³ Wedge Weight: 2.1 tonnes Wedge z-Length: 6.8 m Excavation Face Area: 7.9 m² Sliding Direction (trend, plunge): 25°, 34°</p> <p>Upper Right wedge [6] Factor of Safety: 4 Wedge Volume: 14.7 m³ Wedge Weight: 39.7 tonnes Wedge z-Length: 6.7 m Excavation Face Area: 20.5 m² Sliding Direction (trend, plunge): 296°, 88°</p> <p>Upper Left wedge [8] Factor of Safety: 1.1 Wedge Volume: 8.9 m³ Wedge Weight: 24.1 tonnes Wedge z-Length: 8.8 m Excavation Face Area: 15.7 m² Sliding Direction (trend, plunge): 139°, 60°</p>
---	---

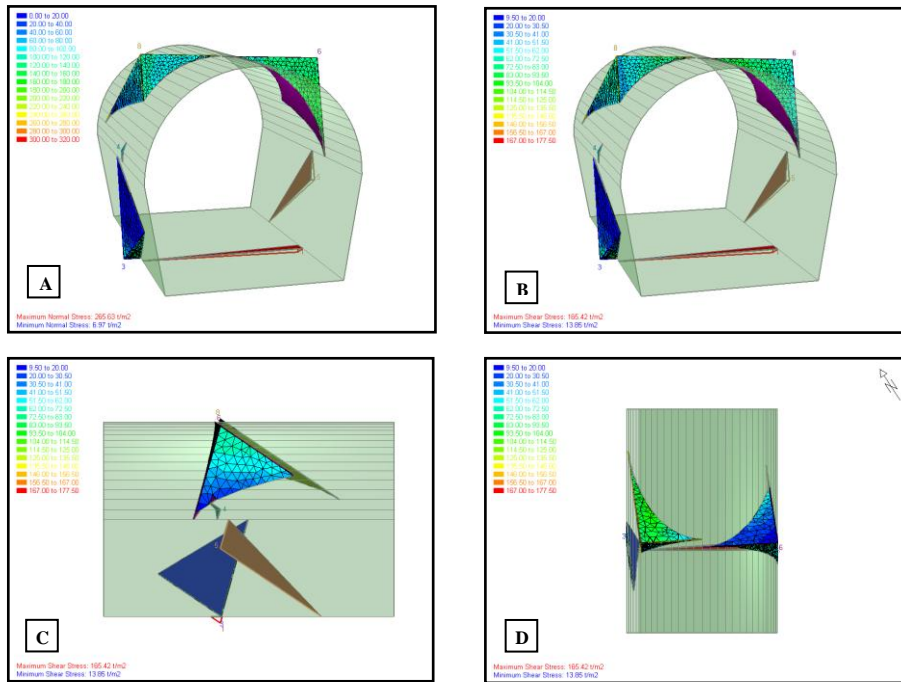

Figure 5.4.3. The finite elements mesh of normal and shear stresses for all possible wedges due to the intersection of discontinuities (Js.3, Js.4 and bedding planes at diversion tunnel. Here the critical wedges based on distribution of shear stress can be observed with A- normal stress distribution, B, C and D are shear stress distributions in perspective view, side view and top view of tunnel respectively. The instability of wedge 8 can be observed in the top view.

The rock mass strength with input data, UCS, GSI, mi, D (disturbance factor) and tunnel depth was assessed using **RocLab**© software and the results are summarized in Table 5.4.5, Figures 5.4.4 and 5.4.5.

Table 5.4.5. The rock mass strength in the lower Asmari unit.

Hoek-Brown Classification	sigci 60 MPa	Hoek-Brown Classification	sigci 84 MPa
GSI 54	mi 8	GSI 71	mi 8
D 0	Hoek-Brown Criterion	D 0	Hoek-Brown Criterion
mb 1.5	s 0.006	mb 2.8	s 0.04
a 0.5	Failure Envelope Range	a 0.5	Failure Envelope Range
Application Tunnels	sig3max 1.3 MPa	Application Tunnels	sig3max 1.4 MPa
Unit Weight 0.03 MN/m ³	Tunnel Depth 100 m	Unit Weight 0.03 MN/m ³	Tunnel Depth 100 m
Mohr-Coulomb Fit	c 0.9 MPa	Mohr-Coulomb Fit	c 2.7 MPa
phi (φ) 48.9°	Rock Mass Parameters	phi (φ) 52.5°	Rock Mass Parameters
sigt -0.2 MPa	sigc 4.6 MPa	sigt -1.2 MPa	sigc 16.7 MPa
sigcm 10.3 MPa	Em 9751.6 MPa	sigcm 22.4 MPa	Em 30700.1 MPa

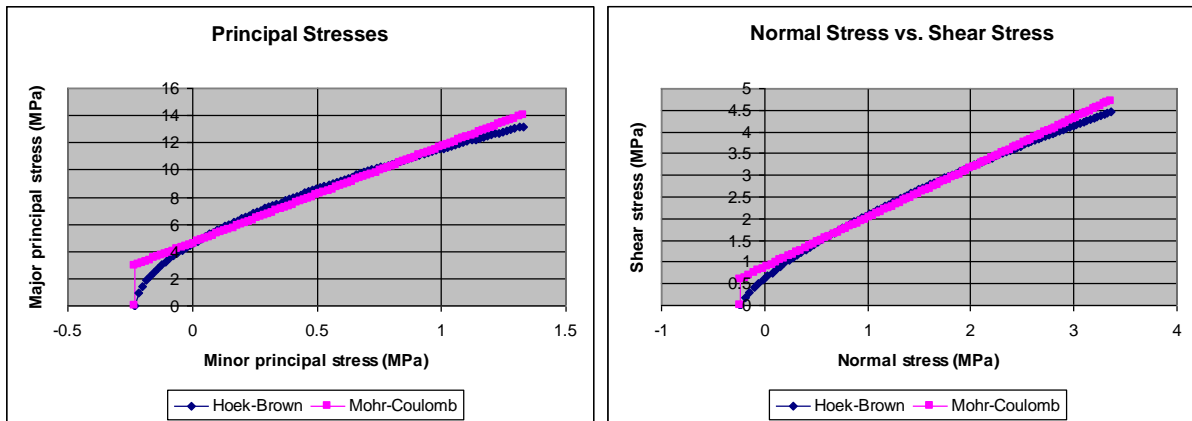

Figure 5.4.4. Relationship between major and minor principal stresses also normal and shear stresses for the Hoek-Brown and equivalent Mohr-Coulomb criteria for GSI 54 in the lower unit of the Asmari Formation.

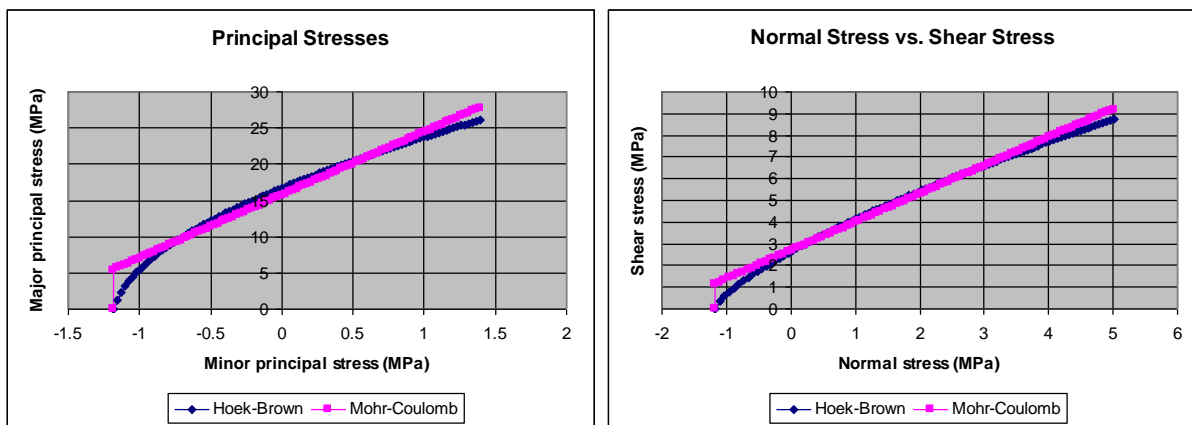

Figure 5.4.5. Relationship between major and minor principal stresses also normal and shear stresses for the Hoek-Brown and equivalent Mohr-Coulomb criteria for GSI 71 in the lower unit of the Asmari Formation.

5.4.1.2. Middle Unit (Middle Asmari Formation- As.2)

The middle Asmari unit comprises lithologically of medium bedded microcrystalline limestone, marly limestone and thin bedded marlstone frequency. This unit is relatively karstified with low to medium permeability. The porosity is 1.4 to 11% indicating high to extremely high porosity for this unit. The RQD of the middle unit (As.2) is 50% to 80% that shows fair to good quality rock mass. Based on uniaxial compressive strength tests and field tests (Schmidt hammer test) the UCS is between 35 to 95 MPa. The *RMR* values based on rock mass rating parameters in Table 3.3 are assessed in Table 5.4.6.

Table 5.4.6. Assessment of Rock Mass Rating for the Asmari Formation (Middle unit).

	Property	Value	Rating
1	UCS (MPa)	35- 95	4- 7
2	RQD	50% - 80%	13- 17
3	Spacing of discontinuities	0.6- 2m,	15
4	Condition of discontinuities	Rough to Smooth	20- 25
5	Ground water	Wet to Dripping	4- 7
6	Adjustment for joint orientation	Very favorable	0
Total : 56– 71 (Fair to Good)			

The *Rock Tunneling Quality Index, Q* is calculated using empirical equation 3.10 (Rutledge, Preston, 1978):

The *Q* values vary between **9.1 (Fair Quality)** to **115.1 (Extremely Good Quality)**.

Table 5.4.7. The rock mass strength in the Middle Asmari unit.

Hoek-Brown Classification	sigci 35 MPa	GSI 51	mi 8	D 0	Hoek-Brown Criterion	mb 1.4	s 0.004	a 0.5	Failure Envelope Range	Application Tunnels	sig3max 1.3 MPa	Weight 0.03MN/m ³	Tunnel Depth 100 m	Mohr-Coulomb Fit	c 0.6 MPa	phi (φ) 44.5°	Rock Mass Parameters	sigt -0.1 MPa	sigc 2.2 MPa	sigcm 5.6 MPa	Em 6266.6 MPa					
					Hoek-Brown Classification	sigci 95 MPa	GSI 66	mi 8	D 0	Hoek-Brown Criterion	mb 2.4	s 0.02	a 0.5	Failure Envelope Range	Application Tunnels	sig3max 1.4 MPa	Unit Weight 0.03 MN/m ³	Tunnel Depth 100 m	Mohr-Coulomb Fit	c 2.2 MPa	phi (φ) 52.9°	Rock Mass Parameters	sigt -0.9 MPa	sigc 14.3 MPa	sigcm 22 MPa	Em 24482.8 MPa

The geological strength index (GSI) was calculated based on two simple equations 3.11 and 3.12 introduced by Hoek and Brown (1997) and the values obtained vary between **51** and **66**.

The rock mass strength with input data, UCS, GSI, mi, D (disturbance factor) for the tunnel application was assessed using *RocLab*© software and is summarized in Table 5.4.7, Figures 5.4.6, and 5.4.7):

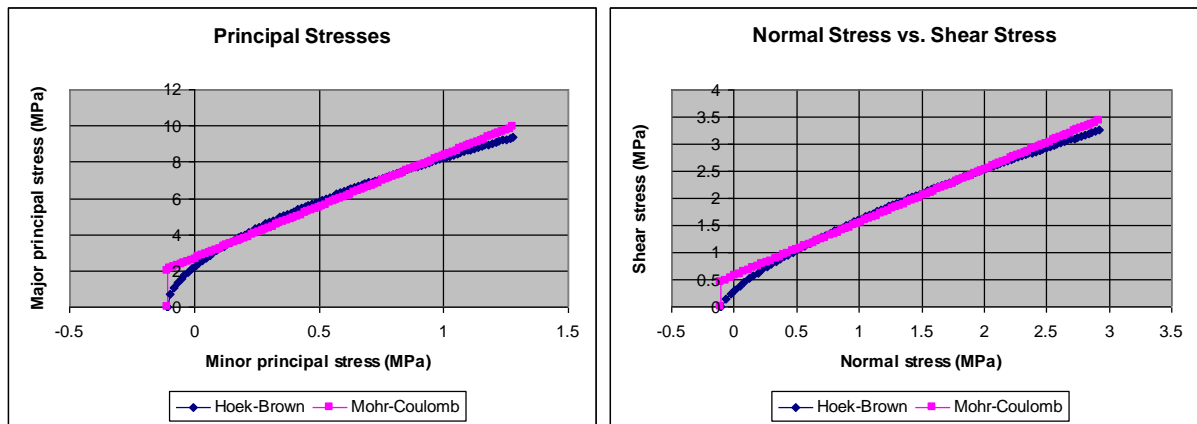

Figure 5.4.6. Relationship between major and minor principal stresses also normal and shear stresses for the Hoek-Brown and equivalent Mohr-Coulomb criteria for GSI 51 in the middle unit of the Asmari Formation.

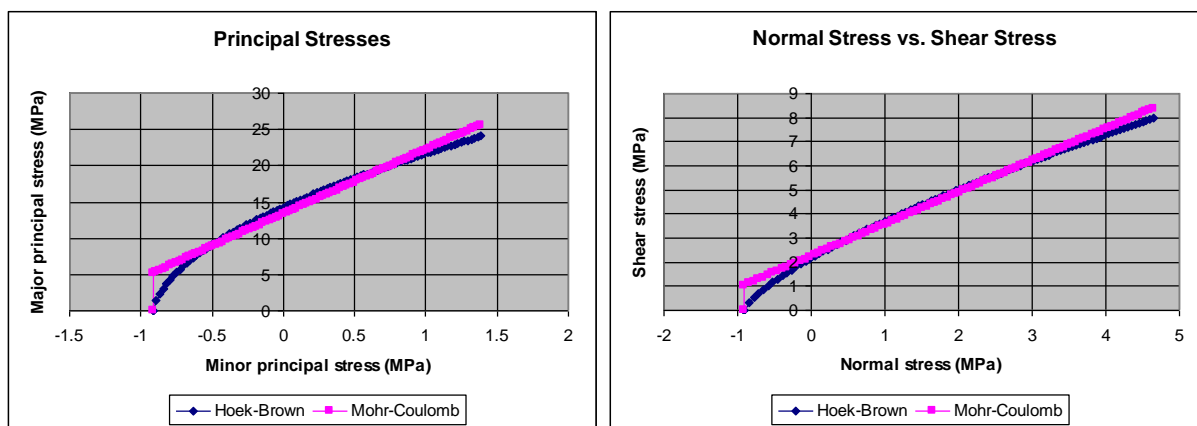

Figure 5.4.7. Relationship between major and minor principal stresses also normal and shear stresses for the Hoek-Brown and equivalent Mohr-Coulomb criteria for GSI 66 in the middle unit of the Asmari Formation.

5.4.1.3. Upper Unit (Upper Asmari Formation- As.3)

The lithology of the upper Asmari Formation comprise 80 m of medium to thinly bedded limestone, dolomitic limestone and marly limestone. The karstification is highly developed especially at the top of unit. The porosity values based on petrographical analysis is 2.7% to 5.4% indicating high porosity for this unit. According to the lugeon test results the permeability is medium to high. The rock quality designation (RQD) is 50% to 70% that imply fair quality rock mass.

The uniaxial compressive strength tests and field tests (Schmidt hammer test) shows UCS values of 35 to 84 MPa.

The *RMR* values based on rock mass rating parameters in Table 3.3 were assessed as in Table 5.4.8.

Table 5.4.8. Assessment of Rock Mass Rating for the Asmari Formation (Upper unit).

	Property	Value	Rating
1	UCS (MPa)	35- 84	4- 7
2	RQD	50% - 70%	13
3	Spacing of discontinuities	0.2-0.6 , 0.6- 2m,	10- 15
4	Condition of discontinuities	Rough to Smooth	20- 25
5	Ground water	Wet to Dripping	4- 7
6	Adjustment for joint orientation	Very favorable	0
Total : 51– 67 (Fair to Good)			

The *Quality Index, Q* calculated indirectly from the equation 3.10.

The *Q* values vary between **3.9 (Fair Quality)** to **58.4 (Extremely Good Quality)**.

The geological strength index (GSI) based on two simple equations 3.11 and 3.12 which introduced by Hoek and Brown (1997).

The *GSI* values vary between **46** and **62**.

The rock mass strength with input data, UCS, GSI, *m_i*, *D* for tunnel application was assessed and are summarized in Table 5.4.9, Figure 5.4.8, and Figure 5.4.9:

Table 5.4.9. The rock mass strength in the Upper Asmari unit.

Hoek-Brown Classification	Hoek-Brown Classification
sigci 35 MPa	sigci 84 MPa
GSI 46	GSI 62
<i>m_i</i> 8	<i>m_i</i> 8
<i>D</i> 0	<i>D</i> 0
<i>m_b</i> 1.2	Hoek-Brown Criterion
<i>s</i> 0.002	<i>m_b</i> 2.1
<i>a</i> 0.5	<i>s</i> 0.01
Failure Envelope Range	<i>a</i> 0.5
Application Tunnels	Failure Envelope Range
sig3max 1.3 MPa	Application Tunnels
Hoek-Brown Criterion	sig3max 1.4 Mpa
Unit Weight 0.03 MN/m ³	Hoek-Brown Criterion
Tunnel Depth 100 m	Unit Weight 0.03 MN/m ³
Mohr-Coulomb Fit	Tunnel Depth 100 m
<i>c</i> 0.5 MPa	Mohr-Coulomb Fit
<i>phi</i> (φ) 43°	<i>c</i> 1.6 MPa
Rock Mass Parameters	<i>phi</i> (φ) 52°
sigt -0.07 MPa	Rock Mass Parameters
sigc 1.7 MPa	sigt -0.6 MPa
sigcm 5.02 MPa	sigc 10.07 MPa
Em 4699.3 MPa	sigcm 17.5 MPa
	Em 18286.9 MPa

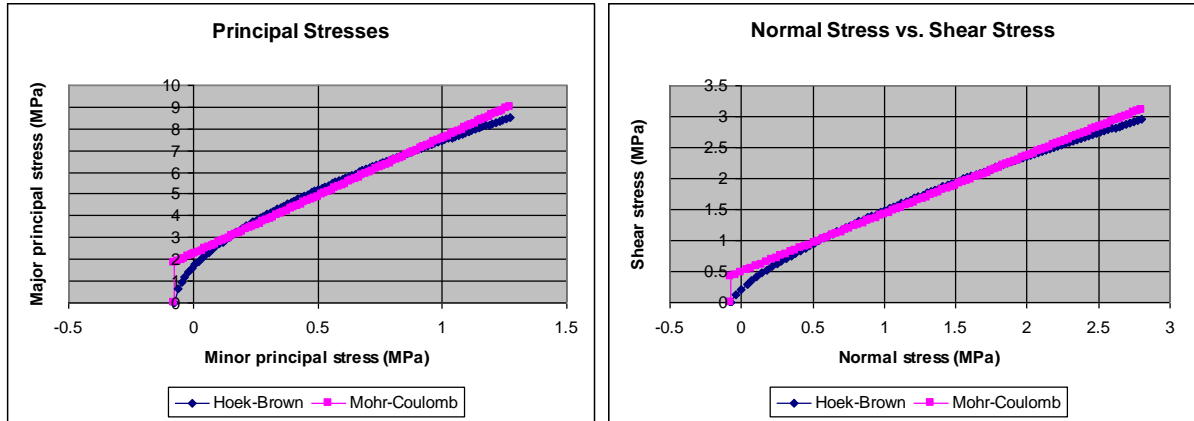

Figure 5.4.8. Relationship between major and minor principal stresses also normal and shear stresses for the Hoek-Brown and equivalent Mohr-Coulomb criteria for GSI 46 in the upper unit of the Asmari Formation.

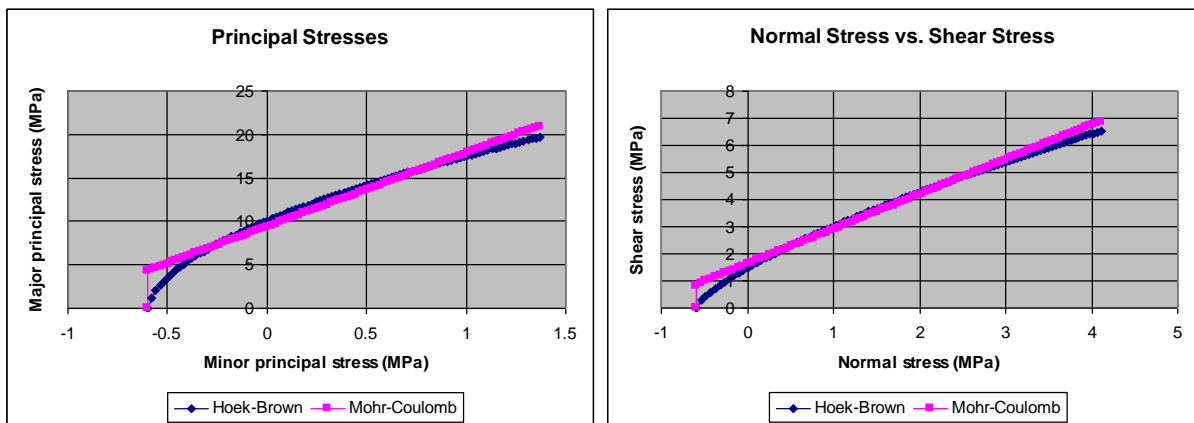

Figure 5.4.9. Relationship between major and minor principal stresses also normal and shear stresses for Hoek-Brown and equivalent Mohr-Coulomb criteria for GSI 62 in the upper unit of the Asmari Formation.

Taking all of the geological strength index values (GSI) of the three rock units of the Asmari Formation into account, the rock mass strength of the Marun dam project can be presented in Figure 5.4.10.

Figure 5.4.10 has been used to estimate the GSI value from field observations of blockiness and discontinuity surface conditions.

The assessment of the strength and other engineering properties of the rock mass of the Asmari Formation at the Marun dam site resulted in Figures 5.4.10 and 5.4.11. The rock mass quality variations are from *Blocky- Well Interlocked* and *Good (BG)* to *Very Blocky- Interlocked* and *Fair (VB/F)*.

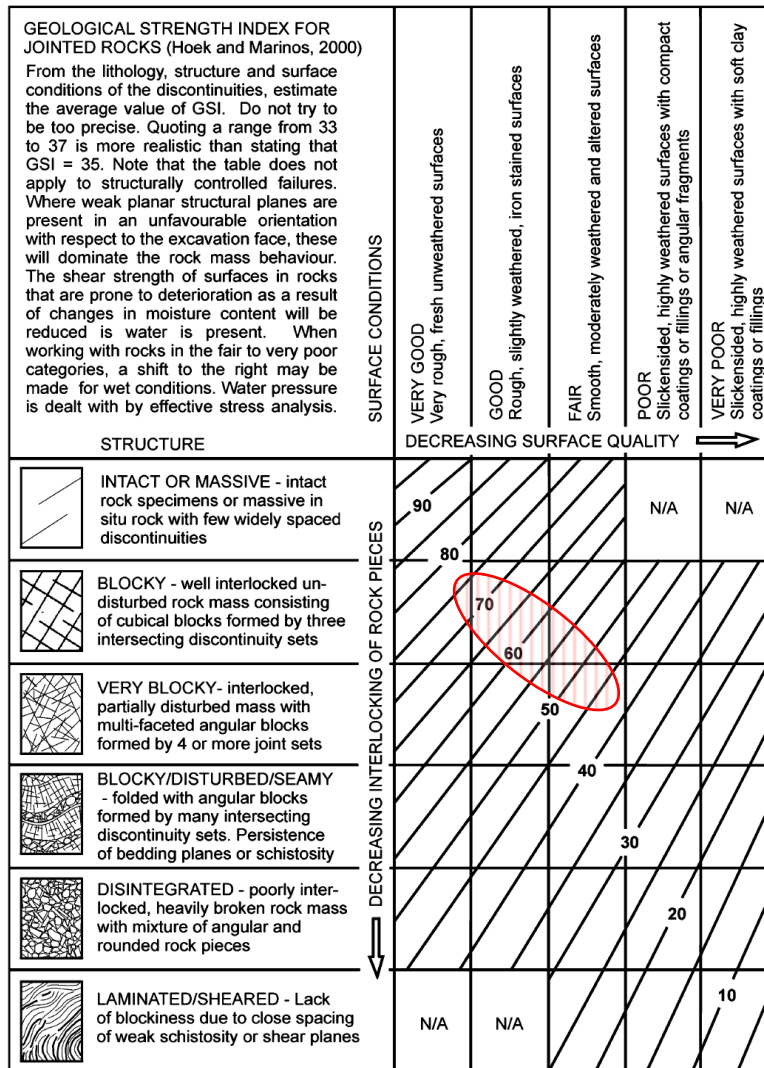

Figure 5.4.10. General Geological Strength Index (GSI) chart, for jointed rock masses (Hoek and Brown 1997, Hoek and Karzulovic, 2001). The shaded area is indicative of distribution of geological strength index of various rock mass units of the Asmari Formation at the Marun dam.



Formation	Thickness	Unit no.	Lithological column	Lithological description	Porosity Z	Karst features	Permeability	UCS/Mpa	RQD Z	RMR	Q	GSI	Mohr Coulumb Fit		Rock Mass Parameters									
													C, Mpa	phi, deg	sigt, Mpa.	sigc, Mpa.	En, Mpa.							
Gachsaran Fm.				Alternation of salt, anhydrite, gypsum marl, marly limestone, limestone and shale																				
ASMARI FORMATION 3700.0 m	800 m	As.3		Medium to thin bedded limestone and and marly limestone, vuggy and fracture porosity, light grey to yellow, with some dolomitic limestone. Microfossils are: Foraminifera such as Dendritina sp., Miliolides and Echinoid shell	5.40	Highly Karstic at top Karstified	Medium to high Permeability	35	Fair (50 to 70)	51	3.9	46	0.48	43.2	-0.07	1.7	4699.3							
					3.70			to		to														
					2.12			84		67								58.4	62	1.60	52.1	-0.6	10.1	18296.9
					2.70																			
	1100 m	As.2		Marly limestone, vuggy and channel porosity, Medium bedded of Microcrystalline limestone with thin bedded of marlstone frequency. Biopellicrite- wackstone to Biolitic boundstone, bioclasts are; Foraminifera such as Peneroplis sp., Miliolides, Austrotrilina sp., Rotalia sp., and Fragments of Pelecypoda, Echinoid shell and Red Algae	9.62	Karstified	Low to Medium Permeability	35	Fair - Good (50 to 80)	56	9.1	51	0.55	44.5	-0.11	2.23	6266.6							
					1.40			to		to														
					11.00			95		71								115.11	66	2.22	52.9	-0.91	14.27	24482.8
					3.80																			
	1800 m	As.1		Massive to very thick bedded limestone, microcrystalline, light grey to grey, dense, high strength, with interbedded of thin marls/ shale. Vuggy, channel, intraparticle, fracture porosity and karstic zones. Intra-biomicrite- wackstone to packstone. Organic components are Foraminifera. Such as Asterigerina sp., Derritina sp., Heterostegina sp., Haplofragnum sp., Pseudotaberina sp., Miliolides, calcareous Red Algae, Echinoid and Pelecypoda shell	3.60	Karstified	Low to Medium Permeability	60	Fair - Good (70 to 85)	59	15.1	60	0.85	48.80	-0.23	4.6	9751.6							
					10.90			to		to														
					1.33			84		76								268.6	71	2.6	52.5	-1.18	16.7	30700.1
					12.70																			
				Marly limestone, thick to medium bedded. Biomicrite- packstone, bioclasts are; Foraminifera shell such as Oberculina sp., Rotalia sp., Miliolides, Pelecypoda shell	14.90																			
					1.63																			
Pabdeh Fm.				Alternation of Marlstone, Marly limestone and shale																				

Figure 5.4.11. The lithological units and engineering rock mass characterization of the Asmari Formation at the Marun dam.

5.5. Engineering Geological Characteristics of the Seymareh Dam and Power plant Project (Engineering Rock Mass Classification of the Asmari Formation)

5.5.1. Lower Unite (Lower Asmari Formation- As.1)

This unit lithologically comprise 188 m medium bedded, fossiliferous dark grey marly limestone and microcrystalline limestone. Only 12 m of this unit outcrops in the area around the anticline axis. The porosity varies between 1.4% to 5.2% that indicates high porosity index.

The rock quality designation (RQD) is about 80%, which indicates good quality rock mass. The permeability values vary from impermeable to medium permeability for this unit. The uniaxial compressive strength (UCS), based on Schmidt hammer field tests and laboratory tests about 95 MPa. The general specifications of the major discontinuity sets in the area are listed in the Table 5.5.1 below.

Table 5.5.1. Major discontinuity sets and their specifications.

Discontinuity Set	Dip Direction (°)	Dip (°)	Spacing	Discon. surface	Opening	Filling	Length
Set 1	170- 175	65-75	0.55 m	Rough-wavy	2-20mm	clay, calcite	3-10m
Set 2	270-275	80-90	0.65 m	Rough-wavy	2-20mm	clay, calcite	3-10m
Set 3	120-130	70-80	1.4 m	Rough-wavy	2-20mm	clay, calcite	3-10m
Bedding	010- 020	25-35	0.35- 3m	Rough-wavy	<2mm	none	>10 m

The **RMR** value for the lower unit of the Asmari Formation (As.1), based on rock mass rating parameters from Table 3.3 can be assessed as in Table 5.5.2.

Table 5.5.2. Assessment of Rock Mass Rating for the Lower Asmari unit (As.1).

	Property	Value	Rating
1	UCS (MPa)	95	7
2	RQD	80%	17
3	Spacing of discontinuities	0.55- 1 m	10- 15
4	Condition discontinuities	Rough to wavy	20
5	Ground water	Wet to Dripping	7
6	Adjustment for joint orientation	favourable	-5
Total : 56 – 61 (Fair to Good)			

The rock tunneling quality index (**Q**) can be indirectly determined by two empirical equations (3.2.5, 3.2.6) introduced by (Bieniawski, 1989) and (Rotelech, Preston, 1978).

Based on equation 3.10, the **Q** values were determined as **9.1 (Fair Quality)** and **21.1 (Good Quality)**.

The Geological Strength Index (**GSI**) according to equations 3.11 and 3.12 (Hoek and Brown, 1997) was estimated to be between **51** and **56**.

The rock mass strength with input data, UCS, GSI, mi, D for general applications, was assessed using **RocLab**© software and Table 5.5.3, Figures 5.5.1 and 5.5.2 are the summary of the results.

Table 5.5.3. The rock mass strength in the Lower Asmari unit.

Hoek-Brown Classification	Hoek-Brown Classification
sigci 95 MPa	sigci 95 MPa
GSI 51	GSI 56
mi 8	mi 8
D 0	D 0
Hoek-Brown Criterion	Hoek-Brown Criterion
mb 1.4	mb 1.7
s 0.004	s 0.01
a 0.5	a 0.5
Failure Envelope Range	Failure Envelope Range
Application General	Application General
sig3max 23.8 MPa	sig3max 23.8 MPa
Mohr-Coulomb Fit	Mohr-Coulomb Fit
c 4.5 MPa	c 4.9 MPa
phi (ϕ) 28.9°	phi (ϕ) 30.4°
Rock Mass Parameters	Rock Mass Parameters
sigt -0.3 MPa	sigt -0.4 MPa
sigc 6.1 MPa	sigc 8.1 MPa
sigcm 15.3 MPa	sigcm 17.1 MPa
Em 10324.3 MPa	Em 13767.7 MPa

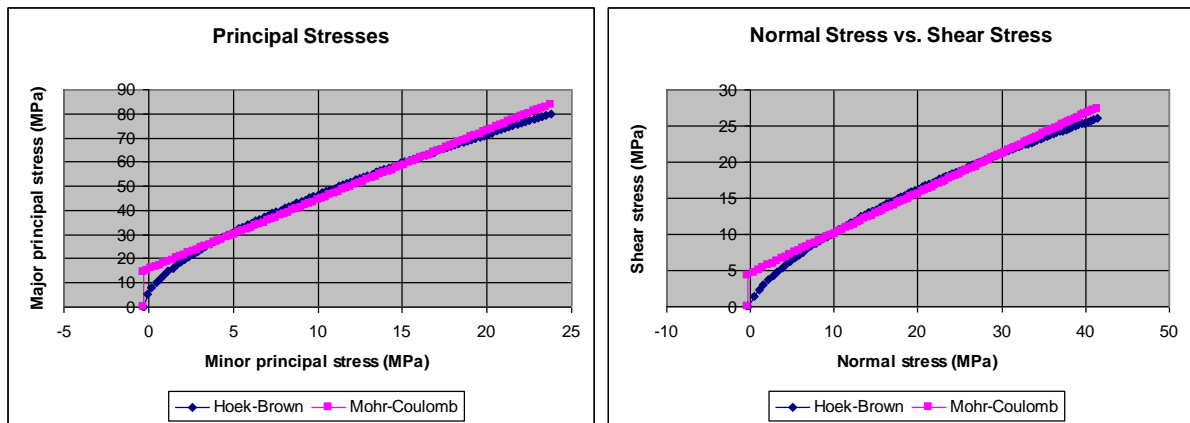

Figure 5.5.1. Relationship between the major and minor principal stresses also normal and shear stresses for the Hoek-Brown and equivalent Mohr-Coulomb criteria for GSI 51 in the lower Asmari Formation.

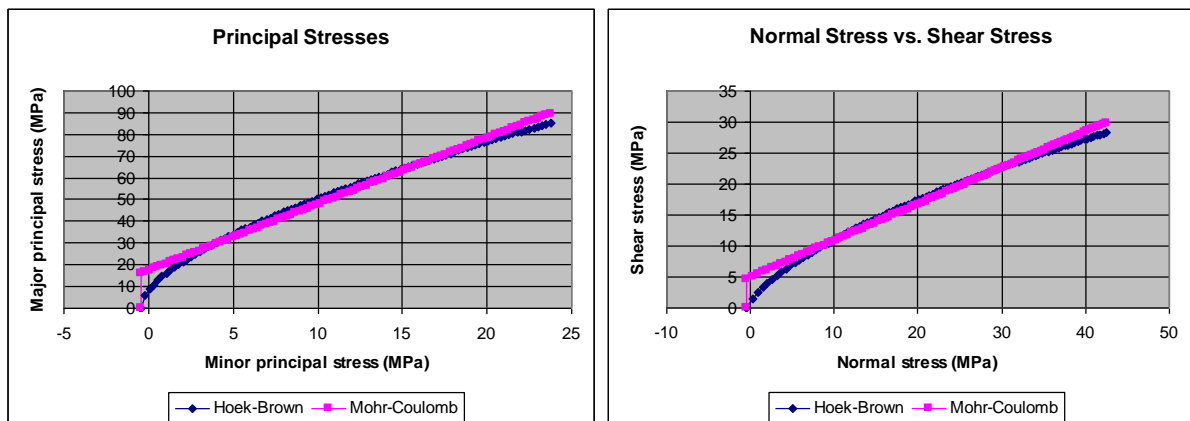

Figure 5.5.2. Relationship between the major and minor principal stresses as well as the normal and shear stresses for the Hoek-Brown and equivalent Mohr-Coulomb criteria for GSI 56 in the lower Asmari Formation.

5.5.2. Middle Unit (Middle Asmari Formation- As.2)

Diversion Tunnel

The river diversion system at the Seymareh dam consists of a rock fill cofferdam 322 m long and 24 m high with two diversion tunnels, 473 m, 395 m long and 10.5, 8.2 m in diameter respectively. The downstream cofferdam is also a rock fill structure, 120 m long and 11 m high. The diversion tunnels are constructed in the right flank and pass through the middle and upper Asmari units. The topographic gradient at the inlet is about 30° but the outlet constitutes an escarpment with gradient nearly 80° (Figures 5.5.3 and 5.5.4).

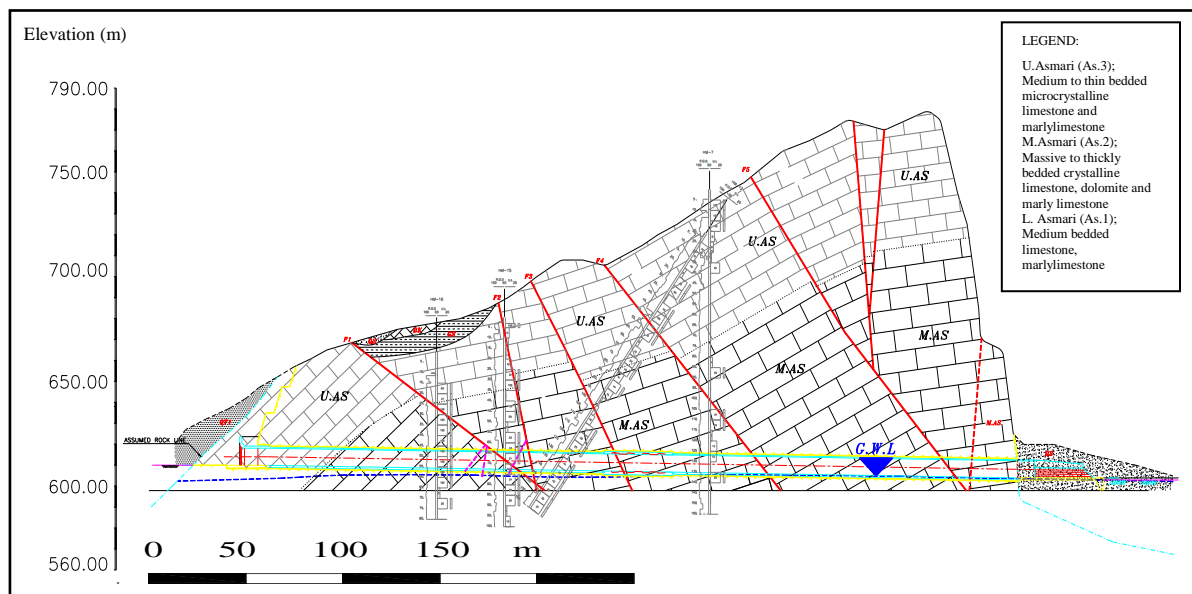

Figure 5.5.3. Engineering geological section along the diversion tunnels. These tunnels pass through the middle and upper Asmari Formation limestone and are 473 m and 395 m long with 10.5 m and 8.2 m diameter respectively (after MG co., 2009).

The Middle unit of the Asmari Formation lithologically comprises 238 m light to dark grey massive to thickly bedded fossiliferous/ crystalline limestone, dolomitic limestone and marly limestone. Except for the first part of the diversion tunnels, all dam structures are founded in this unit. Karst features are observed throughout the unit. The porosity value for the lower part is 7.5% that implies high porosity and gradually decreases in the upper part to 0.95%. The permeability, based on lugeon test results, indicates low to high values. The uniaxial compressive strength (UCS) and rock quality designation (RQD) indicate strengths of 70-100 MPa and 75% - 95% (good quality) respectively.

The **RMR** value for the middle unit of the Asmari Formation (As.2), based on rock mass rating parameters from Table 3.3 can be assessed as in Table 5.5.4.

Table 5.5.4. Assessment of Rock Mass Rating for the Middle Asmari unit (As.2).

	Property	Value	Rating
1	UCS (MPa)	70- 100	7-12
2	RQD	75% - 95%	17-20
3	Spacing of discontinuities	0.55- >3 m	10- 20
4	Condition discontinuities	Rough to wavy	20
5	Ground water	Wet to Dripping	7
6	Adjustment for joint orientation	favourable	-5
Total : 56 – 74 (Fair to Good)			

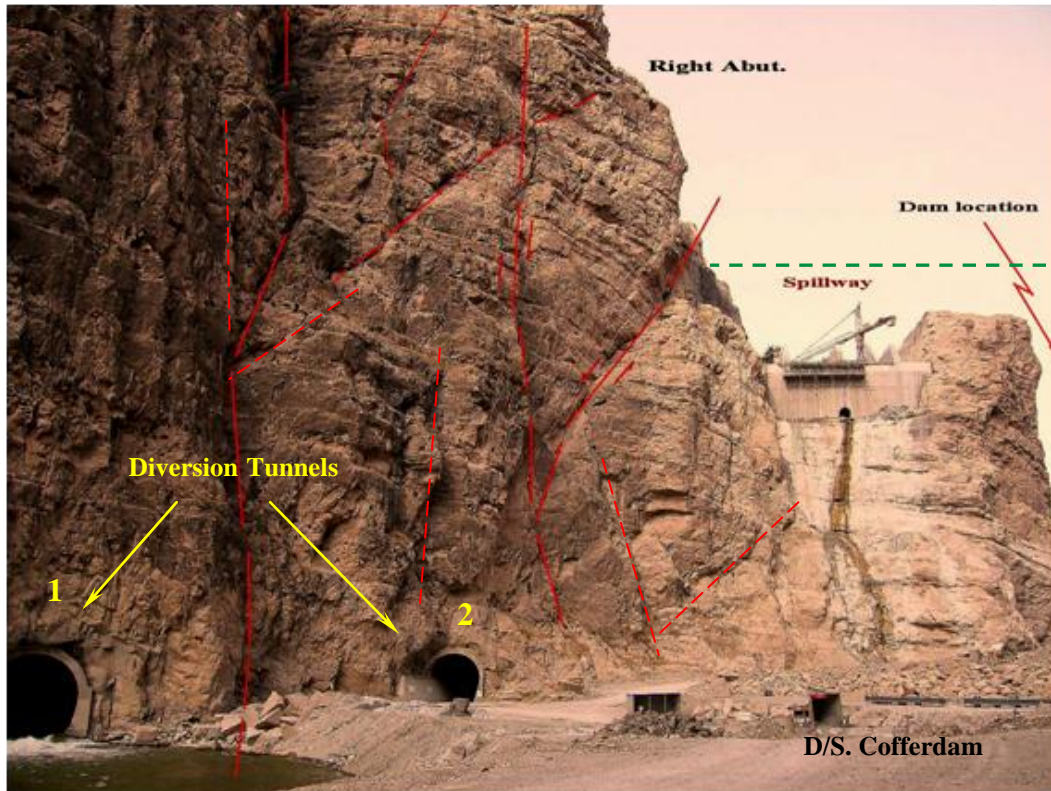

Figure 5.5.4. Downstream view of the Seymareh dam and some accessory structures such as diversion tunnels, spillway and down stream cofferdam. Some major joint sets and faults with small displacement at right bank can be observed.

Based on Table 3.4 the guidelines for excavation and support of a 10.5 m span rock tunnel for the above RMR values are shown in Table 5.5.5.

Table 5.5.5. Rock support types for good and fair rock mass in the diversion tunnel.

Rock mass class	Excavation	Rock bolts (20 mm diameter, fully grouted)	Shotcrete	Steel sets
II – Good rock	Full face, 1- 1.5m advance. Complete support 20m from face	Locally, bolts in crown 3.5- 4 m long, spaced 2.5m with occasional wire mesh	20 mm in crown where required	Non
III – Fair rock	Top heading and bench, 1.5-3 m advance in top heading. Commence support after each blast. Complete support 10 m from face	systematic bolts in crown 3.5- 4 long, spaced 2.5 m in crown and walls with wire mesh in crown.	20 mm in crown where required	Non

The *Stand up Time* for the diversion tunnel with a 10.5 m diameter based on the Bieniawski stand up time graph is 0.5×10^4 hours (208 days) for good quality rock and 2×10^2 hours (8.3 days) for fair quality rock.

The *Rock Tunnelling Quality Index, Q* (Barton, 1974) with values from Table 3.1.11 can be determined based on equation 3.4.

In addition the Quality index (Q) can indirectly be determined by two experimental equations 3.9 and 3.10.

From these equations the *Q*-values vary between **9.1** (*Fair Quality*) and **191.4** (*Extremely Good Quality*).

The *Geological Strength Index* (GSI) was calculated according to equations 3.11 and 3.12 (Hoek and Brown, 1997) and the values obtained vary between **51** and **69**.

The rock mass strength with input data, UCS, GSI, mi, D (disturbance factor) and tunnel depth was assessed using *RocLab*© software and Table 5.5.6, Figures 5.5.5 and 5.5.6 summarize the results:

Table 5.5.6. The rock mass strength in the Middle Asmari unit.

Hoek-Brown Classification	Hoek-Brown Classification
sigci 70 MPa	sigci 100 MPa
GSI 51	GSI 69
mi 8	mi 8
D 0	D 0
Hoek-Brown Criterion	Hoek-Brown Criterion
mb 1.4	mb 2.6
s 0.004	s 0.03
a 0.5	a 0.53
Failure Envelope Range	Failure Envelope Range
Application Tunnels	Application Tunnels
sig3max 1.3 MPa	sig3max 1.4 MPa
Unit Weight 0.03 MN/m ³	Unit Weight 0.03 MN/m ³
Tunnel Depth 100 m	Tunnel Depth 100 m
Mohr-Coulomb Fit	Mohr-Coulomb Fit
c 0.8 MPa	c 2.8 MPa
phi (φ) 49.2°	phi (φ) 53.2°
Rock Mass Parameters	Rock Mass Parameters
sigt -0.2 MPa	sigt -1.2 MPa
sigc 4.5 MPa	sigc 17.8 MPa
sigcm 11.2 MPa	sigcm 25.2 MPa
Em 8862.4 MPa	Em 29853.8 MPa

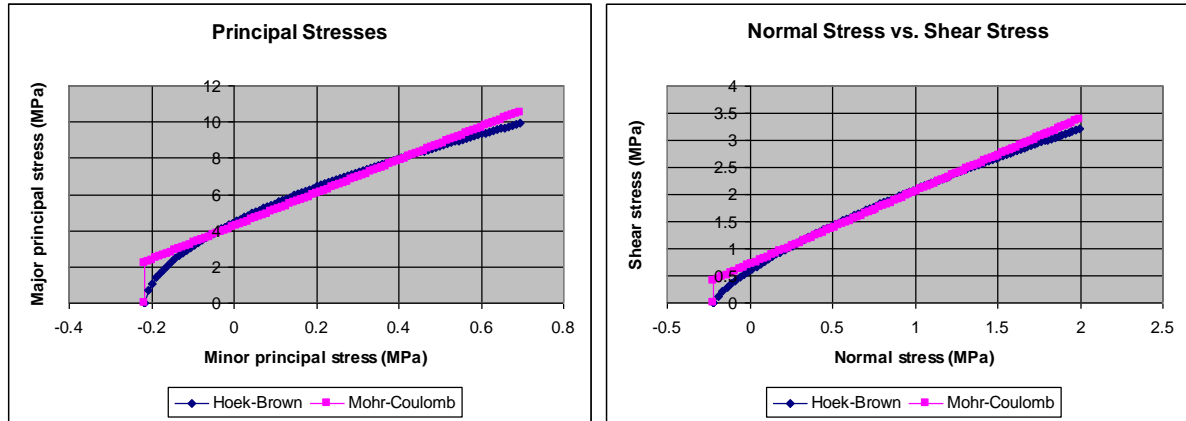

Figure 5.5.5. Relationship between major and minor principal stresses also normal and shear stresses for the Hoek-Brown and equivalent Mohr-Coulomb criteria for GSI 51 in the middle unit of the Asmari Formation.

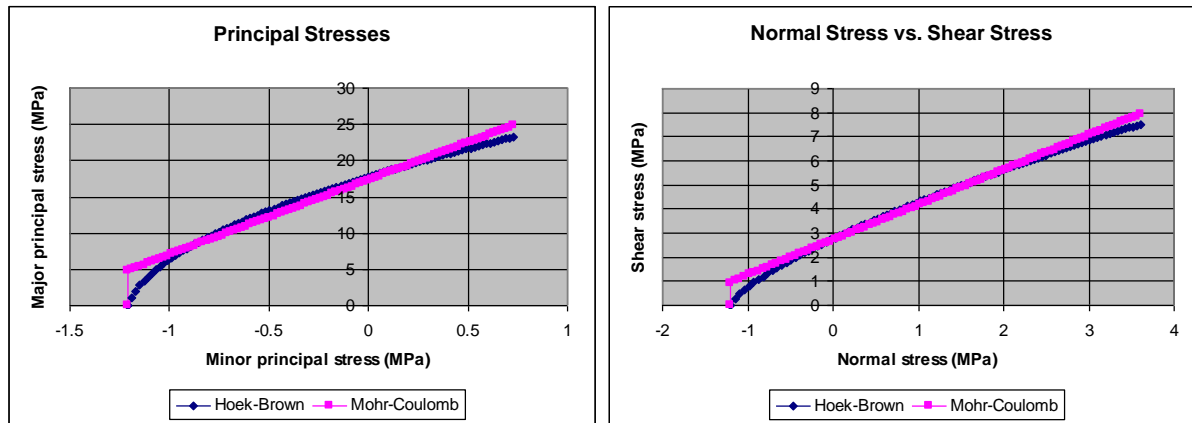

Figure 5.5.6. Relationship between major and minor principal stresses also normal and shear stresses for the Hoek-Brown and equivalent Mohr-Coulomb criteria for GSI 69 in the middle unit of the Asmari Formation.

5.5.3. Upper Unit (Upper Asmari Formation- As.3)

The As.3 unit constitutes the upper part of the Ravandi Anticline and lithologically comprise 150 m grey to dark grey microcrystalline limestone, bioclastic limestone and marly limestone, karstified and medium to thin bedded.

The porosity values are between 0.75% to 4.4% indicating medium to high porosity index. Permeability is high to very high. The UCS and RQD values, based on laboratory tests are 60- 100 MPa and 65%- 94% (fair to good quality) respectively.

The **RMR** value for the upper unit of the Asmari Formation (As.3) based on rock mass rating parameters from Table 3.3 is assessed in Table 5.5.7.

Table 5.5.7. Assessment of Rock Mass Rating for the Upper Asmari unit (As.3).

	Property	Value	Rating
1	UCS (MPa)	60- 100	7-12
2	RQD	65% - 94%	13-20
3	Spacing of discontinuities	0.55- >1 m	10- 15
4	Condition discontinuities	Rough to wavy	20
5	Ground water	Wet to Dripping	7
6	Adjustment for joint orientation	favourable	-5
Total : 52 – 69 (Fair to Good)			

The *Rock Tunneling Quality Index, Q* was calculated indirectly using the equations 3.9 and 3.10 and the results are between **4.6 (Fair Quality)** and **82 (Very Good Quality)**.

The Geological Strength Index (GSI) was calculated according to the empirical equation 3.11 and 3.12 and the values vary between **47** and **64**.

The rock mass strength with input data, UCS, GSI, mi, D (disturbance factor) and tunnel depth was assessed using *RocLab*© software and Table 5.5.8, Figures 5.5.7 and 5.5.8 are the summary of the results:

Table 5.5.8. The rock mass strength in the Upper Asmari unit

Hoek-Brown Classification sigci 60 MPa GSI 47 mi 8 D 0 Hoek-Brown Criterion mb 1.2 s 0.003 a 0.5 Failure Envelope Range Application Tunnels sig3max 1.3 MPa Unit Weight 0.03 MN/m ³ Tunnel Depth 100 m Mohr-Coulomb Fit c 0.7 MPa phi (φ) 47° Rock Mass Parameters sigt -0.1 MPa sigc 3.03 MPa sigcm 8.8 MPa Em 6517.4 MPa	Hoek-Brown Classification sigci 100 MPa GSI 64 mi 8 D 0 Hoek-Brown Criterion mb 2.2 s 0.02 a 0.5 Failure Envelope Range Application Tunnels sig3max 1.4 MPa Unit Weight 0.03 MN/m ³ Tunnel Depth 100 m Mohr-Coulomb Fit c 2.1 MPa phi (φ) 53° Rock Mass Parameters sigt -0.8 MPa sigc 13.4 MPa sigcm 21.9 MPa Em 22387.2 MPa
--	--

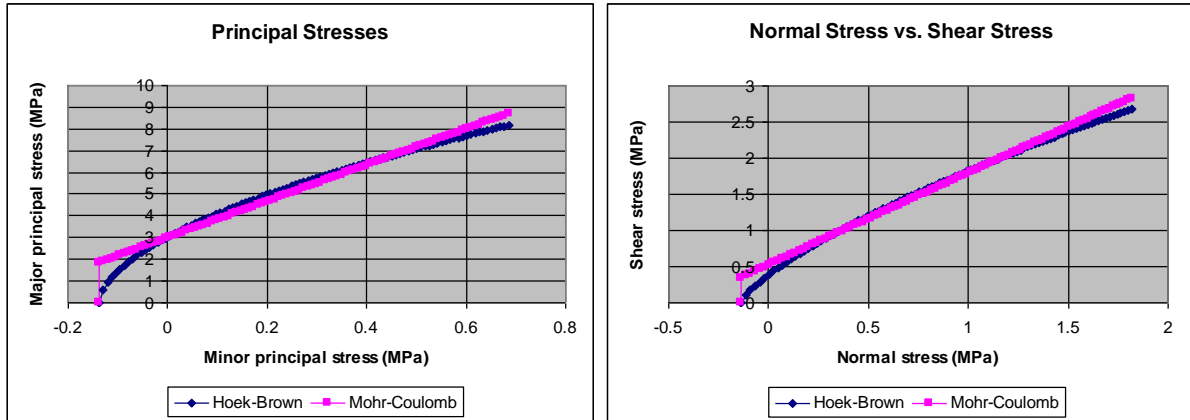

Figure 5.5.7. Relationship between major and minor principal stresses also normal and shear stresses for the Hoek-Brown and equivalent Mohr-Coulomb criteria for GSI 47 in the upper unit of the Asmari Formation.

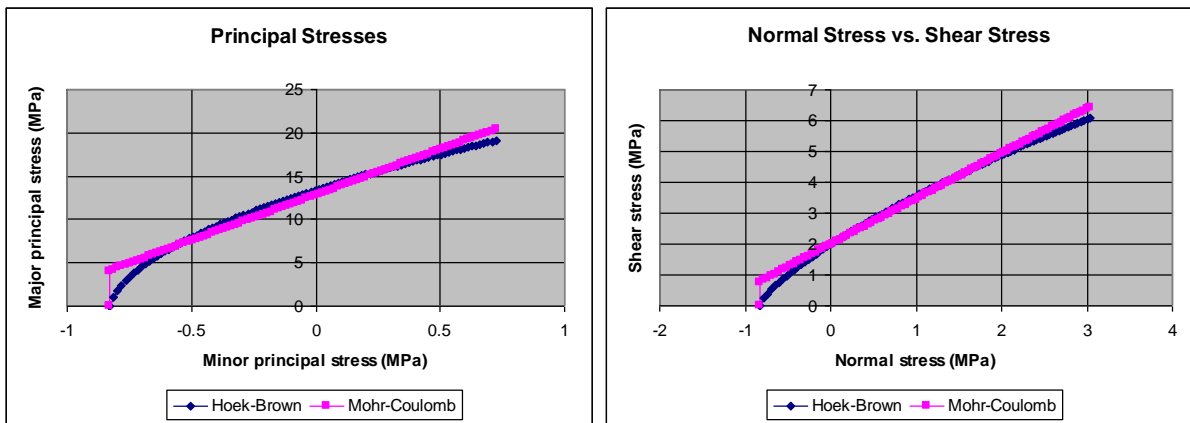

Figure 5.5.8. Relationship between major and minor principal stresses also normal and shear stresses for the Hoek-Brown and equivalent Mohr-Coulomb criteria for GSI 64 in the upper unit of the Asmari Formation.

Structural Stability Control and Rock Support Arrangement elements were determined by using the RocScience Software UNWEDGE©.

Three major and one accessory discontinuity planes (Table 5.5.1) control the shape and dimensions of rock wedges in the diversion tunnel. The main joint sets are Js1, Js2 and Js4 (bedding planes).

The safety factor, volume, dimensions, geometry, wedge weight, wedge length, excavation face area and sliding direction of all blocks are shown in Figure 5.5.9 and Table 5.5.9.

Wedge 8 is the only unstable block of 6.6 m³ with a factor of safety about 1.2. If wedge sliding takes place, the direction of sliding will be toward 087° at angle of 61°. Other blocks based on the Unwedge© program are relatively stable during excavations. After installation of support elements (Table below) the safety factor of Wedge 8 increased to about 3.3.

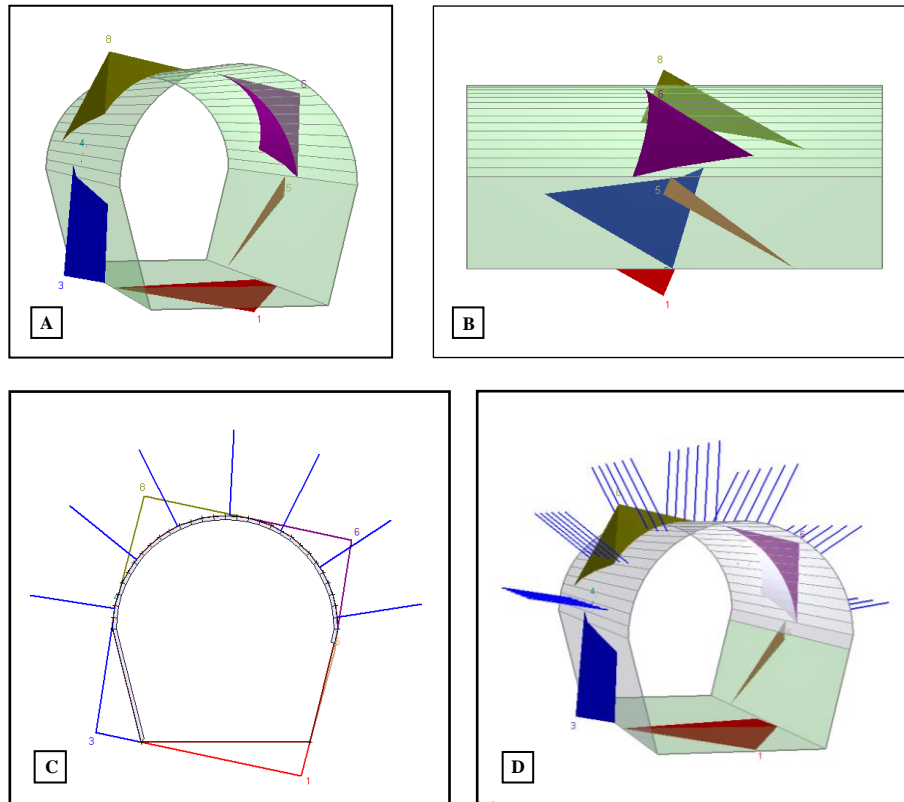

Figure 5.5.9. Dimensions, geometry and structural specifications of wedges resulting from intersection of major joint sets Js.1, Js.2 and bedding planes (Js.4) at 10.5 m diameter diversion tunnel of the Seymareh dam. A- Perspective view, B- Side view of tunnel showing potentially unstable wedges, C (2D view) and D (3D view) of rock support arrangement of the Asmari Formation limestone in the fair quality rock.

Table 5.5.9. The rock wedge specifications in the diversion tunnel resulted by Js.1, Js.2 and Js.4

<p><u>Floor wedge [1]</u> Factor of Safety: stable Wedge Volume: 7.2 m³ Wedge Weight: 19.3 tonnes Wedge z-Length: 3.5 m Excavation Face Area: 13.7 m²</p> <p><u>Lower Left wedge [3]</u> Factor of Safety: 22.3 Wedge Volume: 15.6 m³ Wedge Weight: 42.1 tonnes Wedge z-Length: 9.2 m Excavation Face Area: 24.2 m² Sliding Direction (trend, plunge): 84°, 12°</p> <p><u>Upper Left wedge [4]</u> Factor of Safety: stable Wedge Volume: 0.0 m³ Wedge Weight: 0.0 tonnes Wedge z-Length: 1 m Excavation Face Area: 0.02 m² Sliding Direction (trend, plunge): 170°, 70°</p>	<p><u>Lower Right wedge [5]</u> Factor of Safety: stable Wedge Volume: 0.2 m³ Wedge Weight: 0.4 tonnes Wedge z-Length: 7.6 m Excavation Face Area: 4.94 m² Sliding Direction (trend, plunge): 359°, 29°</p> <p><u>Upper Right wedge [6]</u> Factor of Safety: 5.4 Wedge Volume: 9.3 m³ Wedge Weight: 25.2 tonnes Wedge z-Length: 7 m Excavation Face Area: 17.1 m² Sliding Direction (trend, plunge): 275°, 80°</p> <p><u>Upper Left wedge [8]</u> Factor of Safety: 1.2 Wedge Volume: 10 m³ Wedge Weight: 27.1 tonnes Wedge z-Length: 9.4 m Excavation Face Area: 18.6 m² Sliding Direction (trend, plunge): 87°, 61°</p>
--	--

The rock wedges information and their specifications resulting from the intersection of Js.1, Js.3 and Js.4 (bedding planes) can be shown in Figure 5.5.10 and Table 5.5.10.

According to this data, the small rock wedge 8 in the upper right will be the only unstable block with factor of safety 0 during the excavation process.

After installation of support elements, the factor of safety will be sufficient to continue the excavation operation, and it should also be considered that Js.3 is an accessory discontinuity that sporadically occurs in the tunnel rock mass.

In the other cases, such as the intersection of Js.2, Js.3, Js.4 and Js.1, Js.2, Js.3 there are not any significant instability.

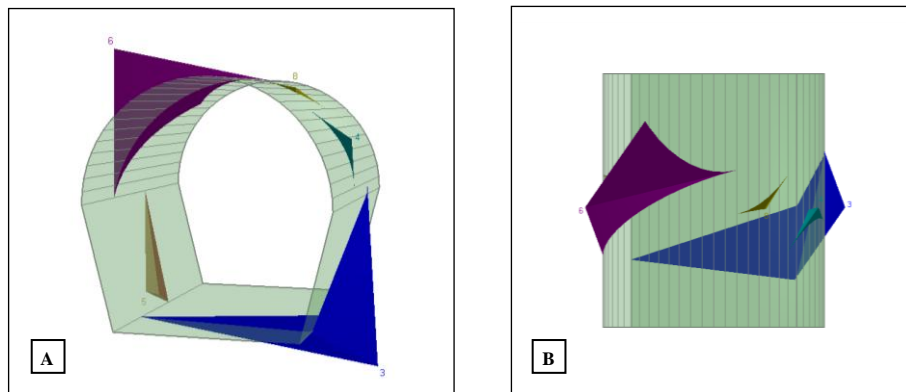

Figure 5.5.10. Dimensions, geometry and structural specifications of wedges formed by intersecting major joint sets Js.1, Js.3 and bedding planes (Js.4) in the diversion tunnel. A- Perspective view, B- Top view of tunnel showing potentially unstable wedges.

Table 5.5.10. The rock wedge specifications in the diversion tunnel resulted by Js.1, Js.3 and Js.4.

<p><u>Lower Right wedge [3]</u> Factor of Safety: stable Wedge Volume: 18.2 m³ Wedge Weight: 49.1 tones Wedge z-Length: 6.2 m Excavation Face Area: 23.0 m²</p>	<p>Wedge z-Length: 1.4 m Excavation Face Area: 2.6 m² Sliding Direction (trend, plunge): 43°, 27°</p>
<p><u>Upper Right wedge [4]</u> Factor of Safety: 12.5 Wedge Volume: 0.1 m³ Wedge Weight: 0.3 tones Wedge z-Length: 2 m Excavation Face Area: 1 m² Sliding Direction (trend, plunge): 170°, 70°</p>	<p><u>Upper Left wedge [6]</u> Factor of Safety: 4 Wedge Volume: 15.8 m³ Wedge Weight: 42.7 tones Wedge z-Length: 6.3 6 m Excavation Face Area: 14.1 m² Sliding Direction (trend, plunge): 125°, 75°</p>
<p><u>Lower Left wedge [5]</u> Factor of Safety: 64.4 Wedge Volume: 0.5 m³ Wedge Weight: 1.3 tones</p>	<p><u>Roof wedge [8]</u> Factor of Safety: 0.0 Wedge Volume: 0.03 m³ Wedge Weight: 0.1 tones Wedge z-Length: 1.9 m Excavation Face Area: 0.5 m² Sliding Direction (trend, plunge): 0°, 90°</p>

A finite element mesh is shown in Figure 5.5.11, constructed to simulate the loading conditions of normal and shear stress and their distribution on all rock wedges in the diversion tunnel. Except for (Js.1, Js.2 and Js.4) other discontinuity sets have smaller influence on the instability of the tunnel. These wedges are mainly considered to be more stable than the cases of A-B because of their geometry (shape) and in situ stress conditions.

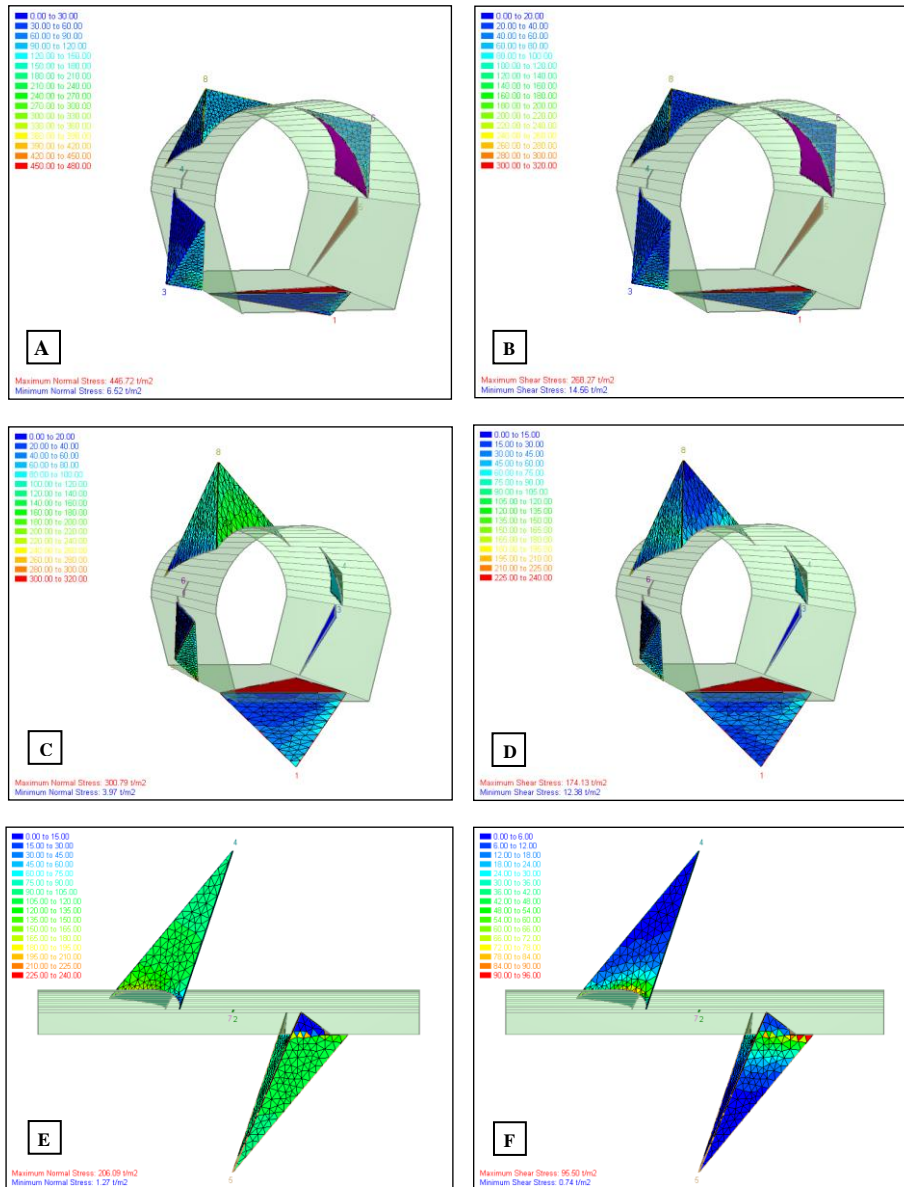

Figure 5.5.11. Finite element mesh of normal and shear stresses for all possible wedges due to intersection of discontinuities in the diversion tunnel. The critical wedges based on distribution of shear stress and the shape of the wedge is A-B (Js.1, Js.2 and Js.4 or bedding planes).

The rock mass strength of the Seymareh Dam is presented in 5.5.12 based on all the GSI values and engineering rock mass properties (Figure 5.5.13) of the three rock units of the Asmari Formation.

The values of the GSI in Figure 5.5.12 were derived from field observations of the blockiness and discontinuity surface conditions.

The rock mass quality variations are from *Blocky- Well Interlocked* and *Good (BG)* to *Very Blocky- Interlocked* and *Fair (VB/F)*.

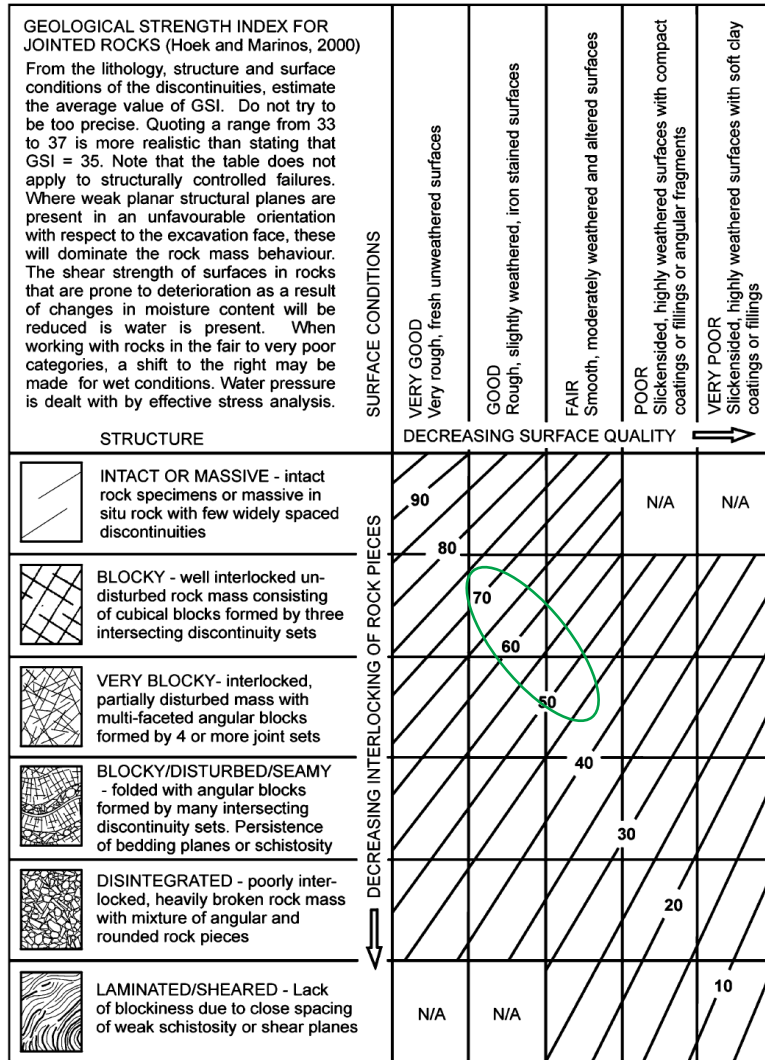

Figure 5.5.12. General Geological Strength Index (GSI) chart, for jointed rock masses (after Hoek and Brown, 1997, Hoek and Karzulovic, 2001). The shaded area is indicative of the distribution of the geological strength index of the various rock mass units of the Asmari Formation at the Seymareh dam.



Formation	Thickness	Unit no.	Lithological column	Lithological description	Porosity Z	Karst features	Permeability	UCS/Mpa	ROD Z	RMR	Q	GSI	Mohr Coulumb Fit		Rock Mass Parameters		
													C, Mpa	phi, deg	sigt, Mpa	sigc, Mpa	En, Mpa
Gachसान F.				Alternation of salt, anhydrite, gypsum marl, marly limestone, limestone and shale													
ASMARI FORMATION 5720 m	1500 m	As.3		Marly limestone Vuggy to fracture porosity Biopelmicrite, packstone, Bioclasts are: Planktonic Foraminifera, Spogionarphides, borelis sp, Mearropsina sp, Miliolides	0.75	Karstified	High to V. high	60	Fair to Good (65 to 94)	52	4.6	47	0.66	47.3	-0.14	3.03	6517.42
				Crystalline bioclastic limestone grey to dark grey, partly recrystallized Intrapelmicrite, wackstone- packstone Vuggy porosity, partly filled by coarse Sparry calcite cement, Bioclasts are: Borelis sp, Rotalia sp, Miliolides, Ditrupa Echinoid shell and Red Algae, Maristone	1.50												
					2.00												
					2.20												
	2380 m	As.2		Marly limestone, fossiliferous Crystalline dolomitic limestone with Extensive dolomitization Biobiointraomicrite, wackstone- packstone Vuggy to fracture porosity Bioclasts are Lepidocyclus sp, Red Algae	0.90	Karstified	Low to High	70	Good (75 to 95)	56	9.1	51	0.84	49.2	-0.22	4.5	8862.35
				Crystalline dolomitic limestone Massive to thick bedded Dolobioomicrite, wackstone, vuggy porosity Karstified, partly filled by microsparry Calcite cement, micritic cement partly changed to rhombohedral crystals of Dolomite, Bioclasts are Operculin sp, Echinoid shell fragments	1.00												
					0.60												
					1.25												
	1880 m	As.1		Microcrystalline and fossiliferous limestone, thin to medium bedded Biomicrite, packstone, bioclasts are Echinoid, Pelecypoda shell fragments Vuggy porosity, Karstified	3.00	Karstified	Non to Medium	95	Good (80)	56	9.1	51	4.5	28.9	-0.30	6.10	10324.3
				Microcrystalline limestone, dark grey Vuggy porosity, partly filled by coarse blocky to microsparry calcite cement Pelmicrite, wackstone micritic cement partly recrystallized to microsparry calcite cement	1.40												
					1.40												
					2.20												
				Fossiliferous marly limestone dark grey in color, vuggy porosity Intrapelmicrite, wackstone to packstone Bioclasts are Archaeos sp, Peneroplis sp, Miliolides, Austrorotina sp, Dendritina sp, Rotalia sp, Bryozoon, Red Algae, Echinoida Spongia and Pelecypoda shell fragments	4.50				61	21.1	56	4.9	30.4	-0.43	8.10	13767.7	

Continue

Figure 5.5.13. The lithological units and engineering rock mass characterization of the Asmari Formation at the Seymarch dam.

5.6. Engineering Geological Characteristics of the Salman Farsi Dam and Power plant Project (Engineering Rock Mass Classification of the Asmari Formation)

5.6.1. Middle Unit (Middle Asmari Formation- As.2)

Diversions Tunnel (middle unit)

Geological data for the diversion tunnel derived from boreholes and surface mapping show that the tunnel is constructed in the middle part of the Asmari Formation. This unit comprise homogeneous and thickly bedded crystalline limestone and dolomitic limestone. The Asmari Formation along the diversion tunnel is in fair to excellent quality rock with *RQDs* generally ranging between 60% to 100%. The major discontinuity sets are shown in Table 5.6.1.

The *RMR* values based on rock mass rating parameters from Table 3.3, can be assessed as in Table 5.6.2.

Table 5.6.1. Major discontinuity sets and their specifications.

Discontinuity Set	Dip Direction (°)	Dip (°)	Spacing	Discon. surface	Opening	Filling	Length
Set 1	131	81	1 m	rough	closed	none	>5m
Set 2	115	85	0.3 m	rough	closed	calcite	6m
Set 3	280	77	1- 1.5 m	smooth	closed	none	>5m
Bedding	019	55	0.1- 1.2m	Smooth to rough			>10m

Table 5.6.2. Assessment of Rock Mass Rating for the Asmari Formation (Middle unit).

	Property	Value	Rating
1	UCS (MPa)	60- 84	7
2	RQD	60% - 100%	13- 20
3	Spacing of discontinuities	0.5- 3m	10- 20
4	Condition discontinuities	Rough to Smooth	25
5	Ground water	Wet to Dripping	7
6	Adjustment for joint orientation	Very unfavorable	-12
Total : 50 – 67 (Fair to Good)			

In addition, based on Table 3.4, the guidelines for the excavation and support of a 15 m span tunnel for the relevant *RMR* values are shown in Table 5.6.3.

Table 5.6.3. Rock support types for the middle unit in the diversion tunnel.

Rock mass class	Excavation	Rock bolts (20 mm diameter, fully grouted)	Shotcrete	Steel sets
II – Good rock	Full face, 1- 1.5 m advance. Complete support 20 m from face	Locally, bolts in crown 4-5 m long, spaced 2m with occasional wire mesh	50 mm in crown where required	Non
III – Fair rock	Top heading and bench 1.5- 3 m advance in top heading. Commence support 10 m from face	Systematic bolts 5-6m long, spaced 2m in crown with wire mesh, sides locally if needed	2X40 mm in crown and 30 mm in sides	Non

The *Stand up Time* for the diversion tunnel with 15 m diameter is assessed based on the stand up time graph (Bieniawski, 1989):

The *Stand up Time* for the diversion tunnel is 2×10^3 hours (83 days) for good quality rock mass and *immediate collapse* for fair quality rock mass.

The *Rock Tunneling Quality Index, Q* can be determined indirectly by two empirical equations 3.9 and 3.10 and the values are between 58.4 (*Very Good Quality*) and 6.4 (*Fair Quality*).

Structural Stability Control and Rock Support Arrangement elements were determined by using the RocScience Software UNWEDGE©.

Table 5.6.1 shows the major discontinuity sets which control the shape and dimensions of wedges in the diversion tunnel.

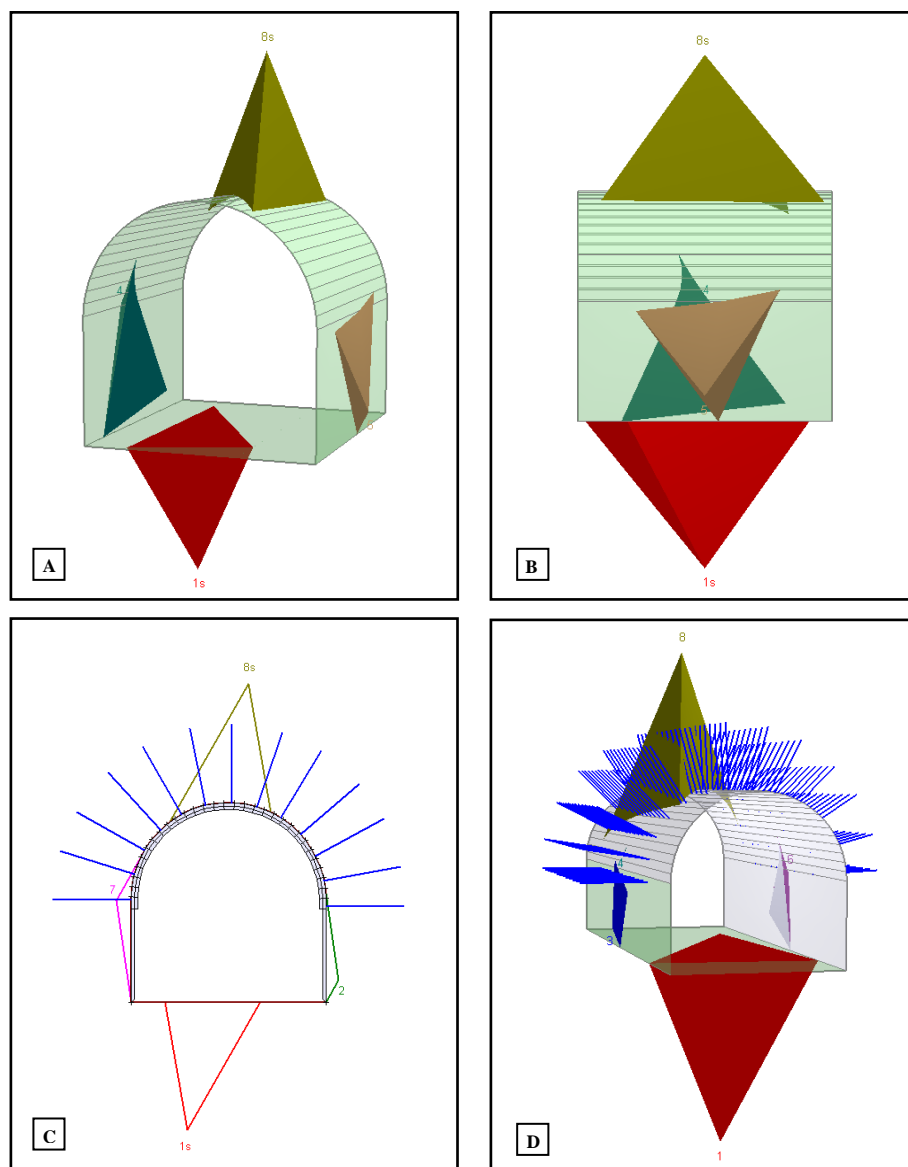

Figure 5.6.1. Dimensions, geometry and structural specifications of wedges due to intersecting major joint sets Js.1, Js.3 and bedding planes in the diversion tunnel at the Salman Farsi dam. A- Perspective view, B- Side view of tunnel showing potentially unstable wedges, C (2D view) and D (3D view) of rock support arrangement in the middle Asmari limestone of fair quality rock mass.

The factor of safety, volume, dimensions, geometry and other specifications of all wedges because of intersecting of Js.1, Js.3 and bedding planes are shown in Figure 5.6.1 and Table 5.6.4.

Table 5.6.4. The rock wedge specifications at the diversion tunnel resulting from joint sets Js.1, Js.3 and bedding planes.

<p><u>Floor wedge [1]</u> Factor of Safety: stable Wedge Volume: 177.6 m³ Wedge Weight: 479.6 tones Wedge z-Length: 15.0 m Excavation Face Area: 54.4 m² Sliding Mode: unconditionally stable wedge</p>	<p>Factor of Safety: 17.0 Wedge Volume: 12.2 m³ Wedge Weight: 33 tones Wedge z-Length: 9.7 m Excavation Face Area: 38.2 m² Sliding Mode: wedge sliding along line of intersection of joints 3 and 4 Sliding Direction (trend, plunge): 353°, 52°</p>
<p><u>Lower Left wedge [4]</u> Factor of Safety: 12 Wedge Volume: 19.8 m³ Wedge Weight: 53.6 tones Wedge z-Length: 11.0 m Excavation Face Area: 52.2 m² Sliding Mode: wedge sliding on joint 1 Sliding Direction (trend, plunge): 131°, 81°</p>	<p><u>Roof wedge [8]</u> Factor of Safety: 1.7 Wedge Volume: 153.9 m³ Wedge Weight: 415.6 tones Wedge z-Length: 15.0 m Excavation Face Area: 53.1 m² Sliding Mode: falling wedge Sliding Direction (trend, plunge): 0°, 90°</p>
<p><u>Lower Right wedge [5]</u></p>	

The figure represents the approximately real possible sizes of wedges, which can occur in the tunnel.

In Figure 5.6.1 it is evident that the roof wedges are potentially unstable and they need to be stabilized. The stabilization will be achieved by the placement of 5-6 m long bolts of Φ 20 (diameter), with 2 m spacing and two 40 mm shotcrete layers in the crown. In the sidewalls, one layer 30 mm shotcrete and rock bolting may be required.

The dimensions on the number, length and capacity of the rock bolts are made on-site by geotechnical staff using equilibrium calculations according to the volume of the wedges defined by the measured trace lengths. For those wedges, which involve sliding on one plane or along the line of intersection of two planes, rock bolts are installed across these planes to increase the sliding factor of safety of the wedge to 1.5. For wedges, which are free to fall from the roof, a factor of safety of 2 is used. This factor is calculated as the ratio of the total capacity of the bolts to the weight of wedge and is intended to account for uncertainties associated with the bolt installation. Early recognition of the potential instability problems, identification and visualization of the wedges which could be released and the installation of support at each stage of excavation, before the wedge bases are fully exposed, resulted in a very effective stabilization program.

The finite element mesh shown in Figure 5.6.2, was constructed to simulate the loading conditions of normal and shear stress and their distribution on all block wedges in the diversion tunnel. Except for Js.1, Js.2, and Js.4 other discontinuities sets have less influence on the instability of the tunnel and produce small and narrow wedges (C-D, E-F). These wedges can be considered to be more stable than the cases of A-B and G-H mainly because of their geometry (shape) and in situ stress. In the cases of C-D and E-F collapsibility is limited to small blocks. To prevent these instabilities light support elements can be used effectively. More information related to these structures are shown in Figure 5.6.2.

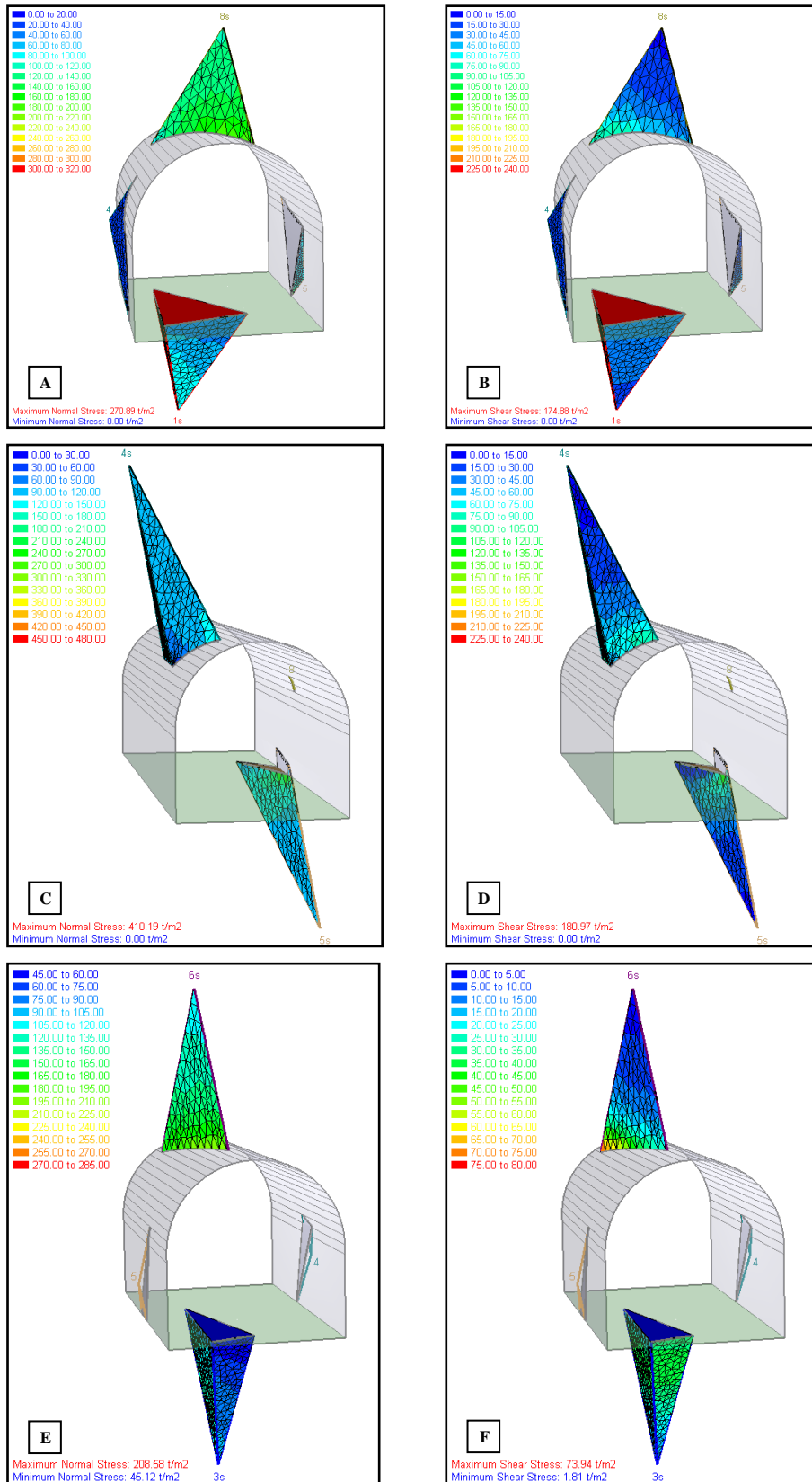

Figure 5.6.2. Finite elements mesh of normal and shear stresses for all possible wedges because of intersection of discontinuities in the diversion tunnel. Critical wedges are based on the distribution of shear stress and the shapes of wedges in A-B and G-H. In the other cases, the instabilities will be small and local.

A-B (Js.1, Js.2, Js.4), C-D (Js.1, Js.2, Js.3), E-F (Js.1, Js.2, Js.4), G-H (Js.2, Js.3, Js.4).

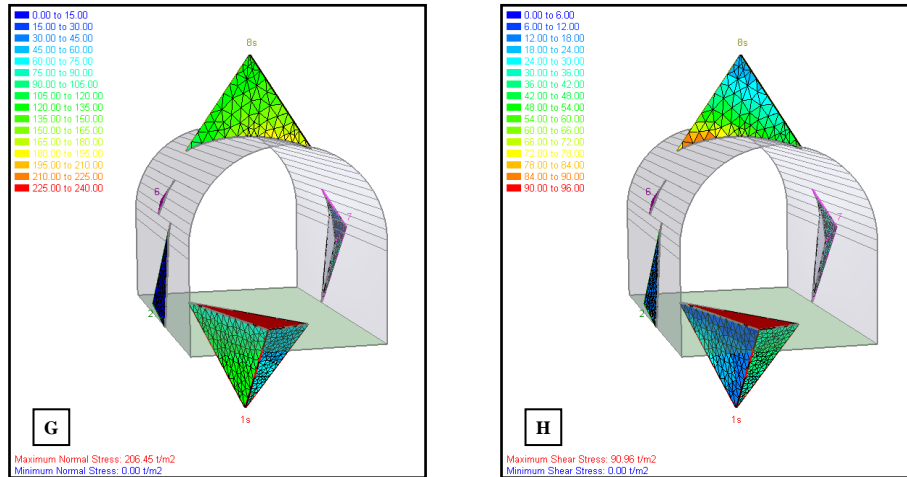

Figure 5.6.2. Continued

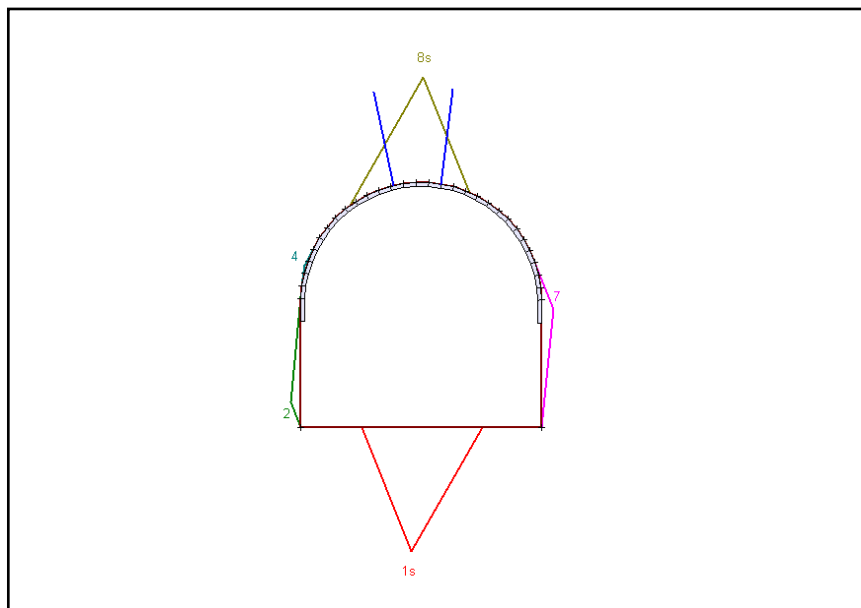

Figure 5.6.3. Pattern and arrangement of rock support elements in good quality rock of the middle unit of the Asmari Formation. The support elements will be spot bolting and 30 mm shotcrete in the roof and in the sides if needed.

Rock support arrangement for the two types of rock mass in the diversion tunnel, can be introduced based on Table 3.1.10 (Bieniawski, 1989) and revised based on a 15 m span for the diversion tunnel in *fair quality* rock mass (Figure 5.6.2):

- Bolt length – 5.0m to 6.0m Φ 20.0mm, in crown, and in sides if required
- Spacing – 2.0 m
- Shotcrete – 40.0mm primary and 40.0mm secondary in crown, and in sides 30.0mm if required

The support arrangement for good quality rock mass in the diversion tunnel can be considered to be as follows (Figure 5.6.3):

-Bolt length – 4.0m to 5m Φ 20.0mm, spot bolting in crown, and in sides if required
-Spacing – 2.0 m
-Shotcrete – 30.0mm in crown and in sides, 30.0mm if required

The *factor of safety* for unstable roof wedges, after installation of the support elements is considered to be about 1.7 for the two cases of good quality and fair quality rock mass.

The geological strength index (GSI) was calculated using equations 3.11 and 3.12 and the values obtained are between **45** and **62**.

The rock mass strength with input data, UCS, GSI, m_i , D (disturbance factor) and tunnel depth was assessed using **RocLab**© software. Table 5.6.5, Figures 5.6.4 and 5.6.5 are the summary of the results:

Table 5.6.5. The rock mass strength in the Middle Asmari unit.

Hoek Brown Classification	Hoek-Brown Classification
sigci 84 MPa	sigci 60 MPa
GSI 62	GSI 45
m_i 12	m_i 12
D 0	D 0
Hoek Brown Criterion	Hoek-Brown Criterion
mb 3.1	mb 1.7
s 0.01	s 0.002
a 0.5	a 0.5
Failure Envelope Range	Failure Envelope Range
Application Tunnels	Application Tunnels
sig3max 1.4 MPa	sig3max 1.3 MPa
Unit Weight 0.03 MN/m ³	Unit Weight 0.03 MN/m ³
Tunnel Depth 100 m	Tunnel Depth 100 m
Mohr-Coulomb Fit	Mohr-Coulomb Fit
c 1.5 MPa	c 0.6 MPa
phi (ϕ) 55.9°	phi (ϕ) 50.2°
Rock Mass Parameters	Rock Mass Parameters
sigt -0.4 MPa	sigt -0.1 MPa
sigc 10.1 MPa	sigc 2.7 MPa
sigcm 20.8 MPa	sigcm 10.2 MPa
Em 18286.9 Mpa	Em 5808.7 Mpa

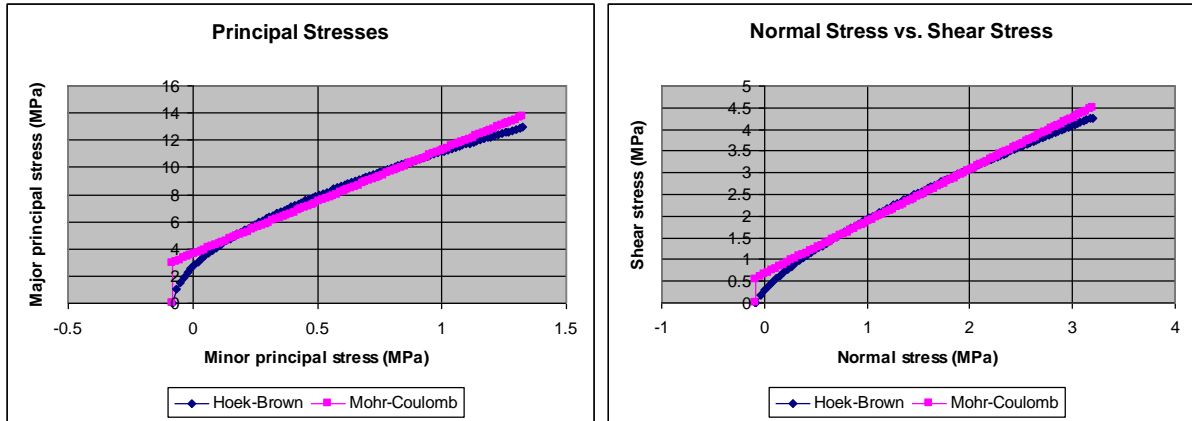

Figure 5.6.4. Relationship between major and minor principal stresses also normal and shear stresses for the Hoek-Brown and equivalent Mohr-Coulomb criteria for GSI 45 in the middle unit of the Asmari Formation.

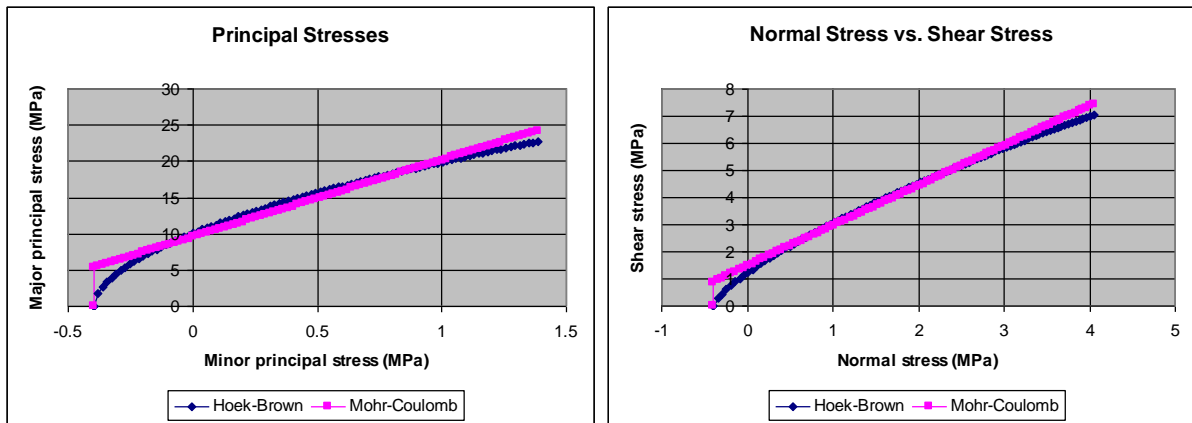

Figure 5.6.5. Relationship between major and minor principal stresses also normal and shear stresses for the Hoek-Brown and equivalent Mohr-Coulomb criteria for GSI 62 in the middle unit of the Asmari Formation.

5.6.2. Lower Unit (Lower Asmari Formation- As.1)

The lower unit comprises regularly bedded fined grained brown limestone and marls, thin to very thinly bedded, with vug, channel and fracture porosity. The rock mass rating can be assessed as in Table 5.6.6 for the discontinuity set specifications as in Table 5.6.1, and the RMR parameters.

Table 5.6.6. Assessment of Rock Mass Rating for the Asmari Formation (Lower unit).

	Property	Value	Rating
1	UCS (MPa)	46- 65	4-7
2	RQD	37% - 50%	8
3	Spacing of discontinuities	0.06- 0.6m	8- 10
4	Condition discontinuities	Rough to Smooth, weathered	20
5	Ground water	Damp	10
6	Adjustment for joint orientation	Very unfavorable	-25, -15
Total : 25 – 40 (Weak)			

The *Rock Tunneling Quality Index, Q* can be calculated indirectly using equation 3.10 (Rotelech-Preston, 1978).

The *Q* values vary between **0.047** (*Extremely Poor*) to **0.6** (*Very Poor*).

The geological strength index (GSI) was calculated using equations 3.11 and 3.12 and the values obtained vary between **20** and **35**.

The rock mass strength with input data, UCS, GSI, *m_i*, *D* (disturbance factor) and tunnel depth was assessed using *RocLab*© software. Table 5.6.7 and Figure 5.6.6 are summaries of the results obtained.

Table 5.6.7. The rock mass strength in the Lower Asmari unit.

Hoek Brown Classification sigci 46 MPa GSI 20 mi 7 D 0 Hoek Brown Criterion mb 0.4 s 0.0001 a 0.5 Failure Envelope Range Application General sig3max 11.5 MPa Mohr-Coulomb Fit c 1.1 MPa phi (φ) 18.8° Rock Mass Parameters sigt -0.02 MPa sigc 0.4 MPa sigcm 3.1 MPa Em 1206.1 MPa	Hoek Brown Classification sigci 65 MPa GSI 35 mi 7 D 0 Hoek Brown Criterion mb 0.7 s 0.001 a 0.5 Failure Envelope Range Application General sig3max 16.3 MPa Mohr-Coulomb Fit c 2.2 MPa phi (φ) 23.3° Rock Mass Parameters sigt -0.1 MPa sigc 1.6 MPa sigcm 6.8 MPa Em 3399.8 MPa
--	--

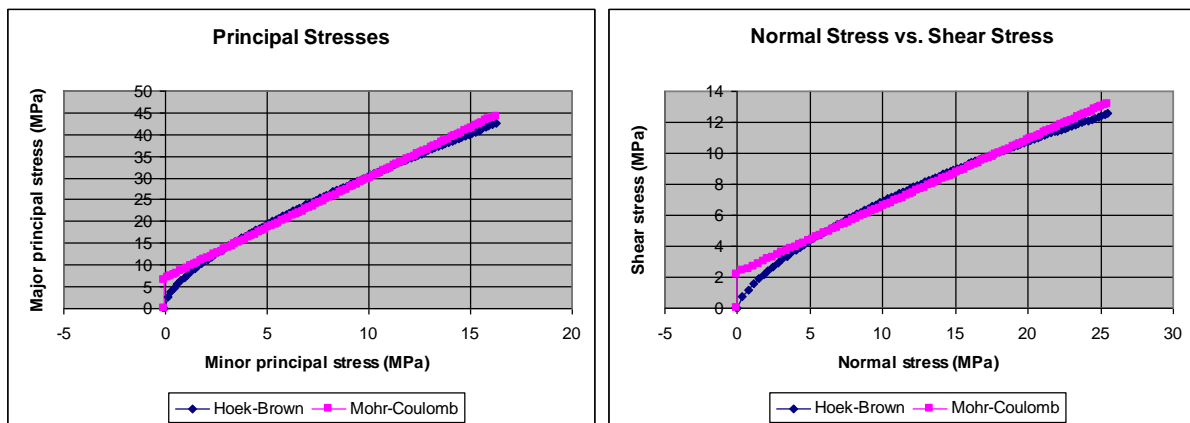

Figure 5.6.6. Relationship between major and minor principal stresses also normal and shear stresses for the Hoek-Brown and equivalent Mohr-Coulomb criteria for GSI 35 in the lower unit of the Asmari Formation.

5.6.3. Upper Unite (*Upper Asmari Formation- As.3*)

The Upper Asmari unit comprises heterogenous alternating thinly bedded shelly limestone, and marly limestone with marls, dolomitic limestone and siltstone, moderate to weak strength, with vug and channel porosity.

Discontinuity set specifications in Table 5.6.1 and RMR factors lead to a rock mass rating RMR calculated as shown in Table 5.6.8.

Table 5.6.8. Assessment of Rock Mass Rating for upper unit of the Asmari Formation.

	Property	Value	Rating
1	UCS (MPa)	39-46	4
2	RQD	58%	13
3	Spacing of discontinuities	0.06- 0.6m	8- 10
4	Condition discontinuities	Rough to Smooth, weathered	20
5	Ground water	Damp	10
6	Adjustment for joint orientation	Very unfavorable	-25, -15
Total : 25 – 42 (Weak to Fair)			

The **Rock Quality Index, Q** can be calculated indirectly by equation 3.10.

The Q values are estimated between **0.047** (*Extremely Poor*) and **0.84** (*Very Poor*).

The geological strength index (GSI) was calculated using equations 3.11 and 3.12 and the values obtained vary between **20** and **37**.

The rock mass strength with input data, UCS, GSI, m_i , D (disturbance factor) for general application was assessed using **RocLab**© software and Table 5.6.9, Figures 5.6.7 and 5.6.8 are a summary of the results obtained.

The rock mass strength of the Salman Farsi Dam is presented in Figure 5.6.9 based on all the GSI values and engineering rock mass properties (Figure 5.6.10) of the three rock units of the Asmari Formation.

The values of the GSI in Figure 5.6.9 were derived from field observations of the blockiness and discontinuity surface conditions.

The GSI graph shows that the rock mass quality vary from *Blocky-Well Interlocked* and *Good (BG)* to *Blocky Disturbed/Seamy* and *Poor (BD/P)*.

Figure 5.6.10 shows the detail information regarding the engineering rock mass characteristics resulting from the above calculations.

Table 5.6.9. The rock mass strength of the Upper Asmari unit.

Hoek Brown Classification		Hoek Brown Classification	
sigci	39 MPa	sigci	46 MPa
GSI	20	GSI	37
mi	7	mi	7
D	0	D	0
Hoek Brown Criterion		Hoek Brown Criterion	
mb	0.4	mb	0.7
s	0.0001	s	0.001
a	0.5	a	0.5
Failure Envelope Range		Failure Envelope Range	
Application	General	Application	General
sig3max	9.8 MPa	sig3max	11.5 MPa
Mohr-Coulomb Fit		Mohr-Coulomb Fit	
c	0.9 MPa	c	1.6 MPa
phi (ϕ)	18.8°	phi (ϕ)	23.8°
Rock Mass Parameters		Rock Mass Parameters	
sigt	-0.01 MPa	sigt	-0.06 MPa
sigc	0.3 MPa	sigc	1.3 MPa
sigcm	2.6 MPa	sigcm	5.0 MPa
Em	1110.5 MPa	Em	3209.1 MPa

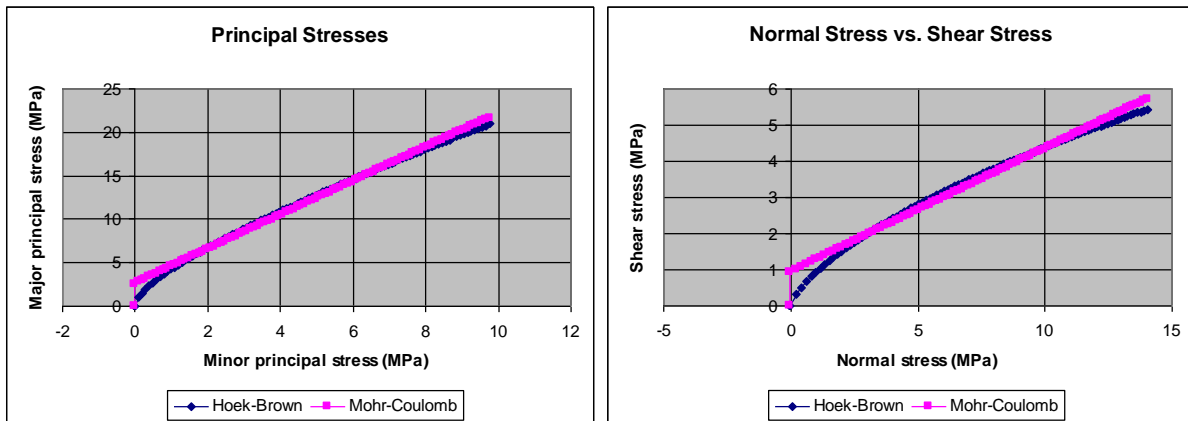

Figure 5.6.7. Relationship between major and minor principal stresses also normal and shear stresses for the Hoek-Brown and equivalent Mohr-Coulomb criteria for GSI 20 in the upper unit of the Asmari Formation.

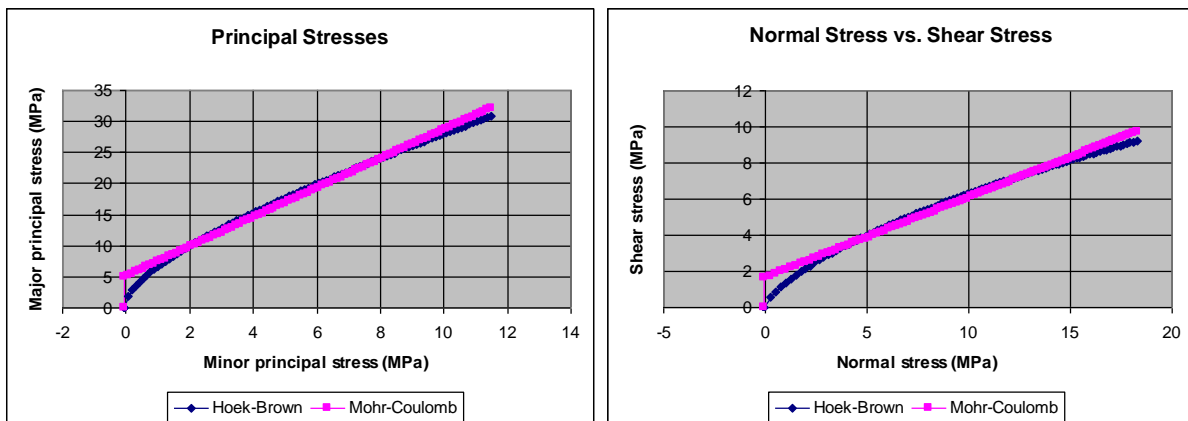

Figure 5.6.8. Relationship between major and minor principal stresses also normal and shear stresses for the Hoek-Brown and equivalent Mohr-Coulomb criteria for GSI 37 in the upper unit of the Asmari Formation.

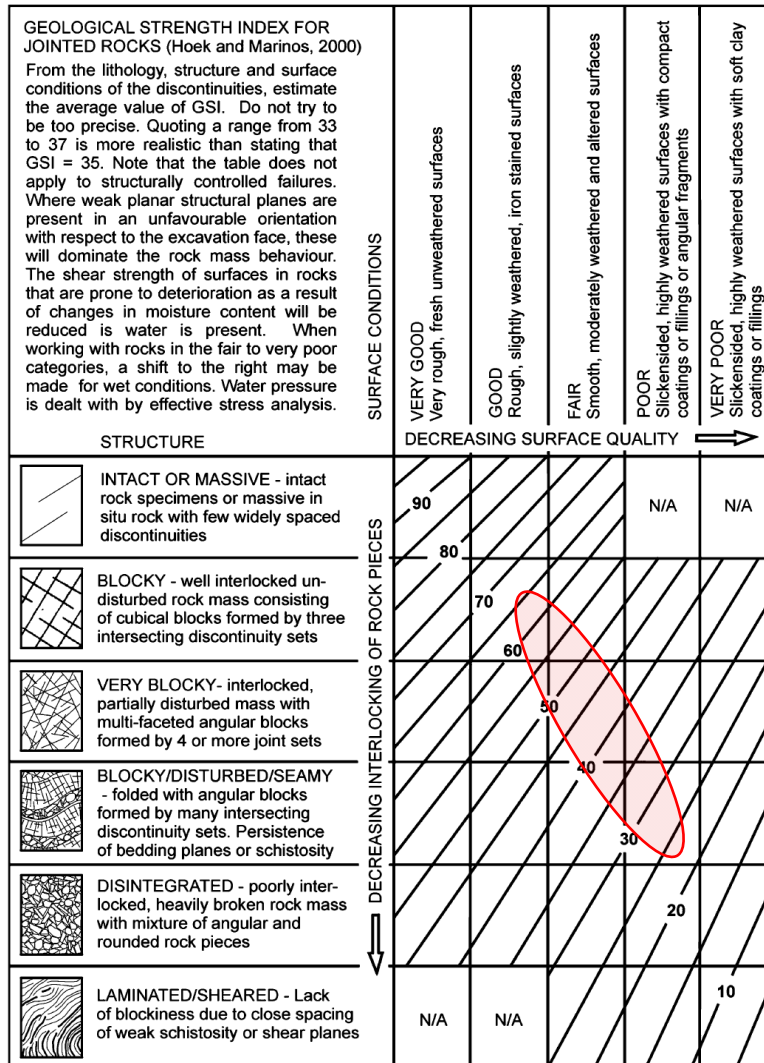
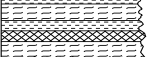
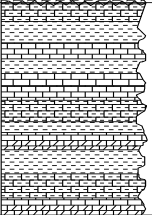
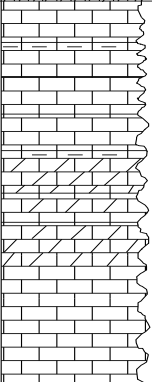
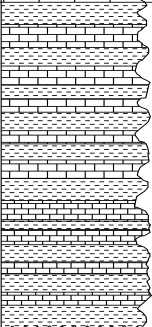



Figure 5.6.9. General Geological Strength Index (GSI) chart, for jointed rock masses (Hoek and Brown 1997, Hoek and Karzulovic, 2001). The shaded area is indicative of the distribution of the geological strength index of the various rock mass units in the Asmari Formation at the Salman Farsi dam.

Figure 5.6.10. The lithological units and engineering rock mass characterizations of the Asmari Formation at the Salmaan Farsi dam project.

Formation	Thickness	Unit no.	Lithological column	Lithological description	Porosity%	Karst features	Permeability	UCS/Mpa	ROD %	RMR	Q	GSI	Mohr Coulomb Fit		Rock Mass Parameters						
													C, Mpa	phi, deg.	sigt, Mpa	sigc, Mpa	En, Mpa				
Razak F.	>1000 m			Siltstone and Shales, with few gypsum beds and marls	Reservoir area																
ASMARI FORMATION 6500.0 m	1500 m	As.3		Thrust zone	19.40																
				Heterogeneous alternating of thinly bedded Shelly Limestone, and marly limestone with Marls and Siltstone	1.60	Very small cavities following the limestone beds.	considered fairly Impervious	39		25	0.84	20	0.93	18.81	- 0.133	0.310	1110.54				
				Moderate to weak strength	4.25	Influence of joint		39	58	to	to	to									
				Biointrasparite, Grainstone Fossil contents are Archaios sp., Miliolide and Pelecypoda shell fragments	1.50																
	2700 m	As.2		Dolomitic limestone, marly limestone and marl, Biadolomitic, Wackstone vuggy and channel porosity, Thinly bedded	7.50	very restricted															
				Fossil contents are Rotalia sp., Miliolides Numulites sp. Operculina sp.	4.00	Small cavities, high porosity															
				Homogeneous and thickly bedded Crystalline limestone, marly limestone	8.00	Chimneys at the intersection bedding joint	High to Very high	43	total (72 - 92)												
				Vuggy, intraparticle porosity	4.00	Chimneys developing to large caves which can cross the layers following joint plans			65 - 85												
				Intra-bio-sparite, Grainstone (calcareonite), Fossil contents are Peneroplis sp., Miliolides, Textularidae sp. Echinoid shell and skeletal fragments	0.30	Chimneys at the interception bedding joint				60 - 80											
				Fine grained cherty limestone	3.00	Karst along bedding planes at the base, wide-flattened cavities chimney in correspondence with joints				75 - 100	50	6.4	45	0.64	50.25	- 0.79	2.68	5808.66			
2300m	As.1		Dolomitic limestone and Dolomite	6.00	Karst seldom	Very Low	84														
			Thickly bedded, low karstified Dolopelnicrite, Wackstone	1.00																	
			Fossil contents are Numulites sp. Miliolides and Echinoid shell fragments	2.50																	
			Thick bedded, Hstrength Fine grained crystalline limestone	1.00																	
Pabdeh Fm.				Biopelnicrite, Wackstone-bioclasts are Operculina sp. and Echinoid shell debris	2.50																
				Vug, channel, intraparticle porosity	1.20																
				Regularly bedded of fine grained brown limestone and marls	1.90	Isolated cavities	Generally low	75													
				Biointra-sparite, Wackstone vug and fracture porosity	1.00																
				Fossil contents are Operculina sp. and some Planktonic species	5.60																