

# **‘It’s rubbish!’**

## **A study of recycled materials to use as interior partitioning in social housing**

**A. Greeff**

Department of Architecture  
University of Pretoria, Pretoria, South Africa e-mail: clemmer@postino.up.ac.za

**Keywords:** waste materials, recycled, modular-infill systems, sustainability

### **Abstract**

This paper investigates the recycling of waste materials for use in social housing in South Africa. The availability, environmental impact, physical, acoustic and thermal performance of these materials are assessed within the context of Soshanguve, Tshwane (Pretoria). Firstly, the paper briefly considers Soshanguve as a suitable context. Thereafter, environmentally responsible materials for use in social housing are suggested in the light of open building systems. The aim of the study is to ascertain which of these proposed waste materials are most suitable for use in the creation of interior partitioning and furniture in social housing schemes. The introduction of these modular infill-systems, made of locally collected re-usable materials, could contribute to the low-cost construction of sustainable social housing in South Africa.

## **1 Introduction**

During the Apartheid era South African cities were systematically planned to support political ideas of segregation and separate development for different racial groupings. Since the demise of Apartheid in 1994, housing has become an important issue in the political transformation of South Africa. However, much of the lower income housing provided remains inefficient [1]. In order to encourage more effective and sustainable housing, alternative ways of delivery are currently being developed and put into practice. Soshanguve is a township situated to the north west of Tshwane (Pretoria). The rapid growth of Soshanguve from a transitional township between rural and urban land into a ‘city’ housing over 500 000 people, created the need for low-cost building solutions [2]. The mixture of informal settlements and government-funded houses has resulted in the often unsafe and unsustainable use of materials and the persistent ‘one house per plot’ typology still uses conventional to tackle an unconventional problem. There exists an urgent need within Soshanguve for sustainable housing development that finds the solutions within the community itself.

It is against this context that this paper investigates the viability of introducing modular infill-systems, constructed out of locally sourced waste materials, into social housing in Soshanguve. This is based on the concept of *open building systems*, as developed in the Netherlands [3]. The house is seen as a flexible/adaptable entity, an armature, rather than a fixed final product [1]. Firstly a survey was conducted amongst certain members of the Benevolence Trust; Soshanguve’s housing foundation, who are also local residents, to identify suitable waste materials available in the area. Thereafter these materials were assessed in terms of their physical, acoustic and thermal performance as well as their impact on the environment and local community. In light of the findings applications of the materials in modular-infill systems are recommended.

## 2 Housing in South Africa

### 2.1 Apartheid's Legacy

Established in 1974 to control the numbers of black people living in Tshwane (Pretoria), Soshanguve is a manifestation of how sprawling cities, with little identity and no commercial core, are the legacy of Apartheid. Housing landscapes which evolved during the Apartheid era still perpetuate an inefficient use of space, typified by monotonous rows of detached, single-roomed houses in carefully laid out townships on the periphery of cities [4]. The urbanization that followed 1994 led to the rapid influx of people from rural areas and other African countries to cities. Thousands have had no choice but to make their homes in these transitional townships [2].

Bordered by the Rosslyn Industrial area in the south, Ga-Rankuwa to the south-west and Mabopane to the west, Soshanguve is situated in the most north-western corner of Gauteng and is part of the Greater Metropolitan area of Tshwane (Figure 1).

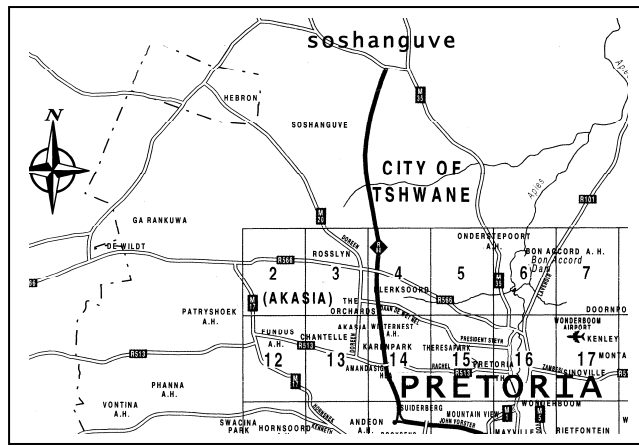

Figure 1: City of Tshwane map showing the location of Soshanguve

### Building materials for low-income housing

The government's institutional subsidy system (for people earning R3 500 per month or less) is currently the prevailing housing scheme used in Soshanguve and is implemented by the Benevolence Trust. This is a non-profit organisation in the area, established to assist in development projects with a focus on housing. Its fine work has even gone on to influence government policy on housing at a national, provincial and local level [2]. This scheme covers about 30% of the total cost of developing a housing unit. Social housing institutions have to find methods to fund the remaining 70% and still keep rentals affordable. There are two approaches to this dilemma. One is for government to raise the qualifying income for its subsidy, enabling institutions to build units for which they can charge higher rentals and thus cross subsidise other units. The other is for institutions to find ways to bring costs down, through cheaper construction and materials resulting in more economical designs [7].

In a study entitled 'Green walls' [4], Deon Brewis, lecturer at Tshwane University of Technology, attempted to find ways of lower building costs. Under his guidance, a group of students conducted an experiment to determine the acceptability of experimental wall panels for a section of the Soshanguve community. Ten panels were designed and constructed to be modular, sustainable, low-cost, utilizing unskilled labour and waste materials. As a result, Brewis [4] suggests the synthesis of indigenous knowledge and modular building. He noted that re-using waste materials for the purpose of building is becoming an accepted practise in low-cost housing. However, this may lead to spaces that are neither acoustically sound nor thermally insulated [4]. This paper addresses and further develops these ideas with regards to the use of modular-infill systems in low-cost housing.

### 3 Material Report

#### 3.1 Identifying possible materials

Interviews were conducted with two members [5, 6] of the Benevolence Trust, also inhabitants of Soshanguve, to ascertain what re-usable waste materials are available. The materials need to be obtainable within walking distance from building sites. They were asked to rate the availability of waste materials on a scale of one to ten. In addition they suggested where and how the materials could be obtained. Comments by individuals in Soshanguve, as reported by Brewis [4] are also used for reference. All the inputs are processed and the results are reflected in Table 1. The materials that rate the highest in terms of availability are marked with an asterisk\*. Only materials that can be described as waste are considered.

Table 1: List of identified materials and availability (Compiled by Greeff, A 2005)

Material	Availability	Material	Availability
1.) Polystyrene foam: as insulation	3.5/10	8.) Tyres: as lining in between materials	5/10
2.) 6mm Pine planks: * as infill-material	8.5/10	9.) Corrugated Iron: * as infill material	7.5/10
3.) Reeds: * for cupboard doors & -shelving	7/10	11.) Gypsum: * disqualified due to cost	8/10
4.) Cardboard: as infill-material	6/10	11.) Particle board: * for cupboard doors & -shelving	6.5/10
5.) Plywood: as infill material	6/10	13.) Corrugated fibreglass: disqualified due to toxicity	5/10
6.) Cloth/plastic bags/sweet wrappers: * as infill-material	9/10	13.) Bubble wrap: as insulation/ protective layer	6/10
7.) Rope: * for shelves and <i>Iciceph</i> weaving techniques	8/10		

Polystyrene and plastic waste materials can be used optimally as insulation inside the infill panels. In order to choose the most appropriate materials to construct infill panels, the remaining materials are examined with respect to:

- physical performance
- acoustic and thermal performance
- impact on the environment and community

#### 3.2 Physical Performance

To determine each material's physical performance the strength, durability and aesthetics are evaluated. The cultural and symbolic values are also evaluated, since in South Africa, most clients firmly reject any notion of natural materials and traditional building methods because of structural integrity concerns and, more importantly, the perceived stigma of inferiority [8].

##### 3.2.1 Pine planks

Wood is aesthetically pleasing, warm both in colour and feel, and with associations of craftsmanship and quality [8]. Classified as a soft wood, pine is light, which makes for easy transport by foot. The durability of wood depends on the surface treatment, which will preserve it against moisture [9]. According to John Makwena [6], 20cm x 100cm planks are available from the Rosslyn Industrial area (Figure 1), where it is used as packaging of car parts. The planks can be machined and fitted together using the 'tongue-and-groove' method, to create a stable structure for panels.

### 3.2.2 Reeds

The hollow-tube nature of reeds makes them structurally strong, and if used correctly they can create a panel that can compete with timber [8]. In Brewis' [4] 'Green Walls' project, a fibre-concrete panel was constructed from reeds, fixed together lengthwise in a local weaving style and used as infill material.

### 3.2.3 Particle board

Particle- or chipboard consists of various sized wood particles that are bonded together with a synthetic resin under heat and pressure. The surface finish is Formica, veneer or vinyl [10]. Moisture coming in contact with the particleboard leads to unsightly 'swelling' and decreases structural integrity. Particle board has high compression strength and can be combined with timber's high tensile strength, for I-beams and posts [8].

### 3.2.4 Corrugated Iron

This locally produced building material is mainly used for roofing, but in informal settlements it also doubles as a wall material. Galvanization creates a durable layer on the surface of these sheets, and the s- and IBR- profile gives the sheets high compression strength [9]. It is a robust material but the aesthetic and emotional values are poor and could be improved by covering it with a mat of woven grass or fabrics.

### 3.2.5 Woven mats (Cloth/plastic bags/sweet wrappers)

In the traditional Zulu weaving method *iciceph*, grass bundles are woven together with palm leaves/ rope [11]. This method could utilize waste materials: colourful wrappers and plastic bags. These are woven together with wire or rope resulting in a contemporary style. A similar application has been used successfully in Japan with Toshiko Mori's project, *Woven Inhabitation*, in which she proposes a simple solution to the vast problem of temporary housing after natural disasters: weaving remnants of industrial fabrics originally used in aerospace, medical and fashion industries, into chicken wire [12]. These woven panels require an external structure to render them stable.

## 3.3 Acoustic and Thermal Performance

When designing for internal partitioning, it is essential to consider privacy and comfort. With regard to acoustics, no matter how good an insulator a partition may be, cracks and holes can very quickly nullify its value [13]. Therefore it is important that the wall-to-ceiling and floor connections are designed to minimize sound transmission. Concerning thermal performance, mass is the main factor that determines effective insulation [13]. The properties of the identified materials with regard to thermal conductivity, sound absorption and dry density are evaluated and compared in Table 2.

Table 2: Acoustic and thermal performance of identified materials (Compiled by Greeff A, 2005)

<b>MATERIAL:</b>	Soft wood e.g. pine	Bamboo/Reeds	Particle board	Corrugated Iron	Cloth
Thermal Conductivity (W/m <sup>2</sup> /°C)	0.135	0.09	0.1	40	0.056
Sound Absorption Coefficient @ 500Hz	0.1	--	0.17	--	0.11
Dry density (kg/m <sup>3</sup> )	650	270	500	6800	50

### 3.3.1 Pine planks

Applying the tongue-and-groove method of joining planks minimizes the presence of thermal bridges. Pine has a similar absorption co-efficient to fabric (Table 2). In addition to these two characteristics pine's high dry density (Table 2) makes it the most suitable material acoustically.

### **3.3.2 Reeds**

Reeds have a porous structure and therefore a low dry density [8]. The advantage of these fibrous materials is that sound is absorbed by setting fibres into motion [13], which makes it appropriate for thermal- and acoustic insulation. The more densely the reeds are fixed together, the fewer the open areas and the better the ability of this panel to insulate.

### **3.3.3 Particle board**

Particle board is more dense than reeds and almost as dense as wood. With similar sound absorption and conductivity to the other two natural materials, its defect lies in the inability to perform in its attributes of association (aesthetically) and in strength.

### **3.3.4 Corrugated Iron**

Corrugated iron does not offer much thermal insulation, due to its ability to conduct heat (Table 2). Should a porous waste material (e.g. Polystyrene) be inserted between two 1mm sheets, the insulation properties increase three times, as illustrated in Equations 1, 2 and 3.

### **3.3.5 Woven mats (Cloth/plastic bags/sweet wrappers)**

The materials that can be woven to form mats are anything from sweet wrappers to expensive fabrics. Producing mats of similar densities and thickness, one may assume similar acoustic- and thermal performances between materials. Cloth is not a conductive material and has a low density (Table 2).

## **3.4 Impact on the Environment and Community**

Currently there is great interest in the design of buildings and the choice of their materials and construction so that they may be readily deconstructed. Thus the full lifecycle of the material is considered and used in such a way as to facilitate use and re-use [13].

### **3.4.1 Pine Planks**

This being a natural material, it has a very low embodied energy and is easily machined [8]. As mentioned before, the proximity of Rosslyn Industrial area makes for a cheap source of timber for the frame-/infill material of the panels. Car manufacturers discard crates made of pine planks and vegetable crates, which can be deconstructed and re-used.

### **3.4.2 Reeds**

Reeds are easy to obtain from the banks of the river that flows through Soshanguve [6]. This material is not traditionally a 'waste material' like all the others discussed, it is considered because it can so easily be obtained at no cost. However, it is important to note that reeds need a protective layer against insects, rats and fire [8]. The eco-friendly version of varnish and insect repellent should be applied (those with a water base).

### **3.4.3 Particle board**

Particle board is sustainable in its very composition in that it is a composite board made from waste produced at timber mills [8].

### **3.4.4 Corrugated Iron**

The rigidity of iron allows it to be produced in sheets as thin as one millimetre. However, it is a material with a high embodied energy, making recycling expensive [9]. The re-use of these widely available sheets is a step towards making it a sustainable material for infill systems.

### 3.4.5 Woven mats (Cloth/plastic bags/sweet wrappers)

The countless materials that can be used for these panels make it the most obtainable of all the mentioned infill materials. Industrial waste such as cloth is available from clothing manufacturers, such as Zero Twelve Clothing, situated in Soshanguve [5].

## 4 Composition of Infill panels

### 4.1 Insulation Materials

The materials studied in the previous section cannot function individually as partitioning. Combinations of materials are suggested using the following construction method: two panels of material (6-25mm) are fixed to a timber frame, creating a 60mm cavity; finally insulation is inserted in the cavity (Figure 2 & 3). Insulation is essential for acoustic privacy and thermal comfort [14].

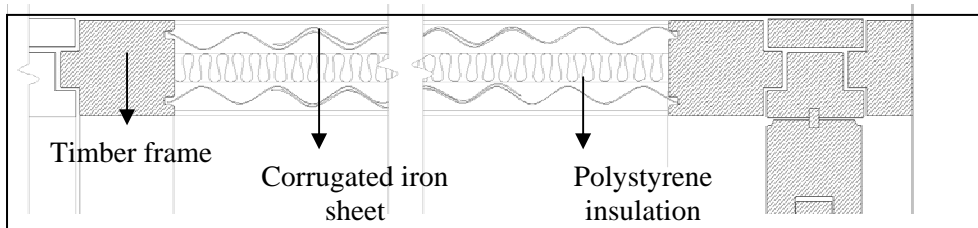

Figure 2: Plan of partitioning: timber frame and corrugated iron infill sheets (Figure by Greeff A, 2005)

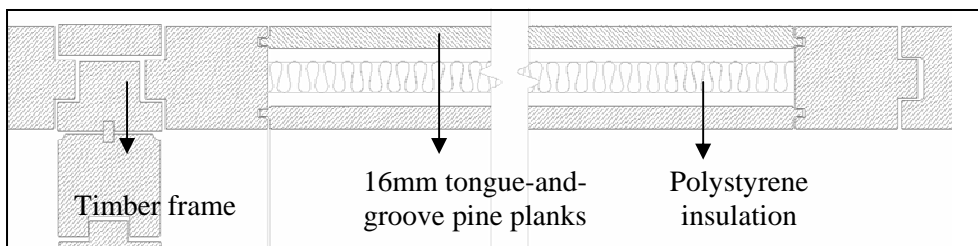

Figure 3: Plan of partitioning: timber frame and tongue-and-groove pine infill (Figure by Greeff A, 2005)

Insulation materials (Table 1) available in Soshanguve are bubble wrap, plastic waste and polystyrene. Polystyrene is the best insulator of the three unfortunately it is the least available material in the area. It could become a future project where Polystyrene used for packaging in Rosslyn is recycled [6]. For the sake of mathematically determining a proposed partition's thermal resistance, the necessary values for each material that it consists of are required. Polystyrene is used in the calculations (Equation 1, 2, & 3) to determine the thermal resistance and acoustic insulation of an 'ideal partition'.

#### 4.1.1 Calculations

In the following calculations, the end value is the thermal resistance / effectiveness of an 'ideal partition': a timber frame with two corrugated iron sheets and polystyrene in the cavity. End values in equations 1 and 2 show the effect of a cavity and insulation material in the cavity when calculated respectively. In these calculations,  $R$  is thermal resistance,  $d_s$  is the thickness of material,  $k_s$  is the thermal conductivity, and  $h_0$  and  $h_i$  respectively denote temperature on either sides of the panel.

For a single 1mm sheet the thermal conductivity  $U$  is:

$$R = \frac{1}{h_0} + \frac{d_s}{k_s} + \frac{1}{h_i}$$

$$R = \frac{1}{25} + \frac{0.001}{57} + \frac{1}{8}$$

$$R \approx 0.04 + 0 + 0.125 \approx 0.165 \text{ m}^2 / ^\circ\text{C} / \text{W}, \quad \text{but} \quad \frac{1}{R} = U$$

$$\Rightarrow U = 6.06 \text{ W} / \text{m}^2 / ^\circ\text{C}$$

[1]

**Equation 1** (Greeff A, 2005)

For two 1mm sheets with a 25mm unventilated air cavity, the thermal conductivity  $U$  is:

$$R = \frac{1}{h_0} + \frac{d_s}{k_s} + \frac{1}{\text{cavity coefficient}} + \frac{d_s}{k_s} + \frac{1}{h_i}$$

$$R = \frac{1}{25} + \frac{0.001}{57} + \frac{1}{6.25} + \frac{0.001}{57} + \frac{1}{8}$$

$$R \approx 0.04 + 0 + 0.15 + 0 + 0.125 \approx 0.315 \text{m}^2 / ^\circ\text{C} / \text{W}, \quad \text{but} \quad \frac{1}{R} = U$$

$$\Rightarrow \underline{U = 3.175 \text{W} / \text{m}^2 / ^\circ\text{C}} \quad [2]$$

**Equation 2** (Greeff A, 2005)

Replacing the air cavity in [2] with polystyrene foam, the thermal conductivity  $U$  is:

$$R = \frac{1}{h_0} + \frac{d_s}{k_s} + \frac{1}{\text{cavity coefficient}} + \frac{d_s}{k_s} + \frac{1}{h_i}$$

$$R = \frac{1}{25} + \frac{0.001}{57} + \frac{0.025}{0.033} + \frac{0.001}{57} + \frac{1}{8}$$

$$R \approx 0.04 + 0 + 0.7575 + 0 + 0.125 \approx 0.9225 \text{m}^2 / ^\circ\text{C} / \text{W}, \quad \text{but} \quad \frac{1}{R} = U$$

$$\Rightarrow \underline{U = 1.084 \text{W} / \text{m}^2 / ^\circ\text{C}} \quad [3]$$

**Equation 3** (Greeff A, 2005)**5 Conclusion**

In conclusion, residents of Soshanguve could apply their indigenous knowledge and local resources, be they waste materials, to the concepts of open building systems and recycling. A number of the waste materials studied have proved suitable for use in interior partitioning. Figures 4 to 8 illustrate possible methods for utilizing the various materials in partitioning systems, from cloth woven into chicken wire or reeds woven together, to tongue-and-groove pine panelling. Since availability of these materials plays a large role, plastic bags, sweet wrappers and cloth rags seem the obvious first choice. However, in the light of physical and environmental requirements it is seen that pine planks are the ideal infill material (Figure 3) for a pre-fabricated timber wall system. Unfortunately wood becomes less desirable in that it will have to be machined, rendering it the most expensive infill material. Therefore in order to produce a partitioning system that is feasible, corrugated iron sheeting should be used as infill (Figure 2). Replacing, moving and altering (Figure 6) these sheets give endless possibilities that can be executed manually. The comfort and therefore the success of such a system will depend, however, on the finish of the surface and the type of insulation in the cavity.

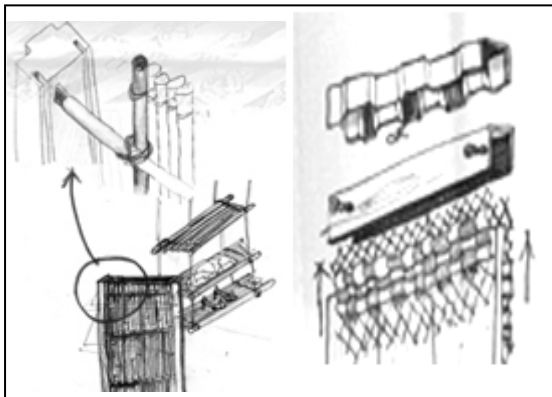

Figure 4: Reeds and woven mats fixed to a timber frame create a partition (Sketch by Greeff A, 2005)

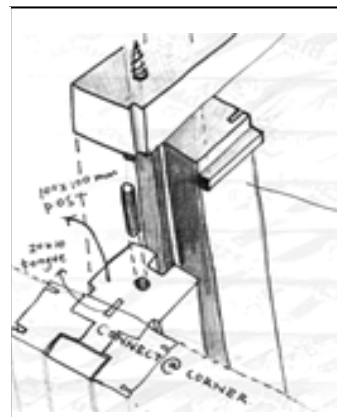

Figure 5: Detail of timber frame fixed to a ceiling (Sketch by Greeff A, 2005)

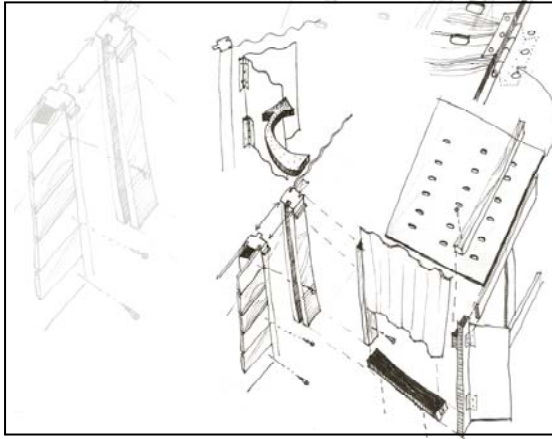

Figure 6: Construction of a partition using the proposed timber frame and re-usable materials. (Sketch by Greeff A, 2005)

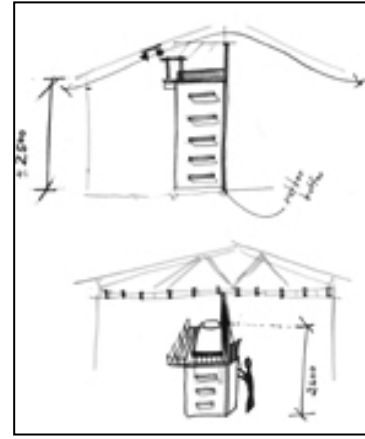

Figure 7: Implementing the partition system combined with a cupboard. (Sketch by Greeff A, 2005)

## References

- [1] Osman, A & Lemmer, C. 2005. Open building principles: an academic exploration in Soshanguve, South Africa. *Open House International*. March 2005. Vol 30. No 1. p71-80.
- [2] Harrison, P., Huchzermeyer, M., Mayekiso, M. 2000. *Confronting Fragmentation: Housing and Urban development in a democratizing society*. Cape Town: University of Cape Town Press
- [3] Habraken, NJ. 1972. *Supports; an alternative to mass housing*. London: The Architectural Press.
- [4] Brewis, D. 2003. Green Walls. Tshwane University of technology. Unpublished Master's dissertation.
- [5] Khontelwayo, Q. Benevolence Project Trust, employee. Survey via telephone, 29 March 2005.
- [6] Makwena, John. Benevolence Project Trust, employee. Survey via fax, 29 April 2005.
- [7] Martin, K. (Ed). 1995. *Guidelines for making social housing affordable*. Social Housing Foundation Johannesburg; pamphlet.
- [8] Marschall, S. and Kearney, B. 2000. *Opportunities for Relevance*. Pretoria: Unisa Press.
- [9] Ashby, M. and Johnson, K. 2002. *Materials and Design*. Oxford: Butterworth-Heinemann.
- [10] Bisonbord. <http://www.pgbison.co.za> (04/05/2005)
- [11] Selepe, M. Honours student at Department of Architecture, University of Pretoria. Personal interview, Pretoria, 25 March 2005.
- [12] Jodido, P. 2001. Woven Inhabitation in *Architecture Now*. Italy: Taschen.
- [13] Lozar, C. C. 1994. Concepts for Recycling construction/ demolition materials: Towards a predictive model. In Sustainable Construction. *Proceedings of the First International Conference of CIB TG 16*, University of Florida, Tampa.
- [14] Flynn, J.E. and Segil, A. W. 1970. *Architectural Interior Systems*. New York: Van Nostrand Reinhold.



XXX IIIAHS  
World Congress on Housing  
Transforming Housing Environments through Design  
September 27-30, 2005, Pretoria, South Africa