



Contents lists available at ScienceDirect

# Renewable and Sustainable Energy Reviews

journal homepage: [www.elsevier.com/locate/rser](http://www.elsevier.com/locate/rser)

## Update on current approaches, challenges, and prospects of modeling and simulation in renewable and sustainable energy systems

Kelvin O. Yoro<sup>a,\*</sup>, Michael O. Daramola<sup>b</sup>, Patrick T. Sekoai<sup>c</sup>, Uwemedimo N. Wilson<sup>d</sup>, Ovevaoghene Eterigho-Ikelegbe<sup>e</sup>

<sup>a</sup> Energy Technologies Area, Lawrence Berkeley National Laboratory, 1 Cyclotron Road, Berkeley, CA, 94720, United States

<sup>b</sup> Department of Chemical Engineering, Faculty of Engineering, Built Environment and Information Technology, University of Pretoria, Hatfield, 0028, Pretoria, South Africa

<sup>c</sup> Department of Biological Sciences, Kadoorie Building, The University of Hong Kong, 999077, Pokfulam, Hong Kong, China

<sup>d</sup> Department of Civil Engineering, Nigerian Defence Academy, P.M.B. 2109, Kaduna, Nigeria

<sup>e</sup> DSI-NRF SARCHI Clean Coal Technology Research Group, School of Chemical and Metallurgical Engineering, Faculty of Engineering and the Built Environment, University of the Witwatersrand, Private Bag X3, Wits, 2050, Johannesburg, South Africa

### ARTICLE INFO

#### Keywords:

Energy systems  
Geothermal systems  
Modeling and simulation  
Model validation  
Renewable energy  
Sustainable energy

### ABSTRACT

Modeling and simulation (M&S) is a well-known scientific tool that could be used to analyze a system or predict its behavior before physical construction. Despite being an established methodical tool in engineering, only a few review articles discussing emerging topics in M&S are available in open literature, especially for renewable and sustainable energy systems. This review critically examines recent advances in modeling and simulation in the energy sector, with few insights on its approaches, challenges, and prospects in selected renewable and sustainable energy systems (RSES). In addition, the concept of model validation in RSES is systematically discussed based on in-sample and out-of-sample approaches, while potential data sources with crucial elements for model validation in RSES are highlighted. Furthermore, three major groups of sustainable energy system models that play important roles in supporting national and international energy policies are presented, to bring to light how the modeling of energy systems is evolving to meet its challenges in the design, operation, and control of RSES. This review also presents a comprehensive assessment of the current approaches, challenges, and prospects in modeling the behavior and evaluating the performance of RSES. Finally, areas that need further research and development in renewable and sustainable energy system modeling are also highlighted.

### 1. Introduction

The development of energy sources that are renewable and sustainable is a critical component in achieving the United Nations' sustainable development goals [1–3]. Although the development of energy systems with renewable and sustainable sources in many industrialized economies is the first step towards attaining global environmental sustainability, studies have shown that meeting the world's energy demands most sustainably has been a major challenge facing humanity since the beginning of the first industrial revolution [4–8]. Therefore, there is a need for an in-depth understanding of sustainable energy systems and their interaction with the environment to optimize their design, operational sustainability, and economic feasibility. Previous studies have defined sustainable energy systems as structures that use energy sources

that are expected to be depleted in a time frame relevant to the human race [9,10]. In this review, a sustainable energy system is defined as a complete structure with energy supply and demand based on renewable energy as opposed to fossil and nuclear fuels.

Substantial research efforts have been made to improve renewable energy production to achieve the sustainability goal initiated by the European Union to reduce energy consumption and CO<sub>2</sub> emission by 20% in 2030 [11–17]. In addition, the tremendous increase in demand for energy in recent times as a result of rapid industrial development and population growth also confirm that the development of renewable and sustainable energy systems is a top priority in many countries of the world today. Thus, it is imperative to not only develop renewable and sustainable energy systems (RSES) for this purpose, but also understand their behavior and performance at different operating conditions. Modeling and simulation is an important and reliable scientific tool that

\* Corresponding author.

E-mail addresses: [koyoro@lbl.gov](mailto:koyoro@lbl.gov), [kelvin.yoroo@gmail.com](mailto:kelvin.yoroo@gmail.com) (K.O. Yoro).

<https://doi.org/10.1016/j.rser.2021.111506>

Received 24 January 2021; Received in revised form 22 June 2021; Accepted 14 July 2021

Available online 21 July 2021

1364-0321/Published by Elsevier Ltd. This is an open access article under the CC BY-NC-ND license (<http://creativecommons.org/licenses/by-nc-nd/4.0/>).

List of abbreviations	
BESS	Battery Energy Storage Systems
EFOM	Energy Flow Optimization Model
ELMOD	Electricity Market Model
HES	Hydro Electric Systems
HOMER	Hybrid Optimization of Multiple Energy Resources
LEAP	Long-range Energy Alternatives Planning System
LEPSMs	Long-term Electrical Power System Models
MAED	Model for Analysis of Energy Demand
MAKRAL	MARKet ALlocation
MAPS	Multi-Area Production Simulation
M&S	Modeling and Simulation
MESSAGE	Model for Energy Supply Strategy Alternatives and General Environmental Impact
NEMS	National Energy Modeling System
OSeMOSYS	Open Source Energy Modelling System
PRIMES	Price-Induced Market Equilibrium System
PROMOD	Production-cost Modeling
ReEDS	Regional Energy Deployment System
RPM	Resource Planning Model
RSES	Renewable and sustainable energy systems
IMPACTS	Simplified Approach for Estimating Impacts of Electricity Generation
SPICE	Simulation Program with Integrated Circuit Emphasis
TIAM	TIMES Integrated Assessment Model
TIMES	The Integrated MARKAL-EFOM System
WASP	Wien Automatic System Planner
WECS	Wind energy conversion system

could be used in this regard.

To date, bench and industrial-scale experiments have been the common approach to studying the behavior and performance of most renewable and sustainable energy systems [18–22]. However, such experiments are usually limited to the operational conditions or situations obtainable in the laboratory. As a result, most investigations on RSES that require conditions that are not feasible in a laboratory or industrial environment are usually ignored, thereby making the generated data or acquired information inadequate for the design of reliable RSES. To circumvent this problem, some researchers have proposed the development and application of mathematical models to predict the behavior of a system at different operating conditions [23–25]. This has unlocked a new prospect for researchers to use and implement the principle of modeling and simulation in RSES. In spite of the substantial research

efforts in the application of modeling and simulation in RSES, little has been reported in the literature about current paradigms, challenges, and prospects of this proposed solution. The main purpose of this study is to systematically review energy system modeling and simulation approaches, challenges, and prospects in selected renewable and sustainable energy systems. The renewable and sustainable energy systems explored in this review include hydroelectric, geothermal, battery energy storage, photovoltaic and wind energy conversion systems.

Modeling and simulation (M&S) have been defined in the past as the application of physical, logical, or mathematical models to describe a system [26,27], an entity [28,29], a phenomenon [30,31], or a process [32,33] to develop data utilized for scientific and technical decision-making. In a typical modeling and simulation problem, numerical analysis skills or a computer program could be used to develop

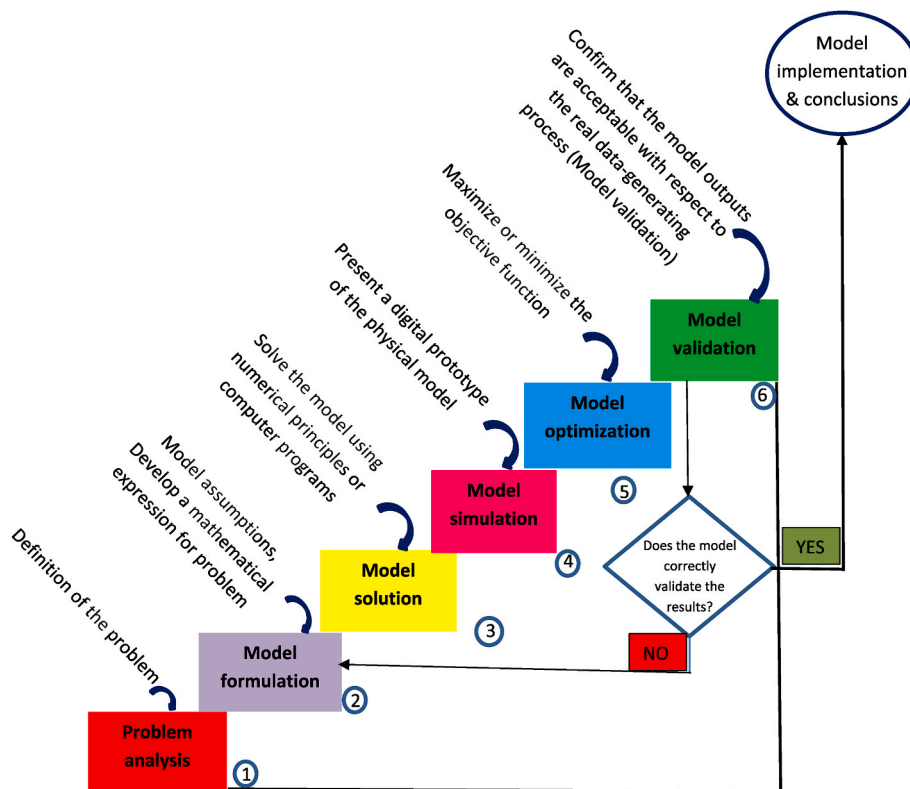

Fig. 1. Schematic steps for modeling and simulation in RSES.

and solve mathematical models containing the most important parameters of a physical system. In such cases, the models developed, together with the assumptions made, are used to represent the physical system in a mathematical form, while simulation starts after the computer calculates and optimizes the solutions of the model conditions and presents the outcome in a machine-readable or human-readable format, depending on the mode of implementation. A proposed step for modeling and simulating RSES from the model development stage to validation and implementation is schematically presented in Fig. 1. Energy models can be used by researchers to study the behavior of complex RSES in detail [34,35]. Therefore, the application of M&S in RSES does not only lead to the advancement of the set-ups, but also leads to the validation of distributed data about the complex interactions in energy systems. Most importantly, modeling and simulation allows policy-makers to comment on how the energy sector needs to be steered to achieve certain policy goals.

Against this background, this review assesses and updates the body of knowledge on the application of M&S techniques in wind energy conversion systems, battery energy storage systems, photovoltaic systems, geothermal systems, and hydroelectric systems for energy generation in the twenty-first century. Additionally, this review evaluates the potential of employing analytical techniques to understand the behavior and evaluate the performance of such systems. Furthermore, this review provides useful information on pressing issues in M&S and how they can be addressed in selected renewable and sustainable energy systems using energy models. The major contribution in this review is the presentation of simplified schematic steps to model and simulate RSES, thereby providing a useful resource and platform for scientists working in this field to conduct their research. Furthermore, the development of a stepwise approach to model, simulate and validate model results for RSES, as well as the presentation of simplified options and steps to fine-tune specific energy models in future research is another unique novelty of this review. It is worth mentioning that as far as could be ascertained, no study has adequately updated the body of knowledge in this field with current approaches, challenges, and prospects of modeling and simulation in the energy sector with a focus on renewable and sustainable energy systems.

## 2. Synopsis of this review

The opening section of this paper summarizes the benefits of modeling and simulation, purpose and the novelty of this review. The third section discusses the concept of renewable and sustainable energy alongside their differences so as to provide a clearer understanding of crucial concepts in the area of sustainability. The application of modeling and simulation, as well as current modeling approaches that are relevant to RSES, are also discussed in this section. Section four presents an exhaustive discussion on the modeling, simulation, and validation of RSES with potential energy modeling tools and software packages available for the development of energy models, as well as a classification of energy system models with crucial elements for validation of RSES. Following that is a discussion section that summarizes the current knowledge on the benefits as well as drawbacks of modeling and simulation in RSES, with the introduction of current paradigms and key challenges arising in the modeling and simulation of RSES, especially cross-disciplinary and integration issues in section six. The prospects of modeling and simulation in selected renewable and sustainable energy systems are discussed in the seventh section of this review for wind energy conversion systems, battery energy storage systems, photovoltaic, hydroelectric, and geothermal systems. Finally, the closing part of this review presents a concluding section embodying the limitations, opportunities, and future outlook in this field. A schematic summary of the research efforts discussed in this review is presented in Fig. 2.

## 3. A brief overview of renewable and sustainable energy

The words “renewable” and “sustainable” have been often used interchangeably by many researchers in the past to describe certain primary energy sources [36–39]. Nevertheless, it is worth noting that these words have very different meanings. Therefore, it is imperative to clarify the distinction between the words “renewable” and “sustainable”. Not every renewable resource is sustainable, therefore, not everything sustainable is essentially renewable. A renewable energy source is naturally restored over time, for example, the growth of new organisms or the natural recycling of materials [40,41]. This means that

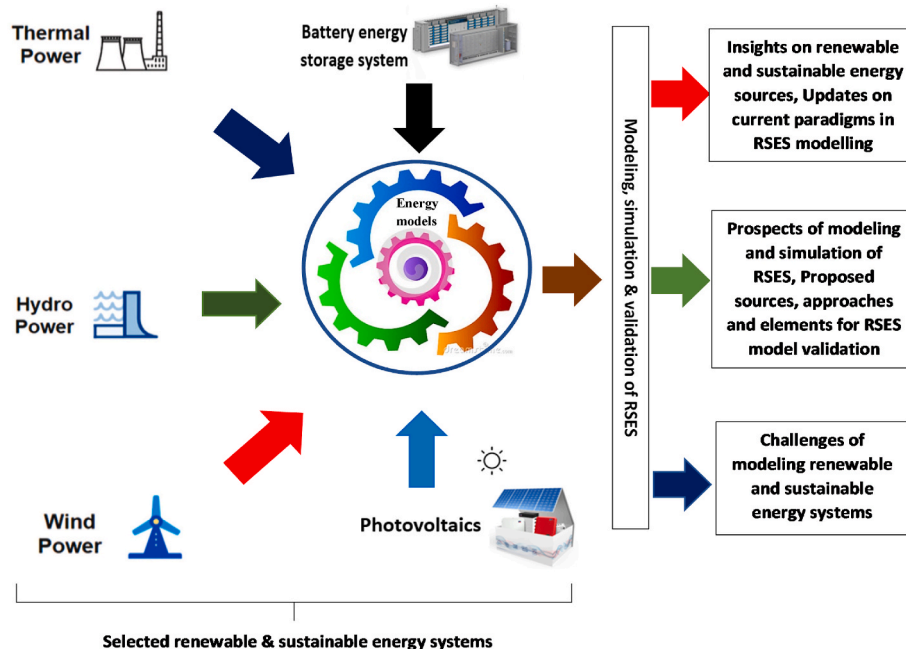

Fig. 2. Graphical representation of the research process in this study.

renewable energy is any energy invention that uses replenishable resources. According to Owusu and Asumadu-Sarkodie [42], renewable energy sources are not quantifiable because there is always the potential to generate more. A renewable resource may be sustainable if used in moderation, but if the consumption rate exceeds the replenishing rate, its continuous use will not be sustainable.

In contrast, sustainable energy is any form of energy that meets current energy demands without running the risk of an unexpected depletion [43]. The use of energy sources that are renewable and sustainable should be widely encouraged because they are environmentally friendly. For energy sources to be sustainable, they must have resources capable of meeting long-term needs. The principle of sustainability requires that its four pillars covering economic, political, social, and environmental factors are considered equally important in describing renewable and sustainable energy systems [44,45]. Therefore, for renewable energy sources to be considered sustainable, they must be economically viable, politically supported, socially equitable, and environmentally acceptable. Although sustainable energy sources are often considered to encompass all renewable sources, it is worth noting that some renewable energy sources do not necessarily meet sustainability requirements. For example, the production of biofuels through the fermentation of ethanol is unsustainable because of the competition of the feedstock employed in the production with the food chain [46–52]. However, most renewable energy sources, such as solar, wind, geothermal, hydro, and tidal are sustainable, as they are stable and available in abundance. Hence, the modeling and simulation of such systems are considered in this review.

#### 4. Modeling, simulation, and validation of RSES

Energy and power system tools can be applied to model the impacts of increasing shares of variable generation at various levels [53,54]. Previous studies have maintained that M&S is the easiest and most cost-effective way to understand, improve, and design a system to achieve improved efficiency, safety, and environmental demands [55–59]. According to the information obtained by imputing phrases like “application modeling and simulation in energy generating systems” and “application of modeling and simulation in renewable and

sustainable energy systems” in Scopus, it was revealed that the application of M&S in energy systems was first reported in 1979 by Ben-Yaacov [60] and so far 1571 articles have been published, while M&S was first applied specifically to RSES studies in 1999 by Martin and Muradov [61]. To date, about 106 articles have been published on the application of M&S in RSES, which shows that the application of M&S in RSES has not been adequately reported. A numerical trend of published articles on the application of M&S in RSES from when it was first reported in literature to date is presented in Fig. 3.

The application of modeling and simulation techniques in RSES extends throughout the life cycle of a plant from offline virtual process concept design to testing and configuration, as well as process development. It is also a useful tool in decision-making, engineering, and operation, thereby covering the whole life span of RSES. In designing sustainable energy systems, modeling techniques could also be used to investigate large amounts of data, while simulations can be used to graphically represent how things might look and feel in such systems.

Sometimes the word “simulation” is used interchangeably with modeling, but in reality, simulation is the result of testing a model because, without a reliable model, there will be no simulation results. A model can be used to reproduce a historical period for validation purposes or to extrapolate data to predict the future in hypothetical studies [62]. Many simulations can be performed with a single model, exploring additional alternatives, or replicating them with each simulation [63]. The main function of a mathematical model is to act as a substitute for reality; especially when it is expensive or inconvenient to produce the actual system; or maybe the actual system is still being designed and does not yet exist. A reliable model is expected to be a less-complicated version of a real system that includes important relationships and omits insignificant details [64,65]. But if variability exists and can be quantified, it can be included in the model to obtain more realistic results.

Typically, a model for the design and evaluation of RSES describes its properties or performance. In RSES, models can be used to describe system design processes, operational patterns, and alter system behavior and performance. In contrast, simulation imitates the evolution of a situation or a system over time. This is achieved by animating behavior, which changes the properties and relationships of model elements. Simulation results are only as good as the fundamental model and its

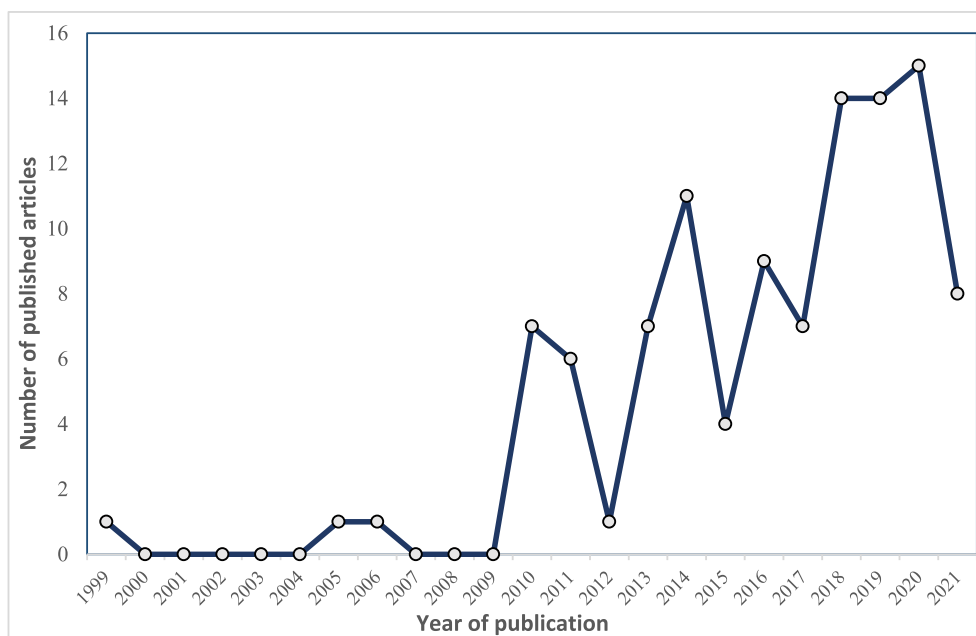

Fig. 3. The numerical trend of published research on RSES from 1999–April 2021.

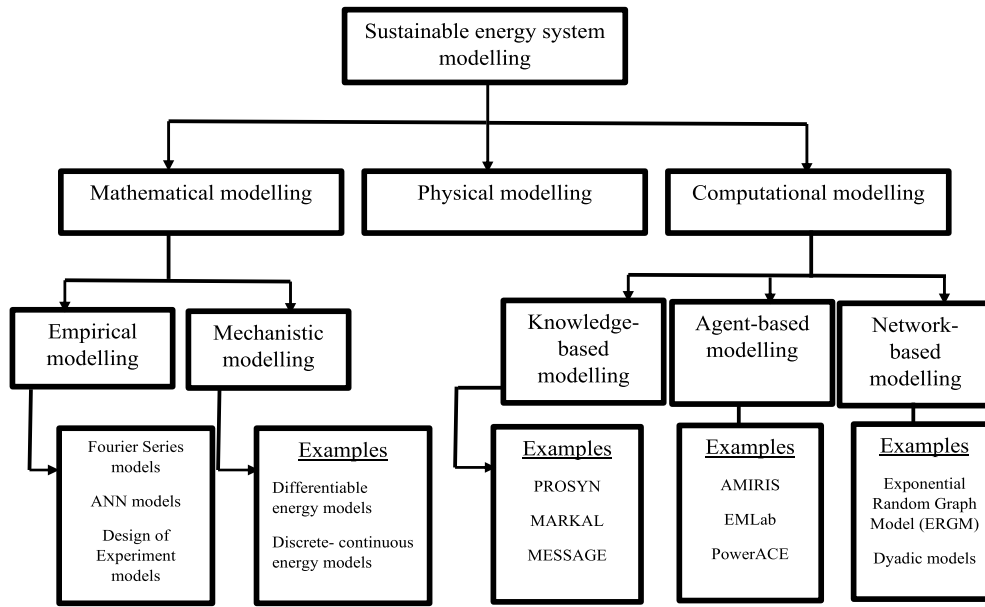

Fig. 4. Energy system model classification based on modeling approach.

assumptions [66,67]. Therefore, engineers, technicians, and system analysts are expected to pay careful attention to the underlying assumptions made during any model development. In this review, modeling and simulation in RSES have been categorized into three broad groups, which largely depend on the modeling approach. A diagrammatic representation of these model groups and subgroups with examples has been developed in this study and presented in Fig. 4. The information available in Fig. 4 reveals that, although physical modeling

is also a reliable modeling approach, it is scarcely used in modeling RSES. Hence the need to further explore the use of physical modeling for RSES in future research. Thus far, computational and mathematical modeling have been the common approaches used in modeling energy systems.

Furthermore, modeling and simulation are mere predictions [68]; hence, model simulation results need to be validated against physical data, and accessibility to data for validating model results has been a

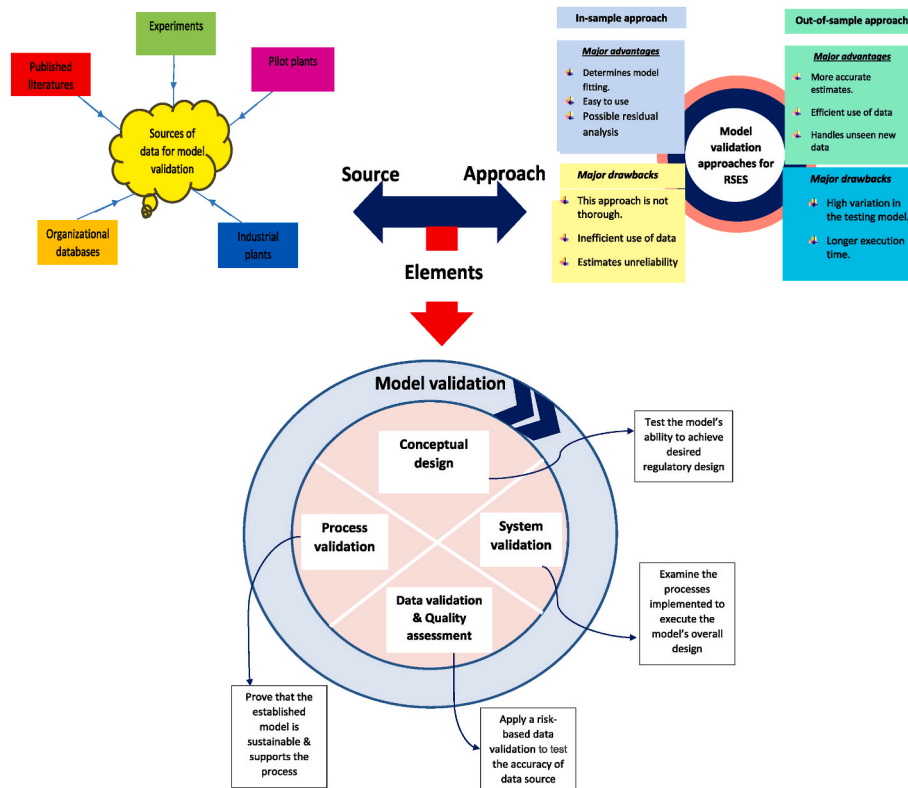

Fig. 5. Proposed data sources, model validation approaches, and elements for RSES.



major limitation in this field. Model validation could be described in the context of regulatory guidance as a set of activities designed to verify that the models performed as intended, based on their design goals and uses. The framework of a model and its available data influence the approach to its validation. Model validation identifies the potential limits and assumptions, then also assesses their possible impact [69]. Model validation encompasses several techniques, which can be broadly classified into two categories (in-sample validation and out-of-sample validation) with slightly different purposes. In-sample validation is concerned with how well the model fits the data on which it was developed. The most common method for in-sample validation is residual analysis. The residuals are an estimate of the error in a model and are calculated by taking the difference between the actual result values and the result values predicted by the model. What is to be determined in the residuals could differ, depending on the type of model being fit.

Out-of-sample validation involves the use of “new” data that is not found in the dataset used to develop the model. This is considered the best method for testing the quality of RSES models to predict results on new unseen data and is sometimes known as cross-validation. In the out-of-sample validation approach, the model is first built on a subsection of the data called the “training set”, and tested on the data that was not used to develop the model which is known as the “test” or “validation” set. This approach enables the modeler to see how good the model is in predicting results for new data. If a validation set of original data is used, the modeler will be able to know what the real-life result is for each data point. This means that the accuracy of RSES models can be assessed by simply comparing the predicted results with the real results. Potential data sources, approaches, and elements for both in-sample and out-of-sample model validation in RSES proposed in this review are presented in Fig. 5.

## 5. Benefits and drawbacks of modeling and simulation of RSES

Before now, some researchers have described M&S as a discipline on its own [70], while others have often assumed that M&S is a pure application due to its numerous application areas [71]. These descriptions and assumptions are not factual because M&S cuts across various disciplines which could also involve other applications.

The application of M&S in the field of engineering is well documented in the literature because simulation technology is a major toolkit for engineers in various areas of application [72], and it has been recently introduced to the body of knowledge for engineering management [73]. Therefore, there are substantial benefits of using simulation-based methods to study the behavior and evaluate the performance of RSES.

Generally, the benefits of M&S cuts across cost savings [74], to a better understanding of the process [65]. In addition, some other benefits of M&S peculiar to RSES include increased product quality and safety. Additionally, M&S provides a possibility to test a system before constructing it physically. Hence, M&S can be used to find unexpected problems during the design of RSES. Energy models can be improved using results from actual experiments, and M&S can be used to speed up or slow down RSES to study changes over a long or short period. In addition, the application of M&S techniques in designing RSES can help the designer to avoid real-life experimentation or testing, which could be expensive, laborious, and slow.

Additionally, valuable perceptions about different choices in the design of RSES could be gleaned from M&S concepts without actually developing the system in real life. M&S could also be used to improve system efficiency through material and energy optimization; thereby increasing system knowledge, as well as improving safety and

environmental management. Finally, the principles of M&S can be used to support experimentations that occur wholly in software packages where system-generated data are needed to meet experimental objectives.

The major drawback of M&S in general is that the results are mere predictions and do not represent real situations. Other drawbacks of M&S in RSES is that the cost of software packages for energy modeling could be exorbitant in some cases; mistakes could also be made in the programming or model assumptions of a simulation problem; understanding and interpretation of some simulation results might also take time, and human reactions to a model or simulation result may not be reliable.

## 6. Current approaches of modeling and simulation in RSES

Before now, the application of modeling and simulation in energy systems has been viewed as a computational activity that algorithmically produces output based on a valid set of input data which provides the necessary information to understand the behavior of a system [75]. In this section, updated approaches, concepts, standards, and theories in three selected energy model groups are discussed.

### 6.1. Power system and electricity market model

The use of power system models to make decisions ranging from investment planning to operational strategies such as the allocation of generators in sustainable power plants (for example hydroelectric power systems) is a common trend in the scientific and engineering community in recent times [76,77]. Power system models are described by exhaustive time variations because a crucial part of an effective power system is the continuous stability between energy demand and supply. Most studies in the past reported that electricity market models are linked to power system models [78,79], but instead of concentrating on important physical characteristics like power balance and grid loads, they focused on electricity markets. Therefore, a combination of different modeling methods involving power systems and electricity markets could be a very helpful tool in understanding the behavior of RSES.

Potential power system models that could be used in simulating RSES as presented in this review include the Wien Automatic System Planner (WASP) and the PLEXOS® simulation software. PLEXOS® simulation software is an economic-centric energy modeling software that uses mathematical-based optimization techniques for energy market forecasting [80,81]. The software is readily available and easy to apply in RSES. It also offers a range of benefits such as enhanced technologies for energy data management, dispersed calculation methods, and a robust simulation system for power generation, while WASP allows the user to get an optimum expansion plan in RSES over a long period according to the conditions set by the energy planner. It is worth noting that both energy models are commercial models that use a conventional dynamic programming algorithm common to power systems instead of the frequently used standard solvers and can be used in large-scale RSES.

Another energy system model that can be used to describe the behavior of RSES is the Electricity Market Model (ELMOD). ELMOD is a bottom-up economic and energy model expressed in the form of a nonlinear mathematical programming problem and used to determine market design for proper investment decisions [82]. ELMOD can also be used to study different congestion management schemes for electricity markets in RSES (for example, wind energy systems) to identify an ideal power plant location decision and to investigate the effect of offshore wind power on the electricity market. Future studies could explore the

application of these energy and electricity market models either individually or in combination with other energy models for performance evaluation in RSES, as this is scarcely reported in this field.

### 6.2. Energy model simulation

Energy simulation models can also be applied in RSES to simulate the behavior, as well as evaluate the performance of energy manufacturers and consumers in response to prices, income, and other signals. Energy models show the logical and theoretical representation of a system and attempt to reproduce how it works. Energy models can simulate technological uptake better than optimization models, but their simulations are often complex due to the requirement for assumptions about their interactive factors [83,84].

In this review, it is envisaged that unlike the commonly used complex mathematical formulation in optimization models, bottom-up simulation models could be built in a modular fashion that incorporates a variety of methods for easy application in RSES. National Energy Modeling System (NEMS) and Price-Induced Market Equilibrium System (PRIMES) are suggested models that can be used to simulate the behavior and performance of RSES in this regard [85]. PRIMES is an economic energy model that could be used to project the production, consumption, conversion, and pricing of energy in RSES, while primary energy sources and carriers such as nuclear/uranium, conventional hydroelectric power, biomass, and other renewable energy systems can be evaluated using NEMS. Additionally, NEMS is made up of a series of submodules solved by a fundamental integration component iteratively. In contrast to NEMS, PRIMES is a segmental system with an integration module [86,87]. The sub-modules in PRIMES represent self-determining agents that can help the model to find a balanced explanation for supply, demand, international energy trade, and emissions [88].

### 6.3. Energy model optimization

Large upstream optimization models (bottom-up models) are the major pillars for M&S in energy studies [89,90]. Bottom-up models that have been used to optimize energy systems in the past focused mainly on the technical components of energy systems [91]. As a result of their complex details, bottom-up models need to make simplifications to remain solvable. To date, the Market Allocation model (MARKAL) and the Model for Energy Supply Strategy Alternatives and General Environmental Impact (MESSAGE) are the two leading groups of established bottom-up models used in energy system optimization [92]. Currently, MARKAL is the most widely used model for optimizing renewable and sustainable energy systems in general. Both models are linear optimization models designed to reduce the overall price of a sustainable energy system. In a typical RSES, the MARKAL and MESSAGE energy models can be used to represent the existence of energy systems on a national, regional, or international basis without discussing the possibility of their evolution. Furthermore, some researchers speculated that by adding another add-on model like Energy Flow Optimization Model (EFOM) to MARKAL, the MARKAL model could be transformed into an integrated MARKALEFOM system, which could be developed into a TIMES Integrated Assessment Model (TIAM) that would be more suitable for optimizing RSES [54]. To date, this interesting speculation has not been fully harnessed for energy optimization in RSES. Therefore, it is a potential area to be considered in future studies.

In addition to the aforementioned energy models currently used by experts in energy system research, it is envisaged that hybrid models could be developed to simulate and optimize energy generation in RSES because most hybrid energy models provide information that pure energy models cannot offer. Discrete energy optimization models have been proposed and tested for optimization in different energy systems in the past [93], but the application of hybrid energy models to optimize RSES is new and has not been adequately reported. Therefore, future studies may consider conducting more detailed research in this area to contribute to the existing body of knowledge in this field. Finally, energy

optimization models may be applied in RSES to determine the ideal blend of technologies with certain constraints and can be used in both top-down and bottom-up approaches. The objective function to be minimized could be expanded to include energy cost, fuel consumption, and carbon emissions.

## 7. Prospects of modeling and simulation in RSES

RSES such as wind and solar, as well as energy storage systems are important components of future energy systems. Modeling and simulation play important roles in the development of these systems. In most cases, the use of models or simulations is the only way to make fair engineering judgments about new process concepts due to the massive scales involved [94]. Hence, the search for a cost-effective, renewable and sustainable energy source with zero carbon emission has led to the exploration of the energy systems discussed in this section.

### 7.1. Wind energy conversion systems

Wind is formed due to the unequal heating of the Earth's surface by the sun, and wind systems can be coupled to an electric grid by power providers (on-grid), or on a stand-alone (off-grid) to generate power [95]. For RSES, small wind electric systems could be a good choice for areas that are not already connected to the electric grid [96]. Modern wind energy is transformed into electricity by converting the rotation of turbine blades into electric current using an electrical generator. However, wind as a source of energy is unpredictable and wind turbines incur high material costs with long construction times [97]. Since the goal of any new technology is to maximize profit, this study suggests that the development of energy models to investigate wind energy conversion systems could be more ideal in investigating the behavior of wind energy conversion systems than using experimental tests which are expensive and time-consuming. To gain a full understanding of the behavior and performance of wind energy conversion systems theoretically, mathematical modeling of such systems should include the dynamics of wind turbines and generator modeling.

A review of previous studies on the performance evaluation of wind energy conversion systems (WECS) reveals that only a few studies have been reported in this area [98]. In most wind energy conversion system studies, researchers have mainly focused on areas such as regional assessment of wind energy [99], wind speed distribution functions [100], the economics of wind energy [101], and area wind energy policies [102]. Thus, no sufficient information has been provided on its actual model development. A schematic diagram of a stand-alone WECS is presented in Fig. 6.

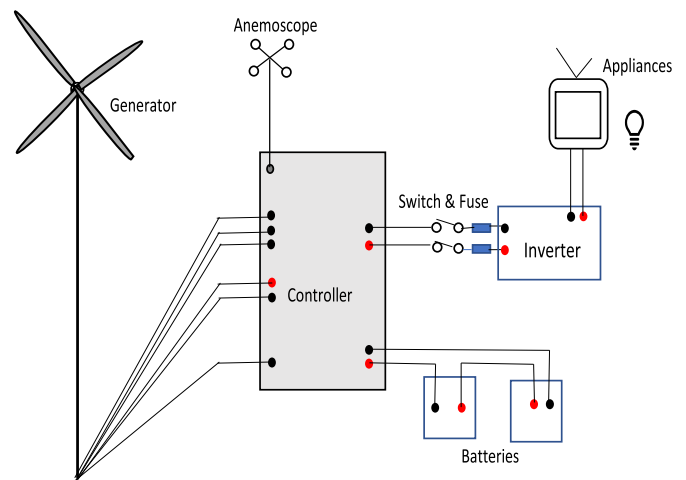

Fig. 6. Wind energy conversion system. Adapted and modified from Emeszuru [103].

Previous studies have established that modeling the behavior of land-based wind energy conversion systems is difficult [104,105], but this becomes even more complex for floating offshore wind energy systems that may be subjected to rolling seas, which might affect their performance. Recent studies reveal that the performance of wind energy systems varies amongst wind turbine models [106–108]. Therefore, selecting an appropriate wind turbine model is fundamental to simulating wind energy systems and their implementation. Furthermore, M&S techniques could be used for wind energy planning, defining the optimum running of wind energy conversion systems, and demonstrating energy efficiency in electricity markets.

Steady-state analysis and dynamic models are the two main groups of energy models that can be applied to analyze the performance of wind energy conversion systems. Steady-state analysis models are simple, while dynamic models for wind energy conversion systems are complex to develop. In this review, it is suggested that the use of dynamic models for WECS should be preferred to using nondynamic models because of their robustness. Dynamic modeling is important in wind energy conversion systems because it can be used for various types of analysis related to system dynamics, stability, control, and optimization. A review of the old and current literature on modeling and performance evaluation of wind energy conversion systems revealed that only a few studies have been reported in this specific area. So far, researchers in this field have mainly explored areas such as modeling regional assessment of wind energy [109], wind speed distribution functions [110] and modeling the economics of wind energy [111]. However, most of the aforementioned studies were based on steady-state analysis and did not consider dynamic modeling approaches. Therefore, the evaluation and modeling of wind energy conversion systems using a dynamic modeling approach is a potential topic that could be considered in future research.

## 7.2. Battery energy storage systems

The modeling and simulation of comprehensive battery energy storage systems (BESS) for power grid use is attracting global attention in recent times due to its reliable storage competence in delivering services and ancillary support for non-programmable renewable energy sources. The literature is rich in studies reporting single-cell BESS [112] and battery pack modeling [113,114] from a system perspective. A few studies have recommended the application of the Newman electrochemical model approach [115,116], while most studies reported in this area have established that battery pack modeling is complicated due to the number of constraints needed to be studied [117]. Apart from the exceptional quality of single-cell models highlighted in previous studies, a battery pack model still needs to consider the manufacturing and aging differences of single-cell models. To provide a more flexible alternative technique for modeling BESS, researchers have suggested the development of battery behavioral models. For example, Kim and Hong [118] studied the ejection behavior of a flooded lead-acid battery cell using a mathematical modeling approach, Bernardi and Carpenter [119] presented a mathematical model to describe the behavior of lead-acid batteries with an oxygen recombination reaction, while Nguyen et al. [120] suggested a flooded-type battery model to investigate the performance behavior of the batteries during discharge relating to cold-cranking amperage and standby volume. However, the major shortcoming in the aforementioned studies is that the battery models used were complex, which made it difficult to express the number of parameters involved. This implies that battery models are subjects that can be applied to assess the hypothetical behaviors of battery designs, but may not be practical in simulating the performance of batteries under any operating conditions.

Typically, a BESS model consists of two parts; the electromechanical transient model and the long-term dynamic model. According to a study reported by Xia et al. [121], a validation of the two parts of the BESS model is done based on the calculation results after first considering it as a single generator system for simulation. The major potential of

modeling and simulations in BESS is that it allows for the analysis of a limitless number of design parameters and operating conditions at a relatively cheap cost. Besides, battery models can also be used to simulate the diffusion of lithium from site to site inside an active particle to help in studying how different crystal structures affect Lithium mobility, how the activation barrier varies with Lithium-ion concentration, and battery models can be used to simulate a BESS using multiple numerical methods.

## 7.3. Photovoltaic systems

Due to strict environmental regulations to achieve sustainable development goals globally, the use of high voltage transmission systems and large power plants for distributed power generation is gradually phasing out in many developed regions of the world [122]. As a result, photovoltaic (PV) systems have attracted tremendous attention in recent times due to their capability to directly convert solar illumination into clean electricity [123]. PV systems are made up of linked components designed to achieve specific goals ranging from powering a small device to feeding electricity into a distribution grid. PV systems are modular because they are built out of several pieces or components which have to be scaled up to build larger systems or scaled down to build smaller systems. The main components of PV systems are the photovoltaic devices themselves, or the solar cells properly assembled with the electronic equipment necessary to connect the system to the other components of the system, such as a storage element in autonomous systems, networks in connected network-to-network systems, and AC or DC loads in DC/DC or DC/AC converters. However, it will be necessary to consider some definite constraints in designing and sizing PV systems while specific models are developed to simulate the electrical behavior.

So far, researchers have made several attempts to model and simulate the performance behavior of PV systems with most of the mathematical models developed based on a current-voltage relationship with simplifications of the double-diode model proposed by Chan and Phang [124]. For instance, Borowy and Salameh [125] presented a basic model to analyze the extreme power output of PV modules after determining its solar radiation and ambient temperature data, while Zhou et al. [126] presented a new simulation model for predicting the array performance of PV systems for engineering applications based on the current-voltage curves of a PV module. In their model, Zhou and co-workers introduced five parameters to account for the complex dependence of PV module performance on the intensity of solar radiation and temperature of the PV module. The major findings from the models reported by the aforementioned researchers are that PV system models are beneficial to engineers in estimating the real operation of the PV modules under quantified working conditions where restricted data is provided by the PV module manufacturers due to the simple nature of the model's underlying assumptions and its easiness to solve. The major shortcoming of the above-mentioned studies is that although the models yielded interesting results, such results have not been validated with real industrial data. A schematic classification of PV systems that can be modeled in future research is presented in Fig. 7.

From Fig. 7, it could be deduced that the main distinguishing factor between the two classifications of PV systems is that in stand-alone systems, the solar energy output is matched to load demands. Many factors influence the development of a PV system [127,128]. Therefore, a complete model for a PV system must quantify how environmental and other factors individually influence the performance of a system. In modeling PV systems, the model structure is usually known, so the task that is left for the modeler is to fine-tune the model according to the options presented in Fig. 8.

The SPICE (Simulation Program with Integrated Circuit Emphasis) model is another mathematical tool with great potential in studying the performance of electrical and electronic circuits of PV systems in a distributed power generation network [129–131]. SPICE is a



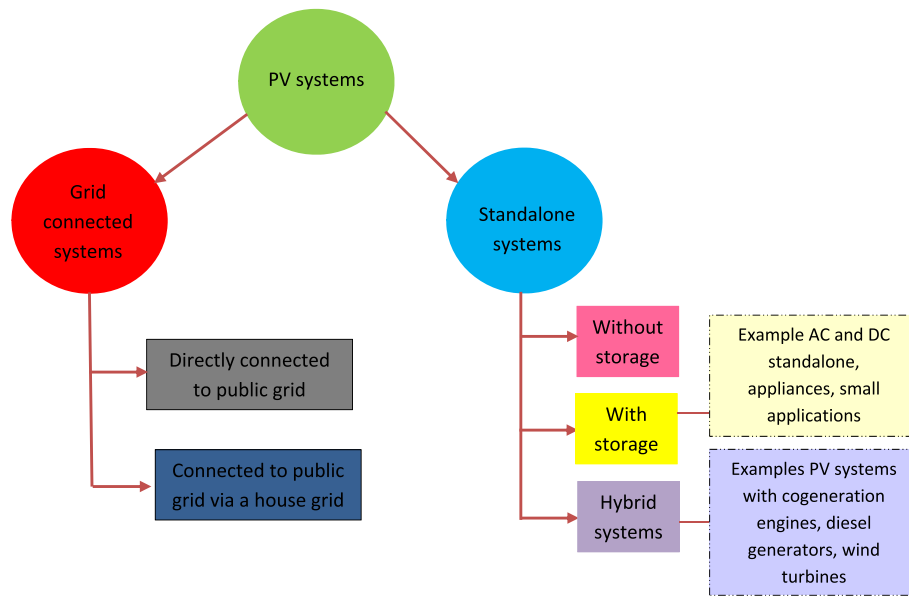

Fig. 7. Classification of PV systems.

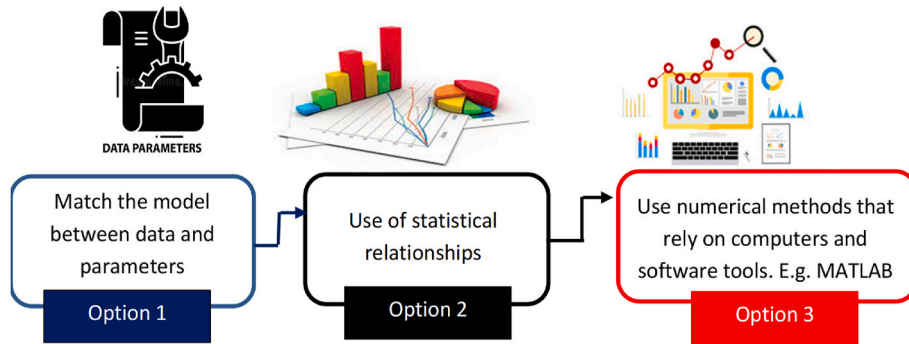

Fig. 8. Proposed options for fine-tuning PV system models.

general-purpose open-source analog circuit simulation package that could be used in a combined circuit and board-level plan to address the veracity of circuit designs and to predict circuit behavior. SPICE modeling could also be used to evaluate the performance of solar cells in a PV network. A SPICE model is a text description of a circuit element used by the SPICE simulator to mathematically guess the behavior of the circuit element in a PV system under varying conditions. Furthermore, it is worthy to note that SPICE models vary from the simplest one-line narratives of a passive component in a PV system such as a resistor to very complex sub-circuits that can be extremely long. The SPICE modeling package could either exist as a PC version (P Spice) or a workstation version (H Spice). However, in recent studies, these two versions have not been adequately harnessed to model PV systems. In this review, it is envisaged that if SPICE modeling is applied in PV systems in future research, sensitivity and distortion analysis, calculation and plotting of frequency spectra, generation of bode plots, and the estimation of DC transfer curves in PV systems could be modeled. In addition to the SPICE modeling approach discussed in this section, neural network modeling may also be tested for PV systems in future research.

#### 7.4. Hydroelectric systems

Hydroelectric systems (HES) play important roles in ensuring a safe, stable, and efficient operation of electric power systems [132,133].

Hence, electricity generation from renewable energy sources including hydropower has gained wide relevance in recent times with different renewable sources delivering up to 30% of electricity globally till 2040 [134,135]. Previous studies have shown that the major challenge in HES modeling is that most of the models do not adequately consider the constraints on HES operations [136,137]. This could be attributed to the shortage of computational resources, unrealistic modeling time needed especially with complex models, or inadequate data to explain hydrological contemplations leading to wrong estimates and the inability of HES facilities to account for flexibility. For effective HES modeling, important model parameters such as the hydraulic surge impedance of the conduit, water starting time in the conduit, storage constant of the surge tank, the relationship between the flow and velocity of water in the conduit, as well as the relationship between the normalized flow and the normalized water velocity in the conduit should be included in the model. Simani et al. [138] submitted that although mathematical models are needed for the description of HES behavior, precise modeling for these processes could be difficult to achieve in practice. Therefore, to precisely model the behaviors and processes in HES, this study suggests that important equations describing the dynamics of the hydroelectric system, such as the flow equation of the conduit, mechanical power, and continuity equations should be correctly represented in the HES model.

Additionally, it is worth stating in this review that the application of production-cost models like Production-cost Modeling (PROMOD), and Multi-Area Production Simulation (MAPS) could be considered for

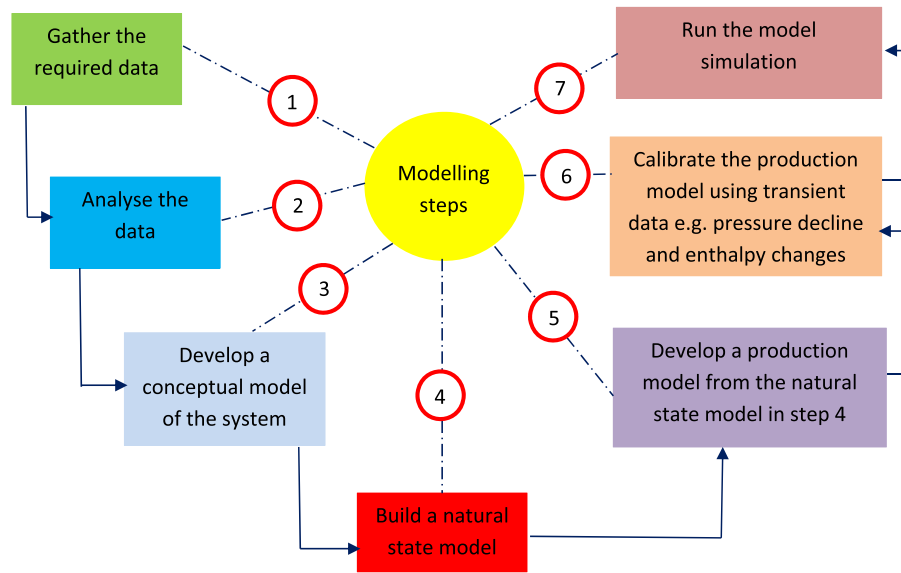

Fig. 9. Proposed steps for modeling geothermal systems.

power system simulation over short time resolutions in HES, because of their potential to model stochastic distributions of inputs like inflows, while capacity expansion models such as the Regional Energy Deployment System (ReEDS), Resource Planning Model (RPM), and selected watershed models could be used to model medium and long-term decisions in HES.

### 7.5. Geothermal systems

According to Moriarty and Honnery [139], geothermal systems have the potential to meet 3–5% of the global energy demand by 2050. Therefore, understanding the behavior and performance of these systems using modeling and simulation techniques is highly sought after. Geothermal modeling is a propitious approach to understanding geothermal energy systems [140]. Important steps in modeling geothermal systems are schematically presented in Fig. 9.

Information presented in Fig. 9 shows that the geothermal modeling process comprises of three important stages. The first stage (Steps 1–2) is the data gathering and analysis stage, stage 2 (steps 3–5) is the model development stage, while the last stage (steps 6–7) is the iteration stage. Geothermal models are complicated and follow several scientific laws. For instance, the law of conservation of mass is expected to govern what goes in and comes out in a geothermal model, the heat conservation law governs the energy expenditure of the model, while Darcy's law may be used to define how hot water and steam move underground in the geothermal system.

Reservoir models are the easiest type of model that could be developed to evaluate geothermal systems because they present much more accurate results, and consider other important external factors. Reservoir models can also be used to explore how a geothermal system is formed, its interactions, and fundamental processes. Dual or single porosity models are also another set of models proposed to study geothermal systems [141]. In a more detailed study, O'Sullivan and O'Sullivan [142] established that although both models can be applied in evaluating geothermal systems, the dual-porosity model is likely to give more accurate results than the single porosity model, especially in cases where there is a possibility of significant interaction between production and injection. Also, the dual-porosity model contains high-penetrability and low-volume fractures entrenched in a low-penetrability matrix. Future studies may consider addressing the issue of model calibration in geothermal systems using both manual methods and inverse modeling software, as this has not been adequately

addressed in recent times. The modeling of engineered geothermal systems that consider the chemistry of geothermal models may also be considered in future research. A summary of the energy modeling and economic software tools for RSES is provided in Table 1.

## 8. Challenges of modeling and simulating RSES

Although modeling and simulation have gained relevance as an essential tool in understanding the behaviors and evaluation of systems performance in science and engineering, it has not fully realized its potential and opportunities in RSES. This section briefly discusses the challenges of modeling and simulation in RSES, and how they can be tackled.

### 8.1. Model uncertainty

Epistemic and aleatory uncertainties are the major challenges associated with the modeling and simulation of energy systems [158]. Although aleatory uncertainties cannot be further minimized, this review opines that epistemic uncertainties may be overcome in RSES modeling if more data or a more flexible model is made available. Furthermore, by applying a deterministic model through the Monte-Carlo approach while varying the input data, uncertainty analysis may be carried out by probing the effects of changes in the input and output data of the model. Stochastic programs may also be developed to deal with uncertainties in energy models [159]. This could be achieved by specifying the distribution of some parameters in the energy model and incorporating any uncertainties into its solutions.

Some researchers have argued that economic energy models mostly describe precise theoretical systems instead of general systems, hence they result in a uniform source of information without other data like experimental or empirical results [160–162]. The researchers further submitted that energy system model outcomes are not verifiable with apparent physical elements, and should be viewed as a basis for probable narratives instead of basic truths. As a result, it was concluded that most problems modeled using energy models cannot be wholly observed and measured. This simply means that such models cannot exhibit a dependable structure across disparities in conditions not computed in the model. Hence, they cannot be accurately corroborated through model validation. More research is required to confirm these claims and the solutions provided.

**Table 1**  
Energy modeling tools and software suitable for RSES.

Energy planning model	Area of application	System type	References
Energy PLAN	Analysis of the large-scale integration of wind and optimal combinations of renewable energy sources	Wind, Combined heat, and power plants	[143–145]
Dispa-SET	Modeling future power systems with a high share of renewables, Balancing, and flexibility of energy grids.	Hydroelectric systems	[146]
LEPSM	Description of power systems with energy storage	Nuclear power plants	[147]
OSeMOSYS	Long-Term Energy Systems Modeling, analysis of energy systems over the medium and long terms.	Energy and electricity systems	[148]
HOMER	Planning of hybrid renewable energy systems	Hybrid Renewable Energy Systems	[149]
SPICE	Performance of electrical and electronic circuits of PV systems in a distributed power generation network	Photovoltaic systems	[150]
MARKAL	Overall price optimization of sustainable energy systems	General RSES	[151]
MAPS	Model stochastic distributions of inputs like inflows	Hydroelectric systems	
LEAP	Energy policy analysis and climate change mitigation assessment, Assessment of water and GHG footprints.	Iron & steel plants, Power generation systems	[152]
WASP	Power system planning.	Power generating system	[153]
SIMPACTS	Evaluation of external costs of different electricity generation technologies, Comparative analyses of fossil, nuclear and renewable electricity generation	Nuclear power plants	[154]
MESSAGE	Mapping energy flows from supply (resource extraction) to demand (energy services)	Energy and electricity systems	[155]
MAED	Evaluation of future energy demands based on medium- to long-term scenarios	General RSES	[156]
PRIMES	Assessment of climate policy in the power sector	Power systems	[157]

## 8.2. Complexity of the modeling domain

Although most energy models are usually developed for specific purposes and audiences, some of them are difficult to integrate within the RSES modeling community, because less scientific attention has been dedicated to creating larger integrated modeling systems. Furthermore, energy systems develop into more intricate and interrelated as they become decentralized, thereby depending on various energy sources with progressively interconnected borders [163]. With these advancements in complexity, some of the existing energy models are unable to sufficiently address all energy optimization problems. This calls for an urgent need to address the complexity of the modeling domain in RSES. According to Highsmith [164] and Boccara [165], complex energy systems are those which do not succumb to compact forms of representation. Based on the findings in this review, it is worth stating that most RSES are perfect examples of such complex systems. Hence, the complexity levels of energy models in RSES are usually offset by the fact that the basic assumptions built into the architecture of a model will determine the accuracy of the model. Sinha and Chandel [166] identified that research on modeling and simulation of energy

systems have consistently used modeling procedures with huge data and hourly profiles of energy usage, therefore in cases where large system and process data are not available, RSES models become difficult to solve.

Finally, most contemporary modeling practices have not adequately addressed the three main features of energy system modeling [167]. This review identified that most energy system modeling research has consistently focused on specific aspects of energy consumption, and only system design models have considered all combined processes in an energy system.

## 8.3. Parameter uncertainty and unavailability

Due to measurement errors, most of the observed data from RSES modeling problems might be uncertain and unavailable [168]. Therefore, there is a need to use substitute data sources or computational correction techniques to improve the accuracy of some energy models. Ideally, all parameters in the model should be expressed alongside their uncertainties, but most studies reported in open literature do not explicitly describe how to deal with parameter uncertainty. In particular, deterministic optimization models are to blame. To tackle data unavailability with parameter uncertainty in RSES modeling, stochastic algorithms like genetic algorithms could be used to provide a set of probabilistic solutions. Other suitable optimization techniques that could be used to tackle this challenge are two-step stochastic programming [169], parametric programming [170], fuzzy programming [171], random constrained programming [172], and robust optimization techniques [173]. Generally, it is necessary to first define the uncertainties of the input parameters and how they feed the modeling methodology in RSES studies before a full model development.

## 8.4. Model integration and assessment

Apart from the two major integrated energy assessment models reported by Collins et al. [174], and Mirakyan and De Guio [175], literature reports on integrated models that consider numerous sectors or disciplines are scarce. Model integration results in both practical and theoretical questions about how different energy models could fit. Activity-based models for RSES present an important prospect for the advancement of bottom-up-based models for resource and energy optimization [176]. Therefore, an extension of these energy demand models to all resources (for example heating, electricity, transport, and fuels) as well as their integration into a coordinated energy network is promising and regarded as an emerging opportunity in the area of energy system modeling.

## 8.5. Policy relevance

The performance of an overall RSES with bottom-up energy models is usually applied to a comparatively narrow set of policy cases [177]. This is a great challenge because the limited perspective neither considers the ancillary effects of policies on an integrated energy system, nor the contradictory effects of other policies. In the face of the multifaceted challenges linked to energy models concerning integrated energy subsystems, the most difficult challenge would be to produce a reliable policy-sensitive RSES model. To address this challenge, energy system model developers should develop models that capture the links between energy systems and subsystems. Modelers should also be mindful of such connections so that model outcomes can be posed in a policy-relevant manner.

## 9. Conclusions and prospects

A large number of energy models have been developed in the past with different formulations, large-scale temporal, and spatial applications. Based on the information obtained from the exhaustive literature

review in this study, it is evident that the principles of modeling and simulation could play a pivotal role in understanding the behavior of renewable and sustainable energy systems owing to their beneficial properties. In addition, this review has identified that there is a scarcity of scientific reports that apply this principle to renewable and sustainable energy systems. To fill this gap, a comprehensive review of the literature in energy modeling for renewable and sustainable energy systems was carried out, and the following major conclusions were drawn;

- The interest in renewable energy consumption is increasing, and detailed energy planning is needed for sustainable development. RSES models are key tools that could be used in assessing better designs, new policies, and related technologies.
- Although modeling and simulation tasks in RSES can now be simplified with the emergence of user-friendly software, the question of model validation in RSES remains unanswered, and in principle, more time will be needed to analyze the model results.
- Macro-economic energy modeling is vital for RSES. As such, high-level modeling techniques like grey prediction, genetic algorithms, fuzzy logic, and particle swarm optimization can be used for macro-economic energy planning in future research to obtain accurate model predictions for RSES.
- The accessibility to quality data for energy system modeling faces a few challenges ranging from open systems to inaccurate boundary definition. Improving the availability of data for RSES modeling is particularly important in energy studies as the demand for clean, renewable, and sustainable energy keeps increasing.
- Model uncertainty, complexity, parameter ambiguity, and unavailability are the major challenges facing modeling and simulation in renewable and sustainable energy systems. These challenges can be tackled by making a robust model assumption, model validation, and revalidation of model results with other data sources.
- Power system, electricity market modeling, energy model optimization approaches could also be used to address the challenges in modeling and simulation of RSES.
- Although different spatial and sequential measures have been applied in previous research to model energy systems, this review identified that the solution and reliability of the resulting models for RSES are sometimes restricted by inadequate data and computational performance.

Finally, this review identified that techno-economic modeling and lifecycle assessment of process models for RSES, as well as its comparison with other electricity generation systems need more attention in future research. For effective modeling and simulation of RSES, future research should develop robust and straightforward modeling techniques that encompass all the behaviors of RSES. Doing this would require an in-depth, comprehensive, and state-of-the-art understanding of modeling and simulation concepts in such systems. Proper tuning and development of important model assumptions for RSES could also be a sure way of producing reliable models in future research. Concerted research efforts in the future should also focus on addressing major issues common with RSES models like model uncertainty and complexity by developing less complex but robust assumptions that adequately capture the behavior of RSES.

#### Credit author statement

Kelvin O. Yoro: Conceptualization, Methodology, Data curation, Writing- Original draft preparation. Michael O. Daramola: Visualization, Writing- Reviewing and Editing. Patrick T. Sekoai: Visualization, Writing- Reviewing and Editing. Uwemedimo N. Wilson: Data curation, Writing- Reviewing and Editing. Orevaghene Eterigho-Ikelegbe: Writing- Reviewing and Editing.

#### Funding

This work did not receive any external funding, but KOY acknowledges Lawrence Berkeley National Laboratory, Berkeley CA, USA for supporting the open access publication of this article.

#### Declaration of competing interest

The authors declare that they have no known competing financial interests or personal relationships that could have appeared to influence the work reported in this paper.

#### References

- [1] Environment, United Nations SDG GOAL 7. Affordable and clean energy. UNEP - UN Environ. Programme; 2017 [Accessed June 2021], <https://www.unep.org/explore-topics/sustainable-development-goals/why-do-sustainable-development-goals-matter/goal-7>.
- [2] United Nations Sustainable Development Goal for Energy and Information and Communications Technologies. Available from: <https://www.un.org/en/chronicle/article/sustainable-development-goal-energy-and-information-and-communications-technologies>. [Accessed June 2021].
- [3] Buonocore JJ, Choma E, Villavicencio AH, Spengler JD, et al. Metrics for the sustainable development goals: renewable energy and transportation. *Palgrave Commun* 2019;5:1–14.
- [4] Yoro KO, Daramola MO. Chapter 1 - CO<sub>2</sub> emission sources, greenhouse gases, and the global warming effect. In: Rahimpour MR, Farsi M, Makarem MA, editors. *Advances in carbon capture*. Woodhead Publishing; 2020. p. 3–28.
- [5] Yoro KO. Integration and synthesis of heat and mass exchanger networks for CO<sub>2</sub> capture in power plants. Thesis; 2020. Available from: <http://wiredspace.wits.ac.za/handle/10539/30079>.
- [6] Moon YB. Simulation modelling for sustainability: a review of the literature. *Int J Sustain Eng* 2017;10:2–19.
- [7] Yoro KO, Sekoai PT. The potential of CO<sub>2</sub> capture and storage technology in South Africa's coal-fired thermal power plants. *Environments* 2016;3:24.
- [8] Yoro KO, Daramola MO, Sekoai PT, Armah EK, et al. Advances and emerging techniques for energy recovery during absorptive CO<sub>2</sub> capture: a review of process and non-process integration-based strategies. *Renew Sustain Energy Rev* 2021;147:111241.
- [9] Kreith F, Krumdieck S. Principles of sustainable energy systems. second ed. CRC Press; 2013. ISBN-13: 978-1466556966.
- [10] Ahuja D, Tatsutani M. Sustainable energy for developing countries. *SAPIENS Surv Perspect Integr Environ Soc* 2009;2(1). <http://journals.openedition.org/sapiens/823>.
- [11] Scarlat N, Dallemand J-F, Monforti-Ferrario F, Banja M, et al. Renewable energy policy framework and bioenergy contribution in the European union – an overview from national renewable energy action plans and progress reports. *Renew Sustain Energy Rev* 2015;51:969–85.
- [12] Bürgin A. National binding renewable energy targets for 2020, but not for 2030 anymore: why the European Commission developed from a supporter to a brakeman. *J Eur Publ Pol* 2015;22:690–707.
- [13] Proskurina S, Sikkema R, Heinimö J, Vakkilainen E. Five years left – how are the EU member states contributing to the 20% target for EU's renewable energy consumption; the role of woody biomass. *Biomass Bioenergy* 2016;95:64–77.
- [14] Bórawski P, Beldycka-Bórawska A, Szymańska EJ, Jankowski KJ, et al. Development of renewable energy sources market and biofuels in the European Union. *J Clean Prod* 2019;228:467–84.
- [15] Mehedintu A, Sterpu M, Soava G. Estimation and forecasts for the share of renewable energy consumption in final energy consumption by 2020 in the European union. *Sustainability* 2018;10:1515.
- [16] Lund H, Mathiesen BV. Energy system analysis of 100% renewable energy systems—the case of Denmark in years 2030 and 2050. *Energy* 2009;34:524–31.
- [17] Lacal Arantegui R, Jäger-Waldau A. Photovoltaics and wind status in the European union after the paris agreement. *Renew Sustain Energy Rev* 2018;81:2460–71.
- [18] Bianchi M, Branchini L, De Pascale A, Orlandini V, et al. Experimental performance of a micro-ORC energy system for low grade heat recovery. *Energy Procedia* 2017;129:899–906.
- [19] Jurasz J, Canales FA, Kies A, Guezgouz M, et al. A review on the complementarity of renewable energy sources: concept, metrics, application and future research directions. *Sol Energy* 2020;195:703–24.
- [20] Prasad AA, Taylor RA, Kay M. Assessment of solar and wind resource synergy in Australia. *Appl Energy* 2017;190:354–67.
- [21] Yoro KO, Amosa MK, Sekoai PT, Daramola MO. Modelling and experimental investigation of effects of moisture and operating parameters during the adsorption of CO<sub>2</sub> onto polyaspartamide. *Int J Coal Sci Technol* 2019;6:225–34.
- [22] Sekoai PT, Ghimire A, Ezeokoli OT, Rao S, et al. Valorization of volatile fatty acids from the dark fermentation waste Streams-A promising pathway for a biorefinery concept. *Renew Sustain Energy Rev* 2021;143:110971.
- [23] Mazur JE. Mathematical models and the experimental analysis of behavior. *J Exp Anal Behav* 2006;85:275–91.



- [24] Subramanian ASR, Gundersen T, Adams TA. Modeling and simulation of energy systems: a review. *Processes* 2018;6:238.
- [25] Yoro KO. Numerical simulation of CO<sub>2</sub> adsorption behaviour of polyaspartamide adsorbent for post-combustion CO<sub>2</sub> capture. Thesis; 2017. Available from: <http://wiredspace.wits.ac.za/handle/10539/22999>.
- [26] Abdullah S, Kamarudin SK, Hasran UA, Masdar MS, et al. Modeling and simulation of a direct ethanol fuel cell: an overview. *J Power Sources* 2014;262:401–6.
- [27] Yoro K, Singo Muofhe M, Daramola MO, Mulopo L. Mathematical modelling of adsorption behavior of sod-ZMOF/chitosan adsorbent during post-combustion CO<sub>2</sub> capture. In: 33rd Annual International Pittsburgh Coal Conference (IPCC 2016), Cape Town South Africa; 2016.
- [28] Adler, M.C., Gonzalez, D.R., Riley, L.P., Gaitonde, D.V., Wall-modeling strategies for large-eddy simulation of non-equilibrium turbulent boundary layers, in: AIAA scitech 2020 forum, American Institute of Aeronautics and Astronautics, n.d.
- [29] Yoro KO, Amosa MK, Sekoai PT, Mulopo J, et al. Diffusion mechanism and effect of mass transfer limitation during the adsorption of CO<sub>2</sub> by polyaspartamide in a packed-bed unit. *Int J Sustain Eng* 2020;13:54–67.
- [30] Yoro KO, Singo M, Mulopo JL, Daramola MO. Modelling and experimental study of the CO<sub>2</sub> adsorption behaviour of polyaspartamide as an adsorbent during post-combustion CO<sub>2</sub> capture. *Energy Procedia* 2017;114:1643–64.
- [31] Luo D, Wang R, Yu W, Sun Z, et al. Modelling and simulation study of a converging thermoelectric generator for engine waste heat recovery. *Appl Therm Eng* 2019;153:837–47.
- [32] Sahinoglu M. Modeling and simulation in engineering. *WIREs Comput Stat* 2013;5:239–66.
- [33] Vakis AI, Yastrebov VA, Scheibert J, Nicola L, et al. Modeling and simulation in tribology across scales: an overview. *Tribol Int* 2018;125:169–99.
- [34] Acha E, Fuente-Esquivel CR, Ambriz-Pérez H, Angeles-Camacho C. FACTS: modelling and simulation in power networks. John Wiley & Sons; 2004.
- [35] Jebaraj S, Iniyar S. A review of energy models. *Renew Sustain Energy Rev* 2006;10:281–311.
- [36] Dincer I. Renewable energy and sustainable development: a crucial review. *Renew Sustain Energy Rev* 2000;4:157–75.
- [37] Hosseini SE, Wahid MA. The role of renewable and sustainable energy in the energy mix of Malaysia: a review. *Int J Energy Res* 2014;38:1769–92.
- [38] Hussain A, Arif SM, Aslam M. Emerging renewable and sustainable energy technologies: state of the art. *Renew Sustain Energy Rev* 2017;71:12–28.
- [39] Wengenmayr R, Bührke T. Renewable energy: sustainable energy concepts for the future. John Wiley & Sons; 2011.
- [40] Bevrani H, Ghosh A, Ledwich G. Renewable energy sources and frequency regulation: survey and new perspectives. *IET Renew Power Gener* 2010;4:438–57.
- [41] Kothari DP, Singal KC, Ranjan R. Renewable energy sources and emerging technologies. PHI Learning Pvt. Ltd.; 2011.
- [42] Owusu PA, Asumadu-Sarkodie S. A review of renewable energy sources, sustainability issues and climate change mitigation. *Cogent Eng* 2016;3:1167990.
- [43] Maczulak AE. Renewable energy: sources and methods. Infobase Publishing; 2010.
- [44] Güney T. Renewable energy, non-renewable energy and sustainable development. *Int J Sustain Dev World Ecol* 2019;26:389–97.
- [45] Kumar M. Social, economic, and environmental impacts of renewable energy resources. *Wind Sol Hybrid Renew Energy Syst* 2020. <https://doi.org/10.5772/intechopen.89494>.
- [46] Connolly D, Lund H, Mathiesen BV. Smart Energy Europe: the technical and economic impact of one potential 100% renewable energy scenario for the European Union. *Renew Sustain Energy Rev* 2016;60:1634–53.
- [47] Sekoai PT, Awosusi AA, Yoro KO, Singo M, et al. Microbial cell immobilization in biohydrogen production: a short overview. *Crit Rev Biotechnol* 2018;38:157–71.
- [48] Sekoai PT, Yoro KO, Bodunrin MO, Ayeni AO, et al. Integrated system approach to dark fermentative biohydrogen production for enhanced yield, energy efficiency and substrate recovery. *Rev Environ Sci Biotechnol* 2018;17:501–29.
- [49] Sekoai PT, Daramola MO, Mogwase B, Engelbrecht N, et al. Revisiting the dark fermentative H<sub>2</sub> research and development scenario – an overview of the recent advances and emerging technological approaches. *Biomass Bioenergy* 2020;140:105673.
- [50] Sekoai PT, Yoro KO. Biofuel development initiatives in sub-saharan africa: opportunities and challenges. *Climate* 2016;4:33.
- [51] Obidike LI, Yoro KO. Effect of zeolitic nano-catalyst on biodiesel yield and biochar formation during the pyrolysis of tallow. *Biofuels* 2021;1:1–10.
- [52] Sekoai PT, Yoro KO, Daramola MO. Batch fermentative biohydrogen production process using immobilized anaerobic sludge from organic solid waste. *Environments* 2016;3:38.
- [53] Després J, Hadjsaid N, Criqui P, Noirot I. Modelling the impacts of variable renewable sources on the power sector: reconsidering the typology of energy modelling tools. *Energy* 2015;80:486–95.
- [54] Ringkjøb H-K, Haugan PM, Solbrekke IM. A review of modelling tools for energy and electricity systems with large shares of variable renewables. *Renew Sustain Energy Rev* 2018;96:440–59.
- [55] Ingemansson A, Bolmsjö GS. Improved efficiency with production disturbance reduction in manufacturing systems based on discrete-event simulation. *J Manuf Technol Manag* 2004;15:267–79.
- [56] Dodds PE, McDowall W. Methodologies for representing the road transport sector in energy system models. *Int J Hydrogen Energy* 2014;39:2345–58.
- [57] Welsch M, Deane P, Howells M, Ó Gallachóir B, et al. Incorporating flexibility requirements into long-term energy system models – a case study on high levels of renewable electricity penetration in Ireland. *Appl Energy* 2014;135:600–15.
- [58] Prina MG, Manzolini G, Moser D, Nastasi B, et al. Classification and challenges of bottom-up energy system models - a review. *Renew Sustain Energy Rev* 2020;129:109917.
- [59] Ozonoh M, Anioke TC, Oboirien BO, Udeh BC, et al. Prediction of emissions and profits from a biomass, tyre, and coal fired Co-gasification CHP plant using artificial neural network: Nigerian and South African perspectives. *J Phys Conf Ser* 2019;1378:022021.
- [60] Ben-Yaacov GZ. Electric utility planning models. In: IEEE PES winter meeting; 1979.
- [61] Martin E, Muradov N. Modeling of sustainable hydrogen production/storage energy systems for remote applications. *ACS Div Fuel Chem Prepr* 1999;44:947–50.
- [62] Ordys AW, Pike AW, Johnson MA, Katebi RM, et al. Modelling and simulation of power generation plants. Springer Science & Business Media; 2012.
- [63] Amiya KJ. Chemical process modelling and computer simulation. PHI Learning Pvt. Ltd.; 2018.
- [64] Geraili A, Sharma P, Romagnoli JA. A modeling framework for design of nonlinear renewable energy systems through integrated simulation modeling and metaheuristic optimization: applications to biorefineries. *Comput Chem Eng* 2014;61:102–17.
- [65] Yoro KO, Isafiade A, Daramola MO. Synthesis of mass exchanger networks using sequential techniques. In: Ao S-I, Kim HK, Amouzegar MA, editors. Transactions on engineering technologies. Singapore: Springer; 2020. p. 173–85.
- [66] Bazmi AA, Zahedi G. Sustainable energy systems: role of optimization modeling techniques in power generation and supply—a review. *Renew Sustain Energy Rev* 2011;15:3480–500.
- [67] Franco A, Vaccaro M. Numerical simulation of geothermal reservoirs for the sustainable design of energy plants: a review. *Renew Sustain Energy Rev* 2014;30:987–1002.
- [68] Lund H, Arler F, Østergaard PA, Hvelplund F, et al. Simulation versus optimisation: theoretical positions in energy system modelling. *Energies* 2017;10:840.
- [69] Yoro KO, Isafiade AJ, Daramola MO. Sequential synthesis of mass exchanger networks for CO<sub>2</sub> capture. In: Proceedings of the world congress on engineering and computer science 2018 vol II WCECS 2018, october 23-25. IAENG; 2018 [San Francisco, USA].
- [70] Allegrini J, Orehoung K, Mavromatidis G, Ruesch F, et al. A review of modelling approaches and tools for the simulation of district-scale energy systems. *Renew Sustain Energy Rev* 2015;52:1391–404.
- [71] Al-abidi AA, Bin Mat S, Sopian K, Sulaiman MY, et al. CFD applications for latent heat thermal energy storage: a review. *Renew Sustain Energy Rev* 2013;20:353–63.
- [72] Calvillo CF, Sánchez-Miralles A, Villar J. Energy management and planning in smart cities. *Renew Sustain Energy Rev* 2016;55:273–87.
- [73] Nunes LJR, Causer TP, Ciolkosz D. Biomass for energy: a review on supply chain management models. *Renew Sustain Energy Rev* 2020;120:109658.
- [74] O'Neill R, Window A, Kenway S, Dargusch P. Integrated operational and life-cycle modelling of energy, carbon and cost for building façades. *J Clean Prod* 2021;286:125370.
- [75] Evins R. A review of computational optimisation methods applied to sustainable building design. *Renew Sustain Energy Rev* 2013;22:230–45.
- [76] Fang H, Chen L, Dlakavu N, Shen Z. Basic modeling and simulation tool for analysis of hydraulic transients in hydroelectric power plants. *IEEE Trans Energy Convers* 2008;23:834–41.
- [77] Bernal-Agustín JL, Dufo-López R. Simulation and optimization of stand-alone hybrid renewable energy systems. *Renew Sustain Energy Rev* 2009;13:2111–8.
- [78] Leuthold F, Weigt H, von Hirschhausen C. Elmod - a model of the European electricity market. Rochester, NY: Social Science Research Network; 2008.
- [79] Assembayeva M, Egerer J, Mendelevitch R, Zhakiyev N. A spatial electricity market model for the power system: the Kazakhstan case study. *Energy* 2018;149:762–78.
- [80] Mahmud K, Soetanto D, Town GE. 5.6 energy management softwares and tools. In: Dincer I, editor. Comprehensive energy systems. Oxford: Elsevier; 2018. p. 202–57.
- [81] Zeljko M, Aunedi M, Slipac G, Jakšić D. Applications of wien automatic system planning (WASP) model to non-standard power system expansion problems. *Energies* 2020;13:1392.
- [82] Egerer J. Open source electricity model for Germany (ELMOD-DE). DIW Data Documentation; 2016.
- [83] Bhattacharyya SC, Timilsina GR. A review of energy system models. *Int J Energy Sect Manag* 2010;4:494–518.
- [84] Pfenninger S, Hawkes A, Keirstead J. Energy systems modeling for twenty-first century energy challenges. *Renew Sustain Energy Rev* 2014;33:74–86.
- [85] Spittler N, Gladkykh G, Diemer A, Davidstottir B. Understanding the current energy paradigm and energy system models for more sustainable energy system development. *Energies* 2019;12:1584.
- [86] Capros YA, Pantelis, Decision support system framework of the PRIMES energy model of the European Commission. *Int J Global Energy Issues* 1999;12:92–119.
- [87] Mantzos L, Capros P. The PRIMES version 2 energy system model: design and features. 2021.
- [88] Krysiak FC, Weigt H. The demand side in economic models of energy markets: the challenge of representing consumer behavior. *Front Energy Res* 2015;3.



- [89] Haydt G, Leal V, Pina A, Silva CA. The relevance of the energy resource dynamics in the mid/long-term energy planning models. *Renew Energy* 2011;36:3068–74.
- [90] Kriechbaum L, Scheiber G, Kienberger T. Grid-based multi-energy systems—modelling, assessment, open source modelling frameworks and challenges. *Energy Sustain Soc* 2018;8:35.
- [91] Berglund C, Söderholm P. Modeling technical change in energy system analysis: analyzing the introduction of learning-by-doing in bottom-up energy models. *Energy Pol* 2006;34:1344–56.
- [92] Hall LMH, Buckley AR. A review of energy systems models in the UK: prevalent usage and categorisation. *Appl Energy* 2016;169:607–28.
- [93] Askarzadeh A. Developing a discrete harmony search algorithm for size optimization of wind–photovoltaic hybrid energy system. *Sol Energy* 2013;98:190–5.
- [94] Li J, Zhou J, Chen B. Review of wind power scenario generation methods for optimal operation of renewable energy systems. *Appl Energy* 2020;280:115992.
- [95] El-Tamaly HH, Mohammed AAE. Computer modeling and simulation of wind energy system connected to utility grid. In: International conference on electrical, electronic and computer engineering, 2004. ICEEC '04.; 2004. p. 879–82.
- [96] Delarue PH, Bouscayrol A, Tounzi A, Guillaud X, et al. Modelling, control and simulation of an overall wind energy conversion system. *Renew Energy* 2003;28:1169–85.
- [97] Roy A, Bandyopadhyay S. Introduction to isolated energy systems. In: Roy A, Bandyopadhyay S, editors. *Wind power based isolated energy systems*. Cham: Springer International Publishing; 2019. p. 1–15.
- [98] Salameh Z. Chapter 3 - wind energy conversion systems. In: Salameh Z, editor. *Renewable energy system design*. Boston: Academic Press; 2014. p. 115–99.
- [99] Rosen K, Van Buskirk R, Garbesi K. Wind energy potential of coastal Eritrea: an analysis of sparse wind data. *Sol Energy* 1999;66:201–13.
- [100] Sfetos A. A comparison of various forecasting techniques applied to mean hourly wind speed time series. *Renew Energy* 2000;21:23–35.
- [101] Milborrow D. Wind energy economics. In: Sayigh A, Milborrow D, editors. *The age of wind energy: progress and future directions from a global perspective*. Cham: Springer International Publishing; 2020. p. 307–26.
- [102] Wang Y, Zhang D, Ji Q, Shi X. Regional renewable energy development in China: a multidimensional assessment. *Renew Sustain Energy Rev* 2020;124:109797.
- [103] Emezuru U. Modeling of small wind energy system. MSc Thesis; 2015.
- [104] Seixas M, Melício R, Mendes VMF. Offshore wind energy conversion system connected to the electric grid: modeling and simulation. In: Camarinha-Matos LM, Falcão AJ, Vafaei N, Najdi S, editors. *Technological innovation for cyber-physical systems*. Cham: Springer International Publishing; 2016. p. 387–403.
- [105] Abubakar U, Mekhilef S, Mokhlis H, Seyedmahmoudian M, et al. Transient faults in wind energy conversion systems: analysis, modelling methodologies and remedies. *Energies* 2018;11:2249.
- [106] Veena R, Manuel SM, Mathew S, Petra I. Parametric models for predicting the performance of wind turbines. *Mater Today Proc* 2020;24:1795–803.
- [107] Veena R, Mathew S, Petra MI. Artificially intelligent models for the site-specific performance of wind turbines. *Int J Energy Environ Eng* 2020;11:289–97.
- [108] Charabi Y, Abdul-Wahab S. Wind turbine performance analysis for energy cost minimization. *Renew Wind Water Sol* 2020;7:5.
- [109] Ganguly P, Kalam A, Zayegh A. 12 - solar–wind hybrid renewable energy system: current status of research on configurations, control, and sizing methodologies. In: Fathima AH, Prabaharan N, Palanisamy K, Kalam A, et al., editors. *Hybrid-renewable energy systems in microgrids*. Woodhead Publishing; 2018. p. 219–48.
- [110] Dorvlo ASS. Estimating wind speed distribution. *Energy Convers Manag* 2002;43:2311–8.
- [111] Elia A, Taylor M, Ó Gallachóir B, Rogan F. Wind turbine cost reduction: a detailed bottom-up analysis of innovation drivers. *Energy Pol* 2020;147:111912.
- [112] Rancilio G, Lucas A, Kotsakis E, Fulli G, et al. Modeling a large-scale battery energy storage system for power grid application analysis. *Energies* 2019;12:3312.
- [113] Dehghani-Sanij AR, Tharumalingam E, Dusseault MB, Fraser R. Study of energy storage systems and environmental challenges of batteries. *Renew Sustain Energy Rev* 2019;104:192–208.
- [114] Dubarry M, Pastor-Fernández C, Baure G, Yu TF, et al. Battery energy storage system modeling: investigation of intrinsic cell-to-cell variations. *J Energy Storage* 2019;23:19–28.
- [115] Gu WB, Wang CY. Thermal-electrochemical modeling of battery systems. *J Electrochem Soc* 2000;147:2910.
- [116] Dubarry M, Baure G, Pastor-Fernández C, Yu TF, et al. Battery energy storage system modeling: a combined comprehensive approach. *J Energy Storage* 2019;21:172–85.
- [117] Li J, Mazzola MS. Accurate battery pack modeling for automotive applications. *J Power Sources* 2013;237:215–28.
- [118] Kim SC, Hong WH. Analysis of the discharge performance of a flooded lead/acid cell using mathematical modelling. *J Power Sources* 1999;77:74–82.
- [119] Bernardi DM, Carpenter MK. A mathematical model of the oxygen-recombination lead-acid cell. *J Electrochem Soc* 1995;142:2631.
- [120] Nguyen TV, White RE, Gu H. The effects of separator design on the discharge performance of a starved lead-acid cell. *J Electrochem Soc* 1990;137:2998.
- [121] Xia T, Li M, Zi P, Tian L, et al. Modeling and simulation of battery energy storage system (BESS) in power system. In: 2015 5th international conference on electric utility deregulation and restructuring and power technologies. DRPT; 2015. p. 2120–5.
- [122] Heuberger CF, Staffell I, Shah N, Dowell NM. A systems approach to quantifying the value of power generation and energy storage technologies in future electricity networks. *Comput Chem Eng* 2017;107:247–56.
- [123] Ciupăgeanu D-A, Lázároi G. Dynamic simulation of a stand-alone photovoltaic/battery energy storage system. In: 2018 international symposium on fundamentals of electrical engineering. ISFEE; 2018. p. 1–5.
- [124] Chan DSH, Phang JCH. Analytical methods for the extraction of solar-cell single- and double-diode model parameters from I-V characteristics. *IEEE Trans Electron Dev* 1987;34:286–93.
- [125] Borowy BS, Salameh ZM. Methodology for optimally sizing the combination of a battery bank and PV array in a wind/PV hybrid system. *IEEE Trans Energy Convers* 1996;11:367–75.
- [126] Zhou W, Yang H, Fang Z. A novel model for photovoltaic array performance prediction. *Appl Energy* 2007;84:1187–98.
- [127] Marion B, Adelstein J, Boyle K, Hayden H, et al. Performance parameters for grid-connected PV systems. In: Conference record of the thirty-first IEEE photovoltaic specialists conference, 2005; 2005. p. 1601–6.
- [128] Pearsall N. The performance of photovoltaic (PV) systems: modelling, measurement and assessment. Woodhead Publishing; 2016.
- [129] Nagel L, Pederson DO. SPICE (simulation program with integrated circuit Emphasis). 1973.
- [130] Castañer L, Silvestre S. Modelling photovoltaic systems using PSpice. John Wiley and Sons; 2002.
- [131] Iero D, Carbone R, Carotenuto R, Felini C, et al. SPICE modelling of a complete photovoltaic system including modules, energy storage elements and a multilevel inverter. *Sol Energy* 2014;107:338–50.
- [132] Yang W, Yang J, Guo W, Zeng W, et al. A mathematical model and its application for hydro power units under different operating conditions. *Energies* 2015;8:10260–75.
- [133] Yang W, Yang J, Zeng W, Tang R, et al. Experimental investigation of theoretical stability regions for ultra-low frequency oscillations of hydropower generating systems. *Energy* 2019;186:115816.
- [134] Conti J, Holtberg P, Diefenderfer J, LaRose A, et al. International energy outlook 2016 with projections to 2040, USDOE energy information administration (EIA), Washington, DC (United States). Office of Energy Analysis; 2016.
- [135] Zsiborács H, Baranyai NH, Vincze A, Zentkó L, et al. Intermittent renewable energy sources: the role of energy storage in the European power system of 2040. *Electronics* 2019;8:729.
- [136] Jardim DLDD, Maceira MEP, Falcao DM. Stochastic streamflow model for hydroelectric systems using clustering techniques. 2001 IEEE porto power tech proceedings, vol. 3. Cat. No.01EX502; 2001. p. 6.
- [137] Guo B, Xu B, Chen D, Ye W, et al. Dynamic modeling and energy distribution analysis in a hydroelectric generating system considering the stochastic turbine flow. *Int J Electr Power Energy Syst* 2018;103:611–21.
- [138] Simani S, Alvisi S, Venturini M. Fault tolerant control of a simulated hydroelectric system. *Contr Eng Pract* 2016;51:13–25.
- [139] Moriarty P, Honnery D. Is there an optimum level for renewable energy? *Energy Pol* 2011;39:2748–53.
- [140] Ghasemi H, Paci M, Tizzanini A, Mitsos A. Modeling and optimization of a binary geothermal power plant. *Energy* 2013;50:412–28.
- [141] Jemuel J, Austria C, O'Sullivan M, Vargas J. Dual porosity models of a two-phase geothermal reservoir. In: In Oral presentation given at the World Geothermal Congress. Melbourne, Australia, 19–25 April 2015; 2015. p. 1–2.
- [142] O'Sullivan MJ, O'Sullivan JP. 7 - Reservoir modeling and simulation for geothermal resource characterization and evaluation. In: DiPippo R, editor. *Geothermal power generation*. Woodhead Publishing; 2016. p. 165–99.
- [143] Lund H. Large-scale integration of optimal combinations of PV, wind and wave power into the electricity supply. *Renew Energy* 2006;31:503–15.
- [144] Lund H. Large-scale integration of wind power into different energy systems. *Energy* 2005;30:2402–12.
- [145] Connolly D, Mathiesen BV. A technical and economic analysis of one potential pathway to a 100% renewable energy system. *Int J Sustain Energy Plan Manag* 2014;1:7–28.
- [146] Pavičević M, Kavvadias K, Pukšec T, Quoilin S. Comparison of different model formulations for modelling future power systems with high shares of renewables—the Dispa-SET Balkans model. *Appl Energy* 2019;252:113425.
- [147] Lai CS, Locatelli G, Pimm A, Wu X, et al. A review on long-term electrical power system modeling with energy storage. *J Clean Prod* 2021;280:124298.
- [148] Dreier D, Howells M, OSeMOSYS-PuLP. A stochastic modeling framework for long-term energy systems modeling. *Energies* 2019;12:1382.
- [149] Bahramara S, Moghaddam MP, Haghifam MR. Optimal planning of hybrid renewable energy systems using HOMER: a review. *Renew Sustain Energy Rev* 2016;62:609–20.
- [150] Moreno A, Julve J, Silvestre S, Castañer L. SPICE macromodeling of photovoltaic systems. *Prog Photovoltaics Res Appl* 2000;8:293–306.
- [151] Savvidis G, Siala K, Weissbart C, Schmidt L, et al. The gap between energy policy challenges and model capabilities. *Energy Pol* 2019;125:503–20.
- [152] Agrawal N, Ahiduzzaman M, Kumar A. The development of an integrated model for the assessment of water and GHG footprints for the power generation sector. *Appl Energy* 2018;216:558–75.
- [153] Vincent I, Lee E-C, Cha K-H, Kim H-M. The WASP model on the symbiotic strategy of renewable and nuclear power for the future of 'Renewable Energy 3020' policy in South Korea. *Renew Energy* 2021;172:929–40.
- [154] Jorli M, Sadeghi H, Naseri A, Agheli L. Estimating the health benefits of improved fuel of the montazer-qam thermal power plant by means of the new version of SIMPACTS. *Iran. Energy Econ* 2018;6:33–56.
- [155] Messner S, Schratzenholzer L. MESSAGE-MACRO: linking an energy supply model with a macroeconomic module and solving it iteratively. *Energy* 2000;25:267–82.

- [156] Capellán-Pérez I, Blas I de, Nieto J, Castro C de, et al. MEDEAS: a new modeling framework integrating global biophysical and socioeconomic constraints. *Energy Environ Sci* 2020;13:986–1017.
- [157] Skoczkowski T, Bielecki S, Węglarz A, Włodarczyk M, et al. Impact assessment of climate policy on Poland's power sector. *Mitig Adapt Strategies Glob Change* 2018;23:1303–49.
- [158] Durga Rao K, Kushwaha HS, Verma AK, Srividya A. Quantification of epistemic and aleatory uncertainties in level-1 probabilistic safety assessment studies. *Reliab Eng Syst Saf* 2007;92:947–56.
- [159] Sahinidis NV. Optimization under uncertainty: state-of-the-art and opportunities. *Comput Chem Eng* 2004;28:971–83.
- [160] Beeck N van. Classification of energy models. 1999.
- [161] Suganthi L, Samuel AA. Energy models for demand forecasting—a review. *Renew Sustain Energy Rev* 2012;16:1223–40.
- [162] Olanrewaju OA, Jimoh AA. Review of energy models to the development of an efficient industrial energy model. *Renew Sustain Energy Rev* 2014;30:661–71.
- [163] Franco A, Salza P. Strategies for optimal penetration of intermittent renewables in complex energy systems based on techno-operational objectives. *Renew Energy* 2011;36:743–53.
- [164] Highsmith J. Adaptive software development: a collaborative approach to managing complex systems. Addison-Wesley; 2013.
- [165] Boccara N. Modeling complex systems. Springer Science & Business Media; 2010.
- [166] Sinha S, Chandel SS. Review of software tools for hybrid renewable energy systems. *Renew Sustain Energy Rev* 2014;32:192–205.
- [167] van Ruijven B, Urban F, Benders RMJ, Moll HC, et al. Modeling energy and development: an evaluation of models and concepts. *World Dev* 2008;36:2801–21.
- [168] Soetedjo A, Lomi A, Widodo Puji Mulayanto. Modeling of wind energy system with MPPT control. In: *Proceedings of the 2011 international conference on electrical engineering and informatics*; 2011. p. 1–6.
- [169] Mavromatidis G, Orehounig K, Carmeliet J. Design of distributed energy systems under uncertainty: a two-stage stochastic programming approach. *Appl Energy* 2018;222:932–50.
- [170] Umeozor EC, Trifkovic M. Operational scheduling of microgrids via parametric programming. *Appl Energy* 2016;180:672–81.
- [171] Sadeghi M, Mirshojaeian Hosseini H. Energy supply planning in Iran by using fuzzy linear programming approach (regarding uncertainties of investment costs). *Energy Pol* 2006;34:993–1003.
- [172] Sanajaoba Singh S, Fernandez E. Modeling, size optimization and sensitivity analysis of a remote hybrid renewable energy system. *Energy* 2018;143:719–31.
- [173] Zhou Y, Wei Z, Sun G, Cheung KW, et al. A robust optimization approach for integrated community energy system in energy and ancillary service markets. *Energy* 2018;148:1–15.
- [174] Collins S, Deane JP, Poncelet K, Panos E, et al. Integrating short term variations of the power system into integrated energy system models: a methodological review. *Renew Sustain Energy Rev* 2017;76:839–56.
- [175] Mirakyan A, De Guio R. Modelling and uncertainties in integrated energy planning. *Renew Sustain Energy Rev* 2015;46:62–9.
- [176] McKenna E, Higginson S, Grunewald P, Darby SJ. Simulating residential demand response: improving socio-technical assumptions in activity-based models of energy demand. *Energy Effic* 2018;11:1583–97.
- [177] Lopion P, Markewitz P, Robinius M, Stolten D. A review of current challenges and trends in energy systems modeling. *Renew Sustain Energy Rev* 2018;96:156–66.