

Preface



“Every people that has produced architecture has evolved its own favourite forms, as peculiar to that people as its language, its dress, or its folklore.... certain shapes take a people’s fancy, and that they make use of them in a great variety of contexts, perhaps rejecting the unsuitable applications, but evolving a colourful and emphatic visual language of their own that suits perfectly their character and their homeland.”
(Fathy, 1976)

A living culture draws on its heritage, depends on it for nourishment and inspiration. The mixture of reference frameworks created by the diversity of cultures in the world establishes the platform for an infinite number of solutions. The life cycle of each individual within these cultures are the main determinant for the presentment of dissolution. The creation of elements through design that stimulate the thought of these diverse cultural individuals is perceived as the ultimate creation.

Contents

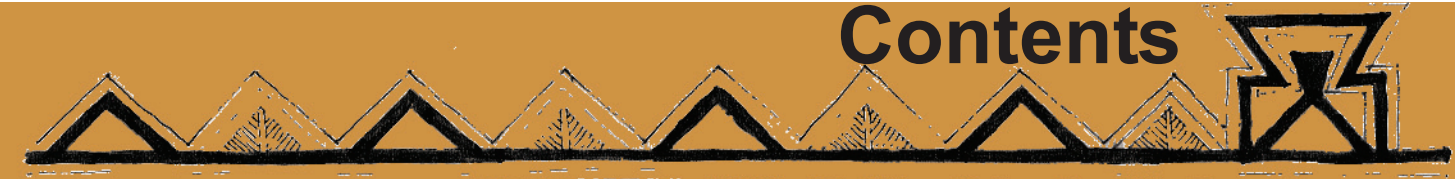

| | | |
|-----------------------------------|---------------------------|---------|
| Preface | |1 |
| Contents | |2 |
| List of figures | |3 |
| Chapter 1 | Introduction |4 |
| 1.1 Objective of study | | |
| 1.2 Problem statement | | |
| 1.3 Sub-problems | | |
| 1.4 Limitations and delimitations | | |
| 1.5 Definitions | | |
| 1.6 Suppositions | | |
| 1.7 Background | | |
| 1.8 Accommodation schedule | | |
| Chapter 2 | Context |9 |
| 2.1 Limpopo province | | |
| 2.2 Soutpansberg region | | |
| 2.3 Makhado municipality | | |
| 2.4 Madi a thavha farm | | |
| Chapter 3 | Baseline |19 |
| 3.1 The ecological footprint | | |
| 3.2 Performance criteria | | |
| Chapter 4 | Site specific |22 |
| 4.1 Site selection | | |
| Chapter 5 | Precedents |26 |
| 5.1 Form re-use | | |
| 5.2 Reading of place | | |
| 5.3 Layering | | |
| 5.4 Passive design | | |
| 5.5 Regional responsiveness | | |
| 5.6 Spatial materials | | |
| 5.7 Sustainability | | |
| Chapter 6 | Design development |34 |
| 6.1 Input - output analysis | | |
| 6.2 Site development | | |
| 6.3 Hierarchy | | |
| 6.4 The "barn" as generator | | |
| 6.5 Passive solar design | | |
| 6.6 Alternative energy sources | | |
| 6.7 Materials | | |
| Chapter 7 | Technical design |47 |
| 7.1 Wall construction | | |
| 7.2 Shading | | |
| 7.3 Space heating | | |
| 7.4 Natural cooling | | |
| 7.5 Infrastructure | | |
| 7.6 Waste management | | |
| Chapter 8 | Drawings |57 |
| Addendum A | |70 |
| Addendum B | |71 |
| Addendum C | |72 |
| Bibliography | |73 |
| Acknowledgements | |74 |

List of figures



| | | | | | |
|------------------|--|------------------|--|----------------|---|
| Fig. 1.3.1 | Sheep shearer barn converted into tourist accommodation | | | Fig. 6.1.1 | Schematic input-output analysis |
| Fig. 1.3.2 | Local kids in Tshiozwi | | | Fig. 6.2.1.1 | Perspective view of existing site viewed from the north |
| Fig. 1.5.1 | Vuyatela Eco-tourism lodge in Sabie Sand | Fig. 2.4.6.2.4.2 | C.S. 1977 | Fig. 6.2.2.1 | Masterplan for new Agri-tourism farm complex |
| Fig. 1.7.1 | Existing agricultural activities | Fig. 2.4.6.2.4.3 | 20th Century Venda "ideal" | Fig. 6.2.3.1 | Central facilities site plan |
| Fig. 1.7.2 | Street arts and crafts with cultural experience in Elim | | | Fig. 6.2.3.2 | Agriculture plant site plan |
| Fig. 1.7.3 | Local labour at Blouberg Mountain | | | Fig. 6.2.3.3 | Part of Accommodation site plan |
| | | Fig. 3.1.1.1 | Ecological Footprint Rating | Fig. 6.5.4.1.1 | Cross section of conference facility |
| | | Fig. 3.1.1.2 | South Africa's ecological footprint | Fig. 6.5.4.2.1 | Longitudinal section of conference facility |
| | | Fig. 3.2.1 | Summary of performance criteria | Fig. 6.6.1 | Eastern elevation of Central facility |
| Fig. 2.1.1 | Map of South Africa | | | Fig. 6.7.1 | Elevation of public ablutions |
| Fig. 2.1.2 | Geographical Regions | | | Fig. 6.7.1 | Plan of public ablutions |
| Fig. 2.2.1 | Southern slopes of Soutpansberg mountains | Fig. 4.1.1.1 | Physical and climatic parameters | | |
| Fig. 2.2.2 | Northern slopes of mountain range | Fig. 4.1.1.2 | Entrance road | | |
| Fig. 2.2.3 | Current visible geology | Fig. 4.1.1.3 | Cliff face | | |
| Fig. 2.2.4 | Local produce | Fig. 4.1.3.1 | Visual assessment and external influences | Fig. 7.1.1.1 | Sitting bench in front of restaurant |
| Fig. 2.2.5 | Stairs at Mapungubwe hill | Fig. 4.1.5.1 | Contour analysis | Fig. 7.1.2.1 | Isometric of Timber and Stone wall |
| Fig. 2.2.6 | The Schoemansdal Pasonage by Paul Mare, Schoemansdal Open Air Museum | Fig. 4.1.5.2 | Site sections | Fig. 7.1.2.2 | Isometric of Reception desk |
| | | Fig. 4.1.5.3 | Zoning map | Fig. 7.1.2.3 | Sandbag and oil drum wall in Restaurant |
| Fig. 2.3.1 | Location Map of Makhado | | | Fig. 7.1.4.1 | Isometric of public ablution wall construction |
| Fig. 2.3.2 | Local art gallery in Elim | | | Fig. 7.1.5.1 | Retaining wall construction at waste recycling storage |
| Fig. 2.3.3 | Village in Elim | Fig. 5.1.1 | Timber roof trusses, Hudson Architects | Fig. 7.2.1.1 | Section of Tourist unit external wall |
| Fig. 2.4.1.1 | Contour model of study area | Fig. 5.1.2 | Sun lit courtyard, Hudson Architects | Fig. 7.3.1.1 | Isometric of underfloor heating in Tourist units |
| Fig. 2.4.1.2 | Location of Madi a Thavha Mountain Farm | Fig. 5.1.3 | Timber structural columns, Hudson Architects | Fig. 7.3.2.1 | Plan: tourist unit |
| Fig. 2.4.2.1 | Ridge where Venda village were located | Fig. 5.1.4 | Shaded southern facade, Hudson Architects | Fig. 7.4.1.3 | Ventilation of Skills training facility |
| Fig. 2.4.3.1 | Packaging of sweet corn | Fig. 5.1.5 | Straw bale wall, Hudson Architects | Fig. 7.4.2.3 | Section through Skills training facility |
| Fig. 2.4.4.1 | Thermal inertia and flywheel effect | Fig. 5.1.6 | Protruding rectangular boxes, Hudson Architects | Fig. 7.5.1.1 | Rainwater harvesting at Restaurant |
| Fig. 2.4.5.1 | Sunrise and Sunset schedule | Fig. 5.1.7 | Double-glazed sliding window, Hudson Architects | Fig. 7.5.1.2 | Rainwater storage tanks |
| Fig. 2.4.6.1.1.1 | Existing farmhouse, southeast elevation | Fig. 5.2.1 | Early sketch of climatic potential, Tropical House. 1996. | Fig. 7.5.2.1 | Solar installation at Agriculture plant |
| Fig. 2.4.6.1.1.2 | Existing pack house and storeroom | Fig. 5.2.2 | Plan of long pavilion, Tropical House. 1996. | Fig. 7.5.4.1 | Water reticulation |
| Fig. 2.4.6.1.1.3 | Sketch of original style and form of existing farmhouse through assumptions and structure analysis | Fig. 5.2.3 | Steel frame junction point, Tropical House. 1996. | Fig. 7.6.2.1 | Section through Eco-San waterless toilet |
| Fig. 2.4.6.1.1.4 | Watercolour presentation of Schoemansdal, A.B. Ellis, 1872, Schoemansdal Open Air Museum | Fig. 5.2.4 | Movable cladding panels, Tropical House. 1996. | Fig. 7.6.3.1 | Artificial wetland |
| Fig. 2.4.6.1.1.5 | Quartzite stone from area used as 'veranda' columns | Fig. 5.2.5 | Aboriginal shelter, Tropical House. 1996. | | |
| Fig. 2.4.6.1.1.6 | Northeastern view of existing swinery and storeroom | Fig. 5.2.6 | Structure & ventilation analysis, Tropical House. 1996. | Fig. 8.1 | Eastern Elevation Agriculture Process Plant |
| Fig. 2.4.6.1.2.1 | 'Kapsteilhuis' at Schoemansdal Open Air Museum | Fig. 5.2.7 | Floating mass above soil, Tropical House. 1996. | Fig. 8.2 | Section of Process Plant |
| Fig. 2.4.6.1.2.2 | Framework of a 'kapsteilhuis' after Walton, J. 1961 | Fig. 5.3.1 | Plan indicating north south axis through site, Otten, K. 2003. | Fig. 8.3 | Eastern Elevation Process Plant |
| Fig. 2.4.6.1.2.3 | Developed 'Kapsteilhuis' with outside cooking area at Schoemansdal Open Air Museum | Fig. 5.3.2 | Permeability from public- to private space, Otten, K. 2003. | Fig. 8.4 | Longitudinal Section of Process Plant |
| Fig. 2.4.6.1.2.4 | Interior of 'Kapsteilhuis', Schoemansdal Open Air Museum | Fig. 5.3.3 | Glass wall and clear-storey windows, Otten, K. 2003. | Fig. 8.5 | Northern Elevation of Process Plant |
| Fig. 2.4.6.1.2.5 | Ox-wagon replica, Schoemansdal Open Air Museum | Fig. 5.3.4 | Fin doors, Otten, K. 2003. | Fig. 8.6 | Section of Workshop |
| Fig. 2.4.6.1.2.6 | 'Kapsteilhuis' lifted onto low walls, Vermaaklikheid, Potgieter, D.J. et al | Fig. 5.3.5 | Lightweight pergola structure, Otten, K. 2003. | Fig. 8.7 | Section through Store rooms |
| Fig. 2.4.6.2.1.1 | Venda hut at Mbilwe, photo by Duggan-Cronin, A.M. | Fig. 5.4.1 | Site plan, Crafford, D.P. 1994. | Fig. 8.8 | Section through Staff Ablution & Kitchen |
| Fig. 2.4.6.2.1.2 | Material used for construction of structures | Fig. 5.4.2 | Bedroom unit plan, Crafford, D.P. 1994. | Fig. 8.9 | Section through Central Facilities |
| Fig. 2.4.6.2.2.1 | Living zones of chief Mphophu's "stat" (1974), photo by Van Der Waal, C.S. 1977 | Fig. 5.4.3 | Section through brick cavity wall | Fig. 8.10 | Western Elevation of Reception |
| Fig. 2.4.6.2.2.2 | Living terraces at Thengwe, photo by Van Der Waal, C.S. 1977 | Fig. 5.4.4 | Section through canvas & roof, Crafford, D.P. 1994. | Fig. 8.11 | Section through Reception |
| Fig. 2.4.6.2.2.3 | Living hut plan, after Van Der Waal, C.S. 1977 | Fig. 5.4.5 | Northwestern view with higher eastern wall, Crafford, D.P. 1994. | Fig. 8.12 | Section through Break-away rooms |
| Fig. 2.4.6.2.2.4 | Cooking hut plan, after Van Der Waal, C.S. 1977 | Fig. 5.4.6 | Gutter and outlet details, Crafford, D.P. 1994. | Fig. 8.13 | Eastern Elevation of Conference Centre |
| Fig. 2.4.6.2.2.5 | Sitting bench, photo by Van Der Waal, C.S. 1977 | Fig. 5.5.1 | South elevation, Beck, H. et al. 1985. | Fig. 8.14 | Section through Restaurant |
| Fig. 2.4.6.2.2.6 | Timber screens, photo by Van Der Waal, C.S. 1977 | Fig. 5.5.2 | North elevation, Beck, H. et al. 1985. | Fig. 8.15 | Longitudinal Section through Restaurant |
| Fig. 2.4.6.2.2.7 | 'Kraal' plan layout, after Van Der Waal, C.S. 1977 | Fig. 5.5.3 | Plan, Beck, H. et al. 1985. | Fig. 8.16 | Section through Arts & Crafts Display Area |
| Fig. 2.4.6.2.3.1 | Authentic, after Van Der Waal, C.S. 1977 | Fig. 5.5.4 | Sun angle manipulation, Beck, H. et al. 1985. | Fig. 8.17 | Elevation of 4xBed Tourist Unit |
| Fig. 2.4.6.2.3.2 | Geometric, after Van Der Waal, C.S. 1977 | Fig. 5.5.5 | Economical space creation, Beck, H. et al. 1985. | Fig. 8.18 | Section through 4xBed Tourist Unit |
| Fig. 2.4.6.2.3.3 | Geometric, after Van Der Waal, C.S. 1977 | Fig. 5.6.1 | "Place of the Wallowing", Rich, P. 2002. | Fig. 8.19 | Section through 4xBed Tourist Unit |
| Fig. 2.4.6.2.3.4 | Threshold, photo by Van Der Waal, C.S. 1977 | Fig. 5.6.2 | View from river, Rich, P. 2002. | Fig. 8.20 | Section of 2xBed Tourist Unit |
| Fig. 2.4.6.2.3.5 | Low yard wall, photo by Van Der Waal, C.S. 1977 | Fig. 5.6.3 | Plan: Detached pavilions, Rich, P. 2002. | Fig. 8.21 | Elevation of 2xBed Tourist Unit |
| Fig. 2.4.6.2.4.1 | "Western" rectangular building, photo by Van Der Waal, | Fig. 5.6.4 | Public space relations, Rich, P. 2002. | Fig. 8.22 | Elevation of Back-to-Back Tourist Unit |
| | | Fig. 5.6.5 | Section through main building, Rich, P. 2002. | Fig. 8.23 | Section of Back-to-Back Tourist Unit |
| | | Fig. 5.6.6 | Defining space boundaries, Rich, P. 2002. | Fig. 8.24 | Section of Staff Unit |
| | | Fig. 5.7.1 | View of Kandalama Hotel, Brawne, M. 1995. | Fig. 8.25 | Section of Staff Unit |
| | | Fig. 5.7.2 | Section indicating design with topography, Brawne, M. 1995. | Fig. 8.26 | Detail of Lean-to roof and Ventilation Panels |
| | | Fig. 5.7.3 | Plan of Kandalama Hotel, Brawne, M. 1995. | Fig. 8.27 | Detail Section through Wind catcher & Cooling system |

Chapter 1

Introduction



The meaning of a place results from accumulated interactions between an individual's life history and a setting.

Place experiences often include some feeling of ownership. Ownership in this case is a psychological phenomenon that does not require legal title to a piece of land or a building, but rather, a sense that the person has some uncommon, special relationship with that particular setting. Although much of what characterizes a place may be very personal. Groups and even entire communities can develop place attachments.

The importance of place may vary from individual to individual. Creating space or an environment for humans where they feel at home, safe, economically enriched, socially enlightened, healthy and enjoying life, are the prerequisites for architecture (we are however creating these spaces for the use by human beings).

1.1 Objective of study

The objective of the study is the design of agri-tourism facilities within the realm of local community development. These facilities need to meet a variety of criteria to fulfil the expectations of the three main stakeholders, being agriculture, tourism and local community. A design that is context, and energy conscious, with a sympathy to existing ecological systems and self-sustainability, will determine the success of this project.

1.2 Problem statement

The problem of the study is the design, including before mentioned criteria, of an agri-tourism complex, where local skills training will form part of the activities on the farm Madi A Thava, Makhado district in the Limpopo province. These facilities must meet the needs of the different clientele for each of the three entities. Each facility has its own identity arising from its specific function. The agri-tourism complex will have a dominant agricultural character, as this facility houses the main activity to ensure self-sustainability of the farm as a whole.

1.3 Sub-problems arising from above statements

1.3.1 Context conscious design

In the design, endemic architecture must be seen as process orientated based on the knowledge of traditional usage and methods. Local materials will be used as much as possible. These materials are ecologically sound and facilitate the upliftment of local workmanship. These methods and materials are also according to human scale (Fig. 1.3.1).



Fig. 1.3.1 Sheep shearer barn converted into tourist accommodation

1.3.2 Energy conscious design.

Embodied energy of materials, future operating costs and maintenance must have a higher priority than initial low capital investment. The project will be a higher energy investment. Local climatic patterns must dictate design possibilities. Alternative energy sources are recommended in order to cut costs of supplying Eskom to rural and untraversable areas.

1.3.3 Socially responsible design

Buildings are built and designed for human beings. Emphasis must be placed on the user friendliness of the layout, material choice, detailing, thermal capacity and workability. The development is for a variety of human

beings with huge differences in their cultural background.

1.3.4 Cultural responsible design

The vast differences in cultural backgrounds that will be present during the operation of this development create a complexity unseen before. The cultural response will be in terms of the historical context of the local community and the sympathetic design in terms of contemporary local cultural trends and lifestyles. The creation of these contemporary styles will emphasize the change these local communities (Fig. 1.3.2) have gone through since being influenced by western civilization.



Fig. 1.3.2 Local kids in Tshiozwi

1.3.5 Biotechnological design

The use of renewable and natural materials is an important consideration that can result in a rich endemic character. The final product must be prolific in ecological lessons for future users. Local labour should be used during construction in order to establish new skills and renew old ones in the surrounding communities.

1.3.6 Self-sustainable

The agricultural sector in South Africa is traditionally seen as self-sustainable; the tourism sector is not. A combination of agriculture and tourism will give the tourism component the necessary elements to be self-sustainable. Tourism is one of the fastest growing sectors in South Africa and will only continue to grow if resources are regenerated instead of being wasted.

1.4 Limitations and delimitations

Conservation of natural resources and the right ecological balance between mankind and environment is of great importance in this development. The operation of the existing activities will be retained but will have to be restructured to make the new development economically feasible. All facilities must form a compact coherence as to not waste any agricultural land. Local materials and skills will be used as far as possible thus trying to exclude high technologically advanced materials and construction methods.

The dissertation will consist of a development framework for the existing farm. This will include the re-structuring of the existing farming activities within the framework. A masterplanning will indicate areas that can be allocated for expansion of the tourism section into exclusive eco-tourism facilities and camping facilities. These allocations will mainly be determined by the requirements of the product offered to tourists and according to the site analysis. A detailed development and design, including before mentioned criteria, of the agri-tourism complex will be done within the proposed framework.

1.5 Definitions

Endemic architecture

Architecture that originated in a specific area or that which belongs to a specific area; that has climated to the area conditions and contributes to its sense of place.

Ecologically conscious

Awareness of natural systems and their mutual relationship with each other. Protection and improvement of these relationships through perspicacious design methodology.

Context

Locally applied precedents (historically and contemporary) and technologies in the Soutpansberg region, Limpopo province.

Agri-Tourism

A practice where tourism is incorporated into the everyday agricultural activities of the farm. Tourists will experience the everyday life of a worker but also as a guest on the farm.

Eco-tourism

Practices that would benefit all concerned parties. Sustainability of resources, economic viability of tourism product, no negative impact on either the environment and local communities, economic benefits flowing to local communities (Fig 1.5.1).



Fig. 1.5.1 Vuyatela Eco-tourism lodge in Sabie Sand

1.6 Suppositions

Suppositions concerning development:

- ~ activities
 - Cultivations of various vegetables
 - immediate packaging of products after harvesting
 - skills training facility for 20 people

- conference facility for 24 people
- tourism accommodation for 54 people
- ~ staff
 - 2 managers
 - 1 assistant manager
 - 1 foreman
 - 6 permanent agriculture staff
 - 20 temporary agriculture harvesting staff
 - 1 chef
 - 4 kitchen assistants
 - 6 temporary cleaning staff
 - 1 site caretaker
 - 2 security staff
- ~ vehicles
 - 1 tractor (Including trailer and implements)
 - 2 commercial vehicles
 - 1 4X4 luxury vehicle
- ~ owner - existing farm owner
- ~ capital - farm owner
- ~ income - self-sustainable, original capital will be supplemented by the income generated from tourism sector and agricultural produce
- ~ for the study it will be accepted that cultural tours will be undertaken to the surrounding areas with farm staff as tour guides.
- ~ it will also be accepted that this development will be used as a model for other similar developments in South Africa.

1.7 Background:

1.7.1 Agriculture

The practice of agriculture has been around since the existence of mankind. Methods used for cultivation purposes has never been managed in correlation with the environment but rather one of getting the most out of the smallest piece of land. The result being arid land depleted of all its minerals and nutrients and never being able to return to its natural state causing permanent damage.

Physical degradation of South Africa's agricultural land results in soil erosion by both water and wind. Another problem is compaction within the soil profile especially in fine sandy soils. The inherent limitations of the natural resource base and variable climate requires land users to be very circumspect in how they use and manage these resources. Ensuring that we manage our inheritance of natural resources with care, so that it provides livelihoods for present and future generations, is the responsibility of all. Those who use land and water must have the incentives, resources and knowledge to use them wisely.

The agriculture sector accounts for 4 to 5% of the Gross Domestic Product (GDP). Its contribution to the overall economy is much greater than is indicated. This is due to the influences of drought periods and good rainfall seasons, that complicate its contribution. The low yields, due to drought, have a negative impact on the national GDP by as much as 0.5 to 2%. A very high figure for a sector which is apparently playing a small role in the economy. Its strong indirect role is a function of backward and forward linkages to other sectors. About 66% of agricultural output is used as intermediate products in the sector. These linkages enhance the sector's contribution to the GDP.

Export earnings of agricultural products, contributes about R10 billion annually. Its share in the country's exports has increased from 8% before 1994 to about 10% in 1997. The share of processed



agricultural products within the country's total agricultural exports has increased from 34 to 50% (National Department of Agriculture). The promotion of efficient small and medium-scale producers, co-existing with large-scale producers, would assist in the realization of its potential. This will also contribute to the Government's objectives of black empowerment, poverty elimination and reduction in inequalities.

South Africa has a dual agricultural economy, comprising a well-developed commercial sector and a predominantly subsistence orientated sector in the rural areas (Fig. 1.7.1). The vision for the agricultural sector implies sustainable profitable participation in the South African agricultural economy by all shareholders. It recognises the need to maintain and increase commercial production, to build international competitiveness and to address the historical legacies that resulted in skewed access and representation. The new land and agriculture policies are designed to accommodate the diversity of agricultural produce in order to reverse the destruction of black farming in South Africa that occurred before our current democratic society was established. Established agriculture has the potential for increased levels of employment and for improving the welfare of farm workers. Small and medium-scale commercial farming, based on family-managed farming producing for the local market, investing in their land, using improved inputs and hiring labour. These create the basis for economic and social upliftment of the immediate communities.



Fig. 1.7.1 Existing agricultural activities

1.7.2 Community Development

A 'community' is a group of people who live and interact in a certain area.

'Development' means improving or bringing to a more advanced state.

Historically, community development was associated with the provision of living areas for financially disadvantaged people in especially developing countries. No consideration was given to uplift these people's social and economic living standards. The environment was never part of these thought processes.



An estimated 16 million South Africans are living in poverty, with the highest percentage, an estimated 70%, being in the rural areas and specifically female-headed households. Poverty in rural areas is associated with agricultural policies which marginalise small scale farmers as their access to resources is limited. A lack of access to adequate, safe and nutritious food, is

closely associated with poverty. While enough food is available at national level, some 30 to 50% of the population is exposed to an imbalanced diet or insufficient food that is a direct result of low incomes (National Department of Agriculture, 1999).



Fig. 1.7.2 Street arts and crafts with cultural experience in Elim

Rural households combine their resources (Fig. 1.7.2) in a variety of ways to enable them to maintain a minimum living standard. These strategies include subsistence farming, off-farm wage labour, Small Medium Macro Enterprises (SMME), pension and reliance on social networks. The opportunities for economic activities are limited for these households. In 1993 it was estimated that only 26% of rural African households had access to land for cultivation and regular wages were the primary source of income for only 32% of these households (National Department of Agriculture, 1999).

| Employment Statistics up to 2004 (DEAT): | |
|---|-------------------------|
| Temporary Jobs: | 34 632 |
| | 45% woman |
| | 22% youth (18-25 years) |
| | 2% with disability |
| Permanent Jobs | 2324 |
| | 45% woman |
| | 15% youth (18-25 years) |
| | 1% with disability |

The South African Government introduced the National Poverty Relief Programme in 1999 as a vehicle to create job opportunities. The Department of Environmental Affairs and Tourism (DEAT, 2005), among others, is a major role player in the implementation of this programme. One of the major advantages in the different employment categories is the non-requirement of high levels of skills and education, thus catering for the grossly unskilled majority which has its highest percentage in the rural areas. This programme started with a budget of R75 million and has increased to a budget of R300 million in 2004/5. This is an indication of government's commitment to poverty alleviation (DEAT, 2005). The main aim for Poverty Relief projects is to ensure that 30% of the funding granted is for community wages (DEAT, 2005). The project is also an economic injection into the local community by making use of local materials, labour and suppliers (Fig. 1.7.3).

The high level of unemployment in South Africa lends itself to the crucial challenge of job creation. In order for job creation to be sustainable, a skills development and training component needs to be incorporated. In all Poverty Relief Projects a min. of 10% of job days need to be utilised for skills development and training.



Fig. 1.7.3 Local labour at Blouberg Mountain

Over 29 672 people have been trained in literacy, numeracy, life skills, managerial skills, vocational and task-related skills and tourism. A total of 1 024 SMME's have been created and are used for construction, manufacturing, retail, tourism and other services (DEAT, 2005)

In his State of the Nation Address of February 2001, President Thabo Mbeki announced 13 rural nodes and 8 urban nodes for initial intervention. The key objectives:

- investment in economic and social infrastructure
- promotion of human resource development
- development of enterprises
- development of local government capacity
- alleviation of poverty
- strengthening of the criminal justice system within the nodes (DEAT, 2005)

The major challenge is to manage development in such a way that economic, social and environmental sustainability are ensured. Development requires the understanding that a healthy environment and a healthy economy are both necessary for a healthy society. These three parts must be taken into account when planning for the future. Establishing a more sustainable culture in these communities.

1.7.3 Tourism

1.7.3.1 Historical

people travelling to foreign destinations started at the end of the 19th century. International tourism is one of the largest and fastest growing sectors of the global economy (since 1950, tourist arrivals increased nearly 28-fold). Although tourism is currently being dampened by terrorism, it is estimated that it will again double by the year 2020 (Mastny, 2001).

The potential of tourism for job creation before 1994, was untested in South Africa. All tourism products was predominantly white owned and no communities were involved.

Since 1994, the tourism industry in South Africa changed dramatically. The annual number of visitors in 1994 stood at 3.7 million (DEAT, 2005). The South African government realised the potential of tourism as a means to generate jobs and foreign revenue. In 1996 the White Paper on the Development and Promotion of Tourism in South Africa was developed. This paper was established to guide the future rate of tourism. The White Paper instituted the vision of a tourism industry that would be government-led, private-sector driven and community-based. Responsible tourism is the key

guiding principle, set by the White Paper, for tourism development in the country. Tourism is South Africa's main objective to enhance its role as driver of socio-economic developments.

After the 1994 elections, an immediate rise in the number of foreigners occurred. By 1998, the annual number of visitors to South Africa increased to 5.7 million (DEAT, 2005). The increasing international terrorism threats proved an unexpected catalyst for tourism growth in South Africa. The country has been seen as a safe destination in terms of terrorism. The three major contributors to South Africa as a destination are its tourism product platform, cultural diversity and natural beauty. In 2002 a Tourism Growth Strategy was launched. Core markets were identified and a more focused marketing strategy was developed and implemented. The main objective for this focused marketing was to

increase tourist arrivals, increase spending, increase length of stay and promote the geographical spread of tourists. Amid a decline in global international arrivals, the foreign tourist arrivals in South Africa grew by 11.1% to 6.4 million. South Africa became the fastest growing tourism destination in the world.

1.7.3.2 Domestic

In May 2004 a Domestic Tourism Growth Strategy was launched by DEAT and SA Tourism. The domestic and international markets are comparable in terms of size and value. The 6.5 million international arrivals in 2003 undertook 53.9 billion trips compared to the domestic market's 49.3 million that is valued at R47 billion (DEAT, 2005). Research done by statutory bodies indicates that only 20% of the domestic population take trips for holiday purposes.



There is an opportunity to expand the domestic market extensively. A vibrant domestic tourism market will lead to improved quality in product and services, as well as improved occupancy levels. It will also reduce the exposure of the industry to the extremely sensitive international market. The international markets are easily influenced by global political and economical factors.

1.7.3.3 Equity

South Africa has an abundance of world-class tourism resources and products. The South African Government has embarked on a policy for the development of black-owned and operated tourism products since these are minimal. Their two main objectives are to build a world-class destination and integrate historically disadvantaged communities into the tourism economy.

1.7.3.4 Communities

As tourism is one of the key drivers for job creation in South Africa, the potential of SMME's are valued as one of the bigger contributors to the local economy. These SMME's operate directly or indirectly within the tourism industry and will contribute to poverty alleviation, job creation and black economic empowerment.

A number of instruments are available for funding and support for the establishing of these SMME's. Some are:

- Small Medium Enterprise Development programme
- The Development Bank of South Africa
- The Industrial Development Corporation

1.7.3.5 Resources

The South African Government has initiated the creation of various institutions to develop a skilled human resource platform and to ensure high quality service in the tourism industry. The tourism industry remains the world's least regulated industry. The failure of many tourism products can be ascribed to the incorrect management programmes and insufficient incorporation of vernacular resources. An assessment of environmental, social and economic impacts must be a prerequisite to developing tourism.

The tourism industry can stimulate investments, generate foreign exchange earnings, create jobs and diversify the economies of developing countries .

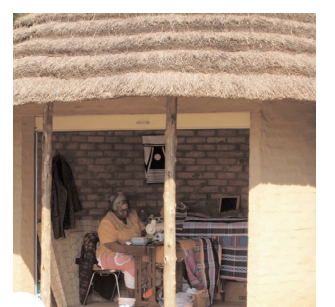

Tourism Economy

- * In 2002, generated R108.5 million
- * Direct impact on economy estimated at 492 700 jobs
 - * Representing 3% of total employment
 - * R31.1 billion of GDP (3%)
- * Total impact on economy is 1 148 000 jobs
 - * 6.9% of total employment
 - * R72.5 billion of GDP (7.1%)
- * Supports R43.8 billion in export services and merchandising
 - * 12.5% of total exports
 - * R17.1 billion of capital investment
- * Government expenditure on tourism - R920 million a year

Responsible Tourism

"an absolute necessity if South Africa is to emerge as a successful international competitor"

(White Paper on the Development and Promotion of Tourism in South Africa, 1996)

In 2002, a major step was taken with the inception of the yearly Imvelo awards for Responsible Tourism and in 2003, with the introduction of the Fair Trade in Tourism South Africa trademark.

Responsible tourism promote principles that emphasise accountability to:

- the environment through balanced and sustainable tourism activities
- local communities living near tourist attractions
- local culture, through preventing over-commercialization and exploitation, and through promoting respect
- the safety, security and health of visitors
- employers and employees, both to each other and to their customers

1.8 Accommodation Schedule:

| | | | | | | | | |
|-------|----------------------------------|---|--|---------------------|---|--|---|---|
| 1.8.1 | Reception: | Foyer Workstation Asst Manager's office Manager's office Kitchenette Safe Cleaning store Storeroom | 30m ² 6m ² 18m ² 20m ² 16m ² 6m ² 1m ² 1m ² | 98m ² | Foreman office Safe Kitchenette Bathroom External working areas | 20m ² 6m ² 8m ² 4m ² | 335m ² | Solar installation Donkey boilers Electrical fencing Arable land Cultivation Tunnels Orchards Hiking trails |
| 1.8.2 | Restaurant (40 people): | General store Cold store Food preparation Wash-up Back of House Dining area (internal) (external) Bar Lounge Staff ablutions Waste recycle | 25m ² 12m ² 30m ² 10m ² 55m ² 42m ² 32m ² 15m ² 22.5m ² 15m ² 15m ² | 258.5m ² | 1.8.9 Nutrient Storage: | Chemical store Fertilizer store General store | 32m ² 32m ² 32m ² | 96m ² |
| 1.8.3 | Lapa Area (24 people): | Seating/Fireplace Bar/Servery | 50m ² 15m ² | 65m ² | 1.8.10 General Storage and Maintenance: | Workshop Storeroom Machinery store Vehicle store 4xRecycling areas(10m ² x4) | 28m ² 6m ² 60m ² 55m ² 40m ² | 189m ² |
| 1.8.4 | Laundry Area: | Wash-up Sorting and Ironing Linen store Chemical store Laundry Line External wash-up | 4m ² 16m ² 6m ² 2m ² | 28m ² | 1.8.11 Temporary Staff (26 people): | Ablutions Male Female Changing/Locker Rooms Dining area | 25m ² 25m ² 16m ² 20m ² | 86m ² |
| 1.8.5 | Conference Facility (40 People): | Seating Display area Storeroom 3xBreakaway rooms (16m ² x3) | 70m ² 40m ² 24m ² 48m ² | 182m ² | 1.8.12 Permanent Staff Units (2 bed): | Stoep Kitchen/Dining Lounge Bedroom Bathroom 5 Units(40m ² x5) | 6m ² 9m ² 6m ² 12m ² 7m ² | 200m ² |
| 1.8.6 | General Ablutions: | Male Female Disabled | 25m ² 25m ² 8m ² | 58m ² | 1.8.13 Standard Tourist Unit (2 bed): | Stoep/deck Kitchen/Dining Lounge Bedroom Bathroom 6 Units | 9m ² 10m ² 6m ² 12m ² 9m ² | 46m ² x6 276 m ² |
| 1.8.7 | Skills Training: | 3xTraining halls (43m ² x3) 3xStore rooms (12 ² x3) Display area Waste recycling stores 10xDormitories (2bed): Bedr 12m ² Entr 10m ² (22m ² x10) Kitchenette Dining | 129m ² 36m ² 72m ² 22m ² 220m ² 12m ² 32m ² | 501m ² | 1.8.14 Standard Tourist Unit (4 bed): | Stoep/deck Kitchen/Dining Lounge Bedroom Bathroom 3 Units | 11m ² 13m ² 8m ² 24m ² 11m ² | 67m ² x3 201m ² |
| 1.8.8 | Pack House Complex: | Packing and sorting Temporary storing General storeroom Cleaning store Cold room Loading zone Manager office | 144m ² 36m ² 36m ² 8m ² 36m ² 12m ² 25m ² | | 1.8.18 Site-works: | Vehicle Parking Deliveries Swimming Pool Water Towers Pump Room Dams for Irrigation Rain water storage Storm water reticulation Artificial wetland systems Septic Tanks Road infrastructure Vegetable gardens | | |

Chapter 2

Context

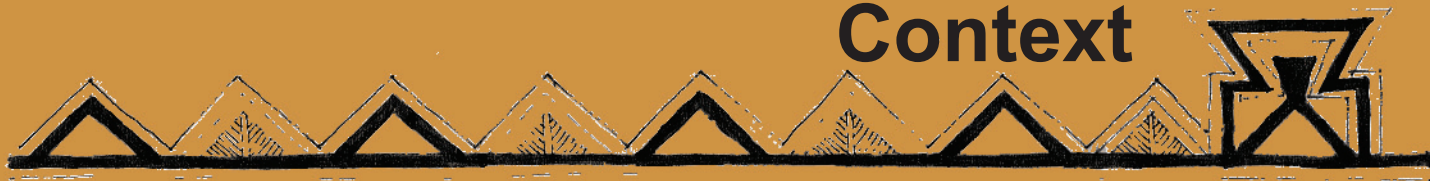

INFORMEL SETTLEMENT.

NEW MATERIALS AVAILABLE & WESTERN INFLUENCE.

• HEAD OF TRIBE ALWAYS PROTECTED THE BEST & HIGHEST POSITION TO HAVE VIEW OVER HIS TERRITORY.

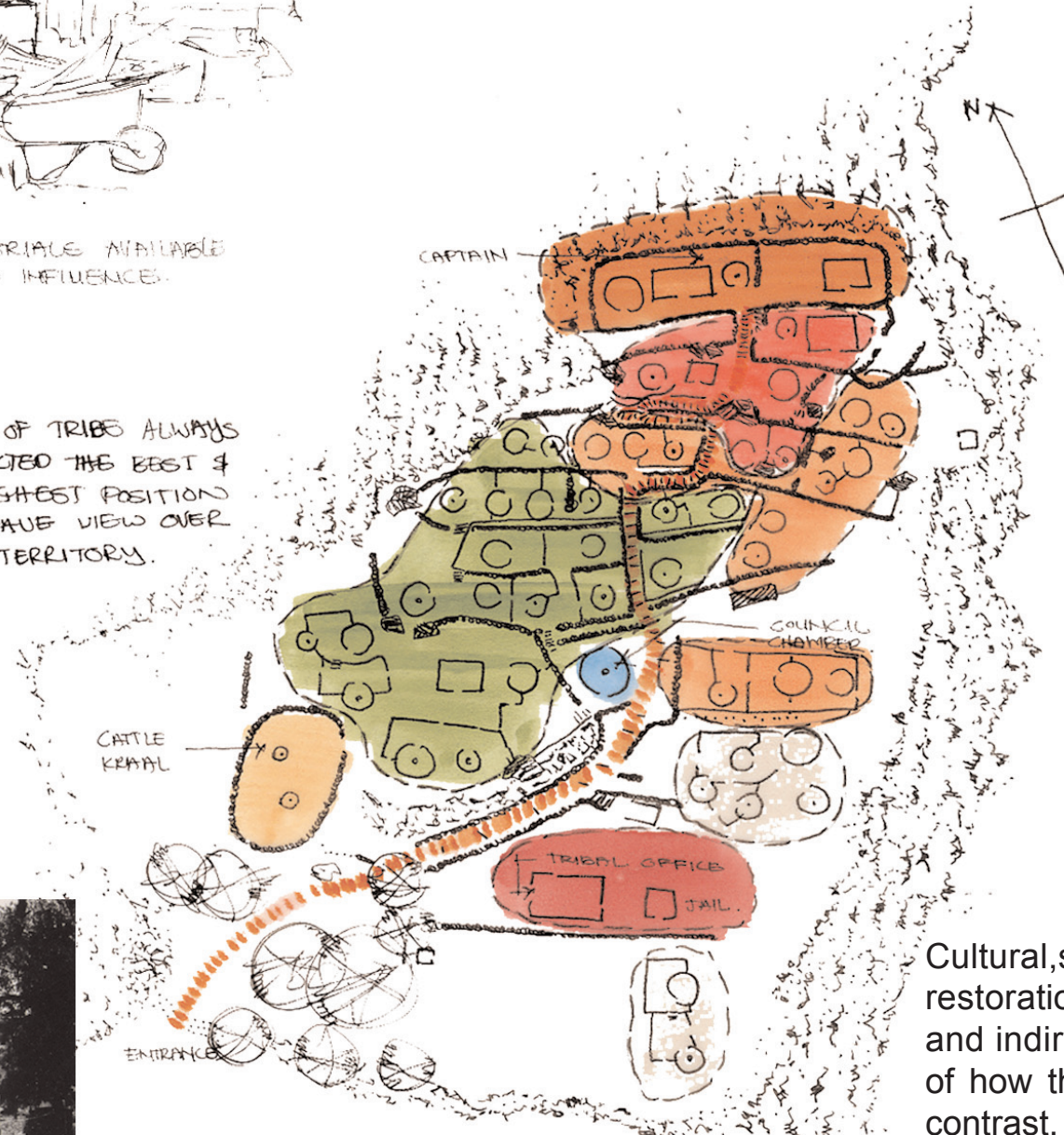

CAPTAIN KHAKHU. 1974.

*“Vernacular, anonymous, spontaneous, indigenous, rural.....
 Vernacular architecture does not go through fashion cycles.
 It is nearly immutable, indeed, unimprovable, and it serves its purpose to perfection.
 As a rule, the origin of indigenous building forms and construction methods is lost in the distant past.”*
 (Bernard Rudofsky, 1964)

Cultural, social, and economic history is needed in the establishment or restoration of self-esteem and identity. Acknowledgement of the direct and indirect influences on a specific setting is providing the parameters of how the “place” was formed and its futuristic potential. Harmony or contrast, forms the backbone of the response to the environment and an analysis of all influences will be the directive for its potential. The successful integration of these elements will contribute to the establishment of a more inclusive society based on common civic values.



2.1 Limpopo Province

Limpopo, 'home of peace', is situated at the north-eastern corner of South Africa. It shares international borders with Botswana in the north-west, Zimbabwe in the north and Mozambique in the east. Limpopo covers nearly 120 000 km² or 10% of South Africa, constituting an area only just smaller than Switzerland and Austria combined (Fig. 2.1.1).

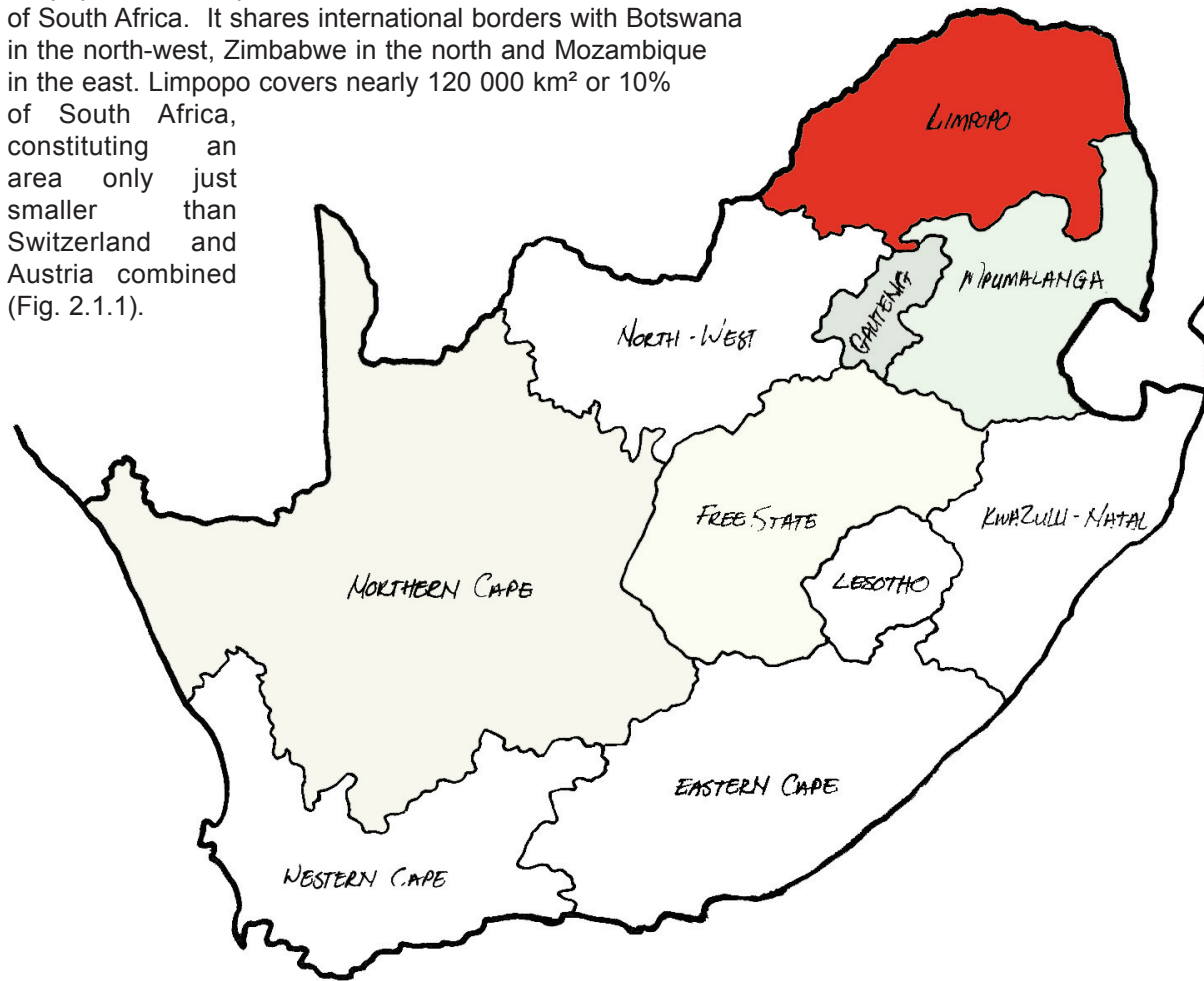

Fig. 2.1.1 Map of South Africa

Limpopo can be divided into four geographical regions. Capricorn region, which is derived from the tropic of Capricorn (which crosses this area) is set in the south. Waterberg Bushveld region, with great natural beauty of



Fig. 2.1.2 Geographical Regions

bushveld savannah and a rich wildlife heritage, situated in the west. Valley of the Olifants region with its scenic lush vegetated mountains and valleys in the east. Soutpansberg region which represents Limpopo, is situated in the most northern part of the province (Fig. 2.1.2).

Limpopo is the fastest growing province in the country, twice the national GDP, the unemployment rate of 36.1% is the highest in South Africa, whereas, households under the poverty line of R800.00 per month, are 36.4%, which is worse than the national rate. The economy of Limpopo still relies on sectors based on natural resources, mainly mining and agriculture, the latter growing rapidly. Trade has a visible share in the provincial economy. Tourism is the high growth industry.

2.2 Soutpansberg Region

2.2.1 Location

The Soutpansberg region is named after the mountain range that stretches for 130km from west to east (fig. 2.2). The region has a variety of natural, geological, archaeological and cultural systems with a rich history dating back centuries when the San roamed the veld. The height above sea-level ranges from 700m to 1700m with the highest point of the Soutpansberg mountain range being 1780m above sea-level. These variations in the landscape gives this region its unique character and mysticism.

2.2.2. Climate

The Soutpansberg area is a summer rainfall area with temperatures averaging 30°C in summer and

20-25°C in winter. The northern region's summer temperatures can reach 40°C. This contributed to the establishment of early settlements in the southern parts where a higher rainfall during summer months occur (Fig. 2.2.1). The main wind direction is from the northwest. These winds are predominantly hot and dry (Fig. 2.2.2). Usage of land topography against climatic factors are evident in early Venda settlements in the region. This topographical influence will be discussed later in the chapter.



Fig. 2.2.1 Southern slopes of Soutpansberg mountains

Average daily minimum temperatures in degree Celsius

(South African Weather Bureau, 2005)

| Year | 2000 | 2001 | 2002 | 2003 | 2004 |
|----------------------|------|------|------|------|------|
| Summer (Oct - March) | 16.3 | 16.6 | 15.9 | 17.0 | 17.5 |
| Winter (Apr - Sept) | 7.5 | 7.9 | 8.3 | 8.6 | 8.3 |

Average daily maximum temperatures in degree Celsius

(South African Weather Bureau, 2005)

| Year | 2000 | 2001 | 2002 | 2003 | 2004 |
|----------------------|------|------|------|------|------|
| Summer (Oct - March) | 28.6 | 28.7 | 30.8 | 31.2 | 30.3 |
| Winter (Apr - Sept) | 24.4 | 25.5 | 25.9 | 25.7 | 25.1 |

Average monthly rainfall in mm

(South African Weather Bureau, 2005)

| Year | Summer (Oct - March) | Winter (Apr - Sept) |
|------|----------------------|---------------------|
| 1991 | 199.0 | 15.5 |
| 1992 | 116.3 | 19.6 |
| 1993 | 165.3 | 26.8 |
| 1994 | 102.0 | 10.2 |
| 1995 | 148.2 | 45.8 |
| 1996 | 285.6 | 104.3 |
| 1997 | 161.2 | 39.0 |
| 1998 | 191.6 | 40.9 |
| 1999 | 160.2 | 42.3 |
| 2000 | 477.7 | 58.7 |
| 2001 | 228.4 | 49.6 |
| 2002 | 115.7 | 23.0 |
| 2003 | 106.0 | 28.0 |
| 2004 | 188.4 | 33.5 |

Average daily Wind speed in m/s

(South African Weather Bureau, 2005)

| Year | 2000 | 2001 | 2002 | 2003 | 2004 |
|------|------|------|------|------|------|
| | 0.82 | 1.00 | 1.12 | 1.29 | 0.9 |

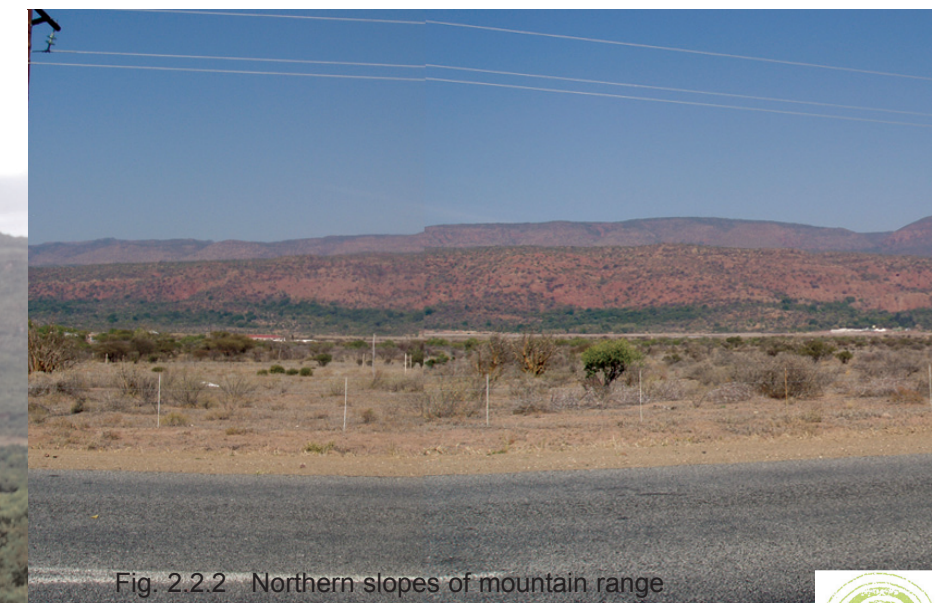

Fig. 2.2.2 Northern slopes of mountain range

2.2.3 Geology

The Soutpansberg sedimentary basin was formed about 1800 million years ago as an east west trending asymmetrical rift. This belt formed between two major crustal blocks, the Kaapvaal in the south and Limpopo belt in the north. Deposition started with basaltic lavas and was followed by sedimentary rocks, including red sandstones that derived their colour from iron oxides. The area was then block-faulted and uniformly tilted to the north. The landscapes as we see it today was formed during the last ± 60 million years through erosion (Fig. 2.2.3). These rocks are not well endowed with economic minerals, and only copper mineralization occurs which is sub-economic. Magnesite is produced from weathered ultramafic rocks. A number of thermal springs occur along major faults. These mountains receive high rainfall and recharge the regional groundwater especially in the northern region.



Fig. 2.2.3 Current visible geology



Fig. 2.2.4 Local produce

2.2.4 Economy

The region is well known for its agricultural diversity that ranges from vegetables, tropical and sub-tropical fruits and nuts, to cattle and game farming (Fig 2.2.4). The area, specifically, the Makhado district, are linked to the Maputo Development Corridor through the Phalaborwa Spatial Development Initiative. A network of road and rail corridors connecting Makhado (Louis Trichardt) to the major seaports will open up trade and investment. Tourism has grown significantly in this area, especially cultural tourism. Cultural experiences are becoming one of the highest priorities for tourists visiting this area because of its rich cultural heritage (Fig. 2.2.5). These economies have shaped the visual perceptions of this region. Traditional Venda villages are scattered through the mountainous areas, living with nature and the traditional farm settlements get the most out of



Fig. 2.2.5 Stairs at Mapungubwe hill

the small pieces of land.

2.2.5 Demography

A great multitude of diverse beings have moved through this area, enriching the area with history and culture. The first inhabitants being known to modern man were the Early Iron age people around AD350 (van der Waal, 1977). Through the following years up to 1700, a variety of tribes infiltrated this area and made a living off the land.

The current Venda tribe established themselves in this area around 1730 (Cameron, 1986). The Venda's only came into contact with western civilization in May 1836 when Louis Trichardt arrived in the Soutpansberg area. Louis Trichardt was the leader of the first group of emigrants from the Cape Colony into the then unknown interior (Theal, 1904). From 1836, western civilizations have been coming to this fair and fertile land. Its deep rich soil, abundant water, and lands covered with thick carpets of the most nutritious grasses, which are ideal for grazing. During this era, many hunters and traders started infiltrating this area through the south and southwest. The first 'white' settlement, Zoutpansberg, was established in 1848 and changed to Schoemansdal (Fig. 2.2.6) after 1855. After a war with the Venda's under Chief Makhado, the small town of Schoemansdal was evacuated. Chief Makhado was living between Schoemansdal and Louis Trichardt. He was succeeded by Chief Mphephu who was driven away by the Transvaal Republican forces in 1898 (van Warmelo, 1940). In 1898 the town Louis Trichardt (today Makhado) was established and seen as a major trading post with the local tribes and led to the development of this area in terms of agriculture and game hunting.

2.3 Makhado Municipality

Makhado (Fig. 2.3.1) is part of the Vhembe District which also includes Musina, Mutale and Thulamela. This area is said to be 'the land of the legend' because of its rich indigenous background. It covers 21 000 km² of the Limpopo Province. Indigenous African cultures thrive in this district.

Louis Trichardt, the urban centre of Makhado Municipality, consists of 265 informal towns and the formal towns of Waterval, Vleyfontein, Vuwani, Dzanani (formerly Makhado) and Tshikota, with vast rural areas in between. It is located

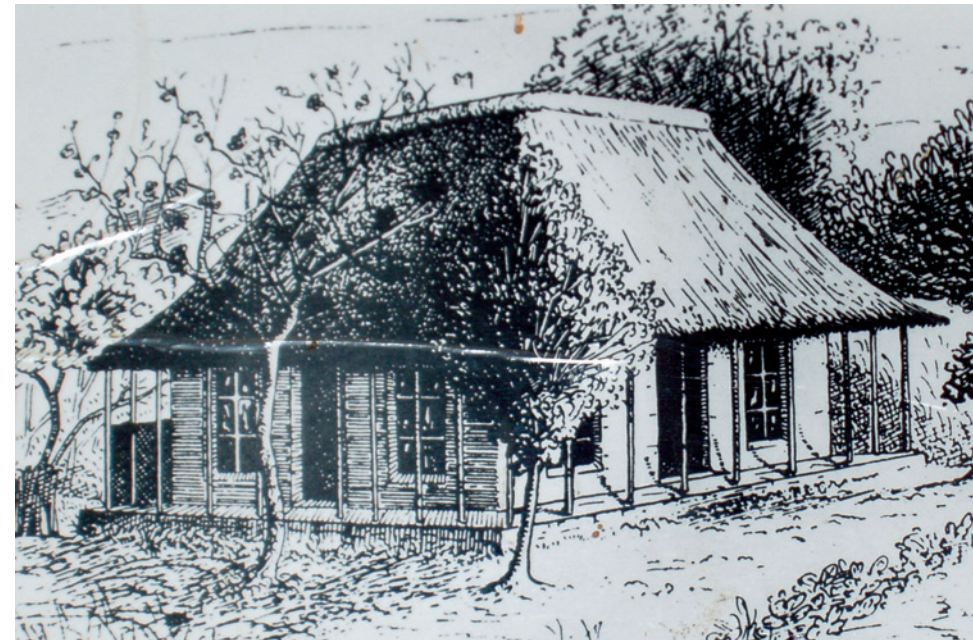

Fig. 2.2.6 The Schoemansdal Pasonage by Paul Mare

stop-over town. The economic value of the rich indigenous cultures in the surrounding areas opened the possibilities for creating a product that makes this area more marketable as a destination (Fig. 2.3.2). Creation of cultural experiences is a product with an added scenic component which will enhance the attractiveness for especially the tourism market (Fig. 2.3.3).

on the main route (N1) between South Africa and other African states (Zimbabwe, Botswana and Mozambique), 114 km south of Beit Bridge border post.

The town was originally named after the leader of the white emigrants from the Cape Colony in 1836, Louis Trichardt. After the democratic elections in 1994 the town was renamed Makhado. Chief Makhado was the one Venda leader, living in the area, that gave the then 1867 Transvaal Republican forces a lot of resistance to put the area under Transvaal Government control.

Makhado can be considered the gateway to African countries to the north. Previously this town was used as a drive through or one night

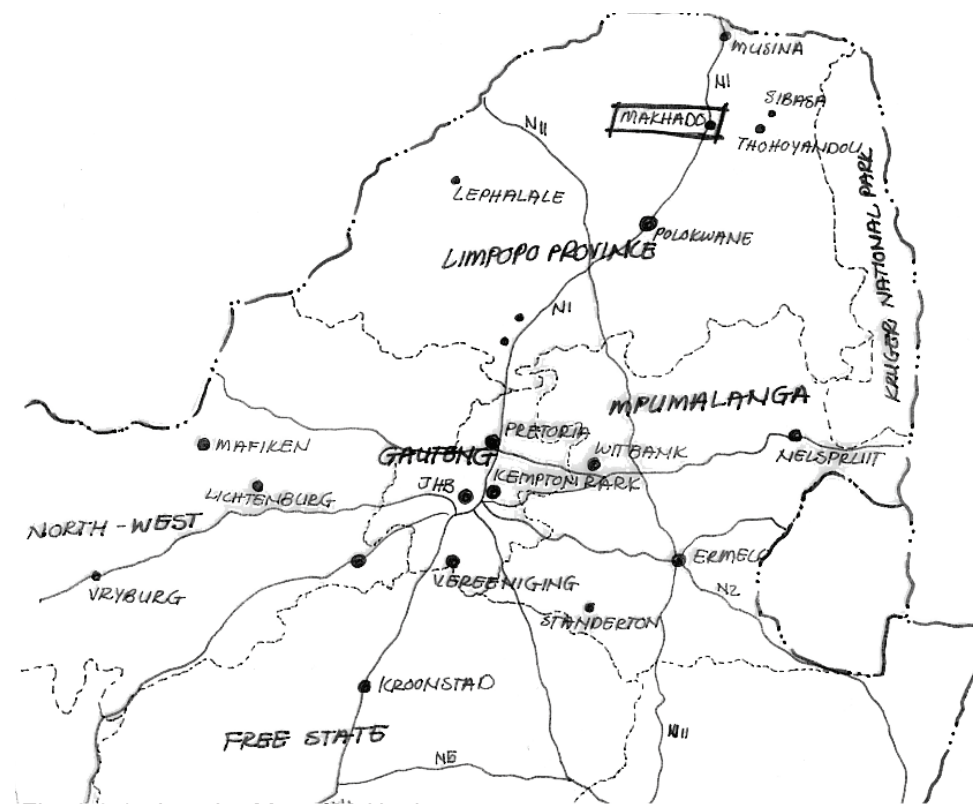

Fig. 2.3.1 Location Map of Makhado



Fig. 2.3.2 Local art gallery in Elim

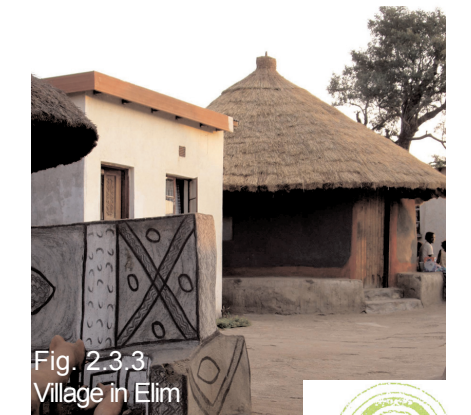

Fig. 2.3.3 Village in Elim

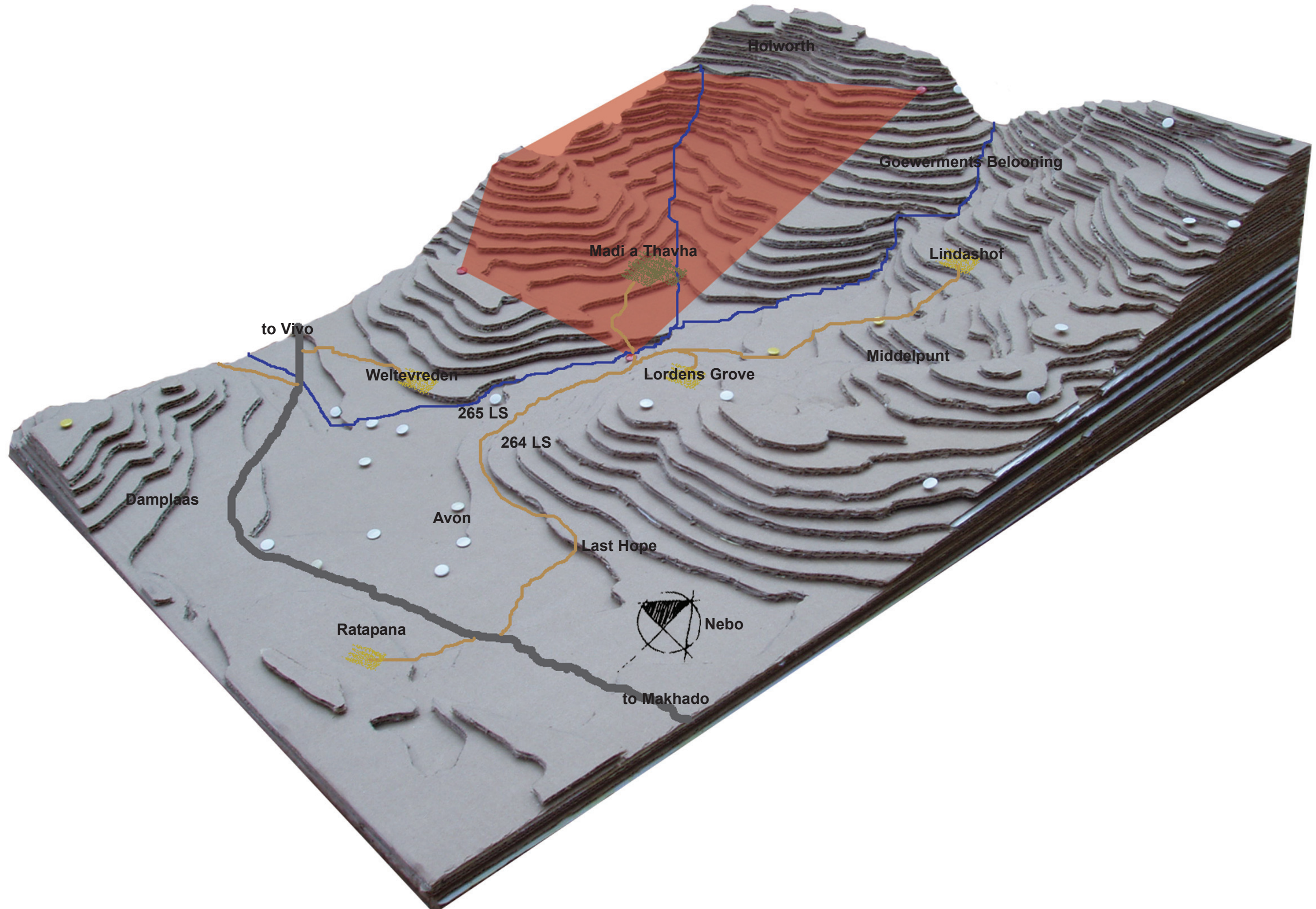

Fig. 2.4.1.1 Contour model of study area



Fig. 2.4.1.2 Location of Madi a Thavha Mountain Farm

2.4 Madi a Thavha Mountain Farm

2.4.1 Location

The farm covers an area of 350 hectares and is located in the Limpopo Province, 8 km west of Makhado on the R522 main road to Vivo. The farm is situated on the southern slopes of the Soutpansberg Mountain range (Fig. 2.4.1.2). Madi a Thavha is in close proximity to essential necessities. The existing permanent workforce reside on the farm but all have other houses off site where the rest of their families stay. These houses are located in the informal settlement of Tshiozwi (10km southeast of the farm) from where temporary staff, needed during harvesting are drawn. Transport for these people is provided by the farm owner. Makhado provides schools, churches, general stores and all other resources normally associated with urban developments. An airport is situated on the southwestern outskirts of Makhado.

2.4.2 Historical background

The name of the farm has changed from 'Samenkomst' through 'Nellies Gardens' to the current 'Madi a Thavha' Mountain Farm. This reflects the historical progressiveness that this land has gone through. Water is the most important component of existence on this land and this emphasis is directly related to the name: "water from the mountain" ('Madi a Thavha').

The current owner, Marcelle Bosch, nor any of the previous owners have attached any historical value to the farm. The first white farmer claiming this piece of land as his farm was in 1950. At that stage there were Venda people staying on a ridge located above the existing farmhouse (Fig. 2.4.2.1). This farmer forcefully removed them and the ruins of this Venda settlement is still visible today. This settlement belonged to Chief Mphephu's kraal which was situated further north of the existing farm boundaries.

entity. Individual vegetable gardens, fruit orchards and poultry will add the much needed elements to develop subsistence farming to its highest potential.

2.4.4 Topography

The agricultural land is situated in a valley basin which was formed due to the geological activities over thousands of years. The valley basin is 800m above sea level, the landscape rises to 1300m above sea level forming the perimeter of the valley (Fig. 2.4.1.1). This basin creates a pocket for a private one on one interface with the environment. The valley basin opens to the south eastern corner, also the entrance to the farm, and gives the connection between basin and the cosmos.



Fig. 2.4.2.1 Ridge where Venda village was located

2.4.3 Economy

The farm is currently functioning as an agricultural entity. The agricultural activities include the cultivation of tomatoes, sweet-corn, butternut, strawberries, cucumbers and green beans (Fig. 2.4.3.1). These products are supplied to the local market. A small portion can be described as subsistence farming but is almost omissible. Subsistence farming needs to play a bigger role in the development in order to become a more sustainable



Fig. 2.4.3.1 Packaging of sweetcorn

2.4.4 Climate

The farm is located in a "water rich" area of the province. The average annual rainfall is higher on the southern slopes than on the northern slopes of the mountain range. The rainfall statistics given in paragraph 2.2.2, are however not a true reflection of the rainfall on the farm. The Levubu Weather station is sited east of Makhado in a much wetter area. Through analysis of incomplete data obtained from farm owners, an average of 40% will be deducted from the annual rainfall data received from the Levubu Weather station. The decrease in annual rainfall is evidence of the severe drought that occurred after the 2000 floods. The rain is mostly accompanied by heavy thunderstorms; hale occurs once or twice during the rainy season, which is from September to February (South African Weather Bureau).

Water sources on the farm consist of fountains and boreholes. These sources are sustainable because of the high water table inside the Soutpansberg mountains. No water can be pumped from the Sandriver due to servitude on the water. In the development, all rainwater will be harvested and used for watering of vegetable gardens, flushing of toilets and other non-human consumption.

The high summer temperatures causes a build-up of heat in enclosed structures. Ventilation of structures are therefore crucial. Cold nights during the winter months are minimal. The cold evenings can be overcome by making use of passive solar design principles. Care must be taken concerning the fly-wheel effect in solid structures so that no heat is radiated to the inside of the building at the wrong time of the day (Fig. 2.4.4.1).

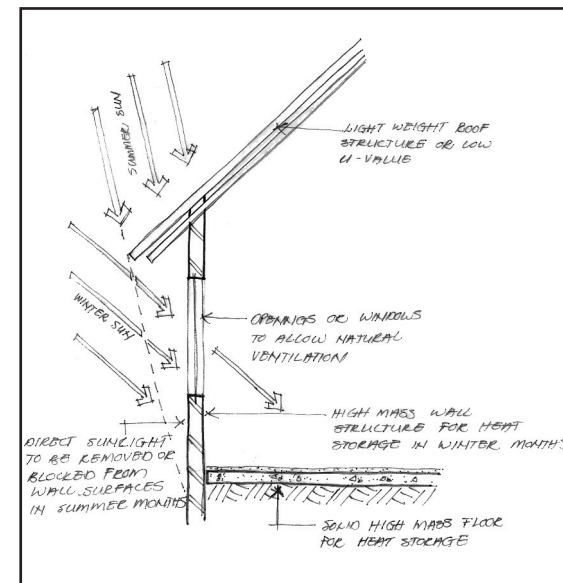

Fig. 2.4.4.1 Thermal inertia and flywheel effect

Wind speeds are low with a maximum average of 1.5 m/s. This is due to the topography of the area. The main wind direction is from the northwest but because of the enclosed basin, the wind tends to swirl around; similar to what can happen in big sport stadiums.

2.4.5 Sun angles

Autumn Equinox (21 March)

Sunrise: 06:03am
Sunset: 06:18pm

Spring Equinox (23 September)

Sunrise: 05:47am
Sunset: 06:04pm

| Time | Altitude angle | Azimuth angle | Altitude angle | Azimuth angle |
|---------|----------------|---------------|----------------|---------------|
| 07:00am | 11° | 95° | 15° | 96° |
| 08:00am | 25° | 102° | 28° | 103° |
| 09:00am | 38° | 110° | 41° | 112° |
| 10:00am | 51° | 122° | 54° | 125° |
| 11:00am | 61° | 141° | 63° | 147° |
| 12:00pm | 67° | 173° | 67° | -178° |

| | | | | |
|---------|-----|-------|-----|-------|
| 01:00pm | 64° | -151° | 62° | -144° |
| 02:00pm | 55° | -128° | 52° | -123° |
| 03:00pm | 43° | -114° | 40° | -110° |
| 04:00pm | 30° | -105° | 27° | -102° |
| 05:00pm | 16° | -98° | 13° | -95° |
| 06:00pm | 2° | -92° | 2° | -89° |

Winter Solstice (21 June)
 Sunrises: 06:39am
 Sunsets: 05:32pm

Summer Solstice (22 December)
 Sunrise: 05:11am
 Sunset: 06:54pm

| Time | Altitude angle | Azimuth angle | Altitude angle | Azimuth angle |
|---------|----------------|---------------|----------------|---------------|
| 07:00am | 3° | 118° | 21° | 73° |
| 08:00am | 14° | 124° | 35° | 77° |
| 09:00am | 25° | 133° | 48° | 80° |
| 10:00am | 34° | 145° | 62° | 82° |
| 11:00am | 41° | 160° | 76° | 83° |
| 12:00pm | 44° | 178° | 89° | -84° |
| 01:00pm | 42° | -163° | 77° | -85° |
| 02:00pm | 36° | -147° | 63° | -83° |
| 03:00pm | 27° | -135° | 49° | -80° |
| 04:00pm | 17° | -125° | 36° | -77° |
| 05:00pm | 5° | -118° | 23° | -73° |
| 06:00pm | -1° | -112° | 10° | -68° |

Occupant comfort are mainly influenced by temperature. South Africa has an abundance of sunlight from a sustainable heat source, the sun.

Occupant comfort can be achieved more easily when the correct methods and techniques are used to manipulate the sun's rays in accordance with the structures we design.

The topography of the area will have a major influence on the sunrise and sunset times, thus adjusting the sun hour period (Fig. 2.4.1.1). This can have a big influence on solar installation which depend heavily on the number of hours daily these panels are exposed to direct sunlight. Passive solar design is also influenced negatively specifically in terms of natural heating of internal spaces. The less direct sunlight on a mass element, the less heat it can store for heating-up the required volumes. The sunrise and sunset angles will also give an indication of the protection needed on the eastern and western facades of buildings. The hot afternoon summer sun normally causes unwanted heating of internal spaces. Care must be taken to block this heat. According to Fig. 2.4.5.1, the sunset in mid winter is at 04:05pm, creating a problem as winter sun can be utilised to heat-up internal spaces. Placement of buildings on site are crucial in order to utilise the shorter winter sun hours to their highest potential.

Sunrise and Sunset Indicators

| Date: | General Sunrise | General Sunset | Actual Sunrise | Actual Sunset | Sunlight loss per day |
|--------------|-----------------|----------------|----------------|---------------|-----------------------|
| 21 March | 06:03am | 06:18pm | 06:42am | 05:00pm | 02h21min. |
| 21 June | 06:39am | 05:32pm | 07:25am | 04:05pm | 02h13min. |
| 23 September | 05:47am | 06:04pm | 06:20am | 05:30pm | 01h04min. |
| 21 December | 05:11am | 06:54pm | 05:50am | 06:20pm | 01h13min. |

2.4.5 Fauna and Flora

An endless expanse of undulating indigenous bush characterises the landscape. Ten percent of the plants occurring in the Soutpansberg can be considered succulents. A succulent is a plant which has the ability to store water in one or more of its morphological components. The conditions that contributed to their evolution had to be related to periods when water were scarce. This is an indication that the Soutpansberg has gone through drought periods that led to the isolation of biological entities. Eight of the 33 succulents found in this area can be described as trees growing taller than 2m. Approximately 58% of all endemic species occur within the mist belt region and no fewer than 30% are restricted to this region. During drought periods, most of the high altitude mountain flora survives on the mist. Not much is known about mist and its interaction with the environment.

The abundance of vegetation must be handled with care so that their environment is not altered. Screening of buildings against the sun, view of hikers, tourist views, and maintenance factors can be done using the available natural vegetation. The vegetation can also be used to filter air going into buildings, and creation of private, semi-private and public spaces.

Approximately 8% of the farm is being cultivated. These activities have caused the invasion of alien plants. Bad environmental management by previous farm owners contributed to this invasion. All alien plant species will be removed in the new development.

Historically this area was roaming with game. The only wildlife still visible on the farm are baboons, one old leopard and a couple of bird species. Re-introducing game to the area will assist in the creation of a sense of place and destination for the farm development.

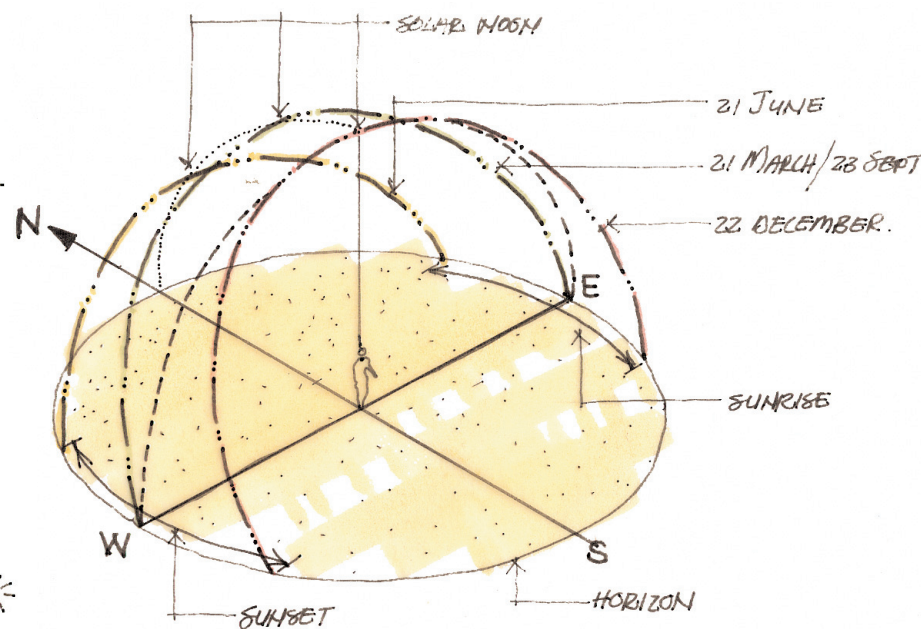
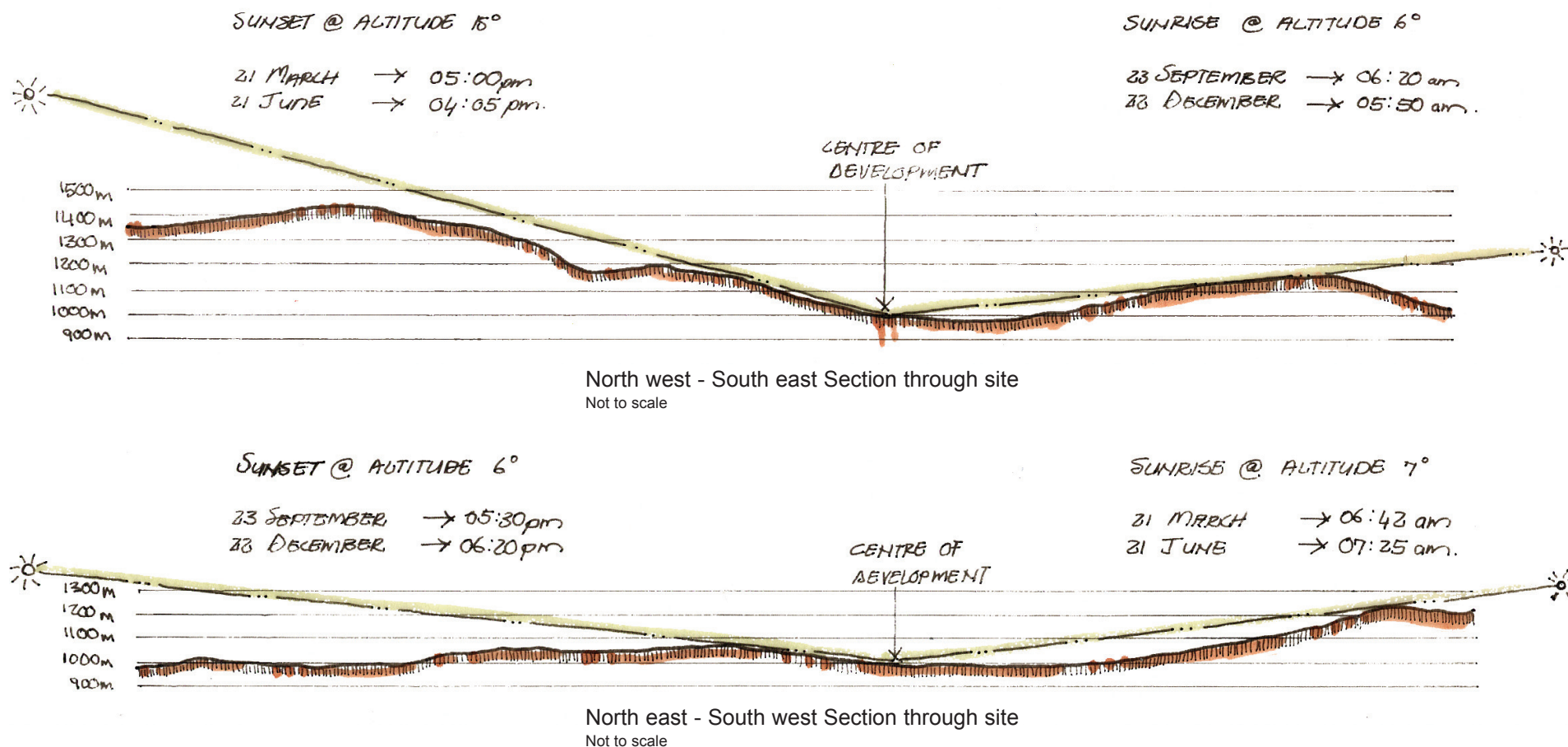

Sun's apparent paths through the sky during different seasons for latitude 23° south

Fig. 2.4.5.1 Sunrise and Sunset schedule



Fig. 2.4.6.1.1.1 Existing farmhouse, southeast elevation



Fig. 2.4.6.1.1.2 Existing packhouse and storeroom

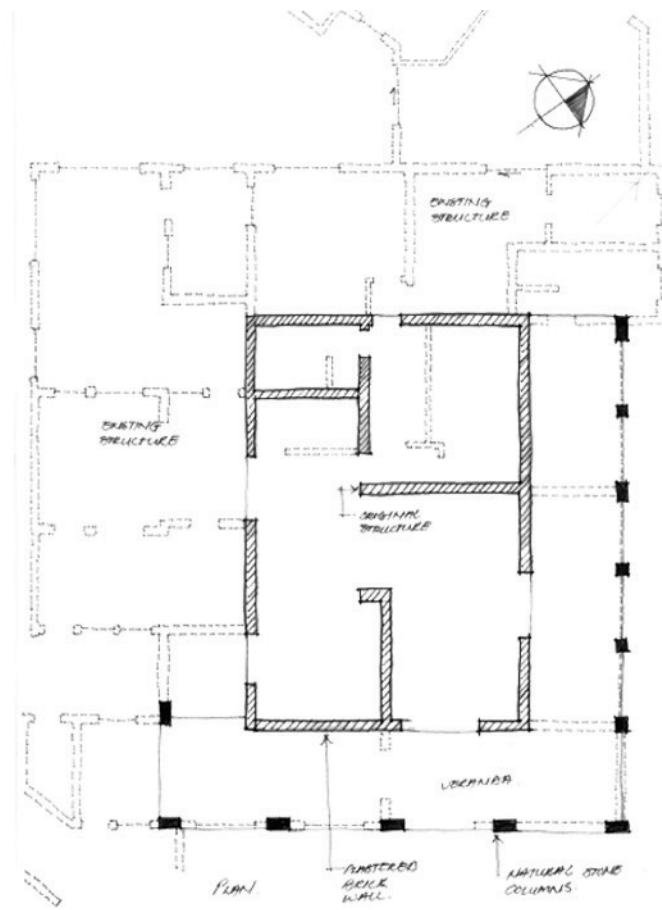
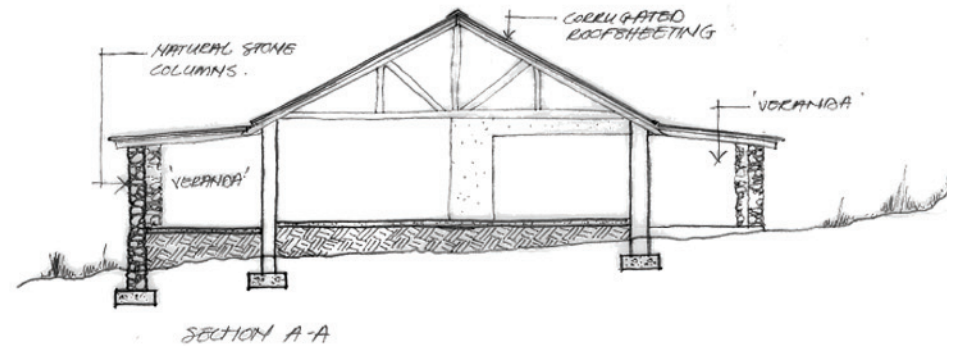
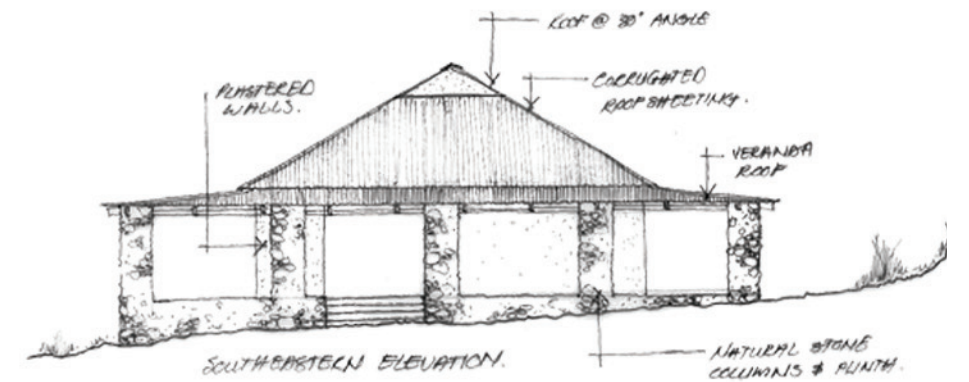

Fig. 2.4.6.1.1.3 Sketch of original style and form of existing farmhouse through assumptions and structure analysis



2.4.6 Building history of area

2.4.6.1 Farm methodology

2.4.6.1.1 Existing structures

The existing farmhouse (Fig 2.4.6.1.1.1) and outbuildings (Fig 2.4.6.1.1.2) reflect the influence of individual intuitiveness and required necessities of each farm owner. The main determinants for the forms of these structures are process generated. They fulfill their practical requirements and nothing more. The ordering and placement of these structures on the site has been driven by rational thought. The farmhouse, taken back to its simplest original form (Fig 2.4.6.1.1.3), signifies the methodology of historical farmhouses as was evident in the historical settlement of Schoemansdal (Fig 2.4.6.1.1.4). The original house (Fig. 2.4.6.1.1.3) made good use of the lean-to roof over the steep area to keep direct sunlight off the main walls. The eastern side of the building is also protected against early morning sun. The solid mass used for the main structure is utilised as a heat storer during the colder winter nights. The afternoon summer sun does not create a problem because of the earlier sunset due to the influence of the topography as illustrated in Fig. 2.4.1.



Fig. 2.4.6.1.1.4 Watercolour presentation of Schoemansdal, A.B. Ellis, 1872

and entrance into the building are lacking. The only way that one is able to find the entrance is in the way in which vegetation and paving has been used. The vegetation does protect the building sufficiently against the climate. This however is immediately perceived as an after thought. The existence of possible roof ventilators indicates that the occupant comfort were taken into account when the original house was designed. These ventilators have however been closed-up for reasons unknown.

Usage of natural stone (Fig 2.4.6.1.1.5) obtainable from the area indicates the tradition of using locally available materials. This tradition can be traced back to the beginning of mankind. An architect who made extensive use of ordinary materials in his designs was Norman Eaton. He used these

materials in innovative ways to make the buildings grow out of the site. He interpreted indigenous African patterns on African screens and smeared lapa floors and walls. He also made extensive use of the rondawel, kraal and grain silos associated with indigenous African cultures. The reinterpretation of these forms gave rise to his individualism concerning regionalism.

The swinery (Fig. 2.4.6.1.1.6) indicates a possible existence of subsistence farming. No thought seems to have been given to the coherence of style between the facilities and even the programme was absent. No sense of place was established as each owner was preoccupied with making the most money in the shortest period of time; no long-term planning was implemented.



Fig. 2.4.6.1.1.5 Quartzite stone from area used as 'veranda' columns



Fig. 2.4.6.1.1.6 North eastern view of existing swinery and storeroom

2.4.6.1.2 Early settlements

In search of a farm methodology that 'fits' the rich historical content, an analysis of the earliest western civilization's settlements will provide a more thorough description of the historical context. Schoemansdal being the first (1855) recognized western settlement in the Limpopo Province presents us with the first forms of structures built by western civilization.

One of the most common temporary dwellings of the "Trekboers" is the 'kapsteilhuis' as seen in Fig 2.4.6.1.2.1. The materials and methods used to construct these buildings were chosen because of the quick and easy assembly/moving of these buildings. The name "Trekboers" indicates that they had a nomadic lifestyle for certain periods of their life. The 'Kapsteilhuis', as its name suggests, consists solely of a thatched roof, carried on a series of about eight couples and reaching right down to the ground. Before the poles are put in position, a trench was dug wherein the thatching and poles were placed. The soil help to prevent sideways pressure generated by the forces in the pole structure. The thatching helped keep the wind and rain outside the building. In its simplest form it has no walls and is in fact nothing more than the roof of a Cape house built at ground level. The connection to the Cape house comes from the fact that these people were all originally stationed for a short period, or actually lived in the cape colony, for a certain time. Eight or more pairs of poles, meeting at the top, are spaced at regular intervals, each pair is joined together by means of a tie-beam, 'hanebalk', all pegged together with wooden pegs and the battens, are secured across these couples to which bundles of reeds and thatch are sewn with "riempies", twine or grass rope (Fig 2.4.6.1.2.2).



Fig. 2.4.6.1.2.1 'Kapsteilhuis'



Fig. 2.4.6.1.2.3 Developed 'Kapsteilhuis' with outside cooking area

2.4.6.1.2.3). The relation between the living area and cooking area reflects the social patterns of these people. All the social gatherings were done outside in the open under a tree or other shaded areas. The "Trekboers" made use of what the environment provided them with, to dwell. The floors were of ant-heap, smeared and made to shine by continued applications of linseed oil or ox blood, polished with a smooth stone (Fig 2.4.6.1.2.4). Furnishing of the spaces were kept to a minimum. This was also influenced by the size and space available on their ox-wagons

(Fig. 2.4.6.1.2.5) which was their main transport vehicle. The choice of materials used for construction were influenced by their weight. The whole structure could be taken down and transported on the ox-wagons with them as these were rather light compared to conventional building material. As Trekboers settled in this area more stable and durable structures were sought after. The provision of added security obtained from the



Fig. 2.4.6.1.2.5 Ox-wagon replica

establishment of a settlement gave the farmers the opportunity to build larger homesteads. These followed the pattern of their earlier dwellings except that they were longer and higher. The 'kapsteilhuis' was lifted onto low sod or stone walls smeared with cow dung, running along each side (Fig 2.4.6.1.2.6). These not only provided added support to the couples but also provided better protection against the climate for the occupants. More durable materials were used because a change in lifestyle was taking

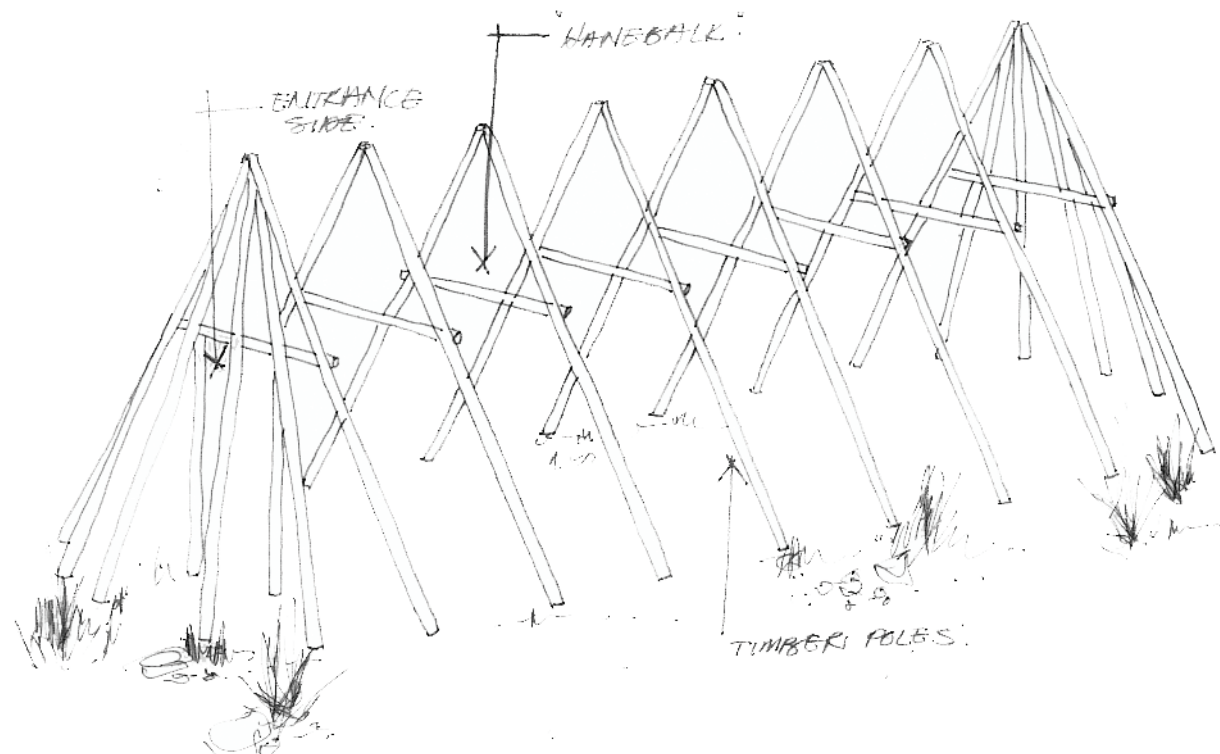

Fig. 2.4.6.1.2.2 Framework of a 'kapsteilhuis'



Fig. 2.4.6.1.2.4 Interior of 'Kapsteilhuis'



Fig. 2.4.6.1.2.6 'Kapsteilhuis' lifted onto low walls

place. The earlier nomads were now staying at specific places for longer periods. The connection between the cooking- and sleeping area was getting stronger; all the previous functions of the separate buildings were now combined under one roof. A materialistic shift was taking place and this new building configuration added to the security that was sought after. The external social activities shifted to the inside spaces. The connection between the environment and these people was slowly disappearing. People were creating these idealistic worlds within their structures, neglecting the environment which made their existence possible.

2.4.6.2 Venda Methodology

2.4.6.2.1 Origin

The only buildings on the farm that have historical significance are the ruins of a few Venda huts up on a ridge north east of the existing farmhouse. Only outlines of where the structures were are visible. These huts were part of Chief Mphephu's kingdom. The Venda people are mainly in the old Vendlalnd but have moved around in the area because of inter-community disputes.

It is believed that the Venda originally came from the Congo area. There is still a tribe that speaks a similar language, Tshivenda, in the Congo valley. They moved down to present day Zimbabwe, where a split occurred in the original group. Part of the group followed the chief Thohoyandou and crossed the Limpopo river in the 17th century. They settled in the Soutpansberg range and mixed with the people that inhabited the area before them: the VhaNgona. The mix of VhaKaranga and VhaNgona groups led to the creation of many small groups/clans with similarities but also differences which are gathered under the name VhaVenda. Venda people are surrounded by myth, legends, stories of witchcraft and all sorts of terrorizing stories which helped this minor group to stay on the map and survive surrounded by huge groups such as the Shona, the Tswana, the north Sotho, the Nguni, and the Tsonga.

The traditional Venda homestead was mainly formed by the climate, topography, availability of material, and technical knowledge of the members of the tribe. These factors are not the only determinants. According to Rapoport (1969) '----- house form is not simply the result of physical forces or any single casual factor, but is the consequence of a whole range of social-cultural factors as seen in their broadest terms'(Fig 2.4.6.2.1.1). The form being a cylindrical wall with tapered roof is associated in Africa with tribes practising agriculture. This form carries a more permanent character than the dome-shaped roofs in Africa associated with nomadic livestock herdsman. For the purpose of this study, the building forms will be interpreted by acknowledging the social-cultural factors and focus mainly on the rationale.



Fig. 2.4.6.2.1.1 Venda hut at Mbilwe photo by A.M. Duggan-Cronin

The huts are relatively small with simple structures. One of the reasons for this is that a large part of life is being spent outside the huts which are mainly used for sleeping and cooking. The material used for building these structures, timber, soil, and grass, is proof of the way in which the Venda's technical creations are associated with the natural environment wherein they live (Fig 2.4.6.2.1.2).



Fig. 2.4.6.2.1.2 Material used for construction of structures

2.4.6.2.2 Physical forces

The Venda 'stat', *modi*, was the typical Venda living pattern (Fig 2.4.6.2.2.1) but for the purpose of the study a detailed investigation will only be done on the Venda 'kraal'. A 'kraal' is where a man with his wife, or wives, and their children live. After the need to live together disappeared at the start of the 19th century the 'statte' started to disappear. The structure and layout of a 'kraal' and 'stat' are very similar with the biggest difference being that the 'kraal' is a lot smaller in physical surface area.



Fig. 2.4.6.2.2.1 Living zones of chief Mphephu's "stat" (1974)

A 'kraal' was normally fenced with planted thorn bushes. The entrance, *khoro*, at the lowest point, is directly connected with the living areas without an internal courtyard, as is practiced in a 'stat' (Fig 2.4.6.2.2.2). The living hut, *nndu*, (Fig 2.4.6.2.2.3) and cooking hut, *tshitanga*, (Fig 2.4.6.2.2.4) are placed opposite each other with the cooking hut normally at a lower level than the living hut. In front of every hut is a partitioned off area used as a yard. The head of the 'kraal' lives on the highest point of the site with his wives on the lower areas. When a very steep site is chosen for the 'kraal', terraces are used for the placement of each hut. The terraces are supported by low stone walls.



Fig. 2.4.6.2.2.2 Living terraces at Thengwe

Low dividing walls between structures are either built of raw bricks or built-up with soil to a height of 1200 mm and are roughly 200 mm

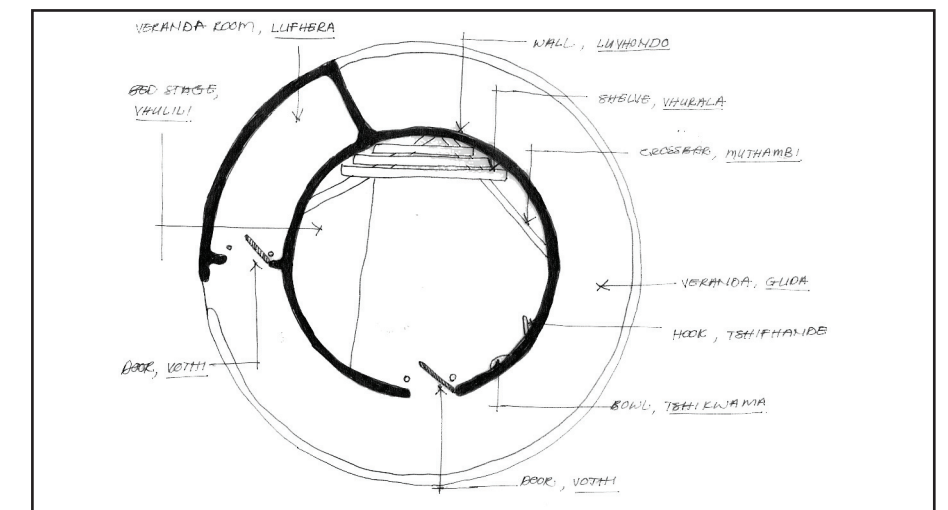

Fig. 2.4.6.2.2.3 Living hut plan

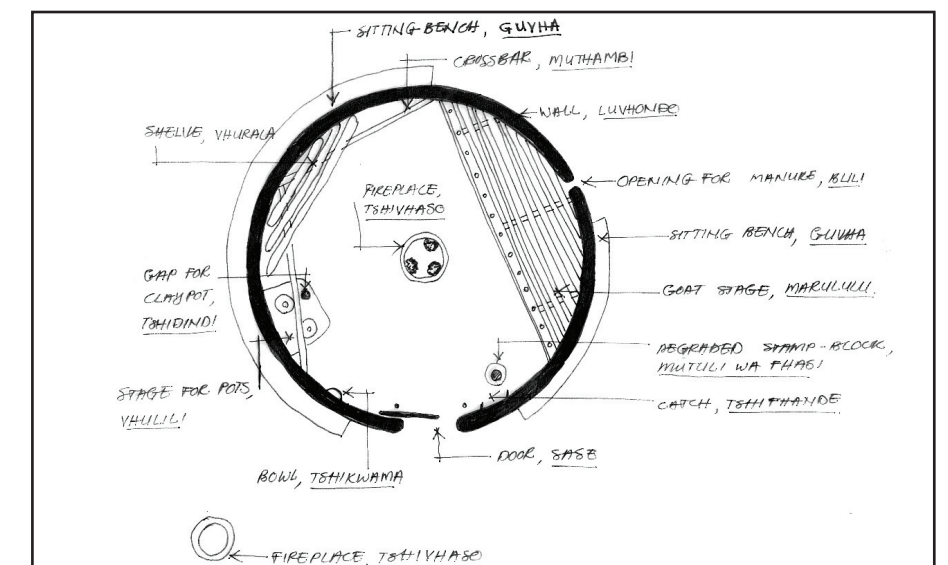

Fig. 2.4.6.2.2.4 Cooking hut plan

thick. These walls are similar to the veranda walls with a sitting bench, *gurha*, against the hut wall (Fig 2.4.6.2.2.5). Two meter high timber poles, are also used as dividing screens. The screens were called *mup funda* (Fig 2.4.6.2.2.6). The dividing walls between huts are never enclosed. There is always an opening of roughly 800mm and similar connecting openings to adjacent households. These low walls are built around sleeping - and cooking huts and stretch from hut to hut or at rights-angles to a terrace wall or other dividing screens (Fig 2.4.6.2.2.7). The floor of the yard that is formed between these walls is sometimes finished with pot fragments. These were done for strengthening of the floor and decoration, *makolo*.

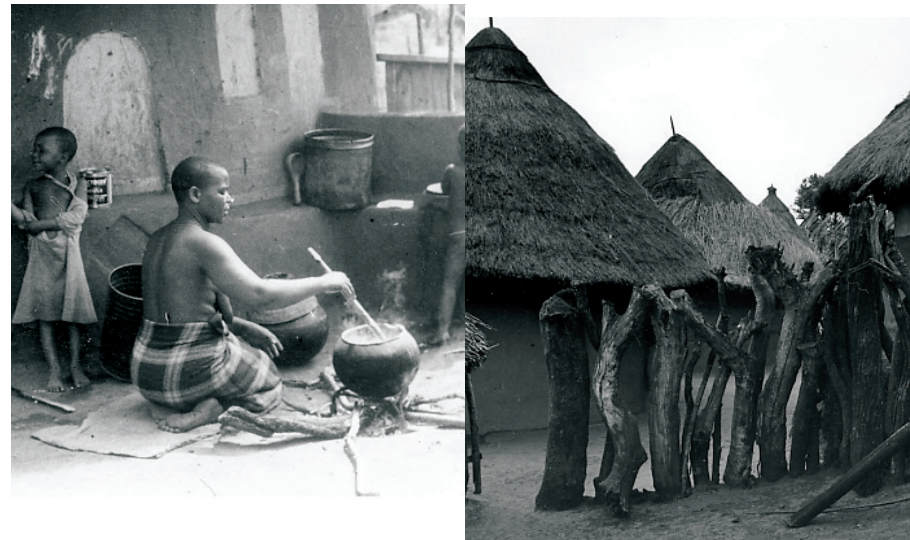

Fig. 2.4.6.2.2.5 Sitting bench

Fig. 2.4.6.2.2.6 Timber screens

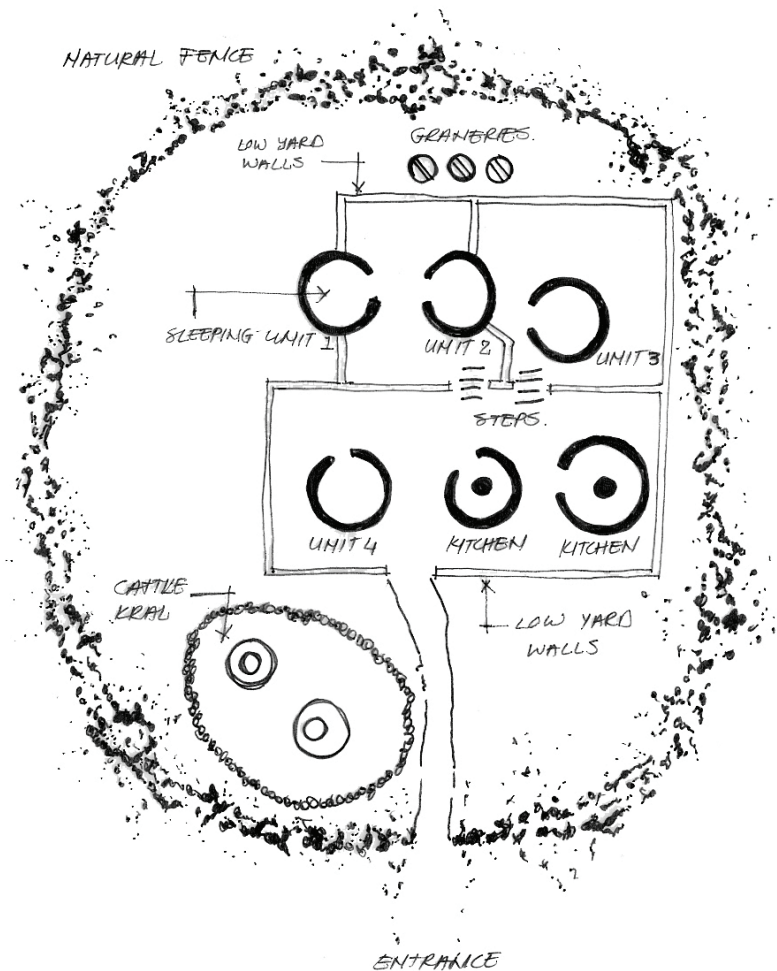

Fig. 2.4.6.2.2.7 'Kraal' plan layout

The architecture of the Venda is unique in the sense that no other group in southern Africa uses a "front and back" hierarchical differentiation of distinction. In these groups distinctions are made using a system of hierarchical differentiation based on a concept of "left and right". Due to the topography of the areas where the Venda normally build their homesteads, the terms "front and back" are synonymous to "downhill" and "uphill". This differentiation can be seen in the domestic unit, where the units associated with the wife/wives will be positioned downhill from those used by the father of the family (Fig 2.2.4.6.2.2.7). The same arrangement are made between the family head and his sons, with their units being located downhill and in front of their fathers'. Another important difference with other groups is in polygamous marriages, where the Venda father has his own courtyard, kitchen and granary. With other groups, the first wife's dwelling is seen as those of the father. This means that, except the head wife, no hierarchy of positioning for the subsequent wives are followed. The location of their dwellings are determined by personal preference and group negotiations.

2.4.6.2.3 Decorations

The areas that are decorated in the Venda homesteads are all plaster finished surfaces, although the surfaces are not equally decorated. Decorations are geometric and authentic. Authentic decorations are simple drawings of plants, animals, and people but it is in the minority (Fig. 2.4.6.2.3.1). Geometrical decorations include a variety of conventionalised motives (Fig 2.4.6.2.3.2 and 2.4.6.2.3.3). These decorations are applied to yard walls and used as moulded frames around an entrance. They are also used as a dividing line between the top and bottom wall surfaces on the outside of huts. These decorations include: concentric circles, diamond shapes, a combination of these circles and diamond shapes into a butterfly, chevron, and parallel stripes. Moulded decorations are also used in decoration of the huts. The threshold, *tshikhuvha*, is 200-300mm high and 200mm wide

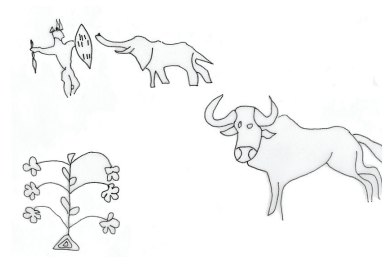

Fig. 2.4.6.2.3.1 Authentic

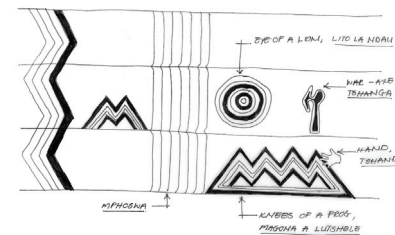

Fig. 2.4.6.2.3.2 Geometric

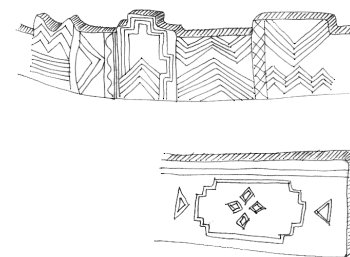

Fig. 2.4.6.2.3.3 Geometric



Fig. 2.4.6.2.3.4 Threshold



Fig. 2.4.6.2.3.5 Low yard wall

built in front of the door. The threshold is sometimes extended up to a metre past the door on either side (Fig 2.4.6.2.3.4). The low yard walls are decorated with stepped or corbelled raw brick (Fig 2.4.6.2.3.5).

These structures were built in the most effective ways possible. The practical approach is complimented by the use of a variety of forms and textures that are reflected in the architectonic use of defined openings, creative texture patterns, and relief work. Through the use of fingers, hands, cloths and brushes symbolic designs are created that give these simple homesteads a sense of place.

2.4.6.2.4 Western influence

New building forms originated after the western influence (1836). The rectangular plan was adopted because of new materials and construction techniques being available. The Venda did not copy everything from western civilization, because they build to generate space and give them protection against the climate. The first structures in the traditional 'stat' that took on a western style were those of the chief (Fig 2.4.6.2.4.1). The western style of buildings with its rectangular plan and corrugated roof sheeting are today seen as status symbol and the ideal of many a Venda.



Fig. 2.4.6.2.4.1 "Western" rectangular building



Fig. 2.4.6.2.4.2 Compacted earth blocks



Fig. 2.4.6.2.4.3 20th Century Venda "ideal"

The Venda homestead uses a lot of timber to build. The strains that were put on the environment to keep supplying the building materials, made the Venda realise the need to look for alternative materials. With the western influence already visible, acceptance of these changes were becoming imminent. This gave rise to the rectangular building blocks (Fig 2.4.6.2.4.2) and rectangular plan as well.

Other changes that are happening are the traditional stone walls that are build with cement. Wall decorations are done with paint bought in shops. Fences and cattle dens are now done with wire and steel droppers (Fig 2.4.6.2.4.3). All the old building techniques are being replaced with new ones. New materials are being accepted and the knowledge of the old materials and techniques is starting to disappear.

Endemic architecture combined with new available technologies based on traditional usage and knowledge will make the positive expectations that are being sought. Local materials must be used. It is ecologically efficient, thus adapted to the climate, fauna, flora and social patterns.

Chapter 3

Baseline

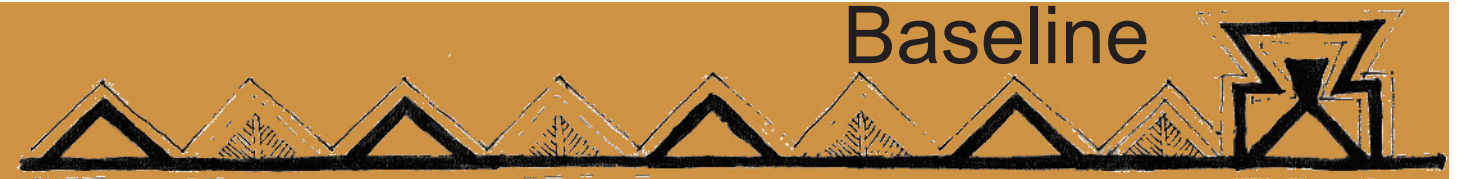

"... if someone thinks that wilderness landscapes are inviting, that person is more likely to engage in activities in wild landscapes on the surface, attitudes were not consistent with behaviours. They do however predict a variety of social norms"
(Bell, Fisher, Baum, Greene, 1996)

Generally a positive attitude towards the environment does not ensure that an individual will consistently avoid the overuse of resources. Attitudes and norms can determine behaviour, which in turn can predict obvious behaviours. Today it is normal to express our concerns over the deteriorating environment, but our feelings concerning wetlands and pollution are not as strong as our feelings towards social norms. There is a huge difference between people that react negatively to filthy areas and overuse of resources and getting these people to do something about these issues in order for people to act on these issues, a substantial modification in behaviour needs to take place. Behaviour change is more important than physical technology in effecting solutions. The effectiveness of any physical technology depends on people's behaviour and the manner in which they use the technology.

3.1 The Ecological Footprint

3.1.1 Characterization

The Living Planet Report 2002 was published in June 2002 by the World Wide Fund (WWF). This report measures the human pressure on the earth, and is related to each country and region. The report measures the ecological footprint of the world (1999) and 146 countries whose population exceeds one million, which includes South Africa (Fig. 3.1.1.1). The ecological footprint is "a measure of the amount of the earth's biological productivity that a human population occupies in a given year" (WWF, 2002). This gives a representation of the biological productive land and water areas necessary to produce the resources consumed by a population and disposal of wastes generated.

Ten countries with largest ecological footprint and ten with smallest ecological footprint

| Rank | Country | Global ha /person | Rank | Country | Global ha /person |
|------------|----------------------|-------------------|------|---------------|-------------------|
| 1. | United Arab Emirates | 10.13 | 137. | Vietnam | 0.76 |
| 2. | USA | 9.70 | 138. | Yemen | 0.71 |
| 3. | Canada | 8.84 | 139. | Myanmar | 0.70 |
| 4. | New Zealand | 8.68 | 140. | Guinea-Bissau | 0.70 |
| 5. | Finland | 8.42 | 141. | Tajikistan | 0.66 |
| 6. | Norway | 7.92 | 142. | Pakistan | 0.64 |
| 7. | Kuwait | 7.75 | 143. | Sierra Leone | 0.54 |
| 8. | Australia | 7.58 | 144. | Bangladesh | 0.50 |
| 9. | Sweden | 6.73 | 145. | Burundi | 0.48 |
| 10. | Belgium | 6.72 | 146. | Mozambique | 0.47 |
| 28. | South Africa | 4.02 | | | |

Fig. 3.1.1.1 Ecological Footprint Rating

3.1.2 South Africa's ecological footprint

The measure of a country's ecological footprint consists of six components, namely: the energy footprint, built-up area footprint, forest footprint, grazing land footprint, cropland footprint, and the fishing ground footprint (Fig. 3.1.1.2). The sum of these components indicates the total area required to produce the resources that a country consumes has a sustainable energy usage, and allows space for its infrastructure.

3.1.2.1 Energy footprint

This is the area needed to produce the country's energy in a sustainable manner. This footprint comprises fossil fuels, biomass, nuclear energy, and hydro energy. The energy footprint is globally the fastest growing component, increasing by an average of 2.6% per year between 1961 and 1999. South

Africa's energy footprint is 2.45 global hectares per person in 1999. More than double the global energy footprint of 1.121 global hectares per person. This component is the largest portion (61%) of South Africa's total ecological footprint.

3.1.2.2 Built-up area footprint

This is the area that is required by a country to accommodate its infrastructure for housing, transportation and industrial production. This footprint's biggest determinant is the population count. The South African built-up area footprint is 0.11 global hectares per person. This component comprises the smallest portion of the total ecological footprint.

3.1.2.3 Forest footprint

The area necessary to produce a country's forest products that they consume. The forest footprint had a growth rate of 50% over the past 38 years. The world and South African footprint are the same at 0.30 global hectares per person. The forest footprint for the average African is 0.23 global hectares, while those of a North American is 1.26 global hectares. There is a 4-fold gap between high and low-income countries.

3.1.2.4 Grazing land footprint

This footprint is related to a country's consumption of meat, dairy, hides, and wool that are produced by livestock that are not crop-fed, but occupy permanent pastures. An 80% increase from 1962 to 1999 in the grazing land footprint came at the expense of forestland. South Africa's footprint (0.27 global ha/person) is again double the global grazing land footprint of 0.12 global hectares per person. A 8-fold difference in the grazing land footprint per person of high and low-income countries is mainly due to the greater amount of meat and dairy products in the diets of higher income populations.

3.1.2.5 Cropland footprint

The cropland footprint is the area required to produce the crops that are consumed by a population. Between 1962 and 1999, the world population almost doubled, but the cropland footprint grew by less than 10%. This can be attributed to improved crop yield by means of increased irrigation and

fertilizer use. A cropland footprint of 0.66 global hectares was available per person in South Africa in 1999. Compared to the rest of Africa and Asia (0.40 global ha/person), South Africa's footprint is again higher. In general, developed countries had larger cropland footprints than less developed countries. There is a 3.5-fold difference between these countries.

3.1.2.6 Fishing ground footprint

This is the area needed to produce the

fish and seafood products that a country consumes. A rapid growth rate of 2.6% per year occurred between 1962 and 1999. The global fishing footprint (0.14 global ha/person) is half of the South African footprint being 0.22 global hectares per person. South Africa is ranked 36th out of 146 countries. In this measure the country with the highest figure was Norway with a 2.62 global hectares per person.



3.1.3 Total ecological footprint

According to the Living Planet Report 2002, the South African ecological footprint was 4.02 global hectares per person in 1999. This is almost double the world average of 2.28 global hectares per person. In 1999, South Africa was ranked 28th of the 146 countries for total ecological footprint.

South Africa's biocapacity in 1999 was only 2.42 global hectares per person. This gave a deficit of 1.6 global hectares per person in relation to the ecological footprint. This is an indication of the unsustainable development that is taking place in South Africa. The human consumption is larger than what the biosphere can provide. This ecological deficit can be ascribed to two possibilities. Imported ecological capacity and the depletion of domestic resources. Importation of capacity is legitimate, but not all countries can import. The second deficit happens when resource use and waste generation exceed the domestic capacity. This results in a nation depleting their resources and accumulating their waste in the environment.



South Africa's ecological footprint

| Ecological footprint | Global ha/person | Biocapacity component | Global ha/person |
|-----------------------------------|------------------|----------------------------|------------------|
| Energy footprint | 2.45 | Forest biocapacity | 0.56 |
| Built-up area footprint | 0.11 | Grazing land capacity | 0.93 |
| Forest footprint | 0.30 | Cropland biocapacity | 0.60 |
| Grazing land footprint | 0.27 | Fishing ground biocapacity | 0.23 |
| Cropland footprint | 0.66 | | |
| Fishing ground footprint | 0.22 | | |
| Total ecological footprint | 4.02 | Biocapacity total | 2.42 |
| Ecological deficit | 1.60 | | |

Fig. 3.1.1.2 South Africa's ecological footprint

3.2 Performance Criteria (Fig. 3.2.1)

3.2.1 Social criteria

Education, health and safety

Educational facilities must be provided for the transfer of information during the construction period and when operational. Access to information on health and safety issues must be easily accessible. All materials used in construction of buildings must have no negative effect on indoor air quality.

Participation

Informal meeting spaces are provided and a sharing of facilities by staff and

visitors will facilitate in the management of the buildings and the local environment

Access to facilities

Staff must be within walking distance of necessary food suppliers and communication facilities. The project must be located in an area that needs an economic boost.

Inclusive environment

All facilities need to be accessible for both disabled and wheelchair users. Visually impaired people will need to be accompanied by an assistant.

Occupant comfort

Adequate day lighting need to be provided to minimize artificial lighting. Natural ventilation is used to keep indoor temperature between 19°C and 28°C throughout the year. Framing a natural view for users from their working position will add to their positive attitudes.

3.2.1 Economic criteria

Local Economy

Building methods should have a simple but efficient technology in order for local contractors to be used for construction. It is planned to utilize on site materials for 40% of the total materials used for construction. Maintenance should be incorporated to provide a constant job opportunity for small contractors in the area.

Efficiency

Buildings should be used an average eight-hour working day for minimum of 5 days a week. The buildings need to have access to Internet and telephone facilities. Material and component sizes have to be incorporated into the design to minimize wastage.

Adaptability

Floor to ceiling heights should be no higher the 3000mm with exception of certain building functions, which required larger volumes. Internal spaces need to be flexible for change in building function.

Ongoing costs

Operating costs of facilities need to be as low as possible. To achieve this goal, local manufactures of cleaning agents are used and local entrepreneurs can do maintenance. Monitoring of water, electricity and waste are done monthly.

Capital costs

The local need for employment and training should start at the beginning of the project idea and be carried out through the whole operation. The tender process has to ensure the involvement of local contractors/suppliers. A 40% share of building cost needs to be allocated to sustainable technology. Construction needs to be labour intensive and reuse of existing buildings will contribute to recycling of materials and space.

3.2.3 Environmental criteria

Water

All roof surfaces are to be used for rainwater harvesting. Runoff from paths and roads will be redirected into the natural vegetation. Water efficient taps and cleaning equipment will be specified. All grey water will be collected and recycled for agricultural irrigation.



Energy

Ventilation of buildings will be all natural systems and no mechanical systems will be allowed. No electrical heating will be used in buildings, only heating allowed will be through passive solar design. All light fittings must be high energy efficient and alternative energy sources must be utilized, wherever possible

Waste

Toxic and inorganic will be taken off-site by local entrepreneurs for recycling. All organic waste will be recycled and reused on site. Sewerage will be recycled on site and used as fertilizers. Building material waste must be kept to a minimum during construction.

Site

The allocated site must be in an already disturbed state or the impact on vegetation should be kept to a minimum. Food gardens provide for on site usage by staff and also visitors. All vegetation is kept indigenous and no green lawns planted. Vegetation must be kept as natural as possible.

Material and Components

Materials with high embodied energy must not be used, keep away from aluminium and plastics. Make use of recycled and reused materials and components for construction. The area disturbed by building process must be less than 150% of building area.

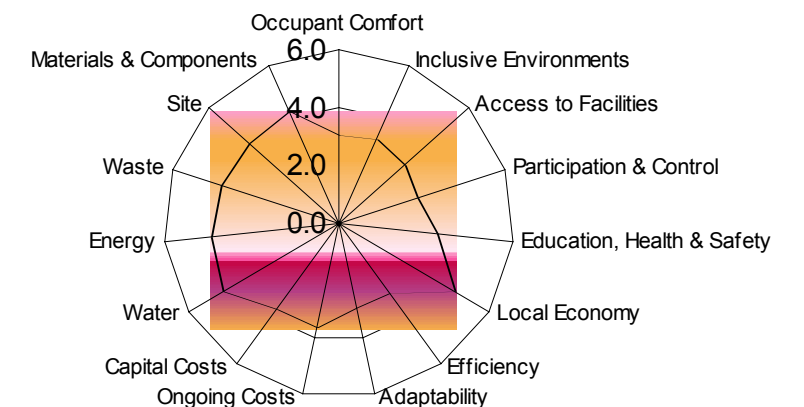
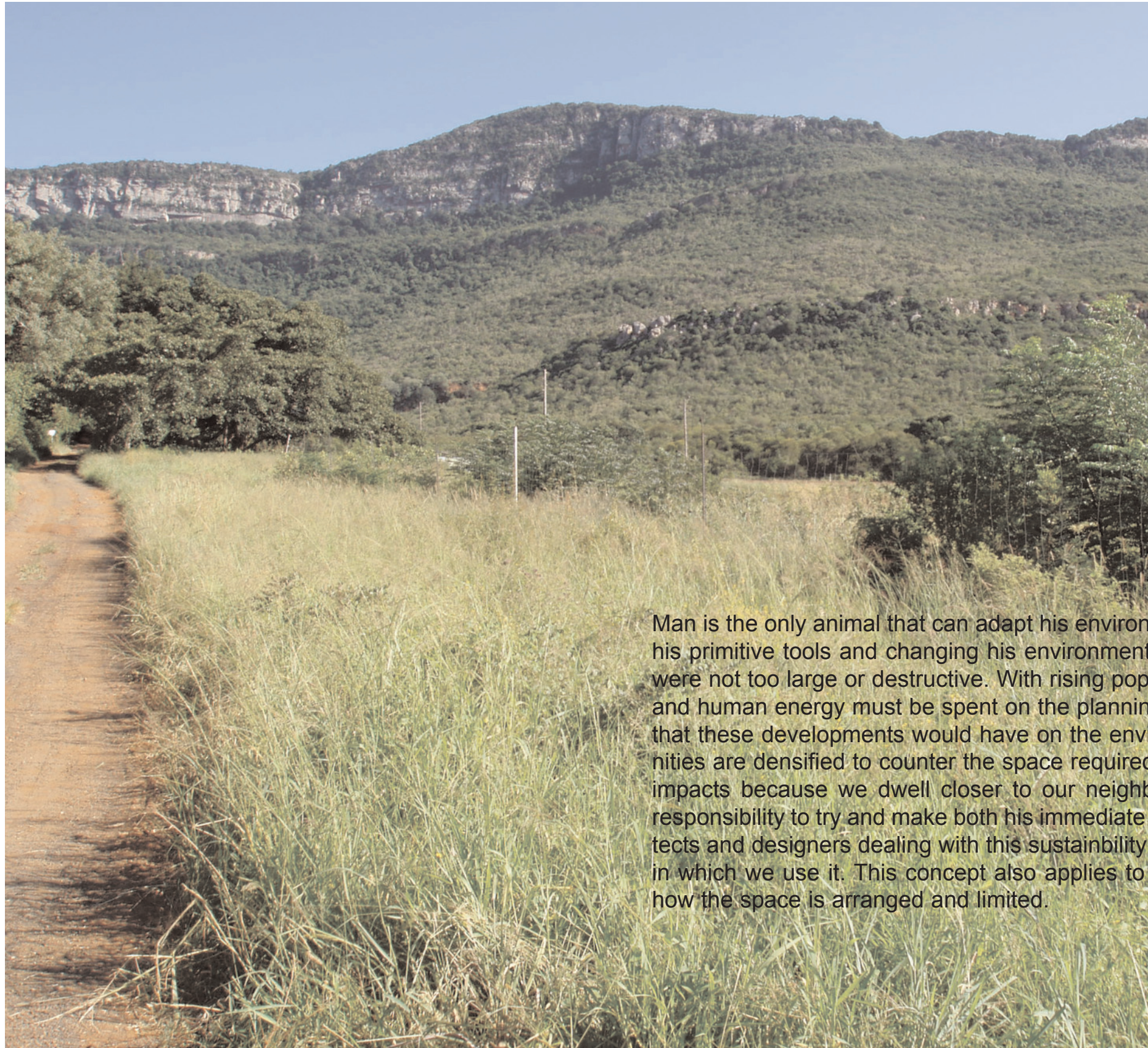

Fig. 3.2.1 Summary of performance criteria

Chapter 4

Site specific



The word “environment” is defined not only as one’s surroundings, but as all conditions affecting life and human behaviour. Wise planning with a long-range point of view for the entire area will benefit the most people, be the most economical in the long run, and create the greatest beauty which can be enjoyed for years

(Lois Davidson Gottlieb, 1965)

Man is the only animal that can adapt his environment to his needs. In pre-historic times when man had only his primitive tools and changing his environment, the mistakes he made weren't that serious because they were not too large or destructive. With rising population, areas left to develop are getting smaller. More time and human energy must be spent on the planning of projects that are identified for these areas. The impact that these developments would have on the environment are increasing considerably because our communities are densified to counter the space required for the population growth. Are we only now noticing these impacts because we dwell closer to our neighbours? Whichever is the right answer, it is each person's responsibility to try and make both his immediate and the entire environment more sustainable. For the architects and designers dealing with this sustainability issue; the materials we use are not as important as the way in which we use it. This concept also applies to the amount of space created, which is not as important as how the space is arranged and limited.

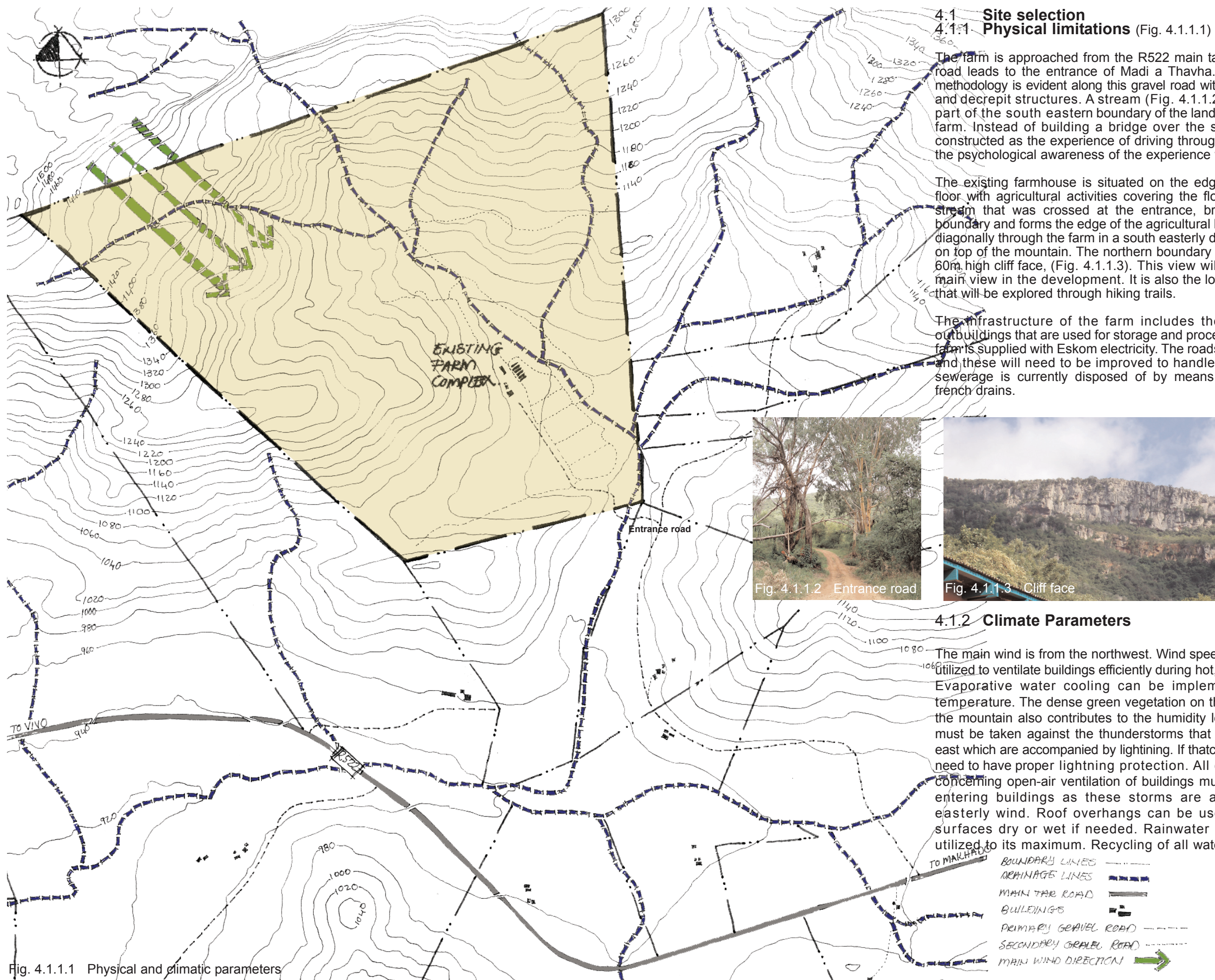
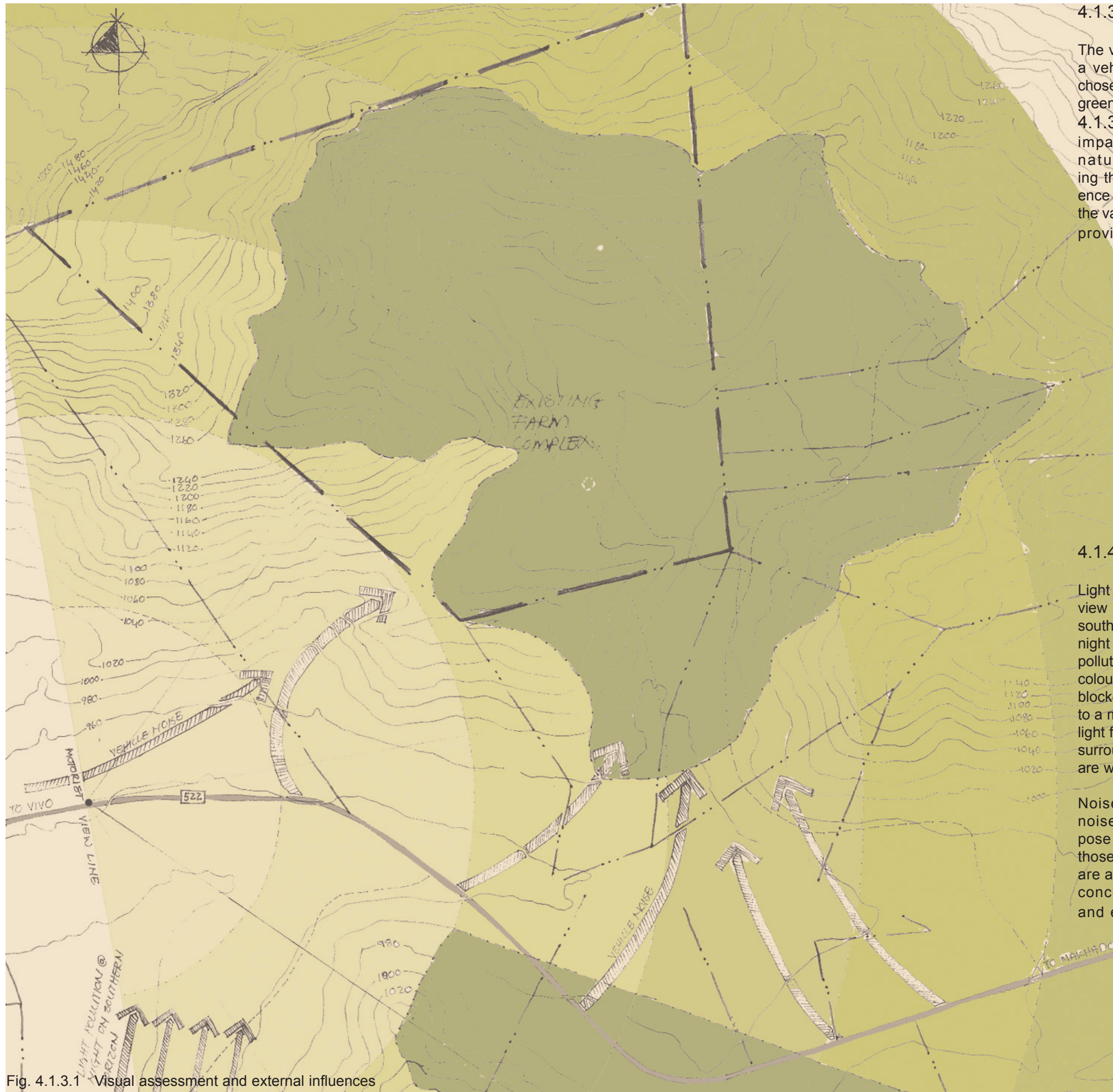

Fig. 4.1.1.1 Physical and climatic parameters

Fig. 4.1.1.2 Entrance road

Fig. 4.1.1.3 Cliff face



4.1.3 Visual impact assessment

The visual impact assessment is done from the perspective of a vehicle travelling east on the R522 main road. The point is chosen in the line of sight of an approaching vehicle. The dark green indicates the area not visible by the occupant (Fig. 4.1.3.1). A development in this area will not have an impact when experiencing the natural beauty of nature. This may however cause some difficulty in locating the farm for first time visitors, but it enhances the experience of discovering nature, the unexpected. The topography of the valley basin, wherein the development will be located, does provide a 360° view of the surrounding landscape.



4.1.4 External influences

Light pollution from nearby townships is blocked from the basin view by the topography of the area. The ridge that forms the southern boundary keeps the township of Tshiozwi out of view. At night the amount of light does not change the skyline. The light pollution at night from the eastern side, towards Makhado, colours the skyline significantly. This view at night must be blocked. Light pollution from the development itself must be kept to a minimum. Low voltage electrical bulbs must be used and no light fittings must point upwards, preferably all downlighters. The surrounding farm complexes do not pose a problem because all are well screened by vegetation.

Noise pollution will be mainly from the main road. These noises are screened by the southern boundary ridge and do not pose a problem. Noise levels of activities on the farm and those surrounding it will be high during the day. These levels are acceptable in that visitors are engaging in an agri-tourism concept. At night time a silence will fall over the valley and enhance the experience of the wilderness at night.

- BOUNDARY LINES ———
- MAIN TAR. ROAD ———
- PRIMARY GRAVEL ROAD - - - -
- EXCLUDED VIEW AREA ■■■■
- CLARITY OF VIEW ■■■■
- DIMINISHES ■■■■
- EXTERNAL INFLUENCE ———

Fig. 4.1.3.1 Visual assessment and external influences

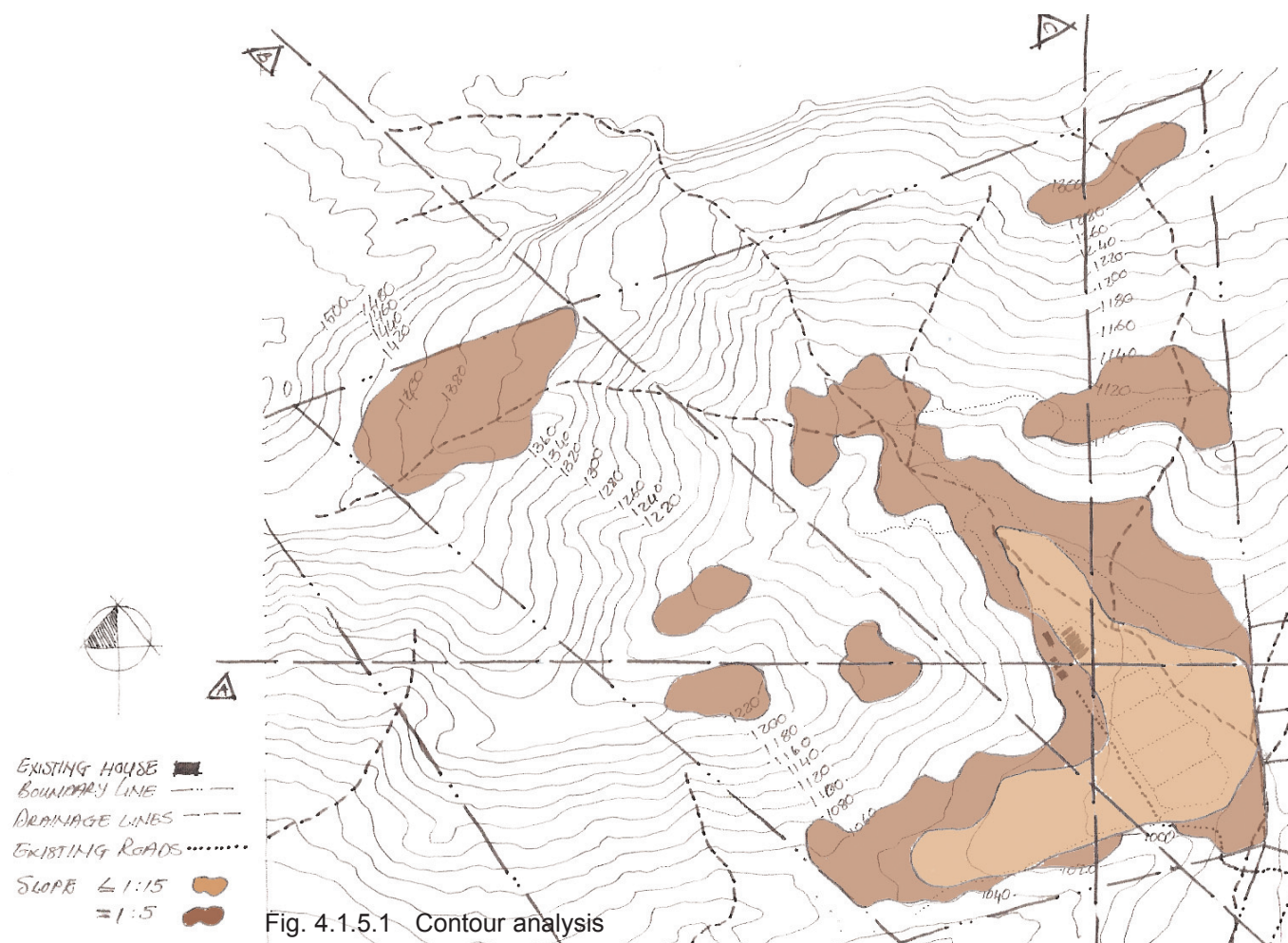

Fig. 4.1.5.1 Contour analysis

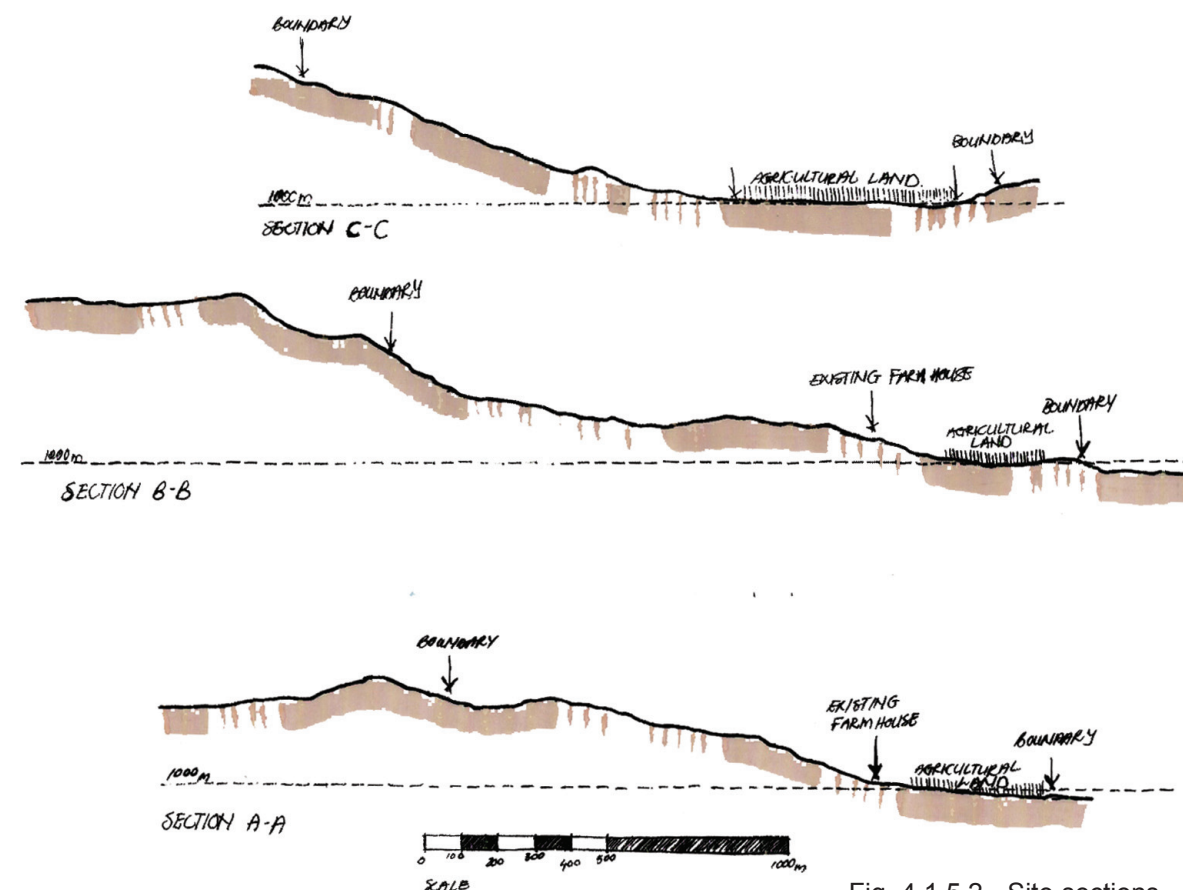

Fig. 4.1.5.2 Site sections

4.1.5 Contour Analysis (Fig. 4.1.5.1 & 4.1.5.2)

The areas chosen with approximately 1:15 slopes will be used for agricultural activities as a minimum of extra measures will have to be taken in terms of prevention of erosion control. No structures can be placed in this area because the biggest area possible needs to be used for agriculture in order to make it feasible. The area on the northern side of the stream will be rehabilitated for animal grazing and minimum of human influence on the stream is needed.

The areas depicted with the steeper 1:5 slopes are the maximum slopes on which structures can be built. Building on a steeper slope will become unfeasible as too much cutting and filling will be required, making the construction cost too high. Smaller single areas do give a better view to experience the environment but existing infrastructure and existing developed areas will be utilized for development. The impact on the environment will be kept as small as possible.

4.1.6 Zoning (Fig. 4.1.5.3)

The proposed areas are divided into five different zones. The agricultural area is fixed as was discussed in 4.1.5. The agri-tourism area includes the agricultural product processing, skills training, reception, conference facilities and tourist accommodation. This forms the basis of the development. Centralizing these activities in relation to agricultural land, makes them more economical and more manageable. The ridge where these activities are located provides the opportunity to raise accommodation units in order to enhance their views.

A variety of the types of experiences give this development that extra scope in terms of marketability. This will give rise to the different types of accommodation. The eco-tourism facilities are located on a platform that will give a 360° view of surrounding areas. It is far enough from the active lands to place the nature experience as main priority. The camping site caters for another type of visitor and its location was influenced by the existing infrastructure and existing accommodation (two timber houses). The private area is for the farm owners where the existing farm house is located. Re-development is needed as much of the agriculture activities are going to be moved to the agri-tourism complex. These developments stay connected to the central facility of the farm by means of view and distance. The decision is up to the visitor whether to participate or not.

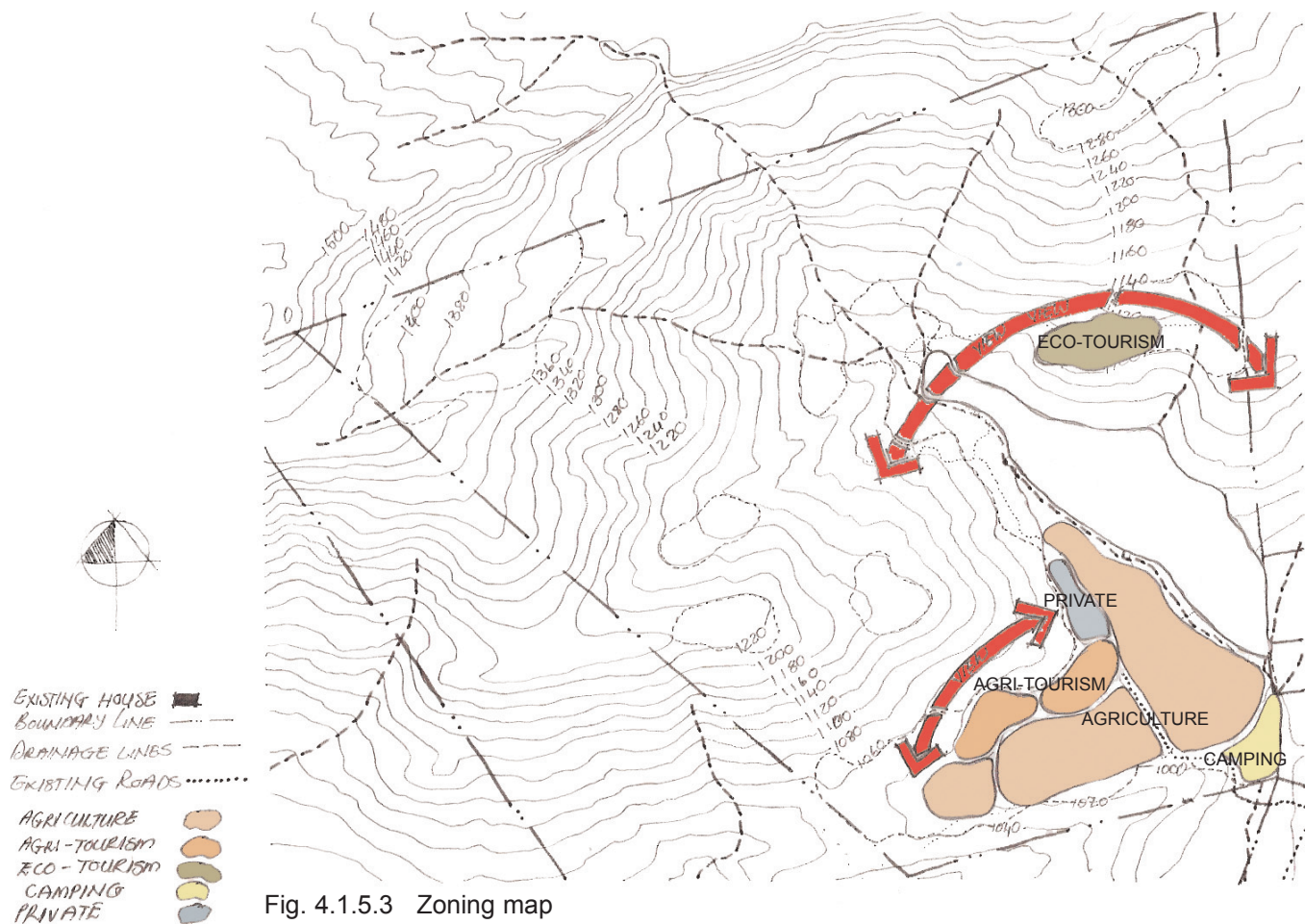

Fig. 4.1.5.3 Zoning map

Chapter 5

Precedents



"Since antiquity, man has reacted to his environment, using his faculties to develop techniques and technologies, whether to bake bread or make brick, in such internal psychological balance with nature that humanity historically lived attuned to the environment."
(Hassan Fathy, 1986)

Hassan Fathy describe in his book, *Natural Energy and Vernacular Architecture (1986)*, how the industrial revolution and the subsequent mechanization manipulated design. The new typology of materials created during this paradigm shift excluded the previously artistic expression found in materials. The pressures that are applied by first world countries through interrelationships, on developing countries are causing a social, economic and ecological instability. Artists in developing countries are becoming insufficient in their trade because of loss of valuable knowledge normally passed on verbally from generation to generation. This path of knowledge transfer is slowly eroding since the historical social patterns of these people are being disturbed. The mass of the populations are subsequently organised by these social patterns. It is these masses that have a personal knowledge of how to live in harmony with nature, which resulted in a psychological equilibrium. Usage of the local materials and climate led to economic building methods with internal and external space arrangement according to each community's social prerequisites.



Fig. 5.1.1 Timber rooftrusses



Fig. 5.1.2 Sun lit courtyard



Fig. 5.1.3 Timber structural columns

5.1 **Anthony Hudson
Quaker Barns, 2002
Norfolk, England**

The project entailed the conversion of two barns, which form part of a complex of farm buildings, into two dwellings. The use of local materials and craftsmanship mixed with a contemporary style assisted in emphasizing the form and details of the original barns. The familiar rectangular double storey, unplastered brick wall surfaces with corrugated pitched roofs and basic agricultural internal usage layout was the main characteristics emphasized (Fig. 5.1.1). This will forms the basis of conceptual departure since the agricultural context within the development carries a big weight.

The internal design of the two barns differ in that the larger one respects the original structure and bay layout while the smaller barn is more of a hybrid that connects two previously unconnected buildings (Fig. 5.1.2). The use of local materials and the inside reflects and remind us of the previous agricultural usage of these structures (Fig. 5.1.3).

Given the specific climate, it was important to make maximum use of the little (compared to South Africa) natural sun energy and sunlight available (Fig. 5.1.4). Both buildings are facing due south (northern hemisphere) for maximum solar gain. These elevations provide the backdrop for the positioning of the thermal inertia designed elements. The straw bale wall with translucent fibreglass rain screen (Fig. 5.1.5) that allows light to filter into the building are in the same surface as the main structure. Protruding rectangular boxes (Fig. 5.1.6) emphasizes the entrance and provides the main natural light on the inside. These framed boxes give the usual flat and boring barn elevation a refreshing playfulness.

Advanced technologies such as double glazed windows and car window seals (Fig. 5.1.7) were used at window opening sections to make it draught-proof when closed. These also contribute to the insulation properties of the barns, minimizing energy consumption.

Discertation applicability: *The use of local materials will assist in the fulfillment of man's psychological needs. The traditional "barn" will be used as a departure point in the process of architectural form generation. These re-interpreted forms must however reflect and compliment the Venda culture.*



Fig. 5.1.4 Shaded southern facade



Fig. 5.1.5 Straw bale wall



Fig. 5.1.6 Protruding rectangular boxes



Fig. 5.1.7 Double glazed sliding window

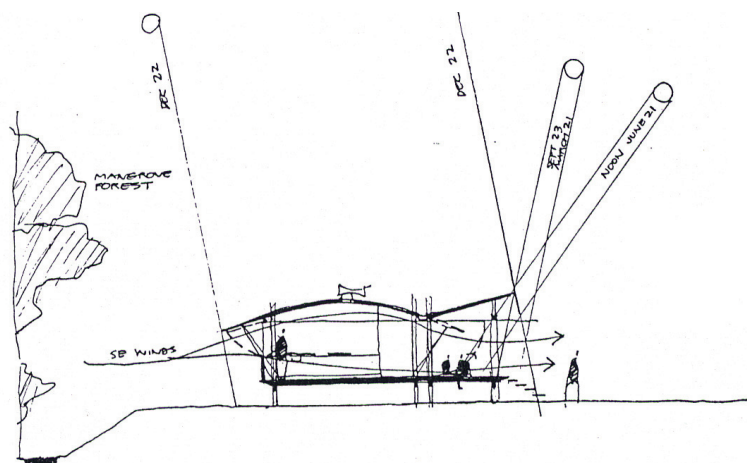

Fig. 5.2.1 Early sketch of climatic potential

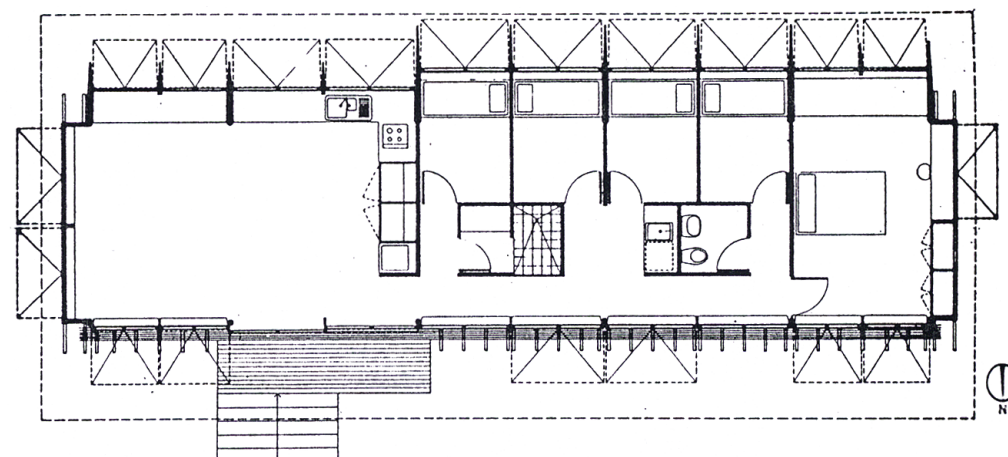
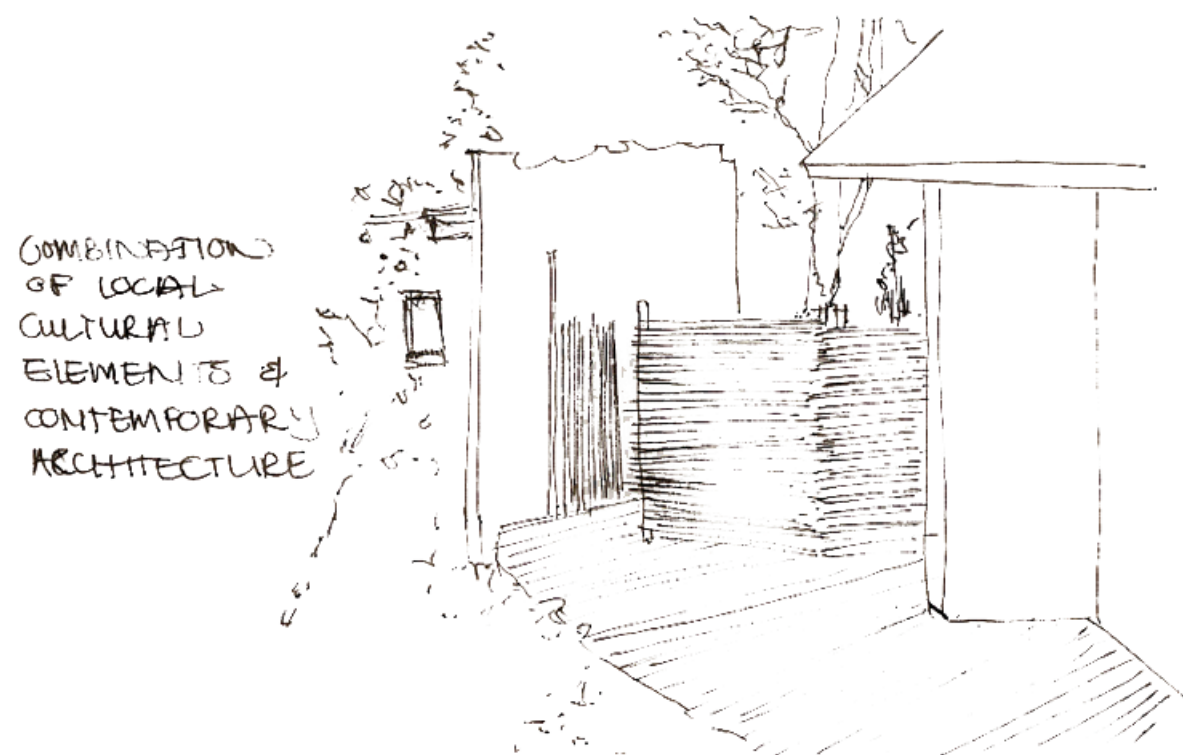

Fig. 5.2.2 Plan of long pavilion



5.2 **Glen Murcutt
Alderton House, 1994
Northern Territory, Australia**

"When considering a project site, Murcutt produces a site section drawing at least a half mile in either direction, and it must be freehand, espousing the virtue of hand-eye movement and its impact on the creative mind. He respects both the power of the landscape and the wisdom of the indigenous people who have had stewardship over this land for 40 000 years....." (Lindsay Johnston, 2003).

The house was designed for an Aboriginal artist's family, deep in the tropics on the north-west corner of the Gulf of Carpentaria. The site is on a narrow spit, with the beach and sea on the northern side (Fig. 5.2.1). Murcutt uses a variant of his long thin pavilion to address the main prospects and uses natural airflow to cool the interiors (Fig. 5.2.2).

Cyclones of up to 63m/s were one of the main factors that influenced the design. The main structure was made-up of steel portal frames (Fig. 5.2.3) that were bolted to piles sunk deep into the ground. These frames were clad with marine ply or slatted tallow-wood shutters (Fig. 5.2.4). These cladding panels can be moved from vertical to horizontal positions. These provide the shaded platforms that now connect the inside with the outside. This is a reinterpretation of the Aboriginal shelter made of branches and leaves (Fig. 5.2.5). When the cladding panels are closed it is still possible for the building to breathe. Opening and closing like a plant, the house embodies Murcutt's concept of a flexible shelter that exists in harmony with nature's rhythms. Together with the ventilators on the roof (Venturi's hot air extraction principle) they serve to equalise internal and external pressures in a typhoon (Fig. 5.2.6). Because the structure rests on stilts, air circulates underneath and helps cool the floor (Fig. 5.2.7). Raising the house also helps keep the living space safe from tidal surges.

The design is not a direct copy of the nomadic Aboriginal's shelter but a reinterpretation of three traditions: the Modern movement, the heritage of Aboriginal building, and the Anglo-Indian architecture of the 19th century colonialists. This building sits lightly on the earth, and it responds with increasing gracefulness to locus, ranging from insight of views to the potential of the microclimate for providing ambient energy to cool the interiors.

Discertation applicability: The arrangement of space in the proposed development will be influenced by climatic factors and the Vendas' social systems.



Fig. 5.2.3 Steel frame junction point



Fig. 5.2.4 Movable cladding panels



Fig. 5.2.5 Aboriginal shelter

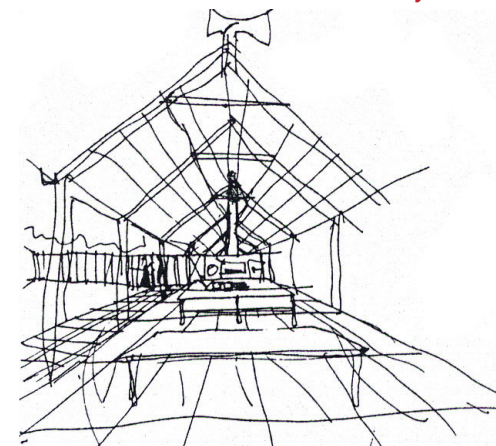

Fig. 5.2.6 Structure & ventilation analysis



Fig. 5.2.7 Floating mass above soil

"Reading of place"

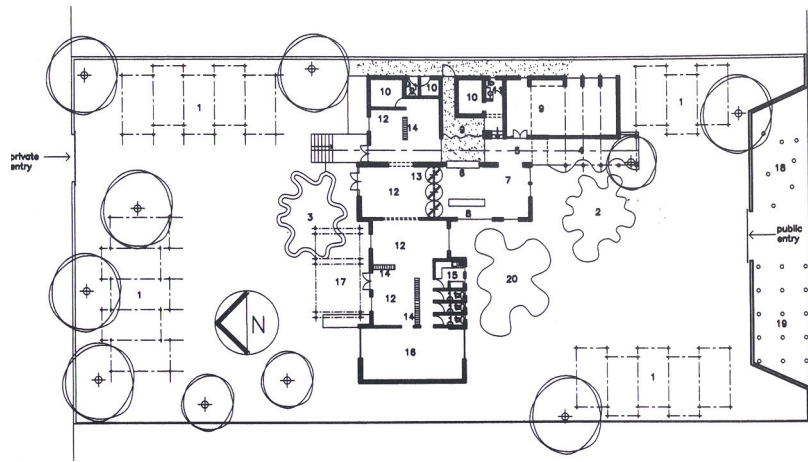

Fig.5.3.1 Plan indicating north south axis through site



Fig. 5.3.2 Permeability from public- to private space

5.3 **Kate Otten
Indigo Marketing Offices, 2003
Johannesburg, South Africa**

The property in Corlett Drive was well situated but the look of the converted house on the site did not attract the right image for the new marketing company.

The presence of two access points to the site, presented the opportunity for an axis through the site from private to semi-private to public space. Layering starts already at the entrance to the site (Fig. 5.3.1). This dialogue created between public and private is so strong that those on either side of this axis are not directly connected. They can however see through from private to public space and vice versa (Fig. 5.3.2).

The layering of space and the manipulative visibility have been implemented through the whole design. The most public space given is the boardroom. It has been given a high visibility by means of a glass wall and clear-storey windows for maximum natural light (Fig. 5.3.3). The covered colonnaded walkway that leads to the boardroom and reception area adds to the legibility of the building. The reception is a big open-plan space with rotating fin doors on its northern side (Fig. 5.3.4). These doors allow the different degrees of privacy and openness.

Going through to the most private part of the building is the design studios. The layering is also evident in these areas by the manner in which bookshelves are used to screen off ablution facilities (Fig. 5.3.1) and how windows are screened. The bookshelves dividers are made of corrugated plastic that allows light through. This design is a simple, natural solution that makes use of local materials for shading and layering and creates a legible and light structure (Fig. 5.3.6).

Discertation applicability: Circulation will be regulated by the public and private spaces. Application of local materials will emphasize these spaces which in turn will heighten the legibility of the development as a whole. The organization of the design will be synchronized through the layering of the existing Vendas' social sytems and the specific 'plant' requirements. This layering will not only be done horizontally but vertically as well.

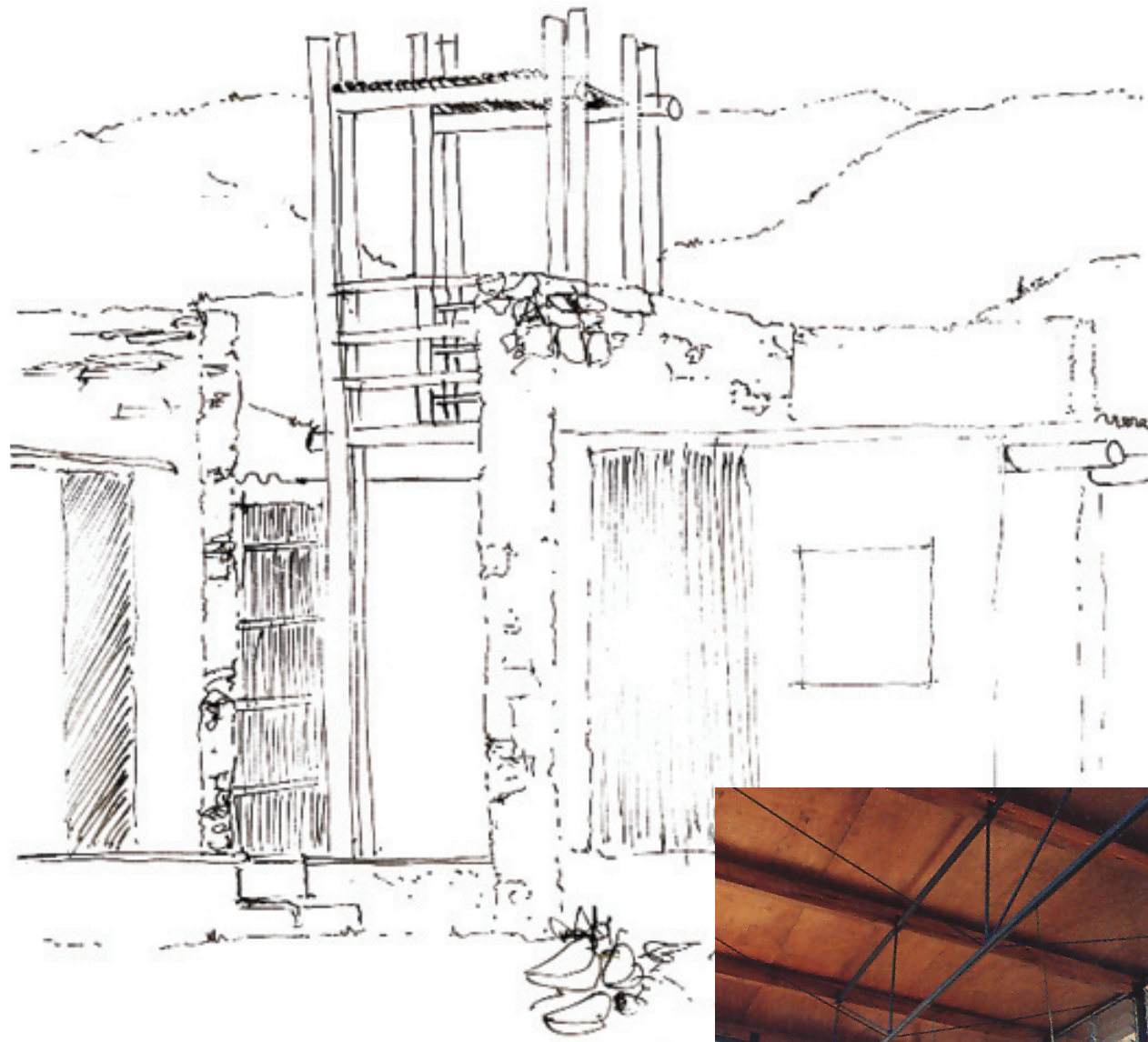

Fig. 5.3.3 Glass wall and clear-storey windows



Fig. 5.3.4 Fin doors



Fig. 5.3.5 Lightweight pergola structure

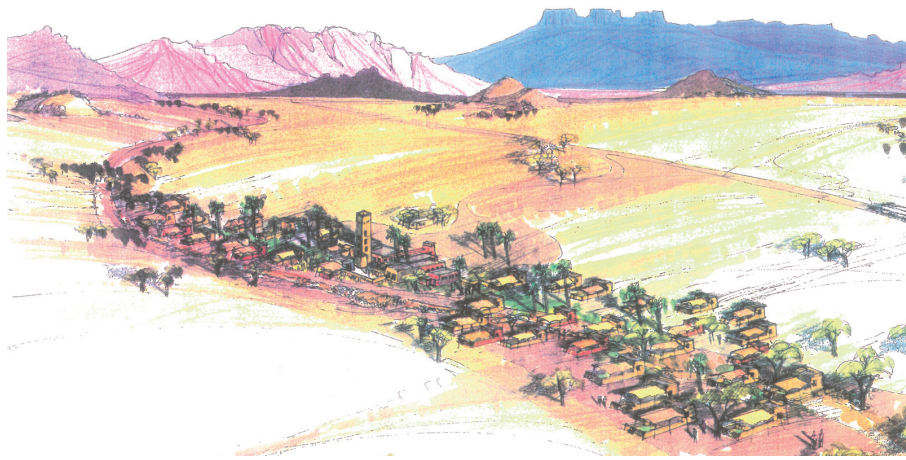

Fig. 5.4.1 Site plan

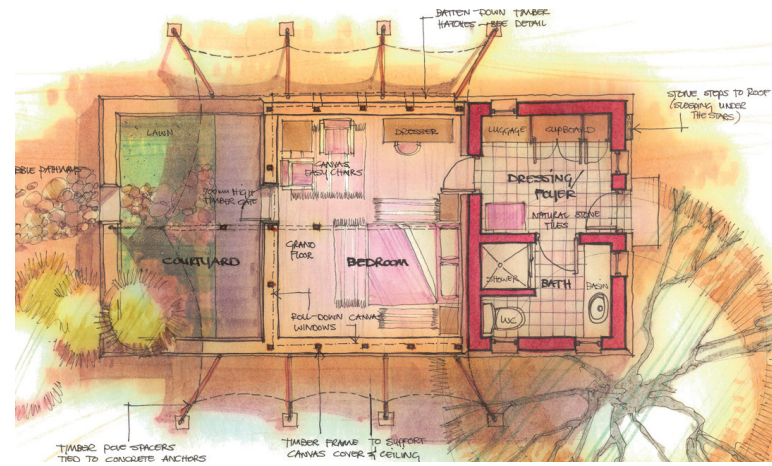

Fig. 5.4.2 Bedroom unit plan

5.4 **Niel Crafford**
Sossusvlei Karos lodge, 1993
Sesriem, Namib Naukluft Park, Namibië

This project is a mega-luxury resort with 45 rooms in a pristine environment with the most severe climatic conditions possible (Fig. 5.4.1). Hostile conditions include the midday heat and freezing night temperatures. The most destructive being the easterly winds blowing from the Naukluft mountains, with wind speeds of up to 120km/h.

All the passive design principles that the architect applied in this project can be best explained by a detailed investigation of a bedroom unit, “Bedouin abodes” (Fig. 5.4.2). The same principles have been applied to the main complex. The design exposes the visitor to the environment: the tall Naukluft mountains to the east and south, the majestic Namib to the northwest, the ever changing colours that makes this the most photographed natural environment in the world.

The bathrooms are solid brick structures with small windows, which will retain the heat of the sun and transmit it inwards in the cold winter nights. These solid blocks have tapering cavity walls that will assist in the depleted transmission of heat during the hot summer months because no shading device has been implemented to take direct sunlight off these heat stores in summer months (Fig. 5.4.3).

The bedrooms are custom-made canvas structures with a 180 degree view over the desert that cools down quickly in the summer once the sun has set. The canvas windows were fitted with shade-netting panels that act as insect screens which are brought by the northerly winds from the desert. The bedroom areas have been equipped with canvas overhangs to keep direct sunlight off canvas wall panels (Fig. 5.4.4). This canvas shades the internal canvas ceiling and an additional woven shade-net also helped to minimize the suction effect of the strong sandstorm winds on the canvas structure. In winter the sun shines on the low brick walls in order to store energy to be radiated to inside of bedrooms at night time. The low walls built next door in the camp site are copied to protect the inhabitants against desert storms. The east facing walls are higher than the western ones because the winter dust storms are caused by incredibly strong easterly winds (Fig. 5.4.5).

The average rainfall in the area is far below the regional average but when it does rain, it comes as a quick storm. Getting this water off the structures as quickly as possible solved the handling of high volumes of stormwater in a short period. The sizes of outlet pipes on the flat roofs are greater than average in relation to its roof area (Fig. 5.4.6). The gutter that was installed between the canvas roof and brick wall made a perfect joining element between the two materials. The gutter size is also bigger than the norm when in relation to the type of roof and surface area.

Elements of other deserts in Africa were incorporated: the mud houses of Morocco, the tented camps of the nomadic tribes such as the Berbers and Bedouins. These were combined using the thermal properties of each to its highest potential.

Discertation applicability: Make use of the climatic conditions to achieve the occupant comfort zones which are required. The architectural features will reflect the influence of the local climate. These climate conditions will be most evident in the creation of micro-climates in and around the structures. Local materials have already climatized and by using it in the right manner and composition, these materials are much more competent compared to imported materials. Natural ventilation and sun energy will be used to decrease the impact on the ecological footprint.

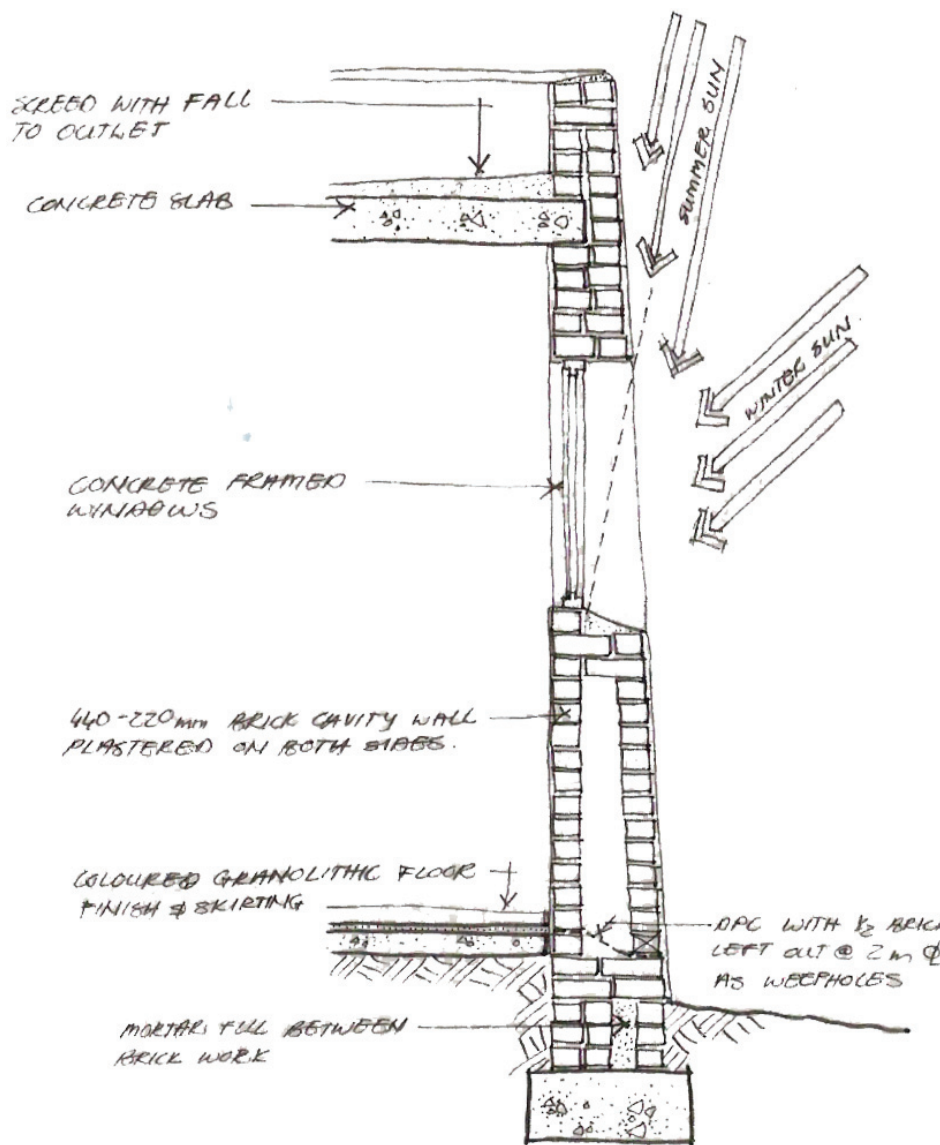

Fig. 5.4.3 Section through brick cavity wall

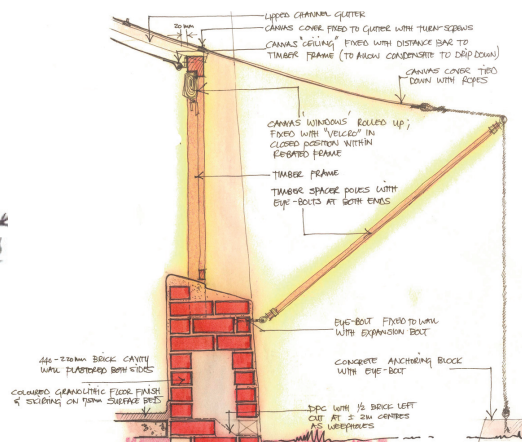

Fig. 5.4.4 Section through canvas & roof



Fig. 5.4.5 North-western view with higher eastern wall

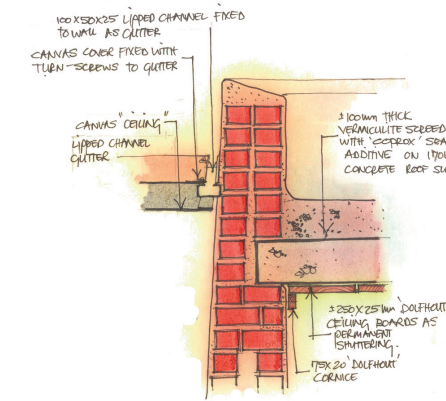

Fig. 5.4.6 Gutter and outlet details

5.5 Norman Eaton
Anderssen house, 1950
Pretoria, South Africa

"For South African architects, the surviving architecture of Norman Eaton is a reminder that buildings can be particular to their country. Eaton's work has that timeless quality which is associated with great architecture....." (Beck, 1985:22)

The Anderssen house was originally designed as a farmhouse (fig. 5.5.1), but sits now in an urban context due to the expansion of Pretoria in recent years. The house is orientated to the north (ideal southern hemisphere orientation) with all living rooms along the northern facade of the building (Fig.5.5.2). The building runs in a rectangular formation from east to west. Separating the semi-public space from the more private space (Fig. 5.5.3). The flat roofs comfortably attaches the building to the African veld.

Pretoria's climate is marked by hot summers and cold winters - extremes on both sides. The large overhangs provide enough shade during the hot months but in the colder months, with the sun angle lower, the sun penetrates the faces to store this energy (Fig. 5.5.4). Through the fly-wheel effect this energy is then radiated at night when it is welcomed during the cold months.

The mansion-like appearance at first glance vanishes after careful examining of the spaces, which are economical and comfortable. The volumes of the spaces stimulate the movement through the building (Fig. 5.5.5). In the lounge, the ceiling lifts up and one descends three stairs to enter the space. The conventionally narrow corridors are replaced with a broad one to facilitate circulation.

The use of local materials, like timber was used for floors, cupboards, doors, windows, ceilings, and fascias. The timber floors reflect the woven grass mats of African huts. The darkened cypress posts and beams and the use of undressed stone in a random pattern also reflects a traditional African building technique. The narrow wall niches in some walls are also an abstraction from African tribal cultures.

Discertation applicability: The design must adhere to the climatic conditions and the cultural context of the area.

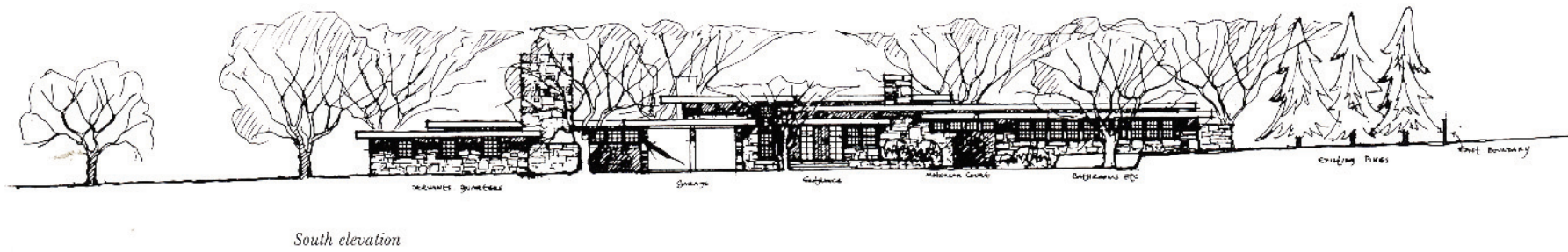

Fig. 5.5.1 South elevation

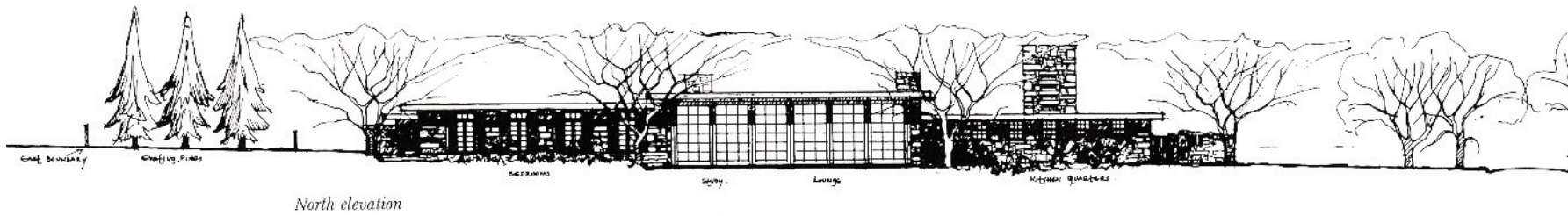

Fig. 5.5.2 North elevation

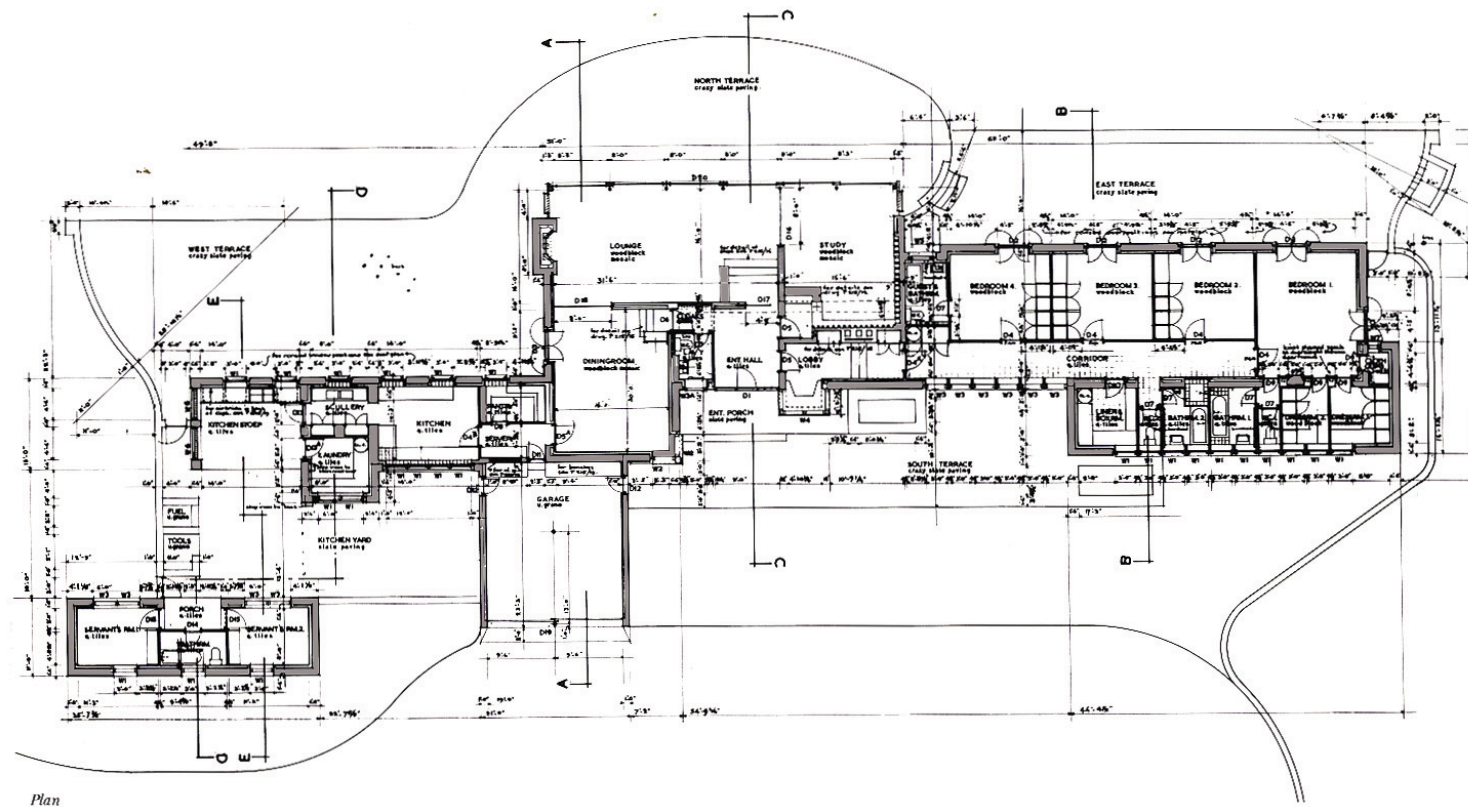

Fig. 5.5.3 Plan



Fig. 5.5.4 Sun angle manipulation



Fig. 5.5.5 Economical space creation



Fig. 5.6.1 "Place of the Wallowing"



Fig. 5.6.2 View from river

5.6 **Peter Rich**
Bopitikelo Community and Cultural Centre,
2001
North-West Province, South Africa

Bopitikelo - "place of the wallowing"

"..... with a minimum of materiality, demonstrates the ability of the architect, through design, to create a cohesive spatial, social and cultural identity." (Van Wyk, 2001:36)

The site was identified as a place where farm animals can drink and where people can rest and interact. This project (Fig. 5.6.1) is an attempt to re-install cultural pride and building tradition in a community that has lost its connections to their origin.

A collection of detached pavilions form the centre of the design (Fig. 5.6.2). Emphasis was also placed on the form of buildings and the spatial relationships between them. The proximity of the river determined the placement of the main building to capture the view of the river (Fig. 5.6.3). The long main thatched building was constructed and proportioned according to the Tswana men's initiation structures (Fig. 5.6.4). The detached pavilions define the outdoor spaces with open-ended, multi-use spaces contrasting with specific, intimate spaces. The spaces between the buildings are treated, as was traditionally done by the Tswana, as very important public spaces (Fig. 5.6.5).

African building traditions are characterised by the use of plant and earth material. Hydraform blocks (soil-cement blocks) are used for enclosure, and soil from the region was used to manufacture these blocks. Traditional thatching was used for the main building. This is a technique that has been used locally for centuries but is slowly disappearing. Local stone from the nearby mountains form paving grids that are filled with granolithic, hand-textured floors. These elements helped to define the changes of level, threshold of entry and movement patterns (Fig. 5.6.6).

Discertation applicability: *Materials that are going to be used will all be locally sourced. Construction methods must be simple in order to use local labour and not imported labour. The materials used in the design will have a huge influence on its occupants. Materials must be used honestly.*

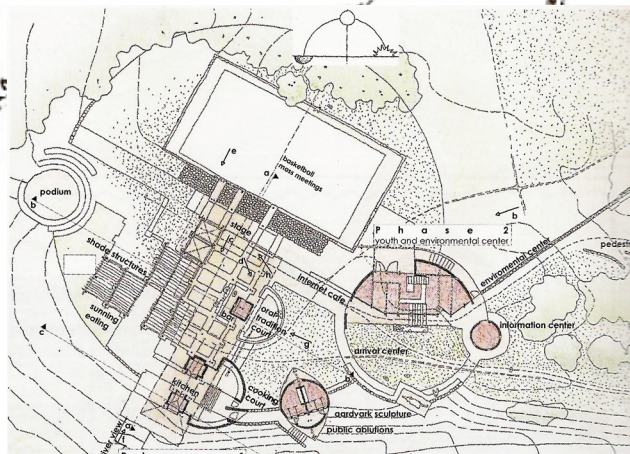
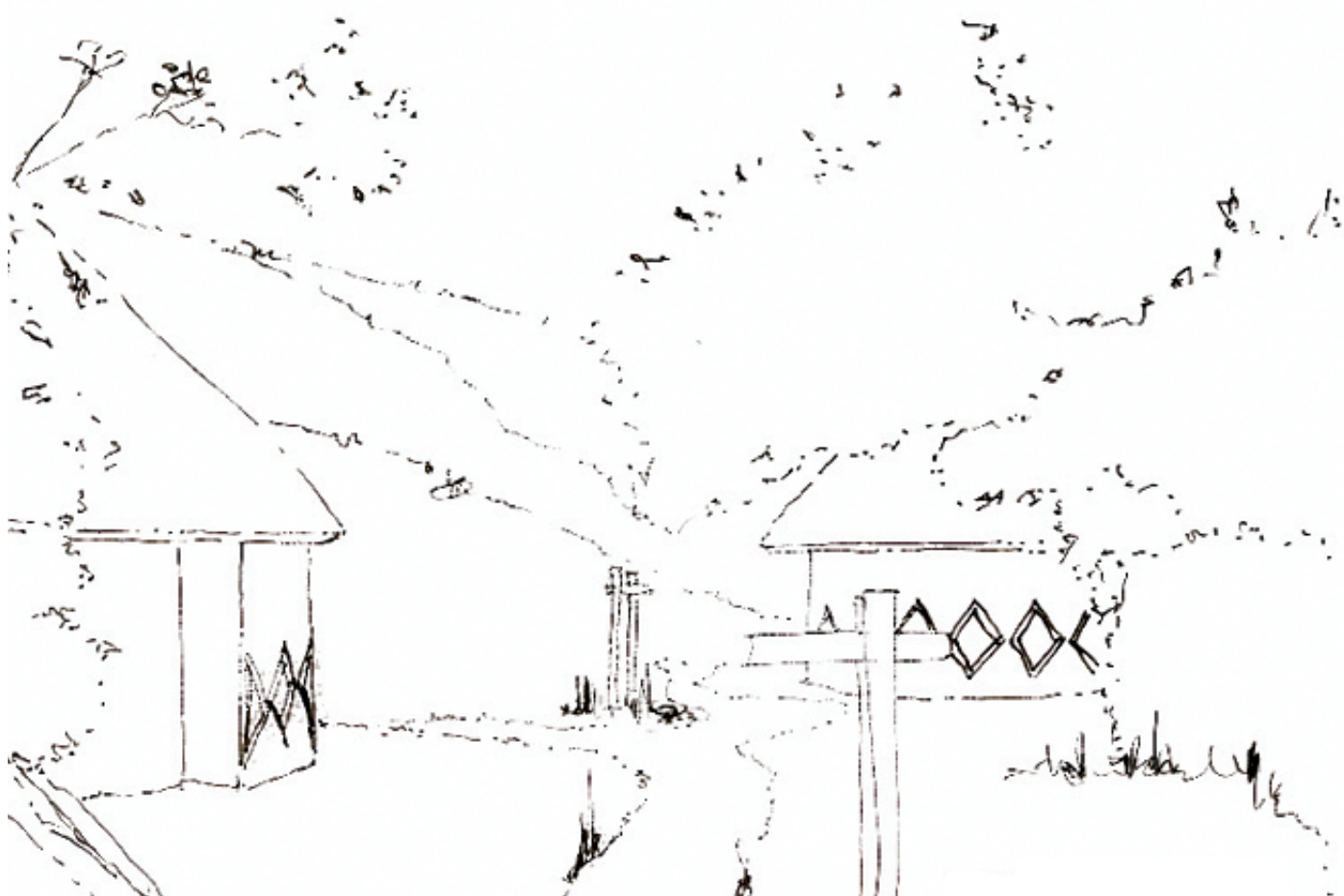

Fig. 5.6.3 Plan: Detached pavilions



Fig. 5.6.4 Public space relations

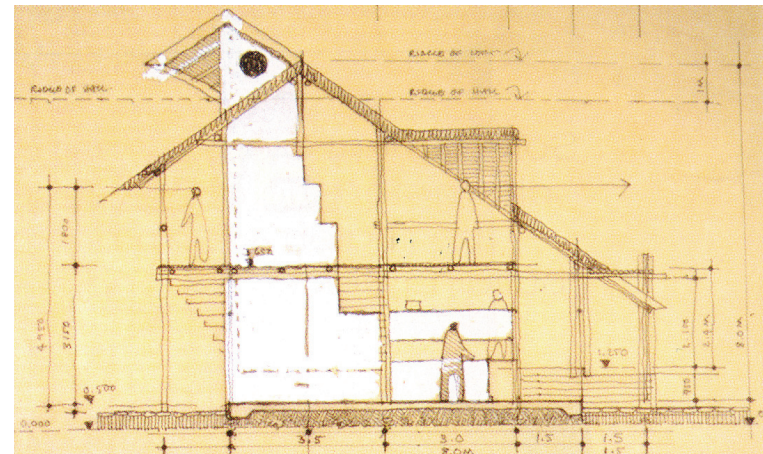

Fig. 5.6.5 Section through main building



Fig. 5.6.6 Defining space boundaries



Fig. 5.7.1 View of Kandalama Hotel

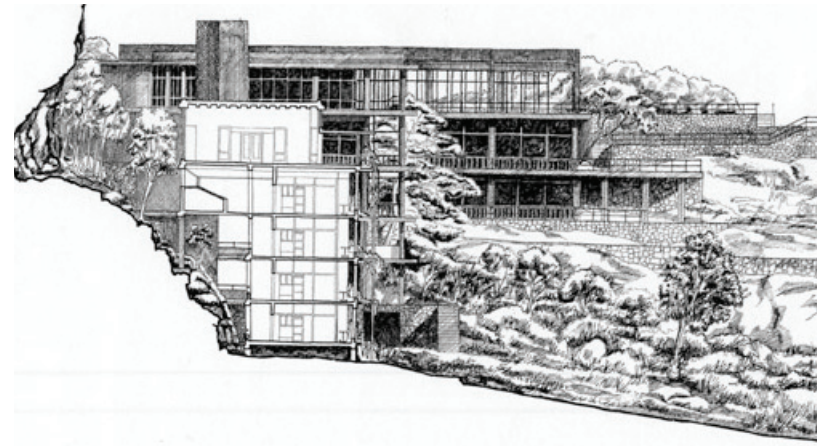

Fig. 5.7.2 Section indicating design with topography

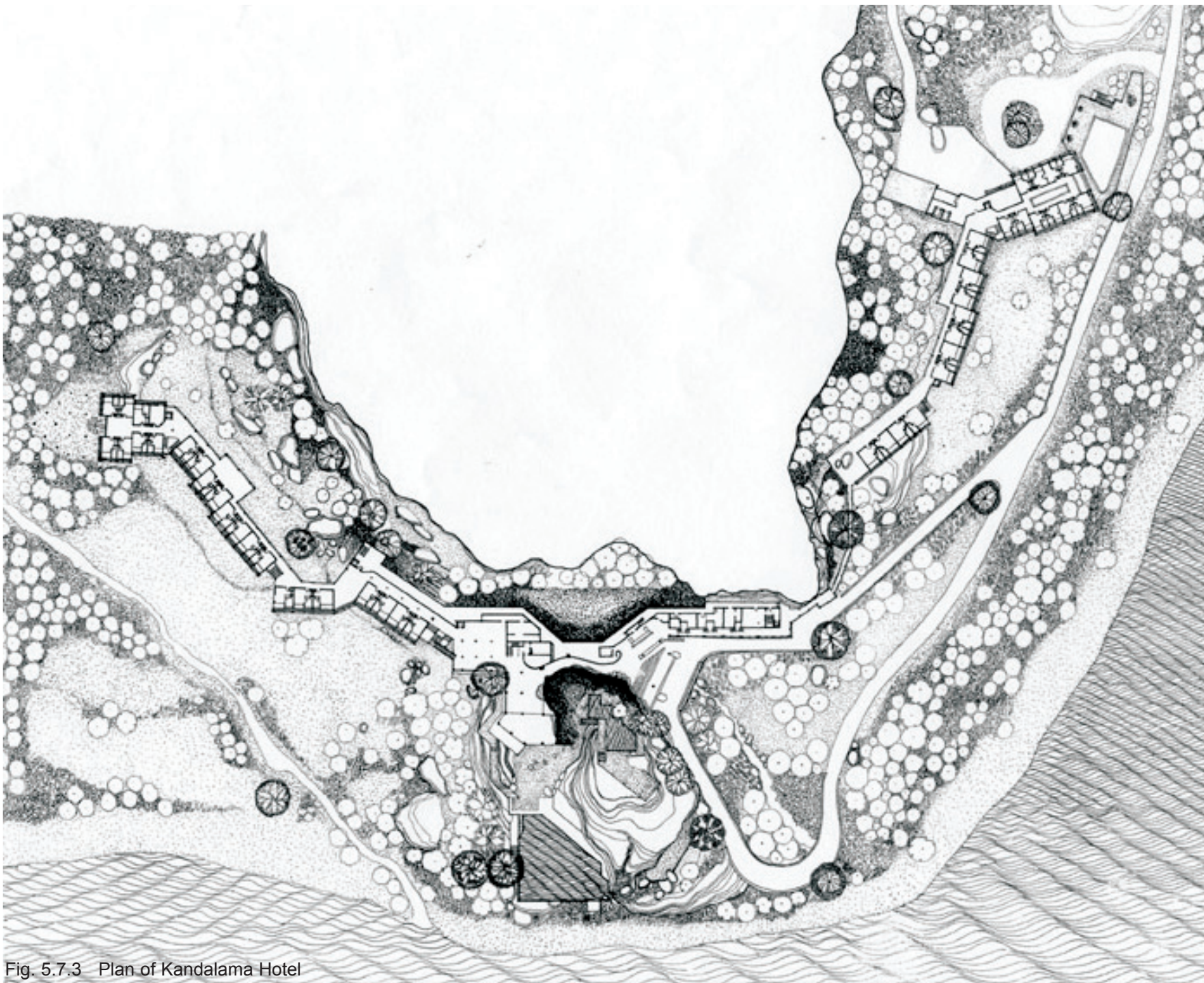

Fig. 5.7.3 Plan of Kandalama Hotel

5.7 **Geoffrey Bawa**
Kandalama Hotel, 1995
Kandy, Sri Lanka

The hotel is located at the crossroads of different ecological zones harboring a spectrum of wildlife in the heart of a cultural triangle. Initially the development was met with much public debate, as many people living in the relatively pristine and undeveloped region were opposed to any tourism development, as the area is one of the most significant regions of the country in terms of wildlife.

The eco-friendly Kandalama Hotel (Fig. 5.7.1) is designed in a way that compliments and enhances the natural environment, despite its size. The building follows the contours of the hill outcrop and in some cases is elevated on concrete piles allowing for existing habitat to remain (Fig. 5.7.2). Open, concrete hallways span the length of the hotel, providing easy access to amenities while providing the guest with an unprecedented view of the surrounding environment. Kitchen and service facilities are located on the hillside of the building. The concrete structure is shaded by ample wooden overhangs. Daylight design has been applied throughout the building. The concrete roof, which can absorb a large amount of passive solar energy is covered by sod with the intent of growing organic produce and insulating the structure. Main walkways are face the large lakes (Fig. 5.7.3).

The park includes a composting pit, a native tree nursery, the wastewater treatment plant, and an eco-library for employees, guests and local school children. The in-house nursery produces indigenous plants for the reforestation program that operates on the 50-acre property and areas outside. The hotel is designed into and around the surrounding rock outcrops (including pools and patios). A gravel parking area is provided but kept small and is shaded with trees. Some of the materials used in the construction were reclaimed wood products. The minimum amount of paint was used and the design included many natural materials for finishes.

Water shortages in the area were overcome by harvesting rainwater, using low flush toilets, and reusing greywater. Energy usage is decreased by using compact fluorescent lamps in all public areas. The hotel encourages the use of bicycles as transport mode and a bus provides service to travel to town and back. The Eco-Park is also used as an educational tool about the environment for local school groups. Recycling is done into 15 categories and the hotel encourages its suppliers to reuse glass bottles and jars for their products. All the locally grown food is served in the hotel's restaurant. The staff and the community are receiving environmental education that is provided by the hotel management.

Discertation applicability: An input - output analysis will indicate the resource usage and waste generated from the development. The important resources such as energy, water and waste will be the main generators for systems adopted in the design. By designing with nature, a distinctive architecture evolves. The topography of the site provides the backdrop into which the architectural composition is perceived.

Chapter 6

Design development



"A person is a member of a living organism that constantly reacts to its environment, changing it and being changed by it"
(Hassan Fathy, 1986)

Architectural form can be ascribed to different regions due to the specific climatic conditions of that region. In the colder regions of the northern hemisphere, the high roof pitch helps to shed the snow during winter months. In the moderate temperature regions the roof pitch is lower, but is still needed to accommodate heavy rainstorms. In hot dry climates, with minimum rainfall, the rooves are generally flat and the main purpose is to keep the hot air and sun out of the internal spaces of the building. Other forms such as window openings can also be ascribed according to climatic characteristics.

Early man built with available local materials and used natural sources of energy to create his desired microclimate. The decisions he made were influenced by his physiological needs. Behavioural studies indicate that climate shapes the rhythm of mans' life, thus contributing to the balance between his physical and divine being and the outer world.

One cannot simply discharge aesthetic quality as less relevant than the behavioural effects of design. Design needs to reflect hope and not mere subsistence. Design can give a measure of selfworth, identity and hope, even when little else exists.

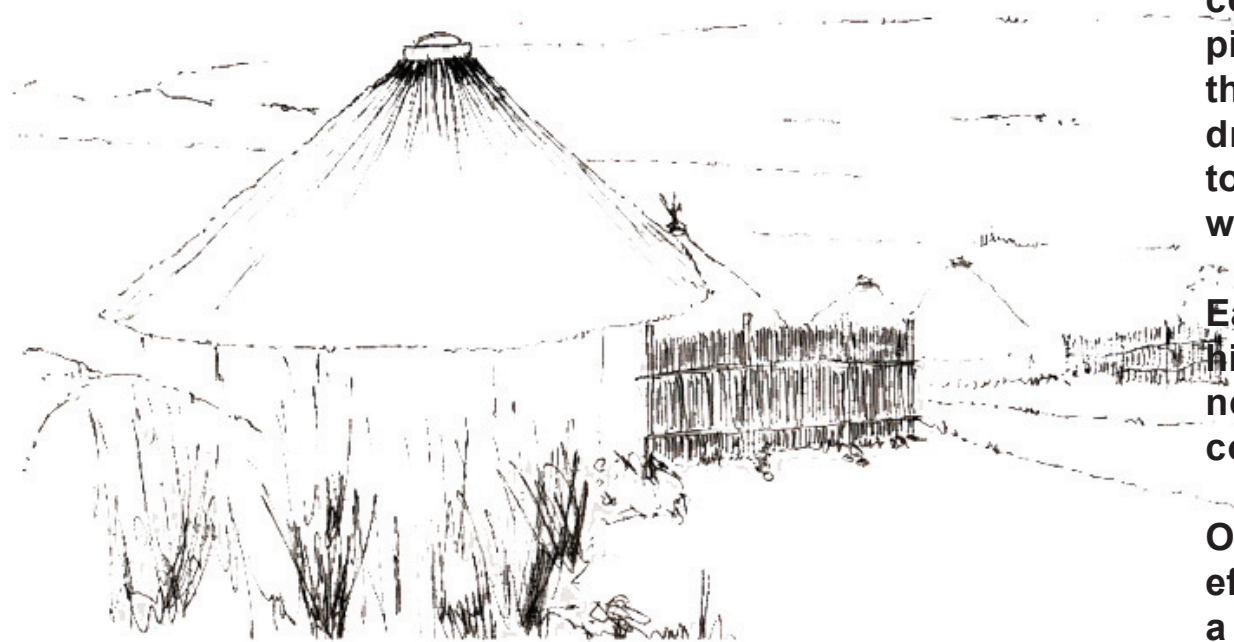

6.1 Input - Output analysis

Fig. 6.1.1 is an analysis of the required input needed and output generated of the minimum requirements and responsibilities to operate the agri-tourism farm complex in a sustainable manner.

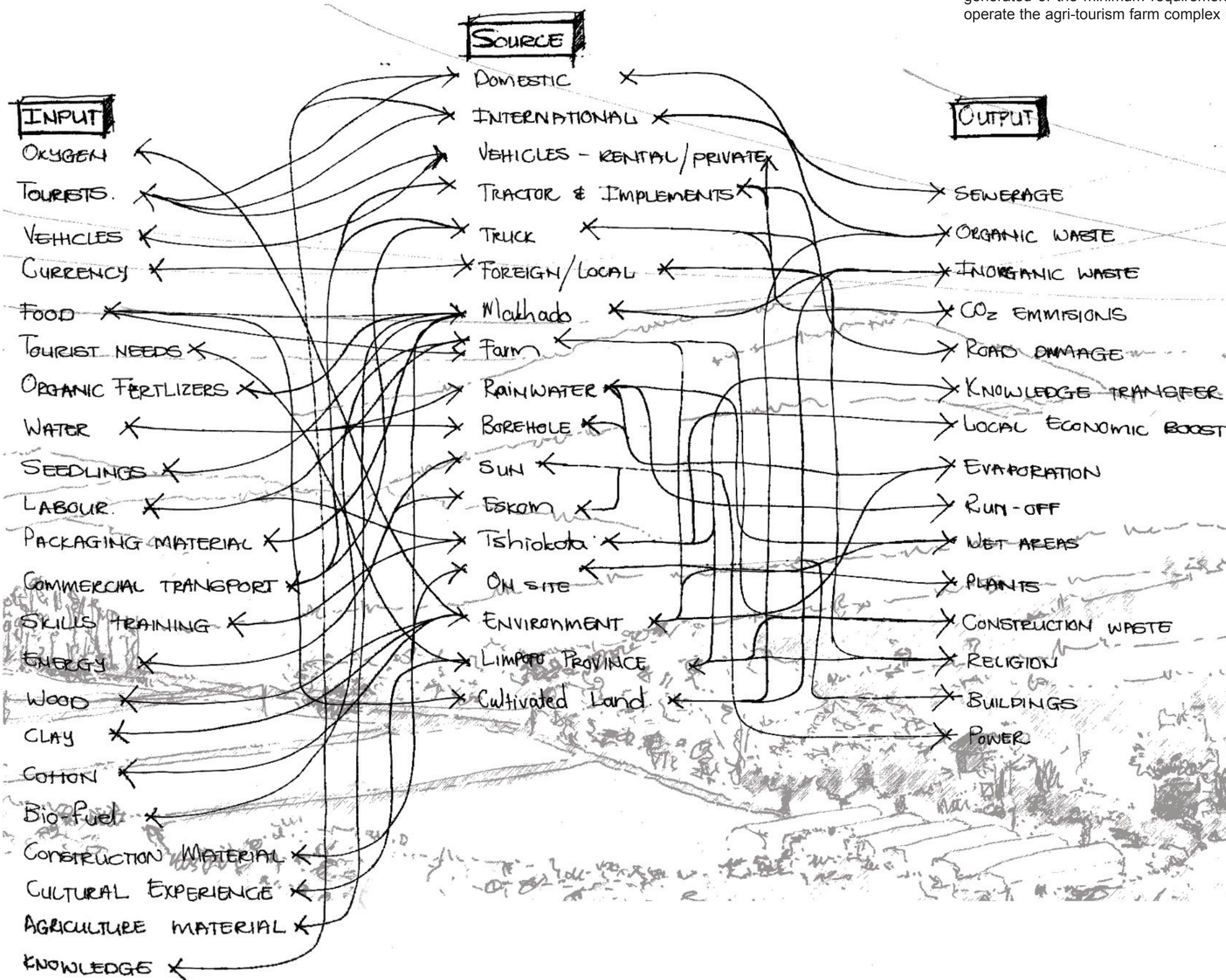

INPUT - OUTPUT ANALYSIS

Fig. 6.1.1 Schematic input-output analysis

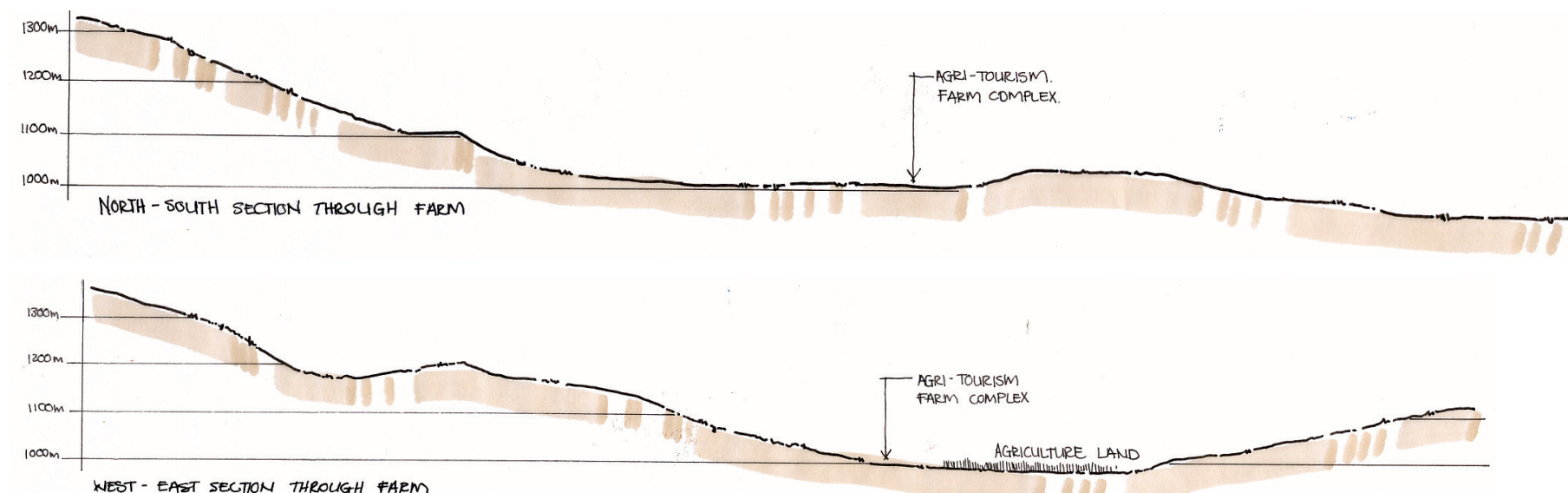

6.2 Site Development

6.2.1 Physical (Fig. 6.2.1.1)

The site falls from west to east and north to south with an approximate max. slope of 1:5. A ridge is present in the middle of the site that divides the site into two visual zones. This division contributes to the hierarchical organization and the zoning of the functions. The slope of the site provides the platform to lift buildings off the valley floor to enhance the viewing spectrum.

The existing infrastructure consists of a three-metre wide gravel road that forms the eastern boundary between the existing agricultural land and the site. The nearest Eskom electricity connection point is 200m east of the gravel road running diagonally through the agricultural land in a northwesterly direction to the existing farmhouse. The main water supply is located 100m north of the entrance gate along the eastern boundary of the farm. This borehole water is pumped to the existing water reservoirs, which are situated behind the farmhouse.



SITE DEVELOPMENT

Fig. 6.2.1.1 Perspective view of existing site viewed from the north

6.2.2 Functions (Fig. 6.2.2.1)

The development consists of three main functions: agriculture, community development, and tourism. These three components consist of administration, restaurant, conferencing, skills training, ablutions, produce processing, workshop, storeroom, temporary staff, and accommodation facilities.

These facilities are grouped into three categories: public, semi-public, and semi-private areas. The public areas (being the point of arrival for visitors) are comprised of the administration section, restaurant, conference venue, and ablution facilities. The produce processing and skills training facilities are semi-public areas to make sure that productivity is not negatively influenced. (Visitors will be limited to specific areas to ensure their safety due to the use of industrial machinery.)

The temporary staff, workshop, storerooms, and accommodation facilities are semi-private areas. The accommodation component is located higher than the public and semi-public components in order to enhance the view from the buildings. These facilities contribute to the beauty and enhancement of the natural landscape in order to maximise the environmental atmosphere that is required to fulfil the psychological needs of tourists. A progression of public to private space will be visible as the elevation of the site increases.

These functions will be grouped into three zones: accommodation (tourists and staff), central facilities (administration, restaurant, conference venue, skills training, and ablutions), and the agriculture plant (produce processing, workshop, storerooms and temporary staff).



SITE DEVELOPMENT

Fig. 6.2.2.1 Masterplan for new Agri-tourism farm complex

6.2.3 Circulation and relationships

The public functions for the central facility's (Fig. 6.2.3.1) arrangement are based on tourist and retail trends. On arrival, tourists will book-in at reception after which visitors can then either go to the restaurant, or the skills training facilities, which also host the arts and craft display shop. For retail functions to be successful, one needs "feet" to pass through those specific areas. Because of the topography of the site and human preference, the visitor is not indirectly forced to go to these areas. Visitors will be able to see the arts and craft display when dining at the restaurant and vice versa. They are rather given the choice to explore by themselves. Behavioural studies indicate that by giving people the opportunity to make his/her own decisions strengthens their psychological need of being in control of their lives. This exploration is resuscitated by means of manipulative visual contact, which is achieved by the dense vegetation and the slope of the site.

The conference facility is placed close to the ablutions because the highest concentration of people will be using the ablutions at a specific time of the day. The conference facility is also used as the direct link with the agriculture plant. This facility will be mainly used for agriculture related seminars and as a formal training facility for skills development, which relates to the arts and craft area.



SITE DEVELOPMENT

Fig. 6.2.3.1 Central facilities siteplan

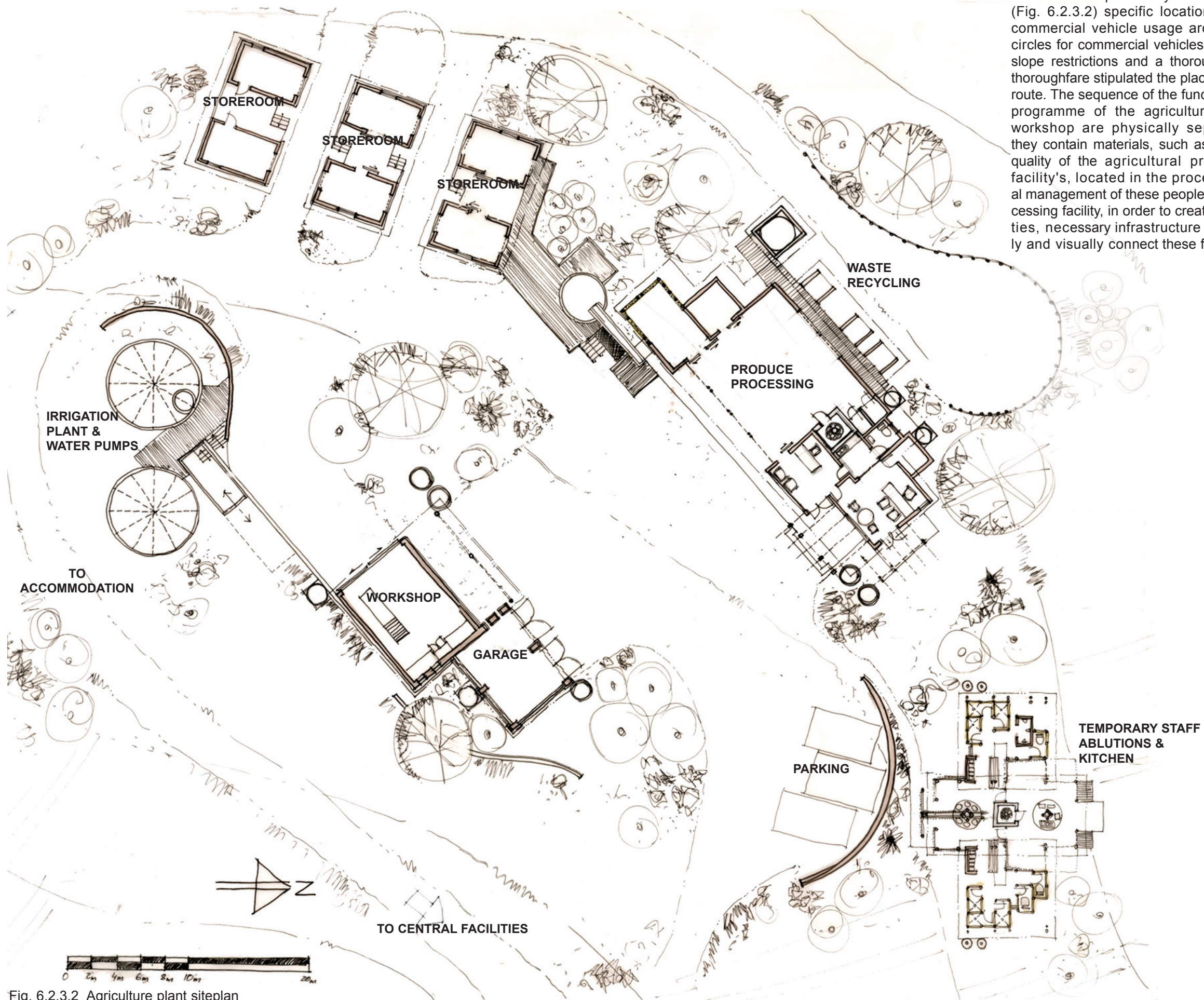

The lower slope mainly determined the agriculture plant's (Fig. 6.2.3.2) specific location, which was indicative of the commercial vehicle usage around these structures. Turning circles for commercial vehicles was done away with due to the slope restrictions and a thoroughfare was used instead. This thoroughfare stipulated the placement of the functions along this route. The sequence of the functions relate to the operational programme of the agriculture plant. The storerooms and workshop are physically separated from the processing as they contain materials, such as toxins, that can intrude on the quality of the agricultural products. The temporary staff facility's, located in the processing plant relates to the visual management of these people by the foreman, located in the processing facility, in order to create a unity between these facilities, necessary infrastructure elements are used to physically and visually connect these facilities to one another.

SITE DEVELOPMENT

Fig. 6.2.3.2 Agriculture plant siteplan

The semi-private tourist and permanent staff accommodation comprises the accommodation zone (Fig. 6.2.3.3). The staff quarters are placed between tourist units. This configuration is a paradigm shift compared to the conventional trend of keeping staff away from tourists and out of sight. This paradigm shift evolved in order to contribute to the synergy of agriculture, eco-tourism, and community development. Another factor, which influenced this decision, is the primary pre-requisite of the tourists to experience the local contemporary culture. The staff is given an economic incentive, by sharing in the profit derived from the tourist units, which they are the hosts of.

Disadvantages of the proximity of staff quarters & tourist units could be noise pollution and the bigger footprint compared to back-to-back staff units. If the physical footprint is put into the context of the whole development, it is omissible. The noise pollution is part of experiencing the culture. By having separated staff units that are dedicated to specific tourist units will better facilitate the interactions between staff and visitor. According to surveys done by South African National Parks; tourists will interact easier with a staff member if that person is assigned to them. This organization of the accommodation will present the opportunity for tourists to interact with the local people on a more personal note.

The tourist units consists of three different types with each designed according to the different needs of tourists expected. The units will be 2 or 4 bed units, which are the best and most economical configuration.(indicated by tourism studies)

Type 1: The four-bed unit will cater for the travelling friends or a small family. The units will be self-catering. These groups will stay for a couple of days and participate in the farm activities or use the location as a base to explore the area, thus a bigger lounge/dining area is needed.

Type 2: The two-bed unit is catering for the travelling couple. These units are self-catering. These couples will stay for a couple of days and participate in the farm activities or use the location as a base to explore the area, thus a bigger lounge/dining area is needed.

Type 3: These units are back-to-back non self-catering units. They are for the tourist who does not travel with his own food and necessities and is staying for shorter periods at a specific place.

The accommodation zone is linked to the central facilities and agriculture plant by means of interesting wandering paths, carrying through the experience of discovering. This method will encourage the preferred mode of transport (walking and not vehicular) on the farm by people.

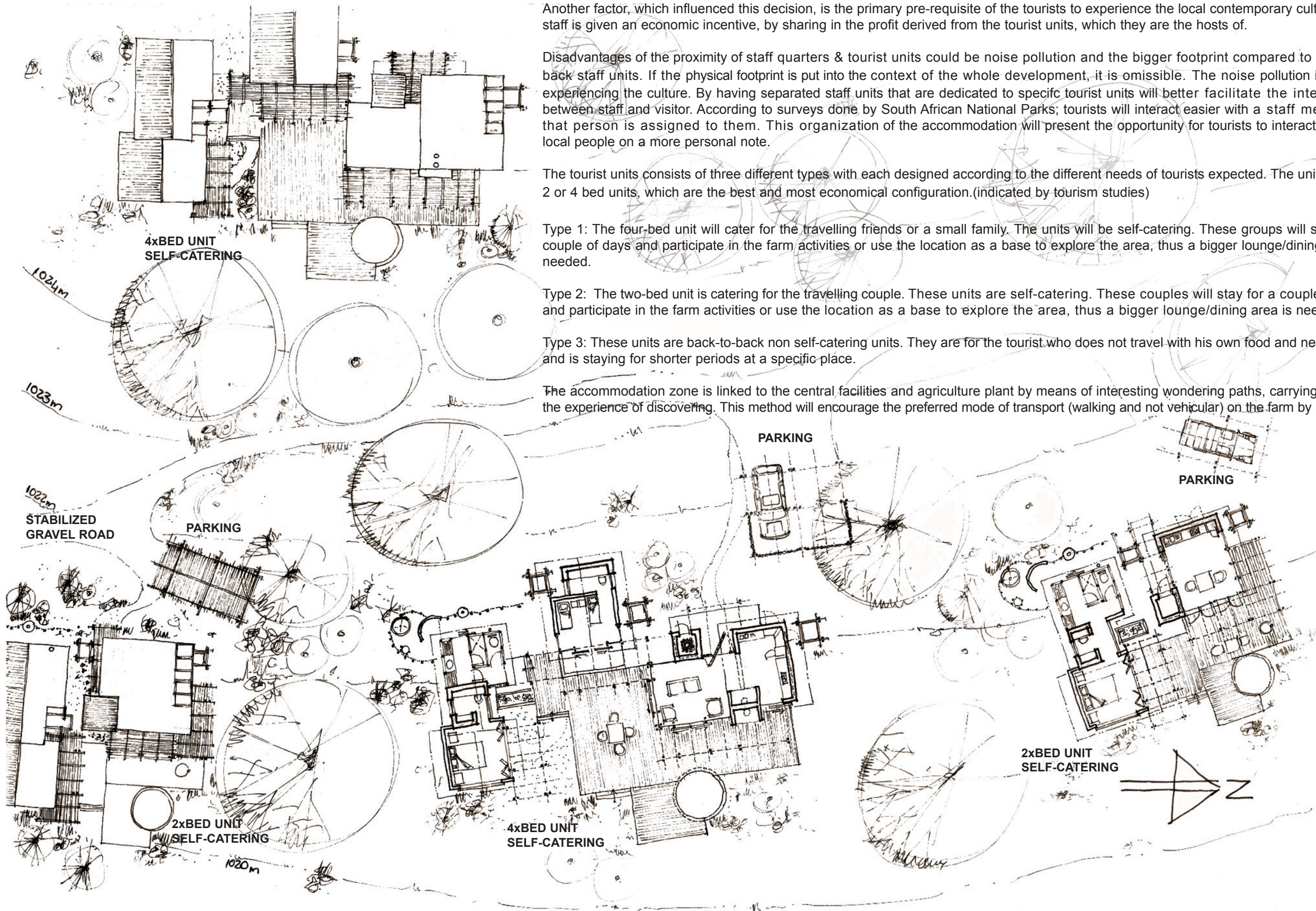

Fig. 6.2.3.3 Part of Accommodation siteplan

6.3 Hierarchy

A hierarchy in the site layout, which is manifested in the traditional Venda culture, is applied to create a coherence of progression. The Venda's arranged their 'kraal' in such a way that the most important person, the chief, was positioned on the highest point with the rest of the people located below him. This configuration was applied in every subsequent family. The head of the family was positioned higher than the rest and the same applied to the building functions. The bedroom units had a

HIERARCHY



Fig. 6.3.1 Section through Agriculture plant

higher priority than the kitchen that were above the courtyard. According to these layouts the more private spaces were higher than the semi-private and subsequent public spaces.

The location of the semi-private section and the people using this zone of the agri-tourism farm complex, are the most important contributors in making sure that the development is sustainable. The semi-public (Fig. 6.3.1) areas provide the base for the semi-private and public (Fig. 6.3.2) areas, and the public areas fulfil the inauguration of the visitor

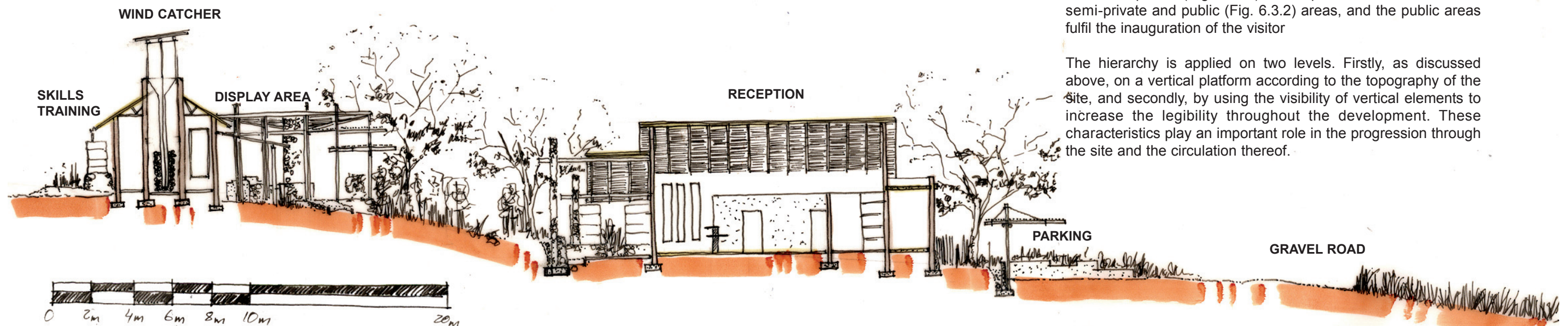

Fig. 6.3.2 Section through Central facilities

The hierarchy is applied on two levels. Firstly, as discussed above, on a vertical platform according to the topography of the site, and secondly, by using the visibility of vertical elements to increase the legibility throughout the development. These characteristics play an important role in the progression through the site and the circulation thereof.

6.4 The "barn" as generator

Agriculture comprises one third of the proposed development and the physical requirements associated with vegetable processing constituted the driving force behind the creation of architectural form. The strong presence of an agricultural language in the context of the site enhanced the choice of departure for form. Agriculture and 'barn' are synonymous in the context of a rural language. The conventional 'barn' is enveloped with the contextual culture from the surrounding areas.

Re-interpretation of the barn (Fig. 6.4.1) is needed in order to accommodate the different functions relating to the whole development. The decisive criteria being the physical dimensions associated with the structure: a rectangular plan, with varying size, which is accessed via the longitudinal axis of the building. This axis was used because of the height provided by the gable wall of the pitch roof. This height was needed for commercial vehicles to enter and for bulk storage. A lean-to roof was attached to the longitudinal sides of the structure that were used for secondary storage space.

An aspect that has a big influence on the re-interpreted 'barn' is the local climate. The derived architectural forms compliment and manipulate the climate in order to achieve the best microclimate inside and around the buildings by making use of intruding and protruding boxes and surfaces. These elements enhance the articulation of the compositions.

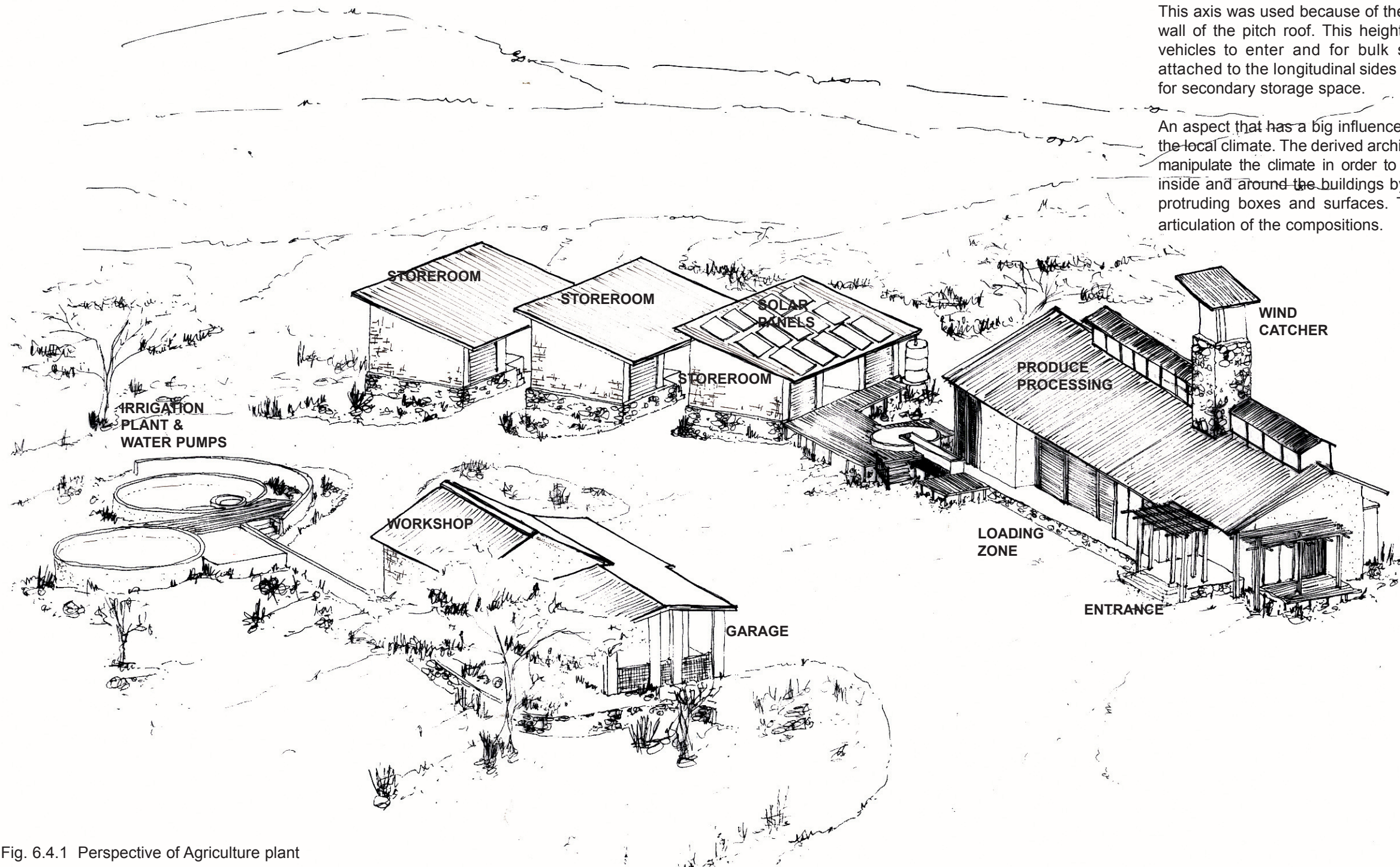

Fig. 6.4.1 Perspective of Agriculture plant

6.5 Passive solar design (Fig. 6.5.1)

6.5.1 Orientation

The best orientation is for a building to be longer east-west than it is north-south, with most windows facing north and a few facing south, east or west. This orientation is best utilized when hot summers and very cold winters are present. The orientation of the structures will mainly be influenced according to the day lighting requirements and the topography of the site because natural cooling is needed during the hot summer months. The chosen site has very hot summers and moderate winter months. No solar heat gain is needed during summer and the heat needed during winter can be obtained by making use of direct and indirect solar gathering methods.

6.5.2 Day lighting

Natural light instead of artificial lighting is provided for internal spaces. By not using artificial lighting the energy demand is reduced. Studies indicate that natural light has healing properties and also improves productivity at work. People respond to the apparent lightness of an environment and its visual interest. This is created by illuminating surfaces and by providing areas of light and shade appropriate to the environment's application with reference to the form and shape of the interior and to the hierarchy of adjoining spaces.

6.5.3 Direct and indirect solar gain

Direct solar gain is whereby the sun's heat directly heats up the building. Heat is stored in the building's thermal mass, such as the concrete and stone floor slabs.

An indirect gain system positions the thermal mass between the sun and the space to be heated. The sun's heat is collected and trapped in a narrow space between the window and the thermal mass. The air in the narrow space is then heated which rises and spills into the room through vents at the top. Cooler air replaces the hot air from the vents at the bottom. The heat circulates throughout the room by convection. The vents can be closed to prevent warm air from escaping. This will be achieved during the winter months when the lower sun angles are allowed beneath the roof overhangs.

A reversal of these systems will be applicable in order to keep the heat out during the summer months. The thermal mass will be prevented from receiving direct sunlight while absorbing the heat in the room, helping to keep the internal temperature cooler.

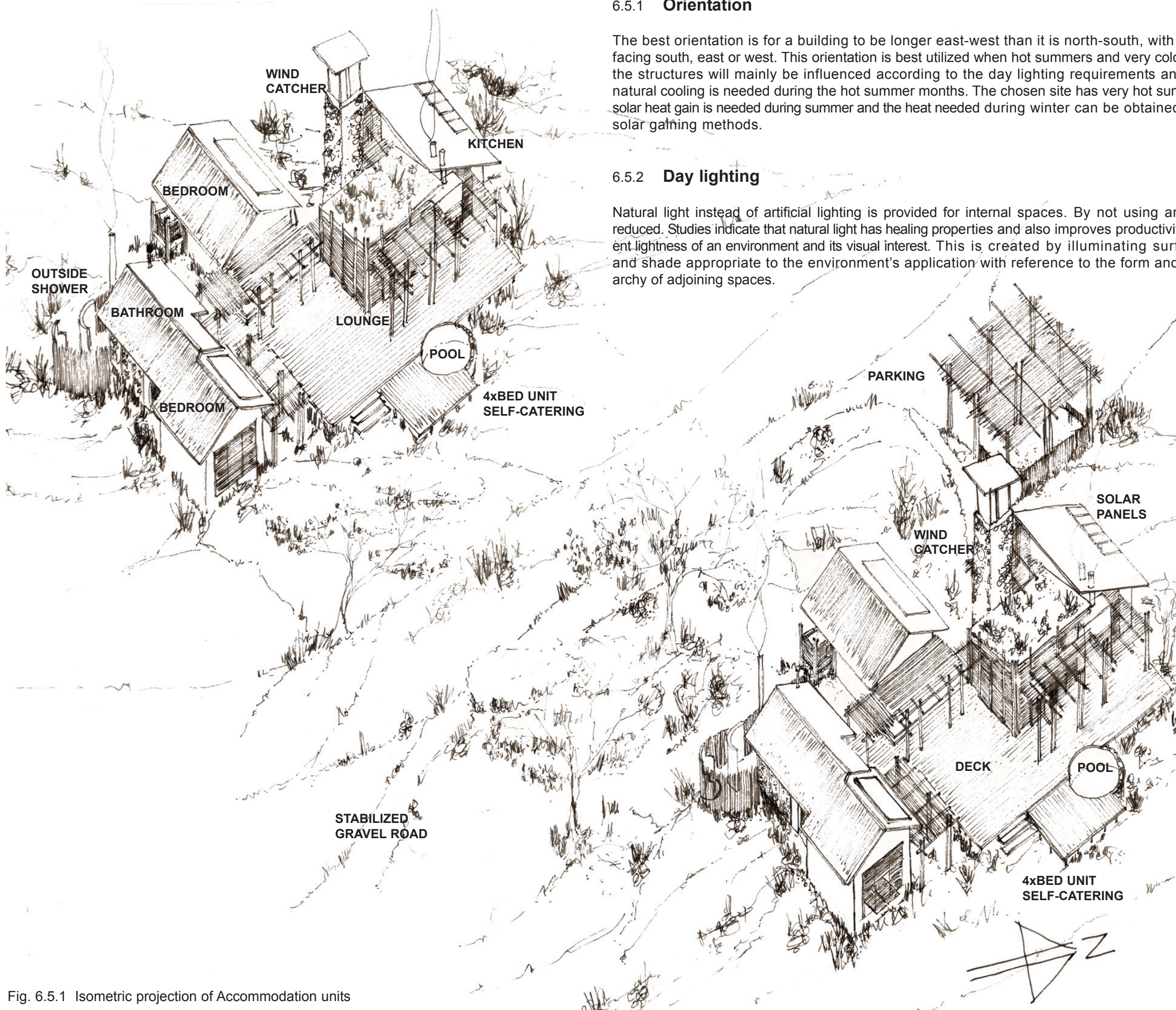

Fig. 6.5.1 Isometric projection of Accommodation units

6.5.4 Natural cooling

6.5.4.1 Ventilation (Fig. 6.5.4.1.1)

There are three major sources of unwanted summer heat: direct solar impacts on a building through windows and skylights; heat transfer and infiltration, of exterior high temperatures, through the materials and elements of the structure; and the internal heat produced by appliances, equipment, and inhabitants.

Panels that open provide ventilation of these buildings. These panels normally consist of two parts, a permeable and a transparent section. During daytime both sections can be opened and during nighttime the permeable section is kept closed to keep insects out but still allow ventilation.

The thermal mass, which is present in the buildings, is kept in full shade, especially between 11:00 am and 15:00 pm during summer months. This is accomplished by making use of the lean-to roof that is associated with domestic farm buildings. Longer roof overhangs are used elsewhere to shade the full height of external vertical planes. (The above-mentioned panels are utilized to ventilate buildings at night, which will remove any heat build up from humans or appliances, in order to have cooler buildings in the mornings).

6.5.4.2 Evaporative cooling (Fig. 6.5.4.2.1)

The simplest way of evaporative cooling is when water evaporates it absorbs a large amount of heat from its surroundings. The most familiar of this is the cooling effect of evaporating perspiration on the human skin. The evaporation rate is raised as air movement is increased. The first manner of obtaining this evaporative cooling is using ponds around the permeable buildings. They are positioned on the north-western (main wind direction) side of the buildings in order to be in the direct path of the wind.

The second method is a combination between the "malgaf" (used extensively in hot arid regions) and the local historical farm "fridge". This application makes use of a wind catcher to direct air movement through a wet permeable surface. To adhere to the requirements of the system a high vertical element in the landscape evolved. The height is needed to catch enough wind above the roof structures and vegetation. These elements are incorporated into the design to facilitate in the legibility and the hierarchy of the development.

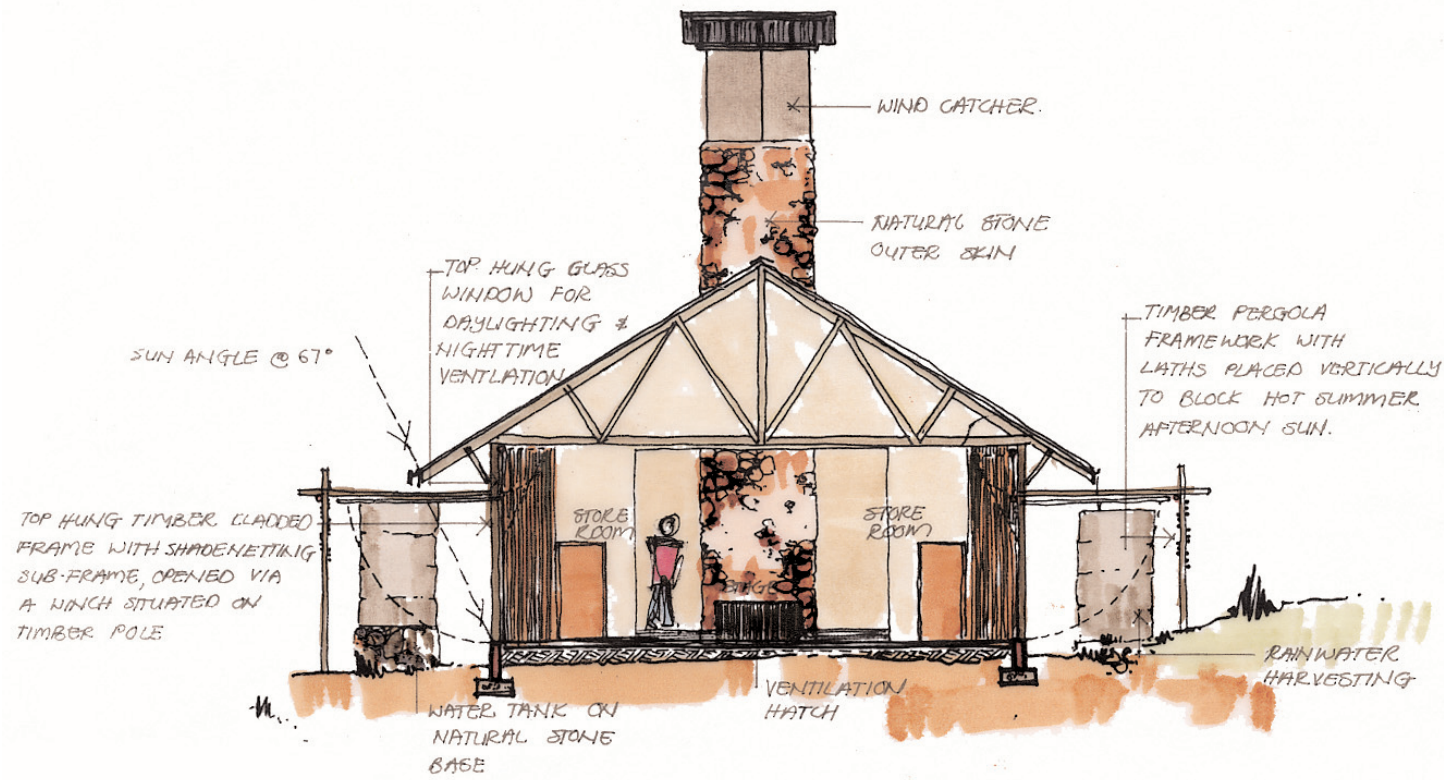

Fig. 6.5.4.1.1 Cross section of conference facility

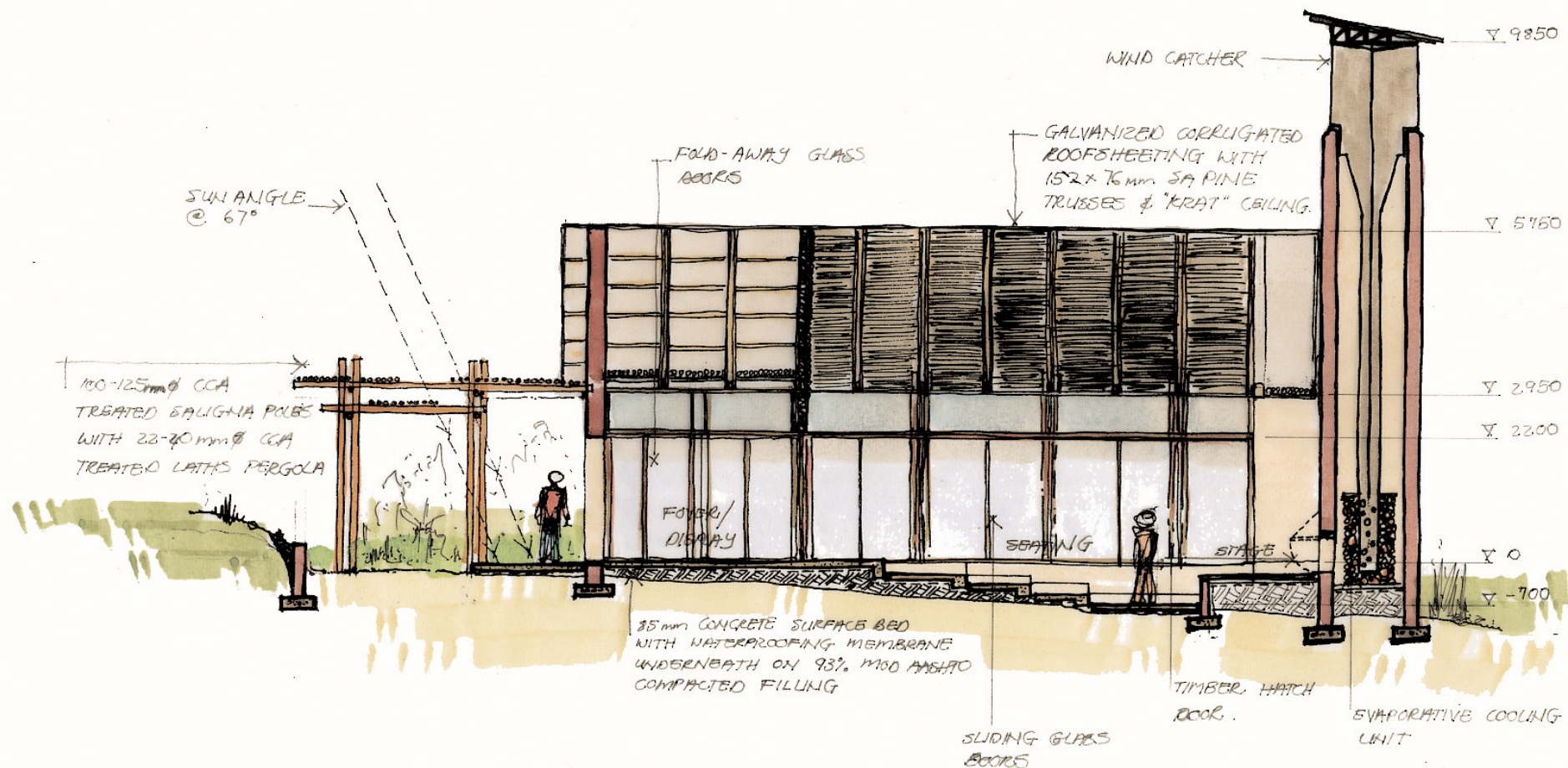

Fig. 6.5.4.2.1 Longitudinal section of conference facility

6.6 **Alternative Energy Sources** (Fig. 6.6.1)

6.6.1 **Solar power**

Our five billion year old nuclear reactor accounts for 99.9% of the total mass of our solar system. Each second about 700 000 000 tons of hydrogen is converted to 695 000 000 tons of helium and 5 000 000 tons of energy in the form of gamma rays (Add reference) Because of the large distance between the earth and the sun, the intensity of the solar energy received by the earth is a lot lower. The energy that reaches the earth's surface is reduced about 30% by the atmosphere so the direct solar radiation that reaches the earth's surface is about 1 kWh per square metre.

The utilization of this renewable resource would satisfy all our energy requirements. Photovoltaics are used to transform sunlight directly into electricity. The photovoltaics are inter-connected to make up a module or solar panel. These panels are solid and have a specific size with a thickness. In order for them to function properly, they must face due north. These criteria are taken into account when incorporating these panels into the design of the facilities.

Given these panels' solid characteristics, they are used to shade wall and floor surfaces in the summer months. These panels have their own sub-frame

that attaches to a structure in order to be oriented due north. They are visible to the users as is the other entire climate controlling system. The visibility of these systems emphasizes the importance of environmental consciousness.

6.6.2 **Direct solar heating**

Water bodies can be used for heating during the winter months. The roof structure is used as the structural support for the water containers. Black polypropylene pipes are the water containers. They are placed in the roof structure, which is in full sunlight during the day. The sections of the roof, which will host these pipes, are elevated above the rest of the structure to better define the allocated areas.

These pipes run down into the surface beds of the spaces that need heating at night. Under floor heating will occur during night time in the bedrooms of the accommodation units. This system is manually operated, again giving the choice to the occupant to make use of the facility or not.



Fig. 6.6.1 Eastern elevation of Central facility

6.7 Materials (Fig. 6.7.1 & 6.7.2)

The main characteristics of materials used for structure is its natural ability to give stability to a structure within its context. The story of the "three little pigs" suggests some simple differences in firmness as a function of materials.

Use of materials in the design will have a huge influence on its inhabitants. We are currently living in a plastic world of contradiction and untruthful visual relationships. Products today have plastic linings that make it difficult to distinguish between the fake and the real. How are we supposed to teach our children ethical values if the materials we use have a quality surface appearance while the inside is actually compressed sawdust covered with plastic pretending to be something that its not. Honesty should always be considered more beautiful than deception.

The process followed in choosing the materials to be used for construction was by establishing which materials the site can offer without having a negative impact on the environment.

Soil and natural stone are materials that are in abundance due to the cutting that will take place. The soil is used as compacted earth blocks, which has excellent thermal qualities, and with additives the required strengths can be achieved for structural elements. The stone was chosen to enhance the psychological connection with nature. The stone has a natural strength that can be used for structural elements and its properties will assist in the passive solar design principles. All the other materials that were used were selected according to its physical and thermal properties.

Timber is used extensively throughout the design, including its thermal and psychological characteristics; it is used to create a collective harmony between the buildings and nature. The recycled materials, such as oil drums, sandbags, tin cans and glass bottles are used for the articulation of elements and re-interpreted function of surfaces.

The manner in which these materials are used according to each other is more important that the types of materials used.

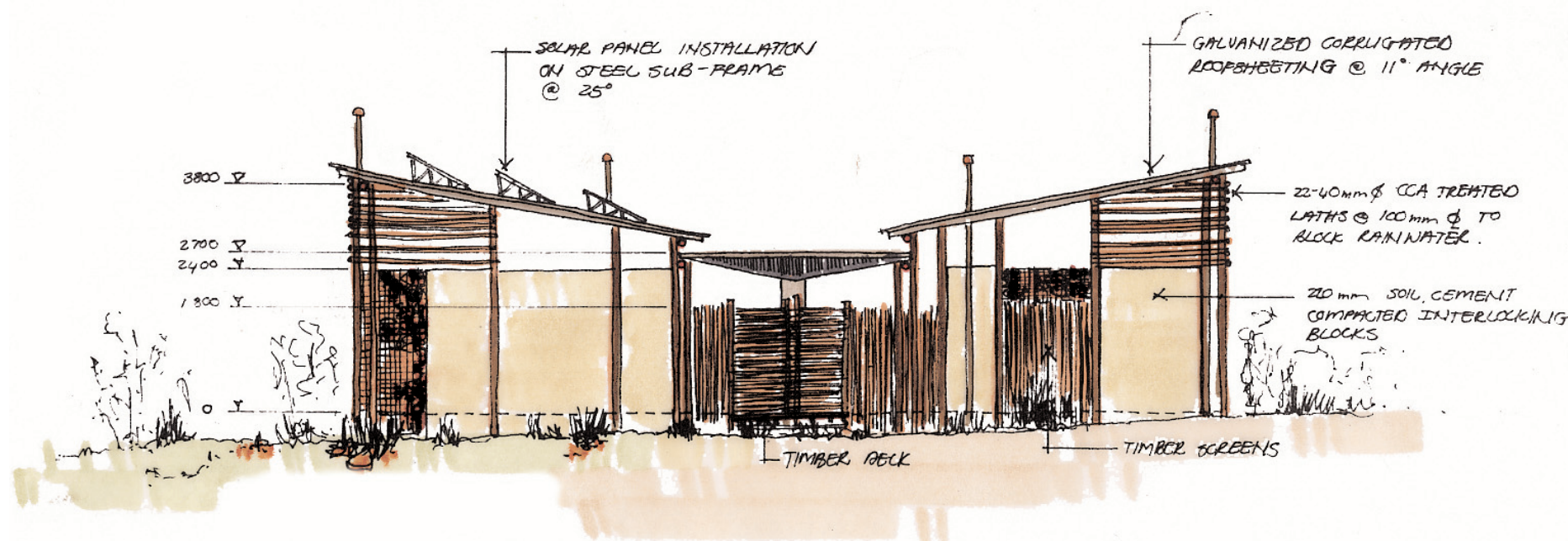

Fig. 6.7.1 Elevation of public ablutions

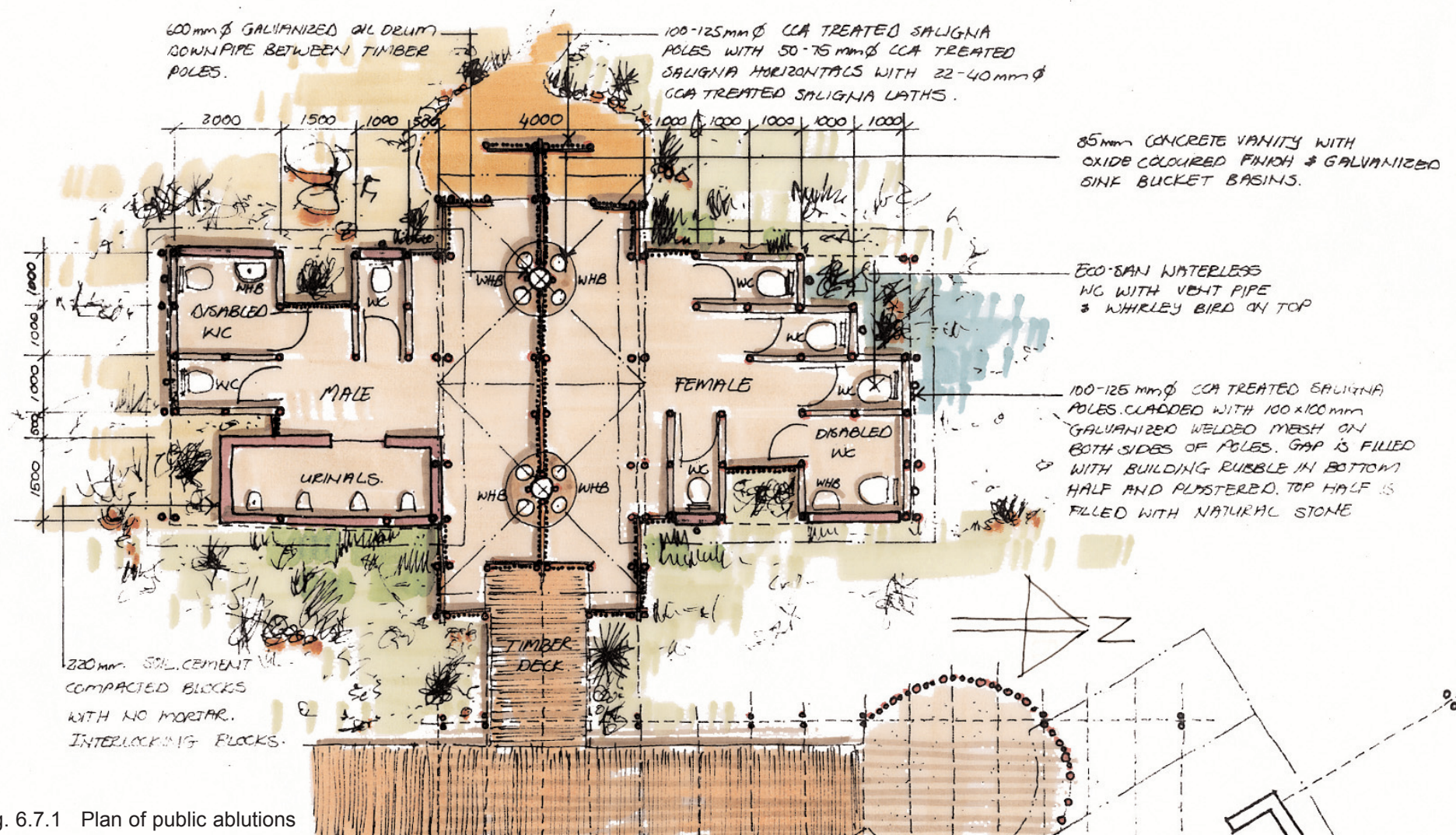
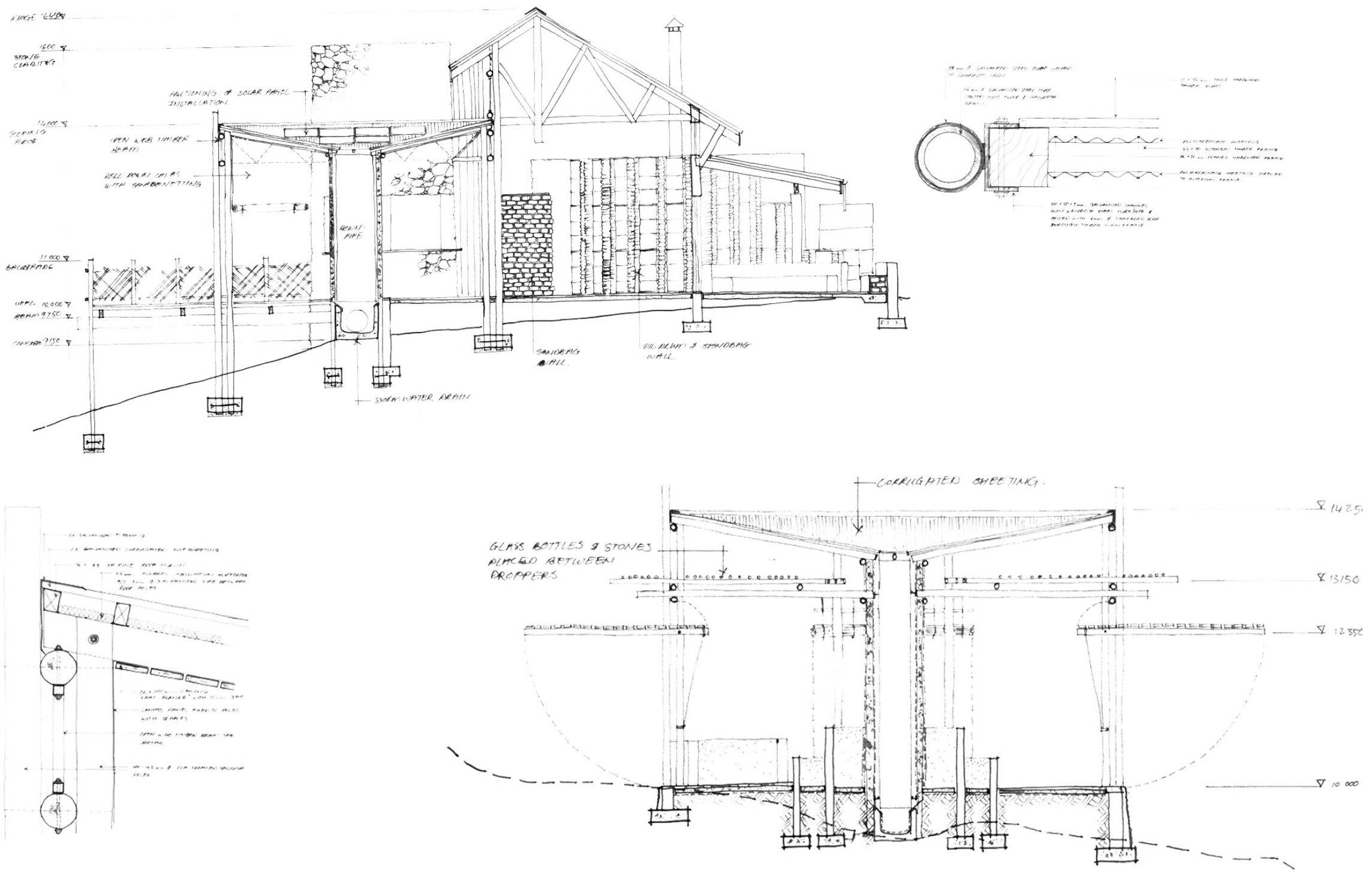

Fig. 6.7.1 Plan of public ablutions

Chapter 7

Technical Design



7.1 Wall Construction

7.1.1 Compacted earth blocks

Benefits of using earth as building material includes:

- Local skills and knowledge of traditional building methods are used
- Thick earth walls in buildings are "energy efficient"
- Earth blocks are cheaper than conventional bricks or concrete
- Using local soil eliminates transport cost of conventional building materials.

Simple tests can be done to establish if the local soils are suitable to make earth blocks and which binder must be added when stabilized earth blocks are made. These tests determine the composition, plasticity and shrinkage characteristics of the soil. Soil composition is done by sedimentation.

Proportions of gravel, sand and clay needed to manufacture:

| Stabilized earth blocks | Unstabilized earth blocks |
|-------------------------|---------------------------|
| Clay : 5% = 20% | Clay : Silt : 50% = 60% |
| Silt : 10% = 25% | Sand / Gravel : 40% = 50% |
| Sand : 25% = 50% | |
| Gravel : 25% = 40% | |

(Bolton, M. et al. 2001)

Usage of the shrinkage test will give an indication to the amount of cement and lime that needs to be added to make stabilized earth blocks.

| Gap | Cement : Soil | Lime : Soil |
|-------------|--------------------|----------------|
| < 15mm | 1 cement : 18 soil | not suitable |
| 15mm < 30mm | 1 cement : 16 soil | not suitable |
| 30mm < 45mm | 1 cement : 14 soil | lime : 14 soil |
| 45mm < 60mm | 1 cement : 10 soil | lime : 10 soil |

(Bolton, M. et al. 2001)

Construction methods for earth blocks are the same as for conventional bricks. The same guidelines must be followed in terms of quality, workmanship and control.

Stabilized earth blocks are used for the foundation walls and one layer around all openings. Normal stretcher bond is sufficient for block laying. Positioning of waterproofing in the structure is similar to conventional structures where it is located under surface beds, and DPC is in the walls and under window cills. Ring beams are necessary to anchor roof trusses and it adds to the stability of the whole structure. These earth blocks however have some structural restrictions which include:

- height of eaves wall max. 2.5m
- length of gable wall max. 6.5m
- width of door or window opening max. 1.5m

These earth blocks will only be used for low non-load bearing walls. Only stabilized earth blocks will be used because no plaster finish will be applied (Fig. 7.1.1.1). These stabilized blocks' weathering resistance will be improved by painting it with a clear waterproofing paint.

Another type of earth block (Hydraform blocks) will be used as structural material. A more consistent and better quality block is produced through the use of manually operated machinery. These blocks are produced by mixing local soil and 5% (4Mpa) or 10% (7Mpa) cement and compressing the mixture in a block-making machine. Blocks are air-dried and their strengths are affected by cement content, quality, and curing time. The blocks are not burnt and therefore environmentally friendly. They are interlocking and dry stacked, minimizing the need for mortar. A typical wall construction is the same as the normal earth blocks, but where stabilized blocks would be used, hydraform blocks must be bedded in mortar and the same applies to the ring beam (Fig. 7.1.1.1).

The reason for using the normal earth blocks is that the machinery needed to make the hydraform blocks is expensive. Renting these machines is more economical, thus the shorter the period it is on site the more economical it would be.

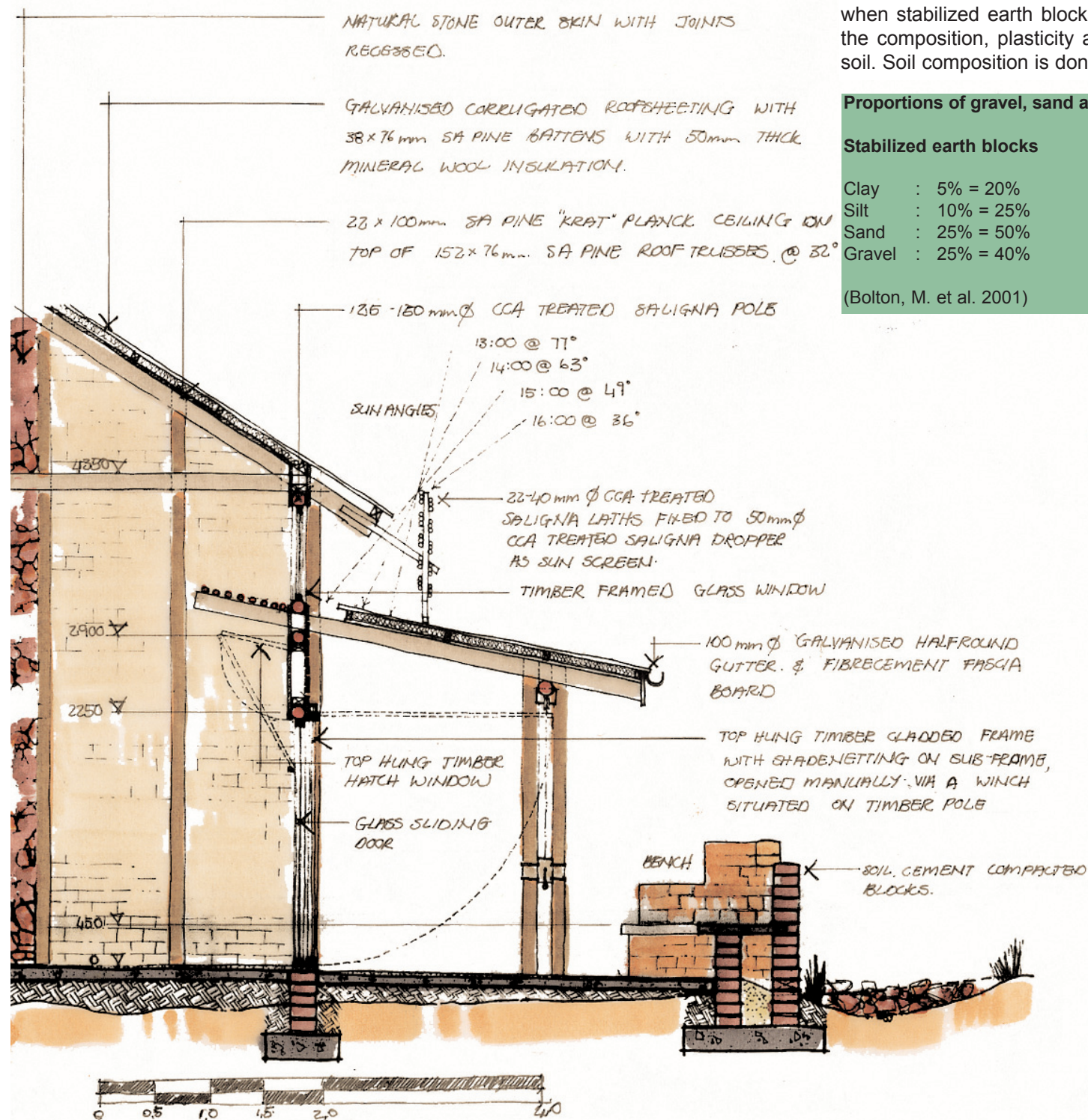

Fig. 7.1.1.1 Sitting bench in front of restaurant

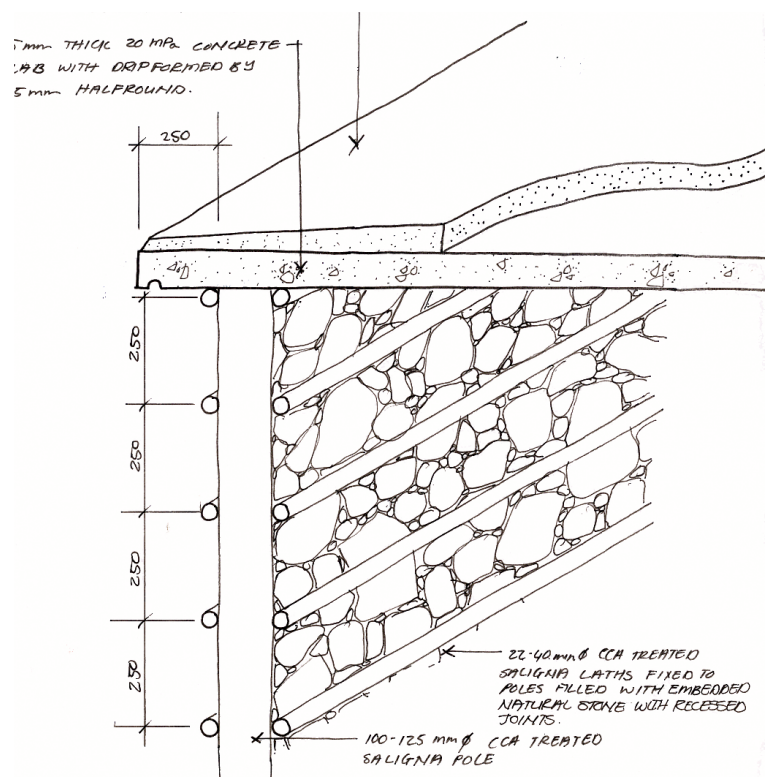

Fig. 7.1.2.1 Isometric of Timber and Stone wall

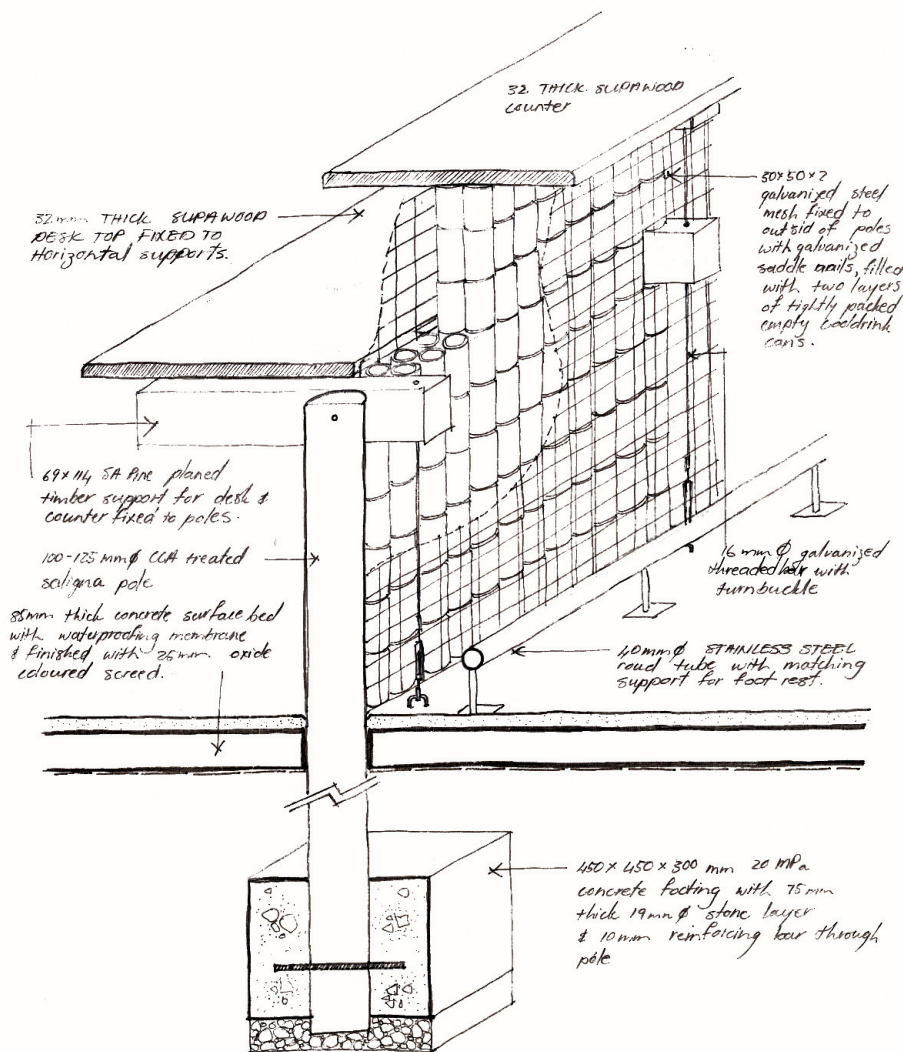

Fig. 7.1.2.2 Isometric of Reception desk

7.1.2 Natural stone and timber

The textures obtained from these materials emphasize the areas where they are applied. The thermal properties of natural stone are a decisive characteristic to its application. Natural stone has similar thermal performance to those of brick and concrete and sometimes even better.

Stonewalls built solid with mortar are used as heat barriers in summer months and a heat store in winter months. This is the reasoning behind the thicker walls. These walls also absorb the heat from the internal spaces, which is generated by humans and appliances to keep the inside temperature cooler during summer months.

The dry stacking of stone is used where permanent ventilation is needed. To give more stability to these walls, timber laths are fixed perpendicular, in relation to the height of the wall, to the timber roof support structure (Fig. 7.1.2.1).

7.1.3 Recycled materials

The function of most internal, non-load bearing walls in buildings are either for privacy, defining spaces or keeping climate out. These elements can be substituted with a material other than conventional brick, as in common practice. The use of alternative materials presented the opportunity to make use of materials, which are available in the area. Contributing to the philosophy of saving nature, recyclable materials such as tin cans (Fig. 7.1.2.2), glass bottles and steel oil drums are sourced from the local communities. Simple construction methods are used to stabilize these surfaces. The resulting textures contribute to the articulation of spaces and elements.

The sandbags that are combined with the steel oil drums were chosen because of their ability to take-on the shape of the drum. This configuration (Fig. 7.1.2.3) created a fairly solid surface that was needed to separate the kitchen from the public space of the restaurant.

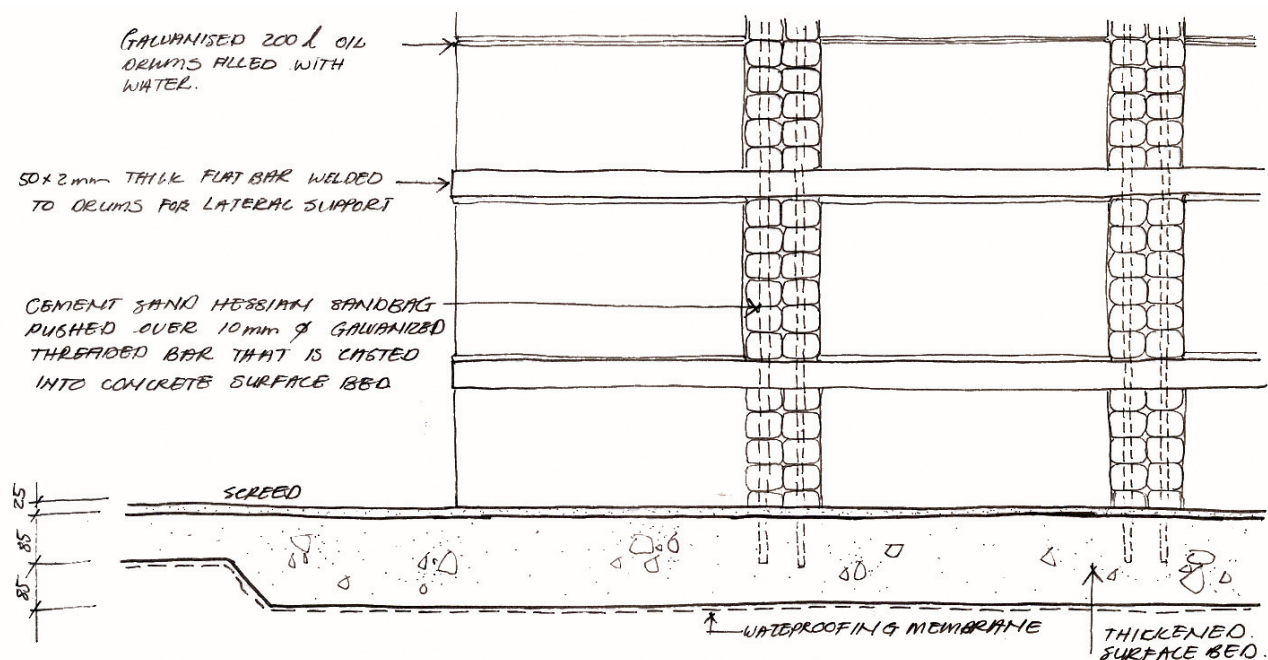
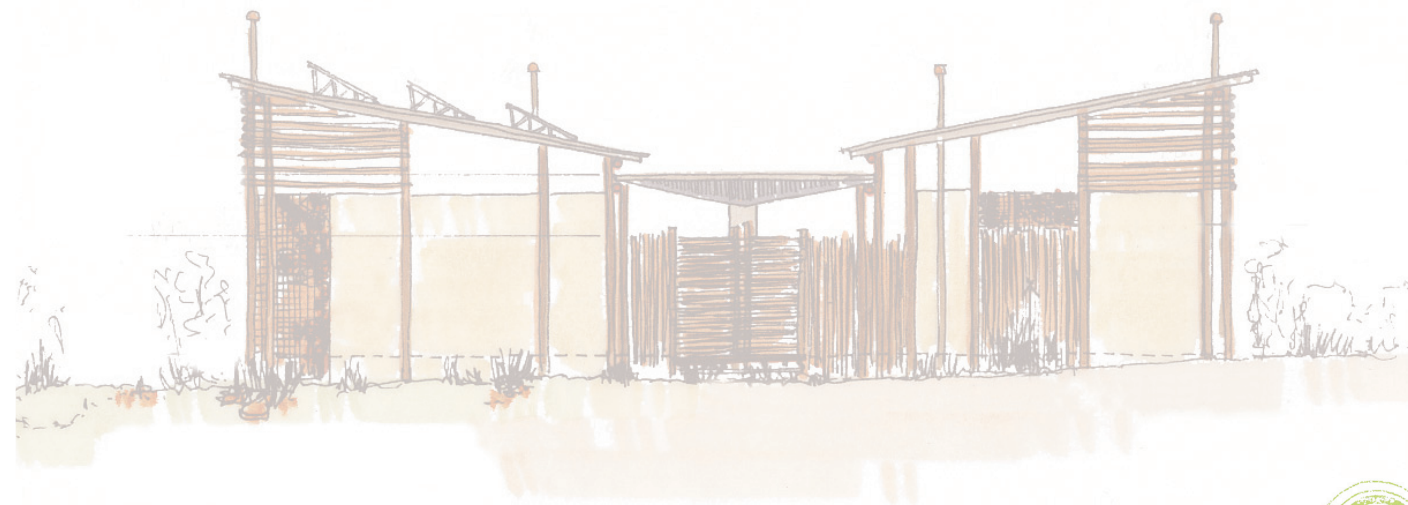

Fig. 7.1.2.3 Sandbag and oil drum wall in Restaurant



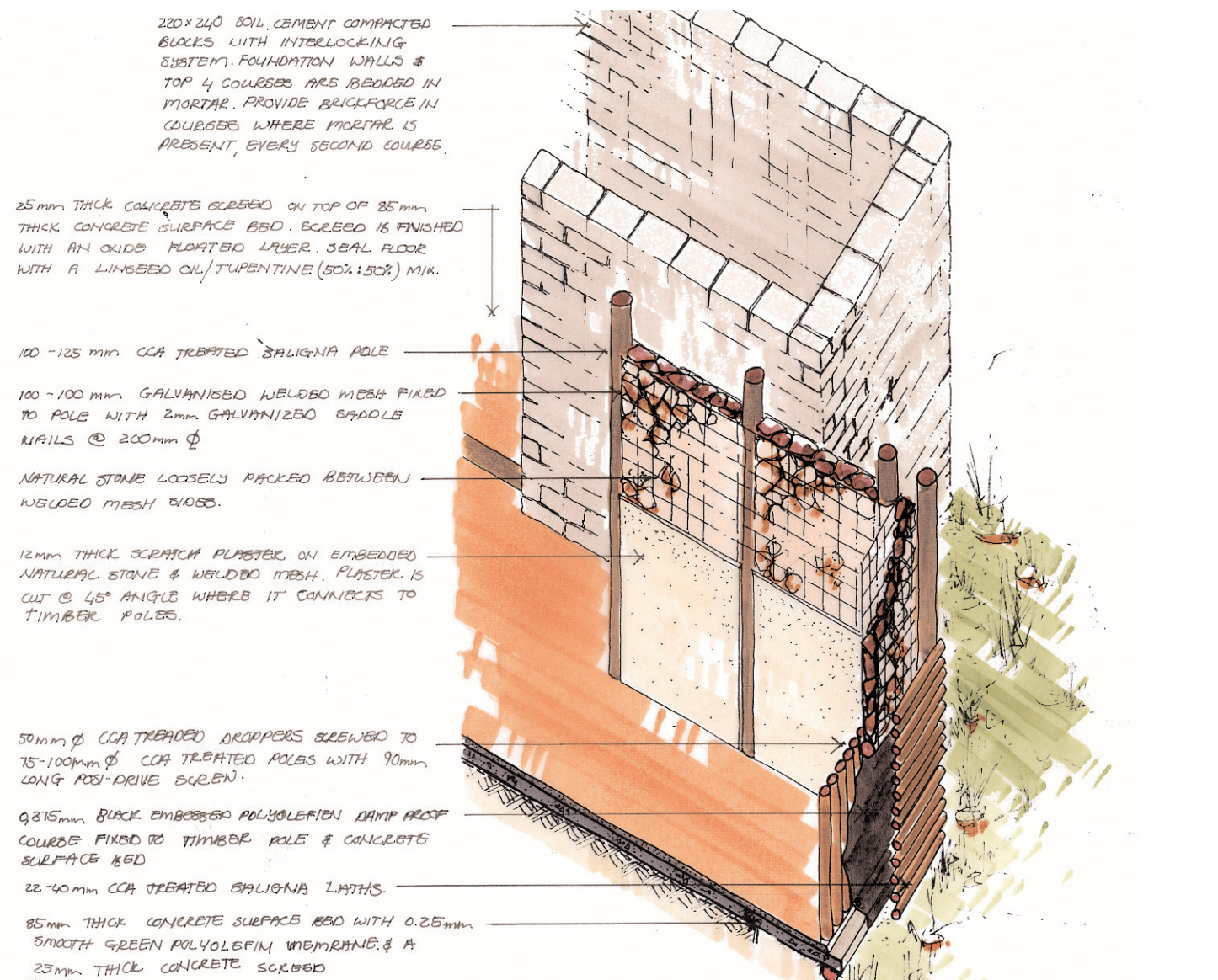

Fig. 7.1.4.1 Isometric of public ablution wall construction

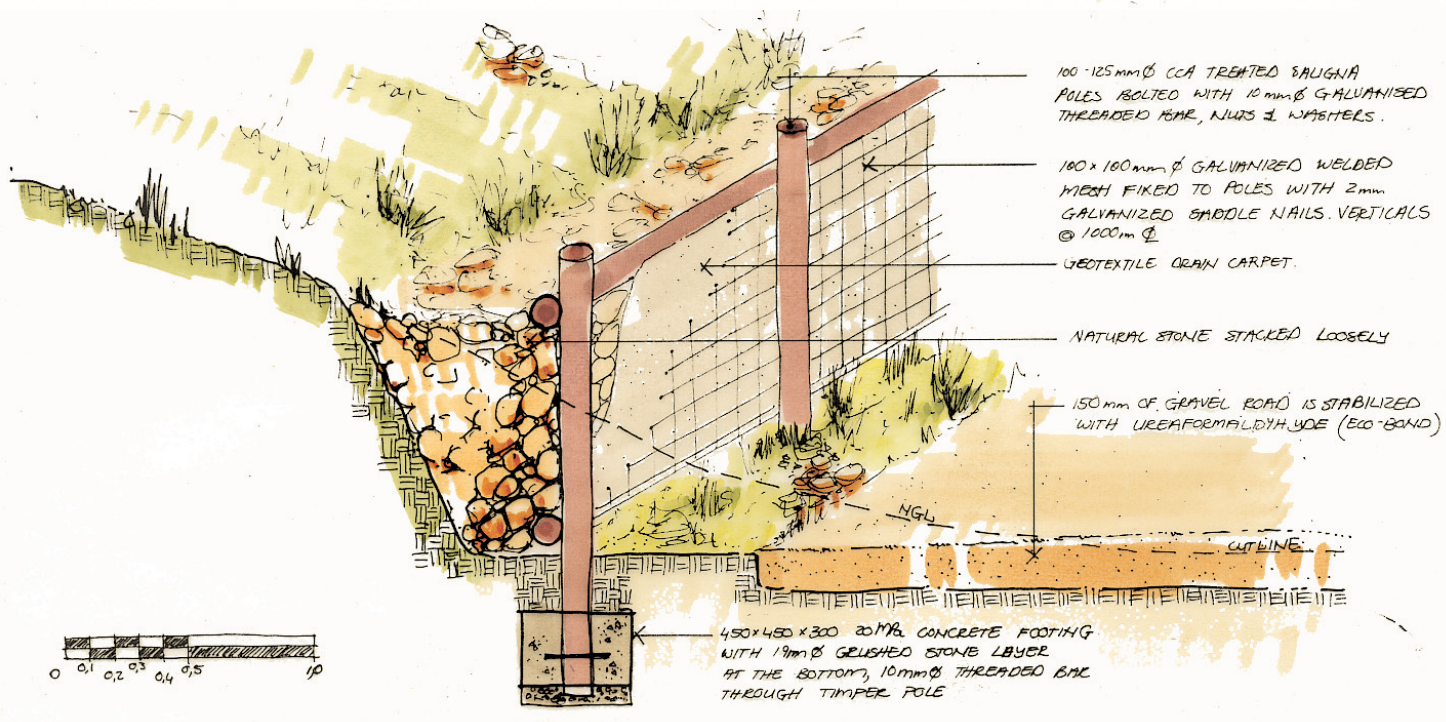

Fig. 7.1.5.1 Retaining wall construction at waste recycling storage

7.1.4 Rubble Walls

The unwanted birdcage, swinery and masonry rubble that are around the existing farmhouse is a resource that can be used as construction material. In order to use this rubble economically, it is used as non-load bearing material. This indicated that roof structures had to have a separate support system.

This rubble is used as infill between vertical roof supports. The cavity formed is then filled with this rubble. Aesthetically the finished surfaced is not complimenting the proposed framework (Fig. 7.1.4.1). The surface is finished with a 12mm thick scratch plaster.

7.1.5 Retaining Walls

Cutting of the landscape, especially for the roads, leaves bare unstable soil surfaces open to weathering. A material was needed which will fade away into the natural landscape after a year or two. The best solution was a combination of timber, welded mesh and geo-textile. The timber poles provided the lateral strength to avoid diagonal sliding of topsoil. The geo-textile matt will allow water drainage and assist in the re-establishment of vegetation. The distance for the geo-textile to span between the vertical supports is too far therefore welded mesh is used to provide the extra lateral support (Fig. 7.1.5.1).

7.2 Shading

7.2.1 Roof Construction

The roof materials were made up of conventional SA pine roof trusses and galvanised corrugated roof sheeting. These elements not only keep the wind and rain at bay and provide privacy, but shelter humans from the scorching sun. The larger roof overhangs shade most of the thermal mass from direct sunlight (Fig. 7.2.1.1), in turn contributing to the cooler temperatures created inside the buildings.

Using a larger size beam, which would have normally been sufficient for the span of the roof truss, creates the roof overhang. The 152x76mm SA Pine beams with the lightweight corrugated roofsheeting are able to cantilever with extra diagonal supports. The roof edges needed to stay clean and simple.

Recycled pallet planks are used as ceiling boards that are fixed to the top of the roof trusses. Mineral wool insulation (50mm thick) is placed on top of the planks before the roof battens are nailed down. This configuration creates an air packet between the roof sheeting and the insulation. By providing vents at the gable walls the air can circulate, removing any hot air from the roof space.

Using thatch simultaneously provides all the natural thermal characteristics criteria. The CCA (Chrome Copper Arsenic) treated Saligna poles used can also achieve the cantilever length needed for the 100% shading of walls during summer months.

7.2.2 Pergolas

Saligna poles and laths are used to make up pergola structures. These structures create a variety of shading devices (Fig. 7.2.2.1). Through the placement of the laths the percentage of shading is manipulated. A closely laid blanket of laths can give up to 90% shading. Opening the gaps between laths creates a filtered light with 70% lower shading. In order to create a 100% shading a retractable roof is added to the structure.

This roof is comprised of a canvas panel, whose sides are fastened to a roller that runs in a channel. It is manually operated by pulling a piece of rope in the front of the canvas panel.

7.2.3 Composite Screens

The timber slats are fixed on to a frame which pivots vertically around its centre point. The opening between the slats is determined according to the sun's angles. No direct sunlight penetration will be allowed in summer months. The lower sun angle in winter allows a percentage of the sunlight through between 09:00am and 15:00pm.

In order to allow a higher percentage of sunlight through, the screens can simply be pushed away. The screens run on a roller and track system. A large sliding window keeps out wind and rain if the wooden screens are moved aside.

The third part of these screens comprise of shadenetting. This shadenetting is used at night in the summer months to allow nighttime ventilation of buildings but stops any bugs trying to get in.

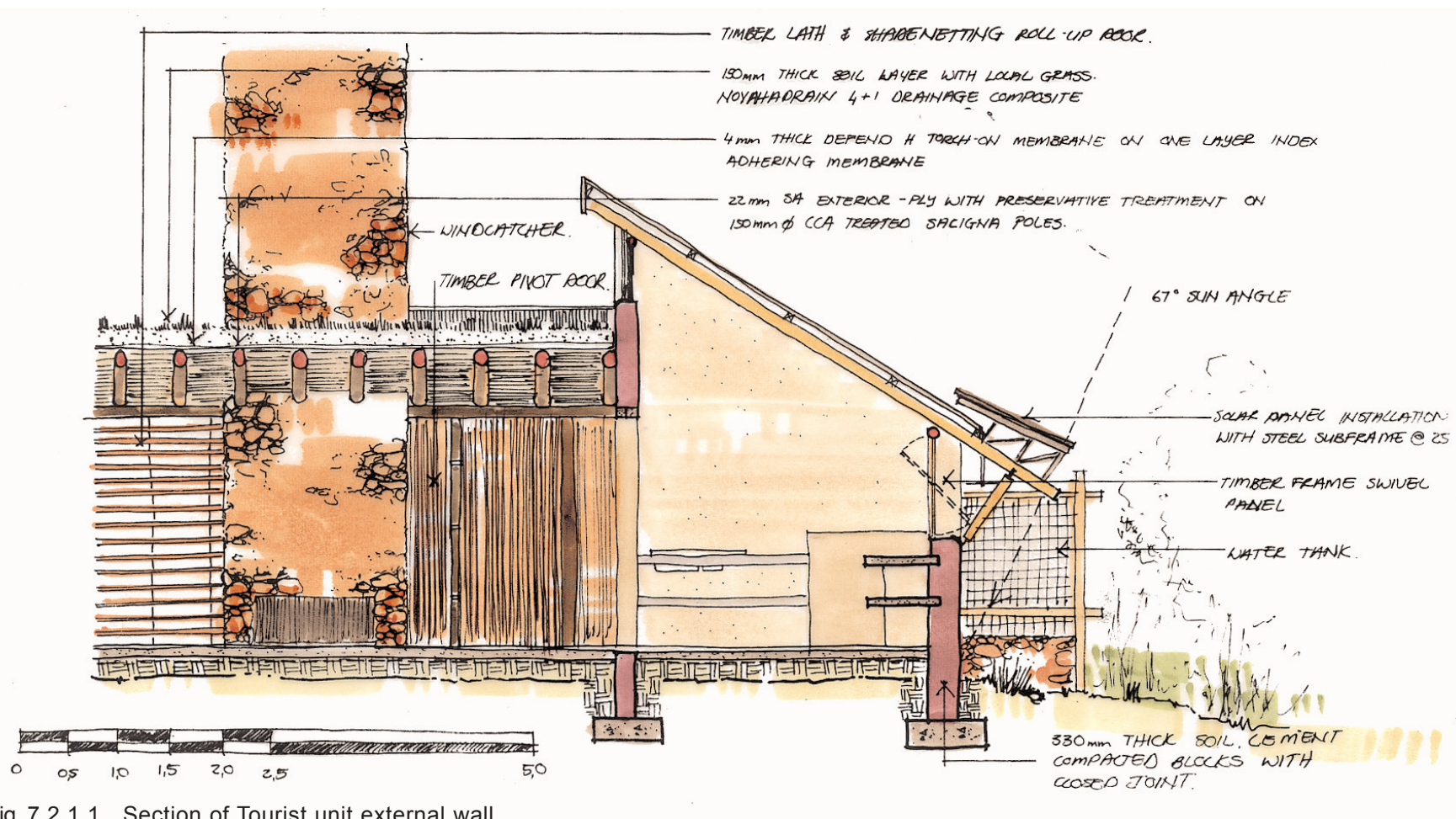

Fig. 7.2.1.1 Section of Tourist unit external wall

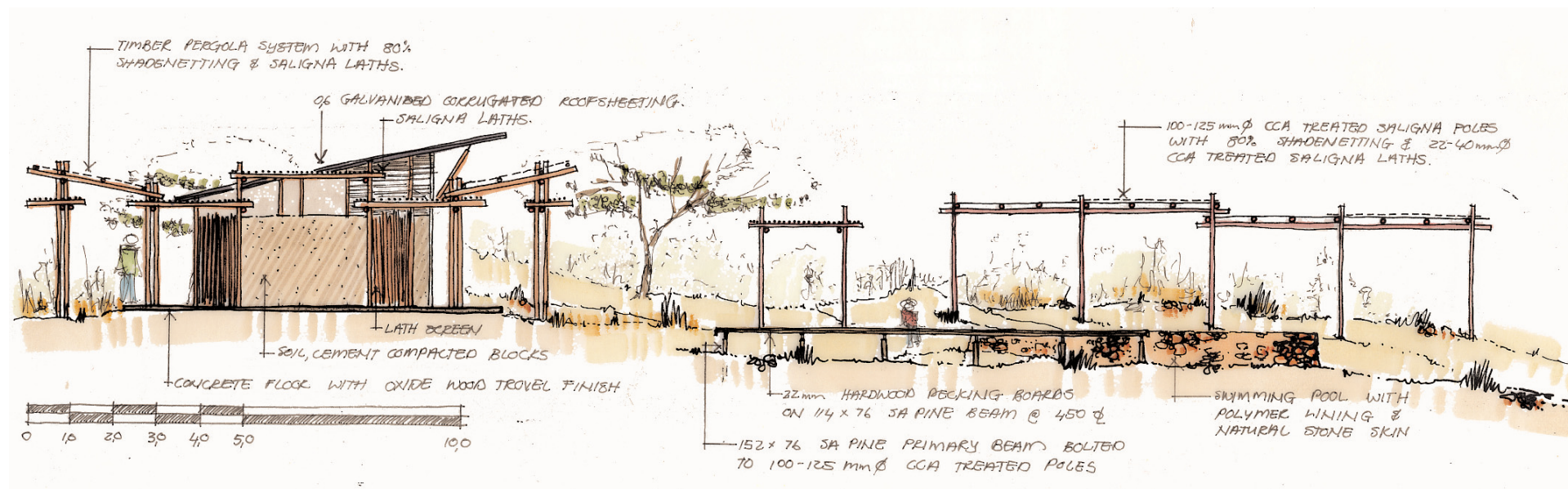

Fig. 7.2.2.1 Pergola structure at public swimming pool

7.3 Space heating

7.3.1 Under floor heating (Fig. 7.3.1.1)

A network of copper pipes is cast into the concrete surface bed in the bedrooms of the accommodation units. The network is equipped with an inlet and outlet valve. The outlet valve connects to the main used water drains, which is subsequently transported by gravitation to the irrigation reservoirs. The inlet valve is connected to the solar water store that is situated in the roof structure.

The solar water store consists of black polypropylene piping, which stores water during daytime. This piping is not in direct sunlight but positioned directly underneath the corrugated roof sheeting because of aesthetics. The air around these pipes is heated through heat transmitted by the corrugated roof sheeting. The thickness of the side wall of the polypropylene pipe and the surrounding hot air will create a measure of insulation after sunset so that the hot water does not lose too much of its heat before being used. The heat is stored in the water until it is needed during cold winter nights when by manually opening the inlet valve to the under floor copper piping, the concrete floor, in turn will radiate the heat into the occupied space.

During the hot summer months, this system will not be operational as no heating of internal spaces is required.

7.3.2 Thermal mass (Fig. 7.3.2.1)

Two bodies in space exchange radiant energy, the warmer body to the cooler body. This basic fact of physics plays a big roll in our comfort in that we are always exchanging heat with our surroundings by radiation (and conduction and convection). In winter we are often warmer than most surfaces around us so part of our heat loss, and comfort and discomfort, is always by radiation.

Comfort is a product of air temperature, air movement, humidity and the mean radiant temperature. Thermal mass walls and floors are warmed by the sun and typically provide warmer surfaces around us than light frame construction with drywall. These warm surfaces provide us with radiant heat and can be comfortable at lower air temperatures.

Thermal mass is needed to store heat for winter days and nights. High thermal construction such as brick, concrete blocks filled with concrete, water in containers, phase change materials and concrete are just some of the materials that can be used for this purpose. Given the specific context, compacted earth blocks and natural stone does allow the same characteristics of other materials to perform and in some cases even better than the more expensive artificial "environmentally friendly" products.

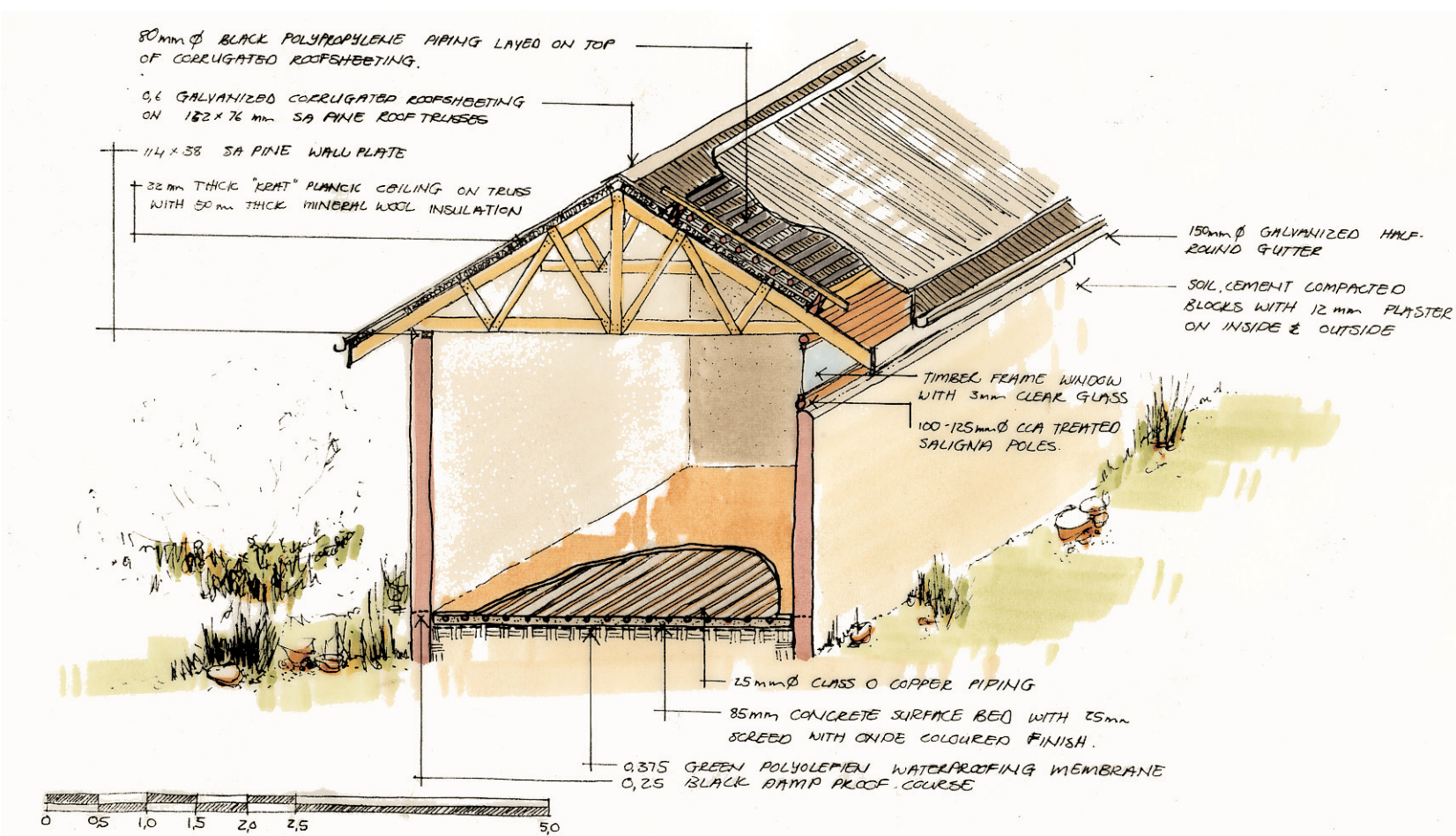

Fig. 7.3.1.1 Isometric of underfloor heating in Tourist units

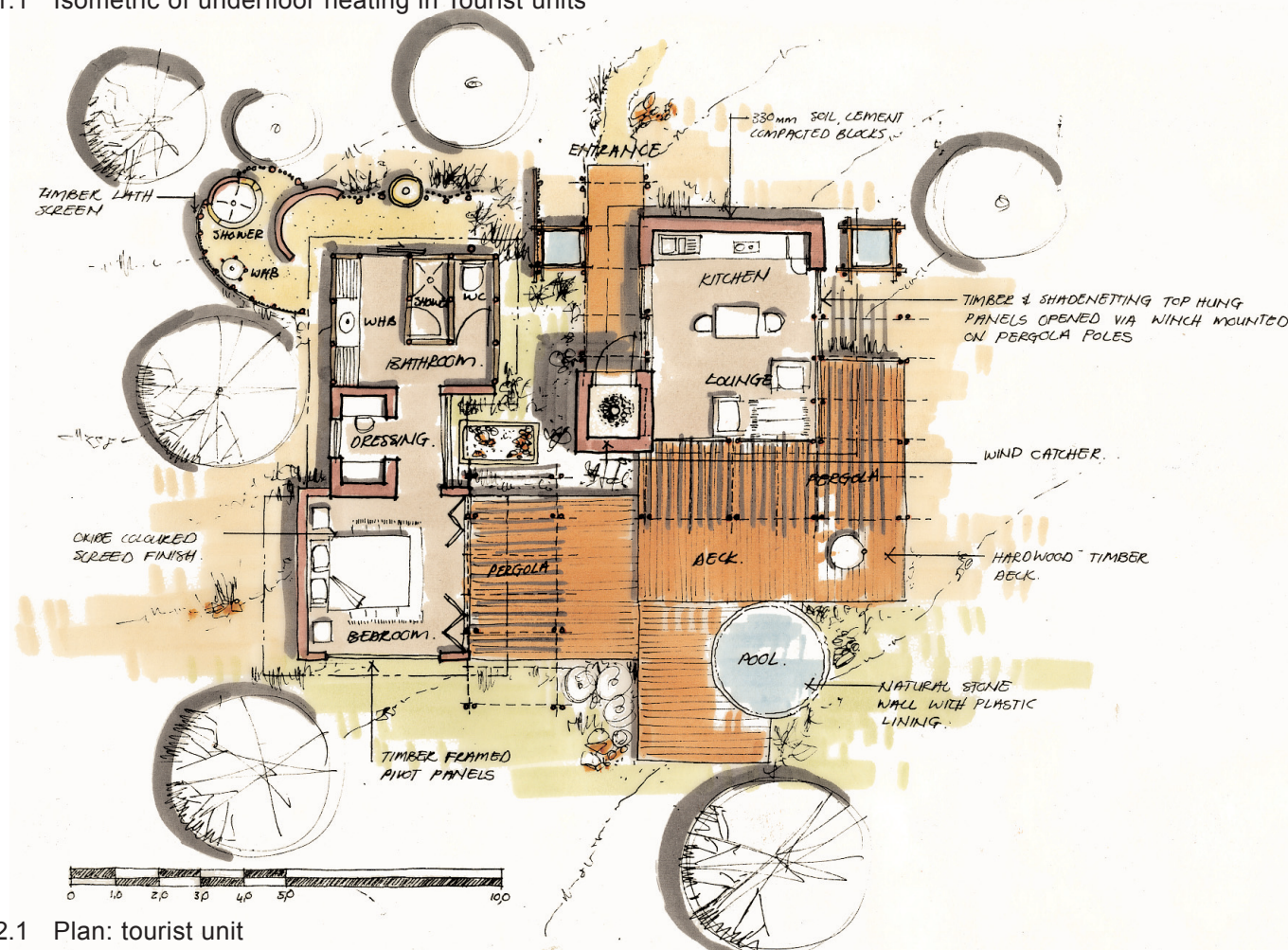

Fig. 7.3.2.1 Plan: tourist unit

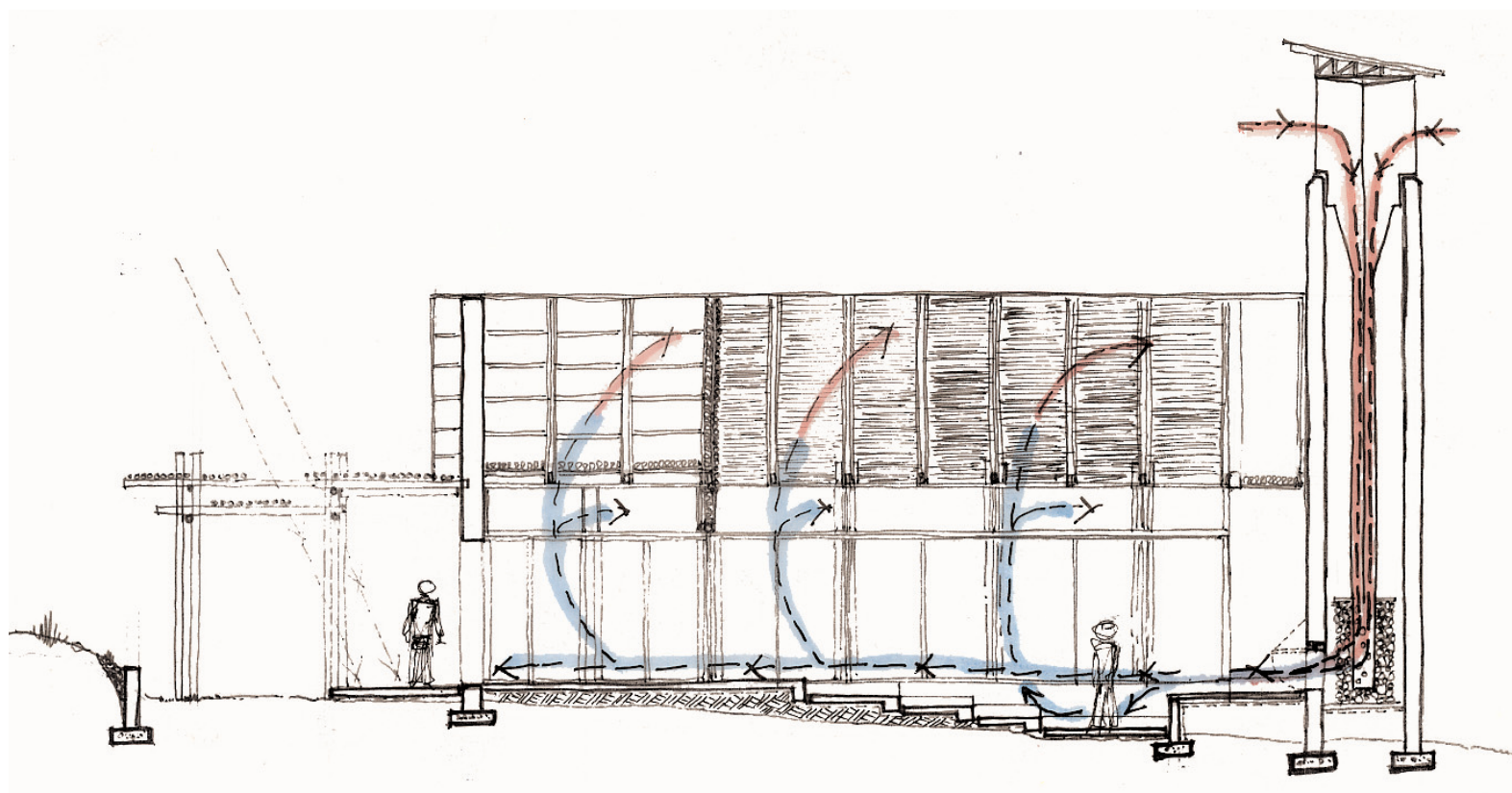

Fig. 7.4.1.1 Ventilation of Conference hall

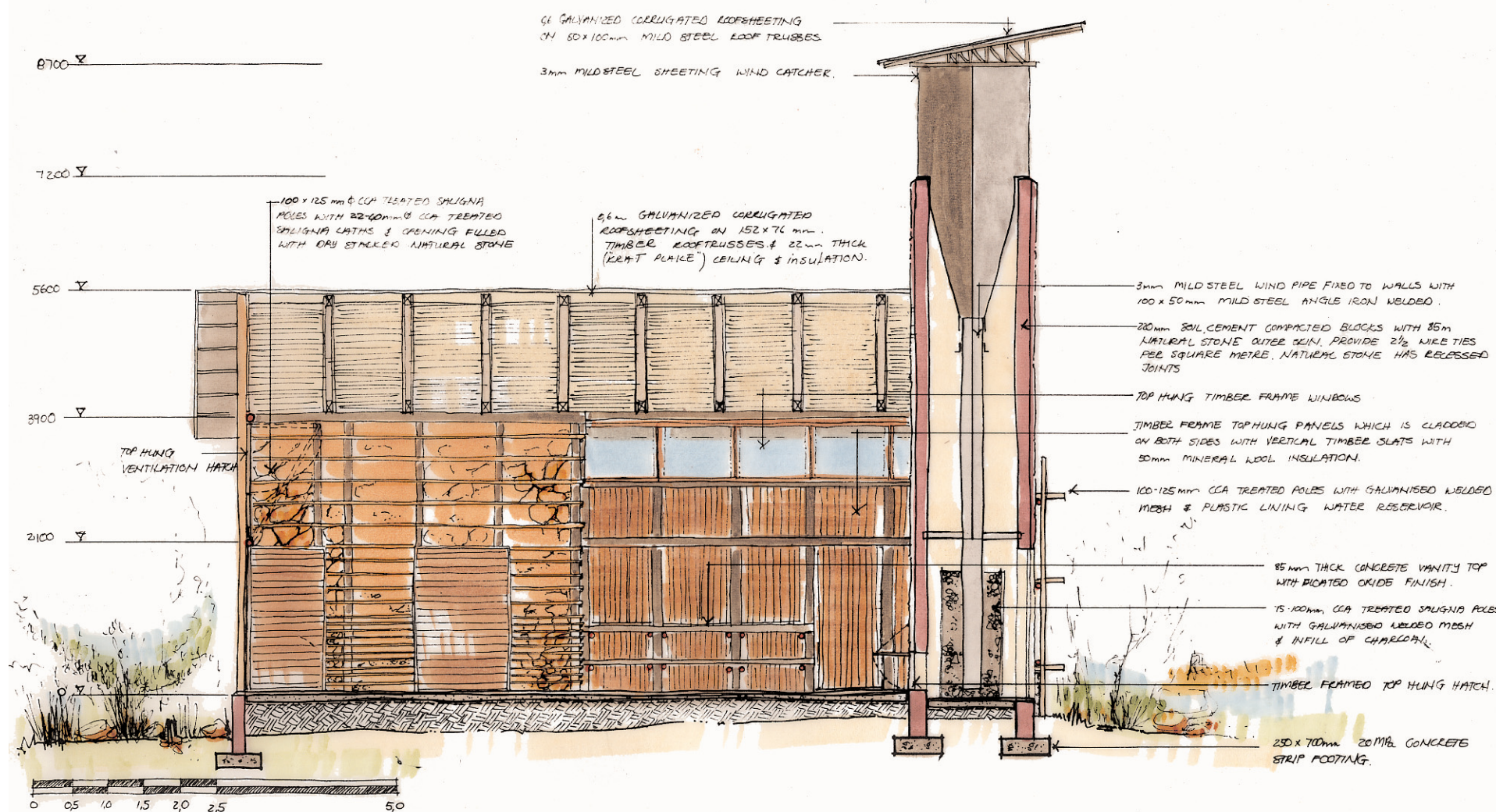

Fig. 7.4.2.1 Section through Skills training facility

7.4 Natural Cooling

7.4.1 Natural ventilation

Ventilation is the replacement of stale air by fresh or outside air. A distinction is made between the requirements for comfort and health. The health requirements must be satisfied in all weather conditions. The requirements for comfort are usually under specific weather conditions only. Two forces operating separately or together achieve natural ventilation of buildings. Thermal or temperature forces and aero motive or wind forces.

Thermal forces are created when the air near the bottom of a stack is heated. Convection currents are set up and the hot air rises up the stack, this air is then replaced by cooler air from the adjoining space. Whenever a difference in temperature occurs, thus a difference in density exists between the air inside and the air outside the building, the exchange of outdoor and indoor air takes place. This exchange can only take place when ventilation openings are provided, which must be of different levels.

The positioning of ventilation openings and the pressure distribution patterns of the wind determine ventilation of buildings by wind forces. Windward walls are subjected to a positive pressure and leeward walls are subjected to a negative pressure or suction. The main roof pitch used in the project is 32°. Therefore the windward slope is under a positive pressure and the leeward slope is under suction (Fig 7.4.1.1).

7.4.2 Wind catcher and Evaporative cooling

Water on a wet surface will evaporate if it is exposed to the air. This air must have a dew point lower than the surface temperature. The rate at which the evaporation will take place depends on the humidity of the surrounding air, the air speed and the surface temperature. Thus the higher the air speed and the lower the humidity in the surrounding air, the higher the evaporation rate.

The system developed was derived from the "malgaf" or wind catcher, which was invented for hot arid zones, and the traditional outside farm fridge. The applied system is a combination of the above-mentioned operations.

Because of the swirling wind in the valley, the wind inlet openings were divided into four. The average wind speed is too low to effectively evaporate the water and create the right pressure in the bottom of the tower. In order to increase the wind speed an inversed venturi stack effect was applied (Fig. 7.4.2.1). The air volume that comes through the opening is compressed by reducing the down pipe cross sectional area in relation to the inlet opening. This compression of air results in a higher air speed through the down pipe. The bottom of the tower is filled with charcoal. This is wet manually by pouring water into a steel container that is perforated at the bottom. This will allow constant moisture content on the charcoal. The down pipe is also perforated on the section, which sits inside the charcoal. The air in the down pipe is then pushed through the charcoal causing the water evaporate and thus lowering the air temperature.

Removable insulated panels on the outer side of the tower are opened to let the colder air into the living spaces. In order for the whole system to start, a small low voltage fan is placed inside the outer wall. This fan will assist in the start up of the system. Once the air is moving a draft is formed and can only be stopped when the panels are shut.

7.5 Infrastructure

7.5.1 Rainwater harvesting (Fig. 7.5.1.1 & 7.5.1.2)

Some of the advantages of rainwater collection are that it is renewable, available at the point of consumption, generally of very good quality and it may be used as drinking water without any treatment. The main application of the rainwater collection in the project is for the irrigation of cultivated land. Seventy percent of the rainwater will be temporarily stored in storage tanks at the point of harvesting. This water can be used for the evaporative cooling system and also any general use such as watering of vegetation and cleaning purposes around the buildings. The other 30% will directly flow to the big water reservoirs at the agricultural plant.

Amount of water obtained from rainwater harvesting:

The total area of catchment surface x Annual rainfall
 2 573 square metre x 550mm per annum

= 1 415 150 litres/year

Total litres per year are multiplied by 80% because of losses due to evaporation and run off that does not flow into the gutters.

TOTAL: 1 132 m³/year

Amount of water needed for irrigation of cultivated land:

Area of cultivated land = 10 hectares + 12 tunnels
 Plants per hectare = 33 000 plants
 Plants per tunnel = 1 500 plants
 Water needed per plant = 0.85l / plant / day for open land
 = 1.5l / plant / day for tunnels

(This figure incorporates annual rainfall)

Water needed for ten hectares: = 30 000pl x 10 hectares
 = 300 000 plants
 = 300 000pl x 0.85l/pl
 = 255 000 l/day
 = 61 200 000 l/year

Water needed for 12 tunnels = 2500 pl x 12 tunnels
 = 30 000 plants
 = 30 000 plants x 1.5 l/pl
 = 45 000 l/day
 = 10 800 000 l/year

Occupation rate of cultivated land and tunnels is 65% (240 days / year)

Total amount of water needed per year
 = 61 200 000l + 10 800 000l
 = 72 000 000 l
 = 72 000 m³/year

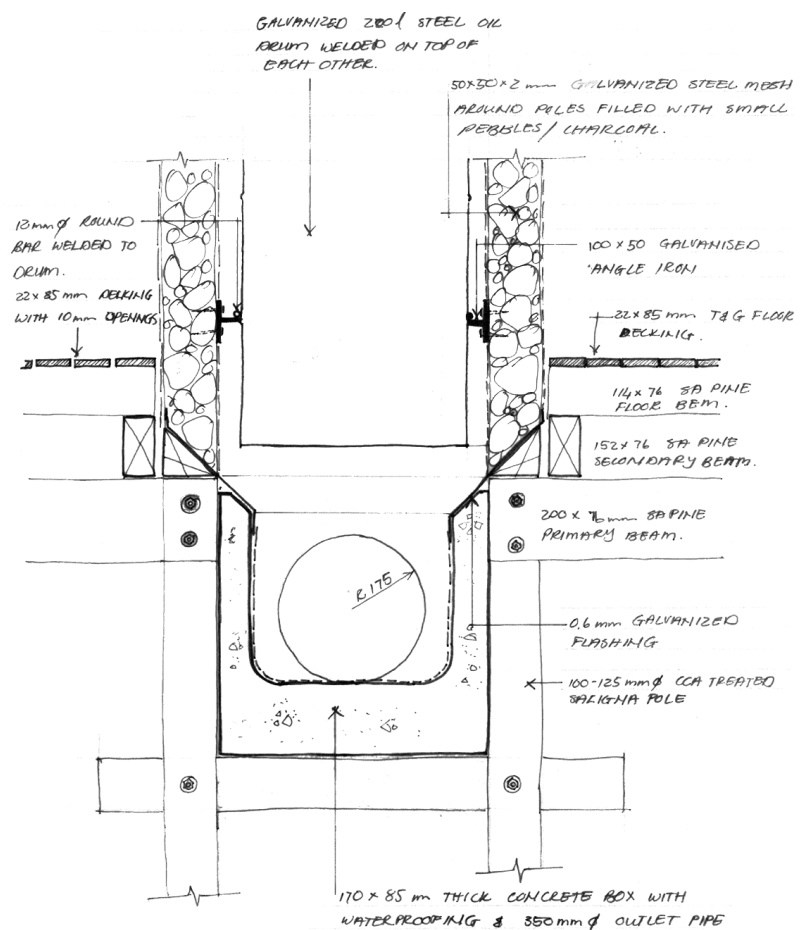

Fig. 7.5.1.1 Rainwater harvesting at Restaurant

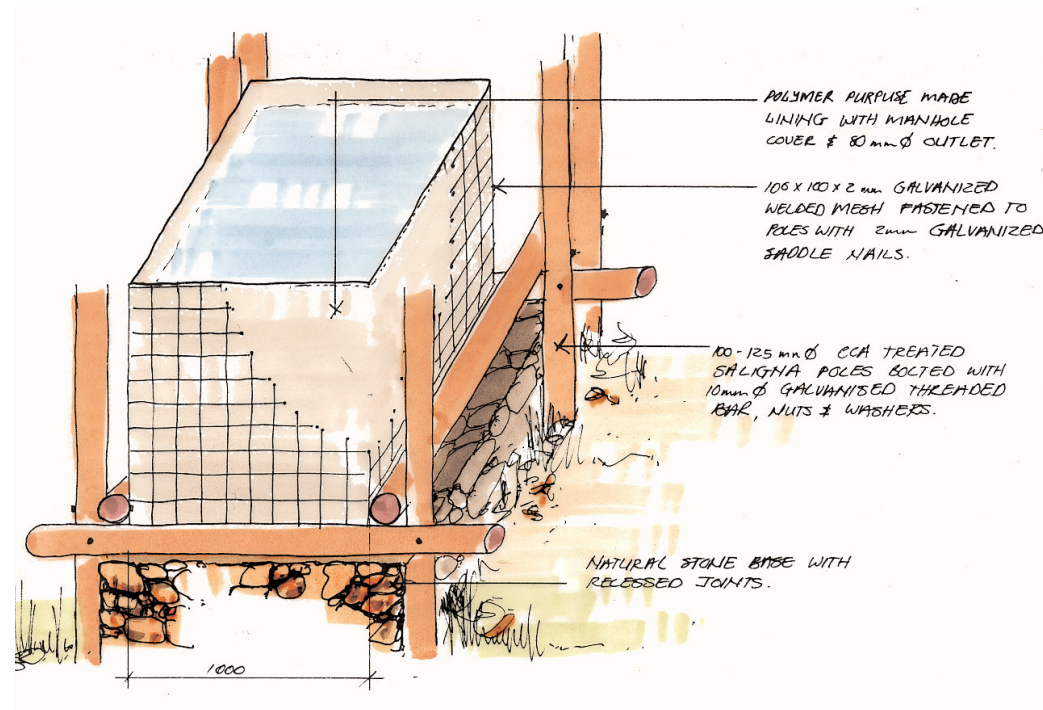
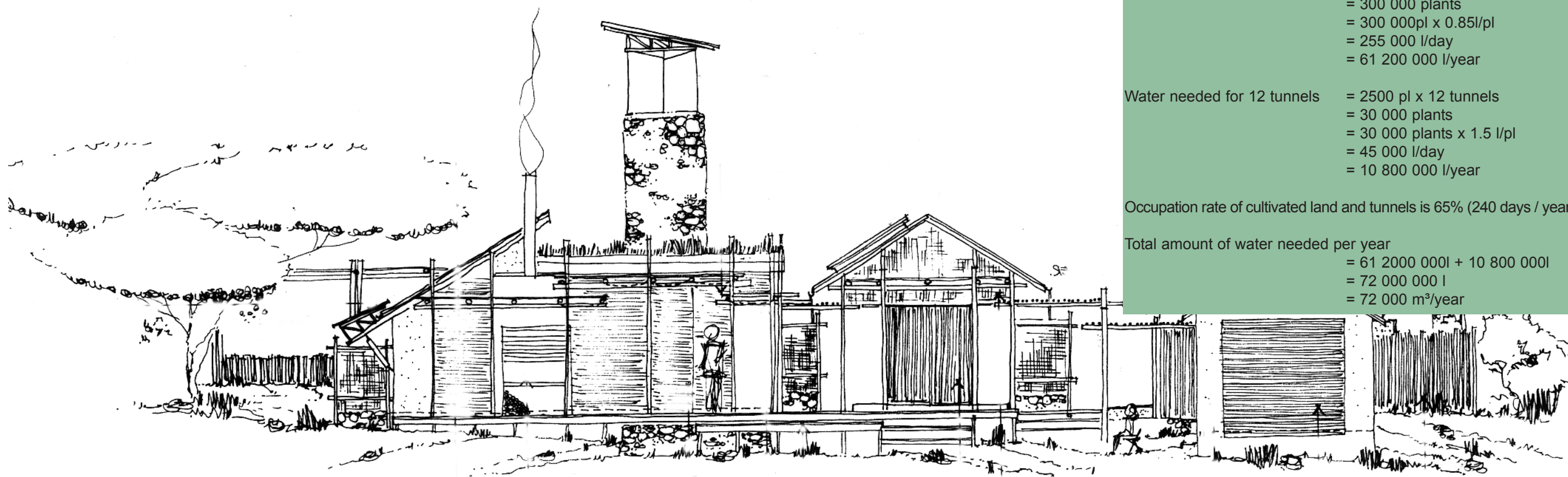

Fig. 7.5.1.2 Rainwater storage tanks



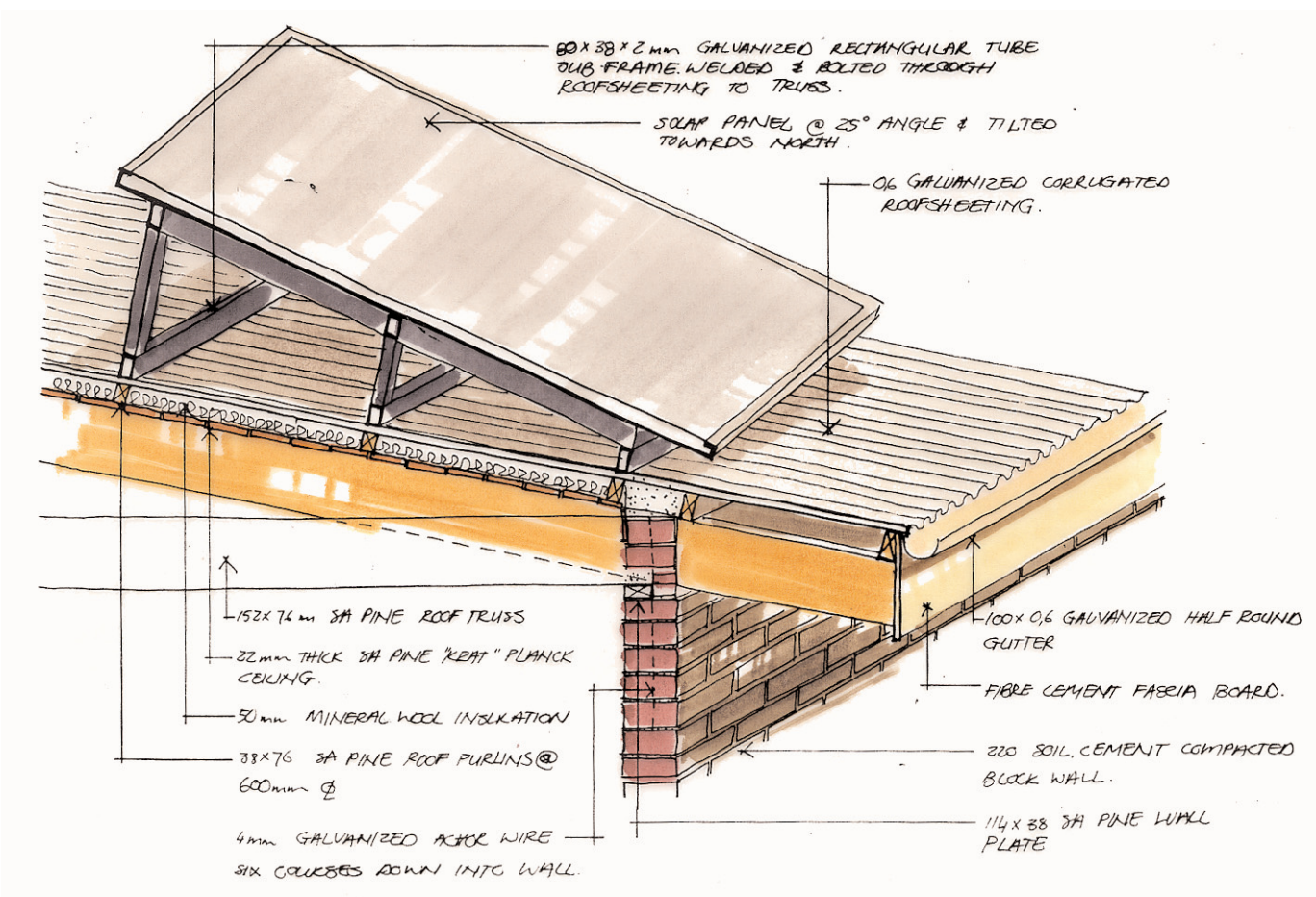

Fig. 7.5.2.1 Solar installation at Agriculture plant

7.5.2 Energy

Four types of energy are used in the project: Eskom, solar power, liquid petroleum gas and bio-fuels.

General usage of lights and low power appliances makes use of solar power, which is obtained from photovoltaics (Fig. 7.5.2.1). The solar installation is split into different zones because a central solar plant would have caused cables to run extreme lengths (power loss directly equivalent to length of cable) to consumption point due to distances between facilities.

Eskom power is used for appliances which need a more constant power supply, such as cold rooms, packaging appliances and water pumps at the agricultural plant.

Liquid petroleum gas is used for all cooking appliances. A 5l instant electric geyser supplies hot water needed at sinks. These geysers are connected to the solar installations. Hot water that is needed for bathroom facilities is supplied via a "donkey" boiler. The organic waste from the agricultural plant is used as fuel for the "donkey" boilers. This waste is left to dry and then compacted into fire briquettes. These briquettes are also used at the braai facilities. No natural wood will be used for any fires.

The solar installation is integrated with the Eskom electricity grid. Any extra power derived from the solar panels after the battery storage is at full capacity, will be put back into the Eskom electricity grid, thus saving more on Eskom electricity.

See Addendum A for calculations.

7.5.3 Roads (Fig. 7.1.5.1)

The width of the road is kept to the minimum required for the use of a tractor and trailer. Passing of vehicles is restricted to certain points allocated along the roads. At these points the roads are widened to enable the one vehicle to park temporarily and wait for the other vehicle to pass.

The road surface is treated with Eco-bond. Eco-bond is a product that stabilizes the top layer by binding the particles. It is compatible with a broad range of soils, only if the clay percentage is less than 20%. The soil is ripped first to the required depth before eco-bond is sprayed on. A rotovator is then used to mix the soil and Eco-bond. After levelling and shaping the roads a roller is used to compact the surface. This application dramatically increases the water resistance and strength of the soil.

The storm water run-off is directed into the natural vegetation. Where the slope causes a run-off along the shoulder of the road, placing of natural stone on the soil directing the water further away from the road surface. The stones are used as a preventative measure for soil erosion.

7.5.4 Water reticulation

Fig 7.5.4.1 is a schematical illustration of the water reticulation between the main facilities.

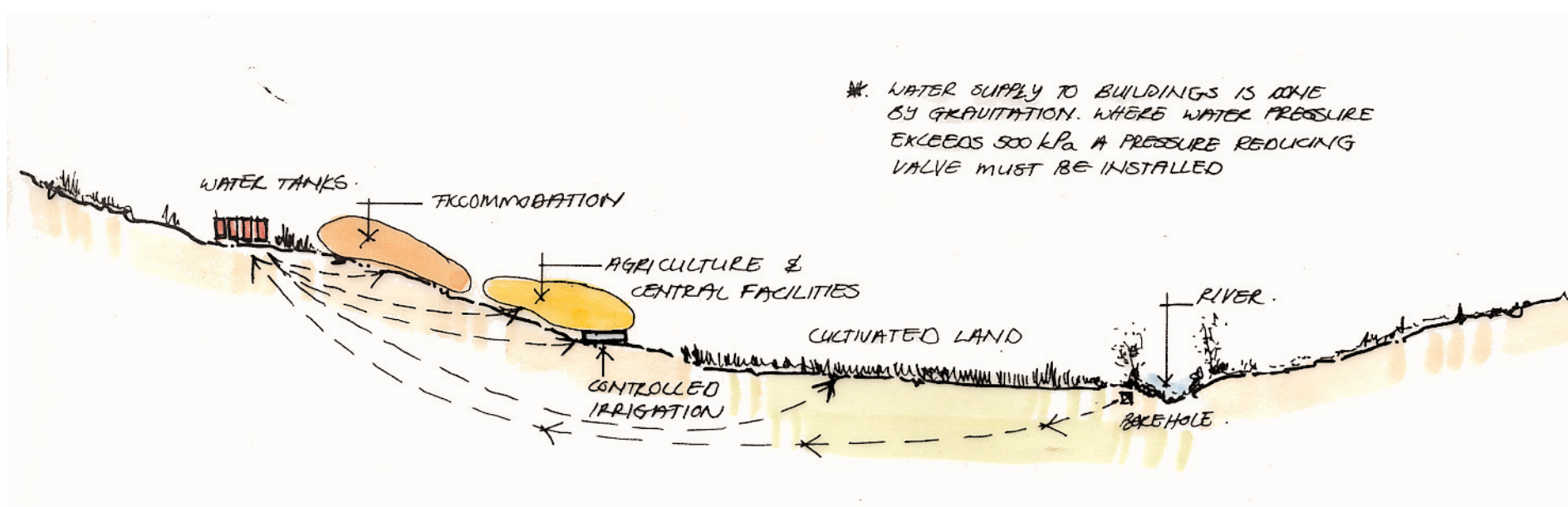

Fig. 7.5.4.1 Water reticulation

7.6 Waste management

7.6.1 Organic and inorganic waste

A recycle area is located on the western side of the agricultural plant. All the organic waste from the agricultural plant is re-used as described in section 7.5.2. Garden refuse is converted into compost that is worked back into the land. All the inorganic waste (tin, glass, steel etc) and organic waste that is not re-used on the farm such as paper (contain possible chemicals) is sorted and removed by entrepreneurs from the local community to acceptable re-cycling facilities.

7.6.2 Eco-San toilets (Fig. 7.6.2.1)

The amount of water saved by using a dry sanitation system is astronomical. Approximately 550l of sewerage is generated per person per year. Taking the water out of the equation results in only 50l of excretion, an annual saving of 500l of water per person. A dry excreta is then the only end product that need to be disposed of or processed.

How it works: Human excreta falls down a vertical chute and into one end of a specially designed helical screw conveyor. Every time the toilet lid is lifted, a steel mechanism rotates the conveyor. With each rotation the product moves slowly. After 25 days in the helical screw conveyor the dry waste falls into a reusable bag. It takes 6 to 9 months for the bag to fill with dry / odourless waste.

The dry waste can now be processed into compost that is used on the agricultural land.

7.6.3 Subterra Artificial Wetlands (Fig. 7.6.3.1)

In natural wetlands, water seeps into the soil, flows along roots and is filtered by various sand and gravel layers and micro-organisms. Artificial reed bed purification systems use a combination of mechanical and biological resources to process wastewater.

Compared to conventional sanitation and washing facilities, a reduced amount of wastewater is generated in the development. This reduction is due to the use of waterless toilets and urinals. The only water that needs to be purified is grey water. The pre-purification of the grey water takes place in the multi-chambered pit. The subsequent transport of wastewater to the reed bed is brought about by a pressure pipe system that guarantees an even distribution of effluent over the filtration bed. The bed consists of different layers of sand and gravel and is planted with reeds. The root system of the plants ensures a constant aeration of the soil. The purified water is now collected in pipes, from where it flows to a control tank, where it can be tested and subsequently used for irrigation of cultivated lands. See Addendum B for an in depth process description

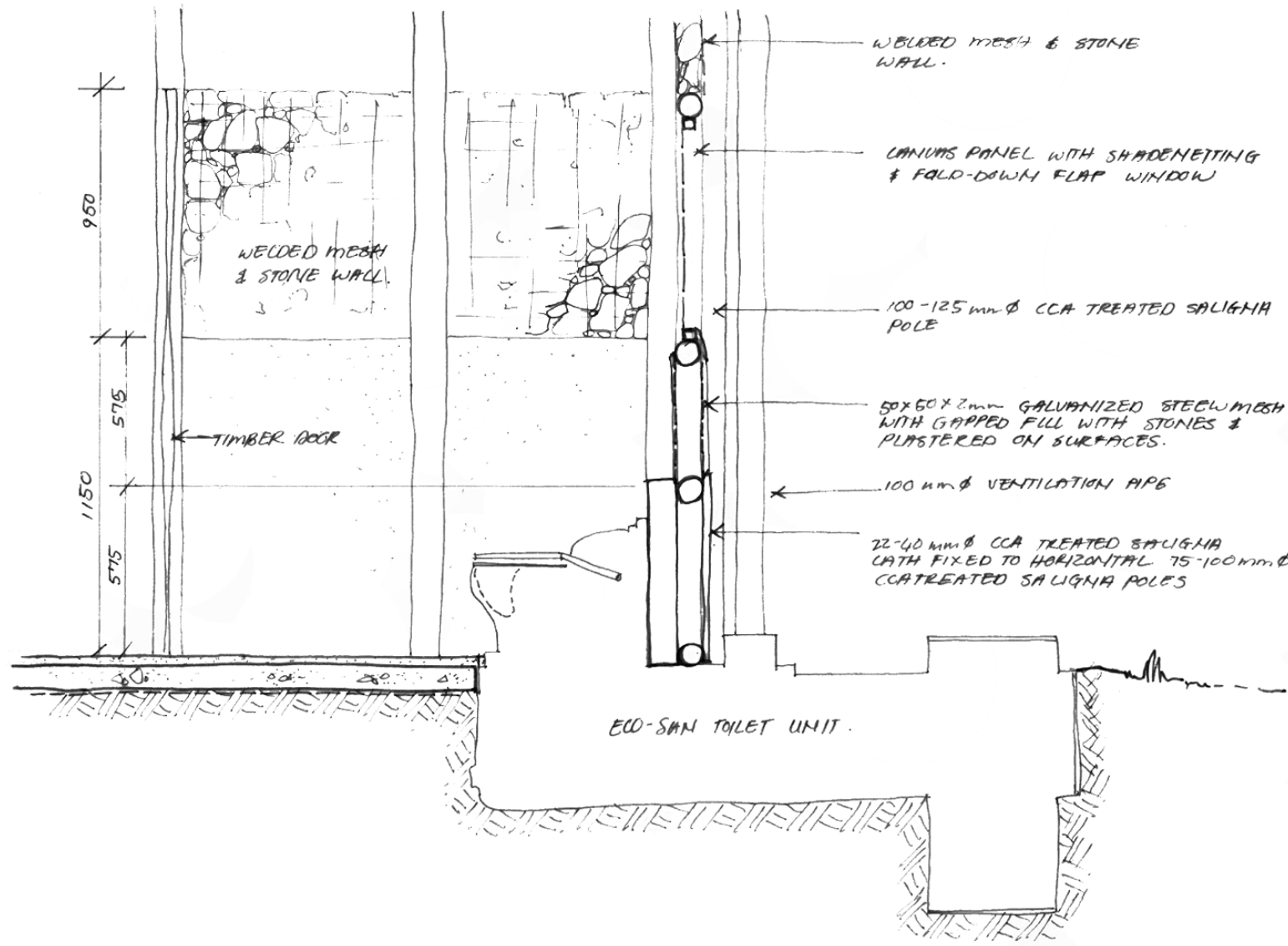

Fig. 7.6.2.1 Section through Eco-San waterless toilet

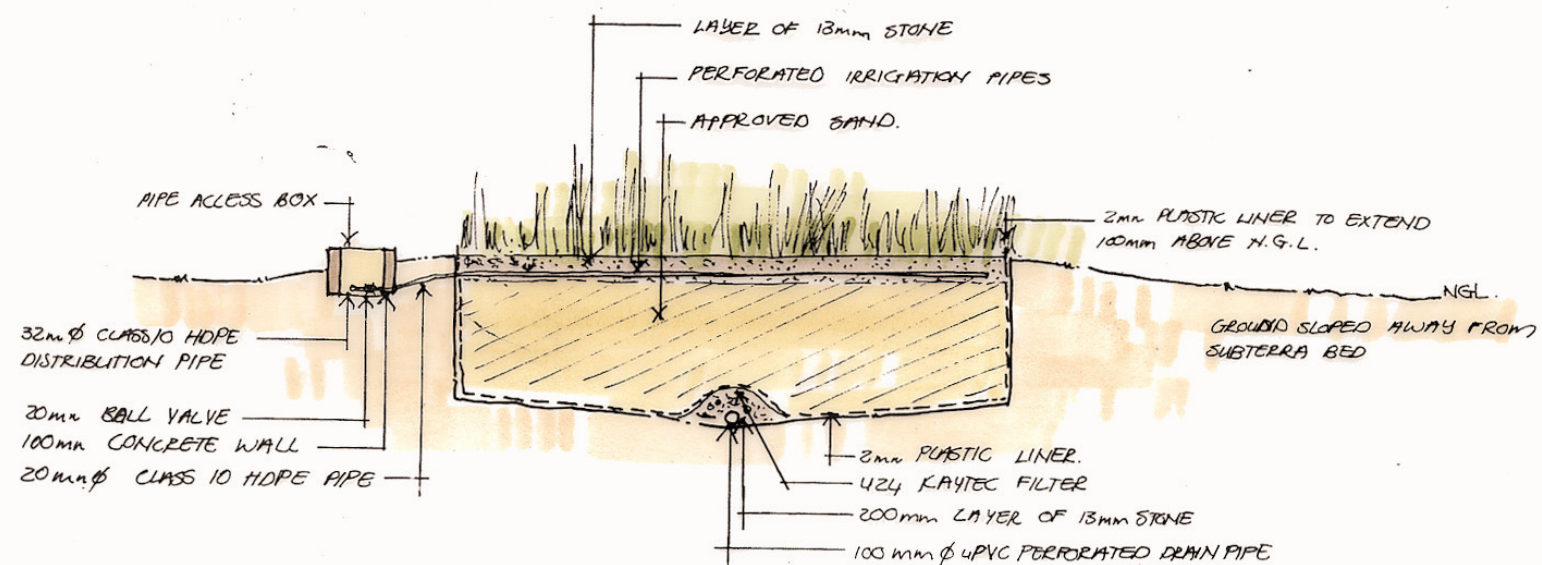

Fig. 7.6.3.1 Artificial wetland

Chapter 8

Drawings



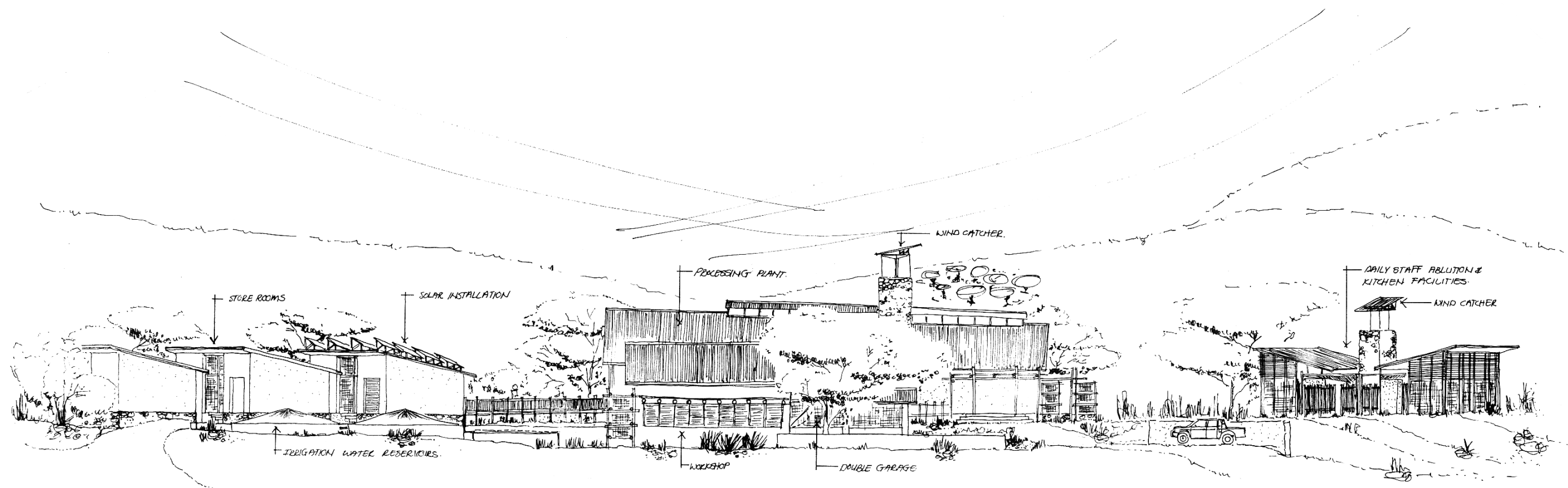

Fig. 8.1 Eastern Elevation Agriculture Process Plant

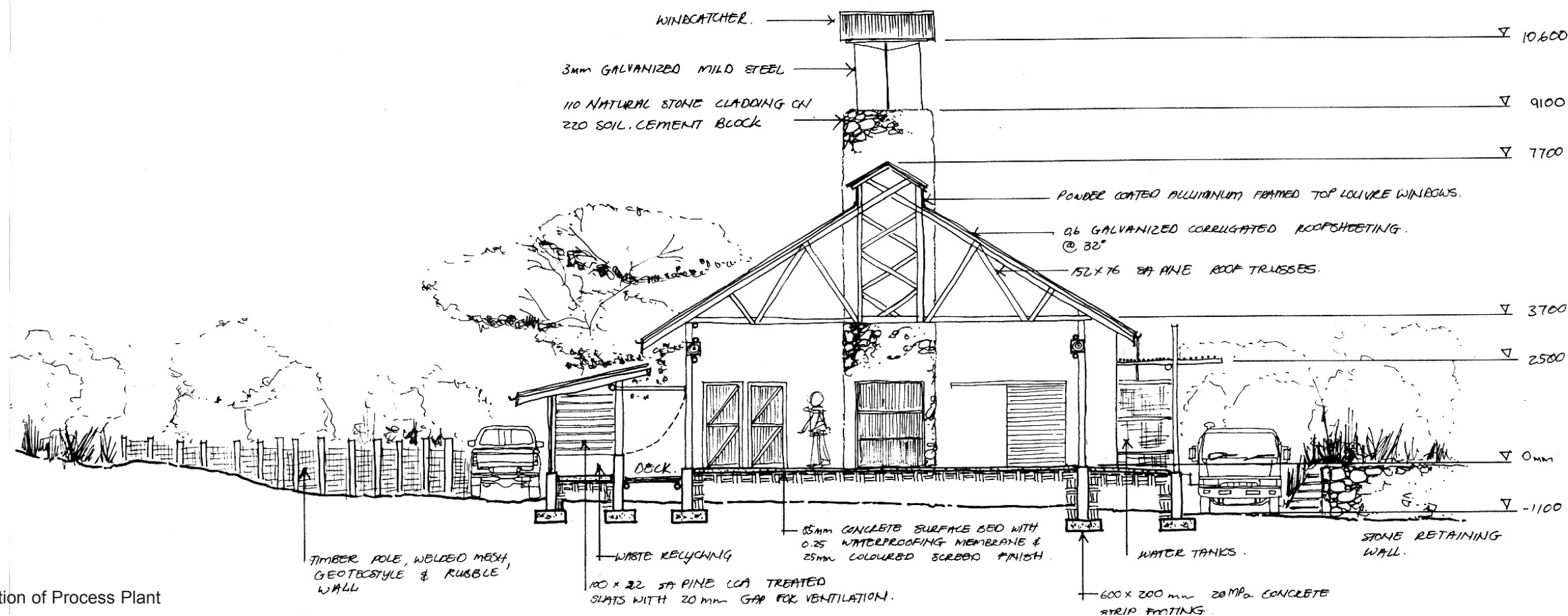

Fig. 8.2 Section of Process Plant

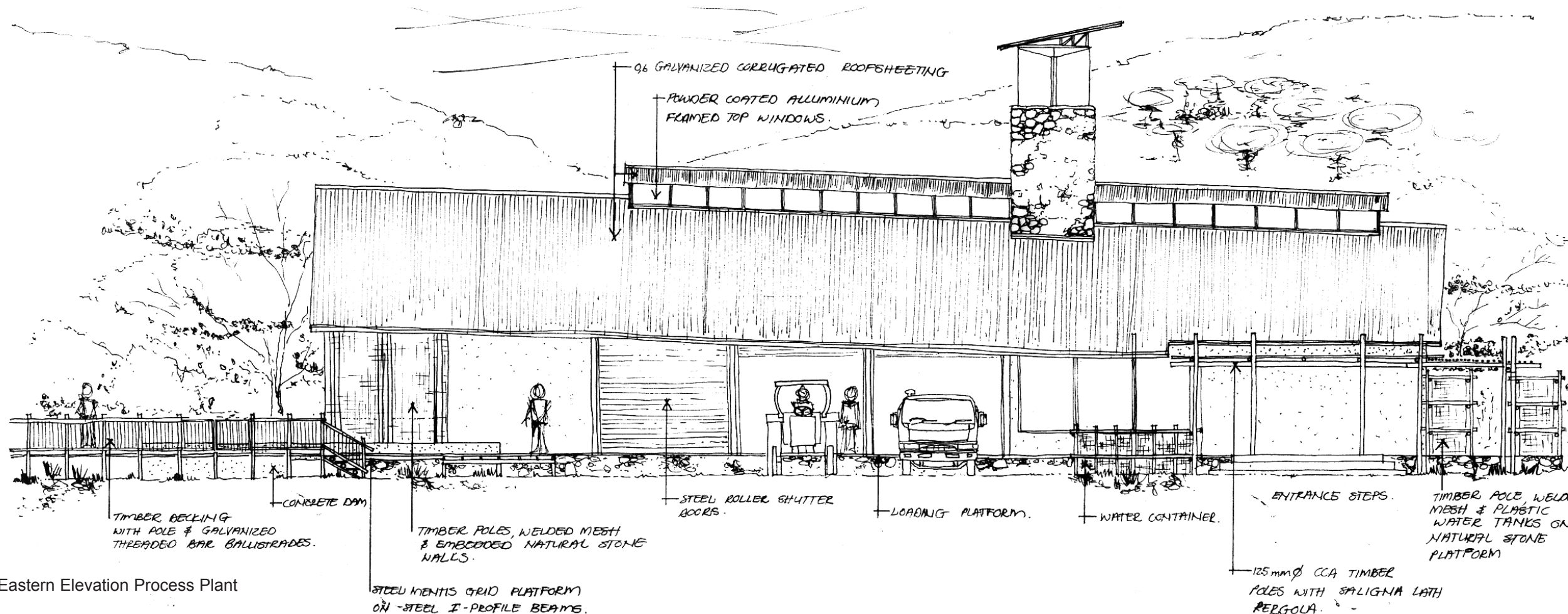

Fig. 8.3 Eastern Elevation Process Plant

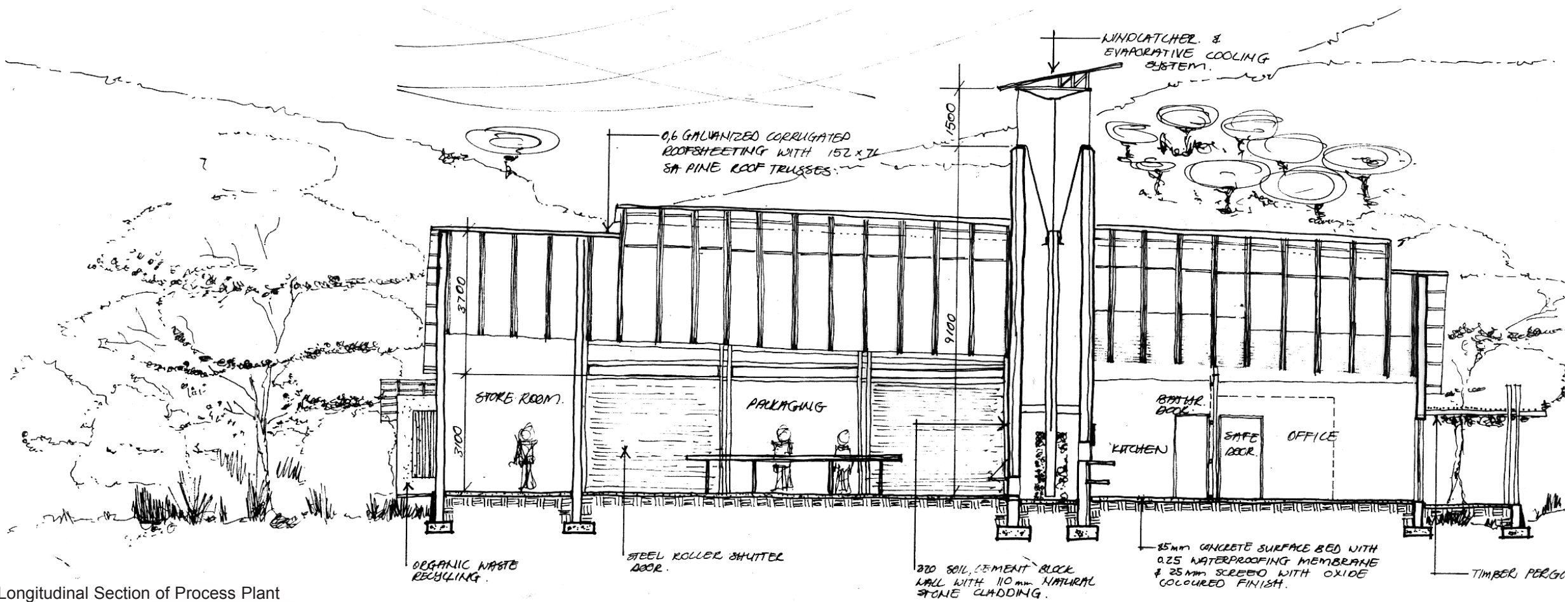

Fig. 8.4 Longitudinal Section of Process Plant

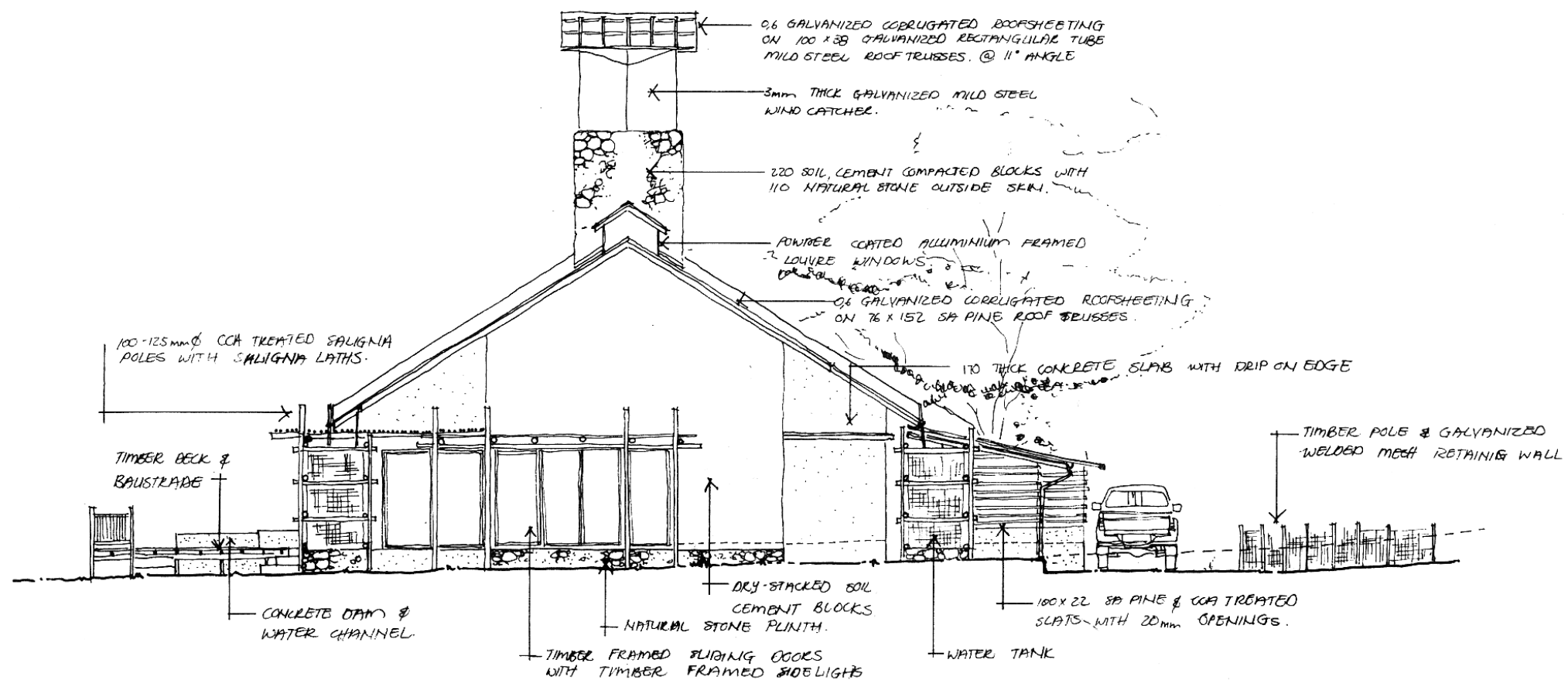

Fig. 8.5 Northern Elevation of Process Plant

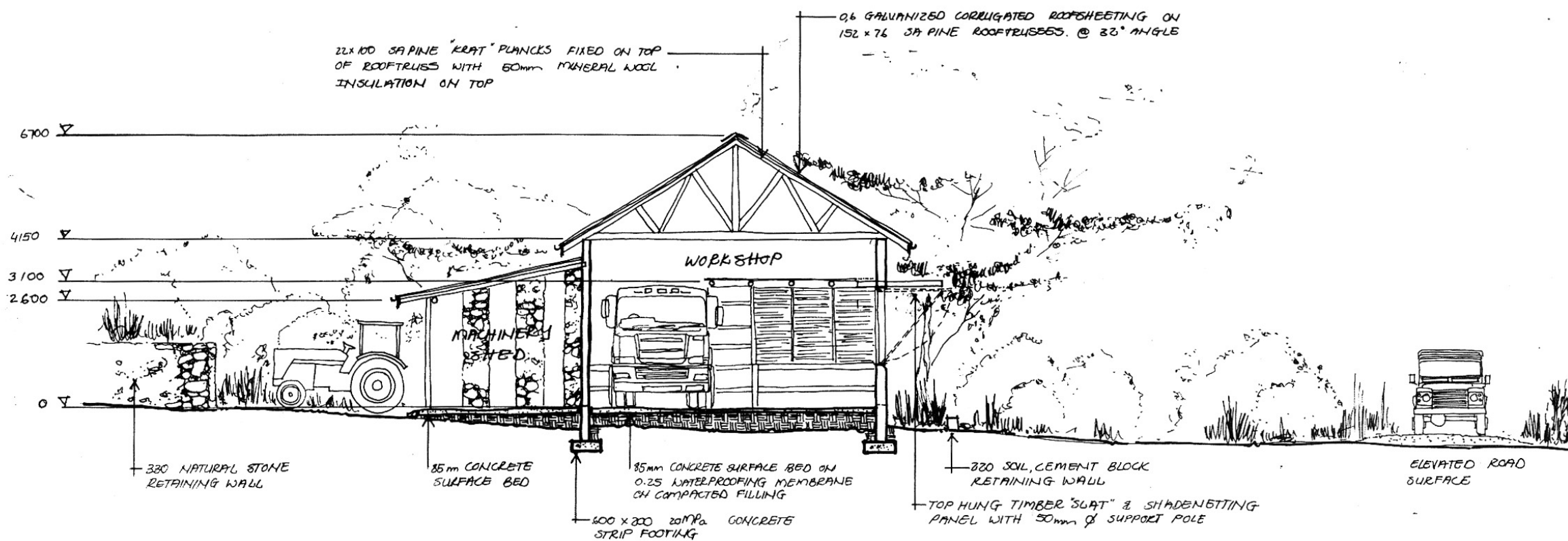

Fig. 8.6 Section of Workshop

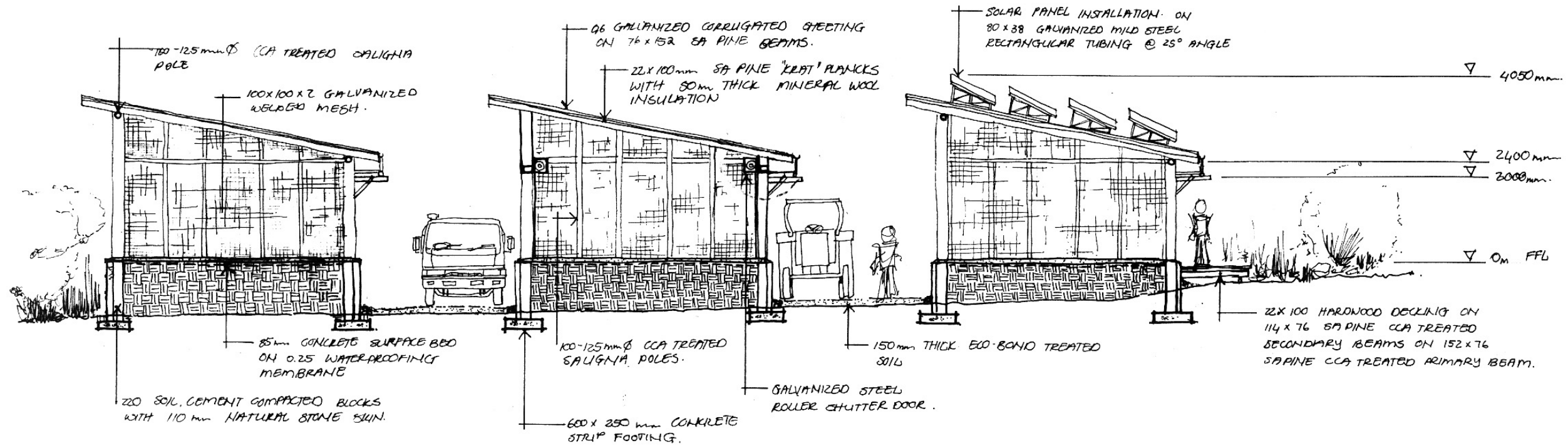

Fig. 8.7 Section through Store rooms

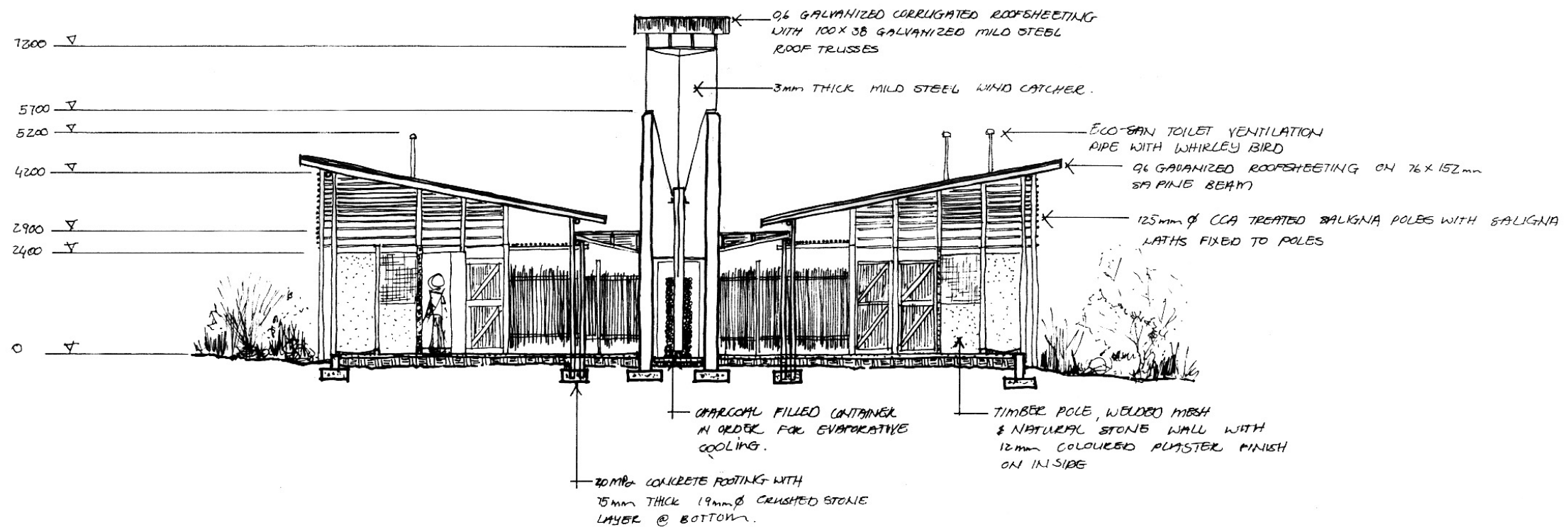

Fig. 8.8 Section through Staff Ablution & Kitchen

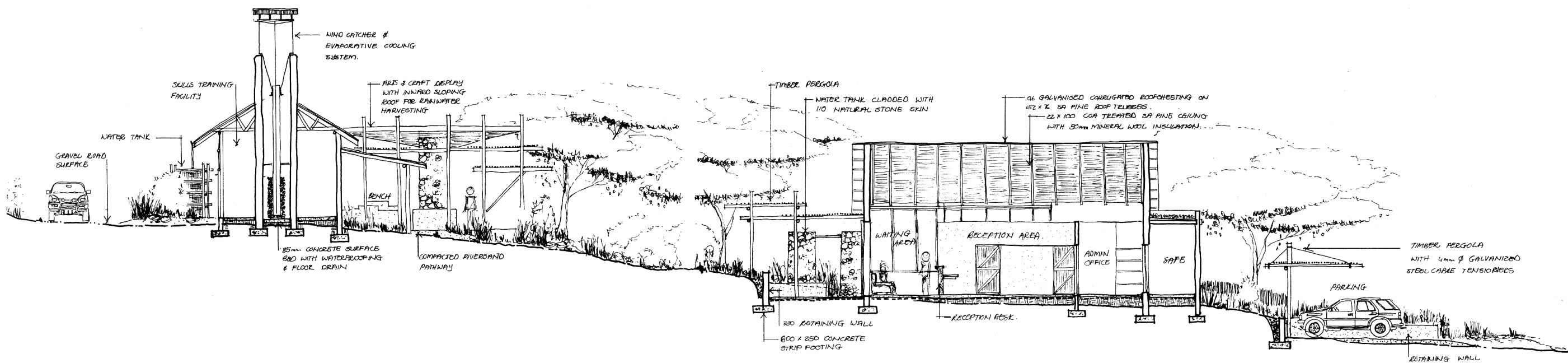

Fig. 8.9 Section through Central Facilities

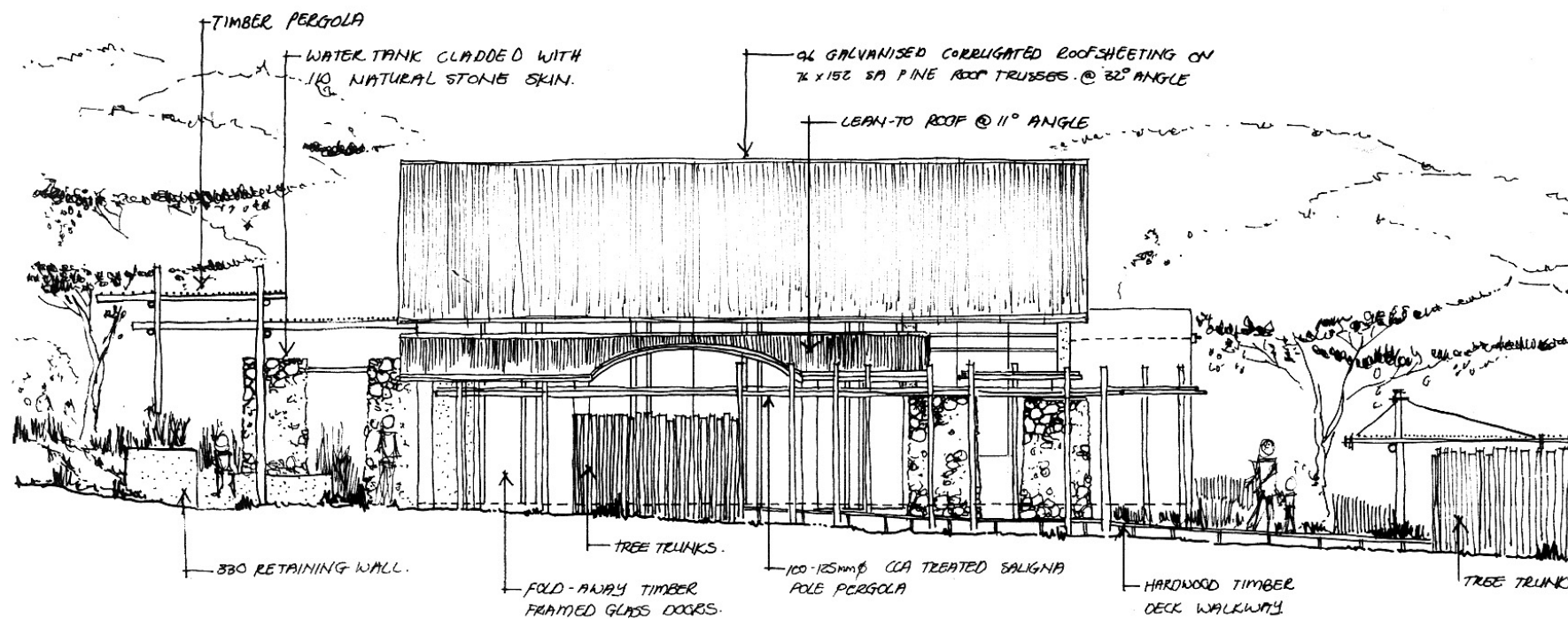

Fig. 8.10 Western Elevation of Reception

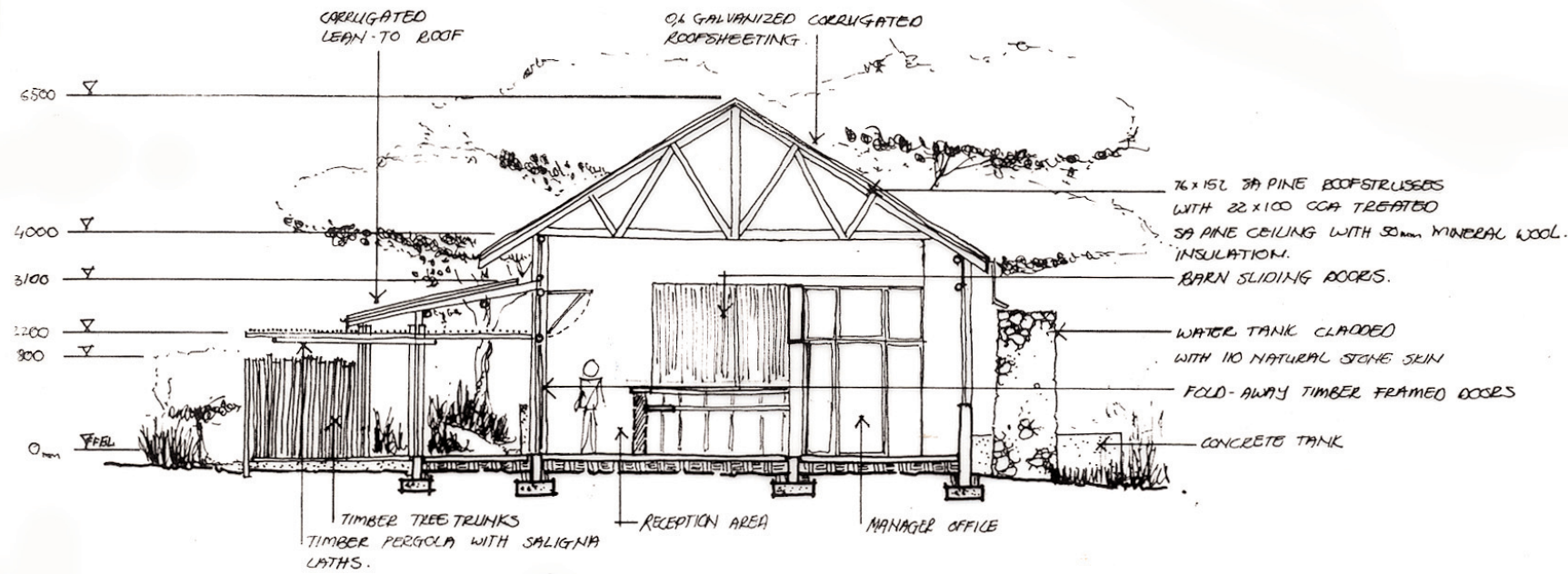

Fig. 8.11 Section through Reception

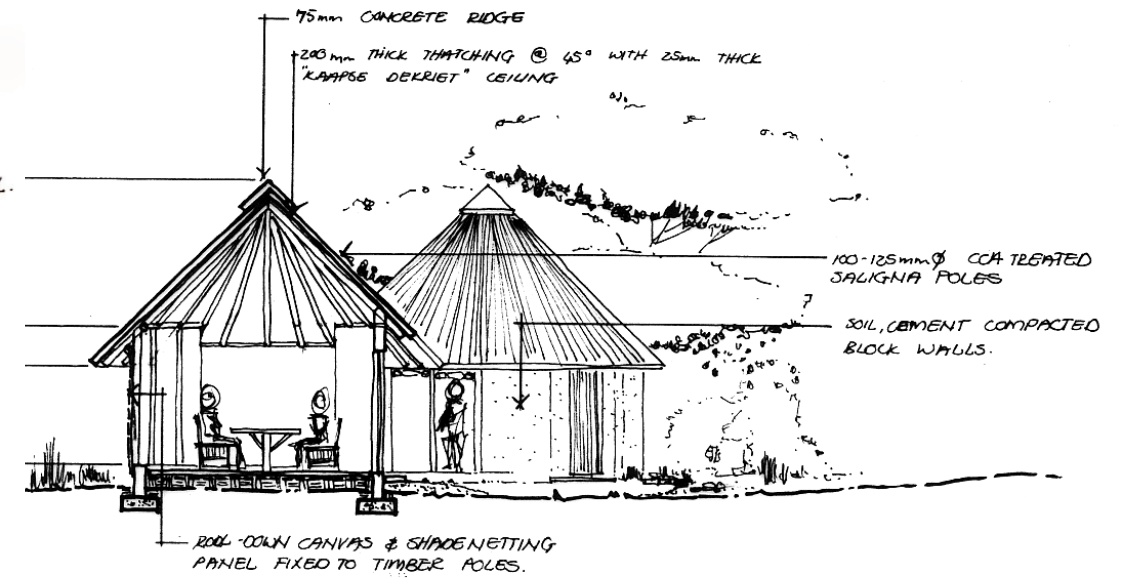

Fig. 8.12 Section through Break-away rooms

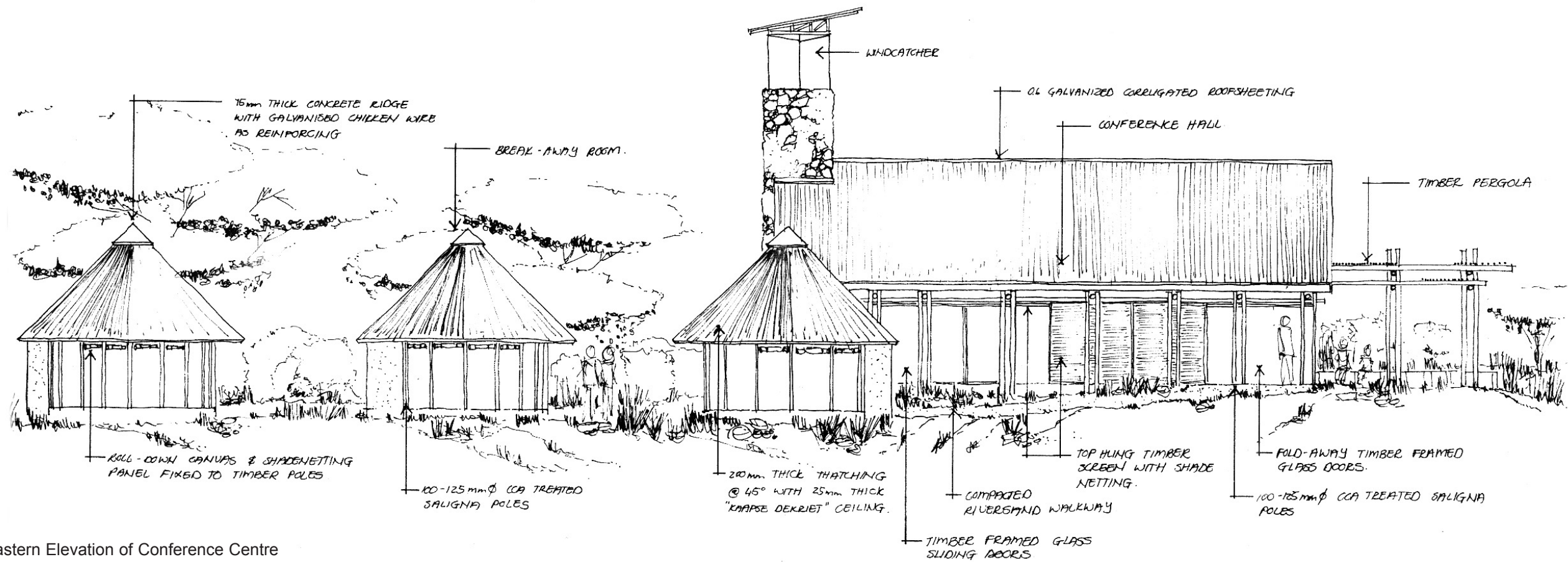

Fig. 8.13 Eastern Elevation of Conference Centre

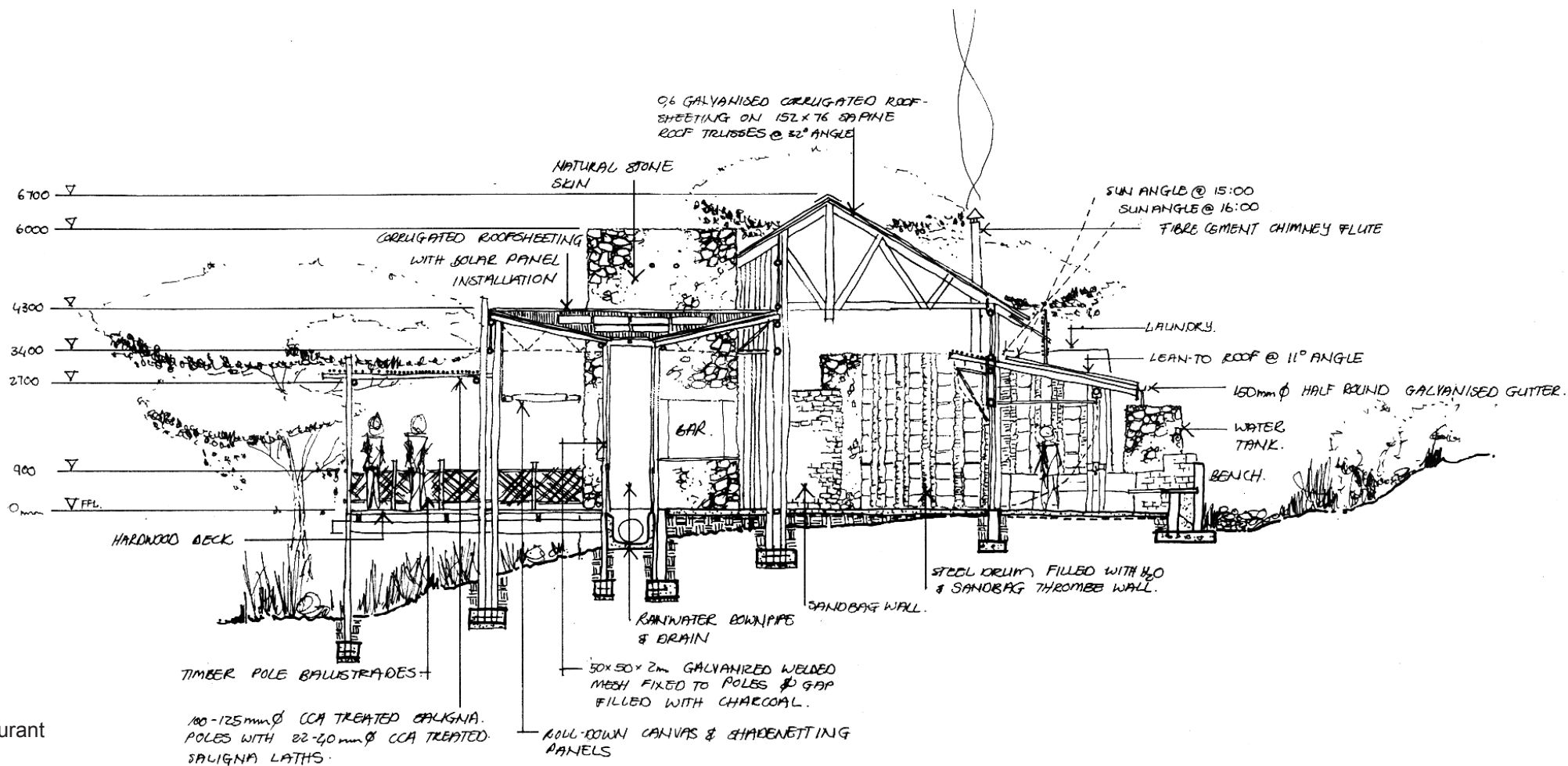

Fig. 8.14 Section through Restaurant

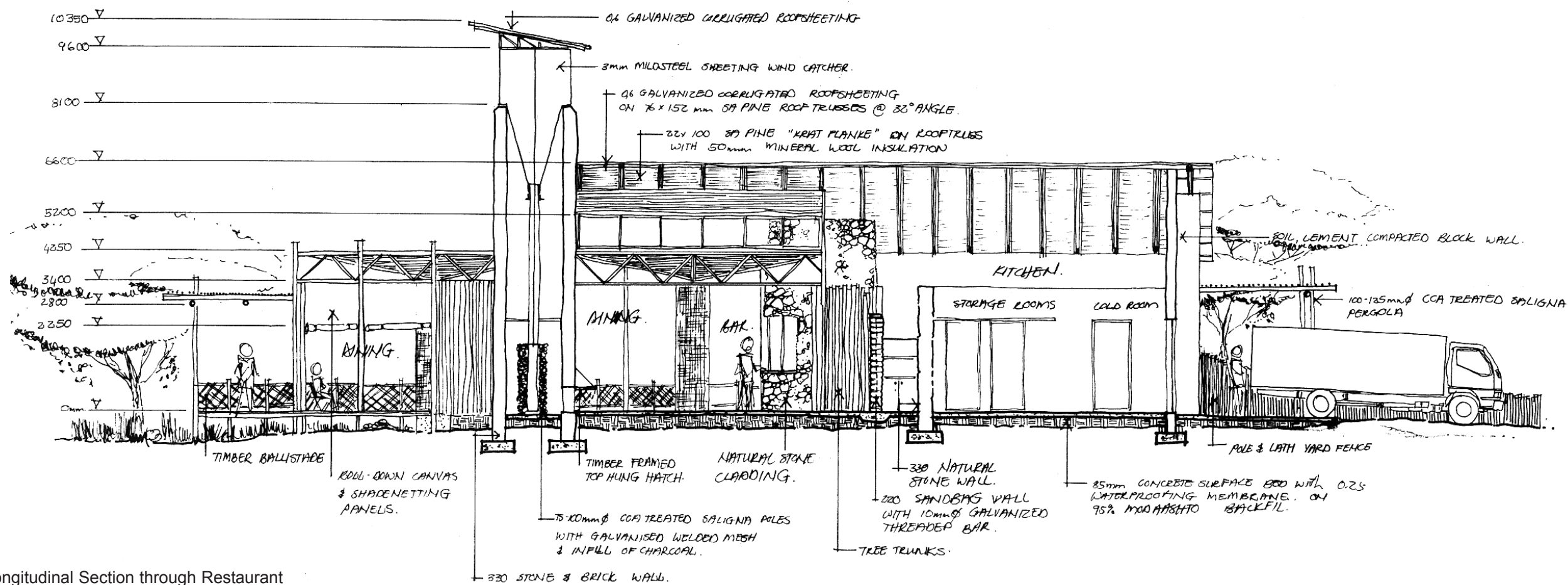

Fig. 8.15 Longitudinal Section through Restaurant

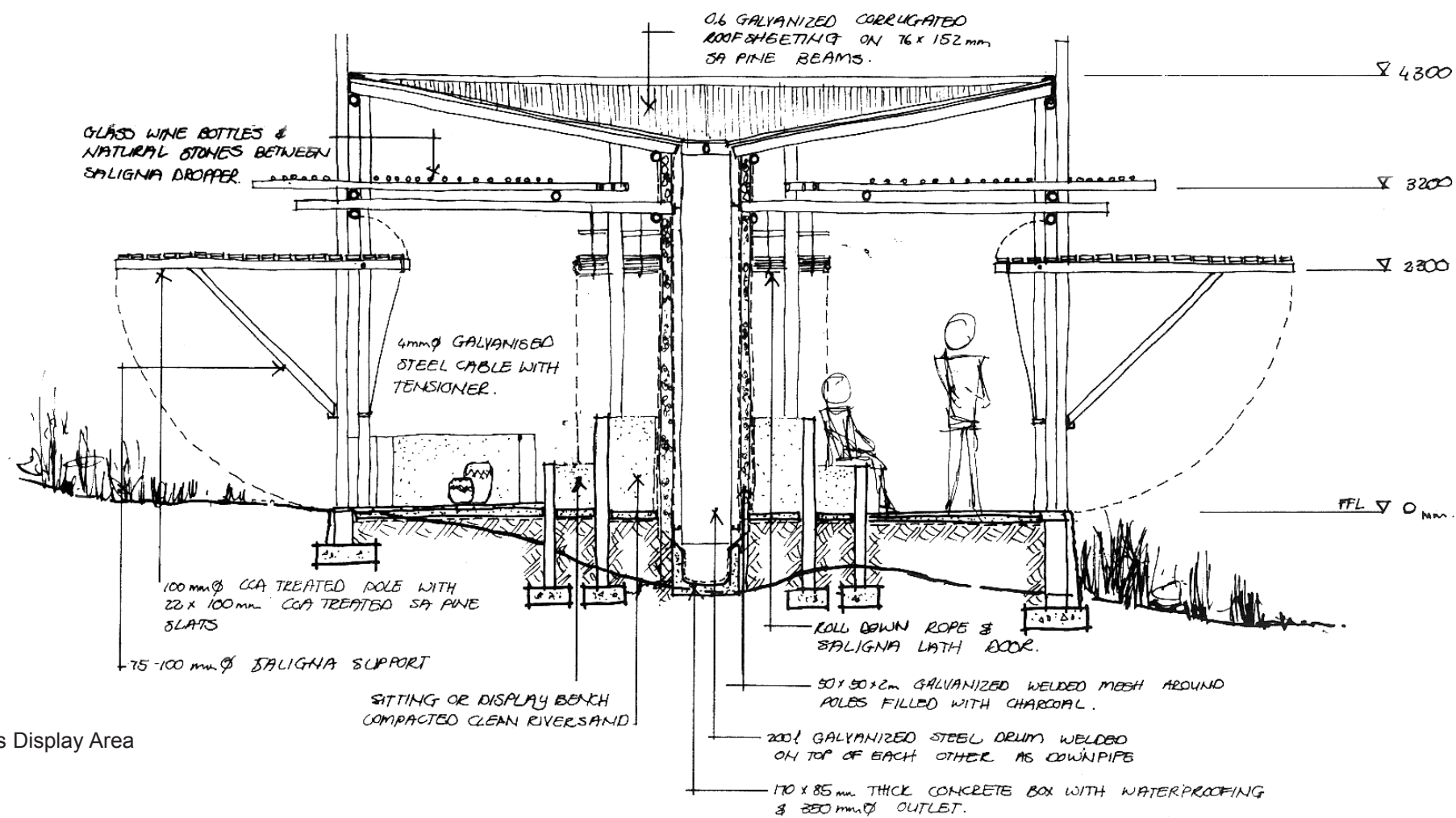

Fig. 8.16 Section through Arts & Crafts Display Area

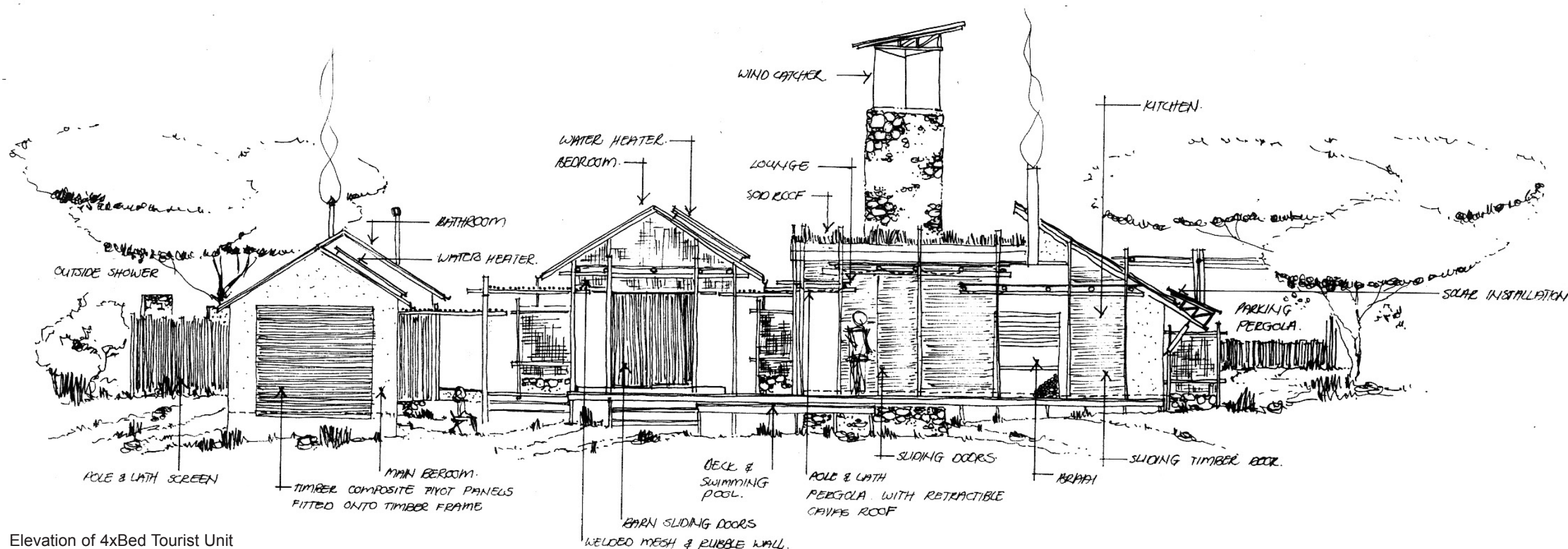

Fig. 8.17 Elevation of 4xBed Tourist Unit

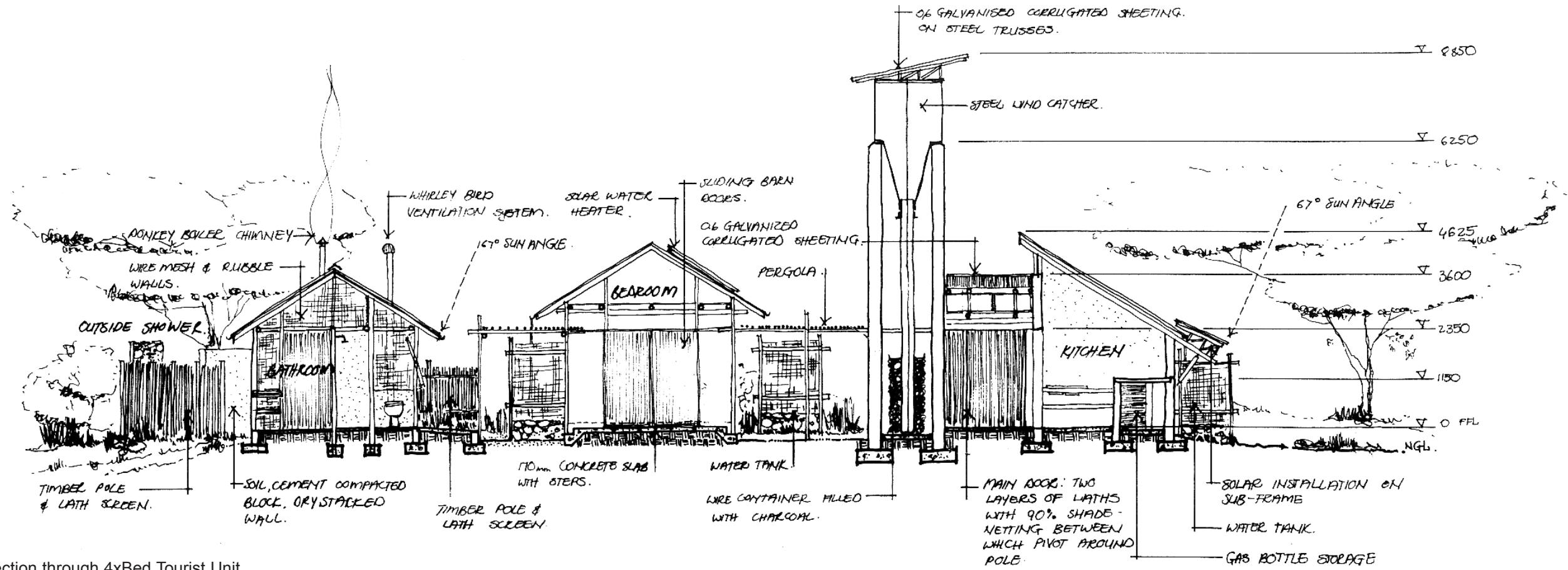

Fig. 8.18 Section through 4xBed Tourist Unit

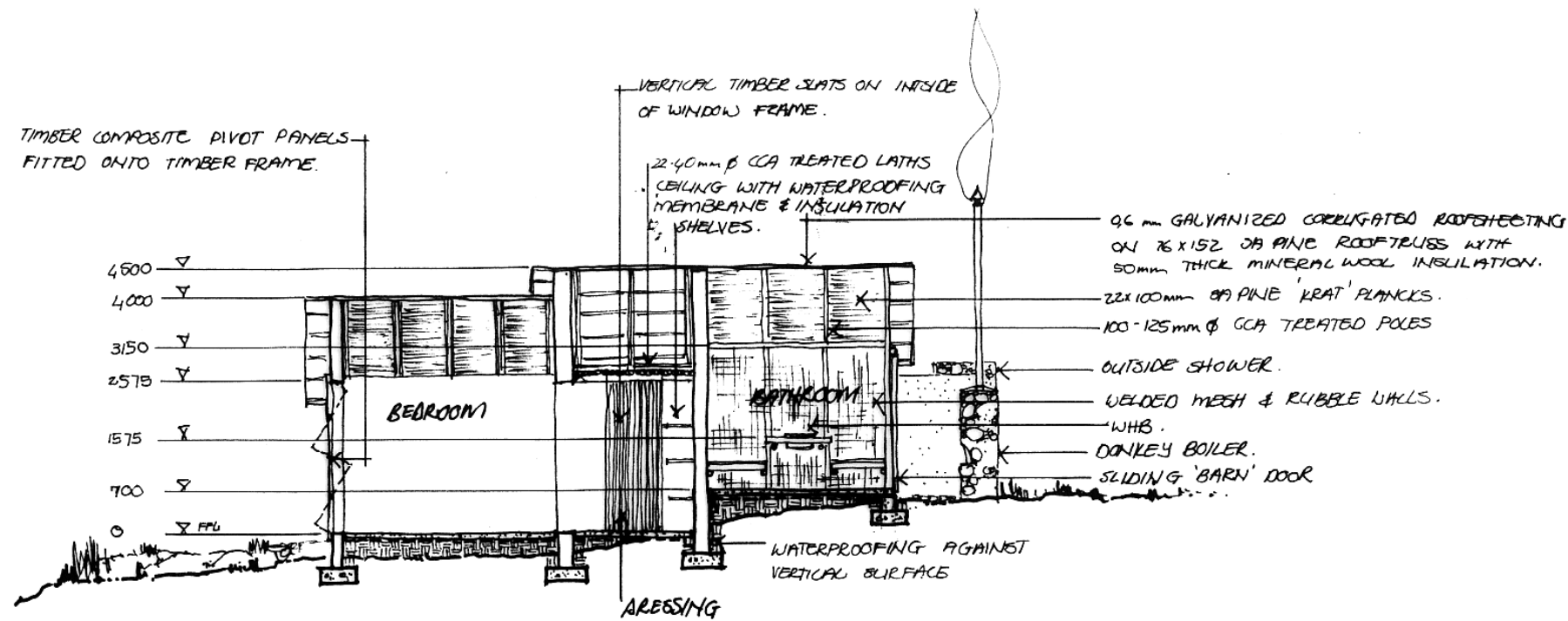

Fig. 8.19 Section through 4xBed Tourist Unit

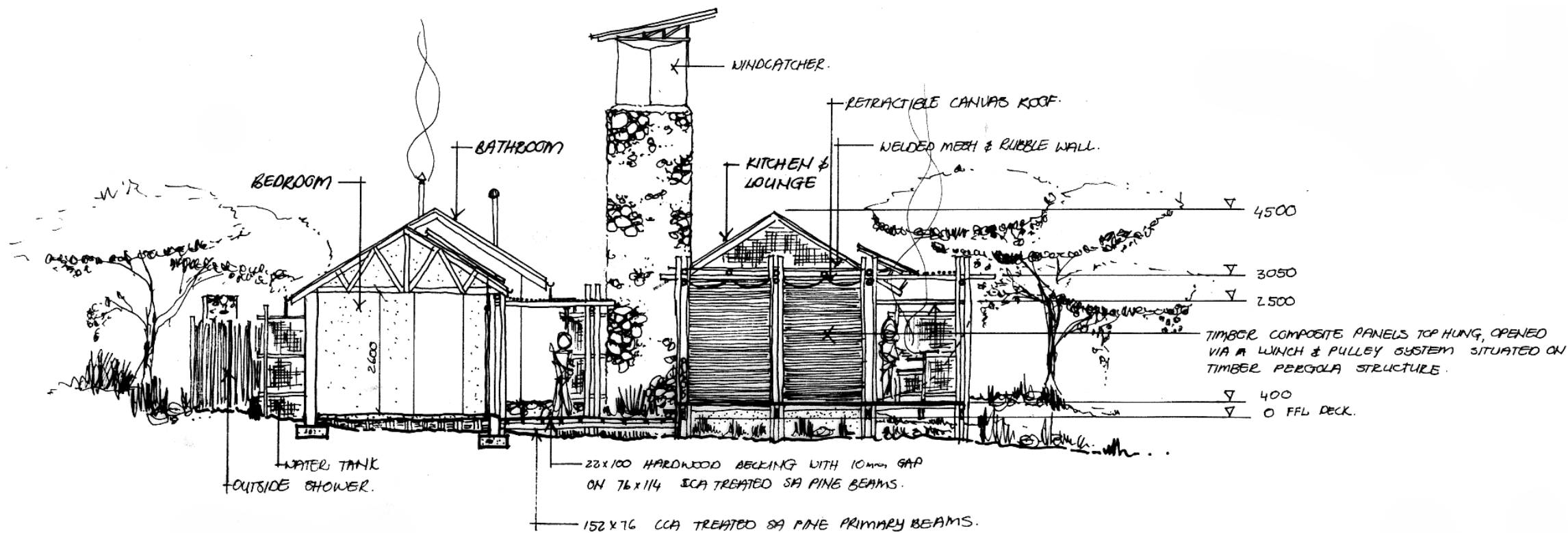

Fig. 8.20 Section of 2xBed Tourist Unit

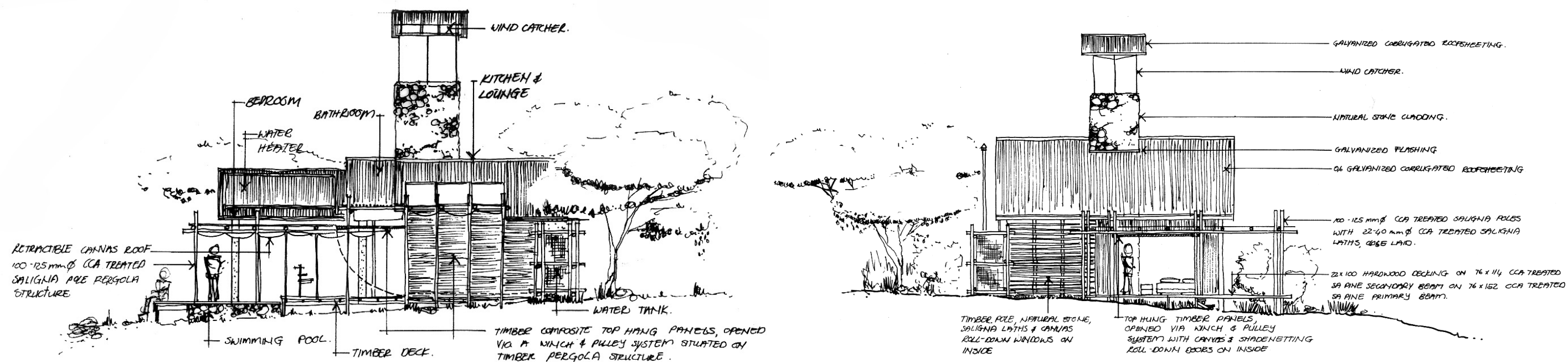

Fig. 8.21 Elevation of 2xBed Tourist Unit

Fig. 8.22 Elevation of Back-to-Back Tourist Unit

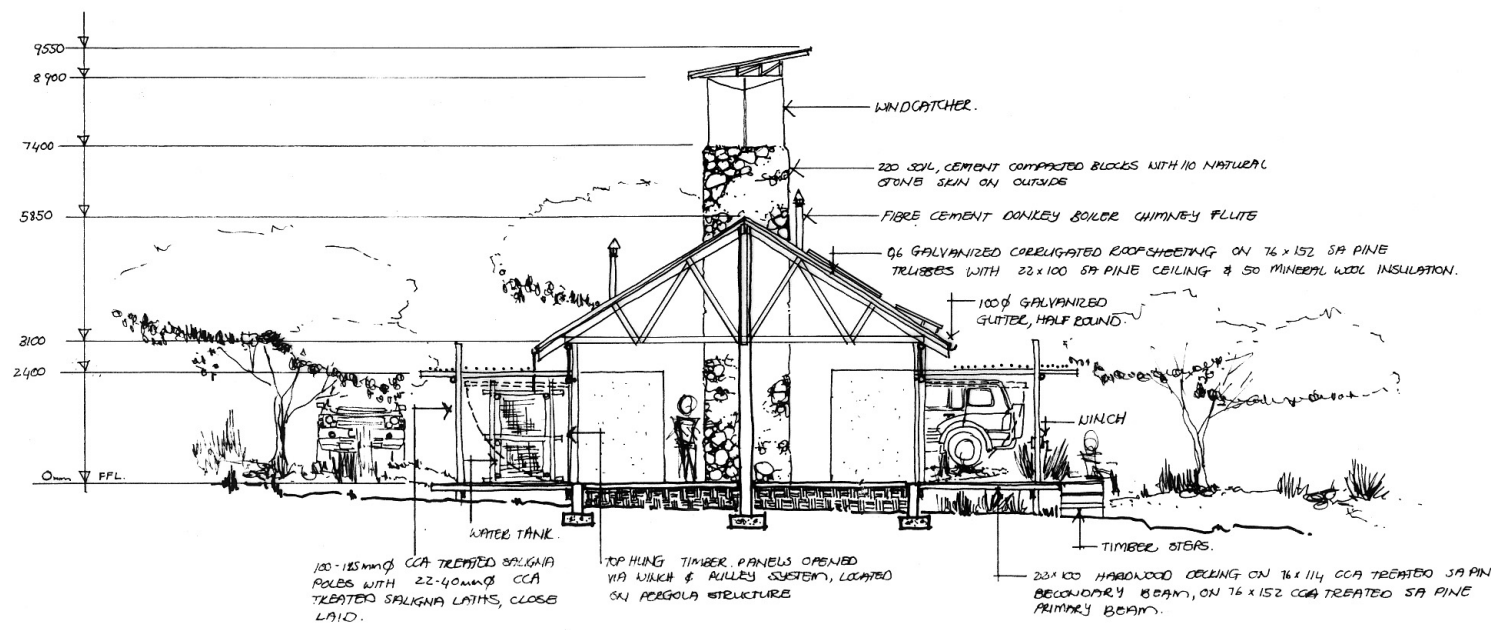

Fig. 8.23 Section of Back-to-Back Tourist Unit

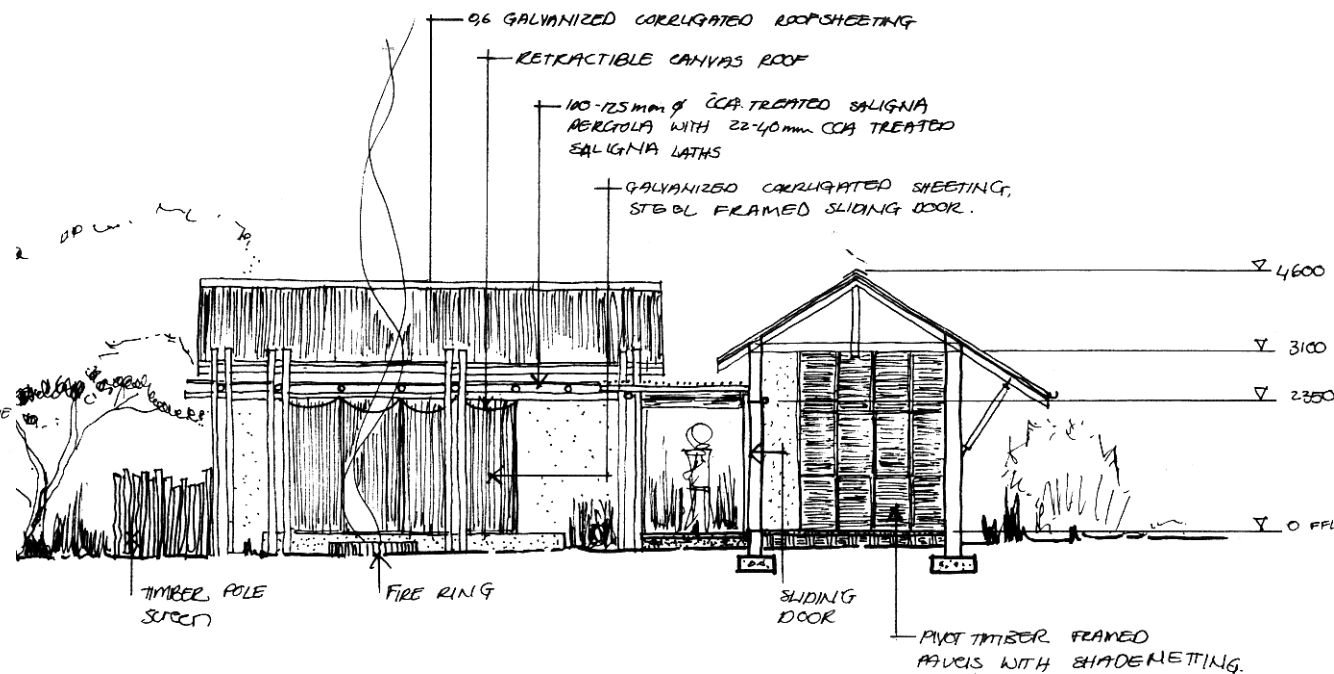

Fig. 8.24 Section of Staff Unit

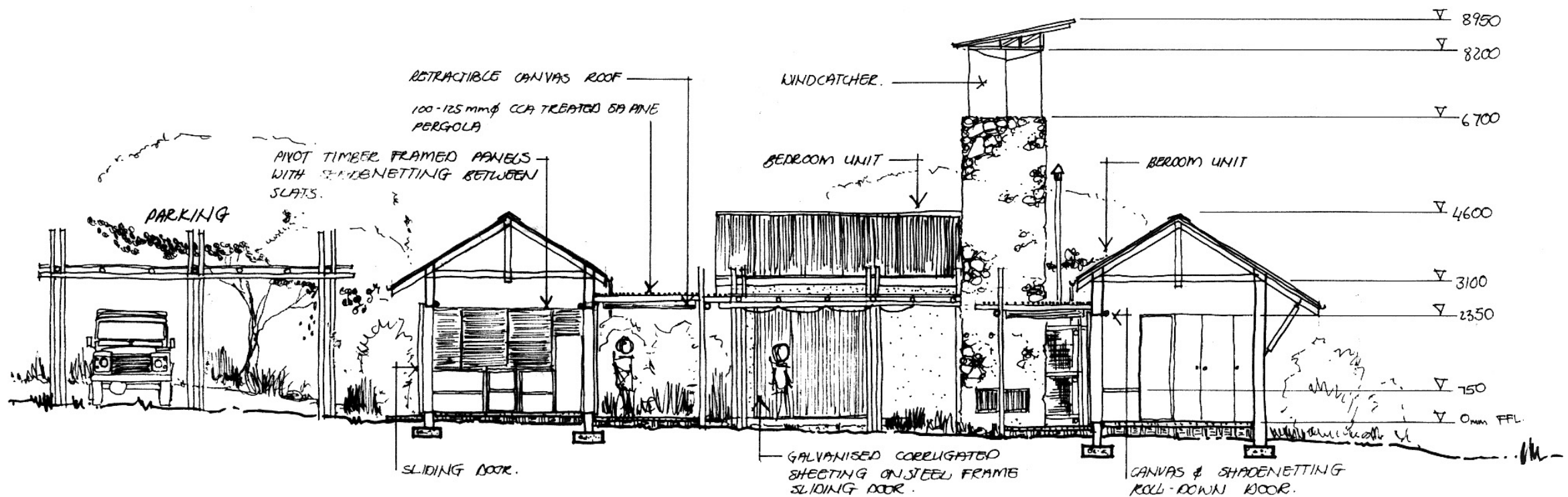

Fig. 8.25 Section of Staff Unit

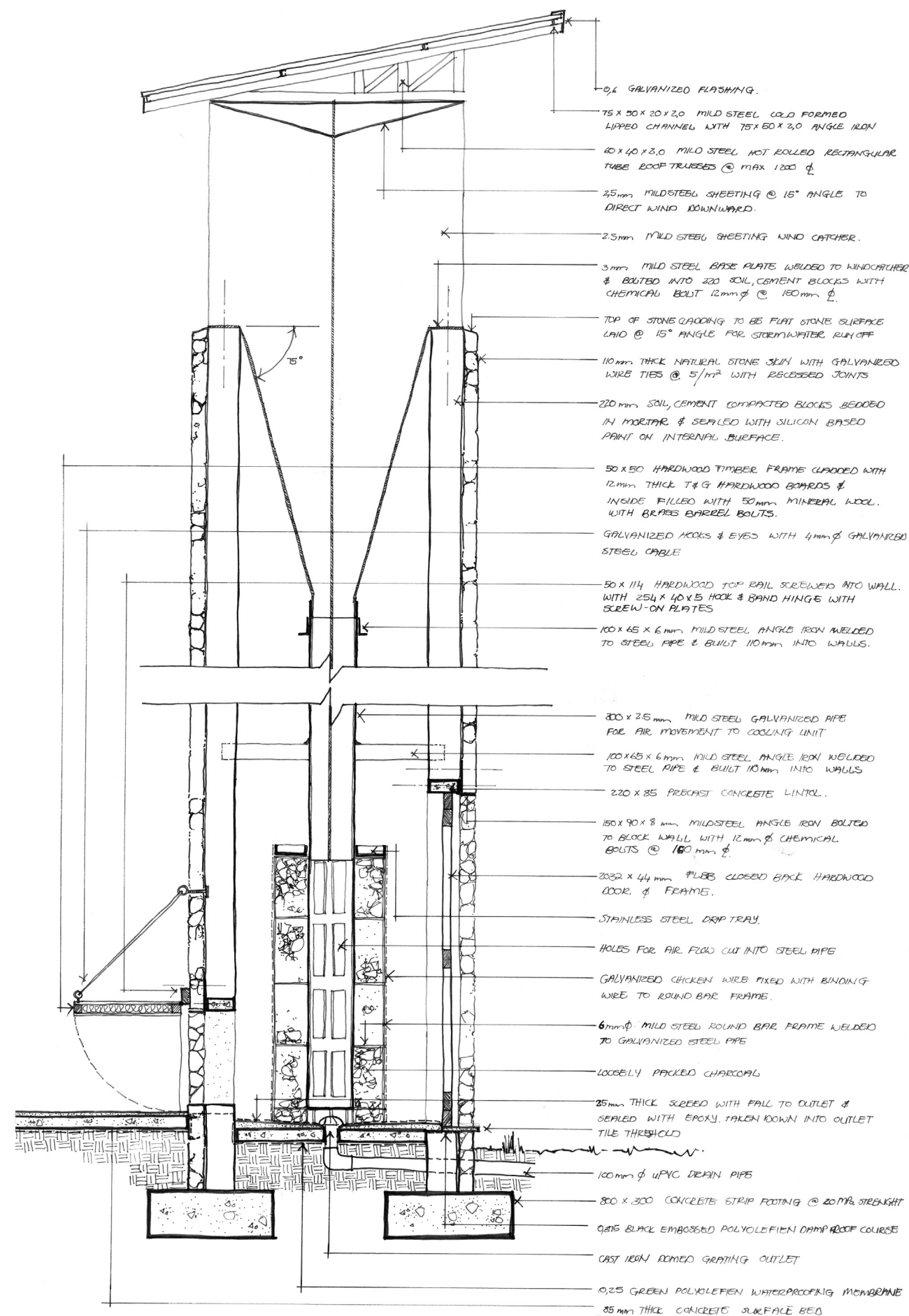
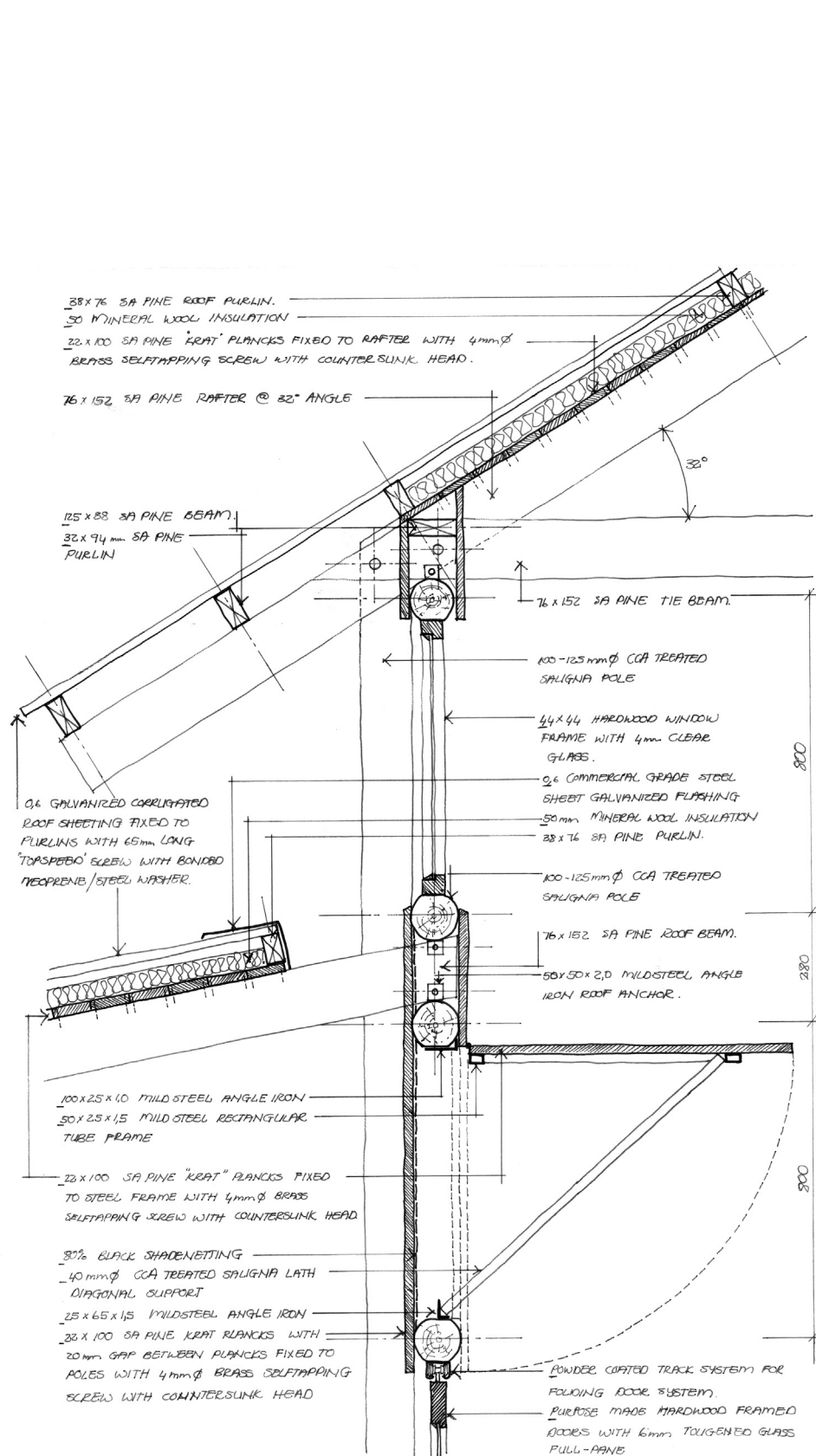

Fig. 8.26 Detail of Lean-to roof and Ventilation Panels

Fig. 8.27 Detail Section through Wind catcher & Cooling system

Addendum A



| SYSTEM LOCATION DATA | | | | |
|------------------------|--------------|----------------|--|--|
| Country | South Africa | | | |
| Location | Pietersburg | | | |
| Latitude (-ve = South) | -24 | | | |
| Longitude (+ve = East) | 29 | | | |
| Elevation (Meters) | 1230 | | | |
| PSH (Max) Hours | 6.06 | | | |
| PSH (Min) Hours | 5.59 | | | |
| PSH Selected | 5.4 | | | |
| Array Tilt Angle | 32 | | | |
| Annual PSH - Tilted | 2,120 | Tilted PSH | | |
| Horizontal | 1,931 | Horizontal PSH | | |
| Selected PSH | | | | |

| NOMINAL VOLTAGE | | | | |
|-----------------|--|--|--|--|
| 12 | | | | |

| DC-LOAD item | Quantity | Watts | Hours | Wh/Day |
|----------------------------|----------|-------|-------|--------|
| Lights | 150 | 11 | 6 | 9,900 |
| Fans | 15 | 50 | 6 | 4,500 |
| System Losses 20% | | | | |
| DC Watt Hours / Day 17,280 | | | | |

| AC-LOAD item | Quantity | Watts | Hours | Wh/Day |
|--|----------|-------|-------|--------|
| LOAD | 1 | 1000 | 1 | 1,000 |
| System Losses 30% | | | | |
| AC Watt Hours / Day 1,300 | | | | |
| Total Daily Watt Hours used by the system 18,580 | | | | |

| SYSTEM SPECIFICATIONS | | | | |
|----------------------------------|------------------|--------------------------------|-----------|--|
| Days Used per Week | 7 | | | |
| BATTERY | SOLAR | | | |
| Capacity (Amp Hours) | 16,002 | Array Peak Watts | 3910 | |
| Depth of Discharge | 40% | Solar Module Peak (W) | 85 | |
| Autonomy (Calculated) | 4.1 | Modules in Series | 1 | |
| Block or Cell Voltage | 12 | Modules in Parallel | 46 | |
| Batteries in Series | 1 | | | |
| Batteries in Parallel | 21 | | | |
| Number of Cells or Blocks | 21 | Number of Solar Modules | 46 | |
| INVERTER | REGULATOR | | | |
| AC Load (Watts) | 1000 | Solar Array (Amps) | 207 | |
| | | DC Load (Amps) | 200 | |

| SYSTEM BUDGET COST INDICATION - ex VAT | | | | |
|--|----------------|------------|-------------------|--|
| Solar Modules | 85W | 2,800.00 | 128,800.00 | |
| Structure per Module | ROOF | 560.00 | 25,760.00 | |
| Battery | RT25 | 1,435.00 | 30,135.00 | |
| Regulator | CML20 | 520.00 | 520.00 | |
| Inverter | 1200W SINEWAVE | 5,300.00 | 5,300.00 | |
| Wiring | - | 0.00 | 0.00 | |
| Installation | - | 0.00 | 0.00 | |
| Delivery | - | 0.00 | 0.00 | |
| Other | - | 0.00 | 0.00 | |
| Other | - | 0.00 | 0.00 | |
| Other | - | 0.00 | 0.00 | |
| | | ZAR | 190,515.00 | |

| SYSTEM LOCATION DATA | | | | |
|------------------------|--------------|----------------|--|--|
| Country | South Africa | | | |
| Location | Pietersburg | | | |
| Latitude (-ve = South) | -24 | | | |
| Longitude (+ve = East) | 29 | | | |
| Elevation (Meters) | 1230 | | | |
| PSH (Max) Hours | 6.06 | | | |
| PSH (Min) Hours | 5.59 | | | |
| PSH Selected | 5.4 | | | |
| Array Tilt Angle | 32 | | | |
| Annual PSH - Tilted | 2,120 | Tilted PSH | | |
| Horizontal | 1,931 | Horizontal PSH | | |
| Selected PSH | | | | |

| NOMINAL VOLTAGE | | | | |
|-----------------|--|--|--|--|
| 12 | | | | |

| DC-LOAD item | Quantity | Watts | Hours | Wh/Day |
|---------------------------|----------|-------|-------|--------|
| Lights | 34 | 11 | 6 | 2,244 |
| Fans | 2 | 50 | 6 | 600 |
| System Losses 20% | | | | |
| DC Watt Hours / Day 3,413 | | | | |

| AC-LOAD item | Quantity | Watts | Hours | Wh/Day |
|---|----------|-------|-------|--------|
| LOAD | 1 | 1000 | 1 | 1,000 |
| System Losses 30% | | | | |
| AC Watt Hours / Day 1,300 | | | | |
| Total Daily Watt Hours used by the system 4,713 | | | | |

| SYSTEM SPECIFICATIONS | | | | |
|----------------------------------|------------------|--------------------------------|-----------|--|
| Days Used per Week | 6 | | | |
| BATTERY | SOLAR | | | |
| Capacity (Amp Hours) | 4,572 | Array Peak Watts | 850 | |
| Depth of Discharge | 40% | Solar Module Peak (W) | 85 | |
| Autonomy (Calculated) | 4.7 | Modules in Series | 1 | |
| Block or Cell Voltage | 12 | Modules in Parallel | 10 | |
| Batteries in Series | 1 | | | |
| Batteries in Parallel | 6 | | | |
| Number of Cells or Blocks | 6 | Number of Solar Modules | 10 | |
| INVERTER | REGULATOR | | | |
| AC Load (Watts) | 1000 | Solar Array (Amps) | 45 | |
| | | DC Load (Amps) | 40 | |

| SYSTEM BUDGET COST INDICATION - ex VAT | | | | |
|--|----------------|------------|------------------|--|
| Solar Modules | 85W | 2,800.00 | 28,000.00 | |
| Structure per Module | ROOF | 560.00 | 5,600.00 | |
| Battery | RT25 | 1,435.00 | 8,610.00 | |
| Regulator | CML20 | 520.00 | 520.00 | |
| Inverter | 1200W SINEWAVE | 5,300.00 | 5,300.00 | |
| Wiring | - | 0.00 | 0.00 | |
| Installation | - | 0.00 | 0.00 | |
| Delivery | - | 0.00 | 0.00 | |
| Other | - | 0.00 | 0.00 | |
| Other | - | 0.00 | 0.00 | |
| Other | - | 0.00 | 0.00 | |
| | | ZAR | 48,030.00 | |

| SYSTEM LOCATION DATA | | | | |
|------------------------|--------------|----------------|--|--|
| Country | South Africa | | | |
| Location | Pietersburg | | | |
| Latitude (-ve = South) | -24 | | | |
| Longitude (+ve = East) | 29 | | | |
| Elevation (Meters) | 1230 | | | |
| PSH (Max) Hours | 6.06 | | | |
| PSH (Min) Hours | 5.59 | | | |
| PSH Selected | 5.4 | | | |
| Array Tilt Angle | 32 | | | |
| Annual PSH - Tilted | 2,120 | Tilted PSH | | |
| Horizontal | 1,931 | Horizontal PSH | | |
| Selected PSH | | | | |

| NOMINAL VOLTAGE | | | | |
|-----------------|--|--|--|--|
| 12 | | | | |

| DC-LOAD item | Quantity | Watts | Hours | Wh/Day |
|---------------------------|----------|-------|-------|--------|
| Lights | 68 | 11 | 6 | 4,488 |
| Fans | 10 | 50 | 6 | 3,000 |
| System Losses 20% | | | | |
| DC Watt Hours / Day 8,986 | | | | |

| AC-LOAD item | Quantity | Watts | Hours | Wh/Day |
|--|----------|-------|-------|--------|
| LOAD | 1 | 1000 | 1 | 1,000 |
| System Losses 30% | | | | |
| AC Watt Hours / Day 1,300 | | | | |
| Total Daily Watt Hours used by the system 10,286 | | | | |

| SYSTEM SPECIFICATIONS | | | | |
|----------------------------------|------------------|--------------------------------|-----------|--|
| Days Used per Week | 7 | | | |
| BATTERY | SOLAR | | | |
| Capacity (Amp Hours) | 9,144 | Array Peak Watts | 2125 | |
| Depth of Discharge | 40% | Solar Module Peak (W) | 85 | |
| Autonomy (Calculated) | 4.3 | Modules in Series | 1 | |
| Block or Cell Voltage | 12 | Modules in Parallel | 25 | |
| Batteries in Series | 1 | | | |
| Batteries in Parallel | 12 | | | |
| Number of Cells or Blocks | 12 | Number of Solar Modules | 25 | |
| INVERTER | REGULATOR | | | |
| AC Load (Watts) | 1000 | Solar Array (Amps) | 113 | |
| | | DC Load (Amps) | 104 | |

| SYSTEM BUDGET COST INDICATION - ex VAT | | | | |
|--|----------------|------------|-------------------|--|
| Solar Modules | 85W | 2,800.00 | 70,000.00 | |
| Structure per Module | ROOF | 560.00 | 14,000.00 | |
| Battery | RT25 | 1,435.00 | 17,220.00 | |
| Regulator | CML20 | 520.00 | 520.00 | |
| Inverter | 1200W SINEWAVE | 5,300.00 | 5,300.00 | |
| Wiring | - | 0.00 | 0.00 | |
| Installation | - | 0.00 | 0.00 | |
| Delivery | - | 0.00 | 0.00 | |
| Other | - | 0.00 | 0.00 | |
| Other | - | 0.00 | 0.00 | |
| Other | - | 0.00 | 0.00 | |
| | | ZAR | 107,040.00 | |

Addendum B

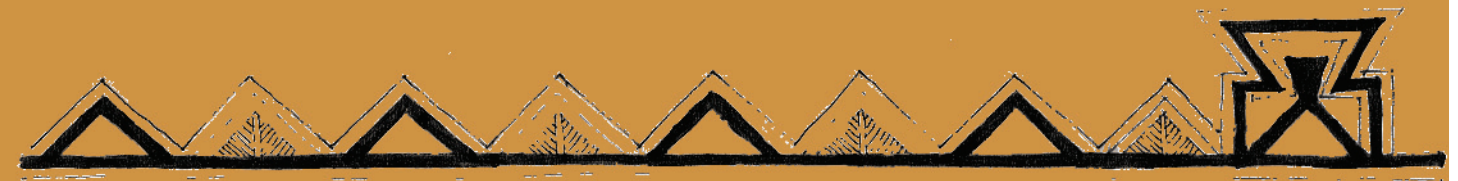

SUBTERRA PROCESS

The "Subterra" process is based entirely on natural processes. The pre-treatment of sewage takes place in a conventional septic tank. Secondary treatment takes place in a vertical flow biological filter. The conceptual drawing below shows the components of a typical small installation: (Drawings with more detail of a typical Subterra natural filter are attached B).

- Pre-treatment in a multi-chamber septic tank;
- Buffer tank to attenuate peaks in demand if necessary (the drawing below shows the buffer tank combined with the septic tank);
- Pump installation and transportation pipe to transport water from the buffer tank to the Subterra beds;
- The Subterra beds.

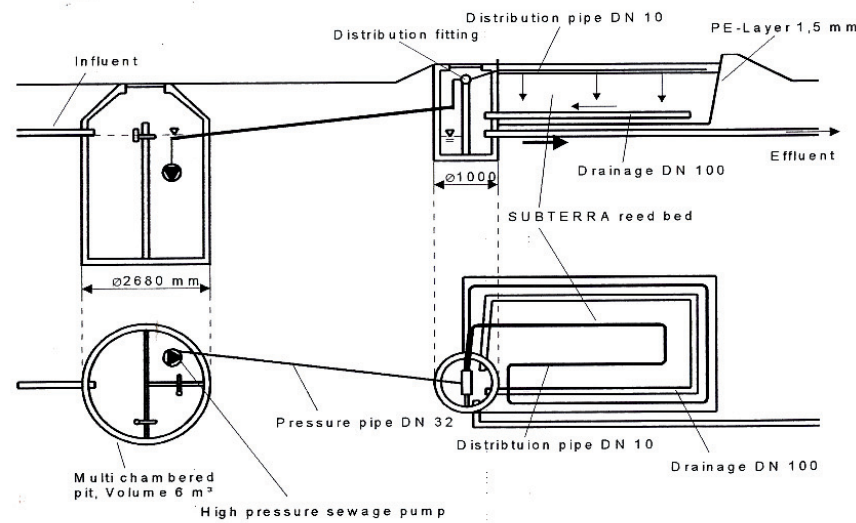

The SUBTERRA system is technically described as a planted vertical flow soil filter. The bed consists of sand and gravel layers and biological substrates to adopt the system to different climates and sewage qualities. An important element of the system is a subsurface irrigation pipe system, which sprays the sewage homogeneously over the entire reed-bed area into the top stone layer of the filter at a depth of 150mm. Irrigation takes place for 5 to 10 minutes per hour only. This ensures that the bed is never saturated but only damp. It also ensures almost constant humidity throughout the bed.

The irrigation pipe material was specifically developed for this purpose and is manufactured in Europe under license from Joachim Kruger Pflanzenkllaranlagen GmbH. The pipe is flexible but very tough. The pipe is perforated in order to spray water into the beds. The perforations only open when the pipe is pressurized to approximately 2 to 3 bar. The pipe's diameter increases from 12mm to approximately 20mm when pressurized. This movement ensures that plant roots do not enter and block the pipe system.

As mentioned above, the bed consists of different layers of sand, substrates and gravel and is planted mainly with reeds e.g. phragmites. The root system of the plants i.e. the rhizomes ensures aeration of the soil. Soil aeration results from the oxygen inflow via the vascular system of the roots and the loosening of the soil by root development. This ensures the hydraulic flow-through on a long-term basis.

A layer of microorganisms forms on the roots and substrates. The grading of the substrate is specified in order to ensure large surface areas for microorganisms to grow. Comparing the specific surface areas of this technology with any of the package plants shows the massive advantage of the Subterra natural filters with thousands of square meters of surface area per cubic meter of substrate.

Nitrifiers and de-nitrifiers break down organic components to such an extent that even benzols and phenols are decomposed.

The purified water is collected in a simple subsurface drainage pipe system, from where it flows to a control tank, where it can be monitored and tested. After that it is discharged to a river, pond or reused for irrigation or secondary water cycle purposes. As the reed-bed has a dry surface and is entirely covered by gravel it has no smell. Seasonal fluctuations have minimal effect on this process and therefore satisfactory quality of effluent is also guaranteed during peak periods.

The mechanical pre-purification of wastewater, before it enters the Subterra beds takes place in a multi-chambered pit. The minimum size is 6m³, but it ultimately depends on the number of connected households. The subsequent transport of wastewater to the Subterra bed is brought about by a pressure pipe system.

Drawings with detail of Subterra natural filters

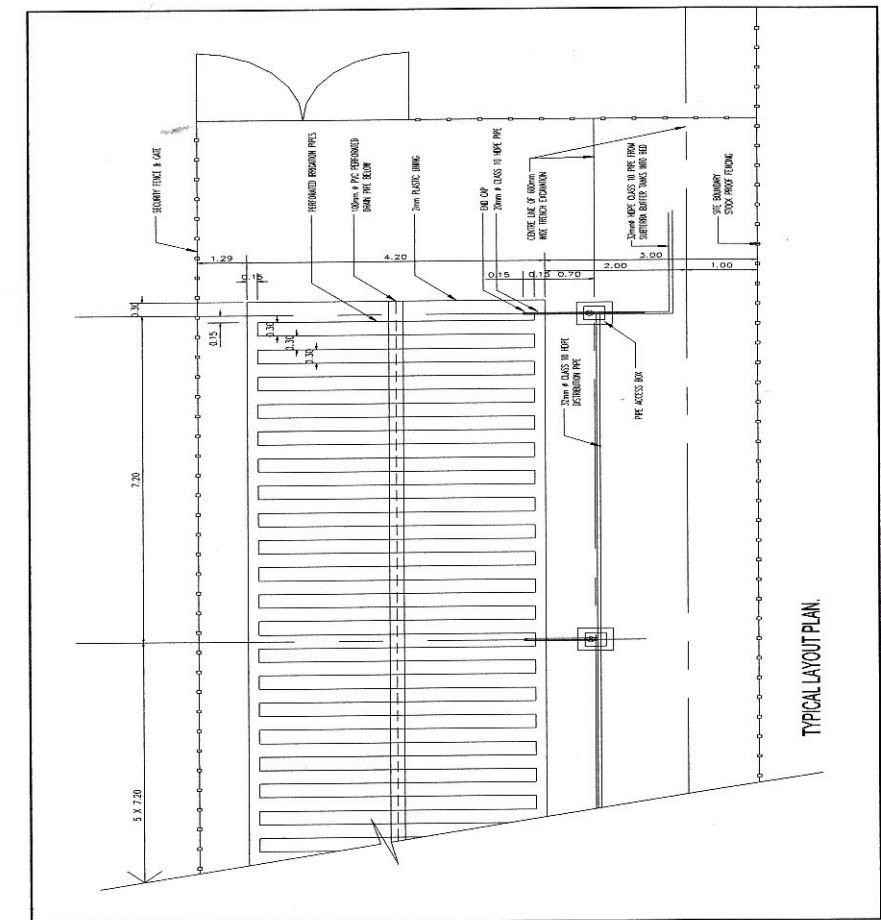

Addendum C

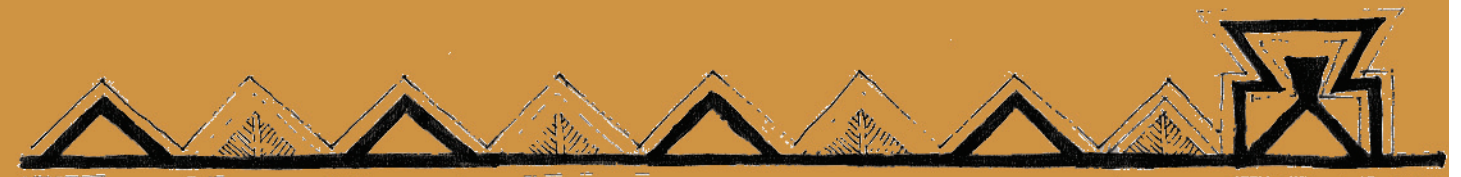

Feasibility Study

Calculation of design parameters:

| | | |
|-------------------------------------|---------------------------------------|----------|
| Dimensions of site | 350 | hectares |
| Footprint of building | 2065 | sqm |
| Number of floors | 1 | |
| Total construction area of building | 2065 | sqm |
| Rentable area | 950 | sqm |
| Parking required | 1.25 per accommodation unit(25 units) | |
| Landscaping area | 31.25 | bays |
| | 124 | sqm |

Estimate of total capital expenditure:

| | | | |
|---------------------------------|------|------------------|------------------------------|
| Estimated current building cost | | | |
| Restaurant | 177 | sqm @ R 4,100.00 | R 725,700.00 |
| Shops | 174 | sqm @ R 3,000.00 | R 522,000.00 |
| Landscaping | 124 | sqm @ R 800.00 | R 99,120.00 |
| Agriculture | 336 | sqm @ R 2,300.00 | R 772,800.00 |
| Accommodation | 882 | sqm @ R 3,100.00 | R 2,734,200.00 |
| Infrastructure | 3500 | m @ R 80.00m@ | R 280,000.00 |
| Central facilities | 496 | sqm @ R 4,000.00 | R 1,984,000.00 |
| | | | <u>R 7,117,820.00</u> |

Escalation:

| | | | |
|---|----------------|-----------------|----------------|
| Pre-contract period escalation factor | 6months@ | 0.50% p.m.comp. | |
| Pre-contract period escalation | R 7,117,820.00 | | R 213,534.60 |
| Building cost at start of construction | | | R 7,331,354.60 |
| Construction period escalation factor | 9months@ | 0.60% p.m.comp. | 1.1137 |
| Adjusted with Haylett & drawn down factor | 0.85 | 0.6 | 0.568 |
| Escalation during construction period | 0.568 | R 7,331,354.60 | R 4,164,114.11 |

Estimated total escalated building cost

R 11,495,468.71

| | | | |
|--------------------|--------|-----------------|----------------|
| Professional fees: | 14.00% | R 11,495,468.71 | R 1,609,365.62 |
| Developer's fee | | | R 70,000.00 |
| Marketing fee | | | R 50,000.00 |
| EIA | | | R 120,000.00 |
| Sundry Fees: | | | |
| Legal fees | | | R 13,000.00 |
| Rates & taxes | | | R 1,000.00 |
| Plan approval fees | | | R 18,000.00 |
| Letting fees | | | R 57,000.00 |

Total cost excl land, cost of capital

R 13,433,834.32

| | | | |
|---|--------------|-----------------|-------------------------------|
| Land cost (incl transfer fees less VAT) | R 525,000.00 | 1.14 | R 460,526.32 |
| Interim interest (cost of capital): | | | |
| Land | 9.00% | R 460,526.32 | 15months |
| Construction period | 9.00% | R 13,433,834.32 | 9 |
| | | | 0.4 |
| | | | R 54,619.62 |
| | | | R 373,787.52 |
| Total project cost | | | <u>R 14,322,767.77</u> |

| | | | | | |
|---------------------------------|--------------|-------------|--------------|--------|---------------|
| Estimated net annual income: | area/ number | esc. Factor | R/smq or bay | months | annual income |
| Shops | 153 | 1.1449 | R 45.00 | 12 | R 94,591.64 |
| Restaurant | 230 | 1.1449 | R 45.00 | 12 | R 142,196.58 |
| Accommodation (per unit) Unit A | 24 | 1.1449 | R 450.00 | 12 | R 148,379.04 |
| Accommodation (per unit) Unit B | 20 | 1.1449 | R 100.00 | 12 | R 27,477.60 |
| Conference Facility | 1 | 1.1449 | R 3,000.00 | 12 | R 41,216.40 |

| | | | |
|---|--------------|-----------------|-------------------------------|
| Nett income Agricultural activities | | | R 1,200,000.00 |
| Total gross income | | | R 1,653,861.26 |
| Less: Non-recoverable expenses | | | R 750,000.00 |
| Total gross income before allowance for vacancies | | | R 903,861.26 |
| Total gross income after allowance for vacancies of | 35.00% | | <u>R 587,509.82</u> |
| (a) Yield (Return on total capital expend.,year 1) | R 587,509.82 | R 14,322,767.77 | <u>4.10%</u> |
| (b) Development Profit | | | |
| Sales price | R 587,509.82 | 9.75% | R 6,025,741.72 |
| Less: Total capital expenditure | | | R 14,322,767.77 |
| Profit | | | <u>-R 8,297,026.05</u> |

Bibliography

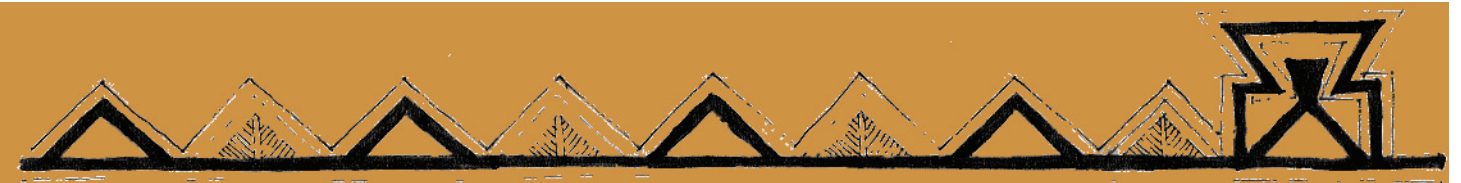

- Alexander, C. 1964. Notes on the Synthesis of Form, Harvard university Press, London, England
- ARC. "Agricultural Research Council Manual". <http://www.arc.agric-za> (20 October 2005)
- Beck, H. et al. 1985. Norman Eaton Anderssen House, Pretoria (1949-50). International Union of Architects Magazine, 1985, Issue 8, p. 22-23.
- Bell P.A., Greene T.C., Fisher J.D., Baum A. 1996. Environmental Psychology, Harcourt Brace College Publishers, New York.
- Bolton, M. et al. 2001. Building Houses with Earth Blocks, CSIR Building and Construction Technology: Pretoria
- Brawne, M. 1995. Paradise Found. Architectural Review, 1995, Vol. 198/1186, p. 70-74
- Burberry, P. 1983. Practical Thermal Design in Buildings, Batsford Academic and Educational Ltd: London.
- DEAT. "White Paper on The development and promotion of Tourism in South Africa, Department of Environmental Affairs and Tourism". [http://www.deat.gov.za/Po1Leg/White Papers/tourism96.htm](http://www.deat.gov.za/Po1Leg/White%20Papers/tourism96.htm) (24 Jan. 2005).
- Chibi, M.C. 1990. Rainwater Harvesting, Water Technology, CSIR: Pretoria
- Crafford, D.P. 1994. Sossusvlei Karos Lodge at Sesriem, Pretoria, October 1994.
- CSIR, Building Technology. 1997. Solar Charts for the design of sunlight and shade for buildings in South Africa, CSIR, Pretoria.
- Duggan-Cronin, A.M. 1874. *The Bantu tribes of South Africa*, Cambridge, Cambridgeshire: Deighton, Bell.
- "Ecobond, turning soil into durable structures" <http://www.ecobond.co.za> (21 October 2005)
- Forty, A. 2000. Words and Buildings: A Vocabulary of Modern Architecture, Thames and Hudson, New York
- Fathy, H. 1986. Natural Energy and Vernacular Architecture, University of Chicago Press: Chicago
- Gottlieb, L.G. 1965. Environment and Design in Housing, The Macmillan Company: New York
- "Heating and Water". <http://theyellowhouse.org.uk/themes/heatwat.html> (23 Augustus 2005)
- Hudson Architects. "Quaker Barns". <http://www.hudsonarchitects.co.uk/quaker.htm> (1 July 2005)
- Kirkaldy, A. "The Darkness within the light: Berlin missionaries Landscape, Identity and religion in Vandaland c. 1870-1900". <http://www.museums.org.za/sam/conf/enc/wirz.htm> (15 Feb. 2005).
- Otten, K. 2003. Indigo Marketing Offices. The Digest of South African Architecture, 2003, vol. 7, p.116-117.
- Limpopo Tourism and Parks. "The preferred eco-tourism destination". <http://www.golimpopo.com/explore%20limpopo/experiences/experiences.htm> (3 Feb. 2005).
- Lindros Whole Earth Consultants. "Reasons and arguments on Organic Agriculture". http://www.lindros.co.za/organic_agriculture.htm (26 Jan. 2005).
- Mastny, L. "Travel light: New Paths for International Tourism". <http://www.worldwatch.net/pubs/paper/159/> (6 Feb. 2005).
- Neville, F.H. et al. 1907. Air Currents and the Laws of Ventilation, Cambridge University Press: Cambridge
- Neufert Ernst & Peter. 2000. Neufert Architect's Data Third Edition, Blackwell Science, Great Britain.
- Noton, N.H. 1982. Farm Buildings, College of Estate Management: London.
- "Passive Solar Guidelines". <http://www.greenbuilder.com/sourcebook/PassSolGuide3.html> (16 September 2005)
- Potgieter, D.J. et al. 1970. Standard Encyclopaedia of South Africa, London: Nasionale Boekhandel LTD. Vol. 1
- Rich, P. 2002. Bopitkelo Cultural Centre. The Digest of South African Architecture, 2002, vol. 6, p.156-158.
- South African Weather Bureau. "Limpopo Province Weather and Climate". <http://www.weathersa.co.za/Menus/WXandProvincejsp?provID=3> (14 March 2005)
- Theal, G, McCall. 1964. History of South Africa since 1795, Struik, Cape town
- "The New Water Free Toilet System". http://www.jojotanks.co.za/body_eco_san_toilet.html (28 October 2005)
- "The Principles of Sustainable Development". <http://www.sustainablesettlement.co.za/issues/susdev.html> (20 October 2005)
- Tropical House. 1996. The Architectural Review, October 1996, p. 40-43.
- Van Der Waal, C.S. 1977. Die Woning en Woonwyse onder die Venda, Universiteit van Pretoria, Pretoria
- Van Straaten, J.F. 1967. Thermal Performance of Buildings, Elsevier Publishing Company: Amsterdam
- Wackernagel, M et al. 2001. Ecological footprint of nations, December 2001 update. Sustainability Issue Brief, Dec 2001.
- Walton, J. 1961. Homes of the Trekboers. Lantern, September 1961, vol.11, no. 1, p. 8-21.
- Wojciech, G.L. 1982. Rationalism and Romanticism in Architecture, McGraw-Hill Book Company: New York.
- WTTC. "Agenda 21 for the Travel and tourism Industry towards Environmentally Sustainable Development". <http://www.wttc.org/promote/agenda21.htm> (24 Jan. 2005).
- WWF. 2002. The Living Planet Report 2002. Gland, Switzerland: WWF.

Acknowledgements



Ma & Pa

Baie dankie vir al julle ondersteuning en geduld deur die jare.

My susters

Liezel Basson
Karen van Helsdingen
Nadia van Rooyen

Amy Blaine
Sonia Cunha
Lerentha Ludik
Sonika van Niekerk

Kate Blaine
John Blaine
Colleen Blaine

Niel Crafford
Abre Crafford
Mireille Bezuidenhout