

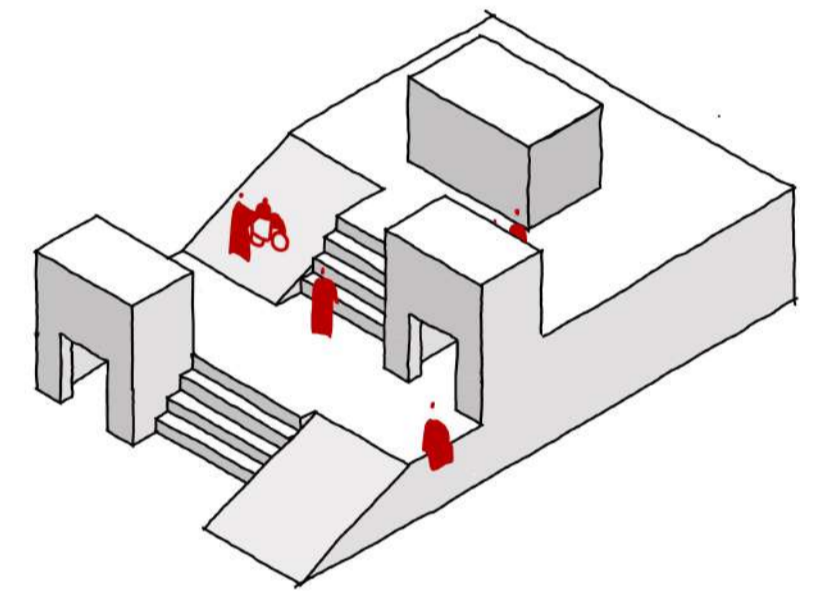

UNIVERSITEIT VAN PRETORIA  
UNIVERSITY OF PRETORIA  
YUNIBESITHI YA PRETORIA

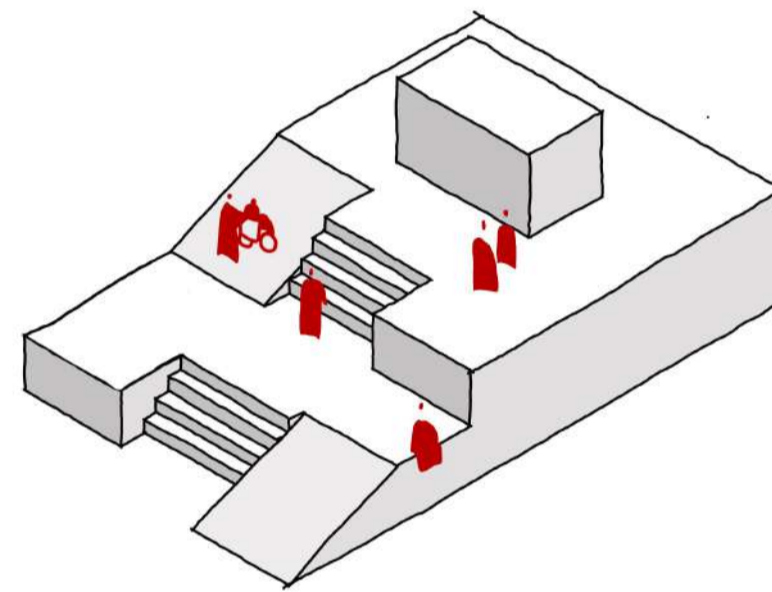
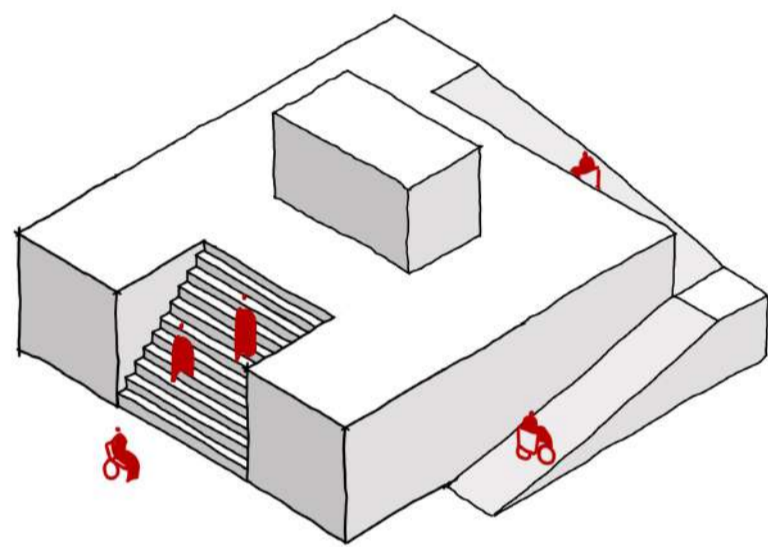
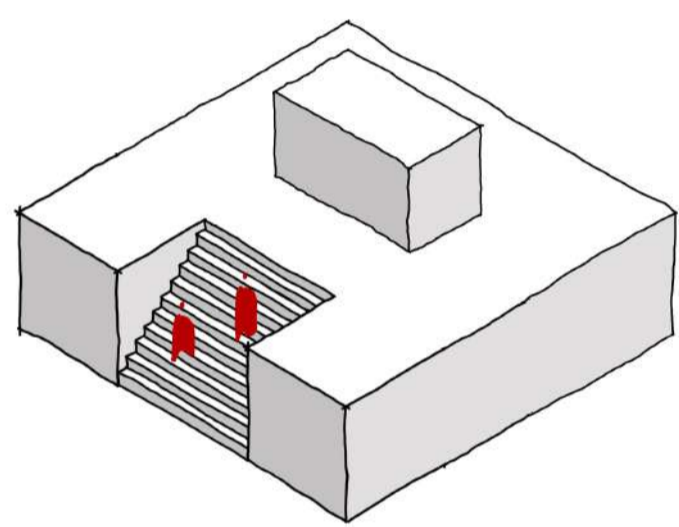

# ENABLING INTEGRATION

ARCADES AS A TOOL FOR INTEGRATION AND UNIVERSAL ACCESSIBILITY IN PRETORIA CENTRAL



# A D I S A B L I N G S O C I E T Y

## A D D R E S S I N G T H E B A R R I E R S T H A T S E G R E G A T E

POPULATION

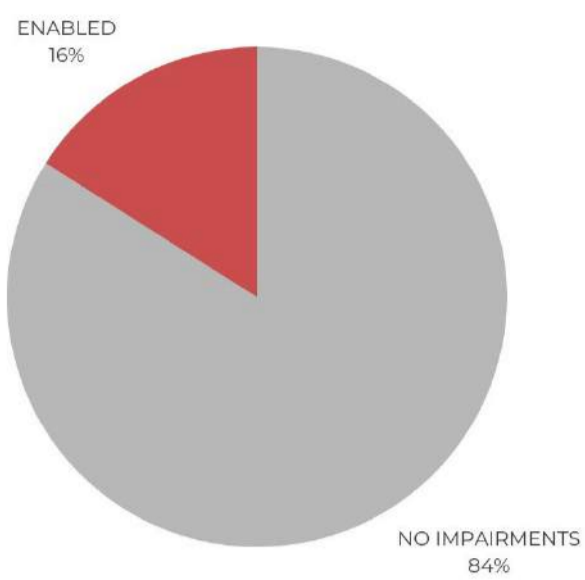

1948

IMPAIRMENT PREVALENCE

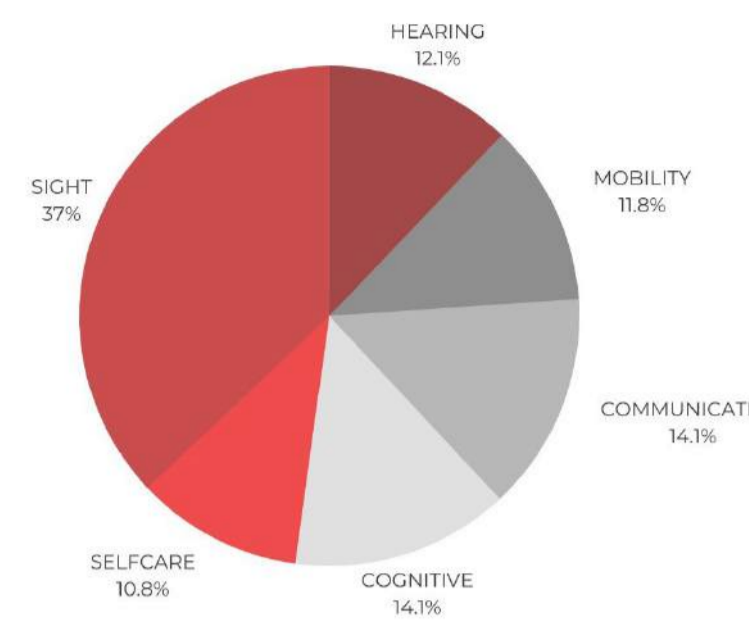

1994

EMPLOYMENT



2023

EDUCATION

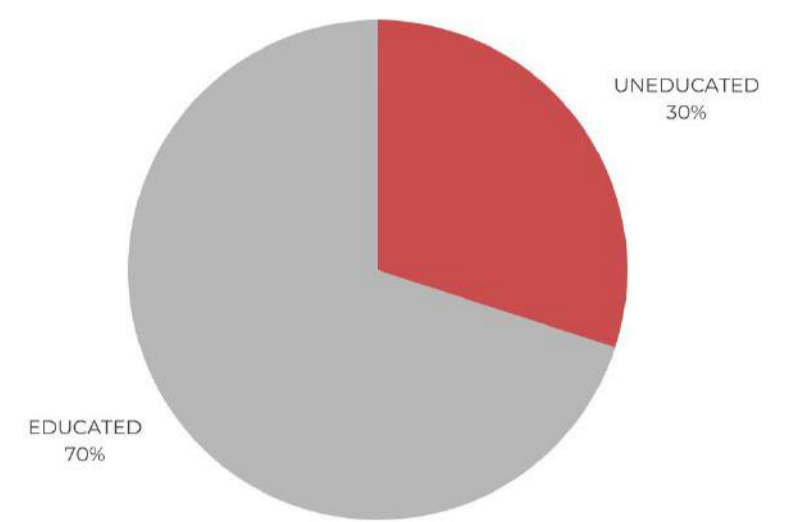

### MEDICAL MODEL

The medical model views disability as a medical condition in the individual, focusing on fixing or treating the impairment. Disability is seen as a condition that needs treating or solving.

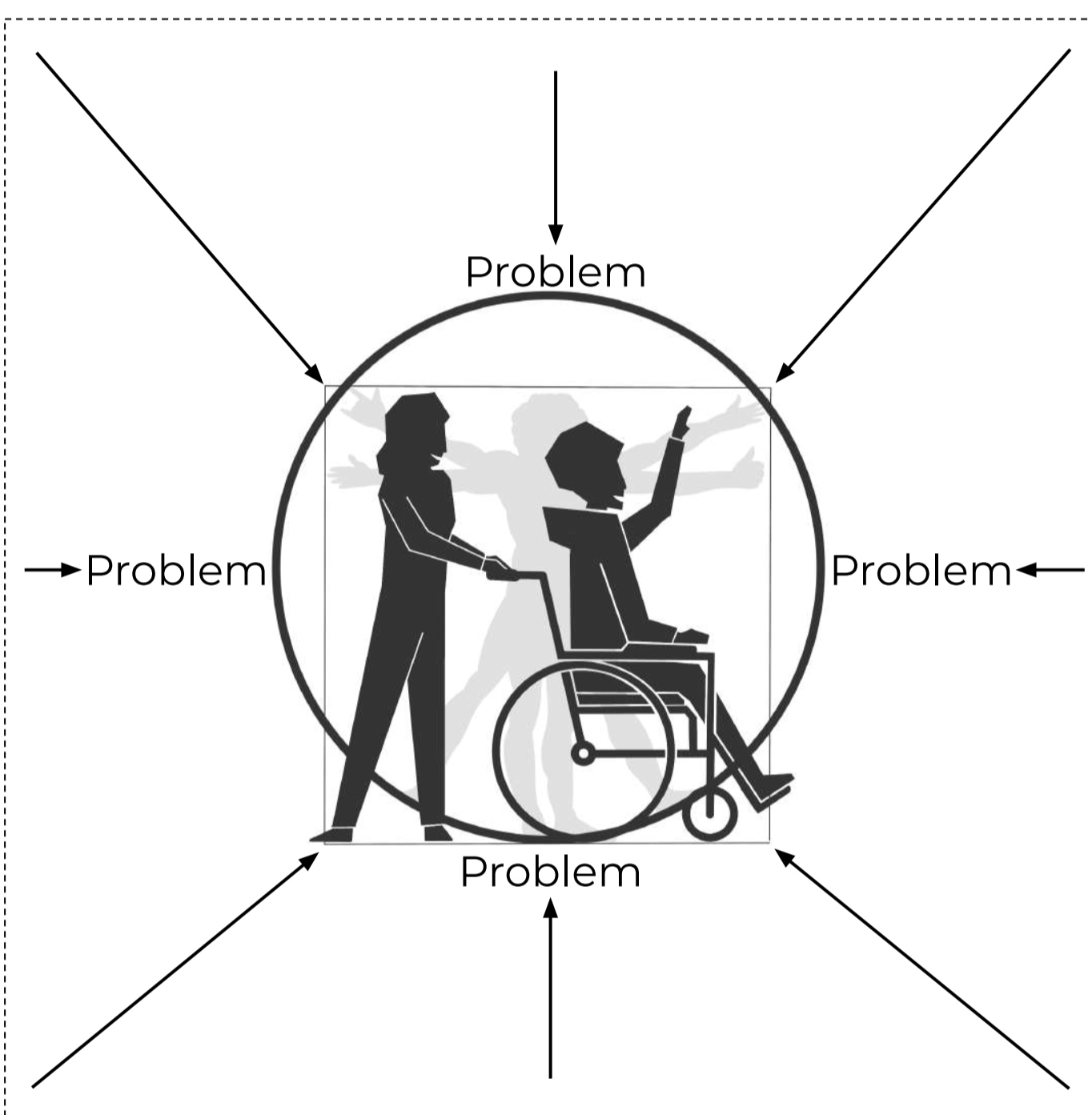

### TRANSFORMATION

**1994** - Reconstruction and development Programme

**1996** - The Constitution of South Africa

**1997** - Integrated National Disability Strategy

**2000** - The Promotion of Equality and Prevention of Unfair Discrimination Act (PEPUDA)

**2007** - South Africa ratified the United Nations Convention on the Rights of Persons with Disabilities

**2012** - National Development Plan 2030 future vision.

### SOCIAL MODEL

Focuses on how society's barriers and attitudes create disability. Emphasising the need for Inclusion and societal change, as a means of allowing for equal access and participation

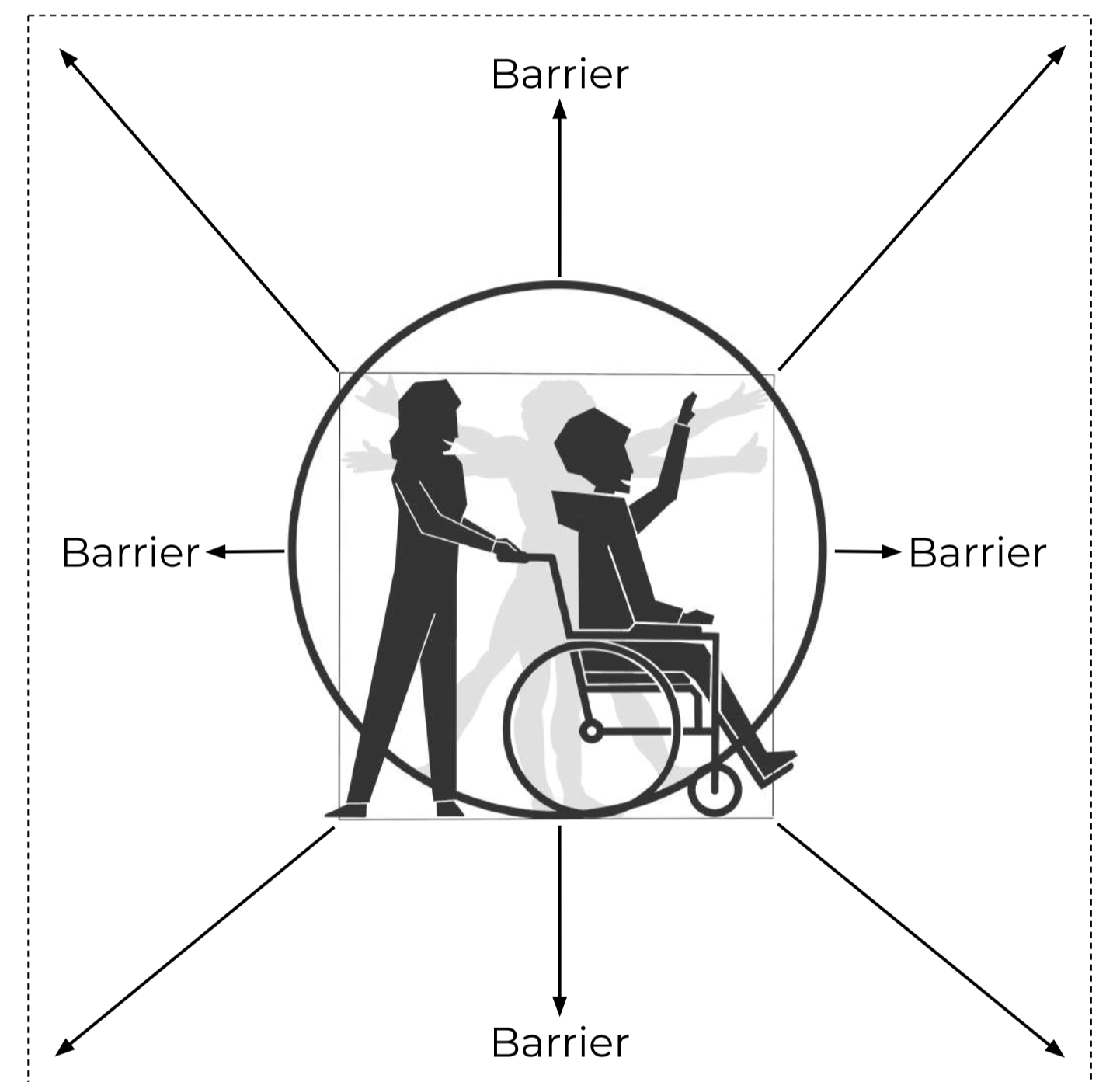

## F R O M I S O L A T I O N T O I N C L U S I O N

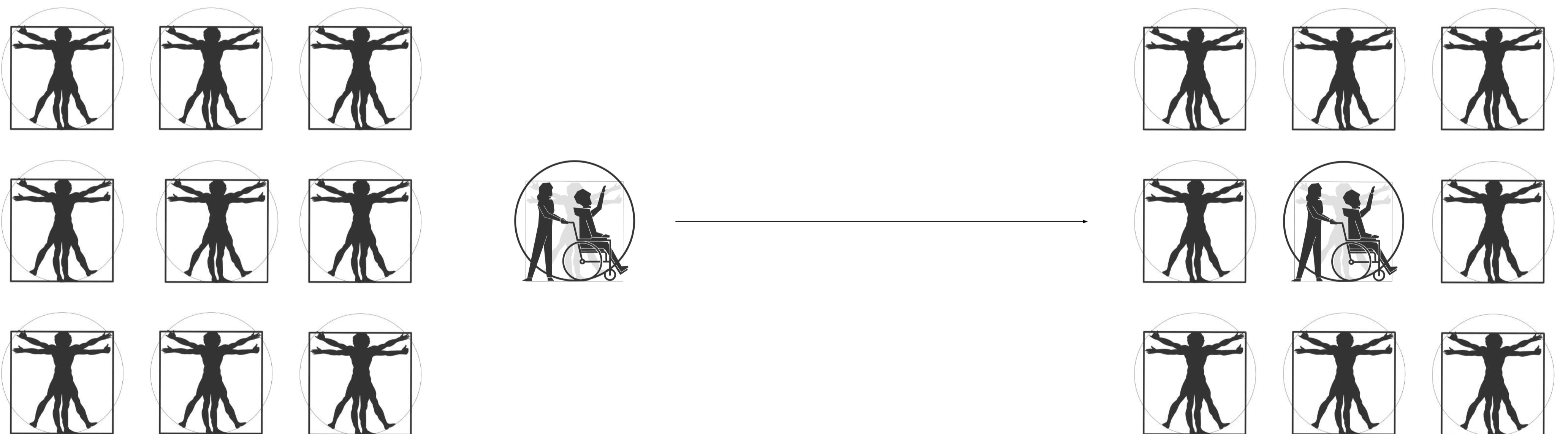

## A P P R O A C H I N G I N T E G R A T I O N

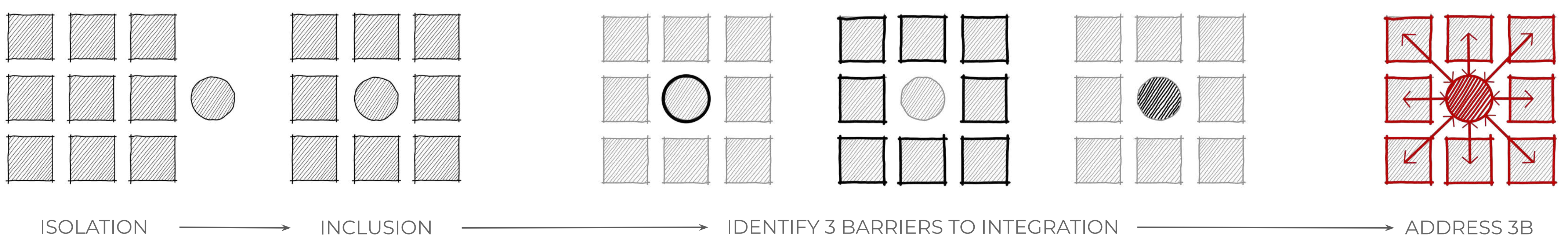

ISOLATION

INCLUSION

IDENTIFY 3 BARRIERS TO INTEGRATION

ADDRESS 3B

# DESIGN INTENTION

## ADDRESSING THE BARRIERS

### INSTITUTIONAL BARRIER

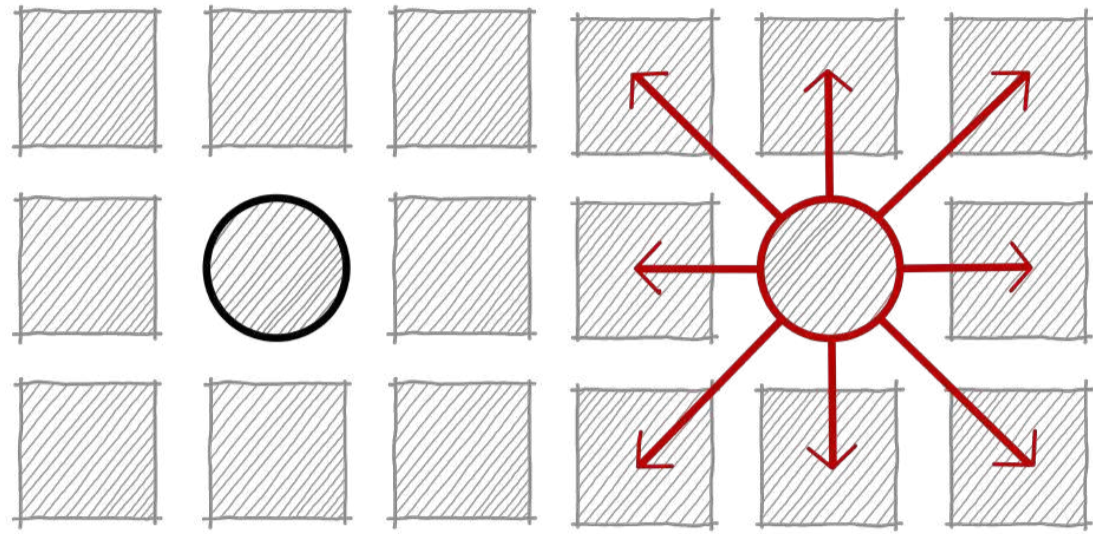

- Lack of employment opportunities
- Lack of Education opportunities
- Non-Inclusive Policies

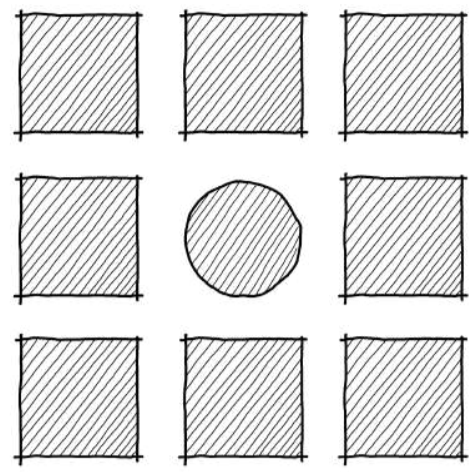

SITE SELECTION

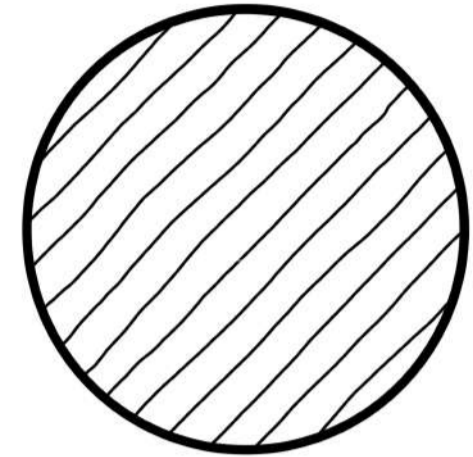

DEFINE PROGRAMMES

### ATTITUDINAL BARRIER

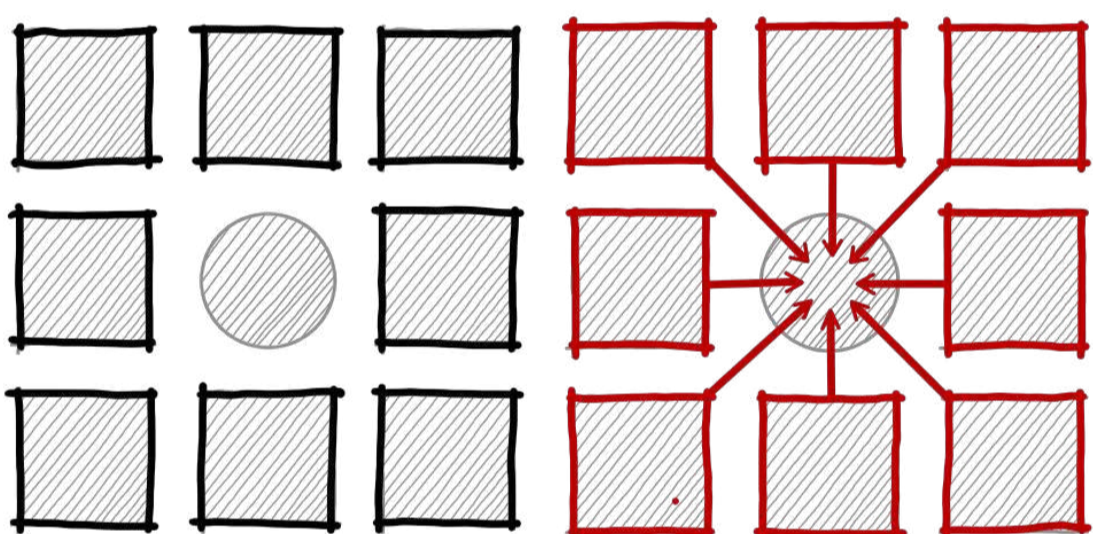

- Negative stereotyping
- Uneducated public
- Social Isolation

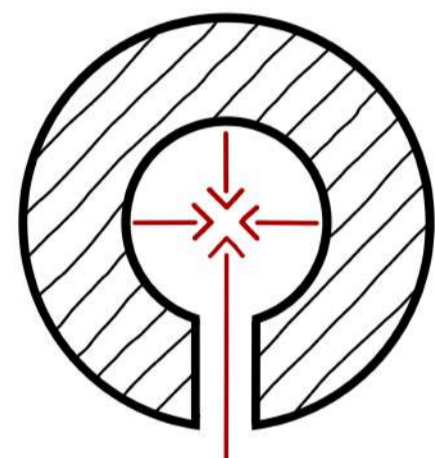

CREATE SHARED SPACE

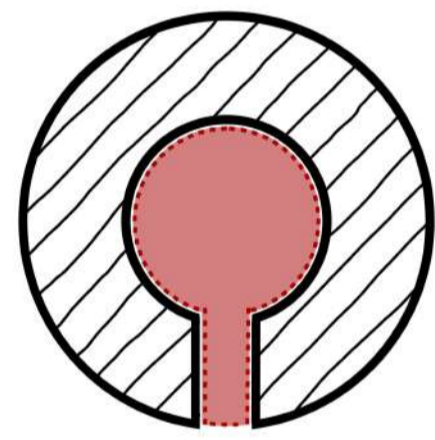

SAFETY

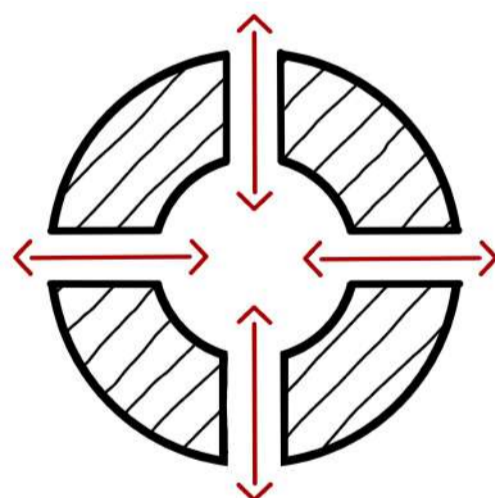

INCREASED PUBLIC ACCESS

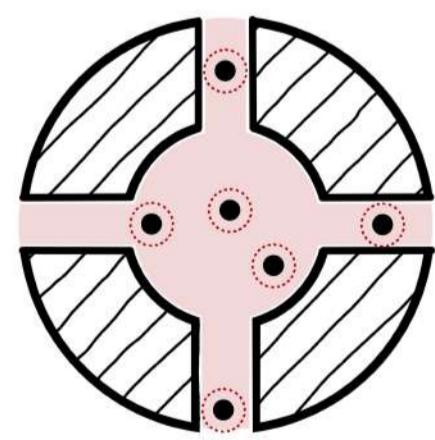

MOMENTS OF INTERACTION

### ENVIRONMENTAL BARRIER

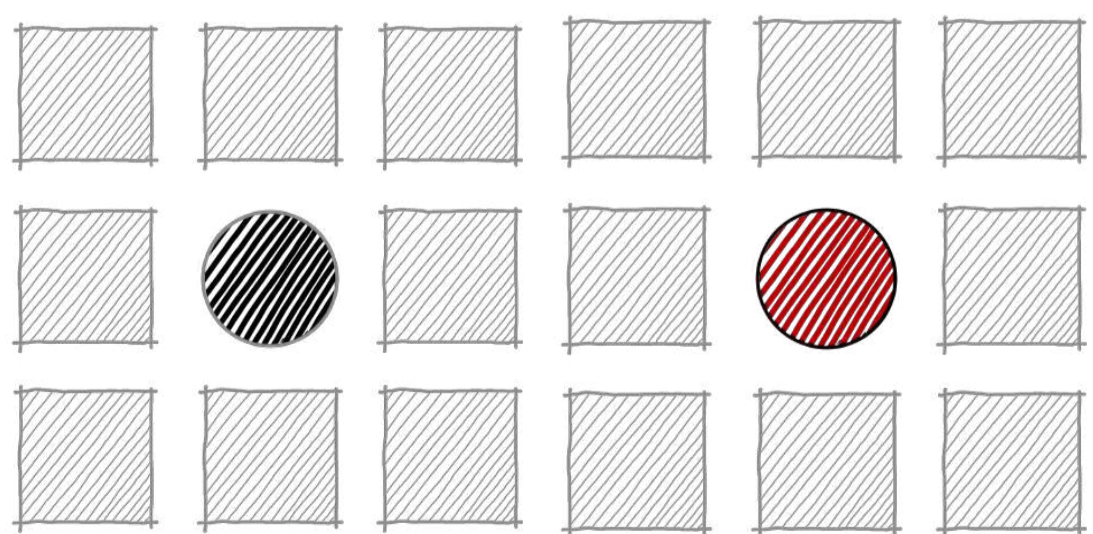

- Inaccessible Infrastructure
- Un-Inclusive design
- Lack of Services



UNIVERSAL ACCESSIBILITY

# MATERIAL CHOICE

## RESILIENCE & REPRESENTATION

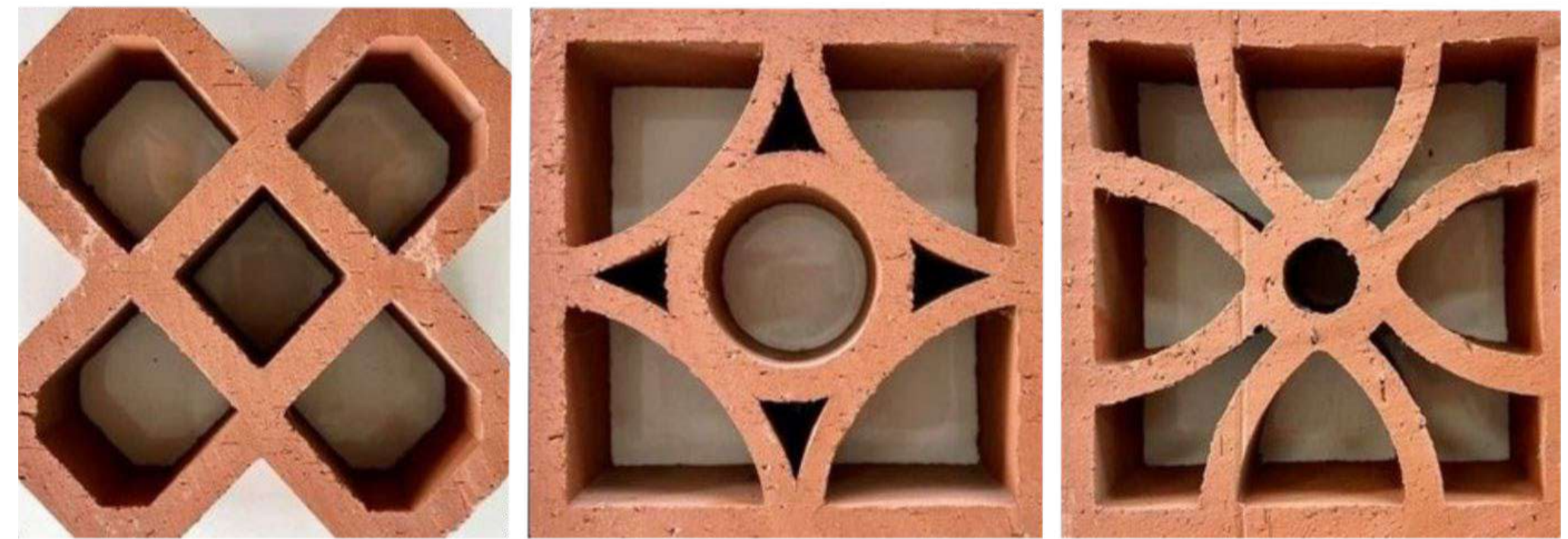
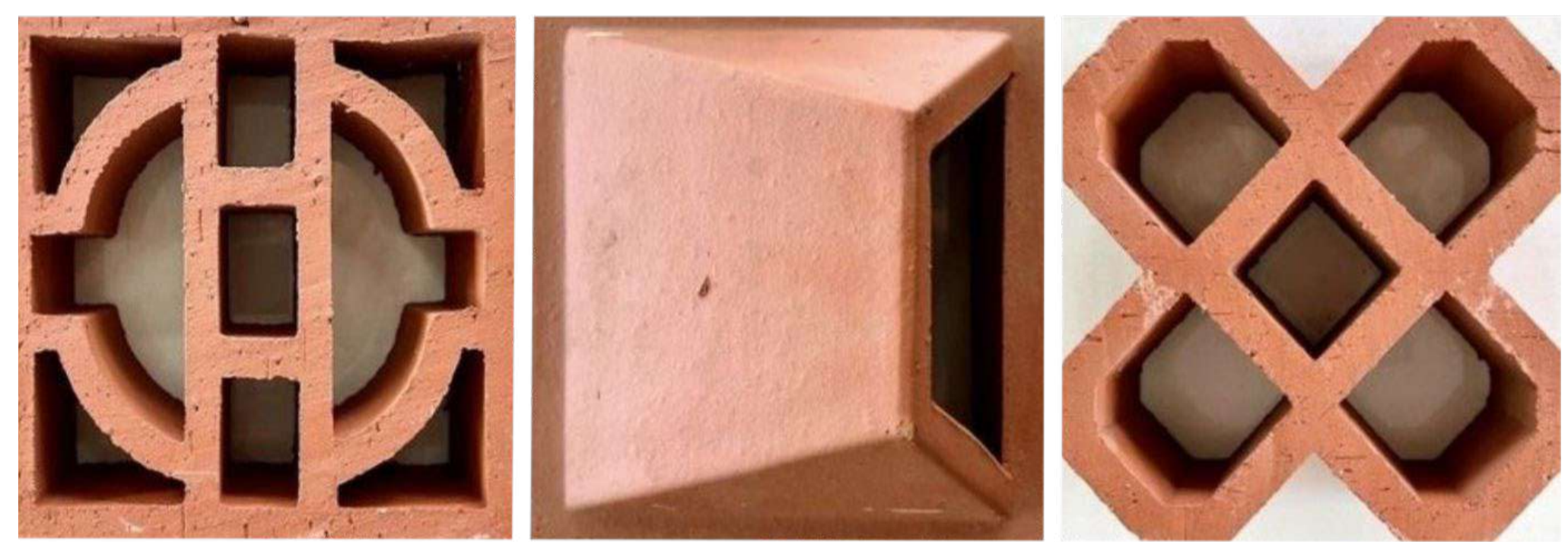
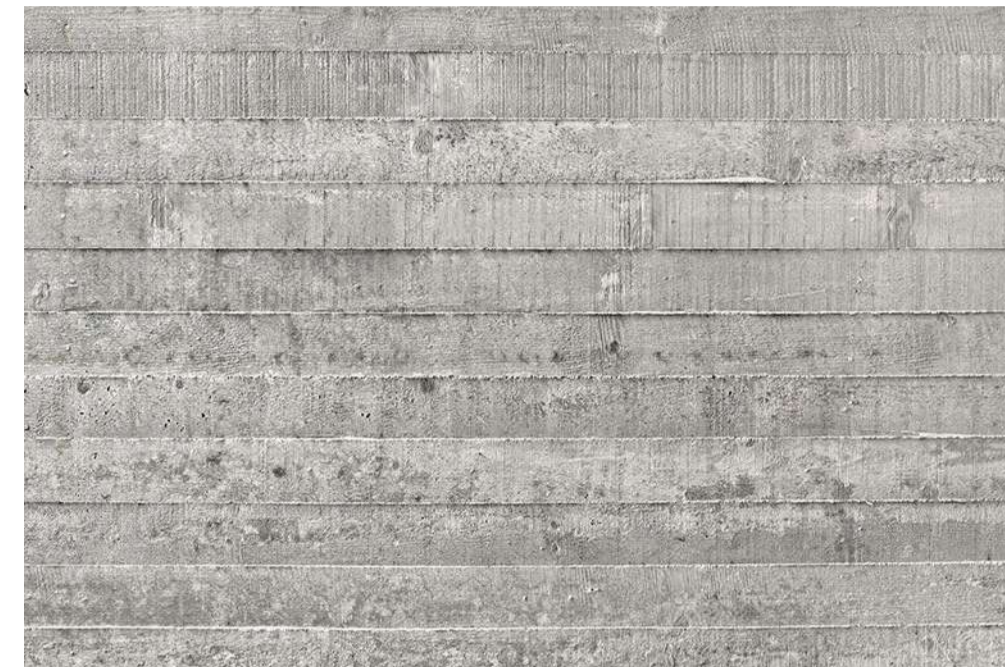
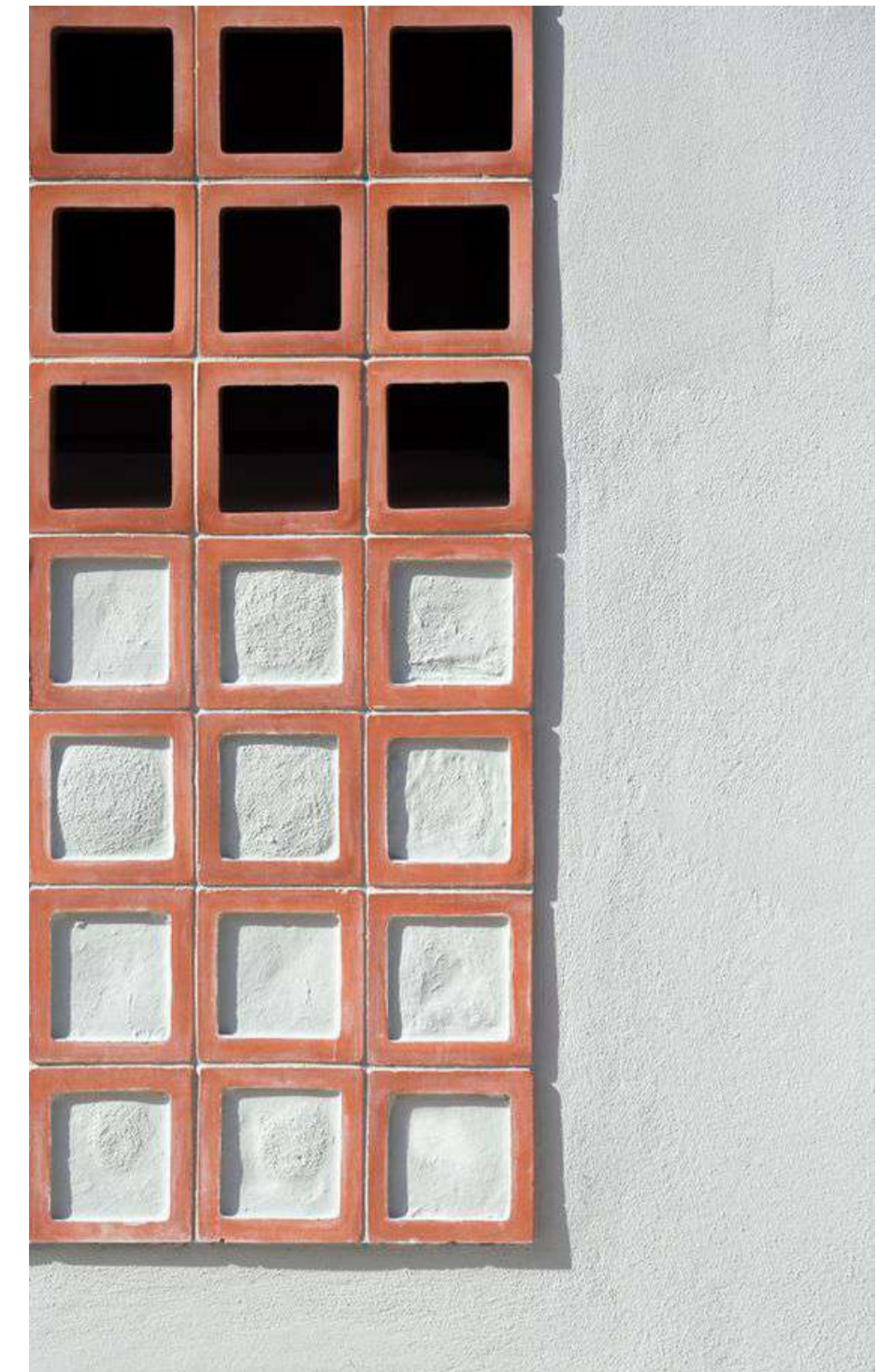
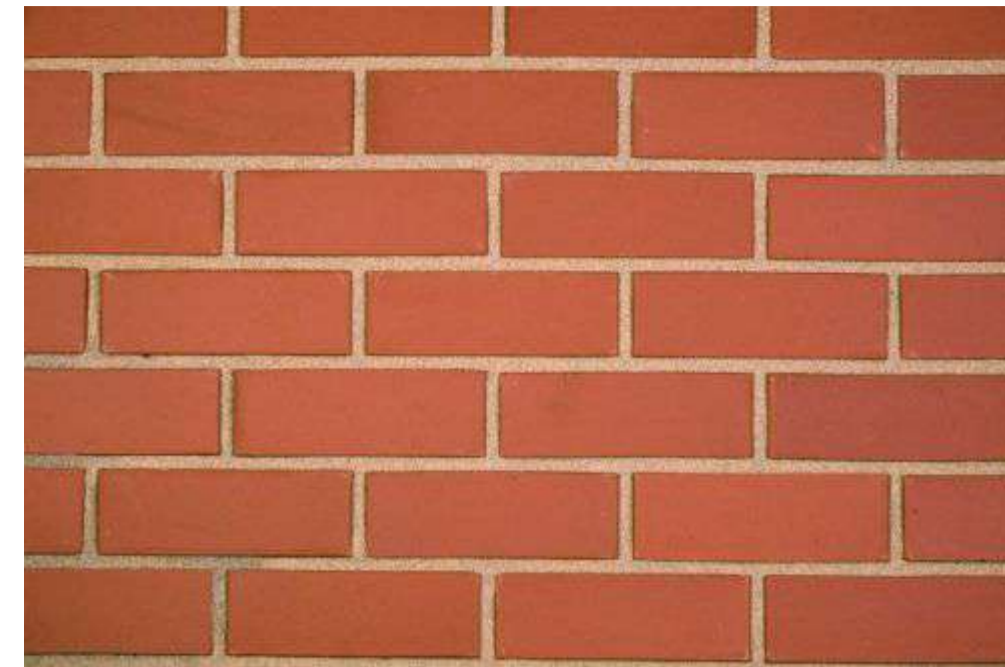

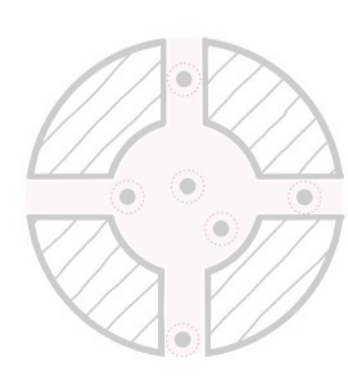
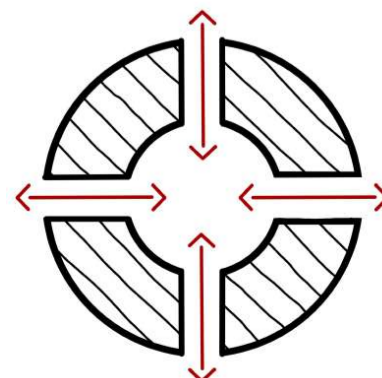
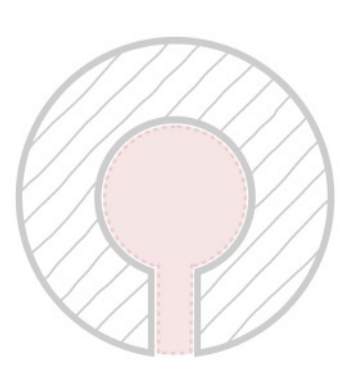
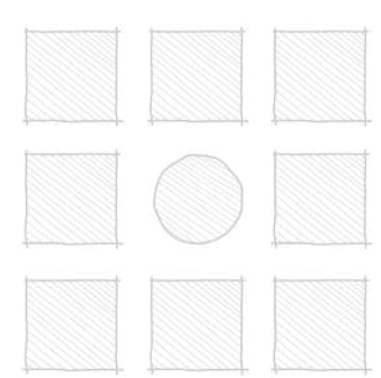
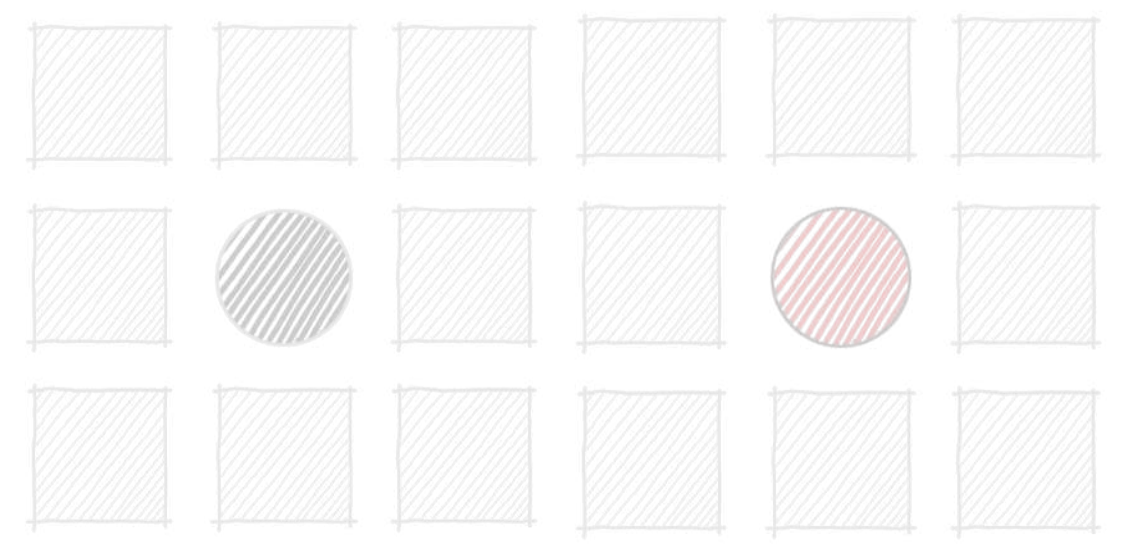
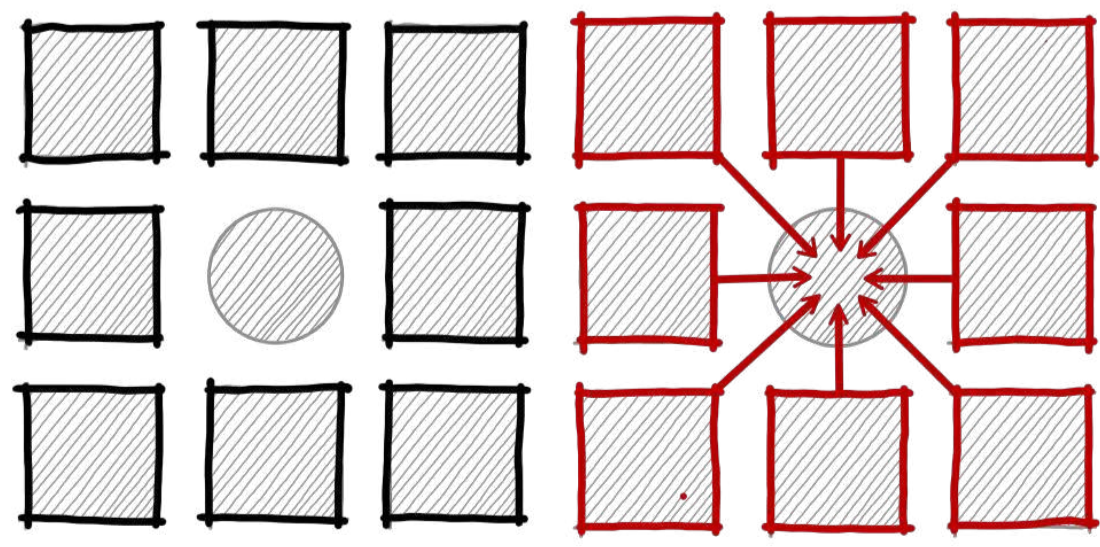
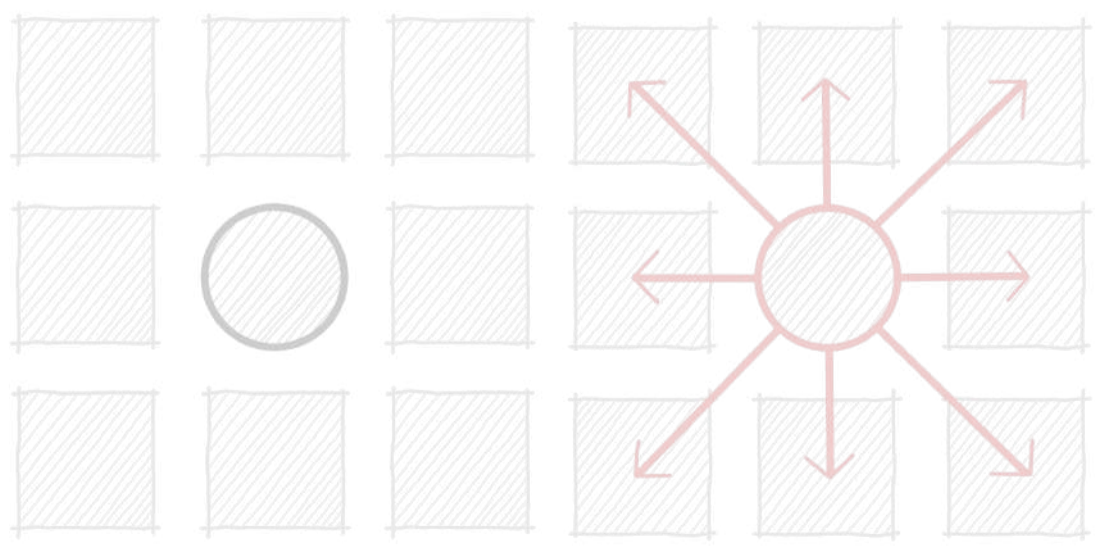
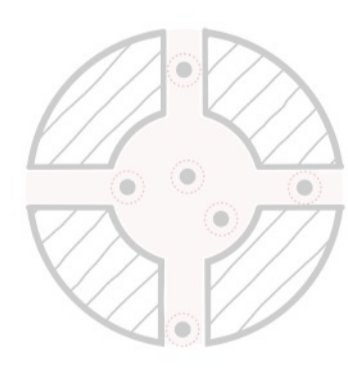
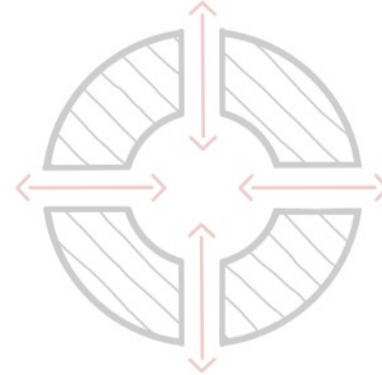
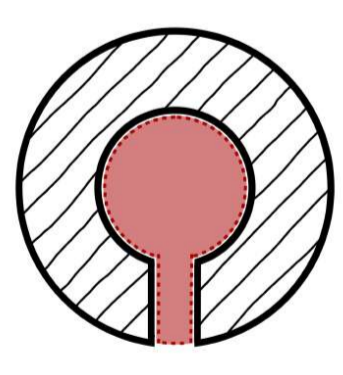
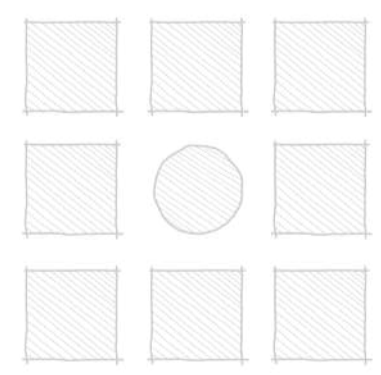
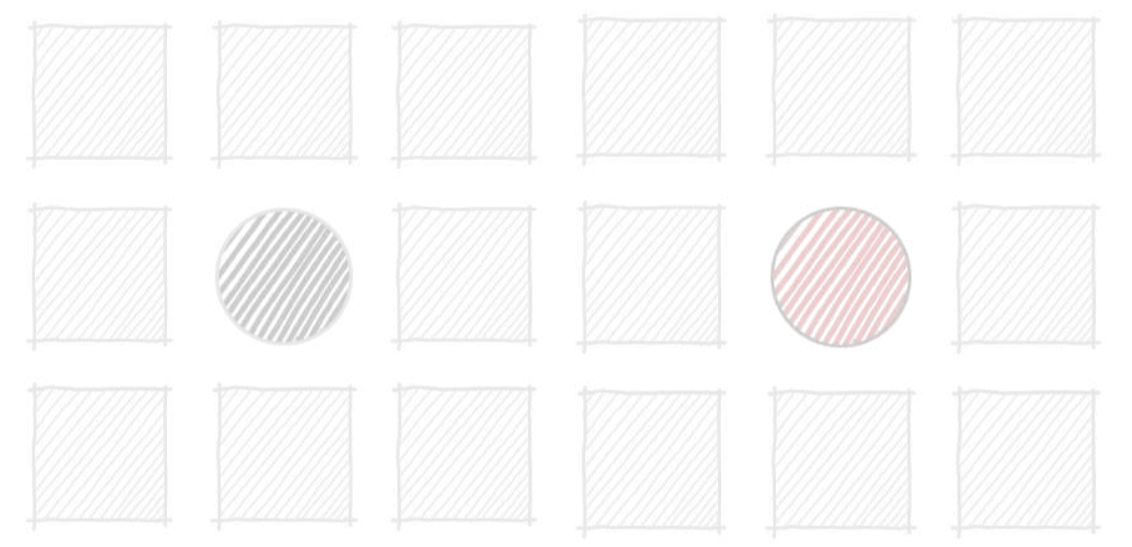
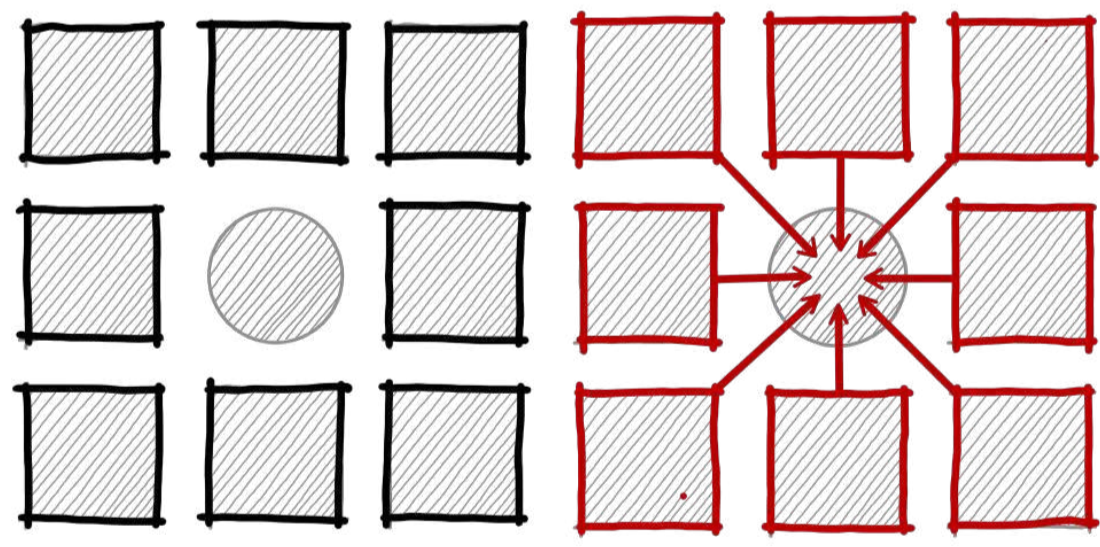
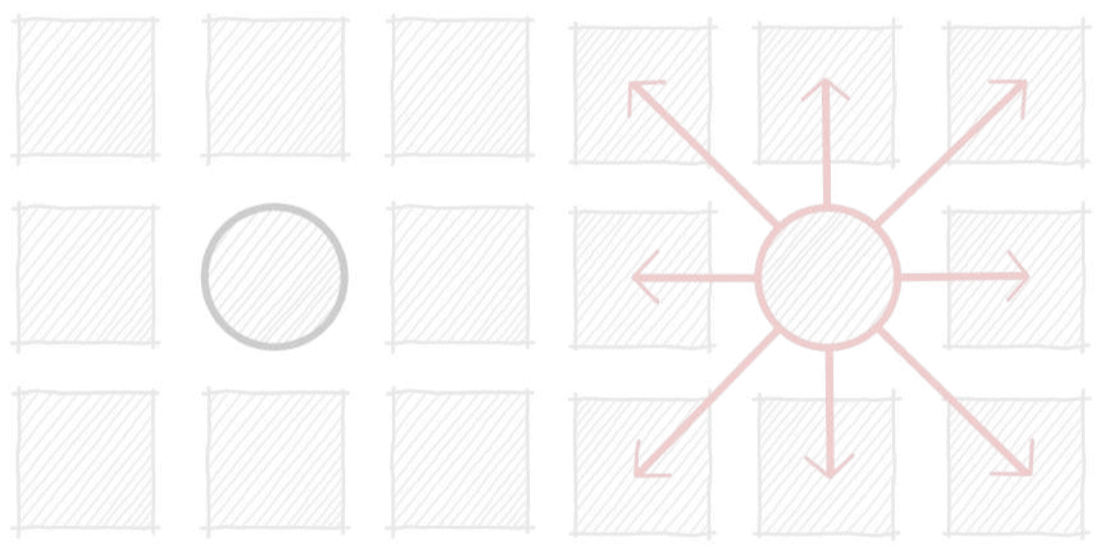
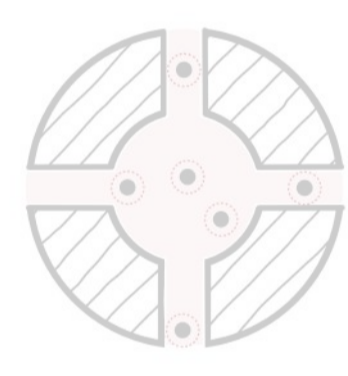
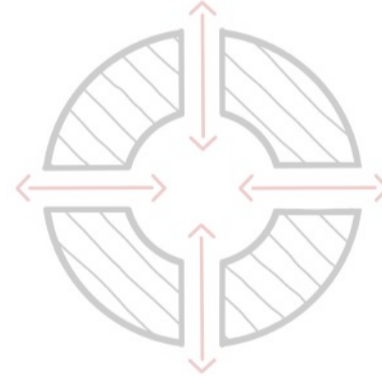
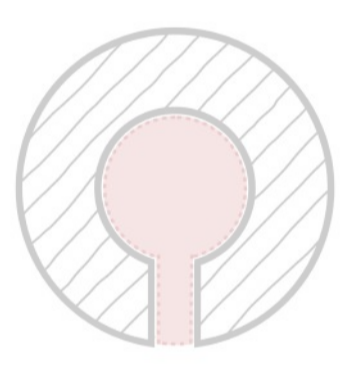
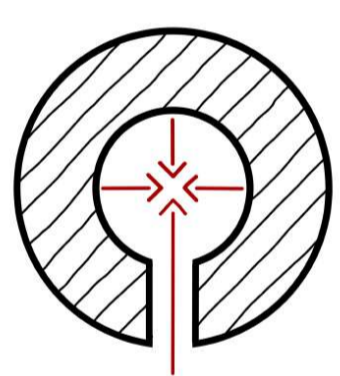
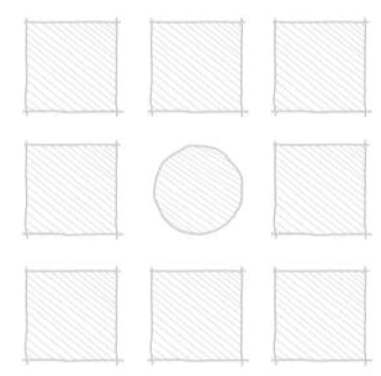
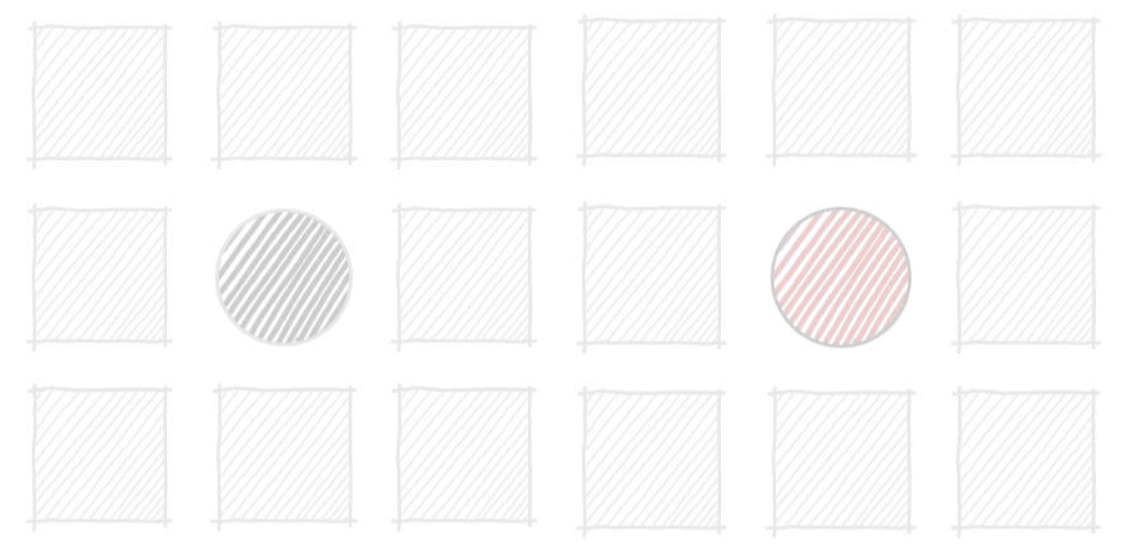
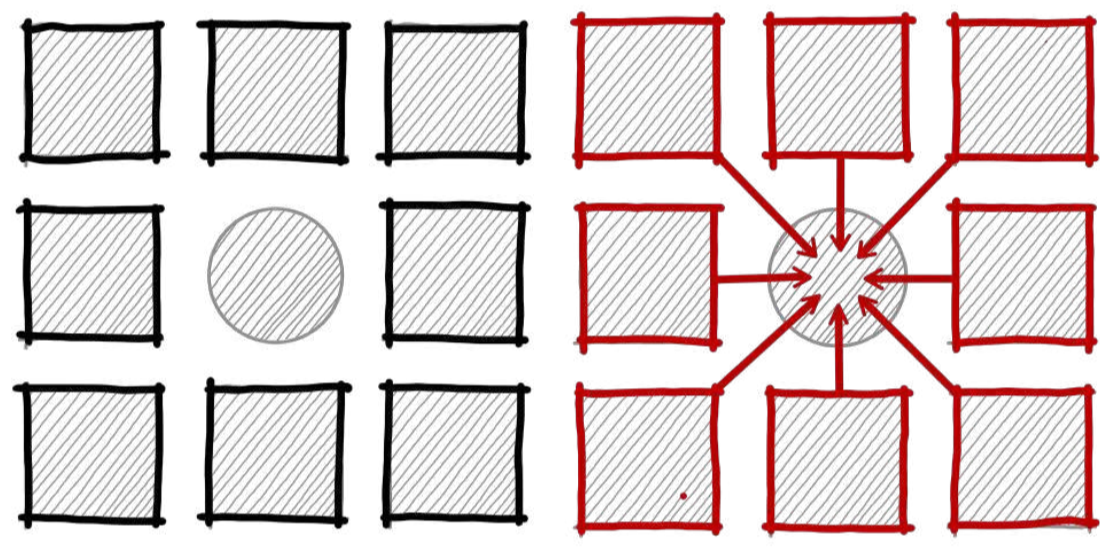
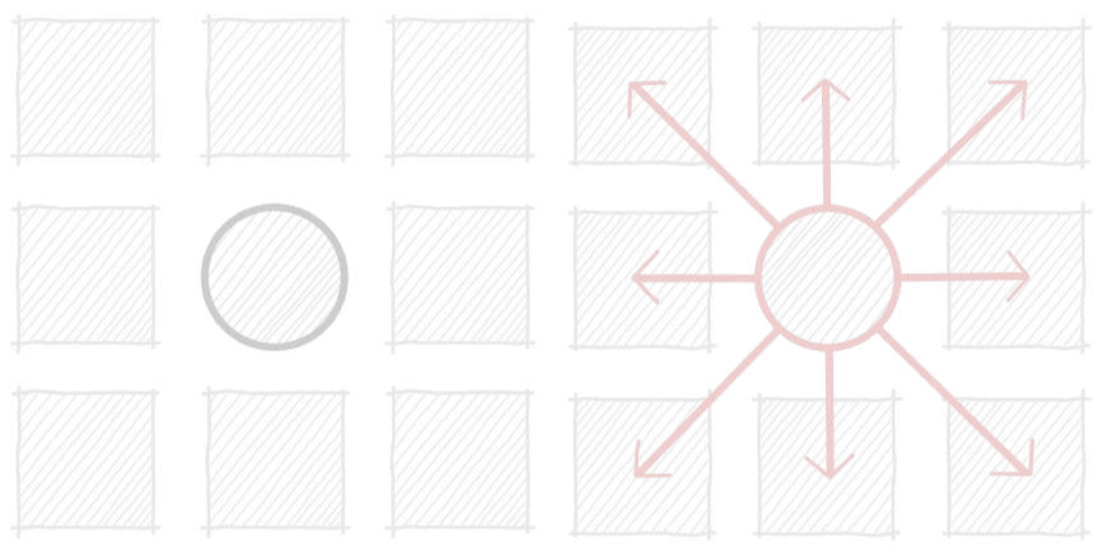
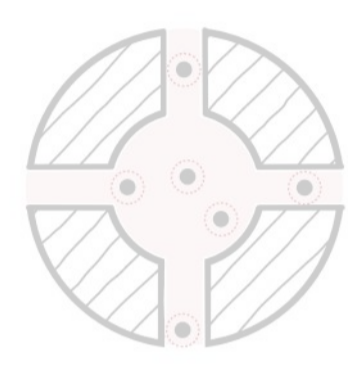
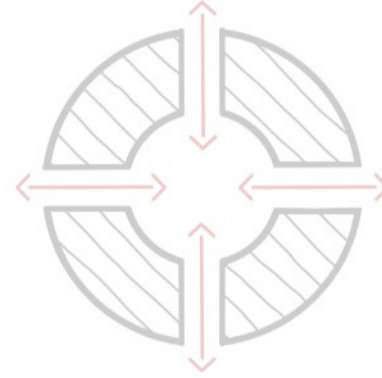
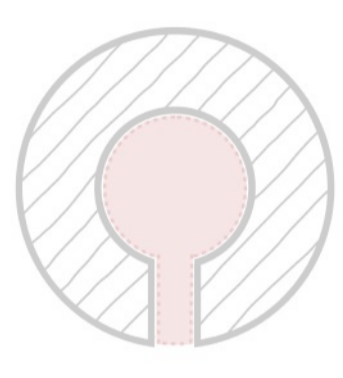
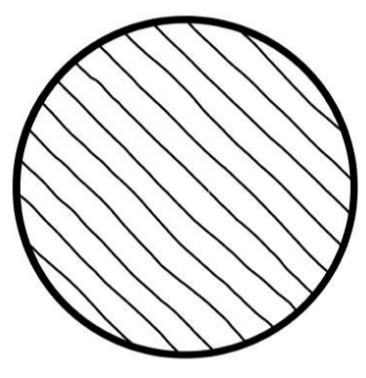
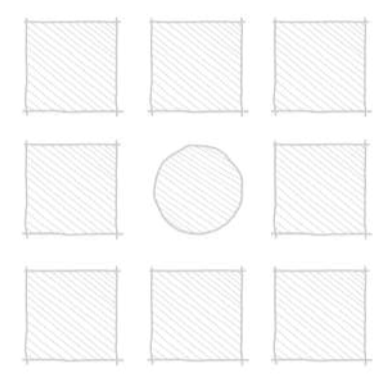
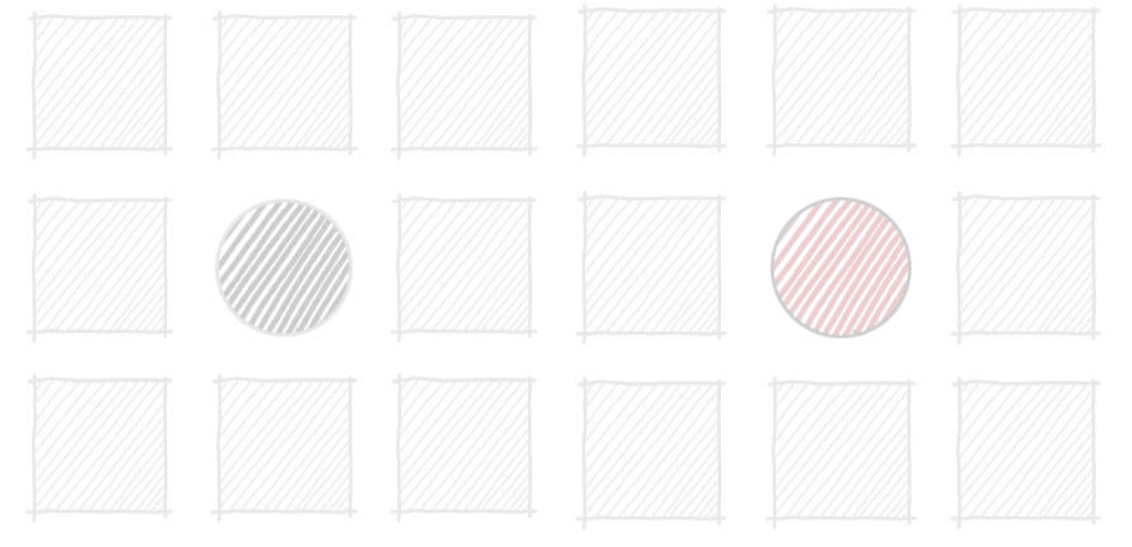
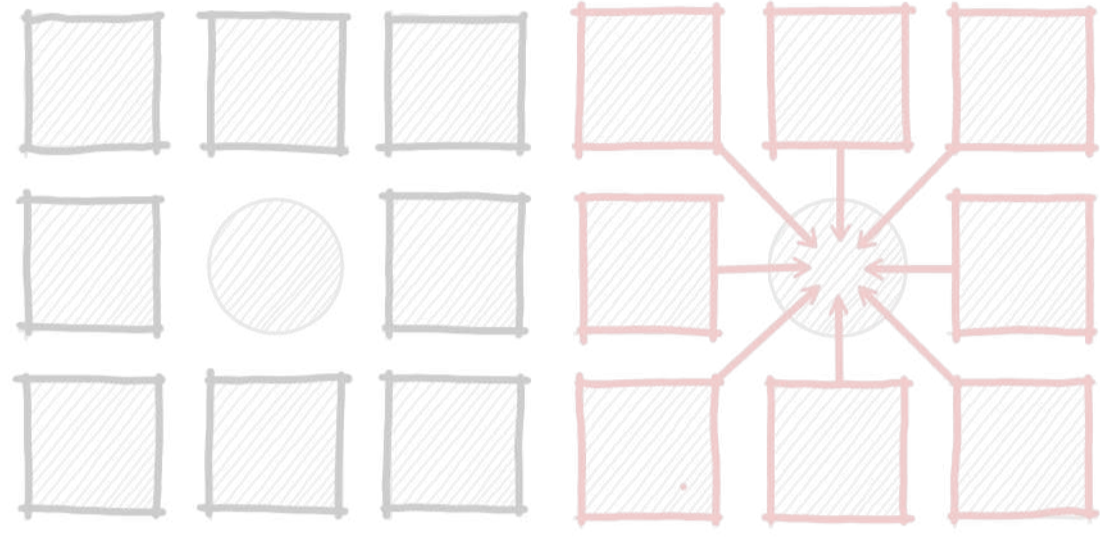
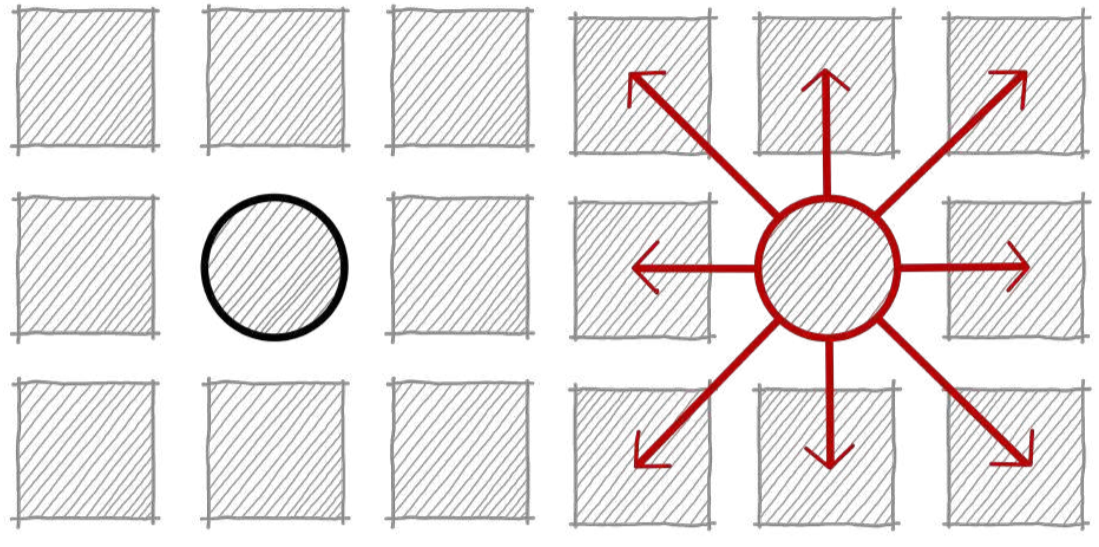
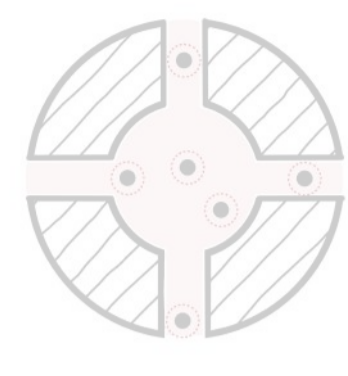
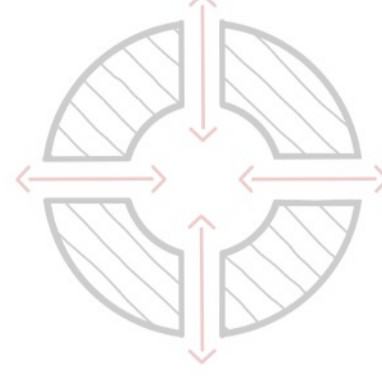
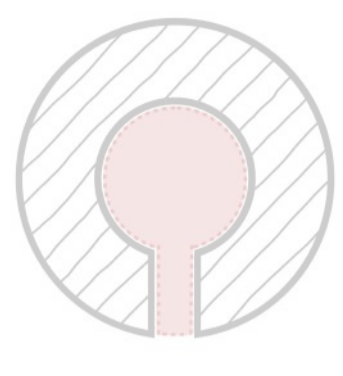
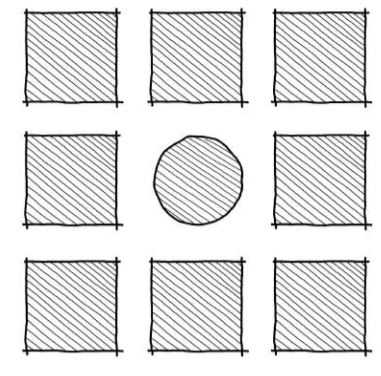
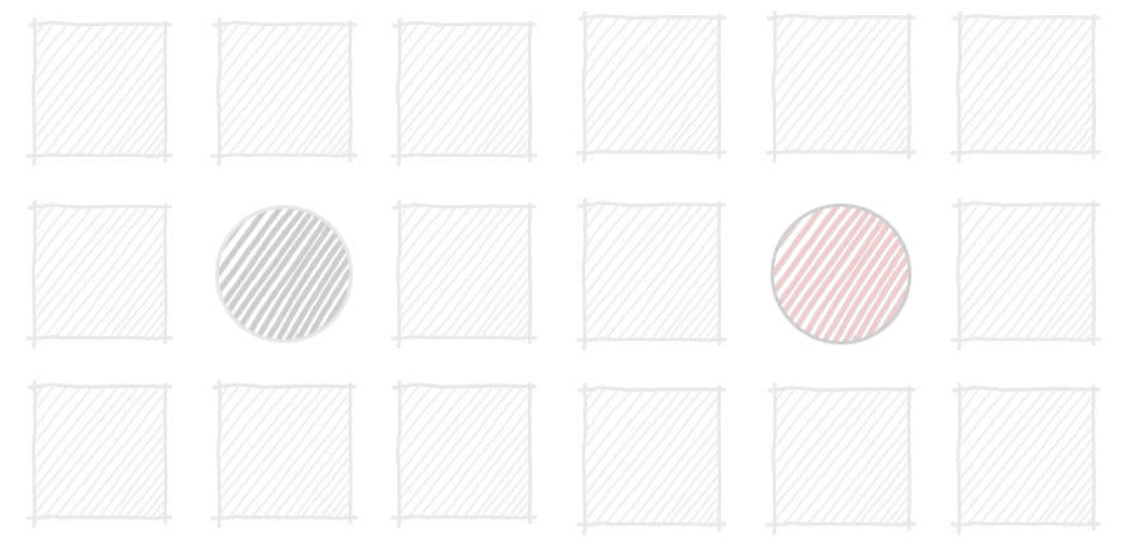
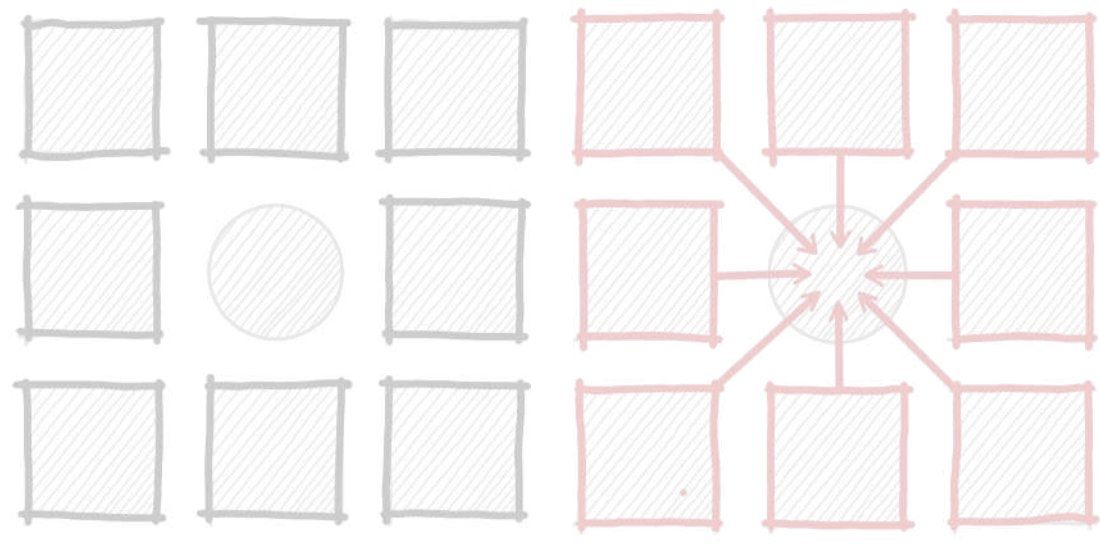
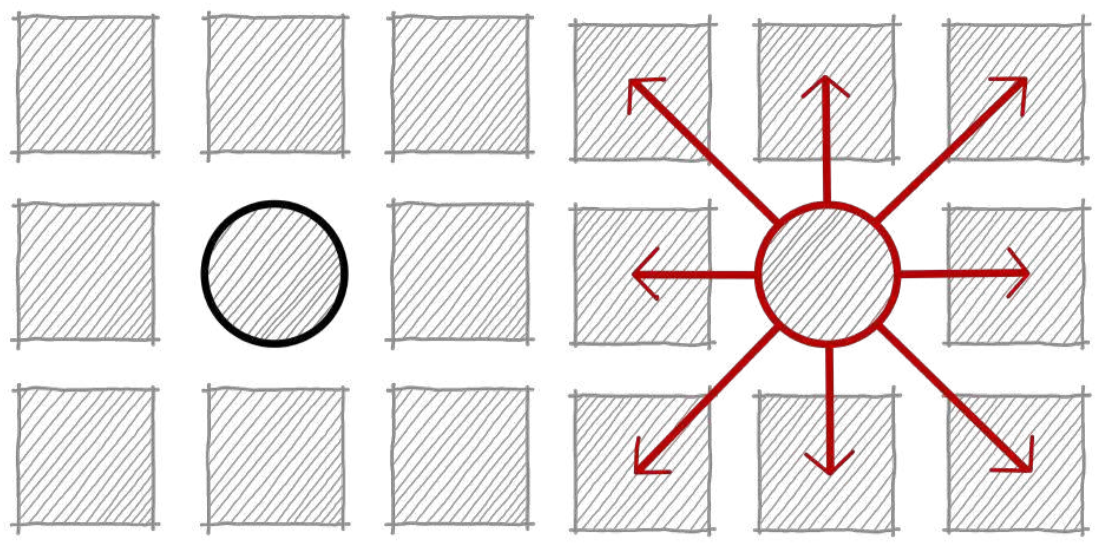

.....

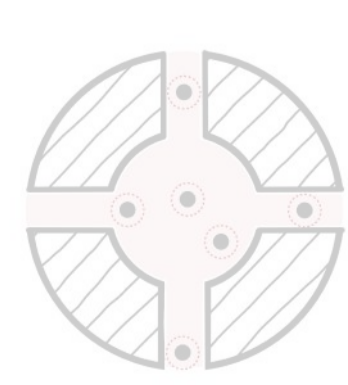
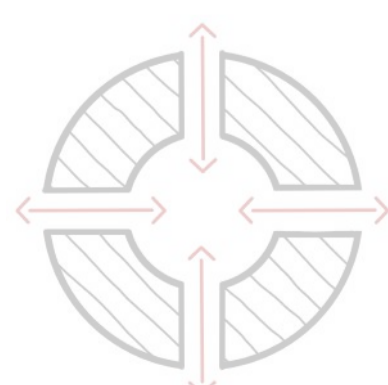
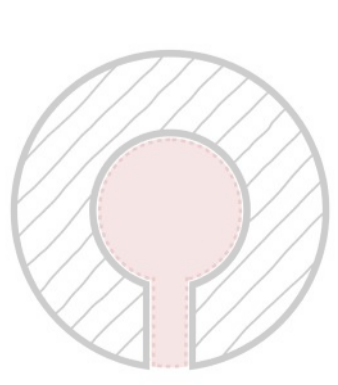
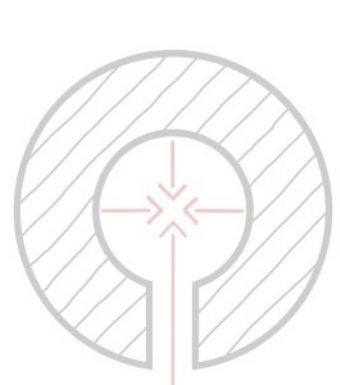
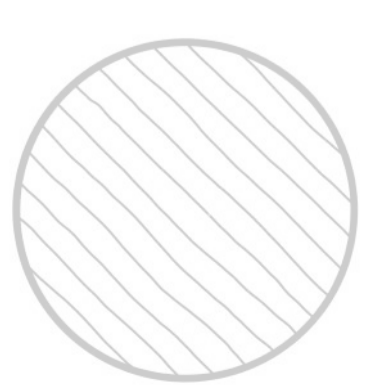
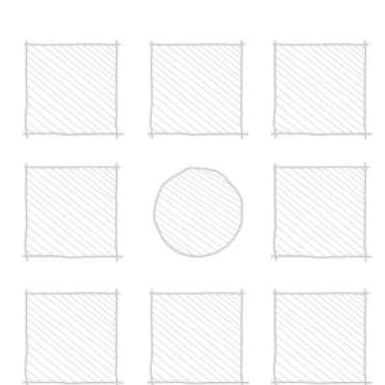
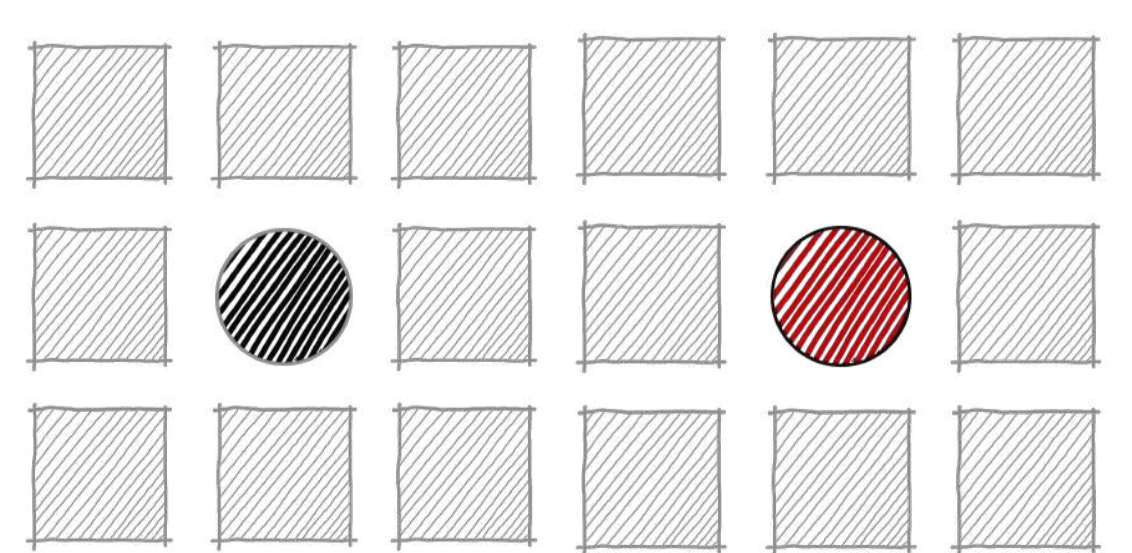
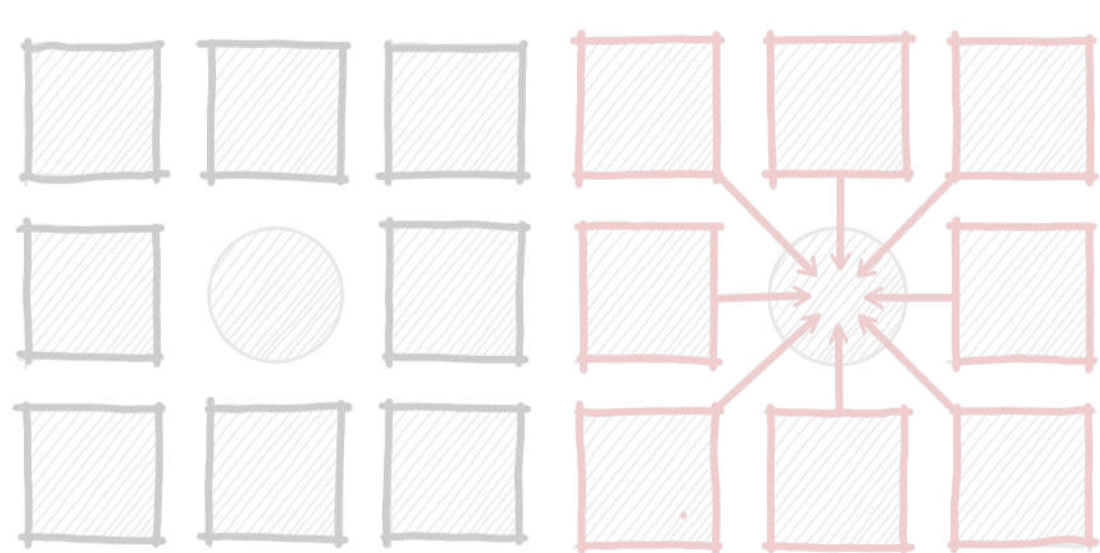
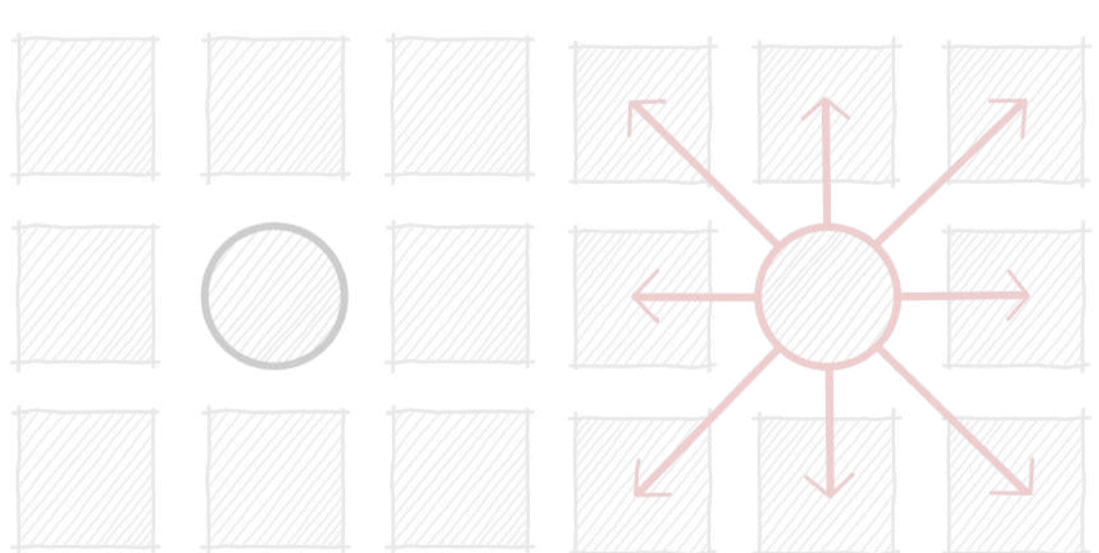
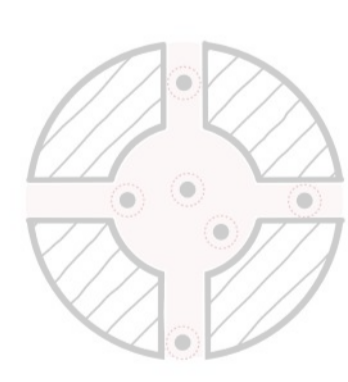
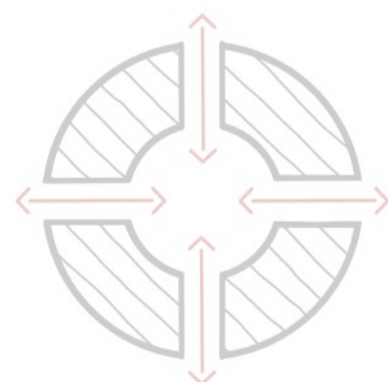
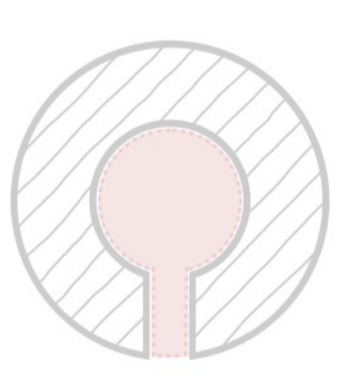
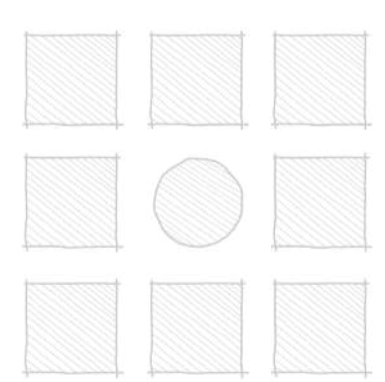
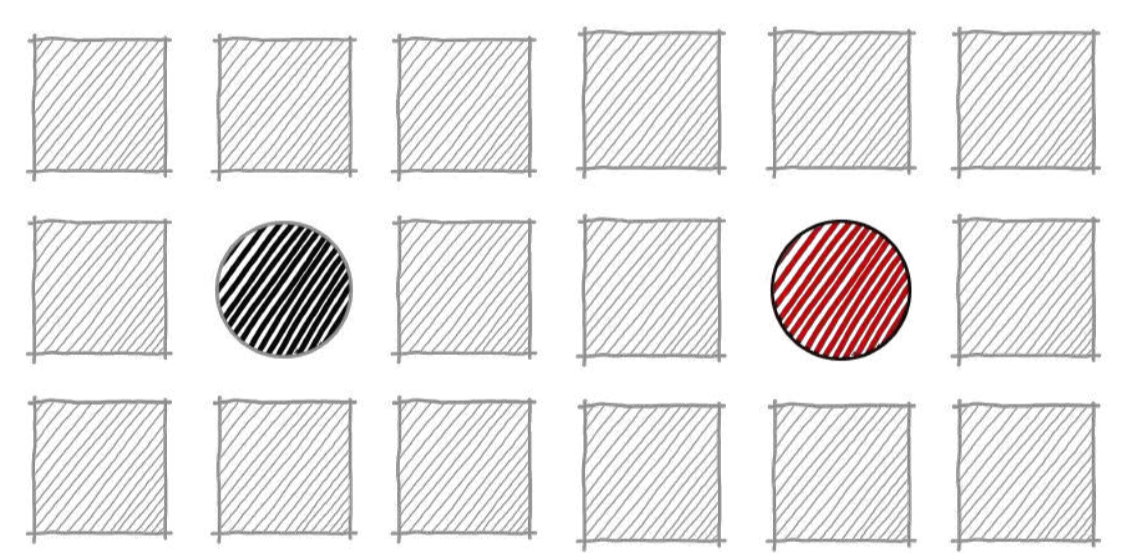
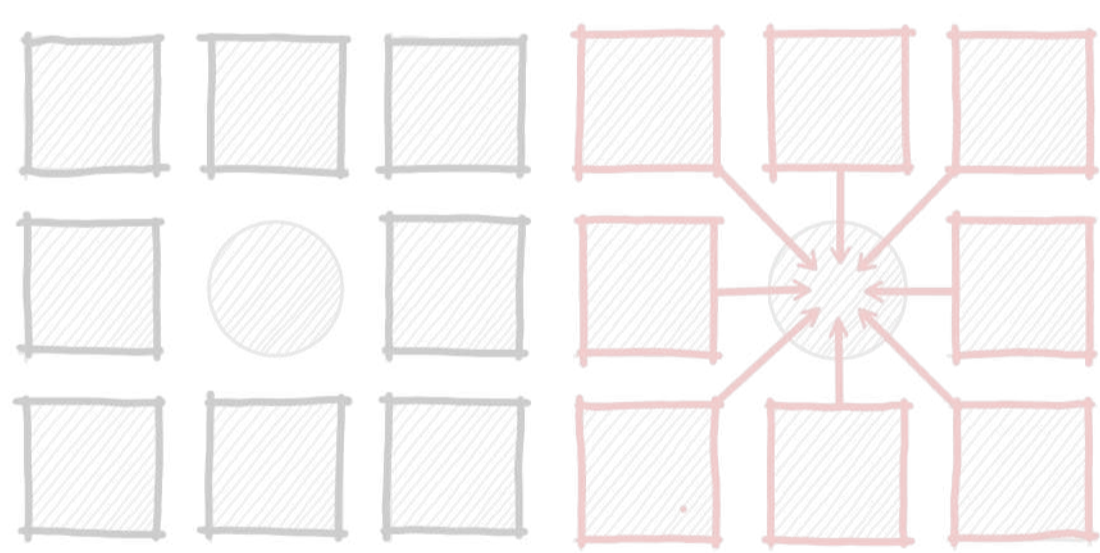
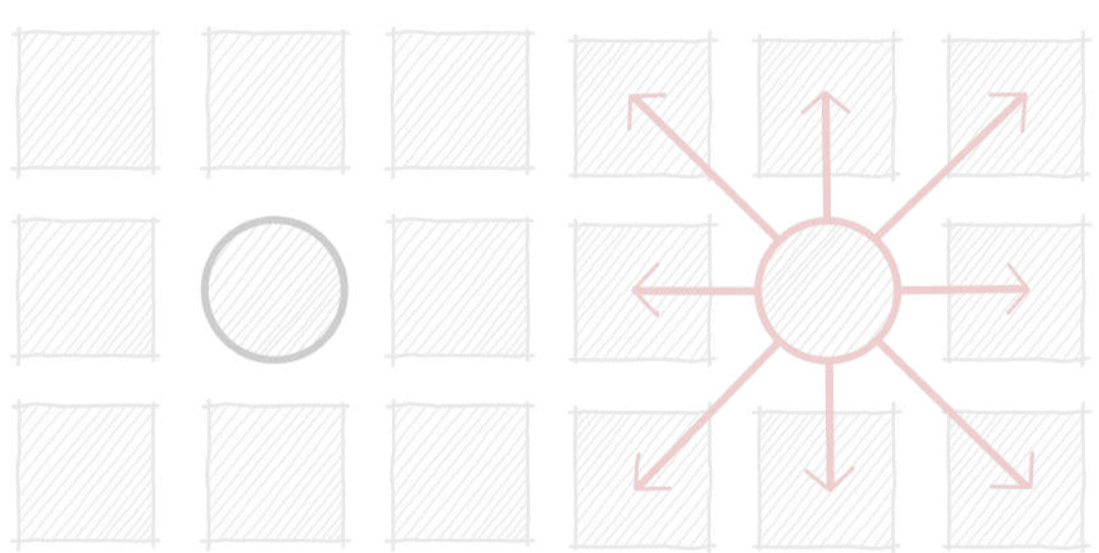
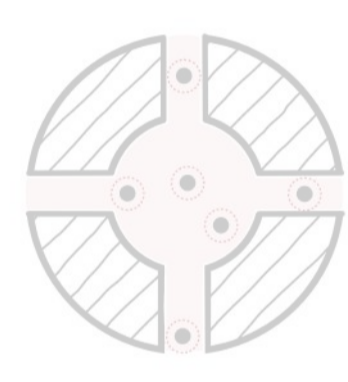
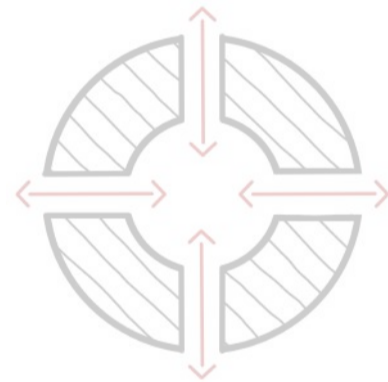
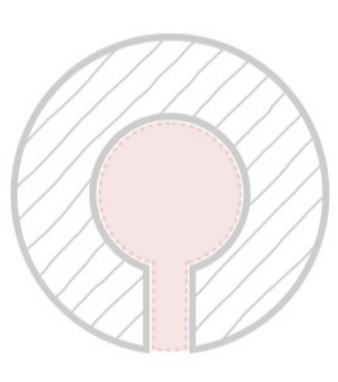
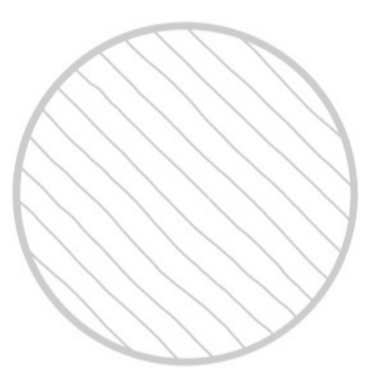
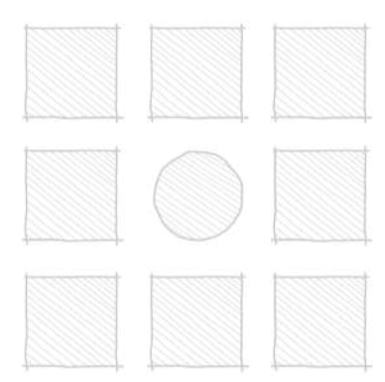
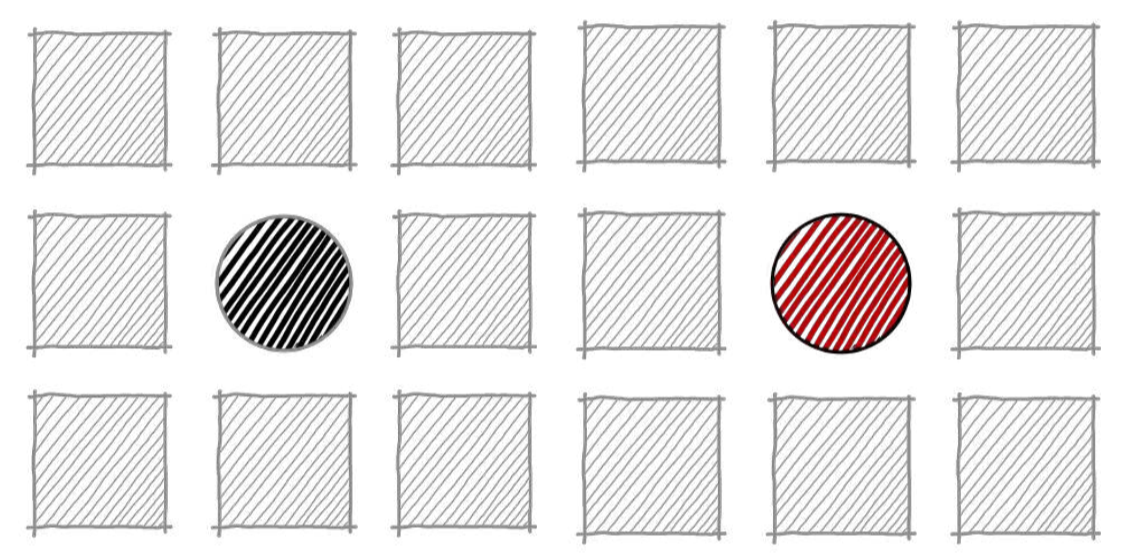
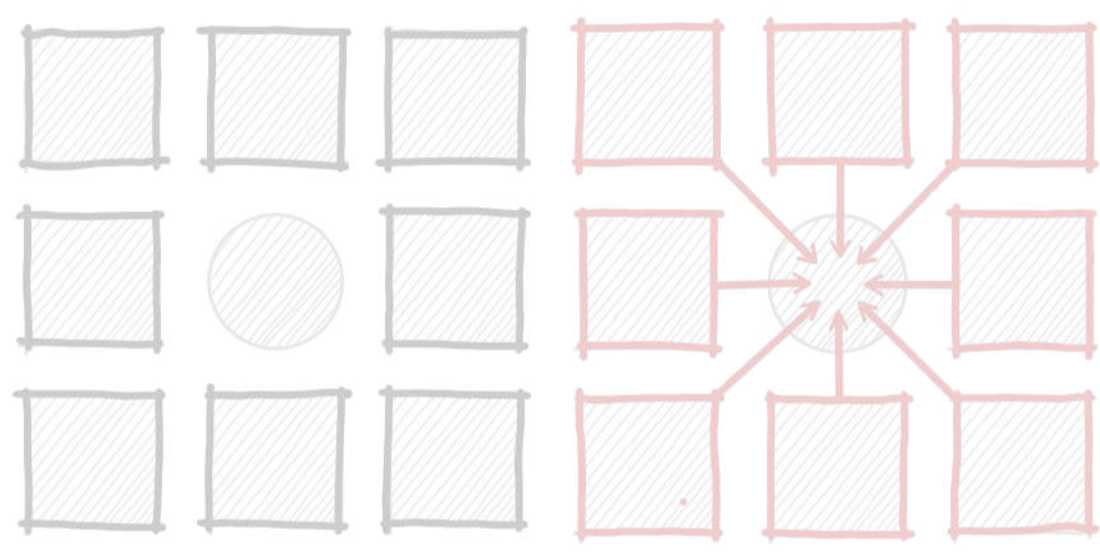
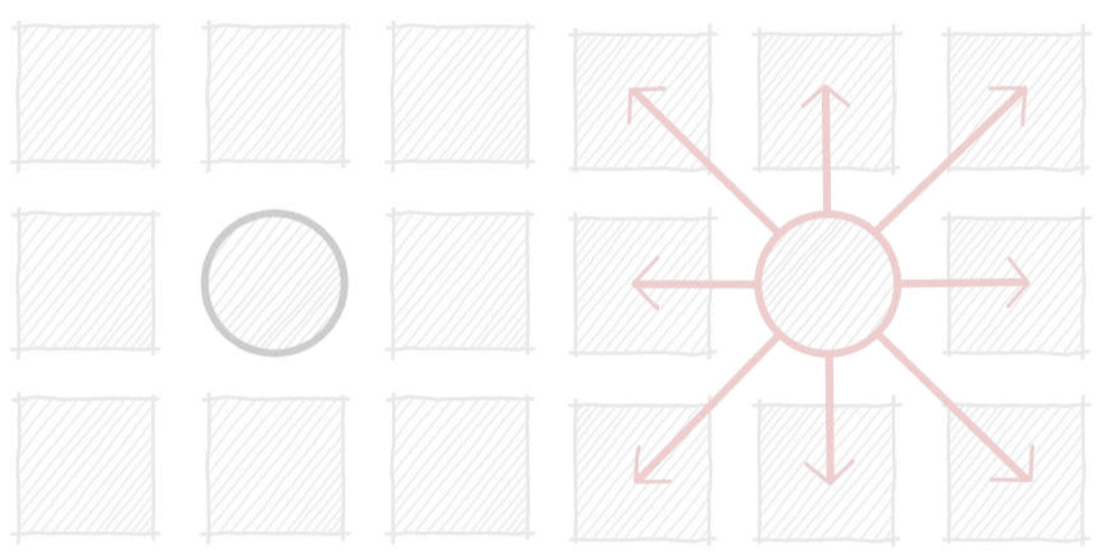
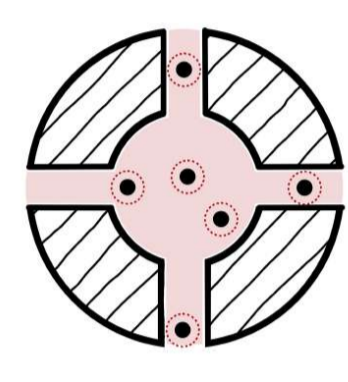
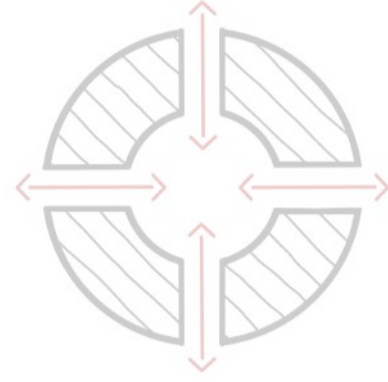
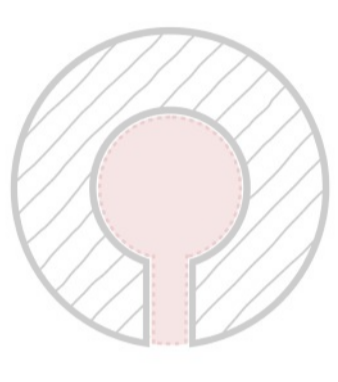
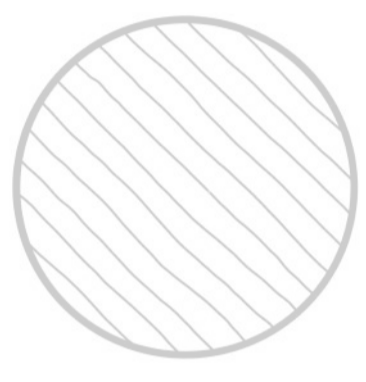
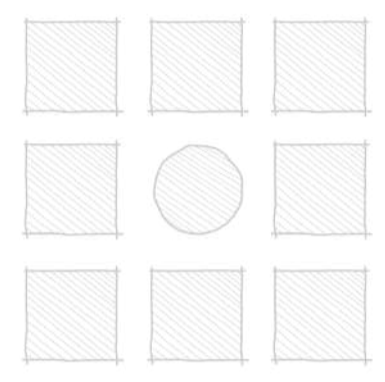
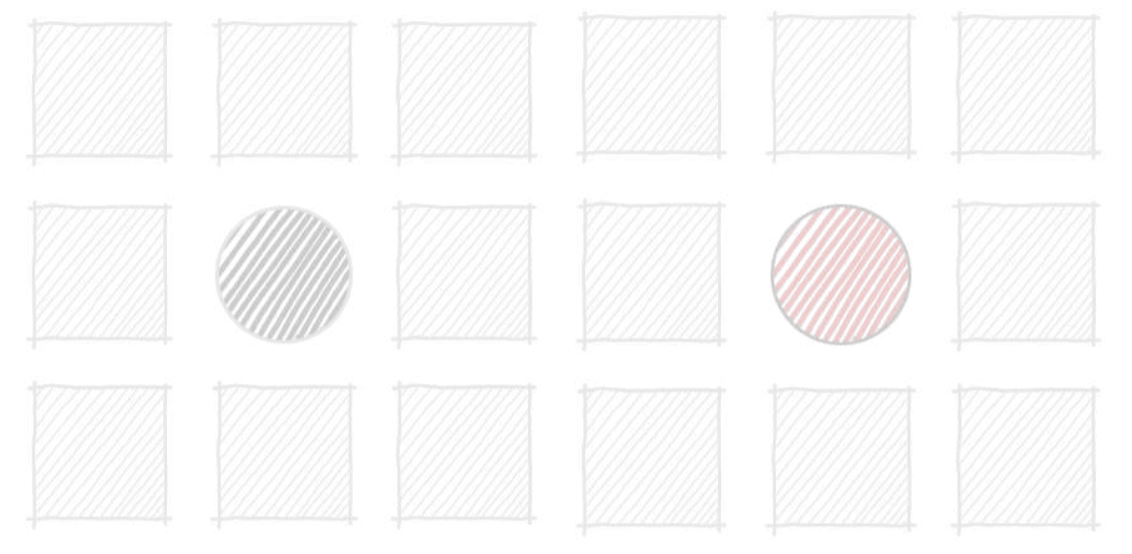
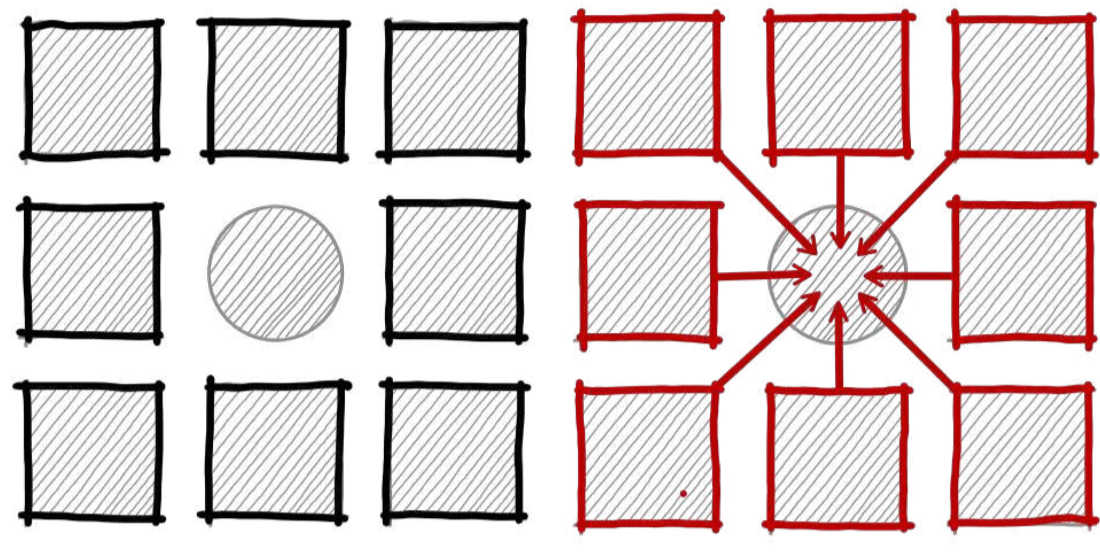
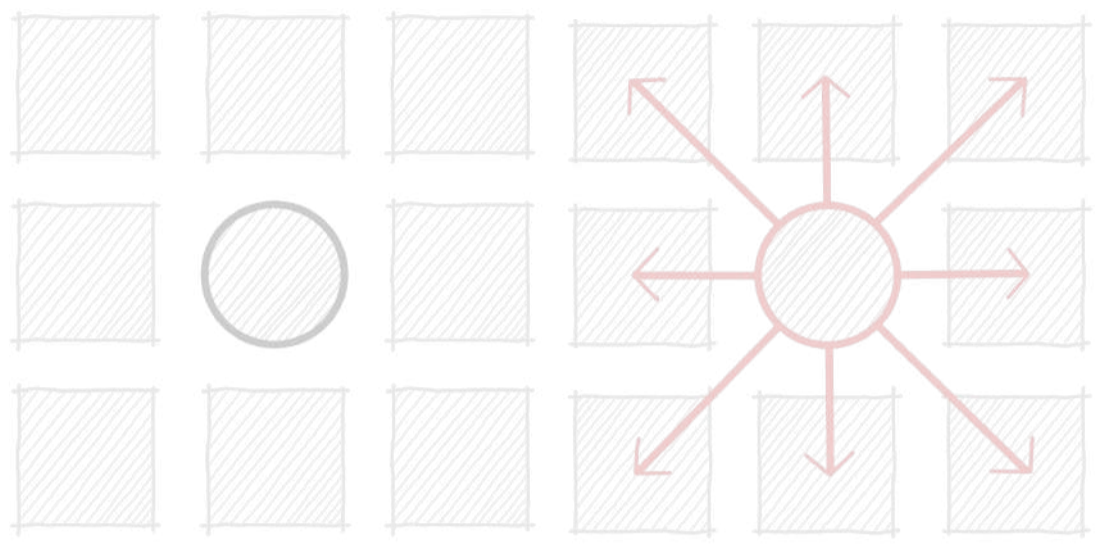
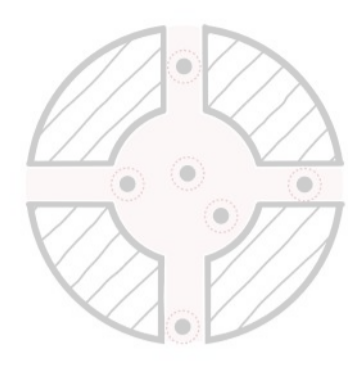
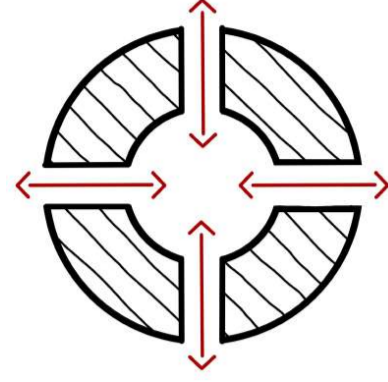
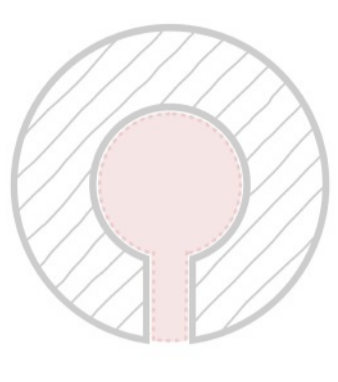
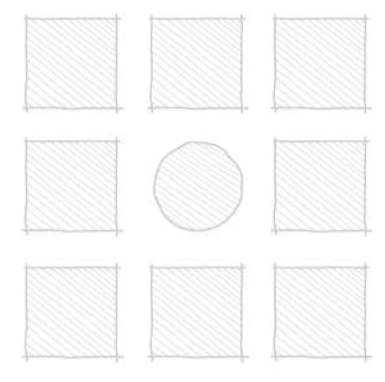
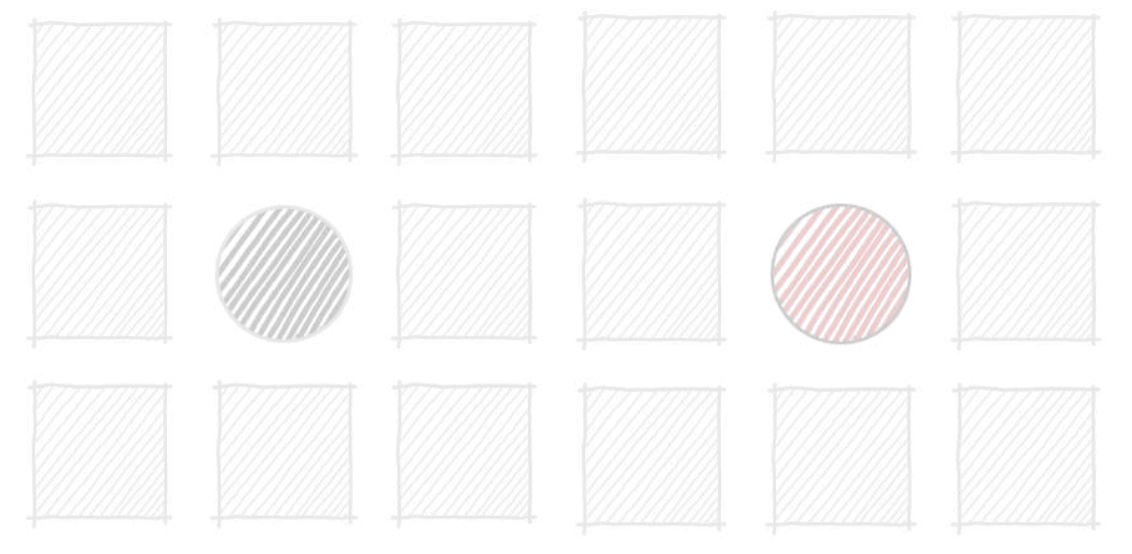
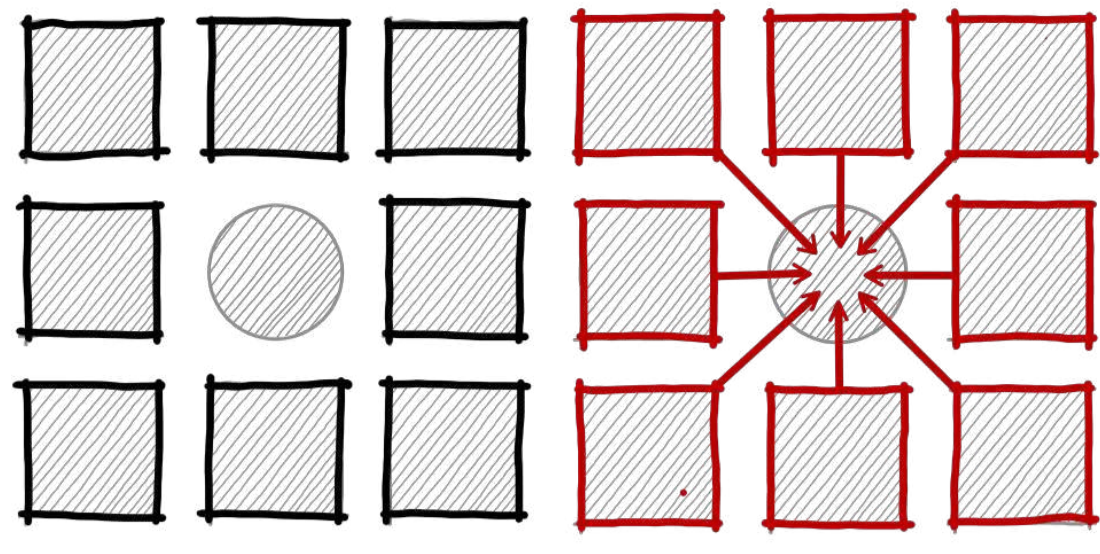
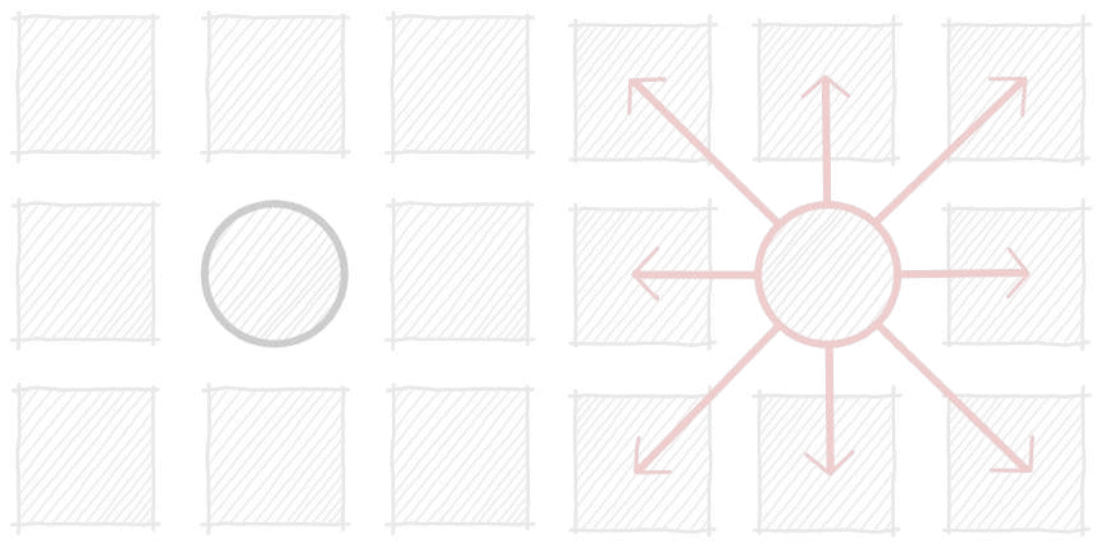

.....

# LOCATING A SITE

## REGION

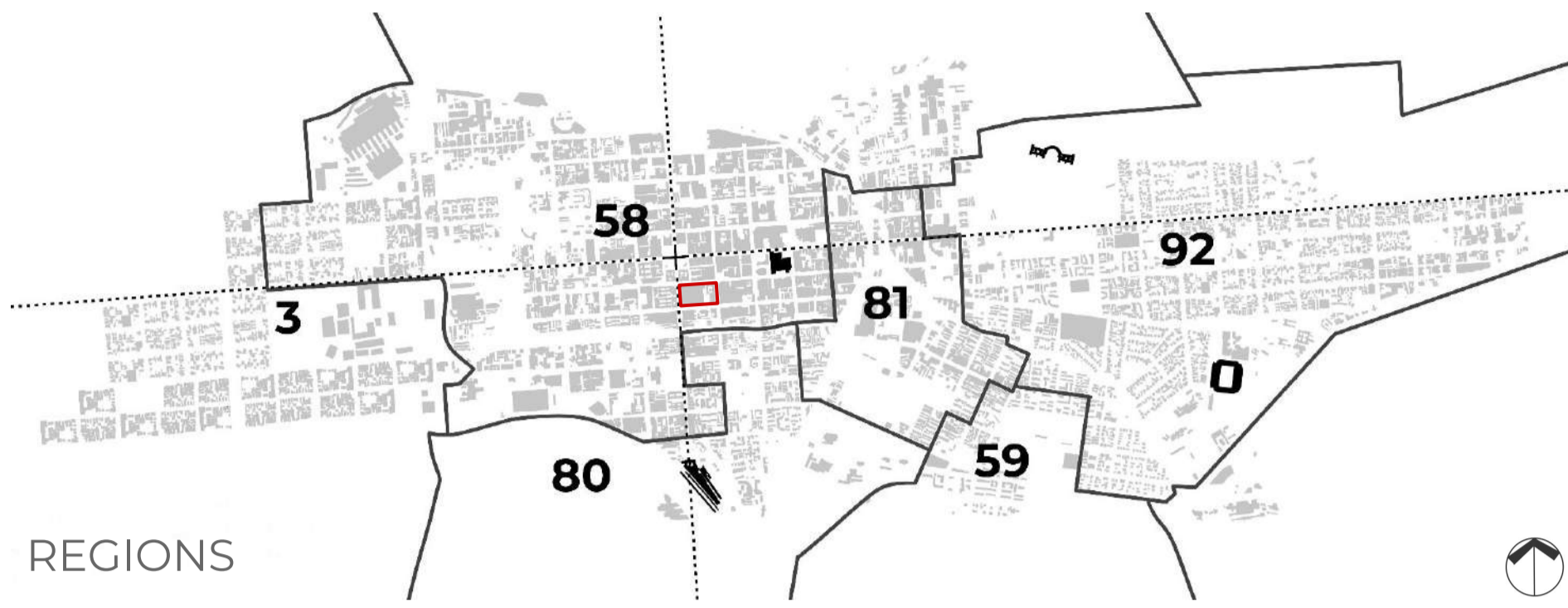
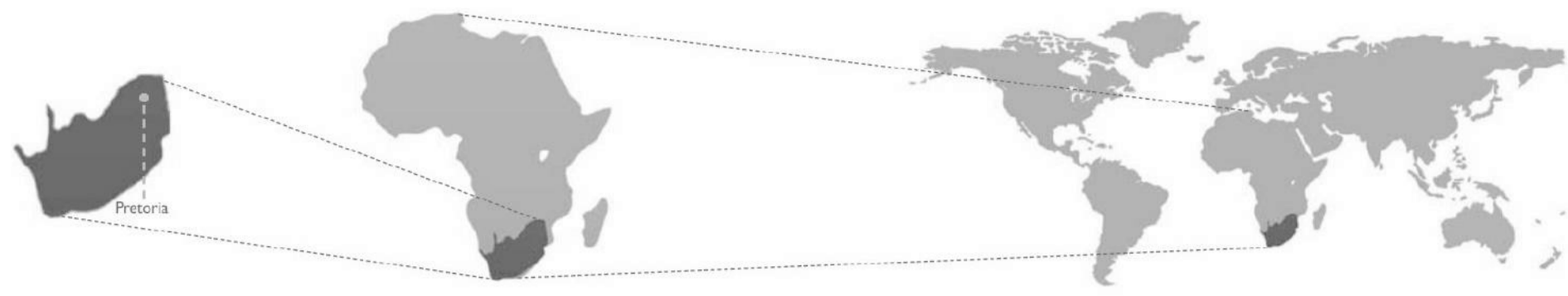

REGIONS

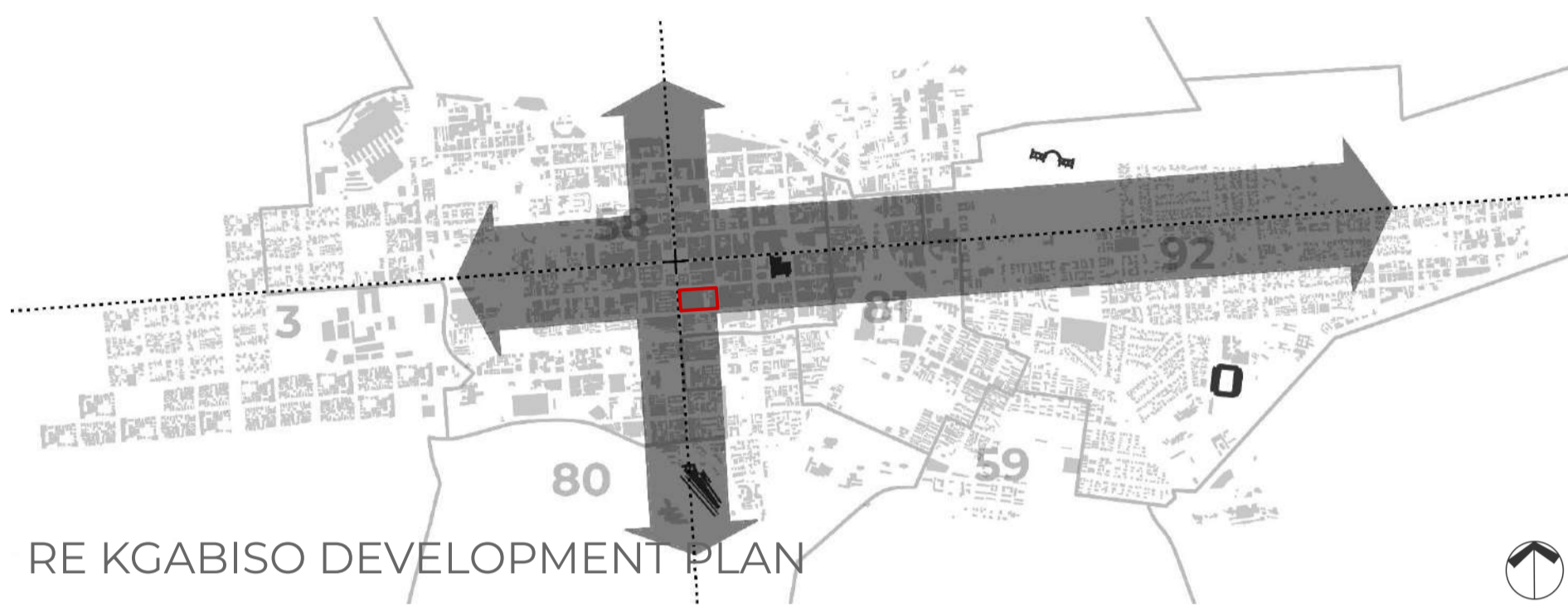

RE KGABISO DEVELOPMENT PLAN



TSHWANE 2055



ARE YENG BUS ROUTES



RAILWAY



FOCUS REGION

# LOCATING A SITE

## CITY BLOCK

### CITY BLOCKS IDENTIFIED

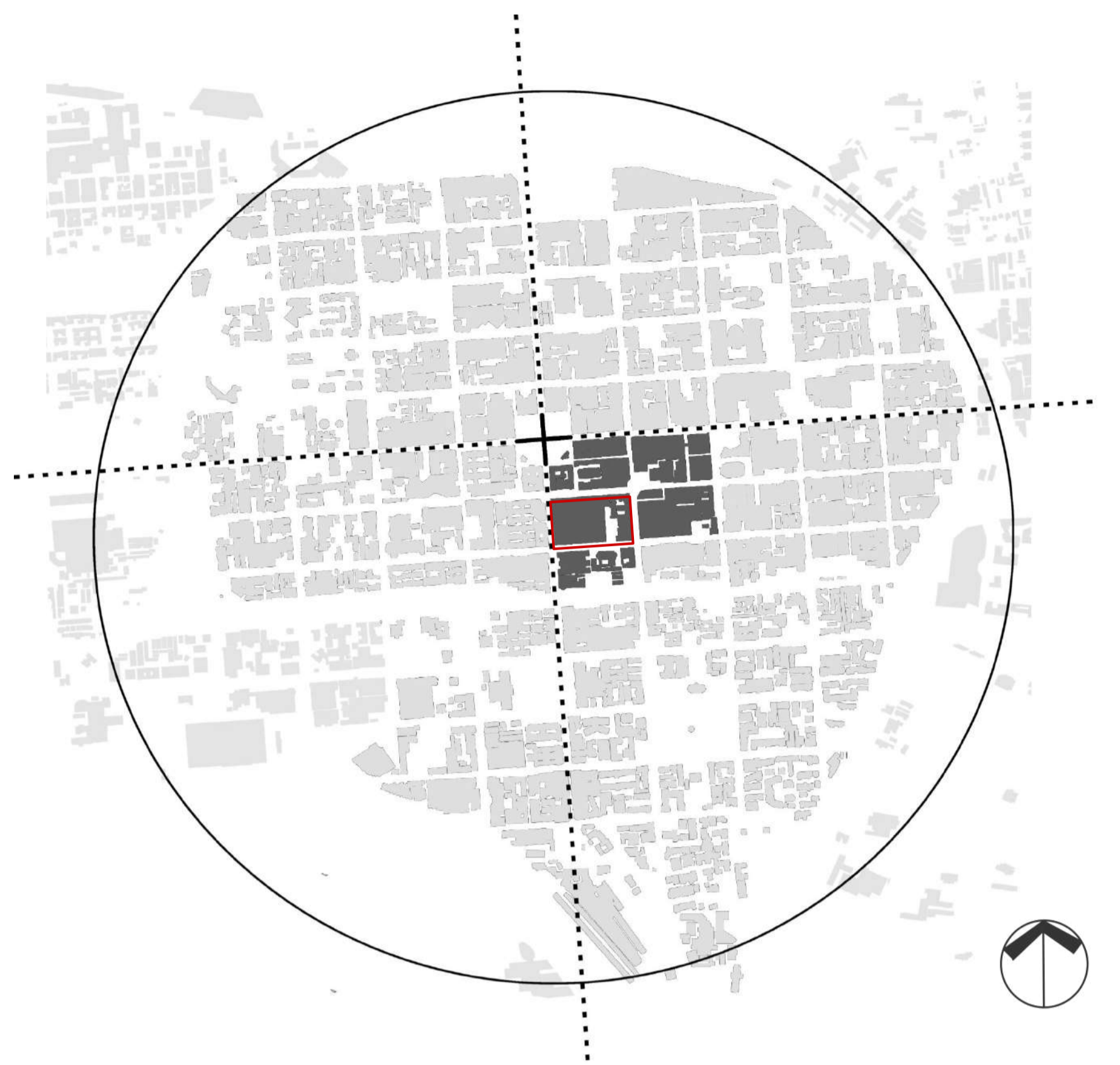

ACCESSIBILITY

PROXIMITY

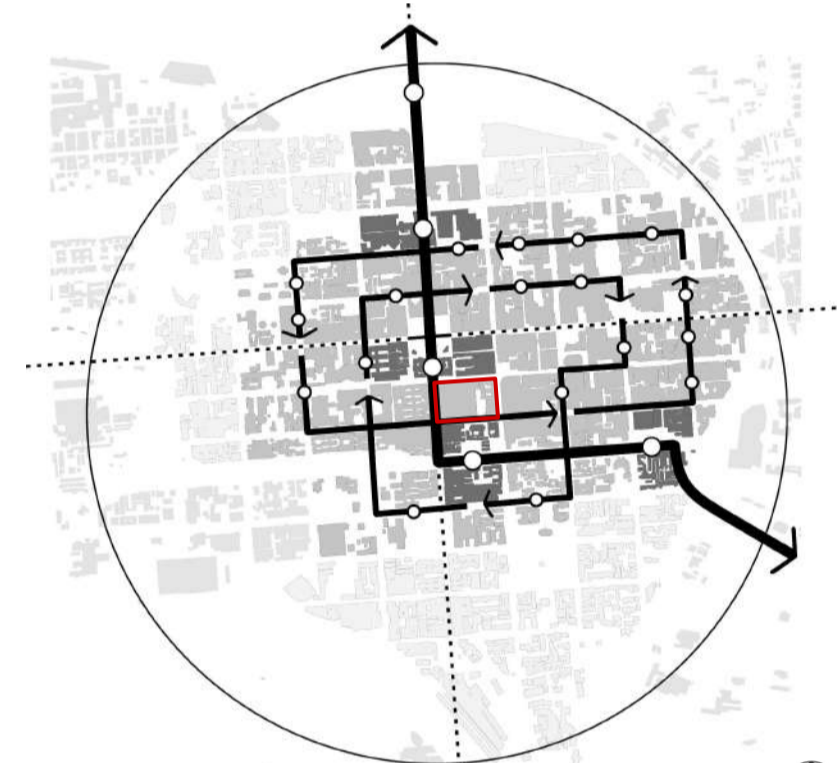

BUS ROUTES PTA CBD



EDUCATIONAL



TAXI RANKS & REACH



MEDICAL



ARCADES



GOVERNMENT

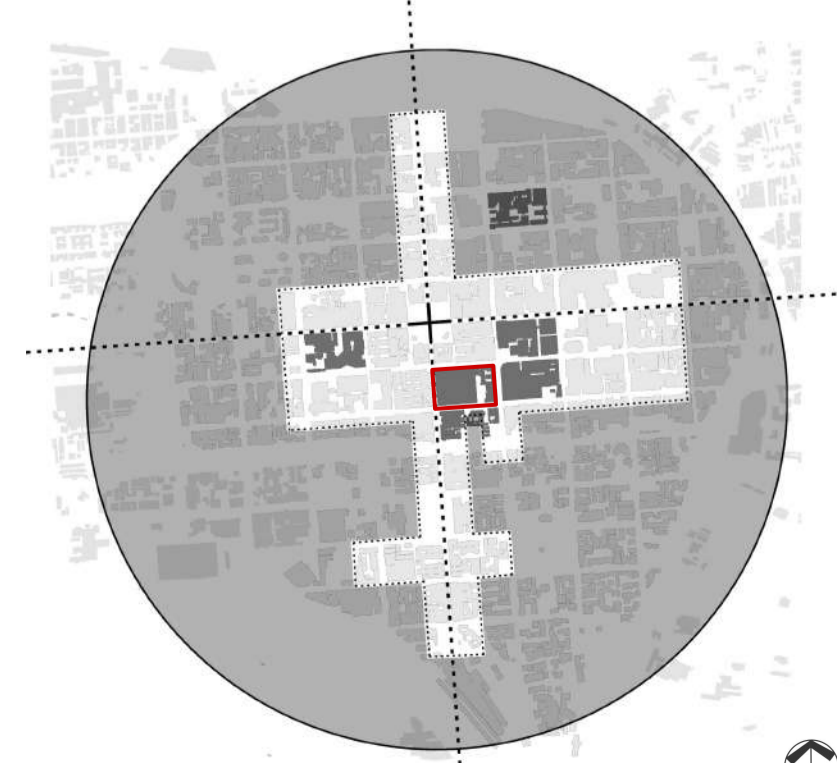

PARCADES



DISABILITY

# SITE ANALYSIS

## SITE PHOTOGRAPHS



# SITE ANALYSIS

## PROXIMITY PHOTOGRAPHS

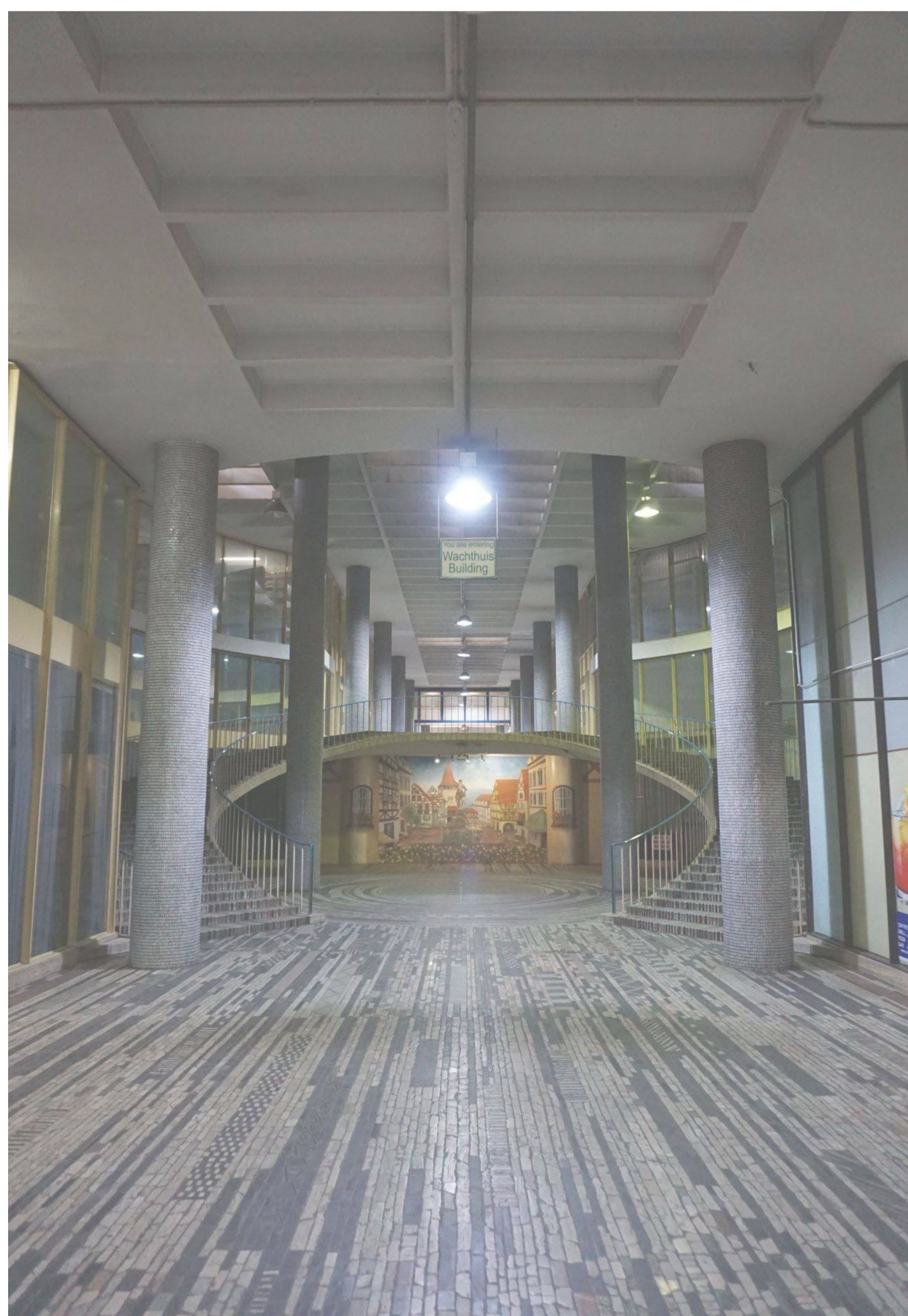



# SITE ANALYSIS

## SUN PATH

### SUMMER

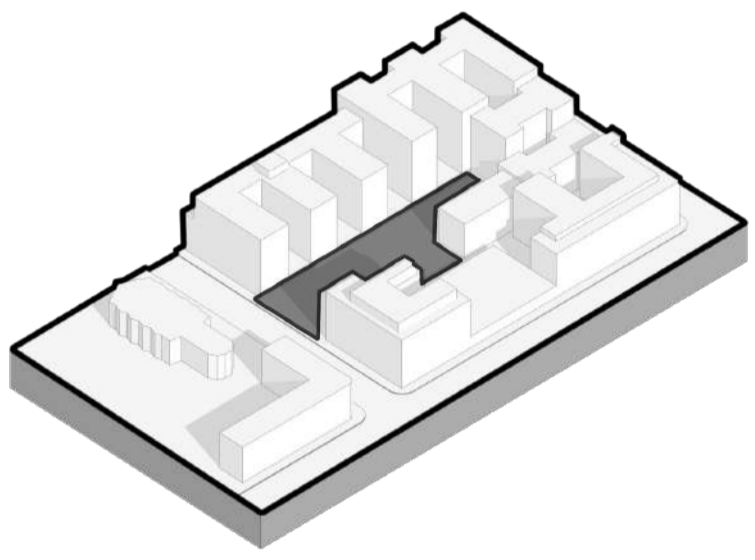
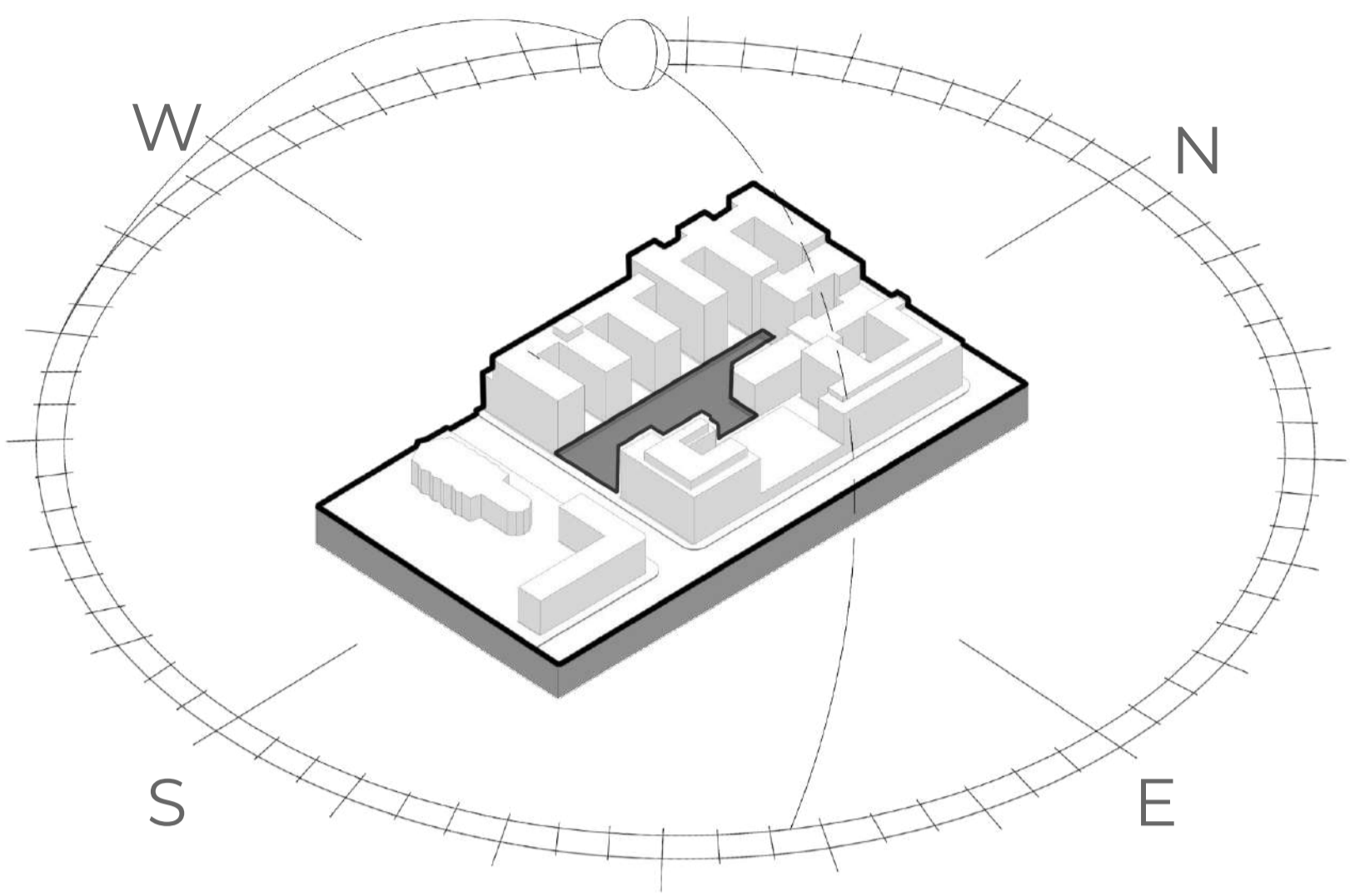

08:00

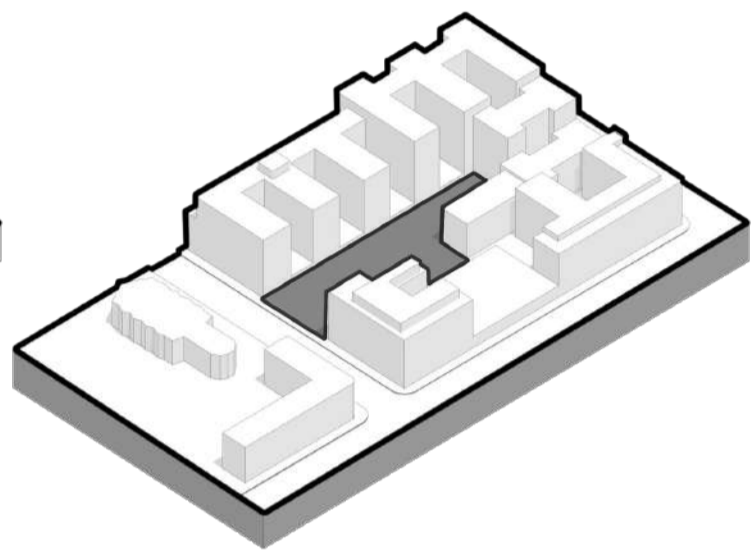

11:00

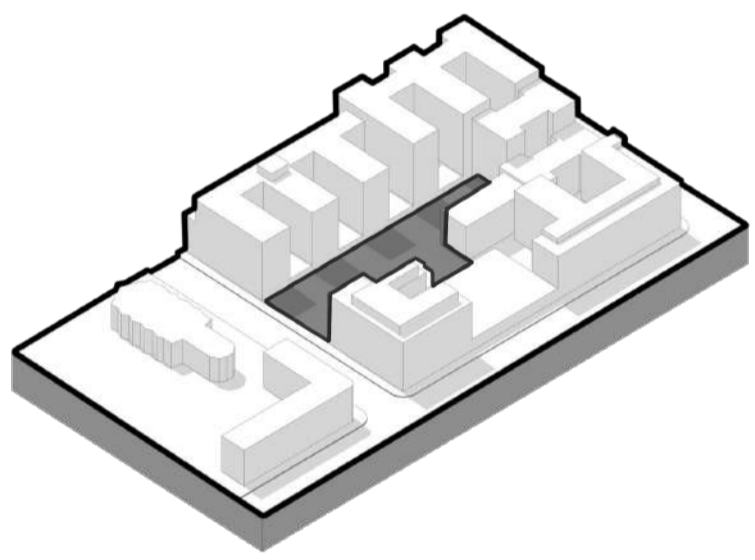

14:00

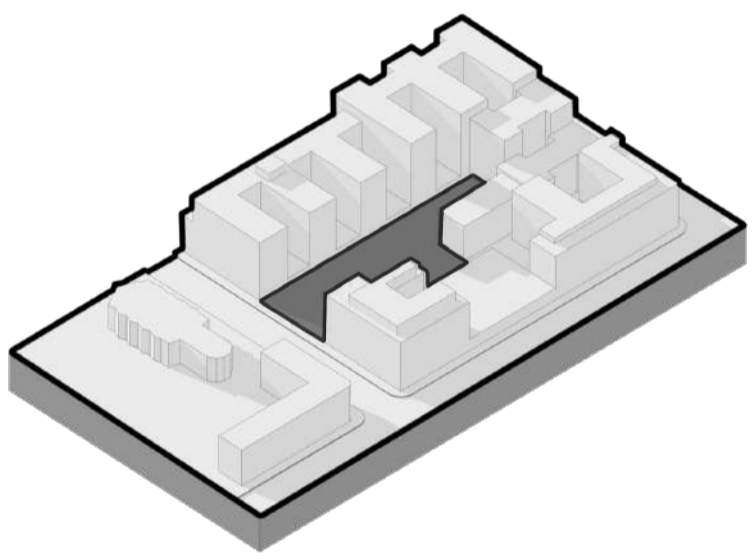

17:00

### WINTER

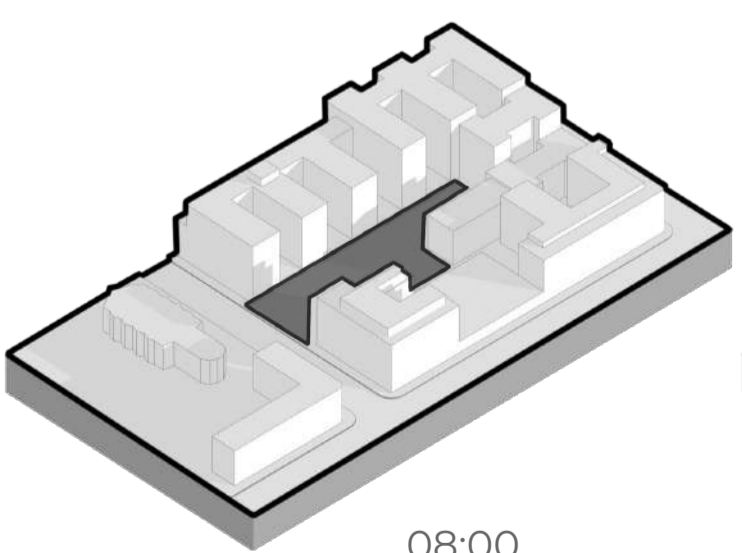
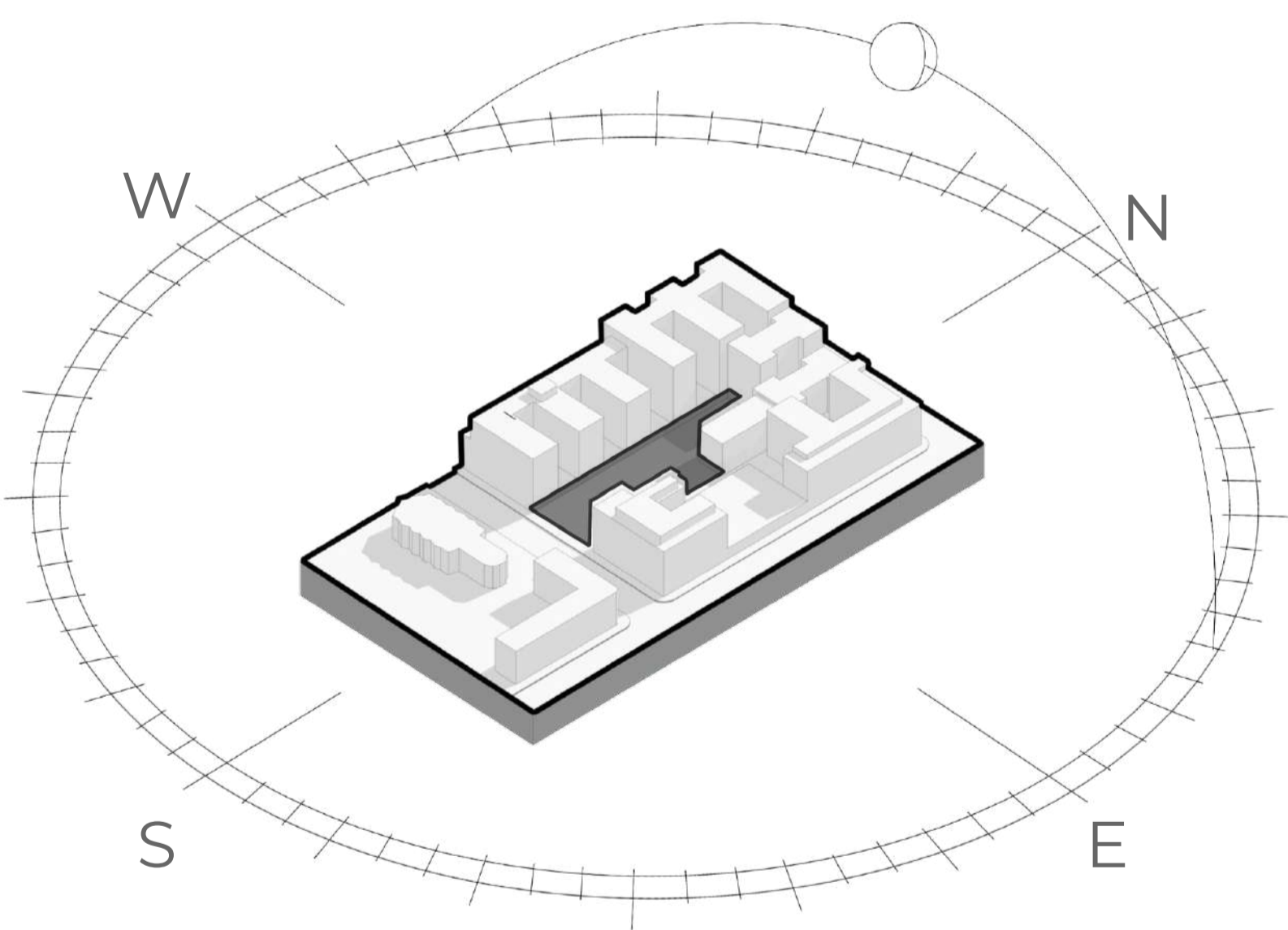

08:00

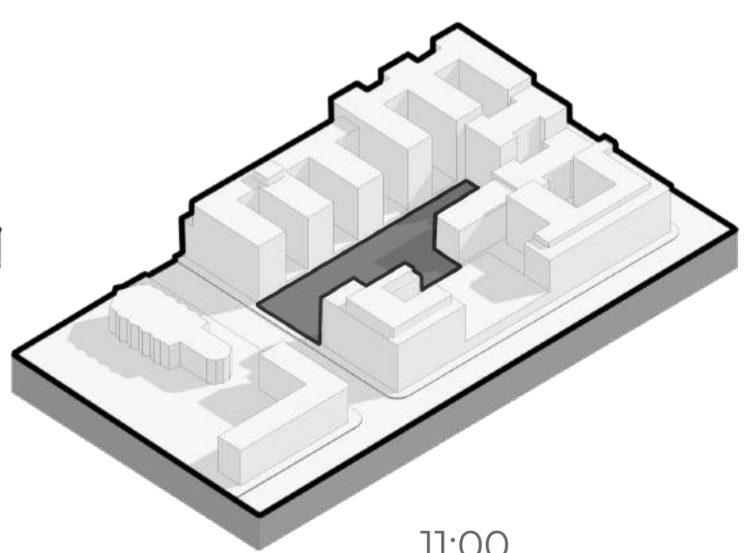

11:00

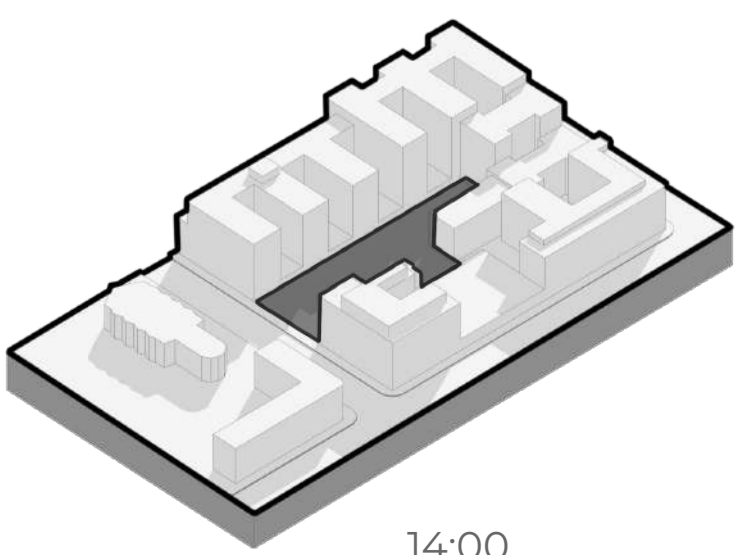

14:00

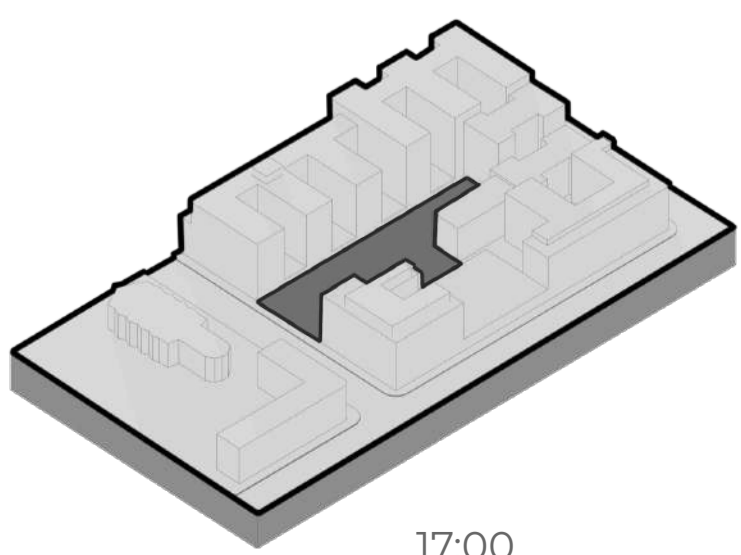

17:00

# SITE ANALYSIS

## EXISTING INFRASTRUCTURE

WACHTHUIS

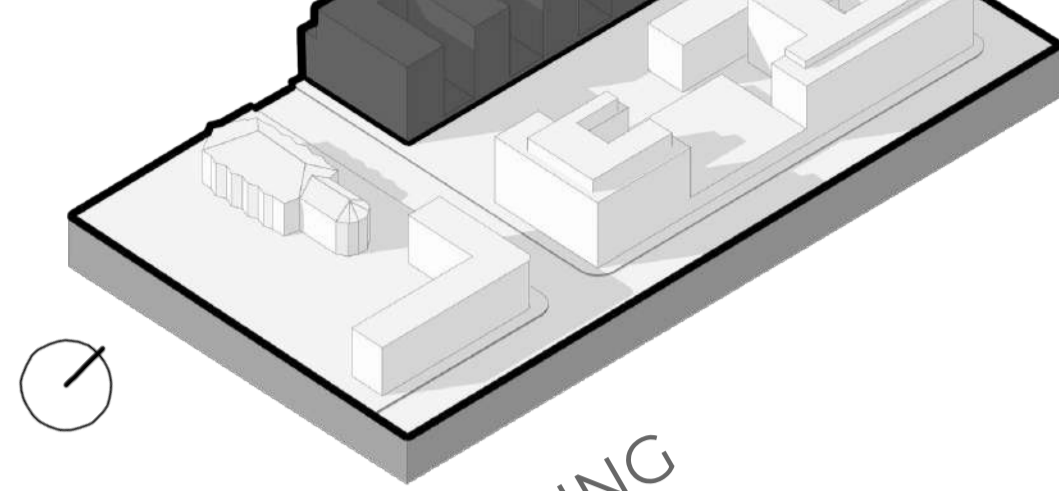

OFFICE

SOUTHERN LIFE BUILDING

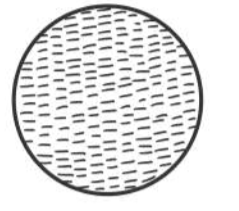
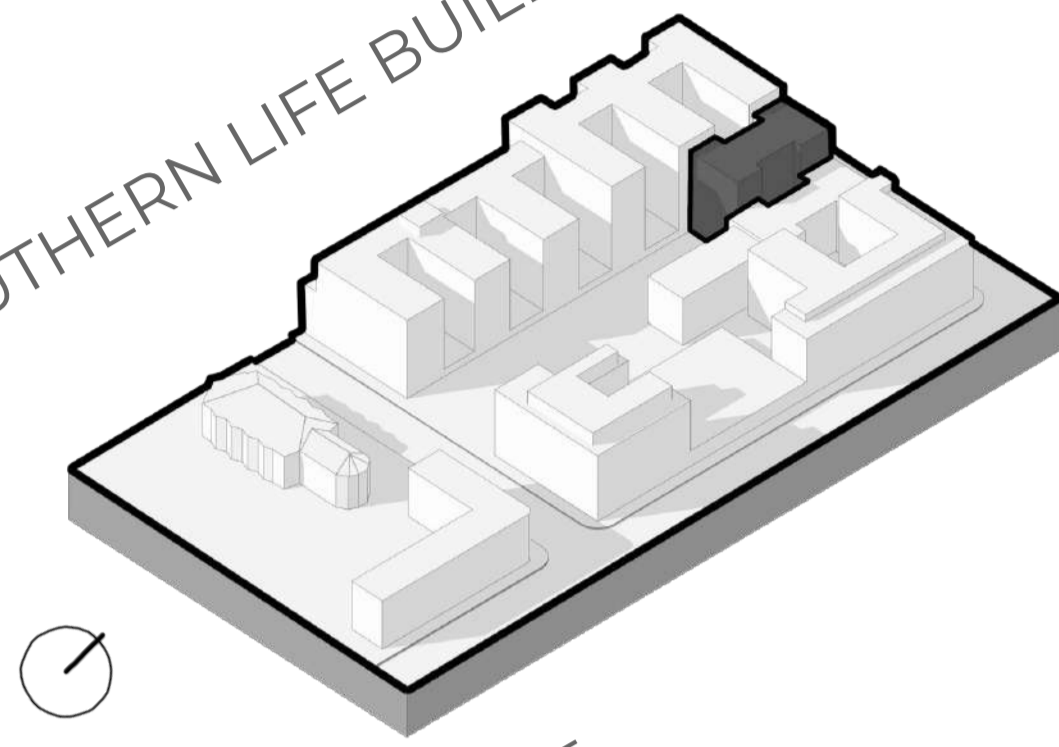

APARTMENTS

ROSEBANK COLLEGE

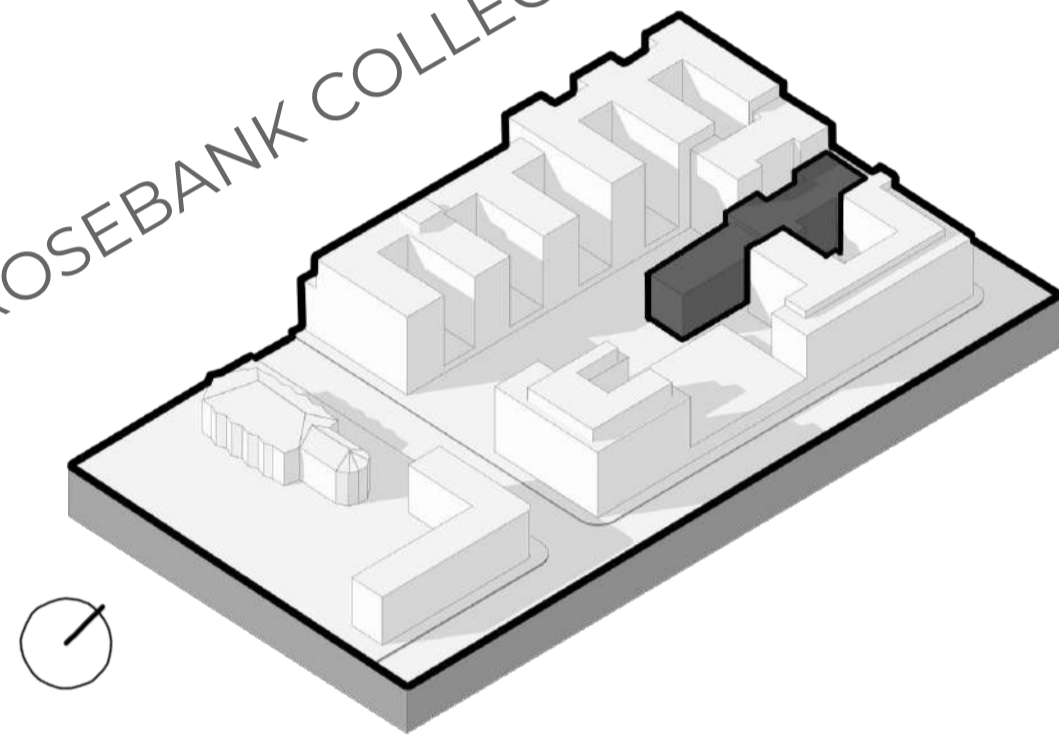

COLLEGE  
EDUCATION

RETAIL SHOPS

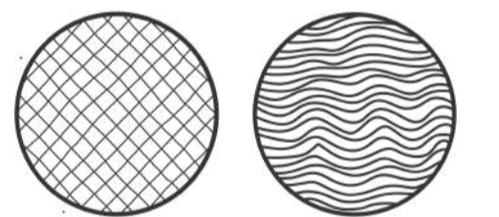

RETAIL & COLLEGE  
EDUCATION

CONSTANTIA BUILDING

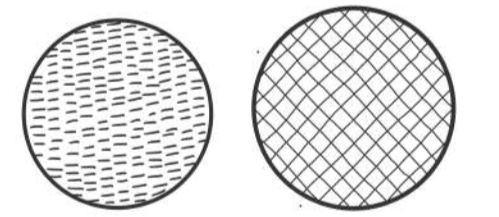
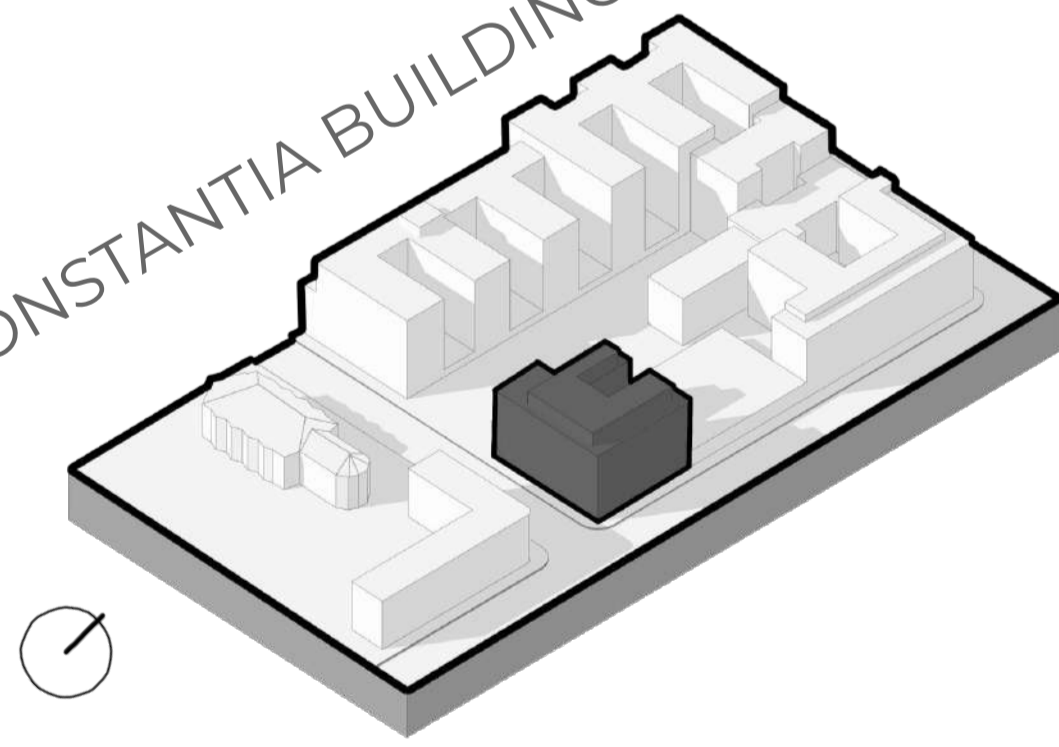

HOUSING & RETAIL

AMANDA COURT

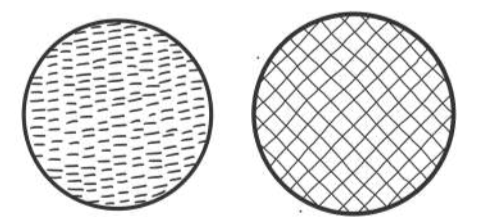
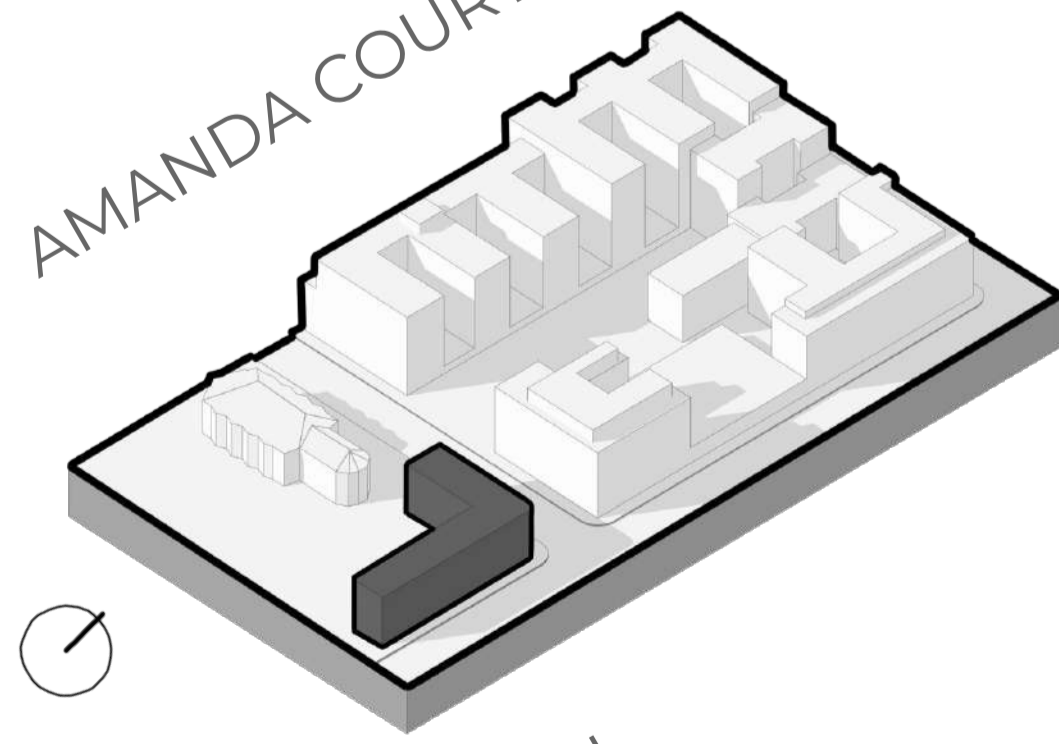

HOUSING & RETAIL

ST ALBANS CATHEDRAL

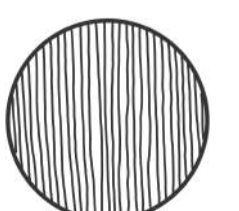
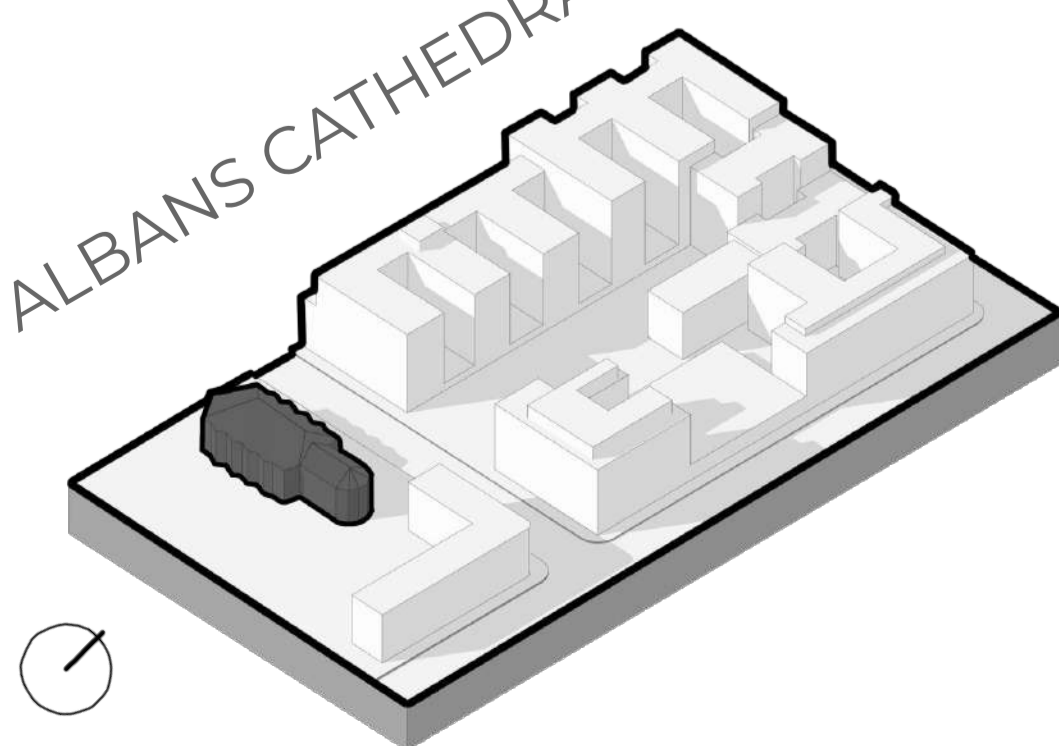

CHURCH

# SITE ANALYSIS

## ACTIVITY & FEATURES

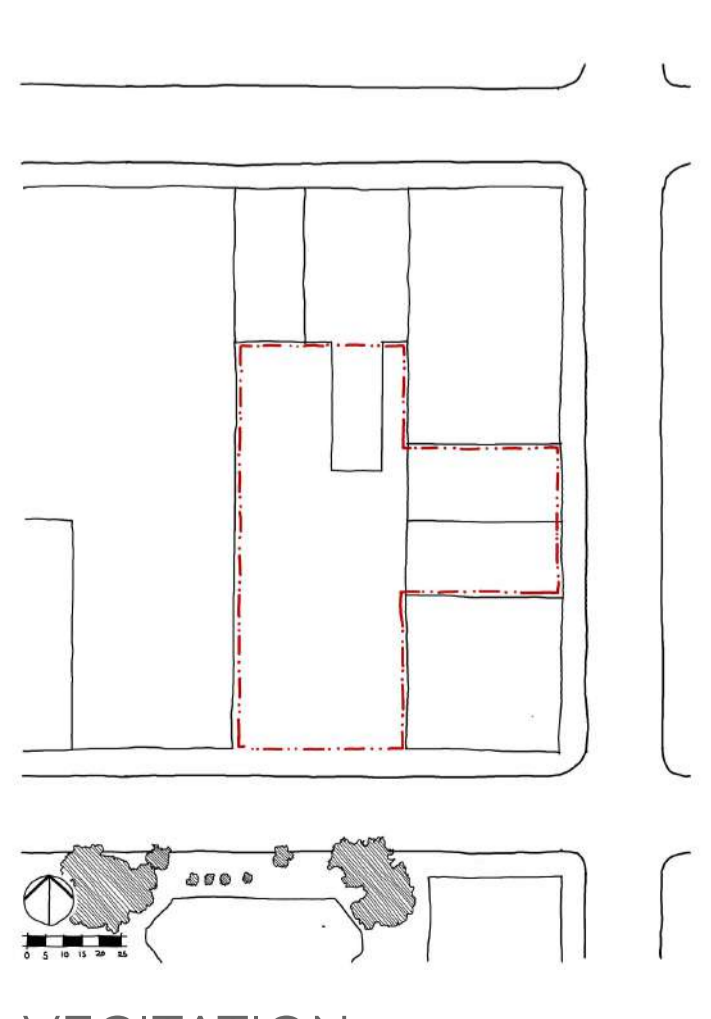
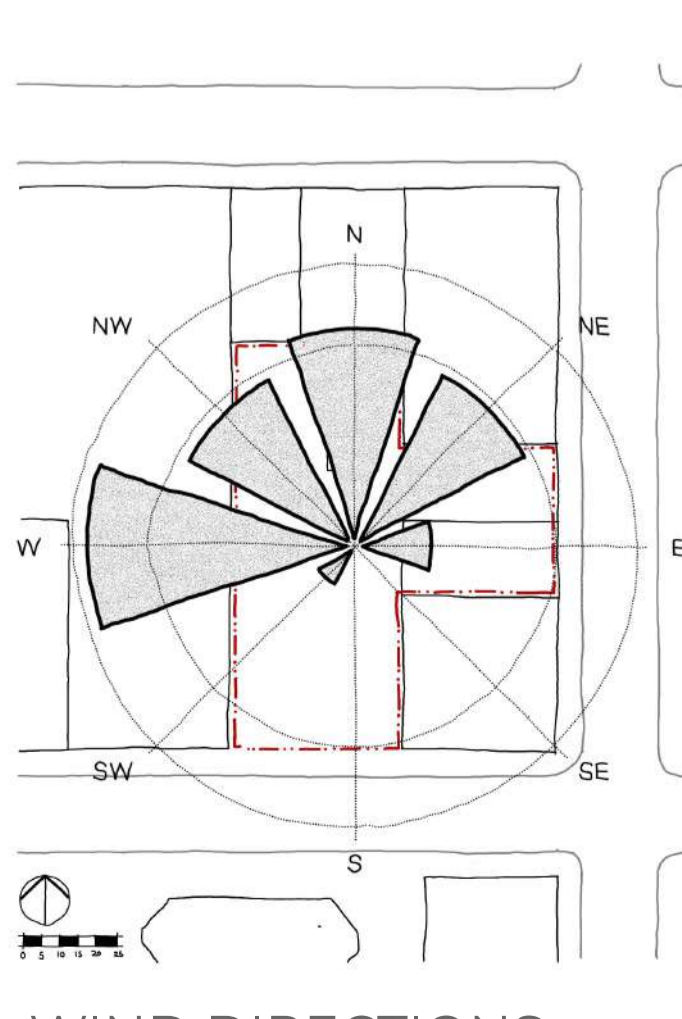
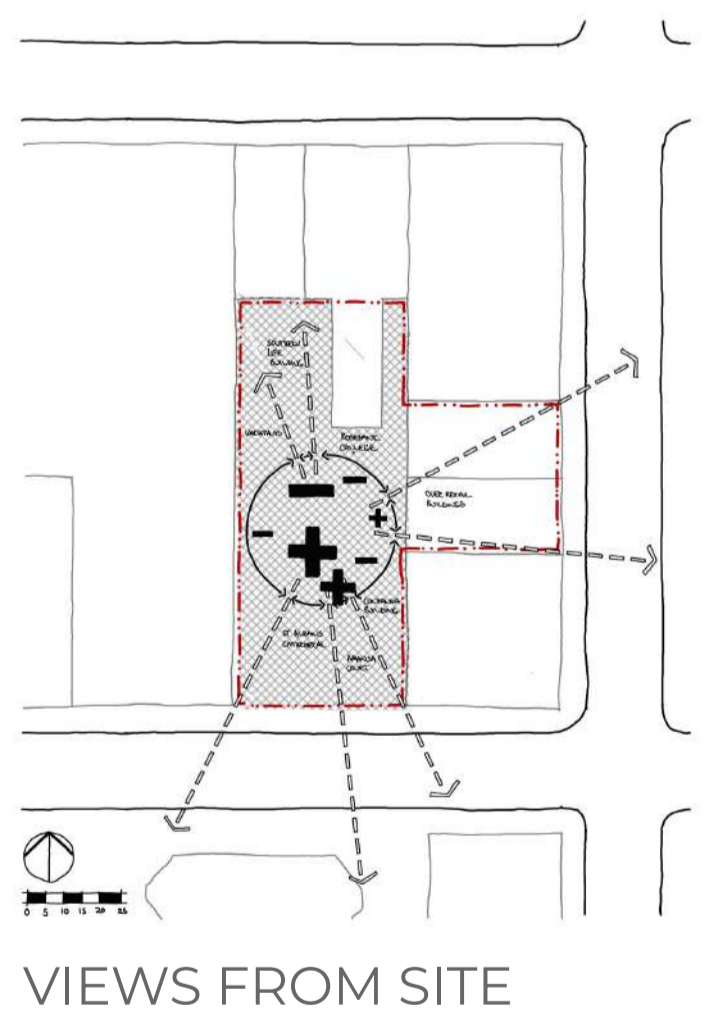
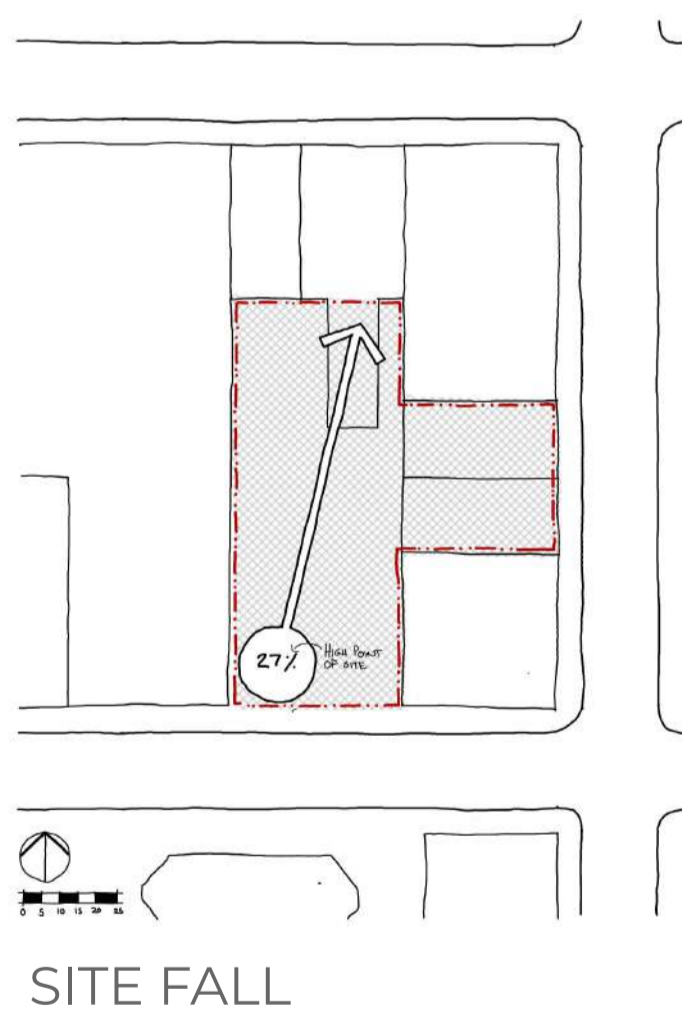
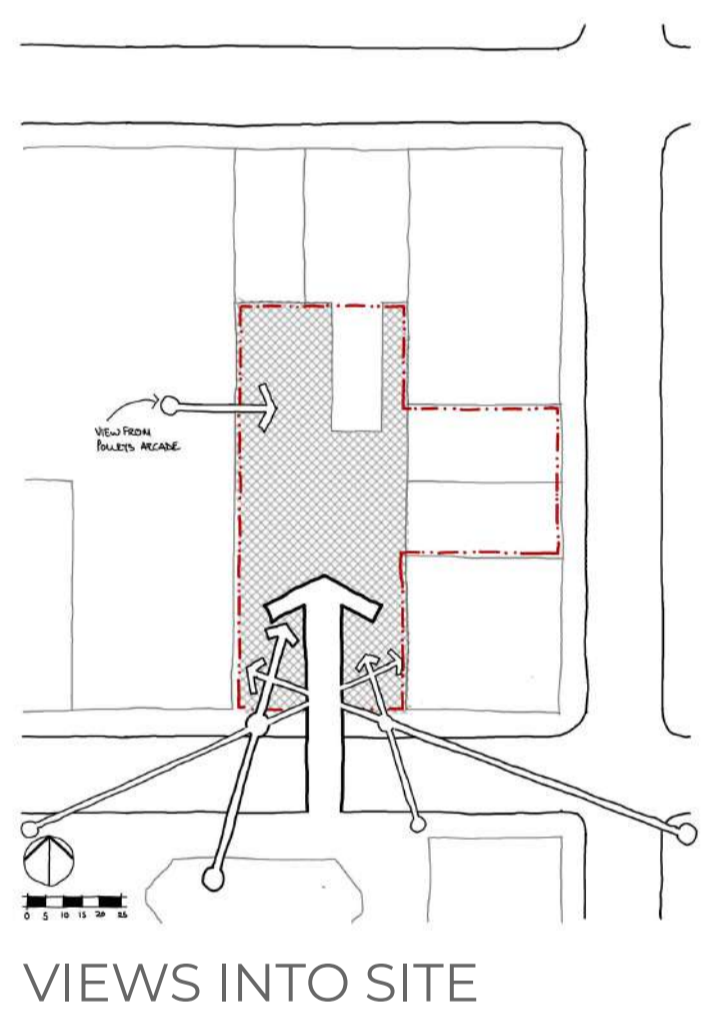
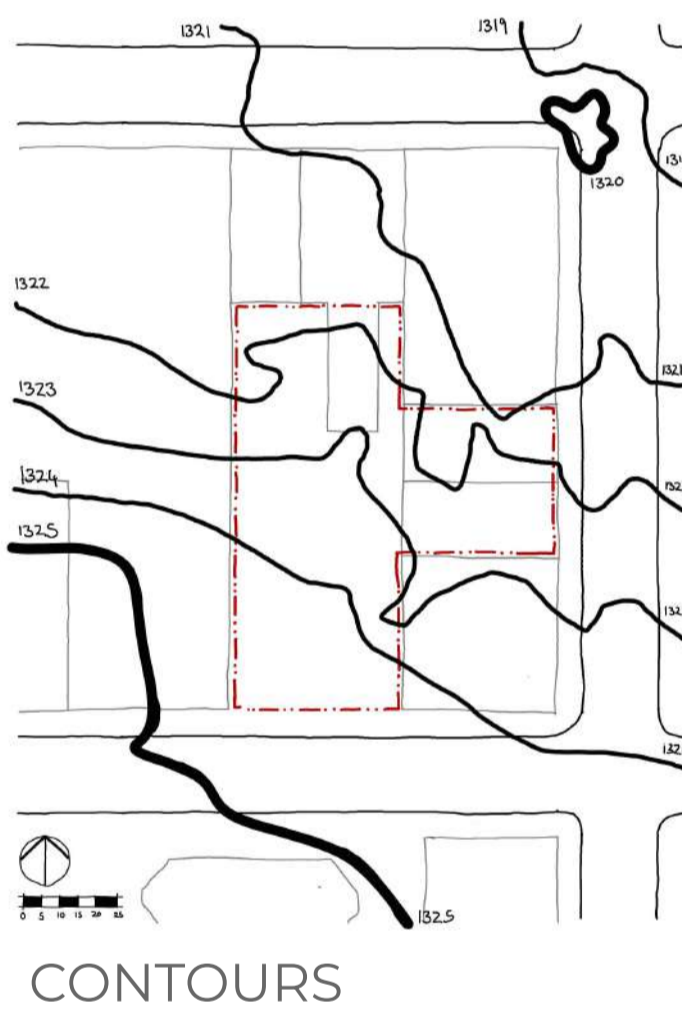
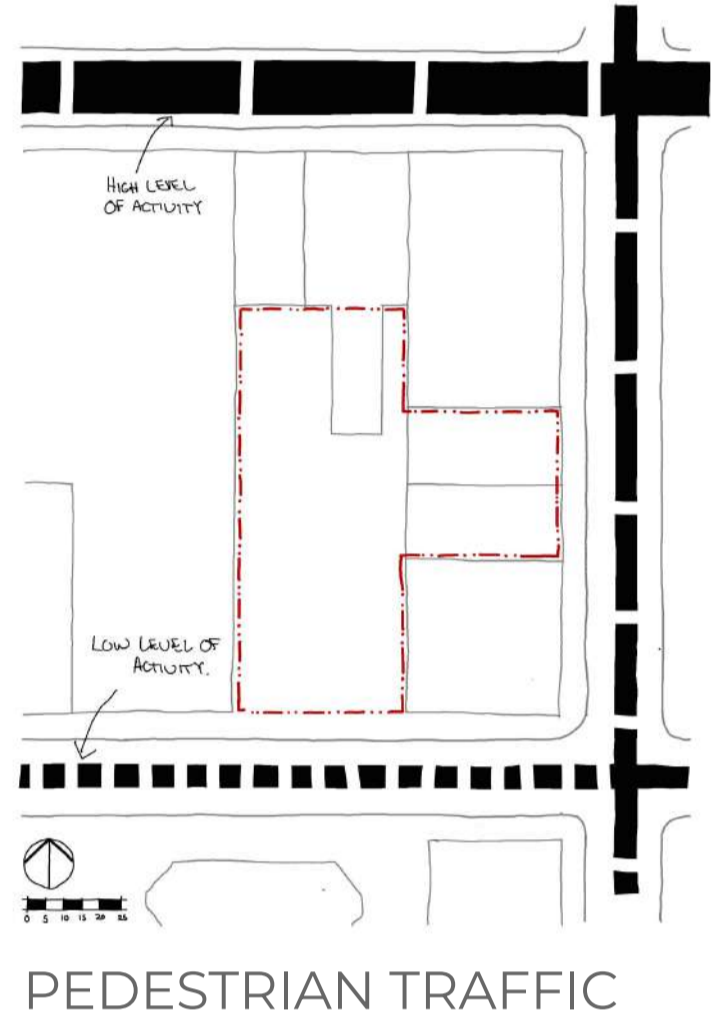
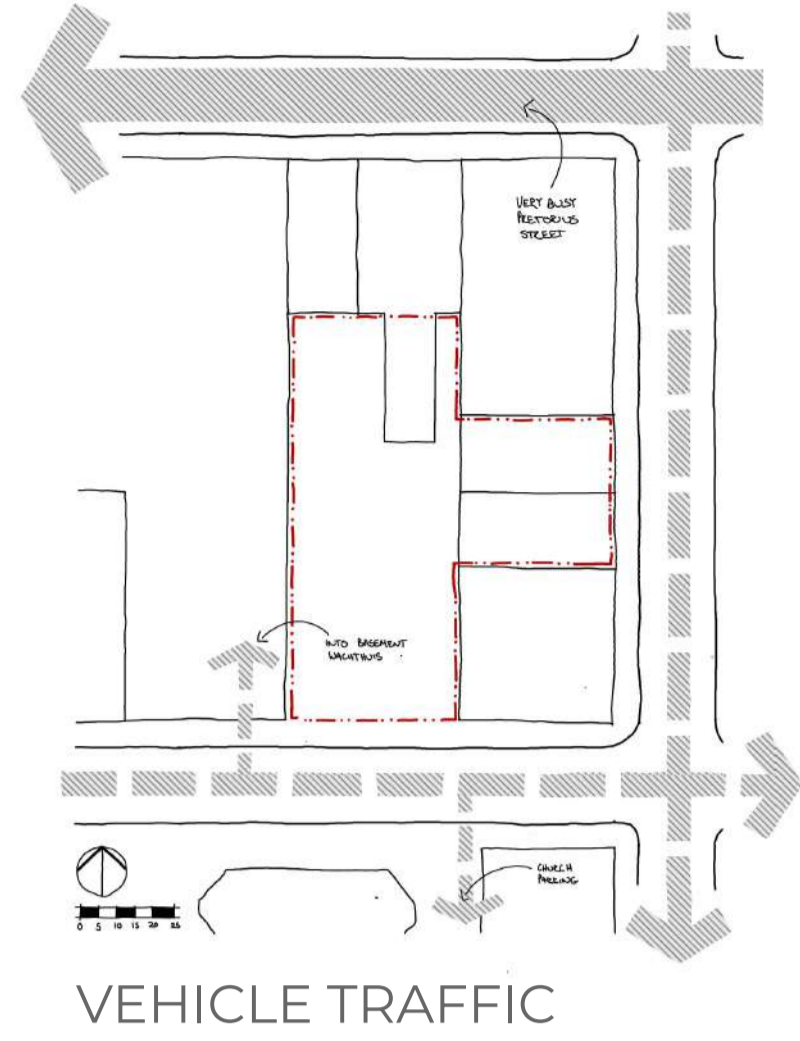
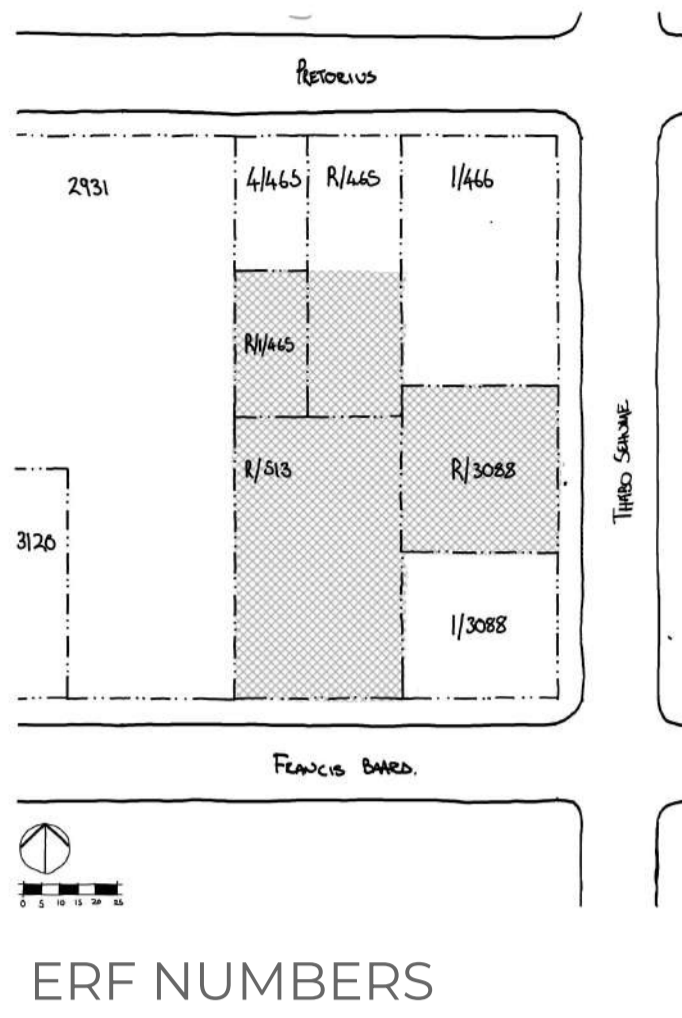

# SITE ANALYSIS

## ARCADES

### ARCADE SYSTEM

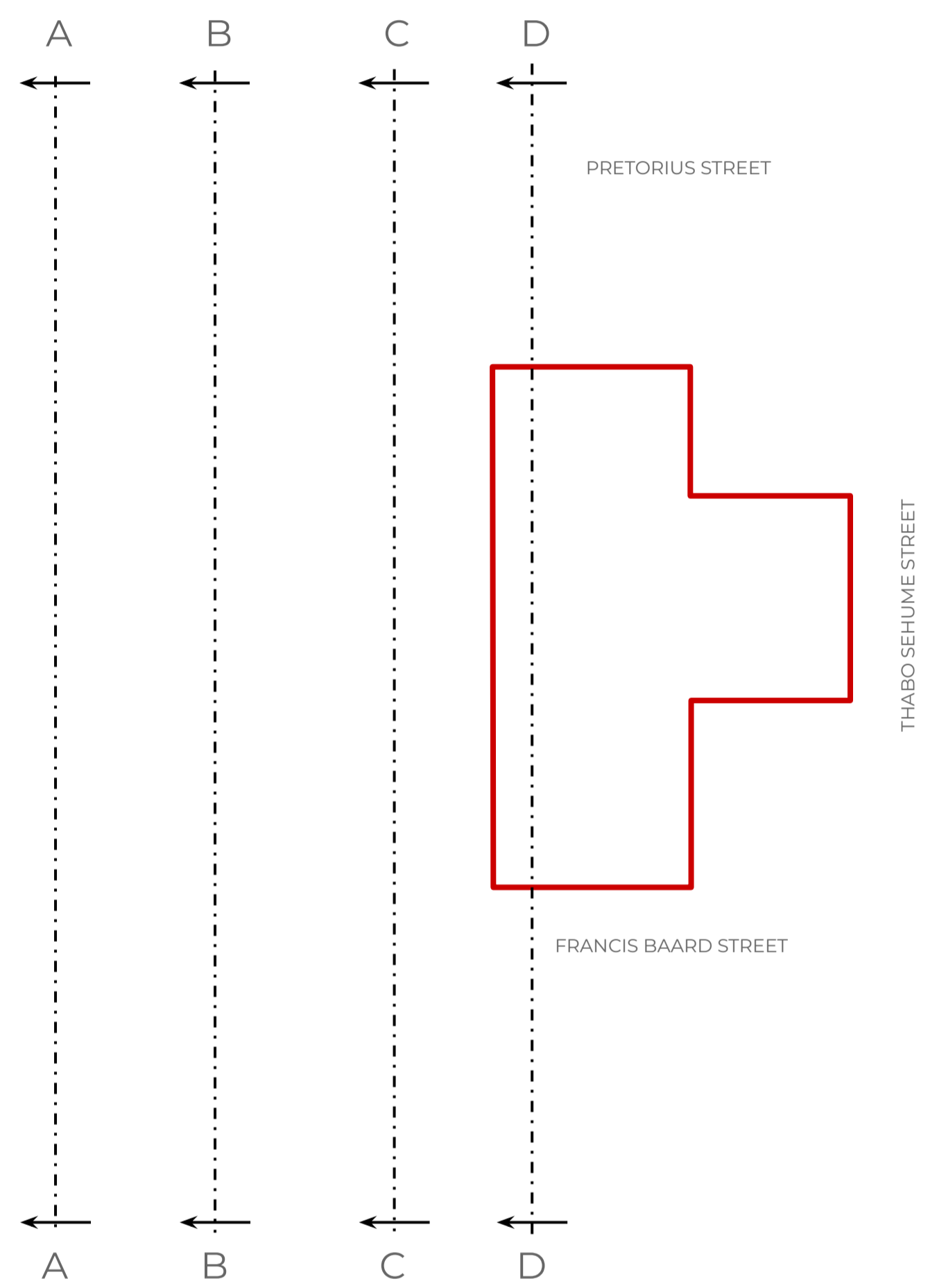
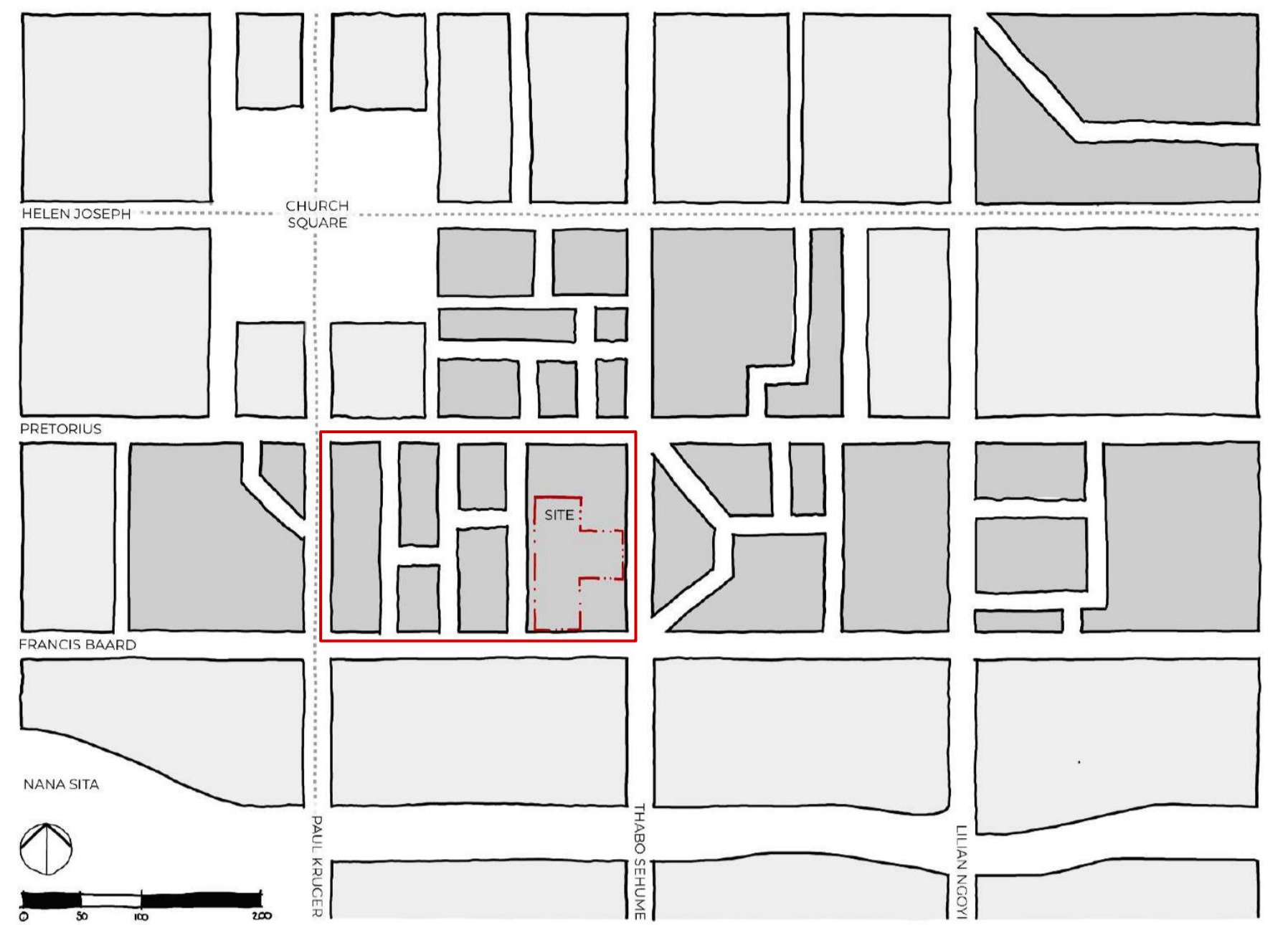

### CITY BLOCK ARCADES

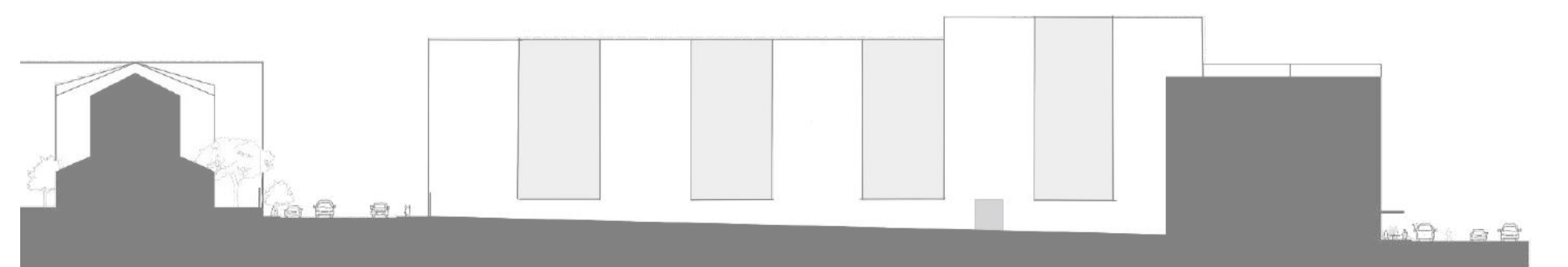
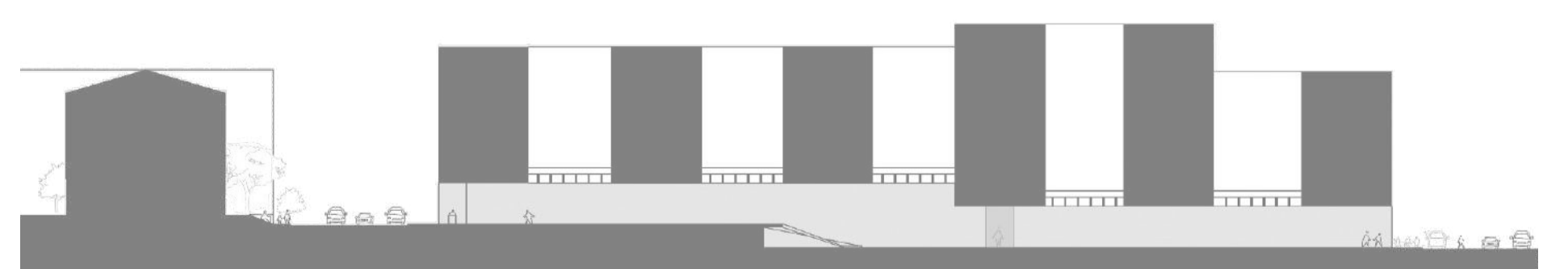
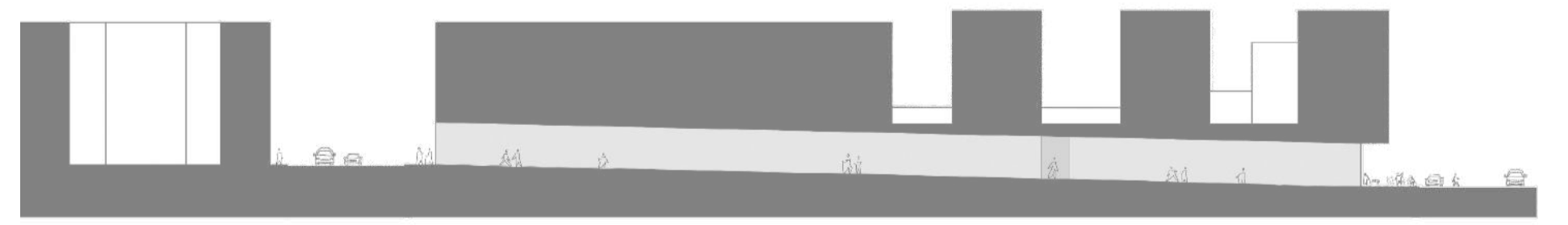
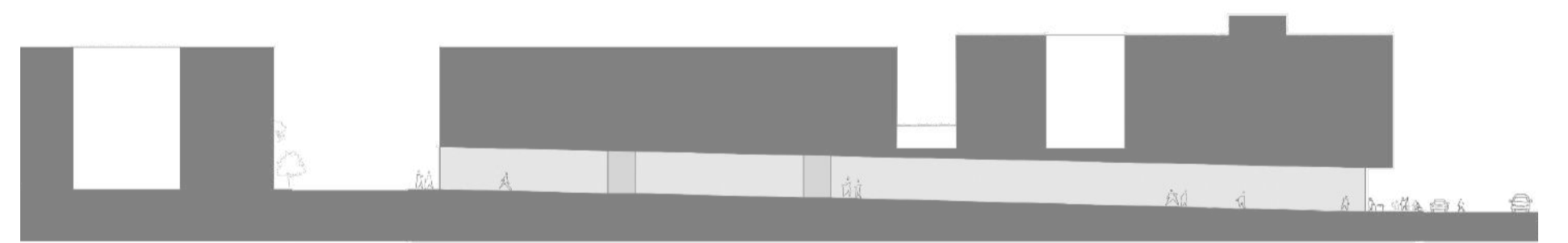

# MESO ANALYSIS

## ARCADE CURRENT CONDITION

ELEMENT

RANGE

ENTRANCE DEFINITION



INTERNAL LIGHT



ACTIVITY

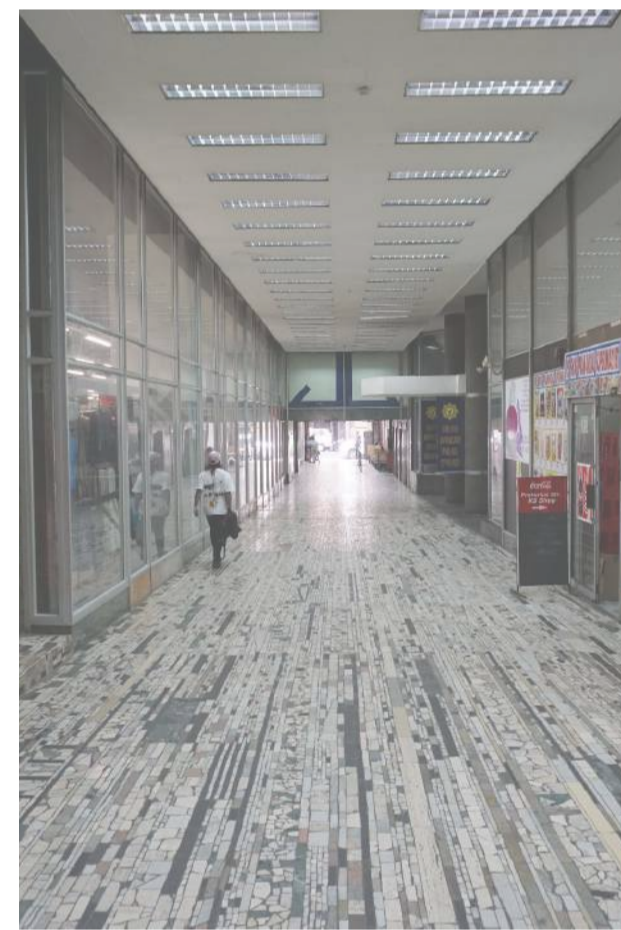

ACCESSIBILITY

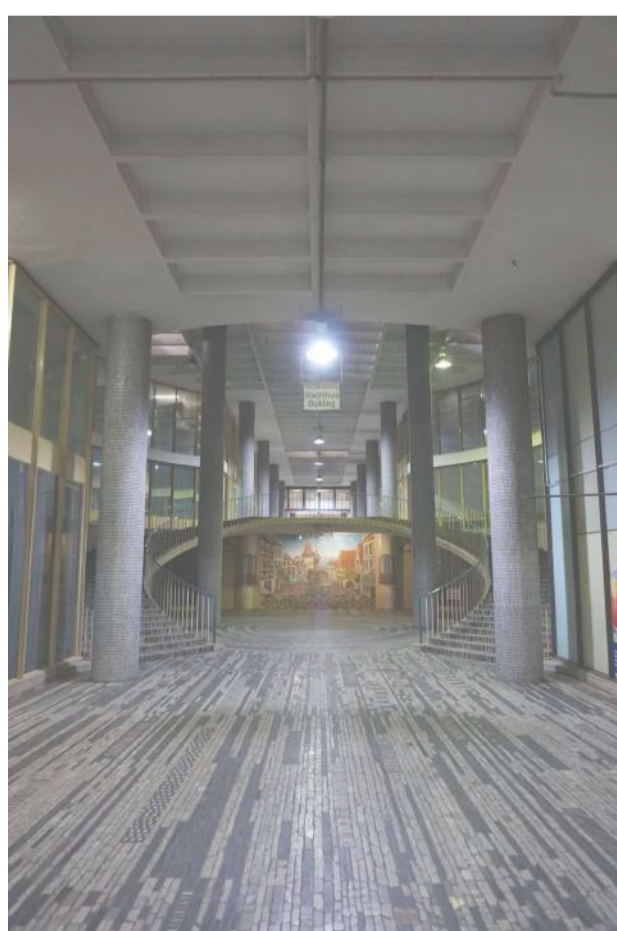

DEFINED SPACE

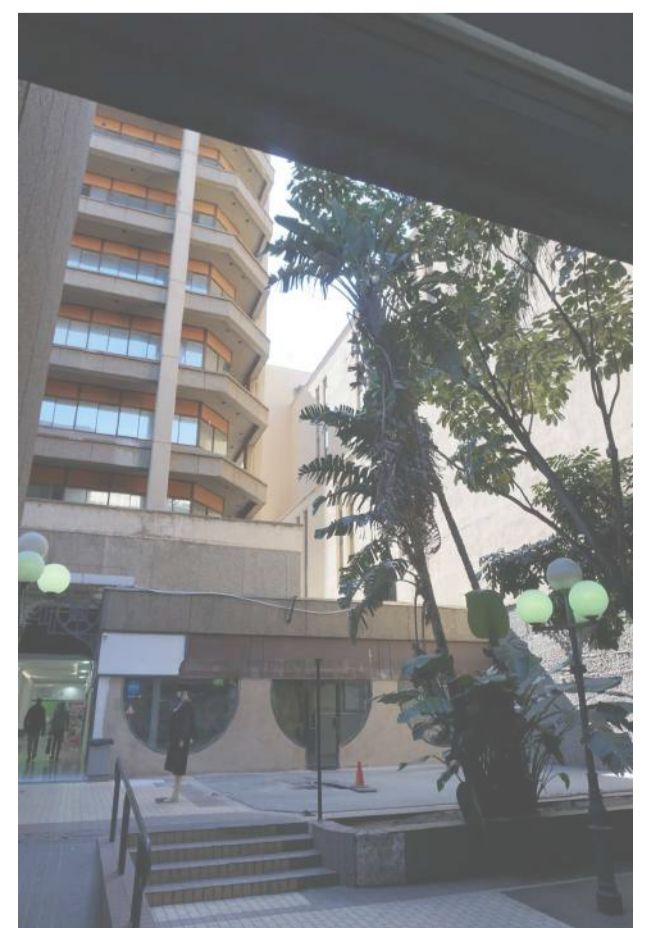

# MESO ANALYSIS

## ACTIVITY & WALKABILITY

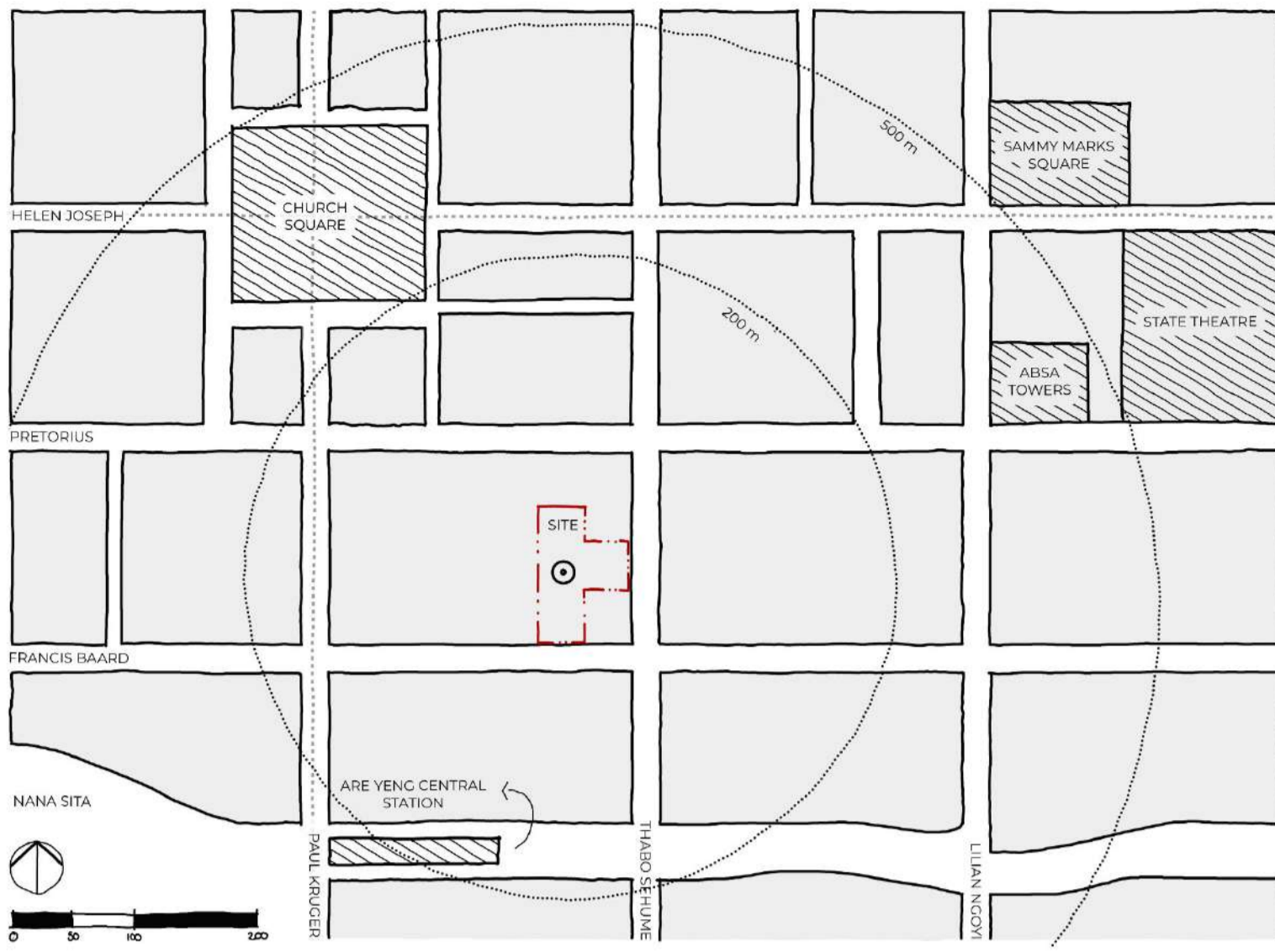

WALKING DISTANCE

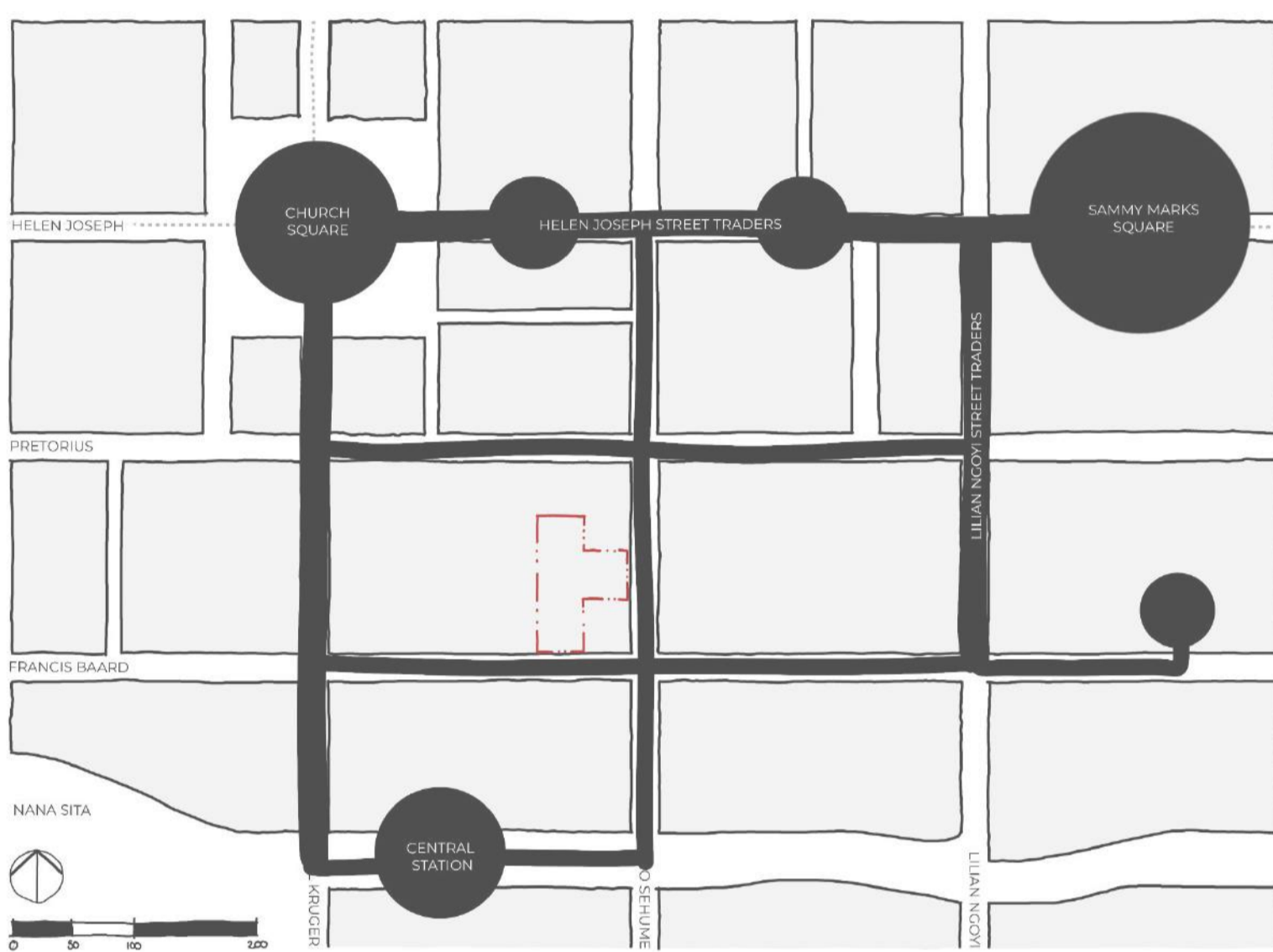

PEDESTRIAN MOVEMENT GENERATORS

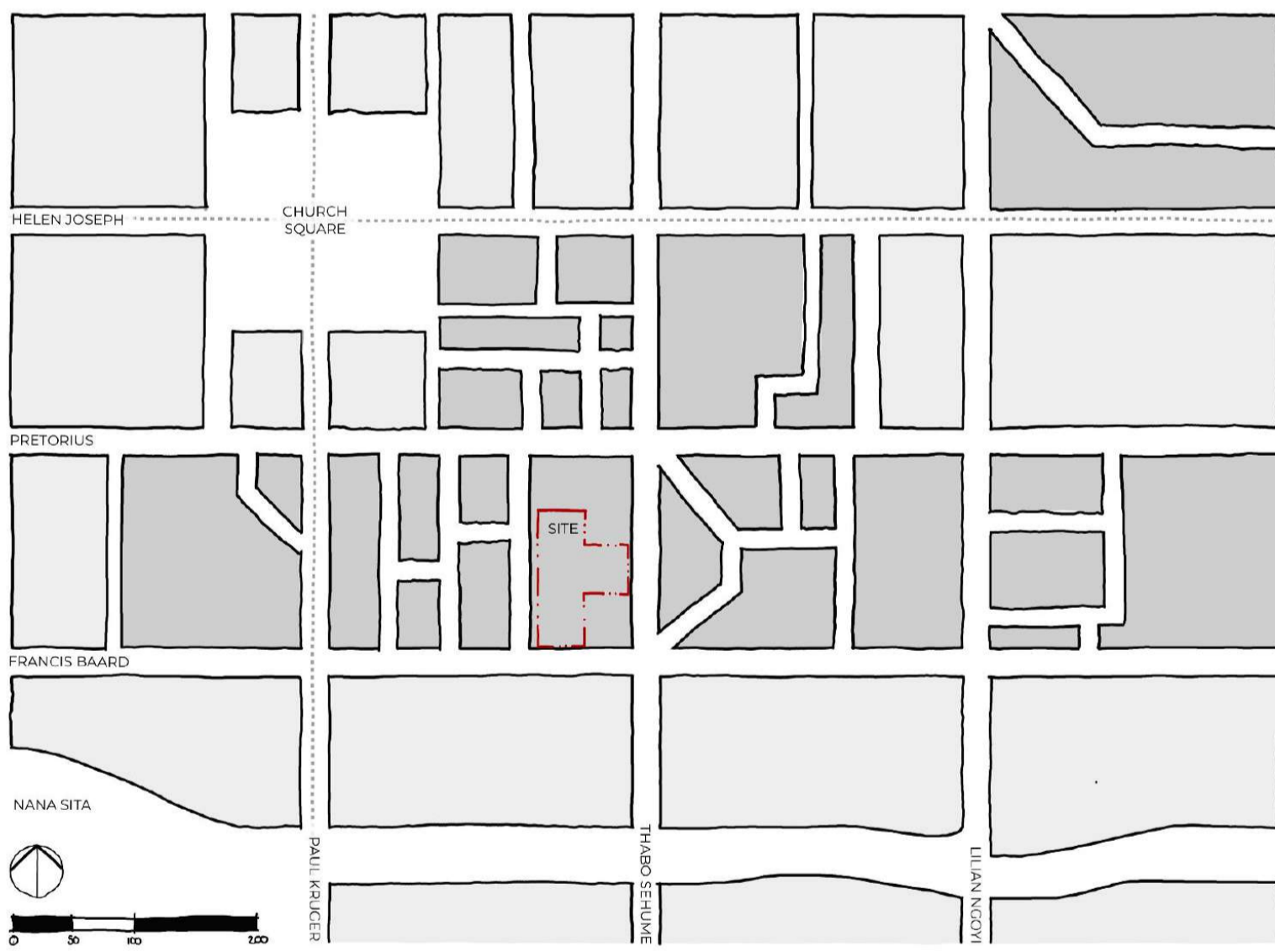

ARCADES

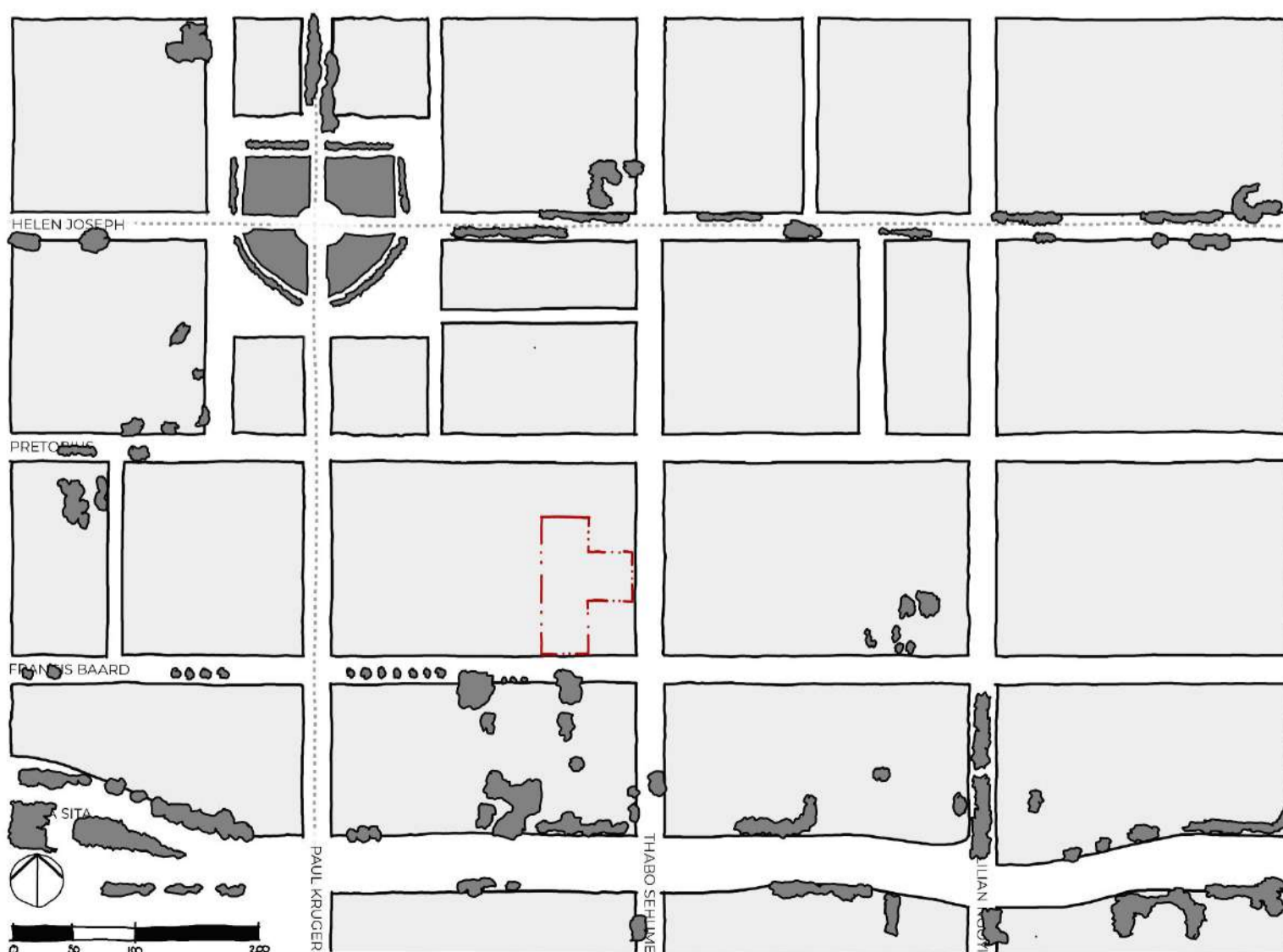

VEGETATION

# MESO ANALYSIS

## CRIME STATS PRETORIA CBD

### COMMON ROBBERY

Position	Station	Province	April to June 2017_18	April to June 2018_19	April to June 2019_20	April to June 2020_21	April to June 2021_22	Count Diff	% Change
1	JHB CENTRAL	GAUTENG	318	284	295	97	205	108	111,3%
2	DURBAN CENTRAL	KWAZULU/NATAL	110	149	205	66	196	130	197,0%
3	CAPE TOWN CENTRAL	WESTERN CAPE	266	220	276	40	158	118	295,0%
4	HILLBROW	GAUTENG	216	211	190	59	140	81	137,3%
5	PRETORIA CENTRAL	GAUTENG	223	228	212	52	123	71	136,5%
6	SUNNYSIDE	GAUTENG	139	179	160	43	110	67	155,8%
7	PARK ROAD	FREE STATE	161	151	142	41	109	68	165,9%
8	BROOKLYN	GAUTENG	51	62	120	37	109	72	194,6%
9	NYANGA	WESTERN CAPE	116	108	65	75	93	18	24,0%
10	PAROW	WESTERN CAPE	96	98	126	29	89	60	206,9%

### SHOPLIFTING

Position	Station	Province	April to June 2017_18	April to June 2018_19	April to June 2019_20	April to June 2020_21	April to June 2021_22	Count Diff	% Change
1	PARK ROAD	FREE STATE	940	1 207	1 058	504	824	320	63,5%
2	CAPE TOWN CENTRAL	WESTERN CAPE	1 901	1 507	1 372	351	805	454	129,3%
3	MIDRAND	GAUTENG	805	867	747	450	716	266	59,1%
4	HONEYDEW	GAUTENG	832	807	714	528	699	171	32,4%
5	DURBAN CENTRAL	KWAZULU/NATAL	1 092	1 012	824	318	662	344	108,2%
6	SANDTON	GAUTENG	1 008	904	838	392	619	227	57,9%
7	JHB CENTRAL	GAUTENG	1 035	998	928	384	606	222	57,8%
8	BROOKLYN	GAUTENG	763	733	713	292	595	303	103,8%
9	MITCHELLS PLAIN	WESTERN CAPE	774	872	874	297	575	278	93,6%
10	PHOENIX	KWAZULU/NATAL	539	538	618	401	561	160	39,9%
11	PINETOWN	KWAZULU/NATAL	591	633	638	385	561	176	45,7%
12	POLOKWANE	LIMPOPO	583	729	744	341	559	218	63,9%
13	RUSTENBURG	NORTH WEST	608	560	592	390	541	151	38,7%
14	PRETORIA CENTRAL	GAUTENG	771	890	795	326	535	209	64,1%
15	WITBANK	MPUMALANGA	719	669	579	326	516	190	58,3%

### VEHICLE THEFT

Position	Station	Province	April to June 2017_18	April to June 2018_19	April to June 2019_20	April to June 2020_21	April to June 2021_22	Count Diff	% Change
1	BROOKLYN	GAUTENG	193	128	206	54	220	166	307,4%
2	HONEYDEW	GAUTENG	156	149	178	93	145	52	55,9%
3	WIERDABRUG	GAUTENG	159	74	130	89	122	33	37,1%
4	SUNNYSIDE	GAUTENG	133	97	134	27	120	93	344,4%
5	ROODEPOORT	GAUTENG	128	106	81	107	106	-1	-0,9%
6	KRUGERSDORP	GAUTENG	122	114	132	66	102	36	54,5%
7	DURBAN CENTRAL	KWAZULU/NATAL	160	170	186	43	101	58	134,9%
8	FLORIDA	GAUTENG	117	90	104	61	100	39	63,9%
9	BOOYSENS	GAUTENG	103	108	97	48	100	52	108,3%
10	VILLIERIA	GAUTENG	94	75	70	41	99	58	141,5%
11	PRETORIA NORTH	GAUTENG	69	100	94	74	97	23	31,1%
12	BERA	KWAZULU/NATAL	158	166	177	43	95	52	120,9%
13	GARSFONTEIN	GAUTENG	109	76	67	36	93	57	158,3%
14	SINOVILLE	GAUTENG	89	72	142	42	89	47	111,9%
15	LYTTELTON	GAUTENG	143	102	120	69	87	18	26,1%
16	PRETORIA CENTRAL	GAUTENG	95	60	92	29	87	58	200,0%
17	JHB CENTRAL	GAUTENG	110	121	91	26	81	55	211,5%
18	BENONI	GAUTENG	68	94	77	49	78	29	59,2%
19	PRETORIA MOOT	GAUTENG	73	52	46	23	77	54	234,8%
20	SILVERTON	GAUTENG	60	39	68	36	76	40	111,1%

### THEFT OUT OF VEHICLES

Position	Station	Province	April to June 2017_18	April to June 2018_19	April to June 2019_20	April to June 2020_21	April to June 2021_22	Count Diff	% Change
1	CAPE TOWN CENTRAL	WESTERN CAPE	1 065	954	1 104	311	437	126	40,5%
2	SUNNYSIDE	GAUTENG	466	457	459	98	325	227	231,6%
3	DURBAN CENTRAL	KWAZULU/NATAL	433	348	428	92	247	155	168,5%
4	STELLENBOSCH	WESTERN CAPE	536	350	406	63	237	174	276,2%
5	BELLVILLE	WESTERN CAPE	275	320	266	120	230	110	91,7%
6	PRETORIA CENTRAL	GAUTENG	288	319	341	101	221	120	118,8%
7	HUMEWOOD	EASTERN CAPE	311	241	322	139	211	72	51,8%
8	BROOKLYN	GAUTENG	281	217	294	72	209	137	190,3%
9	NELSPRUIT	MPUMALANGA	322	309	270	111	195	84	75,7%
10	RUSTENBURG	NORTH WEST	180	180	172	136	188	52	38,2%

### PROPERTY RELATED THEFT

Position	Station	Province	April to June 2017_18	April to June 2018_19	April to June 2019_20	April to June 2020_21	April to June 2021_22	Count Diff	% Change
1	BROOKLYN	GAUTENG	772	540	738	258	617	359	139,1%
2	CAPE TOWN CENTRAL	WESTERN CAPE	1 358	1 205	1 321	484	589	105	21,7%
3	RUSTENBURG	NORTH WEST	691	683	638	380	551	171	45,0%
4	SUNNYSIDE	GAUTENG	710	619	689	182	534	352	193,4%
5	HONEYDEW	GAUTENG	885	732	899	285	528	243	85,3%
6	MIDDELBURG MPUMALANGA	MPUMALANGA	572	467	592	321	490	169	52,6%
7	DURBAN CENTRAL	KWAZULU/NATAL	776	664	769	255	487	232	91,0%
8	PINETOWN	KWAZULU/NATAL	658	588	579	380	486	106	27,9%
9	WIERDABRUG	GAUTENG	682	510	560	331	485	154	46,5%
10	STELLENBOSCH	WESTERN CAPE	1 010	636	715	230	484	254	110,4%
11	NELSPRUIT	MPUMALANGA	635	702	656	309	482	173	56,0%
12	UMBULO	KWAZULU/NATAL	504	631	499	376	471	95	25,3%
13	PARK ROAD	FREE STATE	747	877	848	366	469	103	28,1%
14	BELLVILLE	WESTERN CAPE	562	617	567	256	469	213	83,2%
15	POTCHEFSTROOM	NORTH WEST	628	544	535	236	411	175	74,2%
16	WITBANK	MPUMALANGA	844	908	753	398	408	10	2,5%
17	PHOENIX	KWAZULU/NATAL	413	382	499	292	403	111	38,0%
18	BENONI	GAUTENG	401	481	459	225	395	170	75,6%
19	KEMPTON PARK	GAUTENG	606	621	532	199	389	190	95,5%
20	LYTTELTON	GAUTENG	683	581	666	266	382	116	43,6%
21	GARSFONTEIN	GAUTENG	516	415	396	145	376	231	159,3%
22	ROODEPOORT	GAUTENG	546	459	464	319	369	50	15,7%
23	POLOKWANE	LIMPOPO	458	416	480	271	366	95	35,1%
24	MIDRAND	GAUTENG	682	489	547	204	366	162	79,4%
25	MOUNT ROAD	EASTERN CAPE	555	456	364	247	359	112	45,3%
26	PRETORIA CENTRAL	GAUTENG	483	434	509	169	358	189	111,8%
27	CAMBRIDGE	EASTERN CAPE	481	381	383	245	354	109	44,5%
28	KRAAIFONTEIN	WESTERN CAPE	579	516	436	360	351	-9	-2,5%
29	HUMEWOOD	EASTERN CAPE	528	445	539	302	349	47	15,6%
30	VANDERBIJLPARK	GAUTENG	601	527	474	308	336	28	9,1%

### NON-RESIDENTIAL RELATED THEFT

Position	Station	Province	April to June 2017_18	April to June 2018_19	April to June 2019_20	April to June 2020_21	April to June 2021_22	Count Diff
1	DURBAN CENTRAL	KWAZULU/NATAL	66	64	57	15	60	45
2	JHB CENTRAL	GAUTENG	55	50	54	27	48	21
3	KEMPTON PARK	GAUTENG	39	23	33	19	36	17
4	BUSHBUCKRIDGE	MPUMALANGA	13	24	21	15	36	21
5	PINETOWN	KWAZULU/NATAL	35	20	41	30	34	4
6	ALBERTON	GAUTENG	20	25	22	8	34	26
7	TONGA	MPUMALANGA	10	17	7	3	33	30
8	WITBANK	MPUMALANGA	37	37	60	26	32	6
9	IVORY PARK	GAUTENG	31	23	18	20	31	11
10	INANDA	KWAZULU/NATAL	18	4	13	19	31	12
11	TEMBA	GAUTENG	25	32	36	20	30	10
12	RUSTENBURG	NORTH WEST	15	27	30	18	30	12
13	UMBULO	KWAZULU/NATAL	29	17	21	9	30	21
14	KWADUKUZA	KWAZULU/NATAL	20	9	19	6	30	24
15	PRETORIA CENTRAL	GAUTENG	13	28	12	12	28	16
16	PIETERMARITZBURG	KWAZULU/NATAL	9	9	5	4	28	24
17	PLESSISLAER	KWAZULU/NATAL	20	26	20	38	27	-11
18	JEPPE	GAUTENG	34	14	22	17	27	10
19	MOFFATVIEW	GAUTENG	19	32	13	16	26	10
20	BOKSBURG NORTH	GAUTENG	23	23	34	12	26	14

### OTHER THEFT

Position	Station	Province	April to June 2017_18	April to June 2018_19	April to June 2019_20	April to June 2020_21	April to June 2021_22	Count Diff	% Change
1	CAPE TOWN CENTRAL	WESTERN CAPE	1 369	1 063	937	182	523	341	187,4%
2	MITCHELLS PLAIN	WESTERN CAPE	545	661	679	229	448	219	95,6%
3	PRETORIA CENTRAL	GAUTENG	618	696	633	241	414	173	71,8%
4	PARK ROAD	FREE STATE	507	505	529	213	382	169	79,3%
5	HONEYDEW	GAUTENG	554	506	427	291	372	81	27,8%

# INSTITUTIONAL RESPONSE

## PROGRAMME SELECTION

PRIVATE

PUBLIC

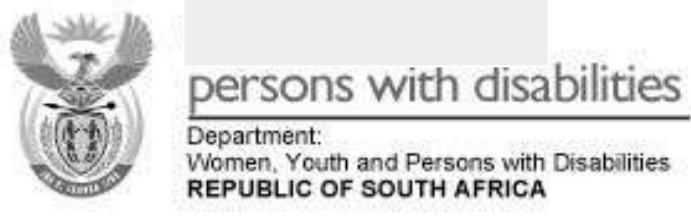

### POLICY

### DISABILITY AWARENESS

### TRAINING

### HEALTHCARE & DISABILITY SUPPORT

### EMPLOYMENT



- POLICY MAKING & IMPLEMENTATION



- AWARENESS SEMINARS

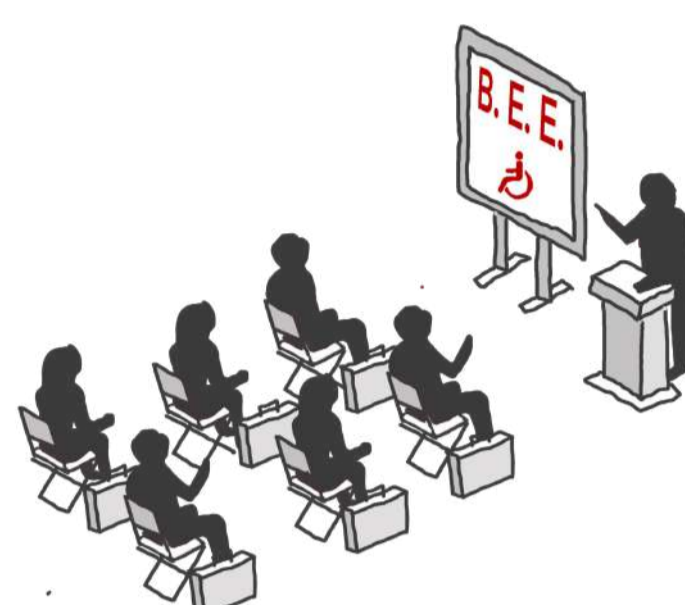

- DISABILITY EQUITY TRAINING

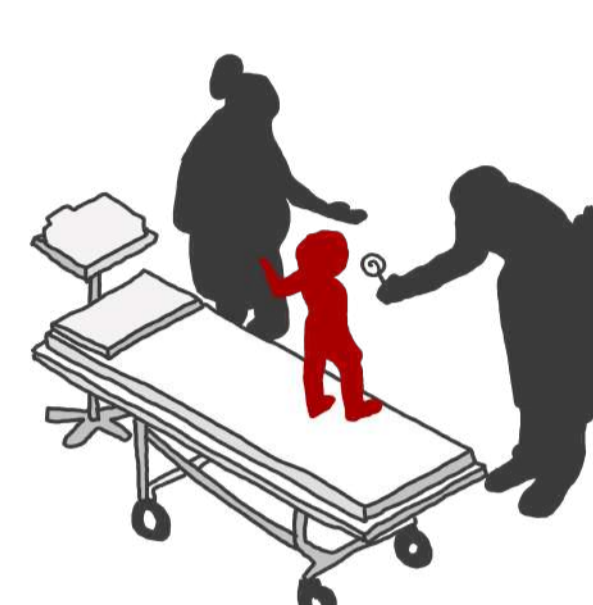

- EARLY CHILDHOOD DETECTION & TRAINING

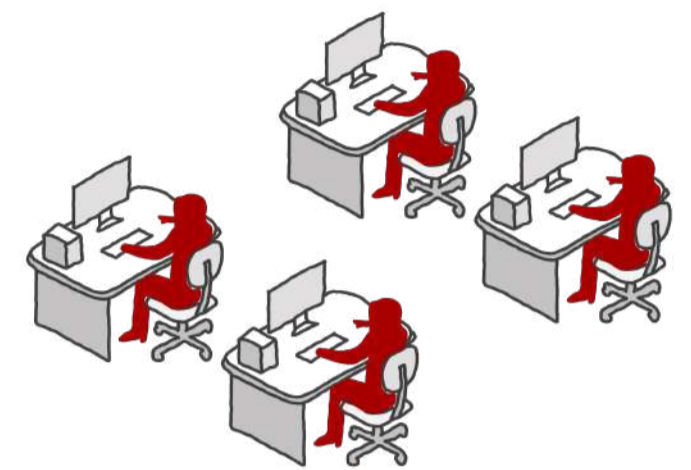

- COMPUTER WORK (GIS)



- GOVERNMENTAL CONFERENCES

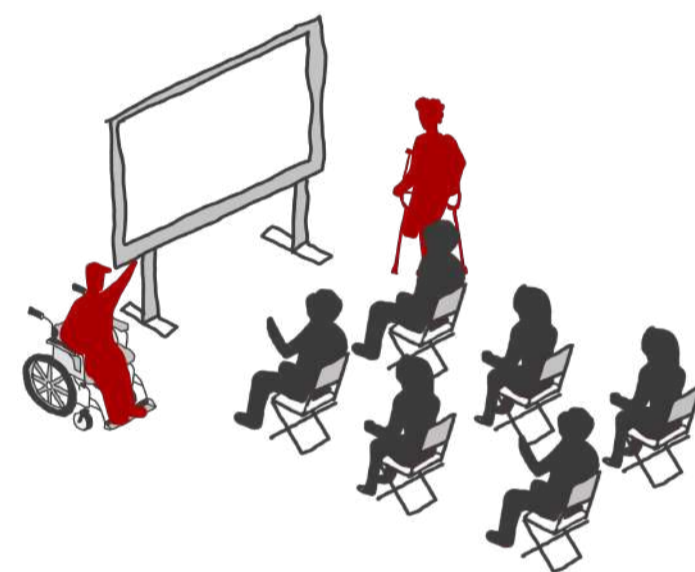

- EXHIBITIONS

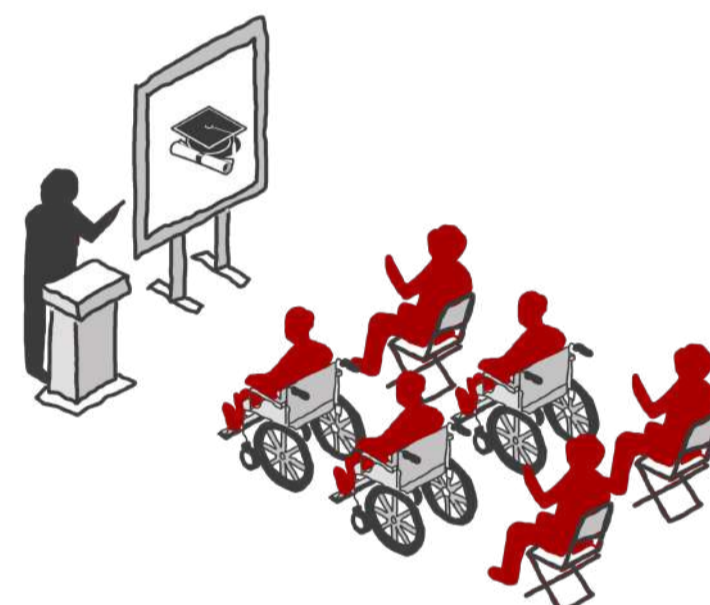

- SKILLS TRAINING

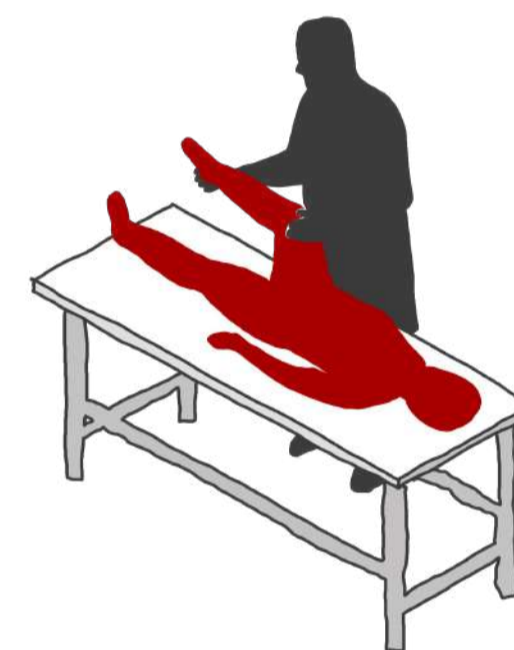

- IN HOUSE OCCUPATIONAL THERAPIST

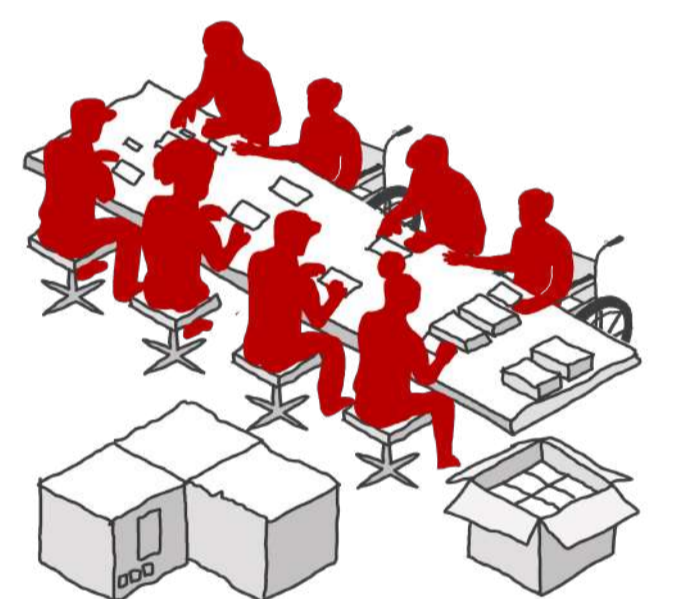

- INDUSTRIAL ASSEMBLY

### HOUSING



- SIGN LANGUAGE EDUCATION

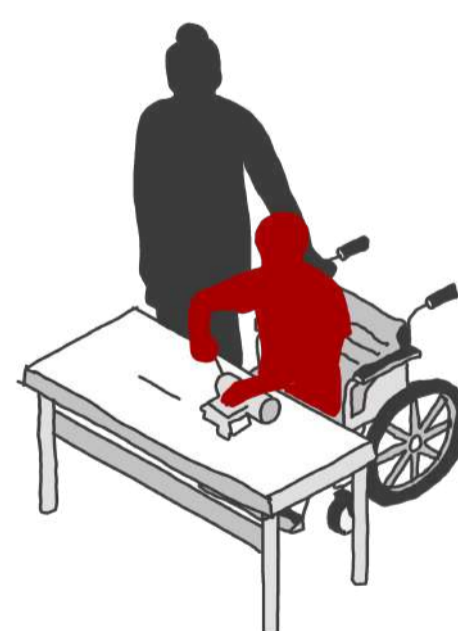

- SKILLS TRAINING

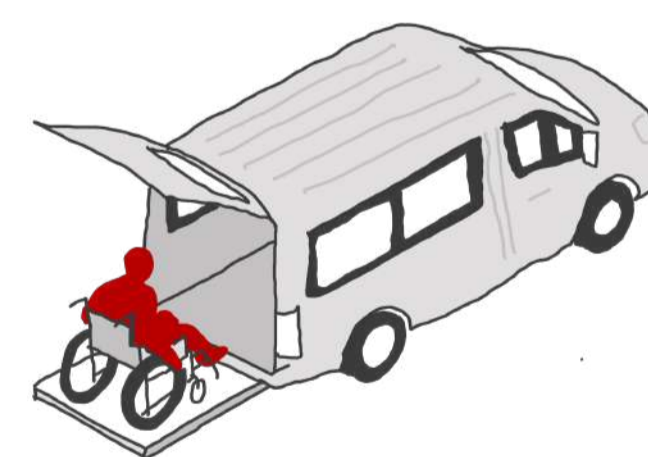

- TRANSPORT SUPPORT

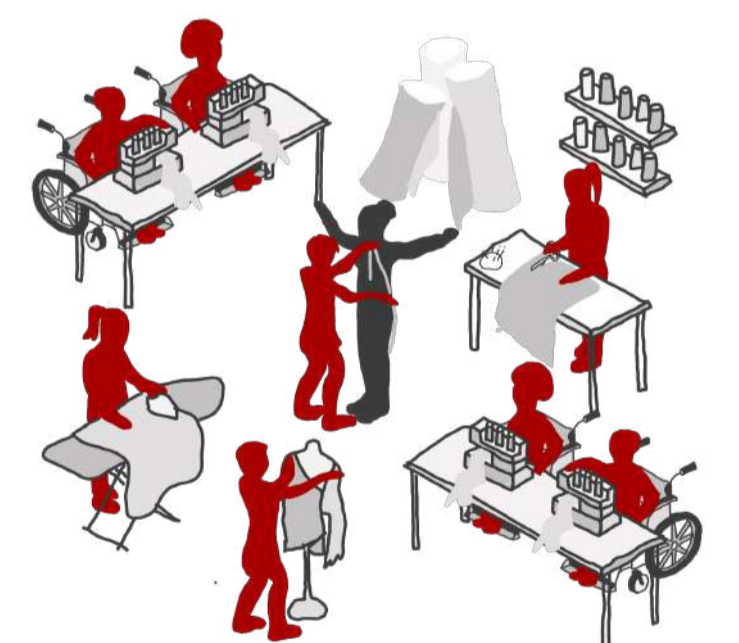

- MATERIAL AND CRAFT



- GOVERNMENT SUBSIDISED HOUSING



- COMMUNITY OUTREACH

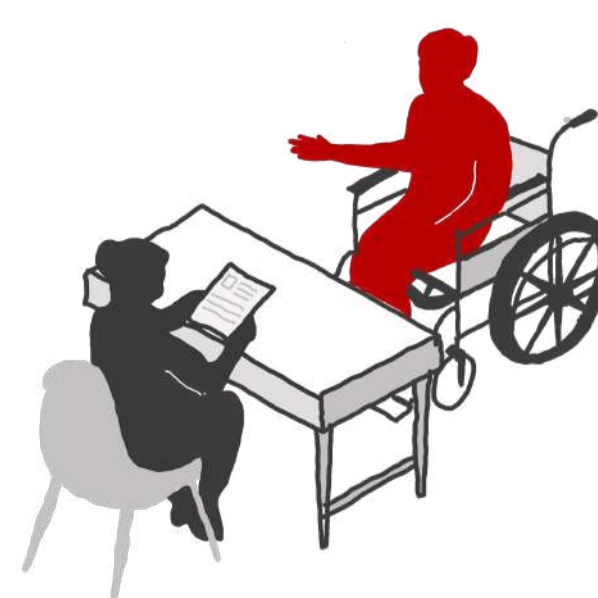

- DISABILITY EMPLOYMENT SUPPORT

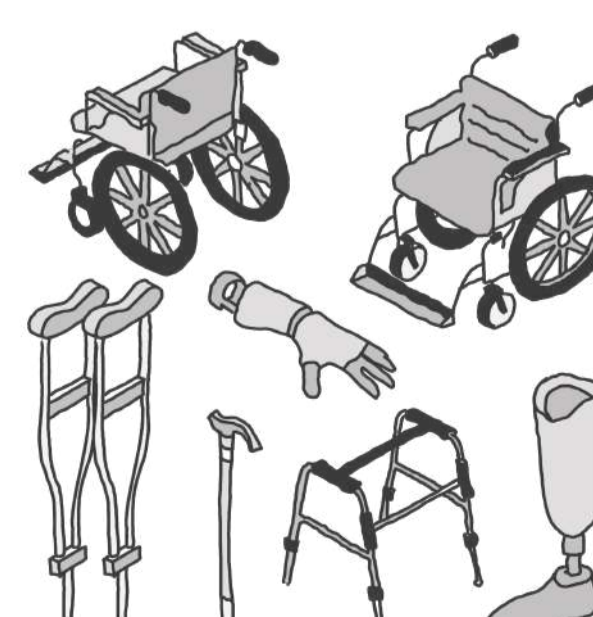

- ASSISTIVE DEVICES REPAIRS

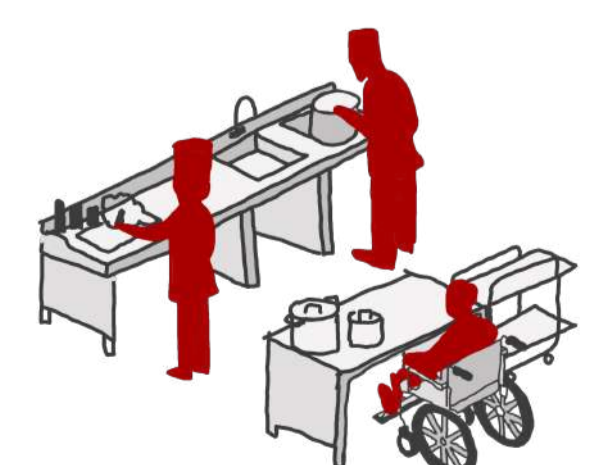

- FOOD SERVICES

# SHARED SPACE

## SITE ADAPTATION

CURRENT SITE CONDITION

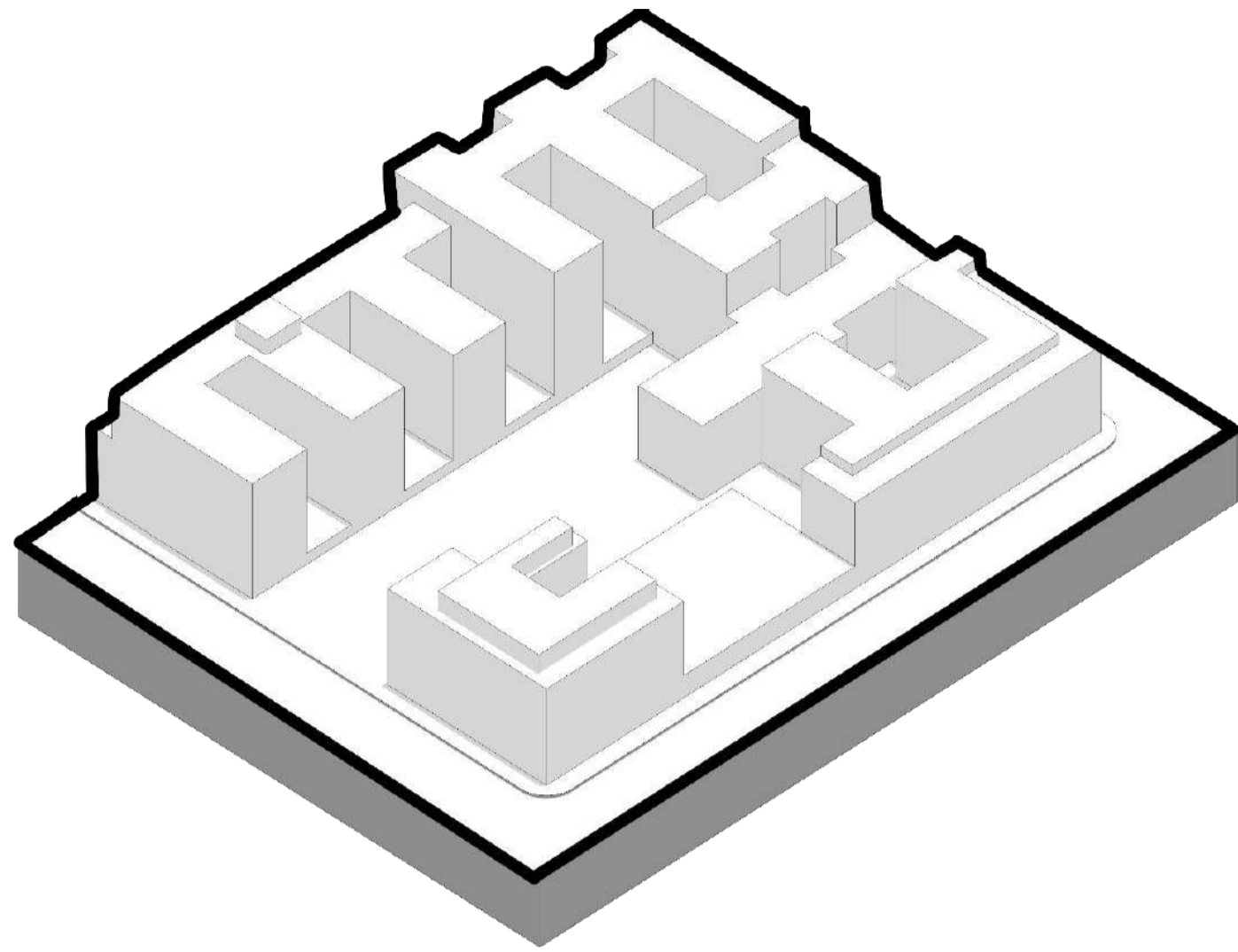

DEMOLITIONS

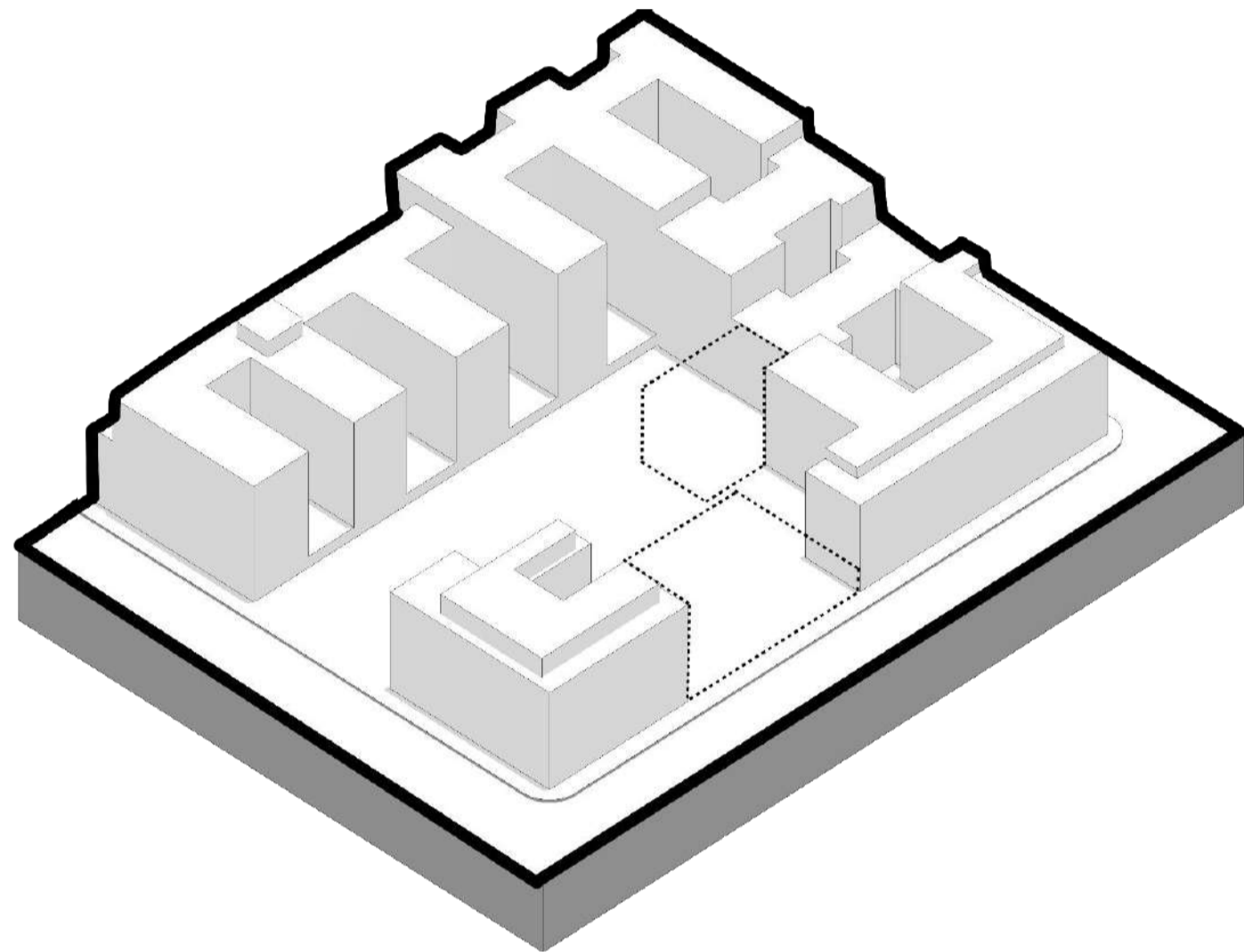

ADDITIONS

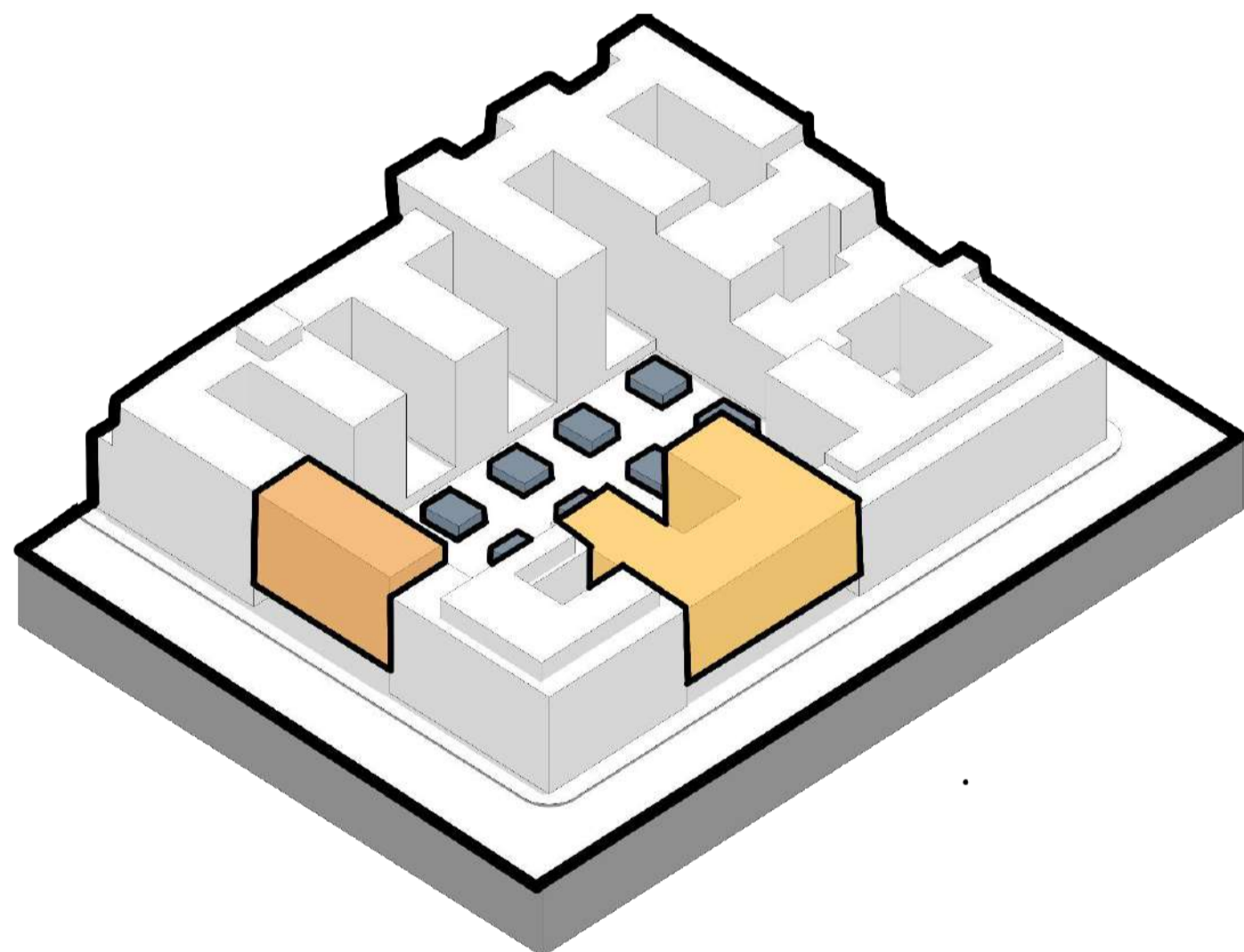

SHARED SPACE

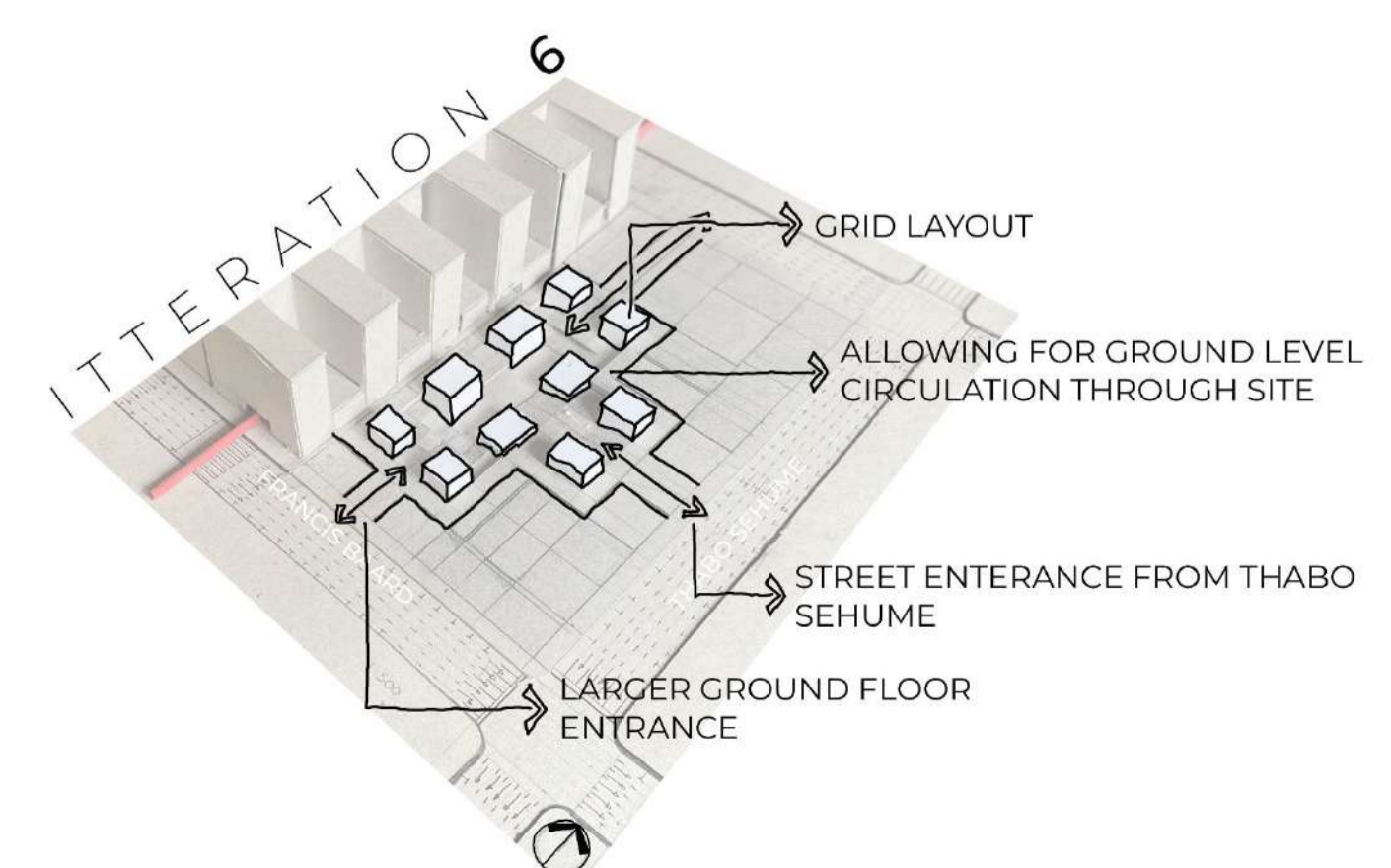
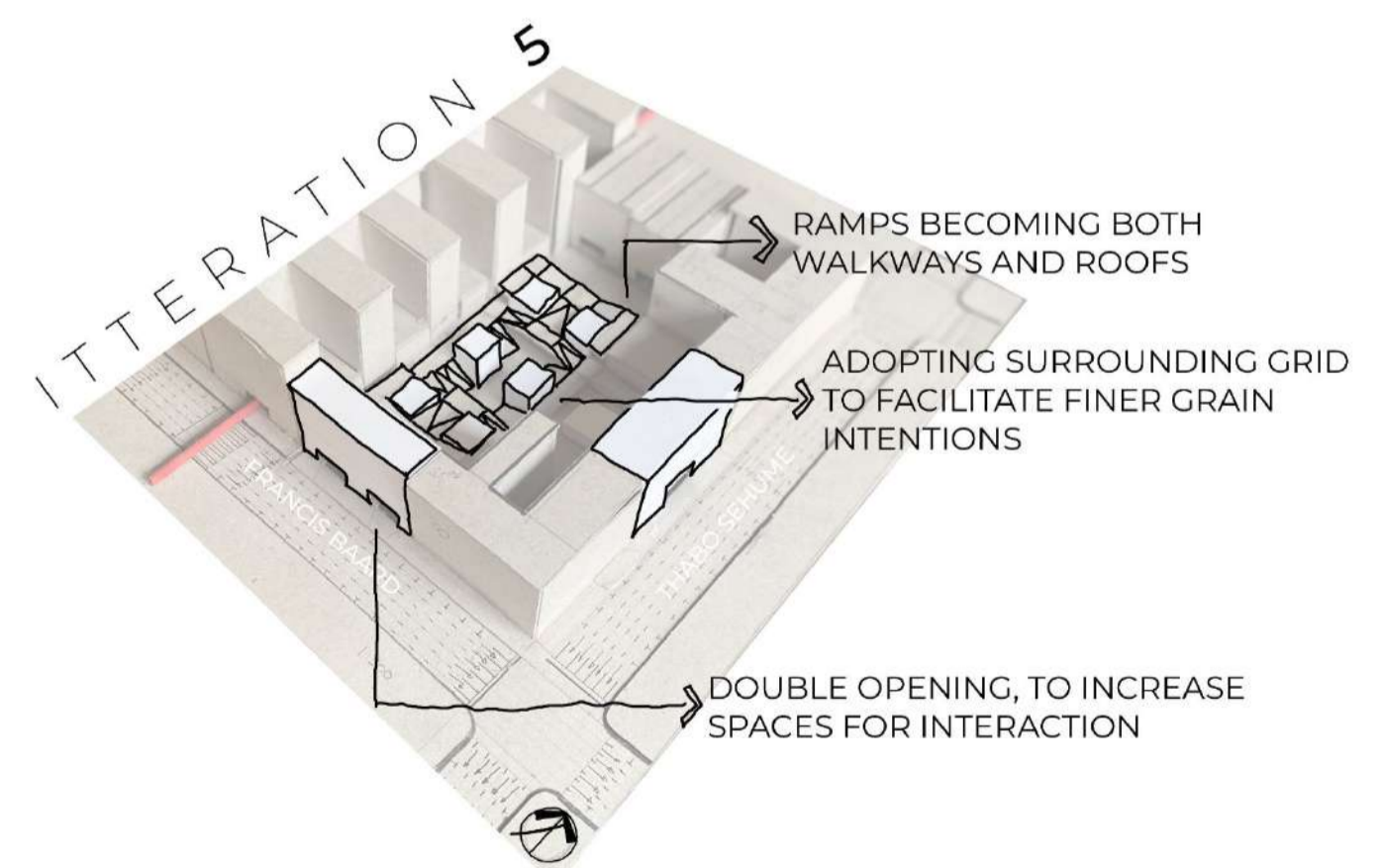
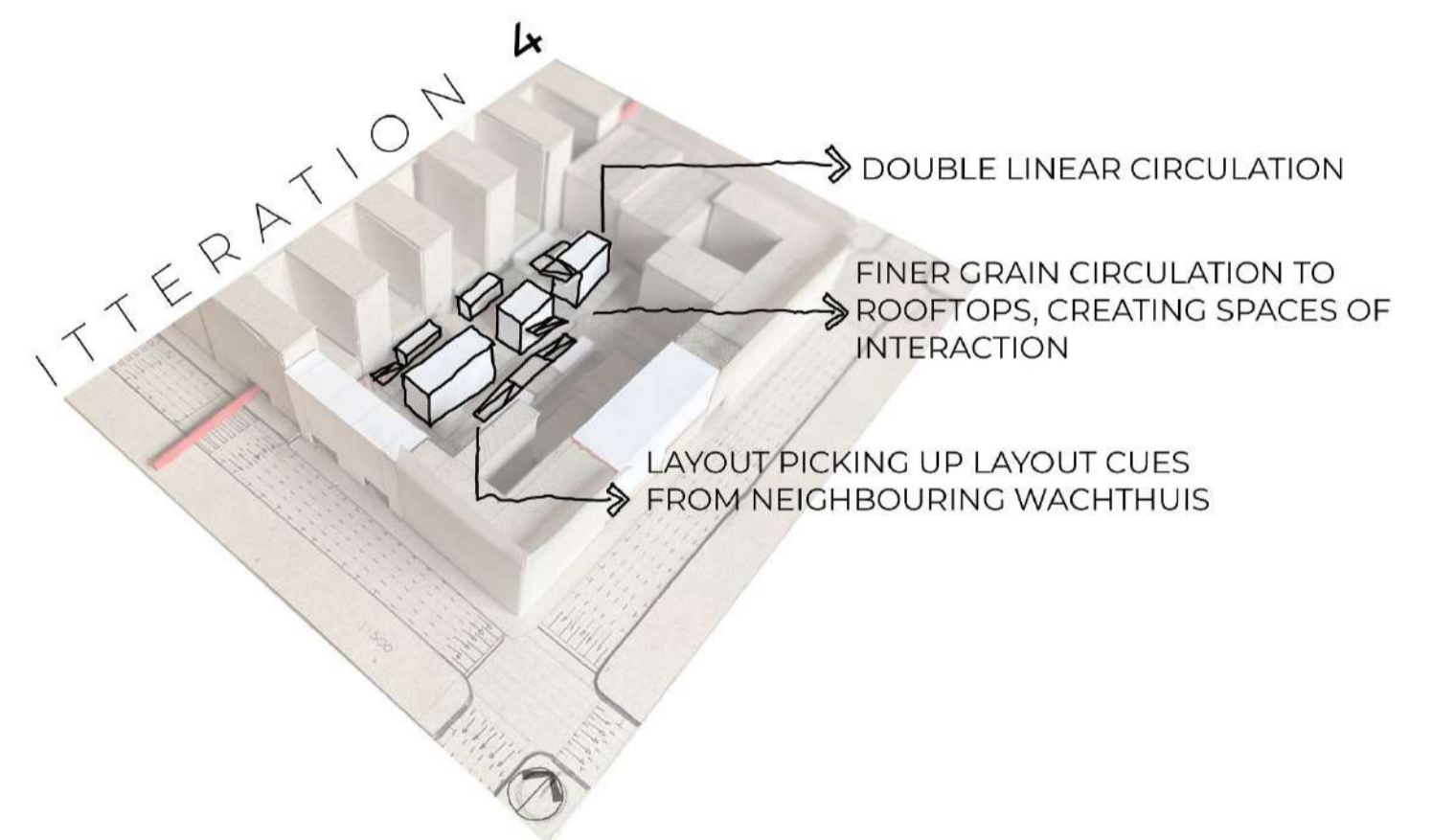
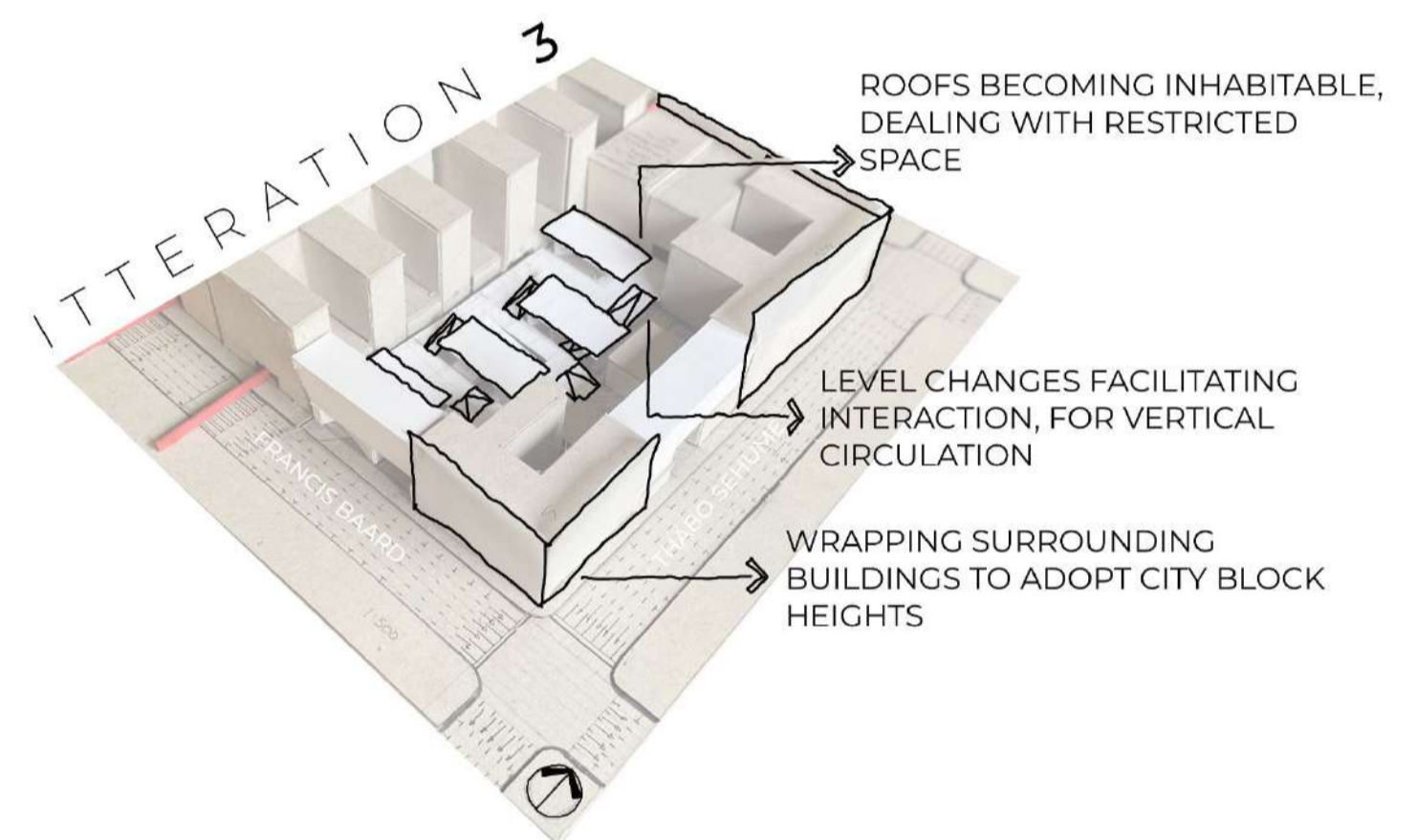
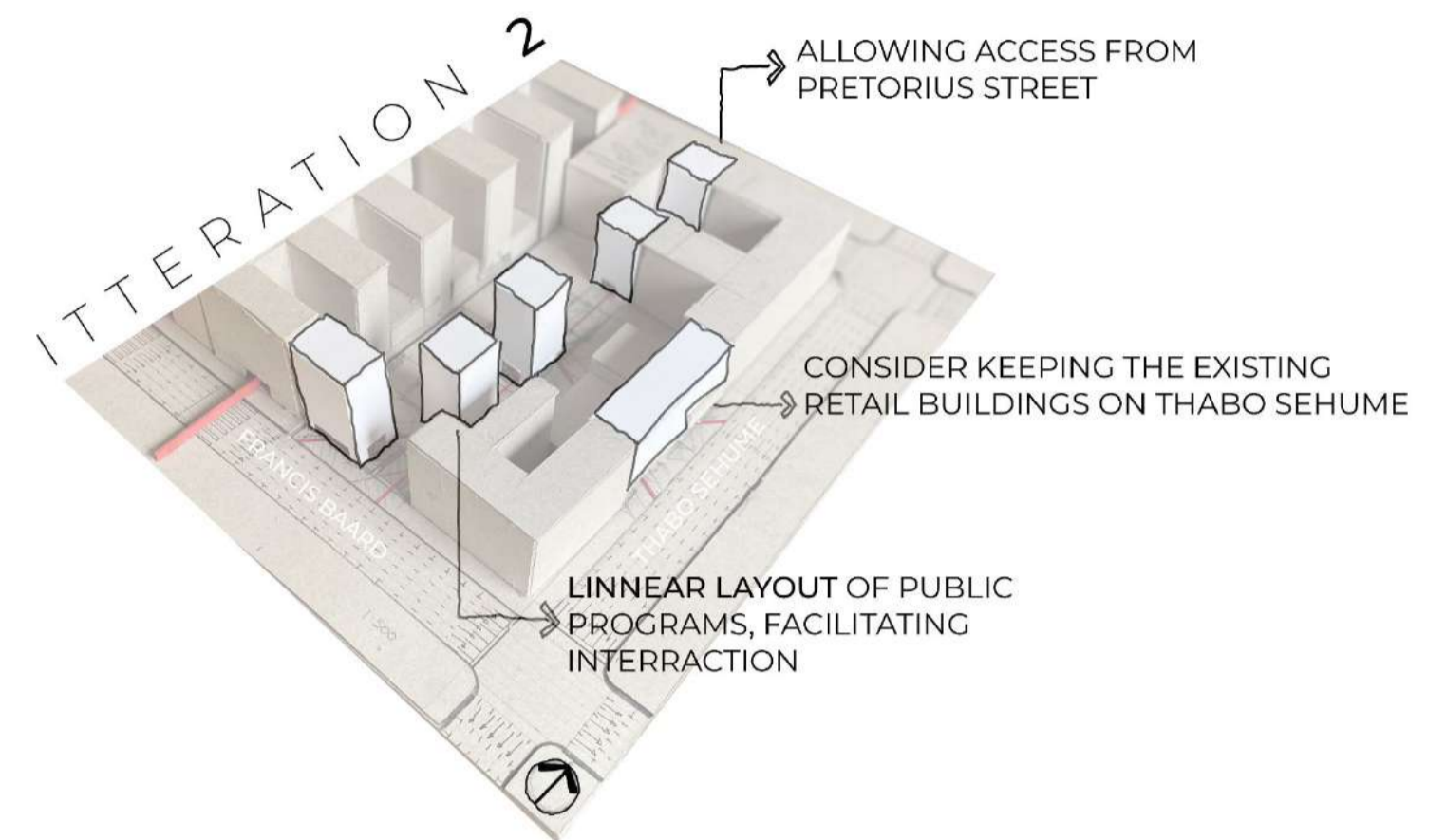
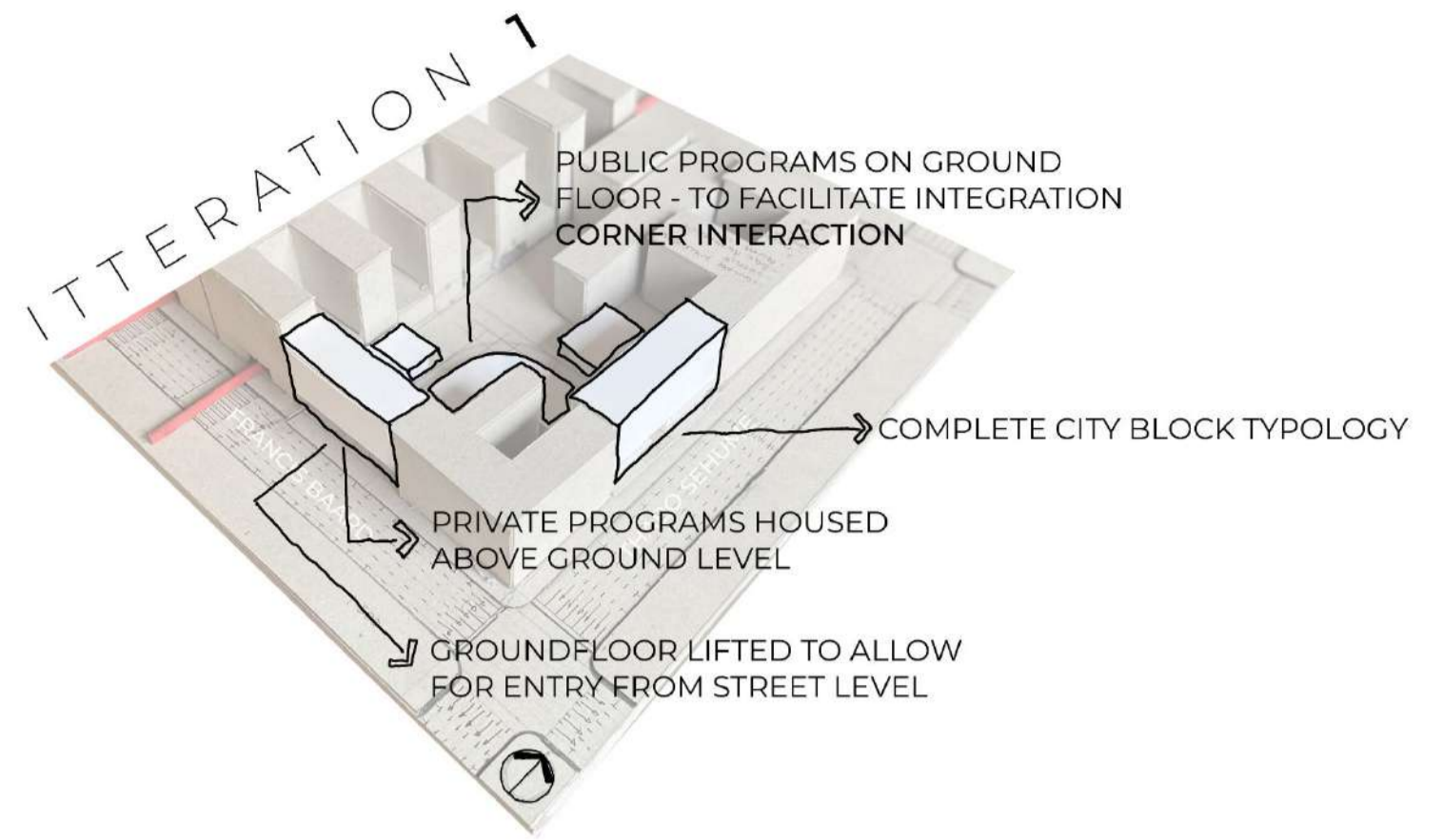
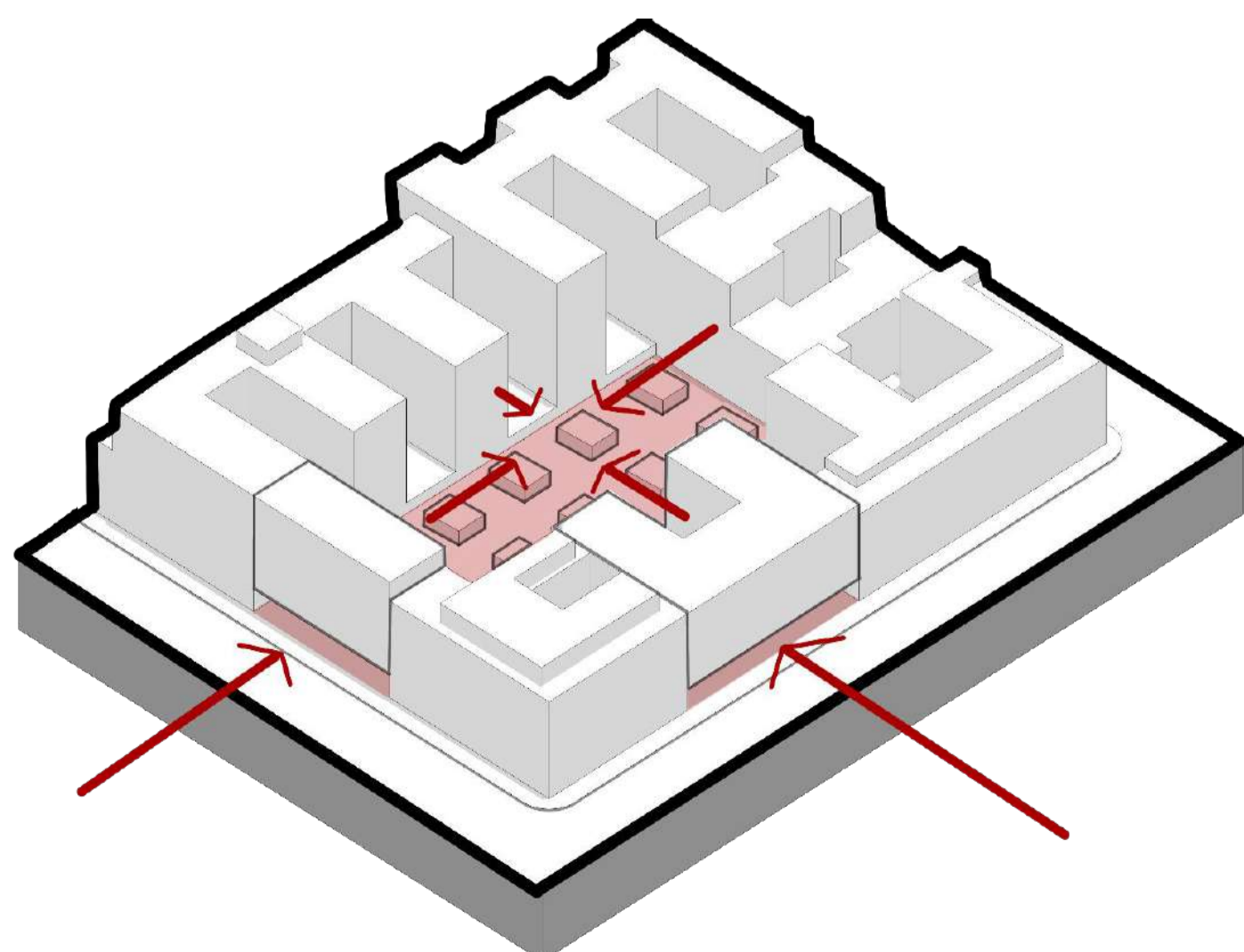

# CRIME PREVENTION THROUGH ENV. DESIGN

## 4 PRINCIPLES

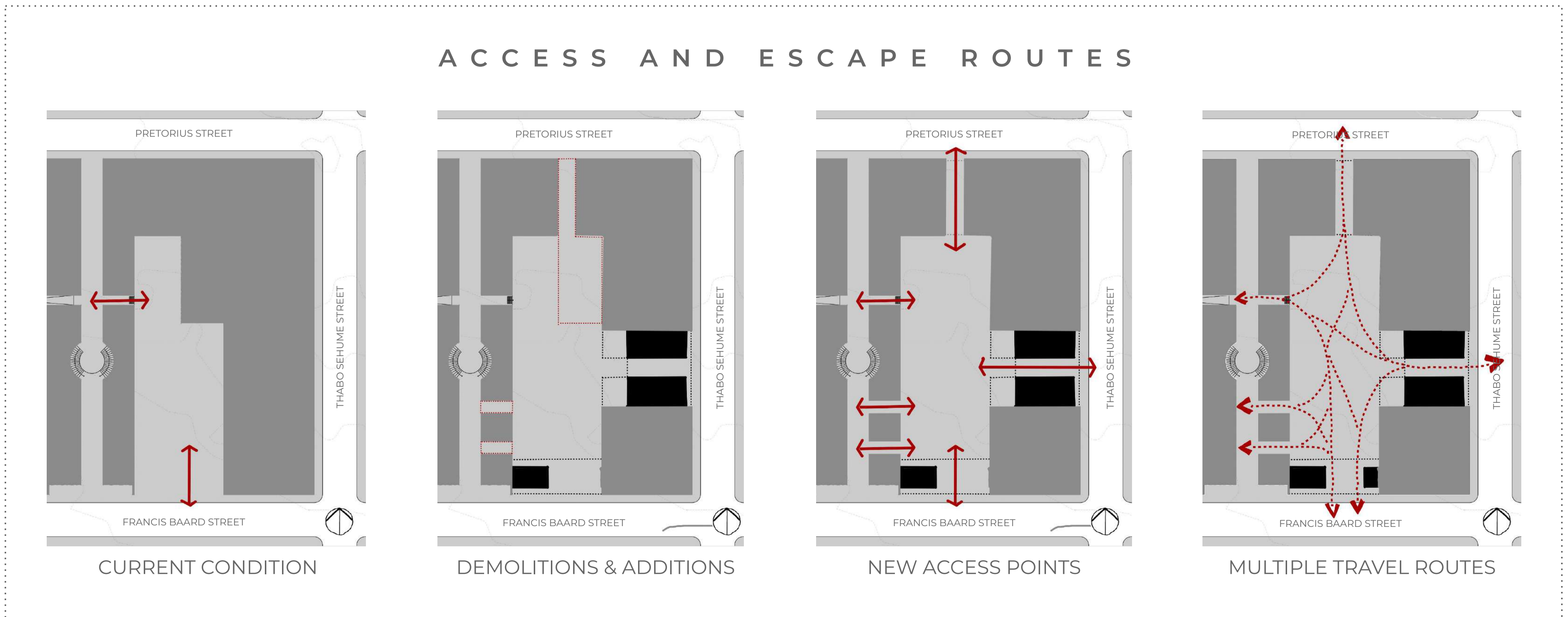
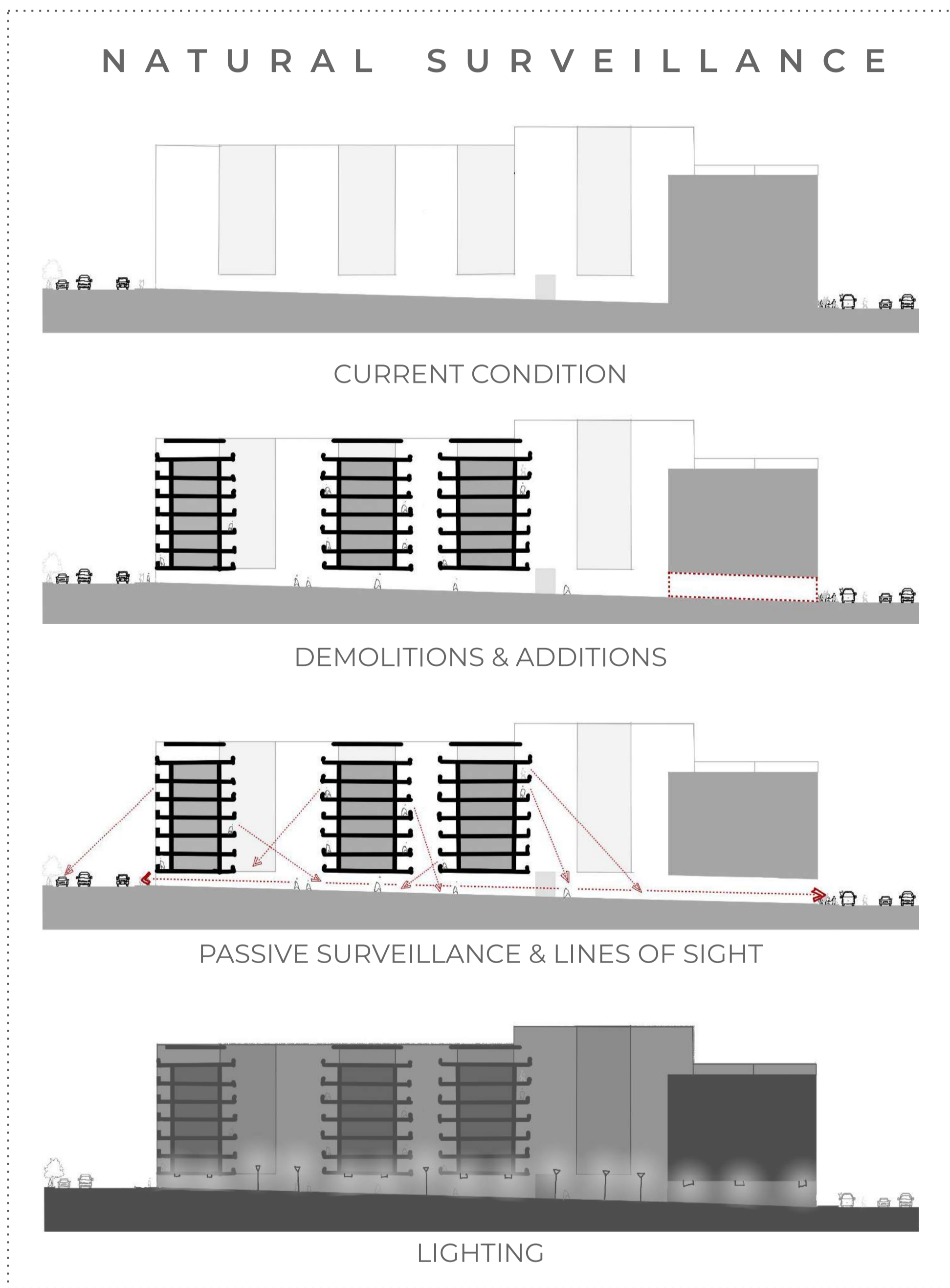
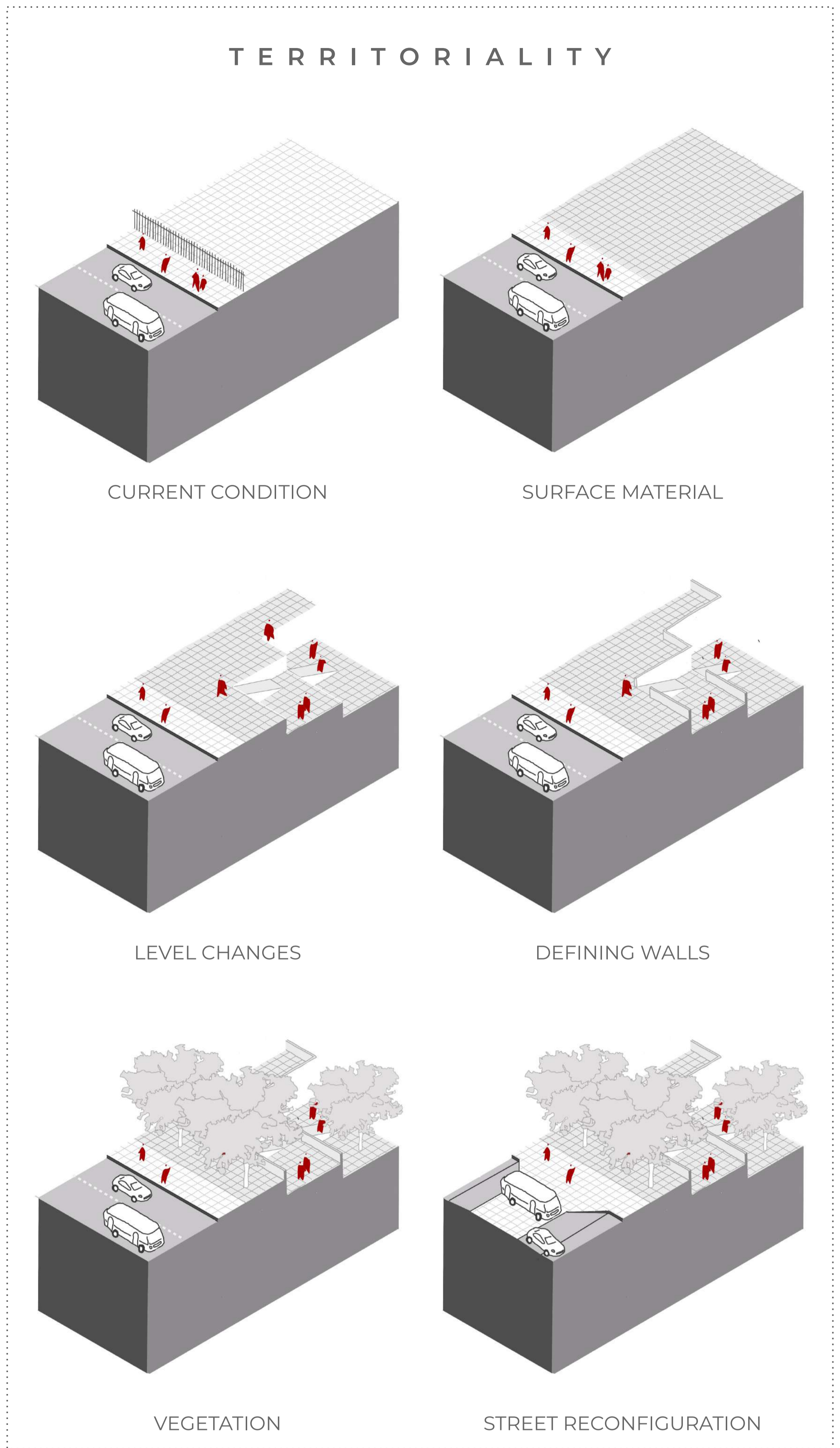
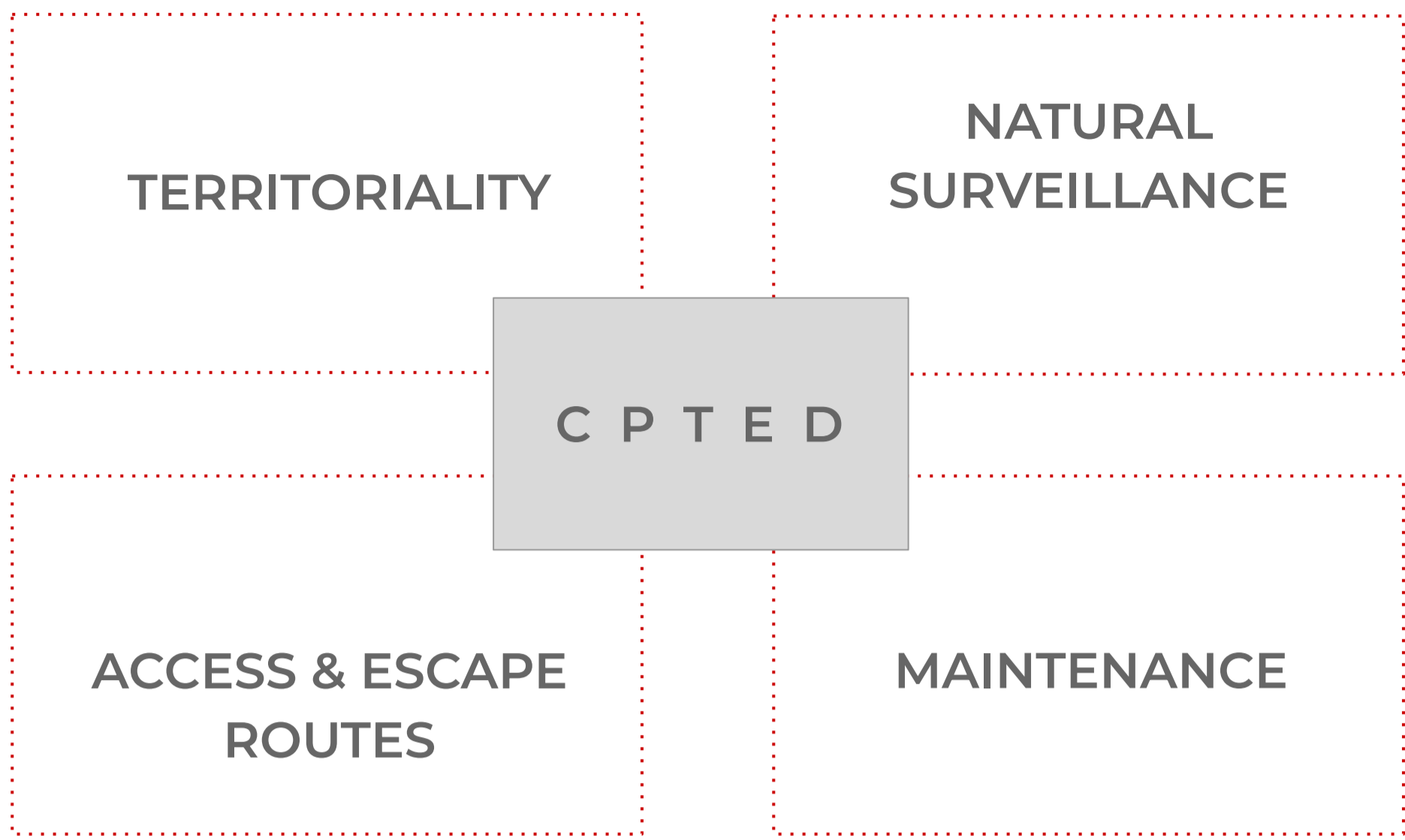

# URBAN RESPONSE

## ENTRANCE CORRIDOR

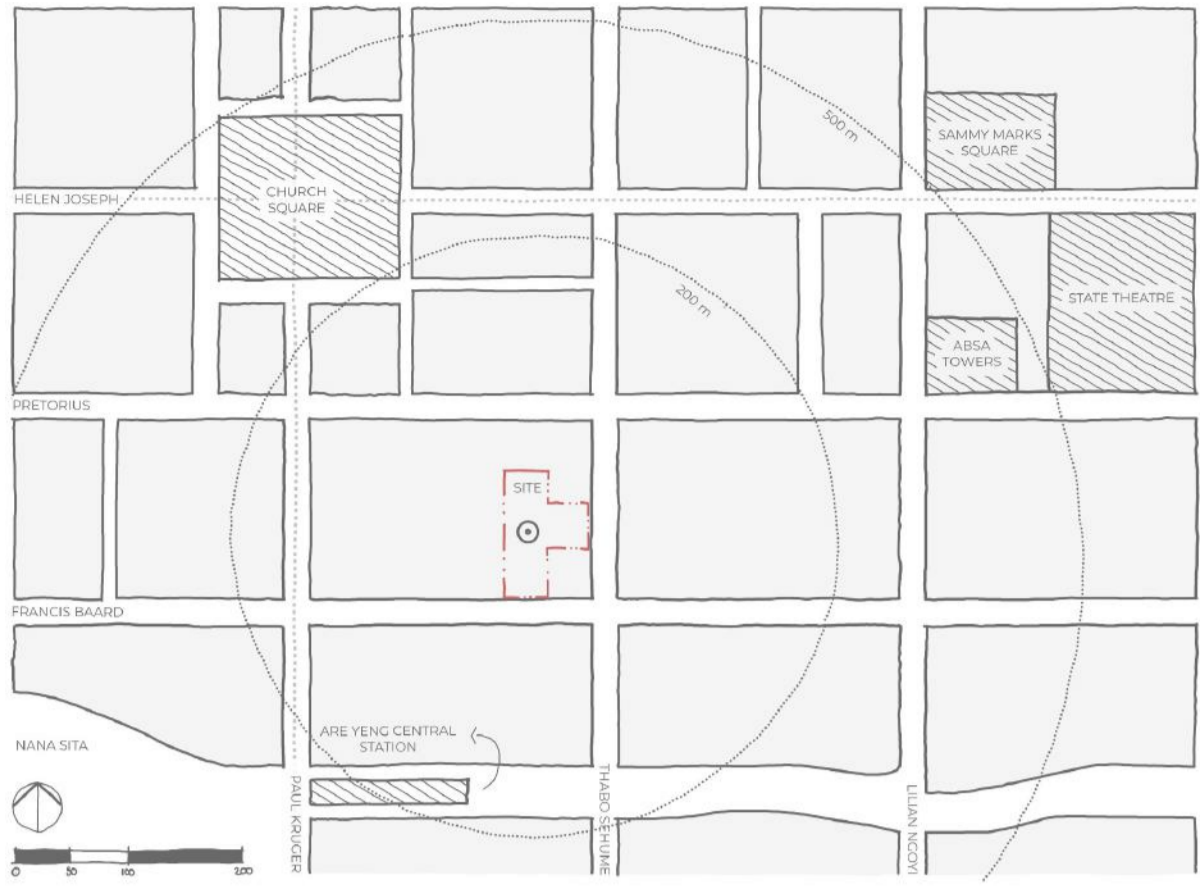

WALKABILITY

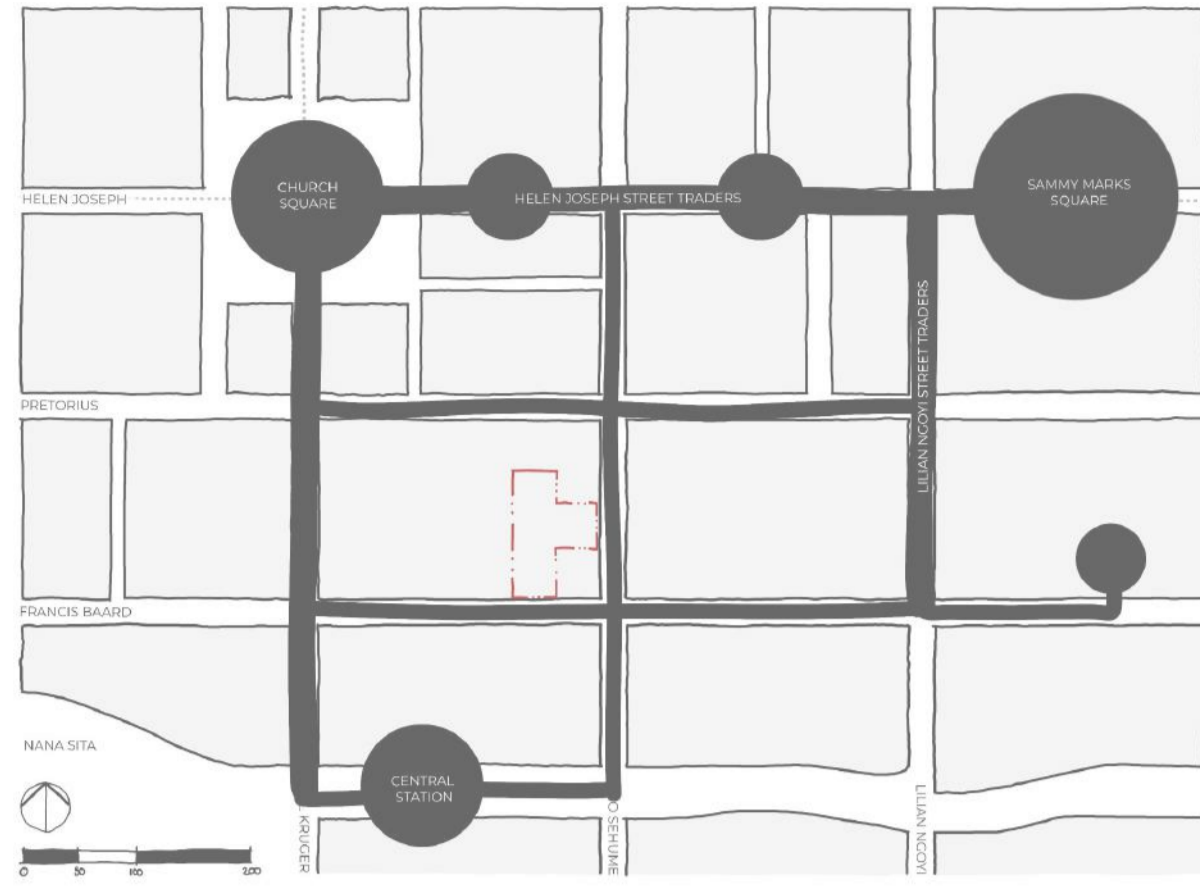

ACTIVITY GENERATORS

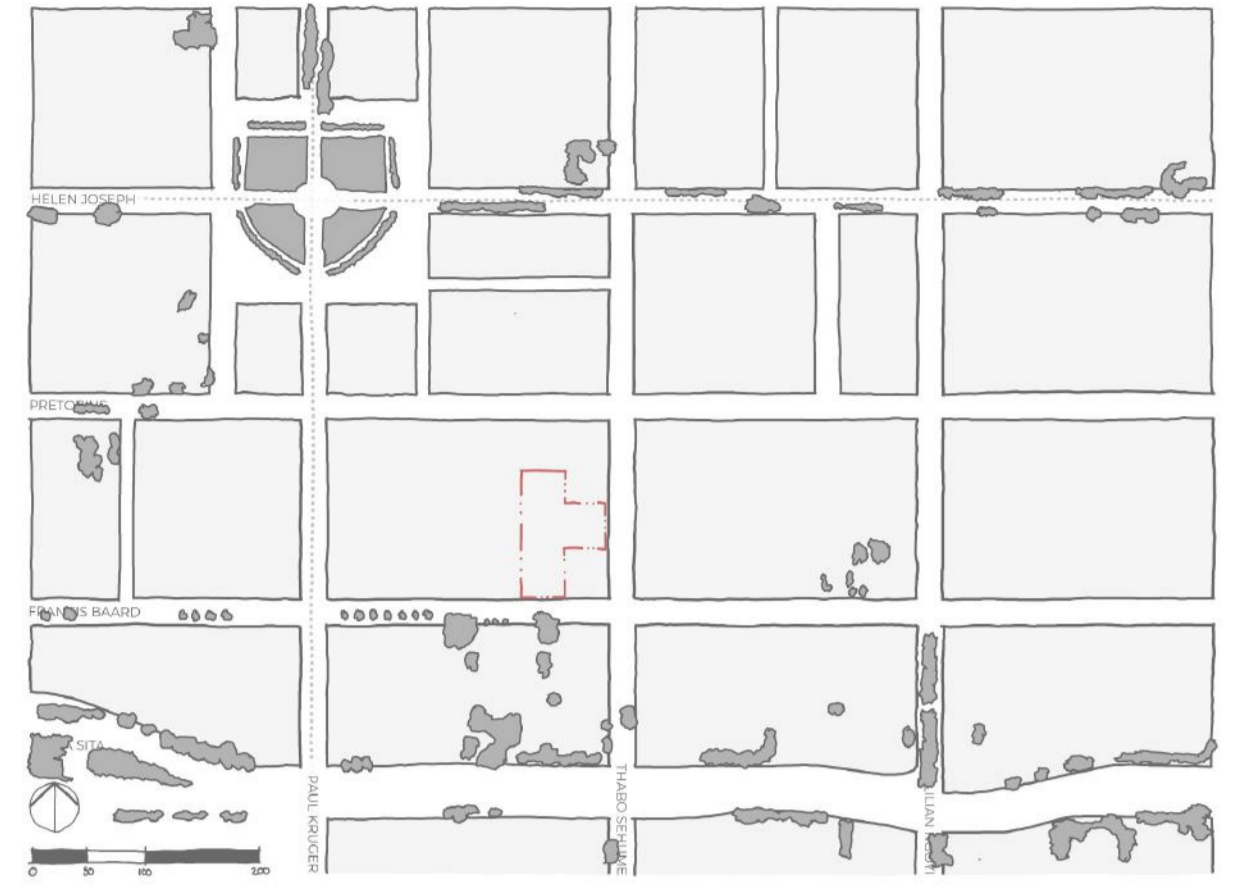

VEGETATION



ARCADES

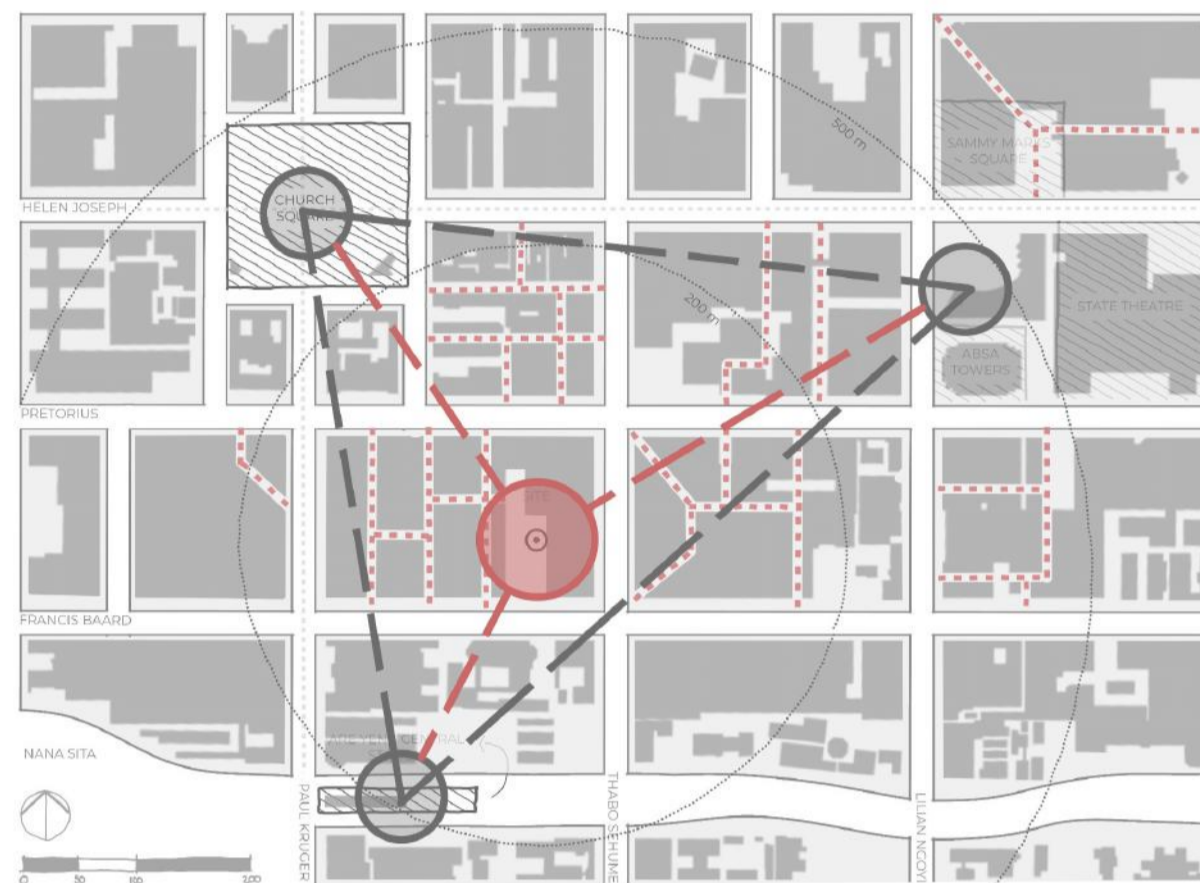

SITE IN CONTEXT TO ACTIVITY GENERATORS

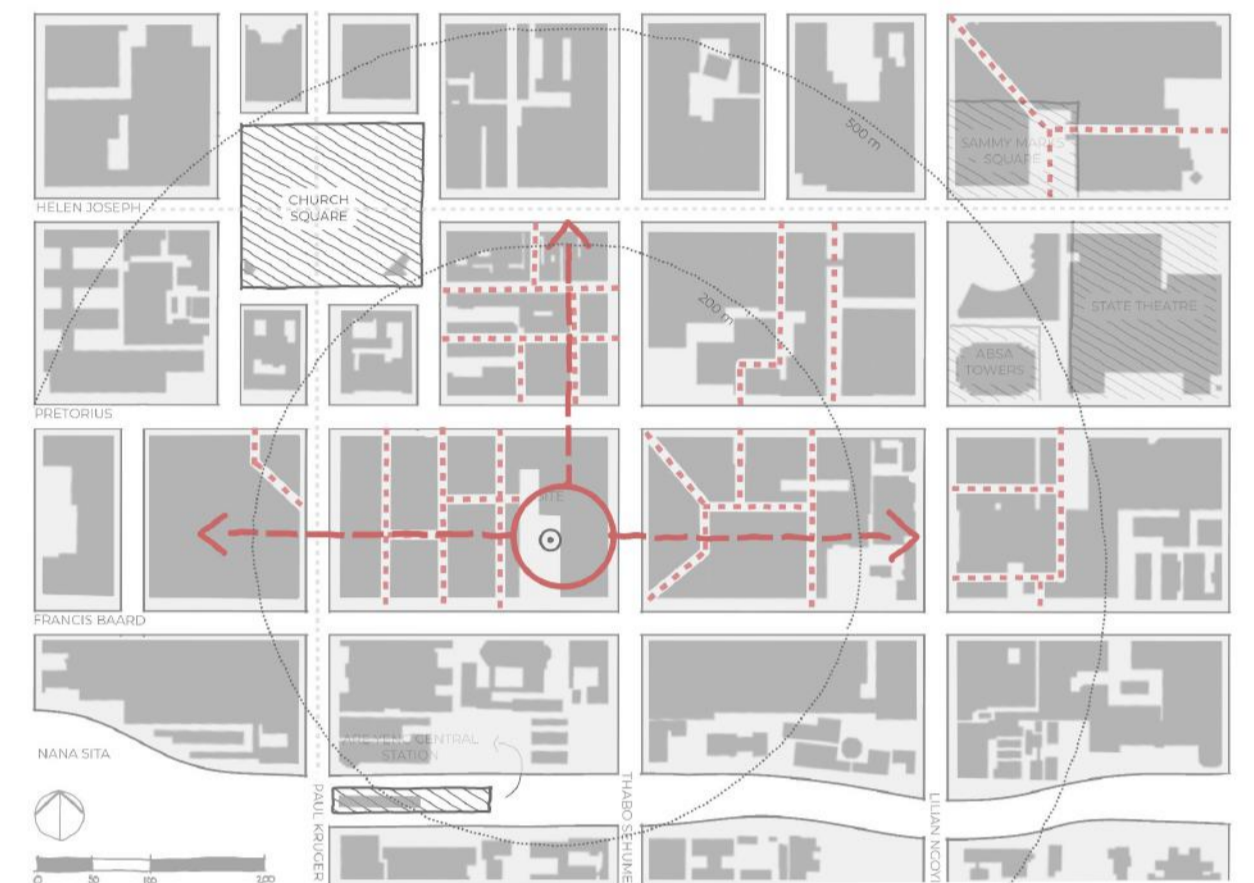

SITE IN CONTEXT TO ARCADES

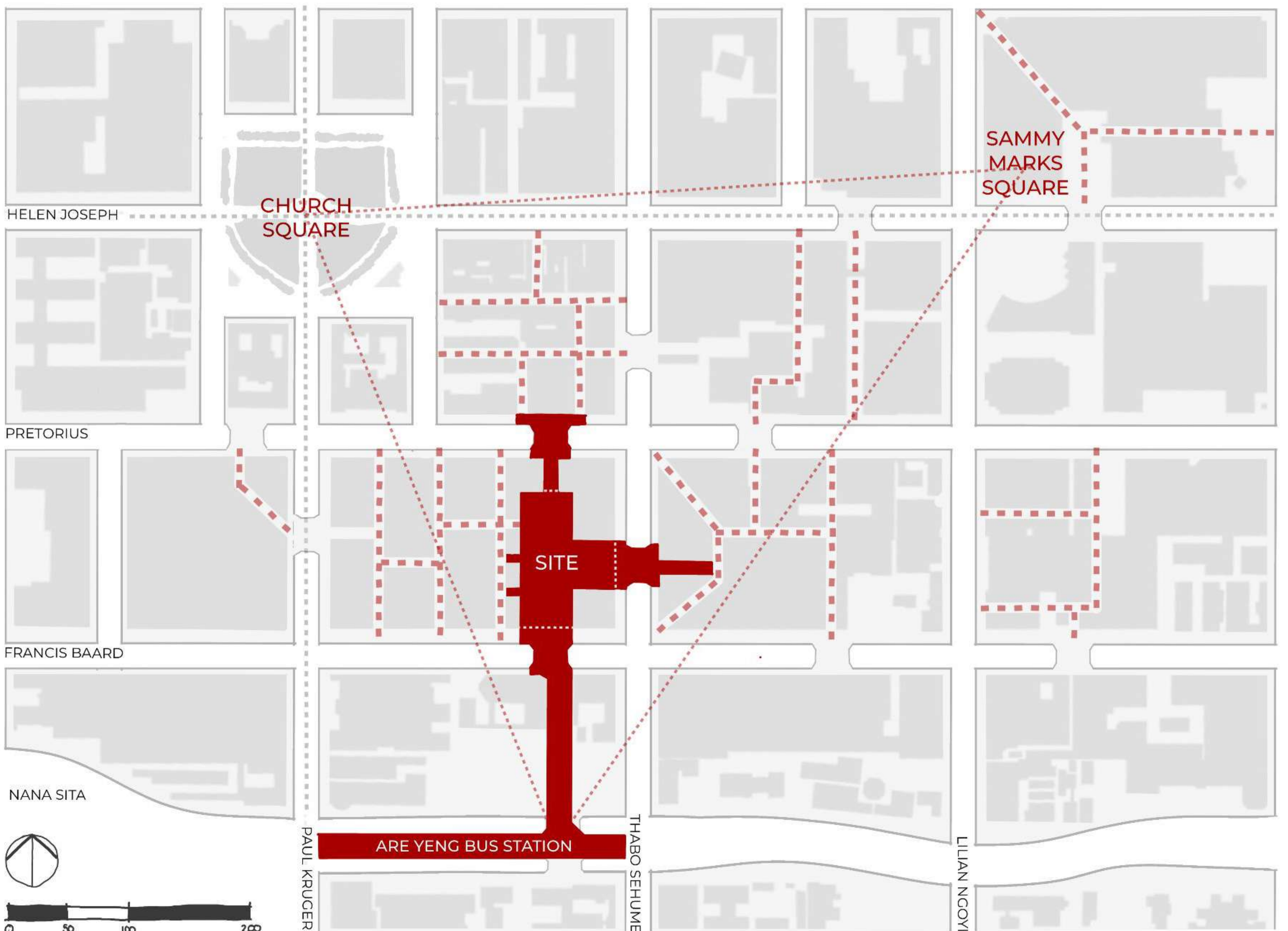

CITY ENTRANCE CORRIDOR



# ARCADES

## ADOPTING ARCADE FUNCTIONALITY

### ARCADE FUNCTIONS

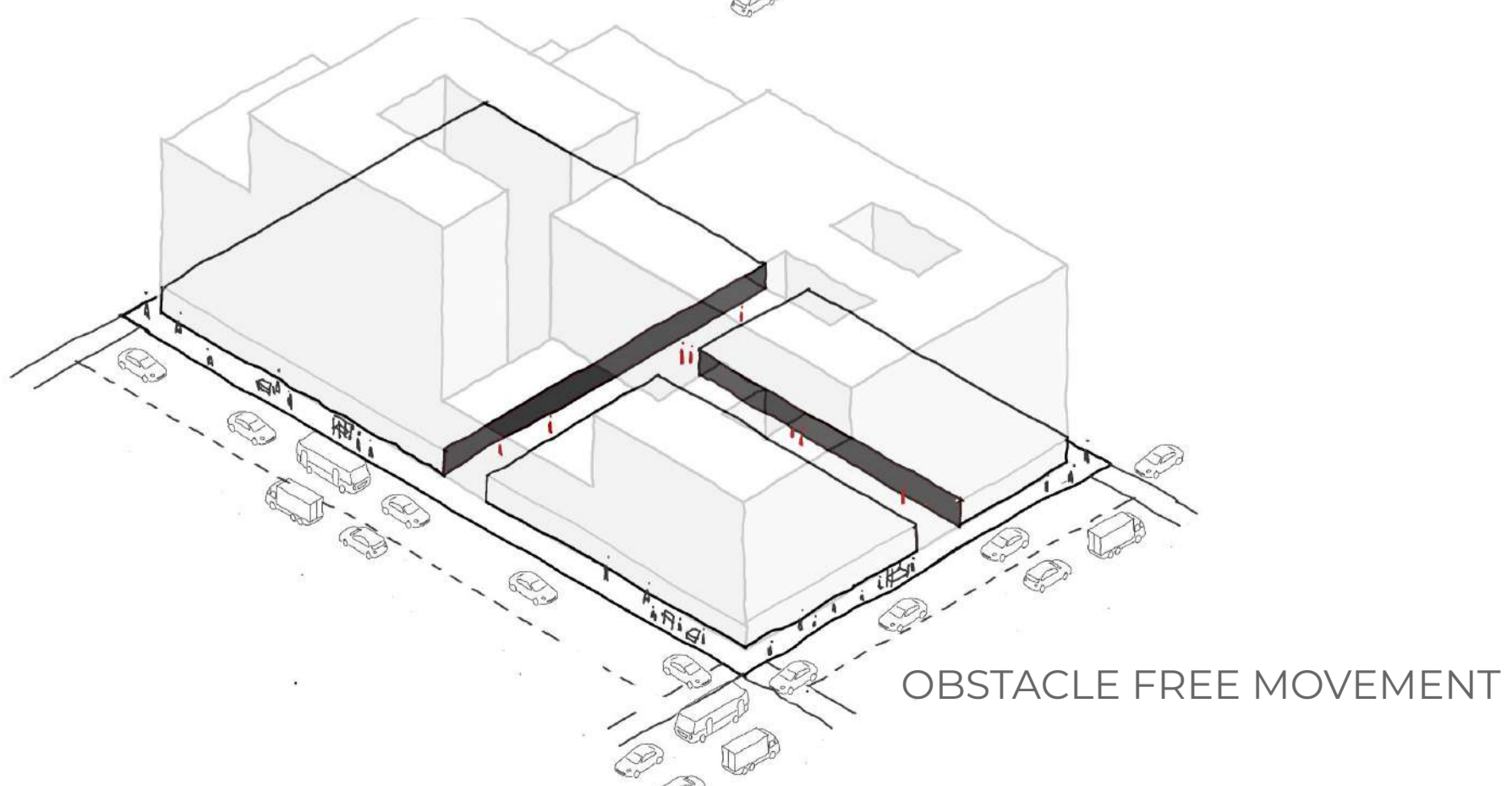
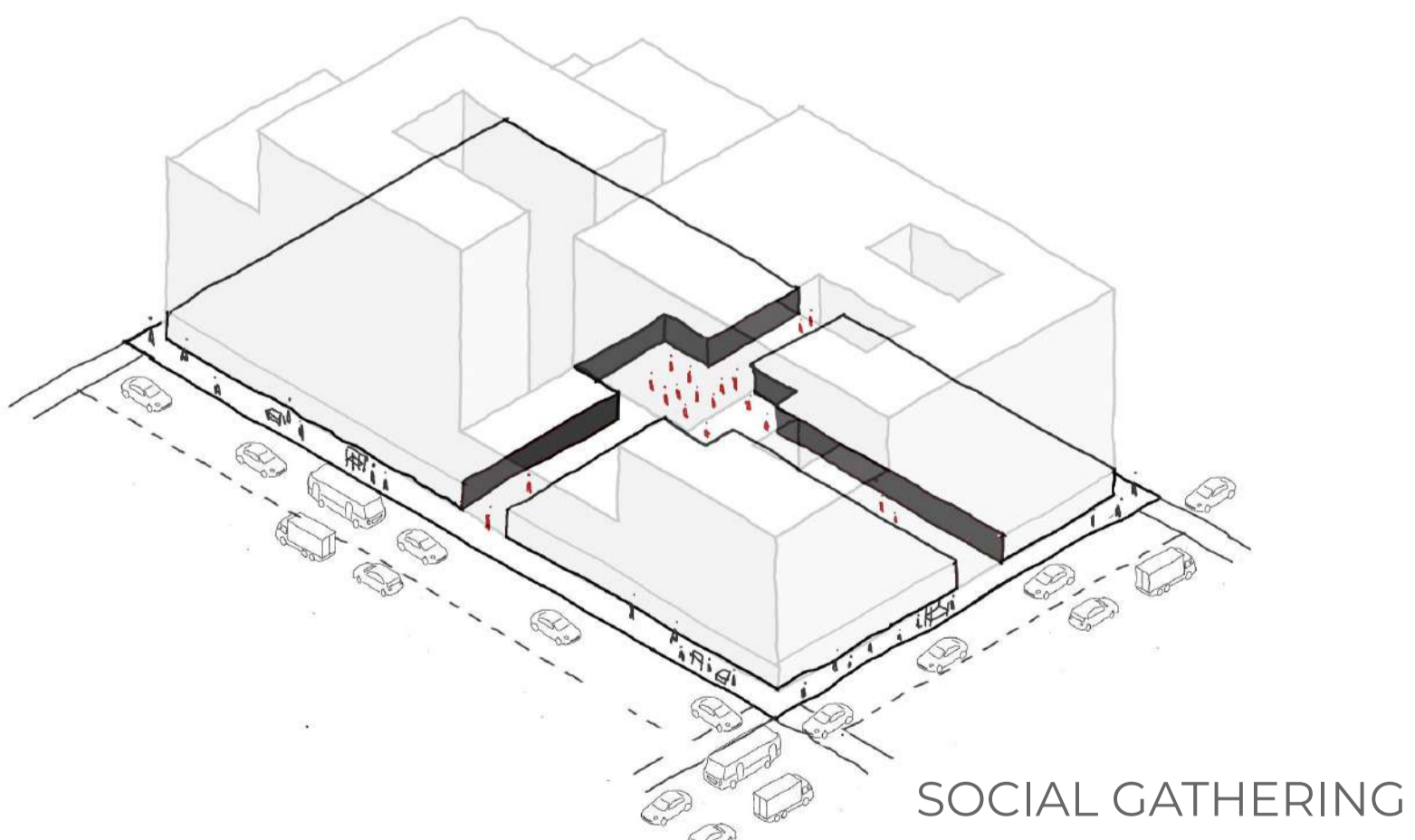
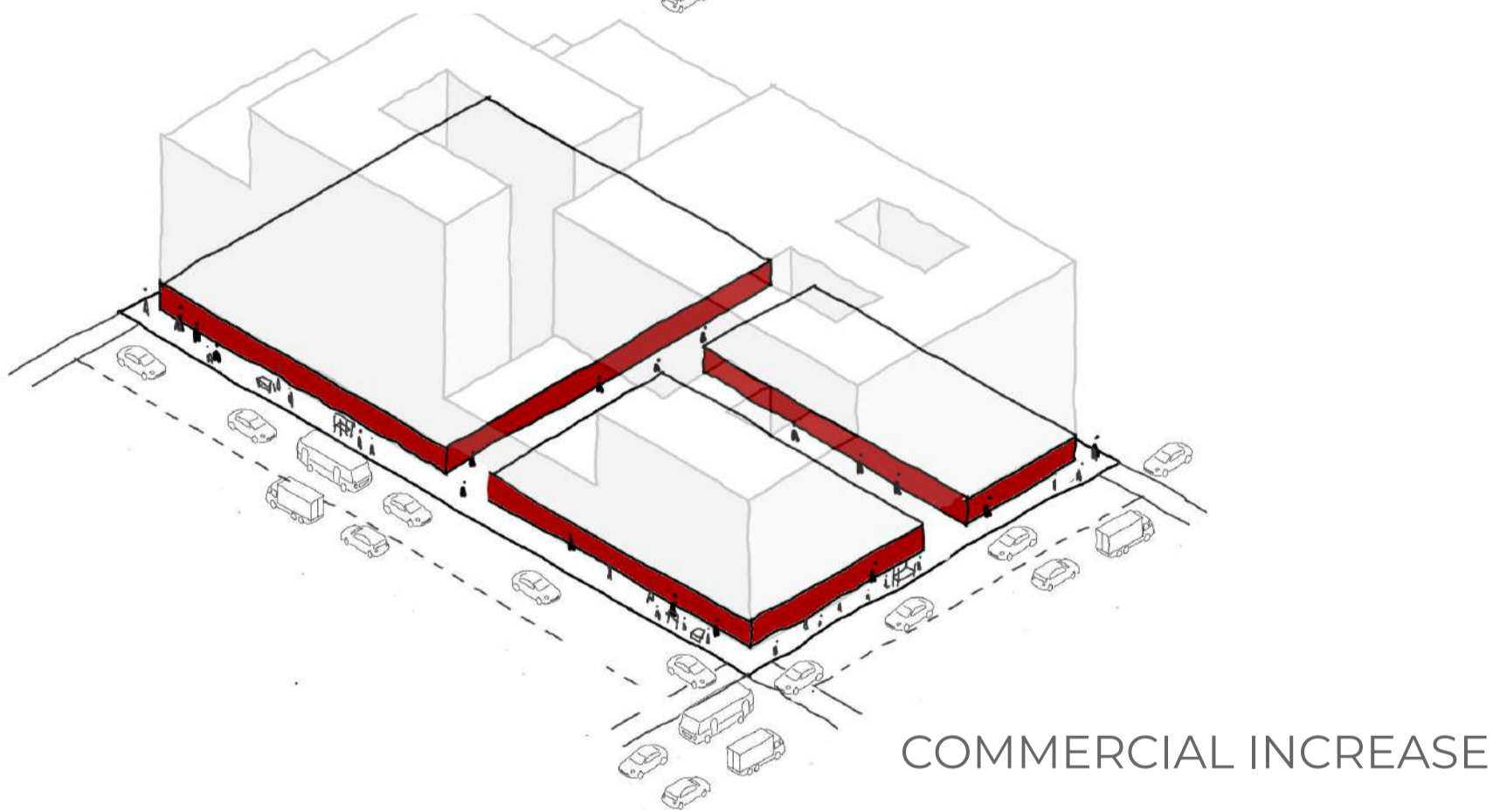
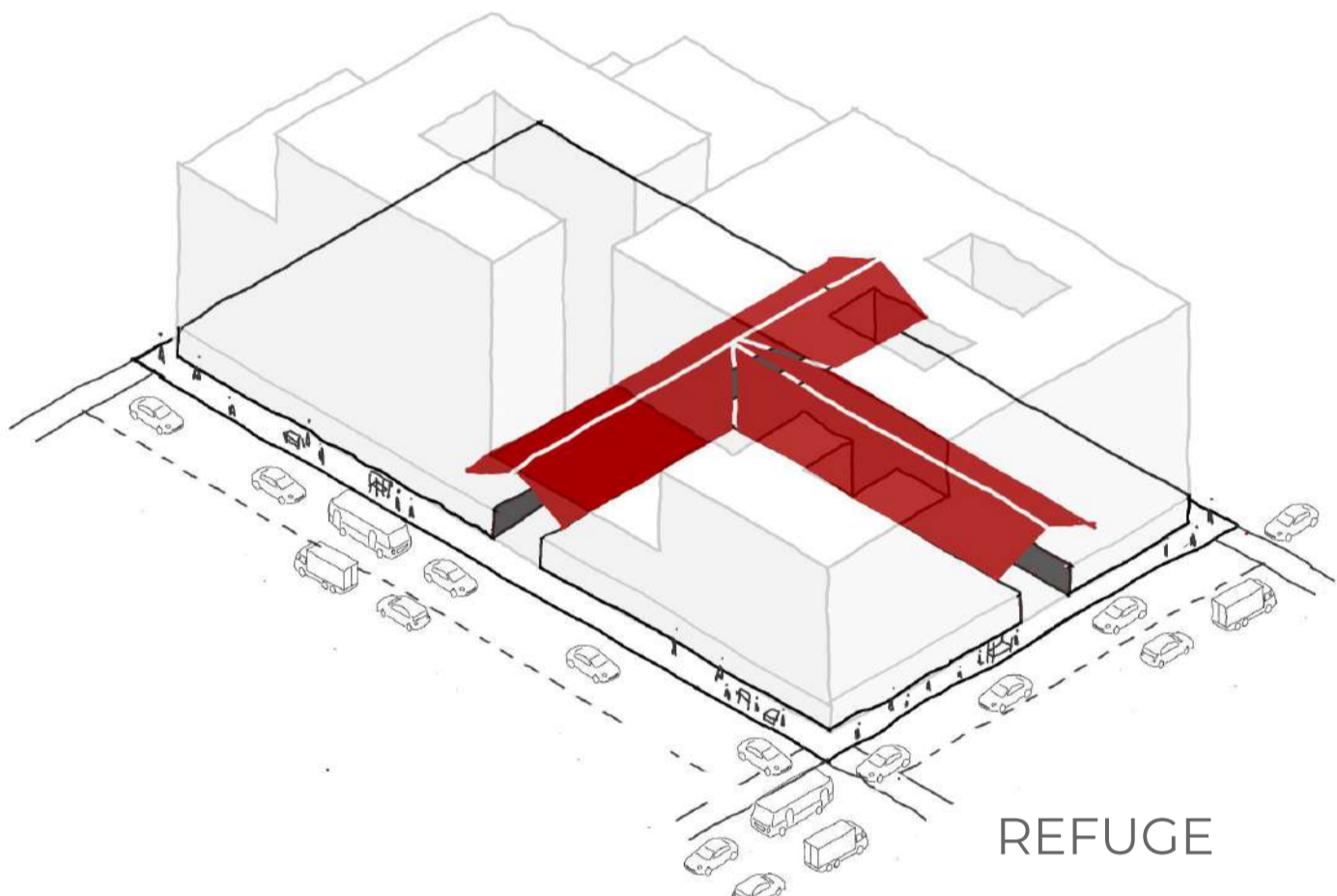
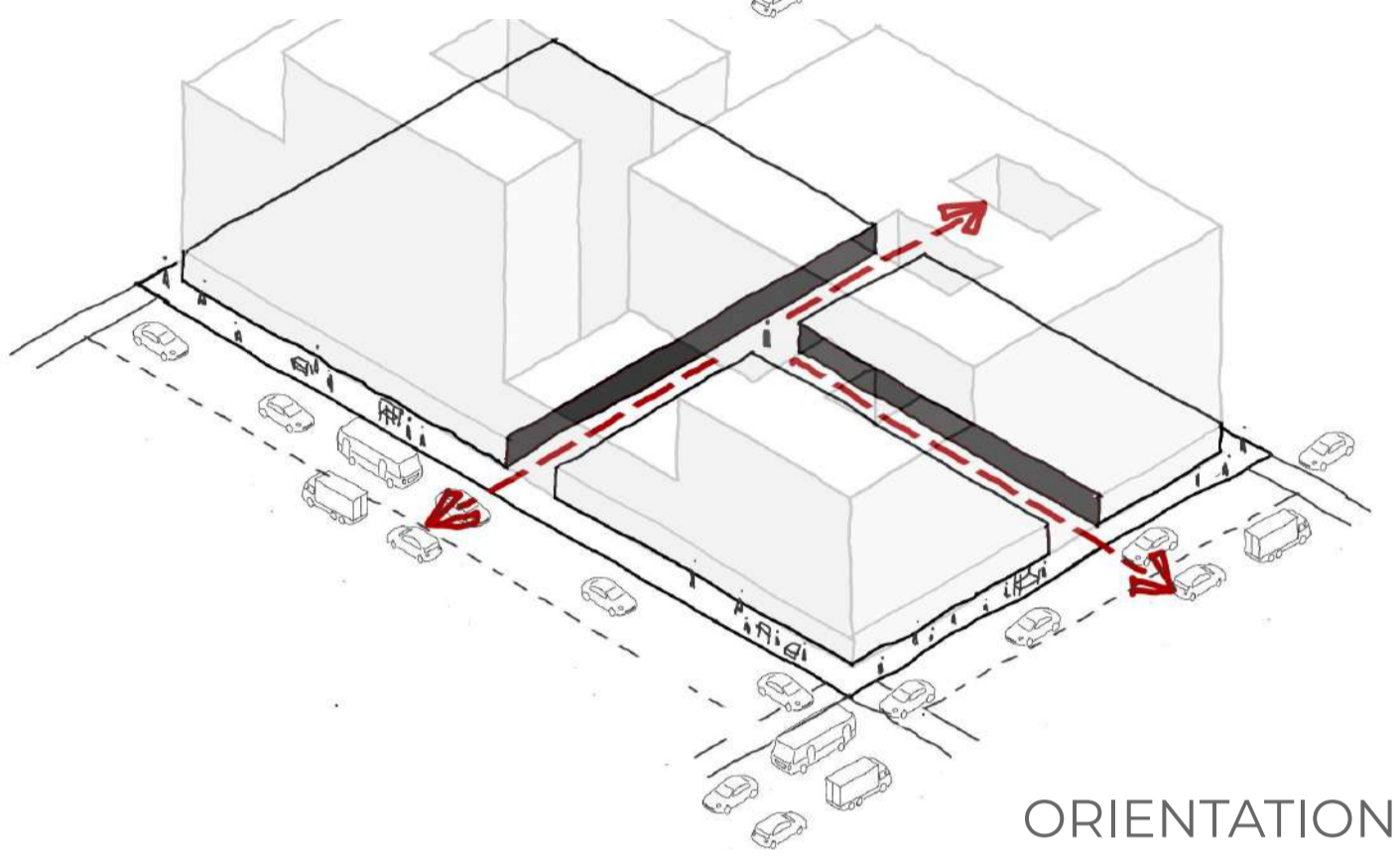
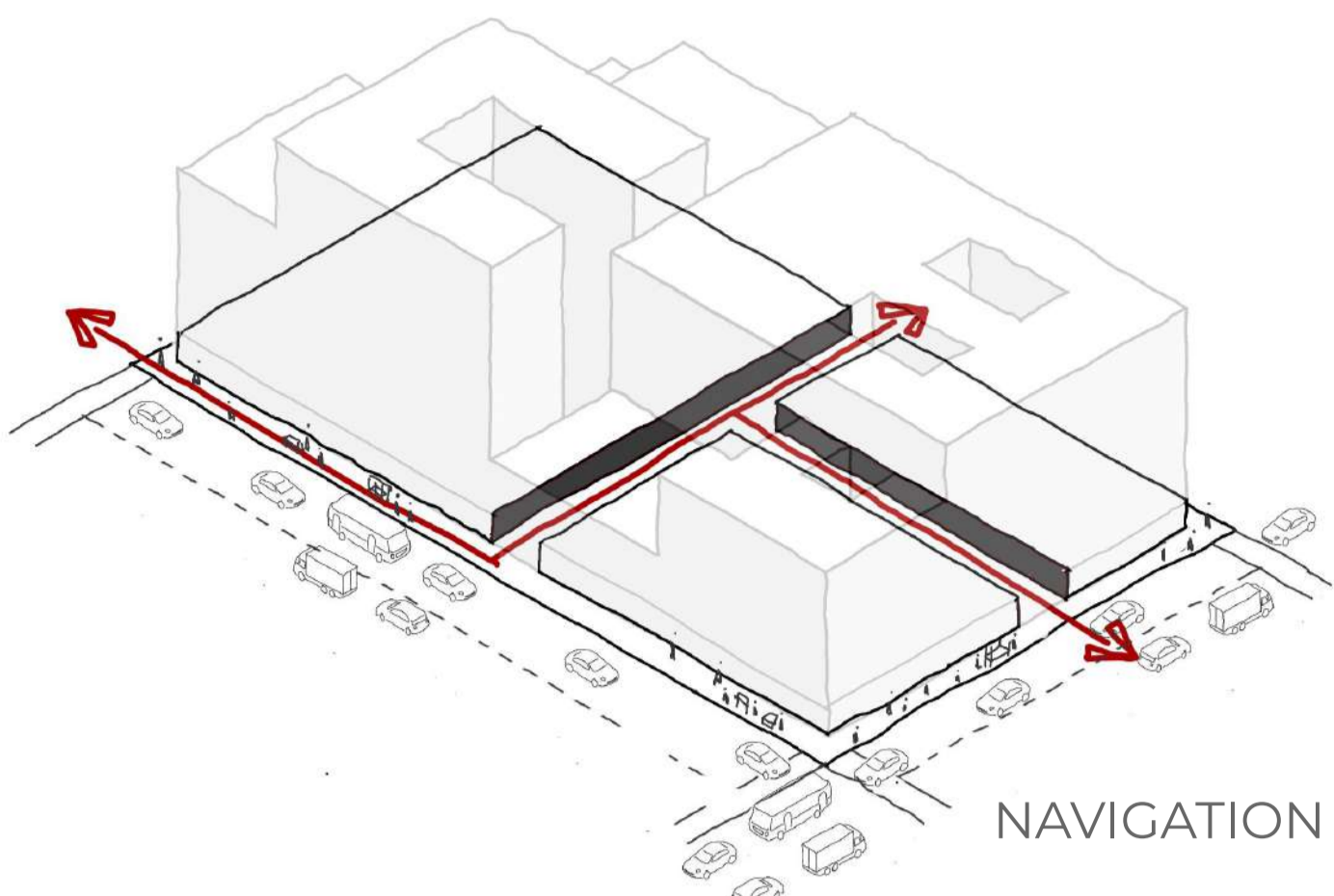

### PUBLIC INCREASE BY ARCADES

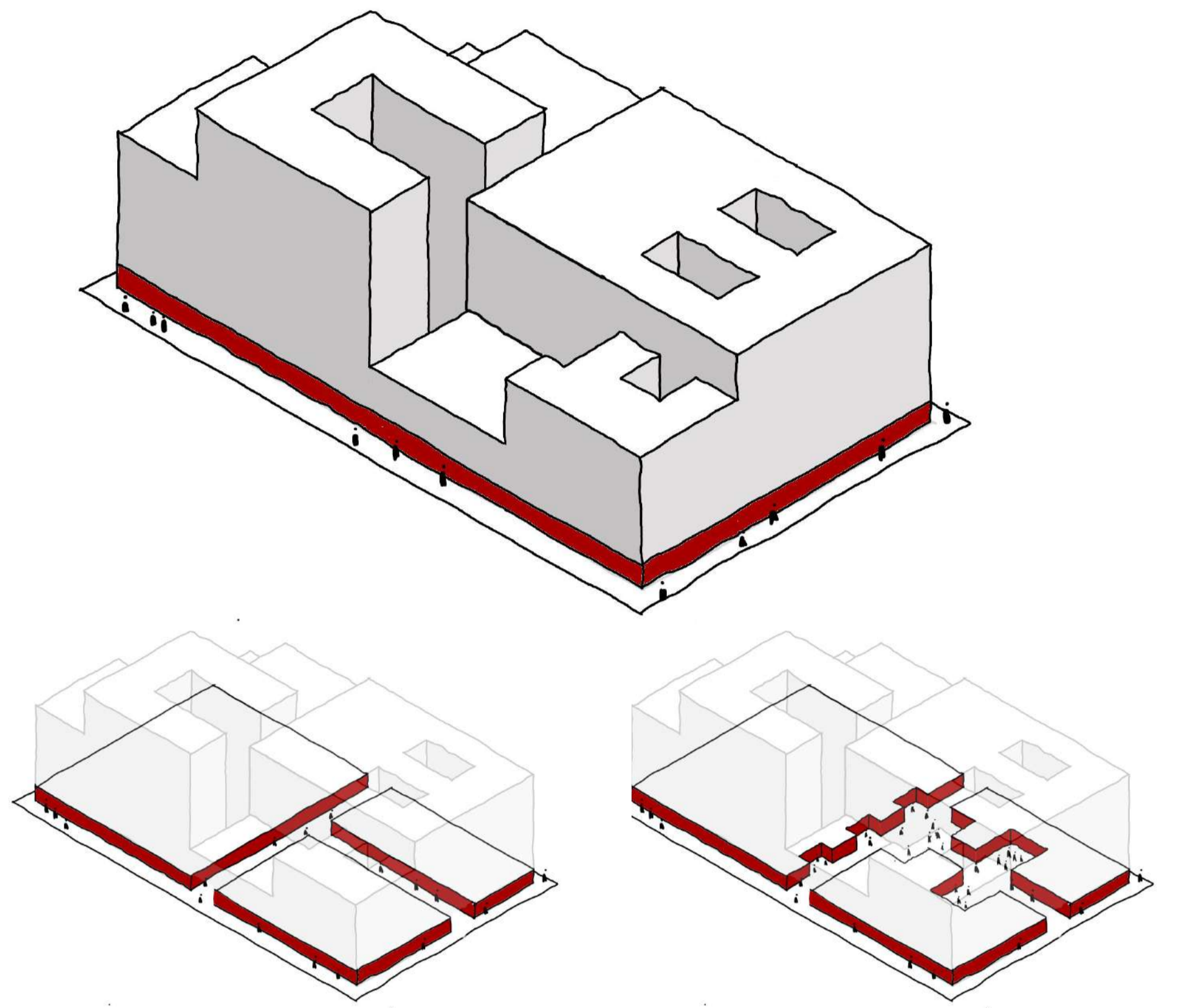

### INITIAL SPATIAL EXPLORATIONS OF ARCADE AS TYPOLOGY FOR INTERACTION

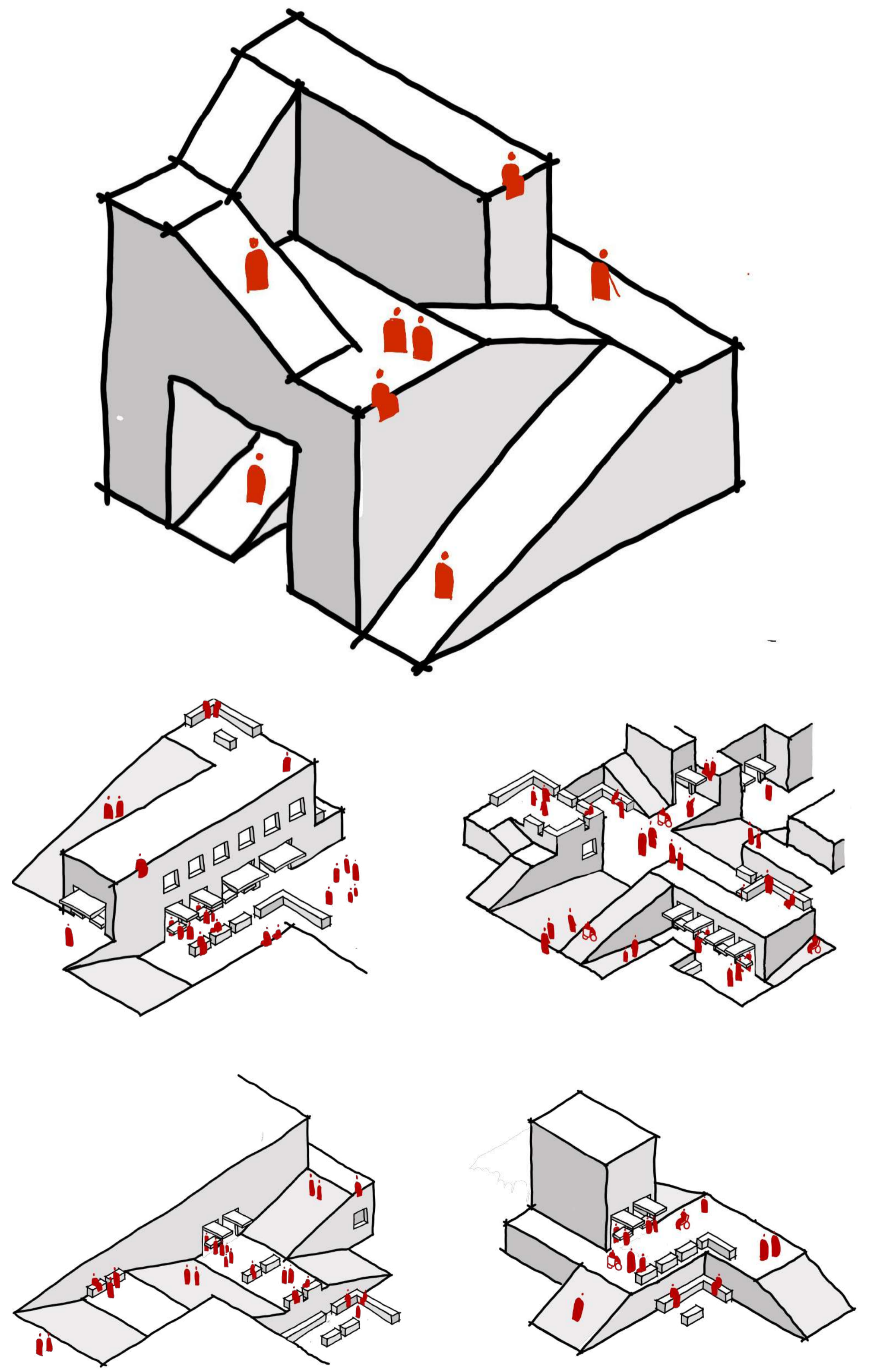

# DEGREES OF INTERACTION

GRADUAL INTERACTION SPATIAL EXPLORATION

PASS

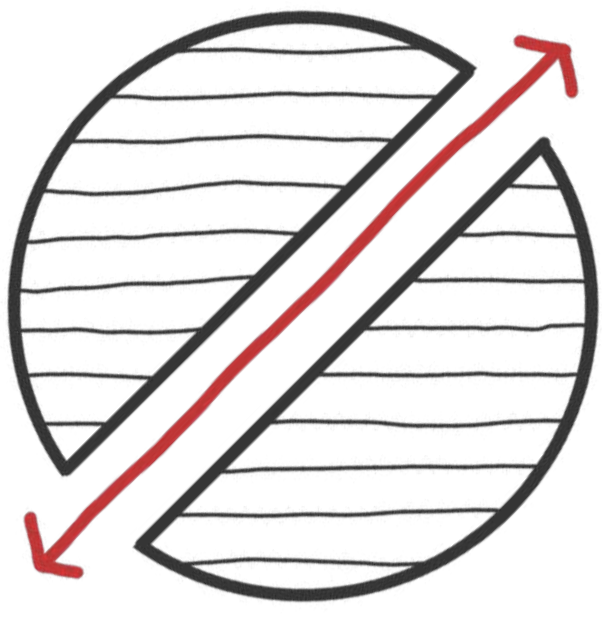

PAUSE

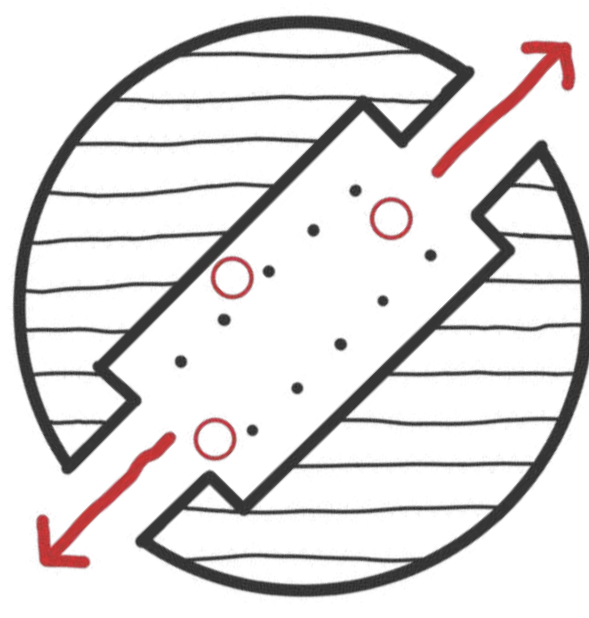

INTERACT

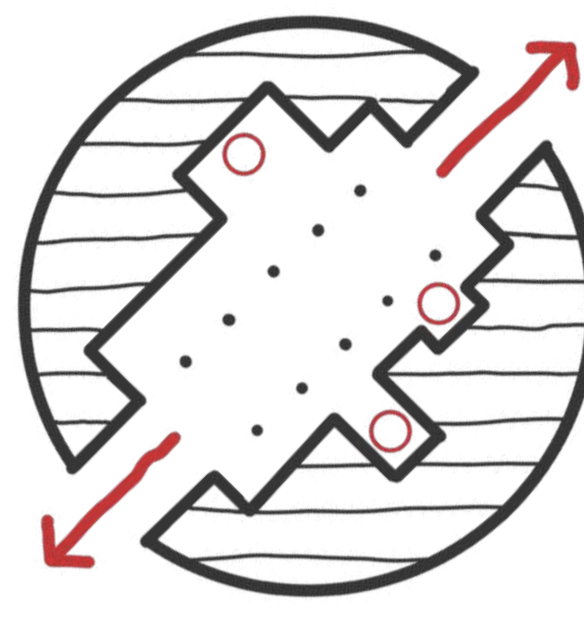

PARTICIPATE

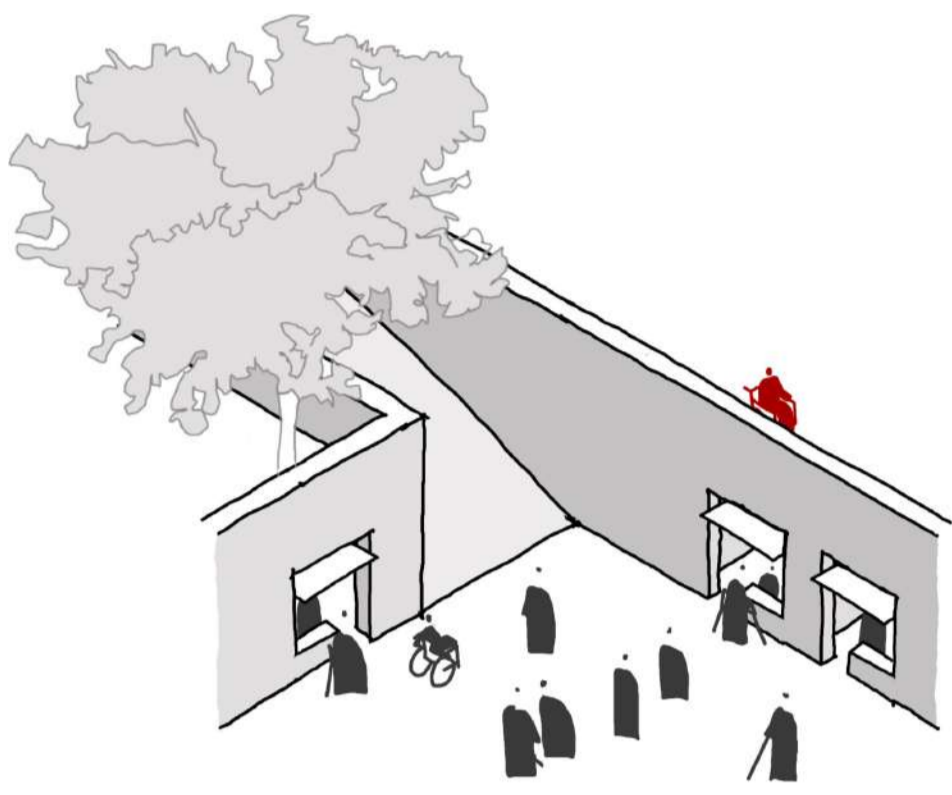
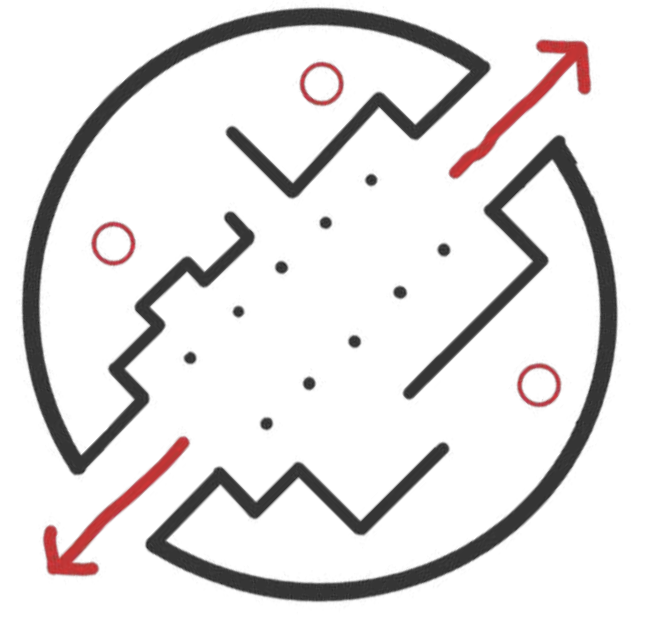

SECLUDED PASSAGE

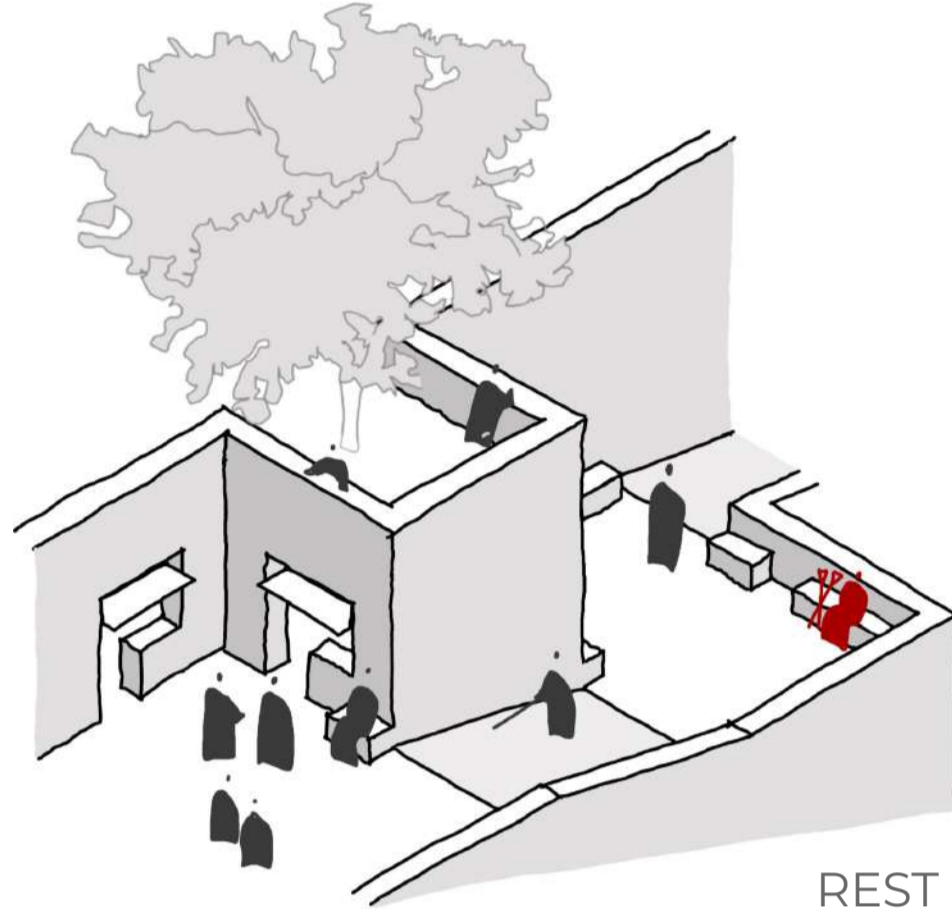

REST

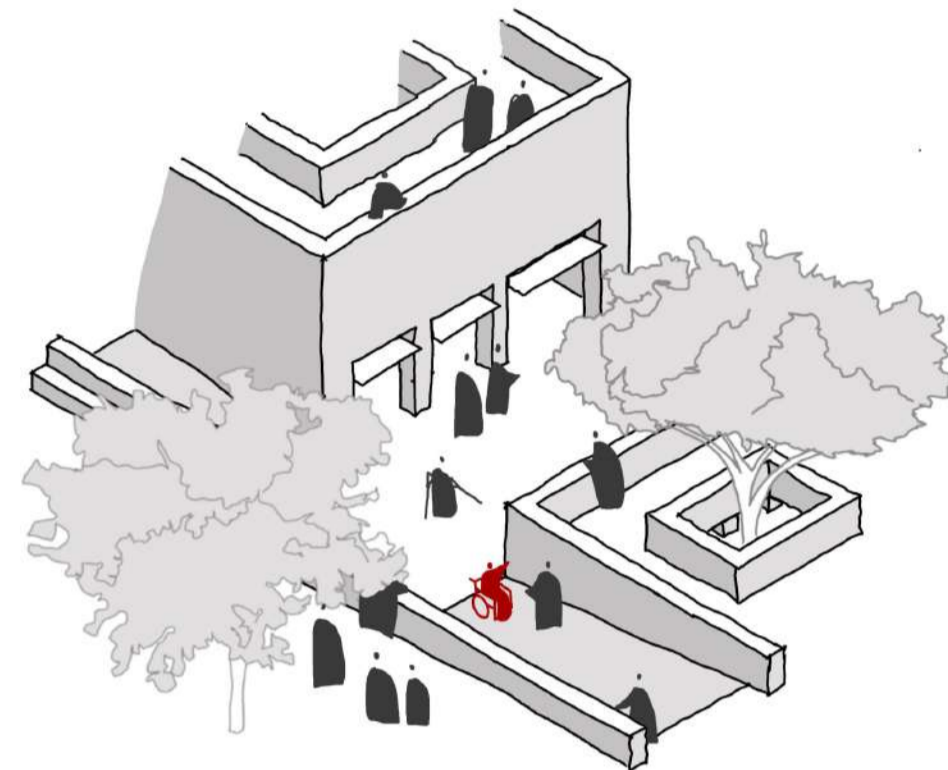

GREET

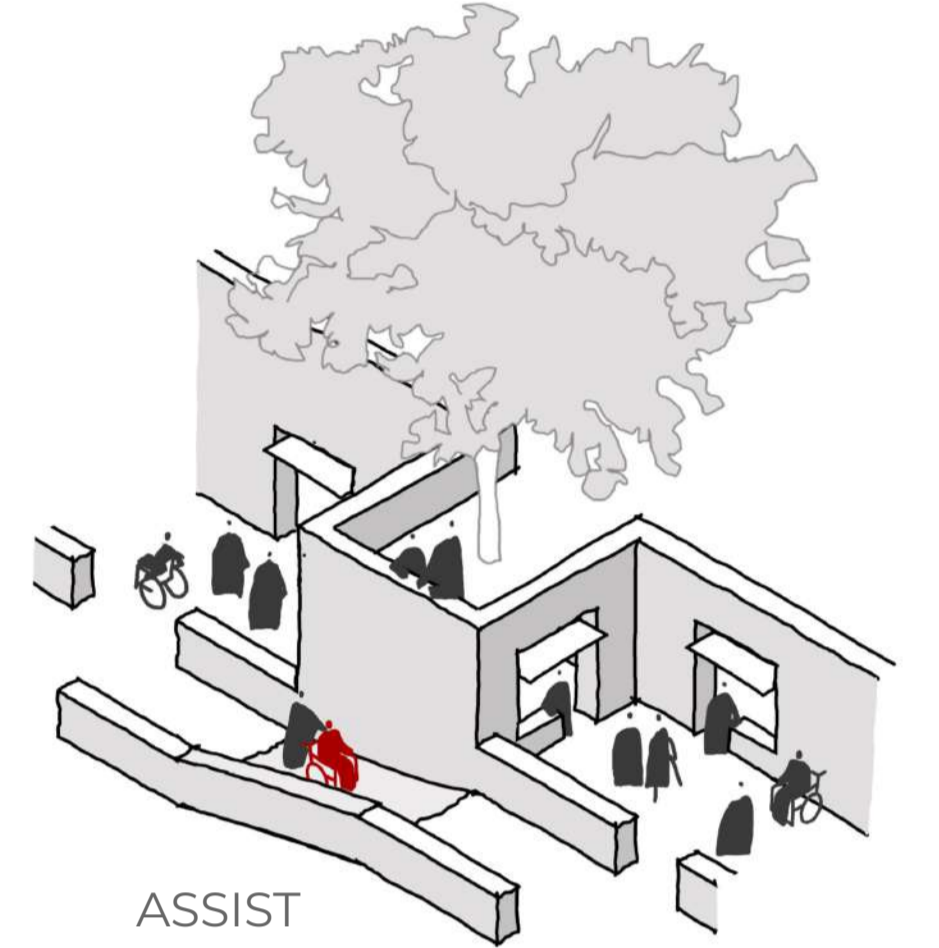

ASSIST

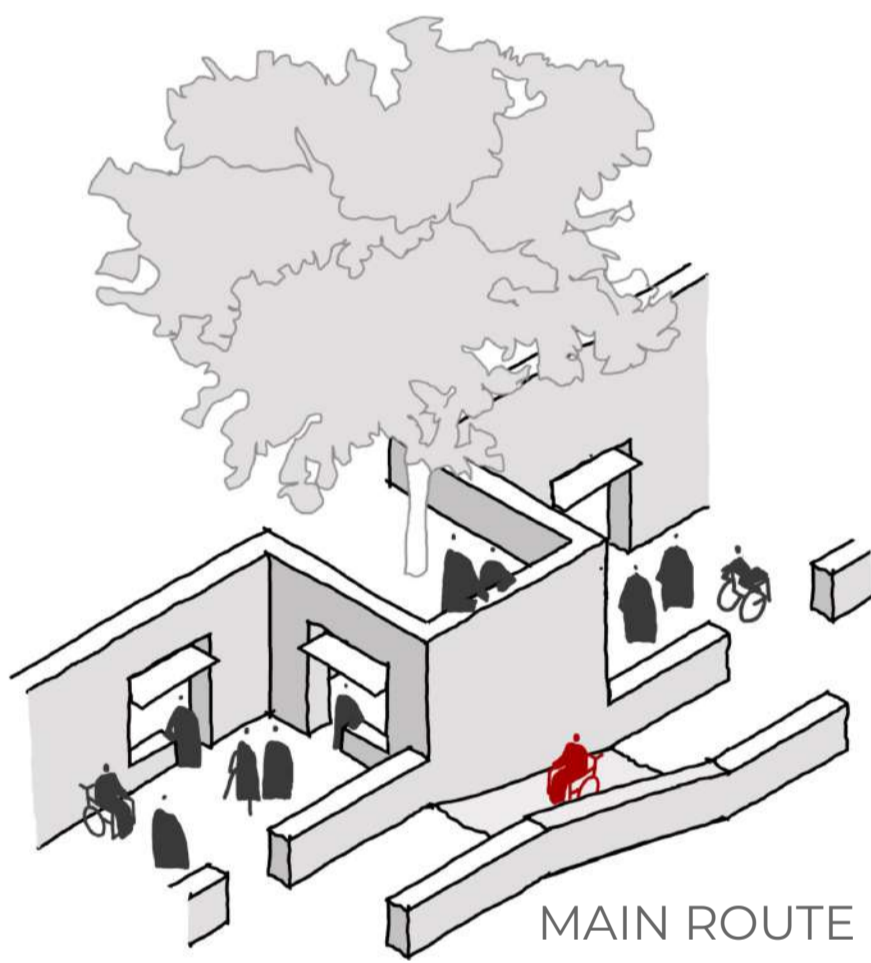

MAIN ROUTE

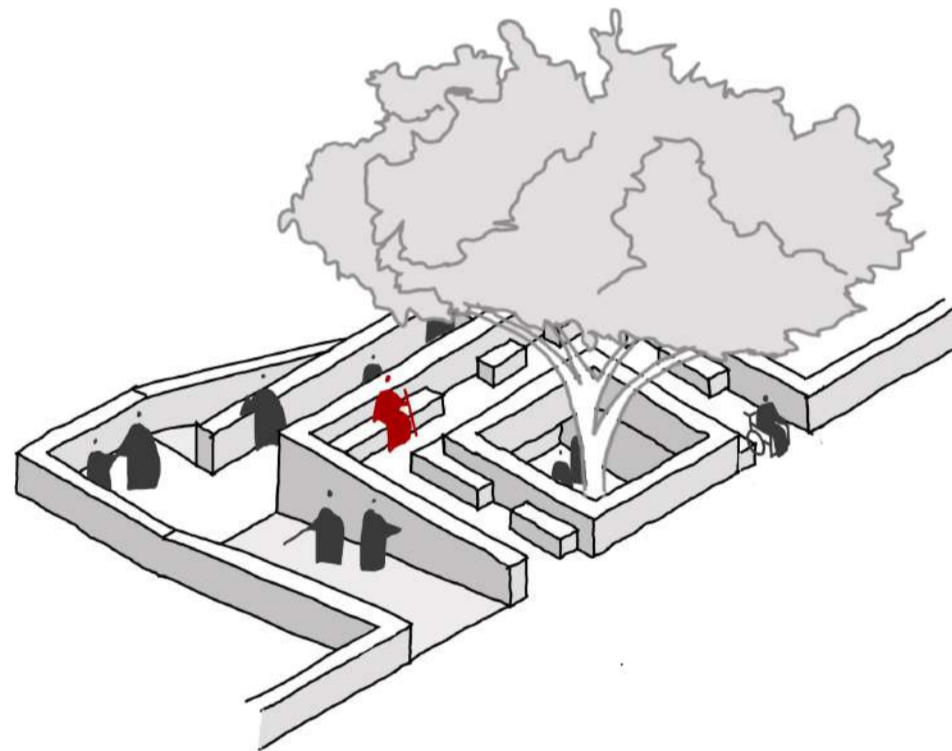

REFLECT

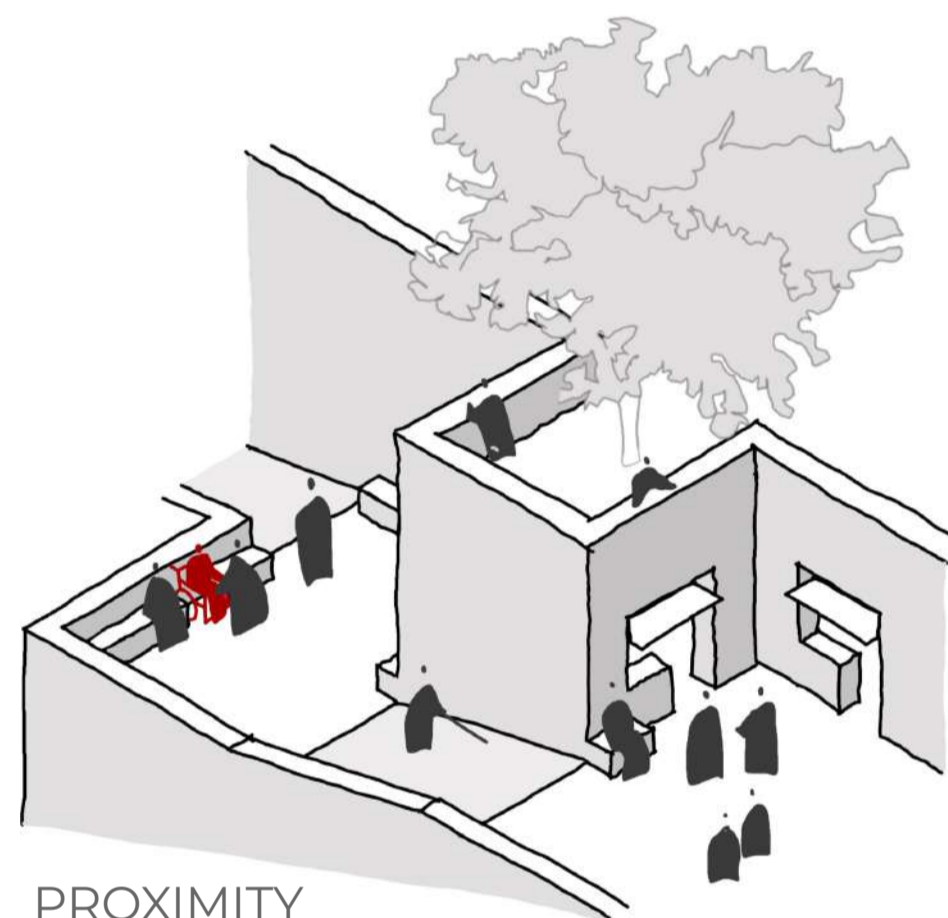

PROXIMITY

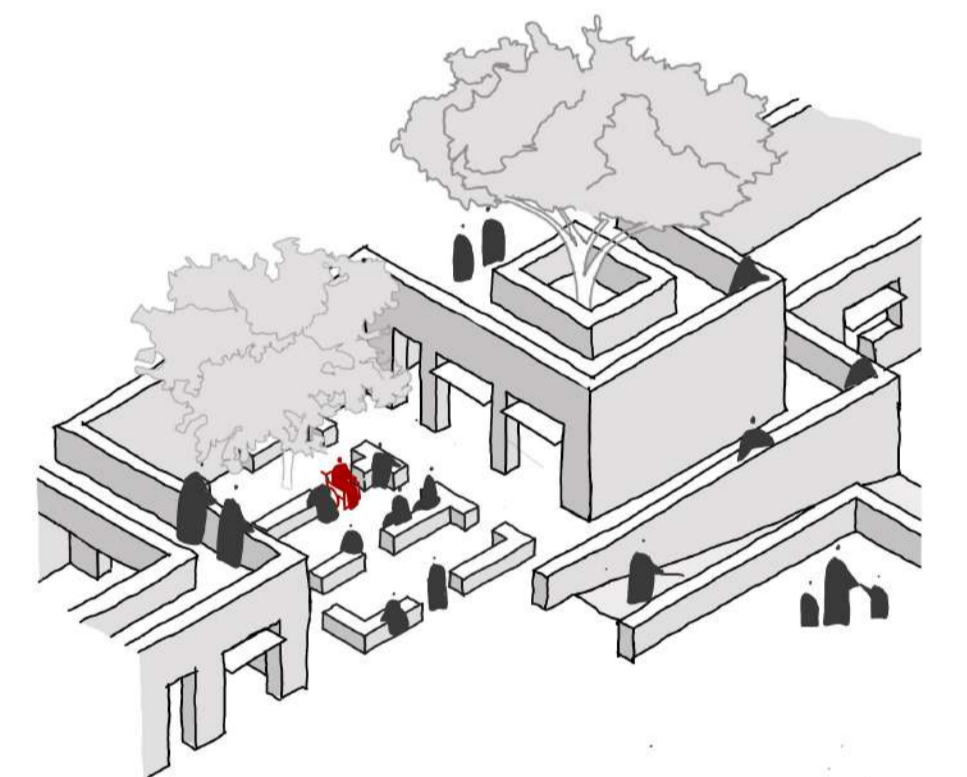

CONVERSE

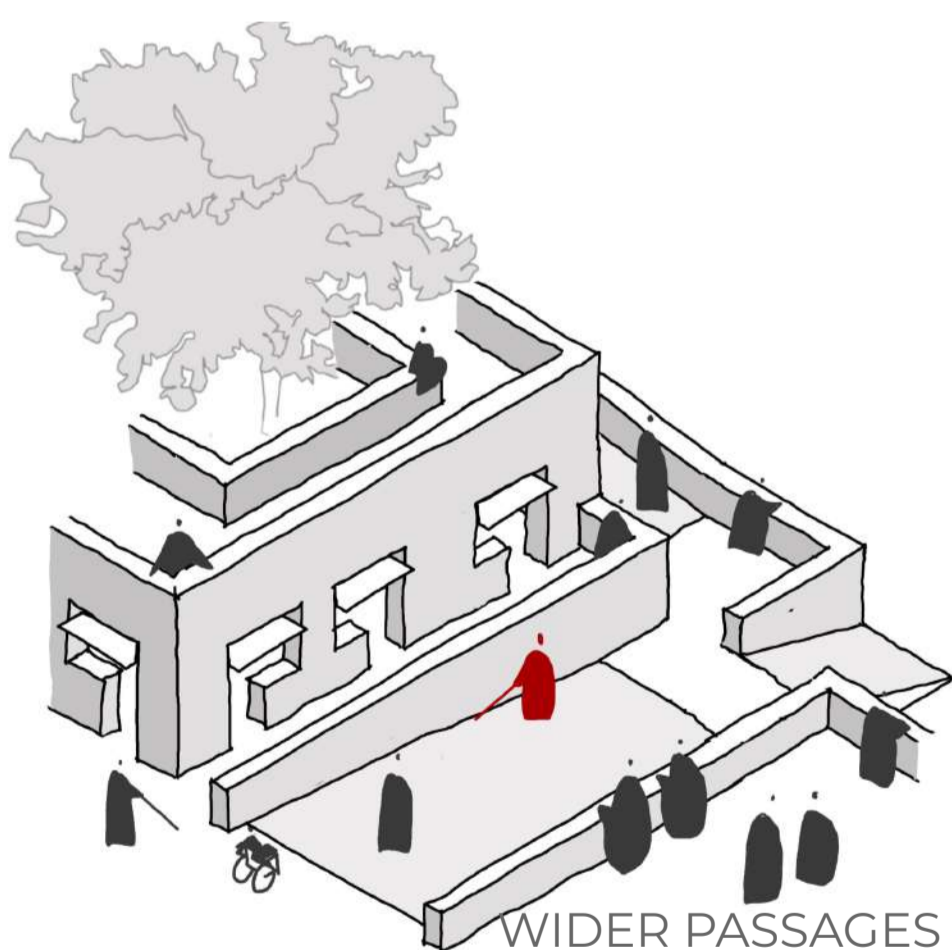

WIDER PASSAGES

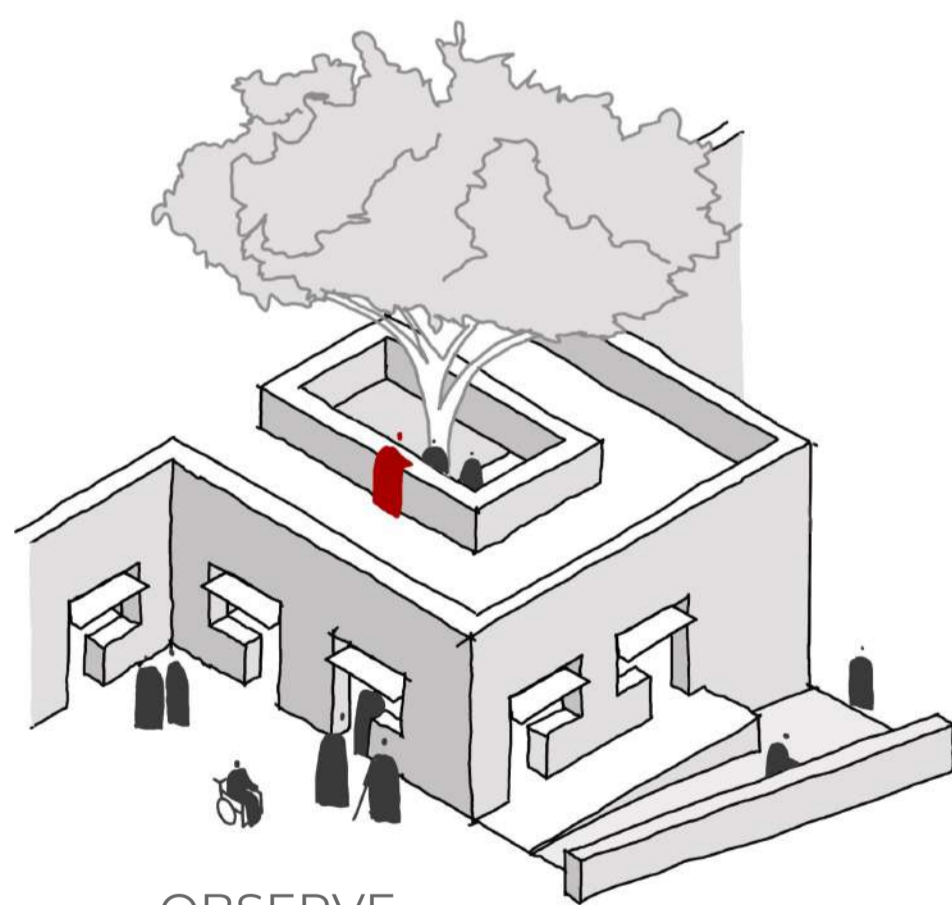

OBSERVE

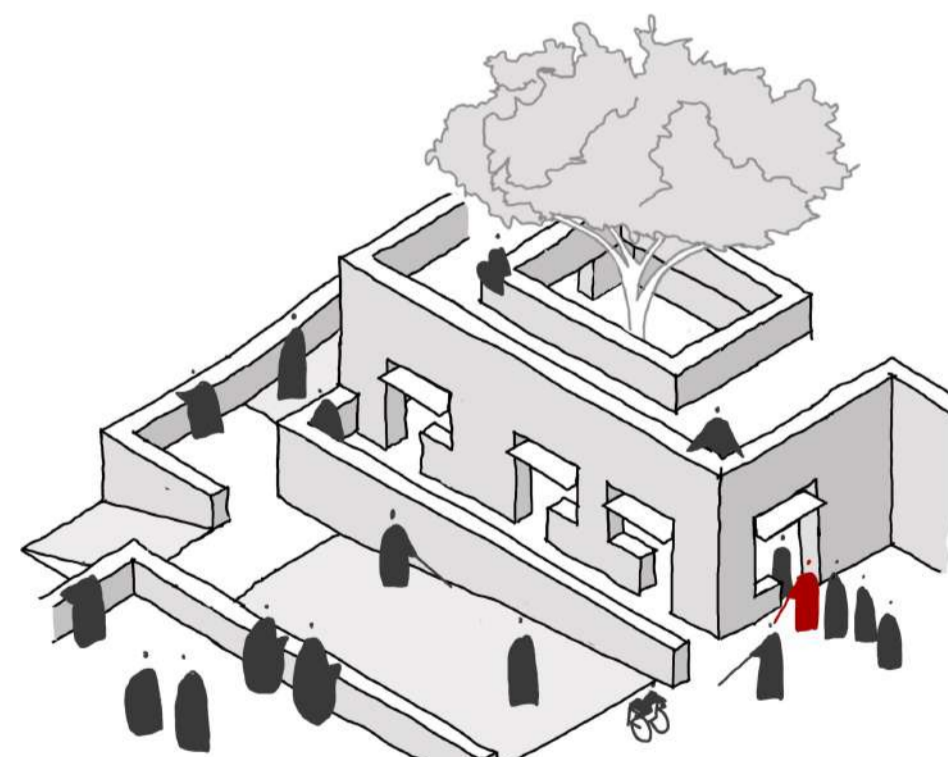

BUY

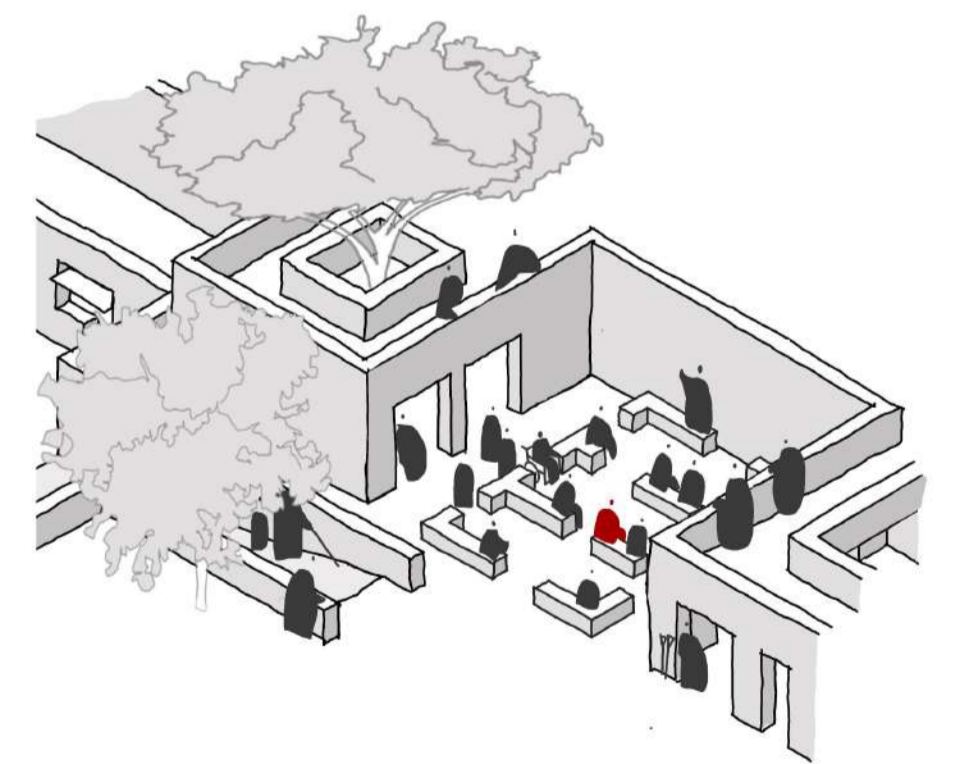

PARTICIPATE

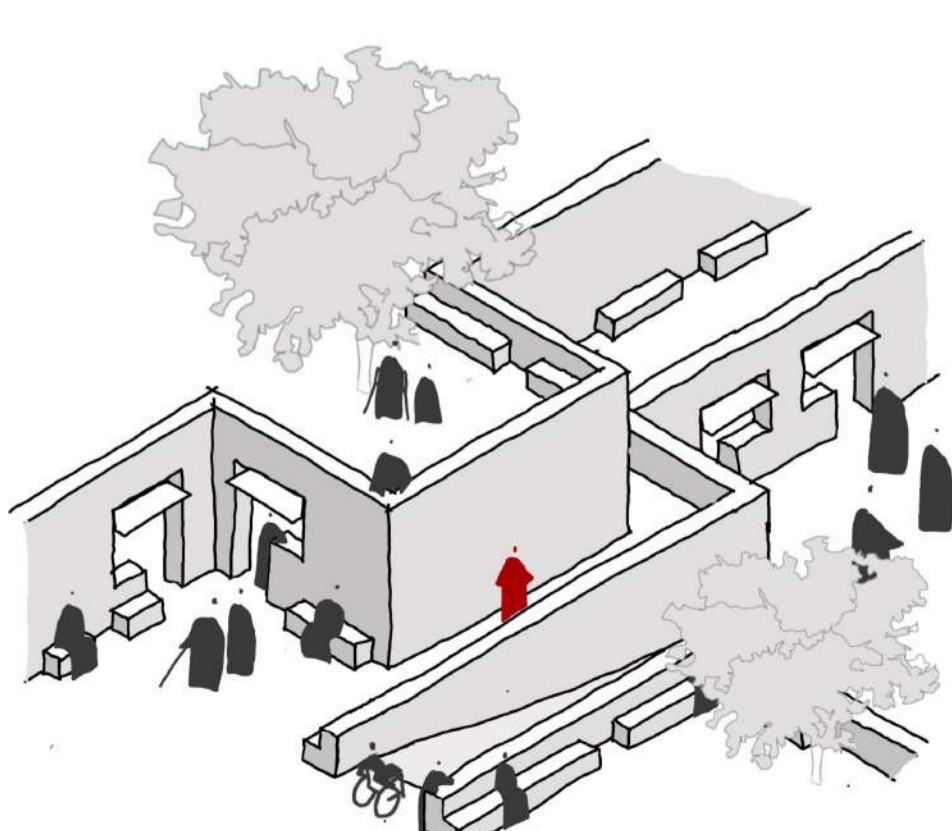

ALLEYS

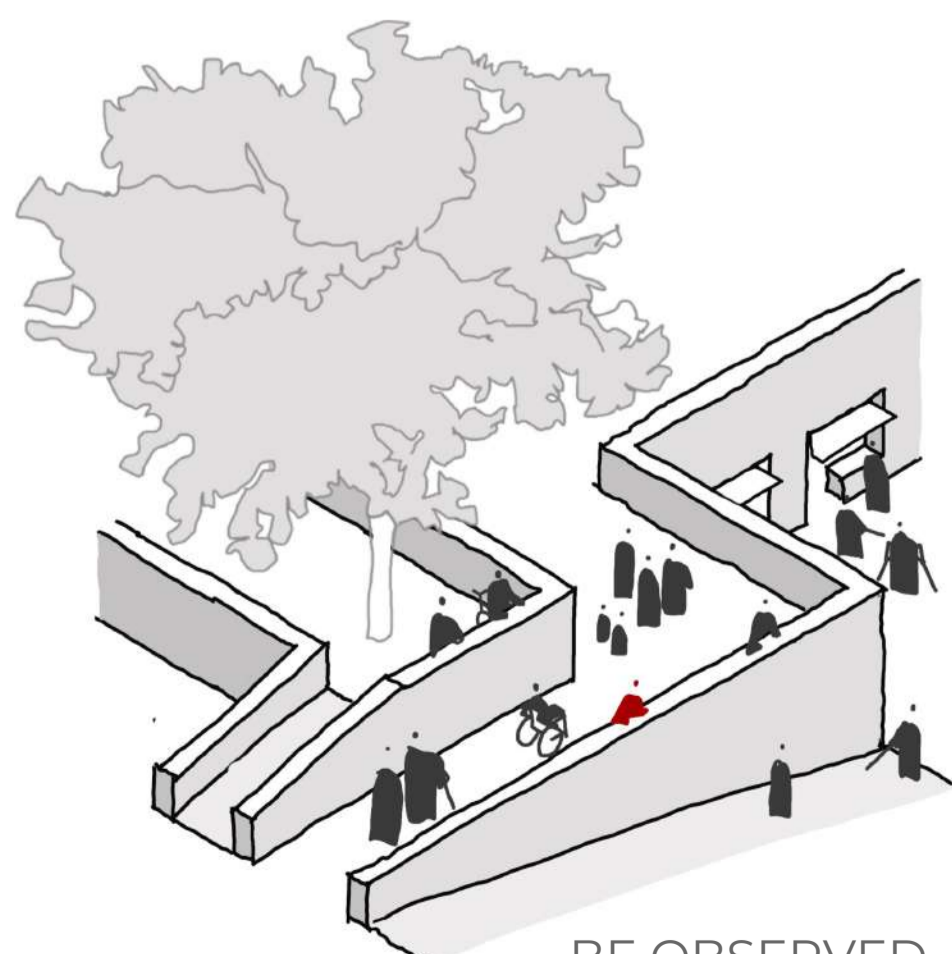

BE OBSERVED

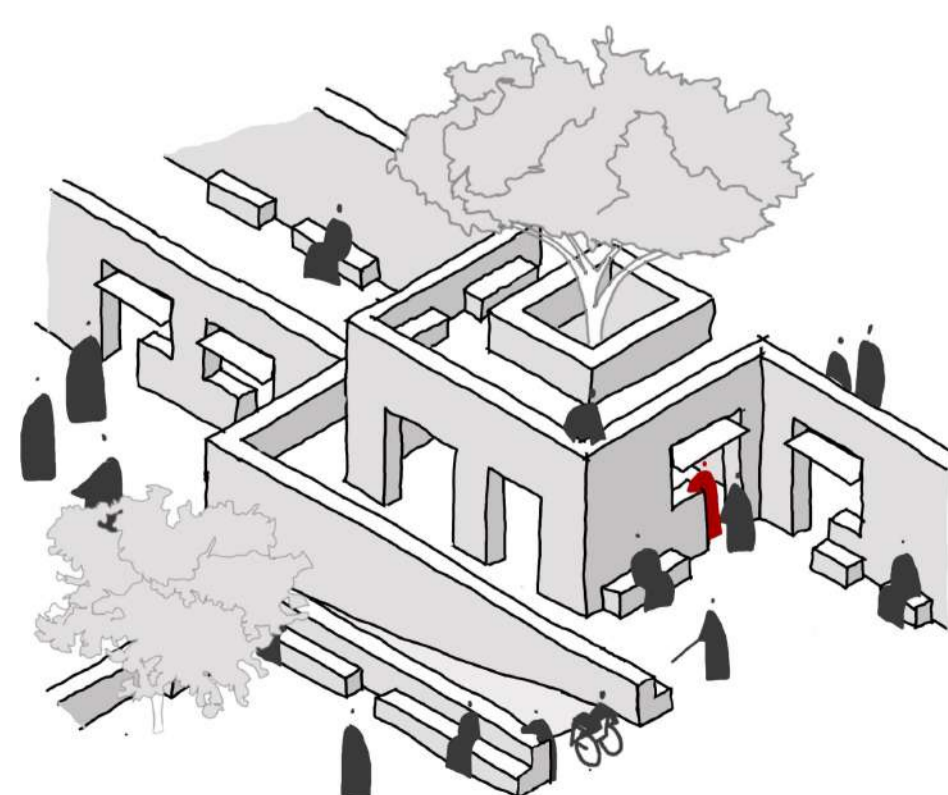

SELL

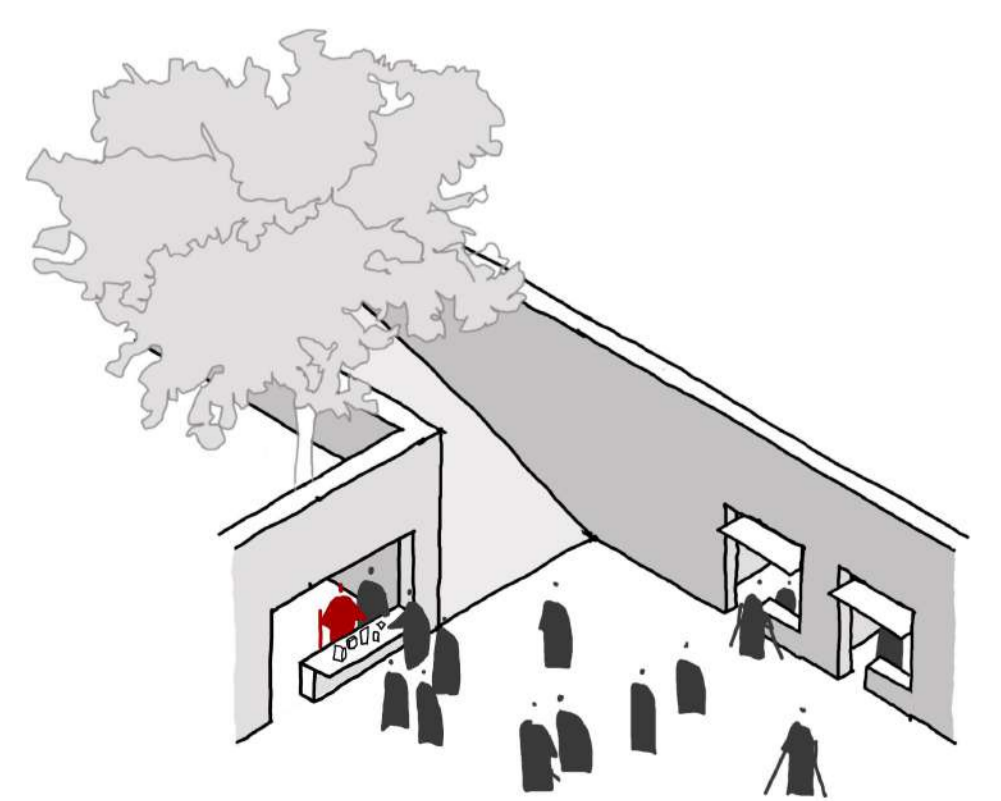

PARTNERSHIP

# USER FRIENDLY DESIGN

## THEORIES & PERSONA SPECTRUM

### ACCESSIBILITY

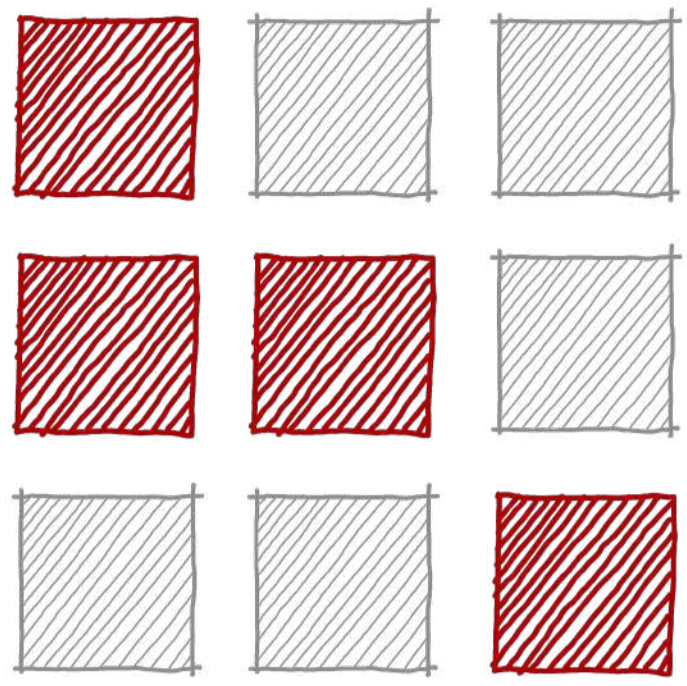

Accessibility is often considered an inherent attribute of architecture, meaning a space is either accessible or not.

### INCLUSIVE DESIGN

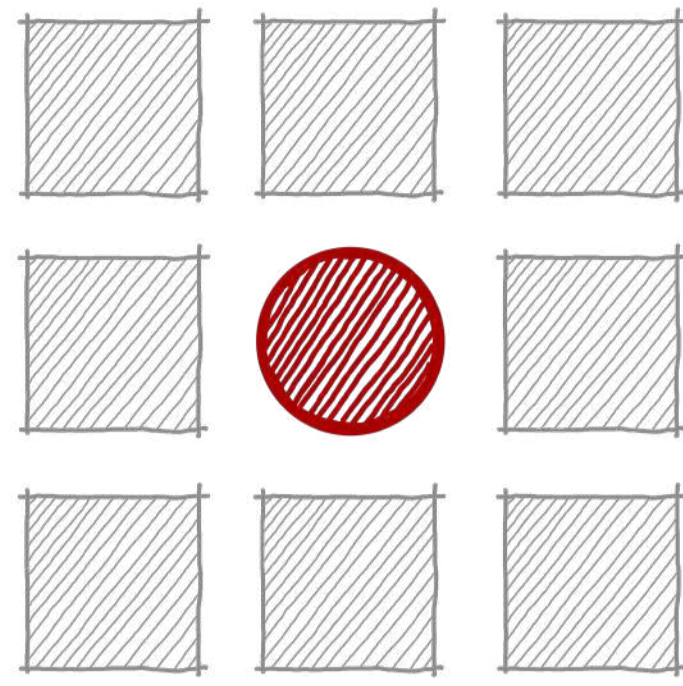

Inclusive design, on the other hand, is a specialised approach that focuses on designing for specific user groups.

### UNIVERSAL DESIGN

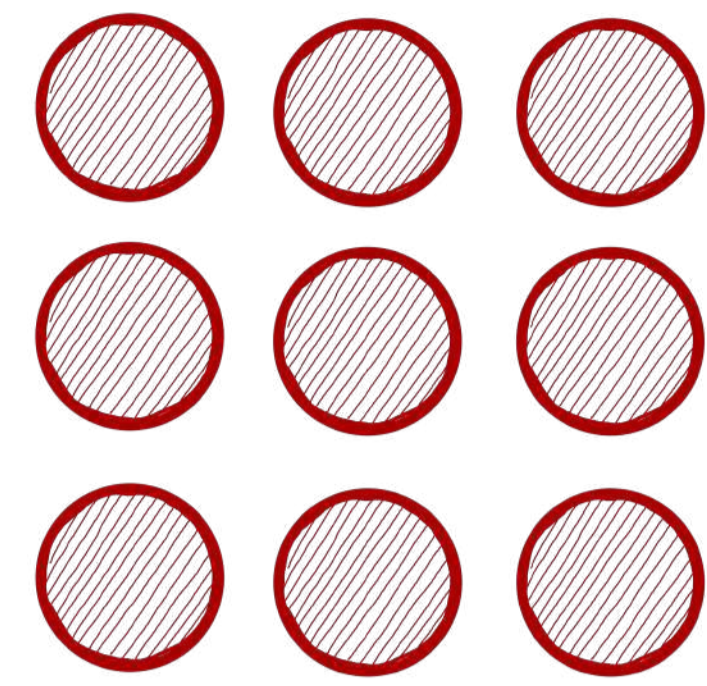

Universal design, as defined here, involves crafting environments to be accessible, understandable, and usable by the broadest range of individuals

## UNIVERSAL DESIGN 7 PRINCIPLES

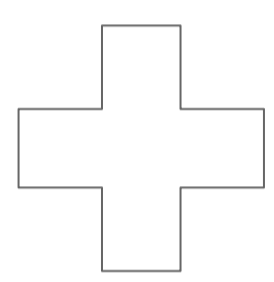

EQUITABLE USE

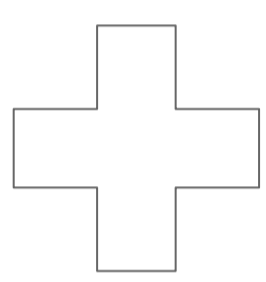

FLEXIBLE USE

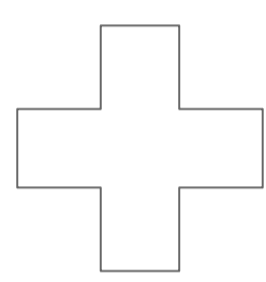

SIMPLE & INTUITIVE

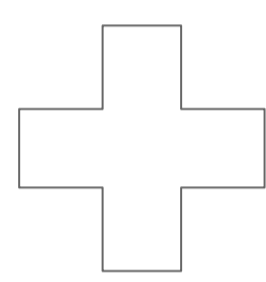

PERCEPTIBLE INFO

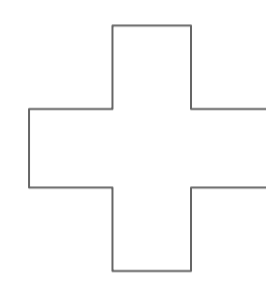

TOLERANCE FOR ERROR

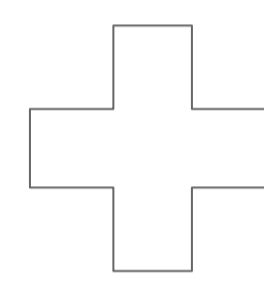

LOW PHYSICAL EFFORT

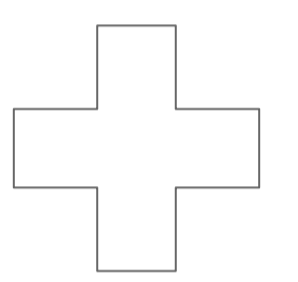

SIZE AND SPACE

## PERSONA SPECTRUM

### MOVEMENT

### SIGHT

### HEARING

### TOUCH

### COGNITIVE

### PERMANENT



WHEELCHAIR USER



BLIND



DEAF



MISSING LIMB

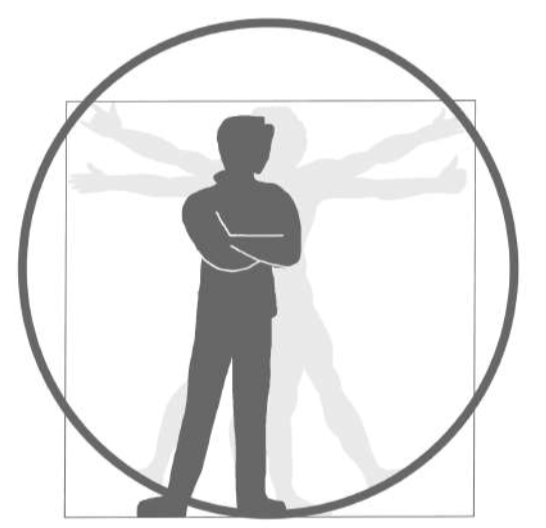

COGNITIVE IMPAIRMENT

### TEMPORARY



KNEE INJURY



CATARACT



HEARING AID



INJURY



CONCUSSION

### SITUATIONAL



MOTHER WITH A BABY



DISTRACTED/GLARE



LOUD MUSIC



MOTHER WITH A BABY

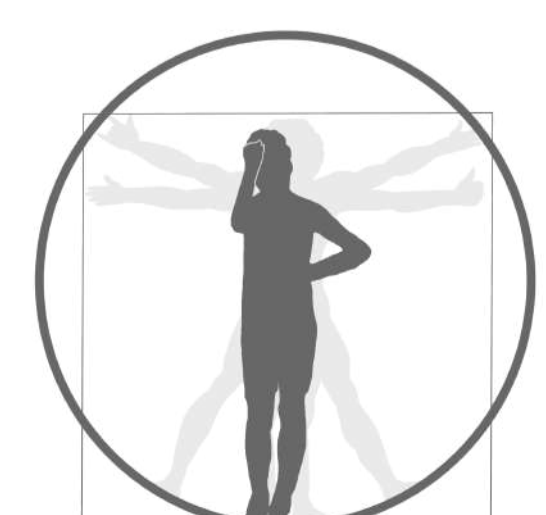

TIRED

# UNIVERSAL DESIGN PRINCIPLES

## SPATIAL EXPLORATIONS

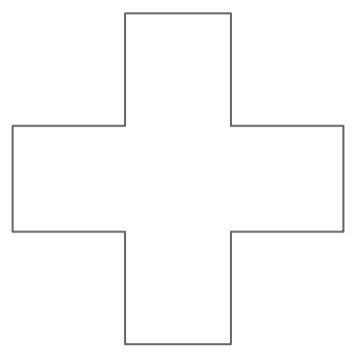

EQUITABLE USE

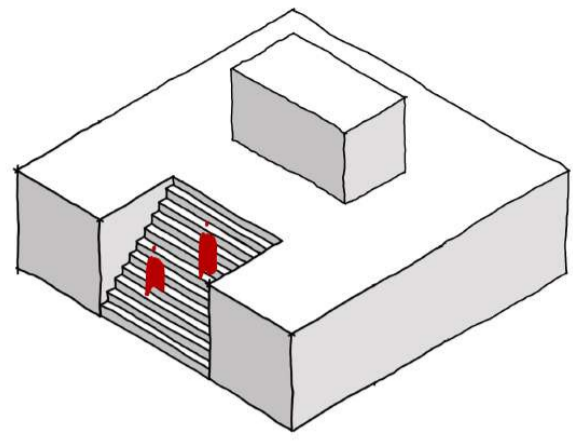

STANDARD

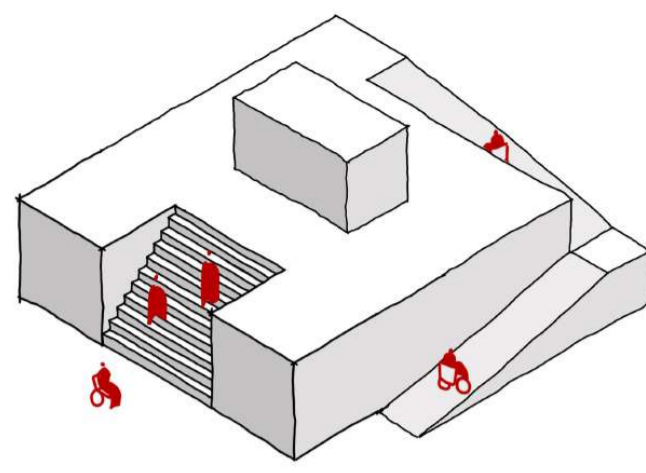

AS AN AFTERTHOUGHT

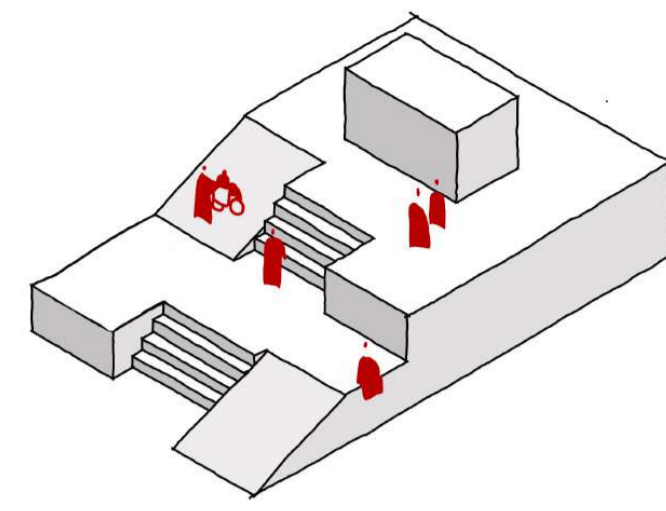

INTEGRATED

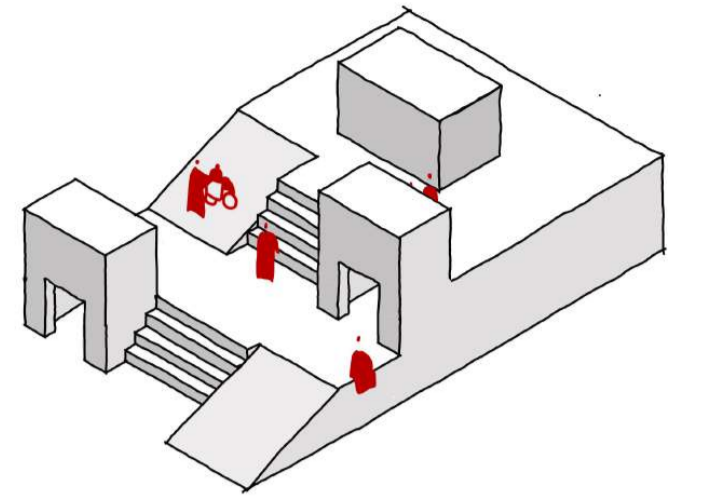

ASSISTIVE TECHNOLOGY

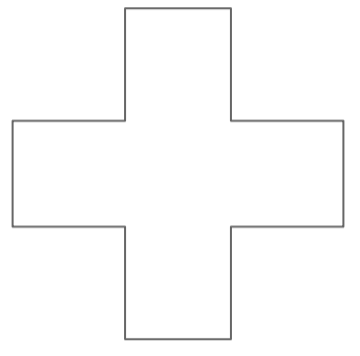

FLEXIBLE USE

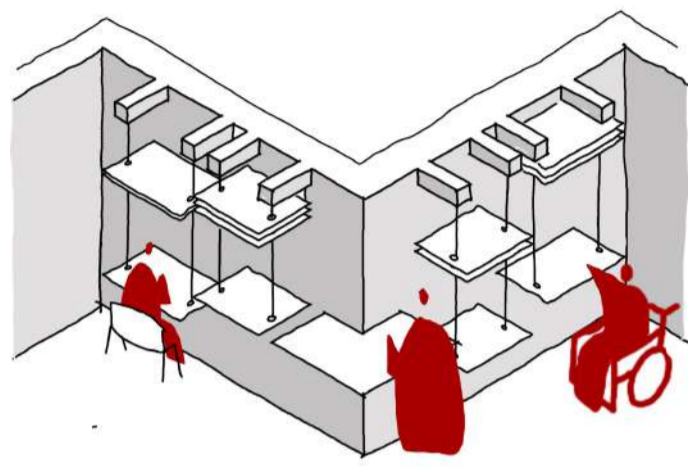

FURNITURE

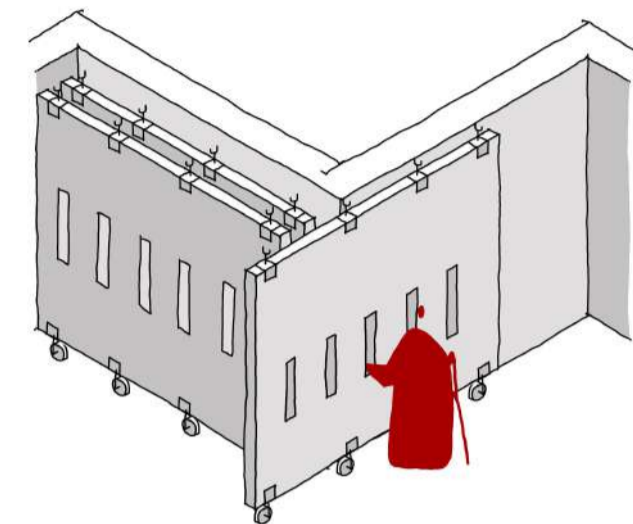

PARTITIONS

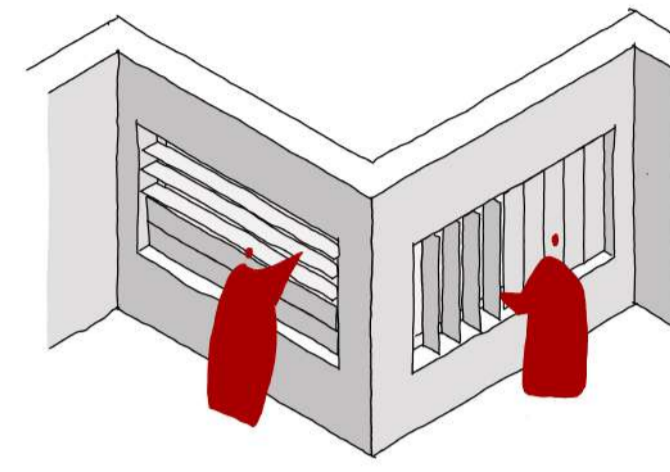

LIGHT SOURCES

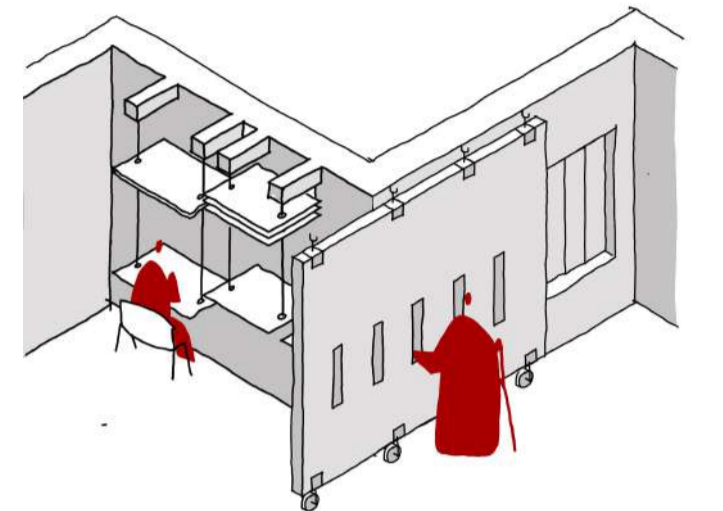

COMBINATION

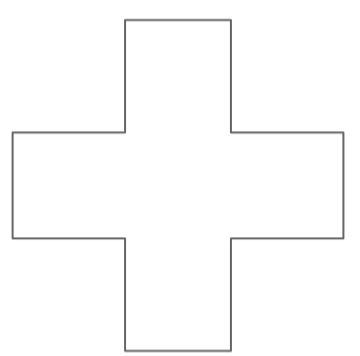

SIMPLE & INTUITIVE

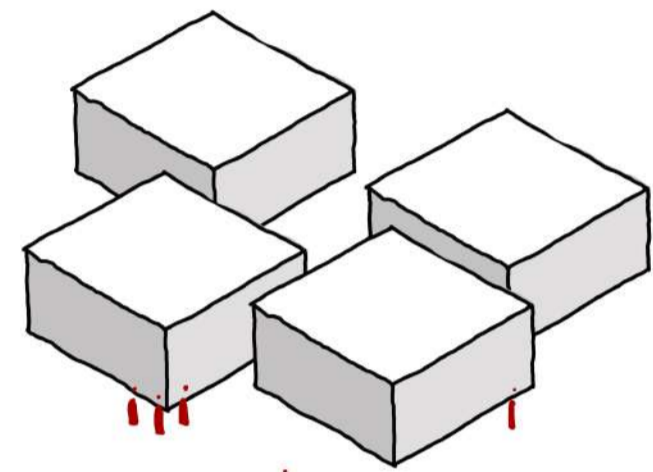

DIFFICULT TO NAVIGATE

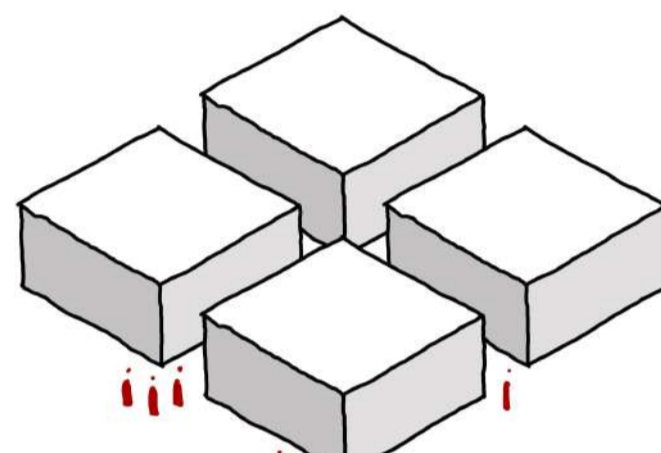

SIGHT LINES / BARRIER FREE

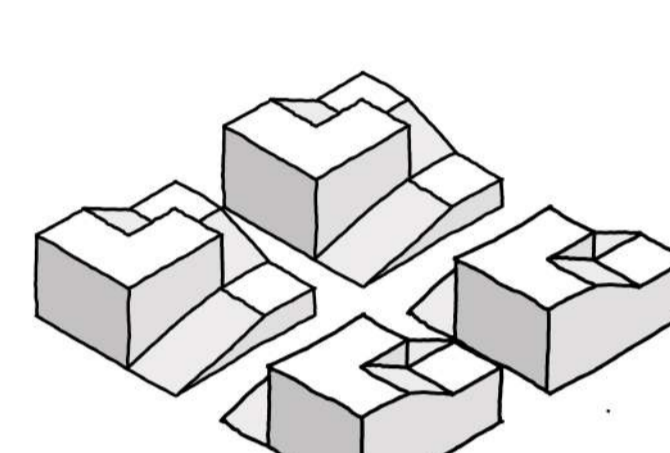

VERTICAL CIRCULATION  
ALONG MAJOR ROUTE

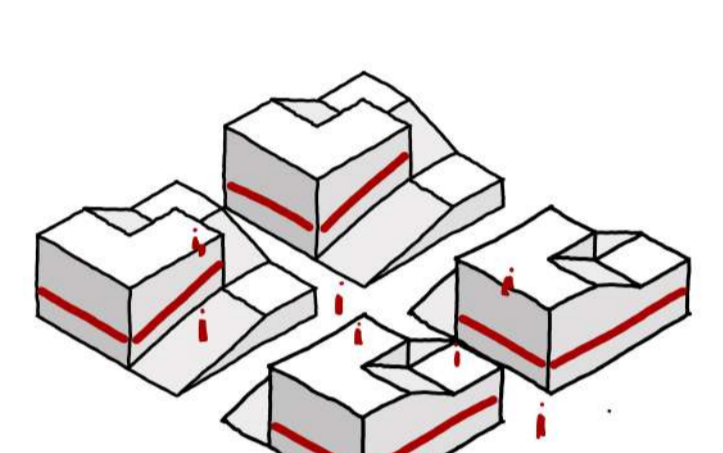

COLOR CONTRAST

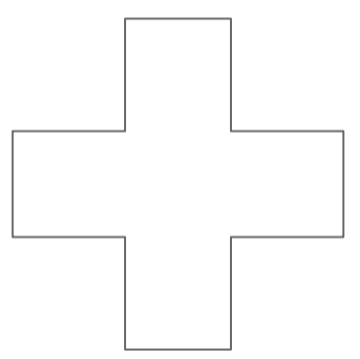

PERCEPTIBLE INFO

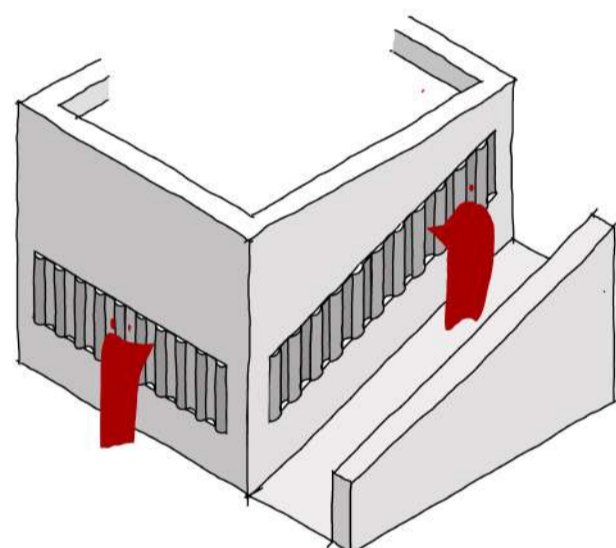

TOUCH

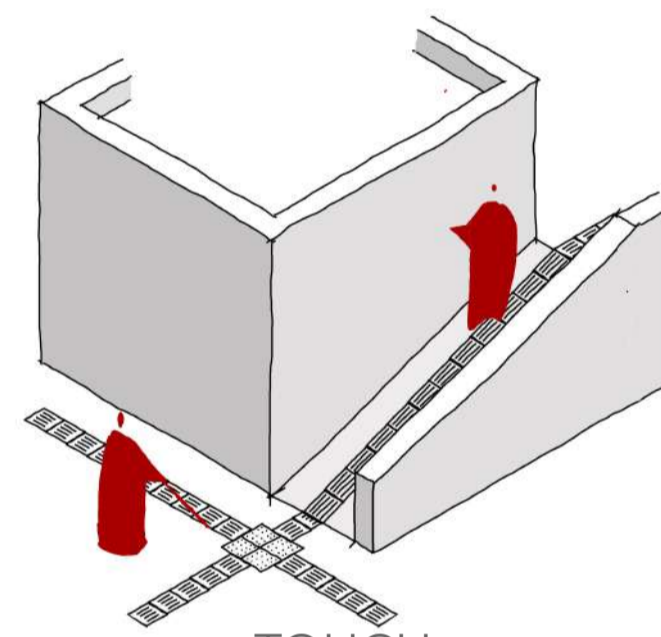

TOUCH

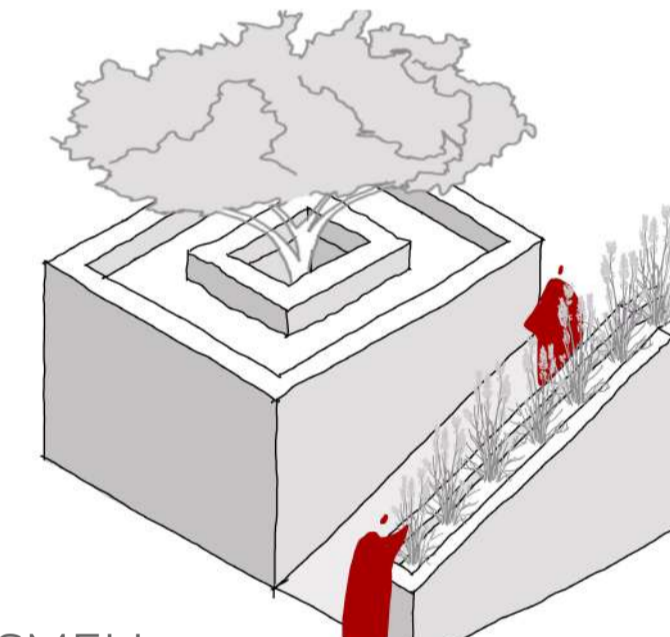

SMELL

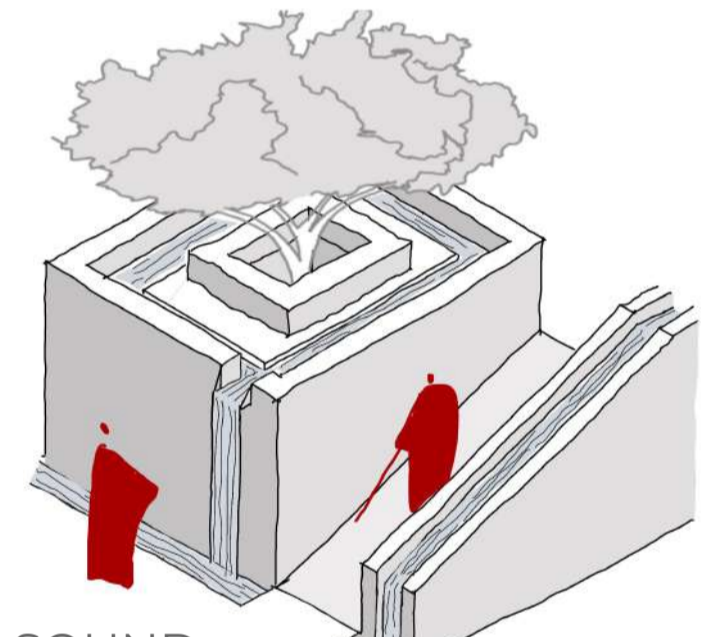

SOUND

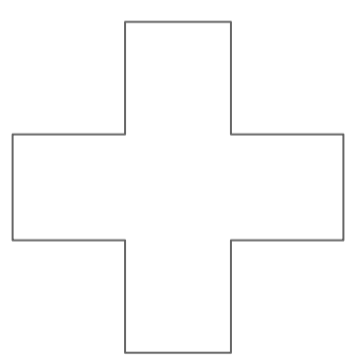

TOLERANCE FOR ERROR

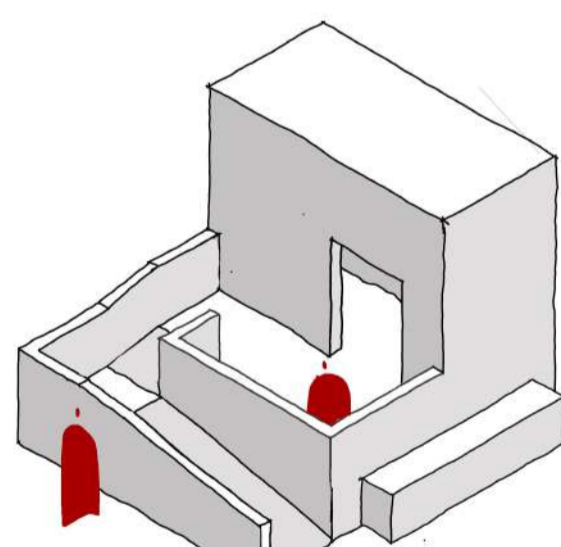

STANDARD

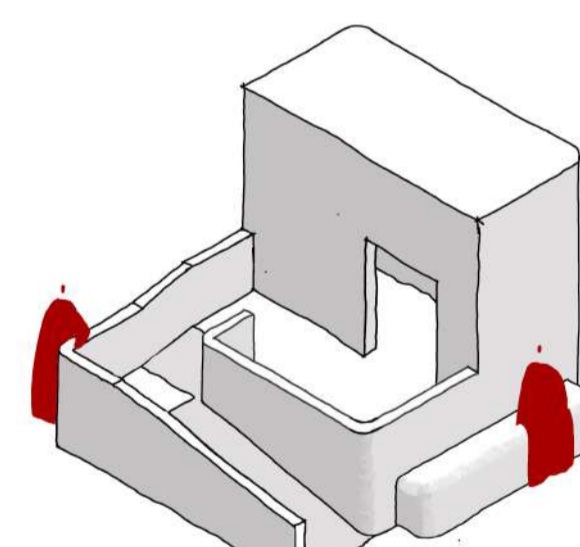

ROUNDED EDGES

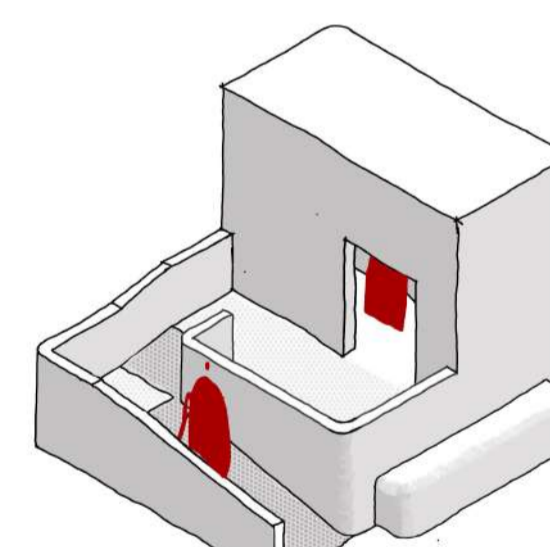

SLIP FREE FLOORING

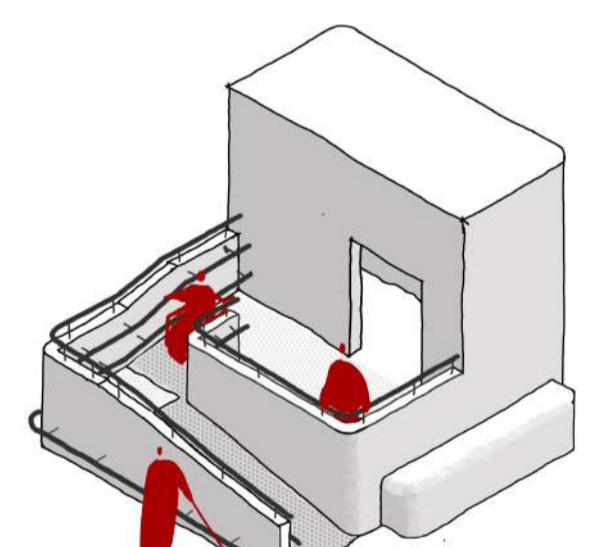

GRAB RAILS

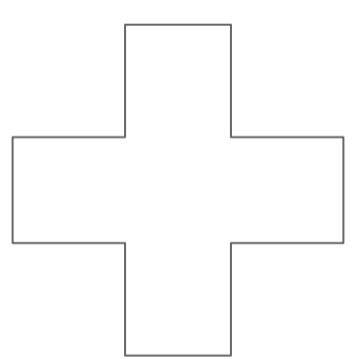

LOW PHYSICAL EFFORT

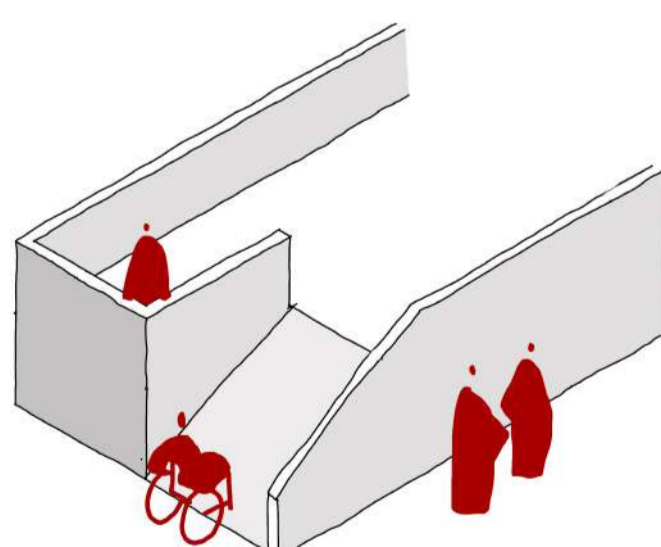

STANDARD

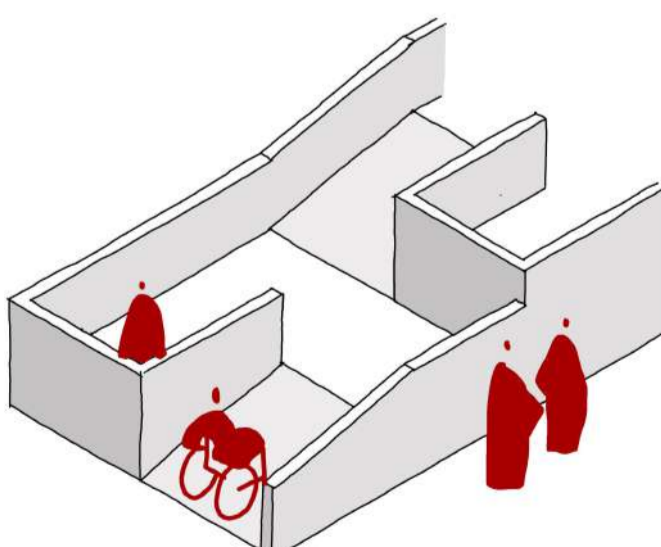

LANDINGS

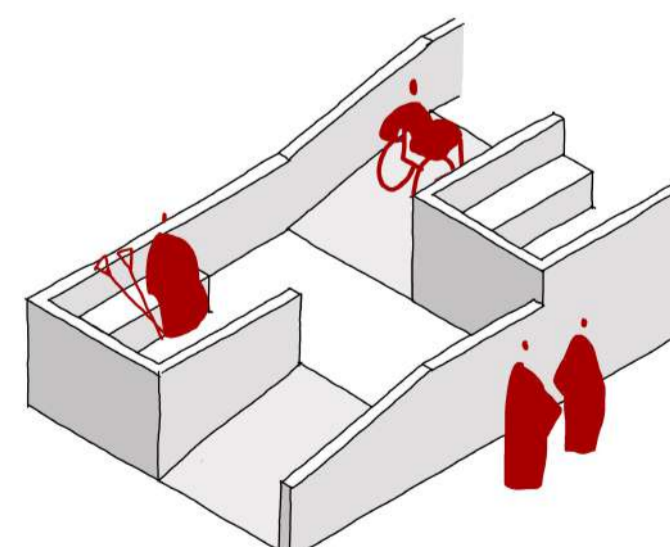

SEATING

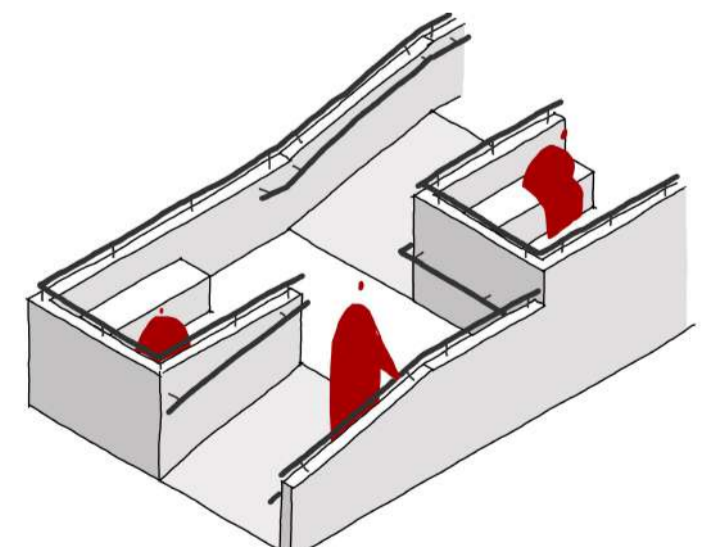

GRAB RAILS

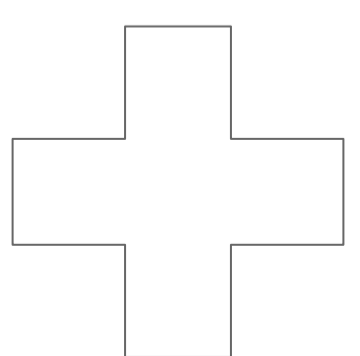

SIZE AND SPACE

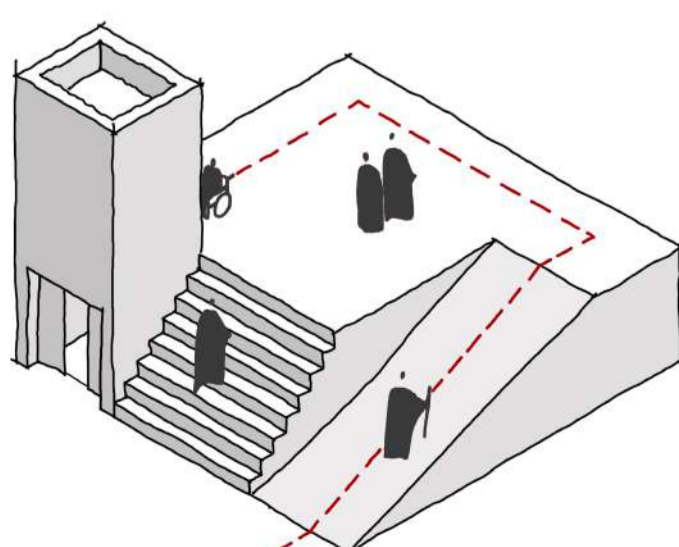

TRAVEL DISTANCE

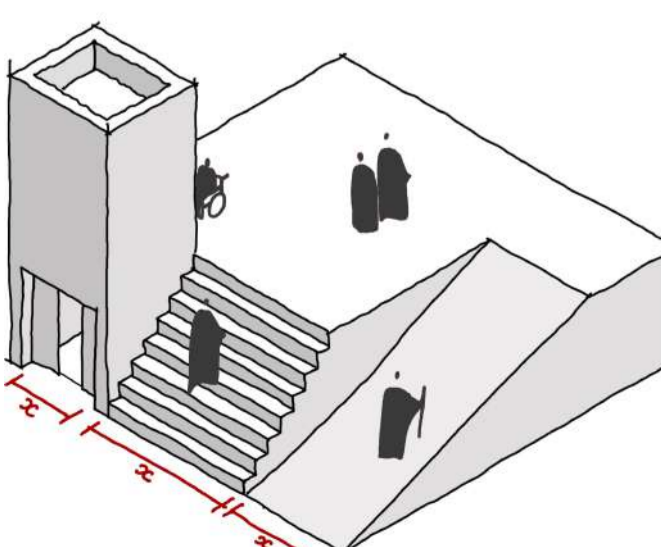

CIRCULATION SIZES

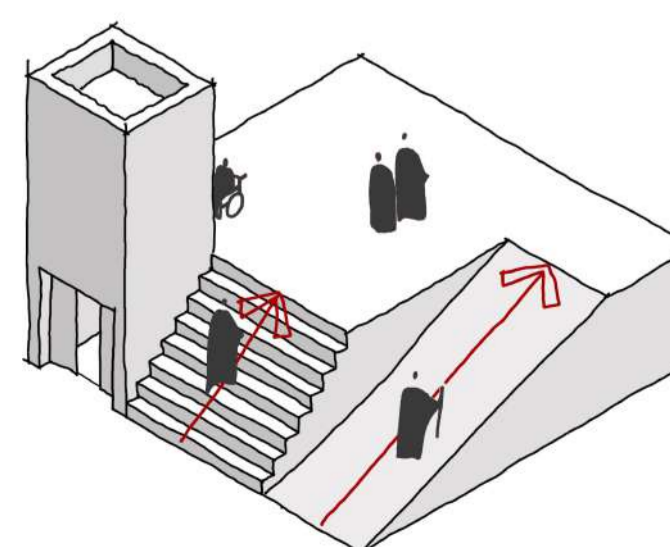

HEIGHTS

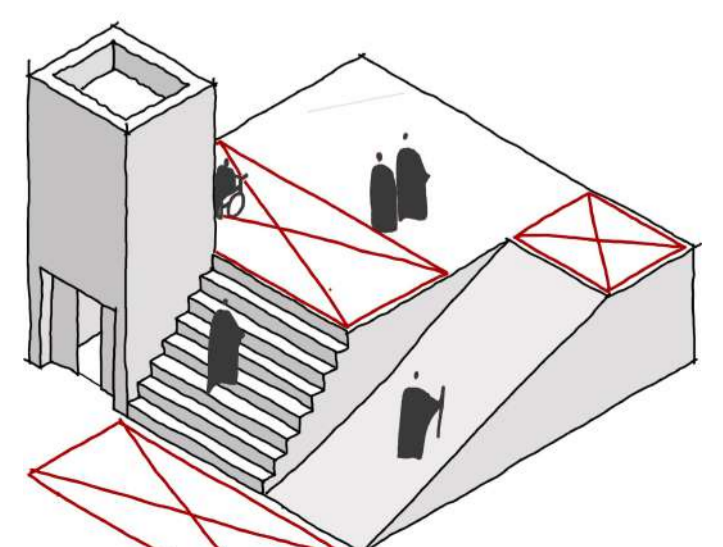

LANDINGS

# DESIGN PERFORMANCE CHECKLIST

## UNIVERSAL ACCESSIBILITY OF ARCADES

### UNIVERSAL ACCESSIBILITY CHECKLIST

69

#### ENTRANCES & HORIZONTAL CIRCULATION

16

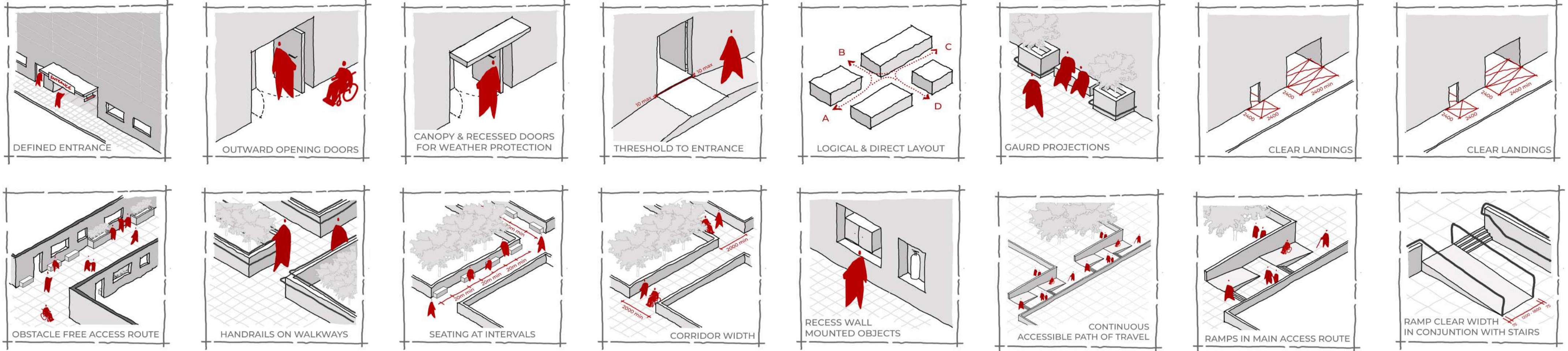

#### VERTICAL CIRCULATION

37

##### RAMPS

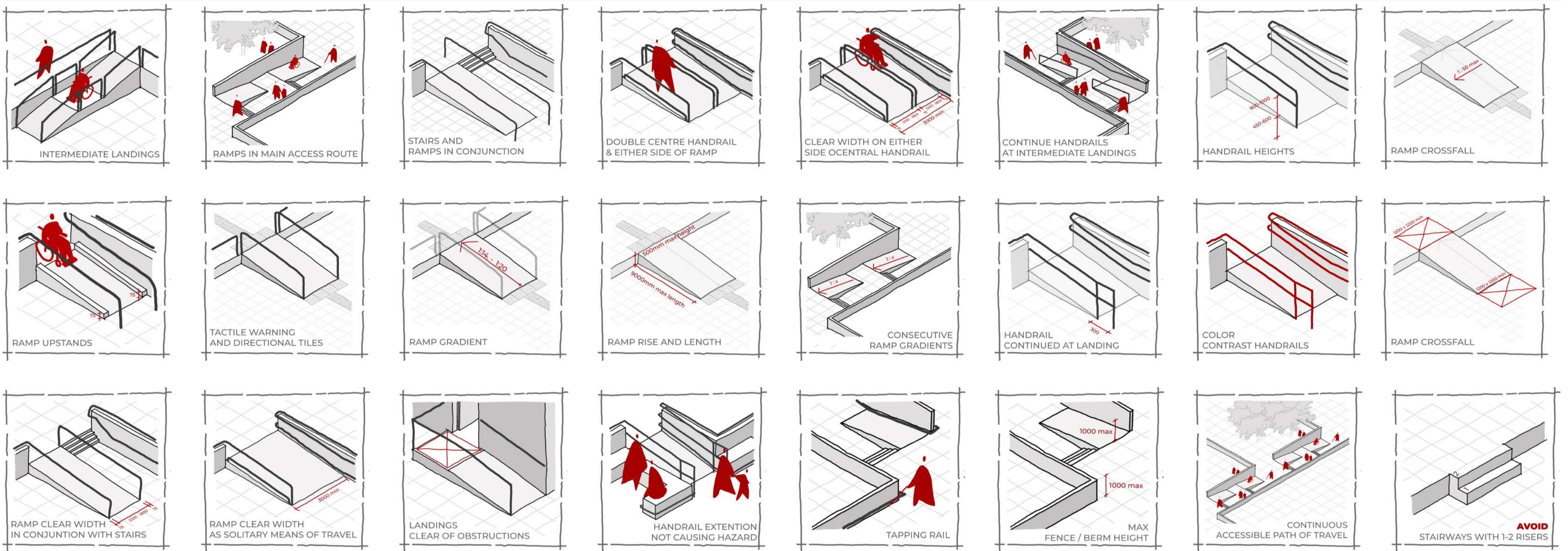

##### STAIRS

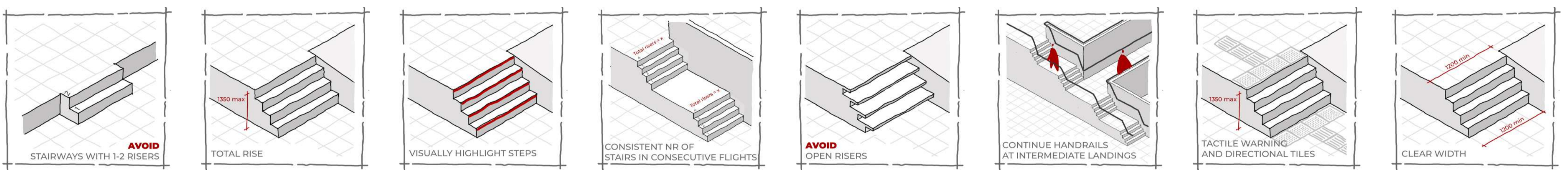

##### PASSENGER LIFTS

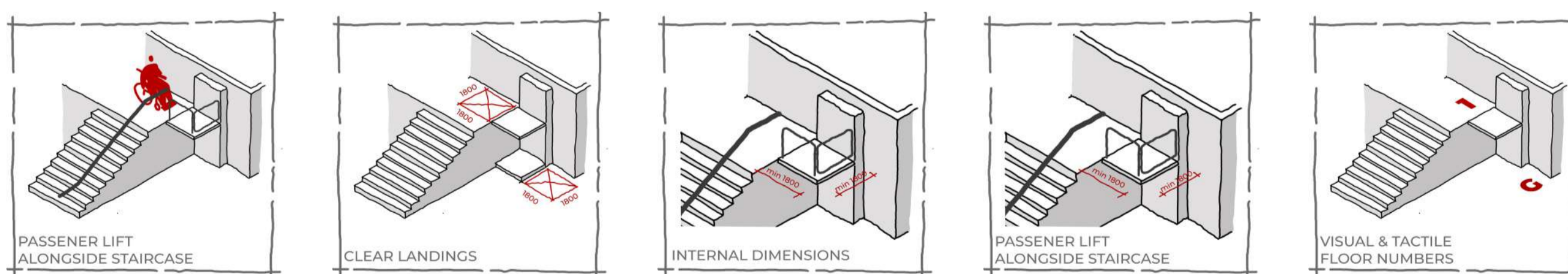

#### EXTERNAL ENVIRONMENT & FURNITURE

16

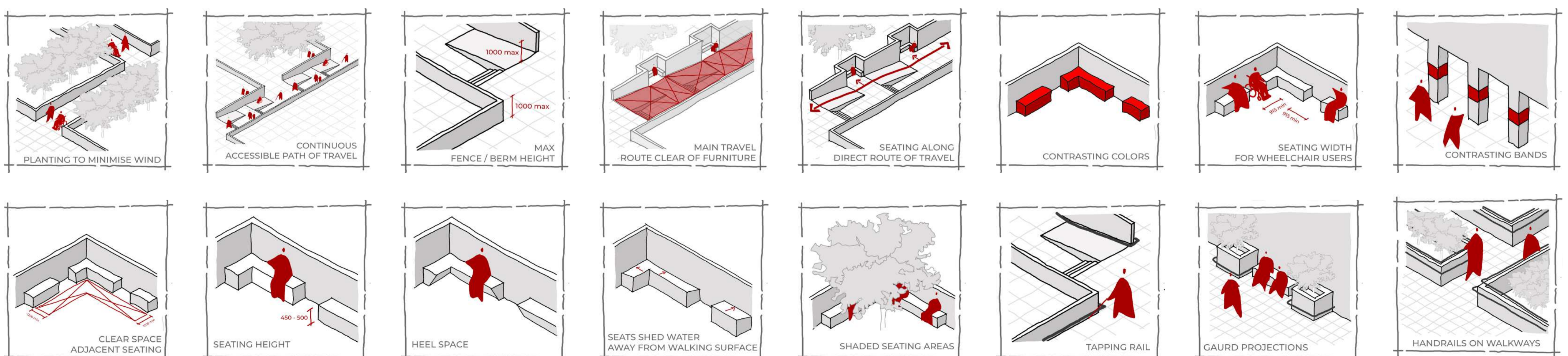

# CHECKLIST

## IMPLEMENTATION & RESULTS

### SITE ARCADES

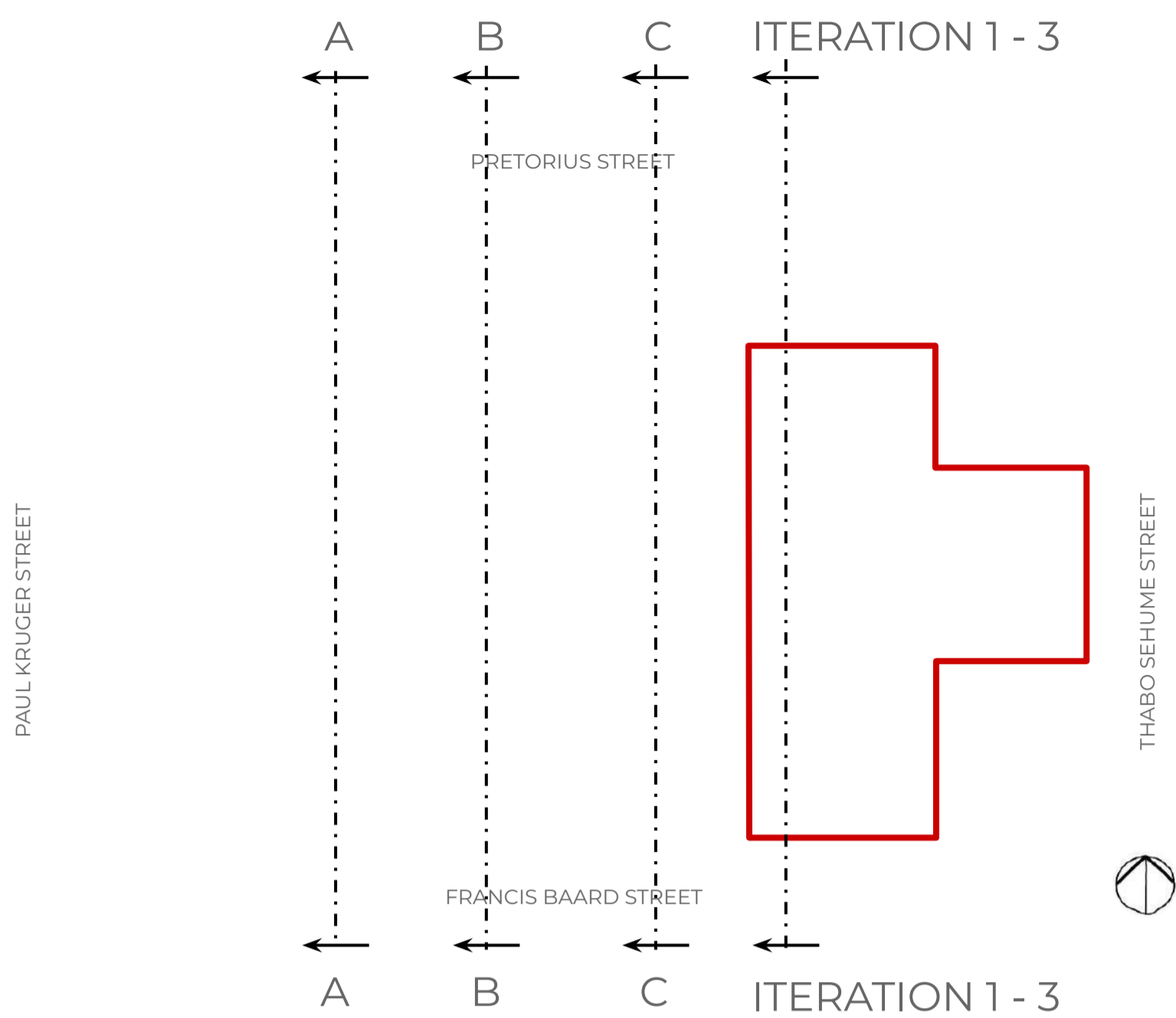

### BASE CASE

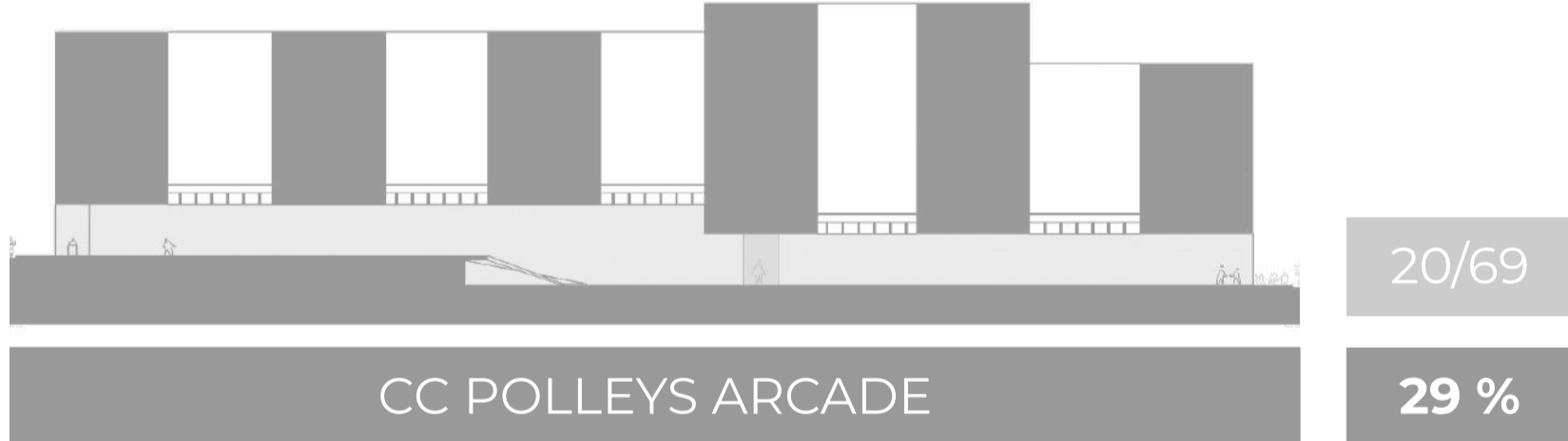
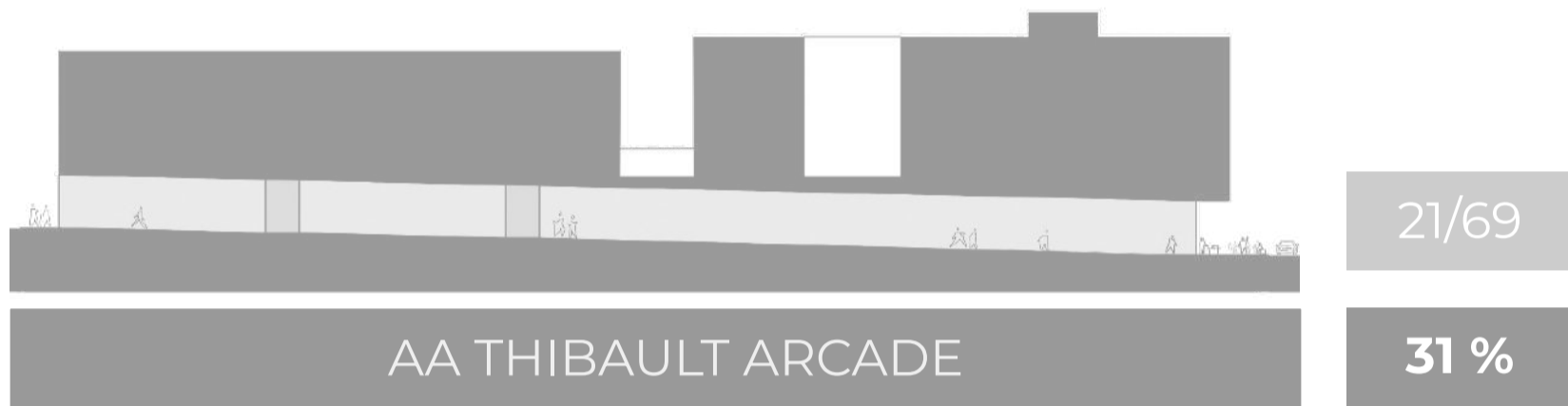

### ITERATIONS

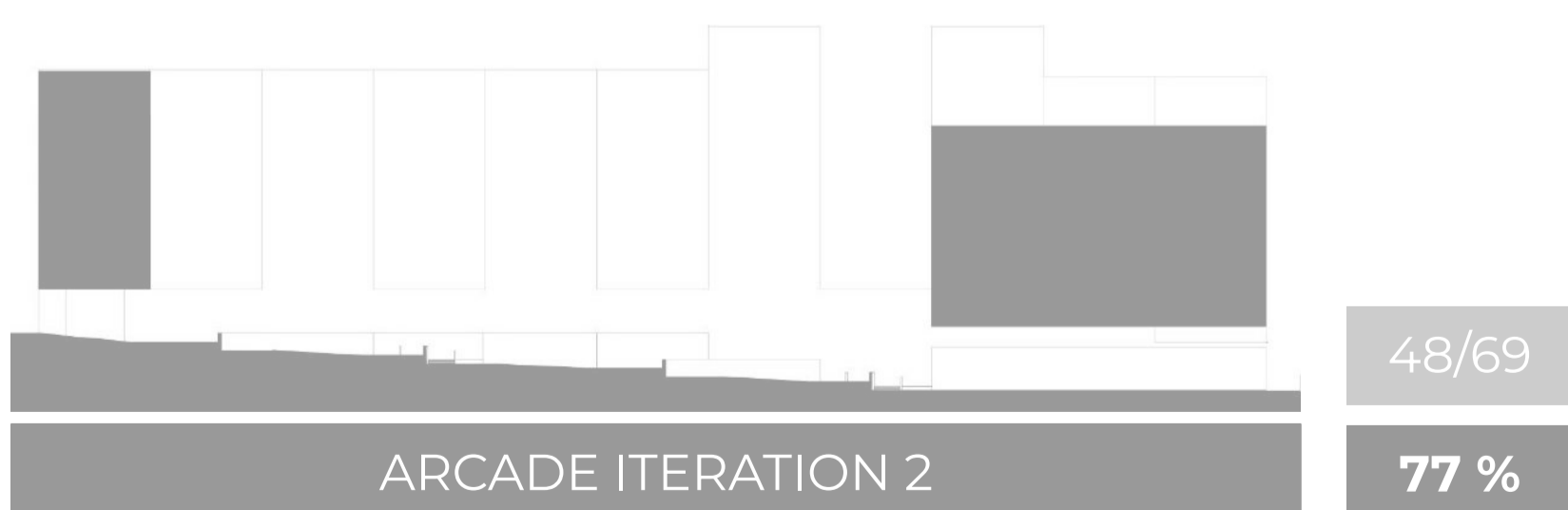
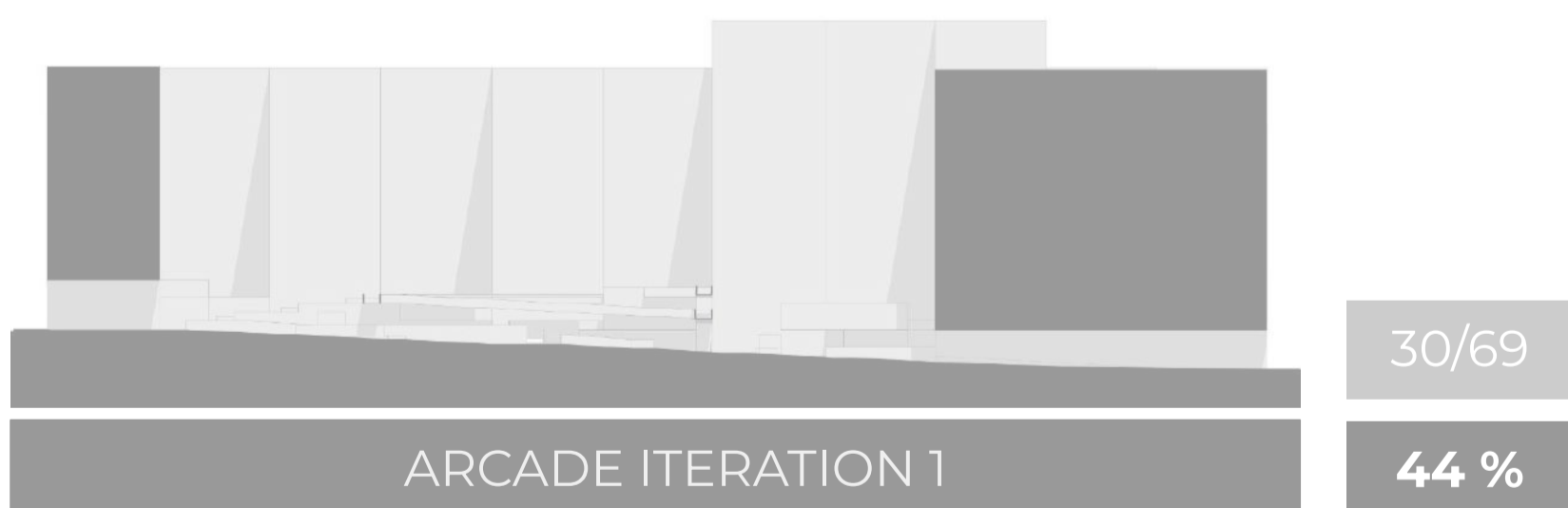

# PRECEDENT

## SPATIAL

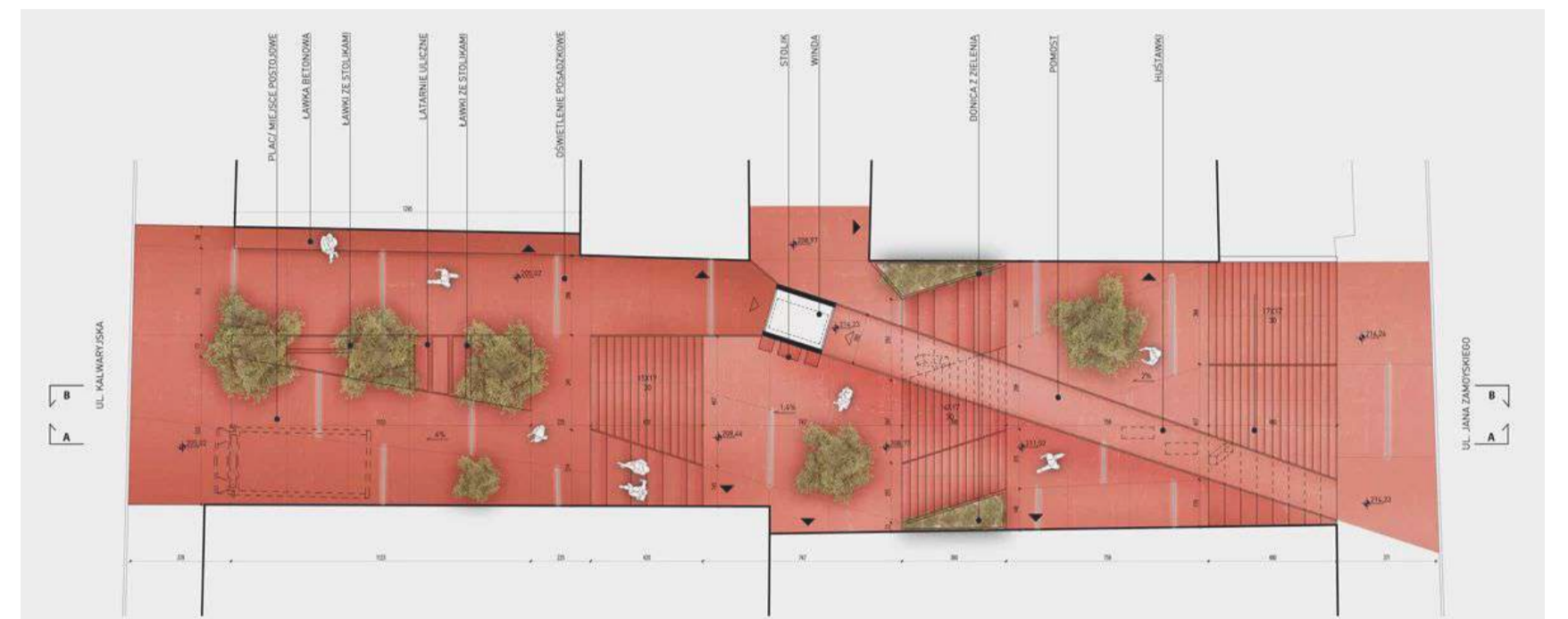
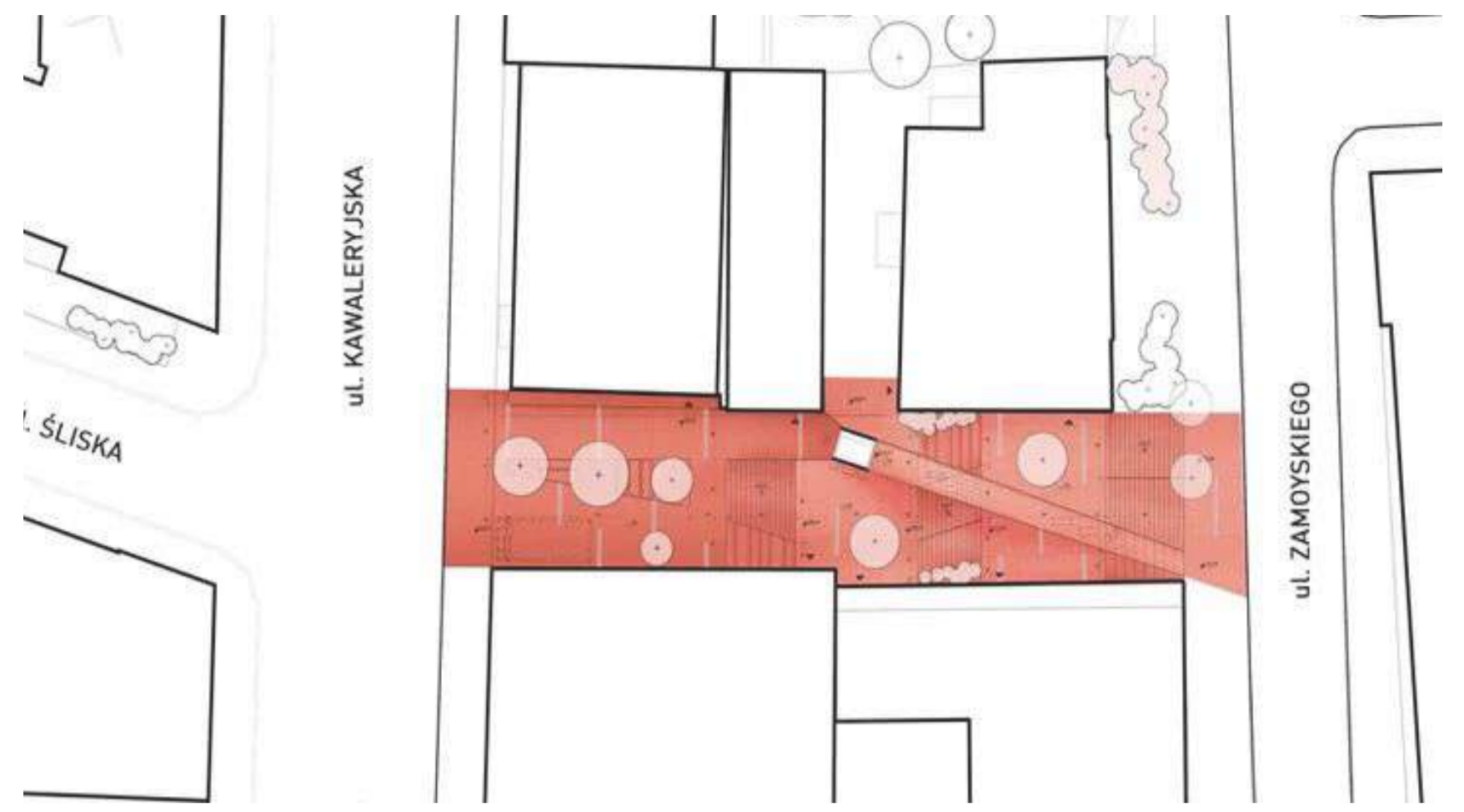

### COMPETITION DESIGN FOR "URBAN STAIRS"

ARCH\_IT STUDIO / KRAKOW, POLAND

The project consists, in simple terms, of three wide spaces located at different heights, differing in function and character, which are connected by stairs. Coming from the side of the street On Śliska Street, the first space is an intimate square approximately 14,5 meters deep, located directly in front of the first flight of stairs.

The project assumes creating a space in this place where stalls could be placed or a food truck could be freely parked, thanks to which the place would gain a new function and new opportunities to spend time there. This space would also offer seating in the form of specially designed benches and tables, subtle lighting and greenery in the form of trees approximately 5-6 meters high. Uniform colors, urban furniture, carefully selected greenery and a small catering or temporary stall create the atmosphere of an **urban living room**, which is definitely missing in the immediate vicinity.

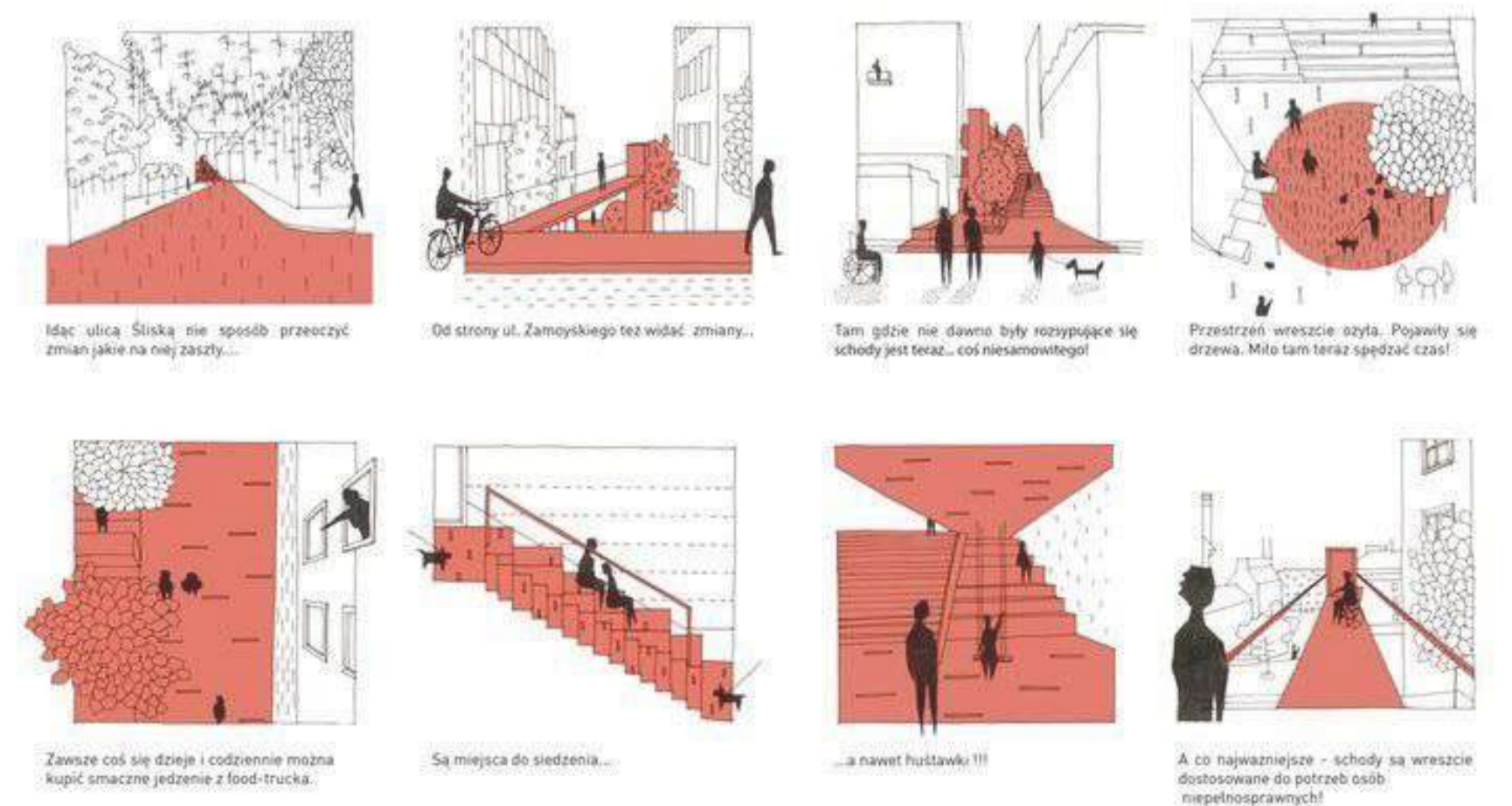

PRECEDENT  
ENVIRONMENTAL

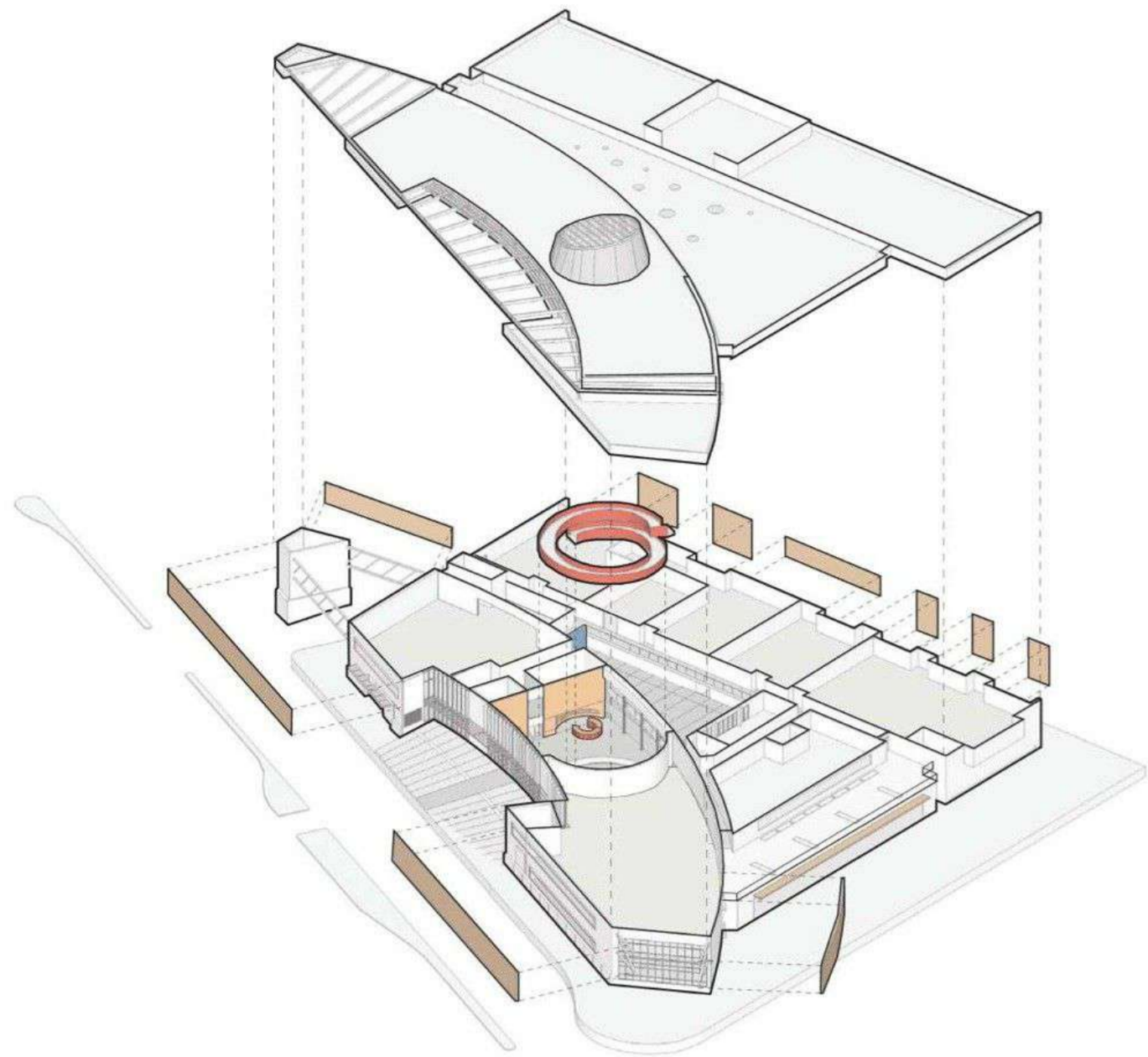

ED ROBERTS CAMPUS

LMS ARCHITECTS + URBAN DESIGNERS / BERKLEY, USA

Designed by Leddy Maytum Stacy Architects and located at the Ashby BART Station, the 85,000 sqf facility embodies the principles of Universal Design—the creation of environments that strive to be **equally easy and intuitive to use for individuals of all abilities. The design far exceeds the accessibility requirements of the Americans with Disabilities Act.** At the heart of the building is a monumental helical ramp to the second floor, prominently placed behind the glazed facade facing the main entry plaza.

Other Universal Design features include seven-foot-wide corridors to facilitate wheelchair use, automatic doors and hands-free building system controls, restrooms that meet a range of abilities, oversized elevators with special controls for wheelchair riders, and an easy-to-navigate wayfinding system aided by acoustical landmarks, high-contrast interior finishes, and colored and textured flooring.

**The two-story building includes offices, exhibition space, community meeting rooms, a childcare center for children with disabilities, a fitness center, job training facilities, and a café.** The campus is designed to present a distinct civic presence celebrating the values of its partner organizations, with an exterior materials palette of sandblasted concrete, stucco, and sustainably harvested Ipê wood shade screens. To the east and south, the building's mass responds to the residential scale of the surrounding neighborhood.

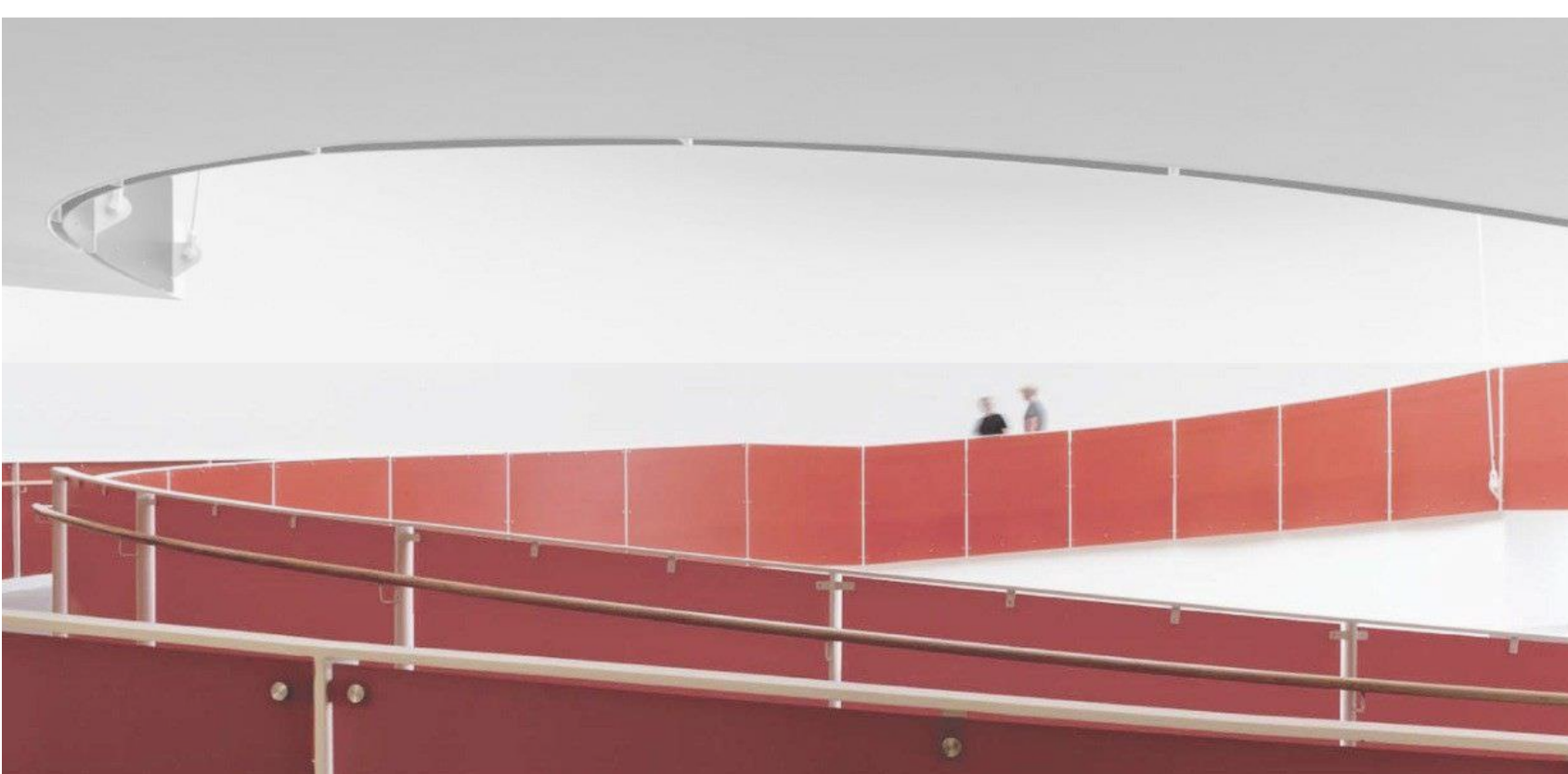

PRECEDENT  
INSTITUTIONAL

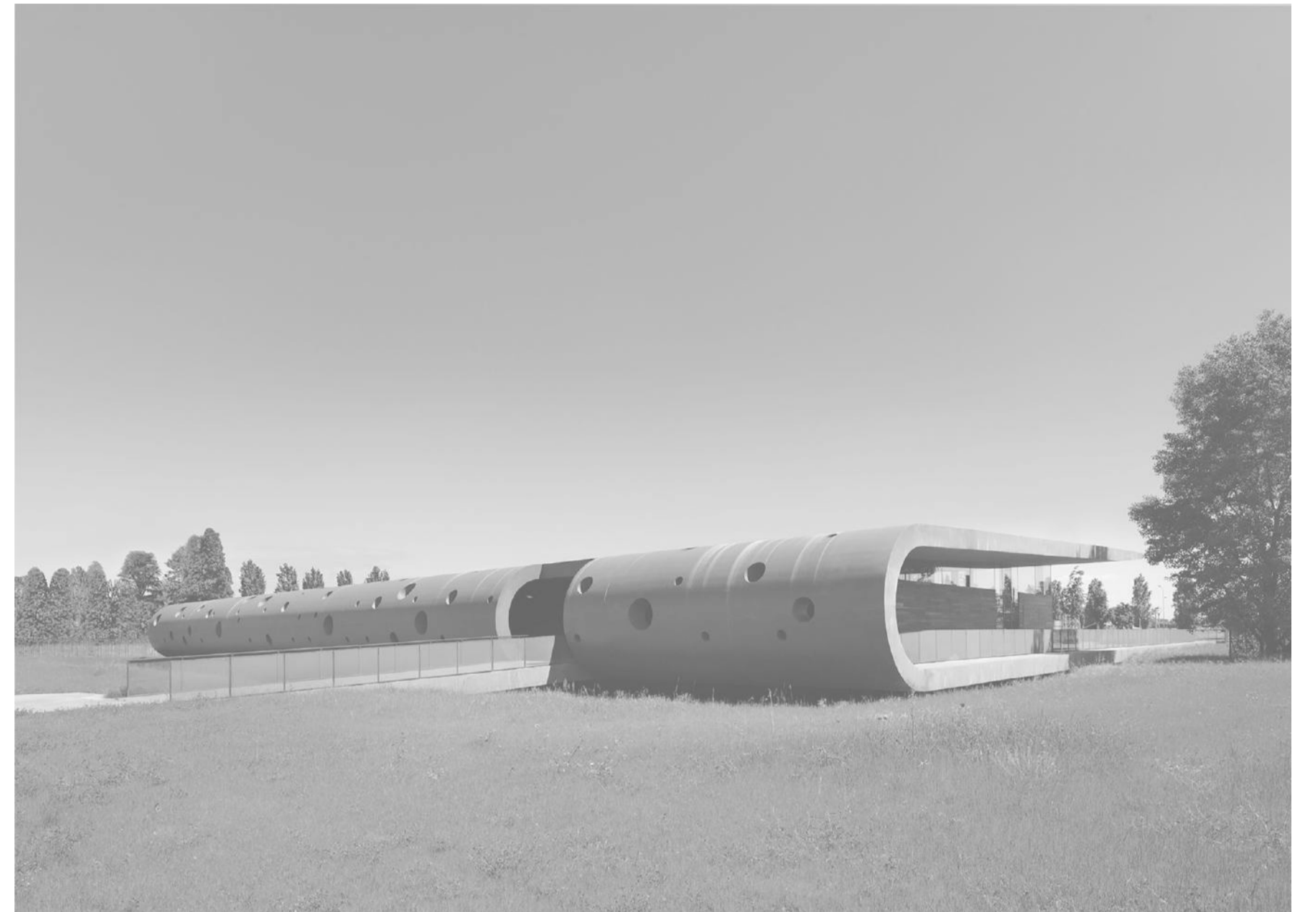

DAY CENTRE AND HOUSING FOR THE DISABLED

ARCHEA ASSOCIATI / SEREGNO, ITALY

The project area is a plot behind a nursery school, alongside an area **which will become a public park**, located in a disorganised residential area.

The functional program, aimed at disabled persons, features **primary and complementary activities – classrooms and workshops – conceived as the structures which are essential to the conduction of the socio-educational activities** associated with the presence of disabled persons.

The project forms a special relationship with the surroundings, hypothesizing a park accessible by a wheelchair user because the trees "perforate" a sill in smooth concrete, the pavement of this kind of artificial forest.

**The area has thus been redesigned as the natural continuation of the park**, which bends to form the architectural volume whose sill is transformed from pavement to roof.

One façade is thus open while the other is closed with the exception of the cut which defines the entrance, which can be reached by a ramp accessible to vehicles. The rectangular plan develops along the corridor communicating with the various rooms, which are also connected externally by a covered path.

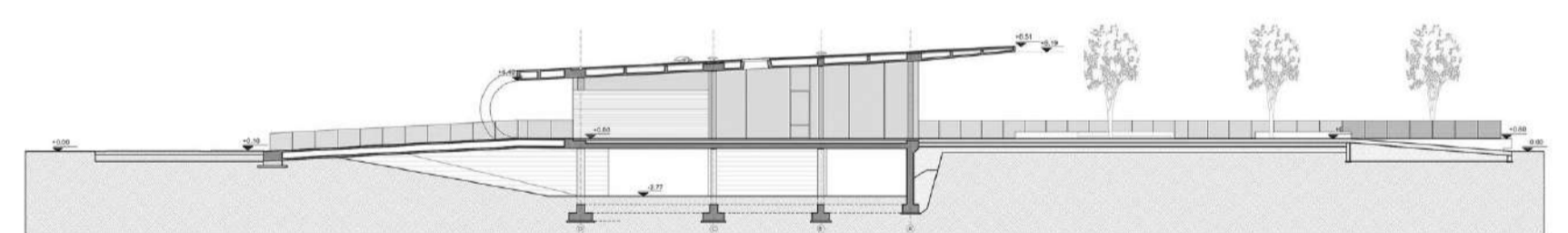

0 10 m Archea Associati  
CDD – centro per disabili / CDD – center for disability  
sezione BB / section BB

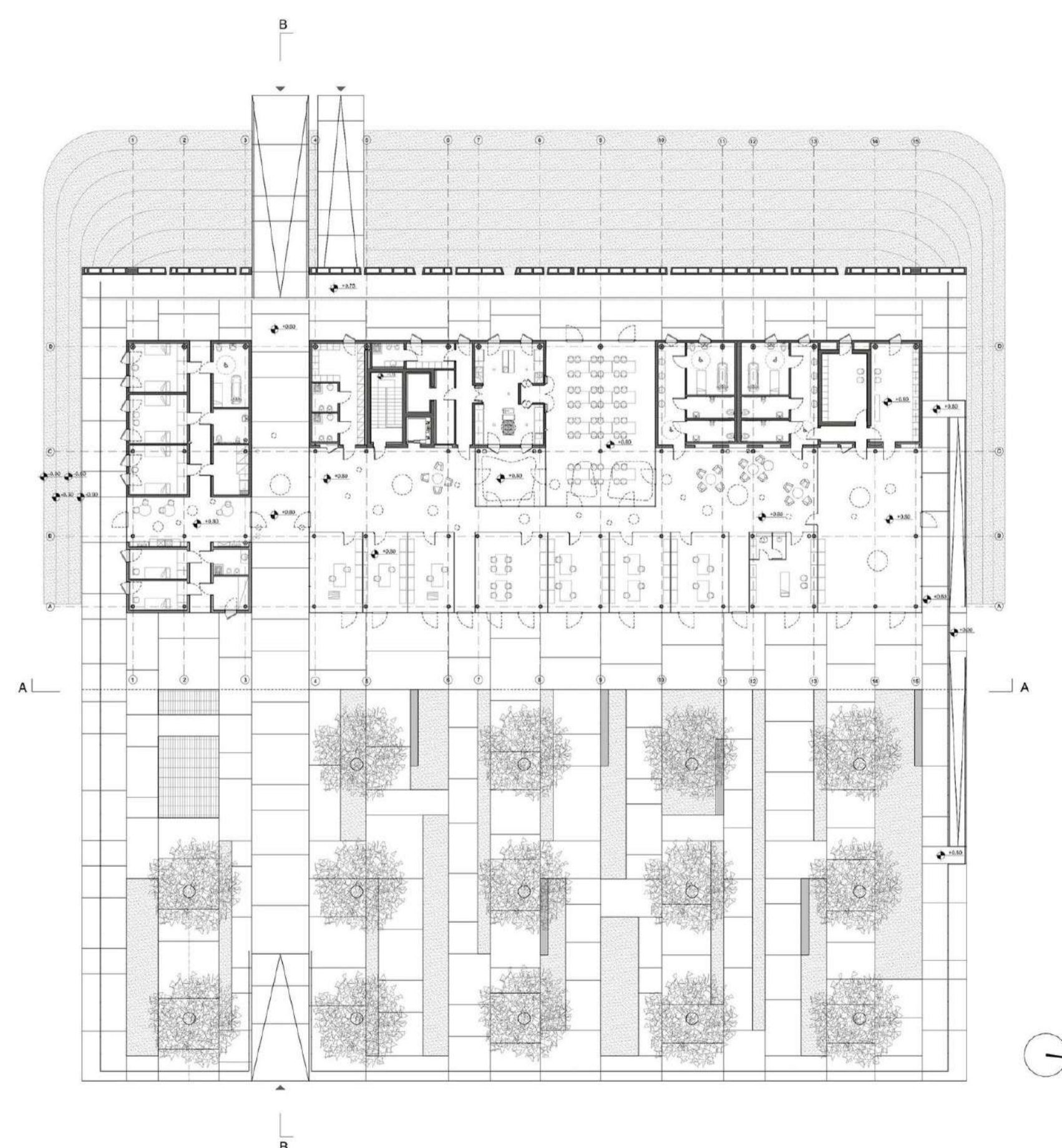

0 10 m Archea Associati  
CDD – centro per disabili / CDD – center for disability  
pianta piano interrato / basement floor plan

# DESIGN ITERATIONS

## EXPLORING THE SHARED SPACE

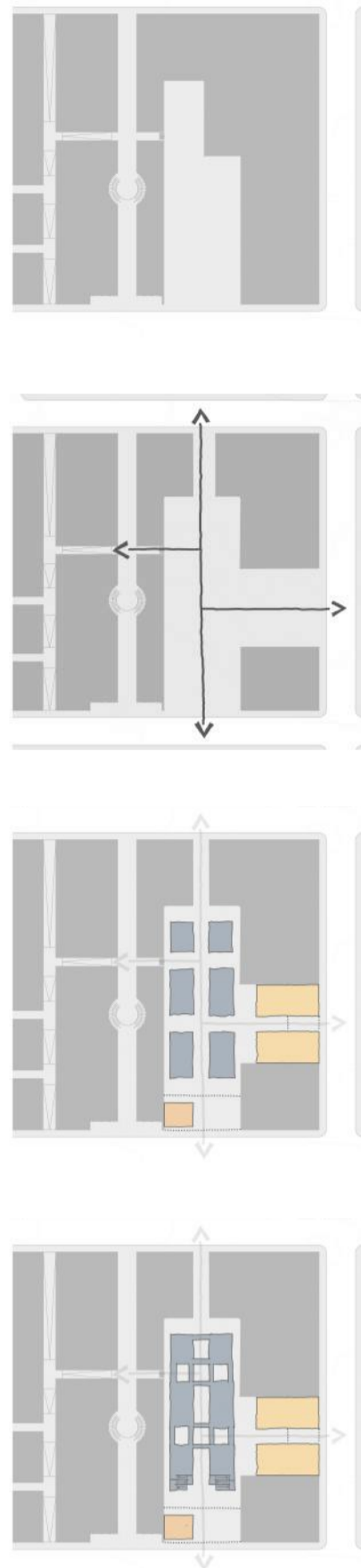

V1

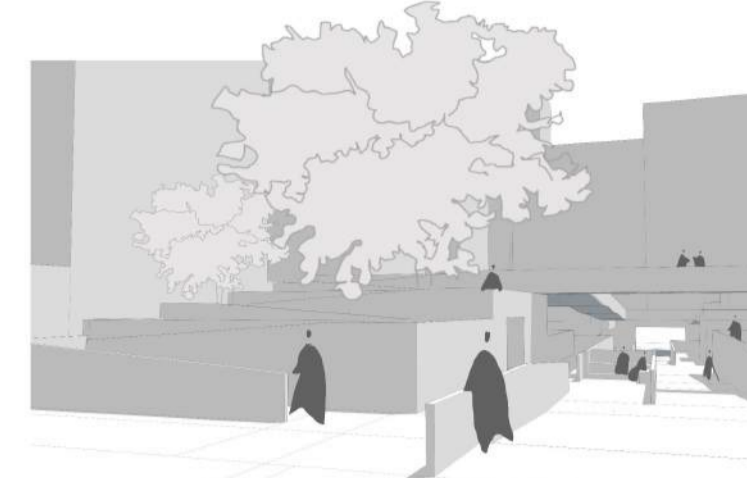
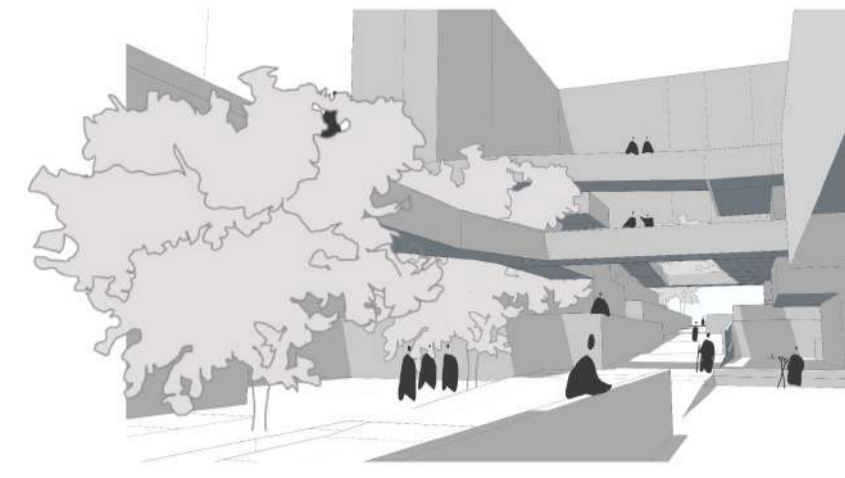
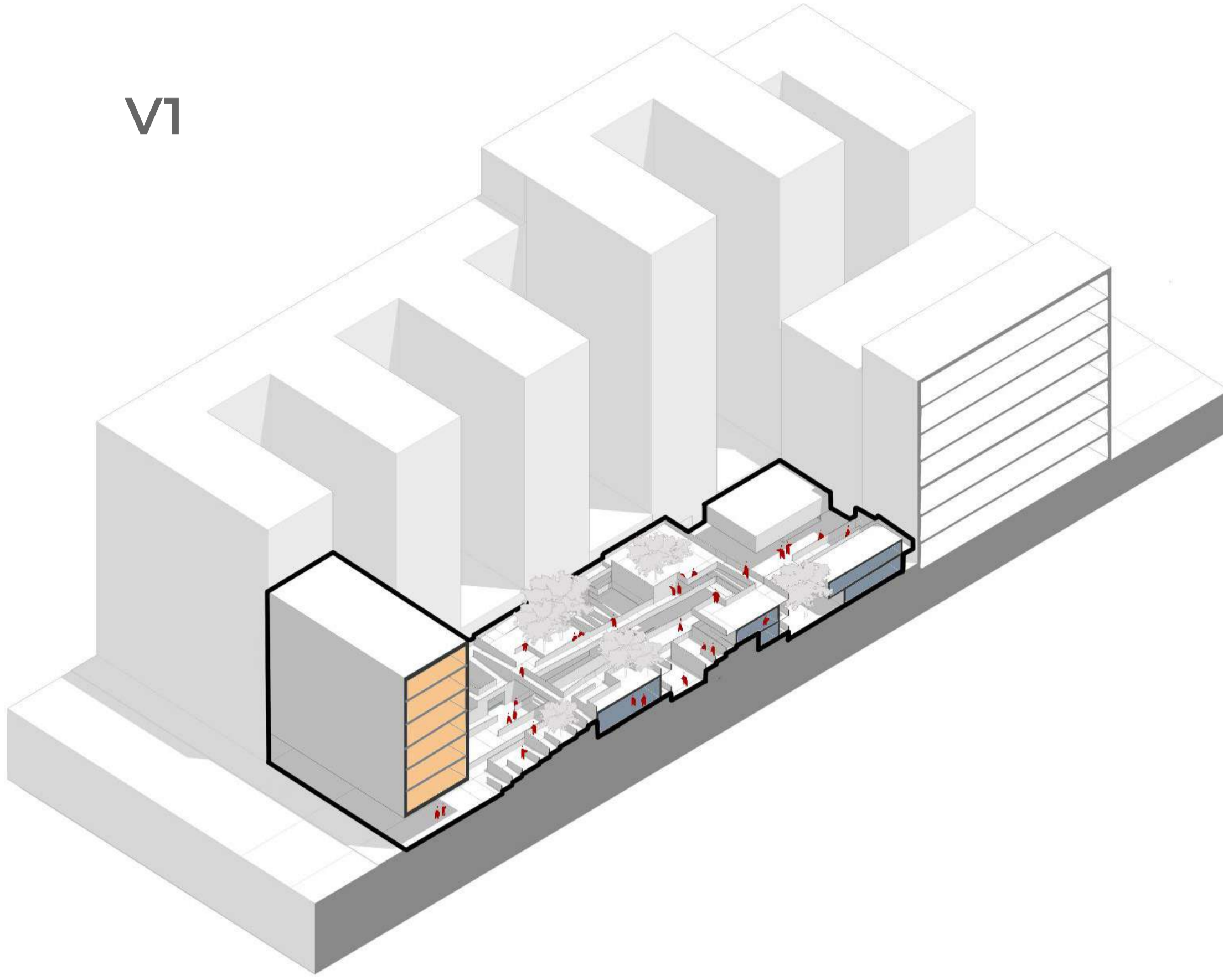

RELEVANT PUBLIC PROGRAMMES  
2/5

SHARED SPACE  
3/5

INCREASED PUBLIC ACCESS  
3/5

CRIME PREVENTION  
1/5

UNIVERSAL ACCESSIBILITY  
1/5

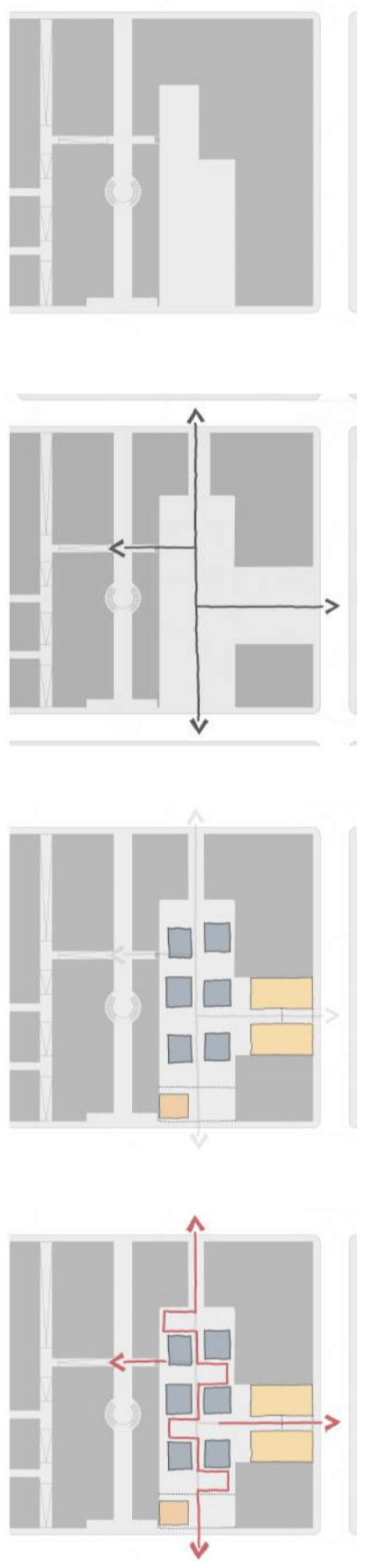

V2

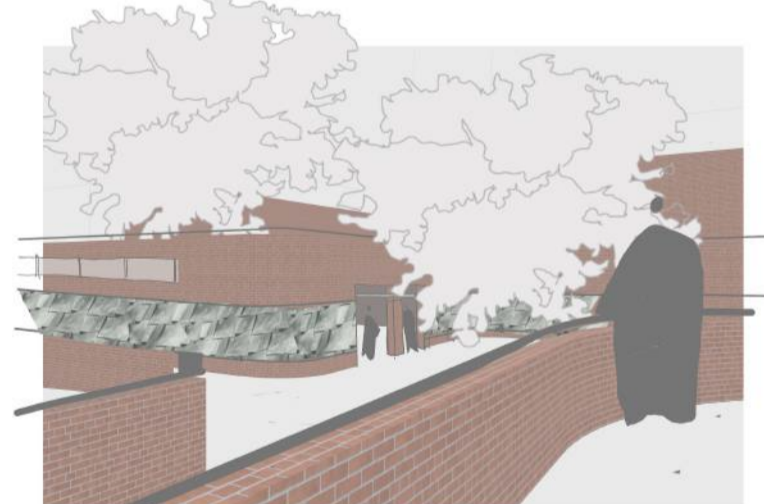
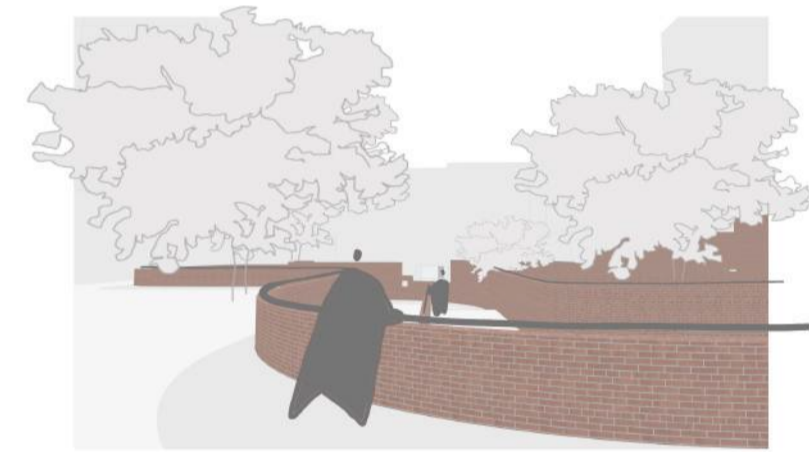
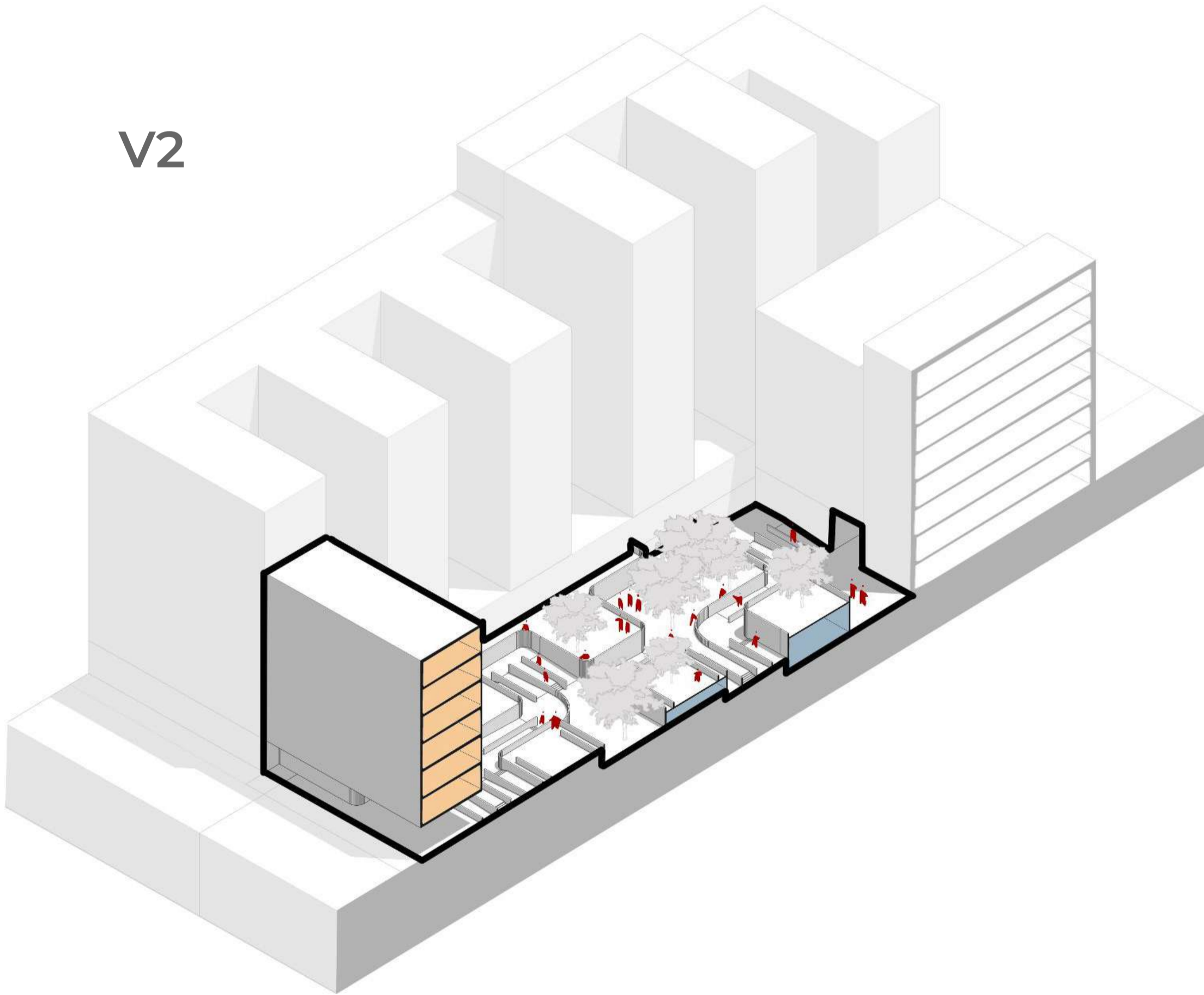

RELEVANT PUBLIC PROGRAMMES  
3/5

SHARED SPACE  
4/5

INCREASED PUBLIC ACCESS  
1/5

CRIME PREVENTION  
4/5

UNIVERSAL ACCESSIBILITY  
3/5

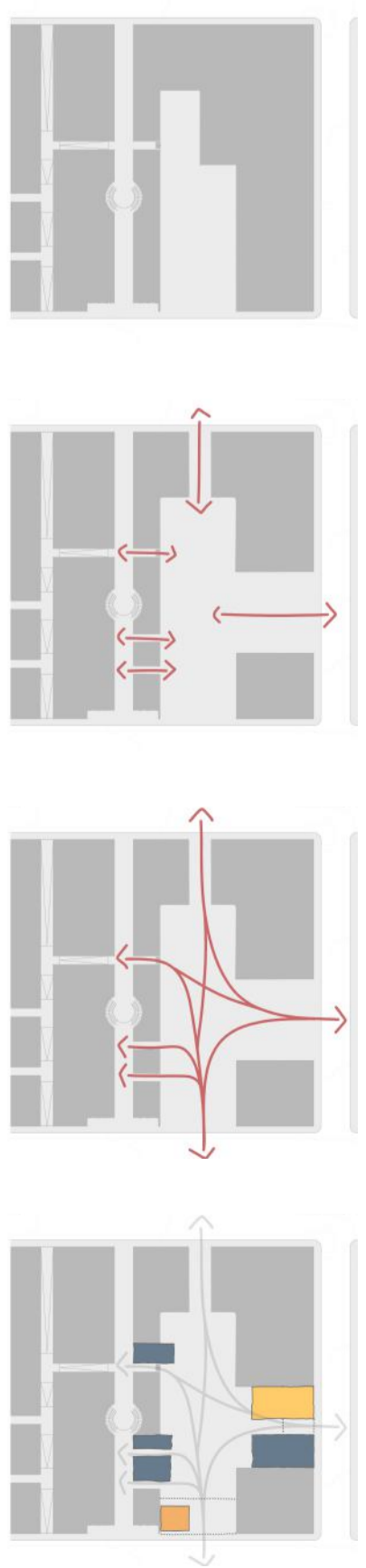

V3

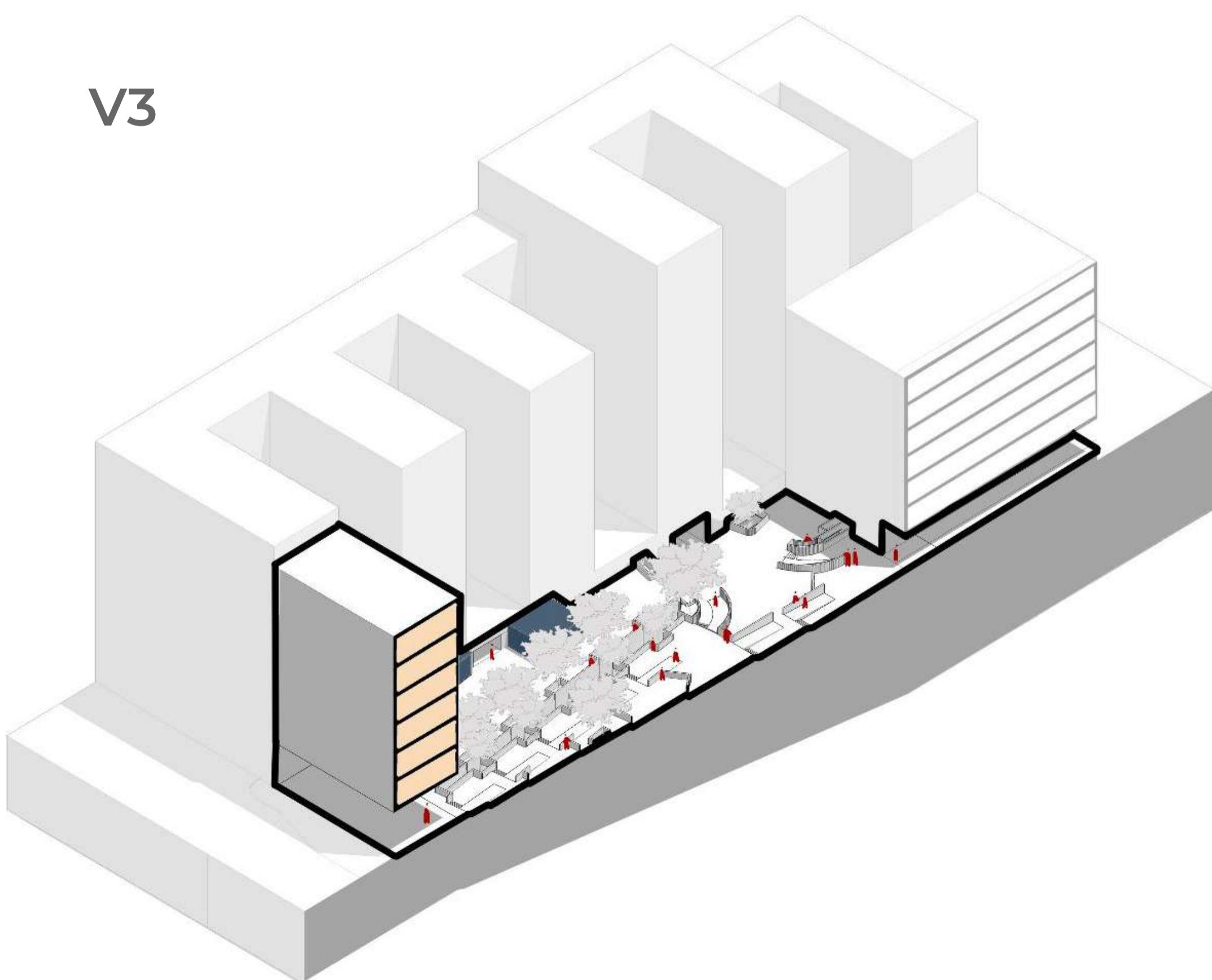

RELEVANT PUBLIC PROGRAMMES  
4/5

SHARED SPACE  
4/5

INCREASED PUBLIC ACCESS  
4/5

CRIME PREVENTION  
4/5

UNIVERSAL ACCESSIBILITY  
5/5