

ON THE STRONG PATH PARTITION CONJECTURE

JOHAN P. DE WET¹, JEAN DUNBAR²

MARIETJIE FRICK¹ AND ORTRUD R. OELLERMANN³

¹*University of Pretoria
Private Bag X20, Hatfield 0028, South Africa*

²*Converse College
Spartanburg, South Carolina 29302, USA*

³*University of Winnipeg
Manitoba R3B 2E9, Canada*

e-mail: johan.dewet@up.ac.za
jean.dunbar@converse.edu
marietjie.frick@up.ac.za
o.oellermann@uwinnipeg.ca

Abstract

The *detour order* of a graph G , denoted by $\tau(G)$, is the order of a longest path in G . If a and b are positive integers and the vertex set of G can be partitioned into two subsets A and B such that $\tau(\langle A \rangle) \leq a$ and $\tau(\langle B \rangle) \leq b$, we say that (A, B) is an (a, b) -*partition* of G . If equality holds in both instances, we call (A, B) an *exact* (a, b) -*partition*. The Path Partition Conjecture (PPC) asserts that if G is any graph and a, b any pair of positive integers such that $\tau(G) = a + b$, then G has an (a, b) -partition. The Strong PPC asserts that under the same circumstances G has an exact (a, b) -partition. While a substantial body of work in support of the PPC has been developed over the past three decades, no results on the Strong PPC have yet appeared in the literature. In this paper we prove that the Strong PPC holds for $a \leq 8$.

Keywords: Strong Path Partition Conjecture, longest path.

2010 Mathematics Subject Classification: 05C38.

1. INTRODUCTION

The number of vertices in a graph G is called the *order* of G and denoted by $n(G)$. A longest path in a graph G is called a *detour* of G . The *detour order* of G , denoted by $\tau(G)$, is the order of a detour in G . If X is a subset of the

vertex set $V(G)$ of G , then $\langle X \rangle_G$ denotes the subgraph of G induced by X . If the context is clear, we omit the subscript G . Throughout the paper, a and b will denote positive integers.

If the vertex set $V(G)$ of a graph G can be partitioned into two sets A and B such that

$$\tau(\langle A \rangle) \leq a \text{ and } \tau(\langle B \rangle) \leq b,$$

we say that (A, B) is an (a, b) -partition of G .

If (A, B) is an (a, b) -partition of G such that

$$\tau(\langle A \rangle) = a \text{ and } \tau(\langle B \rangle) = b,$$

we call (A, B) an *exact* (a, b) -partition of G .

If G is the complete graph K_{a+b} , then every (a, b) -partition of G is obviously exact. There are also noncomplete graphs of order $a + b$ that have the property that every (a, b) -partition is exact, as shown in [9]. On the other extreme, if G is a bipartite graph, then the partite sets of G provide a $(1, 1)$ -partition, which is an (a, b) -partition for all (a, b) , but that partition is not exact if $b > 1$.

The following long-standing conjecture, which became known as the *Path Partition Conjecture (PPC)*, first appeared in the literature in 1983, in a paper by Laborde, Payan and Xuong [11].

Conjecture 1.1 (PPC). *If G is any graph and (a, b) is any pair of positive integers such that $\tau(G) = a + b$, then G has an (a, b) -partition.*

For a survey of results supporting the PPC, the reader is referred to [7].

In this paper we consider the following stronger conjecture, which we shall call the *Strong PPC*.

Conjecture 1.2 (Strong PPC). *If G is any graph and (a, b) is any pair of positive integers such that $\tau(G) = a + b$, then G has an exact (a, b) -partition.*

Conjecture 1.2 has not yet been considered in the literature, but Bondy has stated the digraph analogue of the Strong PPC as Conjecture 4.45 in [2]. Bondy mistakenly attributed that conjecture to Laborde, Payan and Xuong. (Although [11] deals mainly with digraphs, Laborde *et al.* stated the PPC for *undirected* graphs only and they did not require exact partitions.)

A number of conjectures which appeared to be slightly stronger than the PPC have been disproved, the most well-known of these being the Path Kernel Conjecture (PKC) of Broere, Hajnal and Mihók [3]. If K is a set of vertices in a connected graph G such that $\tau(\langle K \rangle) \leq a$ and every vertex in $G - K$ is adjacent to an end-vertex of a P_a (a path with a vertices) in K , then K is called a P_{a+1} -kernel of G . The PKC asserted that every connected graph has a P_{a+1} -kernel for every positive integer a . Aldred and Thomassen [1] disproved the PKC by

constructing a connected graph with detour order 364 that has no P_{364} -kernel. Later, Katrenič and Semanišin [10] constructed a smaller counter-example to the PKC (a connected graph with no P_{155} -kernel) and they also showed that for each integer $r \geq 0$ there exists a connected graph G having no $P_{\tau(G)-r}$ -kernel. However, they pointed out that in each of their examples $\tau(G) - r$ is still bigger than $\tau(G)/2$, so the following conjecture has not been disproved.

Conjecture 1.3 (Revised PKC). *If G is a connected graph with detour order τ , then G has a P_{a+1} -kernel for every positive integer $a \leq \tau/2$.*

Observation 1.4. *Suppose $\tau(G) = a + b$ and G has a P_{a+1} -kernel A . Then, if $B = V(G) - A$,*

$$\tau(A) = a \text{ and } \tau(B) \leq b.$$

We note that if every component of a disconnected graph G has an (a, b) -partition, then so does G . Thus the revised PKC appears stronger than the PPC and weaker than the Strong PPC.

Results from [5, 12, 13, 14] imply the following result.

Theorem 1.5. *Every connected graph has a P_{a+1} -kernel for every positive integer $a \leq 8$.*

Theorem 1.5 implies that the PPC holds for $a \leq 8$. The PPC has been shown to hold for several well-known classes of graphs, such as weakly pancyclic graphs, claw-free graphs, co-graphs and graphs with detour deficiency (the difference between the order and detour order) at most 3, as proved in [4, 6, 7] and [8], respectively. However, the partitioning techniques that were used to prove those results have turned out to be unsuitable for producing *exact* partitions. Even settling the Strong PPC for bipartite graphs seems to be a challenging problem.

In this paper we develop a recursive procedure for finding exact (a, b) -partitions of a graph G with $\tau(G) = a + b$ if $a \leq 8$, thus proving the Strong PPC for $a \leq 8$. This provides an alternative procedure for proving the PPC for $a \leq 8$ which is perhaps a bit simpler than the procedure used to prove Theorem 1.5.

2. PRELIMINARIES

By a k -path in a graph G we mean a subgraph of G (not necessarily induced) that is isomorphic to P_k , the path on k vertices.

If T is a k -path labelled $t_1 t_2 \cdots t_k$ in a graph G , we denote the same path with the reversed labelling, $t_k t_{k-1} \cdots t_1$, by \overleftarrow{T} . Thus the i^{th} vertex of T is the $(k + 1 - i)^{\text{th}}$ vertex of \overleftarrow{T} . If $t_i t_j \in E(G)$ with $|j - i| > 1$, we call $t_i t_j$ an *external edge* of T .

We use the notation $i \sim j$ to indicate that the i^{th} vertex of a given path T in a graph G is adjacent (in G) to its j^{th} vertex. If $|j - i| > 1$, we call $i \sim j$ an *external adjacency* of T .

If L is a path in a graph G , then we call a set I of vertices on L an *independent set of L* if I does not contain two consecutive vertices on L . Note that an independent set of L need not be an independent set in G . By the *neighbours of I on L* , denoted $N_L(I)$, we mean the immediate predecessors and successors of the vertices in I on L . (This may differ from the set $N_G(I) \cap V(L)$.) The following observation concerning independent vertices on a path will be used frequently.

Observation 2.1. *Suppose I is a set of independent vertices on a path L . Then $|I| \leq |N_L(I)| + 1$ and if equality holds, then $n(L) = 2|I| - 1$.*

The notation and implications of the next lemma, illustrated in Figure 1, will be used frequently throughout the paper.

Lemma 2.2. *Let G be a graph with $\tau(G) = a + b$ and let (A, B) be a partition of $V(G)$ such that $\tau(\langle A \rangle) = a$. Suppose B contains a $(b + 1)$ -path X labelled $x_1 \cdots x_{b+1}$ such that*

$$\tau(\langle \{x_1\} \cup A \rangle) > a \text{ and } \tau(\langle \{x_{b+1}\} \cup A \rangle) > a.$$

- (1) *Then $\langle A \rangle$ contains two vertex disjoint paths R, S and two vertex disjoint paths P, Q such that Rx_1S and $Px_{b+1}Q$ are $(a + 1)$ -paths.*
- (2) *Let*

$$P = v_1 \cdots v_p, \quad Q = v_{p+1} \cdots v_a, \quad R = w_1 \cdots w_r, \quad S = w_{r+1} \cdots w_a$$

and assume that P has the maximum number of vertices among the four paths P, Q, R, S . Then both R and S intersect P .

- (3) *Let $w_l = v_i$ be the last vertex of R on P and let R' be the $w_l w_r$ -subpath of R . Also, let $w_f = v_j$ be the first vertex of S on P and let S' be the $w_{r+1} w_f$ -subpath of S . We assume, without loss of generality, that $i < j$. Then each of the following hold.*
 - (a) $w_r, w_{r+1} \notin \{v_1, v_p, v_{p+1}, v_a\}$.
 - (b) *If $w_r \notin V(P) \cup V(Q)$, then w_r has no neighbour in the set $\{v_1, v_2, v_{p-1}, v_p, v_{p+1}, v_{p+2}, v_{a-1}, v_a\}$. The same is true for w_{r+1} .*
 - (c) *Let $q = n(Q) = a - p$. Then $n(R') \leq q$ and $n(S') \leq q$.*
 - (d) *If $w_l = v_1$, then R' contains an interior vertex of Q . Similarly, if $w_f = v_p$, then S' contains an interior vertex of Q .*
 - (e) *If $w_l = v_2$, then either $w_l = w_r$, or R' contains an interior vertex of Q . Similarly, if $w_f = v_{p-1}$, then either $w_{r+1} = w_f$, or S' contains an interior vertex of Q .*

- (f) If $w_r = v_{p-2}$ and $w_{r+1} = v_{p-1}$, then $v_p \in V(R) \cup V(S)$ and v_p has at least two neighbours in $V(R) \cup V(S) - \{w_r, w_{r+1}\}$.
- (g) Suppose Y is a $w_r w_{r+1}$ -path or a $v_p v_{p+1}$ -path in $\langle A \rangle$ with at least three vertices. Then at least one internal vertex of Y has a neighbour in $A - V(Y)$.

Proof. (1) The existence of the four paths P, Q, R, S follows from the fact that neither x_1 nor x_{b+1} is adjacent to an end-vertex of an a -path in $\langle A \rangle$.

(2) Since $n(R) + n(S) = n(P) + n(Q) = a$, our assumption on P implies that each of R and S has at least as many vertices as Q . Thus, if R does not intersect P , then $R\overleftarrow{X}P$ is a path in G with more than $a + b$ vertices, and if S does not intersect P , then $P\overleftarrow{X}S$ is a path in G with more than $a + b$ vertices. This proves that both R and S intersect P .

(3) (a) If either w_r or w_{r+1} is an end-vertex of either P or Q , there is an $(a + b + 1)$ -path in G with vertex set $V(P) \cup X \cup V(Q)$.

(b) Suppose $w_r \notin (V(P) \cup V(Q))$. If $v_1 \in N(w_r)$, then $\overleftarrow{P}w_rXQ$ is an $(a + b + 2)$ -path in G . If $v_2 \in N(w_r)$, then $v_p v_{p-1} \cdots v_2 w_r X Q$ is an $(a + b + 1)$ -path in G . The proofs of the remaining cases are similar.

(c) Since the path $v_1 \cdots v_{i-1} R' X v_p v_{p-1} \cdots v_{i+1}$ has $p + n(R') + b$ vertices but $\tau(G) = p + q + b$, it follows that $n(R') \leq q$. The proof of the second part of this item is similar.

(d) Suppose $w_l = v_1$ and R' does not contain an interior vertex of Q . Then there is a path in G containing all $(a + b + 1)$ vertices in $V(P) \cup V(X) \cup V(Q)$. This contradiction proves the first part of (d). The proof of the second part is similar.

(e) Suppose $w_l = v_2$ and R' does not contain an interior vertex of Q . Then $w_r \notin V(Q)$, since it follows from (a) that w_r is not an end-vertex of Q . Thus, if $w_r \neq w_l$, there is a path in G containing all $a + b + 1$ vertices in $(V(P) - \{v_1\}) \cup \{w_r\} \cup V(Q)$. This proves the first part of (e). The proof of the second part is similar.

(f) In this case, if $v_p \notin V(R) \cup V(S)$, then RXv_pS is an $(a + b + 1)$ -path in G . Thus $v_p \in V(R) \cup V(S)$. If $v_p = w_1$, then $\overleftarrow{S}XR$ is an $(a + b + 1)$ -path in G . If $v_p = w_{r-1}$, then $w_1 \cdots w_{r-1} \overleftarrow{X}w_r S$ is an $(a + b + 1)$ -path in G . Hence $v_p \notin \{w_1, w_{r-1}\}$. Thus, if $v_p \in V(R)$, then v_p has both a predecessor and successor on the path R in the set $V(R) - \{v_{p-2}\}$. A similar argument shows that if $v_p \in V(S)$, then v_p has at least two neighbours in $V(S) - \{v_{p-1}\}$.

(g) Suppose Y is a $w_r w_{r+1}$ -path in $\langle A \rangle$ such that no internal vertex of Y has a neighbour in $A - V(Y)$. Let $Y' = Y - \{w_r, w_{r+1}\}$.

If neither R nor S intersects Y' , then $RY'S$ is a path of order at least $a + 1$ in $\langle A \rangle$.

If R , but not S , intersects Y' , then by our assumption, $V(R) \subseteq V(Y) - \{w_{r+1}\}$. But then $\overline{X}w_rY'S$ is a path of order greater than $a + b + 1$ in G .

If both R and S intersect Y' , then by our assumption, $V(R) \cup V(S) \subseteq V(Y)$. Since $V(R) \cap V(S) = \emptyset$, it follows that $n(Y) \geq n(R) + n(S) = a$. But then YX is a path of order at least $a + b + 1$.

These contradictions prove that at least one internal vertex of Y has a neighbour in $A - V(Y)$. The proof when Y is a $v_p v_{p+1}$ -path is similar. ■

The situation of Lemma 2.2 is illustrated in Figure 1, with thick lines indicating paths and thin lines indicating edges. But note that w_l may be w_r and w_{r+1} may be w_f . Furthermore, R and S may intersect P and Q in several vertices.

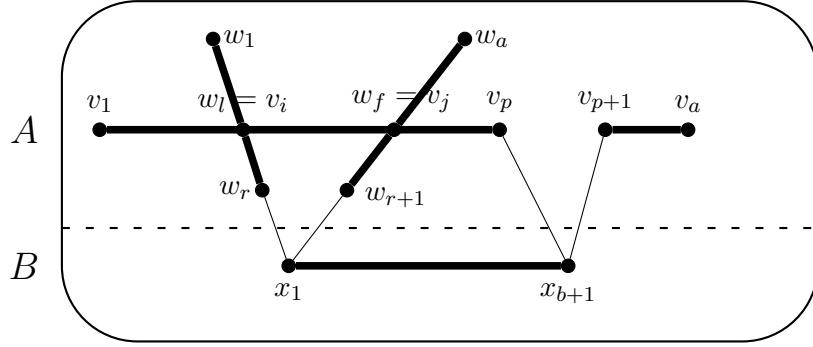

Figure 1. An illustration of paths P, Q, R, S and X in Lemma 2.2.

3. PROOF OF THE STRONG PPC FOR $a \leq 6$

The following lemma will be used to prove the Strong PPC for the cases where $a \leq 6$.

Lemma 3.1. *Let G be a graph with $\tau(G) = a + b$, $a \leq 6$, and let (A, B) be a partition of $V(G)$ such that $\tau(\langle A \rangle) \leq a$. Suppose $x_1 \cdots x_{b+1}$ is a path of order $b + 1$ in B . Then*

$$\tau(\langle A \cup \{x_1\} \rangle) \leq a \text{ or } \tau(\langle A \cup \{x_{b+1}\} \rangle) \leq a.$$

Proof. Using Lemma 2.2, the proof for $a \in \{1, 2, 3, 4, 5\}$ is straightforward and is left to the reader.

Now suppose $a = 6$ and assume, to the contrary, that there is a $(b + 1)$ -path X in $G - A$ such that if x is either of the two end-vertices of X , then $\tau(\langle A \rangle) > 6$. Then, with respect to an appropriate labelling $x_1 \cdots x_{b+1}$ of the

path X , we can define four paths P, Q, R, S as in Lemma 2.2(1), such that P has maximum order among these paths, and the paths Rx_1S and $Px_{b+1}Q$ are 7-paths in G . Let $L = Rx_1S$. In the notation of Lemma 2.2(2), L is the 7-path $w_1 \cdots w_r x_1 w_{r+1} \cdots w_6$. By Lemma 2.2(2), both R and S intersect P . As in Lemma 2.2(3), we let $w_l = v_i$ be the last vertex of R on P , and $w_f = v_j$ be the first vertex of S on P (as illustrated in Figure 1). We assume that $i < p$. Let $q = n(Q) = 6 - p$.

Suppose $p = 5$. Then $q = 1$. It therefore follows from Lemma 2.2(3c) that $w_r = w_l$ and $w_{r+1} = w_f$ and $1 < i < j < 5$. If $i = 2$, let $I = V(L) - \{x_1, v_2, v_3, v_4\}$. Then $|I| \geq 3$. Since $x_1 \cdots x_{b+1} v_5 v_4 v_3 v_2 x_1$ is a $(5 + b)$ -cycle and $\tau(G) = 6 + b$, it follows that I is an independent set and $N_L(I) \subset \{v_2, v_4\}$. Thus, by Observation 2.1, $|I| < 3$, a contradiction. Thus we may assume that $i = 3$ and $j = 4$. But then, since G has no $(7 + b)$ -path, v_4 is the only neighbour of v_5 in $\langle A \rangle$, contradicting Lemma 2.2(3f).

Suppose $p = 4$. Then $q = 2$, and hence Q has no internal vertex. It therefore follows from Lemma 2.2(3d–e) that $w_3 = v_2$ and $w_{r+1} = v_3$. But the fact that G has no $(b + 7)$ -path implies that v_3 is the only neighbour of v_4 in A , thus contradicting Lemma 2.2(3f).

Suppose $p = 3$. Then $Q = v_4 v_5 v_6$. Since Q has only one interior vertex, it follows from Lemma 2.2(3d) and the fact that $\tau(G) = 7 + b$, that we either have $R' = v_1 v_5$ and $S' = v_2$, or $R' = v_2$ and $S' = v_5 v_3$. The first case is equivalent to the case where $p = 5, i = 2, j = 4$, with P being the 5-path $v_6 v_5 v_1 v_2 v_3$ and $Q = v_4$. In the second case, the only neighbours of v_3 in A are v_2 and v_5 , and hence $S = v_5 v_3$. But then, since $n(R) + n(S) = 6$, it follows that $RX\overline{S}$ is a $(7 + b)$ -path in G . ■

We now prove the Strong PPC for $a \leq 6$.

Theorem 3.2. *Let G be a graph with $\tau(G) = a + b$, $a \leq 6$. Then G has an exact (a, b) -partition.*

Proof. We begin by considering any $(a + b)$ -path in G . Then we put the first a vertices of that path in A and the remaining vertices of G in B . If $\tau(\langle B \rangle) = b$, then (A, B) is an exact (a, b) -partition. If not, then let $x_1 \cdots x_{b+1}$ be a $(b + 1)$ -path in $\langle B \rangle$. By Lemma 3.1, we have $\tau(\langle \{x_1\} \cup A \rangle) = a$ or $\tau(\langle \{x_{b+1}\} \cup A \rangle) = a$. If the former, we move x_1 to A ; otherwise, we move x_{b+1} to A . The result is that the detour order of $\langle A \rangle$ remains a , while that of $\langle B \rangle$ remains at least b and there is at least one less $(b + 1)$ -path in $\langle B \rangle$. If now $\tau(\langle B \rangle) = b$, we are done. Otherwise, we repeat the procedure with another $(b + 1)$ -path in $\langle B \rangle$ until we have destroyed all the $(b + 1)$ -paths in $\langle B \rangle$. Then we have an (a, b) -partition of G . ■

4. PROOF OF THE STRONG PPC FOR $a = 7$

Lemma 3.1 does not extend to $a = 7$. Figure 2 shows two “problematic configurations” that can occur in a graph G with detour order $7 + b$. In each of those, $\tau(\langle A \rangle) = 7$ and there exists a $(b + 1)$ -path $x_1 \cdots x_{b+1}$ in $G - A$ such that

$$\tau(\langle A \cup \{x_1\} \rangle) > 7 \text{ and } \tau(\langle A \cup \{x_{b+1}\} \rangle) > 7.$$

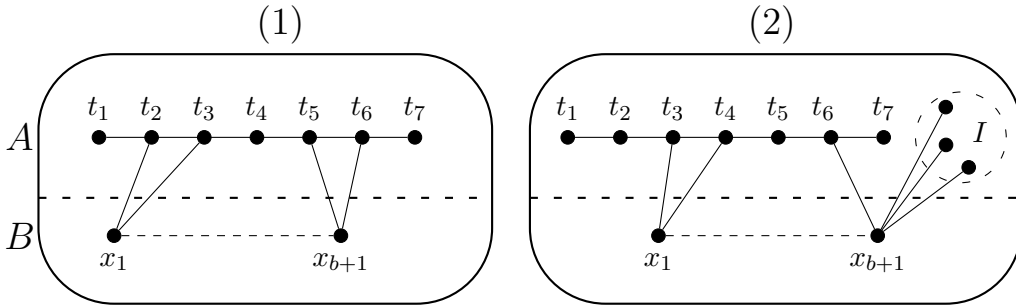

Figure 2. The problematic configurations for $a = 7$.

We now prove that Figure 2 represents the only two problematic configurations for $a = 7$.

Lemma 4.1. *Let G be a graph with $\tau(G) = 7 + b$ and let (A, B) be a partition of $V(G)$ such that $\tau(\langle A \rangle) = 7$. Suppose X is a $(b + 1)$ -path in $\langle B \rangle$ such that if x is either of the two end-vertices of X , then $\tau(\langle A \cup \{x\} \rangle) \geq 8$. Then, with respect to an appropriate labelling $x_1 \cdots x_{b+1}$ of the path X , there are four paths P, Q, R, S in $\langle A \rangle$ such that P has maximum order among these four paths, and Rx_1S and $Px_{b+1}Q$ are 8-paths in G . Now let H be the component of $\langle A \rangle$ containing the path P . Then $\tau(H) = 7$ and if T is any 7-path in H , then T may be labelled $t_1 \cdots t_7$ such that one of the following holds.*

- (1) $N_A(x_1) = \{t_2, t_3\}$ and $N_A(x_{b+1}) = \{t_5, t_6\}$
- (2) $N_A(x_1) = \{t_3, t_4\}$ and $N_A(x_{b+1}) = I \cup \{t_6\}$, where I is a nonempty independent set of vertices in $\langle A \rangle$.

Proof. By Lemma 2.2(2), both R and S intersect P . We let

$$P = v_1 \cdots v_p, \quad Q = v_{p+1} \cdots v_7, \quad R = w_1 \cdots w_r, \quad S = w_{r+1} \cdots w_7.$$

As in Lemma 2.2(3), we let $w_l = v_i$ and $w_f = v_j$ be, respectively, the last vertex of R on P and the first vertex of S on P (as illustrated in Figure 1) and we let

R' and S' be, respectively, the $w_l w_r$ -subpath of R and the $w_{r+1} w_f$ -subpath of S . We assume $i < j$.

Let C be the cycle $R' X v_p v_{p-1} \cdots v_i$ and let L be the 8-path $R x_1 S$, i.e.,

$$L = w_1 \cdots w_r x_1 w_{r+1} \cdots w_7$$

and let

$$Z = \{z_1, \dots, z_m\} = V(R) \cup V(S) - \{v_i, \dots, v_p\}.$$

Then $(V(R) \cup V(S)) \subseteq \{v_i, v_{i+1}, \dots, v_p\} \cup Z$, which implies that $|Z| \geq 6 - p + i$.

We need to consider thirteen possibilities for the triple (i, j, p) . We shall show that if $(i, j, p) = (2, 3, 5)$ we have (1) of the statement of the lemma, and if $(i, j, p) = (3, 4, 6)$ we have (2). In each of the other cases we shall obtain a contradiction.

Let $q = 7 - p$. It follows from Lemma 2.2(3d) that if $q \leq 2$, then $i \neq 1$ and $j \neq p$. Thus $1 < i < j < p$ in each of Cases 1–9.

Cases 1–3. $(i, j, p) \in \{(2, 3, 6), (2, 4, 6), (2, 5, 6)\}$. In all three these cases $|Z| \geq 2$ and, since $q = 1$, it follows from Lemma 2.2(3c) that $w_r = v_2$ and $w_{r+1} = v_j$. Since the cycle C has $b + 6$ vertices and $\tau(G) = b + 7$, it follows that Z is an independent set. Moreover, neither v_3 nor v_6 has a neighbour in Z , and at most one of v_4 and v_5 has a neighbour in Z . Hence $|N_L(Z)| \leq 2$, so by Observation 2.1, $|Z| \leq 3$ and if $|Z| = 3$, then $n(L) \leq 5$, contradicting that $n(L) = 8$. Thus $|Z| = 2$ and $V(L) = \{v_2, v_3, v_4, v_5, v_6, z_1, z_2, x_1\}$. We may assume that $z_1 \in N(v_2)$ and z_2 is a neighbour of either v_4 or v_5 .

Now suppose $v_6 \in N(v_3)$. Then, if $z_2 \in N(v_4)$ it follows that $z_2 v_4 v_5 v_6 v_3 v_2 X v_7$ is an $(8 + b)$ -path on G unless $z_2 = v_7$. But if $z_2 = v_7$, then $X z_2 v_4 v_5 v_6 v_3 v_2 v_1$ is an $(8 + b)$ -path in G . On the other hand, if $z_2 \in N(v_5)$, then $z_1 v_2 X v_6 v_3 v_4 v_5 z_2$ is an $(8 + b)$ -path in G . Hence $v_6 \notin N(v_3)$, so $\{v_3, v_6, z_1, z_2\}$ is an independent set on the path L . But the only possible neighbours of this set in L are v_2, v_4, v_5 , so it follows from Observation 2.1 that $n(L) \leq 7$. This contradiction shows that these three cases do not occur.

Cases 4–5. $(i, j, p) \in \{(3, 4, 6), (3, 5, 6)\}$. In both cases, since $q = 1$, it follows from Lemma 2.2(3c) that $w_r = v_3$ and $w_{r+1} = v_j$. Also, $|Z| \geq 3$ and $n(C) = b + 5$, so any subpath of L in $\langle Z \rangle$ has at most two vertices.

First, suppose v_4 has a neighbour z_1 in Z . If $z_1 \notin \{v_1, v_2\}$, then $v_1 v_2 v_3 X v_6 v_5 v_4 z_1$ is an $(8 + b)$ -path in G , and if $z_1 = v_1$, then $v_6 v_5 v_4 v_1 v_2 v_3 X v_7$ is an $(8 + b)$ -path in G . Thus $z_1 = v_2$. But then neither v_3 nor v_5 nor v_6 has a neighbour in Z , since otherwise there would be an $(8 + b)$ -path in G . But then $n(L) \leq 7$. This contradiction proves that v_4 has no neighbour in Z .

If $j = 5$, then since G has no $(8 + b)$ -path, $v_6 \notin N(v_4)$, so in this case $N(v_4) = \{v_3, v_5\}$. Since $v_3 v_4 v_5$ is a $w_r w_{r+1}$ -path in $\langle A \rangle$, this contradicts Lemma 2.2(3g).

Thus $j = 4$. In this case v_3 and v_6 are the only vertices on C that have neighbours in Z . Since no path in Z with more than two vertices has an end-vertex adjacent to v_3 , there is a vertex $z \in Z$ that is adjacent to v_6 . Thus $v_1 \cdots v_6 z$ is a 7-path in H , and $N_A(x_1) = \{v_3, v_4\}$ and $N_A(x_{b+1}) = \{v_6\} \cup I$, where I is an independent set of vertices in A containing v_7 . Since neither v_4 nor v_5 has a neighbour in Z , any 7-path in H may be labelled $t_1 \cdots t_7$ such that $t_3 t_4 t_5 t_6$ is the path $v_3 v_4 v_5 v_6$. Thus we have (2) of the statement of the lemma, as shown in Figure 2.

Case 6. $(i, j, p) = (4, 5, 6)$. By Lemma 2.2(3f), v_6 has at least two neighbours in Z . But the fact that $\tau(G) = b+7$ implies that v_2 is the only possible neighbour of v_6 in Z . Hence this case does not occur.

Cases 7–8. $(i, j, p) \in \{(2, 3, 5), (2, 4, 5)\}$. In these cases $|Z| \geq 3$. Since $n(C) = b+5$, it follows that $\langle Z \rangle$ does not contain a subpath of L with more than 2 vertices. Also, since $q = 2$, the path Q has no internal vertices.

It follows from Lemma 2.2(3e) that $w_r = v_2$ and if $j = 4$, then $w_{r+1} = v_4$. Suppose $j = 3$ and $w_{r+1} \neq v_3$. Then $v_3 = w_{r+2}$ and neither v_4 nor v_5 has a neighbour in $Z \cup \{v_2\}$. Moreover, neither v_2 nor v_3 is adjacent to an end-vertex of a P_2 in Z . But then $n(R) \leq 2$ and $n(S) \leq 4$, which implies that $n(L) \leq 6$. This contradiction proves that $w_{r+1} \in \{v_3, v_4\}$.

Now suppose $v_5 v_6 \notin E(H)$. Then v_5 has no neighbour in Z . Thus, if Z is an independent set and $I = (Z \cup \{v_5\}) \cap V(L)$, then I is an independent set on L . But $N_L(I) \subseteq \{v_2, v_3, v_4\}$. Thus it follows from Observation 2.1 that $|I| \leq 4$ and if $|I| = 4$, then $n(L) \leq 7$. Hence $|I| = 3$. But $V(L) \subseteq (I \cup \{x_1, v_2, v_3, v_4\})$, which implies that then $n(L) \leq 7$. Thus Z is not an independent set of L .

We may therefore assume that $z_1 z_2 \in E(L)$ and either $z_1 z_2 v_2$ or $v_4 z_1 z_2$ is a subpath of L . In either case, neither v_3 nor v_5 has a neighbour in Z . Thus, if $j = 4$, then L is either the path $z_1 z_2 v_2 x_1 v_4 z_3$ or the path $z_3 v_2 x_1 v_4 z_1 z_2$, contradicting that $n(L) = 8$. Hence $j = 3$. But then either $z_1 z_2 v_2 v_3 X v_5 v_4 z_3$ or $z_3 v_2 v_3 X v_5 v_4 z_1 z_2$ is a $(b+8)$ -path in H .

Thus we have proved that $v_5 v_6 \in E(H)$. Now, if $j = 4$, then $v_1 v_2 v_3 v_4 X v_5 v_6 v_7$ is an $(8+b)$ -path in H . Thus $j = 3$.

We conclude that $v_1 \cdots v_7$ is a 7-path in H and $N_A(x_1) = \{v_2, v_3\}$ and $N_A(x_{b+1}) = \{v_5, v_6\}$. Since $\tau(G) = 7+b$, neither v_3 nor v_4 nor v_5 has a neighbour in Z . Thus, if T is any 7-path in H , then T may be labelled $t_1 \cdots t_7$ such that $t_2 t_3 t_4 t_5 t_6$ is the path $v_2 v_3 v_4 v_5 v_6$. So in this case we have (1) of the statement of the lemma, as shown in Figure 2.

Case 9. $(i, j, p) = (3, 4, 5)$. Since $q = 2$, it follows from Lemma 2.2(3c) that $n(R') \leq 2$, and hence either $R' = w_r v_3$, or $w_r = v_3$. In either case, it follows from Lemma 2.2(3e) that $v_4 = w_{r+1}$.

Suppose $w_r \notin V(P)$. Then v_4 is the only neighbour of v_5 in A , and hence $v_5 \notin V(R)$. Thus, if $v_5 \notin V(S)$, then RXv_5S is a $(9 + b)$ -path in G . But if $v_5 \in V(S)$, then $S = v_4v_5$, and then $RX\overleftarrow{S}$ is an $(8 + b)$ -path in G .

Thus we have shown that $w_r = v_3$ and $w_{r+1} = v_4$. But then, by Lemma 2.2(3f), v_5 has two distinct neighbours $z_1, z_2 \in V(L) - \{v_3, v_4\}$. We note that $z_1, z_2 \notin \{v_6, v_7\}$. Thus, if $z_1z_2 \in E(L)$, then $z_1z_2v_5v_4v_3Xv_6v_7$ is an $(8 + b)$ -path. This contradiction implies that $\{z_1, z_2\}$ is an independent set on L . But $N_L(\{z_1, z_2\}) = \{v_5\}$. This case does therefore not occur.

Cases 10–11. $(i, j, p) \in \{(1, 2, 4), (1, 3, 4)\}$. Since $w_l = v_1$, it follows from Lemma 2.2(3d) that R' contains an interior vertex of $Q = v_5v_6v_7$. Thus, since G has no $(8 + b)$ -path, $R' = v_1v_6$. These cases are equivalent to Cases 4–5, with P being the 7-path $v_7v_6v_1v_2v_3v_4$ and $Q = v_5$.

Cases 12–13. $(i, j, p) \in \{(2, 3, 4), (2, 4, 4)\}$. First, suppose $w_r \neq v_2$. Then it follows from Lemma 2.2(3e) that R' contains the interior vertex v_6 of Q and $j = 3$. Since G has no $(8 + b)$ -path, R' is either the path v_2v_6 or the path $v_2v_5v_6$. In either case, the only possible neighbours of v_4 in A are v_3 and v_6 . Since $v_3 \in V(S)$, this implies that $v_4 \notin V(R)$. If $v_4 \in V(S)$, then $S = v_3v_4$. But then $RX\overleftarrow{S}$ is an $(8 + b)$ -path in G . Thus $v_4 \notin V(R) \cup V(S)$. But then RXv_4S is a $(9 + b)$ -path in G .

Thus $w_r = v_2$. Now suppose $j = 3$. If $w_{r+1} \neq w_f = v_3$, then it follows from Lemma 2.2(3e) that S' contains an interior vertex of Q , and hence $S' = v_6v_3$. Since $N_A(v_4) \subseteq \{v_3, v_6\}$, it follows that $v_4 \notin V(R)$. If $v_4 \in V(S)$, then $S = v_6v_3v_4$. But then $RX\overleftarrow{S}$ is an $(8 + b)$ -path in G . Thus $v_4 \notin V(R) \cup V(S)$. But then RXv_4S is an $(9 + b)$ -path in G . Thus $w_{r+1} = v_3$. But v_6 is the only possible neighbour of v_4 in $A - \{v_2, v_3\}$, contradicting Lemma 2.2(3e).

Thus $j = 4$. Then it follows from Lemma 2.2(3d) that $S' = v_6v_4$. Now $N_A(v_3) = \{v_2, v_4\}$. Thus, if $v_3 \in V(R)$, then $R = v_2v_3$ and then $RX\overleftarrow{S}$ is an $(8 + b)$ -path. Similarly, if $v_3 \in V(S)$, then $RX\overleftarrow{S}$ is an $(8 + b)$ -path. These contradictions show that $v_3 \notin V(R) \cup V(S)$. But then Rv_3S is an 8-path in $\langle A \rangle$.

Case 14. $(i, j, p) = (3, 4, 4)$. It follows from Lemma 2.2(3d) that $w_{r+1} = v_6$ and $S' = v_6v_4$. Since $N_A(v_4) = \{v_3, v_6\}$, it follows that $S = v_6v_4$. But then $RX\overleftarrow{S}$ is an $(8 + b)$ -path in G . ■

We conclude that the configurations (1) and (2) in Figure 2 represent all the problematic configurations for $a = 7$. In either case the component H of $\langle A \rangle$, as described in Lemma 4.1, may contain vertices and/or edges not shown on those sketches. However, certain edges are forbidden, due to our assumption that $\tau(G) = a + b$. We observe the following concerning the structure of H .

Observation 4.2.

- (a) If Configuration (1) occurs, the only allowable external edges of the path T are t_2t_6 and t_3t_5 , and no vertex in $\{t_3, t_4, t_5\}$ has a neighbour in $A - V(T)$.
- (b) If Configuration (2) occurs, the only allowable external edges of the path T are t_1t_3 and t_4t_6 , and no vertex in $\{t_4, t_5\}$ has a neighbour in $A - V(T)$.
- (c) If either (1) or (2) occurs, every 8-path in $\langle V(H) \cup \{x_1\} \rangle$ has an initial or terminal vertex in the set $Y = N_H(t_6) - \{t_1, t_2, t_3, t_4, t_5\}$.
- (d) If either (1) or (2) occurs, x_1 has exactly two neighbours on T and none in $A - V(T)$.

In view of Observation 4.2, we say a 7-path in $\langle A \rangle$ is (1)-eligible if it has no external adjacencies other than $2 \sim 6$ and $3 \sim 5$, and (2)-eligible if it has no external adjacencies other than $1 \sim 3$ and $4 \sim 6$. A 7-path in $\langle A \rangle$ that is either (1)-eligible or (2)-eligible is simply called an *eligible* 7-path.

Observation 4.3. *Lemma 4.1 implies that if there is a 7-path T in $\langle A \rangle$ such that neither T nor \overleftarrow{T} is an eligible 7-path, then the component of $\langle A \rangle$ containing T has no eligible 7-path and is therefore not a candidate for a problematic configuration.*

We now prove the Strong PPC for $a = 7$.

Theorem 4.4. *Let G be a graph with detour order $7 + b$. Then G has an exact $(7, b)$ -partition.*

Proof. We begin by choosing a path of order $7 + b$ in G . We let A consist of the first seven vertices of this path and we let $B = V(G) - A$.

We now describe a recursive procedure for moving vertices back and forth between A and B until we have an exact $(7, b)$ -partition of G .

Step 1. If $\tau(\langle B \rangle) = b$, then (A, B) is an exact $(7, b)$ -partition of G , so then we stop. If $\tau(\langle B \rangle) > b$, we let $X = x_1 \cdots x_{b+1}$ be a $(b + 1)$ -path in $\langle B \rangle$ and proceed to Step 2.

Step 2. If $\tau(\langle A \cup \{x_i\} \rangle) = 7$ for $i = 1$ or $b + 1$, we move x_1 to A if $i = 1$; otherwise, we move x_{b+1} to A . Then we return to Step 1.

Step 3. If $\tau(\langle A \cup \{x_1\} \rangle) \geq 8$ and $\tau(\langle A \cup \{x_{b+1}\} \rangle) \geq 8$, then we define the paths P, Q, R, S as in Lemma 2.2. (If necessary, we reverse the labelling of X so that we can choose P to have maximum order among the four paths.) Now let H be the component of $\langle A \rangle$ that contains P and let T be any 7-path in H . Then by Lemma 4.1, T may be labelled $t_1 \cdots t_7$ such that we have either of the two configurations in Figure 3. In either case, we let $Y = N_H(t_6) - \{t_1, t_2, t_3, t_4, t_5\}$. Then we move x_1 to A and return all the vertices in Y to B . Then we return to Step 1.

First, we note that after having executed Step 2, $\tau(\langle A \rangle)$ obviously remains 7, and it follows from Observation 4.2(c) and (d) that the same is true for Step 3.

Next, we note that throughout our recursive procedure, a b -path is retained in $\langle B \rangle$, and each time Step 2 is executed, the result is that $\langle B \rangle$ has fewer $(b+1)$ -paths than previously. If Step 3 is executed, at least one $(b+1)$ -path in $\langle B \rangle$ is destroyed, but the vertices that are returned to B may then be internal vertices of other $(b+1)$ -paths in $\langle B \rangle$, in which case there may even be more $(b+1)$ -paths in B than previously. However, we shall show that this will not prevent our recursive procedure from terminating, since (roughly speaking) Step 3 can be applied at most twice with respect to a given component of $\langle A \rangle$.

Suppose that at some stage in our recursive procedure we have encountered the configuration (1) or (2) with respect to a path $t_1 \cdots t_7$ in a component H of $\langle A \rangle$ and a path $x_1 \cdots x_{b+1}$ in $\langle B \rangle$ and have consequently executed Step 3, as illustrated in Figure 3. By Observation 4.2(d), the execution of Step 3 does not affect any component of $\langle A \rangle$ other than H . We now check whether the resulting component $H' = \langle (V(H) \cup \{x_1\}) - Y \rangle$ is a candidate for another problematic configuration.

Suppose first that Step 3 was applied to H due to an occurrence of (1). Then H' contains the 7-path

$$T^{(1)} = t_1 t_2 x_1 t_3 t_4 t_5 t_6 \text{ (which has } 2 \sim 4)$$

and its reverse

$$\overleftarrow{T^{(1)}} = t_6 t_5 t_4 t_3 x_1 t_2 t_1 \text{ (which has } 4 \sim 6),$$

as illustrated in Figure 3. Now $T^{(1)}$ is not an eligible 7-path, since $2 \sim 4$ is forbidden in both (1) and (2). Since $4 \sim 6$ is allowed in (2) but forbidden in (1), the 7-path $\overleftarrow{T^{(1)}}$ is (2)-eligible but not (1)-eligible. Thus, at some stage during our recursive procedure, there may be another $(b+1)$ -path in $\langle B \rangle$ which, together with the 7-path $\overleftarrow{T^{(1)}}$, results in the configuration (2). If this is the case, we perform Step 3 again, and then the resulting component H'' contains a 7-path $T^{(1,2)}$ which has both $3 \sim 5$ and $5 \sim 7$, as illustrated in Figure 4. Since $5 \sim 7$ is forbidden in both (1) and (2), $T^{(1,2)}$ is a non-eligible 7-path. The reverse, $\overleftarrow{T^{(1,2)}}$, has $1 \sim 3$ and $3 \sim 5$, and is therefore also non-eligible, since $1 \sim 3$ is forbidden in (1), and $3 \sim 5$ is forbidden in (2)). Thus, by Observation 4.3, there is no eligible 7-path in H'' , and hence H'' is not a problematic component. Subsequent executions of Step 2 may add vertices to H'' but will not remove any vertices from H'' . Thus, for the remainder of the recursive procedure, the components of $\langle A \rangle$ derived from H'' will retain the non-eligible 7-paths $T^{(1,2)}$ and $\overleftarrow{T^{(1,2)}}$ and will therefore remain non-problematic, by Observation 4.3.

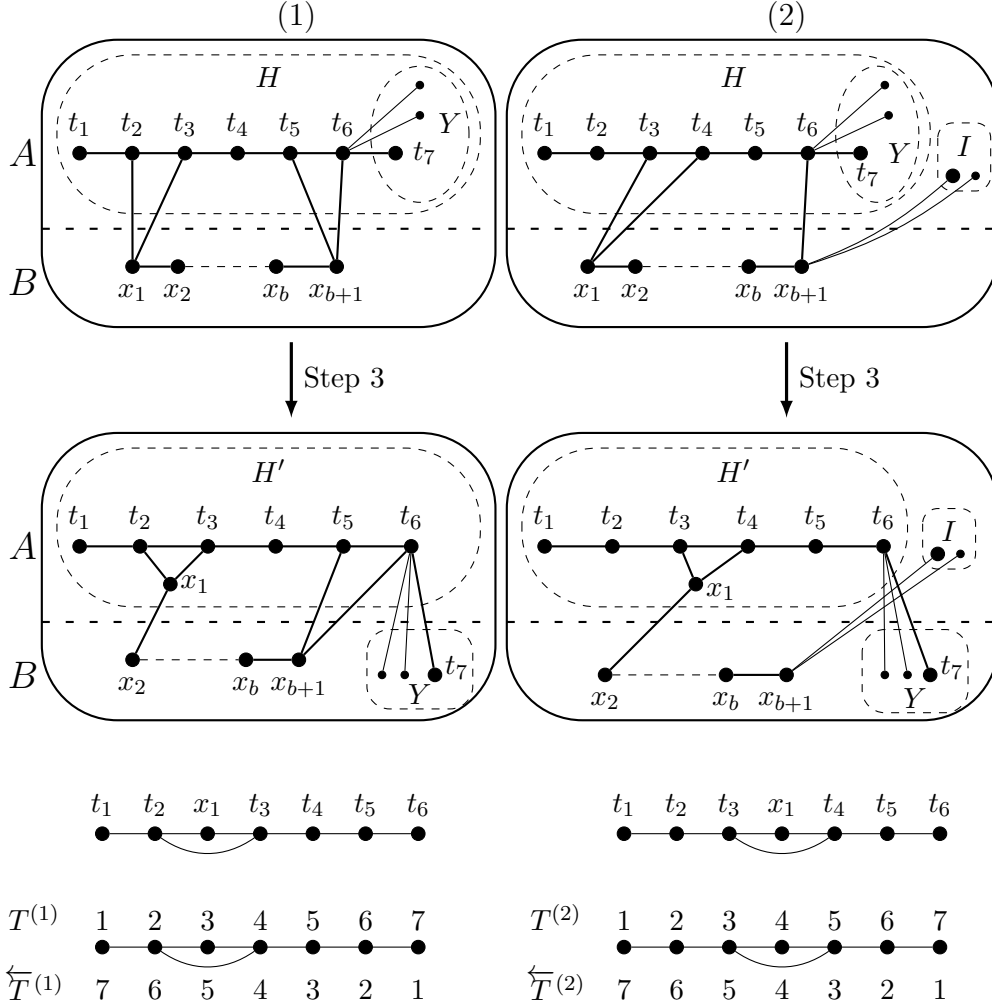

Figure 3. Applying Step 3 if (1) or (2) occurs.

Next, suppose Step 3 was applied to H due to an occurrence of (2). Then H' contains the 7-paths

$$T^{(2)} = t_1 t_2 t_3 x_1 t_4 t_5 t_6 \text{ and } \overleftarrow{T^{(2)}} = t_6 t_5 t_4 x_1 t_3 t_2 t_1, \text{ which both have } 3 \sim 5,$$

as illustrated in Figure 3. Then $T^{(2)}$ as well as $\overleftarrow{T^{(2)}}$ is (1)-eligible but not (2)-eligible. Now, if (1) occurs with respect to a 7-path with $3 \sim 5$, then after Step 3 is performed again, the resulting component H'' contains a path $T^{(2,1)}$ that has $2 \sim 4$ as well as $4 \sim 6$ (as illustrated in Figure 4). Then $\overleftarrow{T^{(2,1)}}$ also has $2 \sim 4$ and $4 \sim 6$. Thus both $T^{(2,1)}$ and $\overleftarrow{T^{(2,1)}}$ are non-eligible. Hence, by Observation 4.3,

H'' has no eligible path and is therefore non-problematic, and executing Step 2 cannot not transform it into a problematic component.

We conclude that problematic components will eventually cease to occur. Thereafter the number of $(b + 1)$ -paths will decrease with each step until $\tau(\langle B \rangle) = b$. ■

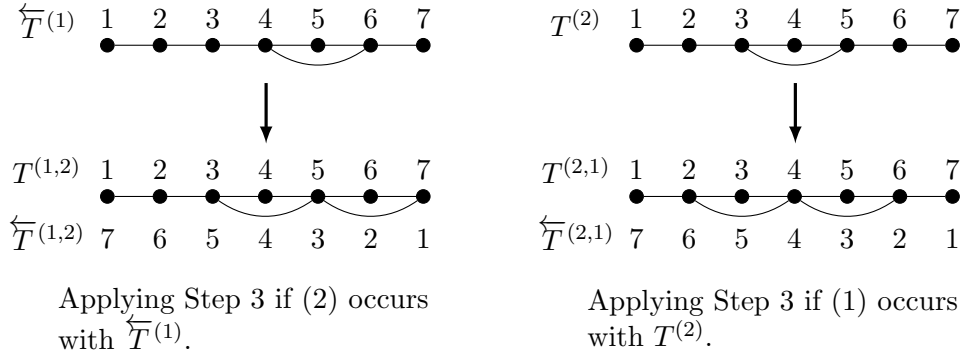

Figure 4. Applying Step 3 a second time if (1) or (2) occurs.

5. PROOF OF THE STRONG PPC FOR $a = 8$

Let G be graph with $\tau(G) = 8 + b$ and let A be a subset of $V(G)$ such that $\tau(\langle A \rangle) = 8$. If $G - A$ contains a $(b + 1)$ -path $X = x_1 \cdots x_{b+1}$ such that

$$\tau(\langle \{x_1\} \cup A \rangle) > 8 \text{ and } \tau(\langle \{x_{b+1}\} \cup A \rangle) > 8,$$

we say that we have a *problematic configuration for $a = 8$* .

In order to prove the Strong PPC for $a = 8$ we shall employ a recursive procedure similar to that used for $a = 7$, although we now have more problematic configurations to address. We have seen that in each problematic configuration for $a = 7$, as shown in Figure 2, the neighbours of x_1 lie on a 7-path in $\langle A \rangle$. The analogue of this result does not hold for $a = 8$. We shall show that there are two types of problematic configurations for $a = 8$: those where *no* neighbour of x_1 lies on an 8-path in $\langle A \rangle$ (henceforth called a Type I problematic configuration) and those where *every* neighbour of x_1 lies on an 8-path in $\langle A \rangle$ (henceforth called a Type II problematic configuration). Fortunately, as we shall see in the proof of Theorem 5.4, our recursive procedure will convert the Type I problematic configurations to Type II problematic configurations or to non-problematic configurations. It is therefore unnecessary for us to determine all the Type I problematic configurations. (Figure 5 shows a few, but there may be others.)

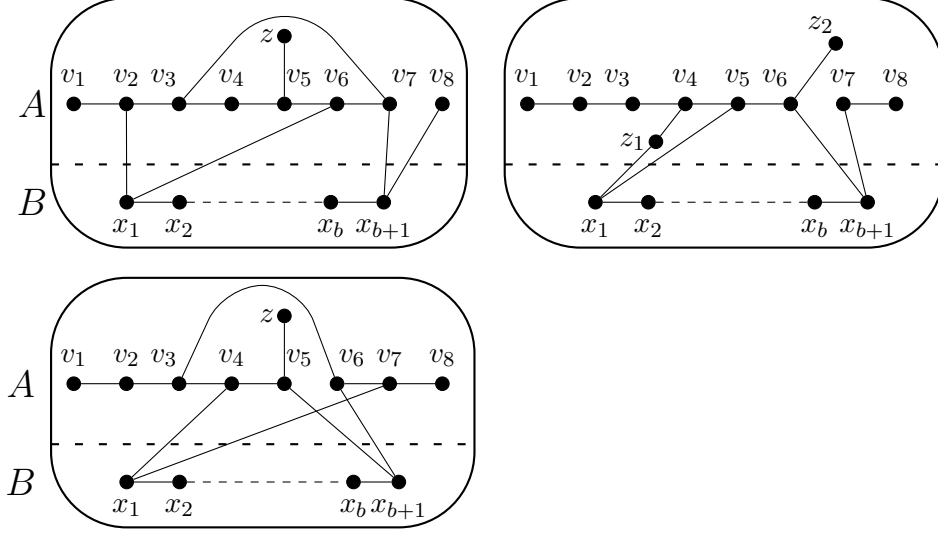

Figure 5. A few Type I problematic configurations.

Our next lemma implies that every problematic configuration for $a = 8$ is either Type I or Type II, and that the four cases in Figures 6 and 7 represent all the Type II problematic configurations.

Lemma 5.1. *Let G be a graph with $\tau(G) = 8 + b$ and let A, B be a partition of $V(G)$ such that $\tau(\langle A \rangle) = 8$. Suppose X is a $(b + 1)$ -path in $\langle B \rangle$ such that if x is either of the two end-vertices of X , then $\tau(\langle A \cup \{x\} \rangle) \geq 9$. Then, with respect to an appropriate labelling $x_1 \cdots x_{b+1}$ of X , there are four paths P, Q, R, S in $\langle A \rangle$ such that P has maximum order among these four paths, and Rx_1S and $Px_{b+1}Q$ are 9-paths in G . Let H be the component of $\langle A \rangle$ containing the path P . Now suppose $\tau(H) = 8$ and let T be any 8-path in H . Then T may be labelled $t_1 \cdots t_8$ such that at least one of the following holds.*

- (1) $N(x_1) \supseteq \{t_2, t_3\}$ and $N(x_{b+1}) \supseteq \{t_6, t_7\}$.
- (2) $N(x_1) \supseteq \{t_3, t_4\}$ and $N(x_{b+1}) \supseteq \{t_6, t_7\}$.
- (3) $N(x_1) \supseteq \{t_3, t_4\}$ and $N(x_{b+1}) \supseteq \{t_7, z\}$, for some $z \in A - V(T)$.
- (4) $N(x_1) \supseteq \{t_4, t_5\}$ and $N(x_{b+1}) \supseteq \{t_7, z\}$, for some $z \in A - V(T)$.
- (5) $N(x_1) \supseteq \{t_2, t_3\}$ and $N(x_{b+1}) \supseteq \{t_5, t_6\}$.

Proof. By Lemma 2.2(2), both R and S intersect the path P . We let L denote the 9-path Rx_1S . In the notation of Lemma 2.2(2) and (3) (with $a = 8$), L is the path $w_1 \cdots w_r x_1 w_{r+1} \cdots w_8$, and $w_l = v_i$ and $w_f = v_j$ are, respectively, the last vertex of R on P and the first vertex of S on P (see Figure 1). We assume that $i < j$. Let $q = 8 - p$.

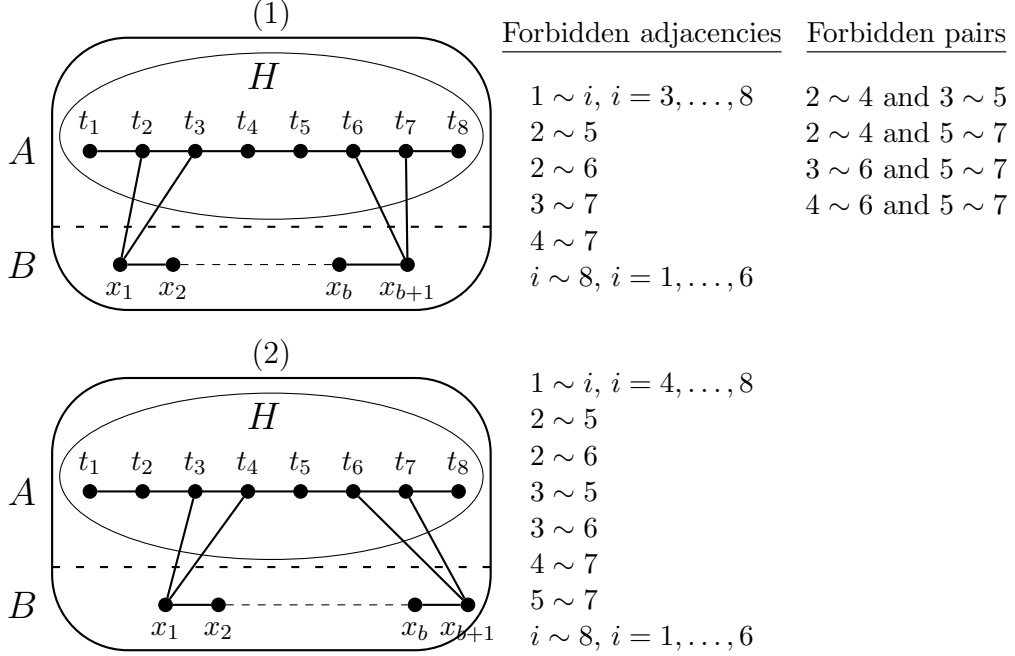

Figure 6. Type II problematic configurations (1) and (2).

Since $v_p \in V(P)$ and both R and S intersect P , the vertices w_r, w_{r+1} and v_p are all in H (but v_{p+1} may be in $A - V(H)$). We now prove the following claims.

Claim 1. *The vertices w_r, w_{r+1} and v_p are all in $V(T)$.*

Proof. First, suppose $w \in \{w_r, w_{r+1}\}$ and $w \notin V(T)$. Then, since H is connected, there is a vertex t_k on the path T such that there is a $t_k w$ -path F in H with all internal vertices (if any) in $A - V(T)$. Since G has no $(b+9)$ -path, $k \in \{3, 4, 5, 6\}$. We may assume that the path T is labelled such that k is either 3 or 4.

Suppose $k = 3$. Then $t_8 t_7 t_6 t_5 t_4 F X$ is a path of order $b + 6 + n(F)$, and hence $F = t_3 w$. Thus every neighbour of x_{b+1} in A lies on the $(8 + b)$ -path $t_8 t_7 t_6 t_5 t_4 t_3 w X$. It follows that $\{v_p, v_{p+1}\} = \{t_3, t_6\}$. But then, since $\tau(G) = 8 + b$, no internal vertex of the path $Y = t_3 t_4 t_5 t_6$ has a neighbour in $A - V(Y)$, contradicting Lemma 2.2(3g).

Thus $k = 4$. We need to consider two cases.

(i) $v_p \in V(T)$. In this case $v_p = t_4$ and $v_{p+1} \notin V(T)$. Moreover, any path in H from either w or v_{p+1} to T contains the vertex $v_p = t_4$. Thus $V(T) \cap V(Q) = \emptyset$.

If $w_r \notin V(T)$, then, by the definition of v_i in Lemma 2.2(3), the $v_i w_r$ -path R' does not contain v_p , and hence the path $v_1 \cdots v_{p-1}$ is in $A - V(T)$. Since $p \geq 4$ (by our assumption on P), and $P t_5 t_6 t_7 t_8$ is a path in $\langle A \rangle$, it follows that $p = 4$, and

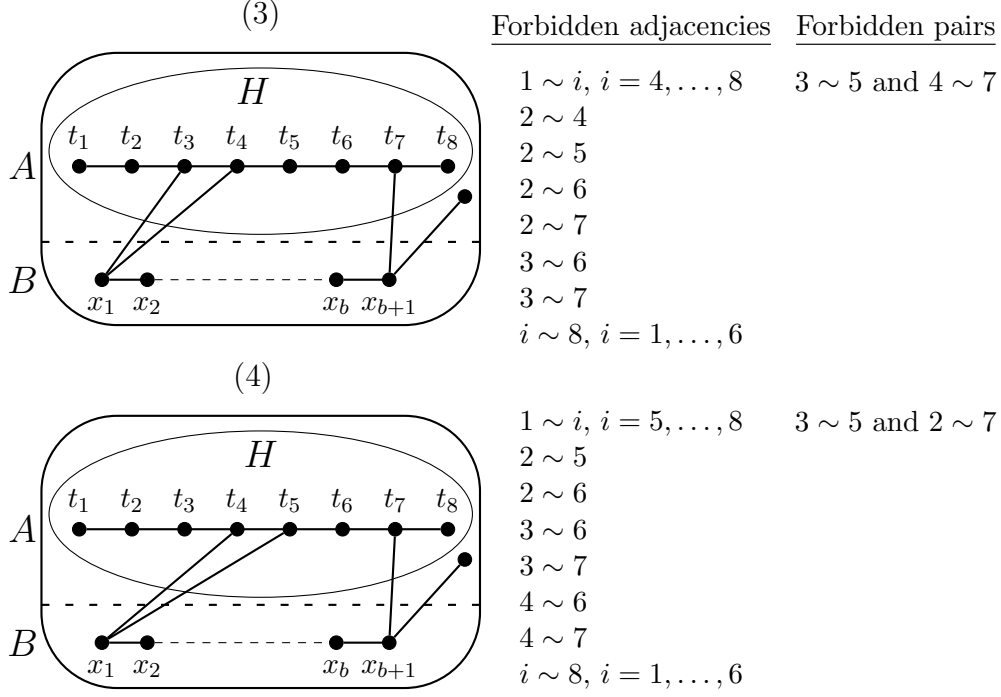

Figure 7. Type II problematic configurations (3) and (4).

hence $q = 4$. If $w_r = v_i$, the path $\overleftarrow{Q} \overleftarrow{X} v_i \cdots v_p t_5 t_6 t_7 t_8$ has more than $8 + b$ vertices. Thus $w_r \neq v_i$ and hence $n(R') \geq 2$. Now, if $i = 3$, then $v_1 v_2 R' X t_4 t_5 t_6 t_7 t_8$ is a path of order greater than $8 + b$. If $i < 3$, then the path $t_8 t_7 t_6 t_5 t_4 \overleftarrow{X} R' v_{i+1} \cdots v_3$ has order greater than $8 + b$.

Thus $w_r \in V(T)$. It follows that $w_{r+1} = w \notin V(T)$ and $w_r = t_6$. Thus $t_1 t_2 t_3 t_4 t_5 t_6 X Q$ is a path of order $7 + b + q$, and hence $q = 1$ and $p = 7$. But then $w_{r+1} \notin V(P)$, and hence $P \overleftarrow{X} w_{r+1}$ is a $(9 + b)$ -path.

(ii) $v_p \notin V(T)$. In this case t_4 is on every path in $\langle A \cup \{x_1\} \rangle$ from x_1 to T , as well as on every path in $\langle A \cup \{x_{b+1}\} \rangle$ from x_{b+1} to T .

If $t_4 \notin N(v_p)$, then any $t_4 v_p$ path has at least three vertices and since $\tau(G) = 8 + b$, it follows that $t_4 w v_p$ is the only $t_4 v_p$ -path in H . Then $t_8 t_7 t_6 t_5 t_4 w v_p \overleftarrow{X}$ is an $(8 + b)$ -path, and hence $N_A(x_1) \subseteq \{w, t_4, v_p\}$. Since v_p is neither w_r nor w_{r+1} by Lemma 2.2(3a), it follows that $\{w_r, w_{r+1}\} = \{w, t_4\}$. Then $t_8 t_7 t_6 t_5 t_4 w X v_p$ as well as $t_8 t_7 t_6 t_5 t_4 X v_p w$ are $(8 + b)$ -paths, and hence $N_A(v_p) = \{w\}$ and $N_A(w) = \{v_p, t_4\}$. It follows that $w_{r+1} = w = v_{p-1}$ and $w_r = t_4 = v_{p-2}$. But then Lemma 2.2(3f) is contradicted. Thus $t_4 \in N(v_p)$.

If $t_4 \notin N(w)$, then $F = t_4 v_p w$, and $N_A(w) = v_p$. But then $w \notin V(P) \cup V(Q)$, contradicting Lemma 2.2(3b). Thus $t_4 \in N(w)$.

Now, if $wv_p \in E(G)$, then, as in the previous paragraph, t_4 is either w_r or w_{r+1} , and hence $v_{p+1} \notin V(T)$. But then $t_8t_7t_6t_5t_4v_pwXv_{p+1}$ is a $(9+b)$ -path. Thus $wv_p \notin E(G)$, and hence $N_A(w) = N_A(v_p) = \{t_4\}$. Moreover, $q = 1$ and hence $p = 7$. But then $w \notin V(P)$ and hence $P\overline{X}w$ is a $(9+b)$ -path.

Thus we have proved that both w_r and w_{r+1} are in $V(T)$.

Next, suppose $v_p \notin V(T)$. Then, since $\tau(G) = b+8$, it follows that $w_r, w_{r+1} \in \{t_3, t_4, t_5, t_6\}$. If $w_r = t_4$, then t_4 is the first vertex on any path from v_p to T . But then, since $w_{r+1} \in \{t_3, t_5, t_6\}$ there is a path in G with more than $8+b$ vertices. By symmetry, this proves that neither w_r nor w_{r+1} is in $\{t_4, t_5\}$. Thus $\{w_r, w_{r+1}\} = \{t_3, t_6\}$. Since $\tau(G) = 8+b$, this implies that $N_A(v_p) \subseteq \{t_3, t_6\}$, and hence at least one of t_3 and t_6 is a neighbour of v_p . In either case, neither t_4 nor t_5 has a neighbour in $A - \{t_3, t_4, t_5, t_6\}$, contradicting Lemma 2.2(3g). \square

Claim 2. *If the vertex t_k of T is w_r or w_{r+1} , then neither v_p nor v_{p+1} is in $\{t_{k-1}, t_k, t_{k+1}\}$.*

Proof. This claim follows from Lemma 2.2(3a) and the fact that if a neighbour of x_1 and a neighbour of x_{b+1} are consecutive vertices of T , then G has a $(9+b)$ -path. \square

Claim 3. *The vertices w_r and w_{r+1} either both precede or both succeed v_p on T . Also, if $v_{p+1} \in V(T)$, then the vertex pair w_r, w_{r+1} either precedes or succeeds the vertex pair v_p, v_{p+1} on T .*

Proof. If $v_{p+1} \notin V(T)$, then $w_r, w_{r+1} \in \{t_3, t_4, t_5, t_6\}$. Then it follows from Claim 2 that v_p does not lie between w_r and w_{r+1} on T . This implies that v_p either precedes or succeeds both w_r and w_{r+1} on T .

Now suppose $v_{p+1} \in V(T)$ and v_p or v_{p+1} lies between w_r and w_{r+1} on T . Then it follows from Claim 2 that $\{w_r, w_{r+1}\} = \{t_2, t_7\}$ and $\{v_p, v_{p+1}\} = \{t_4, t_5\}$. Since Rx_1S is a 9-path in H , it has at least two vertices z_1, z_2 in the set $I = H - \{t_2, \dots, t_7\}$. Since G has no $(9+b)$ -path, I is an independent set and $N_L(I) = \{t_2, t_7\} = \{w_r, w_{r+1}\}$. But then Rx_1S is the path $z_1w_rx_1w_{r+1}z_2$, which has only five vertices. This case can therefore not occur. A similar proof shows that w_r and w_{r+1} cannot both lie between v_p and v_{p+1} on T . Thus w_r and w_{r+1} either both precede v_p and v_{p+1} or both succeed v_p and v_{p+1} on T . \square

Claim 4. *The vertices w_r and w_{r+1} are consecutive vertices on the path T . Moreover, if $v_{p+1} \in V(T)$, then v_p and v_{p+1} are also consecutive vertices of T .*

Proof. Suppose w_r and w_{r+1} are not consecutive vertices of T . By Claim 3 we may choose the labelling $t_1 \cdots t_8$ for T such that neither v_p nor v_{p+1} precedes either w_r or w_{r+1} on T . Then we only need to consider the following two cases.

(i) $\{w_r, w_{r+1}\} = \{t_2, t_4\}$ and $\{v_p, v_{p+1}\} = \{t_6, t_7\}$. In this case, since G has no $(9+b)$ -path, $N_A(t_3) = \{t_2, t_4\}$, contradicting Lemma 2.2(3g).

(ii) $\{w_r, w_{r+1}\} = \{t_3, t_5\}$ and $\{v_p, v_{p+1}\} = \{t_7, z\}$, where $z \in A - V(T)$. In this case, since G has no $(9 + b)$ -path, $N_A(t_4) = \{t_3, t_5\}$, contradicting Lemma 2.2(3g).

Thus neither of the two cases above can occur, which proves that w_r and w_{r+1} are consecutive vertices on T . If $v_{p+1} \in V(T)$ and v_p and v_{p+1} are not consecutive vertices of T , then $\{w_r, w_{r+1}\} = \{t_2, t_3\}$ and $\{v_p, v_{p+1}\} = \{t_5, t_7\}$. This case is symmetric to case (ii) above and can therefore not occur either. Thus Claim 4 is proved. \square

We now use Claims 1–4 to prove that, if T is labelled such that neither v_p nor v_{p+1} precedes w_r or w_{r+1} on T , then we have one of the cases (1)–(5) in our lemma statement.

First, suppose $\{w_r, w_{r+1}\} = \{t_2, t_3\}$. Then $v_{p+1} \in V(T)$ and it follows from Claims 2 and 4 that $\{v_p, v_{p+1}\}$ is either $\{t_5, t_6\}$ or $\{t_6, t_7\}$. Thus we have (1) or (5) occurring.

Next, suppose $\{w_r, w_{r+1}\} = \{t_3, t_4\}$. Then, if $v_{p+1} \in V(T)$, Claim 2 implies that $\{v_p, v_{p+1}\} = \{t_6, t_7\}$, and thus we have (2) occurring. If $v_{p+1} \notin V(T)$, then Claim 2 implies that v_p is either t_6 or t_7 . If $v_p = t_7$, we have (3). Now suppose $v_p = t_6$. Then, since G has no $(b+9)$ -path, v_{p+1} has no neighbour in A , and hence $q = 1$. In this case P is a 7-path in H with t_6 as end-vertex. If $t_7, t_8 \notin V(P)$, then Pt_7t_8 is a 9-path, contradicting that $\tau(\langle A \rangle) = 8$. Hence t_7 or t_8 is in $V(P)$. But since $\tau(G) = b + 8$, there is no path in $H - v_p$ from t_7 or t_8 to any vertex in $\{t_3, t_4, t_5\}$, and hence $t_3, t_4, t_5 \notin V(P)$. But then $Pt_5t_4t_3$ is a 10-path in $\langle A \rangle$. This case can therefore not occur.

Finally, suppose $\{w_r, w_{r+1}\} = \{t_4, t_5\}$. Then Claim 2 implies that $v_p = t_7$ and $v_{p+1} \in V(H) - V(T)$. So in this case (4) occurs. \blacksquare

Remark 5.2. We can convert (5) of Lemma 5.1 to (2) by reversing the labelling of X as well as that of T . Thus the four cases shown in Figures 6 and 7 represent all the Type II problematic configurations for $a = 8$. In each of those four cases, t_7 is in $N(x_{b+1})$ and hence $t_1 \cdots t_7 \overleftarrow{X}$ is an $(8 + b)$ -path, which implies that x_1 has no neighbour in $A - V(T)$. However, x_1 may have a neighbour on T that is not shown in the sketches — we have shown only w_r and w_{r+1} , since they are the neighbours of x_1 that define the specific case.

In each of the four cases in Figures 6 and 7 certain adjacencies between vertices on the 8-path $t_1 \cdots t_8$ are forbidden, due to the fact that $\tau(G) = 8 + b$. The forbidden adjacencies are listed in Figures 6 and 7. We say that an 8-path in $\langle A \rangle$ is (k) -eligible if it has no adjacencies that are forbidden for (k) in Lemma 5.1. An 8-path in $\langle A \rangle$ is eligible if it is (k) -eligible for some $k \in \{1, 2, 3, 4\}$.

Observation 5.3. Lemma 5.1 implies that if there is an 8-path T in $\langle A \rangle$ such that neither T nor \overleftarrow{T} is an eligible 8-path, then the component of $\langle A \rangle$ containing

T has no eligible 8 path and is therefore not a candidate for a problematic configuration.

We are now ready to prove the Strong PPC for $a = 8$.

Theorem 5.4. *Let G be a graph with detour order $8 + b$. Then G has an exact $(8, b)$ -partition.*

Proof. We begin by choosing a path of order $8 + b$ in G . We let A consist of the first eight vertices of this path and we let $B = V(G) - A$.

We now describe a recursive procedure for moving vertices back and forth between A and B until we have an exact $(8, b)$ -partition of G .

Step 1. If $\tau(\langle B \rangle) = b$, then (A, B) is an exact $(8, b)$ -partition of G , so then we stop. If $\tau(\langle B \rangle) > b$, we let $X = x_1 \cdots x_{b+1}$ be a $(b + 1)$ -path in $\langle B \rangle$ and proceed to Step 2.

Step 2. If $\tau(\langle A \cup \{x_i\} \rangle) = 8$ for $i = 1$ or $b + 1$, then we move x_1 to A if $i = 1$; otherwise, we move x_{b+1} to A . Then we return to Step 1.

Step 3. If $\tau(\langle A \cup \{x_1\} \rangle) > 8$ and $\tau(\langle A \cup \{x_{b+1}\} \rangle) > 8$, we let the paths P, Q, R, S be as defined in Lemma 2.2 with $a = 8$. (If necessary, we reverse the labelling of the path X so that P may be assumed to be of maximum order among the four paths.) Now let H be the component of $\langle A \rangle$ that contains P .

(a) If $\tau(H) < 8$, we move x_1 to A . The result is that $\langle V(H) \cup \{x_1\} \rangle$ is now a component of $\langle A \rangle$ with detour order 9. Then we move an end-vertex of a 9-path in $\langle V(H) \cup \{x_1\} \rangle$ to B and, if necessary, repeat the process until the resulting component of $\langle A \rangle$ has detour order 8. Then we return to Step 1.

(b) If $\tau(H) = 8$, let T be any 8-path in H . Then, by Lemma 5.1, we can choose the labelling $t_1 \cdots t_8$ for T such that we have one of the five Type II problematic configurations in Lemma 5.1. If we have (5), we first convert it to (2) as per Remark 5.2 before proceeding. We may therefore assume that we have one of the cases (1)–(4) in Figures 6 and 7. In each case we let $Y = N_H(t_7) - \{t_1, t_2, t_3, t_4, t_5, t_6\}$. Then we move x_1 to A and return all vertices in Y to B . Then we return to Step 1.

We shall prove that after a finite number of steps our procedure will terminate in an exact (a, b) -partition of G . We first note the following.

After having executed Step 2 or 3(a), we obviously have $\tau(\langle A \rangle) = a$. To see that this is also true for Step 3(b), we note that in each Type II problematic configuration, x_1 has no neighbour in $A - V(T)$ and every 9-path in $\langle V(H) \cup \{x_1\} \rangle$ has an end-vertex in Y . Thus, after having executed Step 3(b), the resulting component $\langle (V(H) \cup \{x_1\}) - Y \rangle$ has detour order 8.

Throughout our recursive procedure, a b -path is retained in B . After each execution of Step 2, there is at least one less $(b + 1)$ -path in $\langle B \rangle$, but this is not

necessarily true for Step 3, since the vertices that were returned to B may be internal vertices of $(b + 1)$ -paths in $\langle B \rangle$. We shall show, however, that this will not prevent our iteration procedure from terminating.

If Step 3(a) is executed, the relevant component H of $\langle A \rangle$ is converted to a component with detour order 8. Thus Type I problematic configurations will eventually cease to occur.

Now suppose we have executed Step 3(b) due to an occurrence of one of the four Type II problematic configurations shown in Figures 6 and 7.

In each case, let t_i, t_{i+1} be the first two neighbours of x_1 on the 8-path T in H , and let T' be the 8-path $t_1 \cdots t_i x_1 t_{i+1} \cdots t_7$ in H' . Then $t_i t_{i+1}$ is an external edge of T' and $t_{i+1} t_i$ is an external edge of \overleftarrow{T}' . Thus if (1) occurs, T' has $2 \sim 4$ and \overleftarrow{T}' has $5 \sim 7$. If (2) or (3) occurs, T' has $3 \sim 5$, and \overleftarrow{T}' has $4 \sim 6$. If (4) occurs, T has $4 \sim 6$ and T' has $3 \sim 5$.

Thus, after having applied Step 3(b) with respect to an eligible 8-path T in a component H of $\langle A \rangle$, each of the 8-paths T' and \overleftarrow{T}' in H' has at least one of the following external adjacencies.

- 1(a) $2 \sim 4$ (allowed only if (1), (2) or (4) occurs),
- 1(b) $5 \sim 7$ (allowed only if (1), (3) or (4) occurs),
- 1(c) $3 \sim 5$ (allowed only if (1), (3) or (4) occurs),
- 1(d) $4 \sim 6$ (allowed only if (1), (2) or (3) occurs).

Now suppose T had the external edge $t_h t_k$, $h < k < 8$. Then T' has either $h \sim k$ or $h \sim (k + 1)$ or $(h + 1) \sim (k + 1)$, depending on whether $k \leq i$, or $h \leq i < k$, or $h > i$. We also note that no external edge of T is incident with the vertex t_9 . Thus T' has at least one more external edge than T had, since adding x_1 added at least one, while removing Y did not destroy any.

Thus, repeated applications of Step 3(b) will eventually result in a component H' containing an 8-path T' such that T' as well as \overleftarrow{T}' contain at least one forbidden edge for each of the configurations (1)–(4). Then, by Observation 5.3, H' is not a problematic component. Also if H' is subsequently affected by repeated applications of Step 2, the paths T' and \overleftarrow{T}' will remain as non-eligible 8-paths in $\langle A \rangle$, since no vertices are removed from A during the execution of Step 2.

We conclude that after a finite number of steps the problematic configurations will cease to occur. In fact, the schematic representation in Figure 8 below shows that a Type II problematic configuration becomes non-problematic after at most four iterations in accordance with Step 3(b). (In Figure 8, a “ \times ” after a set of adjacencies indicates that an 8-path with those adjacencies is non-eligible.)

Thereafter, the number of $(b + 1)$ -paths in $\langle B \rangle$ will decrease with each further step of our recurrence procedure, until $\tau(\langle B \rangle)$ becomes b . ■

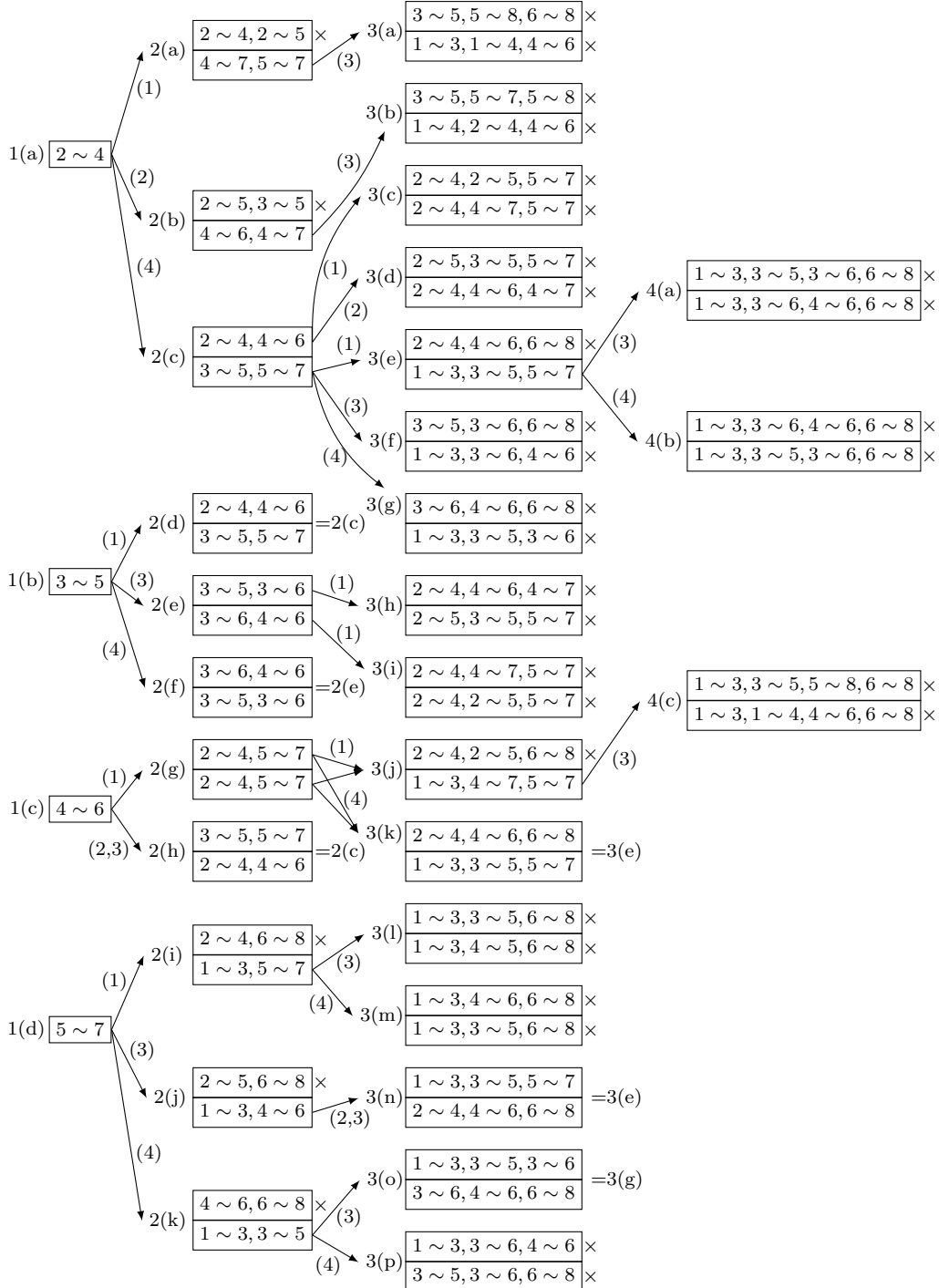

Figure 8. Repeated applications of Step 3(b)

6. CONCLUDING REMARKS

It should be noted that if the Strong PPC holds for $a = k$, it does not follow automatically that it holds for $a < k$. Nevertheless, we have used basically the same algorithm to prove the Strong PPC for all $a \leq 8$, although with each increase in the value of a beyond 6, the so-called “problematic configurations” became more challenging to handle. We showed that for $a \leq 6$ there are no problematic configurations, and for $a = 7$ each problematic configuration involves a component of $\langle A \rangle$ with detour order 7. For $a = 8$ there are many problematic configurations involving components with detour order less than 8, but we side-stepped the problem of determining all those cases, by adapting our recursive procedure to transform those components to components with detour order 8. We could have adopted the same approach for the case $a = 7$, by proving the analogue of Lemma 5.1 for $a = 7$, instead of Lemma 4.1. However, we decided to retain Lemma 4.1 since it provides insight into the structure of the problem.

As a increases beyond 8, several new complications regarding the associated problematic configurations enter the picture. A careful analysis of the types of problematic configurations that may occur if $a \geq 9$ might lead to further progress towards proving the Strong PPC.

Note that it follows from Lemma 2.2 (as illustrated in Figure 1), that a problematic configuration for a given value of a (irrespective of the magnitude of a) can only occur in a graph containing more than one cycle. Thus, using our basic recursive procedure, one can easily prove that the Strong PPC holds for acyclic graphs, as well as for unicyclic graphs. Perhaps the procedures developed in this paper could help prove that the Strong PPC holds for other interesting classes of graphs.

We have not yet attempted to find an asymptotic result for the Strong PPC. It would certainly be worth considering, but it does not seem as though the methods used in [8] can be easily adapted for the Strong PPC.

Acknowledgements

The fourth author is supported by an NSERC Discovery Grant CANADA, Grant number RGPIN-2016-05237.

REFERENCES

- [1] R.E.L. Aldred and C. Thomassen, *Graphs with not all possible path-kernels*, Discrete Math. **285** (2004) 297–300.
<https://doi.org/10.1016/j.disc.2004.02.012>
- [2] J.A. Bondy, Handbook of Combinatorics, Eds. R.L. Graham, M. Grötschel and L. Lovász, The MIT Press, Cambridge, MA **I** (1995) 49.

- [3] I. Broere, P. Hajnal, and P. Mihók, *Partition problems and kernels of graphs*, Discuss. Math. Graph Theory **17** (1997) 311–313.
<https://doi.org/10.7151/dmgt.1058>
- [4] F. Bullock, J.E. Dunbar and M. Frick, *Path partitions and P_n -free sets*, Discrete Math. **489** (2004) 145–155.
<https://doi.org/10.1016/j.disc.2004.07.012>
- [5] J.E. Dunbar and M. Frick, *Path kernels and partitions*, J. Combin. Math. Combin. Comput. **31** (1999) 137–149.
- [6] J.E. Dunbar and M. Frick, *The Path Partition Conjecture is true for claw-free graphs*, Discrete Math. **307** (2007) 1285–1290.
<https://doi.org/10.1016/j.disc.2005.11.065>
- [7] J.E. Dunbar and M. Frick, *The Path Partition Conjecture*, in: Graph Theory: Favourite Conjectures and Open Problems, R. Gera, T.W. Haynes and S. Hedetniemi (Ed(s)), (Springer, 2018).
- [8] M. Frick and I. Schiermeyer, *An asymptotic result on the path partition conjecture*, Electron. J. Combin. **12** (2005) #R48.
<https://doi.org/10.37236/1945>
- [9] M. Frick and C. Whitehead, *A new approach to the Path Partition Conjecture*, Util. Math. **99** (2006) 195–206.
- [10] P. Katrenič and G. Semanišin, *A note on the Path Kernel Conjecture*, Discrete Math. **309** (2009) 2551–2554.
<https://doi.org/10.1016/j.disc.2008.05.002>
- [11] J.M. Laborde, C. Payan and N.H. Xuong, *Independent sets and longest directed paths in digraphs*, Graphs and Other Combinatorial Topics, Teubner-Texte Math. Prague (1982) **59** (1983) 173–177.
- [12] L.S. Melnikov and I.V. Petrenko, *On path kernels and partitions in nondirected graphs*, Diskretn. Anal. Issled. Oper. **9** (2002) 21–35.
- [13] L.S. Melnikov and I.V. Petrenko, *Path kernels and partitions of graphs with small cycle length*, in: Methods and Tools of Program Construction and Optimization, V.N. Kasyanov (Ed(s)), (ISI SB Russian Academy of Science, Novosibirsk, 200) 145–160.
- [14] J. Vronka, *Vertex Sets of Graphs with Prescribed Properties*, PhD Thesis (P.J. Sáfarik University, Košice, 1986).

Received 13 September 2021

Revised 7 July 2022

Accepted 7 July 2022