



Effect of truck speed on the response of flexible pavement systems to traffic loading

Michael R. S. Mshali & Wynand JvdM. Steyn

To cite this article: Michael R. S. Mshali & Wynand JvdM. Steyn (2020): Effect of truck speed on the response of flexible pavement systems to traffic loading, International Journal of Pavement Engineering, DOI: [10.1080/10298436.2020.1797733](https://doi.org/10.1080/10298436.2020.1797733)

To link to this article: <https://doi.org/10.1080/10298436.2020.1797733>



© 2020 The Author(s). Published by Informa UK Limited, trading as Taylor & Francis Group



Published online: 30 Jul 2020.



Submit your article to this journal [↗](#)



Article views: 384



View related articles [↗](#)



View Crossmark data [↗](#)

Effect of truck speed on the response of flexible pavement systems to traffic loading

Michael R. S. Mshali and Wynand JvdM. Steyn

Department of Civil Engineering, University of Pretoria, Pretoria, South Africa

ABSTRACT

The road network in South Africa, particularly in urban areas, is experiencing a steady increase in traffic volumes and congestion. Speed has a significant effect on the response of flexible pavement systems to traffic loading. Truck tyre loads are more often analysed as a static load in order to simplify the computations, although in reality the pavement system is subjected to a dynamic load. This paper investigates the influence of truck speed on flexible pavement system response to moving traffic loading. A truck with standard axle loads was used to conduct runs at controlled speeds and wander over a full-scale instrumented pavement test sections on road R104 east of Pretoria. The findings of this research indicate that pavement deflections increase exponentially as the truck speeds reduce to speeds below 30 km/h. Furthermore, deflections decrease marginally as the truck speeds increase to speeds greater than 40 km/h. Different flexible pavement systems present different exponential factors that reflect differences in sensitivity of the pavement systems to changes in truck speed. It is thus essential to introduce adjustment factors to deflection measurements done at different truck speeds on different pavement systems in order to compare such deflection data.

ARTICLE HISTORY

Received 5 June 2019
Accepted 7 July 2020

KEYWORDS

Pavement systems;
pavement response; speed;
traffic loading; moving load

Introduction

The road network in South Africa, particularly in urban areas, is experiencing steady increases in traffic volume and congestion. Traffic congestion is characterised by slow travel speeds. Speed has a significant effect on the response of flexible pavement systems to traffic loading. Traffic loading is one of the major determinant factors to the deterioration and failure of pavement systems. It follows that traffic loading is one of the important input parameters in mechanistic-empirical pavement design methods. Mechanistic-empirical pavement design methods apply elastic theories to calculate the stresses and strains in pavement layers under a given traffic wheel loading (pavement response to loading) and use empirical relationships to determine the number of load repetitions to failure (distress prediction) (Huang 2004).

Road pavement distress and condition deterioration caused by trucks are dependent on environmental, vehicle, tyre and pavement factors. Most pavement systems in South Africa are constructed with thin surfacing (<50 mm thick) (De Beer et al 1997). The influence of these factors on pavement response is revealed in the analysis of truck-pavement interactions under static or dynamic loading conditions. A moving vehicle passing over a pavement imposes transient loads on the pavement that have both static weight and dynamic force components. Modelling vehicle response under moving load is thus important in the development of mechanistic-based pavement analysis and design methods.

Pavement systems consist of various types of natural and engineered materials which respond differently to vehicular moving loads. A moving tyre load is time-dependent and tran-

sient. Owing to a lack of computational models and empirical data, pavements have traditionally been analysed in a static mode, where it is assumed that both the load input and the pavement response are static and time-independent.

Background

Influence of speed of moving load on pavement system response

In the early days of pavement engineering, researchers considered a moving wheel load in the form of duration of loading (or frequency or rate of loading). Brown (1973) found that simulation of field conditions and in situ testing of pavement response were very complex and expensive and hence engineers relied on the testing samples of materials in the laboratory with the hope that the tests simulated the in situ conditions. At the time, the work of Van der Poel (1954) presented the best approach for the determination of stiffness of bitumen layers under the given loading time or frequency, temperature difference and penetration index of the bitumen.

De Beer (1992) investigated pavement response to moving loads (5–80 km/hr) by measuring pavement deflections using the Multi-Depth Deflectometer (MDD) and strain gauges. The study focused on heavy duty pavement structures comprising 50–70 mm asphalt surfacing placed on crushed stone base, cemented base and asphalt base. The study showed the relative effect of pavement temperature and vehicle speed on pavement response. It was concluded that pavement structural life was not a constant, but varies according to the temperature and speed of moving load effects, depending on the type of

pavement structure. The study recommended further investigation in the effect of vehicle speed and dynamic characteristics (damping and inertia) on pavement systems response.

Synthesis by Gillespie *et al.* (1993) also reported amongst many significant findings that vehicle speed affected the primary response of flexible pavements through the load duration. It was argued that the increase in dynamic loads with speed is compensated for by the shorter duration of an applied axle load at an increased speed.

Sebaaly and Tabatabaee (1993) investigated the influence of vehicle speed on dynamic loads and pavement response using Weigh-In-Motion (WIM) technology. Pavement strains under moving vehicles were measured using strain gauges. The results showed that strains at the bottom of the asphalt layer decreased as the vehicle speed increased. It was found that increasing speed from 32 to 56 km/hr resulted in the reduction of the tensile strains at the bottom of asphalt layer by 50 per cent. It was concluded that a significant speed effect is evident between speeds of 32 and 56 km/hr. It was recommended that rational pavement analysis models that consider the dynamic nature of traffic loads and viscoelastic properties of the asphalt material be investigated further.

Steyn and Visser (2001) investigated the speed spectrum of 40–100 km/hr and showed that incorporating the effect of speed of moving load on pavement response significantly affected the pavement life. An attempt was made to create guidelines for incorporating this effect into South African pavement design procedure (Steyn 2001). Theyse *et al.* (2007) highlights the aspects of South African Mechanistic-Empirical design method that required revision in order to allow for incorporation of most recently developed models and research findings. In this synthesis, it is recommended that the revised design method incorporates traffic loading wander and vehicle speed as part of traffic loading data input through frequency distribution histograms.

Building on previous research, ARA Inc. (2004) incorporated vehicle operational speed into the pavement design procedure by including vehicle speed in the selection of stiffness moduli of asphalt layers. This resulted in the preparation of guidelines that were included in the MEPDG manual. Al-Qadi *et al.* (2008) found that the analysis using the MEPDG approach erred by almost 40–140 per cent in frequency estimations depending on vehicle speed and depth of calculation, which become load input parameter for Hot Mix Asphalt (HMA) laboratory tests.

Loading rate and frequency

In studying moving load, and in particular truck speeds, it is important that calculation of load pulse duration is well defined. Load pulse is largely affected by the vehicle speed and location of the point under investigation in the pavement structure. The transverse, longitudinal and vertical (x,y,z) location of the point of interest influences the response under moving wheel loading. Brown (1973) developed a relationship for load frequency at depth and validated the model against field data. The Brown equation (Table 1) calculated the loading time as a function of vehicle speed and depth beneath the pavement surface. The loading time was considered as the average

of the pulse times of the stresses in the three directions as obtained from the elastic layered theory.

The Austroads Guide to Pavement Technology (Austroads 2012) formula for the calculation of the load pulse time is based on Brown's work, but simplified by expressing time as a function of vehicle velocity (Table 1). Jameson and Hopman (2000) investigated the effect of depth in pavement on load time calculation. A model (Table 1) relating loading time to vehicle speed and depth in pavement was developed (limited to speeds >5 km/hr and 20 mm layer thicknesses).

Table 1 presents some of the relationships between loading time t (s), depth d (m), and vehicle speed v (km/h). These models show that pavement loading pulse time has a logarithmic or exponential relationship with vehicle speed.

Traffic loading of pavement systems is considered in the form of the loading pulse time (time that the tyre patch is in contact with the pavement surfacing) and gap time between successive tyre patches. Al-Qadi *et al.* (2008) explains how this load pulse time is converted into load frequency and used as the input into the loading simulation of asphalt in laboratory tests and its application in ARA Inc. (2004).

Hugo *et al.* (2012) evaluated the performance of asphalt paving mixes using the Model Mobile Load Simulator (MMLS) under different load frequencies as a test variable to simulate harsh trafficking conditions. A synthesis of national and international case studies was conducted. It was concluded that a decrease in MMLS trafficking speed resulted in an increase in the rate of rutting, especially at temperatures of 60°C. Bodin *et al.* (2016) investigated the temperature-dependent viscoelastic behaviour of asphalt pavements as a response to load under varying temperature and traffic speed. The main objective was to develop a method to determine an Equivalent Asphalt Modulus (EAM) for the asphalt layer, which represents the effect of temperature and loading speed on the critical tensile strains. Results showed expected trends of the equivalent asphalt modulus increasing with increasing traffic speed and decreasing with increasing temperature.

Research focus area

Previous research has shown that amongst several factors, traffic speed affects the response of pavement systems to moving load. There has been an impetus in the past decade to develop models that relate temperature and traffic speed to stiffness moduli of viscoelastic asphalt materials, mostly through laboratory work (Bodin *et al.* 2016).

Previous research used static loading and developed pavement response models based on specimens prepared in the laboratory which at the time were believed to simulate the field behaviour of pavement systems. In recent decades, researchers

Table 1. Relationships between the loading time and speed.

Source	Relationship	Parameters
Brown (1973)	$\text{Log } t = 0.5d + 0.2 - 0.94 \log v$	t = loading time (s),
Austroads (2012)	$t = 1/v$	d or h = depth (m),
Jameson and Hopman (2000)	$\text{Log } t = \pi - 1.798 - 2.738 \log (0.981 + 0.352 \log v) - 0.314 \log h$	v = vehicle speed (km/h)

have developed instrumented full-scale experimental sections to validate and improve these models. Recent findings from some of these experiments indicate that traffic speed significantly affects pavement systems in response to traffic loading, and therefore the need for truck speed-sensitive models.

Furthermore, speed-sensitive models are likely to affect processing of deflection measurement data collected by deflection measuring equipment moving at different travel speeds, as is the case with Traffic Speed Deflectometers (TSD).

Thus, this paper investigates the effect of speed on pavement system response using a series of different full-scale experimental sections with instrumented pavement systems.

Experimental section and methodology

The experimental section is located along road R104 between Rayton and Bronkhorstspuit, east of Pretoria. The experimental test section was constructed with ten sections, ranging from flexible, rigid and segmental pavement structures. However, this paper only focuses on the eight flexible pavement sections constructed of natural and engineered pavement materials ranging from granular, cemented to bituminous layers. Figure 1 presents pavement structures on the eight sections. However, section 5 is excluded from this study due to malfunctioning of the MDD.

The pavement material class acronyms in Figure 1 are explained in Table 2.

Pavement instrumentation

Pavement response is generally measured in terms of deflection, strain or stress. Measurement of temperature and moisture of the pavement system are critical to pavement performance monitoring. The eight sections were, therefore, instrumented with some of the following sensors:

- ϵ MU coils (inductive coils) – measuring vertical and horizontal strains (elastic and permanent);

Table 2. Summarised description of pavement material classes used on R104 section.

Class	Description	Class	Description
FTB	Foam-treated base	G1*	Crushed stone layer
ETB	Emulsion-treated base	G4*	Gravel layer- CBR>80%
CTB	Cement-treated base	G5*	Gravel layer- CBR>45%
BTB	Bitumen-treated base	G7*	Gravel layer -CBR >20
HiMA ^{1**}	High modulus asphalt	C3*	Cement-treated gravel layer-UCS 1.5-3 MPa
AC	Continuously graded asphalt		

¹EME (Enrobés à Module Elevé) was referred to as HiMA in South Africa during the early days of transferring of the EME technology

- Strain gauges – measuring vertical, longitudinal and transverse horizontal strains;
- Pressure cells – measuring stresses;
- Multi-Depth Deflectometers (MDD) – measuring vertical deflections in relation to the anchor located at the bottom of the test hole, and
- Thermocouple and Time-Domain Reflectometers (TDR) – measuring pavement temperature and moisture.

Figure 2 shows a schematic presentation of the instrumentation in the pavement systems. This study focused on deflection measurement using MDD data. The MDD is a Linear Variable Differential Transformer (LVDT)-based system that measures vertical elastic deflections of individual pavement layers and the structure as a whole (De Beer 1992).

Traffic loading

Traffic loading on the pavement system was applied by controlled runs of the SANRAL-owned Traffic Speed Deflectometer (TSD) truck. The TSD consists of a prime mover and an 8.2 t single-axle semi-trailer fitted with dual wheels (Figure 3). The 8.2 t axle load, which translates to 80 kN per axle, corresponds to the South African standard design load. A tyre inflation pressure of 700 kPa was maintained on all the wheels at all times.

Section No	1	2	3	4	5	6	7	
Section Length	100	100	100	100	100	100	a	b
Road Surface 0mm	Westbound							
	19/9 Double seal (S-E1)					40 AC		
100mm	150G4	150G1	200FTB	200ETB	200CTB	150BTB	150HiMA	100HiMA
200mm								
300mm	200G5	200C3	150G7	150G7	150G7	150C3	150C3	150C3
400mm								
500mm	150G7	150G7	150G7	150G7	150G7	190G7	190G7	240G7
600mm	Road Bed (Subgrade)							
700mm	Road Bed (Subgrade)							

Figure 1. Flexible pavement systems on SANRAL R104 Experimental section.

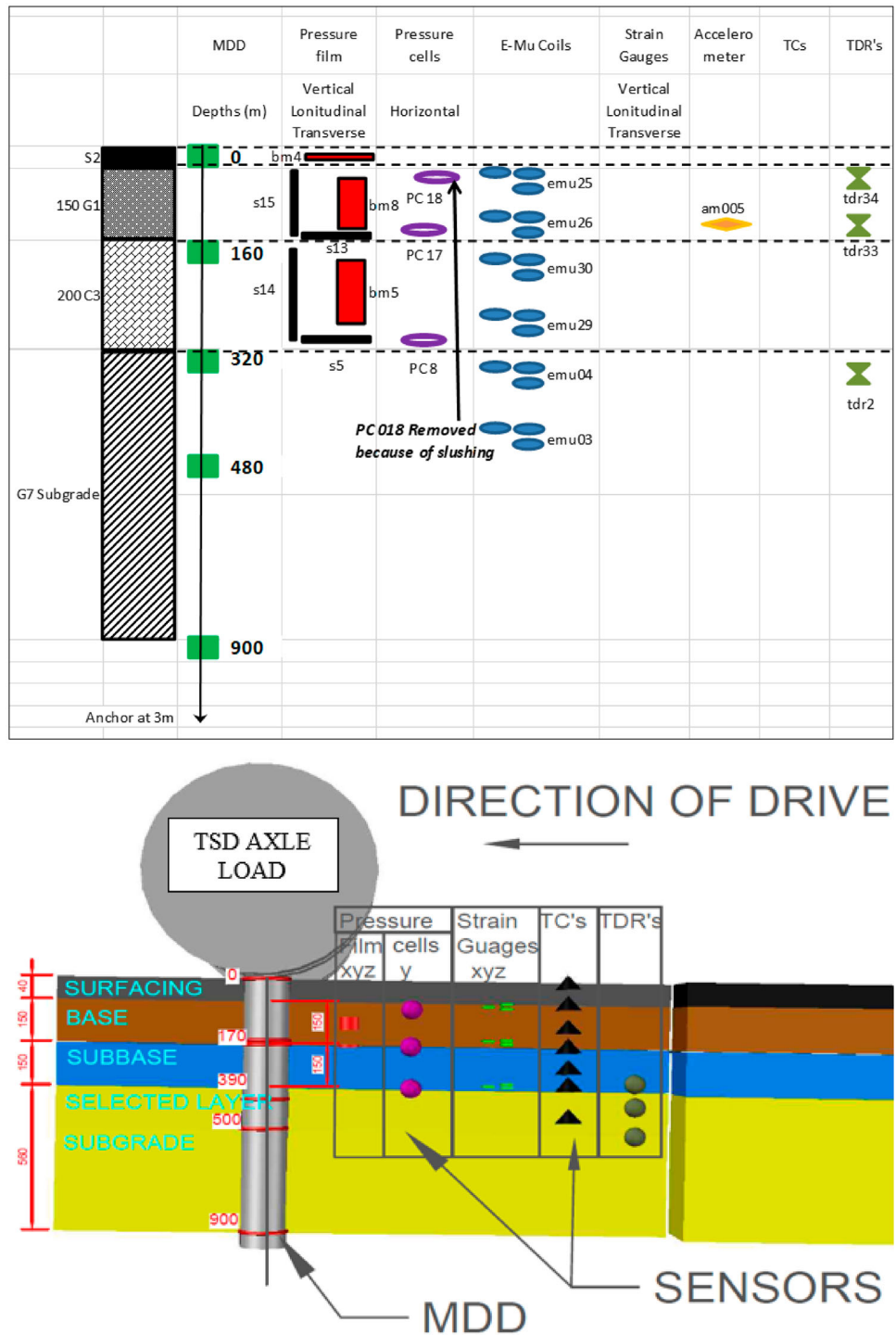

Figure 2. Instrumentation of the pavement systems.

The TSD has the state-of-the-art technology in the form of on-board data storage and retrieval system that mines data from sensors such as Doppler sensors, GPS receivers and 3D cameras/scanners. The TSD measures vertical surface velocity in response to the loaded semi-trailer axle using Doppler sensors. These sensors measure the vertical velocity of various points of the deflection bowl in the wheel path between a set of dual tyres and the pavement surface in front of the axle. The measured surface velocity is integrated with respect to time to yield a deflection value (Baltzer *et al*, 2010).

In this study the TSD was used to provide controlled traffic loading in terms of axle load, speed and wander. The TSD was run at speeds of 2, 5, 10, 20, 30, 40, 60, 80 and 100 km/h. Wanders of 0, 192.5 and 500 mm offsets from the MDD were used. A dashboard laser guide was used to guide the driver towards the target wander lines. The TSD on-board data storage/retrieval system provided speed and test run file logs.

The MDD was used as the reference and target point with centre of left rear double wheels running at either 0 mm offset, ±192.5 mm and ±500 mm (Figures 4 and 5). However,



Figure 3. SANRAL Traffic Speed Deflectometer truck on test section.

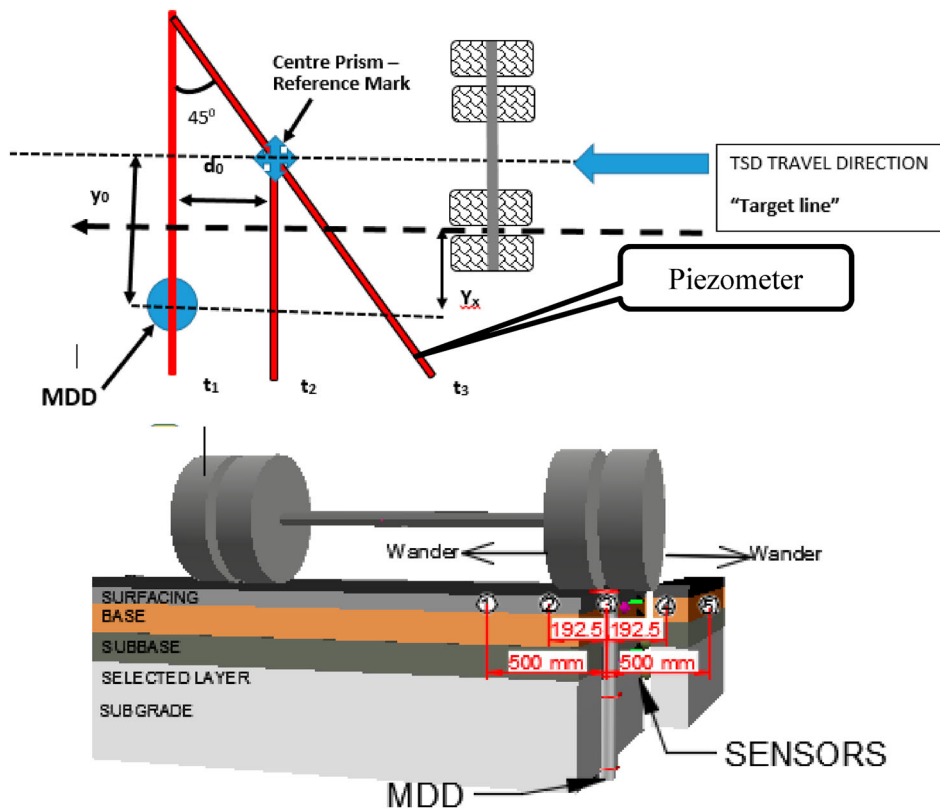

Figure 4. Schematic views of the test section set-up.

the TSD trail dual tyres offset targets were hit with varying accuracy and hence piezometers layout in Figure 4 were used to determine the offsets from the target points for each run. This was used to screen the data from runs that had offsets that were outside the target range (for instance, 62–318 mm for ± 192.5 mm target) and create average offset distance from the MDD for the remaining data.

Table 3 shows the test run matrix covering variation in speed and wander from the MDD. The number of runs at 500 mm offsets was envisaged to be for control purpose and of lesser importance in this study, hence the test run numbers

were reduced. Traffic loading and testing were conducted under ambient temperature and no environmental conditions were controlled. Most test runs were conducted during the day from 9:00 to 16:00 between March 2014 and July 2014. Temperatures of the surfacing ranged between 10 and 35°C.

Pavement response measurement

The MDD measures the transient pavement response induced by the moving axle load. Unlike equipment such as

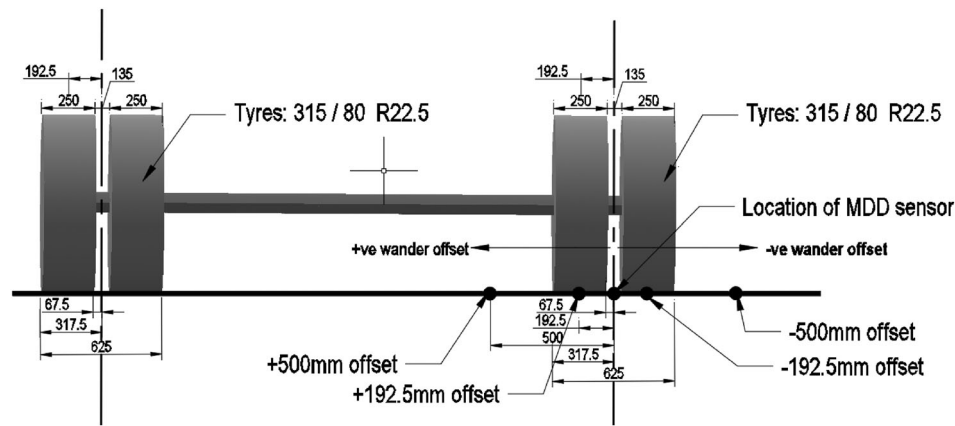

Figure 5. Truck axle showing wander from MDD.

deflectographs that measure actual deflection bowl at each instant, the MDD measures a time series deflection with depth as the axle load approaches and passes through the sensor location (Figure 6). The graph represents the time-series transient response of the pavement at the sensor location as the truck approaches and drives past the test point from right to left.

Results and discussions

Relationship between pavement deflection and speed

In order to investigate the effect of speed on the deflection, an Excel-based code was prepared to extract the rear axle maximum deflections from each test run. The processed data were grouped into data sets that averaged to an off-set of the centre of the rear dual wheel from the centre of the MDD. This was analysed and regression performed between speed and elastic surface deflections. The findings of the analysis for each test section are detailed and presented in the sections that follow.

Section 1 – granular base (G4) on granular subbase (G5)

Test Section 1 is a flexible pavement system comprising a double seal (19/9 mm), 150 mm Granular Base (G4) and 150 mm Granular Subbase (G5). Figure 7 presents measured elastic surface deflections ranging from 300 to 450 μm plotted against truck speed. These are relatively high elastic surface deflections which are typical of a weaker granular base pavement system.

Table 3. Test run matrix showing speed profile and wander.

TSD [km/hr]	Target transverse location (offsets Figure 4 and 5) of centre of the wheels				
	500 mm left	192.5 mm left	0 mm	192.5 mm right	500 mm right
2	2	3	5	3	2
5	2	3	5	3	2
10	2	3	5	3	2
20	2	3	5	3	2
30	2	3	5	3	2
40	2	3	5	3	2
60	2	3	5	3	2
80	2	3	5	3	2
100	2	3	5	3	2

On this section, the TSD could only achieve a top speed of 40 km/hr due to a lack of space for acceleration.

Figure 7 also shows a difference in deflection of approximately 200–300 μm for test runs conducted at 0, 140 and 350 mm off sets from the MDD.

Section 2 – Granular base (G1) on cemented subbase (C3)

This section is a flexible pavement system comprising a double seal (19/9 mm), a crushed stone (G1) base and a cement-treated (C3) subbase. A crushed stone base pavement system is typically stiffer than natural gravel base pavement system. However, elastic surface deflections measured on the section were double the deflections from Section 1. Pavement instrumentation system error was suspected and the data were excluded from further analysis and interpretation.

Section 3 – Foam-treated base (FTB) on granular (G7) subbase

Section 3 is a flexible pavement system comprising double seal (19/9 mm) and a 150 mm FTB placed on a 150 mm granular G7 subbase. Figure 8 shows the elastic surface deflection versus truck speed. It shows that the elastic surface deflections ranged from 350 to 400 μm .

Figure 8 further shows a difference in deflection of approximately 150–200 μm between the elastic surface deflection at 0 mm offset and greater than 350 mm offset. This is a typical characteristic of a bituminous base placed on a weak granular subbase. At an offset of 200 mm, which represents one of the double wheels running on top of the MDD, there is a gradual decrease of deflections by 90 μm from 380 μm at speed of 5 km/h to 290 μm at a speed of 80 km/h. This indicates that the pavement is more sensitive to change in the speed of traffic.

Section 4 – Emulsion-treated base (ETB) on granular (G7) subbase

This section is a flexible pavement system comprising a double seal (19/9 mm), 200 mm ETB placed on a 150 mm G7 granular subbase and shows the elastic surface deflections versus truck

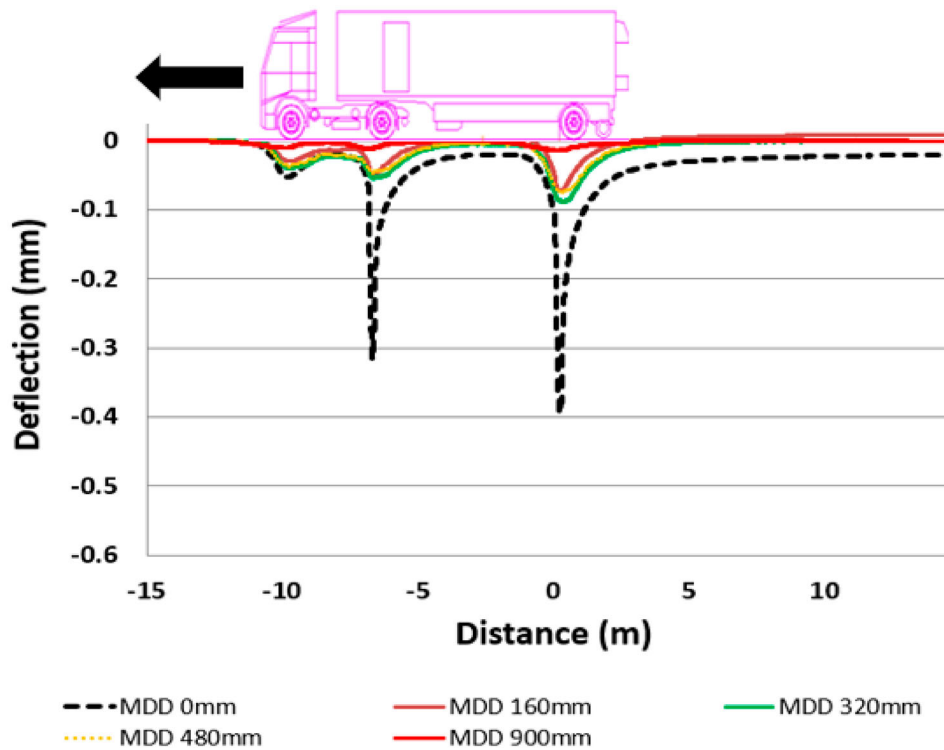

Figure 6. MDD deflection measurements of TSD single pass at 192 mm offset from the sensor.

speed. It shows that the elastic surface deflection is less than 250 μm although it is placed on low stiffness G7 subbase layer. The elastic surface deflection difference measured at 0 mm offset and at 350 mm offset is less than 100 μm. This indicates that the ETB layer has a high stiffness modulus (Figure 9), which shows that the elastic surface deflections decrease with the increase for speed range from 5 km/h to 40 km/h. However, the deflections start to increase for the increase in speeds greater than 60 km/hr. This can be speculated as linked to factors

relating to visco-elastic nature of ETB under different load periods; however, further investigation into this is required in order to better understand this phenomenon.

Section 6 – bitumen-treated base (BTB) on cement-treated (C3) subbase

This section is a flexible pavement system comprising 40 mm Asphalt (continuously graded), 150 mm Bitumen-Treated

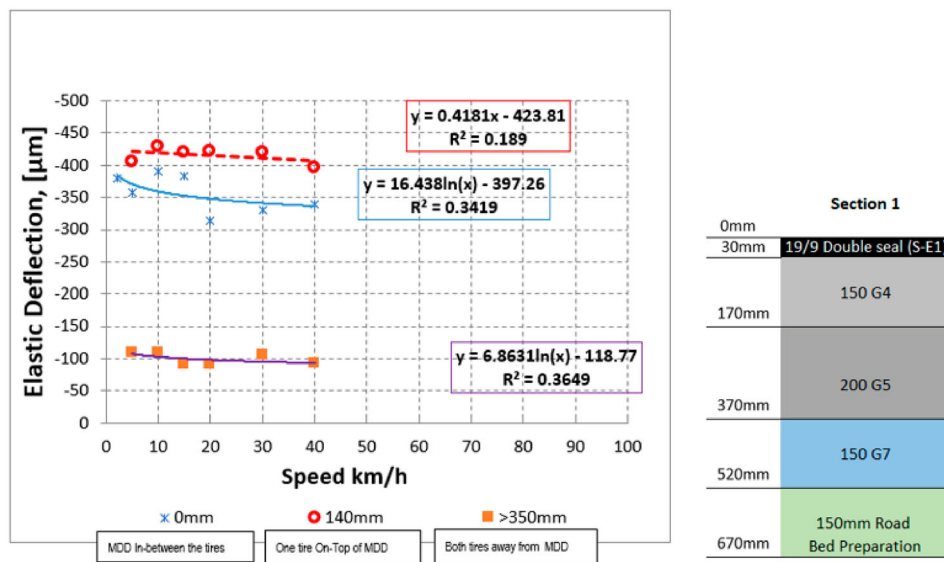

Figure 7. Relationship between elastic surface deflection and speed for Granular Base/Subbase flexible pavement system.

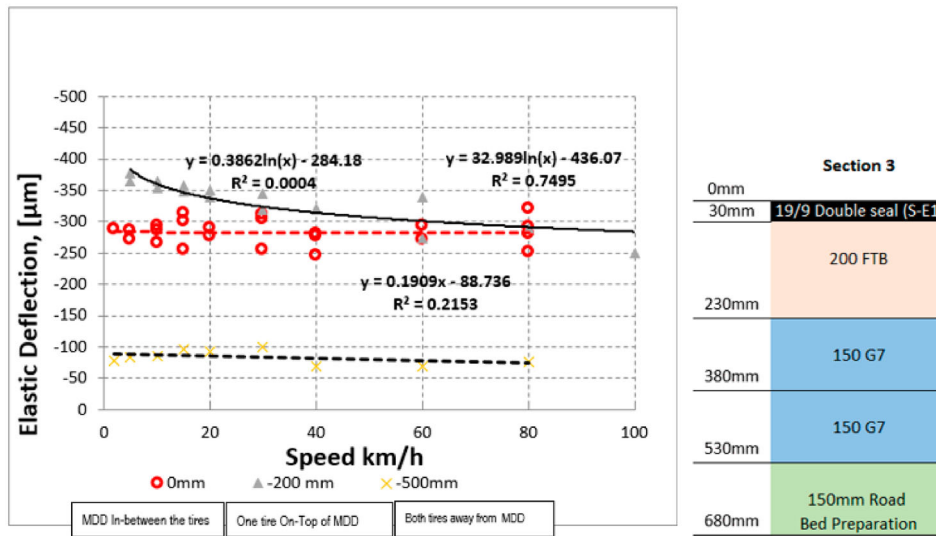

Figure 8. Relationship between elastic surface deflection and speed for FTB Base/Granular subbase flexible pavement system.

Base (BTB) placed on a 150 mm Cement-treated (C3) subbase. Figure 10 shows an exponential decrease in total surface deflections as the speed increases. The surface elastic surface deflections of the pavement system reduce from 350 and 200 µm. This shows high sensitivity of BTB to change in traffic speeds.

Figure 10 further shows a very significant correlation between elastic surface deflections and speed. The difference in surface deflections between zero offset and 350 mm offset measurements decreases as the speed increases.

Section 7a – high modulus asphalt base (EME) on cemented subbase

This section is a flexible pavement system comprising 40 mm Asphalt (continuously graded), 150 mm High Modulus

Asphalt Base (EME) placed on a 150 mm Cement-treated (C3) subbase.

Figure 11 shows the relationship between elastic surface deflections and truck speed over a speed range of 5 km/h to 100 km/h. The low surface deflections ranging from 50 to 140 µm measured at different truck speeds, point to the high stiffness modulus of the EME layer.

Section 7b – high modulus asphalt base (EME) on cemented subbase

This is a flexible pavement system comprising a 40 mm Asphalt (continuously graded), 100 mm High Modulus Asphalt Base (EME) placed on a 150 mm C3 Cement-treated subbase.

Figure 12 shows the relationship between the elastic surface deflections (ranging from 100 to 220 µm) and truck test run speeds. This is slightly greater than surface deflections from

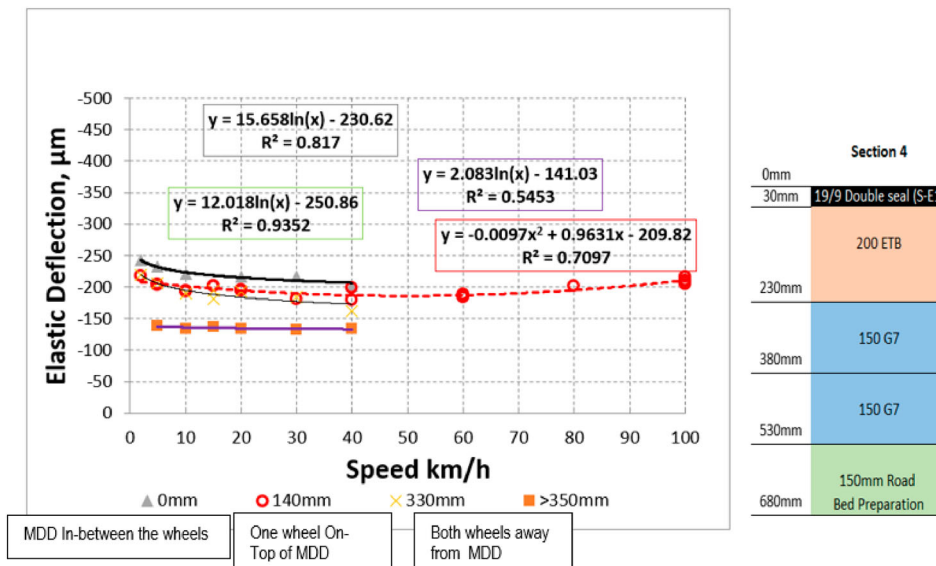

Figure 9. Relationship between elastic surface deflection and speed for ETB Base flexible pavement system.

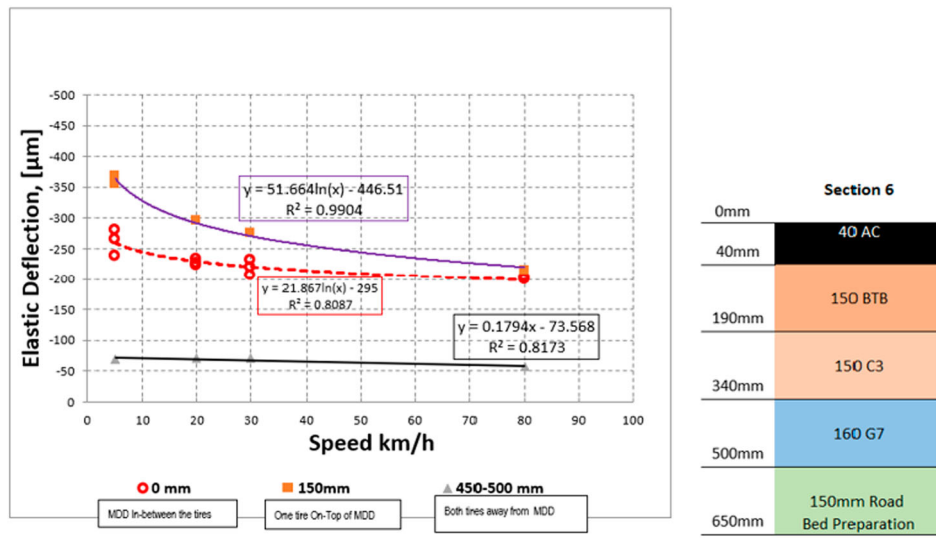

Figure 10. Relationship between elastic surface deflection and speed for BTB Base flexible pavement system

the 150 mm EME base section. The low surface deflections measured at different truck speeds point to the high stiffness modulus of the EME layer.

correlation than the zero offset data. The logarithmic model also fits well to the ±192.5(68–318) mm data.

Regression analysis

A regression analysis was performed on the speed (v) versus deflection measurements (δ) data. Best fit lines were drawn and regression coefficients determined. The response of the pavement systems traffic loading at different truck speeds appears to follow natural logarithm equation

$$\delta_v = a \ln v + b \tag{1}$$

where δ_v, MDD measured deflection; v, speed of the truck; a, b, regression coefficients.

Table 4 presents the regression coefficients and coefficient of correlation which reflect very good correlation between speed and deflection. However, it appears that the ±192.5 mm data have better and more consistent speed and deflection

Relationship between deflections, speed and pavement system composition

The pavement structures investigated vary from low stiffness granular base and subbase to high stiffness-cemented and bitumen-treated base and subbase. Figures 13 and 14 show the effect of speed on deflection of these different pavement structures conducted at target offsets of 0, and 150–200 mm. The high stiffness EME base placed on cemented subbase pavement structures has the lowest deflections, but is significantly sensitive to change in truck speed. The figure further indicates that the granular base with a double seal surfacing displays the highest elastic surface deflections, but it is less sensitive to changes in truck speed than the other structures.

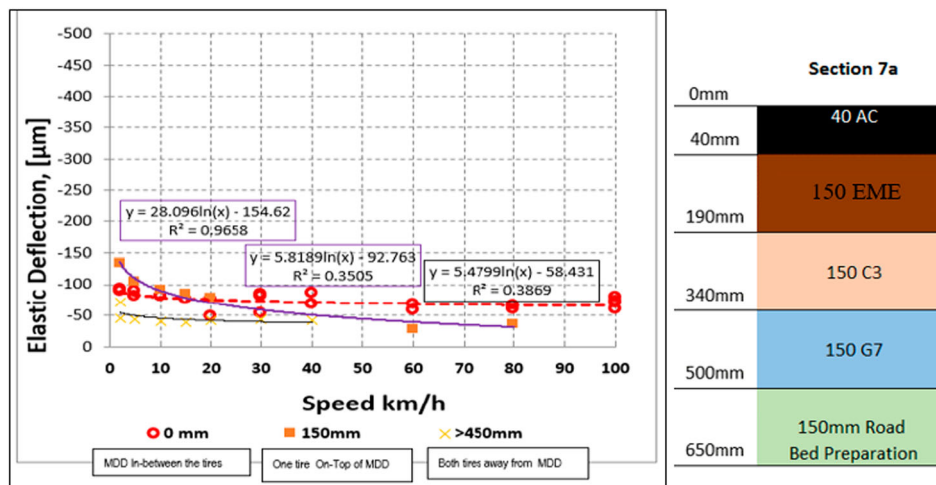

Figure 11. Relationship between elastic surface deflection and speed for 150 mm EME Base pavement system.

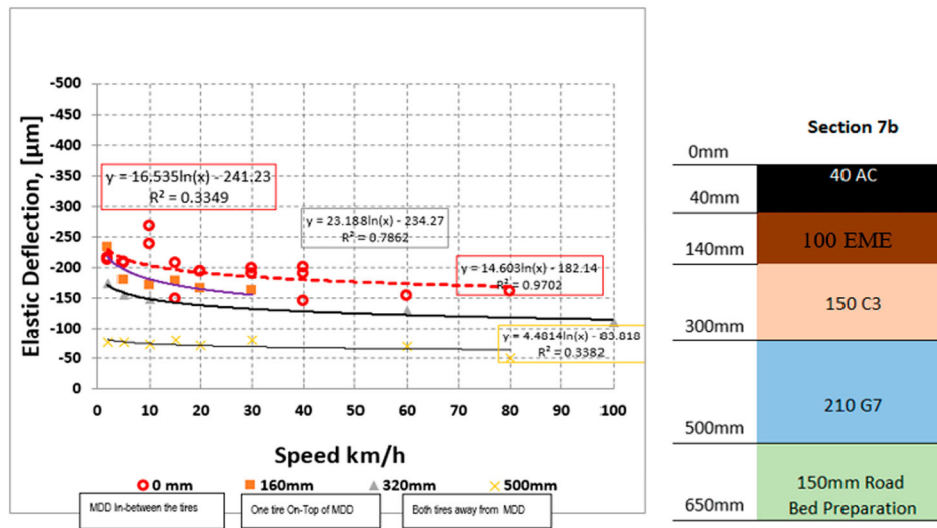

Figure 12. Deflection measurement vs Speed relationship for Section 7b 100 mm EME Base flexible pavement system.

Table 4. Regression coefficients for ±192.5 mm offset data.

Section no	Regression coefficients		
	A	b	R ²
1	16.438	-397.26	0.34
2	26.776	-885.29	0.36
3	32.989	-436.07	0.76
4	12.018	-250.86	0.94
6	51.664	-446.51	0.99
7a	28.096	-154.62	0.97
7b	23.188	-234.27	0.79

Figure 13 deflections are higher than those of Figure 14 indicating, as expected, that high deflections occur directly underneath the wheels and not in-between the dual wheels. Deflections directly under the wheel present the worst-case scenario. This is also consistent with results from the simulation of wheel load on pavement system using elastic theories.

From Figures 13 and 14, the pavement systems can be grouped in three categories. These are low stiffness granular base/subbase systems, medium stiffness Foam and Emulsion-Treated base/granular base pavement systems and high stiffness EME base on cemented subbase pavement systems. These pavement systems were also evaluated for structural capacity using the Pavement Number (PN) method which is an improvement to the Structural Number (SN) method (Horak *et al.* 2015). The PN values ranged from 10 to 29, as depicted in Figures 13 and 14. Some inconsistency in positioning of pavement structures in Figure 14 was noted between BTB placed on cemented subbase (PN = 20) and ETB placed on granular layer (PN = 15). This could be attributed to deflection measurement being a reflection of response of the pavement structures in current materials state only, whereas PN takes into account the performance of different road building materials over the design life.

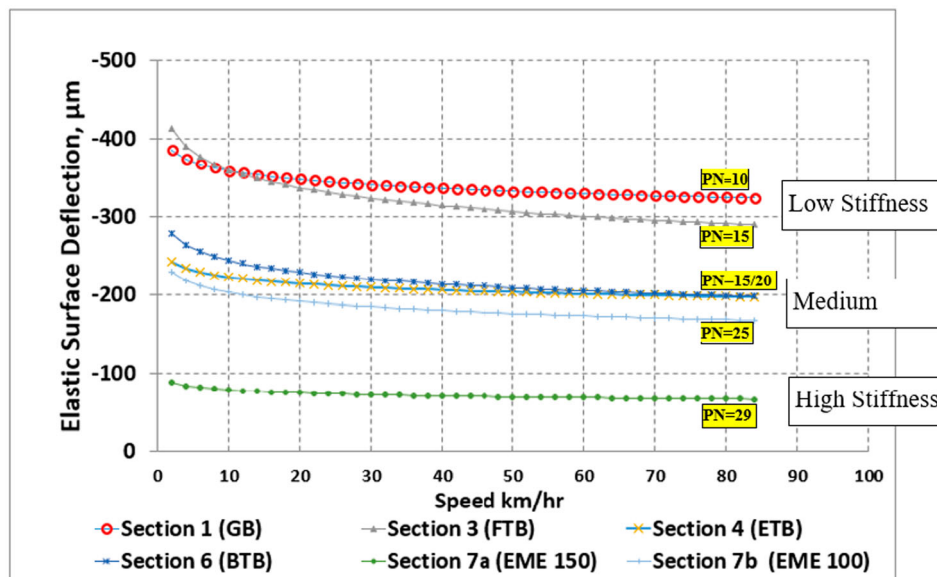

Figure 13. Effect of speed on deflection of different pavement structures trafficked at 0 mm offsets.

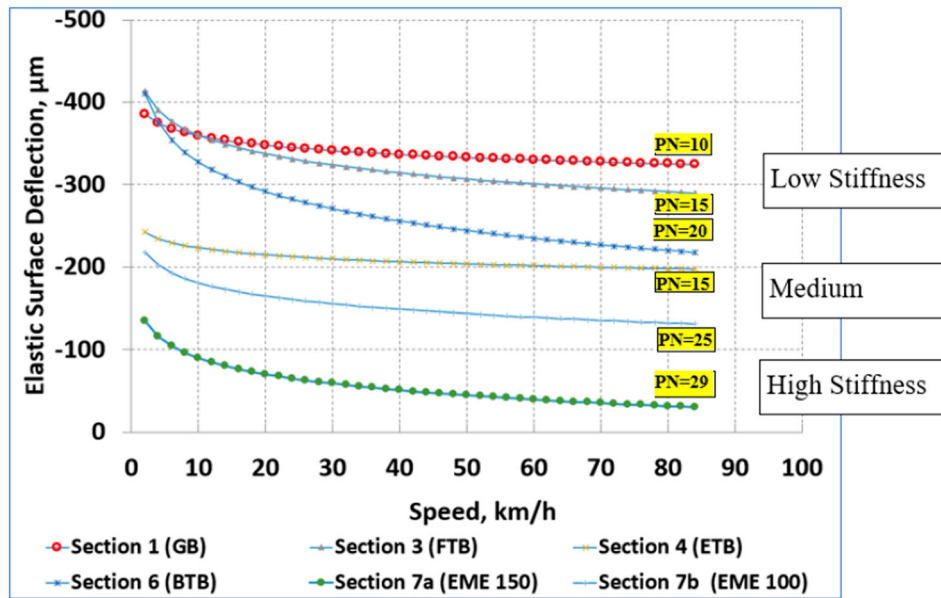

Figure 14. Effect of speed on deflection of different pavement structures trafficked at 150–200 mm offsets.

Development of speed-deflection model

The data in this paper demonstrate the relationship between speed and deflections. However, the correlation between these factors appears to be varying amongst the different pavement systems. The correlation coefficients are better for bituminous bases than on granular bases.

The data analysis performed and reported in this paper established a relationship between deflection measurements and the truck speed for each pavement system. The data are normalised in order to combine measurements of different magnitudes and given equal importance and weighting. Normalised values are obtained by dividing the measured values by the mean (x) of that sample.

Figures 15 and 16 show the relationship between speed and normalised values for different pavement systems. The normalised values are referred to in this paper as Speed Adjustment Factors (SAF). These factors can be used to adjust deflection measurements taken at a given speed to elastic deflections expected at a different speed. Normalised values from deflections measured directly under each of the tyres are higher than the values obtained from in-between the tyres. This difference appears to be due to either upward burging of the pavement area in-between the two wheels under the combined stresses from the two wheels or minimal deflection since there is no direct loading in-between the two wheels. It is thus recommended to use the SAF values from Figure 16 for speed-related adjustment

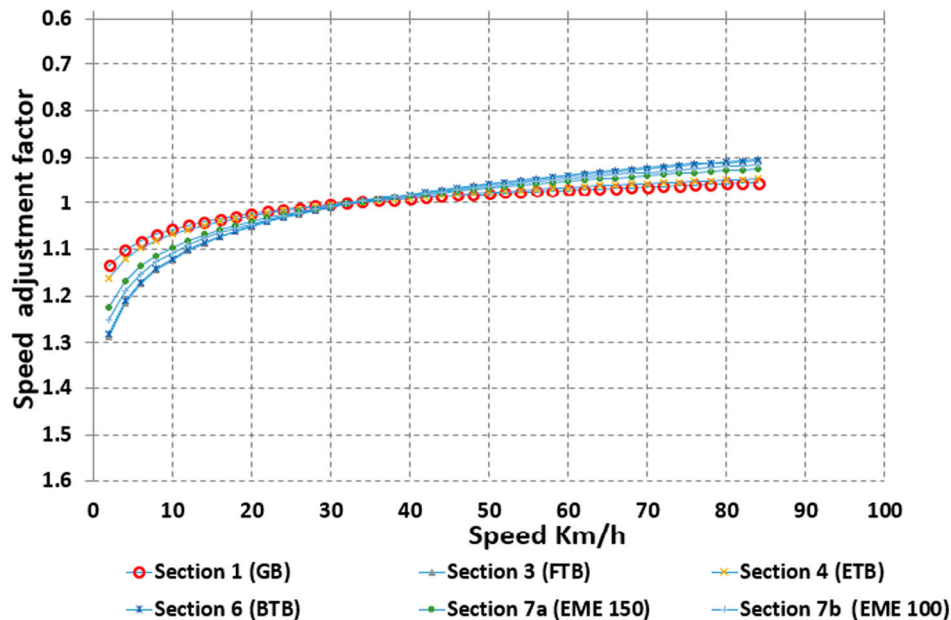

Figure 15. Speed adjustment factors for zero offset test runs.

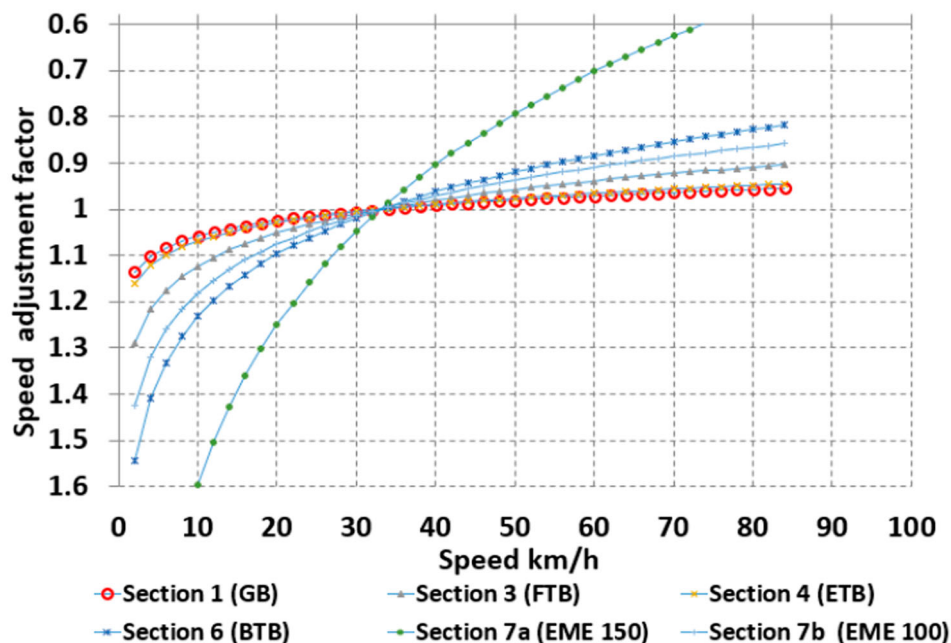

Figure 16. Speed adjustment factors for 200 mm offset test runs.

of deflections. These relationships can also be used to normalise deflection measurements taken by deflectometer run at different speeds. This process falls outside the scope of this paper.

Conclusions

This paper discussed the effect of speed on the elastic surface response of flexible pavement systems to traffic loading through full scale field tests on instrumented pavement sections. From the results (although limited to the pavement systems investigated) the following are concluded:

- Increased vehicle speed results in the decrease in elastic surface deflection response;
- Speeds of 30–40 km/h mark the reflection point in pavement response. Speeds below 30 km/h present a steeper decrease in deflection response with an increase in truck speed than at speeds over 40 km/h;
- Granular Base/Subbase pavement systems present higher deflections and less sensitive to speed than bitumen treated or cemented base pavement systems at all truck speeds;
- Given equal pavement thicknesses and conditions, deflections of ETB pavement systems are highly sensitive to change in truck speeds. Deflections on ETB section under very low truck speeds (<10 km/h) are as high as deflections of granular base. At high speeds (>40 km/hr) the deflections reduce to ranges similar to BTB pavement systems;
- Given equal pavement thicknesses and conditions, EME base layer pavement system has very low deflections and hence presents a pavement system with the highest stiffness, and
- Reduction of EME layer thickness by 33 per cent resulted in at least 100 per cent increase in the magnitude of deflections of the pavement system.

The findings and conclusions indicate the following:

- Measurement and interpretation of elastic surface deflections data from the existing road should take into account the speed/frequency of the deflectometers, and
- Selection of type of flexible pavement systems, in particular on road rehabilitation projects, should take into account the average truck speeds (congestion levels and road grades).

Acknowledgements

The authors would like to acknowledge the technical assistance and provision of field testing equipment provided by SANRAL and University of Pretoria. This research was partly financed by NRF and it is hereby acknowledged.

Disclosure statement

No potential conflict of interest was reported by the author(s).

Funding

This work was supported by South Africa National Research Foundation (NRF).

References

- ARA Inc., 2004. *Guide for mechanistic-empirical design of new and rehabilitated pavement structures*. Washington, DC: Transportation Research Board of the National Academies. Final Report NCHRP 1-37A.
- Al-Qadi, I., Xie, W., and Elseifi, M., 2008. Frequency determination from vehicular loading time pulse to predict appropriate complex modulus in MEPDG. *Journal of the Association of Asphalt Paving Technologists*, 77, 739–772.
- Austrroads, 2012. *Guide to pavement technology: part 2: pavement structural design*. 3rd ed. Sydney: Austrroads.

- Baltzer, S., *et al.*, 2010. Continuous bearing capacity profile of 18,000 km Australian road network in 5 months, 24th ARRB Conference – Building on 50 years of road and transport research. Melbourne, Australia.
- Bodin, D., Chupin, O., and Denneman, E., 2016. Effect of temperature and traffic speed on the asphalt moduli for fatigue cracking and pavement structural design considerations, *Proceedings of the 8th RILEM international conference on mechanisms of cracking and debonding in pavements*, 397–402.
- Brown, S., 1973. Determination of Young's modulus for bituminous materials in pavement design. *Highway Research Record*, 431, 38–49.
- De Beer, M., 1992. Pavement response measurement system. In: V.C Janoo and R.A. Eaton, eds. *Road and airport pavement response monitoring systems*. New York: American Society of Civil Engineers, 78–95.
- De Beer, M., Fisher, C., and Jooste, F.J., 1997. Determination of pneumatic tyre/pavement interface contact stresses under moving loads and some effects on pavements with thin asphalt surfacing layers. *Eight (8th) International conference on asphalt pavements (8th ICAP '97)*, August 10–14, 1997, Seattle, Washington, USA. Vol. 1, 179–227. ISBN 8790145356.
- Gillespie, T.D., *et al.*, 1993. *Effects of heavy-vehicle characteristics on pavement response and performance*. NCHRP Report 353. Washington, DC: Transportation Research Board.
- Horak, E., Hefer, A., and Maina, J.W., 2015. Determination of pavement number for flexible pavements using FWD deflection bowl information. *Proceedings of the 34th Southern African Transport Conference (SATC)*, Pretoria, South Africa.
- Huang, Y.H., 2004. *Pavement analysis and design*. 2nd ed. New Jersey: Pearson Education, Inc.
- Hugo, F., *et al.*, 2012. International case studies in support of successful application of accelerated pavement testing in pavement engineering. In: D. Jones, ed. *Advances in pavement design through full-scale accelerated pavement testing*. AK Leiden: CRC Press.
- Jameson, G. and Hopman, P., 2000. *Austrroads pavement design guide chapter 6: development of relationships between laboratory loading rates and traffic speed*. Vermont South: ARRB.
- Sebaaly, P.E., and Tabatabaee, N., 1993. *Influence of vehicle speed on dynamic loads and pavement response*. *Transportation research record no 1410*. Washington, DC: National Academy Press.
- Steyn, W.J.vdM., 2001. *Considerations of vehicle-pavement interaction for pavement design*. PhD Thesis. University of Pretoria.
- Steyn, W.J.vdM., and Visser, A.T., 2001. Guidelines for incorporation of vehicle-pavement interaction effects in pavement design. *Journal of the South African Institution of Civil Engineering*, 43 (1), 34–39.
- Theyse, H.L., Maina, J.W., and Kannemeyer, L., 2007. Revision of the South African Flexible pavement design Method: Mechanistic–Empirical components. In: *Proceedings of 9th conference on asphalt pavements for Southern Africa (CAPSA)*, Gaborone, Botswana, 256–292.
- Van der Poel, C., 1954. A general system describing the viscoelastic properties of bitumen and its relation to routine test data. *Journal of Applied Chemistry*, 4, 221–236.