

**BATTERY ENERGY STORAGE DESIGN OPTIMISATION IN A PEER-TO-PEER
ENERGY SHARING NETWORK**

by

Daniel Lionel Rodrigues

Submitted in partial fulfillment of the requirements for the degree
Master of Engineering (Electrical Engineering)

in the

Department of Electrical, Electronic and Computer Engineering
Faculty of Engineering, Built Environment and Information Technology

UNIVERSITY OF PRETORIA

December 2019

SUMMARY

BATTERY ENERGY STORAGE DESIGN OPTIMISATION IN A PEER-TO-PEER ENERGY SHARING NETWORK

by

Daniel Lionel Rodrigues

Supervisor(s): Dr. Xianming Ye
Department: Electrical, Electronic and Computer Engineering
University: University of Pretoria
Degree: Master of Engineering (Electrical Engineering)
Keywords: Peer-to-peer energy sharing, energy storage sizing, prosumers, energy management, dynamic pricing

The increase in deployment of microgrids and the mismatch between local energy generation and demand have led to an innovative and versatile peer-to-peer (P2P) energy sharing framework to manage distributed energy resources (DER). P2P energy sharing, described as the energy trade between local prosumers and consumers based on the sharing economy concept [1], is one effective solution that allows excess energy from prosumers DER to be traded within their local community. P2P energy sharing exhibits superior advantages in terms of local power self-consumption, self-sufficiency and return on local generation investment compared with the conventional peer-to-grid (P2G) trading [2, 3]. Existing studies have shown the benefits of battery energy storage systems (BESSs) inclusion [2 – 4], but do not consider optimal BESS sizing with P2P energy sharing under different BESS ownership.

For microgrids of grid-tied solar photovoltaic (PV) prosumers, two different optimal BESS ownership structures under the P2P framework, namely the ESP owned BESS structure and the User owned BESS structure, are investigated in this study which are compared to the traditional User owned BESS structure under the P2G framework. An optimal BESS sizing model is proposed for a P2P energy sharing network (ESN) consisting of a centralised BESS owned by a third-party energy sharing provider

(ESP). A multi-objective optimisation model, considering the ESP energy storage investment net present value and the ESN energy costs, is formulated incorporating the supply and demand ratio [5] for the ESN internal pricing mechanism.

It is found that for a university campus network case study that the P2P structures are more economically beneficial as they achieved greater NPVs in comparison to their BESS size. The most desirable BESS ownership structure, with the greatest NPV of \$1 397 770.04 and an overall reduction in BESS size of 10%, is the User owned BESS structure with P2P energy sharing. However, that is assuming that all prosumers are willing and financially capable of investing in a BESS. The ESP owned structure was found to be less economically beneficial for the prosumers, but provided the opportunity for prosumers to engage in P2P energy sharing and reduce their energy costs without a BESS investment cost. A simplified BESS operation control is also realised with this structure.

Finally, the simulation results from the case study show an approximate linear interaction between the ESP optimal li-ion battery energy storage sizing with the amount of P2P energy sharing and the energy cost for the ESN under the time-of-use tariff. The larger the li-ion battery, the more P2P energy li-ion battery, decreases the BESS NPV and possibly making its deployment infeasible.

ACKNOWLEDGEMENTS

I would like to thank my supervisor, Dr. Xianming Ye for his guidance and support during the preparation of this dissertation. I would also like to thank my father, Carlos Rodrigues for his encouragement for me to pursue tertiary education and my uncle, Dennis Rodrigues, for initiating my interest in electrical engineering with compelling electrical projects from a young age. Lastly, my mother, Veronica Rodrigues for her continuous loving support during my undergraduate and postgraduate studies.

LIST OF ABBREVIATIONS

BESS	Battery Energy Storage
DER	Distributed Energy Resource
DOD	Depth of Discharge
EMS	Energy Management System
ESN	Energy Sharing Network
ESP	Energy Sharing Provider
ESS	Energy Storage System
GHI	Global Horizontal Irradiance
ICT	Information and Communication Technologies
Li-ion	Lithium Ion
MAS	Multi-agent System
MMR	Mid-market Rate
NPV	Net Present Value
NZEB	Net Zero Energy Building
O&M	Operation and Management
PCC	Point of Common Coupling
PV	Photovoltaic
P2G	Peer-to-Grid
P2P	Peer-to-Peer
SDR	Supply Demand Ratio
SOC	State of Charge
TDP	Total Demand Power
TOU	Time of Use
TSP	Total Supply Power

TABLE OF CONTENTS

CHAPTER 1	INTRODUCTION	1
1.1	PROBLEM STATEMENT	1
1.1.1	Context of the problem	1
1.1.2	Research gap	2
1.2	RESEARCH OBJECTIVE AND QUESTIONS	2
1.3	RESEARCH HYPOTHESIS	3
1.3.1	First Predicate	3
1.3.2	Second Predicate	3
1.4	RESEARCH APPROACH	3
1.5	RESEARCH GOALS	4
1.6	RESEARCH CONTRIBUTION	5
1.7	RESEARCH OUTPUTS	5
1.8	OVERVIEW OF STUDY	5
CHAPTER 2	LITERATURE STUDY	7
2.1	CHAPTER OVERVIEW	7
2.2	P2P ENERGY SHARING	7
2.3	ENERGY STORAGE TECHNOLOGIES	8
2.4	P2P ENERGY SHARING FRAMEWORKS	8
2.4.1	Without Intermedia	8
2.4.2	With an Intermedia	10
2.5	INTERNAL ENERGY SHARING PRICING APPROACHES	12
2.6	BATTERY ENERGY STORAGE SIZING	13
CHAPTER 3	METHODS	15
3.1	CHAPTER OVERVIEW	15

3.2	STRUCTURES	15
3.2.1	ESP Owned BESS with P2P Energy Sharing	16
3.2.2	User Owned BESS with P2P Energy Sharing	18
3.2.3	User Owned BESS with P2G Energy Trading	19
3.3	ESP OWNED BESS P2P FORMULATION	19
3.3.1	Load and PV System Modelling	20
3.3.2	Battery Energy Storage System	20
3.3.3	Energy Sharing Power Balance	21
3.3.4	Internal Pricing Policy	21
3.3.5	ESP Owned BESS P2P Objective Function	24
3.4	USER OWNED BESS P2P FORMULATION	26
3.4.1	User Owned BESS P2P Objective Function	26
3.5	USER OWNED BESS P2G FORMULATION	28
3.5.1	User Owned BESS P2G Objective Function	28
CHAPTER 4	RESULTS	30
4.1	CHAPTER OVERVIEW	30
4.2	CASE STUDY	30
4.2.1	Load and solar PV profiles	31
4.2.2	Economic simulation parameters	35
4.2.3	Simulation Optimisation Algorithms	36
4.3	CASE STUDY RESULTS	37
4.3.1	ESP Owned BESS with P2P Energy Sharing	37
4.3.2	User Owned BESS with P2P Energy Sharing	43
4.3.3	User Owned BESS with P2G Trading	44
4.3.4	BESSs Structures Results	45
CHAPTER 5	DISCUSSION	48
5.1	CHAPTER OVERVIEW	48
5.2	ESP OWNED BESS WITH P2P ENERGY SHARING STRUCTURE	48
5.3	P2P ENERGY SHARING AND OPTIMAL SIZING INTERACTION	49
5.4	BESS DESIGN OPTIMISATIONS	50
5.5	SENSITIVITY ANALYSIS	51

CHAPTER 6	CONCLUSION	54
6.1	SUMMARY	54
6.2	RECOMMENDATIONS FOR FUTURE WORK	55
REFERENCES		56

LIST OF FIGURES

1.1	Research investigation, development and modelling approach.	4
3.1	The BESS ownership structures; (a) ESP with P2P Energy Sharing, (b) User with P2P Energy Sharing and (c) User with P2G Energy Trading considered in this study. . . .	16
3.2	Figure illustrating the daily BESS charging and discharging behaviour with P2G energy trading (a) and with P2P energy sharing (b).	18
3.3	An illustration of the ESP owned BESS structure realisation with operational variables.	19
3.4	The internal dynamic pricing as a function of SDR based from economics for prosumers in a P2P energy sharing community.	22
3.5	The internal dynamic pricing with a compensating factor as a function of SDR based from economics for prosumers in a P2P energy sharing community.	22
3.6	The cash flow for the life cycle of the ESP owned BESS structure.	25
3.7	An illustration of the User owned BESS with P2P energy sharing structure realisation with operational variables.	26
3.8	The cash flow for the life cycle of the distributed BESS. Note the addition of the prosumers savings to the positive cash flow.	28
3.9	The cash flow for the life cycle of the User owned BESS with P2G trading. There is no BESS income as there is no P2P energy sharing and therefore no buying and selling.	29
4.1	One-line diagram of the existing campus network.	31
4.2	Daily average GHI for Ithaca, NY.	33
4.3	Energy sharing network buildings daily demand profiles.	33
4.4	Energy sharing network buildings solar PV power and net demand.	34
4.5	ESN prosumers load factor box and whisker plot.	34
4.6	BESS SOC, charge and discharge power.	38
4.7	Energy sharing network SDR against time.	38

4.8	Energy sharing network internal energy price. Note the reduction of the internal buying price during the peak-periods.	39
4.9	Energy sharing network direct versus indirect power sharing.	40
4.10	BESS power exchange with the ESN solar PV generation, grid and ESN demand. . .	40
4.11	BESS income from the exchange of power in Figure 4.10.	41
4.12	Plot showing the simulation Pareto front of community energy costs versus BESS NPV. Note the red square, which is the median point between the two objective functions.	41
4.13	3-D plot showing the linear relationship between the BESS size, BESS NPV and the community energy costs.	42
4.14	Community demand, P2G baseline and the ESP owned BESS structure demand profiles.	42
4.15	The ESN daily grid costs and income. Note the high costs during the TOU off-peak periods when the BESS charges from the grid.	43
4.16	Community demand, P2G baseline and the User owned BESS P2P structure demand profiles.	43
4.17	Energy sharing network internal energy price.	44
4.18	Community demand, P2G baseline and the User owned BESS P2G structure demand profiles.	44
5.1	BESS size against the BESS NPV and the community energy savings showing an approximate linear interaction.	49
5.2	BESS size against the BESS NPV and the amount of P2P energy sharing within the ESN.	49
5.3	BESS size against PV penetration percentage of the community base demand.	52
5.4	BESS size versus feed-in price.	52
5.5	BESS size versus number of prosumers within a community.	53
5.6	BESS size with 3 residential user profiles.	53

LIST OF TABLES

4.1	Campus network prosumer PV capacity and peak demand.	31
4.2	Campus network buildings' names and characteristics.	32
4.3	Input simulation parameters [6].	35
4.4	BESS operational parameters used in the simulation.	35
4.5	The ESP owned BESS structure multiple objective genetic algorithm (<i>gamultiobj</i>) settings.	36
4.6	The User Owned BESS P2P and P2G structures global search non-linear programming solver (<i>fmincon</i>) settings.	36
4.7	The different BESS structures li-ion sizes with corresponding conversion equipment and costs.	45
4.8	Community BESS monthly income and costs.	46
4.9	Building's (Bx) and the total community (Com) simulation optimal li-ion sizes, costs and savings.	47

CHAPTER 1 INTRODUCTION

1.1 PROBLEM STATEMENT

1.1.1 Context of the problem

The aspirations to reduce the global carbon footprint, while improving electricity affordability and energy security, has triggered the on-going energy generation shift from a centralised to a distributed infrastructure. Many energy consumers within the residential, commercial and industrial sectors are investing in renewable distributed energy resources (DER) such as solar photovoltaic (PV), wind power and biomass to become net zero energy buildings (NZEB) or energy producers known as prosumers. NZEBs are highly efficient buildings whose net energy demand is met by its local power generation. With the rapid decline in solar PV costs, an increase in local supply-side management and integration of distributed solar PV power has grown largely and is continually being promoted [7, 8]. This has led many commercial buildings to become prosumers. Electricity generation from solar PV is intermittent due to unpredictable solar irradiance. Excess energy from the dynamic mismatch between the local demand and the solar PV generation during peak solar irradiance hours may be either sold back to the grid at the utility feed-in tariff, curtailed, stored in an energy storage system (ESS), or traded with other energy consumers. Simultaneously, increased supply market DER have caused many countries' energy policies to promote self-consumption by diminishing feed-in tariff-based incentives [4, 9]. As a result, it is essential to develop innovative solutions to improve self-consumption of excess energy to sustain future renewable energy generation installations.

Existing buildings in clusters, such as residential complexes, educational campuses, hospital buildings and commercial office parks, manage their renewable energy systems independently to their counter

parts. This puts high start-up cost strain on the individual users, possibly making the renewable technology implementation unaffordable [10]. Interconnected micro-grids provide new opportunities for building operators to co-operate; improving their energy self-consumption, reducing their energy costs, decreasing the peak community demand and reducing the size of battery energy storage systems (BESSs) [3, 11, 12]. The focus on building clusters and not individual buildings allows for the exploitation of the variety in building energy consumption patterns [11, 13]. Peer-to-peer (P2P) energy sharing and energy storage sharing [14 – 17] are two such opportunities. P2P energy sharing, described as the energy trade between local prosumers and consumers, is an effective solution that allows surplus energy from prosumers DERs to be traded within their local community market [1], exhibiting superior advantages than the conventional peer-to-grid (P2G) trading [2, 3].

1.1.2 Research gap

The topic of P2P energy sharing has been focused on the different frameworks, internal pricing mechanisms and energy sharing models [2, 3, 11, 18, 19]. Existing studies show that P2P energy sharing networks with a BESS can provide significant savings to prosumers within an ESN [2 – 4], but do not consider the optimal BESS sizing under different ownership structures and the interaction between P2P energy sharing and energy storage sizing. Although there are extensive optimal energy storage sizing studies [20, 21] and improvements to BESS's efficiency and life cycle [6], the high capital investment and operational costs for BESS solutions remains an economic feasibility concern. Therefore, correct BESS power and energy sizing is important such that P2P energy sharing with BESSs are viable considering the life cycle cost, including both the investment and operational costs [20, 21].

1.2 RESEARCH OBJECTIVE AND QUESTIONS

The objectives of this study are to investigate BESS design optimisation within a P2P energy sharing network considering different BESS ownership structures and the interaction between P2P energy sharing and optimal BESS sizing. Through the modelling and analyses of different BESS ownership structures within a P2P ESN, the following questions will be answered:

1. How may battery energy storage be optimally deployed within a P2P energy sharing network considering different BESS ownership structures to achieve the greatest return on investment?

2. What is the effect of P2P energy sharing operations on optimal energy storage sizing and the kind of interactions between the two?
3. Is there potential in P2P energy sharing structures that incorporates a third-party energy sharing provider (ESP) BESS investor, which will be self-sufficient and remove the investment burden from the owners, but still sustain energy cost saving for the end-users?

1.3 RESEARCH HYPOTHESIS

1.3.1 First Predicate

Through the deployment of BESSs under optimal ownership structures within a P2P ESN, the realisation of P2P energy sharing with BESSs may be more easily achieved and desirable leading to more efficient DERs.

1.3.2 Second Predicate

With the interaction between P2P energy sharing and optimal ESP energy storage sizing, negotiations between the ESN prosumers and the third-party ESP will be possible and lead to a consensus that will bring energy cost saving to prosumers and income to the ESP with no upfront investment burden on the building owners.

1.4 RESEARCH APPROACH

To address the research objectives and questions, a relevant and detailed literature study will be undertaken followed by an investigation, design and formulation of different optimal battery energy storage sizing models based on different ownership structures. The design, formulation and evaluation of the optimal energy storage sizing and P2P energy sharing models will be carried out in the approach indicated in Figure 1.1. The models will form the basis for the evaluation of the benefits of each ownership structure and their financial feasibilities will be evaluated with a case study against a baseline setup to interpret and compare the results. Furthermore, the effect of the P2P energy sharing on the optimal energy storage sizing will be investigated. The findings shall be summarised, different energy storage ownership structure results discussed and possible improvements suggested for future

work.

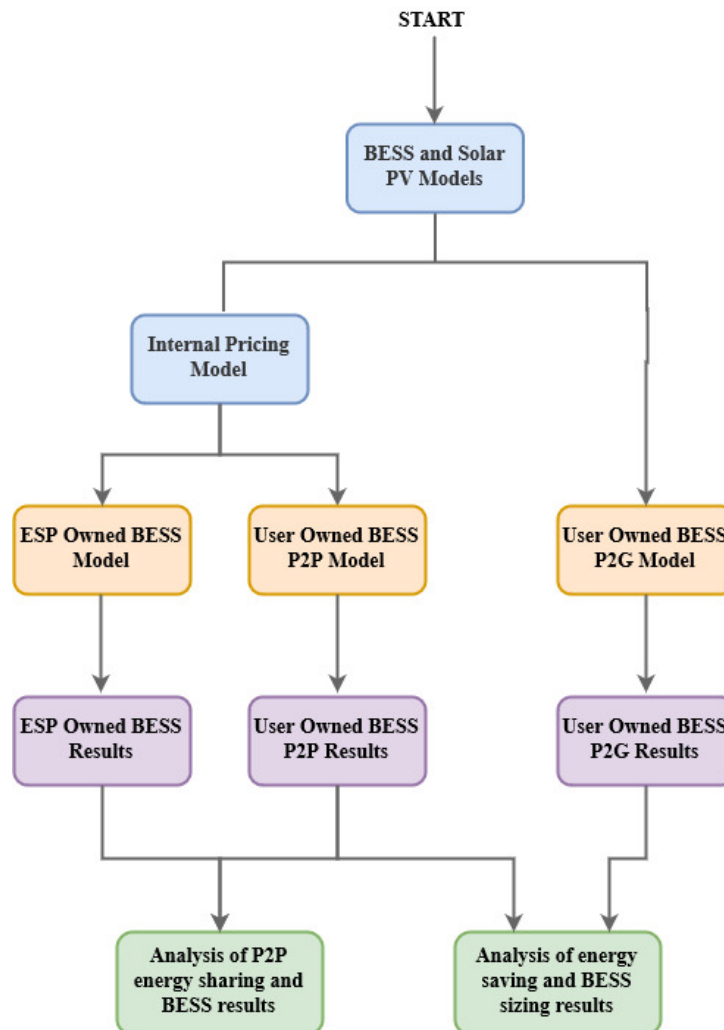

Figure 1.1. Research investigation, development and modelling approach.

1.5 RESEARCH GOALS

The goals of the following study are:

1. to develop an optimal BESS sizing and P2P energy sharing operation multi-objective model in the presence of a dynamic internal energy sharing pricing mechanism for ESNs that will incorporate a third-party BESS investor;
2. to investigate different optimal BESS ownership structures within a P2P ESN based on the net present value (NPV), the battery energy storage size and the investment costs; and

3. to investigate and identify the interactions between P2P energy sharing and optimal ESP battery energy storage sizing.

1.6 RESEARCH CONTRIBUTION

The following study contributes to the knowledge of BESS design optimisation based on BESS ownership within P2P ESN and the interaction between optimal BESS sizing and P2P energy sharing. Cost-effective BESS solutions are important in making BESS's investments, implementations and operations within DER communities more desirable.

1.7 RESEARCH OUTPUTS

1. D. L. Rodrigues, X. Ye, X. Xia, and B. Zhu, "Energy Storage Sizing and Operation Optimisation in a Peer-to-Peer Energy Sharing Community," 11th International Conference on Applied Energy, 2019.
2. D. L. Rodrigues, X. Ye, X. Xia, and B. Zhu, "Battery Energy Storage Sizing Optimisation for Different Ownership Structures in a Peer-to-Peer Energy Sharing Community," Applied Energy, 2020.

1.8 OVERVIEW OF STUDY

This study consists of five chapters each outlining the following main sections:

- In Chapter 2 a summarised literature study provides an overview of optimal battery energy storage sizing, P2P energy sharing, evaluations on previous P2P energy sharing frameworks and internal pricing mechanisms.
- Chapter 3 details the research methodology consisting of the optimal BESS sizing and P2P energy sharing models that are developed and approach discussed.
- Chapter 4 provides a case study with the different ownership structures and their results are presented in different sections to evaluate the performance of the models and to observe output

trends.

- Chapter 5 observes, analyses and discusses the results obtained.
- Chapter 6 presents the conclusions with closing statements and recommendations for future work.

CHAPTER 2 LITERATURE STUDY

2.1 CHAPTER OVERVIEW

In this chapter, an overview of P2P energy sharing is presented in Section 2.2 and of energy storage technologies in Section 2.3. Furthermore, a detailed literature study is provided on: the different P2P frameworks in Sections 2.4.1 – 2.4.2, the internal pricing mechanisms in Section 2.5 and the BESS sizing methodologies in Section 2.6.

2.2 P2P ENERGY SHARING

P2P energy sharing, described as the energy exchange between local prosumers and consumers [1], allows the buying and selling of energy between sharing network participants without the authority of the grid utility. P2P energy sharing has emerged as an alternative to support the deployment of DERs. Advantages include increased local power self-consumption and self-sufficiency, the reduction in prosumer and consumer electrical bills, increased revenue for excess energy and the increased return on local generation DER investments. Although not common in today's electricity markets, P2P energy sharing has been explored in multiple different pilot projects such as Vandebron in the Netherlands, PeerEnergyCloud in Germany, Piclo in the United Kingdom and Electron, which is an open-source decentralised blockchain platform not owned or controlled by any supplier [22].

The topic of P2P energy sharing has had much research undertaken in literature [2, 3, 11, 18, 19, 23]. A P2P architecture categorises the key energy sharing elements into three dimensions. One dimension separates the important functions into layers. Namely, the power grid, information and communication

technologies (ICT), control and business layers [11]. The power grid layer comprises of the actual power distribution network components. The ICT layer contains all the communication devices and networks required to exchange information for the energy sharing platforms. The control layer deals with the distribution network power flow, quality and reliability. The business component of the architecture deals with the way energy is traded amongst the peers, and comprises of different business models, pricing mechanisms and regulations.

2.3 ENERGY STORAGE TECHNOLOGIES

Energy storage has become the key element in driving the modernisation of electrical grids into distributed sources of generation by improving the grid stability and efficiency, and increasing the penetration of renewable energy. Energy storage may be broadly split up into two main categories namely; electrical and thermal energy storage. Of the electrical energy storage technologies, electrochemical has been the most common and implemented technology across multiple different applications [24]. Super-capacitors possess characteristics such as fast charging and extended life span which is currently a demand in modern electrical systems. However, their cost is still relatively high. Contrary to that, battery energy storage has had much development over time and is declining in cost. Different battery varieties based on the chemical and material used to build them exist. The lithium ion (Li-ion) battery, which was initially used for mobile electronics, has found an application in electrical vehicles and larger power systems. These applications have increased the demand and therefore lowered the price, making it a more viable option for consideration in energy systems [25].

2.4 P2P ENERGY SHARING FRAMEWORKS

2.4.1 Without Intermedia

Methodologies proposed for the management of P2P energy sharing may be split into two categories; energy sharing with an intermedia and without. Without an intermedia, a local market is required which allows prosumers to trade energy based on an internal energy price mechanism, with each looking to optimize their own objective function of maximizing their individual benefits from selling energy locally. The following framework manages DERs in a distributed manner, providing users with the full control of their DERs and requiring no central control system. Most of the existing P2P energy sharing literature focuses on different mechanisms based on this framework for residential

communities. The advantage of this framework is that no additional incentive is usually required to make prosumers participate as it allows them full control of their DER. This framework may be divided into three sub-categories: multi-agent system (MAS) based [26], analytical based [5, 11, 27 – 30] and auction based [17, 31].

A MAS consists of multiple peers which interact with each other to achieve their individual objectives. In a P2P energy sharing network (ESN) the agents are the market coordinator, the prosumers and the electricity utility retailer. The downfalls of the MAS iterative frameworks are that they are subjected to divergence concerns and consist of designed exit mechanisms to prevent lengthy waiting periods. Exit mechanisms usually force prosumers to directly trade with the retailer resulting in no P2P energy exchange. They also require intensive computational power and communication systems for energy price bidding [3, 26].

In an auction-based market for P2P energy trading, the coordinator finalises the market exchange by finding the intersection between the ascending supply and the demand. Auctions are independent with each prosumer, submitting a bid without knowing the bids from the other participants or any other information of the community demand [17, 31]. Auction-based trading mechanisms usually have bidding time windows for a certain operation period whereby prosumers are allowed to submit their bids, either being their buying price, selling price, buying power or selling power to the network coordinator. Bilateral contract networks, a similar framework whereby energy contracts are offered to neighbours within the network via a set list of the available energy supply or demand with the price, has also been explored for P2P energy sharing [32, 33]. A P2P energy trading market design using bilateral contract networks realised energy sharing for different market participants such as fuel-based generator sources, consumers with flexible loads and renewable energy sources, by reducing the internal energy prices compared with the grid by 10%. Furthermore, the new scalable design may be implemented for forward submitting and real-time markets [33].

An analytical model bases energy exchange based on a set of rules, calculation methods and game theoretical approaches [5, 29]. Such an example is a dynamic internal pricing model based on the supply demand ratio (SDR) from economics used to setup a competitive local market for

grid-connected prosumers within a community. Prosumers carry out demand response based on the internal price, which resulted in a community and prosumers electricity cost reduction of between 3.3% to 5% [5]. Another study realised a distributed game-based pricing market for solar PV prosumers within a micro-grid to undertake energy sharing using the Stackelberg approach. The micro-grid operator is the game leader setting the internal micro-grid energy price, followed by the prosumers deciding their energy sharing profile in response to the internal energy price [29].

Another market mechanism that has proved to be eligible for the management of P2P energy trading transactions is blockchain [34 – 37]. A concept of a blockchain based microgrid energy market is one which does not require a central intermediary and is a solution which can address the privacy, cyber-security and mutual-trust concerns, which currently face P2P energy transactions. This can be achieved through the application of cryptography and smart contracts which is expected to transform the power distribution system into a transactive distribution system [36]. Seven components were derived for the efficient operation of a blockchain based micro-grid energy market namely; micro-grid setup, utility grid-connection, information system, market mechanism, pricing mechanism, energy management trading system and regulation. It was shown through a case study that blockchain technology is a suitable technology to operate decentralised DERs but failed to meet the last component, regulation, which mostly does not support blockchain structures [34]. The realisation of a faultless and secure blockchain transaction system, via a case study with the use of smart contracts and a decentralised identifier, recognised two major drawbacks that require improvement. Firstly, long periods for interactions among consumers to converge highlights a scalability concern as micro-grids become larger and more complex, and secondly, that current blockchain and smart contract frameworks still require technical infrastructure development if it were to fit into the existing distribution infrastructure [36].

2.4.2 With an Intermedia

Several researchers have completed studies of P2P energy sharing with an intermedia [2 – 5, 15, 38, 39]. Energy sharing is coordinated by the intermedia based on a community global objective such as maximising the community overall benefit or to achieve a specific overall performance for all the DERs. The control of prosumers DERs and energy sharing is controlled by the intermedia, a third-party entity referred to as an ESP in this study. Structures with an ESP require simpler communication systems

and utilise less data processing, compared to market related infrastructures, as no bidding is performed. However, benefit equality within the community becomes a concern as well as the requirement of incentives to promote prosumers to join the sharing policy [26]. An analysis of the end-user benefits coupled with the role of energy storage in the presence of community P2P energy sharing, found that the two proposed local market designs, a distributed and centralised ESS, are both economically viable, and that the local community design decisions need to take into consideration the community setup and desires. The results showed that more than half of the savings came from P2P direct trade and the remaining from the BESS added demand and supply flexibility [38]. The distributed design achieved a 31% overall community saving, while the centralised design achieved 24%, but the study does not consider how the ownership of BESS affects the relevant parties' interests or the market designs.

A proposed, constrained non-linear programming and rule-based, aggregated battery control system realised P2P energy sharing within a residential community by controlling the community's distributed energy storage and energy sharing from solar PV microgrids via an ESP. The proposed system realised a cluster level energy cost reduction of 30%, an increase in solar PV energy self-consumption between 10–30% and an individual consumer energy bill reduction of 12.4% from its modified SDR based pricing mechanism compared to P2G trading. The system also implemented a simple communication structure requiring only the measurements at the point of common coupling (PCC) and a one-way communication system to each micro-grid [3]. A proposed infrastructure, consisting of an ESP equipped with an ESS, improved solar PV energy sharing within the community and reduced the peak and variation of the community's net load by providing the opportunity of buffered sharing within the ESN. A Stackelberg game provided the dynamic pricing platform bringing economic benefits for the prosumers [2].

A novel energy sharing scheme is proposed in which an ESP makes use of an ESN's DERs for peak demand reduction and local load balance. The scheme realises a reduction in peak demand of 17.65% by using a designed incentive mechanism based on sharing contribution [40], which identifies each prosumer's possible contribution to energy sharing, peak demand reduction and local load balancing, and, accordingly provides incentives for the prosumer to make strategic investments in solar PV and BESSs. The scheme also found that the incentive promotes larger investments into solar PV and BESSs but does not show if the increased investment provides a larger return for the prosumer [40]. A bi-level

programming model accomplished savings of around 54% in a real test case study for consumers and prosumers within a community micro-grid, which maximised a community's profit based on the internal pricing. The model also ensured no community members were worse off by engaging in the energy sharing. The ESP redistributed costs and incomes within the community members in a manner that incentivises members and further promotes them to participate using a Pareto-superior condition [39].

A novel P2P energy market, based on a concept of different class energy management, achieved P2P energy sharing based on individual miscellaneous preferences [41]. Such preferences include peer's reputation, generation technology and network location. The objective was to minimise costs related with battery depreciation and system losses, while contributing value by considering individual prosumer energy preferences such as financial, social, philanthropic or environmental. Each prosumer contains attributes of its source which correlates to different classes [41].

2.5 INTERNAL ENERGY SHARING PRICING APPROACHES

In a P2P ESN, the trading of excess renewable energy amongst prosumers becomes an economic operational problem as it becomes difficult to facilitate energy sharing without an internal pricing mechanism. This makes internal pricing mechanisms an important aspect of P2P energy sharing structures. A Game theory pricing mechanism is one pricing methodology that has been investigated and proposed for an internal pricing mechanism for P2P energy sharing networks [2, 18, 19, 29, 30]. A Stackelberg game realised buying and selling prices for an ESN in a distributed method where the Stackelberg equilibrium achieved is the internal price decisions and energy sharing profiles. The market co-ordinator acts as a leader maximising its own profit, while the prosumers are followers equally trying to minimise their costs [19, 29]. A marginal pricing scheme was used for the pricing of trading within an ESN with a social welfare maximisation approach. The framework guaranteed all participants gained benefits of between 28% to 74% [39].

A SDR dynamic pricing mechanism provides an internal trading price based on the community's energy supply and demand during specified periods ensuring competitive internal prices bounded by the electricity retailer export and import prices [5]. The mid-market rate (MMR) provides an

internal price based on the logic that the internal price is invariably at the middle of the utility feed-in and import electricity prices so that prosumers and consumers experience equal energy sharing benefits [18, 30]. The bill sharing mechanism distributes the total energy costs and income of the ESN according to the amount of energy consumed and generated by the prosumer [18]. Based on the multi-agent framework, an overall performance evaluation of the three mechanisms found the SDR mechanism to be the best, followed by the MMR and then the bill sharing mechanism in terms of value tapping, participation, equality, energy balance, power flatness and self-sufficiency for different penetration levels of solar PV and electrical vehicle charging. Both the SDR and MMR mechanisms guaranteed increased benefits and harnessed the most cost-saving, but slightly decreased income equality [26]. An improved SDR mechanism, that includes a compensating factor, ensured more equal benefits by compensating prosumers when the community SDR is larger than one, not undermining the prosumers who export a large share of their PV generated energy [3].

2.6 BATTERY ENERGY STORAGE SIZING

The high investment costs associated with BESSs is a concern when considering energy storage; exhibiting potential for improved sizing methodologies and deployment strategies. BESS optimal sizing can be performed based on three classifications: financial, technical and hybrid [21]. Financial indicators take into account the financial return on the investment and the operation of the BESS system, and consist of different financial indicators such as the NPV [12, 42], the market benefit [43] and the levelised cost of electricity [44]. The benefit of financial indicators is the common unit when comparisons are made. The capital investment cost is the important measure in the cost analysis BESSs which considers the payback period and therefore the life cycle of the battery. Technical indicators, otherwise, do not contain the common units for comparison and rely on constraints or achieving an optimisation goal. In such optimisations, different technical indicators are quantified using binary variables. Technical indicators are separated into two classifications: dynamic and steady-state. Dynamic characteristics consist of time horizons smaller than one minute and revolve around the application of voltage and frequency regulation of a system [45]. Steady-state operation indicators, which include time horizons larger than one minute, consist of energy reliability and curtailment indicators.

Examples of reliability indicators are loss of load expectation, renewable energy self-consumption, system peak-demand and other operational parameters such as the depth of discharge (DOD), the battery life cycle and the charge or discharge rates. Common sizing approaches are hybrid indicators which, simultaneously, consist of financial and technical indicators [20, 46, 47]. Two such hybrid approaches exist. One, where technical indicators fall part of the model constraints and a financial indicator is optimised [20]. The other, being a multi-objective approach consisting of both financial and technical indicators within the objective function [46]. There are many indicators that may be used within the three classifications of which the desired combination selection is based on the nature of the BESS sizing problem being addressed.

Battery degradation, which is mostly affected by the number of cycles and the SOC, affects the life cycle of a battery. For li-ion batteries excessive temperatures, high charging and discharging rates, cycling and DOD are factors which affect the degradation [48]. An optimal placement and sizing performed for a network consisting of distributed solar PV used a cost-benefit analysis with the objective of maximising the NPV, improving the load factor and the voltage profile. The results concluded that the amount of PV penetration is insignificant on the optimal placement of the energy storage and that a higher NPV was obtained for energy storage deployments between 2 and 6 compared to a single energy storage [47]. A sizing study for a solar PV system under different tariffs was found not to be affected by the different time-of-use (TOU) and maximum demand tariffs analysed. All solutions favoured large solar PV systems with a smaller sized battery [49].

CHAPTER 3 METHODS

3.1 CHAPTER OVERVIEW

This chapter introduces and describes the different structures in Section 3.2 followed by the formulation of each structure in Sections 3.3 – 3.5 for the ESP Owned BESS, User Owned BESS P2P and User Owned BESS P2G structures respectively. The load, solar PV, BESS and internal pricing models for the different ownership structures are provided in Sections 3.3.1, 3.3.2 and 3.3.4.

3.2 STRUCTURES

For a community with grid-tied solar PV systems and no prior BESS; sizing, ownership and operation of a BESS are the major concerns for a cost-effective solution. In order to obtain a prioritised BESS in a community with P2P energy sharing, this study investigates three BESS ownership structures, namely 1) an ESP owned BESS with P2P energy sharing; 2) a user owned BESS with P2P energy sharing; and 3) a user owned BESS with P2G trading as shown in Figure 3.1. The first two solutions are the potential BESS designs to be deployed in the P2P ESN, while the third option is analysed and compared to justify potential energy and cost savings by adding BESSs to an existing community. Optimal BESS solutions are obtained for all three structures based on the objective functions in Equations (3.16), (3.27) and (3.36). Further through this study, the three ownership structures will be referred to as ESP owned BESS, User owned BESS P2P and User owned BESS P2G, respectively.

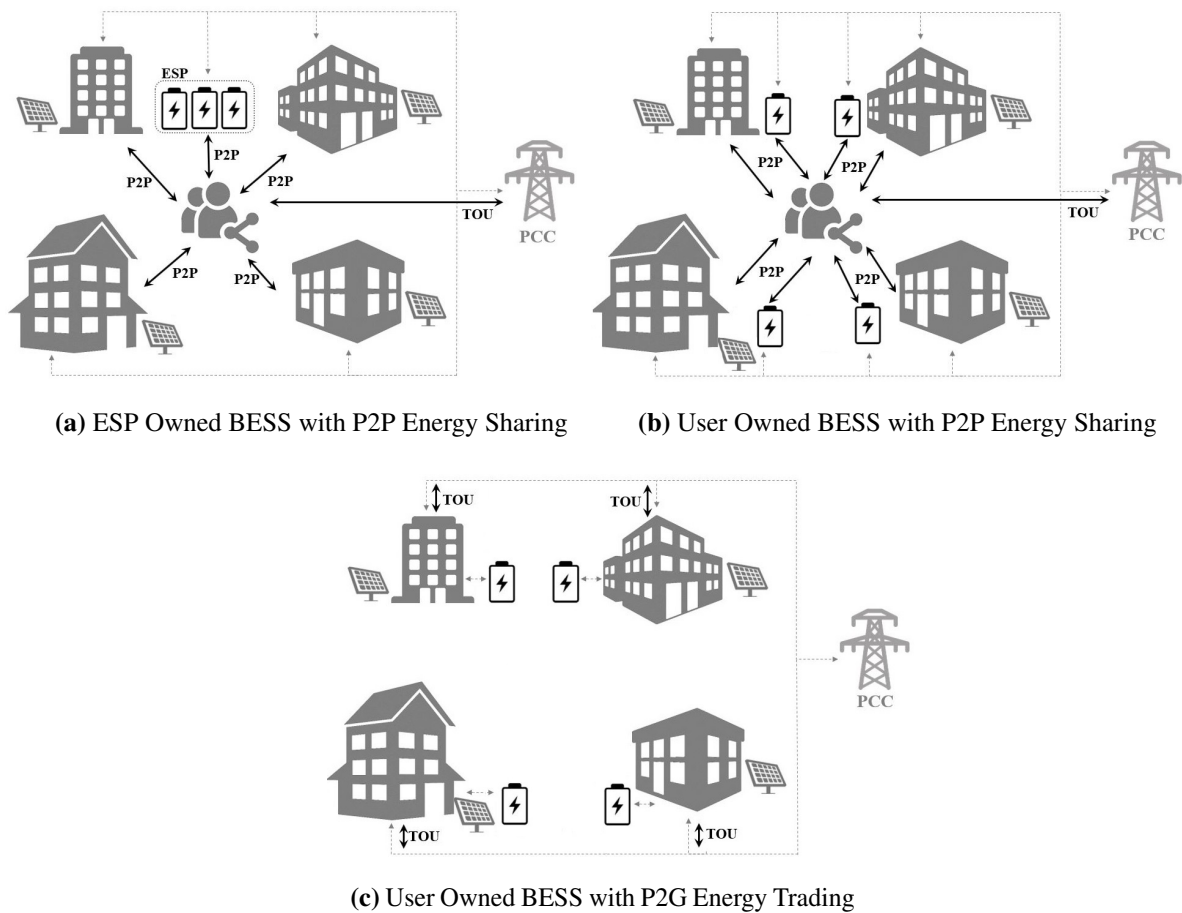
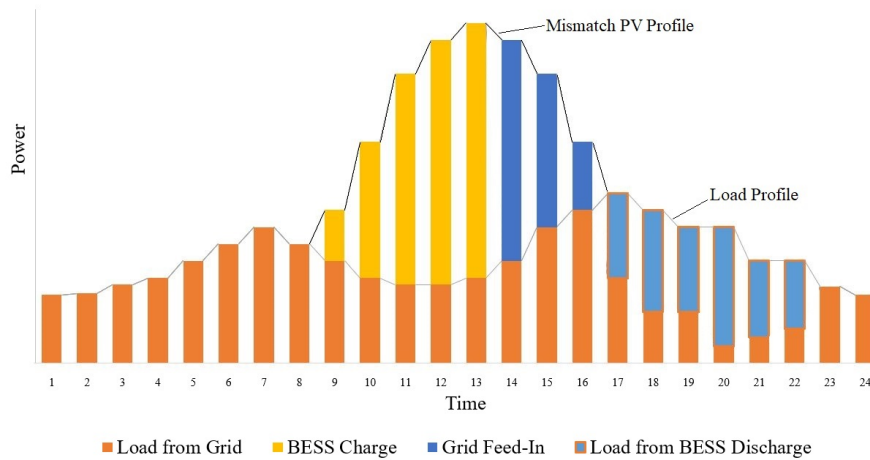

Figure 3.1. The BESS ownership structures; (a) ESP with P2P Energy Sharing, (b) User with P2P Energy Sharing and (c) User with P2G Energy Trading considered in this study.

3.2.1 ESP Owned BESS with P2P Energy Sharing

The ESP owned BESS P2P structure involves the community prosumers, the utility grid and the ESP as shown in Figure 3.1(a). The ESP is the ESN intermedia who facilitates the P2P energy sharing among the buildings and operates the BESS with communications to each of the buildings' and the BESS energy management systems (EMS). In this structure, the required BESS capital investment, operation and maintenance (O&M) costs will be invested by a third-party entity ESP, with income being generated from the BESS buying and selling of excess energy within the community. This structure removes the investment burden from the building owners but still benefits them with energy cost reduction and a more reliable power supply. The ESP BESS is observed as any other prosumer in the community being able to consume or supply power by charging and discharging the BESS. Energy sharing may take place using two methods, direct or indirect. Direct energy sharing is when PV

prosumers share energy among each other when their own demand is met and others require energy in the same time period [2]. Indirect power sharing, which takes place via the BESS, is when the BESS buys and stores energy when the communities' energy demand is met, and sells it later when the community requires the energy. This will occur when the communities' SDR is greater than one. When the solar PV power fails to meet the demand of buildings causing the SDR to drop below one, the BESS sells energy to the community [3]. Both types of sharing may be performed simultaneously within the ESN depending on the community energy supply and demand. The ESP BESS may also interact with the grid to increase or decrease its state-of-charge (SOC). This may lead to charging the BESS during grid off-peak time periods and then selling the energy during peak periods for a profit. This P2P energy sharing and BESS charging and discharging operation is shown in Figure 3.2. There is a reduction in solar PV energy fed back into the grid because of the P2P energy sharing.



(a) BESS behaviour with P2G energy trading.

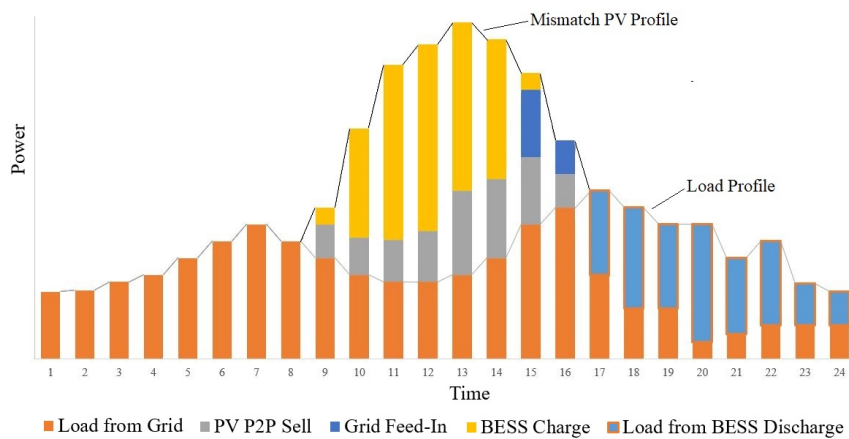

(b) BESS behaviour with P2P energy sharing.

Figure 3.2. Figure illustrating the daily BESS charging and discharging behaviour with P2G energy trading (a) and with P2P energy sharing (b).

3.2.2 User Owned BESS with P2P Energy Sharing

In the User owned BESS P2P structure, each building deploys its own BESS which is invested and maintained by the building owner as shown in Figure 3.1(b). In this structure, P2P energy sharing is performed in the same manner as the ESP owned BESS structure, but without the third-party ESP investor. Energy sharing is realised via the internal sharing network, which requires the information and technology network and communications infrastructure to be setup by the building owners who

are willing to engage within the ESN. In the same way as the ESP; the community is billed from utility grid as a unit, in this case based on a TOU tariff, as indicated in Figure 3.1(b).

3.2.3 User Owned BESS with P2G Energy Trading

The User owned BESS with P2G energy trading is the typical independent BESS deployment structure that involves only the building owner and the utility. The building solar PV and BESS interact solely with the building. The utility grid bills each building based on the TOU tariff as shown in Figure 3.1(c). No P2P energy sharing is realised with this structure.

3.3 ESP OWNED BESS P2P FORMULATION

Considering the ESP owned BESS structure description, an optimal BESS size and power flow are computed based on Figure 3.3 and the following models.

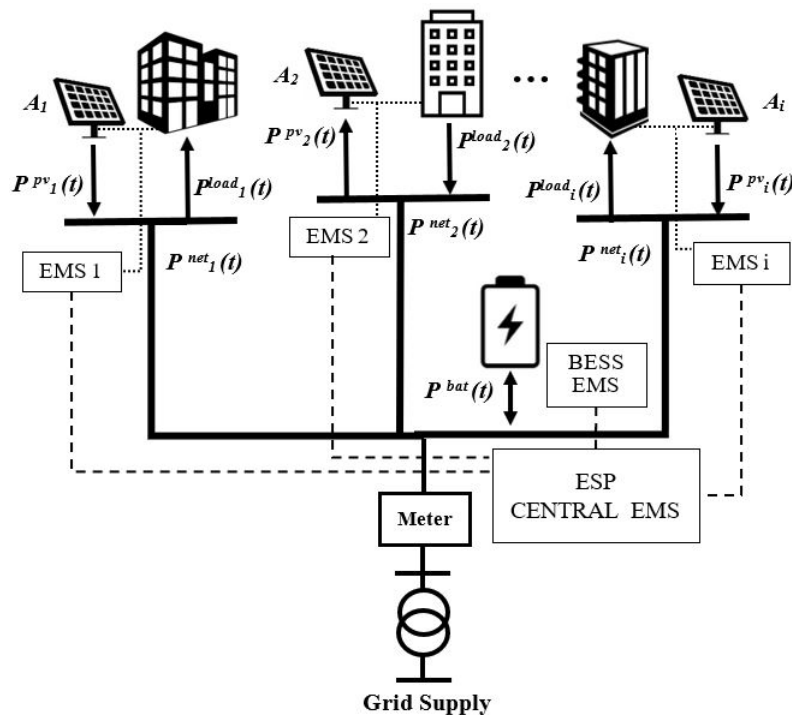

Figure 3.3. An illustration of the ESP owned BESS structure realisation with operational variables.

3.3.1 Load and PV System Modelling

Without loss of generality, we consider the P2P energy sharing in a community with N users. Each of them is equipped with a grid-tied solar PV system. The PV systems are of different sizes, and users also have different energy usage patterns. The power demand of building i is defined as:

$$\mathbf{P}_i = \{P_i(1), P_i(2), \dots, P_i(T)\}, \quad \forall i \in N, \quad (3.1)$$

where T is the total number of time slots t in the operation period. For the prosumers in the ESN, the solar PV power generation for building i at the particular time periods which varies with the solar intensity is:

$$\mathbf{P}_i^{PV} = \{P_i^{PV}(1), P_i^{PV}(2), \dots, P_i^{PV}(T)\}. \quad (3.2)$$

The output power from the buildings' grid-tied solar PV system for building i at time t is given by

$$P_i^{PV}(t) = A_i \cdot \eta \cdot I_r(t), \quad \forall t \in T \quad (3.3)$$

where A_i is the area of solar PV array for building i , η is the solar panel electrical efficiency, and $I_r(t)$ is the global horizontal irradiance (GHI) for the location of the solar panels at time t .

3.3.2 Battery Energy Storage System

The BESS energy flow model takes into consideration the power charging and discharging, the self-discharge losses and the charging and discharging efficiency given by:

$$E^{bat}(t) = \begin{cases} E^{bat}(t - \Delta t) \cdot (1 - \sigma_{DC}) - P^{bat}(t) \cdot \eta_b \cdot \Delta t, & P^{bat}(t) \geq 0, \\ E^{bat}(t - \Delta t) \cdot (1 - \sigma_{DC}) - \frac{P^{bat}(t)}{\eta_b} \cdot \Delta t, & P^{bat}(t) < 0, \end{cases} \quad (3.4)$$

where $E^{bat}(t)$ is the energy stored in the BESS at time t , Δt is the length of each time step, σ_{DC} is the battery self discharge rate over Δt and $P^{bat}(t)$ is the charging and discharging power during time interval $[t, t + \Delta t]$. $P^{bat}(t)$ is greater than zero when the BESS is discharging and smaller than zero when charging. The following BESS model assumes that the discharge and charge efficiencies are equal, and is denoted by η_b . The BESS receives its optimal charging and discharging schedule control signals from the EPS central EMS.

3.3.3 Energy Sharing Power Balance

For each building in the ESN, the power flow balance is required amongst the solar PV, grid and the building power demand as shown in Figure 3.3. This is given by:

$$P_i^{net}(t) = P_i^{load}(t) - P_i^{PV}(t), \quad (3.5)$$

where $P_i^{net}(t)$ is building i 's net power and $P_i^{load}(t)$ is the power required by building i at time t . Because of the different building load profiles and output solar PV power, the buildings may act as energy suppliers or energy consumers at different times. For the ESN and the ESP BESS, the power flow balance is

$$\sum_{i=1}^N P_i^{net}(t) = P^{bat}(t) + P^{grid}(t), \quad (3.6)$$

where $P^{grid}(t)$ is the power flow of the grid supply power to the ESN when positive, and negative when the ESN is feeding power into the grid.

3.3.4 Internal Pricing Policy

An internal P2P dynamic pricing model based on the principle of economic supply and demand [5] with a compensating factor [3] is considered. The internal pricing model considers three main principles:

1. the internal P2P energy sharing prices should be restricted between the utility feed-in and grid electricity prices,
2. the basic principle of economics, the relation between the price and the SDR is inversely proportional and
3. the economic balance should be assured for the ESN [5].

The price at which a prosumer buys energy from the ESN is referred to as the *buying price* further through this study, and the *selling price* for the price at which the prosumer sells energy to the ESN. The buying and selling prices with relation to the SDR are shown in Figure 3.4, which is restricted within the utility grid price bounds [5] where λ^{buy} is the grid purchasing price and λ^{sell} is the grid feed-in tariff price. The improved version of the model shown in Figure 3.5, which incorporates a compensating factor after the SDR is larger than one, ensures all prosumers in the ESN are better off [3]. Without the compensation factor, the internal price remains the same after the SDR is larger than one, and undermines the prosumers who tend to produce excess power during peak solar PV

supply periods and unfairly benefits those who continuously consume the power during those periods as they buy power below the normal grid purchase price.

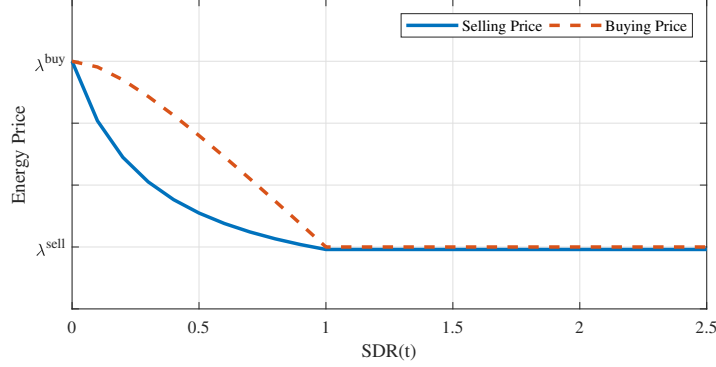

Figure 3.4. The internal dynamic pricing as a function of SDR based from economics for prosumers in a P2P energy sharing community.

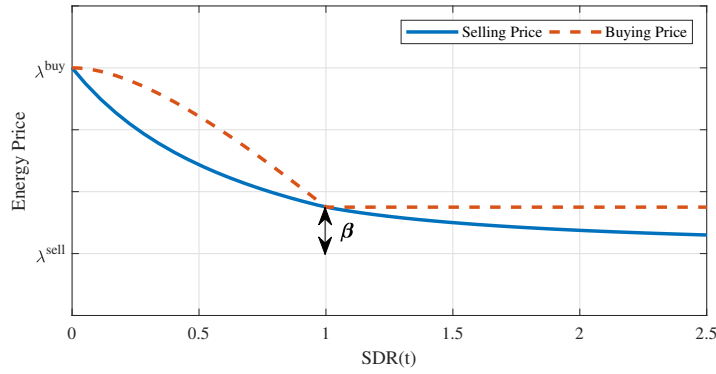

Figure 3.5. The internal dynamic pricing with a compensating factor as a function of SDR based from economics for prosumers in a P2P energy sharing community.

The SDR for the ESN is denoted as:

$$SDR(t) = \frac{TSP(t)}{TDP(t)}. \quad (3.7)$$

where $TSP(t)$ is the total supply power (TSP) and $TDP(t)$ total demand power (TDP) at time t which are calculated using Equations (3.8) – (3.9) as follows:

$$TSP(t) = - \left(\sum_{i=1}^N P_i^{net}(t) - P^{bat}(t) \right), \quad P_i^{net}(t) < 0, \quad P^{bat}(t) \geq 0, \quad (3.8)$$

$$TDP(t) = \sum_{i=1}^N P_i^{net}(t) - P^{bat}(t), \quad P_i^{net}(t) \geq 0, \quad P^{bat}(t) < 0. \quad (3.9)$$

The TDP refers to the total power that is required by each building in the ESN that is not met by its own solar PV power and when the BESS charges. That is when $P_i^{net}(t)$ is larger than zero and $P^{bat}(t)$ is smaller than zero. The TSP is the total power in excess from each building and when the BESS discharges during time t . That is when $P_i^{net}(t)$ is smaller than zero and $P^{bat}(t)$ is greater than zero. Note the addition of the ESP BESS into Equations (3.8) – (3.9), seen as an additional "prosumer". By this, all parties within the ESN contribute to the decision of the internal price. The internal selling and buying price as a function of time is represented as a set as follows:

$$\mathbf{Pr}^{sell} = \{Pr^{sell}(1), Pr^{sell}(2), \dots, Pr^{sell}(T)\}, \quad (3.10)$$

$$\mathbf{Pr}^{buy} = \{Pr^{buy}(1), Pr^{buy}(2), \dots, Pr^{buy}(T)\}. \quad (3.11)$$

The internal prices from Equations (3.10) – (3.11) for the prosumers at a particular period depends on the buildings demand and solar PV power generation, as a prosumer may be purchasing or selling power in a single time interval. Therefore, building i 's internal energy price at time t is described as follows:

$$Pr_i(t) = f(P_i^{net}(t)) = \begin{cases} Pr^{sell}(t), & P_i^{net}(t) < 0 \\ Pr^{buy}(t), & P_i^{net}(t) \geq 0. \end{cases} \quad (3.12)$$

The internal selling and buying price is given respectively:

$$Pr^{sell}(t) = \begin{cases} \frac{(\lambda^{sell}(t) + \beta(t)) \cdot \lambda^{buy}(t)}{(\lambda^{buy}(t) - \lambda^{sell}(t) - \beta(t)) \cdot SDR(t) + \lambda^{sell}(t) + \beta(t)}, & 0 \leq SDR(t) \leq 1 \\ \lambda^{sell}(t) + \beta(t) / SDR(t), & SDR(t) > 1 \end{cases} \quad (3.13)$$

$$Pr^{buy}(t) = \begin{cases} Pr^{sell}(t) \cdot SDR(t) + \lambda^{buy}(t) \cdot (1 - SDR(t)), & 0 \leq SDR(t) \leq 1 \\ \lambda^{sell}(t) + \beta(t), & SDR(t) > 1 \end{cases} \quad (3.14)$$

where $\lambda^{sell}(t)$ is the grid feed-in tariff energy price, $\lambda^{buy}(t)$ is the grid TOU purchase energy price and $\beta(t)$ is the compensating factor restricted by:

$$0 \leq \beta(t) \leq \lambda^{buy}(t) - \lambda^{sell}(t). \quad (3.15)$$

3.3.5 ESP Owned BESS P2P Objective Function

The optimal energy sharing problem is formulated into a constrained non-linear programming multi-objective model, with one objective function Equation (3.16), maximising the BESS NPV over its life span and the other, Equation (3.17), minimising the community energy costs. The BESS NPV consists of the income from the buying and selling of energy and the BESS costs, as seen in the cash flow diagram in Figure 3.6. The BESS costs are split up into the upfront capital investment cost and the monthly O&M cost. The upfront capital investment cost of the BESS contains a power conversion rating cost, C_{con} in \$/kW, incorporating all inverters and power management equipment, and an energy rating cost C_{cap} in \$/kWh for the energy storage cost. The community grid cost consists of the energy cost $\lambda^{grid}(t)$ and the maximum demand charge C_{md} . The decision variables in the following optimisation are the BESS size E^b , the power conversion rating E^{con} , the discharging and charging schedule $P^{bat}(t)$ and the internal energy sharing prices, which contain variable constraints Equations (3.18) – (3.23).

$$\begin{aligned} \max_{E^b, E^{bat}, E^{con}, P^{bat}} BESS_{NPV} &= \sum \left(Income_{NPV}, Costs_{NPV} \right) \\ &= \left(\sum_{t=1}^T Pr_b(t) \cdot P^{bat}(t) - E^{con} \cdot P_{OM} - E^b \cdot E_{OM} \right) \cdot PVF - C_{cap} \cdot E^b - C_{con} \cdot E^{con}, \end{aligned} \quad (3.16)$$

$$\min_{P^{grid}} Com_{grid} = P^{grid}(t) \cdot \lambda^{grid}(t) + P_{max}^{grid} \cdot C_{md}, \quad (3.17)$$

s.t

$$\lambda^{grid}(t) = \begin{cases} \lambda^{buy}(t), & P^{grid}(t) \geq 0 \\ \lambda^{sell}, & P^{grid}(t) < 0 \end{cases} \quad (3.18)$$

$$Pr_b(t) = \begin{cases} Pr^{sell}(t), & P^{bat}(t) \geq 0 \\ Pr^{buy}(t), & P^{bat}(t) < 0 \end{cases} \quad (3.19)$$

$$P_{min}^{bat} \leq P^{bat}(t) \leq P_{max}^{bat}, \quad (3.20)$$

$$E_{min}^{bat} \leq E^{bat}(t) \leq E_{max}^{bat}, \quad (3.21)$$

$$E^{bat}(T) = E^{bat}(0), \quad (3.22)$$

$$BESS_{NPV} > 0. \quad (3.23)$$

The P_{OM} and E_{OM} are the power conversion and energy rating monthly O&M costs, $Pr_b(t)$ is the BESS energy price for either charging or discharging given by Equation (3.12), and PVF is the present value factor defined as:

$$PVF = \frac{(1 + d')^n - 1}{d'(1 + d')^n}, \quad (3.24)$$

where n is the number of years and d' is the equivalent discount rate taking into consideration future energy escalation given by:

$$d' = \frac{d - e}{1 + e}, \quad (3.25)$$

where d is the discount rate and e is the energy escalation rate per year.

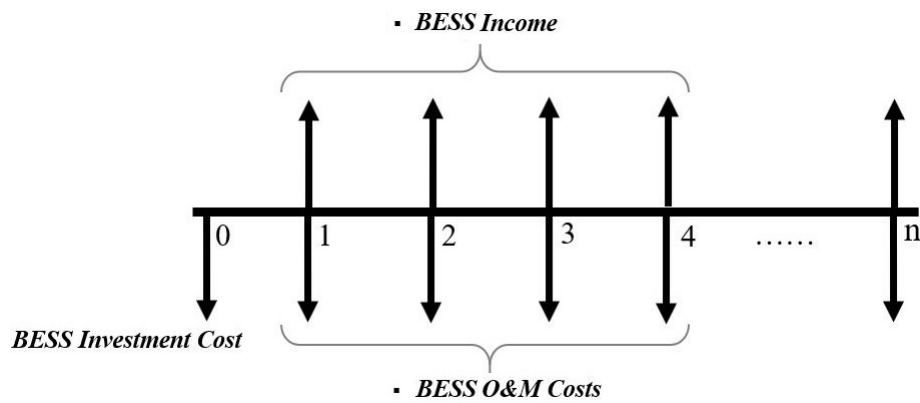

Figure 3.6. The cash flow for the life cycle of the ESP owned BESS structure.

3.4 USER OWNED BESS P2P FORMULATION

The User owned BESS structure with P2P energy sharing is derived using the same load, solar PV, BESS and internal pricing mechanism as the ESP owned BESS structure formulation and described in Equations (3.3), (3.4), (3.6) – (3.16), (3.24), (3.25) and (3.35), but with a different energy balance equation, optimisation objective function and constraints. All BESS parameters ($P_i^{bat}(t), E_i^{bat}(t)$) also obtain a building index i as there is now a single BESSs deployed at each building as shown in Figure 3.7. The ESN energy balance model is given by:

$$\sum_{i=1}^N P_i^{net}(t) = \sum_{i=1}^N P_i^{bat}(t) + P^{grid}(t), \quad (3.26)$$

where P_i^{bat} now becomes a sum for all BESSs deployed within the ESN.

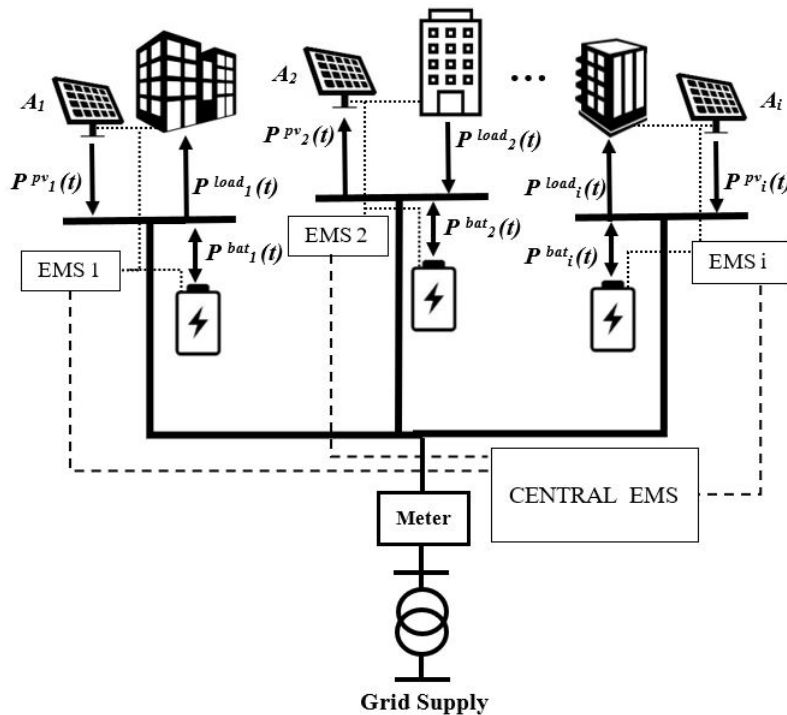

Figure 3.7. An illustration of the User owned BESS with P2P energy sharing structure realisation with operational variables.

3.4.1 User Owned BESS P2P Objective Function

In this structure all the buildings deploy their own BESS without an incentive. It is assumed that they would deploy a BESS size that maximises the NPV of their investment that does not consider an

ESP's income. However, because the buildings will be engaging in P2P energy sharing, a combined NPV for all the BESSs and their individual savings NPV are formulated into a constrained non-linear programming model shown in Figure 3.8 and given by:

$$\begin{aligned}
 \max_{E^b, E^{bat}, E^{con}, p^{bat}, p^{grid}} NPV &= \sum \left(Income_{NPV}, Costs_{NPV}, Savings_{NPV} \right) \\
 &= \left(\sum_{i=1}^N \sum_{t=1}^T Pr_{b-i}(t) \cdot P_i^{bat}(t) - \sum_{i=1}^N E_i^{con} \cdot P_{OM} - \sum_{i=1}^N E_i^b \cdot E_{OM} + (E_i^{cost} - (Pr_i(t) \cdot P_i^{net}(t))) \right) \cdot PVF \quad (3.27) \\
 &\quad - C_{cap} \cdot \sum_{i=1}^N E_i^b - C_{con} \cdot \sum_{i=1}^N E_i^{con},
 \end{aligned}$$

s.t

$$\lambda^{grid}(t) = \begin{cases} \lambda^{buy}(t), & p^{grid}(t) \geq 0 \\ \lambda^{sell}, & p^{grid}(t) < 0 \end{cases} \quad (3.28)$$

$$Pr_i^{bat}(t) = \begin{cases} Pr^{sell}(t), & P_i^{bat}(t) \geq 0 \\ Pr^{buy}(t), & P_i^{bat}(t) < 0 \end{cases} \quad (3.29)$$

$$P_{min}^{bat_i} \leq P_i^{bat}(t) \leq P_{max}^{bat_i}, \quad (3.30)$$

$$E_{min}^{bat_i} \leq E_i^{bat}(t) \leq E_{max}^{bat_i}, \quad (3.31)$$

$$E_i^{bat}(T) = E_i^{bat}(0), \quad (3.32)$$

$$BESS_i^{NPV} > 0, \quad (3.33)$$

where E_i^{cost} is the building's existing P2G energy cost.

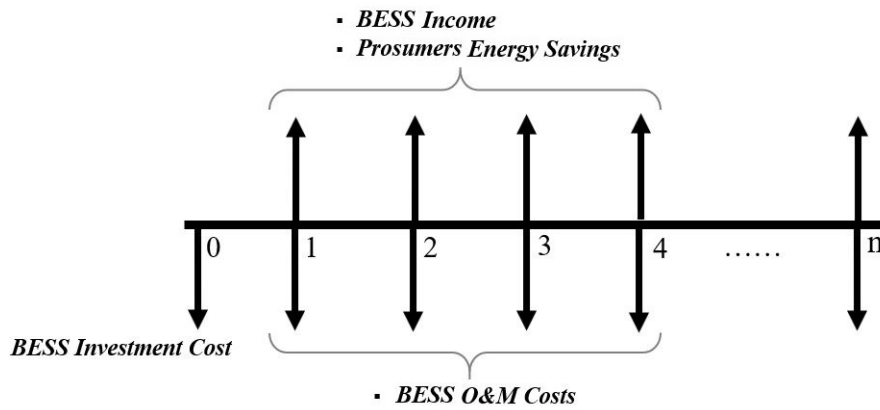

Figure 3.8. The cash flow for the life cycle of the distributed BESS. Note the addition of the prosumers savings to the positive cash flow.

3.5 USER OWNED BESS P2G FORMULATION

The User owned BESS P2G structure, shown in Figure 3.1(c), is derived using the same load, BESS and solar PV models Equations (3.3), (3.4), (3.12), (3.20), (3.21), (3.24) and (3.25) as the ESP owned BESS structure formulation but is charged simply from the grid utility TOU price and contains a different optimisation objective function and constraints. The individual P2G energy balance model is given by:

$$P_i^{net}(t) = P_i^{grid}(t), \quad (3.34)$$

$$P_i^{net}(t) = P_i^{load}(t) - P_i^{PV}(t) + P_i^{bat}(t), \quad (3.35)$$

where P_i^{net} , is the individual building net power, P_i^{bat} is the building energy storage internal power exchange and P_i^{grid} is the building grid power. Note that the grid power is a function of i because of the P2G trading structure.

3.5.1 User Owned BESS P2G Objective Function

The constrained non-linear programming optimisation objective function, with constraints Equations (3.37) – (3.40), is the individual building project BESS deployment NPV which takes into account the BESS costs and the building's savings NPV as shown in Figure 3.9 and given by:

$$\begin{aligned}
 \max_{E^b, E^{bat}, E^{con}, P^{bat}, P^{grid}} \text{Project}_{NPV} &= \sum \left(\text{Savings}_{NPV}, \text{Costs}_{NPV} \right) \\
 &= \left(\sum_{t=1}^T \left((P_i^{bat}(t) + P_i^{net}(t)) \cdot \lambda^{grid}(t) \right) - E^{con} \cdot P_{OM} - E^b \cdot E_{OM} \right) \cdot PVF - C_{cap} \cdot E^b - C_{con} \cdot E^{con}.
 \end{aligned} \tag{3.36}$$

s.t

$$\lambda^{grid}(t) = \begin{cases} \lambda^{buy}(t), & P_i^{grid}(t) \geq 0 \\ \lambda^{sell}, & P_i^{grid}(t) < 0 \end{cases} \tag{3.37}$$

$$P_{min}^{bat_i} \leq P_i^{bat}(t) \leq P_{max}^{bat_i}, \tag{3.38}$$

$$E_{min}^{bat_i} \leq E_i^{bat}(t) \leq E_{max}^{bat_i}, \tag{3.39}$$

$$E_i^{bat}(T) = E_i^{bat}(0). \tag{3.40}$$

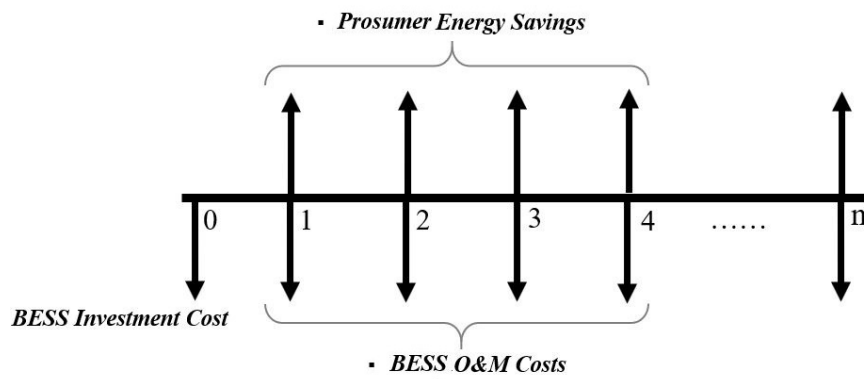

Figure 3.9. The cash flow for the life cycle of the User owned BESS with P2G trading. There is no BESS income as there is no P2P energy sharing and therefore no buying and selling.

CHAPTER 4 RESULTS

4.1 CHAPTER OVERVIEW

The following chapter introduces the case study used to assess the three structure's models in Section 4.2. The simulation results are provided in Section 4.3 and Sections 4.3.1 – 4.3.3 for the ESP Owned BESS, User Owned BESS P2P and User Owned BESS P2G structures respectively. Lastly, the overall results are presented in Section 4.3.4.

4.2 CASE STUDY

An existing network from the Cornell University campus consisting of six buildings is considered for the following case study using historical building demand data [50]. Figure 4.1 shows the network consisting of six buildings linked to the utility at the PCC through the local substation. Each building, indicated with the letter "B" for its demand, contains a grid-tied solar PV system without a BESS and a half-hourly maximum demand as shown in Table 4.1. Excess power is fed back into the grid based on the public service enterprise group feed-in incentive [51]. The buildings energy expenses are managed separately according to the faculties responsible for the educational activities within. To reduce the networks energy costs with the least amount of investment, the proposed optimal BESS structures with P2P energy sharing will be investigated. For the ESP owned BESS structure, the BESS is connected to the ESN at the 1.7 MW rated bus-bar and at each building's incomer bus-bar for the User owned BESS P2P and User owned BESS P2G structures. A simulation operation period of 24 hours and time step length of 1 hour was used for the following simulations.

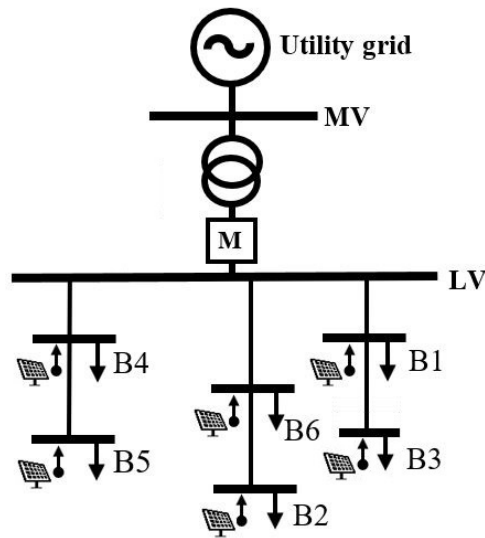

Figure 4.1. One-line diagram of the existing campus network.

Table 4.1. Campus network prosumer PV capacity and peak demand.

Prosumer	Solar Array Area (m^2)	Peak demand (kW)
Building 1	16000	847.34
Building 2	2800	148.53
Building 3	750	68.11
Building 4	1400	96.52
Building 5	1000	97.14
Building 6	5250	303.71

4.2.1 Load and solar PV profiles

Each building has different activities and different physical characteristics such as building size, design and age which leads to different demand profiles. The GHI data used in the solar PV model, Equation (3.3), was obtained from the U.S. Climate Reference Network Ithaca 13E NY weather station database [52] and the daily average obtained for 2017 as shown in Figure 4.2. Table 4.2 provides the different characteristics and the activities for each building which shows that the ESN consists of buildings with different floor areas, levels and activities within. The load demand data was used from the Cornell University buildings Energy Management and Control Systems platform [50]. The buildings' load, solar PV and net power profiles are shown in Figures 4.3 – 4.4, which are averaged from the annual quarter-hourly sampled demand data in 2017.

The energy consumption for the different sized buildings are shown in a load factor box and whisker plot in Figure 4.5. The buildings demands are concentrated around day time hours of 07h00 to 19h00 with peaks at 12h00 and 13h00. At the same time, Figure 4.5 also shows that there is variation in the different demand profiles, with large differences between the maximum and the minimum for the different hourly periods, with some showing outliers (red plus signs) during hours 12h00, 13h00 and 21h00. This variation provides more potential for P2P energy sharing.

Table 4.2. Campus network buildings' names and characteristics.

Building Number	Building Name	No. of floors	Floor Area (m^2)	Activities
1	Weill Hall	4	24155	Laboratories, offices, conference rooms, study centre and lecture halls.
2	Hollister Hall	4	10711	Laboratories, offices and lecture halls.
3	Campus Stores	1	3462	Two food retail stores and dining area.
4	Bailey Hall	2	4406	Auditorium with a capacity of 1324 people.
5	Schwartz Center for Performing Arts	2	10361	Offices, performing art spaces, proscenium theatre, and dance studio.
6	Plant Science	3	16030	Laboratories, offices and lecture halls

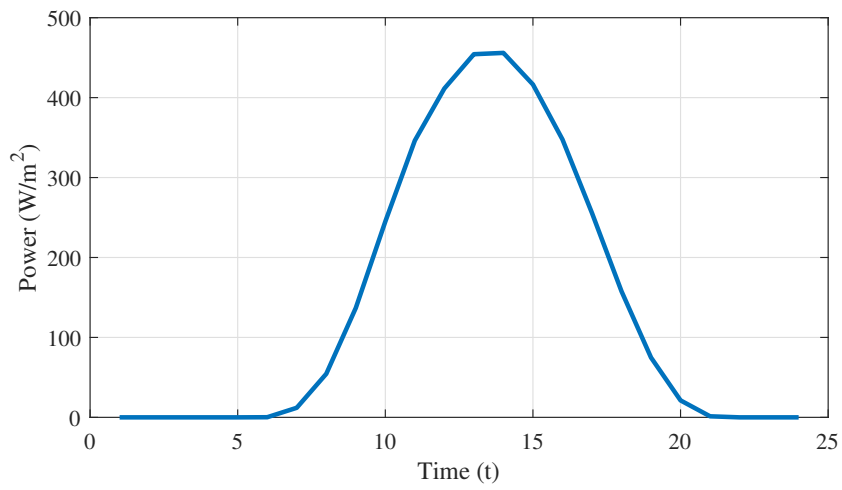

Figure 4.2. Daily average GHI for Ithaca, NY.

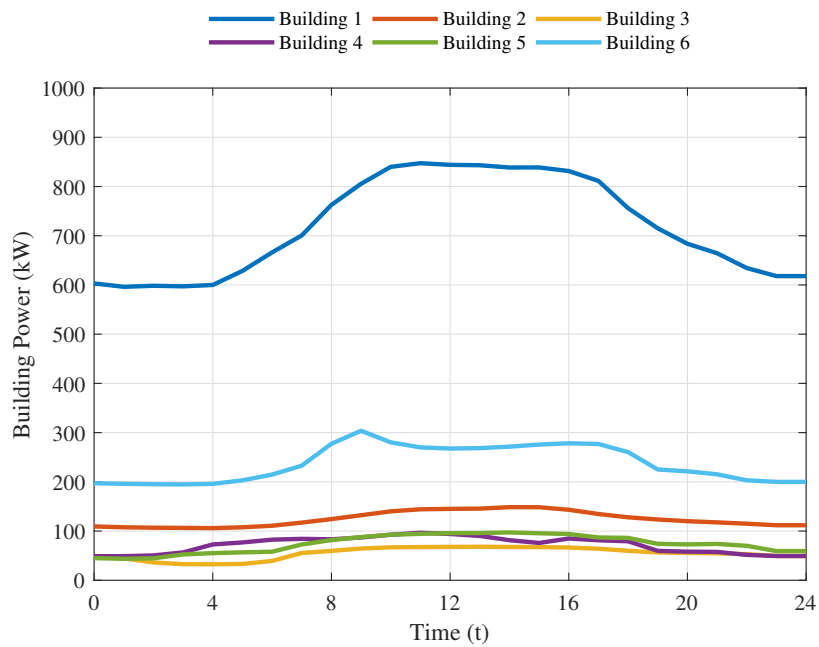

Figure 4.3. Energy sharing network buildings daily demand profiles.

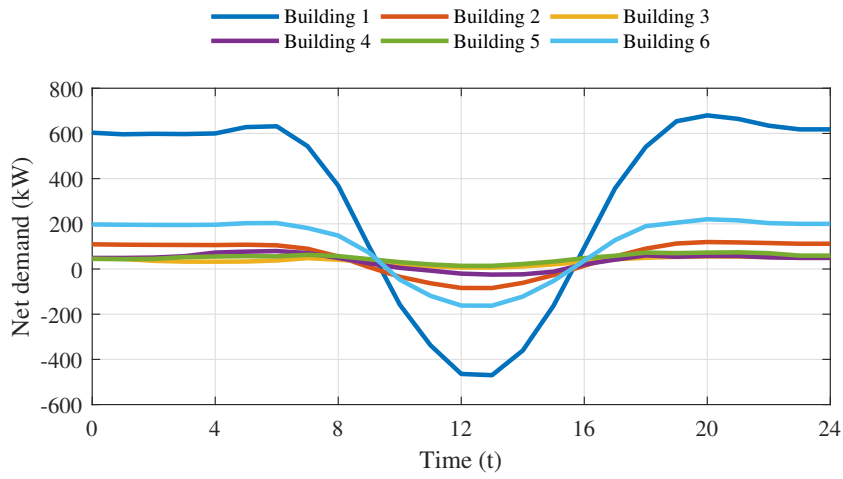

Figure 4.4. Energy sharing network buildings solar PV power and net demand.

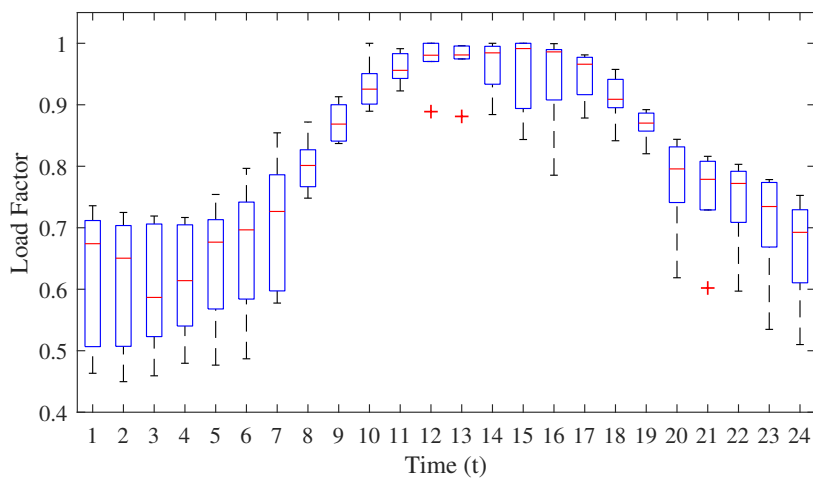

Figure 4.5. ESN prosumers load factor box and whisker plot.

4.2.2 Economic simulation parameters

The grid electricity is supplied from the national utility under the TOU tariff. The peak, standard and off-peak energy prices are \$0.31, \$0.2 and \$0.17 per kWh respectively, and a maximum demand price of \$6 and \$4 during peak and standard hours per kVA [53]. A power factor of unity was assumed for all the buildings within the ESN. The utility power feed-in tariff agreement was at a fixed price of \$0.1688 per kWh irrespective of time [51] and the compensating factor was ¢ 0.096, ¢ 2.496 and ¢ 14.12 for peak, standard and off-peak periods respectively. Table 4.3 shows the technical equipment parameters used in the case study model, with li-ion batteries being the choice for the energy storage and the life cycle of the li-ion batteries being 8 years based on the 80% DOD per day. For the energy storage and power conversion costs, 15% accounts for the procurement and construction costs [6].

Table 4.3. Input simulation parameters [6].

Parameter	Value	Unit
Li-ion storage cost	250	\$/kWh
Power conversion cost	300	\$/kW
Li-ion storage O&M cost	7.5	\$(kWh·year)
Power conversion O&M cost	6	\$(kW·year)
Li-ion storage life cycle	8	year
Solar PV panel efficiency	18	%
Discount rate	6	%
Energy escalation rate	3.5	%/year

Table 4.4. BESS operational parameters used in the simulation.

Parameter	Unit	Value
Maximum depth of discharge	80	%
Self-discharge rate	0.1	%/day
Round trip efficiency	95	%

4.2.3 Simulation Optimisation Algorithms

The simulation results obtained for the following case study were obtained using the MATLAB optimisation toolbox [54]. For the ESP owned BESS model, the multiple objective Genetic algorithm (*gamultiobj*) was used with the input setting parameters shown in Table 4.5, and an initial population of 50 randomly generated points that fall within the model constraints and the individual optimal variables of the two objective functions Equations (3.16) – (3.17). For the User owned BESS P2P and User owned BESS P2G structures, the constrained non-linear multi-variable function algorithm (*fmincon*) with the global search function was used, with the input setting parameters shown in Table 4.6.

Table 4.5. The ESP owned BESS structure multiple objective genetic algorithm (*gamultiobj*) settings.

Setting	User Owned P2P Value
Maximum Generations	3000
Creation Function	gacreationuniform
Constraint Tolerance	1×10^{-6}
Crossover Function	crossoverintermediate
Crossover Fraction	0.8
Function Tolerance	1×10^{-6}

Table 4.6. The User Owned BESS P2P and P2G structures global search non-linear programming solver (*fmincon*) settings.

Setting	User owned BESS P2P Value	User owned BESS P2G Value
Number of Trial Points	30000	30000
Maximum Iterations	100 000	100 000
Maximum Function Evaluations	inf	inf
Optimality Tolerance	1×10^{-6}	1×10^{-6}
Step Tolerance	1×10^{-6}	1×10^{-6}
Constraint Tolerance	1×10^{-6}	1×10^{-6}
Function Tolerance	1×10^{-6}	1×10^{-6}

4.3 CASE STUDY RESULTS

The results for the case study are shown in Figures 4.6 – 4.11 and Tables 4.7 – 4.9. For each structure simulation, the results are provided under each subsection. The three structures were compared against the P2G baseline for the energy saving benefits, which is the existing network setup without a BESS or P2P energy sharing. In the P2G baseline structure, all prosumers energy demand is bought directly from the grid and any excess solar PV energy is sold back to the utility. An additional simulation was undertaken with the optimal BESS sizing results of the User owned BESS P2P structure used in the User owned BESS P2G structure to obtain a better comparison of the two and emphasize the benefits of P2P energy sharing.

4.3.1 ESP Owned BESS with P2P Energy Sharing

Figure 4.6 shows the ESP BESS SOC and hourly charge and discharge for a 24-hour period. The bar plot shows that the BESS has two stages whereby charging and discharging occurs. Grid charging takes place during the off-peak grid periods when the energy price is low, seen within the green regions of Figure 4.6 and in Figure 4.14, and when there is excess community solar PV power during hours 12h00 to 16h00. This is when the prosumers' SDR is larger than one as seen in Figure 4.7, a plot of the community SDR against the time of day. Discharging occurs during peak grid demand periods when prices are high, seen within the red regions of the plot when the solar PV output power is low. The BESS SOC completes one full DOD cycle per day from its maximum SOC to the minimum.

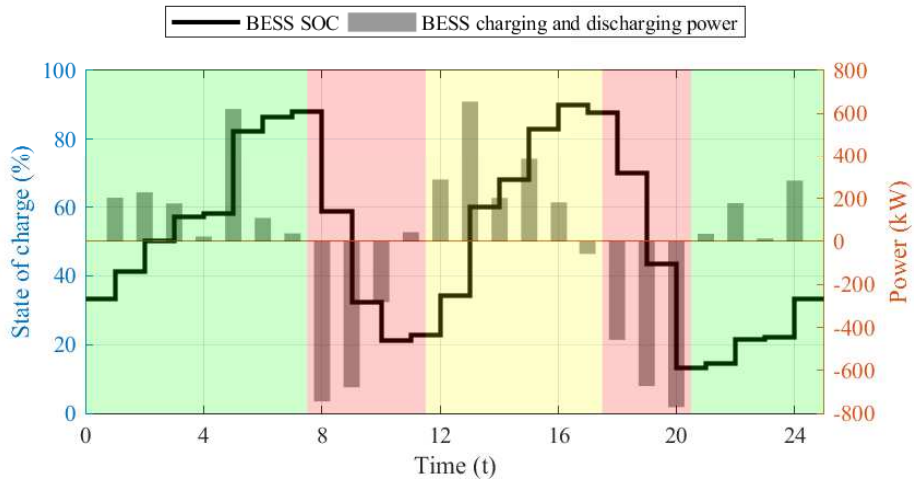

Figure 4.6. BESS SOC, charge and discharge power.

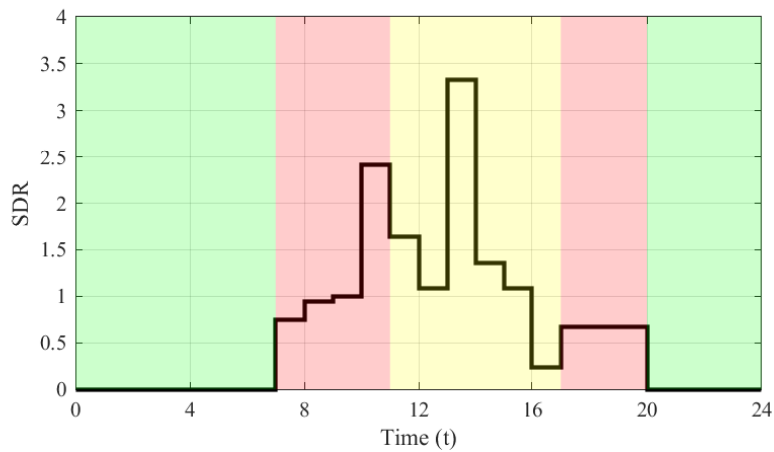

Figure 4.7. Energy sharing network SDR against time.

The internal ESN buying and selling energy price is shown in Figure 4.8. These prices are bounded by grid prices for each period, shown with horizontal dotted lines, and dashed lines for the utility feed-in price. During the peak and the standard periods, the internal buying price is reduced and energy selling price is increased because of the BESS discharging and charging power, reducing the prosumers energy costs and increasing their solar PV excess power income.

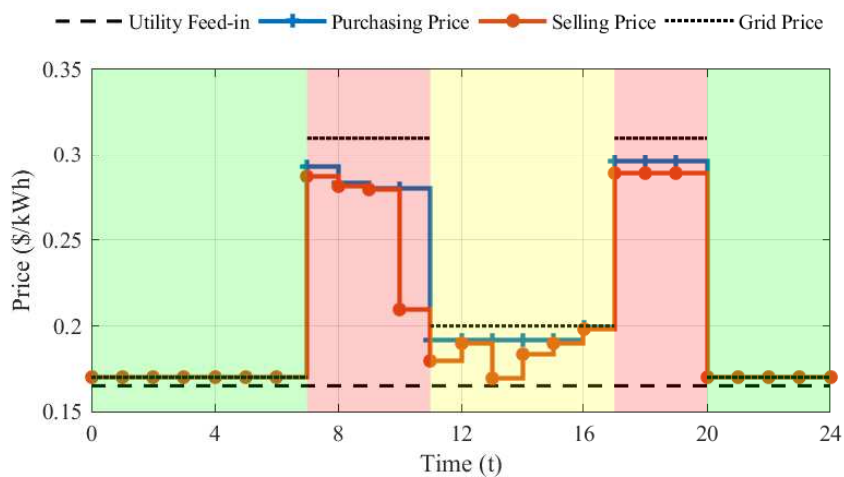

Figure 4.8. Energy sharing network internal energy price. Note the reduction of the internal buying price during the peak-periods.

The amount of P2P energy sharing, direct and indirect, is shown in Figure 4.9. It can be seen that the in-direct P2P energy sharing accounts for a larger portion than the direct sharing. The BESS charges during hours 11h00 to 16h00 and discharges that power during peak and standard periods, hours 17h00 to 20h00, with P2P indirect sharing. Figure 4.10 shows the BESS's daily power exchange with the ESN and Figure 4.11 its corresponding income generated. It can be seen that no power is exported to the grid from the BESS and is only imported during the off-peak periods. The BESS makes its income from buying power during off-peak grid periods and during excess PV power periods and then sells this power to the ESN during the peak grid periods. This helps reduce the ESN costs during the peak-periods by using the power from the peak solar PV power periods.

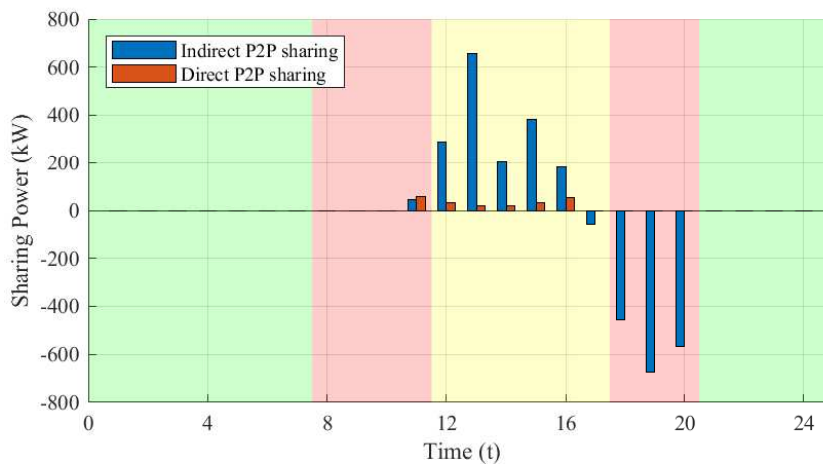

Figure 4.9. Energy sharing network direct versus indirect power sharing.

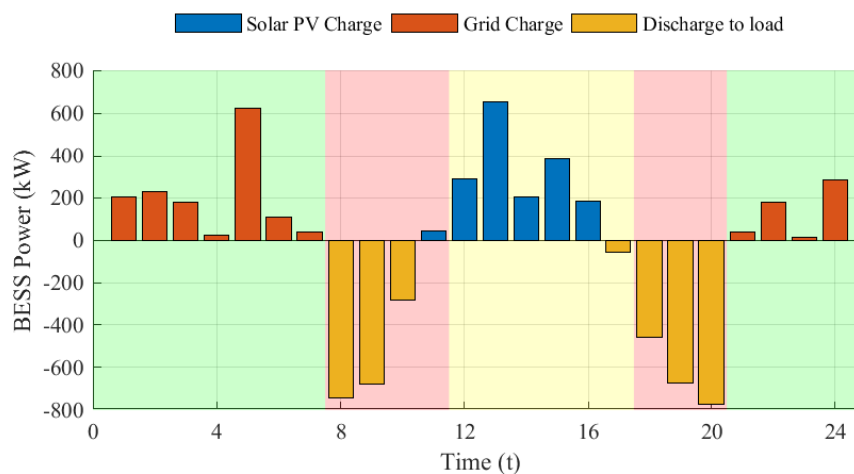

Figure 4.10. BESS power exchange with the ESN solar PV generation, grid and ESN demand.

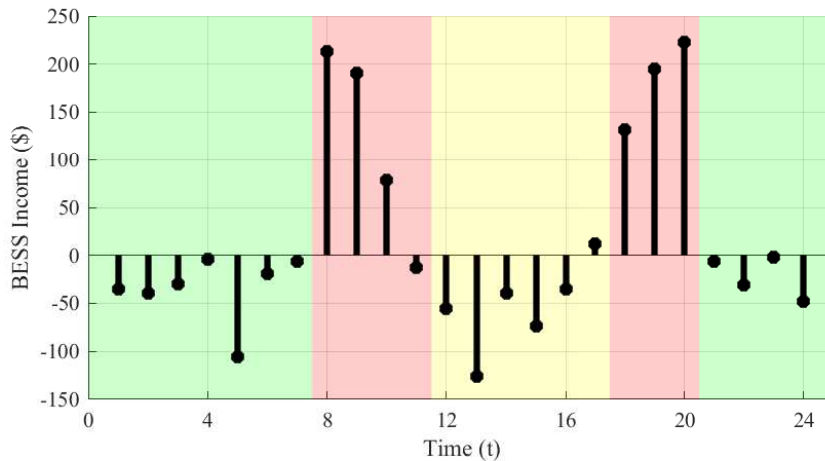

Figure 4.11. BESS income from the exchange of power in Figure 4.10.

The optimal results are from the median point of the multi-objective function Pareto front, giving equal benefits to the prosumers and the ESP. Figure 4.12 shows the plot of the Pareto front with an indication of the median point. Other points on the Pareto front may be considered based on the negotiations between the third-party ESP investor and the ESN prosumers. Figure 4.13 shows a three-dimensional plot of Pareto front with the BESS size.

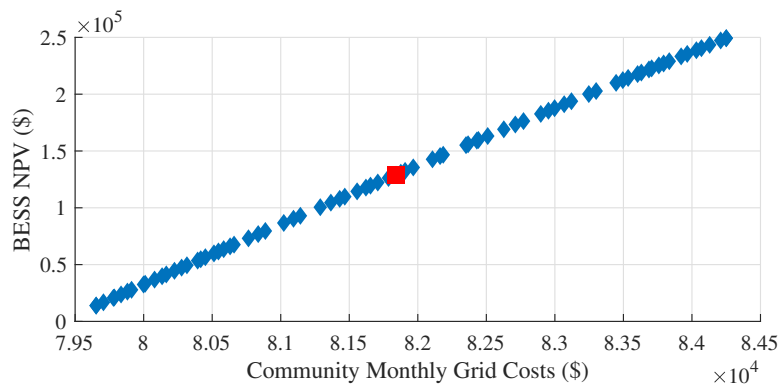

Figure 4.12. Plot showing the simulation Pareto front of community energy costs versus BESS NPV. Note the red square, which is the median point between the two objective functions.

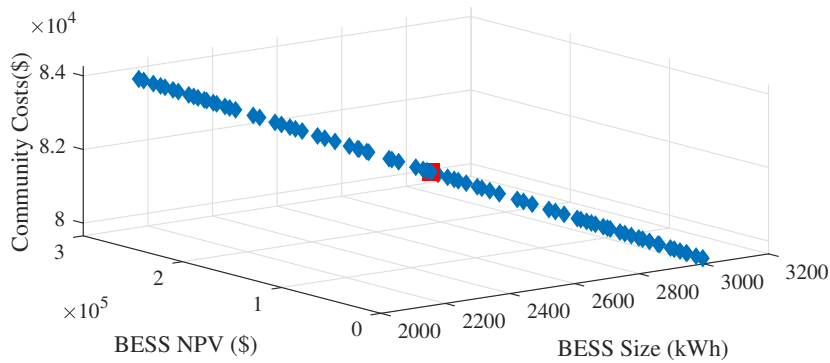

Figure 4.13. 3-D plot showing the linear relationship between the BESS size, BESS NPV and the community energy costs.

Figure 4.14 shows a plot of the community energy demand, the P2G baseline net power demand profile and the simulated ESP owned BESS structure net power demand profile with the BESS charging and discharging. During peak solar irradiance hours, power is still fed-back into the grid but is reduced by 61.7% compared with the P2G baseline. Figure 4.15 shows the corresponding grid costs associated with the ESP owned BESS demand profile. Note the reduction in costs during peak-periods compared to the off-peak periods. During the peak and standard periods, the power drawn from the grid is reduced on average by 41.45% and 40.43%, respectively, as observed in Fig. 4.14. This lowered the maximum demand costs of the community by 67.56%. During the off-peak periods, the peak grid power does increase because of the BESS grid charging, however, this does not negatively affect the maximum demand charges as it is out of the peak and standard periods.

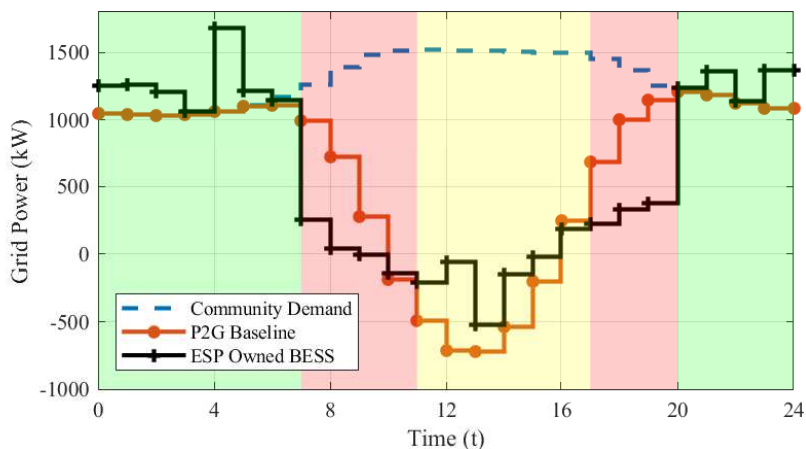

Figure 4.14. Community demand, P2G baseline and the ESP owned BESS structure demand profiles.

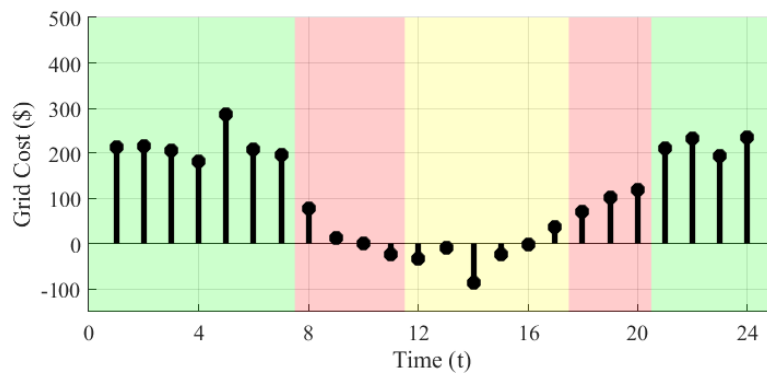

Figure 4.15. The ESN daily grid costs and income. Note the high costs during the TOU off-peak periods when the BESS charges from the grid.

4.3.2 User Owned BESS with P2P Energy Sharing

The User owned BESS P2P ESN grid demand profile is shown in Figure 4.16 against the ESN demand and P2G baseline demand profiles. The amount of power fed back into the grid reduced by 70% compared to the P2G baseline. Compared to the ESP owned BESS structure, this improved by 8.3%. This equates to more solar PV power generated being used within the ESN, increasing the self-sufficiency and self-consumption of the ESN. The ESN buying and selling energy price are shown in Figure 4.17. There is a large reduction in the internal buying price during peak-periods, providing the opportunity for prosumers to save.

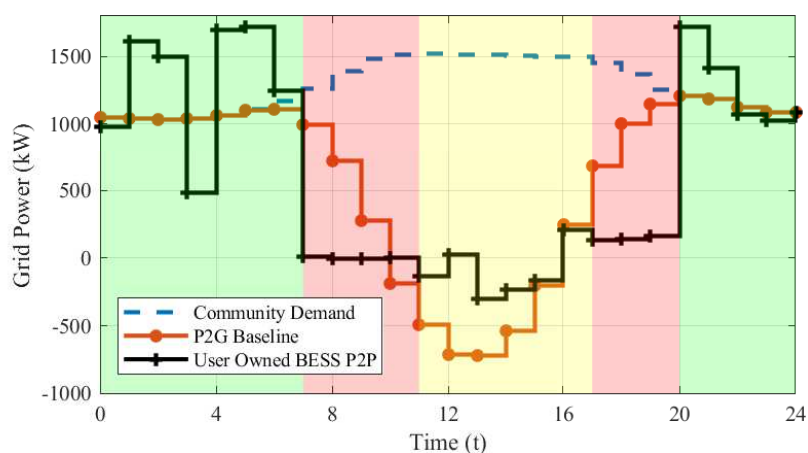

Figure 4.16. Community demand, P2G baseline and the User owned BESS P2P structure demand profiles.

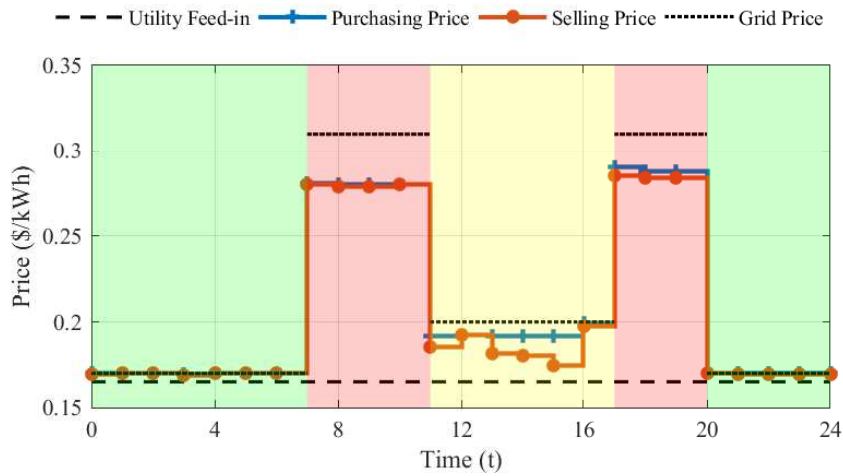

Figure 4.17. Energy sharing network internal energy price.

4.3.3 User Owned BESS with P2G Trading

The User owned BESS P2G ESN grid demand profile is shown in Figure 4.18. The amount of power fed back into the grid is reduced by 90% compared to the P2G baseline, the highest compared to the other structures. This confirms the increasing li-ion energy storage size for the three structures shown in Table 4.7. The User owned BESS P2G structure contains the largest li-ion energy storage, making it able to store more excess solar PV power.

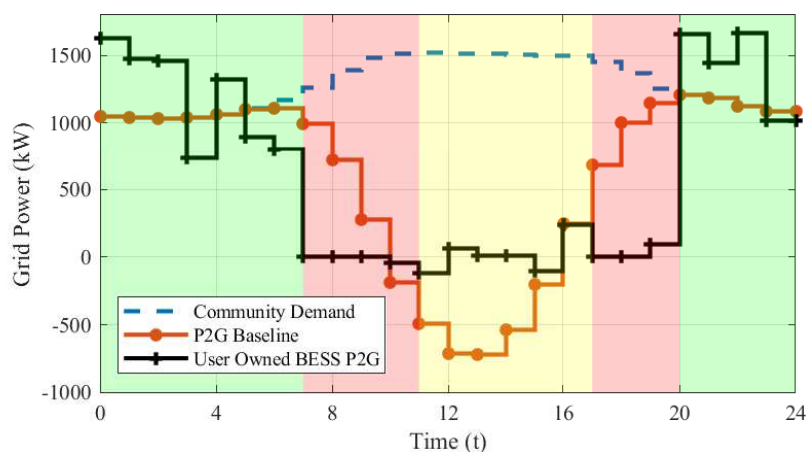

Figure 4.18. Community demand, P2G baseline and the User owned BESS P2G structure demand profiles.

4.3.4 BESSs Structures Results

Table 4.7 shows the optimal BESS parameters for the three structures, the ESN BESS project NPV and the ESN self-sufficiency and self-consumption for the four simulations. The ESN self-sufficiency measures the share of the community demand that is supplied by the communities local solar PV generation, which increases by 6.38%, 7.17% and 7.59% for the ESP owned BESS, User owned BESS P2P and the User owned BESS P2G structures respectively. The ESN self-consumption is the ratio between the net local solar PV energy consumed by the total amount of local solar PV power generated by the prosumers. This improved by 11.86%, 13.34% and 14.12% for the three structures. The project NPV in Table 4.7 accounts for all the total savings, benefits and costs associated with the deployment of BESSs with the P2P energy sharing for the respective structures.

Table 4.7. The different BESS structures li-ion sizes with corresponding conversion equipment and costs.

Structure	Li-ion Size (kWh)	Conversion Rating (kW)	Li-ion Cost (\$)	Conversion Cost (\$)	BESS Cost (\$)	Project NPV (\$)	Self-sufficiency (%)	Self-Consumption (%)
ESP Owned BESS	2552	828	\$638 076.09	\$248 382.84	\$886 458.93	\$1 149 307.33	50.24	93.44
User Owned BESS P2P	3096	985	\$773 945.88	\$295 544.91	\$1 069 490.76	\$1 397 770.04	51.03	94.92
User Owned BESS P2G (Optimised)	3447	1063	\$861 770.33	\$318 963.45	\$1 180 733.80	\$1 386 078.58	51.45	95.70
User Owned BESS P2G ¹	3096	985	\$773 945.88	\$295 544.91	\$1 069 490.76	\$965 780.51	50.03	93.91
P2G Baseline	-	-	-	-	-	-	43.86	81.58

Table 4.8 shows the three structures BESS incomes and monthly costs. The User owned BESS P2G structure does not contain a BESS monthly income because there is no internal energy price for the BESS to interact with the ESN. The energy cost billing is handled individually between the buildings and utility grid based on TOU tariff. The income for the User owned BESS P2P structure BESS is lower than the ESP owned BESS system although the net li-ion energy storage is larger as seen in Table 4.9. This is because the User owned BESS P2P structure maximises the BESS NPV based on the BESS income and the buildings' energy savings, therefore considering the buildings' energy demand. The ESP owned BESS structure maximises its NPV, which is based solely on the BESS income.

Table 4.8. Community BESS monthly income and costs.

Parameter	ESP Owned BESS	User Owned BESS P2P	User Owned BESS P2G
Monthly Income	\$12 918.72	\$11 543.63	-
Monthly Li-ion O&M Costs	\$1 595.19	\$1 934.86	\$2 154.43
Monthly Power Conversion O&M costs	\$413.97	\$492.57	\$531.61

Table 4.9 shows the four simulations BESS li-ion; sizes, investment costs and net energy savings. The structures achieved an average saving of 23.26%, 8.50% and 24.58% for the ESP owned BESS, User owned BESS P2P and the User owned BESS P2G structures respectively. The ESP owned BESS structure savings are a lot lower than the others however, there is no investment cost required by buildings as observed in the Table 4.9. The prosumers that benefited the least for the P2P structures, building 3 and 5, are the ones that contributed the least relative to their size in the ESN. The most beneficial buildings, achieved by building 4 for the User owned BESS P2P structure and building 2 for the ESP owned BESS structure, were the buildings that contributed the most power relative to their demand. These differences are 3.44% for the ESP owned BESS structure and 16.21% for the User owned BESS P2P structure. The differences are affected by numerous factors such as the amount of excess solar PV power, the building demand profile and the internal pricing model compensating factor.

The overall li-ion energy storage reduced by 26% and 10% for the ESP owned BESS and the User owned BESS P2P structures respectively, compared to the User owned BESS P2G structure. The results for building 4's li-ion size increased compared to the User owned BESS P2G structure, giving it a larger saving, because no specific constraint was implemented on the individual building li-ion sizes. For the realisation of the User owned BESS P2P structure, the ESN building owners could engage amongst themselves their desired li-ion size investments based on their financial capacity and interests. A consensus can then be reached based on the individual desired li-ion size that would maximise the ESN BESS deployment.

Table 4.9. Building's (Bx) and the total community (Com) simulation optimal li-ion sizes, costs and savings.

ESP Owned BESS			User Owned BESS P2P			User Owned BESS P2G (Optimised)			User Owned BESS P2G ^a		
Li-ion Size (kWh)	Investment (\$)	Energy Cost Saving (%)	Li-ion Size (kWh)	Investment (\$)	Energy Cost Saving (%)	Li-ion Size (kWh)	Investment (\$)	Energy Cost Saving (%)	Li-ion Size (kWh)	Investment (\$)	Energy Cost Saving (%)
B1	-	9.86	1700	\$553	26.91	1860	\$642	26.82	1700	\$642	22.03
B2	-	10.06	232	\$85 938.73	26.12	311	\$108	26.19	232	\$108	21.89
B3	-	6.62	100	\$36 999.94	15.11	176	\$58 712.57	20.54	100	\$58 712.57	10.63
B4	-	8.07	464	\$171	31.32	207	\$70 695.56	25.69	464	\$70 695.56	27.76
B5	-	6.63	200	\$74 001.10	16.79	242	\$80 922.11	20.16	200	\$80 922.11	17.29
B6	-	9.79	400	\$148	23.35	651	\$219	28.10	400	\$219	19.76
ESP	2552	\$886	-	-	-	-	626.80	-	-	626.80	-
Com.	2552	\$886	3096	\$1 069	23.26	3447	\$1 180	24.58	3096	\$1 069	19.90
		458.93		490.76			733.80			490.76	

^aUser Owned BESS P2G structure with User Owned BESS P2P BESS Sizes

CHAPTER 5 DISCUSSION

5.1 CHAPTER OVERVIEW

This chapter analyses and discusses the university campus network case study simulation results and the observations for the ESP Owned BESS structure in Section 5.2, the P2P energy sharing and optimal sizing in Section 5.3 and the BESS design optimisation in Section 5.4.

5.2 ESP OWNED BESS WITH P2P ENERGY SHARING STRUCTURE

The community savings for the proposed ESP owned BESS model are less than the two other structures and other similar studies [3,4], one saving as much as 31% [38], because of the benefits being split between the ESN prosumers and the third-party ESP. However, the benefit of the split structure is that prosumers require no investment to achieve their savings. The distribution of benefits amongst the prosumers within the ESN may still be further improved with the difference of only 3.44% between the highest contributor and the lowest. This may be achieved by finding an optimal compensating factor that would provide a better distribution based on the prosumers contribution towards P2P energy sharing. Nevertheless, this compensating factor should pay particular attention in finding a balance between benefiting those who contribute with excess power and at same time keeping low contributing prosumers interested in joining the ESN. More significant benefits of up to 20% could be achieved should the li-ion energy storage cost fall to \$150/kWh by 2025 as predicted [6]. With an average saving of 8.50% for the ESN prosumers and a NPV of \$129 078.77 for the ESP, the proposed ESP owned BESS sizing model realises a self-sufficient BESS that significantly benefits both parties without the requirement for any incentives. This demonstrates that there is potential in P2P energy

sharing structures that incorporates a third-party ESP BESS investor.

5.3 P2P ENERGY SHARING AND OPTIMAL SIZING INTERACTION

The interaction between the BESS optimal sizing with 1) the BESS NPV, 2) the community savings and 3) the total P2P energy sharing are shown in Figures 5.1 – 5.2. An approximate linear relationship is observed showing that the larger the BESS, the more P2P energy sharing flexibility is available, increasing the prosumers operational energy benefits. However, increasing the BESS size, decreases the BESS NPV and could possibly make it infeasible. Therefore, a trade-off exists between a larger and more P2P flexible BESS, and a smaller, more economically feasible BESS.

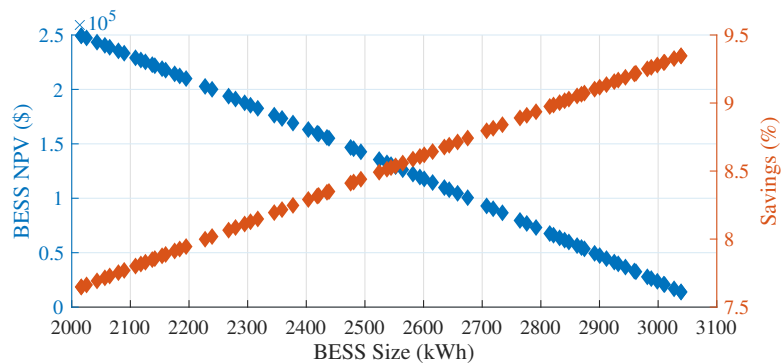

Figure 5.1. BESS size against the BESS NPV and the community energy savings showing an approximate linear interaction.

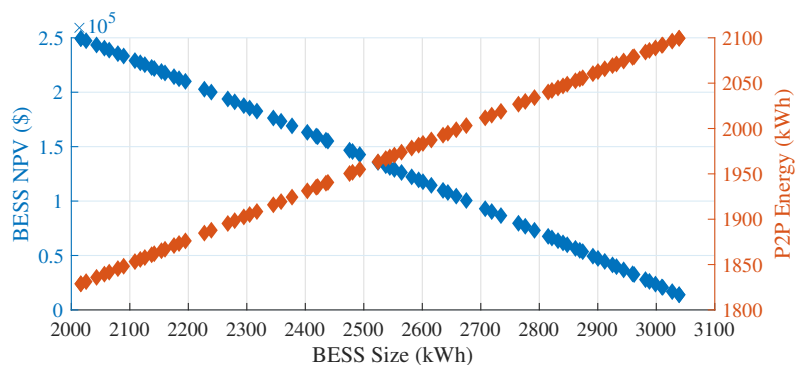

Figure 5.2. BESS size against the BESS NPV and the amount of P2P energy sharing within the ESN.

5.4 BESS DESIGN OPTIMISATIONS

Of the three BESS structures, the User owned BESS structure with P2P energy sharing achieved the greatest NPV of \$1 397 770.04. When comparing the size of the li-ion energy storages in comparison to the NPV for all parties within the ESN, the User owned P2P structure is most beneficial. It achieves an average saving of 23.26%, a mere 1.32% short of the User owned P2G structure but reduces the BESS investment cost and li-ion size by 10%. These results are achieved by implementing energy sharing and emphasises the extent of the achievable benefits with P2P energy sharing.

The optimised User owned BESS with P2G trading achieved the most energy savings with an average of 24.58%. However, it also requires the largest li-ion energy storage and upfront investment cost. For a better comparison of the community total energy saving, li-ion batteries of the same size as the User owned BESS P2P structure were used in the P2G structure as shown in Table 4.9 under the heading *UserOwnedBESSP2G*. The results show that for the same size BESS, the User owned BESS P2P structure has a great saving and NPV of 5% and \$431 989.53 respectively.

The BESS structures achieved solar PV energy self-consumption improvements of almost double that compared to self-sufficiency as shown in Table 4.7 and discussed in Section 4.3.4. This shows that the BESS deployment along with the P2P energy sharing is a larger contributor to consuming excess solar PV power from the ESN than decreasing the ESN's dependence on the grid. The self-sufficiency does not improve as much because of the BESS grid charging and discharging demand response that takes place.

5.5 SENSITIVITY ANALYSIS

A sensitivity analysis was performed to investigate the influence of PV penetration, feed-in tariff, number of prosumers and demand profile on the optimal BESS sizing under different ownership structures. Figure 5.3 shows that the BESS sizes for the three structures is decreasing as the PV penetration is increasing. This occurs because a larger battery size is required to charge during the morning off-peak period than using excess power during peak solar generation periods. The power demands of building 2, 5 and 6 are iteratively changed to the residential profiles, shown in Figure 4.3, to investigate the influence of profile changes on BESS sizes. The results in Figure 5.6 show that both the user owned BESS sizes increased because of the peak demands falling outside the peak solar PV generation periods. The ESP owned BESS reduced in size because more direct P2P energy sharing is possible with the increased variation in profiles. This makes it less viable for the ESP to invest in a larger BESS.

Figure 5.4 shows the BESS size against feed-in price. The ESP owned BESS structure increases in size with an increase in feed-in tariff price because of the feed-in price becoming greater than the purchase price. This makes it viable for the ESP to sell energy back to grid during standard periods using energy from off-peak periods. Figure 5.5 shows that the more prosumers within the community the larger the li-ion size. Comparing the three structures, the user owned BESS with P2G trading has a larger change in size because it is not able to take advantage of P2P energy sharing to reduce its size with increasing number of prosumers.

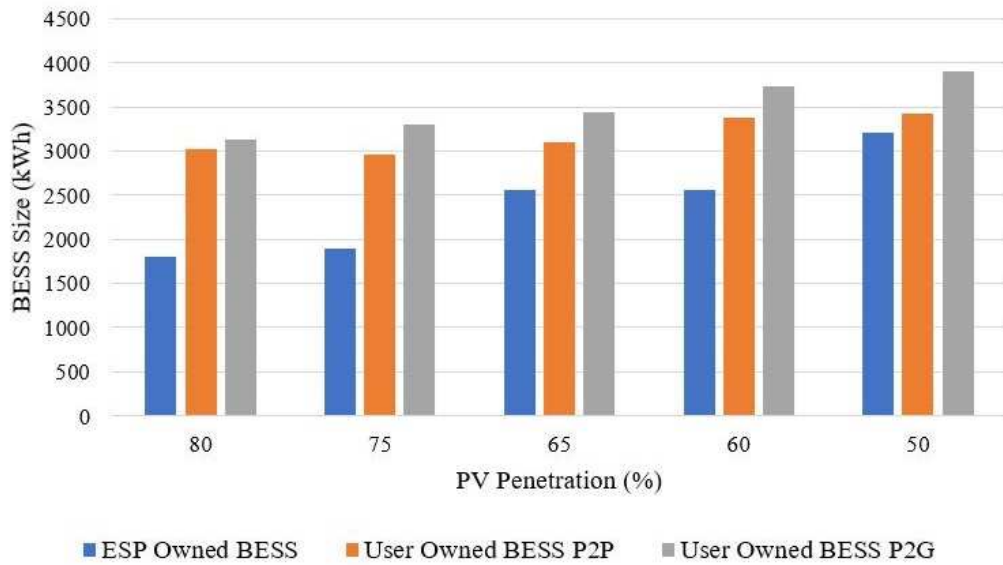

Figure 5.3. BESS size against PV penetration percentage of the community base demand.

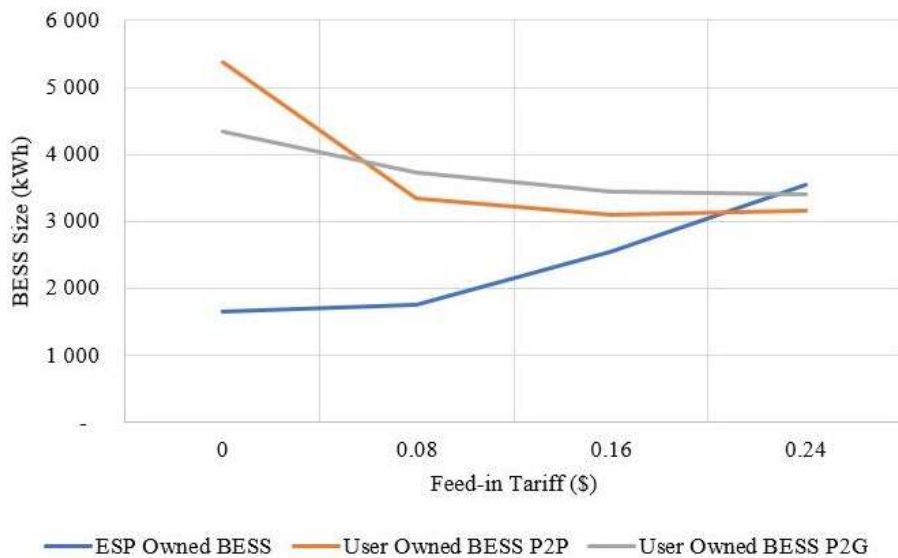

Figure 5.4. BESS size versus feed-in price.

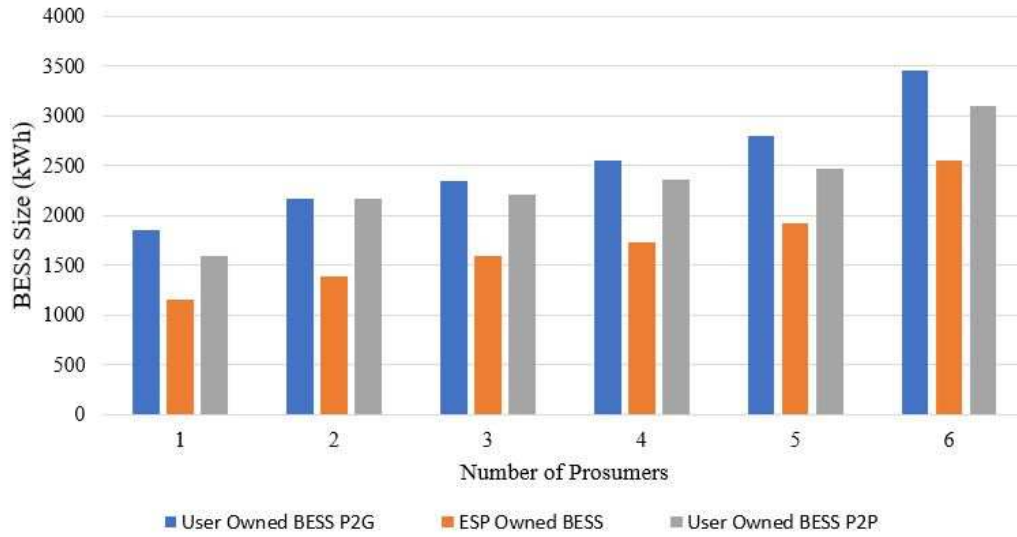

Figure 5.5. BESS size versus number of prosumers within a community.

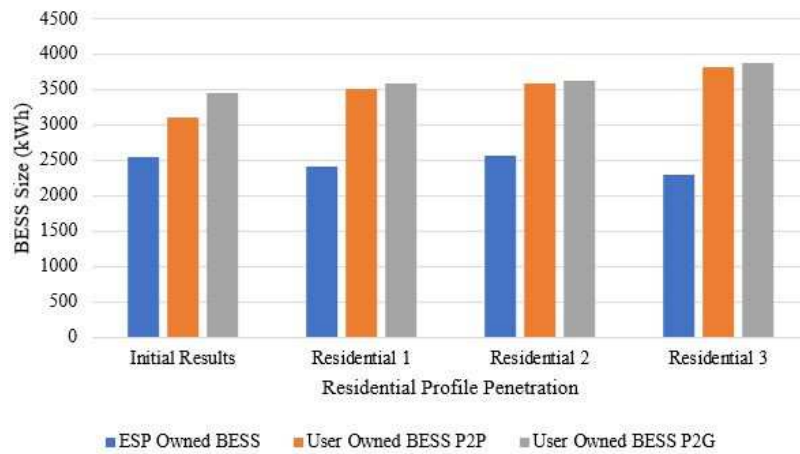

Figure 5.6. BESS size with 3 residential user profiles.

CHAPTER 6 CONCLUSION

6.1 SUMMARY

This study investigates optimally deployed battery energy storage within a P2P energy sharing network considering different ownership structures by comparing three different ownership structures and proposing an optimal BESS sizing multi-objective optimisation model for a centralised energy storage owned and coordinated by a third-party ESP.

The study found that the P2P structures are more economically beneficial as they achieved greater NPVs in comparison to their BESS size. The most desirable BESS ownership structure, with the greatest NPV, is the User owned BESS structure with P2P energy sharing. However, that is assuming that all prosumers are willing and financially capable of investing in a BESS. The ESP owned structure was found to be less economically beneficial, but provided the opportunity for prosumers to engage in P2P energy sharing and reduce their energy costs without a BESS investment cost. Moreover, the study showed the approximate linear interaction between the ESP lithium battery energy storage sizing and the P2P energy sharing for a solar PV ESN under the TOU tariff.

6.2 RECOMMENDATIONS FOR FUTURE WORK

In order to further develop the BESS structures with P2P energy sharing and realise their implementation and operation, future work could include:

- scaled up simulations to include larger number of prosumers within a P2P network,
- a power flow analysis to confirm the power distribution within the university campus,
- improvements to the distribution of benefits for the proposed ESP owned BESS model, and
- the investigation into the influence of different grid tariffs on the optimal BESS sizing within P2P ESNs.

REFERENCES

- [1] J. Hamari, M. Sjöklint, and A. Ukkonen, “The sharing economy: Why people participate in collaborative consumption,” *Journal of the Association for Information Science and Technology*, vol. 67, no. 9, pp. 2047–2059, 2016.
- [2] N. Liu, M. Cheng, X. Yu, J. Zhong, and J. Lei, “Energy sharing provider for PV prosumer clusters: A hybrid approach using stochastic programming and Stackelberg game,” *IEEE Transactions on Industrial Electronics*, vol. 65, no. 8, pp. 6740–6750, 2018.
- [3] C. Long, J. Wu, Y. Zhou, and N. Jenkins, “Peer-to-peer energy sharing through a two-stage aggregated battery control in a community microgrid,” *Applied Energy*, vol. 226, pp. 261–276, 2018.
- [4] S. Nguyen, W. Peng, P. Sokolowski, D. Alahakoon, and X. Yu, “Optimizing rooftop photovoltaic distributed generation with battery storage for peer-to-peer energy trading,” *Applied Energy*, vol. 228, pp. 2567–2580, 2018.
- [5] N. Liu, X. Yu, C. Wang, C. Li, L. Ma, and J. Lei, “Energy-sharing model with price-based demand response for microgrids of peer-to-peer prosumers,” *IEEE Transactions on Power Systems*, vol. 32, no. 5, pp. 3569–3583, 2017.
- [6] S. E. S. Parsons, Energy & Environmental Economics Inc, “South Africa energy storage technology and market assessment,” 1000 Wilson Boulevard, Arlington, VA 22209-3901, Tech. Rep. 640368, 3 2017.

REFERENCES

- [7] U.S. Energy Information Administration, “Eia-860 annual electric generators report,” 2016. [Online], <https://www.eia.gov/electricity/data.php/revenue/>. [Accessed: 22- Jan- 2018].
- [8] R. Luthander, J. Widén, D. Nilsson, and J. Palm, “Photovoltaic self-consumption in buildings: A review,” *Applied Energy*, vol. 142, pp. 80–94, 2015.
- [9] H. Pandžić, “Optimal battery energy storage investment in buildings,” *Energy and Buildings*, vol. 175, pp. 189–198, 2018.
- [10] T. AlSkaif, M. G. Zapata, and B. Bellalta, “A reputation-based centralized energy allocation mechanism for microgrids,” in *2015 IEEE International Conference on Smart Grid Communications (SmartGridComm)*. IEEE, 2015, pp. 416–421.
- [11] C. Zhang, J. Wu, Y. Zhou, M. Cheng, and C. Long, “Peer-to-peer energy trading in a microgrid,” *Applied Energy*, vol. 220, pp. 1–12, 2018.
- [12] I. S. Bayram, M. Abdallah, A. Tajer, and K. A. Qaraqe, “A stochastic sizing approach for sharing-based energy storage applications,” *IEEE Transactions on Smart Grid*, vol. 8, no. 3, pp. 1075–1084, 2017.
- [13] I. Vigna, R. Perneti, W. Pasut, and R. Lollini, “New domain for promoting energy efficiency: Energy flexible building cluster,” *Sustainable Cities and Society*, vol. 38, pp. 526–533, 2018.
- [14] R. Dai and H. Charkhgard, “Bi-objective mixed integer linear programming for managing building clusters with a shared electrical energy storage,” *Computers & Operations Research*, vol. 96, pp. 173–187, 2018.
- [15] A. Taşçıkaraoğlu, “Economic and operational benefits of energy storage sharing for a neighborhood of prosumers in a dynamic pricing environment,” *Sustainable Cities and Society*, vol. 38, pp. 219–229, 2018.
- [16] T. AlSkaif, A. C. Luna, M. G. Zapata, J. M. Guerrero, and B. Bellalta, “Reputation-based joint scheduling of households appliances and storage in a microgrid with a shared battery,” *Energy*

REFERENCES

- and Buildings*, vol. 138, pp. 228–239, 2017.
- [17] W. Tushar, B. Chai, C. Yuen, S. Huang, D. B. Smith, H. V. Poor, and Z. Yang, “Energy storage sharing in smart grid: A modified auction-based approach,” *IEEE Transactions on Smart Grid*, vol. 7, no. 3, pp. 1462–1475, 2016.
- [18] C. Long, J. Wu, C. Zhang, L. Thomas, M. Cheng, and N. Jenkins, “Peer-to-peer energy trading in a community microgrid,” in *Power and Energy Society General Meeting, 2017 IEEE*. IEEE, 2017, pp. 1–5.
- [19] N. Liu, X. Yu, C. Wang, and J. Wang, “Energy sharing management for microgrids with PV prosumers: A Stackelberg game approach,” *IEEE Transactions on Industrial Informatics*, vol. 13, pp. 1088–1098, 2017.
- [20] I. Alsaidan, A. Khodaei, and W. Gao, “A comprehensive battery energy storage optimal sizing model for microgrid applications,” *IEEE Transactions on Power Systems*, vol. 33, no. 4, pp. 3968–3980, 2018.
- [21] Y. Yang, S. Bremner, C. Menictas, and M. Kay, “Battery energy storage system size determination in renewable energy systems: A review,” *Renewable and Sustainable Energy Reviews*, vol. 91, pp. 109–125, 2018.
- [22] C. Zhang, J. Wu, C. Long, and M. Cheng, “Review of existing peer-to-peer energy trading projects,” *Energy Procedia*, vol. 105, pp. 2563–2568, 2017.
- [23] Y. Liu, L. Wu, and J. Li, “Peer-to-peer (P2P) electricity trading in distribution systems of the future,” *The Electricity Journal*, vol. 32, no. 4, pp. 2–6, 2019.
- [24] M. Aneke and M. Wang, “Energy storage technologies and real life applications—a state of the art review,” *Applied Energy*, vol. 179, pp. 350–377, 2016.
- [25] M. Li, J. Lu, Z. Chen, and K. Amine, “30 years of lithium-ion batteries,” *Advanced Materials*, vol. 30, no. 33, p. 1800561, 2018.

REFERENCES

- [26] Y. Zhou, J. Wu, and C. Long, "Evaluation of peer-to-peer energy sharing mechanisms based on a multi-agent simulation framework," *Applied Energy*, vol. 222, pp. 993–1022, 2018.
- [27] H. Wang and J. Huang, "Incentivizing energy trading for interconnected microgrids," *IEEE Transactions on Smart Grid*, vol. 9, no. 4, pp. 2647–2657, 2016.
- [28] W. Tushar, C. Yuen, D. B. Smith, and H. V. Poor, "Price discrimination for energy trading in smart grid: A game theoretic approach," *IEEE Transactions on Smart Grid*, vol. 8, no. 4, pp. 1790–1801, 2017.
- [29] S. Cui, Y.-W. Wang, and N. Liu, "Distributed game-based pricing strategy for energy sharing in microgrid with PV prosumers," *IET Renewable Power Generation*, vol. 12, no. 3, pp. 380–388, 2017.
- [30] W. Tushar, T. K. Saha, C. Yuen, P. Liddell, R. Bean, and H. V. Poor, "Peer-to-peer energy trading with sustainable user participation: A game theoretic approach," *IEEE Access*, vol. 6, pp. 62 932–62 943, 2018.
- [31] P. Shamsi, H. Xie, A. Longe, and J.-Y. Joo, "Economic dispatch for an agent-based community microgrid," *IEEE Transactions on Smart Grid*, vol. 7, no. 5, pp. 2317–2324, 2016.
- [32] D. Wang, J. Qiu, L. Reedman, K. Meng, and L. L. Lai, "Two-stage energy management for networked microgrids with high renewable penetration," *Applied Energy*, vol. 226, pp. 39–48, 2018.
- [33] T. Morstyn, A. Teytelboym, and M. D. McCulloch, "Bilateral contract networks for peer-to-peer energy trading," *IEEE Transactions on Smart Grid*, vol. 10, no. 2, pp. 2026–2035, 2018.
- [34] E. Mengelkamp, J. Gärttner, K. Rock, S. Kessler, L. Orsini, and C. Weinhardt, "Designing microgrid energy markets: A case study: The Brooklyn Microgrid," *Applied Energy*, vol. 210, pp. 870–880, 2018.

REFERENCES

- [35] Z. Li, S. Bahramirad, A. Paaso, M. Yan, and M. Shahidehpour, "Blockchain for decentralized transactive energy management system in networked microgrids," *The Electricity Journal*, vol. 32, no. 4, pp. 58–72, 2019.
- [36] Y. Li, W. Yang, P. He, C. Chen, and X. Wang, "Design and management of a distributed hybrid energy system through smart contract and blockchain," *Applied Energy*, vol. 248, pp. 390–405, 2019.
- [37] S. Wang, A. F. Taha, J. Wang, K. Kvaternik, and A. Hahn, "Energy crowdsourcing and peer-to-peer energy trading in blockchain-enabled smart grids," *arXiv preprint arXiv:1901.02390*, 2019.
- [38] A. Lüth, J. M. Zepter, P. C. del Granado, and R. Egging, "Local electricity market designs for peer-to-peer trading: The role of battery flexibility," *Applied Energy*, vol. 229, pp. 1233–1243, 2018.
- [39] B. Cornélusse, I. Savelli, S. Paoletti, A. Giannitrapani, and A. Vicino, "A community microgrid architecture with an internal local market," *Applied Energy*, vol. 242, pp. 547–560, 2019.
- [40] J. Wang, H. Zhong, C. Wu, E. Du, Q. Xia, and C. Kang, "Incentivizing distributed energy resource aggregation in energy and capacity markets: An energy sharing scheme and mechanism design," *Applied Energy*, vol. 252, p. 113471, 2019.
- [41] T. Morstyn and M. McCulloch, "Multi-class energy management for peer-to-peer energy trading driven by prosumer preferences," *IEEE Transactions on Power Systems*, 2018.
- [42] C. Chen, S. Duan, T. Cai, B. Liu, and G. Hu, "Optimal allocation and economic analysis of energy storage system in microgrids," *IEEE Transactions on Power Electronics*, vol. 26, no. 10, pp. 2762–2773, 2011.
- [43] H. Khorramdel, J. Aghaei, B. Khorramdel, and P. Siano, "Optimal battery sizing in microgrids using probabilistic unit commitment." *IEEE Transactions on Industrial Informatics*, vol. 12, no. 2, pp. 834–843, 2016.

REFERENCES

- [44] C. Shang, D. Srinivasan, and T. Reindl, “An improved particle swarm optimisation algorithm applied to battery sizing for stand-alone hybrid power systems,” *International Journal of Electrical Power & Energy Systems*, vol. 74, pp. 104–117, 2016.
- [45] Y. Yang, H. Li, A. Aichhorn, J. Zheng, and M. Greenleaf, “Sizing strategy of distributed battery storage system with high penetration of photovoltaic for voltage regulation and peak load shaving,” *IEEE Transactions on Smart Grid*, vol. 5, no. 2, pp. 982–991, 2013.
- [46] S. Wen, H. Lan, Q. Fu, C. Y. David, and L. Zhang, “Economic allocation for energy storage system considering wind power distribution,” *IEEE Transactions on Power Systems*, vol. 30, no. 2, pp. 644–652, 2015.
- [47] J. Sardi, N. Mithulananthan, M. Gallagher, and D. Q. Hung, “Multiple community energy storage planning in distribution networks using a cost-benefit analysis,” *Applied Energy*, vol. 190, pp. 453–463, 2017.
- [48] K. Abdulla, J. De Hoog, V. Muenzel, F. Suits, K. Steer, A. Wirth, and S. Halgamuge, “Optimal operation of energy storage systems considering forecasts and battery degradation,” *IEEE Transactions on Smart Grid*, vol. 9, no. 3, pp. 2086–2096, 2016.
- [49] O. Talent and H. Du, “Optimal sizing and energy scheduling of photovoltaic-battery systems under different tariff structures,” *Renewable Energy*, vol. 129, pp. 513–526, 2018.
- [50] Cornell University Facilities Services Energy and Sustainability, “Real time building utility use data,” 2012. [Online], <http://portal.emcs.cornell.edu/>. [Accessed: 10- Feb- 2018].
- [51] National Renewable Energy Laboratory, “Midmarket solar policies in the United States/New York,” 2019. [Online], <https://www.nrel.gov/solar/rps/ny>. [Accessed: 5- Jul- 2018].
- [52] National Centers for Environmental Information, “U.S. climate reference network (USCRN),” 2015. [Online], <https://www.ncdc.noaa.gov/data-access/land-based-station-data/land-based-datasets/us-climate-reference-network-uscrn>. [Accessed: 23- May- 2018].

REFERENCES

- [53] New York State Tariffs, “National Grid U.S.” [Online], <https://www.nationalgridus.com>. [Accessed: 23- May- 2018].
- [54] MATLAB and Optimization Toolbox Release 2017b, The MathWorks, Inc, Natick, Massachusetts, United States.