

M E M O R Y S C A P E

Reconciling Everyday City Dwellers' Memory with Pretoria's Heritage Narrative



by: GISELLE IVY FOURIE

GISELLE IVY FOURIE

2019

Study leader: Arthur Barker
Course co-ordinator: Arthur Barker

Submitted in fulfilment of part of the requirements for the degree Master of Architecture (Professional)

Department of Architecture
Faculty of Engineering, Built Environment and Information Technology (EBIT)
University of Pretoria

PROJECT SUMMARY

Dissertation title

Memoryscape: Reconciling Everyday City Dwellers' Memory with Pretoria's Heritage Narrative

Programme

Museum, Living Archive & Forum Theatre

Site description

An abandoned building site occupying the South-eastern corner of the Sammy Marks Development block in the Pretoria City Centre.

Clients

Department of Arts and Culture- Ditsong Museums
South African Heritage Archives (SAHA)
Oral Histories Association of South Africa (OHASA).

Users

Citizens of Tshwane, Performers, small businesses, SAHA, OHASA, Ditsong employees and Tourists

Site

Erf 3433, Pretoria City Centre
c/o Sisulu (Prinsloo) & Helen Joseph (Church) Street, Pretoria City Centre, Pretoria, South Africa
25° 44' 44.92"S
28° 11' 32.22"E

Research field

Heritage and Cultural Landscapes (HCL)

Edited by:
Stephanie van Niekerk

THANK YOU

My loving family and friends,
for your constant love,
support and belief in me.
I could not have done
this year without you.

Professor Arthur Barker,
for your commitment and
belief in me as a designer,
for inspiring and guiding
me every step of the way.

My fellow fledglings,
my team mates,
for all of the advice,
support and chats shared
over countless cups of coffee-
for becoming friends for life.

The gift of Music,
for energising me
through the late nights.

My Heavenly Father,
for the blessing to be
Your hands and feet
on this earth, for leading me
through this dissertation
each step of the way.
I am in awe of Your Grace.
May Your will be done.

ABSTRACT

MEMORYSCAPE

Reconciling Everyday City Dwellers' Memory with Pretoria's Heritage Narrative

/

Submitted to the Faculty of Engineering, Built Environment and Information Technology (EBIT) in fulfilment of part of the requirements of the degree Magister in Architecture (Professional), MArch (Prof).

Department of Architecture,
University of Pretoria 2019.

In accordance with Regulation 4(e) of the General Regulations (G. 57) for dissertations and theses I, Giselle Ivy Fourie, declare that this thesis, which I hereby submit for the degree of Master of Architecture (Professional) at the University of Pretoria, is my own work and has not previously been submitted by me for a degree at this or any other tertiary institution.

I further declare that this thesis is substantially my own work. Where reference is made to the works of others, the extent to which that work has been used is indicated and fully acknowledged in the text and the list of references.

Giselle Ivy Fourie

Museums, much like any other historical establishment, reflect the perspectives or bias of the people who created them (South African Heritage Online, 2011).

The socio-spatial contribution of museums in the City of Pretoria (Tshwane) has diminished significantly. Existing museums are not fully integrated or engaged with their physical, social, political, or historical contexts and, as a result, are not freely utilized by all the communities they currently claim to serve.

Museums tend to be destinations that are placed outside the everyday conditions and lives of the citizens and, as a result, are on a trajectory to become obsolete.

The Truth and Reconciliation Commission (TRC) took place in South Africa as a means of facilitating healing and forgiveness of past human rights violations during Apartheid. The TRC forms an integral part of South Africa's heritage narrative of moving away from Apartheid and into democracy. Currently, the TRC is under represented and, as a result, memories are slowly being forgotten.

This dissertation embodies the TRC principles of 'translation' and 'transparency' through a new contextually driven museum typology. The design acts as a translation medium between the Pretoria National Archives and the general public in the same way that the TRC intended to function as a healing medium through which South Africa's exclusive Apartheid society could be transformed into an inclusive democratic society.

The aim of the Architecture is to express this narrative and encourage the continual healing process of this young democratic capital while aiming to free the existing museum typologies and turn them into inclusive, relevant and dynamic avenues of expression and change for all the communities they serve.

The vibrant south-eastern corner of the Sammy Marks square block in the inner city of Pretoria is used for the development of a democratic museum that absorbs and translates the everyday nature of the background and its users through the extraordinary lens of the TRC principles. 'Memoryscape' contemplates the creation of the extraordinary museum nestled within the hustle and bustle of the city's daily routine.

Memoryscape explores the museum as a multi-layered typological manifestation that gives the TRC relevance and prominence in the current context. The programs of museum, living archive and a forum theatre, act as landscapes through which the general public and tourists can learn about, experience, express, and record their own memories and experiences on the topic of this society and its on-going journey towards truth and reconciliation.

By reclaiming the past, contemplating, expressing, and recording the present, and projecting towards the future, memoryscape intends to immortalize the intentions and memories of the TRC and what it endeavoured to achieve.

Keywords:

Museum Typology

Memory

Contextual

Heritage

Democratic

Truth and
Reconciliation
Commission (TRC)

Everyday &
Extraordinary

Contents

CHAPTER 01

A Democratic Museum for the TRC

INTRODUCTION	29
1.1 THE GLOBAL ISSUE	31
1.2 THE LOCAL ISSUE	39
1.3 THE ARCHITECTURAL ISSUE	41
1.4 RESEARCH PROBLEM	51
1.5 RESEARCH QUESTIONS	51
1.6 DISSERTATION STATEMENT	51
1.7 METHODOLOGY	52
1.8 LIMITATIONS & ASSUMPTIONS	54
1.9 PROJECT AIMS & INTENTION	55

CHAPTER 02

Theoretical Background to the Truth and Reconciliation Commission and the Expression of 'Deep Memory' through Performance

2.1 A LONG NIGHTS JOURNEY INTO DAY - THE TRUTH AND RECONCILIATION COMMISSION IN SOUTH AFRICA	59
2.2 DEEP MEMORY	62
2.3 PERFORMING SOUTH AFRICA'S	63

29

59

TRUTH AND RECONCILIATION COMMISSION	63
2.4 A BRIEF HISTORY OF THEATRE IN SOUTH AFRICA - A CONTENDED SPACE	64
2.5 THE GENESIS OF DEMOCRATIC SPACE - RICHARD SENNETT	65
3.1 AN EXPERIENTIAL MUSEUM FOR THE TRUTH AND RECONCILIATION COMMISSION	69

CHAPTER 03

Programme & Client

3.2 THE TRUTH AND RECONCILIATION COMMISSION LIVING ARCHIVE	70
3.3 THE FORUM THEATRE - THE THEATRE OF NEW MEMORY	71
3.4 EVERYDAY PROGRAMS	73
3.5 CLIENTS PROGRAMMATIC PRECEDENTS	73

Museum

Theatre

69

CHAPTER **04**

*Urban Mapping
& Urban Vision*

- 4.1 || URBAN MAPPING
- 4.2 || URBAN VISION

CHAPTER **05**

The Site Now and Throughout History

- 5.1 || THE SAMMY MARKS SQUARE BLOCK AS PROTOTYPE FOR A NEW MUSEUM TYPOLOGY
- 5.2 || CHOSEN SITE - SAMMY MARKS SQUARE BLOCK
- 5.3 || HISTORY AND MEMORY ANALYSIS OF THE STATE THEATRE AND SAMMY MARKS SQUARE BLOCKS
- 5.3 || EVENTS THE SITE HAS WITNESSED
- 5.4 || STATEMENT OF HERITAGE SIGNIFICANCE
- 5.5 || HERITAGE LEGISLATION
- 5.6 || BLOCK VISION
- 5.6 || THE WAY FORWARD

CHAPTER **06**

Concept & Design Development

- 6.1 || THE MEMORYSCAPE

85

- 85
- 90

101

- 101
- 101
- 102
- 102
- 103
- 103
- 103
- 103
- 103
- 103
- 114
- 114
- 120
- 120
- 120
- 121
- 121
- 124
- 137
- 137

141

- 142

CHAPTER **07**

Design Resolution

- 7.1 || OVERALL CONTEXT AND PLACEMENT OF PROGRAMMES
- 7.2 || UNPACKING EACH ELEMENT OF THE DESIGN

181

- 181
- 181
- 184
- 184
- 184

CHAPTER **08**

Technical Resolution

- 8.1 || CONCEPT
- 8.2 || STRUCTURE
- 8.3 || MATERIALS
- 8.4 || TECHNOLOGY
- 8.5 || ENVIRONMENT AND SERVICES

199

- 199
- 200
- 201
- 208
- 209
- 209

CHAPTER **09**

Design Resolution- Final Presentation

214

CHAPTER **10**

Conclusion

- REFERENCES
- APPENDIX
- || ARTICLE
- || ES'KIA MPAHLELE LIBRARY LAYOUT PLANS

254

- 268
- 270
- 286

List of Figures

CHAPTER 01

23

- Fig 1.2 -
Conceptual expression of the Democracy its relation to Museums in South Africa, (Collage by Author, 2019) *
compilation of images available at: <https://www.depop.com/products/hileyebony-new-bits-added-for-summer>, <https://beardedmeninknittedthings.tumblr.com/page/78>, <http://www.abouttoday.co.uk/People>, <http://zonfeld-colours.blogspot.com/2017/06/the-duku-crown-african-headwrap-symbol.html>
- Fig 1.3-
Wunderkammern- a German brimful of curiosities (Architectural Review, 2012)
available at: <https://www.architectural-review.com/essays/typology/typology-museums/8640202.article>
- Fig 1.4-
Karl Friedrich Schinkel, Altes Museum. An example of a typical classical museum plan (Architectural Review, 2012).
available at: <https://www.architectural-review.com/essays/typology/typology-museums/8640202.article>
- Fig 1.5-
Le Corbusier, National Museum of Western Art, Tokyo. An example of a Modernist museum (Architectural Review, 2012)
available at <https://www.architectural-review.com/essays/typology/typology-museums/8640202.article>
- Fig 1.6-
Jean Nouvel, Musee Quai Branley, Paris. An example of Post-modernist museum architecture (Jean Nouvel, 2006).
available at: <http://www.jeannouvel.com/en/projects/musee-du-quai-branly/>
- Fig 1.7-
The //hapo museum, Pretoria analysis, (Apple maps adapted by Author, 2019)
- Fig 1.8-
The Red Location museum, PE in context (Apple maps adapted by Author, 2019)
- Fig 1.9-
The Apartheid museum, Johannesburg- in context (Apple maps adapted by Author, 2019)
- Fig 1.10-
Museum typology analysis, (The Architectural Review, 2012)
Museum typology diagrams (Author, 2019)
- Fig 1.11-
Exclusive vs. Inclusive proposed museum typology. (Author, 2019)
- Fig 1.12-
Fashion implemented into museums by Balenciaga (Balesto, n.d.)
- Fig 1.13-
Fashion implemented into museums (Unknown, n.d)
- Fig 1.14-
Judith Manson Plastic bag dress sculpture (Standard Bank Gallery, 2008)
available at: <https://www.clbxg.com/Bag-for-Dress/>
- Fig 1.15-
Judith Manson oil painting depicting the TRC (Constitution Hill, 1998)
available at: <https://cgcp-blog.weebly.com/home/archives/01-2019>
- Fig 1.16-
Architectural Continuum (Author, 2019)
- Fig 1.17-
Musee Quai Branley external boxes (Guillaume, 2006)
available at: <https://www.archdaily.com.br/br/915007/museu-du-quai-branly-ateliers-jean-nouvel/5cae5c36284dd1e5fc0001df>
- Fig 1.18-
Fashion exhibits (Flickr, 2018)
available at: <https://www.flickr.com/photos/dalbera/41886306232>
- Fig 1.19-
artful display of relics (Halbe, 2006)
available at: <https://architectsagainsthomeslessness.com/2019/04/12/musee-du-quai-branly-ateliers-jean-nouvel/>
- Fig 1.20-
visitors relating to fashion (Wired New York, 2006)
available at: <http://wirednewyork.com/forum/archive/index.php/t-9707.html>
- Fig 1.21-
Musee Quai Branley in context (Profil, 2013)
available at: <http://karolina-aroundtheworld.blogspot.com/2014/01/muzeum-quai-branly-w-paryzu-musee-du.html>
- Fig 1.22-
Musee Quai Branley ground floor (Arcdaily, 2008)
- Fig 1.23-
Musee Quai Branley green facade (Halbe, 2006)

available at: <https://architectsagainsthomeslessness.com/2019/04/12/musee-du-quai-branly-ateliers-jean-nouvel/>

- Fig 1.24-
Musee Quai Branley main plan (Arcdaily, 2008)
- Fig 1-25-
Park beneath Musee Quai Branley (Paris Insider, n.d)
available at: <https://www.parisinsidersguide.com>
- Fig 1.26-
Plan of the Apartheid Museum, Johannesburg (Deckler, 2006)
- Fig 1.27-
Interim space between programmes in the museum (Author, 2019)
- Fig 1.28-
Entrance into museum next to water landscape (Author, 2019)
- Fig 1.29-
Walking among the struggle heroes (Author, 2019)
- Fig 1.30-
Video installation of TRC (Author,2019)
- Fig 1.31-
TRC collection exhibition board 01 (Author, 2019)
- Fig 1.32-
TRC collection exhibition board 02 (Author, 2019)
- Fig 1.33-
TRC collection exhibition board 03 (Author, 2019)
- Fig 1.34-
TRC Zapiro comics on display (Author, 2019)
- Fig 1.35-
last of the TRC exhibition (Author, 2019)
- Fig 1.36-
Project Aim as the 'Memoryscape' (Author, 2019)
- Fig 2.1-
Historical Arial photograph of Pretoria (Van Der Vaal, n.d)

CHAPTER 02

53

- Fig 2.2-
Freedom of information logo (Kennedy, 2015)
- Fig 2.3-
Quote -Archives and memory (Kennedy, 2015)
- Fig 2.4-
Graphic explaining the contents of the TRC Final Report volumes (Author, 2019)
- Fig 2.5-
Miriam Makeba (Unknown, n.d)
available at: https://en.wikipedia.org/wiki/Miriam_Makeba
- Fig 2.6-
William Kentridge expression of the TRC (EYE Film Museum, 2015)
available at: <https://www.e-flux.com/announcements/147811/william-kentridgethick-time-installations-and-stagings/>
- Fig 2.7-
Ubu and the Truth Commission (Hoyle, 2014)
available at: <https://www.ft.com/content/d08d7780-31ba-11e>
- Fig 2.8- The Agora (Sennett,1998)

CHAPTER 03

63

- Fig 3.1-
Conceptualisation of programme (Collage by author, 2019)
compilation of images available at: <http://debuzzviews.blogspot.com/2013/01>, <https://za.pinterest.com/pin/441704675952132110/> et al.
- Fig 3.2-
Relationship of programmes to each other (Author, 2019)
- Fig 3.3-
Black Box theatre of the Acting Studio (Acting Studio, 2017)

available at: <https://www.mclgrand.com/facility-rental/black-box-information>

Fig 3.4-

Black Box theatre adaptable interior (Live Design Group, 2018)

available at: <https://za.pinterest.com/pin/429319776973525320/?lp=true>

Fig 3.5-

Memorial to the Murdered Jews of Europe, Berlin- underground (Pudelek, 2012)

available at: https://en.wikipedia.org/wiki/Memorial_to_the_Murdered_Jews_of_Europe

Fig 3.6-

Memorial to the Murdered Jews of European dusk (Drrcs, 2014)

available at: https://en.wikipedia.org/wiki/Memorial_to_the_Murdered_Jews_of_Europe

Fig 3.7-

View from Ministergarten towards Memorial th the Murdered Jews of Europe (Blum, 2016)

available at: https://en.wikipedia.org/wiki/Memorial_to_the_Murdered_Jews_of_Europe

Fig 3.8-

Historical view of the Old Market Theatre (The Market Theatre Foundation, 2018)

Available at: <https://markettheatre.co.za/market-theatre-home/>

Fig 3.9-

The Market thetatre public space (The Market Theatre, 2019)

Available at: <https://markettheatre.co.za/market-theatre-home/>

Fig 3.10-

Performances in the Market Theatre (the Market Theatre, 2019)

Available at: <https://markettheatre.co.za/market-theatre-home/>

Fig 3.11-

How SAHA and OHASA can act as mediator of national and individual memory (Author, 2019)

Fig 3.12-

Conceptual Approach to structuring the building programmatically (Author, 2019)

Fig 3.13-

Ideogram of Museum of the TRC (Author, 2019)

Fig 3.14-

Ideogram of the everyday realm (Author, 2019)

Fig 3.15-

Ideogram of the Theatre of New Memory (Author, 2019)

Fig 3.16-

Ideogram of the Active Archive (Author, 2019)

Fig 4.1- Vision of a human-centred city (Urban Mapping group, 2019)

CHAPTER 04

79

Fig 4.2-

Transect walk routh through the city (Mapping group including Author, 2019).

Fig 4.3-

Selected Mapping Layers as overlays used to draw conclusions (Mapping group including Author, 2019).

Fig 4.4-

Museum District in relation to Pedestrian density in the city (Mapping group including Author, 2019).

Fig 4.5-

Urban Design section vision (Mapping group including Author, 2019).

Fig 4.6-

Diagrams explaining the Urban Design Principles (Mapping group including Author, 2019).

Fig 4.7-4.8- Transformation of typical ARCADE typology using Urban Vision principles (Mapping group including Author, 2019).

Fig 4.9-4.10-

Transformation of STREET CORNER typology using Urban Vision Principles (Mapping group including Author, 2019).

Fig 4.11-4.12

Transformation of PUBLIC SQUARE typology using Urban Vision Principles (Mapping group including Author, 2019).

Fig 4.13-

The current condition of the city (Mapping group including Author, 2019).

Fig 4.14-

Beginning of implementing the principles (Mapping group including Author, 2019).

Fig 4.15-

Final Vision of the city if Urban Vision principles are fully implemented (Mapping group including Author, 2019).

Fig 5.1-

Aerial Photograph of Pretoria, date unknown (Van Der Vaal Collection, 2019)

Fig 5.2-

Site Location (Google Maps adapted by Author, 2019)

CHAPTER 05

95

Fig 5.3-

Existing 'types' on site (Author, 2019).

Fig 5.4-

Location of Market Square (Author, 2019).

Fig 5.5-5.9-

Historical drawings of parket square (Dunston, 1975)

Fig 5.10-

Historical impression of the Market Square, date unknown (Van Der Vaal's Collection, 2019)

Fig 5.11-

Historical image of the Kynoch building taken in 1889 (Dunston, 1975)

Fig 5.12-

The South-east corner of the Sammy Marks block in 1961 (Tshwane Heritage Resource Centre, 2019).

Fig 5.13-

Photograph of the Kynoch and Marks building taken in 1913 (Van Der Vaals collection, 2019)

Fig 5.14-

Construction of State Theatre 1975 (Tshwane Heritage Resource Centre, 2019).

Fig 5.15-

Original Advert for the Gundelfinger business (Dunston, 1975)

Fig 5.16-

Sammy Marks building in 1975 (Tshwane Heritage Resource Centre, 2019).

Fig 5.17-5.20-

Various newspapre clippings of the site over time (Tshwane Heritage Resource Centre, 2019).

Fig 5.21-5.24-

Historical photographic timetime of site development over time (Collage by Author, 2019)*

Fig 5.25-

Goad Maps of block development over time (Tshwane Heritage Resource Centre, 2019).

Fig 5.26-

Plan and Section through Furrow (Van Skalkwyk, 1995).

Fig 5.27-

Plan and Section through Furrow 2 (Van Skalkwyk, 1995).

Fig 5.28-

Excavated furrow outside the State Theatre (Dippenaar, 2013)

Fig 5.29-

Layout of Water Furrows around site according to historical written accounts (Author, 2019)

Fig 5.30-

The South-east corner of the Sammy Marks block in 1961 (Tshwane Heritage Resource Centre, 2019).

Fig 5.31-

Construction of State Theatre 1975 (Tshwane Heritage Resource Centre, 2019).

Fig 5.32-

Aerial View of Sammy Marks construction in 1991 (Tshwane Heritage Resource Centre, 2019).

Fig 5.33-

Sammy Marks Square from the South in 1991 (Tshwane Heritage Resource Centre, 2019).

Fig 5.34-

Proposed Verwoerd Square with old Marks Bldg in foreground 1990 (Tshwane Heritage Resource Centre, 2019).

Fig 5.35-

Tuks architecture students protest against demolition Cannon Bdg in 1990

(Tshwane Heritage Resource Centre, 2019).

Fig 5.36- 5.38-

Proposed useage of Sammy Marks Block (Tshwane Heritage Resource Centre, 2019).

Fig 5.39-

Construction work by Murray & Roberts Bldg at Sammy Marks Square in 1992 (Tshwane Heritage Resource Centre, 2019).

Fig 5.40-5.41-

Proposed useage of Sammy Marks Block (Tshwane Heritage Resource Centre, 2019).

Fig 5.42-

1956 Womans March (Netwerk24, 2019)

Fig 5.43-

Barend Strydom AKA Wit Wolf (IOL, 2011)

Fig 5.44-

Historical Timeline of site development and historical democratic development (Author collage, 2019)*

Fig 5.45-

Events which took place on and around the site (Author collage, 2019) *

Fig 5.46-

Aerial View of Pretoria, date unknown (Van Der Vaals collection, 2019)

Fig 5.49-

Area of interest for block vision (Author adapted from Google Maps, 2019)

Fig 5.49.1-

Initial planning for Block Vision (Author, 2019)
 Fig 5.50-
 Block Vision plan (Author, 2019)
 Fig 5.51-
 Locality plan of site in relation to landmarks (Author, 2019) (Base map by Kirsten, 2018)
 Fig 5.52-
 Location of site (Author Adapted Google Maps, 2019)
 Fig 5.53-5.54-
 Aerial locality of site (Author adapted Google Earth, 2019)
 Fig 5.55- 5.59-
 Existing site conditions and proposed Tshwane 2055 site conditions (Author, 2019)
 Fig 5.60-
 Site Contours (Tshwane GIS, 2019)
 Fig 5.61-
 Photographs of site experience (Author, 2019)
 Fig 5.62-5.65-
 Photographs of existing site conditions taken from roof of Es'kia Mphahlele Library (Author, 2019)
 Fig 5.66- 5.68-
 Original drawings of the Sammy Marks Development (Dias, 2012)
 Fig 6.1-
 Concept of darkness into light & being freed of shackles (Collage by Author, 2019)*.
 images available at: <https://za.pinterest.com/pin/441704675953424611/>

CHAPTER 06

Fig 6.2-
 Place plus memory brings community into mutual alignment (Author, 2019).
 Fig 6.3-
 Principles of the Memoryscape (Author, 2019).
 Fig 6.4-
 Initial Conceptual development sketches (Author, 2019).
 Fig 6.5-
 TRC concept of transparency/ translation Parti (Author, 2019).
 Fig 6.6-
 Parti diagram of the uniting of the everyday and the extraordinary (Author, 2019).
 Fig 6.7-
 Conceptual massing of building on site exploration (Author, 2019).
 Fig 6.8-
 Conceptual exploration of building as urban maze (Author, 2019).
 Fig 6.9-
 Building massing expressing historical route along church street (Author, 2019).
 Fig 6.10-
 Further conceptual massing in relation to urban form exploration (Author, 2019).
 Fig 6.11-
 Re-addressing the concept of theatre as an audience interactive experience (Author, 2019).
 Fig 6.12-
 Exploration of integration of the everyday and the extraordinary (Author, 2019).
 Fig 6.13-
 Initial experiential qualities envisioned for museum (Author, 2019).
 Fig 6.14-
 Parti diagram of new intervention being 'freed' from the old context (Author, 2019).
 Fig 6.15-
 The everyday as a means of freedom (Author, 2019).
 Fig 6.16-
 Contextual Response diagram (Author, 2019).
 Fig 6.17-
 Formal Response diagram (Author, 2019).
 Fig 6.18-
 Site Memory Response diagram (Author, 2019).
 Fig 6.19-
 Heritage Response diagram (Author, 2019).
 Fig 6.20-
 Functional Response diagram (Author, 2019).
 Fig 6.21-

135

Programmatic Response diagram (Author, 2019).
 Fig 6.22-
 Material (technological)Response diagram (Author, 2019).
 Fig 6.23-
 Theoretical response diagram (Author, 2019).
 Fig 6.24-
 TRC Response diagram (Author, 2019).
 Fig 6.25-
 Everyday Response diagram (Author, 2019).
 Fig 6.26-
 Demolishment plan to allow more useable space for intervention- Structure remains (Author, 2019).
 Fig 6.27-
 Willow theatre axonometric (Arcdaily, 2013)
 available at: <https://www.archdaily.com/440635/willow-theater-tim-lai-architect-brad-steinmetz-stage-design>
 Fig 6.28-
 Willow Theatre External view (Arcdaily, 2013)
 available at: <https://www.archdaily.com/440635/willow-theater-tim-lai-architect-brad-steinmetz-stage-design>
 Fig 6.29-
 Willow Theatre Interior (Arcdaily, 2013)
 available at: <https://www.archdaily.com/440635/willow-theater-tim-lai-architect-brad-steinmetz-stage-design>
 Fig 6.33-6.37-
 Photographic record of Design Iteration 1 (Author, 2019).
 Fig 6.38- 6.48-
 Photographic record of various configurations of the building freeing itself of the built fabric through built form and skin treatment (Author, 2019).
 Fig 6.39-
 Axonometric exploration of design (Author, 2019).
 Fig 6.50- 6.51-
 Elevation manifestation of the concept (Author, 2019).
 Fig 6.52-
 Site plan of intervention showing courtyard and public squares created (Author, 2019).
 Fig 6.53- 6.56-
 Basement -1, First, Second, Third floor exploration of design on plan (Author, 2019).
 Fig 6.57-
 Ground Floor exploration of design as open public memoryscape (Author, 2019).
 Fig 6.58- Fig 6.63-
 Sectional exploration of the building EVERYDAY CONNECTIONS TO THE MUSEUM (Author, 2019).
 Fig 6.64- Fig 6.65-
 Perspective exploration of intervention in relation to the everyday public realm (Author, 2019).
 Fig 6.67-6.68-
 Plan development following Iteration 3 (Author, 2019).
 Fig 6.69-
 the everyday activities on the southern public part of the site (Author, 2019).
 Fig 6.70- 6.73-
 Further plan development following iteration 3 (Author, 2019).
 Fig 6.74- Fig 6.77-
 Diagrammatic exploration of intervention as extension of the public realm (Author, 2019).
 Fig 6.78-Fig 6.81-
 Design development of the theatre 'box' following iteration 3 (Author, 2019).
 Fig 6.82-
 diagrammatic exploration of design articulation of smaller details (Author, 2019).
 Fig 6.83- 6.85-
 Perspective exploration of experiential museum route (Author, 2019).
 Fig 7.1-
 Building in context (Author, 2019).

CHAPTER 07

Fig 7.2-
 Exploded Axo showing program relations to one another (Author, 2019).
 Fig 7.3-
 Placement of museum underground and into the everyday (Author, 2019).
 Fig 7.4-
 Building in context showing courtyard and public square (Author, 2019).
 Fig 7.5-7.6-
 The ramp isolated to see how memory boxes sit (Author, 2019).
 Fig 7.7- Fig 7.9-
 Articulation of ramp on plan, Basement -1, Ground, First floor (Author, 2019).

175

Fig 7.10- Elevation ramp- how the ramp goes from Basement-1 to First floor (Author, 2019).
 Fig 7.11- archival tower as connecting device (Author, 2019).
 Fig 7.12- Exit through the market on ground floor (Author, 2019).
 Fig 7.13- positioning of Archive in building (Author, 2019).
 Fig 7.14- Exit through the market on perspective (Author, 2019).
 Fig 7.15- Fig 7.17- Positioning of archive on second and third floor and as connection to museum (Author, 2019).
 Fig 7.18- Theatre in relation to building (Author, 2019).
 Fig 7.19- Adaptability of fly tower and recording (Author, 2019).
 Fig 7.20- balconies used to view public life, catalyse debate (Author, 2019).
 Fig 7.21- various configurations of forum theatre- adaptability (Author, 2019).
 Fig 7.22- Functioning as stage for public square (Author, 2019).
 Fig 7.23- extrenal circulation used as viewing balconies (Author, 2019).
 Fig 7.24- position of back of house functions in Basement -2 (Author, 2019).
 Fig 7.25- Position of tower of truth and reconcilliation (Author, 2019).
 Fig 7.26- Views from tower (Author, 2019).
 Fig 7.27- Programs of building in perspective (Author, 2019).
 Fig 8.1- Expression of the concept of a Marrisonette being freed (Author, 2019).
 Fig 8.2- Tectonic concept parti (Author, 2019).
 Fig 8.3- Fig 8.4- Concept of building being 'freed' from the site (Author, 2019).

CHAPTER 08

Fig 8.5- concept of liberation through technical articulation of each function (Author, 2019).
 Fig 8.6- example of new skin to express new technology (memory) (Author, 2019).
 Fig 8.7 - 8.8- Materiality of intervention (Author, 2019).
 Fig 8,9- Esatern edge column treatment (Author, 2019).
 Fig 8.10- Theatre entrance column wraping (Author, 2019).
 Fig 8.11- 8.14- Column detailing on plan (Author, 2019).
 Fig 8.15- Column articulation of thetate (Author, 2019).
 Fig 8.16- Column treatment in basement museum (Author, 2019).
 Fig 8.17- Plan of State Theatre paving tecxture analysis (Author, 2018).
 Fig 8.18- perspective recording of texture analysis (Author, 2018).
 Fig 8.19- Plan of Market Street paving texture analysis (Author, 2018).
 Fig 8.20- Perspective recording of texture analysis of market street (Author, 2018).
 Fig 8.21-8.24- Lighting analysis exploring LUX levels throughout the day in and around thetate spaces (Author, 2019).

Fig 8.25-8.26- technology of building elements (Author, 2019).
 Fig 8.28-8.29- Expression of tectonic concept through roof articulation (Author, 2019).
 Fig 8.30- Adjustable acoustic aperture model (Author, 2019).
 Fig 8.31-8.32- Adjustable acoustic swivel panels to suit various uses of theatre (Author, 2019).
 Fig 8.33- Articulation of theatre skin materiality and acoustic panels (Author, 2019).
 Fig 8.34- Construction section with theatre detailed (Author, 2019).
 Fig 8.35- 8.36 Space Frame structure introduced into theatre (Author, 2019).
 Fig 8.37- Model exploration of Space frame articulation (Author, 2019).
 Fig 8.37.1- Auckland Art Gallery Toi o Tamaki in New Zealand (Dezeen, 2013) available at: <https://www.dezeen.com/2013/10/04/world-building-of-the-year-2013-winner-auckland-art-gallery/>
 Fig 8.38- 8.39- solar heat gain strategy of overhangs to shade the facades (Author, 2019).
 Fig 8.40-8.41- diagrammatic strategies for water managen=ment and ventilation (Author, 2019).
 Fig 8.44-8.47- Diagramatic exploration of column and roof details (Author, 2019).
 Fig 8.48- roof and column articulation of Theatre box (Author, 2019).
 Fig 8.29- Existing vs new column to roof connection (Author, 2019).
 Fig 8.50- articulation of theatre box (Author, 2019).
 Fig 8.51- Iteration layers of 1:50 section of theatre box (Author, 2019).
 Fig 8.52- Diagrammatic exploration of details (Author, 2019).
 Fig 8.53- Exploration of column and roof structure (Author, 2019).

CHAPTER COVER IMAGES

FRONT COVER: collage of images available at: <https://www.depop.com/products/hileybony-new-bits-added>, <https://beardedmeninknittedthings.tumblr.com/page/78>, <http://www.abouttoday.co.uk/People>, <http://zonfeld-colours.blogspot.com/2017/06/the-duku-crown-african-headwrap-symbol.html>

tumblr.com/page/78, <http://www.abouttoday.co.uk/People>, <http://zonfeld-colours.blogspot.com/2017/06/the-duku-crown-african-headwrap-symbol.html>

CHAPTER 1:Background Photograph- Author 2019

Image of person- <https://www.estiloblack.com.br/2017/12/roupa-branca-com-estilo-black-para-o.html>

CHAPTER 2:Background Photograph- Author 2019

Image of person- <http://senegalcouture.com/pin/our-stunning-models-wearing-our-new-chambers-jacket-and-wide-leg-trousers-new-dia-maxi-and-gorgeous-victoria-blouse-with-matching-skirt-www-chenburkett-com/>

CHAPTER 3:Background Photograph- Author 2019

Image of person- <https://www.glamour.co.za/fashion/today-im-wearing-17304583>

CHAPTER 4:Background Photograph- Author 2019

Image of person- <http://modaemmarte.blogspot.com/2016/>

CHAPTER 5:Background Photograph- Author 2019

Image of person- <https://www.whowhatwear.co.uk/lulama-wolf-style>

CHAPTER 6:Background Photograph- Author 2019

Image of person- <https://wwd.com/eye/they-are-wearing/gallery/they-are-wearing-paris-mens-fashion-week-fall-2014/#!96/paris-mens-fashion-week-street-style-7380515-portrait/>

CHAPTER 7:Background Photograph- Author 2019

Image of person- <https://shakarasquare.com/styles-in-photos/>

CHAPTER 8:Background Photograph- Author 2019

Image of person- <https://m.scoopernews.com/2018/02/13/latest-m>

CHAPTER 9:Background Photograph- Author 2019

Image of person- <https://za.pinterest.com/pin/441704675952132110/>
m e m o r y s c a p e

CHAPTER

towards a democratic museum





CHAPTER 01

A Democratic Museum for the TRC

/

|| INTRODUCTION

Heritage is incomplete without history, memory and relics (Moore & Whelan, 2007:97). Memory is the missing link in the heritage debate; a link that fundamentally ties the everyday city dweller to the city's heritage and, when absent, proves to be a problem (Moore & Whelan, 2007:97). Oral history reveals an open-ended narrative of place, which generates a layered and rich description of the architectural context (Blofson, 2014:i).

The museum district of Pretoria's inner city seems to be on a trajectory of becoming obsolete. The museums remain largely unknown to the people inhabiting the capital city. Upon visiting the museums, one will find the exhibitions badly conserved and outdated.

The socio-spatial contribution of preservation sites in the City of Pretoria (Tshwane) has diminished over the years as the buildings housing these inadequately preserved exhibits are poorly maintained, fenced off or have controlled access regulating public accessibility. The exhibits in Pretoria, although run by Ditsong, do not integrate with their physical, social, political, or historical contexts and, as a result, are not utilized by the communities they claim to serve. It can be speculated that these buildings do not 'fit' into the socio-spatial context of South Africa as a democratic society, as many were built before South Africa became a democracy and, consequently, do not

represent the communities they serve. The main aim of this dissertation is to investigate the creation of museum architecture that is relevant to and serves the everyday user.

The stance of this dissertation is rooted in an understanding of the global, local and architectural issues and their associated background which will be discussed in this chapter. These issues, once distilled, will inform the research problem, research questions, dissertation statement, research and design methodology and the limitations and assumptions that will underpin the dissertation aims and intentions as a whole.



1.2

Global Issue

Museums do not represent the memory of the everyday citizen.

SAHO (2011) elaborates that museums always in some way or another are a reflection on the perspective of the people who created them

Fig 1.2 - Conceptual expression of the Democracy its relation to Museums in South Africa, (Collage by Author, 2019) *

*Full reference of all collage images in list of figures

KEY TERMS:

Oral History - historical fact and information collected through interviews and narratives. Yap & Barsaga argue that oral histories bear relevance when one needs to understand what happened in the past, along with the memories attached to that history, thus, Oral History is employed as evidence of human memory (Yap & Barsaga, 2018).

Memory- the mind's ability to store and recall past sensations, thoughts and knowledge, as well as the tendency of materials or systems to show effects that depend on its past treatment or history (Hutchison, 2013).

Typology- “study of or analysis or classification based on types or categories” (Merriam-Webster Dictionary, 2019)

Truth and Reconciliation Commission (TRC), South Africa ,a courtlike body established by the new South African government in 1995 to help heal the country and bring about a reconciliation of its people by uncovering the truth about human rights violations that had occurred during the period of apartheid. Its emphasis was on gathering evidence and uncovering information—from both victims and perpetrators—and not on prosecuting individuals for past crimes (Encyclopaedia Britannica, 2010)

1.1 || THE GLOBAL ISSUE

Museums do not represent the memory of the everyday citizen.

According to South African Heritage Online (SAHO, 2011), museums are always, like any other historical source and in some way or another, a reflection of the perspectives or bias of the people who created them. Therefore, they often fail to be neutral. Milan Kundera, a Czechoslovakian activist writer, recognized the importance of remembering the past. He said: “The struggle of people against power is the struggle of memory against forgetting.” (SAHO, 2011).

A brief investigation of the evolution of museum typology throughout history is important when investigating why these institutions tend not to function as optimally as intended in a democratic context that presents with a contested heritage.

1.1.1 A Brief Overview of Typology Theory

According to Ayyıldız et al. (2017:3), the subject of typology in architecture can be considered in two ways. The first is relevant to design and regards ‘typology as a form

of knowledge that can be applied directly to design work’. The second approaches typology as ‘a terrain of encounter between inhabitants and architects.’ (Ayyıldız, et al. 2017:3).

“Typology in architecture has been defined as creating [an] archive of the certain types related to architecture styles reduced to their elementary geometrical nature or the search effort of the combination possibilities of the architectural elements to classify the types which are the architectural forms.”
(Ayyıldız et al. 2017:2).

Individualization and classification are the two actions which typology, as a concept, achieves (Ayyıldız et al. 2017:2)
Typological analysis method

“Typology is a systematic study which includes actions such as ‘abstraction, reduction and schematization’ to identify and clarify the phenomenon that [the] researcher has in every field; it is the discussion of the special one which is generalized by mind.”
(Ayyıldız et al. 2017:3).

At its core, typology categorises architecture of similar style, program, movement etc. into classes that follow similar design ‘guidelines’ and recognisable characteristics in their architectural manifestation.

1.1.1 The Typological Evolution of Museums

The Definition of Typology

“[The] study of or analysis or classification based on types or categories.”
(Merriam-Webster Dictionary, 2019).

Pre-modern museums

Typology: Palace museums/temple monument museums –

- are generally situated in adaptive re-use or restored historical museums.

Modern museums

Typology: Modernist – inspired by Le Corbusier’s unlimited growth spiral museum –

- are designed around one intended circulation route (often a ramp);
- have no closed and static geometric forms, and
- vertical planes are used to provide continuous movement in visual angles.

Post-modern museums

Typology: Challenged the typical museums of the past and transformed into a ‘culture-centre’ –

- identities are monumental and iconic;
- multifunctional uses by means of multifunctional spaces;
- temporary and permanent exhibits;
- comprise flexible circulation with some classical typological influences, and
- museums are regarded as artworks.

The word ‘museum’ is derived from Latin which was, in turn, inspired by mouseion, the Greek term for ‘a shrine to the Muses’. In classical Greek mythology, the nine Muses are the goddesses of the arts and sciences, which made them perfect patrons for these knowledge-based institutions (Richman-Abdou, 2018). A deeper look into the evolution of such sanctuaries reveals that museum typology has evolved with the changing desires of those who were

Fig 1.3- Wunderkammern - a German brimful of curiosities (Architectural Review, 2012)



1.6

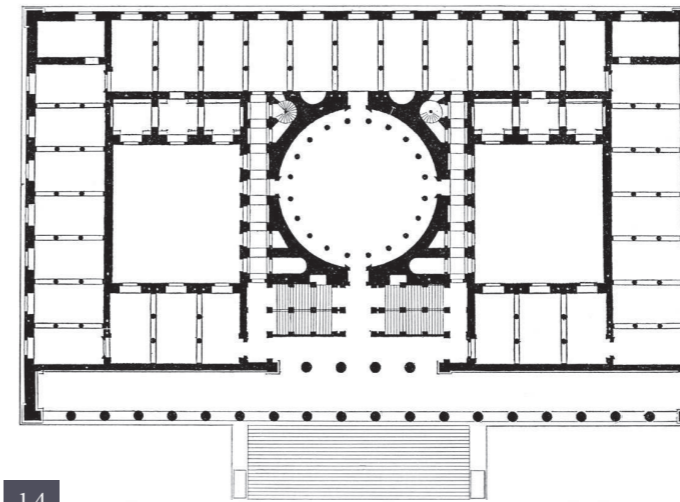

1.4

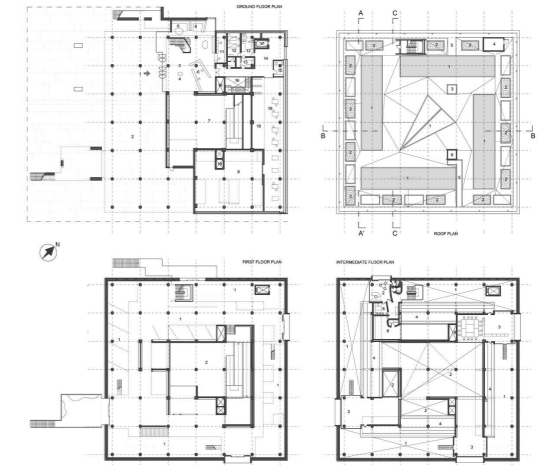

1.5

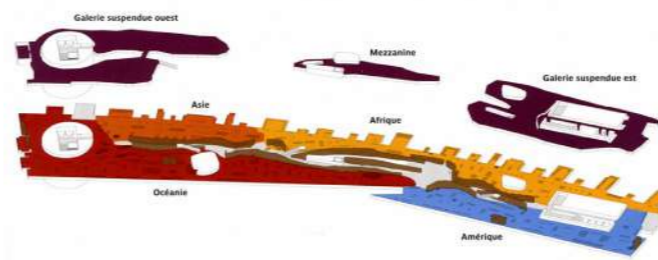

1.6

Fig 1.4- Karl Friedrich Schinkel, Altes Museum. An example of a typical classical museum plan (Architectural Review, 2012).

Fig 1.5- Le Corbusier, National Museum of Western Art, Tokyo. An example of a Modernist museum (Architectural Review, 2012)

Fig 1.6- Jean Nouvel, Musée Quai Branley, Paris. An example of Post-modernist museum architecture (Jean Nouvel, 2006).

in charge of creating them. According to Marotta (2012), such preserves have taken on many guises throughout history. The first was situated in ancient Babylon and could be accessed by invitation only (Richman-Abdou, 2018). Princess Ennigaldi, the daughter of King Nabonidus – the Neo-Babylonian Empire ruler in the 6th century BC – collected and curated Mesopotamian artefacts up to 1,500 years old. During the Renaissance, the great collections belonging to the powerful Medici, Sforza and Gonzaga families were housed privately, with selected access by small groups of scholars. These establishments were known as ‘wonder rooms’ (Marotta, 2012).

In the pre-modern times, museums largely remained private destinations that were only open to the social elite. The elect was allowed in by invitation, and these displays included eclectic collections that were encyclopaedic in nature, such as natural history specimens and scientific wonders, works of art and religious relics. These depositories were known as the ‘Cabinets of Curiosities’

(Richman-Abdou, 2018).

Following the Enlightenment, the British Museum in London (1759), the Louvre in Paris (1793) and the Museo Nacional del Prado in Madrid (1785), among others, began to open collections to the public (Richman-Abdou, 2018).

Foucault uses the term ‘heterotopia’ to describe spaces that have more layers of meaning or additional relationships to other places than immediately meets the eye, which is evident in the various manifestations of the Post-modern museum typologies (Marotta, 2012).

During the post-modern era, heritage storage sites have predominantly opted for either the iconic ‘museum as artwork’ perspective (e.g. Frank Gehry’s Guggenheim Museum in Bilbao) or a completely contradicting stance of ‘museum as landscape’ (e.g. Paulo David’s Art Centre at Casa de Mudanças in Madeira). The aim of the ‘museum as landscape’ is to act as a new way of mediating the infinite memory

of the place in which it is embedded, bound up in nature's infinity (Marotta, 2012).

A local example of 'museum as landscape' is the Apartheid Museum in Johannesburg, South Africa, designed by Gapp Architects and Urban Designers, Mashabane Rose Architects, Britz Roodt Association, and Linda Mvusi Architecture and Design.

It is important to note – from this typological exploration over time and around the world – that museums have always housed physical relics along with manifestations and stories of actual recorded history but often fail to represent memory. As mentioned in the introductory statement, memory is the most important aspect that needs to be implemented in order to generate a full heritage picture, one where the experiences of the layperson are integral to the overall historical narrative. Museums have, over time, shifted from merely housing information and relics – irrespective of the building – to following a processional route through a curated building, to allowing the actual architecture to become as much of an iconic relic as the collections themselves and, finally, to the current environmentally-conscious movement where the building responds to the landscape. It can be concluded that, although preservation areas have become contextual in that they have begun to respond to their physical context, exhibits still neglect the socio-political perspective. It can be speculated

that this inattention largely results from not representing the past and present memory of the everyday citizen.

Post-colonial museums in Africa have not developed distinctly from their Eurocentric counterparts (SAHO, 2011). Today, these museums are still closed off to everyday use and are not enjoyed by the majority (SAHO, 2011). Museums in Africa have remained largely oblivious to the identities and interests of the communities they claim to serve (SAHO, 2011).

An investigation into some of the prominent museums in the South African context (figure number) has revealed that, while the contents often reflect the communities' histories, the narratives tend to be standardized and fixed and, therefore, fail to include programmes that include visitor and community involvement and upliftment. It can be conjectured that the a-contextual museum typology has contributed to their state of disuse by those whose stories they are trying to tell.

Some recently built South African museums, such as Freedom Park in Pretoria, acknowledge the intangible heritage that exists in many African cultures. An example that explores a post-colonial 'intangible' perspective is the //hapo museum at Freedom Park and the Apartheid Museum in Johannesburg. Although the aforementioned establishments acknowledge important

Fig 1.7- The //hapo museum, Pretoria analysis, (Apple maps adapted by Author, 2019)

Fig 1.8- The Red Location museum, PE in context (Apple maps adapted by Author, 2019)

Fig 1.9- The Apartheid museum, Johannesburg- in context (Apple maps adapted by Author, 2019)

histories they are not presented in a way that is engaging to the viewer. It can be postulated that, because the user merely remains a 'viewer' and does not become a 'participant', the nature of the intangible heritage is not actually experienced. Since the exhibition is not 'lived' it is not understood to the degree that it could be, thus the histories are not presented in a way that is engaging to the spectator. According to Kreps (2003:xiii), museums should include multiple voices in order to liberate cultures. The voices of 'the other' (the everyday citizen) are central to the formulation of new museological paradigms (Kreps, 2003:xiii).

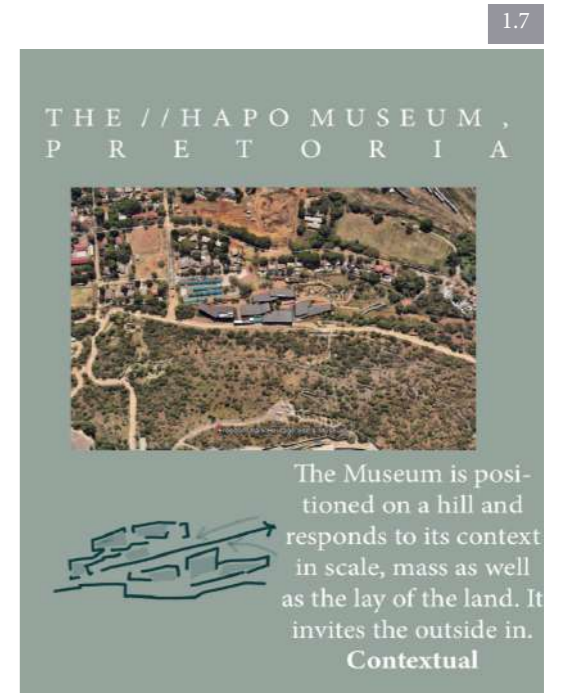

1.7

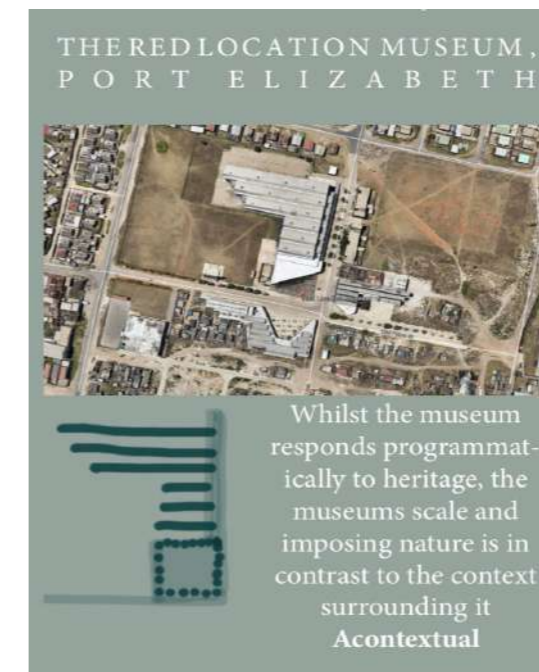

1.8

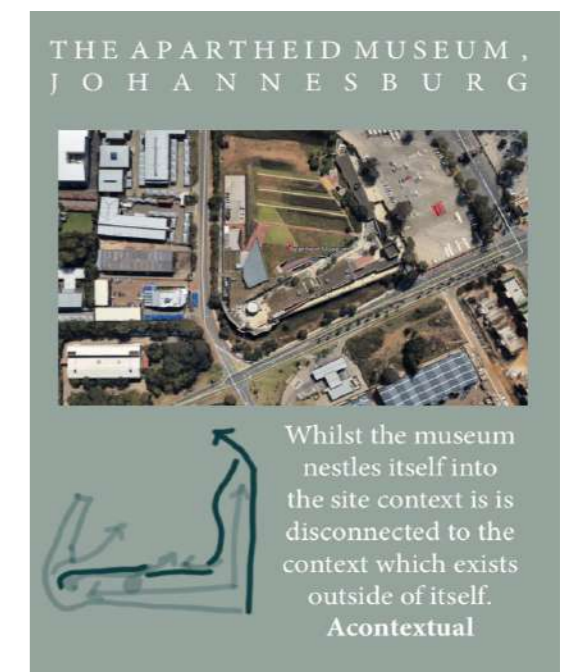

1.9

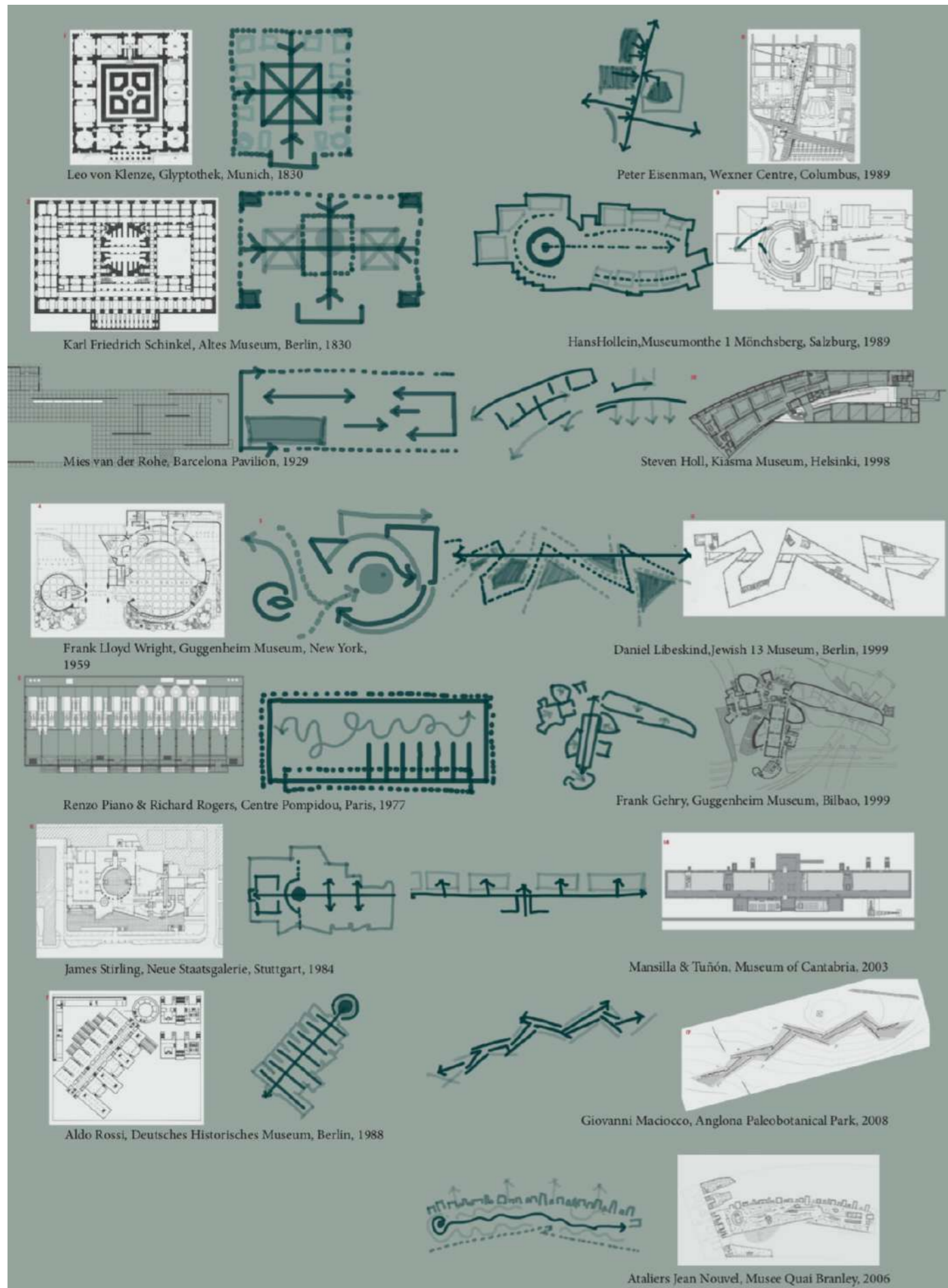

Fig 1.10- Museum typology analysis, (The Architectural Review, 2012) Museum typology diagrams (Author, 2019)

1.1.2 Collective Memory under Siege: Memory as the Peoples' Weapon

“Since memory is actually a very important factor in struggle ... if one controls people’s memory, one controls their dynamism. And one also controls their experience, their knowledge of previous struggles.”
(Foucault, 1989:89-106).

Boyer (2012) puts forth the notion that architectural collective memory is the ultimate ‘archetypal collective memory’ because of its permanently fixed and recognizable state. He argues that, in an age of modern ethics, collective memory and the intangible memories of a nation and its people are never set in stone and, therefore, need to belong to a ‘field of argumentation.’ Instead of embodying the memory of the people, the notion of ‘memory tourism’ has contaminated the authenticity of historic sites and museums as places of commodification, where fixed histories are treated as consumer objects (Boyer, 2012:326).

Memory has the power to act as a voice of resistance, over and above being a tool for moral redemption concerning past trauma and grievances, and can provide a sense of identity in a modern world that is on a trajectory of alienation (Boyer, 2012:326).

What is the relationship between collective memory and the memory of the individual? The notion of ‘palimpsest’ in the urban

fabric assumes that individual memories that have been lost or silenced ‘haunt’ the city’s collective memory (Boyer, 2012:327). It is important, therefore, to construct places where these traumatic, lost and silenced metaphysical voices can be liberated and their fears and desires recognized (Boyer, 2012:327). Boyer (2012:327) explains that the importance of these locations, situated in space, allow people to return and work through contradictory emotions of fear, shame, guilt, sadness, anxiety, and longing, through which they can develop hope for a better future.

Andreas Huyssen argues that the study of memory cannot indefinitely deny a traumatic past in order to avoid the narrative that circles around suffering. He suggests that a better way to deal with recollection is through the human rights discourse, based on truth commissions and judicial proceedings, in addition to healing practices and the design of commemorative public spaces (Boyer, 2012:328).

“Commemorative celebrations enacted in public space, and memory traces stored in archives and memorials, act as prompts to individual memory.”
Boyer (2012:328).

When collective memory is shared on a public platform it forges a process of reinterpretation, preservation and transformation (Boyer, 2012:328).

Local Issue

South Africa is a young democracy with a contested and concealed intangible heritage

The overarching local issue is that South Africa has failed to continue to hear the testimonies of the everyday man such as in the TRC and as a result everyday man is unable to record his experiences of our young democracy (Boshomane, 2016)

1.2 || THE LOCAL ISSUE

South Africa is a young democracy with a contested and concealed intangible heritage.

According to SAHO (2011), museums have certainly tried to redress the prevalent historical silence during the post-colonial or post-apartheid era. South Africa is a young democracy with a contested heritage. If the past and the present are to be accurately recorded, therefore, the oral testimonies and intangible heritages of the people are of the utmost importance, especially in the capital, Pretoria. Hlekiso (2018) reports that the everyday inhabitant's role in South Africa's liberation struggle is not recognized in either museums or recorded history, which leads to further marginalization.

The Truth and Reconciliation Commission (TRC) documented living memories as regards violence and the conflicts of Apartheid (Du Toit, 2005:61). The role of the TRC was to hear thousands of spoken South African histories – in the form of personal testimonies – to address Apartheid's human rights violations (Hutchison, 2013:1). The Commission used individual recollections – via verbal accounts – to create a single, coherent narrative that contributed to the country's national unity.

An overarching local issue is that the testimonies of everyday city dwellers have

not yet been heard. Ordinary citizens have not been granted the opportunity to record their experiences (Boshomane, 2016). Since oral histories are not being collected and curated, the general population's experiences and memories do not form part of the overall heritage inventory of the young democracy.

Remembrance is currently represented in the built environment by way of visual archives such as museums, which have become marginalized in the South African context as they standardize and fix a narrative.

1.2.1 The Role of Oral Histories in the Preservation of Heritage and Memory in Society

Oral history is unique as it draws from the lives of ordinary people and explores a 'history from below' approach (Thomson, 2007). Verbalized accounts are important when dealing with democratic landscapes since they establish an accurate relationship between collective memory and identity (Thomson, 2007).

Llewellyn (2003) asserts that the value of spoken history lies in its ability to present the perspective of the user concerning both historical architectural spaces and the multi-faceted nature of the built environment within everyday life (Llewellyn, 2003).

Voiced chronicles shed light on gaps within written historical records and legislation (De Leao Dornelles, et al., 2017). Narratives capture the sensitive relational facets between the preservation of buildings and social collective memory pertinent to historical sites (De Leao Dornelles, et al., 2017).

Moore and Whelan (2007) argues that urban design professionals, on a broad scale, neglect oral histories and local memories when they construct 'place', therefore, architecture becomes 'objective' and 'out of place'. Memory plays a pertinent role in the formation of personal and situational identity, which becomes critical when framing discourses on heritage preservation and development (Moore & Whelan, 2007).

Verbalized accounts forge a deep feeling of rootedness and 'being in place', and reveal complex connections between people, identity and location and result in 'connecting community' (Butler, 2007).

1.2.2 Oral Histories in the South African Setting

The South African History Conference (SAHA, 2006) reasons that oral histories play a vitally important role in understanding the everyday lives of the people affected by Apartheid, and that spoken testimonies focus on people's experiences as related to a specific place.

Hutchison (2013) argues that diverse oral histories, memories and identities should be reinterpreted and included in the significant spaces, memorials and museums where people can actively gather and recover memory. Exploring different told declarations and recollections is crucial in the creation of an inclusive environment such as South Africa's 'rainbow nation'.

In contemplating the research of oral histories and the creation of memory of place within a South African heritage context, an understanding of what oral history and memory are essential. These concepts contain architectural heritage significance, whether explored through a broad global or a local and more specific understanding. This unpacking of memory and oral history, within a heritage architecture context, has made it apparent that these concepts play an important role in the preservation of the 'memory of place' and the acknowledgment of the everyday citizen.

1.3 | THE ARCHITECTURAL ISSUE

A typological critique of museums: No place has been dedicated to the memorialization and immortalization of the Truth and Reconciliation Commission and its principles.

The SAHA proceedings emphasized the importance of the relationship between archival and oral histories within a democratic society as a means of bringing about public deliberations (SAHA, 2006). The TRC forms an extremely important part of the intangible heritage of South Africa, yet the archived recorded accounts are concealed from the public (Hlekiso, 2018). Hlekiso (2018) recently reported that there is an urgent need for the TRC to be memorialized and made accessible to the public so that history may be known and healing can continue. The TRC archive needs to become accessible to the public if healing is to continue.

According to De la Rey and Owens (1998:270), there is an on-going need for the potential of the TRCs psycho-social rehabilitation to be reached. The authors recommend methods such as asking questions, offering analyses and conducting research (De la Rey & Owens, 1998:269).

The TRC offers the potential to explore a democratic museum typology that engages with the memory of the everyday citizen. It becomes important to understand how to preserve this memory.

follow similar design 'guidelines' and recognisable characteristics in their architectural manifestation.

Barker (2019:11) states explains that typology in architecture acts as a means by which historical linkage is fostered, therefore, a contextual approach to museum making is imperative in a society that has a contested heritage.

Architectural Issue

A typological critique of museums: No place has been dedicated to the memorialization and immortalization of the Truth and Reconciliation Commission and its principles.

Hlekiso (2018) recently reported that there is an urgent need for the TRC to be memorialized and made accessible to the public so that history may be known and healing can continue.

1.3.1 A Brief Overview of Typology Theory

According to Ayyildiz et al. (2017:3), the subject of typology in architecture can be considered in two ways. The first is relevant to design and regards ‘typology as a form of knowledge that can be applied directly to design work’. The second approaches typology as ‘a terrain of encounter between inhabitants and architects.’ (Ayyildiz, et al. 2017:3).

“Typology in architecture has been defined as creating [an] archive of the certain types related to architecture styles reduced to their elementary geometrical nature or the search effort of the combination possibilities of the architectural elements to classify the types which are the architectural forms.”
(Ayyildiz et al. 2017:2).

Individualization and classification are the two actions which typology, as a concept, achieves (Ayyildiz et al. 2017:2)
Typological analysis method

“Typology is a systematic study which includes actions such as ‘abstraction, reduction and schematization’ to identify and clarify the phenomenon that [the] researcher has in every field; it is the discussion of the special one which is generalized by mind.”
(Ayyildiz et al. 2017:3).

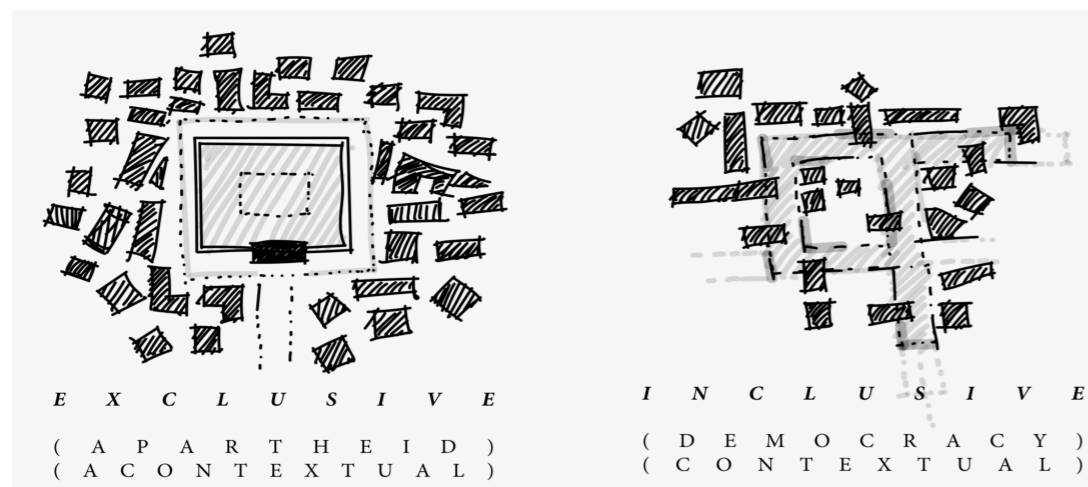

1.11

At its core, typology categorises architecture of similar style, program, movement etc. into classes that follow similar design ‘guidelines’ and recognisable characteristics in their architectural manifestation.

According to Barker (2012:29)
“The importance of typology lies in its relationship to the history of architecture and architectural ideas, and to the human aspect of association. It links...to an understanding of our traditions and their importance in our lives to give us a sense of continuity, connectedness or rootedness”
(Barker, 2012:29).

1.3.2 The Preservation of Heritage in a Progressive Society

Rajagopalan (2012:321) describes museums and archives as ‘bureaucratic apparatuses of modernity’ that define the heritage practices of a country, and introduces David Scott’s theory that ‘... any imagination of the past is ineluctably linked to the present, and ... how we tell histories is as important as what we tell.’ The question, therefore, arises as to how museums can preserve many histories and, at the same time, facilitate a dynamic nature by adding material as time progresses.

Rajagopalan (2012:321) suggests that the subjective framing of what is seen as authentic can ultimately end up as a



1.12

Eurocentric portrayal of heritage, even when implemented in various countries around the world. Furthermore, these institutional narratives have played a key role in what Rajagopalan (2012:321) describes as ‘fossilizing’ some narratives and representations of the past whilst completely ignoring others.

Rajagopalan (2012:322) returns to David Scott’s speculation that all historical perceptions and constructions – as we know them – are ultimately filtered through the anxious and expectant eyes of the present time. Scott argues that all new theories must recognize the importance of heritage meanings and manifestations that never become static but are in constant flux through the influence of contemporary political and social forces (Rajagopalan, 2013:322).

1.3.3 Deliberating Democratic Museum Making

The case of collective memory in South Africa, as expressed by Boyer (2012:334), investigates how a country went from a state of concealment and silencing to a democratic society that elevated voices and made all past injustices transparent (Boyer, 2012:334). Boyer (2012:335) explains that the TRC brought forth memories and allowed questions to be answered in order to right the wrongs of the past.



1.13

It is important to note that the continuums expressed above are of Eurocentric origin. In the context of Pretoria, the museums built before or during the Apartheid-era tend to be of pre-modern typology, with few being classified as modern. Following the abolishment of Apartheid (post-1994) the new museum designs aimed to represent a new, free and liberated future by employing the post-modern categorization with a humble South African identity as opposed to the iconic post-modernism employed by Western society.

An important premise to note with regard to assessing this dissertation is an emphasis on design as a way of connecting people of various backgrounds, cultures, classes, races, and ethnicities in the same way that the TRC did. As a democratic society does or should, the TRC viewed all as being equal. If the TRC principles are to be translated, designing the building through lenses that forge this common ground is of the utmost importance.

1.3.4 Fashion Museology: Relating the Museum to the Everyday City Dweller

One way to liberate the museum and the everyday citizen is through the implementation of a kind of fashion museology that captures the contemporary

Fig 1.11- Exclusive vs. Inclusive proposed museum typology. (Author, 2019)

Fig 1.12- Fashion implemented into museums by Balenciaga (Balesto, n.d.)

Fig 1.13- Fashion implemented into museums (Unknown, n.d)

Fig 1.14-
Judith Manson
Plastic bag dress
sculpture (Standard
Bank Gallery, 2008)



1.14

Fig 1.15-
Judith Manson
oil painting
depicting the TRC
(Constitution Hill,
1998)



1.15

Fig 1.16-
Architectural
Continuum
(Author, 2019)

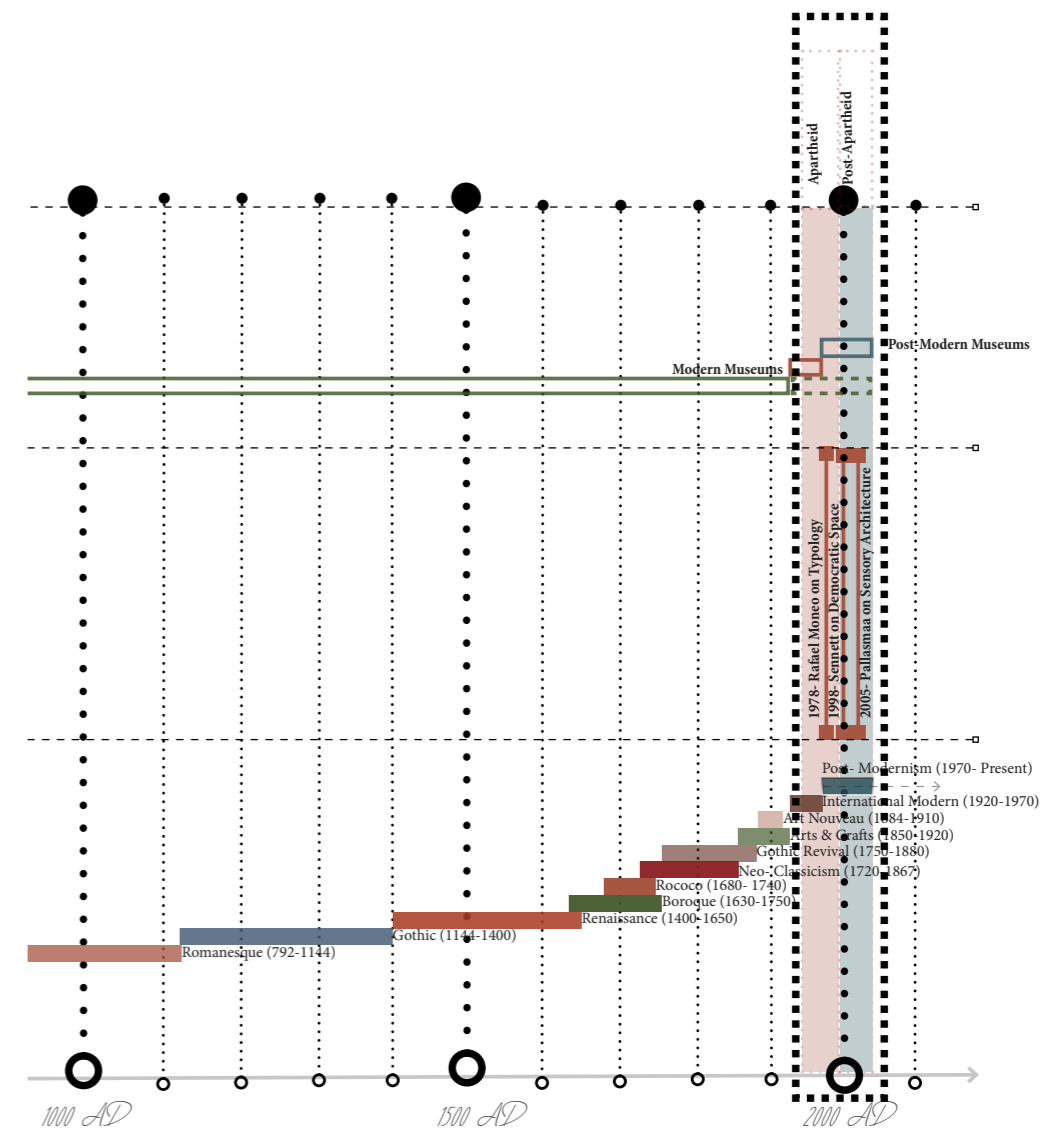

1.16

pop culture, the memory of each individual – hence the collective as a whole – and encapsulating and expressing commonplace experience and making it extraordinary (Melchior, 2011:6).

Clothing displays have been shown to attract younger and more diverse audiences from various socio-economic backgrounds to exhibitions (Melchior, 2011:3). Ordinary people can relate to fashion in one way or another since individuals can place themselves inside the garments on show, which makes accessing various memories and histories more personal (Melchior, 2011:3).

“Clothes are the shorthand for being human.” (Melchior, 2011:3).

The introduction of fashion into museums has been said to ‘dust off the old museum’ in the sense that fashion has its finger on the pulse of pop culture, making it relevant in a changing world (Melchior, 2011:5).

According to Melchior (2011:1), fashion has an innate ability to transform museums into ‘visitor-centred forums’ through which the observers can deliberate and interpret complex socio-political, cultural and behavioural issues and narratives of the past

and the present. Consequently, the museum incorporates current and bygone memory.

Melchior (2011:6) believes that adding fashion displays to collections would satisfy society’s interest in consumer and celebrity culture, thus providing more options as regards economic sustainability. The addition of daily items such as trends or performance can elevate the museum into something extraordinary. The general public is liberated to engage with a museum when the level of interaction transcends mere visual content.

1.3.5 The Everyday and the Extraordinary – Joe Noero

Noero (2009) deems the idea that popular culture holds the key to architecture to be proper and appropriate. He advises that architecture should be created based on the needs and expressions of the man and woman in the street, and elaborates that the role of the architect is to elevate the realm of the ordinary and turn it into something extraordinary.

1.3.6 Through the Eyes of the Skin –

Pallasmaa

“Architecture is the reconciliation between ourselves and the world, and this mediation takes place through the senses.” (Pallasmaa, 2005:72).

The sensory approach needs to be considered as a way of connecting the layperson to an experience that can be perceived as familiar or to evoke a particular encounter or memory on a subconscious and emotional level.

The previous line of reasoning explores architecture as a medium of translating the young South African democracy and the everyday citizen’s experience of its capital city, Pretoria, through the exploration of

a new museum typology that represents the average person in the conservation site’s sense of place. One liberation method – as regards a museum and the regular civilian – is the implementation of fashion museology, as it captures not only collective memories but those of each individual in such a way as to express everyday experience while making it extraordinary (Melchior, 2011:6). An overarching principle of the dissertation is to explore the creation of museum architecture and how it can act as a catalyst through which the ordinary person’s memory becomes an integral part of South Africa’s democratic collective memory.

INTERNATIONAL MUSEUM PRECEDENT:

Musee Quai Branley- Jean Nouvel

2006

Fig 1.17- Musee Quai Branley external boxes (Guillaume, 2006)

Fig 1.18- Fashion exhibits (Flickr, 2018)

Fig 1.19-artful display of relics (Halbe, 2006)

Fig 1.20- visitors relating to fashion (Wired New York, 2006)

This precedent was chosen as it exemplifies how a Museum can grow out of its context at the same time as being designed completely around its subject matter.

Maggiora (2019), reported a direct quote by the architects:

“This is a museum built around a specific collection, where everything is designed to evoke an emotional response to the primary object, to protect it from light, but also to capture that rare ray of light indispensable to make it vibrate and awaken its spirituality” (Maggiora, 2019)

Given the subject matter of the museum, it was intended that the museum as an architectural expression challenge the western creative museum expression.

The architects intended to create a museum that dissolves into its depths of context as well as subject matter.

The sensitive treatment of old vs new is particularly intriguing in conveying the intentions of challenging the western museum typology.

This is one of the few museums in the world that has utilised fashion museology to challenge the western notion of museum typology and is highly successful at doing so.

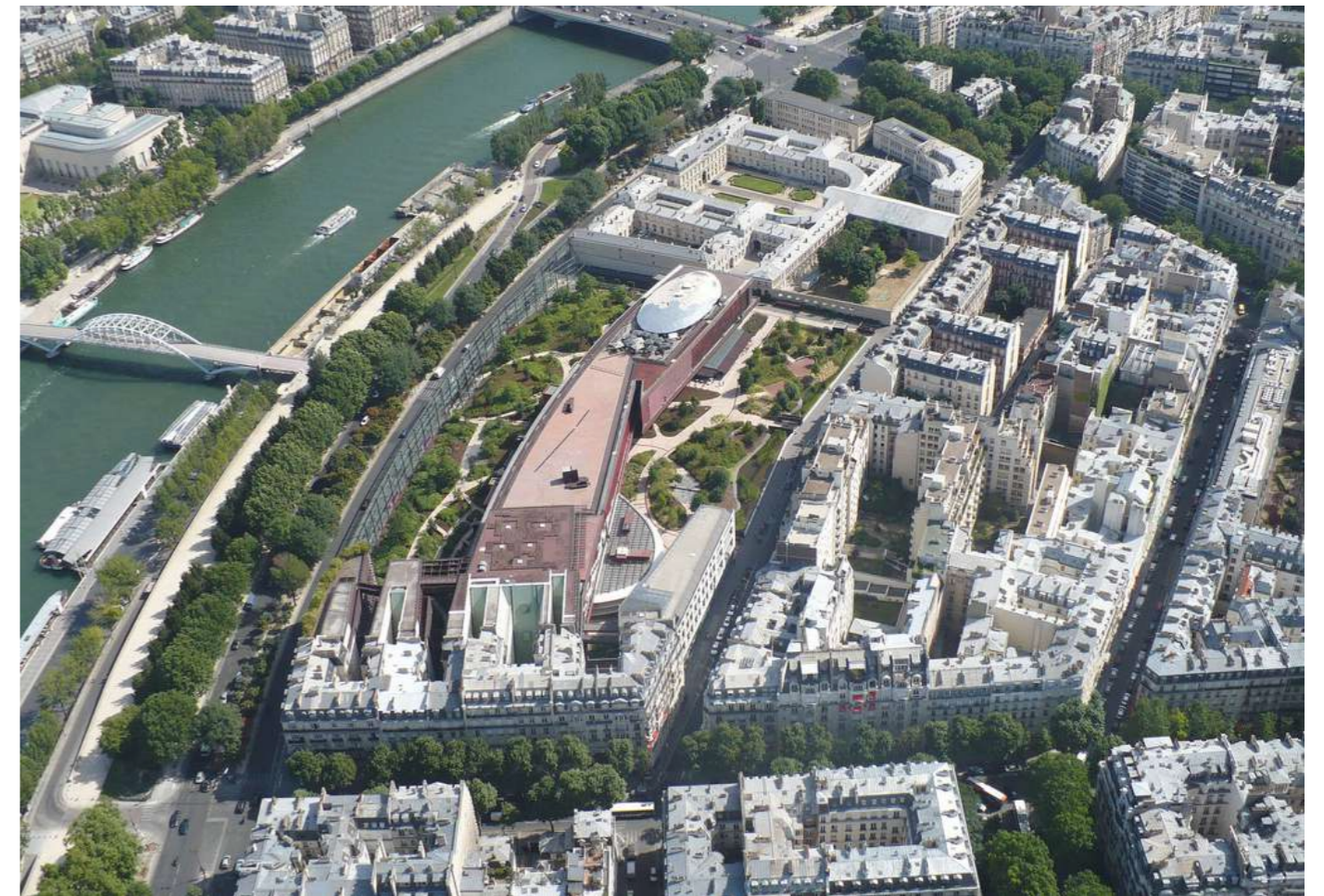

1.21



1.17



1.18



1.19



1.20

Fig 1.21- Musee Quai Branley in context (Profil, 2013)

Fig 1.22- Musee Quai Branley ground floor (Arcdaily, 2008)

Fig 1.23- Musee Quai Branley green facade (Halbe, 2006)

Fig 1.24- Musee Quai Branley main plan (Arcdaily, 2008)

Fig 1-25- Park beneath Musee Quai Branley (Paris Insider, n.d)

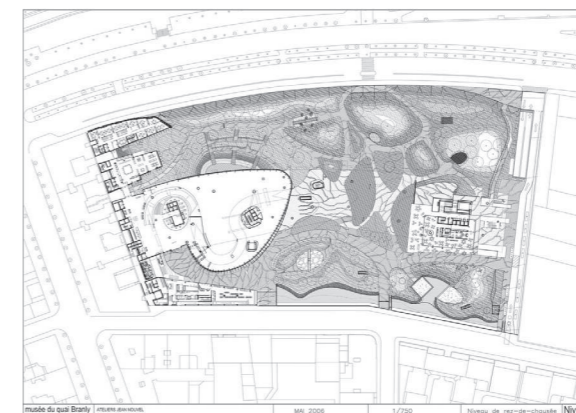

1.22



1.24



1.23



1.25

LOCAL MUSEUM PRECEDENT

*The Apartheid Museum,
Johannesburg, Gauteng*

2001

Gapp Architects and Urban Designers,
Mashabane Rose Architects, Britz Roodt
Association, and Linda Mvusi Architecture
and Design

A local example of ‘museum as landscape’
is the Apartheid Museum in Johannesburg,
South Africa, designed by Gapp Architects
and Urban Designers, Mashabane Rose Ar-
chitects, Britz Roodt Association, and Linda
Mvusi Architecture and Design.

According to Deckler (2006:39), the Apart-
heid Museum is partway buried in Johan-
nesburg’s mining landscape and traces the
origin, development, implementation, and
deconstruction of South Africa’s past Apart-
heid system. The Apartheid museum is
blatantly and intentionally a-contextual as

it turns its back on the existing setting sur-
rounding the site whilst opening itself up to
the old Johannesburg city skyline. The articu-
lation of the plan follows a route through
space and time, indoors and outdoors,
trailing a course that eventually terminates
where it began (Deckler, 2006:39).

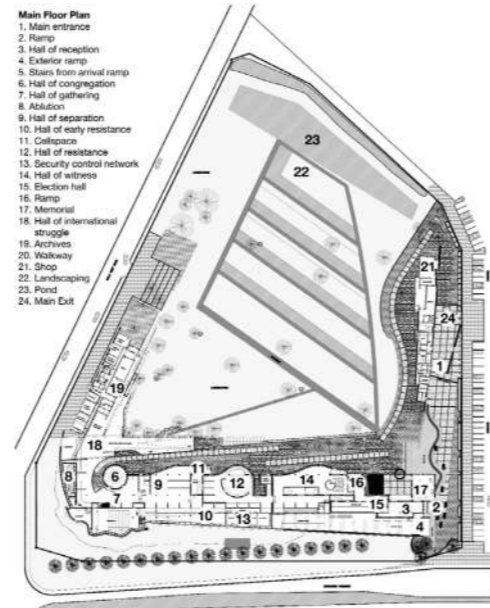

1.26

Fig 1.26-
Plan of the
Apartheid Museum,
Johannesburg
(Deckler, 2006)

Fig 1.27-
Interim space between
programmes in the
museum (Author,
2019)

Fig 1.28-
Entrance into
museum next to water
landscape (Author,
2019)

Fig 1.29-
Walking among
the struggle heroes
(Author, 2019)



1.28

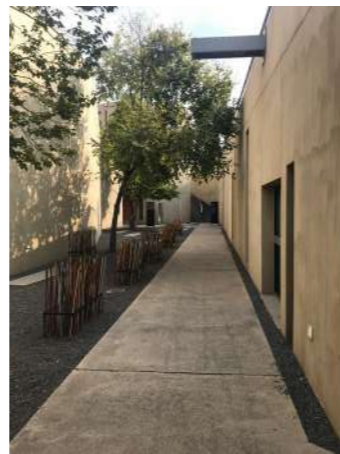

1.27

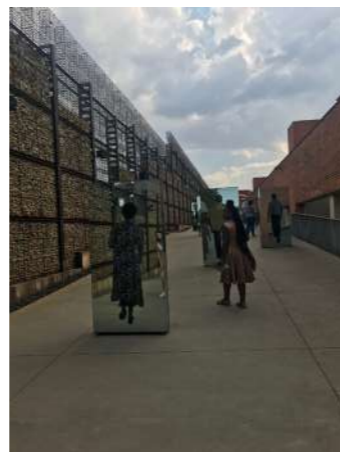

1.29



1.30



1.33

Fig 1.30-
Video installation of
TRC (Author,2019)

Fig 1.31-
TRC collection
exhibition board 01
(Author, 2019)

Fig 1.32-
TRC collection
exhibition board 02
(Author, 2019)

Fig 1.33-
TRC collection
exhibition board 03
(Author, 2019)

Fig 1.34-
TRC Zapiro comics on
display (Author, 2019)

Fig 1.35-
last of the TRC
exhibition (Author,
2019)



1.31

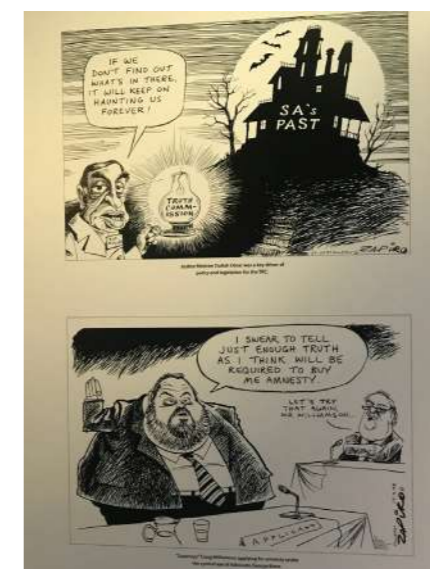

1.34

Fig 1.30-
Video installation of
TRC (Author,2019)

Fig 1.31-
TRC collection
exhibition board 01
(Author, 2019)

Fig 1.32-
TRC collection
exhibition board 02
(Author, 2019)

Fig 1.33-
TRC collection
exhibition board 03
(Author, 2019)

Fig 1.34-
TRC Zapiro comics on
display (Author, 2019)

Fig 1.35-
last of the TRC
exhibition (Author,
2019)



1.32

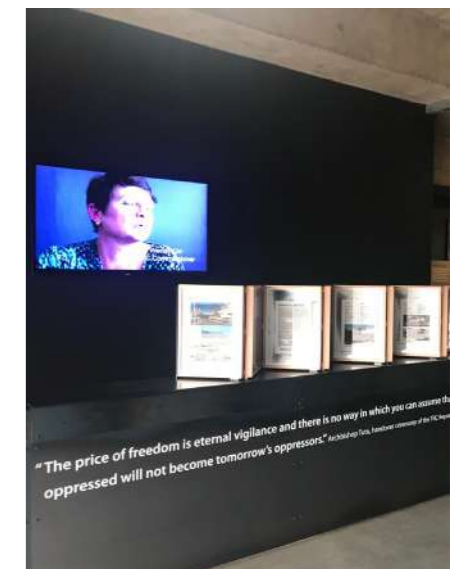

1.35

**Critique of the TRC exhibition at the
Apartheid Museum.**

Although the gist of what the TRC
achieved is portrayed through the exhibi-
tion, it can be argued that intentions what
it aimed to do for South Africa’s journey
into democracy is less clear.

Emphasis is placed on the ‘heroes’ of the
TRC (those who ran it) as opposed to on
the victims. This goes against the TRC’s
intention of bringing a voice to the every-
day citizen.

1.4 || RESEARCH PROBLEM

Museums are, at large, becoming obsolete in the South African landscape largely because of their Eurocentric influences which are representative of an outdated regime. The new democratic museums being built often fail to serve the communities they are located in and are too in a sense a-contextual. Memory is the missing link that ties the everyday citizen to the heritage narrative of his city., Memory and sources that relate to it such as the TRC are under-represented in museum architecture and are as a result being 'forgotten'.

1.6 || DISSERTATION STATEMENT

An approach to democratic museum typology that establishes the everyday realm into the extraordinary nature of a museum that is rooted in an understanding of the socio-spatial relationship between people and place, a museum that engages with and serves the everyday democratic city dweller

1.5 || RESEARCH QUESTIONS

- *How can museum typology in Architecture be adapted to suit the socio-spatial conditions of a specific context?*
- *How can Architecture accelerate the healing of Deep Memory in a young democratic society?*
- *How can Architecture act as a responsible mediator between inaccessible archival resources and the public?*
- *How can Architecture syncretize the principles of the Truth and Reconciliation with a new approach to democratic museum experience as a 'living Monument'?*

1.7 || METHODOLOGY

The ideas expressed fall within the ‘interpretative social science’ paradigm and therefore– if research is to be taken forward – a qualitative methodology should be employed as an overview.

To determine appropriate architectural responses to the research questions outlined, the following methods are applicable:

Historical Studies

This will be used to understand the two historically driven informants of the dissertation:

1. The background to the development of museum typology and the importance thereof.
2. The interpretation and heritage significance of the chosen site including site memory and past events. This historical research will be conducted to develop an appropriate premise from which a contextually driven museum expression can be developed.

Mapping

A thorough understanding of the Pretoria inner-city fabric in relation to the user activity is required in order to determine an appropriate site to act as a prototype for the new museum typology. The relation of pedestrian movement to museum location is

imperative to formulate a hypothesis in determining the location of a user-centric and contextually driven museum typology.

Once the site has been chosen, a thorough analysis of the site history, current conditions, uses and future projections is to be conducted. These will be mapped through a combination of observation, transect walks, historical data analysis of information from the Tshwane Heritage Research Centre and the Vander Waals collection as well as computer based research. This information will be presented as visual analysis graphics and maps.

Critical Theoretical Exploration

Theories to substantiate the identified issues have been identified, in addition Theories that explore the coalescence of museum with place and user are to be explored, specifically, theories relating to the everyday and the extraordinary. Additional theories relating to the expression of heritage and memory through architecture.

Theories relating to heritage charters and architectural heritage approaches are to be applied to the architectural articulation of the built fabric.

Theoretical stances are to be determined at various stages of the design and technology development processes to substantiate design decisions.

Precedent/ Case Studies

Case Studies to be conducted will fulfil two purposes in this dissertation:

1. To establish typological trends in local and international museum architecture to draw conclusions.
2. As design precedents to substantiate design decisions. Case studies include, but are not limited to, contextual, technological, functional, theoretical and programmatic examples.

Secondary Data Analysis

It is imperative that the Truth and Reconciliation Commission and the critique thereof be understood through secondary data analysis as I, the designer, did not personally take part in the process, nor was I old enough to critically evaluate the successes and downfalls of the TRC while it was taking place. My conclusions with therefore be based solely on secondary data analysis.

Interdisciplinary Research

Although brief, the research into theories related to theatre and performance are of importance in this dissertation as they will provide programmatic and formal validity of the architecture.

The design methodology will be heavily influenced by the conclusions reached through the conducted research. It will follow a process of –

- programmatic development,
- concept development,
- design development, and
- technical detailing.

1.8 || LIMITATIONS & ASSUMPTIONS

Although the whole Sammy Marks precinct and civic context surrounding is analysed, the area of focus for this dissertation will be the South-eastern corner of the Sammy Marks block. The broader urban and block visions are indicated, but not designed in this dissertation.

This dissertation will adopt the Tshwane 2055 vision, which defines Helen Joseph and W.F.Nkomo streets (formerly church street) as the 'Ceremonial Boulevard'.

It is Assumed, through secondary sources, that the users of the site are predominantly urban professionals and daily commuters.

Not all as-built documentation of the Sammy Marks block is accessible; therefore, existing site dimensions and details are determined from: Sammy Marks library interior layout plans (located at Tshwane Heritage Research Centre), site documentation included in journal and newspaper articles and limited site elevations. Site

servitudes, contours and aerial photographs are available on the Tshwane GIS online platform, therefore modeling the existing site conditions will not be restricted. The missing detail was determined through physical measuring and photographing elements on site.

The chosen site basement structure was designed and reinforced to host a multi-story hotel which was never built as construction was forced to stop. As a result of this the site has been left as a fenced off building site for the past 22 years. What remains in the reinforced structural columns that are structurally sound and have the ability to be re-appropriated.

It is assumed that, given the proximity of the chosen site to the Pretoria National Archives that the TRC archival material can be transported and digitized in a controlled and safe manner. This will allow the National Archives to continue to act as custodians without compromising on their responsibility to protect the archival materials.

1.9 || PROJECT AIMS & INTENTION

The proposal intends to bring to life the principles of the TRC and aspires to integrate the voices of everyday citizens into the overall heritage narrative of South Africa's young democracy. The dissertation challenges global museum typology and examines what it should become locally, within the capital city of a new and representative system. The context and importance of the capital city are paramount. The exposition will unpack the ways in which the TRCs core philosophies of justice, truth and reconciliation can be conveyed in a museum that has been designed to present the users with experience and that can act as a precedent for museum architecture of this kind in South Africa.

The study means to explore how architecture can play an integral role in housing, conveying, deliberating, and celebrating the memory of South Africa's democratic capital, Pretoria. The purpose is to reveal and memorialize the past – as uncovered at the TRC – through architecture, in order to forge transparency, allow access to the TRC archives for deliberation, create a forum for expression and debate around the TRC – as

an on-going democratic experience – and to finally record the new memories of the people that inhabit the democratic city.

The project's aim is to create a place to memorialize the TRC and create a space where the principles and intentions of the TRC can continue to manifest, thus allowing the everyday city dweller's memory to be recorded as an integral part of the heritage inventory of the City of Pretoria.

In addition, the design aims to create a place to act as mediator between the National Archives TRC collection and the public. Innate in the TRC is the intention that it would function as a catalyst for healing, therefore, the new 'living archive' should facilitate the public's recollections being recorded and included as an integral part of the heritage inventory of the City of Pretoria.

An exploration of how Museum Architecture can be articulated to accommodate the Truth and Reconciliation Commission in South Africa in a way that the "Born free" generation along with those who witnessed the original trials can partake in the continuation of the TRC's memory, processes and legacy.

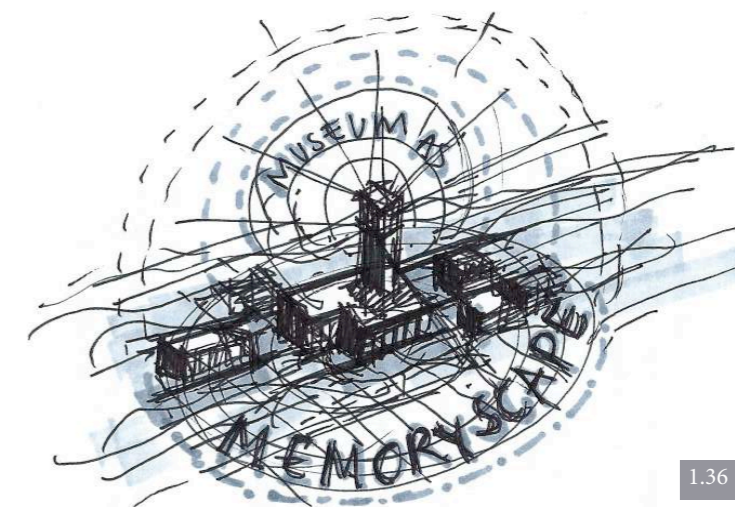

Fig 1.36-
Project Aim as the
'Memoryscape'
(Author, 2019)

1.36

CHAPTER



CHAPTER 02

*Theoretical Background to the Truth and Reconciliation Commission
and the Expression of 'Deep Memory' through Performance*

/

2.1 || A LONG NIGHTS JOURNEY INTO DAY - THE TRUTH AND RECONCILIATION COMMISSION IN SOUTH AFRICA

The Truth and Reconciliation Commission was an imperative part of the journey that South Africa has taken into democracy. The role of the TRC was to hear thousands of oral histories in the form of personal testimonies (Hutchison, 2013:1). Individual memories, through spoken recollections, were utilized to create a distinct, comprehensive narrative that furthered national concord. It can be said that the most important function of the TRC was that it offered reconciliation over restitution in a society that was at its genesis. The TRC was expected to bring a sense of justice regarding the human rights violations that took place under the Apartheid system and to lead South Africa into a future of hope and promise.

The TRC process followed a precisely structured methodology (Truth & Reconciliation Commission, 1998):

1. **Initiation (the start-up)**
2. **Decentralization**
3. **Appointing committee members**
4. **The protocols**
5. **The information management system**
6. **The database**
7. **Hearings –**
 - victims
 - events
 - special hearings
 - institutional hearings
 - policy party hearings
8. **Investigations**
9. **Research**
10. **The amnesty process**
11. **Witness protection**
12. **Overview of the Commission's work**

The TRC recorded the harrowing accounts of the victims of human rights violations that took place over a long period during Apartheid governance. One of the criticisms, according to Tutu (2010), of the TRC was that forcing the victims to recount these tragic memories would cause more pain than if they were to simply continue on their own path of healing. However, Nelson Mandela and Desmond Tutu – the men



Fig 2.1-
Historical Aerial
photograph of
Pretoria (Van Der
Vaal, n.d)

responsible for the creation of the TRC – believed that the wounds of the past needed to be uncovered so that justice could be served and healing could take place through exposing the truth – after reconciliation had occurred – if people were to move forward to forgiveness and start democracy off on a just and equal footing.

One of the main objectives of the TRC was to allow transparency regarding the recorded information so that the everyday citizen may have access to the archived material (Truth & Reconciliation Commission, 1998). This concept was put into place to act as a constant reminder of what happened so that the past would not be repeated and the journey into a successful democratic society may continue.

“The work of the Commission as a whole, together with the specific contributions of its three committees, underlined the need to restore the dignity of all South Africans. In the process, the sons and daughters of South Africa would begin to feel truly ‘at home’”

(Truth & Reconciliation Commission, 1998).

The TRC was one of the few attempts to understand the average person’s individual experiences in the history of South Africa (Hutchison, 2013). When viewed through the lens of reconciliation, the process should be on-going to allow for further public deliberations and the documenting of the everyday citizen’s experience of the young democracy that South Africa still is today.



2.2

2.1.1 SAHA’s Legal Battle in the Fight to Digitize the Truth and Reconciliation Commission Archive

According to Kennedy (2015:94), the South African Heritage Archive has tried relentlessly, even by way of legal action, to gain access to the TRC archives in the National Archives, to no avail. The National Archives are preventing access to information that was meant to be available to the men and women in the street, as a reminder of the past. It is unclear as to why the information is being concealed. SAHA reports that it is being safeguarded as ‘confidential’. The opening volume of the TRC Final Report states:

“One of the unique features of the South African Commission has been its open and transparent nature. Similar commissions elsewhere in the world have met behind closed doors. Ours has operated in the full glare of publicity.”

(Truth & Reconciliation Commission, 1998:1).

“The work of the South African Commission has also been far more extensive than that of other commissions. The volume of material that passed through our hands will fill many shelves in the National Archives. This material will be of great value to scholars, journalists and others researching our history for generations to come. From a research point of view, this may be the Commission’s greatest legacy.”

(Truth & Reconciliation Commission, 1998:1).

‘Archives are contested spaces. Whoever controls the archive, controls the narrative and thus controls official histories.’

– Professor Garth Stevens/The Apartheid Archive Project

2.3

‘Volume 7’ of the TRC Final Report will be the main volume focus of this dissertation. Architecture will be explored as the medium for the creation of a real ‘living monument’ to the TRC



THE TRC FINAL REPORT VOLUME 1 - 7



2.4

This harbouring of information by the National Archives goes against the very principles of the TRC itself. ‘Opening the floodgates’ so to speak, could be the concern. If some are granted access all should be admitted, which would make it difficult for the National Archives to maintain order and governance over the collections it houses. It can be speculated that one of the reasons might be that – by granting SAHA access to all the archival material – the National Archives may not be able to hold on to its guarding custodian role concerning the TRC archival resources, as it has been assigned to do. It is proposed, through this dissertation, that the building acts as a translating medium between the National Archives and SAHA to allow the National Archives to maintain control whilst SAHA is granted access to all archival material that the TRC final report states is rightfully allowed to be accessed by South African citizens.

Fig 2.2- Freedom of information logo (Kennedy, 2015)

Fig 2.3- Quote -Archives and memory (Kennedy, 2015)

Fig 2.4- Graphic explaining the contents of the TRC Final Report volumes (Author, 2019)

2.1.2 The Final Volume of the Truth and Reconciliation Commission Final Report as a ‘Living Monument’ – The Irony

The final volume of the TRC report contains extensive lists of the names of all the citizens that were affected by human rights violations during the time of Apartheid. This final volume is self-named the ‘living monument’ to the victims. Even so, in the year 2019 – 25 years post-apartheid – the final volume is virtually unknown. The very principle of something being a ‘living monument’ entails an air of permanence and monumentality, neither of which is present. An injustice is being done to the victims of these human rights violations as they have not been given a place in the South African landscape where they can actually be remembered in a real memorial that provides a sense of permanence vis-à-vis their memory and the significance of what they fought for.

2.2 || DEEP MEMORY

According to Hutchison (2013:32), ‘deep memory’ refers to the summoning up of an oppressed past that is painful and has left behind traumatic marks on the person who experienced it. These deep memories are too excruciating to be dealt with by simply recording them verbally since recalling these traumatic events can lead to gaps in the testimonies. Hutchison (2013:32) reveals that these profound recollections are far more effectively dealt with through non-verbal expressions, such as performance, instead. Such a representation of intense reminiscence allows past trauma that is ‘unspeakable’ to be transformed and dealt with (Hutchison, 2013:32).

Hutchison (2013:32) elaborates that the TRC process resulted in many disrupted narratives because the Commission mainly employed verbal testimonies that needed to be explained in a rational way (known as common memory). A deep memory approach allowing victims to express these memories so that the unspeakable truth could be revealed, and audiences could become a united part of the narrative that was being expressed through mediums such as poetry, should rather have been employed (Hutchison, 2013:32).



2.5

Fig 2.5-
Miriam Makeba
(Unknown, n.d)

Fig 2.6-
William Kentridge
expression of the
TRC (EYE Film
Museum, 2015)



2.6

2.3 || PERFORMING SOUTH AFRICA'S TRUTH AND RECONCILIATION COMMISSION

According to Hutchison (2013:55), the TRC played a monumental role in the shaping of theatre in South Africa at the start of the democratic era. Theatre moved away from merely ‘bearing witness’ and retelling stories from a particular era to where individuals were allowed to speak for themselves as truthfully as possible. The TRC urged theatre practitioners to adopt a new perspective and encouraged the negotiation of truth, justice and reconciliation (Hutchison, 2013:56).

Hutchison (2013:57) explores how various plays engage with themes that were considered unresolved by the TRC in a bid to utilize performance as a way of engaging the wider community in completing the social action which the TRC began in South Africa.

Deborah Posel says of the Truth and Reconciliation Commission:

“The theatre of these public hearings produced – necessitated – very different genres of truth-telling from those of the more scientific efforts at fact-finding. The hearings gave space for many people to tell their own stories, versions of events that often conflicted with others told in the same forum or which, on closer inspection, were internally inconsistent. Yet none of this seemed to detract from the truth-telling. Truth lay in the emotional power of individual stories and the capacity of the hearings to uncover seemingly pristine, uncorrupted narratives of past brutalization” (Cole, 2010:25, 26).

The TRC process was criticized because emotionally charged reflections that appeared to provide unmediated access to the real and authentic truth at the public hearings were themselves, ironically, highly mediated. Cole (2010) explains that the Commission itself played the role of ‘casting director’ as the delegates chose which ten percent of the victims would tell their stories.

2.4 || A BRIEF HISTORY OF THEATRE IN SOUTH AFRICA – A CONTENTED SPACE

According to VeVe A. Clark in “The Archaeology of Black Theatre” –

“To the person approaching the question from the Eurocentric paradigm, ‘theatre’ is understood within the context of the evolution of the stage from Greco-Roman amphitheatres to the proscenium arch of the present day. All performance traditions before the construction of the first performance space that was recognizably a ‘stage’ are lumped together as a kind of pre-history of the theatre, ‘primitive’ by today’s standards, and are summarily dismissed as ‘pre-logical’, ‘pre-industrial’, or/and ‘pre-literate’ in one breath”

(Opperman, 1993).

Over time, South Africa experienced many changes in the ways that theatre was presented because of a vast array of cultural, racial and political influences and situations (Kavanagh, 2016:2). Based on available research, Deon Opperman (1993) classifies the fundamentals of pre-colonial performance in African communities, which was ‘symbolic in form and ritual in purpose’ and generally took place in the open: a modicum of scenery, if any; song or music; improvisation; audience participation, and dance. These basics became part of African protest theatre, which reached its zenith between 1976 and 1990 (Opperman, 1993). South African theatre has worn many masks and has likewise acted as a voice of protest, hence the term ‘protest theatre’, which was birthed during the Apartheid era (Kavanagh, 2016:2). Protest theatre expressed the everyday citizen’s troubles, joys and the turmoil faced during Apartheid, when voices were silenced, and offered



2.7

Fig 2.7-
Ubu and the Truth
Commission
(Hoyle, 2014)

Fig 2.8- The Agora
(Sennett, 1998)

hope for the future (Kavanagh, 2016:4). During the mid-1980s, free expression was harshly restricted and the theatre was one of the few ways left to say what needed to be said (Opperman, 1993). Throughout South African history, performance has acted as the people’s voice, presenting real-life stories (Kavanagh, 2016:4). With the political changes announced in February 1990, protest theatre was stripped of its primary target all at once, and the results were instant. South African theatre is in the process of finding a new way to express that which needs to be articulated, based on what has gone before (Opperman, 1993). The basic universal elements of ‘black’ theatre, have blended with aspects of ‘Afrikaans’ and ‘English’ theatre.

2.4.1 Ubu and the Truth Commission: The Deep Memory of the Truth and Reconciliation Commission as Portrayed via Theatre

South Africa’s Handspring Puppet Company and William Kentridge worked together on Ubu and the Truth Commission that portrays Alfred Jarry’s original 1888 play for marionettes – which achieved mythical prestige in French theatre culture – in terms of the post-apartheid Truth and Reconciliation Commission. Jarry’s Ubu is an ostentatious, avaricious and power-hungry Macbeth caricature who lawlessly attempts to grab control with the help of his wife (Taylor, 1998).

“Ma Ubu thought her husband was out philandering, but he was actually running a death squad – represented by a three-headed puppet dog – with the complicity of the state. In her blinkered naivety, she seems to regard this as a lesser crime. Pa Ubu isn’t convinced he has anything to apologize for as the new South Africa is born, but for safety’s sake he feeds his incriminating documents, videotapes and instruments of torture to

a paper-shredding crocodile. His amoral indifference is in contrast to the first-hand testimonies we hear about police brutality, translated from the original languages and accompanied by Kentridge’s darkening images.”

(Fisher, 2014).

2.5 || THE GENESIS OF DEMOCRATIC SPACE – RICHARD SENNETT

Richard Sennett explains and critiques democratic spaces by speaking of the Pnyx – an amphitheatre where the people attended deliberations and came to communal resolutions, and the Agora – a public space which formed the hub of the athletic, artistic, spiritual, and political life of Ancient Greek cities. He suggests that these places should be explored in the making of democratic spaces (Sennett, 1998:15). According to Sennett (1998:22), a static sense of self can result in what he terms a ‘psychological death’, which is why he believed that people need cities in which experiences of disorientation and recovery can occur, and where human beings can grow and – owing to this growth – become fully human. Sennett (1998:27) suggests that designers consider theatres as places of political expression because a disciplined performance space commits people to one another in an environment where the eye and the voice are liberated.

“Theatrical forms can attempt to develop civic connections, not of the fleeting sort as in a public square, but of a more sustained and focused sort.” (Sennett, 1998:42).



2.8

CHAPTER



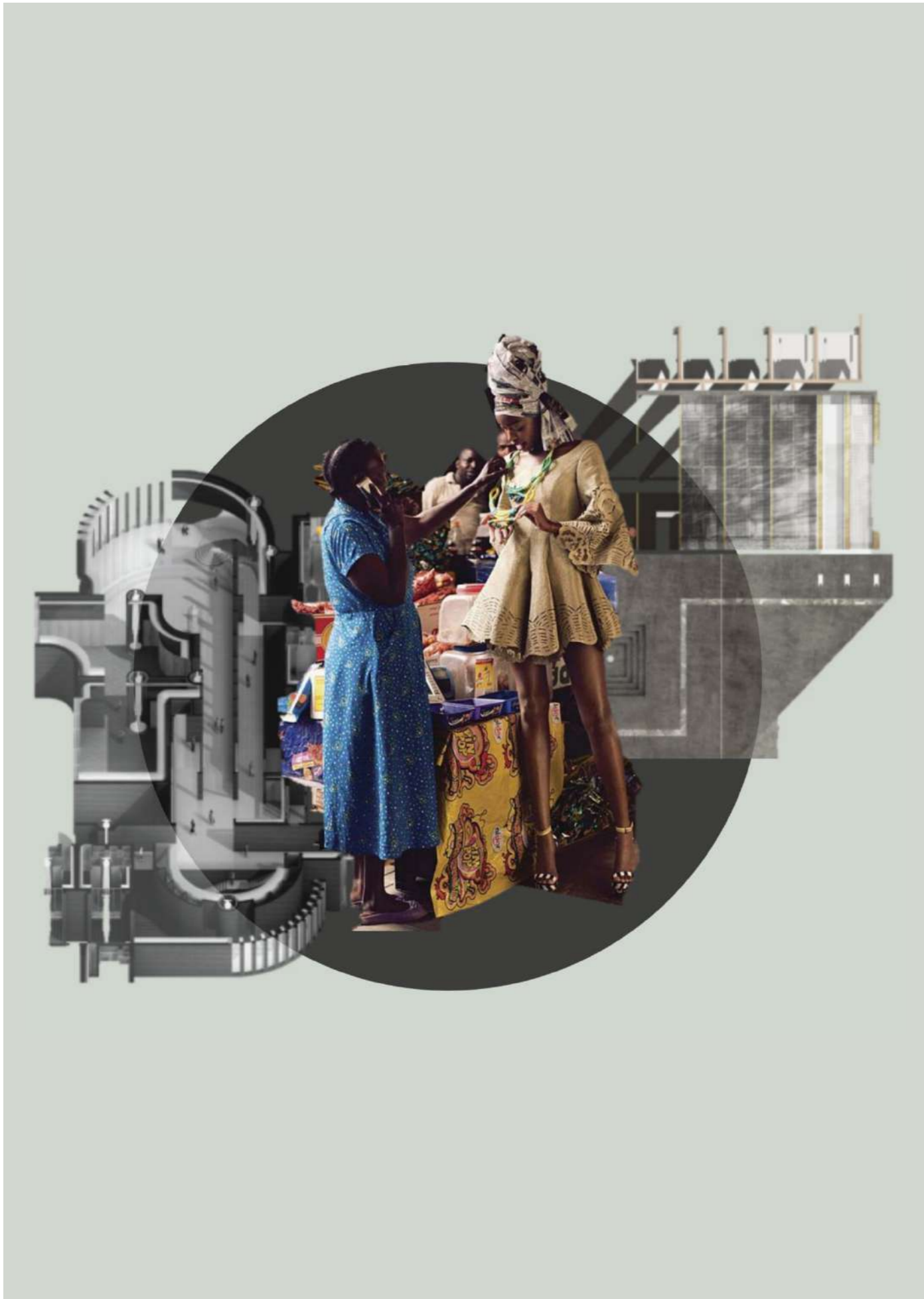

Fig 3.1-
Conceptualisation
of programme
(Collage by author,
2019)

Fig 3.2-
Relationship of
programmes to each
other (Author, 2019)

CHAPTER 03

Programme & Client

/

3.1 || AN EXPERIENTIAL MUSEUM FOR THE TRUTH AND RECONCILIATION COMMISSION

The events disclosed at the TRC had to be 'relived' by the victims throughout the trial process (Truth & Reconciliation Commission, 1998). The TRC was criticized as a result, but the uncovering of these emotions and the terrible events were the only way that reconciliation could be reached. For this reason, it was decided that instead of employing the typical way of museum making that consists of presenting important information through curated information boards and displayed relics (the pre-modern way of museum making) or taking the user on a

very specific route (the modern way of museum making), the best way to completely immerse the user in an understanding of the TRC process – and the emotions attached to it – would be a museum that employs an all-encompassing experience that evokes understanding on a subconscious and emotional level. This approach aims to bring forth the lens of empathy through which the TRC should be understood.

“To cultivate a sense of authentic and enduring meaning, such buildings must connect with the wider civic life and milieu from which they emerge and which sustains them.”

(Slessor, 2012).

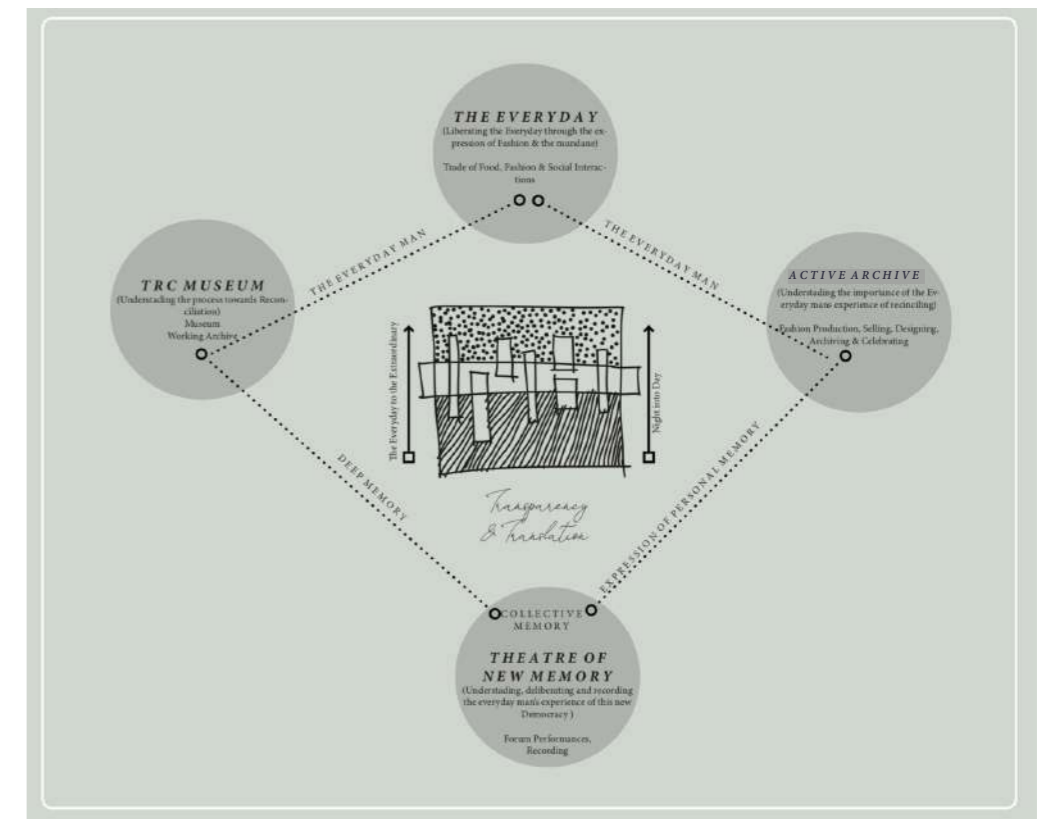

3.1.1 The Museum and Performance

According to Hutchinson (2013:5), when dealing with memories of a painful and distressing history (termed ‘deep memory’), performance is a much better medium of expression for the people involved. Therefore, the expression of the ordinary person’s memory of the past will be most effectively portrayed through the performance medium.

3.2 || THE TRUTH AND RECONCILIATION COMMISSION LIVING ARCHIVE

The greater part of the TRC archival collection is currently housed at the Pretoria National Archive, which is within walking distance of the chosen site at Sammy Marks Square. The collection contains over 3000 cubic meters of archival material such as video and voice recordings. Some of the TRC archive is being digitised and exhibited at the South African Heritage Association (SAHA) in Johannesburg, where SAHA embarked on the monumental undertaking of digitizing selected parts of the TRC material, those parts that the National Archive has selectively granted them access to. The remaining TRC archival material is housed in various other archives and institutions around South Africa.

Although both entities are located in Gauteng the general public would find it very difficult, if not practically impossible, to access either of these archives, which seems to be in contravention of the transparency principle that lies at the heart of the TRC. While the contents of the archives need to be protected it may be asked whether it ought to affect the openness and the general public’s access to the information. Should it be a difficult process to view the original TRC

sources in order to better understand the purpose and outcomes thereof?

The TRC specified that the information gathered during the process be available to the nation (Truth & Reconciliation Commission, 1998). It can, therefore, be concluded that there is a need for an avenue of exchange between the protected archival sources and the general public.

The proposed intervention is to become an avenue of exchange that will enable the visibility and digitisation of the TRC collection currently sheltered in the Pretoria National Archives. Given the proximity of Sammy Marks Square to the National Archives, it would be possible to share the data between the two in a safe and controlled manner.

It is proposed that the new building becomes a place where the TRC archives are translated into digital media. SAHA has already begun the process of digitizing some of the TRC archives at their facility in Johannesburg. This conversion process is decidedly important to allow the raw data to become widely available to the everyday South African citizen in order to make the TRC records and the outcomes transparent whilst allowing an open platform to springboard debate around the progression of South African democracy thus far and into the future.

3.3 || THE FORUM THEATRE – THE THEATRE OF NEW MEMORY

Also referred to as the ‘theatre of the oppressed’ the forum theatre is a form of theatrical experience where the audience is encouraged to become an integral part of the performance (Farmer, 2019). The presentation is performed twice; first by the professional actors and then by the players and any member of the audience who would like to take part and express their own views on the matters being raised in the depiction. The forum theatre is democratically suitable since the building can act as a kind of city forum – a platform where the performers and the audience are placed on equal footing – which would allow the everyday citizen to reflect on his deep memory and reconcile with the past. According to Farmer (2019), the forum theatre is unique in that it affirms everyday citizens to try out courses of action that could ultimately be applied to their daily lives.

It is proposed that the new theatre be adaptable to serve a vast array of functions such as public deliberation/debate during the day; public performances; as a lower-level theatre for State Theatre (which is just across the road) dramatic presentations; to facilitate the comedy nights that are currently held at 012 Central, and to facilitate formal private concerts amongst many other future possibilities.



3.3

3.3.1 The 'Black Box' Theatre as Typological Precedent

The black box theatre is a new theatre typology that is intended to create a blank canvas or neutral setting that gives performers and crews the freedom to set up staging and seating arrangements according to the unique needs of the various performances (Callahan, 2017). The design of a black box theatre is very simple and unadorned and is often painted black inside to literally resemble a 'black box' (Callahan, 2017).



3.4

Black box theatres are much smaller and more intimate than orthodox theatre typologies. Because of the close proximity of the audience to the performers, facial expressions and engagement become all the more powerful and authenticity is of utmost importance. This setting is also conducive to types of performances where the audience to performer relationship is blurred and the audience, in some cases, becomes an integrated part of the performance itself (Lee, 2010:85). Black box theatres bring forth an air of 'humanness' as they enable face-to-face interaction (Lee, 2010:85).

One of the main critiques of the black box theatre, however, is that it still feeds the 'illusion' created by performances in orthodox theatres. One way this can be addressed is to look at the black box theatre as a principle, and to adapt it through the concept of transparency. In order to break down the illusionism created in a black box performance, there should be a connection to the outside world. In the context of this design, the proposed black box theatre will allow for both a physical and visual connection to the surrounding urban context. The theatre will then be able to act according to more of the original adaptability principles presented by the initial black box concept as it adapts its skin together with its interior arrangement.

Fig 3.3-
Black Box theatre
of the Acting Studio
(Acting Studio,
2017)

Fig 3.4-
Black Box theatre
adaptable interior
(Live Design Group,
2018)

3.4 || EVERYDAY PROGRAMS

3.4.1 The Empowerment of Young Businesses (Food, Fashion, Retail)

According to the Parliamentary Monitoring Group (2019), the State of the Nation Address (SOTN) explicitly emphasized that small entrepreneurial businesses will be supported. The SOTN address expressed concern that many micro-enterprises have been excluded from South Africa's 'real economy' (Parliamentary Monitoring Group, 2019). With the adjustment of the government's 30% procurement process – to reflect the goal of growing the economy – there is an opportunity to incorporate kiosks and stalls as tenants on the site. It is proposed that these mini ventures should consist of crafts in order to best fit in with the cultural context, which was historically the Indian-owned market and, for instance, a tailor. When this possibility for the empowerment of small businesses is viewed through a contextual lens, given the memory of the site, it becomes important to maintain the everyday layers of food and fashion; layers that have been ever-present throughout the life of the chosen location.

3.5 || CLIENTS

The Finance Minister, Tito Mboweni, stated the following in his budget speech –

“Officials from the National Treasury and the Department of Arts and Culture will consider proposals for the development of a new national theatre, a new national museum, and also consider financial support for the National Archives, a national orchestra and ballet troupe.”

(Parliamentary Monitoring Group, 2019).

This recent statement by the finance minister has opened the gateway for the validation of a new museum typology that engages with the National Archives and a national theatre.

The proposed clients include the Department of Arts and Culture (funding); the National Archive (as custodians of the inaccessible TRC archival data); **Ditsong Museums** (to run the museum), and the **South African History Archive (SAHA)** (to digitize the inaccessible TRC archival data). **The Oral History Association of South Africa (OHASA)** will record the current memories of the citizens of Pretoria (through oral testimonies and video recordings of performances that take place in the Theatre of New Memory). It is proposed that because this museum falls under the management of the Department of Arts and Culture, the same as the State Theatre (opposite the chosen site) that the forum theatre performances can be run under the guidance of the State Theatre empowerment programs such as: “Indie Spotlight Program”, “Mahofi Program” and “Rendezvous Program”.

Fig 3.5- Memorial to the Murdered Jews of Europe, Berlin-underground (Pudelek, 2012)

Fig 3.6- Memorial to the Murdered Jews of Europe dusk (Drrcs, 2014)

Fig 3.7- View from Ministertgarten towards Memorial to the Murdered Jews of Europe (Blum, 2016)

PROGRAMMATIC PRECEDENTS
Museum

‘The Place of Information’ – a hidden museum beneath the ‘Memorial to the Murdered Jews of Europe’

Architect: Peter Eisenman
Location: Berlin, Germany
Completion Year: 2004

The design of the Memorial to the Murdered Jews of Europe comprises a collection of 2711 concrete stelae that are all 950 mm wide but vary in height as they undulate over the site (Emcke & Berg, 2005). According to Emcke and Berg (2005), Peter Eisenman explains that the design of the Memorial has several explanations: ‘divergence in concept’, the ‘illusion of order’, ‘absolute axiality’ and, finally, ‘hegemony of the visual’ – all of which had to be overcome.

The Memorial has been criticized for looking like a cemetery. However, the design is such that it can mean many different things to different people (Emcke & Berg, 2005). The overarching value of the Memorial is said to lie in its inherent value to keep the memory of an inconceivable period in German history alive and to serve as a reminder to future generations (Emcke & Berg, 2005).

The Place of Information, as the museum beneath the Memorial is called, was designed and built against the wishes of the architect. The information centre is made up of various rooms inhabited by exhibitions that are different in nature to their holocaust counterparts. Since the site of the memorial and museum is not a place of historical significance, the exhibitions on display in the information centre do not present possessions of victims or perpetrators but rather rely on images, words – spoken and written – as well as light and space (Emcke & Berg, 2005).



3.5



3.6



3.7



3.8



3.9

Theatre

The Market Theatre – Newtown, Johannesburg, 1976

Fig 3.8- Historical view of the Old Market Theatre (The Market Theatre Foundation, 2018)

Fig 3.9- The Market theatre public space (The Market Theatre, 2019)

Fig 3.10- Performances in the Market Theatre (the Market Theatre, 2019)

The Market Theatre played a vital role in anti-apartheid activism and the protest theatre that took place during the Apartheid-era (The Market Theatre Foundation, 2018). The theatre was constructed by way of the old Indian Fruit Market, hence its name. The Market Theatre drew international attention and became renowned as South Africa’s ‘Theatre of the Struggle’ (The Market Theatre Foundation, 2018).

The Market Theatre’s significance lies in what it did for the people it served in giving ‘voice to the voiceless’ – despite the trying times during which it was formed – and is also known for the superior quality of the performances that debuted there, for which it has won countless international and local theatre awards (The Market Theatre Foun-



3.10

ation, 2018).

“The Market Theatre’s history is intertwined with the cultural, social and political struggle for freedom in South Africa”

(The Market Theatre Foundation, 2018).

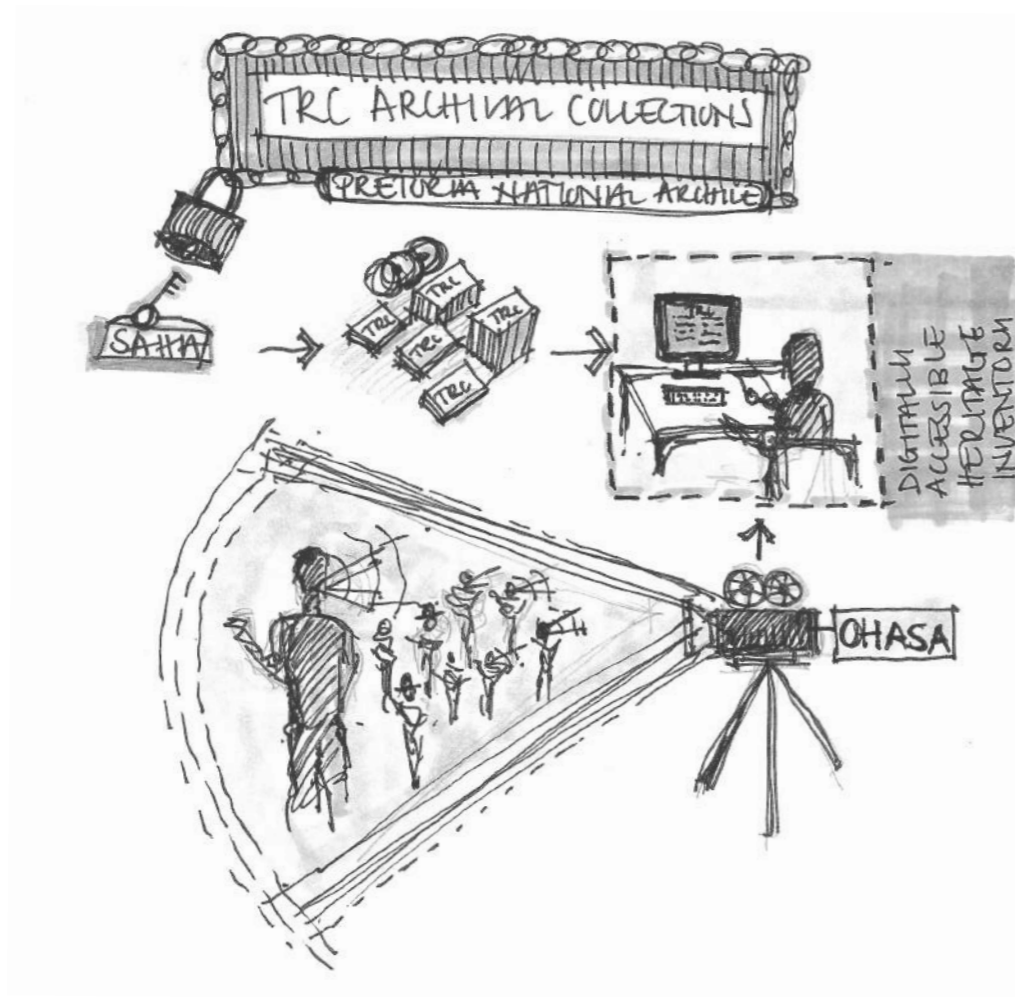
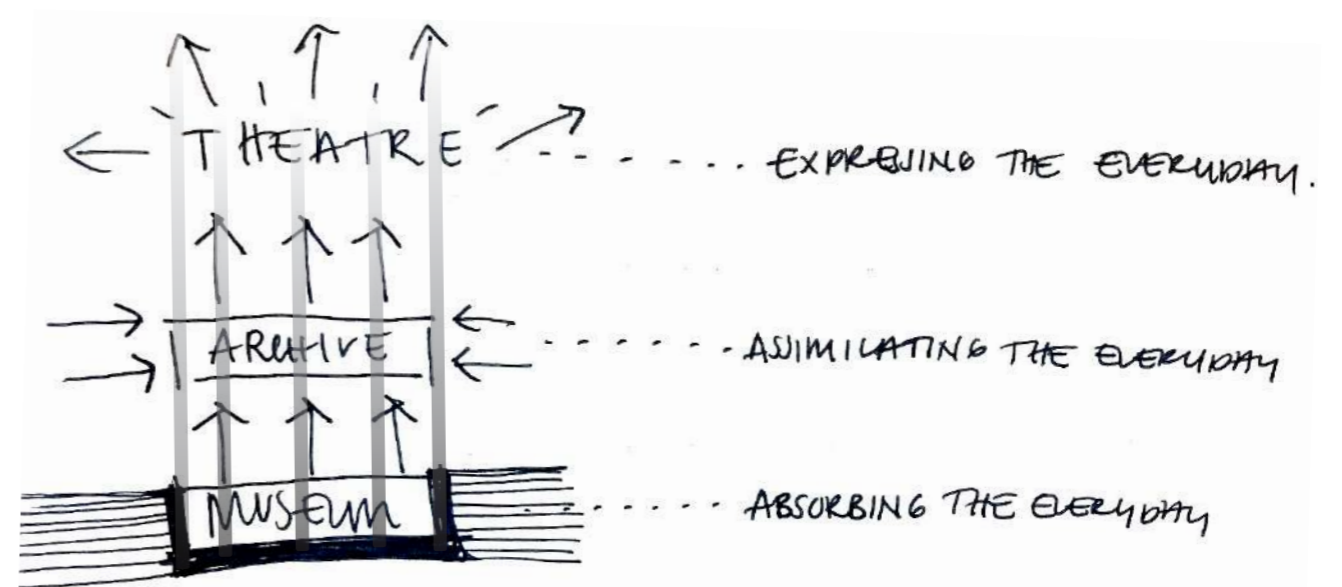

Fig 3.11- How SAHA and OHASA can act as mediator of national and individual memory (Author, 2019)

Fig 3.12- Conceptual Approach to structuring the building programmatically (Author, 2019)



3.12

Conceptual approach to the sequencing of the building (Hierarchy)_ “Long Nights Journey into Day”

Act 1: The Museum of the TRC
(PAST- Oppression & Deliberation)

Intermission: The Everyday realm
(PRESENT- freedom to operate)

Act 2: The Theatre of New Memory
(FUTURE- Liberation from deep memory, creation of living/ new memory)

Reverance: The Living Archive

(showing respect to the audience and conductor/orchestra) (recording of the past, present and making the information transparent and accessible for the future as part of the overall heritage inventory) The audience begins to assimilate and reflect on the performance.

BUILDING OCCUPANCY

A1- Civic Centres

Entertainment & Public Assembly

C2- Museums & Art Galleries

A2- Theatres, Opera Halls, Concert Halls, Theatrical & Indoor Sport

G1- Offices

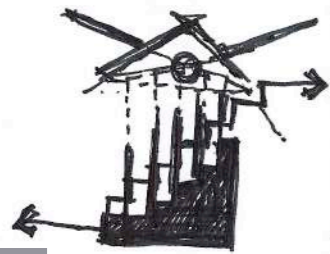

3.13

ACT 1
/
The Museum of the TRC
PAST- Oppression & Deliberation

Spatial Qualities/ Requirements	Area Required
MUSEUM	
Welcoming lobby	100 m ²
Background to the TRC exhibition space	200 m ²
Understanding the heart of the TRC – Human Rights	200 m ²
The Methodology of the TRC	100 m ²
Victims hearings	200 m ²
Events hearings	50 m ²
Special hearings	50 m ²
Institutional hearings	50 m ²
Policy party hearings	50 m ²
Breakaway areas of contemplation/ memory recording	5 x 30m ²
The way forward experience	100m ²
Interactive archival learning	120 m ²
Group meeting/ debate spaces	2 x 60 m ²
Administration	16m ²
MUSEUM RESTAURANT	
Kitchen	60m ²
Ablutions	According to Occupancy C2 Male: 3 x WC, 5 x Urinals, 4 x Washbasins Female: 9 x WC, 5 x Washbaisins
Seating & Tables	150-200m ²
Overflow onto courtyard at night	
SECURITY	
Security office for museum	
Security monitoring room	
Security for archive & offi	
Security for theatre	



3.14

INTERMISSION
/
The Everyday realm
PRESENT- freedom to operate

Spatial Qualities/ Requirements	Area Required
THE EVERYDAY PUBLIC REALM	
Retail	3 x 15m ²
Food Market Space	In Public Space 100m ²
Public Ablutions	To serve as overflow from theatre & museum 120m ²
Transport waiting space	Along site edge 50m ²
Public Square of the Everyday	300-400m ²

Fig 3.13- Ideogram of Museum of the TRC (Author, 2019)

Fig 3.14- Ideogram of the everyday realm (Author, 2019)

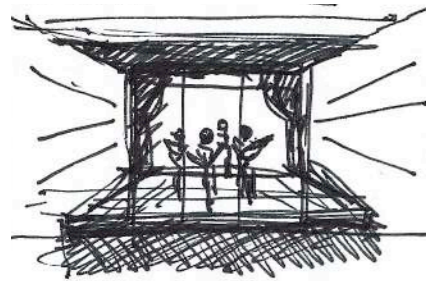

Act 2
The Theatre of New Memory
 FUTURE- Liberation from deep memory, creation of living/ new memory

3.15

Spatial Qualities/ Requirements		Area Required
FORUM THEATRE		
Forum theatre		150m ²
Office for Arts & Culture Trust		100m ²
Shop space for small businesses & food traders		210m ²
Bar		150m ²
Ablutions	According to Occupancy A2 Male: 3 x WC, 5 x Urinals, 4 x Washbasins Female: 9 x WC, 5 x Washbaisins	
Performance 'Rehersal Spaces' Public		2 x 60m ²
Fly Tower		8 x 3m
Performers dressing room		100m ²
Storage for seating		200m ²
Performer rehersal space private		200m ²
SYSTEMS		
Plant room for mechanical HVAC		
Rainwater collection tanks area		
Backstage fly tower lift –connected to prop and chair storage for theatre		

Fig 3.15- Ideogram of the Theatre of New Memory (Author, 2019)

Fig 3.16- Ideogram of the Active Archive (Author, 2019)

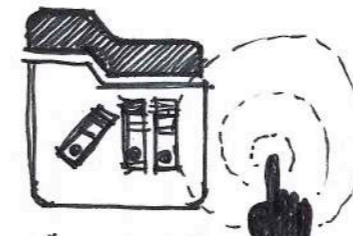

3.16

Reverance
The Archive
 Recording of the past, present and making the information transparent and accessible for the future.
 The performances, TRC digital collection & Oral Histories become a part of the overall heritage inventory The audience begins to assimilate and reflect on the performance.

Spatial Qualities/ Requirements		Area Required
ACTIVE ARCHIVE		
OHASA OFFICES		
Information desk		17 m ²
Open plan offices		35m ²
Meeting Room		10m ²
Staff Kitchenette		10m ²
Storage		20m ²
Cleaning Store room		2m ²
Ablutions		14m ²
GATHERING OF MEMORY RECORDING		
Memory Reflection		20m ²
Small Group Discussion		20m ²
Digital Archiving		50m ²
Performance Installation (video)		30m ²
Service & control room		10m ²
Ablutions		14m ²
SAHA- TRC DIGITIZING		
Reception		10m ²
Storage		20m ²
Open-plan Offices		80m ²
Kitchenette		10m ²
Ablutions		14m ²
Discussion & Meeting rooms		30m ²
Exhibition Curation		45m ²
Store- Original TRC archive		100m ²
Display of TRC data (secure)		100m ²
Public Archival interface		100m ²
Interactive digitising room		100m ²

CHAPTER



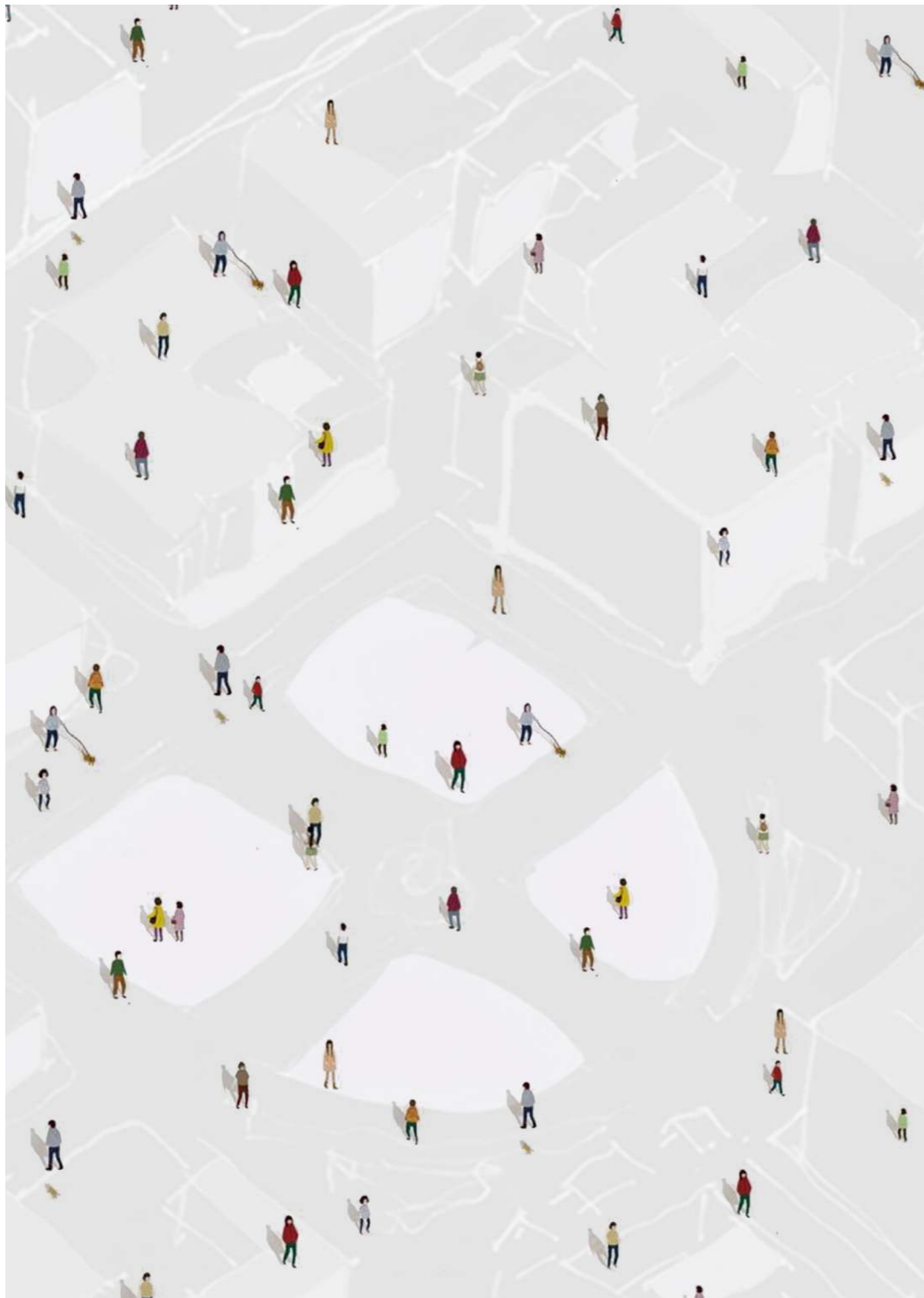

CHAPTER 04

Urban Mapping & Urban Vision /

4.1 || URBAN MAPPING

Pretoria was founded to support the local farmers through providing amenities and trade, and the town was built on the premise of 'Philadelphia', meaning brotherly love; a principle of mutual community care, which allowed the settlement to provide for all of the people.

This support of fellow citizens, when Pretoria was first established, led to our decision to work in the inner city. Our group has a common interest in the design of cities that cater to all the people. We approached our mapping based on the assumption that Pretoria has the latent potential to become a city designed around its citizens once again.

We started by mapping the current condition of Pretoria's inner city by creating strata that can be overlaid. The layering system was designed to be used as a method to reveal the hard and soft nature of specific spaces, and to attempt to delineate why certain areas are used more frequently than others. Combining different layers such as land-use, heritage and transport directed us to the identification of active and inactive nodes, which guided the transect walk. The purpose of the walk was to confirm or disprove the assumption that a correlation exists between an activity node and a soft-edged space on the one hand, and an inactive node and a hard-edged space on the other. Additionally, the transect walk was expected to provide

more detailed information toward mapping the subtle elements that create hard- or soft-edged spaces in the inner city.

Since our mapping precinct is the inner city of Pretoria, the further delineation of our mapping encompasses Church Square, the Cardo (north-south axis) and the Decumanus (east-west axis). This delineation was chosen because of the pertinent value of these axes in the history and formation of Pretoria and, as a result, contains a vibrancy of events and activities.

Fig 4.1- Vision of a human-centred city (Urban Mapping group, 2019)

Fig 4.2- Transect walk route through the city (Mapping group including Author, 2019).

Fig 4.3- Selected Mapping Layers as overlays used to draw conclusions (Mapping group including Author, 2019).

Fig 4.4- Museum District in relation to Pedestrian density in the city (Mapping group including Author, 2019).

One surprising conclusion, based on the overlay of heritage fabric with pedestrian movement, illustrates that people tend to congregate in closer proximity to older buildings of lower height. Possible explanations could be that these older structures – primarily heritage buildings – provide humane elements such as stairs and overhangs at street level, next to predominantly retail-related areas and activities. Newer high-rise buildings often lack a human interface at street level.

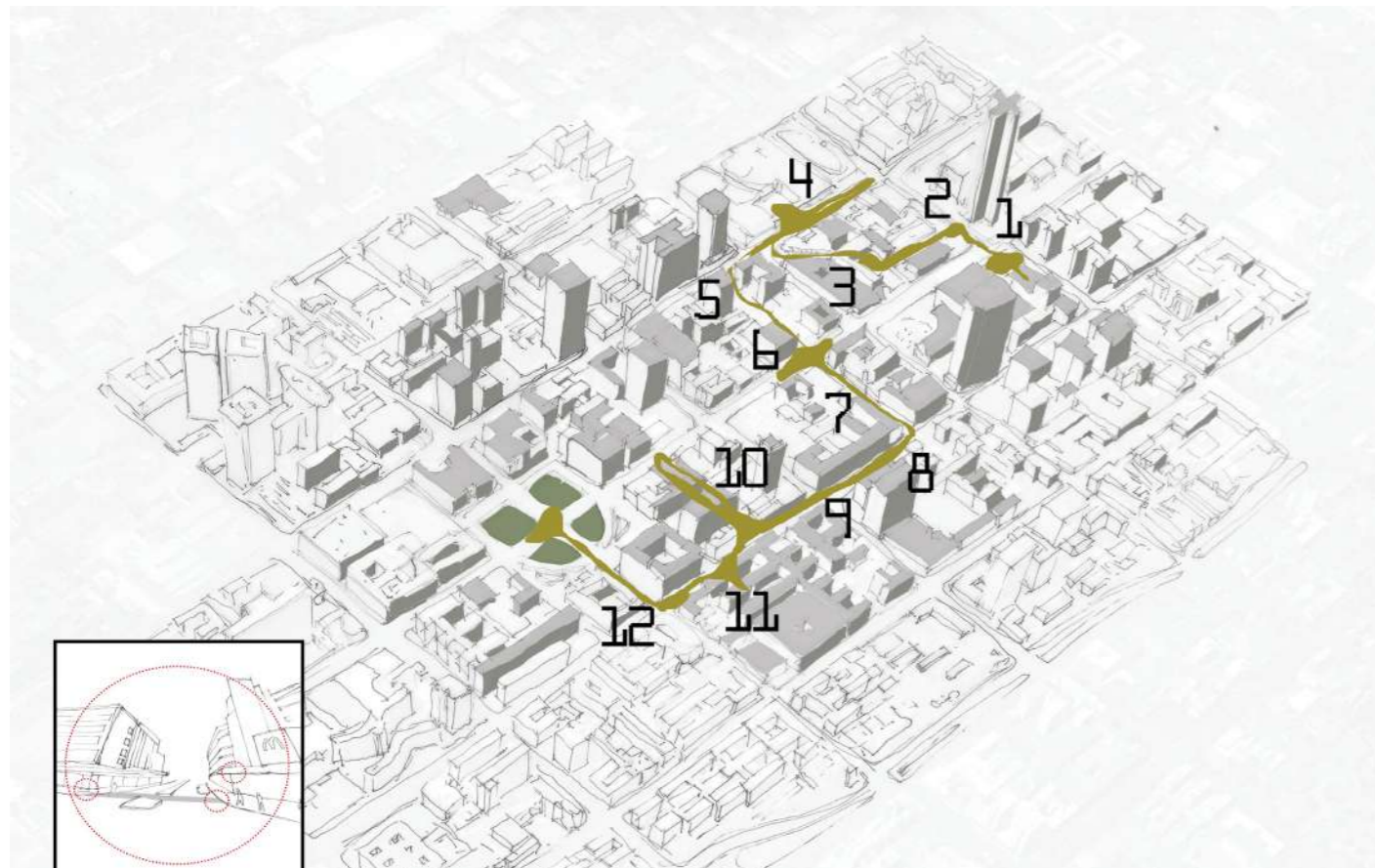

4.2

EXAMPLES OF INDIVIDUAL LAYERS

EXAMPLES OF OVERLAYED LAYERS

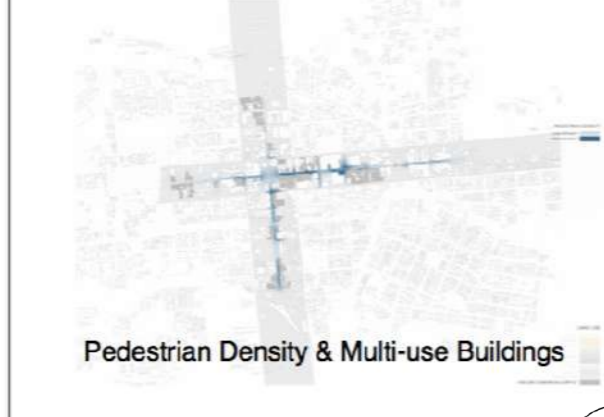
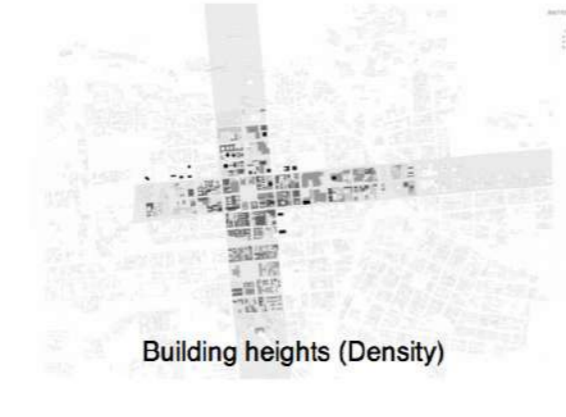
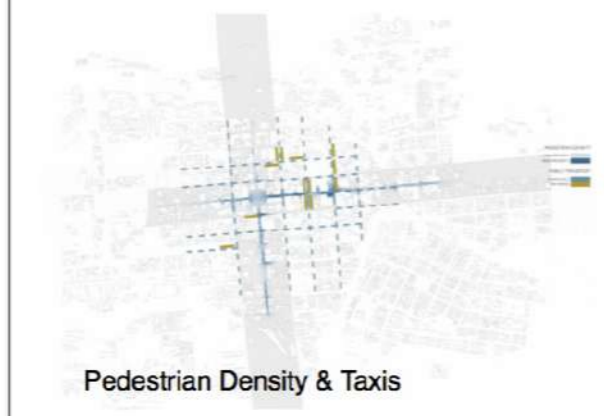
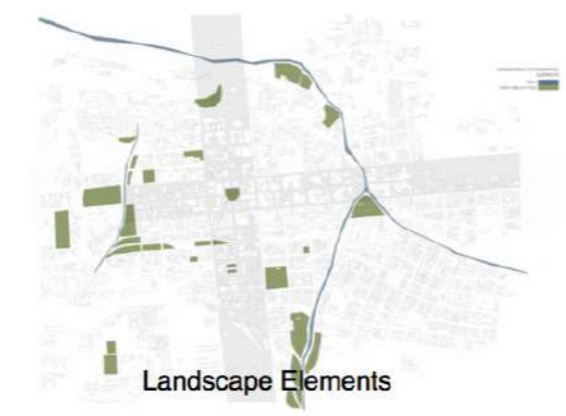
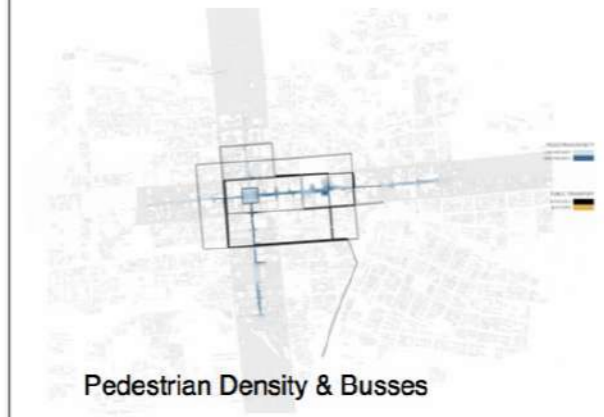
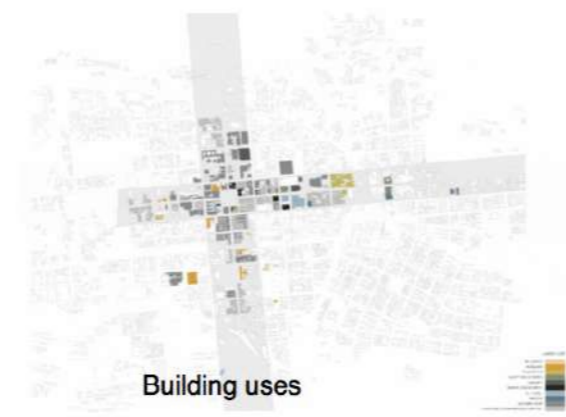
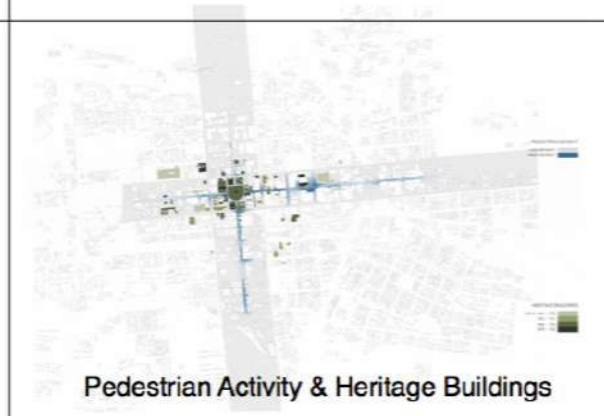
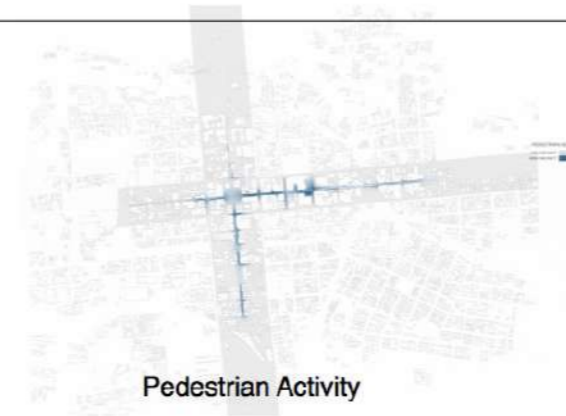

4.3

Urban Mapping

MUSEUMS | GOVERNMENT | CULTURAL | MIXED-USE
PEDESTRIAN TERRITORY | COMMERCIAL | ENVIRONMENT

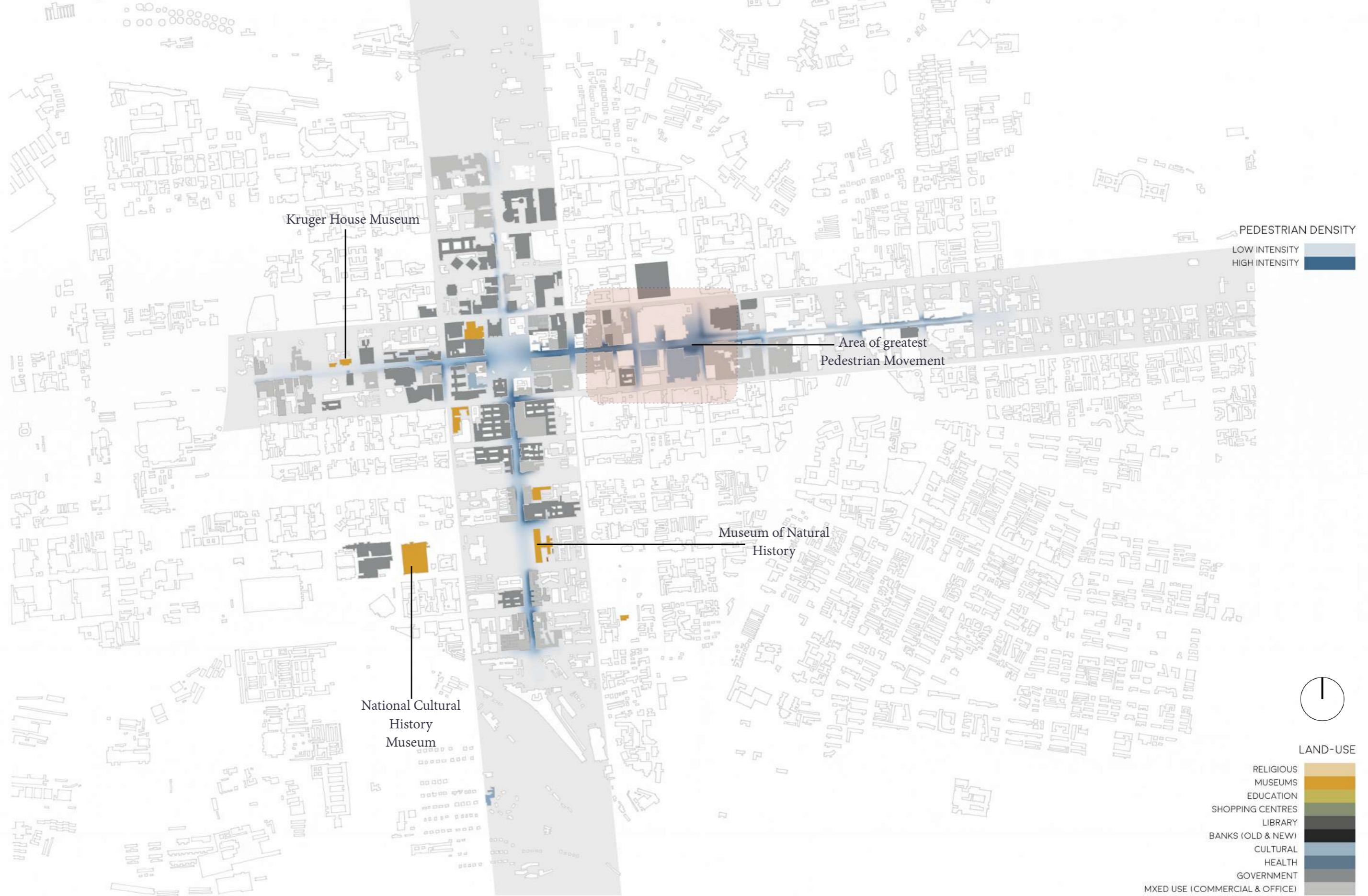

4.2 || URBAN VISION

The Urban Vision Proposal was loosely based on the principles of Jan Gehl and Joel Kotkin. Our stance with regard to urbanity resonates with Gehl and Kotkin's principles and ideas. Both are architectural urbanists that place the way people experience the city at the core of their theories and philosophies.

4.2.1 Theory

Our stance towards urbanity consists of a mixture of Jan Gehl and Joel Kotkin's opinions, which can be summarized in the following quotes:

"Cities [...] should make life better for the vast majority of citizens"

(Kotkin, 2016:19).

"Cities, in a word, are about people, and to survive as sustainable entities they need to focus on helping residents achieve the material and spiritual rewards that have come with urban life throughout history"

(Kotkin, 2016:20).

"Cities have thrived most when they have attracted newcomers hoping to find better conditions for themselves and their families, and when they have improved conditions for already settled resident"

(Kotkin, 2016:20).

"The history of successful cities reveals that, although their functions change, cities have to achieve two things: a better way of life for their residents and a degree of transcendence critical to their identities"

(Kotkin, 2016:20-21).

Fig 4.5-
Urban Design
section vision
(Mapping group
including Author,
2019).



4.5

4.2.2 The Urban Vision ‘For People’

Our vision formulates principles based on our research and on Gehl and Kotkin’s work. It is important that the precepts designed can be implemented on a variety of scales in our own project’s evolution of a user-centric urban experience. The tenets developed are specific to Pretoria and are based on transect walks through the city that helped to determine ‘soft edges’.

The tenets developed relate to our findings of an overpowering amount of hard edges and limited soft edges. In imagining Pretoria’s design of an inner-city for its entire people, our vision envelopes the soft-edge values.

Principles for the creation of a soft-edged space:

1. Appropriate densification of activity through the additional built fabric.
2. Permeable and multi-functional building thresholds.
3. Celebrated building corners.
4. Public courtyards of relief.
5. Biophilic design.
6. Human scale design.
7. Design that is inclusive regarding the disabled, elderly and children.
8. Humane urban textures.

TERM:

“Soft-edged space”- A space that is accommodating to and serves the needs of the everyday citizen, a space that is comfortable and unthreatening to the city dweller

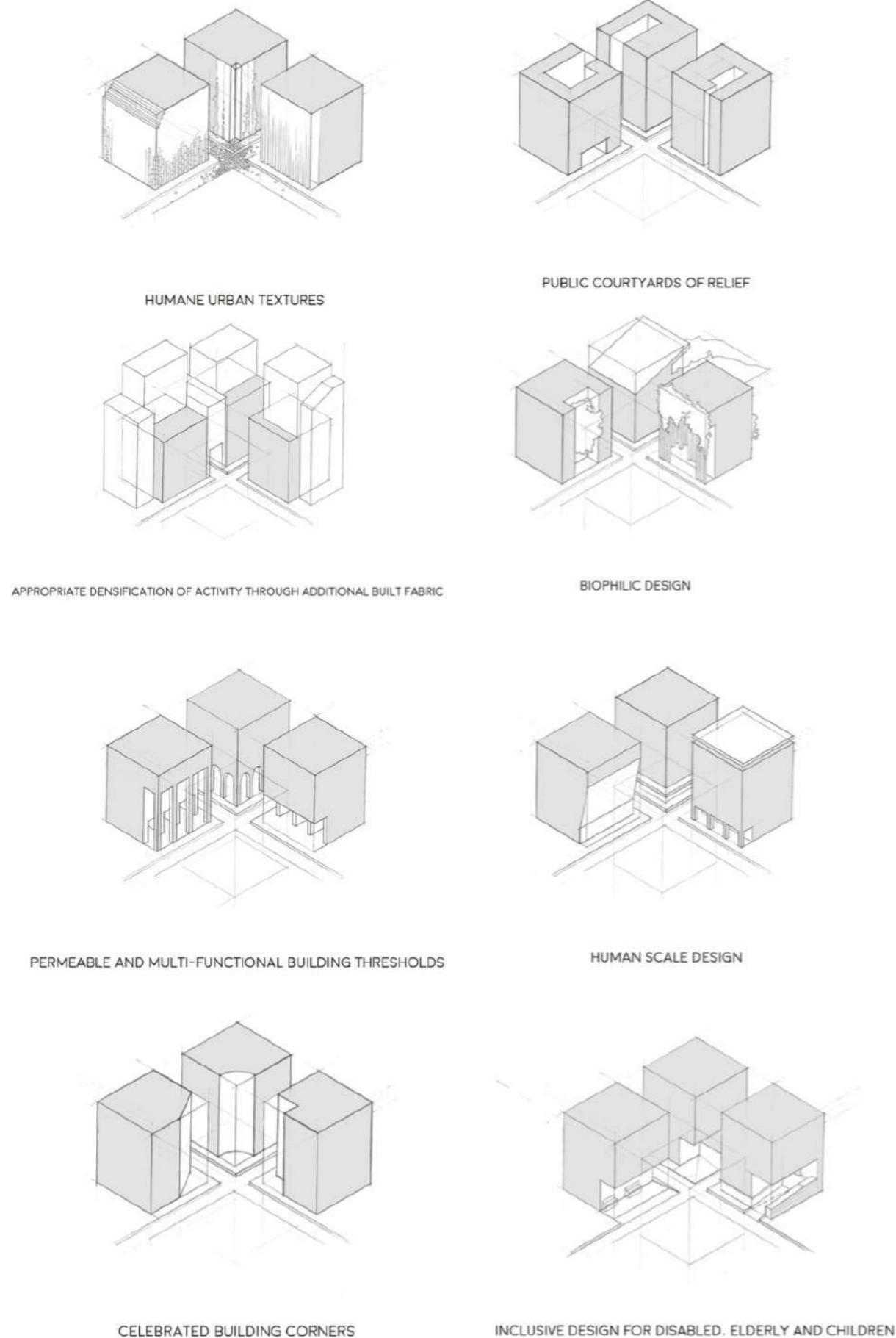

4.6

Fig 4.6- Diagrams explaining the Urban Design Principles (Mapping group including Author, 2019).



4.7



4.8



4.11

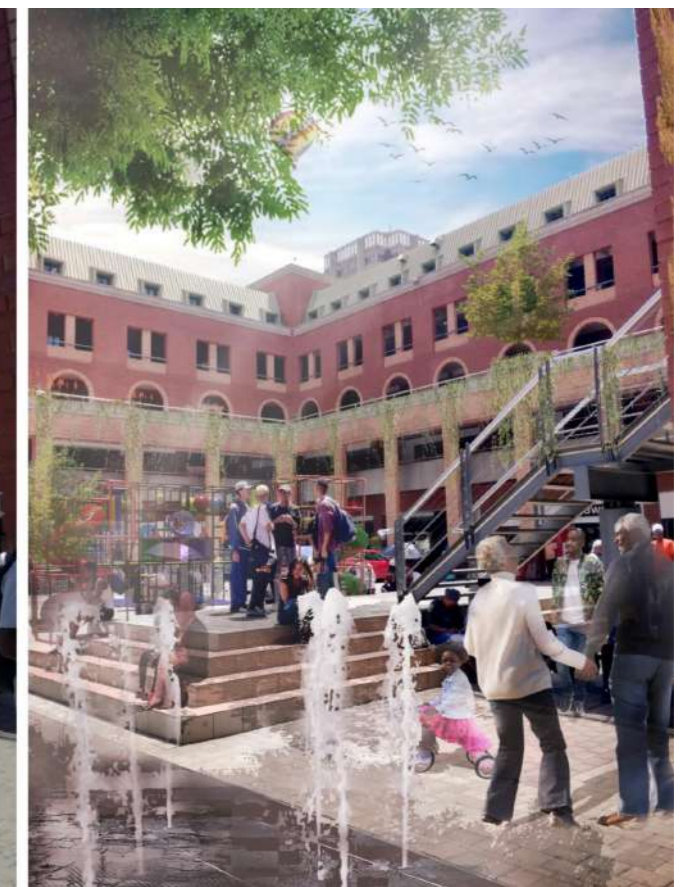

4.12



4.9



4.10

Fig 4.7-4.8- Transformation of typical ARCADE typology using Urban Vision principles (Mapping group including Author, 2019).

Fig 4.9-4.10- Transformation of STREET CORNER typology using Urban Vision Principles (Mapping group including Author, 2019).

Fig 4.11-4.12 Transformation of PUBLIC SQUARE typology using Urban Vision Principles (Mapping group including Author, 2019).

Fig 4.13-
The current
condition of the city
(Mapping group
including Author,
2019).

Fig 4.14-
Beginning of
implementing the
principles (Mapping
group including
Author, 2019).

Fig 4.15-
Final Vision of
the city if Urban
Vision principles are
fully implemented
(Mapping group
including Author,
2019).

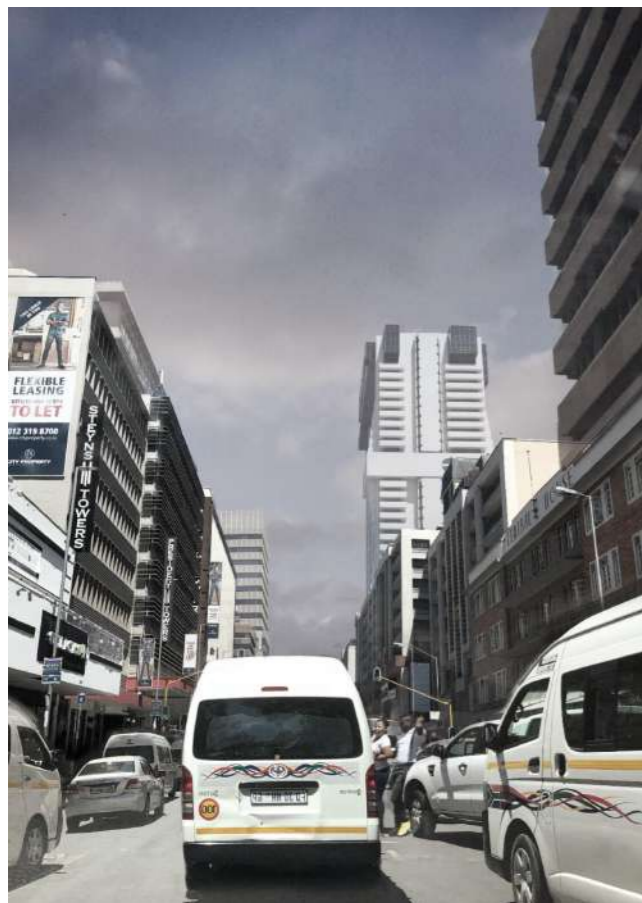

4.13



4.14

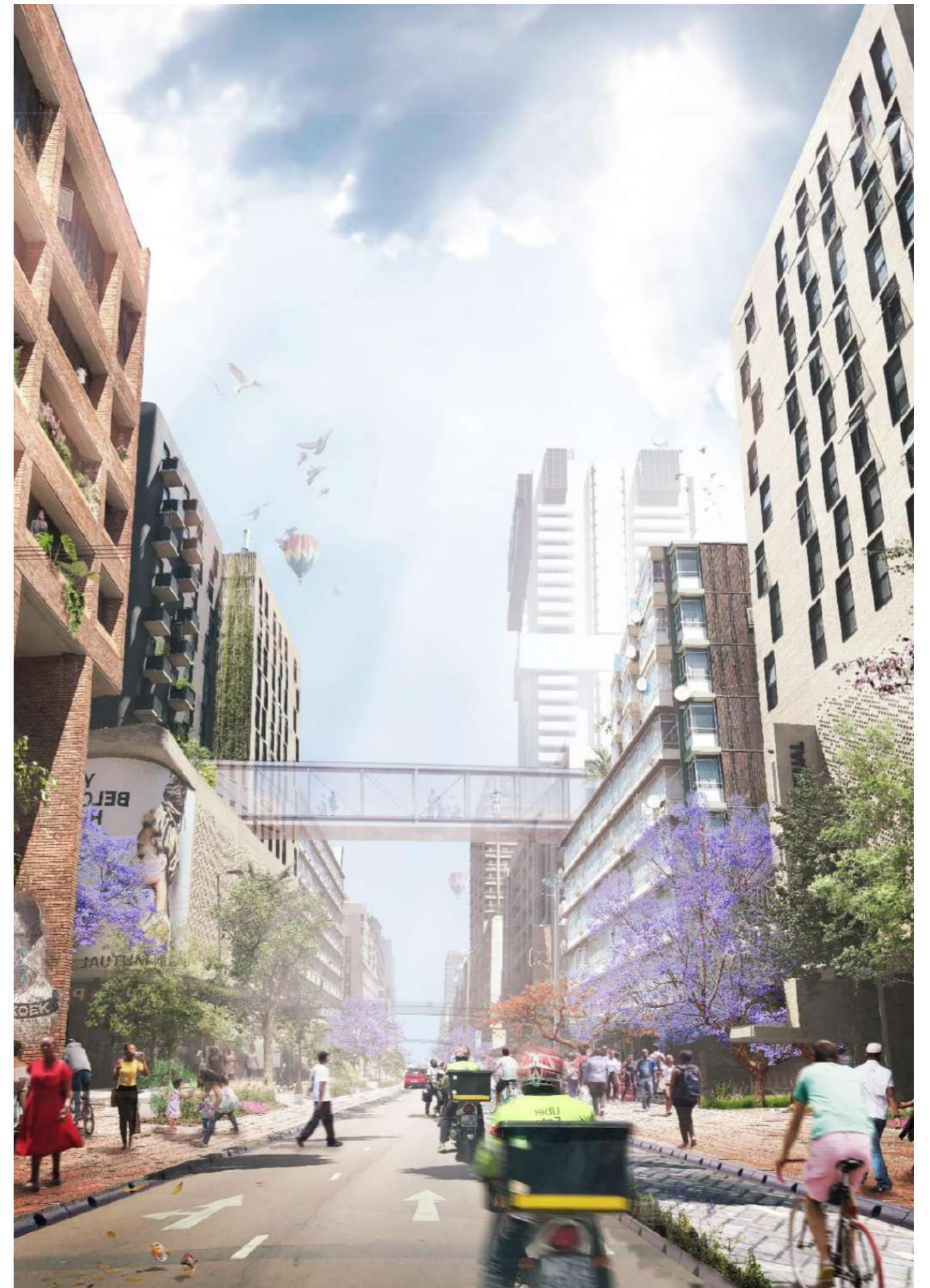

4.15

CHAPTER



CHAPTER 05

The Site Now and Throughout History

/

5.1 || THE SAMMY MARKS SQUARE BLOCK AS PROTOTYPE FOR A NEW MUSEUM TYPOLOGY

Fig 5.1-
Aerial Photograph
of Pretoria, date
unknown (Van Der
Vaal Collection,
2019)

Fig 5.2-
Site Location
(Google Maps
adapted by Author,
2019)

Pretoria's inner city is the context of interest. A site that is central and receives a lot of 'foot traffic' is imperative to the successful incorporation of the everyday into the extraordinary. The chosen location is situated in the heart of the cultural district of Pretoria. According to the Tshwane 2055 Vision, the historic Church Street (now W.F. Nkomo/Helen Joseph Street), will become the new 'Ceremonial Boulevard' designed to give the site future programmatic validity. An additional layer – which influenced the placement choice greatly – was that the positioning should illustrate as much of its own memory and history as the content of the 'museum' that is to be embedded in it.



memoryscape

5.1



5.2

memoryscape

Fig 5.3- Existing 'types' on site (Author, 2019).

5.2 || CHOSEN SITE – SAMMY MARKS SQUARE BLOCK

The chosen site is the Sammy Marks Square block's south-eastern corner, which currently stands vacant. The site is located on the corner of Helen Joseph and Sisulu Streets and was chosen based on the mapping done, which revealed that the site has a huge amount of daily activity in comparison to other locations in the city. The site is situated along the main taxi and bus routes in addition to being positioned along the pedestrianized portion of Helen Joseph Street (previously Church Street). The mapping conducted revealed a variety of uses within this precinct that correlate with a large number of people using the site.

KEY:

- Sammy Marks Development
- Heritage Buildings
- Chosen Site

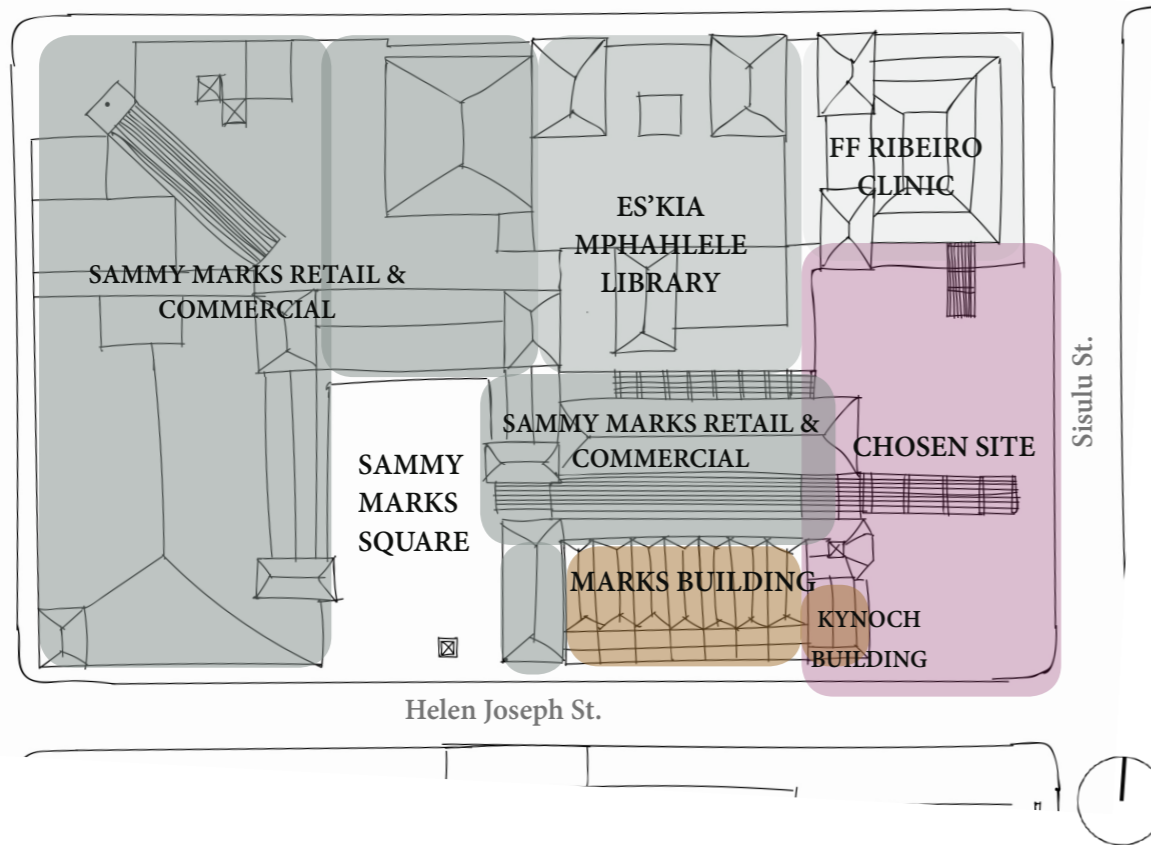

5.3 || HISTORY AND MEMORY ANALYSIS OF THE STATE THEATRE AND SAMMY MARKS SQUARE BLOCKS



5.3.1 The Old Market Square – State Theatre Block

It had been proposed that the old Market Square take the functional place of Church Square as the new centre for trade and auctions in Pretoria. The Market Square comprised the Market Hall and a market building, which could house fourteen shops (Dunston & Dunston, 1975:140). According to Dunston and Dunston (1975:140), the first formal tenants of the building included a general dealer, a gunsmith, traders in musical instruments, and produce merchants. The usage of the building continued to change as time progressed and even contained a successful café. The Market Hall had a smaller

hall to the right (see the Market Hall sketch) that housed the first Government Museum (Dunston & Dunston, 1975:148). The land behind the hall was initially used to house a few animals before the Pretoria Zoo was built.

One of the first functions to be held upon the Market Hall's opening was a Children's Exhibition in 1891. The Market Hall was used to host a vast array of spectacles that were frequently attended by the President, Paul Kruger (Dunston & Dunston, 1975:150). According to Dunston & Dunston (1975:154), the Market Hall even functioned as a court when Rhodes, Farrar, and Phillips pleaded guilty to the charge of high treason. It can be concluded that the lives of Pretoria's everyday citizens revolved around the Market Hall and Market Square since the location characterized inclusivity and was resilient in its multi-purpose and ever-changing nature. It was a site that served the needs of the people as and when those needs arose.



Fig 5.4- Location of Market Square (Author, 2019).

Fig 5.5-5.9- Historical drawings of parket square (Dunston, 1975)

Fig 5.10- Historical impression of the Market Square, date unknown (Van Der Vaal's Collection, 2019)

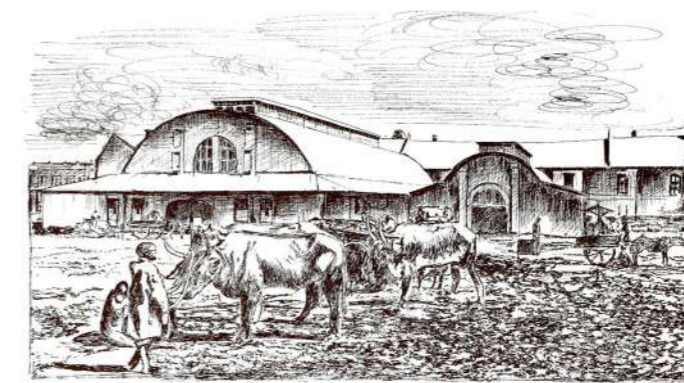

Fig 5.11- Historical image of the Kynoch building taken in 1889 (Dunston, 1975)

5.3.2 The Kynoch Building – Sammy Marks Block

Built before 1889, the Kynoch Building is the oldest surviving commercial building in Pretoria. George Kynoch & Co., a gunsmith that housed an armourer's shop, a tent business, and the Staats Geweers Fabriek, was the first occupant (Dunston & Dunston, 1975:154). According to Dunston & Dunston (1975:154), Liebman's Produce Store and a tailor occupied the building prior to George Kynoch. Other buildings that can be seen to the right of the Kynoch Building hosted small businesses such as a fruiterer, the Market Square Outfitters, a baker, and a watchmaker.



5.11



5.12

Fig 5.12- The South-east corner of the Sammy Marks block in 1961 (Tshwane Heritage Resource Centre, 2019).

Fig 5.13- Photograph of the Kynoch and Marks building taken in 1913 (Van Der Vaals collection, 2019)

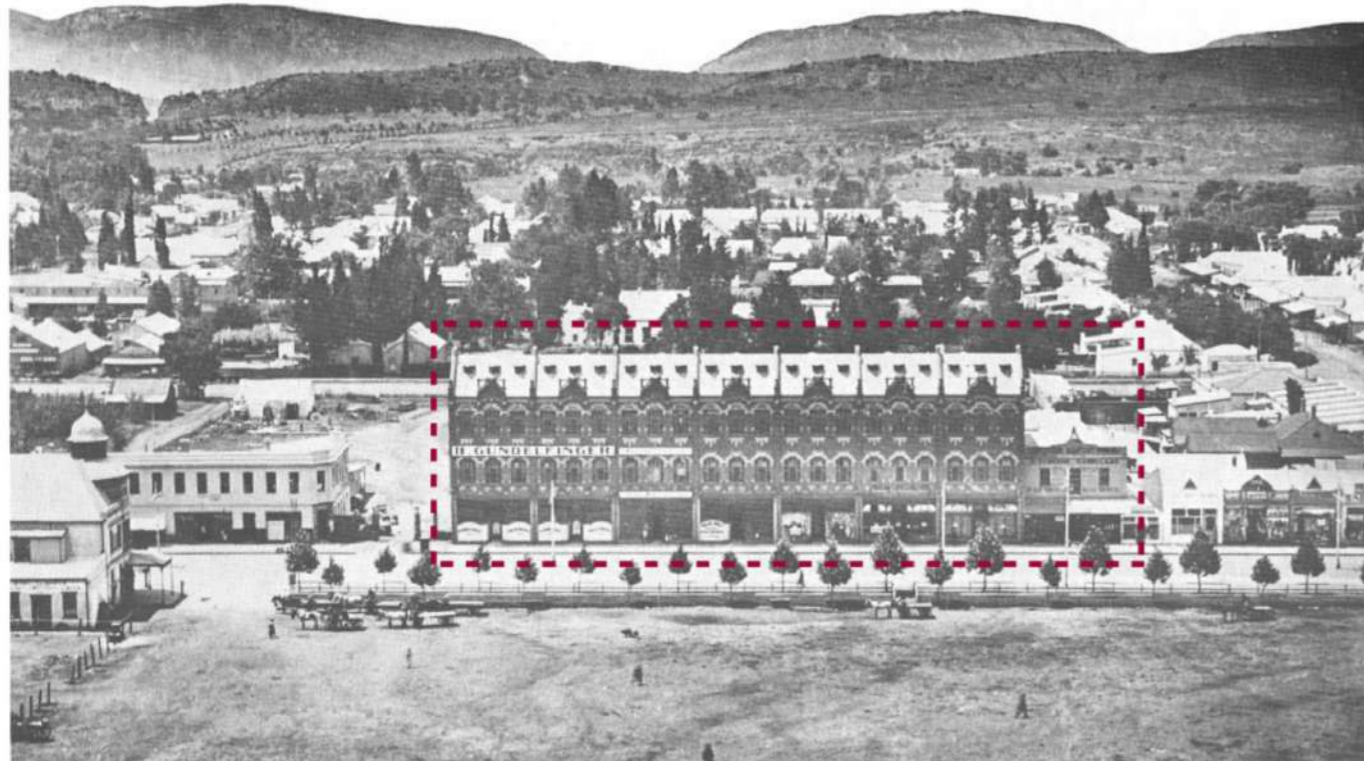

5.13

5.3.3 The Marks Building (Gundelfinger) – Sammy Marks Block

The Marks Building, which was built in 1903 by Sammy Marks, is commonly known as the Gundelfinger Building since the Gundelfingers were the main tenants when it was first opened (Dunston & Dunston, 1975:150).

The Marks Building is one of the buildings designed by famed Pretoria Architect W.J. de Zwaan, and it displays an exemplary example of the Wilhelmiens architectural style that was prevalent in Pretoria in the late 1800s and early 1900s (Artefacts, n.d). The Marks Building was saved from demolition because of its significant heritage value. It has always been a landmark in the city and is incredibly well preserved, both formally and functionally (Dunston & Dunston, 1975:150).

With its charming regular façade repetition



5.14

B. GUNDELFINGER
Wholesale Merchant,
PRETORIA, P.O. Box 19. JOHANNESBURG: HE
OFFICE, Box 207.
BURRAS P.O. Box 146, LONDON OFFICE, 21, LIME ST., 1

IMPORTERS OF
Groceries, Delicacies, Fancy Goods,
Paper Bags, Stationery, Bookware, Tinware
Glassware, Fireworks, Cigars, Tobacco
CONFECTIONERY a speciality.

5.15



5.16

5.3.4 Verwoerdplein becomes Sammy Marks Square

Fig 5.17-5.20- Various newspaper clippings of the site over time (Tshwane Heritage Resource Centre, 2019).

Fig 5.21-5.24- Historical photographic timeline of site development over time (Collage by Author, 2019)*

Fig 5.25- Goad Maps of block development over time (Tshwane Heritage Resource Centre, 2019).

According to Vrye Weekblad (1991), what is currently known as Sammy Marks Square (the site of this dissertation's interest) was not always named after the famed businessman who was born on 11 July 1844 and died on 18 February 1920. Verwoerdplein was renamed Sammy Marks Square in 1991 because of the controversy that surrounded Verwoerd as a symbol of repression (Vrye Weekblad, 1991). The name that had been given to an entire block development and a memorial monument in honour of Hendrik Verwoerd, the man known as the 'Architect of Apartheid', stood for oppression and was unacceptable to many.

Verwoerd Square was initially part of a larger development plan that included two more Pretoria squares; Strijdom Square (now Lilian Ngoyi Square) along with the redevelopment of Church Square.

After Verwoerd was murdered, two-thirds of the block was bought by wealthy businessmen and named after Sammy Marks as a tribute. According to Vrye Weekblad (1991), a R215 million building now known as Sammy Marks Library-, Mall-, Square-, and Arcade was erected.

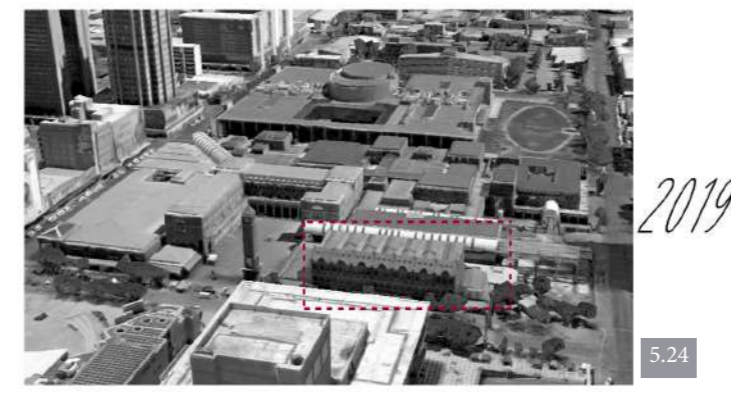
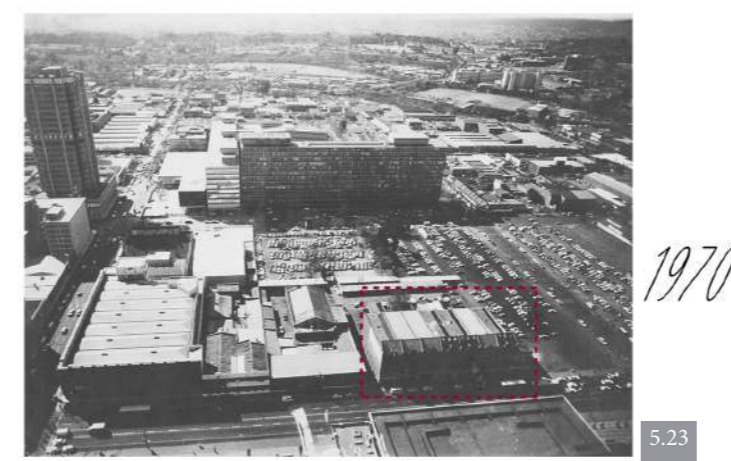
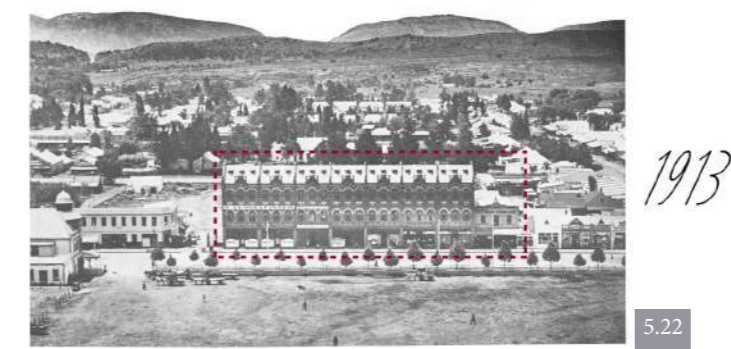
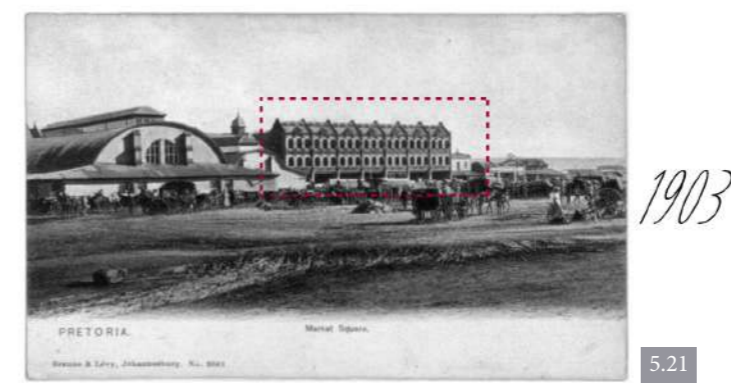
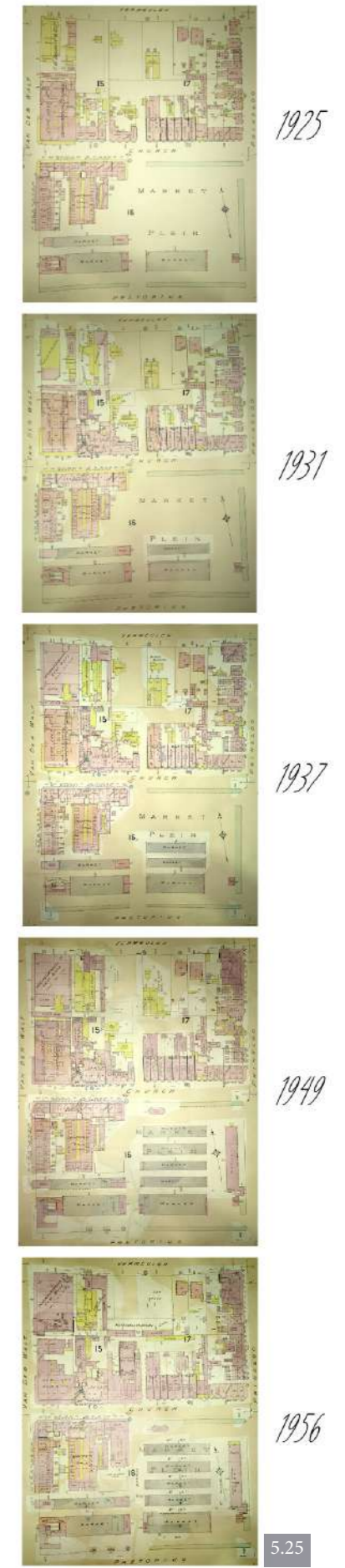

Nou druk 'n Jood Verwoerd van sy plein af!



SAMMY Marks, pionier-aktem in die dae van die ZAR, en nogal 'n Jood, het nou byna vir Hendrik Verwoerd van die plein in die middestad afgedruk.

Die Verwoerdplein son eers die hele straatblok voorant die Strijdomplein bedek het, lagevolge 'n 1966-besluit van die Stadraad. Dit besluit is eerske dae na die moord op Verwoerd gemaak.

5.17 Vrye Weekblad 22 Feb 1991



Fig 5.26- Plan and Section through Furrow (Van Skalkwyk, 1995).

Pretorias' Water Furrows:

According to Van Skalkwyk (1995) Pretoria's water was supplied through water furrows from fountains valley from the year 1891.

Fig 5.27- Plan and Section through Furrow 2 (Van Skalkwyk, 1995).

“Since its early days Pretoria has been supplied with water by a system of furrows from the fountains area south of Pretoria. According to specifications these were 3 ft (0,92 m) wide and 18 inches (0,45 m) deep. The furrow continued through town to the southern or top side of Church Square where it split in two, going round the sides of the square. At this point the furrows were big, 18 inches (0,45 m) wide and 12 inches (0,30 m) deep. The two furrows met again at the bottom of the Square, continued through town and ran back to the Apies River” (Van Schalkwyk, et.al, 1995)

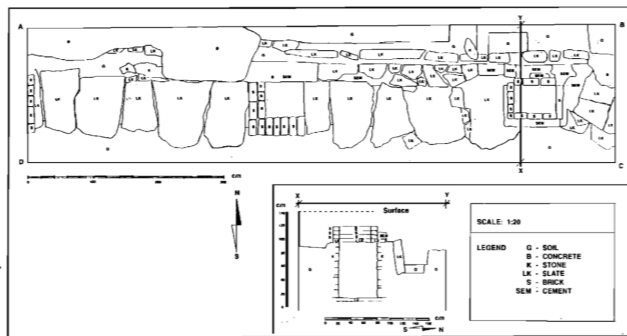

5.26

Fig 5.28- Excavated furrow outside the State Theatre (Dippenaar, 2013)



5.28

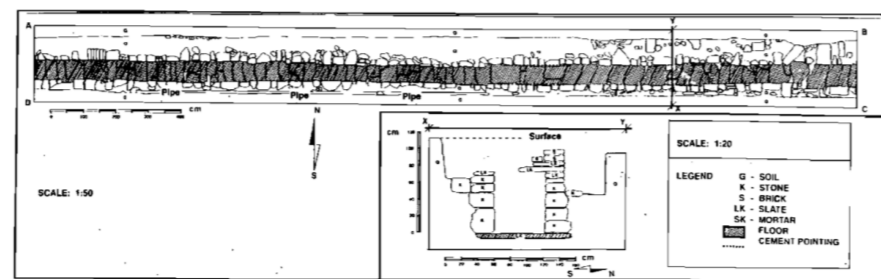

5.27

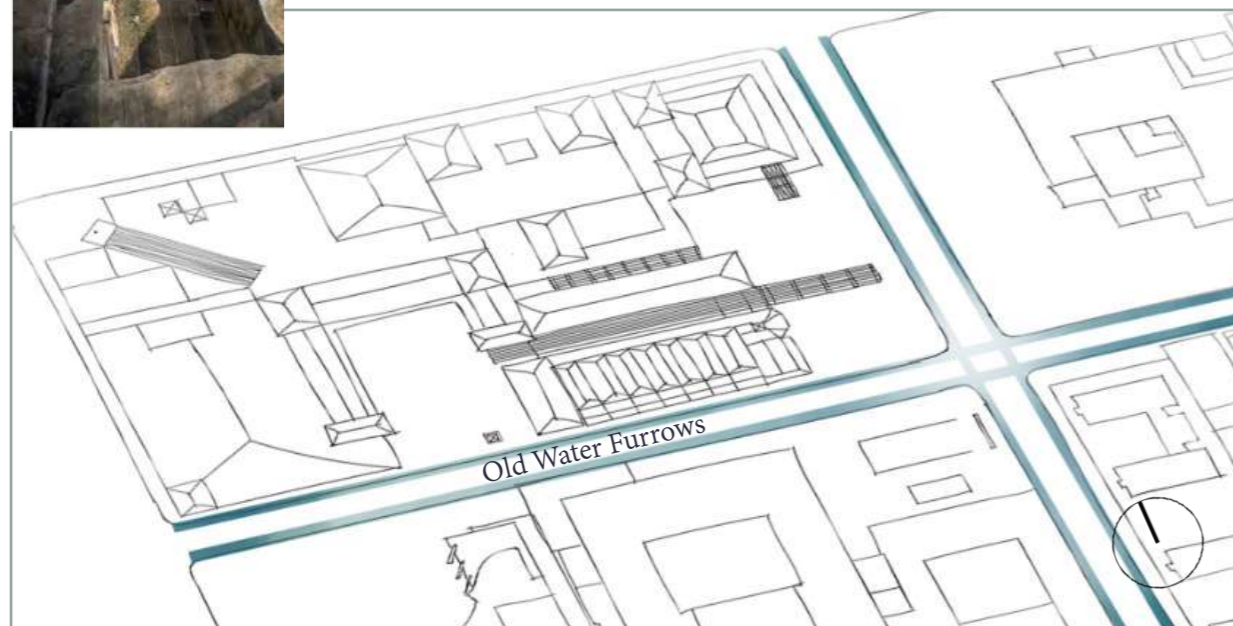

5.29

Fig 5.29- Layout of Water Furrows around site according to historical written accounts (Author, 2019)



5.30

Fig 5.30- The South-east corner of the Sammy Marks block in 1961 (Tshwane Heritage Resource Centre, 2019).



5.31

Fig 5.31- Construction of State Theatre 1975 (Tshwane Heritage Resource Centre, 2019).

Historical Eastern Retail Edge:

According to the Tshwane Heritage Resource Centre Goad Maps, as well as the historical photographs in this chapter and above, there has always been a historical presence of Retail Architecture on the block, but specifically on the Eastern boundary of the block. These shops were owned by small, often family, businesses.

The Kynoch building on the site was all that was left of the small retail buildings following the demolishments made to make way for the Sammy Marks Development.



5.32



5.33



5.34

Fig 5.32- Aerial View of Sammy Marks construction in 1991 (Tshwane Heritage Resource Centre, 2019).

Fig 5.33- Sammy Marks Square from the South in 1991 (Tshwane Heritage Resource Centre, 2019).

Fig 5.34- Proposed Verwoerd Square with old Marks Bldg in foreground 1990 (Tshwane Heritage Resource Centre, 2019).

Fig 5.35- Tuks architecture students protest against demolition Cannon Bdg in 1990 (Tshwane Heritage Resource Centre, 2019).



5.35

The Sammy Marks Development

Designed by Studio 3 architects, the Sammy Marks development was conceptualized to be a ‘peoples’ place’ that also functioned as an identifiable city landmark (Van der Walt et al, 1993:47). The precinct has predominantly acted as a retail environment with an abundance of pedestrian movement and informal trade (Van der Walt et al, 1993:47). Traffic primarily flows around the site in a clockwise direction with an emphasis on public transportation routes. The retail and commercial functions were placed on the western and southern edges of the lot in order to facilitate and emphasize appropriate connections to the Pretoria CBD and pedestrian routes (Van der Walt et al, 1993:48).

The Sammy Marks Square opens up to the southern boundary of the site to form a visual and spatial link to Strijdom Square (now Lillian Ngoyi Square), the State Theatre and the proposed pedestrian portion of Church Street (now Helen Joseph Street) (Van der Walt et al, 1993:48).

According to Van der Walt et al, 1993:49), the development was envisioned as ‘an attractive, scintillating setting for the promotion of tourism’. Historically, the square was the epicentre of commerce in Pretoria’s early era and the only two remaining buildings that serve as a reminder of that time are the Sammy Marks (Gundelfinger) and the Kynoch buildings. The Sammy Marks building was the main inspiration for the new design of the block with regard to material and scale (Van der Walt et al 1993:49). The human scale was an important design principle for the new development as a whole.

The design of the new Sammy Marks development maintains a sympathetic relationship with the existing heritage buildings whilst acknowledging ‘post-modernism’ as a means of ‘contemporary’ translation (Van der Walt et al, 1993:49). The development aims to create a sense of ‘warmth and ro-

manticism’ for the everyday civilian whilst maintaining the civic ‘dignity’ of the precinct.

Building statistics according to Van der Walt et al, (1993:51):

Gross building area:

- City of Pretoria 51 800m²
- Private sector 63 700m²
- Total development 115 500m²

Basement Parking:

- City of Pretoria 565 vehicles
- Private sector 870 vehicles

It is important to note that the Sammy Marks development was supposed to include a tall five-star hotel built on the south-eastern portion of the block, which was never completed. Planning with regard to parking included such a large commercial venture’s requirements in the private sector allowance, as stipulated above. As the venture never materialized the lot is now vacant.

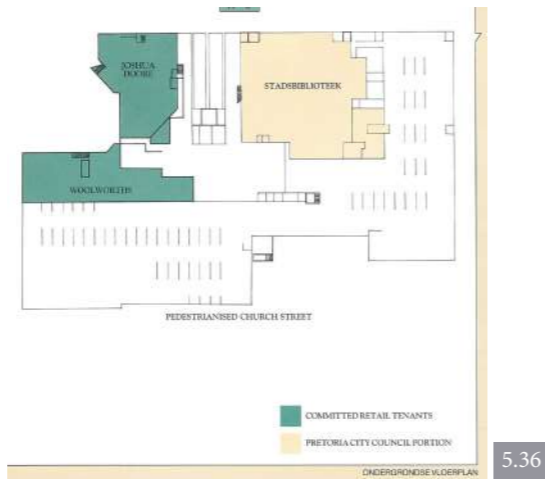

5.36



5.37

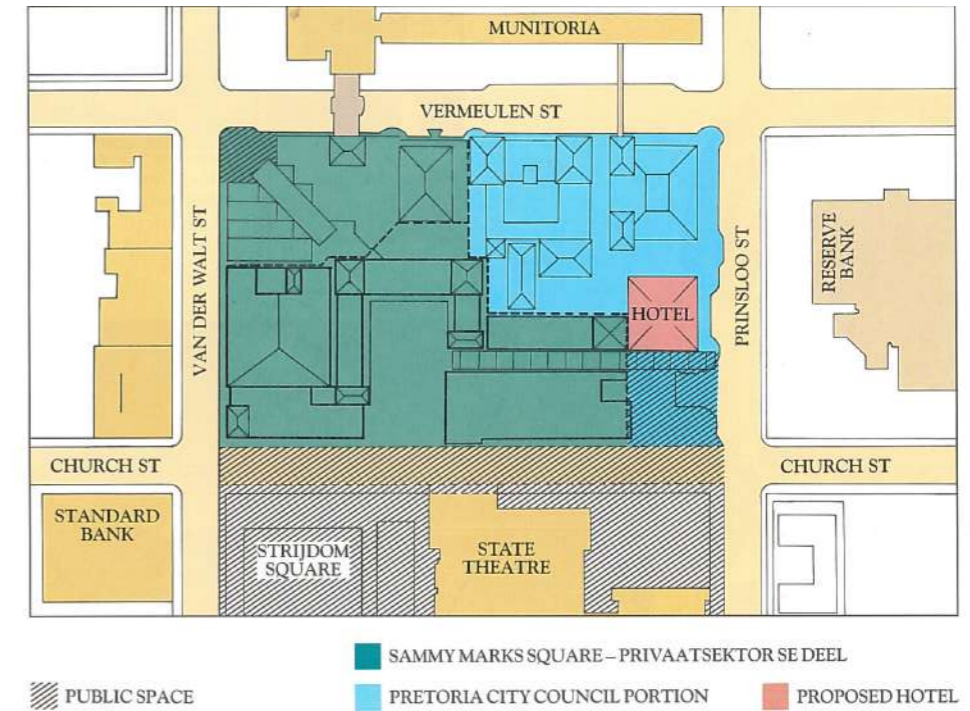

5.38



5.39

Fig 5.36- 5.38- Proposed usage of Sammy Marks Block (Tshwane Heritage Resource Centre, 2019).

Fig 5.39- Construction work by Murray & Roberts Bldg at Sammy Marks Square in 1992 (Tshwane Heritage Resource Centre, 2019).

Fig 5.40-5.41- Proposed usage of Sammy Marks Block (Tshwane Heritage Resource Centre, 2019).

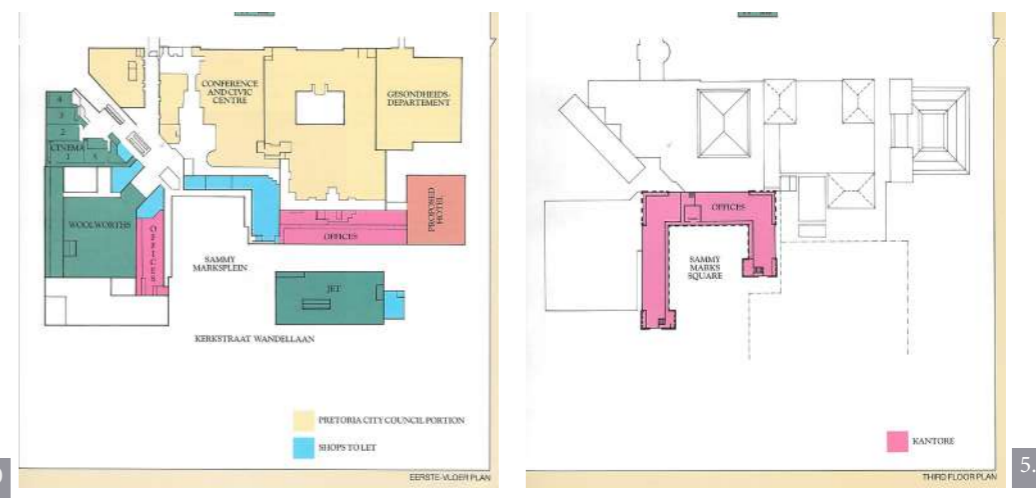

5.40

5.41

5.3 || EVENTS THE SITE HAS WITNESSED

5.3.1 The 1956 Women's March

Between 10, 000 and 20, 000 women marched from Strijdom Square to the Union Buildings on 9 August 1956 to protest against the amendments that were being proposed to the Urban Areas Act (SAHO, 2018).

SAHO (2018) claims that the Women's March bears much significance as it defied the stereotype that women are "politically inept and immature". When the large, determined, yet highly disciplined group of women arrived, they proceeded to fill the amphitheatre at the foot of the Union Buildings. SAHO (2018) claims that the Women's March was the largest demonstration that has occurred thus far.

Prime Minister JG Strijdom did not go out to meet with the crowd and neither did any

of his staff. The large pile of signed petitions was left outside his office. Speculation exists as to whether or not the petitions were removed before Strijdom acknowledged them. Lilian Ngoyi suggested that the crowd should stand in absolute silence for an hour and then sing 'Nkosi Sikelel' iAfrika' before leaving (SAHO, 2018).

Lilian Ngoyi was memorialized in 2006, at the initial starting site of the march. Strijdom Square was renamed Lilian Ngoyi Square to honour her and the monumental achievement of the women who marched with her 50 years earlier (Doubell, 2015).



Fig 5.42-
1956 Womans
March (Netwerk24,
2019)

5.42

5.3.2 Wit Wolf Massacre – Barend Strydom

On 15 November 1988, Barend Strydom murdered seven black civilians at Strijdom Square (now Lilian Ngoyi Square) (Moore, 2018). At the time of the attack, Strydom was in full camouflage-style army dress and wore a belt with the custom engraving "Wit Wolf".

According to Moore (2018), Strydom trudged trails of blood and the prints of his combat boots on Strijdom Square, at the State Theatre and for five blocks around the locale. Moore (2018) postulates that Strydom had the intention of starting a race war and would have continued to kill black inhabitants if he was to be released.

Barend Strydom was sentenced to death in May 1989 (Moore, 2018). However, given that Strydom had been raised in a racist Apartheid society, and was sentenced under Apartheid law, the State granted him amnesty and Strydom – who had still shown no remorse – was released in 1992 (Moore, 2018).

He was released in 1992 as a trade-off with the ANC for the release of Robert McBride (who killed three and wounded 69 white civilians by exploding a car bomb in front of a bar in Durban) by former president FW de Klerk in terms of the negotiated Further Indemnity Act of 1992. Both were indemnified in 1993 because they acted 'with a political object'. Today, Strydom lives out a quiet existence in Hartebeespoort near Pretoria with his family, and McBride became the Executive Director of the Independent Police Investigative Directorate (IPID) in 2014.. Moore (2018) states,

In 2018, a memorial service was held at the Lilian Ngoyi Square, outside the newly built Women's Memorial, for the eight deceased and Strydom's many injured victims (eNCA, 2018). In an interview with two of the victims' sons, eNCA (2018) showed that these men's fathers – along with the others killed that day – are to be remembered as heroes of the Apartheid struggle as they believe that the shooting put additional international pressure on South Africa, which aided in the abolishment of Apartheid some years after the slayings.

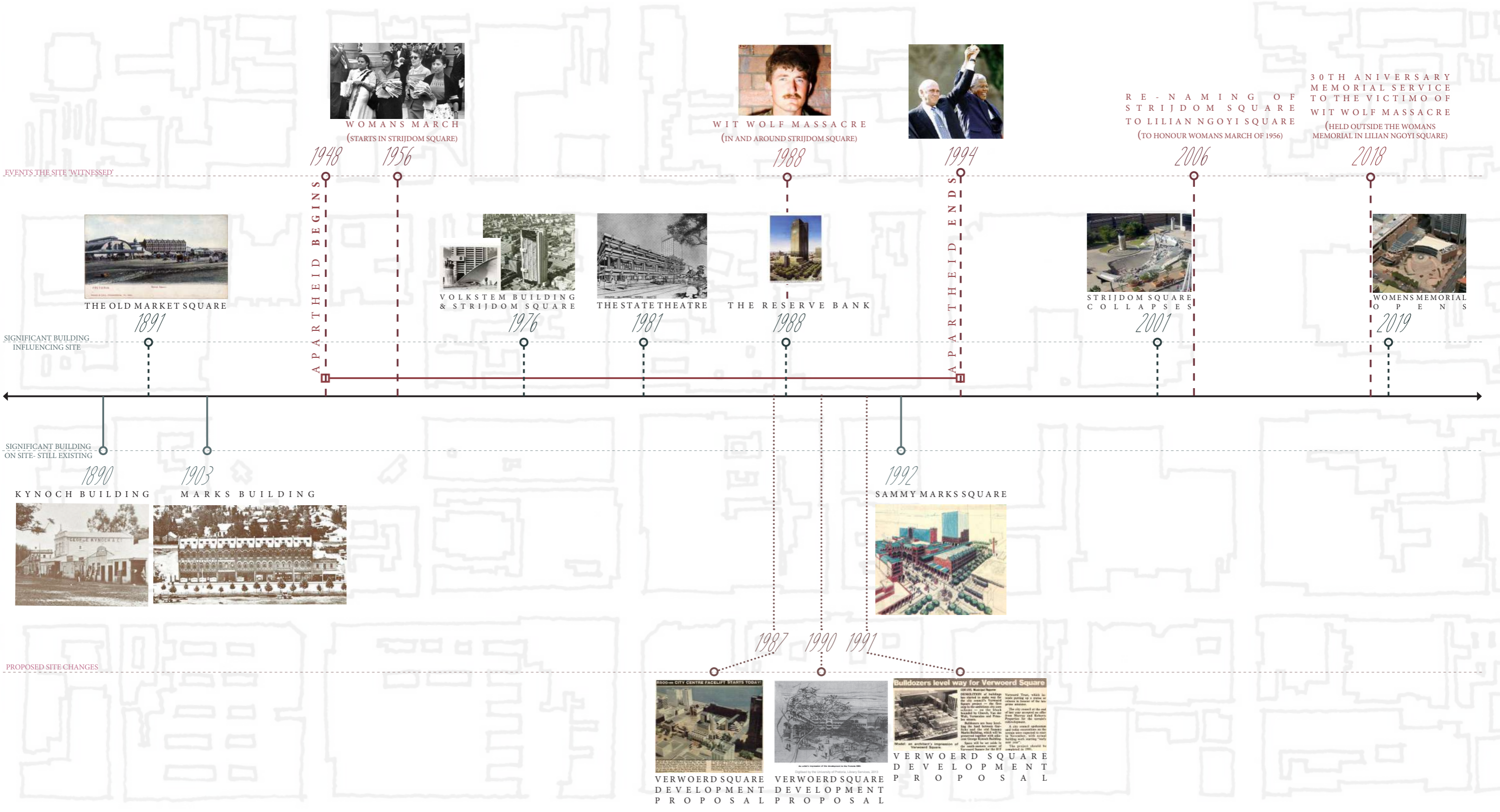

Fig 5.43-
Barend Strydom
AKA Wit Wolf
(IOL, 2011)

5.43

Events the Site has Witnessed

A M E M O R Y A N A L Y S I S O F T H E S I T E
E V E N T S & S I T E D E V E L O P M E N T S O V E R H I S T O R Y



Memory of the Site

EVENTS THAT HAVE TAKEN PLACE AT AND AROUND THE SITE

PRINSLOO
STREET
INDIAN
TRADE MARKET



PREVIOUSLY
NAMED
VERWOERD SQUARE



WIT WOLF MASSACRE
(IN AND AROUND STRIJDOM SQUARE)

1988



WOMANS MARCH
(STARTS IN STRIJDOM SQUARE)

1956

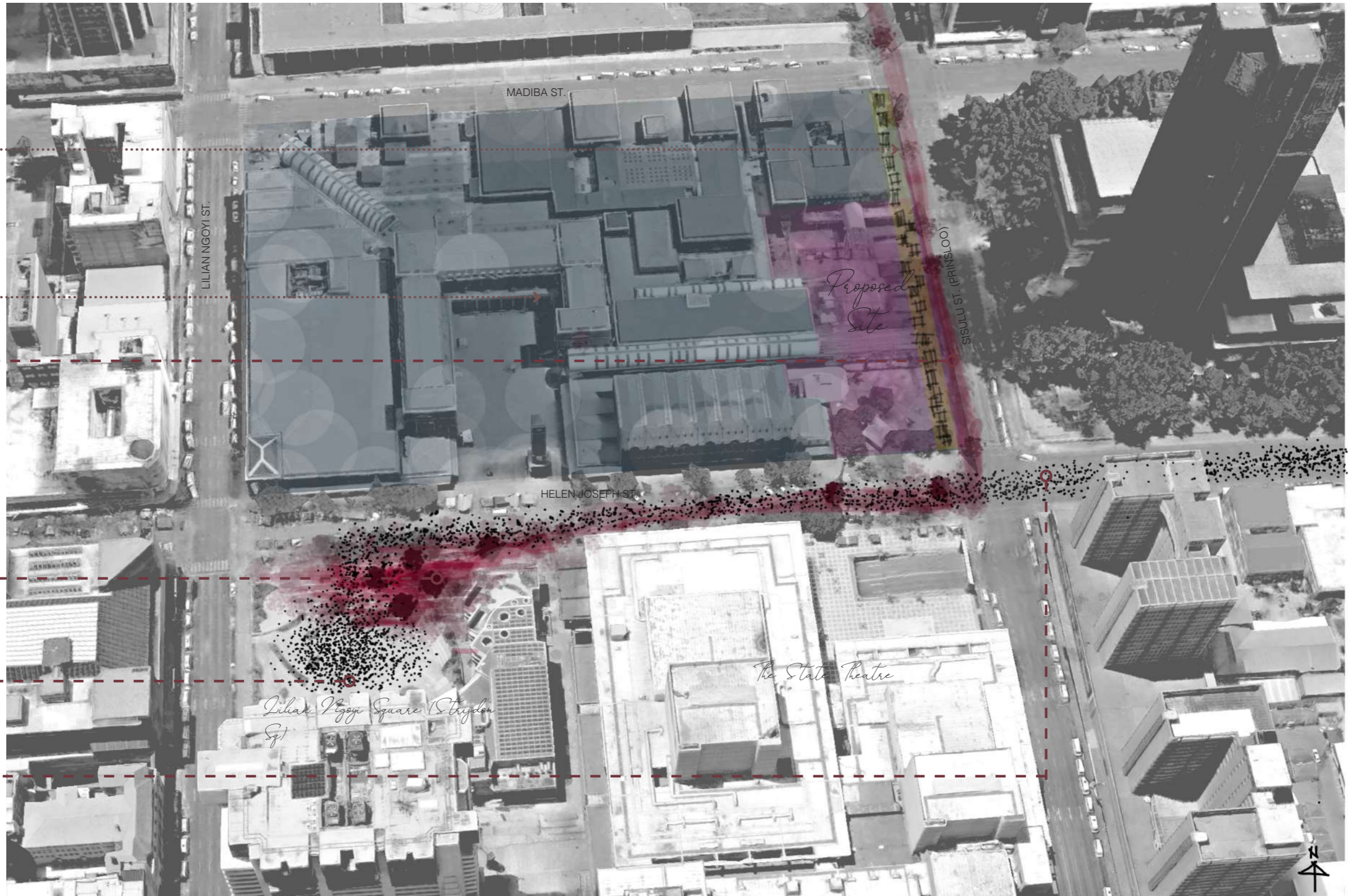

5.4 || STATEMENT OF HERITAGE SIGNIFICANCE

According to the National Heritage Resources Act of 1999, a site's national significance can be determined consistent with the following criteria:

Historical significance

Situated along historic Church Street, the site has protest significance since it was previously called Verwoerd Square, named after Hendrik Verwoerd who was known as the 'Architect of Apartheid'. The area is opposite Lilian Ngoyi Square from which the 1956 Women's March departed and where the 'Wit Wolf' massacre took place. Based on the Tshwane 2055 Vision, the historical protest route will be formalized by being regarded as a 'Ceremonial Boulevard', providing it with future historical significance. The two heritage buildings on the site, the Kynoch Building and the Gundelfinger Building, are important examples of the first retail typology in Pretoria (Kynoch Building) and a prime example of the Wilhelmiens architectural style (Gundelfinger Building).

Architectural and Functional significance

The Kynoch Building, which is the oldest surviving example of the original Pretoria retail typology, still exists. It is protected by South African heritage laws as it was constructed more than 60 years ago. The Sammy Marks Building is one of the prime examples of Wilhelmiens architecture in Pretoria. It is more than 60 years old and is also, therefore, protected by South Africa's heritage laws. The architectural significance of the Sammy Marks block as a whole lies in it being a prime example of post-modern architecture in Pretoria. Both buildings have been declared national monuments on account of their historical value and significance.

Spatial significance

The site, which has historically functioned as a retail environment, formerly supported small businesses and trade such as the Indian-owned market along the eastern side of the block, which has traditionally acted as a social meeting place for the people of the city. The intention to serve the everyday user by creating a human-scale environment and programmes is a significant principle in the proposed design.

PROJECT OBJECTIVES CONSIDERING HERITAGE SIGNIFICANCE

5.5 || HERITAGE LEGISLATION

International Council on Monuments and Sites (ICOMOS) International Cultural Tourism Charter – Managing Tourism at Places of Heritage Significance (1999)

The Charter Ethos:

“At the broadest level, the natural and cultural heritage belongs to all people. We each have a right and responsibility to understand, appreciate and conserve its universal values”

(ICOMOS, 1999:1)

“It encompasses landscapes, historic places, sites, and built environments, as well as biodiversity, collections, past and continuing cultural practices, knowledge, and living experiences”

(ICOMOS, 1999:1)

“It records and expresses the long processes of historic development, forming the essence of diverse national, regional, indigenous, and local identities, and is an integral part of modern life”

(ICOMOS, 1999:1)

“The particular heritage and collective memory of each locality or community are irreplaceable and an important foundation for development, both now and into the future”

(ICOMOS, 1999:1)

According to ICOMOS (1999:1), tourism has the power to realize heritage's economic potential and use it for conservation. Without exploiting the intangible heritage of the area, tourism can generate funding, influence policy and educate the community and visitors (ICOMOS, 1999:1).

The Six Principles of the Cultural Tourism Charter:

Principle 1:

Since domestic and international tourism is among the foremost vehicles for cultural exchange, conservation should provide responsible and well-managed opportunities for members of the host community – and visitors – to experience and understand the host community's heritage and culture first-hand.

Principle 2:

The relationship between heritage places and tourism is dynamic and may involve conflicting values. It should be managed in a sustainable way for present and future generations.

Principle 3:

Conservation and tourism planning for heritage sites should ensure that the visitor's experience will be worthwhile, satisfying and enjoyable.

Principle 4:

Host communities and indigenous peoples should be involved in planning for conservation and tourism.

Principle 5:

Tourism and conservation activities should benefit the host community.

Principle 6:

Tourism promotion programmes should protect and enhance the natural and cultural heritage characteristics.

Fig 5.44- Historical Timeline of site development and historical democratic development (Author collage, 2019)*

Fig 5.45- Events which took place on and around the site (Author collage, 2019) *

Fig 5.46- Aerial View of Pretoria, date unknown (Van Der Vaals collection, 2019)

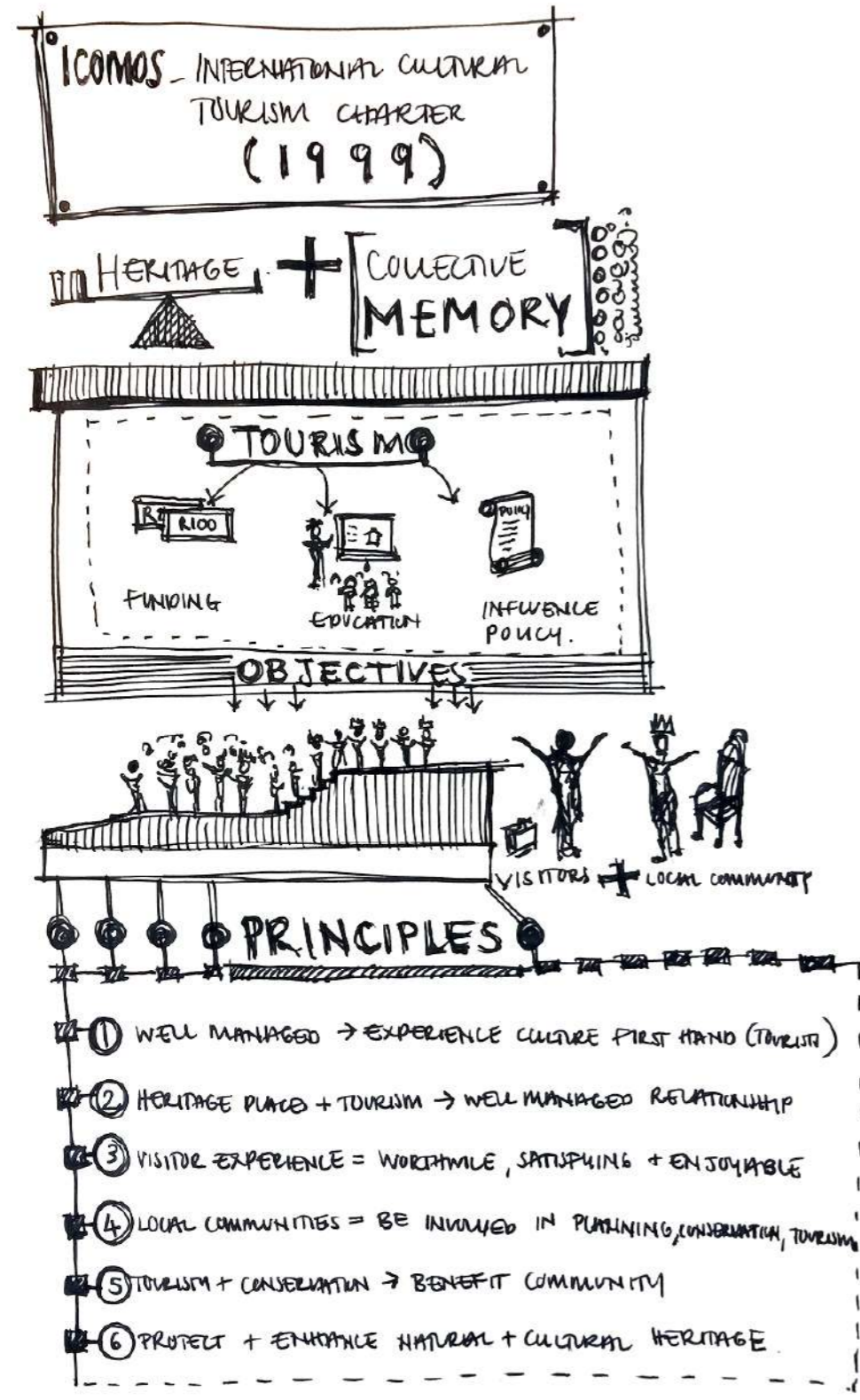

5.47

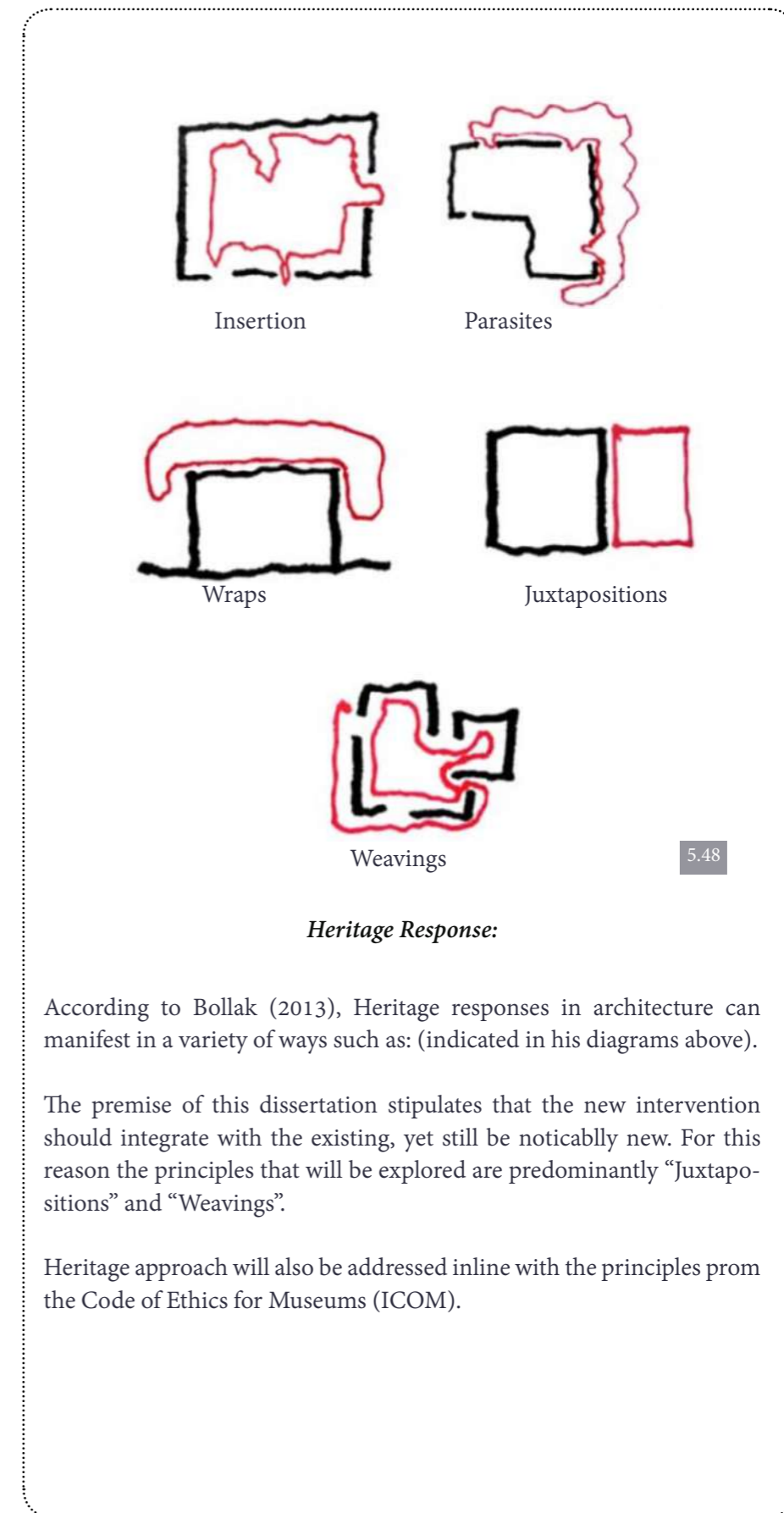

Fig 5.47- The Principles of the ICOMOS international Cultural tourism charter of 1999 (Author, 2019)

Fig 5.48- Diagrams of architectural strategies: Insertion, Parasites, Wraps, Juxtapositions, Weavings (Bollack, 2013)

5.48

Heritage Response:

According to Bollak (2013), Heritage responses in architecture can manifest in a variety of ways such as: (indicated in his diagrams above).

The premise of this dissertation stipulates that the new intervention should integrate with the existing, yet still be noticeably new. For this reason the principles that will be explored are predominantly “Juxtapositions” and “Weavings”.

Heritage approach will also be addressed inline with the principles from the Code of Ethics for Museums (ICOM).

5.6 || BLOCK VISION

The Tshwane 2055 Vision situates the area in what is termed the ‘civic precinct’ of Pretoria’s inner city.

“In 2055, the City of Tshwane is liveable, resilient and inclusive whose citizens enjoy a high quality of life, have access to social, economic and enhanced political freedoms and where citizens are partners in the development of the African Capital City of Excellence”

(City of Tshwane, 2015)

Historically significant landmarks along the Ceremonial Boulevard:

- The Hero’s Acre
- Kruger House
- Church Square
- The Palace of Justice
- The Ou Raadsaal
- Lilian Ngoyi Square
- The State Theatre
- The Reserve Bank
- The Union Buildings

The civic precinct is centred close to the new Tshwane House and comprises:

- Lilian Ngoyi Square
- The Women’s Museum
- The Sammy Marks Building
- The Justice College
- Brown Street

“It is proposed to become a people’s place where access to government services can be obtained and which is a major tourist attraction”

(City of Tshwane, 2015).

The lighting of buildings and open spaces will create a ‘city of lights’ around the civic precinct, which will create uniqueness and attract users, specifically after dark, to establish a 24-hour city. All lighting will be interactive.

The origins of Pretoria as ‘Pretoria Philadelphia’ – meaning ‘a city of brotherly love’ – must be in keeping with ‘kragdadigheid’ (forcefulness) and function well as a city that serves all of its people, regardless of the spectrum. The Sammy Marks development is to form an integral part of the broader civic context, which is intended to be a ‘people’s place’, besides being an identifiable landmark in Pretoria. The urban vision ‘for people’ explores theories by Joel Kotkin and Jan Gehl as a way of creating a metropolitan area that is well suited for and serves the man and woman in the street.

In keeping with this goal, the block vision explores how the precinct – that includes the Sammy Marks Square and the State Theatre – can function so as to enhance the services provided to the everyday citizen. Since the area is a civic sector located along the Ceremonial Boulevard (as per the Tshwane 2055 Vision), it should be envisaged as facilitating public gatherings, protest marches, ceremonial activities, and as the ‘performance of everyday life’ in this hub of creativity and expression.



Fig 5.49- Area of interest for block vision (Author adapted from Google Maps, 2019)

5.49

Fig 5.49.1- Initial planning for Block Vision (Author, 2019)

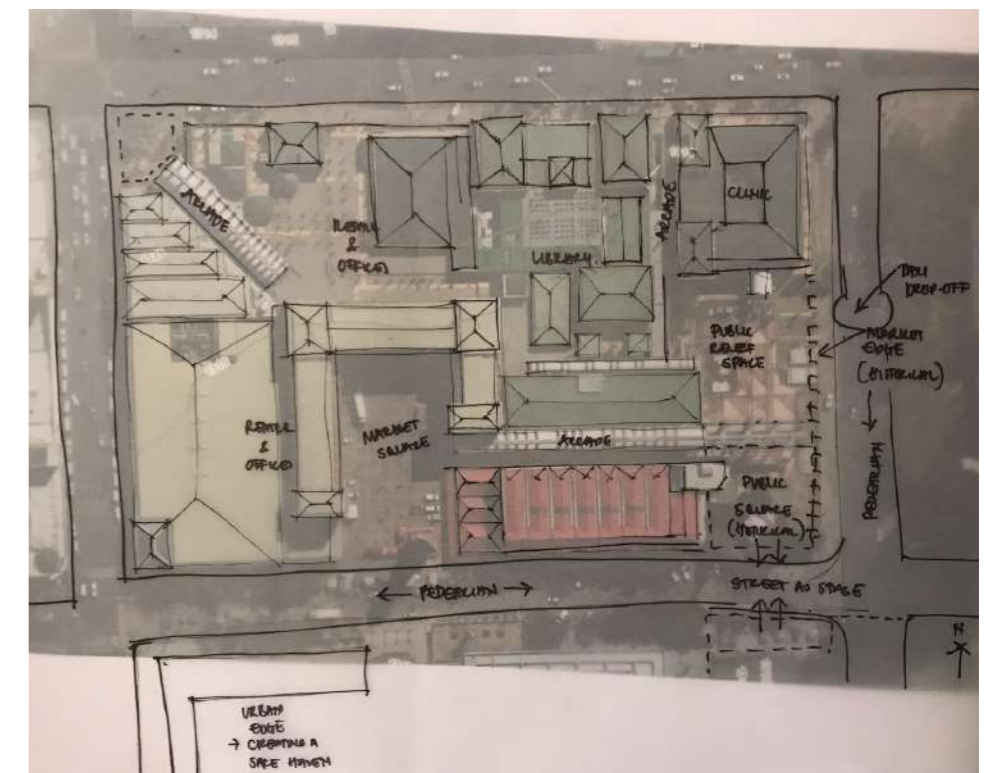

5.49.1

The block vision will implement the following strategies:

1. Densify the precinct through the introduction of housing.
2. Pedestrianize Helen Joseph Street up to Du Toit Street, and Sisulu Street from Madiba Street to Pretorius Street.
3. Open up the public space surrounding the Reserve Bank whilst maintaining security through activities such as introducing young entrepreneurial crafts businesses, in response to the memory of the old Market Square that defined the area originally.
4. Controlled access for cars entering the precinct (deliveries and employees at various businesses). The public entrance to Sammy Marks Square is confined to the Madiba Street entrance and public entrance to the State Theatre is confined to the Pretorius Street entrance.
5. Publicize the square outside the Women's Memorial.
6. Activate and bring more human comfort to the centre of Sammy Marks Square with temporary market stalls and street furniture integrated into planter boxes for trees that shade the public space.
7. All new built fabric is to integrate the public realm and ground floor plane.
8. Frame the periphery of public squares to create public relief courtyards.
9. Create multi-functional buildings that facilitate cultural civic programs.
10. Taxi drop-off zones and public transport routes are to be confined to Madiba and Pretorius Streets.
11. Introduce more food-oriented programs since a sense of community is formed around having a meal together.

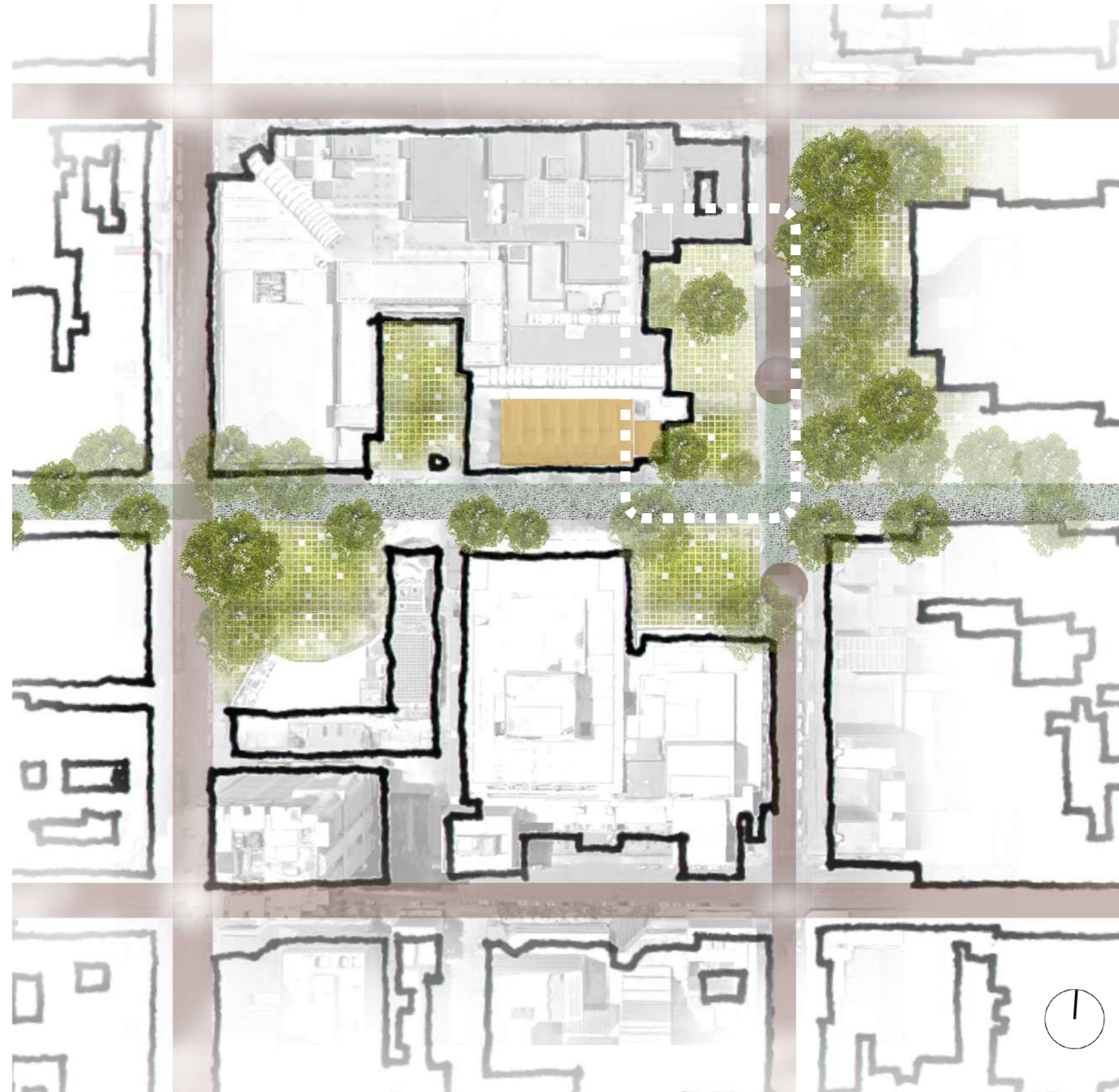
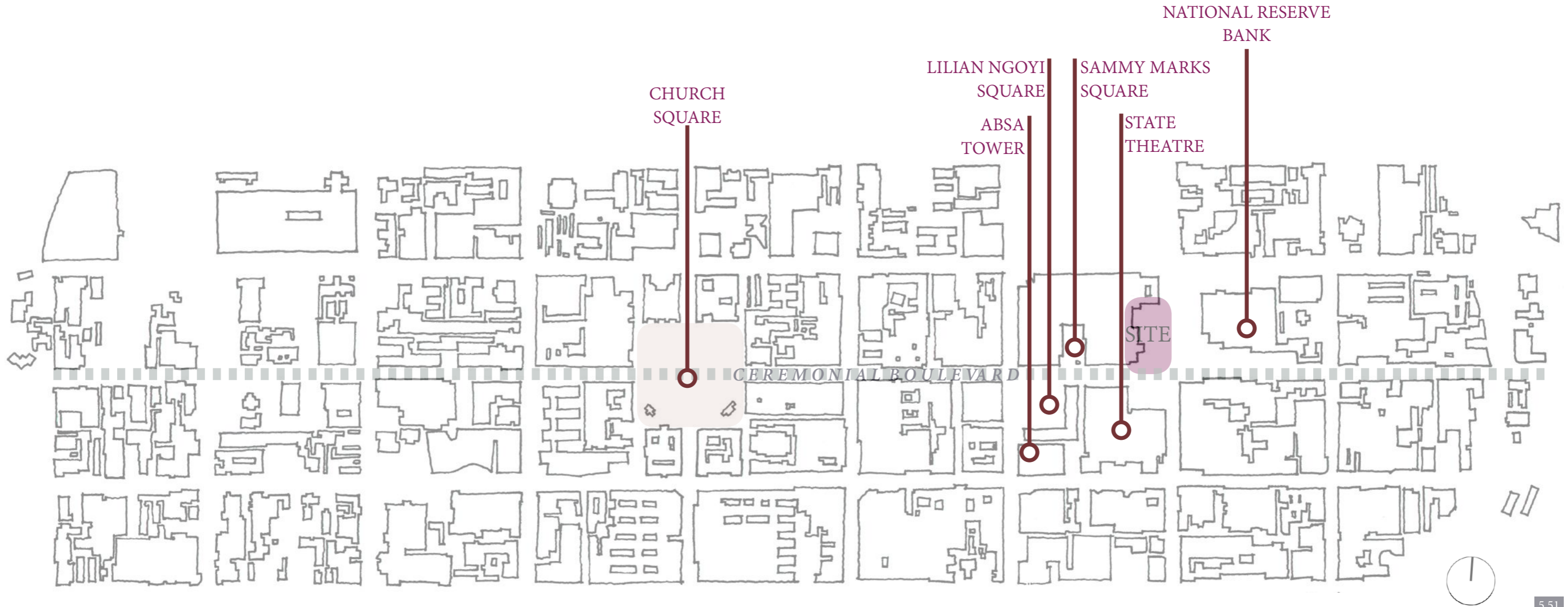

Fig 5.50-
Block Vision plan
(Author, 2019)

5.50



5.51

Fig 5.51- Locality plan of site in relation to landmarks (Author, 2019) (Base map by Kirsten, 2018)



Fig 5.52- Location of site (Author Adapted Google Maps, 2019)

Fig 5.53-5.54- Aerial locality of site (Author adapted Google Earth, 2019)



5.53



5.54

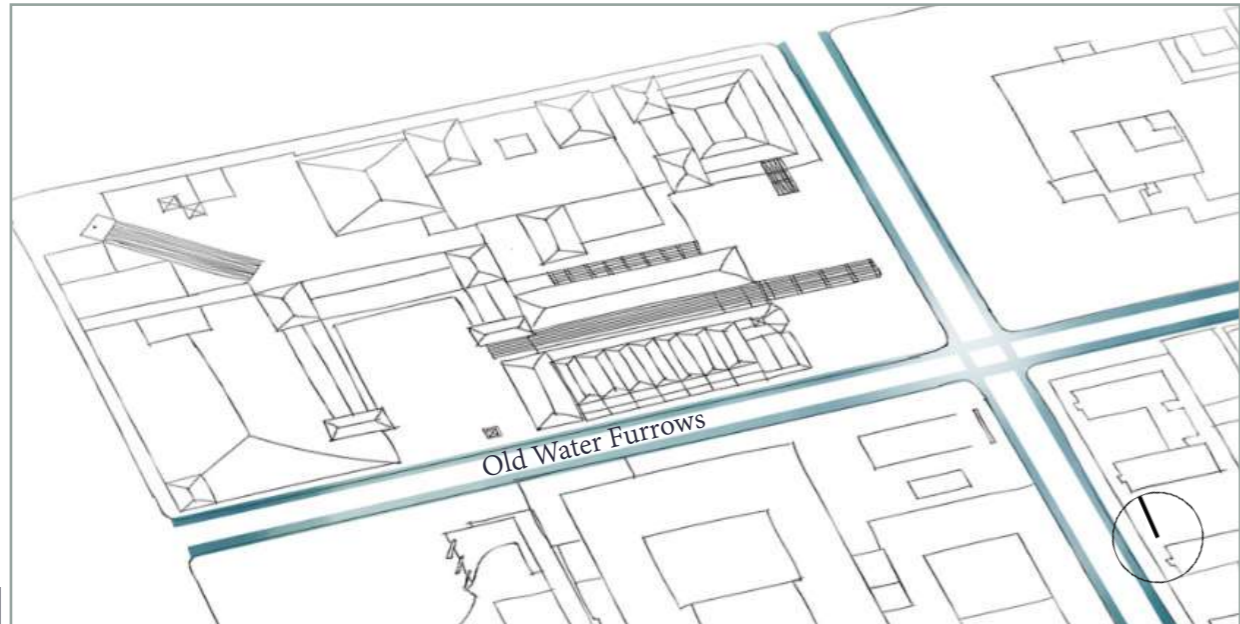

5.55



5.56

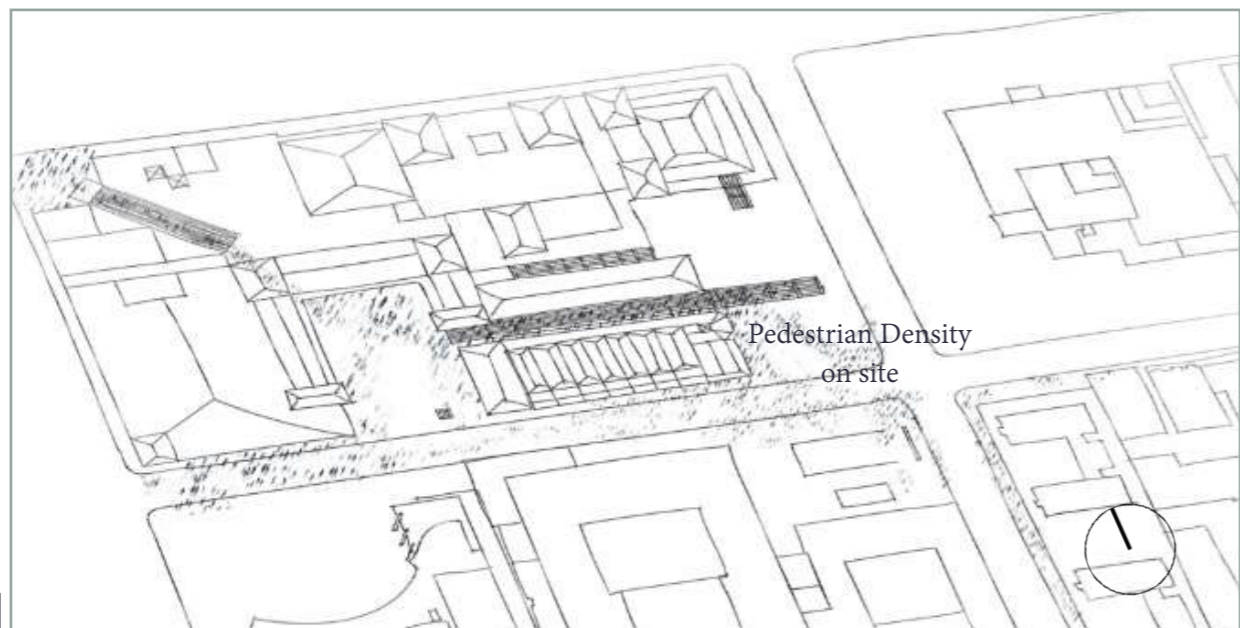

5.57

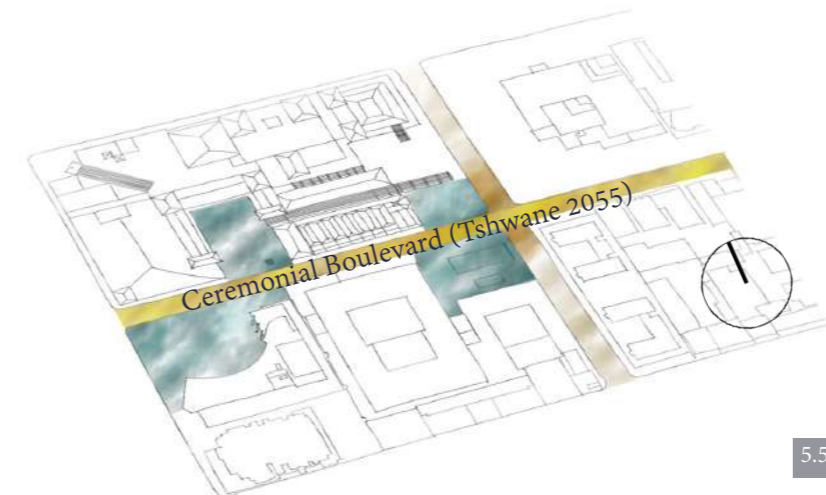

5.58

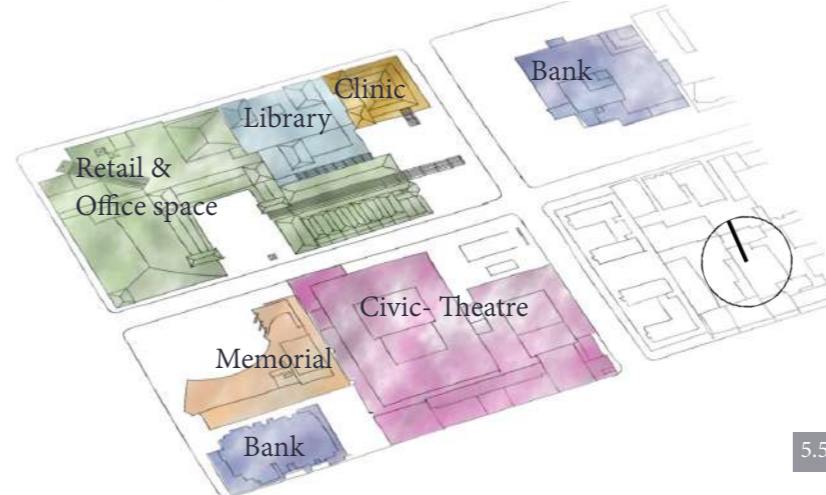

5.59

Fig 5.55- 5.59- Existing site conditions and proposed Tshwane 2055 site conditions (Author, 2019)

Fig 5.60- Site Contours (Tshwane GIS, 2019)



5.60



Fig 5.61-
Photographs of site
experience (Author,
2019)

5.61

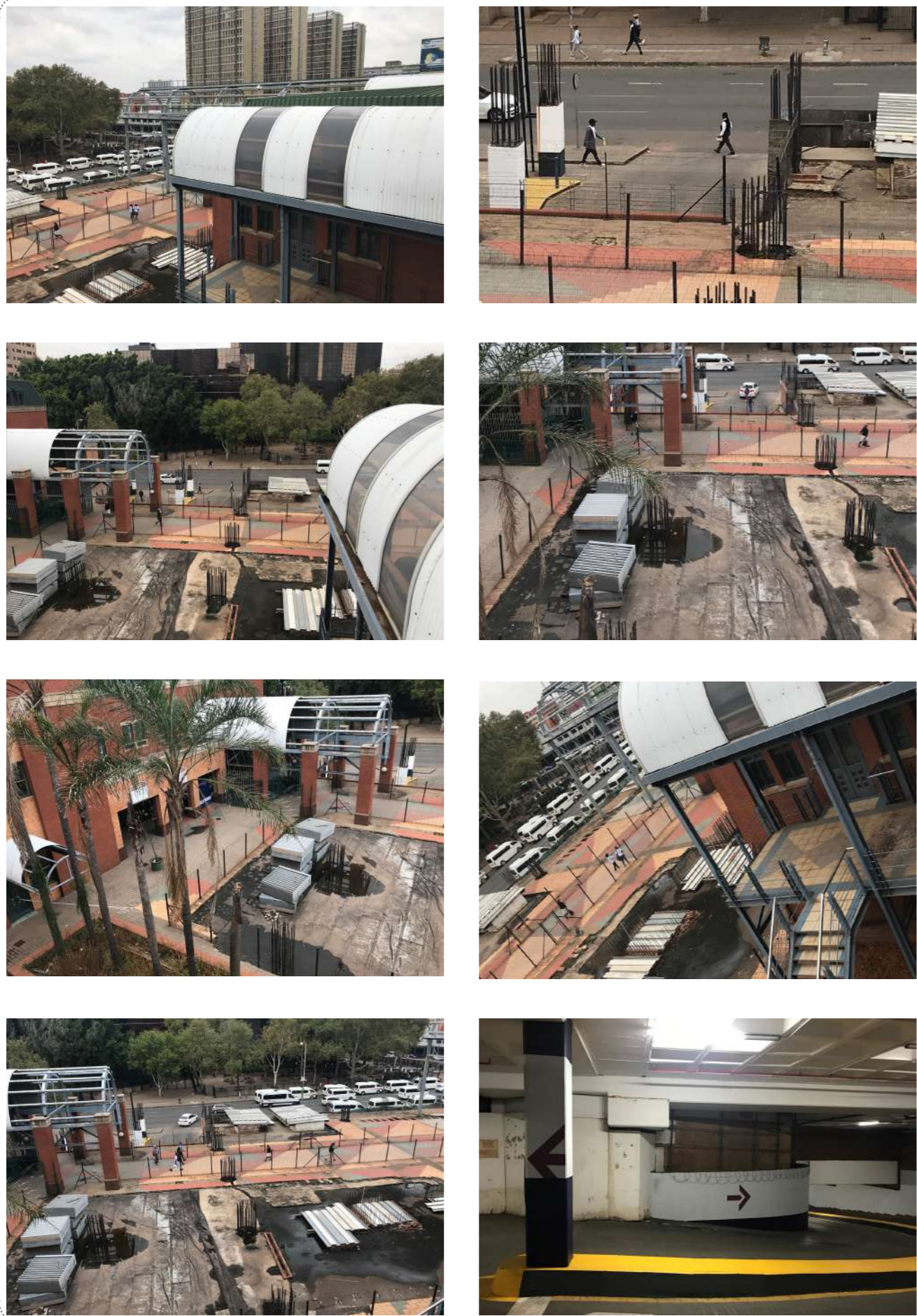

5.62

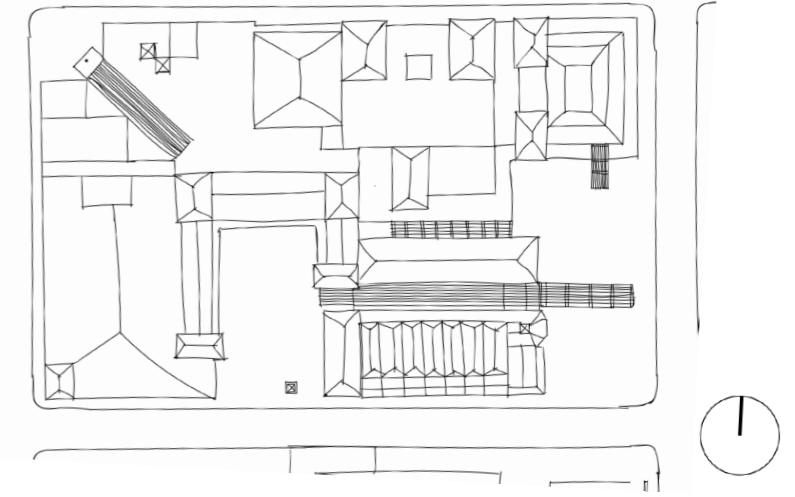

Fig 5.62-5.65-
Photographs
of existing site
conditions taken
from roof of Es'kia
Mphahlele Library
(Author, 2019)



5.63



5.64

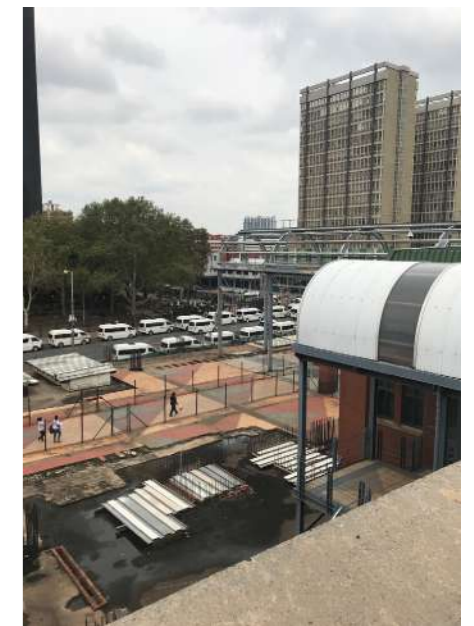

5.65

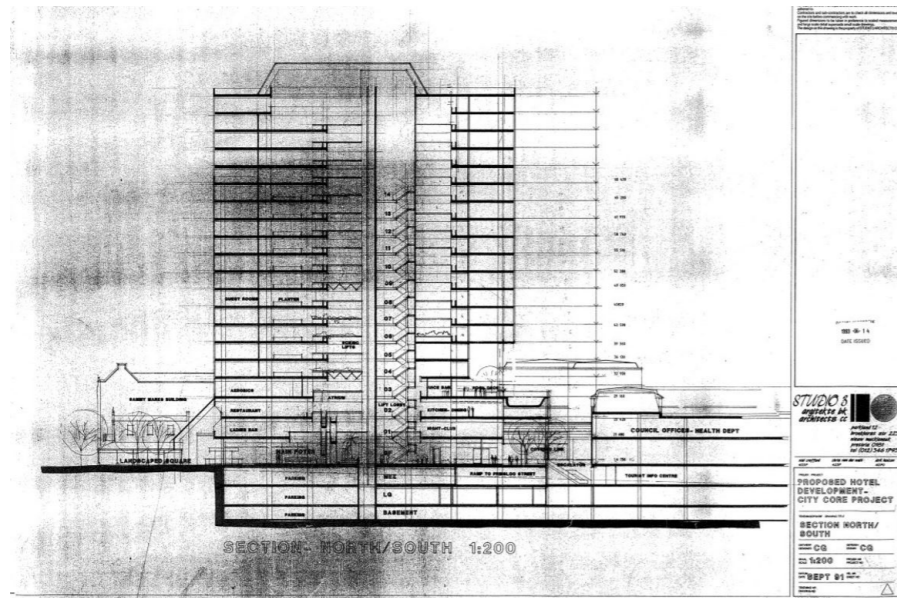

5.66

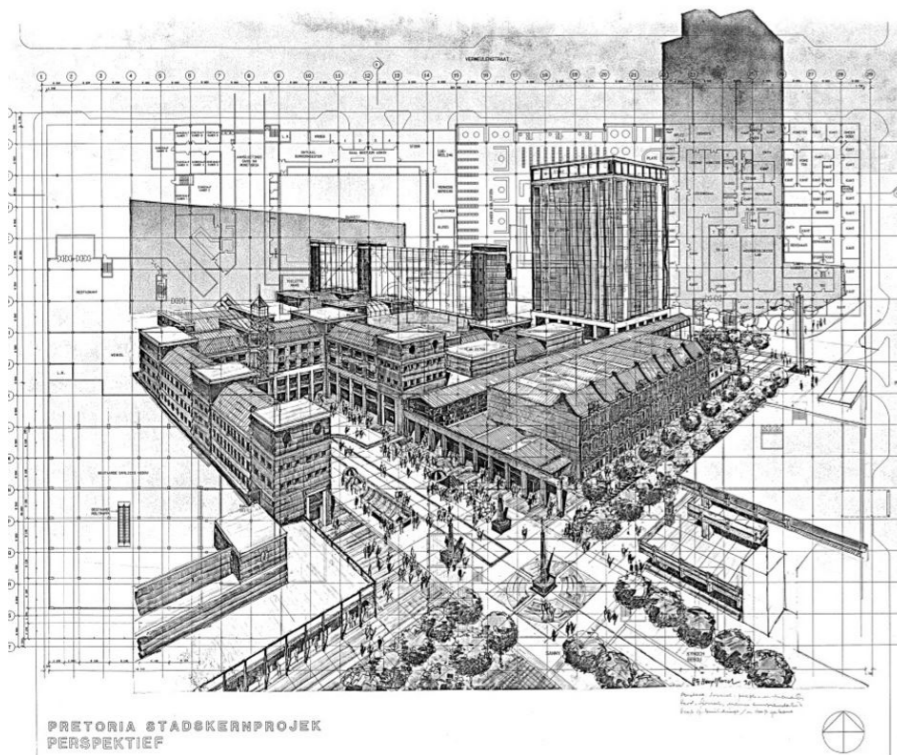

5.67



5.68

5.6 || THE WAY FORWARD

The theory and site history explored throughout this dissertation gave rise to various design strategies that can be implemented in order to create an architecture that liberates the layperson regardless of race, culture, and socio-economic position. One can speculate that the TRC process did not fully delve into the possibility of exploring methods to survey deep memory, which can now be pondered via the addition of a performance forum.

The addition of fashion as an economic means of expressing pop culture proffers the opportunity to keep the museum current and relevant to the community in which it is situated. It is important to implement programs into the museum complex that incorporate the needs of the man and woman in the street, thereby liberating the everyday to a level of the extraordinary.

Fig 5.66- 5.68- Original drawings of the Sammy Marks Development (Dias, 2012)

CHAPTER





Fig 6.1-
Concept of darkness
into light & being
freed of shackles
(Collage by Author,
2019)*.

6.1

CHAPTER 06

Concept & Design Development

/

According to Neke (1999:1), the Truth and Reconciliation Commission (TRC) is recognized as a 'landmark' for the new democratic South Africa. Neke (1999:1) elaborates that the TRC created a forum through which South Africans could face their history. Socio-political art (of all kinds) displays similar features and aims to support the TRC process, which allows the expressive artistic mediums to fulfil a broader role by 'negotiating social understanding and personal ethics' (Neke, 1999:1). The TRC forged a process of 'social catharses' through uncovering hidden events and openly exploring the power relations of the Apartheid regime (Neke, 1999:1).

"Like the TRC, this art negotiates a process of memory and healing through the communication of personal experience of loss and pain in counteraction to the more comfortable options of amnesia or denial"

(Neke, 1999:1).

The site was silenced by Apartheid. Just as the TRC exposed and reclaimed the people's stories, so the site is to be exposed and reclaimed to reveal the narratives of Pretoria and the populace.

The concluding volume of the TRC final report, which lists all the names of the people who experienced human rights violations during Apartheid, is ironically called the 'living monument' to the TRC. This document is neither 'living' nor a 'monument' in the

true sense, however. Is this account being passed off as the only way by which all of these victims are to be remembered? Apart from various expressions representing the TRC, like artworks by William Kentridge, performances such as Ubu and the Truth Commission and small exhibitions in the Apartheid Museum, it is evident that the TRC has not been granted the spatial significance it deserves. The important ones ought to stretch far beyond merely representing one individual but should represent all the faces that can be seen in the extensive list in the 'living monument', as the TRC envisioned.

Apart from it being taught in high school history classes, the TRC is largely unknown to the born-free generation. This could be regarded as a means to conceal the truths revealed about the silent heroes of Apartheid, including those community members who stood up for their neighbours in the face of adversity despite the terror and torment that would befall them for going against the government's laws.

It is highly important that the TRC should become known to the younger generations. One way of achieving this would be by granting the Commission its primary rights of transparency and translation inside a building that educates and projects into the future that which the TRC and its founding members (Nelson Mandela and Desmond Tutu) intended.

How can a subject that is as intangible as

some of the TRCs archival material be intellectually accessible to the everyday citizen? The area under discussion is so unique in its nature that it cannot merely be placed in an ordinary ‘showcase’ museum. As discussed in previous chapters of this dissertation, this museum needs to combine a multi-layered approach concerning not only the programme but also how the building and presentations are to be articulated architecturally.

This is where the concept of ‘Memoryscape’ comes into play. In his exploration of the concept of the memoryscape in landscapes, Timothy Clack reveals the power and significance thereof.

6.1 || THE MEMORYSCAPE

“Culture, emotion, memory, and landscape are all interrelated. The notion of the memoryscape is an expression of the convergence zone that homogenizes these concepts ... Of course, memoryscapes or maps of meaning are not the preserve of elite groups because meaning and intelligibility are inherently individual. The memoryscape is thus a hardwired yet subjective phenomenon that is of species-wide potential but is culturally particular in expression. All human beings dwell within a memoryscape”

Clack (2011: 119).

“Barbara Bender illuminates that, in contrast to the linear narrative of the West, ‘memory collapses time into space’. Thus space, in essence, becomes a landscape of memory. Emotion is involved in this process, as individuals become attached to space and/or responsive to the landscape”

Clack (2011:118).

According to Clack (2011:118), physical and cerebral movement is what creates a landscape. He argues that landscape is only

created through the movement that connects social relations and interactions to places.

“The dwelling is a state of one’s in-depth familiarity with place and the building involves the transformation of place through the purposeful addition of meaning. Dwelling and building are fixed locations that maintain identities (of persons and place) by situating memory”

Clack (2011:118).

Clack (2011:131) considers the memoryscape, *“... a technology for rendering the world intelligible”* where *“Memories, again like histories and pasts, offer feelings of emplacement, rootedness and attachment”*

Clack (2011:131).

Clack (2011:131) also believes that *“Cultural identities concern the conflation of memory and place for they are crucial transducers that bring the community into mutual alignment”*

Clack (2011:131).

In essence, the memoryscape gives a sense of belonging. It is place- and community-specific, much like the intentions of the TRC as a vehicle for making all South Africans feel a sense of belonging. The intention is to create – via the memoryscape concept – an environment where cultural and community identities can be formed and aligned across the merging of memory and place.

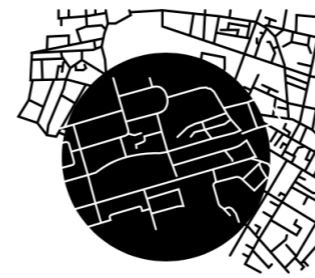

Memoryscape: Museum as a Theatre for Everyday Life:

The intervention and methods regarding the site and the design are approached through the concept of the memoryscape, which are implemented by means of how the everyday person both lives in and interacts with others in the landscape and how they approach the non-living fabric of the site, namely, the newly envisioned architectural intervention. The concept of the memoryscape is fitting when dealing with ‘memory’ – the main source of the TRCs archival material – as it concerns itself equally with the everyday citizen’s physical and cerebral experiences as regards their reality within the city.

The intervention is conceptualized as a progression of experiences through time, poetically portrayed through moving from darkness into light. The mediation expresses the TRCs intention to serve as a guiding light, or beacon, to lead the citizens out of a period of darkness (Apartheid) and into a new future of light and freedom (democracy).

This poetic experience of time is undergone through the senses – mainly sight and touch – as the visitor moves through the various parts of the museum encounter.

As the progression from darkness into the light takes place, the building transforms from being concealed to becoming transparent, not only from the inside but also from the outside looking in, which is representative of the TRCs transparent projection into the future.

Concept Flow:

The everyday is elevated to performance level, with the audience becoming members of the ‘theatre of everyday life’ and the portrayal of memory.

MEMORYSCAPE -> DARKNESS INTO LIGHT -> INTEGRATION OF THE EVERYDAY AS A WAY FORWARD -> TRANSLATION / TRANSPARENCY -> THE STREET AS A STAGE.

Fig 6.2- Place plus memory brings community into mutual alignment (Author, 2019).



Fig 6.3- Principles of the Memoryscape (Author, 2019).

Priming

Memorialising

Thinking

Transparency is not merely achieved through the literal transition from the darkness (where everything is concealed) into the light (where all is visually accessible) but also through the availability of the building's functions. Just as South Africa has changed from a divided society into an inclusive democratic society, the building evolves from being an experientially restricted museum into the inclusive theatre of new memory – through the everyday (public) realm.

The archive acts as a mediator between the constricted and the inclusive, as a partially accessible entity, a translation device that not only converts the straitened into the all-encompassing in the built experience but also as regards the transformation of the sequestered TRC archival material into the digital – to make it accessible to those who wish to read the historical records. The archive has an added function that includes the everyday citizen. Oral histories and

personal testimonies of the past and present human rights-related issues and experiences will be recorded to allow the TRCs work to continue and in so doing form an on-going and actual 'living monument' to the TRC; allowing it to continue acting as a medium of reconciliation for the people while this young democratic society finds its feet.

The idea of performance as a medium for exploring and reconciling the 'deep memory' of a painful past has been expressed by Yvette Hutchinson in her book *South African Performance and Archives of Memory*, as discussed in chapter 1.

- The building as a stage – users as participants that interact with the performance;
- the building manipulates the experiences and emotions of the audience members by turning them into 'performers';
- The experience of the site causes those present feel as if they are taking part in the 'performance' and immersing

themselves in the history of the TRC and the memoryscape site through the placement of programme and site lines;

- a previously exclusive site (Verwoerdplein) and functioning of a museum become an inclusive location and encounter through the integration of the everyday presentations with the extraordinary museum/archive/theatre programs;
- everyday life acquires the same importance as the staged performances held in traditional theatres and museums;
- the connection of 'the everyday' to 'the extraordinary' nature of the museum becomes important to mediate the narrative of the past, present and future memory of the TRC in addition to giving the local inhabitants of the democratic capital city, Pretoria, a vested interest in the intervention and the future thereof;
- because the TRC is predominantly archived in video format the opportunity for multiple 'performances' to be played

out at the same time exists, and the idea of dwelling in the memoryscape becomes apparent as each person has their own personal experience in the museum, archive and theatre; and

- the space provides an opportunity for healing and reconciliation because previously fortified information becomes transparent and can be accessed by all who desire to do so, as the TRC initially intended.

The concept of 'A Long Night's Journey into Day' represents how the Apartheid regime completely excluded the 'other'. A democratic South Africa, however, was constructed to include all, which is also a testament to the narrative of a site that formerly represented Hendrik Verwoerd but is now home to the non-discriminatory Sammy Marks Square. Celebrating the Everyday as a Way of Integrating the Average Resident's Memory into the Extraordinary Narrative of the Capital City, Pretoria:

When the principles of transparency,

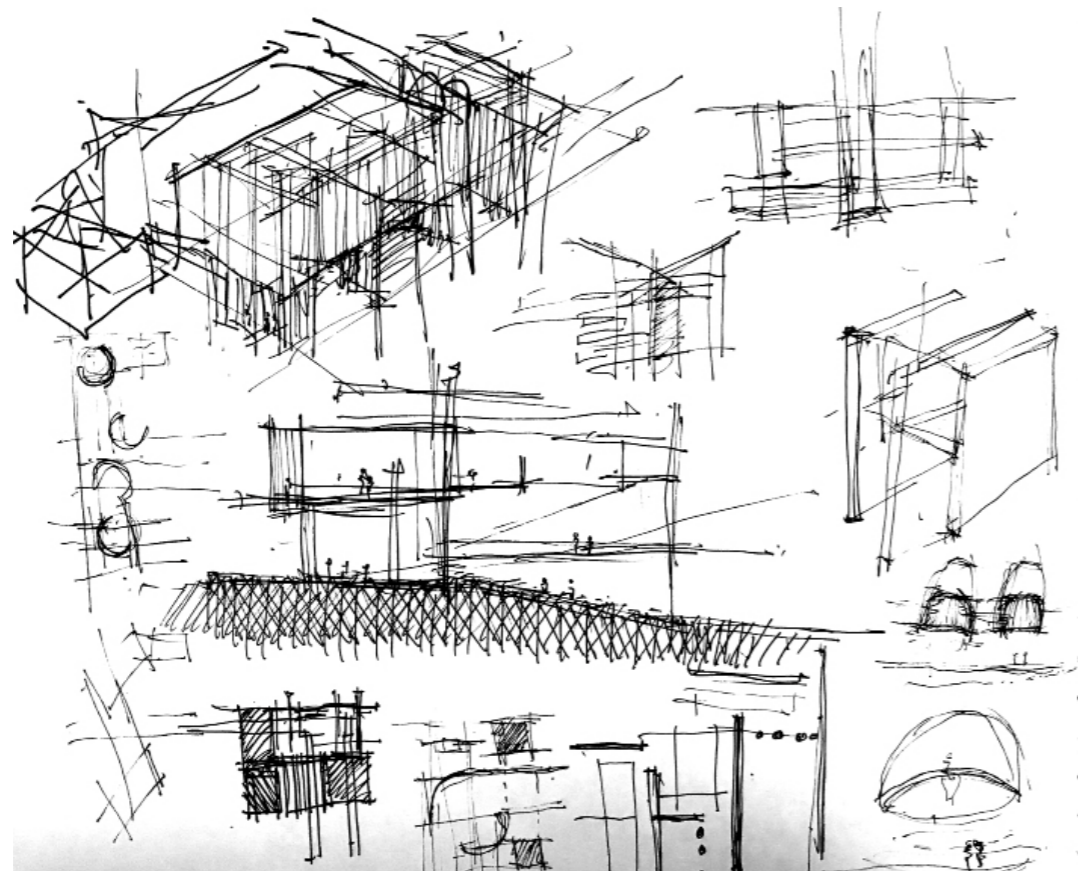

6.4

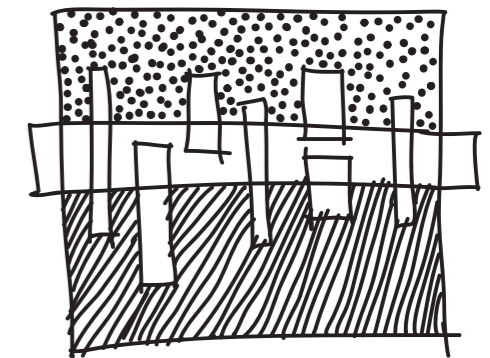

Fig 6.4- Initial Conceptual development sketches (Author, 2019).

Fig 6.5- TRC concept of transparency/translation Parti (Author, 2019).

TRANSPARENCY / TRANSLATION

6.5



6.6

Fig 6.6- Parti diagram of the uniting of the everyday and the extraordinary (Author, 2019).

translation, reconciliation, and adaptability are understood as key characteristics of the TRC, various architectural responses begin to take shape. The previous chapters have revealed a plethora of rich historical, political, cultural, socio-spatial, and programmatic layers that make up the palimpsest of the site.

The following list hierarchically indicates the architectural informants that shaped the conceptual development of the design:

1. Context – Historical (memory), political (memory) and future (new memory) perspectives
2. Function – The building’s programme (the TRC and theatre)
3. Typology – Museums (how form and concept are affected)
4. Theory – Pallasmaa; Scott; Sennett; critiques of the TRCs role in democracy;

Hutchinson on performance and ‘deep memory’, and the theory of South African theatre

5. Technology – Marionette memory, transparency of materials, the liberation of the structure

The main conceptual design strategy that addresses the issue of the mono-functionality and typical disengagement or exclusion of the public in museums took place through the integration of ‘the everyday’, as outlined by Jo Noero, into the creation of the museum.

The concept intends to bring to life the values of the TRC, specifically the core principles of transparency and translation and aims to integrate the voices of everyday citizens into the overall heritage inventory of the young South African democracy. The proposal challenges global museum typology and questions what it should be locally. The project utilizes architecture as a catalyst through which one can experience and

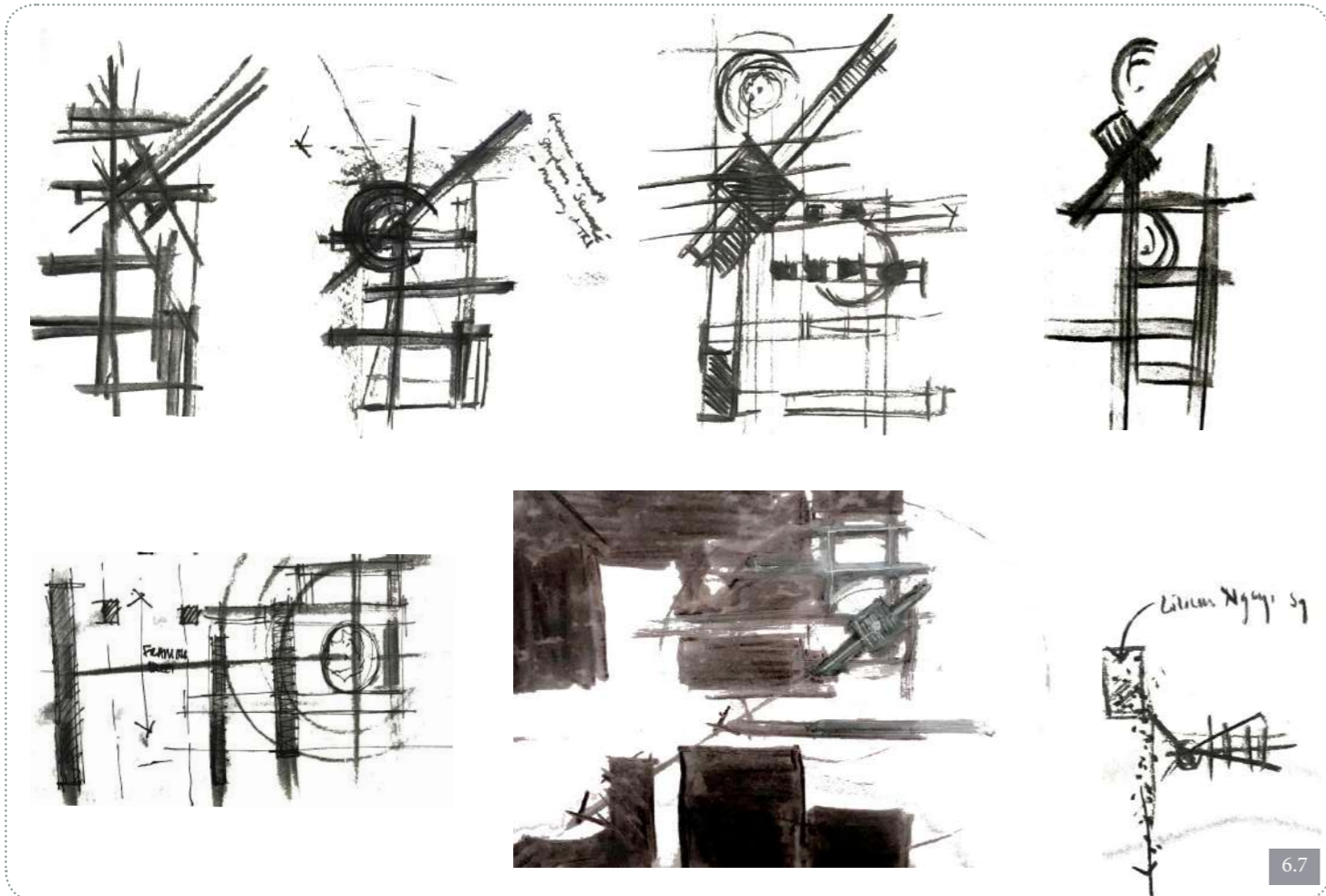

memoryscape

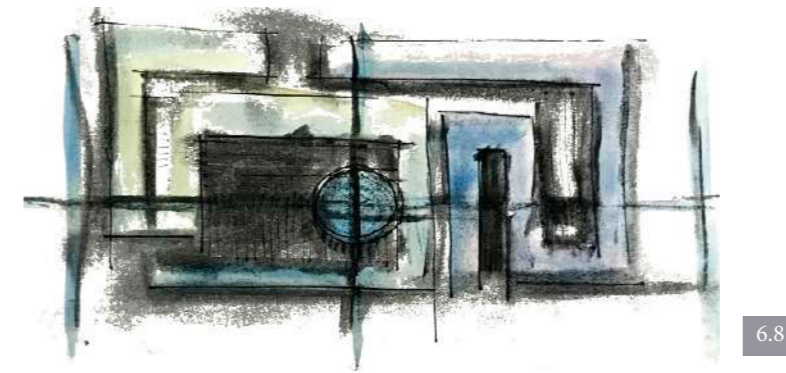

6.8

Fig 6.7- Conceptual massing of building on site exploration (Author, 2019).

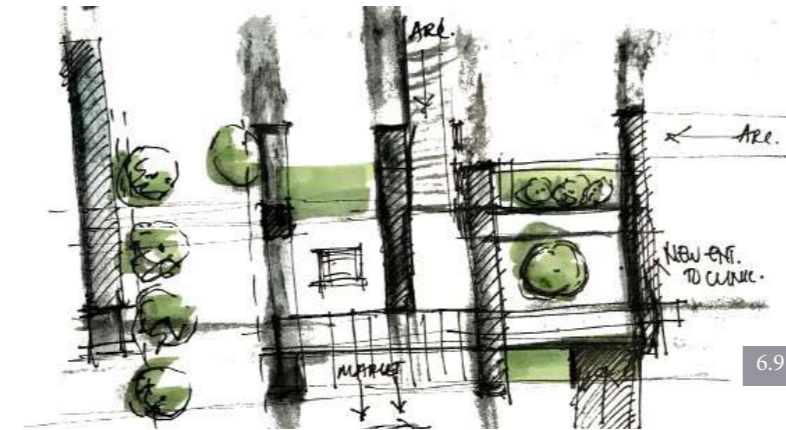

6.9

Fig 6.8- Conceptual exploration of building as urban maze (Author, 2019).

Fig 6.9- Building massing expressing historical route along church street (Author, 2019).

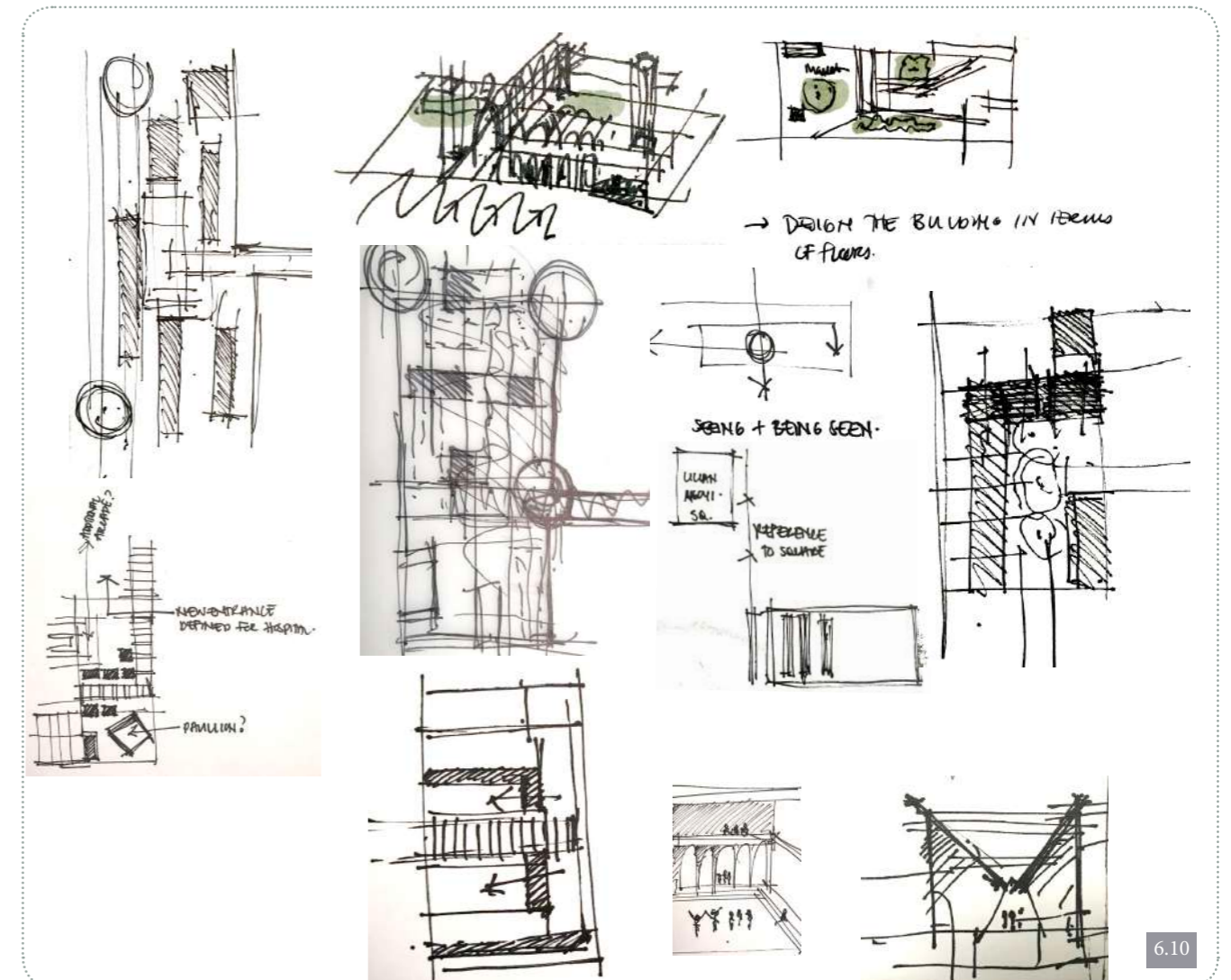

6.10

Fig 6.10- Further conceptual massing in relation to urban form exploration (Author, 2019).

memoryscape

understand the memories uncovered by the TRC in addition to the current memory of Pretoria's inhabitants, remedying the issue of 'non-faces in non-places'. Above all else, the concepts of transparency and translation are the most important drivers for the design.

A Conceptual Approach to the Sequencing of the Building (Hierarchy) – 'A Long Night's Journey into Day':

Act 1: The TRC Museum (the past – oppression and deliberation)

Intermission: The Everyday Realm (the present – freedom to operate)

Act 2: The Theatre of New Memory (the future – liberation from deep memory and the creation of a living new memory)

Reverence: Showing respect to the audience and conductor/orchestra

The Archive: Recording the past and present and making the information transparently accessible as part of the overall heritage inventory for the future

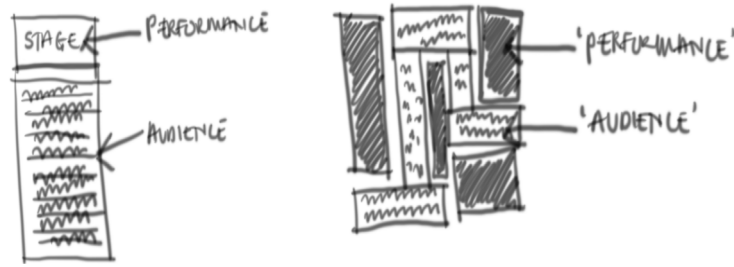

6.11

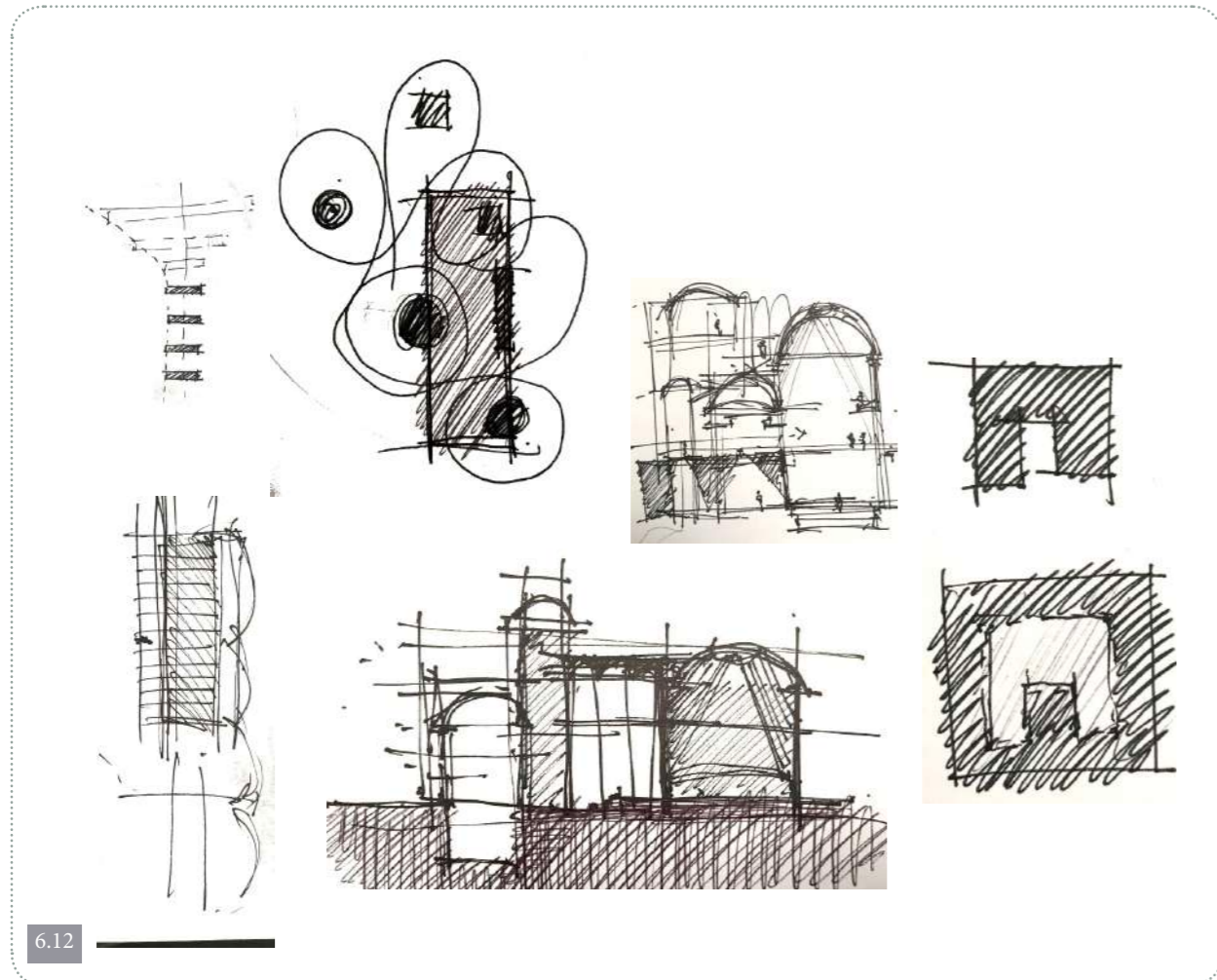

6.12

Fig 6.11- Re-addressing the concept of theatre as an audience interactive experience (Author, 2019).

Fig 6.12- Exploration of integration of the everyday and the extraordinary (Author, 2019).

Fig 6.13- Initial experiential qualities envisioned for museum (Author, 2019).

Fig 6.14- Parti diagram of new intervention being 'freed' from the old context (Author, 2019).

Fig 6.15- The everyday as a means of freedom (Author, 2019).

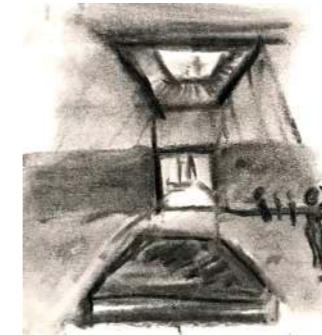
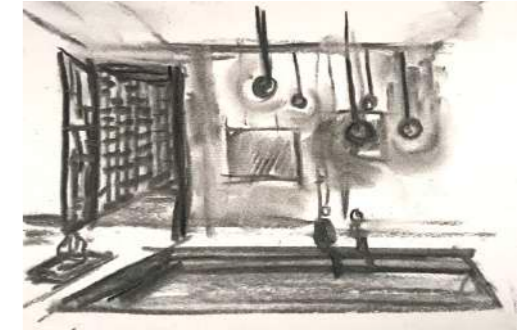

6.13

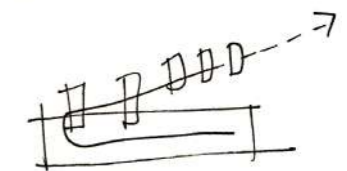

6.14

6.15

1) Contextual Response

The contextual response to the design concept is drawn from the existing interrelated site conditions that should be maintained.

The present circulatory routes on the periphery of the location experiences a lot of daily foot traffic and thus present opportunities for retail activation.

The front of the site, the southernmost part, is currently open and functions as a space where people meet, eat and socialize. The conceptual approach respects that this area is currently serving the public very well and should not be tampered with by means of excessive design intervention. There is an opportunity for this edge of the lot to be maintained as a public square that can communicate with the existing market street and the State Theatre opposite. This public square will be situated along the Tshwane 2055 Vision's Ceremonial Boulevard where protest marches historically took place and will probably occur in the future, giving the new public square future programmatic validity.

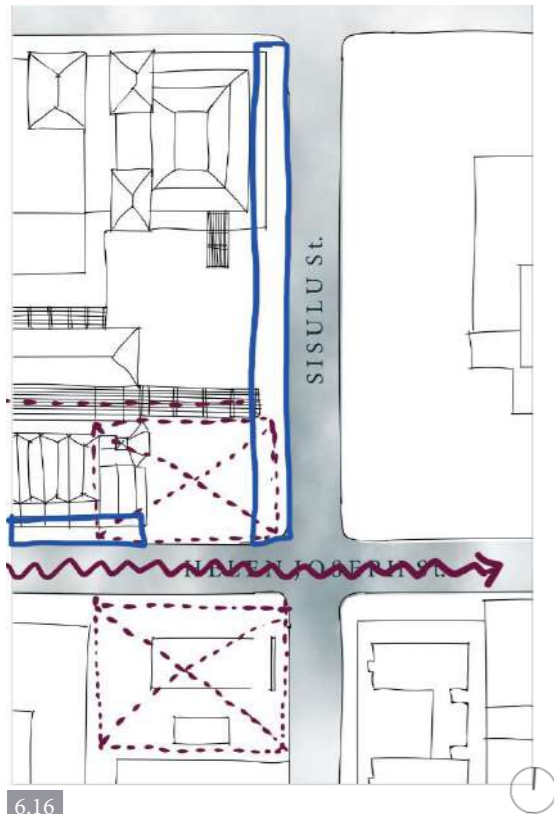

6.16

2) Formal Response

The formal concept is drawn from the current activities and built fabric to be found on the site. The formal response defines and articulates those spaces that open up public realms while closing off areas towards the north where private purposes such as the entrance to the clinic, already exist.

The formal outlay of the building is determined by the existing activities, historical retailing function and the existing Sammy Marks Square arrangement. It is important to maintain the established spatial hierarchy of the location in order to successfully add further built fabric that does not impose on the everyday functioning of the bare site. The scale of the building has been determined to mediate between the Sammy Marks block, the State Theatre, the plinth of the Reserve Bank, and the small Kynoch and Gundelfinger buildings. The predominant height of the structure responds to the scale of the buildings surrounding Sammy Marks Square itself.

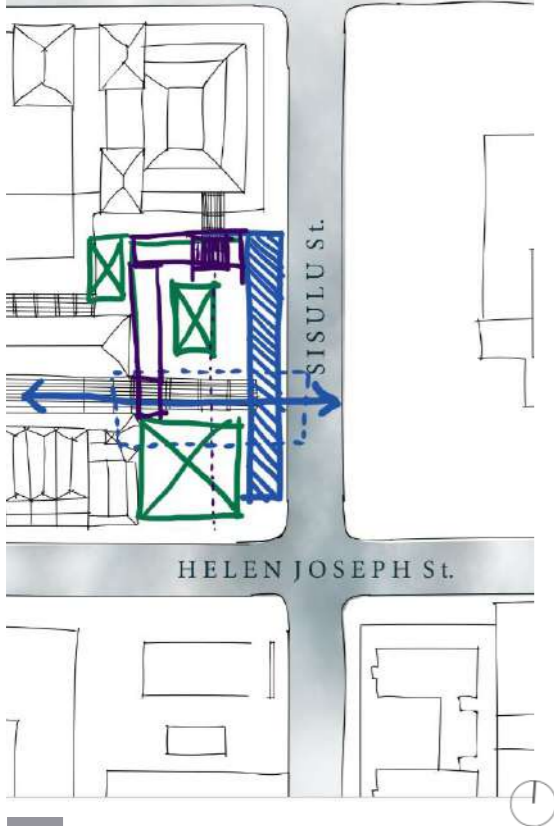

6.17

Fig 6.16- Contextual Response diagram (Author, 2019).
Fig 6.17- Formal Response diagram (Author, 2019).

3) Response to Site Memory

The layers of memory that are pertinent to the location's history and the concept of the edifice lie in the shared characteristic of 'providing for the everyday user'.

The historical layers that will be introduced through the new design intervention, as a palimpsest of memory, are the water furrows and the lost market edge on the eastern boundary of the site.

This palimpsest is to be translated as a way-finding means so that the public may understand the layers of the past. The market/retail edge that existed before Apartheid is to be re-established as an activation of the eastern edge of the site.

4) Heritage Response

The heritage response to the site, based on the statement of heritage significance, aims to translate the existing heritage fabric by respecting some of the traditional values whilst contrasting others.

The heritage response reactivates a site that was operational before Apartheid but was demolished and remained inactive when it was named Verwoerdplein. The plot will now become inclusive, dynamic and available to be used by all people, regardless of race or ethnicity.

The new intervention moves away from the existing fabric so that the only physical connection would be to the old Kynoch Building, this connection is to be made in such a way that it appears to not be physically connected so that the heritage significance of the Kynoch building is maintained. The Kynoch building will also be restored back to its original external finishes as it is the only remaining example of the first Pretorian retail typology. The heritage response of this design proposes that it can be removed to leave the environment almost identical to what it was before the new additions were included.

The materiality of the new intervention echoes the existing face brick of Sammy Marks Square, and transitions to noticeably new materiality as an expression of old vs new being in contrast. Which will be discussed in the material response diagram below.

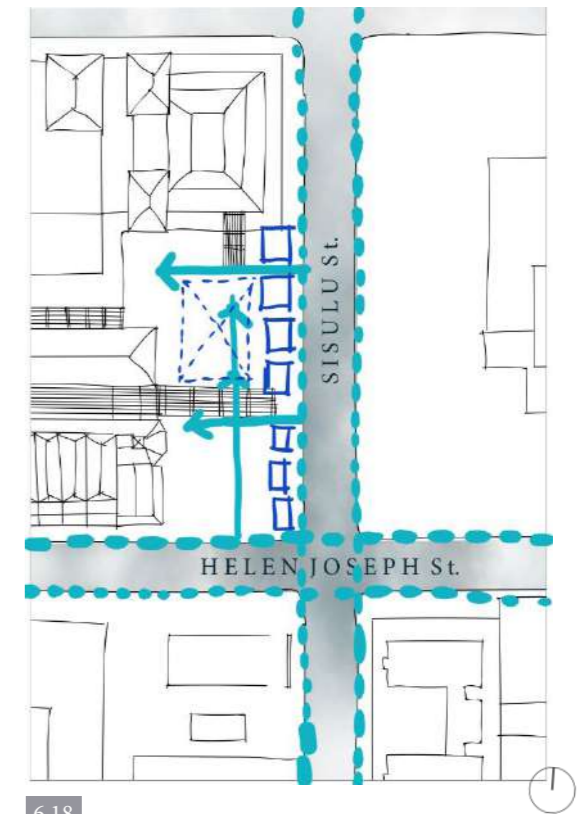

6.18

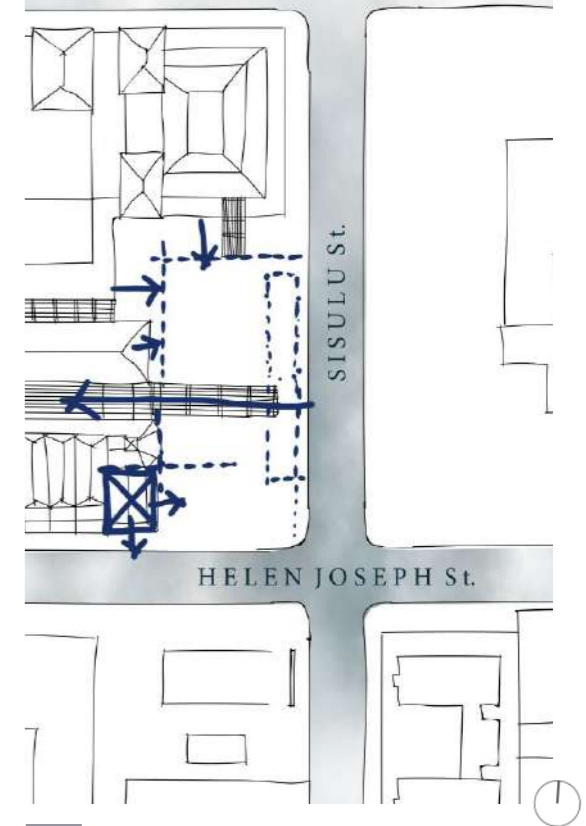

6.19

Fig 6.18- Site Memory Response diagram (Author, 2019).
Fig 6.19- Heritage Response diagram (Author, 2019).

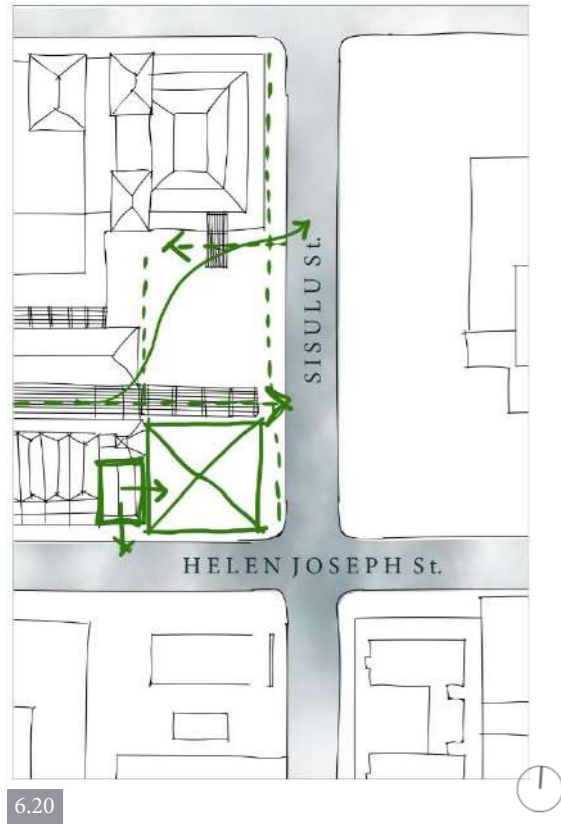

6.20

5) Functional Response

The functional response of the design intervention is based on how the bare site currently functions, without the added intervention, so that the everyday realm of the site is not disturbed but rather enhanced.

The newly added intervention should not disturb the customary use of the arena but should rather add to it sensitively in order to enhance the location's functional potential.

Existing public spaces and routes are to be maintained and enhanced to better serve the daily user. The addition of retail, food and social programmes along the lot's existing functional routes ought to elevate the everyday user's experience of the area as they pass through. The site is used as a waiting zone for taxis and public transportation and can now serve the passengers by enabling them to purchase food and other goods whilst waiting or en-route.

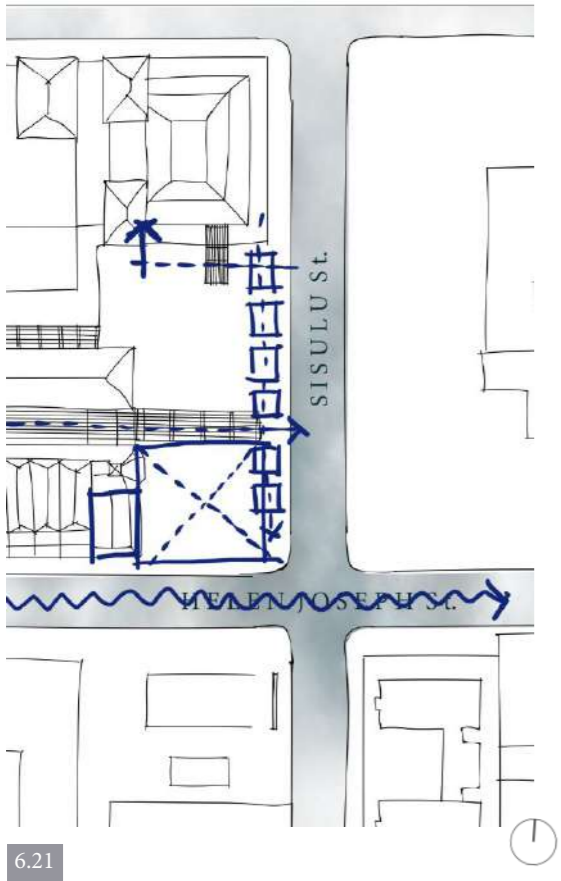

6.21

6) Programmatic Response

The new intervention's programmatic response incorporates the lost historical eastern edge as a retail space.

The programme placement was greatly influenced by existing 'everyday' aspects such as eating, gathering and waiting for buses and taxis, which are already taking place on the site.

The determination of where to add activities and where to leave flexible space is also indicated in the diagram alongside.

New options that are to be implemented in the public domain, such as waiting areas for the new transport hub, will improve the average city dweller's daily commute.

Fig 6.20- Functional Response diagram (Author, 2019).

Fig 6.21- Programmatic Response diagram (Author, 2019).

7) Material (technological) response

The material and technological features respond to the concept of 'transparency' as a means of being sensitive to the site whilst embodying the principles of the TRC.

The materiality of the surroundings is to be echoed in a thoughtful way. The intervention should not look like an addition but should rather whisper 'unity' in an unimposing fashion.

The material response exposes the existing layers on the site and utilizes the presently unfinished structure.

In contrast to the encircling built fabric – such as Sammy Marks Building and the State Theatre – the newly implemented built fabric above the ground echoes transparency. The material response in the basement, however, draws from the surrounding substances, such as the face brick used in the Sammy Marks Building, because this part of the intervention is 'embedded' in the existing site.

8) Theoretical response

The theoretical response to dealing with the TRC and 'deep memory' issues will manifest through the hierarchy and structuring of programmes that will bring forth emotional responses from the user.

The conceptual response to theory aims to deal with 'deep memory' in ways that vary between sensitive and private to public performance.

Theory also manifests through Pallasmaas' and Noeros' theories of experiential design that connects the everyday to the extraordinary nature of the city and the building.

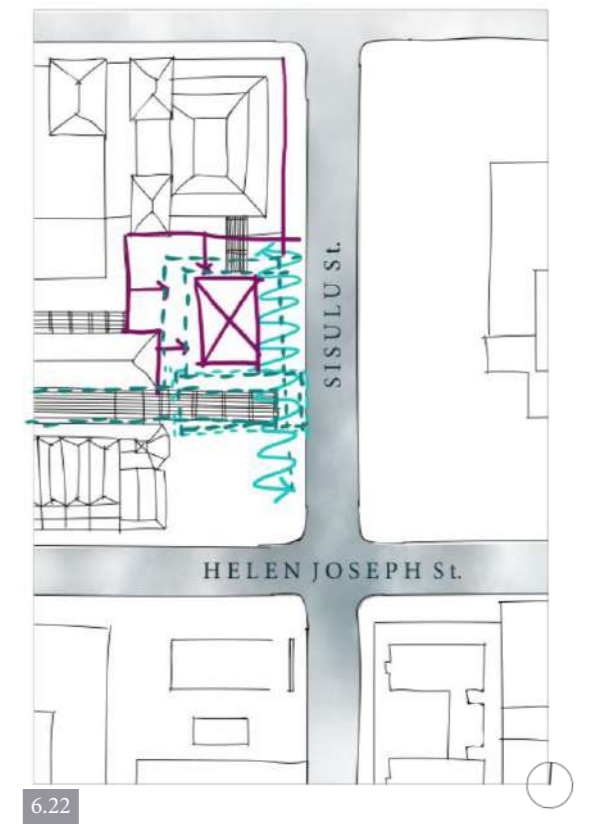

6.22

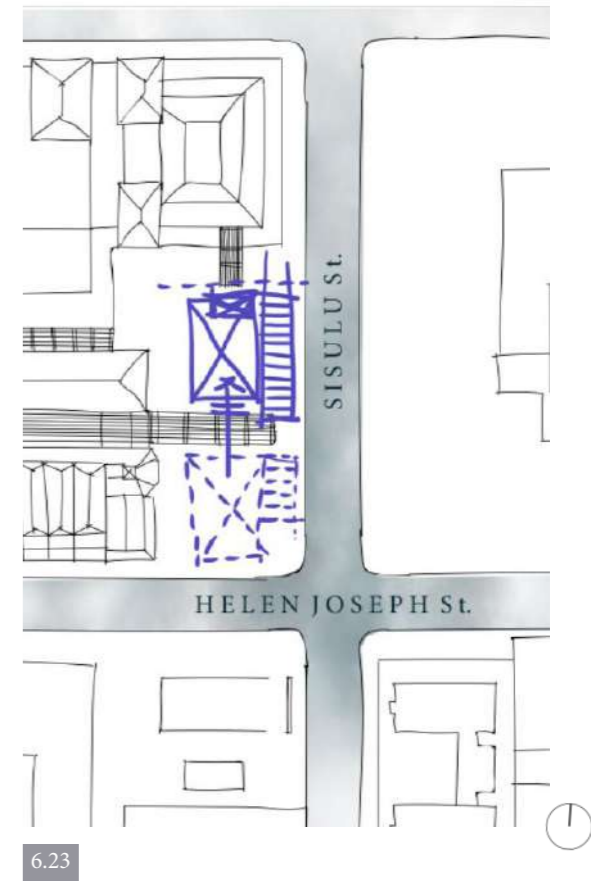

6.23

Fig 6.22- Material (technological) Response diagram (Author, 2019).

Fig 6.23- Theoretical response diagram (Author, 2019).

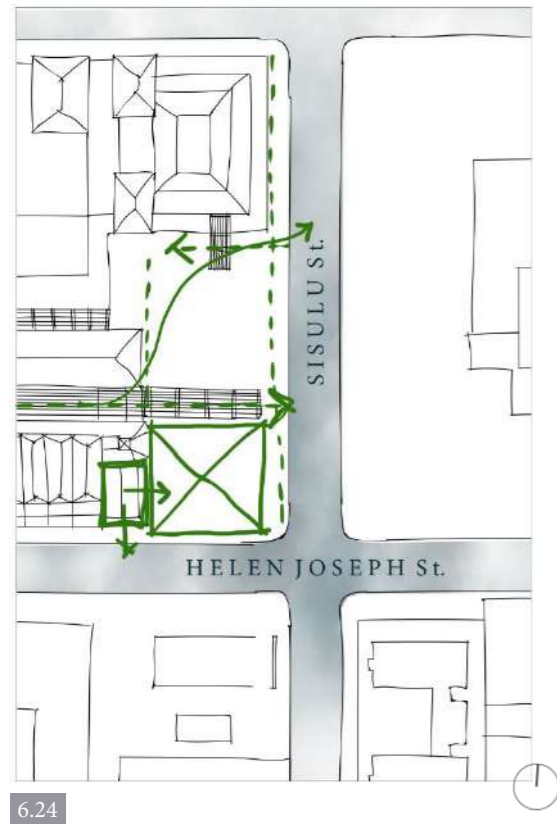

6.24

9) Response to the TRC

Two edges on the site have ‘witnessed’ major events – the 1956 Women’s March and the Wit Wolf massacre – and the conceptual approach that is directly evident emphasizes these TRC subjects .

The responses to the TRC are translated by making these areas public so that all people may ‘bear witness’ to the nature of these past events and deliberate on the present in order to reconcile history within themselves and the broader democratic whole. The creation of a public square on the corner of Helen Joseph and Sisulu Streets memorializes the edges along which these incidents took place. The new public square is also situated along the Tshwane 2055 Ceremonial Boulevard, which projects that there will be more protest marches taking place here in the future.

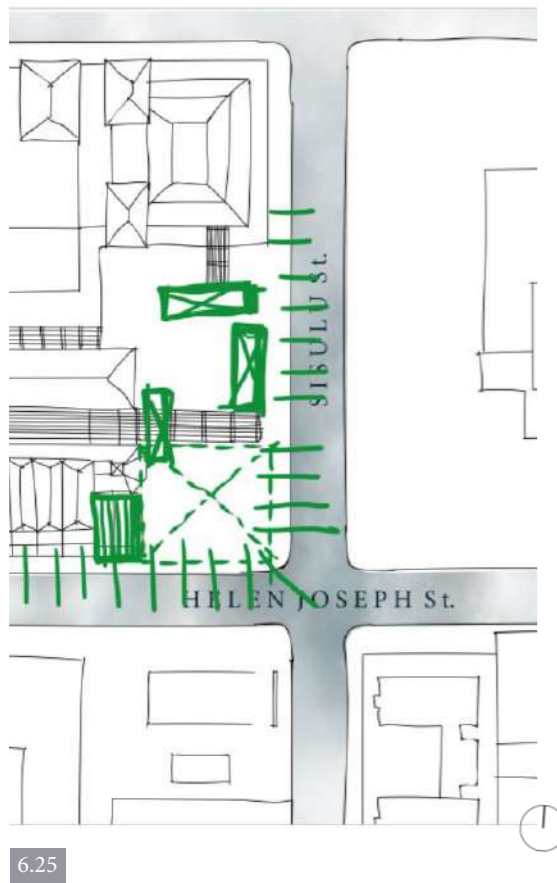

6.25

10) Response to the Everyday

The everyday and its connection to the extraordinary – the museum, archive and theatre – are the most important aspects with regard to the intervention’s success.

In order to create programme transparency on all levels the diagram shows the main points of interaction where actual physical connections between the everyday and the extraordinary realms are proposed to take place.

Connections are also made by means of axes and visual links inside the building and throughout the site.

Fig 6.24- TRC Response diagram (Author, 2019).

Fig 6.25- Everyday Response diagram (Author, 2019).

Fig 6.26- Demolishment plan to allow more useable space for intervention- Structure remains (Author, 2019).



6.26

Fig 6.27- Willow theatre axonometric (Arcdaily, 2013)

Fig 6.28- Willow Theatre External view (Arcdaily, 2013)

Fig 6.29- Willow Theatre Interior (Arcdaily, 2013)

**Willow Theater / Tim Lai Architect + Brad Steinmetz
Stage Design**

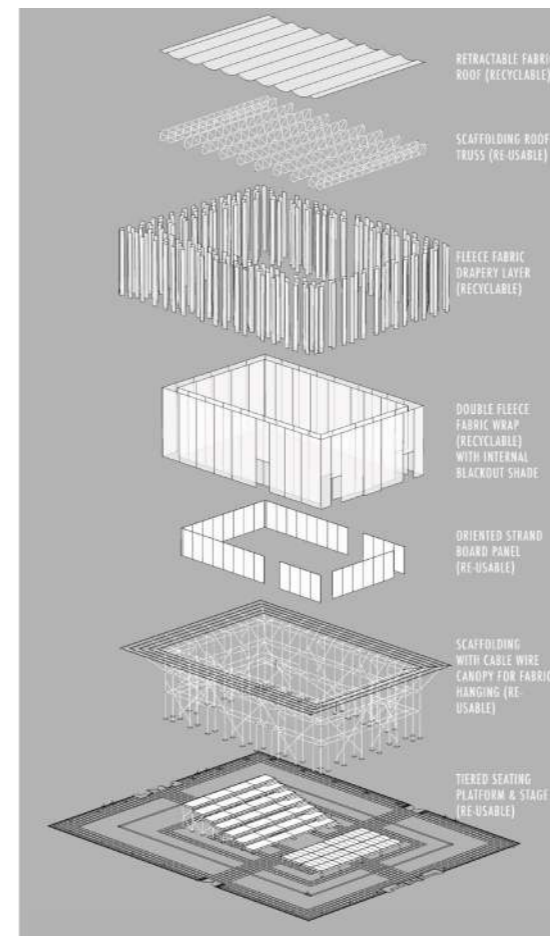

6.27



6.28



6.29

Conceptual Massing- Iteration 1



6.30

Massing Iteration 1:

Existing steel framework maintained, occupying the eastern edge of the site fully. This iteration maintains all circulation routes on site, however, the building does not invite and engage with the context.

Conceptual Massing- Iteration 2

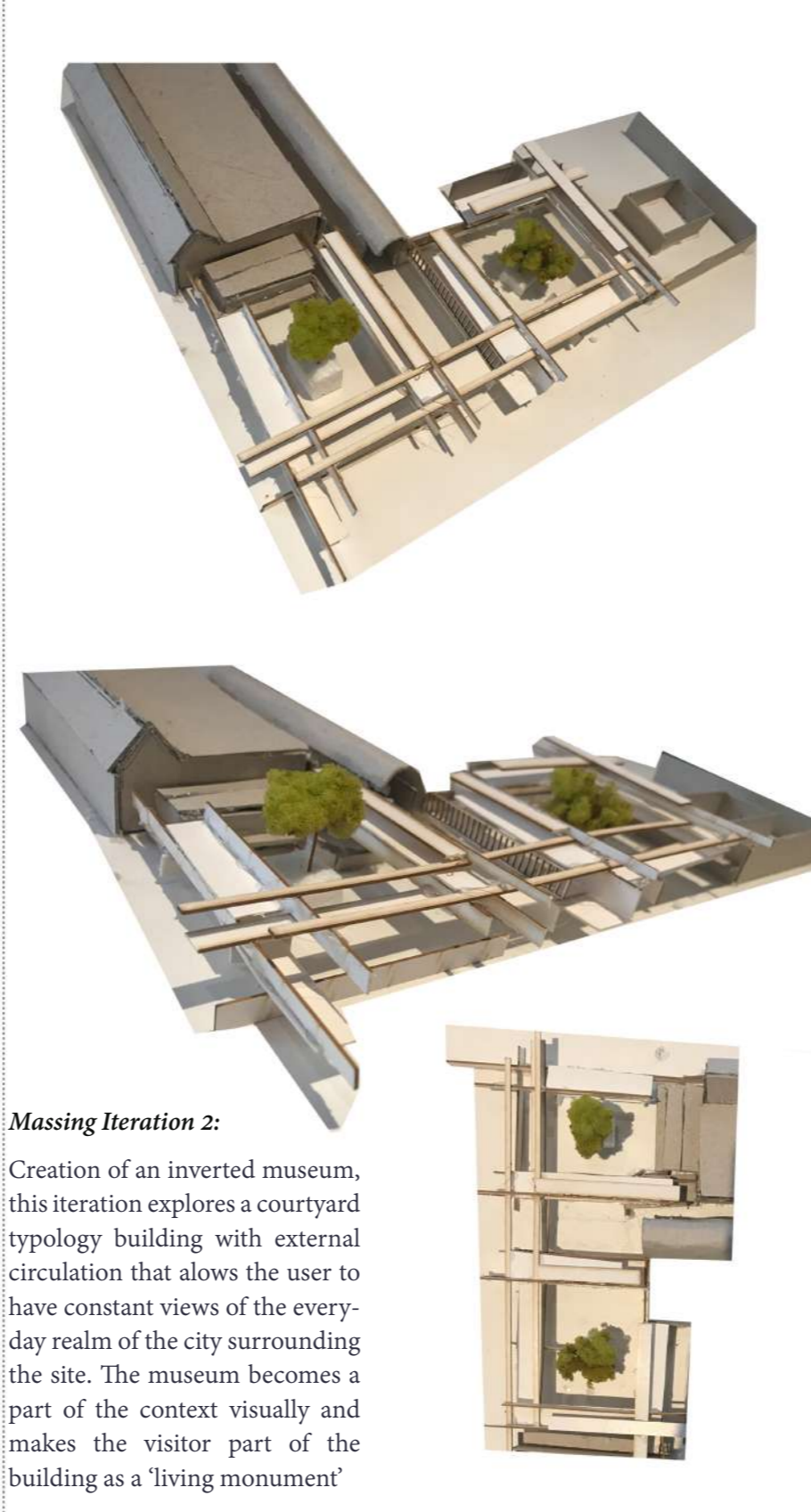

6.31

Massing Iteration 2:

Creation of an inverted museum, this iteration explores a courtyard typology building with external circulation that allows the user to have constant views of the everyday realm of the city surrounding the site. The museum becomes a part of the context visually and makes the visitor part of the building as a 'living monument'

Conceptual Massing- Iteration 3



6.32

Massing Iteration 3:

As a response to the historical events that have taken place predominantly on Lilian Ngoyi (Strijdom), the axis is skewed to gesture to new building towards Lilian Ngoyi Square as an act of memorialising these events. This is a literal translation of memory on the site. Ironically the building contrasts the existing formal geometry of the site and therefore the memory. This is not a successful iteration in terms of the project aims and intentions.



6.33

Design Iteration 1:

It was decided to develop the design from a combination of the pros concerning the massing of the building. this design iteration explores the various scales of building that already exist on site and acts as a mediator thereof. The tower towards the north of the site acts as an axis mundi that controls the space on the site below . The design explores the predominant use of the eastern edge of the building as a response to the memory of the retail edge that existed on site up until the final demolitions took place to make way for Sammy Marks development. The design iteration deals with various scales of private to public. Through this, the user experiences the building being 'freed' of its past bondage both horizontally as well as vertically as the building stretches upwards to the sky. This iteration places the museum/ archive as transparent entity along the eastern street edge, although this brings attention to the museum- the rest of the functions to the west of the site are not integral to the design. The Basement is exposed towards the north of the site to allow for a physical emersion in the existing context to be used to 'expose' the past and show how the building begins to grow out of it.



6.34



6.35



6.36



6.37

Fig 6.33-6.37-
Photographic record
of Design Iteration 1
(Author, 2019).

Fig 6.38- 6.48-
Photographic
record of various
configurations of
the building freeing
itself of the built
fabric through
built form and skin
treatment (Author,
2019).

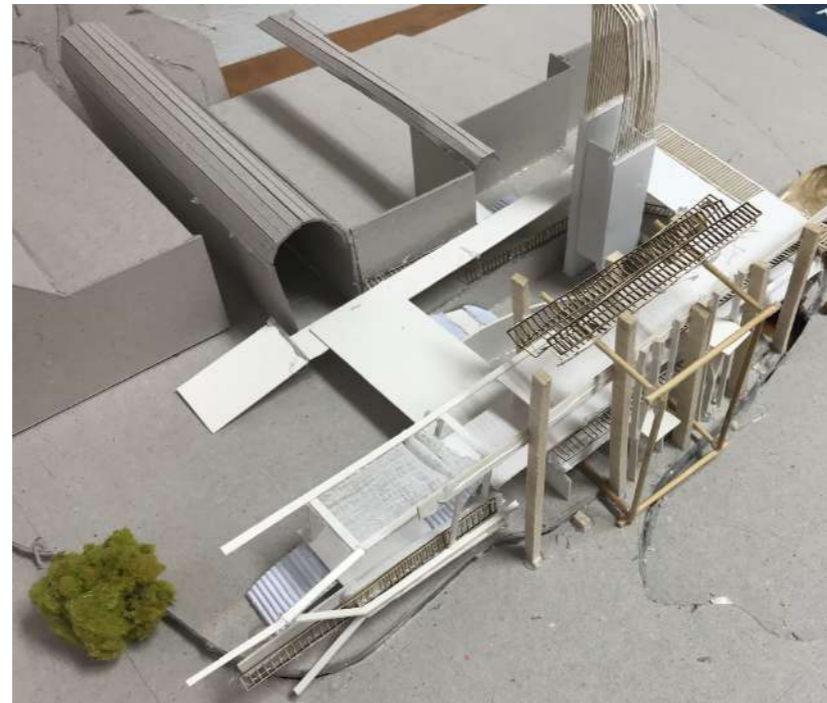

6.38



6.39



6.40



6.41



6.47



6.42

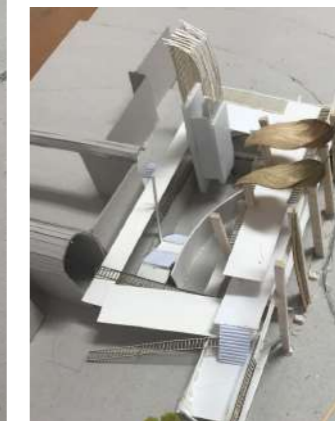

6.44



6.43

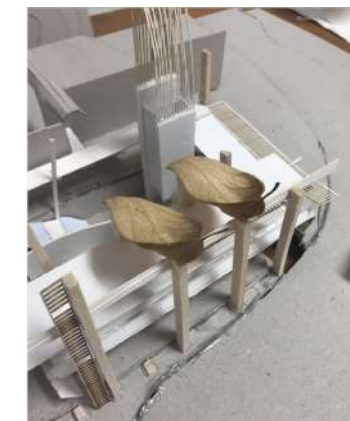

6.45



6.46



6.48

Design Iteration 2:

In this design iteration the same massing as iteration 1 is further explored on a larger scale. Iteration 2 explored the placement of the theatre as an extension of the existing arcade circulatory route on site. Along with this, the iteration envisions the ground plane (the everyday realm) as an extension of public space down into the sunken level which has now been zoned as the museum entrance. The extension of the public realm up from the public square created on the southern edge of the site into the theatre is also explored.

The museum program is zoned predominantly in the basement -1 level as a narrative of the past and as the museum narrative starts to express the future progression forward into democracy does the museum experience move up into the “new memory” of the built fabric.

The circulation tower in this case functions as a beacon of Truth and Reconciliation and indicates the entrance to the museum.

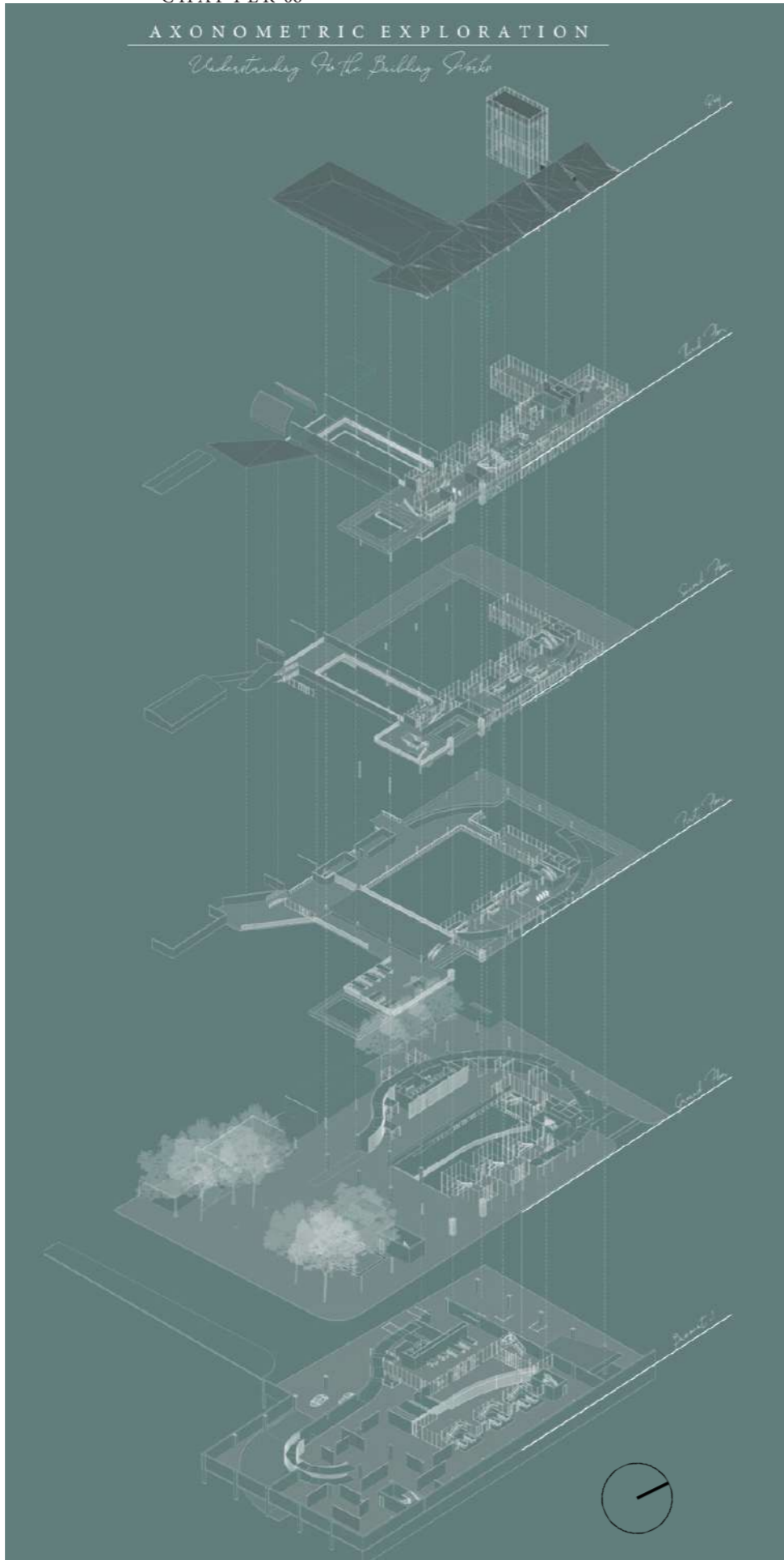

6.49

Design Iteration 3:

as an extension of iteration 2—this iteration deals with the refining of programme as a narrative that is experienced through the sequential use of the museum. This narrative experiences the museum as being embedded in the past, but through the journey of an experiential “way forward” ramp that engages the museum with the everyday, the museum is ‘freed’ of its past and liberated into a place of new memory.

The placement of programs in relation to the museum are to express the new democratic narrative of healing, hence the forum theatre can be experienced as part of the museum route as well as as an extension of the public realm. The roof in this iteration is articulated to create a new identity for the building as well as to exemplify the liberation of the building from the site.



6.50



6.51

Fig 6.39- Axonometric exploration of design (Author, 2019).

Fig 6.50- 6.51- Elevation manifestation of the concept (Author, 2019).

Fig 6.52- Site plan of intervention showing courtyard and public squares created (Author, 2019).



6.52

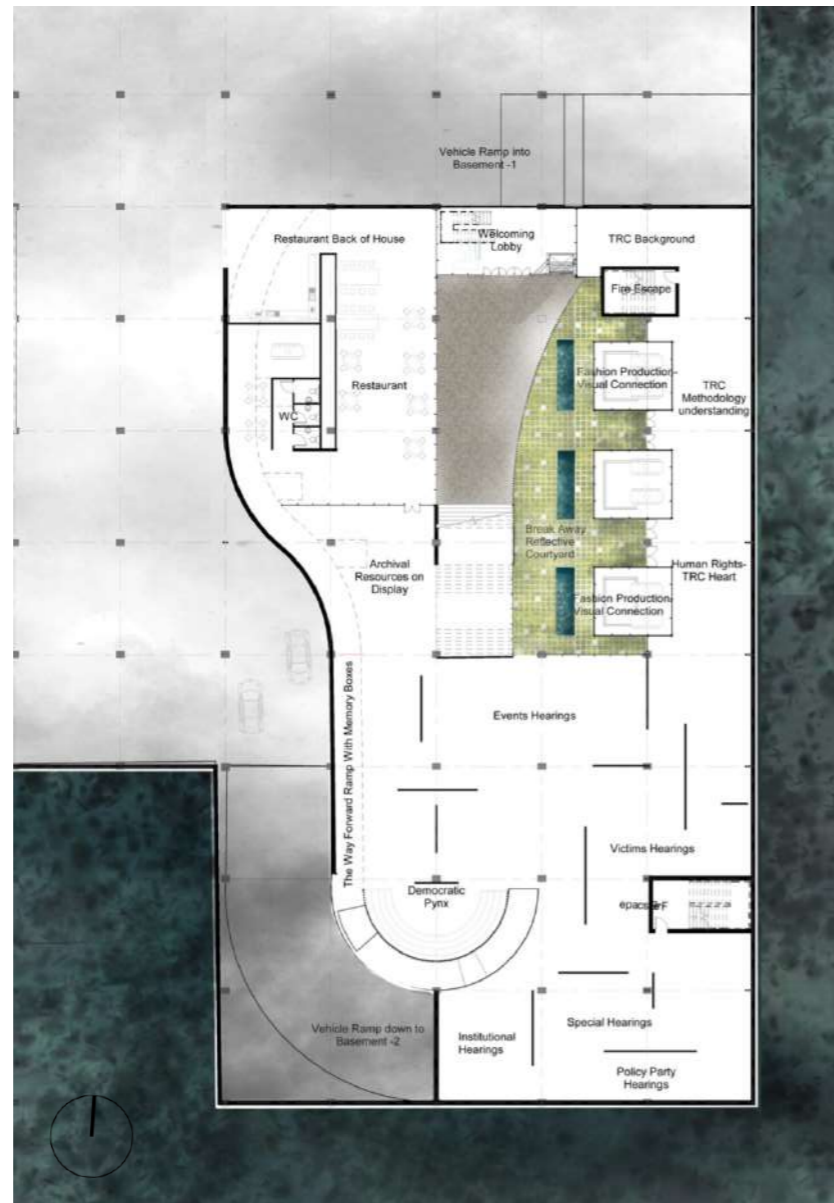

6.53

Fig 6.53- 6.56- Basement -1, First, Second, Third floor exploration of design on plan (Author, 2019).

Fig 6.57- Ground Floor exploration of design as open public memoryscape (Author, 2019).

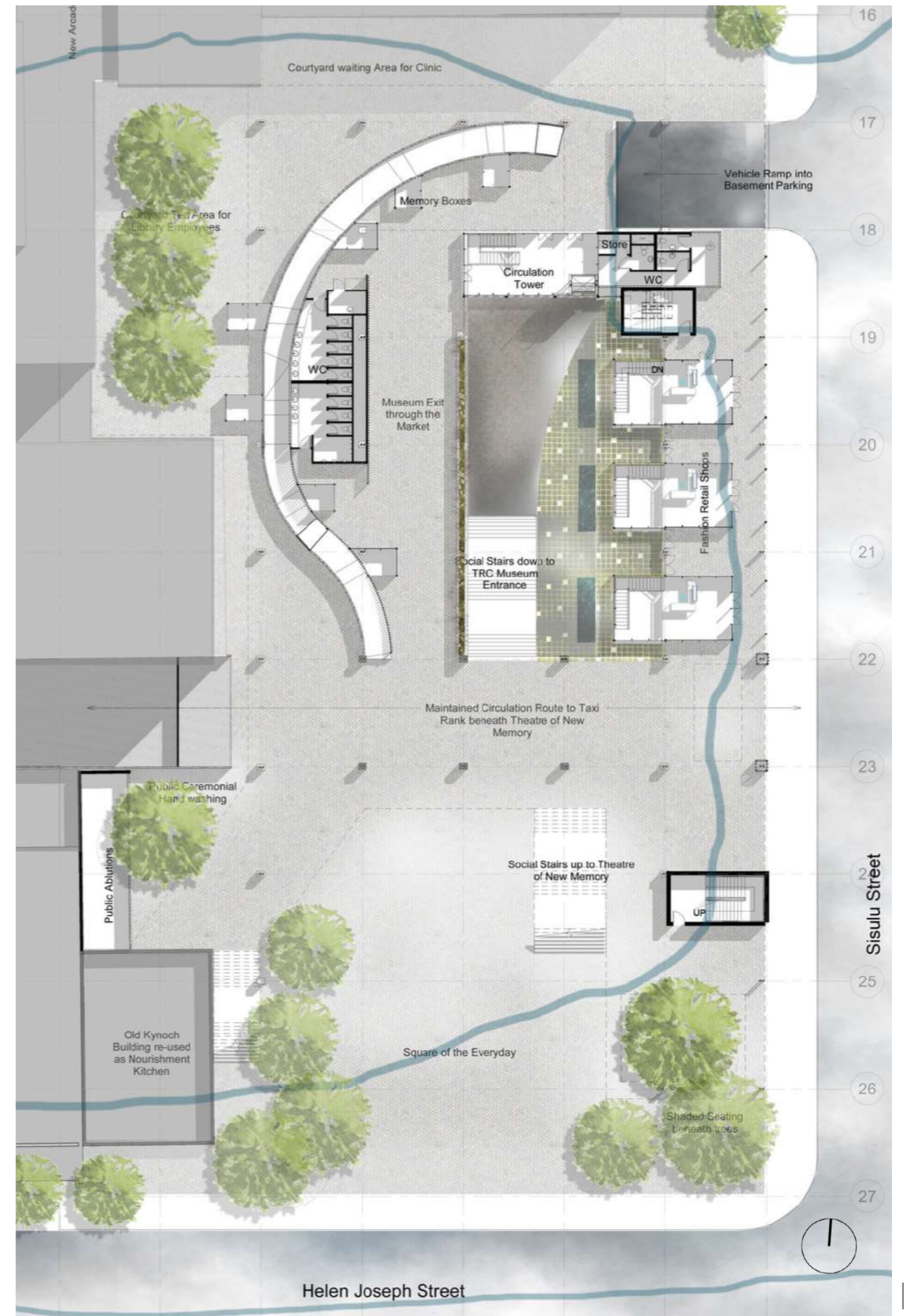

6.57

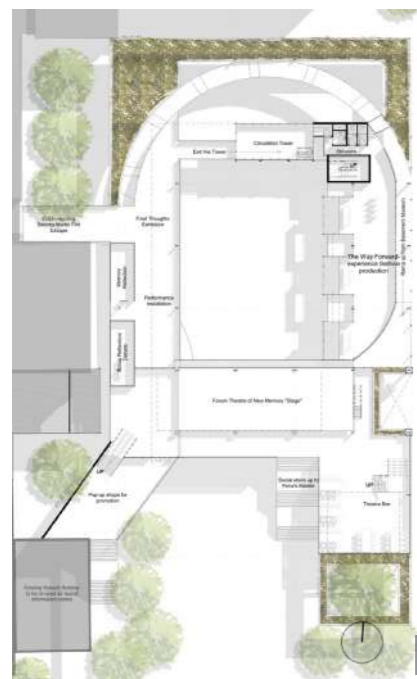

6.54

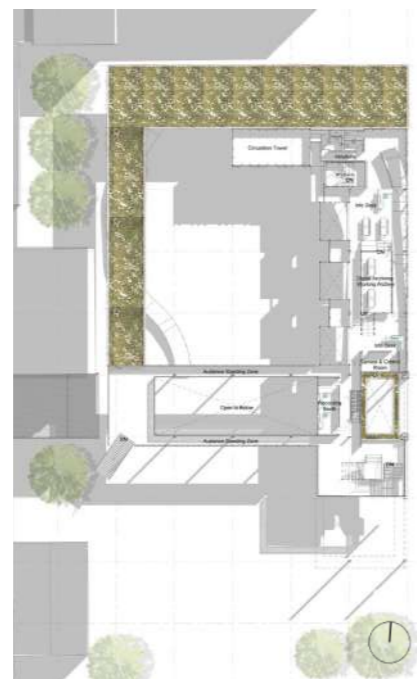

6.55

memoryscape

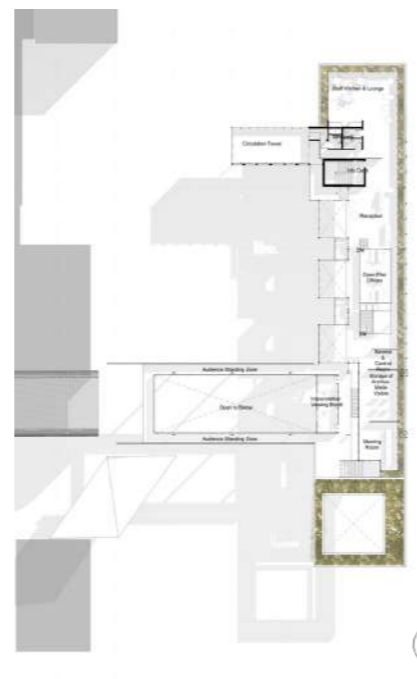

6.56

memoryscape

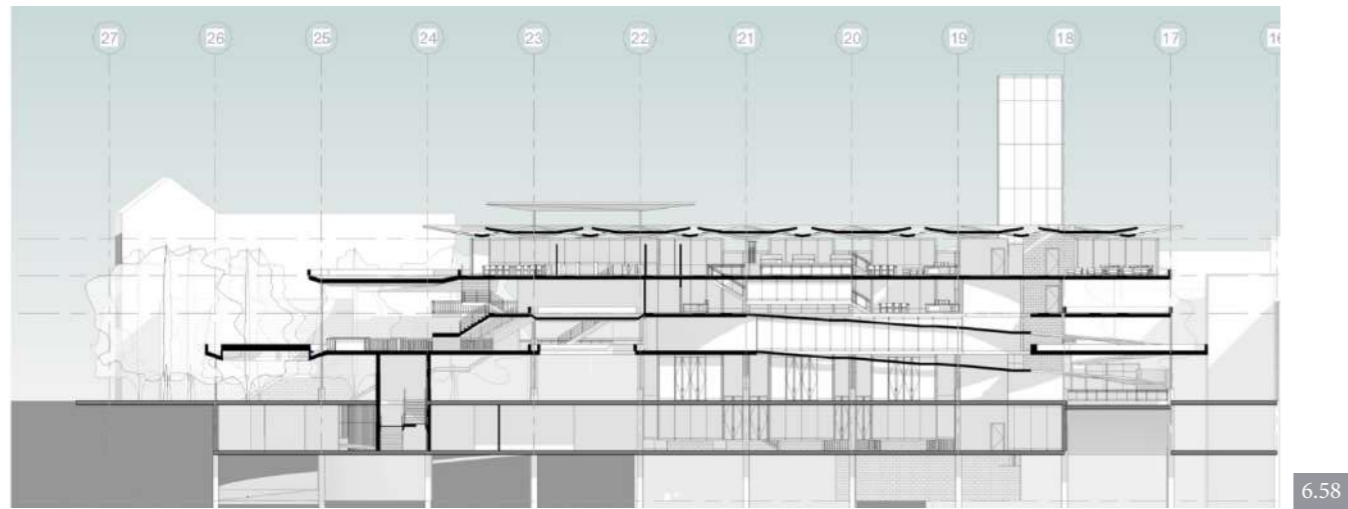

6.58

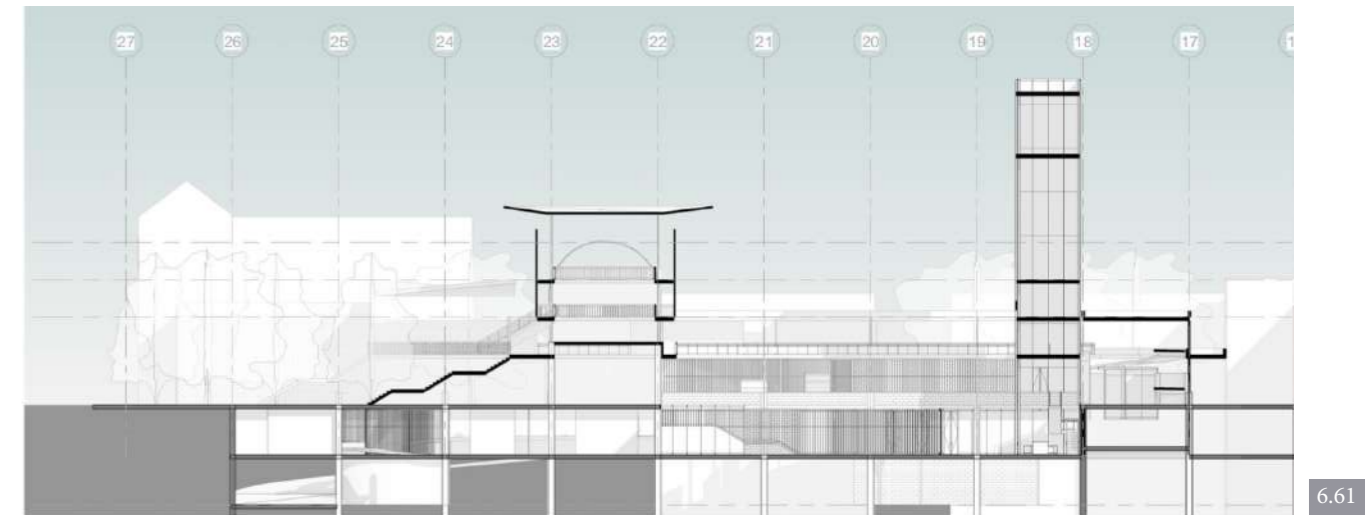

6.61

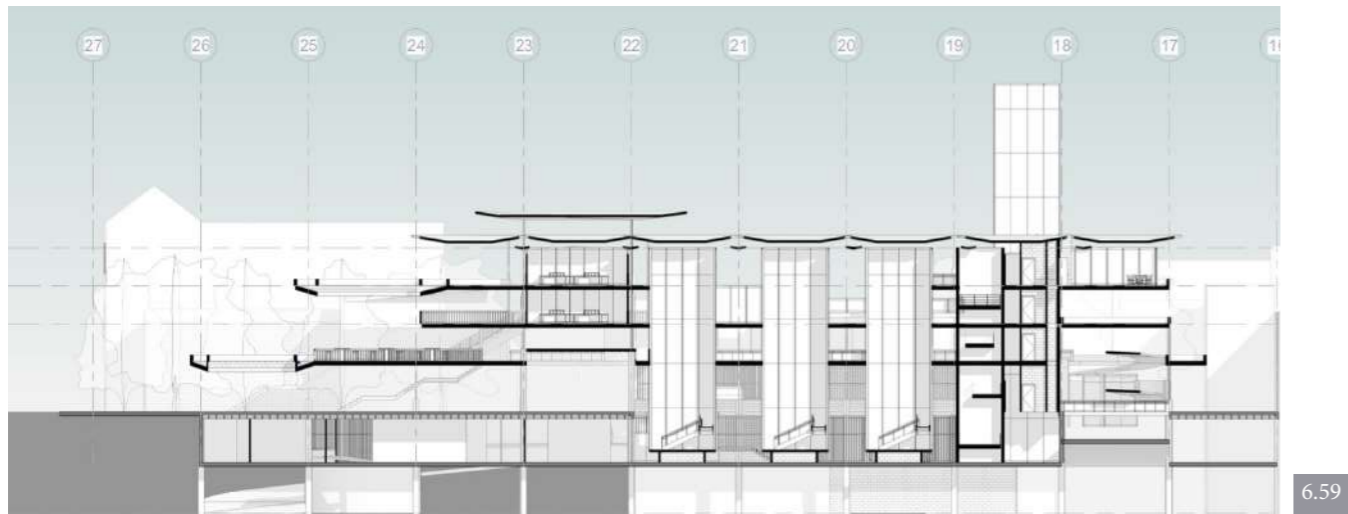

6.59

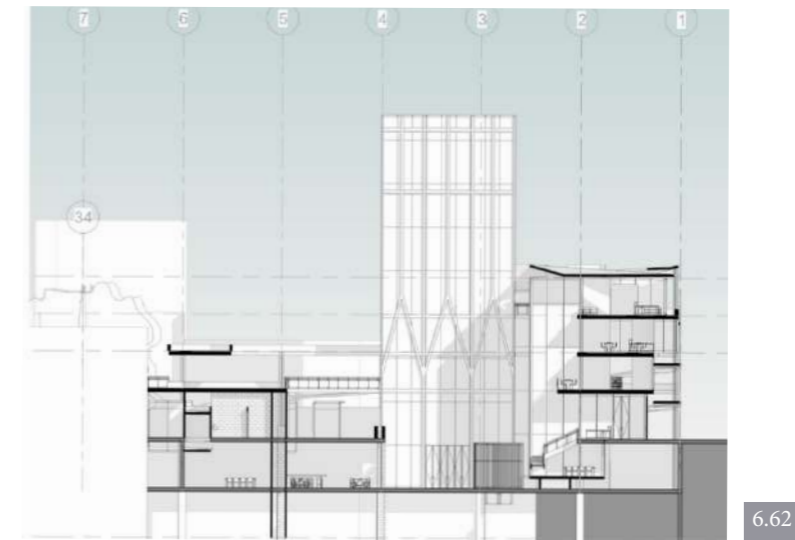

6.62

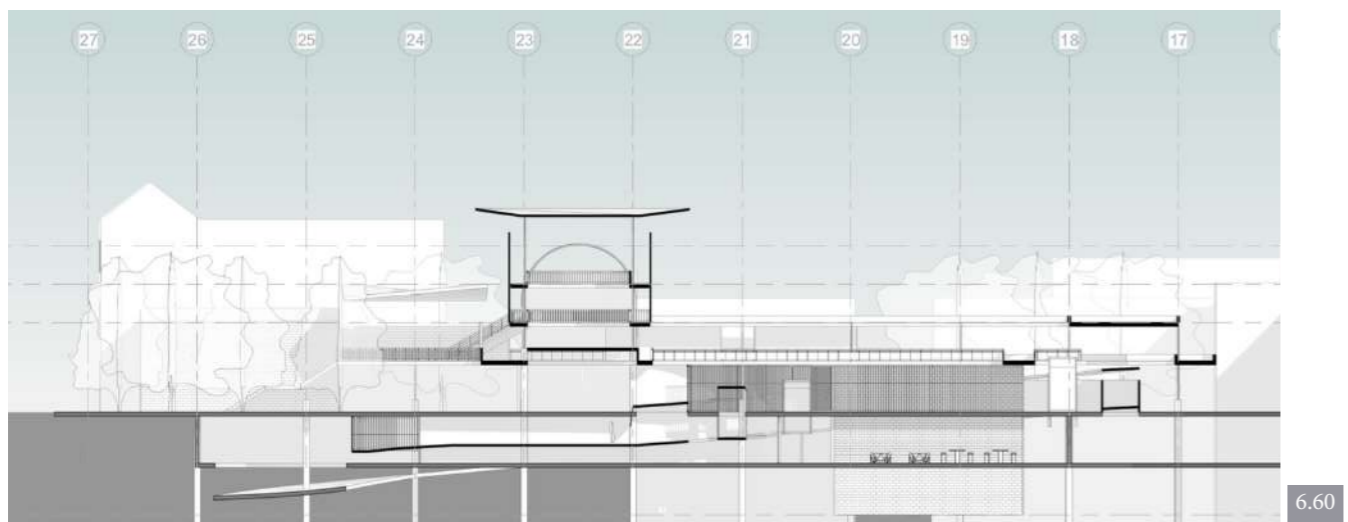

6.60

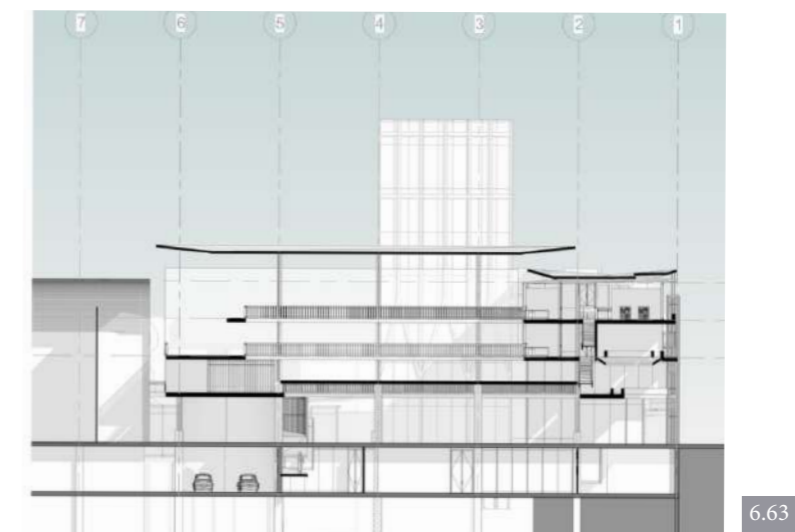

6.63

Fig 6.58- Fig 6.63-
Sectional
exploration of
the building
EVERYDAY
CONNECTIONS
TO THE MUSEUM
(Author, 2019).



View of Square of the Everyday

6.64



Extended Arcade beneath Theatre of New Memory

6.65

Fig 6.64- Fig 6.65-
 Perspective
 exploration of
 intervention in
 relation to the
 everyday public
 realm (Author,
 2019).

Fig 6.74- Fig 6.77- Diagrammatic exploration of intervention as extension of the public realm (Author, 2019).

Fig 6.78- Fig 6.81- Design development of the thetare 'box' following iteration 3 (Author, 2019).

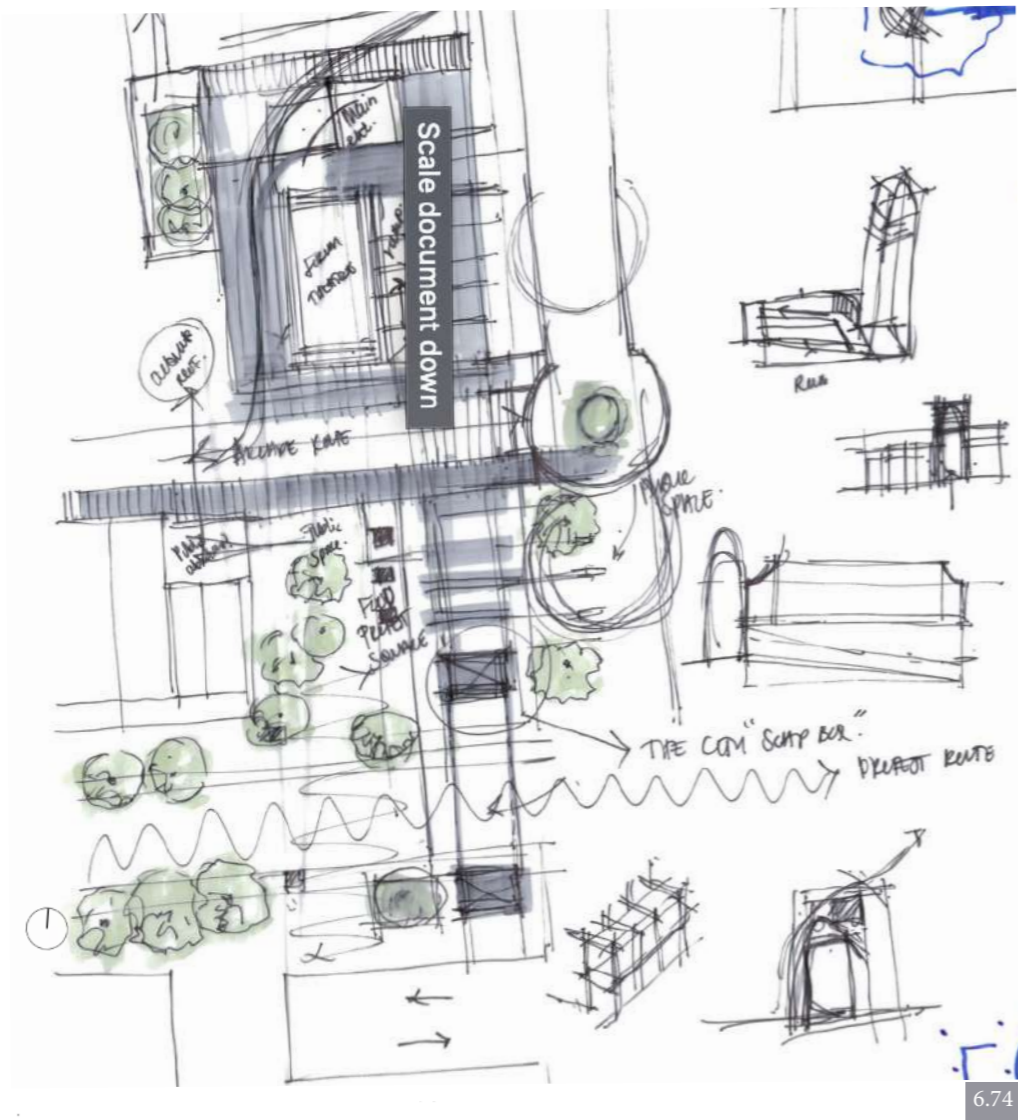

6.74

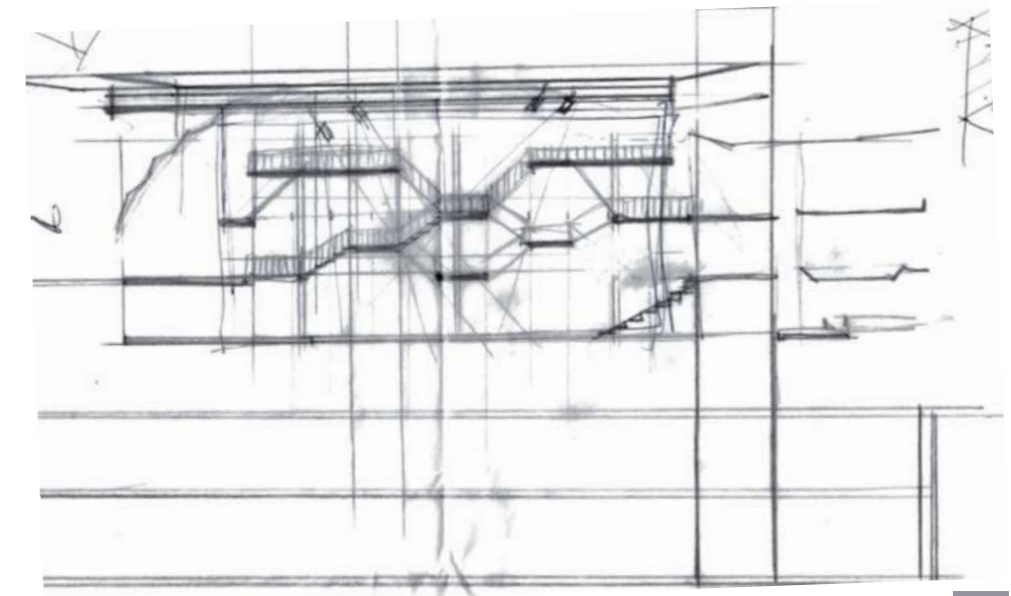

6.78

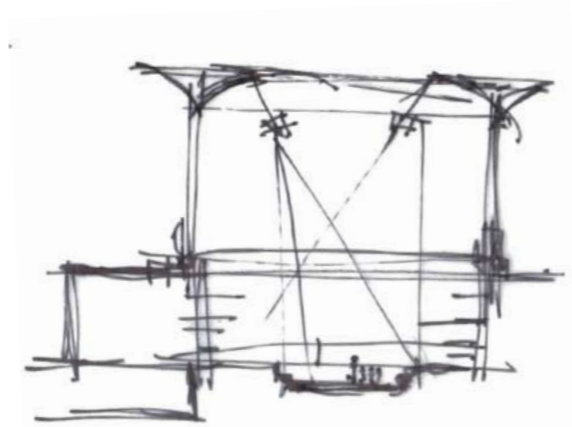

6.79

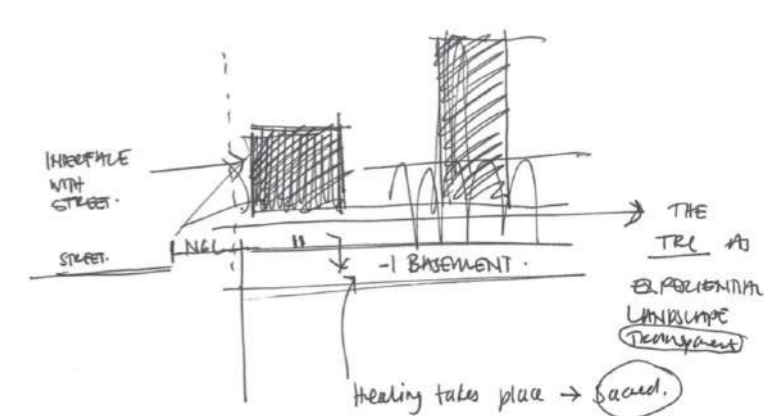

6.80

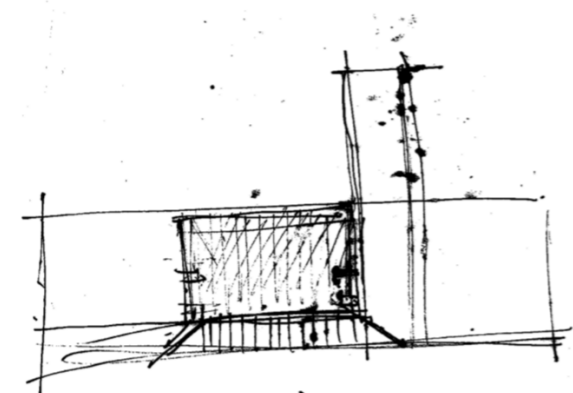

6.75

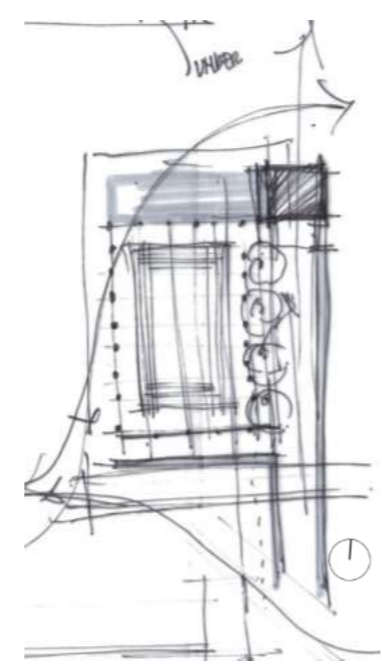

6.77

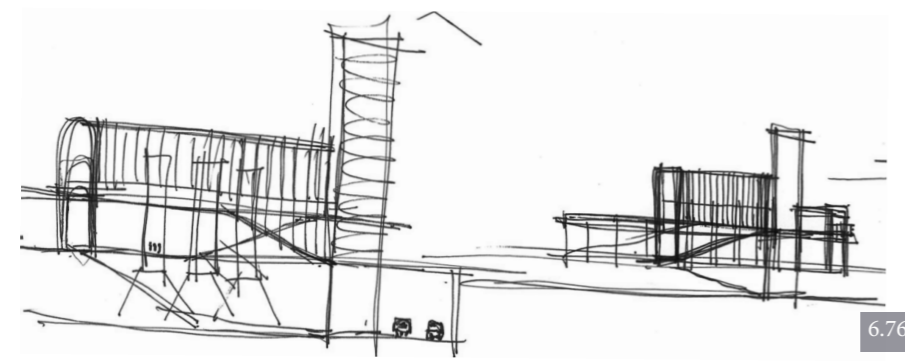

6.76

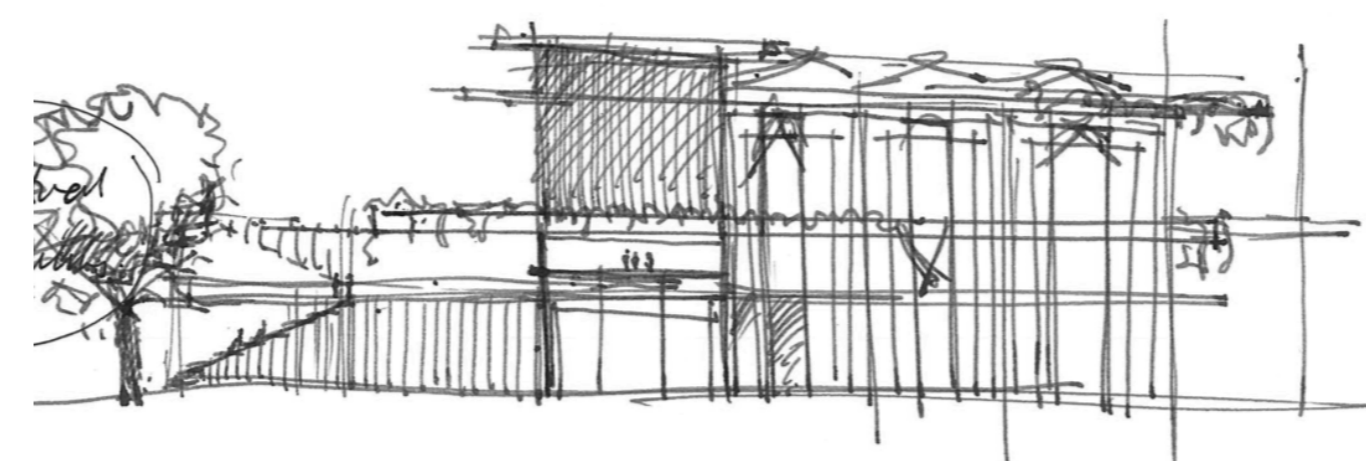

6.81

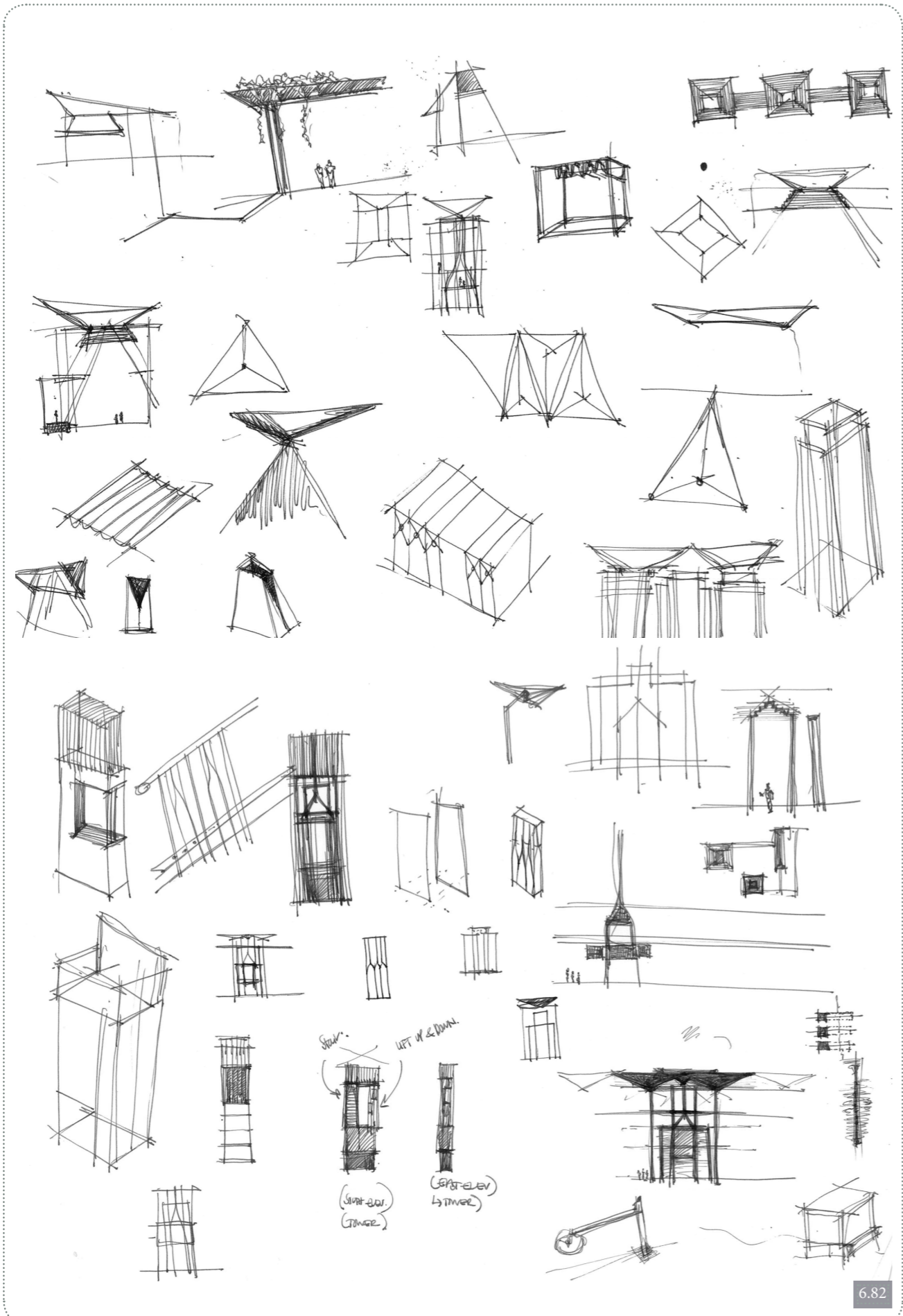

6.82

memoryscape

Fig 6.82- diagrammatic exploration of design articulation of smaller details (Author, 2019).

Fig 6.83- 6.85- Perspective exploration of experiential museum route (Author, 2019).

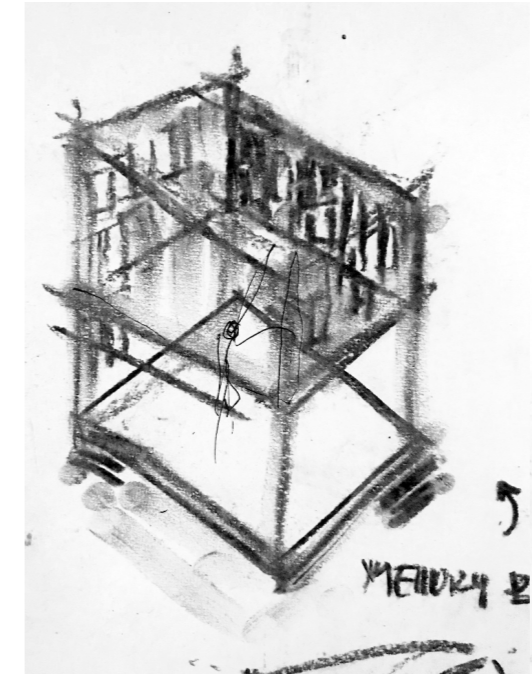

6.83

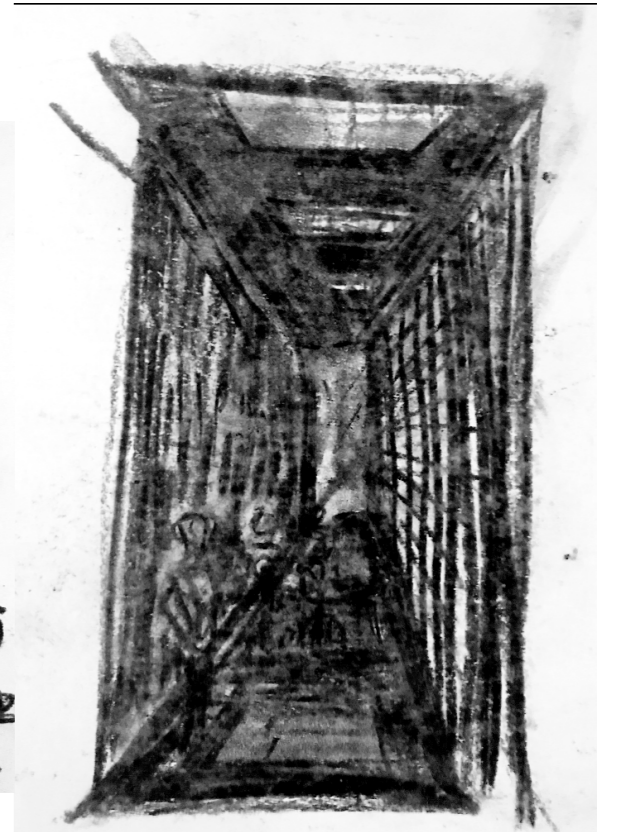

6.84

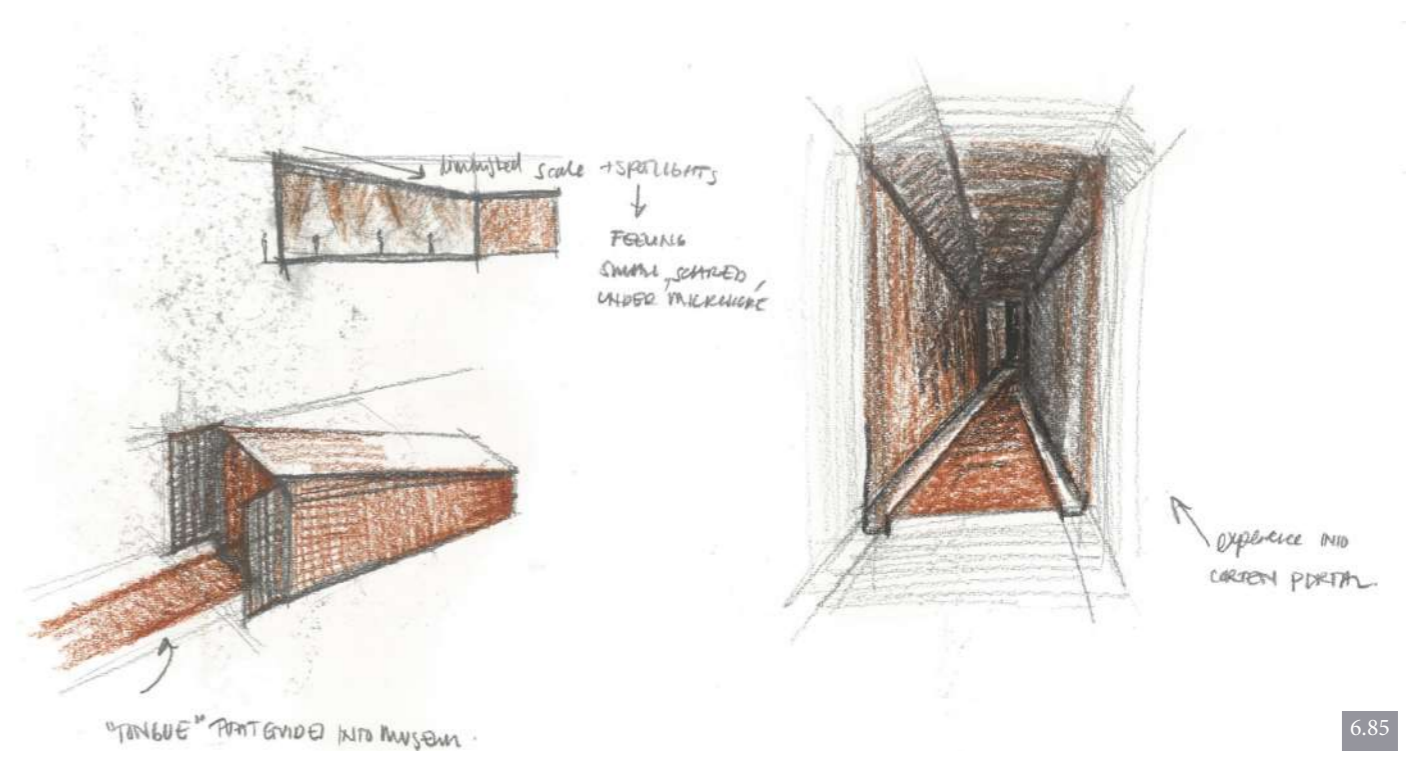

6.85

memoryscape



6.86



6.87



6.88



6.89

Fig 6.86- Fig 6.89-
Photographic docu-
mentation of Design
Iteration 3 for June
exam (Author,
2019).

CHAPTER



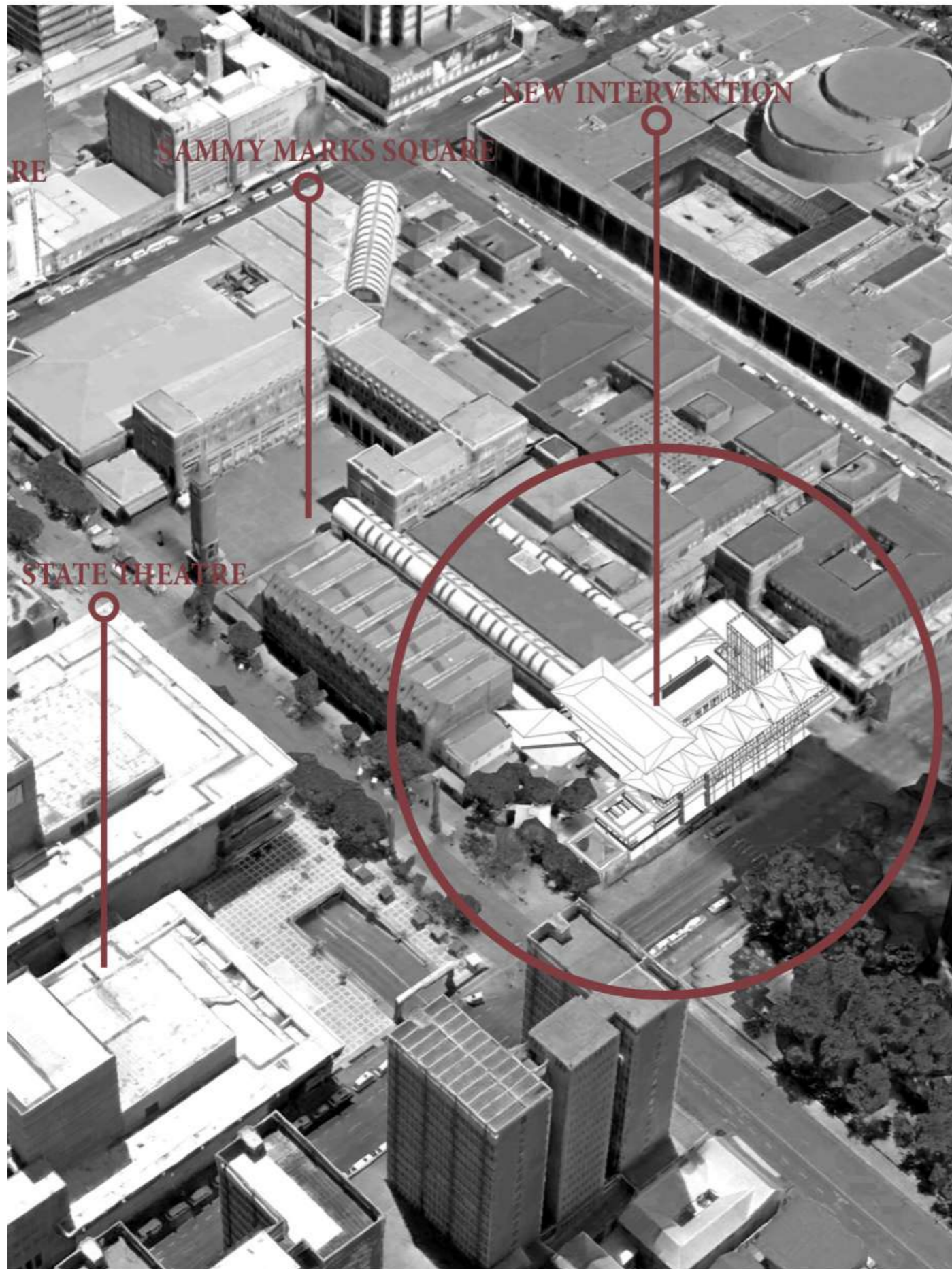

7.1

CHAPTER 07

Design Resolution

/

7.1 || OVERALL CONTEXT AND PLACEMENT OF PROGRAMMES

When approaching the placement of the programmes on the site as a whole there are various existing factors that need to be considered, namely: the present successful functioning of the southern edge of the location – that borders Helen Joseph Street – as a public square; the pedestrianisation of the southern and eastern streets bordering the lot (as per the block vision); the ceremonial boulevard on Helen Joseph Street (as per the Tshwane 2055 Vision); the everyday activities that will take place there (such as eating, mingling, sitting, etc.), and the State Theatre opposite the locale, together with the new interventions that relate to it.

The existing site has a variety of uses that will affect how it is utilized and include the nature of its existing parts. The southern edge of the lot already experiences hustle and bustle as a result of the current programmes, people waiting for public transport and persons on foot using the area like a passageway to get to the Sammy Marks arcade. The north of the site experiences a gradual decline in the hubbub and less overall energy as one goes towards the clinic (on the northern edge) and the library (on the northernmost part of the western boundary).

It is proposed that the overall intervention should not disturb the everyday goings-on but ought to enhance it whilst maintaining the location's integrity. The new configuration is intended to be transparent in its manifestation of all aspects – not only in terms of materiality but also in how readily public movement and engagement can continue undisturbed in the area and the building.

Fig 7.1-
Building in context
(Author, 2019).

Design Considerations:

Historical design Considerations – The new building should be considerate concerning the nature of the historical buildings, which should remain accentuated. Damaging interventions in or around the old edifices should be avoided. The historical memory of the events the site has witnessed should inform the articulation of the public spaces inside and about the new building. The new intervention should emphasize the historical and current dignity of the site in the Civic District.

Design Language:

The rhythm responds to the Sammy Marks façade rhythm. Like the Sammy Marks development, the new structure explores a larger-scale order on the ground level, which becomes finer as it progresses upwards towards the intricate detailing of the roofs that are in contrast to those of the Sammy Marks premises in their articulation. The Sammy Marks

rooftops express the essence of domesticity and privacy through the use of pitch roofs with dormers. The memoryscape, however, reverses this to reveal an inverted, liberated, civic roof that frees the building towards the sky – as opposed to enclosing it as the old edifice does.

Scale:

The human scale is the most important consideration when responding to the design intentions for the Sammy Marks precinct. The scale should not exceed five stories in height. There is an opportunity, however, to express some vertical elements to act as ‘way-finding’ mechanisms that can additionally mediate the monumental scale of the adjacent Reserve Bank.

Space making:

In juxtaposition with the Women’s Memorial along the Ceremonial Boulevard, the area should respond openly to public engagement. The communal pedestrian routes should feature prominently owing to the accessibility of the ground floor area. The location should feel welcoming and comfortable whilst maintaining its civic dignity.

Detailing:

Detailing responds to the intricacies of the surrounding buildings while expressing an innovative design language to reflect the new democratic paradigm. In light of this, the detailing is approached from a heritage response stance of “contrasting the existing”.

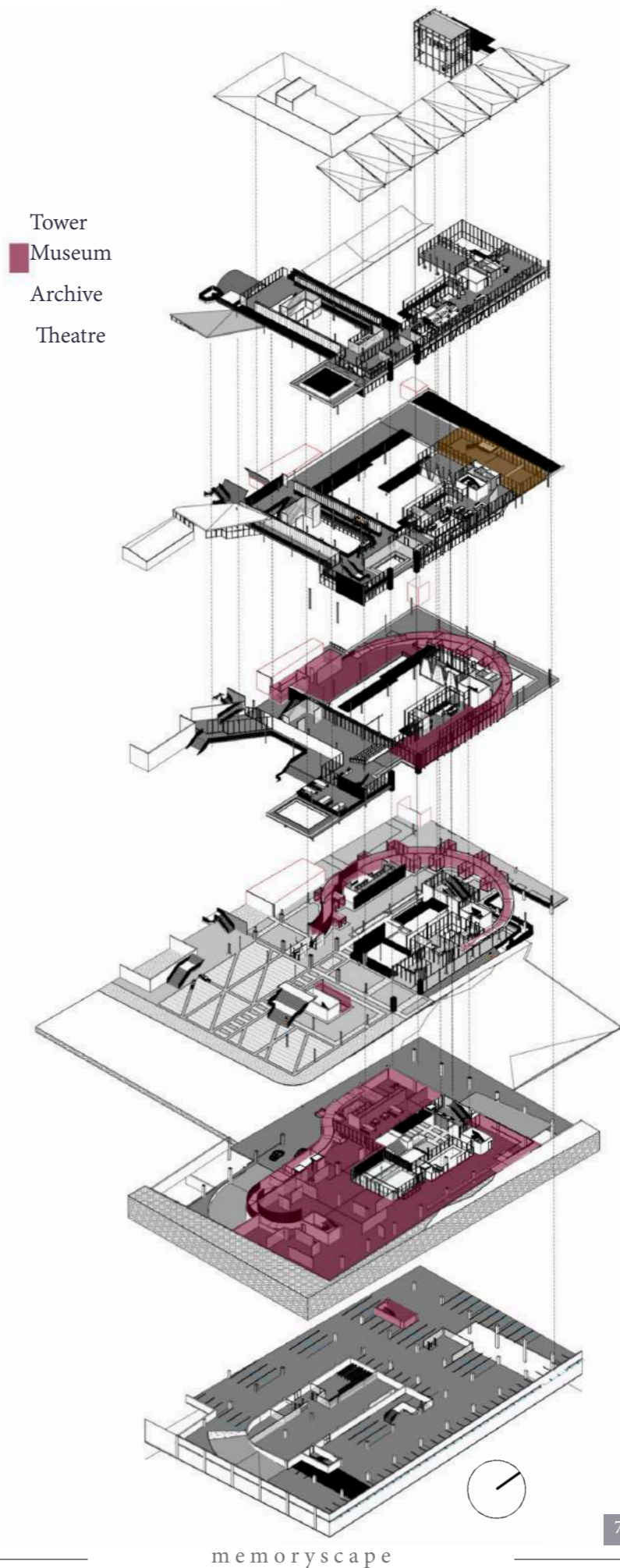

Fig 7.2- Exploded Axo showing program relations to one another (Author, 2019).

Fig 7.3-
Placement
of museum
underground and
into the everyday
(Author, 2019).

7.2 || UNPACKING EACH ELEMENT OF THE DESIGN

7.2.1 The Museum for the Truth and Reconciliation Commission

The museum's design intention is to echo the history that was uncovered through the TRC process and the feeling of being in the spotlight while scrutinized by a nation-wide audience. The museum is relegated to the existing basement 1, the level below the site. Placing the exhibit underground creates a vast array of poetic opportunities to represent these intentions. The museum is to portray a past of exclusion and darkness, both of which are innate to the existing basement experience. The gloom of the basement allows opportunities for dramatic beams of light to be set into the existing slab above that 'cast a spotlight' onto the visitors below, giving them a sense of how it must have felt to be the entire nation's focus of interest whilst being televised.

When the everyday pedestrian arrives to visit the museum they enter via the public staircase, which drops down from and thus extends the everyday public realm into the sunken courtyard created in the existing basement, where visitors and groups can meet before moving into the museum. Users then enter into the tall circulation tower where the experiential TRC route begins. At the beginning of the route, the public is directed through dark, oxidized steel gates into a dim and narrow corridor with only a few lights showing the way. The exhibit comprises a path that simultaneously expresses an abstracted feeling of testifying in the TRC process whilst explaining the procedure and methodology to the visitors. It is important to present the extensive lists of the victim's names as mentioned in the final volume of the TRC report. These names are manifested along the entire route in various ways, as described in the technology chapter to follow, acting as the ghosts of the unsung and silent

heroes of the struggle that guide the guests towards a liberated future. Throughout the museum experience, isolated 'memory boxes' present moments where the visitors can step away from the route and engage in and view archival material in various forms (video, audio, written, etc.). The museum journey also offers 'pockets of relief' where the visitors can momentarily seek solitude and reflection away from the TRC route.

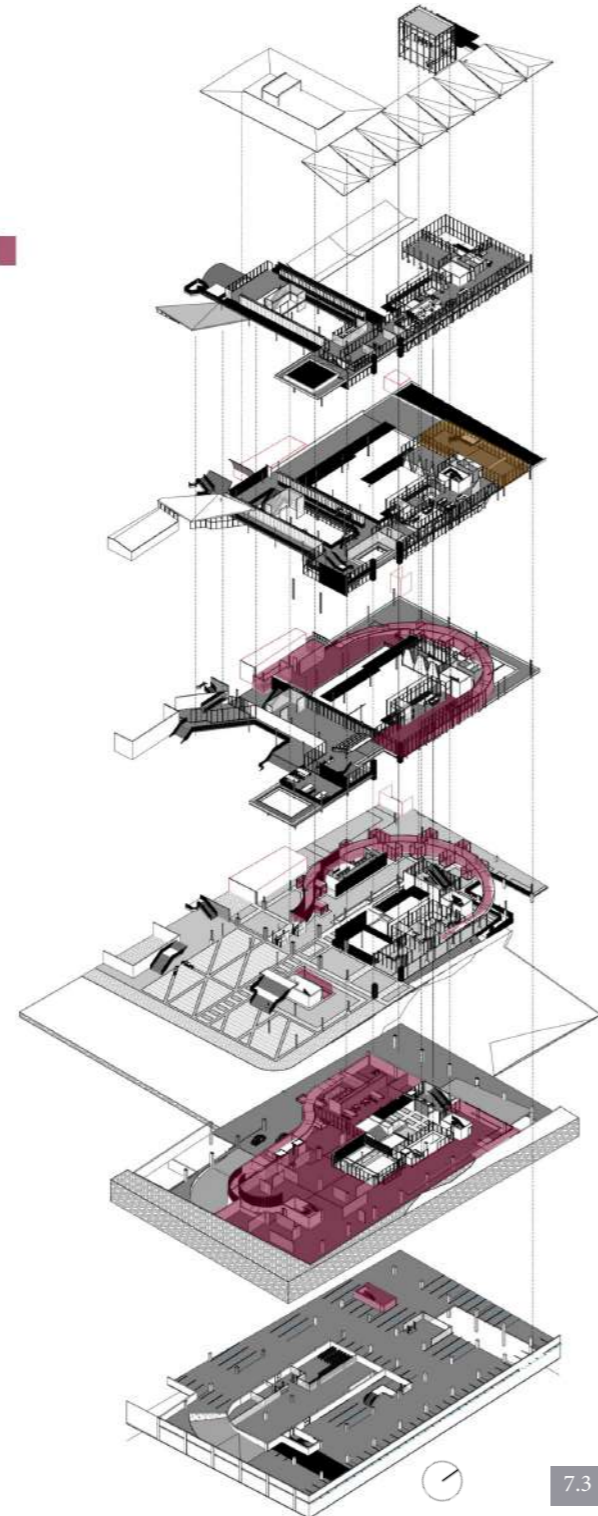

7.3

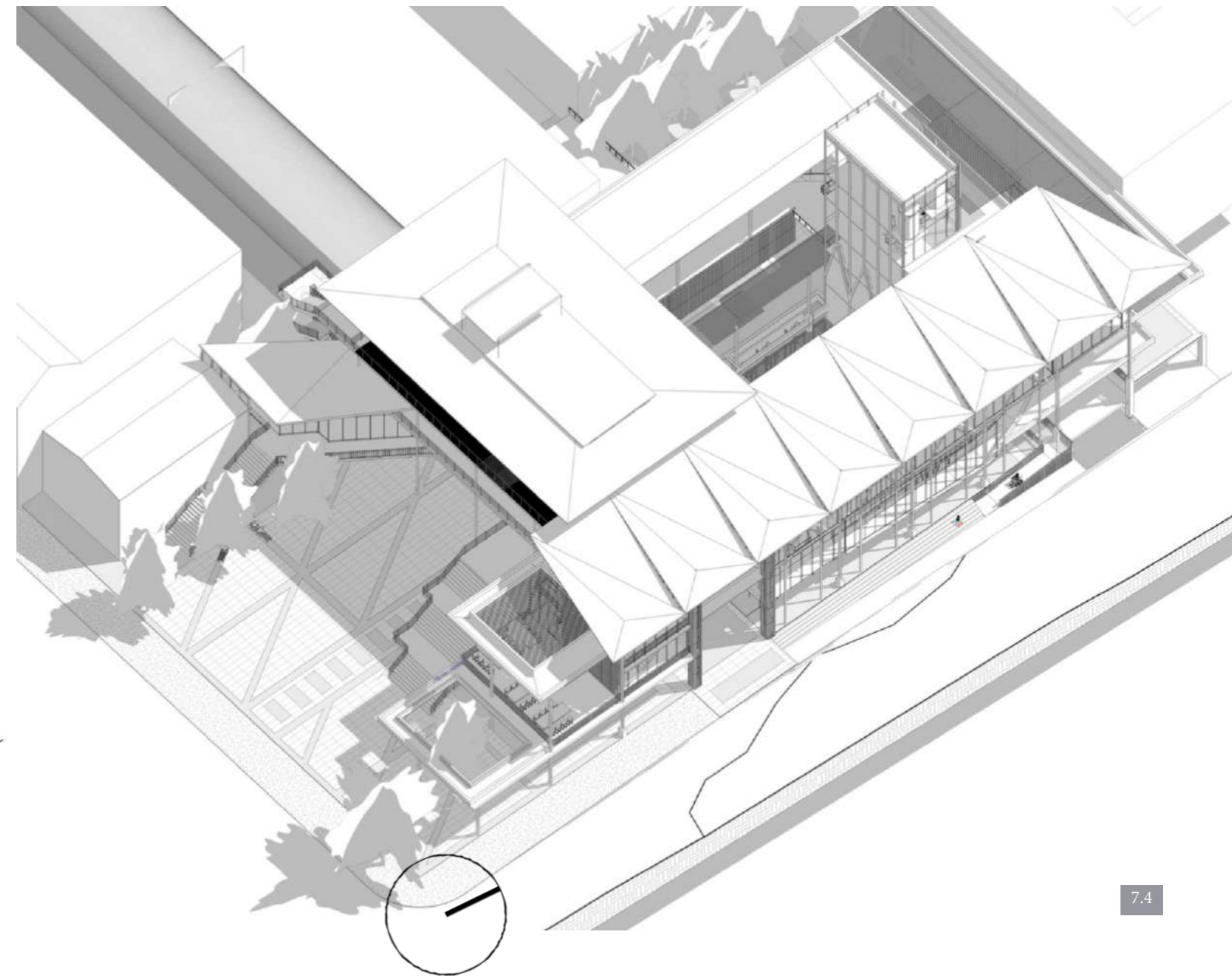

7.4

Fig 7.5-7.6- The ramp isolated to see how memory boxes sit (Author, 2019).

Fig 7.7- Fig 7.9- Articulation of ramp on plan, Basement -1, Ground, First floor (Author, 2019).

Fig 7.10- Elevation ramp- how the ramp goes from Basement-1 to First floor (Author, 2019).

7.2.1.1 The Ramp as Translation Device

After the TRC route has been completed; the visitors will be directed up a narrow and winding ramp that represents the trajectory to a brighter, yet unknown, future. The sightseers will gradually experience the ramp becoming lighter and lighter, revealing more views of the familiar everyday. Additional memory boxes containing accounts of the way forward after the TRC process, and what the TRC managed to achieve for those who took part in the reconciliation mission, will be placed along the ramp. The tourists will gradually begin to see the successes of the TRC course and how it has acted as one of the mechanisms utilized to move forward into democracy. As the ramp progresses into the everyday arena it becomes more and more transparent, not only by allowing in more light but also by permitting a sense of visual relief as the visitors start looking out at the recognizable present.

The ramp and the memory boxes invite the everyday world into the museum experience as it rises up through the ground plane. Similarly, the museum becomes part of the everyday realm as the regular citizen views the various known spaces that they pass on their day-to-day city route.

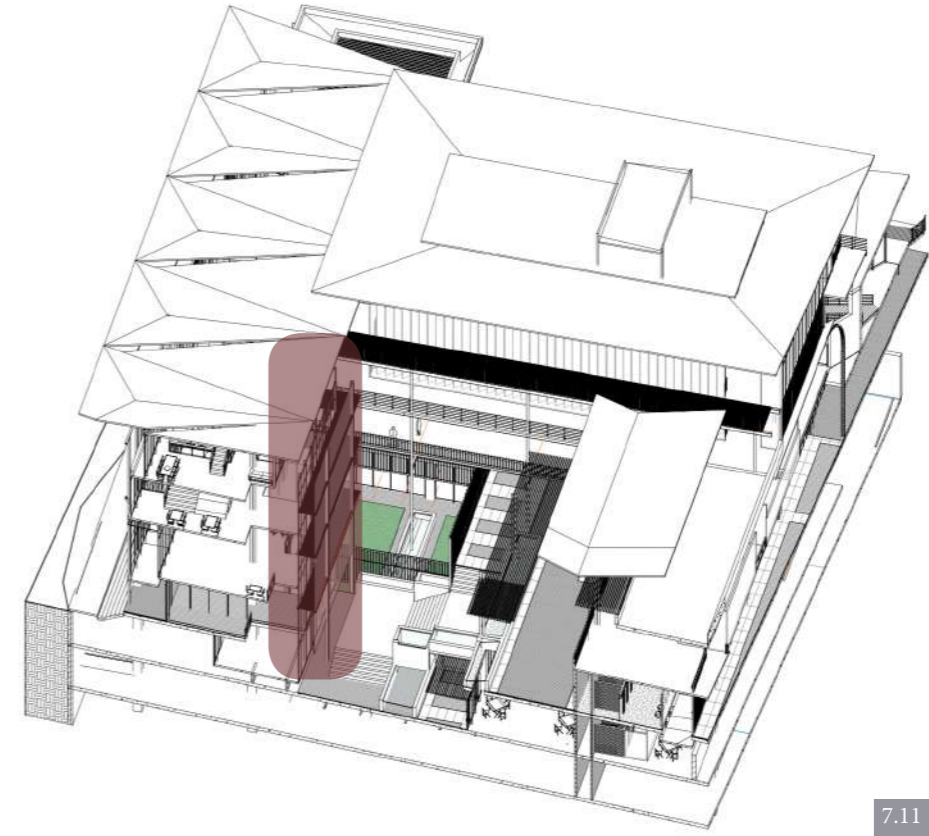
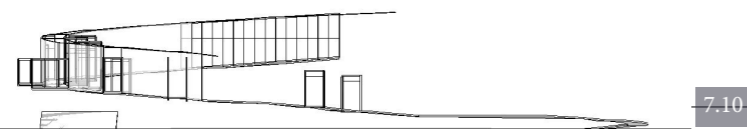
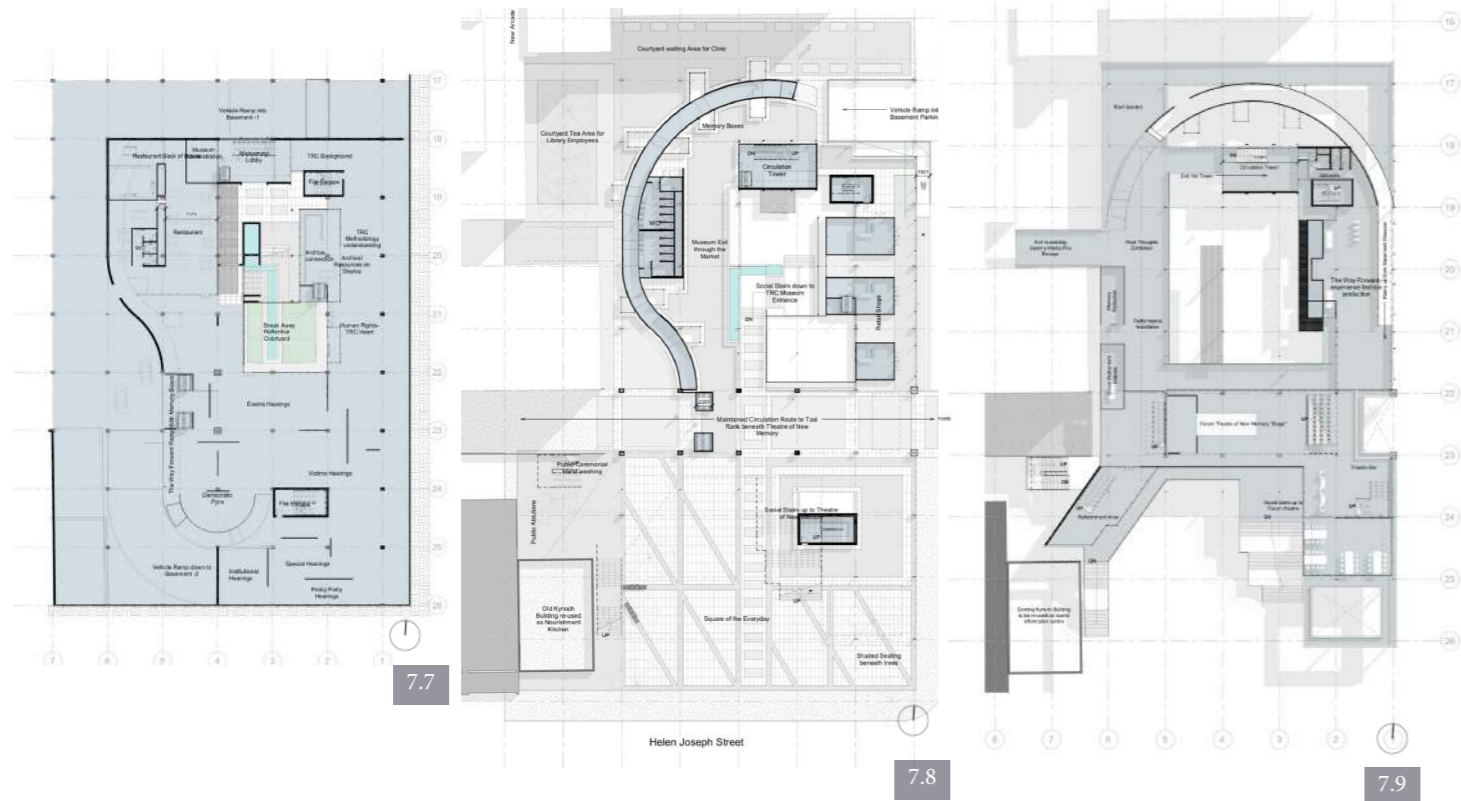
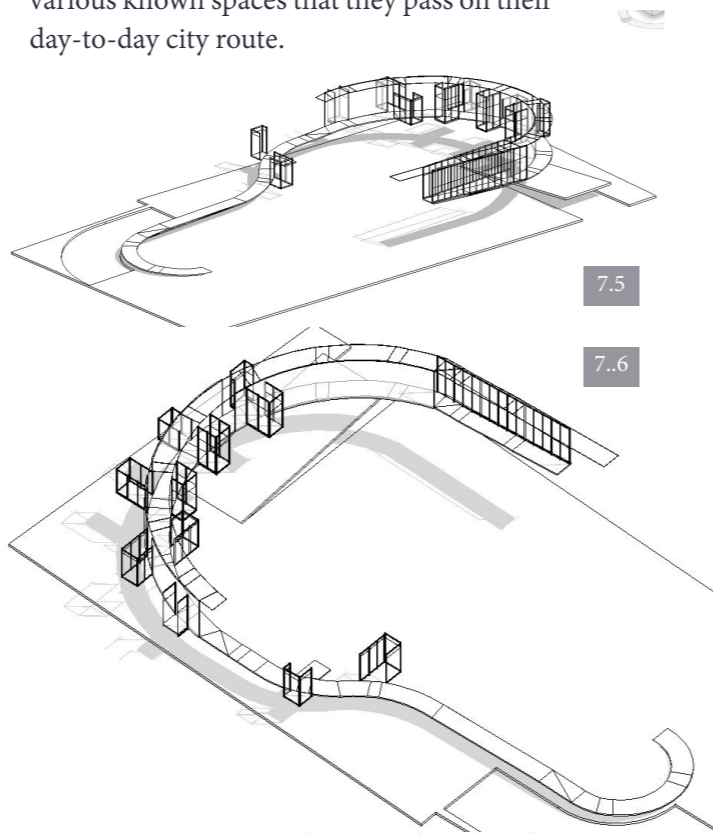

Fig 7.11- archival tower as connecting device (Author, 2019).

7.2.1.2 The Connection of the Museum to the Archive and Theatre

At the termination of the ramp, the visitors will find themselves on the first floor of the building with a view over the pedestrian sphere of the site and its surrounds. It is here that the visitors are given a look into the process of digitization of the TRC archives as well as the recording of oral histories. The TRC archives connect to the main museum level via an 'archival tower' – the 'vehicle' through which the institution's memory base is regularly updated and kept current. The museum connects with the TRCs everyday new memory by way of this active archival tower.

vista, the onlookers are invited to reflect, deliberate and project their experience of the TRC and the future they foresee. This marks the formal end of the museum experience.

As the route continues past the theatre, the visitors can look into the theatre through a glass wall at eye-level, which offers them glimpses into the future of freedom of expression and deliberation that the TRC helped to achieve in the democracy that South Africa has become. Following that

Fig 7.12- Exit through the market on ground floor (Author, 2019).

7.2.1.3 Projection into the Everyday- Exit through the Market

The tourists exit through the same circulation tower through which they entered but, instead of the traditional 'exit through the gift shop' they 'exit through the market' on the ground floor level, into the everyday domain.

Fig 7.13- positioning of Archive in building (Author, 2019).

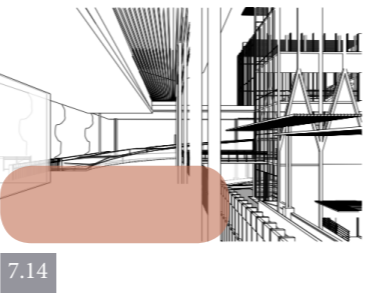
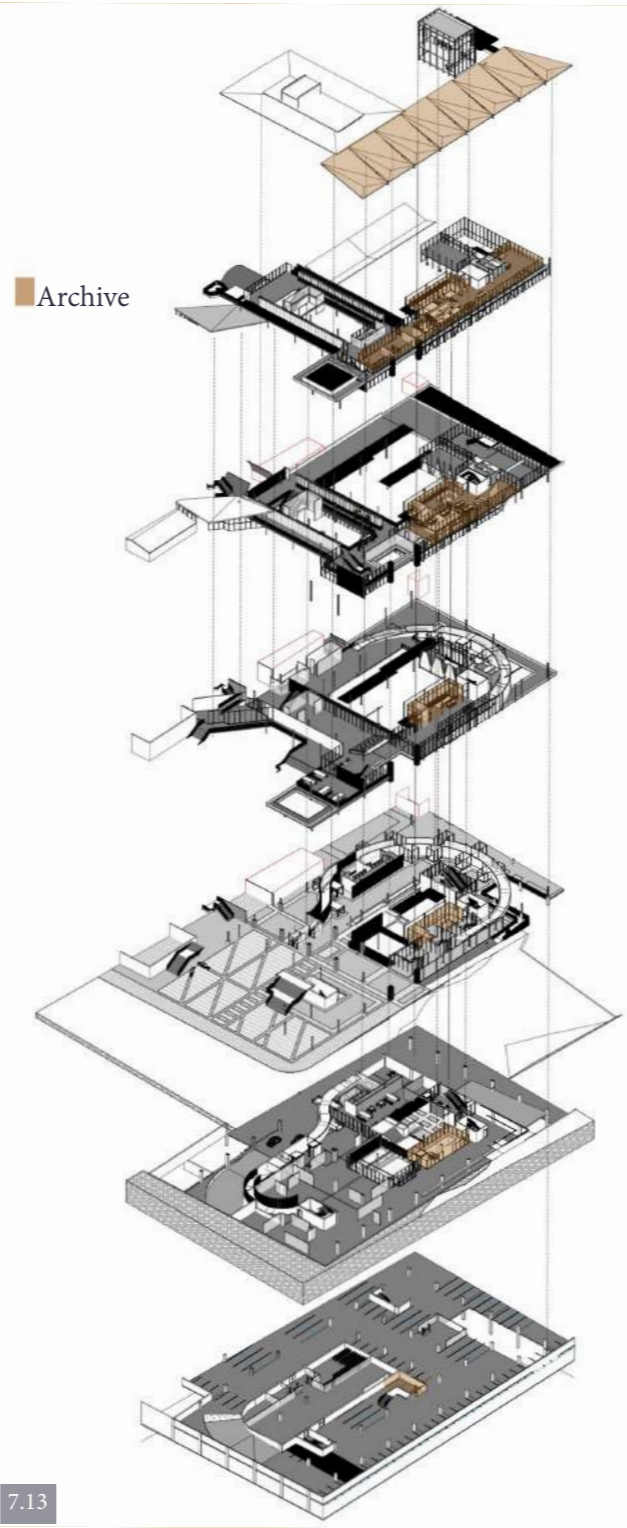

7.14

Fig 7.14- Exit through the market on perspective (Author, 2019).

As opposed to the typical commercial, generic and exorbitantly expensive museum gift shops through which visitors are forced to leave museums, the market expresses a democratic concern for the everyday citizen, the expression of individuality and support for small businesses and crafts.

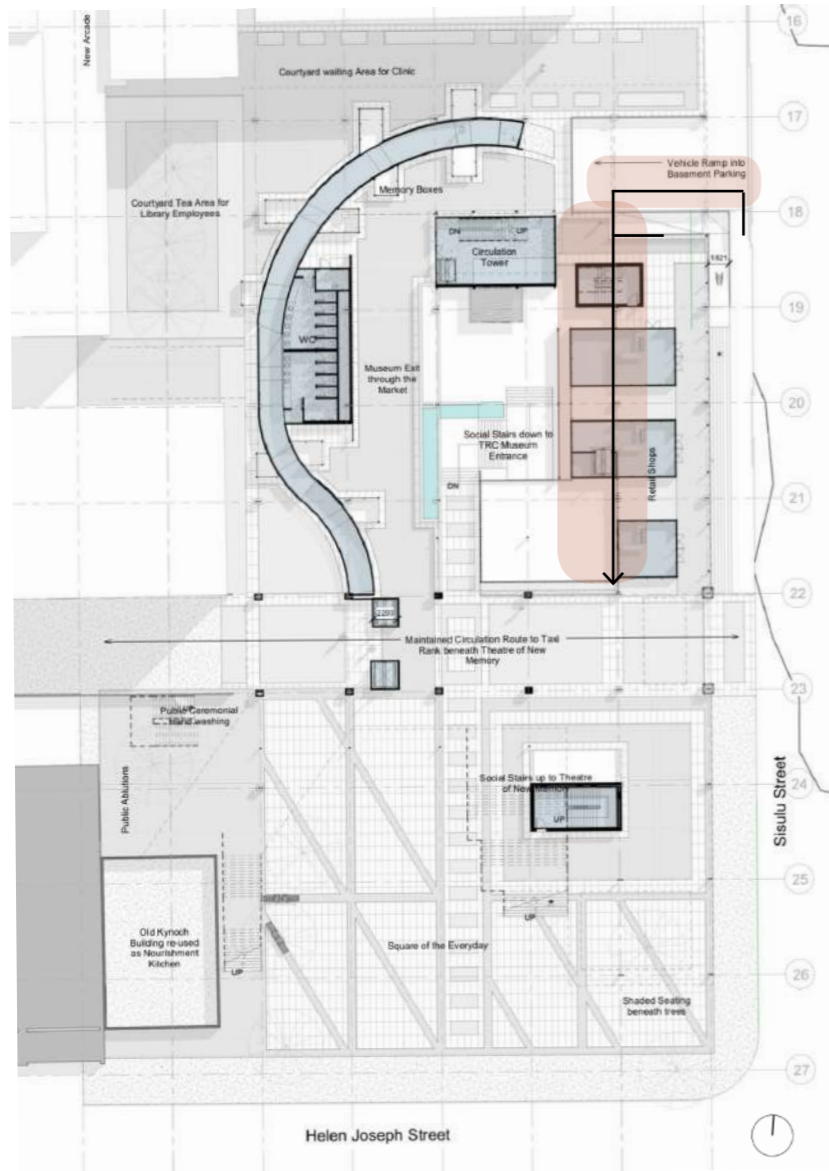

7.12

7.2.2 The Archive for the Digitization of the Truth and Reconciliation Commission and the Recording of New Memory

7.2.2.2 Recording of Oral Histories

The facility for the Oral Histories Association of South Africa (OHASA) is to be housed on the third floor of the main building and will function in collaboration with SAHA by sharing meeting and office spaces. The oral histories relating to the human rights of visitors will be recorded and collated here in order to become an integral part of the overall new memory heritage inventory of the City of Tshwane. *CONNECTION TO THE MUSEUM? MUSEUM VISITORS RECORD THEIR ORAL HISTORIES? CONNECTING THE MUSEUM TO THE EVERYDAY THROUGH ORAL HISTORIES OF EVERYDAY CITIZENS

7.2.2.1 Digitizing the Truth and Reconciliation Commission Archives

Run by the South African Heritage Archives (SAHA), the digitization process of the TRC archives needs to take place in a safeguarded yet visible environment. The archival material is to be delivered to a secure and exclusive drop-off zone on level -2, in the basement, by the National Archives. The documentation travels up a private lift inside the archival tower that delivers it securely to level 2, where the digitization process takes place.

Fig 7.15- Fig 7.17- Positioning of archive on second and third floor and as connection to museum (Author, 2019).

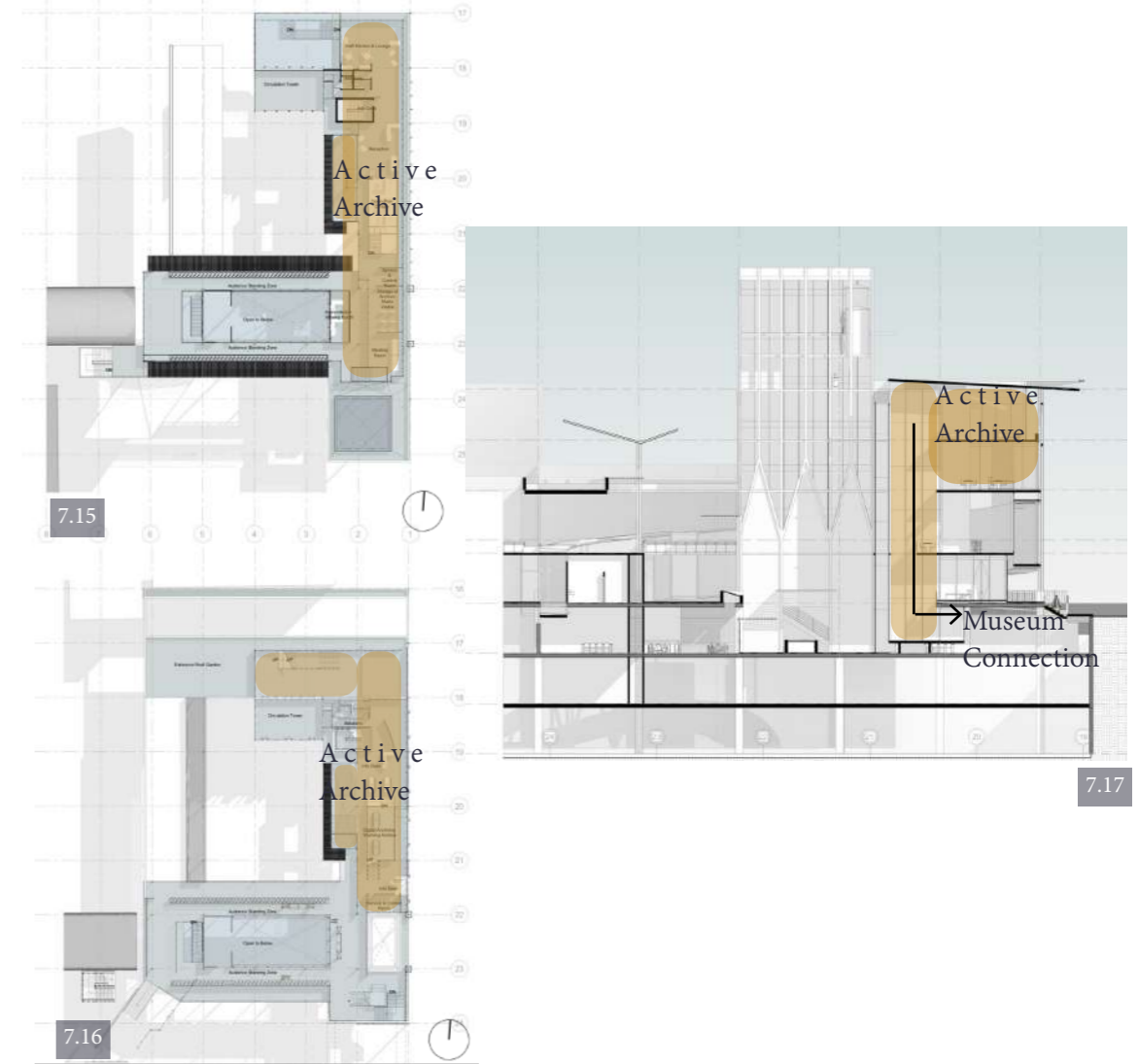

7.15

7.16

7.17

Fig 7.18- Theatre in relation to building (Author, 2019).

Fig 7.19- Adaptability of fly tower and recording (Author, 2019).

7.2.2.3 Recording of Performances in the ‘Theatre of New Memory’

A recording booth will be situated in the theatre on the third floor of the main building, where performances of all kinds can be documented in video and audio format. These chronicled presentations themselves will become part of the heritage archive’s oral history. The recordings of these performances could be accessed and studied by members of the public as the new democratic South Africa’s communal expressions of memory. These performances may be extremely important when analysing the current status of ‘deep memory’ concerning the past.

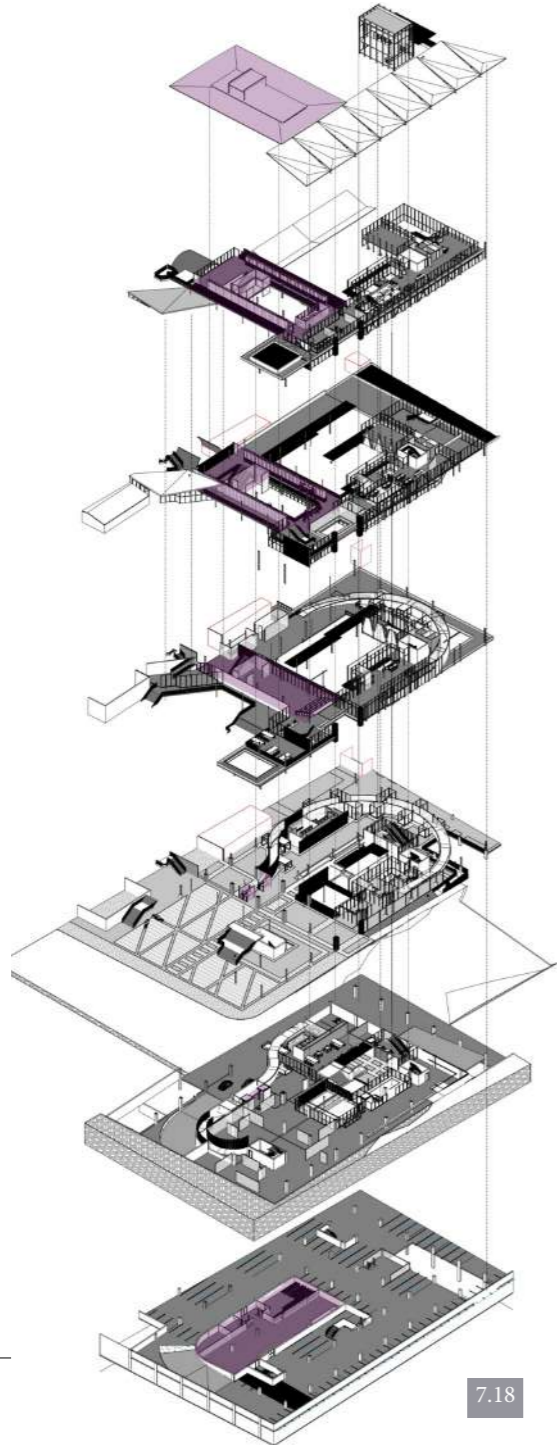

7.18

7.2.3 The ‘Theatre of New Memory’

7.2.3.1 Adaptability – the Fly Tower and Performer Spaces

The main design requirement for the theatre is adaptability and, in order to achieve this in terms of layout and functions, a ‘fly tower’ of sorts will be necessary. In relation to this unconventional theatre design, the ‘fly tower’ will reach from the level -2 basement up and through the museum and ground floor to levels 1, 2 and 3. The fly tower will contain two industrial style lifts to carry performers and seating upward from the rehearsal and storage rooms located in basement -2 and into the theatre box above. The fly tower will be visible but inaccessible from the museum and ground floor levels. Because it will be observable, the tower’s on-going ‘back of house’ functions will become a part of the performance of the site’s everyday life. Whereas back of house functions would usually be concealed, they are to be liberat-

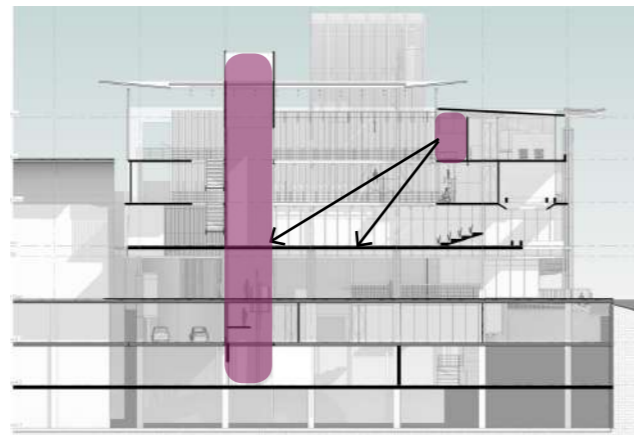

7.19

cape

ed to become an integral part of the ‘performance’ in this instance.

7.2.3.2 Functioning as a Public Forum for Deliberation and Debate

As an important part of the developing South African democracy, the theatre is designed to function as a fully public and open city forum where the state of the democracy can be debated and discussed. The theatre’s layout will be open when functioning in this manner to facilitate public discussion gatherings.

7.2.3.3 Functioning as Typical Forum Theatre

A typical forum theatre or ‘theatre of the oppressed’, as discussed earlier in this dissertation, allows members of the public to merely observe or to freely participate in performance as and when they so desire.

7.2.3.4 Functioning for Performances of Various Stage Articulations

As shown in the various seating and stage arrangement diagrams, the theatre box adapts – like a black box theatre – to accommodate various stage arrangements such as the proscenium stage, thrust stage, theatre in the round, and open-air theatre – amongst other customized layouts.

7.3.3.5 Functioning as a Private Performance Theatre

The theatre will be open to the public most of the time. It can also, however, serve to suit private or paid performances with controlled access. The theatre box is designed to be securely closed when private performances are taking place.

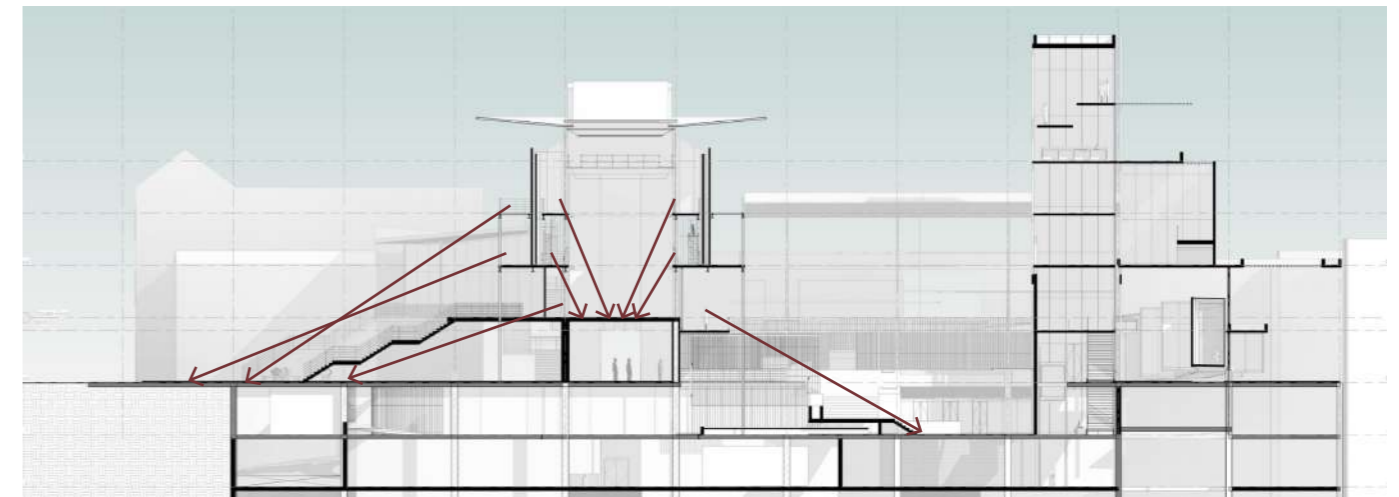

7.20

Fig 7.20- balconies used to view public life, catalyse debate (Author, 2019).

Fig 7.21- various configurations of forum theatre-adaptability (Author, 2019).

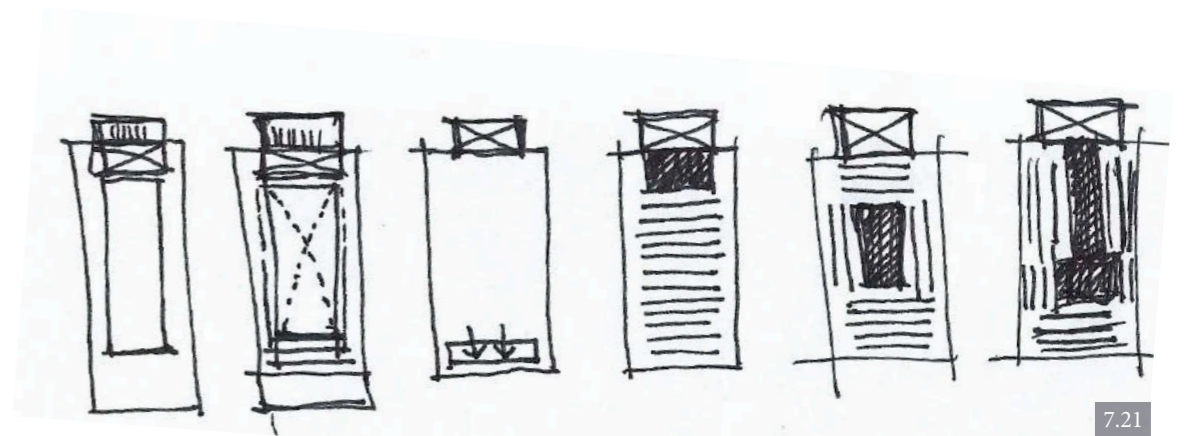

7.21

memoryscape

Fig 7.22-
Functioning as stage
for public square
(Author, 2019).

7.3.3.6 Functioning as a Stage for the Public Square

The southern-most skin on the first floor of the theatre can be lifted up like a hanger door, which creates a 'roof' when open. A stage can then be erected beneath the hanger door roof so that performances or public addresses can take place and be viewed from the public square below. The theatre box would then become the 'backstage' area.

7.3.3.7 Circulation as Theatre Balconies for 'Street as a Stage'

The theatre's publicly accessible circulation areas would be placed on the outside skin to behave as 'balconies' so the audience can simultaneously view the presentation and be part of the 'theatre of everyday life'. As the performance takes place inside the theatre and is viewed from the balconies, so the performance of the everyday outside the theatre – in the public realm – can be viewed from the balconies outside the theatre box.

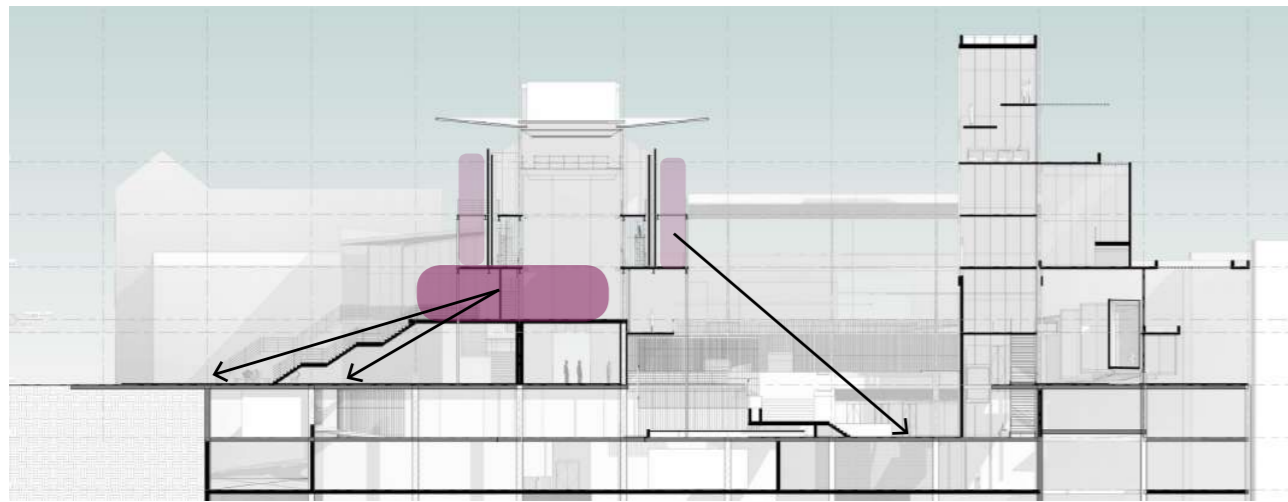

7.22

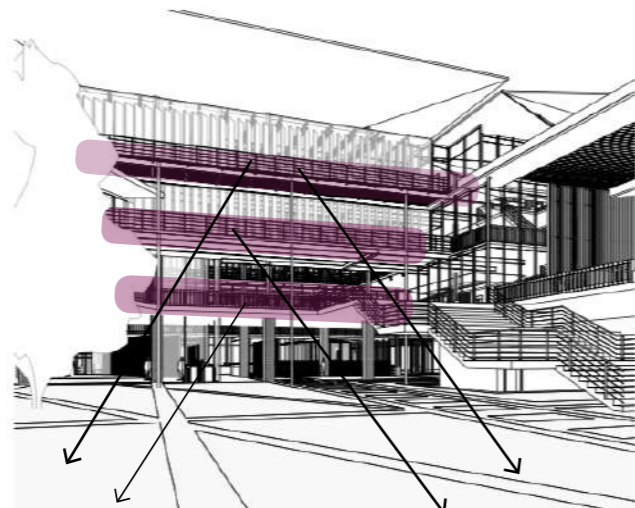

7.23

memoryscape

7.3.5 The Design of 'Back of House' Functions

In order to keep the public realm and the realm above the ground free function, the 'back of house' service functions such as deliveries of restaurant supplies, small performance props, storage of additional theatre seating all take place in the basement levels, predominantly on Basement level -2.

In order to ensure secure delivery and pick-up of TRC archival materials shared between the Pretoria National Archives and SAHA the design of a private and lockable delivery zone in Basement -2 was implemented.

7.3.6 The Tower of Truth & Reconciliation – Viewing Tower

The main circulation tower, also called 'the beacon of truth', houses a bar and city watching area at the top. This observation point will contain a beacon of light, much like a lighthouse, to act as a 'beacon of truth' and

give the whole intervention a significant marker within the city landscape. The observation steeple will be illuminated at night to symbolize the TRC as a beacon of hope vis-à-vis the progression of the democratic capital of South Africa from the darkness of night into the light of a new day.

The beacon of truth will be accessible via various positions, to be indicated throughout the day, and – in order to maintain security – will only be reachable through the museum entrance and via the sunken courtyard at night.

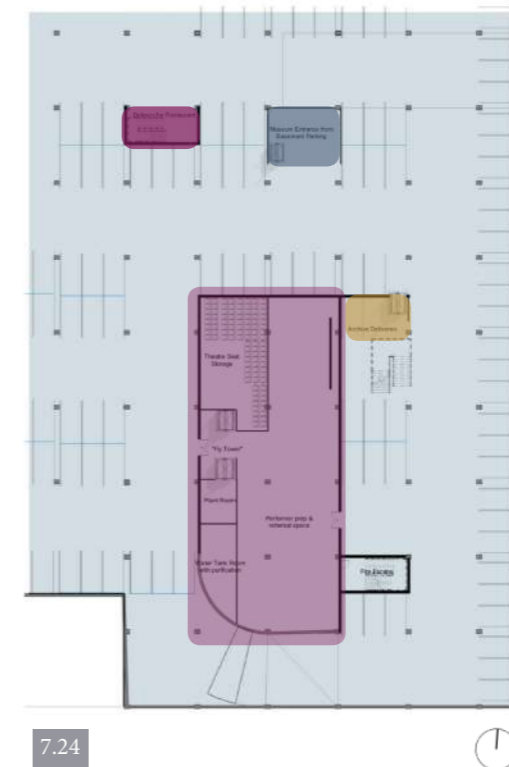

7.24

Fig 7.24-
position of back
of house functions
in Basement -2
(Author, 2019).

Fig 7.25-
Position of tower
of truth and
reconciliation
(Author, 2019).

Fig 7.26-
Views from tower
(Author, 2019).

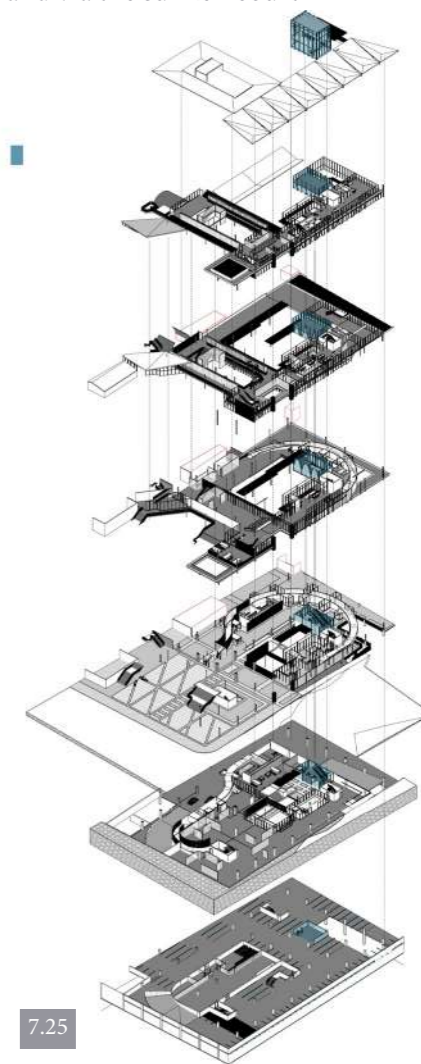

7.25

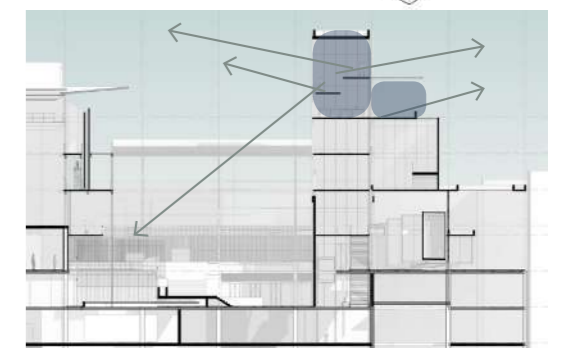

7.26

memoryscape

Fig 7.27- Programs of building in perspective (Author, 2019).

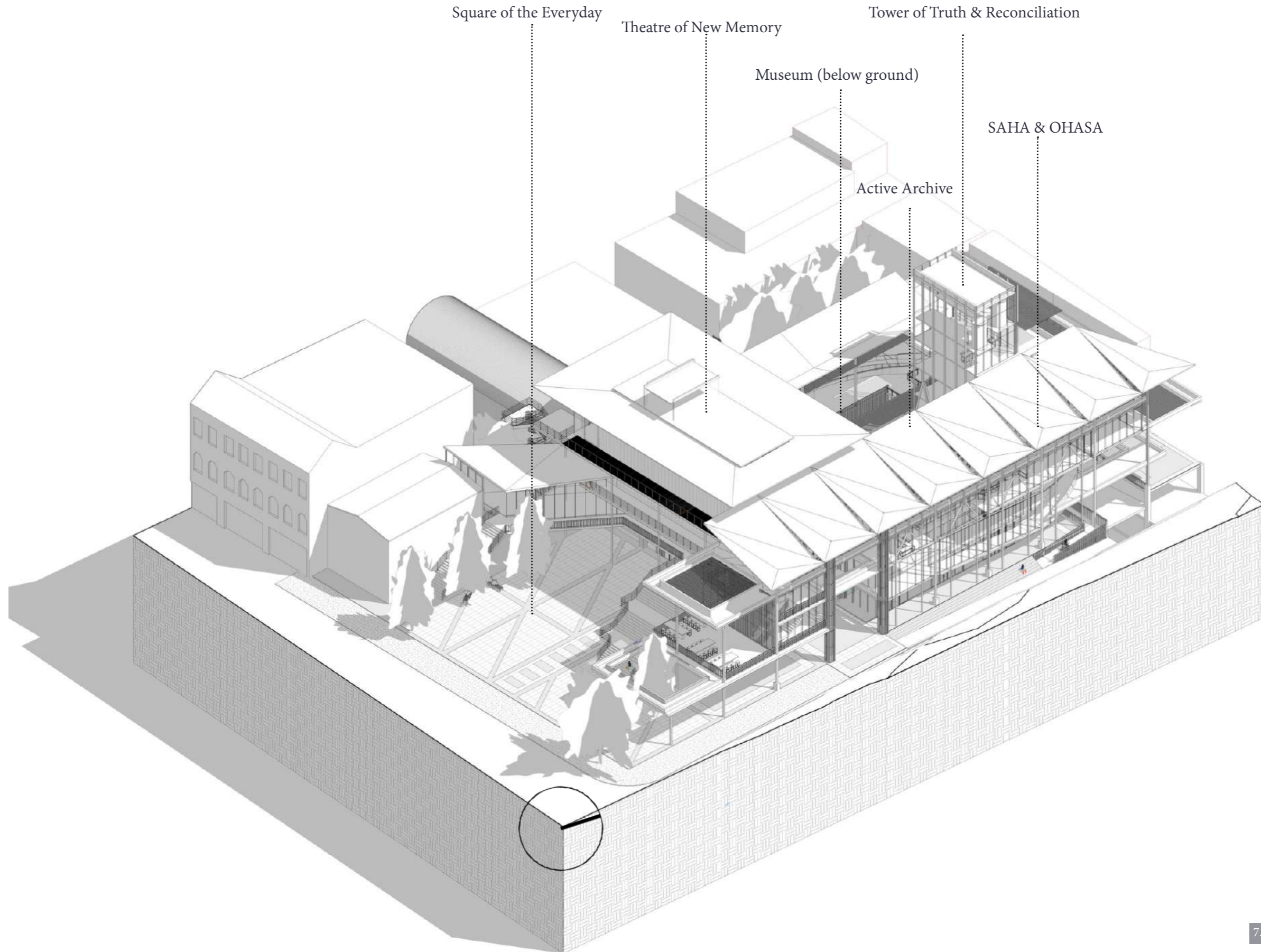

CHAPTER



CHAPTER 08

Technical Resolution

/

8.1 || CONCEPT

Fig 8.1- Expression of the concept of a Marionette being freed (Author, 2019).

Fig 8.2- Tectonic concept parti (Author, 2019).

Fig 8.3- Fig 8.4- Concept of building being 'freed' from the site (Author, 2019).

The technological approach that correlates with the design concept of 'darkness into light' embodying transition. The metaphor of a marionette being freed from its strings – the puppeteer losing control – is used to represent how the TRC helped to free the citizens of South Africa from the shackles of Apartheid in order to aid liberation.

The technology represents this metaphorical narrative through the building being set free from the existing site constructs.

Just as the TRC was the conduit through which the people were liberated into democracy, so the structure is freed from the concepts of the existing location into the vibrant nature of the everyday sphere. The physical manifestations of the notion of darkness into light and the freeing of the building can be seen through the contrasting lenses of restrictedness and concealment towards transparency. An important aspect of being freed from

a previously controlled past is 'adaptability', to be embodied in the nature of a new construction methodology.

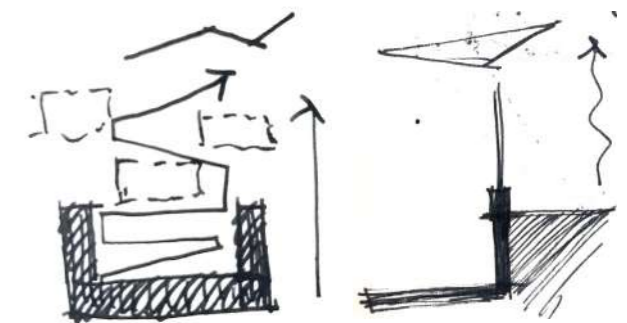
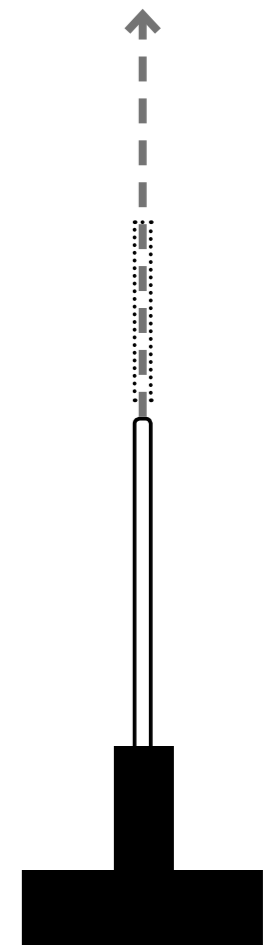

8.2

8.3

8.4

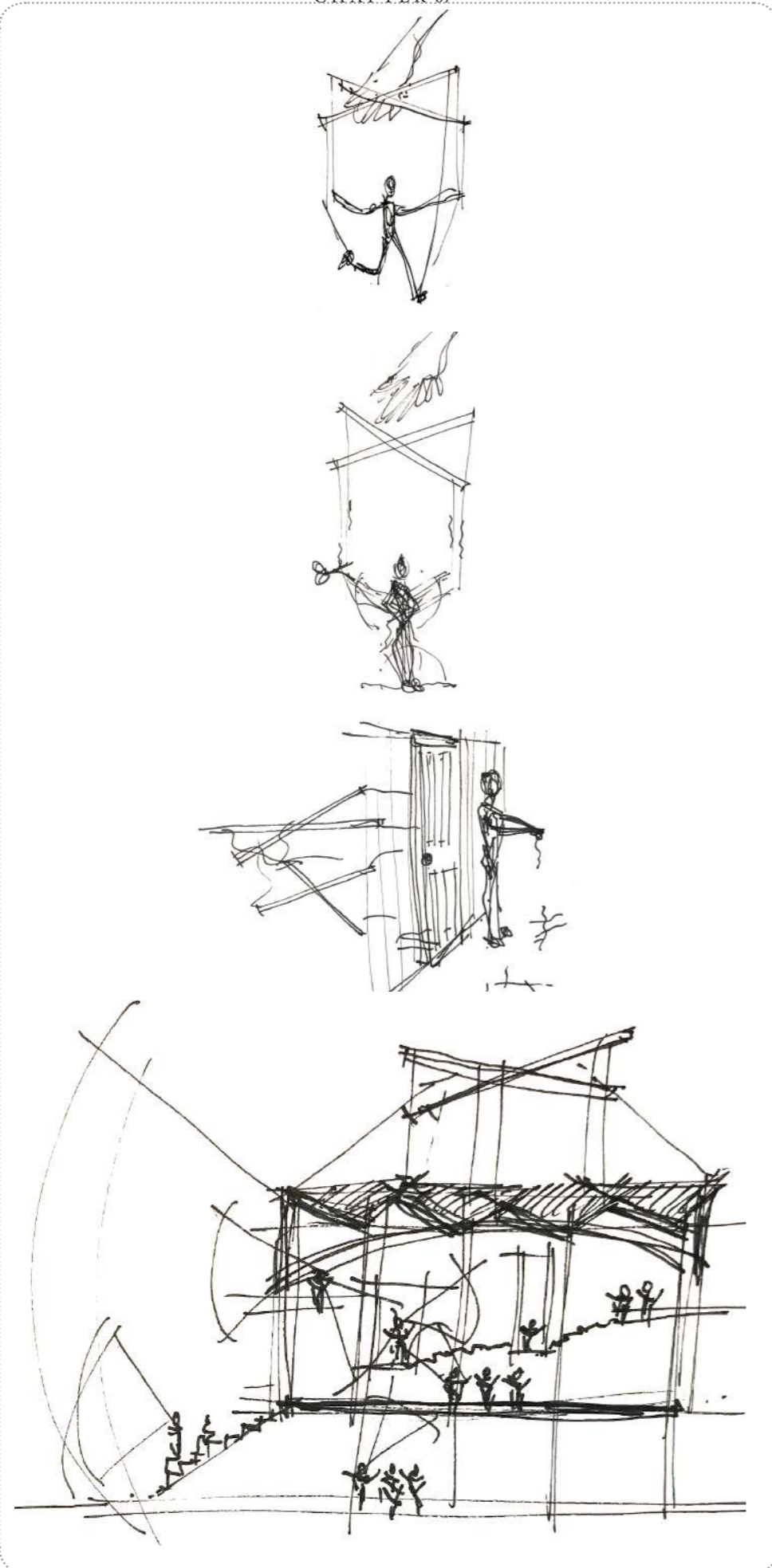

8.1

Fig 8.5- concept of liberation through technical articulation of each function (Author, 2019).

Fig 8.6- example of new skin to express new technology (memory) (Author, 2019).

8.2 || STRUCTURE

The new intervention utilizes the existing 8,5 x 8m column grid of the existing basement below the site that was intended to support a multi-story hotel. The columns are reinforced to support the hotel that was never constructed. The new steel structure (including a space frame) is to be built on top of the existing concrete columns while the intended floor

construction contrasts with the existing basement coffer slabs by exploring a light composite floor system of steel decking. The steel structure allows for future structural adaptability.

Archive over Skin

S C A L E 1 : 1 0 0

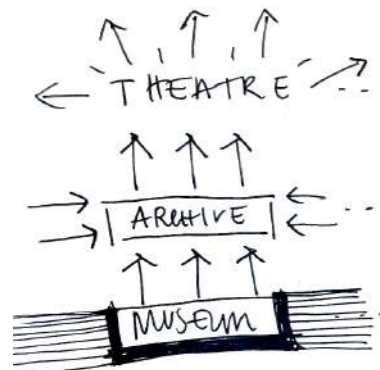

8.5

8.6

8.3 || MATERIALS

The chosen new materials are intended to contrast with the Sammy Marks block's existing materials. Contrasting materials were chosen based on the concept of 'darkness into light'; the existing materials (predominantly concrete and red face brick) embodying 'darkness' and the new materials (steel, polycarbonate, glazing, and timber) embodying 'light'. The materials are implemented in various parts of the building to narrate the transition from darkness into light. Additional materials such as accents of oxidized aluminium panels (screens and solid) are used to portray memory through the patina (memory) they will develop over time, which will give the building its own sense of memory.

Materiality of Circulation tower

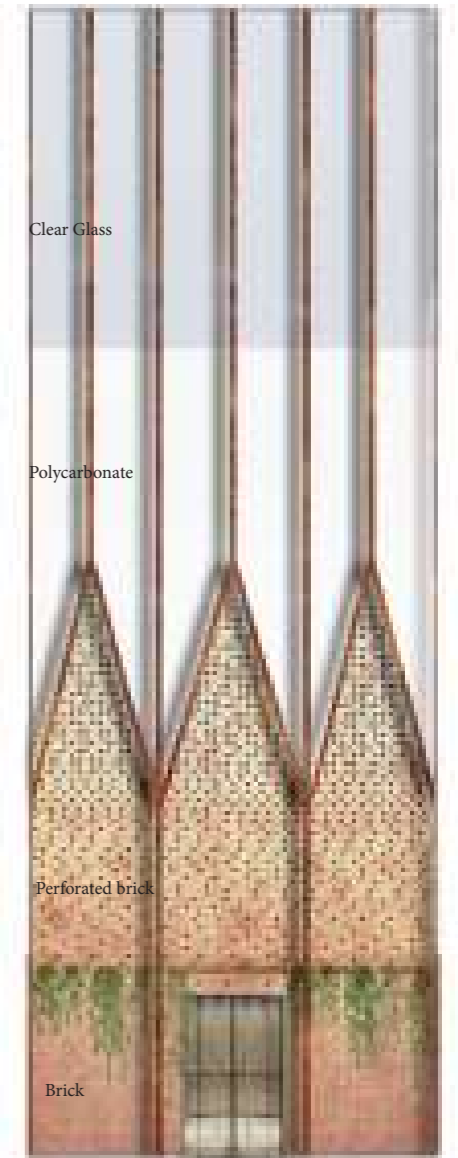

8.7

Fig 8.7 - 8.8- Materiality of intervention (Author, 2019).

Materials- from darkness to light



8.8

Further Exploration of memory and structure- Technological Narrative expressed through column treatment & detailing

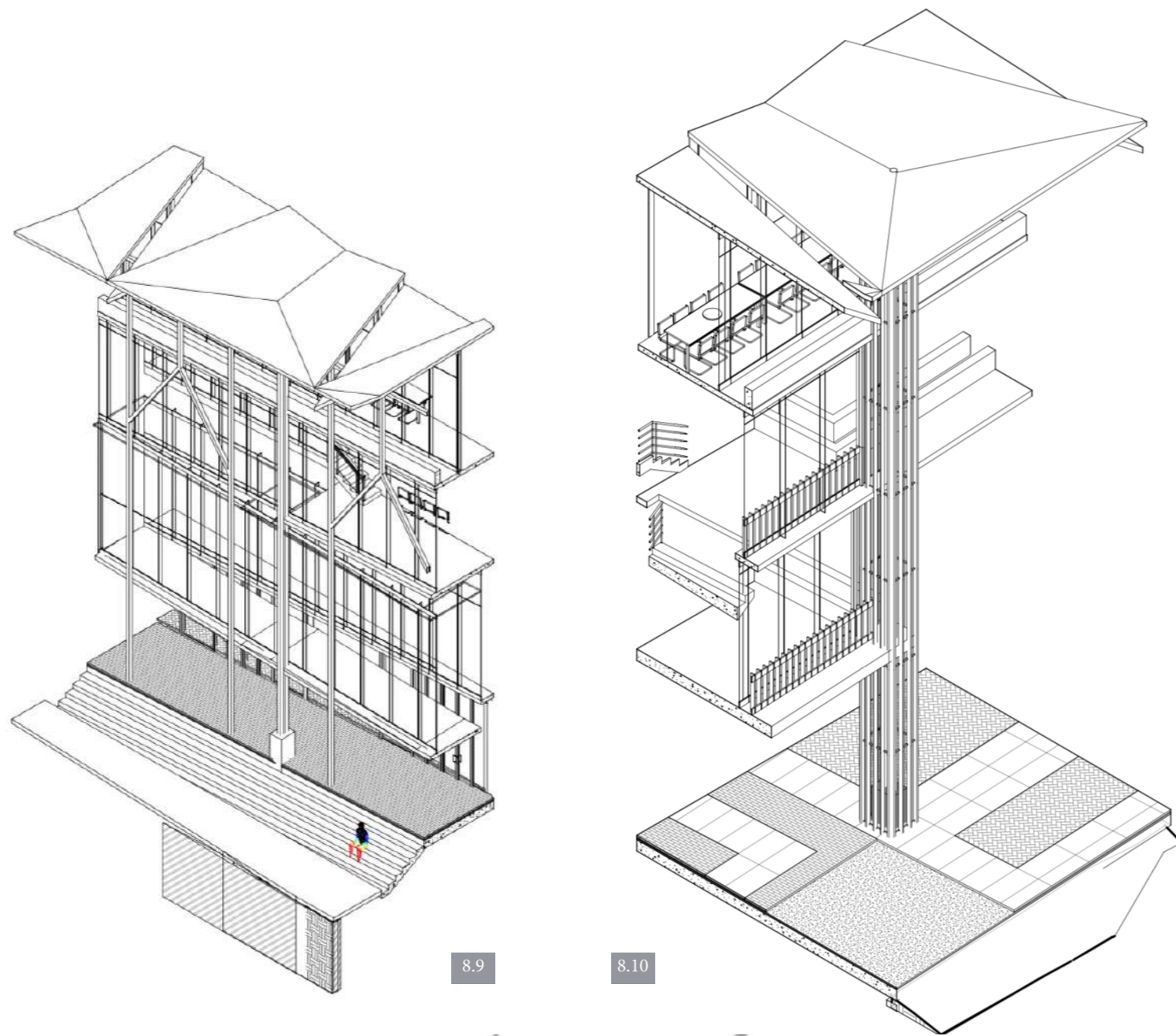

8.9

8.10

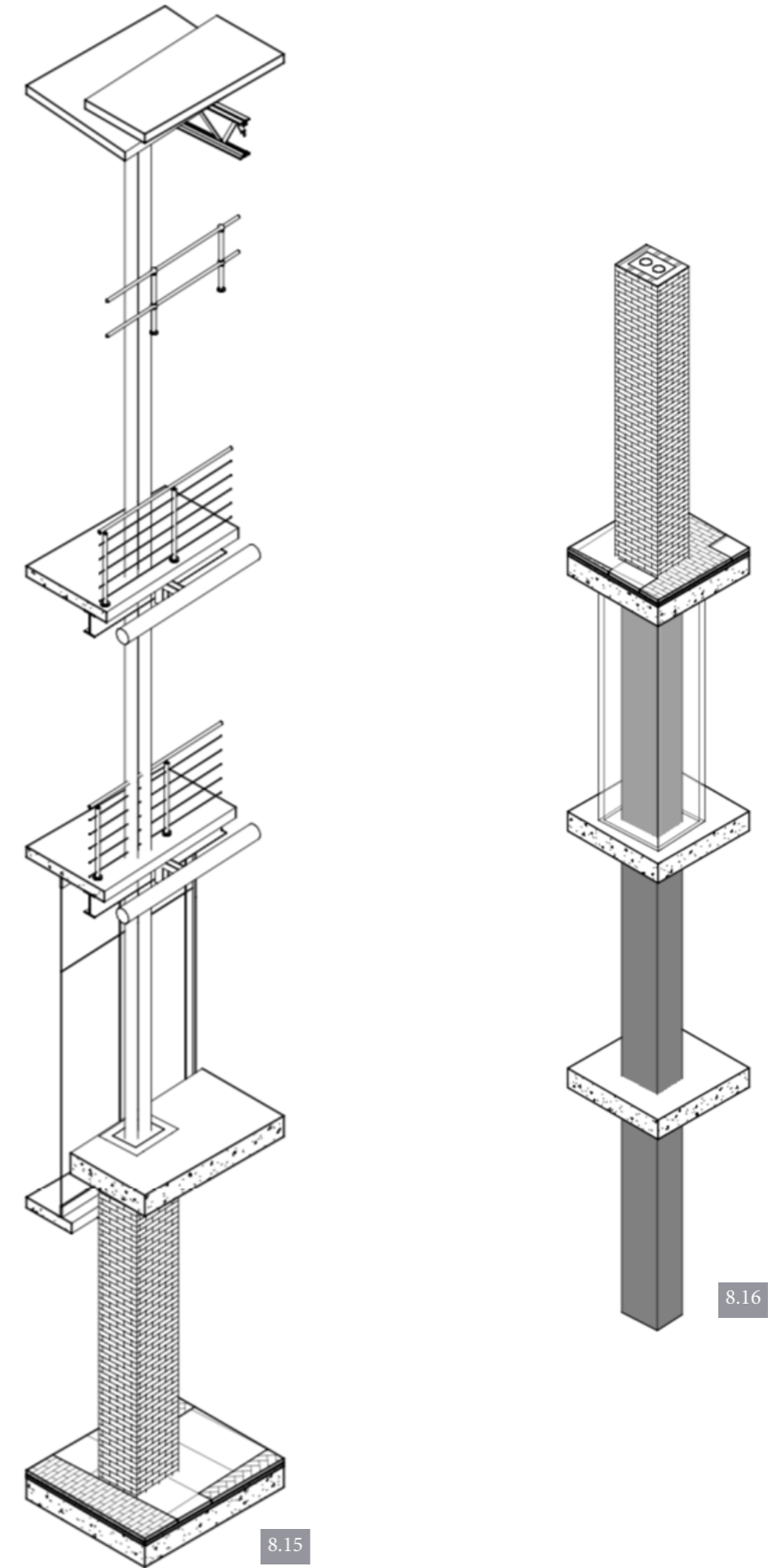
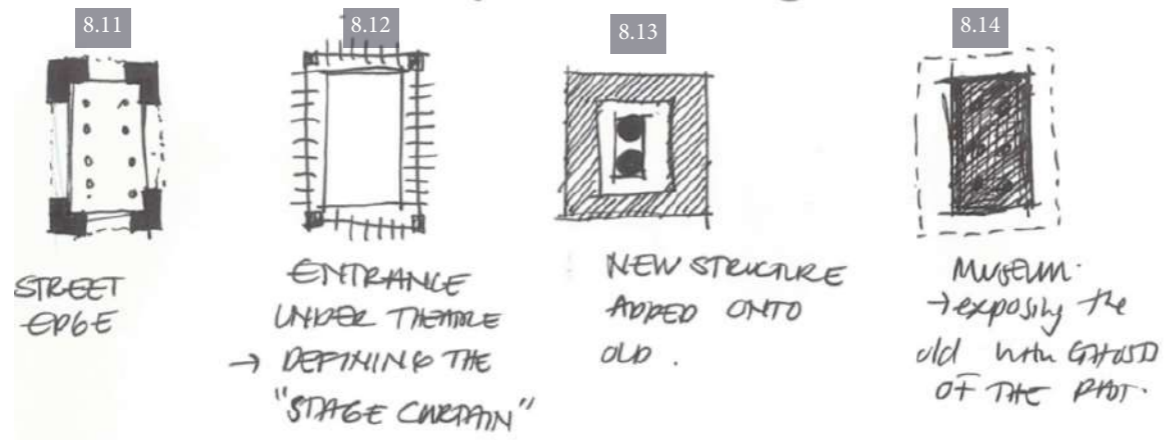

Fig 8.9- Eastern edge column treatment (Author, 2019).

Fig 8.10- Theatre entrance column wrapping (Author, 2019).

Fig 8.11- 8.14- Column detailing on plan (Author, 2019).

Fig 8.15- Column articulation of theatre (Author, 2019).

Fig 8.16- Column treatment in basement museum (Author, 2019).

8.15

8.16

Public Spaces Texture Analysis- Material

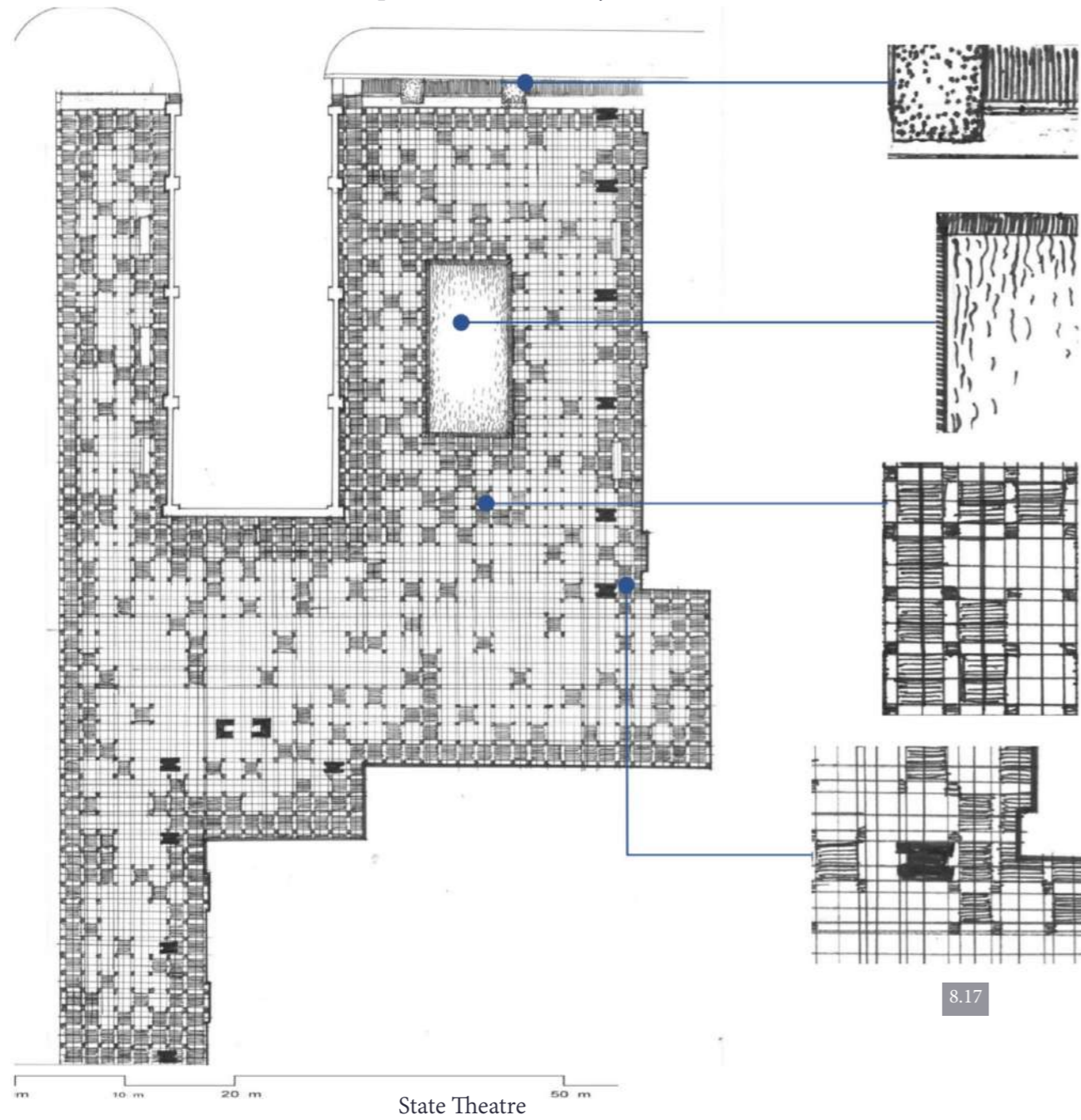

8.17

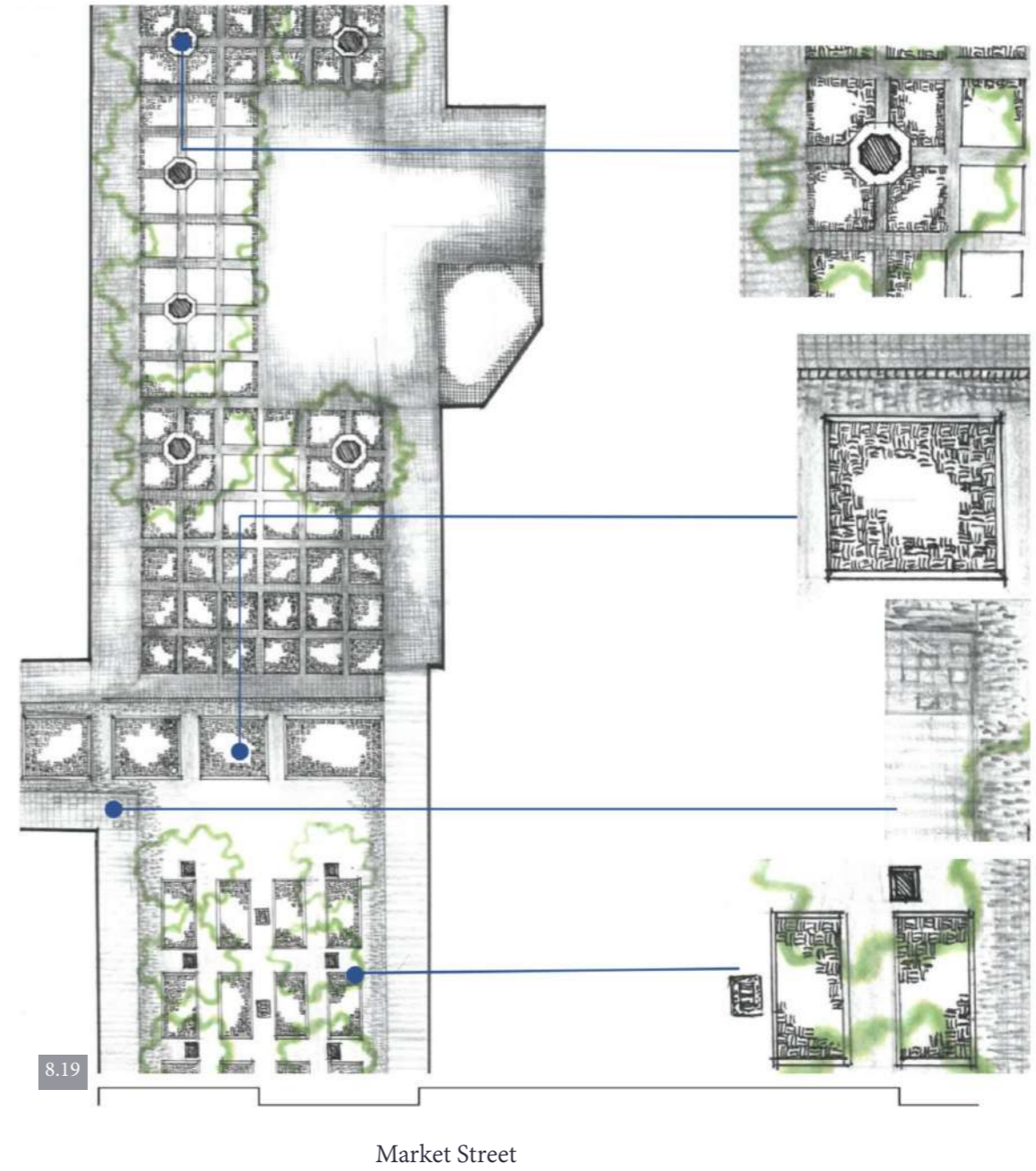

8.19

Fig 8.17- Plan of State Theatre paving texture analysis (Author, 2018).

Fig 8.18- perspective recording of texture analysis (Author, 2018).

Fig 8.19- Plan of Market Street paving texture analysis (Author, 2018).

Fig 8.20- Perspective recording of texture analysis of market street (Author, 2018).

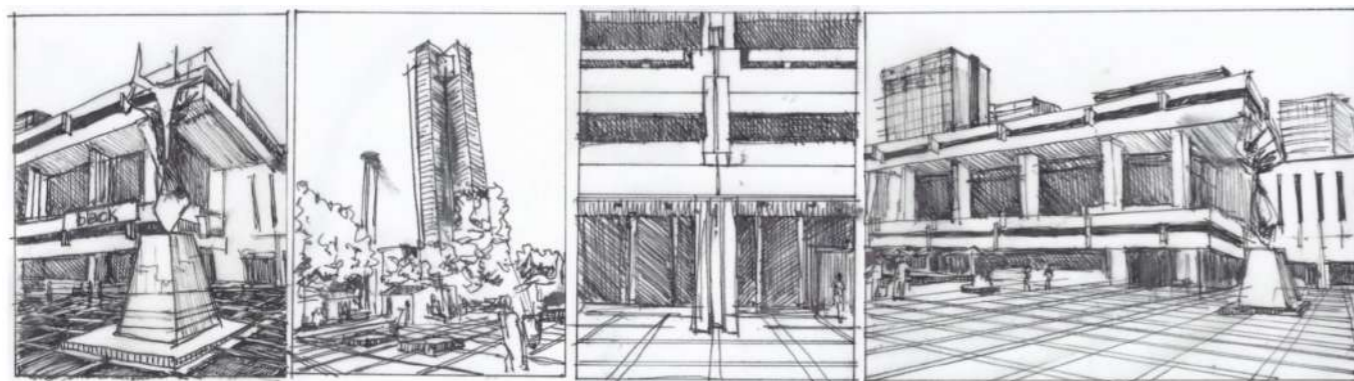

8.18

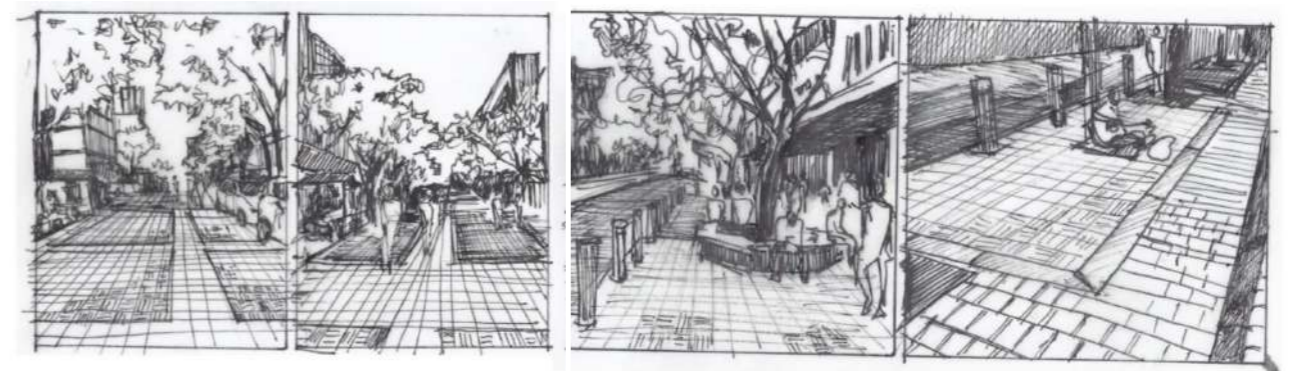

8.20

8.4 || TECHNOLOGY

The new technological system allows the building to be adapted for future uses or removed completely to leave the structure on site in almost the exact condition in which it was found. The new technology is not invasive as per the existing on-site conditions. The technology speaks a new language to the existing and aims to express the concept of being freed from ones shackles as well as various expressions of memory.

Fig 8.25-8.26- technology of building elements (Author, 2019).

Fig 8.28-8.29- Expression of tectonic concept through roof articulation (Author, 2019).

Fig 8.30- Adjustable acoustic aperture model (Author, 2019).

Fig 8.31-8.32- Adjustable acoustic swivel panels to suit various uses of theatre (Author, 2019).

Fig 8.33- Articulation of theatre skin materiality and acoustic panels (Author, 2019).

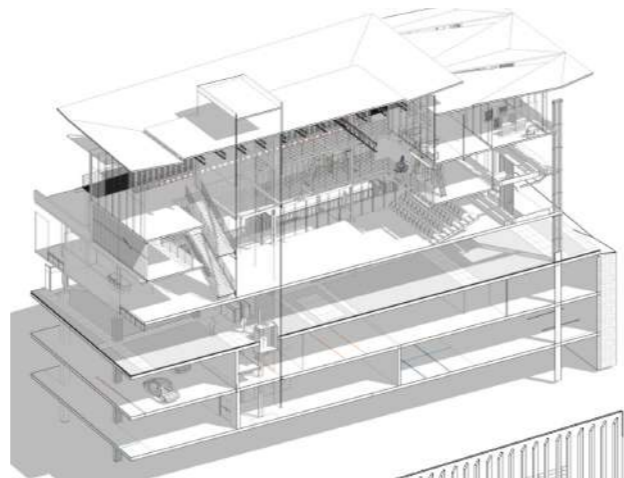

8.26

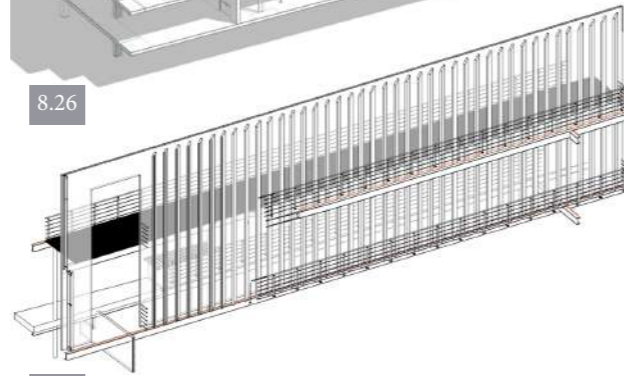

8.27

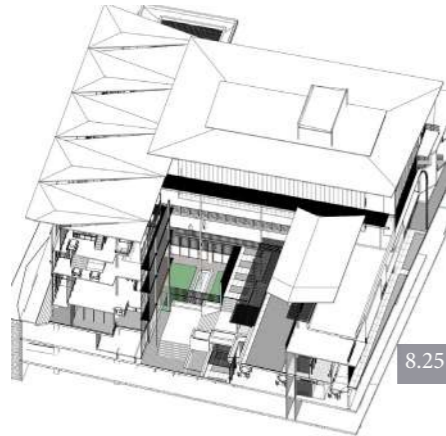

8.25

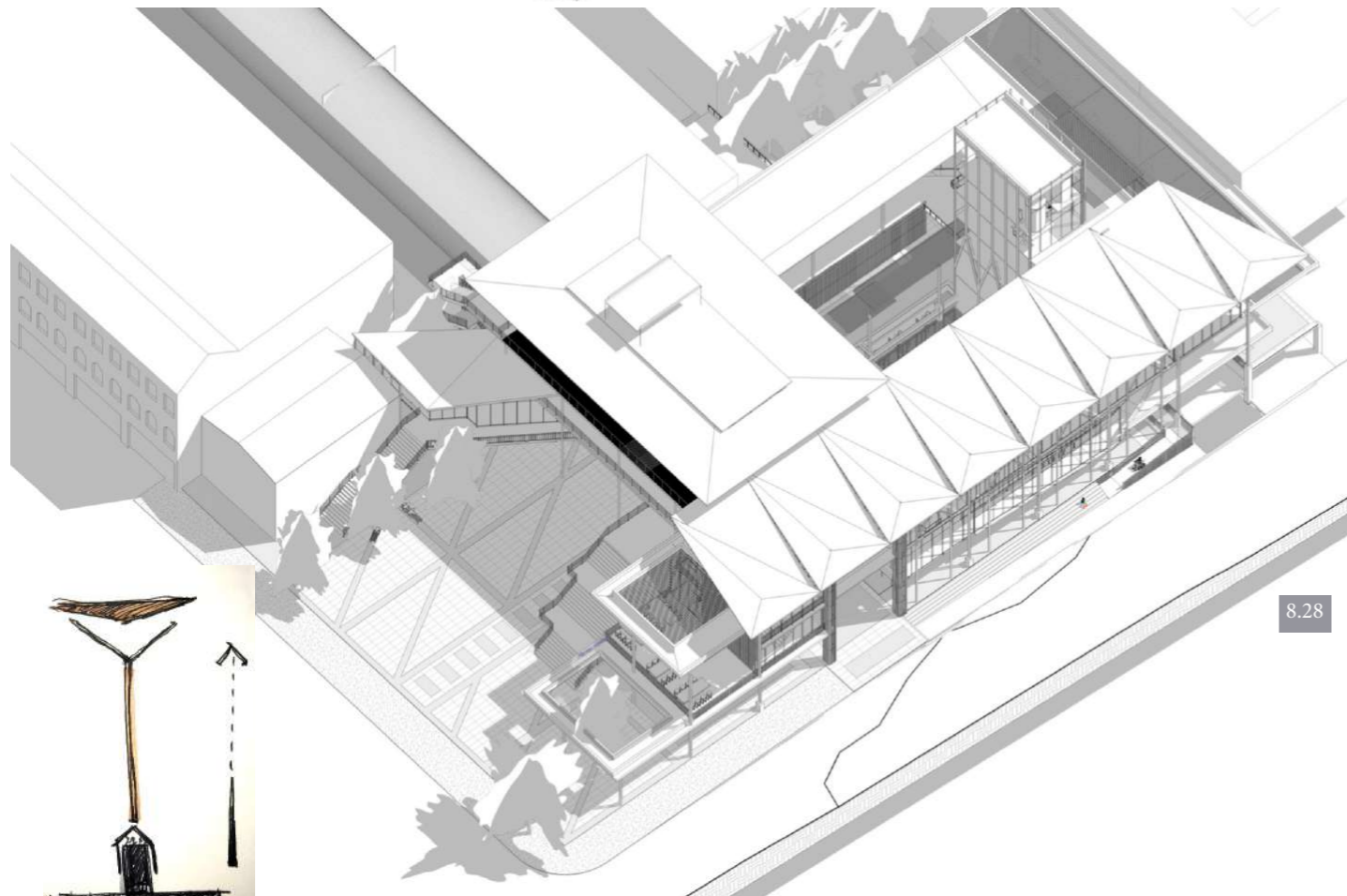

8.28



8.29

8.5 || ENVIRONMENT AND SERVICES

The main environmental elements explored in the design are: acoustics (exploration of innovative and adaptable possibilities for the theatre), natural light and rain water harvesting and purification (for drinking as well as for a gravity-fed greywater system for

bathrooms). Additional systems that are explored include: ventilation (natural and mechanical), thermal performance of the building (strategies to mitigate solar heat gain).

Adjustable Acoustics- hung from theatre roof

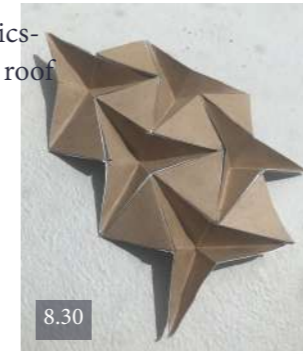

8.30



8.31

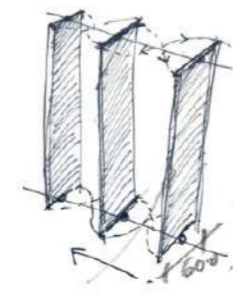

SWIVEL + STEEL

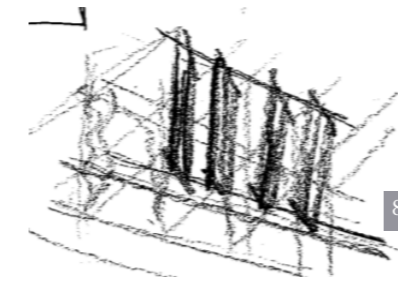

8.32

SCALE 1 : 5 0

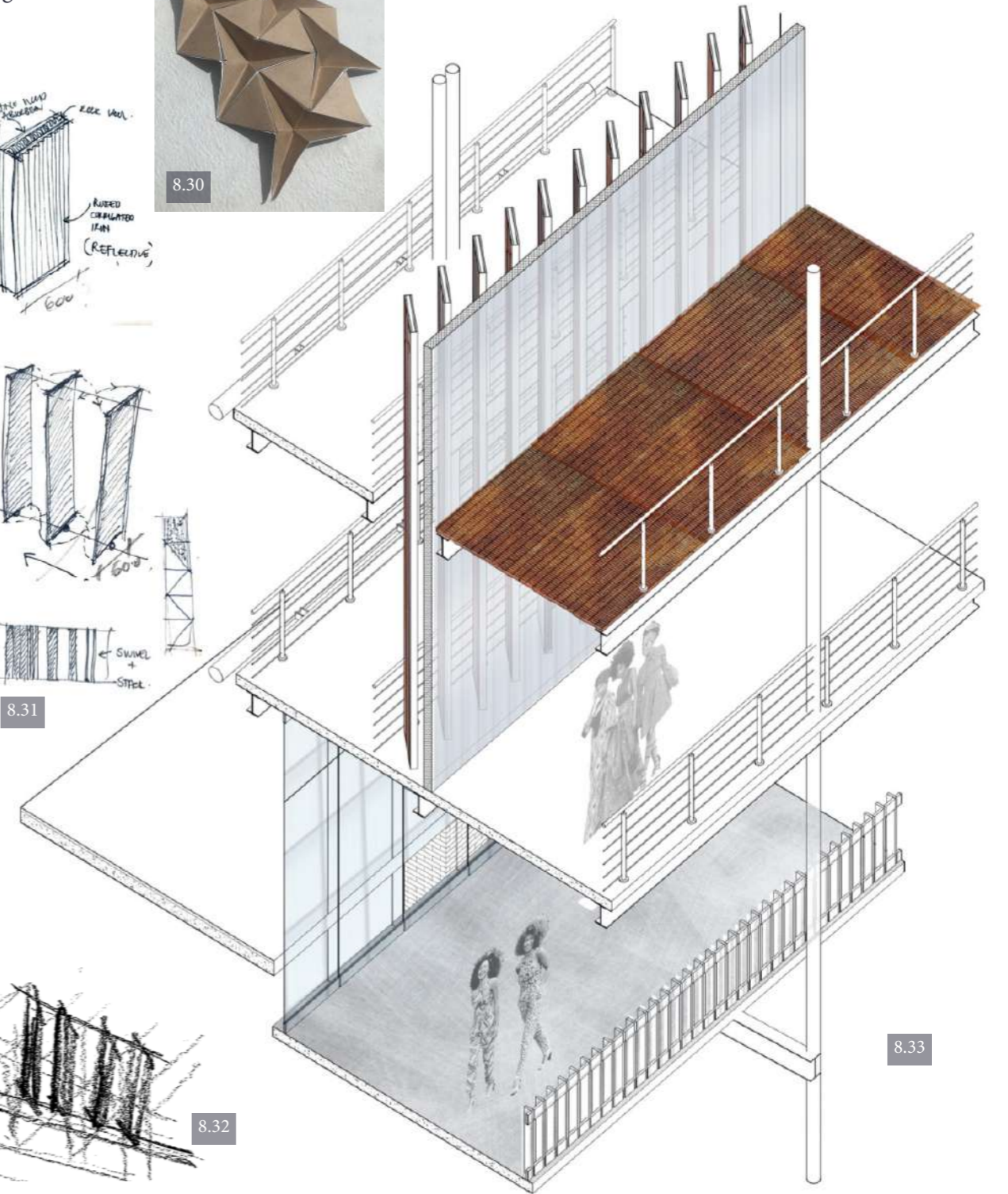

8.33

Fig 8.34- Construction section with theatre detailed (Author, 2019).

1:50 Section- Iteration (not final)

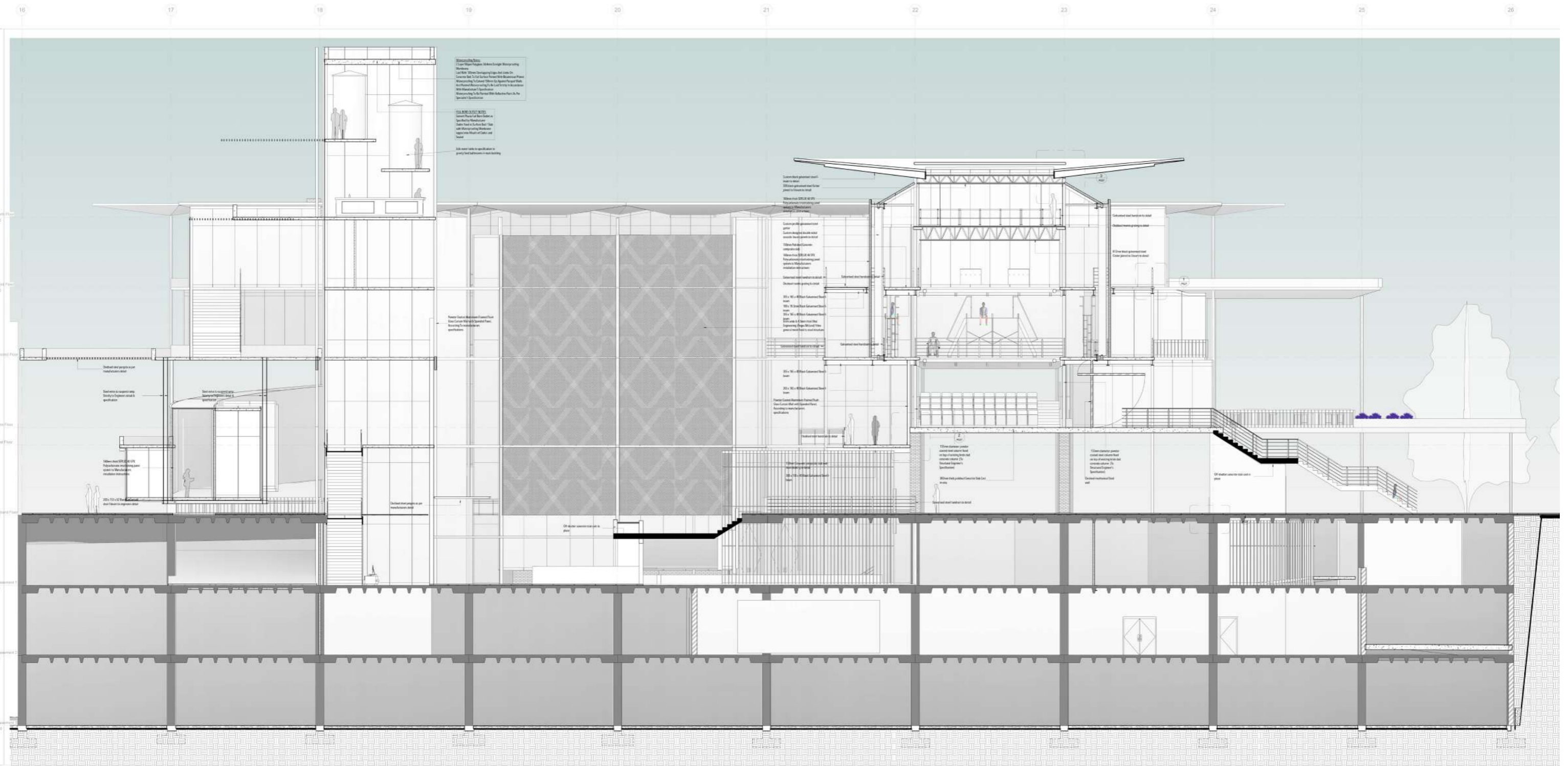
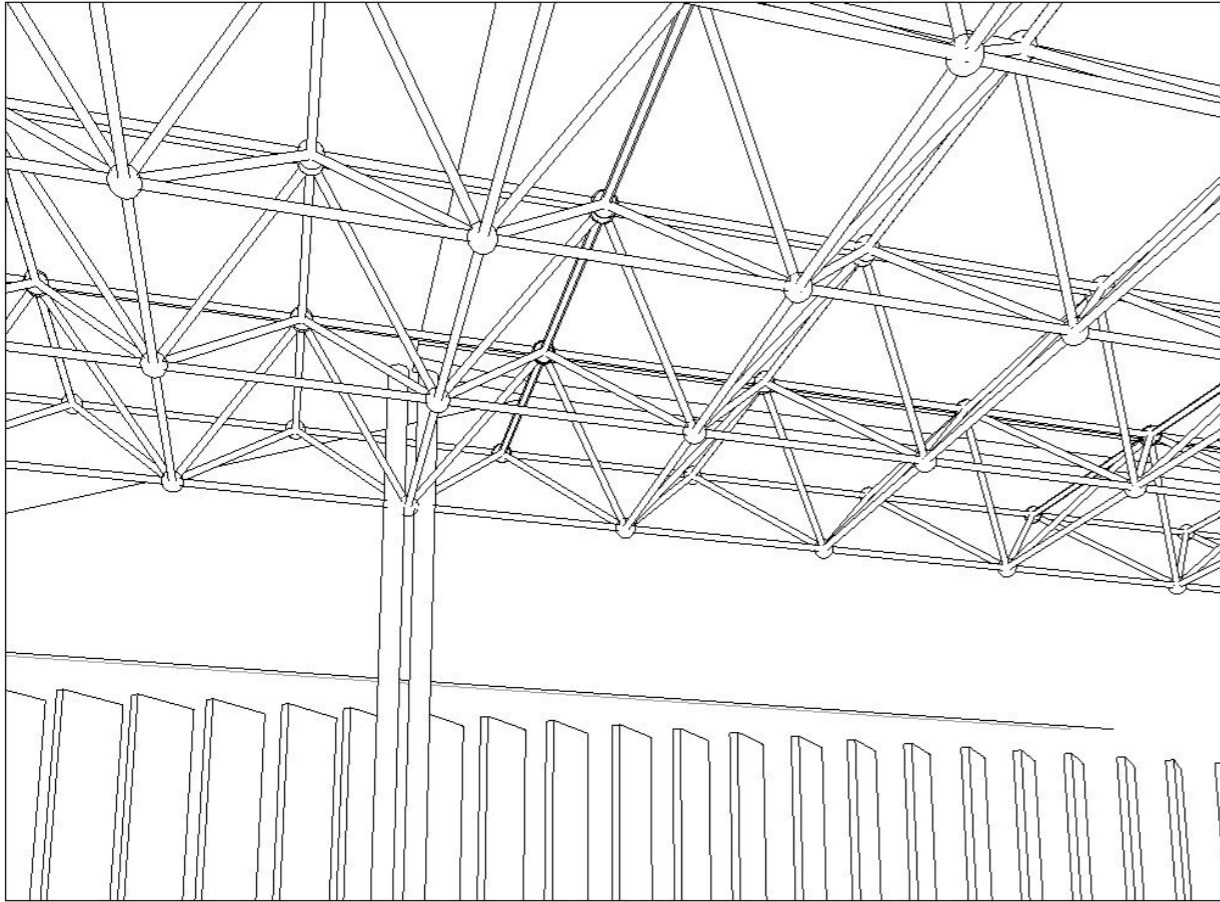

Fig 8.35- 8.36
Space Frame
structure introduced
into theatre (Author,
2019).

Fig 8.37-
Model exploration
of Space frame
articulation (Author,
2019).

Fig 8.37.1-
Auckland Art
Gallery Toi o
Tamaki in New
Zealand (Dezeen,
2013)



8.35

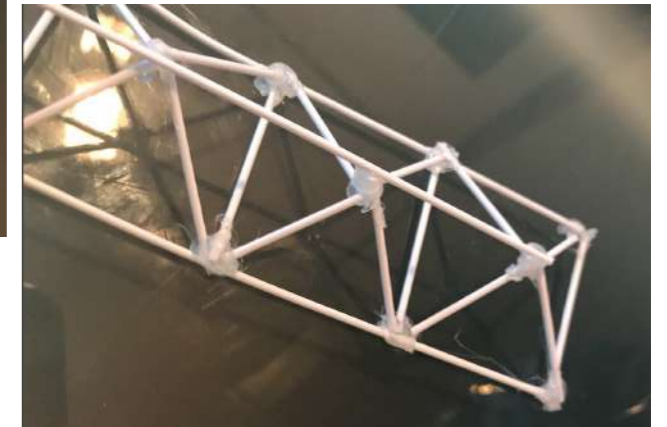
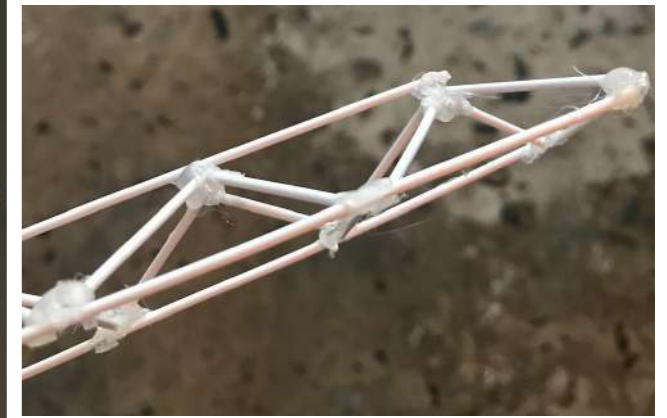
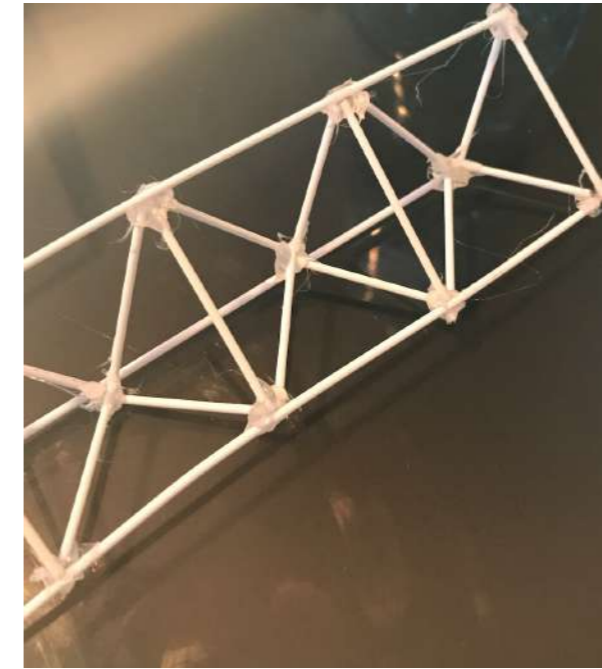

8.37

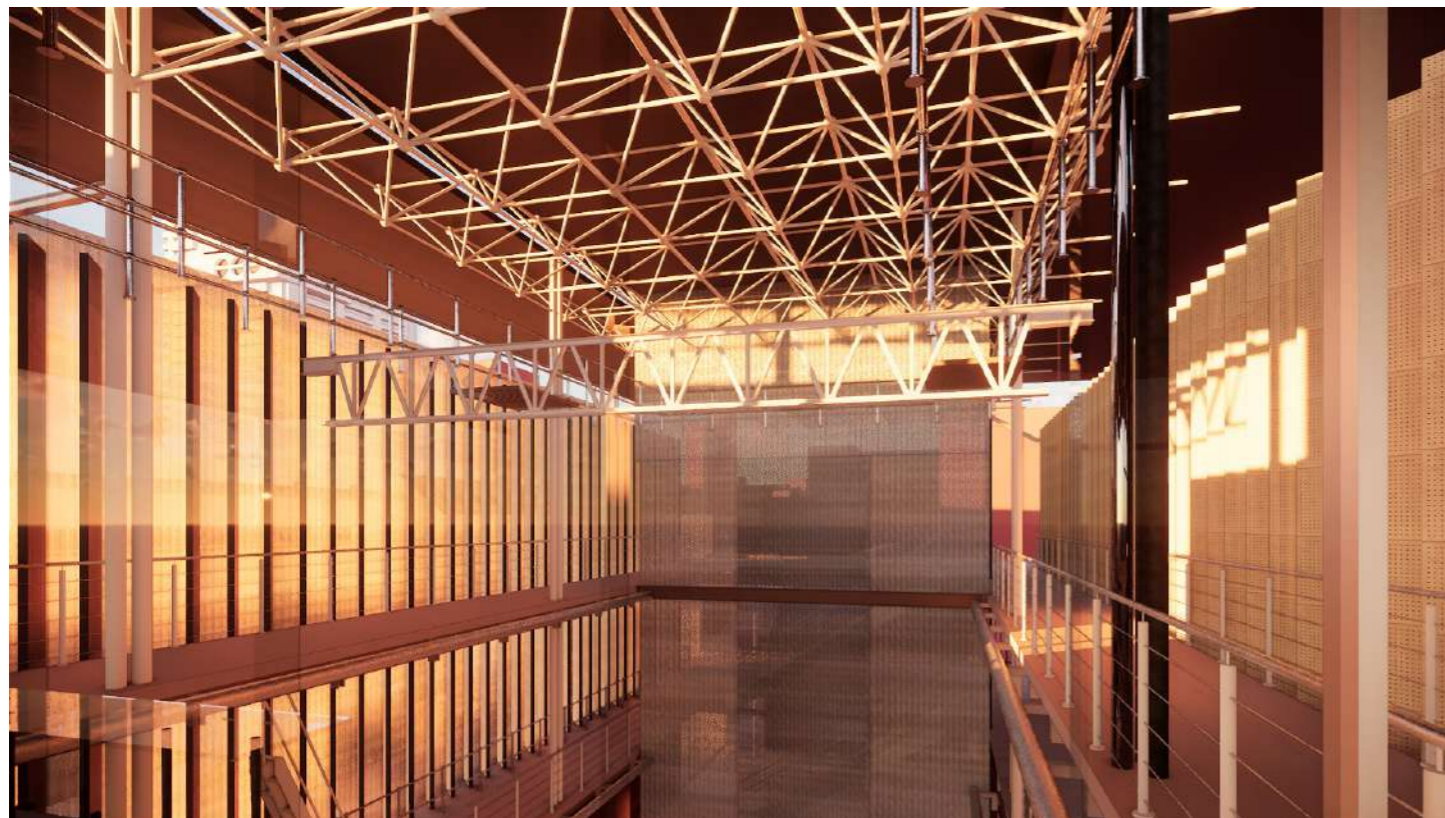

8.36

Auckland Art Gallery Toi o Tamaki in New Zealand



8.37.1

Fig 8.38- 8.39- solar heat gain strategy of overhangs to shade the facades (Author, 2019).

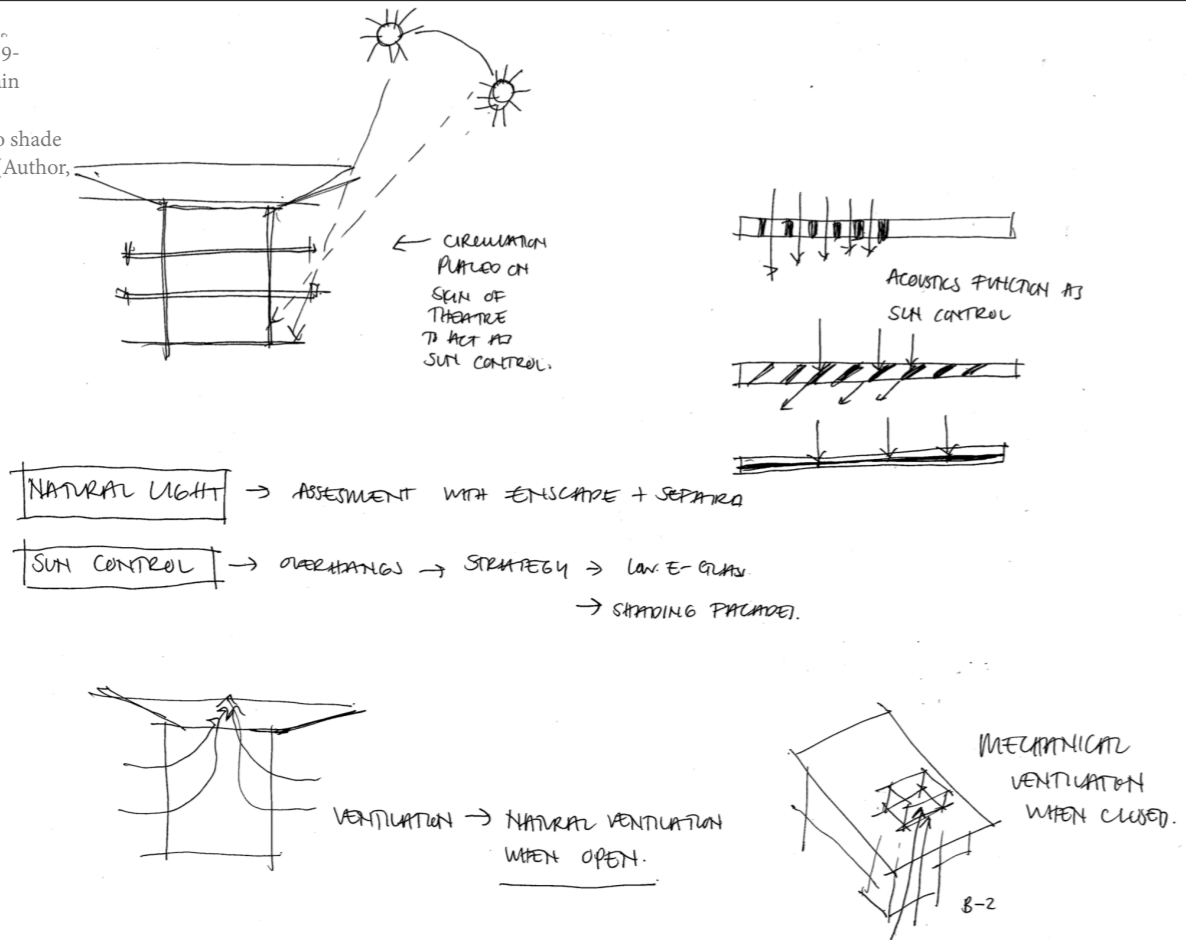

8.38

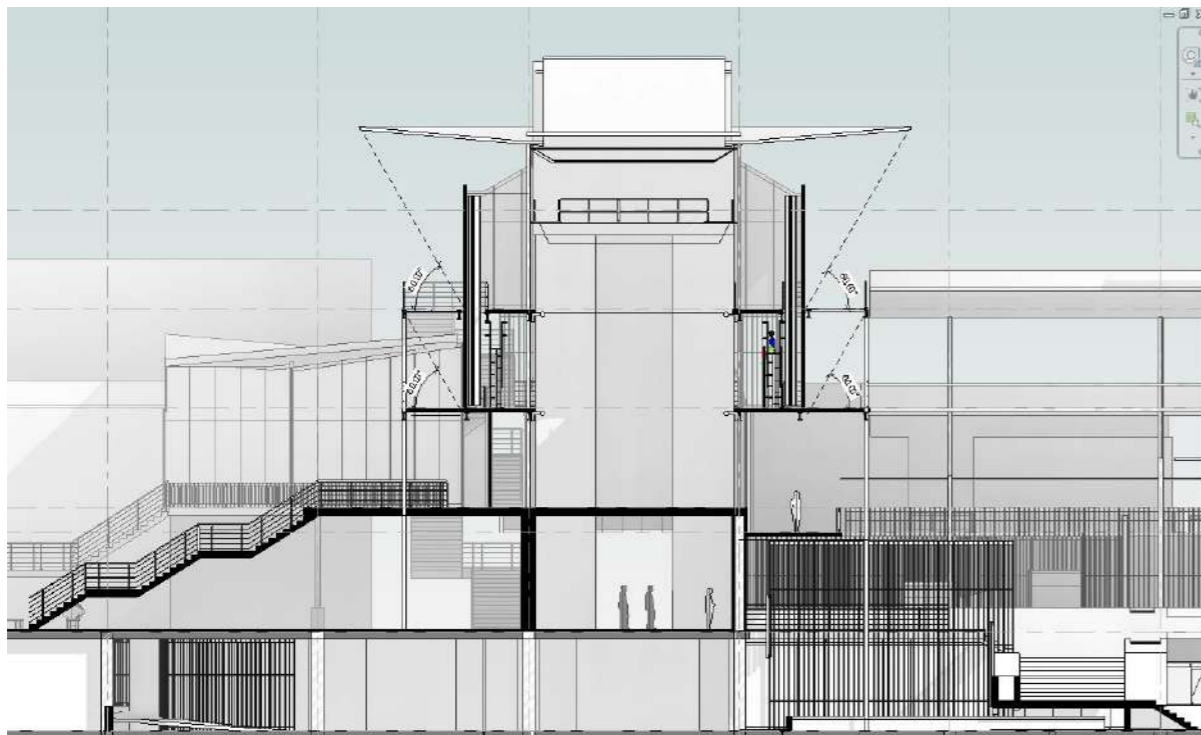

8.39

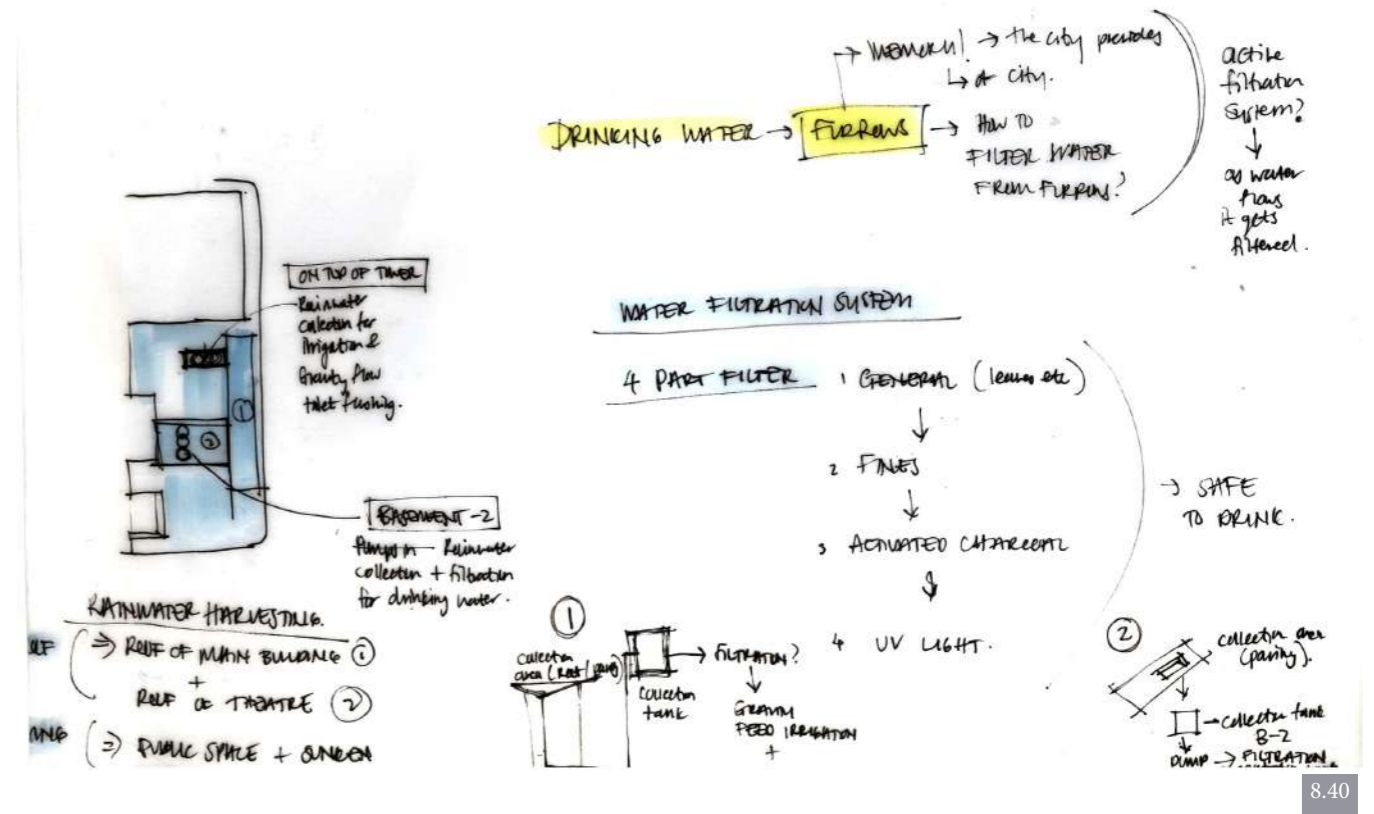

8.40

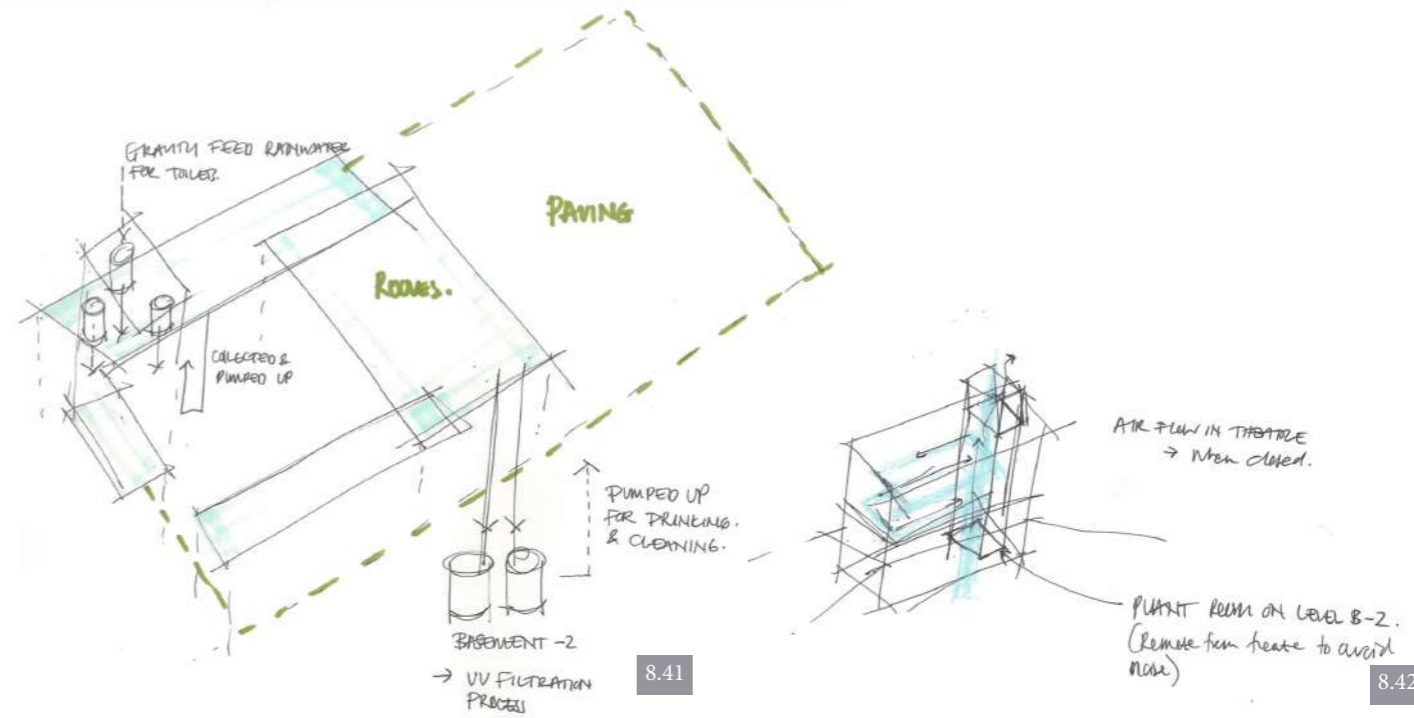

8.41

8.42

Fig 8.40-8.41- diagrammatic strategies for water management and ventilation (Author, 2019).

Fig 8.44-8.47-
Diagrammatic
exploration of
column and roof
details (Author,
2019).

Fig 8.48-
roof and column
articulation of
Theatre box
(Author, 2019).

Fig 8.29-
Existing vs new
column to roof
connection (Author,
2019).

Fig 8.50-
articulation of
theatre box (Author,
2019).

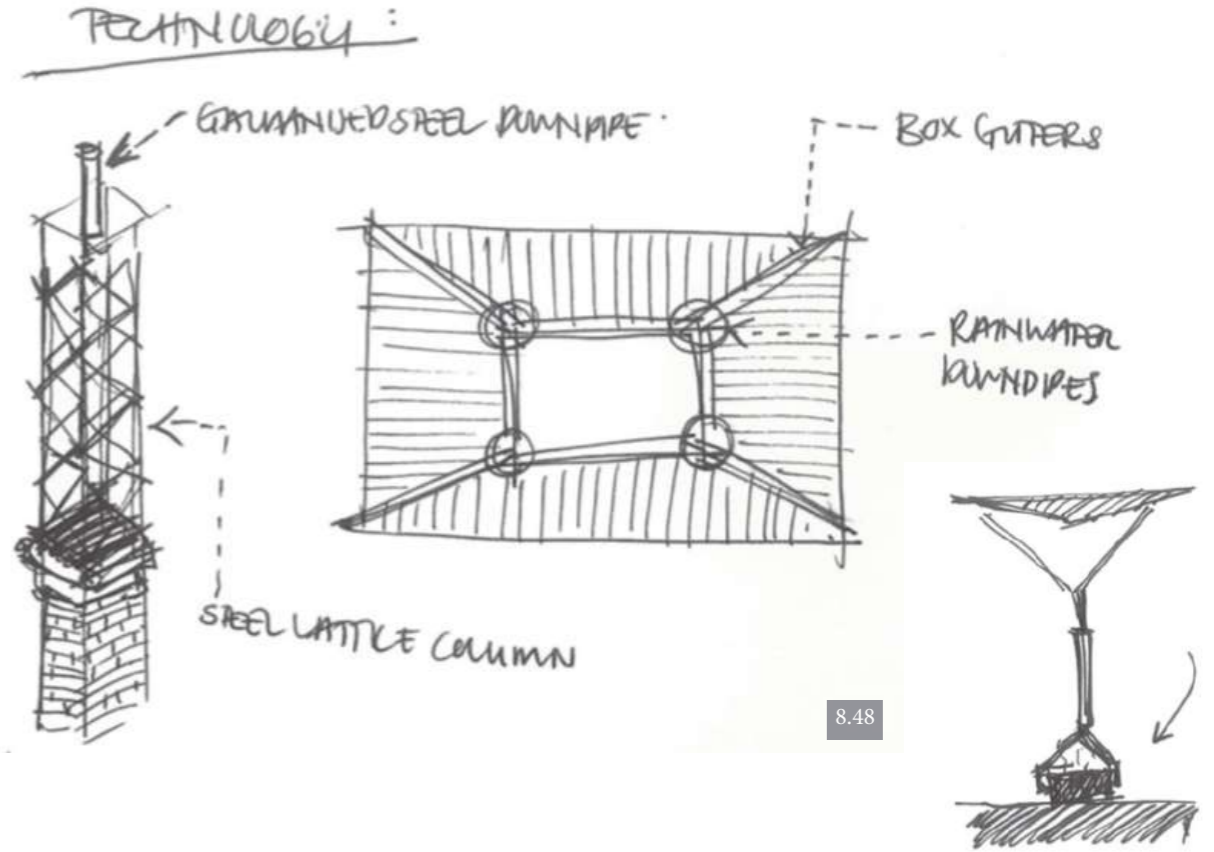
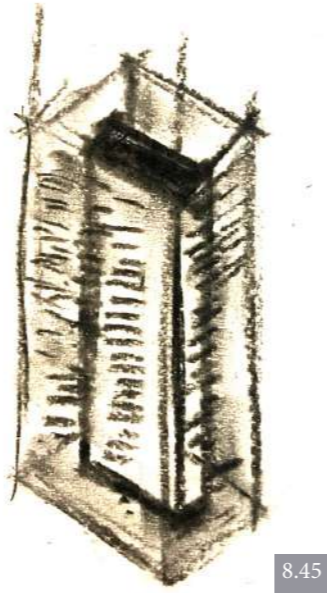
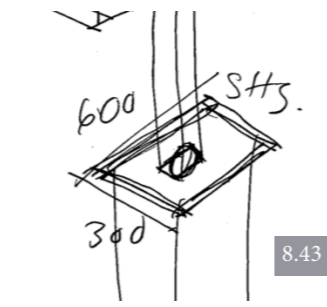
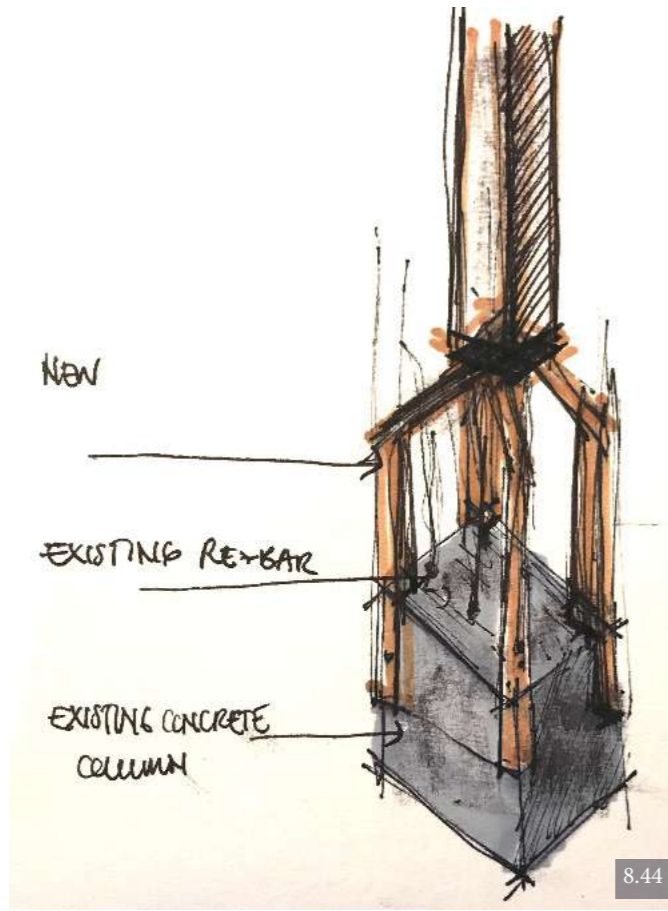

8.49

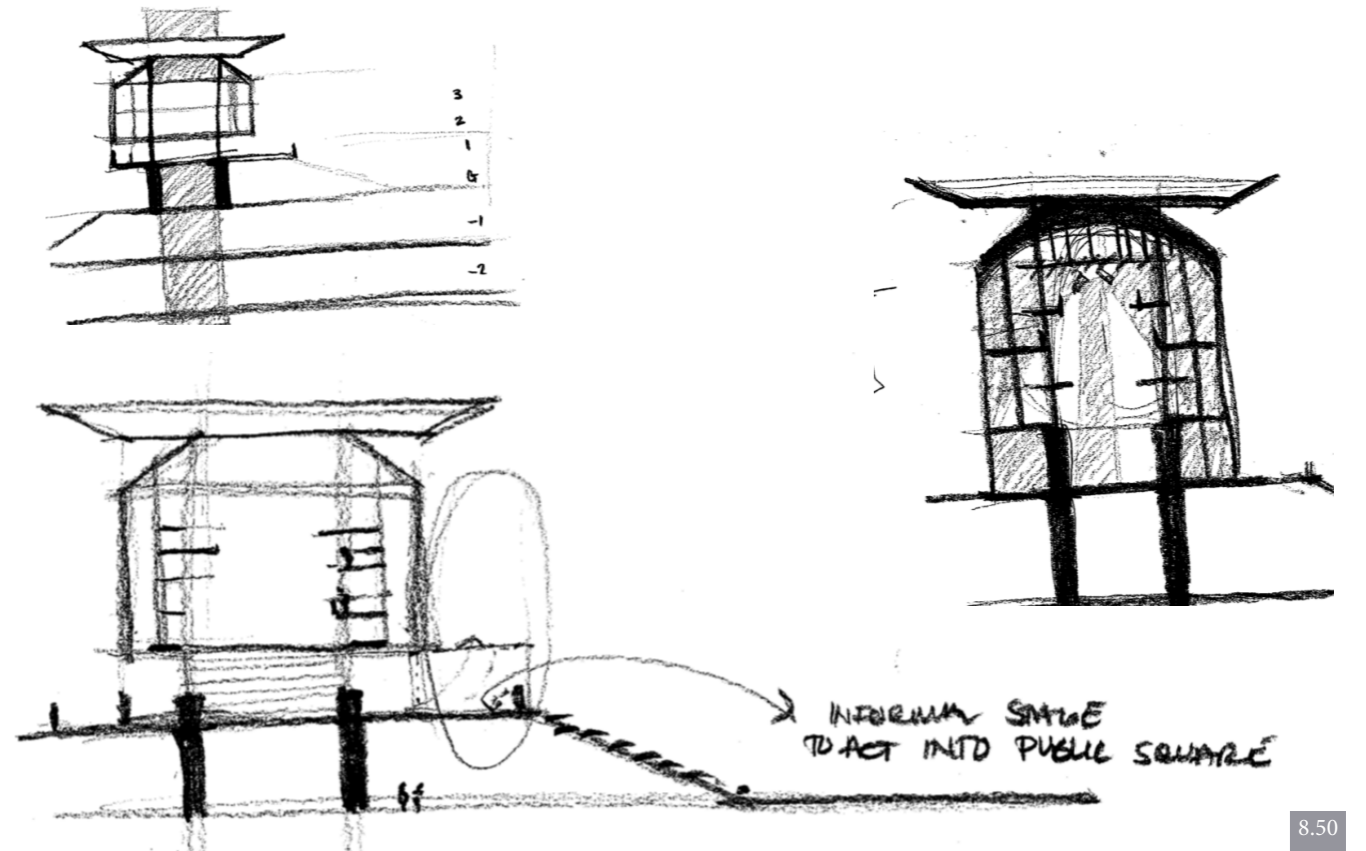
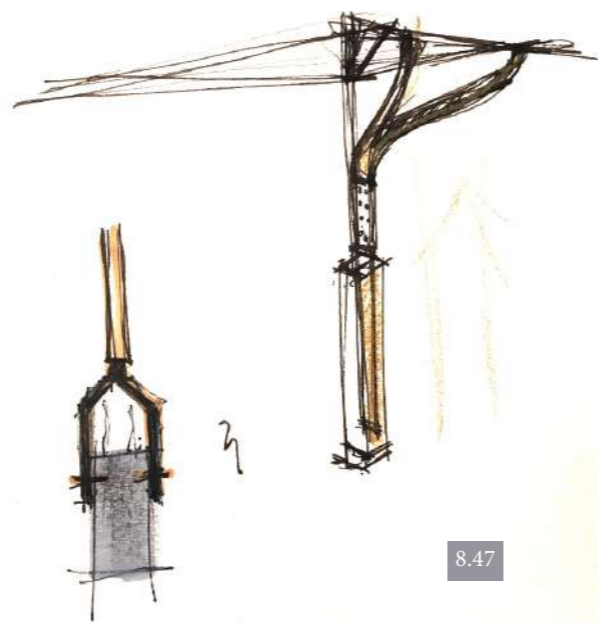

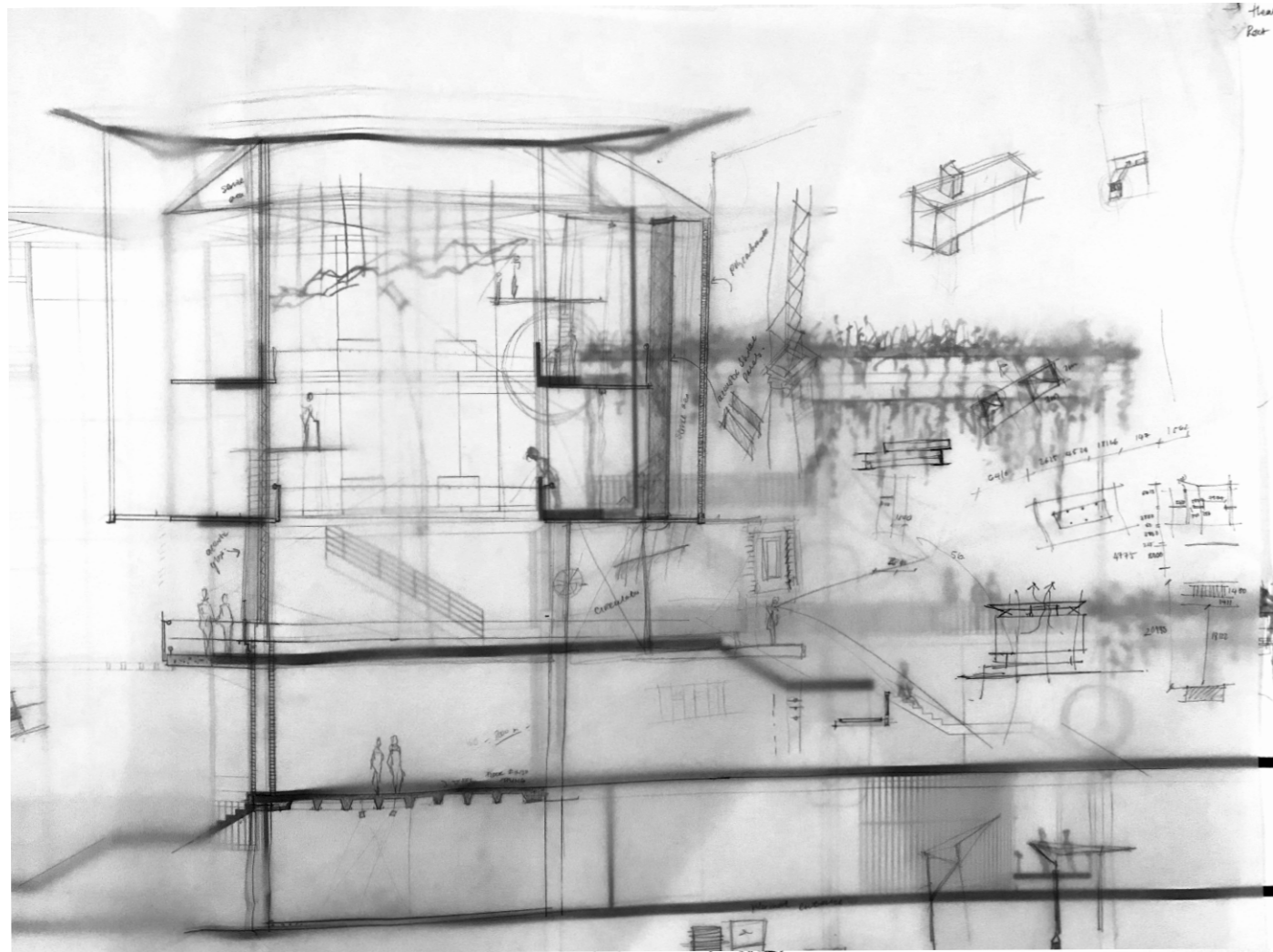

8.51

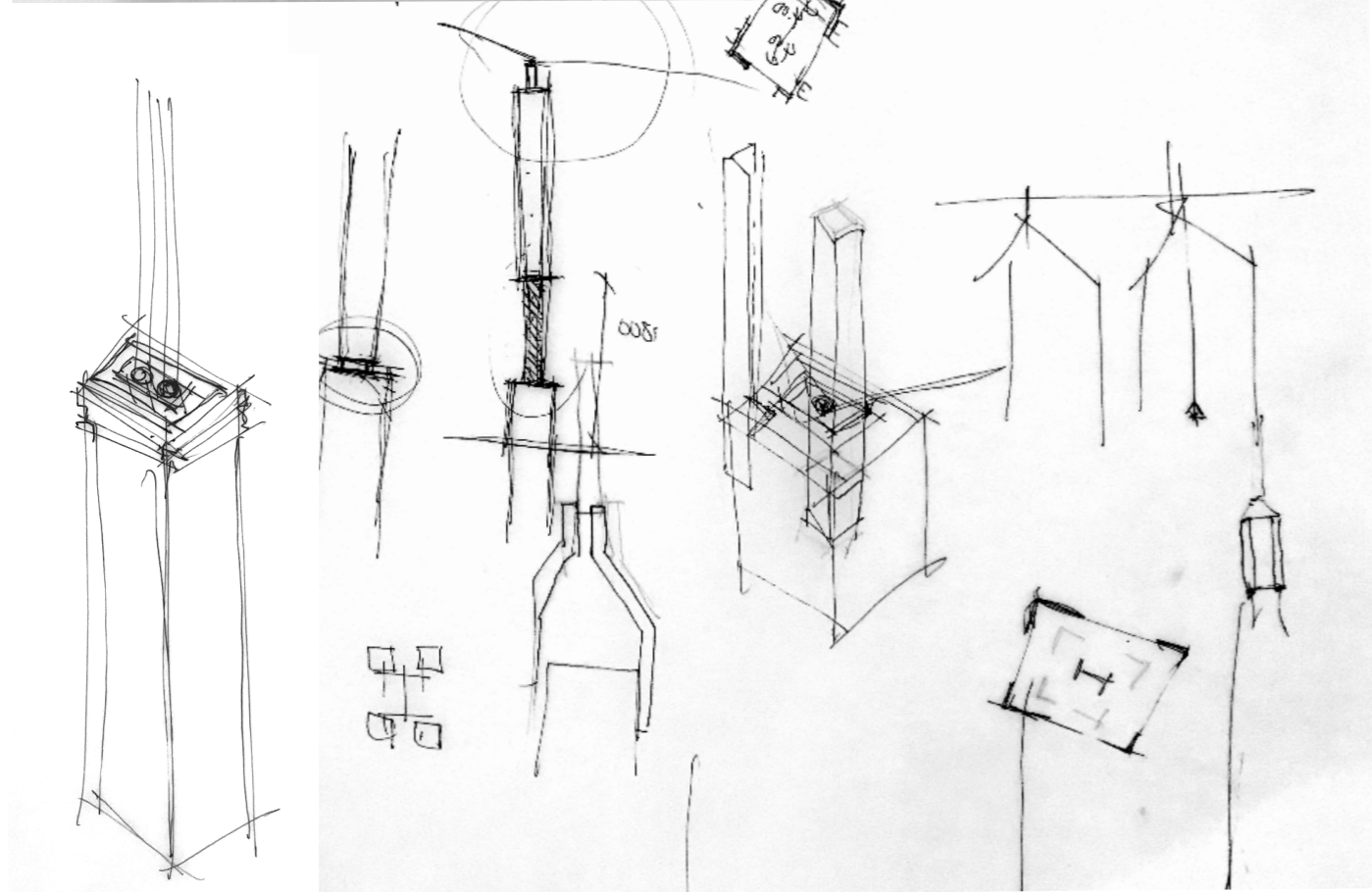

8.52

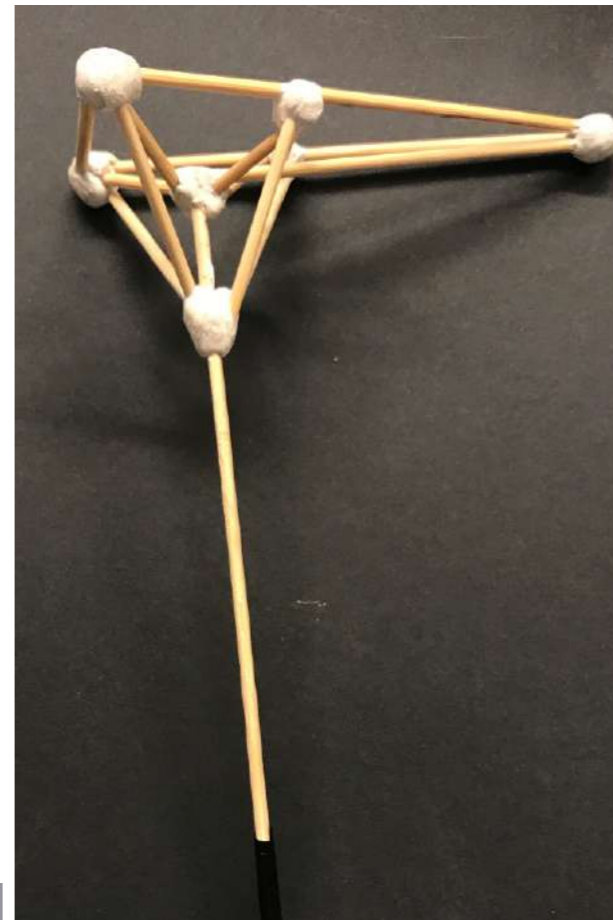

8.53

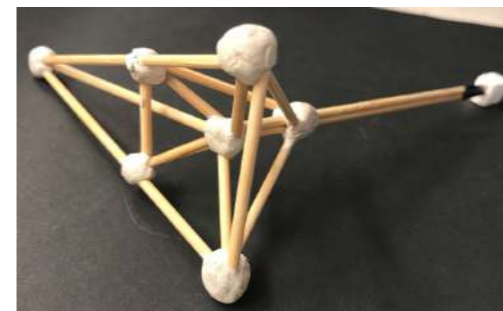
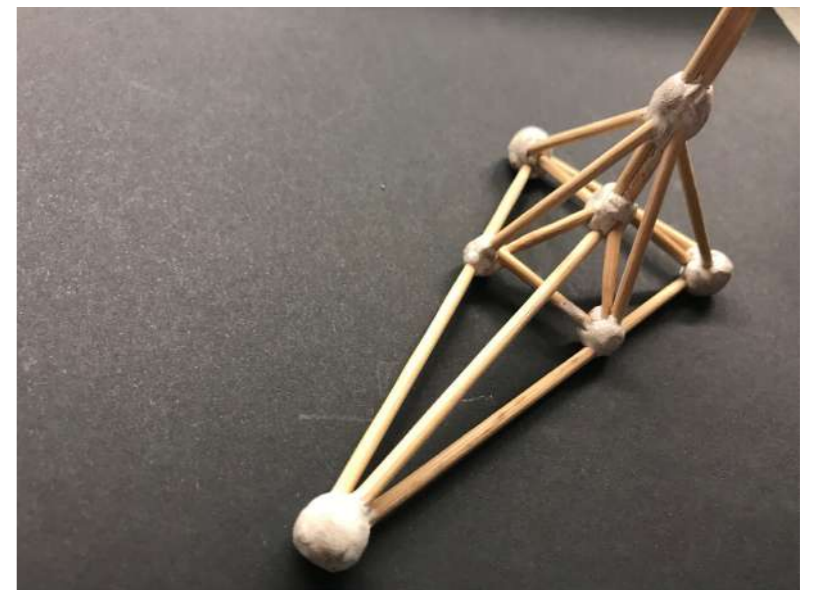

Fig 8.51- Iteration layers of 1:50 section of theatre box (Author, 2019).

Fig 8.52- Diagrammatic exploration of details (Author, 2019).

Fig 8.53- Exploration of column and roof structure (Author, 2019).





CHAPTER

CHAPTER 9

Design Resolution- Final Presentation

/

BUILDING IN CONTEXT

ADDITION TO SOUTH-EASTERN CORNER OF SAMMY MARKS BLOCK

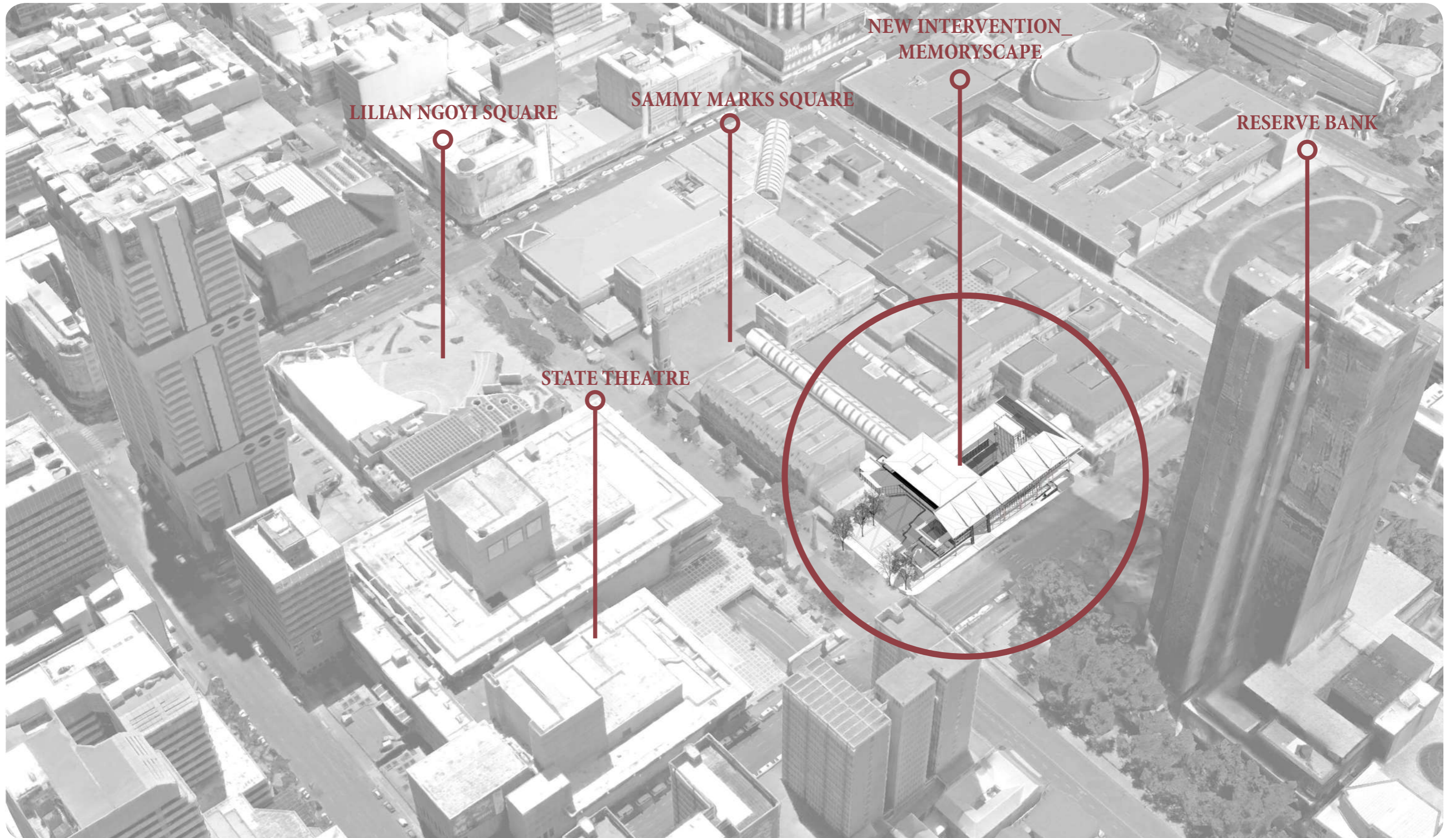

AXONOMETRIC VIEW OF BUILDING LEVELS

Scale 1:200

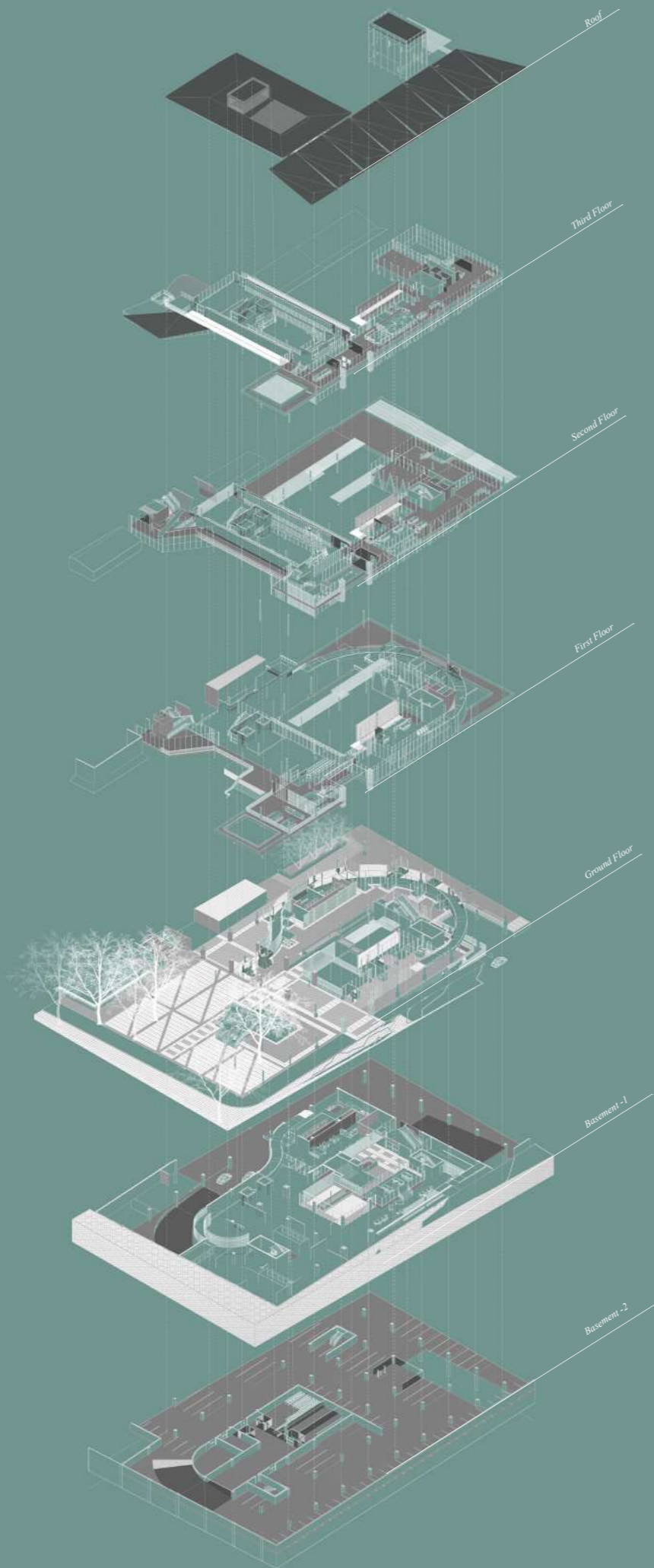

GROUND FLOOR PLAN

Scale 1:100

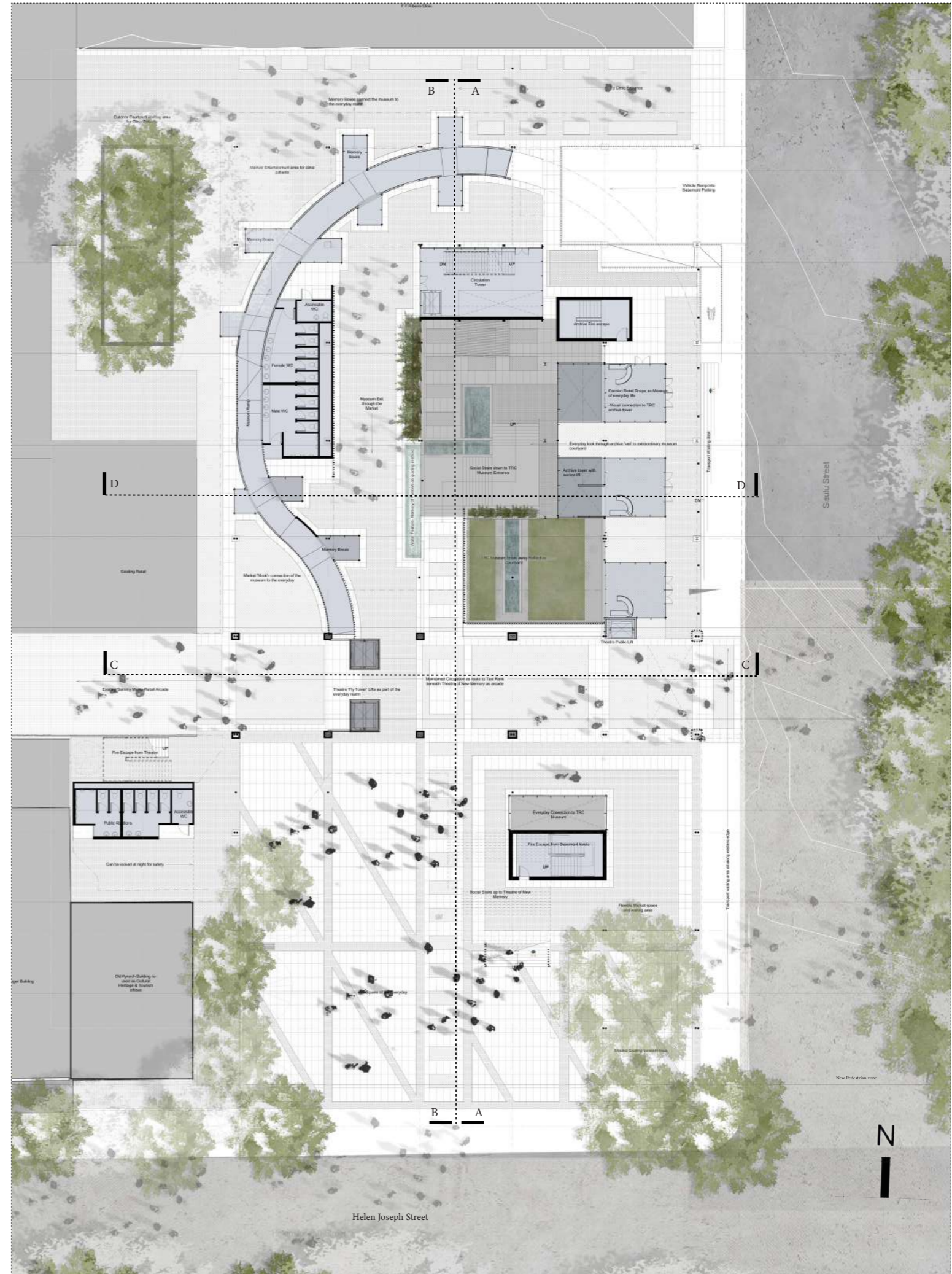

FIRST FLOOR PLAN

Scale 1:200

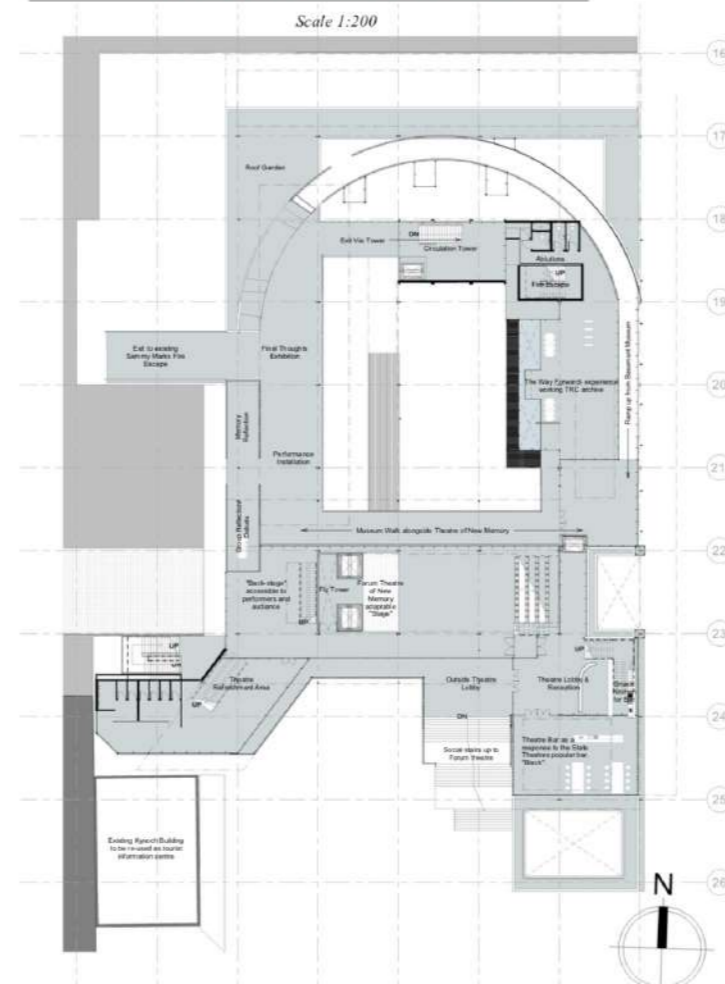

SECOND FLOOR PLAN

Scale 1:200

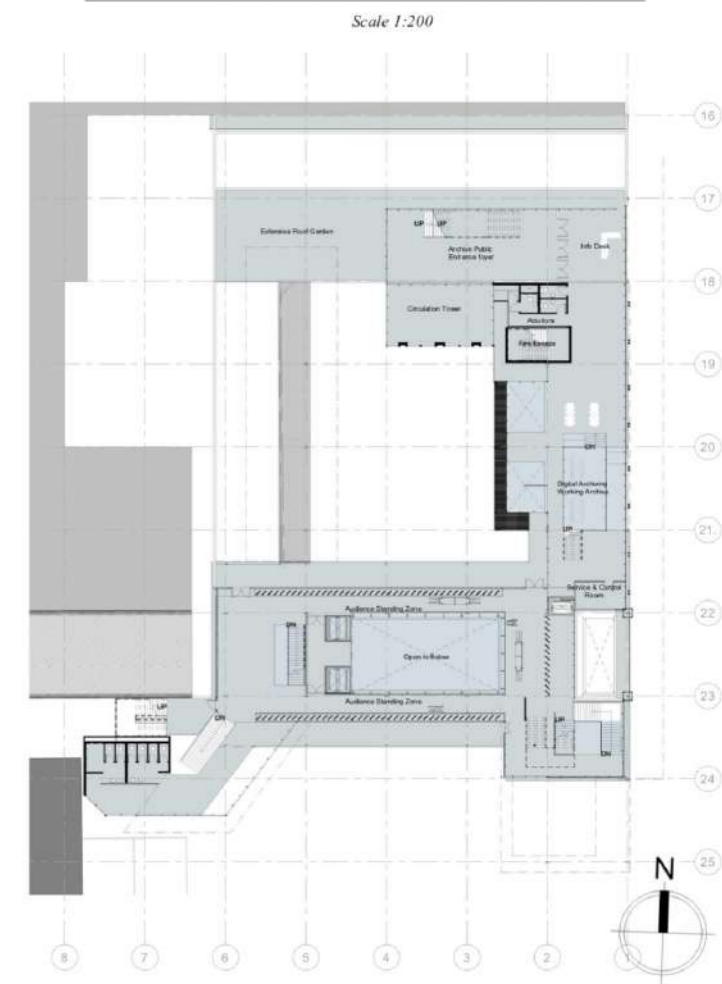

THIRD FLOOR PLAN

Scale 1:200

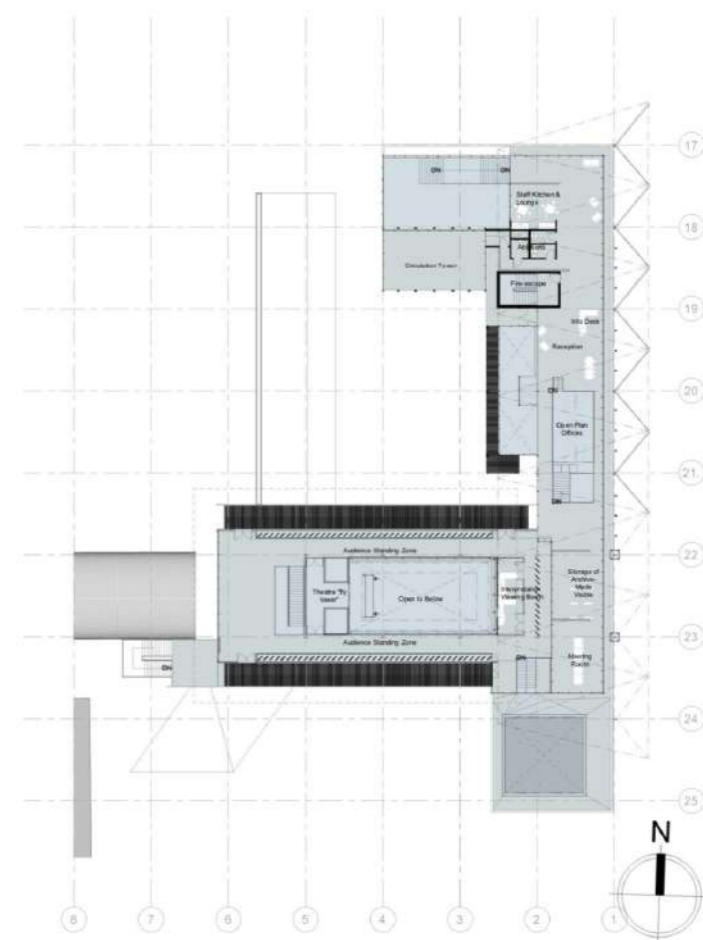

BASEMENT - 2 PLAN

Scale 1:200

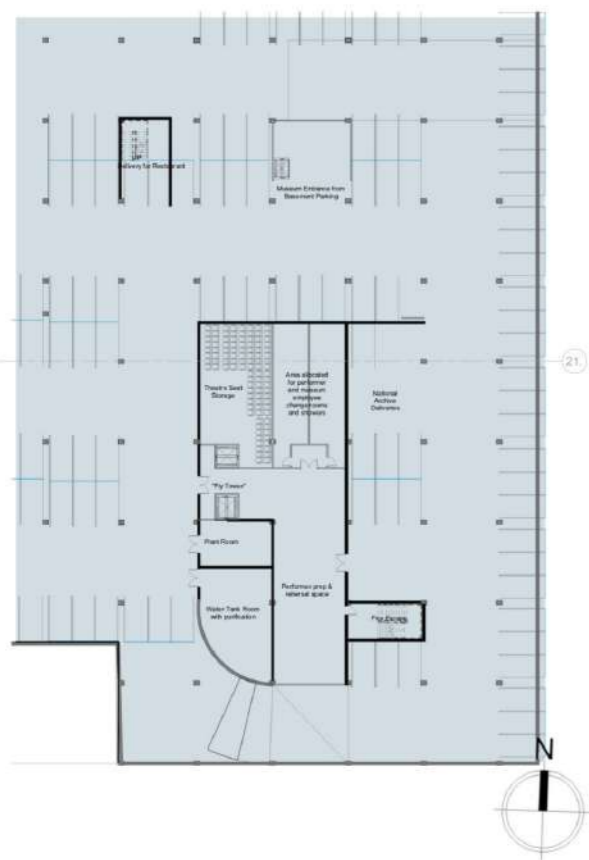

BASEMENT - 1 PLAN

Scale 1:200

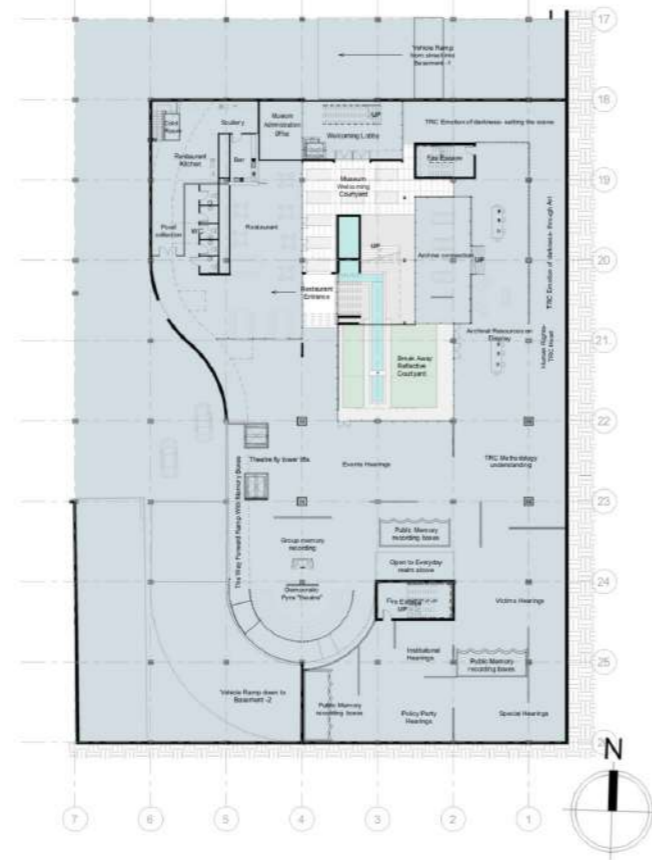

SECTION A_ Scale 1:100

Section through the memory boxes, museum courtyard and Theatre of New Memory looking towards the East



SECTION B_ Scale 1:100

Section through the memory boxes, museum courtyard and Theatre of New Memory looking towards West

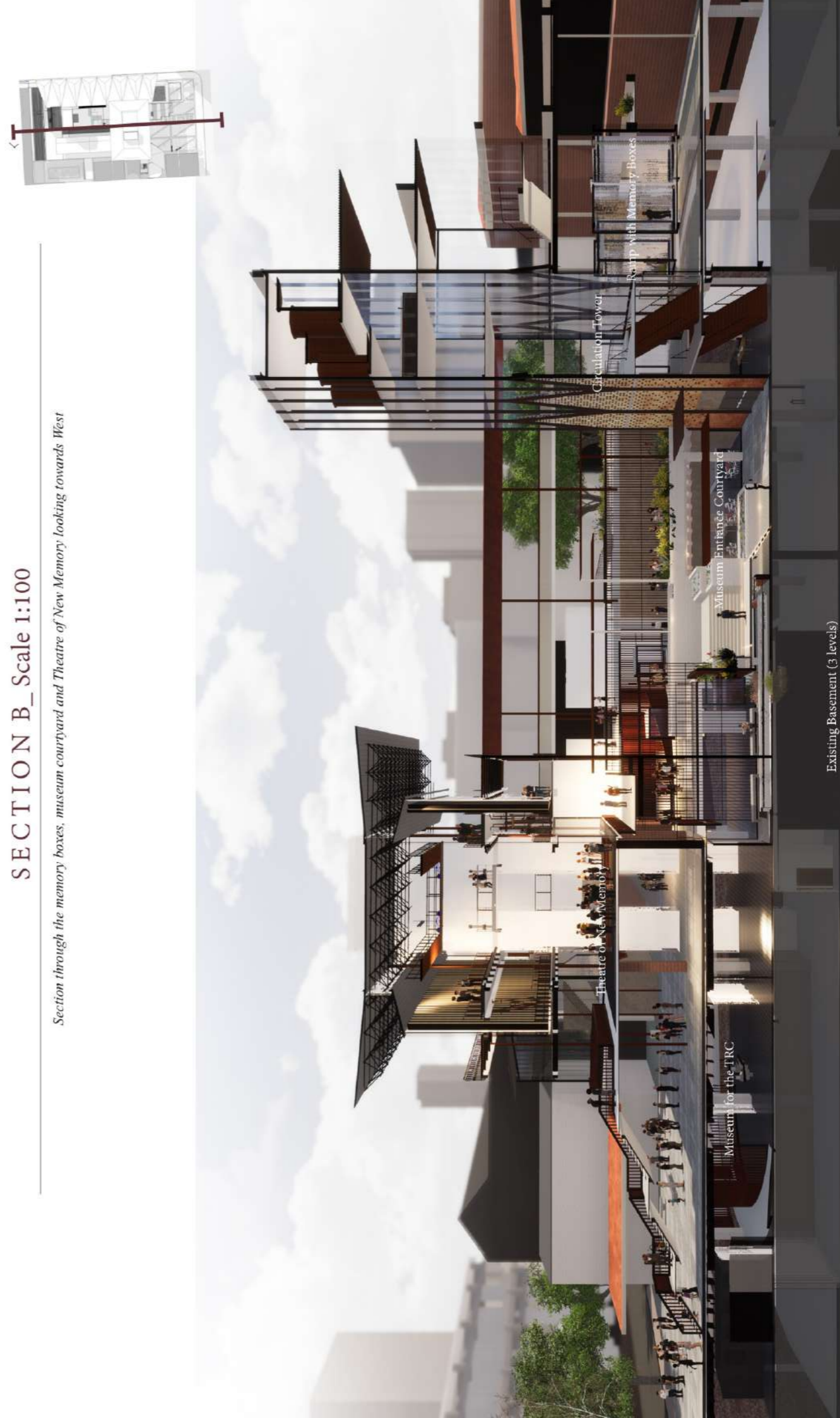

SECTION C_ Scale 1:100

Section through the Theatre of New Memory and the Digital Archive, showing theatre "Fly Tower" connecting to Basement -2

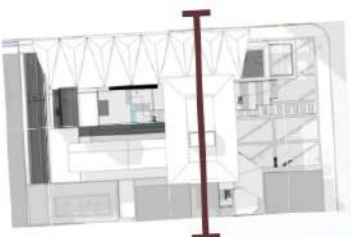

SECTION D_ Scale 1:100

Section through the museum exit through the market, courtyard and Digital Archive. Showing Museum Restaurant in B1

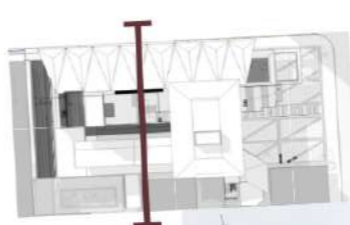

MUSEUM COURTYARD OF RELIEF

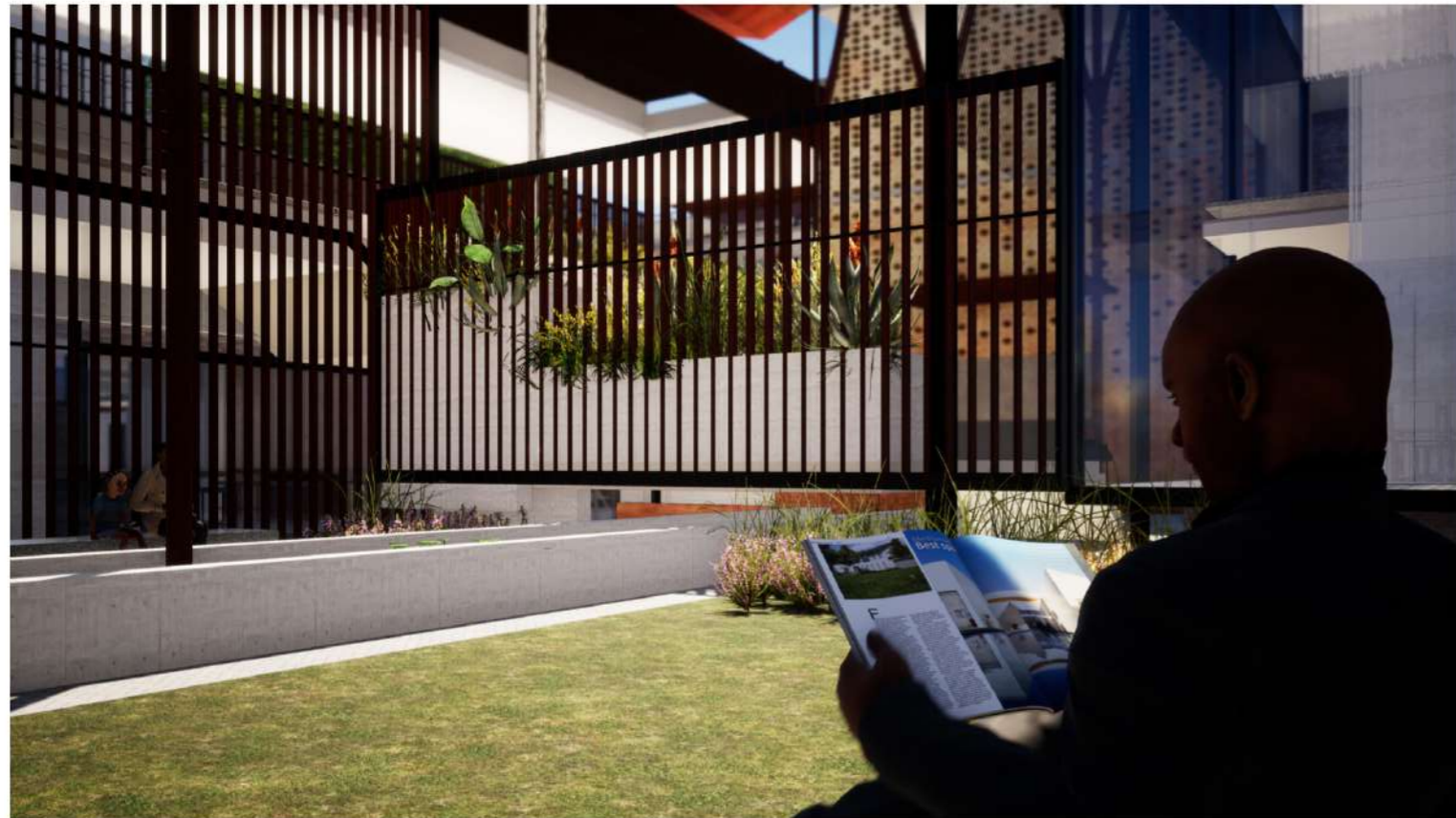

MUSEUM AND RESTAURANT ENTRANCE COURTYARD AT NIGHT



MUSEUM COURTYARD OF RELIEF

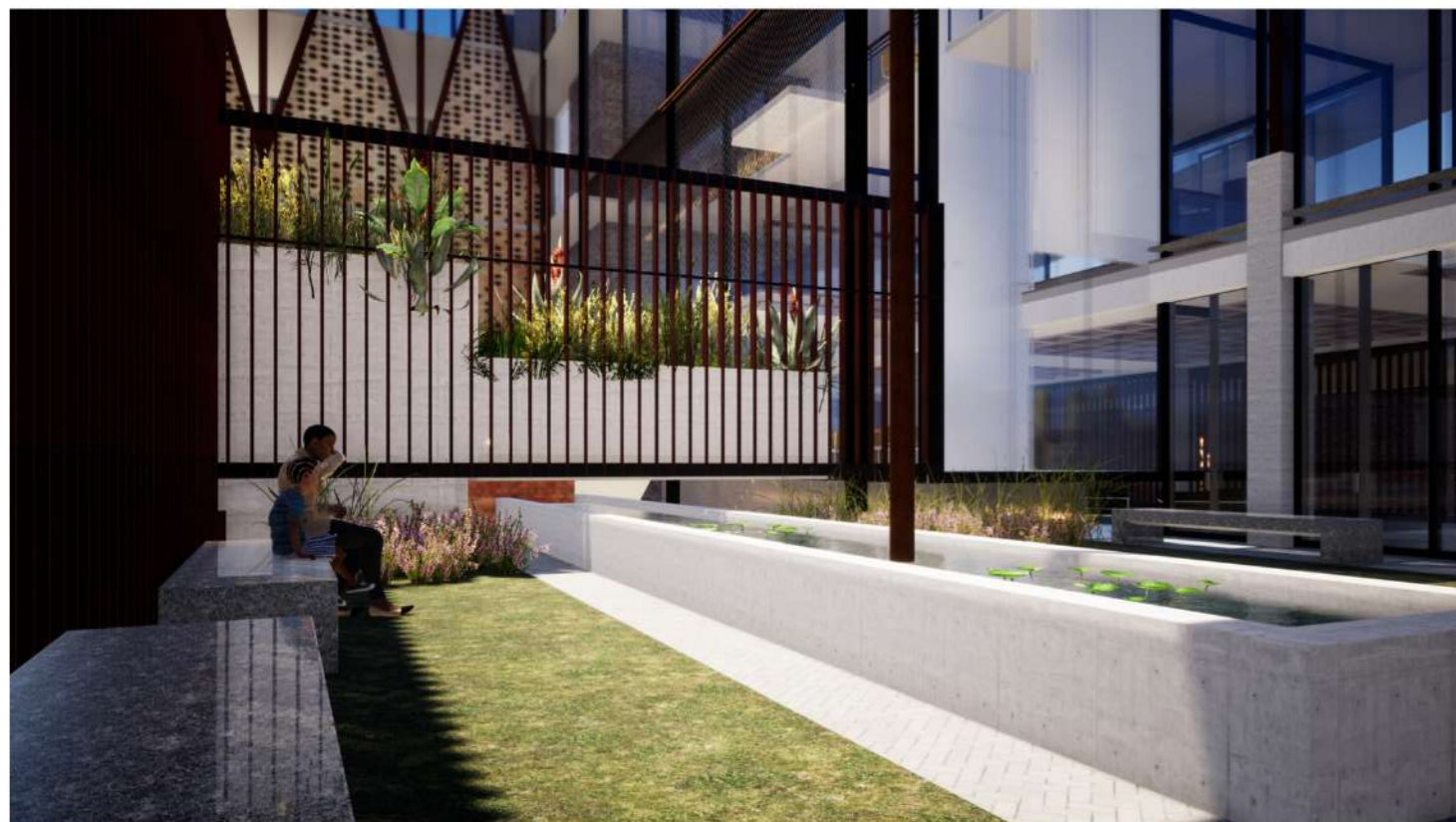

THEATRE BAR (OPPOSITE THE STATE THEATRES' BAR) AT NIGHT OVERLOOKING CEREMONIAL BOULEVARD



LEVEL THREE OF THEATRE OF NEW MEMORY SHOWING SPACE FRAME ROOF



NEW WAITING AREA FOR THE EXISTING CLINIC - VIEWS TO INTO THE MUSEUM THROUGH MEMORY BOXES



VIEW OVER LEVEL THREE BALCONY ONTO MAIN THEATRE STAGE LEVEL

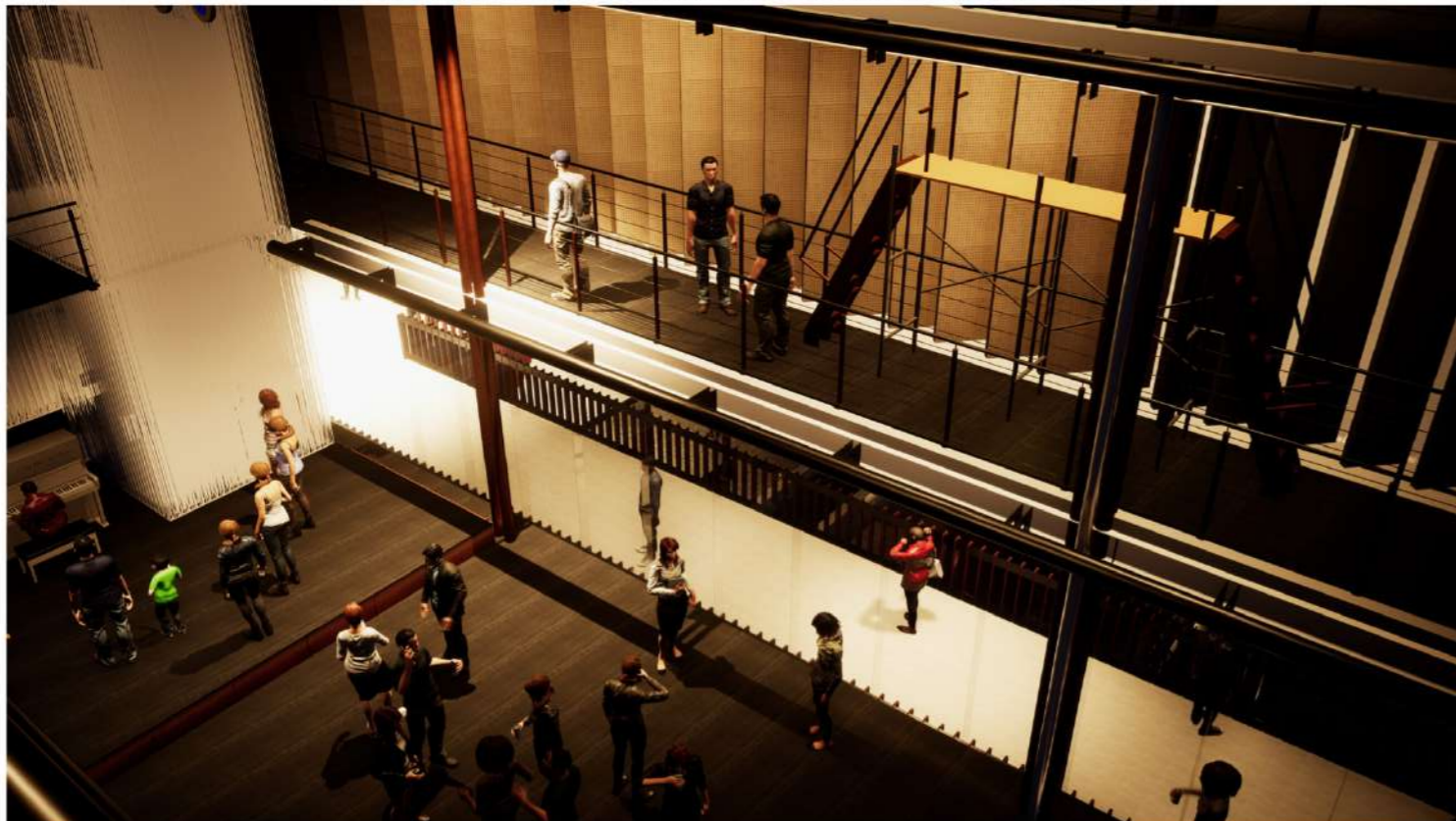

TOWARDS THE TRC MUSEUM ENTRANCE WITH MUSEUM 'EXIT THROUGH THE MARKET' TO THE LEFT



SQUARE OF THE EVERYDAY

View onto the Square of the Everyday - how the building opens up to the Ceremonial Boulevard.



TOWARDS THEATRE OF NEW MEMORY

View across the Square of the Everyday towards entrance stair for the Theatre of New Memory.

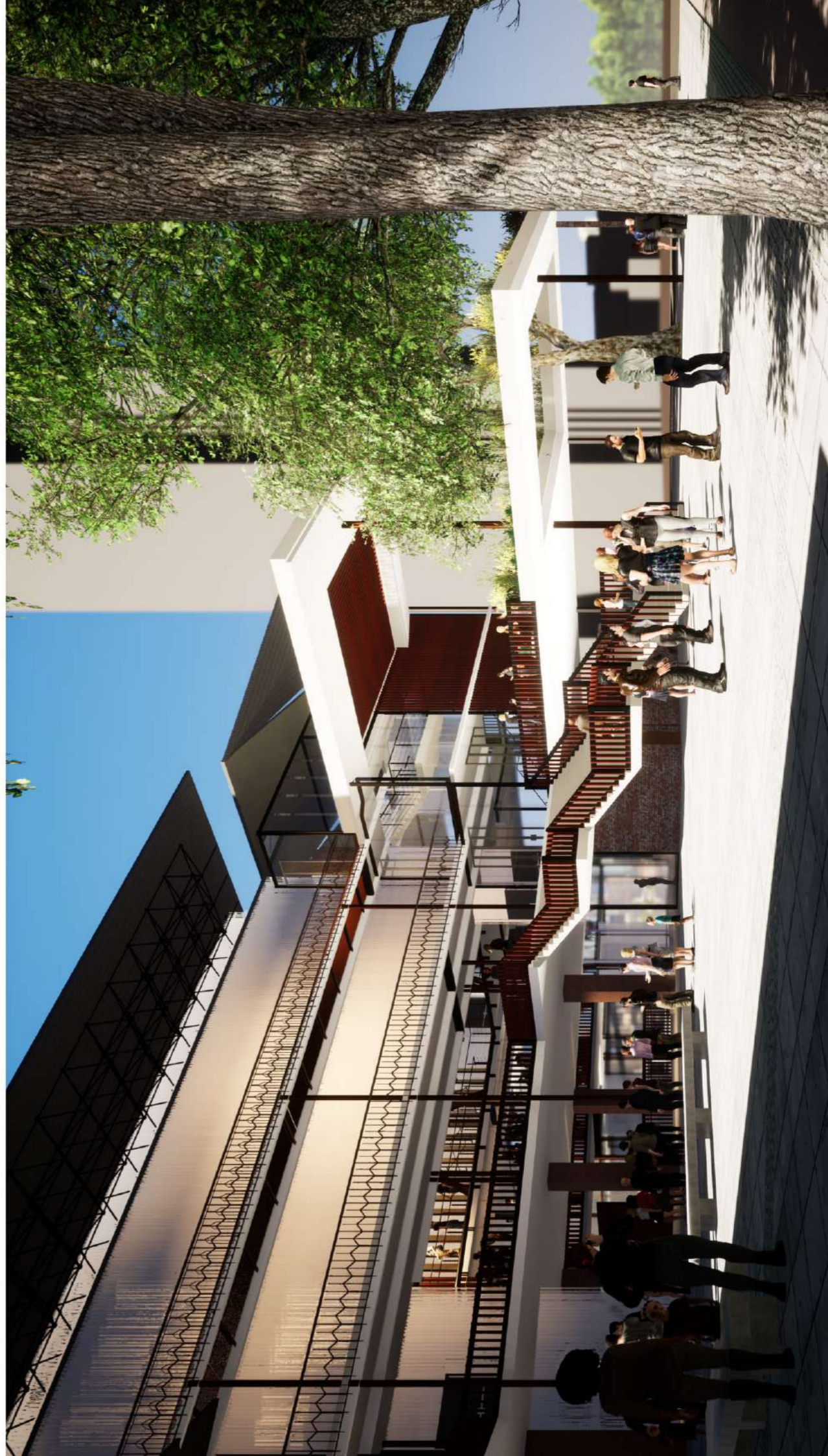

EXTRAORDINARY CONNECTIONS TO THE EVERYDAY

Museum visual experience as part of the everyday realm.



LAYERED PUBLIC SPACE

View looking down into entrance courtyard from top floor of the public Theatre of Memory circulation bridge.



THE MUSEUM ENTRANCE STAIR

Expressing the historical water furrows layer on site, the entrance experience gradually immerses the user into the site through the guiding presence of water



EXIT THROUGH THE MARKET

View looking down from Museum walk onto the exit through the market (market to be appropriated by young fashion entrepreneurs)



MUSEUM EXPERIENCE FROM DARKNESS TO LIGHT

The Narrative of the Museum for the TRC experience



FACADE DETAILING

Narrative of darkness to light through materiality and detailing

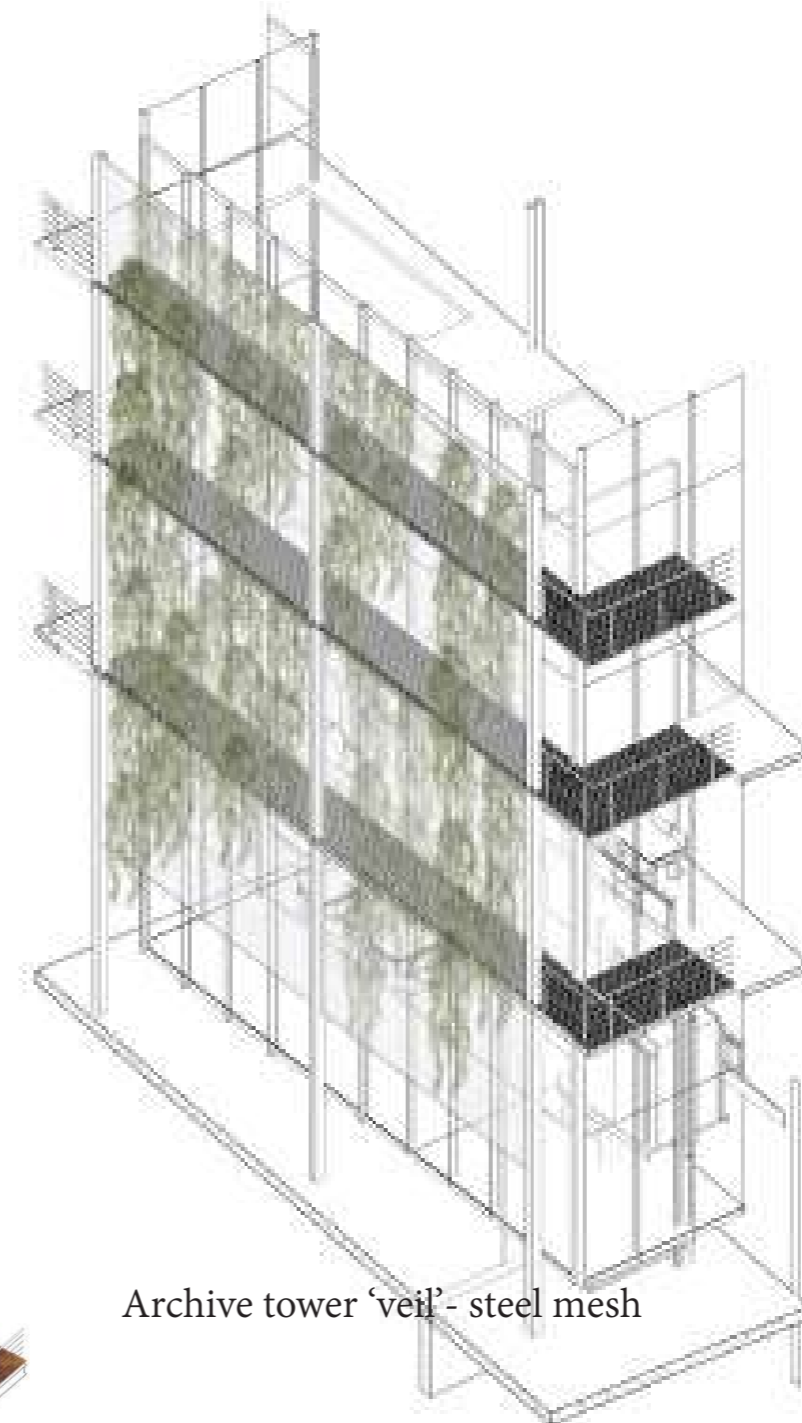
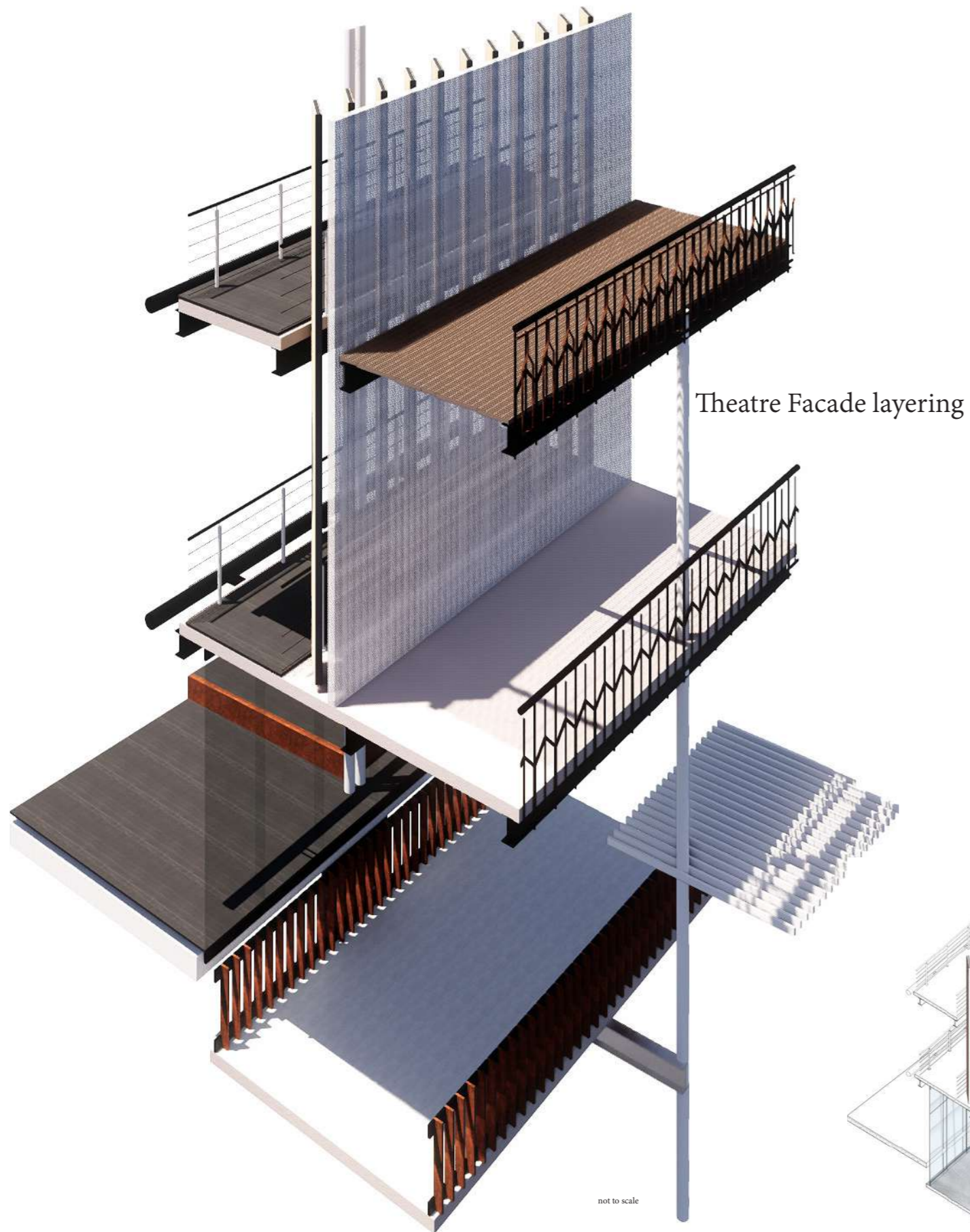

Materiality of Circulation tower

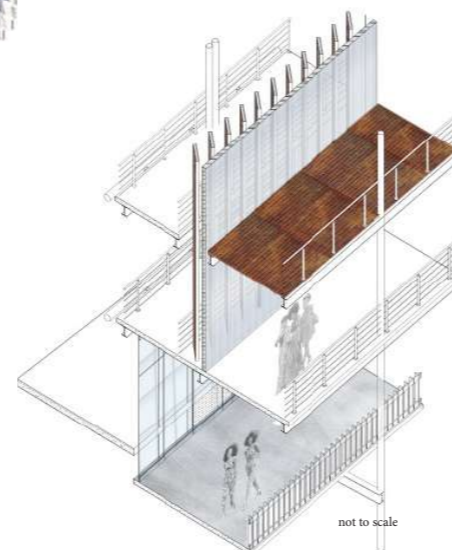
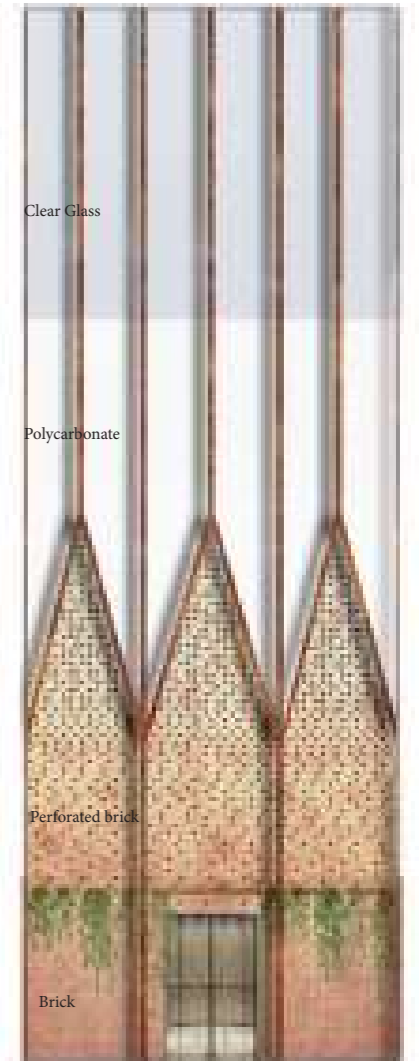

Previous iteration of Theatre layers- expression of memory

Materials- from darkness to light

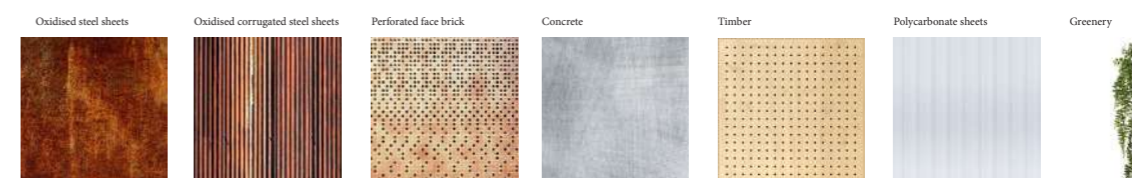

COLUMN DETAILING AS AN EXPRESSION OF OLD AND NEW MEMORY

The Narrative of the building being set free from the constructs of the existing structure

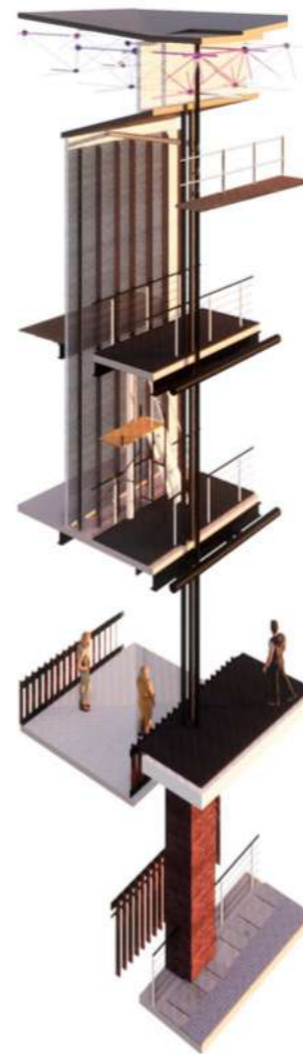
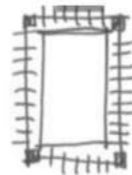

THEATRE COLUMNS

Expression of the new building taking control of the existing site structure and being allowed to be 'free' inspired by scaffolding - adaptability



EASTERN FACADE

Expression of the new building taking control of the existing site structure

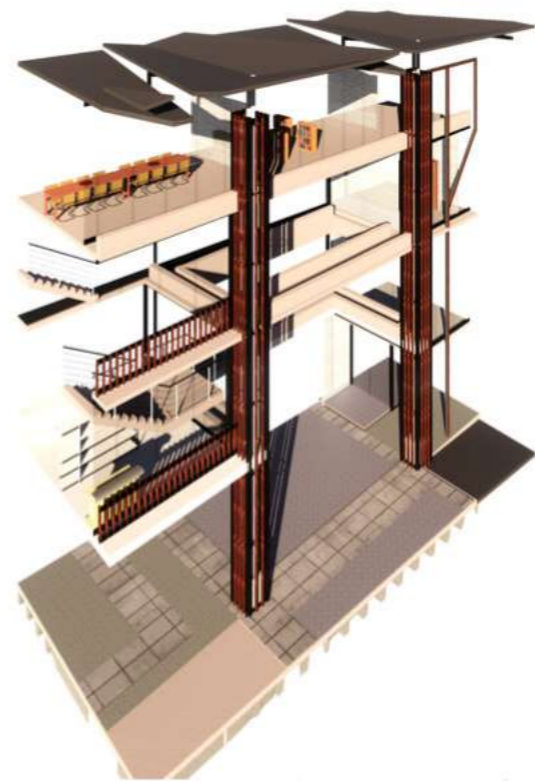

THEATRE 'ENTRANCE'

Expression of new memory covering the old but not concealing it - like a veil



MUSEUM COLUMNS

As an expression of the victims of apartheid's names acting as the 'ghosts' that exposed the past human rights violations victims names to be engraved onto glass veil

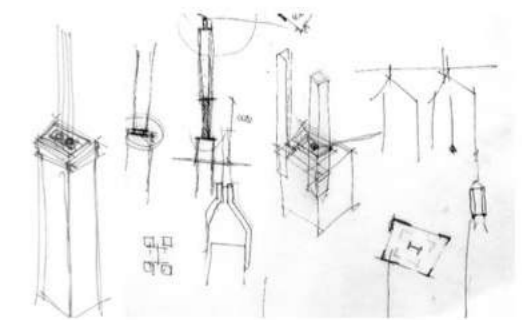

TECHNICAL SECTION THROUGH THEATRE OF NEW MEMORY

Scale 1:50

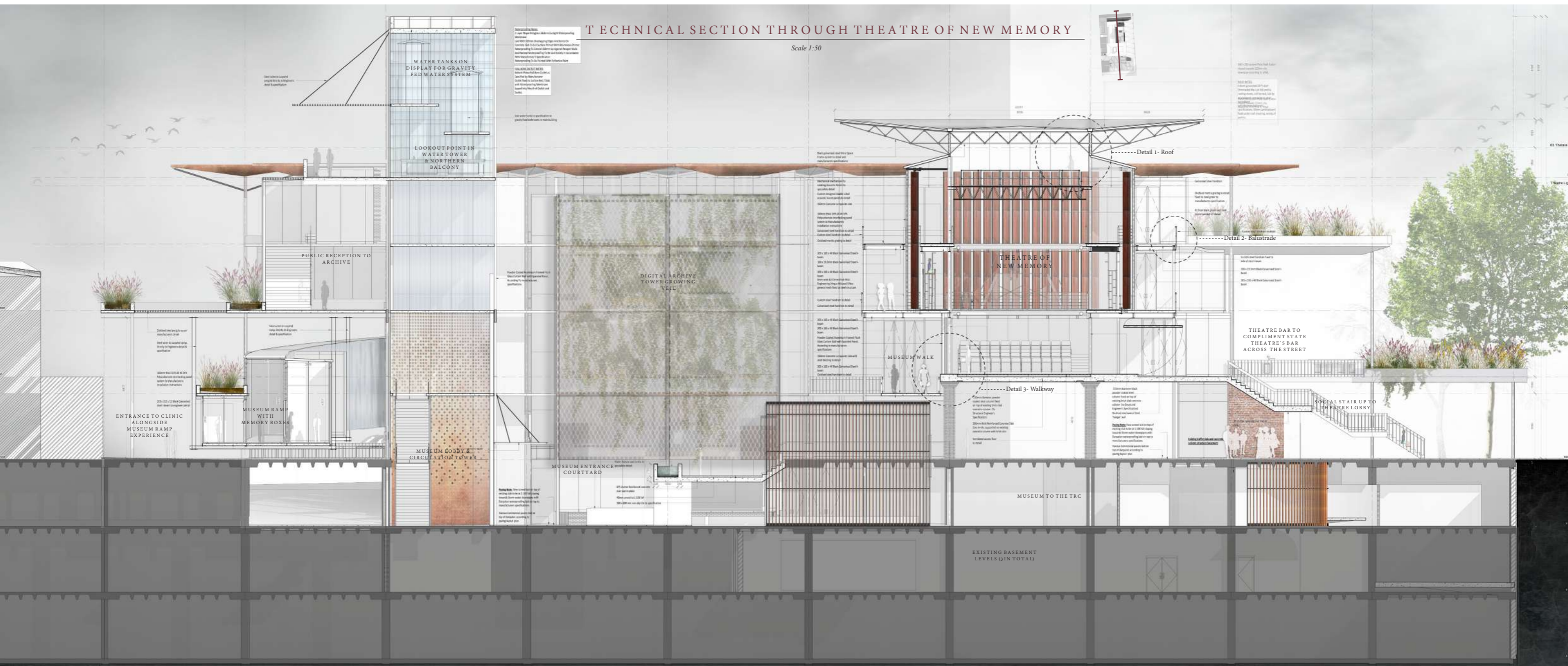

DETAILING

Narrative of darkness to light through materiality and detailing

DETAIL 1- ROOF

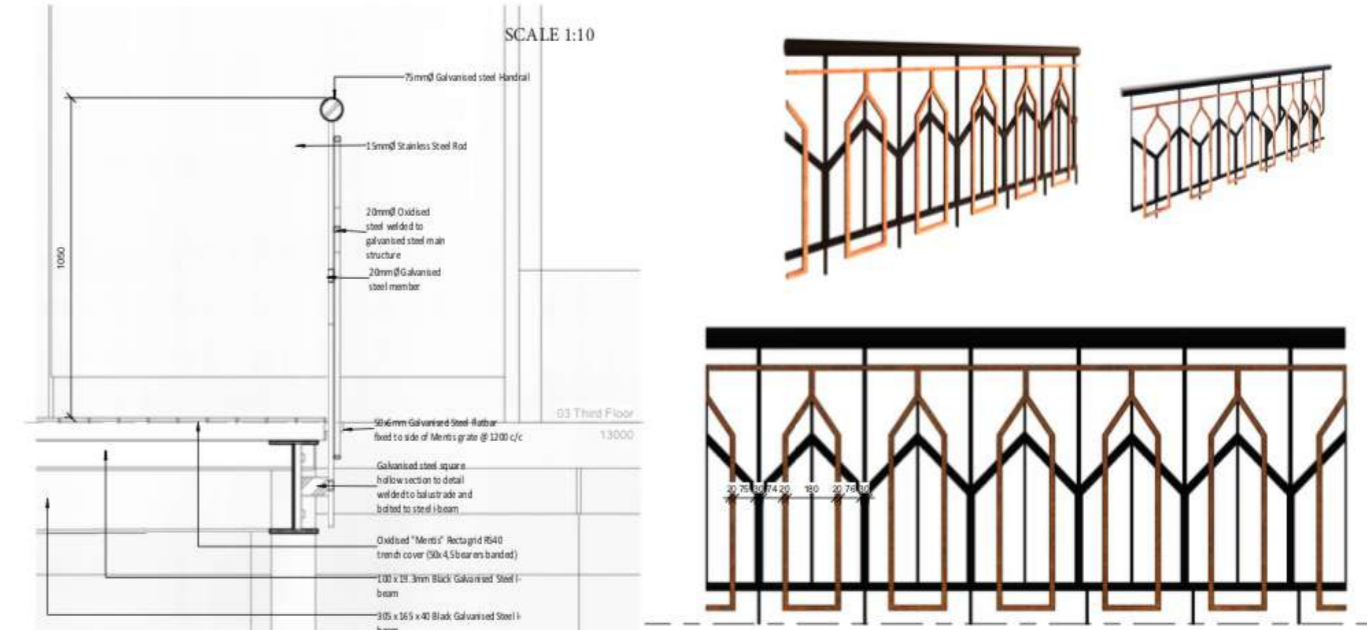
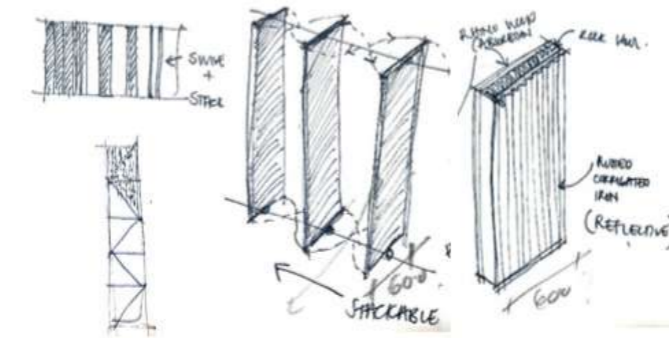
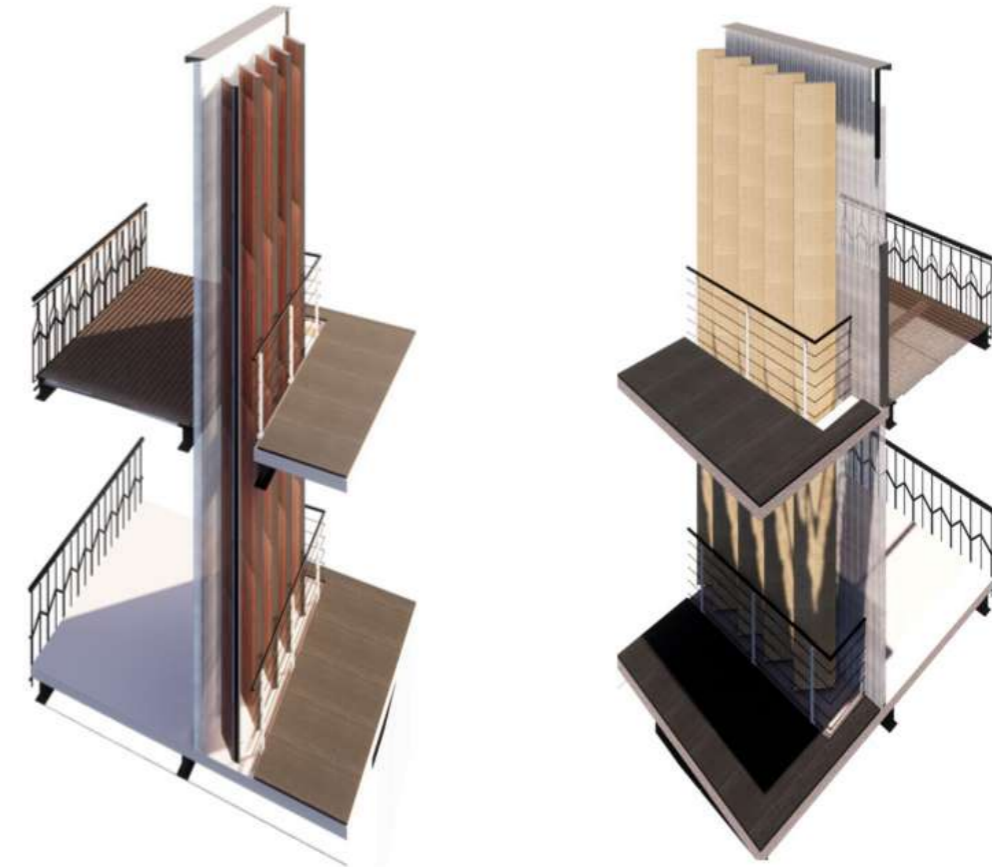
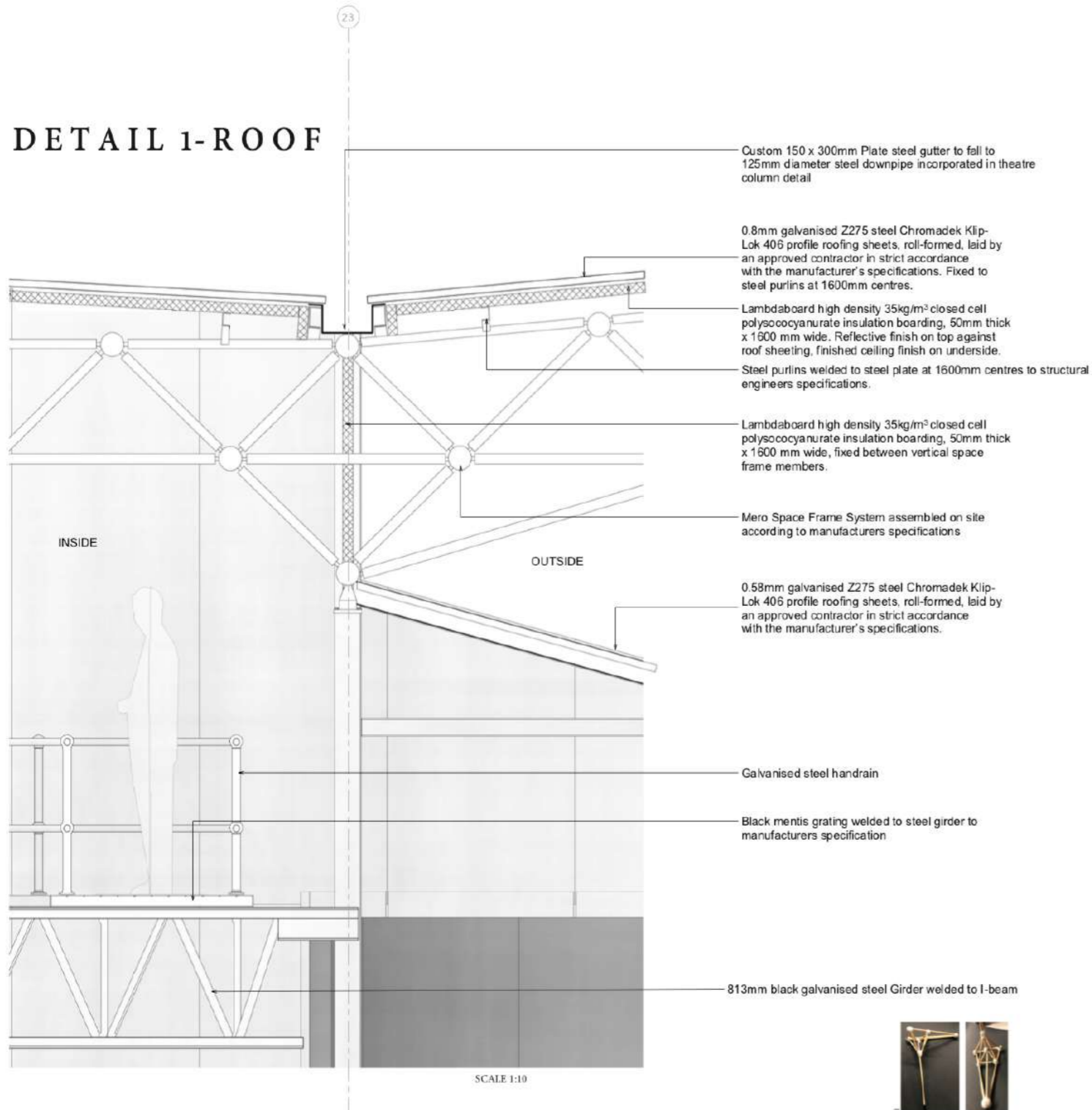

DETAIL 2- BALUSTRADE

The relation of programme to space

DETAILING

Narrative of darkness to light through materiality and detailing

DETAIL 3- MUSEUM WALK

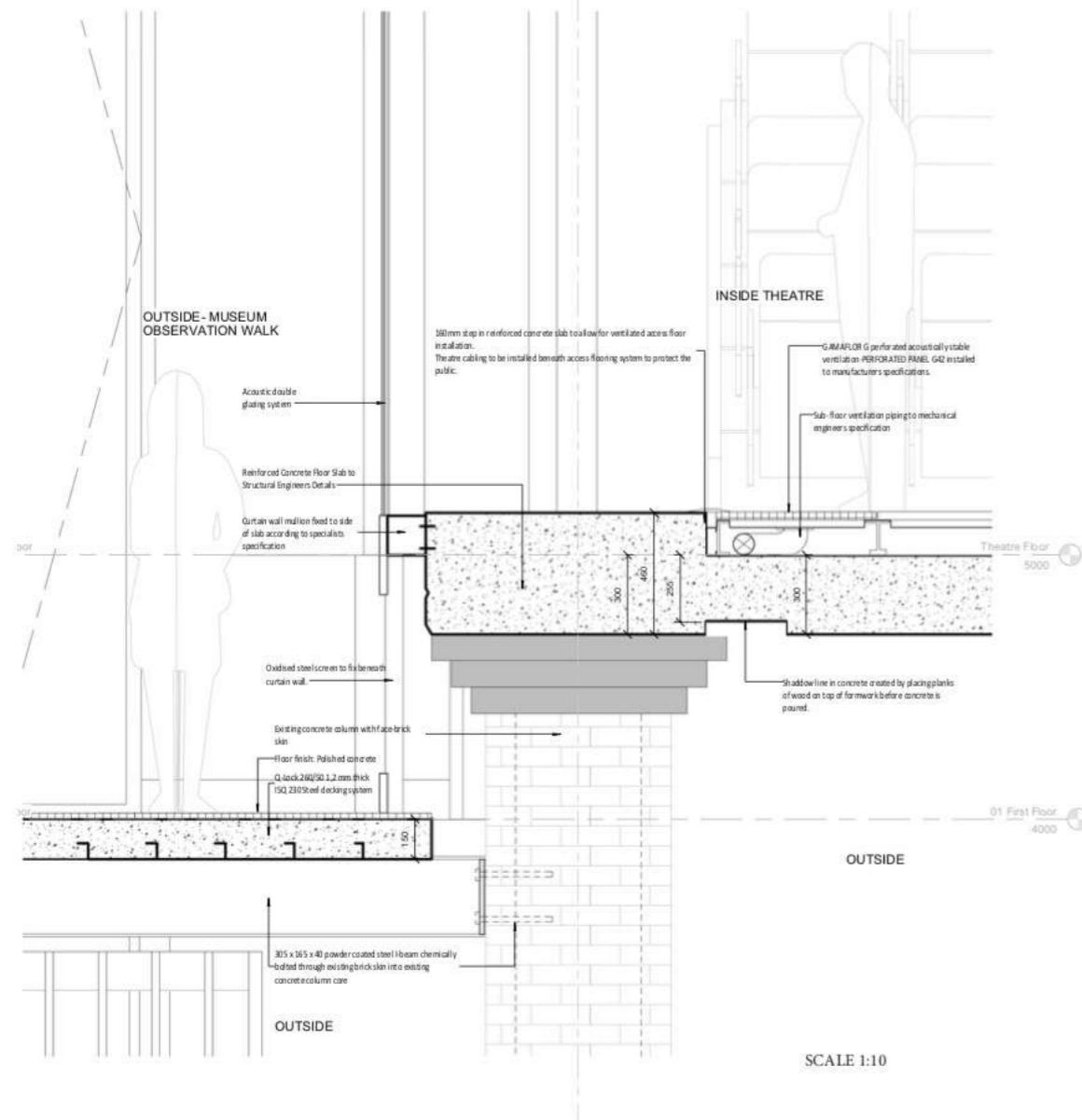

- Tower
- Museum
- Archive
- Theatre

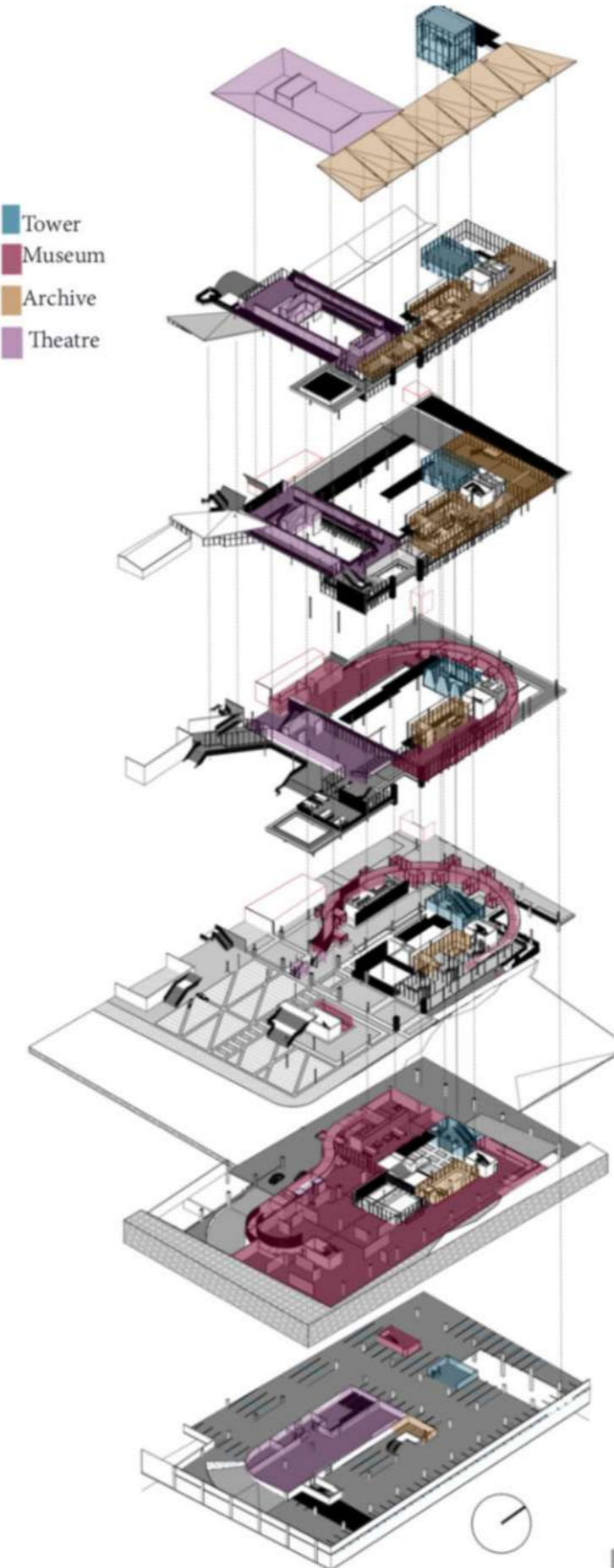

ELEVATIONS

scale 1:200

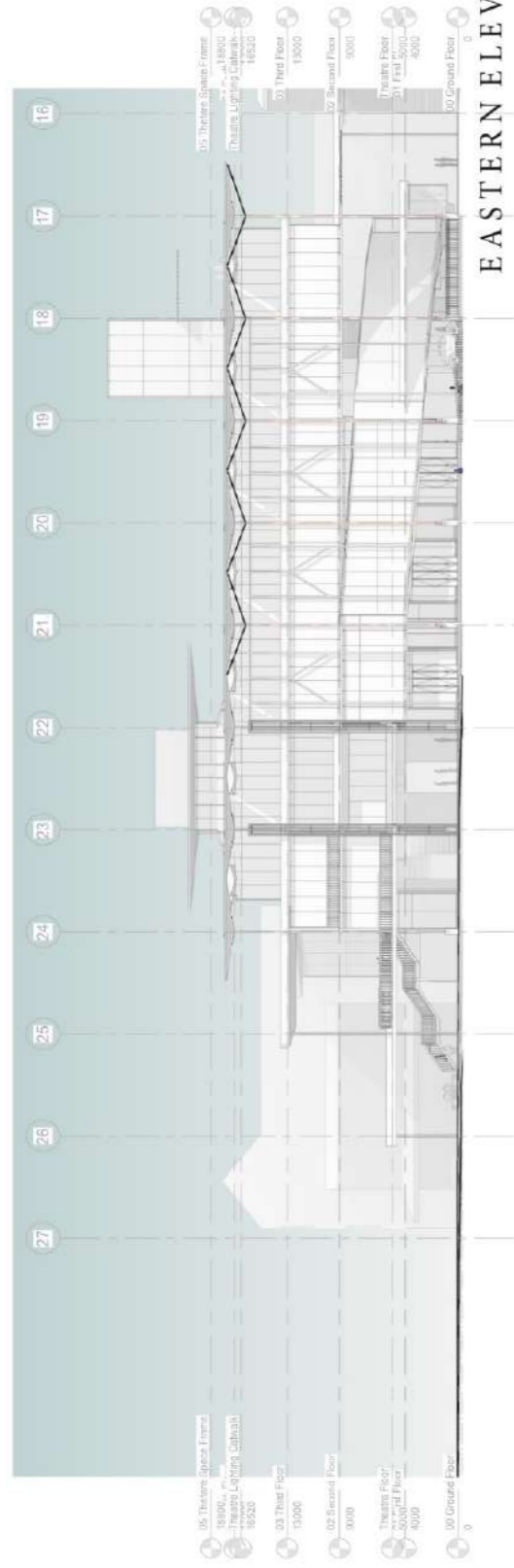

EASTERN ELEVATION

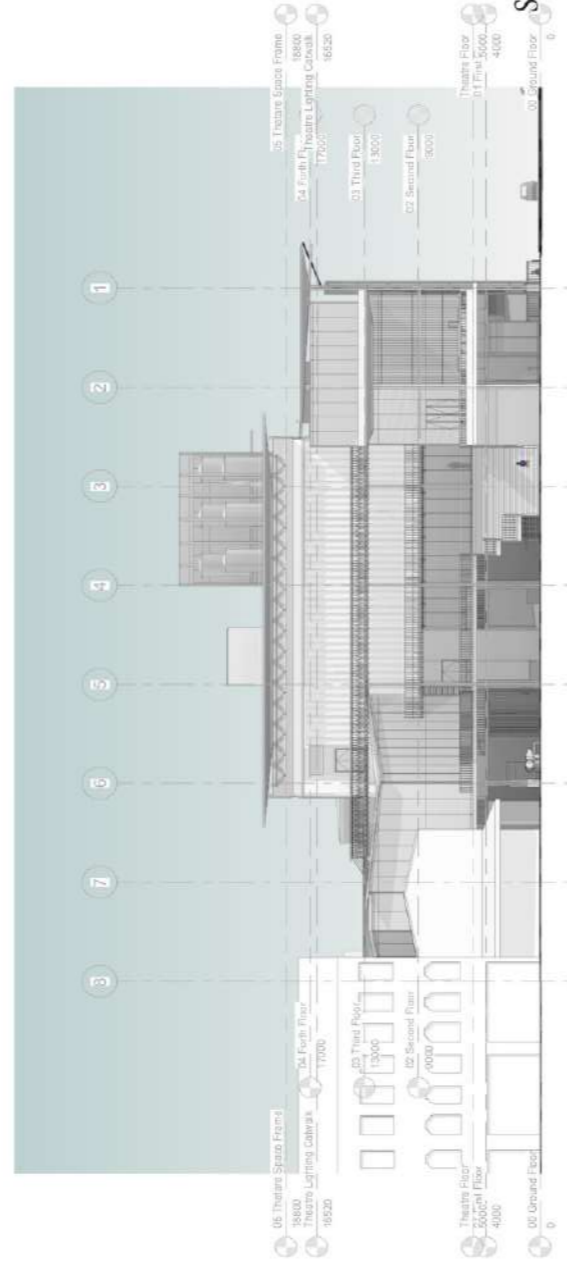

SOUTHERN ELEVATION

ENVIRONMENTAL

Water collection, shading

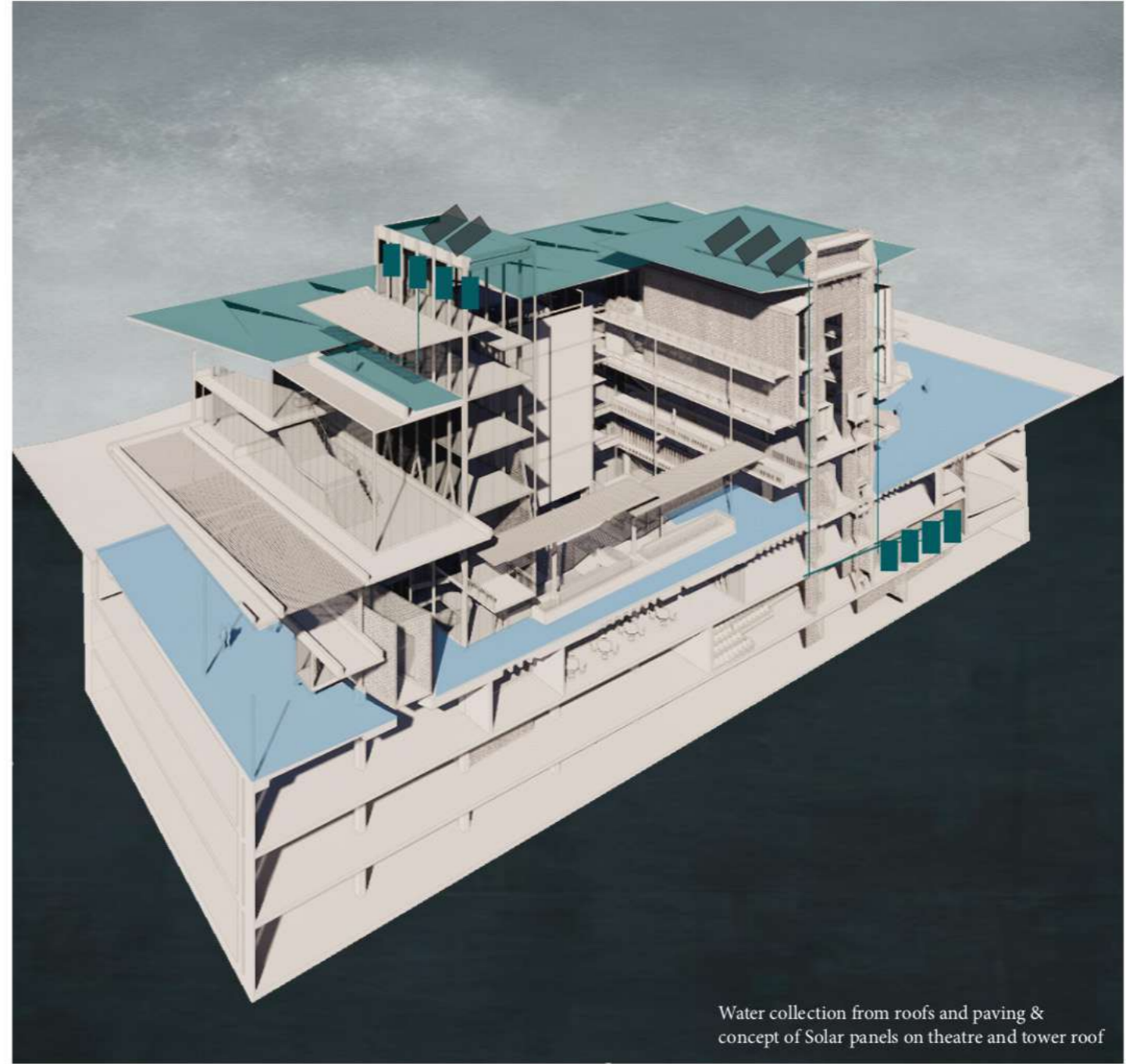

Water collection from roofs and paving & concept of Solar panels on theatre and tower roof

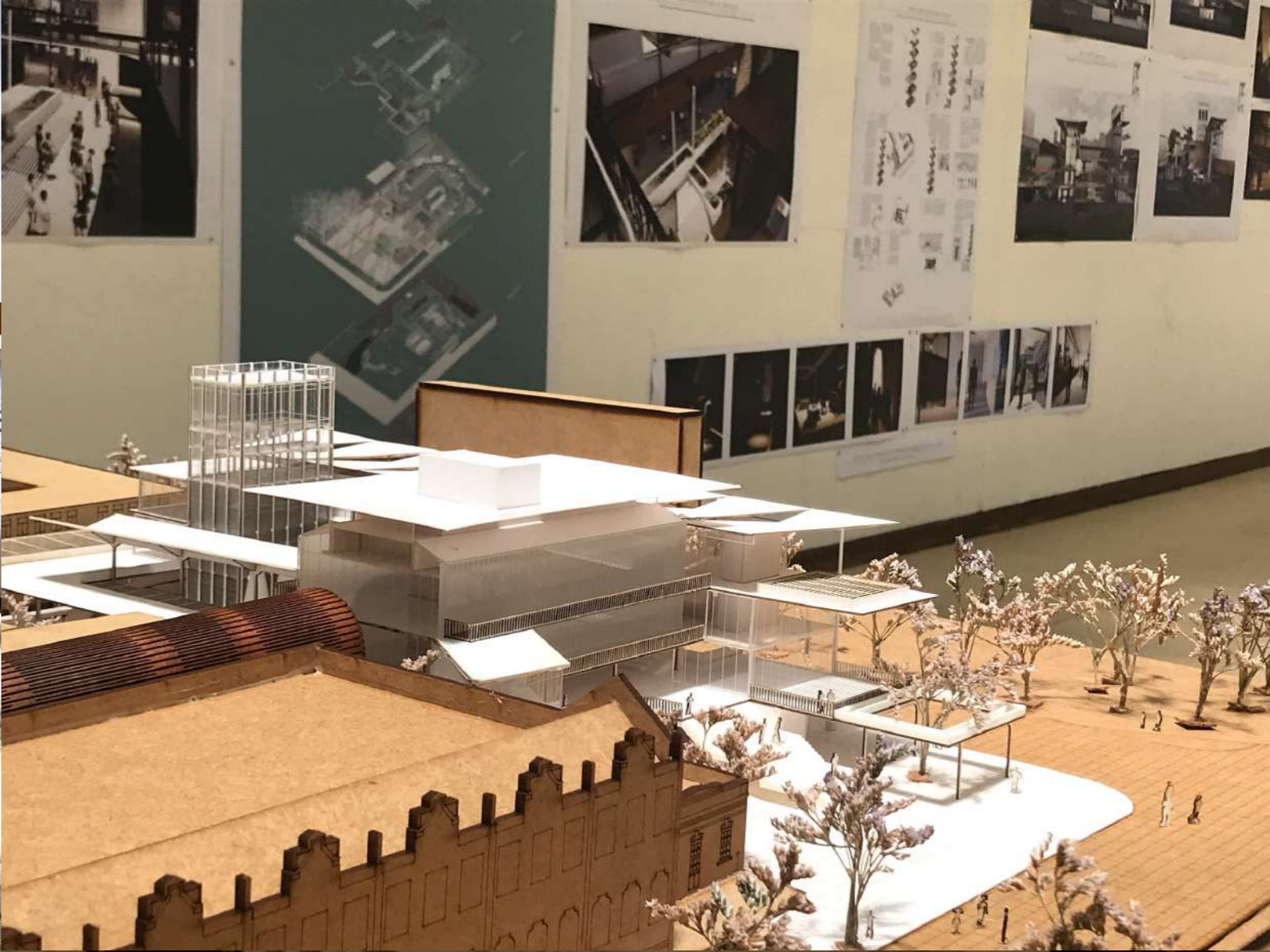



CHAPTER 10

Conclusion

/

The intention of this dissertation was to investigate a contextually driven democratic museum typology that is relevant to and serves the community in which it is located.

Guided by the Truth and Reconciliation Commission (TRC) as the subject matter of choice, the goal of the museum design is to embody the principles of the TRCs lost memory – namely ‘transparency’ and ‘translation’ – in order to re-establish the importance of what the TRC did for South Africa as a young democracy attempting to move forward and away from Apartheid.

The TRC acted as a platform for deliberations on the past, which contributed to liberating the present and future. Similarly, the dissertation sought to explore how a contextually driven typological approach to museum making could contribute to releasing a nation from a past of darkness and oppression into a future of transparency and light.

The project explored an approach to museum making via contemplating the relevance of the TRC and its principles of openness and transformation vis-à-vis the everyday lives of the ordinary citizens of Pretoria and the users of the site, given the circumstances. The design approach integrated the extraordinary nature of the TRC into the ordinary nature of the daily activities on the site by way of assimilating the everyday person with the museum. In this way, the man and woman in the street become an integral part

of the TRC and the democratic narrative. The proposal was driven by the current circumstantial urban conditions in and around the Sammy Marks block in the Pretoria CBD in addition to historical site memories.

The expression of ‘deep memory’, which arises from dealing with a subject matter such as the TRCs main focus, is best expressed through performance as a healing method. The museum took on a multi-programmatic approach by specifically viewing the typology of the museum through the TRCs centre of attention.

The proposed architecture for a TRC museum – considered through the lenses of ‘translation and transparency’ – called for a multi-programmatic approach that could express the TRCs history, facilitate public archival access, public performative deliberation and the manifestation of today’s democracy.

Being a vehicle for openness and transformation, the material manifestation of the new architecture represents a democratic approach that ‘exposes’ the memory of the site whilst not causing any irreparable damage to its existing appearance. Keeping the distinction between old and new in mind is imperative. Furthermore, the structure is explored as liberating itself from the site. Just as the TRC acted as a medium through which people could be set free from the shackles of Apartheid, so the new building ‘liberates’

and ‘frees’ itself from the bondage of the site through the metaphor of the marionette.

The proposal explores the account of the TRCs intentions by offering continued healing to people 25 years later – through the creation of a memoryscape that chronicles the progression of time – from a dark past into a future of light. The manifestation of the narrative through a built form is explored through the memoryscape being structured as a performance. The performance explores a passage through time from the museum (past), through the everyday realm (present) and into the theatre (future) – all of which are governed by the archive (past, present and future).

By synthesizing the TRC report with the description of the context, the typological manifestation of a democratically relevant museum classification that nestles itself in the everyday has created an inclusive exhibit that is programmatically and socio-spatially relevant to the community it serves, answering the question “*How can museum typology in Architecture be adapted to suit the socio-spatial conditions of a specific context?*”.

“... to cultivate a sense of authentic and enduring meaning ... buildings must connect with the wider civic life and milieu from which they emerge and which sustains them”

(Slessor, 2012).



Photographs on this page by: Ashley Brook



Photographs on this page by: Simoni Veldsman



REFERENCES:

- Ayyldz, S., Ertürk, F, Durak, S., & Dülger, A., 2017. - Basic sciences agonize in Turkey! Importance of Typological Analysis in Architecture for Cultural Continuity: An Example from Kocaeli (Turkey). Turkey, IOP Publishing, pp. 1-15.
- Barker, A., 2019. Architectural design in historic contexts, Pretoria: University of Pretoria.
- Blofson, K., 2014. Intervale Out Loud: A Place-based Oral History Project, Vermont: Rubenstein School Masters Project Publications.
- Bollack, F. 2013. Old Buildings, New Forms: New Directions in Architectural Transformation. Monacelli Press
- Boshomane, P., 2016. 20 years after the TRC hearings South Africa's pain persists. [Online] Available at: <https://www.timeslive.co.za/sunday-times/opinion-and-analysis/2016-04-10-20-years-after-the-trc-hearings-south-africas-pain-persists/> [Accessed 20 November 2018].
- Boyer, M. C., 2012. Collective Memory under Siege: The Case of 'Heritage Terrorism'. In: C. G.
- Clack, T., 2011. Thinking Through Memoriscapes: Symbolic Environmental Potency on Mount Kilimanjaro, Tanzania. In: T. Myllyntaus, ed. Thinking Through the Environment: Green Approaches to Global History. s.l.: White Horse Press, pp. 115-134.
- Cole, C., 2010. Performing South Africa's Truth Commission. First ed. Bloomington(Indiana): Indiana University Press.
- Crysler, S. Cairns & H. Heynen, Eds. The SAGE Handbook of Architectural Theory. London: SAGE Publications Ltd, pp. 325-339.
- Deckler, T., Graupner, A. & Rasmuss, H., 2006. Contemporary South African Architecture in a Landscape of Transition. Cape Town (Western Cape): Double Storey Books.
- De la Rey, C. & Owens, I., 1998. Perceptions of Psychosocial Healing and the Truth and Reconciliation Commission in South Africa, Cape Town: University of Cape Town.
- De Leao Dornelles, L., Gandolfi, F. F., Mercader Moysno, M. d. P. & Mosquera Adell, E., 2017. 44. Between the lines of memory and places: Urban rehabilitation and sustainability in the process of preservation of the material-culture heritage in the city of La Plata/Argentina (1982- 2008). Spain, International Congress on Sustainable Construction and Eco-Efficient Solutions, pp. 847-855.
- Doubell, S. L., 2015. Geni. [Online] Available at: <https://www.geni.com/people/Lilian-Ngoyi/6000000021908404951> [Accessed 10 March 2019].
- Du Toit, A., 2005. The Truth & Reconciliation Commission as Contemporary history. In: S. Jeppie, ed. Towards New Histories for South Africa- On the place of the past in our present. Lansdowne: Juta Gariep (Pty) Ltd, pp. 61-79.
- Dunston, L. & Dunston, T., 1975. Young Pretoria 1889-1913. First ed. Pretoria: Dunston.
- Emcke, C. & Berg, S., 2005. Remembering the Holocaust Extracting Meaning from Concrete Blocks. [Online] Available at: <https://www.spiegel.de/international/spiegel/remembering-the-holocaust-extracting-meaning-from-concrete-blocks-a-354837.html> [Accessed 19 June 2019].
- eNCA, 2018. 30 years since right-winger Barend went on a killing spree, Pretoria: eNCA.
- Farmer, D., 2019. Forum Theatre. [Online] Available at: <https://dramaresource.com/forum-theatre/> [Accessed 14 April 2019].
- Fisher, M., 2014. Ubu and the Truth Commission review – exploring post-apartheid South Africa with puppets. [Online] Available at: <https://www.theguardian.com/stage/2014/aug/29/ubu-and-the-truth-commission-review-edinburgh> [Accessed 28 September 2019].
- Hlekiso, C., 2018. The need for memorialisation in South Africa. [Online] Available at: <https://www.news24.com/Columnists/GuestColumn/the-need-for-memorialisation-in-south-africa-20181119> [Accessed 9 January 2019].
- Hutchison, Y., 2013. South African performance and archives of memory. Manchester: Manchester University Press.
- Kavanagh, R. M., 2016. A Contended Space: The Theatre of Gibson Mtutuzeli Kente. Johannesburg (Gauteng): Robert McLaren.
- Kennedy, C., 2015. Activating archives for accountability the TRC records and the duty to remember. RJR, August, Volume 35, pp. 93-96.
- Kreps, C., 2003. Liberating Culture – Cross-Cultural Perspectives on Museums, Curation, and Heritage Preservation. First ed. Abingdon: Routledge.
- Lee, m. s., 2010. re-inventing the black box theatre, s.l.: School of Architecture University of Hawaii.
- Callahan, M., 2017. History of Black Box Theater. [Online] Available at: <https://ourpastimes.com/box-step-in-rumba-dancing-13580406.html> [Accessed 30 September 2019].
- Llewellyn, M., 2003. Polyvocalism and the public: 'doing' a critical historical geography of architecture. Area, 35(3), pp. 264-270
- Marotta, A., 2012. Typology: Museums. [Online] Available at: <https://www.architectural-review.com/essays/typology/typology-museums/8640202>. Article [Accessed 20 June 2019].
- Moore, E., 2018. The day Wit Wolf turned Pretoria red with blood. [Online] Available at: <https://www.iol.co.za/pretoria-news/the-day-wit-wolf-turned-pretoria-red-with-blood-18125595> [Accessed 10 March 2019].
- Moore, N. & Whelan, Y., 2007. Heritage, Memory and the Politics of Identity: new perspectives on the cultural landscape. Hampshire: Ashgate Publishing Limited.
- Neke, G., 1999. [Re]Forming the Past: South African Art Bound to Apartheid, s.l.: HWS.
- Noero, J., 2009. The Everyday and the Extraordinary. Vlaeberg: DAD Publishing.
- Opperman, D., 1993. Deon Opperman, Revolution and conscience: South African theater, June 1976 to February 1990. Evanston, IL: Program of African Studies, Northwestern University no. 5, pp. 14-16, 1993. Publication information: Ann Arbor, Michigan: MPublishing, University of Michigan Library, Passages, 1993
- Parliamentary Monitoring Group, 2019. State of Nation Address impact on Department of Small Business Development; with Deputy Minister. [Online] Available at: <https://pmg.org.za/committee-meeting/27881/> [Accessed 14 April 2019].
- Rajagopalan, M., 2012. Preservation and

- Modernity: Competing Perspectives, Contested Histories and the Question of Authenticity. In: C. G. Crysler, S. Cairns & H. Heynen, Eds. *The SAGE Handbook of Architectural Theory*. London: SAGE Publications Ltd, pp. 308-324.
- Richman-Abdou, K., 2018. How Museums Evolved Over Time From Private Collections to Modern Institutions. [Online] Available at: <https://mymodernmet.com/history-of-museums/2/> [Accessed 25 July 2019].
- SAHA, 2006. *Memory, Heritage and the Public Interest*. Johannesburg, the South African History Archive (SAHA).
- SAHO, 2011. Constructing heritage and heritage resources. [Online] Available at <https://www.sahistory.org.za/article/constructing-heritage-and-heritage-resources-grade-10> [Accessed 10 January 2019].
- SAHO, 2018. The 1956 Women's March, Pretoria, 9 August. [Online] Available at: <https://www.sahistory.org.za/article/1956-womens-march-pretoria-9-august> [Accessed 10 March 2019].
- Slessor, C., 2012. Editorial View: Museums. [Online] Available at: <https://www.architectural-review.com/essays/letters-from-the-editor/editorial-view-museums/8640275.article> [Accessed 30 September 2019].
- The Market Theatre Foundation, 2018. *History of the Market Theatre*. [Online] Available at: <https://markettheatre.co.za/history/> [Accessed 10 June 2019].
- Thomson, A., 2007. Four Paradigm Transformations in Oral History. *The Oral History Review*, 34(1), pp. 49-70.
- Truth & Reconciliation Commission, 1998. *Truth and Reconciliation Commission of South Africa Report*. s.l., s.n.
- Taylor, J. (1998). *UBU and the Truth Commission*. Cape Town: University of Cape Town Press.
- Van der Walt, C. & Becker, J., 1993. *Sammy Marks development, Pretoria, Phase 2- Facilities for the City of Pretoria, s.l.: Institutional Buildings: Project Report*.
- Vrye Weekblad, 1991. Nou druk 'n Jood Vervoerd van sy plein af. Pretoria: Vrye Weekblad.

APPENDIX

/



Faculty of Engineering,
Built Environment and
Information Technology

Fakulteit Ingenieurswese, Bou-omgewing en
Inligtingtegnologie / Lefapha la Boetšenere,
Tikologo ya Kago le Theknološi ya Tshedimošo

Reference number: EBIT/E11/2019

25 April 2019

Prof A Barker, Mr JN Prinsloo & Ms C Karusseit
Department Architecture
University of Pretoria
Pretoria
0028

Dear All

FACULTY COMMITTEE FOR RESEARCH ETHICS AND INTEGRITY

Your recent application to the EBIT Research Ethics Committee refers.

Approval is granted for the application with reference number that appears above.

1. This means that the research project entitled "*Masters professional dissertation in architecture, landscape architecture and interior architecture*" has been approved as submitted. It is important to note what approval implies. This is expanded on in the points that follow.
2. This approval does not imply that the researcher, student or lecturer is relieved of any accountability in terms of the Code of Ethics for Scholarly Activities of the University of Pretoria, or the Policy and Procedures for Responsible Research of the University of Pretoria. These documents are available on the website of the EBIT Research Ethics Committee.
3. If action is taken beyond the approved application, approval is withdrawn automatically.
4. According to the regulations, any relevant problem arising from the study or research methodology as well as any amendments or changes, must be brought to the attention of the EBIT Research Ethics Office.
5. The Committee must be notified on completion of the project.

The Committee wishes you every success with the research project.

Prof JJ Hanekom

Chair: Faculty Committee for Research Ethics and Integrity
FACULTY OF ENGINEERING, BUILT ENVIRONMENT AND INFORMATION TECHNOLOGY



Giselle Fourie

N

Non-Faces in Non-Places: Reconciling the Everyday Mans' Memory with the City of Pretoria

In Search of a new Contextual Museum Typology that integrates the everyday user with the Inner City of Pretoria.

An exploration of how Museum Architecture can be articulated to accommodate the Truth and Reconciliation Commission in South Africa in a way that the "Born free" generation along with those who witnessed the original trials can partake in the continuation of the TRC's memory, processes and legacy.

INTRODUCTION

Heritage is incomplete without history, memory¹ and relics (Moore & Whelan, 2007:97). Memory is the missing link in the debate of heritage, a link that fundamentally ties the everyday man to the Heritage of the City, and when missing, proves a problem (Moore & Whelan, 2007:97). Oral history² reveals an open-ended narrative of place which generates a layered and rich description of architectural context (Blofson, 2014:i).

The Museum District of the Inner City of Pretoria seems to be on a trajectory of becoming obsolete. The museums remain largely unknown to the people inhabiting the capital city of Pretoria. Upon visiting the museums one will find the exhibitions badly kept. The socio-spatial contribution of museum sites in the city of Pretoria (Tshwane) has diminished over the years as the buildings housing these badly kept exhibits are poorly maintained, fenced off or have controlled access controlling public access. It can be speculated that because these museum buildings do not 'fit' into the socio-spatial context of

South Africa as a democratic society as many were built before South Africa became a democracy and as a result do not represent the communities they serve. The aim of this article is to investigate the creation of museum architecture that is relevant to and serves the everyday user of the city. This article will inspect ways in which the anonymity that is speculated to exist between the people and the place of Pretoria can be remedied, the idea I have termed "non-faces in non-places" (Figure 01).

GENERAL ISSUE

Museums in South Africa do not engage with the memory of the everyday man.

According to SAHO (2011) Museums are like any other historical source as they reflect the bias of the people who created them. SAHO (2011) elaborates that museums always in some way or another are a reflection on the perspective of the people who created them, therefore, they often fail to be neutral. Milan Kundera, a Czechoslovakian activist writer recognizes the importance of remembering the past. He said: "The

struggle of people against power is the struggle of memory against forgetting" (SAHO, 2011).

A Brief investigation into the evolution of the museum typology throughout history is important when investigating why they tend not to function as optimally as intended in a democratic context with a contested heritage.

The Typological Evolution of Museums

(Refer to Figure 06 throughout museum analysis)

•Pre-modern museums

Typology³: palace-museums/ temple monument museums

Generally situated in the adaptive re-use restored historical museums.

•Modern museums

Typology: Modernist-inspired by Le Corbusier's unlimited growth spiral museum

Designed around one

intended circulation route (often a ramp). No closed and static geometric forms, therefore vertical planes are used to provide continuous movement in visual angles.

•Post-modern museums

Typology: challenged typical museums of the past. Transformed into a "culture-centre".

Monumental and iconic identities of the museums. Multifunctional uses with multifunctional spaces. Temporary and permanent exhibits.

Flexible circulation with some influence of classical typologies.

Museums regarded as artworks.

"The word 'museum' is derived from Latin which was, in turn, inspired by mouseion, the Greek term for 'a shrine to the Muses' and in Classical Greek mythology, the nine Muses are the goddesses of the arts and sciences, making them perfect patrons for these knowledge-based institutions" (Richman-Abdou, 2018).

A deeper look into the evolution of museums reveals museum typology has evolved with the change in desires of those who were in charge of making them. According to Marotta (2012) museums have taken on many guises throughout history. According to Richman-Abdou (2018) the first museum was in ancient Babylon, Princess Ennigaldi—the daughter of King Nabonidus, who ruled the Neo-Babylonian Empire

in the 6th century BC—collected and even curated Mesopotamian artefacts with origins spanning 1,500 years this museum was accessed by invitation only. In the Renaissance, the great collections belonging to the powerful Medici, Sforza and Gonzaga families were housed privately with selected access by small groups of scholars, these museums were known as "wonder rooms" (Marotta, 2012).

Museums in the Pre-modern times remained largely private destinations that were only able to be accessed by the elite society who were allowed in by invitation these museums included collections comprising eclectic collections that were encyclopaedic in nature, such as natural history specimens and scientific wonders as well as works of art and religious relics. These museums were known as the "cabinets of Curiosities" (Richman-Abdou, 2018).

Following the Enlightenment museums such as the British Museum in London (1759), the Louvre in Paris (1793) and the Prado Museum in Madrid (1785) began to open collections to the public (Richman-Abdou, 2018).

Foucault uses the term "heterotopia" to describe spaces that have more layers of meaning or relationships to other places than immediately meet the eye, this is evident in the various manifestations of



Fig. 01. Below; Global, Local & Architectural Issues of museums for the TRC in Pretoria (Author, 2019)

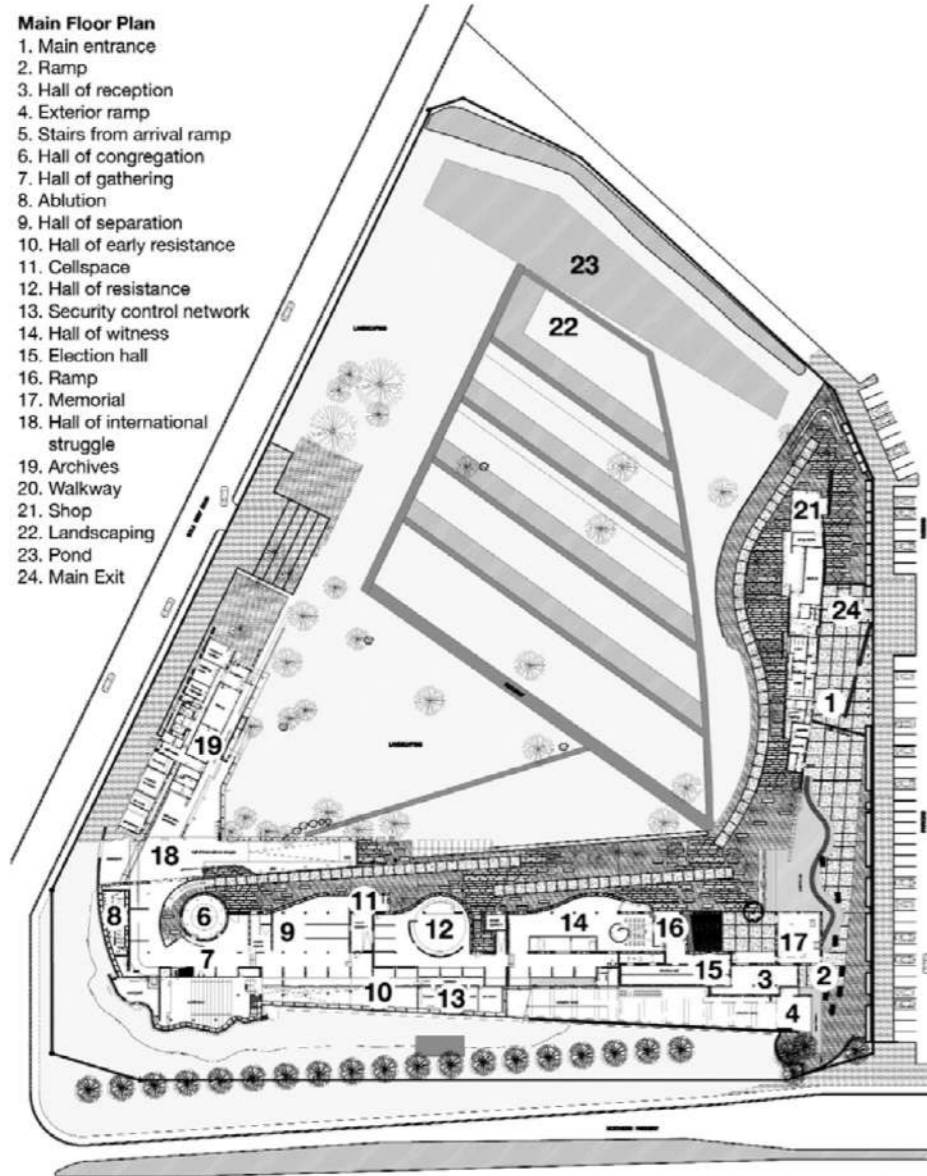

Fig. 02. Left; Apartheid Museum: Main floor plan (ronelwassermangraphicdesigner, 2006)

and stories of actual, recorded history or physical relics but often fail to represent memory. As mentioned in the introductory statement of this article, memory is the most important aspect that needs to be implemented into museums in order to understand a full heritage picture, one where the experiences of the layman is integral in the overall heritage inventory. Museums throughout time have shifted from merely housing information and relics irrespective of the building, to following a processional route through a curated building, to the actual architecture acting as much of an iconic relic as the collections it houses and finally into the environmentally conscious movement of current times where building responds to landscape. It can be concluded that although museums have become contextual in the way that they have begun to respond to their physical context, they still neglect to respond to their socio-political context, it can be speculated that this is largely to do with the negation of representing past and present memory within them (Figure 04).

the Post-modern museum typologies (Marotta, 2012). In the Post-modern times museums, have predominantly opted for either the iconic 'museum as artwork' (e.g. Frank Gehry's Guggenheim Museum in Bilbao) stance or a completely contradicting stance of 'museum as landscape' (e.g. Paulo David's Art Centre at Casa de Mudas in Madeira). The aim of the 'museum- landscape' is to act as a new way of mediating the infinite memory of the place in which it is embedded, therefore, binding it up to nature's infinite time (Marotta, 2012).

A local example of 'museum as landscape' is the Apartheid Museum in Johannesburg, South Africa designed by Gapp Architects and Urban Designers, Mashabane Rose Architects, Britz Roodt Association, Linda Mvusi Architecture & Design. (Figure 02)

According to (Deckler, 2006:39) the apartheid museum is half-buried in the mining landscape in Johannesburg and traces the origin, development, implementation and deconstruction of South Africa's past Apartheid system. The Apartheid museum is blatantly and intentionally a-contextual as it turns its back on the existing context surrounding the site whilst opening itself up to the old Johannesburg city skyline.

The articulation of the plan of the museum follows a route through space and time, indoors and outdoors whilst following a route which eventually terminates where it begins (Deckler, 2006:39). Important to note from this typological exploration of museums over time and around the world is that museums have always housed manifestations

Post-colonial museums in Africa have not developed distinctly from their Eurocentric counterparts (SAHO, 2011). Today these museums are still closed off to everyday use and not enjoyed by the majority (SAHO, 2011). Museums in Africa have remained ignorant to the identities and interests of the communities they claim to serve (SAHO, 2011).

An investigation into some of the prominent museums in the South African context (Figure 03) has revealed that although they reflect the communities' histories and interests in content, they often standardise and fix the narrative and fail to include programmes that have visitor involvement and upliftment. It can be speculated that an a-contextual museum typology has contributed to their state of disuse by those whose



stories they are trying to tell. Some other recently built museums in South Africa acknowledge the Intangible Heritage that exists in many African cultures. An example of a museum which explores a post-colonial intangible perspective is the //Hapo museum at Freedom Park in Pretoria as well as the Apartheid Museum in Johannesburg. Although the aforementioned museums acknowledge these histories they are not presented in a way that is engaging to the viewer, perhaps it is in this very reason that they are unengaging, it can be postulated that by the user merely being a 'viewer' and not a 'participant' the very nature of the intangible heritage cannot be felt, therefore, it is not understood to the degree it could be. According to Kreps (2003:xiii) in order to liberate cultures museums should include multiple voices. The voices of "the other" (the everyday man) are central to the formulation of new museological paradigms (Kreps, 2003:xiii).

The Preservation of Heritage in a progressive society: Rajagopalan (2012:321) describes museums and archives as 'bureaucratic apparatuses of modernity' that define the heritage practices of a country. Rajagopalan (2012:321) introduces the theory of David Scott who argues that "any imagination of the past is ineluctably linked to the present, and that how we tell histories is as important as what we tell". Here the question arises as to how museums can preserve many histories and at

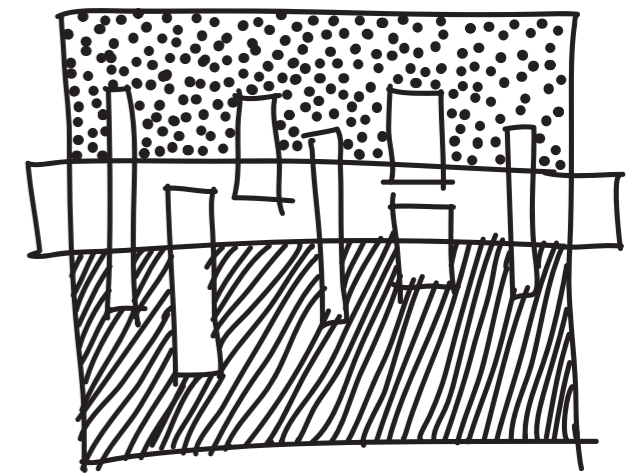
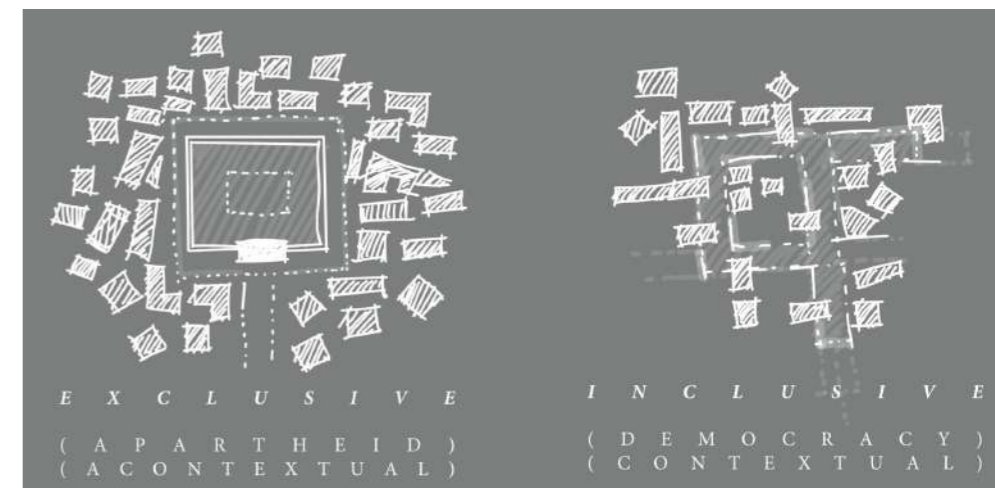

Fig. 03. Top; Analysis of Museums in South Africa in relation to context (Author, 2019)
 Fig. 04. Middle; Diagram expressing exclusive typology vs. proposed inclusive Typology (Author, 2019)
 Fig. 05. Bottom; Diagram of how museum connects the Ordinary and the Extraordinary (Author, 2019)

the same time facilitate a dynamic nature by being added at the same rate as time is progressing. Rajagopalan (2012:321) suggests that the subjective framing of what is seen as authentic can ultimately land up in a Eurocentric portrayal of heritage even when implemented in various countries around the world. Furthermore, these institutional narratives have played a key role in what Rajagopalan (2012:321) describes as “fossilizing” some narratives and representations of the past whilst completely ignoring others.

Rajagopalan (2012:322) returns to the notions of David Scott where it is speculated that all perceptions and constructions of history as we know it are ultimately filtered through the anxious and expectant eyes of the present time. Scott argues that all new theories must recognise the importance of the meanings and manifestations of a heritage that is never static, but rather one that is in constant flux through the influence of contemporary, political and social forces (Rajagopalan, 2013:322).

Collective Memory under siege: Memory as the peoples’ weapon

“Since memory is actually a very important factor in struggle ... if one controls people’s memory, one controls their dynamism. And one also controls their experience, their knowledge of previous struggles” (Foucault, 1989:89-106).

(Boyer, 2012) puts forth the notion that Architectural collective memory is the ultimate ‘archetypal collective memory’ because of its permanently fixed and recognisable state. (Boyer, 2012) argues that in an age of modern ethics, collective memory and the intangible memories of a nation and its people are never set in stone and therefore need to belong to a ‘field of argumentation’. Instead of embodying the memory of the people the notion of ‘memory tourism’ has contaminated the authenticity of historic sites as well as museums as places of commodification where fixed histories are treated as a consumer object (Boyer, 2012:326). Memory has the power to act as a voice of resistance as well as a tool for moral redemption for past trauma and grievances as well as

providing a sense of identity in a modern world that is on a trajectory of alienation (Boyer, 2012:326).

What is the relationship between the collective memory and the memory of the individual? The notion of ‘palimpsest’ in the urban fabric assumes that individual memories that have been lost or silenced ‘haunt’ the city’s collected memory (Boyer, 2012:327). It is important, therefore, to construct places of memory where these traumatic lost and silenced metaphysical voices can be liberated and their fears and desires recognised (Boyer, 2012:327). Boyer (2012:327) explains that the importance of these places situated in space allow people to return and work through contradictory emotions of fear, shame, guilt, sadness, anxiety, longing and through this they can develop a hope for a better future.

Andreas Huyssen argues that the study of memory cannot deny a traumatic past, however, in order to avoid the narrative circling around this trauma indefinitely he suggests that a better way to deal with them

is through the discourse of human rights based on truth commissions and judicial proceedings as well as healing practices and the design of commemorative public spaces (Boyer, 2012:328).

“Commemorative celebrations enacted in public space, and memory traces stored in archives and memorials, act as prompts to individual memory” (Boyer,2012:328).

When collective memory is shared on a public platform it forges a process of reinterpretation, preservation and transformation (Boyer, 2012:328).

Fashion Museology:

One such method of liberation of the museum as well as the everyday man is the implementation of fashion museology as it captures the current pop culture, the memory of each individual as well as the collective and is a way of expressing one’s experience of the everyday and making it extraordinary (Melchior, 2011:6).

The addition of fashion such as dress into museums has been shown to attract younger and more diverse audiences from various socio-economic backgrounds to the museums (Melchior, 2011:3). Fashion is relatable to the layman as in some way or another he/she can place themselves into the garment on display and make accessing the memories and histories more personal (Melchior, 2011:3).

“Clothes are the short hand for being human” (Melchoir, 2011:3).

The introduction of fashion into museums has been said to “dust off the old museum” in the sense that fashion has its finger on the pulse of pop culture, therefore, it remains relevant in a changing world (Melchoir, 2011:5).

According to Melchior (2011:1) fashion has an innate ability to transform museums into “visitor-centred forums” through which the audiences can deliberate and interpret complex socio-political, cultural and behavioural issues and narratives of the past as well as the present, therefore, the museum incorporates current memory as well as past.

According to Melchoir (2011:6) the addition of fashion into museums can



Fig. 07. Left; Result of the TRC (Zapiro, 1997)

incorporate ordinary societies interest in consumer and celebrity culture which allows the museums another way to be economically sustained. The addition of everyday, relatable things such as fashion or performance can elevate the museum to become extraordinary. Along with this the everyday man is liberated and engaged in a museum when the level of interaction transcends merely visual accessibility to content.

The Everyday and the Extraordinary

According to Noero (2009) popular culture holds the key to Architecture that he deems as proper and appropriate. Noero (2009) goes on to advise that Architecture be created from the needs and expressions of the man on the street (the layman). Noero (2009) elaborates that the role of the Architect is to elevate the realm of the ordinary and make it into something extraordinary (Figure 05).

Through the Eyes of the Skin

“Architecture is the reconciliation between ourselves and the world, and this mediation takes place through the senses” (Pallasmaa, 2005:72)

A sensory approach needs to be considered as it is a way of connecting the layman to an experience that can be perceived as being familiar or evoking a particular experience on a subconscious and emotional level.

LOCAL ISSUE

South Africa is a young democracy with a contested and concealed intangible heritage

According to SAHO (2011) museums in the post-colonial or post-apartheid era have certainly tried to redress the silences that existed in the past. South Africa is a young democracy with a contested heritage, therefore, if the past and current time is to be accurately recorded, the oral testimonies and intangible heritages of the people is of utmost importance, especially in its capital, Pretoria. Hlekiso (2018) reports that the role of the everyday man in the liberation struggle of South Africa is not recognized in museums and recorded history, which leads to further marginalization.

The Truth and Reconciliation Commission (TRC) documented the living memories of violence and conflicts of Apartheid (du Toit, 2005:61). The role of the TRC in South Africa was to hear thousands of oral histories in the form of personal testimonies to address past human rights violations of Apartheid (Hutchison, 2013:1). It used individual memory through oral histories to create a single, coherent narrative of the national unity of South Africa.

The overarching local issue is that South Africa has failed to continue to hear the testimonies of the everyday man (Figure 07) such as in the TRC and as a result everyday man is unable to record his experiences of our young democracy (Boshomane, 2016). Oral

Fig. 06. Below; Architectural Continuum (Author, 2019)

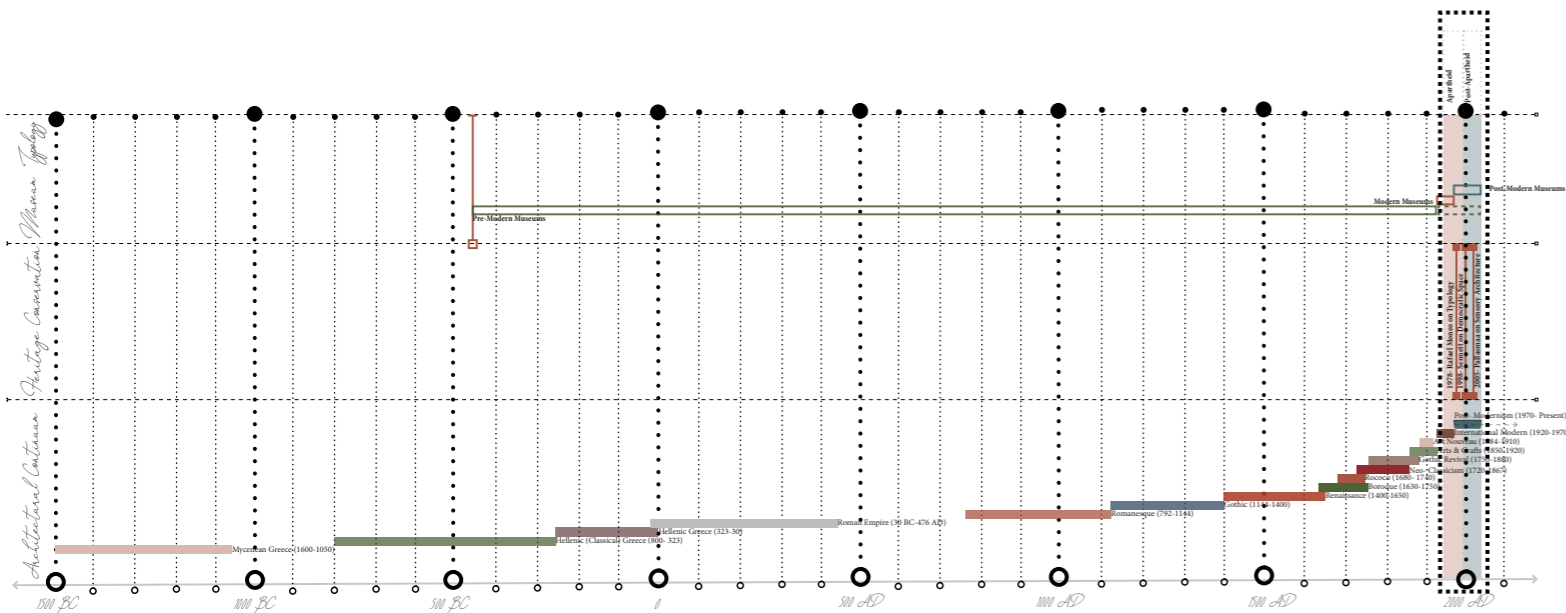

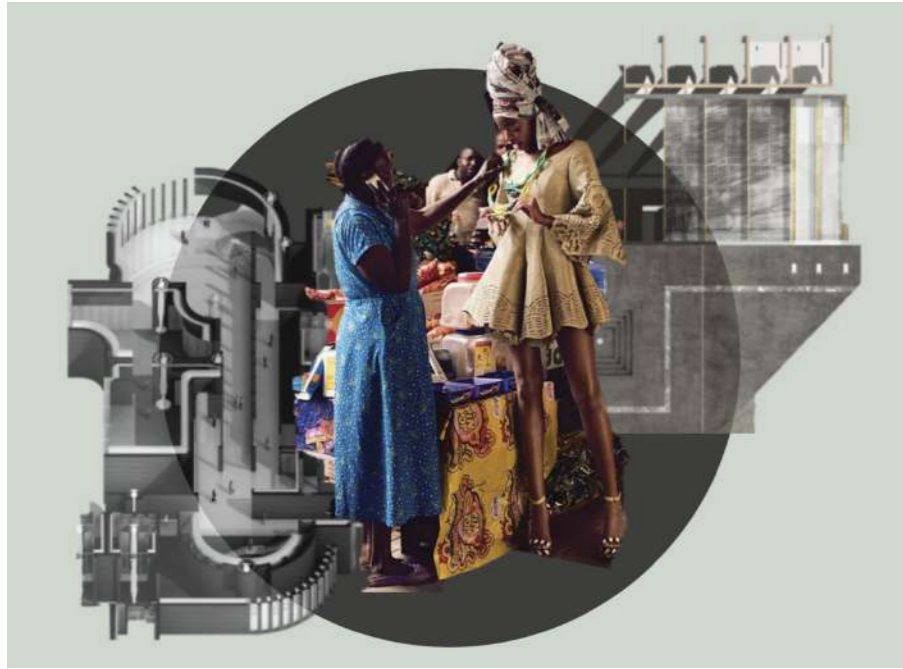

Fig. 08. Left; Programmatic vision of museum that combines the Everyday and the Extraordinary (Author, 2019)

histories are not being continually collected and curated, thus the layman's experiences and memories do not form part of our overall heritage inventory.

Memory is currently represented in the built environment through visual archives such as museums. Museums have become marginalized in the South African context as they standardize and fix a narrative (Hutchison, 2013:3). Hutchison (2013:5,12) urges the interaction of diverse oral histories, memories and identities to be reinterpreted into significant buildings where people can actively experience memory and build a nation.

DEEP MEMORY

According to Hutchison (2013:32) deep memory refers to the memory of an oppressed past, memories that are painful and have left behind physical markings on the person who experienced it. These deep memories are too painful to be dealt with simply through verbally recording as recalling these traumatic events can lead to gaps in these testimonies, instead, Hutchison (2013:32) reveals that these deep memories are far more effectively dealt with through non-verbal expressions such as performance. This expression of deep memory allows past trauma that is 'unspeakable' to be negotiated and dealt with (Hutchison, 2013:32).

Hutchison (2013:32) elaborates that because the TRC process in south Africa employed mainly verbal testimonies that needed to be explained

in a rational way (known as common memory) there were many disrupted narratives that resulted. The TRC process in South Africa should have rather employed a deep memory approach that allowed victims to express these memories in a way that the unspeakable truth could be revealed and audiences could become a united part of the relatable narrative that was being expressed through mediums such as poetry (Hutchison, 2013:32).

The Genesis of Democratic Space

The importance of the Democratic capital city context is paramount. Richard Sennett explains and critiques democratic space making principles such as the Agora which are to be explored in the making of democratic space (Sennett, 1998:15). According to Sennett (1998:22) a static sense of self can result in what he terms a "psychological death", it is for this reason that he believed people need cities in which experiences of disorientation and recovery can occur where human beings can grow and through this growth become fully human. Sennett (1998:27) suggests that designers start to consider theatres as places of political expression as they commit people to one another in a disciplinary space where eye and voice are liberated.

"Theatrical forms can attempt to develop civic connections, not of the fleeting sort as in a public square, but of a more sustained and focused sort"

(Sennett, 1998:42).

DELIBERATING DEMOCRATIC MUSEUM MAKING

The case of collective memory in South Africa, as expressed by Boyer (2012:334) investigates how a country went from a state of concealment and silencing to a democratic society that elevated voices and made all past injustices transparent (Boyer, 2012:334). Boyer (2012:335) explains that the South African Truth and Reconciliation Commission (TRC) brought forth memories and allowed questions to be answered in order to right the wrongs of the past.

It is important to note that the above continuums expressed are of euro-centric origin. In the context of Pretoria, the museums built before or during the Apartheid era tend to be of Pre-modern typology with few being of Modern typology. Following the abolishment of Apartheid (post-1994) the new museums designed aimed to represent a new, free and liberated future by employing the post-modern typology with what seems to be a south African humbleness in identity as opposed to the iconic Eurocentric way of doing post-modernism in western society.

An important premise to note when understanding this article is an emphasis on design as a way of connecting people of various backgrounds, cultures, classes, races etc in the same way that the TRC did. The TRC viewed all as being equal in the same way that a democratic society

does (or should), therefore, designing the building through lenses that forge this common ground to occur is of utmost importance if the principles of the TRC are to be translated.

ARCHITECTURAL ISSUE:

A Typological Critique of Museums: No PLACE dedicated to the memorialization & immortalization of the TRC & its principles

SAHA (2006) emphasizes the importance of a relationship between archive and oral histories within a democratic society as a means of catalysing public deliberation. The Truth and Reconciliation Commission (TRC) forms an extremely important part of the intangible heritage of South Africa. The recorded accounts of the TRC are archived away from the eyes of the Public (Hlekiso, 2018). Hlekiso (2018) recently reported that there is an urgent need for the TRC to be memorialized and stored in a museum that is accessible to the public so that history may be known and healing can continue. The TRC Archive needs a home.

According to De la Rey & Owens (1998:270) there is an ongoing need for the potential of the Truth and Reconciliation Commissions psycho-social rehabilitation to be reached. De la Rey & Owens (1998:269) recommend methods such as asking questions, offering analyses and conducting research.

The Above explores Architecture as

a medium of translating the everyday man's experience of the Capital city of Pretoria and young democracy of South Africa through the exploration of a new museum typology that includes the everyday man in its sense of place. One such method of liberation of the museum as well as the everyday man is the implementation of fashion museology as it captures the memory of each individual as well as the collective and is a way of expressing ones experience of the everyday and making it extraordinary (Melchior, 2011:6). The overarching principle of the proposal is to explore the creation of museum architecture and how it can act as a catalyst through which the everyday man's memory becomes an integral part of South Africa's democratic collective memory through public performance (Figure 08).

PERFORMING SOUTH AFRICA'S TRUTH AND RECONCILIATION COMMISSION

According to Hutchison (2013:55) the TRC played a monumental role in the shaping of theatre in South Africa at the start of the Democratic era. Theatre moved away from merely 'bearing witness' and retelling as truthfully as possible and into an era, influenced greatly by the TRC, where individuals were allowed to speak for themselves. The TRC urged theatre to take on a new perspective, one where truth, justice and reconciliation were encouraged to be negotiated (Hutchison, 2013:56).

Hutchison (2013:57) explores how

various plays engage with themes that were considered unresolved by the TRC in a bid to utilise performance as a way of engaging the wider community in completing the social action which the TRC began in South Africa.

A BRIEF HISTORY OF THEATRE IN SOUTH AFRICA- A Contended Space

South Africa has experienced many changes in the way that theatre is portrayed throughout time because of the vast array of influences such as cultures, races, political situations etc. (Kavanagh, 2016:2). South African theatre has born many masks over time and South African theatre has always acted as a voice of protest hence the term 'Protest Theatre' which was birthed during the apartheid era in South Africa (Kavanagh, 2016:2). Theatre has always offered a voice of the everyday man's experience of the troubles, joys and turmoil's that were faced during the time of Apartheid where voices were silenced (Kavanagh, 2016:4).

Throughout South African history the theatre has acted as a voice for the people. Theatre has taken on many voices and presented the real-life stories of real life people experiencing the democratic society throughout time (Kavanagh, 2016:4). Theatre presents a platform for expression as well as a liberation of the joys and turmoil of everyday life as well as offering hope for the future.

A LONG NIGHTS JOURNEY INTO DAY

The TRC is an imperative part of the journey that South Africa has taken into Democracy. The role of the TRC in South Africa was to hear thousands of oral histories in the form of personal testimonies to address past human rights violations of Apartheid (Hutchison, 2013:1). It used individual memory through oral histories to create a single, coherent narrative of the national unity of South Africa. It can be said that the most important function of the TRC was that it offered reconciliation over restitution in the new democracy South Africa was at the time of its genesis. The TRC aimed to put justice to the human rights violations that took place under the Apartheid regime and lead south Africa into a future that was full of hope and promise.

The TRC process followed a precisely structured methodology (Truth & Reconciliation Commission, 1998):

1. Initiation (the start up)
2. Decentralization
3. Appointing committee members
4. The protocols

5. The information management system
6. The Database
7. Hearings
 - Victims
 - Event
 - Special Hearings
 - Institutional Hearings
8. Investigations
9. Research
10. The Amnesty Process
11. Witness Protection
12. Overview of the commission's work

One of the main objectives of the TRC was to allow Transparency of everything that was recorded so that the everyday man may have access to the archived material (Truth & Reconciliation Commission, 1998). This concept was put into place to act as a constant reminder of what happened so that the past may not be repeated but rather the journey into a successful democratic society may continue.

“The work of the Commission as a whole, together with the specific contributions of its three committees, underlined the need to restore the dignity of all South Africans. In the process, the sons and daughters of South Africa would begin to feel truly ‘at home’.” (Truth & Reconciliation Commission, 1998).

The TRC was one of the only attempts to understand the individual experiences of the everyday man in the history of South Africa (Hutchison, 2013). When viewing this through the lens of reconciliation this process should be ongoing to allow for further public deliberation and recording of the everyday man's experience of the young democracy that South Africa still is today.

THE TRC ARCHIVE

The TRC Archive is currently housed in the Pretoria National Archive which is within walking distance of the chosen site. The collection that is housed contains over 3000 cubic meters worth of archival material such as video and voice recordings. Some of the TRC archive is housed at the South African Heritage Association (SAHA) archive in Johannesburg where the SAHA embarked on the monumental journey of digitizing selected parts of the TRC.

Both of these archives, although located in Gauteng, are very difficult to access by the general members of the public and seem to be in contravention of the very purpose of Transparency which lies at the heart of the TRC itself. Yes, the contents of the archives need to be protected, but should that affect the transparency and access to the information by the general public? Should it be a difficult process to view the original TRC sources in order to better understand the purpose and outcomes thereof?

There is a democratic responsibility set out by the TRC that the information gathered during the process of the TRC is accessible to the nation (Truth & Reconciliation Commission, 1998). Therefore, it can be concluded that there is a need for a medium of translation between the protected archival sources and the general public.

The proposed intervention thus becomes this medium of translation and transparency of the TRC collection that is housed in the Pretoria National Archives. Given the proximity of Sammy Marks Square to the National Archives it is possible for the data to be easily shared between the two (Figure 09).

Fig. 09. Below; Diagram expressing architectural translation of main TRC principles. (Author,2019)



TRANSPARENCY / TRANSLATION

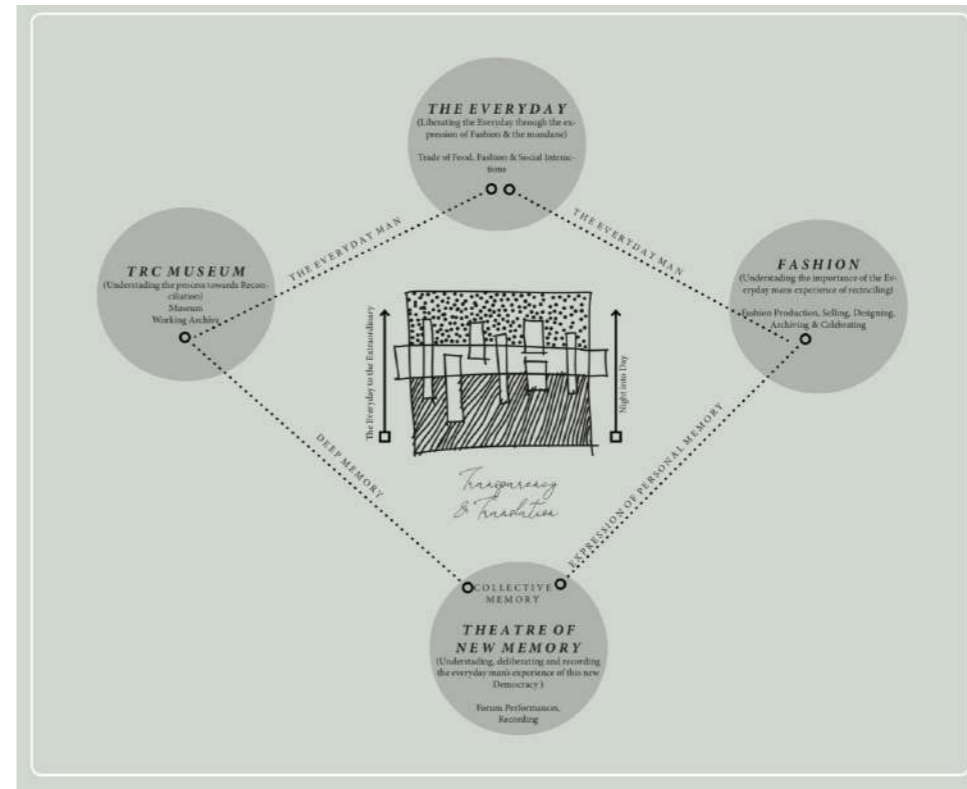

Fig. 10. Left; Programmatic Matrix of proposed new museum typology for the TRC. (Author, 2019)

It is proposed that the new building becomes a place where the TRC Archives are translated into digital media so that the raw data may become transparent and widely available to the everyday modern man. This process becomes a way of making this data as well as the outcomes of the TRC transparent.

THE EXPERIENTIAL MUSEUM FOR THE TRC (Figure 10)

The events portrayed in the TRC had to be ‘re-lived’ by the victims through the trial process (Truth & Reconciliation Commission, 1998). This is one of the biggest criticisms of the TRC. The uncovering of these emotions and terrible events were the only way that true reconciliation could be reached. For this reason it has been decided that instead of employing the typical way of museum making consisting of presenting important information through curated information boards and displayed relics (the pre-modern way of museum making) or taking the user of a very specific route (The modern way of museum making), the best way to completely immerse the user in an understanding of the TRC process and the emotions attached to it a museum that employs an all-encompassing experience that will evoke an understanding on a subconscious and emotional level. This approach aims to bring forth the lense of empathy the

TRC should be understood through.

THE MUSEUM & PERFORMANCE

According to Hutchinson (2013:5) when dealing with memories of a painful and distressing past (termed ‘deep memory’) the medium of performance is a much better medium of expression for the people involved. For this reason, it can be said that the expression of the everyday man's memory of the past will be most effectively portrayed through the medium of performance.

THE FORUM THEATRE THE THEATRE OF NEW MEMORY

Also referred to as the ‘Theatre of the oppressed’ the Forum Theatre is a form of theatrical performance where the audience is encouraged to become an integral part of the performance (Farmer, 2019). In the case of the Forum theatre the performance is performed twice, first by the professional performers and then again by the performers and any member of the audience that would like to take part and express their own views of the matter being raised in the performance. The Forum theatre is suitable for a building such as this as it can act as a form of city forum. A platform where the performers and the audience are placed on equal footings which allows the everyday man to deliberate his deep memory and reconcile with his/her past. According to Farmer (2019) the forum theatre is

unique in its characteristic of allowing the everyday man to try out courses of action that could ultimately be applied to their everyday lives.

THE EMPOWERMENT OF YOUNG BUSINESSES

According to the Parliamentary Monitoring Group (2019) the State of the Nation Address (SOTN) delivered to the nation explicitly emphasized that small entrepreneurial businesses will be supported. The SOTN address expressed concern that many small businesses have been excluded from South Africa's ‘real economy’ (Parliamentary Monitoring Group, 2019). With the adjustment of the governments 30% procurement process to reflect the goal of growing the economy there is an opportunity to incorporate small businesses as tenants on the site. It is proposed that these small businesses are businesses of craft in order to best fit into the cultural context which was historically the Indian owned market and other small businesses such as a tailor.

CLIENT

In his Budget Speech, Finance Minister Tito Mboweni stated: “Officials from the National Treasury and the Department of Arts and Culture will consider proposals for the development of a new national theatre, a new national museum, and also consider financial support for the National Archives, a national orchestra and ballet troupe.”

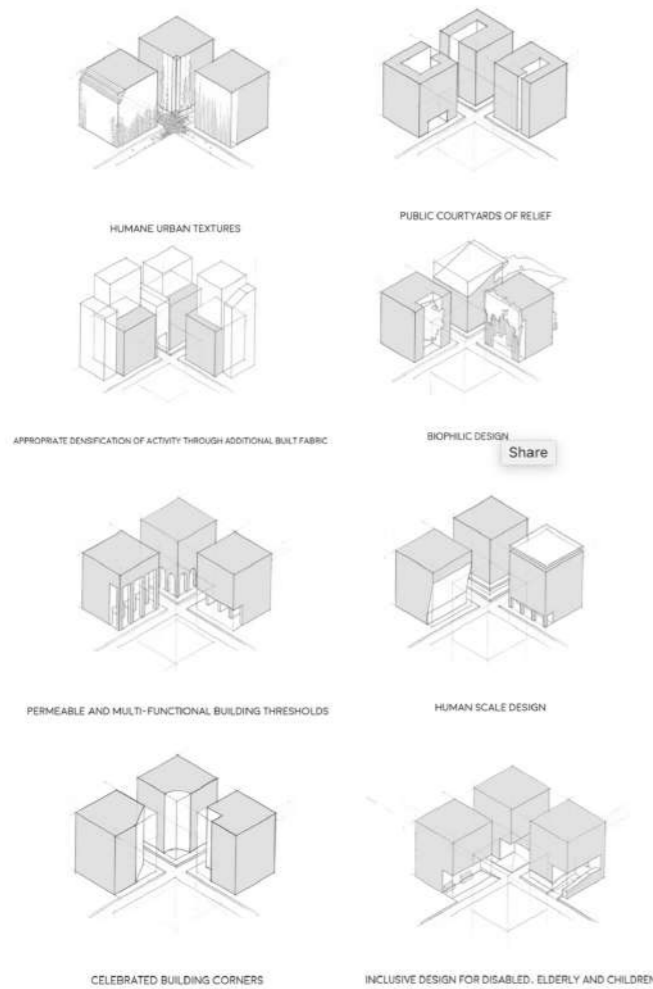

Fig. 11. Left; Urban Framework design principles for the inner city of Pretoria. (Author, 2019)

The proposed clients include: The Department of Arts and Culture, The National Archive (the curators), Ditsong Museums (to run the museum) as well as the South African History Archive (SAHA), the Foundation for Human Rights. The Oral History Association of South Africa (OHASA) who will record the current memory of Pretoria as a young democracy.

THE INNER CITY OF PRETORIA URBAN MAPPING

Pretoria was founded to support the local farmers through providing amenities and trade. Pretoria as a town had the premise of 'Philadelphia', meaning brotherly love, a principle of mutual community care which allowed the 'city to provide' for all of its people.

This love for your fellow citizen (in this dissertation referred to as the everyday man) in the early origins of Pretoria, is what lead our decision to work in the inner city. Our group has a common interest in the design of cities that cater for their people. We approached our mapping based on the assumption that Pretoria has the latent potential to become a city designed around its citizens once again.

This system of layers was designed to be used as a system to reveal the hard and soft nature of specific spaces in Pretoria and to attempt to delineate why certain spaces are used more frequently above others. Combining different layers such as land-use, heritage and transport lead us to the identification of activity nodes and anti-activity nodes, which guided the transect walk.

The purpose of the walk was to confirm or disprove the assumption that a correlation exists between an activity node and a soft edged space or an anti-activity node and a hard-edged space. Additionally, the transect walk was expected to provide more detailed information toward mapping the subtle elements that create hard or soft edged spaces in the inner city of Pretoria.

The mapping precinct is the inner city of Pretoria. The further delineation of our mapping encompasses church square and the Cardo (north south axis) and the Decumanus (east west axis). This delineation was chosen due to the pertinent value of these axes in the history and formation of Pretoria,

and as a result, contains a vibrancy of events and activities.

One surprising conclusion from the overlay of heritage fabric with pedestrian movement illustrates that it seems that people tend to congregate in closer proximity to older buildings of lower height. Possible explanations could be that these older, mostly heritage buildings provide humane elements at street level such as stairs or overhangs and adjacent predominantly-retail land-use and activities. Newer high-rise buildings often lack a street level human interface.

URBAN VISION

The Urban approach is based on the principles of Jan Gehl and Joel Kotkin who are both Architectural Urbanists that place the way people experience the city at the core of their theories and principles which can be summarized in the following quotes.

"Cities [...] should make life better for the vast majority of citizens" (Kotkin 2016:19).

"Cities, in a word, are about people, and to survive as sustainable entities they need to focus on helping residents achieve the material and spiritual rewards that have come with urban life throughout history" (Kotkin 2016:20).

"Cities have thrived most when they have attracted newcomers hoping to find better conditions for themselves and their families and when they have improved conditions for already settled

residents" (Kotkin 2016:20).

"The history of successful cities reveal that, although their functions change, cities have to achieve two things: a better way of life for their residents and a degree of transcendence critical to their identities" (Kotkin 2016:20-21).

The Urban Vision 'For People' formulates principles from our research (based upon Gehl and Kotkin). It is important that the principles designed can be implemented on a variety of scales in our own projects evolution of a user-centric urban experience.

The principles developed from the theories of Gehl and Kotkin relate to

findings (found through transect city walks and observations) of the city of Pretoria, of an overpowering amount of hard edges and limited soft edges. The urban vision developed envelopes the soft edge principles to imagine the design of Pretoria inner city for its people.

Principles for the creation of a soft edged space: (Figure 11)

1. Appropriate densification of activity through additional built fabric
2. Permeable and multi-functional building thresholds
3. Celebrated building corners
4. Public courtyards of relief
5. Biophilic design
6. Human scale design

7. Inclusive design for disabled, elderly and children
8. Humane urban textures

THE SAMMY MARKS SQUARE BLOCK AS PROTOTYPE FOR A NEW MUSEUM TYPOLOGY

The Museum District of the Inner City of Pretoria seems to be on a trajectory of becoming obsolete. The museums remain largely unknown to the people inhabiting the capital city of Pretoria. The socio-spatial contribution of museum sites in the city of Pretoria (Tshwane) has diminished over the years as the buildings housing these badly kept exhibits are

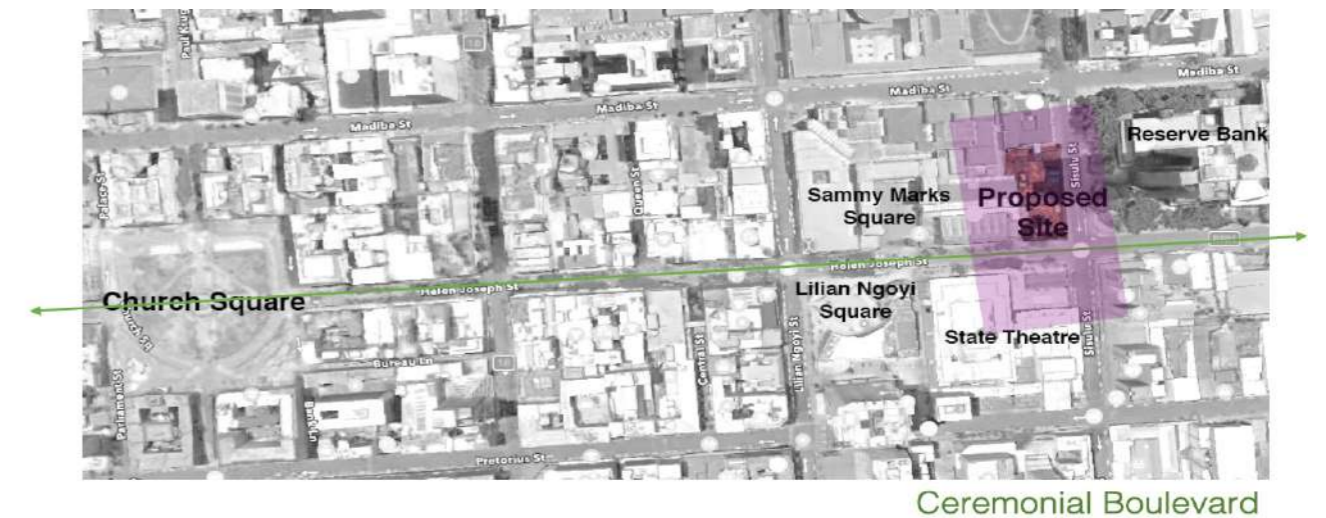
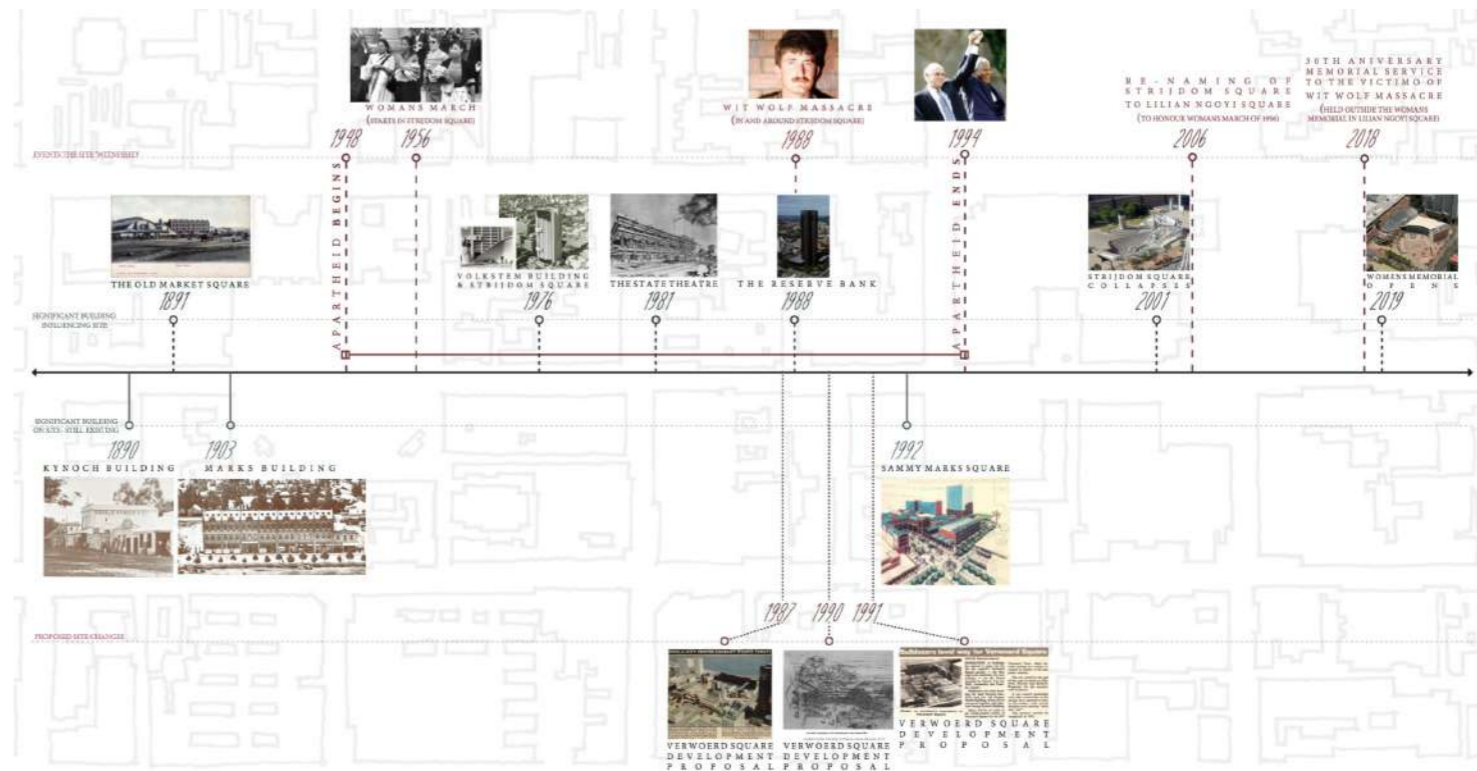
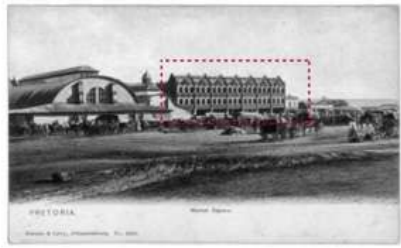

Fig. 12. Top; Positioning of Proposed site in relation to Church Square. (Author, 2019)
Fig. 13. Bottom; Sammy Marks Block development timeline. (Author, 2019)





1903



1913



1970



2019

choice of site greatly was that the site should illustrate as much of its own memory and history as the content of the “museum” which is to be embedded in it.

HISTORY & MEMORY ANALYSIS OF THE STATE THEATRE & SAMMY MARKS SQUARE BLOCKS (Figure 13)

THE OLD MARKET SQUARE_ STATE THEATRE BLOCK

The Old Market Square was proposed to take the functional place of Church Square as the new centre for trade and auctions for the town of Pretoria. The Market Square comprised a Market Hall, a Market Building which could house fourteen shops (Dunston & Dunston, 1975:140).. According to Dunston & Dunston (1975:140) some of the first formal tenants of the building included a general dealer, a gunsmith, music dealers as well as produce merchants. The building continued to change in use as time progressed and even contained a successful café. The Market Hall had a smaller hall to the right (see market hall sketch) that housed the first Government Museum Dunston & Dunston (1975:148). The land behind the hall was also used to house a few animals before the Pretoria Zoo was built. One of the first functions that was held upon the Market Hall's opening was a Children's Exhibition in 1891. The Market Hall was used to often host a vast array of spectacles that would often be attended by the President (Dunston & Dunston, 1975:150). According to Dunston & Dunston (1975:154) the Market Hall even functioned as a court when Rhodes, Farrar and Phillips pleaded guilty to the charge of high treason. It Can be concluded that the Market Hall and Square was a complete centre for the lives of the everyday man in early Pretoria. It displayed a characteristic of inclusivity and was resilient in its multi-use and ever changing nature. It was a site that

Fig. 14. Left; Photographic site evolution over time. (Author, 2019)

Fig. 15. Opposite; Events that occurred on and around the Sammy Marks Block. (Author, 2019)

served the needs of the people as and when those needs arose.

THE KYNOCH BUILDING_ SAMMY MARKS BLOCK

Built pre-1889, the Kynoch building that still stands today is the oldest surviving commercial building in Pretoria. The building was first occupied by George Kynoch & Co.who was a gunsmith and was used to house an armourer's shop, a tent business as well as the Staats Geweers Fabriek (Dunston & Dunston, 1975:154). According to Dunston & Dunston (1975:154). Liebman's Produce Store and a tailor occupied the building in prior to George Kynoch. Other Buildings that can be seen to the right of Kynoch hosted small businesses such as: a fruiterer, the Market Square Outfitters, a baker and a watchmaker.

THE MARKS BUILDING (GUNDELFINGER)_ SAMMY MARKS BLOCK

The Marks Building, built in 1903 by Sammy Marks, is commonly known as the Gundelfinger building as they were the main tenants in the building at the time it was first opened (Dunston & Dunston, 1975:150).

The Marks Building is one of the buildings designed by famed Pretoria Architect W.J. de Zwaan and displays an exemplary example of the Wilhelmiens architectural style that was prevalent in Pretoria in the late 1800's and early 1900's (Artefacts, n.d). The Marks Building was saved from demolition because of its significant heritage value, which according to Dunston & Dunston, (1975:150). is because it has always functioned as a landmark in the city as well as being a building that has been incredibly well preserved both formally and functionally. The Marks Building gives an insight into the style of building of the time with its charming regular façade repetition and rhythm as well as its use of the local materials of the time, namely, red face brick,

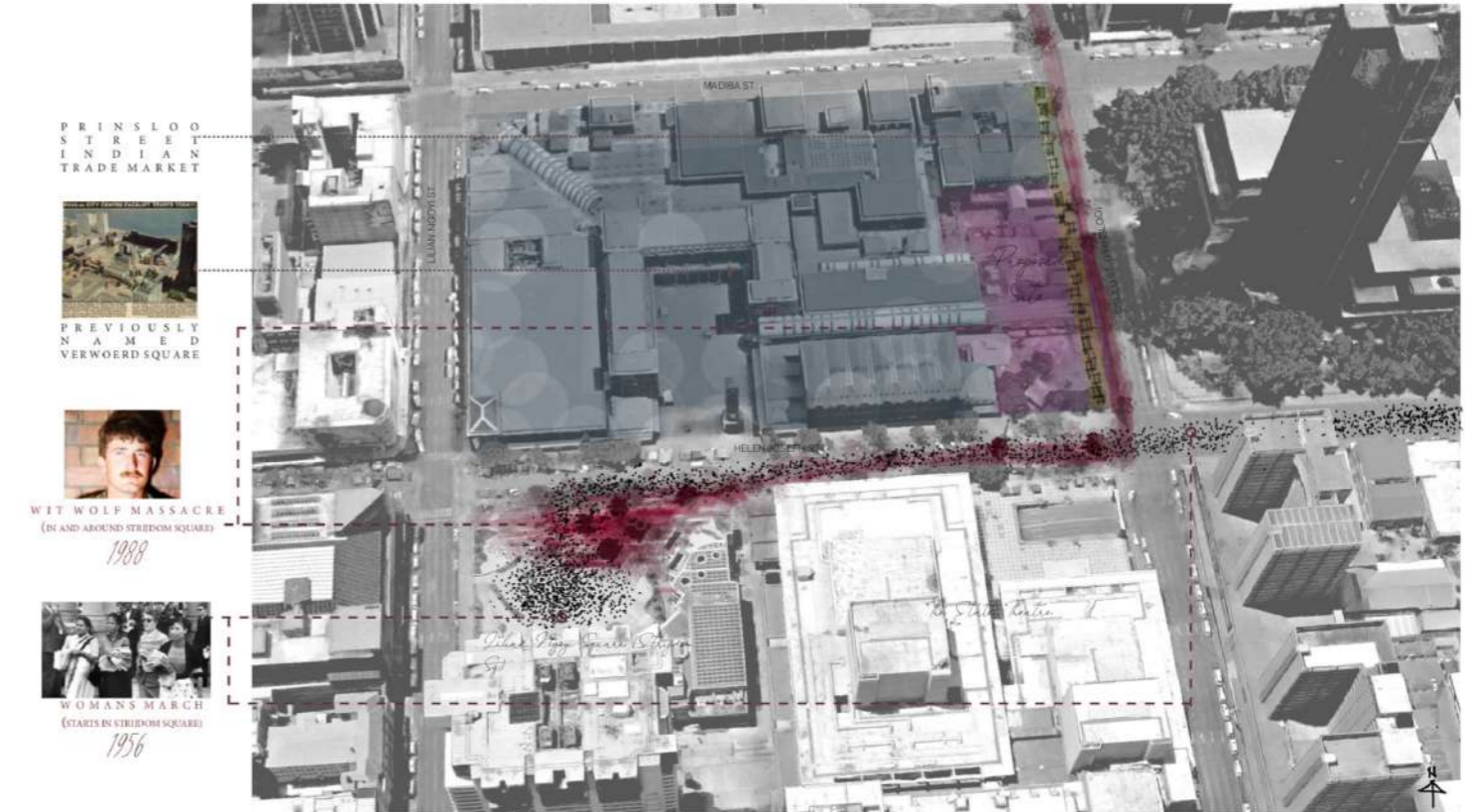

sandstone as well as curved glass and cast iron shopfronts on ground floor (Dunston & Dunston, 1975:151).

VERWOERD PLEIN BECOMES SAMMY MARKS SQUARE

According to Vrye Weekblad (1991) what is currently known as Sammy Marks Square (the site of interest for this dissertation) was not always named after the famed businessman of the early Pretorian era. Sammy Marks Square was renamed in 1991 surrounding the controversy of what an entire block development as well as a memorial monument of the man known as the 'Architect of Apartheid', Hendrik Verwoerd would symbolize to many people. Verwoerd was a symbol of repression to so many (Vrye Weekblad, 1991).

Verwoerd Square was initially part of a larger development vision for three of the squares in Pretoria that also included Strijdom Square (now Lilian Ngoyi Square) as well as the redevelopment of Church Square. After the Murder of Verwoerd the two-thirds of the block was bought up by wealthy business men and named after Sammy Marks as a tribute. According to Vrye Weekblad (1991) a R215 million building would be erected, which today is known as Sammy Marks Library,

Mall, Square and Arcade.

EVENTS THE SITE HAS WITNESSED (Figure 15)

1956 WOMENS MARCH

According to SAHO (2018) on the 9th of August 1956, between 10 000 and 20 000 women marched from Strijdom Square to the Union Buildings to protest against the amendments that were being proposed to the Urban Areas Act.

SAHO (2018) claims that the Woman's March bares much significance as it defies the stereotype that women are "politically inept and immature". When the large group of woman arrived at the Union Buildings in a determined yet highly disciplined manner, they proceeded to fill the amphitheater at the foot of the Union Buildings. SAHO (2018) claims that the Woman's March was the largest demonstration that has occurred yet.

Prime Minister JG Strijdom did not come out to see the large group of Women and neither did any of his staff . The large pile of signed petitions was left outside his office, but speculation exists as to whether or not the petitions were removed before Strijdom acknowledged them. It wasn't until, at

Lilian Ngoyi's suggestion, the crowd stood in absolute silence for a full hour before singing 'Nkosi Sikileli Afrika' and then leaving (SAHO, 2018).

Lilian Ngoyi was memorialized in 2006 on the initial starting site of the March when Strijdom Square was renamed re-named Lilian Ngoyi Square to honour her and the monumental achievement of these Women 50 years earlier (Doubell, 2015).

WIT WOLF MASSACRE _ BAREND STRYDOM

On the 15th of November 1988, Barend Strydom massacred seven innocent black civilians at Strijdom Square (now Lilian Ngoyi Square) (Moore, 2018). According to Moore (2018) Strydom had a smile on his face when he was arrested after his savagely racist shooting spree. At the time of this savage attack Strydom was dressed in full camouflage with a belt that had the custom engraving of "Wit Wolf" which gave him his name of terror. According to Moore (2018) Strydom trudged trails of blood leaving prints of his combat boots on Strijdom Square, around the State Theatre and five blocks around it. Moore (2018) States that Strydom had intentions of starting a race war and would continue to kill innocent black civilians if he was ever released.

poorly maintained, fenced off or have controlled access limiting public access. It can be speculated that because these museum buildings do not 'fit' into the socio-spatial context of a democratic South Africa as many were built before South Africa became a democracy and as a result do not represent the communities they serve. The Inner City of Pretoria is the Context of interest. A site that is central and receives a lot of "foot traffic" is imperative to the success of incorporating the everyday into the extraordinary. The chosen site is the south-eastern corner of the Sammy Marks block (cnr. Helen Joseph & Sisulu st) (Figure 12) which is situated in the heart of the cultural district of Pretoria. According to the Tshwane 2055 vision the historic Church Street (now W.F. Nkomo/ Helen Joseph st) will become the new 'Ceremonial Boulevard' giving the site future programmatic validity. An additional layer which influenced the

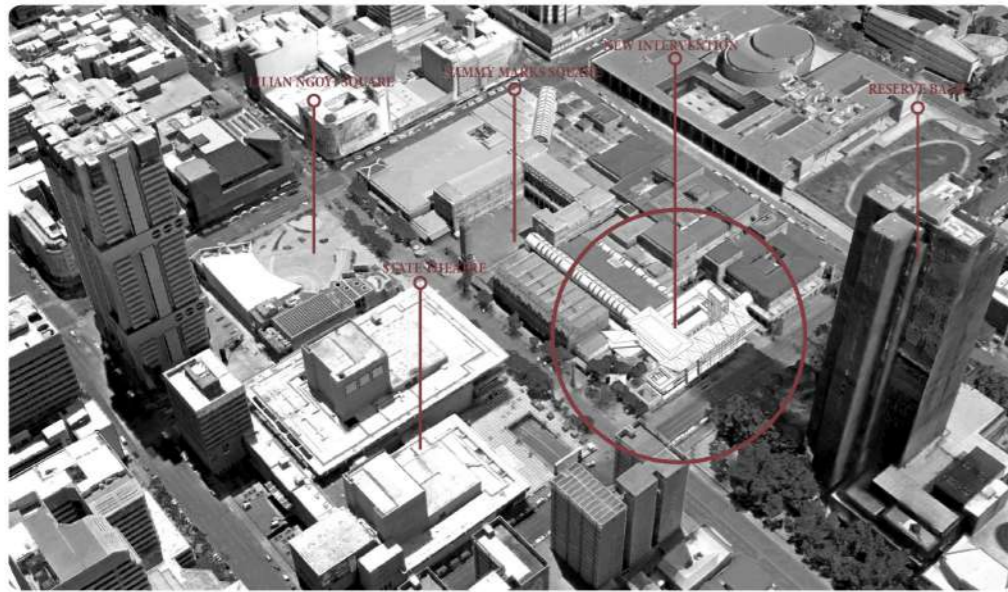

Fig. 16. Left; Proposed new museum on Sammy Marks block. (Author, 2019)

Barend Strydom was sentenced to the hangman's noose in May of 1989 (Moore, 2018). However, given that Strydom had been raised in an Apartheid society that encouraged the extreme racist hatred of black people and given that he was being sentenced under Apartheid law, the state saw it fit to grant him amnesty and Strydom-who had still shown no remorse- was released in 1992 (Moore, 2018). Today Strydom lives out a quiet existence in Hertebeespoort, just outside Pretoria with his family. Moore (2018) States "He came to represent the most repulsive but also the inevitable and tragic outcome of apartheid - a system which described black people as so inferior in law and society that Strydom didn't even regard them as human".

In 2018 a Memorial service to the 8 Victims and many injured civilians was held on the new Lilian Ngoyi square, outside the newly built Women's Memorial (eNCA, 2018). In an interview with two of the victims sons, eNCA (2018) showed that these men's fathers, along with the others killed on that terrible day are to be remembered as heroes in the Apartheid struggle as they believe that the shooting put international pressure on South Africa which led to the abolishment of Apartheid some years after the Massacre.

HERITAGE SIGNIFICANCE

- Previously known as Verwoerd Square, named after Herdrik Verwoerd, the man known as the "Architect of apartheid".

- Situated along historical Church Street giving the site protest significance. The Site is opposite Lilian Ngoyi Square from which the 1956 Womans march departed.
- Witnessed the Barend Strydom "Witwolf" Massacre where 7 non-white civilians were shot dead.
- The Block has historically always had a retail function. The Site formerly supported small businesses and market trade such as the Indian owned market along the eastern side of the block.
- The block has historically always functioned as a social meeting space for the people of Pretoria.
- The Kynoch Building which is the oldest surviving example of the original Pretoria retail typology still exists on the site. It is protected by South African heritage laws as it is older than 60 years of age.
- The Sammy Marks Building (also known as the Gundelfinger building) is one of the prime examples of Wilhelmiens architecture in Pretoria. It is older than 60 years old and is therefore protected by South Africa's Heritage Laws.
- The Significance of the Sammy Marks block as a whole lies in it being a prime example of post-modern architecture in Pretoria. The intention of serving the everyday user through human scale & programme is a significant principle in the design of the block.
- The south-eastern Corner of the site was intended to be a 5-star hotel, however, the project was cancelled before it was built. Some

structural alterations to the site in preparation for the hotel remain today.

The Way Forward:

The theory and site history explored throughout this article gives rise to various design strategies that can be implemented in order to create an architecture that liberates the layman regardless of his race, culture, socio-economic position etc. It can be speculated that the TRC process did not fully delve into the possibility of exploring methods of deep memory, therefore, through the addition of a performance forum these deep memories can now be deliberated. The addition of fashion as an economic means of expressing pop culture offers the opportunity to keep the museum current and relevant to the community in which it is situated. It is important to implement programmes into the museum complex that incorporate the needs of the man on the street, thereby liberating the everyday to a level of the extraordinary (Figure 16).

CONCLUSION: PROJECT INTENTION

The proposal intends to bring to life the principles of the TRC. It aims to integrate the voices of the everyday man into the overall heritage inventory of the young democracy that South Africa is. The article challenged the typology of what a museum is globally and what it should be locally, within a young democratic capital city such as Pretoria. The importance of the capital city context is paramount. The article unpacked ways in which the TRC can

be conveyed in a museum in an effort to develop a precinct of justice, truth and reconciliation that is designed for the experience of the users and can act as a precedent for Museum Architecture of this nature in South Africa.

The project aims to create a place to house the TRC archives and create a place where the principles and intention of the TRC can continue to manifest, thus allowing the everyday man's memory to be recorded as an integral part of the heritage inventory of the capital city of Pretoria.

In conclusion, this article has attempted to convey Ways in which Architecture can be used as a Catalyst to experience the memory of the TRC as well as the current Memory of the inhabitants of the people of Pretoria, in the hopes of remedying the issue of "non-faces in non-places" whilst making the everyday man's stories become an integral part of the capital city, Pretoria's overall heritage inventory.

Endnotes

1. (Yap & Barsaga, 2018) defines **Oral History** as historical fact and information collected through interviews and narratives. Yap & Barsaga argue that oral histories bear relevance when one needs to understand what happened in the past, along with the memories attached to that history, thus, Oral History is employed as evidence of human memory.
2. **Memory** can be defined as the mind's ability to store and recall past sensations, thoughts and knowledge, as well as the tendency of materials or systems to show effects that depend on its past treatment or history (Hutchison, 2013).
1. **Typology:** "study of or analysis or classification based on types or categories" (Merriam-Webster Dictionary, 2019)

References

Blofson, K., 2014. *Intervale Out Loud: A Place-based Oral History Project*, Vermont: Rubenstein School Masters Project Publications.

Boshomane, P., 2016. *20 years after the TRC hearings South Africa's pain persists*. [Online] Available at: <https://www.timeslive.co.za/sunday-times/opinion-and-analysis/2016-04-10-20-years-after-the-trc-hearings-south-africas-pain-persists/> [Accessed 20 November 2018].

Boyer, M. C., 2012. Collective Memory Under Siege: The Case of 'Heritage Terrorism'. In: C. G.

Cryslar, S. Cairns & H. Heynen, eds. *The SAGE Handbook of Architectural Theory*. London: SAGE Publications Ltd, pp. 325-339.

Deckler, T., Graupner, A. & Rasmuss, H., 2006. *Contemporary South African Architecture in a Landscape of Transition*. Cape Town(Western Cape): Double Storey Books.

De la Rey, C. & Owens, I., 1998. *Perceptions of Psychosocial Healing and the Truth and Reconciliation Commission in South Africa*, Cape Town: University of Cape Town.

Doubell, S. L., 2015. *Geni*. [Online] Available at: <https://www.geni.com/people/Lilian-Ngoyi/6000000021908404951> [Accessed 10 March 2019].

Du Toit, A., 2005. The Truth & Reconciliation Commission as Contemporary history. In: S. Jeppie, ed. *Towards New Histories for South Africa- On the place of the past in our present*. Lansdowne: Juta Gariep (Pty) Ltd, pp. 61-79.

Dunston, L. & Dunston, T., 1975. *Young Pretoria 1889-1913*. First ed. Pretoria: Dunston.

eNCA, 2018. *30 years since rightwinger Barend went on a killing spree*, Pretoria: eNCA.

Farmer, D., 2019. *Forum Theatre*. [Online] Available at: <https://dramaresource.com/forum-theatre/> [Accessed 14 April 2019].

Hlekiso, C., 2018. *The need for memorialisation in South Africa*. [Online] Available at: <https://www.news24.com/Columnists/GuestColumn/the-need-for-memorialisation-in-south-africa-20181119> [Accessed 9 January 2019].

Hutchison, Y., 2013. *South African performance and archives of memory*. Manchester: Manchester University Press.

Kavanagh, R. M., 2016. *A Contended Space: The Theatre of Gibson Mtutuzeli Kente*. Johannesburg(Gauteng): Robert McLaren.

Kreps, C., 2003. *Liberating Culture- Cross-Cultural Perspectives on Museums, Curation, and Heritage Preservation*. First ed. Abingdon: Routledge.

Marotta, A., 2012. *Typology: Museums*. [Online] Available at: <https://www.architectural-review.com/essays/typology/typology-museums/8640202>. article [Accessed 20 June 2019].

Moore, E., 2018. *The day Wit Wolf turned Pretoria red with blood*. [Online] Available at: <https://www.iol.co.za/pretoria-news/the-day-wit-wolf-turned-pretoria-red-with-blood-18125595> [Accessed 10 March 2019].

Moore, N. & Whelan, Y., 2007. *Heritage, Memory and the Politics of Identity: new perspectives on the cultural landscape*. Hampshire: Ashgate Publishing Limited.

Noero, J., 2009. *The Everyday and the Extraordinary*. Vlaeberg: DAD Publishing.

Parliamentary Monitoring Group , 2019. *State of Nation Address impact on Department of Small Business Development; with Deputy Minister*. [Online] Available at: <https://pmg.org.za/committee-meeting/27881/> [Accessed 14 April 2019].

Rajagopalan, M., 2012. Preservation and Modernity: Competing Perspectives, Contested Histories and the Question of Authenticity. In: C. G. Cryslar, S. Cairns & H. Heynen, eds. *The SAGE Handbook of Architectural Theory*. London: SAGE Publications Ltd, pp. 308-324.

Richman-Abdou, K., 2018. *How Museums Evolved Over Time From Private Collections to Modern Institutions*. [Online] Available at: <https://mymodernmet.com/history-of-museums/2/> [Accessed 25 July 2019].

SAHA, 2006. *Memory, Heritage and the Public Interest*. Johannesburg, The South African History Archive (SAHA).

SAHO, 2011. *Constructing heritage and heritage resources*. [Online] Available at: <https://www.sahistory.org.za/article/constructing-heritage-and-heritage-resources-grade-10> [Accessed 10 January 2019].

SAHO, 2018. *The 1956 Women's March, Pretoria, 9 August*. [Online] Available at: <https://www.sahistory.org.za/article/1956-womens-march-pretoria-9-august> [Accessed 10 March 2019].

Truth & Reconciliation Commission, 1998. *Truth and reconciliation Commission of South Africa Report*. s.l., s.n.

Vrye Weekblad, 1991. *Nou druk 'n Jood Vervoerd van sy plein af*. Pretoria: Vrye Weekblad.

ES'KIA MPAHLELE LIBRARY LAYOUT PLANS

Bordering on west of site- used to establish site dimensions & column Spacing

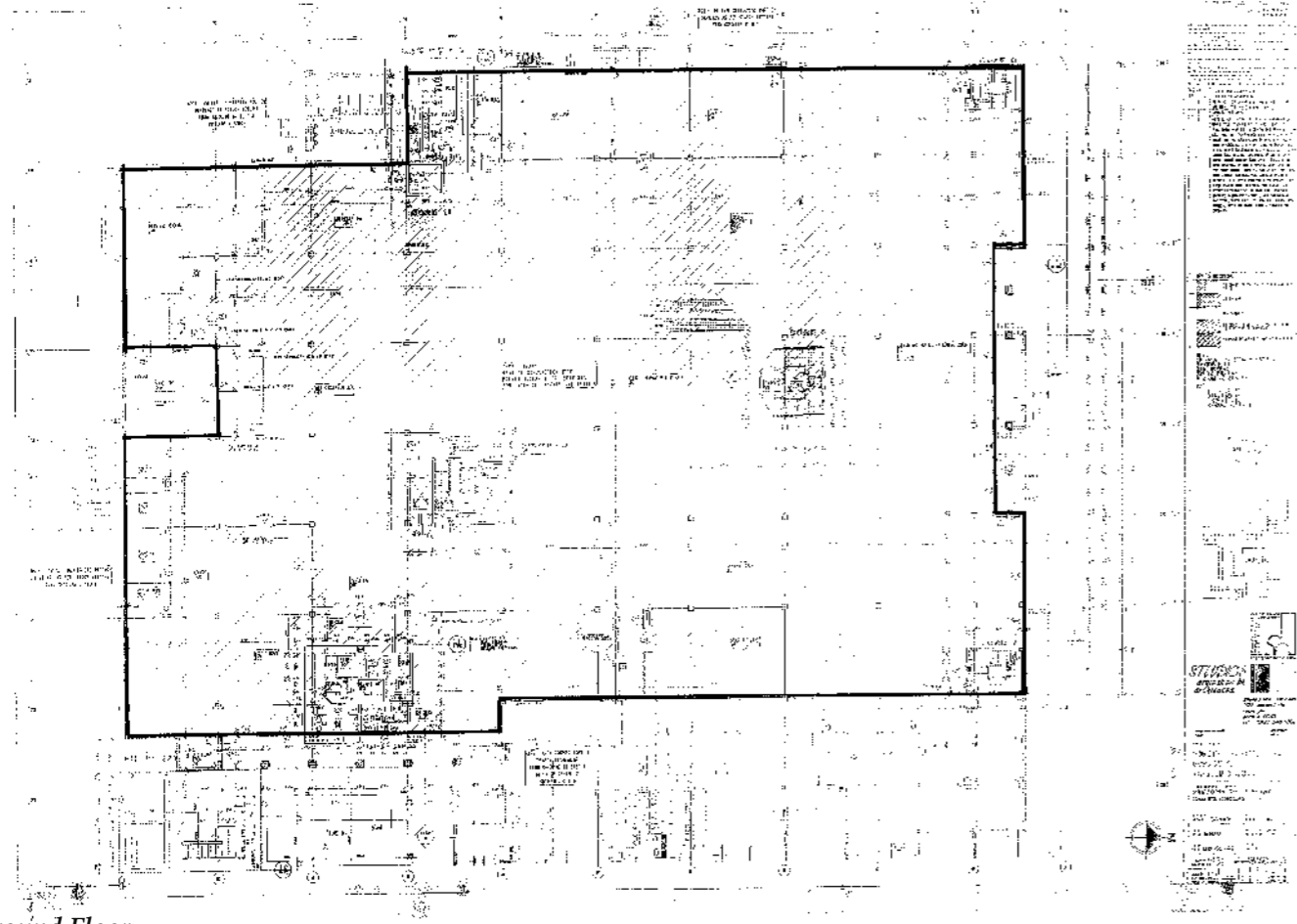

Ground Floor

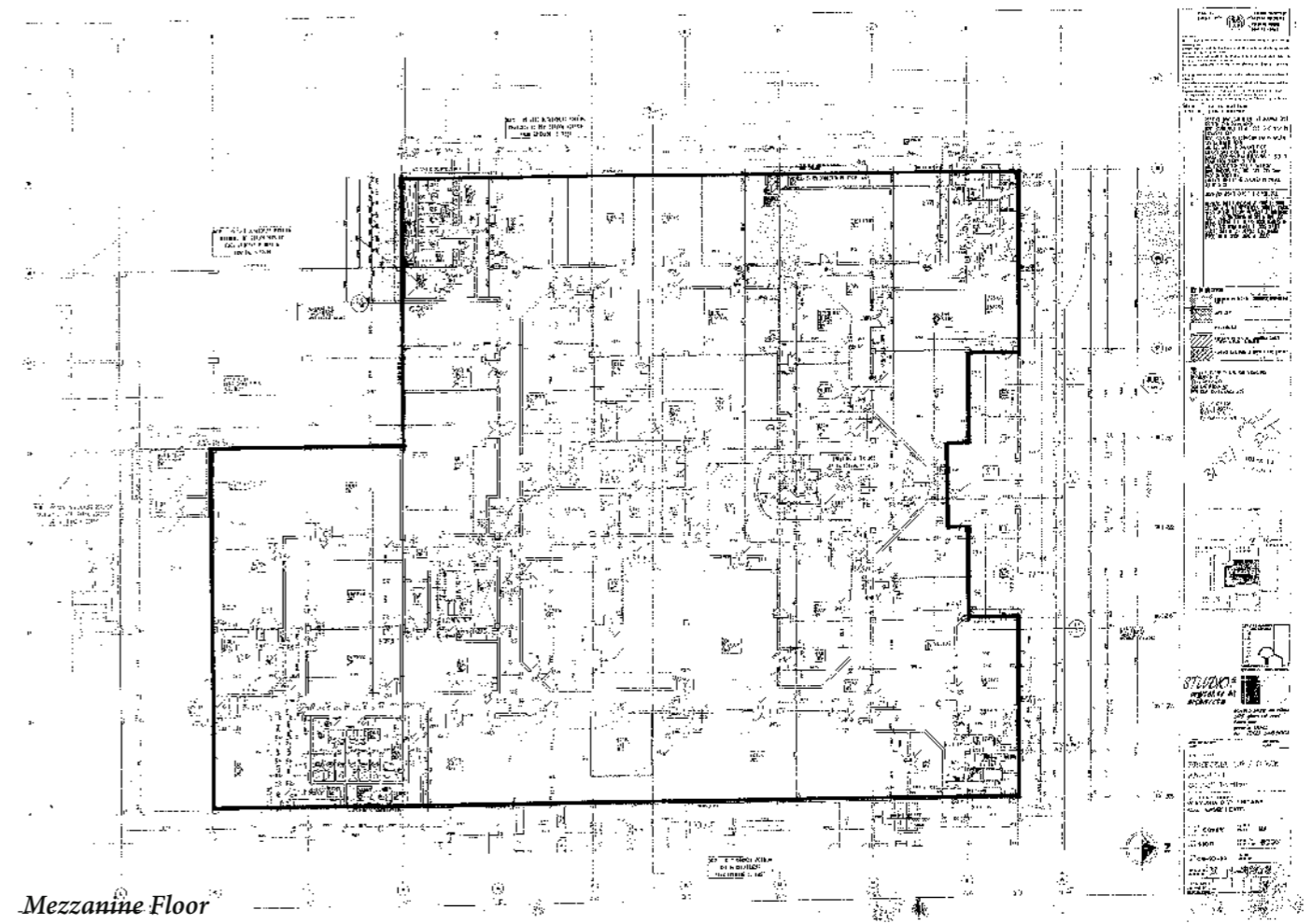

Mezzanine Floor

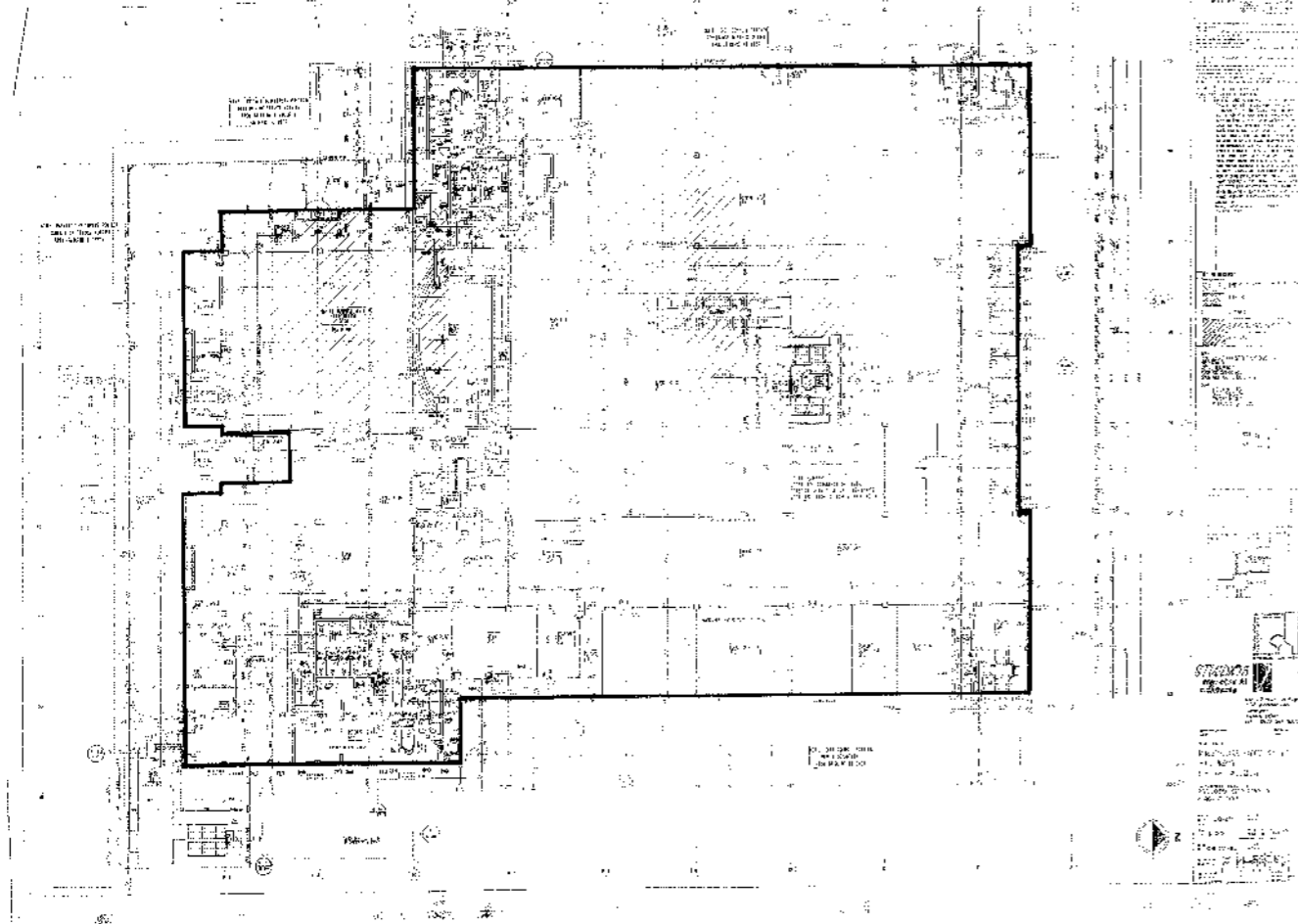

First Floor

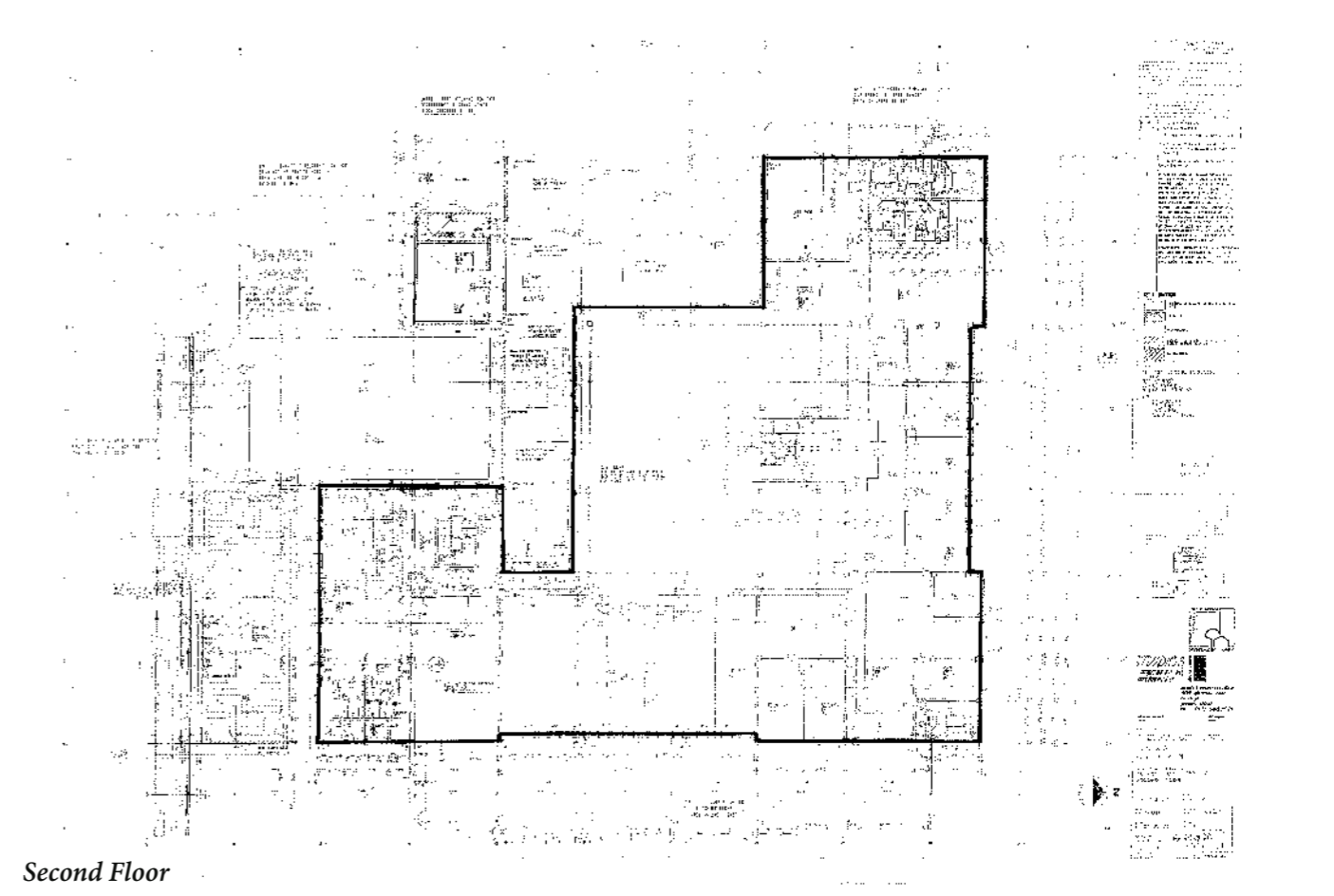

Second Floor



Giselle Fourie
14004969

Study Leader: Arthur Barker
Heritage & Cultural Landscapes (HCL)

M E M O R Y S C A P E

Reconciling Everyday City Dwellers' Memory with Pretoria's Heritage Narrative

Site: South-eastern corner of the Sammy Marks block, Pretoria inner city (cnr. Helen Joseph & Sisulu st).

Programme: Museum/ Archive for the TRC and Forum Theatre.

Client: Ditsong Museums, South African Heritage Archives (SAHA), Oral Histories Association South Africa (OHASA)

Museums, much like any other historical establishment, reflect the perspectives or bias of the people who created them (South African Heritage Online, 2011).

The socio-spatial contribution of museums in the City of Pretoria (Tshwane) has diminished significantly. Existing museums are not fully integrated or engaged with their physical, social, political, or historical contexts and, as a result, are not freely utilized by all the communities they currently claim to serve.

Museums tend to be destinations that are placed outside the everyday conditions and lives of the citizens and, as a result, are on a trajectory to become obsolete.

The Truth and Reconciliation Commission (TRC) took place in South Africa as a means of facilitating healing and forgiveness of past human rights violations during Apartheid. The TRC forms an integral part of South Africa's heritage narrative of moving away from Apartheid and into democracy. Currently, the TRC is under represented and, as a result, memories are slowly being forgotten.

This dissertation embodies the TRC principles of 'translation' and 'transparency' through a new contextually driven museum typology. The design acts as a translation medium between the Pretoria National Archives and the general public in the same way that the TRC intended to function as a healing medium through which South Africa's exclusive Apartheid society could be transformed into an inclusive democratic society.

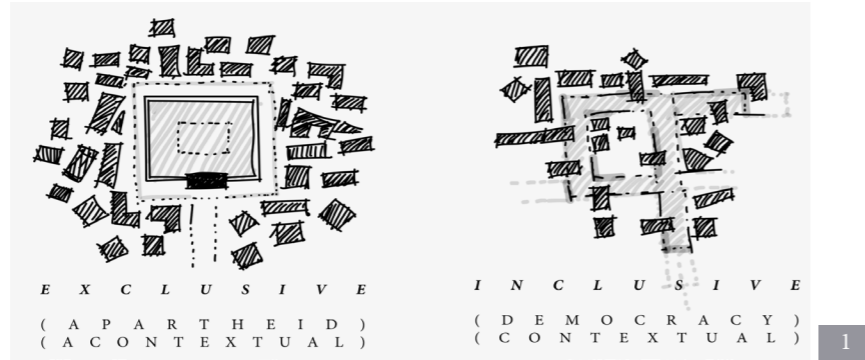

The aim of the Architecture is to express this narrative and encourage the continual healing process of this young democratic capital while aiming to free the existing museum typologies and turn them into inclusive, relevant and dynamic avenues of expression and change for all the communities they serve.

The vibrant south-eastern corner of the Sammy Marks square block in the inner city of Pretoria is used for the development of a democratic museum that absorbs and translates the everyday nature of the background and its users through the extraordinary lens of the TRC principles. 'Memoryscape' contemplates the creation of the extraordinary museum nestled within the hustle and bustle of the city's daily routine.

Memoryscape explores the museum as a multi-layered typological manifestation that gives the TRC relevance and prominence in the current context. The programs of museum, living archive and a forum theatre, act as landscapes through which the general public and tourists can learn about, experience, express, and record their own memories and experiences on the topic of this society and its on-going journey towards truth and reconciliation.

By reclaiming the past, contemplating, expressing, and recording the present, and projecting towards the future, memoryscape intends to immortalize the intentions and memories of the TRC and what it endeavoured to achieve.

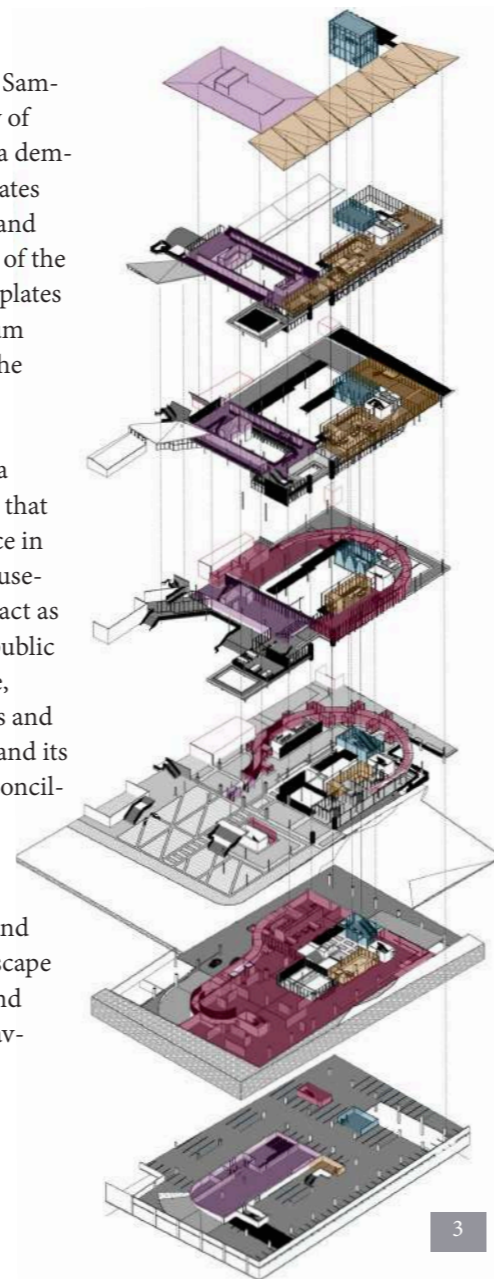

Figure 1: Museum typology now vs. proposed (Author, 2019)

Figure 2: TRC concept of Transparency/ Translation as Parti diagram (Author, 2019)

Figure 3: Exploded Axo of building illustrating placement of programmes (Author, 2019)



Giselle Fourie
14004969

Study Leader: Arthur Barker
Heritage & Cultural Landscapes (HCL)

M E M O R Y S C A P E

Reconciling Everyday City Dwellers' Memory with Pretoria's Heritage Narrative

Site: South-eastern corner of the Sammy Marks block, Pretoria inner city (cnr. Helen Joseph & Sisulu st).

Programme: Museum/ Archive for the TRC and Forum Theatre.

Client: Ditsong Museums, South African Heritage Archives (SAHA), Oral Histories Association South Africa (OHASA)

PROJECT BACKGROUND

The Truth and Reconciliation Commission (TRC) forms an extremely important part of the intangible heritage of South Africa, however, the recorded accounts of the TRC are archived away from the eyes of the Public. Hlekiso (2018) recently reported that there is an urgent need for the TRC to be memorialized and made accessible to the public so that history may be known and healing can continue. SAHA (2006) emphasizes the importance of a relationship between archive and oral histories within a democratic society as a means of catalysing public deliberation. Currently the TRC is not prominently memorialised, its archives are inaccessible and its principles have not continued as a reminder of what it aimed to do and as a result 'deep memory' has not been fully deliberated.

The dissertation explores an alternative museum typology that would best suit the unique nature of the TRC as well as the unique nature of the chosen site located in the heart of the democratic capital, Pretoria. The project explores the narrative of the intentions of the TRC; Transparency and Translation, through a multi-programmatic and contextual approach to museum making and how it can act as a catalyst through which the everyday man's memory becomes an integral part of South Africa's democratic collective memory whilst healing past deep memories. The integration of the 'everyday' realm into the museum facilitates a natural interaction of ordinary citizens with the museum itself. The Memoryscape comprises a museum, archive and theatre of new memory which explores the narrative of 'a long night's journey into day' through an experience through the past (the museum) the present (the recording of the everyday man's memory of Pretoria) and the future (the theatre of new memory for deliberation of 'deep memory').

TECHNOLOGICAL RESOLUTION

Concept: The technological approach that correlates with the design concept of 'darkness into light' embodying transition. The metaphor of a marionette being freed from its strings – the puppeteer losing control – is used to represent how the TRC helped to free the citizens of South Africa from the shackles of Apartheid in order to aid liberation. The technology represents this metaphorical narrative through the building being set free from the existing site constructs. Just as the TRC was the conduit through which the people were liberated into democracy, so the structure is freed from the concepts of the existing location into the vibrant nature of the everyday sphere. The physical manifestations of the notion of darkness into light and the freeing of the building can be seen through the contrasting lenses of restrictedness and concealment towards transparency. An important aspect of being freed from

a previously controlled past is 'adaptability', to be embodied in the nature of a new construction methodology.



Above: Metaphor of marionette

Structure: The new intervention utilizes the existing 8,5 x 8m column grid of the existing basement below the site that was intended to support a multi-story hotel. The columns are reinforced to support the hotel that was never constructed. The new steel structure (including a space frame) is to be built on top of the existing concrete columns while the intended floor construction contrasts with the existing basement coffer slabs by exploring a light composite floor system of steel decking. The steel structure allows for future structural adaptability.

Materials: The chosen new materials are intended to contrast with the Sammy Marks block's existing materials. Contrasting materials were chosen based on the concept of 'darkness into light'; the existing materials (predominantly concrete and red face brick) embodying 'darkness' and the new materials (steel, polycarbonate, glazing, and timber) embodying 'light'. The materials are implemented in various parts of the building to narrate the transition from darkness into light. Additional materials such as accents of oxidized aluminium panels (screens and solid) are used to portray memory through the patina (memory) they will develop over time, which will give the building its own sense of memory.

Technology: The new technological system allows the building to be adapted for future uses or removed completely to leave the structure on site in almost the exact condition in which it was found. The new technology is not invasive as per the existing on-site conditions. The technology speaks a new language to the existing and aims to express the concept of being freed from ones shackles as well as various expressions of memory.

Environment & Services: The main environmental elements explored in the design are: acoustics (exploration of innovative and adaptable possibilities for the theatre), natural light and rain water harvesting and purification (for drinking as well as for a gravity-fed greywater system for bathrooms). Additional systems that are explored include: ventilation (natural and mechanical), thermal performance of the building (strategies to mitigate solar heat gain).

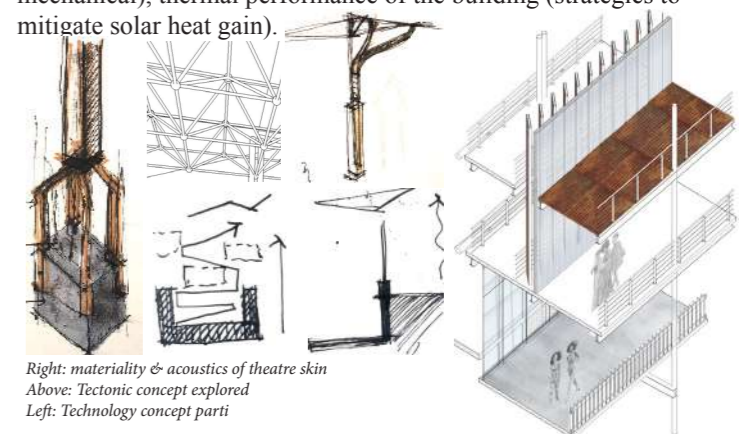

Right: materiality & acoustics of theatre skin
Above: Tectonic concept explored
Left: Technology concept parti