

CHAPTER 04
PROGRAMME AND DESIGN

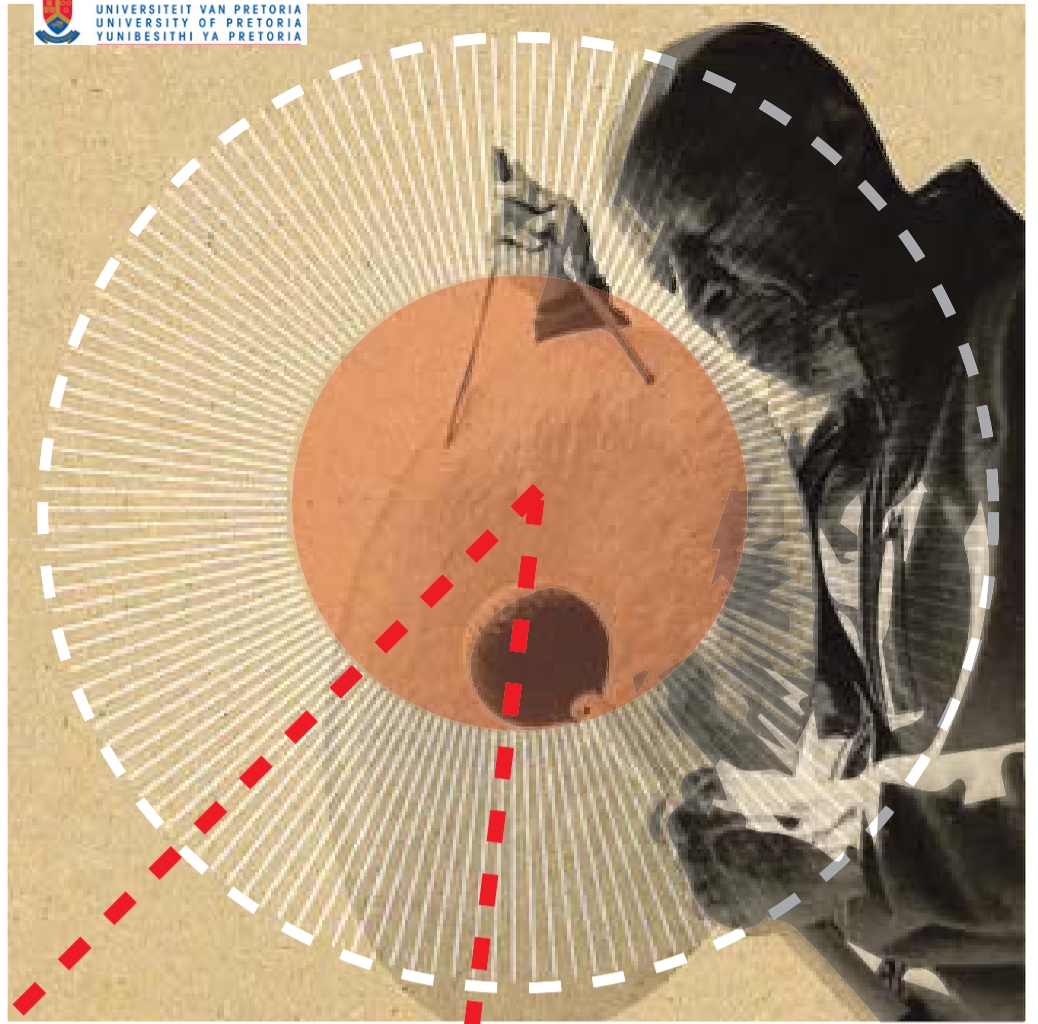

↓ 079 - Programme Graphic

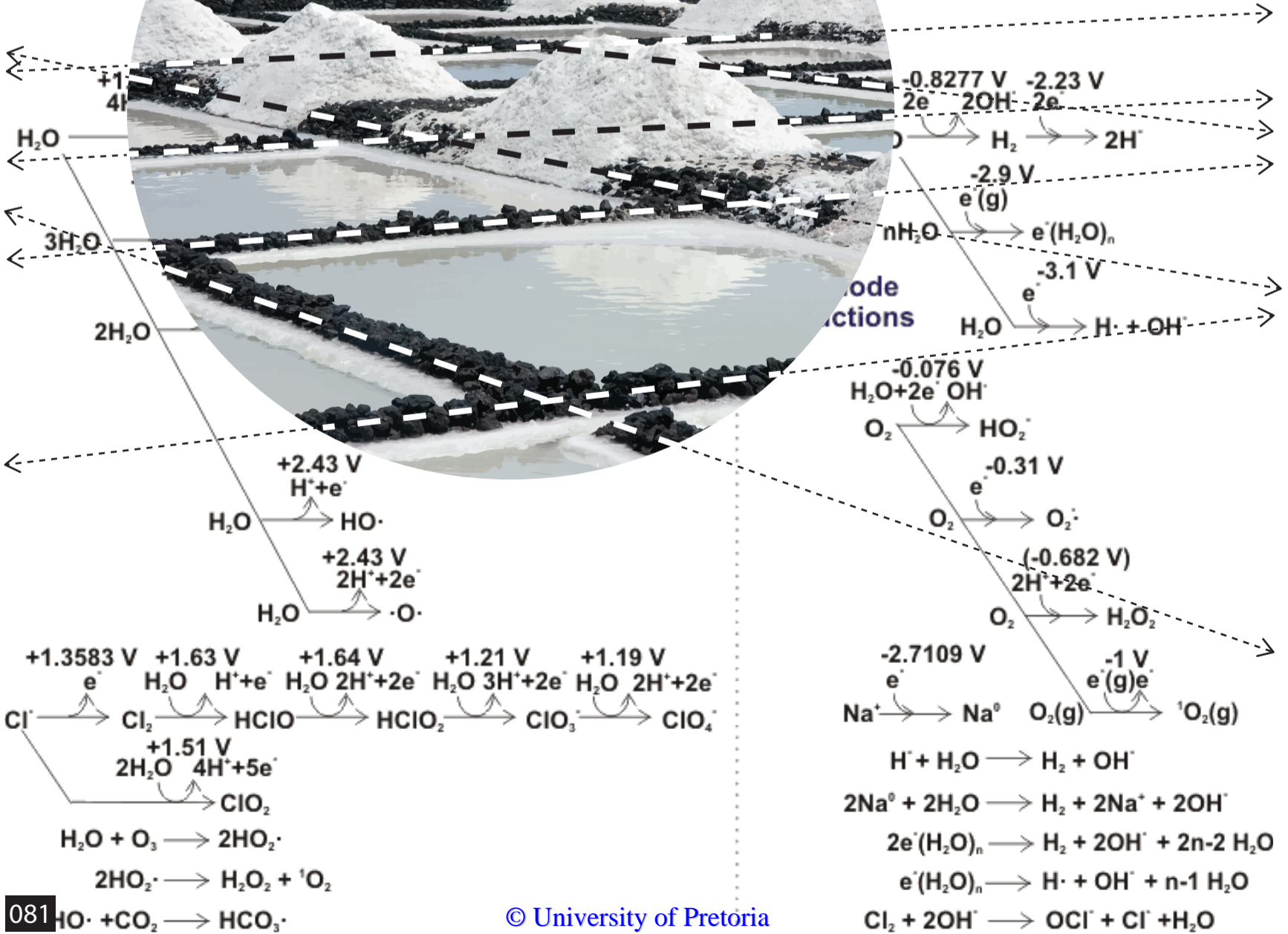
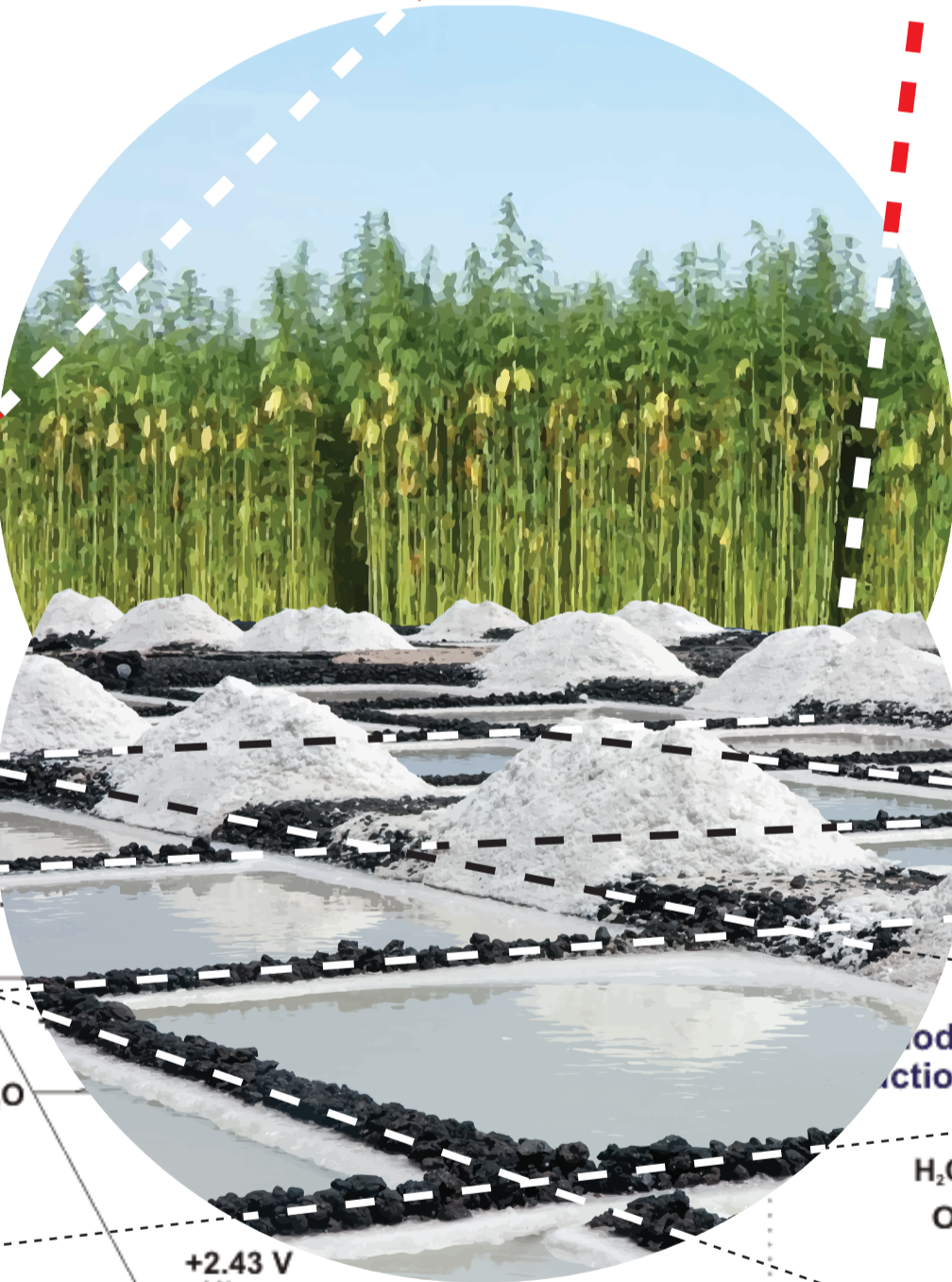

4.1// INTRODUCTION

The Game of Diminishing Returns aims to rehabilitate both Man and Nature. These aims will be achieved through an architectural programme establishing three research laboratories consisting of Agriculture studies, Chemical experimentation and Technological innovation; supported by various bolt-on programmes. Three major outputs will be delivered from the architectural programme: salt extraction and purification, construction technology, and agricultural training. While the determined outputs of the programme are paramount to the success of the architectural intentions, the largest proponent of the entire project will be the physical remediation of slime dam no.7 . This will be done through the three laboratories researching methods of rehabilitation and determining their success after testing implementation.



↑ 080 - Programme Baseline

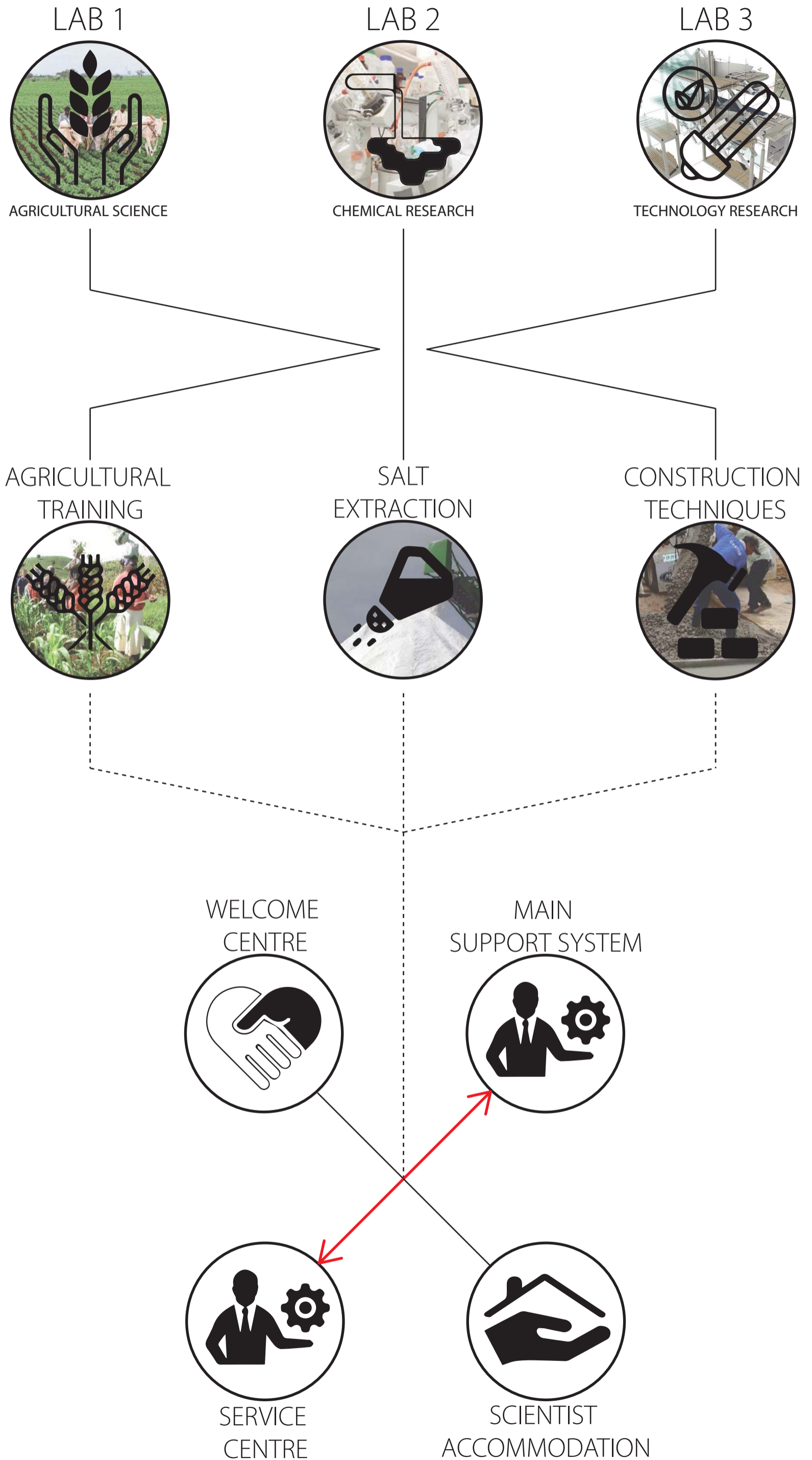

4.2// INPUT AND OUTPUT

AGRICULTURAL SCIENCE LABORATORY

- Testing the effects of diamond mine related chemical water contamination on various local plants species and internationally acknowledged bioremediation species.
- Researching viability and edibility of harvestable crop species after use in bioremediation and establishing codes for effective implementation.
- Agricultural community training through introduction to bioremediation and sustainability principles.
- Testing viability of agricultural zones within Refilwe, utilizing water from slime dam no.7.

CHEMICAL RESEARCH LABORATORY

- Investigations into exact chemical composition of slime dam no.7's water.
- Implementation and testing of salt extraction techniques including: electrolysis systems, active & passive filtration systems and passive settling & evaporative systems.
- Training of Refilwe residents in extraction methods and viability of salt resale for either industrial or household purposes.
- Testing bioremediation plants after water extraction to establish: chemical absorption potential, chemical neutralization potential and edibility of crops used for chemical absorption.
- Investigation chemical settling agents and testing their implementation on small scale samples; to prevent environmental damage through failed tests.

TECHNOLOGY SYSTEM RESEARCH LABORATORY

- Testing architectural technologies to help in bioremediation strategies.
- Testing onsite materials in construction systems; including extracted rock and soils from mine-material dumps.
- Building method testing and training for Refilwe residents.
- Testing passive filtration systems on the chosen site landscape.
- Investigation into passive and active systems for net zero architecture.
- Mechanical training for residents from the Refilwe community.

WELCOME CENTRE ①

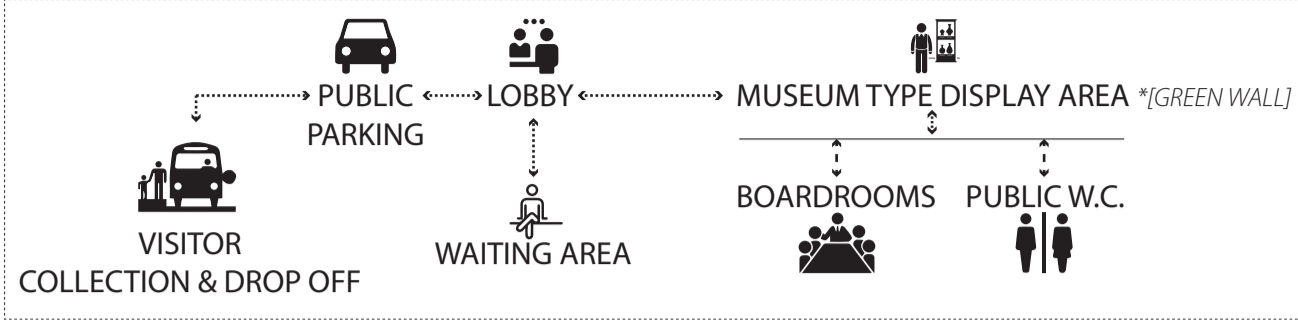

SITE PROCESSING ②



MAIN SUPPORT SYSTEM ③

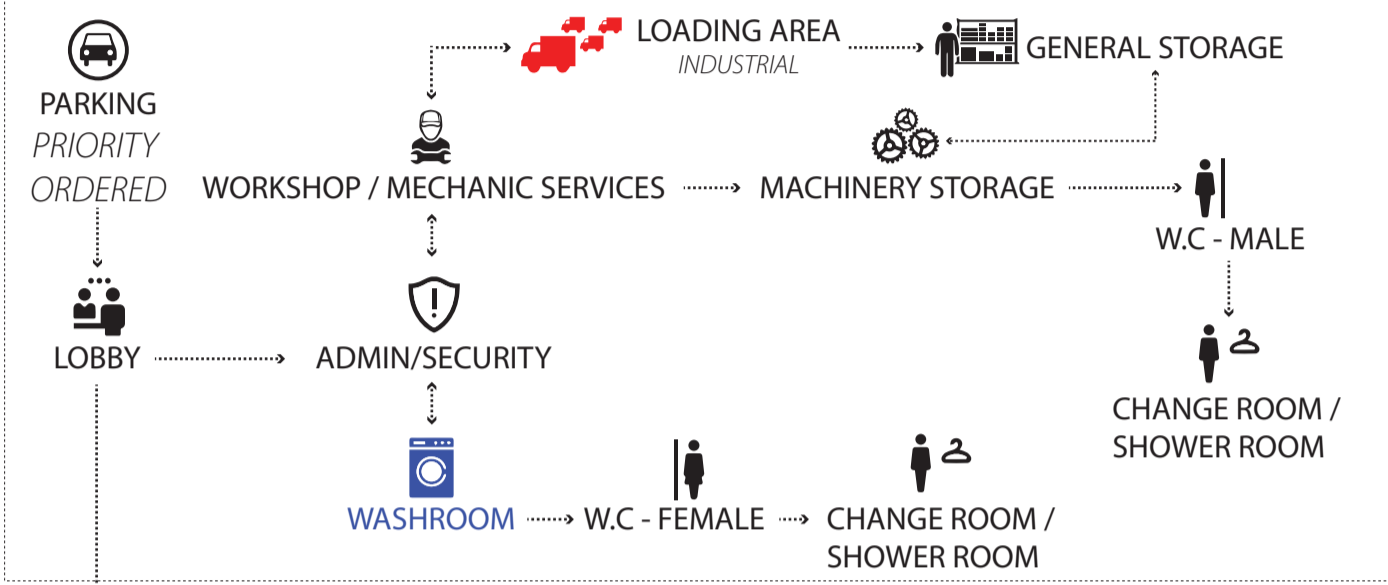

SERVICE CENTRE ④

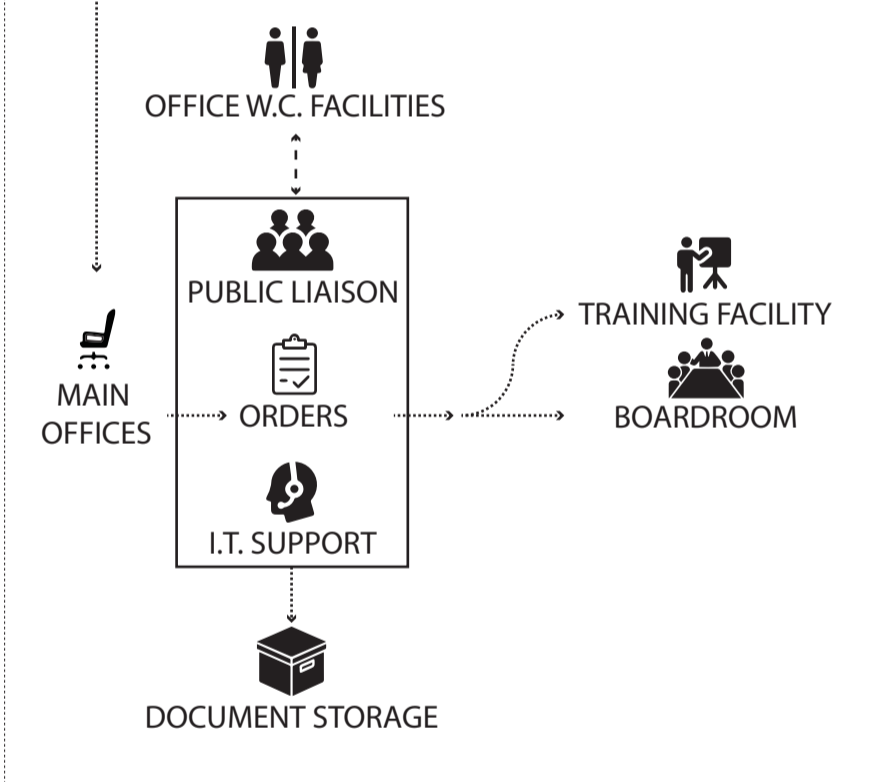

SLIME PUMPING SYSTEM ⑤

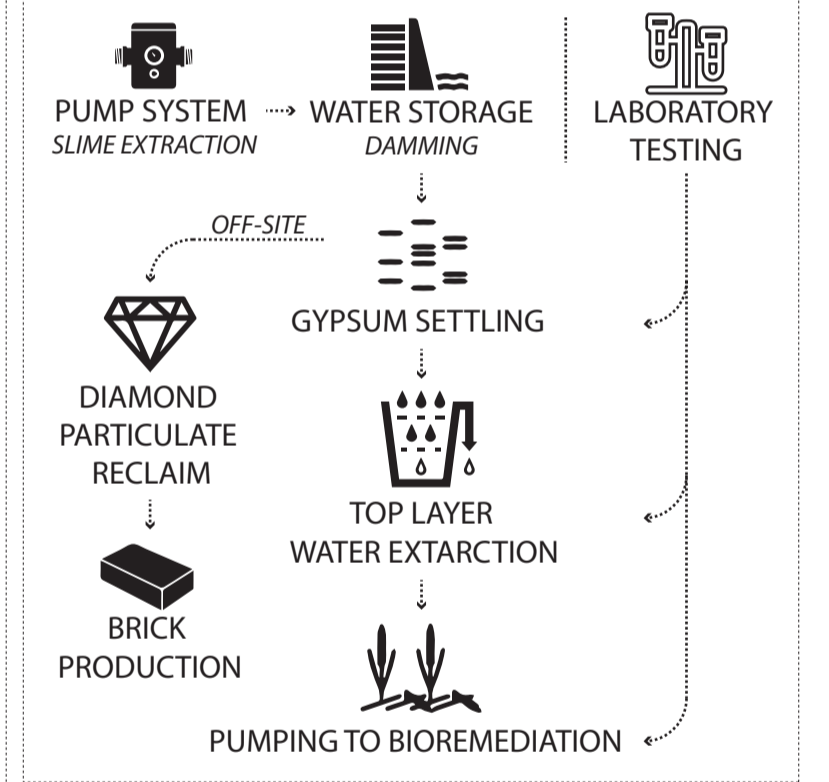

SALT EXTRACTION ⑥



GREENHOUSE ⑦

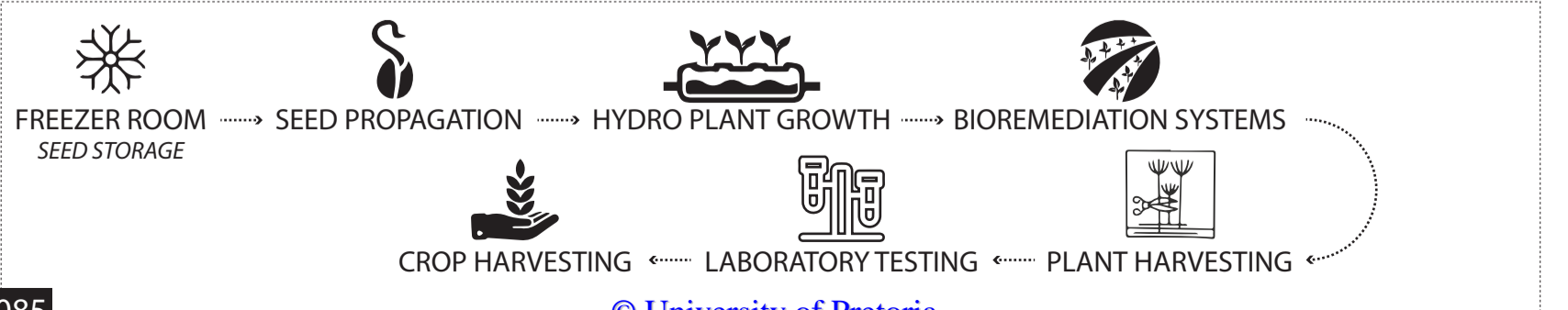

 **AGRICULTURAL LAB ⑧**

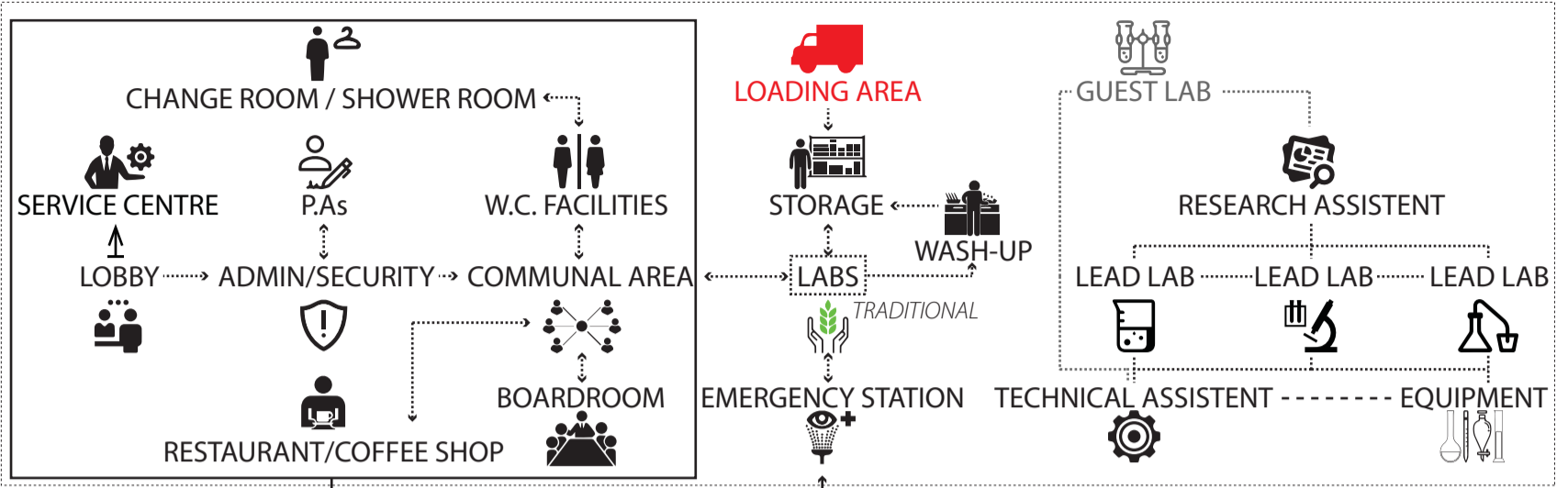

 **CHEMICAL LAB ⑨**

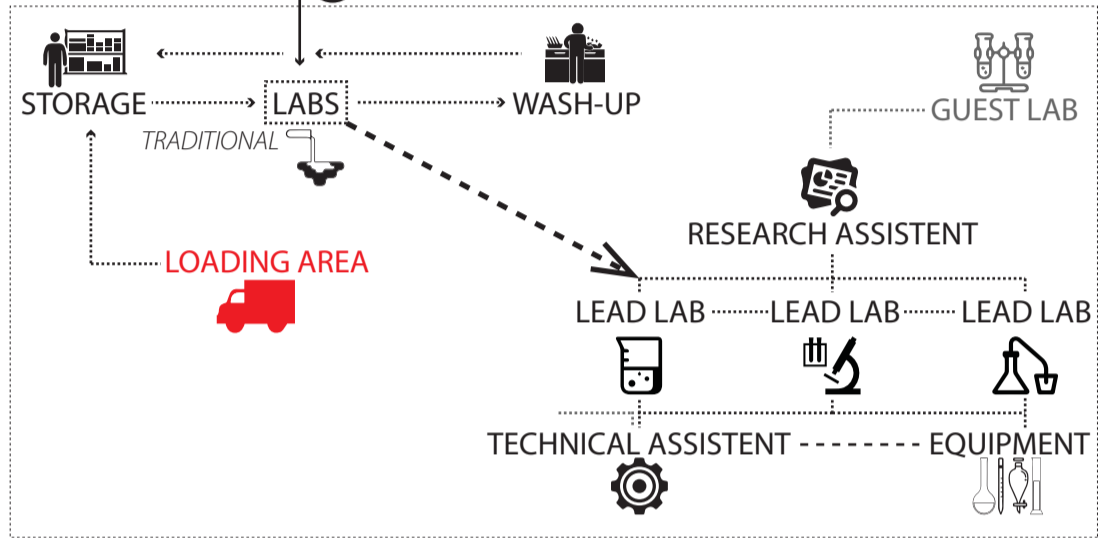

 **TECHNOLOGY LAB ⑩**

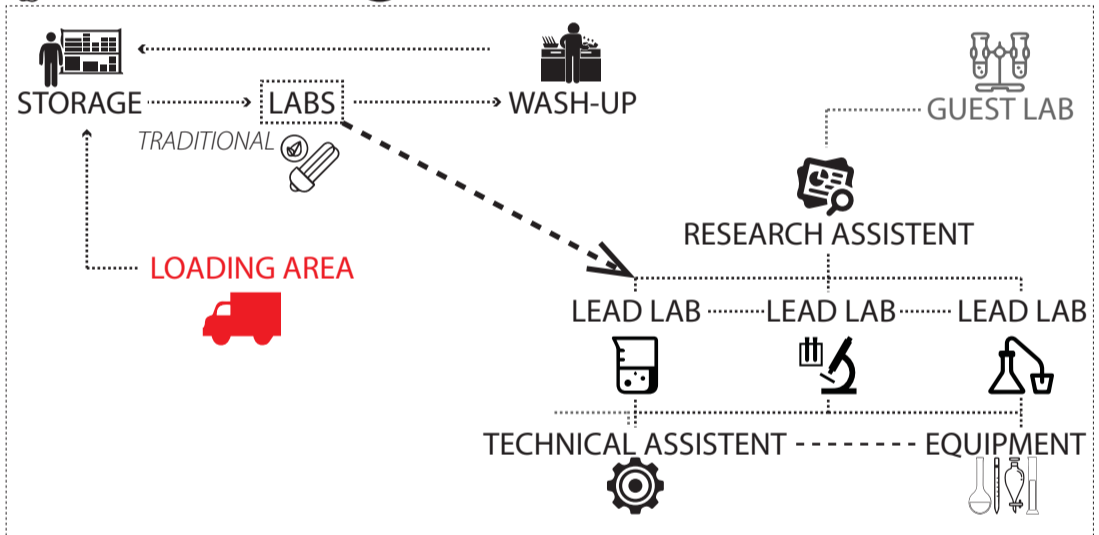

 **VISITING SCIENTIST ACCOMMODATION ⑪**

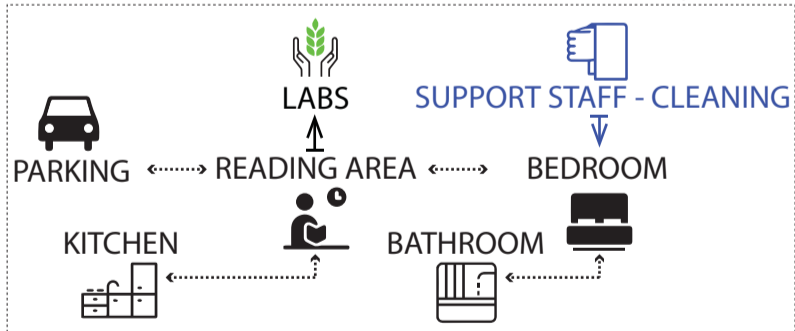



4.4// PROGRAMME DEVELOPMENT
& PLANNING

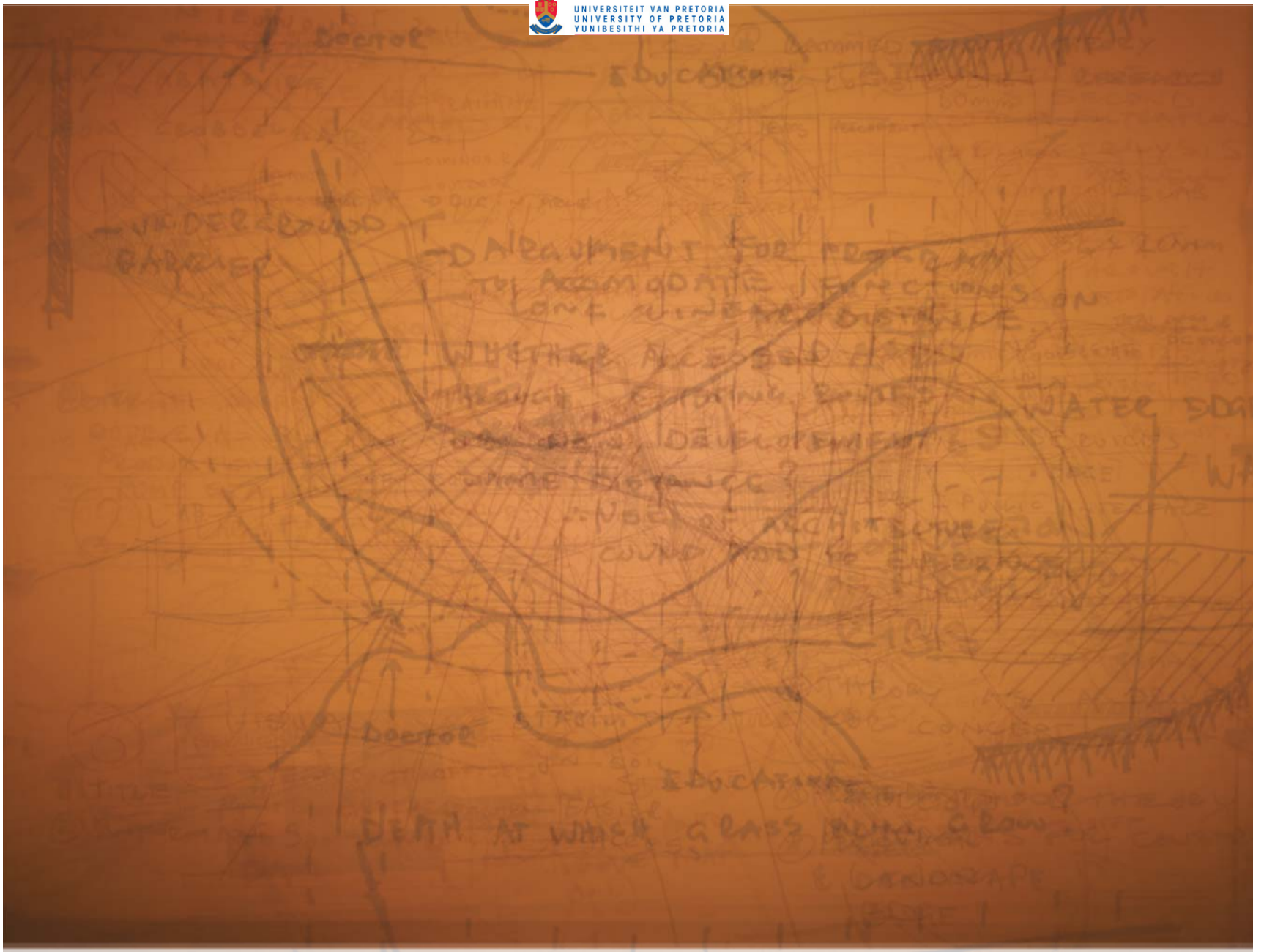

↑ 084 - Site Programme Development

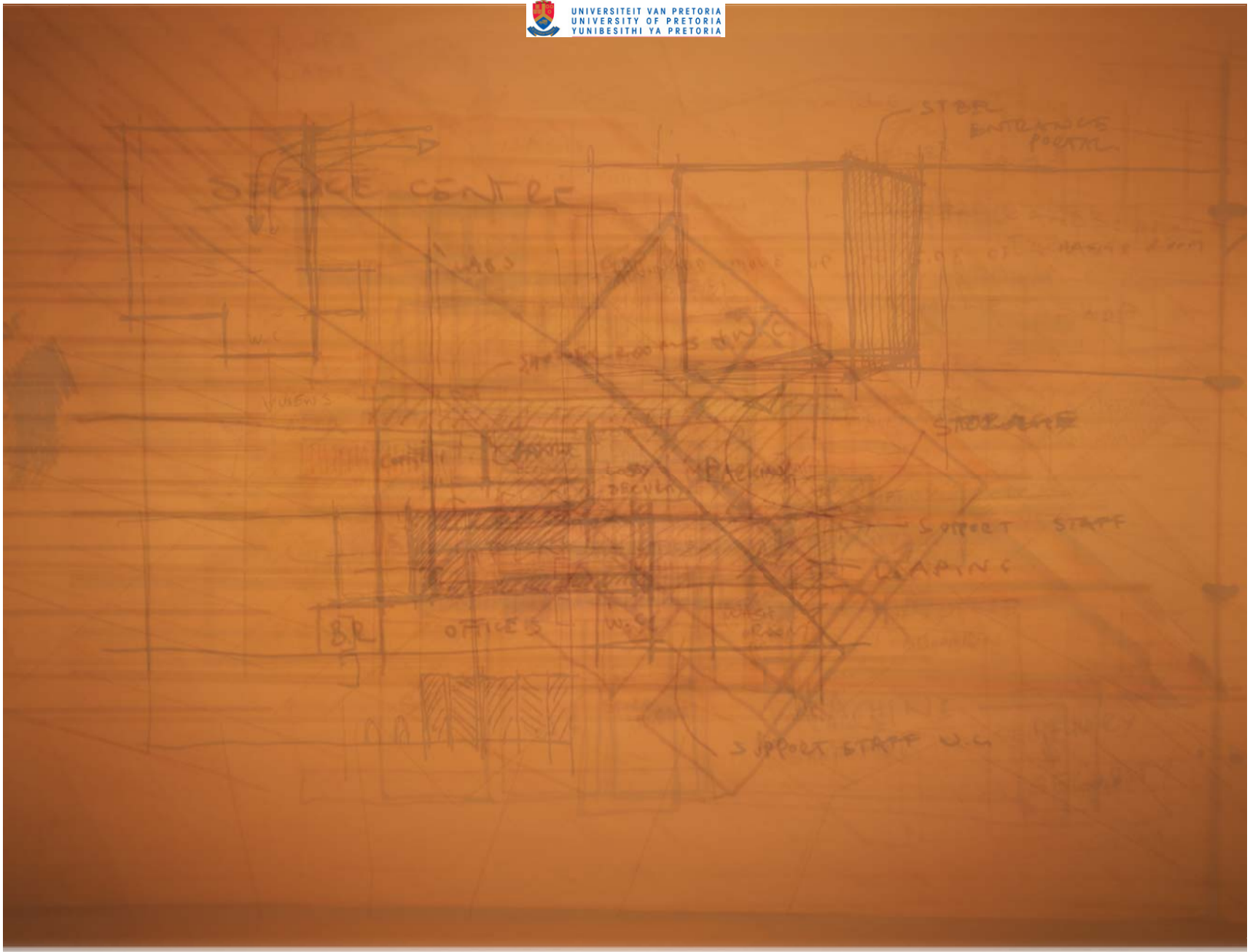

↑ 085 - Architecture Programme Development



4.5// PROGRAMMATIC DISPLAY
& DESIGN RESOLUTION

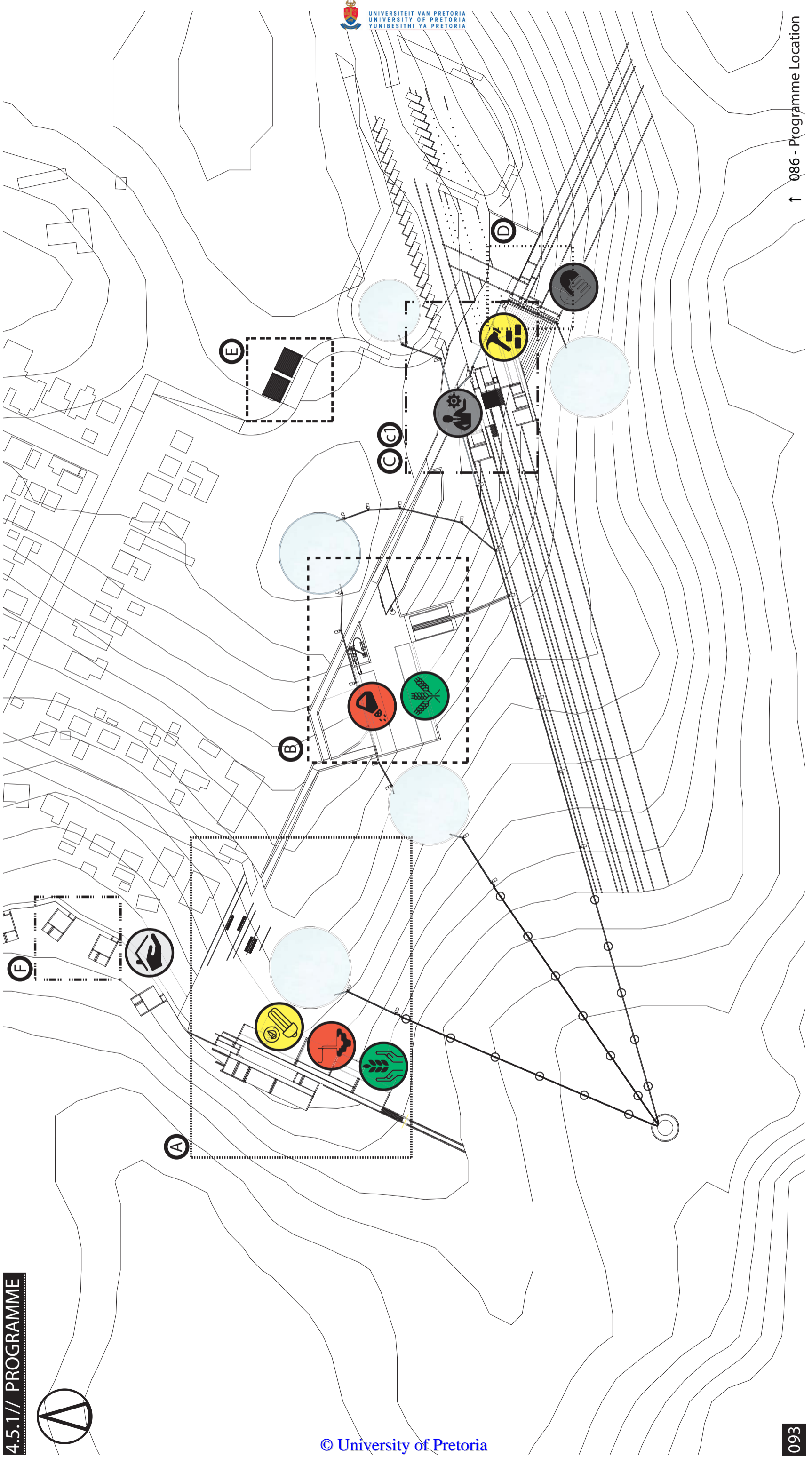

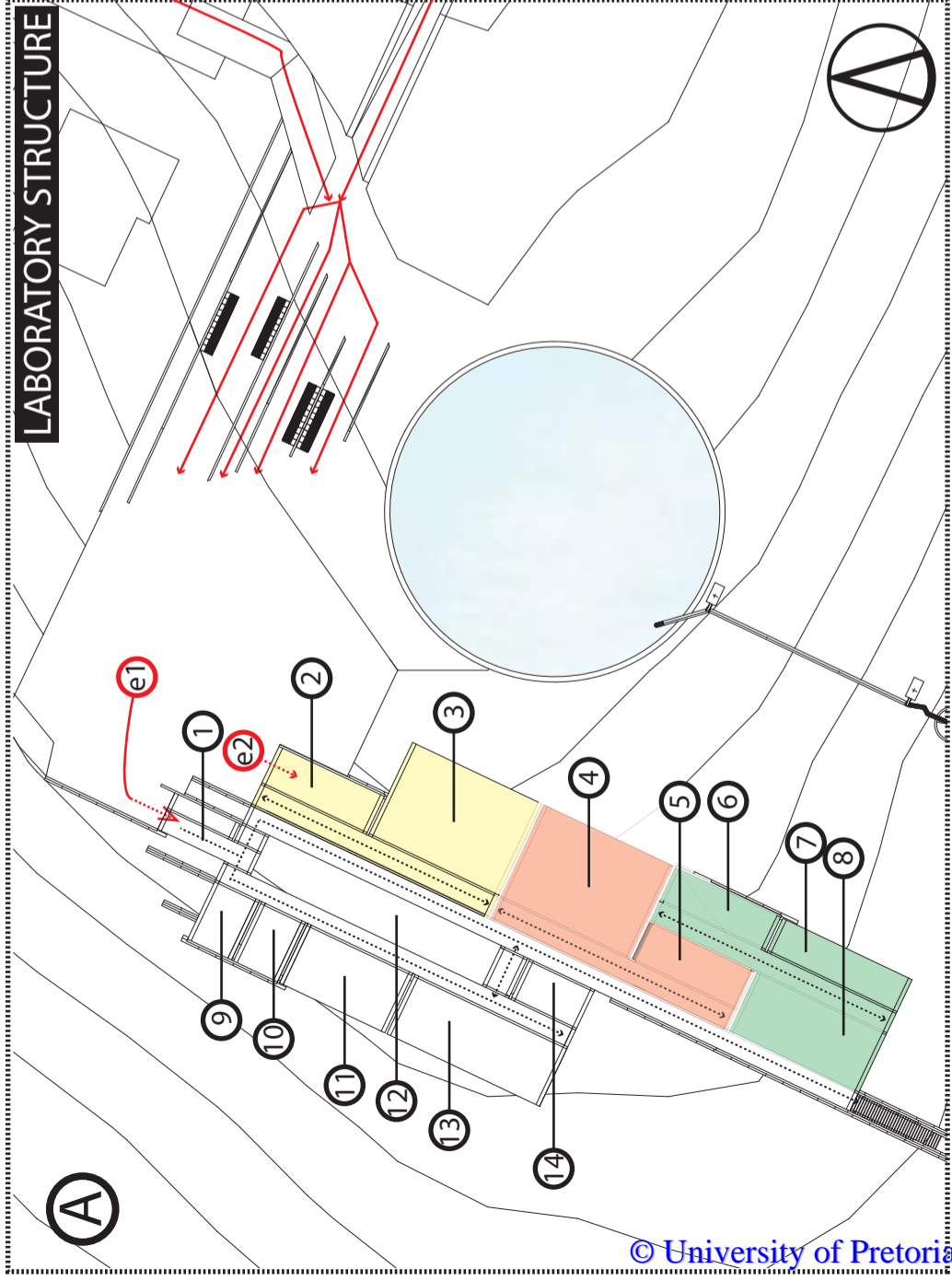

no.	PROGRAMME	m ²	no.	ACCESS
1	Lobby and Administration desk	29	a	Pedestrian access from Refilwe
2	Delivery bay and Storage	38	b	Access from Eastern site operations
3	Technology Research Laboratory	120	e1	Main Laboratory structure access
4	Chemical Research Laboratory	120	e2	Loading bay access
5	Computer Room - Serving all Laboratories	38		
6	Harvested plant testing area	34		
7	Agricultural Laboratory plant testing area	42		
8	Agricultural Laboratory	76		
9	Male W.C. and Change room	23		
10	Female W.C. and Change Room	23		
11	Personal Assistants and Administration	61		
12	Open air courtyard	101		
13	Communal research and Discussion area	90		
14	First Aid and Emergency eye wash area	23		

↑ 087 - Laboratory Programme

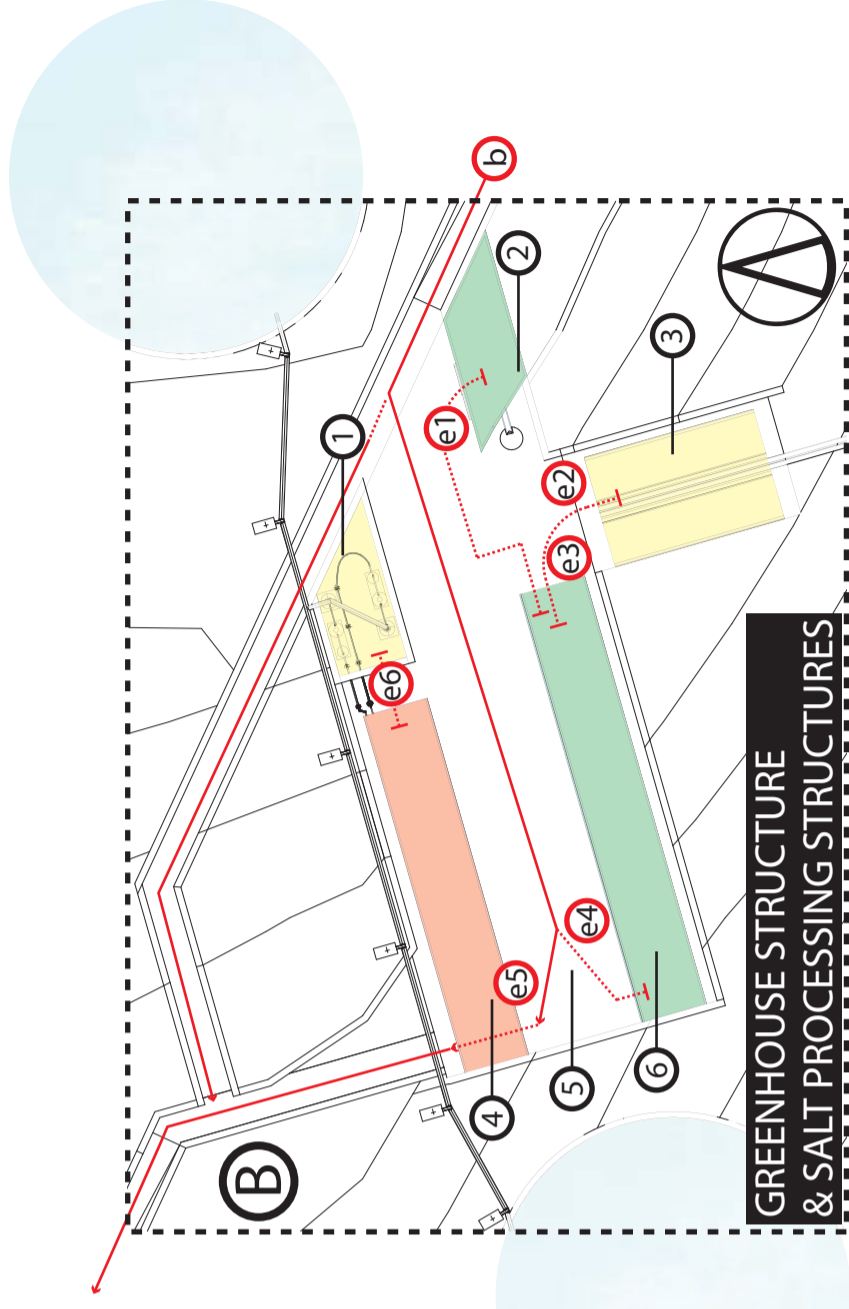

no.	PROGRAMME	m ²	no.	ACCESS
1	Salt Boilers - Salt Purification	67	b	Access from Eastern site operations
2	Seed Bank - Freezer Room	64	e1	Seed Bank access
3	Water pump station - Testing Point	145	e2	Access to Pump station
4	Water evaporation area for Salt collection	175	e3	Secondary access to Greenhouse 1
5	Evaporation area - External area	300	e4	Main access to Greenhouse 2
6	Greenhouse - Bioremediation crop seeding	210	e5	Main access to Salt processing plant
			e6	Secondary access to Salt processing plant

↑ 088 - Greenhouse and Salt Processing Programme

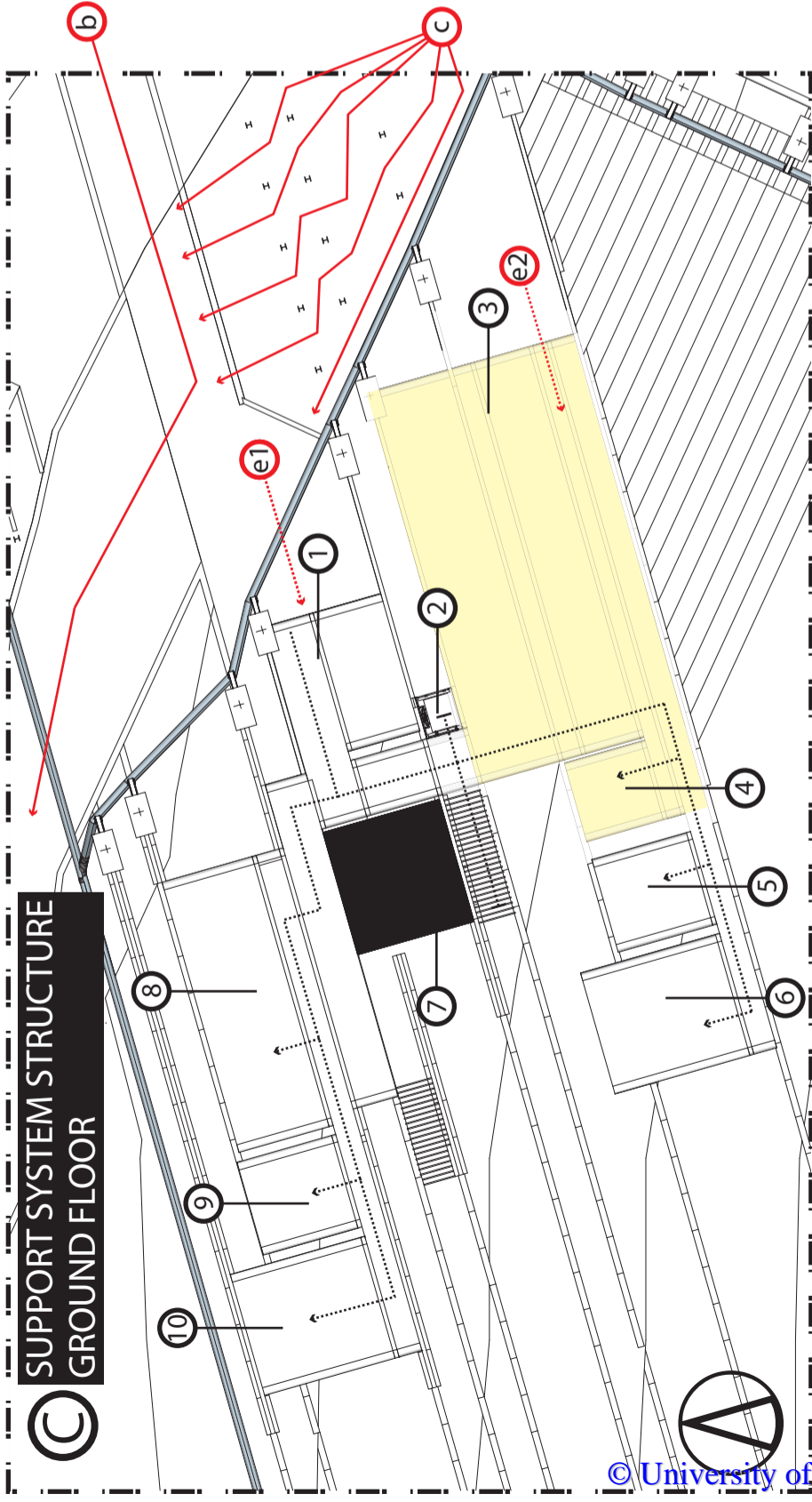

C SUPPORT SYSTEM STRUCTURE
GROUND FLOOR

no.	PROGRAMME	m ²	no.	ACCESS
1	Lobby and Administration desk	42	b	Access from Parking Zone
2	Elevator - access to First floor	4	c	Alternative access from Welcome Centre
3	Delivery bay and Technology Workshop	190	e1	Main Support structure access
4	Storage area	12	e2	Loading bay access
5	Male W.C.	18		
6	Male shower and Change room	34		
7	Open air courtyard	34		
8	Laundromat area	55		
9	Female W.C.	18		
10	Female shower and Change room	34		

↑ 089 - Support System Programme - Ground Floor

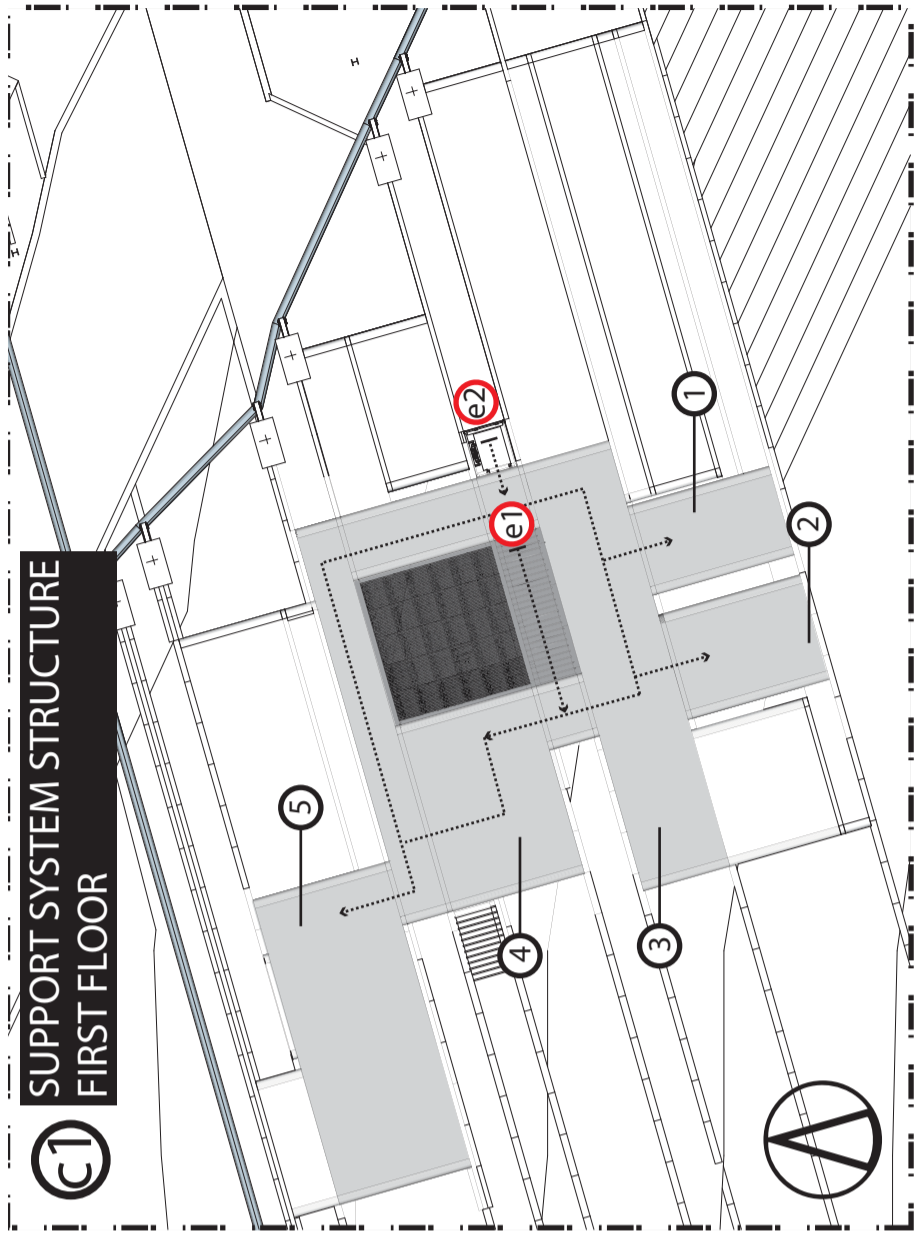

C1 SUPPORT SYSTEM STRUCTURE
FIRST FLOOR

no.	PROGRAMME	m ²	no.	ACCESS
1	Storage and Filing Area - Digital data backup	19	e1	Access via Staircase
2	Unisex W.C.	23	e2	Access via Elevator
3	Administration staff	67		
4	Boardroom	42		
5	Training area	72		

↑ 090 - Support System Programme - First Floor

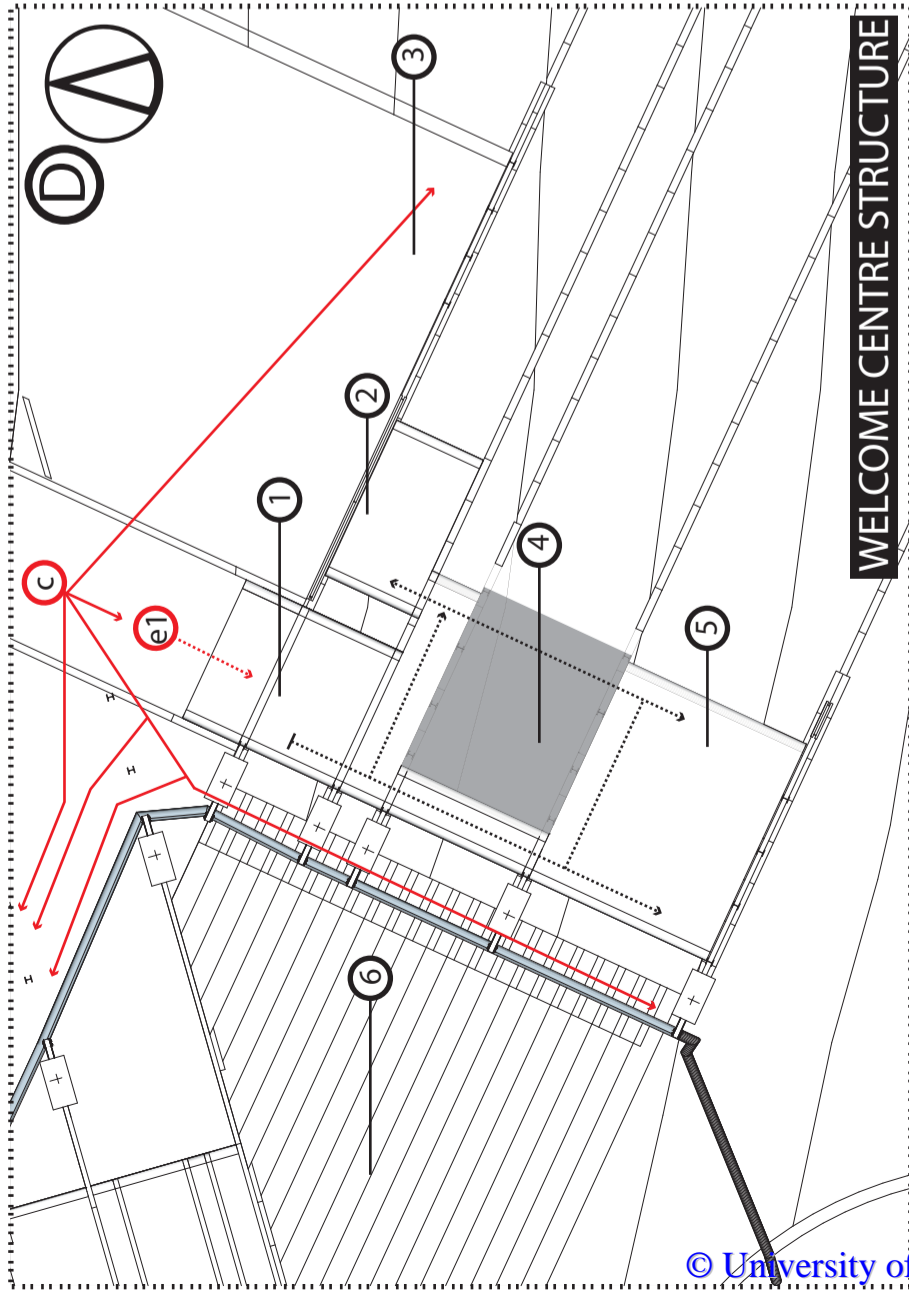

WELCOME CENTRE STRUCTURE

no.	PROGRAMME	m ²	no.	ACCESS
1	Lobby and Administration desk	20	c	Access from Parking Zone
2	Unisex W.C.	23	e1	Welcome Centre structure access
3	Lookout Area	318		
4	Open air courtyard	44		
5	Public Welcome area and Boardroom	67		
6	Amphitheatre area	340		

↑ 091 - Welcome Centre Programme

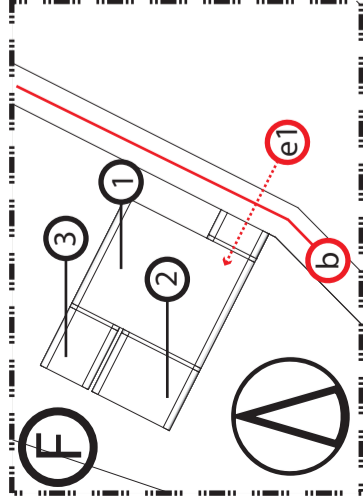

no.	PROGRAMME	m ²	no.	ACCESS
1	Kitchen and Dining area	45	b	Access from Eastern site operations
2	Bedroom and Study area	14	e1	Accommodation structure access
3	W.C. and Shower	8		

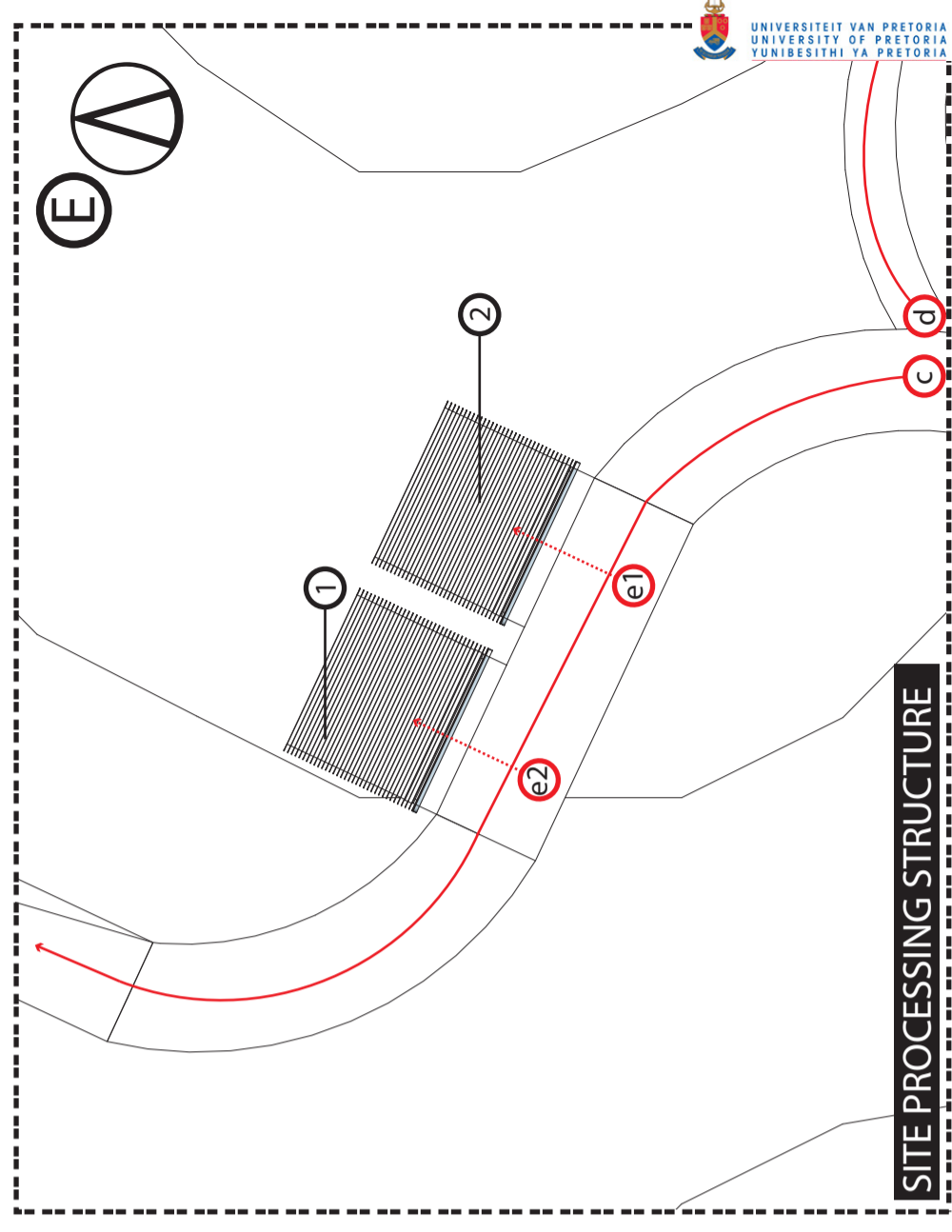

SITE PROCESSING STRUCTURE

no.	PROGRAMME	m ²	no.	ACCESS
1	Refuse collection area	65	c	Access from Parking Zone
2	Power Plant	65	d	Site exit - Route 1
			e1	Power Plant access
			e2	Refuse Processing area access

↑ 092 - Site Processing Programme

4.5.2// WATER SYSTEMS

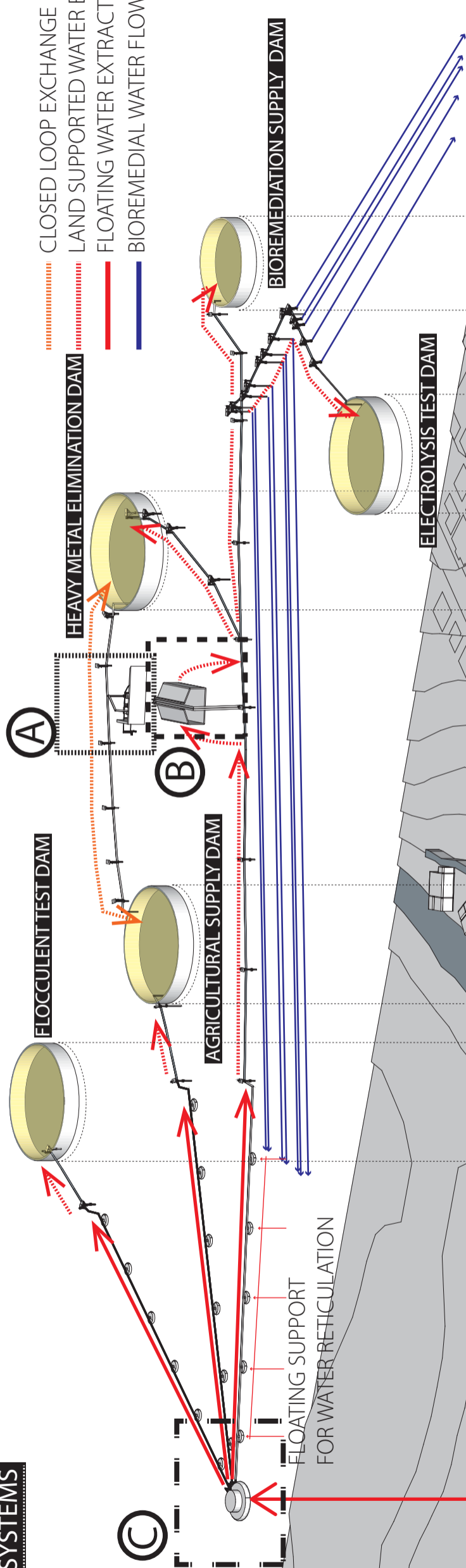

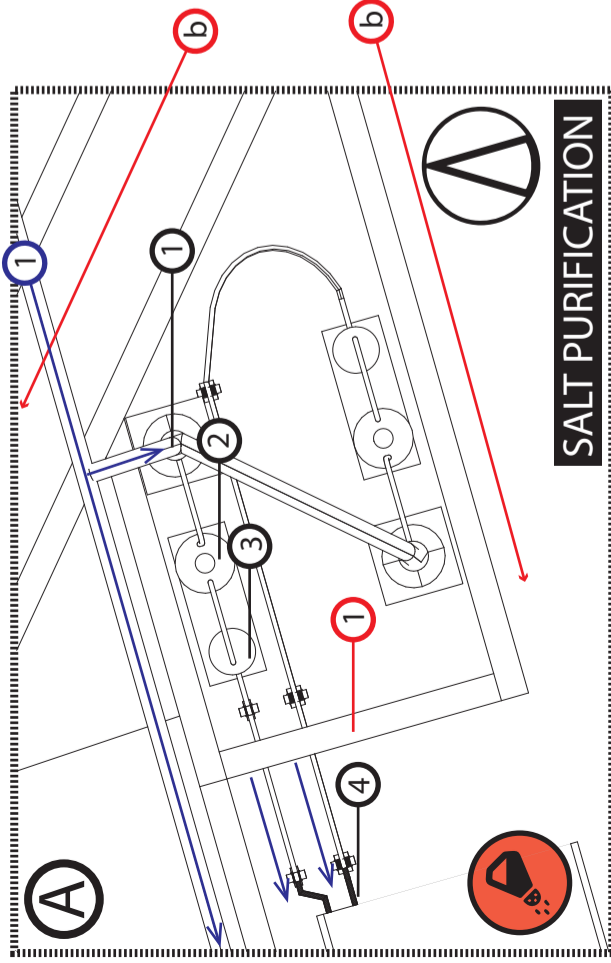

SALT PURIFICATION

no.	PROCESS
1	Boiler
2	Calcium Extraction
3	Filtration
4	Pumping to Evaporation Tables
no.	ACCESS
1	Access from Eastern site operations

© University of Pretoria

↑ 095 - Salt Purification Stages

Gabion Wall Structure - Allow for steam dissipation

Water from Eastern Dam

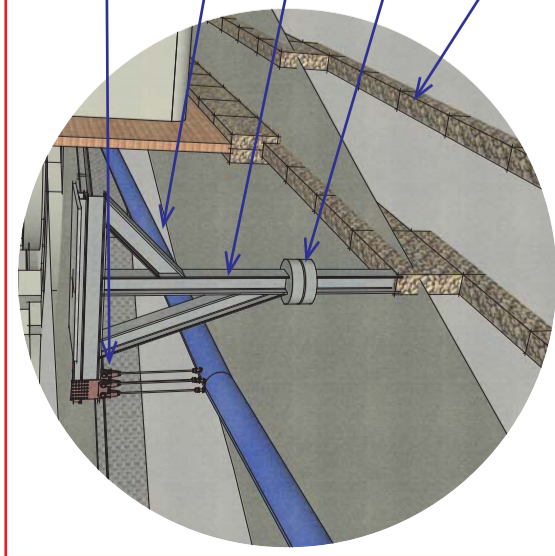

- Custom Powder coated Steel Hanger
- To engineers specifications
- 200mm Polyethylene hdpe
- Water reticulation pipe
- 254x254mm Universal Steel Column
- Water supply system
- Custom Swivel Bearing Mounting System
- To engineers specifications
- 300mm Custom Gabion Rib Channel System

↓ 098 - Water Supply Supports

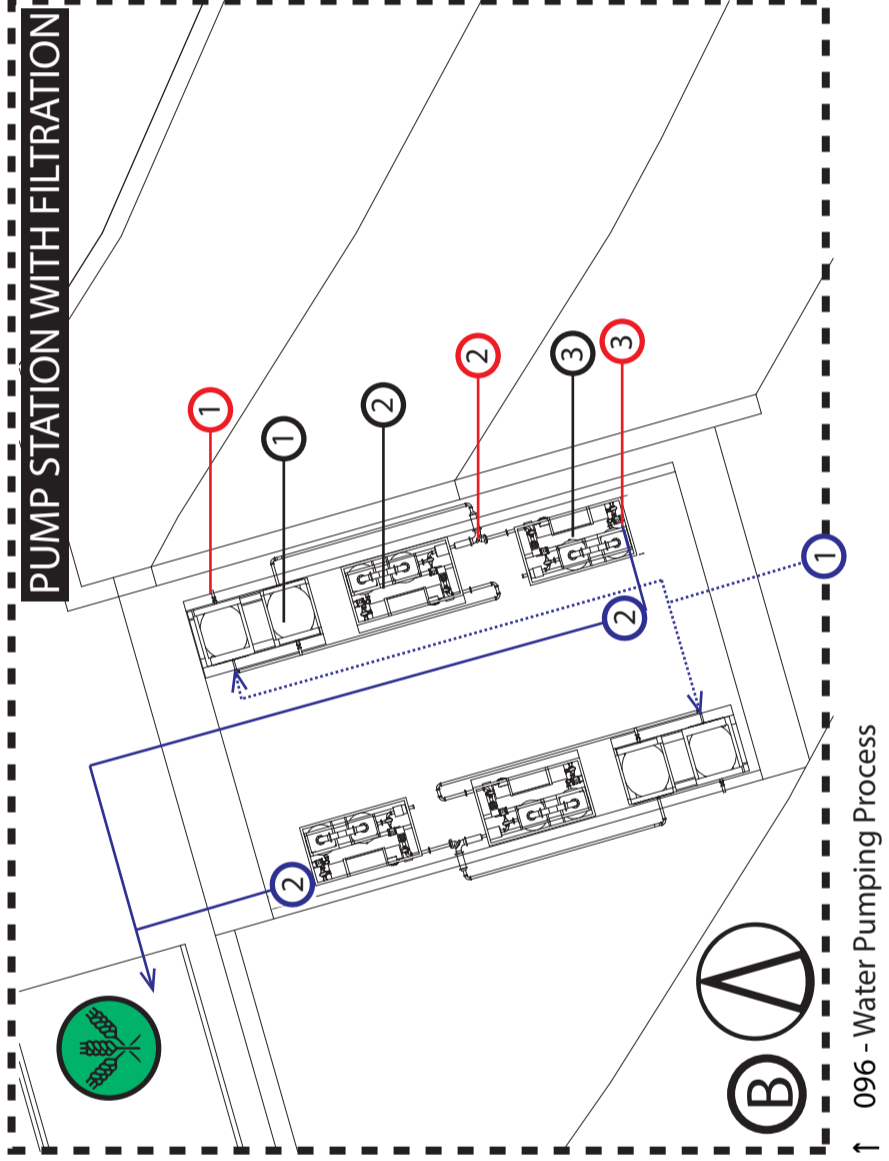

PUMP STATION WITH FILTRATION

no.	PROCESS
1	Large Capacity Pump Unit
2	Primary Filtration Unit
3	Secondary Filtration Unit
1	Pump Outlet to Eastern Dams Filtration Bypass
2	Primary Filtration Link to Secondary Filtration - Test Point
3	Secondary Filtration - Pumped to Greenhouse for Seedlings
1	Water from slime dam
2	Filtered Water to Greenhouse

↑ 096 - Water Pumping Process

↓ 097 - Slime Dam Pump

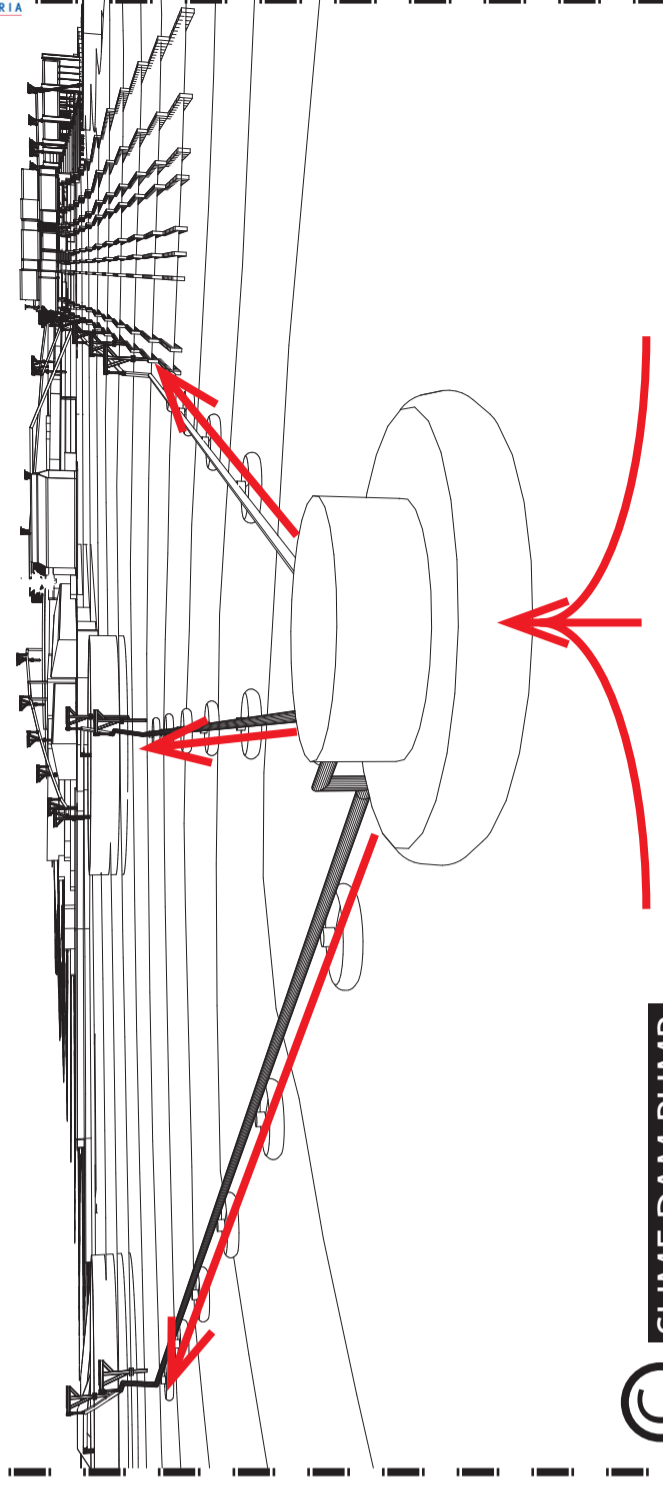

SLIME DAM PUMP

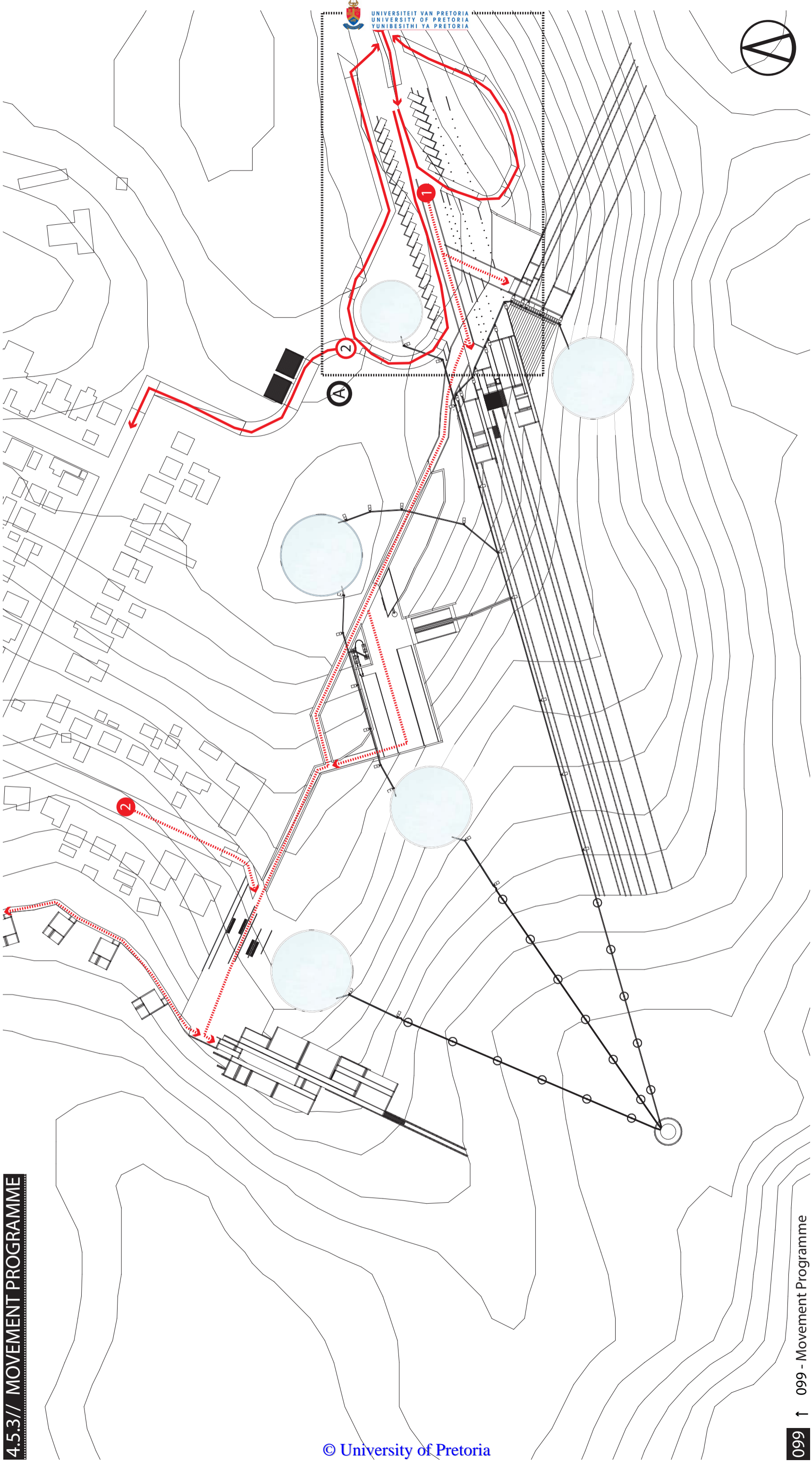

A

PARKING PROGRAMME

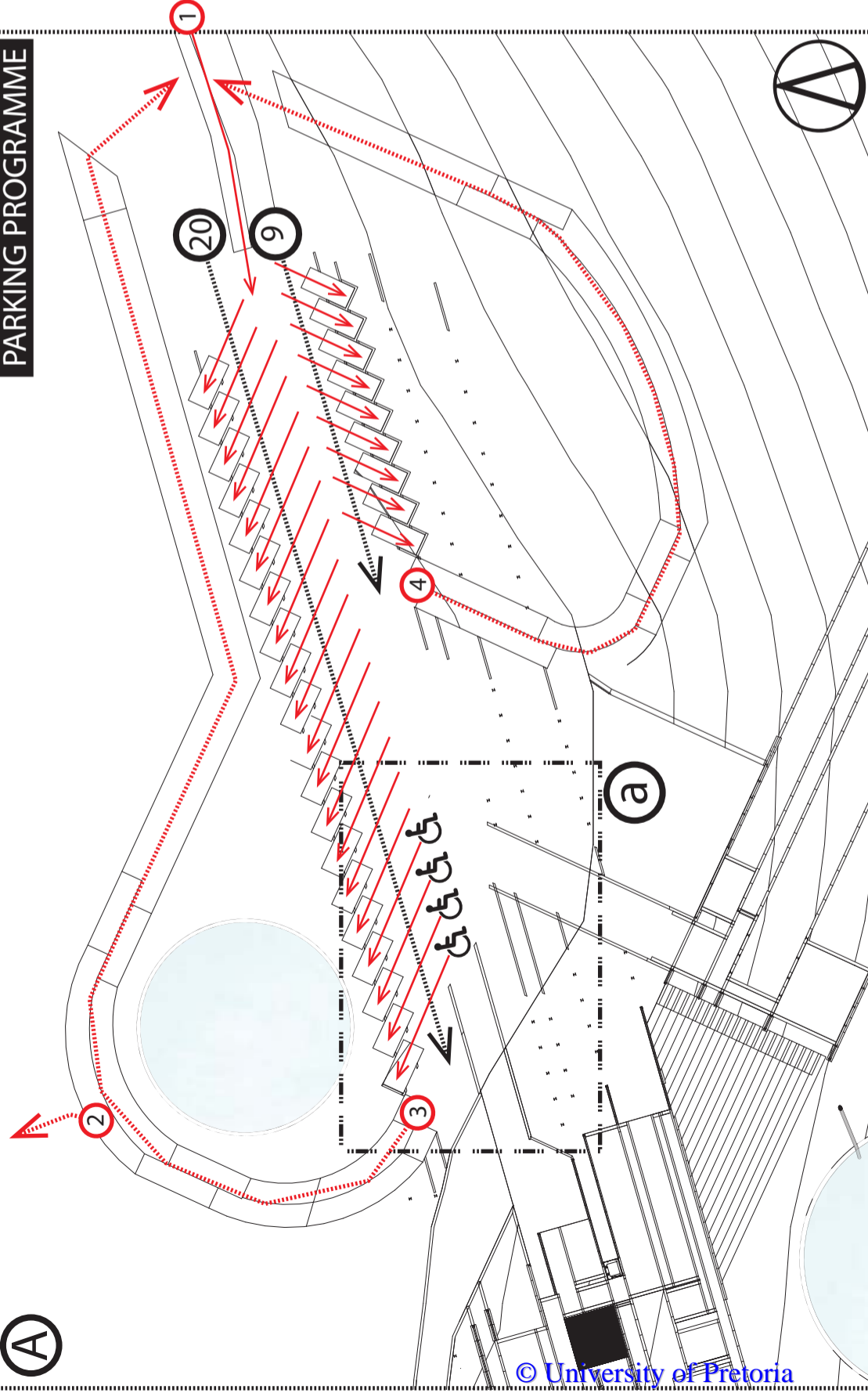

no.	PARKING
20	Twenty Parking Bays - With Priority Parking
9	Nine Parking Bays - General Parking

no.	ACCESS
1	Main Vehicular access - Existing Dirt Road
2	Alternative Site Exit - Main Refuse Exit
3	Main Exit from Site - Northern Parking
4	Main exit from Site - Southern Parking

1	Pedestrian Access to Structures
---	---------------------------------

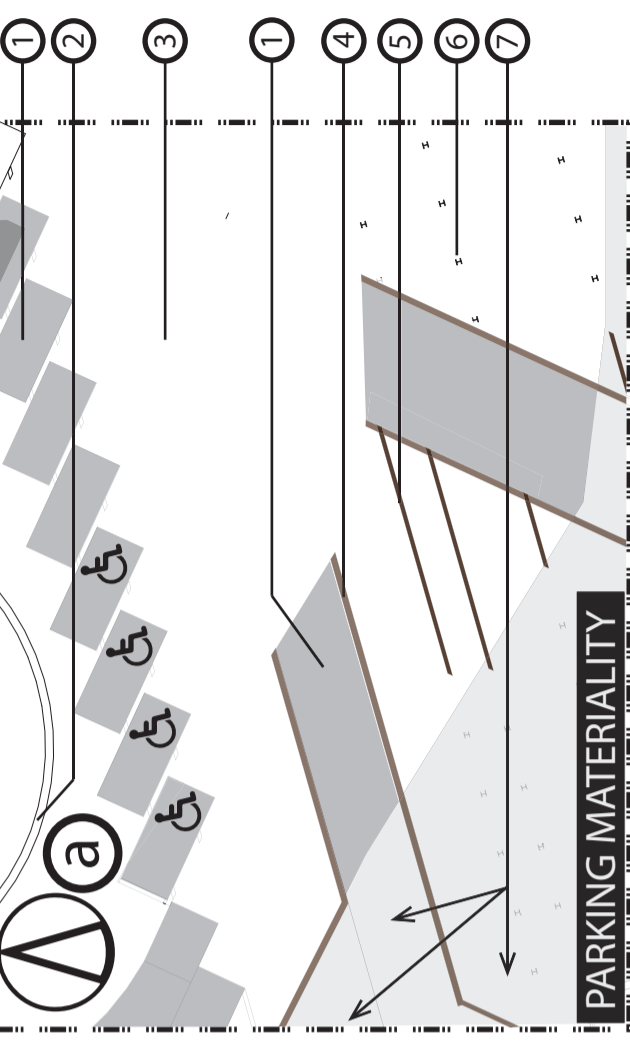

PARKING MATERIALITY

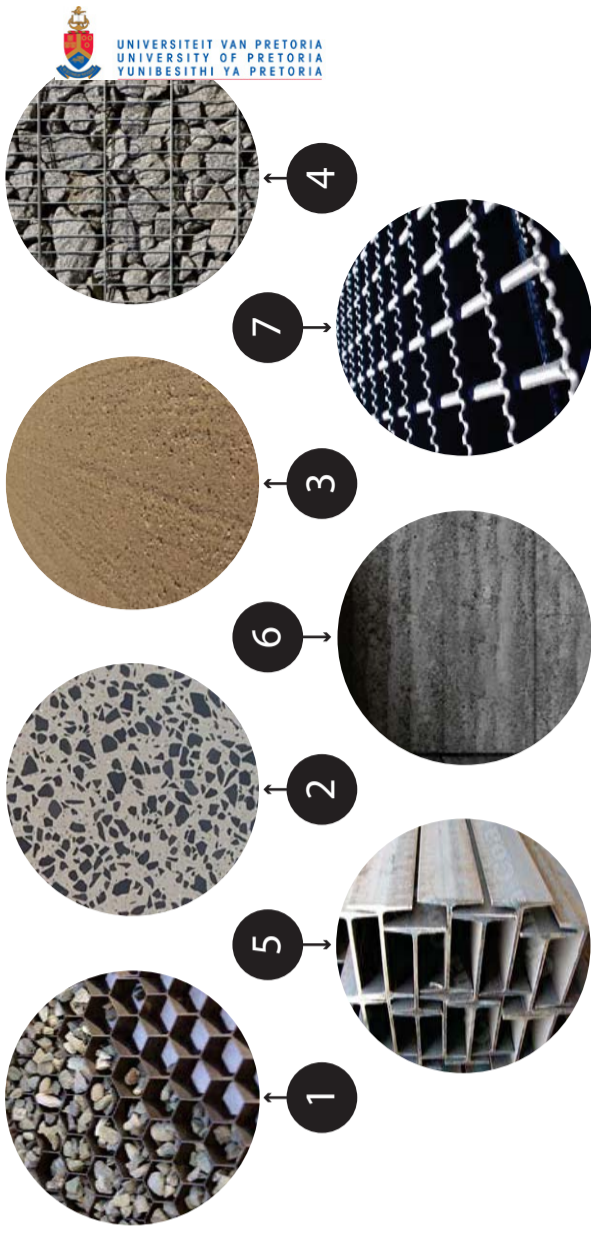

no. PARKING

1	Core Landscape gravel retaining system - Filled with crushed black kimberlite rock
2	Reinforced Cast-in-situ Concrete Dam wall - Kimberlite aggregate
3	Natural landscape surface
4	Kimberlite filled steel gabion systems
5	254x254mm Universal Steel Column Offcuts from Structural systems
6	Rammed earth walls - Dark colouring from kimberlite rich soils
7	Galvanized steel Vitagrid plain grating system - 30x50mm grid spacing (Prevent High heel penetration) ↑ 101 - Parking Materiality

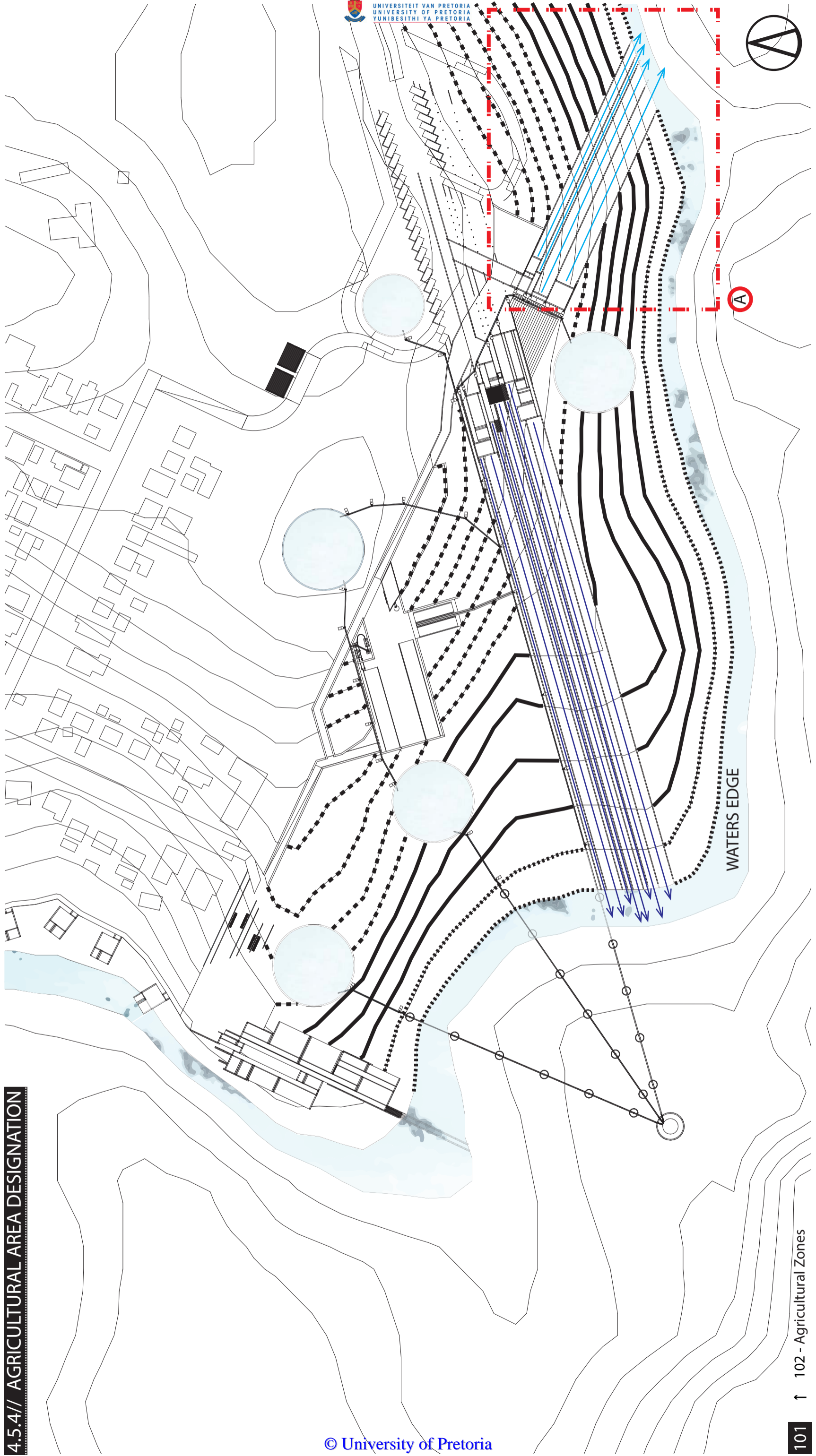

4.5.4// AGRICULTURAL AREA DESIGNATION

AGRICULTURAL LAYOUT STRATEGY

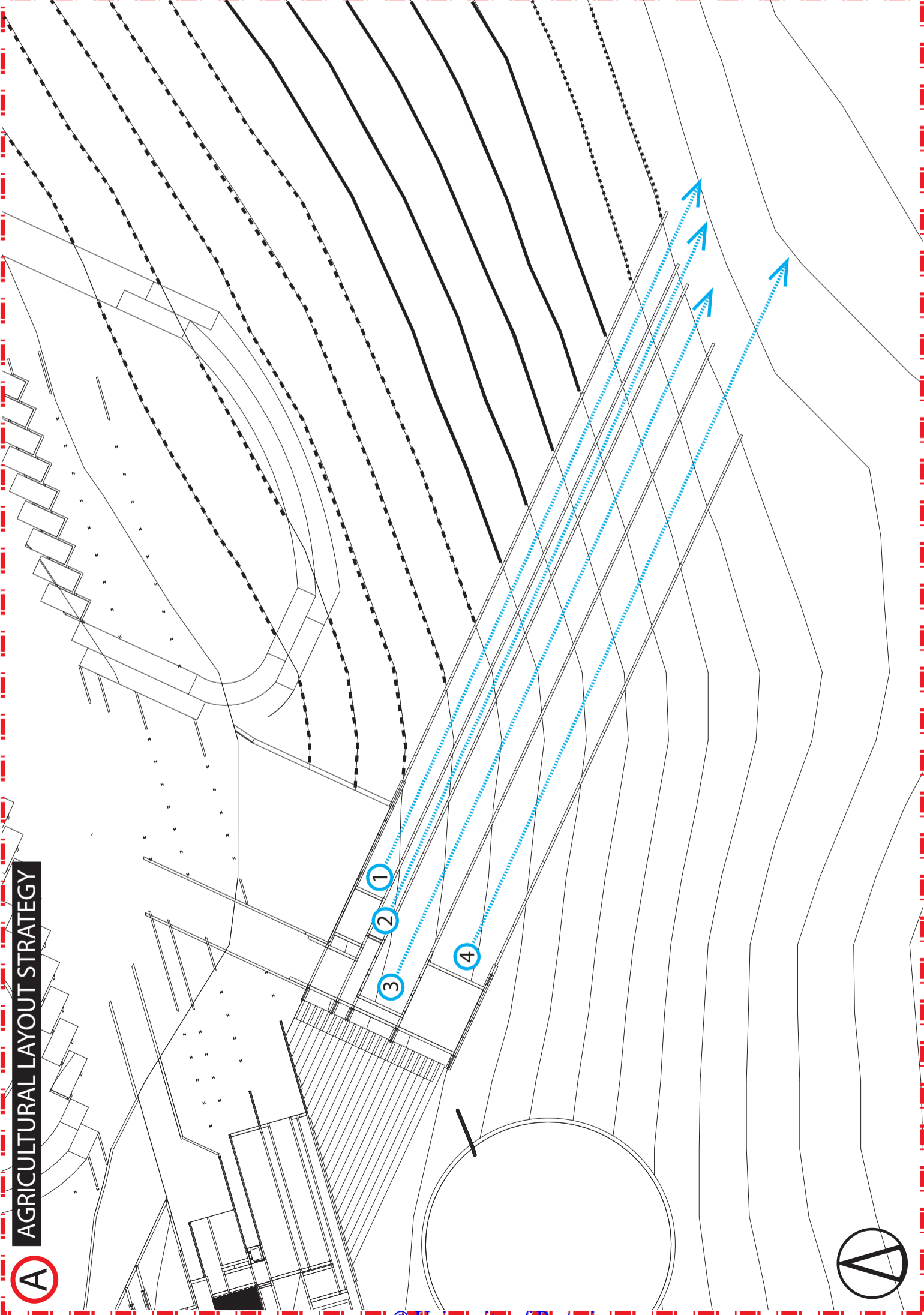

LINE	
.....	
.....	
—	
—	
—	
- - - - -	

TESTED BIOREMEDIAL SPECIES
Nicotiana glauca - Wild Tobacco
Glycyrrhiza lepidota - American Licorice
Helianthus - Sunflower
Thlaspi caerulescens - Alpine Penny-cress
Brassica juncea - Chinese Mustard
Assorted Food Crop Species

Plants with know bioremedial properties are allocated closest to the slime dam, as their effectiveness as bioremediation species is known. The secondary line of remediation species serves as a testing area, which will establish certain plants viability for human consumption. The tertiary line of plants are food related crops. Due to the distance from the slime dam, these crops should be safe for human consumption. Laboratory testing will confirm this theory, before any crops are allowed to be consumed.



UNIVERSITEIT VAN PRETORIA
UNIVERSITY OF PRETORIA
YUNIBESITHI YA PRETORIA

LINE	
.....>	

BIOREMEDIAL TEST SPECIES
Existing Plants from local area

Due to the unknown capabilities of onsite plants, to act as bioremediation species, testing will occur in between gabion rib structures. As mention in Chapter 3, the variable widths and lengths of the bioremediation ribs allows for scientific testing of a certain plants bioremedial capabilities.





4.6// PROGRAMMATIC PRECEDENTS

JACOBSEN SALT CO.

J.Q. DICKINSON SALT WORKS

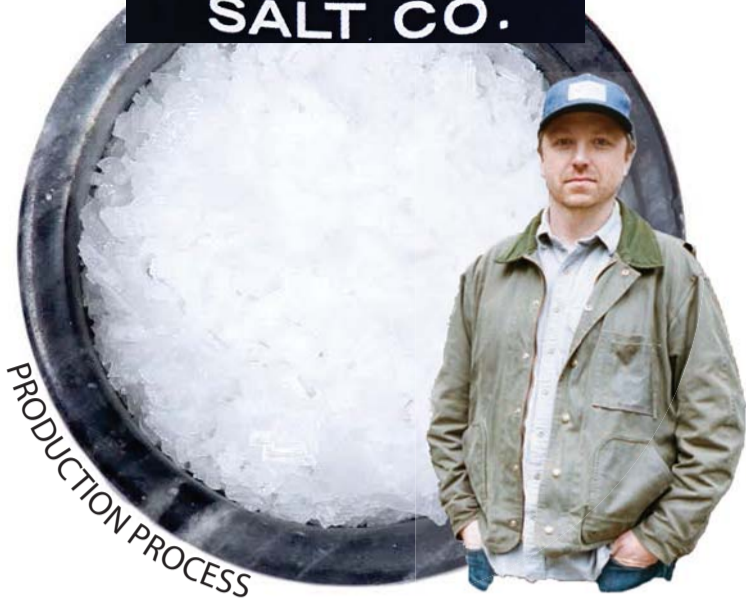

①



Active pumping of the Pacific Oceans water up to the processing site.

②



Gravity fed, sand filtration of the oceans water occurs before it is allowed to settle, removing any algae, which was not filtered out.



③



Water is fed into gas powered boilers. The Brine is then boiled to remove naturally occurring Calcium to prevent bitterness in the final product.

④



The remaining brine solution is then pumped into evaporation tanks. Salt crystals are collected by hand and added to final, moisture removing drip trays. © University of Pretoria

