

## THERMAL PERFORMANCE AND OPTIMISATION OF A GRANULAR-BED HEAT RECUPERATOR

Chandratilleke T.T. \*, Nadim N. and Batsioudis K.

\*Author for correspondence

Department of Mechanical Engineering,  
Curtin University,  
Perth, WA 6845,  
Australia,

E-mail: [T.Chandratilleke@curtin.edu.au](mailto:T.Chandratilleke@curtin.edu.au)

### ABSTRACT

This paper presents a performance analysis and optimisation of a granular bed heat recuperator for thermal energy storage and recovery. Simulating the flow processes in the bed, the study develops a transient three-dimensional turbulent numerical formulation with non-equilibrium porous medium model, where by thermal and fluid characteristics are appraised and examined. In this, Ergun equation is applied for resistance source terms of momentum while the well-regarded Ranz-Marshall and Wakao models are used for interfacial heat transfer. In ascertaining prediction accuracy, the model is initially validated for flow hydrodynamics against experimental pressure drop data. Transient thermal behaviour is then verified against experimental thermal measurements to achieve the most accurate and robust simulation of thermal and fluid characteristics. The simulation model is applied to establish passive optimisation techniques based on thermal storage saturation for a given granular heat recuperator.

### INTRODUCTION

Heat exchanging devices in thermal engineering applications broadly categorised into cases of those undergoing continuous or periodic heat transfer processes [1] between participating media. Popularly used compact heat exchangers fall into the continuous category and are typically designed to maximise the available surface area per unit of volume [2]. On the other hand, heat recuperators deployed in industry applications such as, solar space heating, chemical processing and waste heat recovery, do operate with alternative processes of heating and cooling by fluid streams within storage media. In these, a hot fluid first delivers heat to a solid/porous medium, where thermal energy is temporarily stored. Then, a cold fluid stream subsequently recovers the stored heat to complete the periodic cycle of energy exchange. Compared to conventional heat exchangers, these staggered heating and cooling systems involve complex thermo-fluid fundamentals [3], requiring deeper analysis of parametric interaction between storage media and fluid streams, to achieve optimal thermal effectiveness.

In heat recuperators, dense porous beds are traditionally used as thermal communication media between hot and cold fluid streams albeit fluid pressure-drop concerns. In this with increasing popularity, granular materials are being considered as an alternative offering much higher exposed heat transfer area.

In such applications, comprehension of transport phenomena between granular and fluid phase is a key consideration [4] that emphasises the complexity of these flow fields. Many numerical and experimental studies focus on these aspects of analysis, including the discussion presented in this paper. Reported experimental studies offer significant fundamental and practical knowledge, yet being unable to obtain intricate details of multiphase thermo-fluid fields [5]. Hence, CFD models are regarded as a cost-effective and accurate alternative to analytical and/or experimental approaches [6]. A range of numerical models is available for simulation of granular-fluid field covering traditional porous medium schemes to coupled Euler-Euler models all of which seem to compromise level of field information and computational resources. The current study contributes to improve the present knowledge on the thermal behaviour of granular bed heat recuperators.

This study develops a CFD formulation to describe the complex transport phenomena within a granular bed of a recuperator using a three-dimensional transient turbulent model and incorporating porous media assumption. Reynolds-Averaged Navier-Stokes (RANS) with  $k-\omega$  SST closure is applied as turbulence scheme, while Ergun equation is used for estimation of viscous and inertial momentum source terms, emulating influence of flow resistance from the granular medium. The numerical model is validated for both pressure drop and thermal behaviour of the granular bed, examining the sensitivity of key parameters, such as particle size. Thermal behaviour is appraised by evaluating the convective heat transfer between fluids and solid granules, hence recommending a more accurate heat transfer scheme for simulation and optimisation purposes.

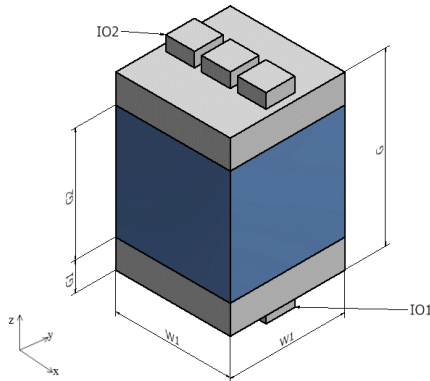
### NOMENCLATURE

$A_{sf}$	[1/m]	Interfacial area density
$c_p$	[J/kg .K]	Specific heat
$c_2$	[1/m]	Inertial resistance
$D_p$	[m]	Particle diameter
$h_c$	[W/m <sup>2</sup> .K]	Convective heat transfer coefficient
$K_{f,s}$	[W/m .K]	Thermal conductivity
$k_f, k_s$	[W/m-K]	Thermal conductivity of fluid and solid
Pr	[-]	Prandtl number
$q_{sf}$	[W/m <sup>3</sup> ]	Volumetric heat transfer rate between solid and fluid phase
$Re_s$	[-]	Superficial Reynolds number

$Re_p$	[-]	Local Reynolds number
T	[K]	Temperature
$\bar{V}$	[m/s]	Superficial velocity
V	[m/s]	Local velocity
Special characters		
$\alpha$	[m <sup>2</sup> ]	permeability
$\varepsilon$	[-]	Porosity
$\mu$	[Pa. s]	Viscosity
$\Phi$	[-]	Sphericity
$\omega$	[1/s]	Specific turbulence dissipation rate
Subscripts		
c		Convective
f		Fluid
in/out		Inlet/Outlet
s		Solid
p		Particle

## GEOMETRY AND BOUNDARY CONDITIONS

Figure 1 illustrates the three-dimensional geometry used for the numerical model, having a porous zone (representing granular phase) in middle and multiple inlet/outlets (IO). Fluid zones ( $G_1=100$  mm) are included at the top and bottom of the porous zone ( $w_1=w_2=G_2=400$  mm), each with multiple flow conduit ( $IO_1=IO_2=100 \times 100$  mm). This would facilitate reduction of uneven distribution of flow over the porous medium with the cases of single or multiple IOs.



**Figure 1** Geometry and boundaries of computational model

Accounting only for key geometrical features of the recuperator, a fully structured uniform and light mesh (771840 cells) is deployed to achieve a smooth, accurate and fast convergence. Inlet boundaries are treated as constant velocity with estimated RANS parameters inputs, while the outlets are taken to be at constant atmospheric pressure. Considering dimensions of the model, wall influence on pressure drop and heat transfer characteristics of porous model is assumed as negligible. All the remaining wall boundaries are modelled as adiabatic non-slip boundaries.

## NUMERICAL METHOD

Single or multiple IO combinations are used to establish the impact from the flow behaviour entering and leaving the granular bed on the heat recuperator thermal performance over heating stage (heat storage by hot fluid in granular bed) and recovery stage (heat removal from granular bed by cold flow). Based on a single phase Eulerian approach, turbulent model is developed

incorporating both viscous and inertial momentum source terms to account for the flow through porous zones. Such a traditional model is proven to be suitable for beds with uniform particle size distribution, operating below fluidisation threshold. Hence, the proposed model qualifies for the use of porosity ( $\varepsilon$ ) and particle diameter ( $D_p$ ) as critical characterising parameters of the granular packed bed, and permits validation against a wide range of available experimental data.

The governing equations for models with and without porous media, are formulated as Reynolds-Averaged Navier-Stokes equations (RANS) for continuity and momentum with the applied  $k-\omega$  turbulence model. The porous media model consists of additional source terms in the momentum equation which includes viscous and inertial resistances. The permeability and inertial resistance are estimated by improved Ergun equation [7] as,

$$\alpha = \frac{D_p^2}{203} \frac{\varepsilon^3}{(1-\varepsilon)^2} \quad (1-a)$$

$$C_2 = \frac{3.9}{D_p} \frac{(1-\varepsilon)}{\varepsilon^3} \quad (1-b)$$

This formulation is constrained by the assumption of spherical particles with constant porosity. Nonetheless, the use of this generic scheme would allow experimental measurement of these coefficients for any irregular particle shape and/or unusual microstructure of the bed. For the flow range under consideration, Reynolds number ( $Re_s$ ) for a single IO ranges between  $1 \times 10^5$  and  $5 \times 10^5$ . Thus, the inertial term significantly contributes to porous pressure drop and fluid flow through the bed may not be assumed as laminar. Hence, RANS scheme with standard  $k-\omega$  equation is applied to account for turbulence characteristics.

Temperature is calculated for fluid and porous phases by independent energy transport equations for each phase. Energy equations are coupled by source terms accounting for interfacial heat transfer. Energy equation throughout fluid phase has common implementation with effective cell-averaged properties, estimated by porosity and heat source in porous vicinities. Energy equation for porous zone however, is solely a transient diffusive scheme having a heat source to couple with fluid energy. Hence, critical term for estimation of thermal behaviour will be the interfacial heat exchange, which is correlated with local Reynolds and fluid Prandtl number. This scheme is implemented with additional assumption of stationary particles and fixed bed structure.

There are two closures widely discussed and applied for granular-continuous heat exchange. Ranz and Marshall [8], which is the more general scheme, essentially estimates interfacial heat transfer coefficient between an individual particle and fluid as,

$$h_c = \frac{k_f}{D_p} (2.0 + 0.6 Re_p^{0.5} Pr^{1/3}) \quad (2)$$

Wakao and Kagueli [9] is another possible closure, which has been proposed as an interfacial heat exchange scheme specifically improved for packed beds as,

$$h_c = \frac{k_f}{D_p} (2.0 + 1.1 \text{Re}_p^{0.6} \text{Pr}^{1/3}) \quad (3)$$

Both schemes have been evaluated, where Wakao equation was found to be slightly better. The perceived improvement is more evident where the temperature difference between granular and continuous phases is higher. Volumetric heat exchange equation (following finite volume convention) is then written as,

$$q_{sf} = A_{sf} h_c (T_s - T_f) \quad (4)$$

This equation determines net heat exchange between solid and fluid phase. The interfacial area density  $A_{sf}$  is estimated as,

$$A_{sf} = \varphi \left( \frac{A}{V} \right)_{particle} \xrightarrow{\text{Spherical}} = \frac{6}{D_p} \quad (5)$$

These thermo-fluid equations formulate a relatively fast and low-resource-demanding CFD framework that is used in the current numerical study, limited by physical assumptions mentioned.

### Material and solver setup

Material properties are taken to be constant for fluid and solid phases throughout study. Particle diameter and porosity, that characterise the structure of granular bed, form the basis for the parametric analysis. Air is considered as continuous fluid phase while glass beads of certain type are taken as granular components. These material properties are tabulated in Table 1.

**Table 1** Thermo-physical properties of materials

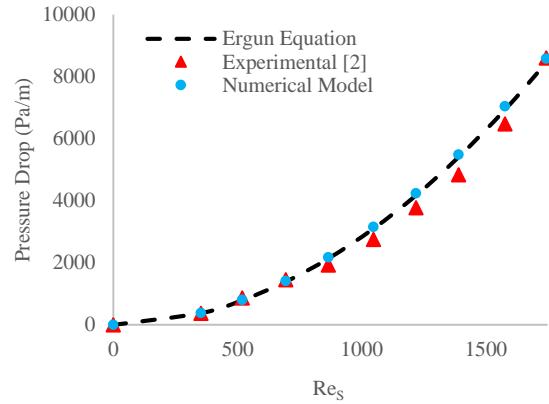
	Air	Solid
$\rho$ (kg/m <sup>3</sup> )	1.225	2300
$k$ (W/mK)	0.0242	1.4
$C_p$ (J/kg-K)	1006	746.2
$\mu$ (kg/ms)	$1.789 \times 10^{-5}$	-

As common algorithm of pressure-velocity coupling in porous media, PISO and Coupled are examined for robustness and convergence time. Couple is identified to have a faster performance with flow Courant number set at 10, explicit relaxation factor of 0.75 for momentum and pressure. As flow rate increases, solver stability becomes sensitive to the relaxation factor of turbulence specific rate ( $\omega$ ). Noting, higher flow rate implies higher interfacial heat exchange, energy equation of fluid and solid areas will require smaller relaxation factor. This suggests, as flow rate increases, abovementioned relaxation factors need to be gradually refined to maintain the solver stability.

### Validation of Numerical Models

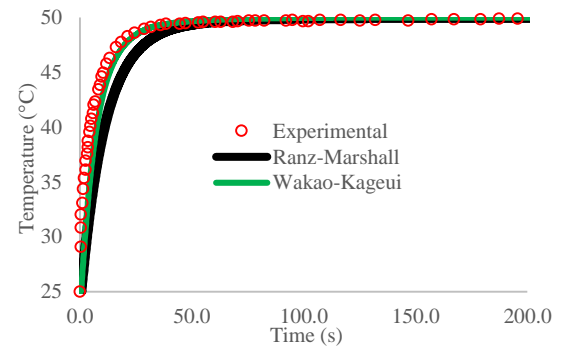
Comparisons are made between numerical results of the current model and experimental data to ensure validation and accuracy of the applied schemes for fluid flow and energy transport schemes. Figure 2 represents the hydrodynamic validation of the field that uses experimental pressure drop measurements [10] over a range of superficial Reynolds number

( $\text{Re}_s$ ). A reasonable agreement is evident, ascertaining the validity of the applied porous medium closure.

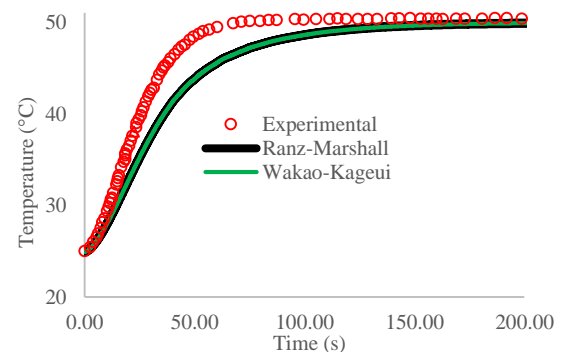


**Figure 2** Validation against experiment and Ergun equation  $\epsilon=0.423, D_p=10$  mm,  $H_{\text{Bed}}=0.4$  m

Transient thermal behaviour of the model is also evaluated to examine the accuracy of interfacial heat exchange scheme between phases. This is to ensure validity of the energy transport equation applied for the granular phase.



(a) 10 mm inlet distance



(b) 48 mm inlet distance

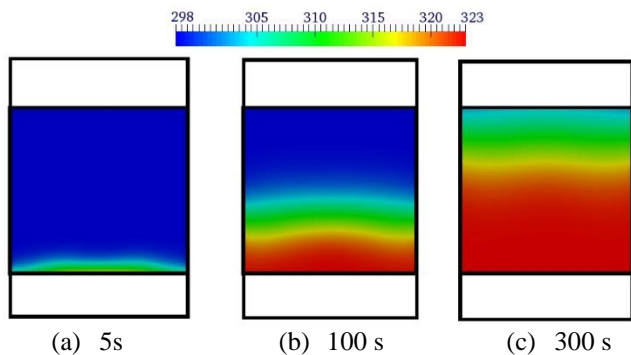
**Figure 3** Evaluation/validation of granular phase temperature

Figure 3 shows the correlation of two established heat transfer schemes against the experimental data [11] at two specific locations over 200 seconds from the inlet of hot flow. This analysis is conducted for the granular bed having the material properties given in Table 1, with the initial temperature at 25 °C, porosity of 0.37 and indicative particle diameter of

3 mm. The hot air stream enters with an inlet temperature of 50 °C and flows at a constant flow rate of 180 Lpm. It is noticed that the enhancement of Wakao scheme is more prominent at location nearer to the inlet in the early stage of heating, where highest temperature difference exists between hot air and granular bed.

## RESULTS AND OPTIMISATION

The study investigates the thermo-fluid behaviour of the granular bed during heating stage, where heat is transferred from hot fluid to solid particles. In developing this thermal analysis, the study considers both interfacial heat exchange and heat diffusion (with effective conductivity) across granular bed. It then appraises optimisation methods for this stage. A compilation of such data is used for validation with the compatible experimental measurements.



**Figure 4** Transient temperature variation in granular bed

Figure 4 shows a typical build-up of temperature field over the central plane in the granular bed. It is observed that, as the hot fluid enters, the bed area closer to the hot flow inlet quickly reaches thermal saturation (i.e.  $T_s = T_f$ ), since this area experiences the highest temperature differential. Thermal saturation then gradually propagates into the bed until the entire bed becomes saturated. Time required for thermal saturation of the entire bed is a key design parameter, which is effectively used in this study to evaluate three proposed optimisation methods.

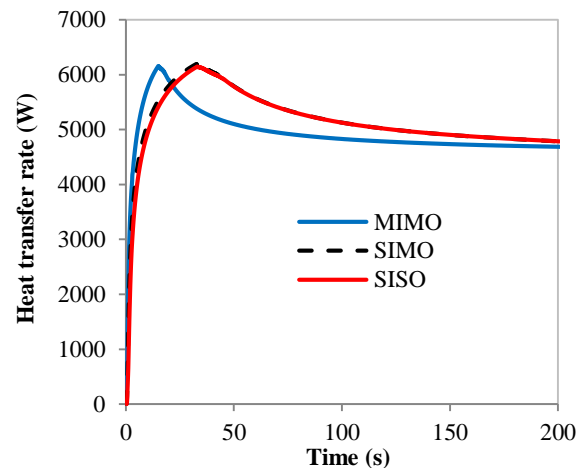
### Flow pattern

The study examines the effects of varying inlets/outlets combinations, so that the flow dispersion and its influence on heat transfer characteristics are examined. Figure 5 presents typical thermal behaviour under three cases of inlet/outlet combinations. They are cases of: Single inlet/single outlet (SISO), single inlet/multiple outlet (SIMO) and multiple inlet/multiple outlet (MIMO), that are compared in Figure.5. The case with multiple inlet/single outlet (MISO) exhibits almost identical behaviour to MIMO, hence not included in Figure 5.

For this study, all other parameters are kept constant including the overall mass flow rate. To quantify the heat storage performance of the system, thermal saturation of the solid bed was defined as the state, where the granular bed is able to store 99% of theoretical maximum heat storage capacity.

From the transient thermal build up illustrated in Figure 5, it is observed that the bed initially undergoes the highest rate of heating followed by a gradually reduction in rate of heat storage

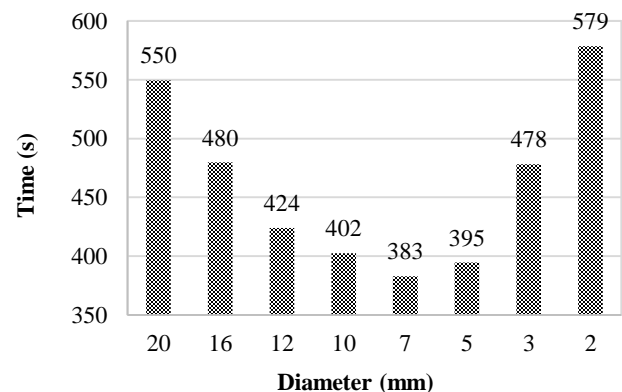
as the bed becomes thermally saturated. Among all inlet/outlet flow combinations, the MIMO arrangement is the quickest to reach the peak heating rate whilst being the fastest decay. Both SISO and SIMO are comparatively sluggish in the heating process, but show lesser rate of decay. Nonetheless, all these combinations eventually collapse to the same rate of heat transfer over the heating duration. This is confirmed by measurement of saturation time as 604, 732, 733 seconds, respectively for MIMO, SIMO and SISO. Therefore, adequate flow dispersion at inlet is recognised as an effective and practical design enhancement (21.4% improvement) wherein influence of flow pattern at the outlet is observed to be marginal (0.1% difference).



**Figure 5** Heat transfer rate for inlet and outlet combinations

### Particle size

The granular bed particle size directly influences the inlet/outlet pressure drop, hence the through flow and thermal characteristics. The study evaluates the influence of granular particle diameter on bed thermal performance and proposes an optimisation method based on the fastest time for thermal saturation as the criterion.



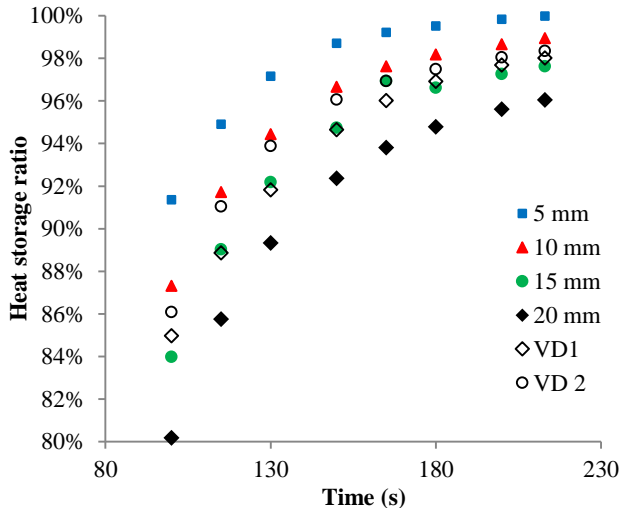
**Figure 6** Saturation time for various particle diameters with constant inlet/outlet pressure difference

Figure 6 compares the thermal saturation time of beds having fixed porosity of 0.37 against a range of particle diameters with a constant pressure difference between inlet and outlet at 6.75

kPa ( $\Delta P=16.875$  kPa/m). This analysis indicates that a granular bed of 7 mm particle size achieves the fastest saturation time, giving 66% reduction within the considered range. Although the flow and thermal characteristics can vary according to the applied pressure difference and porosity, it is realised that an optimised particle size could always be obtained by using thermal saturation as a criterion for a given set of operating conditions.

### Bed with particle size gradient

Another thermal design improvement strategy can be developed by examining granular beds with variable particle sizes. In this, the first case for consideration (VD1) is to have gradually reducing particle diameter from the inlet towards the outlet. This intrinsically facilitates higher Reynolds number in areas of high temperature differentials and larger interfacial area where temperature differentials are low. In modelling this, particle diameter was varied from 20 mm to 5 mm in steps of 5 mm, with 0.1 m height in each particle layer. In (VD2), particle distribution is reversed and analysed. In Figure 7, these two cases are compared against beds with uniform particle size.



**Figure 7** Comparison of heat storage ratio for constant and variable diameter cases

Results indicate an improvement in thermal saturation trend for VD1 and VD2, although with some elevated pressure drop, compared to a bed with the largest uniform particle diameter. This is attributed to the average increase in interfacial area per unit of volume due to variable particle diameter. This analysis is purely an indication of the thermal behaviour with non-uniform granular particle distribution and requires extended treatment to achieve proper optimisation through consideration of both heating and recovery stages.

### CONCLUSIONS

This study considered various combinations of fluid inlet/outlet flow geometries at constant total flow rate, and successfully examined the associated flow patterns to ascertain the favourable manifold arrangements that delivers the highest thermal and hydraulic effectiveness. Results indicate a 21.4% faster thermal saturation within the granular bed when multiple

inlets are used as compared to single-inlet design. It was evident that the outlet configurations impart only a marginal influence of less than 1% in thermal saturation. Recognising particle Reynolds number and interfacial area would impart opposing influences, recuperator performance could be optimised by varying the particle diameter at a fixed inlet/outlet pressure difference and constant bed porosity. An optimum particle diameter is identified with 44% reduction in time to reach thermal saturation for heating stage. A variant of this is investigated by examining a granular bed with varying particle size from the inlet to outlet, but requires extended treatment to obtain an optimised bed particle size.

### REFERENCES

- [1] Schmidt, F. W., Willmott, A. J., and Kreith, F., Thermal Energy Storage and Regeneration. *Journal of Solar Energy Engineering*, 1981, p.178.
- [2] Hesselgreaves, John E. *Compact Heat Exchangers Selection, Design, and Operation*. Amsterdam: Pergamon, 2001.
- [3] Jury, S. H. and Berbano, M. C., Heat Transfer in Packed Bed Heat Recuperators—I. A Precision Numerical Analysis, *Journal of the Franklin Institute*, vol 303, Issue.3, pp. 285-299.
- [4] Amhalhel, G. A. and Furmanski, P. Problems of Modelling Flow and Heat Transfer in Porous Media, *Journal of Power Technologies*, vol. 85, 1997, pp. 55-88.
- [5] Cadavid, F., Herrera, B., and Amell, A., Numerical Simulation of the Flow Streams Behavior in a Self-regenerative Crucible Furnace, *Applied Thermal Engineering*, vol. 30, No. 8, 2009, pp. 826-32.
- [6] Bejan, A., and Pfister., P. A., Evaluation of Heat Transfer Augmentation Techniques Based on Their Impact on Entropy Generation, *Letters in Heat and Mass Transfer*, 1980, pp.97-106.
- [7] Yu, J., Zhang, M., Fan, W., Zhou, Y., Zhao, G., Study on performance of the ball packed-bed regenerator: experiments and simulation, *Applied Thermal Engineering*, vol. 69, 2014, pp.113-122.
- [8] Ranz, W. E., Marshall, W. R., Evaporation from drops. Parts I & II, *Chem. Eng. Progress*, vol.48, 1952, pp.141-146 & pp.173-180,
- [9] Wakao, N., Kaguei, S, Heat and mass transfer in packed beds, New York: Gordon and Breach Science Publishers, 1982.
- [10] Ding, Y., He, Y., Cong, N.T., Chen, W. Y. H., Hydrodynamics and heat transfer of gas–solid two-phase mixtures flowing through packed beds – a review, *Progress in Natural Science*, vol.18, 2008, pp.1185–1196.
- [11] Nie, X. D., Besant, Evitts, R. W., Heat transfer between gas-solid phases within packed particle beds, *Particulate science and technology: an international journal*, vol.29 No.2, 2010, pp.151-162.