

Chapter 8

T E C H N É



HARDWARE / MOTHERBOARD / CPU / RAM



8 . 1 I N T R O D U C T I O N

Chapter 8 is a two-part investigation of firstly the technical resolution of the dissertation project, and secondly its environmental considerations. It starts out with a summary regarding different levels of alterability and permanence of different elements in the design. Then follows the tectonic concept as a starting point for technical decision-making; this is based on a mediative approach to the surrounding context as well as the consideration of alterability. Following this is an overall descriptive analysis of the technical approach to making the building. Subsequent to this is a structural analysis to clarify certain progressive structural elements. Then follows a description of the decision-making regarding the materiality and thereafter the roof form and structure.

In the second section the environmental considerations are investigated; this is in response to compromiser 3 (as discussed in Chapters 5 and 6 - loss of relationship to nature, and its respective counter-strategies). Therefore the main considerations in this section deal with hydroponic planting, as well as a rain-water harvesting system. Lastly section 2 concludes with a passive geothermal heating and cooling system to enhance the thermal comfort of the users inside the building.

Section 1: TECHNICAL INVESTIGATION:

- TECTONIC CONCEPT
- DESCRIPTIVE TECHNICAL INVESTIGATION
 - PRIMARY STRUCTURE
 - STRUCTURAL ANALYSIS
 - SECONDARY STRUCTURE
 - TERTIARY STRUCTURE
- MATERIALITY

Section 2: ENVIRONMENTAL CONSIDERATIONS:

- HYDROPONIC PLANTING
- EXPOSED RAIN WATER-HARVESTING SYSTEM
- PASSIVE GEOTHERMAL HEATING AND COOLING SYSTEM
- SOLAR-ASSISTED STACK VENTILATION



S E C T I O N 1 : T E C H N I C A L I N V E S T I G A T I O N

8 . 1 . 1 T E C T O N I C C O N C E P T

Figure 8.1 illustrates the various generating influences for the overall tectonic concept. The first one is a mediative approach to the existing context (as discussed in both Chapters 5 and 6). This *context* is divided into two sections, firstly (and more broadly) the regionalist architectural identity of Pretoria - of which the characteristics have been examined both in theoretical and design development (Chapters 2 and 7). As these local regionalist constituents include things like materiality (exposed craftsmanship of facebrick, for example) and environmental design considerations, they are also directly generative in the tectonic concept - but will be discussed in depth later.

The second segment of the 'context' is the existing built fabric in the direct vicinity: the GPW block is populated with numerous existing buildings - the oldest dating back to 1896. These all have more or less the same technical composition that alternates between a more solid, heavy, stereotomic base (brickwork and concrete) and a lighter, tectonic steel roof structure with metal sheeting. As already discussed in Chapters 2 and 7, the heritage approach is one of mediation - whereby some elements of the existing context are continued in the new, and others are contrasted with.

Therefore, the tectonic concept of the new building firstly mediates between stereotomic (bottom) and tectonic (top) on a vertical scale - similar to its context. In addition to this, in a horizontal dimension (on elevation), the building responds with a similar, stereotomic nature (in terms of language and form) on the eastern side; then enlightens to the western entrance - opening up to a much more tectonic structure.

Furthermore, the structural concept is an execution of one of the main design intentions of adaptability / transformability to accommodate future change. This intention will be executed in varying degrees of adaptability as laid out in Figure 2.17 and discussed in Chapter 6.

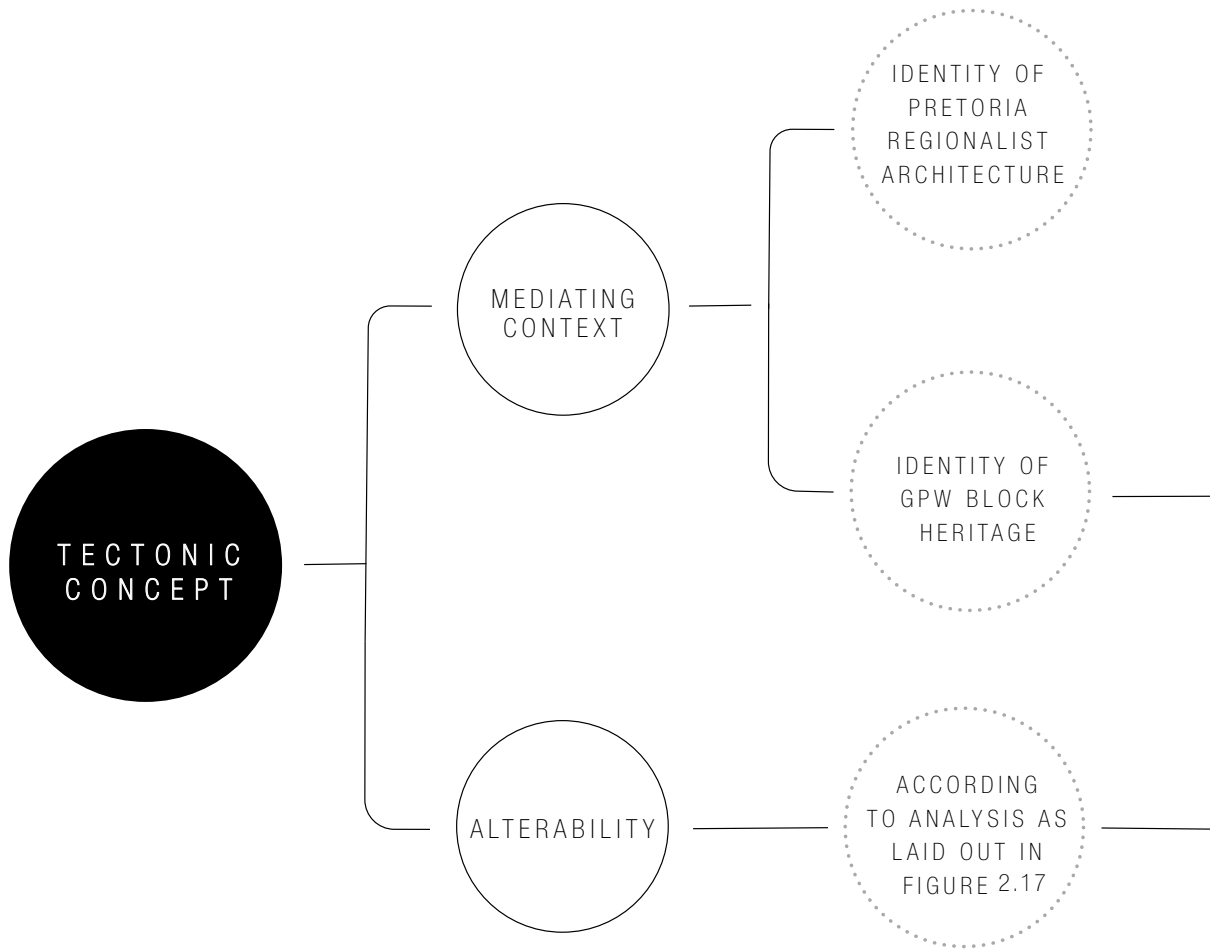
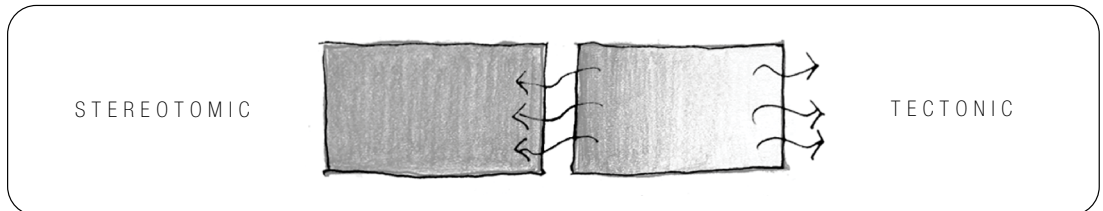
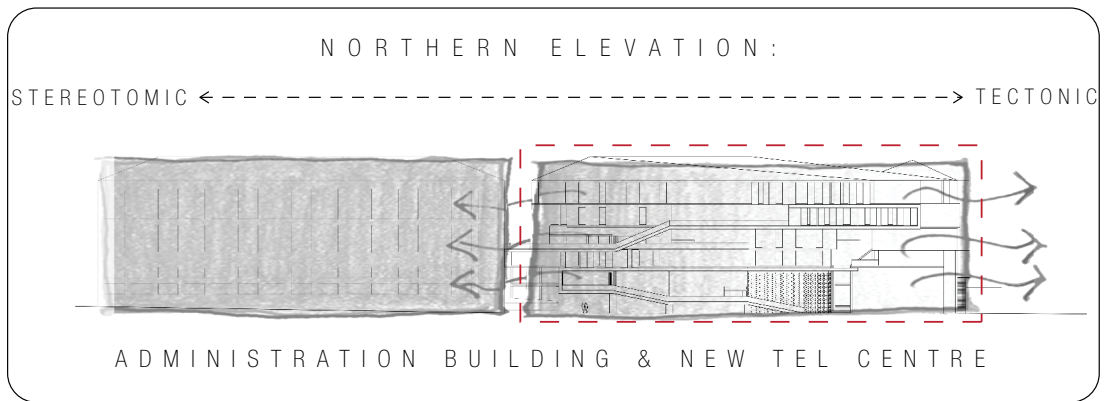
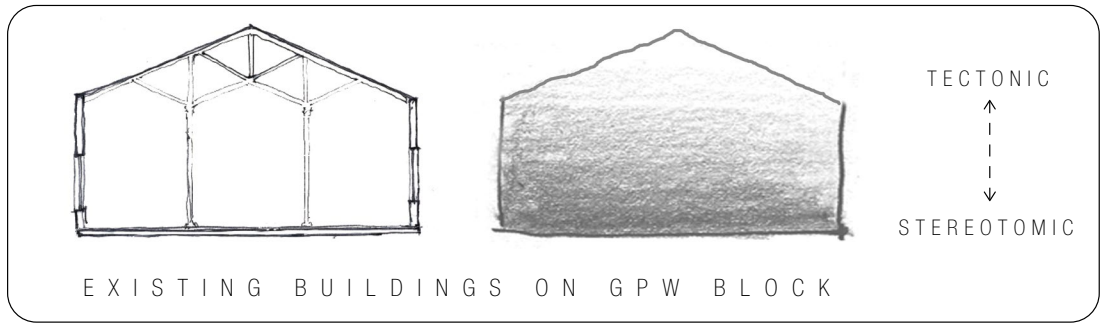
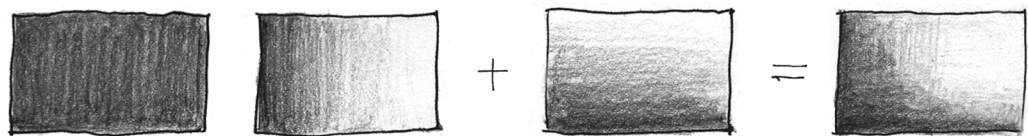

Figure 8.1: Diagram explaining all the informants to the tectonic concept



T E C T O N I C C O N C E P T :



STRUCTURAL & SPATIAL ADAPTABILITY ACCORDING TO VARYING LEVELS OF CHANGE:
(AS LAID OUT IN FIGURE 7.2)



8.1.2 DESCRIPTIVE TECHNICAL INVESTIGATION

8.1.2.1 PRIMARY STRUCTURE :

As discussed in Chapter 7, the overall building-mass concept is illustrated in Figure 8.2, where the levels are shifted to create humanist-scaled ‘green pockets’ throughout the structure where the boundary between inside and outside is blurred. This implies numerous cantilevers throughout the structure in both directions. In addition to this, the structure needs to be able to accommodate future changes in use, which can present the need for certain spatial or structural changes. For both long-spanning cantilevers as well as structural ‘alterability’, steel construction will work better than concrete for the primary structure. In addition to these considerations, steel construction presents numerous other advantages such as time and (therewith) cost savings on construction, easy and fast assembly with the ability to premanufacture many steel components, as well as the recyclability of steel as a material.

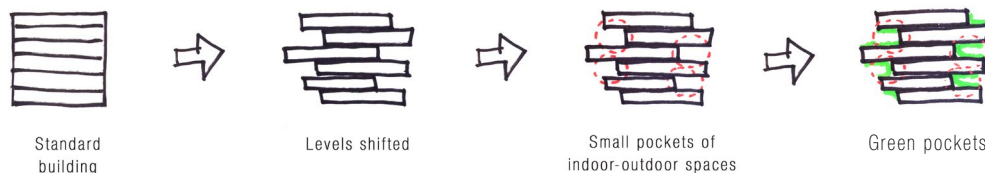

Figure 8.2: Building-mass concept

Figure 8.6 illustrates a structural diagram showing the positioning of the three primary support lines, and Figure 8.4 indicates a longitudinal section-diagram to indicate the segment of the top two floors which is cantilevered. These are constructed by means of two diagonally-braced steel members (Vierendeel-truss beams, Figure 8.3) on each side. The structure adheres to the general rule of thumb for cantilevers which stipulates that the segment which is cantilevered needs a supported ‘backspan’ of three times the length of the cantilever.

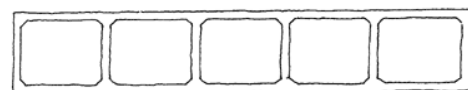

Figure 8.3: Vierendeel truss

As illustrated in Figure 8.5, one Warren-truss beam acts as an ‘upstand’ and one as a ‘downstand’, in which the diagonal bracing is on one side on the fourth level and the other on the fifth, with vertical steel members either suspended from or supported on the Warren-truss beam (only in the cantilevered part). The reason for this is two-fold: the overall building-mass-concept (Figure 8.2) indicates shifted levels; on the northern facade (left on the diagram in Figure 8.6) the topmost level is shifted outwards to provide horizontal sun-shading to the floor beneath it, which means that the Warren-truss beam needs to be on level four (otherwise the diagonal bracing will cut through the middle of the floorplan). On the southern side (right-hand side) the Warren-truss beam is on level 5, because level four stops short of the central atrium. This achieves a 3/4 backspan as necessary for the truss beam (see Figure 8.10) with the truss beams positioned in the outer envelope on both sides.

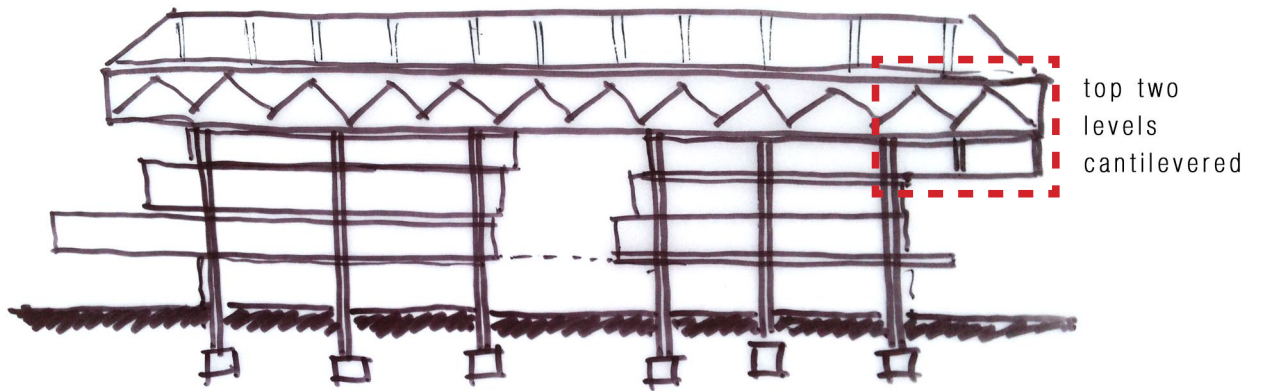

Figure 8.4: Longitudinal section-diagram indicating cantilevered



Figure 8.5: Diagonally-braced girders: 'upstand' and 'downstand'

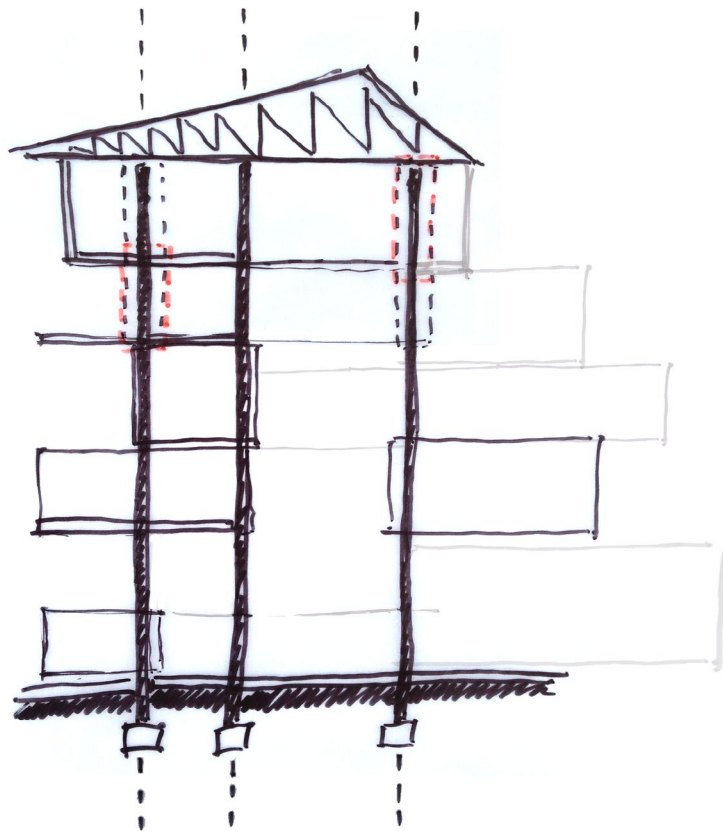

Figure 8.6: Cross section-diagram indicating cantilevered section

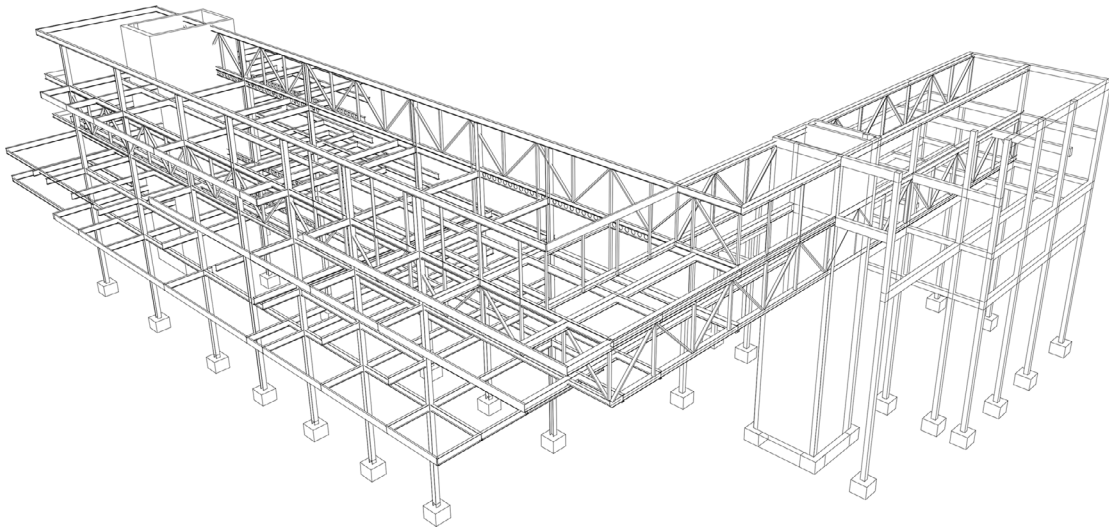

Figure 8.7: Primary structural members for entire building

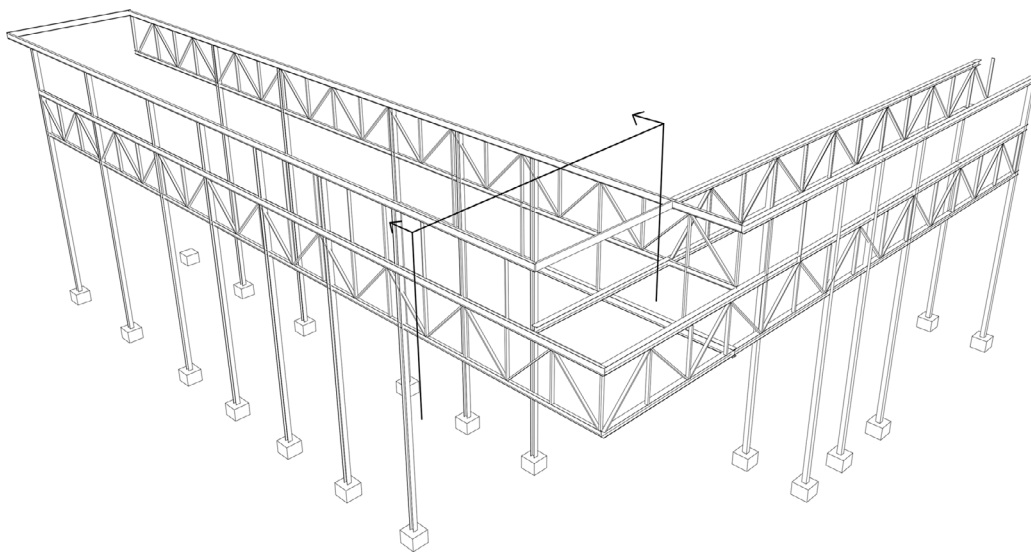

Figure 8.8: 3D showing structural members for corner-cantilever and columns

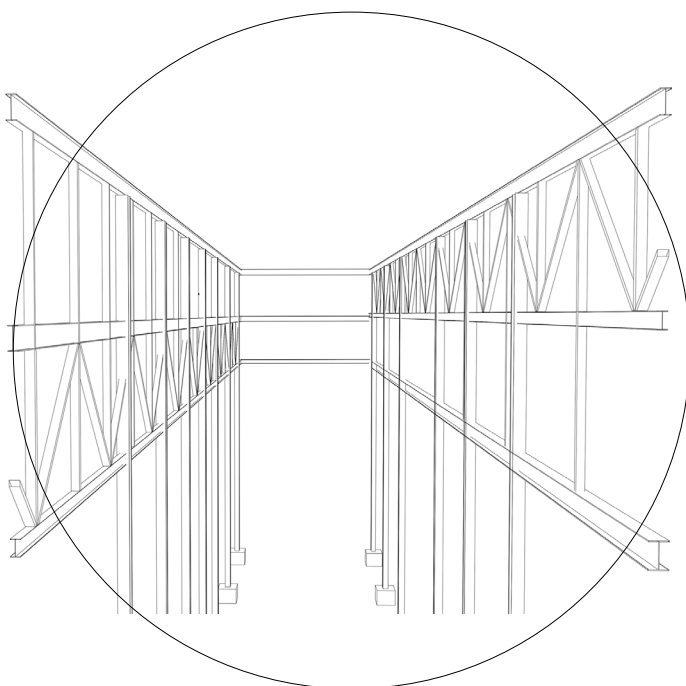

Figure 8.9: 'Upstand' and 'Downstand'

8 . 1 . 2 . 2 S T R U C T U R A L I N V E S T I G A T I O N :

Figures 7.7 - 7.10 illustrate the structural analysis of primary and secondary steel beams and H-profile columns of the first floor and the top floor layouts. They also indicate what parts are cantilevered as well as the diagonally-braced (Warren-truss beam) that are used for the top two levels corner-connecting-bridge structure.

Figure 8.10: Structural layout

first floor structural layout

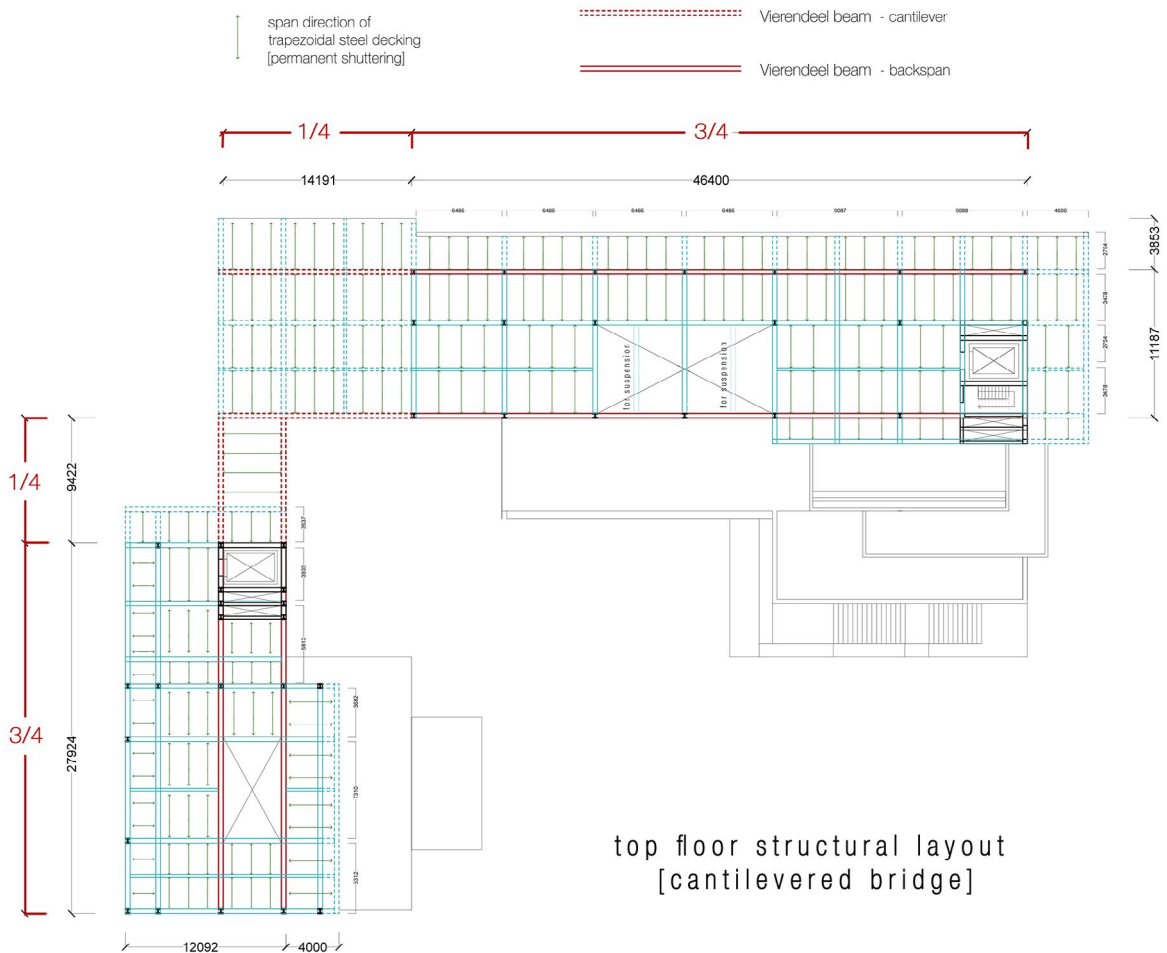
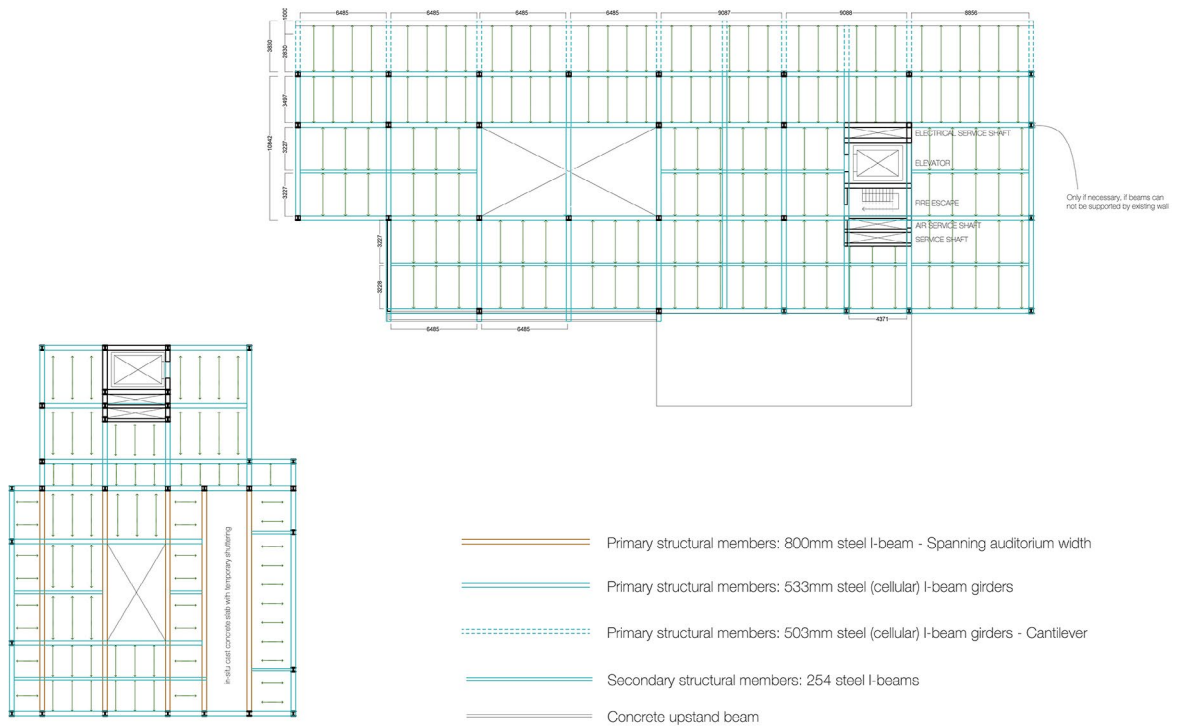

Furthermore, for the reason that the programme of a T.E.L. Centre constitutes a fairly intensive service structure with regards to electronic and electric service distribution, and more importantly, changing electric and electronic services to accommodate changing technologies, a cellular steel beam structure allows for an open infrastructure that can absorb these fast-changing services (more on the service to follow later in the chapter).



In comparison with using castellated beams versus cellular beams, the cellular beam presented a higher degree of flexibility with regards to its opening-dimensions. The castellated beam's hexagonal-dimensions are fixed and are also only 70% of the overall maximum circular opening of the cellular beam (Fig 8.11), which is important for accommodating services. This also means that the cellular beam has an overall lighter weight and flexible strength to weight ratio (Macsteel, n.d.). Furthermore, the infill plates are also something to consider; the cut-outs for the cellular beam can be planned ahead and solid web segments can be left where an end beam connection is to occur. The castellated beams need to have infill-plates reinserted wherever necessary (Fig 8.12), and this can add up to 40% of the initial cost (Macsteel, n.d.). Although the castellated beam uses less steel in its original manufacture, the circular void cut-outs of the cellular beam can be recycled.

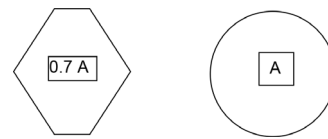
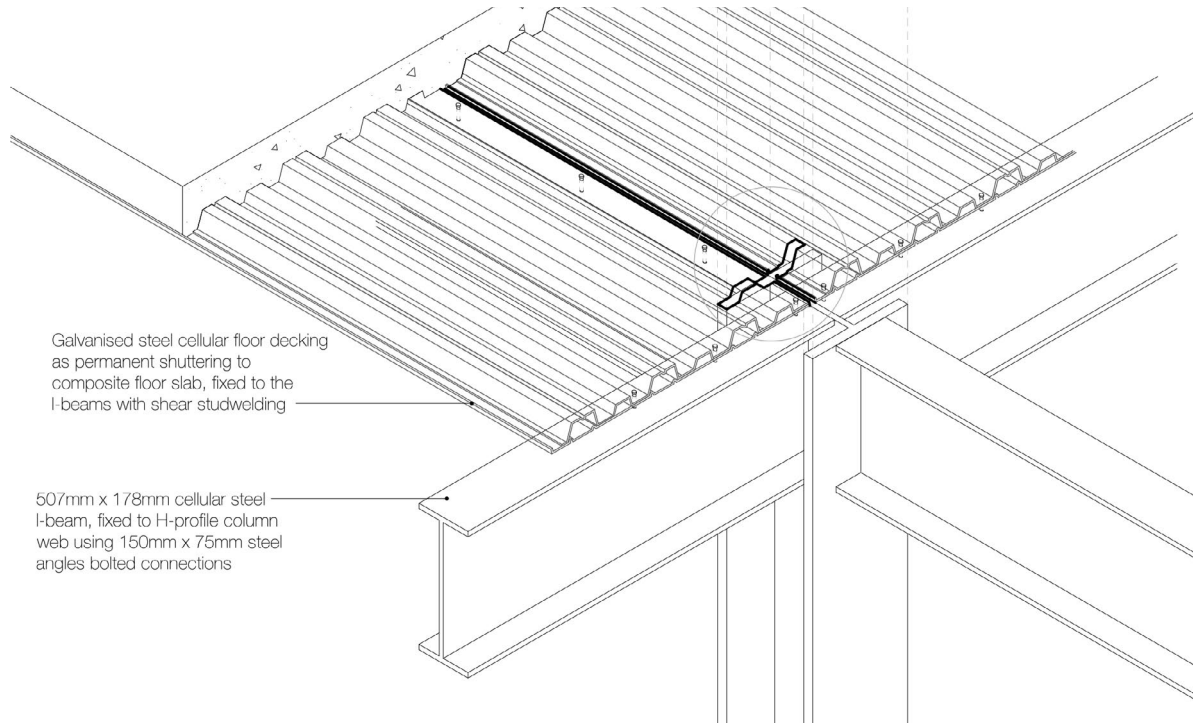

Figure 8.11: Openings of castellated and cellular steel beams (Macsteel, n.d.)

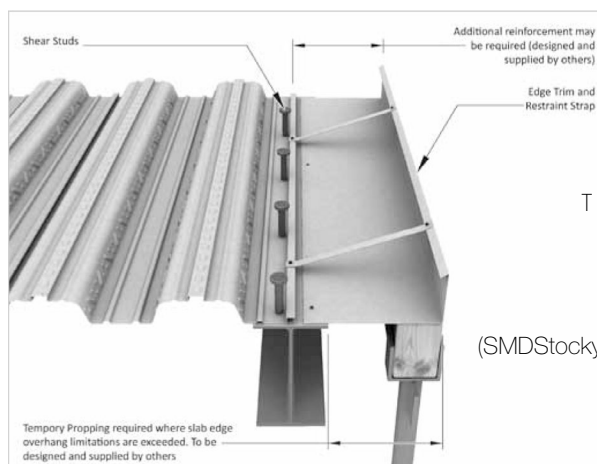
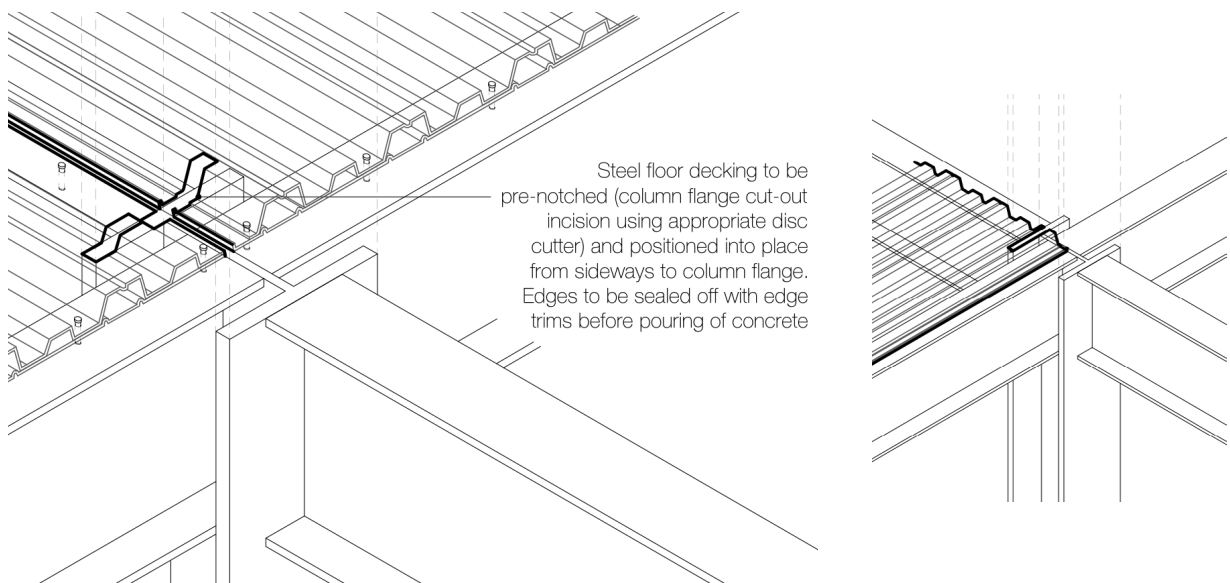

Figure 8.12: Infill plates in castellated beams vs pre-planned cells in cellular beams (Macsteel, n.d)

The floors are constructed of composite steel decking (permanent shuttering) and a concrete topping. Figure 8.12 illustrates some of the typical floor (cut-outs around columns) details as well a temporary structural propping detail for cantilevered edges (when concrete has cured it has attained its structural integrity and prop can be removed (SMD, n.d.)).



STEEL DECKING 'NOTCHING' DETAILS



TEMPORARY PROPPED EDGE DETAIL
[FOR CANTILEVERS]

(SMDStockyards, n.d.)

Figure 8.13: Composite floor details

8.1.2.3 SECONDARY STRUCTURE :

From the first floor upwards, the secondary structure needs to be as lightweight as possible, considering the numerous multi-directional cantilevered levels. Therefore, the exterior infill walling comprises light steel stud wall framing (Fig 8.14) for its very lightweight 60kg/m³ (Weber, 2013) compared with conventional brick infill which is 2100kg/m³, and also for its relatively easy adaptability with regard to future change.



Figure 8.14: Light steel framing

8.1.2.4 TERTIARY STRUCTURE :

These stud walls are clad with two materials that range from stereotomic to tectonic (in light of the technical concept, section 8.2). The solid, denser parts are clad with panels of expanded polystyrene composite material, of which the patent industry term is ETICS (Exterior Thermal Insulation Composite System) - see wall detail in Figure 8.34. This expanded polystyrene cladding panel presents the simultaneous benefits of being extremely lightweight compared with other cladding panels such as fibre cement or single-leaf brick walls; also, this panel presents very good thermal insulation for the exterior walls on the outermost side of the wall, which can be doubled up with insulation material in between the stud-framing as well. The R-value for the ETICS system is 3.67 (Weber, 2013) in relation to 0.88 for a double brick wall, which means that it insulates the building almost four times more than a double-leaf brick wall would.

The lighter cladding system consists of translucent polycarbonate wall sheeting. The patent term is *Palram's Sunlite 7 Multiwall* polycarbonate sheet, which is a 25mm thick panel with a seven-walled polycarbonate structure inside. This system has a U-value of 1.39 W/m²K, which is less than a cavity brick-wall of 1.5 W/m²K and it is very lightweight with a density of 3.4kg/m³.

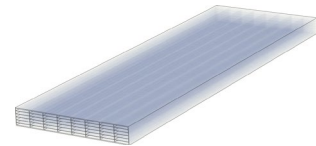
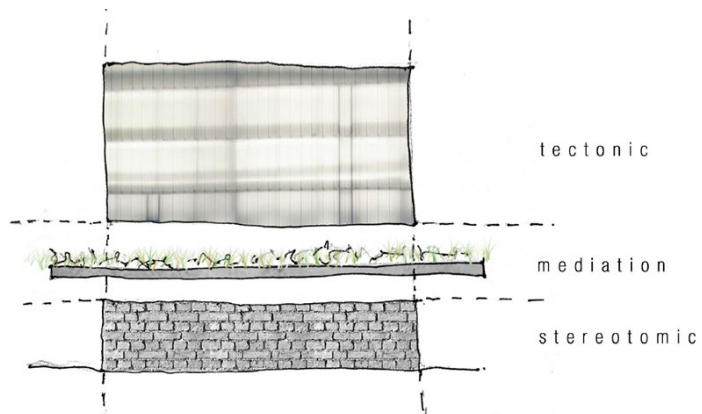

Figure 8.15: Precedents for translucent cladding

MATERIALITY CONCEPT :



As illustrated in the tectonic concept, the secondary structure mimicks that of the existing built context on the GPW block, with a heavy bottom and a light top. The ground floor level has another design-role to fulfill with regards to the counter-strategy to compromiser 1 (loss of slow pace of reality) which is blurred boundaries, soft street edges and a layering of thresholds between street condition, building interior (and exterior) condition as well as the main central square condition in the block. Therefore, the groundfloor boundary walls constitute facebrick infill with variants of the english bond (to tie in with the existing materiality of the GPW buildings) that will mediate between solid wall, protruding header patterns and openings for brise-soleil (for soft, layered street edges), to expose the craftsmanship of brick and tie in with Pretoria regionalist elements.

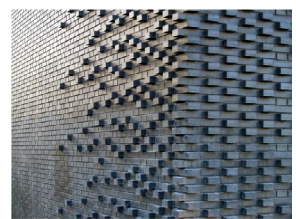
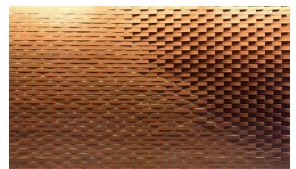
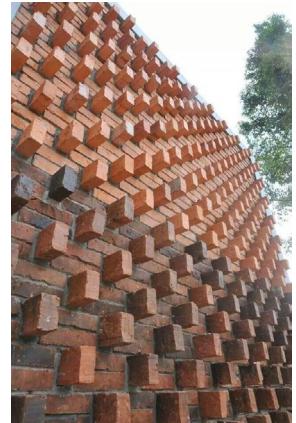
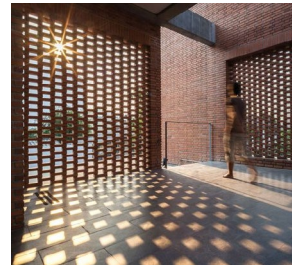
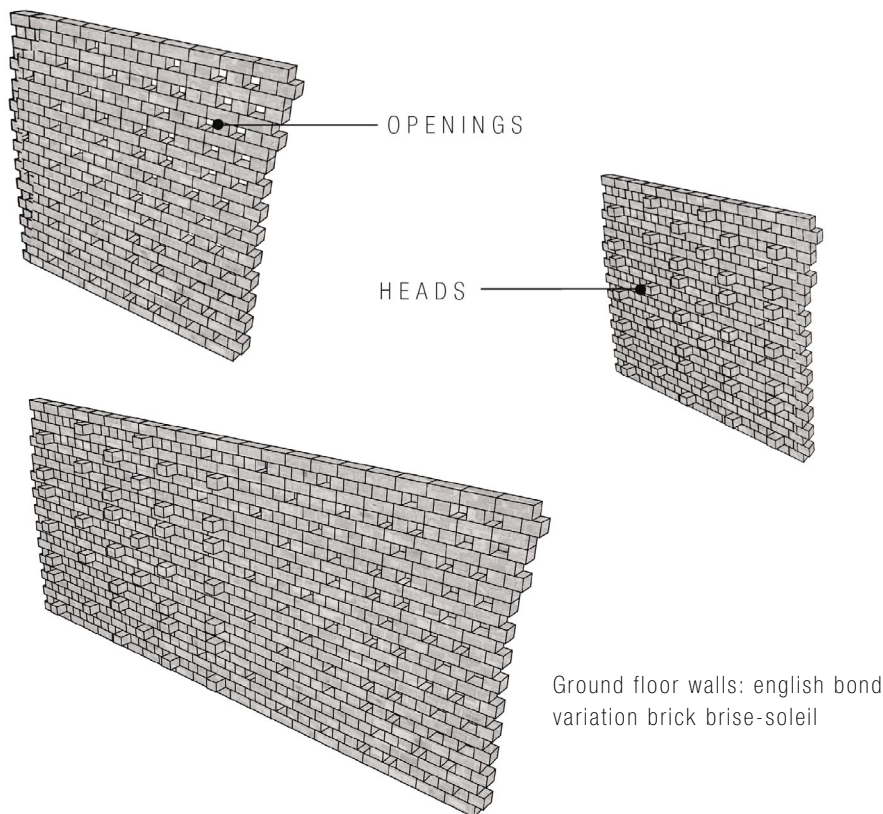
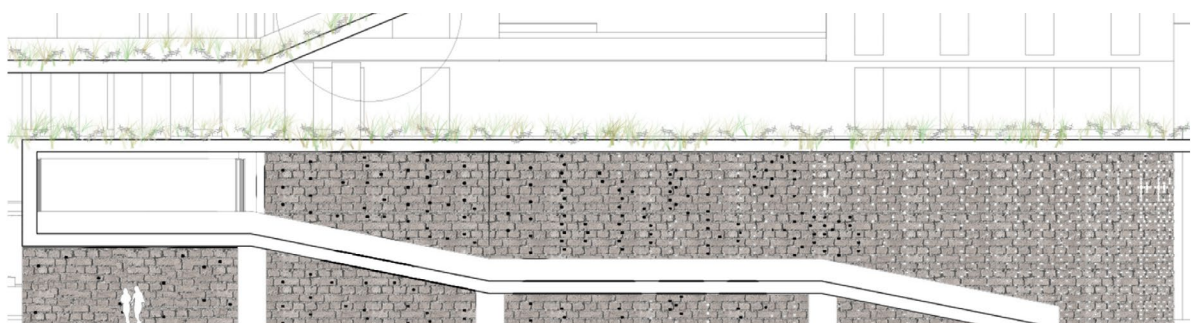

Figure 8.16: Brickwork precedents

NORTHERN FACADE GROUND FLOOR STREET 'BOUNDARY':
GREY BRICK BRISE SOLEIL IN A GRADIENT OF SOLID [HEADS] TO OPEN [OPENINGS]





CHANGE

BENEFITS

TECHNOLOGY

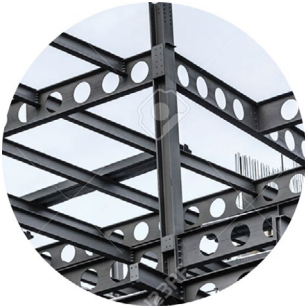

- STEEL STRUCTURE
- LIGHT GAUGE STEEL

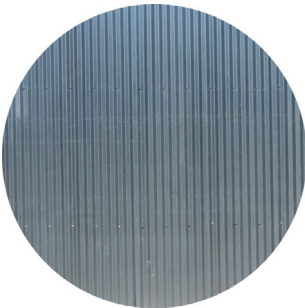

- CORRUGATED IRON
- 'ETICS' CLADDING

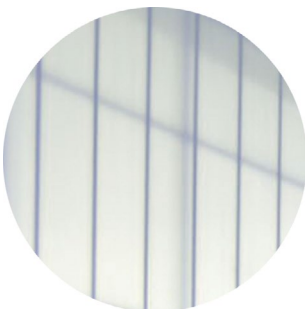

- TRANSLUCENT
POLYCARBONATE

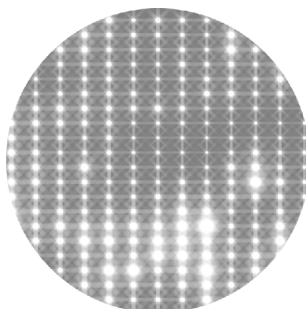
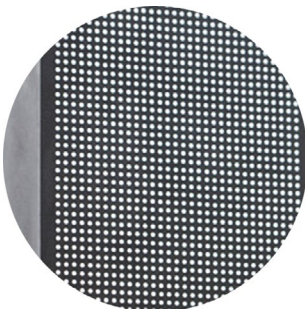

- LED IN CONCRETE
- LED SCREEN (GLASS)

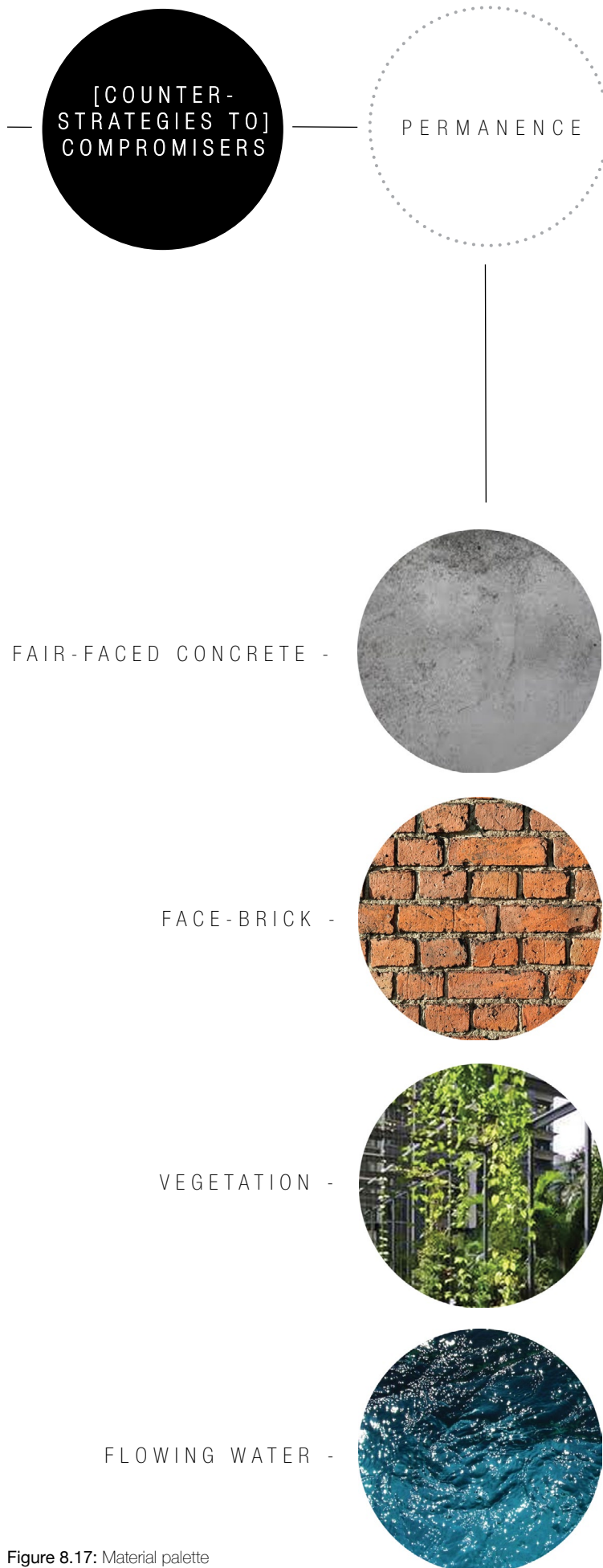

Figure 8.17: Material palette

8.1.3 MATERIALITY

The material palette expresses the inherent duality of the benefits of technology and the counter-strategies to the compromisers of technology (as explained in section 7.3). These dual constituents are also directly linked to the degrees of permanence and change in the structure.

Therefore, the permanent elements (that manifest the counter-strategies) are the solid brickwork and brise-soleil walls on the groundfloor (counter-strategies to compromiser 1 and 4), natural elements such as water and vegetation (compromiser 3), and concrete 'framing of movement' (compromiser 5).

On the other hand, the flexible elements are those that relate to the utilization of technology as well as adaptability regarding usage. These include the primary steel structure, secondary light gauge steel wall framing, the tertiary infill wall panels such as the 'etics' cladding and translucent sheeting as well as roof sheeting; and then also the digital LED screens (whether embedded in translucent concrete or with conventional glass surface).

8.1.4 LED EMBEDDED CONCRETE - *LIGHTSTONE*

In light of the design strategy of 'extending learning material beyond the 'school' boundaries' and 'procuring physical and virtual learning environments in tandem' (see Chapter 5)', Figure 8.20 illustrates the designated facades (on the southern side of the building) for digital display content. This is done by means of *Lightstone* (*DuPont* manufacturers) cladding, which is a concrete surface with LED's embedded into it (Fig 8.19). The reason for using this material is twofold: firstly as the concrete surface makes the material vandal-proof (in comparison with conventional glass LED screens), and secondly as the material can be seamlessly integrated with the rest of the building without seeing a 'screen'. The digital content can be turned off and a normal concrete surface is seen, when it is switched on again it presents the element of surprise of appearing on an unexpected surface (Fig 8.18).

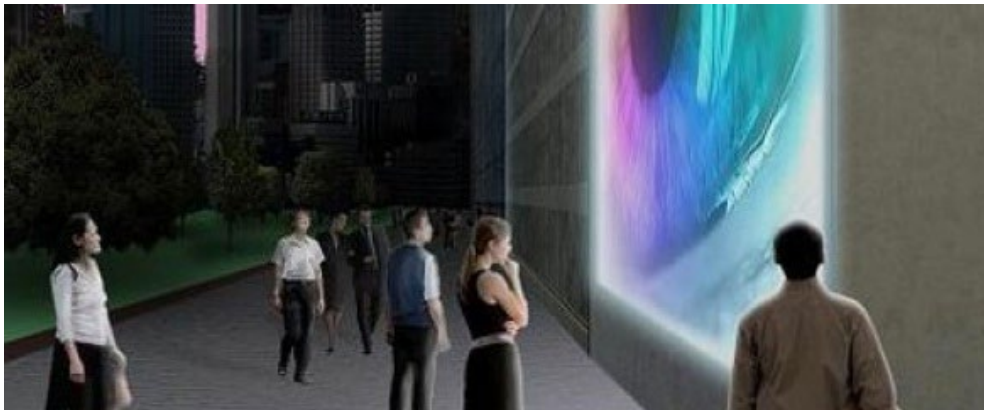

Figure 8.18: Example of seamlessly integrated 'screen'

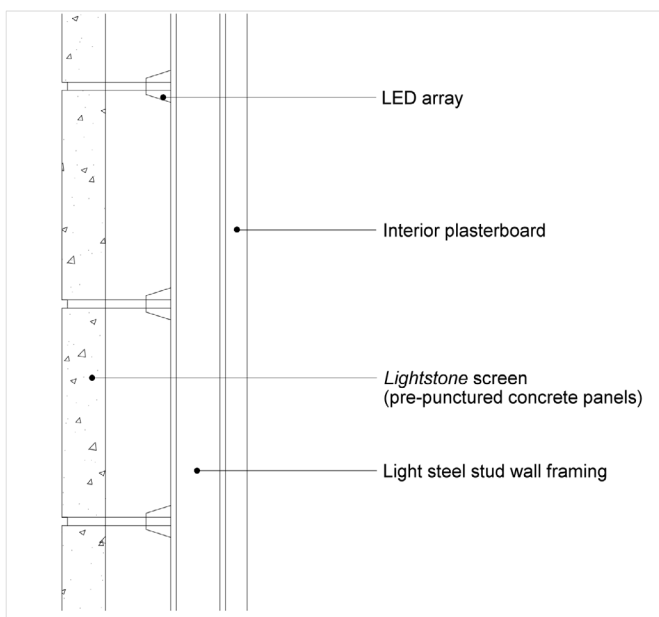

Figure 8.19: Detail section showing LED embedded in concrete



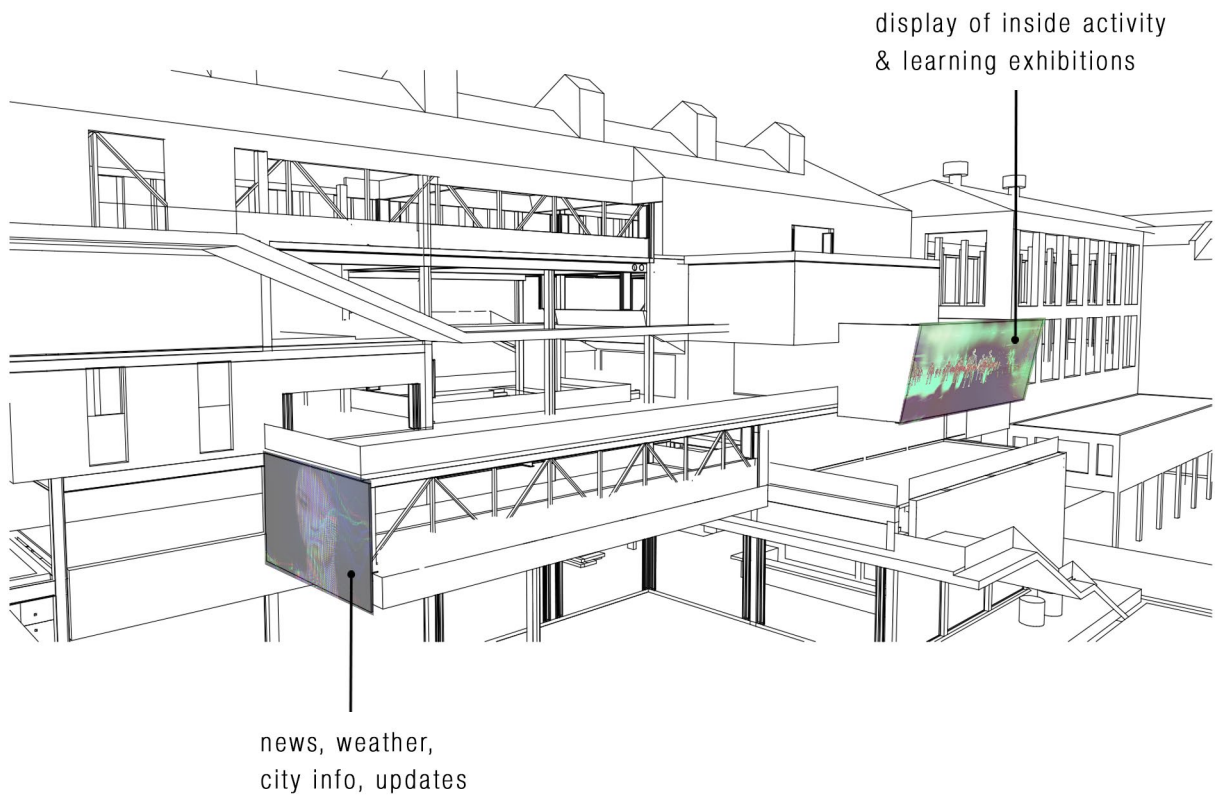

Figure 8.20: Designated digital display screens on facade

SECTION 2: ENVIRONMENTAL CONSIDERATIONS

8.2.1 HYDROPONIC PLANTING

As discussed in Chapters 5 and 6, in response to Compromiser 3 (loss of relationship with nature), the counter-strategy constitutes integrating natural vegetation as much (and as close to the user) as possible - not just as it is necessary in a learning environment but for any living / working environment. The design approach is to incorporate 'green pockets' throughout the building and on all levels. Taking into consideration the cantilevered levels, these vegetation pockets should be as lightweight as possible; implementing greenery by means of soil planting on the upper levels would mean very excessive loading on the already cantilevered structure. Therefore, in order to keep the vegetation as lightweight as possible, the strategy constitutes hydroponically-grown planters throughout the entire 5-storey building. In some instances the planter can be combined with seating, for direct user-contact.



The hydroponic planters make use of the wick-system, whereby the nutrient water is transferred through a cotton wick by capillary action to the growing medium such as vermiculite, which is also very lightweight, all inside a custom-made plastic container. The planting ranges from indigenous still to creeping plants (by galvanised steel rods) which will define a green 'pocket' without creating a solid barrier. Each water-container has its own aerator pump and in the case of stepped planters the nutrient water flows downward from the top to the bottom, through each planter and then it is pumped up again in a continuous cycle (see details).

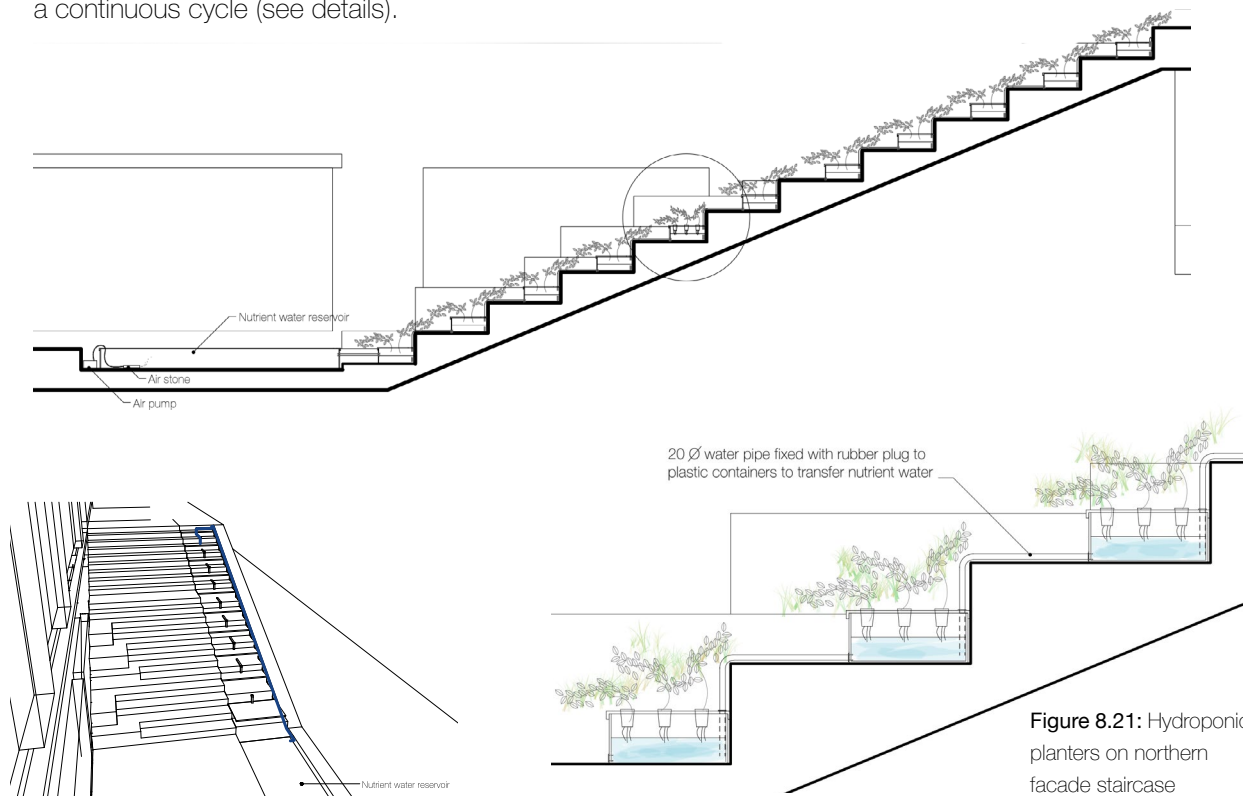

Figure 8.21: Hydroponic planters on northern facade staircase

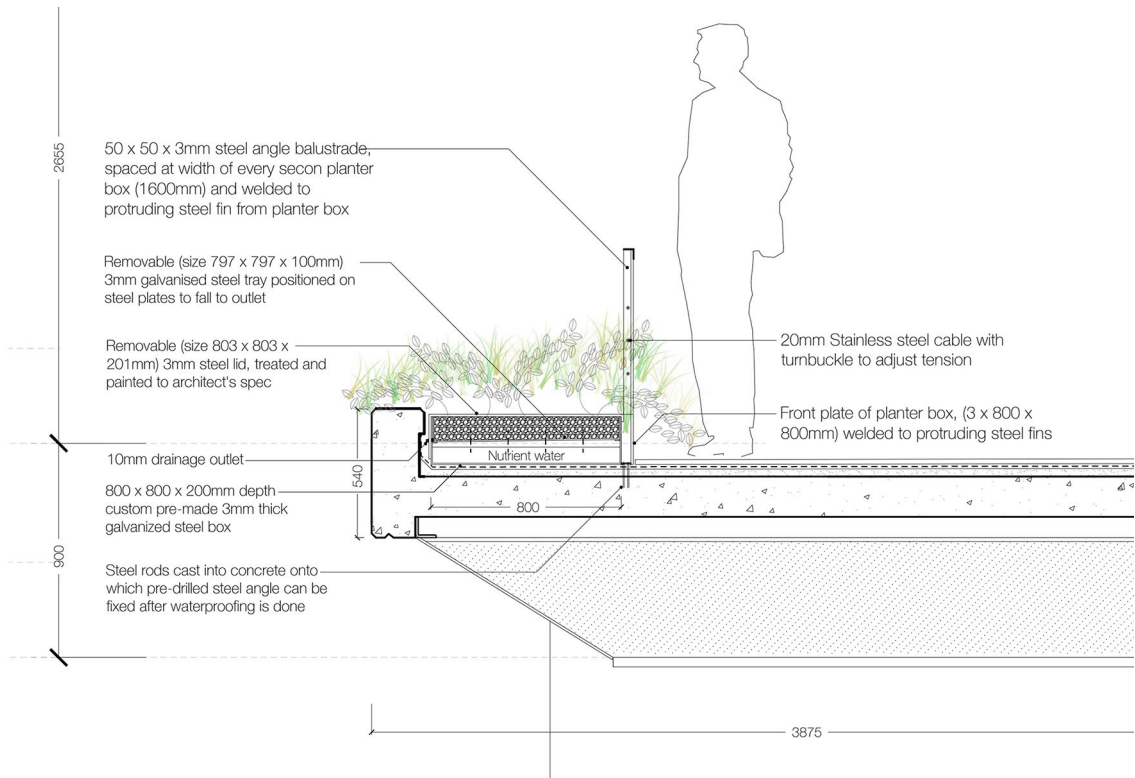

Figure 8.22 PLANTER & HANDRAIL COMBINATION

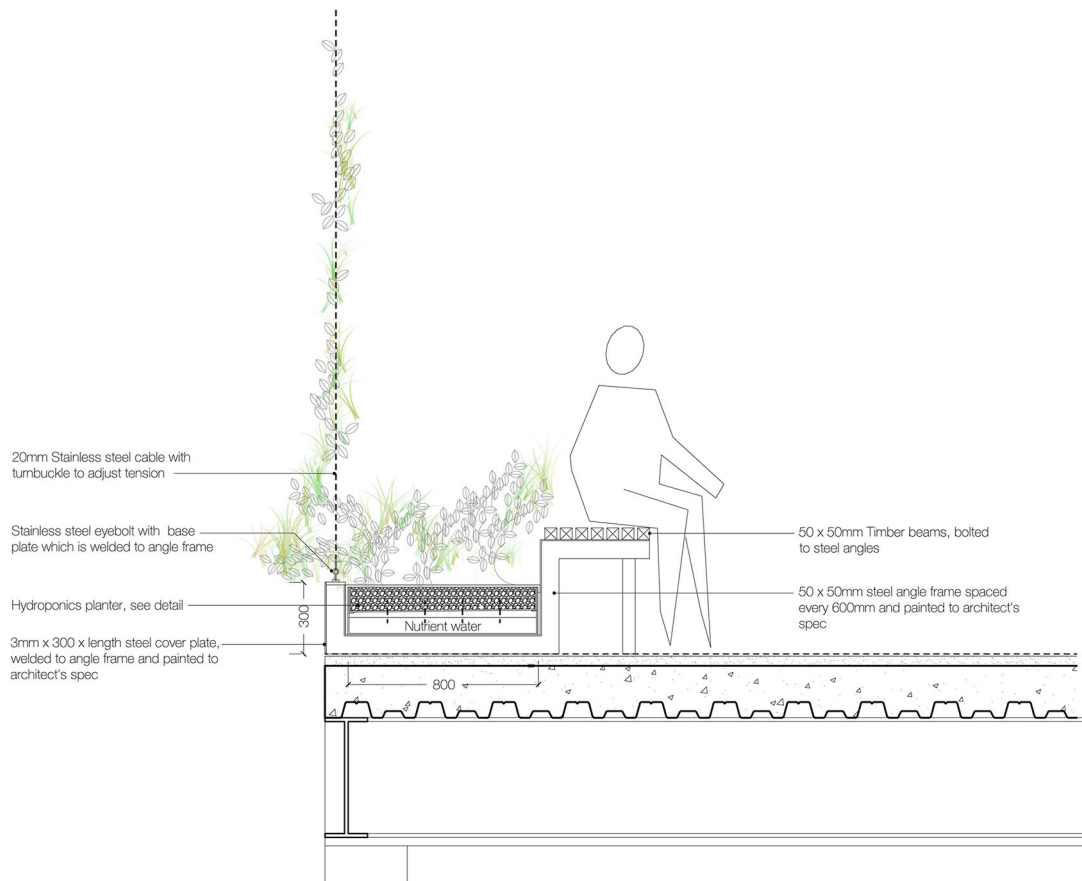
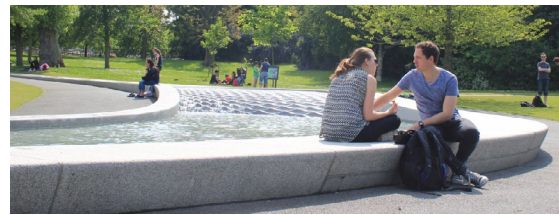

Figure 8.23 PLANTER & SEAT COMBINATION

8.2.2 EXPOSED RAIN WATER-HARVESTING SYSTEM

In further response to Compromiser 3, the rain-water-harvesting system stems from a dual design intention of collecting and reusing rainwater but also for the haptic quality of being in close connection with water as a natural element. The harvesting system therefore constitutes an open-channel water channel that cuts through the site, starting in the Wierda building courtyard (as it is on the higher level - slope falls in a diagonal north-west direction across the site) where it surfaces as a water feature, then it flows naturally down the channel (where it submerges at times and emerges again at other times), through a filter and into a water storage basement tank underneath the western footprint (auditorium) building. From here the water is pumped again to the original point of emergence and continues the flow in a closed-loop cycle.



This water is used as grey water for toilet-flushing as well as for irrigation purposes across the site. Figure 8.25 indicates the catchment areas and flow direction as well as the different emerged and submerged lines of the water-channel. The storage-tank size is calculated (see annex A) according to the cubic meters of grey water necessary to serve all the buildings on the site for the duration of the three (almost) completely dry months during winter.

The intention for the open water channel is that people can engage with it and experience it as an urban public recreational element. Therefore the water channel is moulded into the landscape with different ergonomic approaches. It is also important that the surface of the channel has a polished (for cleaning purposes) finish but still a firm grip - similar to the Diana Memorial surface finish where Cornish granite was used for the surface illustrated in Figure 8.24.



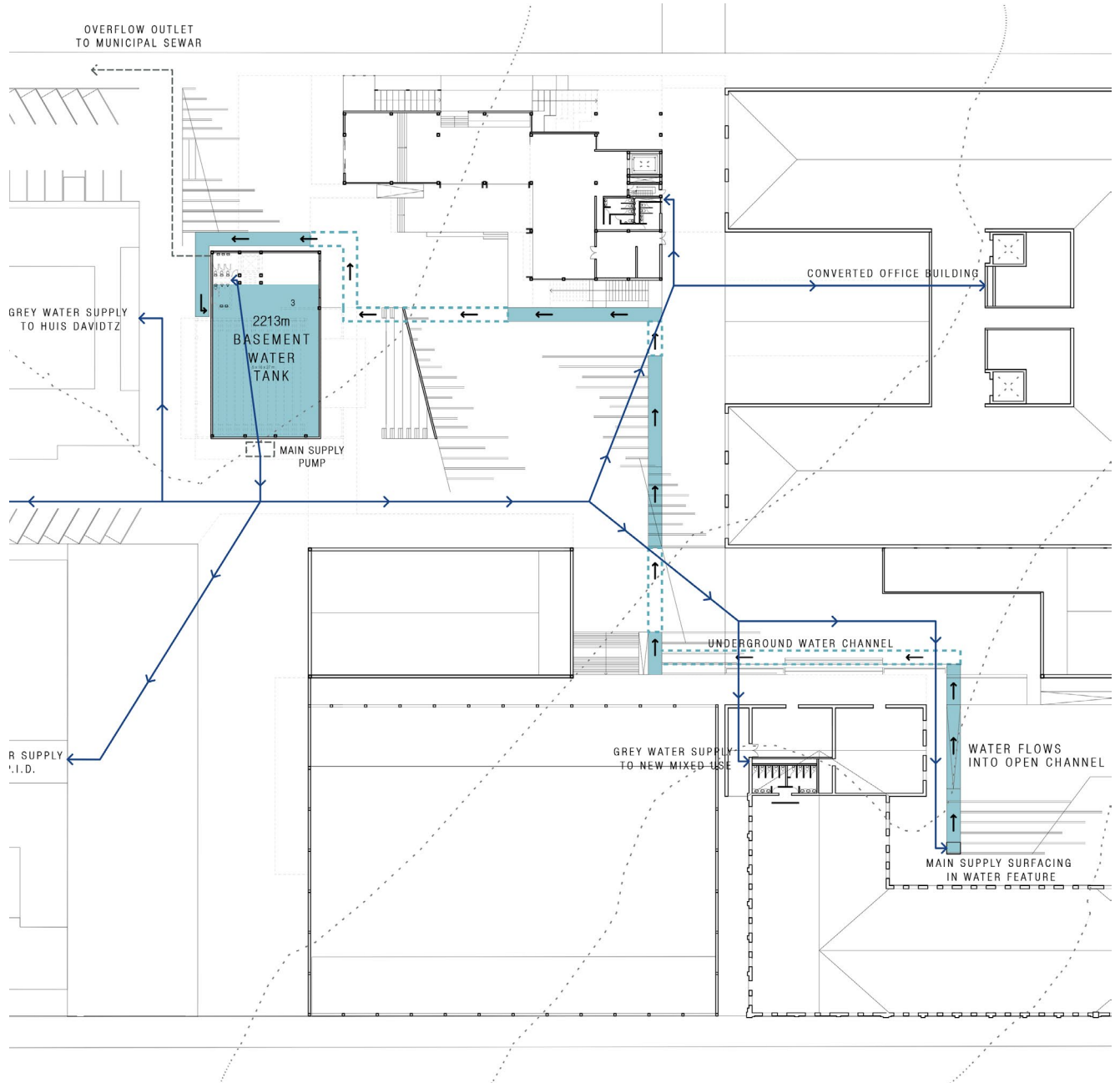
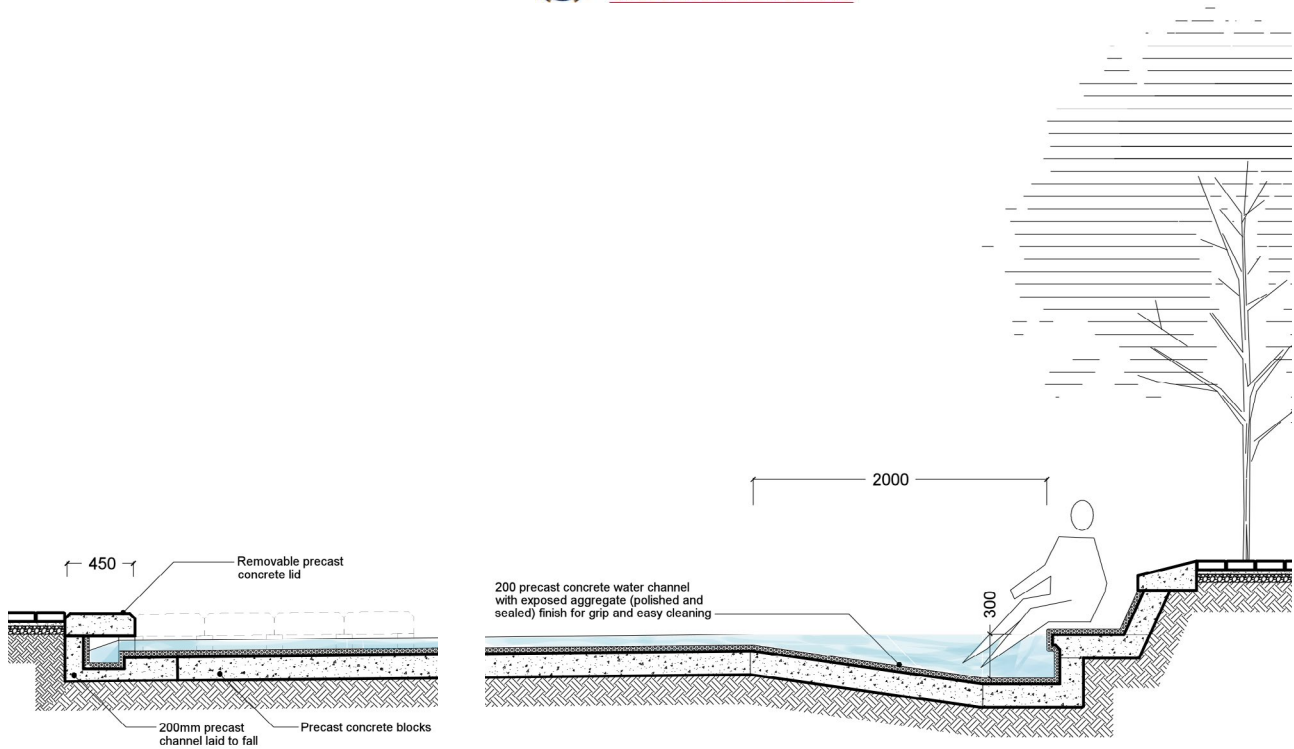
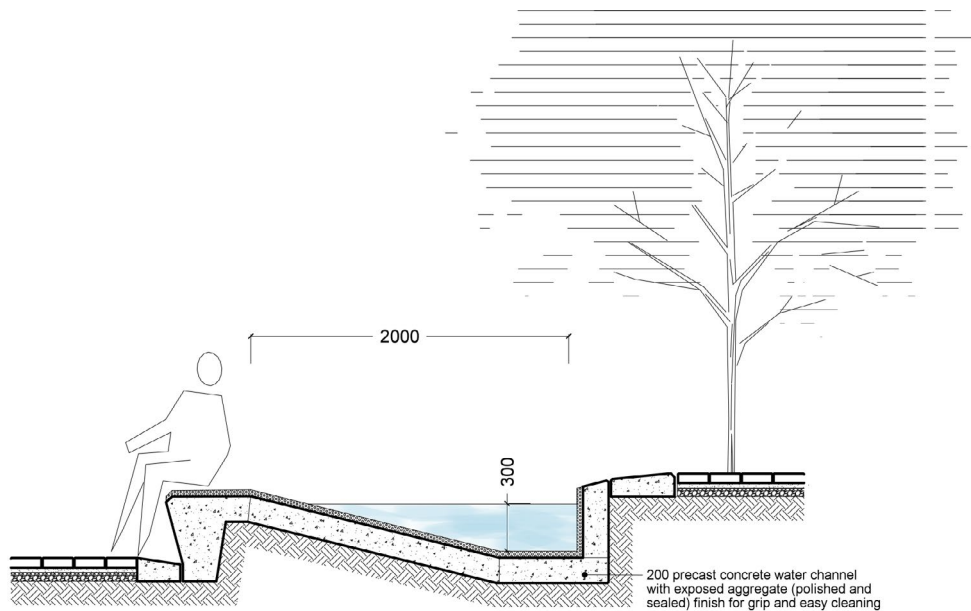

Figure 8.25: Water channel and system layout



OPEN WATER CHANNEL

Figure 8.26: Detail sections through open water channel



OPEN WATER CHANNEL WITH SEAT

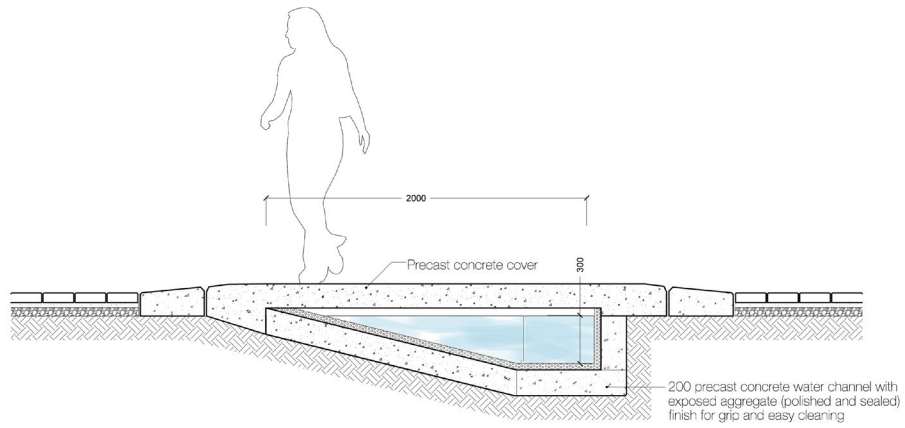

SUBMERGED WATER CHANNEL

Figure 8.27: Detail section through water channel with walkway crossing

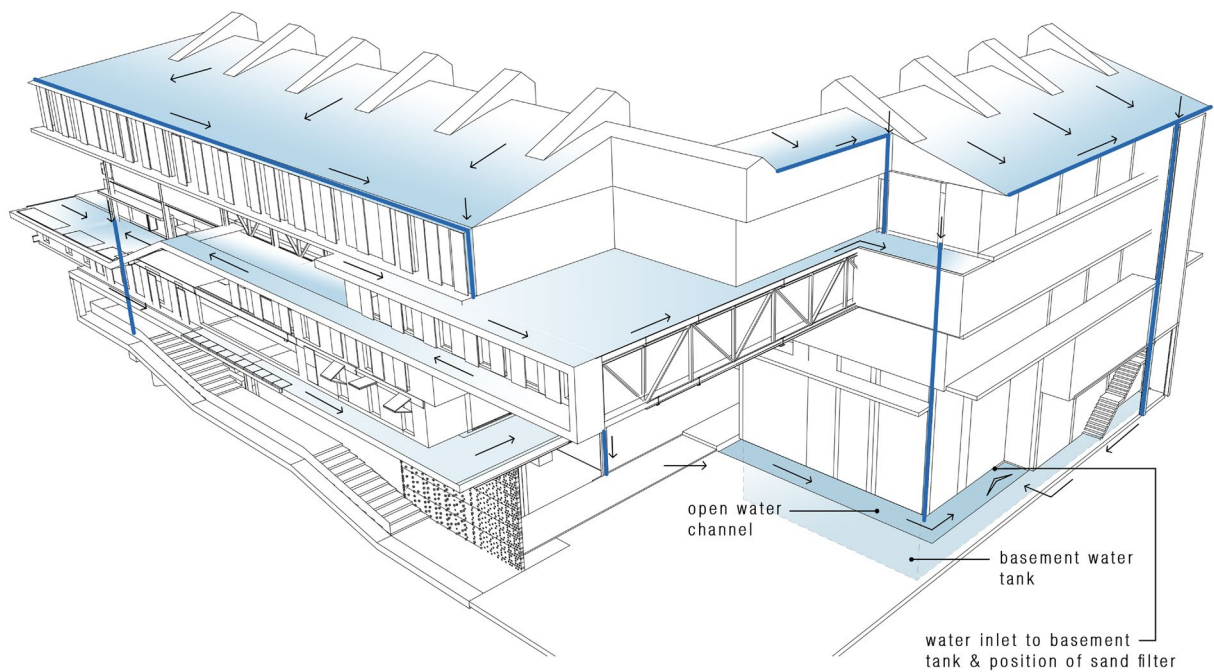

Figure 8.28: Rain-water catchment and directions of flow from building into basement tank

8.2.3 PASSIVE GEOTHERMAL HEATING AND COOLING SYSTEM

Although most indoor spaces inside the T.E.L. Centre make use of cross-ventilation, the electronic equipment inside the building gives off excess heat. Therefore the building makes use of a passive geothermal heating and cooling system by means of earth tubes. The earth's temperature remains at a constant all through the year, which means that it is cooler in summer than the outside air, and warmer in winter. Therefore it cools down the air in summer and warms up the air in winter before it enters the building.

As illustrated in Figure 8.29, the air inlets are positioned in the central open space of the block, in between trees, vegetation and next to the water channel so that it is as far away from vehicular outlet gasses in the surrounding streets as possible. From there the air circulates through the earth in submerged PVC piping. These pipes transfer the air into the service-shaft and vertically upwards, branching off for every level. The warm air inside the building is then sucked out at the top of each level by means of extractor fans and transferred through another pipe down the service shaft and out another outlet vent outside of the central space, away from the inlets.

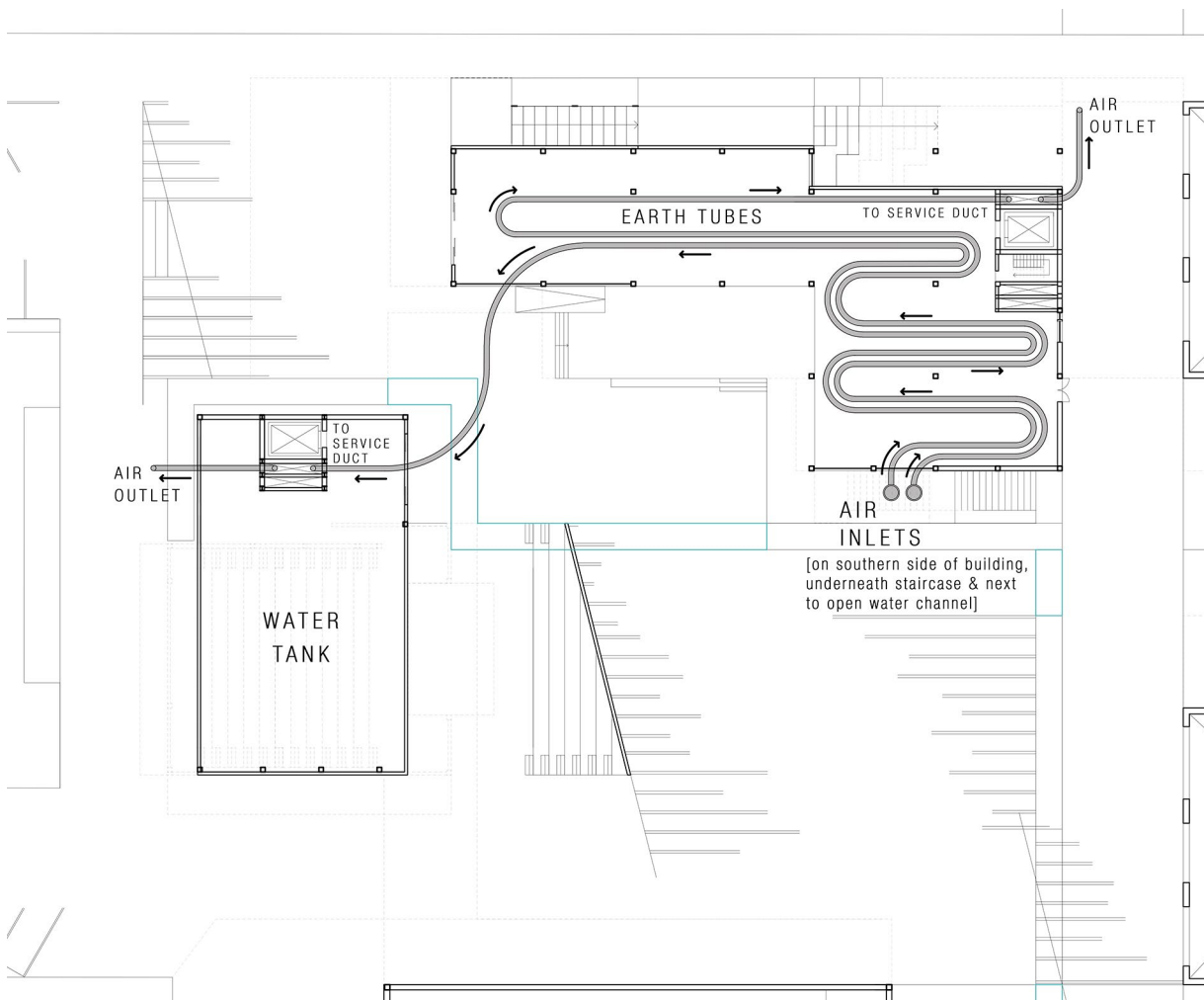

Figure 8.29: Earth tube system layout

8.2.4 SOLAR-ASSISTED STACK VENTILATION

In addition to the geothermal air regulation, the thermal comfort of the interior space is further enhanced by means of a solar-assisted stack-ventilation system. In commemoration of the scientific heritage of the buildings on the GPW block, which constitutes a roof-ventilator system (as discussed in Chapter 7) with a rhythmic repetition of protruded ventilators on the roofs (Fig 7.30), the new building's roof expresses the same elements in a new language.

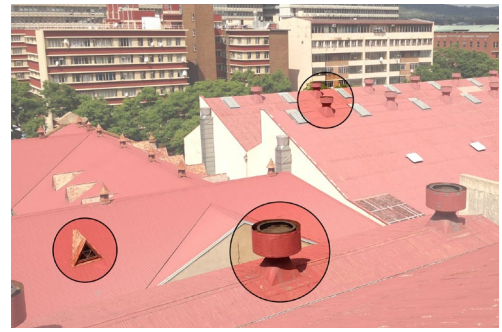

Figure 7.30: Existing roof ventilators in GPW

As illustrated in Figure 8.31 the stack-ventilation system makes use of air-pressure differences to pull the air through the building; warm temperatures have a lower air pressure and a lower air-pressure at the top of the building will passively pull the air upwards. This negative pressure at the top is further enhanced by means of the solar energy that is absorbed through the sky-light by the thermal mass-panel and then slowly released into the cavity between the panel and the glass. Most materials with a high thermal mass capacity are heavy weight like concrete slabs or similar; but because of the lightweight steel roof structure the thermal-mass-panel will rather constitute multiple plastic water canisters in a container which is fixed with angles inbetween the two roof trusses. This will work efficiently as water has a very high heat capacity of 4180 J/kgK (in relation to that of concrete: $C = 880 \text{ J/kgK}$) (Joubert, 2010: 64).

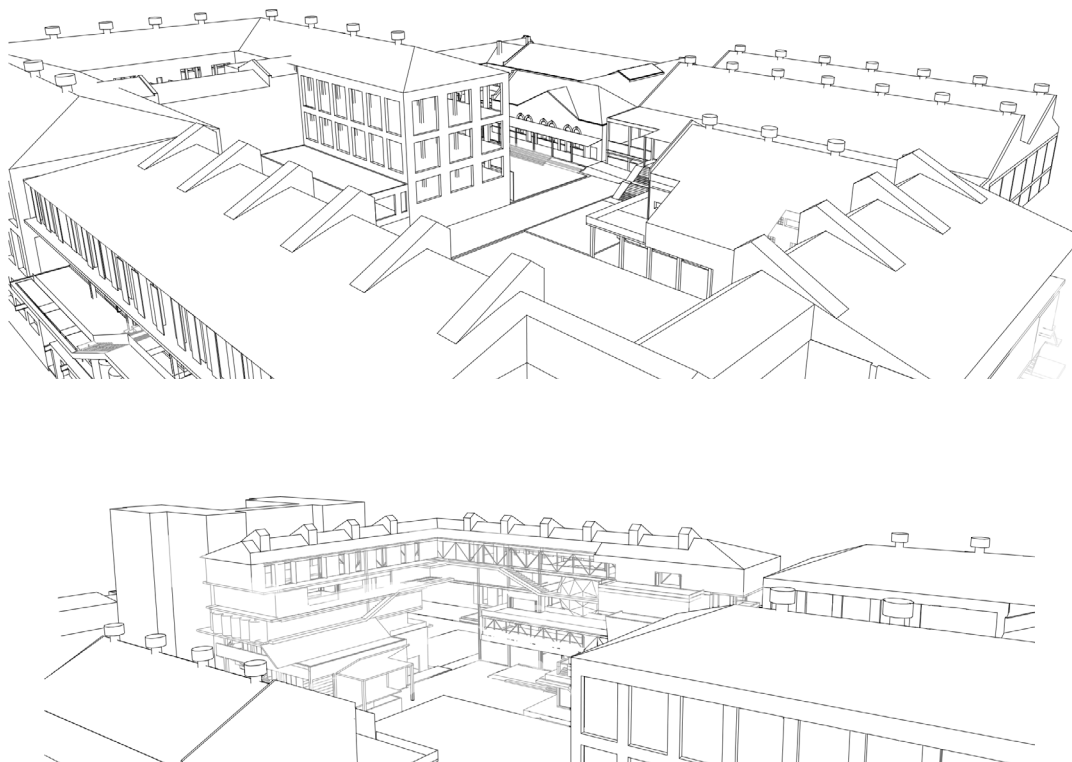

Figure 8.31 A & B: Roof with protruding stacks in relation to existing buildings with stack ventilators on site

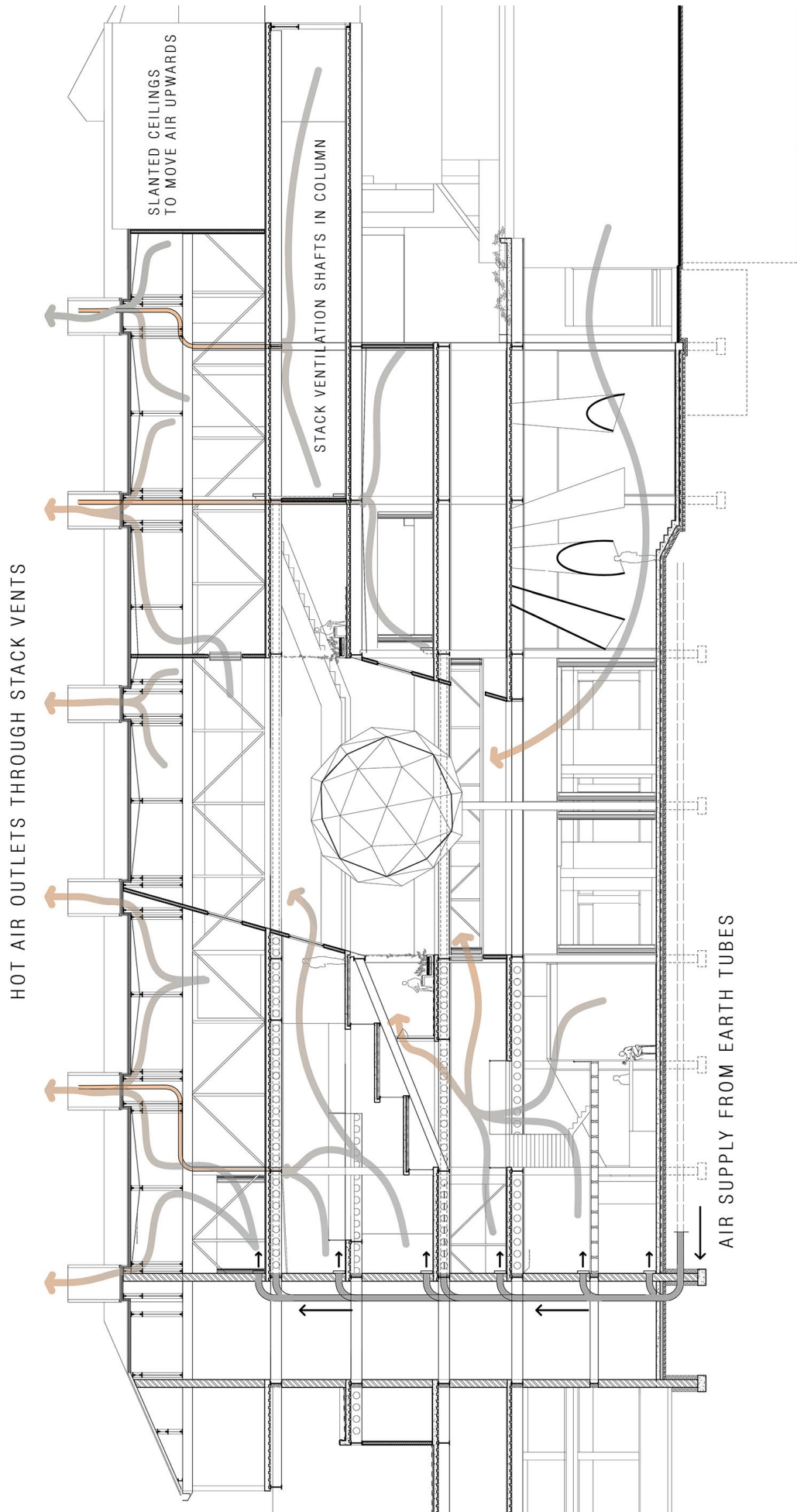

Figure 8.32: Longitudinal section showing airflow through building by means of stack ventilation

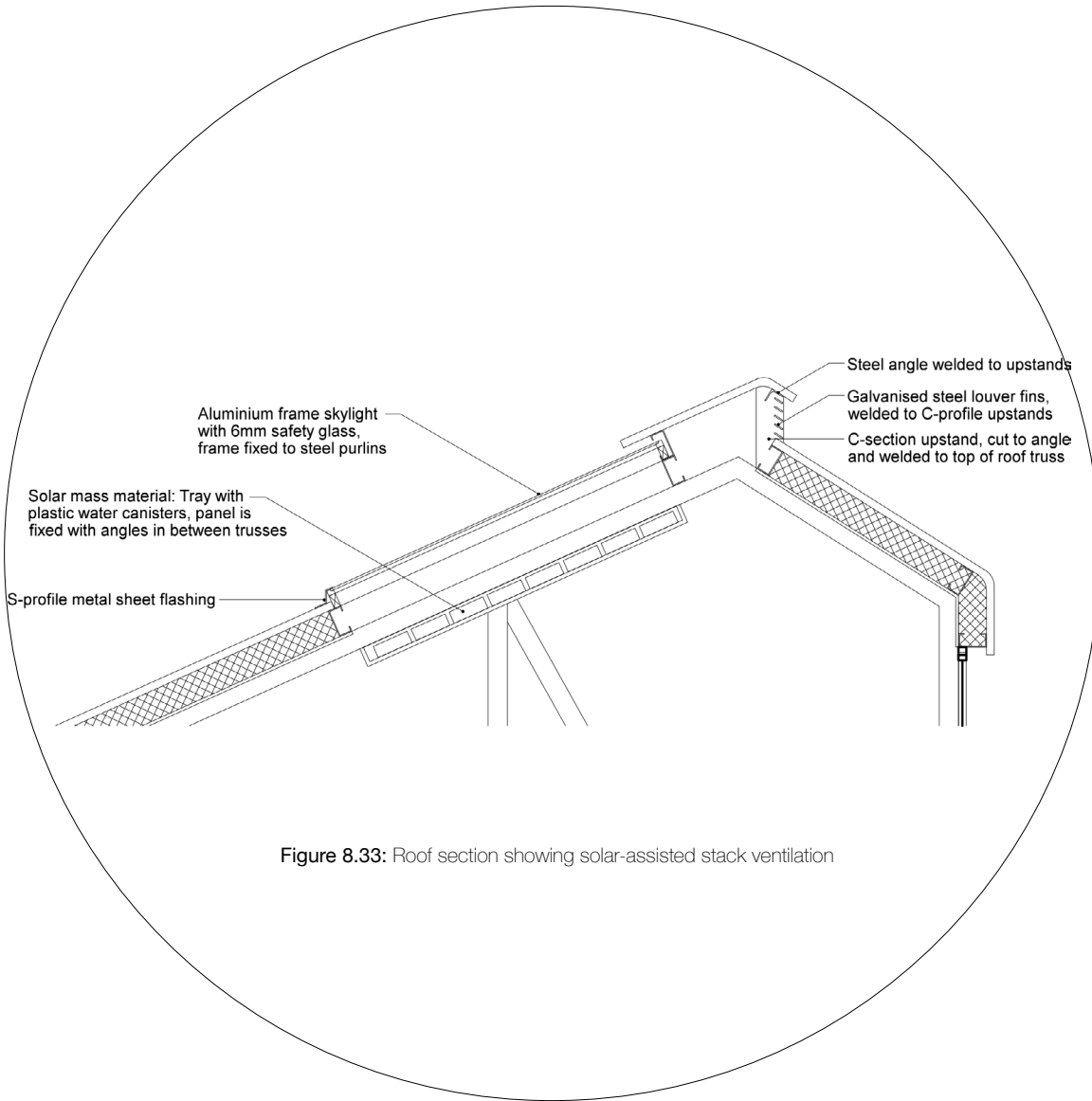
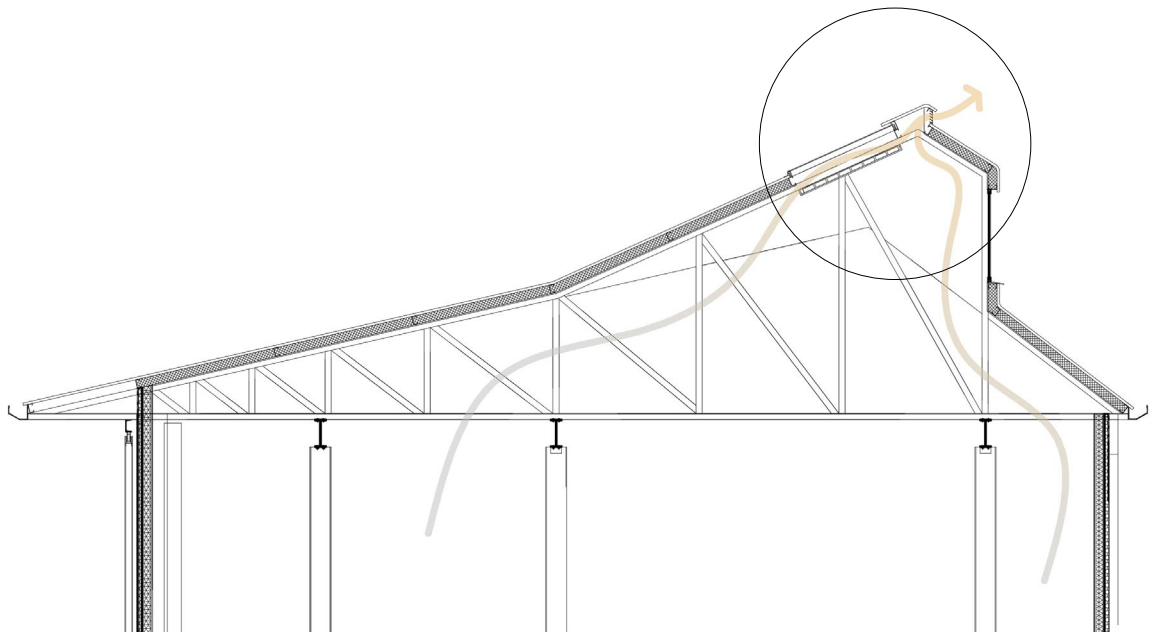
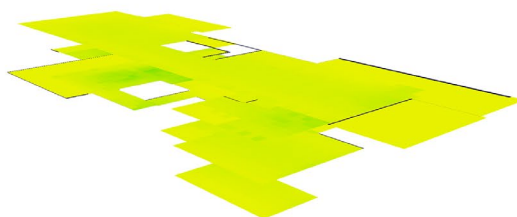
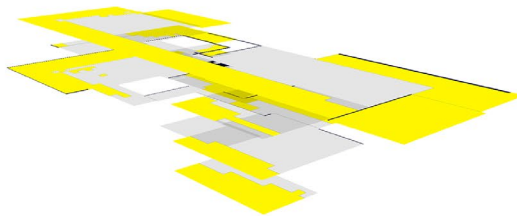
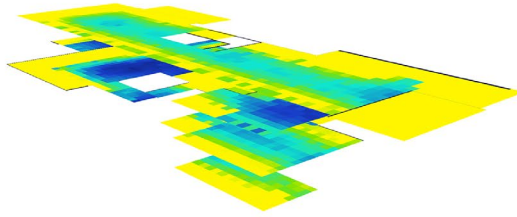
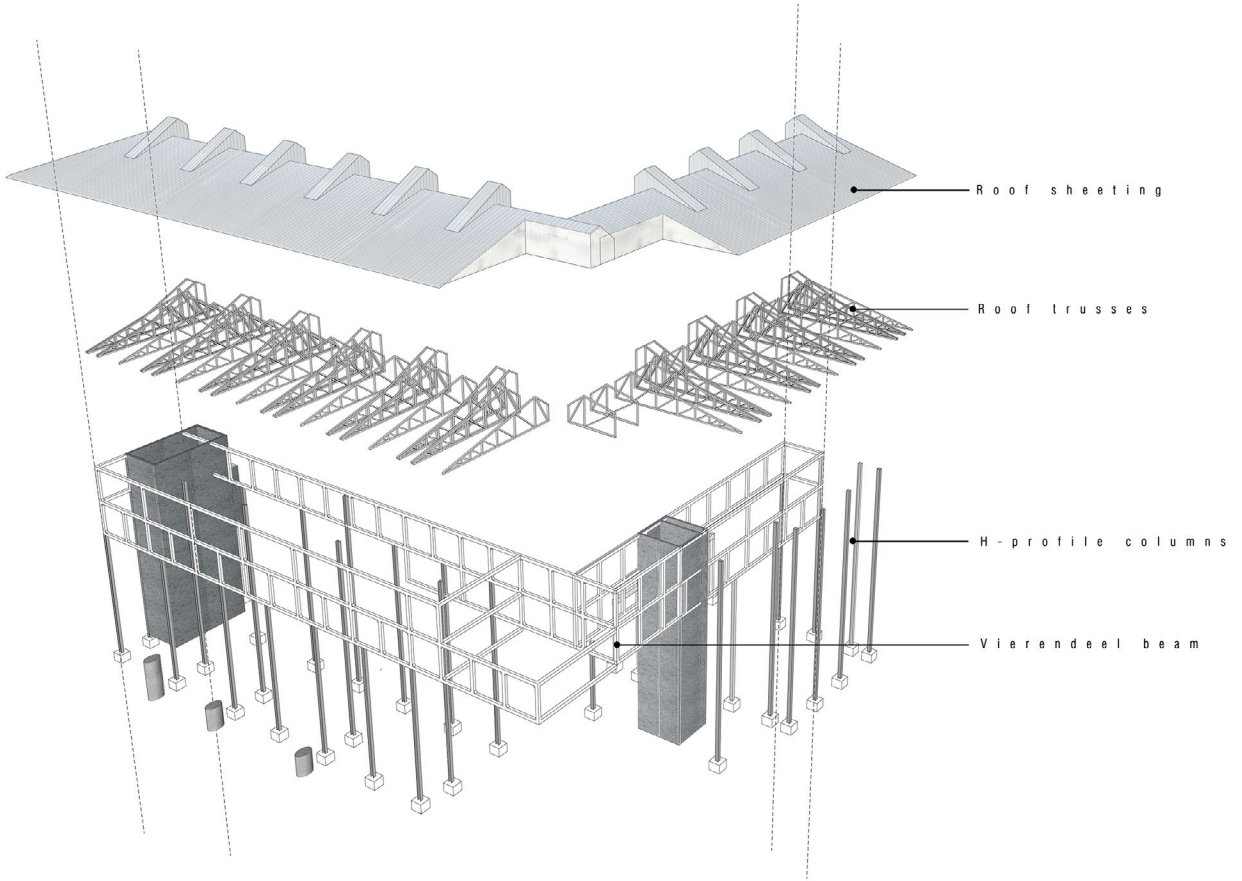

Figure 8.33: Roof section showing solar-assisted stack ventilation



D A Y L I G H T I N G A N A L Y S I S





Exploded structure showing corner cantilever

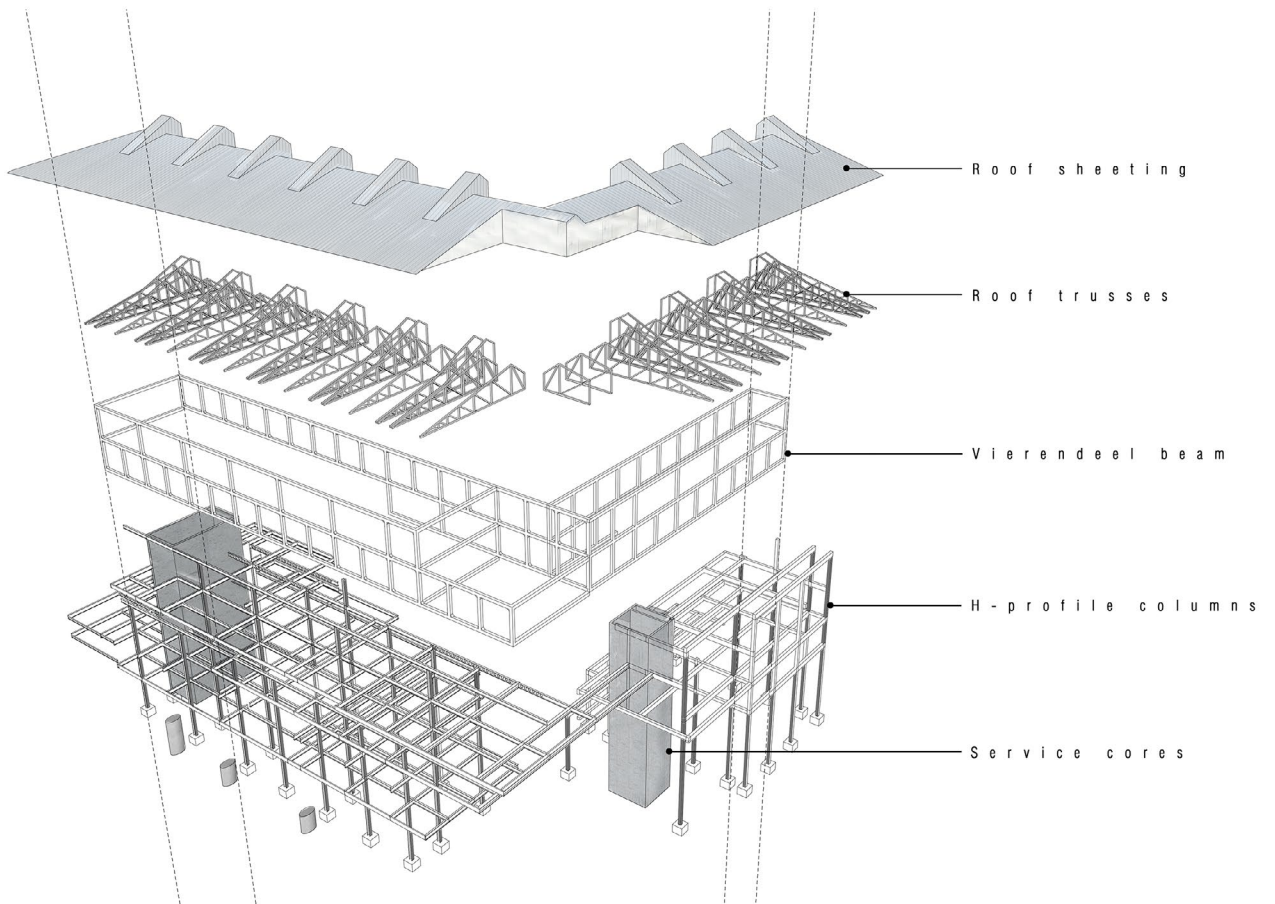

Exploded structure of entire building

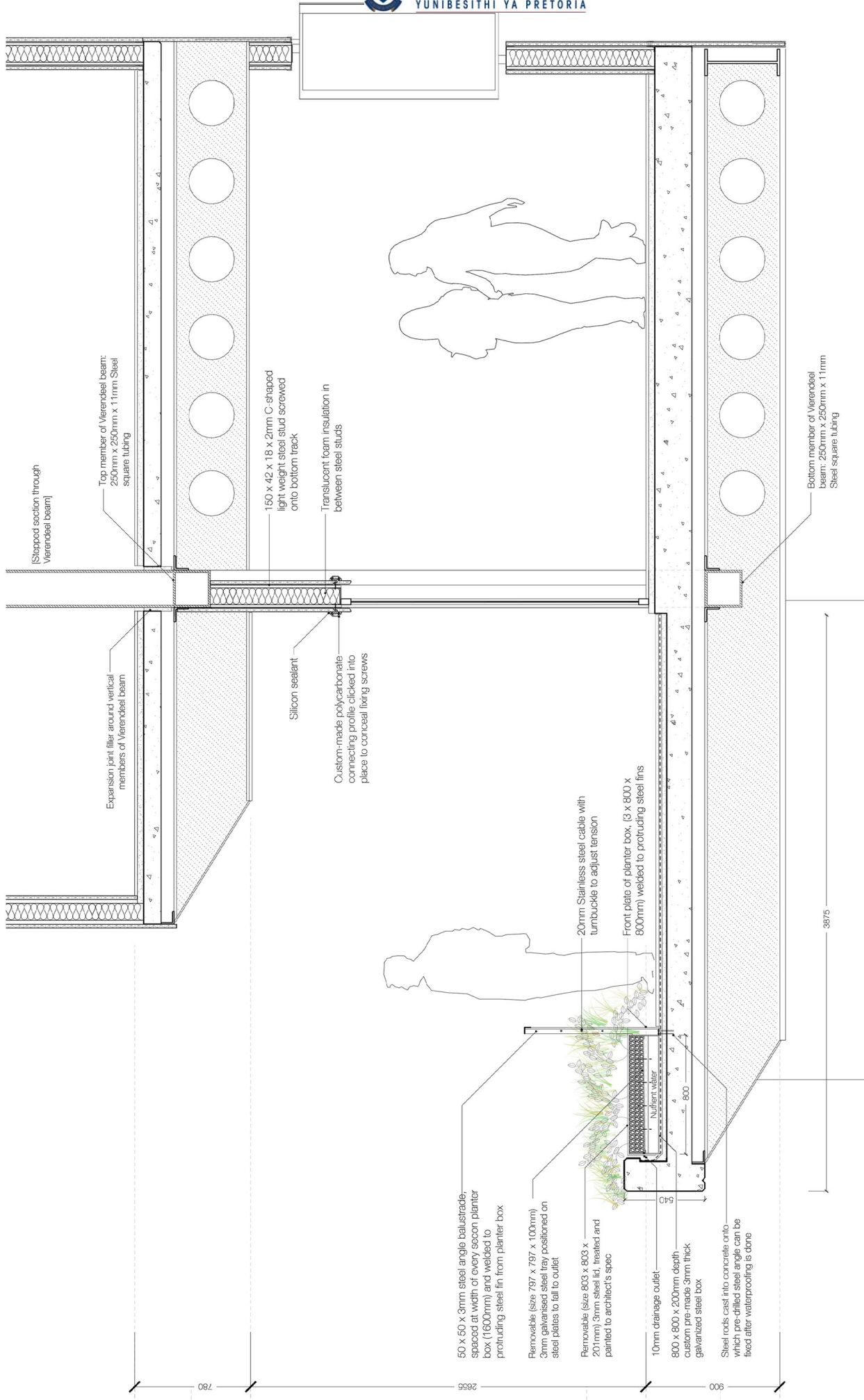

Section A-A Call-out: Stepped through Vierendeel beam & Planter-handrail combination on northern facade

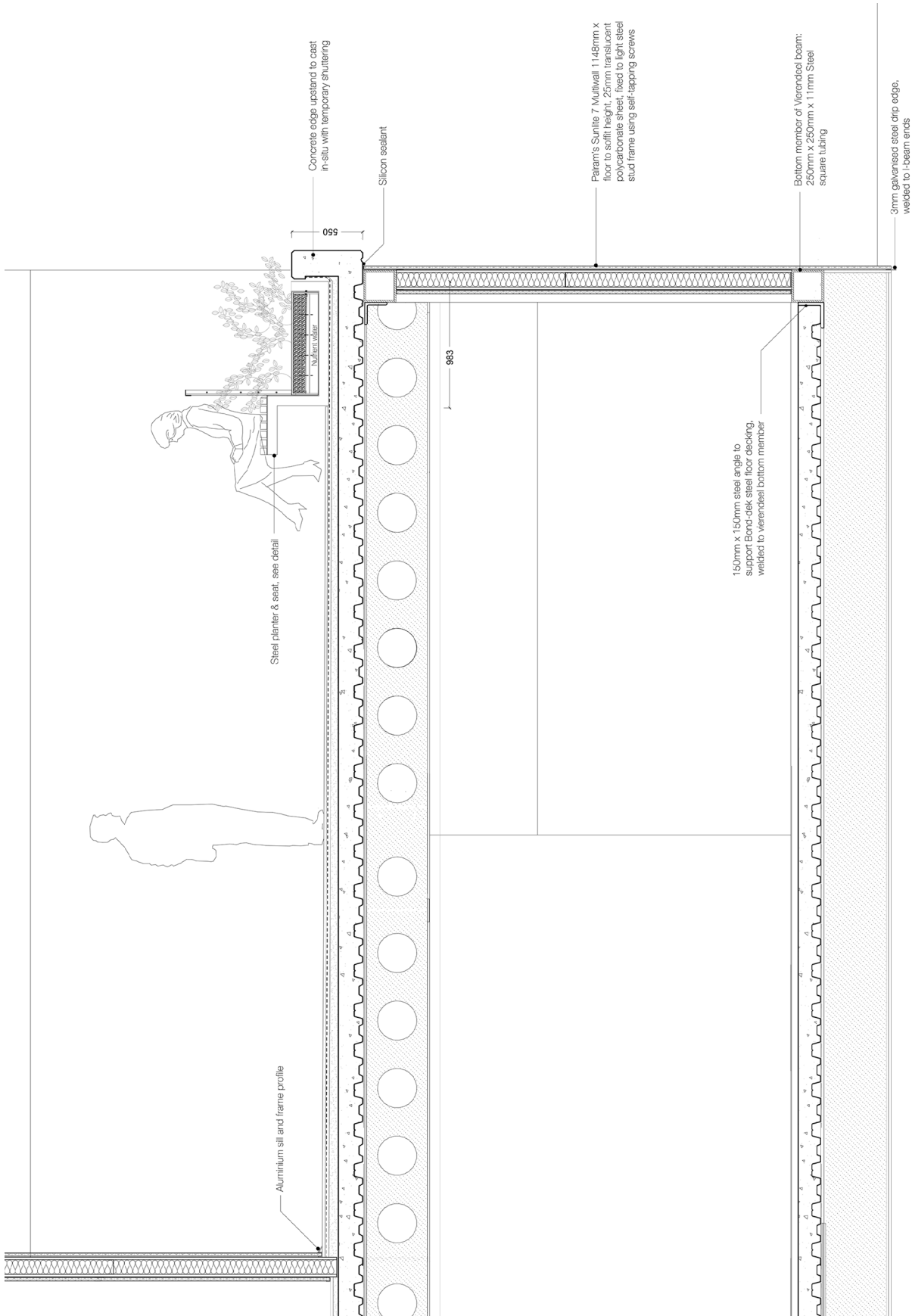

Section through Vierendeel beam [fourth floor, corner cantilever]

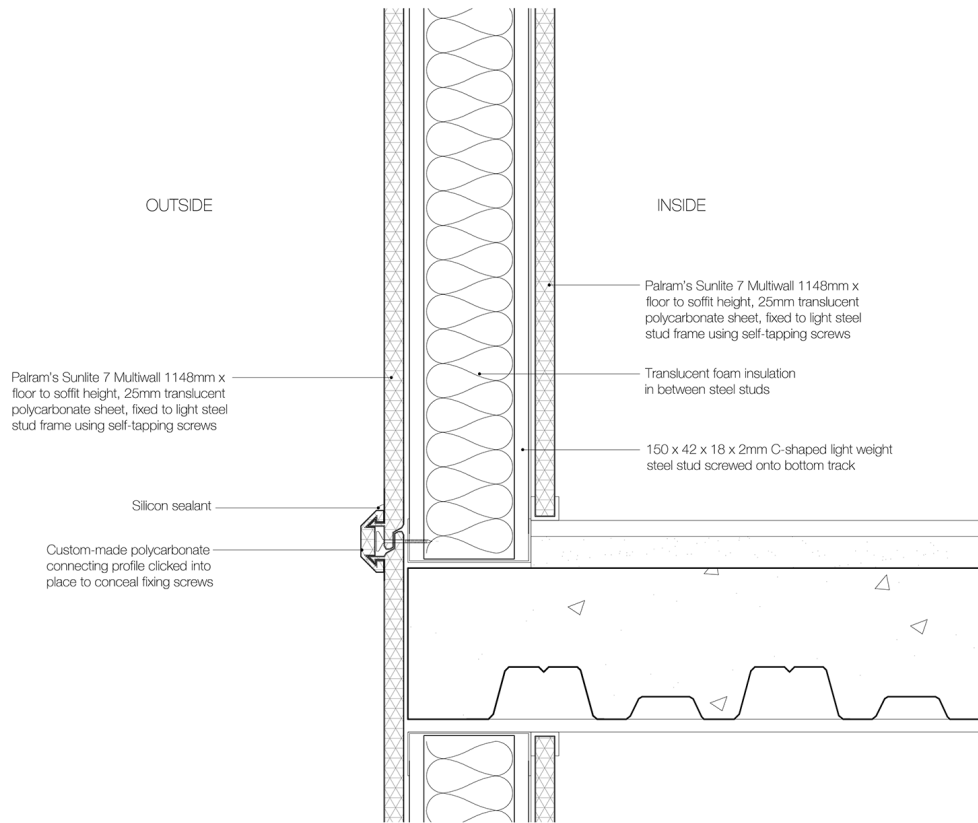

Translucent cladding detail at slab edge

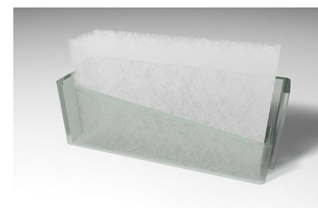
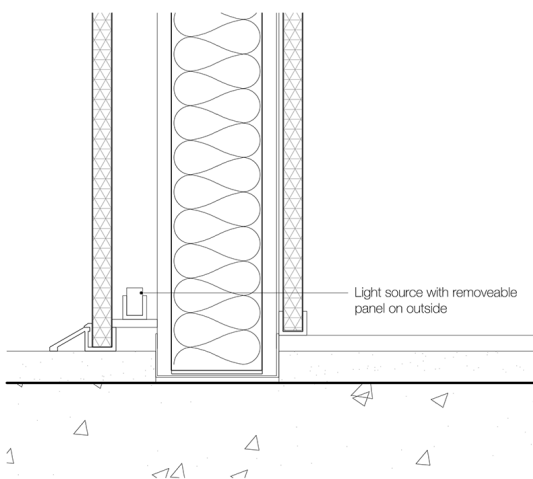

Translucent insulation

- Made from extremely fine glass fibres
- U-value: 1.2 W/m²K

Translucent cladding- position of backlighting source

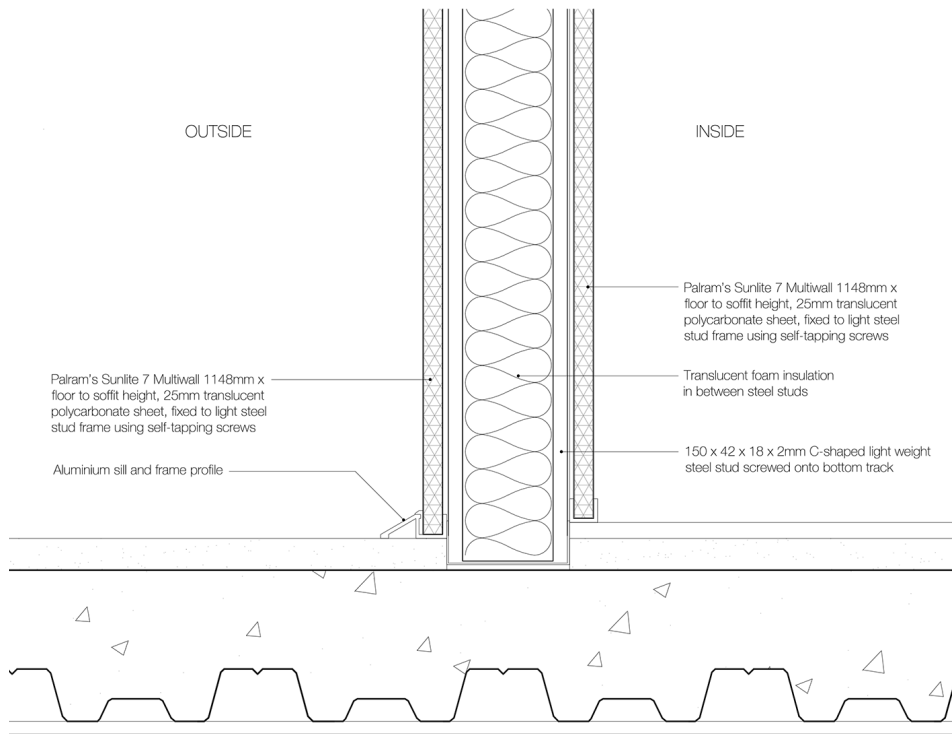

Detail section through translucent cladding

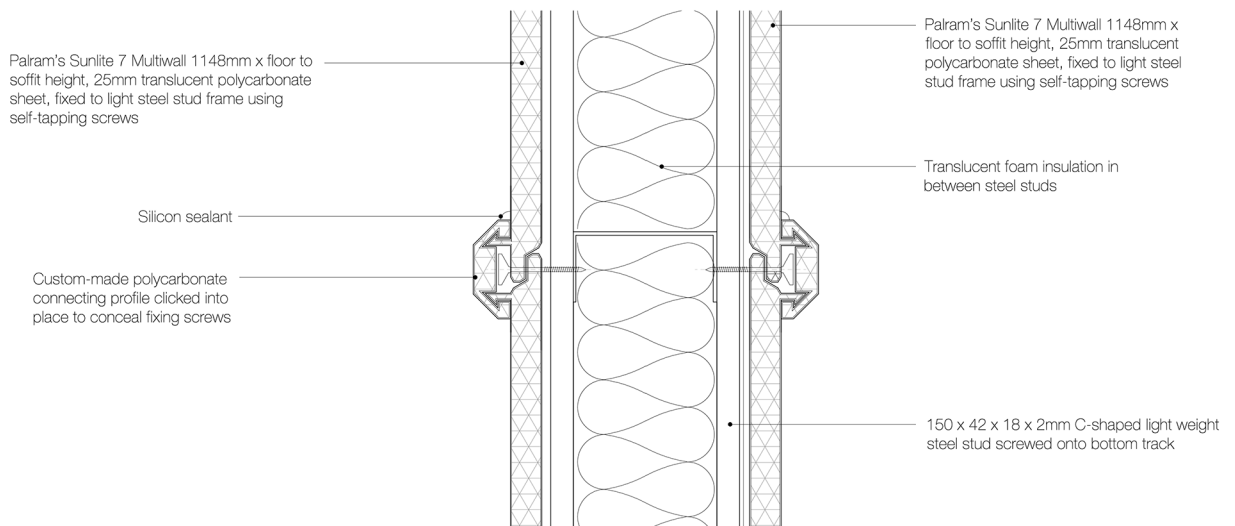

Translucent cladding connection detail

