

THE INTERIOR OF THE CAPE HOUSE

1670 - 1714

by

CAROLYN SAVILLE WOODWARD

submitted in accordance with the requirements
for the degree of

MASTER OF ARTS

in the subject

HISTORY OF ART

at the

UNIVERSITY OF PRETORIA

May 1982

Summary

This dissertation reconstructs, wherever possible, the interior of the Cape house between 1670 and 1714 from the evidence preserved in surviving inventories and vendu rolls located in the Cape Archives.

Chapter I examines those inventories which contribute something to our knowledge of the architecture of the period.

Chapter II reconstructs certain features of doors, windows, fireplaces etc., from clues in the inventories and vendu rolls.

Chapter III considers the way the different rooms in a Cape house were furnished, and relates this to the developments in interior organisation and design that were taking place in seventeenth-century Europe in general and the Hague in particular.

Chapter IV examines beds, window curtains, seat furniture, footstools, footwarmers and screens.

Chapter V examines tables, carpets, chests, coffer, cupboards, cabinets, writing boxes, cellarets, mirrors, pictures, and wall racks.

Chapter VI deals with lighting equipment, aids to cleanliness, basketware, skins, leatherware and cooperage.

Chapter VII examines the various items devoted to eating and drinking.

Chapter VIII covers the domestic pursuits: smoking, reading, writing, sewing, knitting, spinning, music, indoor games, clocks, watches, scientific instruments, weapons and domestic pets.

The Conclusion attempts to place the domestic world at the Cape in the context of contemporary Dutch culture. Comparisons are drawn between the Cape and other Dutch societies, and particularly between the Cape inventories and those of the Hague and New York, in order to pinpoint those qualities and features which are unique to the Cape house and the people who lived in it.

Samevatting

De doel van hierdie verhandeling is om die Kaapse binnehuis tussen die jare 1670 - 1714 te rekonstrueer sover dit moontlik is, deur gebruik te maak van die oorblywende inventarisse en vendurolle wat in die Kaapse Argief bewaar is.

Hoofstuk I ondersoek die inventarisse wat enige bydrae maak tot huidige kennis van die argitektuur van bogenoemde periode.

Hoofstuk II bestee aandag aan sekere eienskappe van deure, vensters, vuurmaakplekke ens.

Hoofstuk III oorweeg die manier waarop verskeie kamers in 'n tipiese Kaapse huis gemeubileerd was en vergelyk die metode van rangskikking met dié wat teenswoordig in sewentiende eeuse Europa gebruiklik was, veral in den Haag.

Hoofstuk IV beskrywe beddens, venster-gordyne, stoele, voetstoele, voetstofies en skerme.

Hoofstuk V behandel tafels, tapyte, kiste, koffers, kaste, kabinette, lessenaars, keldertjies, spieëls, skilderye en muurrakke.

Hoofstuk VI handel oor beligting, skoonheidshulpmiddels, reinigingsmiddels, mandjieware, leergoed, en kuiperswerk.

Hoofstuk VII ondersoek die verskeie gereedskap wat gebruik word vir eet en drank.

Hoofstuk VIII bestee aandag aan huislike werksaamhede soos rook, lees, skryf, naaldwerk, brei, spin, musiek, speletjies, klokke, horlosies, wetenskaplike instrumente, wapens, en troeteldiere.

Die konklusie maak 'n poging om die huislike wêreld aan die Kaap met gelyktydige Nederlandse kultuur in verband te plaas. Vergelykinge is tussen die Kaapse en andere Nederlandse gemeenskappe met die fokus op die Kaapse inventarisse en dié van den Haag en New York gemaak, en daardie kwaliteite en kenmerke wat uniek aan die Kaapse huis en die mense wat daarin gebly het, is bepreek.

Table of Contents

English Summary	i
Afrikaans Summary	ii
Table of Contents	iii
List of Illustrations	iv
Foreword	vii
Acknowledgements	ix
A Note on Sources	x
Introduction	1
The Architectural Framework	12
Interior Architectural Features	42
The Interior	51
Furniture I	96
Furniture II	130
Miscellaneous	168
Eating and Drinking	203
Domestic Occupations and Pastimes	236
Conclusion	265
Bibliography of Works Cited	299
Additional Selected Bibliography	307

List of Illustrations

	Before Page
1. Stellenbosch in 1710	17
2. Stellegift by J. Mulder	19
3. Spier by J. Mulder	19
4. Plan of Cape Town, c 1670	20
5. Plan of Nooitgedacht	26
6. A Lean-To	26
7. Plan of Sneewindt House	28
8. Plan of Helot House	30
9. Alternative Plan of Helot House	30
10. House with Back Gallery	31
11. Plan of Stellenbosch Drostdy	32
12. Constantia in 1710	35
13. Dutch Doorways	42
14. Front of Vergelegen	43
15. Back of Vergelegen	44
15.5 Dutch Windows	45
16. Unnamed House by Mulder	47
17. Dutch Fire-Place	47
18. Cape Interior, c 1690	61
19. Iron Utensils	77
20. "French" Bed	101
21. <u>Katel</u>	101
22. Beds and Their Accessories	108
23. <u>Lit à Housse</u>	109
24. "French" Bed	109

List of Illustrations (cont.)

		Before Page
25.	Canopy Bed	109
26.	Bed by Hogarth	110
27.	Room <u>à Falbala</u>	111
28.	Window Curtains	113
29.	Wheel-Back Chair	115
30.	"Tulbagh" Chair	115
31.	<u>Rustbank</u>	115
32.	Farthingale Chair	117
33.	Rush Stool	117
34.	Turned Chairs with Rush Seats	117
35.	Screen	123
36.	Dressing Table	135
37.	Stinkwood Cupboard	144
38.	Yellowwood Food Cupboard	146
39.	Desk, Hutch and Small Cabinets	147
40.	Mirrors	155
41.	Cloak-Stands	161
42.	Lighting Accessories	171
43.	Hanging Candlesticks	172
44.	Crusie Lamps	173
45.	Standing Oil Lamps	174
46.	Glass Lamps	175
47.	Lanterns	176
48.	Further Lanterns	176
49.	Ewer and Basin	179
50.	Close-Stool and Commode	183

List of Illustrations (cont.)

	Before Page
51. Brooms	186
52. Table-Setting	203
53. Useful Porcelain	209
54. Porcelain Figures	211
55. Garniture of Vases	212
56. Stoneware Teapots	216
57. Glass Items	222
58. Bellarmine and Gallipot	224
59. Pewter	225
60. Smoking Accessories	239
61. Japanese Sewing Box	249
62. Hour Glass and Bird Cages	258

Foreword

I have been considerably exercised in preparing this manuscript by the need to hold a balance between readability and scholarly practice. As far as possible I have allowed myself to be guided by the Modern Language Association Handbook* which tries to take these two requirements into account.

The nature of this study demands a heavily documented text and in order to "avoid large numbers of very short notes" (MLA, p.16, sec.20), I have to some extent complied with the advice "If the reference is brief, insert it, within parentheses, in the text itself" (Ibid.). Common sense, if nothing else, does however limit the number of references that can be incorporated in a text, so I have adopted the following procedure. All references to the inventories and vendu rolls located among the Orphan Chamber papers at the Cape Archives have been abbreviated and inserted in parenthesis in the text (see "Introduction" n.1 for the exact system adopted). This policy enables a reader to follow the majority of archival references with the minimum of effort. Where the text requires more than one reference, which would interfere seriously with the ease of reading, I have used a note. References to inventories and vendu rolls that are located elsewhere in the Cape Archives have been given in a note. All other references, no matter how brief, are noted. As the work advanced I began to feel certain references were being repeated to the point of absurdity and in such instances have limited annotations to direct quotations.

My primary concern in this study has been the archival material itself and I have tried to present this in such a way that scholars much more expert in certain fields than myself can build upon it. For this reason I have made extensive use of Dutch. All original quotations from the manuscripts appear in double inverted commas. Dutch words in parenthesis or italics have modernised spelling but reflect the original vocabulary. In occasional passages where a particular term is under discussion, double inverted commas have been used, but such instances should be clear from the context. Words derived without change of meaning through Afrikaans from the Dutch and commonly used by English-speaking South Africans, like

*MLA Handbook for Writers of Research Papers, Theses and Dissertations
(New York: MLA, 1977).

"voorhuis," "voorkamer" and "solder," appear in roman type. "Rustbank," however, is italicised throughout, as I am not confident that "rusbank," as used today, is an exact reflection of the original meaning.

In reproducing original quotations, abbreviations, like for "ver," have been given in full and, where clarity demands it, ditto marks have been ignored and the word in question substituted. Given the arbitrary capitalisation of the period, it was often impossible to decide what was in fact intended, particularly in the case of "c" and "s". Names of familiar figures, such as Olof Bergh and Johannes Starrenberg, have been spelt in the accepted fashion; other names have been spelt in the form in which they appear in the inventories.

With regard to numerals I have tried to follow the advice of the MLA Handbook to the effect that numerals under a hundred should be in words, and those over a hundred in figures, but in passages where only an occasional high number occurs it has seemed preferable to give it in writing rather than to reproduce all related numbers in figures. I have, however, made an exception for sums of money quoted in reference to passages from the inventories and vendu rolls because, in general, figures appear in these quotations and it has seemed more graceful to use them myself. This has led to the occasional anomaly, particularly when written numerals occur in the original.

Acknowledgements

A study of this kind could not have been completed without a good deal of assistance from others, and I wish to thank the following for their help.

My supervisor, Prof. F. G. E. Nilant, for his support, encouragement and wise guidance through every stage of this work.

The Human Sciences Research Council for the bursary which enabled me to examine a number of New York inventories in situ and to familiarise myself with the work being done in that city with regard to period rooms and other related matters.

The editors of Africana Notes and News and Tydskrif vir Geesteswetenskappe for permission to use material that originally appeared in those publications.

The staff of the various libraries and archives in which I undertook research and in particular Mrs. Yvonne Garson of the Gubbins Library, University of the Witwatersrand, and Dr. Leo Hershkowitz, Director, Historical Documents Collection, Queen's College, City University of New York, Flushing, New York.

The staff of a number of museums from whom I sought guidance and help, in particular Miss L. Immelman of Museum Services, Pretoria, Mrs. E. B. Nagelgast and Mr. T. van Niekerk of the Africana Museum, Johannesburg, Mr. P. Snyman of Groot Constantia Manor House, Mr. Marius le Roux of Stellenbosch Museum, Miss J. Mailey of the Metropolitan Museum, New York, and Mr. K. Stayton and Miss J. Margles of the Brooklyn Museum, New York.

Dr. Anita Lindenbergh and Dr. Edith Raidt, Dept. of Nederlands and Afrikaans, University of the Witwatersrand, for their helpful comments on my translation of passages from the letters of Johanna Maria van Riebeeck.

Mrs. Margaret Cairns for sharing her intimate knowledge of the Cape Archives with me, and most kindly checking through one volume on my behalf.

My sister, Mrs. Margaret Berge, for her unstinting help in the final preparation of the manuscript.

Mrs. Arn Mackenzie, for the thoughtful and meticulous care with which she typed the manuscript.

My husband, for his unflinching support, patience and interest.

A Note on Sources

From 1652 to 1670 the only inventories known to me are those located in a series of volumes, "Transporten en Schepen-kennissen," which have recently been transferred from the Deeds Office, Cape Town, to the Cape Archives Depot. In Holland, the schepenbank was a minor court which, in English, might be translated as a court of aldermen or a bench of magistrates. Its ordinary members were known as "schepenen," its chairman as a "schout," and its principal function was the drawing up of legal documents and maps in connection with land transactions. At the Cape in lieu of a schepenbank, these tasks, which also came to include slave transactions, were carried out by the commander or governor and two officials, and recorded in the above-mentioned series.¹ The first two volumes of this series also include inventories. The majority of these are concerned with the personal possessions of humble sailors and soldiers, but a handful are concerned with the estates of senior officials and are of very considerable interest. After 1665 inventories disappear from these volumes, and for the next few years none appear to have survived.

A volume containing inventories and estate papers ranging in date from 1670 to 1701 is preserved among the Orphan Chamber Papers (MOOC23/5) but the documents concerned were not compiled for the Orphan Chamber but for the Council of Policy, or to the order of individual commanders, governors and visiting commissioners. Included among these inventories are estates of Cape burghers as well as those of officials and naval personnel, and, in one instance, a super-cargo of the English East India Company who had come ashore to recover his health or die. Estates from the 1670's are particularly numerous.

The Board of the Orphan Chamber was set up in 1673.² There were some changes in its composition during the first few years, but then it settled down into a body consisting of a president and vice-president drawn from Company officials and burghers respectively, two

1. Anna J. Böeseken, *Slaves and Free Blacks at the Cape 1658-1700* (Cape Town, 1977), p.1.
2. This account of the Orphan Chamber is taken from C. Graham Botha, Collected Works, III, 131-35.

Company men and two burghers. Every two years the Board was selected by the government from a list of nominations submitted for that purpose. The Orphan Chamber was established for the collection and administration of the property of persons who died intestate and left heirs who were minors or lived abroad. Initially the Board was also responsible for the property of Company men and burghers who died en route to Europe and the East, but it was relieved of this particular burden in March, 1711. In addition, the Orphan Masters were responsible for all estates where the will did not specifically exclude them from acting as executors. Their other duties included the registration of wills of deceased persons; the administration of a minor's property; the receiving and paying out of legacies; the registration of deaths; and the recording of the resolutions and transactions of the Board. In their rôle as executors and trustees it was often necessary for the Orphan Masters to convert the assets of an estate into ready cash. There were no licensed auctioneers at the Cape during the period of Company rule and the right to conduct public sales was entrusted to certain government officials, among them the Secretary of the Orphan Board. A list of the articles sold, known as a *vendu roll*, was kept and this includes the name of the purchaser and the amount paid. All too obviously inventories (MOOC8) and *vendu rolls* (MOOC10) compiled for the Orphan Chamber are incomplete. Fortunately the gaps which are particularly noticeable before about 1695 are compensated for by the volume of inventories already discussed and catalogued as MOOC23/5, as well as by a volume of *vendu rolls* dating from 1676 to 1690 and catalogued as MOOC22/2.

Inventories and *vendu rolls*, from the 1680's onwards, are also found among the Council of Justice papers. The Council was responsible for disputed or confiscated estates, the latter, in particular, being fairly numerous. Once convicted of a crime, the confiscation and disposal of one's property automatically followed, while in the case of debt, goods were seized and auctioned off until the sum realised covered the debt. Once again the early years are inadequately documented, but they do include the interesting estates of several senior Company men. These documents are catalogued as CJ2914-16.

Finally use has been made for comparative purposes of a number of inventories preserved in the Hague and New York. The study of the Hague inventories was not so much a matter of choice as of accident. I had arranged to spend a period at the Hague in mid-1980 because I had been led to expect a good deal of relevant material among the East India Company papers in the Rijks Archief, but on arrival found that the sort of documentation I was interested in began, at best, in the latter half of the eighteenth century. I therefore spent most of my time in the Gemeente Archief instead. Because the Hague was the centre of the Court of the Prince of Orange--a Court which patterned itself on the French model--life in leading circles was not typical of that of Holland as a whole, and scholars interested in the norm have usually concentrated on other centres. For my part I can only say that the Hague inventories seem to reflect interiors essentially at one with the bourgeois milieu presented by other writers. These inventories do not support every minor generalisation made about the Dutch house at this period, but such differences as I have noted seem to have nothing to do with French courtly influence. The most impressive inventories I saw in the Notarial Archives at the Hague are actually closer in spirit to the leading New York inventories than they are to the inventories of the Hôtel de Rambouillet in Paris or those of Ham House, seat of the Duke and Duchess of Lauderdale in Richmond,¹ and it would surprise me very much if they convey an overglamourised picture of Dutch urban life in a broader sense to either side of 1700.

Even when dealing with documents of the same type there are differences in the way they are compiled. As a general rule the Hague inventories are the most helpful. The majority of them are compiled room by room, and individual entries include all the detail one can expect from such documents. The New York inventories rival the Hague inventories in their descriptions of soft furnishings and materials, but only a very small percentage of them are compiled room by room--a severe handicap. On the whole, the Cape inventories fall somewhere between those of the Hague and New York: a useful

1. These inventories feature prominently in Peter Thornton, Seventeenth-Century Interior Decoration in England, France Holland, New Haven/London, 1978.

number of early eighteenth century Cape inventories are compiled room by room, but information with regard to soft furnishings is sadly inadequate.

Introduction

It is the purpose of this study to try to recapture from the inventories and vendu rolls preserved in the Cape Archives the domestic spirit of an age: the nature of the houses that existed at the Cape to either side of 1700, together with the nature, style and arrangement of their contents. The precise period concerned is from 1670 to 1714. The terminus ab quo is dictated by necessity. The documentation¹ which makes this investigation possible is virtually non-existent before 1670: before that date nearly all surviving inventories² are concerned with the personal effects of humble sailors and soldiers in the service of the Dutch East India Company and have little or nothing to tell us about the domestic life of the Cape community. The terminus ad quem has been selected for various reasons. It marks the end of an era in Europe with the deaths of Anne of England and Louis XIV of France. It also marks the end of the second volume of inventories in the Cape Archives. Most important of all, it marks the end of an era at the Cape. The downfall of the Van der Stels in 1707 had put paid to the official policy of immigration, but the steady expansion of the young colony was halted much more surely by the dreadful smallpox epidemic of 1713 with its European death-rate of nearly one in four.³ The enormous increase in the number of inventories of deceased estates for that year have, in addition, proved invaluable for my purpose.

Perhaps I should explain why I have chosen to treat this forty-five year period as a unity and to ignore the natural dividing line offered by the change of century. Here too necessity has played a part. To the best of my knowledge⁴ only six of the surviving inventories were compiled room by room before 1700, but from 1701 a fair number were handled in this way. Naturally it is these which contribute most to our understanding of the domestic arrangements of the period and it seemed advisable to allow the early eighteenth-century documents to throw light on those that came before.

Finally the exact correspondence between my concluding date and François Valentijn's last visit to the Cape, though purely fortuitous, has proved to be most valuable. Valentijn visited the

Cape in 1685, 1695, 1705, and 1714. These visits are described in his monumental Oud en Nieuw Oost-Indiën which concludes with a detailed account of the Cape entitled "Beschryvinge van de Kaap der Goede Hoop".⁵ Much of this is taken from Peter Kolbe's Caput Bonae Spei Hodiernum⁶ but the really valuable passages are based on his own experience. As my knowledge grows, my respect for Valentijn's powers of observation increases. He transcribes chunks of Kolbe, often carelessly and nearly always without acknowledgement, he enjoys gilding the lily and has a tiresome fondness for superlatives, but when we have thought him most in error subsequent research has often proved him right.

Though it is deeply to be deplored that the minutiae of domestic life at the Cape before 1670 are largely unrecorded and so forever lost to us, the documents of the 1670's give the impression that the little settlement had as yet had neither time nor opportunity to develop a distinctive character. Certainly the primitive hardships of the first twenty years can have had little to offer the historian of taste and manners, and though the 1670's show a marked increase in prosperity it is not until the 1680's that the Cape home begins to show an individual flavour. By 1685, as Valentijn makes clear, the comforts and some of the elegances of life could be commanded at the Cape. In that year he is able to write about "one half of a large and fine house,"⁷ to wax eloquent over the Company's Garden, "the loveliest plantation that I ever saw before or since then,"⁸ and to imply that the Cape was already a land of opportunity: Valentijn spent his first night ashore "at the house of a Burgher at the Cape, Gulliam Heems, who had come there penniless with his wife five years previously and was now a well-to-do man."⁹ The picture of the Cape that emerges from Valentijn's account of this first visit has a certain amount of documentary support. In 1672 the estate of Hendrik Van Zuijrwærden totalled an astonishing 22 205 guilders or over 1 500 pounds¹⁰ and included "Een groot Woonhuijs met twee bijhuijskens" worth¹¹ 3 500 guilders (23/5, 21, 1672).¹² In 1685 another inventory enumerates the interesting and varied possessions of the burgher, Elbert Diemer (I, 2, 1685) which were worth the less startling but nevertheless substantial sum of 4 800 guilders. Both these men were granted

their burgher papers in 1657, the year that marks the beginning of the burgher community at the Cape, and both of them, among many other things, plied the trade of tailor and served as burgher councillors.¹³

As prices have changed so much since the seventeenth century it is necessary to grasp at the outset the degree of change that has taken place. At that time a house could be provided with basic necessities for something like 150 to 200 guilders.¹⁴ For 300 guilders a house could be furnished with a modicum of comfort, for 500 guilders with comfort and for 1 000 guilders with comfort and some of life's luxuries. Where property is concerned, a farm or house worth 4 000 guilders apparently represented prosperity. There are few valuations or auction prices for property before 1685 and none known to me exceed 4 000 guilders. From 1685 to 1714 I have found about forty properties, thirteen of them from the seventeenth century, with values ranging from 4 000 to 16 450 guilders. The figure of 4 000 guilders, which represents my own assessment of reasonable prosperity, is confirmed by Valentijn in the following passage:

When these folk first arrived here they were nearly all poor and naked. . . . They have indeed become pretty well-to-do as the time passed, and most have later built fine brick houses on their lands, which they, or their heirs, now own as noble farmsteads, which have become estates of great value, and thus many of them have now become very rich. . . .

Today there is no burgher of any standing who does not own such a farmstead, yielding more or less money according to its size, especially from its cornfields. There are estates worth 4 000, 5 000, 10 000 and even 20 000 Cape guilders of 16 stivers.¹⁵

I have deliberately illustrated the purchasing power of money in terms of the prosperity of the period under review. It has been truly said that the poor have no history and it is equally true that the basic necessities of life contribute little to the distinctive quality of a period. It therefore seems important to stress the fact that by 1685 the Cape was no stranger to prosperity. For some reason, which may have something to do with our respect for the hardship experienced by the pioneer, we have found it difficult to accept the accounts of early travellers. Most of

them were rather impressed by "De Kaap," the name by which the small village at the foot of Table Mountain was known to the Dutch among them. This fact is underlined by the poor impression made on them by the English settlement at St. Helena. Contrast William Dampier's description of the "small Dutch Town" at the Cape, where he counted "50 or 60 Houses; low, but well built, with Stone-walls"¹⁶ and his description of the "small English Town" at St. Helena with "about 20 or 30 small Houses, whose Walls are built with rough Stones [and whose] inside Furniture is very mean."¹⁷ When the Rev. J. Ovington writes that "The Poverty of the Place [St. Helena] may be likewise thought another Ingredient of its [poor] Health"¹⁸ and then says that "there is scarce one part of all the Tripartite Continent, that is furnisht with that abundance of conveniences, which The Cape can boast of"¹⁹ we would do well to believe him and accept the fact that the Cape in the 1690's when he knew it was a very different place from the Cape in the 1650's. By the end of the seventeenth century some of the burghers, as Dr. de Wet well says, could justly be described as prosperous.²⁰

The Cape, like St. Helena, was a halfway house between East and West, but unlike St. Helena it was the toe of a great continent, not a small island. Starvation was not a very pressing problem at the Cape, and with subsistence of a sort assured, the community was preserved from the inertia of hopeless poverty. The Cape was a new community, dominated by yeoman farmer and skilled artisan, but a community founded for the convenience of a great trading company and not slow on its own account to master the intricacies of private trade—both legal and illegal.²¹ Within about thirty years it had prospered to the point where it could begin to evolve a pattern of domestic life that was coloured by its curious geographical position. A port of call for every Dutch ship, whether homeward or outward bound, at a time when its population was small and compact enough to experience this dual influence to the full,²² the Cape was not slow to evolve a way of life and an ambience that was uniquely its own.

The seventeenth-century interior in Holland has been recorded for posterity by innumerable Dutch painters, and enough buildings and household articles have survived to give us a pictorial

image of the material circumstances in which the various classes lived. The seventeenth century was also the great century of Dutch colonial expansion and an Indo-Dutch civilization, markedly different in style from that of the homeland, flourished in the various Dutch dependencies in the East Indies. The Dutch East-Indian communities were small—2 298 was the Batavian total in 1682²³—so surviving artifacts are not all that numerous, whilst artists, in face of the mysterious East, chose to pass over the European interior in favour of more exotic subjects. It is, therefore, a good deal less easy to recapture the Indo-Dutch colonial interior. However enough furniture, silver, etc. has come down to us to enable authors like Dr. F. de Haan²⁴ and Dr. V. I. van de Wall²⁵ to present a relatively concrete and rounded picture of the circumstances in which the wealthier families lived in the seventeenth and early eighteenth centuries.

Most unfortunately the same cannot be done for the Cape. The European community during the period here concerned was admittedly small. In 1670, the white burghers with their families accounted for 165 people while the Company was represented by 208 officials.²⁶ In 1702 the burgher community numbered 1 368 and the Company officials 556.²⁷ In 1712 the burgher community, according to a different source, had risen to 1 939. Then came the smallpox epidemic of 1713 which cast a long shadow. In the year 1716, despite a number of new births, the burgher population was down to 1 697.²⁸ These are not impressive figures but they should be seen in context: there was nothing impressive about the Batavian figures either. Indeed the Cape death-rate in 1713 was lower than a normal yearly death-rate in Batavia. In 1682, 978 Dutch people died in Batavia and the total population at the end of that year was 2 298.²⁹ Adequate manpower was seldom at the Company's command.

Since the smallness of the population, greatly assisted by the untimely indifference of much of the past century, has reduced the first hundred years of European occupation at the Cape to a virtual tabula rasa, we have only two remaining sources of information to draw on: the old inventories and vendu rolls preserved in the Cape Archives and the debris of earlier times that is beginning to attract the spade of the historical archaeologist. It is with the former

that I am here concerned.

Though I have been drawn to this research by a desire to bring a mise-en-scène that is largely lost to us back to life, I am aware that this cannot be done from the bare bones of the archival material alone. Published sources dealing with related fields in other countries have often proved illuminating, particularly those concerned with Holland and the Dutch colonial period in the East Indies and America; but in order that this material should be used as circum-spectly as possible it was desirable for me to familiarise myself with similar documentation elsewhere. In 1980 I had the opportunity to study certain of the inventories preserved in the Municipal and State Archives of the Hague and found it a very illuminating experience. In juxtaposition to the Hague inventories the Cape inventories were seen to have a distinct and revealing character of their own. This character was given an added perspective by the American inventories I was able to consult at the end of 1981. Unfortunately the grant from the Human Sciences Research Council, which made it possible for me to go to the United States of America, came too late for the relevant material to be incorporated in the body of the text, but I have made considerable use of it in my conclusion.

For this sort of study to be reasonably evocative some visual material is essential and I have included illustrations from various sources, as well as a number of my own drawings. I have not used photographs because of the expense and the difficulty of reproduction, but they will be used in any published work which results from this thesis. On the whole, surviving artifacts from this early period are few and far between in our country, which is one reason why many of my drawings have been adapted from overseas publications. Many early artifacts, even those preserved in some of our museums, need to be properly researched before they can be illustrated with confidence, which is another reason for using properly researched material from outside sources. In certain fields, Chinese and Japanese ceramics or Dutch glass and pewter for example, material preserved elsewhere can be used to complete the picture outlined in our own documents. In other fields, such as Oriental lacquer, it should be possible to get close. Yet it is idle to suppose that

even under the most favourable circumstances the past, with its smell and taste and inconsequent diversity, can ever, truly, be recaptured: and in the case of this study the circumstances are far from favourable. The most I can hope to do is to draw a little closer to the domestic world at the Cape in the years to either side of 1700, and to put my trust in the truth of Terence's words, "homo sum: humani nihil a me alienum puto."

Footnotes

1. The principal sources of documentation are the inventories and vendu rolls compiled for the Board of the Orphan Chamber and catalogued in the Cape Archives with an MOOC preface. Two volumes catalogued respectively as MOOC22/2 (1676-90) and MOOC23/5 (1670-1701) contain some early inventories and vendu rolls. References to the former, where both documents and pages are unnumbered, are given in the notes. References to the latter, in the form "23/5,1,1672" which should be read as "MOOC23/5, Doc.1, 1672," appear in the text. Other Orphan Chamber inventories are catalogued under "MOOC8" and are consecutively numbered. Though some reference is made to later volumes, we are principally concerned with Vol.I (1673-1705), Vol.II (1705-14) and Vol.III (1715-1720) where various inventories for 1713-14 are filed out of sequence. References to all MOOC8 volumes are given in the form "III,31,1713" by which is meant "MOOC8, Vol.III, Inv. 31, 1713." The main sequence of Orphan Chamber vendu rolls is catalogued as "MOOC10." Only the first volume is relevant and references to this are given in the form "VR17,1701," by which is meant "MOOC10, Vol.I, VR17, 1701." Unless more than one document is in question, when a note is used, all MOOC references, other than MOOC22/2, are given in parenthesis in the text.

The inventories and vendu rolls of disputed or confiscated estates have also been drawn on in this study and these are found among the papers of the Council of Justice. Three volumes of miscellaneous papers, catalogued as CJ2914-16, commence with relevant material. The documents are not numbered, so that the name of the person and the nature of the document appear in references thus: "CJ2914, Bergh Inv., 1687, p.4." CJ references are always found in the notes.

2. Vol.I (1652-62) and Vol.II (1663-65) from a series entitled "Transporten en Schepenkenissen" which has recently been transferred from the Deeds Office to the Cape Archives contain these early inventories, which were kindly drawn to my

- attention by Mrs. Margaret Cairns. References in the form "Trans & Schep., I, 1652, p.31" are always found in the notes. No inventories from 1666-69 are known to me.
3. Eric A. Walker, A History of Southern Africa (London, 1957), p.70.
 4. Inventories turn up in the most peculiar places in the Cape Archives and new finds are still possible. Some inventories are bound up with the wills (MOOC, CJ and STB) but none of these have much to add to the present study and no further reference is made to them.
 5. François Valentyn, ^{*} Beschryvinge van de Kaap der Goede Hoop, fin. ed., Edith Raidt, 2 vols., Van Riebeeck Society, 2nd series, nos. 2 & 4 (1726; rpt. Cape Town, 1971 & 1973). ^{*} The spelling of "Valentijn" presents a difficulty. I have used "ij" in the text, the normal spelling of the period and the one preferred in modern Dutch, but as "y" is used in the VRS edition this spelling has been used in footnote references to the work.
 6. Peter Kolbe, Caput Bonae Spei Hodiernum (Nurnberg, 1719).
 7. Valentyn, op. cit., II, 271.
 8. Ibid., II, 273.
 9. Ibid., II, 271.
 10. It is not clear in this instance whether Dutch or Cape guilders are in question. The Dutch guilder was worth 20 stivers, the equivalent of 1s 8d in English money. The Cape guilder, a devalued currency, was worth only 16 stivers or 1s 4d. In some Cape documents before about 1680 the Dutch valuation is used; after that date it is very rarely encountered. In converting rixsdollars and schellings to guilders and stivers I have used the Cape valuation throughout. For some reason inventory valuations were usually given in guilders and stivers and auction prices in rixsdollars and schellings, but I have preferred to use guilders and stivers for both. I include the following table for convenience.

1 stiver	=	1 Eng. penny	
16 stivers	=	1 Cape guilder	
20 stivers	=	1 Dutch guilder	
3 Cape guilders	=	1 Cape rixsdollar	= 4 Eng. shillings
3 Dutch guilders	=	1 Dutch rixsdollar	= 5 Eng. shillings
6 stivers	=	1 <u>schelling</u>	
8 <u>schellings</u>	=	1 Cape rixsdollar	
10 <u>schellings</u>	=	1 Dutch rixsdollar	

11. Some inventories are combined with a valuation or taxatie.
12. See above n.1.
13. G. C. de Wet, Die Vryliede en Vryswartes in die Kaapse Nedersetting 1657-1707, Die Historiese Publikasie Vereniging (Cape Town, 1981), pp.72 & 189.
14. C. S. Woodward, "And Pretty Apartments," Tydskrif vir Geesteswetenskappe, 15, 3 (Sept, 1975), 164.
15. Valentyn, I, 187-89.
16. William Dampier, A New Voyage Round the World (London, 1699), pp. 533-34.
17. Ibid., p.546.
18. J. Ovington, A Voyage to Suratt, In the Year, 1689 (London, 1696), p.93.
19. Ibid., p.482.
20. De Wet, op. cit., p.33.
21. The first inventory I have come across coloured by private trade is dated 1662 and belongs to a senior carpenter at the Fortress. It includes 12 doz. spectacles, 53 knives, 48 scabbards (scheiden), 2 000 needles and a cask of glasses (Trans. & Schep., I, 348).
22. Some figures quoted by Prof. Bax lend substance to this argument. In 1669 when, apart from the wives of Company servants and Company slaves who were omitted from the muster rolls, the population of the Cape totalled 322 souls, no fewer than 60 ships called. These ships, Bax estimates, would account for something like 9 500 visitors (D. Bax, Het Oudste Kaapse Zilver 1669-1751, Verhandelingen der Koninklijke Nederlandse Akademie van Wetenschappen; Afd., Letterkunde, nieuwe reeks, dl. 86

- [Amsterdam, 1974], pp.23-24).
23. T. Volker, Porcelain and the Dutch East India Company (Leiden, 1954), p.14.
 24. F. de Haan, Oud Batavia, 2 vols., 2nd rev. ed. (Bandoeng, 1935).
 25. V. I. van de Wall, Het Hollandsche Koloniale Barokmeubel (Antwerp, 1939).
 26. The wives and children of Company officials are never included in the official figures.
 27. De Wet, op. cit., pp, 13 & 17.
 28. Hymen W. J. Picard, Gentleman's Walk (Cape Town, 1968), p.13.
 29. Volker, op. cit., p.14.

The Architectural Framework

Nothing contributes more to the physical presence of a period than its architecture, and the biggest handicap one faces in trying to recapture the domestic ambience at the Cape between 1685 and 1714 is the complete failure of any house to remain in anything like its original condition. In two instances, the 1710 Schreuder House at Stellenbosch and the 1673 Posthuijs at Muizenberg, enough of the original fabric has survived to make an attempt at restoration possible, but how closely the results conform to historical reality is difficult to assess.

In these circumstances it seems a worthwhile though inevitably hazardous pursuit to try to build up a picture of the early houses at the Cape from the various clues present in the inventories and vendu rolls. One thing, immediately apparent, is the amazing diversity: small cottages of wattle and daub rub shoulders with timber constructions of varying degrees of sophistication, and these in turn are found next to brick and stone buildings varying in size from two-roomed cottages to substantial houses with six or seven rooms in addition to the kitchen quarters.

The Wooden House

To the first officials and Company men the slopes of Table Mountain offered a range of excellent timbers¹ and where timber is available a log cabin is a quick, simple answer to the need for shelter. The original fort, completed in 1653, was constructed, naturally enough, from timber and consisted of a series of wooden buildings arranged in a square and surrounded by earthworks.² The so-called timmerage or log cabin was also favoured by the early burghers, but its construction must have been limited by the shortage of wood which soon declared itself. Indeed on 12th February, 1691, the Council of Policy resolved to forbid the use of wooden walls in house, barn, corral or any other building on pain of a fine of seventy-five guilders. Walls were to be built out of clay or brick without any "wandpalen" whatsoever.³

For some reason, perhaps because it was too common to be worthy of mention, the timmerage seldom, if ever, appears in an inventory before 1696. Between 1696 and 1704 it is not exactly commonplace

but one or two occur each year. The Cape Peninsula offers a couple of examples located in Table Valley, another beside the Liesbeeck and a fourth out at Steenberg.⁴ Of the fourteen Drakenstein inventories preserved from the same period three specifically mention a timmerage for a homestead,⁵ whilst others are recorded in the districts of Paarl, Tigerberg, Stellenbosch and the Bottelary.⁶ After 1704 these constructions all but disappear: they were presumably replaced by the "fine brick houses" mentioned in the Valentijn passage quoted in the Introduction.

In these circumstances it may be of interest to note that references to log cabins survive in early histories of the Dutch settlement in the Hudson River Valley. Augustus van Buren in Ulster Country Under the Dutch⁷ was able to show that at Wiltwyck (now Kingston) log cabins with a loft were built between 1653 - 1664. Such houses either had a hole in the roof to let out the smoke from a fire built on the floor or, more comfortably, had wooden chimneys or even chimneys of brick and stone. In early America, then, a wooden house could achieve a certain substantiality and on occasion the same seems to have been true at the Cape. The last example of a timmerage to appear in the inventories up to 1714, and one of the two⁸ such structures I have noted between 1704 and 1714, is found in the estate of Wessel Pretorius, where reference is made to "de plaats of hofstede met de daarop staande timmeragien" (III, 56, 1713). The farm in question was named Mordegat and presumably corresponds to the "outstanding" estate belonging to Wessel Pretorius, "Mayor of Stellenbosch," which Valentijn mentions in discussing the "many lovely estates"⁹ in the district of Moddergat. Certainly, the Pretorius estate offers the only timmerage to be inventoried room by room. It comprised a room on the left, another on the right, and a kitchen. The numerous contents suggest that the rooms were a good size, and in addition to the house there were a cellar (pershuis), a pen (hok) and a stoke-house (stookhuis). It all sounds perfectly presentable and in view of Valentijn's transports, no matter how exaggerated these may be, it seems safe to assume that this wooden house could have held its own with many similar structures in early America.

The House of Wattle and Daub

Houses of wattle and daub which the Council of Policy wished to substitute for wooden cabins¹⁰ occur very occasionally. Only three such houses have been noted and these were obviously inferior to those of wood. Cheaper by 200 guilders than any other town house sold or evaluated at this time was "Een huijs van kleij seer slegt staande in dese tafel valeij bij den boedelhoutster bewoond op de hoek van de tweede Berg dwers straat gewaardeert op f1 000" (I,14,1695). Outside the town, 600 guilders seems to have been about the minimum price for a piece of land with a house on it.¹¹ Among the handful of properties recorded at this level was a fifty-seven morgen farm at Jonkershoek near Stellenbosch "daar op een kleijn kleijen huijsjen met lies bedekt" (I,16,1696). This farm, which belonged to the free black Anthony of Angola, was auctioned, together with a few miserable goods and chattels, for exactly 600 guilders (VR7,1696). The Drakenstein estate of Ester Votie "waarop een kleij huijsjen tot woning" was nearly as cheap. The valuation, which included building implements, was a mere 700 guilders (I,30,1697). If there were handsome houses of clay, I have found no trace of them. What little evidence I have suggests that the house of wattle and daub—the local version of the Dutch leemwand—offered the most primitive accommodation available in the early Cape. There is also evidence to suggest that it was a good deal more common than surviving inventories imply. James Walton has drawn attention to a plakkaat dated 1658 "prohibiting the use by lime and brick makers of the small bushes that grew on the flats, as their destruction was proving a hardship to the farmers who used them to plait the walls of their huts."¹² This regulation and the decision of 1691 to command the use of wattle and daub in place of wood,¹³ hardly accord with a little-used building technique.

The House Recorded Room by Room

The average inventory makes no mention of the material from which the house was constructed, so we must pass on to those inventories compiled room by room which offer instead some guide to the size and layout of the houses concerned. Once allowance has been

made for the occasional reappearance of a house, I have found thirty-nine properties recorded in this way during the forty-five year period under review. Unfortunately the seventeenth century is represented totally inadequately by only five such examples. One is the small town house of a shoemaker, another a fairly prosperous farmhouse in the Paarl district, a third, for which there are two such inventories, a Company homestead, Rustenburgh, at Rondebosch, and the last two the apartments of Company officials situated in the Castle. The first of these is the inventory of the merchant, Albert van Breugel: it mentions a voorkamer, a small upstairs room or "boven Camertje" and a pantry or "bottelerij" (23/5,35,1675). The other records the set of rooms provided for the second military officer. In 1687 Lieutenant Olof Bergh was provided with a downstairs room, two upstairs rooms and a kitchen.¹⁴ Valentijn, writing after the construction of the so-called "Kat" which divided the courtyard of the Castle in half, tells us that the lieutenant's "fine lodging" was situated behind the Kat, where the governor and secunde were housed, on the far side of the "second fine and large square."¹⁵ There is no certainty that these two sets of lodgings were the same, merely a strong probability.

In arranging the remaining thirty-seven houses into groups based on the number of rooms recorded I have ignored all references to lean-tos. Whether this is entirely justified is, however, open to debate. As one tends to look upon a lean-to as an excrescence, as something of minor importance added to the initial structure, it was a little disconcerting to come across a passage in Resolusies van die Politieke Raad which shows that a lean-to or afdak was sometimes part of the original structure. In February, 1670, it was agreed to build a small house for the predikant consisting of "voorhuijs, slaap en studeer camer, nevens een afdakje tot een bottelerij."¹⁶ It is possible therefore that many of the lean-tos which are so much in evidence in the early eighteenth century were likewise original structures, but in arriving at the four basic groups it seemed best to ignore them. Of these thirty-seven houses, twelve have one or two rooms and a kitchen, eleven have three rooms and a kitchen, four have four rooms and a kitchen,

nine have five or more rooms and a kitchen, while Rustenburgh, a small, very early, double-storeyed Company house is in a class of its own.

The One- and Two-Roomed House

The inventory of a farm in the Paardeberg, one of Dirk Verwey's properties, records the basic small house, with a room, a lean-to and a kitchen (III,25,1713). There were also two outhouses, a cellar (pershuis) and a corn-house (korenhuis). Here we have an example of the rectangle traditionally associated with Cape Dutch houses, although the lean-to could have been sited to form an \perp or a \perp .

The most frequently recorded small house, which is found in both town and country settings, has two rooms and a kitchen or kitchen and pantry. It probably consisted of three rooms in a row and it is received opinion that the kitchen was always located at one end.¹⁷ On occasion it may have been, but if this was the normal arrangement it is difficult to account for a description like the following, "inde kamer aande linkerhand van het tegenwoordig nieuw woonhuijs . . . Inde kamer aande Regterhand bevonden . . . Inde Combuijs bevonden" (I,23,1697). This description comes from one of the few seventeenth-century inventories of a house compiled room by room, but three very similar descriptions occur in the eighteenth century.¹⁸ In each case the careful designation of left and right suggest that we are dealing with two front rooms with a kitchen wing at the back or, and this is very much more likely, with a room to either side of a central kitchen.

Several small cottages of this type can be seen in the famous sketch E. V. van Stade made of Stellenbosch in 1710 (Pl.1). Interestingly enough the sketch is reproduced in the 1970 Van Riebeeck Society reprint of the Dagboek van Adam Tas¹⁹ where it is accompanied by a "corrected" version researched by Professor A. M. Hugo and drawn by the architect, Mr. M. C. Stander.²⁰ In the "corrected" version the central chimneys disappear together with the simple thatched cottages, free of end gables, with which they are combined. Shutters are added to nearly every facade and there is a generalised tendency to equalise the roof heights of the various buildings. My familiarity with the early Cape inventories has

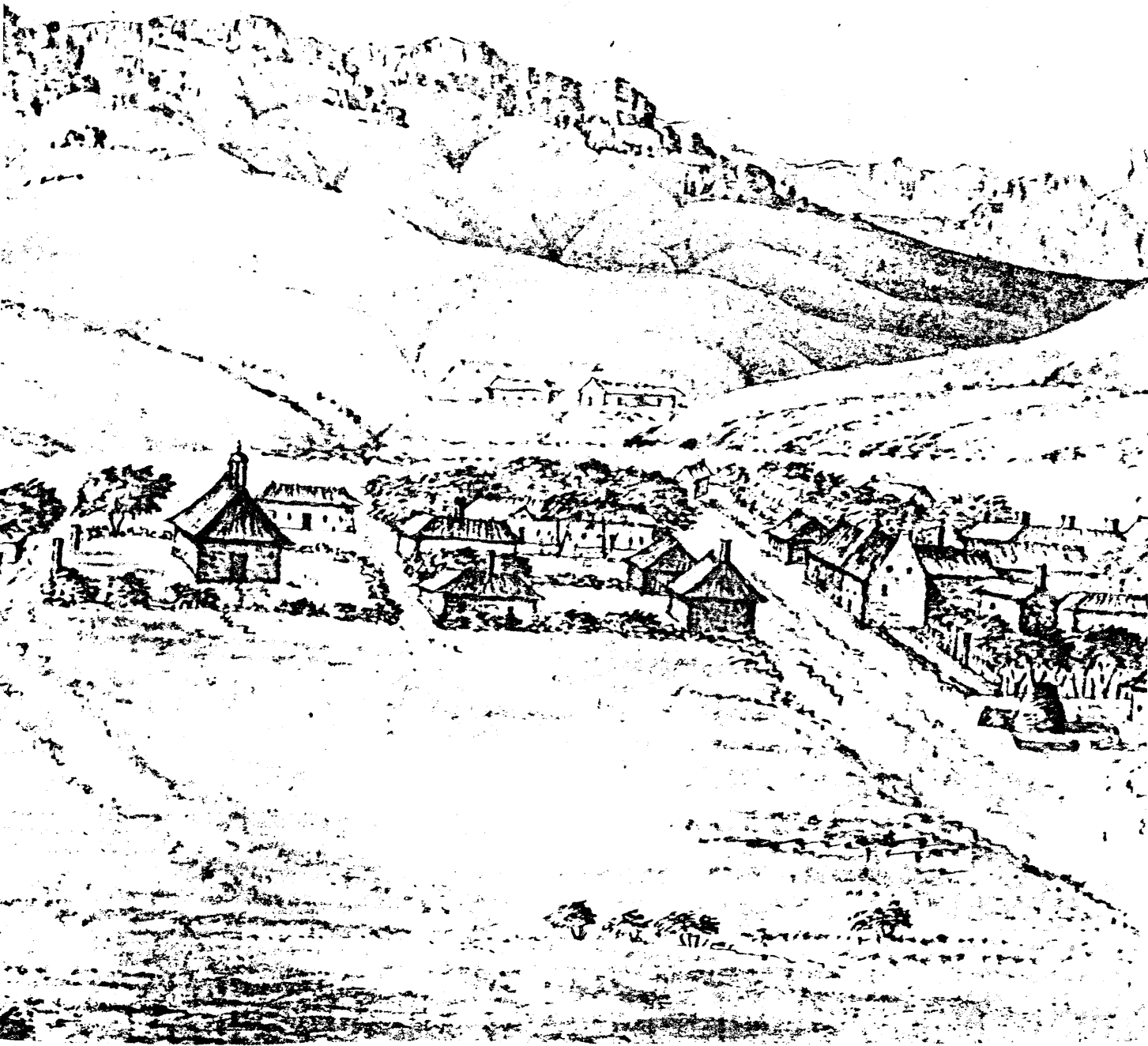

(1) Stellenbosch in February, 1710. Detail of a pen-and-ink drawing by E. V. Stade. Courtesy Cape Archives.

brought me to the point where I wonder whether any of these corrections are justified, and it is a relief to find the Van Stade drawing being treated with much less reserve by Hans Fransen in the chapter "Architecture" he contributed to Stellenbosch Three Centuries.²¹

As far as I know, the late Professor Pearse is the only person to have given some consideration to the central kitchen. In discussing the houses erected under Jan van Riebeeck he says "The plans of these early houses probably consisted of a central kitchen-living room with one or two bedrooms opening off this, a type to be found in most northern European countries at this time."²² This passage, which tends to get overlooked, probably explains the houses with a kitchen, a left-hand room and a right-hand room, and certainly accounts for several other houses. The first of these is a Stellenbosch house with the description "De Caemer aen de linkerhant . . . jn't afdakie . . . jn't Voorhuijs . . . jn de bottelarij . . . Op de Solder . . . jn de Wijn kelder" (III,64,1714). In this house the voorhuis was the kitchen—it had a hearth and all the normal kitchen equipment—while the pantry was large enough to take a couple of beds and combined the roles of storeroom and bedroom. As the voorhuis was not provided with so much as a chair it was not a living room-kitchen but simply a kitchen.

Another example of the voorhuis-kitchen occurs in the deceased estate of Maria Winckelhuijsen, wife of Pieter van de Westhuijsen (I,76,1703). This estate consisted of a prosperous farm in the Tigerberg, planted with 36 000 vines, and was valued at a very substantial 12 000 guilders. The description of house and outbuildings reads "in het huijs is bevonden [followed by the contents of a living room] . . . In het voorhuijs en kombuijs bevonden . . . Inde Bottelarie bevonden . . . Inde kleijne kelder bevonden . . . Inde boven kelder bevonden . . . In het woonhuijs nog bevonden . . . op de plaats bevonden." Here, too, "voorhuijs en kombuijs" was a purely utilitarian kitchen, but in this instance the pantry held so little that it can have been no more than a walk-in cupboard. If it were not for the use of the word "voorhuijs" one would think in terms of two rooms, a living room and a kitchen.

But perhaps the two cellars were also part of this house, in which event the roof above the cellar must have been given a ceiling in order to account for the "boven kelder." One other house in this group has a description reconcilable with a central kitchen. It had a room on the left, a pantry, a kitchen, and a small front room or "Voorkamertje" (II,69,1713).

An interesting small house located beside the Liesbeeck, which was another of Dirk Verwey's properties, had a "grote kamer" with a fire-place, a kitchen, a pantry, a small room, a solder and three lean-tos (III,24,1713). With both a solder and a living room fire-place this must have been rather more impressive than the average two-roomed cottage, and it is tempting to consider it in connection with Plate 2. The little house shown there with its end gables and pair of chimneys represents Stellengift²³ and is one of the small drawings made by Johannes Mulder, landdrost and surveyor of Stellenbosch, on some of the title deeds for which he was responsible.²⁴ Verwey's house, however, was obviously larger and probably included two windows to either side of the front door.

The three remaining houses in the first group show considerable variation. The first of these, the small two-roomed town house of Margareta Blauwpaert, introduces the continental living room-kitchen, inventoried as "de Voorkamer aen de Linkerhand." In addition, this house had a voorkamer on the right and a lean-to (II,70, 1713). It is the sort of house that bears comparison with Mulder's sketch of Spier (Pl.3).²⁵ Both houses were two-roomed cottages, though the use of "left" and "right" in the description of the Blauwpaert house probably means that the entrance was in one of the long walls rather than an end gable as at Spier. The house of Abraham Everstz at Stellenbosch with a room to the left, a voorhuis, a kitchen, and a lean-to is the only unmistakable example of a three-roomed house with the kitchen at one end (II,71,1712). Definitely odd-man-out is Dwars in de Wegh, the Stellenbosch farmhouse of Judith Smit and husband, Arend Gildenhuijs, which had a kitchen, pantry, room on the right, and small back room or "agter Camertje" (II,83,1713).

While the central kitchen, presumably with a hearth built

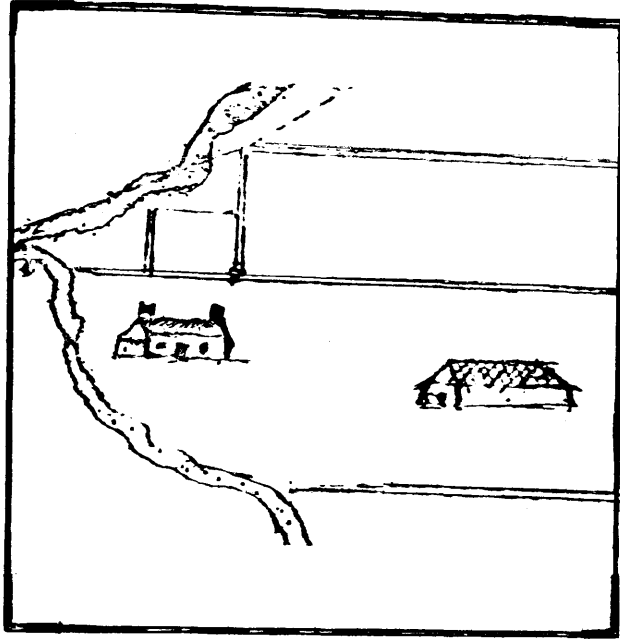

- (2) Sketch of Stellegift by Landdrost Johannes Mulder. The house is shown with two rooms, each with a fire-place built into one of the end gables.

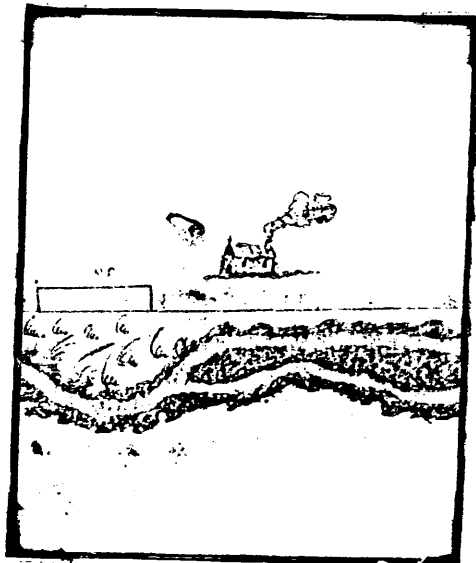





- (3) Sketch of Spier by Landdrost Johannes Mulder. The house is shown with two rooms; an entrance surmounted by a cross in one end gable, a fire-place in the other.

Courtesy Cape Archives

into the middle of the back wall, appears to have been an unexpectedly important feature of the small house at this period, the solder, equally unexpectedly, would seem to have been something of a rarity: only two of the twelve houses just passed under review included solders.²⁶ This does not support Walton's statement that "From early times even the simple dwellings appear to have been provided with ceilings."²⁷ It is in accord, however, with the low cottages with hipped roofs which are a feature of Van Stade's sketch (Pl.1). The absence of solders in buildings of this nature seems to point very strongly to the absence of ceilings and I can offer a couple of additional indications that this was sometimes the case. As well as the great house inhabited by Governor Willem Adriaan van der Stel, Vergelegen possessed "Een boerenhuijs, waarin vier camers zijnde, meest besoldert,"²⁸ whilst among the contents of a Stellenbosch farmhouse mention is made of "20 stucken rondhout of sparren Leggende op de balken" (III,49,1713). One further point to emerge from the inventory descriptions of this first group of houses is the fact that the symmetrical front almost invariably associated with the Cape Dutch style of architecture²⁹ cannot have been in evidence in all these houses: "Inde Grote kamer aande regterhand Inde Combuijs. . . In een kleen kamertie aande Linkerhand" (II,11,1707) cannot be reconciled to a regular facade with a centrally placed front door.

The Three-Roomed House

The next group, which consists of eleven houses with three rooms and a kitchen or kitchen and pantry, either consisted of a wing of four rooms or followed the lines of one of the traditionally accepted ground plans: a front wing of three rooms with a kitchen wing at the back placed to form a  or an . That the simple rectangle developed into an -shaped house in the town is shown by an early plan of Cape Town (Pl.4), and according to Fransen and Cook the -shaped house developed in the country at much the same period.³⁰ The same authorities tell us that this back wing normally ended in a kitchen but might include an "agterkamer" or "spens";³¹ and in his most recent book, Drie Eeuwen Kuns in Suid-Afrika, Mr. Fransen again draws attention

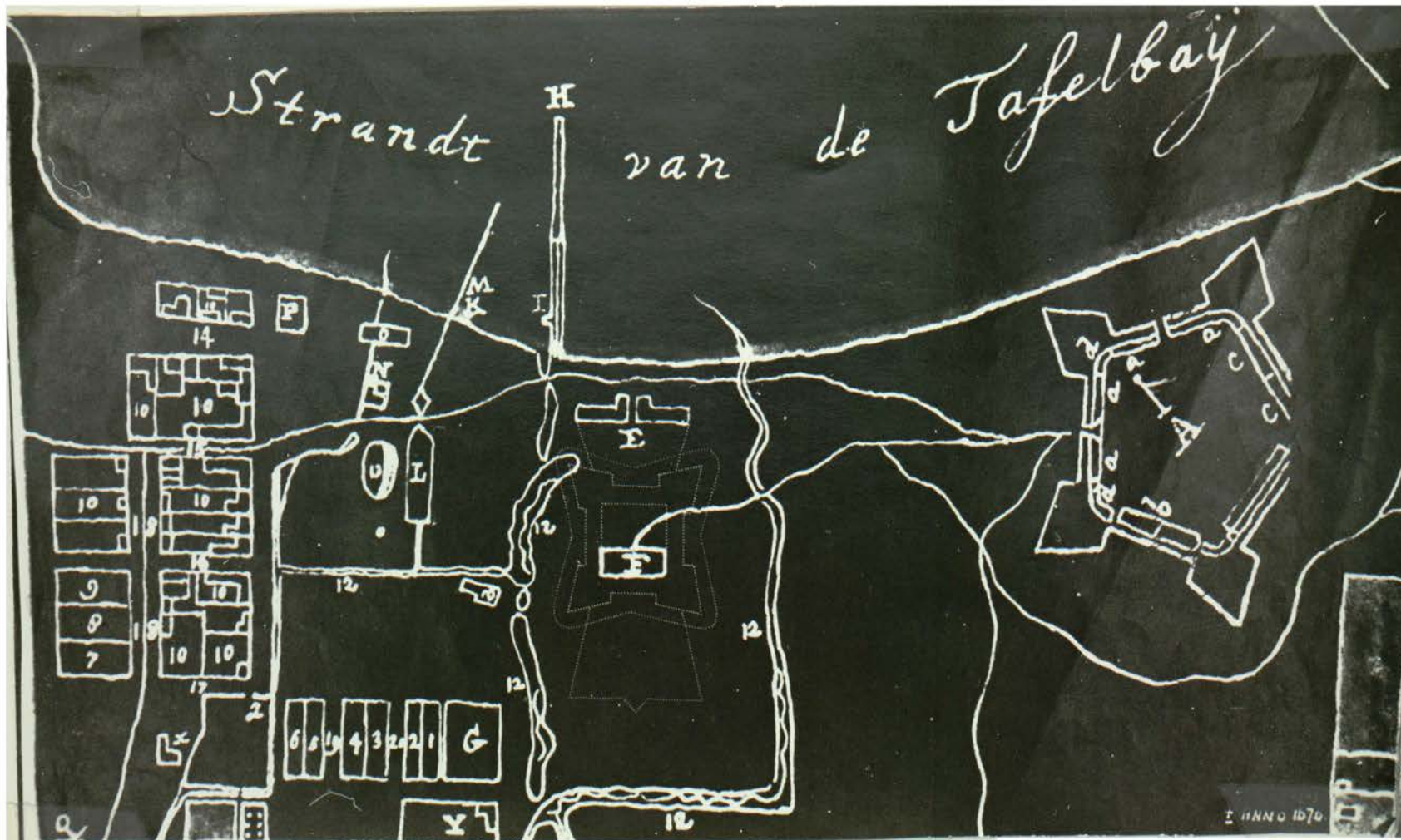

(4) Plan of Cape Town, c 1670

Courtesy Cape Archives

to the possibility of a single room in the "tail"³²—an arrangement dictated by a town erf too narrow to accommodate more than three rooms in a row.

The earliest example from this group was inventoried in 1681 and was the house of a shoemaker named Barent Cornelisz Backer. Located in Zeestraat, which is now Strand Street, the house had a voorhuis, kitchen, bedroom and workshop or "Leerberijderije" (23/5,50). This house might have consisted of a row of small rooms but the "Leerberijderije" was more likely to have been situated at the back. A house in what was then Heerestraat and is now Castle Street, with a valuation of 2 500 guilders, is a typical example of a three-roomed house in the early eighteenth century. The description reads "In't Voorhuijs . . . Inde Camer aande regterhand . . . Inde Camer aande linkerzijde . . . Inde Bottelarij . . . Inde Combuijs . . . Op de Plaats . . . Op de Solder" (II, 120,1714). Similar descriptions varied only by the addition of a lean-to or the absence of a pantry or a solder account for another five houses scattered about town and countryside.³³

Roodenburgh in Rondebosch, the home of Albert Barentsz Gildenhuijs, gives the impression, despite its limited number of rooms and modest fourteen morgen of land, of being something quite out of the common. It is described as follows "In die grote kamer . . . In slaepkamertje . . . In't Voorhuijs . . . In de Combuijs . . . In de Wijnkelder" (II,61,1712). A modest description which does not prepare one for the valuation of 16 000 guilders which is an almost incredible sum for a three-roomed house on a moderate piece of ground. Three years earlier, in 1709, Albert's son, Barent Gildenhuijs, had paid only 9 500 guilders for what was left of Willem Adriaan van der Stel's Vergelegen together with ten additional buildings and 170 morgen, 80 square roods of land, much of it planted with vines.³⁴ As it happens only one other property evaluated or auctioned by order of the Orphan Chamber before 1715 tops this figure: Hendrik Sneewindt's farm, also situated in Rondebosch, fetched 16 450 guilders at auction in 1701 (VR21). Also of note in a house which must have been of exceptional quality is the presence of an apparently

irregular facade and the absence of a solder. In this instance it is hard to credit that there were no ceilings, particularly in view of the brass chandelier in the large room, but whether ceilings were present in all the other houses in this group which were without solders is a good deal more doubtful.

One solderless house poses further problems. It is a garden house built on over two morgen of land in Table Valley and valued at 3 000 guilders. The valuation is followed by the contents of an unnamed room, apparently a voorkamer, and then comes "In d'agter Camer . . . Int afdakje . . . Int klijne kamertje . . . In de Combuijs" (II,114,1714). This description could apply to various ground plans. One possibility is that a room had been added to the back of the original house whilst leaving the kitchen untouched. Another is that "agter" was used loosely to imply a front room beyond another front room, and that the house actually had four front rooms in a row. Yet a third possibility is that the house was roughly square with two front rooms and two back rooms, for there is a theory that the two rooms, one behind the other, which formed the normal ground plan of the multi-storeyed canal house in Amsterdam, were doubled in the single-storeyed Cape house.³⁵ It is a possibility that cannot be entirely discounted, but it was not the norm. The norm was a voorhuis with a room to either side, and it was from this nucleus that the larger houses developed, including the square town house where the courtyard within the was incorporated; a development which is believed to have taken place in the latter part of the eighteenth century.³⁶

An inventory which calls to mind the common Dutch practice of providing a house with more than one kitchen³⁷ is that of Aaltjen Klaasd van Ameijde and Sergeant Louwrens Gerritz Heijs. Located in Zeestraat, the house consisted of a voorkamer, a lean-to, a voorhuis, a large kitchen, a small kitchen and a solder (II,4,1706). In plan the house probably consisted of a front wing of voorkamer, voorhuis and large kitchen with the small kitchen at the back.

Unlike the others, the last house in this group was part of the confiscated estate of Gerrit Meyer. Situated in Table Valley, the house has the following description, "In de kamer boven de kelder . . . In de kelder . . . In het agterkamertie . . . Boven

op de Solder . . . In de Zijkamer . . . Int voorhuijs,— of de Combuijs."³⁸ This description is not only unusual but utterly misleading. The cellar was a cellar but the room above the cellar was a living room. The small back room held kitchenware, the solder was a bedroom, the side room had only a lantern, a table and some benches, while the voorhuis-kitchen served as a carpentry storeroom. Some of this house, at least, appears to have been on three levels. Perhaps the lie of the land encouraged a partially underground cellar which had a mezzanine room above it—a type of room sometimes known as a "kelderkamer."^{38a} To reach such a room would, however, require an internal stair. The zijkamer too poses a problem, but as this is also a feature of Rustenburgh let us first take a look at that house.

Rustenburgh

Two inventories exist of Rustenburgh, the Company property in Rondebosch. The first, which is dated 1673, gives a detailed description of house, garden and orchards (23/5,29) while the second, dated 1677, merely covers the house—and that in almost identical terms (23/5,42). Little had changed at Rustenburgh in those four years. To have detailed inventories of a house that has been described again and again down the years is particularly illuminating. According to Professor Bax, Rustenburgh, which was designed as a pleasure house for the Commander, was probably built in 1663, because on August 31st of that year the Dagregister refers to "het nieuwe huijs."³⁹ A few years later, in December 1666, Monsieur de Monde Vergne, Admiral of the French Fleet, was entertained there and reportedly described it as "well-built and very sumptuously furnished," whilst Kolbe, who was at the Cape from 1705 to 1713, wrote of it as "a noble Pleasure-House for the Governor."⁴⁰ The first inventory description of this "noble Pleasure-House" reads, "In't voorhuijs . . . Int Zijdcamertje . . . Op d' Groote bovenkamer . . . In't eene cleijn camertjie daeragter . . . In't Ander cleijn camertje . . . Noch op diverse plaetsen [followed by tools and kitchenware] ." So, Rustenburgh was a smallish double-storeyed house with two downstairs rooms and three upstairs rooms. The absence of a kitchen but not kitchen equipment is a puzzling feature of both inventories. Cooking facilities must have been provided: either "diverse plaetsen" covers a downstairs kitchen or it refers to one or more

outside rooms, including a cooking shed. A double-storeyed cottage of this nature, though undoubtedly an extreme rarity in the seventeenth-century Cape, hardly seems to have deserved the praise that was lavished on it. Otto Mentzel who described it as "a summer house of modest design for the pleasure of the Governor and others]"⁴¹ was speaking no less than the truth, but then he was familiar with it in the second quarter of the eighteenth century. It is quite likely that for the first twenty or thirty years of its existence Rustenburgh was the most elegant house in the Cape. It was also the type of house that had many parallels in both Europe and Batavia.

The front of the normal Batavian house consisted of two rooms, a voorhuis and a reception room, and the latter was often known as a "zijkamer"; a name probably due to the separate entrance in the side gable with which it was often provided.⁴² At the Cape the zijkamer never appears to have been the main reception room but, at a guess, the term was used for a room with its own entrance. In the 1720's the inventories contain quite a number of zijkamers and achterzijkamers⁴³ and, in a general way, these probably correspond with the much later "buitekamer." This "outside room," Walton tells us, was built on when a son was born; it was normally added to the house opposite the kitchen ~~and was~~ entered by a "separate door from the outside."⁴⁴ Some zijkamers, but by no means all, were also furnished as bedrooms.

The Four-Roomed House

The small group of houses with four rooms and a kitchen offers considerable variety. Firstly there is the town house included in the estate of Johanna Starrenburg. Johanna was the wife of the notorious landdrost of Stellenbosch, Johannes Starrenburg, who was so closely involved with the dubious activities of Willem Adriaan van der Stel that he was recalled to Holland with the governor and various other officials in 1707. In the circumstances one shares the expectations of the late Professor Leo Fouché, expressed in his edition of the Dagboek van Adam Tas;⁴⁵ and anticipates an estate of

exceptional interest and value. The reality is disappointing. Three properties are mentioned, a house and erf in Zeestraat, a second erf adjacent to the former, and a farm in Tigerberg called Onrust (II,28,1709). The farm, Onrust, which was the special concern of Professor Fouché, was the usual sixty morgen in size and consisted of:

1	Woonhuijs	
1	paerdstal	} al onder een dak
1	Coeije hok	
1	Wagenhuijs	
1	Coorenhuijs langh 33 Voet en 13 dos wijt	
1	Wijn kelder	
1	Slaven huijsje	
	Een wingaert groot omtrent van dertig duijsent stocken	
	Een moijs fruijt bogaert	
6	Slaven jongens	
185	Coeijen, ossen en Calveren	
700	hamels en Oijen	
20	paerden	

This was clearly a prosperous farm, but only the vineyards were in any way exceptional and the house itself was modest, with contents limited to basic cooking and eating utensils, four chairs and a broken bed. Onrust, which was sold at auction for an unexceptional 5 250 guilders (VR49,1709), was no latifundium. The Starrenburg town house which consisted of voorkamer, small voorkamer, voorhuis, back room, wine cellar, kitchen and courtyard was also unexceptional. It is, however, the first house we have encountered which may have had more than one room in the "tail." I visualise an L-shaped house arranged round an internal courtyard with a back wing consisting of the back room, the kitchen and possibly the wine cellar, though this last may have been a separate building.

Closely related to the Starrenburg town house was the town house of Dirkie Mathijssse van Westerhout, with a voorkamer to the left, a room to the right, a voorhuis, a back room, a kitchen and solder. Here again we seem to have an L-shaped house with two rooms in the back wing, but on this occasion there was also a solder which was furnished as a bedroom (II,115,1714).

Nooitgedacht in the Stellenbosch district is the third house in this group. It was inventoried twice during our period; once in 1710, when the wife, Susanna Claas, died, and a second time in 1712 at the death of the husband, Matthijs Greef. The first description of Nooitgedacht reads, "In de Groote Camer aen de Regterhand . . . In't Voorhuijs . . . In de twee Clijne Camers

aen de Linkerhant . . . In de Combuijs" (II,40,171C); the second "In't voorhuijs . . . In de Groote kamer aen de Regterhand . . . In't afdakje . . . In de Voorste kamer aen de Linkerhand . . . In d'agterste Camer aen de Linkerhand . . . In de Combuijs . . . In't afdakje aen de Regterhand . . . In't afdak aen de Linkerhand . . . In de bottelarij onder de Trap [stairs] . . . op de Solder"(II,63,1712). Greef apparently enjoyed a prosperous widowhood. Not only have three lean-tos been added but the kitchen area has been remodelled to include a pantry and stair and the roof raised to include a solder. After the alterations Nooitgedacht must have been an important house for its time and place although, like many of the houses in the previous group, its back wing seems to have been limited to the kitchen area. A very tentative reconstruction of the ground plan is offered in Plate 5.

The addition to Nooitgedacht of no less than three lean-tos emphasises the prevalence of these structures. Indeed, half the houses so far discussed had at least one lean-to and though it was seldom an important room, normally serving as an additional bedroom, workshop or storeroom, its ubiquity must have contributed significantly to the appearance of both Cape Town and Stellenbosch. Considerable attention⁴⁶ has been given to a resolution of July, 1686, when the Political Council decided that, to minimise the risk of fire from the thatched roofs, all houses in Table Valley were to be built with proper walls twenty feet in height and free of lean-tos.⁴⁷ That this decision was quite impractical and impossible to enforce becomes clear from subsequent resolutions. A plakkaat of 1691, also anxious to minimise the risk of fire, refers to the existence of lean-tos into which chimneys have been built, and orders that the chimneys be removed within two months, that the inside of the roofs be treated against fire, and that no more lean-tos be built in future.⁴⁸ A few months later, in January, 1692, another plakkaat was issued to the effect that all future houses were to be built with fifteen-foot stone walls and that no houses or plots were to have thorn hedges.⁴⁹ In December, 1697, attention was again focused on the various houses with roofs close to the ground. The resolution with regard to twenty-foot walls was recalled and a new resolution was agreed to. From then on no house or lean-to

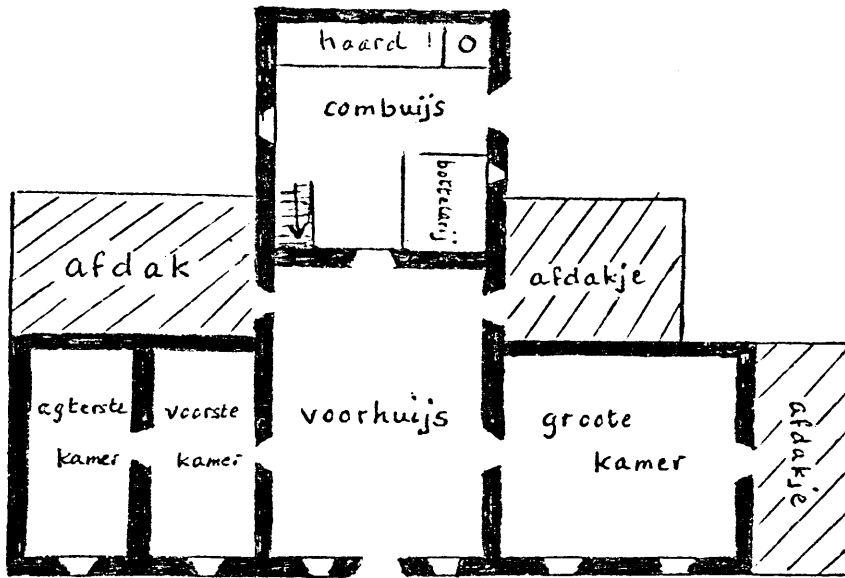

(5) Possible Ground-Plan of Nooitgedacht



(6) Sketch of a House with a Lean-to and Solder

would be permitted with a roof less than eight feet high. When the fire-masters encountered such a roof they would allow the owner a month in which to raise or remove it; thereafter the offending structure would be demolished by the authorities at the owner's expense.⁵⁰





This, then, was the actual position. The lean-to had to be accepted, and the wall height, originally set at twenty and then at fifteen feet, reduced to a mere eight. It is no wonder that visitors to De Kaap were moved to comment on the lowness of the buildings. From Valentijn we hear that "the houses of the town seem unusually low and not at all handsome, since most are of one story only, although when one enters them they are found to be unusually good."⁵¹ And William Dampier, after his visit in 1691, writes, "On the West side of the Fort there is a small Dutch Town, In which I told about 50 or 60 Houses; low, but well built, with Stonewalls, there being plenty of Stone drawn out of a Quarry close by."⁵² It hardly needs saying that no lean-to from this period has survived at the Cape; the one sketched here (Pl.6) is an American example.⁵³

The last house in this group, like the first, is a town house. The property of Helena Besuijdenhout, mother-in-law of François van der Stel, it comprises a voorhuis, voorkamer on the left, gallery, (galerij), big room, and kitchen (III,53,1713). The gallery is a new departure, and though it is common enough in the last group of houses to which we are about to turn, it is an unexpected feature to find in an otherwise unpretentious house.

The Large House

The houses in the last group include, with one exception, either a passage (gang) or gallery and, while they vary in size, all are large enough to be examples of what Valentijn calls a "double house." "These houses" he tells us, "are pretty conveniently constructed, and provided with several very good rooms, a double house having two parlours [*Zaletten*] on the street and various middle and back rooms, also often a large space behind; and such a double house costs here 13, 14 or 15 Rxd a month

according to its size. Most have only 'bol-kozijnen.'"⁵⁴

Although Professor Pearse has suggested that Valentijn's "double-house" was built on the plan of an ,⁵⁵ it seems more likely that it actually formed a  which is the natural extension of the -shaped town house—and all these houses, with the exception of the Sneewindt estate in Rondebosch, were located in Table Valley. Then the presence, in five of the largest houses inventoried at the beginning of the eighteenth century, of a gallery, raises the question as to just how unusual Simon van der Stel's Constantia—the epithet "Groot" is a later addition—actually was. After the fire of 1925 the restoration architect F. K. Kendall discovered that in its original form Constantia had a gallery running round the inside of a somewhat narrower -shaped building,⁵⁶ and from the evidence of the inventories it now seems possible that this was one of the forms taken by a large peninsula house to either side of 1700.

The first estate to mention a gallery is the Rondebosch estate of Hendrik Sneewindt, a prominent burgher who served on the Church Council and as lieutenant in the burgher militia. The Sneewindt house, like Constantia itself, was a country residence and is described as follows, "In het Woonhuijs . . . is bevonden in de voorkamer aan de Linker Zijde . . . In de kamer aan de linckhand [*rechterhand ?*] bevonden . . . In't Voorhuijs bevonden . . . In't kinder kamertjen bevonden . . . In't Wijn kamertjen bevonden [*furnished as a bedroom-cellar*] . . . In't slaap kamertjen van de Weduwe . . . op het soldertjen boven het Wijnkamertjen . . . In de gallerije bevonden . . . In de Bottelarije bevonden. . . In de kombuijs bevonden . . . boven op de solder bevonden . . . In't pars-huijs bevonden . . . In't klein huijsjen bevonden . . . In't oude Woonhuis bevonden . . . In't beestehock bevonden (I, 69, 1701). This estate which, as has been mentioned already,⁵⁷ sold for a hefty 16 450 guilders, demonstrates most eloquently the level attained by some of the leading burghers at the turn of the century. This property cannot have been greatly inferior to the large farm at Zandvliet owned by the predikant, Petrus Kalden, an associate and beneficiary of Willem Adriaan van der Stel, which was sold in 1708 for 20 500 guilders.

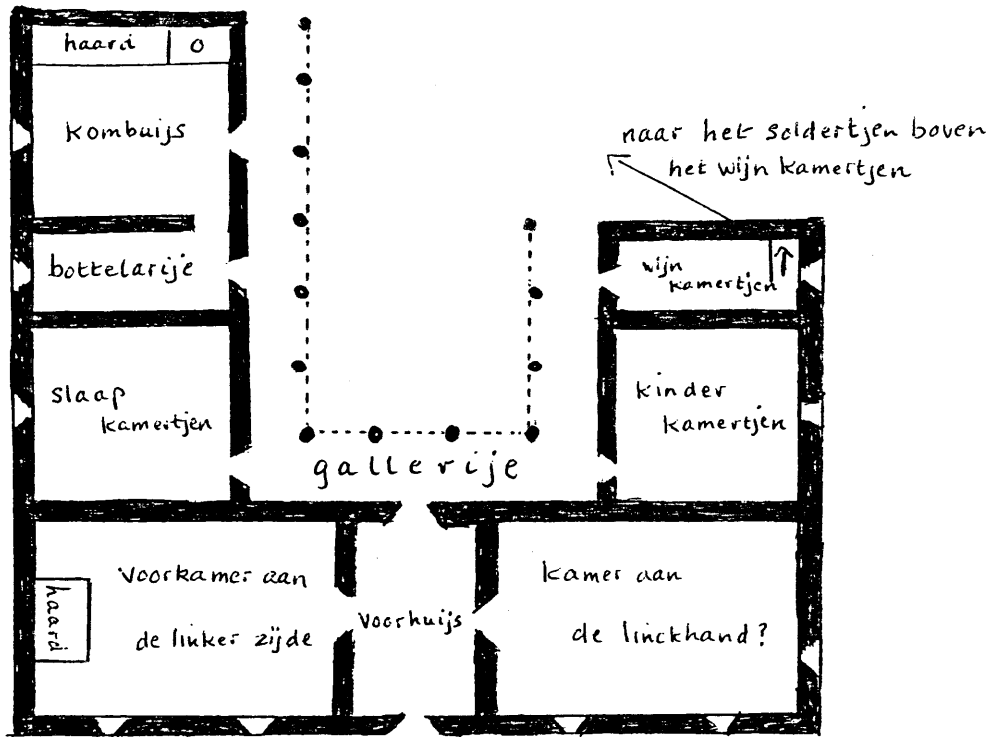



(7) Possible Ground-Plan of the Sneewindt House



"A princely sum," Fouché rightly comments, "sufficient to purchase a magnificent estate in his native country."⁵⁸ Plate 7 shows a possible ground plan of the Sneewindt homestead based on the assumption that "de kamer aan de linckhand" is a mistake.

In 1710 a rather similar house belonging to Christina de Beer and her husband, Mr. Secretary Helot, was recorded. Like all remaining examples with a gallery this was a town house, and the inventory is of especial interest because it reflects the type of establishment kept up by one of the senior Company officials. A few weeks after the death of his wife, Helot became secunde, and a couple of years later acting governor. The description of the Helot house follows, "in de voorste kamer aan de regter hand . . . in de voorkamer aan des linkerhand . . . in de Galderij . . . in de groote Kamer . . . In't eene klijne agter kamertje . . . int andere klijne Kamertje . . . In de Kombuis . . . In de Bottelerij" (II,43,1710). A startling omission in a house of this size is the voorhuis, which may be due to the fact that there was nothing in it. In the town house of the time the voorhuis normally held very little; in one instance a wooden lantern, in another three prints, in a third a bench and two bird cages, in a fourth three planks,⁵⁹ so it seems possible that the Helot voorhuis was quite empty. Another tentative ground plan, based on this assumption, appears in Plate 8. This plan and that of Plate 7 could be varied to show a gallery that extended merely from one back wing to the other, and while this would be at variance with the original Constantia, it would be in accord with the room found in that position in a typical town house of a later period.

The three other houses with galleries are just large enough to arrange round an open gallery in a manner similar to the ground plans sketched above. The first of these, belonging to Christina Does and her husband, Lieutenant Adriaan van Reede, had a voorkamer, a small voorkamer on the right, a voorhuis with "bottelarijtje,"⁶⁰ another small room on the right, a gallery, a back room, a kitchen, a pantry in the courtyard, and a solder (I,74,1703). The second, the house of Elisabet Loenss,⁶¹ had a small voorkamer, a voorhuis, a big room, a gallery, a bedroom and a kitchen (II,37,1709). The third, the house of Abraham Diermer, had a voorhuis, a voorkamer to

the right, a voorkamer to the left, another room to the right, a gallery, a pantry, a back room, a front solder, a kitchen, lean-tos and a yard (III,31,1713). If these houses were -shaped, the two back wings each held a single room. In view of the number of houses already encountered that seem to have had a single room in the "tail" this is an acceptable possibility. It is equally possible that these were not "double houses" at all but -shaped houses with a gallery outlining a part, or the whole, of the inside of the . Certainly the galleried house of Helena Besuijdenhout⁶² was of this type, because it had too few rooms for any other arrangement to be viable.

To visualise these galleries, which to judge from their contents were sometimes, though perhaps not always, genuine open galleries and not, as they later became, inner halls or middle rooms, is not easy; and contemporary descriptions are only mildly helpful. Writing of the "large and airy gallery" at Constantia, "4 or 5 paces wide and about as long as the front of the house, or 80 feet," Valentijn goes on to say "This gallery is of a single handsome story, open on the outer side away from the house, and has at each side a very long wing, or indeed two further galleries half as long as the principal one. In each of these are various doors, of which however the last two are false, though made like the other doors which enter the same number of very neat and ornamentally furnished rooms."⁶³ This description is in keeping with the archaeological evidence and likely to be reliable. Only two further points of interest emerge, however: firstly the gallery was of "a single handsome story," and secondly it was "open on the outer side."

The so-called gallery at Vergelegen was quite different: it ran right through the middle of the house to form the core of the first —or rather double -shaped house—known. Valentijn describes this gallery as "lovely and unusually pleasant" as well as "very airy and high" and gives its measurements as eighty feet by sixteen,⁶⁴ which tallies with the measurement given by Abraham Bogaert. This ardent friend of the burghers, who claims to have got his measurements from the workmen who built Vergelegen, says that the central gallery "running the length of the whole house"

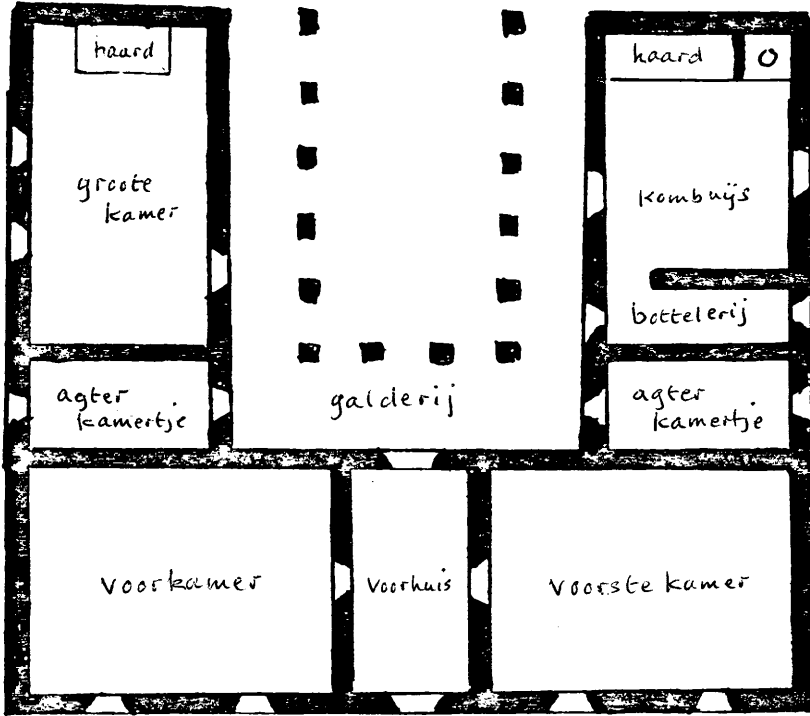

(8)

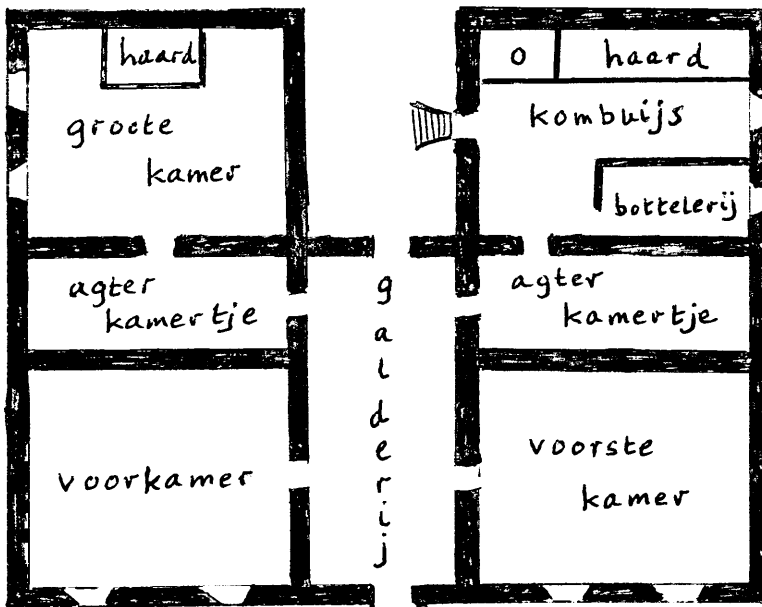

(9)

Alternative plans for the Helot house

had "a breadth of 16 feet and a length of 80 feet,"⁶⁵ Such a gallery is obviously incompatible with a voorhuis, and if employed in a town house would have to have been scaled down to the narrow dimensions imposed by the average town plot. Further to transform the voorhuis of a L-shaped house into a gallery would require the incorporation of at least part of the internal courtyard at an unexpectedly early period.⁶⁶ On the other hand it does offer an alternative plan for the Helot house (Pl.9) which is faithful to the inventory description, as it allows for the absence of a voorhuis. It is also a feature found in several peninsula houses of a later date, such as Bergvliet and Nova Constantia.

Unless some unexpected information comes to light the exact nature of these early galleries must remain a matter for speculation. One other building known to have had galleries at this period was the Company hospital which, Valentijn tells us in a welcome reference, had a gallery with "whitened arches."⁶⁸ Where one arcaded gallery was found there could have been others. In this connection some reference to galleries found in other Dutch dependencies may be apropos. The buildings at Curaçao have some points of contact with those at the Cape. Both settlements had to evolve an architectural style out of limited materials—corallite, lime, clay and straw in the case of Curaçao⁶⁹—and both settlements made use of whitewashed gables.⁷⁰ At Curaçao, however, the gallery was the single most prominent architectural feature, and by 1747, according to Dr. Ozinga, "galleries were the order of the day."⁷¹ The Curaçao gallery, a low wall completed by pillared arcades, was a feature of both the town and country house. In the former the second and third storeys of a four-storeyed building were surrounded or fronted by open galleries. In the latter a double-storeyed core was fronted, lined back and front or surrounded by a single-storeyed gallery. The gallery in combination with the gable produced a curiously mannered architectural style with no exact parallel elsewhere. Nevertheless, the open gallery and the white-washed gable were also features of the Batavian house. By the middle of the seventeenth century a back gallery constructed of



(10) An imaginative reconstruction of a house with an Arcaded
Back Gallery

brick or wooden pillars was often included in a Batavian town house. Such an achtergalerij provided a pleasantly cool living room at the expense of the light in the inner hall—a room that was also known as a "galerij."⁷² There is little doubt that "galerij," unqualified, was used at the Cape in the early eighteenth century for some sort of open gallery or stoep, though it also seems to have been used, as it was later, in the Batavian sense of an inner hall. Plate 10 shows the back of an L-shaped Cape house with an arcaded gallery. It is, needless to say, purely imaginary, and could have been shown equally plausibly with pillars in place of arcades.

The passage, to which we must now turn, appears in three important houses before 1715 and a handful of houses from the 1720's and 1730's. To judge from the contents, the passage may well have occupied much the same geographical position as the gallery, to which it was possibly a rather inferior alternative. Other possibilities are that it filled the gap between the back wings of a U-shaped house, an unexpectedly early but not inconceivable development; or that a plan like that of the third Stellenbosch Drostdy had early prototypes. Erected in the 1760's, the Drostdy had a flat or barrel-roofed passage linking together two long wings with steeply pitched roofs (Pl.11). It is also possible that these were rectangular houses with flat roofs or unusually broad roof spans—the sort of buildings that ultimately proved impractical because of leaking roofs and overstrained lateral walls.⁷³

The house of Jan Dirksz de Beer, who achieved the position of both burgher councillor and captain of the burgher militia, with its voorhuis, two voorkamers, passage, two kitchens, pantry, wine cellar and solder (I,63,1701) would lend itself to various arrangements. It could have been rectangular with a passage dividing the back wing of the house from that of the front, or it could have been U-shaped with a passage link between the two back wings, or it could have been a passage running right down the centre of the U. Equally adaptable was the large house-store of Catharina Cruse, widow of Undermerchant Sieur Willem Corssenaer, where we find a voorhuis, a large room, a room to the right, a back

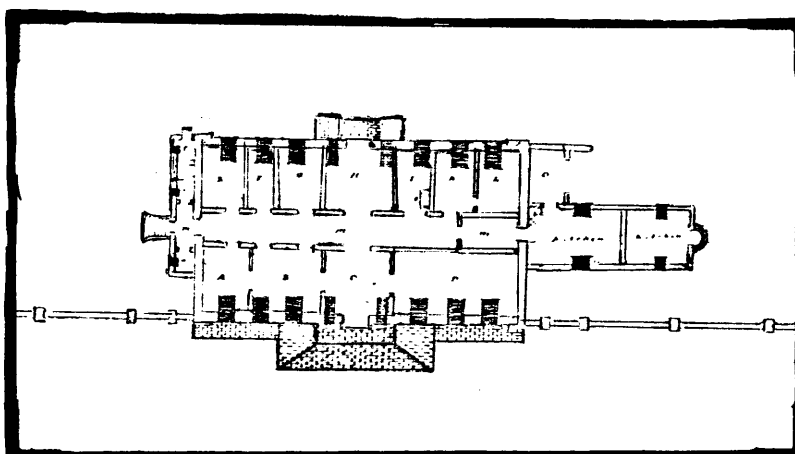

- (11) Ground-Plan of the Third Stellenbosch Drosty drawn in 1826 by the Surveyor, W. B. Rowan. This building was erected in the 1760's. The extension on the right contains the kitchen quarters.

Courtesy Theological Seminary
Stellenbosch

room, a small back room, a pantry or "dispens", a kitchen, a passage, a courtyard, a back solder, a solder, a locked solder, another kitchen—it is not clear whether this is the original kitchen or not—and a shop or "Winkel" (III,37,1713). The third house, which belonged to Willem Basson, with a voorhuis, a room to the right, another to the left, a back room, a passage, a kitchen, courtyard and solder (II,77,1713) is also just large enough to arrange in all these ways provided a single room in each back wing, linked by a passage, can be plausibly accepted.

One substantial house, the last to concern us here, is distinguished by the absence of both a passage and a gallery. This house, which belonged to Joris van Stralen and Jacob van Doorninck, was a "garden" house rather than a town house, and is charmingly described as follows, "Inde slaapkamer na de thuijn . . . Inde kas in't portaal ⁷⁴ . . . In't bottelarijtjen . . . Inde groote kamer aande thuijn . . . In't kamertje na de baij . . . In't voorhuis . . . In de groote kombuijs . . . In't kleijne kombuijsen . . . In't packhuijsen, en daar buijten . . . In de wijnkelder . . . Op de solder (I,62,1701). This house, which seems to fall easily into the shape of a , focuses attention on several major points to emerge from the chapter as a whole. To begin with there is the rare use of the word "slaapkamer." Interestingly enough this inventory is one of two ⁷⁵ in 1701 to describe a room in this way. Yet the term, which was first used in describing a town house in 1681 (23/5,50), remains exceptional, for I have only found it in two other inventories during our period; once in 1709 (II,37) and again in 1712 (II,61). The picture does not change after 1714. Although I have now covered the period up to 1750 fairly thoroughly, I have encountered very few references to "slaapkamers," and this despite the fact that in the large houses the distinction between sleeping and living accommodation becomes clearer as the century advances. What these inventories do demonstrate is the way our forefathers tended to think of a room in terms of its position rather than its function, so that one is much more likely to find "In't kamertje na de baij," or "In de Camer aen de Regterhand," or "In de voorkamer na't Noordwestern" than "In't slaap kamertjen van de Weduwe."

Another point to which the Van Stralen/Van Doorninck inventory draws attention is the presence of a second kitchen. There are several instances among the larger houses of this Dutch practice, which is one never previously associated with the Cape.⁷⁶ Then the whole question of the solder is raised again by this inventory. A solder is mentioned, but to judge from its position it was the solder of the wine cellar, not of the house. This is a surprise, but in two other inventories from this last group the same doubt arises, and in two further instances no solder at all is mentioned. Even among the larger houses, then, a solder seems to have been anything but a matter of course. Lastly, this house, by being the only one of its size not to include either a passage or a gallery, is a timeous reminder of the variety the houses of the period exhibit.

The Double-Storeyed House

In order to leave the picture as complete as possible some further mention should be made of the double-storeyed house. Certain public or semi-public buildings are known to have been double-storeyed and these, of course, include Rustenburgh. They fall into two distinct groups. In one are those houses under a steeply pitched, thatched roof with a series of attic rooms in the solder, like the old L-shaped raadhuis at Stellenbosch, erected in 1687, and Constantia, first built in 1692. In such buildings the attic rooms would have been lit either by low, properly built-out dormers like those in Heydt's 1741 drawing of Groot Constantia; or by "segmentally heightened bits of walling" supporting slightly upswept thatch:⁷⁷ a far from weather-proof and accordingly short-lived window type, but one possibly represented in Van Stade's 1710 sketch of the same building (Pl.12). In the other group are buildings with a flat roof, and this includes little but the Castle.⁷⁸ Double-storeyed houses were also built by some of the wealthier burghers, and these are pin-pointed for us by the invaluable Valentijn.

Several two-story houses have been built since 1695 (at which time I first noticed the change in this respect), of which the first were the two houses of Albert Koopman, standing side by side.⁷⁹ These are very fine for that date, but in 1705 I found larger, higher and more noble houses, for example the two built by Henning Husing, Town Councillor here and one of the richest burghers, standing next to each other on the way to the Fort, of which his own

house, where he had lived, had cost fully 10 000 Rxd.³⁰ as he told me; and that of Fiscal Blesius, also a very fine house, in which (as in that of Heer Husing) there is a double apartment below and above, with a stairway as in the houses of Amsterdam.³¹

The reference to Amsterdam conjures up a picture of a typical canal house with two downstairs rooms, and further attic-type rooms under a pitched roof. Though we have met a not dissimilar little house with the Company's Rustenburgh, it is the only house of this type that I have noted in an inventory, and the only double-storeyed house described room by room before 1715. The next decade or so offers several examples where four or five downstairs rooms are combined with a single upstairs room. Such inventories do no more than suggest that the solder, which was always a favourite place for extra sleeping accomodation, had been equipped with a small room. Thus, in a house in Heerestraat with four downstairs rooms, there was a single "Ager booven Camertjie" (III,95,1719); and another house in the same street with five downstairs rooms had one "op kamertjie"⁸² (IV,122,1726). While it seems possible that the occasional flat-roofed private house was attempted before 1715, it was not until 1717 that the advice of Mr Cranendonk, a Company man, on the construction of a flat roof was made public⁸³ and Mentzel notes that it was only in the 1730's that such a roof was waterproofed with lashings of oil.⁸⁴

Conclusion

In conclusion let it be said that the path followed by Cape Dutch Architecture in the late seventeenth and early eighteenth centuries was neither as straight nor as narrow as has been supposed. It was an age of experimentation. Many of the experiments, like the raadhuis at Stellenbosch, must have gone awry,⁸⁵ for surely the beautiful but limited nature of the mature Cape Dutch style which emerged in the middle of the eighteenth century was governed as much by failure as success. In the years to either side of 1700 the boundaries of the possible and the durable were still open to exploration. And yet, for all the unexpected twists and turns charted in this chapter, these early houses seem firmly grounded in the Cape Dutch tradition.



- (1) Stellenbosch in February,
1710. Pen-and-ink drawing
by E. V. Stade.

Courtesy Cape Archives

"Buildings in this style," according to Fransen and Cook, "have thatched roofs . . . thick walls of any available material, plastered and lime-washed on both sides, and have domino-like ground plans consisting of room added to room in a single row or with wings added at the back, nearly always with a roof span of about 20 feet, and with uniform ridge heights for front row and back wings."⁸⁶ There is little to quarrel with here. The lime-washed interior is now known to have been less than constant⁸⁷ and, as the next chapter will show, was probably so from the start. One other query is the ridge height. There is no doubt that many early houses were built without solders and that a good deal of use was made of lean-tos, but this does not challenge the essential homogeneity between the early houses and those of later date. It was, however, homogeneity of the kind reflected in Van Stade's Stellenbosch drawing: a homogeneity governed by the limited nature of the materials available rather than by any architectural format, and one that was thus virtually inescapable.

Footnotes

1. A. Appel "Die Geskiedenis van Houtvoorsiening aan die Kaap, 1652-1795," M.A. Diss. Stellenbosch, 1966, p.1.
2. James Walton, Homesteads and Villages of South Africa (Pretoria, 1952), p.1.
3. Resolusies van die Politieke Raad, eds., Anna J. Böeseken & G. C. de Wet, 8 vols., Suid-Afrikaanse Argiefstukke (Cape Town, 1957-), III, 232. A plakkaat to this effect was issued nearly a year later (Kaapse Plakkaatboek 1652-1707, ed., M. K. Jeffreys, Kaapse Argiefstukke [Cape Town, 1944], 21-22 Jan, 1692, p.266).
4. I, 21, 1696; I, 33, 1698; I, 65, 1701; I, 39, 1699.
5. I, 43, 1699; I, 55, 1700; I, 70, 1702.
6. I, 73, 1702; I, 65, 1701 (this inventory includes two examples. See above, n.4); I, 80, 1704; I, 59, 1700.
7. This work by Augustus van Buren is cited by Helen Wilkinson Reynolds, Dutch Houses in the Hudson Valley before 1776, (1929; rpt. Dover Publications, New York, 1965), p.17.
8. The other was the Paarl homestead of Coenraad Cijfer (II,25,1708).
9. Valentyn, op. cit., I, 143. In the Dutch text Pretorius is called "Borgemeester" which is used in the Dutch sense of "college van burgemeesters" (Ibid., p.142, n.89). In fact Wessel Pretorius was Heemraad of Stellenbosch.
10. See above p.12.
11. Understandably there are one or two very early exceptions. For example a "hoffstede met seven morgen bouwlant," situated beside the Liesbeeck and sown with $3\frac{1}{2}$ hectolitres of wheat, was valued, together with some building material, an old wagon and 5 oxen, at f 550 (23/5,3,1670).
12. Walton, op. cit., p.2. Resolusies, I, 171-72. Kaapse Plakkaatboek 1652-1707, p.42.
13. See above p.12 and n.3.

14. CJ2914, Bergh Inv., 1687. p.1.
15. Valentyn, op. cit., I, 87.
16. Resolusies, II, 20.
17. For instance Walton, op. cit., p.7, and Mary Cook, Die Kaapse Kombuis, Stellenbosch Museum and Drostdy, Swellendam (Stellenbosch, n.d.) p.14.
18. II,11,1707; II,49,1711; III,56,1713.
19. Dagboek van Adam Tas, ed. Leo Fouché, rev. by A. J. Böeseken, Van Riebeeck Society, 2nd series, no. 1, (1914; rpt. Cape Town, 1970), facing p.208.
20. Ibid., facing p.16.
21. Stellenbosch Three Centuries, ed. Francois Smuts, Stellenbosch Town Council (Stellenbosch, 1979), pp. 81-84.
22. G. E. Pearse, The Cape of Good Hope 1652-1833 (Pretoria, 1956), p.34.
23. Now Simonsvlei.
24. Title Deeds: Stellenbosch and Drakenstein Districts, I, 1692, p.50.
25. Ibid., 1692, p.62.
26. III,24,1713; III,64,1714.
27. Walton, op. cit., p.6.
28. Resolusies, IV, 106.
29. For instance Hans Fransen and Mary Alexander Cook, The Old Buildings of the Cape (Cape Town, 1980), p.2, and Jan van der Meulen, "The Origins of Cape Colonial Architecture," Lantern (June, 1964), 42.
30. Fransen & Cook, Old Buildings, pp. 1-2. Ever since the restoration of the 1710 Schreuder house in Stellenbosch there has been doubt as to whether the L-shaped back wing was part of the original building or not. I understand from the curator, Mr. Marius le Roux, that recent research supports the evidence of early maps where the house is shown as a simple rectangle.

31. Fransen & Cook, Old Buildings, p.2.
32. Hans Fransen, Drie Eeue Kuns in Suid-Afrika (Pietermaritzburg, 1981), p.22.
33. II, 66, 1712; II, 73, 1713; * II, 76, 1713; * III, 30, 1713; * III, 55, 1713. An asterisk denotes the absence of a solder.
34. Resolusies, IV, 120. In addition to the homestead, which may have been partially demolished, there were 3 brick sheep pens, farmhouse, stables, wine cellar, mill, slave house, barn and a pen with a water mill (ibid., p.106). See also Maryna Fraser, The Story of Two Cape Farms (n. p. 1980), p.33.
35. Information ex Prof. F. G. E. Nilant, University of Pretoria.
36. Fransen & Cook, Old Buildings, p.2.
37. Inventories preserved in the Gemeente Archief 's-Gravenhage offer a number of such examples: in 1693 "de keuken" and "'t cleijn agter keukentjen" (Not. Arch., 574, p.133); in 1701 "de Beneden keucken" and "de agter keucken" (Not. Arch., 428, p.833); in 1705 "de keucke" and "het agter keukenje" (Not. Arch., 1786, p.31), etc. See below p.69 and Ir. R. Meischke, Het Nederlandse Woonhuis 1300-1800 (Haarlem, 1969), pp. 98, 300-23.
38. C. J. 2914, Meijer Inv., 1705, p.158.
- 38a. See below, p.41, n.82.
39. Bax, Het Oudste Kaapse Zilver, p.27.
40. Rondebosch Down the Years 1657-1957, ed., F. J. Wagener (Rondebosch, 1957), p.9.
41. Ibid., p.10.
42. Van de Wall, op. cit., p.71. De Haan, op. cit., I, 484.
43. For example IV, 46, 1725 & IV, 115, 1726 in Stellenbosch; V, 4, 1727 in Cape Town; and V, 21, 1728 in Rondebosch.
44. Walton, op. cit., p.7.
45. Fouché, Dagboek van Adam Tas, pp. 345 & 349.
46. For instance C. Graham Botha, Collected Works, 3 vols. (Cape Town, 1962), I, 155 .
47. Resolusies, III, 137.

48. Kaapse Plakkaatboek 1652-1707, p. 261.
49. Ibid., p. 268.
50. Resolusies, III, 320.
51. Valentyn, op. cit., I, 55.
52. Dampier, op. cit., pp. 533-34.
53. The Flatts, Albany (Reynolds, op. cit., Pl.33).
54. Valentyn, op. cit., I, 81. "Bol-kozynen" from the parallel Dutch text has been substituted for "single-paned windows." See below p. 43.
55. Pearse, The Cape of Good Hope, p.65.
56. F. K. Kendall, The Restoration of Groot Constantia, (Cape Town, n.d), p.22.
57. See above, p.20.
58. Fouché, Dagboek van Adam Tas, p.348. The following passage from J. L. Price, Culture and Society in the Dutch Republic during the 17th Century (London, 1974), offers another illuminating perspective: "In 1639 [Rembrandt] bought a house in Amsterdam for the large sum of f 14,000-, which was more than his parents had accumulated in a lifetime of work. He was never able to pay for this house and it finally played a major ~~role~~ in pulling him down into bankruptcy" (p.150).
59. For a more detailed discussion of the contents of the voorhuis see below pp. 67-69.
60. "In het bottelarijtje bevonden int voorhuis." This held a little silver and was presumably a small wall-cupboard with a solid wooden door.
61. The name "Elisabet Loenss" is missing from the inventory but is present on the vendu roll of the same estate (VR56,1709). She was the wife of Hendrik Hagedoorn.
62. See above, p.26.
63. Valentyn, op. cit., I, 195.
64. Ibid., I, 151.

65. Quoted by G. E. Pearse, Eighteenth Century Architecture in South Africa, 3rd ed. (1933; rpt. Cape Town. 1968), p.45.
66. See above, p.21.
67. Illustrations of these galleries may be found in Philippa Dane and Sydney-Ann Wallace, The Great Houses of Constantia (Cape Town, 1981), pp. 68 & 98.
68. Valentyn, op. cit., I, 95.
69. M. D. Ozinga, De Monumentem van Curaçao in Woord en Beeld, Stichting Monumentenzorg (Curaçao, 1959), p.18.
70. The occasional resemblance between these two architectural traditions has not passed entirely unremarked. B. E. Bierman illustrates several Curaçao buildings in an opening chapter where he discusses the effects of Portuguese architecture on the Dutch colonial tradition (Boukuns in Suid-Afrika [Cape Town, 1955] , pp. 1-9). Hans Fransen draws attention to the similarity between the incurling central gable that appears in the sketch of Vergelegen in the Contra Deductie and certain Curaçao gables (Drie Eeue Kuns, p.29).
71. Ozinga, op. cit., p.159.
72. Van de Wall, op. cit., p.71.
73. Roof spans of 40 ft were being attempted according to the measurements of the outbuildings at Vergelegen (Resolusies, IV, 106) as well as the measurements, 108 x 40 ft, of the great barn, Groote Schuur, at Rondebosch (Picard, op. cit. p.136), but imported materials were then needed.
74. Presumably a small back hall.
75. The other is the Sneewindt inventory (I,69,1701).
76. See below, pp. 69-71.
77. Fransen & Cook, Old Buildings, p.6.
78. In 1710, ex-Gov. Gen. Joan van Hoorn in a letter to Gov. Gen. Abraham van Riebeeck writes that at the Cape all the houses are "met riet gedekt, uijtgesondert dat het in 't casteel al platten sijn" (Briewe van Johanna Maria van Riebeeck en ander Riebeeckiana, ed. D. B. Bosman [Amsterdam, 1952] , p.72.).

79. It was a common practice among the wealthier burghers for one person to own two adjacent town plots: the house on one for personal use and the other for hire. Some examples of estates with two adjacent plots (erven) are those of Adriaan van Brakel (I,46,1699), Johanna Starrenburg (II,28,1709) and Albert Barentsz Gildenhuijs (II,61,1712).
80. This sum, the equivalent of 30 000 Cape guilders or £2 000, represented an enormous sum of money. The four parts of Vergelegen realised no more than f24 400 (Fouché, Dagboek van Adam Tas, p.349).
81. Valentyn, op. cit., I, 81.
82. This may have been a "hanging" room. A room known as an "opkamer," "kelderkamer" or "galerijkamer," and reached from the landing of the stair to the upper floor was built out from the back of many Batavian houses. Such a room had a partially underground cellar below (De Haan, op. cit., I, 467).
83. Botha, op. cit., I, 128-29.
84. Cited by Pearse, Eighteenth Century Architecture, p.8.
85. Erected in 1687, the raadhuis was in a parlous condition by 1707. At a meeting of the Political Council that September it was decided to remove the second floor to see whether the ground floor could be saved, or whether it would have to be completely rebuilt with one floor less (Resolusies, IV, 25).
86. Hans Fransen & Mary Cook, The Old Houses of the Cape (Cape Town, 1965), p.vii.
87. The importance of tinted, painted and stencilled walls in the late 18th and early 19th century Cape interior has been established largely during the last decade. The Koopmans de Wet house, Cape Town, and Libertas, Stellenbosch, have neo-classical wall paintings done in the late 18th century. Tinted walls with late neo-classical friezes from the early 19th century have been found at the Van der Bijl House, Stellenbosch, Zorgvleit, Tokai, Boschendal, etc.

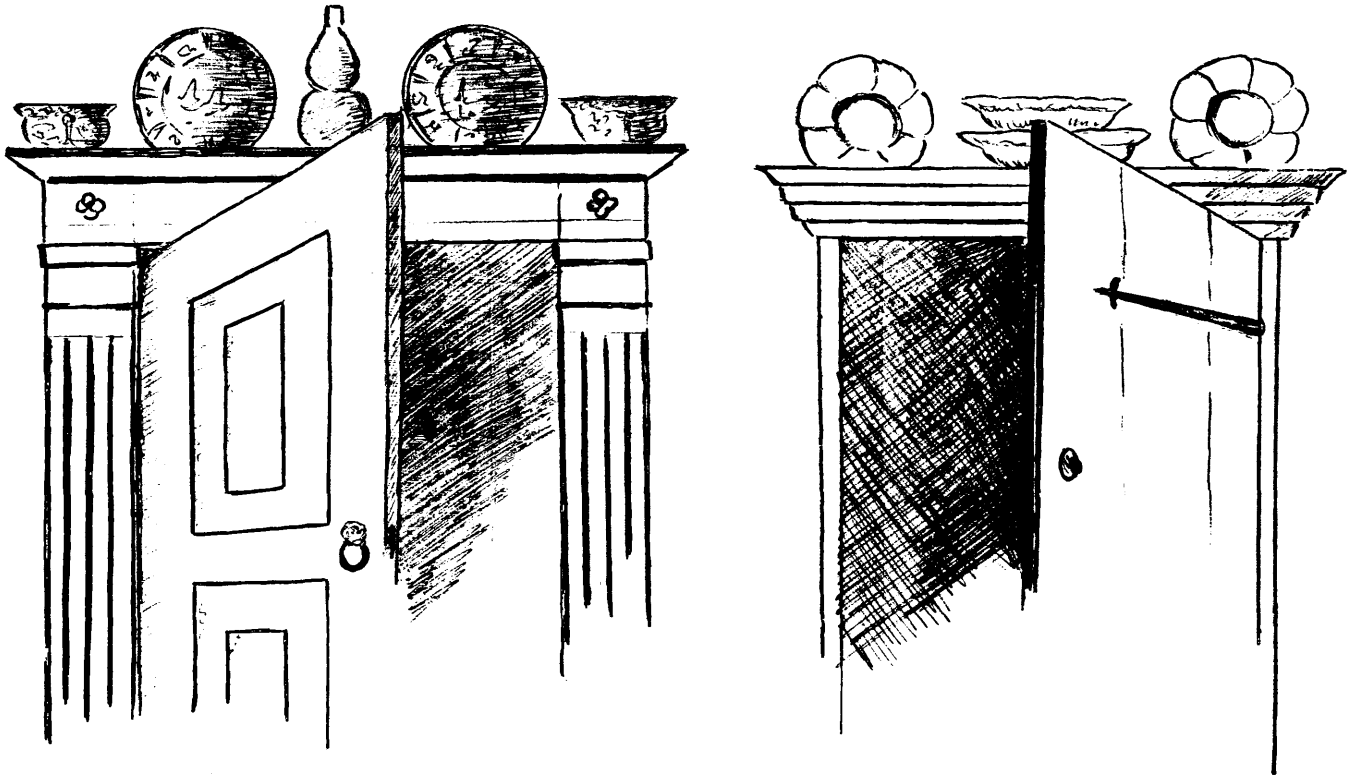

(13) Seventeenth-Century Dutch Doorways surmounted by
Porcelain and Delftware

Interior Architectural Features

Neither inventory nor vendu roll is an ideal source of information on the nature of a room, but in the absence of pictures, prints and detailed descriptions one is glad of any information, no matter how meagre, which adds something to one's knowledge. The frequency with which loose doors and windows and other related objects are recorded at least bears witness to the general concern of the young settlement with building and expansion, and though most entries like "1 oude deur met sijn hengsels" (II,109,1714) merely mark the presence of the items concerned, there are exceptions.

Doors

Doors varied greatly in quality. Auction prices range from fifteen guilders to a handful of stivers and suggest that by the 1690's primitive simplicity was no longer inevitable. Two door frames sold for 39 guilders in 1696;¹ a price high enough to conjure up a picture of classical fluting; a picture which is reinforced by several passages in the inventories where some of the finest town houses are shown to have had internal doorways capable of supporting porcelain. Entries like "5 porsselijne pieringen op de boog van de deur" (I,62,1701) and "eenig porcelein boven de deur" (II,43,1710) are evidence, at least, of a projecting cornice or a recessed archway, and may mean that fluted pilasters and an entablature framed some interior doors (Pl.13). One also learns, this time without surprise, that both the solid door (hele deur) and stable door (twee halve deuren) were in use, while an isolated reference to "1 deur Casijn met 2 Ligten" (VR61,1710) confirms the use of this simple type of fanlight.

Windows

When it comes to the windows the occasional reference to a single frame, such as "1 Enckels Cosijn met sijn Toebehooren" (II,109,1714) or a double frame, "1 dubbelt Venster Casijn" (II,58,1712), alerts us to the fact that windows were not all of one type. The single casement (Pl.29) was the kind of window in general use, if Van Stade's early drawings of Stellenbosch (Pl.1)

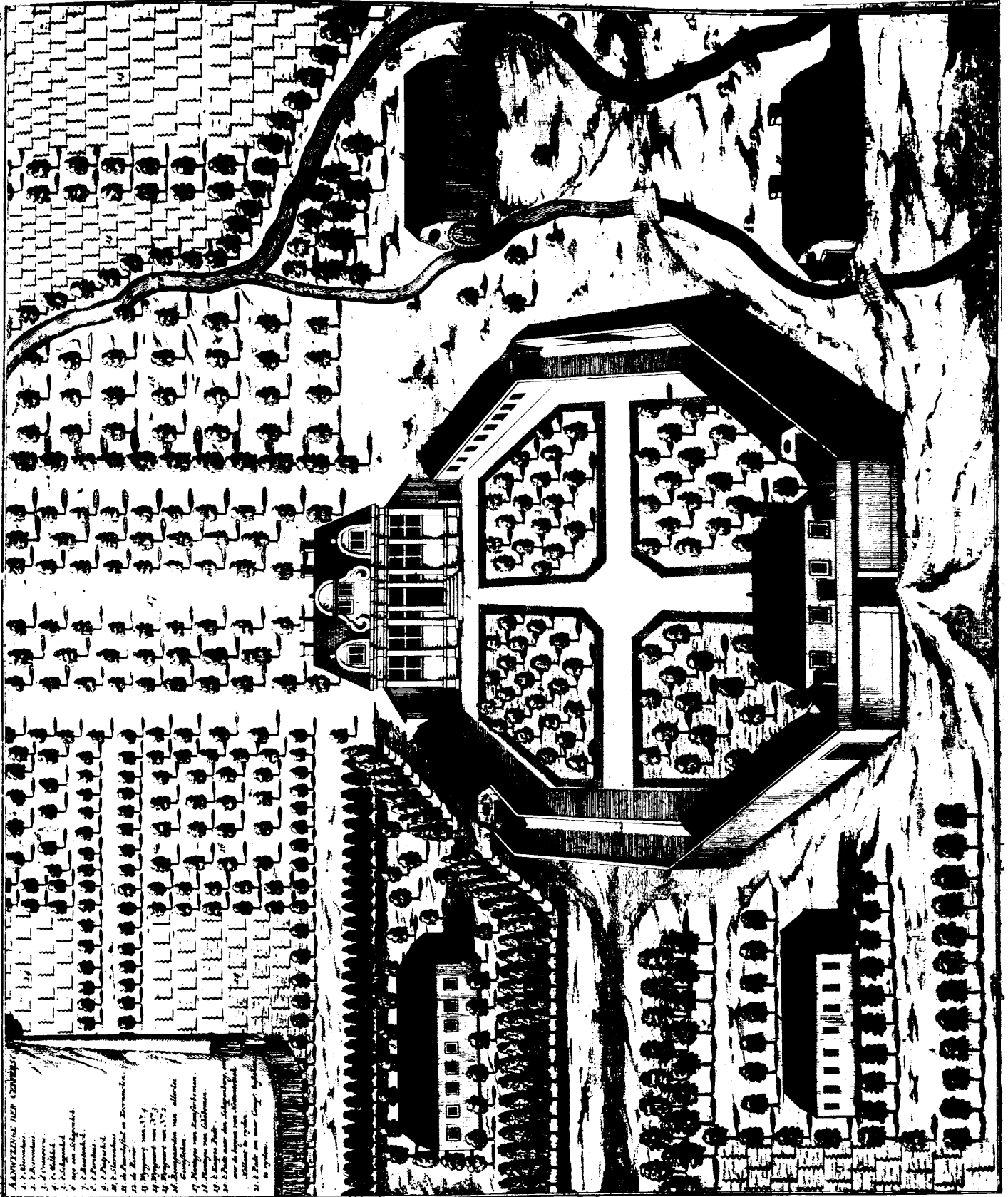

AANDEZENDE REEK VAN
1. A. Middelburg
2. A. Middelburg
3. A. Middelburg
4. A. Middelburg
5. A. Middelburg
6. A. Middelburg
7. A. Middelburg
8. A. Middelburg
9. A. Middelburg
10. A. Middelburg
11. A. Middelburg
12. A. Middelburg
13. A. Middelburg
14. A. Middelburg
15. A. Middelburg
16. A. Middelburg
17. A. Middelburg
18. A. Middelburg
19. A. Middelburg
20. A. Middelburg
21. A. Middelburg
22. A. Middelburg
23. A. Middelburg
24. A. Middelburg
25. A. Middelburg
26. A. Middelburg
27. A. Middelburg
28. A. Middelburg
29. A. Middelburg
30. A. Middelburg
31. A. Middelburg
32. A. Middelburg
33. A. Middelburg
34. A. Middelburg
35. A. Middelburg
36. A. Middelburg
37. A. Middelburg
38. A. Middelburg
39. A. Middelburg
40. A. Middelburg
41. A. Middelburg
42. A. Middelburg
43. A. Middelburg
44. A. Middelburg
45. A. Middelburg
46. A. Middelburg
47. A. Middelburg
48. A. Middelburg
49. A. Middelburg
50. A. Middelburg

(14)
Vergelegen:
The Front

Courtesy
Cape Archives

and Constantia (Pl.12) are in any way reliable; but a double casement is also recognisable on occasion, and one such may be seen in the small building in the foreground of the Constantia sketch. The only clearly drawn windows from this period are those which appear in the two Vergelegen drawings. Plate 14, from the Contra Deductie by Adam Tas and Jacobus van der Heijden shows the front of Vergelegen, and Plate 15, from Willem Adriaan van der Stel's Korte Deductie, the back. I have very little difficulty in believing that both representations are fairly reliable. There is nothing inherently improbable in a building at this time having but one elaborate gable in the front, and if this was the case it would explain why, when faced with charges of extravagance, Willem Adriaan chose to defend himself with a representation of the back of his house. In both illustrations a series of small windows, which can only be single casements, graces the outhouses, and in both the windows of Vergelegen are much more elaborate. The huge windows in the Tas representation are frankly incredible, but the four sections into which they are divided must be correct—the much more convincing windows in the Willem Adriaan sketch show the same number of divisions. The Vergelegen windows were almost certainly tall "kruis kozijnen" with immovable top sections—a common window type in Holland but a rarity at the Cape—at least around 1700.

In a passage from Valentijn quoted in the last chapter we are told that most houses only had "bol-kozynen."² In the Van Riebeeck Society edition of this work it is suggested that "bol-kozynen" are the equivalent of Afrikaans "rondhout-kosyne," but the phrase in the parallel English text is translated as "single-paned windows."³ Neither of these translations is the correct one. In his standard work, Het Nederlandse Woonhuis van 1300-1800, Ir. R. Meischke writes, "Van de middeleeuwen tot het begin van de 18de eeuw, was er in de venstervorm nauwelijks verandering gekomen. Alle vensters van de huizen waren kruiskozijnen, van hout of steen, of varianten erop als bredere kozijnen met drie of vier openingen naast elkaar of halve kruiskozijnen met twee openingen boven elkaar (kloosterkozijnen) en twee openingen naast elkaar (bolkozijnen)."⁴ What Valentijn is claiming, therefore, is that

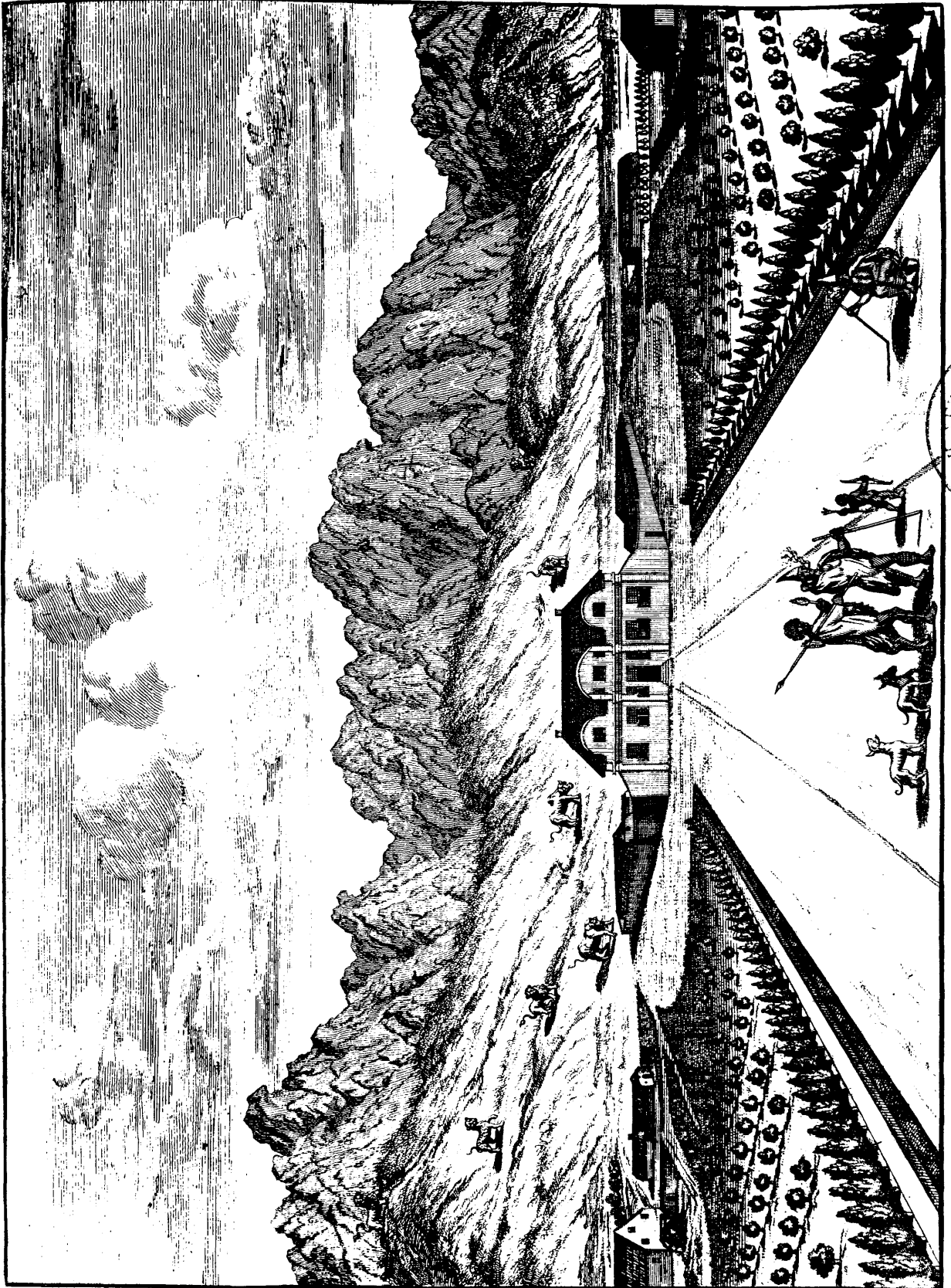

(15)

Vergelegen:

The Back

Courtesy

Cape Archives

most Cape windows consisted of two openings next to each other, and though this may be a slightly exaggerated claim it is otherwise perfectly acceptable. The "dubbelt Venster Casijn" of the inventories is neither more nor less than Valentijn's bolkozijn.

References to glass panes like "een kasje met glase ruijten daarin 32Ops" (II,8,1707) are exceedingly frequent and leave one convinced that by 1700 glazed windows were by no means uncommon, at least in Cape Town itself. The Resolusies van die Politieke Raad regularly refer to glass panes when broken or damaged goods have to be written off. Thus in 1685 "2 474 diverse ruijten" appear in the list of spoilt goods, in 1704 "84 groote [en] 108 klijnd ruijten" suffer a like fate and in 1705 "180 ps groote [en] 355 ps klijne ruijten" are recorded.⁵ From this it seems clear that two sizes of pane were in general use. It is most unfortunate that the number of panes in any one window is rarely given, but in 1687 "1 raemtje met 12 ruijten" appears in the inventory of Olof Bergh⁶ and the use of the diminutive, "raemtje", is an indication that the panes themselves were of no great size. The large panes may have been 23 by 18 centimetres, a common size in early surviving windows, and four or eight such panes would plausibly compose a "deur Casijn met 2 Ligten" (VR61,1710).

As there are several dozen references to windows and their appurtenances—to window frames, glass panes, locks and hinges, it may be significant that I can only find two references to shutters, namely "1 oude Luijk" (II,72,1713) and "2 houte Luijkjes" (VR56,1709). In fact I have been forced to the conclusion that at this period shutters were not in general use, although there is some evidence of their use on important buildings. For instance Henning Hüsing, the Cape's most prosperous burgher round 1700, made large purchases of timber from the government until the end of 1702 which included "teak for the doors, wall cupboards and shutters."⁷ Then, as casements opened inwards at this period, it is quite obviously shutters that appear in Willem Adriaan's representation of Vergelegen (Pl.15) and the fact that they are missing from the Accusation's drawing (Pl.14) need not be taken too seriously. But the houses of Hüsing and Willem Adriaan are known to have been exceptional; in Van Stade's drawings of Constantia (Pl.12) and Stellenbosch (Pl.1) there are no recognisable shutters to be seen.



(15.5) An Old Dutch Tavern. Note the series of bolkozijnen on the ground floor with kruiskozijnen above (Hendrik de Leth, Het Zegenpralant Kennemerlant, 1732).

Walls

Tradition, which associates whitewashed walls with both the inside and the outside of the Cape house, appears for once to be reliable. It is supported by the frequent listing of lime and whiting brushes and the rarity of alternative finishes. To judge from the evidence of painters like Vermeer, Jan Steen and Pieter de Hooch, white walls were a common sight in contemporary Holland even though they were anything but fashionable. Fashionable walls were covered with tapestry, leather, material or the occasional wallpaper. Hangings, probably because they were difficult and expensive to obtain, seem to have been the exception at the Cape. There is mention of "1 roode huijs laer" with a value of 36 guilders (II, 109, 1714), which may have been a leather hanging as the price is impossibly high for a ladder, and there are a handful of references to what could well be Chinese wallpaper. The most important of these refers to "1 Doos met 52 vel sineesche bloemen" (I, 23, 1697), and these were sold off two at a time for prices ranging from 9 guilders to 20 guilders, 10 stivers (VR9). As most Chinese wallpapers were sold in sets of about 25 rolls, each roll 12 feet long by 4 feet wide, and as the favourite motifs up to the middle of the eighteenth century were flowering trees, shrubs and flowers, it seems likely that this enchanting commodity was here in question. If so, the end result of some brisk bidding was that three buyers acquired enough paper to introduce a Chinese room to their homes. Other references to small quantities of "sineesche bloemen" suggest that these rooms were not unique. All the same, it is a meagre tally and does not challenge the supremacy of the whitewashed wall—a feature which Cape houses had in common with those of Batavia.

Floors

In Holland the floors of downstairs rooms are usually shown, in pictures of the period, to have been tiled in contrasting squares of black and white. In some instances—Vermeer's "Milkmaid" is a case in point—they have the appearance of beaten earth or clay.⁷ Floors of this latter type were very common at the Cape at a later period and were presumably so from the start. Floor tiles were listed from time to time—"1 parthy halve vloersteen"

(VR21,1701) for example, but sufficiently infrequently to suggest that their use was not a matter of course. According to Valentijn the entrance hall and rooms to either side at Constantia were floored with "marble" which, in the case of the voorhuis, alternated with "red stones" and included a pentagon worked in the centre.¹⁰ If the "red stones" were local quarry tiles as Mr. Fransen suggests¹¹ they were probably used in other houses of the period, while grey-black Robben Island slate and Batavian tiles were also available.

Fire-places

A living room fire-place, which was an absolute necessity in Holland, was always a little exceptional at the Cape. It was, however, by no means uncommon at this period. Six out of the ten most imposing houses inventoried had such a fire-place, and the general average is about one in four. This means that the oft-repeated statement that the kitchen fire-place was normally the only fire-place in a typical Cape Dutch house¹² does not hold good for this early period, however true it may be for the period after 1750. Chimneys in the mature Cape Dutch style are invariably built into end gables, but at this time, when many houses seem to have had hipped roofs, there is no reason why chimneys should always have been placed against outside walls. In the drawings of both Vergelegen and Constantia no side gables are depicted and some of the chimneys shown look as if they were built into internal walls. A few of the small houses drawn by Van Stade—there is a particularly clear example with two chimneys in his depiction of Drakenstein¹³—carry their chimneys on internal walls, and the same would seem to apply to the interesting little sketch of a nameless house with hipped ends drawn by Landdrost Mulder (Pl.16).¹⁴ Naturally the easiest way of providing a hipped-roofed cottage with a fire-place is to build one out from an external wall, and if the position of its one chimney is a reliable guide this was the sort of fire-place to be found in the farmhouse shown centre foreground in the Accusation's depiction of Vergelegen (Pl.14).

To judge from the inventory descriptions, a living room

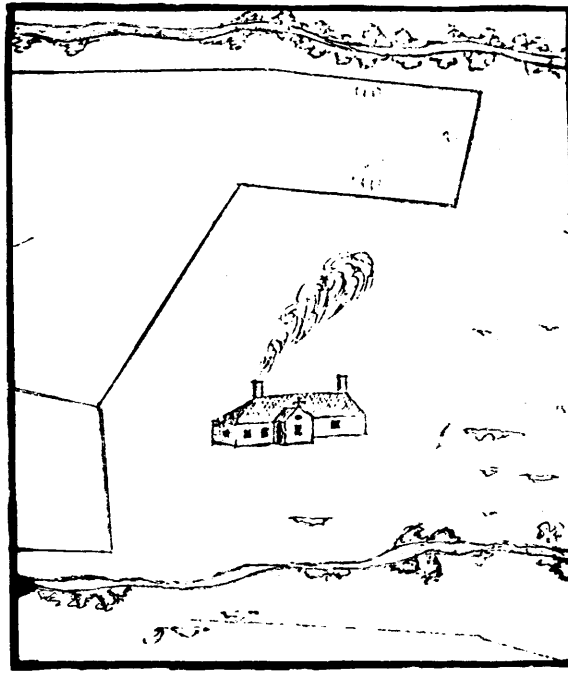

(16) Sketch of an unnamed house by Landdrost Johannes Mulder. The house is shown with what appears to be a \perp -shaped extension with a solder above. It also has hipped ends and two chimneys.

Courtesy Cape Archives

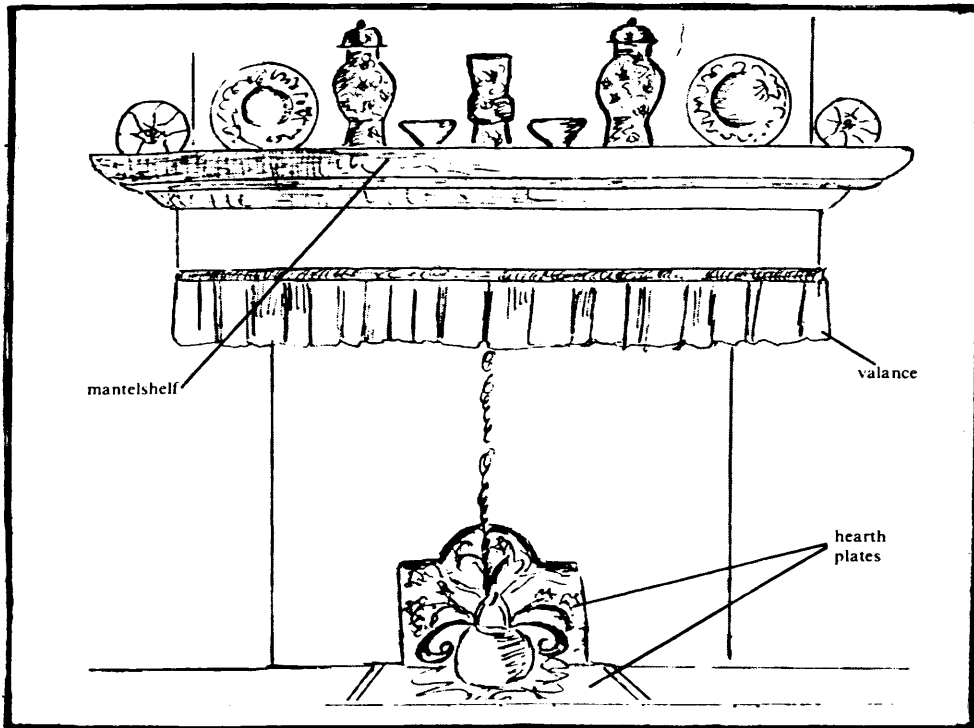

(17) Dutch Fire-Place

fire-place, when present, bore very little resemblance to the kitchen hearth. As a certain number of these fire-places are very discreetly marked—by a chimney valance that is not stored away, by some fire-irons or perhaps a hearth-plate—they may have been inconspicuous constructions like the one preserved at Henning Hüsing's farm, Meerlust. This fire-place—its exact age is uncertain—is concealed behind a door of moulded teak panels. Other fire-places were anything but inconspicuous, for the vast burden of porcelain supported on their mantelshelves proclaims their great size in no uncertain fashion. Twenty-six pieces of porcelain and an alabaster flask stood "Op de schoorsteenmantel" in the small front room of the Loenss town house (II,37,1709); while the fire-place in one of the Sneewindt voorkamers was adorned with a lace-trimmed valance (schoorsteenvalletje), served by a set of brass fire-irons and surmounted by six large porcelain dishes, five smaller ones, and eleven other little objects, among them a pair of Dogs of Fo and a mother-of-pearl drinking horn (I,69,1701). Hearth-plates, either singly or in pairs, were used in a number of living room fire-places. A pair of hearth-plates (ijseren platen) consisted of a heavy sheet of iron on which the fire was built and a second sheet, which it was customary to decorate, that stood against the back wall.¹⁵ A back plate, though probably of later date, is in position in the fire-place at Meerlust. It is decorated with "a figure with a dove of peace, a lamb and a horn of plenty."¹⁶

The combination of capacious mantelshelf, chimney valance and hearth-plates adds up in my mind to the great three-sided, hooded fire-place common to so many Dutch houses (Pl.17). There is nevertheless a discernible difference—in usage if not appearance—and for this the Cape climate was probably responsible. In Holland, at any rate among the common people, the living room fire-place was not only a source of warmth but the place, on winter evenings, for a boiling kettle; a place where apples could be roasted and waffles and pancakes made. Nothing like this could have gone on at the Cape; the fire-places are completely free of the necessary hearth chains, trivets, andirons, etc. The living room fire-place does not appear to have been the heart of the Cape house, which is

no doubt one reason why, during the course of the eighteenth century, it was virtually abandoned.

Conclusion

At this point the temptation to pull all the strands together and recreate in words the range and diversity of these early rooms is irresistible. Oddly enough it is easier to visualise one of the two- or three-roomed cottages than a town house of substance. This is in part due to the unforgettable impression left on student and visitor by the intelligently recreated primitiveness of the Schreuder House in Stellenbosch. This house, part of the Stellenbosch Museum complex, has been restored as far as possible to the condition of the original building of 1710. Inevitably, in the circumstances, every aspect of the restoration is not beyond debate. Even the original ground plan has been arrived at with difficulty. Recent archaeological investigation has shown the L-shaped tail to be a later addition, though during restoration it was felt the construction of the relevant wall showed the opposite.¹⁷ Other hazy points are the ceilings, which are now built of reed and may not have been present at all, the open archways which substitute for internal doors, the oiled linen instead of glass in the windows, and the external shutters. Although these points are not without importance, I believe the general impression is very close to the real thing. A low, thatched roof, an irregular facade with an off-centre stable door, the simplest of windows, a dimly lit interior with earth floors, whitewashed walls and modestly proportioned rooms must have been a common enough sight to either side of 1700.

The town house or the Rondebosch house is an altogether more difficult feat of the imagination. A number of its rooms were generously proportioned, and some of them were not only provided with ceilings but with great unfamiliar fire-places and corniced internal doorways. No town house from this period is still in existence, and it is possible that certain Dutch interiors are closer to these rooms than anything still surviving at the Cape. The type of interior I have in mind appears in Pieter de Hooch's "The Spoilt Parrot" or Jan Steen's "Topsy Turvey World,"¹⁸ where a hooded fire-place is just visible through an archway to the right.

The one undoubtedly alien note in these two pictures is struck by the windows, which are much more elaborate than anything likely to have been found at the Cape.

Footnotes

1. CJ2916, *Frezer Vend.*, 1696, p.10.
2. See above, p.27.
3. Valentyn, *op. cit.*, I, 80-81.
4. Meischke, Het Nederlāndse Woonhuis van 1300 - 1800, pp. 434-36.
5. Resolusies, III, 107; IV, 422 & 458.
6. CJ2914, *Bergh Inv.*, 1687, p.3.
7. Pearse, Eighteenth Century Architecture, p.44.
8. E. A. Entwisle, The Book of Wallpaper (London, 1954), p.44. In England, according to this author, Chinese wallpaper normally fetched 3-5 guineas a roll (p.45) but luxury items at the Cape seldom seem to have realised their full value—a state of affairs to which Valentyn draws attention (I, 208).
9. Significantly, perhaps, a kitchen floor is here in question.
10. Valentyn, *op. cit.*, I, 193-95.
11. Hans Fransen, Groot Constantia, S.A. Cultural History Museum (Cape Town, 1972), p.27.
12. For instance C. de Bosdari, Cape Dutch Houses and Farms (Cape Town, 1953), p.23.
13. Cape Archives, N/1/983.
14. Title Deeds: Stellenbosch and Drakenstein Districts, I, n.d. p.44.
15. "1 staende plaet [en] 1 leggende do" (III, 37, 1713).
16. Walton, *op. cit.* p.34.
17. See above, p.37, n.30.
18. Walther Bernt, The Netherlandish Painters of the Seventeenth Century, 3 vols. (London, 1970), II, Pl.550 & III, Pl. 1 116.

The Interior

Interior decoration in the seventeenth century was motivated by a growing concern for privacy and comfort and an increasing appreciation of a unified decorative scheme. The importance of the new concern for personal privacy which permeated the upper echelons of European society would be hard to exaggerate. It produced a demand for larger houses with more rooms to enable each member of the family to live in part on his own.¹ A natural corollary to the demand for more rooms was the demand for specialised rooms, for without particular rooms in which to sleep and eat and defecate privacy becomes largely a chimera. Specialised rooms in turn demanded specialised furniture. Such rooms, furnished to accommodate one particular activity, were required by court and aristocratic taste to present a spacious appearance, no matter how luxurious they might otherwise be. In the second half of the seventeenth century the fashionable ideal, which had been nurtured in France before spreading throughout Europe, was a specialised room, designed for privacy and furnished with uncluttered unity.

Holland was as responsive to this new ideal as any country, but her response came in two different ways. The Court at the Hague, eager to identify itself completely with international fashion, took its lead from the French Court; the equally, if not more influential, regent class in Amsterdam modified the new ideal to suit its own more sober tastes. The luxurious architectural framework, so much a part of the new scheme of things in court circles, played a relatively minor role in the more modest houses of the Dutch regents, but the new emphasis on intimacy and privacy was exactly suited to their taste and, on the evidence of the art of the period, uncluttered space was something they understood and exploited to perfection.

There was one other aspect of the fashionable room which met with ready acceptance in both regent and court circles in Holland, and this was the unity provided by matching upholstery and a cohesive scheme of decoration—a unity which had become a convention of French aristocratic taste by about 1625.² One does not have to

have a large house with a number of specialised rooms to enjoy the harmony provided by matching upholstery, and by the 1680's the Hague inventories show that this was one aspect of the new dispensation which had filtered down to the lower middle-class home. The home of the prosperous Hague artisan in the late seventeenth century was a meeting place of the old and the new. His house was small, and in the mediaeval tradition he still might conduct his trade under his own roof with inevitable further curtailment of living space; but though it was impossible for him to indulge in specialised rooms and uncluttered space, it did not prevent him from furnishing his multi-purpose rooms en suite.

It was not until I made a study of the Hague inventories that I realised what a strange impression the Cape inventories make. In spite of large areas of similarity, something is lacking. Rather surprisingly it is not the possessions themselves that are missing—many Cape households were adequately though not munificently supplied with the goods of this world—but a fashioned taste. In many important areas the interior at the Cape in 1700 was something like fifty years out of date. The inventories present a picture of a domestic world cut off from its cultural roots and insufficiently cultivated on its own account to convey a sense of style. I do not mean to imply by this that the Cape was immune to fashion or to change, but fashion and a fashioned taste are not the same thing.

By 1700 it is perfectly possible to speak of a fashionable Cape interior, but it is an interior that is fashionable by the standards of the Cape alone. To account satisfactorily for the peculiar nature of the early, prosperous Cape interior is not easy. Two factors are of primary importance: the geographical position and the nature of the Cape community. As a result of Dr. G. C. de Wet's recently published book, entitled Die Vryliede en Vryswartes in die Kaapse Nedersetting 1657-1707, we know that by far the greatest number of early settlers came from the very lowest ranks of the Dutch East India Company, and that senior Company officials together with army and navy officers accounted for less than ten per cent of the Company men to receive their burgher papers up to 1707.³ Even if we allow for the influence

of the senior officials and their wives, an influence which in the first half century or so must have been paramount, there were simply not enough cultivated people, more especially cultivated women, to set their stamp on the development of the Cape interior. Another important factor, particularly when taken in conjunction with the lowly origin of most of the Cape community, is the point in time at which the Cape was settled. It is possible, even likely, that most of the people who came to the Cape before 1700 came from a stratum of society that had little knowledge and even less understanding of the changes that were taking place in the upper levels of that society. If this was indeed the case it would go a long way to explaining why the Cape house shortly after 1700 seems to have much in common with a comfortable European establishment of the first half of the seventeenth century.

The finest rooms on record at the Cape at the end of our period were still designed to serve a number of different purposes and, as a result, were normally fairly full of furniture. In addition they were seldom if ever conceived as a unity. The Cape interior, in other words, was at best petit bourgeois in spirit; and as it was in many ways the creation of a class of small farmer and minor tradesman, this is hardly cause for wonder: the fashionable world was quite beyond its ken. The Cape interior, however, was not straightforwardly old fashioned. It was also a vivid reflection of the settlement's privileged position on the trade route to the East, and even quite modest establishments had their share of Chinese porcelain, Japanese lacquer and Indian textiles—articles which in Europe were the fashionable playthings of the privileged few.

One final factor that needs to be taken into consideration is the isolation of the Cape community, an isolation that was given added importance when the Company abandoned its policy of immigration in 1707. The Cape was far too small to generate an intellectual and cultural life of its own, and some form of stagnation was inevitable. As I see it, the needs and attitudes that had so profoundly changed the domestic world of Europe in the seventeenth century were of little moment, not only to the

seventeenth-century Cape, but to the eighteenth-century Cape as well. Throughout the Dutch East India Company period the Cape—or at least that section of it that was in reach of Cape Town—was quite quick to reflect European fashion, but however superficially fashionable and however large the Cape house might become in the eighteenth century, it was a house inhabited by a family that had little real need for specialised rooms and a very mild interest in personal privacy: by a family with money but little sophistication.

The Interior of the 1670's

In the Introduction I drew attention to the fact that the documents we have from the 1670's give the impression that the Cape interior had not yet had time to develop a character of its own.⁴ It therefore seems advisable to use the material from that decade, particularly the inventories of Rustenburgh, the Company house at Rondebosch, to set the stage.

Rustenburgh, according to Admiral de Monde Verge, who visited it in 1666, "was very sumptuously furnished,"⁵ but unless radical changes for the worse had taken place there between 1666 and 1673, when the first inventory was compiled, either the French admiral was guilty of gross exaggeration or the majority of Cape interiors were so primitive that Rustenburgh's seemed sumptuous by contrast. The furnishings of Rustenburgh as recorded in the inventory of 1673 (23/5,29) and 1677 (23/5,42) were modest, and the atmosphere so casual that seed and tools were present in some of the rooms. The voorhuis, which apparently served as the dining room, was furnished very simply with a table and two forms and cluttered up with two old axes, six old fire-buckets, three worn spades, three spades that were completely worn out, a watering can, a jack-screw, two shovels, and a good winnowing fan. Two brass candle sconces on the wall provided the only touch of quality: the room in all other respects could have attracted the brush of an Adriaen Brouwer. There can be no doubt either that this was the normal state of the voorhuis because four years later the only changes were of the kind wrought by time. Instead of two axes there was only a single old axe without a handle. Both shovels and one of the fire-buckets had disappeared, as well as three of

the spades—not surprisingly, since they had been worn out at the time of the first inventory. The other downstairs room, the "Zijdcamertje", was furnished in both inventories with a four-poster without hangings, "Ledekant Sonder behangsel", an unadjustable table, "vaste taeffel⁶", two turned chairs, and a stool, "schābel". This room, which was obviously only used as a bedroom, also held, at the time of the first inventory, a variety of seed.

The most important room at Rustenburgh was "d'Groote bovencamer" which contained a set of four brass wall sconces, a large table with a cover, a smaller table, and a round tea-table. In addition there were six turned chairs with five red feather cushions, a large chamber pot, a brass hand-basin with its wall fountain, four cloak-stands, two gun-racks, a backgammon board, a goose board,⁷ an ebony mirror, and ten frames or "raemen" for the windows. In the first inventory only, the window frames are described as being with and without thin cloth, or "Sonder of met ondeugend doek." This is an odd way to describe curtains, and perhaps the cloth in question was a substitute for window glass. There is no doubt that this was a presentable room. Furthermore, unlike nearly every other principal reception room inventoried at the Cape before 1715, it did not contain a bed, and this alone must have given it a touch of unusual distinction, but to describe it as "sumptuous" is quite absurd. The main bedroom, where a series of commanders, governors, commissioners and distinguished guests slept, seems to have been situated behind the living room, for it is described as "eene cleijn camertje daeragter." In 1673 this room held a four-poster which was without hangings, two blankets, one with needlepoint lace,⁸ a small table, two old window frames, a cloak-stand and two wooden candlesticks with brass stems or "pijpen." Also present were two mustard pots and two salts of pewter and a tall drinking glass known as a flute. Finally there were nine coarse saucer dishes, two smaller ones, and two ordinary dishes. Some or all of these may have been examples of the coarse, heavy porcelain made in the South of China which is characterised by an unglazed biscuit ring round the centre. Four years later the room had become rather starker with the disappearance of the glass, porcelain

and blankets. The third upstairs room or "'t Ander cleijn camertje" was also a bedroom but an inferior one. It held a "blok Ledicant," which was probably a rough frame intended for, but not provided with, a full set of curtains, as well as a small table, two planks—which according to the second inventory were fixed to the wall—and, in the first inventory only, three red caps with silver braid and a pewter chamber pot. Kitchen utensils which, as we have already seen,⁹ appear under the heading "Noch op diverse plaetsen," were not extensive and are hardly worth recording, apart from a wine cooler, described as "1 coelbackje om fleschen in tersetten," which was damaged in 1673 and had understandably disappeared by 1677: even forty years later a wine cooler was a rarity.

Though the inventories leave one in no doubt that Rustenburgh was a modest pleasure house—modest in its size and modest in its furnishing—there is also no doubt that it had few rivals in the 1660's and 1670's. I can offer no inventory of a burgher house, compiled room by room, to set beside Rustenburgh, but we do have the inventory of the estate of Hendrick van Zuijwaerden who died in 1672 (23/5,21). If any burgher may be said to have prospered during the first difficult half century of settlement that burgher is van Zuijwaerden. Some idea of his multifarious activities can be gleaned from the literature of this period¹⁰ and at his death, as we saw earlier,¹¹ he was worth an impressive 22 000 guilders.

Van Zuijwaerden kept an inn, but as far as I can see the inventory only reflects his personal possessions. Listed under "Huijsmeubels" are two chests, a large wooden cupboard, two tables, six chairs with cushions, a Turkey carpet, and seven paintings. Elsewhere we find some bedding—but no beds, twenty cellarets with empty flasks, four wooden forms, a stool or "sitte banckje" and a backgammon board. The value of this modest array of furniture was 244 guilders, half of which was accounted for by the bedding and the cellarets. I cannot help wondering whether Van Zuijwaerden lived in this fashion from choice or necessity. There is no doubt that he had the money to live much more grandly, for at his death he had the almost incredible sum of 13 000 guilders

in ready cash, but there is considerable doubt as to how easy it was to get hold of decent furniture, and Van Zuijrwæerden appears to have managed better in this respect than most. It is worth emphasising that a particular difficulty at this time seems to have been the bedstead. Van Zuijrwæerden had two feather beds but no bedsteads, and most of his fellow burghers were in the same position¹² and had to content themselves with a "mattress," "veere bedt," or "bultsack." They also had to content themselves with even less furniture. The estate of Jan Israelsz, with a value of 3 791 guilders, is probably a reflection of how the reasonably successful burgher lived in 1670. His furniture comprised a large mirror, five empty cellarets, two feather mattresses, six poor wooden chairs with six cushions of varying quality, a poor black wooden cupboard, two poor tables and three forms (23/5,3).

Other household effects seem to have been easier to obtain than actual furniture. Van Zuijrwæerden had an adequate supply of kitchenware which included a half-~~an~~¹³ copper¹⁴ kettle valued at 30 guilders. He also had a certain amount of pewter, including seven dishes and thirty table plates, and some earthenware dominated by thirty Delft dishes of various sizes. In addition he had a little silver and table linen. Some of the other houses show an equally if not more interesting assortment of this nature. Israelsz had a little silver, a normal array of kitchenware and a variety of pewter tableware—dishes, plates, spoons etc., but instead of Delftware he had nineteen pieces of fine porcelain. In this he was a little unusual, for though porcelain—it is nearly always described as fine at this period—appears in a number of estates, and one such had forty-one assorted pieces including tea-cups and saucers (23/5,17,1672), I am struck by the amount of Delftware in circulation. I am by no means confident that it actually outnumbered porcelain from China and Japan, but I am confident that it was more in evidence at this early period than it was ever to be later. The small estate of Joannes Pretorius in 1679 had six porcelain saucer dishes and a pair of porcelain bowls but it also had five Delft plates, three Delft dishes and four "schulp schaalén," which was the contemporary name for the lovely fluted dishes in pure white Delftware (23/5,47). Albert van Breugel, a merchant in the service

of the Company, who left a very lavish estate full of books, fine silver and expensive jewelry, possessed very few ceramics: his three fine dishes were probably porcelain, then he had five Delft bowls, two Delft dishes and two wine jugs of German stoneware (23/5,35,1675),

Interesting items from the estates of the 1670's will be discussed in detail in later chapters, but I do want to draw attention at this point to the hangings and soft furnishings in use. There were not many, but when present most of them could have come straight out of a home in Holland. A number are found in the inventory of Albert van Breugel. He had a four-poster with blue curtains and three additional sets of bed hangings, one red, one yellow and one purple, made from light woollen materials related to serge, and, in the case of the purple hangings, fringed with silk in accordance with current fashion. Hestertje Coesemans had only one set of hangings fitted with brass rings and made out of a woollen cloth called "Mersaeije." She also had a matching chimney valance with a poor fringe and a pair of matching window valances (23/5,1,1674).

Woollen hangings, Delft ceramics, a small double-storeyed house—these are what the inventories of the 1670's have to offer when they are not recording existence at a subsistence level. It is certainly true that one is reminded from time to time that the Cape was in a privileged position on the trade routes to the East, but one is made much more aware of its relationship with Holland. As yet there is little sign that the Company officials and burghers had adjusted to the different opportunities and changed conditions that prevailed at the Cape, but they were certainly to do so during the next decade.

The Interior 1680 - 1714

Though the Cape house between 1680 and 1714 was not a monolithic structure but one subject to change and development, the organisation and furnishing of its interior had enough of the same essential nature to allow discussion of it in general terms, and this will be our concern for the remainder of the chapter.

The Front of the House: The Voorkamer as Living Room

In most houses at this period it was customary for one of the rooms flanking the voorhuis to combine the roles of common living room and principal reception room,¹⁵ and this was naturally furnished as handsomely as the family means allowed. The most prominent piece of furniture in a room of this sort was the bed. The presence of a bed in such a room was not an innovation. There was a long tradition behind it, and one to which several famous paintings, such as Jan van Eyck's "The Arnolfini Wedding," bear witness, but by 1680 the growing appreciation of the specialised room had certainly made it a thoroughly old-fashioned arrangement in European society. It was, however, a normal arrangement in the house of the ordinary Hollander¹⁶ throughout the seventeenth century and beyond. Where life, in Cape terms, was lived at its most elegant, the preferred bed for such a room was a curtained four-poster. This would have stood in one of the corners: a centrally placed bed was only suited to a specialised bedroom where the floor space was not required for other activities; it was thus an aristocratic convention. In slightly less fashionable Cape circles a second bed was often present, and most people seemed unconcerned if one or both beds were the humble, open katel rather than the curtained four-poster, while the ordinary middle-class Hollander would not have tolerated a second bed—particularly a simple, uncurtained second bed—even in the multi-purpose family living room, let alone in a room where guests were received as well.

After one or more beds disposed in the corners of the room, the voorkamer required a large table, which fashion decreed should be draped, outside mealtimes, with some sort of cover such as a Turkey carpet, and at least half-a-dozen chairs, which were fitted, family means permitting, with matching seat cushions. When not in use both the table and the chairs were probably ranged against the walls to keep the centre of the room clear. Among the other tables present there was nearly always a tea-table catering for the new passion for tea-drinking which, by 1700, nearly everyone at the Cape was able to indulge. To this nucleus some storage furniture

was normally added. Cupboards and cabinets were thoroughly acceptable, but by the beginning of the eighteenth century a slight prejudice against the chest is already detectable.¹⁷ In the leading houses the walls of the main living room were generously decorated with paintings and at least one fair-sized mirror. In a few instances the number of mirrors and paintings coincides with the number of chairs, which would then have stood directly below them.¹⁸ In all but the smartest houses it was customary to combine racks of porcelain with paintings and mirrors, which must have been extremely effective. Naturally the more fashionable room also had its share of Chinese porcelain but this was ranged on top of the cupboard, set out on the tea-table and massed on the mantelpiece; wall-racks were avoided. Other items which seem to have been acceptable in the main room were the rustbank, the folding screen, the writing box, the wall sconce and the guéridon, which in the early years was known as a "knaap."¹⁹ The gun-rack and cloak-stand also found a place there though, by 1715, they were beginning to gravitate to the back of the house in "elegant" circles. Finally there was the Bible, which could be a brass-bound edition of the official "Staten Bijbel" first produced in 1637 to the order of the synod of Dordrecht.

The principal room in Lieutenant Olof Bergh's quarters at the Castle is a nice example of a multi-purpose living room with a Cape quality. It was recorded in 1687 when his possessions were confiscated by the State and he himself exiled to Robben Island—condign punishment for helping himself to some of the treasures from the Portuguese wreck Nostra Signora de los Milagros while he was supervising salvage operations. His room was furnished with an open bed or katel with a blue cover, seven chairs, a brass-bound chest, a cupboard crowned with porcelain, an ebony table draped with an old Turkey carpet, and a small tea-table, also with its Turkey carpet. Round this nucleus clustered a miniature cabinet, a cellaret, an ebony birdcage, "reijslaetjes,"²⁰ Indian baskets,²¹ painted trays, a tin with tobacco quids, ten bottles and some porcelain and glass. The walls were fitted with two heavily laden gun-racks,²² a rack of porcelain tea-ware, a

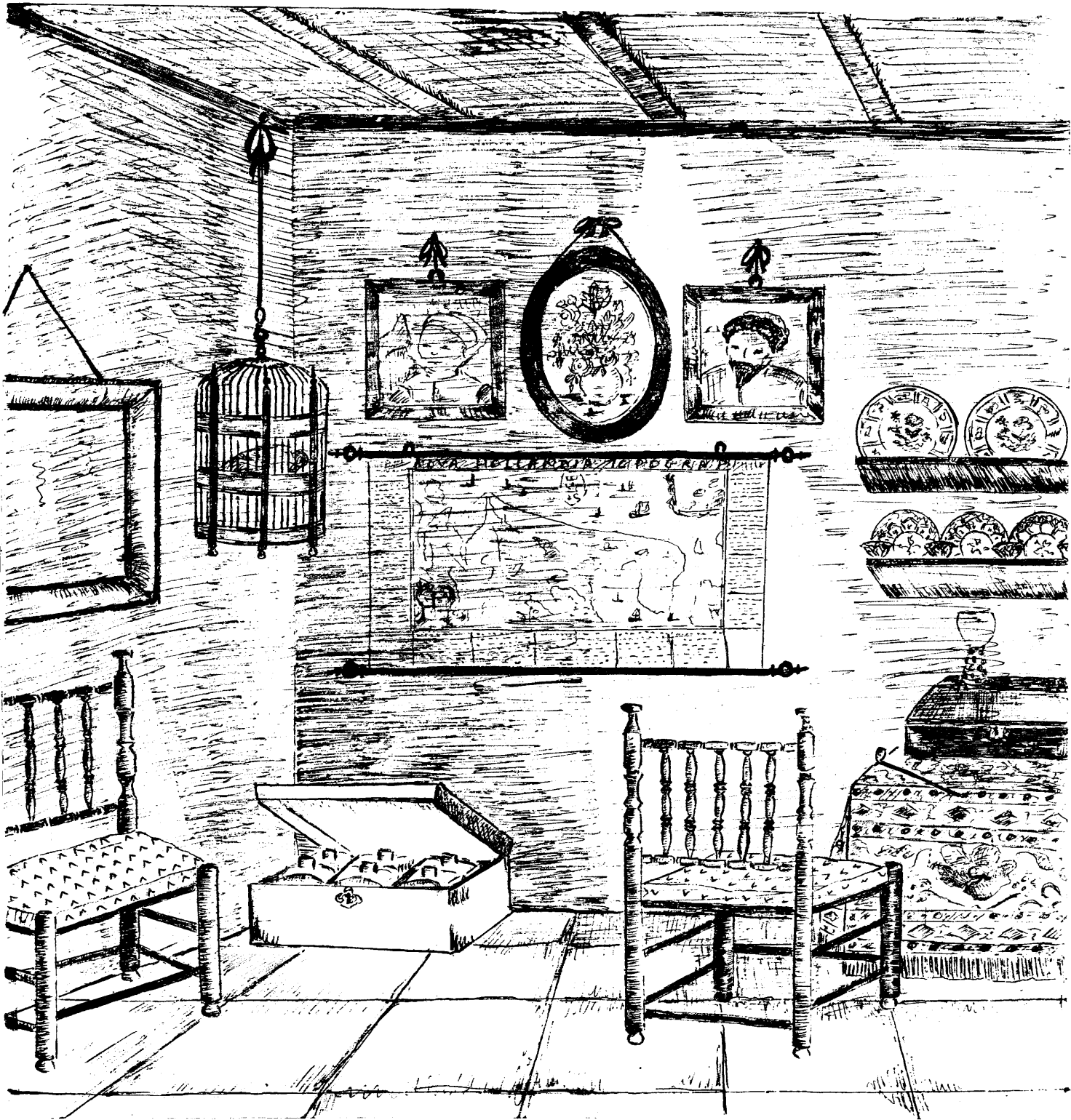

(18) Imaginary Cape Interior, c. 1690

small gilt mirror, a portrait, and four water-colour paintings.²³ It was, as far as I can judge, a pleasant room with an air of casual comfort and rather more furniture than the Dutch masters have conditioned us to expect. To me it is a room which captures the essence of the domestic interior at the Cape during the period of the Dutch East India Company, and it is particularly regrettable that we have no pictorial records of any kind to help us in the act of imaginative recreation. The Dutch paintings that seem to come closest to the sort of picture I have in my own mind are those depicting the study of a doctor or even alchemist. Such rooms tend to have the rather crowded and casual atmosphere I associate with so many Cape rooms, as well as furniture of solid quality. Plate 18, which I have adapted from "The Doctor's Diagnosis" by Joos van Craesbeeck,²⁴ is an attempt to recreate a room of this type.

The Second Voorkamer as Another Living Room

In most of the important houses with various middle and back rooms, as well as in a handful of smaller houses, the second voorkamer was furnished in much the same way as the first, with a bed or beds, one or more tables, and a set of chairs. When an arrangement like this is found the chances are that one room served as the family living room and the other as a type of parlour, only used on special occasions. It is usually possible, when two such rooms occur, to decide which is which. The living room is sometimes obvious, proclaimed by the paraphernalia of daily life, as well as by the presence of chests and wall-racks and slightly inferior furniture. At other times the two rooms are virtually indistinguishable, but there is usually some clue, even if it is only the presence or absence of a Bible, to help one make the choice. The two voorkamers in the Sneewindt house at Rondebosch represent the acme of Cape fashion in 1701. The first room was furnished with a stinkwood four-poster curtained in muslin, a Japanese cabinet on a stinkwood stand, an oval table with a chintz cover, a "beugel" chair,²⁵ and six turned walnut chairs with red plush seat cushions, which may well have stood beneath the gilt mirror and the five large paintings. Also in the room were a gun-rack,

a cloak-stand, a glass birdcage, a brass-bound Bible, a tea-table set out with porcelain, and a poor quality chest containing eleven rolls of tobacco. The fire-place completed the picture with its brass fire-irons, lace-trimmed valance and mantelpiece filled with porcelain. The second voorkamer held a mouth-watering array of fine quality stinkwood furniture²⁶—a turned four-poster, a large wardrobe crowned with a garniture of five vases, a square table, a set of six chairs, a single chair and a rustbank. A cloak-stand, an ebony chair and a "beugel" chair made up the remaining furniture. On the walls were eight paintings and a large black-framed mirror, which again suggests that the formal combination of chair and picture was followed in the arrangement of the room (I,69,1701). Very few houses actually show this degree of formality before 1715 and, from a distance of nearly three centuries, it is not all that easy to decide which room originally had precedence. The first room undoubtedly conjures up the more attractive and comfortable picture, but the presence of the Bible,²⁷ the tin of tobacco and the fire-place point to its having been the family room. The furniture in the second room is handsome and includes the most valuable piece in the house, the great stinkwood wardrobe, but its starkness is disconcerting and can only have been due to the fact that the bed-hangings, cushions and table covers were packed away when the room was not in use. Three chintz table covers and seven chintz cushions were among the contents of the great wardrobe, so it was probably a room of chintz and stinkwood.

In 1713 one room in the house of Catharina Cruse and husband Undermerchant Corssenaer followed the Sneewindt pattern, while the other marked another step forward in sophistication. The room, which held no bed, had eight paintings and a mirror on the walls, and nine chairs, eight of them with cushions, standing beneath them. Three small tea-tables and a Turkey carpet, which may actually have lain in the middle of the room, made up the rest of the basic furniture. The porcelain present probably stood on one table, the nappy tray, a rather treasured item,²⁸ on another, and the brass kettle and brazier, the hand bell (for summoning a slave) and the table mirror on the third. This was undoubtedly a formal reception room which

can only have been intended for all-feminine tea-parties, but I do find myself wondering whether it was actually an attractive interior. If this arrangement was carried out in a room with small casement windows, a tiled or earth floor and white-washed walls with minor pieces of furniture that were no more than pleasantly solid, it could easily have looked inadequate. During the second quarter of the eighteenth century the formal reception room, first encountered at Rustenburgh in 1673,²⁹ became an established feature of the double-storeyed town house, but then it was more than a tea-room and included cupboards and cabinets.

The Second Voorkamer as Bedroom

To think of a voorkamer as a bedroom may be unhistorical but it is difficult to know what other term to apply to those front rooms where one finds a bed but little or no seating accommodation. In a number of houses, big and small, the second room is a rather curious hybrid: both more than a bedroom and less. In the De Beer house, for instance, this room housed a chintz-curtained four-poster, a black wardrobe, two carpet-covered chests, and a square table which probably combined with the large black-framed wall mirror to form a dressing-table. The bedroom atmosphere conveyed so far was, however, challenged by five assorted wall-racks and two tea-racks where a little pewter rubbed shoulders with a great deal of porcelain (1,63,1701). The complete dearth of chairs may be misleading, as we shall see in a moment, but is an oft-repeated feature of similar rooms for all that. To take another example, the small front room in the Van Reede house was furnished with an open bed with a poor quality counterpane, three chests, three Tonkinese baskets, three lacquer clothes trays, two small black mirrors, seven small paintings, and four racks containing over sixty items of porcelain. Once again there were no chairs, and this time there was no table either (1,74,1703). Neither of these rooms would have made a particularly comfortable bedroom. Nothing about them suggests a private retreat, the sort of room where one could retire to read, to write, or to entertain one's intimate friends. By aristocratic standards they were impossible, and by bourgeois

standards strikingly inadequate; for these were both uncomfortable and impersonal rooms. The heavy emphasis on racks of porcelain, though not without parallel, is a little unusual, but some porcelain, even if only a rack of tea-ware, was a normal feature of these rather unsatisfactory rooms.

Five rooms in these years were listed as bedrooms (slaapkamers³⁰) in the inventories as I know them, and though only two of them were front rooms they are all examples of the type of room we are discussing. The bedroom in the Zeestraat house of a shoemaker, Barent Cornelisz Backer, with a bed (kooi), a cupboard, a small mirror, an iron, a candlestick, and a few pieces of porcelain was the simplest and the earliest (23/5, 50,1681). The bedroom in the house of Albert Gildenhuijs, with two curtained yellowwood beds, a small cupboard, a cloak-stand, two chests, a small octagonal table of yellowwood, and various odds and ends including books, a garniture of vases, and a pewter bottle and basin, was the most impressive; but even it was without chairs and a mirror (II,61,1712). Over sixty small items of porcelain displayed on a kapstok³¹ and two racks, together with two beds, a chest and two chairs, made up the principal furniture in the bedroom of Elisabet Loenss (II,37,1709). In this instance it is the table that was missing, while the only mirror available was in the chest. The same pattern is repeated in the other two bedrooms: two chairs are found in the widow's bedroom in the Sneewindt house, but the room was without either a mirror or a table (I,69,1701); while the bedroom in the Van Stralen/Van Doorninck house was yet another to have no chairs (I,62,1701). In short, the most obvious combination and one well established in Europe, that of chairs, table and mirror, is very hard to find in any room that has the appearance of simply being a bedroom. The precedent set by Rustenburgh, where none of the rooms with beds offered much in the way of comfort (23/5,29,1673), was still being followed in the early eighteenth century. This is peculiar, and though it is the first real peculiarity we have struck, it is not going to be the last, so perhaps we should turn aside to look at the nature of the evidence.

How reliable are the inventories? To what extent can we

trust the picture they present of particular rooms ? Was the house, when recorded, in its normal condition ? Apart from one small reservation, my own opinion is that the inventories are thoroughly reliable and that the rooms they reflect are shown as they were in everyday life. My most important reason for this opinion is that the picture presented is a coherent one: patterns, and they are often very minor patterns like the position of a candlestick, endlessly repeat themselves. It also seems significant that the contents of chest and cupboard and cabinet were still in position when the inventories were compiled. The internal evidence is confirmed by outside factors. If the Masters of the Orphan Chambers were responsible for an estate, it was their duty to make an inventory of it as soon as possible, and this was usually done within a week of death. The auction which so often followed came a good deal later. A period of at least six weeks normally elapsed between the compilation of the inventory and that of the *vendu* roll, and in some instances the lapse is three, nine or even sixteen months. It is in the highest degree unlikely that the vagaries of the auctioneer had any effect on the contents of a room. The funeral is, however, another matter. To accommodate all the visitors who arrived to pay their condolences on the day of the funeral, some rearrangement of the chairs in the house would be perfectly natural, and it is possible to imagine circumstances in which the house might then remain undisturbed until the commissioners arrived to compile the inventory.³²

The funeral, then, may be a reason why some bedrooms are recorded without chairs. It is a solution, though, that can only be plausibly offered when one room in a house has an unusual concentration of chairs and the remaining rooms are completely denuded. It seems a likely explanation in the case of the De Beer room where every chair in the house—six eucalyptus chairs, a matching rustbank, an ebony armchair, nineteen poor quality chairs and two poor armchairs are located in one *voorkamer*. It is a less likely explanation for the Van Reede room because chairs are found in two places: three black ebony church chairs, six eucalyptus chairs and eight black ebony chairs in the lefthand *voorkamer*, and an ironwood rustbank and six ebony chairs with eight striped cushions in the gallery. Where Rustenburgh

is concerned, as well as those estates with named bedrooms, there is nothing to justify the funeral explanation, and we must accept that many quite important bedrooms were furnished with startling inadequacy.

A number of incidental items that we normally associate with the bedroom: basins, ewers, shaving bowls, chamber pots etc., are located elsewhere, for it was only in the nineteenth century that these found a permanent home there. The custom of removing these articles when not in use could lead to the finest bedrooms escaping recognition, but this would presuppose that a bedroom could have the appearance of a living cum reception room, and this I doubt. The slightly later bedrooms, on the top floor of the double-storeyed town house, are not impressive.

In a couple of houses, one of the back rooms as well as both voorkamers is furnished as an all-purpose room. Christina de Beer and husband, Secretary Helot, had three rooms, all furnished with paintings, mirrors, tables, a set of chairs and a four-poster (II,41,1710), while the Corssenaer house had a back room which may have been a most superior bedroom. The furniture consisted of a curtained bed, a daybed, seven chairs, three tables, two screens, a footstool, five racks of porcelain and eleven paintings, while the next room, a small back room with books, chairs, table and mirrors as well as paintings and porcelain, may have served as a closet.

Rooms crowded with beds but offering few other amenities turn up fairly regularly, particularly but not exclusively in the smaller houses. The large voorkamer in Elisabet Loenss' five-roomed town house held three stretcher beds (katels), two forms, four chairs with sealskin cushions, a rack of pewter, and a gilt mirror with a gauze curtain (II,37,1709). In another three-roomed town house one front room was furnished with three stretchers, two tables, two forms, four chairs and "vier theen borretjes"³³ (II,120,1714); while in a third town house with nothing but a living-room kitchen and a small voorkamer, the latter contained four stretchers, a cupboard, an oval table, racks of porcelain, a mirror and three paintings (II,70,1713). Looking back over the centuries one feels sympathetic towards this degree of crowding, but in most instances

one's sympathy is probably wasted: in so many houses the space available was not fully exploited.

We have learnt in recent years that serious overcrowding may be biologically disadvantageous, but the need for privacy within the family circle is a need acquired at a fairly advanced level of civilization. In Europe, as we have seen, it was largely acquired during the course of the seventeenth century, but the lower levels of society remained unaffected. This was not merely due to poverty: house after house demonstrates that privacy was not a primary concern of the majority of the Cape community. An illustration of this, admittedly in rather an extreme form, lies in the arrangement of a small house in Table Valley owned by Anna Maria Dominious (II,69,1713). The house consisted of two living rooms and a well-equipped kitchen. One living room, the small voorkamer, held but a handful of furniture: two chests, five chairs, four racks of porcelain, some baskets and a pair of candlesticks. As a room this adds up to nothing. It is neither a formal reception room nor, given the absence of bed and table, can it be classed as a reception cum living room. It has every appearance of having been a white elephant. Nothing could be more different than the other room. There a spoon-rack, eight racks of porcelain and pewter, five small mirrors, a dozen small prints and a pair of carved wooden sconces fought for the available wall space. In the room at large, a long table and two forms catered for meals, no fewer than six beds catered for the family's needs at night, while eight chairs, eight tea-trays and a small tea-table took care of the rest of the day. A chest with a little porcelain and a pile of end-planks completed the furnishing of this versatile, overcrowded room. That the overcrowding was in part a matter of choice is shown by the near-empty voorkamer: in this instance two rooms were one too many.

The Voorhuis

It is generally accepted that the voorhuis in less fashionable circles in Holland served as the family common room and normally held a bed.³⁴ This was not, however, the case at the Hague, where in the last decades of the seventeenth century the voorhuis always seems to

have the appearance of a small entrance hall. The voorhuis in the town house at the Cape was also in most instances simply an entrance hall—a rather small entrance hall, to judge from its contents, for it seldom held much furniture. An orderly voorhuis either contained a few pictures—large maps seem to have been particularly favoured—or racks of porcelain, or even a combination of the two. If porcelain was not available copper and pewter might be substituted, but a display of metalware was obviously less favoured. Some seating accommodation, such as three or four chairs or a bench or two, was quite common, while a birdcage, a lantern and a table were also suitable items.

The Sneewindt voorhuis, for example, held six framed maps, two chairs, a birdcage, and a footstool (I,69,1701); that of Abraham Diemer, three big maps, three small paintings, four cushioned chairs, and a birdcage (III,31,1713); and that of the Van Reedes three racks of porcelain and a chest (I,74,1703). These vestibules all presage interiors of above average quality, and the same is naturally true of the rare voorhuis furnished like a small reception room, such as that of Albert Gildenhuijs, with its nine paintings, mirror, two rustbanken and two tea-tables (II,61,1712), or that of the fashionable Corssenaers, with its wall sconce, gilt mirror, two tables, six chairs, and porcelain beakers (III,37,1713).

A near-empty voorhuis, containing one or two suitable items only, was a not uncommon feature of the town house. Thus in one voorhuis we find only a wooden lantern (II,4,1705), in another three prints (II,28,1709), and in a third a table and lantern (II,115,1714). Such entrance passages—they are unlikely to have been much more than that—promise a reasonably orderly if limited interior. Out of the way objects like the three planks in the voorhuis of the Chinese, Abraham de Vijften, sound a warning note; one of his voorkamers, in addition to the more normal items, housed a loose door and eighteen planks, the other thirteen planks (II,66,1712). This sort of incongruity took other forms, and the entrance to Willem Basson's quite substantial town house was furnished in the said manner of Holland, with porcelain, pewter, and copper, a bed, a footstool, and a tea-table, which left one voorkamer with nothing

but a rack and a tea-table (II,77,1713). We have already discussed the voorhuis in the role of kitchen³⁵, and it also served at times as a workshop or place to receive clientele: the voorhuis in the Zeestraat house of Shoemaker Backer held nothing but models of feet—"110 Leesten 500 bequaam als onbequaam" (23/5,50,1681).

On the whole the country voorhuis, though presumably more spacious, tended to follow the pattern of near emptiness set in the town. Understandably pewter and copper were more decoratively acceptable in the country milieu, and I suppose it is understandable that the stables or worse had a much greater tendency to intrude. We find, therefore, three small paintings, a saddle and a pair of holsters in one voorhuis (II,63,1712) and, in another, a table, birdcage, two small paintings, saw, curry comb, saddle and bridle (II,76,1713). Less understandably we also find, in the large voorhuis of Abraham Diemer's farmhouse, sacks filled with corn to the tune of seven hectolitres, empty sacks, ends of plank, and cleaning and painting brushes as well as racks of porcelain and glass, Chinese paintings, a table, a footstool and three chairs (III,30,1713). The rest of the house harmonised perfectly!³⁶

The garden house of Joris van Stralen and Jacob van Doorninck had a most exceptional voorhuis. It was furnished as a reception room with twenty chairs, a small chintz-covered oval table, three birdcages, and twelve prints (I,62,1701). This is the only voorhuis I have found before 1715 that has the appearance of a drawing room. In the second quarter of the eighteenth century one begins to find the country voorhuis taking the place of one of the voorkamers as the family living room, but when this change took place it was a living room that was most often without a bed.

The Back of the House

The average back room, whether known as the "achterkamer," "kinderkamer," "grote kamer," "wijnkamer," "grote kombuijs," or "slaapkamer," included additional sleeping accommodation. A few back rooms offered the amenities of multi-purpose living rooms, others exhibit the various degrees of lesser sophistication touched on in connection with the second voorkamer, and yet others

appear still more basic. The back of the Helot house had an unusually fully furnished "groote Kamer," with a fire-place, a four-poster, a table, nine chairs, three chests, six paintings, two curtained gilt mirrors, and various other oddments—a room only a shade less handsome than the two voorkamers. A second room, "eene klijne agter kamertje," was of an entirely different order, with stretcher, a child's bed, two cloak-stands and a gun-rack; while the third room, "'t andere klijne Kamertje," was simply a mess, with a heap of lime, some beer bottles, a porcelain butter pot, two earthenware pots and a pot for fish oil (II,43, 1710). Three rather different rooms are found at the back of the Sneewindt house: an adequate "kinder kamertjen" furnished with a curtained bed, three chairs, two chests, a chintz-covered table, a small mirror, two prints and two racks filled with porcelain tea-ware; the not dissimilar "slaap kamertjen van de Weduwe" with a four-poster, cot, two chairs, chest, small cupboard, smoothing iron, abacus or "cijfer leij," books, two little paintings, and rack of tea-ware; and the disconcerting "Wijn kamertjen," an unfortunate combination of bedroom, pantry and cellar where a bed, two chairs, a small table and three racks of porcelain were juxtaposed to two large cellarets with ten and fifteen flasks respectively, an iron meat hook, a vat of tea sugar, a basket or "kanasser"³⁷ of powdered brown sugar, two sets of scales, twenty-one empty bottles and two old fish-vats (I,69,1701).

In the De Beer house the only back room that is not simply a storeroom is the so-called "groote kombuijs." A similar room occurs in two other inventories but as far as I can judge no cooking was done in any of them; they appear to have been related in a rather superficial way to the functional kitchen always present as well. In Holland two kitchens were quite common³⁸ but there the main kitchen, though fully equipped and functional, was left in undisturbed glory as a show piece, and all serious cooking was done in a back kitchen or "snuiver." Even with this provision, however, many Dutch housewives found the whole process of cooking distressingly dirty and smelly and were inclined to limit it to an activity that took place once a week or even less often.³⁹ The grote kombuis at the Cape must have

been an offshoot of the "show" kitchen in Holland, but rather fortunately it does not seem to have transplanted well. In the De Beer house this room was furnished as a conjoint bedroom-kitchen, with a curtained four-poster and a cloak-stand on the one hand and a food cupboard, stores of soap, over fifty pieces of porcelain and nearly two hundred pieces of pewter on the other. There were also, among other things, eight brass candlesticks and nine brass snuffers (I,63,1701). In the Van Stralen/Van Doorninck house the "grote kombuijs" had nothing whatsoever in common with a kitchen. Furnished with a bed, a table, two forms, nine prints, two old winnowing-fans and an expensive copper still, it was a room in which to sleep, eat or brew alcohol (I,62,1701). The third and last example was in the house of Sergeant Heijs. Despite a few kitchen items such as a cooking pan, a colander and a pestle and mortar, the Heijs room, with its eight chairs, two tables, two forms, a picture, a mirror, and racks of porcelain and pewter, was predominantly a living room (II,4,1705). After 1705 the grote kombuis virtually disappears from the Cape inventories—not a difficult feat, as only a change of name would have been needed.

The Gallery and Passage

The average passage and gallery are related to each other and to the kitchen quarters by all or some of their contents. Three of the larger houses had a passage, each of which held a stretcher and a mixture of toilet items and kitchenware. The Corssenaer passage contained a rack with thirty-five porcelain plates and dishes; kitchen items such as a chopping knife, a chopping board, two fish vats, a tartpan, a poffertjespan, a casserole, colander, flat-iron and brazier; and toilet items such as two water buckets, three chamber pots, a wash basin, and a ewer and basin (III, 37, 1713). With unimportant variations this pattern is repeated in the Basson passage (II,77,1713) and partially echoed in the less crowded De Beer passage with its chamber pot, two water buckets, water cask, small beer vat and two riding saddles (I,63,1701).

Of the six galleries to come down to us from this period, two are sparingly furnished and, apart from the absence of a bed, their

meagre contents are largely in accord with those of the passages. Only a glass lamp, a water cask and a small tub found a place in the Loenss gallery (II,37,1709), while that of Helena Besuijdenhout contained two racks, a washing-up tub, a small table, a footstool, two martavans, and a copper basin (III,53,1713). The contents of the Helot gallery were more numerous. Firstly there was the now familiar overflow from the kitchen represented by a tartpan, casserole, colander and poffertiespan on one hand, and by a basin, ewer and stand, bedpan and close-stool on the other. Also familiar were the racks of porcelain and glass. In addition there were empty bottles, cleaning brushes, garden tools, a pile of iron hoops,⁴⁰ and a drill. In short, it was the storage area for a number of different things. But the Helot gallery went one step further. With two chairs, a table, a linen press⁴¹ and two birdcages, it provided a small sitting-out area as well (II,43,1710). Did the contents of a gallery such as this conform perhaps to the area of the house on which it abutted, with a living area at the base of the l, a pantry-like storage area off the kitchen, and an all-purpose storage area in the other wing ?

The three remaining galleries, to judge from their furnishings, had already largely assumed the character of living areas. The gallery in the town house of Abraham Diemer contained two oval tables with their covers, a small square table, three chairs, a small mirror, three small paintings, and three racks of porcelain, pewter, copper and brass (III,31,1713). Were it not for the small number of chairs one would be tempted to regard this as an early dining room. The Sneewindt gallery was even more fully furnished, and in a way that has a good deal in common with the later gallery-dining room. It contained eight cushioned chairs, a rustbank cum daybed with a blanket, a single round table, five paintings with carved frames, eight prints and a small black mirror, as well as the customary racks, which in this instance supported porcelain, glass and pewter, but no copper or brass. There were also cleaning brushes, including two so-called hogs (I,69,1701). Of a similar order was the gallery in the Van Reede house. This had six ebony chairs and an ironwood rustbank with eight striped cushions, a large oval table with a chintz cover, an old table, a

gilt mirror, and nine small paintings together with racks of porcelain, earthenware, pewter and kitchen copper and brass (I,74,1703).

To forge a coherent pattern out of the Loenss gallery, the Sneewindt gallery and the gallery at Constantia is difficult. Were two completely different types of structure in question, one of them an arcaded gallery or stoep and the other an inner hall ? Or was there initially a relationship between the inner hall and open gallery ? It is tempting to argue in favour of some such relationship, particularly in view of the fact that, with the exception of Vergelegen, the gallery at this period only seems to appear in the peninsula. Certainly it is easy to see how the closing in of an open gallery situated on the inside of the L - or U-shaped house would produce an inner hall, but it is impossible to say whether this was the actual pattern of development, particularly as the whole matter is further complicated by the apparently related problem of the passage.

By about 1725 the gallery, which was still largely restricted to the town house,⁴² usually has the appearance of a definite dining room and one that must, in general, have been situated behind the voorhuis.⁴³ As a dining room it was furnished with one or two oval tables, various serving and tea-tables, and a set of chairs. It also commonly held a rustbank, racks of porcelain, pewter and glass, and several cleaning brushes. To judge from the contents of one passage in 1725, it is not inconceivable that this structure, too, sometimes served as a dining room. The passage in question was furnished with an oval table, two square serving tables, two small tables and two plate racks (IV,75). Chairs brought in from elsewhere could have transformed it into an unexceptional dining room.⁴⁴

The Kitchen

As James Walton is of the opinion that it was from the kitchen that the inner hall or dining room originally developed, this seems the moment to examine the justness of his claim. Walton writes:

The kitchen originally served also as a dining room but later a cupboard was placed across the

middle to separate the two parts. When a proper dividing wall was built this cupboard was incorporated into the wall as the familiar wall cupboard, or muurkas. This part of the kitchen, now reserved as a dining room, ultimately developed into the inner hall or achterhuis.⁴⁵

The earliest kitchen of which I have a record is that of Shoemaker Backer, which contained a food cupboard, a table and two forms (23/5,50,1681). This kitchen certainly served the family as a dining room as there was no other seating accommodation in the house, and this I think brings us to the heart of the matter. From 1680 to 1714 and beyond, one can find a kitchen that doubled the role of kitchen and living room, but to expect the combination of kitchen and dining room alone would be anachronistic: it is to look for the expression in the seventeenth and early eighteenth century of the attitudes of the twentieth. When modern living reduces us to two rooms, it seems natural to use one for cooking and eating and the other as a bed-sitting room, but we have long experience of the specialised room behind us which the men and women living in the early Cape had not.

Of the thirty-nine recorded kitchens I have traced before 1715, twenty-six do not include the necessary combination of table and seating accommodation.⁴⁶ Of the thirteen that do, perhaps half-a-dozen are living room-kitchens. In some instances they were the only rooms with seating accommodation in the house, in others they probably served as the family room. In the remainder, the presence of a table and a few chairs or a bench or two is not enough, given the habits of the period, to justify the assertion that they were dining room-kitchens rather than simply kitchens. Furthermore, there is really no reason to suppose that the kitchen cupboard had any bearing on the development of the wall-cupboard with glazed doors. For one thing, the only kitchen recorded during this period where a cupboard is found in the presence of seats and a table is that of Shoemaker Backer, with which the discussion began. For another, a wall cupboard of a sort appears in an inventory as early as 1663.⁴⁷

The number of kitchens recorded which cannot offer the

convenience of seats and a table, though a persuasive argument against the dining room-kitchen fallacy, is nevertheless unexpected. Indeed, many early Cape kitchens seem to have been both uncomfortable and impractical. Five of the thirty-nine kitchens under discussion had no furniture whatsoever,⁴⁸ and another fourteen were either without a rack or some alternative form of storage, or without a table, or without both,⁴⁹ which implies an intolerable degree of inconvenience to the housewife of today. Numbered among these kitchens were those of Van Stralen/Van Doorninck, the Sneewindts, the Van Reedes, the Helots and the Corssenaers, so they were certainly not the result of sheer necessity. I have considered the possibility that activities normally associated with the kitchen took place elsewhere, but a plausible alternative rarely presents itself. I can only suggest that this extraordinary indifference to convenience had something to do with slave labour; but given the Dutch housewife's well-known pride in her kitchen, it is not a very satisfactory explanation. However difficult it is to explain, we must nevertheless accept that in kitchen after kitchen everything that could not be hung from a hook on the wall was piled up on the window sill—and floor.

Not all Cape kitchens were furnished with such uncomfortable sparseness, and a few of them even had a reasonable complement of furniture. One of these, the kitchen of Elisabet Loenss, had two chairs, two racks, a spoon rack, a kitchen table, a square table, and an empty chest (II,37,1709); while another, that of Jacobus van Brakel, had three chairs, two racks, a table and a pot-stand (II,11,1707). The kitchen at Nooitgedacht with nine chairs, a tea-table, a small form, an oval table, three racks and a pot stand (II,63,1712) is apparently an example of a farm kitchen that doubled as a family room, while the kitchen in Margareta Blaupaert's small town house is a straightforward example of a living room-kitchen. It was furnished with eight chairs, a tea-table, a kitchen table, a plate-rack, a spoon-rack, and a backgammon board (II,70,1713). A bed, which is a not uncommon feature of a seventeenth-century Dutch kitchen,⁵⁰ rarely appears there at the Cape. The Van Stralen/Van Doorninck kitchen had a bed, a slaughtering table and a pot-stand (I,62,1701), which curious

array of furniture was virtually paralleled in the Basson kitchen with its two beds and a pot-stand (II,77,1713). When a bed does appear in a kitchen it is hardly likely that it was provided for a slave. A white, female servant would be rather another matter, but such people were few and far between and of the eight unwed orphan girls who arrived at the Cape up to 1707, none was unmarried eighteen months later.⁵¹ Probably such beds were used by family or lodgers; for a kitchen like that of Hendrik Schreuder, if it indeed held three racks, three tables, two benches, a pot-stand, a baker's trough, casks of wine, two beds and their mattresses, a backgammon board, a sword and a musket,⁵² was certainly not intended for servant or slave (II,114,1714).

The primary purpose of every kitchen is naturally the preparation of food, and though there were inevitably some exceptions the Cape kitchen at the end of the seventeenth century could usually show a surprisingly adequate array of kitchenware. To list the contents of particular kitchens would be tedious, but some detail is needed to convey the atmosphere of a typical one. There is no means of telling whether the raised platform which forms the hearth of the old Cape kitchen as we know it today was used there from the beginning. What is clear is that most fires were built directly on to the hearth stones. There were, however, some exceptions. On occasion iron hearth-plates, which were discussed in connection with the living room fire-place,⁵³ seem to have been used. Even more rarely use was made of a vuur- or haardijzer (Pl.19A) which was a single support for a log fire.⁵⁴ When encountered in twos the haardijzer⁵⁵ represents the better-known andiron or fire-dog (Pl.19B). In the Cape kitchen andirons, if encountered at all, are generally of a kind that will support a spit (Pl.19C) as in "1 spit met sijn knegts" (III,53,1713) or "2 ijsere Voeten tot braad speten met 3 do pennen" (I,46,1699). Much more in evidence than andirons and spits are the trivets and gridirons which simply stood in the fire and were virtually indispensable. Indispensable too were the shovel, tongs and brushes needed to tend the fire, and many kitchens also possessed a pair of bellows. A hearth chain, described on one occasion as "een ketting ind' Schorsteen" (23/5, 21,1672), was a length of chain with a hook at the top to secure it

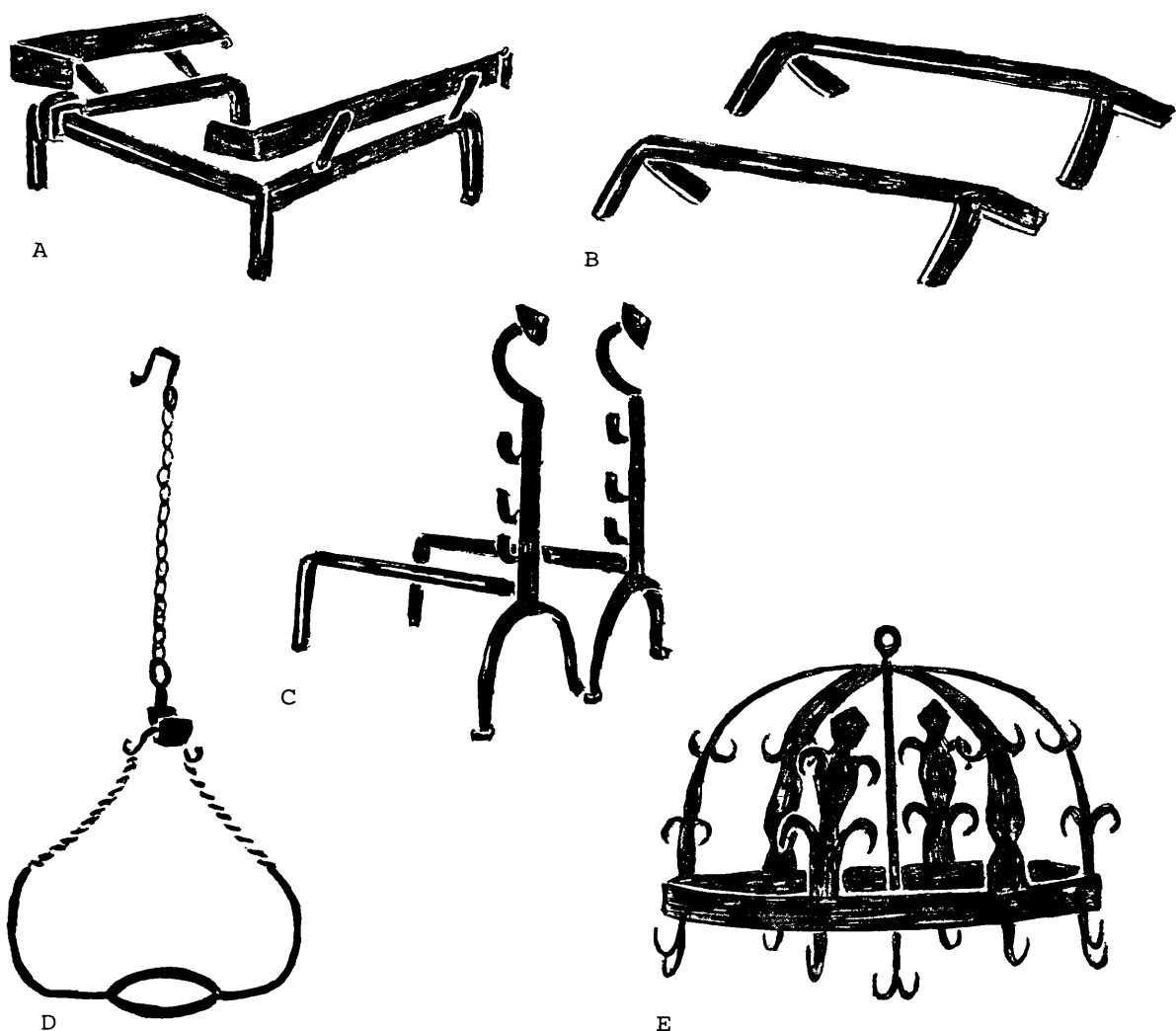

(19) Various Objects of Iron

- A) Adjustable grate for logs (haardijzer)
- B) Pair of simple fire dogs (haardijzers)
- C) Pair of andirons with supports for the spit
- D) Hearth chain with a pan iron (hangijzer)
- E) Meat hook or Dutch crown

in the chimney and another broader hook at the bottom to suspend a pot over the fire (Pl.19D). Most kitchens included two hearth chains, but some had twice that number. The better equipped kitchen often boasted a refinement known as a "hangijzer" (Pl.19D). This object hooked on to a hearth chain and was designed to support something like a waffle-iron or saucepan which was without a suitable handle to hang there on its own account.⁵⁶

Obvious items like braziers, smoothing irons, kettles,⁵⁷ cooking pans and casseroles were made in both iron and copper or brass, and most households had a selection of both. A tartpan was present in practically every kitchen and a tea kettle was exceedingly common. Also present, though not with the same regularity, were chestnut pans, waffle-irons, fish kettles, poffertjespannen,⁵⁸ and bolle buijsjespannen.⁵⁹ Among the numerous utensils for the preparation and cooking of food were to be found chopping boards and knives, pestles and mortars, graters, kitchen scales, Dutch crowns (Pl.19E), colanders, skimmers, iron cooking spoons and sausage makers. Then there were various different scoops, some of iron, others of wood, which were mainly used to position the fashioned dough in the oven. Small wooden items included funnels, butter dishes, spice boxes and the occasional trencher, but the average kitchen was dominated by large items of wood such as water casks, water buckets, barrels, tubs, churns, baker's troughs and rice blocks with their pestles.

The kitchen also housed the plates and other items used in the service of meals. For the most part these were of pewter, and included a set of spoons displayed in a special rack. Although ordinary lead-glazed earthenware was of less importance in the Cape than it was in Europe, a certain amount was in circulation and there are a good many references, in particular, to earthenware pots, many of which were probably cooking pots on tripod legs. Various other items including plates, dishes, bowls, jugs, mugs and colanders are mentioned from time to time.⁶⁰ Most of the earthenware present probably came from Holland, but some of it was made locally.⁶¹ Porcelain from China and Japan also played a part in the Cape kitchen, where a rack or two of plates and dishes, presumably for table use, was not uncommon.⁶² Before 1715,

bowls and dishes which may well have been porcelain are described as "coarse", and in later inventories there are quite a number of unambiguous references to coarse porcelain. Excavations at Stellenbosch and the Golden Acre site in Cape Town have shown the enormous importance of coarse porcelain—the output was largely restricted to bowls and flaring dishes—in the eighteenth century, though it was probably only in the second quarter of the century that this tough, cheap ware from South China with its greyish body, lively blue decoration and unglazed biscuit ring replaced earthenware in the Cape kitchen. Martavans—the large ones sometimes held the day's supply of drinking water— and Siamese pots were other eastern ceramics with a place in some of the early kitchens.

The Pantry

Not everything pertaining to the kitchen was necessarily kept there, and the bigger the house and the better equipped the kitchen the wider the area of the house invaded. We have already encountered kitchen items in the grote kombuis, passage and gallery, while a number of ordinary back rooms were also taken over, at least in part. The most obvious place for the overflow from the kitchen was, of course, the pantry or bottelarij. On the whole the pantry performed so obvious a function that little need be said about it. Anything found in the kitchen, with the exception of items directly related to the fire such as hearth chains and fire-irons, could be found in a pantry. To judge from their contents, pantries differed greatly in size, and a few of the largest apparently doubled as bedrooms. Most obvious in this respect was the pantry—it was called a "dispens" in this instance—in the large Corssenaer house where, in addition to the usual items, there were two chairs, a four-poster and a paper press⁶³ (III,37,1713).

The Lean-To

One or more lean-tos, as we saw in the last chapter,⁶⁴ were a frequent feature of the houses of the period. Their popularity is a little surprising, however, because the additional space rarely seems to have been fully used. For the most part a lean-to

did duty as a sort of store-room: a dumping ground for the overflow from kitchen, cellar, barn, stables or boat-house. It also made a place for another bed. Thus a four-poster might keep company with a corn-sieve, an open bed with the sail of a boat or a horse's saddle, and three beds with three sacks of wheat. Some lean-tos, of course, were nothing but storerooms and a few served simply as bedrooms. One typical lean-to cum bedroom had a feather-bed, some bedding, a chair, two paintings and two tea-trays (II,70,1713). It was all pretty basic.

The Solder

Fifteen solders are recorded before 1715, three of which may have belonged to outbuildings rather than the houses themselves.⁶⁵ Wherever it may have been situated, the solder was the storeroom for everything imaginable. There were to be found the dried food-stuffs, the coffee beans, tea, sugar, salt, rice, corn, rye and beans; there the useful stores of wood: the rafters from Mauritius, the planks from the fatherland, the planks of yellow-wood, stinkwood and teak; there the empty sacks, the sacks of goose feathers, the bundles of whalebone and, time and again, the bundles of Javanese cane; there the vats, buckets, tubs, baskets, flasks and bottles; there the ropes, sails, ploughshares, saddles and winnowing fans; there the seldom used waffle-irons, the superfluous cooking pots, the old stoneware jugs, the Siamese pots and Cape earthenware; there, to particularise, the two new chairs, the unwanted linen press, the cradle, the unmade-up four-poster, the discarded family portrait, the box of wigs, the unseasonal fire-wagon,⁶⁶ and the surely unusable harpsichord; there the chests filled with hundreds of pieces of chintz, or hundreds of beer glasses or hundreds of porcelain cups and saucers, evidence for all time of the lure of private trade; and finally, if there is any finality in a list of this nature, there, discreetly out of sight and smell, was the close-stool.

Not every solder was of this order: one held nothing but wheat and rye (III,55,1713), another little but a "set net" (II,66,1712), and a few served solely as bedrooms. For when the only contents recorded are a mattress, two feather-beds, four bolsters,

six pillows and an old wall rack (II,4,1705) or a feather bed and bolster, two blankets, three pillows, a birdcage, two tea-racks, a pair of scales and two fine chintzes (II,115,1714), no other construction is possible. Some other solders also included one or two beds and these, too, may have been put to use.

The Ubiquity of the Bed

At this point a few words about the rash of beds everywhere apparent seems apropos. In some ways the very variety of their location may give the impression that there were more beds about than was actually the case. There was certainly no shortage, however. Of the thirty-nine inventories compiled room by room, fourteen had six or more beds,⁶⁷ ten had four or five beds,⁶⁸ eight had three beds,⁶⁹ and the remaining seven had two or less.⁷⁰ As the houses were still comparatively small, this is not a bad record, but it should be kept in mind that it is only natural to spend more time and trouble on writing up an interesting property than one that is thoroughly commonplace, so that these thirty-nine inventories must give a lop-sided idea of the Cape house from 1680 to 1714.

Six beds at this period mean that there would have been sleeping accomodation for something like twelve people, for as far as I can judge most of the beds in use were designed for two.⁷¹ Although it was the custom in aristocratic circles in Europe for a husband and wife to use separate bedrooms⁷² and books of etiquette no longer took it for granted that adults of the same sex would share a bed unless "forced by unavoidable necessity"⁷³ to do so, the Cape burghers seem to have continued in the old ways. Even in sophisticated circles in Europe, however, young children of whatever sex slept together, so that once a child had been promoted from cradle or crib—items which are not included in the above figures—he could expect to share his bed with one or more of his siblings. A Cape family, then, which consisted of a man and wife and six minor children, would have found four beds adequate for their needs. In fact, nine of the above houses did belong to such families, although only in one case were all the children young, unmarried, and likely to have been at home at the same time. Still, this is hair-splitting. Family size was naturally one factor involved, but it was not the

only one, since of the fifteen houses in which there were two children or less, eight contained six beds or more.⁷⁴

I find it difficult to believe that a large number of beds qua beds was a source of pride, though obviously a superfluity of furniture in general was one way of demonstrating one's affluence to the world at large. Another possible contributory factor was the round of auction sales. Sales were a social occasion to be attended whether one wanted anything or not, and it is too much to expect that everyone resisted the temptation to buy unnecessarily. After all, one could always sell again, and perhaps at a profit—a natural attitude for a society nurtured on private trade. Most important of all, however, was surely the demand for lodgings felt whenever a fleet was in port. Lodgers meant money. Those who could afford to do so built one or more houses for the purpose of hire, which were commonly adjacent to the owner's own much larger town residence,⁷⁵ and literally everyone was prepared to receive paying guests into his own home.⁷⁶ Apart from the more obvious reasons for welcoming lodgers—the money involved, and the stimulation in a small isolated community of meeting new people and hearing the news from abroad—there was private trade. How easy it must have been to conduct this often illegal activity, but one of such importance to one's financial well-being, with people who were actually lodging under one's own roof or in the house one owned next door. Looked at like this, every additional bed was an investment, and it is probably significant that eleven of the fourteen houses with six or more beds were situated in Table Valley,⁷⁷ and that it was in these houses that the beds tended to be distributed all over the house. A stranger at this period would not only object to sharing a bed but would also have reservations about bedding down in a "dormitory" with various members of the family, unless his own place in the social scale was a fairly humble one.⁷⁸

Things were obviously rather different in the country districts where families often had to manage with very few beds. One feels that the Cape farmer's renowned hospitality must have been exercised very largely at the expense of family comfort, for at this period most farmhouses were too small to accommodate a number of beds except under "dormitory" conditions—and these are seldom found.⁷⁹ Finally

it should perhaps be placed on record that at the opening of the eighteenth century a slave and a bed were seemingly mutually exclusive: neither beds nor bedding were present in the early slave houses.⁸⁰ It is barely possible, I suppose, that a bed in a passage was provided for a valued personal slave⁸¹ and that a bed in the kitchen served the cook, but it is not very likely.

Conclusion

At an early stage in this chapter⁸² I remarked that it was not possessions so much as a "fashioned taste" that the Cape lacked, and I hope that the reason for this comment has begun to emerge. It was prompted first and foremost by what seems to have been a blindness or indifference to that which is both incongruous and unfitting. This blindness assumed added significance when I found it was not endemic in comparable inventories in Holland and America, which were closer in spirit to the fashionable taste of the period with its respect for privacy, appreciation of comfort and concern for regularity, precision and order. A fashioned taste does not furnish a voorhuis with planks of wood or sacks of corn, nor does it copy Godfried Meijhuijsen and juxtapose sacks of peas and valuable paintings in a principal living room (I,23,1697). This last absurdity is underlined by the fact that in both inventory and vendu roll the paintings are described as a set of seven sybils, and this indication that they were admired is confirmed by the high price of 42 guilders, 10 stivers they realised at auction (VR9,1697). Incongruity could hardly go further.

At the Cape the town house, particularly the front section of a large town house, was better ordered than the country house, so standards of a sort prevailed—but lapses, even in the most unexpected places, were numerous enough to be regarded as the rule rather than the exception. I have the impression that it was an enormous effort to be orderly: an effort only worth making where the results could not be missed. How else does one explain the gallery in the town house of Secretary Helot and Christina de Beer, or their squalid small back room? Then there is the messy little "Wijnkamertjen" in the Sneewindt house, and the crazy grote kombuijs in the Van Stralen/Van Doorninck house, as well as the consistently

unattractive passages in the De Beer, Corssenaer and Basson houses. There is also the occasional small but probably telling lapse: the "gemeene cadel" without so much as a counterpane in the main living room of Elisabet Loenss—a very common weakness;⁸³ or the "slegte kist" with eleven rolls of tobacco in one of Hendrik Sneewindt's most adequately furnished voorkamers. Lapses among town houses of minor importance are actually less frequent, probably because the whole house was on view; they include the ends of plank in the crowded living room of Anna Dominious, and the various planks and the loose door in the front rooms of Abraham de Vijften.

Although one or two houses in the country contain nothing that is obviously out of the way, they are the exception. Casks with remains of butter and a quantity of rope invade one front room (II,25,1713), two ladders, a tub and a meal-sieve another (II,58,1712), whilst a third is invaded by two butter-churns, a plough-share and fourteen sickles (III,55,1713). The most extreme example of this type of disorder is provided by the Tigerberg farmhouse of the prosperous Burgher Councillor, Albert Diemer. We have the inventory of both his large town house on the Heerengracht⁸⁴ (III,31,1713) and his farm in the Tigerberg (III,30,1713). That the apparent propriety of the former, which is one of the few large houses free of obvious solecisms, was no more than skin deep is thunderously proclaimed by the latter. There one of the voorkamers with a normal array of furniture also gave shelter to a pile of wheat "naer gissingh 150 Mud," some teak and stinkwood planks, a cask with a little wine, an empty cask, a chest with items like axes and gunpowder, and a corn-sieve. The other voorkamer—it was the principal living room—had nothing worse to show than a collection of empty bottles, a box of shoemaker's tools, a sack of garden seed and a sail. In the voorhuis there was, as we have seen, a quantity of corn, while the two lean-tos, one dominated by racks of pewter and twenty-four hectolitres of corn seed, the other by twenty-one hectolitres of meal and a close-stool, reflect the same spirit. Just to keep the record straight the outhouses comprised a slave house—casks, ropes and wood; a large barn—bundles of reed, four wheels, two tongs,

etcetera; and a fully equipped wine cellar. It was surely unnecessary to strew the fruits of the harvest all round the house in which Diemer and some of his family were actually living at the time of his death.⁸⁵

It would be quite impossible to compile a similar list of incongruities from the Hague inventories. There one encounters the occasional let-down; the broken basin, the empty picture frame, the passage cluttered with household brushes, baskets and a pot-stand. There, too, are a sprinkling of oddly-furnished rooms such as a small front room principally encumbered with a meal-kist and a small trough.⁸⁶ What one does not find, however, is a rash of items proper to stables, barn, carpenter's shop or tool shed disfiguring all or part of a house. What is more, one does not find it either among the inventories of Goudswaard, a small farming community on the Spui. All Goudswaard can offer in this line is a brown-painted cupboard in a main living room filled with empty sacks and yarn.⁸⁷

One thing the Goudswaard and Cape inventories do share, in contrast to those of the Hague, is a general indifference to coherent decorative schemes. The Hague inventories from the last quarter of the seventeenth century show that once a reasonable standard of living had been reached a room was conceived as a unit and furnished accordingly. This is most obvious in the treatment of the soft furnishings: the curtains of the four-poster or the built-in bedsteads, the cushions of the chairs, the table cover and the chimney valance were either made of the ~~same~~ material or chosen to form a unity. In 1696 the upstairs voorkamer of a glassmaker, for instance, had an old four-poster with yellow serge hangings, two table covers and a chimney valance of the same material, and rush chairs with yellow plush cushions,⁸⁸ while in 1713 the parlour or salet of a Hague pastor had a four-poster with a hanging of red "casan"⁸⁹ trimmed with green ribbon, and twelve chair cushions and a table cover to match.⁹⁰

The whole approach seems to have been quite different at the Cape. There the clerks compiling the inventories seldom concerned themselves with the colours of the various materials

present, and when the same type of material, like a chintz or a muslin, recurs, there is no means of telling whether the two lots matched each other or not.⁹¹ This very indifference is suggestive. If something was important or fashionable enough, the inventories tend to draw attention to it. Instead one is left to wonder whether the muslin curtains at the window matched the muslin curtains round the bed or whether half-a-dozen references to chintz meant a matching chintz or a riot of conflicting patterns. What does one make, for instance, of the most formal of the Helot voorkamers? It had a four-poster with a striped hanging and a nameless counterpane, a church chair with a striped silk cushion, anonymous window curtains, a set of eight chairs, again with striped cushions, and finally a nameless table cover (II,43,1710). The Sneewindt voorkamer poses a different sort of puzzle: it contained a muslin bed-hanging, a chintz table cover, a lace-trimmed chimney valance, and a set of red plush seat cushions (I,69,1701). The effect could have been charming but was probably nothing of the sort. Without a concern for harmony one is unlikely to create it out of different materials, and what evidence there is suggests that this was an aspect of current fashion to which the Cape was largely unresponsive.

One can, naturally, search for other explanations: the difficulty and expense of obtaining suitable materials being the most obvious. This may have been a contributory factor, and certainly governed the type of material selected, but it does not really satisfy me. Material was a regular item of trade, both official and unofficial, and if harmony at the hands of the upholsterer had been important in the Cape scheme of things, one would expect the inventories to make this apparent well before 1715.

In conclusion, then, the Cape house of this period, in comparison to the Hague house, shows a much greater tolerance towards incongruous and disorderly elements; a marked indifference to the fashionable concern with matching decorative schemes; and a perceptible lack of interest in specialised rooms and personal privacy. If all this were representative of

a brief phase during the infancy of the new country it would be interesting to record but not of deep significance. I am not at all sure, however, that it was a short-lived phenomenon. As a control I have made periodic forays into the inventories of later periods, and I could illustrate a tolerance towards the incongruous, and a seeming indifference to the réclame of fine soft furnishings, from the inventories of the last fifteen years of the eighteenth century as well as from the first. It would be a list, moreover, in which several double-storeyed town houses would feature prominently.⁹² Finally—and this I find most significant of all—the bedroom, even in the early nineteenth century, continues to exhibit a curious air of neglect. But it was in the bedroom and accompanying closet that the aristocratic movement which transformed the interior of the private house in Europe first made itself felt;⁹³ and while it is true that the Dutch burgher never made a cult of his bedroom, he certainly furnished it with comfort and good sense.

Surely all these different and related strands are due to the fact that the Cape Dutch house was not unequivocally middle class. In aspiration it was petit bourgeois; but in practice the robust taste and untutored spirit of the common man were always there to challenge bourgeois concepts of propriety and elegance. I wonder whether there is any connection between architectural developments in the eighteenth century and the uncomplicated and uninhibited pattern of family life. Could a society uninterested in personal privacy and concerned with specialised rooms ever have produced the beautiful Cape country house? I have begun to doubt it.

Footnotes

1. For a discussion of this question of privacy and the family house in English society of the 17th Century see Peter Laslett, "The Jacobean Age," The Connoisseur's Complete Period Guides, eds., Ralph Edwards & L. G. G. Ramsey, rpt. in 1 vol. (London, 1968), p.271. The attitude towards human life and the moral nature of man which gave precedence to privacy in the personal life of European man is brilliantly illuminated by Michael Oakeshott in On Human Conduct (Oxford, 1975), pp. 235-42.
2. Peter Thornton, Seventeenth-Century Interior Decoration in England, France and Holland (New Haven / London, 1978) p.8.
3. G. C. de Wet, op. cit., p.24.
4. See above, p.2.
5. See above, p.22.
6. I am uncertain of the exact significance here of "vaste," probably the table had an unadjustable and immovable top set on four legs.
7. A board game played at this period was known as "goose." "Ganzebord [sic], z.g. Zeker spel. L'oison, jeu de l'oye, sorte de jeu" (François Halma, Woordenboek der Nederduitsche en Fransche Taalen [Amsterdam, 1710]).
8. Some blankets (combaarsen) were of wool, but lightweight blankets of cotton, chintz, etc. were also in use and these might be trimmed with lace.
9. See above, p.22.
10. De Wet, op. cit., pp. 41, 46, 52, etc. Margaret Cairns, Cradle of Commerce: The Story of Block B, ed. W. Grütter (Cape Town, 1974), pp. 15, 20, 22, etc. In both these works the name appears as Van Suerwaerden.
11. See above, p.2.
12. There were a few exceptions. Notary Jan van Renven had "1 koijs

soner behangsel" (23/5,25,1713) and Francois Chamselaer had "1 slegte koiij met chits behangsel" (I,1,1673).

13. About 75 litres. See also p.201, n.61.
14. A distinction is rarely made between copper and brass. In general I choose the metal which I consider most probable.
15. A family or common room which also combined the function of a kitchen was a feature of many early Canadian houses (Jean Palardy, The Early Furniture of French Canada, trans. from French, Eric McLean [Toronto, 1963] , p. 23).
16. Paul Zumthor, Daily Life in Rembrandt's Holland, trans. from French, Simon Watson Taylor (London, 1962), p.42.
17. This prejudice is present throughout the company period, but never becomes much more marked than it was at the opening of the 18th C.
18. Esther Singleton, Dutch and Flemish Furniture (London, 1907), p.192.
19. For example, "een ijsere Cnaap met een Coopere blaker" (23/5, 35,1675).
20. The direct translation of "reijslaetjes" is "travelling drawers," but I am unaware of a small piece of furniture belonging to the period which could be so described.
21. Probably from the Indies rather than India.
22. See below p.263, n. 73 for the contents of these racks.
23. CJ2914, Bergh Inv., 1687, pp. 1-6.
24. Bernt, op. cit., I, Pl.271.
25. Perhaps another name for the Burgomeester or wheel chair. See also p.117.
26. The quality is clear from the auction prices. The wardrobe, for instance, fetched f 231 (VR21,1701), which was a high price even by the standards of New York and the Hague.
27. In 17th C Batavia the customary place for the family Bible was not the communal living room but the main bedroom (Van de Wall,

- op. cit. p.74), but in Holland, like the Cape, it was to be found in the family living room (G. D. J. Schotel, Het Oud-Hollandsch Huisgezin der Zeventiende Eeuw, 2nd rev. ed., H. C. Rogge [n.d., Leiden], p.290).
28. The nappy tray, which often seems to have been painted or lacquered ("een geschilderd Chinees Luijer bakje" [II,43, 1710]) was a relatively expensive item. Like the beautifully equipped luijermandje which was a traditional gift from mother-in-law to bride, it was a show piece on which the christening robe and other costly items were displayed (Singleton, Furniture, pp. 199-200).
29. See above, p.55.
30. Cape rooms during the Company period are seldom described in terms of their function or decoration, but in terms of their location. This was the custom in Holland in the houses of yeoman and small merchant and to a lesser extent of the leading burgher. In upper-class houses the opposite custom prevailed. Nevertheless, terms like "eetzaal" or "dining room" were by no means firmly established by 1700 (Thornton, op. cit., p.343, n.9).
31. The "kapstok" in this inventory supported "11 pierings / 6 Copjes gesortet / 1 Vergult Leere Camme doos." This is unusual but not unparalleled. I have yet to see a hat- or cloak-stand which would take this amount of porcelain, though examples in Dutch paintings of the period, such as the one sketched in Pl. 41 would also support one or two pieces. See also p. 160.
32. Inventories compiled shortly before the Orphan Chamber was abolished refer to the removal of seals: "In consequence of which the aforesaid property (after the Seals of Office has been removed) was duly inventoried by the undersigned special Commissioners from the Orphan Board" (XLIV, 7, 1830).
33. Tea-trays ? See below, p.218.
34. Singleton, Furniture, p.179. Zumthor, op. cit., p.40.
35. See above, pp.17-19.
36. See below, pp.83-84.

37. See below, p.188.
38. See above, p. 21 and accompanying n.37.
39. Schotel, op. cit., pp. 291-95.
40. "Ijseren hoepen" occur again and again in the documents of the period. These loose iron bands were used to reinforce casks, vats, tubs etc., and their frequent occurrence may show that many families did their own coopering. See below, p.191.
41. In English documents of the period the term "linen press" normally has the meaning "linen cupboard." In the Cape inventories the linen press never appears to have any contents and presumably a press was indeed meant.
42. Several houses in Rondebosch, however, exhibit all the features of a typical town house. We have seen this in the case of the Sneewindt property, and in 1719 a Rondebosch farm, Velthuijsen, included both a gallery room with a four-poster and a gallery proper, sparsely furnished with a table, a rack of odds and ends and two half empty aums (III,95).
43. But there were exceptions: a town house in 1732 with the normal three front rooms, a back room, kitchen quarters, a gallery and a "binne Camer," for instance, echoes a Batavian plan.
44. Very occasionally a room other than a gallery has the appearance of a dining room. In the house of Helena Besuijdenhout the "grote Camer" which appears to have been one of the front rooms held 2 oval tables, 2 square tables, an empty cupboard, a porcelain cupboard garniture, 8 pictures and 2 mirrors. Unfortunately all the chairs in this inventory are listed at the end so one important clue is lost to us (III,53,1713).
45. Walton, op. cit., p.8.
46. 23/5,50,1681;* CJ2914, Bergh Inv., 1687, p.12;+ Ibid, Meijer Inv., 1705, p.162; I,23,1697;° I,62,1701;+ 1,63,1701; 1,69,1701;+ 1,74,1703;° I,76,1703;+ II,4,1705;*+ II,11,1707;* II,28,1709; II,37,1709;* II,40,1710;+ II,43,1710;+ II,49,1711;+ II,58,1712;+ II,61,1712;* II,63,1712;* II,66,1712;* II,69,1713; II,70,1713;* II,71,1713;° II,73,1713;+ II,76,1713;° II,77,1713;+ II,83,1713; II,114,1714;* II,115,1714;+ II,120,1714;°

- III, 24, 1713; * III, 25, 1713; * III, 30, 1713; III, 31, 1713;
 III, 37, 1713; + III, 53, 1713; * II, 55, 1713; III, 56, 1713; *
 III, 64, 1714. + Inventories marked with an asterisk include
 a table and seats in the kitchen.
47. In 1663, the inventory of the secunde, Roeloff de Man, refers to "een cas inde muer gemetselt" (Trans. en Schep., II, 60).
 48. Inventories in n.46 marked with a nought contain no furniture in the kitchen.
 49. Inventories in n.46 marked with a plus sign have some kitchen furniture, but this does not include both a table and some form of storage such as a rack, pot-stand or food cupboard.
 50. Singleton, Furniture, p.196.
 51. De Wet, op. cit., p.147. The girls sailed for the Cape in December, 1687.
 52. There is some doubt about the actual contents of this kitchen, after which all the chairs in the house are listed, so that one is left wondering where kitchen items end and additional items begin.
 53. See above, p. 47.
 54. Jozef Weyns, Volkshuisraad in Vlaanderen, 4 vols. (Antwerp, 1974), 1, 52-53.
 55. Haardijzers were also known as vuurijzers, brandijzers, branders, vuurbokken, etc. (Weyns, op. cit. I, 53-55).
 56. Weyns, op. cit., I, 101.
 57. It should be remembered that the term "ketel" was also used for a copper cauldron.
 58. "Poffertje z. g. Zeker bol gereeze koekje. Sorte de petit gâteau rond & levé" (Halma, Woordenboek). A poffertje is still eaten in Holland today. Prof Nilant, in a personal communication, describes it as a "Flat bolletjie made of buck-wheat."
 59. bolle buijsje was a small cake or fritter.
 60. Earthenware items are often listed as "eenige aardewerk" or "1 parthij aardewerk." Among the exceptions is the inventory of Jacobus van Brakel, where the kitchen utensils include "vier

- aarde stoovpannen met haar Daksels, drie do potten, agt do Schotels . . . vijf aarde Tafelborden, [en] een aarde deurslag" (II,11,1707).
61. Among the handful of references to Cape earthenware the most interesting are "30 stucks Kaaps aardewerk" (I,69,1701); "10 schotels kaapse aardewerk / 12 pieringen dos" (I,75,1703); "een Caabs aarden Scheerbekken" (II,11,1707); and "1 parthij Kaaps aardewerk / 1 do do / 3 kannen do do" (VR29, 1703). Whether these were the products of the Company Potworks or not it is impossible to say, as a burgher named Jan Six was also potting at the Cape from 1692-1707 (De Wet, op. cit., p.76). Fragments of coarse earthenware cooking pots excavated and researched by Mr. Hennie Vos, archaeologist to the Stellenbosch Museum, are the only fragments I have seen that were probably made locally. I have also come across a reference to Cape earthenware in an inventory of 1719 where "1 gorgelet [see below, p.255] Caabs . . . [en] Enig Caabs aardewerk" are listed (III,102).
62. In 1687 the kitchen of Olof Bergh held "enige porceleijne schoteltjes" (CJ2914, Bergh Inv. p.12) and there are many examples from the early 18th C.
63. See below, p. 247.
64. See above, p. 25.
65. I,62,1701; I,74,1703; and II,43,1710. Other estates with solders are I,63,1701; I,69,1701; II,4,1705; II,63,1712; II,66,1712; II,115,1714; II,120,1714; III,24,1713; III,31,1713; III,37,1713; III,55,1713; III,64,1713.
66. See below, p.120.
67. I,62,1701; I,63,1701; I,69,1701; II,4,1705; II,37,1709; II,43,1710; II,63,1712; II,69,1713; II,77,1713; II,114,1714; II,115,1714; II,120,1714; III,24,1713; III,31,1713.
68. I,74,1703; II,40,1710; II,66,1712; II,70,1713; II,76,1713; III,30,1713; III,37,1713; III,53,1713; III,56,1713; III,64,1714.
69. CJ2914, Bergh Inv., 1687, p.1; I,23,1697; I,76,1703; II,11,1707; II,28,1709; II,49,1711; II,61, 1712; III,53,1713.

70. 23/5,50,1681; CJ2914, Meijer Inv., 1705, p.158; II,58,1712; II,71,1712; II,73,1712; II,83,1713; III,25,1713.
71. A judgement supported by an entry like "1 Leedikant met sijn behangsel / 6 groote Cadels 1 do Clijn" (II,109,1714).
72. Thornton, op. cit., p.343, n.9.
73. La Salle, Les Règles de la bienséance et de la civilité chrétienne (Rouen, 1729), p.55. This is one of the many books on etiquette quoted by Norbert Elias, The Civilising Process, trans. from Germ. Edmund Jephcott (1939; Oxford, 1978), p.162. The Elias book makes illuminating reading for anyone interested in the gradual refinement of manners and morals which has produced the "civilised" Western man of today.
74. I,62,1701; I,63,1701; I,69,1701; II,4,1705; II,37,1709; II,43,1710; II,63,1712; II,69,1713; II,77,1713; II,114,1714; II,115,1714; II,120,1714; III,24,1713; III,31,1713.
75. See *above*, p.41, n.79.
76. De Wet, op. cit., pp. 53-55.
77. The three exceptions are II,63,1712, the Stellenbosch farmhouse Nooitgedacht; III,24,1713, a farm on the Liesbeeck River belonging to Dirk Verwey; and I,69,1701, another farm on the Liesbeeck belonging to Hendrik Sneewindt.
78. "You ought . . . neither to undress nor go to bed in the presence of any other person. Above all, unless you are married, you should not go to bed in the presence of anyone of the other sex. . . ." Thus La Salle, Les Règles de la bienséance, in 1729. (Quoted by Elias, op. cit., p.162).
79. Three beds are rarely exceeded in any one room. In Wessel Pretorius's Moddergat farmhouse, for example, there were two four-posters and a katel in one front room and one four-poster and a katel in the other (III,56,1713).
80. Slave house and slave kitchen are seldom found in the first quarter of the 18th century, and those that are listed give the impression of being mere storerooms: they offer no amenities whatsoever. Between 1710 and 1712, Nooitgedacht acquired a

"slavenhuijs" which held nothing but a dozen or so implements, dung-forks, corn-forks, a sledge-hammer, pick, etc. (II,63,1712). The slave house attached to Abraham Diemer's Tigerberg farm held casks of salt, rope and wood (III,30,1713).

81. In the early 17th century servants slept all over the place, and were expected to doss down in the oddest corners. A personal servant normally slept within close reach of master or mistress—at the door of the room or even under the main bed. In this respect, as in most others, one can expect the Cape to have been rather old-fashioned. For further information on this subject see Thornton, op. cit., pp. 59-60.
82. See above, p. 52.
83. Many Cape beds were without a counterpane in houses where such an omission is unexpected. At this period it was fashionable to give most attention, when dressing a bed, to counterpane and head valance.
84. A very early reference to "Een huijs en Erf . . . op de heeregracht."
85. Two factors make this clear: a reference to "vijf naergelate minderjarige kinderen, berustende op de plaets in de Tijgerbergen en aen de Clapmuts Rivier;" and the presence in cash of f 4 441:10.
86. Gemeente Archief 's-Gravenhage, Not. Arch., 428, p.833.
87. Rijks Archief, Goudswaard, Weeskamer, 5, 1681.
88. Gemeente Archief 's-Gravenhage, Not. Arch., 551, p.229. Part of the Dutch text runs "Een out ledicant met geel cherge behangen / Twee taeffel kleetjes en schoorsteen kleet van 't selve ."
89. I have not been able to identify "casan." Cassa or cassaes was a type of muslin from Bengal, but it is improbable that this was intended.
90. Gemeente Archief 's-Gravenhage, Not. Arch., 1765, p.41. The Dutch text runs "1 Ledekant en behansel van root casan met een groen lintje daerom, / 1 dito Tafel kleet, / 12 dito matrassies

met paerde haer daerin op stoelen."

91. The only exception I have noted occurs in an inventory of 1674 (23/5,1). See above, p. 58.
92. An upper gallery equipped as a carpenter's shop, as in XIX,7,1785 and XIX,80,1789, is a powerful illustration of this tolerance towards the incongruous. The indifference to fine soft furnishings cannot be adequately demonstrated in a note, but in 1789 an "elegant" drawing room in a Cape Town house could boast in the way of soft furnishings "4 rood ophaal gordijnen . . . 12 groene trijpe stoel kussens . . . 2 vloer Ceutrissen [from French cuir for leather ?] " and that is all (XIX,66,1789). Such a room would have made a very poor showing in New York or the Hague at the outbreak of the French Revolution.
93. Thornton, op. cit., p.10.

Furniture I
=====

Though most pieces of furniture in inventory and vendu roll are recorded as briefly as possible there are, very fortunately, a number of exceptions. Understandably the clerk responsible for compiling an inventory was more inclined to add a word of description if the piece was exceptionally fine or out of the ordinary in some other way. Thus we hear about an English close-stool, a Japanese lacquer cabinet or a teak chest with a black ebony frame and brass fittings. Because of this very human approach, it is usually clear what woods were in fashion at any one period. Contrary to public opinion it was not simply a matter of ringing the changes in stinkwood, yellowwood and the other indigenous woods. Between 1670 and 1750 four distinct periods emerge. Up to about 1685 furniture seems to have been in short supply, and the occasional words of description do not add up to any observable pattern. All that does emerge is the popularity of ebony. This is hardly surprising. The seventeenth century was the age of ebony, a wood described by Valentijn as "een van de fraayste Boomen, waarvan keurlijk Huisraad gemaakt werd."¹ From 1685 to 1700 the amount of furniture in circulation increased considerably, but ebony remains the type most often singled out by the clerks of the period. Apart from ebony, "black" furniture was also particularised from time to time, doubtless because it was a fashionable colour, and gilt and lacquer received respectful attention, too. The furniture marked out in the next period, 1700 up to about 1720, is a good deal more varied. Ebony, lacquer and gilt maintained their popularity, but could hardly compete in value with the rarer and even more exotic dark red eucalyptus, which was another wood to meet with Valentijn's approval.² This is also the period when well-made furniture of stinkwood, yellowwood and red alder received more attention than it was to do for the rest of the century. Teak and the puzzling, so-called "Chinese" wood³ make an occasional appearance, but only come into their own in the second quarter of the century when, together with amboyna, they dominated the fashionable interior of the large, double-storeyed town house. Examples of European woods, of deal, oak and walnut, also enjoy an occasional mention before 1685 and after 1700, but were seemingly of less interest

to the various clerks than the more exotic Eastern woods.

Apart from highly prized eucalyptus woods, all the foreign woods mentioned so far in this chapter turn up in an unfashioned state in the inventories and *venu* rolls.⁴ This means that some of the wood imported by the Company from Europe, Mauritius and the East found its way into the hands of the burghers; and in addition there was private trade. Appel draws attention to a directive of the Gentlemen Seventeen of 1742 in which the independent fiscal was instructed to see that no private person brought wood to the Cape from either Europe or the East.⁵ This directive is proof that wood was one of the many things illegally traded, and helps explain the presence in private estates of types of wood unrecorded by Appel in his dissertation on the provision of wood at the Cape during the Company period.

All this means that the wood out of which a piece of furniture was made is hardly a reliable guide to its place of manufacture: and it was not only unfashioned planks and beams that were imported, but panels of wainscot for use in the construction of doors, cupboards and shutters.⁶ There could, therefore, be an important difference between "1 Cas van Vaderlands hout" (II,79, 1713) and "een vaderlandsche vuurenhout kist" (II,8,1707). The best ebony came from Mauritius, so there is every reason to suppose that much of the ebony furniture in use was made locally, as well as the popular amboyna furniture of the second quarter of the eighteenth century. Indeed with regard to amboyna we have proof that this was sometimes, if not invariably, the case: "2 in de maak sijnde ambonshoute cabinetten" (VI,67,1743).

Stained or painted furniture was not the sort of article to arouse enthusiasm in the breast of the average clerk, so recognisable examples probably give an inadequate idea of the quantity in circulation. Among recorded examples are "4 Swart gepoljste stoelen" (23/5,47,1679), "12 swarte geveerde stoelen" (I,62,1701), "een kleen geveerd kasje" (II,11,1707) or even "1 Swart geschilderd Ledikant,"⁷ though the use here of "geschilderd" is unexpected. Less specific examples almost certainly referring to painted furniture include "Een roode hout kist,"⁸ "1 Swarte kooij" (VR4,1692) and "1 Roode kist met swarte bollen daeronder" (II,37,1709).

Black and red seem to have been the most popular colours: there were black chairs, cupboards, tables, wall-racks and four-posters; red chests, birdcages, tea-tables, picture frames, and tea-racks—and, just once, a small brown tea-table. From time to time examples of more elaborately painted furniture are also recorded, such as "een geschildert schenc tafeltje" (23/5,35,1675). Cupboards and screens in particular were favoured for painted decoration, as well as small objects like boxes and nappy trays.

Dr. van de Wall is of the opinion that the Cape, with two sources of supply available, remained faithful to the European tradition. "In het algemeen," he writes, "leefden de Hollandsche vrouwen aan de Kaap zooals zij in hun vaderland gewoon waren en bleven haar goede smaak en zin voor het schoone Westersch georiënteerd."⁹ In so far as the circumstances prevailing at the toe of Africa made it unfeasable for the small, isolated settlement to participate fully in the exciting Indo-Dutch culture that flowered in the Eastern dependencies in the second half of the seventeenth century, Dr. de Wall is correct. On the other hand, the average man and woman of the Cape were as fascinated by the fabulous East as their fashionable counterparts in Europe, and their priveleged position on the sea route between East and West was reflected, as we shall see, over and over again in the furnishing of their houses. This fascination, however, was not reflected in any important way in the furniture produced at the Cape, which generally seems to have been oriented westward. Whether this orientation was actually a matter of choice, or whether it was the only possible line of development in the circumstances, is not easy to decide, but I think the latter is more probable. It is true that the Cape, in time, was to depend heavily on slave labour, but expatriate slaves were unlikely to set the main pattern of development in a settlement dominated by Europeans.

Exactly who set the pattern of furniture-making in the seventeenth-century Cape is still something of a mystery. Dr. de Wet, who deals with the occupations and professions of the free members of the Cape community in exhaustive detail, cannot produce a single cabinet-maker before 1707. Among his list of carpenters, however, is a man named Johannes Gerhardus Hobe.¹⁰ This man is

obviously the Johannes Gerardus Hoebie who is described as "cabinet werker alhier" in the vendu roll of the property he left behind in 1696, when he fled the country aboard an English ship.¹¹ Probably a number of other carpenters also turned their hands to furniture, while some of the coopers, a group with cognate skills, are known to have done so.¹² Furthermore, carpenter's tools are such a common item in the inventories of men who had no professional status in this field that many burghers were probably capable of providing their own simple furniture. Finally there were the Company carpenters, who would surely have turned out furniture for the higher officials and even, perhaps, for some of the free burghers. This is all regrettably nebulous, but some explanation is needed to account for the various pieces of furniture made of local woods that appear in a batch of important inventories for the year 1701, especially as much of this, if the prices received at auction are a reliable guide, could compare in quality with the imported article. Seventeenth-century references to furniture of Cape provenance are virtually non-existent, but this means very little. In an inventory of 1679 the clerk wrote down "4 stoelen van gemeene Caaps hout," and then corrected this to read "4 Swart gepoljste stoelen" (23/5,47); while an auction roll of 1686 includes "2 Caapse houten stoelen."^{12a}

Before embarking on a discussion of the various different types of furniture that had a place in the Cape interior it should perhaps be mentioned that the lower ranks of seventeenth-century society had to manage with very little. If one had a chest filled with one's belongings on which to sit by day and sleep by night, one was already a couple of moves away from extreme poverty. Many people sat and slept on the floor. Many more made do with a barrel or upturned basket for a seat, and contrived a primitive form out of a plank for both sitting and sleeping. In the third quarter of the seventeenth century it seems inevitable that a number of people at the Cape had to manage with little, if any, furniture and, like the peasants recorded by Adriaen Brouwer, they no doubt used whatever came

their way to make life more comfortable. Extreme poverty did not disappear in 1675, but if most people had lived like Ditloff Bibout, who shared his small town house with a wife, three tiny children, a slave called Lijsbeth, a few household oddments, and two bits of furniture—an old chest and an old table (1,14,1695)—there would be almost nothing to say about the furniture found in the Cape home.

The Bed

For many people at the Cape, particularly before 1700, the bed, if they had a bed, together with its often more expensive bedding, was their most valuable possession. Enough has been said already¹³ to show that at the Cape the bed at this period was still an important and extremely dominant item of furniture though, in the European scheme of things, it was no longer quite as dominant as it had once been. There were three different terms for a bedstead in regular use at this time, "ledikant," "katel," and "kooi." "Ledikant" is the Dutch version of the French term "lit de camp"—a type of bed known in England as a "field bed." The origin and purpose of this bed is inherent in its name. It was a travelling bed, a bed that could be taken apart and packed into box or bag, a bed that could accompany its owner from one establishment to another and onto the field of battle. According to Jozef Weyns¹⁴ the word "ledikant," which was in use by the second quarter of the sixteenth century, was applied to two very different bed types. One of these was an open bed with a tall headboard and sometimes a footboard¹⁵ or short end-posts as well. The other was a four-poster with a wooden tester, and it was to a bed of this kind that the term was normally applied at the Cape—and at Batavia. It is just conceivable that an entry like "1 ledikant sonder behangsel" should be understood to mean a bed that was not designed for hangings rather than a bed without its hangings, and that the same sort of interpretation should be placed on "1 ledikant sonder stijlen."

In the more settled conditions of the seventeenth century, the field bed or ledikant lost much of its popularity in Europe,

(20) A French Bed. The fixed frame was meant to be completely hidden by the hangings.

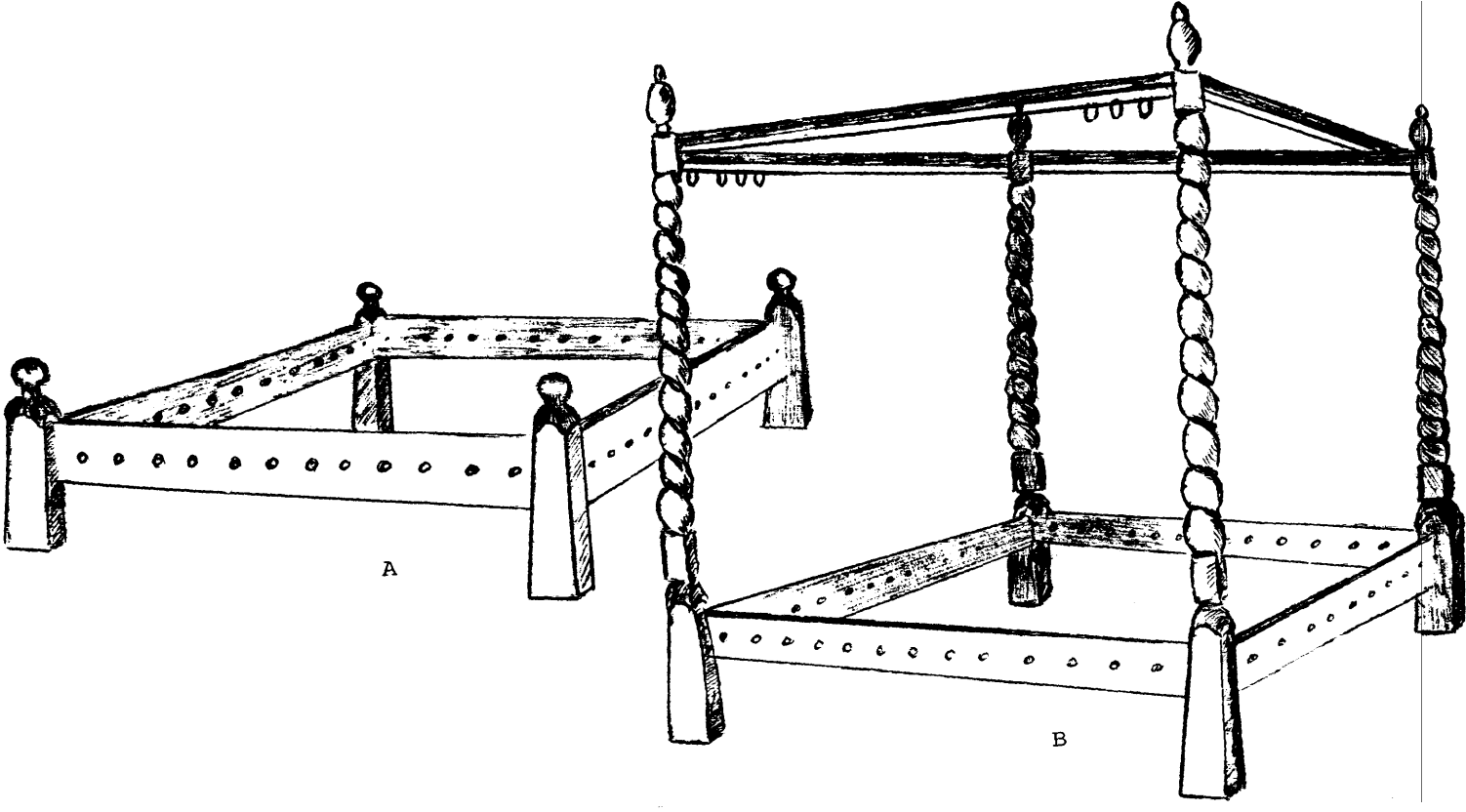
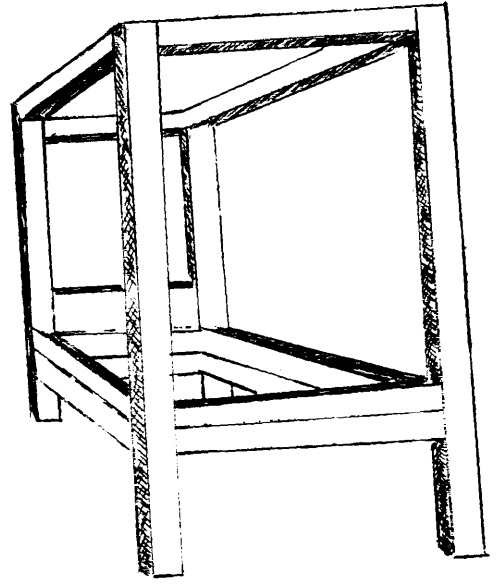

(21) A simple Frame-Bed with and without Turned Posts. A Katel and a Katel met Stijlen ?

where it was replaced by a variety of beds that were not designed to be moved about. The most common of these was a rectangular boxlike construction that provided a frame for all the important hangings and was of little moment on its own account (Pl.20). When dressed in its curtains, this bed—the English called it a "French" bed—could present a very similar appearance to the field bed, but it was not designed to be dismantled. In Holland a careful distinction does not seem to have been made between these two types of four-poster, and if, as seems likely, both were in use at the Cape, the French bed was not particularised. Some inventory references unquestionably concern the field bed. There is nothing ambiguous about "1 rood onopgemaakte Ebbenhoute Ledikant" (II,43,1710), nor about "4 booven stijlen tot een Leedikant" (III,31,1713), and in general an expensive ledikant or one where attention is focused on the wood rather than the hangings is likely to have been of field type. Both the inventories of Rustenburgh¹⁶ refer to a "blok Ledikant" and I have wondered whether a French bed was intended, but to the best of my knowledge the term does not appear again. The wooden components of the French bed were so simple that its life was measured by that of its hangings, and even in Europe few specimens have survived.¹⁷ At the Cape no bed at all is known from this period, so that the whole subject unfortunately remains highly speculative.

Apart from a very occasional hammock (hangmat) such as "Een brasilsse hangmat" (23/5,35,1675), the katel was the simplest bed in common use. According to Mentzel the "katel," a term not found in Holland, was used for a frame standing upon four legs or suspended from the ceiling with ropes and plaited with Spanish cane or covered with sealskin.¹⁸ Beds of the first type are easily recognisable, thus "1 Raem van een Cadel" (III,31,1713), which would have had the legs set straight or crossed like a stretcher (Pl.21A). Beds of the second type are not; but for Mentzel their presence would not have been suspected. To judge from the price range, the term "katel" was also applied to something more substantial, and the word probably covered everything from the simplest bed frame to a substantial bed with head- and footboards. To add to the

confusion some katels had both posts and hangings, as in "1 Cadel daer om een wit behangsel van Sousjes"¹⁹ (II,33,1710) and "1 Cadel met stijlen en beddegoet Capok" (II,114,1714). What distinguished a katel with hangings from a ledikant can only be a matter of guesswork. One possibility is that it had no headboard and was merely a frame with posts (Pl.21B); another that it had a fixed frame and resembled a French bed (Pl.20). Both ledikant and katel came in different sizes: "1 klijn geelhout Leedikantje met bast"²⁰ behangsel" (II,61,1712) and "6 groote Cadels 1 do Clijn" (II,109,1714). It seems clear, though, that the large double bed was a good deal more common than the single bed.

After years of vacillation as to whether the kooi was an independent bed type or not,²¹ I have finally decided that it was not. "Kooi," another colonial word and one not accepted in polite circles in Holland,²² has the same sort of origin as "kombuis;" the former derived from the ship's bunk and the latter from the ship's galley. According to Van de Wall no distinction was made in Batavia between a "ledikant" and a "kooi," while "bed" was used for a ledikant of European origin.²³ If Van de Wall was right about this usage of "bed," things were different at the Cape. In local parlance "bed" always seems to designate a feather bed rather than a bedstead proper, as in "1 bed voor oelof berg daerejn peule, kussens, en 2 combaerssen, met een katel,"²⁴ or "1 p^s kadel, daar op een bedt met een kombaars, met sijn toebehooren" (I,23,1697). In entries like "1 vaderlands bedt, met peulen, en 3, ps kussens" (I,36,1698) no bedstead is in question.

In the seventeenth-century Cape when the term "kooi" is most in evidence, it seems to have been used as a virtual synonym for ledikant: "1 swarte kooij uijt de ander genomen,"²⁵ "1 slegte kooij met chits behangsel" (I,1,1673), "2 slaap kooijen met / 2 kadels / 2 behangsels" (I,10,1694). On one occasion a bed described in the inventory as "1 ledicant met een zits behangsel" appears in the vendu roll as "1 kooij met een chitz behangsel," which seems clear proof that the terms were interchangeable.²⁶ As I have noted elsewhere, however, the kooi with a price range, before 1700, of

six to just over twenty guilders, was significantly cheaper than the ledikant which, during the same period, ranged from nine to just over fifty guilders.²⁷ All I can suggest is that a clerk confronted by an important bedstead instinctively abandoned the local kooi for the more formal ledikant. No other explanation occurs to me that would account for "1 klijn geelhout Leedikantje met bast behangsel" valued at 30 guilders, followed immediately afterwards by "1 geelhoute Cooij met groen behangsel" valued at a mere 18 guilders (II,61,1712). It would also be understandable if a certain confusion reigned between the kooi and the katel met stijlen.

"Kooi" in the first half of the eighteenth century was also a synonym for the generalised English term "bed;" a fact clearly demonstrated by the following: "1 klein kinder kooijtjen" (I,69, 1701); "twee witte kooij lakens" (II,7,1706); "twe kadels met Cooij goet" (III,55,1713); "2 veld koijs²⁸ met hun behangsel" (VI,67,1743); and "1 paviljoen kooij met sijn behangsel" (VII,71, 1748). This last reference introduces us to a special kind of curtained bed, known as a "paviljoen" (Pl.25). The paviljoen was a bed with a canopy suspended by cords from the ceiling. The canopy was usually shaped as an inverted bowl, was trimmed with a valance, and supported two or three large curtains which had to be long enough to reach out and cover the end of the bed. Such canopies were known to the French as "pavillons," and the Dutch made use of the same word. Beds of this kind were popular in Europe in the middle of the seventeenth century, but there are very few references to them at the Cape, particularly before 1715. In 1664 the inventory of an ensign (vaandrig) at the Castle mentions "1 Paviljoen van Chits"²⁹ and in 1707 "een pakje franje tot paveljoen kamelhair" is listed (II,8,1707), and that is about all.

Because the hangings were the most prominent part of a curtained bed, the wood beneath is rarely mentioned, and when attention is drawn to it this may mean that the wooden members were not entirely concealed by the curtains. The ebony four-poster occurs more often than any other, probably a tribute to the popularity of the wood as much as anything else, and some of

these were undoubtedly costly, such as "1 p^s Ledicandt Ebbenhoudt" which fetched 90 guilders in 1712 (VR74). Yellowwood and stinkwood examples taken together more or less equal the number of ebony four-posters, and the prices—60 guilders for "1 stinkhoute Ledikant met baste behangsel" (II,61,1712)—show that handsome bedsteads were in question. An occasional bed of red alder is mentioned, and in 1698 the flamboyant and wealthy Henning Hüsing bought a "Verguld Ledikant" at auction (VR11).

Apart from ebony, a black four-poster which must have owed its blackness to a coat of paint or a stain occurs more often than any other. For so ordinary a bed to be mentioned so frequently may indicate that it was a very common type. Some of these beds commanded a respectable price and so are likely to have been field beds, but a coat of black paint could easily have been applied to the frame of a French bed as well. However, as a really cheap ledikant never seems to rate a description, this is mere guesswork. Plate 20 shows an absolutely simple bedframe redrawn without the hipped tester; it is taken from a French perspective drawing of the seventeenth century.³⁰ I suggest that something very similar, with or without a coat of black paint, was in use at the Cape, and that when one comes across a four-poster worth less than ten guilders this may be the sort of bedstead one should picture.

Katels, which even at best were comparatively humble objects, are seldom described in any way. Exceptions include the occasional East Indian katel such as the "indische Cadel" in the estate of the merchant, Albert van Breugel, (23/5,35,1675), and several ebony katels, one of which sold for as much as 24 guilders (VR47,1708). In most households, katels made up the majority of beds, and while this was largely because they were cheap there is some evidence that they were actually preferred on occasion. Olof Bergh slept on a katel although there was an empty ledikant in the same room: an understandable preference on a hot summer night at the Cape. There is little to say about either the cradle or the crib, though the former, at least, was a fairly common entry. Now and then the cradle is listed as "1 houte Wiegh" (III,30,1713), and this probably means that the use of wood was worth noting

because the average cradle was of basketwork which, on the evidence of Dutch paintings, appears to have been the case in Holland. At times there is mention of a foot, as in "1 groote wiegh, met sijn voet,"³¹ and in such cases the foot may either have been part of the cradle or—and this is perhaps more likely—a separate stand on rockers.³² The crib or cot rarely occurs, but an entry like "1 houte krebbe" (I,69,1701) probably refers to something of the sort. Occasional references are also made to children's beds, such as "1 klein kinder kooijtjen" (I,69,1701) and "Een kinder kateltje" (II,43,1710).

Further clues as to the construction of these early beds are scant. Rare entries confirm the presence of beds with turned posts, as in "1 ledicant van stinckhout, met gedraaijd" (I,69,1701) and "4 Gedraijde stijlen" (II,76,1713); and other occasional entries show that a cane bottom occurred on both ledikant and katel: "2 slaap-kadels een gerottingt, en een sonder do" (I,69,1701), and "1 Nieuw Ledicant ongerottingt" (I,75,1703), and "1 onberottinde kadel / 1 bos rotting" (VR47,1708). It is probably significant that while one or more bundles of cane, in particular Javanese cane, turn up over and over again, there appear to be no references to riempie. Entries like "5 Riemen" (II,76,1713) surely refer to substantial leather thongs or straps. In Europe, canvas or a network of rope was sometimes used to support the mattress, and both these materials were fairly readily available at the Cape.

The most important sleeping accessory was the feather bed, often referred to simply as "bed," and a feather bed, particularly one imported from the fatherland, was a most costly possession. In general the feather bed of the seventeenth century served as a mattress rather than an eiderdown,³³ and, as more than one support made for added comfort, beds are recorded, even at the Cape, with anything up to four feather beds. The "bultzak," so-called, was a less favoured form of mattress which, at its humblest, was stuffed with straw. Only a few straw-filled bultzakken appear in the Cape inventories, presumably because kapok, an East Indian import, was freely available. A bultzak filled with feathers occurs from time to time, and an estate of 1703 included "1 hollands tijke³⁴ veere bedt" worth 30 guilders and "2 veere Bultzakken" worth 27 guilders

(I,76). An entry such as this makes one wonder whether the feather bed was occasionally an eiderdown, but it is very much more likely that the term "bultzak" was sometimes used for a feather bed—particularly an inferior feather bed.

Most beds were provided with a bolster (Pl.22D) and every bed in use had one or more pillows. As a large number of pillows was a status symbol, and as they also served to repel draughts—the night air was greatly feared even in the heat of summer—one can find as many as sixteen to a bed. This suggests that it was the practice to sleep against a mound of pillows banked up against the bolster, and that the upright sleeping position customary in the Middle Ages had not been generally abandoned.³⁵ In the heat of the tropics another use was found for the bolster: it was placed between the legs to absorb the sweat,³⁶ but given the less exiguous Cape climate there can have been no great incentive to adopt this Batavian practice.

Although Thornton is of the opinion that only the very poorest beds were without sheets in the seventeenth century,³⁷ it is my belief that sheets were not much used at the Cape; a belief strengthened by the information conveyed by Weyns that, among the small farming communities in Flanders at the beginning of this century, it was still a privilege to sleep between sheets, and one not often granted to the younger members of the family.³⁸ At the Cape, the apparent indifference to sheets was probably due in part to the fact that beds, if they were equipped with blankets at all, were generally equipped with light cotton blankets, so that sheets would not have added greatly to the comfort of the sleeper. Anyway, one can search through the inventories of several leading families without finding a single bed with sheets, though the exceptions are there to persuade one that their absence is not something that must be explained away. Let us look at the bedding in the Sneewindt inventory—always a yardstick of excellence at this period. At Sneewindt's death the household consisted of his widow and three children, and the main house at Rondebosch included six beds. One of these, a child's bed, was provided with two pillows and nothing else, the others each had a feather bed or a feather mattress (bultzak), one or more pillows (the

maximum was eleven), one or two Indian blankets (kombaarsen)³⁹ and, in two instances, bolsters. The bed in the widow's bedroom was the only one to have a sheet—and it was a single sheet at that. Also on this bed were five pillows, two Indian blankets and a feather bed—she had no bolster (I,69,1701).

Although it is rare to find a sheet in use, the more prosperous households were not without bed-linen. Much Cape bed-linen was made of the Indian cottons, but the most prized sheets and pillowcases were of Dutch linen, which was famed throughout Europe for its unusual whiteness.⁴⁰ Coloured linen does not seem to have been much in favour, but turns up now and again.⁴¹ The "Indische Kombaarsen" that occur so often in the Sneewindt inventory were exceedingly common at this period and were possibly of Javanese rather than Indian provenance. Blankets of Indian chintz were also much in use. Green blankets such as "1 groene vaderlands Kombaars" (I,62,1701) and "2 groene Wolle Combaarsen" (III,95,1719) are sometimes mentioned and must have been particularly welcome on a cold winter night for I have found but one reference to a warming-pan (23/5,35,1675). Counterpanes, as the Sneewindt beds demonstrate, were not used as a matter of course, and a bed, such as the one slept in by Elisabet Loenss, which boasted not only two sheets but "een fijne sprij over-trocken" (II,37,1709) seems to have been fairly unusual. On special occasions, however, the best bed probably was tricked out in a handsome counterpane, for many households had one or two tucked away in a cupboard or chest. Descriptions are rare: most counterpanes seem to have been made of chintz, but among the exceptions to be described we find lace-trimmed counterpanes, red silk counterpanes and yellow counterpanes. Quilts (dekbedden) only turn up on one or two occasions and cannot have been in general use.

Though there was nothing very extravagant about the bedding found in the Cape house, it was nonetheless expensive. The difference in price between a good four-poster and a set of good quality bedding is vividly demonstrated in the most prosperous estate of Senior Surgeon ten Damme⁴², where "7 ledikanten" were valued at 378 guilders and "7 bedden met sijn toebehooren" at

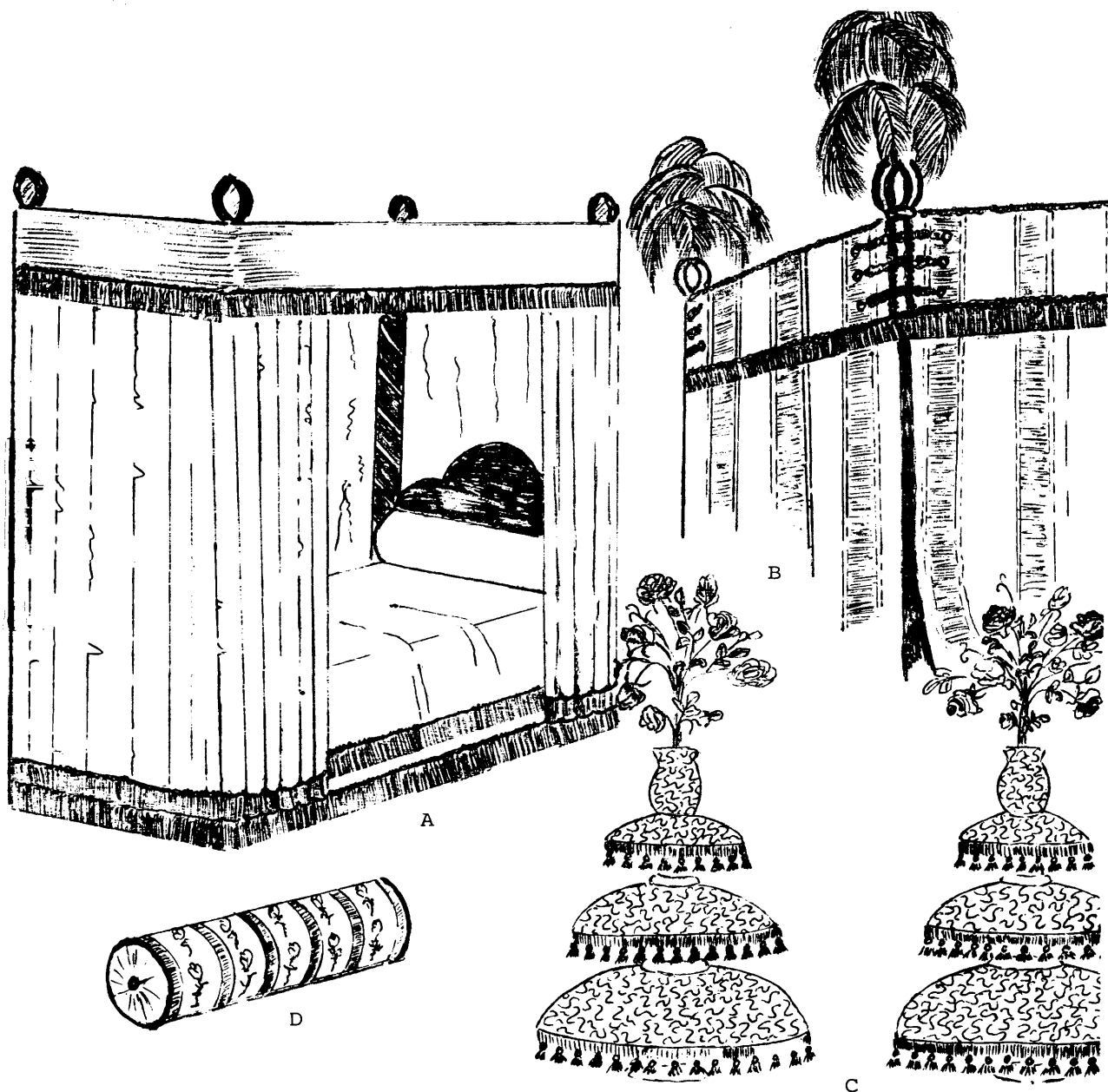

- (22) Beds and their Fittings. A) Ledikant with fringed silk hangings and cloth-covered posts. B) Curtained bed with plumed corner posts. C) A pair of elaborate padded and fringed corner posts terminating in artificial flowers. D) A bolster for the head of the bed, seen in position in A.

840 guilders (II,117,1714).

This comparison is a timely reminder that we are dealing with a period when fine cloth was the most valuable commodity available, and the upholsterer's bill much heavier than that of the cabinet maker.⁴³ In these circumstances the upholstery for a state bed could cost a fortune, and a lavishly dressed four-poster was the upholsterer's finest creation. It needed a terrifying amount of material and expensive metal fringe to do the job properly; for apart from the tester with its valance, the curtains and the headcloth, a correctly dressed bed required cantons (additional outer curtains hung at the corners to conceal the meeting point of the main curtains), an inner valance, covers for the posts, a base valance, a counterpane, and corner cups lavishly decorated with plumes, fringe or artificial flowers⁴⁴ (Pl.22B&C). The cost of such beds was exorbitant. In 1699 the estimate for the plumed cups alone, for the state bed at Hampton Court Palace, was a little over a hundred pounds.⁴⁵

There was nothing remotely like this at the Cape, where few bed hangings were worth more than thirty guilders and a number were worth five guilders or less. Unfortunately, not a single entry known to me describes the bed hangings in detail and most of the evidence available is negative. In the absence of a reference to anything resembling a plumed cup, or pomme as the Dutch called it, one assumes that they were not used much—if at all. Possibly Simon and Willem Adriaan van der Stel slept in beds dressed on a scale commensurate with that shown in Plate 22 B, the sort of bed in use among the wealthy Dutch merchants, but I doubt it. Plate 22 A, perhaps made up in red silk with a contrasting fringe, and Plate 23 dressed in what is believed to be the lit à housse style, are probably as grand as anything achieved at the Cape. But even something like these must have been exceptional. There is only one set of hangings noted, "een paars saaije behangsel met sijde franje," belonging to Albert van Breugel (23/5,35,1675), that appears to belong in this class, and the use of serge—a material quite unsuited to the Cape climate—is an almost certain sign that these hangings were brought out from Holland and not made up at the Cape. For the rest no

- (23) Probably a Lit à Housse.
Tasselled cords were
provided on the inside as
well, so that the curtains
could be tied up out of the
way.

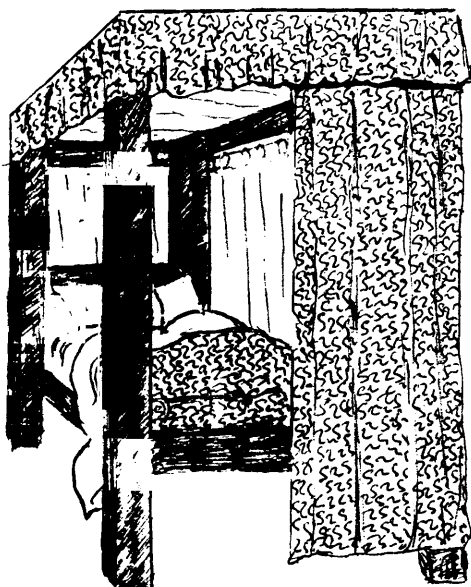
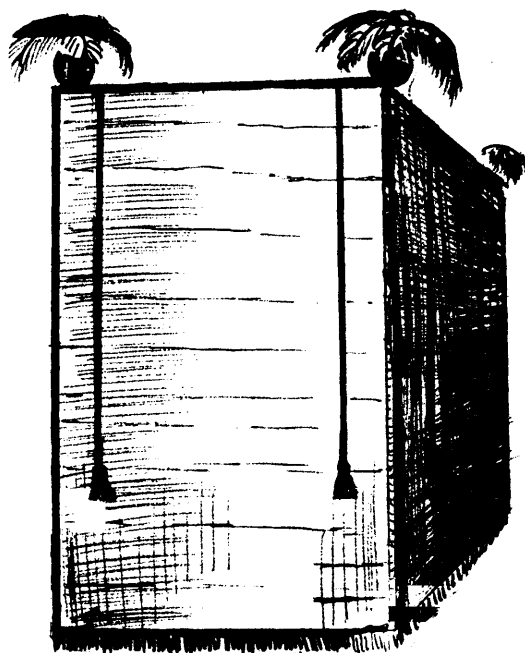

- (24) Black-Painted "French" Bed
with Simple Chintz Curtains.

- (25) Canopy Bed or Paviljoen.
Note the deep fringe edging
the dome.

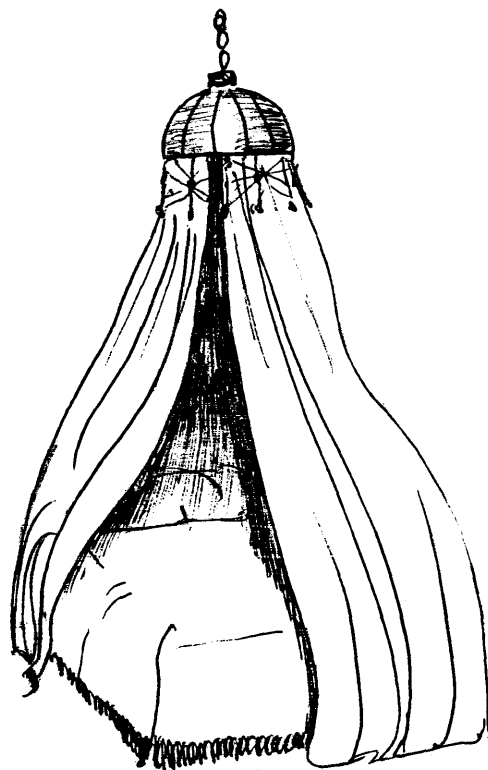

trimming of any sort is mentioned. It is possible that worsted or crewel fringe was cheap enough or common enough to pass unrecorded, but silk fringe was surely too expensive to have escaped the notice of the clerks, even if the price of better hangings was not too low to make its use at all likely. A metal fringe of gold or silver is quite out of the question: it was far, far too expensive.

Plate 24, which has no prototype except in my imagination, depicts a black-painted bed with a fixed frame, chintz curtains, valance and headcloth. The matching chintz blanket, also shown, may be an unwarranted improvement on the effect made by the average Cape four-poster. Furthermore, the cheapest hangings were not made to pull; they were merely tacked in place and tied back at need. Understandably the simplest beds and hangings almost never survive the depredations of the centuries, and even their pictorial representation is unusual. The bed-in-the-wall with a scrap of material tacked in front of it occurs in some Dutch genre scenes, but that is no help in regard to the Cape. The bed in the Hogarth cartoon (Plate 26) was drawn in 1726, but it has the timeless quality of extreme simplicity and is probably faithful to the spirit of the average Cape four-poster, not only before 1715 but throughout the eighteenth century.

When it comes to the material of the hangings a good deal of information is available. The charming—and practical because washable—Indian cottons with their printed and painted designs, which were known as chintzes,⁴⁷ were far and away the most common. Chintz bed hangings appear twice as often as those of any other material, but apart from a couple of references to black chintz, an indication that the pattern was reserved on a black ground, no other information is given. In view of the prices quoted it is apparent that little use was made of the extremely beautiful hand-painted chintzes, and most chintzes found at the Cape were probably printed—and printed in the three commonest colours: rose madder, indigo blue and purple. As the Cape documents give no details about the components of the hangings in use, I cannot rest quoting a section of a letter preserved in the records of the English East India Company. In 1682 orders were sent to Madras for painted chintz and bed hangings in the following words:



(26) Hogarth
1726

100 Suits of painted Curtains and Vallances, ready made up of Several Sorts and Prices, strong, but none too dear, nor any overmean in regard you know our Poorest people in England lye without any Curtains or Vallances and our richest in Damask, etc. The Vallances to be 1 foot deep and 6 1/2 yards compass. Curtains to be from 8 to 9 foot deep, and two lesser Curtains each 1 1/2 yards wide, the two larger Curtains to be 3 1/2 yards wide. The Tester and Headpiece proportionable. A Counterpane of the same work to be 3 1/2 yards wide and 4 yards long, half of them to be quilted and the other half not quilted... Each bed to have 12 Cushions for Chairs of the same work.⁴⁸

Other Indian materials used for bed hangings at the Cape were the muslins, neteldoek and betilles; the plain calico known as baftas; and popular cotton-and-silk mixtures like soosies and doreas which came from the Bengal region and enjoyed great popularity in Europe. All these fabrics, with the possible exception of baftas,⁴⁹ were available in colourful stripes and checks, with blue and white the most common combination available. A thin, plain-coloured worsted known as bunting (vlaggedoek) was the European material most in use for hangings, and the red variety was much preferred to the white. Other European materials recorded are linen, a woollen material called estamine,⁵⁰ and a thin silk named armozine.⁵¹ Striped hangings enjoyed quite a vogue, and though the material never seems to be mentioned, an Indian cotton of some kind can safely be taken for granted. Plain hangings in red, blue, green and white, the four colours that predominate in early upholstery, are also found. The emphasis throughout is on lightweight materials from India, and though such emphasis was no doubt paralleled in Batavia, it had no echo in Europe, where boldly hued, plain woollen fabrics, like serge, curtained the average bed.⁵²

Before leaving the subject of bed hangings, a subject of great interest to everyone dealing with a period house, I would like to speculate a little about the valance of the tester. A straight valance was the normal form in the seventeenth century (Pl.22A), and such a valance, with—or more probably without—fringe and trimming must have been in use at the Cape. Even more common,

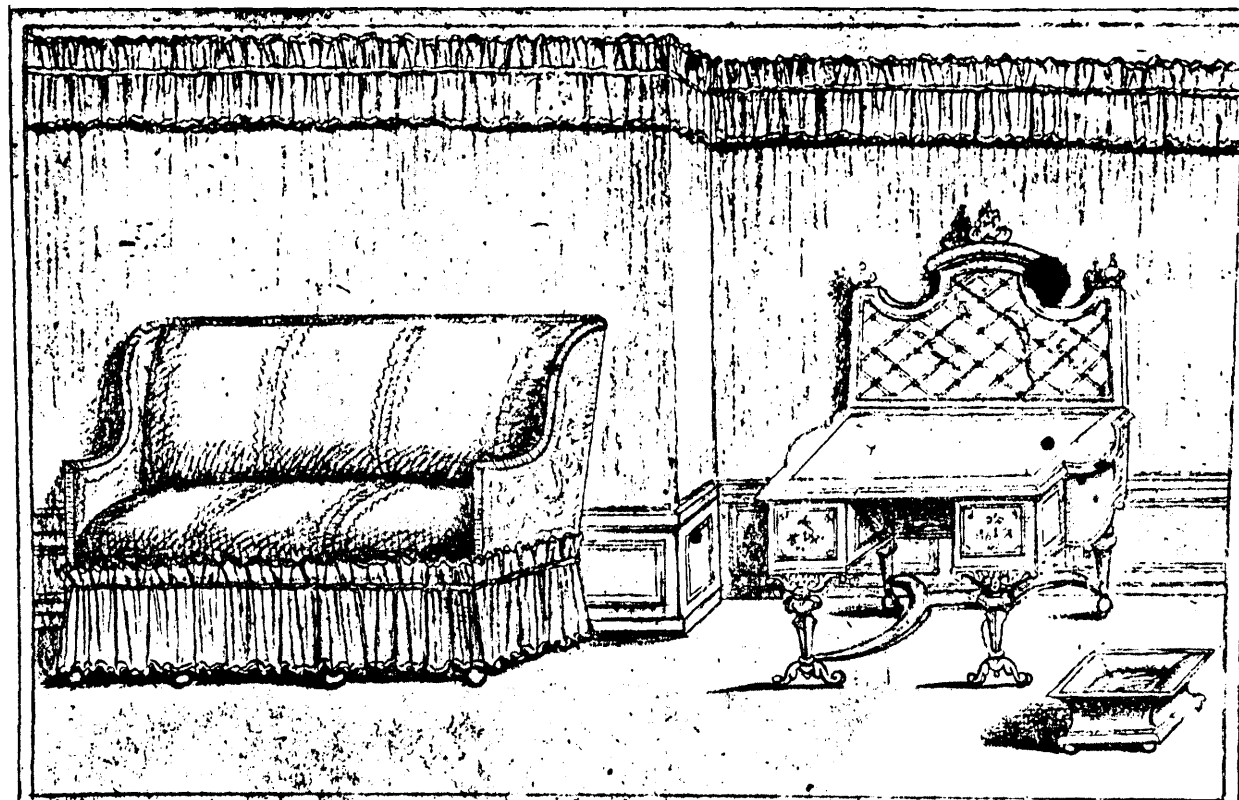

Grand sofa de velours rouge galonné doré au
falbala bordé de galons dorés, 9 pieds de long, 20
pieds de haut, 1 p. 2 de profondeur

Capitonné de camelot
à falbala rouge doré
pieds de haut

Bureau nouveau de commodité à l'usage
galonné à pieds de haut sur 3 positions
pieds 2 pouces de large

(27) A Room with Sofa and Walls upholstered à Falbala.
Designed for the Apartments at the Grand Trianon in
the 1690's.⁵⁴

I suspect, would have been a strip of material tacked into position without the taut precision of a straight valance (Pl.24). Shaping, of some sort, may well have been used, particularly in the first half of the eighteenth century (Pl.26), and after 1709 a finish à falbalas becomes a possibility. This attractive pleated frill or furbelow (Pl.27) was in use for the window valance at this period⁵³ and in view of the close relationship that normally existed in Europe between the treatment of the window and the bed there seems no reason why it should not have been used at times for the bed valance as well.

The Window Curtain

As the relationship between window curtains and bed hangings has arisen this seems the obvious place to say a few words about the former. Before 1700 curtains were rare. One or two are listed singly prior to 1686. In 1687 Olof Bergh possessed "1 stuckje dobbelsteene gardijn goed,"⁵⁵ five years later Joost Lons had "2 groene gardijnen 2 gardijn roeden" (I,4,1692). A similar reference to "2 gardijnen met roeijen" occurs in the Freser sale of 1696.⁵⁶ It can be deduced from both these last references that each rod held a single curtain, which was the normal European method of hanging curtains until the last quarter of the century (Pl.28C&D). The divided curtain was finally introduced to cater for the growing concern for symmetry, but shortly before that it had become customary, in the case of a pair of windows, to see that balance was preserved by drawing the curtain of each to left and right respectively. In 1701 the estate of Melchior Kemels, a senior Company man, had a dozen curtains in sets of four which suggests they were divided: they are listed as "4 gordijnties voor de glaasen / 4 do Blauwe / 4 do Roode" (I,66). The Kemel curtains, like many other curtains mentioned at this period, do not seem to have been provided with rods, which probably means that they were tacked into place and looped back when light was required⁵⁷ (pl.28A). In the early 1700's curtains begin to appear more often, though it is only after 1710 that they become a matter of course in the better type of house, and even then their use is confined to the principal room or pair of rooms. Entries such as "2 Roode

Gardijntjes / 1 Gardijn Roeij" (II,63,1712) or "2 Gordijnen betieljes met een rabat" (VR49,1709) must refer to divided curtains, but the single curtain had not disappeared completely. There were still voorkamers with only "1 venster gardijn" (II,115,1714), and there are other suggestive references such as "2 Venster gordijnen met Rabatten" (VR49,1709) where divided curtains would require a single rabat, or valance.

The materials used—chintz, bunting, muslin, doreas, etc.—are the same as those used for bed hangings. To judge from the price, which is generally extremely modest, for it involves sums like 3 guilders, 12 stivers for "2 Venster gordijnen met Rabatten" (VR49,1709), and 3 guilders, 6 stivers for "5 Vlaggedoecke gordijnen" (VR85,1713), fairly small quantities of material were normally involved and the average curtain must have been just large enough to cover the window surface. A survey of seventeenth-century paintings shows that curtains, unlike those of today, usually hung within the window embrasure, and that when the lower half of a casement window was opened the curtain, provided it was not confined to the top half of the window alone, was looped over the open window which, again unlike the modern window, opened inwards (Pl.28C)

Curtain rings were commonly sewn directly onto the top of the curtain (Pl.28B&C) or secured to the top of the curtain by looped tabs (Pl.28D), a method which made the curtains less liable to stick when being pulled. Both rings and rods were generally of iron, though horn rings are known to have been used in Europe. Brass rings, according to Thornton, were an eighteenth-century development⁵⁸ but they are mentioned in a Cape inventory dated 1674.⁵⁹ In a later inventory, reference is made to "18 zilver gardijn ringen" (IV,122,1726) ! When rings were unavailable the rod may well have been threaded through the looped tabs themselves.

Towards the end of the seventeenth century, shortly after the divided curtain had achieved acceptance in fashionable Europe, there were two further innovations. One of these was the "pull-up" curtain which came to be known in England and America as the "Venetian curtain." The pull-up curtain was drawn up to the top of the window by an arrangement of cords that worked on much the same principle as the modern Venetian blind, and was so arranged that it hung down from the top of the window in two, three or more festoons.⁶⁰ To

(28) Window Curtains

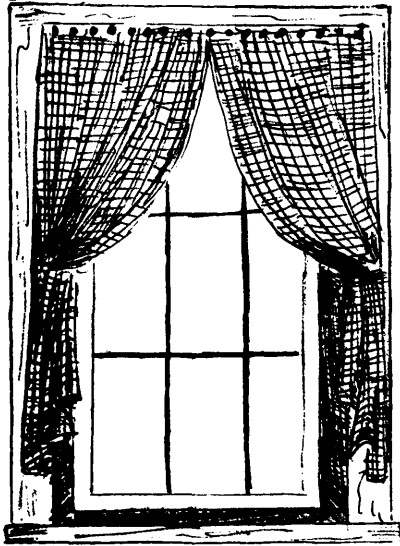

A

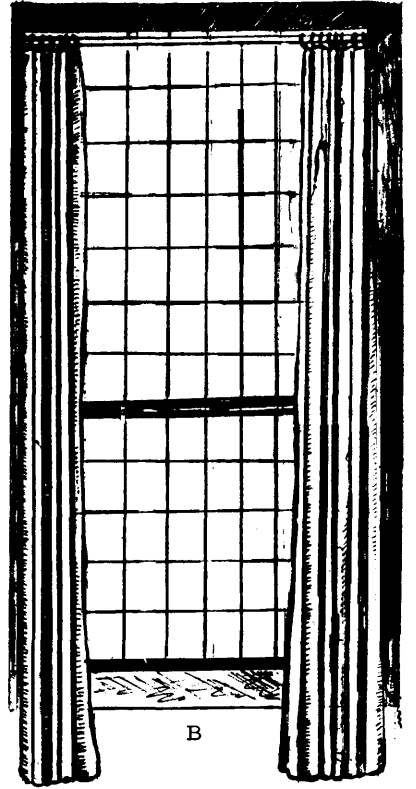

B

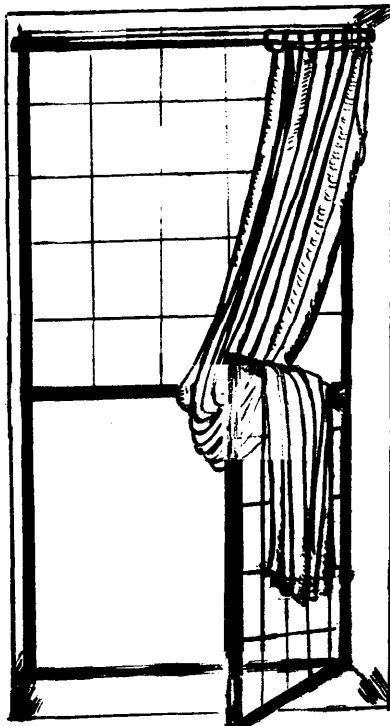

C

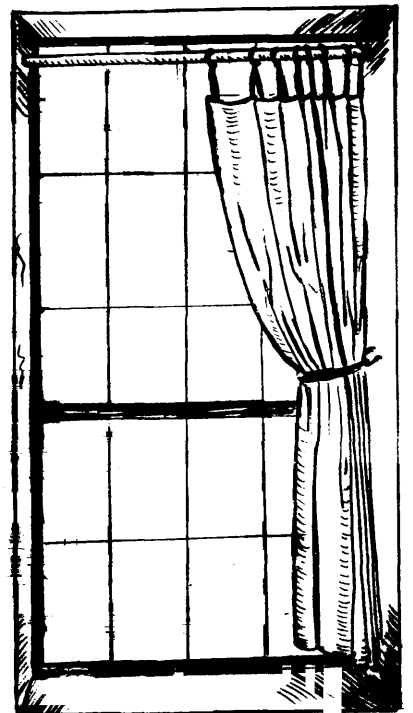

D

begin with this curtain too was confined within the window, but later a projecting pulley-board (plank⁶¹) came to be fitted to the top of the window. The fashion was slow to reach the Cape, where the first reference to an ophaal Gordijn I have noted occurs in 1730,⁶² but once there it quickly established itself and was to retain its popularity until the end of the Napoleonic Wars, when the fashion for draw curtains—known in England as "French curtains"—finally reached the Cape.

It was also in the late seventeenth century that the window curtain began to be given a valance (valletje of rabat) to conceal the hitherto exposed rod and rings or the equally exposed nail heads.⁶³ This improvement found its way to the Cape quite quickly, and "2 Gordijnen met haar falbalaes / 2 do betieljes met een rabat" are recorded in 1709.⁶⁴ Though a valletje, probably with a straight finish, was more common than one made with furbelows (falbalas), it is interesting that furbelows found their way here as quickly as they did. They were the height of fashion in Europe in the 1690's. During that decade they graced the Dauphin's apartment at Versailles, as well as one of the apartments at the Grand Trianon (Pl.27), and at much the same time the English traveller, Celia Fiennes, noted some white damask silk curtains of Lady Donegal's which had "furbellows of callicoe printed [with] flowers."⁶⁵ The furbelow valance seems to have enjoyed about fifteen years of fashionable life at the Cape: it drops from sight round 1725.

Seat Furniture

Dr. de Haan tells us that the terms "katel," "bank," and "rustbank" were used more or less interchangeably in the Batavian inventories, and that in the wealthier households an open bed (katel) or daybed (rustbank) was preferred to the curtained bed for the afternoon siesta.⁶⁶ Rather unexpectedly, I can find no record of a similar confusion at the Cape. "Katel," as we have seen,⁶⁷ was the colonial word in use for the simplest beds, which probably resembled the "slaapezels" of Flanders.⁶⁸ "Slaapbank," the Dutch term for a bench bed, plank bed or alcove bed,⁶⁹ is a word rarely encountered in the Cape documents, where the term "bank" seems to have the same meaning as English "form", which is primarily a piece of seat furniture without backrest or end supports.

Until the end of the sixteenth century, forms had been provided for use with the long heavy tables that stood in the halls of great houses. With the introduction of the draw-table, which could be adjusted to different lengths, the long form became unwieldy and was replaced by the more adaptable stool or chair. In the early Cape, the table and form remained in general use. Normally associated together as in "twee slegte tafels met drie bancken" (23/5,3,1670), "Een tafel / Twee bancken" (I,5,1688) and "8 houten banken waar van 2, kleijn / 4 Lange tafels" (I,6,1693) they remain fairly common items throughout the period under review. Unfortunately the few inventories compiled room by room before 1700 do not allow one to generalise about the position of these items: at Rustenburgh they were found in the voorhuis (23/5,29, 1673); in the Backer house, in the kitchen (23/5,50,1681); and the other documents of this type do not mention them at all. By the early eighteenth century, however, tables and forms are routinely confined to the nether regions of all but the poorest houses. Few forms cost more than a guilder, and few of the accompanying tables more than two: prices that point to roughly finished furniture of extreme simplicity. Some examples were much more expensive, such as "1 Lange Tafel en bank" which fetched 17 guilders, 4 stivers in 1701 (VR17), but in contexts which suggest superior quality rather than a change of function.

In contradistinction to "bank," the term "rustbank" refers to a relatively valuable piece of furniture but not necessarily to furniture of the same kind. It is here, if anywhere, that confusion reigns. To begin with the term seems to cover both the daybed and the wooden bench, and it may also have been used, as it was to be later, for the padded sofa that first came into fashion in the latter part of the seventeenth century (Pl.27).

The daybed with its single headrest and no backrest was certainly designed for an afternoon siesta, but there is no reason to suppose that it was ever confused with the katel, even if the katel often served the same purpose. For one thing the rustbank was more expensive, and for another it was normally provided with either a cushion or a squab (matras) which was a more tightly stuffed and more decorative adjunct to comfort than the yielding bultzak and veere bed. A handsome daybed with a single

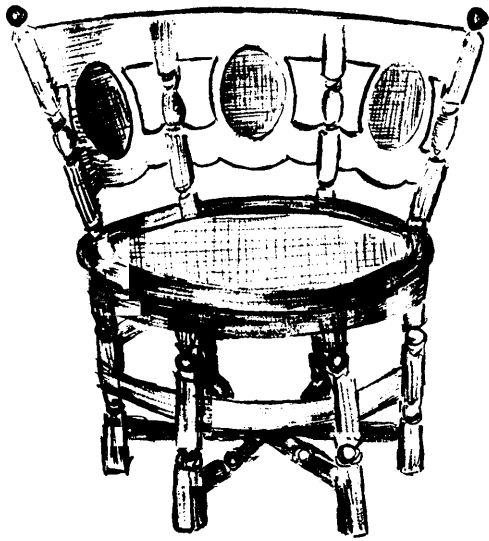

(29) Wheel-Back Chair

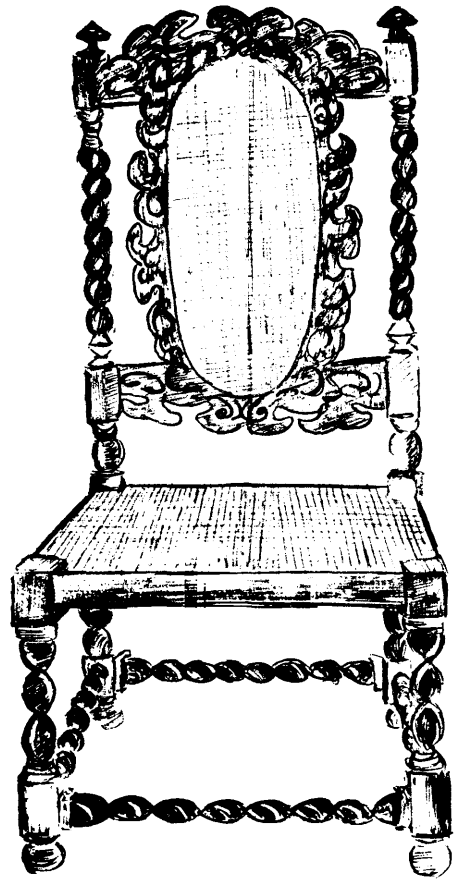

(30) "Tulbagh" Chair

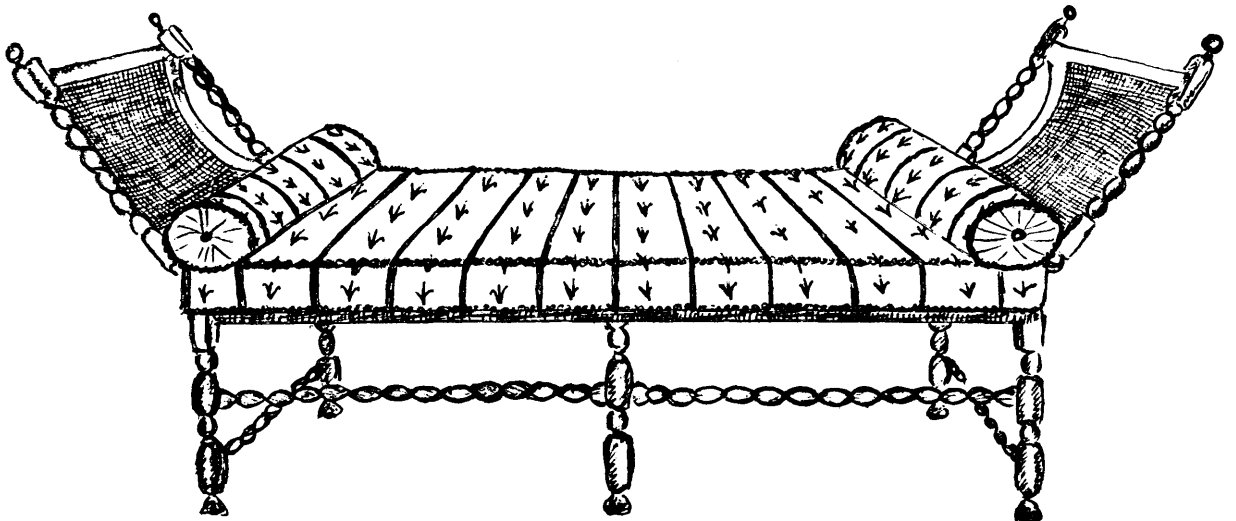

(31) Double-Ended Rustbank with Squab and Bolsters

headrest dating from before 1700, and probably of Cape workmanship, is preserved at Groote Schuur, and formed the model for the double-ended rustbank in Plate 31. A rustbank with a single end-rest is probably covered by descriptions such as "1 Rustbank met een peullie" (II,28,1709), where the presence of a single bolster is likely to be significant; "1 Rustbank / 1 peuluwe / 1 Combaers" (III,37,1713), and even, perhaps, by "2 rustbanke met 2 matrasse en 3 Combaarsse" (IV,75,1725). A piece of furniture halfway between the daybed and sofa-bench may be intended by a description such as "1 Rustbank daerop / 1 Cussen / 2 peuluwes / 1 hooft Cussen / 1 Combaers" (III,31,1713), where the two bolsters point to a pair of end-supports (Pl.31).

Except when a blanket or a single bolster is recorded, it is not easy to separate the bench-type rustbank from the daybed, because both were commonly equipped with a squab or perhaps a cushion. An entry like "1 Rustbank met een Matras" (VR66,1710) is quite often met with before 1720, and becomes a more or less standard entry thereafter. Furthermore, it is a standard entry in the Hague inventories as well, so that one cannot be too confident that a forebear of the familiar nineteenth-century Cape rustbank is always in question. Some examples, either due to their location or because they match a set of chairs, were obviously seat furniture, but it would be rash to assume that everything described simply as "een rustbank en zijn matras" was indeed a seat: this is one area where any attempt to draw fine distinctions is fraught with pitfalls. Since, however, the daybed in Europe was normally placed in the bedroom, it seems probable that the one or two rustbanken found increasingly often in the voorhuis as the century advances were designed to be sat on; the voorhuis was a room where a bed as such was seldom to be seen.

The rustbank was not cheap and seldom cost less than twenty guilders. Once again, ebony is the wood most often mentioned, but ironwood and eucalyptus were also used, and a few stinkwood examples, such as "1 rustbanck van stinckhout" (I,69,1701) appear as well. The most expensive example noted before 1715 belonged to Jan Dirksz de Beer; made of eucalyptus and displayed in the same room as six eucalyptus chairs, it fetched just over fifty

guilders at auction (VR18,1701). There is no reason to suppose that the padded sofa was a common piece of furniture in the early Cape, though "1 Swart Ebbenhoute Rustbank met een Chitse spreij" (III,92,1719) may refer to something of the sort. However, it is more likely that the "spreij" was no more than a straight cover with which the bench was draped—a practice with its roots in the Middle Ages.⁷⁰ Before leaving the subject of the rustbank it should perhaps be emphasised that most early examples seen today, with their often awkward proportions and their naked cane or riempie seats, would have presented a very different and rather more inviting appearance in their youth.

The upholstered chair so characteristic of the new standard of comfort in contemporary Europe was seldom seen at the Cape, though a few examples such as "6 Vaaderlantsche bekleede stoelen" (III, 13,1714) did find their way there. Plate 32 is a sketch of the so-called "farthingale chair," the commonest form of covered chair in the seventeenth century and one in use all over Europe. It is highly unlikely that attempts were made to produce anything of the sort locally. Chairs in general use at the Cape were seldom worth more than a guilder or two, and most of them were probably the work of local carpenters. Such cheap chairs never rate any further description, apart from the periodic use of the belittling epithet "ordinary" (gemeen). At the time the "ordinary" Dutch chair was rush-bottomed, and a certain number of these must surely have been imported, but to date I have only come across one clear reference to matte stoelen, namely: "2 stoelen sonder mat" which fetched 3 guilders, 6 stivers in 1711 (VR69). This is a disturbing entry. As the rush was only recorded because it was not there, one is left to wonder whether such chairs were actually quite commonplace. So much of our past has not survived the centuries that one cannot assume their rarity in 1700 because they are hardly known here in the 1980's (Pl.34).

Unless all the gemene stoelen in use in these early years have disappeared without trace, some of them must have been spindle backs of local manufacture (Pl.18). Hans Fransen places the origin of the so-called "tolletje stoel"—a term I have yet to encounter in any inventory—in the early eighteenth century,⁷¹ but it would surprise

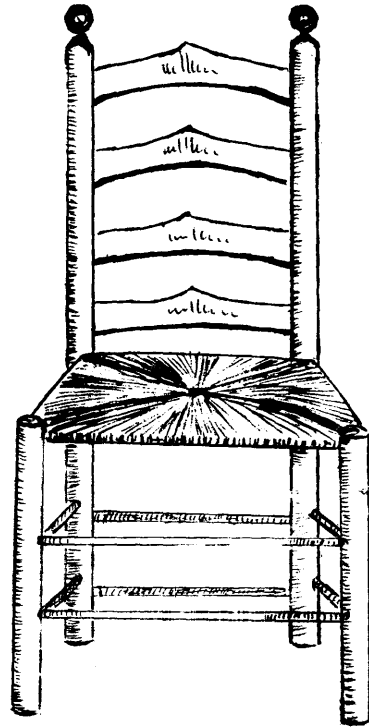
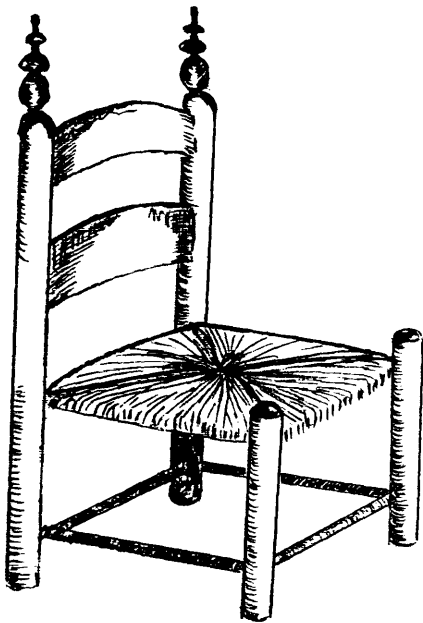
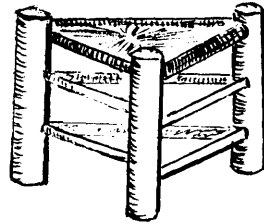
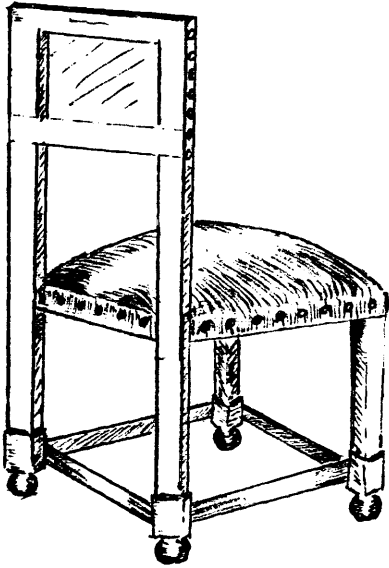

- (32) Upholstered "Fathingale" Chair
- (33) Three-Legged Rush Stool
- (34) Two Turned-Chairs with Rush Seats

me very much if they were not being made well before 1700. Whether the ordinary Cape-made chair of early date had a riempie seat or not is another matter. I have already drawn attention to the fact⁷² that while bundles of cane were much in evidence, there is little, other than tradition and availability, to support the use of leather thonging at this date.

Though most chairs were undoubtedly considered very ordinary, there were a number of exceptions. Two of the most striking are "6 gesneden stoelen / 4 do Cussens" which sold for the very considerable sum of 81 guilders in 1696⁷³ and "6 kaliatoirehoute stoelen" which realised 78 guilders at a sale in 1703. In the same sale six ebony chairs realised 48 guilders, a fairly standard price for a set of good chairs (VR27). Ebony, as we have come to expect, is the wood most often mentioned, and a set of matching ebony chairs: "6 ebbenhoute hoge stoelen"⁷⁴ for example, occurs quite often. Chairs of stinkwood and the puzzling "Chinese" wood are occasionally recorded and were probably local products—which is unlikely to have been the case with the Sneewindt's "6 stoelen gedraaijd van notebomen hout" (I,69,1701). A set of more than six chairs only becomes common a little later in the century, but there are exceptions such as the "12 Root Elsenhoute stoelen" found at Nooitgedacht, and the "12 swarte geveerde stoelen" mentioned earlier.⁷⁵

Among the special chairs pride of place must go to the church chair which accompanied the women of the household to church on Sundays. Frequently of ebony, and as handsome as possible, the kerkstoel could be worth as much as ten to ~~fifteen~~ fifteen guilders. In Batavia the normal place for such a chair was the voorhuis⁷⁶ but at the Cape at this time it nearly always graced one of the voorkamers. A rather mysterious object known as a "beugelstoel" occurs as a single entry in a few important estates like that of Sneewindt. I have not been able to find out the precise significance of "beugel," but it suggests something hooped or rounded and I have wondered whether the chair known today as the "burgomeesterstoel" or "wheel chair" could have been intended (Pl.29). Other chairs mentioned are the armchair (leuningstoel) which would have had wooden arms, and the deckchair (dekstoel) which was presumably a

folding chair and may have had a canvas seat. The child's chair (*kinderstoeltje*) also makes an occasional appearance. This may have been a miniature chair or a high chair for use at table, though in contemporary Holland it was rarely considered necessary to provide children with a dining chair; as the art of the period shows, they were expected to stand at mealtimes—a practice the Cape perhaps followed for the first century or so. Another possibility presented by the *kinderstoeltje* is the commode; Weyns illustrates a number of small chairs, their wooden seats pierced to accommodate the potty, under this name.⁷⁷ The corner chair (*hoekstoel*), which is generally considered one of the earliest chair types made at the Cape,⁷⁸ does not appear in a recognisable form in any early inventory, and this is certainly disconcerting.

If, as I suspect, the chronology at present accepted with regard to the early Cape chair is based on the assumption that no furniture of importance was made locally before 1700 and very little of note before 1725, it is perhaps time that the whole subject was reconsidered. Chairs may have been in short supply in the 1670's, but this had been remedied well before 1700. In 1685, to cite a few concrete examples, Elbert Diemer owned twenty chairs (I,2); in 1699, Adriaan van Brakal had thirty-two (I,46); in 1703 Christina Does, wife of Lieutenant Van Reede, owned forty-two chairs; and in 1714 Senior Surgeon ten Damme actually had fifty chairs (II,117). A number of these were certainly imported, but I would expect the majority to have been made locally. Are we really right in dating the earliest and finest of our "Tulbagh" chairs with their typical late seventeenth-century form (Pl.30) to the 1740's?⁷⁹

Just as the hard unyielding appearance presented by the generality of *rustbanken* is misleading, so too is the uncushioned state currently imposed on nearly every old Cape chair. In the prosperous seventeenth-century households, and more generally in the eighteenth century, relief was provided by loose cushions. It is for this reason that the front legs of certain old chairs, such as the spindle backs, extend a few centimetres above the seat—a feature that helped, and should still help, to keep the cushion in place. Most cheap chair cushions are not described at all. Very

occasionally cushions of sealskin (robbevel), worth between one and two guilders, are recorded, and many an undescribed cushion may have been of this tough, comfortable, "indigenous" material. Coarse chintz cushions were equally cheap, and so were "5 speldewerks⁸⁰ kussens" in the inventory of Senior Surgeon ten Damme (II,117,1714). Fine chintz was quite expensive and came out at three guilders a cushion, so that a pretty cushion was every bit as costly as an ordinary chair: a fact well illustrated in the Ten Damme inventory just cited, where fifty chairs and thirty cushions were valued at three guilders apiece. Much prized and far from common were chair cushions of plush velvet (trijp)⁸¹ or damask.⁸² In 1675 Albert van Breugel, who had obviously made the most of his position as merchant in the Dutch East India Company, owned "ses trijpe kussens / ses damaste dos / ses oude trijpe dos" (23/5,35). In 1701 "2 trijpe stoel kussens" sold for the astronomical price of 23 guilders, 10 stivers (VR21), yet a year later five similar cushions fetched 24 guilders (VR24). If the first two were fringed in accordance with European fashion, like the "12 stoel kussens met Franjes" listed in 1726 (IV,118), the marked difference in price becomes explicable. Cushions of red plush, the finest of them perhaps with a gold fringe, seem to have been something of a status symbol. First mentioned in 1701 (I,69), they graced the front rooms of the leading burghers and officials right through into the nineteenth century.

Stools, Footstools and Footwarmers

There is a good deal of evidence, both written and pictorial, to show how important the stool was in the seventeenth and eighteenth centuries. Indispensable at court and in upper class circles generally, it was often included in a set of fashionable seat furniture, while at the other end of the social scale it offered the cheapest specialised seating available. The stool ranged in quality, then, from a luxury item, carved, gilt, and fitted with a brocade squab, to a humble object of rough planks and a handful of nails. One expects the simplest stools to be common in the early Cape inventories but they are, instead, extremely elusive. Very occasional references such as "2 p^s

houte drie voet stoelen" (I,16,1696) and "1 houte 3 voets stoeltje" (VR11,1698) must refer to the familiar triangular Dutch stool (Pl.33) which at times had one of the legs extended to provide a primitive backrest. The diminutive of "bank" seems to have been the Cape word for a square or rectangular wooden stool, as in "3 houte bankjes en 1 stoof,"⁸³ but even the bankje was not a common piece of furniture in the early Cape.

A single footstool, usually known as a "voetbank" though the term "schabel" is used in both Rustenburgh inventories, turns up fairly regularly. In aristocratic European circles, a footstool often accompanied the "chair of state" which was reserved for the head of the family or a guest to whom precedence was due.⁸⁴ At the Cape it may well have had much of the same significance, though there is something faintly comic about a footstool in the kitchen—and that is where one occasionally turns up—being designed to honour the pater familias. The voorhuis or one of the voorkamers was a more normal setting for it, however. The footstool was one of several items of furniture that was sometimes provided with a cover or a small oriental carpet, and Olof Bergh had "1 voet banck met een gescheurde alcatieff" in his quarters at the Castle.⁸⁵

In Holland foot-warmers, those small wooden cubes with an open side and a pierced top designed to hold a brazier, were in almost constant use by the women of the household. Whether attending church, or drinking tea, or relaxing on the front verandah on long summer afternoons, the Dutch woman kept her foot-warmer by her,⁸⁶ and in painting after painting the two are shown together. Perhaps the foot-warmer was a woman's preserve in the Cape of 1700 as well, but if so many women had to do without it. Though foot-warmers were not exactly uncommon in the years before 1715, a number of estates do not include them, and when they do occur it is generally in ones and twos—"twee stoven met twee aarde tesjens" (II,8,1707). Later in the eighteenth century, foot-stoves are often present in considerable number—twelve or more to a household, but by then the living-room fire-place had largely disappeared. While on the subject of warmth, brief mention should perhaps be made of an unusual item that was in a sense a larger relation of the foot-stove. This was the fire-wagon (vuurwagen). In essence

the fire-wagon was a portable grate with the appearance of a toy wagon; filled with burning charcoal or something similar, it could be trundled from room to room and even to church.⁸⁷ Among the half-dozen or so households equipped with a fire-wagon was that of the Helots, where "1 ijsere vuur wagentje" had a place in the kitchen.

The Screen

As the screen was designed to increase the comfort of a person laid upon a bed or seated on a chair, the end of this chapter seems as good a place as any to consider it. Screens were not particularly common in the opening years of the eighteenth century, and are only found in the houses of leading citizens and Company officials. It is rather surprising, therefore, to find that of the handful recorded a couple were actually lodged in the solder, where, one must presume, they had been put to get them out of the way. The inventory of Jan Dirksz de Beer lists an old four-leaved screen in the solder, which must be the same as the "Scherm van 5 deuren" which fetched 7 guilders, 2 stivers at the subsequent auction (VR.18,1701). The Sneewindt solder also contained "1 scherm van 4 deuren met blaauw bekleet" (I,69,1701) which sold for 15 guilders, 12 stivers, a not inconsiderable sum (VR21,1701). A couple of other four-door screens feature round about 1700, while Melchior Kemels had "1 Seijldoecks Scherm" which was valued at 6 guilders (I,66,1701). According to Peter Thornton most screens were made with an even number of leaves and covered on one side only by nailing the material into place through a tape running round the outer edges—a method which helped to prevent fraying⁸⁸ (Pl.35). After 1701 almost nothing is heard of the screen for nine years, and when it reappears a change of sorts has taken place. It is no longer customary to mention the number of doors and the screen, if it is described at all, is normally described as painted. Screens of this later type are represented by "een geschilderd scherm" in one of the front rooms of the Helot house (II,43,1710). As these later screens are normally found in rooms without fire-places, there is no reason to suppose that they were fire-screens, and in all probability the four-leaved screen had by then become so commonplace that the number of leaves could be taken for granted.⁸⁹ The exact significance of

"painted" is also something that I can only speculate about. Hand-painted Chinese silk was used for the occasional fashionable screen in Europe, but it is unlikely to have been used as a matter of course at the Cape. I suspect the painting was done locally, and that the material was something cheap and obvious like canvas, or even paper. Whatever it was like, the painted screen was to remain popular for twenty years or more.

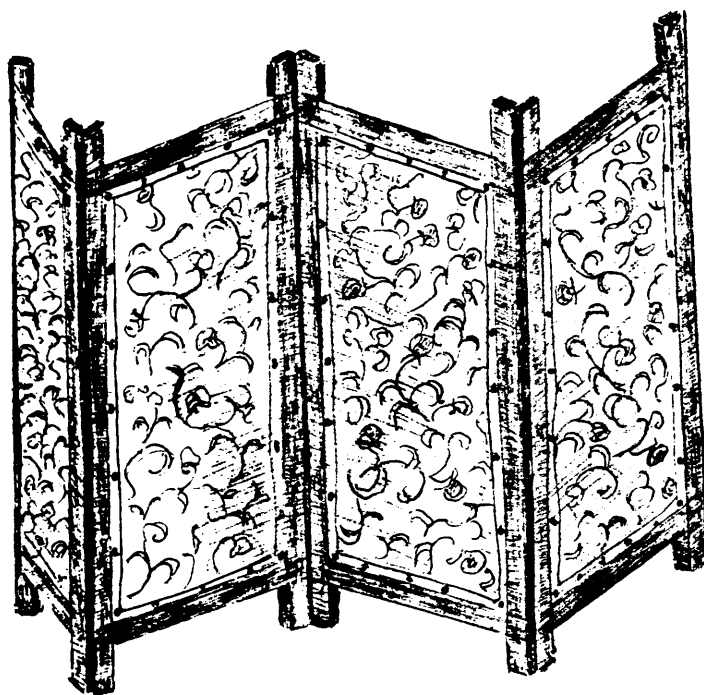

(35) Four-Door Screen with Chintz Panels

Footnotes

1. Quoted by Van de Wall, op. cit., p.13.
2. "...ook zijn er Timmerlieden," enthuses Valentijn, "die ongemeene fraeje rustbanken, zitbanken, Tafels, Stoelen en Ledikanten van ebbenhout, Caliatoerhout etc. zeer konstig met allerley bloemen, dieren etc. voor gering geld en met zeer weynig gereedschap uijthouwen." This passage, which refers to Indo-Dutch furniture, is quoted by Van de Wall, op. cit., p.23.
3. Appel notes the importation of Chinese planks from Batavia in 1764 and 1783, and the need for 100 such for the parsonage at Stellenbosch in 1754 (op. cit., p.12). They are found earlier in the inventories and vendu rolls and must account for the "Chinese stoelen" popular in the second quarter of the 18th century.
4. For instance "2 vaderlandse planken" (VR18,1701), "1 pertijj Ebbenhouten planken" (VR24,1702), "3 Chineese planken / . . . 1 ambonshoute plank" (VI,71,1744), "9 Ciate planken" (VR46,1708), "2 ps Root Ebbenhoute planken" (II,63,1712), "7 blaaden wortelhout / . . . 6 blaaden ijkenhout" (VII,71,1748).
5. Appel, op. cit., pp. 146-7.
6. For example "5 bladen Wagenschot" (II,40,1710).
7. CJ2914, Meijer Inv., 1705, p.161.
8. This chest belonged to Secunde Roelof de Man, who died in 1663 (Trans. en Schep., II, 59).
9. Van de Wall, op. cit., p.96.
10. De Wet, op. cit., p.66.
11. CJ2914, Hoebie Vend., p.55.
12. De Wet, op. cit., p.73.
- 12a. MOOC22/2, Van Dieden Vend.; n.n.c., n.p.
13. See above, pp. 55, 59, 80-82.
14. Weyns, op. cit., I, 335-44.
15. The boat-shaped, open bed with matched head- and footboard that

- came into fashion during the French Empire is also known as a "ledikant" (Weyns, op. cit., I, 334).
16. 23/5, 29 & 42, 1673 & 1677.
 17. Thornton, op. cit., p.160.
 18. O. F. Mentzel, A Geographical Topographical Description of the Cape of Good Hope, 3 vols, Van Riebeeck Society, nos. 4, 6 & 25 (1787; rpt Cape Town, 1921-44), I, 30.
 19. A cotton and silk mixture from Bengal, often checked or striped.
 20. Probably calico, known as "baft" or "bafta." See n.49 below.
 21. Woodward, "And pretty apartments," pp. 167-68; "Domestic Arrangements at the Cape," p.11.
 22. Information ex Prof. F. G. E. Nilant of Pretoria University.
 23. Van de Wall, op. cit., p. 141.
 24. CJ2914, Bergh Inv., 1687, p.10.
 25. CJ2916, Freser Vend., 1696, p.5.
 26. The exact nature of the kooi has exercised so many of us in recent years that the evidence deserves to be aired in full. In the inventory reference is made to "1 ledicant met een zits behangsel / . . . 1 ledicant met zits behangen" and four katels (I,62,1701). The vendu roll records "1 Ledek^t met behangsel / . . . 1 kooij met een chits behangsel" and four katels (VR17,1701).
 27. Woodward, "And pretty apartments," p.168.
 28. Obviously travelling beds of some sort. It is interesting to find "kooi" substituted for "ledikant"; an indication that the original meaning of the latter had been forgotten.
 29. Trans. en Schep., II, 88.
 30. The original is reproduced in Thornton, op. cit., Pl.156.
 31. CJ2914, Meijer Inv., 1705, p.161.
 32. Several different cradle-stands are illustrated by Weyns, op. cit., p.378.
 33. Thornton, op. cit., pp. 177 - 78.

34. Ticking, a cloth especially made to cover mattresses or ticks, was normally striped, and as national preference governed the size and colour of the stripes, it was possible to distinguish ticking of other countries from "Dutch tike of small stripe" (Thornton, op. cit., p.117).
35. Weyns, op. cit., I, 328.
36. Information ex Prof. F. G. E. Nilant of Pretoria University.
37. Thornton, op. cit., p. 178.
38. Weyns, op. cit., I, 321.
39. "Kombaars" was originally ship's slang for a sailor's blanket.
40. Thornton, op. cit., p.178.
41. For instance "2 blauwesloopen" (Trans. en Schep. I, 1652, p.11) and "3 bonte sloopen / 1 wit do" (II,37,1709).
42. Willem ten Damme was an associate of Willem Adriaan van der Stel, from whom he received 3 grants of land in 1701-06 (Fouché, Dagboek van Adam Tas, p.37, n.15). At his death his estate was worth f 64 116 : 10 (II,117,1714).
43. At Hampton Court Palace in 1699 the estimate for a handsome carved walnut screen was £2 " 5s, and that for the 2 yards of damask needed to upholster it £4 " 6 " 10 1/2 (Hampton Court Palace Estimates. Photographic copy now in Victoria and Albert Museum. Quoted by Edward F. Strange, "The Furnishings of Hampton Court in 1699," The Connoisseur [March, 1906] p.172.)
44. Thornton, op. cit., p.150.
45. Strange, op. cit., p.172.
46. For instance f 25 : 14 for a pair of gloves with silver fringe (VR12,1699) or f 72 for an imported black damask gown with its matching petticoat trimmed with silver fringe (VR59,1709). In 1688 John Hervey, later Earl of Bristol, paid £17 "for gold and crimson fringe for the India bed quilt." (Quoted by Singleton, Furniture, p.286.)
47. Contemporaries could recognise the origin of most chintzes, and

reference is made to chintz from Surat, Tuticorin and Bengal. These categories reflect the three main centres of production: the first in north-west India centred on Gujurat, the second along the Coromandel coast in the south-east, and the third in Bengal in the north-east. A fascinating and invaluable guide to the complicated history of Indian textiles, which I follow throughout, is John Irwin & P. R. Schwartz, Indo-European Textile History, Calico Museum of Textile (Ahmedabad, 1966).

48. Indian Office Archives, Letter Book VII, 208. In 1685 the London Directors stopped further orders because there were still 20 sets unsold (Letter Book VIII, 43). (Quoted by Irwin & Schwartz, op. cit., pp 35-36.)
49. Baftas is a generic name for plain calico varying in quality from coarse to fine. Baftas sent to Europe was usually white, but for the Asian markets it was often dyed red, blue or black. Baftas at the Cape followed the Asian pattern as we find references to "1 Blaauw bafta" (I,23,1697), "1 blauwe bre-de bafta / . . . 1 stucks gestreepde slegte baft" (I,74, 1703) and "1 ps Root bafta" (VR55,1709). The reference to striped baftas is unexpected and may be due to imprecise terminology.
50. The material, estamine, takes its name from "stamiga," the Italian word for strainer, so must have had an open weave originally. It was a respectable material in the first part of the 17th century, but by the 18th century "tammy," as it was called in England, had become an undistinguished worsted with a plain weave and a rather springy texture (Thornton, op. cit., p.115).
51. Armozine takes its name from the town, Ormus (Resolusies, II, Glossary). The term seems to have been used rather loosely for a thin, taffeta-like silk. Plain colours, red, blue, white, black and grey are the rule, but a shot armozine has been noted: "1 Lapje weerscheijne armosijn" (I,74,1703), as well as "1 Lap armosijn met swarte blomme" (III,21,1716).

- Reference is also made to green armozine from China (II,8,1707) and armozine from Bengal (V,109,1731).
52. Thornton, op. cit., p.114.
 53. For example "2 betieljes gordijnen voor de Vensters met haer falbalaers daer boven" (II,28,1709).
 54. From a series of drawings inscribed "à Trianon." The reference is to the Grand Trianon, which was begun in the winter of 1686-87. The volume of drawings belongs to the Bibliothèque de la Conservation of the Chateau de Versailles.
 55. CJ2914, Bergh Inv., p.3.
 56. CJ2916, Freser Vend., p.15.
 57. Florence M. Montgomery, Printed Textiles : English and American Cottons and Linens 1700-1850, A Winterthur Book (New York, 1970), pp. 66-69. A chapter in this book, "Furnishing in American Homes," includes useful sections on bed and window hangings.
 58. Thornton, op. cit., pp. 140-41.
 59. Namely "een Mersaeije behangsel tot een koiij met copere ringetjes" (23/5,1,1674).
 60. Thornton, op. cit., p.138.
 61. For example "1 blauw ophaal gordijn met zijn plank" (XIX,7, 1785). No plank seems to be mentioned in connection with the pull-up curtain at the Cape until after 1750, perhaps because the earlier clerks took them for granted. In 1748 "2 gordijn plankjes" are listed separately (VII,71).
 62. A town house in 1730 had "2 ophaal gardijnen" in one voorkamer and "1 ophaal gardijn" in the voorhuis (V,79).
 63. Thornton, op. cit., pp. 138-39.
 64. The curtains sold for f12 : 6 and f14 : 10 respectively (VR49,1709).
 65. The Journeys of Celia Fiennes, ed., Christopher Morris (London, 1947), p.345..
 66. De Haan, op. cit., 1,509.
 67. See above, pp. 101-04.

68. The slaapezel, as described and illustrated by Weyns, seems to have been a bed of similar type (op. cit., I, 348). I have picked up the occasional reference to "esels," e.g. "3 Houte Esels" valued at f6 in 1701 (I,66) and "1 ongematte Esel" (II,72,1713). It is possible that these were slaapezels, particularly as the word was used in this sense in Batavia. An "ezel," according to Van de Wall, was "een soort brits, waarop een losse matras met eenige kussens en een spreij werden gelegd In de eerste tijden der kolonisatie diende deze brits bij nacht voor slaapstede en bij dag voor zitplaats of tafel" (op. cit., p.140).
69. In American Dutch houses the slaapbank, which refers to a built-in alcove bed as distinct from the cupboard bed, was in general use (Maud Esther Dilliard, An Album of New Netherland [New York, 1963] , p.86).
70. The bench that appears in "The Arnolfini Wedding" by Jan van Eyck has red cushions and a red bankkleed.
71. Fransen, Drie Eeue Kuns, p.40.
72. See above, p.105.
73. CJ2916, Freser Vend., p.6.
74. CJ2914, Louis van Bengalen Vend., 1705, p.120.
75. See above, p.97.
76. Van de Wall, op. cit., p.71.
77. Weyns, op. cit., I, 385-91.
78. M. G. Atmore, Cape Furniture, 2nd rev. ed. (Cape Town, 1974), p.60. Fransen, Drie Eeue Kuns, p.40.
79. Fransen, Drie Eeue Kuns, p.40. The "Tulbagh" chair, according to this authority, owes its name to the fact that it first became popular during the reign of Governor Tulbagh, but as far as I know it is not a name ever used in the inventories of the period.
80. Presumably the speldewerk or lace was made by the women of the household, otherwise it is difficult to account for the low price of f1 a cushion.

81. The robust and popular woollen velvets originated in France, but by the 16th century weavers of this material had established themselves in various other parts of Europe, including Holland, where especially good trijpen wære made (Thornton, op. cit., p.112). In these circumstances a reference in the Bergh inventory to "5 ellen schaers indische doncke bruijne indische trijp" (CJ2914, 1687, p.5), is, to say the least, intriguing.
82. Probably wool damask rather than silk.
83. CJ2914, Meijer Inv., 1705, p.160.
84. Thornton, op. cit., p. 180.
85. CJ2914, Bergh Inv., 1687, p.9.
86. "Een stoef met vier daer in, is een bemint juweel by onse Hollandsche vrouwen, bysonder als de sneeuwvlocken vlieghe ende hagel ende rijp het lof van de boomen jaeght" (Roemer Visschers, Sinnenpoppen, quoted by Schotel, op. cit., p.14). For the use of foot-warmers at tea-parties see *ibid* p.379, and for their use during the evening gossip on the front verandah see Zumthor, op. cit., p.74.
87. Weyns, op. cit., I, 66-68.
88. Thornton, op. cit., p.255.
89. If four doors were the norm the reason for the following highly unusual entry becomes obvious: "1 geschildert scherm van drie bladen" (V,4,1727).

Furniture IIThe Table

Among the tables in a house the dining-table has always had pride of place, and though few tables were actually described as such in the years round 1700, they are usually easy to recognise in important European inventories. For one thing, in a fashionable household, the room where the family took their meals was often reserved for this purpose alone, and accordingly designated "dining room," "eetzaal," or "salle à manger."¹ In houses where the main family living room continued to serve as a dining room—and such rooms were still in the majority in Holland—the room's dual function was proclaimed not so much by the presence of a large table, for this was a feature common to most rooms, but by the presence of a buffet or serving-table (schenktafel). Unfortunately, where the Cape inventories are concerned neither factor is of much help: the word "eetzaal" never appears, and a serving-table, specifically so-called, is hardly ever encountered. This is tiresome and inevitably leads to doubt in certain instances, but where the family living room is recognisable one can look to find the dining-table there with some confidence.

The nature of the dining-table underwent considerable change during the course of the seventeenth century. The trestle-table off which people had dined for centuries was replaced, round about 1600, by the heavy but adjustable draw-leaf table. Later in the century the draw-table was replaced in its turn by a lighter round or oval drop-leaf table.² This sort of table suited the growing taste for more intimate meals and was in addition readily manoeuvrable, so that it could be stored against the wall when not in use, thus leaving the centre of the room free for other activities.

A light, manoeuvrable table was well suited to the needs of the Cape, where most houses were small and most rooms had to serve many different purposes, so it is not surprising that the oval table in particular was a routine entry during the period under review and the commonest type of large table listed. Its most usual location is one of the multi-purpose living rooms. Indeed, in those houses where two or more rooms offer all the

facilities of the normal living room, the presence of an oval table in only one of them may be enough to settle the question of both the dining table and the main family living room, always provided that the second room does not include a round table, which was undoubtedly an acceptable alternative to the popular oval one. Among the more interesting references to the latter are: "1 Ovale toeslaende tafel" (I,4,1692), "1 groote ovaale tafel daarop een Zitse kleed" (I,74,1703), and "1 groote Ovale tafel met een groen kleet daerop" (II,66,1712). Though the oval gate-leg table is very familiar to the student of Cape-Dutch furniture, no example made before 1715 has, as far as I know, been identified, but it seems safe to assume, nevertheless, that a certain number were made here before the end of the seventeenth century. It is highly regrettable that the average Company clerk thought it sheer supererogation to include both the shape of the table and the wood of which it was made, so that an entry like "1 viercante tafel van stinckhout" (I,69,1701) is all too rare. Square tables seldom seem to have been used for dining, but one does meet the occasional apparent exception such as "een vierkante tafel met gedraijde poten daarop een cits tafelkletie" which was the principal table in the house of Jacobus van Brakel (II,11,1707). The other large table, the long rectangular table, has already been discussed in connection with the forms that usually accompanied it.³ A useful but unfashionable type, it seems most often to have had a fixed frame and immovable top, but an occasional example was combined with trestles (schragen).

The ritual of a seventeenth-century meal normally required one or more serving tables which had several uses. Firstly, a serving-table was needed for reserve supplies of food, as well as for the piles of clean plates on which there was constant call throughout the meal.⁴ Secondly, it played a prominent part in the dispensation of drink. At banquets tables were crowded with an imposing array of dishes which left no room for the glasses and the great quantities of alcohol required to ensure that no member of the party ended the meal in a state of unconivial sobriety.⁵ In the first half of the seventeenth century wine was served from a massive buffet which rose up in tiered shelves and was designed

not only for the dispensing of the meal but for the display of the family's gold and silver plate. In the latter part of the century the buffet went out of fashion and its place was taken by the lighter and more adaptable serving-table which, as often as not, was simply a straightforward table. It was at the serving-table that the wine was decanted from a bottle or flagon into a wine-jug, then poured into a wineglass and finally carried to the diner on a small salver. It seems reasonable to assume that most Cape homes with social pretensions followed this practice, and that some of the various tables listed acted as serving-tables, but with a couple of exceptions—"een geschildert schenc t2feltje" belonging to Albert van Breugel (23/5,35,1675), and "een gevervd schenktafeltje" owned by Hendricus Munkerus (II,8,1707)—they are never particularised.

During the second quarter of the eighteenth century, when the gallery and/or voorhuis had begun to function as a dining room, one encounters several suggestive juxtapositionings involving large oval tables and small square tables and an unequivocal reference to "2 vierkante schenktafels" (IV,75,1725). Small oval tables are also suggestively positioned at times, and it is most possible that many of the smaller square and oval tables inventoried before 1715 were used as serving tables—at least on special occasions.

In the following unique entry, "1 vierkante taafel met een coopere koelvat daerin" (III,13,1714), a serving table of quite a different kind seems in question. A cistern of brass, pewter or lead, known today as a wine-cooler, was common in Europe, where it stood on the floor beside the serving-table. Filled with cold water, the cistern was used to cool the flagons and containers of wine and beer. Apart from the "coelbackje om fleschen in tersetten" found at Rustenburgh,⁶ this is the only reference to a wine-cooler I have encountered, for all the other koelvatten mentioned at this period are linked with stills and have to do with the brewing, not the serving, of alcohol. In this instance the table seems to have been fitted with the cistern, and perhaps bore some resemblance to the later wash stand.

"Tables," according to Thornton, "specially designed for the taking of tea only made their appearance late in the century,"⁷ so

in this respect the Cape appears to have been in the very vanguard of fashion. There was a tea-table at Rustenburgh in 1673 ! In 1687 Lieutenant Olof Bergh possessed "een ebbenhoutte tafel / 1 theetafeltje / 2 oude alcativen"⁸ and from then on tea-tables appear with some regularity. A room especially furnished for the popular tea-party seems to have been a feature of certain Dutch houses before the end of the century,⁹ but though Willem Corssenaer and his wife may have attempted something of the sort¹⁰ the average Cape wife was content with a tea-table in the family living room, though if the house ran to a second room for the reception of guests, a tea-table was also a probability there. While seldom worth more than a few guilders tea-tables, perhaps because it was exceptional to hide them under a cover, often received a more detailed description than dining tables. References include: "1 Verlakt theetafeltje" (II,63,1712), "een vierkant Thee tafeltje" (II,43,1710), "een Ovale rood Ebbenhoutte Thee tafel" (II,43,1710), "1 stinkhoutte teetafeltje" (II,61,1712), "2 Roode thee taafeltjes" (II,79,1713), and the pièce de résistance "een Tonquinse"¹¹ vergulde en verlakte theetafel" valued at 12 guilders (II,8,1707). The Batavian form of the tea-table with its solid, rectangular lines and a drawer in the apron to hold the various appurtenances attendant on the taking of tea¹² does not seem to have been favoured at the Cape, but some early tables may have had the traylike top common to both Oriental and European tables in the late seventeenth century, which would explain why table covers and tea tables are seldom found together. The familiar form of the tea-table, which combines a tip-up top with a pillar and tripod stand developed, probably in Holland, at the end of the century. Early models keep the raised rim but this was soon abandoned so that the tea-tray could be accommodated more easily.¹³ When not in use most tea-tables probably stood empty, but a few were permanently arrayed with tea-ware so that one finds "1 thee tabuletjen daar op / 23 do kopjes en do pieringtjes . . ." in one Sneewindt voorkamer (I, 69,1701) or "2 Tabletjes met wat porsselijn" in the home of Josina Pretorius (II,74,1713). Though on the wane, the charming custom of arranging the best tea-service or "beste kopjes" as they are called on a small table in the drawing-room is still to be met, as I know from my own experience, in Holland

today.

Apart from tea-tables, a good many other small tables are recorded including "1 p^s toeslaande agtkant tafel" (I,23,1697), "1 kleijn ovaal verlacqt taffeltje" (I,74,1703), "1 Japans tabletje" (II,40,1710), "1 agtkante Ovale tafel"—it sold for 22 guilders, 14 stivers (VR51,1709), "1 agtkant geelhout tafeltje" (II,61,1712), and "Een Lankwerpig tafeltie" (III,55,1713). Some of these tables probably functioned as tea-tables, others as serving-tables, and yet others as dressing-tables. Before 1700 a piece of furniture which we would view today as a knee-hole desk was in use as a dressing-table in fashionable European circles (Pl.27) but most people at that time, and indeed for many years to come, were perfectly content with an ordinary table, suitably draped, and combined either with a small table mirror or with a wall mirror canted forward to reflect the image of anyone seated before it (Pl.36). Until one reaches the period of the specialised bedroom at the Cape, dressing-tables merge with all the other furniture in the room, and though it is possible that some of the tables, chairs and mirrors listed serve this purpose, the dressing-table and chair (kaptafel en kapstoel) found in seventeenth-century bedrooms in Holland¹⁴ are never mentioned, and the dressing-mirror (kapspiegel) is a great rarity.

That any doubt should exist on this point is extraordinary. It is also an indication of the inadequate provision made for the personal toilet which is reflected in different ways throughout the Dutch East India Company period and beyond. There is not a trace at the Cape, even at the end of our period, of the bouquet de nuit which made an appearance in elegant Dutch circles in the early 1670's, nor any mention of the toilette which was probably in use in Holland even earlier. Both these refinements, as their names show, originated in France. The toilette, a light cloth of some washable material, was laid over the rich carpet or table cover of the dressing-table to protect it from powder and hair.¹⁵ Its absence, at the least, is perhaps explicable: at the Cape chintz was the normal material for table covers, and as most of it was washable¹⁶ this would obviate the necessity for a second protective covering. The "nachtbouquet"

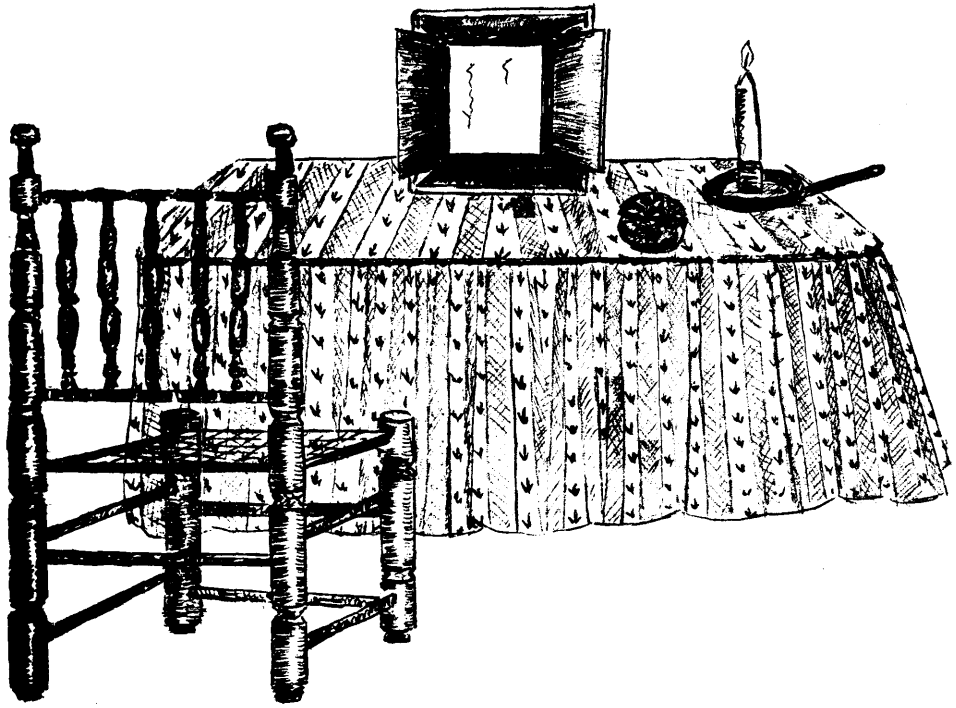

(36) Dressing-Table

as the Dutch called the bouquet de nuit was a pretty little chest containing everything a lady might needs at her toilet, such as a mirror, comb, hairbrush, powder box, and even candlestick and snuffers.¹⁷ Perhaps one should note en passant that not only is there no trace of the nachtbouquet at the Cape but that it is only in the earliest inventories—those before about 1680, that one routinely comes across individual toilet accessories like combs, brushes and powder boxes. The inference is obvious: the articles of this sort in general use were cheap and ordinary enough to be dismissed as sundries (rommeling) in the later inventories.

The most fashionable furniture combination of the seventeenth century was a table with a hanging mirror above and tall candlestands to either side. This triad, often executed with great elaboration, looked imposing in a reception room and formed a practical dressing-table in more intimate surroundings, but it does not seem to have made itself much felt in the early Cape. The earliest candlestands, which were still known as "knapen," nearly always occur singly. It is only towards 1715, and then in the most important houses, that two or more candlestands, by this time listed as "gerridons," begin to appear.

During the seventeenth century some form of table cover was common throughout Europe. In the following century most of Europe restricted the table cover to the dressing table, where a delicate confection of muslin or silk, which often included a "scarf" for the mirror, was greatly appreciated. In Holland, however, the table cover retained its popularity, a popularity which extended to the Cape but not to the Dutch dependencies in the East.¹⁸ At the Cape in the eighteenth century only those who could not afford a cover for the dining-table failed to provide one, and other tables, particularly large tables, were often treated in the same way. Some use was made of table carpets such as "1 viercante tafel daarop/1 oude allecatieff met een Zitse kleed" (I,74,1703), but most tables, like most beds, were covered in Indian chintz. Chintz was such a common material at the Cape that one becomes blasé about it quite quickly and has continually to remind oneself that in contemporary Europe it was a treasured and highly fashionable exoticism. Some other

types of cover mentioned are "1 groen tafelkleet" (II,70,1713), "2 tafelkleetjes met Rouaanse strepen" (VR11,1698), "Twee tafelkleden met kant" (II,43,1710) and "1 Blauw vaaderlands Taeffelsprij" (II,109,1714). Incidentally, a round table with a floor-length blue cover fringed in yellow features prominently in a portrait of the Wernich family executed in pastel and watercolour by Pieter Willem Regnault. Dated 1754 this is one of the only representations we have of an eighteenth-century Cape interior.¹⁹

At meal-times table-cloths (tafellakens) of linen or damask were used. These either replaced the normal covers or, at more informal meals like breakfast, were laid over them so that perhaps ten centimetres of the original were visible at the bottom. A table-cloth embellished with sharp folds to form a pattern of regular squares was much admired, and the generously proportioned napkins provided for each diner were also folded into fancy shapes. The crisp folds, fashion decreed, could be achieved most easily by means of a press, and presses such as "1 Linde pars met een voet" (VR9,1697) turn up quite regularly. Some of these were substantial pieces of furniture:²⁰ "1 linde pars met een kasjen" sold for 37 guilders, 8 stivers in 1702 (VR24), and "1 houte Linne pars" for 27 guilders, 6 stivers in 1710 (VR66). On the other hand a small linen press fetched only 3 guilders at the Van Reede sale (VR27,1703), which means that small table models, probably designed solely for napkins, were also about.

The linen in a prosperous Cape house cannot compete with the great quantities recorded in Holland, but the table linen in particular is always impressive. In 1675 Albert van Breugel owned nineteen fatherland sheets, six cotton sheets, fourteen pillow-cases, fourteen towels, three large table-cloths of "Sindis" damask, five large table-cloths of Dutch damask, twelve napkins of "Sindis" damask, and sixty-five napkins of Dutch damask (23/5,35). Just on forty years later, Willem ten Damme possessed twenty-four sheets, sixty pillow-cases, twelve table-cloths and two hundred napkins (II,117,1714). The heavy preponderance of table-napkins in both lists is perfectly normal because eating with a fork was still far from usual in 1714. So much so, in fact, that a book of manners, "Civilitéé Francaise" which was aimed at the bourgeoisie and published anonymously at

Liège in 1714 instructs "Cut with the knife, holding still the piece of meat in the dish with the fork, which you will use to put on your plate the piece you have cut off; do not, therefore, take the meat with your hand."²¹ Once it was on one's own plate, however, nothing is said against touching the meat with the fingers. In these circumstances a napkin was an absolute necessity, and as it normally ended the meal like a greasy rag, a fastidious household could account for a considerable number of napkins daily.

Carpets

Before passing on to the chest, I would like to turn aside for a moment to explore the subject of carpets a little more fully. We have already met them resting on footstools and tables, and will encounter them in a moment lying on chests. On the evidence of the Dutch masters, including Jan Vermeer, carpets used in this fashion were not, from choice, restricted to the top of chest or table, but were preferred reaching to the floor on all four sides. Most tables have a drop of about seventy-five centimetres, which means that the ideal carpet was a hundred and fifty centimetres longer and broader than the actual table top. Even if in practice most people accepted a smaller drop, we are not necessarily considering really small rugs. I hammer this point because the prices, when given, challenge the evidence of the Dutch masters; they are extremely low, even for small rugs.

In 1685 three carpets were valued together at eighteen guilders (I,2). At a sale in 1701 four carpets were sold: the first two for around seven guilders each; the second two, which were described as "old," for about three guilders each (VR18). The most expensive carpet to feature before 1715 realised exactly eighteen guilders (VR24,1702), the cheapest "een oud alcatijv tot een kist" no more than twelve stivers (II,8,1707). The alcativ, which first appears in the Van Zuijwarden inventory (23/5,21,1672), is the only carpet mentioned before 1715, and other than the fact that some specimens are described as "old,"

no additional information is given. The word "alcativ" derives from Al Qatīf, a town on the south-west coast of the Persian Gulf, and was originally coined by the Portuguese.²² Presumably carpets exported from this port first became known by its name, which in due course became the normal word among Portuguese and Dutch traders for any pile carpet of Eastern origin.

As a variety of Turkey carpets with their bright colours and slightly coarse pile were the commonest and cheapest carpets to reach Europe in the seventeenth century, the Cape carpets are likely to have been of this type, but even for Turkey carpets they are startlingly inexpensive. Turkish prayer rugs with an outline of the prayer niche in the decoration were known in England as "Musketta carpets." In a note on an English inventory of 1638, Peter Thornton draws attention to several "Musketta carpets" and says "They seem to have been small; one lay on a table and two together were valued at only £1."²³ Ten shillings, or seven-and-a-half guilders, is the sort of price commanded by the average Cape "alcativ," which was also, perhaps, a small Turkish prayer rug.²⁴ There were a few exceptions: in 1719 an inventory mentions "1 groote alkatief" (III,92) and in 1725 "3 Zuratse alcatieven" appear (IV,75). Carpets in Persian style were made in India at Agra and Lahore,²⁵ and as the Dutch must have handled these at Surat, their main seventeenth-century office in north-west India, they named them accordingly.

It is unlikely that any of these carpets were normally put on the floor. To stand or walk on a carpet, even in the seventeenth century, was still something of a privilege. In the fifteenth century, a Van Eyck or a Memling Madonna was often depicted in a chair of state with her feet resting on an Eastern carpet. In the sixteenth and early seventeenth centuries, carpets began to creep into the portraits of the great. In the later seventeenth century, a wealthy bourgeois might lay down a carpet for a special occasion and take it up again afterwards.²⁶ It is not surprising, therefore, that the one place where an "alcativ" at the Cape is known to have been laid down is the Church. At a meeting of the Council of Policy in December, 1700, at which damaged, lost and worn goods were written off, we hear of "6

alkativen, door lang jarig gebruik in de kerk, avondgebed als dagelijks bezigen in d'Ede. Heer Gouverneurs huijs, versleeten en t'eenemaal onbruikbaar geworden."²⁷ On a similar occasion eleven years later "1 p^s Persiaanse middelbare alcatijf"²⁸ from the Governor's house was written off—proof that the Persian carpet was not quite unknown. Any floor covering at the Cape was exceptional, nevertheless, throughout the eighteenth century. Matting, which evolved from the rush floors of the Middle Ages, was common enough in Europe in the seventeenth century but does not appear at the Cape until the second quarter of the eighteenth century, when a kamer mat is infrequently listed. It is only with the opening of the nineteenth century that the pointedly named vloertapijt and voetmat begin to appear with some regularity in the townhouse, but it is in these self-same houses that one also comes across the voetzyl and the vloerzyl. For a canvas floor covering to be in use in important houses after the Napoleonic wars is an indication of how backward the Cape was in its treatment of the floor. Even the possibilities offered by a kaross or a skin carpet were not exploited until the nineteenth century was well under way.

The Chest and Coffers

Chests lost much of their importance in Europe when the peripatetic life of the Middle Ages gave way to the more static conditions of early modern times. After 1600 their normal setting was the farm-house. Colonial conditions and the long sea voyage which inevitably precluded the arrival not only of the new settler and his belongings but many of the necessities and luxuries of life, provided the chest with a number of new uses. But for all that, it never quite regained its previous status. There was no chest in the principal room at Rustenburgh in the 1670's, and in the opening decade of the next century it was seldom found in the principal room of any town house of standing, while by 1714 there was a new tendency to confine it entirely to the back of the house.

However suited a chest may be to travel by sea or ox-wagon, or for the storage of one particular commodity like rolls of tobacco, clay pipes, soap, porcelain, lengths of material, etc., it is not an ideal container for a variety of things in daily use, since everything has to be removed from the top to reach something at

the bottom. The move to replace the chest as a receptacle for clothes and linen by the more convenient cupboard and chest-of-drawers was naturally not lost on the Cape where the wardrobe, at least, was enthusiastically adopted, though the chest-of-drawers took a long time to establish itself and the chest, for all its inconvenience, was tolerated throughout the eighteenth century. Two factors may have contributed to this long tolerance. Private trade was quite clearly the life-blood of the Cape burghers, and chests were convenient for housing its spoils and continually in demand for this reason alone. Then the chest-of-drawers, as a receptacle for clothing, was something that properly belonged to the more private regions of the house, and this was an area which few people troubled much about in the Cape of the eighteenth century; the chest, which was cheaper and easier to construct, did well enough.

Before 1700, when cupboards and cabinets were still in short supply, the chest was the principal means of storage and virtually every estate where the contents are listed includes one, while in half of them at least three are to be found. After 1700 the picture begins to change. One or two chests of good quality for the storage of personal possessions and clothing are present fairly regularly, but a large number was only needed in households heavily engaged in private trade. Such chests were usually worth only a few guilders and were kept out of sight in selder, kitchen and back bedroom. In the early 1700's, when a chest is found among the contents of one of two similarly furnished voorkamers, its presence is a probable indication that the room was in regular use as a bedroom. For instance in the De Beer house what appears to be the principal bedroom—it is described as the "Voorkamer na't Noordwesten"—contained, among other things, a wardrobe and two chests. The former held linen and clothes; one of the latter contained pewter, porcelain and lengths of material; the other coins, silver articles, bedding, materials, and a couple of pairs of stockings (I,63,1701). Both chests were covered with "kist alicativen," but the one described in the vendu roll as "1 kleer kistje" was of no account while the other, "1 groote kist van Indiense hout met coper beslagen,"

subsequently fetched the large sum of 87 guilders, 12 stivers (VR18,1701). There were six other kists in the house: a kist of sugar in the pantry and five kists in the "grote kombuijs." Three of the latter were empty, the other two held various oddments, soap and table plates. At the auction none of these empty chests brought more than five-and-a-half guilders, and most of them realised less than four.

It must be obvious from this that many chests in use were not the kind of article the average clerk was inclined to describe, and it seems safe to claim that the chests in the following list belong to the small minority that served as genuine pieces of storage furniture, rather than the vast majority that served as mere packing cases. We start with the fairly humble painted chest, "1 Roode kist met swarte bollen daeronder en 1 sprij daerop" (II,37,1709); move on to those whose woods are specified, "een vaderlandsche vuurenhoutte kist" (II,8,1707), "een Oude ijke kist" (II,71,1712), "een kiate houtte kist zonder beslag met een oud alcatif" (II,8,1707), and to those with metal-mounts, "Een kist met ijser beslag met Zijn schragen" (II,43,1710), "een kiate houtte kist met swart ebbenhout lijsten en koper beslag" (II,8,1707), and end with the chest in the process of transforming itself into a chest-of-drawers, "1 Cist met Schufladen" (II,39,1710). The finest kists, particularly those with brass mounts, were expensive. "1 roode Ebbenhoutte kist met swart ingeleijt" was valued at 42 guilders (II,109,1714); "1 kist met koper beslag" sold for just under 44 guilders (VR17,1701); "1 ebben houtte kist met koper beslag" was valued at 60 guilders (II, 117,1714), and "1 ^{PS} Leedige kist met koop: beslag" sold for a formidable 102 guilders (VR74,1712). The turned feet which gave a finish to an important chest were detachable items and the occasional subject of an independent entry: "1 paar voeten onder kisten" (II,62,1712).

The diminutive "kistje" can cover everything from a smaller version of the free-standing chest to a little decorative box, and this should be borne in mind when contemplating the following list: "2 ledige vierkante kisjes" (I,4,1692), "1 kleijn kisjen met kopere hengsels" (I,74,1703), "2 Ebbhoutte Cisjes met Coper

beslagh" (II,33,1709), "1 Clijn Cisje met pærlemoen ingeleijt" (II,58,1712) and "1 Leedig stinkhoute Cistje" (III,30,1713), which is the first reference I have to a chest of Cape wood, and may be a comment on the indifferent quality rather than the actual rarity of the local product. Prices vary a great deal: 3 guilders for "2 klijne kiaten kistjes" (II,109,1714) and 60 guilders for "1 kisjen met silver beslag" (VR27, 1703). Among the numerous cheap chests circulating, most of them worth only a guilder or two, were sea or sailor's chests, horse chests and numerous carpenter's chests. The first of these, the sailor's chest, seems to have been a standard size; one and a half foot wide and high and four feet long.²⁹ There was also the occasional medicine chest—suitably equipped.

Very much rarer than the chest was the coffer with its rounded top, and descriptions such as "1 oude koffer met wat boekjes" (VR12,1699) and "1 Coffer met out ijser" (II,62,1712) suggest that it was of little account. Rather more intriguing are the small coffers or caskets which feature among the many minor pieces of Oriental lacquer then in fashion; "een Japans verlackt Coffertje met Cooper beslagh" belonged to Van Breugel (23/5,35,1675), while "2 Verlaagte kufferties" (VR24,1702) and "1 Japans Coffertje" (VR51,1709) sold at auction for 9 guilders, 6 stivers and 3 guilders, 12 stivers respectively.

The Cupboard

"The classic furniture in good Dutch society," according to Zumthor, "was the cupboard . . . But the cupboard was an expensive article at that time, the basic luxury of the household symbolising success, social ambition, wealth and comfort."³⁰ This comment is equally true of the Cape, for it is among the kasten, or more specifically the kleerkasten, that the most valuable pieces of furniture are to be found. A handful of cupboards made of local woods are mentioned, and some of the prices these commanded are very convincing evidence of the high standard of local craftsmanship. Indeed, the most expensive piece of furniture I have noted before 1715 is "1 groote kleerkas van stinckhout" in the estate of Hendrik Sneewindt (I,69,1701): it sold at auction for 213 guilders (VR21); a very substantial price in any context.³¹

There is a cupboard at Groot Constantia made of teak and stink-wood which, with its heavy straight cornice, two doors with raised panels, two half-width drawers below, and five ball feet beneath, echoes a well-known Dutch seventeenth-century form.³² Its sheer quality, and the fact that nothing else like it has survived, have raised doubts as to its authenticity,³³ but the evidence of inventory and vendu roll show that the quality, at least, need not trouble us (Pl.37).

To find any sort of cupboard mentioned before 1670 is an unexpected bonus, and to find a built-in cupboard is very interesting indeed, but there is nothing ambiguous about "In een cas inde muer gemetselt," which occurs in the inventory of Secunde Roelof de Man, which was drawn up in 1663.³⁴ That the cupboard in question was capacious is shown by the long list of contents which includes clothes, household linen, lengths of material, jewelry and other treasured personal possessions. This was not, of course, a cupboard with glazed doors, and though other built-in cupboards, usually described as "bottelarijtjes," are mentioned from time to time³⁵ this is the only example of a built-in clothes cupboard known to me. The familiar wall cupboard with glazed doors was a very much later development: the first example noted, "een Vaste glase Kas in de Muur" occurs in 1719 (III,102).

All the cupboards mentioned in the seventeenth and early eighteenth centuries, whether built-in or free standing, will have retained the flat-topped lines of the seventeenth century. If any proof of this is needed, it is provided by the amount of porcelain massed on top of many a cupboard inventoried in the first half of the eighteenth century. Another indication that the Groot Constantia cupboard was a familiar type is the presence of one or two drawers underneath, to which attention is drawn from time to time: "1 laad onder de kas" (II,75,1713). Once again ebony is the wood most frequently cited in connection with cupboards, and most examples were expensive, so that we find "een kas van rood Ebenhout" valued at 108 guilders (II,8,1707), "1 Ebenhoute Cast" auctioned for 156 guilders (VR66,1710) and "1 Ebenhoute Kas" valued at 180 guilders (III,33,1713). Some other

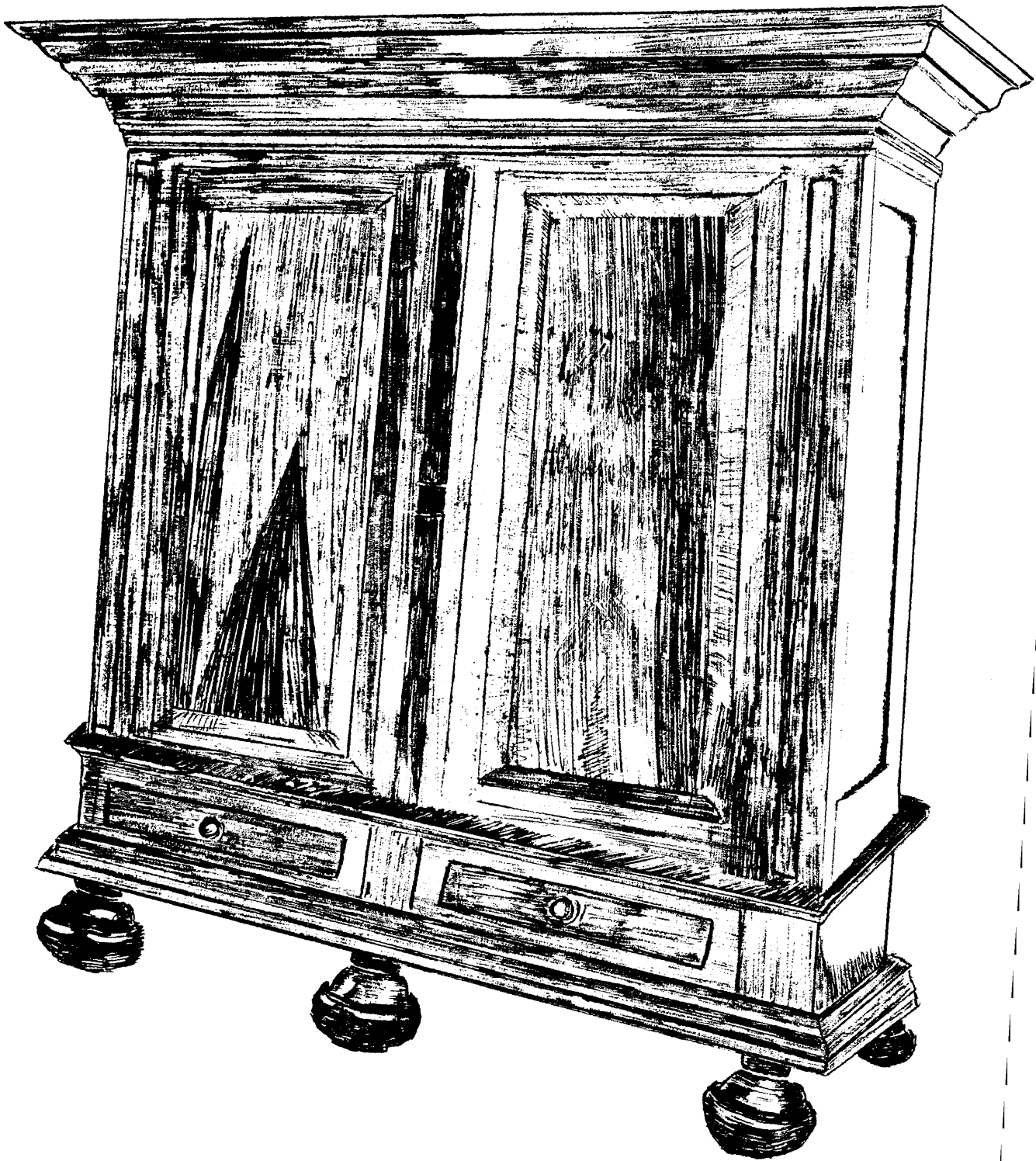

(37) The Constantia Cupboard of Teak and Stinkwood shown with Turned Wooden Drawer Knobs instead of the Brass Replacements. ± 1730.

more detailed entries include "een Slegte Swarte houtte kas"— a very early reference (23/5,3,1670); "1 Swarte kleeer kas" 92 guilders 10 stivers (VR18,1701); "Een geschilderde kas" (II,42,1710); "1 gemeene gevlamde Cas," 24 guilders (I,1,1673); "1 Cas van Vaderlands hout," 30 guilders (II,79,1713) and "1 Geel houtte Cas," 80 guilders (II,61,1712). Not all highly priced cupboards include a description, and there are several frustrating entries like "1 groote kleeer kas," 150 guilders (VR27,1703) or "1 kas daarop een stel potten," 200 guilders (II,84,1713). The great cupboard at this period seems to have been used to house a fairly standard collection of articles and was obviously nice and roomy. A typical mixture includes clothes, linen, lengths of material, silver etc. A piece of furniture of such prestige and importance was naturally designed to be seen and admired, so it usually graced the most important room in the house and was at any rate to be found in one of the two front rooms.

Few houses ran to more than one great kast but a number of lesser cupboards were also present. These included small clothes cupboards such as "1 kinder kleeerkasje" valued at a mere 6 guilders (II,50,1711), and the second cupboard in the De Beer house, "1 kleeer kasje," which fetched a substantial 37 guilders, 14stivers (VR18,1701). A glass cupboard, presumably for display, appears in the 1690's, but becomes rather more common after 1710. In 1711 "een glaase kas" was valued at 48 guilders (II,55) and an indential estimate was given for another "Glasekas" in 1714 (II,114). This sum suggests a large piece of furniture without distinction or a fine piece of moderate size. Another example fetched just on 75 guilders at auction (VR85, 1713), while Willem ten Damme's two small glass cupboards were valued at only six guilders each (II,117,1714); the sort of price associated with a miniature piece for table display. There were numerous cheap, small cupboards, some of them hardly worthy of the name— "2 kleine kasjes met doek daar voor" (I,75,1703); as well as a number of cupboards, or cases, designed for a particular purpose such as "1 pijpse kas met vijftig dosijn Langepijpen" (II,33,1709); "Een glase kasje tot bergen der spijsse" (II,42,1710);

"1 Vierkante kas met wat peeper" (III,37,1713) and "Een papieren kasjen" (I,36,1698).

The food cupboard or etenskast seems to have been the most important, because the most common, of specialised cupboards. It is a general assumption that as the etenskast was designed for the storage of food it was characterised by some form of openwork—spindles were the normal seventeenth-century solution—to provide the food with proper ventilation. That ventilated cupboards were not unknown at the Cape is shown by the magnificent yellow-wood example made about 1725 in the collection of the Franschoek Museum (Pl.38). Michael Baraitser and Anton Obholzer express surprise at how few food cupboards have survived, and conclude that the European passion for ventilated cupboards never really caught on at the Cape,³⁶ but the inventories show that the etenskast was a routine item throughout the eighteenth century. In these circumstances it has occurred to me to wonder whether the etenskast was invariably provided with ventilation. A cupboard with two short drawers above, and a pair of doors enclosing shelves below, is illustrated by Weyns as a "Broodschap' of schapraai uit Limburg."³⁷ Its resemblance to our so-called "jonkmanskas" is unmistakable, and possibly significant in that "jonkmanskas" seems to be a comparatively recent coinage. Further, any cupboard of kitchen type may also have been known originally as an etenskast.

At the time with which we are particularly concerned the references to etenskasten do little to solve the problem. That they varied in size is clear from entries like "1 klein Etens kasjen" (I,28,1697) and "1 groote Etens kas"—this sold for a substantial 26 guilders, 4 stivers (VR24,1702), but as small food cupboards or hutches are known in Europe with dimensions of perhaps forty by fifty centimetres (Pl.39A), this does not get us much further. The etenskast in the kitchen of Abraham Diemer held old earthenware pots (III,30,1713), but was unusual in both its content and location. Most food cupboards, when inventoried, were completely empty and, though kept in the back regions of the house, were seldom found actually in the kitchen: negative evidence that does point to their having been used to store perishable items that would not benefit from the heat of the kitchen fire.

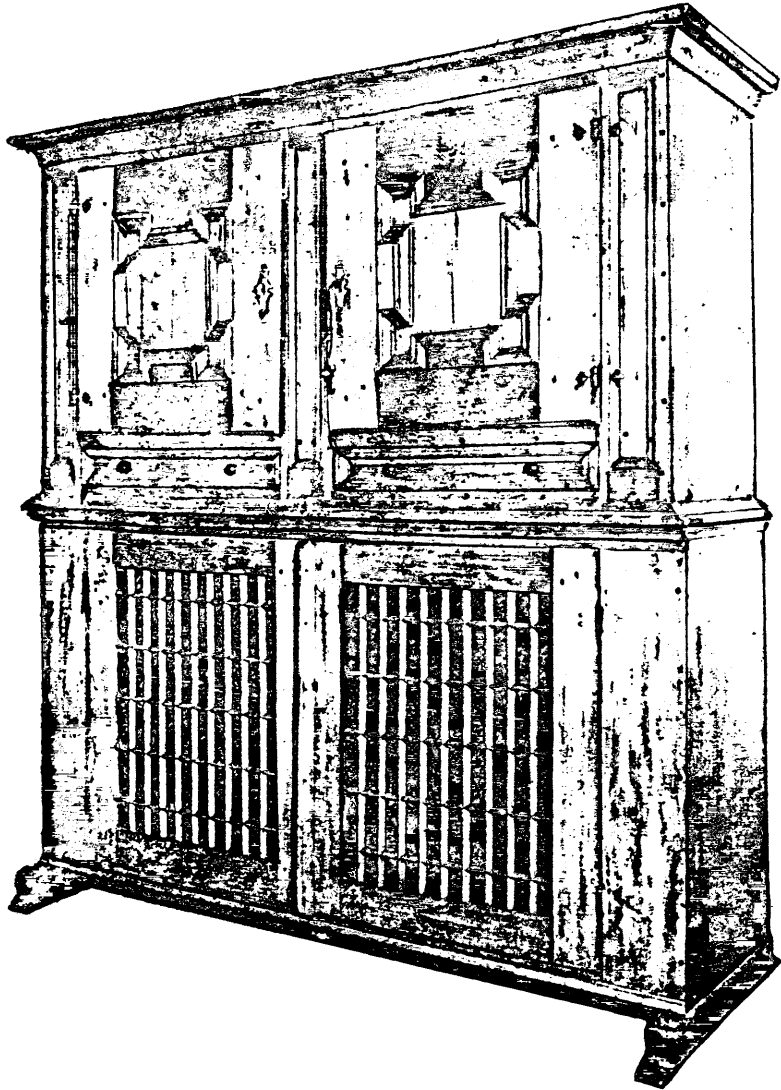

(38) Yellowwood Food Cupboard. Cape. † 1725

Courtesy Huguenot Memorial Museum
Franschoek

The Cabinet

Through most of the seventeenth century the cabinet-on-stand was the most fashionable and prestigious item of furniture. The finest workmanship went into its making, and a lavish ornamental cabinet (kunstkabinet) could be worth thousands of guilders. The more practical writing cabinet was generally less expensive. Both versions had an upper section, filled with numerous small drawers and sometimes pigeon-holes as well, which was supported on a stand with four or more long, prominent legs, but whilst the upper section of the ornamental cabinet was enclosed by a pair of doors (Pl.39 B&D) the writing cabinet had a straight drop front which, when open, served as a writing surface. After 1685 the cabinet began to make way for the newly fashionable chest-of-drawers and bureau bookcase, but these items of furniture were slow to establish themselves at the Cape.

Large cabinets do not seem to have been very common in the years round 1700, but when they do appear their importance is obvious, for they took precedence in any voorkamer that was without a large wardrobe. Nearly all the early cabinets for which we have descriptions were of ebony or lacquer, and they include "1 rood Ebbenhout kabinet met sijn voet" which fetched 67 guilders, 8 stivers;³⁸ "1 Japans kabinet met / 1 stinckhout2 voet," 49 guilders, 14 stivers (VR21,1701), and "1 verlackt kabinetjen met een voet," 40 guilders, 8 stivers (VR24,1702). Unfortunately the four cabinets belonging to Senior Surgeon ten Damme were not described, but as they were valued at 105 guilders each they must have been exceptionally handsome and of far greater importance than his two cupboards, which were only worth 60 guilders apiece (II,117,1714).

Cheap, small cabinets, though far from commonplace, were distinctly less rare. They include "I Verlackt Kabenetje," 6 guilders (VR32,1705); "1 kabinetje en voetje met eenige rommeling," 3 guilders, 12 stivers (VR4,1692); and "1 kabinetje met laatjes," 4 guilders, 14 stivers (VR11,1698). Entries like these must refer to miniature cabinets-on-stand or small table cabinets, for delightful small examples, some of them less than 30 centimetres high, were made in both Europe and the Far East in these years (Pl39, B&D).

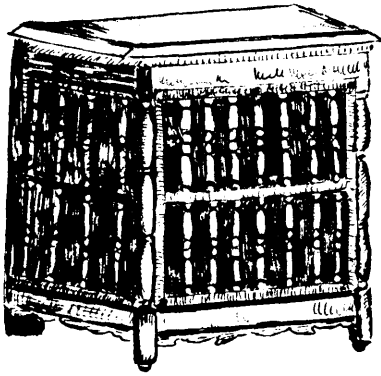

A

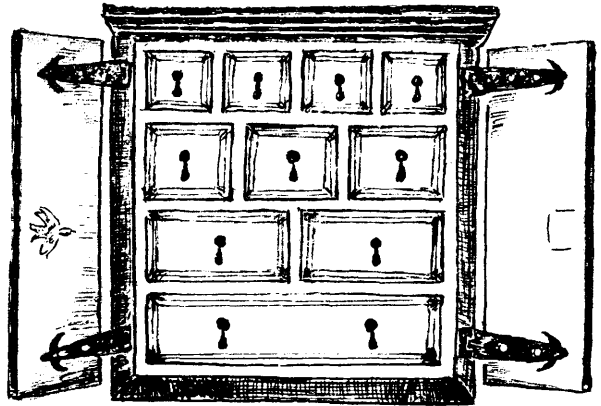

B

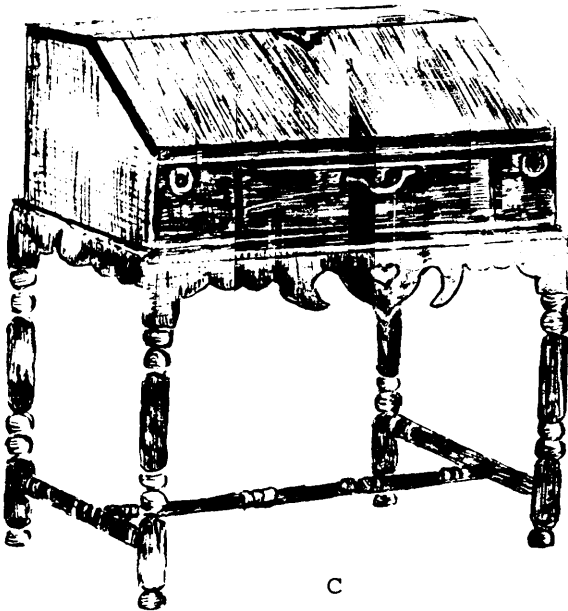

C

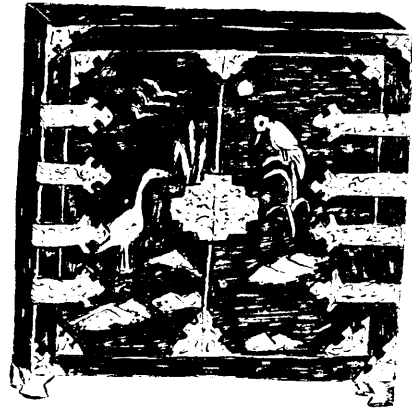

D

- (39)
- A) Small Hutch or Food Cupboard, English, 17th C
 - B) Table Cabinet of oak and iron, English, Late 17th C
 - C) Writing-Box on Stand, American, Early 18th C
 - D) Black and Gold Lacquer Cabinet, Japanese, 17th C

"Kantoor(tje)" and "comptoir(tje)" seem, at this period, to have been more or less synonymous with "kabinet(je)." ³⁹ These words were derived from the counter, comptoir or kantoor, where money was counted and business transacted; they were applied to the office or study where such matters were handled before being used to designate items of furniture, so that one would expect their application to be restricted to the writing cabinet. However, no distinction of the kind seems to have been made, at any rate until rather later. ⁴⁰ Few examples sound important, the most striking being "1 Japans Komptoir" which fetched 63 guilders (VR17,1701) and "een Japans verlakt Comptoir met vergulde vigeuren" worth 48 guilders (II,8,1707). An "Oostindische Comptoir," presumably of ebony, with a value of only 12 guilders (II,47,1710), was much less important. Once again it is small inexpensive examples with a price range of from 2 to 8 guilders that occur most often. Albert van Breugel had "een jvoor Cantoortje" in which he kept his coins and medals, jewelry and small items of silver (23/5,35,1675), but most kantoor-tjes, when particularised, are again of ebony or lacquer: "1 verlakt Tonquis Cantoortie" (VR36,1705); "1 swart Ebbenhoute Contoortje met Cooper beslag / 1 do Swart Japans" (II,109,1714); and "een klein ledig Japans vuurenhoute comptoirtie met koper beslag" valued at 6 guilders (II,8,1707). The only difference between the two groups, and it is merely a matter of emphasis, is that while a good many cabinets are recorded with stands, a stand is rarely associated with the kantoor. Among the few exceptions are "1 Swart ebbenhoute kantoortje met koper beslagen en op een ebbenhoute voet" ⁴¹ and "1 kantoortjen op een voet met laatjes" (I,32,1697).

Most of the cabinets and kantooors present at the Cape before 1715 seem to have been imported, and nothing, apart from porcelain, demonstrates the privileged position of the Cape vis-à-vis the Far East more eloquently than the presence of a significant quantity of Oriental lacquer. Apart from a few large cabinets, most of the pieces were quite small; dainty cabinets-on-stands, table cabinets, tea-tables, tea-trays like "1 verlackt teebakje" (VR59, 1709), clothes trays like "1 verlacqt kleebackje" (VR27,1701),

nappy trays like "1 Japanse verlakte Luijerbak" (III,31,1713), and a variety of boxes and cases including "vier verlakte kleine doosjens" (II,8,1707), "I verlakte kooker" (II,30,1709), and Albert Breugel's "Japans verlack Cruijt doosje met silvere affschotten" (23/5,35,1675).

The finest lacquer was made in Japan, and this was the source of quite a lot of the lacquer circulating at the Cape. Most anonymous lacquer, like most anonymous porcelain, probably came from China. Then there was Tonkinese lacquer from the region now known as Vietnam, while some of the unattributed lacquer may also have come from Java. All this minor lacquerware obviously made an important contribution to the unique flavour of the early Cape interior: a touch, though not the only touch, of the highly fashionable in a society whose domestic arrangements were in some ways notably backward-looking.

Perhaps it should be made clear at this point that the cabinet to emerge from the inventories before 1715 was in general a very different article from the cabinet listed after that date, and it is possible that the four expensive cabinets in the estate of Willem ten Damme⁴² were examples of the new cabinet—a piece of furniture known today, for some completely unhistorical reason, as an "armoire." The cabinet, which was the dominant piece of furniture at the Cape in the second quarter of the eighteenth century, was a large object sometimes made of local wood, which might be provided with one or more drawers and which, in the 1720's, was still invariably flat-topped.⁴³ A large cabinet was normally filled with clothes and linen, and so fulfilled precisely the same function as the great kast, over which it immediately took precedence. A reference to a stinkwood cabinet in 1726 (IV,118), is proof that some cabinets had been made at the Cape by this date, but it is my personal opinion that most of the early cabinets in teak, ebony and amboyna were of local workmanship.⁴⁴

The Writing Box

A small writing cabinet can occasionally be singled out from the various kabinetjes and kantoortjes by reason of its contents:

"1 kabinetje op sijn voet met papieren" (I,36,1698); or, at a slightly later date, by its description: "3 schrijff kantoortjes met koper beslag"⁴⁵ (IV,75,1725). The so-called "schrijflaadje," which was a small, often luxurious writing box, appears in quite early inventories and reappears on occasion throughout the eighteenth century. We first meet it in 1687, when Olof Bergh had "1 Swart ebbenhoutte Schrijfflaetjes met vergulde dopjes en beslag."⁴⁶ The Batavian schrijflaadje, as described and illustrated by Van de Wall,⁴⁷ was a miniature sloping chest with elaborate metal mounts. It was a luxurious little container for writing implements, but offered no surface on which to write the briefest note. The schrijfflessenaar, which is apparently rarely mentioned in early Batavian inventories, is equated by Van de Wall with the straight-fronted schrijfkabinet,⁴⁸ and it is quite likely that the very occasional lessenaar that appears in the Cape documents of the seventeenth century⁴⁹ should be interpreted in a similar way. The lessenaar at the Cape in the early eighteenth century, however, was almost certainly a larger and more practical version of the schrijflaadje which combined the functions of container and writing slope. A desk of this type is well-known in Europe and America, where it is found both with and without a stand, and the form still lingers on in the typical school desk with which we are all familiar.

It is not until the end of the second decade of the eighteenth century that one encounters a desk and stand, namely "1 Lessenaar met sijn voet" (III,83,1718), so that the various lessenaars recorded between 1700 and 1715 were portable desks designed for use on a table (Pl.18). The majority were worth no more than three guilders, though an occasional exceptional example was worth twenty-five or more. No lessenaar is accorded much in the way of a description, and entries like "een Lessenaar met een parthij papieren" (II,43,1710), or simply "1 Lessenaartje" (III,53,1713) are sadly uninformative. One reference, "twe Cnietens tot een Lessenaar" (II,11,1707), offers the only additional clue, and a rather puzzling one at that. Perhaps a pair of runners for the support of the open lid were intended, in which case they must

originally have formed part of a desk-on-stand.

Plate 39C shows an early American writing box-on-stand, a piece of furniture that would be known at the Cape as a "Bible desk" in English and a "knaap" in Afrikaans, but which is known in Europe as a "slant-top desk on stand." Atmore considers that there is no need to change our name to conform to overseas practice. "When they were in use at the Cape," he suggests, "the devout early settlers probably spent more time reading Bibles than writing correspondence and the large size and depth of the storage box with strong lock would have afforded ample and safe storage space for a cherished possession—the family Bible."⁵⁰ This commonsensical view, however, is not borne out by the facts. It is true that the average lessenaar seldom seems to have fulfilled its proper function—instead it made a suitable "strong box" for silver items and pieces of jewelry; but it did not serve as a Bible desk. The "knaap" which is occasionally inventoried before 1740 was a simple stand with the same sort of function as the guéridon.⁵¹ In the 1740's one begins to encounter entries like "1 knaap met 1 groote bijbel" (VI,118,1747), but such references nearly always occur in inventories where a lessenaar is recorded as well. Two other significant facts emerge: in no eighteenth-century reference to a knaap with which I am familiar is there mention of a foot, though "1 lessenaar met sijn voet"—an entry from the same inventory as the bijbelknaap just cited—remains common throughout the century; then, I know of no reference that suggests that the Bible, or indeed anything else, was to be found inside the knaap, though many references mention the contents of the lessenaar. To me it seems clear that the knaap and the lessenaar were two distinct pieces of furniture, and it would not surprise me if the original knaap was simply a lectern.⁵² Perhaps it was only when the lessenaar was provided with a ridge to hold a book in place, a feature which would at once render it useless as a writing desk, that the term "knaap" became associated with it, though it is quite possible that this type of furniture was also known as a "lees lessenaertje," a term noted in an inventory of 1819 (XXXIII,2). During our period, however, the bijbelknaap was not yet in use and the Bible, when present, was kept on a table.

The Cellaret or Bottle Case

The cellaret (kelder) is a rather minor article to warrant a separate section, but its importance in the early Cape house perhaps justifies the emphasis. Normally fitted with flasks, the cellaret was a box-shaped container which was presumably provided with compartments to hold the flasks (Pl.18). There was a considerable range in size, and while some of the small cellarets may have taken only four flasks, a good many took fifteen. Examples with one, five, seven and thirteen flasks have been noted, but awkward numbers like these were probably the result of breakage. The flasks designed for the cellaret would have been square like the case bottle, and may indeed have been case bottles, but their material never seems to be mentioned.

An inventory of 1652 includes "1 kelder met 7 vlessen"⁵³ and the cellaret, though far rarer than the ordinary chest or the carpenter's chest, is among the few items apart from tobacco, clothes and personal effects to occur with some regularity before about 1670.⁵⁴ In the later inventories, which make it possible to visualise the cellaret within the context of a house, it is most often encountered in the kitchen region, particularly the pantry, though it is also quite usual to find one or two in a voorkamer. Its position in the house seems to have been governed very largely by its contents. In most instances the cellarets were recorded with empty flasks as in "vijff leedige kelders ijder van 15 vlessen" (23/5,3,1670), but among the exceptions were those holding fish oil, linseed oil, distilled water, vinegar and brandy. Empty cellarets or those filled with brandy such as "12 flessen brandewijn in een oud kelder" (I,62,1701), are those most often found in the front rooms, but cellarets of fish oil were naturally kept out of the way.

A cellaret with fifteen empty flasks was usually priced between six and ten guilders, a variation probably due to age and condition rather than to any marked difference in quality; the sum suggests a plain construction of wood with an iron lock. The inventories, and more particularly the vendu rolls, show that an ordinary household often had two or three cellarets in the seventeenth century, and numbers increased considerably in the early eighteenth. The cellaret was naturally most in evidence among the effects of men who dealt in liquor;

thus the inn-keeper Hendrik van Zuijwaerden could boast twenty cellarets in 1672 (23/5,21). Not all cellarets continued to hold their flasks, and when parted from these they made useful hold-alls and are found, among other things, filled with clothes, old ironwork, small pictures, crucibles, pistol holsters and books.

Houses which we have come to know well with a cellaret or two in one of the front rooms include those of Olof Bergh, Van Stralen/Van Doorninck, Elisabet Loenss and Abraham Diemer. On the whole, however, the cellaret is even more commonly on view in less exalted circles: the small Verbrugge farmhouse in the Stellenbosch area did not run to a single bed, but their front room on the right-hand side had one cellaret with flasks and one without, and the front room on the left "1 Celder met eenige flessen" (II,58,1712).

The Mirror

The mirrors in the estate of Hendricus Munckerus, which are evaluated and described in unique detail, make a useful introduction to the subject—but first a few words about Munckerus himself may be in order, particularly as his estate is going to feature quite prominently from now onwards. After a year or two as Landdrost of Stellenbosch, Munckerus was promoted, in 1698, to undermerchant and cashier. In these roles he obviously came up against Governor Willem Adriaan van der Stel, and though in the words of the burghers "een braef eerlijck Man," he was so oppressed, hounded and frustrated by the Governor that he was brought to the point of shooting himself dead with a pistol.⁵⁵ Perhaps the unusual care with which his inventory was compiled, an event that took place in 1707 though he had died in 1705, was in some measure a personal tribute on the part of the clerk concerned.

The most important mirror in Munckerus's possession was "een spiegel van een el groot" which was worth 30 guilders. The mirror was linked with "twee kopere schulpen" and "twee behangsels" which were each worth 12 stivers. It was then the practice, for reasons to which I shall shortly return, to provide the occasional large mirror with a protective curtain which was fitted to a rail running along the top of the frame, but to find a pair of curtains is

a little unusual. The two brass shells are rather puzzling, though a decoration of Batavian mirrors, noted without explanation by de Haan.⁵⁶ In several paintings, including Jan Vermeer's "Lady at the Virginal with a Gentleman," a mirror is shown suspended from a single brass fitting projecting from the top of the frame (Pl.40A). It is easy to imagine a pair of such fittings serving a similar purpose, though as one inventory refers to "1 spiegel met 3 coopere schulpen (II,28,1709) and another to "twee Coopere haecken tot een Spiegel" (23/5,35,1675), the "schulpen" may simply have been a decorative boss.⁵⁷ A second mirror is described as "een spiegel met een Ebenhoute Lijst van een el hoog gevlekt / twee doeriasse gordijne daartoe / twee kopere schulpen," which were valued together at 24 guilders—a reduction explained by the spotting of the glass. Then there was "een spiegel gevlekt van een 1/2 el met een Ebenhoute lijst" valued at 4 guilders, 8 stivers, "twee ovale spiegels met vergulde lijsten," 7 guilders, 8 stivers, "een spiegel van 1/2 el met een vergulde lijst," 6 guilders, and "een ovale spiegel met een vergulde Lijst," 4 guilders, 8 stivers (II,8,1707). In size and style these mirrors seem fairly representative of the sort of thing present in the leading town houses at this time. The Dutch ell was equal to about seventy centimetres⁵⁸ and this is probably the height of the majority of "grote spiegels," particularly as they are nearly always valued at about thirty guilders. Also of interest in the dramatic reduction in price as the size decreases: a large mirror was a luxury for the few, a small mirror was a commodity most people could and did afford. The frames—some of ebony, some of gilded wood—are also typical for the early eighteenth century, though the mirrors mentioned before 1680 were, almost without exception, either made of ebony or treated to resemble it, and include "een Spiegeltje met een ebbenhoute Lijste" (23/5,I,1674), "een groote Spiegel met een ebbenhoute Lijst" (23/5,23,1672), "een Spiegel met fruweel [velvet] en silver beslag" (23/5,35,1675) and "1 Spiegel van een voet glas" (23/5,47,1679). Later references of interest include "1 spiegel met vergulde lijst," 35 guilders, 4 stivers (VR21,1701); "1 Spiegel met een Swarte Lijst," 33 guilders, 12 stivers (VR18,1701); "een Spiegel met een vergulde Lijst en ijsere boog tot behangsel" (II,43,1710); "1 Vergulde Spiegel met /

2 Cooper Schulpen" (VR56,1709); "1 groote Spiegel"—the inventory shows it to have been black-framed—which sold for a hefty 60 guilders (VR27,1703); and just once "1 klein kap spiegeltje met een vergulde lijst" (I,63,1701). In addition to wall mirrors of some importance were small hanging mirrors worth 3 to 6 guilders, table mirrors (tafelspiegeltjes), hand mirrors such as "1 Clijn doosje waerin / 1 Spiegelje" (II,37,1709) and little book mirrors (boekspiegeltjes), which were very popular in the seventeenth century. Rarely worth more than a few stivers, these amusing little toys combined three or more small mirrors in a way that would reflect something like a hundred images.⁵⁹

The manner in which a mirror was secured to the wall varied. A number of mirrors, many of them quite substantial, were held to the wall by a fitting of greater or lesser elaboration attached to the top of the frame. This could be hooked over a nail—the usual method, or it could be threaded with a cord which was then tied to a hook or nail. Either of these methods held the mirror flat against the wall in the modern manner (Pl.40 A&C). Many mirrors were required to cant forward, however, and these were suspended on cords attached to fittings low down on the back of the frame (Pl.40B). In Europe such cords were sometimes fitted with tassels and tied with great elaboration, but there is no trace of this practice in the Cape inventories.

Before turning from mirrors to pictures a few words must be said about the significance of the former. The mirror, to the men and women of the seventeenth and eighteenth centuries, was not only a convenience and an important decorative accessory but an object of power. Its property of reflecting was long considered magical and it was employed, for instance by the ancient Greeks, for divining the future. Primitive man believed that the mirror not only reflected his physical presence but his soul as well. Illness meant that there was a possibility of the soul escaping from the body into the mirror, and this led to the widespread and enduring custom of covering any mirror in a sickroom. It was for a similar reason that mirrors in a house where someone lay dead were covered between death and burial.⁶⁰ Other beliefs associated with the mirror in Flanders and retailed by Weyns were linked to the well-being

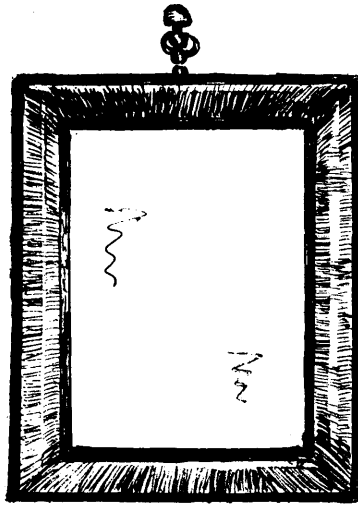

A

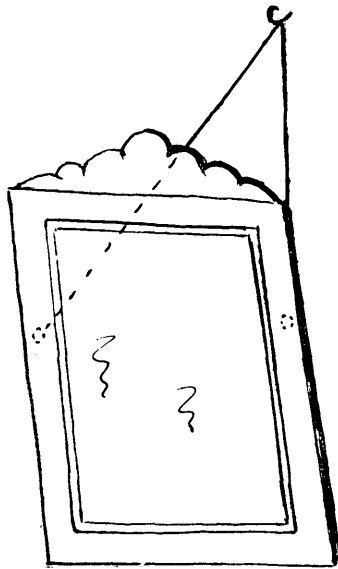

B

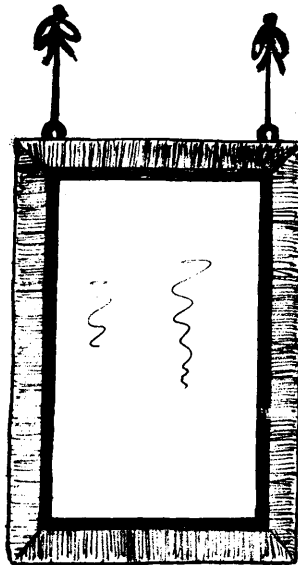

C

(40) Mirrors and their Methods of Suspension

of the bridal couple. It was the father-in-law who made a present of a mirror to the bride, because for the groom to do so would break their love. It was also considered dangerous for the bride even to look in a mirror.⁶¹ One way and another, then, it is not surprising that some large mirrors were provided with curtains—not to protect the mirrors, but to protect the people living in their vicinity, and before we smile too broadly at the quaint beliefs of our ancestors let us remind ourselves of our own sense of unease when we spill the salt, walk under a ladder, have our path crossed by a black cat—or break a mirror. And let us remember, too, all the people who pay more attention to their daily horoscope than the news of the world.

Paintings, Maps and Prints

Contemporaries were frequently intrigued by the number of people who owned paintings in seventeenth-century Holland; and Bredius claimed that it was not unusual to find a hundred or even two hundred paintings in a modest household.⁶² There is no doubt at all that the Dutch love of pictures was strongly reflected in the life of her colonies as well. Dr. de Haan has recorded that paintings were omnipresent in seventeenth-century Batavia, where they occur even in quite humble estates, though in the eighteenth century there was a growing tendency to confine them to the houses of the rich.⁶³ The same theme was sounded, with slight variations, at the Cape. There, it was probably in the early eighteenth century rather than the late seventeenth that paintings were most widespread, with a few prints and one or two paintings found, at times, in quite modest estates, and collections of one to four dozen pictures at the upper end of the social scale. Larger collections were to be found later: in 1764 the widow of Sergius Swellengrebel left an enormous collection of one hundred and thirty-four paintings;⁶⁴ and in addition to his famous library Joachim van Dessin, who died in 1761, was the owner of seventy-four European paintings and an unknown number of Chinese ones,⁶⁵ but such collections reflected the eighteenth-century tendency to concentrate art in the hands of the few.

The self-conscious aestheticism of the twentieth century, coupled with the astronomical prices we are prepared to pay for the work of artists we value, make it difficult for us to understand the spirit in which paintings were collected in and around 1700. At that time paintings were part of the furnishings, valued for their contribution to the total scheme of things, so that their size and shape and the colour and finish of their frames were of major importance, and—understandably but frustratingly—this is the information that the company clerks take it upon themselves to record. The subject matter, though hardly irrelevant, was of secondary importance, despite the fact that it probably influenced the room in which the picture was hung. An artist's handbook of 1675 discourses on the subjects suited to the different rooms: "Let the Hall be adorned with Shepherds, Peasants, Milk-maids, Flocks of sheep and the like . . . in the Bedchamber put your own, your wives and childrens pictures,"⁶⁶ and so on and so forth. At the Cape the subject matter is so seldom given that it is impossible to tell what, if any, were the prevailing conventions. There is only one discernible preference: a liking for large maps in the voorhuis, though they were by no means restricted to this locale (Pl.18). The name of the artist responsible for the painting, the one thing that obsesses us most today, was something that nobody troubled about unduly. The Hague inventories occasionally supply the name of a particularly famous artist, but I have yet to encounter an artist's name in a Cape inventory.

A really valuable painting was unheard-of at the Cape, and a picture worth more than ten guilders was something of an exception. An entry like "1 schilderijten met een gesneden lijst" which sold for 14 guilders, 10 stivers (VR24,1702) leaves one wondering whether the painting itself or the carved frame was exceptional, while the brief entry "2 p^s Schilderijen" does nothing to prepare one for the high price of 40 guilders, 8 stivers (VR18, 1701). The majority of paintings commanded less than three guilders, and a reference like "6 p^s Schilderijtjes met vergulde lijst" which sold for 2 guilders, 4 stivers (VR74,1712) goes a long way to explain their presence in unexpected places. Prints,

it hardly needs saying, were usually a little cheaper; thus "negen printjes portraijtjens van papier met lijsten" were valued at 3 guilders (II,8,1707). Faced with prices like this, one must guard against the assumption that such paintings were quite unimportant. The minor seventeenth-century Dutch masters were thought of as craftsmen and paid accordingly. Towards the middle of the seventeenth century, for instance, when the widow of a Rotterdam art dealer died and her property was put up for sale, 180 paintings fetched 357 guilders, 7 stivers,⁶⁷ or just on 2 guilders each, while the great Jan Steen himself settled a debt of 27 guilders by painting 3 portraits for his creditor.⁶⁸

Most of the paintings and prints found at the Cape must have come out from Holland, and when the subject matter is referred to it usually belongs to one of the well-known types favoured by the Dutch artists of the period. Firstly there were portraits: "een Schilderije vande overledene met een groote ebbenhoute Lijst," in the estate of Hestertje Coesemans (23/5,1,1674); "1 Schilderij of 't eijgen Contrefijtsel / 1 do van Johannes pretorius" (II,29, 1710); or "een jongelings portrait / een dogters do sijnde suster en broeder van Juff^vmunkerus" (II,8,1707). These last two, incidentally, were valued like the Jan Steen portraits at 9 guilders each ! Classical subjects mentioned include a series of the seven sybils sold together for 42 guilders, 10 stivers (VR9,1697) and "1 schilderij van Andromeda."⁶⁹ There were flower pieces such as "2 Schilderijen Bloem Werk";⁷⁰ landscapes like the "3 Gemeene Schilderijen zijnde Landschappen met geringe Lijste" valued at 18 guilders (II,50,1710); and religious subjects like "1 Schilderije, gent. Juda met tamor . . . [en] 1 do van Ahasuerus en hester" (23/5,17,1672).

Reference has already been made to two Munkerus portraits, and this invaluable inventory details a number of other interesting paintings such as "twee Italiaanse Zehavens," 12 guilders; "twee Landschappen," 18 guilders; "een shilderij verbeeldende een boere kermis," 6 guilders; "een Dronke boer en boerin," 3 guilders; "een Boere schoolmeestertie," 6 guilders; "een Boere marketje," 6 guilders; "drie boere kermessen oud," 18 guilders; and finally "twee verbeeldende Zetjens," 12 guilders.

In addition to seventeen imported paintings and a couple of dozen prints, Munckerus also owned "vijf geramponeerde schilderijen Caabse kunst" valued at 4 guilders, 2 stivers. There is only one other recognisable piece of Cape art recorded before 1715, a painting of Eekelenburg,⁷¹ one of Jan Dirksz de Beer's farms, which is listed as "1 schilderij van de plaats" (I,63,1701), but Professor Bax draws attention to another fairly early reference, "8 schilderijtjes waar van ses aan de Caab" (Jan,1729).⁷² References like these do make one wonder whether a significant proportion of the paintings in circulation were done locally. If the early settlers felt strongly about paintings in their homes it would be natural enough for attempts to have been made to meet their wishes, but I am only aware of the name of one early artist, Johannes Craaij from Dresden, who, in 1709, married Barbara van Brakel, the sister-in-law of Adam Tas; he was known for his painting in Stellenbosch and Drakenstein.⁷³

Apart from one reference to red frames, all picture frames were either black or gilt like the frames of the mirrors, for it was only in about 1720 that the brown frame came into fashion. The plain frame was the norm, but a few carved frames, including empty examples like "2 gesneede lijsten sonder schildereijen" (I,62,1701) are recorded. Pictures were hung in the same way as mirrors (Pl.40). Many frames had a fitment, often simply a semicircle of iron, designed to slip over a hook or nail, fixed to the top (Pl.40, A&C), while others had fitments at the back (Pl.40B), which made it possible for them to be canted forward; in rooms lined with rows of pictures it was the sensible practice to treat the top row in this way. Maps were sometimes framed like pictures, but large ones were treated rather differently. Numerous paintings show them stretched between two narrow wooden rods with turned finials—a most attractive method of display (Pl.18). One of the first inventories to mention any sort of picture, that of Roelof de Man, records "8 stuckx prenten sonder rolletjes / 13 do die aen de muer hangen," which seemingly indicates that paper prints might also be hung on rollers.⁷⁴

The Rack

At the Cape a room where the walls were decorated with nothing

but mirrors, pictures and the occasional candle bracket was uncommonly "elegant." In the average house wall-racks made a most important contribution to the general effect. A plank of wood bracketed to the wall to form a shelf is a cheap and easy answer to the need for more storage space, and a normal feature of the houses of the poor at any period. A similar but more acceptable solution is offered by a proper rack, particularly a rack designed for a specific purpose: for plates, tea-ware, tankards, spoons, eggs, weapons, or hats and cloaks. All these racks appear in the early inventories, and a house without a cloak-rack, a tea-rack and one or two plate-racks was virtually unfurnished. As there are nearly as many ways of designing a plate rack as there are of designing a chair, it is a great pity that we have nothing but the very inadequate inventory descriptions to guide us.

When racks of plates and tea-wares were included in furnishings of the front rooms, an interesting convention emerges with regard to their contents: porcelain alone was acceptable. Pewter, even though it was often more expensive than porcelain, copper and brass, properly belonged to the middle and back rooms and the kitchen quarters. Racks of pewter in the voorhuis are a pointer to the lowly social status of their owner, for even among the farming community the porcelain convention seems to have been honoured. Outside Batavia this emphasis on porcelain must have been virtually unique. In Europe the class of people who made use of wall-racks in their front rooms did not own quantities of porcelain with which to fill them.

The average plate-rack seems to have been quite a simple affair, and an entry like "1 gesnede rak"⁷⁵ is seldom to be found. A carved tea-rack, like "1 bruijn gesneedene teerak" (II,37,1709) or "1 gesnede theerak" (II,70,1713), occurs a little more often. The gun-rack and the cloak-rack, which also had a place in the front rooms of all but the most sophisticated houses, were also occasionally of fine quality. Elisabet Loenss had "1 bruijn uijt gesnede geweer rak" (II,37,1709) and Olof Bergh had "1 Loeffwerckx kapstock"⁷⁶ which was the contemporary way of describing the elaborately carved Batavian furniture.⁷⁷

The function of the cloak-rack (kapstok), unlike the function of plate-, tea- and gun-rack, was not always as obvious as one might

expect. On several occasions a "kapstok" is listed whose only function was the display of a dozen or more small items of porcelain,⁷⁸ and at times a careful clerk found it necessary to specify a "klere kapstok." Plate 41 shows two cloak-stands in use in Holland in the seventeenth century which, with slight variations, appear in a number of different paintings, but though the cloak-stands at the Cape were undoubtedly of this kind, others served much the same purpose as an étagère, and as they had little to do with hats or cloaks, they would not be given the name "kapstok" today. Some eighteenth-century kapstokken were provided with a curtain, as in "1 Capstok met een witte gardijn" (II,74,1713). I visualise a curtain hung across the corner of a room, with a row of pegs behind.

Before putting the subject of wall decoration and wall furniture behind us, let us take a look at the overall treatment of the various items concerned. There are any number of Dutch interiors from the seventeenth century to show us that there were no hard and fast rules in this matter. Some rooms had walls where paintings and mirrors were organised with mathematical balance and exactitude, while in others no discernible pattern is visible. Pictures and mirrors were handled in all kinds of ways: sometimes hung flat against the wall, sometimes canted forward, sometimes hung high up, sometimes low down, sometimes massed together, sometimes hung singly, the acceptable permutations may have been even greater than they are today.

If one excludes the most formal arrangements, which were dominated by the architectural framework, the same variety was probably to be found at the Cape. The Corssenaers may have arranged the large mirror, thirteen paintings and fourteen chairs in their "grote kamer" with formal symmetry (III,37,1713), but Johana Starrenberg, with a voorkamer hung with a mirror with three small paintings beneath it, four other small paintings and three large paintings, must have been content with an informal arrangement (II,28,1709). More informal still were the rooms where mirrors and pictures brushed shoulders with wall-racks of various kinds. This combination can also be found in an occasional Dutch painting, but in those representing the interiors of lower middle-class homes rather than those of the true middle class. The principal room at "Mordegat," the farmstead

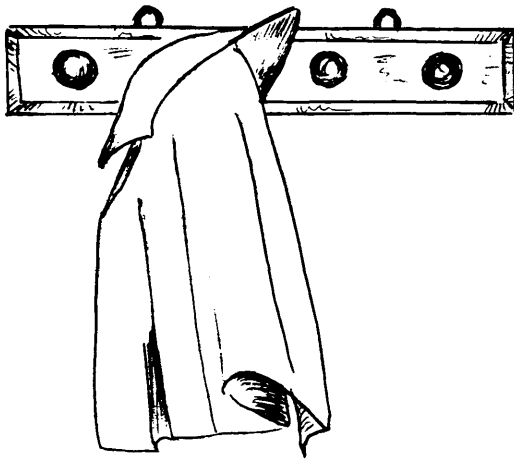

(41) Two Cloak-Stands, Dutch, 17th C

of Wessel Pretorius, heemraad of Stellenbosch, is a typical example of this sort of arrangement. There we find a gilt mirror and two small paintings, three tea-racks filled with porcelain cups and saucers, two larger racks with an assortment of porcelain plates, dishes, bowls and flasks, a kapstok, and a gun-rack (III,56,1713). At its most refined, this combination is seen in the main room of Elisabeth Loenss's town house. There, a large painting hung above the door, while a mirror, six prints, an openwork gun-rack, four porcelain-filled tea-racks and a porcelain-decorated kapstok, shared the remaining wall space, which was dominated by a large fire-place with over twenty-four smallish pieces of porcelain set out on its mantel-piece (II,37,1709). It is a room of this type, casual, crowded, colourful, that I have tried to evoke in Plate 18.

Footnotes

1. The unqualified term "dining room" began to acquire its modern meaning in the middle of the 17th century, ~~but~~ was not generally accepted until well into the 18th century (Thornton, op. cit., p.282).
2. Ibid., p.226.
3. See above, pp. 113-14.
4. See below, pp. 203-04.
5. The Dutch were known throughout Europe for the almost ritualistic manner in which they consumed huge amounts of alcohol on special occasions. "The Dutch bourgeois distrusted anyone who drank less than he did, and would have reproached himself for rudeness if he had not got all his guests drunk " (Zumthor, op. cit., p.172).
6. See above, p. 56.
7. Thornton, op. cit., p. 230.
8. CJ2914, Bergh Inv., p.2.
9. Zumthor, op. cit., p.177.
10. See above, pp.62-63.
11. Tonkinese. The D.E.I.C. had an office at Kachui (Jiaozhou) in Tonking, which was an independent kingdom on China's southern border. It is now Vietnam.
12. The form is described and illustrated by Van de Wall, op. cit., p.105.
13. Thornton, op. cit., p.230.
14. Schotel, op. cit., p.15.
15. Thornton, op. cit., p.302.
16. Indian craftsmen had a range of blues, reds, pinks and purples that could be dyed fast and, with a more fugitive dye, could add green and yellow (Donald King, "Textiles," Connoisseur

- Period Guide, p.435).
17. Schotel, op. cit., p.15.
 18. This was due to a reluctance to hide the richly carved apron and feet of the fashionable ebony table under a cover (Van de Wall, op. cit., p.75).
 19. This painting is on view at the Koopmans de Wet House, Cape Town.
 20. Most surviving Cape linen presses date to either side of 1800. They rest upon a cupboard section which may be surmounted by a drawer.
 21. Quoted by Norbert Elias, op. cit., p. 95.
 22. De Haan, op. cit., I, 407, 511 & 538, n.1.
 23. Thornton, op. cit., p.354, n.18.
 24. Some prayer rugs from Bergamo on the Mediterranean coast of Turkey measure only 76 x 106 centimetres. Rugs and carpets from this source are thought to occur in early paintings such as "The Ambassadors" by Hans Holbein, National Gallery, London (Philip Bamborough, Antique Oriental Rugs and Carpets [Poole, 1979] , p.110).
 25. King, op. cit., p.441.
 26. Schotel, op. cit., p.9.
 27. Resolusies, III, 376.
 28. Ibid., IV, 245.
 29. The matrozenkist was not carried by the ordinary sailor who was limited to a nameless chest, 40 x 16 inches. For details of baggage allowed the various ranks see Nederlandsch - Indisch Plakaatboek, ed. J. A. van der Chijs, Vol IV, 1709-43 (Batavia, 1887), 40.
 30. Zumpthor, op. cit., p.39.
 31. The equivalent of £14 " 11s. Singleton lists 11 cupboards to show that "the great kas" was "highly appraised" by the Dutch in America round 1700. Only three of these exceed the Sneewindt cupboard

in value: " 'a cupboard or case of French nutwood, £20' (1686);
. . . 'Holland cubbart furnished with earthenware and porcelain,'
£15 (1692); . . . one 'great Dutch kas that could not be removed
from Flatbush' the home of Mrs. van Varick, who died in 1696 and,
therefore, was sold for £25" (Furniture, p.260).

32. This cupboard could date to 1735 or so. Mr. Kevin Stayton, Assistant Curator, Brooklyn Museum, New York, pointed out to me that early 18th century American cupboards do not have the highly raised panels of earlier examples.
33. A personal communication from the previous curator, Mr. P. Snyman.
34. Trans. en Schep., II, 60.
35. For example "4 plankies inbijde bottelerijtjes" in a voorhuis-kitchen (CJ2914, Meijer Inv., 1705, p.162). See also p.39, n.60.
36. Michael Baraitser & Anton Obholzer, Cape Country Furniture, 2nd rev. ed., (Johannesburg/Cape Town, 1978), p.260.
37. Weyns, op. cit., 269. Though "scapraai," a term dating back to the Middle Ages, had wider implications than "etenskast" the terms were often synonymous.
38. CJ2916, Freser Vend., 1696, p.6.
39. "Cantoorkens of cabinetkens schoon ingeleyt . . . voor neerslaende of met 2 deurkens," 1634, quoted under "Kantoor," Woordenboek der Nederlandsche Taal, ed. A. Beets & others, 21 vols. ('s-Gravenhage, 1882 - 1971), Vol. VII.
40. See below, p.149
41. CJ2914, Bergh Inv., 1687, p.9.
42. See above, pp.146, 165, n.45.
43. In an inventory of 1719 two cabinets appear. One, made of red ebony, supported 15 pieces of porcelain; the other had the main section filled with linen and underwear whilst 3 old sheets were "Inde Schuijs [schuif ?] Laa in't Cabinet" (III,92). In 1728 a cabinet was inventoried with 10 pieces of porcelain

- on top of it, a quantity of silver, linen and jewelry "in het Cabinet," and various oddments "inde Latjes van't Cabinet" (IV, 115).
44. Atmore, in a discussion of Cape armoires of the cabinet-on-stand type, suggests that they derived from a Dutch prototype which appeared in Holland about 1730 (op. cit. p.187), but the Cape cabinet must have derived from a somewhat earlier prototype.
 45. This usage continues into the 19th century, though in later references the "Schrijf Comptoir" (XIX,66,1788) and "schrijfkantoor" (XXXIII,2,1819) appear as substantial pieces of furniture.
 46. CJ2915, Bergh Inv., 1687, p.10.
 47. Van de Wall, op. cit., p.116. Pl.41A.
 48. Ibid, pp,116 & 131.
 49. For instance "1 ledige lessenaer" in an inventory of 1673 (23/5, 25).
 50. Atmore, op. cit., p. 208.
 51. For example, "Een ijsere Cnaap met een Coopere blaker" (23/35, 1675) and "1 houte knaap en een kapstok" valued at f2 (II,51, 1711).
 52. In Batavia the bijbelknaap had the form of a lectern, but the normal height was such that it was too low to read from when standing on the floor and too high to read from when placed on a table. It was simply a resting-place for the Bible when not in use (De Haan, op. cit., II, D23).
 53. Trans. en Schep. I, 21.
 54. In 1713 fleskelders for 12 bottles feature prominently in the baggage allowance of Senior Company men and had no doubt long done so (Nederlandsch - Indisch Plakaatboek, IV, pp. 39-40).
 55. " 't is dan waeragtigh, dat den Cassier Henricus Munckerus die by

ieder een voor een braef eerlijck Man bekend stont, en sulcks oock in waerheydt was, van den Gouverneur seer is gedruckt, vervolgt, en in alles gedwarsboomt . . . dat hy tot het desperate voornemen is gekomen, sigh selven met een Pistoool te doorschieten (Willem Adriaan van der Stel, Korte Deductie [Amsterdam, 1708] , p.53. A.35).

56. De Haan, op. cit., I, 515.
57. A painting by Samuel van Hoogstraten in the National Gallery, London, shows a regular black-framed mirror with a brass fitment at the top and two decorative brass studs at the bottom of the frame (K. D. Haley, The Dutch in the Seventeenth Century, [London, 1972] , PI.111).
58. The Amsterdam ell actually equalled 0,688 m as opposed to the Hague ell of 0,694 m, (Woordenboek der Nederlandsche Taal, ed. J. A. N. Knutter & others, Vol III, 1916).
59. See "Spiegel," Woordenboek der Nederlandsche Taal, ed. J. A. N. Knuttel & others, Vol. XIV.
60. The Oxford Companion to the Decorative Arts, ed. Harold Osborne (Oxford, 1975), p.569.
61. Weyns, op. cit., III, 1018.
62. Cited by J. L. Price, Culture and Society in the Dutch Republic During the 17th Century (London, 1974), p.133.
63. De Haan, op. cit., I, 507-08.
64. D. Bax, Zuid-Afrika's Eerste Openbare Verzameling op het Gebied van Kunst en Ethnologie 1764-1821, Verhandelingen der Koninklijke Nederlandse Akademie van Wetenschappen, Afd. Letterkunde, Nieuwe Reeks, Deel 75, No. 3, p.116. The Swellengrebel collection was the largest 18th-century collection known to Prof. Bax.
65. Ibid., p.12. The paintings and ethnographic material in the Van Dessin Collection are the subjects of this work, which makes particular enquiry into their subsequent fate.
66. William Salmon, Polygraphics, or the Arts of Drawing, Engraving, Etching, Limning, etc. (London, 1675), III, chap. XV (quoted by Thornton, op. cit., p. 254).

67. See above pp. 10-11, n.10.
68. Price, op. cit., pp. 121-2.
69. CJ2914, Capt. van der Velde Inv., 1696, p.44.
70. Ibid.
71. Presumably Eklenburg, one of the early grants of land to the Free Burghers in 1658, which was situated on the Liesbeeck River.
72. Bax, Zuid-Afrika's Eerste Openbare Verzameling, p.116.
73. J. L. M. Franken, "Adam Tas en Sy Familie," Die Huisgenoot, 1 Okt., 1926, pp. 31-35.
74. Trans. en Schep. II, 1663, p.65.
75. CJ2916, Freser Vend., 1696, p.6.
76. CJ2914, Bergh Inv., 1687, p.9.
77. De Haan, op. cit., I, 497 & 554.
78. See above, pp. 64, 99, n.31.

MiscellaneousLighting

The modern wax candle, with its inoffensive smell and fully combustible wick, and the bright steady flame of the modern paraffin lamp, give a completely false impression of what life by artificial light was really like in the years round 1700. Wax candles, even the finest of them, needed constant attention. The cotton wicks did not burn evenly and did not burn away, and to keep them from smoking unpleasantly they had to be regularly trimmed or snuffed. Lighting in need of constant care is best kept within arm's reach and, according to Peter Thornton, most lights were placed between table and shoulder height. The position of the lights, coupled with the fact that every light flickered and pulsed, created an effect that could hardly have been more different from the steady overhead lighting we now take for granted.¹

Wax candles were expensive luxuries, and except on great occasions even the rich used them sparingly. Furnishings that exploited the light-catching properties of polished metal, gilded wood and gleaming silk formed a particularly happy partnership with the muted, dancing light of candles frugally used, and the general delight in rich furnishings was surely linked with their ability to give pleasure by candlelight. If it is difficult to visualise the quality of artificial light in the past, it is even more difficult to visualise how very little light there actually was. As far as possible life was lived in the daylight, and those who had to read, write or sew after dark were to be pitied. The best light available was that cast by the fire, and the average family was without the means to create a blaze of light, no matter what the occasion.

Before 1700 it was only the leading Cape households that could offer much in the way of lighting equipment. In 1670 burgher Jan Israelsz had two candlesticks, a chamber-stick (blaker) and a small lamp, all of brass (23/5,3). In 1675 Merchant Albert van Breugeŀ had two pairs of silver candlesticks, a silver snuffer and tray, two brass candlesticks, two brass snuffers (snuiters) and an iron stand with a brass chamber-stick (23/5,35). In 1685 Elbert Diemer, a prominent burgher, owned four candlesticks and two chamber-sticks (I,2),

and in 1699 Adriaan van Brakel possessed a pair of silver candlesticks, four pairs of brass snuffers, three brass candlesticks, three brass chamber-sticks, two lanterns and a candle-tray (I,46,1699). There is nothing particularly lavish about any of these lists, but they have more to offer than most. The far from negligible estate of Catharina van Swaanswijk with two lamps (I,36,1698), or that of Jacob de Wilt, he^hemraad of Stellenbosch, with two lamps and a brass candlestick (I,47,1699) are much more representative, and a number of families seem to have managed with a single lamp or candlestick or, quite often, with nothing at all.

The most impressive array of lighting recorded in the seventeenth century was to be found at Rustenburgh, the Company house at Rondebosch. The voorhuis had a pair of sconces described as "2 copere ligtarmen aen d'wandt," the principal upstairs room had four brass wall sconces, and what appears to have been the principal bedroom had "2 houte candelaers met copere pijpen." No other lighting is mentioned in this five-roomed house, and the four wall-lights found in the main room may safely be regarded as the standard for extravagant lighting in the Cape of the seventeenth century (23/5,29,1673).

The early eighteenth century saw some improvement. Now quite modest estates could boast three or four candlesticks, and that of Jacobus van Brakel, Adriaan's son, with two pewter candlesticks, another candlestick, a brass chamber-stick and three snuffers, is fairly representative (II,11,1707). Apart from the two pewter candlesticks which stood, unexpectedly, on a cupboard in the large front room of this Tigerberg farmstead, everything else was to be found in the kitchen, for it was in the kitchen or other related areas like the pantry, gallery or passage that lighting equipment was routinely housed when not actually in use. It is perhaps interesting to mention, at this point, that the art of the period reveals a similar practice in the treatment of candles. Except, perhaps, for a single example for use in an emergency, candles when not in use were removed from permanent fittings like wall brackets and chandeliers.

The de Beer house was generously provided with lighting equipment, but when the inventory was made it was all to be found in the back of

the house. There were three lamps, three brass candlesticks and a lantern in the kitchen, four brass candlesticks and two brass snuffers in the pantry, and eight brass candlesticks and nine brass snuffers in the "groote kombuijs." There was also a candle tray (kaarsenbak) and a plentiful supply of lamp wick—"2 1/2 bondel lamp pit" (I,63,1701). Twelve years later the situation was very much the same. The lighting in Abraham Diemer's country estate was supplied by four candlesticks, three lamps and two lanterns, which were all kept in the kitchen (III,30,1713); while his town house was provided with seven candlesticks in the gallery, nine candlesticks, a chamberstick, four snuffers and two lamps in the kitchen, and eleven pairs of snuffers under the stairs (III,31,1713). As most households owned nearly as many snuffers as candlesticks, it seems fairly obvious that snuffers were set down beside each candlestick when the lights were brought out at dusk. Snuffer trays appear periodically—"een silvere snuijter met 1 do backje" (23/5,75,1675), and "1 tinne Snuijterbakje" (III,31,1713)—but were apparently exceedingly rare.

Apart from the more or less obligatory snuffers, a few households were also equipped with a small extinguisher (dompertje), and even fewer with an interesting little object known as a "profijtertje" (Pl.42C&D). The extinguisher needs no explanation, but the profijter, which literally means "save-all," was a little gadget which fitted into the candlestick on which the last fragment of candle could be impaled so that nothing was wasted.² Most profijterjes were brass, but among the numerous possessions of the Widow Corssenaer were "1 silvere snuijter, blaker en profijtertje" (III,39,1713). Another fairly common item which was designed for the storage of candles was the candle tray (kaarsenbak); and the candle drawer (Kaarsenla) and candle box (kaarsendoos) were much the same sort of thing (Pl.42B&E). Most examples were made of wood but some were of metal and others, which may have been intended for melted wax rather than candles, were of earthenware.

Candles, though undoubtedly the commonest source of light, are not recorded very often, but it is still clear that several different sorts were available. Later inventories refer at times to Batavian wax candles, and these were certainly available before the end of our period; in October, 1713, "25 lb Bataviase waxkaarsen" were written off from the Company stores and a year later a similar entry recurs.³ Apparently wax candles were one of the many things that had

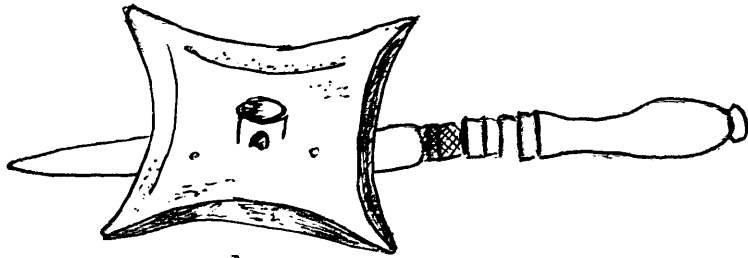

A

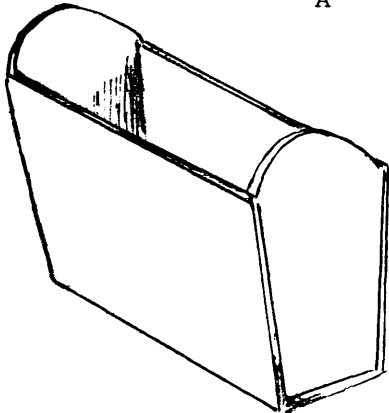

B

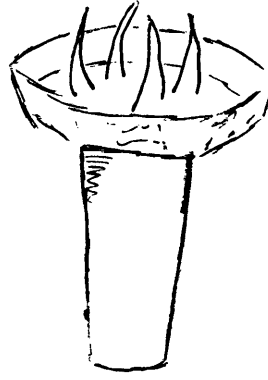

C

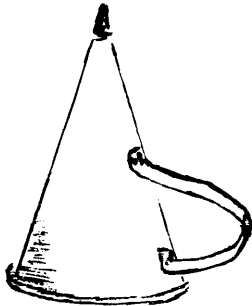

D

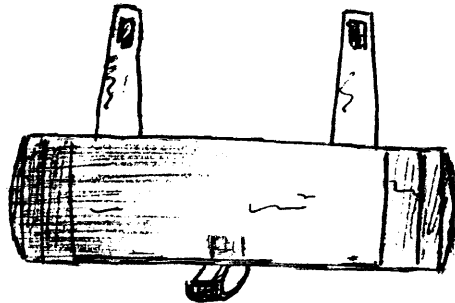

E

- (42) A) Steekblaker B) Wooden Candle Tray
C) Profijtertje D) Extinguisher
E) Candle Box, Rolled, Tinned and Japanned
Iron. A - D: Dutch; E: Early American.

to be imported, but as Batavia was also entirely dependent on imported candles, such entries need a word of explanation. According to De Haan, Batavia was supplied with wax candles from both Holland and China,⁴ so that the so-called "Batavian candles" must actually have originated in the latter country. Also present, presumably illegally, and clearly highly valued, was the ship's candle (scheepskaars). It seems reasonable to deduce that these were wax candles of Dutch origin. Finally, there was the tallow candle (vetkaars), which must have been present in most households despite the fact that it is seldom mentioned. A resolution of 1659 allowed the "stadsborgers" living around the fort to sell candles,⁵ which is convincing evidence that the making of tallow candles, even at that early date, was a normal household activity. With the possible exception of "drie delvse caasvorpjens" (II,8,1707), the candle mould is conspicuous only by its absence in the years before 1715: early Cape candles were made by repeated dipping.

Most candlesticks were made of brass—or copper, though pewter examples were also fairly common. Candlesticks of wood and iron were the cheapest, but they are seldom to be met with, and when they do appear, as at Rustenburgh, it is not often in conditions of poverty. The comfortable town house of Dirck Vroonhof included "1 houte Candelaer met do blacker" among an otherwise typical assortment of lighting equipment (II,109,1714), while two of the thirteen candlesticks in the Van Stralen/Van Doorninck house were of iron (I,62,1701). Silver candlesticks were costly,⁶ and the preserve of the privileged few. Most impressive in this respect were the estates of Merchant Albert van Breugel—two pairs of candlesticks, snuffer and tray (23/5, 35,1675), and the widow of Undermerchant Willem Corssenaer—a pair of candlesticks, a chamber-stick, snuffers and "profijtertje" (III, 39,1713). If one was fortunate enough to own a silver candlestick one did not use it daily, but put it carefully away with other family treasures in a chest or cupboard and only brought it out on high days and holidays.

The shape of the low, flat chamber-stick (blaker) was readily adaptable to more specialised purposes. One simple variation was the steekblaker which was fastened to a knife, by means of which it could be thrust into a beam or other suitable piece of wood (Pl.42A).

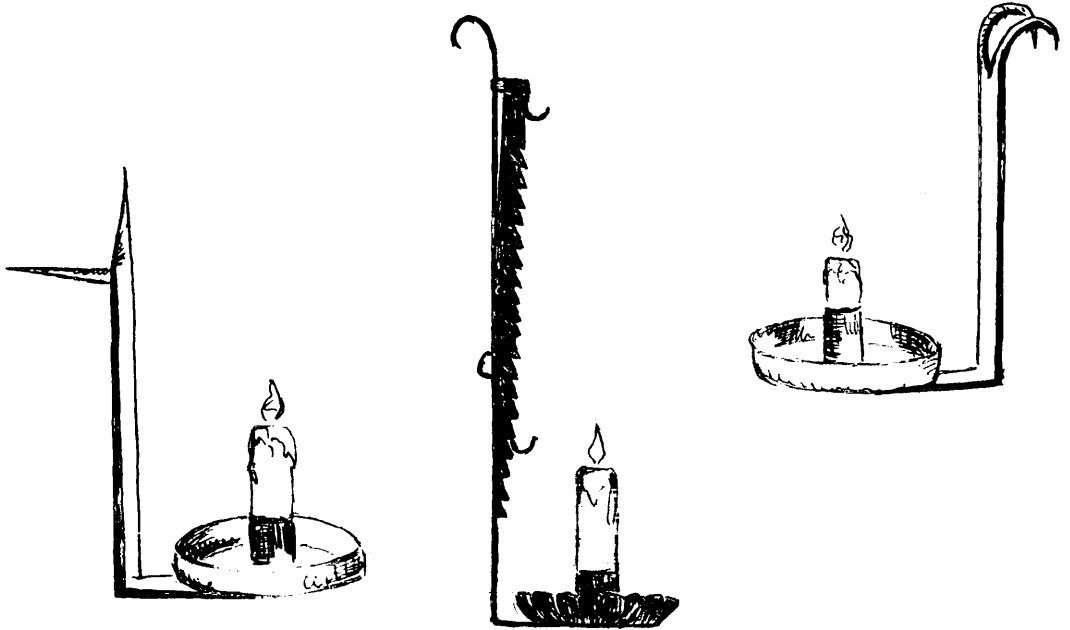

(43) Hanging Candlesticks of Iron. Early American.

Rather more common, at least at the Cape, was the so-called "hangblaker,"⁷ a term which almost certainly covers two quite distinct types of candleholder. Plate 43 shows three different but related examples of hanging candlesticks in forms that have survived in Europe and America. Usually made of iron, portable holders of this kind were a convenient means of introducing light into a dark and awkward corner of outhouse, cellar or solder. At the Cape, the commonest form of hangblaker was made of brass or wood, sometimes carved wood. A number of these occupied a permanent place in voorhuis, voorkamer and gallery, and were obviously a type of wall sconce.⁸ The wall sconce enjoyed a variety of names at this period, and one finds "1 hout hang Blaakertie" (II,115, 1714), "1 hout armblakers" (III,37,1713), "4 gesneede houte hang blaakers" (III,13,1714), "6 houten wand Lugters" (II,79,1713), "4 coopere armen" (23/5,29,1673), "een kopere hangblaker . . . [en] "drie kopere armen" (II,8,1707). These last two examples, both from the inventory of Hendricus Munckerus, make one wonder whether the "hangblaker" of brass was sometimes of the type illustrated in Plate 43, which is unlikely to have been the case with the "hangblaker" of wood.⁹ Be that as it may, one thing is quite certain and that is the rarity of any sort of wall sconce before 1715, though the time was not far off when a set of sconces—the wood used never seems to have been mentioned—became fashionable in important rooms.

The blaker form appeared at its most splendid in the construction of the seventeenth-century chandelier: a form of lighting much appreciated in Holland but one hardly ever seen in a private house in the early Cape. The "Coopere Croon," valued at twenty-four guilders, which graced the principal room at Roodenburgh, Albert Gildenhuijs's Rondebosch estate, is the only undoubted reference to a chandelier at this period (II,61,1712). The Helot kitchen contained "1 ijsere kroon" (II,43,1710), which is described in exactly the same way in the vendu roll (VR66) and may, therefore, have been a chandelier, though the kitchen locale makes it much more likely that a vleeskroon or meat hook was intended.

In view of the heavy reliance on the ordinary candlestick it is surprising that the candle-stand was not in greater favour, for it was a convenient means of adding stature, both literally and

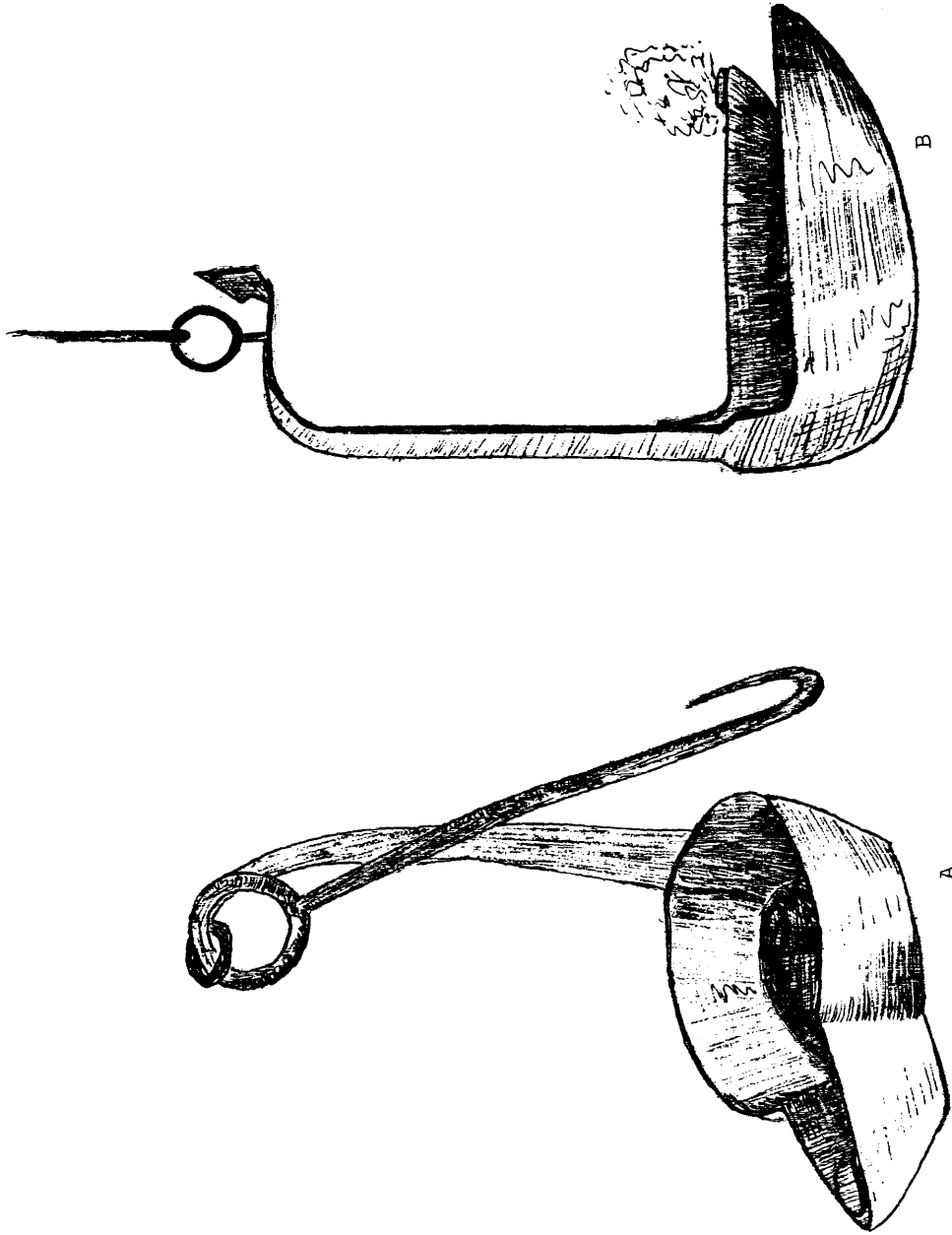

(44) Iron Crusie Lamps. The single Crusie is Dutch and the double Crusie, German.

metaphorically, to a single candlestick or pair of candlesticks.¹⁰ It does not appear to have been expensive; Senior Surgeon ten Damme had twelve examples valued at four guilders each (II,117,1714), so I find it extraordinary that there are no more than half-a-dozen references to the knaap and guèridon before 1715.

A lamp fuelled with oil or fat has provided man with light for thousands of years. The lamps of the Romans and the lamps in use throughout Europe in 1700 worked on the same simple principle as the lamps of prehistoric man at Lascaux.¹¹ All that is involved is a small open dish where a properly prepared wick¹² floats on a film of oil which floats, in its turn, upon water. By anchoring the wick in some way the efficiency of this type of lamp is increased, and until the end of the eighteenth century this was the only important improvement made. The so-called "Crusie lamp," an English term which was adopted on the Continent, was the lamp in general use during the period we are considering. The single Crusie was a hanging oil lamp with an open saucer and little or no wick support, while the double variety was given a second pan to catch the dripping fuel (Pl.44).

Though not to be compared in popularity with candlesticks, two or three lamps were routine additions to the Cape household in town and country, which settles the question raised by Dr. Mary Cook as to whether oil lamps were ever used at the early Cape.¹³ In kitchen after kitchen one or two iron lamps are listed and these, unlike the candlesticks, snuffers and lanterns so often present as well, were probably in use there. An oil lamp at this time gave little light but it was cheap to buy, and fairly easy to use. The wick certainly needed to be freshened from time to time — some lamps were even equipped with a pricker (Pl.45A)—but it gave less trouble than the candlewick. The great advantage of the lamp was its economy, for it would burn day and night for a week on a mere half-litre of fuel.¹⁴ The cheapest fuel was fish-oil (traan), which at the Cape was always derived from seal blubber,¹⁵ and it can be taken for granted that this was what fuelled the average lamp. Whether derived from whale or seal, train oil has an overpowering smell, and the majority of kitchens must have reeked of fish once the lights were lit. Brass lamps required much polishing to keep them looking

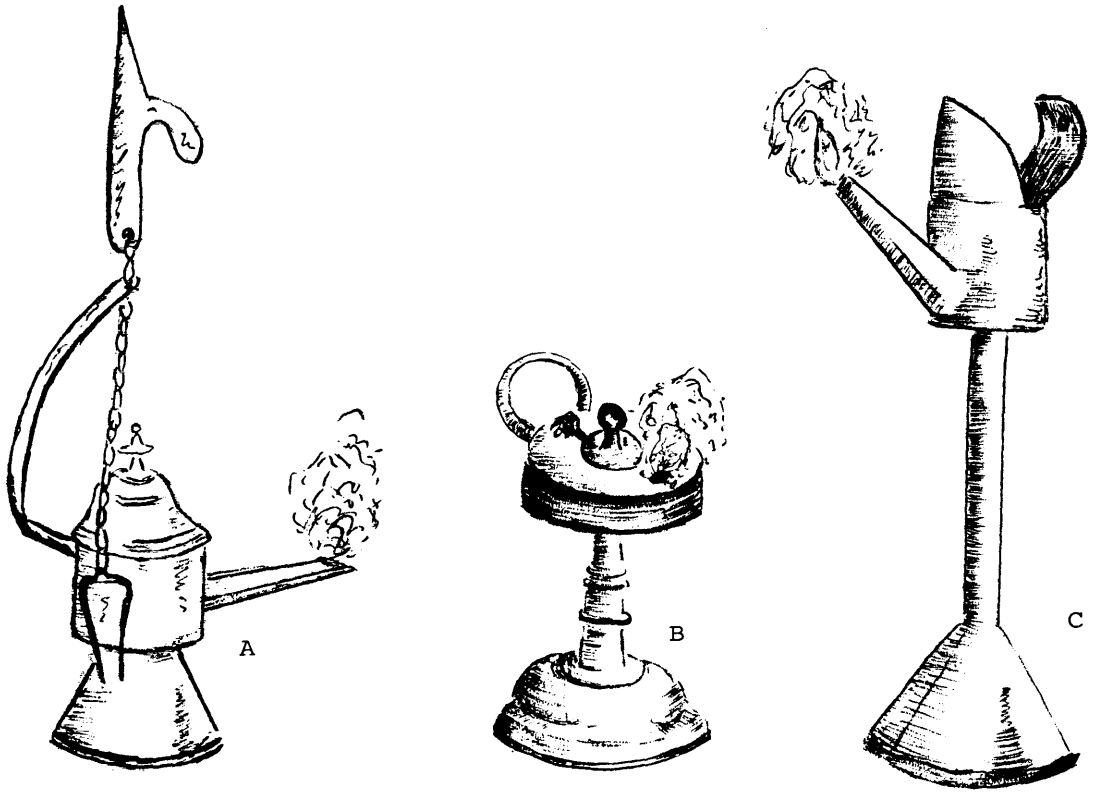

(45) Three Oil Lamps. B is pewter. A—with a pricker attached to freshen the wick—and C are brass. A is Flemish. B & C are Dutch. \pm 1700.

good, and for this reason were less popular than those of iron. Nevertheless there were a fair number about, and most houses contained examples of both metals. Descriptions show that brass lamps varied in size, and that standing lamps (staande koperenlampen) and hanging lamps (koperen hanglampen) were present. Further than this they do not go, and even an entry like "1 Copere grote hanglamp" (II,37,1709) is exceptional. Brass lamps, particularly if they were important-looking, probably found their way into the front of the house, where they may have been filled with something less smelly than fish-oil (Pl.45). Tin, silver and glass lamps also feature occasionally, and there were probably a few pewter examples as well. So far, I have not been able to find an illustration of an important glass lamp of about 1700, which is disappointing as it is a hanging glass lamp that elicits the most detailed description bestowed on any lighting fitment during these years, namely "1 glase Lamp met een Cooper verdeksel en kettings" (II,37,1709). In the same year we hear of "1 Glas tot een Lamp"¹⁶ (II,33).

The only seventeenth-century lamps of glass that I have found in the literature have been small specimens of the float-wick variety. These include a cup-shaped lamp with short stem and foot—a type that with slight improvements was in use throughout the eighteenth century.¹⁸ De Haan, without offering any precise date, illustrates a glass lamp shaped like a flared beaker which slips into a circular attachment protruding from a wall sconce.¹⁸ The whole arrangement looks simple enough to date back to the seventeenth century, though the example illustrated looks mid-eighteenth century (Pl.46B). A popular glass lamp that developed a little later in the eighteenth century was known as a "peg lamp." This combined a bulb-shaped glass reservoir with a metal disk fitted with a wick tube known as a brander.¹⁹ Such lamps terminated in a short peg and could thus be fitted into the nozzle of a candlestick or even into the mouth of a glass bottle (Pl.46A). Other lamps mentioned before 1715 are the ship's lamp, designed to survive the ravages of wind and water, and the night lamp, which was shaded so as not to disturb the sleeper.

Although a number of lanterns are listed in the inventories they were something the ordinary household could manage without, and

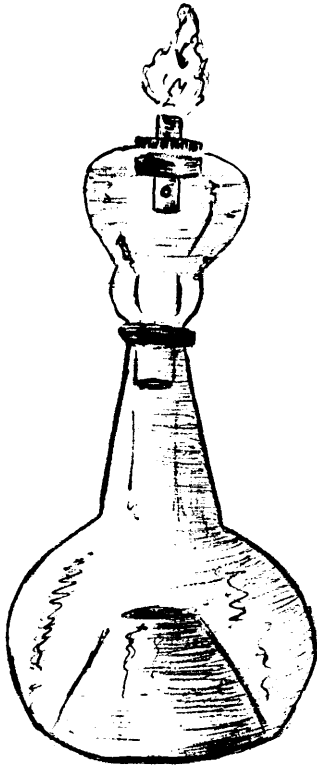

(46) A. Glass Peg Lamp in a Bottle, Dutch, Mid-18th Century.

B. Glass Lamp and Wooden Wall-Sconce, Batavian, Mid-18th Century.



in the earlier part of our period even the most important estates made do with a single example. By 1714 lanterns had become more numerous and several families owned two or three of them, but even at this date they were not exactly commonplace. The most spectacular of them were the great brass hanging lanterns which were elaborately decorated underneath with piercing and repoussé work (Pl.47A). Unless the occasional "huijs lantaarn" was actually of this kind, it was only in the second quarter of the eighteenth century that the hanging lantern, a Dutch speciality, became a feature of voorhuis and gallery. The ordinary lantern was portable, and as it was needed for expeditions after dark, the voorhuis was a convenient place in which to keep it. Several instances of this arrangement are met with before 1715, and it was to become more frequent later. The commonest place for the lantern when not in use was the kitchen area with all the other lighting equipment, but a few families found it convenient to keep a lantern in the solder.

Various different kinds of lantern occur. In 1709 "1 kopere Lantaarn" sold for thirteen guilders (VR56), and though this must have been an unusually handsome example there are several other references to brass lanterns. Wooden lanterns such as "1 houte groote lantern" (III,13,1714) are also mentioned, as well as those of tin—and glass. Most if not all these lanterns would have been powered by a candle, and several methods were used to protect the candle from the elements while allowing light to escape. The simplest lanterns were those of iron or tinned iron where light was emitted through holes punched in the metal. Plate 47C shows an interesting object which I have redrawn from a contemporary Dutch print called "De Lantaarnmaker."²¹ One assumes that this is an unusually shaped lantern, but it has an uncanny resemblance to an object illustrated by Weyns as a "slakorf"²² and which was known at this period at the Cape as a "slaemmer" or "slamandje." Punched iron lanterns of conventional form were made in Europe in the seventeenth century, but most surviving examples are, at best, eighteenth century (Pl.48A). The iron lantern is rarely mentioned in the Cape inventories,



(47) Lanterns. A is a brass hanging lantern, B is a glass-paned lantern, and C is either an iron lantern or a salad bucket. Dutch. - 1700.

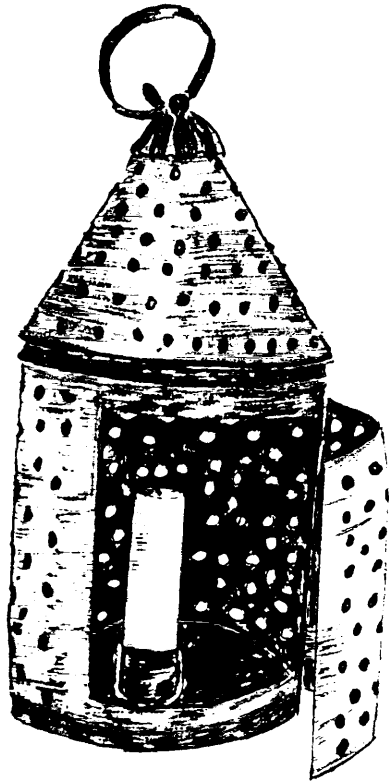

(48) A) Iron Lantern with
Punched Holes.
Dutch, 18th Century.

B) Dark Lantern,
Repoussé Iron and
Stamped Copper.
French, 17th or 18th
Century.

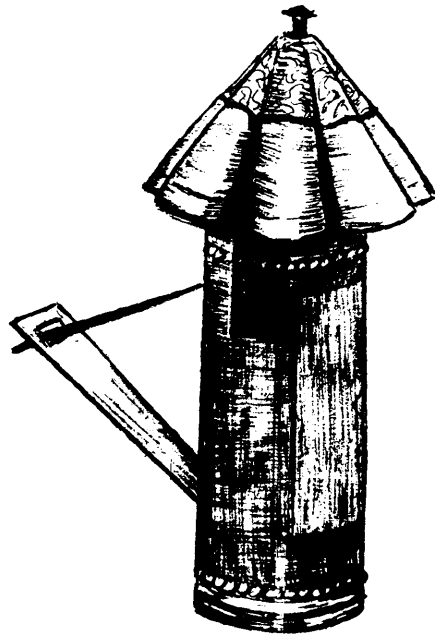

presumably because it was too ordinary to warrant a description and simply appears as "1 lantaarn"—the normal unhelpful entry. Thinly pared panes of horn which adjust easily to the curve of a round lantern were used a great deal, and though surviving lanterns usually have brass frames (Pl.47, D&E), the combination of wood and horn was probably more common originally. The brass top always includes pierced or punched decoration of some sort to allow the smoke and heat to escape, and at its best a brass lantern is a work of art. As horn produces a soft diffuse light, glass panes were introduced into the most efficient lanterns. At this period glass could not follow the curve of the round lantern, and the necessary straight panels that had to be provided often resulted in an awkward-looking object. The usual reference is simply "1 glaasje lantaren" (23/5,47,1679), but a "vierkante Lantaarn" confiscated in 1705²³ may have had glass panes. The same confiscated estate includes a "kooperen slonsie"²⁴ and other examples of the slonsje or thieves' lantern occur at long intervals until shortly before 1715, when they begin to appear more regularly. So far I have not been able to establish whether there was any difference between the dark lantern (Pl.48B) and the thieves' lantern. If there was it was slight. Both were small hand lanterns that emitted light from one side only: light that could be cut off by a flap or shutter. In the Munkerus estate we meet a lantern described as "1 oude kruijt-lantaren" (II,8,1707), which must have been a safety lantern for use in the vicinity of gunpowder.

One important point about which the inventories and vendu rolls are quite unhelpful is the origin of all these different light fittings. Were they all imported, or were some of them made locally? One can assume that simple iron lamps and lanterns were not beyond the skill of the various smiths at work in the young colony,²⁵ but nearly all the brass and copper items may have originated elsewhere: only one burgher coppersmith, Herman Remajenne, is known to have been at work in the Cape before 1707 — Remajenne's period of production was 1657 to 1682,²⁶ though the Company did have its own coppersmiths and brassfounders.*

* Marius Le Roux, The Cape Copper-Smith (Stellenbosch, 1981), pp. 25-28.

Toilet Arrangements and Personal Cleanliness

Naked public bathing was general for both sexes in the Middle Ages. In 1387 Frankfurt-au-Main had a total of thirty-nine public baths, but by 1530 this number had dwindled to nine. Two reasons contributed to this dramatic decline. The Church, which was in the process of formulating new standards of modesty, condemned public bathing, and the contagious diseases of the sixteenth century, especially the virulent epidemic of syphilis, powerfully reinforced the Church's teaching. Public baths, which never lost their popularity in Russia and Finland, reappeared in the West during the seventeenth century, but by then mediaeval innocence was lost and they were little more than brothels for the entertainment of the rich.

Fernand Braudel, whose account I have followed up to now,²⁷ believes that "Bodily cleanliness left much to be desired at all periods and for everyone," despite that fact that the privileged were moved at times to comment on the "repulsive dirtiness of the poor." He also believes that there was a significant regression from the fifteenth to the seventeenth centuries. Among the points Braudel draws to our attention are the sewer-like state of the streets of Paris; the fact that "fleas, lice and bugs conquered London as well as Paris, rich interiors as well as poor"; the fact that a daily change of underpants in place of lined breeches only became an established practice for men in the latter part of the eighteenth century; and the fact that a bathroom was a very rare luxury in Parisian houses of the seventeenth and eighteenth centuries.

Though Holland was famous for the cleanliness of its streets and houses, a cleanliness made possible by the ready supply of water in the canals, the Dutch were in no way remarkable for bodily cleanliness. "Bathrooms," as Professor Nilant of Pretoria University put it, in a personal communication, "were a very late addition to the grachten-houses of Amsterdam."

Until recently, no one has queried the essential truth of the picture drawn by Braudel. Many accounts of the lack of fastidiousness found in the seventeenth and eighteenth centuries exist, not a few of them provoked by conditions at Versailles and recounted by famous diarists like the Duc de St Simon and the Marquis de Dangeau. These used to be regarded as expressions of the norm but are now being looked at as

expressions of disgust recounted disapprovingly for readers expected to disapprove likewise. "It may well be," writes Thornton, "that people in the seventeenth century were in general not so very different from what we would be if we did not have running hot and cold water freely available."^{27a}

I have tried to approach the inventories at the Cape in this new spirit and have met with some encouragement and rather more discouragement. Men's underpants (onderbroeken), first noted in the early 1660's, become increasingly common with every decade, but are only occasionally present in sufficient quantity to suggest that they were changed daily. In 1701 a list of soiled clothes included "6 witte linden hembden sijnde vuijl . . . 1 onderbroeken do do (I,62, 1701). The proportion of shirts to underpants here is illuminating and typical, but at least underpants were in use at the Cape well before 1700, as they were in the Hague and New York, so in this respect Braudel's picture is blacker than it should be. In most other respects the evidence of the inventories is inconclusive, but if the people at the Cape were genuinely appreciative of personal cleanliness, it is hard to understand why they made things so difficult for themselves. While it is true that a metal ewer and basin are not necessary to the act of washing, and that a basin alone—or, indeed, a bucket—makes an efficient substitute, it is still discouraging to find so few ewers and basins, particularly as it is seldom possible to tell whether some of the buckets and other basins present were used for this purpose as well. Unless something is actually described as a "wasbecken" (III,37,1713), and this hardly ever happens, one is completely in the dark on this point, because all toilet articles of this sort were routinely kept in the kitchen region which effectively obscures their precise purpose. Besides, I find it hard to credit that a bucket would long prove an acceptable substitute once the means were available to provide something better. The leading families alone possessed ewers and basins, and even they never went in for them in quantity. They were content with one or possibly two examples, so that the De Beers had "1 tinne lampet schootel en een do oude kan" (I,63,1701), the Van Reedes "1 kopere Lampet kan/ . . . 1 kopere Bekken . . . 1 kopere Lampet en / 1 do kan" (I,74,1703), and the Helots "een kopere Lampet met Zijn schotel" (II,43,1710). This hardly



(49) Dutch Pewter Ewer and Basin.

seems adequate provision in households where a wash was part of the daily routine and it is, perhaps, more likely that the ewers and basins of brass and pewter (Pl.49) were used, as they had been for centuries, for the ritual handwashing at mealtimes²⁸ and little else. Such a practice would lead naturally to the use of a wall cistern and basin, an arrangement never found in a bedroom but often encountered in the voorhuis or gallery-dining room of the second quarter of the eighteenth century and occasionally met with much earlier. In 1673 the large upstairs room at Rustenburg held "1 coper handbecken en Fonteijntje" (23/5,29), in 1707 Hendricus Munkerus had "twee Bengaalse Lampetten met 1 ijsere voet" (II,8), and in 1713 Barbara van Brakel had "1 Waater fonteijntjen groen geverft" (II,79). A Chinese porcelain wall cistern decorated in underglaze blue which dates from this period is on view at Groot Constantia.

Ewers and basins were rare and the preserve of the leading families; wasbalies or washtubs were no less rare, but they were to be found in all sorts of houses including quite humble ones. The straightforward assumption is that the wasbalie was a tub in which to sit and take a bath, and it is used in this sense by De Haan who writes "Een badgelegenheid binnenshuis vinden wij al in 1750, maar dan ook extra primitief: op de achterplaats is een washuijs', waar eene 'waschbalie of bad' staat, dat wil zeggen eene groote ton met hoepels."²⁹ One only needs to add that the taking of an occasional bath was the practice in some circles in Europe by the end of the seventeenth century³⁰ and the whole matter seems satisfactorily settled. There are, however, several puzzling features about the wasbalie at the Cape, and as I have yet to find a Cape house with any sort of bathroom up to 1830, we are deprived of one important clue as to its exact significance. A wasbalie located in a pantry, wine-cellar or solder could be an adult-size bath-tub, or the equivalent of the wastobbetje present in a lying-in chamber (kraamkamer) in Holland,³¹ but it could just as easily be a tub for dirty washing. Of the handful of wasbalies priced at this period, some have a value of one or two guilders, the price of the average bucket. This can be explained away: the half-alm cask with a capacity of seventy-

odd litres normally cost about four guilders, but examples of half aums and even larger casks worth one or two guilders are recorded, and one wasbalie valued at one guilder is described as both old and small (II,50,1711). A wasbalie of quite a different quality, bound in brass with a matching pair of buckets or "was Emmers" was an indulgence of the Van Reede family. At auction it brought 9 guilders and the buckets 6 guilders, 9 stivers each (VR27,1703)—a reasonable price for an exceptionally fine balie of half-aum capacity. I cannot credit that such a set was intended for dirty washing, and feel that in this instance, anyway, we are confronting a bathtub which was carried into the bedroom when required. To complicate the issue still further there are occasions in the second quarter of the eighteenth century when the wasbalie appears to have been a handbasin, as in "1 kopere fontaintje met een was balij" (IV,115,1728). Finally the wasbalie in its role as bathtub holds no place in the Cape tradition so that Dr. Mary Cook, our leading authority on balies, has apparently never heard of such a thing,³² and this despite the fact that an occasional wasbalie turns up throughout the eighteenth century and beyond.³³ One way and another, it seems possible that wasbalie was a term used for more than one type of tub. Unfortunately the only other clue, a reference on one occasion to "1 was balijtje met sijn vaatje" (III,56,1713) and on another to "1 was vaatje met een baleije" (V,79,1730) is open to more than one interpretation. Was the vaatje used in filling and emptying the balie, or was it placed in the balie instead of the more usual chair³⁴ for the bather to sit on? Soap appears to have been a fairly regular household item. When present in small quantities, it is only the inventories of the first twenty or thirty years of settlement that bother about it; later it is seldom recorded except in amounts that point to private trade. Spanish soap seems to have been the variety most readily available, and the De Beers had "1 kist daar in bevonden / 46 1/2 steenen Spaanse Zeep" (1,63,1701), but soap from Surat in India also turns up at times: "een halve kist met Zuratse Zeep" (II,8,1707). Towels (handdoeken) are only found in a few important estates but, as the English term "bath sheet" implies, the towel like the sheet was originally

made of linen, damask or cotton, as was the case with Albert van Breugel's "veertien handtdoecken van servetgoet" (23/5,35, 1675). In most households the napkins would have served as hand towels and, when necessary, a sheet would have taken the place of a bath towel.

The male face during the period was clean shaven, which required the services of a razor. Rather surprisingly, since a good razor can hardly have been worthless, it is only the inventories made before 1685 or so that bother much about them; the later inventories only trouble to record the accompanying barber's bowl (scheerbekken), a popular item characterised by a bite out of the rim to accommodate the chin. It was most often made of porcelain, though examples in pewter, copper, silver, and even Cape earthenware are recorded. Mouth hygiene, in household inventories, never goes beyond the toothpick, and the leading members of the community provided themselves with a silver tandestoker which they sometimes carried about in a tortoiseshell case. An obscure but intriguing inventory of a good stock of saleable items included four "tande borsjels" and three tooth scrapers or "Zilver tander peuters"³⁵ for both of which there must have been a small demand.

Hairbrushes and combs are yet other items to receive but scant attention in the later inventories, but the inventory with a small store of toothbrushes also records a varied selection of about a hundred combs; among them coarse combs, curved (kromme) tortoiseshell combs, ordinary tortoiseshell combs, horn combs and mother-of-pearl combs. Other references of some interest include "5 fijne heele kammetjes / 8 groove haar kammen" (II,4,1705); "4 dosijn wijde haijrkammen"(I,63,1701) and "1 kam-huijsjen met 4 kammen" (VRII,1698). The last entry includes a comb-case, which often seems to have been more important than the comb itself. It was, certainly, a very much more substantial item than its modern counterpart. Some cases were about eighteen centimetres wide and, when opened out, a metre or more in length. They were filled with pockets into which slipped three or four of the broad combs of the period with their row of long teeth to either side of a central core. We hear, for instance, of "1 camcooker, met 1

spiegel,"³⁶ "1 gout Leere Camdoos" (VR56,1709), and "een groot fulpe Cam lap met goud kant" or one large velvet comb cloth with gold lace (23/5,35,1675). The hairbrush is less in evidence than either comb or clothes brush, but it is sometimes listed, and at its finest is silver backed. Unlike hairbrushes, a great many clothes brushes are recorded. Most of them are merely listed, not described, but among the exceptions are "1 cleerborstel met vergult leer" (23/5,40,1676); "een Zwart ebbenhout cleerborstel" (23/5,1,1674); "een cleerborstel met Schildpadt ingeleijt" (23/5,23,1672) and, perhaps, "1 Swarte fluwele borstel met vergulde nagels."³⁷ People, I think, were proud of their clothes brushes. A special hat-brush, though anything but common, appears in one or two inventories.

The chamber pot, known in Dutch at this period as a "waterpot," is the only toilet article that one can actually say was present in the majority of houses after about 1690, but even so a significant number seem to have managed without it. The generality of chamber pots were made of pewter, but porcelain pots were quite common too, and earthenware examples—especially, for some reason, large earthenware examples—are mentioned now and then. When not in use chamber pots, like ewers and basins, were customarily kept in the kitchen or pantry. Many households were content with a single chamber pot, but the more prosperous might include half-a-dozen or more, and the Van Reede's was equipped with seven pewter and eight porcelain examples (I,74, 1703), sufficient for most eventualities ! At night the chamber pot was not tucked discreetly under the bed but was placed on the floor beside the bed, or preferably on an adjacent chair. Occasionally, though not as far as I know at the Cape, a special low table was provided like the "kleyn tafelken . . . met goude leer overtrocken" provided at the Dutch palace, Noordeinde, in the 1630's, "diende om den pispot op te setten."³⁸

More substantial provision for the needs of nature was offered by the "stilletje" or "gemakhuisje." Both these words were used for an important, portable privy of a type known in English as a close-stool; a fact which emerges clearly from the papers concerned with the estate of an English supercargo, Peter

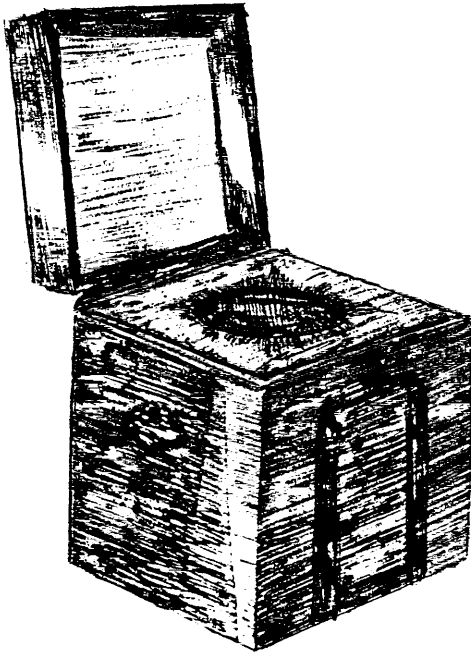

(50)

A) Close-stool or
Stilletje. English

B) Child's Chair or
Kakstoel. Dutch.

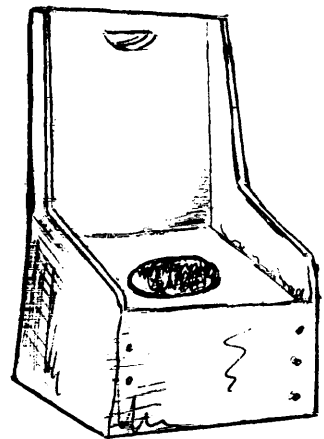

Powers, who came ashore at the Cape to die. Here the "Gemack stilletje" of the Dutch inventory (23/5,59,1701) is referred to by one of the English officers involved as a "Close stole" (23/5,58,1701). The close-stool was a box-like object with a lid which opened to reveal a pierced and padded seat with a large pewter pan beneath (Pl50A). A fine close-stool was expensive: Adriaan van Brakel had "2 houte stillitjes" and "1 kackstoel" (I,46,1699), and at auction one of the former fetched no less than 18 guilders, which makes it more expensive than any chair (VR24,1702). The kakstoel—Van Brakel's realised 4 guilders, 2 stivers—was a less solid and decidedly cheaper alternative to the stilletje which ranged from a pierced wooden stool to a pierced wooden armchair. It was also, according to a contemporary dictionary, provided largely for the use of children,³⁹ which would equate it with many of the small commodes described by Weyns as "kinderstoeltjes"⁴⁰ (Pl.50).

Like the ewer and basin and the wasbalie, the stilletje and the kakstoel were exceptional conveniences for which no special provision was made. In the great houses of Europe the close-stool, by the end of the seventeenth century, was often located in an alcove or small room leading off an important bedroom, while in Batavia an outside privy (gemakhuisje) does not seem to have been particularly unusual.⁴¹ At the Cape some families fortunate enough to own a stilletje housed it discreetly but inconveniently in the solder; others placed it in one of the outhouses, like the barn, while yet others preferred to have it nearer to hand. The Helots were apparently unabashed by the presence of a close-stool in their gallery (II,43,1710), and at Nooitgedacht it was in the first front room on the left—a room which probably served Matthijs Greef as a bedroom (II,63,1712).

A bedpan, something that most modern households manage happily without, was a desirable though still, in the early eighteenth century, an uncommon possession. Were the two pewter bedpans present, for instance, in the De Beer house (I,63,1701) required for invalid nursing, or were they made desirable by medical confidence in the beneficial effects of an enema? It is true that only one or two families owned their own enema syringe before

1715, but by the second quarter of the century it had become quite a normal household object and, in my own mind, klisterspuit and ondersteekbekken are firmly linked together.

As we come to the end of this survey, I cannot stress too strongly that most houses offered no toilet facilities whatsoever other than a chamber pot, and that even this was not ubiquitous. On the whole it seems improbable that the majority of people at the Cape were overly fastidious either about their persons or their body linen, but one cannot afford to be categorical. A napkin, a bucket of water and a piece of soap is all that is needed to keep oneself clean, and in similar circumstances we would have managed somehow. Few clothes which have survived from the past are distastefully stained, and this should be enough in itself to stop us from jumping too easily to unpleasant conclusions. If the men and women of the early Cape did indeed achieve a standard of reasonable cleanliness one can only applaud, for the difficulties they must have overcome appal me. There is no mention of anything that remotely suggests a sanitary napkin, so how did women cope with the menses? Childbirth in the absence of a maternity chair (kraamstoel) or rubber sheet must also have presented horrendous problems. But about one thing one can be quite sure: clothes and bedding were far too valuable to be put at risk, so cope they did.

There was one thing, however, that in the absence of disinfectants and water-borne sewerage no one could cope with, and that was the unpleasant smell of excreta. In Batavia the effluvia from river and shit-house were known as "negenuursbloemen" because it was between the hours of 9 p.m. and 4 a.m. that the slaves emptied the contents of the "gemakhuisjes" into river and canal.⁴² Cape Town and Stellenbosch, like all other cities in the seventeenth and eighteenth centuries, stank, and the canals which ran down the streets of both towns were nothing but open sewers. In these circumstances, the liking for strong perfume may have been more because it was a protection against the "negenuursbloemen" than because it disguised one's own body odours.

There are just enough references to scent at the Cape to show that the priveleged few were able to enjoy its benefits.

Men favoured the strong-smelling odour of musk. Lieutenant Bergh owned a box with four balls of musk and probably walked round with a small piece in his pocket, while fourteen flasks of rosewater, which he also owned, were presumably for his wife.⁴³ In addition to rosewater the Cape women enjoyed a preparation known as "eau de la reigne." A small flask, frequently mounted in silver, and known as an "odelareijne flesje" appears now and again.

The Cleaning Brush

The Dutch housewife, renowned throughout Europe in the seventeenth century for her almost unnatural house-pride and passion for cleanliness, was wont to arm herself generously in the struggle against dirt, with the result that many inventories contain a formidable array of cleaning utensils. This is not the case at the Cape. In the seventeenth century, references to any sort of cleaning brush are few and far between. Olof Bergh owned "1 kamerbesem met een koper steel"⁴⁴ which was a rare treasure. For the rest, one encounters a small number of whiting brushes (witkwasten) and a handful of brushes (borstels) and "schuiers" which sometimes seem to have been small household brushes rather than clothes brushes.⁴⁵ In 1697 an interesting sale was held of the goods confiscated from Captain Abraham van de Velde⁴⁶ of Noortgouw. This enterprising man had twelve dozen brushes among his merchandise: an assortment of borstels, stoffers, stoffertjes, vrijschuijers, kamerbesems, luiwagens (long-handled scrubbing-brushes), glazenwassers (window-cleaners), witkwasten, kleerborstels, and haarschuiertjes.⁴⁷ Since Governor Simon van der Stel walked off with just over nine dozen of these brushes, it seems likely that well-made brushes of different types were hard to come by.

The early eighteenth century does not show much of an improvement. In most inventories no cleaning brushes are listed, in others one encounters nothing but a whiting brush, and the presence of even a couple of household brushes is a mark of status. Thus we find "2 borstel varkens, om te stoffer" in the Sneewindt household (I,69,1701); "een glase wasser / een

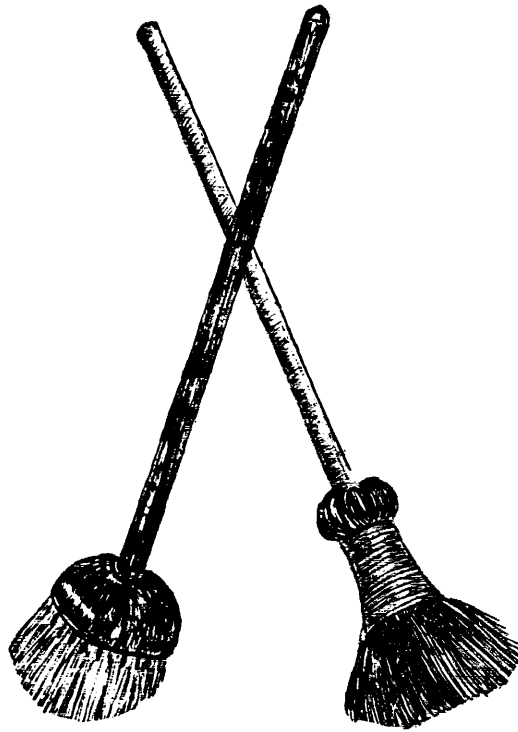

(51) Two Brooms. Dutch, 17th Century.

Stoffer" at the Helots (II,43,1710), and "1 Camer bezsem en Stoffer" in the Gildenhuijs establishment (II,61,1712). Hendricus Munkerus, with five whiting brushes, three scrubbing brushes (boenders), a broom, a stoffer and a schuier (II,8,1707), and the Diemer household with eight whiting brushes, two flat scrubbing brushes, a broom and two schuiers, are something of an exception. Household brushes were to be found, at times, in the pantry, but the gallery was also favoured, and in the second quarter of the century this was the normal place for them. A cleaning brush is not the sort of thing that is likely to survive the centuries, so the two brooms in Plate 51 are based on examples in the work of contemporary artists.

Basketware.

A number of baskets, often very beautiful baskets, grace the Dutch paintings of the seventeenth century, testifying to their manifold variety as well as to their importance in the domestic world of the period. Baskets may not have been quite as common in the Cape household as they were in the Dutch, but the inventories, and even more the vendu rolls, show that they were put to considerable use. Jozef Weyns points out that the basket must be one of the earliest methods of storage known to man, and starts his discussion of storage furniture with the great hamper (sluitmand).⁴⁸

The sluitmand, at any rate in Flanders, was most often square or rectangular in plan, though the round form was also known. It was finished off by a hinged lid which was fastened by a peg or, if required, a padlock.⁴⁹ The sluitmand, though obviously a most useful container, was not particularly common at the Cape, where a single example—it is rare to find more than one—occurs from time to time in the houses of families like the Helots, the Greefs, the Diemers and the Corsse-naers. A large sluitmand must have been fairly expensive, and in 1707 "1 rottang Sluit mantie" sold, despite its small size, for 4 guilders, 2 stivers (VR43). It was not only the hamper that was used as a container. The ordinary basket was particularly favoured for breakables, and one frequently finds it packed with china and glass. One also finds it packed with a very varied assortment of other articles, ranging from dried quinces

to old pieces of silver and lengths of rope. Most common of all, however, was a basket filled with odds and ends, and time and again the vendu rolls record "een mand met rommeling."

One of the most interesting objects of basketware mentioned is the fire-basket (vuurmand) or nappy-basket (luiermantje). These were alternative names for the basket which stood near the cradle, and which held everything pertaining to a baby's needs. Generally an oval basket with a lid,⁵⁰ the luiermantje, which was a traditional gift from mother-in-law to bride, might, in Holland, be beautifully lined and covered with serge or some even richer material.⁵¹ If the luiermantje was ever lined at the Cape, and I have no evidence one way or another on this point, the material used is likely to have been chintz. The first "luiermantje" noted occurs in the Van Zuijwaerden inventory of 1672 (23/5,21). A confiscated estate, of which we have three copies of the vendu roll, had a nappy basket described in one instance as "1 partij luijermants goed" (VR9,1697) and in another as "1 Luijer mant;"⁵² the lot realised the considerable sum of 31 guilders, 8 stivers. Other examples include "3 luijermantjes" (I,28,1697) and "2 Vuijrmanten" (VR66,1710). Although several more examples could be cited, the nappy basket was not particularly common, which may have been due to the fact that it always had to be imported. An even rarer item from the nursery world was the bakermantje or bakermat.⁵³ The bakermat was a wickerwork swaddling seat which was placed close to the fire for the mother or nurse to sit in when feeding or swaddling the baby and which, when not in use, could be hung on the wall by its handle. In shape the bakermat was a traylike object with a raised rim which extended to form a curved support for the back at one end, while the other was just high enough to hold the feet in place when sat in straight-legged—a position that made a safe and comfortable lap for the baby. Adriaan van Brakel had "1 Indische bakermantje" which sold for 9 guilders, 3 stivers in 1702 (VR24), and it is interesting and surprising to find such an essentially Dutch article made in the East Indies, where it can hardly have been necessary to nurse a baby in front of the fire. Perhaps a society where the women of all races had a predilection for sitting in the floor

found it a cool and comfortable swaddling seat in hot weather. In the more kindly climate of the Cape it was always a great rarity. Among the other types of basket in circulation were the sewing basket and the clothes basket, but neither of these appear at all regularly. Something known as a "ballast basket" makes several appearances, as in "5 balast mantjes van rotting" (I,36,1698), and "4 ballastmantjes" (II,56,1711), but I do not know exactly what this was used for, unless it was intended for carrying a load of broken stone.

Probably the basket most often encountered in the early Cape was something known as a *kanaster*, and the inventories and *vendu* rolls contain many references like "2 kanassen poeder suijker" (I,63,1701), "1 kanasser 3/4 met bruijne poedersuijker" (I,69,1701), "1/2 Canasser poeijersuijker" (111,37,1713) and, more correctly, "1 canaster met theesuicker."⁵⁴ The "kanaster" which owes its origin to Spanish "canastra" was originally used for the baskets in which tobacco was imported from South America, but it also came to mean a coarse rush basket designed to hold sugar.⁵⁵ The references at the Cape suggest the sugar canaster had a standard capacity, but apart from the fact that it was clearly a sizeable basket, I can offer no further information.

The majority of baskets served no especial purpose but were available at need, and one meets with "7 Manden" in a wine-cellar (III,25,1713), "10 mantjes" in a kitchen (III,30,1713) and "6 bennetjes" in a front room (II,69,1713). Nests of baskets such as "1 Nesje Mantjes" (II,68,1712) are also recorded. Attention is sometimes drawn, as in "5 rottingh mantjes" (I,69,1701), to baskets of cane. These were clearly surperior to other baskets in circulation, many of which must have been of rush, though others were of wood—"1 klijn houte Mandtje" (II,33,1709). Baskets, like so many other things at the Cape, came from both East and West. There were baskets from Japan like "1 Japans mantjen" (I,71,1702); from Tongking, "3 tonquiense mantjes" (I,74,1701); from the East Indies, "2 jndische bennetjes;"⁵⁶ and from Holland, "1 vadelandse Sluitmand" (II,66,1712). There is nothing in the documents under consideration to show that any of the baskets listed were made at the Cape, and basket-weaving does not feature among the pursuits of the free burghers recorded

by de Wet; but the presence in estate after estate of Javanese cane makes me hesitate to conclude that baskets were not made there. What I do feel is that while ordinary baskets may have been available locally, the more important ones were probably imported, otherwise one would expect to find the sluitmand and luiermant much better represented.

Skins and Leatherware

To include a section on skins and leatherware is hardly justified because they seem to have played an almost negligible role in the Cape house after 1670. This, however, is sufficiently surprising in itself to be worth recording, since one thing that was not in short supply in the early Cape was wild game, and it is a natural assumption that the skins from this source were put to many uses—both decorative and practical. The fashionable voorhuis in seventeenth-century Holland was, according to Schotel, filled with "schilderijen of hertenkoppen en jachtgereedschap";⁵⁷ and G. M. Theal describes the original Council Chamber in Van Riebeeck's fort as follows: "round the walls hung various trophies of the chase, chiefly skins of slaughtered lions and leopards, and over the end windows and the doors which on each side opened out into smaller rooms were polished horns of some of the larger antelopes. At the end opposite the entrance usually stood the figure of a zebra made by stuffing the hide of one of those animals with straw."⁵⁸ One expects to find that decoration of this sort played a prominent part in many a private house at the Cape, but as far as I can judge this was not the case during the period we are considering.

Prepared skins, some domestic and some wild, are recorded, and among the references are "2 bereijde hartebeestevellen" in a kist in the voorhuis (I,74,1703); "2 beestevellen" in the wine-cellar down below (II,49,1711); "7 paer Schapenvellen berijd" in a kist in a voorkamer (II,63,1712); "2 tijgerboscatte vellen" in the front solder (III,31,1713); and "7 p^s bontevellen" also in a solder (I,63,1701). There is nothing in the least odd about this list except for the location of the skins and the fact

that I cannot produce another list showing skins in use or skins on display. Seemingly the romance of Africa had little appeal for the early settlers, who were happy to rid themselves of skins and horns—always supposing they made use of them at all—the moment mirrors and pictures were available to replace them. This, if unexpected, is understandable, but it is odd that nothing in these documents suggests that skins were used either as floor coverings, or as bed coverings. On several occasions chair cushions of sealskin are recorded, and once or twice pillows with leather covers; otherwise there is nothing to indicate the use of leather as a furnishing material. The one domestic object which appears with some degree of regularity and was probably made of leather was the tar-bucket (teerputs), and a few households kept a "Leere brand Emmer" (III,30,1713). There are also a couple of references to leather pots, but all in all it is a far from impressive tally. There were other areas in which leather was indeed put to use. It was as indispensable for saddles and harness as it was for shoes, and it was also used for breeches, gloves and even stockings, but this is by the way, and does not explain why the furnishing possibilities of leather were virtually ignored at a time when it could have made an important contribution to the comforts of the home.

The Art of the Cooper

No account of the interior of the early Cape house would be complete without a few words on the subject of the tubs, casks and barrels everywhere apparent. This is one of the very few instances when the evidence preserved in the inventories is actually given form and substance by a painting, albeit a later painting. The Regnault painting of the Wernick family executed in 1754⁵⁹ includes an interesting but unfortunate vista. Through a doorway on the right we are vouchsafed an excellent view of a room where a corner chair stands amidst rows of barrels. This prosaic touch is utterly at odds with the stiff formality of the family group seated to the right round a blue-draped table; and it is extremely fascinating to find this startling example of the incongruous in one of the only eighteenth-century interiors that has come down to us.

Some of the cooper's work found in the Cape home probably originated elsewhere: every passing ship, after all, had its complement of water and meat casks which the average purser would have regarded as a source of personal profit, however illicit. Some of it was also made locally, and it is possible that this was quite a substantial portion. In addition to the Company coopers, De Wet has traced the names of six free burghers who practised the trade between 1671 and 1707.⁶⁰ Furthermore, I have a suspicion that the coopers were not the only people to make tubs and barrels at the Cape. In estate after estate, piles of iron hoops are listed whose purpose is explained by the occasional more detailed description such as "20 halve leggers ijsere hoepen" (I,69,1701), which makes it clear that they were used to reinforce wooden casks of half-leaguer capacity. This, coupled with the fact that carpenter's tools were omnipresent and cooper's tools not restricted to known coopers, is at least suggestive. Finally, in the inventory of Abraham Staal, there are two pages of "Schoenmakers gereetschap" including "een groot half hondert legger duigen" worth 129 guilders, and "agtien ijsere legger hoepels" worth 15 guilders (II,14,1708). It seems likely that this shoemaker was planning to do his own coopering.

What with importation and local production, the art of cooper was present at the Cape in considerable quantity and impressive variety. The largest cask in general use was the leaguer, which stood well over a metre high; its capacity varied considerably but was somewhere in the region of six hundred litres. Casks of this size were expensive, and in good condition realised anything from thirty to forty-five guilders. Most leaguers and half-leaguers belonged in the wine-cellar, where they queened it over the smaller aums, half aums and ankers. These five cask sizes descend in a ratio of one to two and represent the principal liquid measures in use at the Cape.⁶¹ Among the more unusual wine containers the mum-pipe (mompijp) is the only one that occurs regularly. Mum was a heavy beer originally from Brunswick, and the mum-pipe was obviously a cask of known capacity, though one I have not been able to establish exactly. It was used at the Cape very largely for wine—"1 mompijp met oudewijn" (VR9,1697)—

and auction prices suggest that its capacity lay somewhere between that of the leaquer and half leaquer.

Though the casks mentioned so far were mainly used for wine and, to a lesser extent, for beer and brandy, they were naturally used for other liquids, particularly milk and water, and one also meets with an anker of butter, a half aum of pepper, or a mum-pipe of black sugar. Casks or barrels of no particular capacity were known as "vaten". These ranged in size from small vaatjes with a capacity of a few pounds to great casks capable of holding 200 pounds of butter or more. Indeed, Senior Surgeon ten Damme owned "3 stuck vaten" worth 75 guilders each (II,117,1714); casks which must have had double the capacity of a leaquer at least. Many vaten were designed for a particular item: for water, milk, cream, fish, bacon, butter, vinegar, meat, rice, fish oil, or beer. Most of these seem to have been distinguishable, either on account of their size and shape, or because they were branded with their original contents, so it was possible to write of "1 spēckvat vol swartesuijker" (I,62,1701), and to assign many an empty cask, though by no means all, to its original purpose.

For the most part, contemporaries seem to have made a distinction between the vaten which were barrels or casks and the balies which were tubs. Some tubs conformed to one of the liquid measures, so that one encounters "2 leggers balies / . . . 1 half aam balitje" (III,30,1713) or "2 halve leggers balijs" (VR68,1711). The list of specialised balies parallels, in some respects, that of casks, with balies for water and, very occasionally, milk, beer and butter, but for the rest their purposes were quite different. Most cellars included persbalies and trapbalies for pressing and treading the grapes, but these should not be confused with a proper wine press, which was very much more valuable.⁶² Then there was the wasbalie which has already been discussed⁶³ and the spoelbalie, listed in one inventory as a "balitje om glasen in te spoelen met een Voet" (III,95,1719), which was obviously the early name for what we now call a "teegoedbalie." Other balies mentioned are the intriguing haesbalie or hare-tub; the doopbalie or vlootje which was a small tub in which butter was placed for table use; and the spuwbalie which was a sand-filled tub in which to spit—an inelegant importation from shipboard life.

Pride of place in any account of the balie in the nineteenth century would go to the great brass-bound waterbalie with its stand, cover and brass top, but such a balie does not seem to have played an important part in the eighteenth century. In the majority of early kitchens the supply of water for the day was simply kept in the buckets in which it was collected. (Incidentally, the wooden shoulder yoke designed to carry a pair of water buckets has been used at the Cape since the seventeenth century.) In many other houses it is not possible to say whether any of the casks and tubs listed were actually used for water, and in yet others a watervat, waterhalfaam or waterbalie is specifically mentioned. It is rather surprising, though, that for every house with a waterbalie there are three houses or more with a waterhalfaam and two houses with a watervat. This distribution only applies to the period up to 1714, but later inventories rarely include a waterbalie, and even in the years immediately after the Napoleonic Wars it is a waterhalfaam, now often accompanied by a brass beaker, that one comes across, rather than a waterbalie with a brass tap. In these circumstances one has to ask oneself if the rarity of the waterbalie during the Dutch East India Company period was more apparent than real: whether in other words it was not just a question of imprecise terminology. In modern Afrikaans, after all, the terms "waterbalie" and "watervat" are used interchangeably⁶⁴ and it is quite possible that they always have been. As in the case of the wasbalie, however, the evidence seems to me inconclusive. On the one hand entries like "1 Watervat en 1 baelie met ijsere banden" (II,28,1709), "4 vaten [en] 1 baelie met Rogge" (II,49,1711) or a single inventory with references to "7 Water Emmers / 1 do halvaam / 1 do balij / . . . 2 Water Vaten" (II,75,1713) suggest that the two were distinct. On the other hand, an entry like "1 Watervat met / 1 deksel" (VR56,1709) could well refer to the type of waterbalie we know today except, of course, that it was without a stand and a tap, refinements rarely mentioned in connection with water containers of the seventeenth and eighteenth centuries.

A tub is a useful object, and in addition to the specialised balies one often encounters two or three empty specimens in an inventory which were no doubt intended for general household use. Tubs were also pressed into service as containers and are found filled with rye, salt, teapots, glasses, and shoes. These are isolated instances; it is as a container for tea that the balie was particularly favoured. Entries like "2/3 van een balie groen thee" (VR59,1709), "1 halve baalj theeboey"⁶⁵ (III,13,1714) and "1 baellij met thee" (III,37,1713) run like a leitmotif through the eighteenth-century documents and seem to imply that the balie used for tea had a standard capacity.

It was obviously convenient at times to have a barrel in constant use raised up in some way, and when "1 vaetje en / 1 banke" (VR56,1709) and "1 halve aam met 2 banckjes" (VR24,1702) were sold together, they may possibly have belonged together. Wooden supports, known as "Stellingen," and sometimes described, as in the Meijer inventory, as "3 Stillinge tot vaaten"⁶⁶ occur from time to time. They must have been a form of scaffolding, and may well have been designed to keep barrels in place on their sides.

Although most of the objects produced by the cooper belonged to cellar or kitchen, they are often recorded in the most surprising places. Among the farming community in particular a leaguer of wine, casks of butter and even empty barrels had a tendency to find their way into the front of the house. Thus a Hout Bay farmhouse, in addition to casks of salt, iron hoops, and various wine casks in the cellar, and three water buckets and a water cask in the kitchen, had seven fish barrels and a tub outside one of the doors, a cask of butter, a cask of fish oil, and a churn in the lean-to, an old barrel in the voorhuis, two old barrels in one voorkamer and two churns in the other (II,76,1713); while a Paardeberg farmhouse had two butter casks and some butter in the only front room, eight casks and a tub in the lean-to, four water buckets and three tubs in the kitchen, and various leaguers, half-leaguers etc. in the wine-cellar (III,25,1713). This kind of seepage did not happen all the time, and most people clearly preferred to keep their barrels and tubs out of the

front rooms, though a lean-to or a back bedroom was rather a different matter. As we have seen, many of the finer types of house included at least one room that was a bedroom cum storeroom,⁶⁷ and in one town house three beds, a mum-pipe and a half aum were among the contents of the back room (II,77,1713). It was one thing, however, to keep tubs and barrels out of the front of the house, and another to keep them out of sight. The Regnault painting well illustrates the result of an unsuitable vista and, as we know nothing about the prevalence of internal doors in the early Cape, it is quite possible that the houses were rather vulnerable in this respect.

There are more than enough references to loose iron hoops to show that they were used to reinforce the majority of barrels and tubs, and this is also confirmed by the occasional more detailed description such as "1 balijtjen met ijsere banden" (I,63,1701). A reference in the same estate to "2 ledige Vaaten met houtenbanden" is a reminder that casks could be made of wood alone, but as the inventories and vendu rolls have little more to say on this subject, there is no means of telling how common they were. Unlike bands of iron and wood, bands of brass were not likely to escape attention, and as they were rarely mentioned, they were presumably seldom to be found,⁶⁸ as were the brass taps that were occasionally fitted to the small beer kegs—"1 bier vaatje met 1 kopere kraan" (II,43,1710). Two red ebony tubs described as such in both the inventory and vendu roll realised a hefty twenty guilders at auction (VR47,1708) and were unmistakably exceptional. Unfortunately it is less easy to decide whether the array of painted tubs and barrels in another estate was equally exceptional. Had the inventory been compiled by one of the regular clerks there would be no question about this, but as it was not drawn up according to the usual formula, and includes various unusual titbits of information, one is left wondering whether other people also painted their buckets and balies. This estate records two red-painted waterbalies, three green-painted waterbalies, three green-painted buckets and one green-painted anker vat (II,79,1713). The only other reference of a similar sort which I have come across

occurs very much earlier: "2 roet vaten waar van het eene voor een gedeelte is geconsumeert" (23/5,33,1675). Personally I can contemplate the picture of an array of painted buckets and water casks with equanimity, for I have yet to see a convincing reason advanced for the lack of early painted ware at the Cape. As every ship would have had a supply of paint among the boatswain's stores, the argument that it was difficult to obtain carries little conviction. Paint in its dry state is recorded from time to time, and so is the verfmolen needed for its preparation⁶⁹ but as it is not the sort of thing that necessarily makes its presence felt, and as painted doors and windows have always been accepted as part of the Cape tradition, one can make little of its presence or absence. That an inventory drawn up to an unusual formula should contain such a wealth of painted items⁷⁰ is an altogether different matter, and may illustrate the truth of the seventeenth-century inscription on the wall of a corridor in Skokloster, Sweden: "Il savio sa trovar tutto nel poco"—"To the wise man a trifle may reveal all."⁷¹

Footnotes

1. Thornton, op. cit., p.268.
2. Weyns, op. cit., II, 754.
3. Resolusies, IV, 363 & 426.
4. De Haan, op. cit., I, 517.
5. Picard, op. cit., p.5.
6. The only silver candlestick sold or valued throughout the period was a small blakertje which sold, together with 3 silver spoons, for f10:8 (VRI,1691). It can hardly be regarded as representative and was most probably a toy. In 1748 twelve silver candlesticks were valued at just over f47 each (VIII,71 1/2). Good brass candlesticks could also be expensive; a pair went for f16:2 at the Sneewindt sale (VR17,1701).
7. "Hangblaker. z.m. Chandelier à prendre, ou qu'on pend à un clou" (Halma, op. cit.).
8. The only form of hangblaker described by de Haan is a wall fixture (op. cit. I, 518).
9. In the 2nd quarter of the 18th century when wall sconces become common they are normally listed as "armblakers" or "armtjes"—even "houte armtjes"—and at the same time the houte hangblaker seemsto disappear, which is a further indication that they are one and the same thing. The brass hangblaker, however, continues to appear in later inventories and may be found in a kitchen, which suggests that it was sometimes, if not always, a movable fitment.
10. See above, p.135.
11. Hermanna W. M. Plettenburg, Licht in Huis, Rijksmuseum voor Volkskunde, "Het Nederlands Openluchtmuseum" (Arnhem,1968), p.33.
12. The following advice on wick-making was given in 1778: "Tot het pit hier, toe moet men het kattoen omtrent twee uren in

brandewijn weeken: en als het droog is, het zelve vier, vijf, zes dik maaken naar believen, na de dikte van het gaatje: dan moet de wasch gesmolten worden, op een half pond wasch zult gij een once zwavel doen, als deeze wel heet is, zult gij er uw pit een reis twee drie maale doorhaalen, hetgeen men ter lengte van een el (vroeger variërend naar de plaats van 683 - 701 mm., nu gewoonlik 69 cm.) kan maaken, daarna moet men het rollen met een plankje om het gladder te maken, en gelijker, even zoo als de waschkaarsen. . . ." (Quoted by Plettenburg, op. cit., pp. 33-34).

13. Cook, op. cit., p.38.
14. Plettenburg, op. cit., p.33.
15. De Wet, op. cit., p.59.
16. A reference in 1752 to "1 parthij lampglasen" (VII,70), suggests a standard shape and size and may refer to peg lamps.
17. Stanley Wells, Period Lighting (London, 1974), p.51.
18. De Haan, op. cit., II, D26.
19. Plettenburg, op. cit., p.44 & Pl.47.
20. "De Lantaarnmaker" by Jan Luijken (1694 - 1712), illustrated by Plettenburg, op. cit., p.67. Pl.47B&E are redrawn from the same source.
21. Adapted from "Cook Cleaning Utensils" by Pieter van der Bosch (Bernt, op. cit., I, Pl.154). The brass piercing has been simplified and should not be taken as a pattern of 17th-century work.
22. Weyns, op. cit., II, 494.
23. CJ2914, Meijer Inv., p.162.
24. Ibid., p.160.
25. De Wet has traced 19 burgher blacksmiths who worked at the Cape between 1658 - 1707 (op.cit., p. 68).
26. Ibid., p.75.
27. Fernand Braudel, Capitalism and Material Life 1400-1800, trans. from French Miriam Kochan (London, 1967), pp. 206, 225, 240.

- 27a Thornton, op. cit., p.326.
28. According to Schotel this practice was restricted to court and aristocratic circles (op. cit. p.316), but I am reluctant to follow him in this, particularly as De Haan records it as a routine practice in Batavia (op. cit., I, 531). Furthermore, Halma associates "lampetkan" and "lampetschotel" solely with the washing of hands: "Lampetkan, z. v. Aiguïère; sort de vase qui contient l'eau qu'on verse dans un plat pour laver les mains."
29. De Haan, op. cit., I, 490.
30. Thornton, op. cit., pp. 315-21.
31. Schotel, op. cit., p.24.
32. In discussing the voetbalie, Dr. Cook draws attention to the absence of a bathroom in the Cape house, and her failure to mention a wasbalie in this connection can only be due to the fact that surviving examples, if any, are unrecognisable and that there is no living tradition associated with them (op. cit. p.76). There is no mention of a wasbalie either in Baraitser and Obholzer.
33. For instance "2 Waschbalitjes" (XIX,80,1789) and "een wasch balij" (XXXIII,35,1817).
34. Thornton, op. cit., Pl.305.
35. A volume catalogued in the Cape Archives as MOOC8/75 contains certain loose inventories, some of which are both anonymous and undated. Inv. I, which unquestionably dates to the 17th century, appears to list the contents of some sort of store, and includes a number of minor articles of great interest.
36. Trans.en Schep. I, 1662, p.340.
37. Ibid, II, 1663, p.61.
38. Noordeinde Inv., 1663. Quoted by Thornton op. cit. p.321.
39. "Kakstoel. z. m. Selle percée, siege fait pour les enfants, où on les met pour décharger leur ventre" (Halma, op. cit.). Inconclusive but suggestive references in the Cape inventories include "1 kinder kack-stoel" (I,6,1698) and "1 vuurmand, Wieg

- en kakstoel" valued at f9 (II,51,1711).
40. See above, p.118.
 41. De Haan, op. cit., pp. 463, 481, 482.
 42. De Haan, op. cit., I, 193.
 43. CJ2914, Bergh Inv., 1687, pp. 6, . 12.
 44. Ibid., p.11.
 45. A "schuijer" in modern Dutch is the word for a carpet brush, but in the past it was often a clothes brush (Halma, op. cit.). An inventory of 1675 refers to "twee schuijers met silver beslagh" (23/5,35), and one of 1713 to "2 porseleijne Schiuers / 1 do stoffer" (III,24) and none of these is in the least likely to have been a floor brush. In general, however, the stoffer was a small floor-brush, as is clear from references to "stofvarkens" (II,73,1713) and "kamerstoffers" (I,71,1702), as well as from a line of poetry quoted by Schotel: "Myn stoffer is myn swaerd, myn bussem is myn wapen" (op. cit., p.3).
 46. His name is spelt thus in the inventory, but in the vendu roll he appears as Abram van de Velden.
 47. CJ2915, van de Velden Vendu, 1697, pp. 4-5.
 48. Weyns, op. cit., I, 233.
 49. Ibid.
 50. Weyns, op. cit., I, 370.
 51. Schotel, op. cit., p.22.
 52. CJ2914, Meijhuijzen Vend., 1697, p.95.
 53. "Bakermat. z. v. Ouvrage de vanier, claion d'osier, avec des rebords tout autour, plus relevez à l'un des côtez, dont on se sert pour emmailloter les enfants en hiver devant le feu" (Halma, op. cit.)
 54. CJ2914, Bergh Inv., 1687, p.12.
 55. Van Dale Groot Woordenboek der Nederlandse Taal, ed. C. Kruijskamp, 10th rev. ed., 2 vols. ('s-Gravenhage, 1976).
 56. CJ2914, Bergh Inv., 1687, p.12.

57. Schotel, op. cit., p.7.
58. G. M. Theal, History of South Africa, 11 vols. (1919-26; rpt. Cape Town, 1964), III, 152.
59. See above, p.136.
60. De Wet, op. cit., p.73.
61. The capacity of the leaquer varied considerably, not only from country to country but from town to town. To complicate matters still further, the old Amsterdam leaquer of oil was not the same as the old Amsterdam leaquer of wine. According to De Wet, the leaquer equalled 575,687 litres (op. cit. p.229). According to Eric Walker, it was "some 133 gallons" i.e. 604,614 litres (op. cit., p.57, n.2). Van Dale Groot Woordenboek der Nederlandse Taal gives 582 litres as the standard leaquer measure for arrack and oil (the latter derived from an aum of 145,52 litres), and 620,8 litres for a leaquer of wine (from an aum of 155,22 litres). A conversion table based on the old Amsterdam aum of wine gives:
- | | | |
|--------------|---|--------|
| leaquer | = | 620,88 |
| half leaquer | = | 310,44 |
| aum | = | 155,22 |
| half aum | = | 77,66 |
| anker | = | 38,83 |
62. The average persbalie was worth about f6 but a "wijnpars met zijn toebehooren" sold for f150 (VR65,1710).
63. See above, pp. 179 - 80.
64. For instance, Mary Cook, op. cit., p.79. It is also likely that the term "botervaatje" for what is actually a butter tub in modern Afrikaans has a long history. Either the "botervaatje" encountered so frequently in the years round 1700 was misnamed, or there was a change of shape without a change of name before the 1820's: for while the last Dutch inventories preserved among the Orphan Chamber papers refer to "botervaatjies," the first English inventories which appear in the 1820's refer to "butter tubs."
65. "theeboeij: Chinese tee genoem na die berg Boe-ie of Woe-ie in die provinsie Hokkien" (Resolusies, IV, Glossary).

66. CJ2914, Meijer Inv., 1705, p.159.
67. See above, p.70.
68. Dr. Cook's statement that 18th-century balies were made of teak and reinforced with brass bands while 19th-century examples were bound with iron (op. cit. p.76) was arrived at empirically and is not confirmed by the inventories. Brass-bound balies and buckets probably survived because they were highly valued, but they appear to have been outnumbered by those bound in iron at every period of the 18th century.
69. For instance "3 sakjes met Verw / 1 partij verw / 1 partij do / 1 do do" (Vr9, 1697) and "1 Verv Moolen, en 2 Schalen en balans" (VR18,1701).
70. The green-painted wall-fountain from the same estate has already been mentioned (p.179), as has the brown tea-table (p.98). In addition there was "1 Groenen flessen kelder," a black table, and two red tea-tables (II,79,1713).
71. The epigraph to Thornton's Seventeenth-Century Interior Decoration.

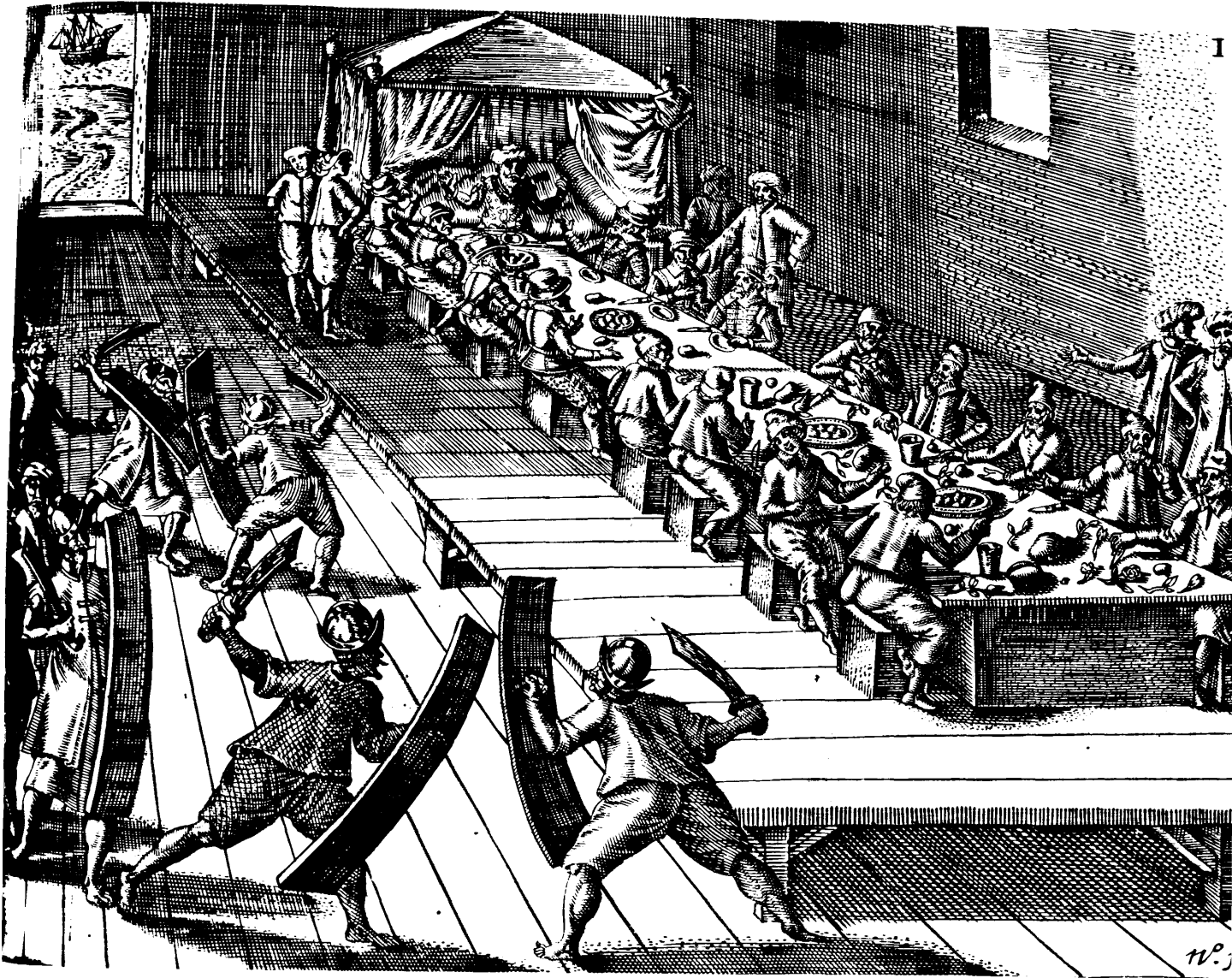

(52)

Gastmaal des Koninckx van Ternaten

An engraving showing a typical table-
setting of the seventeenth century.

Eating and Drinking

At the Table

It is impossible to write generally about the service of meals and table rituals at the early Cape, for though in comparison to England or Holland it was an extremely homogeneous society, the inventories make clear that table practice ranged from the most simple to—if not the most sophisticated, at least the relatively sophisticated. In the sphere of table manners, as in so much else, the seventeenth century was a period of change. At its opening, when forks were not in general use, manners and modes were little altered since the Middle Ages, and eating remained the messy business it had always been. Yet there was one important improvement: the greater prevalence of the individual trencher.

Before the arrival of the trencher, people ate out of a communal dish, but kept a chunk of bread at hand to catch the drips of gravy or hold an ovenhot piece of meat, and it was this piece of bread that was replaced by a flat dish of wood, earthenware, pewter or silver.¹ An engraving entitled "Gastmael des koninckx van Ternaten" from a book published in 1646² gives a clear picture of the table appointments. Though the table is sparingly laid, a careful distinction is made between the important guests at the head of the table, each of whom is provided with a trencher, and the much humbler guests at the foot, who are not. The food is contained in great dishes which are spaced down the centre of the table: one for each group of four. The meal has yet to begin, but it is obvious that those at the bottom of the table are intended to eat directly from the central dish, a process in which they will have a knife, the only cutlery provided, to assist them.

No doubt many dinners given in the middle of the seventeenth century followed the old ways, in part or in whole, but a new spirit was abroad. People were beginning to recoil from overmuch sharing and to want their own plate and their own wine cup, and even a clean plate for every dish. A passage in the diary of Samuel Pepys well captures this new fastidiousness. On 29th

October, 1663, he attended a Mayoral dinner at the Guildhall, London, which did not meet with his standards, and he wrote "Many were the tables, but none in the Hall, but the Mayor's and the Lords of the Privy Council that had napkins or knives, which was very strange . . . I sat . . . at the Merchant Stranger's Table; where ten good dishes to a messe, with plenty of wines of all sorts . . . but it was very unpleasing that we had no napkins nor change of trenchers, and drank out of earthenware pitchers and wooden dishes."³

It is in this very same year, 1663, that a Cape inventory, that of Secunde Roelof de Man, first includes an array of tableware, and shows that in government circles it was perhaps possible to serve a meal with a degree of refinement that matched, though it certainly did not better, that of Pepys's Mayoral banquet. De Man had a collection of pewter tableware that was closely paralleled in earthenware and, when combined together, provided him with fifteen serving-dishes of different sizes, four bowls, two dozen table-plates, three salts, three mustard pots, and a table bell. In addition he had one silver salver, while his cutlery consisted of twenty-four pewter spoons, four knives which may have been for table use, and a silver knife with a matching, but damaged, fork.⁴

This assortment of unmatched tableware bears only a slight resemblance to what we ourselves are accustomed to, and it is necessary to remember that the formal dinner where course follows course from the soup to the savoury was a nineteenth-century innovation. In the seventeenth century it was customary to serve one or two courses consisting of a variety of different dishes. On special occasions, a course might offer as many as twenty different dishes: a mixture of fish, fowl, meat, game, and, where the last course was concerned, tarts, fruits, nuts and puddings as well. A crowded table was a mark of consequence and, as at all times and in all places, there was a right and a wrong way of doing things. At this point I am going to read history backwards. In 1746 a fascinating and once popular book called De Volmaakte Hollandse Keuken Meid was first published in Amsterdam. The anonymous authoress devoted a chapter to the serving of meals, which she illustrated with seven different menus and annotated

diagrams of the correct table settings.⁵ Her approach was sensible and unpretentious, and must bring us closer to the second half of the seventeenth century than anything we ourselves have known.

For a dinner to be served according to De Volmaakté Hollandse Keuken-Meid, two kinds of round serving dish were necessary: the schotel or dish, and the saucierken or saucer-dish, each in three or four different sizes. The largest schotel held the principal dish, such as venison or swan pie, and took pride of place in the centre of the table. In slightly smaller schotels it was correct to serve the great roasts or "groot gebraad," such as beef, pork and mutton. "Klein gebraad" which included chicken, duck, snipe and pigeon were served on dishes of the third size, whilst tarts, jellied meats, cakes and so on were placed in the smallest schotels. The saucierkens or saucer-dishes which sometimes, as here, seem also to have been called "assietten,"⁶ were used for stews and ragouts, as well as salads, vegetables, small cakes and, when special dishes were not available, fruit. In addition various small dishes and bowls were needed for such things as butter,⁷ mustard, pickles, sugar, spices and cream. The reader was further instructed always to place two similar dishes well apart and diagonally opposite each other: a piece of advice intended to ensure that every guest was in reach of the greatest possible variety, and that the whole arrangement was elegantly symmetrical—a facet of table planning that no one had bothered about prior to the seventeenth century. Another interesting point is the writer's assumption—and this is the mid-eighteenth century—that most meals would be served on a mixture of pewter and porcelain, which led her into advice like "de water-visch discht men in posteleine schotels op, de gekookte vis in tinne schotels."⁸ Certainly such a mixture, rendered even more varied by silver and earthenware, is shown in the popular *Breakfast Still Lives* painted throughout the seventeenth century, and it is also recorded time and again in the Cape inventories of the seventeenth and early eighteenth centuries.

Roelof de Man, it should now be clear, had the dishes and plates to serve a dozen people with one generous or two modest

courses. He could also, if the nature of the food required it, have supplied each of his guests with a spoon, but nothing else. Pepys, as we have seen, had been no better provided, though he resented the absence of a knife—something that fifty years earlier no one would ever have looked for.⁹ Unless one knew the exact circumstances under which one would be dining, it was obviously still a wise precaution, in the latter part of the seventeenth century, to carry a knife about one's person. Some people also carried a fork. Forks were not table utensils in western Europe during the Middle Ages and even in the fifteenth and sixteenth centuries; they were only used for certain foods like fruit and sweetmeats. Meat forks first came into use in Italy, where the fastidious began to object to the meat in the communal dish being fingered by everyone at the table, and to use a fork to convey food from it to their own trencher. The English traveller, Thomas Coryat, who visited Italy in 1608, wrote:

I observed a custome in all those Italian Cities and Townes through the which I passed, that is not used in any other country that I saw in my travels, neither doe I thinke that any other nation of Christendome doth use it, but only Italy. The Italian and also most strangers that are commorant in Italy, doe alwaies at their meales use a little forke when they cut their meat. For while with their knife which they hold in one hand they cut their meate out of the dish, they fasten their forke which they hold in their other hand upon the same dish, so that whatsoever he be that sitting in the company of any others at meale, should unadvisedly touch the dish of meate with his fingers from which all at the table doe cut, he will give occasion of offence unto the company as having transgressed the lawes of good manners, in so much that for his error he shall be at the least brow-beaten, if not reprehended in wordes.¹⁰

Nothing is said here about conveying the meat to one's mouth on a fork, just as nothing is said about this in the passage from the Civilitéé Francaise quoted above,¹¹ which was written more than a hundred years later. The presence of a table fork in an inventory certainly marks a step forward in refinement, but does not mean that the fingers were no longer in use. There are one or two references to knives and forks at the Cape before 1663. In

1658 the inventory of a midshipman includes "2 messen en / 2 Vorckens"¹² which may have been for table use, and in 1662 Undermerchant Paulius de Molier had "1 mes [en] 1 forck van Silver vergult wegende 4 onsen," as well as "1 cooker met 3 messen en 1 forck,"¹³ but the inventories of the first twenty or even thirty years contain very few references, not only to knives and forks together, but to any form of table cutlery. Knives on their own are a little more common than knives and forks, and silver and pewter spoons occur most often of all. Some of the silver spoons mentioned, "Aght Silvere lepels" (23/5,17,1672), "Thien Silvere leepels" (23/5,21,1672), and "veertien silvere Lepels" (23/5,35,1675) may have been matched sets. In addition to the fourteen silver spoons just mentioned, the Van Bruegel estate contained three sets of knives, "tien roe hegte messen met silver ingeleijt / ses Swarte hegte messen / tien witte hegte tafelmessen."¹⁴ Merchant van Breugel, unlike Secunde de Man, was in a position to set a knife for each guest, and was probably among the first at the Cape to have been able to do so, but the fork did not feature prominently among his possessions. The "twee messen en twee vorcken" in his pantry were most likely for kitchen use.

Until the latter part of the seventeenth century, knives and forks for the table were individual possessions and, as such, often elaborately treated. When they began to be made in sets of a dozen or more for general household use they became much more standardised, and only individual travelling sets continued to receive the old imaginative decoration. Both household and travelling sets were recorded at the Cape in the last quarter of the seventeenth century, but even at this period no form of cutlery was in the least common. A fair sprinkling of households included spoons, particularly pewter spoons, which might be present in quantity, and the prize in this field goes to Paul Maron with forty-four (I,13, 1695). A single silver spoon, which may have been a christening gift, is occasionally listed, and by the 1690's a set of twelve silver spoons can be anticipated in most prosperous estates, but a set of knives, "8 Messen, met een koker" (VR12,1699), is still a rarity, and even individual sets, "1 koker waarin drij messen en een

vorck" (23/5,40,1676) or "1 mes en vork met silver beslag"^{14a} are quite out of the common. Only one estate before 1700 contains anything approaching a set of forks. The sale in 1696 of the goods of the erstwhile book-keeper and dispenser, Christiaan Freser,¹⁵ accounted for twelve silver spoons and six silver forks which realised 65 guilders.¹⁶ Can it be that the presence of a set of forks is a sign that the fork had at long last been initiated into its modern role? It is certainly not impossible, but in general the people at the Cape, whatever their estate, can be said to have eaten with their fingers throughout the seventeenth century, although the most refined of them probably kept their hands out of the communal serving dish. Where the lower and middle ranks of society were concerned one is frequently faced with estates in which no cutlery of any kind is mentioned. Quite possibly this is a true reflection of the table habits of the households concerned, but it is not entirely out of the question that a certain number of well-worn knives and humble wooden spoons got overlooked. It must not be forgotten that the adult guests in Pieter Bruegel's "Peasant's Wedding" are shown wielding short wooden spoons—one of the attendants bears his in his hat—though the child in the foreground is tackling the custardlike substance in her saucer-shaped dish with her fingers.

In the early eighteenth century there is a notable increase in the amount of cutlery recorded, and by 1714 the majority of estates possessed a set of pewter spoons, while the most important contained sets of knives and forks in steadily increasing quantities. In 1701 the Sneewindts owned twenty-four silver spoons, a silver pap-spoon, half-a-dozen silver forks, a silver "thee lepeltjen en do Vorkjen," and a case of six table knives (I,69). In 1703 the Van Reedes had thirty silver spoons, six silver egg spoons, twelve silver forks, "1 Silvere messekokker," two silver teaspoons, two silver knife handles, two knives with carved handles, five-and-a-half silver spoons, and fourteen knives with silver bands and knops (I,74). And in 1713 Abraham Diemer had eleven silver spoons and forks, two silver spoons and a fork for preserves, nine silver spoons, three silver forks, ten knives with silver mounts, eleven table knives, "6 Silvere ijsere Leepeltjes," and six further knives (III,31).



(53) Useful Porcelain.

- A. Japanese Oil and Vinegar. B. Chinese
Lidded Butter Pot. C. Chinese Kendi.
D. Japanese Ewer. E. Chinese Beer Mug.
F. Japanese Salt. G. Japanese Mustard.
Seventeenth or Early Eighteenth Century.

Interesting individual sets continue to appear: "1 doosje met 1 ijvoore Lepel en Vork" (II,77,1713) and "1 Mes en vorck met barensteenheft" (III,13,1714) for example, but are already less common than the more uniform sets of solid silver.

I have come across a very occasional reference to iron or wooden serving spoons like "1 ijsere pollepel" (I,45,1700) and "3 houte pollepels" (III,25,1713), but there is no doubt that the serving spoon was not as yet a fashionable requirement. In these circumstances it is not safe to assume that the custom of eating with the fingers had as yet been abandoned at any level of society. There is, after all, no logic in objecting to the communal dishes being fouled by the fingers of the diner but not objecting to the same fork being used both to serve and eat with. Louis XIV, after all, ate with his fingers to the day of his death in 1714,¹⁷ but this operation can be done delicately with the tips of two clean fingers or crudely with the whole dirty hand. Refinement is not dependent on the fork.

After this excursion into the history of cutlery, we must return to plates and dishes and pick up our story where we left off: with the estate of Secunde Roelof de Man. It was, for its date of 1663, a quite exceptional estate, and we hear almost nothing more on the subject of plates and dishes until the 1670's. This decade, the first for which we have a number of inventories of household effects, was no stranger to pewter or earthenware and had more than a nodding acquaintance with fine porcelain. In 1670 the estate of the free burgher, Jan Israelsz, had, like several others at this period, an adequate supply of pewter for the daily service of meals, namely eight assorted dishes, one-and-a-half-dozen table-plates, a dozen spoons, a bowl, a beaker, a salt cellar and a flagon (kan).¹⁸ He had no earthenware. Instead he had a nice little collection of porcelain which complemented his pewter: "Ses fijne porceleijne Schotels, cleijn en groot / thien dos commetjes cleijn en groot / drie do kannetjes " (23/5,3). Considering the time and place, the Israelsz household was well provided for. The estate of another burgher, that of Joris Jansz in 1672, had an even more impressive collection of porcelain numbering forty-one pieces and including bowls, pots, dishes, tea-bowls and saucers, spouted jugs, and a chamber pot, as well as thirty-six pounds of "Verscheijde tinnewercx" (23/5,17). Van Zuijrwærden combined a pewter collection

embracing a mustard and salt, seven dishes and eight table-plates, with "dertigh Stux delffs aerde schotels soo groot als cleijn" (23/5,21,1672) and Joannes Pretorius, yet another burgher, had a dozen plates and two dishes of pewter, five mugs which were nameless, four shell-shaped white dishes (schulpschaalen),¹⁹ three dishes and five table-plates of Delftware, and six saucers and two bowls of porcelain (23/5,47,1679). There are rather more estates at this period, however, which include a little kitchenware but no tableware at all. A typical example is the estate of Jacob Clouten with "Vier ijsere potten [en] twee Copere Lepels" (23/5, 5,1670), and in such a case the family must have eaten out of the cooking-pot. As it is difficult to find an estate with a few serving dishes but no table plates, I have the impression that the fortunate few at this period normally made use of both serving dishes and individual table-plates, while the majority ate straight from the pot, presumably with the traditional trencher of bread in front of them.

Both ceramics and pewter are present in much greater quantities in the last two decades of the seventeenth century. In 1685, Elbert Diemer had thirty dishes, fifty saucers and a flask of porcelain, "een kannebort met 6 porceijne kannen en 6 do Commen" and a solitary Delft pot; he also had a dozen pewter dishes, two dozen pewter table plates, and a pewter bowl (I,2). Two years later the confiscated estate of Lieutenant Bergh included about a hundred and fifty porcelain items, a handful of European ceramics, and a couple of dozen pieces of pewter,²⁰ while in 1699 Adriaan van Brakel had about two hundred pieces of porcelain and eighty pieces of pewter (I,46).

In the early eighteenth century the holdings, particularly of porcelain, continued to increase: the Sneewindts had over two hundred and sixty pieces of porcelain, nearly seventy pieces of pewter, thirty pieces of Cape earthenware, and a few examples of European earthenware and stoneware (I,69,1701); the fashionable van Reedes had something like four hundred pieces of porcelain, eighty pieces of pewter and seven "vaderlandshe kannen" (I,74,1703); while Abraham Diemer—in his town house alone—had about five hundred pieces of porcelain, three dozen or so items of earthenware,

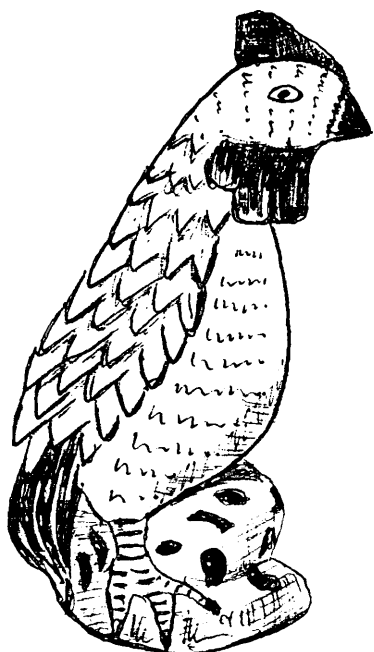

A.

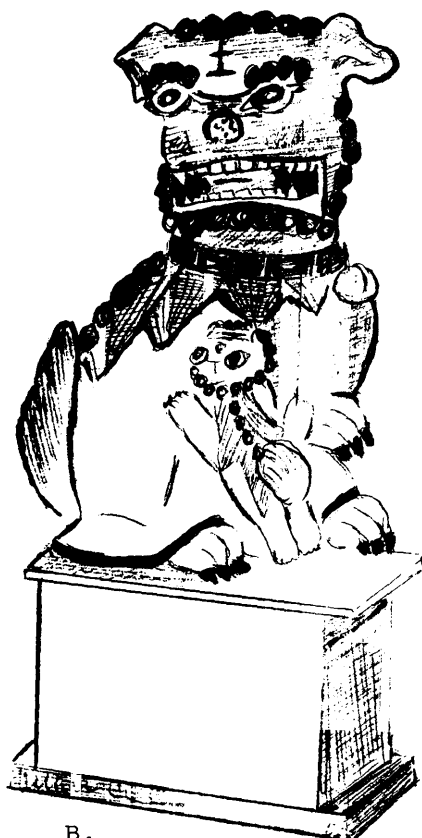

B.



C.



D.



E.

- (54) Chinese Polychrome Porcelain Figures
A. Cock B. Dog of Fo (Leeuwtje)
C. Twin Spirits of Mirth and Harmony
D. Budai (Pu-tai) with Bag of Happiness
E. Guanyin, Goddess of Mercy
Kangxi, 1682 - 1722.

and approximately sixty pieces of pewter (III,31,1713).

By no means all the items represented by these figures were tablewares, but bowls, plates and serving dishes account, in each case, for a substantial quantity of the pewter and porcelain. The figures, however, are illuminating for several reasons. Firstly they demonstrate the ever-increasing quantities of porcelain to be found in the leading estates—a trend which is echoed, though much less dramatically, at every level of Cape society. Secondly they show that, in comparison to porcelain, all of which was of Eastern origin, European wares were now of very minor importance. Ten years ago I was of the opinion that a good deal of blue-and-white Delftware was listed simply as porcelain,²¹ but I have since come to the conclusion that that is unlikely. This is due in part to the fact that greater knowledge of the inventories has increased my confidence in their accuracy, and in part to the extreme rarity of Delftware among the ceramic fragments excavated during the 1970's from the Golden Acre site in Cape Town and various different locations in Stellenbosch. It was only during the earliest years of her history that Delftware was of much importance to the Cape. Thirdly, the figures show that while the quantity of porcelain steadily increased there was not a similar increase in the amount of pewter recorded: even the most important estates were content with about six dozen pieces, and this seems to call for some explanation.

It would hardly be surprising if households of upwards of a hundred pieces of porcelain contained very little pewter; instead they usually contain enough pewter to meet the needs of any ordinary meal. Furthermore, one is much more likely to find an ordinary household with an adequate supply of pewter but little or no porcelain tableware—though teaware, to which we shall come later, is rather a different matter. To take a few concrete examples: in 1692 the estate of Joost Lons had two kannetjes, a bowl and a lidded butter pot of porcelain, two plates of wood, and eight dishes, nine table plates, two bowls, two beakers, a salt, a mustard, and seventeen spoons of pewter (I,4); in 1699, Jacob de Wilt of Stellenbosch had four dishes and two pots of porcelain, and twelve dishes, thirty-two plates, a jug, two salts, three spoons, and a

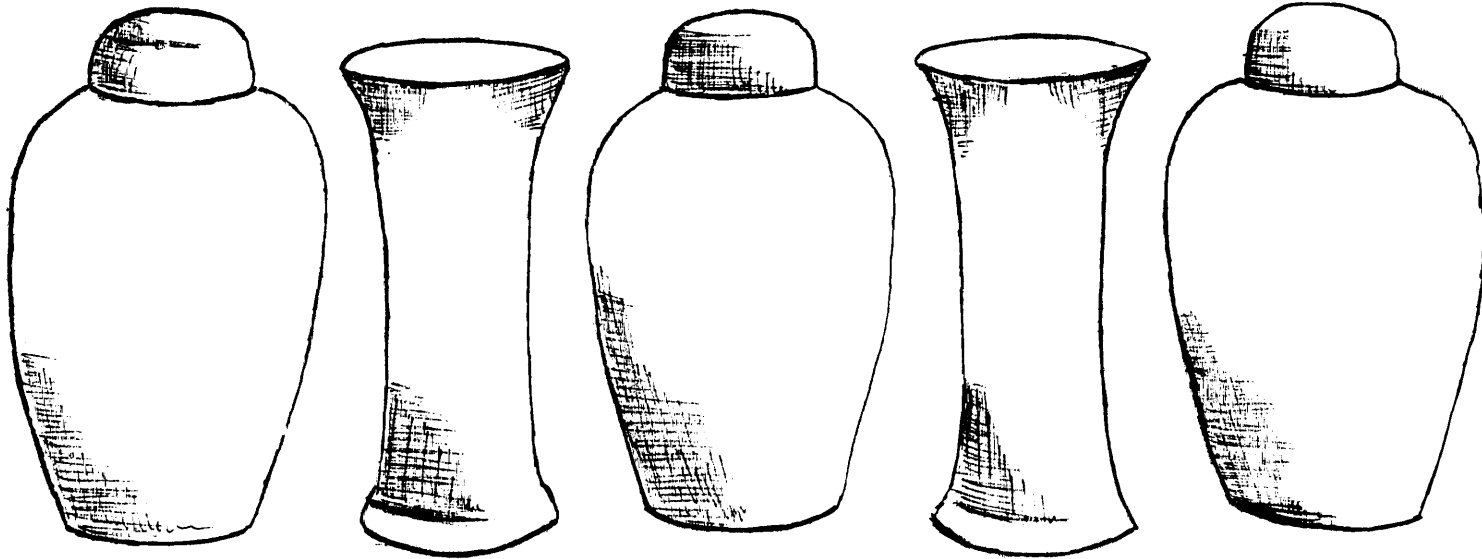

(55) A Five-Piece Porcelain Cupboard Garniture. Kangxi, 1700+.

tart dish (taartplaat) of pewter (I,47); and in 1711 Jannetje Verschuijjer had eighteen saucer dishes (pierungen)²² of porcelain, and twelve dishes, thirty plates, twelve spoons, three salts, and a mustard pot of pewter (II,48). There can, I think, be little doubt that pewter was the normal tableware throughout the period under discussion, which would be perfectly understandable if it were cheaper than porcelain—but, if anything, it seems to have been a little more expensive.²³ On special occasions one assumes that porcelain, when present, was called upon to supplement the pewter, and in some of the grander households where supplies of both porcelain and pewter were to be found in kitchen or pantry they may have been used together as a matter of course. On the whole, however, porcelain, even the ordinary bowls and dishes and plates, seems to have been collected because it was good to look upon, its decorative possibilities were exploited to the full, and useful porcelain²⁴ (Pl.53) was displayed with decorative porcelain, with figures (Pl.54), flower pots, garnitures of vases (Pl.55) and miniature garnitures known as "kabinetstelletjes,"²⁵ while people of all classes, except the poorest, continued to dine off pewter.

Silver table appointments, apart from cutlery, were not of great importance. In Europe, on special occasions, as much use was made of silver as possible, but people at the Cape seem to have been quite content to substitute porcelain instead, and while it was obviously desirable to introduce the odd salt cellar, mustard pot and hand-bell of silver, nobody bothered about silver plates and dishes. Every decade from the 1660's onwards throws up one or two inventories with a nice little collection of silver. To start with, the silver items present had more to do with drinking than eating, but a silver salver, described in the inventory of Roelof de Man as "1 Silvere Schenck taefel bort,"²⁶ and used no doubt to present wine at table, has some claim to being considered as tableware. Albert van Breugel had an octagonal silver salver, a great silver salt cellar, a silver mustard pot, and a pair of small flat-handled bowls (23/5,35,1675). Christiaan Freser had six silver salt cellars and a silver salver²⁷ and the Van Reedes, three small salvers, six salts, a pepper pot and a mustard pot with its spoon (I,74,1703). Simon van der Stel, however, could boast some "schuijtjes massief goud" (*nefs?*) and a considerable amount of table silver,^{28a} salvers etc.

Of one thing there is no trace at this period, and that is a set of matching plates and dishes. People assembled their dinnerware piecemeal and were quite unconcerned by a mixture of pewter, silver, and differently patterned porcelain. In their unconcern the people at the Cape were more or less at one with their fellows in Europe. Though matching services of polychrome Italian maiolica are known from the early sixteenth century,²⁸ the dinner-service, as such, was of very minor importance throughout the seventeenth century, and for this the century's passion for blue-and-white Chinese porcelain may well have been largely responsible. However arbitrarily assembled, Chinese blue and white, particularly when it is much of a period, creates a harmonious impression which could well have had an adverse effect on the development of matching services. Towards the end of the century, the Chinese and Japanese potters began to delight Europe with a fine selection of polychrome ceramics. From the China of Emperor Kangxi came the famous famille verte palette, where a vibrant and translucent copper green was combined with blue, red, yellow and aubergine. This palette was reinterpreted by the Japanese on their delicate and equally famous Kakiemon porcelain. Then, too, there were the wild splendours of the Japanese Imariware, where red, blue and gold predominated—a palette and a style refined and pruned in the numerous Chinese imitations. Society, bedazzled by all this colour, began to realise the advantage of an actual service; an advantage visibly demonstrated by the sets of tea-bowls and saucers flooding into Europe to cater for the new passion for tea. At this juncture, events in Paris provided an important additional stimulus.

In 1709 Louis XIV issued an edict which obliged the French to hand over their silver plate to the mint, where it was melted down in the interests of the national war effort. "Within a week," wrote Saint Simon, "Society went in for faience, emptied the shops, and set a wild fashion for this ware."²⁹ At the beginning of the eighteenth century a ceramic service of distinction came from two sources: from the China of Kangxi, a source exploited, in particular, by the Directors of the English East India Company,³⁰ and from the potters at Delft who, before 1720, supplied services to

George I of England, Frederick I of Prussia, and the Bourbon Comte de Toulouse.³¹ The new trend for matching dinnerware seems to have left the Cape almost untouched for another hundred years. With very few exceptions dinnerware there remained blue and white and, no doubt for this very reason, continued to be assembled bit by bit throughout the eighteenth century. Sets of porcelain were reserved for the tea-table.

Tea

The first tea known to have reached Europe arrived in Holland in 1610 and had been purchased at Hirado in Japan as a curiosity.³² But as early as 1637 the Directors were writing to Batavia in the following vein. "As tea begins to come into use by some of the people, we expect some jars of Chinese as well as Japanese tea with every ship."³³ In 1699 the chaplain of King William III could claim that "the Drinking of it [tea] has of late obtain'd here so universally, as to be affected both by the Scholar and the Tradesman, to become both a private Regale at Court, and to be made use of in places of public entertainment."³⁴ Moreover, by 1739 tea was the most valuable single commodity handled by the Dutch East India Company.³⁵ In face of all this, it may seem absurd to claim that the Cape, where tea first makes its presence felt in the inventories of the early 1670's, was in the forefront of fashion. The claim looks a little less exaggerated, though, when one learns from Weyns that the first reference he has found to anything to do with tea in the inventories of the farming communities of Flanders was in 1714,³⁶ and is further strengthened by a passage such as the following, from John Galt's Annals of the Parish:

Before this year [1761], the drinking of tea was little known in the parish, save among a few of the heritors' houses on a Sabbath evening; but now it became very rife: yet the commoner sort did not like to let it be known that they were taking to the new luxury, especially the elderly women, who, for that reason, had their ploys in out-houses and by-places, just as the witches lang syne had their sinful possets and galravitchings; and they made their tea for common in the pint-stoup, and drank it out of cups and luggies, for there were³⁷ but few among them that had cups and saucers.

More convincing than any literary source, perhaps, is the fact that in Britain tea was not popular enough to be regarded as a source of revenue, except in a minor degree, before the 1690's. It is true that in 1660 a tax was imposed on all beverages drunk in the coffee-houses, but it was not until 1695 that a tax of a shilling on the pound was imposed on tea lawfully imported by the East India Company, and one and six on all unlawful importations.³⁸ Yet by 1695 at the Cape nearly everyone was drinking tea—and drinking it too, often enough, from porcelain cups.

My first reference to tea occurs in 1670 with "drie kopere teeketels" in the inventory of Jan Israelsz (23/5,3). Then in 1672, "10 postelijne fijne teekopjes / [en] 8 dos pierings" appear in the inventory of the burgher, Joris Jansz (23/5,17). Several other inventories of the 1670's also refer to teaware and one of these, the inventory of the Widow Thielman Hendrix³⁹ does so in no uncertain manner. The estate contained "1 fles Tee 3/4 vol / . . . 1 fles tee vol / 1 Tee vles waarin wat Candi Suijker / . . . 8 Stx gesorteerde posteleijne teekopjes in een back / 12 Stx pieringhe / 32 Stx gesorteerde Teekopjes / . . . 2 tee pierings / 12 tee kopjes / 7 do pierings / . . . [en] 1 Teeketel" (23/5,41, 1677). During the next decade the drinking of tea rapidly established itself, and by the 1690's had been adopted at every level of Cape society. Indeed, an examination of the first fifteen documents from the first volume of Orphan Chamber inventories (MOOC8/1), which are largely concerned with the period 1690 to 1695, does not turn up a single document where the household effects are itemised⁴⁰ that does not include at least one item of teaware, and some of these estates are very modest indeed. The contents, for example, of Ditloff Bibout's town house are disposed of in seven lines, the last of which reads: "20 p^s theekopjes en pieringtjes" (I,14,1695).

Tea-drinking in the seventeenth-century Cape was not surrounded by a lot of complicated accessories, and one does not often find more than a tea-table,⁴¹ a tea-kettle, a tea-pot or two and some cups and saucers; indeed, one often finds much less. The seventeenth century tea-cup was a small bowl without a handle and the matching saucer, which was usually but not necessarily present, had no depression

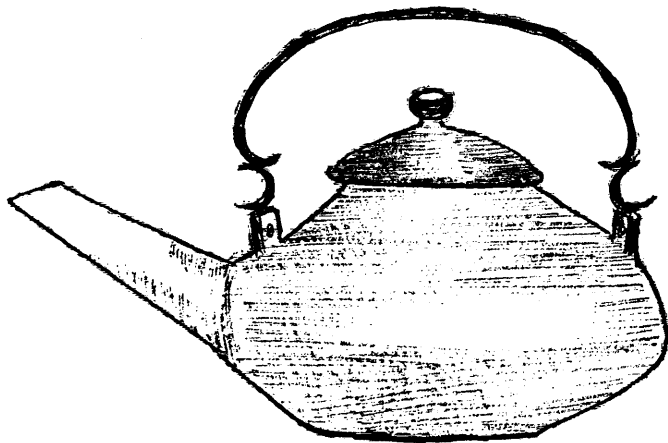
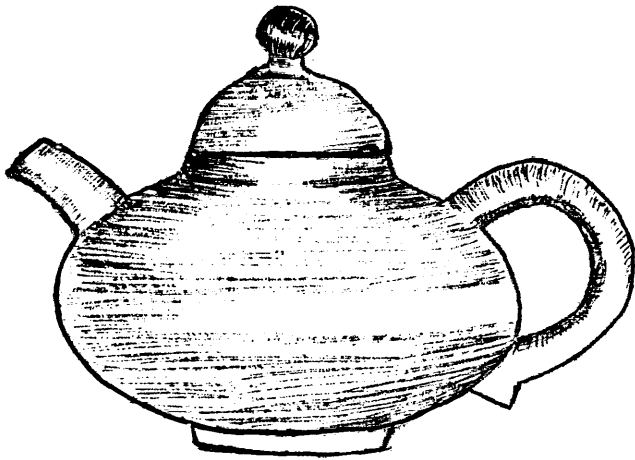

(56) Red Stoneware Teapots from Ixing (I-hsing), China
Seventeenth Century.

to steady the cup. In taking tea it was permissible to pour the contents of the tea-cup into the saucer and so partake of the traditional "dish of tea." It may also have been permissible, particularly in the very early years, to pour the tea directly into the saucer, because one occasionally comes across nothing but a set of saucers, as in the 1681 estate of Shoemaker Backer with "6 thee pierings," (23/5,50). Alternative ways of taking tea were to raise the bowl alone, holding it by the stand-ring, or to raise both bowl and saucer together—a difficult action to perform without mishap with one hand and a straight baby finger, especially in the absence of a stand-ring.⁴² Creamers and sucriers are never mentioned in the Cape inventories of the seventeenth and early eighteenth centuries, and as it was only in about 1730 that these accessories are known to have come into use in Holland,⁴³ their absence at the Cape is no cause for surprise. It was a Dutch custom, when taking tea, to dispense with sugar and to hold a piece of candy in the mouth while drinking unsweetened tea, or coffee. "All women at the Cape," wrote Mentzel who knew the Cape in the 1730's, "have bad teeth . . . In this they resemble the women of Holland; it is believed to be caused by the large quantities of sugar-candy they take in their mouths when drinking tea or coffee."⁴⁴ Perhaps they also held lumps of sugar in their mouths, for some use must be found for the tea-sugar to which constant reference is made both before and after 1700.

The tea-pot, which was very small at this period, seldom matched the rest of the service, for though some matching tea-pots were made in the first half of the eighteenth century, an individual item of silver or red stoneware was much preferred.⁴⁵ A silver tea-pot rarely, if ever, graced a Cape tea-table until the eighteenth century was well advanced, though some pots were mounted in silver and even gold; "een trekpotje met goud beslagen waarop een dopje met een ketting" (II,8,1707). Red stoneware pots that probably came from China but may sometimes have come from Delft are quite often recognisable (Pl.56). In 1699 Adriaan van Brakel owned "10 porseleijne rood aarde trekpotten / 5 do Wit do do" and "4 porseleijne stelletjes thee goed" which were almost certainly nothing but cups and saucers. He also owned seven tea-trays

(theebakjes) and four copper tea-kettles (I,46). For the seventeenth century this represented a most generous array, which is seldom matched and never bettered.

In the early eighteenth century there is a sharp increase in the amount of teaware listed, and some households were so lavishly provided with tea-sets that I have come to wonder whether a superfluity of porcelain in general and fine cups and saucers in particular had become the status symbol of the period. Quite a few estates could boast over five dozen cups and saucers: at the Stralen/van Doorninck sale 17 "stelletjes theegoed" were sold for 3 to 4 guilders each—a good price (VR17,1701), and at the sale of Johanna Elsevier's possessions in 1709, "2 stellen⁴⁶ teegoed" appear eight times, while "9 stelletjes teegoed" formed another lot, but the price realised—2 guilders, 6 stivers—is an indication that these were miniature sets (VR59). Though sheer quantity has a fascination of its own, I am going to concentrate on a couple of estates that cannot compete in this respect, but do offer unusual detail. Elisabeth Loenss had one rack with twenty brown cups and saucers and two red tea-pots; another carved, brown rack with twenty-six cups painted red and blue and fifteen matching saucers, and the porcelain on her chimney-piece included three small tea-pots. Then there were nineteen red and green painted coffee cups and saucers, a small rack with seven tea-cups and two saucers, a "kapstok" with eleven saucers and six assorted cups, a doorway crowned with eleven cups and saucers, and yet another small tea-rack with fifteen cups and saucers. Finally there were two copper tea-kettles in the kitchen (II,37,1709). The second estate, that of Dirck Vroonhof, had two tea-tables, five tea-trays and three tea-racks as well as a balie with some tea. It also contained three copper tea-kettles and one of brass, while the porcelain consisted of "2 groote Blauwe Treckpotten / 3 klijn do / 1 do Japansse / 8 do roode / 1 do Chinese / 1 Blauwe Porsselijne Booterpot / 4 do Thee bossen⁴⁷ / 1 stel Japans Theegoed / 2 Stel Blauwe do / [en] 1 stel Bruijn do" (II,109,1714). Polychrome porcelain, as opposed to blue and white, was very expensive. The set of Japanese porcelain, which was probably Imari, was valued at 9 guilders, while the

brown set in which a brown glaze would have been combined with blue and white was worth 1 guilder, 14 stivers. It was probably cost, as much as anything else, that made the teaware at the Cape so much more varied than the dinnerware. A few large pieces of Japanese Imari were certainly to be found, but their role was likely to have been largely decorative; at a time when a single "Japanese booterpot vergult" was worth 7 guilders, 8 stivers (VR59, 1709), only the really wealthy could afford to treat it as everyday ware.

Other items linked to the tea cult which have either not been mentioned, or not been mentioned with sufficient emphasis, include flasks for the storage of tea which were of lead or pewter or tin, tea caddies of silver or porcelain, large earthenware tea-pots, and painted and lacquered tea-trays. There is also an item known as a "borretje," "theeborretje," or "schenkborretje" which may have been a type of tray. The Sneewindts owned "1 silvere thee lepel-tjen en do Vorkjen" (I,69,1701), and the Van Reedes "2 Silvere thee Lepeltjes" (I,74,1703), the only references to teaspoons I have found. As spoons and forks for preserves like "2 silvere Confituijr Leepelties / 1 do do Vorkje" (II,31,1713) are less rare than teaspoons, the latter can hardly be said to have been in use. The custom of drinking unsweetened tea while holding a lump of sugar or candy in the mouth probably accounts for this. Sugar basins (suikerpotjes) and sugar boxes (suikertrommels) are occasionally present, but never in contexts which are unequivocally associated with the taking of tea.

Caudle, Chocolate and Coffee

Caudle, a warm drink of sweetened or spiced ale or wine which was given to the sick and more especially to women in childbirth, was drunk in Europe before tea or coffee was heard of; and it had long been the custom for the women friends of the mother to gather in the lying-in chamber to celebrate a new birth with this sustaining beverage.⁴⁸ Caudle, like most other drinks, can be drunk from any small bowl, and does not need a lot of specialised equipment, but references to anything to do with caudle are so rare that one hesitates to claim that it was much drunk. The

Hendrix inventory, which has a notable collection of early tea-ware,⁴⁹ contains "8 Candeel koppen" and "1 candeelkom" (23/5, 41,1677). A handful of later inventories, including that of Helot's wife, have a silver caudle spoon which may have been used to convey the caudle from the bowl to the handleless cup, Dirck Vroonhof had "1 Tinne Candeel Com met een deksel" (II,109,1714), and that, apart from a caudle bowl sold in 1676,^{49a} is about all.

Chocolate, too, was known in Europe before tea and coffee. The sixteenth-century Spanish conquistadors found that Montezuma "took no other beverage," but even so it did not become popular in Europe until the seventeenth century, when chocolate houses were established in London, Paris and Amsterdam.⁵⁰ It was a relative popularity, however; because of its cost, chocolate-drinking was very largely restricted to the fashionable classes. Where the cocoa trade was concerned, the Cape enjoyed no special privileges, so that it is hardly surprising that chocolate was not often drunk there. I have as yet to encounter any reference to chocolate in the seventeenth-century inventories and vendu rolls, and they are few and far between in the early eighteenth-century documents. Chocolate cups first appear, to my knowledge, in 1716 (III,21); before that, Hendricus Munkerus had both "een kopere Chocolaatkan" and "een kopere convoor tot een chocolaatkan" (II,8,1707); while a "Coopere" chocolate pot was present in the estate of Corssenaer's widow (III,37,1713), and Helot's wife had "een blikke Chocolaatbos" (II,43,1710).

Coffee, which was introduced into Italy by Venetian traders in 1615 fared a little better; but while regular imports of coffee from Mocha to Amsterdam began in 1663,⁵¹ the first reference to coffee in a Cape inventory that I have found comes in 1701, when two coffee-cups appear in the Van Stralen/Van Doorninck inventory (1,62). In the same year "1 blikke koffij can" and "1 copere koffij-can" appear in the De Beer inventory (I,63), and the vendu roll also includes "1 Coffij moolen" (VR18). From now onwards one finds a sprinkling of metal coffee pots, a few coffee-mills and even some coffee beans. The can-shaped coffee cup which, unlike the tea-cup, always had a handle, makes two or three further appearances before 1715. We have already mentioned

the red and green set—it was probably famille verte—that belonged to Elisabet Loenss,⁵² and Johannes Pijthius had "20 bruijne coffij poties / 17 do pierenties." He also had a coffee mill, a brass coffee-pot with a brazier, and two further coffee-pots (III,13,1714). If coffee still had a very long way to go before it could rival tea in popularity, it was beginning to make impressive advances.

Wine, Beer and Other Drink

Tea, which we now look upon as one of the more innocuous substances consumed by man, was not always so regarded. There was a time when moralists and "do-gooders" considered it a most unsuitable substitute for the traditional small beer and wine, particularly in the case of the lower orders. "I have no desire to appear captious," writes Dr. Johnson, "and shall therefore readily admit, that tea is a liquor not proper for the lower classes of the people, as it supplies no strength to labour, or relief to disease, but gratifies the taste without nourishing the body."⁵³ Perhaps the learned doctor, who was himself passionately addicted to tea, had a point, but the consumption of tea at the Cape seems to have been in addition to, rather than instead of, the consumption of alcohol. When Louis van Assenburg, who took over from Willem Adriaan van der Stel at the beginning of 1708, felt that the Cape was held together by gutsing and sozzling or, as he put it, "vreten en suijsen,"⁵⁴ he was not likely to have had tea in mind. Nor was he the first official to view the Cape community in this light; Commander Wagenaar had already described the burghers as "versopene, luije, lompe vlegels."⁵⁵ It is, however, important to know and to remember that the Dutch colonists elsewhere were described in similar terms and with equal harshness. Jan Pietersz Coen, the great governor general of Batavia, considered that his burghers were a "godloozen hoop" who "gants onbequaem is tot planting van colonie," for, as he put it, "Tot noch toe siet men hier weijnich, die niet met de vrijheijt in beesten veranderen."⁵⁶ The burghers at Banda were described briefly as "onse droncken Neerlanders."⁵⁷ Then, too, though the Cape may have earned her name, "The Tavern of the Seas," it would have suited New Amsterdam

(now New York) equally well. In 1648 New Amsterdam had a hundred and seventy Church members and not less than seventeen "taphhuijsen," with the result that a quarter of the town consisted of "croegen van brandewijn, cuffen van tobacq off van bier."⁵⁸ With this as a precedent, one is not quite so impressed by the report in 1672 of Commissioner Mattheus van den Broeck, who estimated that there were between eighteen and twenty bars at the Cape, where the life of the publican was preferred to that of the farmer.⁵⁹ In a hard-drinking age, the Dutch colonists, wherever they might be, drank enormously: the Cape was merely part of the pattern.

In the circumstances, it is understandable that most of the early burghers who prospered at the Cape were involved in the liquor trade: among them Joris Jansz, Thielman Hendrix and Hendrik van Zuijwaerden. Many more fortunes would have been made in this way if the Company had not set out, as early as 1665, to control and milk the liquor trade to its own advantage.⁶⁰ Still, when one looks at the list of publicans published by Dr. de Wet, one encounters many familiar names, such as Jan Israelsz, Elbert Diemer, Godfried Meijhuijsen, Jan Dirksz de Beer, and Johannes Pijthius: despite the Company, there was money to be made from alcohol.⁶¹

Drink of a sort seems to have flowed pretty freely at the Cape, though some of the local wines and brandies were of very poor quality. " 'Tis Colour'd like Rhenish," wrote the Rev. John Ovington of the wine, "and therefore they pass it under that specious name in India, but the taste of it is much harder and less palatable; its operations more searching, and the strength of it more intoxicating and offensive to the Brain."⁶² Liquor available in sufficient quantity to be contracted for under government control ranged from the wine of France, Spain and the Rhineland to imported beer, rum, arrack and malt beer and the local wine, beer and brandy.⁶³ Fortunately, we are not here concerned with the ugly effects of over-indulgence in alcohol but with the various fascinating receptacles for its storage and consumption in the house.

Despite the fact that much beer, today, is bought in tins, and

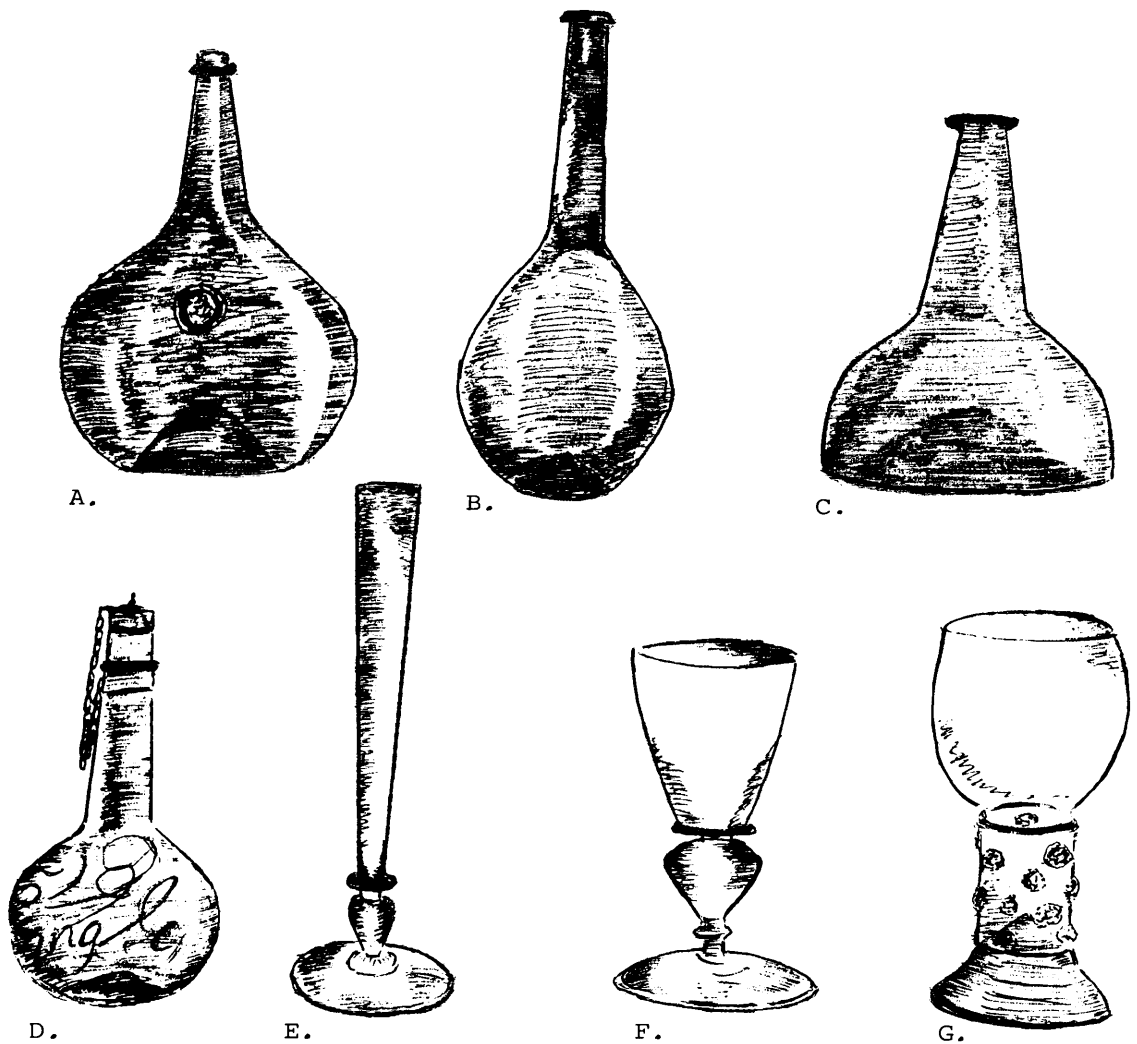

(57) Dutch Seventeenth-Century Glass

- A. Wine Bottle B. Water Flask
C. Wine Bottle D. Silver-Mounted
Flask with Engraved Inscription
E. Tall Drinking Glass (Fluit)
F. Ordinary Wine Glass (Kelckie)
G. Glass for White Wine (Roemer)

cheap wine has recently become available in plastic and cardboard containers, glass vessels still dominate the world of the drinker. We delight in the colour and movement of wine and beer as revealed by a fine translucent glass. It is a delight which certainly goes back to the Romans and was probably known to the Egyptians, but a delight which we ourselves have inherited in unbroken succession from the seventeenth century; for it was in the seventeenth century that the pre-eminence of Venetian glass was broken and the glass houses in many countries, including Holland, began to establish a national style.⁶⁴ Once this happened, glass ceased to be the preserve of wealth and privilege.

Yet glass does not seem to have been at all prominent in the seventeenth-century Cape. The green glass wine-bottles of the time with their long, tapering necks, chunky igloo-shaped bodies and powerful kicks were in use. Christiaan Freser, for instance, had over a hundred glass bottles and Adriaan van Brakel seventy. If the cellaret flasks were also of glass, examples were in circulation from the first year of settlement, and the early importance of glass is beyond question. Table-glass was definitely in short supply, but a little is recorded. For wine there was the green roemer with cup-shaped bowl and strawberry pruned stem, the graceful flute in white metal, with short foot and dramatically long, tapering bowl, and the ordinary "kelkje" which, at least originally, must have had a cup-shaped bowl (Pl.57). There were glasses for beer which may have been tumbler-shaped or cylindrical and occasionally had lids, while for brandy there was the pimpeltje—an unusual shape at the Cape.

In 1662 the chief carpenter at the Fortress had "1 vat met glasen";⁶⁵ in 1664 an ensign named Pieter Evriad owned "2 bierglazen / 1 fluijt om uijt te drincken / 1 wijn roemer,"⁶⁶ in 1696 Freser owned "2 gesnede christalijne glazen," which fetched 5 guilders, 4 stivers,⁶⁷ and in 1697 Meijhuijsen had "4 glaase flesjes" and "1 Wijn Roemer" (VR9). Glass is found in other estates before 1700, but never in quantity. The interesting sale of the goods confiscated from Captain van der Velde⁶⁸ also took place in 1697 and included nearly 300 drinking glasses—an assortment of wijnroemers, kelkies, bierglazen, bierkannetjes, and

and bierkannen. Governor Simon van der Stel bought 72 kelkjes for 15 guilders, 12 stivers, which works out at 2 stivers per glass, and a single lot of "5 bier kannen en 5 botellies" for 10 guilders, 4 stivers⁶⁹—perhaps an indication that this sale presented an unusual opportunity to buy table glass as well as household brushes.⁷⁰

Glass in the early eighteenth century is more prevalent but, perhaps, less so than one might expect. The periodic write-off of broken and damaged goods from the Company stores show that it was regularly imported. In 1702, 128 drinking glasses were written off; in 1704, 58 pieces; in 1705, 44 pieces, etc.⁷¹ When we turn to the inventories and find that the Sneewindts were content with "8 glaase bottels" and "1 Drinck roemer, met een deksel" (I,69,1701), and the Van Reedes with "1 glaase kan met een silvere deksel" and "1 glaase kannetje, of botteltje" (I,74,1703), it becomes clear that glass had a very small part in the interiors of the time. There were several estates with a good deal of glass but in these cases the bulk of it was, almost without exception, stored in the solder. In the Van Stralen/Van Doorninck house 2 glass flasks were present in one of the secondary rooms, 24 small wine roemers were kept in the cellar, while the solder held "356 bierglaasjes in een kasje / 122 kelkjes in do" (i,62,1701). In the Diemer town house a kist in the back room held "1 Glase Commetje met 5 Glaesses," while the solder accomodated a number of empty bottles and flasks, 2 baskets with glasses, and one lot of drinking glasses (III,31,1713). The same pattern was repeated in the Corssenaer house, where there was a single "bocael" in the "groote kamer" and the solder held 2 big baskets with roemers and 9 other baskets with assorted glasses (III,37,1713). I can offer no explanation for this rather curious state of affairs, but it does seem unlikely that glass in daily use was kept in the solder. Households with only a little glass were more likely to have it either on view or close at hand. Elisabet Loenss had "1 glase bakje daerop 6 glasen" in her voor-kamer (II,37,1709), and the Helots had "een rakje met eenige glasen, roemers en kelken" in their gallery (II,43,1710). Some of the other more interesting references are "twee Christalle bier glasen" (II,8, 1707); "2 gesleepe bierglasen" (II,58,1712); "3 glase bocalen" (II,77,1713) and, in the estate of Matthijs Greef, "1 Sootpies

(58) Japanese Porcelain
Gallipot or Medicine
Flask. \pm 1700

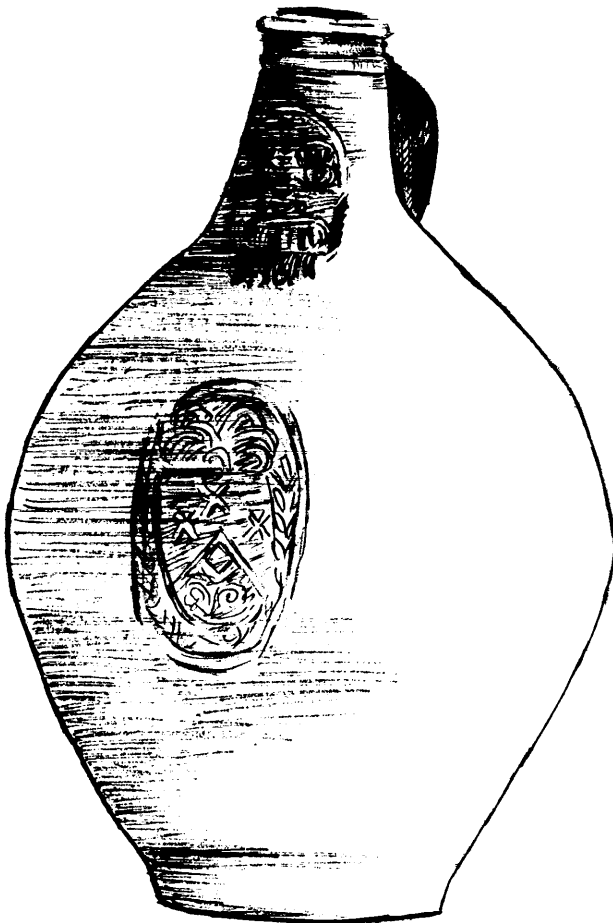
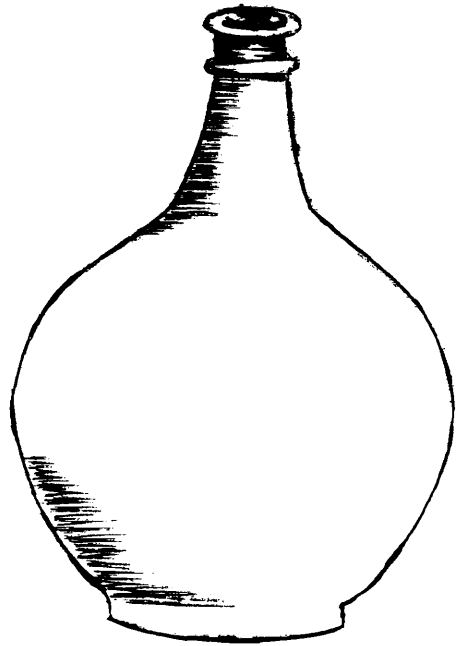

German Stoneware Jug
in Brown Salt-Blazed
Stoneware known as a
Bellarmine Jug.
1660 - 1690

Glaesje en potje / . . . 2 Glasen bottelsties met silvere deksels / [en] 1 Gesnede glas met sijn deksel" (II,63,1712).

The carboy, which is normally understood to mean a large glass bottle with basket work or other casing, designed for the storage of dangerous chemicals, is more precisely defined by Webster's Dictionary as a cylindrical container of about five to fifteen gallons capacity made of glass or metal with a neck and sometimes a pouring lip,⁷² and is encountered quite frequently in the years to either side of 1700. One hears nothing of any sort of casing, perhaps because this was taken for granted, and one hears little of dangerous chemicals; most carboys when listed were empty, but some held wine or brandy. As an empty carboy normally fetched between 7 and 10 guilders it was an important object. If an estate had a carboy at all, it probably had several of them. Adriaan van Brakel had "5 glaase karbaas" (I,46,1699); De Beer had 25 carboys, most of which were empty, but there was "1 karba met caapsewijn" and "4 karabassen met caapse brandewyn" (I,63,1701). The Helots had 8 empty glass carboys (II,43,1710), and Ten Damme had 26 examples valued at only 4 guilders, 10 stivers each (II, 117,1714). Hendricus Munkerus rather upsets the picture with "twee oude porcelijne Carbassen"—they were probably large Japanese gal-lipots (Pl.58)—in addition to eight carboys of glass (II,8,1707). "Keulse" (Cologne) was perhaps the term for all salt-glazed stoneware, for if it only covered blue-and-grey ware, as it was to do later, one has to explain the absence of the popular brown serving jugs of bellarmine type whose fragments appear in early Cape sites (Pl.58). Albert van Breugel had "twee Delffs⁷³ Ceulse Wijn Kannen" in 1675 (23/5,35) and Keulse kannen appear in increasing numbers thereafter.

Drinking vessels in porcelain, and to a lesser extent earthenware, were varied and numerous. Among the more common items in this line were porcelain beakers and flasks: "Eenige klijne porsselijne flesjes" (II,58,1712) for instance, or "1 partij flesjes en beekertjes groot 40 a 50" (II,66,1712) or "Een partij postelijne beekerties en flespotties" (III,13,1714). Also specified from time to time are porcelain bottles such as "11 p^s porsselijne botteltjes" (I,26,1697) and "twe porceleine Japansche bottels" (II,11,1707). Jugs and tankards, both normally recorded as "kannen" or "kannetjes" were

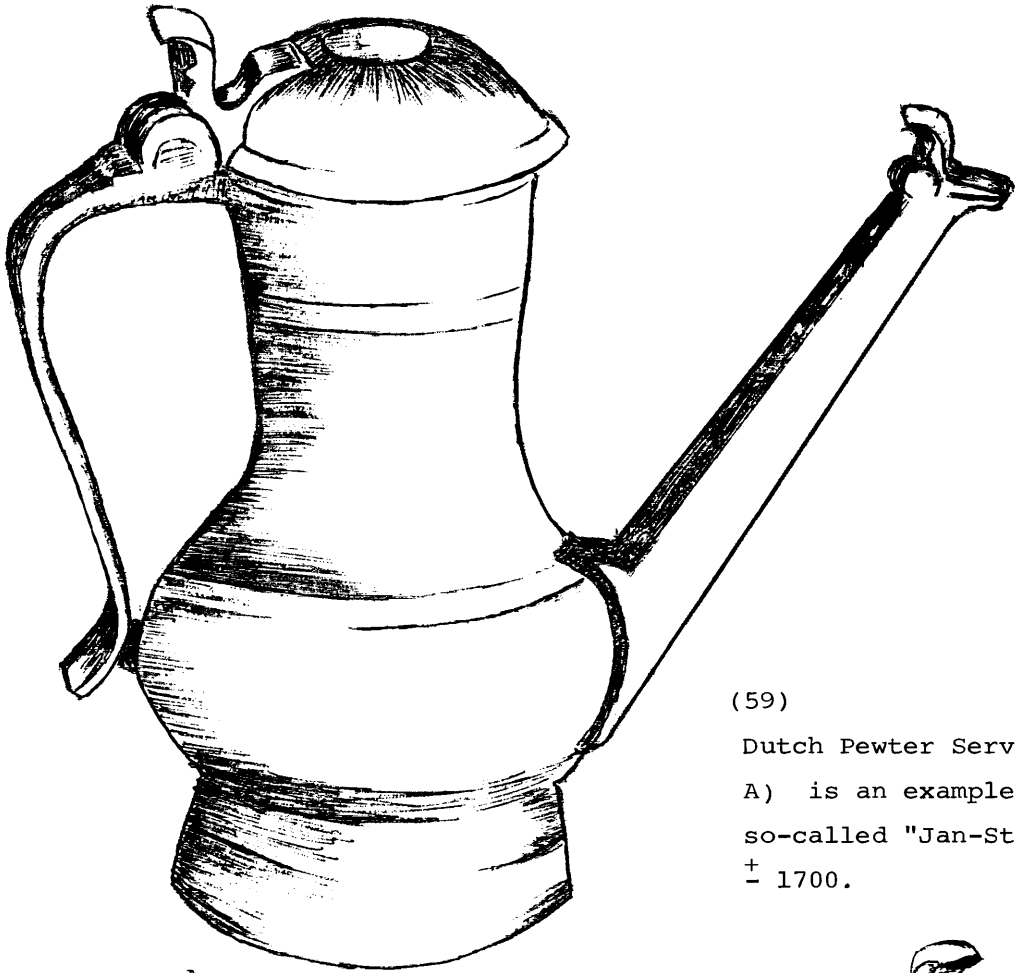

A.

(59)

Dutch Pewter Serving Jugs.

A) is an example of the
so-called "Jan-Steen Kan."
† 1700.



B.

extremely common in both earthenware and porcelain, and a certain number of them were provided with metal lids. A few examples include "2 blauwe aerde cannetjes,"⁷⁴ "2 aarde kannen met tinne deksels" (1,69,1701) and "6 vaderlandsche kannen met silvere deksels / 7 porsselijne kannetjes met do do" (I,74,1703). Among the more specific references to drinking utensils are "4 spawaters kannetjies" (III,31,1713), "een porceleine bierkannetie" (II,11 1707), "3 blauwe Wijnflessen" (3,31,1713), "1 aarde bier kan" (23/5,41.1677), "3 drinkbeekertjes" (II,21,c1708), and "1 porceleijne gorgelet."⁷⁵ None of these need any explanation save the last. The word "gorgelet" derives from Portuguese "gorgoletta" and was the old term for a kendi (gendi).⁷⁶ A kendi is a drinking vessel with a bulbous body and narrow cylindrical neck which is characterised by a second, mammalian-shaped spout on the body. The Dutch acquired a taste for them in the East, where they were very common, and a certain number were shipped to Holland. In time the word "gorgelet" came to mean no more than a water-flask in the Cape inventories, and as earthenware examples, such as "een gorgalet van aarden" (II,11,1707), begin to appear round about 1700, the change may already have been taking place: to the best of my knowledge no earthenware kendis were being made in the East at that period.

Pewter, which was still of such importance on the dining-table, was also of considerable importance to the drinker, though perhaps a little less so in 1715 than in 1700. First of all there were the flasks—sometimes, as in "een tinne Waterfles" (23/5,35, 1675), designed for water rather than anything stronger. Then came the liquor-jug or flagon, which is not always easy to distinguish from ordinary jugs and tankards. This was used for serving wine or beer, and though it is by no manner of means a hard and fast rule, I have been told by leading Amsterdam dealers that the flagon for wine tended to have longer, more slender lines than the beer flagon, which was often a little portly (Pl.59B). All flagons had a hinged lid, some of them had a small lip to facilitate pouring, others did not, and the famous "Jan Steen-kan" (Pl.59A), which was definitely a wine-flagon,⁷⁷ had a long straight spout and was the most handsome of the various spouted flagons made in Holland in the seven-

teenth and eighteenth centuries. Inventory descriptions rarely go beyond so many "tinnen kannen"; among the exceptions are "3 tinne flap kannen" (23/5,41,1677) and "1 tinne pijpkan" (II,83,1713); similar entries occur in other inventories. The Sneewindt inventory contains "2 tinne Menglens kannetjes" (I,69,1701), which sound as though they had something to do with the mixing of drinks. Pewter measures of various sizes were quite common, particularly after 1700, and some characteristic entries are "1 tinne halv mutsjes kannetje" (I,36,1698); "1 tinne pints kannetje / 1 do mutsjes do" (I,69,1701); "1 tinne pintje sonder deksel"⁷⁸ (II,28,1709) and "1 tinne halfpintje" (II,49,1711). Drinking vessels are represented by tankards (kannetjes) and beakers. The De Beers had "19 tinne kannetjes, soo klein als groot" but kept them in the solder (I,63,1701). The Van Reedes had 8 pewter "kannetjes" in their kitchen (I,74,1703) and Gerrit Meijer had "seven tinne kannetjes, groote en kleine maat" which were also in the kitchen and were valued at 8 guilders (II,120,1714). Other estates had some pewter tankards, but by no means the majority. The pewter beaker in the seventeenth and eighteenth centuries was usually trumpet-shaped and sometimes had a flared lip as well: the cylindrical form was not very common.⁷⁹ The beaker, at this period, is found even less often than the tankard, and when it does appear, as in the Sneewindt or Diemer estates, it is in ones and twos. It can hardly be classed as a luxury item, however: there were "3 tinnebeekerties" in the kitchen of Maria Vitou's Drakenstein farmhouse (II,49,1711). The comparative rarity of pewter tankards and beakers⁸⁰ serves as a reminder that any form of specialised drinking vessel was a non-essential piece of household equipment: beer and wine can be drunk without difficulty from a small bowl or pot, and this must have been done over and over again.

A pewter, tin or brass funnel (tregter) is encountered with a certain frequency and obviously had a part to play in house as well as cellar. Its use may have been confined to the kitchen, but it may also have been used to decant liquor. A still, which is an obvious piece of equipment for a wine farmer—Albert Barentsz Gildenhuijs had one valued at seventy-five guilders in his cellar at Roodenburgh (II,61,1712)—was sometimes present in a town house.

There was, for instance, "1 kopere disteleer ketel, met helm en slang" in the Van Stralen/Van Doorninck kitchen. The Van Reedes did not have a still but kept instead "1 groote kopere bier ketel, met do deksel" in their solder (I,74,1703). Home-brewed beer and witblitz has a venerable if undistinguished career in this country.

Even at this early period in the history of the Cape, a survey of drinking equipment must take some account of silver. The purchase of silver was a form of investment, and quite a few families had acquired small collections by 1715. The most popular silver drinking accessory was a beaker. There were also bowls, pap-boats (a careful distinction does not seem to have been made between "Kommetjes" and "papkometjes"),⁸¹ brandy cups, wine cups, and, as we have seen, salvers.⁸² In 1662 Undermerchant Paulus de Molier had a most impressive collection of silver for that early date, which included "1 silver schenckbort: 19 oncen / . . . 1 do Beecker wegende 6 once / 1 do cleijner beecker: 2 once / 1 do brandewijn Schaelje 1 once."⁸³ It is a collection which is seldom equalled during the rest of our period. In 1675 Albert van Breugel had "twee silvere Commetjes met Ooren / . . . een do Spaanse Wijn schaal / . . . een do acht Cant schenck bort / . . . een do Moscovis schaalje" (23/5, 35). Nearly thirty years later the Van Reedes had "3 Silvere schenckbortjes / . . . 1 do deckseltje van een flesje / . . . 2 silvere beekers met do deksels / 1 do Engelse kan" as well as a number of porcelain and earthenware tankards with silver lids⁸⁴ (I,74,1703). When it comes to silver, the burghers could not compete with the company men. Nevertheless, in 1670 Jan Israelsz had "een Silvere Brandewijns bekertje" (23/5,3), while two years later Joris Jansz had "een silvere schaelkje / een do beeke" (23/5, 17), and Hendrik Zuijwaerden "twee Silvere beekers" (23/5,21). Turning to the eighteenth century, the situation is not markedly different. Hendrik Sneewindt had "1 silvere groot schenckbort / 1 do geschulpt schaalje / 1 do geschulpt kommetjen" (I,69,1701). Matthijs Greef had a small array of silver which included "2 Glasen bottelsties met Silvere deksels / . . . 1 Silvere kommetje / 1 do beeker / . . . 1 Silver proset"⁸⁵ (II,63,1712), and Abraham Diemer had "1 Silvere Com" and "2 Silvere Schenkborden" amongst an otherwise far from negligible collection of silver (III,31,1713). Other

estates include a few interesting silver vessels such as "1 kleijn Silver drinckkopje,"⁸⁶ "1 silvere soopjes schaalte" (I, 62,1701), "een brandewijns flesje" (II,8,1707), "1 silvere gedrevene beeker" (II,37,1709), and, in the Helot's list of silver, "een drink Moolen" (II,43,1710). Silver was expensive. In 1691 "1 Silveren beeker met deksel" realised 25 guilders, 10 stivers (VR1); at the De Beer sale two silver "kannen" were sold for 33 guilders and 43 guilders respectively, while a silver bowl at the same sale fetched 81 guilders, 12 stivers (VR18,1701). Hendrik Sneewindt's large silver salver sold for 48 guilders, his dish for 19 guilders, 8 stivers, and his small bowl for 22 guilders, 8 stivers (VR21,1701). Finally, "2 Zilvere brandew: s schaaltes" belonging to the Van Stralen/Van Doorninck estate brought 7 guilders, 8 stivers (VR17,1701): they must have been very small or badly damaged, as a pair of silver spoons normally commanded 9 to 12 guilders.

Before bringing this chapter on drinking and eating utensils to a close, a few additional words on the subject of salvers seem called for. The silver salver (schenkbord) has featured several times in these pages, and its role in the service of a formal dinner has already been elucidated.⁸⁷ The pewter salver, which was also in use at this period, presents no problem--it performed an identical function. Then there was the so-called "bandees." "Bandees," according to De Haan, was a word of Portuguese origin that was used in the East Indies for a salver or "presenteerblad"; and a little further on the same author refers to Tonkinese "bandeezen."⁸⁸ A "bandees" is recorded in quite a number of the more important Cape inventories including that of Olof Bergh, where there is "1 kleijn en 3 poppen bandees."⁸⁹ This is not a particularly illuminating entry, and none of the other references is of any further help. As it was never considered necessary to mention the material out of which a "bandees" was made, the word was probably reserved at the Cape for one particular type of tray or salver of East Indian provenance. The Van Reedes, for example, had a "groote Bandees" in their voorkamer where they also kept three silver salvers, while their back room contained "3 theebackjes / 1 Bandees," a juxtaposition which does not suggest

contemporary confusion (I,74,1703). The "kannebord" is another type of article associated with drinking vessels. The probable explanation here is that we are dealing with a wall-rack fitted with hooks to hold tankards, jugs and flagons, but there are times when I wonder whether this was always the case. Olof Bergh had "1 kannebort met dr e glase en een steene kan alle op een na gebroken,"⁹⁰ and Elbert Diemer "een kannebort met 6 porceleijne kannen en 6 do Commen" (I,2,1685); a tray of a kind cannot be entirely ruled out.

Footnotes

1. Weyns, op. cit. II, 540-50.
2. Begin ende Voortganch van de Vereenigde Nederlandtsche geoctroyeerde Oost-Indische Compagnie, ed. Isaak Commelin, 2 vols. (Amsterdam, 1646), I, Ch. VIII, p.8. Pl.I.
3. The Diary of Samuel Pepys, ed. Henry B. Wheatley, 8 vols. (rpt. 3 vols., London, 1942).
4. Trans. en Schep. II, 59-66.
5. De Volmaakte Hollandse Keuken Meid, facs. ed. (1761, rpt. Leiden, 1965), Bk. I, pp. 135-47. I am indebted to Mrs. Eve Ritchie of the Gubbins Library, Witwatersrand University, for checking the date of the first edition.
6. "Assiette" is the French word for table-plate, but it was certainly not used in this sense at the Cape. My own opinion is that it had the same meaning as "saucierken" and referred to a saucer-shaped serving dish. The invoice for the Swellen-grebel service, which is dated 1751, lists 2 large soup tureens, 12 "vlacke schotels" in 4 different sizes, and then "8 asjetten." After that come 24 soup plates and 60 "vlacke borden"; this leaves me in little doubt about the shape of the "assiette." (See C. S. Woodward, Oriental Ceramics at the Cape of Good Hope, 1652-1795 [Cape Town / Rotterdam, 1974], pl.140.)
7. In the seventeenth century the flat butter dish was almost indistinguishable from the table-plate, and bills of lading sometimes refer to "common-plates or butter-dishes" (Volker, op. cit., p.63).
8. De Volmaakte Hollandse Keuken Meid, Bk. I, p.135.
9. The Oxford Companion to the Decorative Arts, "Cutlery," p.290. I follow this brief but reliable account throughout.
10. Coryat's Crudities quoted by The Oxford Companion to the Decorative Arts, p.290.

11. See above, p.137.
12. Trans. en Schep. I, 130.
13. Ibid., p.357.
14. Perhaps for use during periods of mourning.
- 14a. CJ2916, Freser Vend., 1696, p.13.
15. In 1695 a shortfall of f18 656:8:12 was found in Freser's books. He was subsequently found guilty of misappropriation, deprived of rank and pay, and deported on 1.3.1696 (Resolusies, III, 297, n.56).
16. CJ2916, Freser Vend., 1696, p.13.
17. Saint Simon, Memoires, ed. Gonzague Truc, 7 vols., (Bibliotheque de la Pléiade, 1950).
18. The translation of "kan," which can mean a tankard, a jug or a flagon, presents difficulties which I have not been able to overcome.
19. Among the most handsome dishes made by the Delft potters were pure white moulded examples which resemble stylised chrysanthemums. Known at the time as "schulpschalen," "schulpschotels" and "schulpkommen," they appear in several Cape inventories to either side of 1700. Two examples from the early eighteenth century are on view at Boschendal Manor House.
20. CJ2914, Bergh Inv., 1687, pp. 2-12.
21. Woodward, Oriental Ceramics, pp. 161-62.
22. "Piering" and "tafelpiering" were other ways of designating the saucer dish at the Cape.
23. In 1693, 16 porcelain dishes were valued at f18, 8 pewter ones at f24, 12 pewter plates at f15, and 36 porcelain table-plates at f30 (I,8): many related prices could be cited.
24. Other porcelain tablewares found at this period are oil jugs, oil and vinegar sets, skewers, egg-cups, salt cellars, mustard pots, salvers, fruit dishes, butter dishes, butter pots, sugar pots, pickle pots, lidded bowls, rimmed bowls called "klapmutsen," handleless bowls for drink and soft foods called "spoelkommen,"

pots for preserves, and little saucers for the same purpose. Cups and saucers of red stoneware and butter pots of German stoneware (Keulse boterpotten) are some of the more unexpected ceramic items listed.

25. One "kabinetstelletje" is inventoried as "1 klijn Cabinet stelletje bestaende in 7 beekers, en 3 potjes" (II,37,1709). The miniature cabinet set should not be confused with the cupboard garniture or kaststel which usually consisted of two beakers and three lidded vases. The most popular porcelain figure was a lion dog of Fo, listed in the inventories as a "leeuwtje"; some estates had a dozen or more. Other human and animal figures were also popular: the van Reedes had 12 small porcelain figures (I,74,1703), and Johannes Pijthius had 19 small figures and 5 large ones (III,13,1714). The flower pot, on the other hand, occurs only rarely, and always in ones or twos.
26. Trans. & Schep. II, 1663, p.63.
27. CJ2916, Freser Vend., 1696, p.7.
28. For instance, the Ridolfi Service made at Urbino c1525. Museo Correr, Venice.
- 28a. Anna J. Böeseken, Simon van der Stel en sy Kinders (Cape Town, 1964), pp.221-22.
29. Saint Simon, op. cit., III, 170.
30. David Howard & John Ayers, China for the West, 2 vols. (London/New York, 1978), I, 33.
31. See Jkvr C. H. de Jonge, Delfts Aardewerk (Rotterdam/ 's-Gravenhage, 1965), pp. 254-55 for a description of the service made for Frederick I.
32. Volker, op. cit., p.48.
33. Ibid.
34. Rev. J. Ovington, An Essay upon the Nature and Qualities of Tea (quoted by Bevis Hillier, Pottery and Porcelain 1700-1914 [London, 1968] , p.68).

35. C. R. Boxer, The Dutch Seaborne Empire 1600-1800 (London, 1965), p.177.
36. Weyns, op. cit., II, 608.
37. John Galt, Annals of the Parish, (Everyman, 1926) p.11.
38. Hillier, op. cit., p.78.
39. It is not clear to me whether this is the inventory of Hendrix himself or his widow, but I suspect the latter.
40. In 4 inventories no particulars are given, and a 5th is concerned solely with silver.
41. See above, p. 133.
42. See contemporary illustrations like the frontispiece to Jonas Hanway's Essay on Tea (reproduced by Hillier, op cit., Pl.33), or sculptures like those decorating the Chinese tea-house at Sans-Souci, Potsdam, 1754-57 (reproduced by Hugh Honour, Chinoiserie: The Vision of Cathay [London, 1961], Pl.73).
43. D. F. Lunsingh Scheurleer, Chine de Commande, (Hilversum, 1966), p.104.
44. O. F. Mentzel, A Geographical Topographical Description of the Cape of Good Hope, 3 vols., Van Riebeeck Society, (1787, rpt. Cape Town, 1921-44), III, 104. Mentzel left the Cape in Jan. 1741.
45. Hillier, op. cit., p.80.
46. The term "stel" was used very loosely, but in a general way may be understood to mean anything from 4 to 12 matching cups and saucers.
47. Perhaps these were "bussen" or tea-canisters.
48. See "Kandeel," Woordenboek der Nederlandsche Taal, ed. A. Beets & others, Vol. VII.
49. See above, p. 215.
50. Hillier, op. cit., p.82.
51. Ibid., pp. 81-82.
52. See above, p. 217.

53. Samuel Johnson, "Review of Hanway's Journal and Essay on Tea" (quoted by Hillier, op. cit., p.77).
54. Briewe van Johanna Maria van Riebeeck, p.100.
55. De Haan, op. cit., p.45.
56. Ibid.
57. Ibid.
58. Ibid., n.l.
59. De Wet, op. cit., p.47.
60. Ibid., pp. 46-50.
61. Ibid., pp. 50-52.
62. Quoted by Walker, op. cit., p.57.
63. De Wet, op. cit., pp. 50-52.
64. The Oxford Companion to the Decorative Arts, "Glass," p.399.
65. Trans. en Schep. I, 349.
66. Ibid., II, 88.
67. CJ2916, Freser Vend., p.7.
68. See above, p.200, n. 46. An auction roll of 26.5.1676 includes over two dozen glasses -(MOOC 22/2, n.no., n.p.)
69. CJ2915, Van de Velden Vend., p.2.
70. See above, p.185.
71. Resolusies, III, 392, 409, 422. These glasses were broken accidentally and not, as was done at times, to honour an important guest.
72. Webster's Third New International Dictionary, ed. in chief Philip Babcock Gove (London/Springfield, Mass: 1959).
73. Perhaps this should read "twee aarde Ceulse wijn Cannen," as I cannot decide whether the ditto mark refers to "delffs" which it is directly underneath, or "aarde," which is perhaps more likely.
74. Trans. en Schep. I, 1662, p.343.
75. CJ2914, Bergh Inv., 1687, p.2.

76. De Haan, op. cit., I, 407 & 516.
77. A. J. G. Verster Tin door de Eeuwen, (Amsterdam, 1957), p.24.
78. The group of measures illustrated by Verster have handles but no lids (op. cit. Pl.7), so perhaps this entry is drawing attention to the obvious and not recording a missing lid.
79. Verster, op. cit., Pls. 57 & 58.
80. Beakers of tin and copper were also in use.
81. The silver "kommetje" in one of the inventories relating to Corsenaer's widow, is described as a "papkommetje" in another (III,37 & 39, 1713).
82. See above, p.211.
83. Trans. en Schep. I, 1662, p. 357.
84. See above, p.225.
85. Perhaps a posset pot.
86. CJ2914, Bergh Inv., 1687, p.6.
87. See above, p.132.
88. De Haan, op. cit., I, 407 & 499.
89. CJ2914, Bergh Inv., 1687, p.9.
90. Ibid., p.2.
91. But note the following unambiguous entry in a contemporary American inventory: "One Cann board wth hookes of brass" (Cornelis Stenwick Inv., 1686, Liber 19B, 1677-85, Historical Documents Collection, Queen's College, Flushing).

Domestic Occupations and PastimesSmoking

During the course of the seventeenth century the Dutch embraced the tobacco habit with a zeal that elevated pipe smoking to a national pastime and pipe making to a national speciality. Tobacco was not only enjoyed as a pleasant, harmless stimulant but viewed as a miracle herb; as a cure for boils and running sores, for catarrh and constipation, for headwounds and hysteria, for plague and rheumatism, and even for asthma and coughing fits. Such a panacea was naturally exploited as fully as possible and found its way into an endless variety of ointments and infusions, while the tobacco-smoke enema syringe was a favourite instrument among the medical profession for nearly two centuries. The contemporary faith in tobacco is well captured in the title of a work published in 1690: Tabacologia ofte korte verhandelinge over de Tabak, deszelfs deugd, gebruijk, ende kennisse: Waar door aangewesen wordt een wegh om lang, vroolijck ende gezond te leven. The author, Professor Joannes Ignatius Worp Beintema van Peima, M.D., even takes the rather daring step of advising women to smoke.¹

Though the pipe was the most frequent manner of introducing nicotine into the system, snuff had become sufficiently popular by the end of the seventeenth century for people to turn their attention to the production of suitable accessories. Olof Bergh had no fewer than ten snuff boxes in 1687, so that the trappings not only of pipe smoking but of snuff taking are in evidence from an early date. From its inception the snuff box was a small, elegant trifle, and Lieutenant Bergh was one of the few people at the Cape to indulge himself with a number of them; his examples included a box with silver mounts, another of carved ivory and eight of horn.² Most men of substance were satisfied with one, or at most two snuff boxes of silver, while Hendrik Sneewindt contented himself with a single gold box from Japan. Several tin snuff boxes are also inventoried but the snuff grater, a popular accessory in Europe, is not recognisably present, though many of the brass graters (raspen) mentioned probably served this purpose.

A number of early inventories record small quantities of pipes and tobacco; the inventories for May, 1652, alone contain "2 Rolletjens tabacq," "1 rolletje tabacq ende wat oude Pijpen" and "1 rolletje toubacq: met 2 messen."³ As we approach 1700, pipes and tobacco only seem to have been worth recording when they were present in quantity, and in some cases present in the sort of quantity that marks them out as probable items of private trade.⁴ There was, as Dr. de Wet confirms, a flourishing but illegal trade between the burghers and the crews of visiting ships. "Die vryliede het vleis, graan an selfs wyn in die geheim aan mense op die skepe verkoop en het veral tabak en Europese drank aan land gesmokkel."⁵ Some of the tobacco in the examples that follow almost certainly had a rather dubious history. Thus we find Hendricus Munkerus with seven rolls of tobacco weighing eighty-four pounds and valued at sixty-three guilders (II,8,1707), Sneewindt with eleven rolls (I,69,1701) and Jan Dirksz de Beer with a formidable twenty rolls (I,63,1701). At auction, incidentally, tobacco was sold off a roll at a time, and a household like that of Van Stralen and Van Doorninck with "2 Rollen taback in graauw papier / 1 de loss do" (I,62,1701) had more than enough for its private needs. Tobacco in the seventeenth century came from many sources: from America, from Europe, and even from Mauritius. The Cape inventories seldom concern themselves with the origin of the tobacco, but there is one unequivocal reference to Mauritius tobacco (II,27,1708), and Jan de Beer had a lead box with "weijnigh verinesse tabacq" which may have been *Verinas* snuff tobacco.

The white clay pipe with its long slender stem was a rather fragile article which was normally bought by the half gross—six dozen pipes was the ordinary auction lot at the Cape—or even by the gross. Pipes were possibly a less favoured medium of trade than tobacco, and they certainly took up a lot of room for little in the way of return: in 1709 a small chest with thirty-eight dozen long pipes sold for less than fifteen guilders (VR51). Short pipes were even cheaper, but they are mentioned so rarely that they cannot have enjoyed much favour. Because pipes were kept in considerable quantity, they are normally encountered by the chestful:

"1 kistje met korte pijpen" (VR17,1701); by the basketful, "1 pijp Mandtie" (II,63,1712); in an old cellaret, "1 kelder met pijpen";⁶ or in a specially designed cupboard, "1 pijpekass met vijftigh dosijn Langepijpen" (II,33,1709). Silver stoppers were available, "10 Zilver peijpe dopjes"⁷ and may have been used with clay pipes. As the clay pipe improved with use it was to the smoker's advantage to handle it with care. A simple but inelegant way of carrying the pipe safely was to thread it through a hole in one's hat, a habit illustrated by the art of the period; a better but more expensive method was to provide it with a close-fitting protective case (Pl.60A). The pipe-holder, which varies in length from fifteen to twenty-five centimetres, closely follows the outline of the pipe, and though the oldest known examples only date to the beginning of the eighteenth century⁸ a reference to "1 blikke pijpedoos" in 1698 (VR11) shows that they were in use even at the Cape before the end of the seventeenth century. Pipe-holders with silver mounts are mentioned most often and were probably made mainly of wood, while examples in silver and ivory also occur. A pipe-rack does not appear in the documents before 1715, but is quite a common item from 1725 onwards, when it often occupied a position in the voorhuis.

A box to hold the tobacco when chopped up and ready for use was a common smoking accessory. The most valuable examples recorded at the Cape were silver. An early example, "1 silveren tabaxdoos," was sold in 1691 (VR1), and a fair number appear during the next quarter century. In 1695 the merchandise in one estate included twenty-five leather tobacco boxes valued at nine guilders (I,13). Other tobacco boxes listed are of tortoiseshell with silver mounts, tin and lead. Many handsome brass boxes with engraved decoration have survived in Holland (Pl.60B), but they were seemingly so common that only the inventories of the 1660's and 1670's pay them much attention. They are certainly mentioned later, but not very frequently, so that when one finds an undescribed tobacco box it is most likely to have been brass. Pipe smoking required that tobacco be cut from the roll and finely chopped. For this special boards and knives were made. These were not common at the Cape, where the ordinary kitchen chopping knife (hakmes) and chopping board (hakbord) were probably pressed into service, but in 1719 "2 Toebaks messen met planken" are inventoried

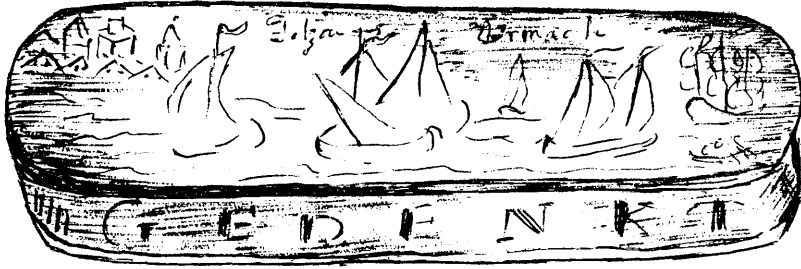

A.

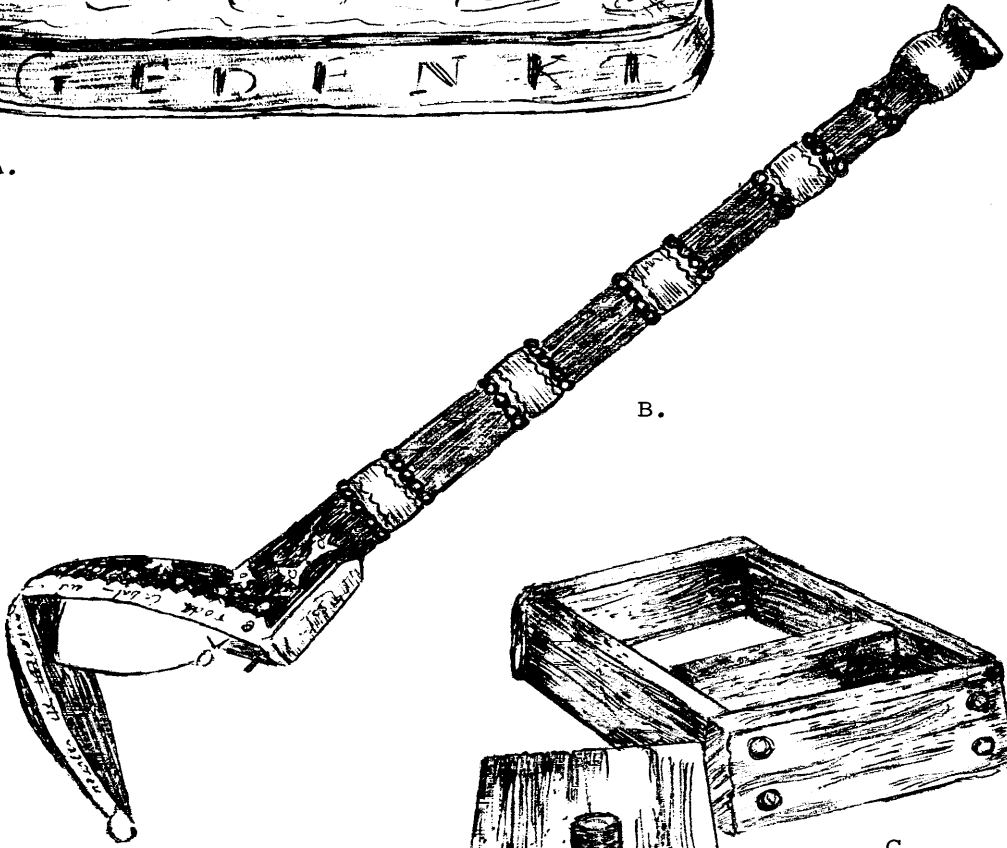

B.

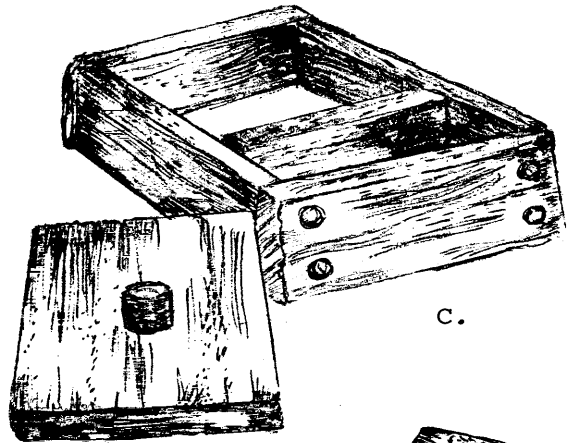

C.

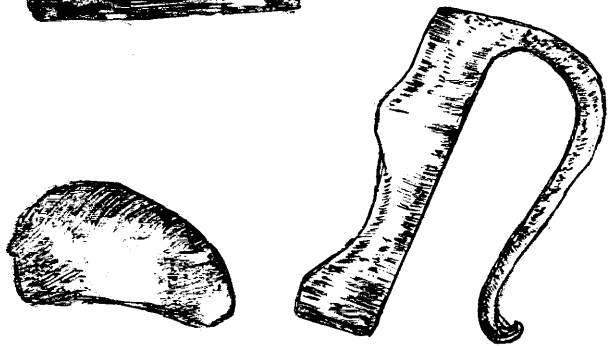

D.

(60) Smoking Implements

- A. Brass Tobacco Box
- B. Wood and Brass Pipe Case
- C. Wooden Tinder Box with
a Compartment for Kindling
and Another for Flint and
Steel
- D. Flint and Worn Steel

All Dutch except for the Steel
which is English Early Eighteenth Century.

(III,95). A pipe-cleaner to clean the pipe and freshen the burning tobacco is essential to all pipe smokers. Though it is true that other things will do the job equally well, it is probably their relative insignificance that keeps pipe-cleaners out of the inventories: an exception is an inventory of 1652, which records "2 rolletjens toubacq I Prick ende Pijpen."⁹

A pipe smoker is in constant need of a light, and the easiest source of a light in the days before an efficient match was produced was a small brazier, so every smoker in the seventeenth and eighteenth centuries kept a brazier beside him. To transfer the fire from the brazier to the pipe, small tongs were sometimes made, but these were exceptional and most people used sulphur matches. In Holland matches were often made from dried stinging nettle stems or hemp. These were cut to the right size, bunched, and the tips dipped into sulphur.¹⁰ It would be unexpected if some substitute for the nettle was not quickly found at the Cape, and the concomitant sulphur is mentioned on several occasions—"1 papier met swavel" (L,63,1701). Braziers (komfooren) and fire pans (tesjes) were common household items, but only very occasionally qualified by the epithet "tabaks." Much more common than "4 koopere Tabaks Confoortjes" (III,92,1719) or "1 silver tabax Confoortje"¹¹ or "1 Coopere tabaks Tesje"¹² are the vuurtesjes which appear in copper, brass and iron and were probably identical to the tabakstesje. The overwhelming majority of braziers and fire-pans inventoried are not ascribed to any particular purpose and, as all such articles were stored in kitchen or pantry when not in use, their location offers no clue as to their purpose. A goodly number, however, probably ministered to the needs of pipe smokers.

In most household inventories there is nothing to show how fire was produced in the first place, but the loose inventory from the seventeenth century which is concerned with some sort of store¹³ shows that this is one of the minor fields in which the inventories are incomplete. Listed there are "280 Engl: vuer Steene / 76 holl: do do / 30 tontel doosen / 29 vuer staalen." In private inventories one also finds a very occasional flint and steel and tinder box (Pl.60C), one of the latter, "een Tonte doosje," being in the Munckerus estate (II,8,1707). In addition there are one or two

references to burning glasses (brandglazen).

The concern of early books of etiquette with the niceties of spitting show that it was part of the European way of life centuries before the introduction of tobacco.¹⁴ Tobacco, however, was an added stimulant. Until subjected to the improved manufacturing methods of the twentieth century, tobacco whether chewed or smoked intensified the activities of the salivary glands and made it very difficult not to spit.¹⁵ As the Dutch housewife was sufficiently houseproud to object to her menfolk spitting on the floor—a degree of fastidiousness which astounded foreigners¹⁶—the spittoon was introduced to cope with the excess saliva. The early spittoon was an attractive article, usually made of brass, with a rounded belly and dramatically flaring lip. The first inventory to record anything of this sort is that of Albert van Breugel with "twee silvere spuij beckettjes" (23/5,35,1675), but it is only as we approach 1700 that spittoons begin to appear at all frequently, and it is rare to find more than one or two per household. In addition to brass spittoons there were a few porcelain and silver examples in use: the Sneewindts had two of the former and Senior Surgeon ten Damme one of the latter. The first estate to include a great many spittoons is that of Hendricus Munkerus. He had two pewter spittoons and fourteen "bengaalse quispedoors" in three different sizes (III,8,1707). In the last few years under review a few other households found a place for a dozen or more spittoons, but it was still customary to store them out of sight in kitchen and pantry. A permanent array of spittoons in the living area was not appreciated at this period, nor at any time during the first half of the eighteenth century. If a couple of spittoons did creep out of the kitchen area, they seldom got further than a back room.

Reading

The system of primary school education in the Netherlands of the seventeenth century had many glaring faults, but it was nevertheless in advance of its time and ensured a standard of literacy that was unparalleled elsewhere in Europe. It seems to me possible that the Cape enjoyed a degree of literacy in the early years of her history which she found impossible to maintain. I make this

suggestion because I am struck by the number of early households that owned a few books—books which presumably at least one member of the family could read, and because I have the impression that books, like paintings, were distributed more widely at the beginning of the eighteenth century than they were at its end. It may also be significant that one is much more likely to find a detailed catalogue of books in a seventeenth-century inventory than in a later one, which does suggest that books were regarded with great respect, if nothing else. This does not mean that most estates during this period included books, for nothing could be further from the truth. Indeed, for every household that contained one or more books, there were something like three with no books whatever, but even this, when one considers the humble origins of most of the population,¹⁷ is not a bad record. Dr. de Wet has drawn up a table of literacy based on whether a man is known to have been able to sign his own name or not, and estimates that between 1657 and 1707, 29,2% of the male burghers were literate, 20,1% were not, while no confirmation was available for the remaining 50,7%.¹⁸ Again, given the circumstances, this is not a bad record, though it should be remembered that an ability to sign one's name is no guarantee of one's ability actually to read a book.

The belief that the Bible was an essential item in an early Cape household while other books were virtually ignored is part of our folklore, but one which contains only a modicum of truth—at least when applied to the period we are here considering. It is true that a Bible, or a copy of the New Testament, or a psalm book, may be present in estates where no other books are mentioned, but this is not normally the case: for every house with a Bible or part thereof, there are at least three with a more varied selection of books, which means that most families with a Bible or New Testament were sufficiently literate to make use of it. Another point of interest is that Bibles were a good deal less common than New Testaments and psalm books. This is particularly noticeable in the seventeenth century but holds true in the eighteenth century as well. In short, the inventories do not reflect a society uniformly devoted to Old Testament Calvinism¹⁹—a religious turn of mind that may possibly have been nurtured by the dispersion that

began shortly after 1715.

Bibles were expensive, which no doubt helps to account for their relative scarcity. A large example with brass or silver mounts ranged in price from about twenty to a hundred guilders, and even a small Bible could be worth ten guilders or more, particularly when provided with the desired metal mounts. Because of their often considerable value, Bibles received a good deal of attention and one comes across "een Spaensche bijbel in folio" (23/5, 23,1672), "1 franse bijbel in 4" (I,47,1699), "1 groote staaten bijbel met coperen slooten" (I,63,1701), "1 hoog duijtse bijbel met silver beslagh" (II,63,1712), or "1 bijbeltie met silver beslag en do ketting" (I,74,1703). New Testaments were not only mounted in gold and silver—"een testament in 8^o met silver beslagh en kettings" (23/5,1,1674), but in silver gilt and gold. Lieutenant van Reede's wife had a gold-mounted New Testament that sold for 181 guilders, 8 stivers (VR27,1703). Psalm books, the majority with silver mounts, nearly always occur in pairs, and were presumably carried to church by husband and wife.

Books have been present at the Cape since the very beginning. In June, 1652, Ensign Bartelt Jansz left a "Partije Boucken," and in July of the same year another ensign left "9 stuckx groote es [sic] kleijne boeckjens."²⁰ The first detailed record of books at the Cape that has been traced concerns a case of unmarked books which, when opened on January 8th, 1661, in the presence of Commander van Riebeeck by the Secunde Roelof de Man and his subordinate, J. Blank, was found to contain books and some drawing materials. The books—twenty-four in all were listed—form an interesting assortment and include the Herbal of Dodonaeus, Kepler's Harmonicus Mundi in five volumes, and Eusebius's History. There were books on astronomy, astrology and trigonometry as well as a two-volumed History of the United Dutch Chartered East India Company, an Arabic grammar, and three books on architecture, one of which ran to ten volumes.²¹ The next detailed library to come down to us is that of Roelof de Man himself, who died in 1663; his inventory lists twenty-two different titles.²² Several later inventories— they are mostly from the 1660's and 1670's—also include a catalogue of the books present. The first of these is the theologically

oriented library of about fifty titles left by the Sick Comforter Jan Jorisz Graan, who died in 1665.²³ In 1672 Undermerchant Daniel Fromanteau left a varied assortment of about thirty books (23/5,23), and the following year Jan van Renver, free burgher and procurator, left an interesting mixed library of just on seventy books (23/5,25). The largest of these libraries belonged to Merchant Albert van Breughel who left about a hundred and forty books, only half of which were considered worth particularising (23/5,35,1675). Finally there is the early eighteenth century library of Undermerchant and Cashier Hendricus Munkerus from Haarlem, a most interesting collection of close on seventy books. The largest library dispersed at the Cape by public auction during this period consisted of four hundred books. The books belonged to a fiscal whose name, in the relevant passage in the Placcaatboek, is indistinct but resembles Pieterij—the Christian name has been left blank. This man was not a member of the Cape Government and had presumably died en route to the Cape. Unfortunately nothing more is known about this collection except that it was sold at the Fortress in 1673.²⁴

Books at the Cape, or at any rate those which were considered worth inventoring in detail, were, with one exception, the property of senior Company officials, but the estates of the burghers also included books. In 1699 the widow of the burgher Jacob Bisseux left "1 bijbel met 50 ps andere boekjés" (I,45,1699), and in the same year another burgher, Jacob de Wilt, "1 franse Bijbel in 4 / 30 ps kleijn boekjes" (I,47,1699). All too often books are recorded unhelpfully as "1 party gedruckte boeken," "eenige boeken" or "1 party oude boeken"²⁵ but we know that the Van Stralen/Van Doorninck estate had just on thirty books, that the Sneewindt estate included twenty-six books, and that of the Huguenot Surgeon of Drakenstein, Gideon le Grand, a hundred and twenty books, which, one presumes, were medically orientated and of little general interest—a presumption based on the auction price, for while his five large dictionaries sold for just on thirty-five guilders, the remaining books brought in about twenty-five guilders, a derisory sum (VR60,1710).

The Diary of Adam Tas confirms that books were not the preserve of the officials but had a part to play in the lives of some of the burghers. The first page of his diary refers to a messenger arriving at Stellenbosch from Cape Town and bringing with him "the book containing the history of the brothers Cornelis and Jan de Wit, and eleven numbers of the 'Boekzaal' lent some time ago to Mr. Starrenburg." A couple of lines later, Tas refers to the "predikatie-boek" by the well-known liberal predikant Balthazar Becker.²⁶ On a Sunday several weeks later he recorded that it was nonsensical for anyone who was literate to walk to Church to hear a reading,²⁷ and on 6th July, 1705, he wrote "to Stellenbosch and paid Mr. Mahieu 2 1/2 rixdollars for three books bought at the sale of Mr. van Loon's books."²⁸

People, both burghers and officials, did read at the early Cape, and even if most people regarded it as a rather poor substitute for drinking and smoking, it is interesting to know what sort of books, other than almanacs and memory books, they had about them. The six libraries recorded at this period were rich in books on theology and law. Legal titles like Van Alphen's Papegaai, Damhouder's Civile en Criminele Practijk, Van Leeuwen's Het Roomsche Hollandsch Recht, Coren's Observationes Rerum, Peckius's Handopleggen en Besetten, and Hugo de Groot's Inleiding tot de Hollandsche Regtsgeleerheid, soon sound a familiar note.²⁹ Theological works include books, in translation, by several of the great Puritan theologians such as William Ames, William Perkins, and Thomas Goodwin, as well as the works of Dutchmen like the great Erasmus; Willem Teelingh; the Utrecht theologian, Gisbert Voetius; and an obscure but obviously popular author, Christofferus Love. Most books are unattributed but the titles are colourful and evocative: Tractaet van de Gevalle Conscientie, Conferentie en Aenhangsel over Praedestinatie, Cort bewijs der Weederdoopers, Verhandeling van de Duijvel en Adherenten and Eens Christen Val en Overstaen.

For more relaxed reading there were biographies like 't Leven van J: V: Oldenbarnevelt, Henriette Marie and 't Leven en Bedrijf van W^m de 3^e; histories like Der Griecken Op en Ondergangh and Geschiedenis van Onses Tijts; travel books like De Reizen van Jan Huijgen van Linschoten, De Beschrijving van d' Cust Malabar

Ceylon and De Beschrijving van China and unclassifiable titles like Den Op en Ondergang der Groten and Morgen Mecker [Mecca ?] der Princen. Two books enjoyed great popularity, Batavische Arcadia by Joan van Heemskerck which was first published in 1637,³⁰ and Die Persiaense Rosegaert, which sounds delightful.

Though Latin dictionaries and Latin grammars appear in several of these libraries, I have the impression that the owner of only one of them, Hendricus Munckerus, read Latin with ease and pleasure. In addition to Aesop's Fables, a Horace and an Ovid, he had several volumes of poetry by obscure Latinists of the seventeenth century. Elsewhere one comes across a Livy and an Ovid, but the Latin classics are not much in evidence. Dutch classics fare only a little better; there are a few works by Vondel, Hoogstraten and Cens. Huijgens, and I may have overlooked others whose titles are unfamiliar to me. Like Dr. de Wet, I have found nothing to suggest that Jacob Cats was read at the Cape, despite Huizinga's statement that this was the case.³¹ Albert van Breugel had a copy of Don Quixote, and titles such as De Sweetse Soldaat, Cleopatra, and De Getroude Chriseijde apparently catered for the contemporary taste for the picaresque on the one hand and romantic history on the other.

As well as dictionaries and grammars in a variety of different languages, several libraries had books on mathematics, and there were also books on medicine and astrology. Graan had a French Atlas and Munckerus had an atlas with a hundred and fifty-six plates that was valued at sixty guilders. Finally the work of the humanist and neo-Stoic Justus Lipsius appears in at least two of the libraries. For those who wanted to read and knew the right people, the early Cape was not a complete cultural desert. It is perfectly understandable how the German, Joachim van Dessin, who arrived at the Cape in 1727, was able to put together a library of 3 800 books and numerous manuscripts, for though Professor Franken has been able to show that a number of the Van Dessin books were ordered directly from Holland, many of them were bought at the Cape.³² At his death in 1761 the Van Dessin Collection became the nucleus of the first public library in this country, and the names of the original owners with which many of them are incised bear witness to their provenance.

Well-educated parents are reluctant to tolerate illiterate children, but educating one's children was an uphill battle at the Cape. Primary school education of a sort was certainly available in the towns, and the whole subject has been covered by P. S. du Toit in his Onderwys aan de Kaap onder de Kompanjie, 1652-1795.³³ In the Dagregister for August 18th, 1676, the following books are listed for school use: "4 boecken getituleert Christelijke Zeevaart, 34 letterkonsten, 38 ABC boeckjens, 12 gebede boeckjens [en] 21 historien soo van David als Tobias."³⁴ Some of these titles turn up again in the inventory of the anonymous store to which several references have been made³⁵ where "30 Letter Kunst schoolboeken / 25 Kate Chismus do do / 25 a:b:c: boeken" are recorded.³⁶ It is likely that most of the prominent families kept a few educational books for the benefit of their young, but apart from Catechisms, one or two copies of Christelijke Zeevaart, and various grammars and dictionaries such as Een Klarebondige Methode om Latijn te Leren, I have noted only a single reference to "1 party schoolboekjes" (VR51,1709). On the whole the education of the primary schools of the period probably achieved little more than a knowledge of the alphabet and a parrotlike familiarity with the main tenets of the Faith. That this was all that was aimed for is made clear by a School Ordinance of August 21st, 1714, which required the schoolmaster to ensure a knowledge of the Our Father, the Ten Commandments, the articles of the Christian Faith, morning and evening prayers, grace before and after meals, the singing of psalms and the Catechism. It was also the duty of the master to see that the older children had a proper understanding of the Sunday sermon. The ordinance further concerned itself with discipline, deportment and rewards, but had nothing at all to say about purely academic matters.³⁷ An education of such narrow intent was hardly unusual, but in Europe it was supplemented by the intellectual life of the home and of society at large. At the Cape the deficiencies of the school were less easy to remedy. A few people sent their children home to Holland, but this was a dangerous exercise as well as an expensive one. Given all the circumstances, it would not be in any way surprising if the eighteenth century actually saw a regression in matters intellectual—a regression which is perhaps charted by the

total lack of detailed interest in books when present, and by the negligible prices they commanded at auction.

Books were stored in a number of ways. There are references to books in chests: "2 kistes met wat oude boeken" (III,37,1713); to books in coffers: "1 oude koffer met wat boekjes" (VR12,1699); to books in wall cupboards: "Int bottelarijten / 26 gedrukte gesorteerde boeken / . . . [en] 1 houtte Rack" (I,62,1701); and to books on open shelves "1 Rakje met boeken" (II,49,1711). Glass-fronted bookcases were fast coming into fashion in Europe round 1700, but there is no reason to suppose they had reached the Cape by 1715, and at no stage of the eighteenth century do they seem to have been much in use there. In the seventeenth century when books were arranged on shelves they were normally placed with their spines to the wall, which was an inconvenient practice but had the merit of protecting fine bindings.

Whilst on the subject of bindings it seems worth recording that books at this time left the printer unbound, which is why Albert van Breugel's library contained "veertigh ongebonde boeckjes" (23/5, 35,1675). One or two estates, including that of Corssenaer's widow, owned a paper press (papierpers). Such presses consisted of two metal sheets with screws at the corners and a carrying handle in the centre of the upper sheet. They were essential equipment for anyone who wanted to bind his own books. A book with a handsome binding was expensive. Munckerus's "drie deelen vander op en ondergang der groten 1698 in france banden" were quarto size and worth twelve guilders (II,8,1707).

Writing

An estate which includes books is an estate in which one also looks to find an inkstand, a small but telling piece of evidence that the family concerned was literate. Early inkwells were substantial affairs with a container for the ink, another for the sand, some sort of support for the pen, and frequently a small drawer underneath for accessories like sealing wax and a knife to trim the quill pen. Types of inkstand (inktkoker) found at this period include examples of glass, wood, ivory, brass and pewter. Bundles of quill pens like "29 bossen schagten" (II,66,1712) are recorded

periodically, though seldom in such quantity, and there are a few references to silver and gold pens: "een silveren schrijfpenn" (I, 68 1/2, 1701). Books of writing paper like "3 boecken schrijfpapier" (23/5, 36, 1675) are quite usual in the early inventories but are ignored in later documents. Ink is seldom recorded, but the inventory of our anonymous store lists "14 pakjes inkt poeijer" as well as "9 Stange Zwart Lak";³⁸ for sealing wax was not only required for official documents but used to seal ordinary letters at a time when envelopes were unknown. Albert van Breugel had "negen Cijfer stempels" (23/5, 35, 1675).

A writing slate (lei of schrijftlei) and an abacus or numbering slate (cijferlei) are mentioned on a number of occasions, and though they may have had a part to play in the schoolroom their role was obviously not restricted to the education of the young. To me it seems possible that their early popularity is an indication that, along with the equally popular measuring rod (el)³⁹ and weights and measures, the writing slate and abacus made a contribution to the efficient conduct of various personal transactions involved in the private trading on which the prosperity of the burghers so heavily depended.

Sewing, Knitting and Spinning.

Sewing, unlike a knowledge of reading and writing, was not something a young girl could be allowed to master imperfectly or not at all; it was the girl who could not set a fine seam that was ill educated, not the girl who could barely sign her name—a fact acknowledged by the attention given to sewing in the primary school education of the Netherlands.⁴⁰ This does not necessarily mean that the majority of clothes were made in the home. Anne Buck in her recent scholarly work, Dress in Eighteenth Century England, points out that the number of tailors recorded in the small towns and villages of England at every period of the eighteenth century indicates that even among the common people all but the poorest had their clothes made by the local tailor.⁴¹ It is not unreasonable to suppose that what held true for England also held true for the Continent, but did it hold true for the Cape as well? The answer, I think, is very probably yes. Dr. de Wet has traced

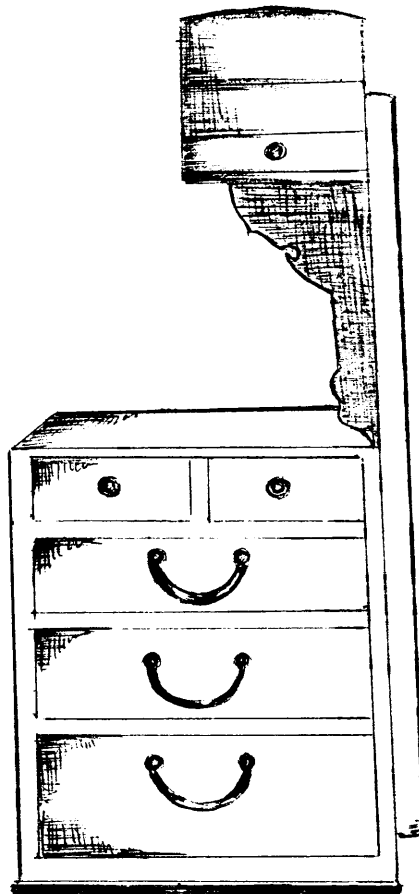

(61) Haribako or Sewing Box.
Mulberry Wood with Copper
Fittings. Japanese.
Nineteenth Century.

the names of seventeen burghers who practised the trade of tailor before 1707,⁴² and in addition to this far from negligible group there were the Malay slaves with their talent for the needle. This does not necessarily imply that the women spent little of their time bent over their stitchery. Underwear, like shifts and shirts, usually seems to have been made at home, as does the household linen. The preparation of a trousseau, even if this involved no dressmaking, was an important and time-consuming activity in the life of a young girl. Then there was embroidery. Fine embroidery was much admired and added a cachet to numerous accessories such as slippers, gloves, aprons and kerchiefs, not to mention cushion covers, chair covers and bedspreads.

Given the circumstances it is surprising how small a mark the paraphernalia indispensable to the needlewoman has left in the inventories and vendu rolls. Slave labour is no explanation: sewing requires certain tools no matter who is engaged upon it. Since the handful of personal possessions belonging to the average sailor with which the earliest inventories are largely concerned often included needles and thread, pins and sewing scissors, one has to conclude that from about 1680 the blanket term "rommeling" has a lot to answer for. This does not mean that one cannot cite a list of articles related to sewing. Most in evidence is an object known as a Japanese naaikussen or Japanese sewing cushion. The first reference I have noted occurs in 1674 and is unusually detailed: "een Japans verlact coffertje off naeijcussen met een verguld curieus overtrecksel, slot en sleutel" (23/5,I). This is only partially illuminating, but could possibly refer to a Japanese sewing box or haribako. This is a small square box about a foot tall with various drawers for sewing accessories. It is characterised by a support on one side that extends above the main box and ends in a small container designed to hold a pincushion. Several strands of thread are sewn loosely through the cushion and are then looped over a pin piercing the corner of the garment on which one is sewing. In this way the fabric can be held taut, which makes it easier to do hems and other finishing work requiring a blind stitch⁴³ (pl.61). It should perhaps be recorded here that Jozef Weyns was also exercised by the problem of the "naaikussen" in the Flemish inventories, though never, as far as I know, by a Japanese naaikussen. He suggests that

it was sometimes a lace-maker's cushion and sometimes a pin-cushion,⁴⁴ One would like to suggest that it could be a lace-maker's cushion as well as a haribako at the Cape, too, because otherwise a lace-maker's cushion is conspicuous by its absence. There is a problem, though: the Japanese never made lace.

In addition to the Japanese naaikussen there are the occasional sewing basket and sewing box. One entry reads "1 beugel tas met / 1 naijdoos" (VR56,79), which shows that the sewing box could be carried about, either attached to the chatelaine or within the purse. Then there are quite a few pincushions. The speldenkussen was not always a very useful object. A handsomely worked pincushion was made for a new-born baby and the day of its christening saw the names or initials of the child picked out on it in pins.⁴⁵ Other small articles recorded include the needle-case (naaldkoker), the pin-box (speldenbakje), which occurs in pewter, silver and tortoiseshell, the thimble (vingerhoed), which is only mentioned after about 1680 when made of silver,⁴⁶ the tailor's thimble (naairing), sewing scissors such as "een naij Schaartje met Silvere handgreep" (23/5,1,74) and, of course, pins and needles. Daniel Fromanteau, an undermerchant in the Company, seems to have traded privately in sewing accessories and his inventory records "Vier dosijn brieven Spelden / Ses dosijn naeij ringen / Vier duijsent Stx Naeij naelden / een dousijn grote scharen / een do cleijnde / Noch twee dousijn schaeren/. . . achthien douzijn vrouwe vingerhoeden" (23/5,23,1672). Also to be found are the cotton, wool and silk yarns, the gold and silver wire, the buttons, lace, braid and fringe, and length after length of material. It is all there, but in the minority of inventories. In most cases there is no mention of so much as a needle. To redress the balance, however, the store inventory is particularly rich in items of this nature.

It is virtually impossible to decide whether knitting was a regular activity in the early Cape or not. Three unspecified "brijnaalden" and "1 copere brijnaelt"—this last cannot have been pleasant to knit with—were sold in 1709 (VR59), and in 1696 the Freser sale contained "1breij houtje";⁴⁷ these are the only traces of knitting I have noted after 1690. The store, however, had a stock of "24 Stelle Staale brij naalden,"⁴⁸ and a few knitted garments

appear in the early inventories. "Vijf paar gebreijde witte handtschoenen . . . [en] een witte gebreijde roc voor Joanna" in the Van Breugel inventory, for instance (23/5,35,1675).

Another elusive object is the spinning wheel, which only occurs in one inventory (II,117,1714). Spinning was a routine activity for the common people of Holland, and numerous examples appear in the Goudswaard inventories. A spinning-wheel, however, is not something that would ever have been ignored or dismissed as "rommeling," and we can safely conclude that spinning was not a normal domestic occupation at the Cape. Though the Company wanted wool and were disapproving of the burghers' preference for the fat-tailed, hairy sheep of the country, they wanted wool to export to the fatherland. Efforts to encourage stock improvement were not particularly successful and when a certain amount of Cape wool did reach Amsterdam—in 1714 and 1716 for example—its quality was so poor that it proved unsaleable for spinning purposes.⁴⁹ This is not the place to consider the indifference of the farming community to stock improvement—an indifference which may have been influenced by the indifference to spinning evinced by the females among them—but the lack of suitable wool obviously accounts for the virtual lack of spinning wheels. As far as I know the only person to put the local wool to really good use at this period was the Huguenot immigrant, Isaac Taillefert. In the 1690's Taillefert used wool to manufacture fairly good hats; a skilled pursuit in which he had no colleagues or successors.⁵¹

Indoor Games

The Erasmian element that the historian, J. H. Huizinga, stresses in the Calvinism of seventeenth-century Holland⁵⁰ seems to have coloured life at the early Cape, where board and card games could obviously be enjoyed with a clear conscience. Backgammon, if the number of boards listed is any guide, was one of the most popular domestic pastimes. The normal backgammon board was made of wood and when closed had the appearance of a square

shallow box; when open it provided two identical boards with raised edges. Few backgammon boards were worth less than *three guilders* and good examples were much more expensive. Elisabet Loenss had "2 verkeerborden met haer ijvooren en ebbenhoute schijven waervan een met Cooper beslag" (II,37,1709), which realised about 24 guilders each at auction (VR56). Trick-track, a popular Dutch version of backgammon, is marked by the occasional "ticktackbord" (I,46,1699), and one meets as well with the still more occasional draughts board (dambord). Backgammon and trick-track were games for two players, usually two male players, and as trick-track in particular was played a great deal, and often for high stakes, in contemporary Holland, it is likely that money also changed hands in this manner at the Cape. Later in the century trick-track tables were made, though not *for the most part* by the cabinet-makers at the Cape. Two trick-track tables believed to have originated in Batavia in the latter part of the eighteenth century are in the collection of the Cultural History Museum, Pretoria.

Card games, at least in the circle where Adam Tas moved, were also popular: "Des namiddags quamen t'onsen huijze juffw. van der Bijl en Gildenhuijs, neevens nonje Geertuij van der Bijl. Zij geraakten met elkanderen aan't kaart spelen, en zijn tegens den avond vertrocken."⁵² And this is but one of several references to card-playing in the Dagboek. Cards are seldom mentioned in the inventories except when present in considerable numbers: thus among the merchandise in the seventeenth-century inventory of Paul Maron there are "12 ps speelkarten" valued at 1 guilder, 10 stivers (I,13,1695), while Munkerus had "113 spellen kaarten" valued at 13 guilders, 4 stivers (II,8,1707), and the Van Stralen/Van Doorninck household "7 1/2 dosijn speelkarten" (I,62,1701) which sold for 14 guilders, 4 stivers (VR17). Among the items at the store there were "16 Spel Engl: Kaarte / 19 do holl: do,"⁵³ As a single pack of cards was extremely cheap, there were probably few families without one. Card tables were certainly made at the Cape, but were probably not introduced before the middle of the eighteenth century.

There are isolated references to several other games. Attention has already been focused on the game of goose found at Rustenburgh.⁵⁴

Roelof de Man had "1 kolff met 4 Penneballen"⁵⁵ which would have been played either with a bat or a club and may have been an early form of golf, and Joost Lons had a game of skittles: "1 kegel spel met sijn toebehoren" (I,4,1692). I am a little surprised that skittles, a game much enjoyed by the ordinary people of Holland, is not encountered more often at the Cape.

Music

Musical instruments were few and far between in the years to either side of 1700—so much so that one can dismiss the possibility that music-making played an important part in the home life of the people. A musical instrument of a sort appears in about a dozen documents, but even so modest a figure as this is misleadingly generous, as it allows for a household with only a couple of tom-toms, another with a single brass trumpet, and a third with a harpsichord (klave-cimbel) which was presumably unplayable, as it had been dumped in the solder (II,77,1713). Actually there are only two instances where the number of instruments recorded allow one to think in terms of musical literacy. Music seems to have played a part in the life of Burgher Councillor Abraham Diemer and his family. The voorkamer given over to family life in his Tigerberg farmhouse contained a flute and hautboy—an early form of oboe, while in his townhouse there was a viol in one voorkamer and a trumpet in the kitchen (III,30 & 31, 1713). A possibly even greater interest in music is reflected in the estate of Johannes Pythius, where we find a harp, a bass-viol (basviool), and two viols (III,13,1714). Then there is the vendu roll of the estate of Elisabet Loenss, where "1 fiool met / 1 strijkstok" was sold, as well as "1 Jonge Pieter genaamt en / 1 harp"; a lot which realised 321 guilders (VR56,1709). A musician slave was a valuable possession.

Reading between the lines one can deduce that a trio or quartet could be scraped together to provide music for a dance, and—given the social situation—the musicians on these occasions would almost certainly have been slaves. The marriage of a daughter traditionally committed the parents to two celebrations. The first of these, known as the "Commissioner Dinner" took place after the obligatory Saturday morning visit to the Matrimonial Court to obtain a

certificate from the Commissioners to the effect that there was no legal impediment to the marriage. The second was the marriage feast itself; an event which, at this period, still took place on a Sunday, as it was then the custom to perform the marriage rite at the end of the Sunday service.⁵⁷ Dancing was a well-established Dutch custom at both these feasts,⁵⁸ Sundays and Church disapproval notwithstanding. Indeed it is understandable how such parties assumed, if possible, an even greater importance in the more restricted life of the young colony than they had in the fatherland.

The love of dance was probably an important stimulus to the early musical life of the Cape, but it may have had the not entirely happy result of making music a preserve of the slave population. A reasonable level of musical accomplishment was expected of both men and women in polite society: an expectation which the people at the Cape must have disappointed. One unregarded harpsichord, three harps, half-a-dozen violas, two or three flutes and an oboe, do not seem to reflect a musically concerned society, particularly when so many of the leading families were without an instrument at all.

Clocks, Watches and Scientific Instruments

While the use of a scientific instrument may rightly, on occasion, be regarded as a domestic occupation, and a watch or clock is constantly consulted in the home, this section is only marginally linked to domestic pursuits. I include it here for want of a more suitable place.

Any sort of timepiece at this period was a rare treasure. The life of the average farmer was governed by the sun, while for the townsfolk the sun was supplemented by the boom of the Castle gun and the calls of nightwatchmen, whose duty it was to mark the passing hours from 10 p.m. until dawn.⁵⁹ The useful hourglass (zandloper), a much illustrated object because of its symbolic role in the popular Vanitas paintings of the time, is seldom mentioned—a fact difficult to account for. A typical seventeenth-century example is reproduced in Plate 62. The pocket watch is recorded regularly but infrequently from an early date. Valentijn, in a passage illustrating the

depressed prices at the Cape, mentions that Helot paid 50 rixdollars (150 guilders) for a repeater watch (slaghorloge) worth 400 guilders.⁶⁰ It must have been a beautiful watch, and even at a bargain price much in excess of anything the leading burghers were prepared to pay. Pocket watches were ordinarily worth from 10 to 20 guilders, but even at that price remained the preserve of the most important burghers and officials. In 1662 Undermerchant Paulius de Molier had "1 silver oorlogie"⁶¹ and in 1686 a burgher, Willem van Dieden, had a silver watch.⁶² In 1696 Christiaan Freser had "1 Silver Orlogie met sijn Cas,"⁶³ and in 1698 Maria Catharina van Swaanswijk had "1 horologie in een kasje met silvere Nagelties" (VR11,1698). There was also a solitary silver watch among the stock of the store. In the eighteenth century silver watches were owned by Hendrik Sneewindt, Helot's wife, Christina de Beer, Abraham Diemer, and Corssenaer's widow, Catharina Cruse, while Jan Dirksz de Beer had "1 Coper sak horologie" (VR18).

A clock, understandably, was even more uncommon than a watch, and I can only offer two examples from the period under review. The seventeenth-century inventory of Paul Maron includes "1 huijs horologie" which was valued at 90 guilders (I,13,1695) and the inventory of Sussana Claas, wife of Matthijs Greef, records "1 hang oorolosie" worth 45 guilders (II,40,1710). In the latter instance, in any case, we are obviously dealing with a wall clock, a type of clock which was going to become rather more common in the 1730's and 1740's.

A compass, which occurs in an inventory of a Swedish carpenter serving at the Fortress as early as 1662,⁶⁴ occurs in several other early inventories. In 1664 Ensign Pieter Evriard, stationed at the Fortress, had "3 kompasjes, 2 kopere, 1 Ivore"⁶⁵ and in 1675, van Breugel had "een ijvoore Compas met een sonne wijsen" (23/5,35). Later inventories, for some inexplicable reason, rarely if ever record compasses or pocket sundials. A brass astrolabe was among the contents of the De Beer solder, but does not appear elsewhere. As the astrolabe was used for taking altitudes, this is hardly surprising. Two items which were unusual at this period but were to become less so later were the globe and the spy glass (verrekijker). Abraham Diemer had a globe—it was kept in the solder—and

other examples, one of which was made of ivory, also occur, but there are about half-a-dozen references to spy-glasses. The first of these occurs in the inventory of Roelof de Man who died in 1663,⁶⁶ but the others nearly all belong to the end of our period, and they become much more frequent thereafter, so that by the middle of the eighteenth century a number of estates include two or even three spy-glasses. The spy-glass was not restricted to the town house, and one begins to wonder whether it was indeed only the movements of ships that interested their owners, or whether there were any number of Miss Marples at the Cape.

The Pursuit of Arms

By no stretch of the imagination can the pursuit of arms be considered a domestic activity; on the other hand none of the other activities explored in this chapter contributed so much to the domestic atmosphere. A room with an array of guns and swords is a very different place from one without, and a living room without a couple of weapons was probably first seen in the fashionable town house sometime after 1700. The ubiquity of some form of arms was due in part to the elements of danger with which the early settlers had to contend: every man had to be ready to defend himself and his family from wild animals, raiding Hottentots and revengeful slaves. It was also due to the obligations of citizenship which required military service of the burghers. Finally, there was hunting—a pastime very generally enjoyed.

Practically every household, then, included a musket or two—the type in common use was the so-called snaphaan,⁶⁷—and in most cases a sword as well. Next in popularity came a pair of pocket pistols or a pair of pistols with holsters, the latter presumably saddle holsters, though an unambiguous entry like "1 Zadel met holsters en pistoolen" (III, 26, 1713) is rare. To this nucleus a wide variety of other weapons might be added. Many of the men seem to have taken an interest in their weapons and built up collections more varied and interesting than necessity dictated. Guns listed include the blunderbuss,⁶⁸ carbine,⁶⁹ rifle (getrokkenroer)⁷⁰ and matchlock (musqueton); while the swords include the ordinary sword (degen), poinard (sekade), broadsword (houwer), sabre and bayonet.

Out-of-the-way items range from a partisan, which was a type of halberd, to an assegai and a Sinhalese broadsword with fittings of silver. There were also many appurtenances; the powder horns, cartridge pouches, cross belts (bandeliers), swordbelts (draagbanden), sword suspenders (portepées)⁷¹ with their silver mounts, saddle-cloths (sjabrakken), boots and spurs.

A collection of this sort was invariably on display, and, though there were exceptions, the voorkamer that served the family as a living room was normally favoured at the Cape, rather than the voorhuis which was the Batavian choice.⁷² Gun-racks were common but, if absent, a series of nails driven into the wall probably allowed for much the same effect. In addition to the guns and swords and powder horns, the gun-rack was also the place for the walking cane—an indispensable masculine accessory at this period. A gun-rack in the Sneewindt family room held a carbine, two pairs of pistols, a silver sword, two poor-quality swords, a blunderbuss, and two silver-mounted canes (I,69,1701); while a pair of pistols, a sword "met een silver oorband en haak," a broadsword, a cane with a silver knop, and a cross belt with two powder horns were somehow accommodated in the large front room of the Tigerberg farmhouse belonging to Jacobus van Brakel (II,11,1707). In my own view a single rifle or musket hanging on the wall introduces a touch that is both casual and aggressively masculine, and the sort of display so common at this period must have coloured the atmosphere of room after room. The most overwhelming display of this nature was in the downstairs room in the Lieutenant's quarters at the Castle, which was furnished by Olof Bergh. There two gun-racks were filled with a dozen swords, a dozen picks, five pistols, five walking canes, a flintlock, a matchlock, and various other bits and pieces.⁷³ It was the sort of collection that would completely dominate any room.

Household Pets

The domestic world mirrored in the art of the seventeenth century was frequently invaded by birds and small dogs, and rather less often by cats and monkeys. There is no evidence in the documents we are considering that the European passion for pet dogs was indulged at the Cape. Dogs, dog-kennels and dog-collars are conspicuous

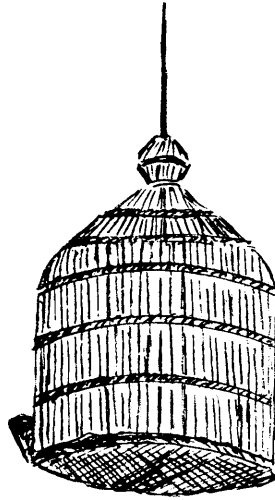

A.



B.

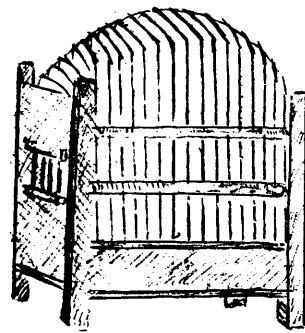

C.

- (62) A. Birdcage, Cane
B. Hour Glass, Wood and Glass
C. Birdcage, Wood and Iron
Dutch, Seventeenth Century.

only by their absence. One can argue that dog-kennels were considered superfluous and that dog-collars were not worth inventing, but it is not possible to argue away the absence of the dogs themselves. One would seem justified in concluding that the domestic dog and the working dog were the exception at this period. Yet birds were another matter. Several birdcages turn up in the Cape documents of the seventeenth century, and they become more and more numerous during the course of the eighteenth century. It is not only that more estates include birdcages, but that the number of birdcages found in one estate increases. Before 1715 three seems to have been the limit, but later in the century I have noted six, eight and sometimes a dozen or more birdcages in a single household.

At the opening of the eighteenth century the voorhuis, always providing the house had such a room, was the correct place for the caged birds, and we find the Van Stralen/Van Doorninck voorhuis with "3 Vogel kooijtjes met eenig kanarij vogeltjes"⁷⁴ (I,62,1701); the Sneewindt voorhuis with "1 Vogelkooijtjen met een vogeltjen daar in" (I,69,1701); and that of Elisabet Loenss with "1 grote roode Voogel kooij / 1 Clijne do do" (II,37,1709). In the second quarter of the century, when the family room shifted from the voorkamer to the gallery or middle room, there was a tendency to include the birds in the family circle, as had always been done in Batavia.⁷⁵ Many cages, however, continued to hang in the voorhuis. The ordinary small cage, which at a guess was constructed of wicker or wood (Pl.62), cost a guilder or two, while some of the larger cages exchanged hands for fifteen guilders or more. A number of remarkably similar and very handsome birdcages constructed of iron and brass appear in the paintings of the mid-seventeenth century (Pl.18), but the most magnificent birdcages belong to the early eighteenth century. The best of these are usually surmounted by a crown with repoussé decoration and have a pierced gallery at the bottom which prevents some of the seed being scattered. All these early cages are beautifully decorated underneath, because this is the angle from which they were seen by the viewer. They are also provided with a ring at the bottom which served two purposes: firstly it could be grabbed with a hook so that the cage, which was often hung on pulleys, could be pulled down for cleaning and for feeding the bird; and secondly it could be decorated with flowers and mistletoe for weddings

and other festive occasions.⁷⁶ A birdcage of this type⁷⁷ cannot be recognised from the couple of Cape entries which are more detailed than usual. Olof Bergh had an ebony birdcage for which we have no price. The large red cage belonging to Elisabet Loenss actually sold for twenty-one guilders, which is a steep price for the painted wooden cage which seems to be in question. More puzzling still is the second birdcage in the Sneewindt house which hung in the family voorkamer and is described as "1 vogel kooijtjen v: glas" (L,69,1701). A glass birdcage is entirely new to me and seems an unhappy conceit—at least from the point of view of the bird. The contents of the store included "13 Voogel glaase"⁷⁸ but these were almost certainly small containers for seed and water which slipped into fixtures at each side of the cage. Apart from birds, canaries first and foremost, then parrots and turtle doves, which actually enjoyed over a century and a half of popular favour, domestic animals seem to have contributed very little to the home life of this period.

Footnotes

1. Cited by Georg A. Brongers, Nicotiana Tabacum (Amsterdam, 1964), p.28. I am indebted to the chapter in this work entitled "Tobacco Used for Medicinal Purposes" for the information in this paragraph.
2. CJ2914, Bergh. Inv., pp. 2,6, & 10.
3. Trans. en Schep., I, 9, 10, & 14.
4. The estates of sea offers show that pipes and tobacco were popular items of private trade. Captain Abraham van de Velde of the ship Noordgouw had "3 kassen met tabax pijpen / 1 kist met dos / 1 oxhoofdt [300 kg] met tabacq . . . 1 kist met hoeden en tabacq . . . 1 rol tabacq (CJ 2916, van de Velde Inv., 1696, pp. 8 & 9).
5. De Wet, op. cit., p.123.
6. CJ2914, Etlig Vend., 1694, p.16.
7. MOOC8/75, 1, n.d.' This is the inventory of some sort of store to which reference has already been made
8. Brongers, op. cit., p.99.
9. Trans. en Schep., I, 16.
10. Brongers, op. cit., pp. 112-13.
11. CJ2196, Freser Vend., 1696, p.7.
12. CJ2914, Meijer Inv., 1705, p.160.
13. MOOC8/75, I, n.d. See above n.7.
14. The subject of spitting is dealt with in fascinating detail by Norbert Elias, op. cit. pp. 153-60. I reproduce one of the quotations he cites from a 15th-century work, The Book of Curtesye: "If thou spitt over the borde, or elles opon, / thouschall be holden an uncurtayse mon."
15. Brongers, op. cit., p. 163.
16. The Frenchman De Parival wrote: "De vloeren worden schier alle dagen gewasschen, met zand geschuurd, en men houdt ze zoo zuiver,

- dat de vreemden er somwijlen niet op spouwen durven." Quoted by Schotel, op. cit., p.286.
17. See above, pp. 52-53.
 18. De Wet, op. cit., p.155.
 19. C. Graham Botha, op. cit., I, 212-13.
 20. Trans. en Schep. I, 23 & 27.
 21. C326, Attestatiën, 1652-1665, p.200.
 22. Trans. en Schep. II, 1663, pp. 65-66.
 23. Ibid., 1665, pp. 197-198.
 24. C680. Placcaatboek, I, p.335. The entry was made on 8/4/1673. I am indebted to Mrs. Yvonne Garson of the Gubbins Library, Witwatersrand University, for drawing my attention to this collection.
 25. Similar entries occur in the Hague inventories, however, (see below, p.275) as well as those of Batavia (De Haan, op. cit., I, p.535).
 26. Dagboekvan Adam Tas, p.35.
 27. Ibid., p.58.
 28. Ibid., pp. 71-73.
 29. I am indebted to the list of law books published by Graham Botha for the correct form of these titles (op. cit. II, 167-69).
 30. De Haan, op. cit., I, 684.
 31. De Wet, op. cit., p.131.
 32. J. L. M. Franken, " 'n Kaapse huishoue in die 18de eeu," Archives Year Book (Cape Town, 1940/41) pp. 1-87.
 33. P. S. du Toit, Onderwys aan de Kaap onder de Kompagnie 1652 - 1795, Ph.D. Diss. Stellenbosch (Cape Town/Johannesburg, 1937 [Pref.]).
 34. Quoted by Bax, Het Oudste Kaapse Zilver, p.26.
 35. See above, n.7.

36. MOOC8/75, 1, n.d.
37. Resolusies, IV, 419-21.
38. MOOC8/75, 1, n.d.
39. Some measuring rods (ellen) were handsome: for instance "1 El met silver beslagh" (III,31,1713).
40. "Sommige matressen," writes Schotel, "hielden des voormiddags leer-, des namiddags, nai-breij-en-spelde-werck-school" (op. cit., p. 91).
41. Anne Buck, Dress in Eighteenth-Century England (London, 1979), p.185.
42. De Wet, op. cit., pp. 72-73.
43. Patricia Salmon, Japanese Antiques (Tokyo, 1975), pp, 54-55. I am indebted to Mr. T. van Niekerk of the Africana Museum, Johannesburg, for drawing my attention to this reference.
44. Weyns, op. cit., III, 1034.
45. Schotel, op. cit., pp. 45-46. Examples dating to the 18th and 19th centuries are preserved in the Africana Museum, Johannesburg.
46. The inventory of the store contains "18 stelle Vinger hoed / 26 koper do do / 8 bordeur do do" (MOOC8/75, 1, n.d.).
47. CJ2916, Freser Vend., 1696, p.13.
48. MOOC8/75, I, n.d.
49. Walker, op. cit., p.59. Theal, op. cit. III, 488.
50. J. H. Huizinga, Dutch Civilisation in the Seventeenth Century, trans. from Dutch A. J. Pomerans (London, 1968), p.53.
51. De Wet, op. cit., p. 2.
52. Dagboek van Adam Tas, p.52.
53. MOOC8/75, I, n.d.
54. See above, p.55.
55. Trans. en Schep. II, 1663,p64.
56. Ibid., p.63.
57. Graham Botha, op. cit., I, 130-36.

58. In Holland a party took place after the first publication of the banns (H. Brugmans, Het Huizelijk en Maatschappelijk Leven Onzer Voorouders, 2 vols. [Amsterdam, 1914], I, 110).
59. Graham Botha, op. cit., I, 162.
60. Valentyn, op. cit., I, 208.
61. Trans. en Schep., I, 343.
62. MOOC22/2, Willem van Dieden Vend., 1686, n.no., n.p.
63. CJ2916, Freser Vend., 1696, p.13.
64. Trans. en Schep., I, 343.
65. Ibid., II, 87.
66. Ibid., II, 66.
67. The standard Dutch musket with a flintlock action.
68. A short hand-gun with a wide bore.
69. A light musket popular in Germany (Barry M. Berkovitch, The Cape Gunsmith, Stellenbosch Museum, [Stellenbosch, 1976], p.9).
70. The rifling of the barrel at this date was straight, not spiral.
71. In a note to Tas's text (Fouché ed., rev. Böeseken, Dagboek, p.68, n.82) "port-épée" is equated with "draagband" though the editor is aware of the correct meaning of the word. I consider this unlikely: a clear distinction always seems to be made between the two in the inventories, and it is improbable that Tas would misuse a word that was in general use.
72. van de Wall, op. cit., p.71.
73. The contents of the two gun-racks are given as: "9 gesorteerde deegens / twee houwers d'een met een Silver gevest met een geborduert hengsel en silver beslag / twee beslage silvre rottings / een onbeslagen japans do / een bosje indische rotting / twee rottings met ijvoire knoppen / een houwer met een koper gevest en ijvoire greep gesegte behoren aen den boeckhouder diodati / twee sackpistolen met haer overtrecksels met een clappers chint hoorntje / een flint vuerslag / een patroon tas / een paer laersen / een paer sporen / een paer lange pistolen met hare overtrecksels / een lange roer / een out sack pistool / een paer hart leere

hantschoenen / 9 onbeslage indische pieckstocken / 3 do
partuisanen / 1 hasegaije / 2 gevlamde piecken / 1 musquetton
[en] 1 vuerroer" (CJ2914, Bergh. Inv., 1687, p.1).

74. The vendu roll lists five canaries which sold for 6 guilders (VR17, 1701).
75. Van de Wall, op. cit., p.73.
76. Peter, Nancy & Herbert Schiffer, The Brass Book, (Exton, Penn., 1978), p.101.
77. A fine example from the early 18th century can be seen in the voorhuis at Boschendaal.
78. MOOC8/75, I, n.d.

Conclusion

My purpose in this concluding chapter is to try and place the Cape home in the context of Dutch culture of the seventeenth and early eighteenth century. Our main points of comparison will be the inventories of the Hague and New York, a number of which I have been able to study in situ. Some reference will also be made to other Dutch settlements, but these I am familiar with only through secondary sources.

To compare the Dutch settlement at the Cape with that in America may initially seem a little arbitrary but is, I consider, more than justified. In northern America and southern Africa the Dutch were pioneers in lands where the indigenous cultures were too primitive to challenge their European heritage. This was not the case with the Dutch settlements in the East Indies: there, in response to an alien civilization, the Dutch developed an Indo-Baroque culture of great originality but limited influence. The Cape, though on the far-flung periphery of this culture, was never a part of it.

The Dutch settlement in North America dates back to 1609 and was the responsibility of the Dutch West India Company.^{1a} It was a part of the world, however, where Dutch interests clashed with those of the English, for England was anxious to gain possession of an uninterrupted line of Atlantic coast from French Canada in the north to Spanish Florida in the south. Finally, Charles II presented New Netherland to his brother James, Duke of York and Albany, and in 1664 James sent a fleet to take possession of New Amsterdam, the seat of Dutch government. The fleet of four frigates accomplished its task without bloodshed, and New Amsterdam became New York. In 1673, while at war with England, the Dutch recaptured New York but this time held it only for a matter of months. In 1674, the Treaty of Westminster ceded Surinam to Holland, and in return England regained the Dutch possessions in North America. Through most of our period, then, New York was officially English, but the city clung to the traditions of the past and remained overwhelmingly Dutch. This is clearly reflected in the inventories: many of the family names are Dutch; the occasional inventory continues

to appear in Dutch;¹ and the inventories written in English are full of Dutch terms, sometimes literally translated,² sometimes not.³

The Hague inventories are naturally the most impressive of our three groups and, apart from a few that record life in aristocratic circles, reflect a wide-ranging pattern of bourgeois domesticity, both ordered and comfortable, at levels that are comparable but superior to those that New York or Cape Town can supply. New York, in its turn, can offer some inventories⁴ that are clearly superior to anything the Cape is able to provide. Having said that, I must stress that the correspondences between the inventories of these three centres remain substantial and are even at times minutely endearing: they all reveal a taste for red plush cushions in the best room and show that the loft or solder was often viewed as a suitable spot for the close-stool; they all reflect the eager interest with which paintings and ceramics were collected and displayed, and show that books and musical instruments were a less favoured source of household expenditure; finally, they all partake to a greater or lesser extent in the fashion for Eastern wares.

In all three centres one finds those objects peculiarly associated with seventeenth-century Holland: the great kast lavishly crowned with porcelain or Delftware, the ebony-framed mirror, the lace-trimmed chimney-valance, the table carpet, the ebony chairs, the silver beaker, the brass tobacco box, the copper bolle buijsjepan, the gilt-framed flower piece and the brass-bound Bible. Finally the great hooded fire-place, the dominant feature of so many Dutch rooms in the seventeenth century, found its way to New York⁵ as it seems to have done to Cape Town.⁶

There was, then, much that was the same, but naturally there were differences as well. On the whole the New York house, far removed from the Eastern trade route, reflected an interior in Holland rather more faithfully than did that of the Cape. Both sets of inventories show Delftware to have been more important than Chinese porcelain, and European materials than those of India. There is also a marked tendency to draw attention to the same woods,⁷ particularly oak and walnut. Even the chairs are nearly related—the humble chair with a seat of rush, the upholstered chair with its covering of wool and the Russian leather chair. Some of these correspondences were not merely a matter of trade or a common origin

but of climate. The icy New York winters do much to account for the continued popularity of chairs upholstered in woollen fabric, beds snugly hung with serge or say,⁸ and windows curtained against the cold. New York, however, also had a broiling hot summer and because of that was a ready market for the ordinary run of Indian cottons.

Indian cottons play a negligible role in the Hague inventories. There one encounters an occasional chintz coat, a little muslin body linen—particularly cravats—an odd pair of white cotton curtains, and only once, in the inventories with which I am familiar, a bed-chamber hung with flowered Indian stuff; a reminder, since this was the bed-chamber of a count,⁹ that there was a vogue for the finest Indian textiles in high society—a circle sparingly represented in a random collection of inventories. The New York inventories provide further evidence of the fashionable role of fine Indian chintz, but again it is only the exceptional document that records the presence of a "chint flowerd" carpet (table cover) or chintz counterpane. Once again one encounters the odd reference to cotton and muslin, but this time one also encounters many references to calico. Calico, which takes its name from Calicut in India, is a generic name for a plain white cotton cloth which varies from fine to coarse. White bleached or unbleached calico was in demand in the West but plain dyed and striped calicos were also made. A lot of white calicos are listed in the New York inventories; others are described as red, blue, green and brown; yet others as striped, checked or flowered; and others as painted or even East Indian. Whether "calico" was used advisedly or whether it covered various different Indian cottons¹⁰ is not very important; what matters is that ordinary Indian cotton was in general use: for clothes and underwear, for bed linen and bed hangings, for cushions and curtains. In summer a New York parlour with red or green calico bed hangings, white calico window curtains and flowered calico table carpet must have been a very normal sight, and it hardly needs saying that a similar collection of soft furnishings would have been equally at home in a voorkamer at the Cape, where Indian cottons were not only important but predominant.

The importance of Indian textiles at the Cape is underlined by

the knowledge with which the various textiles were listed; chintz from Surat, Bengal and Tuticorin, salem pores,¹¹ percale,¹² niquania,¹³ malle mol,¹⁴ morees,¹⁵ hammans,¹⁶ gingham,¹⁷ photas,¹⁸ dragam,¹⁹ chelas,²⁰ bafta,²¹ betilles,²² atlas,²³ etc. Names exotic and for the most part long forgotten, which pinpoint a range of plain, striped, checked and flowered cottons, together with the manner of weave and decoration, the place of origin, and even, at times, the length of a "piece." De Haan and Van de Wall provide almost no information about the materials found at Batavia. One assumes an even heavier dependence on Indian and other Eastern textiles than that found at the Cape. But the Cape was in Africa, not Asia, and it seems safe to claim that outside Asia no European community was more dependent than the Cape on the textiles of India. New York did not run Cape Town a close second, but Indian textiles were important there—much more important than at the Hague, and probably more important than they were in any centre in northern Europe.

If one turns from Indian textiles to other products of the Eastern trade apart from porcelain, one searches the ordinary inventories of the Hague and New York without a great many results. From the Hague inventories one culls a modest list, nearly all from the top ten per cent of those studied. The President of the Courtleet of Brabant had a small East Indian coffer of gilt;²⁴ another estate had an ebony spice box, a Japanese counterpane and an "Oostjndische lit rothing"²⁵ which sounds like a cane bed; Japanese sheets (dekens) turn up in several estates; and Groot Gorcum, an eighteen-room mansion of undoubted standing, had a couple of its beds and a room hung with "casiant"²⁶ which may possibly refer to caseïne—a fine wool better known as cashmere. The ordinary New York house was also bare of such Eastern goods, but a couple of estates I encountered—they are estates well known to the scholars of the period—contain quite a variety of Eastern wares. The most important of the two in this respect is the estate of Margreta Van Varick, where we find, in addition to a certain amount of ebony furniture of unspecified origin, a large East Indian cabinet with a wrought ebony foot, two East Indian cabinets with brass handles, ten East Indian looking glasses, fourteen East Indian paintings, some with black and others with gilt frames, a Japanese wooden dish, a fine East Indian dressing basket and another round basket of the same, two

wooden East Indian trays of gilt lacquer and a round "thing" of the same, and nine examples of wrought East Indian silver—three cups, two dishes, and six boxes.²⁷ While the other estate, that of Jacob De Lange, had a cupboard, a waxed cabinet, eight "filled spreads," five paintings, thirteen prints, a basket, a chafing dish, and five small kettles, which were all described as East Indian.²⁸ These estates puzzle me. If Esther Singleton is right in seeing them as representative of the Eastern taste in fashionable New York society at the end of the seventeenth century, then the Cape, for all its privileged position on the Eastern trade route, would be hard put to show a single inventory that could rival them. But should these two American inventories really be regarded as representative? The silver, the baskets, the kettles, the looking glasses, even the pictures are improbable items for trade with the New World. Then, too, there is so little evidence of this sort of thing in any of the other estates I picked out for study, even those of considerable importance. Finally, I am made doubly cautious by the knowledge that several Hague estates of men of wealth and position have little or nothing to offer in the way of Eastern curiosities. Maybe further research into the New York inventories will produce a harvest of Eastern wares—other than textiles and porcelain—which will show that these two are indeed representative of their class and period, but without some such support they could be quite untypical: the result of unusual family connections and circumstances. An inventory of 1722 that includes one-and-a-half dozen Indian boxes in its list of merchandise strikes me as a much more normal manifestation of the Eastern wares available in New York.²⁹

A question which presents itself at this point is: how widespread was the Eastern cult of the period? The Hague even in 1700 was in easy reach of Amsterdam, but it was not a port, and, unlike Amsterdam, had no particular ties with the Eastern trade. If the inventories of that city are representative of a European community without such ties, the answer would seem to be: not at all widespread. Common sense suggests that the inventories of London, Amsterdam and Lisbon would yield a much richer harvest in this respect, but common sense also suggests that in none of these centres would Eastern cabinets, lacquer boxes and painted Chinese wall paper be anything other than modish or curious: the playthings for the most part of fashionable

aristocrats and rich East Indian merchants. The average home probably had no part in them, and the Little Masters of the seventeenth century reveal a series of Dutch interiors that owe little, other than an occasional piece of porcelain, to the Eastern trade, and this despite the fact that Holland was a small country and her East India Company had no fewer than six Chambers, all with direct ties with the East. At the Cape, however, the common run of Eastern goods was too familiar to excite much curiosity, and some of the cheaper items like baskets, metalware, clothes and small pieces of lacquer occur in decidedly modest estates. Few people at the Cape could afford the finest Eastern wares, but they were familiar with them—a fact underlined again by the way in which the various objects are listed in the inventories. In the Hague and perhaps still more in New York everything Eastern, be it a painting on glass, a piece of lacquer, or a piece of silver, is mainly entered as East Indian. At the Cape, similar items are confidently ascribed to Japan, China, Tonkin, the East Indies, or the relevant parts of India. The Cape was at home with the products of the East.

The Dutch loved ceramics, whether they were the earthenware products of their own factories at Delft or the true porcelain from the East. They collected them avidly, and displayed them in such a way that they were an integral part of their seventeenth-century houses. Though the Dutch carried their love of ceramics to New York, very few of them were able to compete there with their compatriots in the fatherland. The ceramics listed are a mixture of Oriental porcelain and Delftware, with the emphasis on the latter. One finds, without surprise, that a large number of New York estates contain very few if any ceramics—but there are exceptions. The Van Varick and De Lange estates, which have already engaged our attention, had large holdings of porcelain; about a hundred and eighty and three hundred pieces respectively. Another estate, that of Cornelis Stenwick, had a mere twenty pieces of porcelain in contrast to about three hundred and fifty items of Delftware.³⁰ Mrs Van Varick had a china cupboard; she also had more than half her collection packed away in barrels. Jacob De Lange had one room where both the mantelpiece and the cupboard were lavishly arrayed with porcelain, but neither of these inventories offers further help as to how the bulk

of the porcelain was housed or displayed. The inventory of Cornelis Stenwick is more informative. The best room, known as the "great chamber," held the twenty pieces of porcelain and two earthenware flower pots. The all-purpose living-room, called the "kitchen chamber," had sixty pieces of earthenware, arranged for the most part on three wooden plate-racks, and the rest of the collection, apart from five dishes in one of the other rooms, was stored in the attic. But all this was quite exceptional. The average New York inventory records an array of pewter, and in a few of them pewter is supplemented by a little porcelain and earthenware. Even in the second quarter of the eighteenth century ceramics remained in short supply in New York, and an estate with four China basons, eight earthenware plates and eighteen china cups and saucers³¹ was in no way out of the ordinary even in the 1730's.

Not unnaturally the Hague estates are also supplied—though much more generously—with a mixture of Oriental porcelain and Delftware. There are exceptions to every generalisation but on the whole the average Hague family concentrated on Delftware: sixty pieces of Delftware and three pieces of Chinese blue and white in the case of Reijner Nootman;³² forty-four pieces of Delftware and two red Chinese teapots from Ixing in the case of Elisabet van Hennen.³³ Such collections were not intended for ordinary use but for display—on any suitable surface and in virtually every room. In 1701 the leather merchant Dirck van Schorrenbergh had eleven Delft dishes in front of the chimney-breast in his front upstairs room, and a tea-rack and a mantelshelf of Delft dishes in his upstairs back room, where there was also an old oak cupboard with small pieces of Delftware on top. In the "kelder kamer" a pair of walnut tea-racks held porcelain cups and saucers, and a mixture of porcelain and Delftware decorated not only the chimney-piece but the tops of the built-in beds, a child's cupboard and a walnut cupboard as well. The downstairs kitchen held a tea-rack of cups and saucers, while the back kitchen had Delftware in front of the chimney and three racks of Delft on the walls.³⁴ This estate held rather more porcelain than usual, but its disposal about the house is extremely typical. Points to notice are the presence of tea-racks in some of the rooms, the fact that plate-racks only appear in the kitchen, and the absence of a china cabinet.

The importance of the china cabinet, and the care lavished on it by the Dutch housewife, was a popular literary theme and one whose truth has never been questioned, so it is unexpected and possibly fortuitous that this, like many other Hague inventories, does not record one.

As one moves up the social scale the proportion of Delftware to porcelain changes. Philip van Leeuwen, a wealthy advocate whose estate runs to over a hundred pages, had about a hundred and seventy pieces of porcelain, around twenty items of Delftware and one lot of red earthenware.³⁵ Dominie Allardus Titsing who died in 1713 lived fairly modestly but for his collection of porcelain and pictures. His parlour held approximately a hundred and forty pieces of porcelain and forty pieces of Delftware; his office or "spreekamer" had nothing but some soapstone cups and dishes and fifteen pieces of Delft; his bed-chamber contained eight porcelain dishes on the chimney breast and another sixty-odd pieces of porcelain, including a five-piece garniture, which may all have been accommodated in or on a cabinet; his great chamber gave house room to another eighty or so pieces, most of them porcelain; his kitchen contained sixteen Delft dishes and six fine porcelain coffee cups and twelve saucers; and his "provisie kamer" held a fine porcelain fish bowl.³⁶

Although nearly every Hague inventory includes decorative ceramics, large collections with two hundred pieces or more are hard to find. For these presumably one looks to the inventories of Delft, Amsterdam—and Cape Town. In the opening years of the eighteenth century over half the surviving Cape inventories contain ceramics, most of which are the porcelains from China and Japan. Something like a third record upward of fifty pieces, and something like a sixth upward of a hundred. Since the Cape inventories cover every level of society, including the very poorest—a class which hardly appears at all in the Hague inventories—these figures are rather startling; and the biggest collections, for hundred or so pieces in the estate of Lieutenant van Reede's wife in 1703, and five hundred odd pieces in the estate of Burgher Councillor Abraham Diemer in 1713, are in excess of anything noted in New York or the Hague.

One can with perfect justice describe the last decade of the seventeenth century and the first quarter of the eighteenth century as the Age of Porcelain at the Cape. Such a description is called forth not only by the amount of porcelain in circulation, but by

its extraordinary prominence in the average interior of the period. During these years no one tucked his porcelain out of sight in kitchen or pantry, and it seldom found its way into a wall cupboard or display cabinet. Porcelain was out in the open. In racks it lined the walls, and in generous groups stood atop doors, cupboards, tables and mantelshelves. There were rooms with four or five racks of porcelain on their walls, and cupboards with more than twenty pieces crowded on top of them. Except for the greater prominence of the plate-rack which, unlike the tea-rack, was generally confined to the kitchen at the Hague, the two centres were at one in their approach to ceramics in the home; but when it is remembered that in Cape Town the houses were generally smaller and the ceramic collections rather larger, the effect must have been overwhelming and, in the eyes of those making their first voyage to the East, unexpectedly impressive.

So far the Cape's position vis-à-vis the East has ensured it a privileged position in this comparative examination, for at a time when the West was entranced with its vision of Cathay, the Cape was full of fashionable things. There is nothing particularly privileged about the Cape, however, in any of the other areas that seem to me worthy of comparison. To assess the intellectual and artistic life of our three communities we now move into a world of pictures, books and musical instruments.

The Dutch love of pictures, like the Dutch love of ceramics, is reflected in each of the three centres, though this is a field where the Hague inventories have by far the most to offer, for at least three out of every four houses recorded there held pictures, and the pictures themselves are recorded with a certain care: the subject matter is quite often given, and even the artist's name may be included: "een Wintertje van van goije."³⁷ At the Cape, where about one inventory in three mentions paintings or framed prints, it is unusual to find any reference to subject matter and the artist is invariably ignored. I cannot offer any figure for New York, where I only concerned myself with the more interesting inventories, but these leave me with the impression that the situation there was similar to, but a little better than, that at the Cape. Once again the subject matter is usually ignored, though in this respect the

De Lange and Van Varick inventories are again exceptional. The former, which describes thirty-seven paintings and refers to five East Indian paintings and thirteen unframed East Indian prints, must be set beside the Cape inventory of Hendricus Munckerus, which describes seventeen paintings and mentions another nine paintings and twenty-nine framed prints.³⁸ Though in size the two collections both number fifty-five pieces, and the titles show that each included a number of Dutch paintings of the seventeenth century, there is no doubt as to which was the finer. Though two or three other Cape collections approach that of De Lange in size, they, too, are very much less valuable.³⁹

In the Hague many a room was enlivened by both pictures and a massed display of ceramics, and this was true of rooms in Cape Town and New York as well, but in New York a room was more likely to be decorated with a few pictures only, while at the Cape a massed display of ceramics was more common. Pictures and ceramics seem to have been purchased and displayed in much the same spirit. They were visible evidence of a certain prosperity and an attractive addition to the home. They were the products of craftsmen of varying degrees of skill, and appreciated and enjoyed as such. They are not evidence of an educated milieu.

Music was yet another important strand in the cultural life of the Netherlands. Jan Sweelinck, the greatest Dutch composer of his time and "father of the fugue," was organist at Amsterdam from 1577 - 1621.^{40a} Like Bach, Sweelinck composed and performed both religious and secular music. His midweek evening concerts in which singers took part were not only musical events but fashion parades, and were well attended by every section of the community—by Catholics, sectaries and Jews as well as Protestants. In his day Sweelinck played voluntaries before and after church service but was not required to accompany the psalms. Though he had no successors of his stature, the tradition of church music he had consolidated grew and expanded; it had led by the end of the seventeenth century to organ accompaniment for the psalms becoming generally accepted, and culminated in the building of the great baroque organs at the beginning of the eighteenth century.

Music making in a secular context was a popular subject with the

artists of the period and one treated by great artists such as Vermeer, Terborch, Hals and Jan Steen and lesser artists such as Willem Bartsius, Gerard van Honthorst, Jacob van Loo and many more. All classes of society are represented in these pictures, which range from the peasant viol player in Adriaen Brouwer's "The Performance" to the pair of elegant young ladies engaged with what looks like a spinet and viola da gamba in Gerard Terborch's "The Concert." Then there are the musical instruments, the flutes, lutes, viols et al which are included in many a Breakfast Still Life and Vanitas painting. Music, in short, is presented in the art of the time as a national pastime. In the inventories, however, musical instruments are oddly elusive. I have noted their rarity in the Cape inventories,⁴⁰ so justice demands that I also make a point of their rarity in the New York inventories—a fact noted with surprise by American researchers in the field⁴¹—as well as their rarity in the Hague inventories. Is it possible that even at this period of musical florescence the number of people actively involved in its performance was really quite small ?

Books are the most obvious key we have to a cultured, educated milieu, and one naturally anticipates that in this respect the Hague inventories will reflect the active literary life associated with the whole of Holland at this period, and show an effortless superiority over those of the other two centres. J. F. Huizinga, the great Dutch historian, in his famous essay "Dutch Civilisation in the Seventeenth Century" writes "Every one commissioned or collected pictures, all were patrons of poetry, of the church and of learning,"⁴² and as he expands on this statement it becomes clear that he does mean virtually everybody: the burgher patriciate, members of the learned professions, and a broad stratum of traders and members of the lower middle classes.⁴³ Dutch colonial scholars sing a very different tune. De Haan points out that books were little regarded in Batavia, where reading could not begin to compete in popularity with smoking and drinking;⁴⁴ and Esther Singleton remarks that as a rule the early settlers in New Netherland were exceedingly illiterate.⁴⁵

In these circumstances, it is very disconcerting to find that where books are concerned there is not a great deal of difference between the Hague, New York and Cape inventories. We have already seen that at the Cape about one estate in four contained one book or more.⁴⁶ I cannot offer comparative figures for New York, although it is clear that books enjoyed

rather more prominence than they did in the Cape. Settler libraries, when present, tend to be larger, but as they seldom exceed a hundred books the difference is not very great. There is also evidence that it was not always easy to sell books in New York. The last entry in the Van Varick inventory reads "more a parcell of printed bookes not yet apprizd, most of them High Garmen and forreing languages, soo of little vallue here, werefore they are packt up to be kept for the use of the Children, when at age." A similar note is struck in the inventory of Peter Jacobsen Marius: "The ffollowing goods [ninety-one assorted Dutch books] would not sell at ye vendue wherefore the same were apprizd by the sworn apprizzer as followeth..."⁴⁷ The sum in question, £7¹⁰/₃, does not suggest that these books were worthless; they were merely unwanted, and yet there is no suggestion in any other New York inventory known to me that anything else was unwanted. Books did, however, enjoy one advantage in New York—they were regular items of private trade. The average New Yorker, like the average Capetonian, was a trader, and lists of merchandise are found in the inventories of both; in New York they quite often include books,⁴⁸ in Cape Town they do not. In the main the New York market was for simple books of a devotional or educational nature; but at least a market did exist, and it existed, I feel sure, chiefly because the population in and around New York was large enough to support it.

At the Hague approximately one estate in three contains one or more books, but if one excludes those estates with nothing but Bibles, Testaments and Psalm Bookks, which will hardly do on their own as evidence of literary culture, one is left with perhaps one estate in four. Most of these have not got a great deal to offer; "some books and oddments,"⁴⁹ "an old box with twenty-one old books, Latin and otherwise,"⁵⁰ "some old books above the bedsteads,"⁵¹ etc. It is only the top ten per cent of the Hague inventories, and these for the most part are the inventories of professional people, that can show much in the way of books. This picture is superior, but not dramatically so, to that shown by the Cape.⁵²

One can offer several explanations to account for this unexpected picture. Perhaps the Hague, for some strange reason, did not take the same interest in poetry and learning as the majority of Dutch towns, or perhaps the Hague inventories are totally misleading and offer us a completely distorted picture of the reading habits of that city. If, however, the Hague inventories are reasonably reliable and reasonably representative of Holland as a whole, it would appear that about one household in three was in

a position to read a book—or spell out a book—and an even smaller percentage actively engaged in the literary life of the nation. I do not know whether other facts can be reconciled with this picture: whether, for example, the 50 000 copies of an illustrated edition of *Jacob Cats*, which were sold before 1655,^{53a} could have been absorbed by rather less than thirty per cent of the population, even though *Cats*'s didactic, homely verse with its answers to the problems of daily life was second in popularity only to Holy Writ. If, however, any weight can be given to the Hague inventories, it seems that literary culture flourished in Holland and languished in the Colonies less because of the poor quality of the immigrants and the isolated nature of colonial life than because Holland alone had enough people to sustain it. It was not the proportion of educated households that was the deciding factor but their number in absolute terms, for, as we all know, when the number of a species falls below a certain point it is doomed to extinction. Most men at the early Cape who read books, collected books, kept diaries, men like Albert van Breugel, Hendricus Munckerus, Adam Tas and Joachim van Dessin, were either Company men or immigrants.

We now come to the last area in which I wish to draw comparisons: the ordering and arrangement of the houses in general and the individual rooms in particular. Here for me the Hague sets the standard because I have been able to study the inventories of that centre for myself and because secondary sources confirm that in essence, if not in every particular, these houses reflect the type of surroundings in which the bourgeois townsman of Holland lived. A certain amount has already been said about the nature of this domestic world⁵³ but I should like once more to set down the salient features of such establishments. As one moves through these houses from the kitchens to the attics one is confronted by a series of orderly rooms that bears witness to a well-established pattern of domestic life. It is a pattern where the progression from the house of a petty tradesman to that of a wealthy regent is a steady, subtly nuanced ascent, rather than the series of sudden steps and plateaux characteristic of a more stratified and less homogenous society.

Apart from the *voorhuis*, which in the Hague was a simple entrance hall, and the "*comptoir*" which was a small office or study, the main

body of rooms in such a house were usually described according to their position or their size. Although by this time the principal rooms in houses with more than one living room were assuming special roles as family rooms, reception rooms and dining rooms, this is not readily apparent from the way they are described, or even, at times, from the way they are furnished. In the last quarter of the seventeenth century many of these rooms among the ordinary bourgeoisie continued to house a free-standing bed together with dining-room and sitting-room furniture. In many smaller houses a pair of built-in bedsteads—these were commonly provided with curtains and valances, presumably in lieu of cupboard doors—took the place of a ledikant. In some houses the presence of built-in bedsteads in some rooms and a free-standing four-poster in others is a help in isolating the living rooms from the bedrooms, as a four-poster was always preferred in a living room. The soft furnishings in these rooms were nearly always harmonious. Rooms done out in one colour were common but two colours may have been even more popular, and the changes were rung with the fashionable colours of the period such as red and blue, red and yellow, blue and green, and purple and green. An important bedroom, at any rate on paper, had much the same furnishings as a living room, but lesser chambers were more sparingly treated and minor chambers with a built-in bed, a small table and a couple of chairs were quite normal. What was not normal was a room with lots of beds in it, and except for the servants' quarters in the attics one hardly ever finds a room with more than one free-standing bed or two built-in bedsteads. With the increase in wealth most of these houses were now one-family homes, for the mediaeval practice whereby the master had his shop or workshop in his own home and housed his workmen or apprentices there was now dying out.

Between the ordinary bourgeois houses just described, the houses of the professional classes and the houses of high fashion there was no sudden dividing line. By the 1670's there were many professional households where the best bed had been withdrawn from the principal room and others where a specialised dining room had been introduced—a room which can be difficult to recognise in the absence of a serving table as it often continued to hold a bed. The Hague bedroom,

made more recognisable by the disappearance of the bed from the parlour, was furnished practically and comfortably, but it never seems to have been the most luxuriously treated room in the house. Presumably the Dutch ideal of womanhood, so different from that of the French and the English, prevented them from adopting the aristocratic approach to the bedroom. A luxurious bedroom as a setting for elegant dalliance and intimate friendship may hold great charm for a woman of fashion, but it strikes the industrious housewife as an absurd extravagance. Except for his parlour, his office and perhaps his dining room, the wealthy Hague burgher was not inclined to enlarge his house to make room for aristocratic refinements like libraries, music rooms, picture galleries and ballrooms. No matter how great his wealth, his house rarely expanded beyond a dozen rooms: it was the domain of intimate family life with a modest retinue of servants in attendance. The most sophisticated inventories I located at the Hague are strongly coloured by the aristocratic ideal but never fully partake of it⁵⁴—and this in the Hague, where the court of the Prince of Orange was centred. There seems no reason to doubt that the domestic ideal of all but a tiny minority of Dutchmen was bourgeois in spirit, and it was this ideal they carried with them to Asia, America and Africa.

The ideal was probably infused with some success into the Dutch settlements in Asia. The Batavian house which Dr. de Haan brings to life for us⁵⁵ was naturally modified to suit very different circumstances but in scale, and to some extent nomenclature, it was related to the town house of Holland. The ground floor with its nucleus of *voorhuis*, reception room (*zijkamer*) and inner hall (*galderij*) was, during most of the seventeenth century, the only living area of the house and the multi-purpose room the norm. In the eighteenth century the upper floor, which in the early years had served as a storeroom, came to house the bedrooms, for in keeping with developments elsewhere, the bed was no longer acceptable in the more public areas of the house. The furnishing of the rooms was spectacular. Ebony furniture with simple lines and elaborately carved surfaces contrasted boldly with the cool white walls, and together the two provided an ideal background for the lavish displays of porcelain and lacquer and the bright pools of colour offered by cushions of silk or brocade. Bedrooms when present were furnished

in similar style but rather less handsomely—a point I am most grateful to Dr. de Haan for noting. The woman who presided over this household from her place in the galerij was probably ill-educated and had almost certainly adopted many of the local customs of dress and deportment that eased the burden of life in the tropics, but her pride in her house remained unchanged and she saw to it that a bevy of slaves kept everything in immaculate condition, even when this demanded a twice-daily assault on the dirt.

To write in general terms about the Dutch house in New York is made rather difficult because so relatively few inventories are compiled room by room, and one is forced to rely on a tiny proportion of the whole. A few New York inventories, like a good many Cape inventories, reflect a rather inchoate pattern of domestic life at the end of the seventeenth century. Having made this point I must go on to stress that it was certainly a good deal more glamorous than anything to be found in Cape Town. For one thing, prosperity came earlier to New York. This was partly because it had been around longer—New Amsterdam was officially founded in 1625—partly because it was very much larger, and partly because it was no longer under the control of a Company whose lodestar and raison d'être were profit. A New York estate of 1686 was valued at over four thousand pounds,⁵⁶ the sort of figure first encountered at the Cape, and then in the estate of a Company official, in 1714,⁵⁷ so it is understandable that substantial houses existed at that period. Inspired by the town house of Holland, the early New York house was a brick building with stepped gables and a steeply pitched pan-tiled roof. It was built in several storeys with a cellar, at least two main floors, a loft and a garret. Such a house was furnished in a manner that the Cape could not begin to emulate until the 1720's, and was in many ways a close parallel to the town house at the Hague.

One feature which characterises the prosperous New York house at this period was the frequent presence of a "shop" which was commonly, though not invariably, located in a downstairs front room. This, as we we have seen, was no longer a common feature in prosperous circles at the Hague, and it had not as yet become a feature of the prosperous Cape Town house.⁵⁸ The amount of merchandise involved in private trade at the Cape rarely needed a special room to accommodate it—not,

that is, until the second quarter of the eighteenth century.

When the finest New York houses are compared with those of the Hague one gains the impression that quantity was often cultivated at the expense of harmony. A New York room seems to have been less carefully put together. Money was lavished on soft furnishings in a way the Cape did not attempt to emulate but, in comparison with the Hague, there was less emphasis on matching upholstery—a fact already observed by Esther Singleton.⁵⁹ The choice of furniture also seems to have been less studied, and there are fewer rooms recorded where all the chairs belong to one matched set. In houses of lesser importance a distinctly careless attitude is occasionally evidenced. In one house, for example, a mass of unsuitable merchandise including brooms, pails, shovels, baskets and cases of crockery, was permitted to overflow from the shop into the living room—and this in 1722.

Most important New York rooms at the end of the seventeenth century continued to combine a bed with sitting and dining room furniture. Some houses included three such rooms which were presumably beginning to function as reception room, family room and main bedroom. A few inventories show that the bed was in the process of disappearing from the main reception room, and there is sporadic evidence of the emergence of a dining room—a room where the bed continued to linger on. Most rooms were described without reference to their function: fore room, great chamber, lower back room, upper chamber, chamber above the kitchen and so on and so forth. But this was soon to change. Under English influence, the early eighteenth century saw the increasing use of unambiguous terms like parlour, dining room, bedroom and common room, and their occasional early use can be helpful in charting the changes that were taking place.

The New York inventories, with their undoubted colonial uncertainties, cannot measure up to the Hague inventories. It is clear that the standard, in each case, was much the same, but the effortless conformity of the Hague was lacking in New York. But for all that the New York house is yet another unquestionable monument to the bourgeois spirit of the fatherland. If any one thing can illustrate this convincingly, it is the approach to the bed—an approach which illustrates the gap that divides Cape Town on one side from New York and the Hague on the other. In the latter two centres the approach was virtually identical.

Unless the bedstead were built in, in which case two became permissible, no room other than the maids' room ought to contain more than one bed. When a bed appeared in a living room, be it an alcove bed or a four-poster, fashion—and, no doubt, good manners as well—required it to be suitably curtained. This was expensive. A number of New York beds with their hangings and other equipment were worth from fifteen to twenty-five pounds—both figures in excess of anything recorded at the Cape.⁶¹ If beds in Holland and New York were more valuable, there were, at the same time, fewer of them per household. I can offer only one New York inventory with over six beds—a figure quite often matched in Cape Town—and three out of the seven beds occupied the maids' room. How different, as we saw in an earlier chapter, was the role of the bed at the Cape.⁶² Very few Cape households other than those of an occasional Company official honoured the standards of bourgeois society in this respect; standards that had evolved to meet the growing demand for privacy within the home and which were in the process of establishing the complete withdrawal of the bed from the living areas of the house.

While the bed has served us well as a touchstone for privacy, order, which I view as another significant facet of the bourgeois home, is a more difficult quality to assess. All the evidence we have, including that offered by the Hague inventories, shows that order and cleanliness had become a cult in the homes of the burghers of Holland. There is less evidence about these aspects of domestic life in the East Indies, but Dr. de Haan was satisfied that the Dutch housewife in Batavia was at one with her sisters in Holland in this particular respect. My own impression is that the Dutch houses in New York could not really compare in orderliness with those of the Hague although they were a definite improvement on those of the Cape; for one thing, their cupboards and chests are much more logically arranged—a small point, but a very significant one. Anyway a Boston lady, Madam Knight, writing of the Dutch houses in her Journal of a Trip to New York in 1704 pronounced "the insides of them . . . neat to admiration."⁶³ Few Cape houses would seem to have deserved such a comment, and I cannot credit that they were the focus of the unremitting love and care of their womenfolk. Perhaps slavery must take all the blame for this, but that makes the immaculate Batavian house, as recorded by De Haan, difficult to explain. Probably there were

several reasons: the growing dependence on slavery; the unsophisticated and untutored response of people suddenly confronted with the burden of leisure; possibly, too, the inescapable boredom of the male in a society which discouraged agricultural initiative and commercial enterprise proved infectious for the female, who also succumbed. Whatever the reason, Johanna Maria van Riebeeck found nothing "neat to admiration" at the Cape when she saw it in 1710.

Johanna, the granddaughter of Jan van Riebeeck, the founder of the Cape settlement, had her first experience of the Cape when she passed through it with her husband, Joan van Hoorn, en route to Holland. Until that point her whole life had been spent in the East Indies, most of it in leading Government circles. Her first husband, Gerrit de Heere, was Governor of Colombo and her current husband, Joan van Hoorn, had been Governor General of Batavia for some years when, in 1708, he was succeeded by his father-in-law, Abraham van Riebeeck. The personality that emerges from the letters that the thirty-year-old Johanna wrote from the Cape to her parents in Batavia is not a particularly pleasant one: she appears arrogant and critical. A fairly free translation⁶⁴ of the relevant section of a letter written on 13th January, 1710, reads:

This place looks prettier and pleasanter from the roadstead than it does from the land. It is a miserable place. One sees neither grass nor trees. The roads everywhere, those by the castle and those through the town, lie criss-crossed with holes, as if wild pigs had been rooting in them. As a result one fears a fall if one rides to town or to the Company gardens which are also so "lovely"⁶⁵ it's positively heart-stopping! When one steps inside there's nothing that doesn't look "lovely"; such as the laurel trees which grow very high, although the paths are very narrow. Then there are fruit trees everywhere, but little fruit and none of it ripe. Then there are fine vegetables but planted wildly instead of in a nice and orderly way. Then there is the soil that looks very raw, and resembles a "volgeesie"^{66a} of juffr Moutmaker. But people at the Cape do not hear this willingly. There is nothing pretty to be seen along the shoreline here. The castle is very peculiar⁶⁶ and the house of the governor is so like a rabbit warren that one is easily lost in it. The other houses here resemble prisons. In addition there are the Hottentots who are a very ugly and smelly people, and the Hollanders

in the management of their houses are also very dirty [my italics]. One sees a lot of queer phizzes among the people here and the way of life is also peculiar. The governor is a very dashing man and, it seems, enjoys having the ladies in his company from time to time, so that there is a good deal of courtly ceremony here, but all of it in Hottentot style.

I must confess that I have never seen a worse place. But as for the food it is better than at Batavia, as is the climate.

In another letter written nearly three weeks later on 30th January, she writes in a similar vein.⁶⁷

A little way from the beach stood a carriage with six horses and was it dirty (Hottentotish like everything else hereabouts) ! By this means we came to the governor's house within the Castle, and entered a house that is a strange building and so grimy and grubby everywhere that it might well belong to Pater Smeerlant in Ceylon. The Castle has a wretchedly slovenly appearance and the buildings within are peculiar⁶⁶ in style. The town, for a place of this nature, is reasonably large, but the roads are terrible, full of holes, very uneven, and look as if they would bring a rider down, so much so that the roads in Boejong Gede are much prettier and much better and would be like highways here. Outside the town the roads are no less rough. It is a pity that there is not a governor here who is more careful and who would set a better example. The whole place would then be transformed as well as its people who are, at present, very cantankerous with each other. . . .

Mrs Dablijn [the wife of Secunde Johan Cornelis d'Ableing] is a sweet, modest little woman and there are two or three other women here who are like her, but they do not stand in the governor's good graces at all because they prefer each other's company. For such people this is a very sorry place.

Johanna's disgust is expressed in these letters with a contemptuous lack of sympathy that is the reverse of endearing, but this does not make her account any the less valuable. Allowing for the inevitable touch of exaggeration, she paints a picture of the domestic scene at the Cape which, on first reading it a short time

ago, I found rather reassuring. Johanna, viewing the Cape with strict feminine eyes, had come to much the same conclusion about it as I had myself. It was not the poverty of the place or the paucity of goods that struck her, but the dirt and disorder: everything was "Hottentotachtigh," a word introduced into the family vocabulary by her young step-daughter Petronella.⁶⁸ Though "Hottentotachtigh" is vivid enough, some of her images are odd at first sight; and the prison image may have been evoked less by the architecture than by the untidy and crowded interiors; the sort of interiors one finds in Hogarth's representations of prison life.⁶⁹

If the Cape house was not in the running for prizes for order and cleanliness in the expatriate world of the Hollander, it was certainly capable of leaving a favourable impression on the mere male. Dominie Valentijn is lavish with his praise: by 1705 the best of the town houses were "entirely in the Amsterdam style, with magnificent apartments below";⁷⁰ in addition to Constantia and Vergelegen there were "innumerable other fine residences, among which may be reckoned at the Table Bay . . . the property of Donker, those of Fiscaal Blesius, of Captain Bergh, of the Town Councillor Henrik Bouwman, the ornamental though small house and garden of Under-Merchant van Putten (bought in 1714 by the Cassier Voet for 2 200 Cape gld.), and the noble garden of a certain Marquart just above or to the side of the Company's Garden towards the Table Mountain, that of Pistorius, and very many others which I do not now recall."⁷¹ In a more sober fashion the English padre, Ovington, describes the houses in Cape Town as "strong and neatly built with Stone Walls and pretty Apartments."⁷² Whether the favourable comments of these two men of God were called forth entirely by the architecture or whether they were also influenced by the furnishings is not clear, but the latter strikes me as much more probable. After all, the furnishings of many Cape houses must have been pretty, and with their collections of porcelain and their Oriental wares, some of them must have had an air almost of luxury. To those familiar with the mean conditions in which the average peasant lived in Europe, as well as the virtual destitution of the urban poor,⁷³ the Cape interior was surely a most pleasant surprise, and no one but a Dutch housewife would

have seen beyond the porcelain, the tea-table, and the lacquer tray to the extra bed, the straying saddle, the dusty window-sill and the drink-stained table-cover. Let us remember, too, Mrs. d'Ableing and her small band of friends who met with the arrogant approval of this wife and daughter of governor generals. Presumably such women set an example not only in deportment but in household management. Some houses at the Cape were not only comfortably furnished but properly run, and most would have appeared as havens of comfort to the poor of Europe. It was not without reason that people were prepared to settle at the Cape. All the same, Johanna van Riebeeck's remarks add an important perspective, and one we should also bear in mind.

Before bringing this study to a close I would like to say a few additional words about the architecture of early Cape Town. Two passages with which I recently became familiar have given me new insight into how the little town might have appeared to contemporaries. Johanna's husband, Joan van Hoorn, in a letter to his father-in-law and successor Governor General Abraham van Riebeeck, mentions his attendance at divine service and goes on to say "the church is certainly the most handsome building at the Cape and approaches the small church at Batavia, though, like all houses other than the flat-roofed buildings within the Castle, it is roofed with reed and built in such an antique way [my italics] that one can only wonder at it."⁷⁴ How different in tone is the following passage from John Josselyn's Account of Two Voyages to New England, 1674: "New York is built with Dutch brick alla-moderna, the meanest house there being valued at one hundred pounds."⁷⁵

For contemporaries to describe New York as alla-moderna and Cape Town as "antique" is, to say the least, intriguing. Bierman in Boukuns in Suid-Afrika argues exactly the opposite: it was New Amsterdam with its stepped-gables and high, tiled roofs, directly imported from Holland, that exhibited a style that was rooted in Gothic Europe and outmoded when the Cape was founded in 1652; it was the Cape which, in keeping with most other Dutch dependencies including Batavia and Curaçao, was built on the sure foundations of Portuguese colonial architecture in the classical tradition.⁷⁶ With hindsight it is easy to point to the architecture of the Castle and the two sketches we have of Vergelegen (Pls. 14&15) as evidence that the Cape was part of this tradition from the start, but it seems to have been

much less obvious at the time.

Probably the most obvious features of Cape Town in about 1700 were the lowness of its walls and the pervasiveness of its thatched roofs, neither being elements which the men and women of the period would have associated with modern town architecture. Thatch was completely outmoded, and a straw roof had become not only a sign of the past but a sign of poverty.⁷⁷ Many cities had introduced ordinances against the use of thatch and wooden shingles, and in some places the introduction of slate shingles and terra cotta tiles was achieved by coercion and even by means of subsidies.⁷⁸ The wisdom of such measures had recently been graphically demonstrated by the Great Fire of 1666 which devoured the thatch-roof houses of London, and it was certainly not disputed by the Cape authorities who were all too familiar with the danger posed by the prevailing wind in the Cape Peninsula, the famous south-easter. The use of thatch in Cape Town was an acknowledged pis aller. From the thirteenth century, if not before, a respectable European town house was never less than two storeys and was often three or four storeys high,⁷⁹ and the fact that the vertical emphasis and narrow streets of the Gothic town had been superseded by the horizontal lines and broad vistas favoured by Renaissance classicism made very little difference to the actual height of the houses. The Cape Town houses, which were often only one and seldom, if ever, more than one-and-a-half storeys high, were therefore too low—and everything from the mountain backdrop to the broad streets and numerous lean-tos must have served to emphasise the fact. Add to this the poor state of the unmade roads, and Cape Town probably had more in common, superficially, with a mediaeval European village than a new colonial town in the classical tradition. New York, on the other hand, unquestionably looked like a town, and the description "alla-moderna" was probably not much more than a tribute to this very fact.

If Cape Town, for reasons which were unavoidable, looked more like a village than a centre of urban life, the interiors of the houses were also, but for rather different reasons, an imperfect image of the Dutch bourgeois spirit. Huizinga in another famous essay, "The Spirit of the Netherlands," writes:

The solidarity of the Dutch people springs from their bourgeois character. Whether we fly high or low, we Dutchmen are all bourgeois—lawyer and poet, baron and labourer alike. Our national

culture is bourgeois in every sense you can legitimately attach to that word.⁸⁰

The bourgeois spirit, however, is only at home in an urban setting, or in a setting readily reached by urban values, as was the case, according to Huizinga, in rural Holland; for the qualities properly associated with the word "bourgeois" are urban qualities. In those overseas settlements which were basically urban in character, such as Batavia and Colombo, the bourgeois nature of the Dutch again took root but in circumstances where the exigencies of the climate, the corruption of slavery and the obsession with money-making produced a society which the Dutch historian, Pieter Geyl, has described as "distressingly materialistic and gross" and one bent on "ostentatious display."⁸¹ Nowhere was the corruption of slavery more painfully apparent than in Surinam, a Dutch dependency in South America. Conditions in Surinam were generally inimical to bourgeois values, for a society developed there that was similar in structure to other plantation and slave-owning communities, such as those of Antilles and Brazil. There an embryo middle class of white overseers, clerks and merchants was sandwiched between the white owners of the sugar plantations and the unfortunate negro slaves. So unfortunate were the latter that Professor Charles Boxer can actually write of "the sadistic cruelty, pig-headed selfishness and short-sighted cupidity of successive generations of its [Surinam's] planters and their overseers," and conclude that "man's inhumanity to man just about reached its limits in Surinam."⁸² Life for the Dutch in North America, particularly those of them who settled in and around New York, could hardly have been more different. Within a few decades at least one genuinely urban setting had been created in which middle-class virtues and values could grow and flourish. It was a setting moreover that was blessed with a less hostile climate than that of Surinam or Batavia, and one that also escaped the evils of slavery. As a result the society that developed there was able to mirror many of the qualities associated with the townsman of Holland. Whether Dutch life retained its genuine bourgeois nature outside New York in the settlements along the Hudson and Delaware rivers is a matter on which I cannot speak, but with New York in the background and their own folk memory to guide them it does not seem entirely impossible—although it cannot have been easy.

At the Cape a pattern of life developed with no close parallel in any other Dutch settlement. Though a slave-owning community, the Cape could not offer the world any of the great staples such as sugar, wheat or spices. There was, therefore, no reason for the intensive cultivation of the soil which would almost certainly have led to a slave economy like that of Surinam and the sugar islands.⁸³ Nor could the Cape follow the pattern of life that was growing up in and around New York, in part because of the institution of slavery, but largely because there were far too few people. Before the smallpox epidemic of 1713, which reduced the European population by a quarter, the burgher population had not quite reached the two thousand mark.⁸⁴ This figure is tiny; it represents the population of a very small town in the seventeenth century and that of a village in our own times. A census taken in 1791 shows that the population at the Cape had risen to some 1 500 officials, 14 000 burghers and 17 000 slaves,⁸⁵ and at the end of the eighteenth century was the equivalent of a small modern town. Another way of throwing the population figures at the Cape into perspective is provided by some immigration figures to America. During the six-year period, 1769 to 1774, Irish immigration to that land amounted to 44 000 or under 8 000 a year.⁸⁶ These figures are offered by Fernand Braudel as illustration of the relatively modest number of people involved in the colonisation of North America, but this is not how they strike the student of our own history. Immigration to the Cape in the fifty-year period, 1700 to 1750, did not even amount to 600 people.⁸⁷ It is true that after the trouble between the burghers and Willem Adriaan van der Stel the Company decided against a policy of immigration,⁸⁸ but would the outcome have been all that different had it not done so? Braudel, with no conceivable axe to grind, believes that Europe had little interest in Africa in the eighteenth century because Africa was a particularly tough proposition, and because all Europe's superfluous energy was mobilised by trade with the East and the American adventure.⁸⁹

Whether the product of the Company's restrictive practices or of circumstances largely beyond control, the Cape did not offer an entirely favourable environment to the values of urban Holland. It is hardly surprising, therefore, that the Cape inventories show that the bourgeois spirit was not the well-rooted growth recognisable in the

inventories of the Hague, and even those of New York. It was challenged by a lack of conformity, a lack of order, a lack of interest in personal privacy and, according to Johanna van Riebeeck, by a tolerance of dirt. The early Cape house was not one more clear manifestation of middle-class values, and the size of the white population is unquestionably a crucial factor in explaining why this was the case. The humble origin of so many of the early settlers would surely have contributed less to the final pattern if they had found themselves in an urban environment, or had been able to create such an environment relatively quickly. In the event, the bourgeois spirit of the fatherland was not only distorted by the institution of slavery, which made of every white man a master and of every farmer a plantation owner manqué,⁹⁰ but continually assailed by the less complicated and less restrained spirit of the farmer in a wild and sparsely populated land with the great sub-continent of Africa lying enticingly in the rear.

Yet the bourgeois spirit never completely succumbed. Inventory after inventory shows that attempts were made to meet its obvious requirements—sometimes with considerable success. Ironically, perhaps, this too was largely due to the smallness of the population. During the period covered by this study the Cape settlement had not yet spread beyond the reach of Cape Town and, with the population still below the two thousand mark, both rich and poor alike were able to benefit from and be influenced by the Cape's position on the Eastern trade route. It was the visiting ships—between 1700 and 1714 these averaged sixty-seven a year⁹¹—with their cargoes, passengers and crew that nurtured middle-class values, stimulated commercial enterprise in however small a way, and provided the common man with exceptional opportunities to add to the number of his possessions. It is undeniable that even the poorest estates sometimes included one or two luxuries—a featherbed, some porcelain cups, a copper tartpan, or a cask of wine—while the majority included a number of items that added to the pleasure and comfort of life. When Ovington writes of the Cape farmers that "very few of any Substance but easilier may increase their Goods than their Treasure," he has already noted that by means of calling ships "there is scarce one part of all the Tripartite Continent, that is furnisht with that abundance of Conveniences, which the Cape can boast of."⁹²

Where there are possessions to cherish the bourgeois spirit is not readily overcome—unless it is replaced, as in Surinam, by the seignorial spirit.

A house is the sum total of its parts, and to me there are two factors, one tangible, the other intangible, which are in large part responsible for the unique flavour of the Cape Dutch interior. On the one hand, the houses in this newly settled corner of Africa were the products of an unusually balanced mixture of East and West, and on the other hand they were the meeting place of the urban and rural spirits. It was Sir Charles Leonard Woolley who wrote of the houses of Ur from the third millenium B.C.: "if we do not know in what surroundings people moved and had their being we shall understand very little of their attitude towards life."⁹³ Probably the most important message these interiors have for us is that, up to 1714, the Cape was not only a Dutch colony in fact but also, in many ways, in spirit. That there were alien tensions is undeniable. Life in "dese africaanse wereld"⁹⁴ was not like life in Holland. Few Cape interiors were perfect settings in which to mould and thus perpetuate the disciplined elaborations of the healthy bourgeois spirit. But while the settlers could anticipate no more than moderate wealth, and while they also remained within comfortable reach of Cape Town and the ships that sailed the seas under the flag of Netherlands India, the lack of conformity could be contained. There were no Afrikaners in 1714.

Footnotes

- 1a. For the facts in this paragraph I follow Dilliard, op. cit., pp. 13-14.
1. For instance Elijsabet Bancker Inv., 1693, file no. 7, Historic Documents Collection, Queens College, Flushing.
2. Examples include "cap stick" (kapstock), "Cann board" (kanneboard), "stick bason" (ondersteekbekken), "Japon coat" (Japone rok).
3. Examples include "flesshes" (flessen), "list" (lijst), "tripe" (trijp), "matt" (gematte), "ledi kant" (ledikant), and "tapijt."
4. In the colony of New York, a law of 1665 and another of 1692 show that an inventory was only required by law of estates of those who died intestate (Kenneth Scott, "New York Inventories, 1665.1775," National Genealogical Society Quarterly Nov, 1966 pp. 246-249).
5. The two-roomed house of Jan Martense Schenk built in c. 1675 and now incorporated into the Brooklyn Museum has a large hooded fire-place without jambs in each room. The fire-places are reconstructions, but are known to reflect those originally present (information ex Mr Kevin Stayton, Assistant Curator, Dept. of Decorative Arts, Brooklyn Museum).
6. See above, pp. 46-48.
7. Cedar is the only indigenous wood mentioned with some regularity in the New York inventories.
8. A fine woollen material related to serge.
9. Gemeente Archief, 's-Gravenhage, Not. Arch., 372, Inv. of Willem Boers, Concierge of the Prince of Orange, 1681, p.251. The heading reads, "In de slaep Camertje vanden Compt." See also p.274. n.54.
10. In the last three decades of the 17th century Indian cottons, often known as calicos, were printed in Europe, and in America calico acquired the meaning of a printed cotton cloth. See also p.124, n.20 & p.126, n.49.

11. Salempores: a plain cotton cloth normally 16 yards in length from Serampore. Plain red or blue examples occur in addition to white.
12. Also parecala or percallaes; fine cotton from the Coromandel coast, used for painted designs. Each piece was 10 yds in length.
13. Niquania; a cheap striped cotton from Surat.
14. Mallemol; fine muslin often embroidered with flowers and combining gold and silver thread.
15. Also moeris or mouris; standard category of plain woven cloth, 10 yds in length, from the Coromandel coast, often dyed plain, check or stripe.
16. Also humhums; plain cotton of thick stout texture.
17. Gingham; striped or checked cotton patterned in the loom; sometimes a cotton and silk mixture; at the Cape is also described as flowered or painted or twilled.
18. Also photassen or fatasse; a checked cloth of strong weave, usually blue and white.
19. Also dromganh; cheap dyed cotton cloth, usually striped or checked; at the Cape is generally described simply as blue or black.
20. Chelas; fine cotton, often striped blue and suitable for handkerchiefs; at the Cape is also described as red.
21. See above, p.126, n.9.
22. Betailles, muslin from the Coromandel Coast, sometimes plain coloured, sometimes striped, flowered or embroidered.
23. Atlas; a shiny cotton or satin; at the Cape sometimes described as flowered.
24. Gemeente Archief 's-Gravenhage, Not. Arch., 574, Nicolaas Kann Inv., 1693, p.133.
25. Ibid., 551, Reijnier Nootman Inv., 1696, p.229.
26. Ibid., 1781, Agata Colijn Inv., 1712, p.495.
27. Margreta Van Varick Inv., 1695-96, file no. 134, Historical

- Documents Collection, Queen's College, Flushing.
28. Ibid., Dr. Jacob De Lange Inv., 1685, file no. 47.
 29. Ibid., Gertrye Splinter Inv., 1722, file no. 245.
 30. Ibid., Cornelis Stenwick Inv., 1686, Liber 19B, 1677-1685, n.p.
 31. Capt. John Deane Inv., 1733, Inventories 1730-1752, p.74, Surrogate's Court, New York.
 32. Gemeente Archief 's-Gravenhage, Not. Arch., 551, Reijndier Nootman Inv., 1696, p.229.
 33. Ibid., 1779, Elisabet van Hennen Inv., 1704, p.69.
 34. Ibid., 428, Dirck van Schorrenbergh Inv., p.833.
 35. Ibid., 1800, Philip van Leeuwen Inv., 1711, p.199.
 36. Ibid., 1765, Allardus Titsing Inv., 1713, p.41.
 37. Ibid., 728, Helena Cleijberg Inv., 1707, p.811.
 38. See above, pp. 157-58.
 39. De Lange owned 6 pictures worth £1 " 10s - £3 " 5s.
 - 40a. For the facts in this paragraph I follow Haley, op. cit., pp. 89-90.
 40. See above, pp.253-54.
 41. In a personal communication with Dr. Leo Herszkowitz, Director, Historical Documents Collection, Queen's College, Flushing.
 42. J. H. Huizinga, Dutch Civilisation in the Seventeenth Century, selected by Pieter Geyl & F. W. N. Hugenholtz, trans. from Dutch Arnold J. Pomerans (London:1968) p.40.
 43. Ibid., pp. 40-43.
 44. De Haan, op. cit., I, 534.
 45. Esther Singleton, Dutch New York, (New York: 1909), p.172.
 46. See above, p.241.
 47. Peter Jacobsen Marius Inv., 1702, file no. 174, Historical Documents Collection, Queen's College, Flushing.
 48. For instance the merchandise of Cornelis Stenwick in 1686 included "67 Dutch bookes / 76 french, English, Latin etc. / 24 greate

- of ditto tonges / 160 middle sorts and small of severall tonges / 28 bookes Dutch" (Liber 19B, 1677-85, Historical Documents Collection, Queen's College, Flushing); and the shop of David Provoost, Jr held "4 doz proverbs of Solomon / 3 1/2 doz of David / 26 Testaments / 14 1/3 doz a b books / etc." (David Provoost, Jr. Inv., 1701, Rutherford Family Papers, New York Historical Society).
49. Gemeente Archief 's-Gravenhage, Not. Arch., 551, Reijnier Nootman Inv., 1696, p.229.
50. Ibid., 335, Gertruijt Louckers Inv., 1693, p.223.
51. Ibid., 1786, Philip Bonck Inv., 1705, p.31.
52. See above, pp. 240-46.
- 53a. Haley, op. cit., pp. 124-25.
53. See above, pp. 52-54. 82-86.
54. As a matter of interest the description of the principal house in the estate of Willem Boers, concierge to the Prince of Orange, compiled in 1681, reads: "Groot kamer [furnished as a reception room without a bed] . . . Int Blauwe Camertien [a dining room without a bed] . . . Slaep Camertie . . . In de slaep Camertje vanden Compt . . . In't Portaal . . . In't Voorhuijs . . . Op de Boven kamer daer de Cornet slaep . . . Op het Camertje van de Compt zijn soon genaemt Goedert . . . Op het Camertje van den Compt zijn soon genaemt Gillis . . . [inventory continues with attic and kitchen quarters] . The choice of materials is, typically, more adventuresome than that found in middle-class houses. The reception room had a wall hanging and a table cover of Rouen stripe, white striped window curtains and chairs of Haarlem brocade, flowered green and red. The dining room had a hanging of gold leather on a red ground, and chairs and table cover of flowered plush, and the Count's bedroom had a wall hanging of flowered Indian material, bed hangings and window curtains of red serge, and chairs upholstered in green woollen cloth (Gemeente Archief, 's-Gravenhage, Not. Arch., 372, p.251).
55. De Haan, op. cit., I, 464, 469, 471-73, 491-518.
56. Cornelis Stenwick Inv., 1686, Liber 19B, 1677-1685, Historical Documents Collection, Queen's College, Flushing.
57. Senior Surgeon ten Damme Inv. (II,117,1714). The sale of Simon van der Stel's furniture, wine and slaves—Constantia itself reverted to the Government—brought over £6000 (Böeseken, Van der Stel, p.221).

58. In 1680 Company officials were forbidden to keep shops. These were a privilege of the burghers, who might only sell such goods as would not prejudice the Company (Botha, op. cit., I, 169). The first inventory with a shop, however, belonged to Under-merchant Corssenaer's widow (III,37,1713) ! Officials often used their wives to get round such prohibitions.
59. Singleton, Dutch New York, p.88.
60. Gertrye Splinter Inv., file no. 245, Historical Documents Collection, Queen's College, Flushing.
61. "Expensively" furnished beds at the Cape were worth f150 - f180 or £10 - £12.
62. See above, pp. 80-82.
63. Quoted by Dilliard, op. cit., p.85.
64. The Dutch text reads:
Dese plaase doet hem, van de ree af te sien, mooyer en plesierigh(er) op, als wanneer men aan lant is. Het <is> seer mieserabel; men siet lover noch gras staan, en de wegen overal bij het casteel en door de statsstraate leg<g>en schuyns en over met gaten, als offer de wilde varkens het hadde omgevroet, soodat men met vrees is van omvallen, als men naar de stat sal rijden of <naar> de Companje's tuyne, daar het ook soo fraaij is dat een mens sijn hart toe sluyt. Als men daarin komt, niet is dat noch wat fraay lijckt, als de laurierbomen, die seer hoog hier groeyt (sic), hoewel de paden heel naauw sijn, ende alle de vrugtbomen vol staan, maar wijnigh vrugte en noch niet rijp benne, en schoone groentens, maar gans niet fraay op ordere geplant, en de gront heel bar ook siet, en wel soo een volgeesie van juffr Moutmaker geliĳkent, maar de Caapse luyde hoore dit niet garen. Hier op dese <plaas>, heeft men langs strantkant niet mooys te sien, en het casteel is mede heel aardig en het huys van de gouvernuer lijckt wel doolhuys, men souder ~~mack~~lijck in kenne verdwaalt raken, en de andere huysen hierin lijcken wel gevangenhuisen, en buyten de Hottentots, dat heele lelycke en stinkende mense bennen, en so benne. de Hollanders in haar huyshouwen ook seer morsigh, en men siet hier aardige troonies van menschen, en hier is een aardigh mannier van leven.

En de goevernuer is een man van heel veel swiers, en hout, scheidt <'t>, veel van dames altemets tot zijn geselschap hebben, soodat hier een hele hoofse swier is, maar evenwel alles op sen Hottentots.

Ik moet bekennen dat ik van aansienhalve geen sleghter plaas hebbe gesien. Maar wat de spijs belanght, is het beter als op Batavia, en ook het klimaat (Briewe van Johanna Maria van Riebeeck, ed. Bosman, p.69).

65. This passage is obviously meant to be ironical.
66. The editor of the Dutch text, Dr. Bosman, cannot explain this word. Perhaps it derives from "volgeest" (see Halma, "Volgeestig, byv. Geestryk, vernuftig. Ingénieux, industrieux, plein de bon sens") and means a "crazy joke" or "drunken jest."
66. The original word "aardig" (nice) is one Johanna used a great deal when voicing a criticism. Whether it should be understood ironically or in the sense of peculiar (eienaardig), or whether it had already taken on an unfavourable meaning in Colonial Dutch is impossible to say. (See Bosman, Briewe van Johanna van Riebeeck, p.69, n.12.)
67. The Dutch text reads:
- Een wijnigh van strant af stont een karos met 6 paarden daarvoor en sag er wat morsig uijt (gelijck overal hier soo wat hottentot-aghtigh is) daar wij mede tot binne het Casteel, voor het huys van de goevernuer reeden, en in huys quamen dat een seer aardig gebouw is, en soo vuyl en smeerigh overal, offet tot Pater Smeerlant op Cijlon was. Het casteel sieter miserabel slorsigh daaruyt, en ben(n)ne aardige vatsoentjes van gebouwen die hierin staan. De stat is voor dese plaas redelijck groot, maar de wegen overal seer slordigh, vol met gaaten en hoog en laag, dat lijkt als men rijt alsof men omvallèn soude, soodat de wegen na Boejong Gede veel mojer en beter sijn, en een heerewegh hier bij is. En buyten is het ook niet minder hollebolligh. Het is jammer dat hier geen goevernuer en is die daarop en geen meer kureues hijet en heeft, en ook van een beter leven is. Dese hele plaas soude dan ook wel veranderè, en ook de menschen, die nu malkandere seer nijdig sijn....

Juffr Dablijn is een heel soet, modest vroukje en dan noch twee à drie vrouwe hier, maar die staan gans niet wel in de

- goevernuers graasi, omdat die haar met de andere in geselschap
<niet ?> wille veel voegen. Het is voor sulke luyde hier
een seer droevige plaas (Ibid., p.78).
68. " . . . daar [de Kaap] Pieternelletje segt het al hottentots
gelijkt" (Van Hoorn to Abraham Van Riebeeck, 12.1.1710 [Ibid., p.71]).
69. For example "Scene in Bridewell" from A Harlot's Progress and
"The Prison Scene" from The Rake's Progress. (See Hogarth:
The Complete Engravings, eds. Joseph Burke and Colin Caldwell
London: 1968 , Pls. 137 & 160.
70. Valentyn, op. cit., II, 283.
71. Ibid., I, 199.
72. Ovington, op. cit., p.508.
73. This subject receives a good deal of attention from Fernand Braudel,
Capitalism and Material Life 1400 - 1800, trans. from French Miriam
Kochan, (London:1973), pp. 195-205.
74. Briewe van Johanna Maria van Riebeeck, p.72.
75. Quoted by Singleton, Dutch New York, pp. 45-46.
76. Bierman, op. cit.,pp. 1-14.
77. Braudel, op. cit., p.195.
78. Ibid. See also Carl F. Barnes, Jr., "The Mediaeval House," in
The Secular Spirit: Life and Art and the End of the Middle Ages,
The Metropolitan Museum of Art (New York: 1975) p.18.
79. Ibid., pp. 15-18.
80. Huizinga, op. cit., p.112.
81. Pieter Geyl, The Netherlands in the Seventeenth Century, Vol. II,
1648-1715 (London/New York 1964), p.185.
82. Boxer, op. cit., pp. 151 & 241.
83. This point is developed by C. W. de Kiewiet, A History of South Africa
Social and Economic (London, 1941), p.9.
84. See above, p.5.

85. Walker, op. cit., p.106.
86. Braudel, op. cit., p.12.
87. F. C. Dominicus, Het Huiselik en Maatschappelik Leven van de Zuid-Afrikaner ('s-Gravenhage, 1919), p.7.
88. Walker, op. cit., pp. 65-66.
89. Braudel, op. cit., p.12. The fleets of the D.E.I.C., for instance, required 3 000 - 5 000 men annually, which Holland had great difficulty in supplying from her own resources and those of her Protestant neighbours (Geyl, op. cit., p.182).
90. In 1743 Governor General van Imhoff made a report on the Cape in which he regretted that Europeans had not been sent out in large numbers in the early years because the introduction of slavery had caused every white man to regard himself as a master while most land owners had become not farmers but masters of plantations (Theal, op. cit., IV, 68-69).
91. 1 070 ships called during this period, 683 of them Dutch (ibid., III, 492).
92. Ovington, op. cit., pp. 502 & 482.
93. Quoted by Barnes, op. cit., p.19.
94. Van Hoorn to Abraham van Riebeeck, 12.1.1710 (Briewe van Johanna Maria van Riebeeck, p.71).

Bibliography of Works CitedA. Social and Historical Background

- Appel, A. "Die Geskiedenis van Houtvoorsiening aan die Kaap 1652 - 1795." M.A. Diss. Stellenbosch, 1966.
- Böeseke, Anna J. Simon van der Stel en sy Kinders. Cape Town: Nasou, 1964.
- . Slaves and Free Blacks at the Cape, 1658 - 1700. Cape Town: Tafelberg, 1977.
- Botha, C. Graham. Collected Works. 3 vols. Cape Town: C. Struik, 1962.
- Boxer, C. R. The Dutch Seaborne Empire 1600 - 1800. The History of Human Society. Gen. Ed. J. H. Plumb. London: Hutchinson, 1965.
- Braudel, Fernand. Capitalism and Material Life 1400 - 1800. Trans. from French Miriam Kochan. London: Weidenfeld & Nicolson, 1973.
- Brugmans, H. Het Huizerlijk en Maatschappelijk Leven Onzer Voorouders. 2 vols. Amsterdam: Elsevier, 1914.
- Cairns, Margaret. Cradle of Commerce: The Story of Block B. Ed. Wilhelm Grütter. At the inauguration of the new Woolworths store. Cape Town: Woolworths, 1974.
- Commelin, Isaak, ed. Begin ende Voortgangh van de Vereenigde Nederlandtsche geoctroyeerde Oost-Indische Compagnie. No. pl. [Amsterdam], n. publ., 1646.
- Dampier, William. A New Voyage Round the World. Vol. I of two individually titled works. 3rd ed., with corrections. London: printed for James Knapton, 1699.
- De Haan, F. Oud Batavia. 2nd rev. ed. 2 vols. Bandoeng: A. C. Nix, 1935.
- De Kiewiet, C. W. A History of South Africa Social and Economic. London: Oxford Univ. Press, 1941.
- De Wet, G. C. Die Vryliede en Vryswartes in die Kaapse Nedersetting 1657 - 1707. Ph.D. Diss. Stellenbosch. Cape Town: Historiese Publikasie-Vereniging, 1981.
- Dominicus, F. C. Het Huiselik en Maatschappelijk Leven van de Zuid-Afrikaaner in de Eerste Helft der 18de Eeuw. 's-Gravenhage: Martinus Nijhoff, 1919.

- Du Toit, P. S. Onderwys aan de Kaap onder de Kompanie 1652 - 1795.
 Ph.D. Diss. Stellenbosch. Cape Town/Johannesburg: Juta,
 1937 (pref).
- Elias, Norbert. The Civilising Process. Trans from Germ. Edward
 Jephcott. 1939; rpt. Oxford: Basil Blackwell, 1978.
- Fiennes, Celia. The Journeys of Celia Fiennes. Ed. Christopher
 Morris. London: Cresset Press, 1947.
- Franken, J. L. M. "Adam Tas en Sy Familie." Die Huisgenoot,
 1.10.1926, pp. 31-35.
- Galt, John. Annals of the Parish. Everyman's Library. London:
 Dent, 1926.
- Geyl, Pieter. The Netherlands in the Seventeenth Century. Vol II
 (1648 - 1715). London: Benn; New York: Barnes & Noble, 1964.
- Haley, K. D. The Dutch in the Seventeenth Century. London: Thames
 & Hudson, 1972.
- Huizinga, J. H. Dutch Civilisation in the Seventeenth Century. Selected
 by Pieter Geyl & F. W. N. Hugenholtz. Trans. from Dutch Arnold J.
 Pomerans. London: Collins, 1968.
- Kolbe, Peter. Caput Bonae Spei Hodiernum. Nurnberg: Pieter Conrad
 Monath, 1719.
- Laslett, Peter. "The Jacobean Age." The Connoisseur's Complete Period
Guides. Eds Ralph Edwards & L. G. G. Ramsey. Rpt. in 1 vol.
 London: The Connoisseur, 1968, pp. 263-76.
- Mentzel, O. F. A Geographical Topographical Description of the Cape of
Good Hope. Trans. from Germ. H. J. Mandelbrote. 3 vols. Van
 Riebeeck Society. Nos. 4, 6, 25. 1787; rpt. Cape Town, VRS, 1921 - 44.
- Oakeshott, Michael. On Human Conduct. Oxford: Clarendon Press, 1975.
- Ovington, J. A Voyage to Suratt, In the year, 1689. London: printed
 for Jacob Tonson, 1696.
- Pearse, G. E. The Cape of Good Hope 1652 - 1833: an account of its
buildings and the life of its people. Pretoria: J. L. van Schaik,
 1956.
- Pepys, Samuel. The Diary of Samuel Pepys. Ed. Henry B. Wheatley.
 8 vols. Rpt. 3 vols. London: G. Bell & Sons Ltd., 1942.
- Picard, Hymen W. J. Gentleman's Walk. Cape Town: C. Struik, 1968.
- Price, J. L. Culture and Society in the Dutch Republic During the 17th
Century. London: B. T. Batsford, 1974.

- Saint Simon, Duc de. Memoires. Ed. Gonzague Truc. 7 vols.
Paris: Bibliothèque de la Pléiade, 1950.
- Schotel, G. D. J. Het Oud-Hollandsch Huisgezin der Zeventiede Eeuw.
2nd rev. ed., H. C. Rogge. Leiden: A. W. Sijthoff, n. d. [1903].
- Singleton, Esther. Dutch New York. New York: Dodd, Mead & Company, 1909.
- Theal, George McCall. History of South Africa. 11 vols. Facsimile
of "Star" edition, 1919 - 1926; rpt. Cape Town: C. Struik, 1964.
- Valentyn, François. Beschryvinge van de Kaap der Goede Hoop met de
zaaken daar toe behoorende. Fin. ed. Edith Raidt. Dutch with
parallel Eng. text. Eng. trans. R. Raven-Hart. 2 vols. Van
Riebeeck Society. 2nd series, nos. 2 & 4, 1726; rpt. Cape Town:
VRS, 1971 & 1973.
- Van der Stel, Willem Adriaan. Korte Deductie. No. pl. [Amsterdam],
n. publ., 1708.
- Volmaakte Hollandse Keuken Meid, De. Anon. Facsimile of 1761 edition;
rpt. Leiden: A. W. Sijthoff, 1965.
- Wagener, F. J., ed. Rondebosch Down the Years 1657 - 1957. Rondebosch:
n. publ., 1957.
- Walker, Eric A. A History of Southern Africa. London: Longmans, Green
and Co., 1957.
- Zumthor, Paul. Daily Life in Rembrandt's Holland. Trans. from French,
Simon Watson Taylor. London: Weidenfeld & Nicolson, 1962.
- B. Art, Architecture and the Decorative Arts
- Atmore, M. G. Cape Furniture. 2nd rev. ed. Cape Town: Howard
Timmins, 1974.
- Bamborough, Philip. Antique Oriental Rugs and Carpets. Poole (Dorset):
Blandford Press, 1979.
- Baraitser, Michael & Anton Obholzer, Cape Country Furniture. 2nd rev. ed.
Cape Town/Johannesburg: C. Struik, 1978.
- Barnes, Carl F. "The Mediaeval House." In the Secular Spirit: Life
and Art at the End of the Middle Ages. The Metropolitan Museum of
Art. New York: E. P. Dutton & Co Inc, 1975.
- Bax, Dirk. Het Oudste Kaapse Zilver 1669 - 1751. Verhandelingen der
Koninklijke Nederlandse Akademie van Wetenschappen, afd., letterkunde,
nieuwe reeks, dl. 86. Amsterdam: Noord-Hollandsche uitg.
maatschappij, 1974.

- Zuid-Afrika's Eerste Openbare Verzameling op het Gebied van Kunst en Ethnologie. Verhandelingen der Koninklijke Nederlandse Akademie van Wetenschappen, afd. Letterkunde, nieuwe reeks, dl, 75, no. 3. Amsterdam: Noord-Hollandsche uitg. maatschappij, 1970.
- Berkovitch, Barry M. The Cape Gunsmith. Stellenbosch: Stellenbosch Museum, 1976.
- Bernt, Walther. The Netherlandish Painters of the Seventeenth Century. Trans. from 3rd Germ. ed by P. S. Falla. 3 vols. London: Phaidon Press, 1970.
- Bierman, B. E. Boukuns in Suid-Afrika. Cape Town/Amsterdam: A. A. Balkema, 1955.
- Brongers, Georg A. Nicotiana Tabacum. Trans from Dutch W. C. ter Spill. Amsterdam: H. J. W. Becht's Uitgeversmaatschappij, 1964.
- Buck, Anne. Dress in Eighteenth Century England. London: Batsford, 1979.
- Cook, Mary. Die Kaapse Kombuis. Stellenbosch: Stellenbosch Museum and Drostdy Swellendam, n.d.
- "Cutlery." The Oxford Companion to the Decorative Arts. Ed. Harold Osborne. Oxford: Clarendon Press, 1975.
- Dane, Phillipa and Sydney-Ann Wallace. The Great House of Constantia. Cape Town: Don Nelson, 1981.
- De Bosdari, C. Cape Dutch Houses and Farms. Cape Town/Amsterdam: A. A. Balkema, 1953.
- De Jonge, Jkv C. H. Delfts Aardewerk. Rotterdam/'s-Gravenhage: Nijgh & Van Ditmar, 1965.
- De Leth, Hendrik. Het Zegenpralent Kennemerlant. Facsimile of 1732 edition; rpt. 's-Gravenhage: Kruseman, 1966.
- Dilliard, Maud Esther. An Album of New Netherland: Dutch Colonial Antiques and Architecture. New York: Bramhall House, 1963.
- Entwisle, E. A. The Book of Wallpaper. London: Arthur Barker, 1954.
- Fransen, Hans. "Architecture." In Stellenbosch Three Centuries. Ed. Francois Smuts. Official commemorative volume. Stellenbosch: Stellenbosch Town Council in collaboration with the Oude Meester Group, 1979, pp. 81-145.
- , Drie Eeue Kuns in Suid-Afrika: beeldende kuns, bouwkuns, toegepaste kuns. Pietermaritzburg: Anreith, 1981.
- , Groot Constantia: its history and a description of its architecture and collection. Cape Town: S.A. Cultural History Museum, 1972.

- Fransen, Hans & Mary Alexander Cook. The Old Buildings of the Cape. Cape Town: A. A. Balkema, 1980.
- The Old Houses of the Cape. Cape Town: A. A. Balkema, 1965.
- Fraser, Maryna. The Story of Two Cape Farms. No place: privately printed, 1980.
- "Glass." The Oxford Companion to the Decorative Arts. Ed. Harold Osborne. Oxford: Clarendon Press, 1975.
- Hillier, Bevis. Pottery and Porcelain 1700 - 1914. The Social History of the Decorative Arts. Gen. Ed. Hugh Honour. London, Weidenfeld & Nicolson, 1968.
- Hogarth: The Complete Engravings. Eds. Joseph Burke and Colin Caldwell. London: Thames & Hudson, 1968.
- Honour, Hugh. Chinoiserie: The Vision of Cathay. London: John Murray, 1961.
- Howard, David & John Ayers. China for the West. 2 vols. London/ New York: Sotheby Parke Bernet, 1978.
- Irwin, John & P. R. Schwartz. Indo-European Textile History. Amedabad (India): Calico Museum of Textiles, 1966.
- Kendall, F. K. The Restoration of Groot Constantia. Cape Town, Juta & Co, n.d.
- King, Donald. "Textiles." The Connoisseur's Complete Period Guides. Eds. Ralph Edwards & L. G. G. Ramsey. Rpt. in 1 vol. London: The Connoisseur, 1968, pp. 429-42.
- Le Roux, Marius. The Cape Coppersmith. Stellenbosch: Stellenbosch Museum, 1981.
- Meischke, Ir. R. Het Nederlandse Woonhuis van 1300 - 1800. Reconstructie-tekeningen H. J. Zantkuijl. Vijftig jaar vereniging Hendrik de Keyser. Haarlem: H. D. Tjeenk Willink & Zoon, 1969.
- "Mirrors." The Oxford Companion to the Decorative Arts. Ed. Harold Osborne. Oxford: Clarendon Press, 1975.
- Montgomery, Florence M. Printed Textiles: English and American Cottons and Linens 1700 - 1850. A Winterthur Book. New York: The Viking Press, 1970.
- Oxford Companion to the Decorative Arts. Ed. Harold Osborne. Oxford: Clarendon Press, 1975.
- Ozinga, M. D. De Monumenten van Curaçao in Woord en Beeld. Curaçao: Stichting Monumentenzorg, 1959.

- Palardy, Jean. The Early Furniture of Fench Canada. Trans. from French, Eric McLean. Toronto: Macmillian, 1963.
- Pearse, G. E. Eighteenth Century Architecture in South Africa. 3rd ed. 1933; rpt. Cape Town: A. A. Balkema, 1968.
- Plettenburg, Hermanna W. M. Licht in Huis. Monografieën van het Rijksmuseum voor Volkskunde "Het Nederlands Openluchtmuseum," dl. VI. Arnhem: 1968.
- Reynolds, Helena Wilkinson. Dutch Houses in the Hudson River Valley before 1776. 1929; rpt. New York: Dover Publications, 1965.
- Salmon, Patricia. Japanese Antiques. Tokyo: Art International Publishers, 1975.
- Salmon, William. Polygraphics, or the Arts of Drawing, Engraving, Etching Limning, etc. London, 1675.
- Scheurleer, D. F. Lunsingh. Chine de Commande. Hilversum: W. de Haan, 1966.
- Schiffer, Peter, Nancy & Herbert. The Brass Book. Exton (Pennsylvania): Schiffer Publishing, 1978.
- Singleton, Esther. Dutch and Flemish Furniture. London: Hodder & Stoughton, 1907.
- Scott, Kenneth. "New York Inventories, 1665 - 1775." National Genealogical Society Quarterly, Nov. 1966, pp. 246-259.
- Strange, Edward F. "The Furnishings of Hampton Court in 1699." The Connoisseur, vol. XIV (March, 1906), 169-72.
- Thornton, Peter. Seventeenth-Century Interior Decoration in England, France and Holland. New Haven/London: Yale University Press for Paul Mellon Centre for Studies in British Art, 1978.
- Van der Meulen, Jan. "The Origins of Cape Colonial Architecture." Lantern, June, 1964, pp. 42-48.
- Van de Wall, V. I. Het Hollandsche Koloniale Barokmeubeubel. 's-Gravenhage: Martinus Nijhoff; Antwerp: De Sikkel, 1939.
- Verster, A. J. G. Tin door de Eeuwen. Amsterdam: J. H. de Bussy, 1957.
- Volker, T. Porcelain and the Dutch East India Company. Leiden: E. J. Brill, 1954.
- Walton, James. Homesteads and Villages of South Africa. Pretoria: J. L. van Schaik, 1952.
- Wells, Stanley. Period Lighting. London: Pelham Books, 1974.

- Weyns, Jozef. Volkshuisraad in Vlaanderen. 4 vols. Antwerp: eigen beheer, 1974.
- Woodward, C. S. " 'And Pretty Apartments': die binnekant van die dorps-huis 1685 - 1699." Tydskrif vir Geesteswetenskappe, 15, 3 (Sept. 1975), 161-81.
- . "Domestic Arrangements at the Cape as Revealed in the Inventories for 1709 - 1712." Africana Notes and News, 24, no 1 (March, 1980), 1-15.
- . Oriental Ceramics at the Cape of Good Hope 1652 - 1795. Cape Town/Rotterdam: A. A. Balkema, 1974.

C. Dictionaries

- Halma, François. Woordenboek der Nederlandsche en Fransche Taalen. Utrecht: Willem van de Water; Amsterdam: Pieter Mortier, 1710.
- Van Dale Groot Woordenboek der Nederlands Taal. Ed. C. Kruijskamp. 10th rev. ed. 2 vols. 's-Gravenhage: Martinus Nijhoff, 1976.
- Webster's Third New International Dictionary of the English Language, Unabridged. Ed. in chief Philip Babcock Gove. London: G. Bell & Sons; Springfield (Mass.): G. & C. Merriam, 1959.
- Woordenboek der Nederlandsche Taal. Various editors. 21 vols. 's-Gravenhage: Martinus Nijhoff, 1882 - 1971.

D. Archival Sources

1. Published.

- "Kaapse huishoue in die 18de eeu ('n)" in Archives Year Book for South African History. Ed. J. L. M. Franken. Cape Town: Union of S.A. Archives, 1940.
- Kaapse Plakkaatboek 1652 - 1707. Ed., M. K. Jeffreys. Kaapse Argiefstukke. Cape Town: Cape Times, 1944.
- Nederlandsch-Indisch Plakkaatboek. Ed. J. A. van der Chijs. Uitgegeven door het Bataviaasch Genootschap van Kunsten en Wetenschappen met medewerking van de Nederlandsch-Indische Regering. Vol IV (1709 - 1743). Batavia: Landsdrukkerij; 's Hage: M. Nijhoff, 1887.
- Resolusies van die Politieke Raad, 1651 - 1715. Ed. Anna J. Böeseken. Vols I - IV. Suid-Afrikaanse Argiefstukke. Cape Town: Publikasie-afdeling van die Hoofargivaris, 1957 - 62.

Tas, Adam. Dagboek van Adam Tas, 1705 - 1706. Ed. Leo Fouché. Rev. by Anna J. Böeseken. Dutch with parallel Eng. text. Eng. trans. J. Smuts. Van Riebeeck Society, 2nd series, no 1. 1914; rpt. Cape Town: VRS, 1970.

Van Riebeeck, Johanna Maria, and others. Briewe van Johanna Maria van van Riebeeck en ander Riebeeckiana. Ed. D. B. Bosman. Amsterdam, privately printed, 1952.

2. Unpublished.

Cape State Archives, Cape Town

- (i) Political Council (C)
C 326 Attestatiën, 1652 - 1665.
C 680 Placcatboek, I.
- (ii) Council of Justice (C J)
C J 2914 - 2916. Various Inventories, Vendu Rolls and Estate Papers.
- (iii) Orphan Chamber (MOOC)
MOOC8/1 - 44. Inventories, 1673 - 1830.
MOOC8/75. Assorted Inventories, unbound and sometimes undated.
MOOC10/1. Vendu Rolls, 1691 . 1717.
MOOC22/2(a) Assorted Vendu Rolls, 1676 - 1690.
MOOC23/5. Assorted Inventories and Estate Papers, 1670 - 1701.
- (iv) Deeds Office Papers Transferred to the Cape Archives, 1981.
Transporten en Schepenkennissen, I - II, 1652 - 1665.
Title Deeds, Stellenbosch and Drakenstein Districts, I - II, 1689 - 1785.

Gemeente Archief, 's-Gravenhage

- (i) Notarieel Archief. Vols. 428, 446, 466, 502, 510, 550, 551, 574, 586, 664, 708, 728, 778, 911, 1764, 1765, 1769, 1777 - 1783, 1786, 1787, 1800. Inventories of deceased estates are scattered throughout this series. The volumes are not numbered consecutively and range in date from 1673 - 1714.
- (ii) Recht: Archief. Vol. 291.

Rijks Archief, 's-Gravenhage

Goudswaard, Weeskamer, 5. Inventories.

Historical Documents Collection, Queen's College, City Univeristy of
New York, Flushing, New York.

Inventories, 1666 - 1699. File nos. 1 - 149.

Inventories, 1700 - 1775. File nos. 1 - 295.

Liber 19B, 1677 - 1685. Assorted Documents Including Inventories.

Liber 3, 1685 - 1686. Assorted Documents Including Inventories.

Record of Wills. Surrogate's Court in New York County, 1665 - 1683.

Some inventories included.

New York Historical Society.

New York Inventories.

Rutherford Family Papers.

Surrogate's Court, County of New York, 31 Chambers Street, New York.

Inventories, 1730 - 1752.

Additional Selected Bibliography

Berendson, Anne. Antiek in Nederland. 2nd ed. Amsterdam: Palladium,
1964.

Böeseken, Anna J. Jan van Riebeeck en sy Gesin. 1938; rpt. Cape Town:
Tafelberg, 1974.

Bosman, D. B. "Die eerste boekveiling aan die Kaap." Quarterly
Bulletin S.A. Library, I, no. 4 (June 1947), pp. 96-7.

Botha, C. Graham. The French Refugees at the Cape. Cape Town: Cape
Times, 1919.

Botha, Marielise. Herkoms van die Kaapse Stoel. Cape Town/Rotterdam:
A. A. Balkema, 1977.

Boyazoglu, Jan & Louis de Neuville. Les faïences de Delft. Paris:
Grancher, 1980.

D'Allemagne, Henri René. Decorative Antique Ironwork. Trans. from
French Vera K. Ostoia. New York: Dover Publications, 1968.

De Bree, J. Zeeuws Zilver: Voornamelijk met betrekking tot Middelburg.
Schiedam: Interbook International, 1978.

De Jonge, C. H. Holländische Möbel und Raumkunst von 1650 - 1780.
's-Gravenhage: Martinus Nijhoff, 1922.

De Kleyn, J. Volksaardewerk in Nederland 1600 - 1900. Zeist: W. de
Haan, 1965.

- De Villiers, C. C. Geslagregisters van die Ou Kaapse Families. Rev. with additions C. Pama. 3 vols. Cape Town/Amsterdam: A. A. Balkema, 1966.
- Dilliard, Maud Esther. Old Dutch Houses of Brooklyn. New York: Richard R. Smith, 1945.
- Dubbe, B. Tin en Tinnegieters in Nederland. Zeist: W. de Haan, 1965.
- Fransen, Hans. The Cape Chair. Stellenbosch Museum Exhibition, 1969. Stellenbosch: Stellenbosch Museum, 1970.
- Frederiks, J. W. Dutch Silver. 4 vols. The Hague: Martinus Nijhoff, 1952 - 61.
- Gans, M. H. & Th. M. Duyvené de Wit-Klinkhamer. Dutch Silver. Trans. from Dutch Oliver van Oss. London: Faber & Faber, 1961.
- Hattersley, A. F. An Illustrated Social History of South Africa. Rpt. with corrections. Cape Town: A. A. Balkema, 1973.
- Heller, David. Further Researches in Cape Silver. Cape Town: Maskew Miller, 1953.
- A History of Cape Silver 1700 - 1870. Cape Town: Heller, 1949.
- Hoge, J. Personalalia of the Germans at the Cape, 1652 - 1806. Archives Year Book for South African History. Cape Town: Union of S.A. Archives, 1946.
- Jansen, Béatrice. Catalogus van Noord- en Zuidnederlands Glas. Den Haag: Gemeentemuseum, 1962.
- Kirk, John T. Early American Furniture. New York: A. Knopf, 1970.
- McNulty, Robert H. "Common Beverage Bottles: Their Production, Use and Forms in Seventeenth- and Eighteenth-Century Netherland." Journal of Glass Studies. The Corning Museum of Glass, Vol. XIII.
- Morrison, Mollie N. The Silversmiths and Goldsmiths of the Cape of Good Hope, 1652 - 1850. Johannesburg: the author, 1936.
- Nederlandsche Volkskunst. Anno Teenstra Ed. Amsterdam: Elsevier, 1941.
- Pama, C. Vintage Cape Town. Cape Town: Tafelberg, 1973.
- Pearse, G. E. Eighteenth Century Furniture in South Africa. Pretoria: J. L. van Schaik, 1960.
- Praz, Mario. Het Europese Binnenhuis. Trans. from Ital. Elka Schrijver. Utrecht: A. Oosthoek's Uitgeversmaatschappij N. V., 1965.
- Raesly, E. L. Portrait of New Netherland. New York: Columbia Univ. Press, 1945.

- Raven-Hart, R. Cape of Good Hope 1652 - 1702: The First Fifty Years of Dutch Colonization as seen by Callers. 2 vols. Cape Town: A. A. Balkema, 1971.
- Renaud, J. G. N. Oude Ambachts Kunst. Amsterdam: Hamer, 1943.
- Schotel, G. D. J. Het Maatschappelijk Leven onzer Vaders in de Zeventiende Eeuw. 2nd rev. ed., H. C. Rogge. Leiden: A. W. Sijthoff, n.d. (c. 1904).
- Scott, Amoret & Christopher. Tobacco and the Collector. Illus. by Cecile Curtis. London: Max Parrish, 1966.
- Sluyterman, K. Huisraad en binnenhuis in Nederland in vroegere eeuwen. 2nd rev. edition. 'S-Gravenhage: Martinus Nijhoff, 1925.
- Staring, A. De Hollanders Thuis: Gezelschapstukken uit drie eeuwen. 'S-Gravenhage: Martinus Nijhoff, 1956.
- Sugden, Alan Victor, & John Ludlam Edmondson. A History of English Wall-paper. London: Batsford, 1925.
- Textile Collections of the World. Ed. Cecil Lubell. Vol. I, United States and Canada. Vol. II, United Kingdom and Ireland. London: Studio Vista, 1976.
- Trefois, C. V. Oudnederlandse architectuur in Zuid Afrika. Melle: Frans Meyers-Trefois, 1970.
- Trotter, Alys Fane. Old Colonial Houses of the Cape of Good Hope. London: Oxford University Press; Cape Town: Maskew Miller, 1899.
- Old Cape Colony: a chronicle of her men and houses from 1625 to 1806. Westminster: Constable, 1903.
- Van der Meulen, Jan. Die europäische Grundlage der Kolonial-architektur am Kap der Guten Hoffnung. 3 vols. Marburg: Nolte (printer) 1962.
- Van Onselen, Lennox E. Cape Antique Furniture. Cape Town: Howard Timmins, 1959.
- Varley, D. H. Adventures in Africana. Cape Town: Univ. of Cape Town & the Trustees of the S.A. Library. 1949.
- Welz, S. A. Cape Silver and Silversmiths. Cape Town: A. A. Balkema, 1976.