

The development of a simplified track modulus calculation procedure



Louis Mostert
University of Pretoria
WorleyParsons RSA
louis.mostert@worleyparsons.com



Prof Hannes Gräbe
Chair in Railway Engineering
University of Pretoria
hannes.grabe@up.ac.za

BACKGROUND

With the constantly increasing demand for heavy freight transportation, railways have become an extremely important element in the economic wellbeing of any country, and particularly in a developing country like South Africa. It is thus the duty of track engineers to maintain a continued understanding of the rail track infrastructure. Track designs should be as cost-effective as possible and should be sensitive to the costs associated with the planning, development and maintenance of the track structure. Extensive and continuous research is therefore required to determine the influencing parameters and to maximise the track performance and the lifetime of the track structure.

Deformation of the track structure is a good measure of the structural capability of a track structure or of the expected track performance. This deformation is vastly dependent on the support of the track structure. The ballast support and the foundation of the track structure are therefore key components. Poor support will lead to large deformations, which in turn will accelerate track deterioration. This will increase the maintenance need and therefore the total cost of operating the asset within an acceptable functional condition.

THE PRIMARY OBJECTIVES OF THE RESEARCH

Track modulus is defined as the supporting force per unit length of rail per unit deflection and can be used as an enumeration of track performance. This research was aimed at finding an effective and simple way to determine track modulus and incorporated non-disruptive and mobile measuring techniques. An up-to-date record of track modulus, and thus track performance, will enable engineers to plan optimum maintenance operations and increase the potential revenue of the rail infrastructure.

The objective of this research was therefore to develop a simplified procedure for determining track modulus to provide track engineers with a useful tool to do quick and low-cost track modulus assessments.

TRACK DEFLECTION

Resilient and permanent deformations (deflections) are the two types of deformations occurring in the track structure, and represent the two most important aspects in the design and per-

Figure 1: a) Strains during one cycle of load application, redrawn from Lekarp *et al* (2000)

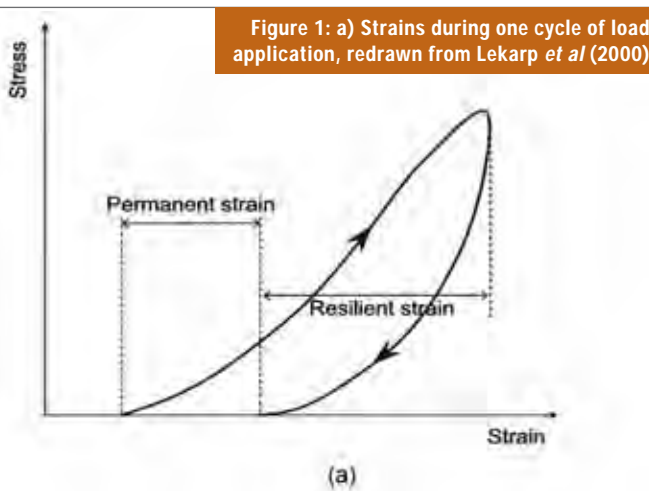

(a)

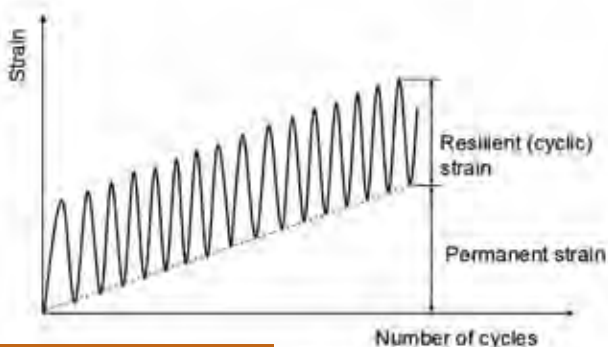

(b)

Figure 1: b) Permanent and resilient strains, adapted from Selig & Chang (1981)

formance of track formations. Figure 1 illustrates the difference between resilient and permanent deformation.

Resilient deformation (elastic deformation) is the recoverable deflection in the formation while train wheels are passing over the rails. The majority of the deformation caused by vehicle loading is recovered after the train has passed. Permanent deformation (plastic deformation) is deformation that is not recovered, hence it is the total settlement of the track structure over time after repeated loading (Gräbe *et al* 2005). The structural state of a railway track foundation can be computed by measuring the deflections (deformation) of the track subject to train loads. The state of the foundation will be reflected in terms of stiffness or track modulus (Bowness *et al* 2006). The focus of this project was on the resilient deformations caused by the wheel loads of passing trains. Permanent deformation is beyond the scope of this study.

As a result of the non-linear load-deflection relationship present in any track foundation, track deflection measurements can easily ignore the initial seating stiffness of the track. Equally important is the potential gap between the sleeper and the ballast, often referred to as a “blind slack”. Both these aspects manifest as initial soft or low stiffness of the track upon first loading, followed by increased stiffness as the load increases (Selig & Waters 1994). When the initial seating stiffness of the track or the possible presence of a slack is ignored in track deflection measurements, inaccurate track modulus and stiffness values are calculated.

TRACK MODULUS

Track foundation modulus, commonly referred to as track modulus, is defined as the supporting force per unit length of rail per unit deflection. Track modulus is thus a measure of the vertical stiffness of the track foundation and is related to the vertical deflection of the rail under a specified or known vertical wheel load. A related parameter, track stiffness, is a measure of the vertical stiffness of the whole track structure (effects of rail included). Track modulus is closely related to track performance as it is a measure of the structural state of the track. The effects of the fasteners, ties, ballast, subballast and subgrade are included in the track modulus.

Track modulus is seldom measured and its magnitude is unknown for most sections of railway track. Track modulus is, however, regarded as an important parameter, and time should be taken to enumerate this parameter. The optimum value for track modulus should neither be too high nor too low. Too high a value (too stiff) would lead to fatigue, fracture and excessive vibrations. A too low track modulus value would cause unwarranted deformations and even permanent deformations (Selig & Li 1994).

Extensive research was done by Selig & Li (1994) to relate track modulus to track response parameters including rail deflection, sleeper deflection and subgrade surface deflection. An increase in track modulus generates a decrease in all deflection parameters.

According to Selig & Li (1994) the track component having the most influence on the track modulus is the subgrade.

A slight increase in the track modulus can be obtained by increasing the ballast or subballast modulus. The overriding factor, however, is the subgrade resilient modulus. By increasing subgrade resilient modulus with a factor of ten, an increase in track modulus by a factor of eight will be achieved. The small

effect of the ballast and subballast on track modulus, compared to the effect of the subgrade, can be attributed to the thin ballast and subballast layers, compared to the relatively thick subgrade layer. The subgrade modulus also varies significantly more than the ballast and subballast moduli.

An increase in the granular layer (ballast and subballast) thickness leads to an increase in track modulus. An increase in subgrade layer thickness leads to a decrease in track modulus. The explanation for this phenomenon is that the subgrade modulus is generally lower than that of the ballast and subballast.

The track foundation layer thickness and the moduli both influence the track modulus individually. There is, however, a greater effect on track modulus when these two factors are combined. The effect of the ballast and subballast moduli on track modulus increases with increasing thickness of the granular layer. The effect of the subgrade modulus on track modulus is equally important, regardless of the subgrade layer thickness.

Better track performance is normally achieved with a higher track modulus. Too high a track modulus will, however, not produce acceptable performance as it would lead to fatigue, fracture and excessive vibrations. The upper limit of track modulus has not been determined yet and many research and field experiments are needed to define a desirable value (Selig & Li 1994). Considering the content of the previous section, the following changes can be implemented to increase the track modulus if too low a track modulus is assumed (in decreasing order of efficiency):

- Increase subgrade resilient modulus.
- Increase granular layer thickness.
- Increase fastener stiffness.

If the track modulus is assumed to be too high, the opposite of the above actions should be taken.



Figure 2 : The Remote Video Monitoring (RVM) system

This project focused on the simplified determination of track modulus by measuring deflections without any disruptions to normal railway operations. Transnet Freight Rail (Track Technology) and the University of Pretoria developed a system based on research by Bowness *et al* (2006) to measure deflections in a non-disruptive manner. This system is called Remote Video Monitoring (RVM)

PROJECT DESCRIPTION

This project focused on the simplified determination of track modulus by measuring deflections without any disruptions to normal railway operations. Transnet Freight Rail (Track Technology) and the University of Pretoria developed a system based on research by Bowness *et al* (2006) to measure deflections in a non-disruptive manner. This system is called Remote Video Monitoring (RVM). The RVM system consists of a high-quality video camera which captures digital video images of a target mounted onto a sleeper or onto pegs driven into the formation, from which deflections are obtained. This deflection measurement system is shown in Figure 2.

Several methods have been developed by various researchers for the determination of track modulus. After careful consideration of these different methods, it was decided that an adapted version of the method by Kerr (1998) would be used.

A wagon (car) on two-axle bogies (trucks) as shown in Figure 3 is used to demonstrate this method, which in turn is based on the beam-on Elastic Foundation Method.

The expression for the rail deflection at the left wheel of Truck I (Figure 3), caused by all four wheels, is obtained using the following equation:

$$\delta(0) = \frac{P\beta}{2u} + \frac{P\beta}{2u}e^{-\beta l_2}(\cos\beta l_2 + \sin\beta l_2) + \left(\frac{nP\beta}{2u}e^{-\beta l_3}\cos\beta l_3 + \sin\beta l_3\right) + \frac{nP\beta}{2u}e^{-\beta l_4}(\cos\beta l_4 + \sin\beta l_4)$$

Where (from Figure 3)

$$P_1 = P_2 = P \text{ and}$$

$$P_3 = P_4 = n.P$$

n = factor to relate Truck I and Truck II, obtained by weighing

l_2, l_3, l_4 = lengths between axles

$$\beta = \sqrt[4]{\frac{u}{4EI}}$$

u = track modulus

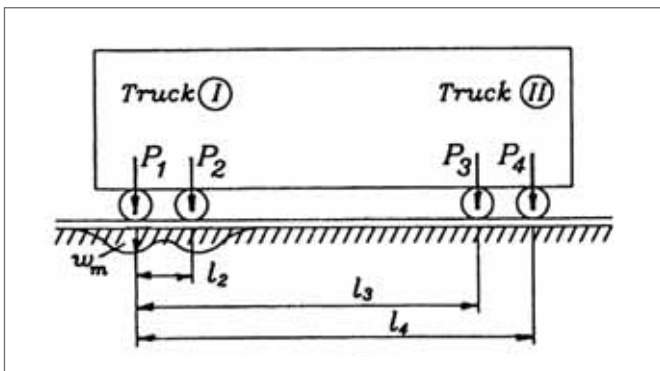

Figure 3: Railway wagon on two-axle bogies (Kerr 1998)

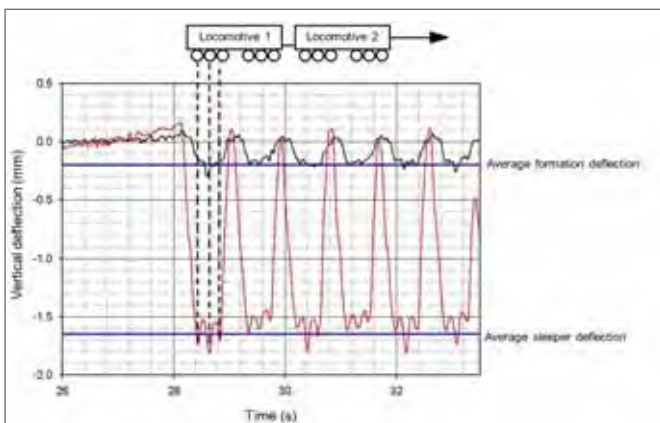

Figure 4: Example of typical track deflection measurements



Figure 5: Bloubank test site (Coal Line) with three test stations

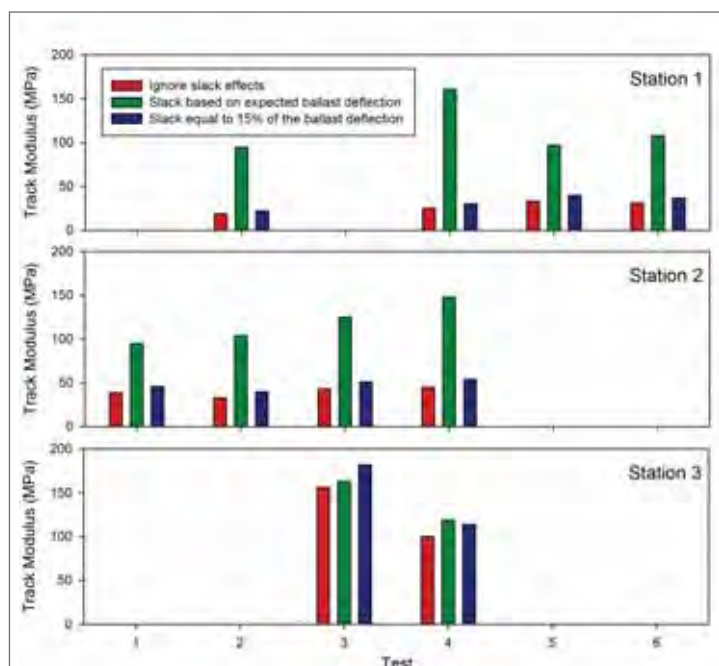

Figure 6: Track modulus values calculated according to the three slack effect methods

Track modulus, u , is obtained by equating this deflection with the measured wheel deflection at the left wheel of Truck I, that is assuming $\delta(0) = \delta_{\text{measured}}$. This gives:

$$\frac{\delta_{\text{measured}}}{P} = \frac{\beta}{2u} [1 + e^{-\beta \cdot l_2} (\cos\beta \cdot l_2 + \sin\beta \cdot l_2) + n \cdot e^{-\beta \cdot l_3} (\cos\beta \cdot l_3 + \sin\beta \cdot l_3) + n \cdot e^{-\beta \cdot l_4} (\cos\beta \cdot l_4 + \sin\beta \cdot l_4)]$$

Where:

δ_{measured} = deflection measured using the RVM system

Because the mass of the locomotives are known and additional weighing measurements could be avoided, it was decided that only the deflections caused by the locomotives would be analysed. Locomotive loads were assumed to be spread evenly across all axles. A moving train, whose deflections were captured by the RVM system, was assumed to be static at the point where the first locomotive wheel was in line with the RVM target. By making this assumption, dynamic factors were taken into account. The average of the wheel-induced deflections was used in calculations.

After repeated cyclic loading on a railway track, the ballast settles downwards. The result of this is an opening forming between the sleeper and the ballast bed. This opening is referred to as a slack, and the slack is taken up under a small initial load (seating load) before deflection of the structure takes place. Slack effects were taken into account by assuming the slack to be equal to the difference between the expected ballast deflection (affected by ballast modulus and original ballast thickness) and the measured ballast deflection. With these assumptions made, all the parameters in the equation, except track modulus, are known for a given field test. The track modulus can now be solved iteratively.

Figure 4 shows an example of typical deflection measurements using the RVM system.

Once the track modulus had been calculated, the subgrade modulus could be calculated using the equation below, based on the layer of springs method (Kerr 1998). This is, however, just a quick, only fairly accurate, estimation.

$$k_s = \frac{1}{\frac{1}{u} - \frac{1}{k_b}}$$

Where:

k_s = subgrade modulus

k_b = ballast modulus

u = track modulus

SITE DESCRIPTION

Tests were conducted at the Bloubank Test Site which is located on the Transnet Freight Rail Coal Line between kilometre 60/16 and 60/17, with kilometre 0/0 at Vryheid and increasing kilometres towards Richards Bay. The RVM measurement instruments were installed at three stations at the test site. The three stations are at 5 m intervals. An averaging effect over the three stations was thus implemented. The three stations are indicated in Figure 5.

RESULTS

Answers obtained for track modulus and subgrade modulus are shown in Table 1. The same results are graphed in Figure 6.

Three different methods of addressing the possible presence of a slack were considered, namely:

- Ignoring the slack or seating stiffness in totality
- Calculating the slack using a ballast stress (calculated with GEOTRACK) with ballast modulus = 300 MPa, ballast stress = 400 kPa and the original ballast thickness =

300 mm, where slack = measured ballast deflection – expected ballast deflection

- Calculating the slack as equal to 15% of the measured ballast deflection.

Figure 6 clearly demonstrates the effectiveness of applying the different slack effect consideration methods. From previous

Table 1 Calculated track modulus and subgrade modulus

Test no	Loading	Station 1		Station 2		Station 3	
		Track modulus (MPa)	Subgrade modulus (MPa)	Track modulus (MPa)	Subgrade modulus (MPa)	Track modulus (MPa)	Subgrade modulus (MPa)
Ignoring slack effects							
1	7E	–	–	39	46	–	–
2	7E	19	21	33	38	–	–
3	11E	–	–	43	52	156	415
4	11E	25	28	45	55	100	167
5	7E	33	38	–	–	–	–
6	19E	31	35	–	–	–	–
Calculating slack as measured ballast deflection - expected ballast deflection							
1	7E	–	–	95	153	–	–
2	7E	95	153	104	178	–	–
3	11E	–	–	125	250	163	468
4	11E	161	452	148	363	119	227
5	7E	97	158	–	–	–	–
6	19E	108	190	–	–	–	–
Assuming slack as 15% of the measured ballast deflection							
1	7E	–	–	46	56	–	–
2	7E	22	24	40	48	–	–
3	11E	–	–	51	64	182	669
4	11E	30	34	54	69	114	210
5	7E	40	48	–	–	–	–
6	19E	37	43	–	–	–	–

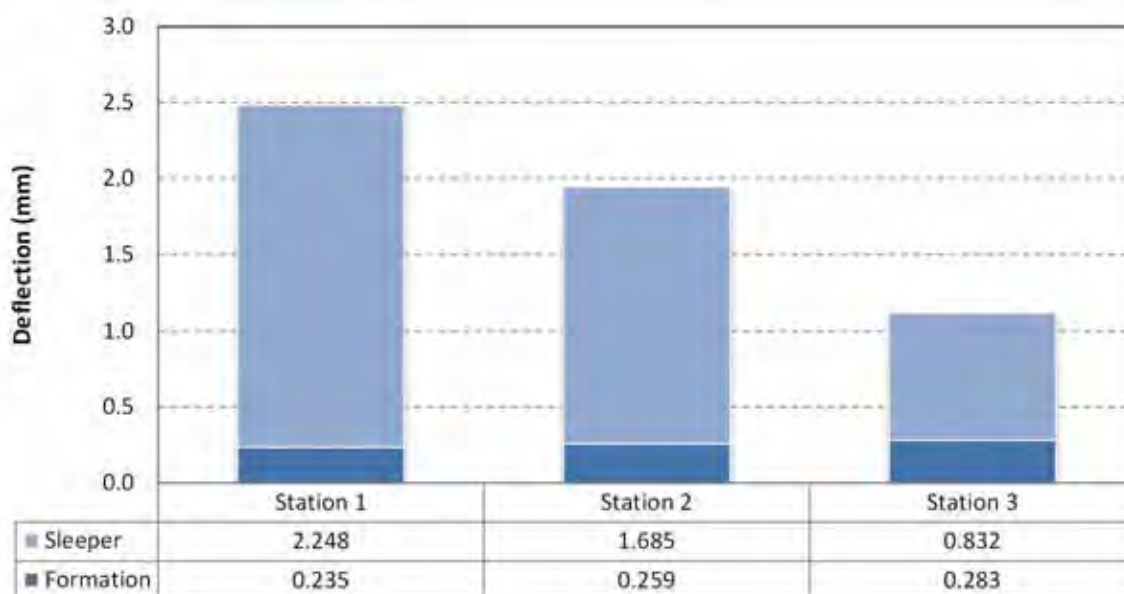

Figure 7: Deflections measured at different stations

measurements at the test site, the track modulus is expected to be approximately 100 MPa – 150 MPa at the three measuring stations. Station 3 is the station with the least disturbance and subsequently the smallest slack. All three methods produce more or less the same track modulus. However, at Stations 1 and 2, a considerable slack is present. The second method, whereby the slack is calculated based on the expected ballast deflection, produces extremely realistic values. The third method slightly increases the track modulus in the direction of the expected value, but not adequately. For small slacks, this method is expected to also produce realistic values.

The average deflection measurements for the three test stations are indicated in Figure 7. The deflections measured in the formation remains constant for the different test stations. This is an indication of constant formation strength beneath all the test sites. The deflections measured on the sleepers, however, differ at the various test stations. These variations could be the result of different ballast conditions or different slack magnitudes at the different stations. Previous testing and disturbance of the ballast at these locations were responsible for significant slack formation at these test stations.

DEVELOPMENT OF TRACK MODULUS CALCULATION PROCEDURES

Two tools were developed to provide track engineers with a quick tool to calculate track modulus, namely Track Deflection and Modulus Charts, and a newly developed program, Track Modulus Calculator.

Both the Track Deflection and Modulus Charts and the Track Modulus Calculator, in combination with the RVM method, provide engineers with a quick tool to do a low-cost track modulus assessment. The deflections measured using the RVM method could be used to read off track modulus values directly from the Track Deflection and Modulus Charts. These charts, however, have limited options: only some rail types can be chosen from and slack effects are ignored.

Track Deflection and Modulus Charts

Track Deflection and Modulus Charts have been developed for 7E, 11E and 19E locomotives and different rail sections. If the deflection is known, these charts could be used for a quick estimate of the track modulus. It should be noted that the effect of slack was ignored during the preparation of these charts. The Track Deflection and Modulus Chart for UIC-60 kg/m rail is shown in Figure 8.

Track Modulus Calculator

The Track Modulus Calculator is an easy-to-use computer program developed to do quick calculations of track modulus and subgrade modulus. The calculations are based on the formulae used in the adapted Kerr (1998) method. Figure 9 shows a screenshot of the Track Modulus Calculator.

The calculator uses as input the vehicle, rail profile, assumptions related to the ballast stress, and lastly the measured sleeper (superstructure) and formation deflections. Most of the popular South African rail types are available to choose from. The user is allowed to choose from a set of pre-defined vehicles, but can also use custom dimensions and loads.

A choice is then given between the four methods of handling the slack or seating stiffness of the track. These methods include

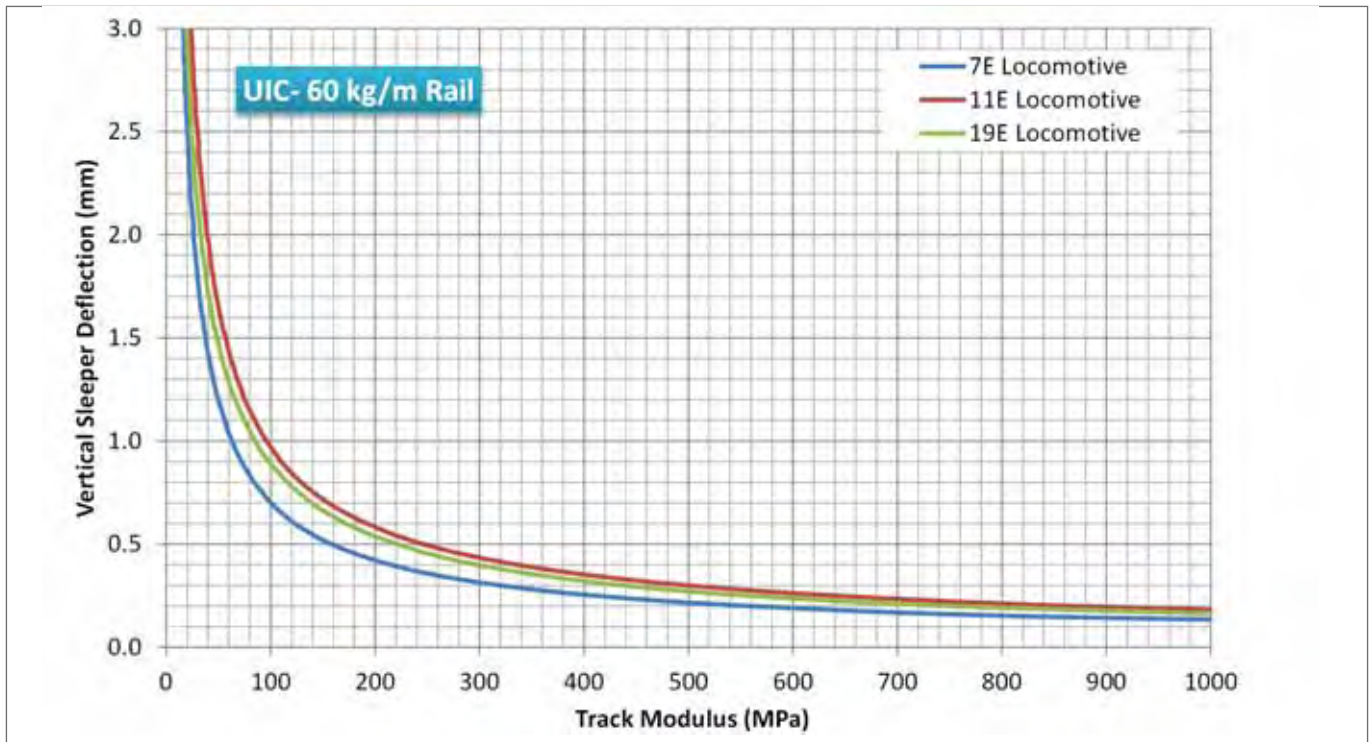

Figure 8: Track Deflection and Modulus Chart for UIC-60 kg/m rail

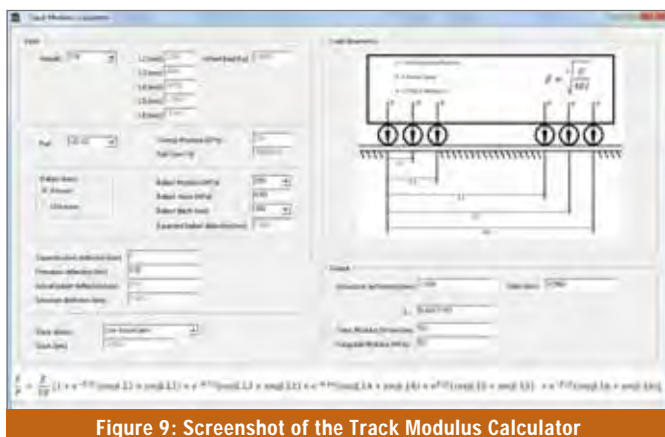

Figure 9: Screenshot of the Track Modulus Calculator

no slack at all, a fixed slack (in mm), slack as a percentage of ballast deflection and calculated slack value using ballast deflection calculations. The output from the calculator includes the track as well as the subgrade modulus values.

A final advantage of the Track Modulus Calculator is that it displays a warning when unrealistic results are obtained.

CONCLUSIONS

The adapted Kerr method (1998) provides a simple procedure for determining track modulus. The effects of slack can be incorporated by making various assumptions. The calculation of slack as the difference between the expected and measured ballast deflection provides a useful method of ensuring accurate calculation of the track modulus. Depending on the magnitude of the slack, other methods have been proposed to take the slack or seating stiffness of the track into consideration when calculating track modulus.

The development of the Track Deflection & Modulus Charts and the program Track Modulus Calculator, in combination with RVM track deflection measurements, provides track engineers with a tool to do quick and cost-effective track

modulus assessments. It is believed that these tools will be useful in the investigation of existing track foundation structures with a view to future rehabilitation or upgrading.

ACKNOWLEDGEMENTS

The authors wish to acknowledge Transnet Freight Rail for allowing the field tests on the Coal Line, as well as the staff of the Track Testing Centre (Track Technology) for providing assistance in carrying out the field work. TLC Engineering Solutions is also acknowledged for the development of the RVM software.

BIBLIOGRAPHY

- Bowness, D, Lock, A C, Powrie, W, Priest, J A & Richards, D J 2006. Monitoring the dynamic displacements of railway track. *Journal of Rail and Rapid Transit*, 221:13–22.
- Gräbe, P J, Clayton, C R I & Shaw, F J 2005. Deformation measurement on a heavy haul track formation. Proceedings of 8th International Heavy Haul Conference, Rio de Janeiro, Brazil, pp 287–295.
- Kerr, A D 1998. On the determination of rail support modulus. *International Journal of Solids and Structures*, 37:4335–4351.
- Lekarp, F, Isacsson, U & Dawson, A R 2000. State of the Art, I: Resilient response of unbound aggregates. *Journal of Transportation Engineering*, 126(1):66–75.
- Raymond, G P 1985. Analysis of track support and determination of track modulus. *Transportation Research Record 102*.
- Selig, E T & Chang, C S 1981. Soil failure modes in undrained cyclic loading. *Journal of the Geotechnical Engineering Division, ASCE*.
- Selig, E T & Li, D 1994. Track modulus: Its meaning and factors influencing it. *Transportation Research Record 1470*, pp 47–54.
- Selig, E T & Waters, J M 1994. *Track Geotechnology and Substructure Management*. First edition. Thomas Telford, London. □