

JAPAN LIBRARY  
Andrew Maynard Architects



12.11  
**design precedent pods**



fig. 158

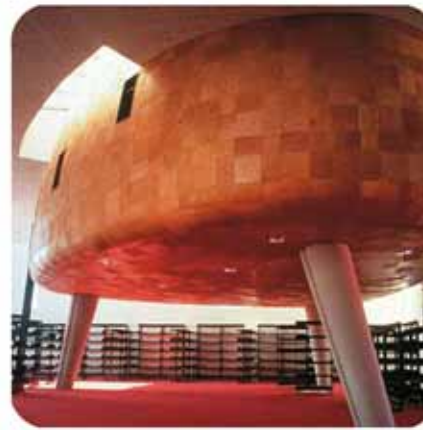
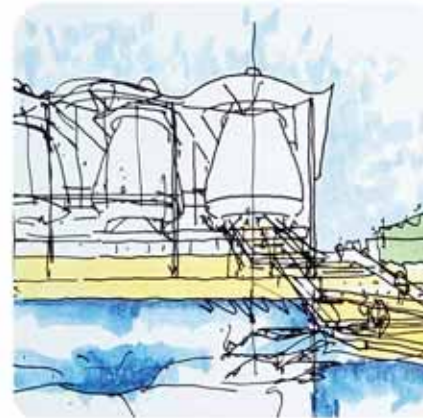

fig. 159



PECKHAM LIBRARY  
Will Alsop 2000

BORDEAUX LAW COURTS  
1992-1998  
Richard Rogers



fig. 160

# 12.12 design precedent pods



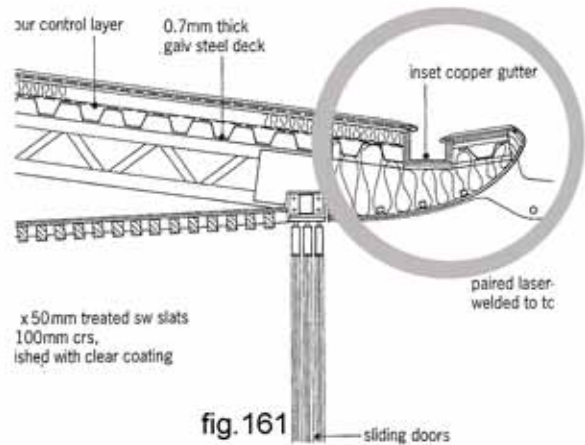

fig.161

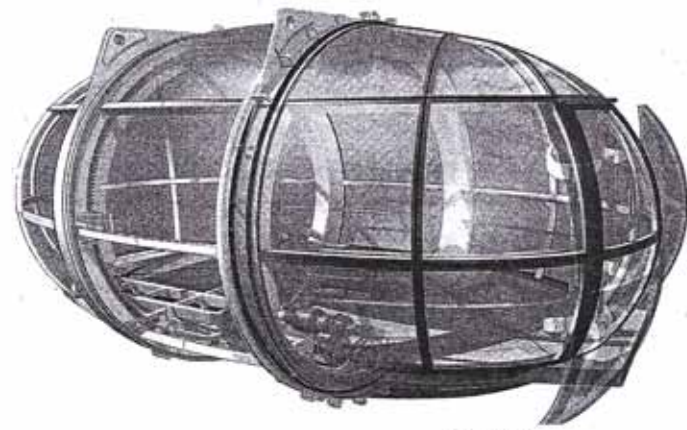

fig.162

Note: glass fixed to frame with black 2-part structural silicone. ss patch fittings are used at corners of glass for safety and to secure the panels while the silicone is drying

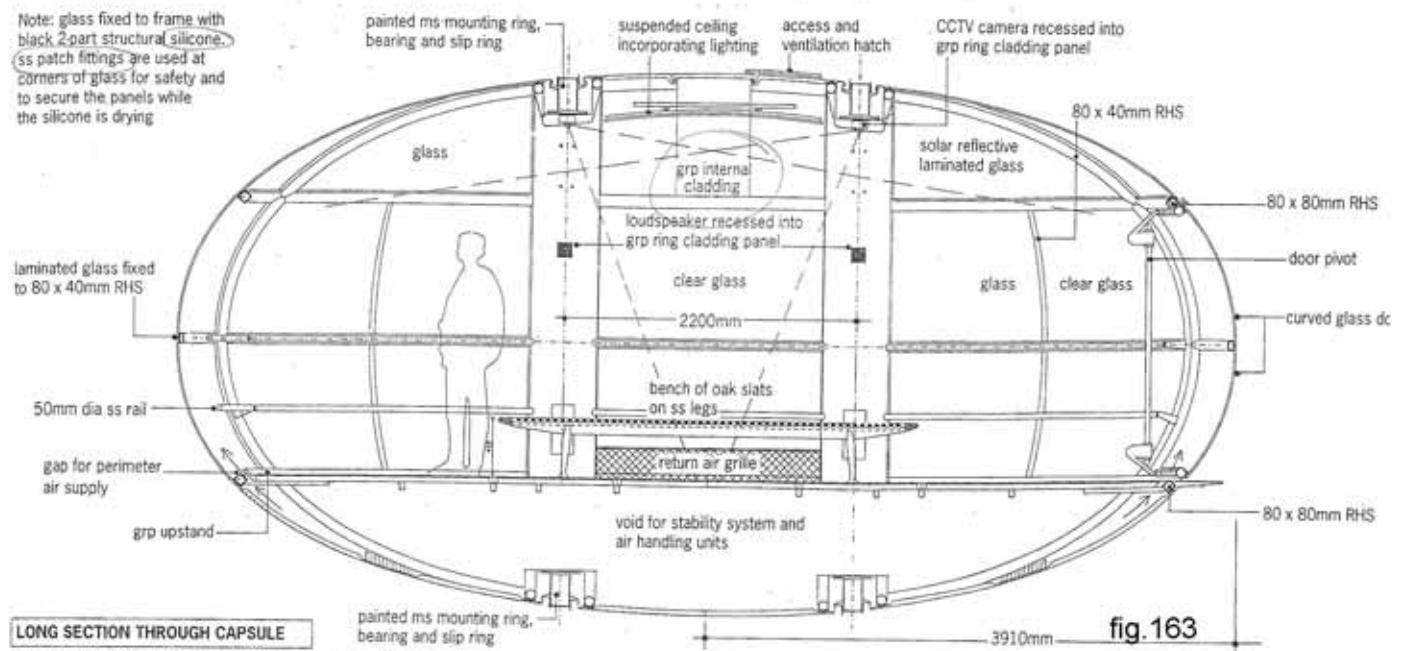
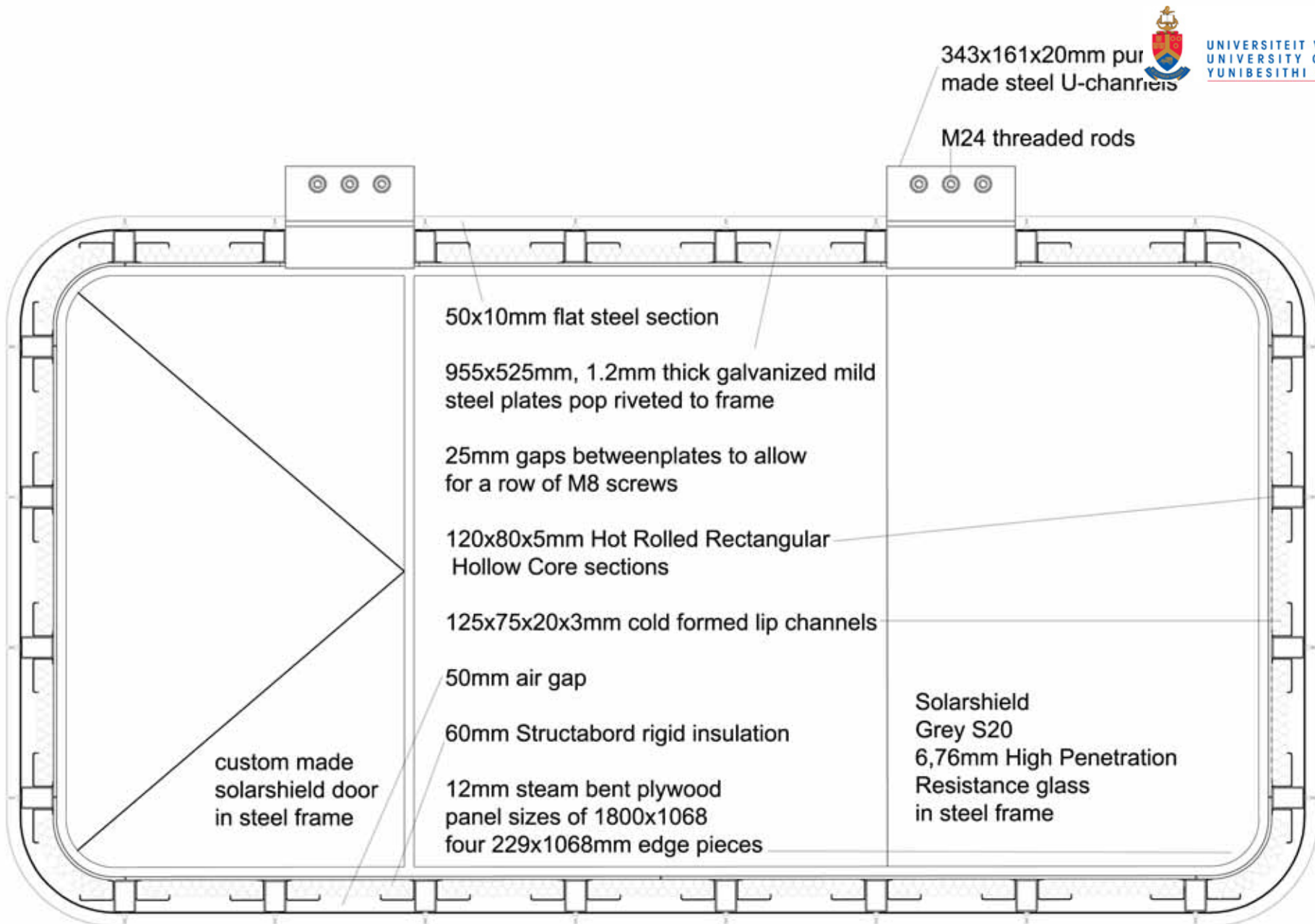

fig.163

12.13  
technical precedent pods



12.14  
**pod detail section 1:20** fig.164



Hannibal roof tent 100% waterproof polyamide 380g cotton ripstop canvas.fig.165

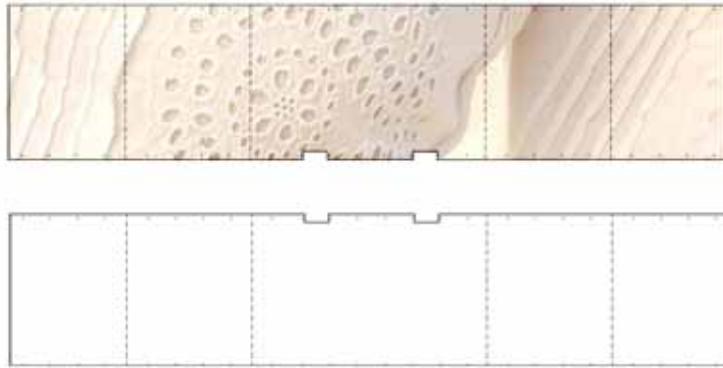

fig.166



25,4mm thick Dual Lock Reclosable Fastener Tape 250S Heavy Duty Velcro. fig.167

## 12.15 p o d s s k i n s

KNOOP consists of three floor constructions and two floor finishes depending on the traffic demand of the area.

The first floor is a two way spanning waffle slab of 510mm. The floor was designed to achieve the ground floor height of 595mm above NGL as set out in the design guidelines for projects on site. Because ground is very heavy ( $2t/m^3$ ) it was decided to rather step the waffle slab at the corners of the building to allow the level difference, than to use ground fill.

All the floors from first floor level to the fourth floor level are constructed from pre-tensioned 200mm concrete cast into permanent brownbuilt shuttering. All edges are cast flush with the steel beams with shutter plates that are removed after the concrete has been cured. All joints between the floor and the steel frame are filled with a polystyrene strip of which the top is burnt away with petrol, to allow a 10mm Sondorband to be placed in the joint. According to calculations ( $\Delta L = \Delta T L \approx 25(6000)12 \times 10^{-6}$ , the joint only has to be 1,8mm, but to allow for a neat joint, 10mm Sondorband is used.

The floors are steel power floated and left unfinished in most areas, to allow the floor level to remain constant.

All high traffic walkways are constructed from metal 'vastrap' that are supported by 100x50x5mm Hot Rolled Rectangular Hollow sections @ 1500mm spacing. The rectangular sections are supported by an edge frame of 203x102 Universal Beams that rests on 75mm diameter hollow core tubular columns @ 1500mm spacing.



**MATERIAL CHOICE**

- LIGHT WEIGHT
- 'non-permanent'
- DISASSEMBLY POSSIBLE → RECONSTRUCTION.
- 'backdrop' FOR CREATION STATIONS
- PASSIVE DESIGN → allow cooling
- SPACE COLOURS, TEXTURES, CONTRAST

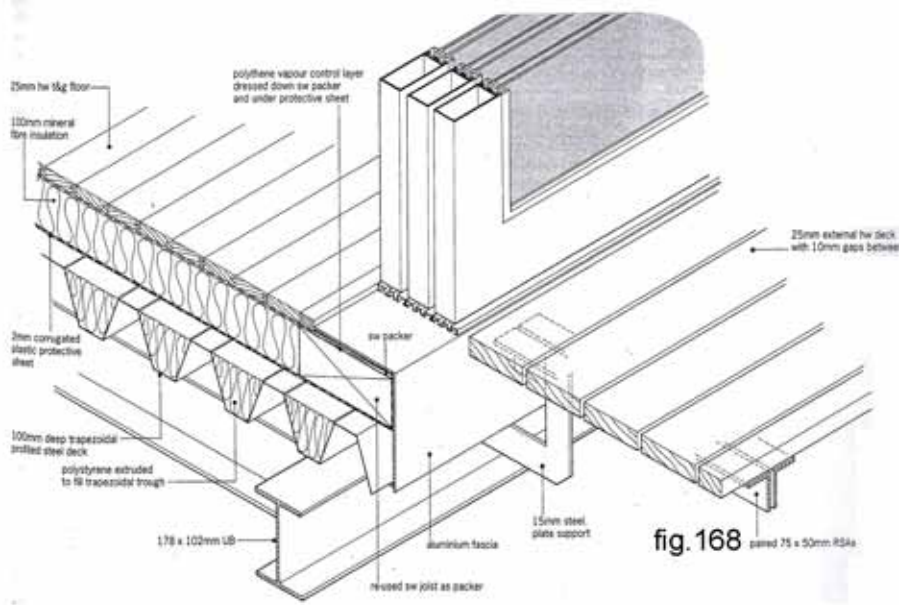
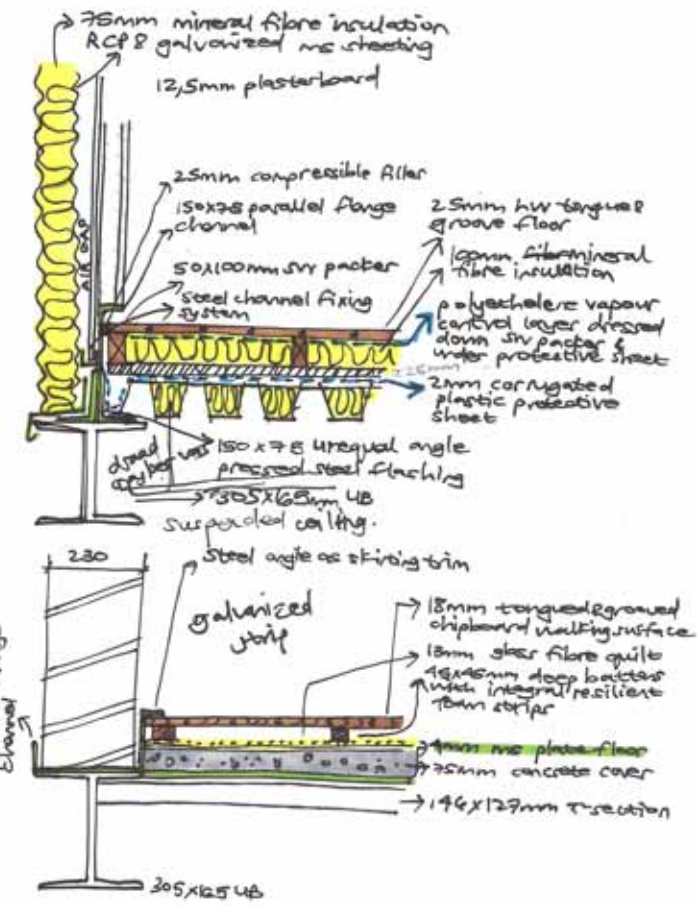

fig. 168



Floor construction development fig. 170

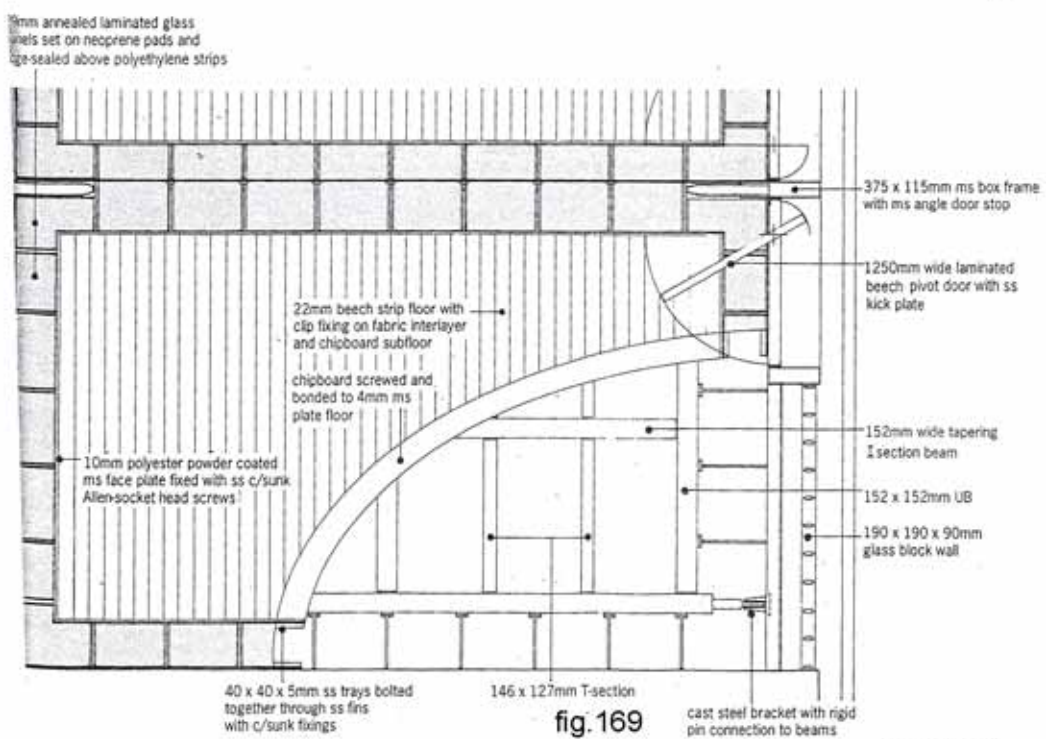
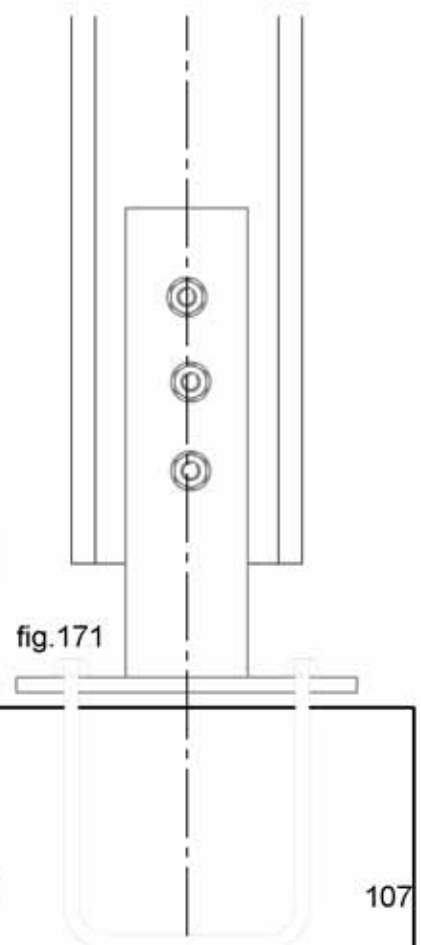
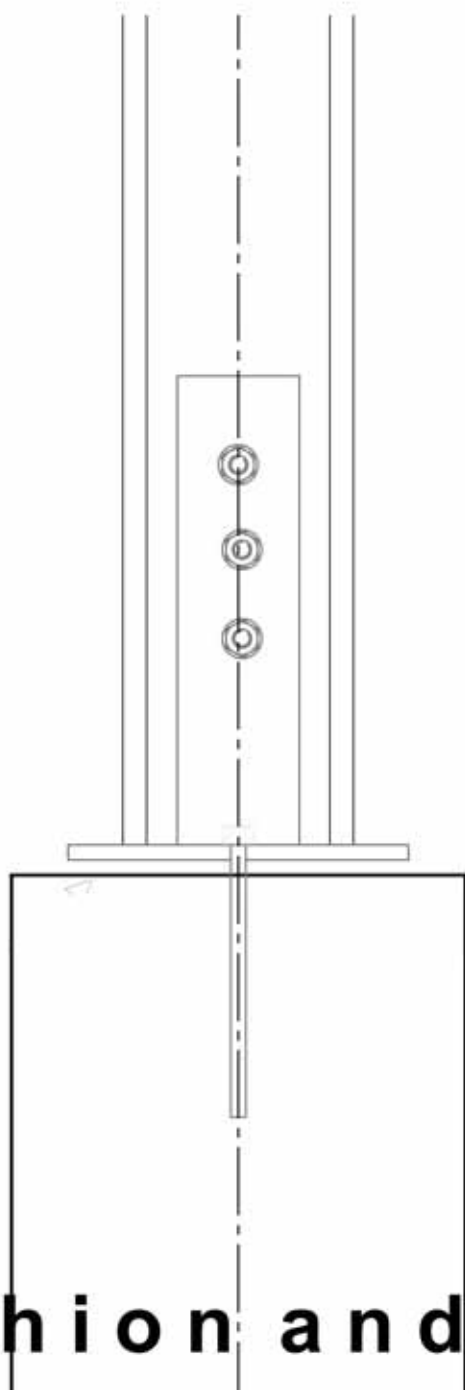

fig. 169

12.17

# technical precedent floors



**fashion and architecture**



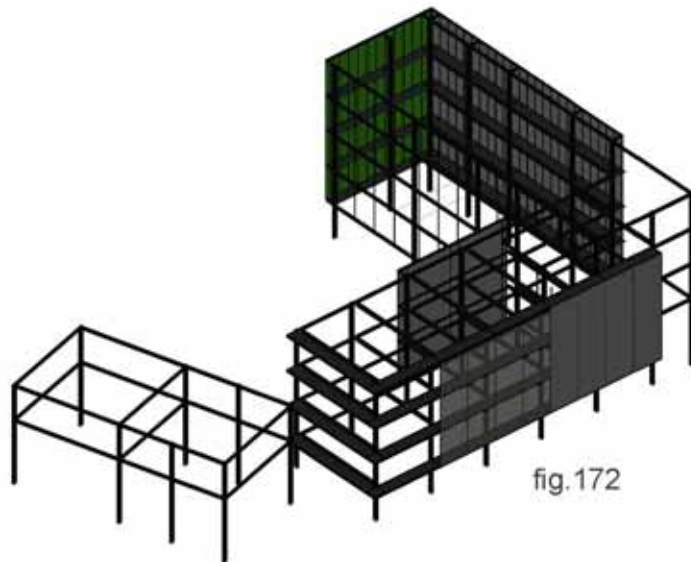

fig.172

In keeping with the theory of creating a visual language that reveals the inner functioning of KNOOP, it follows naturally that all services of the building should be exposed. This is done by allowing all ducts and pipes to run on the outside of the building in a 900mm gap between the building and its secondary skin.

There is a service corridor along the gap allowing easy access for service maintenance and window cleaning. The corridor walkway frame is constructed from 203x102 Universal Beams bolted to the main frame columns and supported by 46 x 75mm purpose made unequal leg channels. The material on the walkway is metal 'vastrap' supported by 100x50x5mm rectangular hollow core steel sections at 1500mm spacing. These rectangular sections are bolted to the walkway frame.

Because the building has a narrow width, moving all ducting to the exterior façade saves a lot of functional space

## 12.18 services

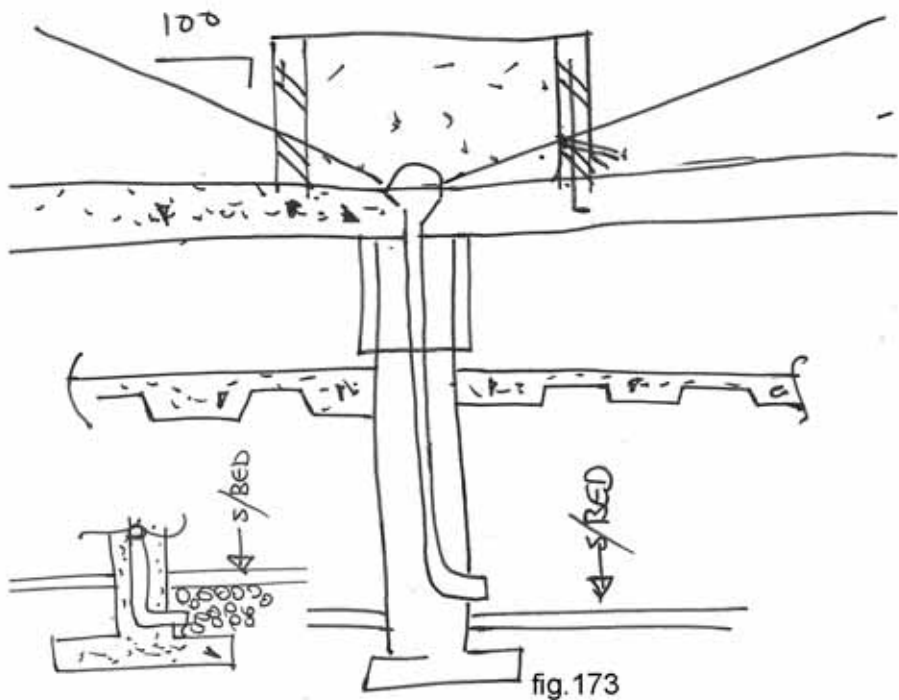

The courtyard slabs are cast in sizes of 5000x600mm according to the basement column grid. Each slab has a screed that falls towards drains that allows water to enter gutters that terminate in gravel beds in the basement parking. All outlets in the basement parking is then hidden in the gravel bed and water is allowed to trickle towards the railway reserve, because the slabs are cast at a slope of 1:60.

All trees on site are planted in planters that are placed on the column grid, to allow the basement columns to carry the load of the trees.

## stormwater



The toilet facilities are situated in the eastern side of KNOOP. They are right next to the main staircase and lift and are used by all the users of the building's different functions. The disabled toilet is situated next to the Tribeca and is easily accessible, because it is on the public square level, negating the need for a ramp. There are three toilets per female abluion (total 9), one toilet per male abluion and three urinals. (Total 3, 9)

There are three hand wash basins per female abluion and one per male. There are also three basins in the corridor area outside of the toilets, for the use of students using the prototyping lab who want to wash their hands, or for students who want to drink some water on their way to class.

The amount of sanitary fittings are compliant with the SANS requirements for the building occupation type A3 Educational.

## sewerage



fig.175



second floor



fig.176

There are three areas that need to be served with water in KNOOP. The **toilets** on the eastern side, the **Tribeca** Coffee shop to the south and the **ironing and washing rooms** of the fashion labs to the north.

Water for the fire extinguishers will be discussed later.

The same principal applies for the water pipes as for the sewerage pipes and all other service ducting, as it is exposed on the building façade.

According to NBR TT 16.2 a building with more than three floors needs two unobstructed escape routes.

The first escape route in KNOOP is the well demarcated 'vastrap' walkway that connects the main staircase and the fire escape. The second escape route is the external 900mm walkway that is usually only used for maintenance. The travel distance from any point in the building to the nearest escape door is less than 45m.

An automatic fire sprinkler system is installed in KNOOP according to the requirements by the ASIB Automatic Sprinkler Inspection Bureau (Pty) Ltd. and receives its water from the wet core on the eastern building edge.

All steel members are painted with a thin-film mastic coating and all internal walls are fire proofed with a coat of B-Seal.





fig.177

Because of its footprint on site KNOOP has large western and eastern frontages. The northern side of the building also houses the student working areas and care had to be taken to allow sufficient solar control in these areas.

The greatest design challenge was to provide sufficient solar shading on the western façade that houses the 'creative link' between the craft area and the fashion labs and should ideally be exposed entirely.

This was done by adding the external building skin to shield the interior from the harsh summer sun. Because the screens are woven and will cast shadow patterns on working surfaces all walkways was located on the western edge of the 'creative link' to catch shadow patterns leaving working surfaces at lower levels with quality lighting.

Screens on the northern façade work on the same principal, except that internal screens are moved in front of the windows when the shadow patterns become hazardous.

Screens were omitted on the southern side of the building to allow good quality light to enter the fashion labs where the cutting tables are situated. A screen was however introduced on the south western corner, to communicate the visual language of the building becoming less permeable towards the pods. Comfort was enhanced by the screen, because it covers the sewing rooms that will need all the shading possible to keep cool.

## 12.19

# solar control

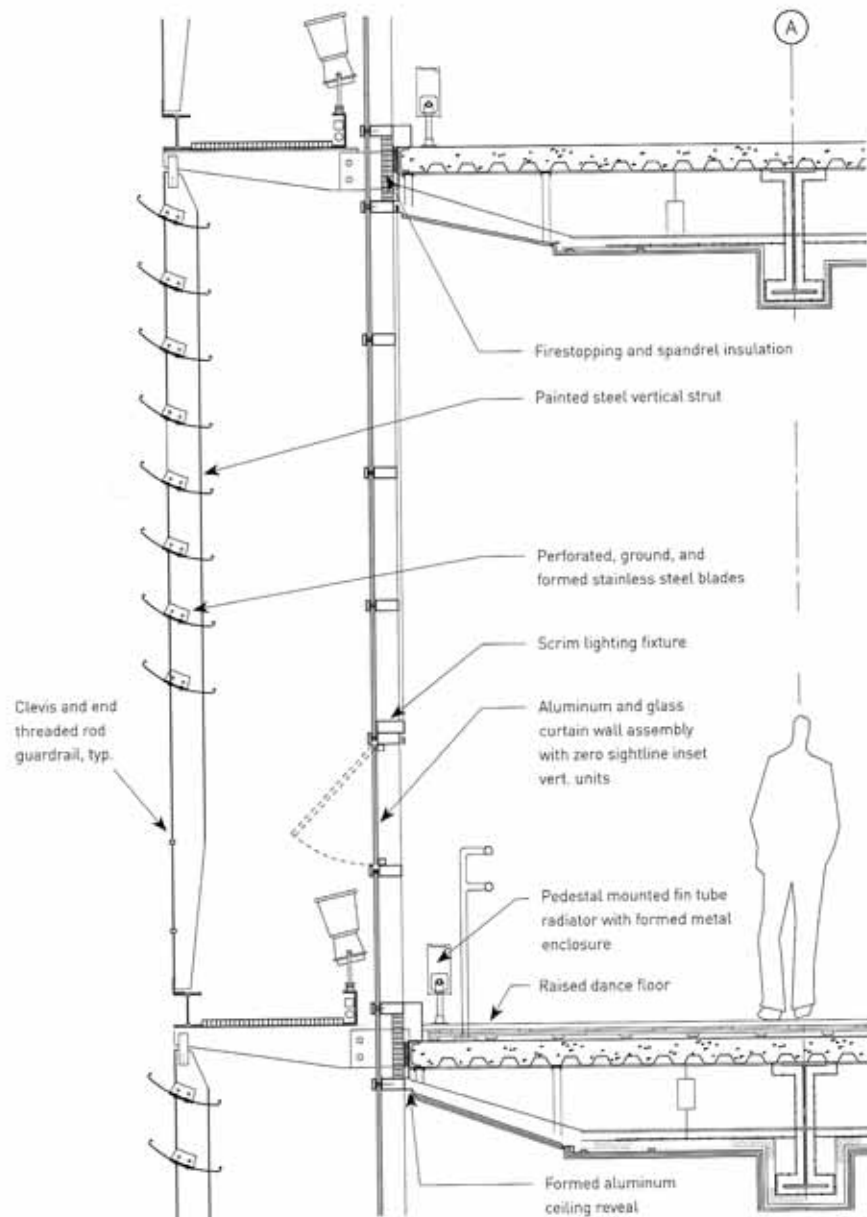

fig.178

NEW 42 STUDIOS

New York/ Platt Byard Dovell White Architects

12.20  
**technical precedent**

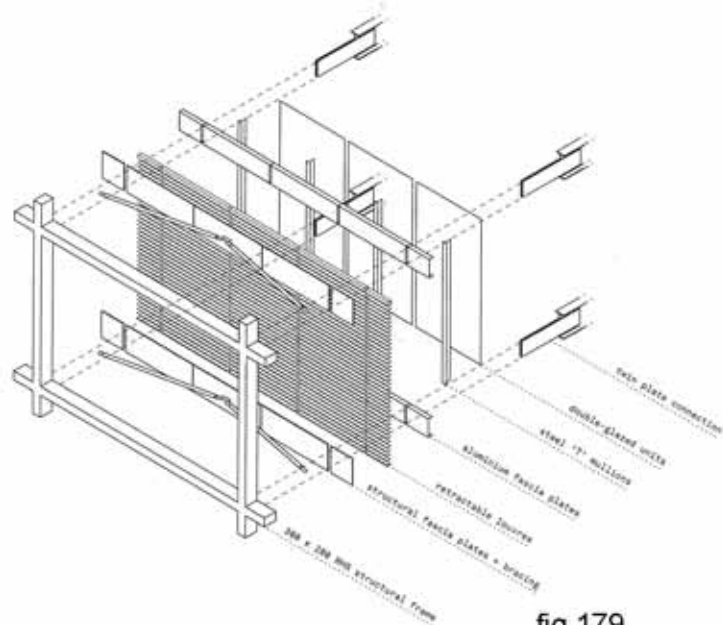
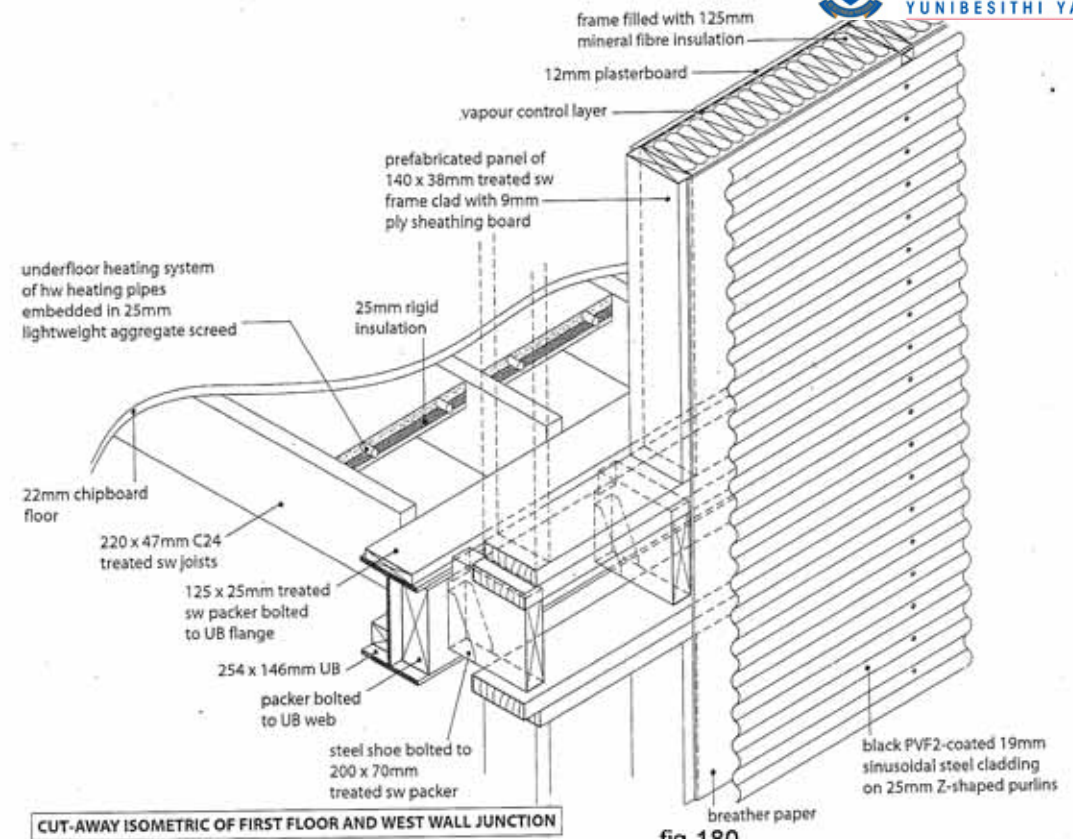
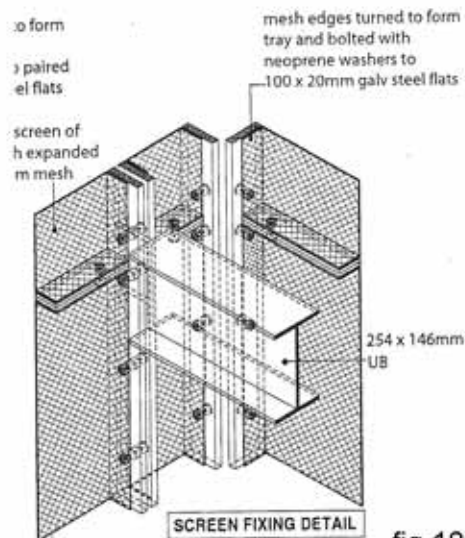

fig.179



CUT-AWAY ISOMETRIC OF FIRST FLOOR AND WEST WALL JUNCTION

fig.180



SCREEN FIXING DETAIL

fig.181

12.21

technical precedent skin



The following specialized Smartglass glazing was used in KNOOP:

In the pods	Solarshield Grey S20 6,76mm High Penetration Resistance glass 2440x2000 max pane size 5,8 (W/m <sup>2</sup> ).k U-value 33 ISO rating noise control
In the creative link	Coolvue Clear 3000x1000 max pane size In purpose made black powder coated aluminium frames according to manufacturer's specifications 5,8 (W/m <sup>2</sup> ).k U-value 35 ISO
In the sewing rooms	Soundprufe Clear 8,76mm High Penetration Resistance glass 3210x2500 max pane size 38dB
In the fashion labs and modeling school	Mirrors  Copper free 5mm thick 3210x2250 max. size Edges beveled and polished



**SABISA**  
South African Building System  
Association  
General Specification for  
drywall partitions &  
lightweight internal walls  
Annexure 3

	lluminance & Glare Index Productivity Value (min.av) lux
Restaurants	500
Lounges	150
Kitchens	500 <sup>3)3)</sup>
Cold stores	150 <sup>3)</sup>
Self-service counters	300
Shops	300 <sup>1)2)</sup>
Passages & Lobbies	150
Stairs & Ramps	150
Lifts (interior)	100
Reading room	500
Machine & fitting	400 <sup>3)</sup>
Printing	1000 <sup>1)</sup>
Reception	200
Computer lab	500
Reading tables	400 <sup>2)</sup>
Lecture rooms	500
Chalkboards	500 <sup>1)2)</sup>
Hand tailoring	1000 <sup>1)</sup>
Embroidery / sewing rooms	500 <sup>1)2)</sup>
Boot & shoe making	1000 <sup>2)</sup>
Hat making	400

## 12.22 light quality

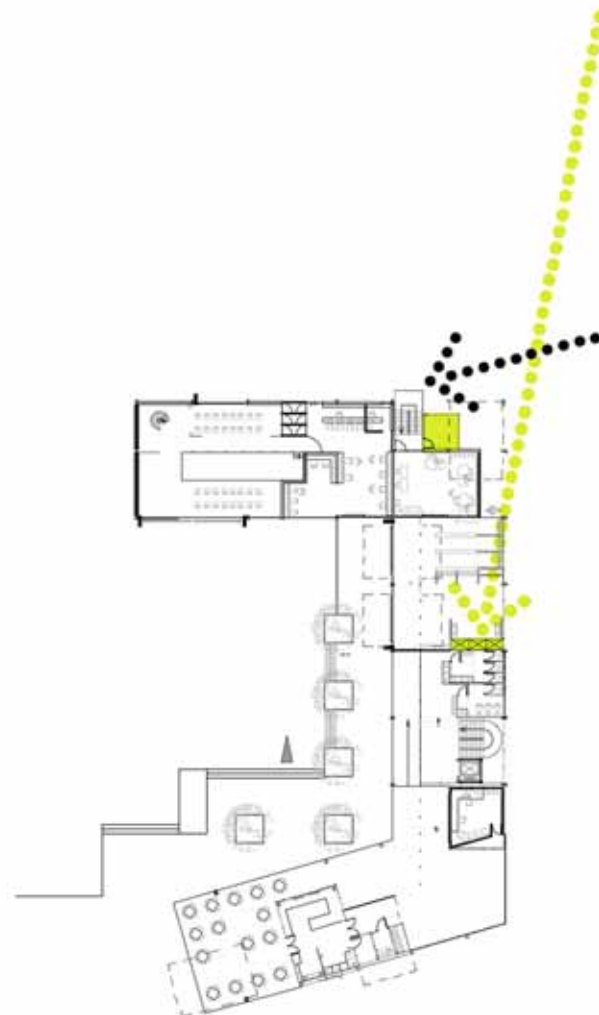

fig.182

The **internal sub-station** with transformer room, generator room and telecommunication cables are situated as centrally as possible on the ground floor. It is situated in the prototype lab where it is very visible and easily accessible. From here extruded metal conduits are run overhead to the specific points and power poles serve working tables from above, allowing for unobstructed working areas in the labs.

The **server room** is situated to the north of the building, close to the computer labs on the north eastern corner to minimize cabling distances. The room is 9m<sup>2</sup> in total.

The server room is constructed from a 230mm brick wall with battens on the outside, bolted to the wall @ 2000mm heights. Corrugated stainless steel sheets are then screwed to the battens to form the outer skin and insulation is placed between the wall and the corrugated plate on top of the battens. This creates a well insulated wall. Because the room heats up immensely due to the machinery inside, a split unit creates positive air pressure inside the room and a louvered air vent allows excess heat to escape.

All computer cabling are then run overhead in 38mm stainless steel tubular sections to the computer pods above and inside cabling is kept tidy in galvanized cable trays that are fixed to the pod frame.

## 12.23 electricity

The building width was kept to a minimum to enhance natural ventilation of all areas, except in the computer labs and sewing rooms where mechanical cooling was required due to heat buildup caused by machinery. In the warm summer months axial wind fans on the southern and eastern facades aid ventilation and prevents heat gain, especially at the roof spaces of the top floors.

The computer labs and sewing rooms are cooled by LG Art Cool split unit air conditioners with all mechanical units exposed on the building façade, but hidden by the building skin.

School type windows in the fashion labs allow users to open and close windows as their comfort requirements change. The windows are situated on the northern and southern façades and if windows are opened at a lower level on the northern side and at a higher level on the southern side in summer, the predominant north western wind in Pretoria will be able to enter the lab. The axial wind fans will also enhance the air movement through the room.

The 'creative link' of KNOOP has high volume spaces and hot air will rise naturally, leaving working areas on the ground level comfortable. Bottom hung pivot windows and axial fans on the eastern edge will omit heat from higher level areas.

A living wall was designed for the north western corner of KNOOP to cool the environment in the extreme summer months. The wall consists of PVC coated copper wires that are woven between the screen support frames @ 900mm away from the building facade. A deciduous creeper that grows from soil beds at the bottom and top of the frame is then allowed to grow on the wires. A sprinkler system that receives water from the same pipes as the washing machines in the sewing rooms will irrigate the plants early in the mornings and late in the afternoons.



fig.183

## 12.24 ventilation



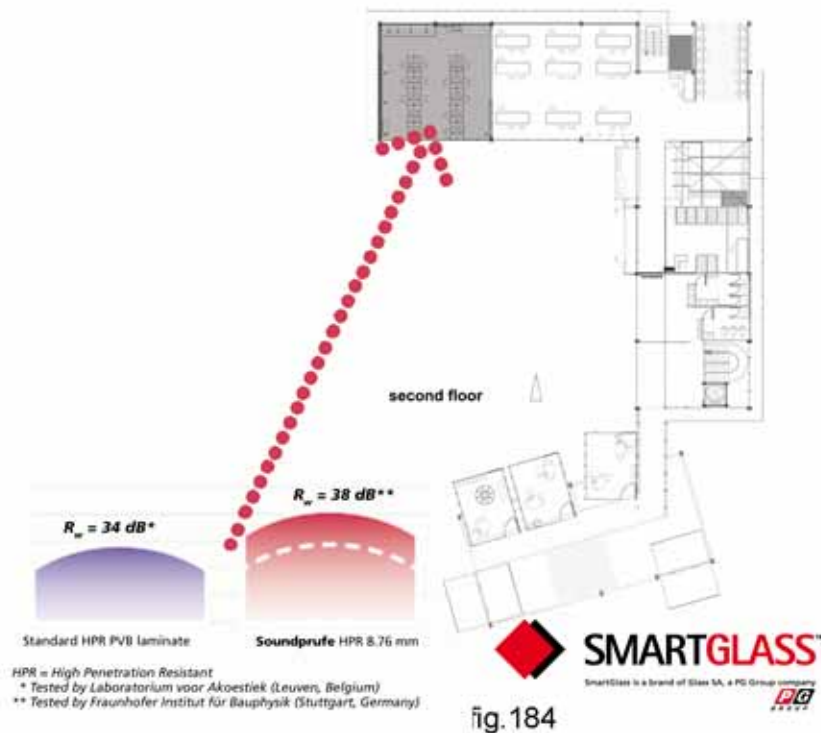

Because it is in the interest of the users of the building to be inspired by one another and exposed to as many as possible creative energy, KNOOP needs to be an vibrant place where many sounds can add to the tapestry of experiences.

Still, care was taken to ensure that no mechanical noises would interfere with conversations and that is the reason the sewing rooms are separated from all other functions. Onlookers can still see students using the machines, but they will hear nothing because double glazed Soundprufe walls will prevent noise entering the rest of the building. An airtight mechanical sliding door at the entrance of each sewing room will be specified by an acoustical engineer and will work similar to gates at airport terminals.

Care was taken to ensure an environment that is conducive to creativity. Resources are readily available in an inspirational environment where comfort was not limited for space.

The correct ergonomic size for a fashion cutting table is 1764x864mm @ 864mm high according to the Vogue sewing book. The cutting tables in Knoop are 3000x1000mm and allow three students to work comfortably next to each other.

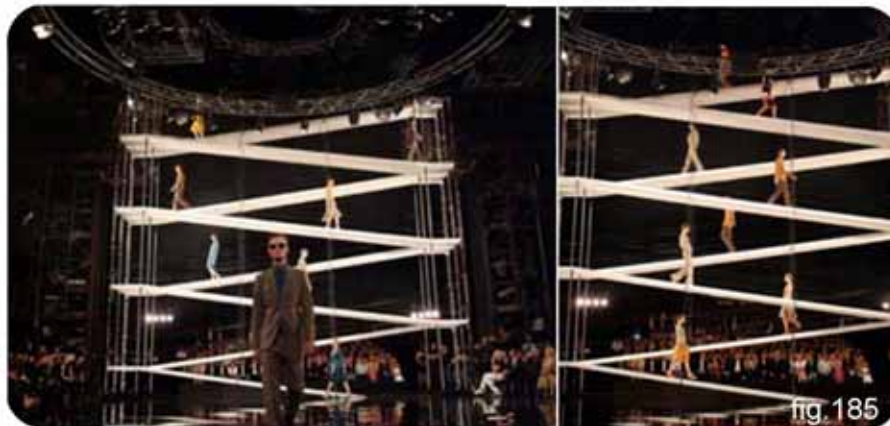

Because KNOOP was set out in a logical way that takes the daily activities of the user into account, the circulation of the building is extremely important. This is because the walkways have to ease the flow of movement from one task to the next. It is also the one place where onlookers can see how the daily routine of a designer works and where many ideas are discussed and concepts enriched by conversations with fellow students in the pass by.

The main circulation areas are clearly demarcated by the different floor material of metal 'vastrap' on the walkways and ease of movement is ensured by the ample width of 2500mm. This is the same width as a standard fashion runway and was used throughout the building as a guideline, relating back to the fashion theme and implying that a person crossing the walkway can feel like a model on a runway for an illusionary moment.

All balustrades are standard stanchions with tennis wire between members to prevent people falling through the openings. The wire and stanchions are all painted black.

## 12.26 circulation

**“Fashion is architecture: it is a matter of proportions,”**  
Coco Chanel





The technical resolution of KNOOP involves drawing inspiration from the fashion industry and applying it in an architectural manner.

The building has a tactile quality and the structure exposes all construction joints as if it is a jacket that was turned inside out to unveil all the seams and stitches of the tailor. Through exposing the elements that create the building, the design process is revealed to the users.

Because fashion is not heavy and robust but kinetic, the main aim of the building is to be lightweight and to allow change without too many implications. To achieve this, a lightweight steel frame forms the basis of the design with lightweight floors and wall systems shaping the building boundaries. A secondary skin dresses the building externally in the form of permeable screens. These screens elevate comfort inside KNOOP, by providing solar control and conceal all service ducting that are exposed between the building and its skin.

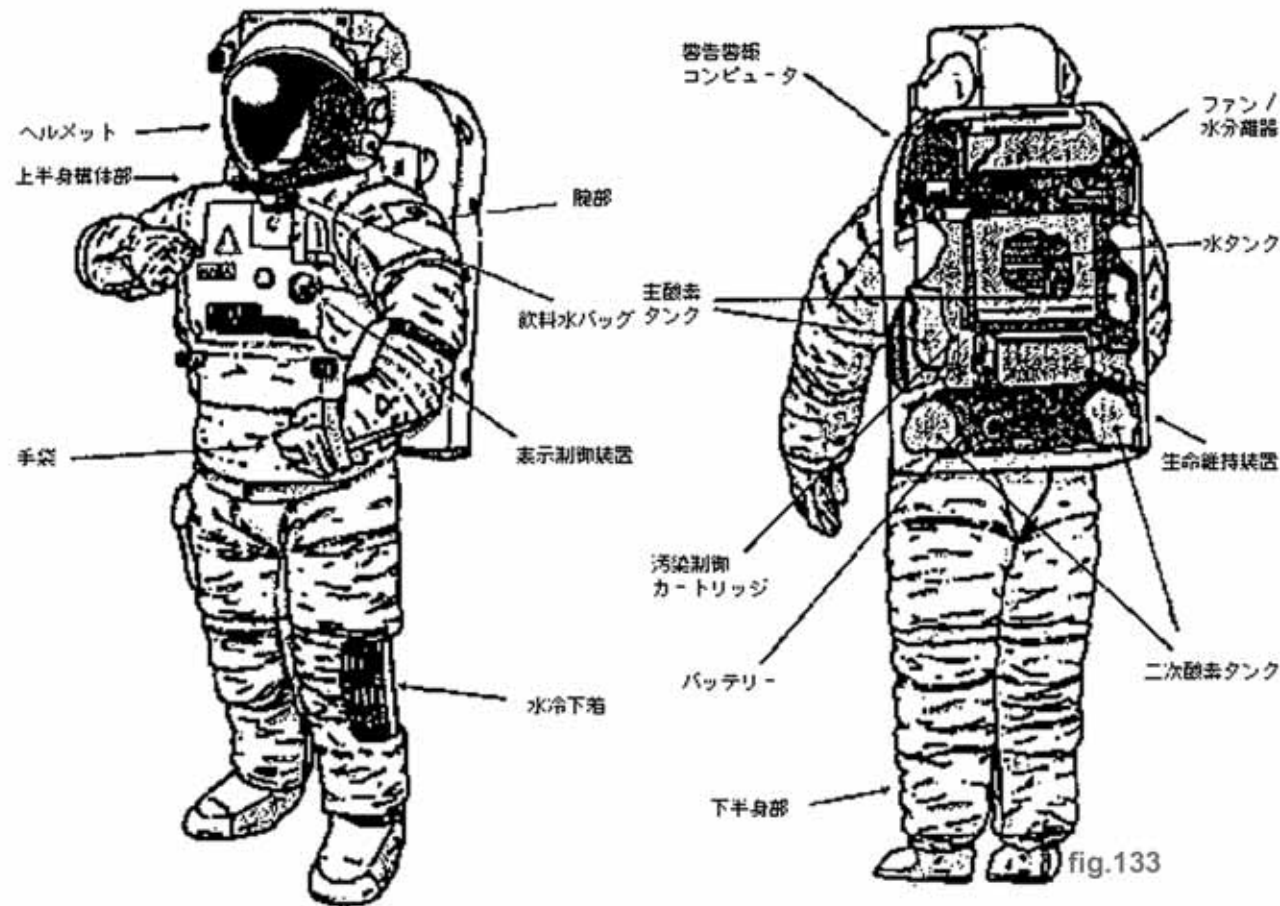

fig.133

**“The mechanisms of space exploration made it necessary for the functions of dwelling and clothing to be unified in a single object, bringing fashion and architecture closer together.”**

(Quinn, B.2003:206)

## EXTERIOR

Foundation	Concrete
Frame	Steel
Walls	Corrugated metal and plasterboard system
Roof	Cast in situ concrete
Insulation - Walls - Roof	Structabord rigid insulation Elastomeric modified membrane
Windows	Glazed school type window in metal frame Dorma FSW-G folding sliding walls
Doors	Smartglass soundprufe In metal frame
Fire Escape	Steel stairs
Downspouts & Guttering	Metal
Porches and steps	Concrete steps to main entrance

## INTERIOR

Floors	Poured concrete on
Ceilings	Permanent shuttering Exposed brownbuilt
Doors & Trim	Custom made Smartglass Soundprufe door in aluminium frame
Clear Height	GF: 2890mm Other: 3500mm
Plumbing	All ducting exposed
Air-Conditioning	Split unit in computer & sewing labs
Electrical	Service entrance 400V Exposed hot galvanized cable conduits
Fire Protection	Smoke sensors throughout Pull stations located at main exits Fire alarm panel located in prototype lab (central)
Sprinkler System	The Globe Quick Response GL Series Sprinklers

## 12.1

# brief specifications





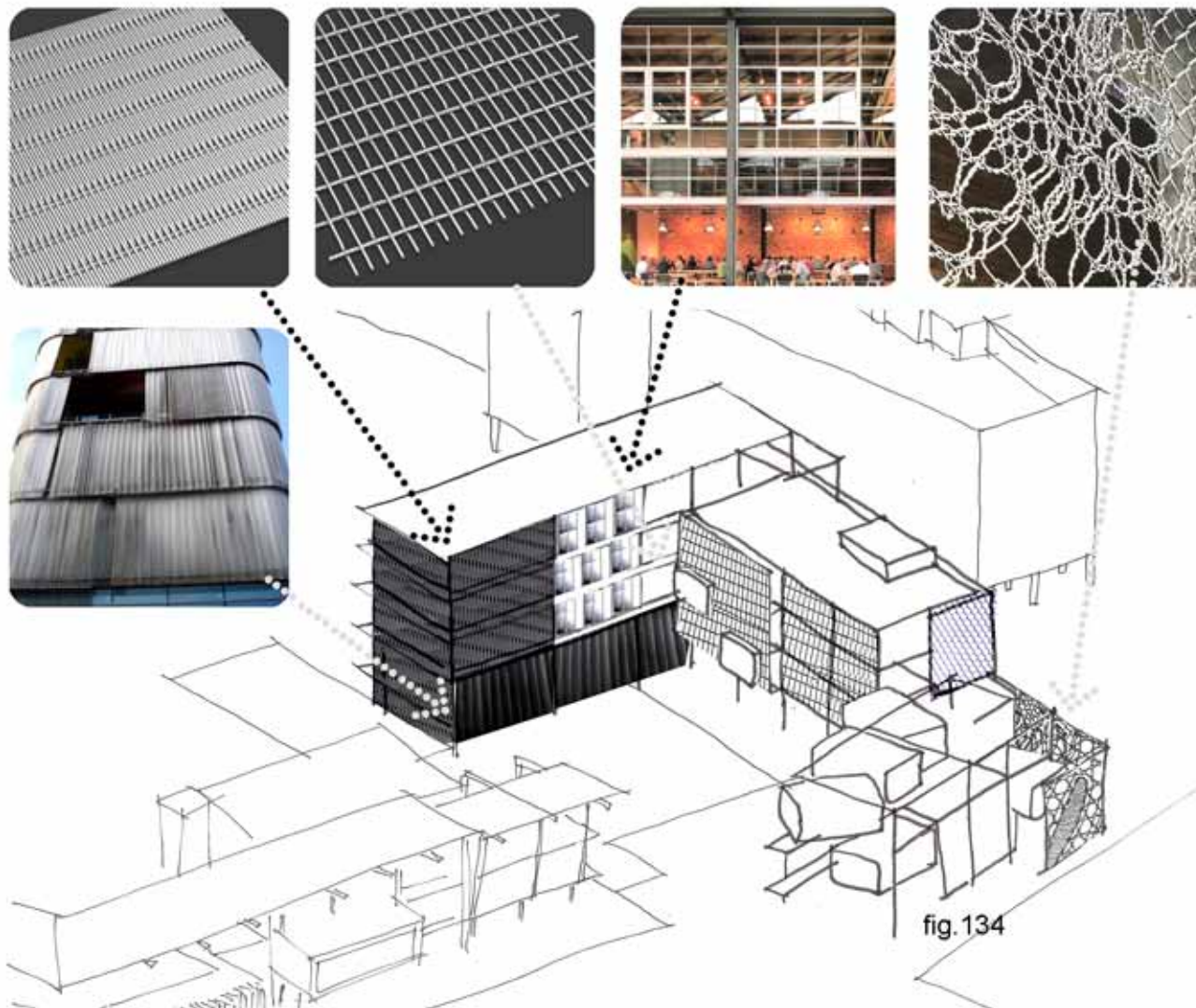

There are two main driving factors in the material choices for KNOOP. The first concern is that the building had to be lightweight and the second concern, in keeping with the theory of reconstruction, is that all building materials should have a high recyclable quality.

All school type windows and stanchion balustrades were reclaimed from old buildings.

## 12.2

# material choice

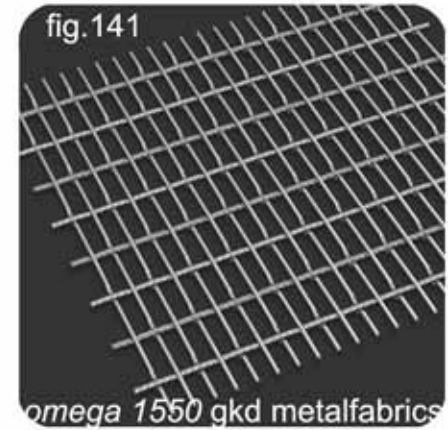
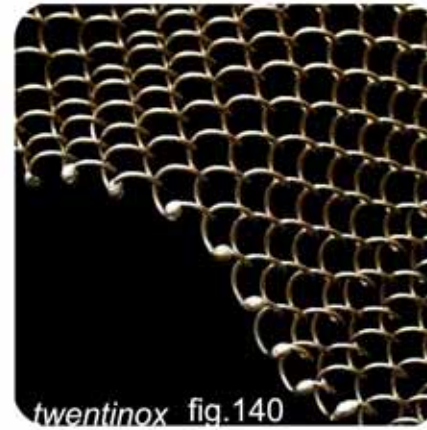
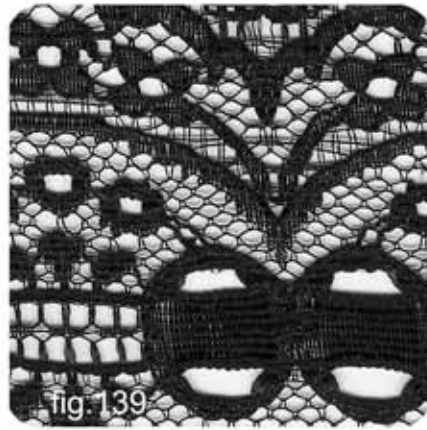
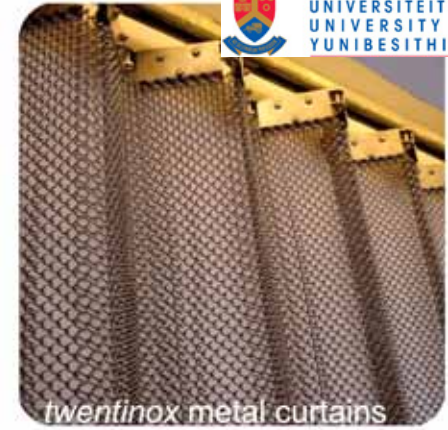
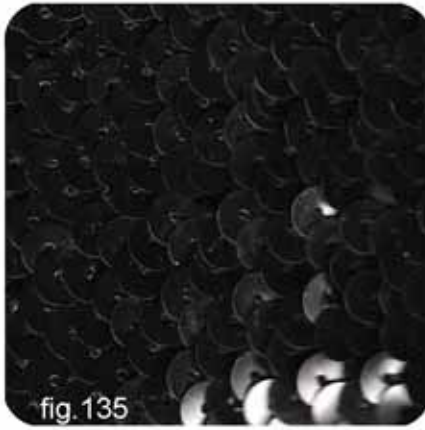

Articulate fashion materials into architectural materials to dress the building frame as a fashion designer would dress a mannequin.



# materials



KNOOP is constructed from 305x305 H columns and 305x165 Universal Beams according to engineer's specifications.  
(NOTE: All steel details are according to engineer's specifications)

A basic frame was calculated to determine the minimum number of structural members. It is taken into account that the frame must be strong enough to carry the bending moments caused by suspended pods from the beams.

The total weight of the steel frame supporting the pods is 60 tons. Each pod will weigh 45 tons according to calculations that uses a live load factor of five to include the weight of computers.

All beam and column connections are pinned to allow future disassembly of the structure and re-use of the steel. Pinned connections are formed by bolting all members with M24 high tension bolts to standard steel angle cleats welded onto the structural frame.

KNOOP is situated on top of a basement parking with a layout for 300 parking bays. This had a big influence on the building design, as all structural columns had to line up with basement columns. The basement columns are cast in situ concrete, and all steel frame footings had to be hinged connections, to allow for deflection.

This was achieved by having a two bolt connection to a 450x450x20 steel base plate.

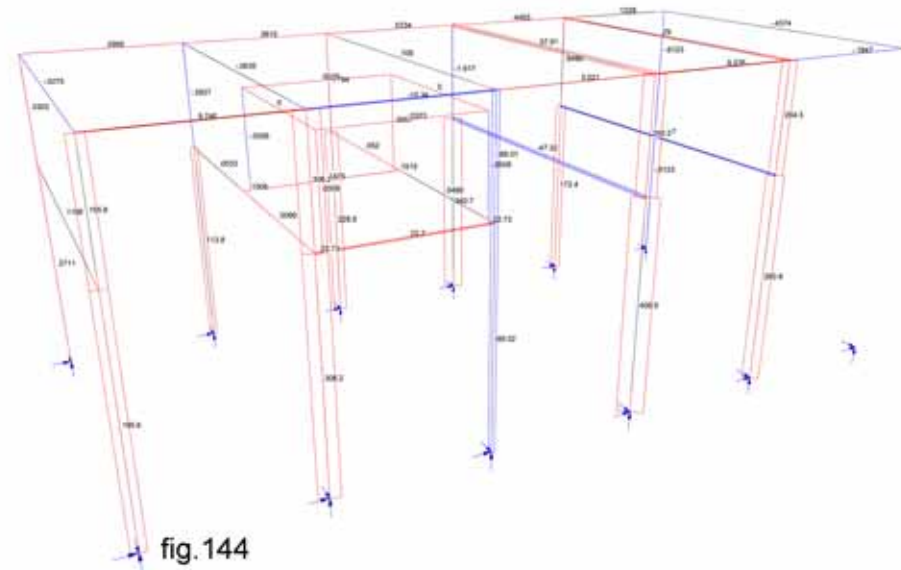
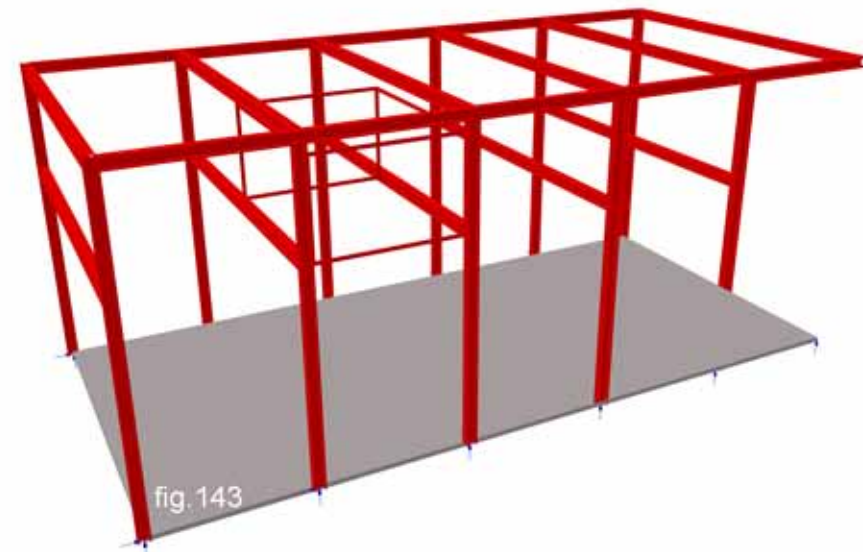

## 12.3 frame



KNOOP is situated right next to the train reserve, and it was of concern to regard the influence of vibrations on the structural integrity of the frame. The train track will be designed to include Trackelast pads under all sleepers to absorb most of the train vibrations. Care was however still taken in the building detail design to allow for movement at all connections to minimize the impact of any possible vibrations that could still have an influence on the materials.

The manner in which the building touches the ground relates to the fashion theme, in that the structure 'lifts its hemline' towards the courtyard. All columns that edge the courtyard are raised 150mm from the base plate, whilst all columns on the outer edge of the building meet the base plates on the ground.

There is a secondary row of 76,2mm diameter hollow core steel tubular columns that support the internal walkways and are situated 2500mm inside of the building @ 1500mm spacing. They soften the building boundary and create an edge that is symbolic of the cut lines on a pattern that go from solid lines to dashed lines.

"A fabric surface constructs a second elastic skin to human scale that masks and conceals the body's frame. Body-conscious dress is the equivalent of architecture intended to blur the boundaries between structure and landscape." (Quinn, 2003:234)

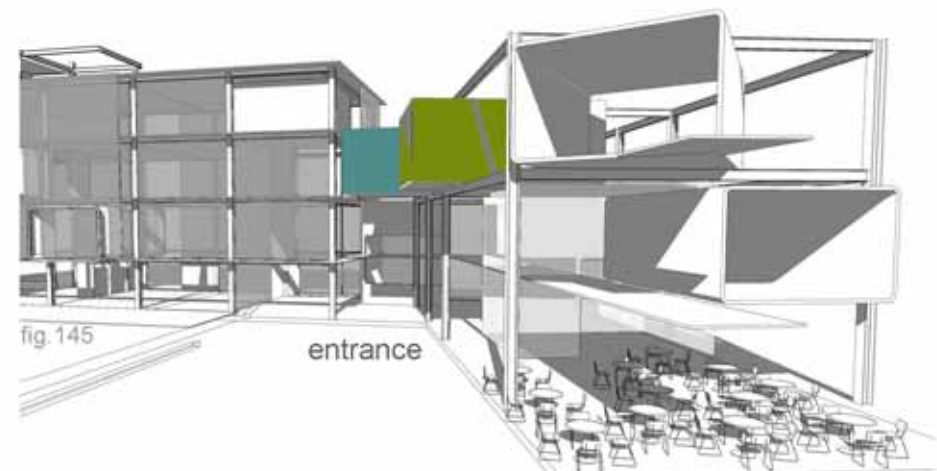



"The structure encloses a large, single volume and supports different types of external skin that respond to conditions of climate."

The roof construction consists of a flat lightweight deck which is well insulated and covered by a single skin polyester membrane.

People enter from an average external temperature of 38 c (which can go up to 45 c), into the large volume of the Pavilion which has a temperature of 30 c and the temperature drops gradually as they move through to the fully air conditioned internal pods, conditioned to 23 c."

(<http://www.grimshaw-architects.com>)

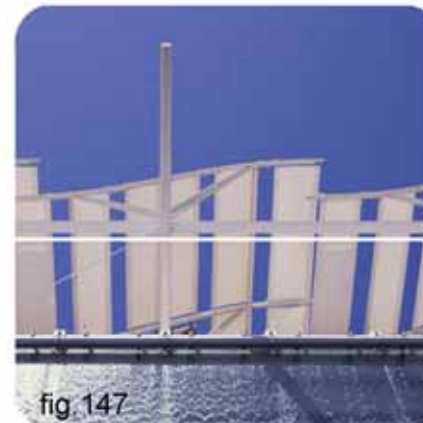

BRITISH PAVILLION FOR EXPO 92

Seville, Spain / Grimshaw Architects

## 12.4 technical precedent

The fashion term “Ombre” describes fabric that has a gradient from very dark to very light, revealing more where the fabric fades and concealing more where the colour intensifies. The inspiration for the design of a secondary building skin was the reference to ‘revealing and concealing’ by Bradley Quinn in his book ‘The Fashion of Architecture’.

By using screens that differ in density and by overlapping screens at certain points, areas of KNOOP are hidden from the public eyes, whilst other areas are exposed.

Because the screens are not intended to compete with the colourful and textured pods, they are kept simple and painted a uniform colour, black.

The screens are made from AISI Type 316 stainless steel GKD metal fabric in the Omega range. The edges of the fabric is bent and fixed between a flat bar and an angle bar that is then fixed to a support frame 900mm from the façade boundary.

The support frames are 2835x100x10mm steel flat bars that are supported by 50x50x5mm equal leg steel angles that are bolted to the 203x102 walkway beams.

The “Omega” range is available with different percentage open areas and a gradient was achieved in the building façade by using more dense screens on the western façade and less dense screens towards the southern wing of the building.



fig. 148

## 12.5 skin



The internal skins of the building are constructed from well insulated light weight walls. The wall system comprises 15mm "Nutec" flat sheet on one side and 17,5mm corrugated steel wall cladding on the other, with 125x75x20x3mm cold formed lip channels as an internal frame of struts and girths. The struts are spaced @ 1200mm centres and keep the mineral insulation (80kg/m<sup>3</sup>) in position. Girths support the wall cladding every 2000mm. All wall edges are finished with purpose made flashings and all corners terminate in 50x50x2mm purpose made flashings of the same material was the walls.

All walls were treated with the Eco paint product B-Seal from B-Earth.

"B-Seal is a water bond, ready to apply elastic waterproofing sealant for filling and sealing cracks and joints in metal, concrete and wood surfaces, which prevents water penetration. When cured, it forms a tough, highly durable, flexible seal that has ultimate protection properties and can tolerate thermal shrinkage movements of the substrates. It is ideal for application to metal roofs, parapets, dams, gutters, down pipes, concrete roofs, pre-cast panel walls, glazing, etc"

The product forms an elastic seal that has a high fire resistance.



BIOVAC INSTITUTE  
Pinelands, Cape Town



"The sun control skin is separated from the fenestration skin by a walkway allowing users to have coffee brakes etc. between the skins and also to service/clean windows."  
(Architect and Builder June-July 2007:65)



WALL HOUSE  
by FAR frohn&rojas architects  
Santiago de Chile

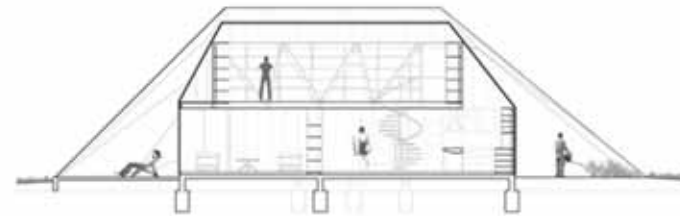

© FAR frohn&rojas

12.7  
**technical precedent skin** fig.150





EKO PARK EXPO PAVILION

Warsaw, Poland / Apa Kurylowicz & Associates

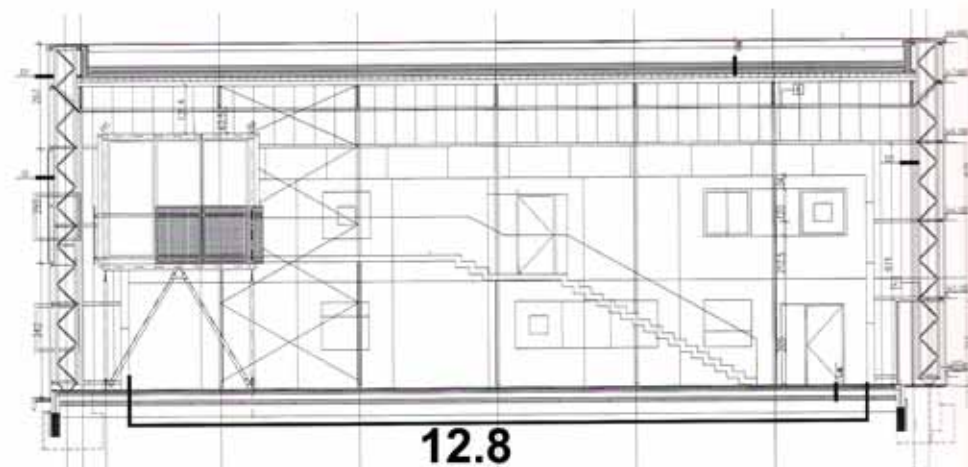

**technical precedent** fig.151

To respect the simplicity of the building frame and create a simple back drop for the dynamic and intricate pod structures, it was decided to keep the roof flat.

The roof is constructed in exactly the same manner as the floors of the building, with the addition of an elastomeric modified membrane for waterproofing and a screed falling towards the eastern columns, where full bores drain the roof of the building. The screed is cast at an angle of 1:50, with its highest point being 194mm above the 200mm post-tensioned concrete roof slab.

Because the roof is accessible, tiles form a layer on top of the membrane to allow people to walk on the roof. The tiles will also protect the membrane from solar damage. Stainless steel stanchions with chain link infill prevents people falling from the roof.

Because of its construction it would be possible for the two roofs to be utilized as floors in future applications. The building thus allows for future reconstruction.

The pod structures form the main feature of KNOOP. They were designed as framed offices suspended from the main frame. The pods will not be moved or changed, but the skins of the structures can easily be removed and changed to show the new fashion trends of each new season.

Caravan construction was investigated to inform the design of the pods.

The frames are constructed of 120x80x5mm Hot Rolled Rectangular Hollow sections. The edges have a radius of 350mm. On the exterior, the pods are clad with 955x525mm, 1.2mm thick galvanized mild steel plates that are pop riveted to the structural frame with blind rivets traditionally used on aircraft leading edges. There are 25mm gaps between the plates to allow for a row of M8 screws to be welded to the frame to form the fixing mechanisms for the pod skins. There are three rows of screws per pod that are situated on the two edges of the pod and on the centerline. The exterior edges of the pods have 50x10mm flat steel section edges for a tidy finish against which the fabric skin terminates.

On the interior, the pods are clad with 12mm steam bent plywood in panel sizes of 1800x1068 and four 229x1068mm edge pieces. The ceiling panels are cut away where the pod suspension mechanisms enter the pod and edged with hardwood strips to protect the plywood.

The internal layer of each pod consists of a 50mm air gap and 60mm Structabord rigid insulation held in place by 125x75x20x3mm cold formed lip channels that are welded to the frame members.

Each pod has two 343x161x20mm purpose made steel U-channels that are welded onto the pod frame. Each U-channel has three holes to allow M24 threaded rods to fix the U-channel to two 200x100x20mm purpose made unequal leg channels welded to the main structural frame of the building. The rods are fixed with nuts and washers.

Typical roof tent construction was investigated to inform the design of the pod skins.

The skins are made of 100% waterproof polyamide 380g cotton ripstop canvas. All seams are double stitched, edged with binding and waterproofed by welding all UV stabilized PVC seams. Stitching is of superior strength UV stable quality S25 thread.

Each pod has two skins that overlap on the pod centerline. The skins have ringed holes on their outer edges that fit over the M8 screws that are welded to the pod frame. The skins are then fixed to the screws with nuts and washers. The outer edges of the two skins that meet at the bottom of each pod fix together with 25,4mm thick Dual Lock Reclosable Fastener Tape 250S Heavy Duty Velcro.

The skins were designed to ensure that they would also fit the two pods that puncture the western wing of KNOOP.

Because sublimation printing is available on site, there are no limitations to the patterns of the skins and the fashion school can change the skins of the pods with each season without much more effort than removing a few nuts.

The safety of persons responsible for changing the skins are ensured by safety eye bolts welded to the main structural frame allowing the use of a safety cable system similar to the protection method used by window washers of large buildings.



fig.152



andrew maynard japan library



200x100x20mm  
purpose  
made unequal  
leg channels

M24  
threaded  
rod

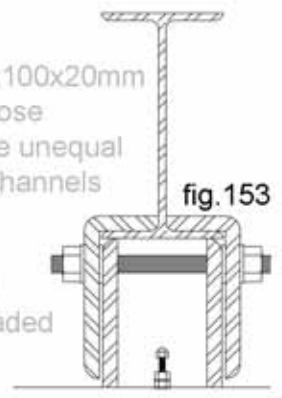

fig.153

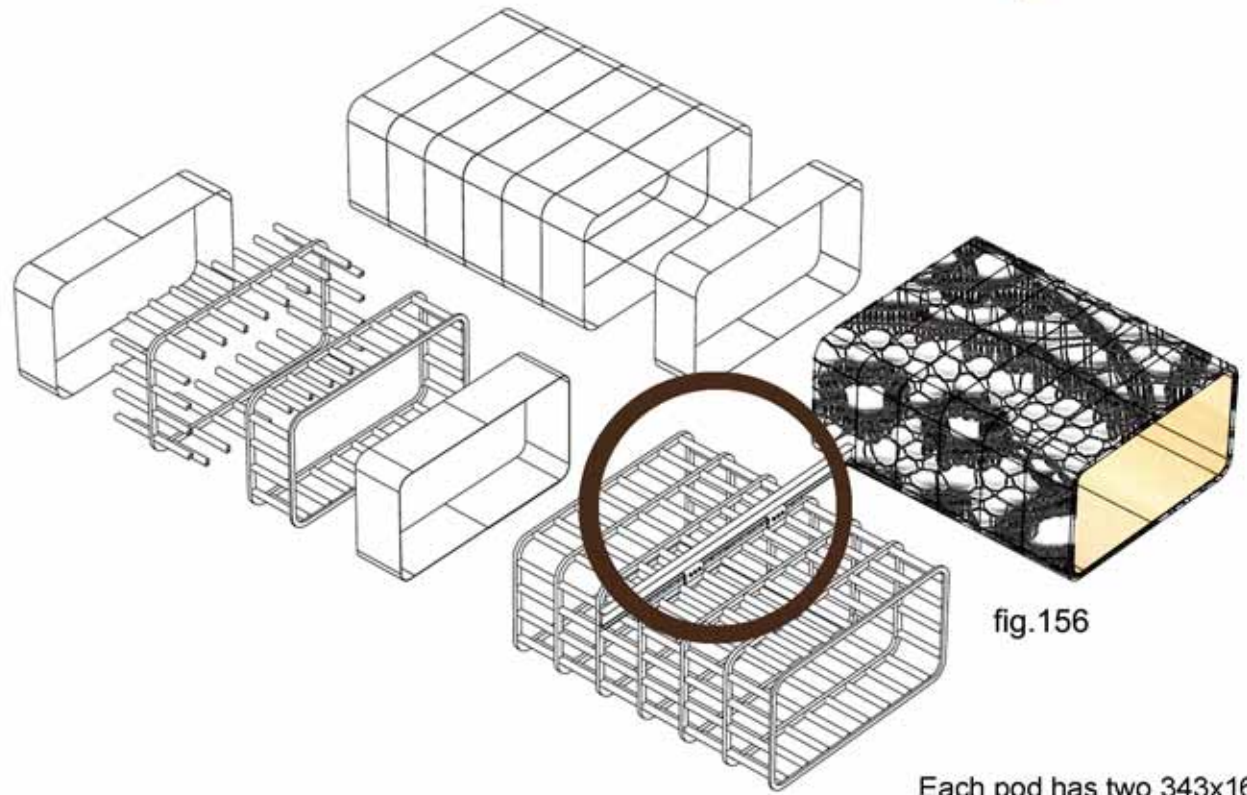
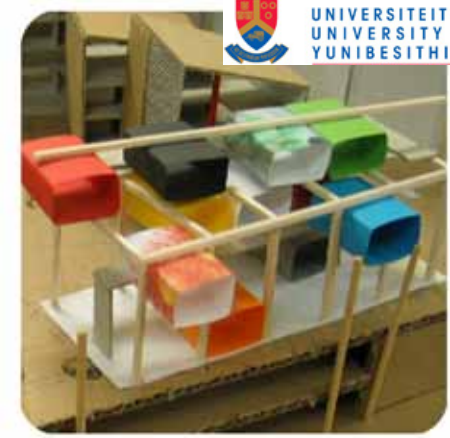

fig.156

Each pod has two 343x161x20mm  
purpose made steel U-channels  
that are welded onto the pod frame.



fig.155  
claireandsean.com flatpack



# pod s