

A FAMILY SYSTEMS ANALYSIS OF SERIAL MURDER

BY

GIADA ALESSIA DEL FABBRO

**SUBMITTED IN PARTIAL FULFILLMENT OF THE REQUIREMENTS FOR
DEGREE**

PHILOSOPHIAE DOCTOR

IN THE FACULTY OF HUMANITIES

AT THE UNIVERSITY OF PRETORIA

MAY 2006

A FAMILY SYSTEMS ANALYSIS OF SERIAL MURDER

OPSOMMING

Die navorsing het op die fenomeen van reeksmoorde vanuit 'n sisteemteoretiese perspektief gefokus. Die doel was om gesinsistemiese insig te verkry met betrekking tot reeksmoorde in 'n Suid-Afrikaanse konteks. Deur gebruik te maak van 'n gesinsistemiese teoretiese raamwerk en die genogram-metode, is gegewens van gesinsisteme van individue wat reeksmoorde gepleeg het, ingesamel, kwalitatief ontleed en deur middel van 'n tematiese inhoudsanalise ondersoek. Die ondersoek het hoofsaaklik emosionele prosesse, multi-generasionele en verhoudingspatrone van gesinsisteme beklemtoon.

Inligting is uit verskeie bronne versamel. Onderhoude is onder andere gevoer met individue wat tans vonnisse uitdien vir reeksmoorde, sowel as met hul gesinslede, asook met professionele persone wat by hierdie persone betrokke was. Inligting is ook uit kliniese observasies en argiefdata verkry. Die resultate van die inhoudsanalise demonstreer aansienlike ooreenkomste, maar dui ook op verskille in die organisering en funksionering van gesinsisteme van individue wat reeksmoorde gepleeg het. Teoretiese insig is ook verkry aangaande die rol van reeksmoorde in gesinsisteme en wat die tans heersende teoretiese perspektiewe met die klem op die enkel individu en lineêre oorsaaklikheid uitdaag.

Hierdie studie bied die geleentheid vir verdere sisteemteoretiese navorsing, veral om die moontlikheid van die betekenis van reeksmoorde in relatief kleiner (bv. ouer-kind of portuurgroepsverhoudings) of groter kontekse (die politieke, kulturele en sosiale sisteme) te ondersoek. Verder bied dit ook geleentheid vir 'n alternatiewe kyk na die fenomeen van

reeksmoord in terme van teoretiese, definiërende, tipologiese, ondersoekende en korrektiewe benaderings.

ABSTRACT

The research aimed to explore the phenomenon of serial murder from a systems theory perspective. The purpose of the study was to develop an understanding of serial murder in a South African context from a family systems approach. Utilizing a family systems theoretical framework and the genogram method, the study, which was qualitative in nature, explored information about the family systems of individuals who committed serial murder via content analysis. The investigation focused mainly on emotional processes, multigenerational and relationship patterns in family systems.

Information was gathered from numerous sources and included interviews conducted *inter alia* with individuals currently incarcerated for serial murder and their family members, and with professionals involved with such individuals; as well as information obtained from clinical observations and archival data. The results of the content analysis demonstrated considerable similarities but also differences in the organization and functioning of the family systems of individuals who committed serial murder. Importantly, the analysis shed novel theoretical light on the role of serial murder within family systems and challenged established dominant theoretical perspectives on serial murder that have emphasized linear, causal and/or individual-focused explanations.

The study opened up considerable opportunities for further exploration of the phenomenon from a systemic perspective, specifically with the focus on the meaning of serial murder in

relatively smaller (e.g., parent-child or peer relationships) or larger (e.g., political, cultural and societal) systems. It also provided opportunities for alternative vistas from which the phenomenon of serial murder can be viewed in terms of theoretical, definitional, typological, investigative and correctional approaches.

10 KEY PHRASES: serial murder; family system; multigenerational patterns; emotional cut-offs; triads; genogram; case study; nuclear family system; violent crime; relationship patterns

AFFIDAVIT

I declare that **A Family Systems Analysis of Serial Murder** is my own work and that all references have been fully acknowledged in the text and the bibliography.

Opinions expressed and conclusions arrived at in this research are those of the author and not necessarily those of the Department of Psychology, Faculty of Humanities, South African Police Service or Department of Correctional Services.

GIADA A DEL FABBRO

Johannesburg

02 May 2006

TABLE OF CONTENTS**ACKNOWLEDGEMENTS****LIST OF TABLES****LIST OF FIGURES****Chapter**

1. INTRODUCTION	1
1.1 SERIAL MURDER AS PHENOMENON	2
1.2 MOTIVATIONS FOR THE STUDY	3
1.2.1 Interaction of popular and academic sources	3
1.2.2 Limited available research on serial murder in South Africa	7
1.2.3 The novelty of the systemic perspective	8
1.2.4 Applications to correctional and investigative systems	9
1.3 PURPOSE OF THE STUDY	10
1.4 RESEARCH FOCUS AND DESIGN	11
1.4.1 Research design	11
1.5 A NOTE ON THE PATHOLOGICAL MODEL	11
1.6 RESEARCH OUTLINE	12
1.7 CONCLUSION	12
2. LITERATURE REVIEW: HISTORY, DEFINITIONS AND CATEGORIES OF SERIAL MURDER	14
2.1 DEFINING SERIAL MURDER	14
2.1.1 Mass and spree murder	14

2.1.2 Serial murder	15
Definitions of serial murder: international	16
Definitions of serial murder: South Africa	20
2.1.3 Differences and similarities of definitions	23
Quantity of murders	24
The “cooling off” period	24
Motive	26
Sexuality and lust murder	30
Number of perpetrators	32
Gender	33
Victim/offender relationship	34
2.1.4 Concluding remarks of definitions	36
2.1.5 Definition of serial murder for the purposes of this study	40
2.2 HISTORICAL BACKGROUND OF SERIAL MURDER	41
2.2.1 History of serial murder: international	42
2.2.2 History of serial murder: South Africa	46
Muti murder	59
2.3 WAYS OF CATEGORIZING SERIAL MURDER	61
2.3.1 Topological classification schemes	61
The FBI’s disorganised/organised typology	62
Holmes and De Burger’s visionary, missionary, hedonist and power/control typology	65
Leibman’s ego-syntonic and ego-dystonic classification	70
2.3.2 Geographical classification	71
2.3.3 Concluding remarks on classification schemes	74

3. LITERATURE REVIEW: THEORETICAL FRAMEWORKS CONCERNING SERIAL MURDER	75
3.1 ORGANIC THEORIES	76
3.1.1 Neuroanatomy/neurology	76
3.1.2 Genetics	78
3.1.3 Critique of organic theories	79
3.2 PSYCHOLOGICAL THEORIES	81
3.2.1 Psychodynamic theories	82
The role of fantasy in psychodynamic theories of serial murder	84
The role of primary attachments in psychodynamic theories of serial murder	87
3.2.2 Critique of psychodynamic theories of serial murder	89
3.2.3 Cognitive-behavioural and learning theory models	92
Learning theory	92
Cognitive-behavioural theories	93
Rational choice models	94
An addiction model of serial murder	95
3.2.4 Critique of cognitive-behavioural and learning theory models of serial murder	96
3.2.5 Other theories emphasizing psychological factors	97
3.2.6 Critique of other theories emphasizing psychological factors	103
3.3 SOCIO-CULTURAL THEORIES	105

3.3.1 Sociological and criminological schools and crime	105
Socio-cultural theories focusing specifically upon	
serial murder	108
3.3.2 Seltzer's theory of serial murder and wound culture	112
3.3.3 Cameron and Frazer's social constructionist theory of	
serial murder	113
3.3.4 Holmes and DeBurger's socio-cultural interactionist approach	
to serial murder	114
3.3.5 Jenkins' social constructivist theory of serial murder	115
3.3.6 Simpson and the popular representation of serial murder	116
3.3.7 Feminist theories of serial murder	117
3.3.8 Hook's post-structuralist approach to serial murder	118
3.3.9 Du Plessis' grounded theory approach to serial murder	120
3.3.10 Critique of socio-cultural theories	121
3.4 THEORETICAL FRAMEWORK FOR THE CURRENT STUDY	122
4. FAMILY SYSTEMS THEORY	126
4.1 DEFINITION OF "THE FAMILY"	126
4.1.1 Dictionary definitions	126
Family as household	128
The family in terms of the function or role of its members	128
Family as ancestry or blood lineage	129
4.1.2 Summary of dictionary definitions	129
4.1.3 Contemporary view and definitions of the family	130
4.1.4 Summary of contemporary definitions of the family	132

4.1.5 A South African definition of the family	134
4.1.6 Conceptualisation of the family for this study	135
4.2 THE CONTEXT OF THE FAMILY	136
4.2.1 The post-modern family	137
4.2.2 The family and deviance	139
4.2.3 The family and larger systems	140
4.3 FAMILY SYSTEMS THEORY	141
4.3.1 Watzlawick, Beavin and Jackson's theory of communication and interaction	142
Wholeness	143
Circular or cybernetic causality	144
Feedback	144
Reflexivity	146
Equifinality	147
Types of interaction	147
Pathological communication	148
Definitions of self and other	150
Punctuation	152
4.3.2 Summary of Watzlawick, Beavin and Jackson's view	153
4.3.3 Bowen's family theory	154
Differentiation of self	155
Triangles	155
Nuclear family emotional system	162
Family projection process	163
Emotional cut-off	164

Multigenerational transmission process and sibling position	165
Emotional process in society	165
4.3.4 Summary of Bowen's family theory	166
4.3.5 The symptom in the family system	167
4.3.6 The individual in a family systems approach	168
4.4 KEY FAMILY SYSTEM CONCEPTS FOR THIS STUDY	170
4.4.1 Emotional processes	171
4.4.2 Multigenerational patterns	173
4.4.3 Relationship patterns	174
4.5 SUMMARY OF THE CHAPTER	177
5. METHOD OF RESEARCH	179
5.1 METHODOLOGY	179
5.1.1 Evaluating qualitative research	181
5.2 RESEARCH DESIGN	182
5.3 SAMPLING	183
5.3.1 Case study one: Mr X and family	185
5.3.2 Case study two: Mr Y and family	185
5.4 DATA COLLECTION	187
5.4.1 Clinical observations	187
5.4.2 Interviews	188
5.4.3 Genograms	189
Mapping the family structure	191
Recording family information	191

Showing family relationships	192
5.4.4 Archival data and other records	193
5.5 PROCEDURE	194
5.6 ETHICAL CONSIDERATIONS	197
5.7 DATA ANALYSIS	197
5.7.1 Discussion of the case study method	198
Yin's criteria for defining a case study	198
The unit of analysis	199
5.7.2 Content analysis	200
5.8 DATA INTEGRATION	201
5.9 CONCLUSION	202
6. RESULTS	203
6.1 CASE STUDY ONE – MR X AND FAMILY	203
6.1.1 Persons interviewed	203
6.1.2 Biographical information	204
6.1.3 Clinical observations	205
Mr X	205
Mr X's family	206
Interaction between mother X and father X	209
6.1.4 Genogram	210
Paternal side of the family system	212
Maternal side of the family system	212
Nuclear family	214
Additional family systems of friends	216

6.1.5 Archival data and supplementary interview data	216
Interview with prison psychologist	217
Interview with psychiatrist involved in Mr X's competency to stand trial assessment	217
Additional data sources	219
6.2 CASE STUDY TWO – MR Y AND FAMILY	219
6.2.1 Persons interviewed	219
6.2.2 Biographical information	221
6.2.3 Clinical observations	221
Mr Y	221
6.2.4 Genogram	225
Paternal side of the family system	227
Maternal side of the family system	228
Nuclear family system	228
Mr Y	231
Additional family system of Mr Y's co-accused, Mr H	235
6.2.5 Supplementary data sources	237
Interview with prison psychologist, Ms V	237
Interview with Mr Y's cellmate, Mr Z	238
Additional data sources	239
6.3 CONCLUDING REMARKS	241
7. DISCUSSION OF RESULTS	242
7.1 DISCUSSION OF RESULTS OF CASE STUDY ONE – MR X AND HIS FAMILY	242

7.1.1 Genogram interpretation	243
Category one: family structure	243
Category two: life cycle fit	251
Category three: pattern repetition across generations	255
Category four: life events and family functioning	261
Category five: relational patterns and triads	268
Category six: family balance and imbalance	279
7.1.2 Thematic content analysis	293
Themes relating to emotional processes in the X family system	294
Themes relating to multigenerational patterns in the X family system	307
Themes relating to relationship patterns in the X family system	312
Summary of themes	326
7.2 DISCUSSION OF RESULTS OF CASE STUDY TWO – MR Y AND FAMILY	327
7.2.1 Genogram interpretation	327
Category one: family structure	328
Category two: life cycle fit	339
Category three: pattern repetition across generations	345
Category four: life events and family functioning	354
Category five: relational patterns and triads	364
Category six: family balance and imbalance	381
7.2.2 Thematic content analysis	397
Themes relating to emotional processes in the Y family system	397
Themes concerning multigenerational patterns in the Y family	

system	409
Themes concerning relationship patterns in the Y family system	419
Summary of themes	432
8. DISCUSSION OF FINDINGS, CRITIQUE AND RECOMMENDATIONS	435
8.1 COMPARISON OF MR X AND MR Y AND THEIR FAMILIES	435
8.1.1 Biographical information and genogram	435
Emotional processes	438
Multigenerational patterns	441
Relationship patterns	442
8.2 CONTRIBUTIONS TO THE GENERAL LITERATURE	445
8.3 DEFINITIONS	446
8.4 HISTORY	447
8.5 CLASSIFICATION SYSTEMS OF TYPOLOGIES	448
8.6 THEORETICAL ASPECTS	449
8.7 METHODOLOGY	451
8.7.1 Evaluation of qualitative research	452
8.8 CRITIQUE	456
8.9 RECOMMENDATIONS	459
REFERENCES	461

ACKNOWLEDGEMENTS

Firstly, I would like to thank God for giving me strength and guidance at this time as well as throughout my professional and personal life journeys.

I would also like to thank my incredible family for the love, patience, support and care that they have given me. Dad, for understanding and questioning, helping me to develop my own understanding and clarity better; Mom, for bringing out the lighter side of this experience and always making sure I kept a balance; and Oriana, for your encouragement, empathy and endless cups of coffee. And to all of you, thanks for the proofreading!

My friends and colleagues - for their understanding, appreciation and encouragement.

My supervisor, Prof Dave Beyers, for his knowledge and insight, patience and inspiration, together with my co-supervisor, Dr Gerard Labuschagne, for his professional guidance, friendship and meticulous attention to detail.

Academic staff at the Department of Psychology at the University of Pretoria, particularly Prof Maria Marchetti-Mercer and Ms Annelies Cramer. Maria, thank you for being an incredible source of inspiration and for your support and advice; Annelies, your understanding and encouragement during my M1 year was priceless.

Lastly, I would like to dedicate this doctoral thesis to my late grandmother, Bruna Perrone, who was with me at the beginning of this journey and continues to inspire, guide and support me. Grazie, nonna!

LIST OF TABLES

Table 2.1.	South African serial murder cases 1936-2003	52
Table 2.2.	Disorganised/organised typology	64
Table 2.3.	Holmes and DeBurger typology of serial murder	69
Table 8.1.	Comparison between Mr X and Mr Y (biographical information and genogram).....	437

LIST OF FIGURES

Figure 1.	Diagrammatic Representation of a Family System.....	178
Figure 2.	Mr X's Genogram.....	211
Figure 3.	Mr Y's Genogram.....	226
Figure 4.	Maternal Grandfather's Remarriages.....	250
Figure 5.	Pattern of Relationships in X Family System.....	259
Figure 6.	Parent-Child Triad One.....	268
Figure 7.	Parent-Child Triad Two.....	269
Figure 8.	Parent-Child Triad Three.....	270
Figure 9.	Couples Triad One.....	272
Figure 10.	Multigenerational Triad One.....	273
Figure 11.	Multigenerational Triad Two.....	274
Figure 12.	Multigenerational Triad Three.....	274
Figure 13.	Triad: Other.....	276
Figure 14.	Roles in the X Family System.....	283
Figure 15.	Household One for Mr Y.....	329
Figure 16.	Household Two for Mr Y.....	329
Figure 17.	Household Three for Mr Y.....	330
Figure 18.	Father Y's Sibling Constellation.....	331
Figure 19.	Mother Y's Sibling Constellation.....	333
Figure 20.	Parent-Child Triad One.....	365
Figure 21.	Parent-Child Triad Two.....	366
Figure 22.	Parent-Child Triad Three –Supplementary.....	367
Figure 23.	Divorced/Remarried Triad One.....	369

Figure 24.	Divorced/Remarried Triad Two.....	370
Figure 25.	Foster/Adopted Triad One.....	372
Figure 26.	Multigenerational Triad One.....	374
Figure 27.	Triad Other: One.....	377
Figure 28.	Triad Other: Two.....	378
Figure 29.	Emotional Processes in X and Y Family Systems.....	439
Figure 30.	Emotional Cut-Offs in the X and Y Family Systems.....	440

1. INTRODUCTION

Crime and criminal behaviour have been studied and analysed since before the end of the nineteenth century (Stephenson, 1992). Disciplines as diverse as sociology, psychology, criminology, penology, medicine, psychiatry and philosophy have all studied crime, often focusing on the individuals who commit crime as well as criminal behaviour. A crime that has attracted some scientific and much popular attention for the greater part of the twentieth century is serial murder (Hickey, 2006).

Research in the field of crime and criminal behaviour has focused on its causes, prevalence, nature and impact, with the aims of enriching our understanding of crime and criminal behaviour; developing methods of preventing crime; apprehending individuals who commit such acts; assisting victims; as well as conceptualizing ways of punishing, managing or “treating” convicted individuals. As man’s way of understanding himself and his surroundings has changed with the particular Zeitgeists of the last centuries, so has man’s method of conducting social research. From a positivist view, man has expanded his research approach to include post-modern ways of conducting research, including systemic and social constructionist paradigms.

This research study has chosen to tap the above two areas, namely serial murder and post-modern research approaches, by exploring the phenomenon of serial murder from a systemic perspective, specifically with regards to the role played by serial murder in the family systems of individuals who commit such crimes. This chapter will briefly discuss serial murder as an international and local phenomenon and outline the motivation and purpose, as well as focus of the study.

1.1 SERIAL MURDER AS PHENOMENON

One of the academic issues regarding research on serial murder is the difficulty to determine a precise definition of the concept serial murder. The reason is probably that definitions differ with regard to various disciplines' views (e.g., criminology and psychology - these similarities and differences will be discussed in chapter two), despite overlapping to various degrees regarding their descriptions of serial murder. For the purpose of this study, a generic definition was developed, namely: multiple murders committed over a period of time by one or more individuals.

Serial murder constitutes a very specific category of criminal behaviour. After emerging and increasing rapidly in prevalence in the United States of America (USA) during the 1960s and 1970s, figures for serial murder prevalence in the USA show that 50% of the known cases of serial murder in the USA occurred during the time period 1975-2004 (Hickey, 2006). Gorby (2000) found the same pattern for most non-European countries in comparison to European countries that show a slight decrease from 1975-1995, after peaking in the period before this (1950-1974). Consequently, it would appear that serial murder, as a type of criminal behaviour, has been noticed and attended to largely during the last and current century.

South Africa has a particularly high crime rate, specifically in terms of violent crime. Between 1994 and 2004, South Africa's national rate of murder was 57.7 per 100 000 (http://www.saps.gov.za/statistics/reports/crimestats/2004/_pdf/crimes/Murder.pdf), while that of rape was 120.6 per 100 000 (http://www.saps.gov.za/statistics/reports/crimestats/2004/_pdf/crimes/Rape.pdf). Despite the fact that the above figures show a decrease in both murder (by 8.8%) and rape (by 2.8%)

over the last two years, South Africa's crime statistics are still comparatively high in relation to the rest of the world. For example, the USA recorded 7.1 homicides per 100 000 people for 2001 (<http://www.ojp.usdoj.gov/bjs/homicide/homtrnd.htm>), in comparison to South Africa's rate of 47.8 per 100 000 for the same year (http://www.saps.gov.za/statistics/reports/crimestats/2004/_pdf/crimes/Murder.pdf).

South Africa shows a similar pattern to the USA in terms of the proportion of murders accounted for by serial murder (namely, less than 1.0%, with 55 recorded cases of serial murder between 1994 and 2004). The obvious question to be posed is: why is there a crime such as serial murder; a crime that includes several victims, where it seems as if usually one person shows a repetitive pattern of killing people? Hickey (2001) has attempted to explain the USA data in relation to the proliferation of violence in the media; sado-masochistic and violent pornography; and the patriarchal societal system. In terms of the South African situation, Labuschagne (2001) and Gorby (2000) have argued that the less extensive infrastructure; less robust economy; and rapid urbanization and crowding that characterize developing societies may make them more vulnerable to serial murder. Given the large number of answered questions that remain concerning serial murder, it is evident that further research into this phenomenon is required.

1.2 MOTIVATIONS FOR THE STUDY

1.2.1 Interaction of popular and academic sources

Despite the general increase in serial murder cases over time in the USA during the latter part of the last century, this type of criminal behaviour accounts for less than one percent of the total homicide rate for the USA in any given year (Meloy, 2000). However, this

phenomenon attracts a large amount of attention and fascination from the general population. Public fascination with serial murder overseas/internationally has been reflected in, and sustained by, many fictional books and films on serial murder. Examples of these are the books of Thomas Harris, namely *Red Dragon* (1987), *Silence of the Lambs* (1991), and *Hannibal* (1999), as well as films such as *Copycat* (1995), *Se7en* (1995) and *Kiss the Girls* (1997). Hickey (2006) states that during the 1990s there were 150 films upwards with the theme of serial murder.

It would seem that serial murder has featured frequently in the popular media and that a large proportion of knowledge production and information dissemination on serial murder has taken place via this channel and possibly influenced academic or scientific exploration of the phenomenon. In South Africa, this popular media attention to serial murder has been in the form of newspapers, television programmes, non-fiction crime literature and fictional works.

With regards to newspaper sources, references and articles dealing with serial murder can be found across South African newspaper types. The following are examples of serial murder references in the press: Rapport (31 January, 1999) ran an article titled “Spanwerk los reeksmoord op” (team work solves serial murder); the Weekly Mail and Guardian (9 September, 1994) featured an article titled “Station Strangler – Who’s Fooling Whom”; City Press (7 December, 1997) featured an article titled “ ‘Electrician’ may be next serial killer”; Beeld (14 August, 1995) featured an article titled “Reeksmoordenaars nie ‘dieselfde mens’ ” (Serial murderers not the same person); and The Star (21 August, 1997) featured an article titled “18 murders linked in hunt for serial killer”. These form part of a considerably larger sample of articles on serial murder that have featured across newspapers in the past two decades.

Television programmes featuring serial murder have occurred on local series such as *Carte Blanche*, *Third Degree* as well as in the form of documentaries such as *Criminal Minds* (2003) and *Psycho Factory* (2004). *Carte Blanche* has aired episodes on Micki Pistorius, previous head of the Investigative Psychology Unit of the South African Police Services, on serial murder cases in South Africa, as well as episodes on forensic entomologist Mervyn Mansell and the serial murder case of Samuel Sidyno, the Capital Park serial murderer (“Crawling with evidence”, April, 13, 2003). The local actuality programme on e-tv, *Third Degree*, has also featured an episode on serial murder in South Africa (“Copy Cat Killers”, March 13, 2001).

Examples of popular non-fiction crime literature in South Africa include the works of Micki Pistorius, namely *Catch Me a Killer* (2000), *Strangers on the Street* (2002) and *Fatal Females* (2004). Local fictional works featuring serial murder include Deon Meyer’s *Dead Before Dying* (1999) and Amanda Patterson’s *I See the Moon* (2003).

In addition to popular sources of serial murder information, there are scientific or academic sources of information; but these seem to influence perceptions of the phenomenon to a lesser degree. International academic research has been conducted by David Canter, Kim Rossmo, Harold Smith, Al Carlisle, Steve Egger, Eric Hickey, Ronald Holmes and James DeBurger and Philip Jenkins, as well as John Douglas, Robert Ressler, and Robert Keppel; locally academic studies also exist and have been conducted largely as part of post-graduate studies by individuals such as Micki Pistorius, Gerard Labuschagne, Cobus Du Plessis, Jackie De Wet, Brin Hodgskiss, and Derek Hook.

The interaction between academic and popular sources of information on serial murder, both locally and internationally have led to certain problems. As described by Hook (2003), there seems to be a tension in the processes of knowledge production on the topic of serial murder, between “biases of popular opinion” (p. 6) as reflected in and by the popular media,

and scientific or academic fact. This would appear to be further complicated by the apparent frequency with which academics and professionals in South Africa feature in the popular realm on the subject of serial murder and make knowledge claims about the topic with limited experience or reference to sources of empirical support. For example, Robert Ressler, an ex-member of the FBI Behavioural Science Unit, chose the *Beeld* (17 July, 1995) to make his claim that the end of Apartheid ushered in a new era for serial murder in South Africa due to the lifting of tight police controls and the exposure of consequences relating to brutal, unfair and unjust practices of the 70's and 80's. His statements in this article featured no details about supporting arguments or evidence upon which such claims were based. Often these academics and professionals make opinions in the popular media without ever having consulted the investigator or seen the case file materials (Labuschagne, personal communication, 2006).

In the same vein, Pistorius (1996) attributed serial murder in South Africa to poverty, crime, violence and the disbanding of families in the press, despite her academic work that places emphasis on intrapsychic factors in the etiology of serial murder. Dr Mark Welman, previously of Rhodes University (*City Press*, 11 January, 1998), Dr Rika Snyman, a Unisa criminology researcher (*Independent Newspapers*, 1997), and Dr Irma Labuschagne, a criminologist (*Maxim*, August 2000) are individuals who have also been featured in newspaper articles on the topic of serial murder, in the context of more popular rather than scientific understandings of serial murder.

As a result, it would seem that some of the confusion surrounding understandings of serial murder, both locally and internationally, may be attributed to the blurring of popular and professional contexts, with professionals frequently failing to support their arguments or make claims in the way expected of them in the scientific community when they feature in the popular media. This may also be as a result of the manner in which the popular media

reports on the statements and arguments of the afore-mentioned professionals, as well as general lack of clarity on aspects such as definitions and psychological/investigative tensions.

Thus the two systems of academia and popular media become interlinked often with problematic consequences for their “creations”.

In the absence of frequent productivity in the research and academic field with regards to serial murder, there is little evidence or support with which to challenge popular misperceptions, especially when voiced by “experts”, or to stem the sensationalism with which this topic may be covered. Hence, it would seem that an encouragement of valid and reliable productivity in this area is advantageous.

1.2.2 Limited available research on serial murder in South Africa

Despite a period of awakened interest in serial murder as a research topic in South Africa in the mid-nineties running through to the early part of the year 2000, there has been a tapering off of formal research into the area (possibly due to less media focus on serial murder that has also taken place during this period). Serial murder as a type of crime continues to sustain itself in South Africa, however, and, in the absence of a large volume of available local research, much still has to be done to understand South African serial murder, especially in light of its significant difference from international serial murder in areas such as offence, offender and victim characteristics (Hodgskiss, 2003). Consequently, this study’s exploration of South African understandings of serial murder would be useful in developing the existing pool of South African research on the topic of serial murder, and making novel contributions from a systemic perspective.

1.2.3 The novelty of the systemic perspective

Many approaches have been made to understand serial murder by theoretical contributions on the causes of serial murder (Jenkins, 1994; Meloy, 1988; Norris, 1988); geographical profiling techniques (Canter, 1994, 2000; Rossmo, 1995, 1997); and typologies (Holmes, 1990; Holmes & DeBurger, 1988; Ressler, 1985; Ressler, Burgess & Douglas, 1988). These will be discussed in further detail in chapter three. However, none of the above has attempted to understand serial murder from a systemic perspective, specifically with respect to the family system of each individual. Some theories on serial murder (Keeney & Heide, 2000; Ressler et al., 1988; Sears, 1991) have made reference to “dysfunctional” families in this context.

The dysfunctional family type has served as a means of attributing responsibility for the serial murder behaviour to experiences of abuse (sexual, physical or emotional) in the family settings of the individuals concerned. However, no prior study has attempted to directly interview members of the families of individuals who commit serial murder to elicit their interpretation of this behaviour; to understand the individual who committed serial murder as he sees himself in relation to his family; and to see the role of serial murder within such a system.

Family plays a big part in most of South Africa’s diverse cultures. Across the majority of cultures that make up South Africa’s ethnic demographic, the family system is an important source of support (financial, emotional or practical) for individual members. In terms of the form of South African families, the 1996 South African census demonstrated that the nuclear family is the most prominent household type (23, 89%) across all ethnic categories (Ziehl, 2001), with groups who traditionally displayed a more extended family form moving

increasingly towards the nuclear family form with greater urbanization and employment or financial opportunities (Amoateng, 1997; Moller, 1998).

Locally and internationally, the researcher is aware of no research that focuses on the family systems of individuals who commit serial murder, or which has interviewed family members of such individuals. The novel approach afforded by a family systems theory to serial murder would resist interpreting the phenomenon within the framework of linear causality, and as such, would provide unique input points at which change could be initiated at a systemic level to bring about changes in the behaviour of individuals who commit serial murder. In the literature, rehabilitation is frequently negated as an option for individuals who commit serial murder (Pistorius, 1996; Ressler, 1997). However, this has largely been based on linear notions of causality. Family systems' approaches, with their emphasis on "circular causality" (Bateson, 1979), would be of particular use to those groups and individuals who could play a role in effecting change in individuals who commit serial murder such as prison warders, psychologists, as well as family members.

Additionally, an individual can be recognized as a system within such a theoretical paradigm (Guttman, 1991; Kerr & Bowen, 1988) in the absence of other members of the family system of which he/she is a member. Although a social systems approach addresses family or groups of people, the individual in and part of the system is still recognized as a system: in itself as well as part of a specific group or family. This aspect will be discussed again in Chapter 4.

1.2.4 Applications to correctional and investigative systems

Locally and internationally, there is little research that has been conducted with actual offenders. Consequently, a research study that could add to the limited pool of research that

has managed to interview offenders directly would be advantageous, specifically with regards to understanding criminal behaviour.

This study of serial murder from the family perspective in South Africa may also assist with police investigations and the use of techniques such as offender profiling. By attending to the particular way in which serial murder exists in the South African context, police work can benefit from greater accuracy and consequently efficiency in the apprehension of individuals who commit serial murder in this country.

An exploration of a South African understanding of serial murder from a family perspective could reflect the degree to which the application of overseas theories to the above areas is applicable or not. The family systems approach to understanding serial murder adopted in this study might also illuminate certain patterns in family systems that increase the probability of serial murder occurring within a family system, and allow for proactive, preventative interventions based thereon, or even assist investigators by providing patterns of family behaviours they can look for in families of potential suspects in a serial murder investigation.

1.3 PURPOSE OF THE STUDY

Given the above discussion on the motivations for the current study, the purpose of this study is to:

- investigate serial murder from a systemic point of view with the aim of increasing local understandings of serial murder.

1.4 RESEARCH FOCUS AND DESIGN

In order to achieve the above ends, the following question is proposed as focus of the study:

- “How does the family system of a person who commits serial murder function?”

That is, what is the family structure, who are the people in the family system and how do they maintain the family system.

1.4.1 Research design

The research design will be exploratory and qualitative in nature, adopting a case study method to thoroughly investigate specific examples of individuals who have committed serial murder in South Africa and their particular family systems. Data will be analysed by means of a content analysis in line with the theoretical framework of family systems theory and interpreted with reference to the research focus above. It is hoped that this study will yield novel and useful findings about serial murder in South Africa, as well as the utility of the family systems approach in understanding such phenomena.

1.5 A NOTE ON THE PATHOLOGICAL MODEL

The so-called pathological model is not addressed in this study and seems to be overlooked. Models based solely on individual psychopathology (i.e. those focusing on intrapsychic factors or internal pathologies of an individual) seem to be a preferred way of

trying to understand crime in general. Many studies have already attempted to explore crime as well as serial murder specifically in a similar manner (see Douglas & Olshaker, 2000; Harbort & Mokros, 2001; Pinto & Wilson, 1990). However, for this study, pathology is defined from a systemic theoretical point of view, as explained by Watzlawick, Beavin and Jackson (1967). To these authors, it is essential to take into account interpsychic factors that play an important role towards the understanding of human behaviour. This needs to be applied in research; therefore the theoretical aim of this thesis is to study serial murder from an interpersonal, systemic perspective.

1.6 RESEARCH OUTLINE

The introductory part of the thesis will be followed by a discussion of the literature on serial murder; a review of the body of theoretical work on serial murder; as well as theories of family systems. The methodology chapter will discuss the research design and epistemology that will guide the study, as well as the research method, data collection techniques, sampling strategies and methods of analysis. This will be followed by the results for the cases used; a discussion of the results; and finally, a conclusion that will include an assessment of the limitations of the study as well as suggestions for possible future studies.

1.7 CONCLUSION

This chapter has briefly outlined the topic of the current study, namely serial murder in South Africa. The motivation and focus for the current study has also been provided, together with an outline of the proposed study procedure and thesis outlay.

To summarise, this study will attempt to investigate the topic of serial murder in South Africa from the perspective of family systems theory. It is hoped that this study will thereby develop an understanding of serial murder from a systemic perspective that may contribute a novel perspective on the subject and hopefully allow for better management of individuals who commit serial murder, and the prevalence of this type of criminal behaviour in larger society.

2. LITERATURE REVIEW: HISTORY, DEFINITIONS AND CATEGORIES OF SERIAL MURDER

For the past two decades, serial murder seems to have occupied an increasingly privileged place in the fascination of popular culture. Such fascination appears to have combined with academic and investigative endeavors to produce a plethora of historical and theoretical explorations of the subject. This literature review will investigate defining the concept of serial murder and outline the historical origins of the phenomenon of serial murder as well as the various ways in which serial murder has been classified and understood.

2.1 DEFINING SERIAL MURDER

There is much confusion, even in the scientific community, with regards to defining serial murder. In 2005 at the FBI's serial murder symposium, one of the symposium's objectives was to come to a consensus amongst professionals about the definition(s) of serial murder (Labuschagne, personal communication, 2006). In order to arrive at defining this concept, it is necessary to distinguish serial murder from other acts of multiple murder, such as mass murder and spree murder (Douglas & Olshaker, 2000; Dubner, 1992; Gresswell & Hollin, 1994; Lane & Gregg, 1992; Warren, Hazelwood & Dietz, 1996).

2.1.1 Mass and spree murder

Mass murder has been defined as "an act in which a number of people are slain by a single assassin during a short period of time in roughly the same location" (Lane & Gregg, 1992, p.1). Consequently, the murders all take place in the same location and are committed

quite closely after one another, if not simultaneously. An example of mass murder in South Africa would be Barend Strydom who in 1981 murdered a number of people in Strydom Square in Pretoria.

Spree murder involves “multiple killing [which] takes place over a marginally longer period of time – hours or days” (Lane & Gregg, 1992, p.1) usually at different locations. Consequently, it would seem that, on the continuum of multiple murder, spree murder is further along a distance dimension with regard to time and location with murders that are spaced out more than in the case of mass murder, yet within the context of one ongoing event. An example of spree murder in South Africa would be Charmaine Phillips and Peter Grundling who in 1983 murdered four victims over a three week period during which they moved from their starting point in Durban, to Melmoth, Secunda and ended in Bloemfontein (Labuschagne, 2003). Definitional commonalities between these two types of multiple murder, appear to lie in the act itself - that is, murder is committed - and the plurality of the act concerned – that is, two or more murders take place.

It would appear that the above differentiations are based primarily upon differences in temporal and spatial dimensions, with respect to the amount time passing between individual murders and the number of locations at which the murders are committed. All three forms of multiple murder can be seen as lying upon a continuum with respect to distance in space and time. Now, the definitions of the third type of multiple murder, serial murder, will be discussed.

2.1.2 Serial murder

Academics and law enforcement professionals have attempted to create a suitable definition for serial murder for the purposes of communication, research, and theoretical

understanding, as well as practical applications in the form of criminal investigation tools. As a result, there has been a proliferation of definitional postulates for serial murder that have varied greatly with regard to the fundamental elements stipulated as essential to classifications of serial murder. Whilst there are a number of communalities in almost all, there are considerable differences in opinion as to what serial murder entails and a few of these definitions will be discussed now. This discussion will first deal with international, predominantly US, definitions and then move on to South African definitions of serial murder. The pros and cons of each will briefly be highlighted.

• **Definitions of serial murder: international.**

Definitions of serial murder from the USA would appear to originate predominantly from the domain of law enforcement, specifically the Federal Bureau of Investigation (FBI) of the United States, which played a central role in defining and investigating serial murder in the 70's and 80's.

Ressler *et al.* (1988) from the Behavioural Science Unit of the FBI define serial murder as:

- three or more separate murders, with
- an emotional cooling-off period between homicides, and
- taking place at different locations.

This definition does not specify the number of suspects or perpetrators involved and does not make reference to motivation. It does, however, refrain from referring to gender, which allows for the possibility of both male and female perpetrators of serial murder.

John Douglas, a retired FBI behavioural scientist, together with Mark Olshaker, a journalist, defines serial murder in the following manner in his popular crime non-fiction piece *Anatomy of Motive* (2000):

- murders take place on at least three occasions,
- there is an emotional cooling off period between each incident (this cooling off period may last hours, days, weeks, months, or years), and
- each event is emotionally distinct and separate.

This definition makes no reference to location or to motivation and, as with the first definition, specifies three occasions as the minimum number. The duration of the cooling off period is also allowed to be short enough to possibly result in confusion with spree murder, and due to neglecting to specify separate locations, may result in confusion with mass murder. With regards to law enforcement, such a definition may prove difficult to apply in terms of its emphasis on emotional distinctness which can only be gathered from self-report on the part on the suspect, and hence, difficult to assess prior to the arrest of the suspect.

Holmes and De Burger (1988), who come from a primarily academic background in Professional Justice Administration and have provided the police with assistance on a consultant basis in numerous cases, provide a definition that is descriptive, namely:

- repetitive homicide;
- murders usually occur between two people - a victim and a perpetrator;
- the relationship between victim and perpetrator is usually that of stranger or slight acquaintance;
- apparent and clear-cut motives are typically lacking;
- motives originate within the individual and do not reflect passion, personal gain, or profit tendencies; and
- a common perception that all serial killers are lust killers in light of evidence or observations to indicate the murder was sexual in nature.

In this definition, once again, the notion of serial murder as stranger murder is evident, and the number of people involved in the crime is limited to two, namely, the perpetrator and

victim, and thereby seems to exclude teams of two or more perpetrators. As with previous definitions, the motive is situated within the psychological workings of the individual concerned and not externally available or obvious. The number of murders is not specified, and victimology (beyond “stranger”) is absent in this definition. Interestingly, this definition starts to introduce sexual aspects of serial murder, which have been elaborated in literature that will be discussed later. However, the introduction of a sexual element may limit other non-sexual cases from being included. Furthermore, labeling occurs and the person implicated in such a definition seems categorized with the “diagnosis” of “killer” ignoring the complexities of the person who commits murder.

Egger (1990), a professor of Criminal Justice at the University of Texas provides the following in a detailed definition of serial murder:

- the murders may involve one or more individuals.
- the murders are committed mostly by males.
- there must be at least two murders
- there is no apparent prior relationship between victim and attacker.
- the murders occur at different times and are unconnected.
- the murders are usually in different geographic locations.
- the motive is not for material gain.
- the motive is largely related to the murderer’s desire to have power over his victim.
- the victims have symbolic value and are perceived to be prestigeless and powerless given their situation in time, place or status within their immediate surroundings. For example, vagrants, prostitutes, migrant workers, homosexuals, missing children, and single and often elderly women

This definition mentions motive as well as victimology and defines the relationship between victim and perpetrator as one between strangers, as introduced by Holmes and DeBurger (1988) above. There is a more explicit reference to gender with an acknowledgement of the greater proportion of males committing serial murder. The previous definitions have allowed for the possibility of prior relationship between victim and perpetrator and have not elaborated upon victimology in the extensive manner of this definition. However, the definition of serial murder victimology above appears to be quite narrow, and inherently contradictory in that, as much as victims are proposed as having symbolic value, unique to the individual committing serial murder, their specification as vagrants, prostitutes and so on, is derived from socially marginalized groupings and hence, sources external to the psychological motivations of the individual concerned.

Lane and Gregg (1992), academic researchers, list six criteria for serial murderers in their *New Encyclopedia of Serial Murder*, namely,

- the murders are repetitive.
- the murders often escalate over a period of time, sometimes years and continue until the killer is taken into custody, dies or is himself killed.
- the murders tend to be one-on-one.
- there is no (or very little) connection between the perpetrator and the victim.
- individual murders within a series rarely display a clearly defined or rational motive.
- the perpetrators may move rapidly from one place to another often before a murder has been discovered.
- there is usually a high degree of redundant violence, or 'overkill', where the victim is subjected to a disproportionate level of brutality.

This definition repeats the absence of relationship between perpetrator and victim as well as notions of motive or apparent lack thereof and location. There is no specification of number of offences necessary to constitute serial murder. In this definition, there is an elaboration on modus operandi or manner in which the crime is committed, namely as “overkill”. Once again, the above definition avoids specifying gender of the likely perpetrator and does not explicitly specify the possibility of more than one individual committing serial murder.

Finally, Harbort and Mokros (2001), two German academic researchers, define serial murder in the following manner:

- the perpetrator may be fully or partially culpable. Consequently, severe mental disorder or disturbance would not render him/her accountable for his deed.
- serial murder may be committed alone or with accomplice(s).
- serial murder involves at least three completed murders.
- the murders have to be premeditated and characterized through a new, hostile intent.

Once again, the minimum number of murders appears to be set at three, and each event has been specified as having to be distinct from each other. Interestingly, the possibility of more than one perpetrator in serial murder is introduced as well as notions of insanity and mental disorders as precluding individuals from being classified as having committed serial murder. In other words, *menses rea* (or criminal intent) becomes an important criterion for serial murder.

• **Definitions of serial murder: South Africa.**

In terms of South African definitions, Pistorius (1996) defines serial murder in the following way in her doctoral thesis, *A Psychoanalytical Approach to Serial Killers*:

- A serial killer is a person (or persons) who murder/s several victims.

- These victims are usually strangers.
- The murders take place at different times.
- The murders are not necessarily committed at the same location
- There is usually a cooling-off period between murders.
- The motive for serial murder is intrinsic and consists of an irresistible compulsion, fuelled by fantasy that may lead to torture and/or sexual abuse, mutilation and necrophilia.

Similar to Holmes and DeBurger (1988), this definition appears to describe the person who commits serial murder solely in terms of the acts that they have engaged in, thereby reducing understandings of such a person to their criminal activity rather than encompassing the totality of the individual concerned, for example as someone's partner, son or daughter. Perhaps there needs to be a greater delineation between understandings of an individual who commits serial murder (in terms of personality and character structure for example), and definitions of what serial murder as a type of crime or behaviour entails. This is not clear in the above definition.

The label "serial killer" is additionally sensationalistic and used more by the popular media and fictional domain than academic and law enforcement areas. The definition also neglects the number of murders necessary, and is also too specific in terms of the paraphilias or sexual perversions that may accompany serial murder (but is not always the case). The definition however, is advantageous in its allowance for more than one perpetrator, as well as specification of motive nature and temporal and geographical distinctness.

Labuschagne (2001) in his doctoral thesis entitled *Serial murder revisited: a psychological exploration of two South African cases*, defined serial murder as involving:

- a person who is motivated to kill,

- a person who commits three or more murders occurring at different times, and in an ostensibly unconnected manner,
- a motive that is not primarily for material gain, revenge, or the elimination of a witness.

In this definition, neither victimology nor location are referred to. There is no specification of relationship between victim and perpetrator, nor clear discussion of the number of perpetrators who may be involved. However, temporal individuation of murders and motive are clearly delineated in as much as ulterior primary motives are immediately empowered to discount classification as serial murder.

This definition was subsequently revised in 2004 as the following, and appears to include a number of the excluded dimensions discussed above:

- The person(s) are intrinsically/psychologically motivated to kill.
- The murder of two or more victims.
- The murders occur at different times.
- The murders appear unconnected.
- The motive is not primarily for material gain, nor elimination of witness/es.
- The motive is not primarily for revenge. Revenge may play a role but more indirectly, as against a certain category of individuals such as prostitutes, as opposed to a specific person.
- The victims tend to be strangers (Labuschagne, 2004).

This definition appears to encapsulate the core elements involved in serial murder, and whilst not specifying a specific number of perpetrators, allows for the possibility of more than one perpetrator. However, it omits geographical aspects such as whether the murders have to occur at different geographical locations.

An important note with regards to terminology concerns distinctions between “murder” and “killing”. Whereas murder constitutes a crime punishable by law, killing refers to a more general action of taking life. Consequently, if definitions make reference to killing and killers, they may include many individuals who take life legitimately on a regular basis, or on at least two or more occasions. Such individuals may be military and law enforcement personnel or civilians working in places such as abattoirs or slaughterhouses, killing animals for commercial consumption. One is not indicted for killing, but for murder. To this end, it would seem that the use of the term murder is preferable.

2.1.3 Differences and similarities of definitions

As can be seen from the above definitions, all appear to have a number of factors that overlap, despite and in the presence of obvious variations and differences. These commonalities include number of victims, motive, temporal and geographical distinctions, number of perpetrators, relationship between victim and perpetrator and, in some cases, victimology. An exclusive emphasis on these factors may be disadvantageous however, in that it may prevent dialogue around alternative possibilities and factors that may be equally salient. In this way, novel understandings and definitions of serial murder may be silenced or prevented from emerging.

With regards to differences, these appear to concern the number of murders necessary to constitute serial murder, as well as the extent to which motive and victimology is elaborated upon. All definitions appear to be gender neutral, despite the fact that an overwhelming proportion of the literature operates under the assumption that serial murder is largely perpetrated by males and in some cases, holds that it is impossible for females to commit serial murder. These differences and similarities will now be discussed.

- **Quantity of murders.**

With respect to criteria regarding the number of murders necessary for a series of murders to qualify as serial murder, definitions vary between two or more (Egger, 1990; Labuschagne, 2003), and three or more (Douglas & Olshaker, 2000; Harbort & Mokros, 2001; Labuschagne, 2001; Ressler et al., 1988) while some definitions leave this number unspecified (Holmes & DeBurger, 1998; Lane & Gregg, 1992; Pistorius, 1996).

Merriem-Webster's (2005) dictionary defines the word "series" as - "a group of usually three or more things or events standing or succeeding in order and having a like relationship to each other" (p. 2073). However, any attempt to stipulate a specific number of murders is problematic for the following reason. Egger (1984) highlights problems with setting the number of murders for serial murder at three with reference to individuals who may have committed only two murders before being apprehended but for whom these two murders were the beginning of a "harvest of victims" (p. 5) as part of a serial murder sequence. However, this argument may also be applied to cases where individuals who would go on to commit additional murders are apprehended after the first offence. Hence, any definition that specifies a particular number of murders risks omitting part of its intended sample.

On the other hand, definitions that do not specify the number of murders involved risk loss of clarity, and place decisions to classify a case as serial murder at the discretion of any individual who uses such a definition. As a result the reliability and consistency with which such a definition can be applied uniformly is compromised, and one could argue that the validity with which it characterizes serial murder is also limited.

- **The "cooling off" period.**

Several definitions (Douglas, Burgess, Burgess & Ressler, 1992; Douglas & Olshaker, 2000; Pistorius, 1996; Ressler *et al.*, 1988), notably those from FBI behavioural science sources,

allude to a cooling off period to account for the temporal spacing between murders within a series and thereby, distinguish serial murder from other types of multiple murder such as spree and mass murder.

Such a period is described as emotional in nature (Douglas & Olshaker, 2000; Ressler *et al.*, 1988) and, as will be elaborated upon in discussion of the theories of serial murder, has been argued as constituting a time period in which the individual who commits serial murder temporarily satiates his/her need to murder or enact his/her fantasy of murder, and either regenerates such a fantasy and the desire to act upon it (Douglas & Olshaker, 2000) and/or plans his/her next murder (Hazelwood & Warren, 1995).

The inclusion of an emotional cooling off period in certain definitional criteria raises a number of salient issues. Firstly, despite the stipulation of a cooling off period, there is little detail as to how much time this period entails. Douglas *et al.* (1992) describe such a period as consisting of days, months, weeks or even years; however, this appears to be too broad, and as a result, may lead to confusion between types of multiple murder. For example, the recent Washington sniper in the United States, murdered several people over a spate of days and was classified as a serial sniper. The basis for this classification is unclear (possibly because of the nature of the murders), but the classificatory rationale in this case would certainly seem to omit considerations of time between murders or a cooling off period stipulation that, if adhered to, would have made the Washington sniper an individual who committed serial murder.

Secondly, if the cooling off period is stipulated too narrowly or specifically, it may overlook individual nuances in the psychological and emotional processing of the separate murders within a series by offenders, which may vary from one serial murderer to another. As a result, this may omit certain cases of serial murder or erroneously include others.

Additionally, little research has been done with respect to the qualitative aspects of the cooling off period. These aspects may include details such as whether the length of time period involved varies with age, temperament, gender and personality characteristics or differences between individuals in the ability to self-regulate; impulse control; fantasy life; or intensity of affective functioning. In this regard, the length of cooling off period may vary between individuals with regard to the above factors or within an individual across time in relation to developmental changes and progression, or even coinciding life events or situational factors. For example, one might hypothesize that the presence of stressful life events such as death of a loved one or end of a relationship might impact upon the cooling off period an individual who commits serial murder needs before committing another murder.

Finally, the choice of phrase used to describe such a period, namely, “cooling off” would appear to portray serial murder in a certain light. It seems to imply that murders take place as a result of an intense emotional outburst that overwhelms the capacity to normally contain such emotional material in the individual concerned, after which the individual requires a resting period during which those emotions reaccumulate. It would seem inadvisable to narrow understandings of serial murder in such a way, as it may exclude cases of serial murder where this does not occur, such as where the time lapses between murders may occur as a result of victim availability. Additionally, if police are unable to find bodies (because they have been buried or hidden or moved to another area), they may mistakenly believe that the suspect is in a cooling off period, instead of taking extra steps to find bodies.

- **Motive.**

Motives for crime can be classified as external and internal (Labuschagne, 2003). An example of external motives is a case where a witness is murdered. The motive in this case would be to conceal another crime, with the murder in question being a means to another end, that is, to

get away with the first crime. Internal motives or psychologically motivated crime refers to cases where there is no external benefit for the offender and there is frequently no obvious relationship between offenders and victims. The crime serves to satisfy a psychological need. For example, the kleptomaniac will steal to satisfy an internal drive or compulsion as opposed to the thief who steals for external profit. In some cases, internal and external motives may occur in combination. An example may be a case where a hijacker steals a motor vehicle for external profit in terms of payment but tortures the owner of the vehicle due to a personal sadistic need.

With reference to the above definitions, some do not make reference to motive specifically (Douglas & Olshaker, 2000; Harbort & Mokros, 2001; Ressler *et al.*, 1988), while those that do refer to motive specify this as being located internal to the individual concerned (Egger, 1990; Holmes & DeBurger, 1988; Labuschagne, 2001, 2004; Lane & Gregg, 1992; Pistorius, 1996). Definitions that include motive additionally do not classify it as related to profit, revenge, or passion (Egger, 1990; Holmes & DeBurger, 1988) but in one case, defined it as relating to power as a function of the interpersonal relationship between perpetrator and victim (Egger, 1990) and in others claim that motive in serial murder is not rational (Holmes & DeBurger, 1988; Lane & Gregg, 1992).

Definitions that do not refer to motive at all are problematic in that they may include individuals such as contract murderers, who murder for profit, or individuals involved in organized crime, which murder for personal gain, profit or religious or ideological reasons. There has been much debate around this particular point, namely whether those who commit multiple murders and derive some form of evident gain in the sense of material profit or professional kudos, such as the assassin, qualify as being individuals who commit serial murder (Pistorius, 1996; Wilson, 2000). However, by not specifying any details with regard to

motive, definitions may suffer the same threats to consistency as discussed above with reference to quantity of murders.

Definitions that do refer to motive appear to situate this motive intrinsically or internally to the individual concerned (Egger, 1990; Holmes & DeBurger, 1988; Labuschagne, 2004; Lane & Gregg, 1992; Pistorius, 1996). Serial murder is consequently frequently understood as being psychologically motivated (Labuschagne, 2003). Such definitions have implications for the manner in which such an individual is treated after being apprehended as well as investigative methods used to track and apprehend such a person. By defining serial murder as having motives that are internal, these same attempts to track and apprehend such an individual become very difficult, as there are limitations to the certainty with which future criminal behaviour can be assessed.

Additionally, by virtue of definitions of such motives as being psychological in nature, it seems as if an individual who commits serial murder is distinguished from the criminal population for whom motives are external, which may not always be an accurate assessment. This follows from the possibility that as much as motives may differ, offence behaviour and criminal decision-making may follow similar patterns. Additionally, by excluding cases where there is an obvious external motive, definitions may omit cases where, in spite of this external motive, there is a stronger internal motive that is less obvious but nevertheless, the primary motivation. This may occur in a case where an individual kills a young couple and steals their motor vehicle but where the murder of the two individuals satisfies the suspect's primary need.

Some definitions that refer directly to motive go as far as to specify what kinds of internal motives these are such as power (Egger, 1990; Holmes & DeBurger, 1988), lust (Holmes & DeBurger, 1988) and compulsion (Pistorius, 1996). Whereas a more detailed description of

motive in definitions may be helpful with respect to investigation of serial murder, motive-based definitions that are too specific may omit cases of serial murder where motives differ.

Additionally, given that such motives are internally located, there may be large differences in interpretation of such motives between those who apply the definition and those who are involved in serial murder. For example, definitions that emphasize the role of power motives in serial murder remain ambiguous in that power itself as a concept is defined and interpreted subjectively with respect to the nature of power - physical, psychological, emotional and/or financial - and relationship, in the sense that power involves a differential between the individual who is powerful in relation to another who is not. The perpetrator may select victims whose powerlessness is obvious to him/her in accordance to an internal set of values and norms but not obvious to those applying power motive-based definitions. As a result, such definitions may omit this individual or fail to link a series of murders. To combat this, Jenkins (1994) has suggested that motive should be included in definitions in as much as the murder is consistent with the perpetrator's internal set of values. This, however, holds little worth for investigative applications in that it would only be possible to establish this information post-arrest, and hence is not helpful in guiding searches for possible suspects. This can also be applied to motive-based definitions that emphasise compulsion or drive, and lust.

Motive-based definitions that are too specific may also often result in presumptive labeling or attributions in investigation. Should a motive-based definition be too exclusive, individuals who commit murder for the pure enjoyment of the act of killing are left out. Additionally, typology-based definitions such as that of Holmes and DeBurger (1988) that classify serial murder in terms of visionary, mission-oriented, hedonistic and power/control motivations, risk creating fixed serial murder types which do not allow enough flexibility for variation in motive or new kinds of motives.

Police investigation that utilizes such types may also narrow its focus to evaluate crime scenes and murder cases within the confines of the typology as opposed to deducing motive from crime scene details and case facts. Such inductive exposition is not entirely accurate and Turvey (1998) warns against the dangers of such inductive logic in terms of the inherent flaws in going beyond the available data with no justifiable ground from which to do so. Definitions which promote certain kinds of motives in serial murder may consequently not only tautologically confirm their definitional elements by reference to subsequent instances but also base their “evidence” on untenable and flawed causal links.

- **Sexuality and lust murder.**

Some definitions of serial murder appear to introduce a sexual component (Egger, 1990; Holmes & DeBurger, 1988; Pistorius, 1996). This may be with respect to motive, as with Holmes and DeBurger (1998) and to a lesser degree, Pistorius (1996); with respect to concomitant paraphilias or sexual deviance (Pistorius, 1996); or with regards to the type of victim selected, such as prostitutes and homosexuals in Egger’s (1990) definition.

Definitions such as that of Pistorius (1996), that includes reference to paraphilias such as necrophilia and components such as sexual abuse, risk omitting cases where those components are absent. In South Africa, the extent to which such elements have been seen in serial murder cases varies. Whereas individuals such as Stewart Wilken, engaged in some post-mortem mutilation, cannibalism and necrophilia (Labuschagne, personal communication, 2005), individuals such as the Saloon Killer, Velaphi Ndlangamandla, did not, and shot his victims from a distance with a .22 caliber rifle.

Additionally, there may not be consistency across murders in a particular case of serial murder with respect to sexual elements. For example, Samuel Sidyno strangled his male victims, and yet raped some of the females that he murdered. The case of David Mbengwa

illustrates another difficulty with including sexual components in a definition of serial murder. Much the same as with most motive-based definitions, what constitutes as sexual may vary between perpetrators as well as those applying definitions or interpreting crime scenes. David Mbengwa shot his victims and thus his modus operandi was not explicitly sexual in nature. However, his targets were young couples making love. Whether this constituted a sexual stimulus for Mbengwa or not will depend on his worldview, which may conflict with those of the individual applying a definition of serial murder with sexual components. This may also only be determined on apprehension. Much the same debate has occurred with international serial murderers such as David Berkowitz, the Son of Sam, who also shot his victims, which were young couples as well (Lane & Gregg, 1992). Douglas and Olshaker (2000) as well as FBI profilers such as Robert Ressler (1997) have argued that the gun in these cases represented a phallic object, and hence, the murders were sexual in nature. This would seem to be open to argument however.

Sexual homicide has been defined as “the intentional killing of a person during which there is sexual behaviour by the perpetrator” (Meloy, 2000, p. 2). Ressler *et al.* (1988) define sexual homicide as “...murders with evidence or observations that indicate the murder was sexual in nature.” (p. 13), which is not very helpful. Given that sexual homicide appears to refer to a separate kind of homicide or murder, it would appear that in cases where murders within an instance of serial murder conform to the above definitions in terms of displaying obvious sexual components, it would seem more appropriate to classify such an instance as a particular case of serial sexual homicide, as opposed to incorporating sexual elements into a standard definition of serial murder. In other words, serial sexual murder (or homicide) would constitute a sub-type existing within the broader category of serial murder, together with other subtypes such as serial murder as part of organized crime, which would encompass individuals working as contract killers.

- **Number of perpetrators.**

Definitions of serial murder appear to vary with respect to the number of perpetrators that they specify. Whereas some do not specify number at all (Douglas & Olshaker, 2000; Ressler *et al.*, 1988), others appear to be divided between specifying one perpetrator (Harbort & Mokros, 2001; Lane & Gregg, 1992) and more than one perpetrator (Egger, 1990; Holmes & DeBurger, 1988; Labuschagne, 2003; Pistorius, 1996).

Definitions that refer to single perpetrators risk omitting cases where serial murder involves two individuals such as the Moors murders in England (Ian Brady and Myra Hindley), Fred and Rosemary West in England, as well as Jacques Coetzee and John Frank Brown and the NASREC pair of Mazankane and Motsegwa in South Africa. Those definitions that allow for more than one perpetrator generally appear to avoid specifying a maximum number of individuals that may be involved, or the ways in which aspects of serial murder may vary as a result. For example, in cases where more than two individuals appear to be involved in committing murders, such as the Manson murders in the 1970's in the United States, questions arise as to the apportioning of accountability and responsibility, as a result of group dynamics such as "mob thinking" (Asch, 1956; Janis, 1972). Additionally, definitions that include the possibility of more than two perpetrators appear to avoid specifying whether gangs of individuals who commit multiple murders would qualify as instances of serial murder. It also seems to be unclear whether the same individuals would have to be involved in every murder in a particular series, or whether each individual would have to carry out the same tasks in each instance.

- **Gender.**

With regards to gender, some definitions seem to directly frame serial murder as perpetrated by males (Egger, 1990; Harbort & Mokros, 2001; Lane & Gregg, 1992) while others avoid specifying a particular gender (Douglas & Olshaker, 2000; Holmes & DeBurger, 1988; Labuschagne, 2004; Pistorius, 1996; Ressler *et al.*, 1988).

Definitions that describe serial murder as perpetrated solely by males omit cases of serial murder where the perpetrator or co-perpetrator has been a female. These include, Myra Hindley (part of the Moors Murders team with Ian Brady – convicted of three murders) and Rosemary West (part of a team with Fred West – convicted of ten murders) in the United Kingdom, and Aileen Wuornos (convicted of six murders), Christine Falling (convicted of three murders), Janie Gibbs (convicted of five murders) and Gwendolyn Graham and Caroline Wood (convicted of six murders) in the USA. In South Africa, Daisy de Melker is argued to have committed serial murder in the 1930's on Johannesburg's East Rand by poisoning her two husbands and stepson (Lane & Gregg, 1992); however her motive is largely acknowledged to be financial.

Those definitions that do not explicitly refer to a particular gender, while leaving the possibility for a female perpetrator open, do not seem to go far enough by failing to explicitly stating that perpetrators can be male or female. This appears to be reflected by the inconsistent classification of females who commit multiple homicides as serial murderers - for example, individuals such as Daisy de Melker and Aileen Wuornos, as mentioned above.

On the topic of gender, the sexualisation of serial murder definitions (discussed above) has frequently been critiqued by feminist theorists such as Cameron and Frazer (1987) and Caputi (1992), in as much as this often limits the extent to which women can be subsumed under such a definition due to popular conceptions regarding the extent to which a woman can aggressively display her sexuality. As a result, these theorists feel that males who commit

multiple murders are frequently overrepresented in serial murder samples as opposed to women who commit the same crime. In fact, the number of female serial murderers increases by 10-15% in the USA if sexual motives are excluded from definitions of serial murder.

The effects of serial murder definitions that include sexual components can be seen in the recent debate over the classification of Aileen Wuornos, an American woman who murdered six individuals while working as a prostitute in the USA (Lane & Gregg, 1992). While writers such as Douglas and Olshaker (2000) consider her to be the only female American serial murderer, a researcher such as Blanchard (1995) critiques their selective application of serial murder definitions that have excluded other females involved in serial sexual murders such as Catherine Bundy, Karla Homolka and Judith Neely, or conceded their inclusion in classification of serial murder cases by framing female offenders as part of a team, in a more secondary role to their male counterpart (Geberth, 1998). This will be discussed further in the following chapter on theoretical understandings of serial murder.

- **Victim/offender relationship.**

Finally, the aspect of specified relationship between victim and perpetrator in definitions of serial murder will be examined. Some definitions do not make any reference to the details of such a relationship (Douglas & Olshaker, 2000; Harbort & Mokros, 2001; Ressler *et al.*, 1988) while others characterize this relationship as between strangers (Egger, 1990; Holmes & DeBurger, 1988; Labuschagne, 2004; Lane & Gregg, 1992; Pistorius, 1996) and between two people or one-on-one (Holmes & DeBurger, 1988; Lane & Gregg, 1992). Labuschagne (2003) allows for the possibility of more than one victim at a time.

Definitions that do not describe the nature of the relationship between offender and victim appear to be limited in the degree to which they can be useful for investigative purposes.

Those that describe such a relationship too explicitly, such as Egger (1990) in terms of his

description of victims as powerless and prestigeless and in terms of membership to certain social categories such as homosexuals, vagrants, and prostitutes, suffer the same criticism with respect to their possible omission of cases of serial murder where this is not the case such as in the case of Jacques Coetzee and John Frank Brown, who were homosexual themselves, Coetzee being a homosexual prostitute, and whose victims were male homosexuals. They also appear to be weakened by the many ways in which “power” and “powerlessness” can be defined and interpreted.

Definitions that characterize the relationship between victim and offender as one between strangers risk failing to link cases where there is an established connection between these two individuals. An example would be Nicolas Ncama in South Africa whose victims included the daughter of a family friend, a housemate and his stepdaughter (Pistorius, 1996) as well as Stewart Wilken who murdered his own daughter and neighbour’s son (Labuschagne, 2004). Definitions that characterize such a relationship as one-on-one are also challenged by cases where this is not the case such as South Africa’s Wemmer Pan killer, Cedric Maake, as well as David Mbengwa, who killed couples. The same criticism would apply on the grounds of cases where there is more than one perpetrator, such as the Moors murders or the Wests in the United Kingdom.

Definitions that emphasise a lack of relationship between victim and offender also appear to propose this as a core feature of victim selection in serial murder. However, frequently this is not the case, and victim selection operates primarily from personal motives of the individual concerned, to which the nature of relationship with the victim is incidental. For example, for John Wayne Gacy, the American serial murderer convicted of the murder of thirty three victims, his particular victim choice was young boys, regardless of whether a prior relationship existed or not (and in fact, in many cases, he was familiar with his victims who worked for him) (Lane & Gregg, 1992).

2.1.4 Concluding remarks on definitions

The Concise Oxford Dictionary (2004) defines a “series” as a “number of things each of which is similar to the preceding or related to it as it to its predecessor”. Serial murder consequently would refer to a series of murders with each element of the series related in some way to its precedent and antecedent. Definitions should consequently illuminate necessary connections between instances of murder. One would surmise that consistency of perpetrator would be sufficient to link instances of murder. However, this is challenged by the fact that this is evident only after the individual concerned has been apprehended and by cases where there is more than one individual involved such as serial murder teams or duos.

For investigative purposes, connections thereby come in the form of similarities in the way the murder is committed which results in extensive exploration of apparent modus operandi and elements such as signature, victim choice, location and time between murders, and motive which are assumed to be manifested consistently by an individual perpetrator or perpetrators. Assumptions of consistency cannot be reliably proven to withstand challenges and there have been many instances in which apprehended individuals have claimed responsibility for murders considerably different to the series for which the individual has been charged.

The choice of the term “serial” is of interest in that it reflected a need to create a distinct crime category as opposed to viewing a number of linked murders as a result of a compulsion or addiction on the part of the individual/s concerned, which would have been more in line with a psychological or medical model as opposed to a legal-investigative model.

Consequently, when psychological concepts such as “emotional cooling off period” (Douglas & Olshaker, 2000), “motives...that originate within the individual” (Holmes & DeBurger, 1988) and statements such as “motive is intrinsic; an irresistible compulsion, fuelled by

fantasy...” (Pistorius, 1996) are included in definitions of serial murder, complications arise due to the fact that such concepts and statements are not always as empirically and veridically accessible as necessary for investigative applications. Tenuous links that are drawn between the two domains not only add to debates around definitions of serial murder but also frequently add to the confusion surrounding what constitutes serial murder. It would appear that, as much as psychological explanations and concepts might be utilized to inform definitions, should the purpose of accurate definitions of serial murder be largely for investigative purposes, they should be phrased in these terms.

Ferguson, White, Cherry, Lorenz and Bhimani (2003) argue that a clear definition of serial murder is essential in order to standardize reporting of prevalence statistics and to educate criminal justice professionals and the public. Different definitions not only result in general public confusion and misperceptions but also additionally mean that research frequently focuses upon different populations of offenders without acknowledging this difference.

In this light, it is necessary to highlight what appears to be an underlying tension with regard to definitions of serial murder, between psychological and investigative perspectives. Although it would seem that the two domains overlap frequently in understandings of serial murder, and are not essentially mutually exclusive, there are differences between their respective emphases that frequently result in competing tensions within serial murder definitions. For example, the inclusion of the notion of a cooling off period in definitions such as Douglas and Olshaker (2000) and Ressler *et al.* (1988) can be seen to constitute a reference to psychological interpretations of the temporal lapses between the various offences of the perpetrator.

If these definitions were to be strictly investigative oriented it would suffice to say that murders occurred at different times (days, weeks, months apart) such as Egger (1990).

Another example of this is descriptions of victims as having symbolic value (Egger, 1990) that also invokes a need for psychological interpretations of the individual in question.

This interplay is problematic in that it frequently obfuscates the absolute character with which investigative definitions and criteria need to be applied in order to make them as effective as possible. Due to the relativity and multiplicity of psychological approaches available with which to interpret definitional criteria, it is possible to conceive of a number of ways in which such criteria can be structured and applied. For example, psychodynamic approaches may interpret David Berkowitz's use of a gun to commit his crimes as a form of phallic affirmation, and consequently invoke the sexual criterion of serial murder in spite of the absence of overtly sexual elements in his crime scenes and modus operandi (Lane & Gregg, 1992). Other schools of psychology, such as cognitive-behavioural approaches, may not interpret actions in the same way and find no basis for a sexual interpretation and consequently not invoke the sexual criterion as essential for definitions of serial murder.

Such confusion and definitional relativity are counter-productive to investigative applications that necessitate greater clarity and certainty with which to make absolute pronouncements, despite being necessary for dialogue concerning psychological understandings and theories of serial murder. It is interesting to note that most of the above definitions have emerged from law enforcement backgrounds, and that a definitive theory or theories of serial murder are difficult to find (as will be discussed in sections to follow). It is the opinion of the author that there needs to be a greater awareness of these perspectives in serial murder definitions and a separation of their respective elements in definitional criteria so as to facilitate greater clarity.

One solution may lie in a distinction being drawn between definitional criteria and characteristics of serial murder, with the former relating more to law enforcement and investigative purposes, and the latter related more to psychological understandings of serial

murder. To elaborate, definitional criteria might include factors such as number of murders, and timing between murder instances, while characteristics would be more explicitly related to personality and psychological traits, allowing for individual variations within classifications based on the afore-mentioned criteria. These might include factors such as the nature of motive, and possible personality traits, such as disorganised/organised as conceptualized in Holmes and Holmes (1996) below. Until these aspects are distinguished more clearly, definitions of serial murder run the risk of inconsistency with respect to the manner in which cases of serial murder are classified. Consequently, the definitional criteria might be used after the fact, so to speak, to classify an individual as someone who had committed serial murder. Concurrently, a set of characteristics based on personality traits and psychological factors associated with individuals who commit serial murder could also be established and allow for more variation between individuals. Such a group of characteristics would then capture those exceptions that may not meet all the definitional criteria, and yet display personality traits or behavioural patterns characteristic of serial murder.

Labuschagne (personal communication, 2006) elaborates on the above and states that one of the most confounding problems with serial murder definitions is the creators' habit of mixing a criterion with a characteristic. If one looks at a parallel, the DSM diagnostic system (American Psychological Association, 1994), it has a few set criteria that are necessary to make the diagnosis. The DSM then goes on to discuss the characteristics of the disorder. In relation to serial murder, it can be said that to murder two or more victims is a criteria; the fact that they are often prostitutes or vagrants is a characteristic. If it is elevated to a criterion, then it becomes limiting, in that if the victims are middle-class, working people, can the crime not be classified as serial murder? A similar concern could be raised in relation to other characteristics/criteria such as the sexual element. It is a characteristic that the crimes are sexual in nature but if it is elevated to a criterion then a number of murders where the suspect

strangled women could not be classified as a series. Labuschagne further feels that this is in part due to the problem of some definitions defining the concept (serial murder) and some defining the person (serial murderer). Defining the concept might be more useful for investigators; defining the person might be more useful for the criminal justice system, researchers and psychologists.

2.1.5 Definition of serial murder for the purposes of this study

In light of the above discussion and critique, the following definition of serial murder is proposed for the current study, namely as:

- multiple murders committed,
- over a period of time
- by one or more individuals.

In this way, the broadness of many of the above definitions is avoided and a working definition is provided which may then be elaborated upon in terms of characteristics associated with serial murder, from different perspectives (such as psychology, law enforcement, sociology, and other disciplines). This study also chooses to use the term “serial murder” rather than “serial homicide” due to the fact that South African legal terminology for types of crime makes reference to murder and not homicide. Additionally, serial murder will be utilized rather than “serial killing” due to the previously discussed sensationalistic nature of the latter term, as well as the fact that one may kill but the act of killing does not necessarily constitute an illegal act. For example, killing in self-defence or as part of a national defence force in armed conflict. Finally, the phrase “individual/s who commit/s serial murder” will be used rather than “serial murderer/s” in an effort to view such individuals

holistically, and not to adopt a reductionist stance of viewing such individuals as consisting of the sum total of their criminal behaviour/activity.

As discussed above, definitions of serial murder have frequently lost precision due to an apparent attempt to satisfy both psychological and law enforcement or policing perspectives with regards to its usage. By formulating a basic definition such as that above, the author intends to provide a basis for identifying instances of serial murder, which then may be expanded to include exceptions or variations in associated characteristics (such as motive, number of perpetrators, gender and victim/offender relationship, for example). In this way, it is hoped that a clearer distinction is made between a definition of serial murder and the characteristics associated with instances of serial murder, two areas that previously have been less clearly distinguished in attempts to define serial murder.

The author will now discuss some of the ways in which serial murder has been classified. As will be illustrated, many of these classification schemes operate largely on assumptions about the type of individual/s who commit/s serial murder and have been developed predominantly to assist with profiling and investigative applications.

2.2 HISTORICAL BACKGROUND OF SERIAL MURDER

In the following section, the historical background of serial murder will be explored, taking into account the history of serial murder in an international and local South African context. As will be demonstrated in the ensuing discussion, it would appear that a debate concerning the origins of serial murder runs consistently through attempts to document the history of this phenomenon. This debate is concerned with whether serial murder is a recent phenomenon or whether it has existed for the greater part of contemporary history. This

debate together with the international and South African historical background of serial murder will now be discussed.

2.2.1 History of serial murder: international

Considerable contention surrounds the issue of when the first noted case of serial murder occurred. While some argue that serial murder is a recent phenomenon, having risen to prominence over the last three decades (Anderson, 1994; Ferguson *et al.*, 2003), others argue that serial murder has always been part of the human experience, and that the ways in which it has been understood and described have varied with different historical periods and the dominant understanding of human behaviour at that time (Jenkins, 1994; Simpson, 1999; Whitman & Agawa, 2003; Wilson, 2000).

Arguments for and against serial murder as a recent phenomenon may be subject to the effects of crime reporting. Generally, reported rates and statistics for serial murder are considered skeptically due to differences and variability in reporting (especially in light of the different definitions that are utilized) as well as linkage blindness or the lack of reliable linking of cases comprising the series of homicides in a single instance of serial murder (Stote & Standing, 1995). As a result, it is not always easy to assess, with sufficient certainty, whether reported increases or lack of increase are accurately reflecting the phenomenon of serial murder.

Within the literature, the earliest suggested instance of serial murder is claimed to be as early as 54 AD in the form of Locusta of Gaul - a woman who poisoned several members of the Roman royal family to assist others to usurp their positions (Whitman & Akutagawa, 2003). It is also thought that accounts of "monsters" such as werewolves and vampires like Vlad the Impaler in the early 17th and 18th centuries may have been early references to serial

murder (Jenkins, 1994; Simpson, 1999; Wilson, 2000). This sketchy history of serial murder is further elaborated upon by reports of individuals such as Gilles de Rais in the 15th century, Countess Elizabeth Bathory in the 18th century, and Dr Neill Thomas Cream in the 19th century, who are thought to have sadistically preyed upon the local peasants and innocent patients respectively, with postulated victim counts of up to thousands (Lane & Gregg, 1992; Wilson, 2000).

The earliest popular documentation of serial murder in the currently accepted format originates in the late nineteenth century, with accounts of Jack the Ripper (Wilson, 2000). This individual is believed to have terrorized the Whitechapel area of the East End of London from August to December 1888, violently murdering five female prostitutes (Douglas & Olshaker, 2000). Police were never able to apprehend the perpetrator and as such, Jack the Ripper's true identity remains a mystery, rendering this modern "antihero" to near mythological status (Lane & Gregg, 1992). Various modern theorists, novelists, profilers and investigators have attempted to identify the most likely candidate from a plethora of possible suspects, but Jack the Ripper's identity remains a case of speculation, ranging from links to royalty to a deranged local butcher.

The romanticization of the Jack the Ripper case in popular fiction can be seen in a multitude of fictional works such as the Sherlock Holmes novels of Arthur Conan Doyle and in several popular films such as *Edge of Sanity* (1989), *Deadly Advice* (1993) and recently, *From Hell* (2001). As a result, it would appear that serial murder has experienced a similar romanticization and elaboration in fictional and factual works, with the borders between these two realms blurred and the representations contained within each utilized interchangeably by the general public and popular understandings. The individual who commits serial murder seems to enjoy a similar elevation to mythical status as a consequence and certain elements of

the romantic in his portrayal in the various expressions of the popular culture in which he is situated.

Since Jack the Ripper in the late nineteenth century, serial murder appears to have attracted attention once again in the 1960's which saw an overwhelming volume of cases such as the Manson family, and Albert DeSalvo (the Boston Strangler) followed by Ted Bundy, Dean Corll, John Gacy and Randall Woodfield in the 1970's in the United States; the Moors murders (committed by Ian Brady and Myra Hindley) and the Yorkshire Ripper, John Sutcliffe, in the United Kingdom; Pedro Lopez, the "monster of the Andes" in South America; and Arthur Chikatilo, Citizen X, in Russia from the 1970's through to the 1990's (Lane & Gregg, 1992; Wilson, 2000).

The 1970's also saw the birth of the term "serial killer", allegedly penned by the Behavioural Science Unit of the Federal Bureau of Investigation (FBI) in the USA, as well as the emergence of the psychological profile and investigative science aimed specifically at the tracking and apprehension of this "new" criminal type (Wilson, 2000).

There appears to have been a lack of attention to serial murder during the period between the sensation that accompanied the case of Jack the Ripper at the turn of the century, and the re-emergence of such sensationalism with the serial murder cases of the 1960's. The available literature does not appear to suggest any explanations for this silence. One may postulate a number of possible explanations. One explanation may be that crime statistics and crime reporting failed to reflect incidences of serial murder.

Another explanation may be that the frequency of wars during this period in the form of the First (1914-1919) and Second World War (1939-1945), as well as the Korean War (1950-1953), masked incidences of serial murder that may have been noticeable at other times due to either deflection of media and criminal justice concerns to the war effort; absorption of potential serial murderers into a war effort that may have channeled their aggressive

tendencies in more sanctioned pursuits; or, with reference to a more systemic perspective, that a war-time society focused upon survival had no function for an individual working counter to the collective aims of that particular society (Wilson, 2000). However, one could argue that this theory is challenged by incidences such as the Vietnam War (1968-1972) that took place concurrently to the rise of the serial murder phenomenon in the USA and the United Kingdom and does not seem to have masked the serial murder phenomenon in a similar way.

Another explanation may be derived from the work of Jenkins (1994) in the sense that the emergence of serial murder may reflect a need for disciplining society at times when society moves away from conservatism towards a state of more flexible morals and norms. Both the end of the Victorian era (e.g., Jack the Ripper) and the 1960's represented eras where society adopted a more relaxed attitude to norms and values, reflecting a change in the social system. Through victim choice and representation as evil or other, the serial murderer prescribed acceptable behaviour. For example, Jack the Ripper targeted prostitutes, as did many of the 1960's group of serial murderers in the USA (together with homosexuals, vagrants, and other social deviants). In this way, certain ways of life were considered dangerous and made one vulnerable to victimization, encouraging a return to more conservative ways of life. This argument will be elaborated upon further in discussion of the theories that have attempted to explain serial murder (see Chapter 3).

To return to the debate surrounding the historical origins of serial murder, Wilson (2000) counters attempts to trace the historical origins of serial murder to the earliest parts of the history of the human race, by arguing that serial murder is a recent development in criminal history. He attributes the use and origin of the term "serial murder" in 1980's America to an increase in sex crime and "motiveless murder" in the previous twenty years. Conversely, Lane and Gregg (1992) hold that understandings of patterns of behaviour of individuals who

commit serial murder such as those of the Federal Bureau of Investigation (FBI) Behavioural Science Unit or the “psychologization” of serial murder are more recent developments.

Such developments are argued to have increased the attention bestowed upon serial murder over the last two decades (as an academic topic, psychological case study, media attraction, entertainment feature and fictional protagonist) and have contributed to a false perception of such a phenomenon as recent. Stote and Standing (1995) compared a number of newspaper and statistical sources reporting rates of serial murder in the USA from 1950 to 1990 and found that increases in serial murder had occurred proportionately to increases in general violent crime and homicide. Ressler (in Holmes & Holmes, 1996) supports the view that serial murder is a recent phenomenon and holds that serial murder did not exist in the United States before 1950. Once again, such a statement is arguable but does point to a certain viewpoint, which sees serial murder as a possible chronological benchmark in cultural development, although what constitutes such development remains unclear.

The author will now discuss how serial murder developed in South Africa, including local variations on the above debate concerning the origins of serial murder.

2.2.2 History of serial murder: South Africa

Serial murder in South Africa appears to have risen to prominence in the early nineties (Hodgskiss, 2003; Labuschagne, 2003; Pistorius, 1996). Available crime statistics demonstrate that over the last two decades, South Africa has accumulated a tally of over 50 cases of serial murder (Hodgskiss, 2003). The last decade in particular has contributed considerably to this total (Schonteich & Louw, 2001). In the last twelve years alone, only Russia and the USA surpassed this tally on an international level (Hodgskiss, 2002; Holmes & Holmes, 1996).

The apparent proliferation of serial murder in the early 1990s might be likened to the way that serial murder seemed to rise to prominence in the USA and the United Kingdom in the 1960s and 1970s (Wilson, 2000). In much the same way as debates surrounding international interpretations of the apparent proliferation of serial murder in the twentieth century could be divided roughly between those who view this phenomenon as recent (Anderson, 1994; Ferguson et al., 2003), and those who believe that serial murder has existed historically in some form (Jenkins, 2002; Simpson, 1999; Whitman & Agutagawa, 2003; Wilson, 2000), the considerable increase in awareness of serial murder in South Africa has been debated along similar lines.

In other words, these can be divided between a belief that serial murder is a recent phenomenon in South Africa (Ressler, 1997) and one that it is not a recent phenomenon (Marsh, 1999; Pistorius, 1996). With regards to the former, explanations proposed include the political transformation and social upheaval of the early nineties due to a change from Apartheid government to a democratic system in South Africa, as well as increased Westernization and influence of an apparently Western phenomenon such as serial murder (Ressler, 1997). With reference to socio-cultural explanations of serial murder, one may refer to theories such as that of *anomie* (Durkheim, 1897) and Strain Theory (Merton, 1968) to understand serial murder in South Africa. With regards to the former, the transition, and accompanying reassessment of societal norms and values, that affected South African society in the early nineties, after the end of Apartheid, may have created a climate that fostered an increase in serial murder. With regards to Strain Theory, the end of Apartheid ushered in a period of great expectation and hope amongst a majority population who had previously been denied opportunities for success, prosperity and achievement. One could argue that the apparent increase in serial murder in the early nineties may have been a response to the lack of immediate realization of such opportunities in a democratic South Africa, or the selective

availability of opportunities to realize such goals amongst certain sectors of the previously disadvantaged, and not others.

Individuals such as Marsh (1999) claim that a failure to notice serial murder before 1990 may reflect biases in crime reporting. For example, Elifasi Nsomi murdered 15 people in Kwazulu-Natal province over a period of 18 months in 1950. He blamed the tokoloshe (traditional African spirit) for his crimes but was sentenced to death (Labuschagne, personal communication, 2006). Pistorius (1996) explains the lack of attention to serial murder prior to 1990 as a result of a lack of awareness of such a phenomenon; poorer ability to link cases of murder; insufficient sensitivity or discrimination between crime types on the part of the South African media; and lack of specialized training on the part of South African law enforcement, which only began in the mid-1990s (Pistorius, 1996).

With reference to Marsh (1999), the lack of attention or popular awareness of serial murder in South Africa prior to the nineties may have been the result of differences in reporting of instances of serial murder pre- and post-1990. However, this is difficult to assess given general problems with the ability of crime records to accurately reflect patterns of crime (Stote & Standing, 1995) and problems with crime reporting in the South African context such as: a biased reporting and recording of criminal activity and violent crime during Apartheid, and poor availability and inconsistency in archive management (Marsh, 1999). Schonteich and Louw (2001) support the above and argue that due to the fact that South African Police crime figures during the Apartheid era excluded crimes committed and reported in the homelands and KwaZulu-Natal Province; official crime statistics prior to 1994 should therefore be interpreted cautiously.

With respect to media attention, it would appear that local media attention to South African instances of serial murder seemed to emerge during the early nineties. This can be evidenced in articles across the publication spectrum, such as “Verkragter nie versteurd –

getuie” in the *Beeld* (22 September, 1993) about the Norwood rapist, Cobus Geldenhuys; “Spanwerk los reeksmoord op” in the *Rapport* (31 January, 1999) about the Capitol Hill serial murder case; “Still no end to serial killing” in the *Weekly Mail and Guardian* (22 September, 1995); and “2410 years on jail for ghoulish serial killer” in the *City Press* (7 December, 1997), both about Moses Sithole. Prior to this period, South Africa’s media and popular press were interested in, and aware of, true crime stories, particularly those of “sensational crimes” or crimes of passion such as William van der Merwe, the “screwdriver rapist” of the 1970s (Marsh, 1999) and cases such as the Suitcase Murder of 1964 (Kennaugh, 1968). However, references to serial murder appear to be absent in the popular media during this period. This may indicate a lack of awareness of, and/or a lack of interest in serial murder as a type of crime by media sources, or simply reflect the greater lack of awareness of this phenomenon in the wider police and socio-cultural context.

Although considerable skepticism appears to surround South African crime statistics prior to 1990, it is interesting to consider the third option, namely that serial murder did actually increase in prevalence post-1990. Ressler (1997) has attributed the seeming emergence of serial murder during this time period to larger socio-cultural and political developments such as the end of Apartheid and transition to an era of democracy as well as increased exposure to Western culture, which may have encouraged the assimilation of Western phenomena, such as serial murder, into African culture. Pistorius (1996) has argued that a combination of factors such as a highly mobile population and widespread poverty and unemployment appeared to aggregate at this particular point in time, possibly by virtue of socio-cultural developments and political change, creating an atmosphere conducive to the development of serial murder. Hodgskiss (2003) elaborates upon this, utilizing the work of Holmes and DeBurger (1988) and Hickey (2001), to argue that high rates of violent crime in South Africa post-1990, increased urbanization and overcrowding of urban areas resulting in anonymity and

depersonalization, and normalization of interpersonal violence may have created an environment that fostered the development and increase of serial murder in South Africa in the early nineties.

Given the above, it would appear that establishing serial murder prevalence prior to 1990 with considerable validity is difficult. However, individuals such as Pistorius (2002) and Labuschagne (2003), possibly due to their involvement in policing investigation initiatives directed at identifying, investigation, convicting and containing serial murder have attempted to outline a tentative chronology of serial murder in South Africa, based on their own experiences and case file material, which will be discussed now.

Pistorius (2002), in an attempt to historically document serial murder in South Africa in her source-book *Strangers on the Street*, holds that the first known case of South African serial murder actually occurred in Milnerton in the 1930s followed by sporadic incidences spread across the remaining pre-1992 period. Her attempt to retrospectively classify cases of apparent multiple murder as instances of serial murder can be critiqued on a number of levels, notably the possible lack of validity across time and availability of sufficiently detailed archival data on which to base such classifications, as well as on the basis of the general problems with South African crime records highlighted by Marsh (1999) above. Pistorius (1996) herself has highlighted that, prior to initiatives launched by the Investigative Psychology Unit (IPU) of the SAPS in specialized training in serial murder in the early 1990's, a majority of investigating officers were not specifically trained in serial murder investigation. In light of the above, it would seem that retrospective classification of cases of serial murder is flawed and potentially further complicated by disagreements concerning definitional stipulations around serial murder, as discussed previously.

It is consequently the position of this study that although serial murder may have been prevalent in South Africa prior to the nineties, it is only from 1990 onwards that it can be

documented with any arguable accuracy. Additionally, triangulation of data from numerous sources such as police case files, professional discussion and academic research publications, popular media sources, and court records has enabled a more grounded evaluation and confirmation of such cases (Labuschagne, 2001) as may be evidenced in the following table.

Table 2.1

South African Serial Murder Cases 1936-2003 (Adapted from Labuschagne, 2004)

Series name	Location	Suspect Name	Years	Victim number
None	Johannesburg	Cornelius Burger	1936-1937	5
None	Cape Town	Salie Lingeveldt	1940	5
None	Kwazulu-Natal	Elifasi Msomi	1953-1955	15
Pangaman	Pretoria	Elias Xitavhudzi	1960s	16
None	Atteridgeville	John Phukokgabi	1974-1978	16
None	Soweto	Joseph Mahlangu	1979	13
None	Pietermaritzburg	Phillip Magoso	1983	5
Station Strangler	Cape Town	Unknown	1986-1994	22
Vlakgrafte	Kuilsrivier	Zola Mqombuyi	1987-2001	5
Norwood Serial	Norwood	Cobus Geldenhuys	1989-1992	5
None	Port Elizabeth	Brydon Brandt	1989-1997	4
Boetie Boer	Port Elizabeth	Stewart Wilken	1990-1997	10
None	Cape Town	Wessels & Havenga	1991	4
None	West Rand	Moses Mokgeti	1991-1993	7
Kaap prostituut	Cape Town	Unknown	1992-1995	19
Eva Nosal	East Rand	Christiaan De	1993-1994	2

Wet				
None	Witbank	Nolan Edwards	1993-1994	3
Cross Dressing	East Rand	Brown &	1993-1995	5
		Coetzee		
NASREC	Johannesburg	Mazankane &	1993-1998	17
		Motsegwa		
Cleveland	Cleveland, JHB	David Selepe	1994	14
Strangler				
Pinetown	Pinetown	Unknown	1994-1995	3
Strangler				
Atteridgeville	Atteridgeville,	Moses Sithole	1994-1995	38
Strangler	Boksburg,			
	Cleveland			
Donnybrook	Natal Midlands	Christopher	1994-1995	8
		Zikode		
Pheonix	Pheonix, Durban	Sipho Twala	1994-1997	17
None	Louis Trichardt	Willem Grobler	1995	2
None	Mdantsane, East	Vuyani Mpezo	1995	2
	London			
Kranskop	Newcastle	Bongani Mfeka	1995	4
Wemmerpan	Johannesburg	Cedric Maake	1995-1997	35
Lenyenye	Tzaneen	Unknown	1996-1997	5
Oos Kaap	Kwazakele	Nicolas Ncama	1996-1997	4
None	Carltonville	Unknown	1996-1998	6

None	Thohoyandou	David Mbengwa	1996-1998	10
Roadside	Northwest Province	Francois Potgieter	1996-2000	16
Langlaagte	Johannesburg	Unknown	1996-2000	2
Piromaan	Jeppe, JHB	Norman Hobkirk	1997	3
Saloon Killer	Piet Retief	V. Nglanamandla	1997-1998	16
Maize Field	Kroonstad	Daniel Ramayisa	1997-1998	3
None	Upington	JAC Nel	1997-1998	2
Skiereiland	Cape Town	Unknown	1997-	3
Nagmerrie				
Doringdraad	Empangeni	Unknown	1997-1998	16
Sleepy Hollow	Pietermaritzburg	Unknown	1997-1999	8
Capital Park	Pretoria	Samuel Sydino	1998	7
None	Vereeniging	Unknown	1998-1999	2
None	Natal	Juan Jordaan	1999	3
None	Barberton	Frank Ndebe	1999	4
Osizweni	Newcastle	Sidney Dlamini	1999-2000	5
Rioolplaas	Cape Town	Unknown	1999-2000	9
Riverman	Durban	Unknown	1999-2001	13
Kleine Fonteine	Pretoria West	Unknown	1999-2001	5
RDP Strangler	Potgietersrus	Ephraim Legodi	2000	4
Hospital View	Potgietersrus	Ephraim Legodi	2000	1
Strangler				

None	Kwa Dukuza	Unknown	2000-2001	4
None	Keiskammahoek	Mcperson	2001	2
		Nyonga		
PE Prostitute	Port Elizabeth	Unknown	2001	4
None	Randfontein	Unknown	2001-2003	7
None	Mapelo Hans	Awaiting trial	2002	3
Highwayman	Pretoria	Elias Chauke	2002	5
Newlands East	Durban	Unknown	2002-2003	13
Johannesburg	Johannesburg	Awaiting trial	2003	7
Mine Dump				
Rustenburg	Rustenburg	Awaiting trial	2003	2
Child Killer				
Stellenbosch	Stellenbosch	Unknown	2001-2003	3
Child Murder				

Since the early nineties, and apparent rapid subsequent increment, serial murder has been approached in a manner that has seen considerable efforts made to improve investigation (and consequently apprehension) methods especially given the pervasive doubt in the rehabilitation capacity for the individuals who commit such crimes (Pistorius, 1996). One such measure was the creation of the Investigative Psychology Unit (IPU) as part of the South African Police Services' Serious and Violent Crime Component in 1995. The IPU has done considerable work to introduce training programmes for police officers and investigators of serial murder cases, provide investigative support; and conduct research, with the result that South Africa seems to hold the world record for the quickest apprehension time in a serial murder case (six

weeks from first murder and another within 48 hours of a task team being put together). The SAPS also has a hundred percent conviction rate for its serial murder cases brought to trial (Labuschagne, personal communication, 2003).

The IPU is also one of the few law enforcement units in the world with a full-time unit of functional members, albeit stretched in terms of resources given its small compliment of three members. Given its positioning at national level, it is able to centrally communicate with detective units across the country and consequently greatly limit linkage blindness. Each province has a co-coordinator of serial murder and serial rape investigations who also assists in detecting cases and monitoring investigations. The unit also possesses a mandate to be involved in all serial murder cases, which means that it is able to continually monitor serial murder in South Africa, as well as its interventions in relation to it. It is also the only unit in the SAPS allowed to do offender profiling.

Generally, the IPU is concerned with three roles – investigative support; training; and research. It is the only police service in the world with regular training on serial murder for: crime scene photographers; general detectives; serious and violent crimes detectives; family violence, child protection and sexual offences detectives; forensic science laboratory field workers; and facial identification unit members, and additionally, it has a specialized three week course in serial murder investigation (Labuschagne, 2003).

In addition to the IPU, investigative handling of serial murder in South Africa has been supplemented by crime mapping technology, which has allowed for greater ability in terms of linking crimes and offences within cases of serial murder. Such technology has allowed for better presentation in court cases, and has involved liaising with cellular network providers for itemized billing, transmission towers and maps of coverage in cases where cellular phones have been stolen or used by the offender. The SAPS first used computerized crime mapping in 1998 with a nationwide computerized crime mapping system in

development during the last quarter of 2000. Computerized crime mapping has allowed for greater ease of distribution of information within police areas as compared with previous wall maps. In this way, serial murder cases can be identified quickly and monitored effectively, as well as facilitating possible geographical profiling applications.

Many factors still need to be addressed in the realm of investigative police work however. The SAPS lack resources such as money and equipment in order to operate at an optimum level. The varied nature of the South African crime scene and its interaction with cultural factors additionally requires sensitivity to such factors so as to avoid confusion in classifying instances of serial murder. One such confound is muti murder which has may be frequently misattributed to serial murder on the basis of its surface presentation (Labuschagne, 2004). This will receive greater attention in later discussion.

In addition to the above considerations, a large population of mobile, migrant labour also constrains effective investigation and apprehension of criminals as well as surveillance of victims and tracing of missing persons. As such the victims of an individual who commits serial murder may only be discovered months after they have been murdered or abducted, and never identified. The significant amount of poverty which characterizes the South African context also hampers police investigation in terms of providing a large pool of potential victims as well as fostering conditions in which serial murder (according to international literature) may flourish (Hodgskiss, 2002).

To supplement arguments of the importance of law enforcement effectivity in the apprehension of individuals who commit serial murder, studies in the US and Canada (Collins, Johnson, Choy, Davidson & Mackay, 1998) have pointed to lack of/poor communication between law enforcement and criminal justice agencies as allowing for reduced detection of individuals who commit serial murder. Crime linkage techniques in these countries were seen to fail as a result of a lack of detail in reports compiled by investigators

concerned; subjective interpretations of crime scene information; as well as question formats that were too open-ended and broad. It may be safe to presume that some of these factors have also played a part in the South African context and influenced the perception of serial murder and consequently prevalence statistics. However, it appears that initiatives such as the development of an investigative psychology unit in the SAPS; better communication between provincial and regional police stations; and the IPU at national level, training of investigators and other SAPS members in the identification of serial murder, as well as technology such as crime mapping, may improve crime linkage in serial murder cases.

In conclusion, it would appear that South Africa has made considerable advances in a relatively short period of time to develop effective techniques for preventing and containing serial murder at an investigative level. However, many of these techniques require empirical verification and support in the form of a substantial base of research from which these techniques can be developed and informed. Keppel (1989) emphasizes the importance of the collection of physical evidence and interviewing techniques in serial murder cases. He advocates a standardization and clarification of procedure in order to demystify apprehension techniques and common popular perceptions of serial murder investigation which emphasise “luck”, hunches or intuitive practice as opposed to a more realistic and accurate emphasis on routine police procedure, something that the training offered by the IPU hopes to achieve.

Additionally, it would seem that psychological methods for dealing with and understanding serial murder, and working with individuals who commit serial murder after they are incarcerated, are to a large degree still lacking in South Africa. As will be discussed and shown in the following section, many of the research studies on serial murder in South Africa have touched on aspects of the psychology of serial murder (De Wet, 2005; Du Plessis, 1998; Labuschagne, 2001, 2003; Pistorius, 1996), but these have yet to be consolidated into a body of recommendations for dealing with serial murder both proactively and after

incarceration. Further research in the above areas, in a manner that takes the cultural nuances of the local context into account, may go a significant distance in assisting interventions at police, correctional services and psychological levels for dealing with serial murder in South Africa.

- **Muti murder**

Muti murder is defined as “a murder in which body parts are removed from a live victim for the sole purpose of using the victim’s body parts medicinally” (Labuschagne, 2004, p.191). These parts may or may not be mixed with other medicinal substances in the creation of the final end product or medicine (muti). The cause of death of the victim is usually due to the loss of blood from wounds inflicted in attaining the necessary body parts. Labuschagne (2004) also states that muti murder usually involves three role players (in addition to the victim), namely, the client; the traditional healer; and the murderer. These roles may be filled by three different individuals, or occasionally involve one individual performing more than one role.

Turrell (2001) demonstrates factors comprising muti murder which are useful in distinguishing this from serial murder. He states that firstly, muti murder is usually done on behalf of a chief seeking power, business advocate or doctor for powerful medicine. The victim may be related to the beneficiary in some way. Flesh is removed from the victim while they are still alive, and no blood must be spilt. Given the cultural dilution of pure traditionalism that has developed with the growing influence of Westernisation, this type of murder has been criminalized and developed increasingly along the lines of such influence with the result that capitalist competition has played a larger role in its manifestation. Such cases are important as they highlight the cultural particularities which colour the South

African criminal, investigative context and which necessitate a locally sensitive approach in dealing with the phenomena at hand.

Labuschagne (2004) states that muti murder can be confused with serial murder (and vice versa) and consequently mislead the way in which investigators approach the crime scene; compile suspect lists; and draw up profiles to assist with investigation. As a result, one needs to be cautious when encountering a series of murders involving mutilation of the body or removal of body parts. Labuschagne (2004) highlights a need to distinguish between muti murder and other types of murder such as sadistic mutilation and serial murder and discusses a number of ways in which this may be possible.

With regards to sadistic mutilation, there may be more wounds that are less severe as opposed to fewer, more functional wounds that would characterize muti murder. Additionally, in sadistic mutilation the aim of the wound is more about inflicting pain and suffering, whereas with muti murder, the aim is usually to remove the necessary organ. Mutilation or sadistic murders may also demonstrate evidence of sexual assault, including traces of semen, and may be guided by a fantasy being played out – two features which are not usually expected in muti murder (Labuschagne, 2004).

With regards to serial murder, muti murder differs in that it is often an isolated incident, as opposed to being part of a series of incidents. Serial murder may also demonstrate similar mutilation on bodies, whereas with muti murder body parts are specified and consequently, mutilation is unique to a particular victim. As with the above, serial murder may be guided by fantasy, thereby differing from muti murder, and finally, body parts may be kept as souvenirs in serial murder whereas they are usually handed over to traditional healers in muti murder (Labuschagne, 2004).

Despite the above distinctions, the presentation of muti murder continues to mislead investigations due to the subtlety with which the differences present themselves

(Labuschagne, 2004) and classification of serial murder series should proceed with caution to avoid including cases that are not part of the same series, or failing to recognize a series of murders committed by the same individual.

2.3 WAYS OF CATEGORIZING SERIAL MURDER

Throughout the literature, a number of ways of categorizing different variations of serial murder and individuals who commit serial murder have been proposed. These categories often appear to be based on the manner in which the murders comprising a series are committed. Some of these will now be discussed and critically commented upon.

2.3.1 Topological classification schemes

A review of the literature indicates a number of different classification schemes that have been devised to classify serial murder. Such schemes have been devised for investigative purposes, to assist police investigators in searching for possible suspects or devising offender profiles, interviewing suspects once arrested, and drawing up possible victim profiles (Turvey, 1998).

The FBI and their Behavioural Science Unit have devised a typological classification scheme for serial murder that draws distinctions between disorganised/organised offenders (Ressler & Schachtman, 1992). Such an effort stemmed from general work that was done by the FBI in devising crime classification schedules such as the *Crime Classification Manual* (Douglas, Burgess, Burgess & Ressler, 1992) to assist in investigative applications.

This has been followed by similar schemes such as the Holmes and DeBurger (1988) typology as well as Leibman's (1989) ego-syntonic and ego-dystonic classifications of serial

murder. Finally, a classification based on crime scene geography, as put forward by Canter (1994, 2000) and Rossmo (1995, 1997) will be discussed.

- **The FBI's disorganised/organised typology.**

The disorganised/organised typology of serial murder (Ressler & Shachtman, 1992) was constructed by a group of FBI agents in the 1970's and 1980's in the USA from interviews conducted with 36 individuals incarcerated for sexual murder. It consists of a classification scheme based upon the offender's manner of interpersonal interaction together with information about developmental and early life experiences. Such factors were used in conjunction with information about the individual's modus operandi and general crime planning. This also included details such as the way the offender committed a crime and left a crime scene, pre- and post-offence behaviour and lifestyle to classify such an individual as either disorganised or organised.

Ressler and Shachtman (1992) then extrapolated such information and typological links to isolate certain common characteristics or clusters of features that they believe were typical of disorganised and organised types of offenders. Consequently, they argue that when these clusters of features are encountered at a crime scene, investigators can then assess whether they are searching for a disorganised or organised individual and structure their search accordingly. The FBI is quick to stress that classification is often not either/or but often involves a mixed presentation with elements from different categories occurring simultaneously in one offender.

Scientifically, this typology lacks ecological validity due to its limited sample base, lack of falsifiability, and lack of empirically proven reliability (Turvey, 1998). Canter, Alison, Alison and Wentink (in press) hold that there is only one small-scale empirical test of this typological model and that such a test is open to many challenges. Despite the cursory lack of

scientific rigor, however, this typology is still widely used on the basis of anecdotal success. The introduction of a “mixed” classification additionally weakens the dichotomous basis for the disorganised/organised typology, especially if a large number of cases are found to fall into this type (Canter *et al.*, in press).

Turvey (1998) also criticizes inductive profiling applications such as the FBI disorganised/organised typology on the basis that they lack standardized terminology across investigative applications. He believes that the use of such typologies is dangerous especially when involved in the production of gross generalisations across offender type. Canter *et al.* (in press) tested the disorganised/organised typology using a multidimensional scaling procedure to see whether such discrete subsets of offence behaviour could be elicited from the frequency with which they co-occurred in crime scenes of serial murder cases. They found that such discrete subsets could not be supported, and that, rather, only organised clusters could be identified.

Table 2.2 (Adapted from Ressler & Schachtman, 1992)

Disorganised/Organised Typology

Disorganised, asocial offenders	Organised, nonsocial offenders
IQ below average, 80-95 range	IQ above average, 105-120 range
socially inadequate	socially adequate
lives alone, usually does not date	lives with partner or dates frequently
absent or unstable father	stable father figure
family emotional abuse, inconsistent	family physical abuse, harsh
lives and/or works near crime scene	geographically/occupationally mobile
minimal interest in news media	follows the news media
usually a high school dropout	may be college educated
poor hygiene/housekeeping skills	good hygiene/housekeeping skills
keeps a secret hiding place in the home	does not usually keep a hiding place
nocturnal (nighttime) habits	diurnal (daytime) habits
drives a clunky car or pickup truck	drives a flashy car
needs to return to crime scene for reliving memories	needs to return to crime scene to see what police have done
may contact victim's family to play games	usually contacts police to play games
no interest in police work	a police groupie or wannabe
experiments with self-help programs	doesn't experiment with self-help
kills at one site, considers mission over	kills at one site, disposes at another
usually leaves body intact	may dismember body
attacks in a "blitz" pattern	attacks using seduction into restraints
depersonalizes victim to a thing or it	keeps personal, holds a conversation
leaves a chaotic crime scene	leaves a controlled crime scene
leaves physical evidence	leaves little physical evidence
responds best to counseling interview	responds best to direct interview

- **Holmes and De Burger's visionary, missionary, hedonist and power/control typology.**

Holmes and DeBurger (1988) devised a typology to organise individuals who commit serial murder according to the nature of motivation for their crime - that is, with regard to whether the murders are committed because of:

- visions as with the visionary type;
- a particular mission;
- the pleasure derived from the crime and
- the power obtained in the act of murder.

These four types of serial murder stem from four aspects of the offence namely, the background of behaviour (psychological, sociogenic and biological); victimology (specific/non-specific, random/non-random and affiliative/stranger); pattern and method (act/process focused, planned/spontaneous and organised/disorganised); and finally, location (concentrated/dispersed).

- **The visionary type.**

Such an individual is motivated to murder by visions, godly messages, voices, demon possession, telepathic messages, and alter egos. He/she may experience hallucinations and, for example, believe that they hear a voice instructing them to murder blonde women. Certain theorists (Lane & Gregg, 1992; Leyton, 2001) believe that Charles Manson from the USA could be classified as a visionary type due to his belief that the Beatles' songs Helter Skelter and Blackbird were calls to take up arms and launch an offensive on elements of American society.

- **The missionary type.**

Such an individual believes that they have a special function to fulfill such as ridding society of “undesirables” such as prostitutes, homosexuals, and drug addicts. Peter Sutcliffe, the Yorkshire Ripper in England, believed it was his mission to rid the streets of prostitutes (Lane & Gregg, 1992).

- **The hedonist type.**

This category is divided into another three types based upon the nature of pleasure that is derived from the act of murder. The lust-oriented hedonist is thought to have sexual gratification as his primary motivation and is thought to inflict a considerable amount of mutilation on the sexual organs in the commission of the offence. The thrill-oriented hedonist has the thrill of the act of murder itself as primary motivation and any sexual pleasure as secondary. The comfort-oriented hedonist takes pleasure from the act of murder primarily, but also obtains a secondary benefit/profit such as financial gain.

This last type has been understood differently however by authors such as Lane and Gregg (1992) who hold that the act of murder is incidental to the gain obtained. Some such as Pistorius (1996) have argued that if such a definition is accepted than these individuals should not qualify as serial murderers as they are not motivated primarily by the act of murder.

- **The power/control seeker type.**

The feeling of power motivates such an individual over another life and control of the pain inflicted on the victim. Lane and Gregg (1992) postulate that such a type is reflective of low self-esteem and may manifest sadistic traits.

Holmes and DeBurger (1988) qualify their typology by stating that these “types” may be found in combination within an individual. This typology has additionally been grouped in terms of process/act distinctions. Process/act distinctions are based upon how important the

murder is for the individual concerned. A focus on act applies to individuals for whom the murder of a victim is less important than what is symbolized by that victim and consequently, the murder itself takes place relatively quickly. A focus on process signifies that the individual concerned prefers to draw out the act of murder – the victim is primarily a vehicle for the gratification obtained from the murder process and is recognized minimally for the particular characteristics they possess. Process-focused individuals are thought to engage in excessive violence and may mutilate the body post-mortem (Holmes & DeBurger, 1988). An example of this may be a sadist, who derives enjoyment from the suffering of the victim in the process of finally murdering him/her.

Process/act distinctions have also been interpreted in terms of their explanatory potential in conjunction with the disorganised/organised typology (Holmes & DeBurger, 1988). Frequently, act-focused types are thought to reflect the same characteristics as disorganised type serial murderers, and process-focused types with organised types. It is not clear whether this is advisable as process/act distinctions may represent a distinct alternate classification scheme for serial murder. It would also seem that for classification schemes to be robust, such interchangeability between overarching schematic structures and crime scene characteristics is not advisable and often results in a dilution of the relevance with which such schemes may be applied. This can be seen in articles such as Anderson (1994) that equate disorganised/organised distinctions with process/act-focused distinctions, ignoring subtle definitional distinctions originally stipulated.

Holmes and DeBurger (1988) additionally use disorganised and organised as criteria for their typological scheme. For example, the visionary type is thought to be disorganised whereas the remaining types are thought to be organised. This is problematic in that there is no elaboration upon which aspects of the disorganised and organised classifications should be evident in crime scenes, nor empirical support both for the inclusion of these types as criteria

and for the co-occurrence of their respective constituent elements in the classification types of Holmes and DeBurger (1988). As a result, there seems to be a set of assumed relationships between criteria based on anecdotal experience and theoretical speculation (Canter *et al.*, in press).

Table 2.3

Holmes and DeBurger Typology of Serial Murder

Serial murder type	Visionary (v)	Mission-oriented (m)	Hedonistic Lust (l)	Thrill(t)	Comfort(c)	Power/control(p)
Factors:						
Victim specific		m	l			p
Victim non-specific	v			t	c	
Random choice	v		l	t		
Non-random choice		m			c	p
Victims affiliative	v	m	l	t	c	p
Victims - Strangers						
Methods						
Process-focused	v	m	l	t	c	p
Act-focused						
Planned		m	l		c	p
Spontaneous	v			t		
Organised		m	l		c	p
Disorganised	v			t		
Location						
Concentrated	v	m	l		c	
Dispersed				t		p

(Adapted from Holmes & DeBurger, 1988)

- **Leibman's ego-syntonic and ego-dystonic classification.**

Leibman (1989) differentiates between ego-syntonic, ego-dystonic and psychotic serial murderers. Within this classification, the ego-syntonic type sees the act of murder as congruous with his/her beliefs and consequently does not experience conflict with his ego functioning or negotiation of reality. The ego-dystonic type experiences considerable conflict with regards to his/her actions of murder, which is not congruous with his/her beliefs.

Consequently he/she will disassociate him/herself with the murder on a conscious level.

Finally, the psychotic type is thought to murder due to a mental illness or symptoms such as hallucinations. As a result, the actions of such a type are not perceived to be based in reality.

Leibman (1989) holds that most serial murderers are ego-dystonic. Adopting a psychodynamic perspective, Pistorius (2002) suggests that ego-dystonic serial murderers may have a degree of super-ego functioning while those for whom murder is ego-syntonic may have very limited super-ego development.

Such a classification scheme may work towards enriching psychological understandings of individuals who commit murder/serial murder, and possibly methods for rehabilitation in terms of psychodynamic psychotherapy, but is not *prima facie* useful in terms of crime scene interpretation for investigative purposes. Additionally, the use of the term ego-dystonic/syntonic to refer to individuals is problematic - it would probably be more useful to refer to their relationship with the act of killing/murder as either ego-dystonic/syntonic.

Finally, the literature indicates that psychosis is rarely found in individuals who commit serial murder (Meloy, 2000).

2.3.2 Geographical classification

Canter (1994, 2000) and Rossmo (1995, 1997) have attempted to classify individuals who commit serial murder, and other serial crimes, with regards to the geographical context in which such individuals operate. Within an environmental psychology paradigm, Canter (2000) has attempted to demystify serial murder by arguing that individuals who commit such a crime follow general patterns which can be applied to other crime categories as well. His classification method focuses predominantly on the geographical planning and situation of criminal activity as well as clusters of behavioural elements that have been found to repeatedly occur within a serial murder sample. As such, classifications which result in the creation of types of serial murderer are avoided and rather clusters of behavioural elements are grouped together to indicate which elements are likely to co-occur, on the basis of observed frequency of types of criminal actions (Canter, 2000). He also argues that this method is more reliable, empirically verifiable and scientific than deductive, inferential profiling approaches based on personal opinion and anecdotal evidence.

Lundrigan and Canter (2001) have applied their work to assisting investigative initiatives with regard to serial murder. They argue that despite the belief that serial murder is an outcome of heightened emotion and poor impulse control, choices involved in details of the various murders can be seen as guided by rational decision-making processes. Spatial patterns of disposal locations have been demonstrated to operate subject to a rational logic and vary according to the range over which the offender operates. It was found that offenders centred their criminal activity around their primary residence; that the location of each subsequent body disposal location was in a different direction to that directly preceding it; and that this process was strongest for individuals who traveled less than 10km on average, and weakest for those who traveled 30km or more on average. In this way, the geographical movements of

offenders can be modeled and assist in identification of a series, tracking an offender and predicting future offence disposal sites with an aim to apprehend the individual concerned. Canter (1994) distinguishes between two predominant types of criminal based on the geographical arrangement of their crimes, namely a commuter type and a marauder type. A commuter usually travels some distance from his/her home base to commit a crime, whereas a marauder will travel shorter distances from his/her home base. This approach has been critiqued due to its ambiguous nature – namely, Canter (1994) is vague in terms of describing what constitutes a short as opposed to long distance quantitatively, thus rendering application of such a model subjective to the investigator concerned and increasing difficulty of ultimately locating the suspect's home base.

Rossmo (1995) supports the notion that criminals tend to commit their crimes close to where they live, according to the “least efforts” or “nearness principle”. The area in which crimes are committed, specifically the first in a series, usually represents the individual's comfort zone, both in terms of physical or geographical factors and psychological elements. Rossmo (1995) additionally states that a number of factors have to be considered when establishing the comfort zone or geographical profile of an individual. These include area demographics with regard to types of victims selected and the geographical distribution of such victim types; arterial routes with respect to street patterns and transport methods such as bus routes; physical barriers such as highways, or rivers; mental barriers such as a lower socio-economic offender not wanting to go into a richer neighbourhood; and displacement, namely possible moves that result due to police activity or media reports. Geographical profiling may also differ if different aspects of the crime are considered. For example, if first point of contact with victims is taken into account, a different profile may emerge than if body disposal sites are focused upon (Rossmo, 1997).

In many ways, this system is less reductionist than schemes that create types of serial murderer. However, the statistical technique (Small Space Analysis) from which such clusters are derived possesses a degree of flexibility and variability that leaves much to the discretion of the researcher for its interpretation (Rosenthal & Rosnow, 1991). Consequently, factors may be grouped into different clusters by another researcher.

Rossmo's (1995, 1997) approach is useful, specifically in terms of suspect evaluation and crime prevention; however, Labuschagne (2003) has highlighted the importance of complete and accurate information for such approaches to be useful to police investigations. If any crimes are omitted or any irrelevant crimes are erroneously included or linked within a single series, the geographical profile may be skewed and consequently, inaccurate.

Labuschagne (2003) argues that in South Africa, there is little anecdotal evidence to support the claims of Canter (1994, 2000) and Rossmo (1995, 1997) consistently. For example, Cobus Geldenhuys, the Norwood serial murderer, and Moses Sithole, operated close to their homes; however, Elias Chauke, the Highwayman serial murderer, did not. This still requires empirical testing and validation to establish whether geographical classification methods would be useful in South Africa.

It may also be the case that due to the different nature of the South African geography as compared to the USA, Canada or United Kingdom, as well as the different transport systems and widespread mobility of people, and multiple households occupied by individuals at any one time, it may be difficult to successfully apply geographical profiling in its current format to the investigation of serial murder in South Africa. However, this may be used to inform further research into the applicability of existing methods to South Africa, or the formulation of a geographical profiling approach that is more suitable for South Africa.

2.3.3 Concluding remarks on classification schemes

Classification schemes seem problematic for a number of reasons. Many are largely unscientific in terms of empirical criteria of validation, falsifiability, standardisation and reliability; they run the risk of labeling and as such confining the individual in question to fitting his “type” with little scope for contradiction resulting in a tautological kind of argument; they ignore the psychological diversity and multiplicity of human beings; and they encourage inductive profiling of offender characteristics from crime scene data (Canter *et al.*, in press; Turvey, 1998).

Canter *et al.* (in press), criticize typological classification schemes on the basis that human beings rarely can be found to fall into distinct types, and hence, such schemes will struggle to find strong, consistent empirical support. Their optimal use may lie rather in identifying characteristics of the crime scene (i.e. disorganised/organised, process/act focus) without extrapolating grossly to offender characteristics/type.

As discussed with regard to definitions of serial murder, typological classification schemes incorporate many psychological principles despite having been devised primarily for law enforcement purposes. As a result, they may be seen to be characterised with similar tensions as discussed in relation to definitions. The interpretative relativity that results is not assisted by the fact that few of these typologies have been tested empirically, and tend to rely predominantly on anecdotal accounts of their successful or unsuccessful application. As a result, it is difficult to claim, with any certainty, that typological classification schemes aid or hinder understandings of serial murder, or their investigative analysis.

Additionally, none of the above typological schemes have been tested for their empirical validity in a South African setting (Labuschagne, 2003). As a result, it is not possible to state

whether individuals who commit serial murder in South Africa can be classified in the same manner, or require different schematic distinctions.

The following chapter will critically examine theories about serial murder from a number of different perspectives ranging from those that focus more on individual factors, to those that take the broader social context into account.

3. LITERATURE REVIEW: THEORETICAL FRAMEWORKS CONCERNING SERIAL MURDER

The author will now critically examine the different ways in which serial murder has been understood from various theoretical positions and paradigmatic orientations. Such theoretical positions mimic theoretical divisions relating to general violence and crime with different disciplines analyzing the causes of violence at different levels such as the structural, institutional, interpersonal and individual.

Generally, such theories frame the “creation” of serial murder as a manifestation of some dysfunction at any one of these levels. The basic viewpoints can be grouped under: individual focused theories and contextual viewpoints. The author will begin discussion of theories of serial murder with a review of the individual focused theories on serial murder. Due to the small amount of theories (both locally and internationally) that have attempted to explain serial murder specifically, this chapter will first outline theories addressing violent behaviour in general for each section and then move on to discussing any theories within the specific sub-category (e.g. individual and contextual) that have attempted to explain serial murder, in particular.

Individual-focused theories seem to argue for some nature of dysfunction either in the physical aspect and biology of the person involved or in the psychological development or functioning of the individual concerned. These positions will now be discussed under the headings of organic, psychological and socio-cultural theories.

3.1 ORGANIC THEORIES

Organic theories operate at the level of the individual, assuming that people have a neurological or genetic tendency towards violent behaviour (Reiss & Roth, 1993). These will be discussed with regards to approaches that focus more specifically on neuroanatomy/neurology and genetics respectively in relation to criminal behaviour and serial murder in particular.

3.1.1 Neuroanatomy/neurology

In terms of neuroanatomy, the limbic system has been drawn upon as an area that may affect the emotional processing of events by individuals who commit murder (Money, 1990). This part of the brain is responsible for the mediation of emotional states and regulation of emotional responses to the environment (specifically response to perceived threats from such an environment and decisions to attack), a lesion in, or damage to limbic system may affect the individual's ability to respond with accurate emotion to their environment (Ellis & Walsh, 2000; Hagan, 1996).

In the case of sexual sadism, Money (1990) argues that the aggressive signal is incorrectly coupled with the sexual drive, and hence violence is eroticised or sexually stimulating to the individual concerned. The difficulties in the processing of emotional stimuli mentioned above in terms of limbic system functioning have also been explained by investigating the differences in hemispheric processing in the brain. It has been suggested that individuals who commit serial murder may rely predominantly upon left, verbal-analytic hemispheric

processing than right hemispheric processing with the result that the “feeling” part of emotional interpretation is lacking resulting in a lack of empathy and callousness (Money, 1990). Little data exists however, indicating the number of cases in which such a neurological dysfunction has been present and accountable for the sexually sadistic behaviour. Additionally, it is difficult to separate the influence of psychological and environmental factors on etiology in many of these biological theoretical arguments.

Research has also focused on the diencephalic structures of the thalamus and hypothalamus, which have been suggested as having a direct role in aggressive behavior, as well as a role in associating positive or negative emotions with incoming stimuli (Siegel, 2000). Abnormalities in the thalamus have been proposed to explain a serial murderer's inability to maintain personal relationships or display empathy for his victims (Sears, 1991).

The thalamus has also been associated with pathological activation of fearful and combative behavior (aversive experiences) along with oral and sexual functions (pleasant experiences). When one area is stimulated, arousal may extend to other areas, producing pleasurable feelings associated with violent acts. The hypothalamus plays a role in the reticular activating system, which may block otherwise stimulating activity from reaching the judgment-related cerebral cortex. It has been suggested that such a mechanism may be what is responsible for chronic underarousal in the psychopath, leading to antisocial behavior in an attempt to increase cortical levels of arousal (Bartol, 1980).

In some cases, specifically with respect to those serial murderers classified as disorganised types (Holmes & Holmes, 1996; discussed previously), it has been suggested that these individuals may suffer from a degree of mild to moderate mental retardation. This has been applied to individuals such as Edmund Kemper and Harrison Graham in the USA (Leyton, 2001). However, the link is not particularly tenuous for the reason that it has not

been consistently shown to be the case that individuals who are mentally retarded manifest a disorganised manner of committing murder.

Additionally, it is particularly dangerous to construct a link between mental retardation and violent crime, particularly serial murder, in the absence of reliable evidence, given the additional stigmatization that may be placed upon this group of individuals. Whereas mental retardation on the part of the individual who commits serial murder may influence the manner in which the murders are carried out, it may be inaccurate to go the further step of claiming that the mental retardation itself causes the offending behaviour.

3.1.2 Genetics

Genetic factors have also been implicated in arguments of causality with regards to criminality (Stephenson, 1992). One theory that has been applied increasingly to the category of sexual crimes and violence is that of the XYY chromosome (Kumra, Wiggs, Krasnewich, Meck, Smith, Bedwell, Fernandez, Jacobson, Lenane & Rapoport, 1998; Schroder, De la Chapelle, Hakola & Vikkunen, 1981). The XYY theory refers to a condition where a male individual has an extra Y chromosome as a result of irregular sperm propagation on the part of the biological father. Such individuals are usually considerably taller than average; have a greater amount of facial hair; and are thought to exhibit pronounced masculine traits and hypersexuality (Berner, Grunberger, Sluga, Schnedl, Wagenbichler & Herbich, 1977; Diego Nunez, Prieto Veiga, Rey Sanchez, Salazar Veloz, De Manueles Jiminez, Santos Borbujo, Martin Ruano, Alvarez Aparicio & Cedeno Montano, 1992).

During the 1960's, these individuals were found to be overrepresented in legally incarcerated populations, leading to widespread beliefs that XYY individuals were by nature more likely to commit crimes, specifically those involving considerable sex and violence

(Berner *et al.*, 1977). These beliefs have recently been dispelled (Delisi, Friedrich, Wahlstrom & Crow, 1994) however, and it appears that the mild learning and behaviour problems that may accompany the syndrome are responsible for those XYY individuals who do undertake criminal activity being apprehended more easily (Berner *et al.*, 1997).

With regard to serial murder, to date, no individual who has committed serial murder has been found to have been an XYY individual, although Edmund Kemper, an American serial murderer who, responsible for the “Co-Ed” series of murders in Santa Cruz in the 1970’s, was the subject of such speculation given his physical characteristics (above average height and build) and hypersexuality (Lane & Gregg, 1992; Leyton, 2001). However, it was later established that his chromosomes were normal (Leyton, 2001). Consensus on the XYY syndrome link to serial murder (and general criminal behaviour) appears to be that such links to the XYY syndrome are largely correlative at best with no solid causal links established (Faber & Abrams, 1975).

3.1.3 Critique of organic theories

Organic theories can be critiqued on several grounds in general. Firstly, samples upon which these theories or suggestions are based, frequently are contrasted by samples of serial murderers who either manifest the problem behaviour in question without the accompanying organic dysfunction or manifest no such behaviour in the presence of neurological dysfunctions (Kolb & Whishaw, 1996).

Samples of serial murderers upon which organic theories are based are additionally very small and often anecdotal in nature, often on account of these samples being limited to incarcerated serial murderers (Egger, 1984). This may not completely discredit these theories but samples are too small to discount the potential influence of other factors in the

manifestation of serial murder, be they biological or environmental or psychological. As a result, organic theories run the risk of being reductionist and eliminating the opportunity and need for change or amelioration of social/environmental conditions and factors that may play a part in “etiology”.

Causal direction in organic theories is also frequently unclear with uncertainty surrounding whether pathological behaviour alters brain functioning or vice versa (Kolb & Whishaw, 1996). This general critique of organic theories of neuropathology may be extended to organic theories that attempt to explain serial murder in the sense that the direction of causality may be queried with regard to brain or other organic abnormalities and serial murder offending.

A large proportion of the critical scrutiny and assessment of organic theories as related to violent behaviour has proceeded from the legal domain (Rice, Harris & Quinsey, 1990). Organic arguments have often been involved in legal applications in terms of assessing culpability of individuals committing murder and serial murder with the result that they are often viewed skeptically as attempts to exonerate such individuals and as such, divert the cause of justice (Litwack & Schlesinger, 1987). Such a context has resulted in research that has examined the thinking and feeling components of neurological functioning with the aim of establishing whether individuals who commit murder may “know” that their actions are wrong or immoral yet not feel the same way to support varying legal arguments.

Additionally, whereas aggression has largely been viewed as a biologically-based behaviour, violence is a social construction (Rivara, 2002). Much debate characterizes the literature with regards to defining and distinguishing these two concepts (Monahan, 1999; Rivara, 2002), however it would appear that whereas aggression refers to a biological factor present throughout the animal kingdom and related to ways of acting, violence is more man-made and dependent upon the consequences of an act of aggression, that is, involving

intentional harm to the object at which aggression is directed (Archer, 1994). Consequently, it may be argued that organic theories may be able to explain aggression, but necessitate an understanding of the social context, and relationship between actor/s and object/actor in order to explain acts of violence. Given that serial murder constitutes an act of violence, organic theories are limited in their ability to explain such a phenomenon independent of other violent acts.

Finally, organic theories frequently negate the possibility for rehabilitation of serial murderers or influence forms of rehabilitation that isolate an individual either physically or behaviourally (Vachss, 1993). These forms of rehabilitation are often accompanied by the neutralization of such an individual via medical technology either in the form of psychotropic drugs or psychosurgery. As a result, it remains to be seen whether rehabilitation of a serial murderer is a viable possibility.

3.2 PSYCHOLOGICAL THEORIES

Psychological theories that have been applied to the understanding and explanation of serial murder can be differentiated with respect to where they position themselves along a continuum of more intrapsychic or more interpersonal outlooks. Psychodynamic theories emphasise the intrapsychic and tend to focus upon phenomena that take place within the mind or psyche to explain human behaviour (Schwartz, 1999). These theories tend to place less emphasis on external factors in the person's context or environment. Interpersonal theories and cognitive psychology or behavioural theories tend to engage in less depth psychology, and rather place greater emphasis on the person's interaction with their environment or significant persons or elements within such an environment - that is, they appear to be more socially oriented. Psychological theories of serial murder will now be discussed with respect

to the psychodynamic position; the cognitive-behavioural and learning theory position; and then examine other psychological theories used to explain serial murder that do not fit into the above classifications.

3.2.1 Psychodynamic theories

As with organic theories above, psychodynamic theories focus on the individual in order to explain serial murder. Psychodynamic theories refer broadly to those theories that emphasise the unconscious as the primary element of intrapsychic processes together with elements such as conflicts and instinctual energies. These theories examine the interaction of these unconscious and conscious processes as they influence personality, behaviour and attitudes (Schwartz, 1999).

Psychoanalytic theories refer specifically to the theories of Sigmund Freud and fall within the broader category of psychodynamic theories. While maintaining an overarching emphasis on the role of the unconscious, psychoanalytic theory focuses more specifically on processes such as repression and concepts such as infantile sexuality and the psychosexual stages (oral, anal, phallic/oedipal and latency), resistance, transference and division of the psyche into the id, ego and superego (Harre & Lamb, 1983).

Within psychodynamic theory, serial murder is thought to be a reflection of the workings of inner drive processes and remnants of internalized developmental conflicts with significant care figures. Psychodynamic theories are considerably prevalent in theories exploring the psychological factors that influence serial murder (Douglas & Olshaker, 2000; Holmes & Holmes, 1996; Pistorius, 1996; Ressler et al., 1988; Ressler & Schachtman, 1992; Whitman & Akutagawa, 2003). These schools of thought have been thought to automatically lend themselves to explanations of serial murder by virtue of the fact that psychodynamics has

emphasized the role of both sexual and aggressive drives in its theoretical tenets and serial murder is frequently considered to have strong sexual and aggressive overtones.

Further, the concept of fantasy plays an important role in psychodynamic theories and serial murder (e.g. the oedipal complex). Due to emphasis on the role of fantasy and dysfunctional family in some theories (Holmes & DeBurger, 1988; Ressler *et al.*, 1988) of serial murder, and understandings of serial murder as a psychologically/internally motivated crime (as discussed in Chapter 2), psychodynamic theories with their emphasis on primary relationships and internal psychological fantasy life (Freud, 1966) appear well suited. These aspects will now be examined within a psychodynamic theoretical paradigm after a cursory note on the role of the dysfunctional family in theories of serial murder.

The role of the dysfunctional family in theories of crime has featured in both cognitive and social learning, and psychodynamic theories of serial murder (Douglas & Olshaker, 2000; Ressler *et al.*, 1988). The individual who commits serial murder is seen to have been affected developmentally by the dysfunction, which characterises his environment and so develops into an adult who repeatedly attempts to resolve such dysfunctional development or mimics the behaviour or conditioning such an environment has cultivated in him. Such an environment may consist of persistent abuse (physical, emotional or sexual) at the hands of caregivers or neglect. Lloyd (1995) found a link between violence and abuse in childhood, while Jehu (1991) found that up to 57% of sex offenders reported being sexually abused in childhood.

Supporting evidence for such theories in cases of serial murder is mixed however. Serial murderers such as Edward Gein and Albert DeSalvo in the United States, and Stewart Wilken in South Africa, report childhoods characterised by abuse and neglect (Lane & Gregg, 1992); however, individuals such as Jeffrey Dahmer and Ted Bundy in the United States, report happy childhoods (Lane & Gregg, 1992). As a result, references to the importance of the

dysfunctional family in the etiology of serial murder should be interpreted cautiously, especially as what constitutes dysfunctional has yet to be clearly specified.

- **The role of fantasy in psychodynamic theories of serial murder.**

The role of fantasy, specifically sexual and sadistic fantasy, has been postulated to play a strong role in serial murder, and serial sexual murder specifically (Claus & Lidberg, 1999; Myers, Burgess & Nelson, 1998). Psychodynamic perspectives have lent themselves easily to discussions of the role of fantasy in serial murder by virtue of their emphasis on internal processes, drives and sexual energy or libido (Smith, 1996), all of which can be used to explain different elements of fantasy.

Prentky, Burgess, Rokous, Lee, Hartman, Ressler and Douglas (1989) define fantasy as “an elaborated set of cognitions characterized by preoccupation anchored in emotion, and originating in daydreams” (p. 889). Johnson and Becker (1997) regard sexually sadistic fantasies to be indicators of future homicidal pathology and interviews with individuals who committed serial sexual murder in the USA by both Prentky et al. (1989) and Warren *et al.*, (1996) found violent sexual fantasies in at least 80% of the individuals interviewed.

The fantasy-based motivation model has further been supported by Burgess, Hartman, Ressler, Douglas and McCormack (1986) who found evidence for daydreaming and compulsive masturbation in 80% of their sample of 36 sexual murderers when this model was tested, as well as Prentky *et al.* (1989) who found a higher prevalence of fantasy as well as five paraphilias (compulsive masturbation, indecent exposure, voyeurism, fetishism and cross-dressing) in a sample of serial murderers when these were compared to a sample of single murderers. Similar models have been proposed by Norris (1988) as well as Abel and Blanchard (1974) who argue for social learning processes as pairing deviant fantasy with sexual arousal.

Burgess *et al.* (1986) developed a fantasy-based motivational model for serial sexual murder. This model consisted of five components, namely,

- impaired development of early attachments;
- formative traumatic events;
- patterned responses that serve to generate fantasies;
- private, internal world consumed by violent thoughts that leaves the person isolated and self-preoccupied; and
- a feedback filter that sustains repetitive thinking patterns.

Hazelwood and Warren (1995) elaborated upon the structure of sexual fantasy and also argued for five components, namely:

- relational (that is, involving a relationship between individuals);
- paraphilic (that is, involving some form of deviant sexual behaviour);
- situational (that is, taking place in a particular location);
- self-perceptual (that is, furthering the individual's sense of self in some manner);
- and
- demographic (that is, involving specific details about the other individuals involved such as age and/or race and/or gender).

Meloy (2000) argues that the manner in which a sexual fantasy is structured along the above lines, is useful in establishing the manner in which sexual murders will be carried out by a particular individual, as well as the types of victims that such an individual will search for.

This can be seen to have useful applicability for investigative operations in terms of guidance with regard to type of offender and victim. The fantasy may also be a useful guide in terms of gaining insight into developmental experiences of the offender that may have contributed to both the shaping of the fantasy as well as the serial murder behaviour.

The model of Burgess *et al.* (1986) above, is elaborated upon by Whitman and Akutagawa (2003) who detail the processes entailed in an acquired dependence upon fantasy in serial sexual murder. Whitman and Akutagawa (2003) argue that in the absence of secure attachment and affection from the primary caregiver, the individual concerned turns to fantasy as a pleasurable substitute. The emotional unavailability and distancing of the caregiver prevents the child from developing empathy for others as well as healthy means by which to channel and modify libido and aggression in appropriate manners (Money, 1990). The role of fantasy in serial sexual murder thus functions as a means of reducing the anxiety associated with rejection, or anticipated rejection, by significant others and a means of challenging libido and aggression that have remained relatively unmodified from their original, immature state (Whitman & Akutagawa, 2003) and a means of enacting power, domination, manipulation and control (Douglas & Olshaker, 2000; Holmes & Holmes, 1996).

Ressler *et al.* (1988) have attempted to explain how individuals move from fantasy to acts that attempt to fulfill their particular fantasies in reality. They argue that certain antecedent factors may provoke such a move. These include life stressors (such as loss of a job, end of a relationship), frame of mind (such as anger, hostility or frustration) and planning (such as details of where, and when the murder will occur) (Ressler *et al.*, 1988). Meloy (2000) states that an individual will also tend to act on the fantasy when the response tendency exceeds the intensity of the rehearsal fantasy, and a viable opportunity for such acting out is available.

Holmes and Holmes (1996) argue for a cyclical process with respect to the acting out of fantasy, both in terms of activity leading up to the first murder and then with respect to each subsequent murder. Initially, each attempt to begin to act out a fantasy (which may include voyeuristic activity, compulsive masturbation, or other paraphilic activity and rape) is thought to temporarily reduce anxiety or fulfill the particular fantasy of the individual concerned after which the cycle of frustration, subsequent and more detailed attempt and temporary

satisfaction gained thereby is repeated. Eventually, according to Holmes and Holmes (1996), a murder is committed, and the cycle continues with each subsequent murder an attempt to fulfill sadistic fantasy with greater accuracy.

To summarise, theorists who have emphasized the role of fantasy in serial murder appear to view fantasy as serving to empower the individual concerned in light of perceived abandonment or emotional neglect by the primary caregiver; traumatic experience; and subsequent anxiety in relation to these experiences (Burgess *et al.*, 1986; Hazelwood & Warren, 1995) as well as similar experiences in adulthood (Ressler *et al.*, 1988). Such a dependence upon fantasy appears also to be cyclical (Holmes & Holmes, 1996). As a result, interviewing the current and past girlfriends and wives of suspects in an investigation may yield considerable insights into the fantasies of that individual which can be used to further guide the investigation and interview potential suspects (Labuschagne, personal communication, 2004).

- **The role of primary attachments in psychodynamic theories of serial murder.**

Ressler *et al.* (1988) postulate that individuals who commit serial murder have ambivalent attitudes towards their mother as a result of mixed messages communicated towards the individual as a child and anger towards an absent or emotionally unavailable father. Whereas the above may be seen to draw more upon interpersonal than intrapsychic relations, Ressler *et al.*, (1988) describe the role of fantasy, namely that serial murder involves a continued, repetitive attempt to enact the fantasy in reality, echoes Freud's repetition compulsion to resolve points of fixation in development. Such fantasy, and its constituent elements, is thought to be derived from developmental experiences and significant figures that featured during such a period, and is largely a manifestation of introjected, intrapsychic dynamics.

The attachment theory of Anna Freud (1966) has been used by Ressler and Schachtman (1992) who postulate that individuals who commit serial murder have been deprived of love in their primary attachments with their mothers. Such relationships are thought to be characterized as uniformly cool, distant, unloving and neglectful with little physical contact or emotional warmth. As a result, the innate aggressive impulses and drives of such individuals are left unmodified and the capacity for empathy vastly diminished. This lack of an emotionally fulfilling, warm relationship with the primary caregiver is thought to explain the individual's use of auto-eroticism (in the absence of pleasurable physical contact with the mother) as well as withdrawal and dependence on fantasy as a pleasurable substitute to the absent attachment relationship.

Pistorius (1996), develops Ressler *et al.*'s (1988) and Ressler and Schachtman's (1992) theoretical arguments further, and holds that a major causal agent of serial murder is a fixation at one or more of the stages of psychosexual development. This fixation is seen to fuel and shape the fantasies that characterize later life. Due to the emotional poverty that characterizes the relationship with both parents, Pistorius (1996) argues that super-ego development is limited and consequently, the relatively unmediated division between conscious and unconscious encourages fantasy life. The lack of super-ego would also explain a lack of guilt or fear of perceived punishment on the part of the individual concerned. This, and the lack of mediation between conscious and unconscious is thought to be responsible for the lack of repression of primitive sexual and aggressive impulses which result in a fixation at latency, characterized by an inability to socialize, empathize and develop positive interpersonal relationships.

Whitman and Akutugawa (2003) argue that anxiety related to feelings of inner emptiness and impotence in the serial murderer persists into later development and adulthood. As a result, compulsive masturbation, paraphilias and fantasy are used to relieve such anxiety. It is

thought that serial murderers defend against such underlying anxiety with reaction formations that transform feelings of impotence into omnipotence. The emotional starvation that exists as a result of failed early attachments is postulated to leave an intense, chronic state of emotional hunger and rage that is only temporarily satisfied by each murder. Whitman and Akutugawa (2003) argue that the relative rarity of serial murderers is a result of mediating biological factors which act as necessary conditions for factors such as failed attachments to contribute fully to the development of a serial murderer.

As can be seen from the above work, the physical or emotional absence of the primary caregiver appears to be a significant factor in psychodynamic and attachment theory perspectives on the etiology of serial murder (Pistorius, 1996; Ressler *et al.*, 1988). Its significance appears to be particularly prominent in accounting for the considerable rage, violence and anger with which some of the murders are committed (Whitman & Akutugawa, 2003).

3.2.2 Critique of psychodynamic theories of serial murder

With regards to psychodynamic theories of serial murder, these are problematic for the following reasons. They are largely anecdotal in nature, focusing upon intensive case studies that lack valid generalisability (Schwartz, 1999). They are not falsifiable, by virtue of their grounded tautological argumentation with regard to psychosexual stages and personality structure (Cooper, 1996). They are also too broad in their characterization of the “causes” of serial murder, which appear to be explicable with reference to a fixation at any stage that can be seen to match offending behaviour patterns post hoc (Smith, 1996). This is not really helpful for case investigation or guidelines when searching for suspects.

As with organic theories, psychodynamic theories negate the possibility for rehabilitation of serial murder due to the expense and duration of psychoanalysis; the limited number of therapists willing to practice such a therapy in the context of prison; and the ingrained permanence that is attributed to the fixations postulated. Additionally, no explanation is provided of what happens to these drives when an individual is incarcerated. Many individuals who have committed serial murder have been found to function adequately within a prison system without any aggressive behaviour (Stephenson, 1992). Intrapsychic theories appear to ignore the influence of contextual factors that may mediate and alter the behaviour and coping ability of such individuals (Labuschagne, 2001).

Psychodynamic theories also place considerable emphasis on the role of fantasy. Although present in a proportion of serial murderers, fantasy does not always play a role in serial murder. This is notably the case with South African serial murderers, who seldom reflect the central role of fantasy in relation to their offences, and seldom report engaging with a rich fantasy life (Hodgskiss, 2002; Labuschagne, personal communication). Additionally, there appears to be a lack of attention to non-sexual serial murder and the role that fantasy does or does not play in such a series. As a result, the overriding impression from the international (predominantly law enforcement FBI arena) seems to be that serial murder and serial sexual murder are one and the same thing, and that consequently, all serial murder is sexual in nature, when in fact, individuals such as Leyton (2001) argue that serial murder is frequently more about class inequality.

With respect to the “dysfunctional family” and its role in serial murder, another significant problem is the many occurrences of cases in which individuals who have committed serial murder such as Ted Bundy and Jeffrey Dahmer in the USA, who have reported relatively normal childhoods with no instances of significant dysfunctional developmental milestones such as failed attachments (Masters, 1993). In the case of these

individuals, no biological anomalies have been found either, and as a result the “necessary condition” qualification of psychodynamic theories such as those discussed in Whitman and Akutagawa (2003), does not save these theories from their evident weakness in accounting for certain cases of serial murder.

With regards to the applicability of Pistorius’ (1996) theory to the South African context, her work can be critiqued in that it appears to take limited cognizance of particularly South African aspects of serial murder and seems to reinforce dominant Western paradigms, and is based on a very small sample.

Most of her analyses are also based upon anecdotal evidence and lack verifiable empirical proofs. She draws frequently upon the work of Robert Ressler and other FBI behavioural science individuals such as John Douglas to substantiate her theory. As discussed previously, it has been shown that the work of such individuals is based upon samples that differ considerably from South African cases (Hodgskiss, 2004). Psychodynamic theory may also be limited to the extent to which it may inform investigative applications due to the variability in the manner in which aspects of crime scene and criminal behaviour can be interpreted within such a paradigm, as discussed previously (Smith, 1996).

Pistorius (1996) has also been inconsistent with respect to her explanations of serial murder - on the one hand, being cited as claiming that cultural context is not important with regards to serial murder in the press and on the other, attributing the incidence of serial murder in South Africa to poverty, crime, violence and the disbanding of families (Pistorius, 1996).

3.2.3 Cognitive-behavioural and learning theory models

Whereas psychodynamic theories of serial murder appear to emphasise sexual and aggressive drives and internalized representations of relationships with primary caregivers, cognitive and behavioural schools emphasize thought patterns and observational learning as factors that contribute to the development of criminal behaviour (Moorey, 1996).

- **Learning theory.**

Learning theory argues that individuals model their behaviour on what they observe in their environment (Weiten, 1995). Following from this, it has been argued that criminals “learn” their behaviour as a result of observing such behaviour in their immediate environment at early developmental stages and adolescence. Bandura (1973) conducted some of the foundational studies on aggression and observational learning, in which he established the increased likelihood of observers learning aggressive behaviour when that behaviour was seen to result in positive consequences for the modeling agent. Consequently, if an individual grows up in a family where violence is used as a means of achieving goals and resolving conflict, he/she may learn to behave in similar ways later on in life. A similar argument could possibly be made for the development of deviant sexual behaviour, specifically with reference to families or developmental environments where sexual abuse may have taken place.

Dollard and Miller’s (1950) social learning theory has been interpreted as indicating that individuals are socialized to seek affection and approval from those whom they love (Wright & Hensley, 2003). When such an interaction is mutually fulfilling, the individual in question learns trust and empathy in relation to interpersonal relationships and social interactions. However, in situations where the individual in question’s need for approval is frustrated, and he/she is prevented from retaliating towards the aggravating individual, he/she may seek out

other persons, animals or objects upon which to vent their anger. Wright and Hensley (2003) have used such theories to explain serial murder and the potential graduation link from cruelty to animals in childhood to serial murder in adulthood. Their theory may explain how an individual goes on to commit violent acts towards others, but there is nothing that specifically links this outcome to serial murder behaviour.

Hale (1993) goes further than Wright and Hensley (2003) by arguing that it is only individuals who internalize humiliation as a motive that go on to commit serial murder. Using Hull (1943) and Spence's (1936) theories of discriminant learning, Hale (1993) argues that the ability to discriminate between similar situations and behave in a way appropriate to the situation in question is based upon the presence of a reinforcement or rewarding stimulus. Hale (1993) states that in early caregiving relationships of individuals who go on to commit serial murder, there is an absence of a rewarding stimulus. Consequently, individuals who commit serial murder are unable to discriminate between the original and subsequent perceived humiliating situations. In this way, the individual will displace the aggression and anger associated with the original humiliation in childhood, upon a new, weaker victim in the presence of a potentially humiliating situation. This approach may be critiqued by arguing that many individuals who witness similar interactions or relationships between others do not necessarily go on to commit serial murder. Additionally, this approach does not explain why individuals who commit serial murder go to the extent of murdering another individual as opposed to engaging in sadistic or humiliating behaviour patterns with others.

- **Cognitive-behavioural theories.**

Other salient factors in cognitive theories of crime and criminals include distorted thinking patterns or cognitions; deviant conditioning; and lack of empathy. Developing the argument for the role of cognitions and thought processes in crime and criminality, Yochelson and

Samenow (1976) claim that criminal thinking patterns are characterized by different reasoning ability and a greater degree of irresponsible and erroneous thinking. Such thinking develops as a result of faulty social learning which results in unrealistic perceptions of the world as an arena for self-indulgence, and an inability to recognize the rights of others or personal responsibility (Stephenson, 1992). This theory has been applied to the area of psychopathy (Finkenbauer & Kochis, 1984; Launay & Murray, 1989), specifically to the frequent tendency towards rationalization of criminal behaviour evidenced in psychopathic behaviour. This could also be used to explain the traits of neutralization and compartmentalization discussed previously in relation to serial murder.

Cognitive-behavioural theories and interventions have been used specifically in relation to sex offenders (Jehu, 1991), who are understood as manifesting dysfunctional thinking patterns; deviant arousal and conditioning; lack of empathy; poor self-esteem; as well as overwhelming shame and guilt. The literature on serial murder does not seem to document any attempts to use similar interventions with individuals who have committed serial murder. It would be interesting to see if such interventions could be applied successfully and a deeper exploration of such thinking patterns in the individuals concerned, given previous arguments with regard to the frequently sexual nature of serial murder (Geberth, 1998; Holmes & DeBurger, 1988).

- **Rational choice models.**

Extending the cognitive argument that emphasizes the role of thought processes in governing criminal behaviour, is the rational choice model of crime. Rational choice theories of crime argue that the decision to commit a crime is subject to the same processes of reasoning that characterize non-criminal human behaviour (Stephenson, 1992). Tuck and Riley (1986) applied Ajzen and Madden's (1986) Theory of Reasoned Action to explain criminal

behaviour as the product of beliefs about the consequences of behaving in a particular way and evaluation of those consequences. Consequently, a decision to behave in a criminal manner is based upon attitudes towards the crime in question and evaluation of the pros and cons of behaving in that particular way. If the pros outweigh the cons, the crime is committed.

A rational choice to commit a crime involves an evaluation consisting of beliefs about the outcome of the crime; normative beliefs or attitudes and individual motivation to comply with such norms; and beliefs about resources and opportunities available (Ajzen & Madden, 1986). Once again, the literature on serial murder does not appear to document any attempts to explain serial murder as the product of rational choices on the part of the individual concerned. It would seem that any such attempt would still have to explain the deviant nature of the behaviour in question and questions of etiology. However, it may well be that planning of the murders in question operates along rational choice lines.

- **An addiction model of serial murder.**

Another variation on the cognitive-behavioural model of crime is one that argues that criminal behaviour may operate as a form of addiction. Pomerleau and Pomerleau (1988) defines addiction in the following way, namely, as

the repeated use of a substance/ or a compelling involvement in behavior that directly or indirectly modifies the internal milieu (as indicated by changes in neurochemical and neuronal activity) in such a way as to produce immediate reinforcement, but whose long-term effects are personally or medically harmful or highly disadvantageous to society. (p. 345).

Anderson (1994) holds that serial murder can be seen as an addiction to murder by virtue of the fact that the individual is driven to murder by an intrusive fantasy life. The act of

murdering temporarily (but incompletely) satisfies the fantasy with the result that the drive regenerates and eventually results in another murder. Shaped by a dysfunctional childhood and faulty learning, Anderson (1994) believes that the individual who commits serial murder develops fantasy as a coping mechanism. As a consequence, in times of stress in later life, fantasy is called upon in order to deal with such stress.

The murder component, for Anderson (1994), constitutes a related effect required to fuel the richness and power of the fantasy life. An addiction model of serial murder would seem appropriate in terms of capturing the apparent compulsive element that characterizes some instances of serial murder. However, Anderson's (1994) theory does not seem adequately supported in terms of establishing that murders occur in the service of fantasy. Given previous discussions, it would seem that stronger support is provided for the act of murder as the central component of serial murder (Harbort & Mokros, 2001; Holmes & Holmes, 1996), and that, rather, this is the addictive element. Additionally, the addictive element in the form of the act of murder appears to disappear once these individuals are incarcerated. This theory does not account for how this is transformed or what happens to the individual's need or dependency on the act of murder once he/she is in prison.

3.2.4 Critique of cognitive-behavioural and learning theory models of serial murder

Cognitive-behavioural theories of serial murder appear to hold considerable promise with regard to the potential for viable interventions and rehabilitation that they offer. Cognitive Behavioural Therapy (CBT) has demonstrated considerable effectiveness with sex offenders (Jehu, 1991) and is generally more cost-effective and efficient than psychodynamic alternatives (Moorey, 1996). Cognitive-behavioural and learning theories also potentially

provide more tangible, empirically testable elements (such as thought processes and behaviour) than psychodynamic theories (such as parental introjects) (Barkham, 1996).

As with theories of serial murder across the theoretical spectrum however, cognitive-behavioural and learning theories of serial murder are plagued by exceptions and inconsistencies. For example, social learning theory approaches to serial murder may be challenged by examples of individuals who report growing up in relatively healthy family backgrounds such as Jeffrey Dahmer (Lane & Gregg, 1992) or Ted Bundy (Leyton, 2001) and observational learning can be challenged by examples of individuals who have grown up in environments or families modeling violence as a means to achieve goals and who have not gone on to commit serial murder, or any other violent crime.

An example may be the sibling of an individual who has committed serial murder, such as Albert De Salvo who had sisters that did not go on to commit serial murder despite growing up amidst considerable physical abuse by their father. Theorists such as Wright and Hensley (2003), while providing useful and plausible theories of serial murder, are also weakened in the same way as some psychodynamic theories (such as Ressler *et al.*, 1988) by virtue of their use of anecdotal case studies and popular source material such as true crime novels.

3.2.5 Other theories emphasizing psychological factors

The discussion of serial murder will now review other theories that have attempted to explain the phenomenon with reference to psychological factors in a broader sense, with postulates derived from various paradigmatic orientations and blended in the theoretical explanations.

Ressler *et al.*'s (1988) theory of serial murder (specifically serial sexual murder) incorporates the family context; substance abuse; structural factors such as the community

and education system; and interpersonal skills. They argue that social bonding is affected in the development of serial murder due to the stifling of the formation of close contact or bonds within the family. The individual concerned is consequently limited in terms of his ability to form close bonds with individuals outside of the family. This may occur as a result of neglect on the part of the parents or as a result of the rationalization or normalization of unacceptable behaviour by parents or caregivers. Substance abuse within the family, as well as criminality and psychopathology in the family, may further contribute to the development of deviant behaviour patterns in the individual who will go on to commit serial murder.

Ressler *et al.* (1988) additionally postulate that there may be emotional, physical or sexual abuse present, resulting in distress which is ignored by the parents and consequently results in the individual concerned being desensitized, lacking the ability to empathise or display positive affect and forming negative interpersonal relationships. According to Ressler and Schachtman (1992):

In a situation where you find a distant mother, an absent or abusive father and siblings, a non-intervening school system, an ineffective social services system, and an inability of the person to relate sexually in a normal way to others, you have almost a formula for producing a deviant [not necessarily murderous] personality (p. 93).

Turvey (1998) incorporates the familial context; relationships with primary caregivers; and community or social intervention. According to him, there may be prevalent criminality, substance abuse and emotional abuse within families of individuals who commit of serial murder. He holds that in these individuals, the first formative years (birth to age six or seven) may be characterized by poor relationships with primary caregivers that lack warmth and love and demonstrate poor supervision. As a result the individual in question may lack empathy and display an abundant egocentricity in relation to the rest of the world.

Turvey (1998) holds that individuals who grow up in such conditions and do not go on to commit serial murder may receive some form of intervention in preadolescence. This may involve nurturing peer relationships or relationship with another significant adult or intervention by social services and removal from the household. In the absence of any intervention, the dysfunctional behaviour of pre-adolescence is thought to be consolidated. Adolescence may reflect some acting out and antisocial tendencies such as substance abuses and fire starting and the commencement of a criminal record.

As a result of poor interpersonal skills, the individual experiences considerable social isolation, cultivating a greater dependency upon fantasy and exclusively auto-erotic sexual experimentation – in Turvey's (1998) study, 79% of serial murderers engaged in compulsive masturbation, 72% voyeurism, 81% pornography and 72% fetishism. Turvey (1998) holds that there is possibility for further intervention during adolescence at the level of the school or social services that may encounter the individual concerned in relation to more minor offences.

Holmes and Holmes' (1996) theory of serial murder may also be seen as adopting an interactionist stance by virtue of its seeming blending of cognitive and psychodynamic psychological components. For these theorists, serial murder is a result of an individual trapped in a pattern of five cyclical phases. The first stage consists of distorted thinking patterns, which sees the individual, concerned overly aware of intrinsic or extrinsic rewards at the expense of an awareness of the consequences of his actions. The second stage is called "the fall" and involves a reality challenge to the ideals of the individual concerned by a real or imagined event. Such a reaction or experience leads on to the third stage where there is a negative inward response that necessitates a need to validate self status in the form of stage four or the negative external response (which frequently involves murder). Following this, potential dangerous consequences are realized which necessitates restoration or steps to

minimize personal risk. The cycle builds up again to the first stage as a result of fantasy and other possible intrapsychic mechanisms such as internalized primary relationships, or possible paraphilic traits.

Labuschagne (2001) adopted a systemic interactional approach to investigate serial murder. He described such an approach as attempting to investigate serial murder in as much as it is situated as part of a relationship between persons and manifests as part of the manner in which an individual interacts with his/her context. Interviews were conducted with two individuals incarcerated for serial murder and were supplemented with psychometric measures such as the Thematic Apperception Test (TAT).

Labuschagne's (2001) findings were that, within an interactional paradigm, serial murder may signify a communication or act against something. Further work by Labuschagne (2001) found that serial murder may be symptomatic of larger dysfunction in South African society. He stated that an increase in crime coupled with low effectiveness of government services equipped to deal with such a phenomenon may have resulted in a change in the social ecosystem which results in a mutation or new phenomenon, namely, serial murder. Within such an interactional perspective serial murder may be seen as a negative symptom possibly maintained by the system due to a perceived secondary gain. Labuschagne (2000b) acknowledged the limitation of his small sample of individuals and recommended research based on a larger sample as well as acknowledging the need for more work from a social constructivist perspective to supplement the existing research base.

Labuschagne's (2001) work is advantageous in that it takes the local South African socio-cultural system replete with its particular historical features into account and consequently, lays a more locally-specific platform from which to develop South African understandings and involved interviews with incarcerated serial murderers in South African prisons. The perspective adopted, namely an interactional approach, provides a novel way at understanding

serial murder, and would appear to be particularly advantageous in that it affords an opportunity to examine the manner in which an individual who commits serial murder might interact with other individuals, as well as his/her context, as well as the socio-cultural significance of serial murder as an act against something at a broader systemic level (Labuschagne, 2001). This may have possible applications for rehabilitation.

Hodgskiss (2001) conducted research on the offence behaviours of South African serial murderers for his Masters dissertation, also by interviewing incarcerated offenders. To this end, he attempted to create a multivariate model of serial murder offence characteristics in South Africa, using the technique of Multi-Dimensional Scaling (MDS) and Small Space Analysis (SSA), evidenced greatly in the work of David Canter at the University of Liverpool in the service of geographical profiling. Hodgskiss (2001) work would appear to be particularly useful in that it seems to be one of the first South African studies that draws specific attention to differences between South African serial murder and serial murder as it exists in the available literature. These differences will now be examined more closely.

Hodgskiss (2001) found the following differences in terms of developmental and psychiatric factors: an absence of the following: catathymia; cruelty to animals; violent fantasies and history of child conduct disorder; and Macdonald's behavioural triad (1961) components such as bed-wetting, fire-setting and as above, cruelty to animals in South African cases. Hodgskiss (2001) also found that the role of fantasy in instances of South African serial murder was considerably reduced, as well as the correlation between the content of fantasy and details of offences.

Hodgskiss (2003) additionally argues that due to the nature of the South African context and socio-economic composition, factors incorporated into international typologies like the Disorganised/Organised typology (Holmes and Holmes, 1996) such as vehicle ownership, level of education and employment history are of little use. Local offenders are more likely to

make use of public transport systems and educational requirements and desirable levels of attainment will differ; as well as types and profile of employment levels and opportunities in the country (Hodgskiss, 2003).

Hodgskiss (2001) also found differences with respect to ethnicity and age characteristics of offenders and their victims, as well as duration of serial murder cases. Ethnically, many US studies (Holmes & DeBurger, 1988; Ressler & Shachtman, 1992) have stated that serial murderers will choose victims from within their own ethnic group – in South Africa, five out of eight white offenders interviewed by Hodgskiss (2002) chose victims of a different ethnicity. Reasons for this are postulated to be more about victim availability than politics. In South Africa, the lower socio-economic grouping is comprised mainly of black individuals and this group is more available as potential victims of serial murder.

The USA sample of individuals who have committed serial murder consists of a dominant profile of white males between the ages of 25 and 34, with cases varying in duration from less than 1 year to 37 years (Gorby, 2000; Holmes & Holmes, 1996) contrasts sharply with a predominantly black male South African sample varying in age from 16 to 54 years of age, with cases varying from less than 1 year to 5 years (Hodgskiss, 2003).

In terms of offence characteristics, South African serial murder shows a greater degree of heterogeneity - murder is largely the central focus of the offence, and the victim, in most cases, is depersonalized and treated as object (Hodgskiss, 2002). In these terms, one could say that South African serial murder is predominantly act-focused, if interpreted with respect to the Holmes and DeBurger (1988) distinction.

South African offences also seem to be less sexually driven than postulated for international serial murder, and more about total control as the driving motivation with little attempt at interpersonal relationship development before the offence (Hodgskiss, 2001).

External events prior to offence also appear to play a large role in influencing offence characteristics during the offence.

In terms of offender characteristics, developmental and psychiatric factors in common between South African and international findings included mood disorders, anxiety, substance abuse, chronic interpersonal isolation, lack of sexual abuse, psychotic features but not serious enough to constitute psychotic disorder, paranoid and schizoid traits (Labuschagne, 2001).

In light of Hodgskiss' (2001) work, the validity of applying international research uncritically to the local context is evidently compromised and seems to necessitate a greater impetus on locally oriented research in order to aid the development of South African understandings of serial murder and investigative initiatives based thereon. Hodgskiss' (2001) research also appears to be particularly useful to investigative applications by virtue of its focus on offence and offender characteristics in South African cases of serial murder.

His research can be critiqued however in that it uses a methodology, namely Small Space Analysis (SSA) that may be interpreted in a number of different ways, each with equitable validity and support if provided (Wilson, 2000). In this way, his findings may be viewed as one of a number of ways in which the data on offence characteristics in South Africa can be interpreted. In order to consolidate Hodgskiss' (2001) findings, replication of the study would be advisable. This appears to be of even greater saliency given the lack of similar studies on serial murder in South Africa, which may provide confirmatory or supportive findings. As with Labuschagne's (1998, 2001) work, Hodgskiss' (2001) sample is small, consisting of interviews with thirteen individuals and archival data such as casefiles, and hence, generalization to South African serial murder as a whole, is limited.

3.2.6 Critique of other theories emphasizing psychological factors

The above theories may be challenged by examples of siblings of such individuals who have been raised in the same environment and not become serial murderers. In these cases, response to criticism often sparks reference to biological theories that are used to supplement such explanations.

With regard to theories or models such as that of Ressler *et al.* (1988), data on which their study was based was derived exclusively from self-report information from individuals incarcerated for sexual murder, who were prepared to participate in the study. Consequently, their model is only applicable to a limited sample of individuals who have committed and been apprehended for serial murder, neglecting those still at large or never detected. Additionally, this data may be subject to possible social desirability effects, which refer to when respondents attempt to answer in a manner that portrays them in a more favourable light or in accordance with how they assume society expects them to behave. Turvey's (1998) theory is more helpful in as much as it provides tangible entry points for possible interventions to proactively assist individuals who potentially may go on to commit more serious violent offences.

The above theories appear to hold the greatest promise with regard to their greater holistic interpretation of etiological factors in serial murder. In this way, the theories avoid reductionism and provide numerous points that could be targeted both in proactive prevention of serial murder and offender rehabilitation. Criticism, however, can be leveled at the etiological model that is applied (in much the same way as with intrapsychic and organic theories). There is an implicit assumption that serial murder is a condition, pathology or illness at an individual or social level, whereas it may be the case that it is a variation on general criminal behaviour patterns such as envisioned by economic models of crime (Stephenson, 1992).

3.3 SOCIO-CULTURAL THEORIES

Theories of crime frequently make reference to the socio-cultural context to explain its form and etiology. It is argued that the nature of criminal activity frequently reflects core tenets of the cultural and social networks in which it takes place, and is a manifestation of the dominant trends, values and philosophies of the time and place in which it occurs. Serial murder has not been immune to theoretical exploration with reference to socio-cultural developments, and such discussion will now be detailed, commencing with a general overview of criminological theory of deviance and progressing to more specific application of these theoretical positions.

3.3.1 Sociological and criminological schools and crime

Durkheim's (1897/1952) theory of *anomie* has often been used to account for criminal behaviour especially with respect to societies in transition. *Anomie* refers to a state where norms or expectations on behaviours are confused, unclear or absent. Durkheim (1897/1952) held that this state is particularly prevalent in societies that are undergoing or have undergone a transition period in which the norms and values are re-evaluated and assessed. For him, deviance could be explained with reference to states of *anomie*, where restrictions imposed by clearly defined norms are relaxed as a result of norm confusion. This theoretical position argues that crime or the criminal is a necessary component of society in terms of its role as an indicator of loosening social bonds and dilution of value systems.

According to Durkheim (1897/1952), the sophistication of a society is dictated by the degree to which its individual members are interdependent, although individually specialized. Morality is a means by which such interdependence is celebrated. During times in which there are great transitions in a relatively short space of time, “old ideals and the divinities which incarnate them are dying because they no longer respond sufficiently to the new aspirations of our days, and the new ideals which are necessary to orient our life are not yet born” (p. 47).

With South Africa having undergone significant political changes in the course of the last decade, this theoretical position has great potential for understanding crime in a South African context, specifically with regard to South Africa’s considerable increment in violent crime post-1994. Labuschagne (in Hodgskiss, 2004) argues that the increased diversity and broadening of parameters that occurred around 1994 may have contributed towards an increase in serial murder as part of a greater susceptibility to crime in general in society, together with a sense of anonymity created by ineffectiveness of government services to manage crime problems. Understandings of the place of serial murder within such a transition, and as a possible indicator of loosened societal norms and bonds, may provide insights into the character and nature of South Africa’s *anomie*, and possibly indicate which aspects of social cohesiveness require reinforcement.

Merton’s Strain Theory (1968) has also been made use of to explain crime as one of the ways tension between society and the individual is manifested. Strain Theory argues that the real problem is not created by a sudden social change, as Durkheim (1897) proposed, but rather by a social structure that holds out the same goals to all its members without giving them equal means to achieve them. It is this lack of integration between what the culture calls for and what the structure permits that causes deviant behaviour. Deviance then is a symptom of the social structure. With respect to serial murder, strain theory has not been used specifically to explain such a phenomenon. However Myers, Raccoppa, Burton and McElroy

(1993) found that a predisposition to resort to illegitimate means to obtain social goals was confirmed in 60 percent of serial murderers having previous criminal convictions. Despite such findings, it would appear that a relationship between serial murder and social opportunity or “strain” is spurious and may be influenced by a number of other factors such as individual characteristics of the person concerned.

In South Africa, changes in the political leadership and culture of the country ushered in a democratic era with the promise of many new opportunities for previously disadvantaged groups. Over the last decade, however, many of these opportunities remain out of reach for the majority of the population, and consequently, Strain Theory may be one way of explaining the apparent increase in general crime this country has experienced. However, this theory does not explain why certain types of criminal activity or deviance occur more frequently than others and hence, cannot really provide further insight into the relatively recent proliferation of serial murder.

The Chicago School of Criminology (Park, Burgess & McKenzie, 1925) has also lent considerable impetus to the development of understandings of crime and the criminal. It holds that structural and social factors are important in understanding crime and deviance, and focuses upon the surrounding community or ecology to explain the causes and form of criminal behaviour (Holmes & Holmes, 1996). Humans are viewed as social creatures and their behaviour as a product of their social environment. This environment provides values and definitions that govern behaviour. Frequently, urbanisation and industrialisation break down older and more cohesive patterns of values, thus creating communities with competing norms and value systems.

The breakdown of urban life results in basic institutions such as the family, friendships and other social groups becoming impersonal and almost anonymous. As values became fragmented, opposing definitions about proper behaviour arise and come into conflict with

other behaviour. Given South Africa's extensive history of migrant labour and generally high population mobility between and within urban areas, effects of urbanization and traditional value fragmentation could very well be causal factors in relation to South African crime. Once again, as with the above theory of crime, there is little scope for understanding the prevalence of certain types of crime such as serial murder.

Sutherland's (1937) theory of differential association asserts that criminal behaviour is learned in primary group relationships as opposed to secondary sources such as television and the press. Mitchell (1997) has attempted to apply this to serial murder by arguing that many offenders are incarcerated prior to their first murder, and may learn techniques and formally conceptualise their plans in prison stays. Holmes and Holmes (1996) have stated in this regard, features of *modus operandi* such as the application of duct tape as a restraining technique may be learnt in prisons. While such a theory may explain how certain elements involved in committing a crime may develop, it does not seem able to convincingly argue that differential association causes serial murder.

- **Socio-cultural theories focusing specifically upon serial murder.**

The following arguments are grounded in one or a combination of the above socio-cultural theories, but have focused specifically on serial murder. Reinhardt (1962) argues that individuals who commit serial murder lack a workable system of social or personal frames of reference due to never having experienced normal communication with a dependable, understanding part of the social world around them. Hazelwood and Douglas (1980) support such a view by arguing that a lack of socialization in the midst of a climate of conflict and neglect results in a lack of available positive ways of coping developing in the individual concerned.

While lack of socialization may explain some aspects of serial murder, particularly antisocial or psychopathic traits, it would appear to fail to explain causation of serial murder completely. As mentioned previously with respect to the dysfunctional family, a number of individuals grow up in similar environments and do not go on to commit serial murder (Mitchell, 1997). The above observations have also not been tested against suitable control groups and, just as discussed with regards to the dysfunctional family, it would seem that biological and personality factors may also play a part in the development of such individuals.

Wilson (2000) argues that the nature of prevalent crime or developments in the nature of criminal activity is frequently indicative of the cultural development of a society. He states that an increase in sex crime in the 1900's actually reflected a general improvement in the conditions of society that freed up a greater proportion of the population from concerns of work. The Industrial Revolution changed the nature of "work" or work activity so as to free up more leisure time. Within a Maslowian paradigm (Maslow, 1954), an increase in leisure time and relative security of the work proportion of one's life, meant that crime evolved to focus on intimacy and sex or love as opposed to previously focusing upon subsistence.

As views towards sexuality have become less conservative over the progression of the twentieth century, crimes have developed and centred more on resentment and a desire for recognition or acknowledgement than sex, progressing according to Maslow's next level of hierarchy. Serial murder, for Wilson (2000), constitutes a combination of a need for recognition together with sexual desire or need for intimacy and a deviant attempt via which to secure these ends in contrast to the more conventional means that usually characterize this level of development.

Marsh (1999) supports the Durkheimian view with respect to societies in transition, which he believes are more vulnerable to crime in general and serial murder due to the fact that they often involve a decay of social support structures resulting in a lack of healthy outlets for

success. Social messages advocating the importance and desirability of success continue however with the result that individuals seek such power by any other means, namely deviant ones, in line with Merton's Strain Theory (1968).

Tannahill (1992) also supports this by arguing that the sexual revolution of the 1960's resulted in complacency towards sex that inspired a desire for difference and ability to shock that encouraged more deviant sexuality. This coupled with desensitization to violence in the general media, and the representation of the individual who commits serial murder as quasi-celebrity in popular sources may have contributed to a cultural milieu that accommodated the serial murder phenomenon.

In this light, Gresswell and Hollin (1994) argue that the initial motivation for serial murder may be superseded by the need to generate and maintain public interest. Ressler *et al.* (1988) found that a proportion of their sample of individuals convicted of serial murder followed their crimes in the media, as a means to increase post-offence excitement.

Mitchell (1997) argues that the large amount of public and media interest surrounding serial murder serves to glorify it, and he believes that these frequently contribute towards copycat murders such as with Jack the Ripper, where newspaper coverage of the crimes is thought to have resulted in similar crimes being committed by another individual. Theories that emphasise the role of the media may explain part of the motivation for serial murder, particularly for individuals who may enjoy the attention. However, such theories still fail to reveal what the initial motivation consists of, or why many more people who are exposed to serial murder in the media and press do not go on to commit such offences.

Leyton (2001) argues that multiple murderers are "very much products of their time", their arrival "dictated by specific stresses and alterations in the human community" (*ibid.*) - "he is in many senses an embodiment of the central themes in his civilization as well as a reflection of that civilization's critical tensions" (p. 258). Leyton (2001) consequently divides

multiple murderers according to periods pre- and post-Industrial Revolution, much like Wilson (2000), in terms of their particular characteristics as well as those of their victims. He argues that the pre-Industrial Revolution multiple (or serial) murderer was an aristocrat who preyed on peasants while during the Industrial Revolution, the multiple (or serial) murderer was a new bourgeois who preyed upon prostitutes, homeless boys and housemaids. In the post-Industrial Revolution era, the murderer is more than likely a faded bourgeois who stalks middle class figures such as university women.

It seems that Leyton (2001) is postulating that individuals reflect the general issues of crisis affecting their class in their offences. One must wonder why multiple murder and not, say, theft would reflect this and Leyton (2001) does not provide answers to these questions. Additionally, despite their development within a post-Industrial Revolution era, many individuals who commit serial murder, such as Peter Sutcliffe in the United Kingdom, selected prostitutes as victims.

Similar to Leyton (2001), Ratner (1996) argues that serial murder represents an ideological leakage, in the sense that serial murder constitutes a rupture in the ideological status quo of society. Operating on the assumption that the early environment of individuals who commit serial murder involves a lack of adequate socialization, Ratner (1996) claims that such individuals lack ideological controls.

At a broader societal level, consequently, serial murder represents a means by which to homeostatically return society to a state in which conservative ideology is more firmly established. This would appear to apply aptly to the South African context, given that serial murder seemed to emerge at a time of great social upheaval and ideological uncertainty. However, this argument would seem to represent serial murder in a light that potentially frames it as a social necessity in times of uncertainty, with the individual who commits serial murder potentially framed as a martyr-like sacrifice for the benefit of society. As a result, this

argument would always border on potentially condoning serial murder, which one would think is not acceptable. Additionally, as with Leyton (2001) above, there is no justification as to why serial murder in particular assumes this social role.

3.3.2 Seltzer's theory of serial murder and wound culture

Seltzer (1998) sees serial murder as an artefact of a public wound culture of “addictive violence” (p. 1) characterized by public fascination with the wound or open body. The serial murderer as one aspect of such a culture forms one of many representations of a crossing point of private desire and public fantasy. For Seltzer (1998) the wound in the twentieth century, has become a fashion accessory, and hence one who inflicts the wound (and thereby displays his own) becomes fashionable especially with respect to the serial murderer who does so on such a grand scale.

Senseless murder, however, additionally represents the area where our basic senses of body and society, identity and desire, violence and intimacy are secured and brought to crisis. Seltzer (1998) believes that sex crime in particular elicits a postmodern fluidity between public and private spaces and identities, and as such, the individual who commits serial murder becomes iconic to the twentieth century and its postmodernism by tapping such a fluidity, specifically with regards to perception and identity. He also argues that as part of the growing culture of information, numerical data, repetition, number counts – the individual who commits serial murder conforms to such a culture by virtue of the seriality of his particular crime.

During the nineteenth century, Seltzer (1998) argues there was a cultural shift in ways of looking at crime and sexuality from the nature of the act, to the character of the actor. It is in the midst and intersection of such a shift, that the serial murder typology was created. He

identifies the following factors as contributing towards the creation of the serial murderer, namely:

- a pathological public sphere characterized by stranger-intimacy,
- an intricate rapport between murder and machine culture (enumeration, statistics, graphomanias, recording) and
- the mass in person as characterizing the form of the person who commits serial murder.

Seltzer's (1998) account may be a bit relativist but is a very competent post-modern, constructivist view of serial murder, which sees it as a phenomenon of the transformed 1800-present cultural milieu as opposed to an entity existing of its own accord.

3.3.3 Cameron and Frazer's social constructionist theory of serial murder

Cameron and Frazer (1987) see serial murder as a result of a number of historical, popular and cultural strands that have woven together to create the phenomenon concerned. The sex murderer of the late 19th and early 20th century was framed in either two ways, namely, either as someone outwardly repulsive or monstrous; or as a Jekyll/Hyde master of dual identity - one socially acceptable, the other deviant. Such an individual grew in the fascination of the public via the increasing attention paid to crime in broadside publications and true crime magazines. The voyeuristic public fascination with crime and the criminal is thought to have been coupled with a Gothic genre that encouraged a fascination with evil and terror as well as sex and death. Individuals such as the Marquis de Sade depicted the sadist as a rebel and martyr, challenging accepted convention and unrecognized by a repressed and ignorant society.

This followed the philosophical trend epitomized by existentialism that saw murder as the ultimate manner in which true essence and freedom could be embraced by one's liberation from the laws of both man and God. The third strand involved the development of a clinical model of the sexual deviant in the newly created disciplines of criminology and psychology as well as more established fields such as medicine.

Within such a model attempts were made to locate the source of the pathology or the pathology itself, which was causally linked to deviant sexual behaviour. Cameron and Frazer (1987) claim that these three strands cemented the sex murderer as a phenomenon of social awareness, public fascination and professional preoccupation, and can be seen to have laid the foundations for ideas surrounding modern day serial murder.

3.3.4 Holmes and DeBurger's socio-cultural interactionist approach to serial murder

Holmes and DeBurger (1988) argue that "violence-associated learning" (p. 43) plays a part in influencing the development of inclinations toward serial murder. The first source of such learning is to be found in a continuous culture of violence coupled with a continually changing relationship of the individual to his environment. With reference to American culture, they believe that the following factors are responsible for an increase and perpetuation of violence, namely – normalizing of interpersonal violence; emphasis on personal comfort; emphasis on thrills; extensive violence; magical thinking; unmotivated hostility and blaming of others; normalizing of impulsiveness; violent role models; anonymity and depersonalisation in overcrowded areas; extensive and accelerating spacious geographic mobility; and emphasis on immediate gratification of needs.

The second source involves patterns of interaction between the individual and their immediate family. Such a theory explains how serial murder is accommodated, promoted or

nurtured by the socio-cultural milieu but seems to depend on family dysfunction to explain how it may manifest itself in the individual.

Leibman (1989) elaborated upon the second source of violence by suggesting five factors that may characterize the dysfunctional family context. These include:

- a childhood marked by cruel and violent patterns;
- rejection by parents;
- rejection by a member of the opposite sex during adulthood;
- confrontation with the law during adulthood; and
- admittance to psychiatric hospitals.

The final factor may be more effect than cause though (as may the other factors). Leibman's (1989) study had a very limited sample however – four case studies – and there will be many cases of serial murder which can be shown to have none of these developmental factors as well as many individuals who have been subjected to similar childhood backgrounds and not committed serial murder.

3.3.5 Jenkins' social constructivist theory of serial murder

Jenkins (1994) has explored the social construction of serial murder and debates the functions that such a construction may serve in contemporary society. He argues that serial murder as a socially constructivist phenomenon emerged at a time in American history, namely the early 1980's, where there was a need to reinforce conservatism and social control after the liberalism and freedom of the 1960's and 1970's.

Jenkins (1994) argues that the serial murderer has been constructed as an individual who exercised no control over aggressive and sexual impulses and demonstrated no respect for criminal law or social convention. He also believes that the serial murderer has

simultaneously been constructed as extremely dangerous, evil and/or mentally disturbed. These two portrayals of the serial murderer, in turn, are thought to construct the serial murder as needing to be contained, thereby prescriptively reflecting the consequences of transgressing conservatism and societal norms and reinforcing agencies of law and order within such a society, such as the FBI, and conservative values. Jenkins (1994) argues that newspapers and the popular media served as vehicles through which such constructions were communicated and further elaborated so that the concept of serial murder developed through the interaction of the ostensible reality of criminal justice and popular culture.

3.3.6 Simpson and the popular representation of serial murder

Simpson (1999) describes serial murderers as immortal and profitable cultural icons that answer a human need to personify free-floating fears aggravated by the indeterminacy of the postmodern world. Adopting a strategy similar to that of Jenkins (1994) above, Simpson (1999) argues that serial murder encodes cultural phobias in terms of its victim selection and characterization. Simultaneously to the revulsion with which he/she is regarded, the individual who commits serial murder is also paradoxically elevated to hero status due to his/her ability to transcend societal norms.

Simpson (1999) supports Jenkins (1994) by arguing that the construction of serial murder serves to maintain the societal status quo and patriarchal dominance by diverting attention away from more pressing “evils” such as social or government policy, that actually affect a wider group of persons. Simpson (1999) analyzes the construction of serial murder in popular fiction and isolates the following dominant themes, namely, the coupling of murderous impulse and creative urge; the serial murderer as superb game player; the serial murderer as masculine hero; and the serial murderer as demonic messenger or punisher. He believes that

there is a significant interaction between constructions of serial murder in fiction and general perceptions of serial murder in the public domain.

3.3.7 Feminist theories of serial murder

Serial murder has invited considerable analysis and commentary from feminist theorists. This may be attributed to the overwhelming majority of male perpetrators and female victims that constitute the American, English and South African profiles of serial murder. As a result, serial murder has come to be viewed as a manner in which patriarchal dominance is reinforced and female subjugation ensured. These theories will now be examined in further detail.

Caputi (1992) views the serial murderer as one of many patriarchal agents responsible for enforcing female submission. Serial murder symbolizes an extreme patriarchal measure required increasingly as a result of the comparative increase in freedom and opportunities for women that threaten the dominant power imbalances. Caputi (1992) argues from a feminist perspective that the origins of violence against women, and consequently most serial murder, lie in systems of gender inequity – “they're actually performing a cultural function in enforcing misogyny in showing that women are prey, etc. and acting out masculinity in totally dominating the feminine” (p. 45). Serial murderers perform a cultural function in terms by disciplining women and reinforcing their subjugation via fear and behavioural inhibition.

Feminist views such as these have been extended by authors such as Cameron and Frazer (1987) in relation to serial murder. They hold that, other than feminist perspectives, all other theories of serial murder fail to address the question of gender directly. Victims of serial murder remain mostly female while the perpetrators of serial murder are increasingly male. Serial murder generally therefore constitutes violence against women with male sexuality

within such an act constructed as aggressive and predatory requiring unlimited access to the female.

The female consequently has to police her own sexuality to guard against potential attacks and sexual murder can consequently be perceived as sex terrorism on the female population. Additionally, sexual murder can be seen as masculine transcendence from the struggle to free oneself from the material constraints dictating human destiny (as discussed above with respect to the influence of existentialism). The subject of such transcendence is masculine however and consequently attempts to transcend one's objective nature that are lauded in the masculine subject are represented as "foolish" or "wicked" in the female subject. Serial murder consequently becomes an additional tool to limit the expression of female sexuality and further oppress the female under patriarchy (Cameron & Frazer, 1987).

3.3.8 Hook's post-structuralist approach to serial murder

Hook (2003) undertook a post-structural deconstruction of psychoanalytic narratives surrounding the life history of Cobus Geldenhuys, the individual labeled as the "Norwood serial murderer". He found that accounts of the life history of Geldenhuys and explanation of his criminal behaviour were influenced largely by popular representations of serial murder informed by popular psychoanalytic theory, reflected in an emphasis on aspects such as a domineering mother and absent father; prohibition on masturbation and early adolescent sexual experimentation or expression which manifested in a phallic fixation; ambivalent feelings towards women; and insufficient super-ego development.

Hook (2003) additionally perceived such accounts as being sensationalistic, sentimental and moralistic in tone and persistently adhered to in the face of alternative explanations and contradictory accounts. Hook (2003) explained such processes as necessary for the

objectification and othering of the individual who commits serial murder. He argues that this othering serves the purpose of distancing the individual who commits serial murder from those who talk of and observe such an individual so as to prevent identification with such a person and his criminal actions.

Hook's (2003) study provides insights into social processes and the social construction of serial murder, and demonstrates that post-structuralist work lends considerable qualitative richness to understandings of serial murder. Also, this work demonstrates the complex interaction of popular culture and psychology, as well as the politics of information and knowledge production.

This would appear to be an important factor to bear in mind when conducting research on serial murder, especially given the seemingly large amount of attention bestowed on this phenomenon in particular by the popular media. However, there seems to be a lack of grounded support for Hook's (2003) claims, and as a result this paper appears to be based on the anecdotal, personal interpretations of the writer. This may be due to Hook's (2003) lack of specialization in the field of serial murder or criminal psychology, and his primary specialization in discursive psychology. Hence, the topic of serial murder serves to increase understandings of popular cultural and socio-cultural constructive processes, as opposed to understandings of serial murder specifically.

Additionally, Hook's (2003) work would appear to bear little use for investigative applications, and does not contribute to a solid etiological explanation from a psychological perspective. Given the methodology utilized, a single case study does not appear problematic for the study in question; however, it is difficult to state whether similar processes may occur with different cases of serial murder. This is made more difficult by the absence of detail regarding Hook's (2003) sources. The detail that is provided would appear to situate such accounts as deriving from "expert" opinion such as that of the criminologist Irma

Labuschagne, and the third year psychology students taught by Hook (2003). This would have to be borne in mind when evaluating the reasons why narratives and interpretations may have been shaped in the way documented, and it may be interesting to conduct similar exercises in different contexts to establish whether the same themes and processes prevail.

3.3.9 Du Plessis' grounded theory approach to serial murder

In line with social constructionist attempts to study South African serial murder, Du Plessis (1998) explored the psychological themes in serial murder via a grounded theory approach as part of his thesis for a Masters degree in psychology from interviewing serial murderers incarcerated in South African prisons. He highlighted the following themes as the most salient: a dependent personality structure with underlying anxiety; presenting as reasonably normal without indications of severe pathology; an incapacity to form meaningful relationships; and a possibility of growing up in a psychologically deprived environment. He also clustered themes with respect to theoretical perspectives.

As a result, Du Plessis (1998) identifies ego-syntonic and ego-dystonic references (psychodynamic); cluster C personality traits (psychopathology); elements such as conditioned conscience and modeling (social learning theory); and evidence of neurological difficulties (neuropsychology). From a systemic perspective, Du Plessis (1998) interprets serial murder as serving a function within the system of the family from which the individual originates: for example, his behaviour may serve as a common problem that holds a family together. He also identifies themes that emerge that are in common with previous work in the literature such as an absent father figure; abused childhood; introversion, shyness and poor peer relations; inability to maintain meaningful relationships; self-centredness; and a

charming personality with an absence of hallucinations. These themes were found across the sample of two individuals interviewed as opposed to consistently in each case.

Du Plessis' (1998) study is useful from a psychological perspective in that, given the extent to which serial murder has been understood as the product of intrinsic motivation (Holmes & DeBurger, 1988; Labuschagne, 2001; Pistorius, 1996), a research approach such as grounded theory, which aims at ethnographically exploring the world view of the research participant from his/her perspective, seems particularly useful in understanding such the nature of the afore-mentioned motivation. His systemic interpretations are also useful in that the system in which an individual who commits serial murder functions, may be enlarged to apply to a particular society or at the level of culture.

As with Hodsgkiss (2001) and Labuschagne (1998, 2001), the sample size was small (two individuals) and consequently, as mentioned above, generalization is limited. While restricting the extent to which Du Plessis' (1998) study might be useful for investigative purposes, the size of the sample might not pose as significant a challenge to the grounded theory approach as discussed above.

3.3.10 Critique of socio-cultural theories

Theories that focus upon sociogenic factors give a large volume of information on the etiology of serial murder in terms of the social forces and structures which produce such a phenomenon, but are limited in terms of their potential for investigative and rehabilitative application.

From an investigative perspective, socio-cultural theories do not provide any information that could be used pragmatically to guide investigations. Any insights that are provided are at an abstract level, framed in social processes, and are limited in their ability to provide

practical details necessary for serial murder investigation. They seem better suited at developing understandings of serial murder at a phenomenological level.

In terms of rehabilitation, sociogenic theories provide little input at the individual level, in terms of immediate interventions that could be used to help individuals who commit serial murder and prevent or limit future cases of serial murder. Rather they illuminate flaws in the broader social structure, which would require a longer spate of time in which any effects of modification in the character of social fabric could be monitored, assessed, or observed.

Finally, as has been mentioned in discussion of socio-cultural theories, as much as they explain and describe the roots of deviance and criminality in society with convincing argument, they do not appear to explain why certain types of crime or deviance occur. Even with reference to those that have attempted to focus specifically on serial murder, their argument may apply equally as well to other types of crime prolific in the twentieth century.

3.4 THEORETICAL FRAMEWORK FOR THE CURRENT STUDY

The current study has chosen to work from a systemic theoretical paradigm, focusing specifically on family systems theory in order to investigate serial murder. The systemic framework facilitates a focus on relationships and process as opposed to the content and individualistic focus of more intrapsychic approaches. Additionally, systemic theory provides an alternative to established linear ways of conceptualizing pathology by proposing a more circular approach to causality, and avoiding blaming or pathologizing individuals for symptomatic or problem behaviour (Goldenberg & Goldenberg, 2004). As a result, problems are viewed as interactional and situational, and as having a particular function within a system. In the case of serial murder, such an approach is useful, specifically in relation to

family systems, as it has not always been productive to blame specific family members (such as parents) for the occurrence of serial murder behaviour in another member.

An approach that focuses on relationships also taps an important aspect of serial murder, namely the relationship between perpetrator and victim which has frequently been fundamental in discerning serial murder from other types of crimes, mainly due to the fact that these two individuals are frequently strangers (i.e. the victim is not known to the perpetrator). Consequently, this would seem to point to the fact that it is the relationship between the two individuals rather than individualistic, personality factors that influence the manifestation of serial murder. An approach that focuses on this aspect, such as systemic theory, may yield productive findings as a result.

Importantly, the systemic view does not discount approaches that have a more intrapsychic, individual focus; rather it views such approaches as alternative ways of viewing phenomena. As a result it is possible to study serial murder from a systemic perspective and yet still integrate traditional literature into one's final understanding of the phenomenon. Given the lack of success that traditional approaches appear to have had in fully comprehending serial murder and the individuals who commit serial murder, an alternative approach that focuses more on process and patterns and family systems may yield information that could be used effectively either on its own or combined with existing data.

The systemic perspective's reluctance to engage in blaming and pathologizing of behaviour means that it may offer a novel approach to understanding criminal behaviour and challenging perceptions regarding the individuals who engage in such behaviour. It may free up such individuals as well as their families to be viewed as consisting of more than the criminal behaviour concerned in terms of public perceptions and opportunities for constructive work with such groups and individuals. This is not to say that the behaviour

should be condoned, but rather that individuals associated with such behaviour need to be viewed in their own right.

Consequently, the systemic theoretical perspective appears to provide an opportunity for a novel approach to studying serial murder and thus possess considerable potential for producing findings that may extend and elaborate understandings of such a phenomenon. In the following chapter, such an approach will be elaborated upon with regards to how it will be used to inform the current study.

4. FAMILY SYSTEMS THEORY

Discussion will now turn to the concept of the family. Firstly, the author will examine definitions of the family, as they have appeared in dictionaries, contemporary sources and the South African literature. The author will then discuss family systems theory and elaborate upon the aspects of this theoretical approach that will be utilized to interpret the data in the current study. Finally, the author will provide a summarized version of the definitions and theoretical perspectives that will be used to inform the present study.

4.1 DEFINITION OF “THE FAMILY”

Arriving at a solid and universally applicable definition of the family is the subject of much debate, given the proliferation of family structures that have emerged in the greater part of the last century (Bell & Vogel, 1968). The author consulted three dictionary sources for definitions of the family and will now discuss these in further detail.

4.1.1 Dictionary definitions

Merriam-Webster’s Dictionary (2005), *The Concise Oxford English Dictionary* (2004) and the *Penguin Concise English Dictionary* (1992) were consulted for definitions of the family. *Merriam-Webster’s Dictionary* (2005) defines family in three possible ways, namely, as

- “the collective body of persons who live in one house, and under one head or manager; a household, including parents, children, and servants, and, as the case may be, lodgers or boarders” (p. 541),

- “the group comprising a husband and wife and their dependent children, constituting a fundamental unit in the organization of society” (p. 541), and
- “those who descend from one common progenitor” (p. 541).

The *Concise Oxford English Dictionary* (2004) defines the family as:

- “members of a household, parents, children, servants, etc” (p. 436),
- “set of parents and children, or of relations, living together or not” (p. 436), and
- “all descendants of common ancestor, house or lineage” (p. 436).

The *Penguin Concise English Dictionary* (1992) defines the family as:

- “a household, including dependants and servants” (p. 278)
- “a group of parents and children” (p. 278), and
- “a group of persons interrelated by blood and marriage” (p. 278).

The three dictionary sources of definitions of the family, when examined together, all appear to have three common types of definitions for the family. Additionally, all three sources appear to argue strongly towards a conception of the family that is very similar to notions of the nuclear family (discussed below).

On examining the types of definitions in each source, the following three types of definitions would appear to emerge across the sources. The first type seems to focus on the family as a household; the second type appears to define a family more in terms of the roles that this group is expected to play in society such as “organizational” (Merriam-Webster’s Dictionary, 2005) and in terms of fixed roles of parents and children; and the third type seems to focus on blood lineage, or ancestry as definitional criteria for a family.

These types will now be discussed in terms of their suitability to contemporary notions of family, as well as to the present study.

- **Family as household.**

The first type of definition makes allowance for servants, lodgers and boarders, in addition to traditional family members such as father, mother and children. This is useful in that frequently a person's psychological conception of family may not refer member-for-member to one's biological family, in that many of the above non-biological household members may play integral parts in helping the biological family function as an organizational unit in society, as stipulated by the second definition. Additionally, if one looks at the roles within a family such as father or mother, individuals who are not necessarily the biological parents of the individuals concerned may perform these.

However, as will be demonstrated below, the first type seems to be referring more to a household than a family. It is important to distinguish a household which refers to a spatial category where a group of people, or one person, is bound to a particular place from a family which entails blood and marriage ties (Muncie & Sapsford, 1995). These two terms cannot be used interchangeably because a family may form part of a household, but that household may not be exclusive to that family. For example, a family may rent a room to a lodger, or a member of the extended family may come and stay for a while.

A single family may also be spread over two households. For example, a husband may leave a family temporarily to go and work elsewhere, in which case he would reside at another household for a while. The first type would appear to be more suited to censuses and household surveys, where the household is the primary focus for data collection (Nam, 2004).

- **The family in terms of the function or role of its members.**

The second type introduces an important facet of the family, namely that the family performs certain functions in society, however, these functions may not be exclusively limited to the organization of society, as stated in the definition. The family may also provide emotional

support for its members, or act as a refuge from the pressures of society (Muncie & Sapsford, 1995). This definition also seems to be too narrow as it excludes extended family members such as grandparents and aunts or uncles.

The definition seems to be referring to what has come to signify the “nuclear family”. The term nuclear family is laden with a number of normative assumptions, and has been mostly used to refer to a family type that consists of a married man and woman and their offspring (Murdock, 1968). This is distinguished from an extended family, which refers to two nuclear families affiliated through the extension of a parent-child relationship rather than that of husband-wife (Murdock, 1968). Unfortunately, studies that have limited their study of the family to the nuclear family have often missed out on the considerable impact that extended generations frequently have on the phenomenon of interest (McGoldrick & Gerson, 1985).

- **Family as ancestry or blood lineage.**

The third type of definition would appear to define membership of a family in terms of common genetic links. This is also a bit exclusive in the sense that it would omit cases where families consist of adopted members or fostered members, as well as cases where individuals have remarried and formed a new family unit with their children from the previous marriages.

4.1.2 Summary of dictionary definitions

It would seem that the above definitions, on their own, are unsuitable as criteria for what constitutes as a family, especially with the emergence of alternative family types such as single parenting, same sex parenting, cohabitation, fostering and extended family and kin networks (Murdock, 1968).

However, the three types above are of use in the sense that they do capture a number of common themes in general understandings of “family”, such as genetic or blood links, a common household and nuclear formation (father, mother and children). For this reason, the gestalt of the three definitions can be utilized with flexibility and awareness of the variations that may occur on this theme (such as those outlined above), as well as variations occurring on each definitional strand (such as a family with members living in two households). In other words, if used together with contemporary theoretical information concerning recent developments and alterations to notions of family, the gestalt of the three types can be of use in the present study, especially due to the fact that many of the individuals in the study sample grew up at a time when alternative family types were not recognized as prolifically in society.

Contemporary views and definitions of the family will now be examined, after a brief cautionary note about the temporal development of “the family”. Studies that focus upon the family have to also be aware that this grouping may change over time. For example, a family member may pass away, members may remarry or new members may be added via adoption or pregnancy. For this reason, definitions of family should allow for changes over time and be aware of their impact upon family organization (e.g. AIDS households headed by a child “parent”).

4.1.3 Contemporary view and definitions of the family

More contemporarily, that is, with the advent and progression of the twentieth century, the traditional family structure has undergone a number of changes. Some of these changes have been outlined by Ravanera and Rajulton (2000) and include the following:

- an increase in cohabitation with children;
- an increase in the amount of children that leave their home later;

- a change in the household division of labour, with females facing; responsibility as breadwinner and executor of household duties;
- changing family values which have seen cohabitation and divorce becoming more socially acceptable; as well as
- a reduction in the emphasis placed on marriage and an increase in preference for egalitarian spousal relationships and parent-child relationships.

Such changes have necessitated a re-examination and revision of traditional ways of defining the family.

The emergence of post-modernism has also influenced contemporary understanding and definition of the family (Hossfeld, 1991). With its emphasis on multiplicity and pluralism, as well as post-traditionalism, the concept of the family has been made more flexible with regard to the ways in which such a unit is understood and defined (Gubrium & Holstein, 1990). Contemporary definitions of the family are more interpretative and tend to refrain from viewing the family as an objectively knowable entity, but rather view it as a complex, contingent lived reality between members (Bernardes, 1997; Morgan, 1996).

Some examples of contemporary definitions of the family include:

- the family as a discursive construction with relationships constituted and maintained through routine dialogue and communication (Gubrium & Holstein, 1990);
- the family as an interactional process as opposed to a structure or set of social ties (Morgan, 1996, 1999); and
- the family as a system of negotiated intimacies (Gillies, 2003).

Family types have also been defined in terms of individualism and collectivism (Corder, 2001). Collectivism refers to a position encompassing co-operation and central planning, as well as a commitment to the values, norms or mores of a system or society (Hofstede, 1994).

Collectivist families are those families in which there is an emphasis on co-operation, resources are pooled, and social commitments (such as attendance at weddings and other family ceremonies) are of great importance (Corder, 2001). In these families, for example, members of the family who are employed would support unemployed members.

Individualism refers to a position encompassing independent thought and action, as well as the predominance of the rights of the individual within the social system. Individualistic families may consequently be understood as those families where loyalty to the family is secondary to the advancement of the individual members (Corder, 2001).

In collectivist families, Corder (2001) has argued that children will be influenced more greatly by others and their actions judged in a social environment where transgression signifies humiliation. In individualistic families, he argues that the independence of children is encouraged and transgression results in guilt. Consequently, persons growing up in these two types of families may develop different attitudes both towards their society and social setting as well as the systems of which they are members. Importantly, families may not fall into either extreme completely, but may position themselves at points along an individualistic/collectivist continuum (Corder, 2001).

4.1.4 Summary of contemporary definitions of the family

Such definitions are both advantageous and disadvantageous. In terms of their advantages, contemporary definitions allow for greater flexibility in terms of membership of the family unit. By avoiding references to household, conjugal relationships, or blood ties, these definitions avoid many of the problems discussed above with respect to the dictionary definitions, by not excluding many alternative family types that have emerged with the post-modern age.

Additionally, these contemporary definitions allow for the psychological perception and interpretation of an individual to play a greater role in defining the family unit of which he is a member. In other words, rather than a top-down prescription which states that the individual's family must consist of his biological parents and siblings or household, regardless of whether the individual himself felt any familial ties to these people, these definitions allow the individual to define his family for himself. This is of particular usefulness in South Africa, where many individuals are raised by individuals other than their biological kin, or distantly related family members, or where households have lost both parents to AIDS and the eldest child takes on the role of head of the household.

However, these definitions are still very broad and do not seem to illuminate clearly enough how (or whether) a family is different from other types of social groupings such as a workplace or sports-team, for example. Minuchin (1974) seems to accept this fact: "the theory of family therapy is predicated on the fact that man is not an isolate. He is an acting and reacting member of social groups" (p.2). Intuitively, it would seem that the family as a social grouping is different to the workplace, however these definitions do not go far enough in drawing distinctions between the different kinds of groups.

Finally, the South African literature was reviewed with respect to current definitions of the family in South Africa. The following definition was obtained from the South African Government's Department of Social Development and will be used to inform the present study (discussed further below).

4.1.5 A South African definition of the family

The South African Government's Department of Social Development (2003) defines the family in the following manner in its *Baseline Document for the Development of a National Policy for Families*:

- “as extended, multi-generational, nuclear or consisting of one or more parents and children, and single parent with children, recombined families with step-parents and step-children, or gay families” (p.24);
- “social units governed by family rules” (p.24);
- “individuals who either by contract and/or agreement, by descent and/or adoption, have psychological/emotional ties with each other and function as a unit within a social and/or economic system, not necessarily living together intimately” (p.24).

The first part of this definition seems to be more about family types, than providing a definition that can be applied to a group to thereby identify such a group as a family. In this way, it excludes family types such as unmarried, cohabiting individuals or families with adopted children. It is advantageous in that it includes many modern, alternative family types such as gay families, but doesn't specify that marriage is necessary.

The second part of the definition makes more progress in terms of providing a more practical, applicable definition. However, it is too broad and could refer to an organised crime syndicate, for example, where none of the members of this group are related to each other in the more traditional sense of family. Additionally, little further information is provided with regard to what constitutes the “family rule”.

The third part of the definition appears to be the most useful in terms of capturing what the family signifies and being applicable in terms of identifying such groups in wider society. This definition captures the psychological aspect and subjective perception of family (as

discussed above) by including psychological and emotional ties, as well as allowing the notion of family to extend beyond the household, by including members who may live elsewhere but who are still psychologically or emotionally linked to the family group. The definition also refrains from excluding any alternative family types, by acknowledging that families may emerge as a result of factors other than blood lineage or common genetic material (such as legal unions, or adoption).

A number of definitions for the family have been discussed above, largely with respect to dictionary and contemporary definitions of the family. The author's will now propose a definition of the family that will inform the present study.

4.1.6 Conceptualisation of the family for this study

Given the different ways of understanding the family outlined above, the study will attempt to use a combination of the two main approaches, namely, contemporary and more modern notions. While this study chooses will focus primarily on the immediate blood relatives of the individual concerned, specifically those with whom he has grown up, and secondarily on the extended family, such as grandparents, aunts, uncles and cousins, or significant others who may have performed roles usually associated with nuclear or extended family members, it will also allow for flexibility with respect to alternative family types and changes over time as well as the individual's own definition of what he considers to constitute his family. Hence, a family in this study is defined as:

- the group of individuals biologically related or otherwise, with whom one is involved in intimate, interactional relationship/s over time; and
- whom one subjectively recognizes as playing a significant role in this regard.

Extended family will refer to all those family members, related to the individual concerned, who do not fit into the category above. That is, those individuals to whom the individual is related or with whom that individual has interacted with on a basis that is not as intimate as the above.

This study will also investigate any attempts to begin a family of procreation (inclusive of alternative types such as gay couplings) by the individuals concerned. Prior to examining some of the core aspects of family system's theory, as well as discussing both how a symptom is understood within the family system, the author will shortly discuss the family system's relationship with other systems and the influence of society and culture.

4.2 THE CONTEXT OF THE FAMILY

The family does not exist in isolation, but rather is situated within particular social and cultural contextual settings – the supra-system (Bateson, 1979). Such contexts play an influential role in shaping the way in which a family perceives itself, as well as the form it may take (Connell, 1987). The socio-cultural context, in particular, frequently influences perceptions of what is acceptable with regards to how that family should function in that system (Dallos, 1995; Muncie & Sapsford, 1995). For example, if the socio-cultural context is dominated by conservative values, the traditional nuclear family may be perceived as the norm and as a result, any non-traditional forms, such as single parent or same-sex caregiver families, might be blamed for moral decay, increased crime, unemployment and drug-taking in society.

Muncie and Sapsford (1995) state that families are frequently shock absorbers of change in society. They argue that families absorb socio-cultural changes in various areas such as gender roles, intergenerational relationships, racial attitudes, politics, economics and science,

and as a result, may develop new family forms, relationships or functions. Within a systems framework, one could argue that families with particularly rigid interactions and who cling strongly to stability or homeostasis, might struggle to deal with changes in the socio-cultural milieu. As a result, one might expect these kinds of families to start to exhibit some degree of symptomatic behaviour.

Prior to commencing with the discussion of the theoretical background and conceptual framework that will guide the study, a short cursory discussion on the role of context will be conducted with an aim to illustrate the contextual issues that the author has utilized as part of her guiding frame of reference in the analysis of the data. The main areas discussed are the post-modern family, the role of deviance and the interaction of the family system with larger contextual systems.

4.2.1 The post-modern family

Sociologists such as Shorter (1975), Gergen (1991) and Hossfeld (1991) have detailed influences on the family unit of one such socio-cultural change and its influence on the relationship between family systems and the context in which they are situated: namely, the change from a modern to a post-modern society.

The modern (or post-industrial) family resembles the nuclear family unit and evolved in response to the needs of an industrial society (Parsons, 1956). The modern family exhibited some of the following characteristics:

- it consisted of definite sex role distinctions, with the man or husband as breadwinner and woman or wife as caretaker of the household;
- it acted as a lynch-pin of social cohesion; and

- it functioned as a fundamental building block of order and moral health in society, frequently reflecting the normative views of the particular society.

With the advent of post-modernism, Hossfeld (1991) states that many varieties of other family types (such as single parent families and same sex parent families) were ushered in. Shorter (1975) argues that these emerged out of:

- the economic liberation of women;
- the lack of faith in the previously established order due to the disillusionment in human progress; and,
- the influence of the electronic media, which reflects and legitimates family diversity.

The post-modern family has also become more permeable, specifically with regard to the last point, where the media has brought the global village with its multiplicity of viewpoints and perspectives, into the family living room. As a result, the boundaries between the family and other systems are more blurred (Shorter, 1975).

Gergen (1991) has elaborated on this point, labeling the post-modern family as the “saturated family” on account of the degree to which family members are exposed to different views, personalities and relationships. He argues that the post-modern family is more vulnerable to fragmentation and chaos due to this saturation, and that the home, no longer the refuge it symbolized in the modern age, becomes a site of confrontation between different views, ages, genders and ideologies.

Other sociologists such as Denick (1989) and Gillies (2003) adopt a more positive view. Denick (1989) argues that such variation (or saturation) encourages a child growing up in a post-modern family to become more flexible in terms of being able to adapt to different spheres and information, as part of his or her socialization process and individualization or identity formation. Gillies (2003) states that a post-modern family reflects post-traditionalism,

balancing individuality with love and intimacy and economic obligation with an emphasis on relationship together with intimacy and love.

The possible influence of socio-cultural changes on the family, as discussed above, will be an important consideration in the current study. Many of the individuals in the sample, together with their families, lived through a period of considerable social change in South Africa, both in terms of transitions from modern to post-modern trends, as well as the political transformations during, towards and after Apartheid.

Amoateng (1997) in his research on changes in the composition of the South African family from 1994 to 2001, has documented that contemporary South Africa is composed of two main family types, namely, the extended (mostly among African and Coloured racial groups) and nuclear (mostly among White and Asian racial groups) family types.

Additionally, he has documented an increase in cohabitation (and lower marriage rates) and female-headed households amongst families in South Africa. Additionally, the African family has traditionally placed considerable importance on descent lineages within the larger kinship network together with the nuclear family (Caldwell, Caldwell, Ankrah, Anarfi, Agyeman, Awusabo-Asare & Orubuloye, 1993). Consequently, the conceptualization of the family for the present study will take the above into account during the analysis and interpretation of the data.

4.2.2 The family and deviance

Another area that has been examined with respect to the relationship between the family and larger context, is that of deviance.

Hoffman (1981) states that deviance serves three purposes for social systems, namely:

- to promote cohesion;
- to keep an outmoded group functioning long after it should have collapsed; and
- to mediate where people are in conflict.

Deviance may occur at the level of the family, where a member who displays deviant behaviour serves to unite the family or keep the family from extinction, and/or at the level of society where a certain type of deviant behaviour may serve to achieve one or all of the aims outlined above by Hoffman (1981) for the society in question. This work is of particular interest in studies such as the present one that focuses on deviant or anti-social behaviour such as serial murder.

4.2.3 The family and larger systems

Finally, families have rules for interaction within larger systems. Involvement with representatives of such systems may be an attempt to fill voids left by cut-off members, divert attention from internal strife, or to support family myths (Imber-Black, 1988). For example, if the eldest sister of a family is the member to whom others go for advice or to talk about their problems, and she leaves, the family may then enlist the help of a psychologist or counselor when future problems arise, if no other member assumes that role within the family system.

The theoretical background of the study, namely family systems theory, will now be outlined, followed by a more detailed description of the conceptual framework that will be derived from family systems theory to guide the analysis and interpretation of the data.

4.3 FAMILY SYSTEMS THEORY

Family systems theory developed from the application of systemic theory, pioneered by individuals such as Bateson (1979) and Bateson, Jackson, Haley and Weakland (1956) to the family. This took place largely in the 1950's when the psychotherapeutic community working with families began looking for alternatives to the predominant psychoanalytic approaches that dominated practice (Nichols & Schwartz, 1991).

Family systems theory also developed from the considerable body of research that was being done during the 1950's time on the families of schizophrenic individuals, by individuals such as Gregory Bateson and Don Jackson at the Palo Alto Veterans Administration Hospital (Vorster, 2003). Their pioneering paper, together with Jay Haley and John Weakland, titled the "Theory of Schizophrenia", ascribed the source of the thought disorder in the patient to the form of communication exchanged between family members (Bateson *et al.*, 1956). This ushered in a new approach to working with families by applying the new science of cybernetics, or the regulation of self in a social or biological system, to the description of family pathology, and, later on, to devising methods of treatment (Guerin, 1976).

A system can largely be understood as consisting of a number of interconnected elements which mutually and continually influence each other (Dallos, 1995). Given this definition, it is evident how systemic theory could be applied to the family. The family is an organic unit that is made up of interconnected individuals who perform various tasks and fulfill various roles in relation to each other (Muncie & Sapsford, 1995). Consequently, the principles of a system should apply equally to the family, as to other systems. Within a systemic paradigm, the family may be defined as consisting of a number of interrelated members, whose behaviour (together with emotions, actions, thoughts, and beliefs) mutually influences each

other, together with the family as a whole. This view of the family provides pragmatic avenues of change, as well as new ways of understanding pathology and processes in a family, and individual members.

From a systems theoretical point of view, Guttman (1991) sees the family as:

- a cybernetic system (a system of interconnected parts, and as a system that governs itself through feedback);
- a homeostatic system (that is, that negative feedback maintains homeostasis in a system by reducing any deviation that results from the introduction of new information); and
- a rule-governed system (that the mechanisms maintaining homeostasis operate according to certain rules that condition or 'set' the range within which a given behaviour can vary)

This section will now look at aspects of family systems theory. It will first examine some core aspects of family systems theory, as outlined in Watzlawick, Beaven and Jackson (1967) and Bowen (1978), as well as Minuchin (1974) with respect to the structural organization of families, hierarchies within family systems and power. The discussion will then examine the genogram as a means of understanding and conceptualizing family systems, the role of the symptom in families, as well as the family's position within other larger systems and society.

4.3.1 Watzlawick, Beavin and Jackson's theory of communication and interaction

Watzlawick *et al.* (1967) describe objects of interactional systems as "persons-communicating-with-other-persons" (p. 120). An interactional system consists of 'two or more communicants in the process of, or at the level of, defining the nature of their relationship' (p. 121). They distinguish between two types of systems:

- open systems, and
- closed systems (Watzlawick *et al.*, 1967).

Open systems exchange materials and information with the environment, whereas closed systems do not permit the introduction of any novel stimuli from outside of the system.

Systems exhibit the following properties:

- wholeness,
- feedback, and
- equifinality (Watzlawick *et al.*, 1967).

- **Wholeness.**

The property of wholeness means that every part of a system is related to other parts so that a change in one part results in a change in the total system. Consequently, a system is not summative, but emerges from a combination of elements, and can be viewed as a gestalt of such elements, as opposed to a cumulative, linear aggregation of its various parts. As a result, parts are not unilaterally related, but rather demonstrate circularity with respect to the manner in which they interact. For example, the consequences of A's actions towards B are not limited solely to B, but rather impact on the way that B then reacts to A, and so on.

Applying this principle to family systems, wholeness means that a change in one member of the family, will affect the other members, as well as the family as a unit (Kilpatrick & Holland, 1999). For example, the departure of the eldest son of a family of four, may result in the other sibling having to assume additional responsibilities, and depression over the loss of a child from the household and anxiety over aging in the parents, together with the family having to redefine itself as a unit of three and potentially have to accommodate extension in the form of a new spouse and children from the eldest son who has now moved onto the next phase of his life.

A corollary to the principle of wholeness is circular or cybernetic causality, which will be discussed now.

- **Circular or cybernetic causality.**

Circular causality refers to the fact that, due to the principles of wholeness (where a change in one member of a system impacts upon the behaviour of other members) as well as homeostasis (or keeping levels of system activity within an acceptable range, discussed below), each member's behaviour in a system is maintained by the actions of the other/s. In other words, each person within a family is seen as influencing the other, and their responses, in turn, influence the first person, whose response influences the others, and so on.

Over time, many of these interactions, or circularities (Watzlawick *et al.*, 1967), may become more regular and repetitive, giving the impression that they serve as possible rules that are necessary for the functioning of the family (Jackson, 1957). For example, a father may shout at his son on account of his son's behaviour at school, to which the son may react by increasing aggressive behaviour at school as a way of getting back at his father. This then makes the father increase his disciplining of his son, which in turn may result in increased aggressive behaviour at school.

- **Feedback.**

Feedback is related to the principle of homeostasis. It means that part of the output of a system is fed back into that system as an input to modify system activity (Watzlawick *et al.*, 1967). For example, many of the systems on the human body operate according to feedback mechanisms and monitor if levels of hormones, excretory products, or neurotransmitters are at optimal levels. Feedback also operates in human systems, and especially families, where it serves to regulate processes and interaction within the family unit and between members.

Feedback usually occurs in relation to a system norm or set level (Watzlawick *et al.*, 1967). The system then decides on how to proceed as a result of how feedback input relates to the system norm, and the type of reaction it wants to achieve, that is, to amplify or reduce deviation from the norm. An example of such a norm in families may be rules around acceptable behaviour, within each individual has to operate. A system tends to calibrate itself around a norm so as to achieve constancy within a defined range. This principle has often been likened to a thermostat, in which there is a lower and higher limit within which the thermostat functions and adjusts itself to achieve the desired norm.

Consequently, there are two types of feedback (Watzlawick *et al.*, 1967). Positive feedback or escalation (Bateson, 1979; Jackson, 1957) results in an amplification of output deviation from a system norm, whereas negative feedback or stability results in the opposite, namely a reduction of output deviation from a system norm. In a human system, positive feedback usually results in change, whereas negative feedback tends towards stability or homeostasis. In the above example, an individual who deviated from a family norm may be disciplined or sanctioned so that he/she came back into line with the system norm, thus maintaining homeostasis.

This can frequently be seen in the case of families who seek help for a member displaying behavioural problems, and yet appear to frequently jeopardize attempts to bring about change in such a member. Such families and relationships can be seen as particularly rigid closed systems, where change is resisted on account of the threat posed to homeostasis and stability of the family unit (Jackson, 1957).

A system that is constantly threatening to exceed homeostatic limits frequently engages in “runs” (Hoffman, 1981). Normally, when a plateau is exceeded, a deviation-amplifying process sets in and destroys the system. However, less drastic runs frequently delay this process due to the fact that the imbalance in the nuclear family may be trying to correct an

imbalance in the larger kin system or other systems (Hoffman, 1981). As a result, the family pathology is stabilized. Should the stabilizing member leave, or other systems undergo certain changes, this process may break down.

Both stability and escalation are necessary for a family to function as a viable social unit: escalation or an open system, allows for adaptability to novel circumstances while stability allows a family to maintain a certain degree of constancy in the face of such change (Dallos, 1995). Either process, at its extreme, threatens the survival of the family: an overly rigid closed system not being able to adapt to changes, while a highly unstable, open system risking the fragmentation or dissolution of the family unit.

Watzlawick *et al.* (1967) were not the only theorists to view the family as a system that tends towards homeostasis. Both Jackson (1957) and Haley (1970) have also advanced this notion in the sense that they claim that the family system attempts to maintain equilibrium (Hoffman, 1981).

- **Reflexivity.**

Reflexivity refers to a system's capacity to monitor and reflect on its own actions. This operates in accordance with feedback. Watzlawick *et al.* (1967) argue that because a system can store and keep a record of previous adaptations and feedback patterns, a pattern of redundancies (although complex) within the system can be recognized and predictability is possible. As a result, family systems can begin to form rules or expectations concerning types of situations or challenges and ways of dealing with them, by grouping together past experiences of similar feedback patterns and responses.

- **Equifinality.**

The property of equifinality means that any alterations in state after a period of time in a system are not determined so much by initial conditions as by the nature of the process and system parameters (Von Bertalanffy, 1968; Watzlawick *et al.*, 1967). In other words, the same results in two systems may spring from different origins because of differences in parameters, interactions within the system, and informational exchanges with other systems. In closed systems, where there are no exchanges outside of the system, results may be determined by initial conditions. In open systems however, where this exchange does occur, equifinality is possible, both with respect to the above and its opposite, that is, different results from the same origins. For example, serial murder has often been problematically linked to nature or nurture explanations due to the fact that many individuals who commit serial murder have siblings who do not go on to commit such crimes. However, if serial murder is understood within the context of the family system, it becomes less problematic to understand how this may be possible.

- **Types of interaction.**

Watzlawick *et al.* (1967) describe two main types of interaction:

- symmetrical, and
- complementary.

In symmetrical interactions, the partners involved mirror each other's behaviour. In this way, each partner attempts to use his/her turn to minimize the extent to which the other partner may be one up on him/her, and thereby minimize any difference between the two. In this way, symmetrical relationships are based on equality but may become quite competitive (in order to prevent either partner from getting too far ahead of the other).

Watzlawick *et al.* (1967) have likened symmetrical interactions to a seesaw, where if one partner goes up a bit, the other adjusts to meet the movement. Symmetrical interactions and relationships may escalate into “runaways” where the stability of the relationship is lost and a quarrel or fight takes place. This may also lead to escalation, where the intensity of the behavioural responses increases with each adjustment in each partner.

In complementary interactions, one partner’s behaviour complements the other, and the pair are usually arranged in a one-up and one-down position (Watzlawick *et al.*, 1967). Who occupies which position may vary with each interaction between two partners, however, frequently complementary relationships will have one partner set in the one-up position and the other in the one –down position. For example, in a married couple, there may be one partner who is dominant or assertive, while the other is more submissive or passive.

Conflict may take place when one of the partners (frequently the partner in the one-down position) attempts to take the opposite position. Alternatively, one partner may want to change their position but be prohibited from doing so by a powerful partner or circumstantial factors which may lead to frustration and despair as well as self-estrangement, depression and acting out on the part of the dissatisfied partner.

- **Pathological communication.**

Watzlawick *et al.* (1967) see behavioural, emotional and psychological problems as an outcome of sustained pathological communication between individuals. With the concept “pathological” they mean ways of communication of which the effects and the process of these effects are ineffective. They argue that human beings cannot avoid communicating, for, even by choosing not to communicate with someone, they are, in fact, communicating a certain statement to that someone (namely, “I don’t want to communicate with you”). Given this condition, namely the impossibility of not communicating, and if an individual cannot

leave the field in which such interaction takes place, the following options may be available to the person, namely:

- rejecting communication;
- accepting communication;
- disqualifying communication; or
- manifesting a symptom as communication (Watzlawick *et al.*, 1967).

Rejecting communication may involve informing the individual directly that one has no desire to communicate with them, for example, by telling them so or leaving the room.

Accepting communication involves responding and starting an interaction with the person concerned, for example, by replying to their statement. Disqualifying communication involves disqualifying the communication of either oneself or the other person, and is frequently found in situations where the individual concerned does not want to communicate but is obligated to do so. Disqualification may be achieved by contradicting oneself, inconsistencies, subject switches, tangentializations, incomplete sentences, misunderstandings, literal interpretations of metaphors or metaphorical interpretations of the literal (as found frequently in people suffering from schizophrenia). Consequently, “crazy” communication may not be exclusively an indicator of mental illness, but rather, may be viewed as an indication of an individual who may be reacting to an absurd or untenable communication context, or both (Watzlawick *et al.*, 1967).

Lastly, communicating by means of a symptom involves non-verbally communicating certain information to one’s family or others. This differs from intentional feigning of an illness to avoid communicating or interacting with others. Here, when a symptom develops, the individual with the symptom is convinced that he or she is suffering from that particular problem or illness. In this way, the individual avoids the reproach of significant others as well as his or her own guilt. For example, one may become violently ill or suffer an upset stomach

before an important public speech or examination, or start to experience psychotic symptoms such as hearing voices.

The last two aspects of pathological communication are particularly relevant for the current study, in as much as they will be applied to understanding how serial murder may be a means of communicating certain information to the family of individuals who engage in this criminal behaviour. This theory is also useful to examine how communication in general takes place in the families of these individuals and if any common patterns emerge.

Ways of communicating do not only have implications for specific behavioural, emotional or psychological behaviour but also for the way in which an individual defines him/herself in relation to others (Watzlawick *et al.*, 1967). This will now be discussed with respect to the communication options outlined above, namely with respect to how rejecting, accepting or disqualifying communication, or communicating a symptom, are related to the way one defines oneself.

- **Definitions of self and other.**

When individuals communicate and interact with one another, one person, A, for example, will periodically indicate “This is how I see myself”, and the reaction of the other individual, B, will have implications (Watzlawick *et al.*, 1967). These reactions have been grouped into three types, mainly:

- confirmation;
- rejection; and
- disconfirmation (Watzlawick *et al.*, 1967).

If B chooses to confirm A’s statement, then communication is generally promoted. If B chooses to reject A’s statement, then A may experience the rejection as painful and the relationship may be strained for a while. However, given that B’s rejection involves a degree

of recognition of what is being rejected, namely A's self, rejection does not involve a negation of the reality of A.

In contrast with rejection, which involves a negation of A's statement, disconfirmation, involves a negation of the source of the statement, namely, A. For example, A makes a statement indicating, "This is A". Should B disconfirm A's perception of themselves, this may result in A assuming that B does not understand or love them, while B may remain totally oblivious to A's dissatisfaction and assume that A feels understood. This may result in an alienation of A.

Alternatively, B might disconfirm A's self perception but A may not register that his/her message has not gotten through. As a result, a vicious circle ensues in which A may be confused at how their behaviour continually does not achieve the ends that he or she intends. As a result, this individual may be perpetually mystified leading to despair and frustration and a sense that life does not make sense.

As indicated in the examples above, disconfirmation may result in persistent vicious circles, with great potential for pathological behavioural outcomes in the individuals concerned. This has been researched by individuals such as Laing (1961, 1965), who found that such communication is frequently found in families of individuals suffering from schizophrenia. This has been explored largely within the framework of the double bind (Hoffman, 1981; Watzlawick *et al.*, 1967). This refers to an instance of pathological communication where an overt demand at one level is covertly nullified or contradicted at another level (Hoffman, 1981).

Individuals caught in such communication patterns frequently have to find ways of communicating that satisfy the paradox, and consequently, appear to make no sense to other individuals outside of the paradox, as in the case of a person suffering from schizophrenia (Selvini-Palazzoli, Boscolo, Cecchin & Prata, 1978). A frequently used example of a

paradoxical communication such as the double bind is the command, “Be spontaneous!” (Watzlawick *et al.*, 1967). In this case, a person cannot obey the command without contradicting him or herself.

Haley (1970) argues that in a family where double bind communications are used frequently, there is a perpetual struggle for control. As a result, the members use disqualifications of meaning to control the behaviour of the other members and/or to prevent their behaviour from being controlled. Disqualifications may range from pretending one has not understood what another member has said, ignoring another member’s communication or changing the subject to taking the literal as metaphoric and vice versa, as is often exhibited by individuals with schizophrenia (Watzlawick *et al.*, 1967).

This aspect of Watzlawick *et al.*’s (1967) theory will also be utilized in the study to investigate how definitions of self have been negotiated in the families of individuals who commit serial murder and how this may have impacted upon the behaviour of the individual concerned.

- **Punctuation.**

Punctuation refers to the process whereby people develop a set of self-fulfilling perceptions or beliefs about their relationships that interlock to produce repetitive patterns (Watzlawick *et al.*, 1967). This process serves as a means to explain and predict, construct and maintain each other’s behaviour, another means by which to ensure the stability of the system.

Punctuation is how we frame our reality. For individuals in a system, it is nearly impossible to place oneself outside the system to observe the full cycle of interaction. Consequently, punctuation is a means by which the individuals attempt to define a cause-effect or beginning and end to his communication, due to the influence of linear thinking.

Once again, utilizing the example of the father and son, the father may perceive his son to be a “rebel without a cause” whereas the son may perceive the father to be pedantic and disciplinarian. On an occasion where the son stays out past his curfew, the father may reprimand him, confirming the son’s perception of his father. The son may then react by shouting at his father and protesting against his strong discipline, thereby confirming the father’s perception of his son as rebellious. This may then escalate his disciplining behaviour, which would confirm the son’s perceptions further.

4.3.2 Summary of Watzlawick, Beavin and Jackson’s view

Watzlawick *et al.* (1967) focus upon the nature of communication in the context of an interactional system between two or more people. They demonstrate how the nature of this communication can impact upon the nature of the system as well as individuals who function within such a system.

They classify two types of systems, namely open and closed systems, based on the degree of interaction and exchange systems undertake with other systems or elements. Further, they attribute three properties to open systems, namely, wholeness, feedback and equifinality. Feedback may be positive or negative, and operates in relation to system norms or relationship rules.

Watzlawick *et al.* (1967) also discuss various aspects of communication and types of relationships between persons in a system. These include symmetrical and complimentary relationships. In symmetrical relationships, the individuals involved aim to equalize differences between the two of them, whereas complementary relationships involve maximization of difference. As discussed, both of these types may have pathological outcomes when taken to their extremes.

Watzlawick *et al.* (1967) also discuss different types of response to situations in which one cannot avoid communicating. These are rejection, acceptance, disqualification and manifestation of a symptom.

Watzlawick *et al.* (1967) additionally address how perceptions of self and other may be negotiated in the context of interactions between two people in a system. These include confirmation, rejection and disconfirmation. Pathological outcomes may result in individuals caught up in vicious circles that are generated by incongruent or problematic communication that takes place about self and other.

4.3.3 Bowen's family theory

Bowen (1978) emphasises the family as an emotional system. He argues that the intense emotional interdependency in families makes interactions in families more predictable than in other groups, and that this interaction crystallizes in particular patterns through time. These patterns may be repeated in subsequent generations. Bowen's family theory (1978) has a number of basic concepts. These are:

- differentiation of self;
- triangles;
- nuclear family emotional system;
- family projection process;
- emotional cut off;
- multigenerational transmission process;
- sibling position; and
- emotional process in society (Hall, 1981).

These will now be dealt with separately.

- **Differentiation of self.**

This refers to the extent to which an individual is embedded in the emotional matrix of the family (Bowen, 1978). An individual that has a better differentiated self, will be able to have a more established notion of self, and make decisions independently of the family matrix of which that person is a member. Less differentiated individuals will be more fused to the identity of the family and depend on the common self of the family unit for direction and beliefs.

Bowen (1978) holds that families generally tend towards fusion. However, the greater flexibility that a particular family has, will enable its members to be sufficiently differentiated. Differentiation, taken to its pathological extreme, will result in isolation or cut-offs, but ideally, should allow for direct meaningful contact with one's family's emotional system but also being sufficiently outside to be objective about one's self and others.

Bowen (1978) also speaks of a *hard-core self* which refers to those parts of one's self that are non-negotiable with others or one's firmest held convictions and beliefs; as well as a *pseudo-self*, which refers to opinions of others that are absorbed as one's own despite having no personal commitment to the beliefs underlying these opinions. With increased differentiation, more use is made of one's hard-core self.

- **Triangles.**

To discuss this aspect of Bowen's theory, Ackerman (1984) will be made use of to supplement Bowen's theoretical discussion. The family as a system can be distinguished by its parts together with their relationships, and behaves as a whole, not as an aggregate (Ackerman, 1984). These relationships between members are often easier to understand when broken up into groups of threes, or triads. Depending on the number of members in the

family, there may be any number of these triads in operation at any one time. For example, in a family of three, there will be one triad; in a family of four, there may be up to four triads at any one time; and in a family of five, up to nine triads.

The relationship of any two entities in a triad, is largely conditional upon the state of the third, with the sum of the quantity of interaction of the three relationships that comprise a triad, remaining constant. For example, if A, B and C are members of a triad, if A increases interaction with B and C, then the interaction between B and C will decrease.

In a balanced triad, all three members have the same amount of interaction and take responsibility for their actions in the context of the relationship (Ackerman, 1984). Additionally, in a balanced triad, relationships between all three members are positive, or at times, there may be one positive relationship or coalition between two members who are both in conflict with a third (Hoffman, 1981).

An unbalanced triad occurs when all three relationships are negative or when there is one negative relationship, or conflict between two members, and two positive relationships, that is between each of the two who are in conflict, and a third member (Hoffman, 1981).

Balance or homeostasis does not necessarily imply harmony or health, but refers rather to the leveling out of positive and negative relationships in the triad (Hoffman, 1981). Additionally, as long as triads are relatively flexible they may stand a better chance of resisting pathological outcomes. As soon as triads are rigid with respect to the organization of their members and the coalitions within them, they are more likely to become pathological (Hoffman, 1981).

This can be illustrated by means of an example of a person suffering from schizophrenia. Such an individual is frequently situated within a closed, rigid family system where interactions are limited in number and set in quality (Selvini-Palazzoli *et al.*, 1978). Additionally, in line with the “double bind” theory of schizophrenia (Bateson *et al.*, 1956;

Searles, 1959; Sluzki & Veron, 1971), the person suffering from schizophrenia is usually the subject of a paradox, where communication at a digital or verbal level is negated at an analogue or non-verbal level.

This double bind is usually the result of a “game” that is being played out between the parents of the person suffering from schizophrenia, in which both partners covertly vie for control over the spousal relationship (Haley, 1959; Selvini-Palazzoli *et al.*, 1978). This is undertaken covertly as a result of the family system not being able to tolerate the breakdown of the spousal relationship, the loss of a spouse or change in general due to its closed and rigid nature as a system. Due to the contradictory messages received by the person suffering from schizophrenia, this person then attempts to behave in a manner that disobeys neither level of the message, resulting in the symptomatic behaviour associated with schizophrenia, and thus maintaining homeostasis in the closed system.

Processes within a triad may include progressive segregation, centralization, and triangulation (Ackerman, 1984). Progressive segregation refers to the process whereby parts that are interdependent differentiate so as to become more independent of one another (Ackerman, 1984). For example, in a family, as children grow older, they may find work and become less dependent on their parents for financial support. Consequently, the family may still be interdependent for emotional support, but more independent with respect to material provision.

Taken to its extreme form, progressive segregation may result in insulation. In a triad, this may be the result of one member being distanced/distancing to the point of being cut off, thereby losing relatedness to the other two members and becoming autonomous. Signs of insulation may include withdrawal and inability to relate to others on the part of the insulated member, as well as attempts by any of the other members to act in anticipation of, or to prevent, the response of the insulated member to any other person (Ackerman, 1984).

Centralization refers to the process whereby functions are assigned in a hierarchical manner so that the system becomes unified and efficient, and small changes in the large or dominant parts may result in larger changes in other parts (Ackerman, 1984). For example, in a family, the primary breadwinner (father or mother) may be assigned the function of providing for the family, with supplementary support from any other members who may be earning money.

Just as insulation would be the extreme end-point of progressive segregation, fusion is the extreme outcome of centralization. Fusion, within a triad, results in one member engulfing or overwhelming another member, with personal boundaries being blurred (Ackerman, 1984). A fused relationship between two members will frequently result in the exclusion of the other member (as well as many other outsiders) and is often based on a need in one member to aggrandize himself at the expense of the other. As a result, a fused relationship results in two members behaving almost as a single individual with one behaving exclusively for the other.

In systems, such as the family, both centralization and segregation are necessary for successful integration of members and efficient and effective functioning. It is important for a family to be united in common goals, and yet for members to be sufficiently differentiated in order to effectively achieve such goals, by performing diverse functions. Loss of differentiation results in a closed system and fusion, whereas loss of centralization results in fragmentation and isolation. Within triads also, fusion and insulation accompany each other, so that in cases where two members are fused, the third member will be insulated, and so forth.

It is important to remember that fusion and insulation, while properties of the system, or triad, are not properties of the individual concerned. For example, an insulated member within a family may be very involved in his/her community. In fact, individuals who insulate

themselves from their family of origin, frequently try to make a whole family out of another individual (Ackerman, 1984).

Triangulation (Haley, 1976; Minuchin, 1974) refers to the process in a triad where one individual stands in relation to two other in such a way as to be the focus of the relationship. The two latter members generally relate only by communicating about the third party and thus avoid direct, personal exchanges, which may result in open conflict as a result (Ackerman, 1984). For example, a mother and father may attempt to avoid relating to one another by becoming overly involved with a child. Triangulation can be observed every time a member of a family speaks on behalf of another, or about one member to another, or is involved in the middle of a conflict between two other members.

Bowen (1978) viewed triangulation as the basic building block of an emotional system, operating as safety valve for when emotional tension in a two-person system exceeded a certain level. In a two-person relationship, the tendencies of progressive segregation and centralization frequently result in power struggles, where greater interaction usually implies that increased centralization with one partner increasingly burdened, and the other humiliated while decreased interaction may result in the loss of the relationship. Consequently, the solution to this dilemma frequently involves the addition of a third member, or development of a triad, where distancing and closure of the dyad is prevented.

Frequently, however, such triads develop into triangulation patterns with barricading or incomplete personal communication between two members, and pseudo-responsibility (see below) with respect to the third party. An example of this process may be evident in a marriage when the decision to have a child is made to prevent the collapse of the dyadic relationship. The married couple can then avoid directly confronting each other about issues and concern themselves with the child. Ackerman (1984) argues that whereas fusion or

insulation often signals the demise of a family, triangulation is a means whereby to keep the system going, albeit not necessarily by “healthy” means.

Ackerman (1984) has identified three patterns of triangulation, namely:

- focused triangulation;
- triangulation with an intermediary; and
- shifting triangles.

Focused triangulation occurs when the third member is ignored as an independent member of the triad, and responsibility for that member is taken by the remaining two, such as in the example above.

Triangulation with an intermediary occurs when the third member is utilized as a go-between for the other two members. For example, parents communicate via a child in the case of a separation or divorce proceedings. Scapegoating is also an example of this type of triangulation, and involves one member being labeled as the “black sheep” of the family and consequently assuming responsibility for all the faults within such a system. This member consequently acts as a means for the other two to avoid self-blame as well as preventing more dangerous warfare between more powerful family members.

Shifting triangles involve intense open conflict, with frequent interruptions, so that different members occupy different positions within a triangulation at different times. For example, two parents triangulate around a child. When forced to confront one another, and their conflict is out in the open, the child may jump to the defence of the mother, and shift the triangle so that she and her father avoid direct conflict, and triangulate around the mother, and so forth.

Triangulation also involves the processes of pseudo-responsibility and barricading. Pseudo-responsibility refers the process whereby a member appears to take responsibility for another, but is actually using the other member for his or her own requirements, such as either

avoiding conflict with another member (such as in focused triangulation). The third member of a triangulated relationship is always in a pseudo-responsible relationship to the other two. An extreme form of pseudo-responsibility is fusion, where one member takes complete responsibility for the other.

Barricading refers to when communications between two members are not complete. This is usually the case between the two members of the triangulated triad who assume pseudoresponsibility with regard to the third member.

A consequence of triangles is a tendency to repeat behaviour patterns automatically, especially in stressful situations. For example, if a mother involves her mother in a triangle when experiencing tension with her child, this pattern will be repeated each time a stressful situation with the child occurs. Additionally, triangles may be multigenerational, both in their spread across the family system (that is, a triangle may involve members from different generations), and in the sense that triangling patterns can be passed on from one generation to the next. For example, if a parent was allied with his same sexed parent, against the parent of the opposite sex, this pattern may be repeated with his children in the subsequent generation.

Although many theorists have conceptualized types of triangles, this discussion will focus on the classifications as proposed by Minuchin (1974). Minuchin conceptualized four types of rigid triads that could lead to pathology, namely:

- triangulation;
- parent-child coalition;
- detouring-attacking; and
- detouring-supportive.

Triangulation has been discussed above and refers to a situation, for example, where two parents in overt conflict try to get the child's support against the other. A parent-child coalition triad refers to a triad where a coalition already is in place between one parent and a

child, and both are in conflict with the other parent. A detouring-attacking triad involves a coalition between the two parents who then scapegoat the child. The conflict with the child frequently serves as a means to keep the parents united, and usually manifests behavioural problems as symptoms.

In a similar vein, a detouring-supportive triad also serves to keep parents together by focusing on the child. However, in this instance, all relationships are positive as the parents focus on the child as an object of concern or to be protected. In this triad, the child will often manifest psychosomatic symptoms. For example, a detouring-attacking triad would have the parents uniting to discipline the child, whereas a detouring-supportive triad would have the parents uniting to look after a sick child. In both triads, the parents are avoiding dealing with the real issues in their relationship (which may result in open conflict) by focusing on the child, or detour.

- **Nuclear family emotional system.**

This refers to the inner core family processes as opposed to multigenerational processes (Hall, 1981). Going back to differentiation, the level of differentiation of the spouses generally determines the family level of differentiation. As will be discussed later, differentiation level tends to be perpetuated across generations due to the fact that an individual usually chooses a spouse having a similar level of differentiation. The lower the level of differentiation in a family, the more fused such a family will be, and as a result, this type of family will exhibit a greater degree of reactivity and tight interdependence between members, which restricts behavioural options.

Generally, an overload of anxiety between spouses is dealt with via

- marital conflict;
- dysfunction of a spouse; or

- projection to a child/children (Hall, 1981).

Symptoms normally develop in a family member when only one strategy is used. Marital conflict is usually the result of excessive fusion, where neither spouse will give in (Bowen, 1978). Dysfunction of a spouse usually occurs where there is a great degree of fusion and one spouse sacrifices their pseudo-self to the other, who then assumes a higher functioning level (Hall, 1981). Consequently, the couple operates in accordance with one common self, largely dictated by one of the spouses.

The adaptive spouse, who has given up their pseudo-self, generally will start to develop symptomatic behaviour such as physical or emotional illness, social acting out (such as alcohol abuse and promiscuity), as a result of having to bear the full load of anxiety of undifferentiation on their own. The dominant spouse is usually unaware of the problems of the adaptive spouse. The dysfunction, however, serves to absorb the undifferentiation or anxiety present in the couple. Consequently, the dysfunction is perpetuated, the other spouse gains strength, and marital conflict or projection to the children, is prevented. Projection to the child or children will be dealt with in the following section.

- **Family projection process.**

Family projection is a means for dealing with surplus undifferentiation in the nuclear family system (Hall, 1981). The level of differentiation of each spouse will influence the degree of fusion in his or her relationship (as discussed above). Should such fusion within the spousal relationship be inadequate to deal with the amount of undifferentiation present, then this residual undifferentiation will remain in the family system, and is usually projected onto a child or children, who absorb this. Family projection is usually accompanied by some marital conflict and dysfunction of a spouse. For example, in a relationship between a mother and child, a mother may reduce her own anxiety levels by projecting it onto the child, and seeing

the child as a problem or needing help or protection. The reader is reminded that Bowen's interpretation and use of the term "projection" does not correspond to psychodynamic conceptualizations and use of the same term. Rather, Bowen's projection signifies a manner in which the system attempts to distribute anxiety and intense emotional processes that may arise from enmeshed relationships along other avenues as a means of preserving homeostasis.

Factors influencing the selection of a child include the sibling position of the parents and the intensity of the parents' dependency on their own parents (that is, the level of differentiation of the parents). The child most trapped is the one who is the most emotionally attached to their parents (Bowen, 1978). This may be manifested as overt closeness or intense repulsion. Popular choices for children include children in the oldest, youngest or only child positions.

- **Emotional cut-off.**

Emotional cut-off is a means of dealing with intense fusion in the family system and signifies an attempt to achieve independence or prevent an annihilation of the self (Bowen, 1978). However, cut-offs generally do not result in greater differentiation but rather result in a gain in pseudo-self and a greater degree of fusion in other relationships.

A precondition for emotional cut-offs is a high level of anxiety in the self or family system (Hall, 1981). Triangles may result in emotional cut-offs where a distanced third person loses contact with the other two. The duration of the emotional cut-off is an indication of the investment of feelings each party has in continuing the distancing. Extreme forms of emotional cut-offs include psychotic symptoms, where the individual suffering these symptoms cuts him/herself off emotionally from the family system and invests these emotions 'outside' of the system, in fantasy (Selvini-Palazzoli *et al.*, 1978) as well as the most extreme form of emotional cut-off, namely, death (premature, suicide or from symptoms).

Emotional cut-offs may be multi-generational (Hall, 1981). When emotional cut-offs exist between parents and grandparents, children are more likely to be cut-off in their relationships as an interpersonal strategy (Haley, 1970).

- **Multigenerational transmission process and sibling position.**

As mentioned above, levels of differentiation, triangles, and emotional cut-offs patterns of behaviour may be transmitted between members of different generations of the same family (Bowen, 1978). Sibling position in a family system tends to influence vulnerability to projection and multigenerational transmission processes (Hall, 1981; Tolman, 1951). As mentioned, oldest, youngest and only children tend to be targets for projection. These positions do not necessarily have to be the chronological positions, but rather the functioning sibling positions. For example, the object of projection is often treated as the youngest, and the child concerned will behave accordingly, or in families where there are large gaps between siblings, the siblings may function as only children.

- **Emotional process in society.**

Bowen (1978) does not exclude the impact of social influence on family processes. In society, he argues that emotional processes move either towards extinction or towards adaptation. If togetherness in society predominates, then differentiation is impeded, and a society tends to stagnate, like a closed system. A society which is largely fused, and characterized by high anxiety levels will manifest “symptoms” such as high crime rates, violence and high rates of divorce, for example (Bowen, 1978).

When differentiation predominates, society generally improves and develops constructively, similar to an open system (Bowen, 1978). The level of anxiety in society (as with the family) generally determines the degree of differentiation in society, which in turn

influences family units (Bowen, 1978). In other words, the process is cyclic in nature. The greater the amount of anxiety in society, the greater the degree of togetherness or fusion, the greater the degree of problem behaviour, which results in societal regression and, over time, societal extinction. Well-differentiated and flexible families are better suited to withstand external impairment influences in society, while fused and brittle families may collapse or explode in response to additional stress from outside (Hall, 1981).

4.3.4 Summary of Bowen's family theory

Bowen (1978) views families as complex emotional systems with patterns of behaviour that are repeated and consequently, predictable. These repetitive patterns are particularly evident during times of stress.

The self emerges out of family interaction. The family tends towards fusion and a common self. Families may take a number of possible positions along a continuum of flexibility and rigidity. Flexible families respond better to stress and allow for greater differentiation of self in their members. Rigid families tend more towards fusion and do not respond as well to stress. The more fused a family is, the higher the level of anxiety within such a system.

Bowen's theory enables one to see how individual functioning and self-determination is a product of family processes, and one's emotional relationship with the family system. It also shows how behaviour may also be influenced by patterns that have been transmitted across generations, as well as in response to emotional processes in society.

4.3.5 The symptom in the family system

Within a systemic paradigm, a problem would be defined as any process that threatens the stability of the system. A system consequently develops its own solutions (Boscolo, Cecchin, Hoffman & Penn, 1987). For example, a family may be growing apart, so, in order to unite the members, the system may produce a solution in the form of a family member who develops a symptom. As a result, the family members will rally around and unite in the cause of the affected member. Further, on examining the history of the afore-mentioned problem or symptom, one might see that it often appears during crisis moments in family life; thus, the problem or symptom helps to restore stability. Symptomatic behaviour consequently may balance or unbalance the system, and not necessarily, by definition, signify pathology for the family concerned (Hoffman, 1981).

Consequently, within family systems theory, pathology in an individual member is secondary to what the presence of such pathology signifies for the system, that is the family, and the function it performs within such a system.

Minuchin (1974) argues that a symptom in a child, frequently indicates the presence or absence of stress in parents. He states that the executive dyad of the nuclear family (which is frequently the parents) may undergo a change or crisis, which exceeds the couple's usual coping mechanisms, and involve the child as a result. The child may then manifest symptomatic behaviour, and if the child is overwhelmed, the involvement may move onto another level, such as other members of the nuclear family, the extended family, or other systems in wider society.

In the case of a child whose problems keep the parents together, the marriage often seems uneven, with one partner appearing to have more power than the other, that is in a complimentary relationship. The couples may also be intensely clinging, intensely avoiding

conflict and/or have children who are disturbed. The child's behaviour influences the balance of power between parents, so that his behaviour may provoke the more powerful or one-up partner, but will be such that only the one-down partner is able to deal with it.

As a result, this couple functions according to what has been termed a "homeostatic seesaw" (Hoffman, 1981, p. 132). If the seesaw is too uneven, the parent/child may develop a symptom; if the seesaw is too even, the couple may split; and if the child's symptom disappears (Hoffman, 1981), a symptom may develop in another part of the system, such as with one of the parents or another child. With such a lot "invested" in a symptom, the system may resist any attempts to "cure" the symptom.

4.3.6 The individual in a family systems approach

It would appear that individual and systemic psychologies have generally been perceived as mutually exclusive. However, many theorists (Haley, 1978; Kerr & Bowen, 1988) have challenged this on the basis that a family system can be reflected in the psychology of the individual and vice versa, due to the circular nature of the impact that these two units of understanding have upon one another. Haley (1978) argues that "the smallest unit [of the family system] could be considered to be the individual" (p. 147). Kerr and Bowen (1988) challenge traditional notions of the psychology of the individual by advocating the placement of such a psychology within the larger systemic context of the family system. Consequently, an individual (although representing only one unit within the family system) can be understood as part of a network of interlinking relationships between members of a family system. It follows that the role that such an individual has performed within such a system and the relationships of which he has been a part will impact upon his psychology and that it

is possible to understand an individual by understanding the family system of which he is a part.

In discussing the place of the individual in a systemic point of view, Nardone and Watzlawick (1993) state that if you observe the behaviour of individuals from the systemic and cybernetic point of view, personal entities can be viewed as “not standing on their own and having their own ‘determined’ evolutive and behavioural scheme, but...interacting inside a system of relationships or a context characterized by a continuous and mutual exchange of information between single entities that influence one another” (p. 36). Similarly, McClendon and Kadis (1990) stress an important point. They base their assumption (from Miller, 1969) on their view of general systems theory (GST). Although every unit is made up of smaller units and the larger unit is more than the sum of its parts, the application of GST seems to focus entirely on the larger unit with the assumption that significant change in the family unit will necessarily result in change in the individual. They believe while this may be so, it misses an important point:

The family is made up of individuals and each person brings his or her own personal history to the party, perceives and interprets events in the context of his or her own personal history, makes decisions about him/herself and the world, and finally acts on the basis of this personalized processing (p. 137).

The authors quote several studies confirming their point: “that it may not be enough to focus on the system without attending to the individuals who compromise the system” (p. 137).

Following from the above, Kerr and Bowen (1988) state that the evaluation and treatment of families in systemically-oriented psychotherapy can involve any number of members, as

long as the therapist approaches the conceptualization, evaluation and treatment of the issues at hand from a systems perspective (i.e., he or she punctuates the issue hand in a systemic manner). Methods of evaluation include interviews with family members (Kerr & Bowen, 1978) and genograms (McGoldrick & Gerson, 1985). With regards to the latter, McGoldrick and Gerson specify that although interviews with clients and different members of the family may increase the reliability of information obtained, such a scenario is not always feasible and the interview can then be used with one member (usually the client). In such a case, Guttman (1991) points out that information obtained is as useful, and can be analysed by client and therapist to elicit adaptive and maladaptive patterns across generations. Beyers (personal communication, 2006) points to the caution with which an individual perspective in family psychotherapy and research should be approached but also argues that to exclude individual perspectives when additional family members are unavailable is to undermine the utility and value of an individual's perceptions, beliefs and knowledge of his own family and to diminish the scope of family and social research. The responsibility lies with the researcher in terms of carefully listening with openness to the individual's story about his family system, weighing and evaluating the manner of communication and personal involvement; of how the individual recalls his history; how the interactions between family members are described and communicated; and be aware of his own role in the process of research.

4.4 KEY FAMILY SYSTEM CONCEPTS FOR THIS STUDY

Prior discussion has included an elaboration on the definition of the family that will be used in this study as well as an overview of family systemic theory. Whereas the former will be utilized as a means by which to select the unit of analysis for this particular study (that is, the family system), the latter will be used to interpret the findings of the analysis. In terms of

achieving the latter, it is necessary to narrow down family systems theory to those theoretical elements that the researcher feels are of particular importance in understanding and interpreting family systems. These are:

- emotional processes;
- multigenerational patterns of structure and function; and
- patterns of relationship.

In line with the spirit of reflexivity that characterizes qualitative research, other researchers may have chosen to focus on other aspects of family systems theory, which would have influenced the results of the study in turn. Perhaps this may provide inspiration for future research where other aspects could be used and the results compared. This will be discussed further in chapter 6 however and the different elements selected for this study will now be elaborated upon further.

4.4.1 Emotional processes

Emotional processes form a significant component of family systems, specifically in terms of the manner in which members that are part of such a system encounter emotional processes as part of their relationships with other members, and ways of dealing with such emotional content and process are established at both individual and systemic level.

Emotional processes in the context of serial murder appear to have been dealt with in two predominant ways. On the one hand, serial murder has been portrayed as an act involving aggressive and violent emotional processes (Douglas & Olshaker, 2000; Holmes & De Burger, 1988; Ressler, 1997); while on the other, individuals who commit serial murder have frequently been portrayed as unemotional or detached from the affective component of their acts (Holmes & Holmes, 1996; Meloy, 2000). In this way, the author intends to investigate

the manner in which emotional processes have been negotiated within the family system of an individual who commits serial murder in order to make further sense of the above. This is also imported by the notion of the family as a homeostatic and cybernetic system (Guttman, 1991). Emotional processes interconnect the parts of the system; it also governs the system through feedback. Furthermore, emotional reactions (or not) within the family maintain homeostasis and reduce any deviation that results from the introduction of new information making it difficult to introduce “new” or other emotions into the system.

In terms of emotional processes, Bowen’s concept of differentiation as well as his discussion of the role that anxiety and stress play in the family system will be used. It will be of particular interest to see the manner in which the spousal sub-system of family systems deals with anxiety, specifically the impact that this has on the marital relationship, dysfunctions or symptoms in spouses or involvement/projection onto the child subsystem.

An examination of this aspect of family systems becomes important when one considers proposed classifications of individuals who commit serial murder that have been based on an individual’s ability to manage their emotions. For example, in terms of Eysenck and Eysenck (1977) who proposed classifying criminals into extroverts or thrill-seekers who actively seek out emotional stimulation, and introverts with little overt emotional expression or affectivity. Additionally, Hickey (2006) has also included suggestions in his work on serial murder that this type of criminal behaviour may result from an inability to control and manage internal emotion states such as anger, hurt, fear and anxiety which results in the externalization of these feelings onto outsiders.

Additionally, individuals such as Leyton (2001) have argued that serial murder frequently represents an attempt on the part of the individual who commits serial murder to assert himself and to be recognized as an important and distinct individual in society. By using Bowen’s concept of differentiation together with Ackerman’s (1984) concepts of fusion and

isolation, this study may illuminate interesting developments with regard to the manner and extent to which individuals who commit serial murder are a part of their family system.

4.4.2 Multigenerational patterns

The author has also chosen to focus on multigenerational patterns with regards to the family systems of individuals who commit serial murder mainly due to the large role attributed to multigenerational patterns by theorists such as Bowen (1978) and Minuchin (1974) in the perpetuation and escalation of faulty coping strategies and problem solving attempts within a family system. In this way, across generations the family system may develop ways of preserving homeostasis that ultimately may compromise the ability of certain individual members to function optimally. Consequently, the author intends to investigate the role of serial murder behaviour in an individual member within a family system may represent repetition of relationship and other patterns from previous generations, which may serve as a means to maintain homeostasis or perform other system functions.

In terms of Bowen, it will be of interest to see how levels of differentiation are transmitted through the extended family system as well as how stress and anxiety have been managed across generations. The effects of projection across generations will also be examined together with an investigation of repeated patterns of emotional processes in the family system and their impact on the system.

Sibling position and its effect on the family system (especially where sibling constellations are repeated in some manner) will be included in an investigation on multigenerational patterns also. Given that serial murder has frequently been linked to physical, sexual and other types of abuse during the early developmental period by individuals such as Cleary and Luxenburg (1993), and Hazelwood and Warren (1989), it will

be interesting to see what forms an inability to deal with stress and anxiety at other levels of the family system have taken; whether some of these forms include abuse; and whether some of these incidences reflect patterns that have been repeated in other parts and levels of the system.

Minuchin (1974) will lend a more structural interpretation to examination of multigenerational patterns. In this way, the study will examine the manner in which the family system is divided into sub systems, as well as the manner in which these subsystems interact and organize themselves with regards to membership rules and the way in which individual members adopt certain roles within different subsystems. The way in which boundaries are structured around family systems and subsystems will also be of interest with respect to the degree of flexibility or rigidity which characterizes these boundaries, and thereby mediates intra- and inter-system interaction (that is, how much do subsystems interact with each other, and how much does the family interact with outsiders).

As discussed in the literature review (see chapter 3), serial murder has been argued as being the result of the isolation of the individual member who commits serial murder, as well as the entire family system, from other systems or individuals (Hickey, 2006; Ressler *et al.*, 1988). In this way, it will be interesting to examine the extent to which rules and boundaries of sub-systems and the entire family system have influenced interaction between systems and consequently, the behaviour of individual members or sub-systems.

4.4.3 Relationship patterns

Serial murder involves an event between people, who usually do not know one another, and yet become connected by virtue of the criminal act that transpires between them.

Individuals who commit murder have often been thought to have a particular view of

interpersonal relationships and other people, which may necessitate, facilitate or contribute in some way to their serial murder behaviour (Holmes & DeBurger, 1988; Egger, 1990; Labuschagne, 2001; Lane & Gregg, 1992; Pistorius, 1996). Consequently, the author has chosen to focus upon relationship patterns within family systems of individuals who commit serial murder as the final component of her conceptualization of the family system for the current study. In this sense, she intends to examine how relationship patterns within the family system occur as well as the particular relationships within the family system in which the individual who commits serial murder has been involved, and whether some of these patterns are repeated in (or impact upon) the serial murder behaviour of the individual concerned.

Both Ackerman (1984) and Bowen (1978) ascribe the primary importance of the triad as the fundamental unit of relationships in family systems. Consequently, relationships within the family systems of individuals who commit serial murder will be examined with respect to their arrangement into triangles or triads, and the subsequent influence of these arrangements on the organization and functioning of the family system. In order to achieve this, Bowen's concept of triads, together with the more structural or hierarchical view of Minuchin (1974) in terms of his triads will be used in order to tap both the emotional processing implications (via Bowen) as well as the organizational or subsystem and boundary implications (via Minuchin).

Given the role of power that has frequently been mentioned with respect to serial murder (Prentky, Burgess & Carter, 1986; Ressler *et al.*, 1988), the aspects of family systems theory that deal with relationships in terms of hierarchy and power will be of particular interest in terms of interpreting the family systems of such individuals. The approaches used will thus include Watzlawick *et al.*'s (1967) concepts of symmetrical and complementary relationships, as well as Minuchin's (1974) concepts of hierarchy, coalitions and alliances in family systems.

The theoretical conceptualization above (namely, emotional process, multigenerational patterns and relationship patterns) is illustrated in the diagram (Figure 1 below). As can be seen, emotional processes within the nuclear family, as well as in extended family systems and larger external systems impact upon each other, as well as on individual members. Bowen's theory will be used to interpret these processes in the current study.

In addition to emotional processes, there are also multigenerational factors and processes that may impact upon the nuclear family. These can be seen in the arrows going from extended to nuclear family systems. Additionally, these arrows are bi-directional indicating that activity within the nuclear family system will in turn impact upon extended family systems. For example, if an eldest son refuses to follow in the footsteps of his father, this will have repercussions for the relationship of the son's nuclear family with the extended paternal family system. In order to understand this multigenerational activity, Bowen and Minuchin's theory will be used here.

Finally, the relationships between members within family systems as well as between systems can be seen in the diagram. Firstly, there are bi-directional arrows between members of the nuclear family depicting the relationships between these members. These will be interpreted via Watzlawick's theory as well as Bowen, Minuchin and Ackerman's theories of triangulation. Secondly, there are bi-directional arrows between both nuclear and extended family systems and the larger social milieu (as well as other external systems). The extent to which these arrows are able to operate and the predominant direction along which activity will flow (that is, from the family system outwards or from the outside in towards the family system) will vary from one family system to another.

4.5 SUMMARY OF THE CHAPTER

Family definitions have historically focused on the nuclear family and excluded alternative family types such as single parents and same-sex unions, as well as the manner in which families may change over time.

This study has chosen to interpret the concept of family more holistically, in terms of the nuclear and extended family, as well as allowing for variations along alternative lines.

Family systems theory applies the theory of cybernetics to the family, and examines how processes and outcomes within the family context occur in line with the principles of systemic theory. Within such a paradigm, the family can be viewed as consisting of a number of inter-related members, whose actions and behaviour influence the other members in the family as well as the family system as a whole.

The principles and concepts of family systems will be used to interpret the data in the current study and applied to understand the role that serial murder plays in the family system, specifically with reference to a conceptual framework that focuses upon emotional processes, multigenerational and relationship patterns in family systems. These different aspects are not mutually exclusive but rather influence each other in a circular manner.

The following chapter will examine the methodology for the current study, including aspects such as research design, data collection techniques, sampling strategies and methods of data analysis for the current study.

Figure 1. Diagrammatic Representation of a Family System

LARGER SOCIAL SYSTEM OR OTHER SYSTEMS

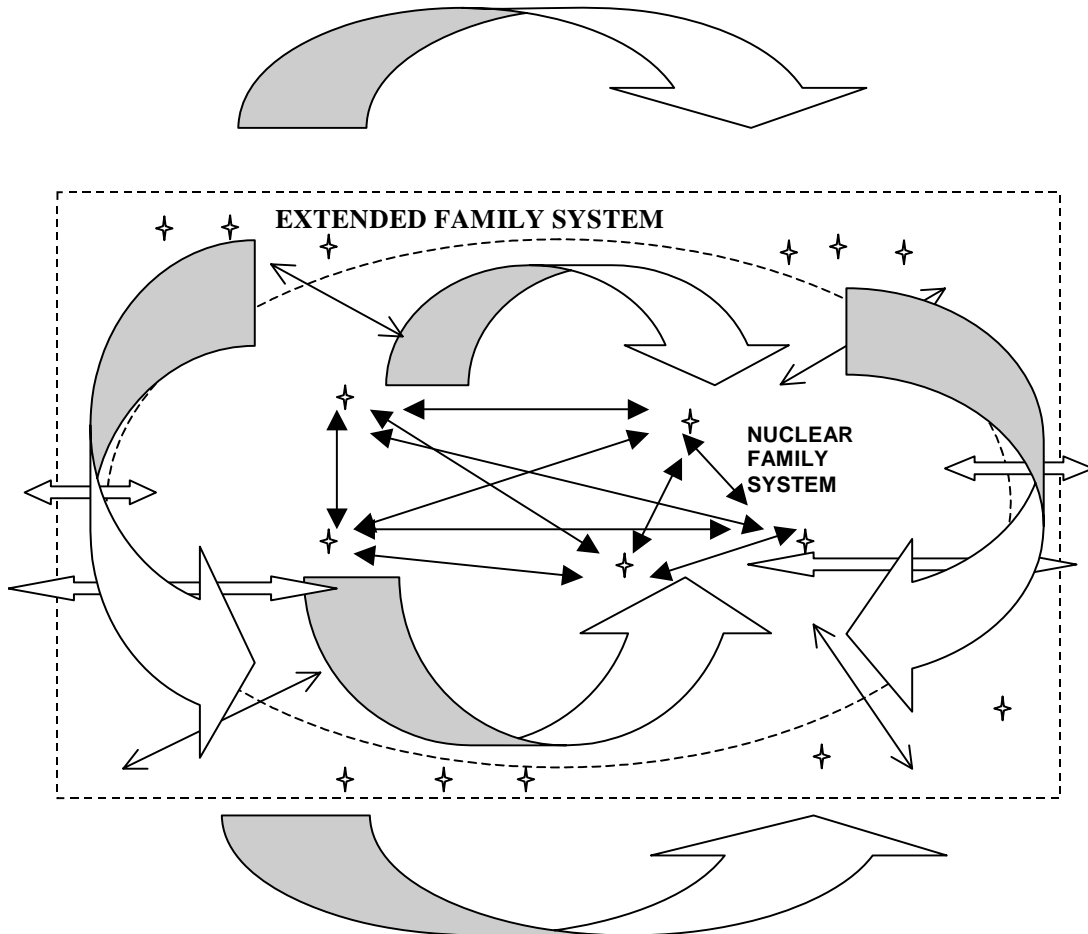

Key to diagram

- Boundary between systems (in systems with rigid structures)
- ↔ Relationships (between members)
- ↔ Relationships between nuclear and extended family systems
- ↔ Relationships between nuclear/extended family systems and larger systems
- ↪ Emotional processes
- ✦ Individual members

5. METHOD OF RESEARCH

Previous chapters have discussed the body of theoretical work on serial murder. The approach used to interpret the current findings, namely family systems theory, has also been discussed. In Chapter 1, the purpose of the study was spelt out, namely: to investigate serial murder from a systemic point of view. To achieve the above, the following question was proposed as focus:

- “How does the family system of a person who commits serial murder function?”

That is, what is the family structure, who are the people in the family system and how do they maintain the family system.

This chapter explains the methodology, research design, procedures, ethical considerations, data analysis and data integration of the study.

5.1 METHODOLOGY

This study is qualitative in nature. Qualitative research has been understood as “the interpretive study of a specified issue or problem in which the researcher is central to the sense that is made” (Banister, Burman, Parker, Taylor & Tindall, 1994, p.2). Qualitative research focuses on the meaning of experience, actions and events as they are interpreted through the eyes of certain researchers, participants and cultures or groups, and is sensitive to the particular contextual nuances of the study topic (Harre & Secord, 1972) as well as the impact that the relationship between researcher and the participant/s and context has on interpretation of the study topic. *Quantitative* research focuses on measuring, manipulating

and specifying relationships between certain variables in order to test causal hypotheses (Henwood, 1996).

Parker (1992) describes the differences between quantitative and qualitative research in terms of three “methodological horrors” (Woolgar, 1988). These are indexicality, inconcludability and reflexivity.

In terms of *indexicality*, an explanation is always tied to a particular context, and will change as the context changes. This is viewed as problematic in quantitative research and is addressed via reliability and validity. Qualitative research does not view this as a problem and instead it into the research process by focusing on specificity with respect to the topic of study. The qualitative researcher does not and cannot generalize his findings, but provides an understanding of the phenomenon as it occurs.

In the current study, the researcher focuses specifically on serial murder in the South African context and acknowledges that this phenomenon is subject to change as the South African political and socio-economic and cultural climate changes, or as policing initiatives targeting individuals who commit this crime become more sophisticated and accurate. Consequently, the current research is framed by specific contextual parameters, and findings will be interpreted with reference to those parameters.

In terms of *inconcludability*, an account can always be added to, and as more is added to it, so it will mutate. Quantitative research deals with this “problem” by having a representative sample size; however, in qualitative research, the inconcludable nature of research is accepted and therefore, methods such as single case studies are acceptable. In fact, much qualitative research treats each study as if it was a case study and aims to provide an in-depth examination of the different meanings at work within a different context.

As will be discussed further, this study will focus on case studies of individuals who have committed serial murder in South Africa and will attempt to develop an understanding of

these individuals and their family systems. The researcher acknowledges the sample size and findings that will be generated are by no means complete; and that these findings may be contradicted, elaborated or supplemented by other research on the same topic, or with the same individuals, for example. Yet, understanding and knowledge about serial murder within the context of family may shed light on aspects such as interpersonal familial patterns, emotional processes within the family and family structures.

Finally, *reflexivity* refers to the researcher's awareness of his own subjectivity in terms of the way that a topic is conceptualized, and findings are interpreted. The way in which a researcher characterizes a phenomenon will change how it operates for him and that will change the way that that phenomenon is perceived. Rather than attempting to eliminate subjectivity as quantitative research attempts to do, qualitative research includes the researcher's subjectivity as a resource in the research process.

In this study, the researcher has chosen to define the concepts under investigation in a certain way – see definitions of serial murder (Chapter 2) and family (Chapter 4). It is understood that these definitions impact upon the cases selected for analysis and data collection and that another researcher may have chosen different definitions, and obtained different findings possibly as a result. Additionally, the conceptual framework for family systems theory devised by the researcher will also impact upon the analysis of the data and findings generated, and will be kept in mind throughout the analysis and assessment of findings.

5.1.1 Evaluating qualitative research

As opposed to quantitative research, which focuses on validity and reliability to evaluate the strength and generalizability of a study, quantitative research has its own set of criteria by which a study can be evaluated.

These criteria are:

- credibility;
- transferability;
- dependability; and
- confirmability (Marshall & Rossman, 1995).

Credibility requires that the researcher must demonstrate that the study was conducted in such a manner that the subject was accurately identified and described.

Transferability refers to the question, how applicable or transferable are the findings to another setting or group of people? The burden of demonstrating transferability lies with the investigator who would make that transfer rather than the original investigator.

Dependability refers to the degree to which one can be sure that the findings would be replicated if the study were conducted with the same participants in the same context. In order to satisfy this criterion, the researcher has to account for changing conditions in the phenomenon.

Confirmability refers to the extent to which the findings are reflective of the subjects and the inquiry itself rather than being brought about by the researcher's own prejudices. This study will be evaluated by the researcher in relation to these four criteria, and this evaluation will be included in Chapter 8.

5.2 RESEARCH DESIGN

The research design is exploratory in nature. Exploratory or descriptive research does not concern itself directly with causal explanations but rather details empirical observations made by the researcher (Rosenthal & Rosnow, 1991). Consequently, the researcher does not specify research hypotheses prior to the study but rather generates findings that may be used in other

studies in ways that may or may not be causal. Exploratory research is frequently used when the topic under study is novel; when little research is available on the topic of interest; when a researcher wishes to test out methods or approaches that may be formalized in a future study; or when the researcher wishes to generate findings that may be tested in a more formal manner in another study (Rosenthal & Rosnow, 1991).

As discussed previously, although serial murder has not been researched extensively in South Africa, a few studies (Du Plessis, 1998; Hodgskiss, 2003; Hook, 2003; Pistorius, 1996; Labuschagne, 2001) have been conducted. Additionally, no prior study has assessed the role of serial murder within a family systems theoretical approach. Therefore, the topic of serial murder in South Africa is suited to an exploratory research design, which will be adopted for the current study, and which hopefully will yield findings that can be tested further in future research.

5.3 SAMPLING

Given the usual small population targeted by qualitative research, in this case individuals who have committed serial murder and are currently incarcerated in prisons in South Africa, the sampling strategy is a non-probability purposive sampling strategy. Non-probability sampling does not involve random sampling and consequently is limited with respect to how well it can be said to be representative of a particular population (Trochim, 2002). Given that qualitative research does not require representativeness in as strict a sense as quantitative research, and that the sample population is limited, non-probability sampling is suitable for this study.

There are two types of non-probability sampling, namely accidental and purposive sampling. This study will use a purposive sampling strategy. According to Trochim (2002)

purposive sampling is ideal when the researcher is seeking a certain predefined group; when a targeted sample is needed quickly; and where proportionality is not a primary sampling concern. The current study meets the first and third criteria, namely:

- individuals who have committed serial murder constitute a certain predefined group; and
- proportionality is not of primary importance given the small population size.

According to the various types of purposive sampling strategies proposed by Patton (1990), the strategy adopted by this study can be further classified as a criterion-based purposive sampling strategy. This means that cases are selected on the basis of meeting some criterion – in this case, the generic definition of serial murder discussed in chapter two. Patton also states that this sampling strategy allows for quality assurance in purposive sampling.

The selected sample for this study consists of individuals who are currently serving sentences in various prisons in South Africa. A case consists of instances of serial murder behaviour and the family systems of which they are a part. It was important to select cases from similar cultural and ethnic backgrounds (namely, White, Afrikaans-speaking) as opposed to others (such as Black and speaking an African language) due to the researcher's objective of obtaining a thorough, in-depth understanding of the phenomenon within a family system. In order to do this, the researcher selects the sample according to those with which she feels that she could communicate most adequately without potential contamination or influences that may have resulted due to lack of familiarity with linguistic practices. The introduction of a translator may also affect the system's response and may dilute the investigation further. Future research may possibly aim at extending the realm of cultural backgrounds with regards to serial murder.

Two individuals who meet the criteria for an offence of serial murder are chosen. A brief description of each and their family follows:

5.3.1 Case study one: Mr X and family

Mr X is a White, Afrikaans male in his early forties who is currently incarcerated in a prison in South Africa. He was convicted on five counts of murder, seven counts of rape and one count of attempted rape. His victims were all females, of various ages and ethnicities and he committed his crimes over a period of two years. His immediate family consists of a mother and father and no siblings. The mother and father are pensioners and are of the same ethnic background as Mr X. Mr X's mother still works in the catering industry whilst his father is retired.

5.3.2 Case study two: Mr Y and family

Mr Y is a White, Afrikaans male in his late forties who is also currently incarcerated in a prison in South Africa. He was convicted of three counts of murder, three counts of robbery and one count of attempted murder. His victims were all White males, of various ages and he committed his crimes over a period of ten months. Mr Y's family is estranged and both his mother and father are deceased. After extensive unsuccessful attempts to contact other members of Mr Y's family, it is decided to proceed and document the family of Mr Y via interviews conducted with him: the way he experiences his family.

The reasons to proceed with Mr Y, without having had any available support for the research from his family members are follows:

- He was one of only a few who fulfills the basic cultural criteria, namely from Afrikaans background and origin.
- He was from the White ethnic group.
- He is of male gender.
- He fulfills the criteria set for the definition of serial murder.
- From a theoretical point of view as explained in Chapter 4, the individual is still important in family theory. The individual can still be interviewed and evaluated especially where the genogram is applied as instrument to identify repetitions, adaptive and maladaptive interactional patterns across generations (Guttman, 1991). Given that the genogram information may lead to a decrease in reliability (McGoldrick & Gerson, 1985) the ethical responsibility now rests fully on the shoulders of the researcher to allow for this limitation. In effect, it means that the researcher should apply his/her clinical skills to the full. She should listen carefully, but with openness, weighing and evaluating the person's manner of communication, interpersonal style and involvement (Beyers, personal communication, 2006).

For both cases, the family system in each instance is defined in line with the operational definition of family in chapter 4, namely, as those individuals included by Mr X and Mr Y in their conceptualization of their "family". Where these individual are alive and give consent, interviews are conducted with them as outlined below. Alternatively, the individual's own description of their family and relationships within the family system is accepted, as with Mr Y.

5.4 DATA COLLECTION

This study uses four sources of data collection, namely:

- clinical observations of the participant/s;
- interviews with
 - individuals who have committed serial murder;
 - their family members; as well as
 - prison staff, investigating officers and/or other professionals involved in the cases of these individuals;
- genograms of the families of individuals who have committed serial murder; and
- archival records in the form of
 - police case files for the individuals concerned;
 - psychological reports or evaluations;
 - newspaper reports; and
 - recorded television interviews.

These four sources will now be discussed in further detail.

5.4.1 Clinical observations

Clinical observation refers to the direct observation of an individual in order to learn more about that individual's behaviour and, more specifically, their mental health or psychological functioning (Sadock & Sadock, 2003). Aspects of the individual that are focused upon may include appearance, body size, hygiene, eye contact, attention and concentration, speech and language, mood, thinking process, memory, ability to interact with others, problem-solving strategies, and repetitive behaviours such as tics. The context in which clinical observation

can take place ranges from more formal settings such as the psychiatric ward of a general hospital to less formal contexts such as casual conversation in a non-psychiatric setting.

This study uses clinical observations of the individuals interviewed (participants and their family members). These observations provide information regarding the behaviour of the individuals interviewed and their interaction with their immediate surroundings (including kinetic aspects such as tone of voice, posture, body language, and use of affect) as an additional data source.

5.4.2 Interviews

The interview used in this particular research study is a qualitative one. In line with the research design, the purpose of the interview method is exploratory as opposed to hypothesis testing and aims to elicit and explore the family and individuals who have committed serial murder. The intention is to allow the data and themes to emerge relatively unrestricted from the interviewees. The researcher conducts all the interviews personally and makes use of interpreters/translators where necessary. The potential influence of such a device on the narratives and themes drawn is noted and included in analysis. Informed consent and confidentiality are ensured.

The interviews are semi-structured and consist of open-ended questions about the family system. The interviews are structured only in the sense that the interviewer will keep the focus on serial murder, the family system, the views of family members about the occurrences and feelings towards the incarcerated member, and the subject's views or perceptions of his own family. The basic format of the interview follows the interviewee's interpretations, explanations, and sense/meaning-making of the topic (Breakwell, 1995). Effort is made to interpret and clarify meanings expressed by the interviewee throughout the interview so as to

ensure the quality of analysis. Sensitivity to the emotional well being of the interviewee is practiced throughout the interview process and is used to inform interview questions.

The semi-structured interviews are open ended, which means that the researcher listens carefully and proceeds by reacting to the cues given by the participant (Kvale, 1996). The researcher's actions are based on her own manner of communicating, the messages of meta-communication, and could be explained in a simple way as the constant phrasing of questions in her mind, such as:

- what is happening in the interview between researcher and participant?
- under what circumstances is it happening (what and where)?
- how does it happen?
- why does it happen?
- how is what is happening connected to what follows?
- how and with what can the researcher behave to intervene without contamination of the research process?

5.4.3 Genograms

The genogram is “a format for drawing a family tree that records information about family members and their relationships over at least three generations” (McGoldrick & Gerson, 1985, p.1). It provides an effective graphical representation of family patterns, which enables the researcher to view how problems within the family or affecting individual members may be related to these patterns across the system. A genogram is a flexible assessment instrument and can be used for research purposes, as well as a clinical tool to inform therapeutic interventions (McGoldrick & Gerson, 1985).

The genogram has traditionally been paired with Bowenian family systems theory but is not exclusive to it (Mauzey & Erdman, 1995). Within this framework, the genogram assists with formulating hypotheses about family systems and designing interventions into them. Additional clinical benefits of the genogram include organizing data in a graphical way; engaging a family in sessions; teaching systemic ideas; clarifying family patterns and characteristics; and developing intellectual understanding of issues in family systems (McGoldrick & Gerson, 1985; Wachtel, 1982). Consequently, it would appear that the genogram is useful as both a clinical intervention and tool for working with family systems, as well as from a research-oriented perspective in terms of understanding and representing family systems.

Most traditional approaches to genogram construction focus upon the basic structure of the family; demographic information; and relationships. However, it is possible to expand creatively on these bases (Mauzey & Erdman, 1995). Additionally, the genogram has been shown to have considerable usefulness in terms of developing cross-cultural understandings of family systems, as well as validity for application to multi-cultural groupings in studies conducted in South Africa (Marchetti-Mercer & Cleaver, 2000).

This study makes use of the genogram method to organize and interpret data gathered on the family systems of individuals who commit serial murder. The decision to use a genogram is based on its proven utility in organizing data related to family systems; graphically representing such systems and illuminating relationships between members; fit with theoretical approaches utilized for the current study (such as that of Bowen (1978)); and its proven cross-cultural suitability and applicability, especially given the multicultural composition of current South African society.

The standardised method for compiling a genogram as outlined in McGoldrick and Gerson (1985) is used. The standardized method consists of three steps, mainly:

- mapping the family structure;
- recording family information; and
- showing family relationships (McGoldrick & Gerson, 1985).

These will now be elaborated upon in turn.

- **Mapping the family structure.**

The graphic depiction of family relationship and structure involves constructing a map of how different family members are related (McGoldrick & Gerson, 1985). This map consists of figures, lines and symbols, representing people and their relationship to each other. The main information represented on the map includes marriages, deaths, divorce or separation, adoption or fostering of children, twins and households.

- **Recording family information.**

The family structure can be considered the “skeleton of the genogram” (McGoldrick & Gerson, 1985). Once compiled, further family information is added, namely:

- demographic information;
- functioning information; and
- critical family events.

Demographic information includes dates of birth and death, ages, locations, occupations and educational level. Functional information refers to the medical, behavioural and emotional functioning of family members. Critical family events refer to important events that may have impacted upon family functioning or the functioning of the individual concerned. These include transitions, migrations, failures and successes, demographic events such as births and deaths, and loss of job, for example.

McGoldrick and Gerson (1985) stress the importance of including housekeepers, extended family such as aunts, uncles, cousins, foster children and adopted children in the analysis of families for clinical or research purposes. They also state that ethnic groups may vary considerably in the structuring of their family trees and that for this reason godparents and other kinship networks should not be ignored in terms of the role that they might play for a particular family group. Stack (1974) states that when a close friend is especially important to a family, this individual may become a member of the informal extended kinship network and that he or she should be included in any analysis of the family.

- **Showing family relationships.**

The final step of creating the genogram involves delineating the relationships between family members. This process is largely inferential and is based on information gathered from family members as well as observation of the family members.

The definition of family discussed in chapter 4 will be used to designate the group of individuals that would be used to construct the genogram for each case. The genogram for each family system is compiled from interviews with, and direct observation of family members as well as the primary research participants in the study, and will go back three generations to the grandparents of the individuals concerned. Due to the fact that the index individuals are incarcerated, and as a result of strict Department of Correctional Services access regulations, it will not be possible to observe the interaction between them and their family members.

Analysis and interpretation of the genogram data takes according to the following categories, namely:

- Category one: Family structure, with respect to
 - household composition;

- sibling constellation; and
- unusual family configurations;
- Category two: Life cycle fit;
- Category three: Pattern repetition across generations, with respect to
 - patterns of functioning;
 - patterns of relationships; and
 - repeated structural patterns;
- Category four: Life events and family functioning, with respect to
 - the coincidences of life events;
 - the impact of life changes, transitions and traumas;
 - anniversary reactions; and
 - social, economic and political events;
- Category five: Relational patterns and triangles; and
- Category six: Family balance and imbalance, with respect to
 - the family structure;
 - roles;
 - levels and style of functioning; and
 - resources (McGoldrick & Gerson, 1985).

5.4.4 Archival data and other records

Archives are the “ongoing, continuous records of a society” (Rosenthal & Rosnow, 1991, p. 354). Archival records may include actuarial records of births, deaths, and marriages; political and judicial records; other government records (such as crime reports, and police

case files); the mass media; sales records; industrial and institutional records; and various other written documents.

This study uses archival records in the form of police records, and case files in order to select participants and psychological reports together with documentation in the form of newspaper reports as well as video interview footage as part of the data analysis.

It is hoped that by using multiple sources of data, the study will obtain a rich and complex interpretation of the topic of interest (Patton, 1990), and satisfy the criterion of credibility. By using interviews with individuals who have committed serial murder and their families, together with reports from psychologists who assessed them, and direct observation of family interaction, the consistency of the overall impression of the family system can be established and any contradictions can be included in the analysis and/or explored by accessing other sources of data, which may become available as the process of evidence enquiry develops.

To be able to review the drafts of participants, all information gathered is put together and assessments and analyses conducted with the aim of possibly determining if any new or additional information is needed. Additionally, the participants are asked to confirm the researcher's understanding of their beliefs, ideas and perceptions as expressed during interviews and in this way, key informants are allowed to review the information collected in the study and relative consistency in understandings between the researcher and participants is ensured, thus attempting to fulfill the criterion of reflexivity.

5.5 PROCEDURE

The procedure followed by the research study consists of the following steps, namely:

- review literature;

- choose approach and design;
- research media for possible cases;
- identify possible cases;
- get permission from University of Pretoria and Department of Correctional Services;
- review case files and other archival data; speak to experts;
- approach subjects for permission;
- interview individuals who have committed serial murder;
- interview family, prison staff and other professionals;
- compile genogram;
- examine data in light of theoretical approach (Family systems theory); and
- compile results.

All interviewees are briefed before interviews. Briefing consists of defining the situation for the subject, describing the purpose of the interview as well as allowing for any questions on the part of the interviewee. This includes a semi-formal social introduction, the sharing with the participant the aims of the research, as well as ethical and confidentiality issues. This also includes the participants' permission or willingness to participate. Confidentiality is stressed and anonymity guaranteed with regards to interview data, collection and publication of the research.

A statement is made that participation will possibly contribute to the understanding of violence in general and more specifically to serial murder. Initial questions in the interviews are unstructured and open-ended, aimed at developing a sense of rapport with participants. Later, more focused, semi-structured questions are introduced in order to gather information about the family, using circular questions and the genogram to further generate questions and

information for clarity. In addition to the above, some structured questions are also included to obtain biographical and chronological data about the family.

Debriefing after the interview(s) consists of summarizing the main points of the interview and allowing for feedback from the interviewee. Such feedback may go towards verification in later stages.

The above examples of how the interviews are to be introduced may differ depending on the immediate meta-communications and interactional/interpersonal cues in the researcher's relationship with the interviewee (Watzlawick *et al.*, 1967). The processes and interactions during the interviews are also described and analyzed.

The researcher conducts between three and five interviews of approximately two to three hours with each individual who has committed serial murder, and approximately one interview of one to two hours with family members. The idea is to continue until some form of saturation of information is reached before interview(s) are terminated.

Interviews with prison psychologists are used for both Mr X and Mr Y (approximately one interview of one hour each); in the case of Mr X, the psychiatrist who assessed him for competency to stand trial is also interviewed (one interview of approximately one hour); and with Mr Y, his cell-mate, Mr Z, is also interviewed (approximately five interviews of two hours each). These interviews are unstructured and are integrated into total data analysis, together with primary interviews (with participants and family members), as supplementary data sources. These interviews consist of semi-structured questions concerning the interviewees' perspectives on the individual concerned; the topic of serial murder and their impressions of the families of these individuals where is contact with these individuals.

5.6 ETHICAL CONSIDERATIONS

In order to safeguard the privacy of the family members interviewed, names of people and places are withheld in line with ethical considerations concerning confidentiality. This is done in spite of the fact that the details of the crimes committed, as well as identity of the individuals sampled for the case studies, are public record. Many of the family members interviewed have avoided public attention due to the sensitive nature of the crimes committed by a member of their family, and their wishes with regards to privacy in this respect are observed.

Additionally, all individuals interviewed are offered the opportunity for debriefing after every interview if they experienced stress or trauma as a result of recounting painful or other experiences. Informed consent is obtained from all individuals interviewed.

Permission to conduct the study is granted by the Research Ethics Committee of the University of Pretoria, and the Department of Correctional Services, after carefully scrutinizing the nature and conditions of the research.

5.7 DATA ANALYSIS

After data is collected via the various methods discussed above, analysis takes place in two ways, namely:

- a case study method; and
- content analysis.

5.7.1 Discussion of the case study method

The case study method selected for this study is a multiple case study exploratory research design, as described by Yin (1994). A case study approach is selected due to the fact that the author desires an in-depth, rich, descriptive conceptualization of the participant and the family system of the participant concerned. On account of the fact that the study does not wish to make any causal attributions about the phenomenon in question, namely serial murder, it is not necessary to use an experimental design with control groups or a quasi-experimental design (Nachmias & Nachmias, 1981). The case study approach is also amenable to the epistemology and theoretical framework of the study.

- **Yin's criteria for defining a case study.**

Yin (1994) has two main criteria for defining a case study, namely that the study must consist of “an empirical inquiry that investigates a contemporary phenomenon within its real-life context” (p. 13); and that “the boundaries between phenomenon and context are not clearly evident” (p. 13).

Serial murder is a contemporary phenomenon, especially in South Africa, where, as discussed in the literature review, it has been particularly prolific over the last ten years (Pistorius, 1996). It is the opinion of the author that serial murder is frequently linked to the context in which it is situated, which, for the purposes of this study, is the family, as well as broader social, cultural and political contexts, to a lesser degree. Additionally, in accordance with Yin's second principle, it is often difficult to draw definite lines between serial murder as a behaviour of one particular individual (as well as serial murder as a cultural phenomenon),

and the context in which this behaviour takes place. This can be seen in the numerous theories discussed in the chapter 3 that attribute serial murder to an individual's upbringing in a "dysfunctional family". Consequently, it would appear that Yin's (1994) two definitional criteria are satisfied, and that a case study methodology is appropriate for this study, and the topic of serial murder.

- **The unit of analysis.**

The unit of analysis is defined by establishing:

- what constitutes a case;
- the time boundaries of a case; and by
- distinguishing what is inside a case from what is outside (Yin, 1994).

A case in this study refers to an individual who has committed serial murder and meets sampling criteria, together with the available family members of this individual. This is because the author intends to study the role played by the family in contributing towards serial murder behaviour in the participant concerned. Family is defined according to the definition in chapter 4 (see p.133).

This study uses the two cases discussed above, taking into account that there are not many individuals incarcerated for serial murder in South Africa.

The time boundaries of the cases that are used in this study consist of the amount of time necessary to establish rapport with the participant concerned as well as their family, and the time necessary to complete enough interviews to reach saturation with the participants and their families.

5.7.2 Content analysis

This study uses a content analysis method to analyze the data collected. Content analysis is a technique whereby messages (in the form of written or oral statements) are studied via being exposed to criteria of selection (Holsti, 1968), after which statements are made about such messages with regard to frequency, grouping or other interpretative frameworks. As a technique, content analysis has been interpreted as both quantitative and qualitative in nature (Smith, 1975). Content analysis involves a consideration of what to count, the nature of levels and units of analysis and how to use coding frames or categories (Berg, 1995; Franzosi, 2004).

It is thought that seven major elements in messages can be counted in content analysis (Berelson, 1952; Berg, 1983; Merton, 1968; Selltitz, Jahoda, Deutsch & Cook, 1959). These are words or terms; themes; characters; paragraphs; items; concepts; and semantics. These elements can be considered types of units of analysis that are then organized in terms of coding frames (Berg, 1995). Coding frames or categories are used to sort cases or units of analysis into some specified special class according to certain criteria. Franzosi (2004) states that coding categories for content analysis have a number of properties, namely:

- the design of coding categories follows the theoretical interest of the researcher;
- coding categories are abstract, general and highly aggregated;
- since the coding categories follow the theoretical interest of the researcher, a researcher with different interests with respect to the texts used or subject matter may choose different categories;

- coder discretion plays a role in trying to fit concrete text into abstract coding categories and thus there may be ‘contamination’ of the measurement which needs to be addressed in terms of reflexivity;
- links and connections between categories are not specified, that is, causal statements are not usually made; and
- coded output bears little relationship to the original text.

This study adopts a qualitative approach to the content analysis method used. The unit of analysis for this study consists of themes that emerge from the collected data (namely, interviews, clinical observations, genograms and archival records) for each case study, and coding proceeds on the basis of theoretical classes based on the family systems conceptual framework discussed in chapter 4 (see p. 167), such as emotional process, multigenerational patterns and relationship patterns. These coding frames or categories are further structured with respect to their various constituent elements (as specified by the conceptual framework in chapter 4).

Therefore, emotional process are further subdivided into differentiation within the family system and differentiation in the social milieu, and themes coded on the basis of how they fit into the various categories. A similar procedure is repeated with multigenerational processes (in terms of Bowen’s projection and Minuchin’s sub-system or structural approach) as well as with relationship patterns (in terms of triangulation and triads, as well as interactions and hierarchies).

5.8 DATA INTEGRATION

Data collected and analysed as outlined above is integrated in order to explore the topic of serial murder as outlined in the research focus, namely: “How does the family system of a

person who commits serial murder function?" That is, what is the family structure, who are the people in the family system and how do they maintain the family system.

After data analysis, there should be an awareness of possible meta-patterns in the family system of each case, which illuminate the connections or relationships between the serial murder pattern of behaviour of one of the members of the family system and other patterns of behaviour in the family system.

5.9 CONCLUSION

This study investigates the role that serial murder plays within the family system via an exploratory qualitative research design. The various criteria for evaluating such a study have been outlined and will be referred to again in chapter 8, when assessing the limitations of the current study.

Importantly, analysis of data first examines each case individually, and then explores the patterns that emerge across cases. In this way, findings may reveal patterns that can be elaborated upon in future research by the addition of other cases or testing of particular patterns. The following chapter will examine the results of the current study.

6. RESULTS

This chapter will present the information obtained for the two case studies, namely Mr X and Mr Y and families respectively. These will be presented in accordance with the format discussed in chapter 5 on methodology, namely with regards to clinical observations, interviews, genogram and archival data obtained. When dealing with systemic descriptions, it is often difficult to separate results from a discussion of results due to the fact that ‘results’ are already interpretations of the system in some form. Consequently, this chapter will outline the information obtained and used to develop an understanding of the family systems of Mr X and Mr Y.

6.1 CASE STUDY ONE – MR X AND FAMILY

6.1.1 Persons interviewed

In accordance with the definition stipulated in chapter 4 “family” and “nuclear family” will refer to Mr X, mother X and father X, whereas the term “extended family” will refer to all other members of the X family system, namely, the siblings of mother X and father X respectively (and their respective families), and the maternal and paternal grandparents (as well as their spouses, in the case of the maternal grandfather).

The following persons were interviewed:

- Mr X

- A series of five interviews of approximately two hours each, were conducted from 31 March, 2004 until 18 April, 2004 at his place of imprisonment.
- Mother X
 - One interview of two and a half hours on 24 May, 2004 at her place of residence.
- Father X
 - One interview of two and a half hours on 24 May, 2004 at his place of residence.
- Prison psychologist at Mr X's place of imprisonment
 - One interview of approximately one hour on 4 April, 2004.
- Psychiatrist responsible for original forensic assessment of Mr X at the time of his trial
 - One interview of approximately 45 minutes on 10 June 2004 at her place of work.

Given ethical considerations in terms of confidentiality and anonymity, the names of the family members, victims and of the individual concerned have been omitted.

6.1.2 Biographical information

Mr X is a White, Afrikaans-speaking South African male. He was convicted for the murder of five women as well as the seven counts of rape. His victims were of mixed racial background and ages. His crimes took place over a two-year period.

6.1.3 Clinical observations

- **Mr X.**

Mr X is in his early forties. He was stably employed with the same organization from school until arrest. He had no criminal record history.

He presents as a shy, introverted individual. He is soft-spoken and polite. Initially he had difficulty maintaining eye contact during interviews and interactions but this gradually became more frequent towards the end of the interview period. His emotional range appeared limited. Affect was blunted but congruent to the content of his speech. His mood appeared to be consistent throughout the interviews. He rarely showed elation or elevated moods but rather appeared indifferent, and at times became teary-eyed when expressing remorse for his actions. Whereas this show of emotion did not appear insincere, it was unclear whether this demonstrated true remorse or self-pity. Mr X appeared to be very adaptable and seemed to have integrated himself into prison life.

At times his thought process appeared to exhibit circumstantiality. His memory did not appear to be very good in terms of remembering specific details such as offence dates or certain aspects of his childhood. However, this seemed to operate selectively as he had very good recall of specific details of the offences that he committed (such as location, interaction with the victim and the layout of the house). Mr X appeared to have no gross impairment of his ability to remember general information concerning events in his remote past.

Although no intellectual assessment was conducted, Mr X appeared to be of average to below average intelligence. His thinking appeared to be very concrete in nature. Mr X demonstrated considerable intellectual insight into his crimes and serial murder behaviour and was interested in finding out more about the reasons for such behaviour in cases involving other individuals. He asked questions regarding the researcher's opinion on the probability of

re-offending in such cases as well as her opinion on addiction, specifically addiction to sex. He did not show any attention problems and was able to stay focused throughout interviews. He listened carefully to the questions asked.

In terms of the interaction and relationship with the interviewer, Mr X was co-operative and seemed interested in assisting with meeting the aims of the study as they were presented to him. He was very aware of prison protocol and procedure and was anxious to ensure that the interviewer utilize the correct channels to communicate with him in terms of any changes to the interview schedule. The interviewer felt comfortable with Mr X. He did not threaten or intimidate the interviewer on any occasion, and the interviewer did not experience considerable fear or anxiety in his presence. This may have been due to the fact that Mr X was always well behaved and polite. In the final interview, he even apologized to the interviewer for the content of the interviews in case some of the offences may have disturbed her on account of them having been committed against women. The interviewer felt pity for Mr X, which may have been due to the fact that he presented as a victim, and exhibited considerable self-pity.

- **Mr X's family.**

In terms of Mr X's family, mother X and father X presented in a varied manner. Mother X is a White, Afrikaans-speaking woman in her early sixties. She does not show any signs of physical illness and appears to care for herself adequately. Mother X presented as a depressed and anxious individual. She was particularly eager to please and to co-operate in the current study. She seemed to become more nervous when father X left the room and she attempted to speak to the interviewer about issues that she felt she could not share with father X, due to fears of upsetting him. These issues centred mostly on the harassment that the X family had experienced since the arrest of Mr X in the form of hate mail and abusive telephone calls.

In the interview with mother X and father X, mother X referred to an abusive anonymous letter together with a video tape (of the documentary featuring Mr X) that she had received that “he [father X] doesn’t even know that someone sent us the video...because I don’t want to disturb him, you know, try to stay strong for both sides”. Mother X sighed frequently throughout the interview. She demonstrated a large amount of resignation paired with frustration in relation to the situation of Mr X. In the interview with mother X and father X, she stated “it gets me a bit, trying to handle things and [after visiting him in jail] it hurts you to, you know, because you don’t understand what happened and you want to get an explanation and in the end, you don’t get an explanation.” She appeared to be determined to establish the reasons for the criminal behaviour of Mr X. In the interview with mother X and father X, she stated “I would love to know what happened and why it happened, because it’s tragic for us, it’s very tragic for us.”

Mother X’s answers were not very clear with respect to the interview questions and she shifted from one topic to another, demonstrating some circumstantiality (as seen in Mr X). She appeared to have her own agenda with regard to what she wanted to communicate to the interviewer. This was not experienced as an attempt to lie to the interviewer or to conceal certain details, but rather as an attempt to make herself heard and to make use of an opportunity to recount her version of events; guilt over possibly having contributed to the behaviour in Mr X; and to express her confusion about Mr X’s behaviour.

Father X is a White, Afrikaans-speaking male in his early sixties. He is currently a pensioner. He was previously employed as a civil servant. He walks with a slight limp but does not appear to suffer from any other physical disabilities. He also appeared to be able to care for himself adequately. His interview was conducted together with mother X at their place of residence. Father X presented as distant and disinterested in the interview. He rarely spoke and frequently left the interview room to attend to his own business, only to return

again periodically. Towards the end of the interview, he left the place of residence and was only seen again when the interviewer left. At times, he appeared guarded and spoke defensively. He gave the impression that he wanted the interview to finish as soon as possible. This contrasted with mother X who appeared to enjoy sharing details about Mr X's life and to welcome an opportunity to discuss her experiences of Mr X's criminal behaviour.

Father X's mood was reserved and he frequently showed irritation at mother X's responses, specifically when she tended to digress from the interviewer's questions. His speech was unclear and his responses were mostly monosyllabic. The interviewer got the impression that he had been persuaded to take part in the interview, possibly by mother X, but that he did not want to be part of the process. He was also selective in the information that he provided in the interview. It appeared that he would volunteer information on family friends and correct mother X if some of her information (such as dates, ages of individuals, and time frames) was inaccurate. However, he appeared to be particularly uncomfortable when the subject of Mr X's criminal behaviour and serial murder behaviour was raised and on one occasion, he attempted to change the topic.

In the beginning of the interview with mother X and father X, the following dialogue appears to illustrate the above. The interviewer asked how Mr X was as a child. Mother X responded with "Mm, he was very quiet. He didn't speak much...ultimately a very loving child – he wasn't argumentative or didn't get angry or anything...what more can you remember? [to father X]." Father X then cleared his throat and stated "There's nothing more to say, so..."

A second example occurred towards the end of the interview when mother X expressed her frustration with being excluded from previous documentations and research on Mr X. She stated that "you [the interviewer] are the first one in twelve years that has come to us...it's a pleasure to help, we must find out the reason and-" at which point she was interrupted by

father X who said, “As you [mother X] have heard, he doesn’t know the reason himself...” and then got up and left.

He appeared to be a retired, but very active man who seems to need to busy himself with various tasks such as acting as caretaker for the block of apartments in which they live. Both parents appear to be of average intelligence.

- **Interaction between mother X and father X.**

The interaction between mother X and father X was varied. Mother X assumed a more prominent role in the interview with regards to taking responsibility as the spokesperson for the family. However, she frequently appeared to seek permission or support from father X to discuss certain topics or to verify certain information. Father X was generally withholding on these occasions or provided minimal information to assist mother X. On various occasions that father X left the room, mother X disclosed certain information that she felt she could not share with father X in order to prevent him from becoming upset or hurt. Consequently, her selective disclosure was interpreted as a means to protect father X. Contrary to the manner in which mother X described her relationship with father X (namely, as mutually supportive, and filled with warmth, tenderness and love), the couple did not appear to be very close emotionally. There was no physical contact between mother and father X and they sat a notable distance apart from one another in the interview room. Mother X sat closer to the interviewer. This, together with her disclosure to the interviewer in father X’s absence may indicate an attempt on the part of mother X to draw the interviewer into an alliance or coalition. This will be discussed further in later sections however.

The home of mother and father X was neat, clean and well looked after. Décor was conservative and traditional. Notably, there were no family photographs or pictures of Mr X

in the house. There was an old South African flag and a republican flag of the old Transvaal and Orange Free State or “vierkleur” flag hanging behind the door of their home.

6.1.4 Genogram

A genogram for Mr X (see figure 2) was compiled from the interview data, as well as case file sources, according to the genogram method outlined in McGoldrick and Gerson (1985). The genogram captures three generations of the X family, with Mr X representing the third generation, or youngest tier; father and mother X and their respective siblings, representing the second generation or middle tier; and the grandparents of Mr X (on both father and mother X’s sides of the family) representing the third generation and eldest tier. The author will now elaborate upon the family information gathered from Mr X, father X and mother X in order to compose the genogram.

Figure 2.

Mr X's Genogram

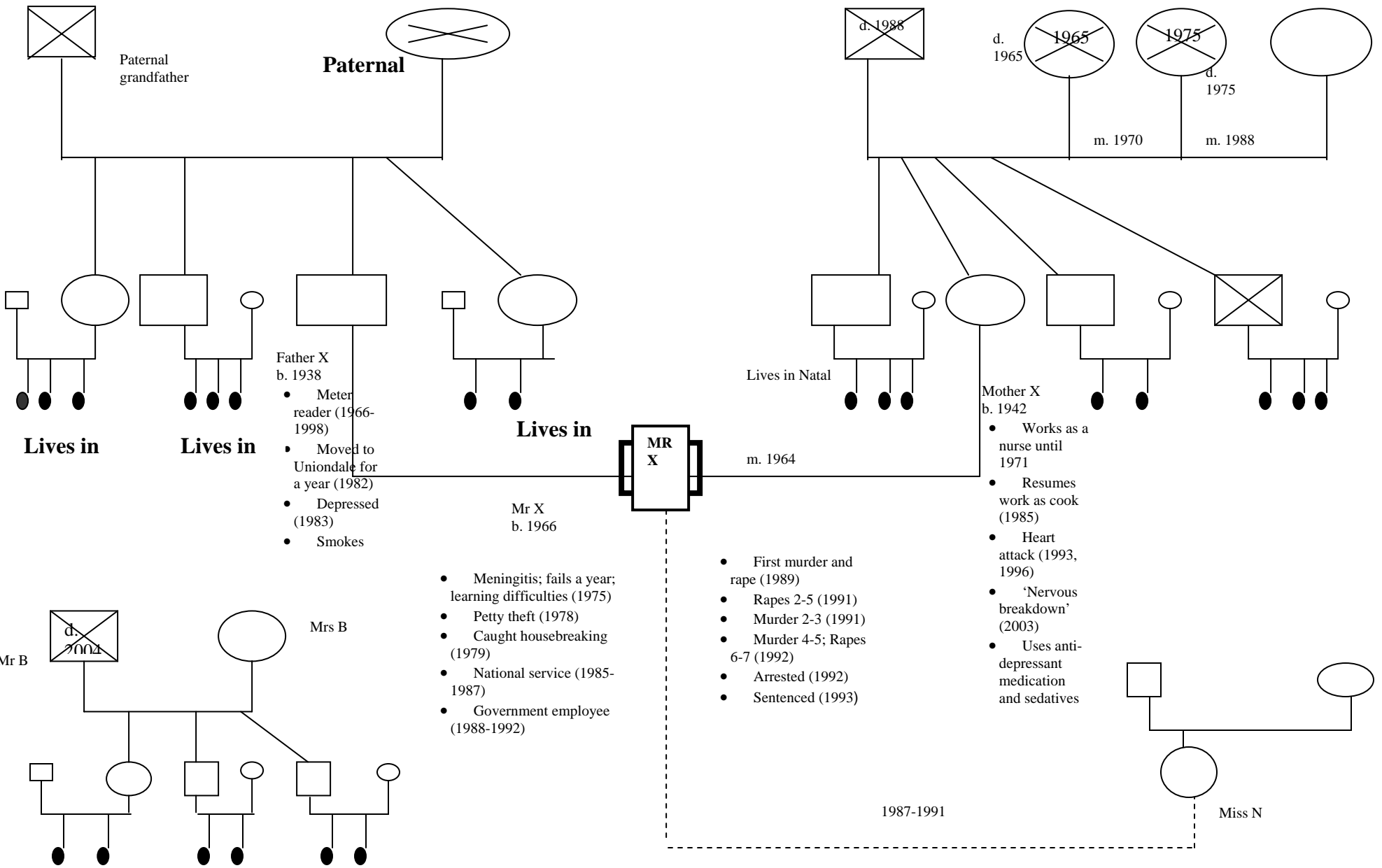

- **Paternal side of the family system.**

With regards to his side of the family system, father X stated that, “We are a bit estranged because my, shall I say, his aunts- he never knew them because they are a bit ‘high society’- we are more simple. And my nieces, I don’t know where they live.”

With regards to father X’s oldest sister, J, mother X stated that, “he [Mr X] had more to do with your [father X’s] sister J – because there was better contact because he knows J...” and that “[Mr X] knew J best...and he was mad about her.”

Despite father X stating that he did not know where his nieces lived, mother X stated that J’s children lived in Limpopo Province, at which point father X stated that his youngest sister’s children lived in the Free State, and, when prompted further by mother X, that his brother’s children live in Limpopo Province also. Mother X attempted to explain the lack of contact with father X’s family in the following way, “it’s mostly elderly people – of our age – retirement age so...but they rarely came to visit us.” Mr X stated that “look, on my father’s side...I didn’t know my father’s parents.”

- **Maternal side of the family system.**

With regards to the maternal side of the family system, mother X stated that “we knew them very well as children but they don’t live close to us [now].” With regards to the relationship between Mr X and his maternal grandfather, mother X stated that “my father and Mr X were very close, you know, and all of a sudden, he had a grudge against Mr X.” With regards to the maternal grandfather, Mr X stated that

I knew my grandfather on my mother’s side well and there were good times with him – okay there were also bad times with my grandfather- he wasn’t really an alcoholic but he

drank and then he got bombastic and, which, you know, a person doesn't like seeing how a drunk person reacts. But it was good because it made me decide never to be like that and to drink until I was drunk.

He also stated that

my grandfather got married three times- I didn't know my first grandmother- I knew my second grandmother well but not for long because – I knew her when I wasn't even in school yet -I was in crèche when I became aware of having a grandmother but then I started going to school and she died when I was in standard three [grade 5]. I don't know exactly when she died but I just know that I didn't know her long but then I didn't know my third grandmother that well either because at that stage, my friendship with my grandfather wasn't good...

It would appear that mother X attempted to facilitate a reconciliation at her father's wedding to his third wife but that this was strained – “I [Mr X] spoke with him a bit but you know, there wasn't good conversation – just hello and how are you...” Mr X stated that his grandfather had a stroke soon after the wedding and that he died shortly afterwards (in 1988). Mother X confirmed that her mother had died in 1965, her father had remarried in 1970 and that his second wife died in 1975 and that he remarried in 1988.

Mother X stated that “I have two brothers, C and P, - he [Mr X] knew them well and their relationship was very good – he got on with them very well.” She stated that one of her brothers lives in Kwazulu-Natal province. With respect to this brother, Mr X stated that

[his wife] wrote to me...we have never really spoken...she is also a psychologist and helps people who have lost their jobs...her children are married and live in New Zealand...my uncle goes to New York often on business- he's in the antiques business.

Mother X stated that she was the second oldest and that her youngest brother had passed away in his early twenties (approximately 1975).

- **Nuclear family.**

In addition to the clinical observations and biographical information discussed for each member of the nuclear family, the following information was also used to compile the genogram.

Mr X stated that his parents

visit me once a month- they are pensioners and okay, my mother still works but she doesn't get a lot of money and she works for an old age home and she's a cook there and they don't get a lot of money – so I think once a month is good – I don't fight about that and accept it- they give me an allowance and toiletries – everything I need...

He stated that father X is retired and on pension. He stated that he did not know his father's age because he had "never asked him" but thought that he may be in his early sixties. Mother X confirmed her own age (62) and father X's age (64) in the interview conducted with her. Mr X also stated that he was an only child. Mr X stated that he had lived in the same place until

standard seven [grade 9] or eight [grade 10] when I stayed in the Cape Province, in a hostel [boarding] because there wasn't a technical school at the place where my dad had bought a shop – where farmers would come and get supplies. My parents fetched me on

the weekend and I would work in the shop. But at some point, the business fell through because the person who we bought the shop from, withdrew the contract because he wanted a certain amount and my dad had given the amount up until that point but then we had to get a loan from the bank and the person didn't want to wait for the loan to come through and he withdrew the contract. So, we had to come back after a year due to lack of funds...it was a big knock for my parents and you could see it in my father – he wasn't very happy and he was really a bit down... so we went back to our old place.

Mother X confirmed that she currently worked as a cook but that “I was a nurse but when Mr X was smaller I stopped working and then we went to the Cape for a bit and when we came back, we helped my father who was on the committee at the old age home and that was it – next year I'll have been there 20 years...”

Mother X also stated that she suffered from anxiety and that she had had two heart attacks (in 1993, 1996) and a “nervous breakdown” (in 2003) since Mr X had been arrested. She is currently on anti-depressants and sedatives (which she was prescribed after the first heart attack).

Father X stated that he had worked at the council as a meter reader and that he was “done – 32 years, I've worked enough...” He is a smoker. Mother X also stated that “[Mr X] is straightforward...and his father is also straightforward – I might hold things back to keep the peace...but Mr X and his father are straightforward – like my one brother in Natal [KwaZulu-Natal Province].”

Mother X stated that she could not recall Mr X having any kind of problems with regard to developmental milestones, or hospitalizations or severe physical conditions or injuries other than meningitis when he was nine years old (1975). According to Mr X, this may have been

responsible for the learning difficulties he experienced at school from that point onwards. With regards to his criminal behaviour, Mr X stated that this commenced while he was in primary school, in standard five [grade 7] (1978) and involved stealing money out of his mother's handbag. This then escalated to breaking into houses in the neighbourhood and stealing money (also standard five [grade 7]). His parents caught him when he was 13 and punished with a hiding. Mr X stated that "when I was caught, I got the hiding of my life but it didn't solve my problem, you know?" He was never arrested.

Mr X stated that he completed his compulsory national service from 1985 until 1987, and then began working for the anti-hijack unit of the SANDF from 1988 until 1989. He was fired from the anti-hijack unit of the SANDF due to aggressive outbursts and joined the railway police where he worked from 1989 until his arrest in 1992. He has smoked periodically since the age of 18 but quit two years ago. With regards to Mr X's criminal behaviour, he stated that the first rape and murder took place in 1989; the second to fifth rapes and second and third murders took place in 1991; the fourth and fifth murders and sixth and seventh rapes took place in 1992. He was then arrested in 1992 and sentenced in 1993.

- **Additional family systems of friends.**

Both father X and mother X spoke of being very close to another family, the B family. Mr B is a work associate of father X. They have known this family for 20 years and recently, Mr B passed away. Mother X stated that "they [B family] are very good to us. Even their children are very good to us and we don't complain – we get a lot of love from their children...they have been very supportive." The B children are in their forties and thirties and have their own children.

Another family that was added to the X family genogram was the family of Mr X's girlfriend prior to his imprisonment, namely the family of Miss N. Mother X stated that Miss N was a "lovely child" and that she went to a school for children with learning difficulties because she was a "bit slow". She also stated that "we really loved Miss N – she had more freedom by us because she had a very strict father...they [Mr X and Miss N] went out a lot and he loved her – they would have married – her father lent Mr X money for the flat..." Mr X stated that Miss N was an only child and that they had dated for four years (1987-1991), before he was arrested.

6.1.5 Archival data and supplementary interview data

As discussed above, in addition to interviews with Mr X and members of his family, interviews were conducted with the prison psychologist at Mr X's current place of imprisonment, as well as with the psychiatrist who initially assessed Mr X for the purposes of his trial. Additionally, newspaper reports were also consulted. These sources of data will now be summarized briefly.

- **Interview with prison psychologist.**

The prison psychologist shared his clinical observations of Mr X with the researcher. He stated that Mr X appeared to be agreeable and placid. He complied well with prison regulations and protocol and appeared to have no problems with other prisoners. He stated that Mr X kept to himself frequently and was a loner.

He stated that Mr X displayed an interest in his criminal behaviour and frequently made attempts to understand this behaviour and expressed a desire to prevent it from happening in the future. In this respect, he stated that Mr X appeared willing to undergo rehabilitation.

He also stated that Mr X displayed a limited affectual range and appeared to demonstrate a lack of motivation in sustaining or engaging in meaningful interpersonal relationships. This was confirmed in the researcher's own experience of Mr X where he made no attempt to sustain the relationship or interaction between himself and the researcher beyond the parameters of the interview process, despite having shared a great deal of personal information and having participated intensively in this process. The prison psychologist was not able to comment on any of the family members of Mr X.

- **Interview with psychiatrist involved in Mr X's competency to stand trial assessment.**

The interview with the assessing state psychiatrist in the trial of Mr X yielded further information concerning Mr X's interpersonal style and behaviour. In South Africa, competency to stand trial evaluations are conducted by state employed mental health practitioners and at state psychiatric facilities. The defense may employ their own psychiatrist to conduct a competency to stand trial evaluation parallel to that of the state appointed one. The psychiatrist stated that Mr X had demonstrated no signs of organic or physiological pathology that may have contributed to his criminal behaviour or personality style.

She stated that Mr X displayed a typical psychopathic behavioural presentation, specifically with regard to limitation in affective display and need for excessive stimulation. She also stated that she believed that Mr X could function well within a correctional system such as a prison but felt that his prognosis would be limited if he was expected to function in the greater social

system. The psychiatrist was also unable to make any comments on any of the family members of Mr X. Her insights were similar to the researcher's own experience and that of the prison psychologist.

- **Additional data sources.**

Newspaper articles – “Verkragter nie versteurd – getuie” in the Beeld (22 September, 1993) and “Bloedverskynsel by ‘Norwoodman’ uiters seldsaam hoor hof” in the Beeld (12 June, 1993) - covering the trial of Mr X make no reference to the family of Mr X. This confirms reports from mother X stating that she and father X did not attend the trial of Mr X and attempted to escape any media attention immediately surrounding the trial as well as in the time since the arrest and imprisonment of Mr X.

6.2 CASE STUDY TWO – MR Y AND FAMILY

6.2.1 Persons interviewed

In accordance with the definition stipulated in chapter 4, family and nuclear family will refer to Mr Y, father Y and mother Y, whereas the term extended family will refer to all other members of Mr Y's family system, namely, the siblings of father Y and mother Y respectively (and their respective families), the maternal and paternal grandparents (foster and biological), as well as the various spouses of mother Y, and any children that she had with them (such as Mr Y's half-brother and half-sister). The following individuals were interviewed:

- Mr Y

- a series of five interviews of approximately two hours each, were conducted from 04 August, 2004 until 01 September, 2004 at Mr Y's place of imprisonment.
- Prison psychologist at Mr Y's place of imprisonment (Ms V)
 - One interview of approximately one hour on 30 July, 2004.
- Cell-mate of Mr Y, Mr Z
 - a series of five interviews of approximately two hours each, were conducted from 04 August, 2004 until 01 September, 2004 at Mr Z's place of imprisonment.

Both of Mr Y's parents are deceased. Additionally, he has had no contact with any other members of his immediate or extended family since the age of 21. Consequently, interviews could not be conducted with any members of the family system, and his isolation from the family system was incorporated into the analysis of the family system.

The decision not to pursue interviews with members of the extended family was based on two considerations, namely: that contact details were unavailable and no information was available concerning the current whereabouts of other family members; and that Mr Y's definition of his immediate family system included individuals who were deceased (that is, his mother and father) or uncontactable (such as his step-father). Given that the study wanted to capture the family system specifically from the perspective of the individual concerned, and in terms of those members significant to that individual, members who may have been traceable but were excluded by Mr Y in his definition of the family were also excluded.

Given ethical considerations in terms of confidentiality and anonymity, the names of the family members, victims and of the individual concerned have been changed.

6.2.2 Biographical information

Mr Y is a White Afrikaans-speaking South African male. He was convicted for three counts of murder, one count of attempted murder and three counts of robbery. His victims were all male and White, mostly homosexual (all victims except one murder victim) and of various ages. His crimes took place over a period of 10 months. He committed his crimes together with another male, with which he was involved in a relationship.

6.2.3 Clinical observations

- **Mr Y.**

Mr Y is in his early forties and presents as a physically strong individual. He is muscular and gives the impression of being a body-builder. As a result, he is physically imposing. He is balding but his hair is shaved close to his scalp so that the balding is less noticeable. His piercing blue eyes are a distinctive feature of Mr Y and he frequently blinks as if clearing them.

His manner appears calm and relaxed and this was carried out throughout the interview series. His physical posture would often reflect this and he would frequently sit back in his chair and stretch his legs out, or adopt similarly relaxed positions. However, after spending more time with Mr Y, this seems to be more contrived and rather may be a result of considerable control that he exerts on his behaviour in order to prevent more intensely aggressive affect from emerging.

Mr Y was able to concentrate throughout the interview sessions and respond adequately to the interview questions. In this sense, there appeared to be no problems with respect to his recall of any of the information or events, specifically with regards to his criminal behaviour. Initially, he claimed not to remember details of his early childhood; however, this may have operated as a defensive measure, as he was able to recall these details as the interview series progressed, and he developed more of a relationship with the interviewer. At times, when asked a question, it appeared as if he needed to actively orient himself to the present moment, almost showing a degree of dissociation. However, on these occasions, he managed to answer the question adequately, and did not have to ask for it to be repeated. Sometimes, he would respond to certain clarificatory questions with irritation or annoyance, as if the interviewer was asking obvious questions. In this sense, it may have been part of his attempt to gain power in the relationships by assuming an air of superiority and insinuating intellectual inferiority through choice of basic question on the part of the interviewer. Other times he misinterpreted certain questions, acting very defensively, as if being judged or blamed by the interviewer. He recovered quickly from both of these types of instances however, and resumed with his previous controlled style of answering. Affect, consequently, seemed appropriate to content of his responses, but his mood fluctuated between irritability and controlled relaxation, with an underlying tension throughout, at some times more evident than others. This was also evident in his motor behaviour, where he continually twitched his leg.

In terms of Mr Y's thinking, he did not appear to show any gross disturbances in form or process of his thinking. However, he appeared to use intellectualization as a defence against talking too much about his own feelings, vulnerabilities, or when discussion became too personal. When this occurred, he would talk in general about topics such as the occult, homosexuality or

religion, and avoid addressing his personal experiences in these areas, or allude to them very vaguely. In terms of thought content, he appeared to have a number of overvalued ideas, namely with regard to being persecuted, and of grandeur. This was evident in his reporting of events in his life, as well as in his attitude towards the interviewer.

There appeared to be no disturbances in speech or intelligence. Mr Y appeared to be of above average intelligence and demonstrated a great capacity for abstract thinking. He showed little insight into his criminal behaviour however, and his judgment appeared to be adequate in situations where he was not affected emotionally or where his self-esteem or control of a situation was not threatened. In the latter situations, it appeared as if his judgment became clouded as he acted to reinforce his apparent needs for grandiosity.

As alluded to above, he seemed to give off an air of superiority and appeared to ensure that the interviewer was aware that he was doing the interviewer a favour by consenting to partake in the study. In this respect, he seemed to attempt to assume control in the interview sessions with regard to when he arrived (frequently too early); when he left (frequently he would look at his watch or make excuses as to having to collect his lunch or resume his duties at the prison gym); as well as initially resisting coming to the first interview after having agreed to take part in the study during a prior meeting. After his initial resistance, however, he came to the remaining interview sessions without protest or further resistance.

Mr Y appears to be interpersonally manipulative and appears to challenge the authority of the prison personnel, as well as correctional system on a regular basis. With regards to the former, throughout the interviews, Mr Y attempted to convince the interviewer to assist him in contacting his co-accused (located at another correctional facility). This occurred despite the fact that he had attempted to occur his co-accused on previous occasions, to which his co-accused had responded

by asking him not to contact him further. In this light, it also seems that Mr Y may find it difficult to accept the wishes of others if they conflict with his own needs or desires. He also made frequent demands on the interviewer with regards to requests for cigarettes and cigars in exchange for his participation.

With regards to challenging of authority, he frequently was involved in altercations with warders. In this light, he seemed to have difficulty taking responsibility for his part in any of these instances, and claimed that they occurred due to the warders' prejudice against, and envy of, homosexuals such as himself. Additionally, he would frequently discuss his grievances with the correctional system and their treatment of him, during the interviews, and yet claimed that any effort to discuss these with the authorities concerned would not amount to anything and therefore was not worth attempting. This continued despite offers by the prison psychologist to act as mediator. Consequently, it appears as if Mr Y may frequently assume the role of the unjustly persecuted individual in his life, possibly as a means to justify any aggressive behaviour on his part as a means of possible defence.

At the end of the interviews, it appeared that Mr Y was only interested in carrying on any relationship with the interviewer if it served to benefit him in some manner. Any further contact appeared to be conditional on whether the interviewer could make beneficial input either in his appeals to the parole board with regard to sentencing or in relation to efforts that could be made on the interviewer's part to assist Mr Y in contacting his co-accused.

6.2.4 Genogram

A genogram for Mr Y (figure 3) was compiled from the interview data, as well as case file sources, according to the genogram method outlined in McGoldrick and Gerson (1985). The genogram captures three generations, with Mr Y representing the third generation, or youngest tier; father Y and mother Y and their respective siblings and spouses (in the case of mother Y), representing the second generation or middle tier; and the grandparents of Mr Y (on both father Y and mother Y's sides of the family) representing the third generation and eldest tier. The author will now elaborate upon the family information gathered from Mr Y in order to compose the genogram.

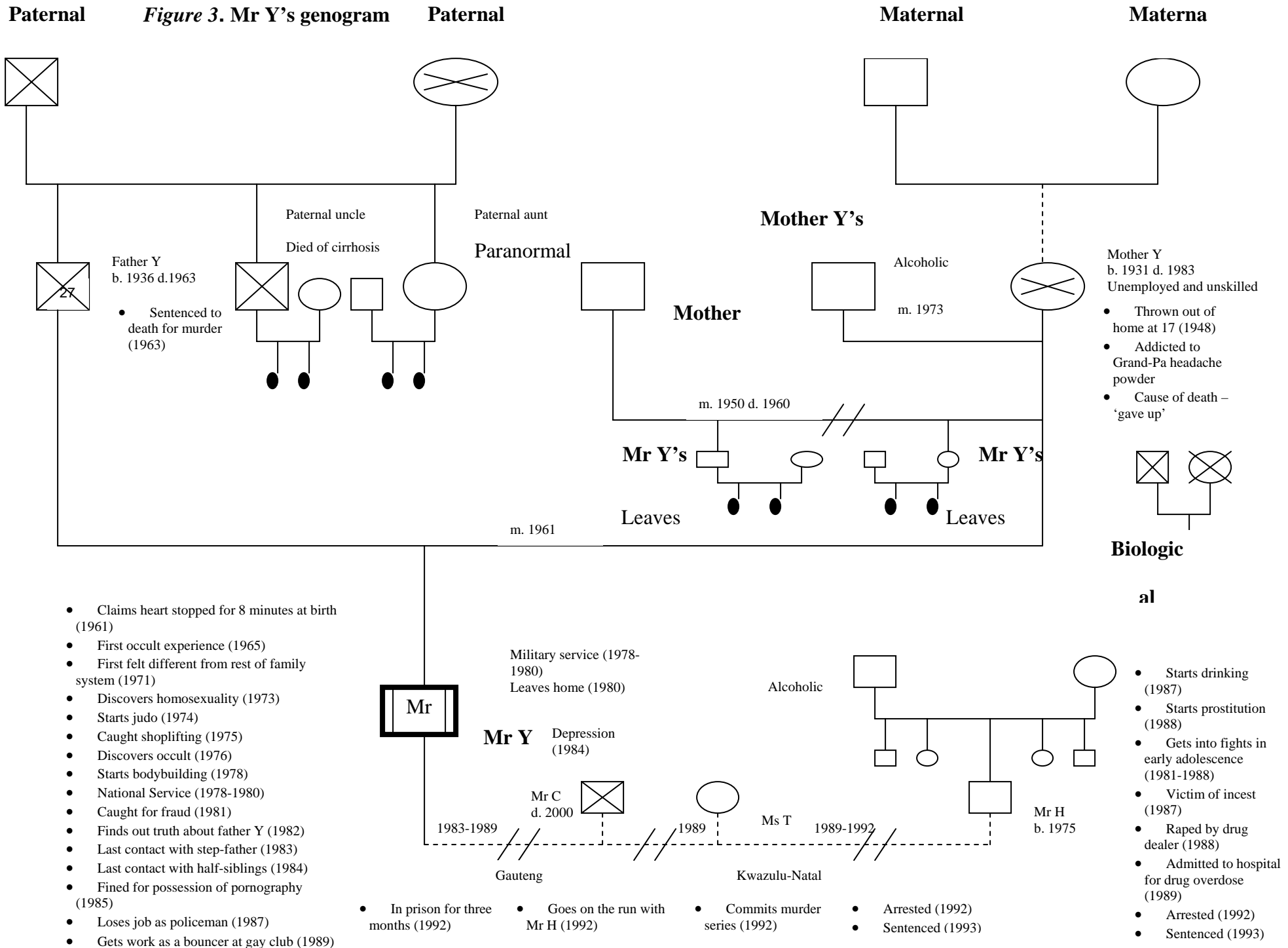

- **Paternal side of the family system.**

It would appear that Mr Y was more familiar with the paternal side of the family system due to the fact that his mother was an orphan and had cut off contact with her foster parents (discussed later). He described the paternal side of the family system as “your average, low class, white characters...raw and mostly uneducated – common is the right word...” He stated that “there was an aunt, an uncle and they all stayed in the same area – all of them used to pot [drink] and ja, my uncle actually died of liver cirrhosis.”

It appears that Mr Y was not fond of this part of his family and felt that “I don’t fit in with my family at all – totally, totally, totally an outsider –I don’t think like them, I don’t act like them, I never liked them outside...the whole setup sort of made me feel different.” Additionally, it would appear that Mr Y did not spend considerable time with this side of the family in his late childhood, specifically after the death of his father. He stated that “it’s very seldom that I ever saw them during my childhood.”

It appeared to be important for Mr Y to stress his dislike for, and difference from his father’s family in the interviews. He stated that

I was young, about 10 years old – I knew I didn’t like this – I couldn’t stand my grandfather...I couldn’t let him touch me – I’d freak out...he didn’t do anything, he’d just be like, “Kom hier, seun” [Come here, boy] and phew, I’d run away – something inside me just kept blocking...

However, it appeared that Mr Y attributed the inheritance of some of his “supernatural abilities” from the paternal side of the family system. He stated that, “on my father’s side of the family – they all had certain abilities, paranormal abilities – you see, my aunt could see my father – he apparently sat and spoke to her then, after his death and that kind of thing.”

- **Maternal side of the family system.**

With respect to the maternal side of the family system, Mr Y stated that, “she had a hard life...she was an orphan.” He stated that his mother “came from a poor family all the way, you know and married into a poor family and that kind of thing...” He also said that “she hardly ever spoke about her childhood...very little information from her...probably circumstances were not very good.”

With regards to her foster family, Mr Y stated the following, “she had one set of foster parents and then, apparently, they kicked her out of the house...and she was a young girl of about 17, 18 – she had to start looking out for herself...”

- **Nuclear family system.**

With regards to the nuclear family, Mr Y described his father as “the apple of everybody’s [in the paternal family] eye”. He was the eldest of his family. Mr Y did not find out about the true cause of his father’s death until he was 21 years old and “my mother showed me the death certificate – death by judicial hanging...he had this argument with the employer – the guy owed him money for his pay and they had words and my father apparently became angry and hit the guy with a tyre iron- killed him...” His father ran away initially but then “gave himself up a week later – his conscience couldn’t handle it- okay, court case wasn’t that long apparently and death penalty...about three weeks later he was hung.” Mr Y additionally stated that he believed that his father’s sentence had been too harsh because “he actually, only out of anger, killed a guy.” Mr Y felt that the judge may have been prejudiced towards his father because “the guy he [Mr Y’s father] killed was a Jewish guy...the judge was also Jewish.”

With regards to his father, Mr Y also stated that “I have no idea what I inherited from my father...all I know about him was the fact that he used to get angry very easily – he’d fly into a rage but he never assaulted or lifted his hand to my mother.”

With respect to mother Y, Mr Y stated that “she was an orphan” and “came from a poor family all the way, you know, and married into a poor family and that kind of thing.” He stated that “I tend to be embarrassed for my mother as well...because she’d swear constantly, you understand...she was absolutely neurotic.” Mr Y stated that “she looked after me very well”, especially after the death of his father. Additionally, “she was an excellent housewife, she kept the house clean constantly- she had this fetish about cleaning constantly- it never stopped...carried on the whole day, you see...[as a teenager] I used to freak out when she goes and cleans my room the whole time, you understand.”

Mother Y also appears to have been quite an anxious person. Mr Y stated that “she used to stress for the slightest reason and she’d make a big thing out of something, you understand...my mother was quite emotional- totally emotional...I mean she would freak out for the slightest thing.” In terms of her style of parenting, Mr Y stated that,

she wasn’t very worried about my schoolwork and stuff like that because- there they left me to go on my own...I wasn’t allowed to have friends at home...they weren’t allowed to come to my house...I think my mom was embarrassed due to the fact that she could not get on with people...she couldn’t have, like, a discussion with the next-door neighbour or anything like that, no way.

Mr Y felt that he had inherited this trait from his mother. He stated that, “I don’t particularly like having people around me...the home was a sanctuary...” He stated that “she never trusted anybody and that I picked up from her as well” and that she was of average

intelligence – “she couldn’t understand one word of my schoolwork...she had a very low self-esteem.”

Mr Y described his relationship with his mother as close and that they frequently had to stand together against his stepfather (mother Y’s third husband) when he became abusive.

Mr Y stated that,

he [his step-father] used to drink a lot...typical abusive parent scenario, you know...he’d chase us around with an axe and things like that...he was very abusive towards her [mother Y] and...he’s have his freak out sessions, you know and then me and my mother would have to run...but she would always go back to him.

Mr Y’s stepfather was 13 years younger than mother Y. Mr Y stated that his mother was addicted to Grand-Pa® (453.6 mg Aspirin, 64.8mg Caffeine, 324mg Paracetamol) headache powder and that he felt considerable guilt about leaving home, and leaving his mother to remain with his stepfather. He stated that

I couldn’t take it eventually- I had to leave...because I knew that I was getting to a point in my life where I was going to kill this guy [his step-father]...when I left home, I was worried about leaving her in the house and only 6 months later, my mother died...when I asked the hospital at the time – how did she die – they gave me the weirdest answer...she gave up living – there was nothing wrong...she just gave up, she died...

Mother Y had been married to a sailor prior father Y and had two children from her first marriage. They were considerably older than Mr Y. He stated that, “even from childhood, I was always like sort of like left out- they were much older than me...I mean, when I was seven years old, my brother was 15...my sister was only two years younger than him- I mean

there's a gap and it's not their father...so we were never very close." Additionally, these siblings left the household when they were 16 respectively.

Mr Y appears to have harboured intense resentment and suspicion regarding his stepfather. Mr Y stated that when he was apprehended together with his co-accused, he was in the process of attempting to locate his stepfather so that he could kill him. Mr Y stated that

well, they arrested us...I was looking for him, I wanted to kill him, I was going to shoot him because of all the crimes – everything started pouring out, you understand...and I wanted to kill him because my mother had never been the same- the amount of abuse she went through, she just gave up...

Mr Y also stated that he believed that the circumstances surrounding his mother's death were questionable, specifically regarding the involvement of his stepfather. Mr Y stated that

a week after she was buried, I went to go and visit him because he was so distraught during the service...and I found that he's got another woman there, living there with her two children and everything...then I found out he was seeing this woman a long time already, on the side and I started putting two and two together and- my mother had an insurance policy, I was the beneficiary...he changed it, put his name in there...and I actually realized he killed her in some form...and he changed the policy to make him the beneficiary...

- **Mr Y.**

Mr Y spent the first two years of his life together with his mother and biological father, before his father was sentenced to death for murder. He was raised primarily by his mother and developed a close relationship with her. Mr Y stated that "we [he and his mother] used to

talk...I was like a friend as well and that kind of thing...she tried her best to be a good parent but she was suffering continually- psychological problems and so on..."

Mr Y describes himself as of above average intelligence and appears to feel that his achievements and success in life made him superior to the extended family system. Mr Y stated that, "I did fairly well at school...I did my Matric [grade 12], did sports and started doing bodybuilding- well started from round about- I was 13 years old, I started judo till about 17, when I started bodybuilding" and also that "I lived in a higher bracket than my entire family, you understand, because I was the only one that made Matric [grade 12]."

Mr Y did his compulsory national service from 1978-1980. He appeared to enjoy this experience but claims that he got the first indication of his tendencies towards violence whilst in the army. Mr Y stated that, "I should have known that something was wrong because something unusual started happening there...one sergeant said that if...you see any dogs chasing horses...I must shoot the dog [to protect the horses]...this somehow stuck in my head and every dog that I saw from then on, I shot...even if it wasn't [chasing a horse]."

Mr Y started working for the Railway Police on his return from compulsory national service and began his first long-term homosexual relationship. This ended due to the fact that his partner's father (Mr Y's supervisor at his place of work) found out and Mr Y was asked to leave his job due to the fact that he was a homosexual. Mr Y stated that, "I was in the police force...and someone squealed...and either I could resign or be fired...in that year I started drinking..." Mr Y's mother also died 6 months prior to this occurrence. Mr Y then worked at a series of private security companies after which he moved to KwaZulu-Natal Province where he began working as a bouncer at a gay nightclub. He had one relationship with a woman, Ms T, before he met his co-accused.

Mr Y met his co-accused, Mr H, one evening while working at the nightclub and describes this occurrence as momentous. He stated that, "I was madly in love at the

time...completely in love...we were perfect for each other and I wanted to keep him at all costs.” Given that Mr H was 15 years Mr Y’s junior, and a minor, the Child Protection Unit attempted to end their relationship and Mr Y received a six month jail sentence.

Mr Y then stated that the two men went on the run in 1992 to preserve their relationship. They then committed the first murder – the victim was a runaway that Mr H had brought with him. The remaining two murders were also committed in 1992 and he was arrested in the same year. In 1993, Mr Y was sentenced to death for his crimes.

Mr Y spoke of this time in the following way,

basically what it boils down to is that two overzealous policemen decide they want to arrest this gay guy and his younger lover, and the two gay guys...decide no, well this is not on...and they start running- and obviously to their surprise they commit one crime and it carries on and gets worse and gets worse and gets worse- I mean, let’s face it...a month and a half, these were the charges...ranging from housebreaking, theft, car theft, hijacking, three murders, one attempted murder...

Mr Y had had previous criminal convictions for possession of pornography, shoplifting and petty fraud. However, Mr Y had the following to say about the crimes for which he is currently imprisoned – “when I think about it now, I can’t believe that I did what I did...I didn’t enjoy any of those things...it was the worst time of my life...ended in prison.”

Mr Y also dabbled in the occult and this had started when he was 15 years of age. He stated that,

I was 15 years old...I had no contact with anyone that was practicing any form of witchcraft...it was dead quiet, I went to the garage and I sat there and I drew a circle, placed candles not knowing what I was doing actually...got undressed, sat in the

middle of this circle and then it just started coming...all these things and it went through the night...I actually started feeling the physical presence of spirits.

It would appear that the theme of supernatural abilities ran strongly in Mr Y's life from an early age. This was based on a number of stories recounted to him by his mother. He stated that,

My mother used to say that certain things happened to me when I was a child...like first of all, my heart stopped...and before that, when she was walking down the road where she was staying...there was a big commotion...she approached the people, she asked them- she was carrying me, I think...she was eight months pregnant...they said no, there's a poltergeist...at work in this flat...but at that point she felt an incredible sharp pain on the inner leg...something pinched her.

He also recounted that, "I was about...four or five years old...they found me screaming...there in the room and carrying on and on...and they found me stuck, in the corner of the walls, stuck in the top." With respect to the incident where his heart stopped, Mr Y stated that, "when my mother was in labour with me...my heart apparently stopped for eight minutes...so I was basically clinically dead- I would have been brain dead...now I don't know whether something happened or lack of maybe, oxygen, or something like that caused some future reaction..."

With regards to Mr Y's sexuality, he stated that he discovered his homosexuality while he was still young and has had two serious homosexual relationships while outside, and two relationships while in prison. Mr Y stated that he had several criteria that potential partners had to satisfy and that he was very selective when choosing his partners. He stated that,

I was twelve years old and I realized, mm...I kind of like both worlds...I enjoy sexual intercourse with females as much as I enjoy it with a male...I'd say that I would, if you put the two together, I'd first go with the guy...I don't live like a normal gay person does...I don't even look like a gay person does- to me, I can do anything that any other straight guy can – even far better, talent-wise...it's something that you are born with, nobody can actually make you gay...no matter what experience you have as a child, you will not remain gay...I've been involved with gay society for ages...

In relation to the criteria he set for partners, he stated that

when it comes to a relationship or sexual encounters, I'm extremely fussy...I can't just go for anyone – for instance, there are factors that- there's things that that person needs to have...personality-wise, body-wise...everything has got to be in a certain formula, put it that way...before I would be interested...good-looking of course...personality- gentle, full of fun...not someone with a criminal mentality...

- **Additional family system of Mr Y's co-accused, Mr H.**

With regards to additional family systems, the family of Mr H will be discussed, specifically in terms of their interaction with the current family system, as diagrammed in the genogram (figure 3).

It would appear that Mr H came from a family from a low socio-economic background. Mr H was the middle child and had four siblings. According to Mr Y, it would appear that Mr H was neglected considerably in his family set-up and that Mr Y was looked to as someone who could assume the responsibilities neglected by Mr H's own parents and family. Mr Y stated that, "his father even told me, he said that seeing as he [Mr H] only listens to me and not to them, then I must look after his son and I must make sure he's alright...but it's a low

class family...his father worked on the railway...he didn't fit in his family at all, so he was singled out."

Additionally, Mr Y stated that "it didn't seem to bother them at all that their son was arrested...the only time that they actually appeared in court...was because they were actually forced by the police then to be in court." Mr Y also said that, "there was no contact between him and his parents [while they were awaiting trial]...they didn't bother. Now do you understand why I felt so protective about him. I became the father, mother, the brother, the lover, everything to him...I bought his clothes..."

Mr Y described Mr H as "very normal in the sense of – he was tough...tough little guy...he didn't have any criminal records or anything like that." Mr H was in trouble with the welfare department on numerous occasions however on account of his truancy and resistance to going to school. Additionally, Mr Y reported that Mr H had a history of sexual abuse and had been dealing drugs to earn money. However, Mr Y insisted that Mr H did not commit any of the murders when they ran away together. Mr Y stated that, "He was with me the whole time...I didn't allow him to do any of the killing or any of the crimes himself...I didn't want him to experience that...I took it upon my self to basically do what we did to survive."

Once arrested and sentenced, the two individuals were separated and incarcerated in different places. This is a source of considerable worry for Mr Y, who desires to be reunited with Mr H. Mr Y stated that

there are unsaid things between the two of us...we were separated from each other by external forces...we didn't separate on our own...and I feel responsible for what happened...the fact that he ended up in prison as well...I need to speak to him...I need to get it off my chest- I need to ask his forgiveness...

6.2.5 Supplementary data sources

As discussed above, in addition to interviews with Mr Y, interviews were conducted with the prison psychologist at Mr Y's current place of imprisonment as well as Mr Y's cellmate in his current place of imprisonment. Additionally, the following archival data was consulted, namely: the psychological assessment report of Mr Y for his trial and the television documentary on Mr Y. These sources of data will now be summarized briefly.

- **Interview with prison psychologist, Ms V.**

As with the previous case, the prison psychologist, Ms V, shared her clinical observations of Mr Y with the researcher. She stated that Mr Y presented as a narcissistic individual and displayed all the behavioural traits that she associated with psychopathy, namely grandiosity, manipulateness, lack of remorse, impulsivity, and failure to accept responsibility for his actions. She stated that most of the time he displayed considerable control over his emotions but that he was prone to sudden, violent outbursts and episodes of intense anger or rage. She stated that he managed to provoke the warders on a number of occasions with sexually inappropriate comments. She stated that Mr Y frequently attempted to exert his influence and power in his prison section by intimidating his fellow inmates and warders with attempts to make them question their sexuality and with his physical strength. In this light, she stated that there had been a number of complaints and trouble with regards to Mr Y.

In addition to the above, she stated that Mr Y had made numerous requests with regards to contacting his co-accused, Mr H, with the aim of bringing about Mr H's transfer from the correctional facility where he was located to Mr Y's correctional facility. His reasons for the request were predominantly based on Mr Y's expressed concern that Mr H be exposed to the

best facilities available (namely, those at Mr Y's current place of imprisonment) and so that he could apologise and reconcile with Mr H.

- **Interview with Mr Y's cellmate, Mr Z.**

Mr Y and Mr Z have been cellmates for the past two years. Mr Z stated that Mr Y was detached from most of the other inmates and acted in an aloof and superior manner towards them. Mr Z, also a homosexual, stated that Mr Y felt that this superiority was based on his sexual orientation and physical strength, and took pleasure from the fact that he threatened the inmates in both these regards. Mr Z stated that he and Mr Y would speak at length about Mr Y's relationship with Mr H and that Mr Y experienced considerable emotional pain in this regard and suffered being separated from Mr H. Mr Z went to great lengths to convince the interviewer to contact Mr H on behalf of Mr Y and to facilitate communication between the two individuals.

The relationship between Mr Y and Mr Z appeared to be a complimentary relationship, with Mr Z occupying the one down position and very much submissive to Mr Y. It would appear that Mr Y was very protective of Mr Z, even though he appeared to view him as inferior on account of Mr Z's weaker personality and greater emotionality. It would appear that Mr Z's respect and deference to authority (namely, prison authority) was also a source of derision for Mr Y. Mr Z stated that the two had never been romantically involved with each other because they were not well suited. Mr Z stated that Mr Y needed a large amount of personal or emotional space and frequently needed to be left alone. If this time was interfered with, he would react aggressively or ask Mr Z to go to sleep. Mr Z supported Mr Y financially in prison, although Mr Z stated that Mr Y was very reluctant to accept this support.

Mr Y had also taken responsibility for developing the physical strength and stamina of Mr Z by training him in the prison gym. This also appeared to function so that Mr Z could inform

Mr Y of the reaction of the other prison inmates to Mr Y's impressive physical prowess in the gym (which, on most occasions, was reported by Mr Z to be one of considerable envy).

- **Additional data sources.**

Additional data sources consulted included the psychological assessment report of Mr Y for his sentencing and the television documentary, featuring Mr Y's criminal case.

- Psychological assessment report of Mr Y for his trial (Clinical Psychological Report on Mr H (17) and his relationship with Mr Y, 23 November, 1992).

A clinical psychologist for the trial of Mr Y and Mr H in 1992 compiled the psychological report for the state regarding sentencing for the two individuals. The psychologist conducted over 17 hours of interviews with Mr Y, Mr H, as well as the family members of Mr H. He also consulted various data in the form of police reports, victim statements, medical reports and letters written by the respective parties while in custody.

The report stated that Mr H and Mr Y were calculating, chaotic and opportunistic in terms of their disposition towards the psychologist. Mr H is reported to have been anxious and confused when alone with the psychologist, yet confident and aggressive when interviewed with Mr Y. Mr Y is reported to have lied to the psychologist on numerous occasions, and to have attempted to intimidate the psychologist.

Mr Y is reported to have disclosed that the issue of power over males was central to his personality, and to be concerned with antisocial omnipotence as well as altruistic attachment to Mr H. The psychologist stated that Mr Y perceived himself as an outcast, sustained by his attachment to Mr H, and subject to violent depression and destructiveness without this attachment. Mr Y is additionally described as irresponsible and grandiosely aggressive, with pride in his murder behaviour. The report also confirmed Mr Y's interest and partaking in

occult activities and belief in the power of the supernatural. Ultimately, the psychologist diagnosed Mr Y with severe Borderline Personality Disorder with antisocial and narcissistic tendencies (as per DSM-III-R criteria).

Mr Y's early history is described as having been dominated by female figures in the family such as his paternal grandmother and aunt, as well as his close relationship with his mother, and the report stated that Mr Y felt that he was doomed to follow in his father's footsteps from an early age. Mr H is described as having had an early history deprived of emotional attachment, subject to maternal neglect, coldness and hatred, and paternal neglect and brutality.

The relationship between the two is described as complimentary with Mr Y in the one-up position, and the report stated that it was unlikely that Mr H would have also engaged in the criminal activities that the two individuals were accused of if not under the influence of Mr Y. The report recommended that the two individuals be imprisoned at separate locations.

- **Television documentary on Mr Y.**

An episode of a television documentary dedicated to exploring the psychological motives behind a number of crimes committed in South Africa, as recounted by the individuals who committed these crimes was used. One of the episodes concerned itself with the crimes of Mr Y, and contained interview footage of Mr Y together with narrative explaining the events that took place, as well as expert comment from various psychiatrists and a criminologist.

In the episode, Mr Y recounted details of his early life and childhood, as well as how he met Mr H, and how they committed the crimes that they were convicted for. Mr Y presents as arrogant, self-assured and unremorseful. Throughout the interview, he appears unapologetic and recounts details of the crimes matter-of-factly. At points during the interview, he laughs, almost to shock the audience with regards to the extent of his lack of remorse, and appears to

enjoy attempting to intimidate the audience with details of the extent of his violent and aggressive behaviour during the murders, coupled with his appearance during the interviews as controlled and relatively unemotional.

The content of the programme in terms of the details disclosed by Mr Y concerning his criminal behaviour and the murders does not diverge greatly from the content of the psychologist's report above, and interviews conducted for the current study (with Ms V and Mr Y). However, in interviews for the television programme, Mr Y mentions that his stepfather sodomized him when he was 13 years old. When asked about the television programme during interviews with Mr Y for the current study, Mr Y stated that he did the television programme so as to explain his actions to individuals who may have known him before the murders took place. It was the interviewer's impression that this communication may also have been directed at Mr Y's step-father, as a means of possibly intimidating him or hurting him.

6.3 CONCLUDING REMARKS

This chapter has presented the results obtained for Mr X and Mr Y in the form of clinical observations, interviews, genogram and supplementary archival data. In the following chapter, these results will be discussed in terms of findings yielded after they were analysed with respect to the genogram interpretation and thematic content analysis.

7. DISCUSSION OF RESULTS

This chapter addresses the results of each of the case studies in chapter 6 with respect to the genogram and thematic content obtained and then comparatively discusses these results, with regards to the dominant themes yielded by each individual analysis. Discussion of results will bear in mind the research focus of the current study, namely:

- “How does the family system of a person who commits serial murder function?”

That is, what is the family structure, who are the people in the family system and how do they maintain the family system.

The discussion will commence with the case study of Mr X, followed by that of Mr Y, attending predominantly to the focus of the research, whilst the latter portion of this chapter will reflect upon any similarities between the two case studies, and if the findings of this research are similar to other research or theories which have commented on the families of such individuals.

7.1 DISCUSSION OF RESULTS OF CASE STUDY ONE – MR X AND HIS FAMILY

As discussed in the previous chapter (chapter 6), the clinical observations of the members of the X family, the genogram and the interviews conducted yielded considerable information concerning the family system of Mr X. This information was supplemented with interviews with the prison psychologist of the prison where Mr X is being held, as well as the psychiatrist who initially assessed Mr X for the purposes of his initial trial. Newspaper reports were also consulted as a secondary source of information.

Discussion of the results will now involve presentation of such results in accordance with the genogram interpretation method outlined by McGoldrick and Gerson (1985), followed by an interpretation of the information via a thematic content analysis applied to results.

7.1.1 Genogram interpretation

The genogram will now be interpreted with respect to the six categories outlined in the methodology section (chapter 5), namely:

1. Family structure;
2. Life cycle fit;
3. Pattern repetition across generations;
4. Life events and family functioning;
5. Relational patterns and triads;
6. Family balance and imbalance (McGoldrick & Gerson, 1985).

Each section will commence by outlining the main aspects applicable to the section found in the genogram, and then will elaborate upon each aspect in greater detail in terms of how it relates to the family system in the discussion section.

- **Category one: family structure.**
 - Nuclear family
 - Sibling constellation
 - Unusual structural configurations
 - Summary of family structure.

- Nuclear family.

As can be seen in the genogram (Chapter 6, figure 2), the family of Mr X takes a nuclear form, consisting of Mr X, father X and mother X. Neither father X nor mother X has been married previously, and Mr X is their only child. Mr X also appears to be the eldest grandchild for both maternal and paternal sides of the family system (see section on the nuclear family system where Mr X is described as having been the only child at many family gatherings when young due to having been the first grandchild). All of this information was obtained from the interview with mother X and father X, as discussed in the family data section in the previous chapter.

The nuclear family form seems to be the predominating form in this family system (see genogram). This form can be seen in both the maternal and paternal siblings, as well as on the side of the paternal grandparents. However, there is a deviation from this pattern in the case of the maternal grandparents, where the maternal grandfather remarried on two occasions (see chapter 6).

As evident in the previous chapter, the nuclear families within the family system are geographically and emotionally distant from each other, with little interaction between any of the sibling nuclear families on both maternal and paternal sides of the system. This was also the case with the paternal grandparents. The only link between members of the extended family system and those of the nuclear family system appears to have been between the maternal grandfather and mother X and Mr X (as stated by mother X – see chapter 6).

- Sibling constellation.

The genogram yields the following information concerning the sibling position of the members of the nuclear family:

- Father X was the third eldest of four siblings, and the youngest male with an older sister and brother;
- Mother X was the second eldest of four siblings, and the only female; and
- Mr X was an only child, and the eldest grandchild.

As evidenced in the previous chapter, both the father and mother of father X are deceased.

According to father X, he is not close to any of his siblings and does not keep in contact with them. He also described his sisters as “high society” and states that the nuclear family (father X, mother X and Mr X) is “simpler”.

As the youngest of two brothers and a middle child, he may have developed into a more introverted character, not able to assert himself (Toman, 1961). Growing up as part of a sibling constellation where the eldest position was occupied by a woman in charge may explain the spousal arrangement in his own house, with mother X taking responsibility for the household duties, while he provided instrumental support as the primary breadwinner.

This is stated by Mr X where he confirmed that “my dad just provided for us, he wasn’t, you know, he didn’t help me with my schoolwork or- there wasn’t a strong bond between me and my dad’ and ‘my mom basically raised me.”

With reference to the maternal side of the family system (chapter, 6), it would appear that mother X has three siblings and was the only female child in her family. She has one elder brother and two younger brothers. Her youngest brother is deceased. Both of her parents are deceased, and her father married three times. Mother X stated, as with father X, that she also was not in contact with any of her siblings.

As the only female child in the family, mother X may have been faced with taking responsibility for many of the household chores and duties associated with traditional assumptions about the role of the female in the family. She may have been socially excluded

from playing with her brothers due to the fact that they were boys and she was a girl, and consequently, this may have left her feeling quite lonely growing up.

She may have developed very segregated, and narrowly defined notions of gender and gender roles – namely, that men and women did separate things; did not socialize together; and had different responsibilities. This can be seen in her own spousal relationship. Mr X described the relationship between his parents as being very polarized with regards to duties and responsibilities, with his mother responsible for raising him, and his father for providing the financial support for the family. Mr X stated that “my mother basically raised me...my father looked after us but he didn’t help me with schoolwork or there wasn’t a strong bond between us...he was there but he was busy with his own things.”

Mother X’s notions of gender can also be seen in the following statement that she made during the interview with her. It appears that mother X seems to see women as more manipulative and deceptive in order to be successful peacemakers, whereas men are seen as blunt, straightforward and more brutally honest. Mother X stated that “I’ll keep things back, to keep the peace and so on...I’ll try to protect people to keep the peace...but Mr X and his father are straightforward...mothers always have a soft spot, you know, and I think most women have a soft spot...”

Given the implications of their respective sibling positions, the following statements may possibly be made about the spousal relationship of father X and mother X. Father X and mother X appear to be considerably compatible when viewed in light of their respective sibling positions and experience with peers of different sexes within their respective families. In other words, father X was used to females occupying a position of responsibility with regard to household chores and duties due to his experience with his elder sister, and mother X was used to occupying that position in her own family. Thus, she possibly met his expectations in this regard. Similarly, mother X was used to being taken care of by older

males, and hence, had little problems with father X's assumption of the role of primary breadwinner, and being older than mother X.

Additionally, father X's isolation from the nuclear family; and the segregated, rigid roles of husband and wife performed by father X and mother X in the nuclear family may have possibly been influenced by their respective patterns of interaction with peers of their own age group within their families of origin. Once married, both father X and mother X grew increasingly isolated from their extended family network. Father X stated that "we [his family members] are estranged, [Mr X] never knew his aunts because they are a little bit 'high society' – we are simpler. And my nieces, I don't know where they stay." Mother X stated that "we knew my family well when [Mr X] was very young but then they moved away and we lost contact...just my father and [Mr X] were very close...I don't know anything about my nieces or nephews."

This isolation is consequently geographical in the sense that all of their siblings live a considerable distance from the X nuclear family, as well as each other, and all seem emotionally distant. The only family member who lived close to the X nuclear family was the maternal grandfather. Mother X kept up contact with her father throughout the time that Mr X was growing up, and this appears to be the only extended family member with which contact was maintained (see the maternal side of the family system (chapter 6)).

Father X, conversely, was always very isolated from his extended family. While Mr X was younger (up until the age of about 13), the family would visit mother X's family in another province periodically; however, these visits declined over time, and now contact with the extended family is minimal (see chapter 6).

As indicated in chapter 6, it would appear that Mr X was an only child in the nuclear family system, as well as the first and eldest male grandchild in the extended family system. Mr X's position within the family system as the first and eldest male grandchild, as well as

the only child of father X and mother X, may have contributed towards pressure to carry the family name and reputation forward.

Due to the fact that many of the remaining members of the second generation did not have children of their own for some time after the birth of Mr X, he may have lacked peers of his own age with which to interact, and had to learn to interact with adults and play by himself from an early age. Mr X stated that “[at family gatherings] I was the only child and didn’t really have anyone to talk to, that would have made it more enjoyable for me...so it was difficult.” This may have lead to Mr X becoming socially independent and less oriented to social relations, and maintained close attachments to his parents throughout life. Mother X describes Mr X as “very quiet, he was very loving and he didn’t have many friends – one or two that I know of.” This persisted into later life as can be seen in Mr X’s statement in that “I grew up alone...maybe that’s why I’m an introvert and not an extrovert, I don’t know.”

Mr X’s position as an only child may also have contributed towards a strong identification with Miss N, his first girlfriend, who was also an only child. Their relationship may also have been complicated by their close attachments to their parents – in Mr X’s case, this would appear to be his mother, and in Miss N’s case, this appears to have been her father (see chapter 6) – as well as the considerable immaturity that both seem to have exhibited as a result of parental overinvolvement. Mother X stated that Miss N “had a strict father... [who] loaned them money to buy a flat.”

Neither appears to have possessed the interpersonal skills necessary to assert themselves and break away from the influence of each other’s respective parents. This, together with competition for the privileged position and attention from those around them, may have placed considerable stress on their relationship. Mr X’s lack of experience of competition with his peers may have meant that he had to find other outlets to express this. Additionally, the relatively closed nature of the X family system may have limited the number of outlets

available for the release of stress within the X family system. Consequently, these outlets may have taken more deviant or extreme forms. For example, after an argument with his future father-in-law, he went out and committed the fourth murder near to the area in which Miss N and her family lived.

Finally, father X and mother X may have found it difficult to identify with Mr X's sibling position, as a result of both of them having grown up in families with other siblings. This may have made it difficult for them to recognize Mr X's need to socialize with peers of his own age.

- Unusual structural configurations.

The genogram demonstrates two significant unusual structural configurations, namely:

- absence of single children; and
- maternal grandfather's remarriages.

The genogram demonstrates that throughout the extended family system, other familial units in the system all have many offspring. Mr X is the sole instance of an only child within the family system. This may have contributed towards pressure on Mr X to carry the line of his parents further, and resulted in an increase in the intensity of emotional processes in any triangulation that may have occurred between himself and his parents (in the absence of another sibling with which to share the load).

Additionally, given that Mr X was the eldest and only grandchild for a considerable period of time, his position within the family system may have isolated him from experiences of competition or rivalry with peers of his own age or slightly older or younger (see quote above). Consequently, he may have had to compete with adults around him as a child (due to the absence of peers of a similar age). He may have always come off second best in these

exchanges that may have resulted in feelings of frustration, lack of power and low self-esteem, which would have persisted, into adulthood.

Figure 4.

Maternal Grandfather's Remarriages

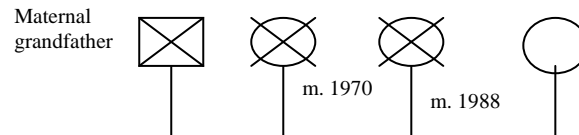

The genogram demonstrates that throughout the family system (extended and nuclear), each member of a family unit has stayed married to their first spouse. The only exception to this was the maternal grandfather, who was married three times (see chapter 6). His first two wives died of natural causes and he only remarried after the death of his previous spouse. Consequently, there appears to be no indication of separation or divorce in the family system (extended and nuclear). Both of these exceptional aspects of the family system will be discussed, in the section on balances and imbalances in the family system.

- Summary of family structure.

The first category, family structure, yielded the following notable aspects of the family system of Mr X. The family system, consisting of both extended and immediate family systems, consists exclusively of nuclear family units. These appear to be relatively isolated from each other. The sibling position and constellation of the respective members of the nuclear family system (namely, father X, mother X, and Mr X) consist of two middle child position parents, and an only child. The respective sibling positions and constellations may contribute towards understanding father X's introversion; mother X's caretaking role with

respect to both father X and Mr X; and Mr X's relatively impoverished interpersonal skills and social isolation. The sibling positions of the respective members of the nuclear family system also add to understandings of the gap between Mr X and his parents; and his relationship with Miss N. Father and mother X appear compatible in certain aspects in light of their respective sibling positions. The nuclear family system also appears to be isolated from sibling family systems within the larger familial system. Unusual structural configurations include the absence of only children and the remarriages of the maternal grandfather. Mr X's position as the sole child in the nuclear or extended family systems may have contributed towards pressure on him within the family system to occupy a certain role within the system, namely as the member of the X family system to carry the X name onto a subsequent generation.

- **Category two: life cycle fit.**

The genogram and interview data revealed the following significant areas in the life cycle of the family system, namely loss and death, and intimate relationships.

- **Loss and death.**

The genogram appears to reveal a great deal of activity in the family system on occasions of loss and death. These occasions are:

- o the death of the maternal grandmother;
- o the death of the maternal grandfather's second wife; and
- o the death of the maternal grandfather.

As can be seen from the genogram as well as data used to compile the genogram (see chapter 6), Mr X was born in 1966, a year after the death of his maternal grandmother (1965). Given the close timing of these two events, these may be significant with regards to the family

system. Mr X may have signified a possible replacement within the family system for the lost member, in terms of the role that she may have performed or function that her position served. Mr X appears to have had a very close relationship with his maternal grandfather throughout his childhood (see chapter 6) which may be significant given that he was born a year after the death of his maternal grandmother. He may have acted as a consolation to his maternal grandfather. The maternal grandfather only remarried again in 1970 (see genogram, Figure 4), when Mr X would have been four years of age and probably less available due to commencing school or other possible commitments.

Another co-occurrence in the family life cycle, is Mr X's failing of Standard 3 [grade 5] due to illness (he had meningitis, see chapter 6) and commencement of his learning difficulties in 1976, the year after the death of his maternal grandfather's second wife (1975). This (together with the above) may be an indication of triangulated relationships and emotional fusion within the family system.

The death of the maternal grandfather (1988) coincided with a number of significant events in the family system. A year prior to the death of the maternal grandfather, 1987, he and Mr X had had an argument that resulted in the two of them breaking ties with each other. That same year, Mr X and Miss N started dating. In the year of his death, 1988, the maternal grandfather had remarried for the third time. In the year following the death of the maternal grandfather, namely, in 1989, Mr X was demoted at work, and committed the first rape and murder of his series.

As stated above, the clustering of significant events around areas of loss and death in the family system (specifically with respect to Mr X and his maternal grandparents), may be indicative of intense emotional fusion between the respective members involved.

The above also reflects a difficulty within this family system of dealing with loss and death, specifically on the maternal side of the family. The greater intensity of apparent

emotional involvement on mother X's side of the family and seemingly greater impact on the family from events from the maternal side, may have contributed towards father X's isolation from his extended family.

- Intimate relationships.

In terms of life cycle events, the capacity to develop intimate relationships, and leave the nuclear family system to form one's own nuclear family unit, is important within a family system and is an indication of a healthy family system. In this light, two problematic areas emerge in the family system of Mr X, namely:

- o Mr X's delayed and limited capacity for intimate relationships; and
- o the maternal grandfather's relationship history.

As can be seen in the genogram from data reflected in chapter 6, Mr X appears to have had his first girlfriend at the age of 21. This may indicate a delay in the development of a capacity for intimate relationships outside of the family. Interestingly, this event, namely going out with Miss N, coincided with the argument between Mr X and his maternal grandfather (1987). This may indicate that the withdrawal of the maternal grandfather from Mr X liberated a position for someone else to fill, and that this may have influenced the nature of the relationship between Mr X and Miss N in turn.

The frequency with which the maternal grandfather remarried, together with the short amount of time between spouses, reflects incomplete emotional processing between relationships as well as a particular attitude towards women (see figure 4). Incomplete emotional processing would have been on account of the maternal grandfather's own limited capacity to invest emotions outside of the family system and the message that may have been conveyed to Mr X was that women were replaceable and served to fill whatever void was left

by their predecessor. This can be seen as an indication of the limited adaptability of the family system.

Additionally, this behaviour may have reflected a possible ignoring of the intensity associated with emotional loss and bereavement and a lack of ability to bring about adequate closure to relationships. The “serial” nature of the maternal grandfather’s relationship history may have set up a model of ways of conducting relationships with the opposite sex, which was interpreted more violently and deviantly by Mr X in later life. It also seems to be apparent that he originally modeled on his maternal grandfather, being close to him for almost 19 years (see chapter 6). This, together with the emotional detachment in the relationship between his two parents, can be seen as playing an important part in characterizing his attitudes towards his victims and nature of his crimes, namely via their serial nature; his lack of empathy and objectification of his victims; and emotional detachedness from the violence of his murders and rapes. It is also significant that the one woman with whom Mr X’s maternal grandfather had a permanent, consistent relationship, was mother X. Mother X stated that “he [Mr X] was always close to my father, we used to spend a lot of time with him, good times...”

- Summary of life cycle events.

The second category, life cycle events, revealed two main areas that had considerable impact on the family system. These are loss and death, and intimate relationships. Loss and death events in the family system of Mr X have a considerable impact on the system. Loss and death events that appear to have impacted seem to be on the maternal side of the family system. These include the death of the maternal grandmother; the death of the maternal grandfather’s second wife; and the death of the maternal grandfather. This may have

contributed towards Mr X's possible emotional fusion with this side of the family in the family system.

Intimate relationships, relationship history and capacity for intimate relationships outside of the family system are also important areas in the family system life cycle. Two main observations emerge from the genogram and interview data, namely, that Mr X has difficulty in forming intimate relationships, and that the maternal grandfather has a relationship history that indicates a certain attitude towards women and seems to have had an absence of emotional loss after the death of his wives. Both of these aspects may explain Mr X's considerable fusion in the family system that would explain his difficulty in forming intimate emotional relationships outside of such a system, and thus a tendency towards aggressive and violent behaviour.

- **Category three: pattern repetition across generations.**

- Patterns of functioning
- Patterns of relationship
- Summary of pattern repetition across generations

- **- Patterns of functioning.**

In terms of patterns of functioning, the genogram demonstrates the following patterns being repeated across generations in the family system:

- emotional distance and cutting off as a means of dealing with confrontation;
- diminished coping skills with stress and anxiety;
- distribution of success and failure;
- movement; and
- absence of divorce or separation.

It would appear that the complete family system tends to deal with the disapproval of other family members or outsiders to the family system, and with conflict by distancing and emotionally cutting off from the individuals concerned.

This pattern of avoidance and detachment in response to confrontation and disapproval repeats itself in all three generations. In the first generation, the maternal grandfather distanced himself emotionally and withdrew from Mr X after their argument (as mentioned by mother X, see chapter 6); in the second generation, father X did this with his sisters who he felt believed that they were too good for him (as mentioned by father X, see chapter 6); and in the third generation, Mr X repeated this pattern in his relationship with both Miss N and her father by withdrawing and distancing himself from the relationship when he did not meet with the approval of her father, or when conflict had occurred between himself and Miss N's father (as described by Mr X in interviews, see quotes below).

Mr X stated that he had asked the maternal grandfather if he could borrow his truck to go to work and then used the truck to also help some people move house. The maternal grandfather was unhappy about this and as a result "[they] fought and then he wanted nothing else to do with me...my mother and him had a relationship but he would not talk to me." Mr X also stated that "three months before I was arrested, our engagement was called off because...the experiences that I'd been through [his crimes] had made lose respect for older people and their wishes which caused me to argue with my [future] father-in-law...and as a result, the engagement had to be called off."

In terms of coping skills, there appears to be a limited capacity to deal with conflict and stress in the family system, specifically on the maternal side. This is evidenced in the genogram and information obtained from interviews with father X, mother X and Mr X (see chapter 6) which demonstrates the maternal grandfather's alcohol use, mother X's history of sedative use, father X's and Mr X's smoking habits as well as Mr X's own coping strategy of

criminal behaviour, which he describes as “an addiction.” It would also appear that violence as a coping strategy or means to achieve one’s ends is present in the system as evidenced by mother X’s disciplining of Mr X when he was a young boy. Mr X stated that

there were good times [at home] but everything revolved around my studies...and it was very difficult for me at that stage – I couldn’t understand why my mother had to be so strict...ultimately, I was actually quite scared of my mother...she raised me and if I did something wrong she would give me a hiding...like when I couldn’t remember my work properly.

In terms of patterns of success and failure, it would appear that siblings on the maternal and paternal sides of the family system have managed to achieve considerable success in comparison to the X nuclear family. Father X refers to his sisters as “high society”, while mother X has a brother who is has successful antique business. This may have contributed to pressure on father X to achieve comparable success, which may have sparked his business venture in 1982. His subsequent failure in this venture may have placed increased strain on his family and consequently, increased pressure on Mr X, as the only child, to succeed where his father had failed. Mr X stated that “it [the failure of father X’s business venture] was a big setback for them [father and mother X] and I could see it in my dad - he wasn’t very happy and he was a bit down.”

As demonstrated in the genogram, there is a pattern of considerable physical movement or general restlessness within the family system. This is reflected mostly in the second generation, where siblings have moved to different areas and changed residence a number of times. This includes father X and mother X who have moved in search of business opportunity (the Cape Province in 1982), as well as around the eastern Gauteng Province; the maternal siblings live in Kwazulu-Natal Province and the Northern Cape Province

respectively; and the paternal siblings live in the Northern Province and the Free State Province respectively.

Mr X seems to have repeated this pattern in his own life, actively pursuing jobs that involved a large degree of travel, and enjoying moving around. Considerable movement also characterized his criminal behaviour, namely serial murder, with the murders comprising his series taking place across the Gauteng Province. Mr X stated that “I enjoyed seeing new places and enjoyed new experiences and discovering new things - it was great for me to see new places.”

There seems to be a repeated pattern of marital functioning in the genogram in the sense that there is no indication of family break up or marital splitting throughout the system, regardless of the issues of conflict and emotional distance between members. Marriages in this family system seem to end only if the other spouse dies. For example, although the maternal grandfather remarried twice, he only remarried after the death of his spouses. The traditional and conservative Protestant ethic of “till death do us part” seems a strong principle in the family belief system. Despite the apparent emotional distance between father X and mother X (as indicated by Mr X’s description of the marital relationship as well as clinical observations of the researcher, see chapter 6), they may have felt greater pressure to make the marriage work or stay together due to the absence of any other marital failure in the family system. This may have contributed towards anxiety within their own nuclear family system, which could have found an outlet in a number of ways, some of which (while achieving system objectives such as homeostasis) may have impacted negatively on individuals within the system and those (such as the victims of Mr X) outside of the system.

- Patterns of relationship.

With respect to patterns of relationships, there appear to be two significant patterns that are repeated across generations in the family system of Mr X. These are a close parent-child relationship with the isolation of the other parent and the emotional distance and isolation of father X.

Within the family system, specifically with respect to the maternal side of the system, there appears to be a repeated pattern of lack of emotional investment in the spousal relationship, and close emotional attachment with a child across the maternal second and third generations. With the maternal grandfather, frequent remarriages and a rapid cycling of spouses may reflect a lack of adaptability or flexibility in the family system that necessitated the introduction of replacements or temporary members to maintain stability within the system. The first instance of this pattern therefore occurs between mother X and her father (the maternal grandfather), with mother X's mother, and then each of the subsequent spouses becoming isolated.

Figure 5. Pattern of Relationships in X Family System

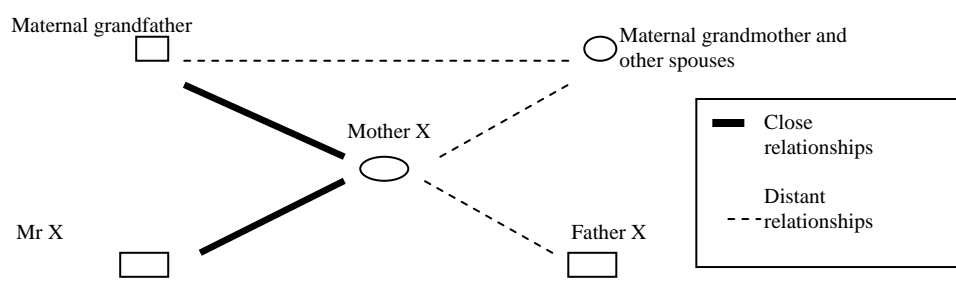

This pattern is then repeated with respect to mother X, Mr X and father X, with mother X and Mr X forming a close partnership to the exclusion and isolation of father X. Mr X stated

that “my mother raised me...my father just provided for us...he was a very quiet person and he was just busy with his things - I can't say much about him because he wasn't very active in my life.”

Father X's emotional distancing and isolation also appears to be repeated across generations and instances. Firstly, he distances himself from his own family of origin (as reported by father X, see chapter 6), and then with respect to his own nuclear family (as described by Mr X in the above quote). This pattern seems to have been carried over to Mr X, who is emotionally distant and isolated from any social groups of which he is a part, as well as from his father (as indicated in the above quotes). This may be another indication of the limited adaptability and rigidity of the system, which possibly made it difficult for members to expand the number of groupings of which they were a part.

In terms of Mr X's own development of ways of relating to others as well as his family, the above two patterns may have contributed towards a conflicting role for Mr X within the family system. On the one hand, his mother would have been drawing him closer and developing a close emotional relationship with him (whether harmonious or conflictual), and on the other hand, his father would have been passing on a pattern of relating to others which entailed emotional distance from the family or other social system of which he was a part. Mr X may have experienced considerable anxiety and forged a compromise in the sense that his emotional closeness to both his mother and maternal grandfather was paired with emotional distance and isolation from any other familial or social setting of which he was a part. Mr X stated that

On my father's side, I didn't know my grandparents but on my mother's side, I knew my grandfather well. There were good times with my grandfather...he read to me and we would discuss things, make jokes – he was there for me when I needed him...he really showed his love for me.

Mother X also confirmed this relationship in her interview (see chapter 6).

- Summary of pattern repetition across generation.

In terms of the third category, pattern repetition across generations, the genogram demonstrates a number of patterns of functioning that are repeated across generations. These include emotional distance and cutting off as a means of dealing with confrontation; diminished coping skills with stress and anxiety; the distribution of success and failure; movement; and the upholding of marriage despite relative emotional poverty.

The genogram also reveals a number of patterns of relationship that are repeated across generations. These include a close parent-child relationship with the isolation of the other parent and the emotional distance and isolation of father X. Notably, these patterns appear to predominate from the maternal side of the family system, and have influenced Mr X's functioning and relationship styles, as well as his criminal behaviour.

• Category four: life events and family functioning.

- Coincidental events
- Impact of life changes, transitions and traumas
- Anniversary reactions
- Summary of life events and family functioning

- Coincidental events.

There are a number of coincidental events that appear to emerge from the genogram, mostly from the maternal side of the family system. These can be arranged chronologically into three

significant clusters, namely a first cluster (1964-1966), a second cluster (1975-1980) and a third cluster (1987-1989).

The first large cluster of co-occurring life events spanned from 1964-1966. As can be seen in the genogram, in 1964, father and mother X were married. One year later, in 1965, the maternal grandmother died, and the following year, in 1966, Mr X was born. It would appear that the system would only allow a new member to move in when another had left (as also indicated possibly by the maternal grandfather's relationship history).

The second cluster of co-occurring life events spanned from 1975-1980. As can be seen in the genogram, the second wife of the maternal grandfather died in 1975. At the same time, Mr X developed meningitis and failed the school year. He had learning difficulties for the remainder of his primary school career, resulting in increased supervision of his learning and harsh discipline from his mother. Mr X stated that "it all revolved around my studies – what I should have been studying but it was very difficult for me at that stage...if I didn't know my work properly, there would be an outburst and I would get a hiding."

As indicated by the genogram, in 1978, Mr X started stealing from his mother's handbag and engaging in other instances of petty theft as well as housebreaking. He was caught housebreaking by his parents in 1979. In 1980, Mr X reported that his mother stopped physically disciplining Mr X and changed her attitude towards him, to one that was more loving and affectionate. He could not provide a reason for this but claims that it may have been because she felt alone and rejected by him and that their relationship had deteriorated. Mr X stated that "later it got better and I could learn by myself, in high school because those things [strictness and hiding] happened in primary school...my mother surely realized that I was moving away from her and then she tried to show me that she loved me..."

The third cluster of co-occurring life events spanned from 1987-1989. As indicated in the genogram, in 1987, Mr X completed his compulsory national service. In that year, Mr X also

had an argument with his maternal grandfather that resulted in a cut-off and rupture of the relationship between the two of them. Mr X also met Miss N, his first girlfriend, in 1987. One year later, in 1988, Mr X's maternal grandfather married for the third time. The maternal grandfather also died in that year. The following year, in 1989, Mr X lost his job with the anti-hijack section of the police force and was demoted to normal police duty, due to aggressive outbursts on duty. In 1989, Mr X committed his first rape and murder in the eastern part of Gauteng Province.

The following are a number of other events that appear to coincide on the genogram and in the family history:

- mother X's cessation of her work as a nurse the year after her father married his second wife (1971);
- mother X's resumption of work, as a chef at a retirement home, after Mr X commenced his compulsory national service in 1987. At this time, the X family also took in foreign male students as lodgers; and
- mother X's heart attacks after Mr X's arrest. The first heart attack took place in 1993 after Mr X's arrest; the second in 1996, after receiving hate mail and recently, she suffered a "nervous breakdown" or "exhaustion" (as stated by mother X, see chapter 6, p. 212) in 2003 after a television programme was screened detailing Mr X's case.

- Impact of life changes, transitions and traumas.

On examining the above coincidences and clusters, a number of observations can be made concerning the impact that these appear to have had on the family system. Firstly, the death of the maternal grandmother and the subsequent birth of Mr X, may have meant that he inherited her particular role within the family system.

The co-occurrence of the death of the maternal grandmother (1965) a year after the marriage of father X and mother X (1964) may signal that the introduction of father X into the family system and possible withdrawal of mother X from involvement in emotional processes with the spousal coupling of her parents (the maternal grandparents), may contributed significant strain on this relationship. As will be discussed in more detail later, the maternal grandmother's death may signify an overload in this part of the system.

Throughout the clusters, it appears that the maternal grandfather made considerable impact upon the family system, specifically in relation to the various remarriages and deaths that occurred on this side of the system. After the death of her mother (1965), mother X stated that she involved herself more in looking after her father, withdrawing from her own family (namely, Mr X and father X). Consequently, when her father remarried, it may have freed her up to pay more attention to her own family. Mother X stated that the decision underlying her stopping work in 1971 was in order to take care of Mr X. However, this may have followed her possibly having less obligations with respect to caring for her father, who was no longer alone after having remarried.

When the maternal grandfather's second wife died in 1975, mother X may have withdrawn from her nuclear family again to take care of her father. However, this time, Mr X's illness and learning problems may have prevented her from doing so to the extent that she had the first time. In this way, mother X may have faced considerable strain or anxiety due to the demands placed on her by both Mr X and her own father, which may have contributed towards her short-temperedness and harsh attitude towards Mr X. Mr X's acting out in terms of his early petty theft and housebreaking may also signify attempts to draw mother X to the nuclear family. This behaviour may also be a response to the various transitions and emotional pressures within the family system.

With respect to the third cluster, Mr X's escalation in criminal activity to rape and murder (1989) can be seen as a possible response to the changes in the system that saw his maternal grandfather die without having resolved the differences between the two of them, as well as his demotion at work (which occurred together with the collapse of his relationship with his maternal grandfather). The additional pressure as a result of his relationship with Miss N's father (and his expectations for his daughter's relationship) may also have placed considerable stress on Mr X. In this cluster, Mr X's lack of ability to deal with conflict is also evident.

The close, fused relationship between Mr X and his mother can also be seen in the co-occurrence of life events, namely with mother X's deterioration in health linked to anxiety over Mr X's crimes. In this sense, it would appear that she has shouldered the majority of the emotional strain with regard to Mr X's crimes, in comparison to father X.

Father X's distance and underinvolvement in the system is evident from the fact that he appears to have had a different role in the system, in comparison to other male figures such as the maternal grandfather, and Miss N's father. His underinvolvement in the system may have freed up space for other members to take on roles and functions within the system that may have traditionally been associated with the paternal membership position. It would appear that the maternal grandfather was possibly able to involve himself more in the X nuclear family system due to the underinvolvement of father X, specifically with regards to emotional bonding with Mr X. This is evident in the statements of mother X and Mr X, as seen in chapter 6. Additionally, mother X may also have involved herself more with Mr X as a result of father X's underinvolvement and take on more of distance may have also allowed mother X to develop a closer relationship with Mr X, and assume additional roles within the system.

- Anniversary reactions.

There appears to have been an anniversary reaction with respect to life stages. This reaction concerns the stage at which members in the nuclear family system are expected to start families of their own and leave their family of origin.

Within the nuclear family system, father X was married and starting a family of his own by the age of 26 (as derived from the genogram and interview data, see chapter 6). Consequently, as Mr X approached this age, he may have felt increased pressure to start his own family from the family system and societal system. However, at the same time, the system did not allow him to move on. His attempts to continue the tradition can be seen in the way that he started making wedding plans with Miss N in 1992 (when Mr X was also 26). However, in contrast with his father, Mr X would have had considerably less social and interpersonal capability to achieve this, and was additionally very fused in his relationship with his mother and his nuclear family system, in a closed system.

Within this family system, adult children appear to distance themselves emotionally from the nuclear family of origin (specifically on the paternal side) when they form their own families. Mr X made plans to get married to Miss N and start his own family, thus leaving the household, may have represented a challenge to the homeostasis of the closed system may have contributed towards increased anxiety within the system, as well as pressure on Mr X, who would have been in the ambivalent position of feeling pressure to start his own family system (from his paternal side), and also pressure not to leave the nuclear system. Often, when a closed system's homeostasis is challenged, a symptom presents itself (see chapter 4). Mr X's criminal behaviour, as symptom, may have provided a necessary outlet for system anxiety that prevented the escalation of anxiety levels beyond the capacity of the system, as well as a means to manage his ambivalent position within the system. Once this symptom provided positive feedback to the system with regards to management of anxiety levels and

homeostasis, it may have become a strategy that was used more often by the system in order to achieve these ends. In this way, Mr X's serial crimes may be seen as a possible technique used by the system at times when homeostasis became threatened or anxiety escalated.

Additionally, Mr X's criminal behaviour in the form of entering into other people's homes or lives may reflect a testing of the boundaries of his own system, and the extent to which this system would be flexible enough to permit such movement. It may also reflect a fascination on the part of Mr X with the lives of others on account of the lack of development that characterized his social understanding within his own system (which was closed, with no contact with family or friends).

- Summary of life events and family functioning.

In terms of category four, life events and family functioning, the genogram of Mr X revealed three clusters of co-occurring events in the family system. These were all in relation to events from the maternal side of the system, and had to do mostly with changes to the system in the form of loss and separation (as discussed in the previous section).

With respect to the impact of these life events on the family system, implications included the possible assumption of the role of the maternal grandmother in the family system by mother X; mother X's close relationship and caretaking of her father and the resulting tension between her involvement with her father and her own nuclear family; and Mr X's crimes being an outlet for the considerable pressure placed on him within the family system and the anxiety and loss reactions that he may have felt.

With regard to anniversary reactions, it was found that Mr X may have experienced considerable pressure to start his own nuclear family at the same age as his father and yet was in an ambivalent position due to the pressure from his mother to remain in the nuclear family system.

- **Category five: relational patterns and triads.**

- Triads: parent-child triads
- Triads: couples
- Triads: multigenerational
- Triads: relationships outside of the family
- Triads: other
- Summary of relational patterns and triads

A number of relationship triads are evident in the genogram of Mr X. The most significant triads with respect to the current analysis will now be discussed according to the particular types highlighted in McGoldrick and Gerson (1985). Triangular patterns and structural configurations in the family system will be further elaborated upon in later discussion.

- **Triads: parent-child triads.**

There appear to be three significant parent-child triads, namely:

- between the maternal grandfather, mother X and the maternal grandmother (parent-child triad one);
- between father X, mother X and Mr X (parent-child triad two); and
- between Mr X and Miss N, and Miss N's father (parent-child triad three);

Figure 6.

Parent-Child Triad One

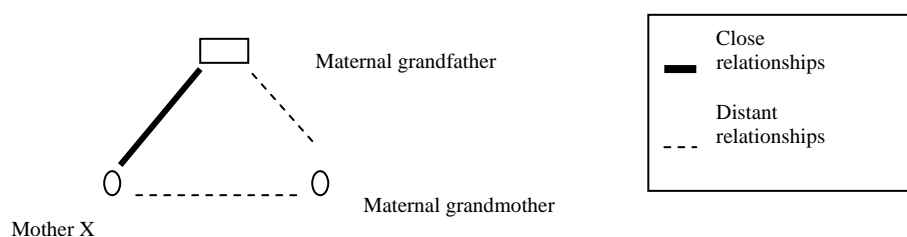

The first significant parent-child triad appears to involve the maternal grandfather, mother X and the maternal grandmother. This triad is characterized by a close relationship between mother X and her father, and a more distant relationship with the third member of the triad, originally the maternal grandmother. After the death of the maternal grandmother, this position was occupied by each subsequent spouse of the maternal grandfather (as well as father X forming couples triad four). As discussed previously, it would appear that mother X had to perform dual roles of daughter and maternal grandmother before the maternal grandfather's second marriage.

The above triad appears to have simultaneously involved the isolation of the third member, and an increase in the emotional closeness between the other two members, namely mother X and her father. It would appear that the position made more available by the withdrawal or isolation of one member, allowed the remaining two members to become closer, or one of these members to occupy the functions or roles partially vacated by the absent or isolated member. This emotional closeness can be seen in the way that mother X looked after her father when her mother died, and after that, when he was left alone after the death of his second wife. Her father's alcohol use may also have drawn mother X closer to him in terms of taking responsibility for his well being (discussed further under couples triad three). Mr X stated that "there were also bad times with my grandfather...he drank and then got aggressive...and a person doesn't enjoy seeing how a drunk person reacts...a drunk person doesn't always realize what they are doing."

Figure 7.

Parent-Child Triad Two

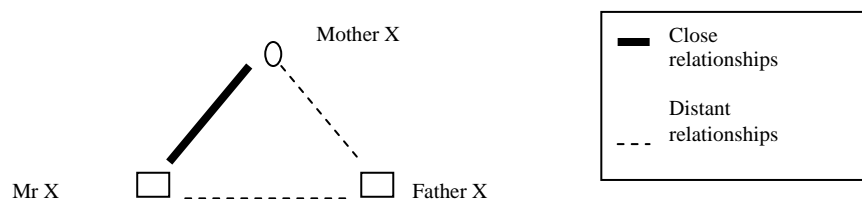

The second significant parent-child triad involves father X, mother X and Mr X. In much the same way as the above triad involved a close relationship between a parent and child to the exclusion of the other parent, this triad involves a close emotional relationship between mother X and Mr X, and isolation of father X (the inverse of the previous triangle). Mr X's relationship with father X is evidenced in the above quotes. His relationship with his mother was not close in the traditional sense of a loving, caring relationship but did appear to involve a considerable emotional investment or enmeshment on the part of both members in terms of the conflict and contest for power over self-definition inherent in this relationship. This is evidenced by the way that mother X suffered significant physical illness at the time of Mr X's arrest and at various points throughout his incarceration (see figure 2).

It is not uncommon to see a repetition of triads across generations within a family system (Bowen, 1978). One might predict that if Mr X had started his own family, he may have repeated a similar triangular relationship, with Mr X or wife of Mr X possibly developing a close relationship with one of his children, to the exclusion of his spouse.

Figure 8.

Parent-Child Triad Three

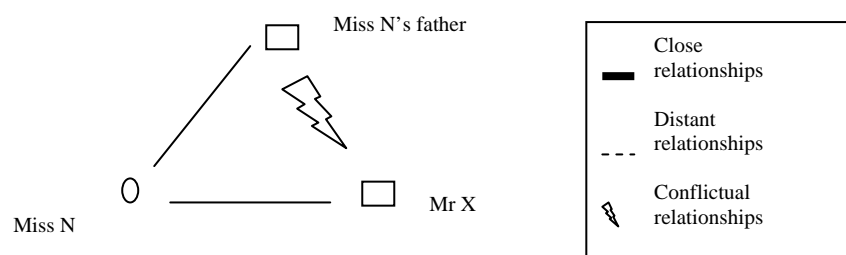

The third significant triad involving a parent and child appears to be that between Mr X, Miss N and Miss N's father. In this triad, the relationship between Mr X and his future father-

in-law appears to have been conflictual, while Miss N appears to have had a close relationship with both Mr X and her father. Miss N's learning difficulties and slight mental impairment may have contributed to her father's strong role as caretaker over her within and outside of their family. This may be seen in him assuming responsibility for the decision-making on her part regarding the wedding arrangements, as well as taking charge of the financial arrangements to provide for Miss N and Mr X's living arrangements once married (as stated by mother X in chapter 6). This also appears to resemble parent-child triad one, specifically with reference to mother X's relationship with her father. This resemblance and potential repetition of the above triad in the subsequent generation (in line with homeostasis) may have evoked feelings of resentment in Mr X as he periodically may have occupied the position of distanced or isolated member when Miss N was close to her father.

Despite this possible resentment, Mr X may also have been caught in the ambivalent position of wanting to assert himself and take the position of the dominant male of the triad, and yet may have felt constrained by the particular societal system he was simultaneously a part of with its emphasis on respect for one's elders. In this sense, it would appear that Mr X was caught in a double bind position. One might also hypothesize that Miss N may have suffered some degree of physical or psychological symptoms as a result of being the third member in the centre of the conflicting pair. Mother X stated that "Miss N was a lovely child...she went to school at [name omitted] and it's for people that are slow at learning...she had that little problem but she was good at needlework."

- Triads: couples.

The genogram appears to demonstrate one significant triad involving couples in the family system, namely:

- o between the X family, Miss N's parents and Mr X and Miss N (couples triad one);

Figure 9.

Couples Triad One

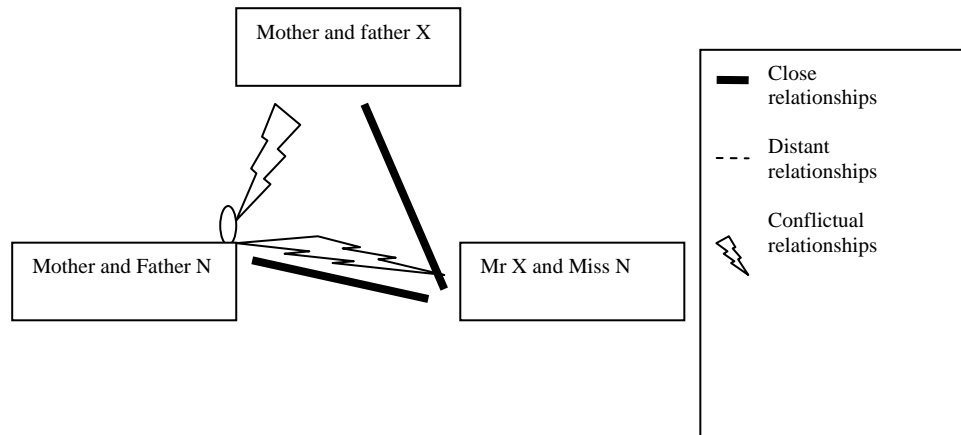

The first significant couple triad involves mother and father X (as one unit), Mr X and Miss N's parents (as one unit), and Mr X and Miss N (as one unit). In much the same way as Miss N's learning difficulties and slight mental impairment may have contributed towards her father taking a role of caretaker towards her, Mr X's similar learning difficulties as well as his status as an only child (also the case with Miss N) may have also contributed towards his parents being over-responsible towards him too. The conflict between Mr X and father N may have resulted in mother and father X being drawn in on Mr X's side in disputes concerning the relationship between Miss N and Mr X, as well as the wedding arrangements. This triad consequently consists of a conflictual relationship between both Mr X and his parents and Miss N's parents, and a united, close relationship between Mr X and his parents. As a result, conflict with the parents of Miss N served to push Mr X and his parents (specifically his mother) closer together, and thus possibly further the stability and rigidity of the X family system, by strengthening the relationships between members.

- Triads: multigenerational triads.

Whereas previous triad types have involved members from different generations within the family system, these members have usually been from two successive generations within the

family system. Multigenerational triad patterns will examine relationships between members from three different generational tiers.

The genogram demonstrates three significant multigenerational triads in the family system, namely:

- between Mr X, the maternal grandfather and mother X (multigenerational triad one);
- between father X, Mr X and the maternal grandfather (multigenerational triad two); and
- between father X, mother X and the maternal grandfather (multigenerational triad three).

Figure 10.

Multigenerational Triad One

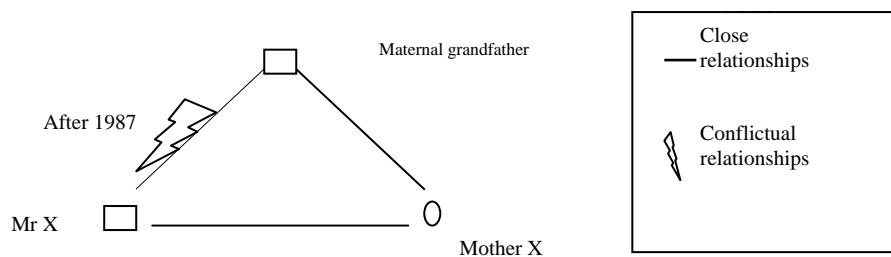

The first important multi-generational triad involves Mr X, his maternal grandfather and mother X. In Mr X's early youth up until his late adolescence, this triad consisted of a close relationship between all three members of the triad. When Mr X and his grandfather had an argument in 1987, there was a breakdown in their relationship. The triad changed to a conflictual, cut-off relationship between Mr X and his maternal grandfather, and a close relationship between mother X and both Mr X and her father. The breakdown of the relationship between Mr X and his maternal grandfather would appear to have strengthened

the relationships between mother X and both her father and Mr X. However, this breakdown did have considerable ramifications within the triad, evidenced in Mr X's employment, relationship and behavioural problems that followed.

Figure 11.

Multigenerational Triad Two

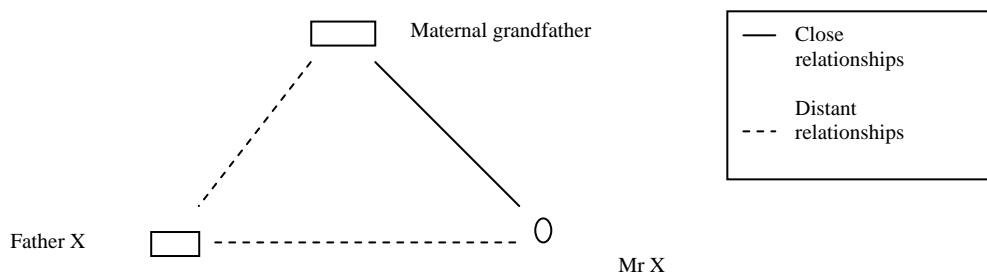

The above triad would have further distanced father X within the family system, as can be seen in the second multigenerational triad, involving father X, Mr X and his maternal grandfather. In this triad, there was a close relationship between Mr X and his maternal grandfather, with emotionally distant relationships between Mr X and his father, as well as father X and his father-in-law. Father X may have been displaced as the primary male figure with which Mr X would have identified growing up, resulting in a greater identification with his maternal grandfather in terms of male gender role. This configuration may have also contributed towards the alienation of father X further from his wife, and the nuclear family unit.

Figure 12.

Multigenerational Triad Three

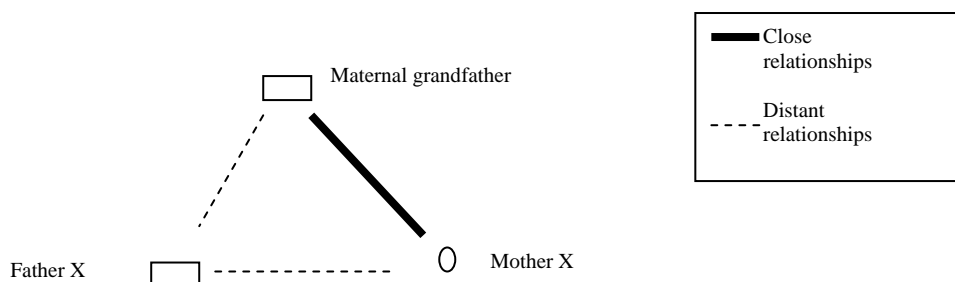

This triad involves a close relationship between mother X and the paternal grandfather, and the isolation of father X.

- Triads: relationships outside the family.

The X nuclear family system is particularly closed and consequently, relationships with others outside of the family system do not feature frequently in the genogram. Emotional processes within systems will be discussed in greater detail further on. However, it is important to note that there is one triad involving a relationship with others outside of the family system, namely the family of Mr B, a work colleague of father X (as seen in figure 2). The emotional distance and isolation of father X within the nuclear family system, may have contributed towards him forming close attachments to other entities (such as pastimes, his job, or other people) outside of the system. This can be seen in father X's dedication to his work as well as his fondness for his friend Mr B and his wife and children. In comparison, Mr X's and his mother's lack of relationships with others outside of the system can be explained by the extent to which they were emotionally involved in triads and relationships within the family system (and consequently emotionally isolated from individuals outside of the system). Father X stated that "it's almost 53 years that we worked together...we know each other well." This was one of the few areas that father X commented on throughout the entire interview.

- Triads: other.

It is important to mention the last type of triadic relationship in the family system that involved a member and another entity, and another member of the family system. There are two instances of this type of triad in the family system, namely:

- o between the maternal grandfather, his alcoholism and significant others; and
- o between Mr X, his criminal behaviour and significant others.

Figure 13.

Triad: Other

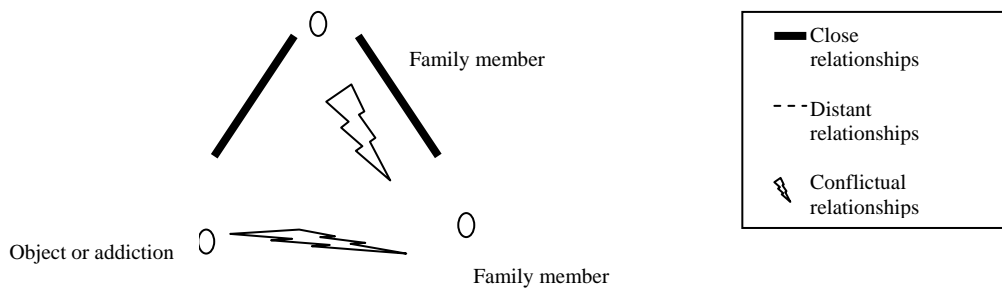

This triad involves relationships between two individuals and a third inanimate entity, such as an addiction. Two such triads emerge from this family system. The first instance involves the maternal grandfather, his alcoholism and mother X (as well as other significant individuals in his life). This triad consists of a close relationship between the maternal grandfather and his addiction, an antagonistic relationship between mother X and the addiction, and an ambivalent, close relationship between mother X and her father. It would appear that each time the maternal grandfather engaged in his addictive behaviour more frequently, thereby introducing an external entity into the system (in the form of alcohol), the larger external family system drew upon resources in the X nuclear family system (in the form of mother X who was pulled closer to her father and would take responsibility for him and care for him) in order to maintain stability and to reinforce the rigid, closed boundaries of the system. This addictive behaviour may have been essential for maintaining homeostasis within the system through absorbing excess anxiety in the system but paradoxically also threatened the system by virtue of making its boundaries more diffuse. This pattern may also have been repeated with any of the wives of the maternal grandfather. In the absence of any new member to take the place of mother X in the X nuclear family system during these occasions, the X family system may have pulled mother X back after a time in order to

maintain its own homeostasis. This pattern and “recycling” of members between extended and nuclear family systems may have been repeated on a number of occasions in line with maintaining stability in the entire family system (both extended and nuclear together).

The second instance of this type of triad involves, once again, a repetition of the above. This triad involves Mr X, his addiction (namely, his criminal behaviour) and mother X (or other significant individuals). In the same way, that the maternal grandfather’s alcoholism served to bring mother X closer to him, Mr X’s petty theft and housebreaking functioned similarly in the sense that after he was caught in 1979, his mother became less harsh towards him and more loving. One may argue that his subsequent criminal behaviour and serial murder may have been attempts to elicit care taking or responsibility taking on the part of another. This may be another example of a faulty strategy or solution developed by the system to maintain homeostasis and rigid system boundaries. One may additionally hypothesize that this was finally satisfied when he was arrested and the Department of Correctional Services took permanent responsibility (resulting in a cessation of the problematic behaviour). Mr X stated that

initially I would steal money to escape from the strictness at home...but at a later stage, it wasn’t necessary to escape anymore because, like I said, my mother changed and the strictness disappeared...but it became a habit, because you got a benefit out of it which was the money...it was like a drug that you get addicted to...and it got bigger and bigger...and your mind gets corrupted and you do bigger crime- I could have gone on to rob banks but I didn’t go that route.

- Summary of relational patterns and triads.

In terms of category five, relational patterns and triads, the genogram demonstrates a number of triads. However, only those significant to the current analysis were selected for study. With

respect to parent-child triads, three significant triads emerged from the genogram. These involved the maternal grandfather, mother X and the maternal grandmother (parent-child triad one); father X, mother X and Mr X (parent-child triad two); and Mr X, Miss N, and Miss N's father (parent-child triad three). These triads show a repeated pattern of a close relationship between a parent and child, and exclusion of the other parent. Once again, these triads demonstrated the strong impact of the maternal side of the extended family system on the nuclear family system.

With respect to triads involving couples, one significant triad emerged from the genogram, namely between mother and father X, Miss N's parents and Mr X and Miss N (couples triad one). The triad demonstrated the role and impact of Miss N and her family on the family system.

With respect to multigenerational triads, three significant triads emerged from the genogram. These were Mr X, the maternal grandfather and mother X (multigenerational triad one); father X, Mr X and the maternal grandfather (multigenerational triad two); and father X and mother X and the maternal grandfather (multigenerational triad three). The multigenerational triad pattern indicated the considerable influence of the maternal side of the extended family system, as well as the isolation of father X from the nuclear family system.

With respect to triads involving relationships outside of the family system, there is one significant triad in the genogram between father X and the family of a work colleague, Mr B. This demonstrated the considerable isolation of father X from the nuclear family system and his investment in relationships outside of the family.

Finally, the role played by addiction in the family system was demonstrated by the triadic form involving a member, another entity, and another member of the family system (triad: other).

- **Category six: family balance and imbalance.**

- Family structure
- Roles
- Level and style of functioning
- Resources
- Summary of family balance and imbalance

This section will examine the extent to which the genogram appears to have certain aspects represented or distributed in unequal proportions across it as a whole. In this sense, areas in which the family system may be imbalanced will be demonstrated and possible functions served by such imbalances discussed accordingly. The discussion will examine imbalances in four main areas, namely: structure, roles, level and style of functioning, and resources.

- Family structure.

The genogram reflects two main imbalances with regards to the structure of the family system, namely:

- number of offspring; and
- remarriages.

The first imbalance occurs in relation to the number of offspring of the second and third generations. This has been discussed in the section on family structure (category one); consequently only points pertaining to the impact of this structural factor on balance in the family system will be discussed here. The siblings of both father X and mother X have all had more than one child each, and these children (that is, members of the third generation) have all gone on to have children of their own. In this way, they have successfully continued the extended family system.

Conversely, father X and mother X are the only couple to have had only one child, namely Mr X. Additionally, due to his particular life circumstances and experiences, Mr X has not gone on to have children of his own. Consequently, the larger family system has not been extended, sustained or perpetuated in any way along the branch of the system managed by father and mother X. One may argue that Mr X's crimes, and the "infertility" of this part of the family system may reflect a breakdown in the family system at this point, or may serve a purpose within the family system as a whole. This will be explored further below. However, this imbalance in family structure may have contributed towards pressure on Mr X to perpetuate the system, and a greater level of urgency to marry Miss N and start his own family. Any obstacles to this, like interference on the part of her father, for example, may have contributed towards stress and anxiety in Mr X, and possibly formed part of patterns involving an outlet for anxiety in the system along more indirect lines, for example, in the form of Mr X's criminal behaviour. This possible tentative solution may have become a further problem for the system, in that in doing what seemed logically right with regards to maintaining homeostasis, the system may have contributed towards its eventual downfall.

The second imbalance in the family structure involves the spousal relationships within the family system. On examining the genogram, it is evident that there are no instances of divorce throughout the family system. In fact, it appears that when members of this family (extended and nuclear) get married, the spouses do not ever separate. This may have been influenced by possible supra-systemic cultural prescriptions of the time, namely that divorce was a less acceptable option than possibly might be the case in more current times. The notable exception to this, however, is the maternal grandfather. He is the sole instance in the system where a change in spouse has taken place (to be exact, three changes). These changes have all taken place due to the deaths of the spouses in question. As a result of the multiple spouses of the maternal grandfather in comparison to the remainder of the family system, there is an

imbalance with regard to marriage in the system. This has also been discussed in family structure; therefore only points pertaining to balance in the family system will be discussed.

Two developments in the system appear to have been possible, both of which are supported by the genogram and interview information. Firstly, the notable absence of divorce or separation in the system may point to a possible family belief system that prescribed the unacceptability of divorce in the system and their inability to resolve interpersonal issues. Accordingly, spousal conflict would have to have been endured, whether by open conflict; avoidance or displacement. This would have placed greater stress on couples in the family system, specifically on weaker spouses in the spousal pair (if avoided) or children in the system (if displaced). In a family system in which divorce or separation was prohibited, Mr X's break up with Miss N may have signified a transgression of a family rule. As a result, his feelings of failure and rejection in relation to Miss N and her family may have been intensified by feelings of failure and rejection in relation to his own family system.

Secondly, the imbalance in the system involving the remarriages of the maternal grandfather, may have necessitated an imperative in the system to balance this out at another level in order to maintain homeostasis. Given the appearance of the genogram, as well as his identification with his grandfather when growing up, Mr X may have taken on this imperative within the system. This may explain the split with Miss N as well as the nature of his criminal behaviour (namely, the rape and murder of a series of women). Thus, the imbalance appears to have been addressed at both explicit (Miss N) and covert (criminal behaviour) levels.

- Roles.

The genogram and interview information reveals that role allocation in both nuclear and extended family systems is not balanced, with certain members taking on multiple roles, and other members performing fewer roles. These members are:

- o Father X;
- o Mother X; and
- o the maternal grandfather.

In comparison to father X, whose sole role within the system appears to have been as the breadwinner or provider for the nuclear family system, mother X appears to have been responsible for raising Mr X as a mother, looking after the household as wife, as well as taking care of her father, as daughter in the extended family system. Father X's isolation from both his family of origin, as well as his own nuclear family, meant that he may have faced less responsibility for roles such as son, father and husband. In terms of the latter two roles, his responsibility was narrowly defined in terms of financial caretaking or provision, with little emotional caretaking or physical affection on his part (see above quotes) as well as little input into the manner in which Mr X was raised. Mr X may have looked outside the family system to someone else, such as his maternal grandfather for the qualities that his father lacked. Mr X stated that "he [the maternal grandfather] showed me that he was worried about me- the one day I hurt my foot...and he took me to the doctor and helped me...so he showed me that he was a good person and showed me love."

Mother X may have faced considerable strain given the demands of her multiple roles as mother, wife and daughter. Additionally, this strain may have been intensified by the fact that two of these roles positioned her between two systems, each of which tended towards eliciting her exclusive membership. This may be illustrated by a triad (figure 14) that appears to have existed between mother X, her father and Mr X, involving the isolation of father X and the spousal relationship between father and mother X and her role as wife being more about the pragmatics of running the household and caring for the children than about emotional support or interaction.

Figure 14.

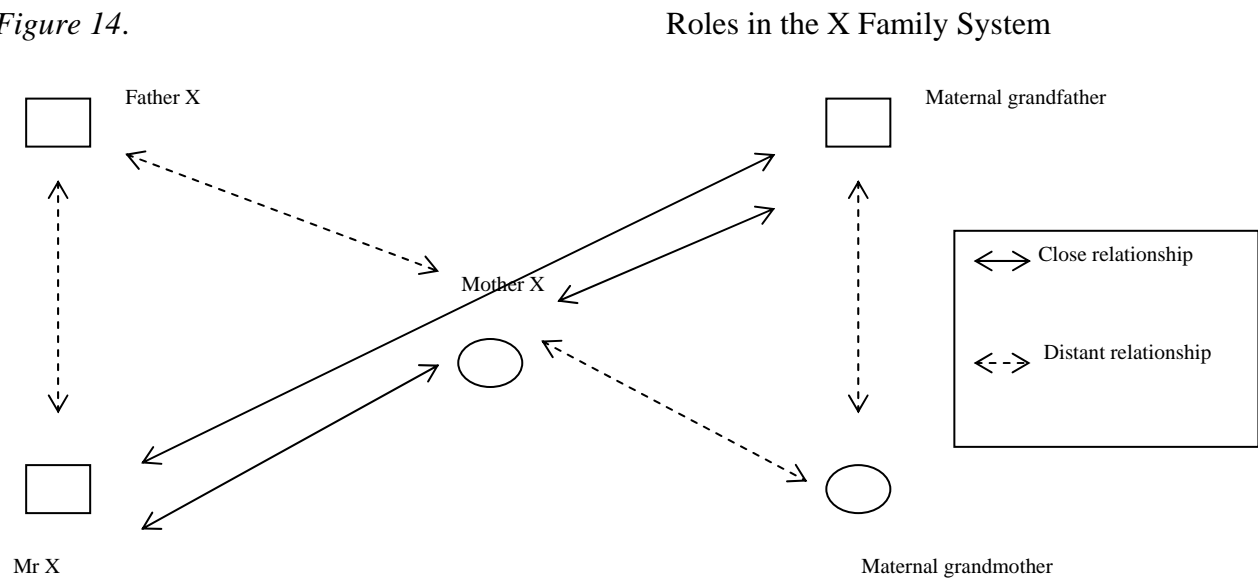

The above triadic relationships (figure 14), as well as father X's narrowly defined role as father, may have contributed to the maternal grandfather performing numerous roles as husband, father, grandfather and "surrogate father" to Mr X (see above quote). His involvement in a triad with his daughter and grand-son, as well as his dual role as grandfather and surrogate father may have isolated him emotionally from his other children and respective spouses, and the three members of this part of the triad may have increased their mutual interdependence. Mother X's siblings may have felt resentment towards her due to her "privileged" position in relation to the maternal grandfather, and isolation from the nuclear family units of these siblings may have increased further.

The above is supported when one contrasts the quote above concerning the paternal grandfather and a quote concerning father X where Mr X stated "he [father X] only did things if I asked him to take me somewhere or for something, then he did it...but there wasn't a bond between us where we would talk, talk about personal issues, we didn't play together."

- Level and style of functioning.

In terms of level and style of functioning, the genogram and interview data reveals imbalances in these main areas:

- o emotional style;
- o over- and under-functioning;
- o gender roles; and
- o success and failure.

With regard to emotional style, it would appear that father X's role was to contribute little to the nuclear family with respect to emotional content. He is isolated and distant and plays a very pragmatic role as father (namely, providing financial support but no physical affection). Mother X, conversely, invests her attachments and relationships with considerable emotional content. This may be in terms of positive emotion such as affection (as can be seen in relation to her father and Mr X from 1980); or negative emotional content such as harshness or anger (as can be seen in the way that she raised Mr X until 1981). In order to address the imbalance resulting from father X's emotional distance, her emotional investment may have been of a higher intensity. For example, her punishment and strictness is described both Mr X and herself as excessive. Additionally, the maternal grandfather may also have been enlisted to address the imbalance as can be seen by his relationship with Mr X (especially as he was growing up) which involved considerable physical affection and emotion which was absent from father X. Mother X stated that "I was very strict- he couldn't lie to me...maybe I was too strict...I've blamed myself over this- that maybe this caused everything..."

The genogram and interview information reflects that mother X appears to have taken a particularly active and over-responsible role in many of the relationships in which she was involved. Many of the other individuals involved in these relationships took a more passive stance with regards to making an effort to fulfill the requirements of that particular

relationship, as well as developing skills towards interpersonal functioning in general. In this regard, additional strain may have been placed on mother X which may have increased her general anxiety and stress levels. This additional anxiety may have expressed itself via physical complaints or behavioural problems (as seen in the genogram).

For example, in the spousal relationship, mother X appears to have done most of the work to maintain the relationship as well as the various duties of the spousal couple such as parenting and the running of the nuclear family. On account of the resulting additional strain, she may have been harsher in her treatment of Mr X.

Mother X stated that

he's [father X] an introvert with a good sense of humour but he's very good...he's also very direct- I tend to hold things back to keep the peace or try to protect a person to keep the peace but Mr X and his father are more direct...but mothers always have a soft spot, you know, so I think many women have a soft spot.

Additionally, mother X may have experienced further responsibility (and stress) in her relationship with her father. The maternal grandfather may have been used to taking a more passive role in his relationships with his first wife and daughter and may have inadequately developed his capacity for taking responsibility for himself (as can also be seen in his alcoholism). This may be illustrated by the process whereby mother X would take care of him and become more involved with the maternal grandfather when his wife died.

Mother X appears to have carried the majority of the responsibility in this relationship as well, resulting in greater strain, and possibly greater harshness in her relationship with her son. She may also have resented having to play the role of wife or caretaker to her father; however, the maternal grandfather fulfilled an important role in the family system as "father" to Mr X. This may be seen as another double bind in the family system with regards to mother

X and may have been particularly prevalent when father X was more unavailable than usual to perform the role of father. The above may have also been worsened by the fact that throughout the genogram, there does not appear to be any evidence of attempts on other members' part to address the imbalance resulting from an outnumbering of under-functioners to over-functioners in the family system.

Given the tendency of patterns to repeat themselves in systems (as discussed above), it is not surprising that mother X appears to have repeated this tendency to over-function and be over-responsible in her relationship with Mr X. This may explain Mr X's general under-functioning, specifically with regards to emotional experiences. This under-functioning and little experience of dealing with emotional relationships in extra-familial contexts (due to the apparent closed nature of the family system), may have contributed to Mr X possibly being overwhelmed by exposure to emotionally intense situations outside of the nuclear family system.

The above would also explain the style in which Mr X committed his rapes. Mr X's modus operandi with respect to the rapes that he committed attempted to mimic consensual sexual intercourse. Frequently, he would smoke a cigarette with his victim after having raped her, and he would attempt to "take care" of his victim by allowing her to take a bath and making conversation with her. In this way, one could argue that he was attempting to balance his under-responsibility and under-functioning in his relationships within his nuclear family system, in his interactions outside of the system. The murders committed by Mr X may also have possibly been a way in which he attempted to end or avoid emotions that were too difficult to deal with. Mr X described the second rape-

while I was standing in the doorway I told her I wouldn't shoot and that everything would be alright...I had sex with her and she asked me some questions like if I wanted a drink or a cigarette or if I wanted to talk about anything...then I went out.

Mr X also describes the fourth rape-

then I had intercourse with her and when we were finished I saw the cigarettes on the bedside table and I gave her a cigarette and I lit one for myself also and smoked...then she asked me if she could go to the toilet and when she went to the toilet I told her to take a bath.

Mr X's under-functioning in his family emotional relationships would also explain his confusion and inability to deal with emotional (conflict or otherwise) aspects of his relationship with Miss N.

In terms of gender roles, there appears to have been an imbalance on the maternal side of the family system, specifically after the death of the maternal grandmother. As the only female child, mother X may have been used to taking care of the traditionally female duties in the household, together with her mother. However, with the death of her mother, and her father being left alone, she may have taken over this role in the family, taking on her mother's responsibilities. She appears to have had dual roles as mother and wife after getting married to father X. This may have contributed to a complex pattern of movement between nuclear and extended family systems as the maternal grandfather introduced new members in the form of his subsequent spouses who would have challenged mother X for her role as "wife" in her family of origin. This may have contributed towards the subsequent wives of the maternal grandfather being made to feel superfluous, alternating with possible loss of power and control for mother X due to other individuals assuming her role in her family of origin. Given that father X also performed a dual role as father to both mother X and Mr X, each time he got remarried may have also threatened his availability to perform the role of father to Mr X.

In order to maintain homeostasis, the maternal grandfather may have also moved between extended and nuclear family systems.

Growing up with a dominant female figure such as mother X, and in the absence of any female siblings to possibly dilute such a figure or provide alternate types of gender representations, Mr X might have grown up with certain expectations of females. These expectations might have seen women as overly responsible; overwhelming; dominant; and, given father X's isolation and his grandfather's alcoholism, may have made him fear his ability to develop, maintain and sustain his own identity as a male, with a female. Consequently, the female gender may have appeared threatening, which would explain his choice of a partner such as Miss N, who appeared to be the antithesis of mother X by virtue of her submissiveness and under-responsibility in relation to her own nuclear family, specifically her parents. This may also reflect an attempt on the part of the system to introduce female gender representatives that would balance and compliment existing females (such as mother X). Mr X stated that "I don't hate women...I'm an introvert, not an extrovert and my relationships with women- there weren't many girls in my life and I didn't date many girls so maybe that had an influence on things."

Within the family system, women, specifically those who were not of the dominant type such as mother X, like the spouses of his maternal grandfather, for example, may also have been seen as dispensable or replaceable, given the manner in which the maternal grandfather replaced his wives soon after their expiry. This may explain Mr X's treatment of women in his criminal behaviour, namely, as objects that he could destroy or violate. Additionally, this may have been another attempt to introduce female influence that balanced or complimented existing females such as mother X in the family system.

The genogram and interview data appear to demonstrate a repeated pattern of failure in a male in each successive generation. In the first generation, this position is filled by the

maternal grandfather, in terms of his alcoholism, as well as his repeated failed attempts at a sustained marriage.

In the second generation, this position appears to be filled by father X in relation to his siblings, as well as those of mother X. His sisters are reported to have succeeded materially and financially in life so that they are “high society”; the remaining members of his generation in the genogram have also had more success in terms of their fertility in the family system, producing numerous offspring to carry on the system, in comparison to his solitary effort; and, his wife runs the household. Additionally, the one attempt that he did make to start a business (1982) and advance himself ended in failure after a year.

In the third generation, so as to maintain the balance of success and failure in the system, Mr X appears to have filled this position. This can be seen in terms of his relationship failure; inability to further his line via producing a child; and his criminal behaviour. When the maternal grandfather died, there would have been an imbalance between success and failure in the family system (in favour of the former). Consequently, the principle of homeostasis (discussed further on in greater detail) would have dictated that this imbalance needed to be addressed. Mr X’s commencement of his murder series one year after his grandfather’s death may indicate an attempt to fill his grandfather’s vacated position as a failure in the system, and consequently, to balance the successes within the system.

During the same period of time (approximately, 1988-1992), the degree of success in the family system, as well as in parallel family systems such as that of Mr B, would have been increasing as members of the third generation such as Mr X’s cousins and the children of Mr B, started their own families and careers (as can be seen in the genogram). Mr B was a work colleague and one of the few acquaintances that were permitted to remain on the periphery of the X family system consistently for a number of years (see chapter 6). Although there appears to have been little interaction in terms of visits to each other’s houses or play between

Mr X and the B children (that is, direct involvement and exchange of members between systems), both father X and mother X appeared to have kept a running, peripheral interest in the lives of the B family members, which also appears to have been reciprocated. Mother X stated that “they [Mr B and his wife] are very good to us – even their children are very good to us – they are married...have teenage children that are in high school.” Interestingly, this pattern may mimic that of Mr X’s housebreaking – as a vehicle whereby members of the X family system could observe how other, possibly more open, family systems operate.

In order to maintain balance in the family system, either another position of “failed member” would have to have been created, or the member filling this position would have to have increased their degree of failure accordingly. Mr X’s escalated frequency of criminal behaviour, notably between 1991 and 1992, where he committed up to three rapes and two murders over the period of three months, would indicate the latter approach was taken to maintain balance in the system.

- Resources.

In terms of the balance of resources in the family system, the genogram and interview data indicate three main areas of disparity, namely:

- o extended family;
- o social support; and
- o coping skills.

In terms of extended family, it would appear that father X did not draw on any resources from his extended family and was isolated and detached from his extended family system. Mother X, conversely, was detached from her siblings; however, she remained closely attached to her father until his death in 1988. Mother X appears to have had more extended family resources available to her than father X. Father X may have felt pressure to fuse or integrate himself

more into mother X's side of the family system. Given the nature of the spousal relationship, namely conflict-avoidant, as well as father X's interpersonal style (as discussed in chapter 6), it would appear that he avoided conflict arising from pressure to conform to mother X's side of the family system by isolating himself and distancing himself further. With the resulting emotional distance, mother X may have drawn further on the emotional resources and support in her extended family network to balance the resulting disparity.

Lacking a diversified and substantial extended family network from which to draw resources, Mr X may also looked towards mother X's side of the system, and his maternal grandfather for any resources that he required (and could not obtain from other sources, such as the nuclear family or community, for example). The maternal grandfather may have felt greater strain resulting in symptomatic behaviour such as alcoholism, and use of his respective spousal relationships to deal with his anxiety.

In terms of social support, the X nuclear family appears to have had little resources. As a closed system, the X nuclear family tended to look within the boundaries of the system for support resources. A number of members were forced to play multiple support roles within the system (for example, mother X, and the maternal grandfather, as discussed above) and exhibited behavioural problems such as alcoholism (the maternal grandfather) or criminal behaviour (Mr X); premature deaths such as in the case of the spouses of the maternal grandfather; and physical illness such as the heart condition of mother X.

As is typical with closed systems, the system started to become dysfunctional due to a lack of new input. Problems or stress may have been ignored or avoided (as indicated by mother X in the interview, see chapter 6), and as a result not expressed openly in the system to prevent the system from collapsing and this pattern of interaction may have led to the development of certain problems or symptoms in members of the family such as Mr X in the

form of his criminal behaviour. The implications of such processes will be discussed in further explanations.

There appears to be a considerable lack of coping skill resources within the nuclear family together with a multigenerational pattern of avoidance, both of which appear to have been encouraged by the closedness of the system, keeping the system in a dysfunctional homeostasis. This is evident in the maternal grandfather's alcoholism; mother X's physical illness; and father X's isolation and emotional cutting-off. Mr X appears to have perpetuated this pattern and does not appear to have developed appropriate and beneficial ways of dealing with stressful situations and conflict. This is evident in his emotional cutting off and distancing from Miss N's family after experiencing conflict with her father, as well as his use of criminal behaviour to deal with stress.

- Summary of family balance and imbalance.

In terms of category six, family balance and imbalance, the genogram revealed a number of areas of imbalance in the family system. With respect to structural imbalances, these occurred in the areas of number of offspring and remarriages. Both of these aspects have been discussed previously in the section on family structure; however, these aspects were examined in the present section in terms of their impact on balance in the family system.

With respect to roles, the genogram demonstrated that both mother X and the maternal grandfather played multiple roles in the family system, whereas father X played a lesser role in both the nuclear and extended family systems. Once again, the considerable impact of the maternal side of the family system was noted, together with the isolation and detachedness of father X from the nuclear and extended family systems.

With respect to level and style of functioning, four main areas were discussed. These were emotional style; over- and under-functioning; gender; and success and failure in the

family system. It was found that there was an imbalance between the emotional investment of father X and that of mother X, the maternal grandfather and Mr X in the nuclear family system; that mother X was over-responsible with respect to her father, Mr X and father X; that Mr X was exposed to very particular and extreme typifications of the female gender and that this may have impacted upon his criminal behaviour and victim choice; and that there was a considerable imbalance between success and failure in the family system, notably with the nuclear family system accounting for the failures in the system together with the maternal grandfather.

With respect to resources, imbalances were found in the genogram in the areas of extended family, social support and coping skills. It was found that the nuclear family system was particularly low on extended family resources due to its isolation from other systems. This also applied to social support. Finally, coping skills resources were found to be lacking in the nuclear family system, as well as in the maternal grandfather. As can be seen in the above sections, the X family genogram reveals a number of significant structural configurations and processes in the family system. These will be elaborated upon further and used to support themes that emerged in the content analysis of the study data.

7.1.2 Thematic content analysis.

The above body of data was then analysed using the content analysis method and the resulting themes will now be elaborated upon in terms of the family systems theoretical framework discussed in the methodology section (chapter 5), namely in terms of emotional process, multigenerational patterns and relationship patterns.

- **Themes relating to emotional processes in the X family system.**

In terms of emotional process, the following themes emerge, namely:

- low levels of differentiation in the nuclear family system (Theme one);
- fears of loss of self due to extremely fused relationships (Theme two);
- emotional cut-offs as
 - a result of isolation of members excluded from fused relationships between other members, and
 - as a conflict and anxiety management strategy (Theme three);
 - and
- high anxiety amongst members involved in fused relationships (Theme four).
- **Low levels of differentiation in the nuclear family system (Theme one).**

The X nuclear family system demonstrates a considerably low level of differentiation. This may reflect a multigenerational pattern of low differentiation in the larger system, together with a decrement in levels of differentiation with each subsequent generation. There also appears to be a low level of spousal differentiation.

The low level of differentiation at higher tiers of the family system can be seen specifically on the maternal side of the extended family system. This is observable in the first generation with the maternal grandfather's alcoholism. This low level of differentiation was passed on to mother X. This is evident in her close attachment to both Mr X and her father, and her high levels of anxiety and emotionality. Her sibling position as only daughter may have contributed towards a more fused and enmeshed relationship with her family system.

On the paternal side of the extended family system, father X's isolation and distance from his family of origin may reflect a pattern of low levels of differentiation on his part. The fact that his siblings isolated themselves in the same way once they had formed their own nuclear

families, may indicate that his family of origin was also of a low differentiation level. His isolation from his family of origin may have contributed towards an initial fusion or enmeshment with his nuclear family. However, this appears to have changed quite soon as this relationship may have threatened to overwhelm and challenge homeostatic patterns from his family of origin as well as his self-identity, and he may have repeated his coping response of distancing and isolation, this time in relation to mother X and Mr X.

Spouses will frequently choose individuals of similar levels of enmeshment with regards to their families of origin. This can be seen with respect to both father and mother X, as well as Mr X's choice of Miss N, who was also very enmeshed with her nuclear family. As a result, there does not appear to have been any input into the family system that could have forced an increment in differentiation, or a challenge to the pattern of enmeshment. In this way, homeostasis appears to have been preserved in the X family system.

Mr X may have perpetuated multigenerational patterns of enmeshment, fluctuating between very close fused relationships (such as that with mother X and his maternal grandfather) and isolated and cut-off relationships (such as those outside of the family system and his relationship with father X).

The overload of anxiety that accompanies enmeshed relationships appears to have resulted in a combination of spousal dysfunction and projection on to the child in the X nuclear family as attempts to manage anxiety in the family system. These two aspects will now be discussed briefly.

In the X nuclear family, marital conflict does not appear to have occurred between father and mother X. Father X avoided conflict with his wife (and, in general) by isolating himself emotionally. This was observed by the author in the interview with father and mother X where any disagreement or potential conflict was avoided by mother X deferring to father X. For example, the following sequence occurred over recollections of Mr X's arrest.

Mother X: 'Mr X was there in the room and naturally they put him in chains and-'

Father X: 'No he was still free...'

Mother X: 'No, weren't there chains on his hands and feet?'

Father X: 'No...'

Mother X (not convinced): 'Mmm and the media...'

Another example of avoidance of conflict is also indicated in mother X's hiding of the anonymous videotape sent to their house (see chapter 6).

Usually, open conflict in the spousal relationship absorbs a large amount of the anxiety present in the family system. However, conflict avoidance on the part of father X and mother X, may have necessitated that one spouse adapt and surrender themselves to the dominance of the other in the relationship, in order to preserve homeostasis. This appears to have been mother X in the current example.

Mother X may have been used to playing an adaptive role in her relationships with men due to being the only female in her family of origin. She appears to have repeated this role in her own nuclear family. In the adaptive position, mother X appears to have been responsible for managing a large amount of the anxiety in the spousal sub-system and may have attempted to achieve this via symptoms such as heart attacks, anxiety and physical violence towards Mr X.

Periodically, however, the system resources available to mother X, from which she would have been able to draw to perform her dual adaptive roles in both her relationship with her spouse, and her relationship with her father (discussed below), may have been depleted. The breakdown of the spousal relationship or separation of father X from mother X would have threatened family rules and the supra-system's rules against such occurrences (discussed above), as well as the homeostasis of the larger system. Mother X's symptoms (such as anxiety or physical ailments) may have drawn necessary resources to the system in the form of assistance from representatives from other systems (such as doctors from the larger supra-system) as well as within the family system (for example, father X may have involved himself more with the nuclear family at these times), which allowed her to go on performing the dual roles and maintaining homeostasis.

Additionally, spousal conflict may have been avoided in a faulty attempt to not put further strain on the system and to maintain homeostasis. Paradoxically, avoidance of open conflict contributed further to strain and anxiety in the spousal sub-system. However, in order to successfully avoid conflict, especially when system resources were limited, the spousal sub-system may have adopted a strategy of projection onto Mr X in accordance with systemic principles of homeostasis and stability. The effects of this projection will be discussed in the following section on family projection process.

As a result of the overburdening of the adaptive spouse, namely mother X, in the marital relationship, a proportion of the anxiety in the family system would have periodically needed to be dealt with to prevent open conflict between the spouses and breakdown of the family system. Consequently, this surplus anxiety was projected onto Mr X. Mr X's selection as a target for spousal projection appears to have been based on a number of factors, namely, his status as only child as well as his close relationship with mother X.

A significant instance of projection occurred in 1978 (as indicated in figure 2), when Mr X developed meningitis and learning difficulties. Significantly, it was also at this time that mother X was faced with additional caretaking duties in relation to her father (the maternal grandfather) who had been widowed that year. She may have been taxed in terms of her ability to manage the anxiety in the nuclear family system and marital relationship and surplus anxiety from the spousal sub-system may have been projected onto Mr X. Importantly, this episode was followed by the start of his criminal behaviour in the following year, when he began stealing from his mother's bag and breaking into houses. This may also signify the start of an important role for Mr X within the nuclear system, as a member of the system who assisted in the management of surplus anxiety. Mr X's criminal behaviour may also have reflected a repeated pattern of coping that he learnt from mother X – namely, that when mother X appeared to be over-burdened, she may have developed symptoms to attract further resources to the system, specifically in the form of father X's greater involvement at these times. Mr X's symptoms may have signified a means to draw mother X back into the nuclear system at times when it appeared that she was more involved with the external family system or her role as "wife" to the maternal grandfather. In this way, mother X would have also avoided confrontation with the maternal grandfather.

The death of the maternal grandfather's second wife may also have resulted in increased levels of general anxiety in the family system due to the loss of a member and the necessitated response of the system in line with principles of homeostasis. Such increased levels in general anxiety would have also contributed to the higher levels of anxiety in the nuclear family system.

It would appear that the above pattern and arrangement remained constant for some period of time in the family system until there was an escalation in 1987 which resulted in Mr

X's argument and distancing from his grandfather, his demotion at work and the first rape and murder in 1989 (as indicated in Figure 2).

A number of new developments may have increased the level of anxiety in the system, namely the introduction of Miss N, as well as the maternal grandfather's new spouse to the family system. Given that the X family system is a very closed system, the introduction of new members from outside the system would have been a source of increased stress as the system attempted to maintain stability and homeostasis. Increased stress in the system would have resulted in a greater demand on the system to process this stress in some manner. Mr X may have been a more frequent target for projection and he may have attempted more drastic solutions to cope in this role within the system, as possibly reflected in his escalated criminal behaviour and distancing from his grandfather, repeating multigenerational coping strategies from both mother X's (addictive behaviour) and father X's (distancing and isolation) sides of the family system.

o **Fears of loss of self due to extremely fused relationships (Theme two).**

In the nuclear family system of Mr X, there was extreme progressive segregation or isolation between the dyad of mother and son (namely, Mr X and mother X) and father (father X). As discussed previously, father X was isolated and emotionally detached in the system.

Conversely, there was extreme centralization or fusion between mother, son and grandfather (namely, mother X, Mr X and the maternal grandfather). This fusion revolved around the maternal grandfather as dominant member. As a result, this threesome functioned as an alternative fused nuclear cluster, to varying degrees of intensity across time.

The intense fusion that operated within the centralized threesome meant that the members would have been considerably isolated from individuals outside of the cluster. This can be

seen in Mr X's emotional distance from his father as well as persons outside of the family system. Mother X stated that

he [Mr X] didn't have one specific friend, he was an introvert...like his father...he was very quiet, didn't talk much...he read and he loved animals a lot...he didn't have any specific hobbies that I can remember...like the movies.

When his grandfather died in 1987, there would have been considerable anxiety about loss of self and identity in both Mr X and his mother due to the dominant role played by the grandfather in the fused triad. Mr X engaged in greater acting out and antisocial behaviour in an attempt at self definition (as discussed in previous sections), possibly attempting to recruit other members, in the form of the murder and rape victims into the position and role vacated by the maternal grandfather. Alternatively, perhaps Mr X attempted to take the role of his grandfather and the crime victims served as replacements for the position and role left by Mr X. It would appear that mother X also attempted to rectify the imbalance created by the loss of the maternal grandfather by becoming more enmeshed with Mr X (thereby possibly intensifying his need for independent self assertion and antisocial behaviour).

Mr X's low level of differentiation, and tendency towards fusion in some of his close relationships with family members and Miss N, the fear of self-annihilation or being overwhelmed by the other may have been a considerable factor in Mr X's close relationships (such as those with his mother and grandfather). He may have staged attempts, at various points in his life, to differentiate himself from the family system, and thereby prove that his self had not been completely annihilated through fusion with his mother or the family system. For example, it appears that he attempted to do this by achieving physical distance from his family via his occupation. Additionally, Mr X may avoid close relationships with individuals outside of the family system due to fears of being overwhelmed due to the considerable

potential for fusion and loss of identity experienced by him in interpersonal relationships.

This avoidance can be seen in the descriptions of both the psychiatrist and psychologist (see chapter 6) as well as the interviewer's own clinical observations (see chapter 6).

However, it was via his criminal behaviour (such as the petty theft and housebreaking of his early youth and later, the murders and rapes) that he appears to have gained the greatest self-confirmation as well as outlet for the high levels of anxiety he would have experienced due to low levels of differentiation.

Mr X stated that

I started stealing when I was in about standard five [grade 7], because I felt that the circumstances at home were too strict and I wanted to escape from the strictness, and the only way was to escape from the house for a bit longer...I used the money that I stole to play pinball and *pacman* at the corner *kafee* [convenience store] when they sent me to buy bread – that way I could stay away from the house.

The intensity of fused relationships in the X family system appeared also to function to prevent the movement of members away from the system, and to ensure that the system (specifically the nuclear family system) remained considerably rigid and closed to outsiders, in line with systemic principles of homeostasis. This theme can be seen with regards to both mother X and Mr X. After the death of the maternal grandmother, mother X distanced herself from the nuclear family in order to care for her father. Soon afterwards, Mr X developed meningitis, and later, learning difficulties as a result of this illness. Mother X, consequently, was forced to return to her nuclear family to look after Mr X.

One could argue that Mr X's choice of work, namely, in the strict, controlling environment of the police force may have constituted an involvement with another system

that resembled the family system which he had at home, thus continuing the trend and defeating attempts on the part of Mr X to change or move away from his family system.

With respect to Mr X, his attempts to form his own family with Miss N and distance himself from his own nuclear family resulted in a number of events which pulled him back into the family system to preserve homeostasis and the closed nature of the system. This included a demotion at work that resulted in conflict with Miss N's father and the end of their relationship, as well as an escalation in his criminal behaviour that ultimately resulted in his incarceration. System imperatives also appear to have made Mr X's attempts to move forward through his remaining life stages, and become independent of his family difficult. This can also be seen in the way that Mr X moved home during this period, ostensibly to avoid being caught, but, in terms of the family system, to preserve homeostasis. Mr X stated that "[after murdering the third murder victim] I decided that problems would just get worse here, so I decided that, no, I must go back to [place of residence], so I moved out [of work accommodation]...and moved back home."

o **Emotional cut-offs (theme three).**

As stated in above, emotional cutting off between family members would appear to occur as:

- a result of isolation of members excluded from fused relationships between other members; and
- as a conflict and anxiety management strategy.

There are three significant instances of emotional cut-off in the X family system, namely:

- Father X and the family system (nuclear and extended);
- Mr X and the maternal grandfather; and
- the maternal grandfather and his spouses.

The first instance is father X. Father X's original nuclear family system may have developed patterns of distancing and isolation in order to cope with possible low levels of differentiation and enmeshed relationships. Father X appears to have repeated this pattern by cutting himself off from his extended family and forming a nuclear family of his own. However, his fears of self-annihilation in close emotional relationships and need for the system to maintain homeostasis saw him repeat the above coping patterns in his nuclear family as well and investing himself in a more fused relationship with his work, which may have been less threatening. This is evident in that the only time throughout the family history where father X is reported to have been openly affected emotionally was when his business failed in 1982, resulting in a period of depression (see above quotes); and that his closest emotional relationship appears to be with a work colleague and his family, namely Mr B and his wife. As discussed previously, his emotional isolation from his family was accompanied by a closer relationship between Mr X and his mother, and Mr X and his grandfather.

The second instance of emotional cutting off is when Mr X had a disagreement with his grandfather in 1987. This disagreement is the first (and last) instance of conflict between Mr X and his grandfather. It may be that the argument, at base, concerned dominant and adaptive positions in the relationship. Throughout his life, Mr X took the adaptive role in his relationship with his grandfather. However, by refusing to give in to his accusations concerning the borrowing of the motor vehicle, Mr X was challenging for the dominant position in the relationship; as well as challenging the multigenerational pattern of avoiding conflict that appears to have characterized the family system.

Given the threat that Mr X's challenge provided to the family system with regards to homeostasis, it would appear that the only way that the system could deal with such challenges was via creating distance between Mr X and the maternal grandfather until another member (that is, mother X) intervened to recreate a non-confrontational relationship style via

organizing a reconciliation between Mr X and the maternal grandfather. Despite the fact that this reconciliation was unsuccessful, it still functioned to preserve homeostasis by circumventing a confrontation between the two and thus preserving the multigenerational pattern. The impact of this cutting off (and the death of his grandfather the following year) on Mr X coincided with his subsequent problems at work and escalation of criminal activity.

Finally, other examples of cutting-off in the system include the deaths of the spouses of the maternal grandfather. It is significant that all of his wives died in close succession, possibly revealing the great need of the maternal grandfather for adaptive partners to assist in the absorption of the considerable undifferentiation and anxiety in the system. The extent of spousal dysfunction can be evidenced by their deaths soon after their introduction into the system, with fusion, enmeshment and possible loss of self in the spousal relationship, and excessive isolation from the maternal grandfather when he moved away from the spousal subsystem into the nuclear family of mother X, in his role as surrogate father to Mr X.

As discussed previously, this may have impacted upon Mr X's attitude towards women and his criminal behaviour. As much as he was a target for projection of surplus anxiety in the nuclear family system, he lacked external relationships in which he could work through some of this anxiety, or a level of differentiation which would have enabled him to work through this anxiety, due to his emotional isolation from the outside world and fusion with the nuclear family system. Consequently, the women that he selected as victims may have functioned as a means by which to release this anxiety as well as avoid developing physical symptoms of his own, in much the same way as the spouses of his maternal grandfather may have functioned for his grandfather (namely, to absorb surplus anxiety). In this way, this pattern may have served as a concrete way of maintaining the system by replacing missing role players. Mr X stated that "I didn't feel physically different on the days that I committed the murders...I just

felt an urge to go out, maybe it was for the adrenalin rush...and the sense of accomplishment you felt afterwards.”

o **High anxiety amongst members involved in fused relationships (theme four).**

After the death of his maternal grandfather in 1988, mother X may have been left with a surplus of undifferentiation which normally would have been absorbed in her relationship with her father, in accordance with systemic principles of wholeness and homeostasis. This undifferentiation may have been channeled into her only other close, fused relationship with Mr X, who may have escalated his attempts to differentiate himself. This may be reflected in the increase in severity that characterized his crimes during this period with Mr X committing rape and murder for the first time in 1989.

It is important to examine how Mr X's antisocial and criminal behaviour fitted into the homeostatic processes of the family system, especially with regard to the management of high anxiety in the system. Mr X's antisocial behaviour does not appear to have received negative feedback from the family system at any point. From early puberty, his petty theft and housebreaking went unnoticed and unpunished. As discussed in the previous section on Bowen's theory, this behaviour may have served as an outlet for residual anxiety and undifferentiation in the system. As a result, the behaviour in question would have received positive feedback due to the beneficial effects such behaviour would have had on the system as a means towards homeostasis. When Mr X was caught housebreaking when he was in Standard five [grade seven], he received a hiding and the incident was forgotten. Additionally, this event resulted in further positive feedback in the sense that his mother became less punitive towards him afterwards. Mr X stated that

in the beginning, you're a bit scared that you'll be caught- I was caught once [housebreaking when he was in standard five] but it just made me more careful...when

I was caught, I got the hiding of my life but it didn't solve what I was doing...the hiding...or threats to take me to the police...it didn't help to solve the problem, it just made me more careful because they didn't focus on the problem or try to get me help...

He also stated "...like I said, my mother had changed by then, so it wasn't necessary for me to escape anymore, the strictness wasn't there anymore..." Paradoxically, the change in his mother's attitude may have intensified his antisocial behaviour in an attempt to maintain homeostasis, by attempting to restore continuity to their relationship. In other words, he would use more of the same in an attempt to elicit the punishment that he was used to from her. The more that this did not occur, the greater the escalation in his criminal behaviour. Mr X stated that

it was a while after that [getting a hiding] that I started stealing again...I knew what I was doing was wrong but it felt as if I could do nothing about it, or didn't want to do anything to stop it because I benefited from it...I could get money and spend it on what I wanted...and I kept on doing it until it got bigger and bigger...my mind got corrupt and you do bigger crime...

As discussed previously, Mr X's antisocial behaviour may have served as a means by which he could assert himself independently of the enmeshed relationships within the family system. As he grew older, and threatened to distance from the family by forming his own family with Miss N, and developing greater independence with regard to his work, homeostatic pressure for stability and fusion would have increased, resulting in greater fears of self-annihilation in fused relationships, and consequently, an escalation in antisocial behaviour as an outlet for the increased anxiety. Mr X stated that "I went out with her [Miss N] for two years and I was

engaged to her for two years...I was arrested three months after we'd called off the engagement and three months before we would've got married."

Mr X's escalation in antisocial behaviour, especially after his grandfather's death when he committed the first murder and rape, can be understood with reference to the family system's need for a "bad guy". As discussed previously, father and mother X appear to have been unable to adequately manage high levels of differentiation in the system, and yet unable to accept responsibility for the consequences of their failed attempts at managing these aspects of the family system. This was evident in the author's clinical observations (see chapter 6) as well as in the interview content (see chapter 6). Consequently, the family system may have required a bad guy member to function as scapegoat by accepting blame, and consequently protecting father and mother X from taking legitimate responsibility in the system, and around which they could triangulate (discussed further) to prevent the spousal relationship from splitting up.

It would appear that on account of his alcoholism, and breach of family rule around marital success, the maternal grandfather fulfilled this role for the family system. However, when he died, the systemic principle of homeostasis may have necessitated that a new member would have to take on this role to prevent a loss of stability in the system. Mr X took on this role – firstly, by ending his relationship with his fiancée, thereby also breaking a family rule; and secondly, by escalating his antisocial behaviour to a point where his role as "bad guy" was legitimated by outside societal systems such as the justice system, and media.

- **Themes relating to multigenerational patterns in the X family system.**

In terms of multigenerational patterns, the following theme emerged, namely:

- weak generational boundaries and poorly defined subsystems (Theme five), in terms of

- parental subsystem;
- spousal subsystem; and
- sibling subsystem (of father X and mother X).

Multigenerational transmission of low levels of differentiation may also be considered a theme of multigenerational processes. However, this has already been discussed as part of theme one.

o **Weak generational boundaries and poorly defined subsystems (theme five).**

The X family system appears to have been characterized by poorly distinguished generational tiers. This can be seen predominantly with respect to the maternal side of the family system, where the maternal grandfather and mother X appeared to increasingly move between the first and second generational tiers of the family system. This pattern appears to have been repeated with regards to the parental subsystem in the nuclear family.

The parental subsystem of the X nuclear family frequently appeared to consist of mother X and her father rather than father and mother X. In this regard, there appear to have been weak boundaries between the grandparental and parental subsystems. There also appears to have been considerable movement between child and parent subsystems in mother X's family of origin, where she frequently took on the role of "mother" or caregiver to her father, as opposed to her natural role as daughter or child. She may have struggled to develop a sense of independence or responsibility with regard to personal decision-making. This can be seen in mother X's inability to deal with life stress or stressful situations in her own life, and dependence on father X.

Despite the considerable permeability in her own parental/child subsystems, within the nuclear family, it would appear that boundaries between Mr X, as child, and mother X, father X and the maternal grandfather (as the parental subsystem) were more rigid. Given this, one

would expect Mr X to have developed relative independence and autonomy, at the expense of feeling cared for or nurtured. However, this configuration appears to have been complicated by the intensely fused (albeit conflictual) relationship between mother X and Mr X. Mr X may never have felt the sense of autonomy that would be expected given the rigid boundaries between child/parental subsystems, but he may have felt the neglect or lack of warmth that would have accompanied such a configuration. Interestingly, when Mr X was in high school, it would appear that mother X attempted to make the boundaries between parental/child subsystems more diffuse. This may have accompanied the increasing distance of both father X and her father (due to his marriages). At first Mr X resisted, but he may have been further pulled in which may explain the conflict that subsequently arose between himself and his maternal grandfather. Additionally, this may have further strengthened his need to act independently or autonomously in other areas of his life (such as symbolized by his criminal behaviour).

The diffuse boundaries between parental and grandparental subsystems may also have contributed to confusion around issues of discipline and executive style. Mr X may have grown up with conflicting ideas surrounding male authority figures which he would have experienced on the one hand as nurturing and caring (as exemplified by his maternal grandfather), and on the other, as distant and aloof (father X).

Additionally, despite the diffuse nature of boundaries of subsystems within the X family system, the system itself appears to have had very rigid boundaries with regard to external systems or subsystems. The X family system appears to have defended its autonomy from the surrounding social or other system/s and thus limited options for looking to areas outside the family system to supplement coping resources or for alternate forms of assistance in times of need. This can also be seen in mother X's behaviour with regards to finding out possible motivations behind the behaviour of Mr X. Despite professing a desire to find out why Mr X

acted in the way that he did, mother X has made no effort to contact the prison psychologist or any other possible sources of information outside of the X family system or the immediate surroundings. In this way, it is possible to see the degree to which the X family system's rules against turning outside for support are present. This was further supported by the guarded and defensive behaviour of father X during the interview.

Due to considerably closed boundaries, the family system may have had to bear considerable strain as a result of having to deal with its own problems via the limited resources within the system. Additionally, it would appear that within the family system, there were certain alliances that were less exclusive than others, and consequently, certain members were more accessible than others with regard to support, assistance and guidance. It would appear that father X was particularly inaccessible, while the maternal grandfather was very accessible, and thus frequently called upon by the nuclear family system for support (namely, by mother X and Mr X). When the maternal grandfather died, the nuclear family system would have been considerably depleted in terms of helping resources and had to manage increased strain. Mr X's escalation in criminal behaviour may have been a response to such an occurrence (namely, after the death of the maternal grandfather) and his arrest appears to have allowed the system to become even more closed and self-reliant.

The interactional style between mother X and father X in the parental subsystem can be viewed as a repetition of their interactional style in the spousal subsystem. It would appear that for the most part of their marriage, father X was distant, isolated and uninvolved in the marriage, other than in relation to his primary role as financial breadwinner. Mother X may have looked to her father as well as Mr X for the emotional support lacking from the spousal subsystem. Alternatively, or additionally, father X may have further distanced or isolated himself from the spousal subsystem as he viewed other family members taking on this function. The spousal subsystem in the maternal first generation (that is, involving mother X's

father and his different wives) appears to demonstrate a similar pattern, with a close relationship between parent and child, and the isolation of the spouse. Consequently, the repetition of this pattern in the second generation may have been a way of the system maintaining homeostasis. Mr X stated that “my mother raised me...my father just provided for us...he was a very quiet person and he was just busy with his things.”

In terms of the sibling subsystems of father X and mother X, it would appear that father X was quite isolated and cut off from his siblings. This may have contributed towards the development of a pattern of interactional style that involved him behaving in a more introverted and distant manner when with others, thereby possibly limiting the possibility of new members being attracted into a closed and rigid family system. This was further supported in the clinical observations during the interview with him as well as mother X's description of him as “an introvert...he doesn't speak for no reason, he's quiet but when he's with his friends, everyone talks.” Additionally, he may have failed to assimilate principles of emotional interaction and connection within a system, and focused more on the practical duties and roles involved in a sibling and family subsystem, explaining his emotional detachment from his own nuclear family system.

Mother X, conversely appears to have been well integrated with her siblings in the sibling subsystem on the maternal side of the extended family system. However, as discussed above, boundaries between parental and sibling subsystems may have been diffuse, specifically with respect to mother X who took on a parental role in relation to her father on a number of occasions. Additionally, within her sibling subsystem it would appear that responsibilities and roles were defined largely along normative gender lines, with mother X taking on a traditionally female household role within the family.

- **Themes relating to relationship patterns in the X family system.**

Relationship patterns will be discussed with respect to the following themes, namely:

- the use of triads and triangulation to form coalitions between members of the family system (Theme six); and
- themes of power implicit in the way that relationships are structured in terms of these coalitions and interactional patterns (Theme seven).

- **Triads (theme six).**

As discussed above, in the interpretation of the genogram, it would appear that a number of significant triads emerge. These will now be discussed in more elaborate detail, specifically with regard to their function within the family system. Additionally, it is important to note that many of the triads below are indicative of weak generational hierarchies and sub-system boundaries as discussed previously.

Figure 10. Multigenerational Triad One

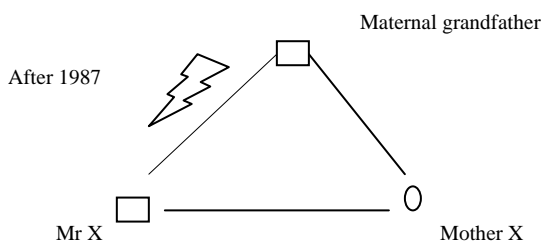
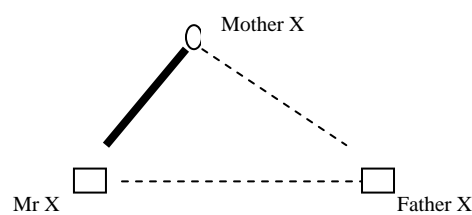

Figure 7. Parent-Child Triad Two



Within the family system, it would appear that the triad between mother X, Mr X and his maternal grandfather, and the triad between father X, Mr X and mother X, served to manage the emotional content of the system as well as the role of father with respect to Mr X. Father X's emotional isolation from his family appears to have accompanied closer relationships

between mother X and Mr X, as well as mother X and her father. Due to the circularity of causality in systems, the closer relationships in the triad between mother X, Mr X and the maternal grandfather, and the emotional isolation of father X would have mutually impacted on each other – for example, father X may have grown more isolated as the other three members became closer, which may have further increased the closeness between the three members, and in turn, further increased father X's isolation.

Multigenerational triad one can also be classified as a nexus of warring triads, with shifting coalitions (Haley, 1970; Jackson, 1957; Minuchin, 1974). This is because there appears to have been a covert competition between all three members for the position of least responsibility. The member around which triangulation took place, as either scapegoat or victim, appears to have changed frequently, together with shifting coalitions between members. A coalition between two members may have made it necessary for the third member to look for alliances outside of the triad. The maternal grandfather may have used his addiction to alcohol, as well as his wives, as alliances; Mr X appears to have used his addiction and work (and later, relationship with Miss N); and mother X appears to have used her work (to a lesser degree though given that she was the member most frequently involved in a coalition).

Parent-child triad two can be classified as a balanced, perverse triad (Haley, 1970; Jackson, 1957; Minuchin, 1974). This is because it involved a covert coalition between Mr X and his mother, and an isolation of his father. During times of stress, however, this formation changed to a detouring-attacking arrangement, involving scapegoating or punishment of Mr X, in order to prevent conflict between father and mother X from emerging into the open. An example of this is when Mr X developed learning problems in primary school, possibly as a symptom whose function was to draw attention and prevent imbalance. At this time, the nuclear family system was under considerable stress due to the death of the maternal

grandfather's second wife. By triangulating around Mr X and his learning difficulties (which were treated as an affront to be punished, as opposed to with pity or sympathy), the couple avoided possible conflict, and possibly was forced to assume a more direct role as parents by virtue of helping Mr X to overcome his difficulty.

Additionally, Mr X appears to be repeating a pattern implicit in the above triads, namely a close relationship or coalition with a female and antagonistic or distant relationship in relation to another male in the life of this female. This seems evident in his relationships since he has been in prison where he has corresponded on numerous occasions with female prisoners at other prisons. Many of these females have been or are involved in abusive relationships with another male, thus enabling the triangular pattern above to repeat itself.

Figure 11. Multigenerational Triad Two

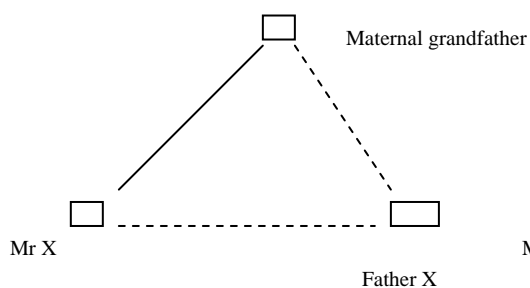
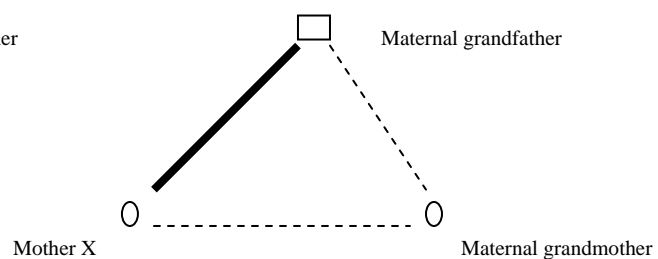

Figure 6. Parent-Child Triad One



The emotional isolation and lack of physical affection and interaction of father X as father in the family system, appears to have been accompanied by Mr X attaching himself emotionally to his maternal grandfather, who appears to have fulfilled the requirements of the father role more completely in relation to Mr X (see above quotes). Mr X may have identified more with his grandfather with regards to gender roles in terms of the emotional processing component of masculinity, whereas he identified with the material, pragmatic aspects of this

role that his father portrayed (namely, hard worker and financial provider). Mr X may have found himself in a position within the system where his identification with his father and grandfather served to increase the presence and importance of that member in the family system. This position may have placed him ambivalently, with considerable pressure to “side” with either his father or his grandfather, thus entrenching their position further in the system. Mr X may have attempted to resolve this ambivalence by identifying partly with his father and partly with his grandfather. This may possibly be evident in a number of Mr X’s characteristics. For example, he appears to have lacked the ability to effectively deal with emotions (such as stress and anxiety) due to his grandfather’s deficit in this area, as seen in his alcoholism, which may explain his similar use of addictive behaviour (crime, in his case) to deal with stress. Additionally, Mr X appears to have adopted the strategy of isolation, avoidance and cutting off used by his father as a means of dealing with conflict. This can be seen in Mr X’s emotional detachment towards violence, as well as the rapes and murders that he had committed. Mr X stated that

[after raping the fourth rape victim] I saw her climbing towards the bathroom window and I knew that she would scream so I told her that she should climb down, then I just aimed the weapon at her and I shot her and then I went back [to the barracks] and I decided that problems would just get worse here, so I decided that, no, I must go back to [his parents’ home], so I moved out of [where he had been living] and moved back home.

When asked what he felt with regards to the crimes and his victims, Mr X stated

it’s now in the past and I can’t do anything more- once I’ve done my sentence, I’ve paid for what I did – but okay, you’ve never finished paying because the stigma stays

with you everywhere you go for the rest of your life but it's not something that I'm going to let affect me, that's all I can say.

Mr X also stated that "I got a hiding on the back of my head or on the bottom [when I was young] and it was difficult for me and sometimes I wished that I was dead...and then it was like I went dead inside and switched off and then I started stealing."

Figure 8. Parent-Child Triad Three

Triad Three

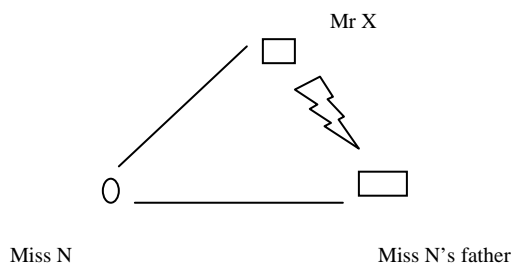
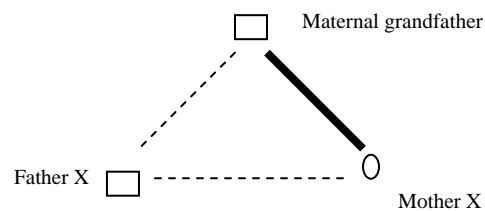

Figure 12. Multigenerational



The triad between Miss N, Mr X and Miss N's father appears to replicate a similar triad between father X, mother X and the maternal grandfather, with Mr X identifying with his father's position. The triangular pattern in question is focused triangulation, with the two males in the triad arguing over the third member or female. The female member appears to lose independence and responsibility within the triad, and the conflict between the two males drives each closer to the female member. In the case of the first instance of this triad (father X, mother X and the maternal grandfather), the close relationship between mother X and her father accompanied the isolation of father X who may have emotionally distanced himself to avoid the resulting conflict, but cut-off emotionally from the maternal grandfather. In the second instance, Mr X appears to repeat this pattern by distancing himself from Miss N and

her father. In parent-child triad three the repetition of the perverse triad formation can also be seen in the sense that Miss N and her father forged a closer relationship, to the exclusion of Mr X.

Mr X stated that

after I was arrested, she broke off the engagement and said that she could not go on with the relationship...I accepted it- I couldn't expect her to stand by me...and her father prohibited her from having any contact with me, I think she's still at home...I tried to phone her at one stage but I didn't speak to her- just to hear her voice but I realized that it was more painful for me than for her so I stopped doing it.

Figure 12. Multigenerational Triad Three

Triad One

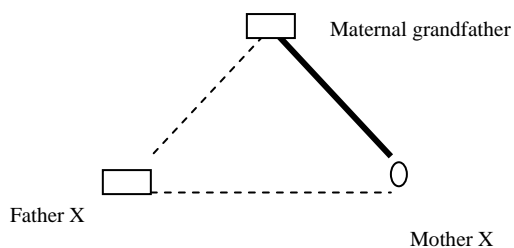
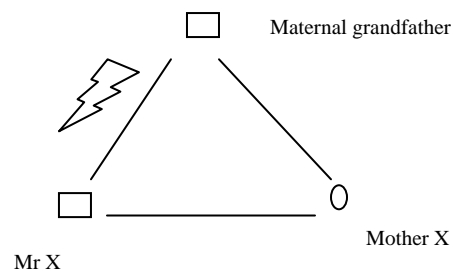
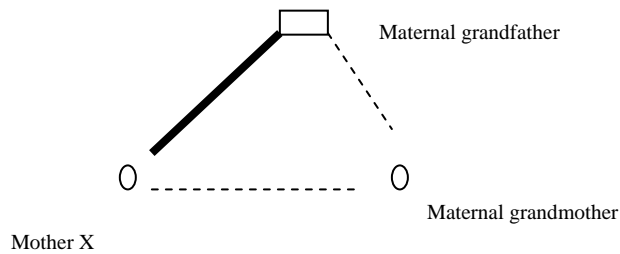
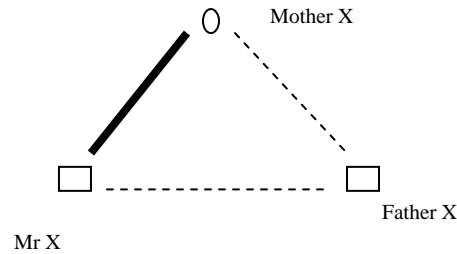

Figure 10. Multigenerational



Mr X's identification with his father's position had implications for his position in the triad between himself, his mother and grandfather. It appears to have been accompanied by conflict between Mr X and his maternal grandfather, as can be seen in 1987, the same year that Mr X started going out with Miss N. Mr X appears to have adopted the same strategy as father X in relation to his maternal grandfather, namely emotional cutting off and distance. However, he seems to have had fewer options in terms of dissipating undifferentiation, resulting in his behavioural problems (demoted 1989 and first murder in 1989).

Figure 6. Parent-Child Triad One*Figure 7. Parent-Child Triad Two*

There also appears to be a parent-child triangular pattern that is repeated across generations on the maternal side of the family system. This pattern involves a focused triangulation with a parent-child coalition against the other parent. In the first instance of this pattern, mother X and her father (the maternal grandfather) formed a coalition or close relationship that excluded the maternal grandmother as well as each of the subsequent spouses of the maternal grandfather. As will be discussed below, the degree of isolation and emotional cut-off of the excluded parent/spouse can be seen in the premature death of these individuals (as indicated in the genogram, chapter 6).

In the second instance, mother X formed a coalition with Mr X, excluding father X. In this way, mother X identified with her father's position, and Mr X identified with mother X's position in the first instance, and the repetition of this pattern across generations served to increase the degree of fusion in the triad that existed between mother X, Mr X and his maternal grandfather, due to their respective identifications in the multigenerational parent-child triads. Fusion appears to have increased and the maternal grandfather appears to have taken on an increasing role in defining the collective identity of the fused triad, as well as of each of the respective members. In line with the principles of differentiation and fusion, the

proportion of the fused identity that could be influenced by a member of the triad would have decreased with each subsequent generation, and Mr X would have had the least say, increasing feelings of self-annihilation and impotence within the family system.

For example, after having the argument with the maternal grandfather, Mr X was persuaded by mother X to make peace with the maternal grandfather. The hierarchy within the fused triad and family system is thus evident. Mr X stated that

then there was a fight over it [the use of the maternal grandfather's car] and then he didn't want to have anything to do with me but then he pulled my mother into it- they still had a relationship but he didn't speak to me- then when he got married and my mother said that I should come with and speak to him and try to make peace.

The effect of the death of the maternal grandfather had on this triad and the respective members will be examined further in discussions of the family emotional processes below.

o **Triangulation in the family system (theme six).**

Given the imminent threats of total fusion and isolation posed by the above processes that were present in the family system, triangulation may have been necessary as a means to prevent system collapse. This seems to have been used in the following areas:

- o to prevent the collapse of the spousal relationship between father and mother X;
- o to preserve the fused triangular relationship between mother X, Mr X and the maternal grandfather; and
- o to cope with the effects of Mr X removal from the system when arrested.

With respect to the nuclear family system of Mr X, father X and mother X, total isolation and cut off of father X appears to have been prevented via triangulation around Mr X, who acted

as an intermediary between the spousal dyad of father and mother X. By presenting with learning problems as well as his antisocial behaviour, Mr X was able to function as a scapegoat for the nuclear family system, and thereby prevent the collapse of the system via a split between the spousal pair. This intermediary role as scapegoat continued after his imprisonment, enabling father and mother X to continue a pseudo-relationship through avoiding conflict within their own relationship by focusing on Mr X. Mother X stated that

I don't get a chance to speak to him [Mr X] in private when we visit him [in the prison] and I don't handle that very well I have a good husband though who takes me for coffee after we've finished visiting him [Mr X] because it really upsets one- you don't understand why he did it.

In the same interview, mother X also stated "he's our son and we must be his family to him and support him where we can and not cast him away."

With respect to the fused centralized threesome of Mr X, mother X and the maternal grandfather, total fusion and system collapse seems to have been prevented by triangulating around various external parties. These included the alcoholism of the maternal grandfather, as well as his various spouses; and the antisocial behaviour of Mr X. Mr X's relationship with Miss N also constituted an attempt to prevent total fusion (in much the same way as the various spouses of the maternal grandfather served to do). However, the attempt with Miss N was unsuccessful as Mr X was faced with another fused system in the form of Miss N's family, and faced the choice of either being assimilated into such a system (further losing self) or remaining an outsider (and consequently a threat to the homeostasis of that system).

After Mr X's arrest and imprisonment, the loss of two important members of the family system (and fused threesome) would have placed considerable strain on mother X (who may have feared self-annihilation in the absence of the members with whom she had fused within

the system) as well as the relationship between father and mother X due to the loss of an intermediary in the form of Mr X around which they could triangulate. The considerable threat of system collapse that resulted may have contributed towards mother X interacting with persons outside of the family system. Such persons included her psychologist, medical practitioner and work colleagues. This, in turn, may have allowed for absorption of some of the anxiety in the system, and introduction of alternative third members for other triangulation processes. An example of such a process would be the alliance between mother X and her psychologist in order to scapegoat Mr X. Mother X stated that

people at work always ask how it's going with Mr X...they are actually very loving towards me, I can't complain about that...Mrs A (name withheld for anonymity and confidentiality), one of the officials [at work] always stands by me, she spoke kindly with me about the phone calls [abusive phone calls received after the screening of the television documentary] and that sort of thing.

Mother X also stated that

[her psychologist] told me, no, it always happens that the mother blames herself for these things...he told me that Mr X was 25 when this happened and that he was old already and that something else must have happened...our dominee and parish also pray for us a lot...it gives us a bit of strength...also the students that stayed with us and that have moved away [phoned us] and gave us support.

In order to maintain stability, it is essential that Mr X remain in the role of the scapegoat, thus cementing the relationship between father X and mother X (thereby preventing the collapse of the system and transgression of family rule), as well as to allow them to continue being pseudo- and non-responsible in relation to the family system. Mr X may have replaced his

maternal grandfather in this position, that is, as someone to care for or look after (specifically in terms of mother X's role in the system). One might hypothesize that grandchildren would have taken on this role if there were any.

This role serves the additional purpose of validating Mr X's membership within the system, thus preventing his total isolation and system collapse as a result. The quotes below demonstrate how he exonerates mother X and his family from any blame for his actions, and positions this indirectly on himself. Mr X stated that "...my mother changed and the strictness wasn't there any more. She allowed me to decide how to study and do my schoolwork and if I needed help I could go to her...so it wasn't necessary for me to steal anymore but it became a habit." He also stated that "[my family] new nothing about it [the crimes] and they took it very badly...and to allow your parents to go through that process is not nice."

o **Power and interactional patterns (theme seven).**

In terms of coalitions and alliances, the previous section can be referred to for a discussion of how coalitions and alliances in the X family system manifest themselves in the various triads that occur in the system. Suffice to say, the main coalitions in the X family system appear to be between:

- mother X and the maternal grandfather;
- Mr X and mother X; and
- Mr X and the maternal grandfather.

As discussed previously, many of these coalitions occur across generations and diffuse parent-child subsystem boundaries. With regards to interactional patterns, these can be discussed with reference to the pattern of symmetrical and complementary relationships in the family system.

- Symmetrical and complementary relationships.

There are four main complementary relationships within the family system, namely:

- a. between father X and mother X;
- b. between mother X and her father;
- c. between Mr X and mother X; and
- d. between Mr X and his grandfather.

Mr X occupied the one-down position in all of his relationships. In addition, given that these relationships were all fused, this meant that the other party in each of the relationships was dominant, and assumed responsibility for defining the identity of the fused pseudo-self between the two individuals. Given that he had no close relationships with anyone outside of the family system, he may have struggled to find legitimate alternative avenues through which to achieve some sense of independent self, and allay the anxiety surrounding self-annihilation, until he discovered that his antisocial behaviour provided a suitable vehicle with which to achieve this and allow him to be in a one-up position without endangering his family system.

This can be seen in the manner that Mr X describes the way that his early crimes gave him freedom and financial independence in terms of getting out of the house, as well as being able to choose how he would spend the money that he had stolen (see above quotes).

Additionally, Mr X stated that

you could say that I led two lives, what people saw was a very sweet little boy and what came out was the monster and I take it as part of the ugly person and it doesn't bother me because it's in the past now...and it wasn't just my parents who were surprised [at finding out about the 'second Mr X'], there were many other people who were shocked, who knew me...

Mr X's argument with his maternal grandfather constituted a challenge to the relationship status quo. By contesting his grandfather's authority, Mr X risked challenging for the one-up position in the relationship. The relationship broke down, ending in disconfirmation of Mr X by his grandfather. This disconfirmation would have intensified feelings of self-annihilation and non-existence that would have intensified the need to assert himself and validate his existence. His antisocial behaviour escalated soon after this conflict and the first rape and murder was committed. Mr X stated that "it [the argument with the maternal grandfather] was never made right so it's like it basically never happened...and after he slammed the door in my face I went back to try and talk to him but he wasn't at home...but while we were on a good foot, he was alright..."

If one examines the genogram, it is evident that the complementary relationship patterns alternate with each generation. Father X and mother X occupied the one down position in relation to their parents; father X and mother X then assumed the one up position in relation to Mr X; and if Mr X had gone on to produce a family of his own, one could predict that he would have assumed the one up position in relation to his wife and child. However, Mr X was not able to form his own family, and lacked siblings or peers with which to try out a one up complementary position. He appears to have used his crimes to achieve this as can be seen in his one up position in his relationship with his victims.

Disconfirmation reactions are present in relation to Mr X throughout the family system. Initially, father X's lack of involvement with Mr X, emotional withdrawal and lack of physical affection towards him would have negated Mr X's status as son or as an individual who required emotional warmth and affection. Conversely, mother X would have validated this part of Mr X and nurtured him along these lines. Mr X developed a more fused relationship with his mother. However, he would have felt ambivalently about his emotions and expressing this side of himself. It is evident that he felt more comfortable in

demonstrating emotions towards women than men. This is based on the author's observations in interviews as well as Mr X's interaction with his victims.

Further disconfirmation occurred when he experienced learning problems as a result of his meningitis when he was eight years old. His mother's harsh discipline and punishment of Mr X when he struggled to complete his homework correctly communicated that he was not acceptable if he was less than perfect. This situation was repeated later in life when Miss N's father refused to accept Mr X into his family until he had completed his sergeant's exams.

These examples of disconfirmation reactions in Mr X's relationships serve to illustrate the extent to which Mr X was made to feel non-existent, and expendable in the family system on a repeated basis. These reactions, together with his one-down position in the significant, fused complementary relationships he was part of, may have contributed towards considerable anxiety in Mr X concerning self-annihilation and non-existence. He appears to have found a means by which to assert himself and absorb some of the anxiety that he experienced, via his antisocial behaviour that allowed him to communicate his independence and existence outside of the family system.

Finally, it would appear that Mr X, as the only child, mediated the complementary relationship between his parents. His symptomatic behaviour when younger can be seen as a manner in which he prevented father X from possessing too much power in the relationship by acting out in a manner that only mother X was able to remedy (that is, requiring emotional support) thus increasing her importance in the family system. This would have also occurred when father X's business failed when Mr X was a teenager, thus possibly circumventing the necessity for Mr X to act out in this instance.

- **Summary of themes.**

There appear to be a number of themes in the X family system, with respect to emotional process, multigenerational patterns and relationships. It would appear that processes and relationships in the family system are characterized by high levels of anxiety due to the low levels of differentiation in family members, and the X family system as whole (themes one and four). These factors also appear to influence the nature of interactions between family members and other systems (theme six), as well as the extent to which this interaction took place (themes three and six).

Weak boundaries between subsystems as well as poor hierarchical distinctions between generations (theme six) may have contributed to feelings of confusion with regard to roles and responsibilities within the family system, as well as possibly increasing levels of undifferentiation in the system and subsystems. Fears of loss of self due to higher levels of differentiation, unclear roles and fused relationships (theme two) may have contributed to emotional distancing, cutting off (theme three) or deviant, alternative or dysfunctional behaviour in order to assert the self (theme four). Additionally, coalitions and interactional power struggles may have developed (theme eight) in order to compensate for lack of structural hierarchy and as a means of repeating previous triangular relationships (theme eight) in previous generations as a means to maintain family system homeostasis.

Mr X's criminal behaviour appears to serve a function within all of these themes as has been reflected in the discussion above. Primarily, however, it would appear that the predominant role functions may have been concerned with:

- maintaining system homeostasis through serving as a means to liberate excess system undifferentiation or anxiety;
- achieving homeostasis through repetition of relationship patterns at higher levels; and

- serving as a means via which the X family system could maintain rigid, closed boundaries, preserve the spousal subsystem, and prevent interference from outsiders or other systems.

These are only a sample of possible functions that have been discussed in the above results, and many more may emerge from alternative perspectives on the data or repeated analysis in subsequent study. The sample highlighted in this discussion reflects those suggestions that the researcher feels are most strongly supported by the data. These will be addressed further in Chapter 8.

7.2 DISCUSSION OF RESULT OF CASE STUDY TWO – MR Y AND HIS FAMILY

As discussed in the previous chapter (chapter 6), the clinical observations of Mr Y, the genogram and the interviews conducted yielded considerable information concerning the family system of Mr Y. This information was supplemented with interviews with the prison psychologist of the prison where Mr Y is being held, as well as Mr Y's cellmate, Mr Z. The psychological assessment report for Mr Y's trial as well as an episode of a television documentary were also consulted as secondary sources of information. Discussion of the results will now involve an interpretation of the data provided by the genogram in accordance with the method outlined by McGoldrick and Gerson (1985), followed by a discussion of the thematic content analysis applied to interview data.

7.2.1 Genogram interpretation

The genogram will now be interpreted with respect to the six categories outlined in the methodology section (chapter 5), namely:

- Family structure;
- Life cycle fit;
- Pattern repetition across generations;
- Life events and family functioning;
- Relational patterns and triads; and
- Family balance and imbalance (McGoldrick & Gerson, 1985).

Each section will commence by outlining the main aspects applicable to the section found in the genogram, and then will elaborate upon each aspect in greater detail in terms of how it relates to the family system.

- **Category one: family structure.**

- **Nuclear family.**

There appear to be three significant households in the nuclear family system of Mr Y. In chronological order, these are:

- household one (the remarried family form) consisting of mother Y, father Y, Mr Y and his two half-siblings;
- household two (the single parent family form) consisting of mother Y, Mr Y and his two half-siblings; and
- household three (the remarried family form) consisting of mother Y, Mr Y and his stepfather.

The first configuration of the immediate family system of Mr Y appears to take the remarried family form. The members of this household include Mr Y, mother Y, father Y, and the two children of mother Y from a previous marriage (the half-brother and half-sister of Mr Y). This household ended when father Y was executed in 1963.

Figure 15.

Household One for Mr Y

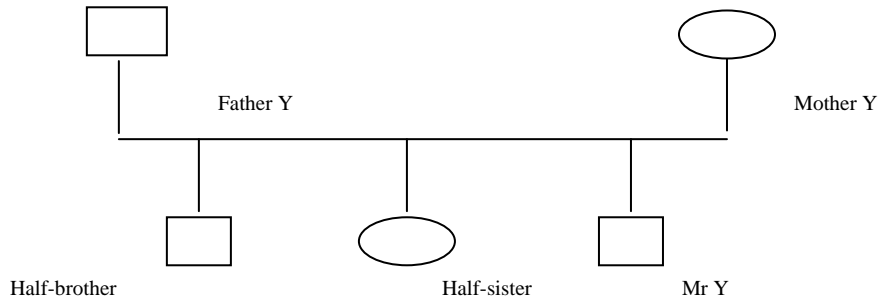

The second configuration of the immediate family system of Mr Y takes the single parent family form. The members of this household include Mr Y, mother Y and the two half-siblings. This configuration occurred as a result of the death of father Y and lasted until mother Y's remarriage to Mr Y's stepfather. During this time, both the half-brother and half-sister left the household to start their own families.

Figure 16.

Household Two for Mr Y

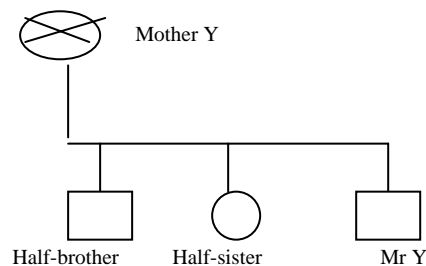

The third configuration of the immediate family system of Mr Y takes the remarried family form. The members of this household include Mr Y, mother Y and her third husband

(Mr Y's step-father). This configuration lasted until Mr Y left the household in 1981 after returning from compulsory national service.

Figure 17.

Household Three for Mr Y

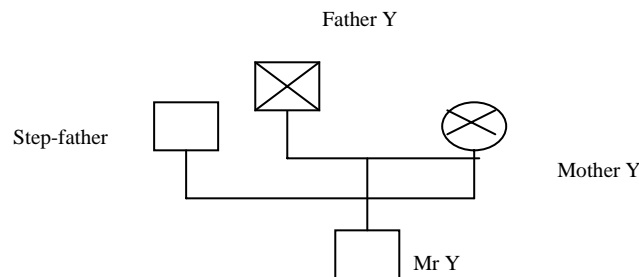

The remaining portions of the extended family system, specifically on the paternal side, take a nuclear family form. On the maternal side, however, there are two significant configurations, namely:

- o the foster family of mother Y; and
- o the first marriage household of mother Y.

Mother Y was orphaned at an early age and taken into several foster homes throughout her early life. Her final set of foster parents expelled her from the house when she was 17. Mr Y stated that she was forced to live on the streets for two years before meeting her first husband. Mr Y stated that “she [mother Y] was an orphan...she had one set of foster parents who apparently kicked her out of the house...and she was a young girl of about 17, 18.”

The first marriage household of mother Y took the nuclear family form and consisted of mother Y, her first husband and their two children. Mr Y was not able to recall why the marriage ended but stated that mother Y's first husband was a sailor. Consequently, there appear to be a variety of household types in the family system of Mr Y. Most of these appear to be on the maternal side of the family system.

- Sibling constellation.

The genogram (figure 3) yields the following information concerning the sibling position of the members of the nuclear family:

- o father Y was the eldest of three siblings, and the oldest male, with a younger brother and sister [figure 18];
- o mother Y was an orphan and only child in her family of origin, and may have occupied various sibling positions in her respective foster families; and
- o Mr Y occupied two sibling positions in the various households of which he was a part. These were:
 - youngest of three siblings, with an older half-brother and half-sister (in households one and two); and
 - only child (in household three).
 -

Figure 18.

Father Y's Sibling Constellation

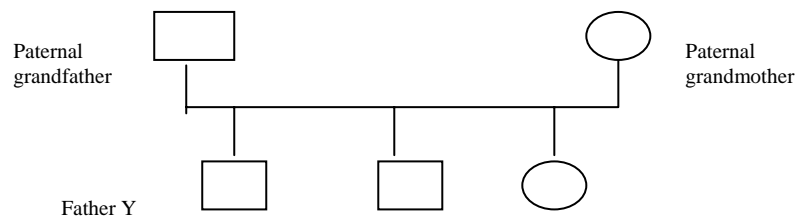

According to Mr Y, father Y had two siblings: one younger brother, and one younger sister. Mr Y also described his father as the favourite of the family and stated that the family had high expectations of him. Mr Y also stated that father Y's siblings continued to think fondly of him after his death. The younger sister was married with children of her own. The younger brother also started a family of his own but died of cirrhosis due to his addiction to

alcohol. Mr Y stated that “from what I used to hear from my grandfather, grandmother and so on...was that he [father Y] was...the apple of everybody’s eye” and then “there was an aunt, an uncle...and they all stayed in the same area...all of them used to *pot* [drink]...my uncle actually died of liver cirrhosis.”

Mr Y’s last contact with the paternal side of the family system was when he was 18 years of age (1979). Mr Y claimed that he always felt different from the paternal grandparents and siblings. There is an air of superiority and contempt in his attitude towards his aunt, uncle and grandparents on the paternal side of the system. Mr Y stated that

that’s why I say that I don’t fit in with my family at all...totally, totally, totally an outsider...I don’t think like them, I don’t act like them, I never lived like them outside...your average, low class, white characters are raw and mostly uneducated...common is the right word...it was something I couldn’t stand.

As the eldest son, father Y may have felt considerable pressure to live up to the expectations of his family. Given that the paternal side of the family system was financially poor and of a low socio-economic status, these expectations may have been particularly intense. The death of father Y may have placed considerable pressure on the extended paternal family system to find a replacement for the role of fulfilling the expectations of the family. The alcohol abuse and premature death as a result of cirrhosis on the part of the remaining male child in the paternal side of the family system, may reflect the intensity of these expectations in the absence of father Y. One may hypothesize that these expectations extended to Mr Y in the absence of father Y, and then father Y’s younger brother.

Given that father Y had a younger sister, he may have been used to taking an authoritative role in relation to the women in his life, and may have assumed a protective role in relation to other women in his life. Additionally, given that his brother was younger than him, he may

have been quite assertive around other males and assumed a role of leadership or dominance around other men, especially those younger than him.

Figure 19.

Mother Y's Sibling Constellation

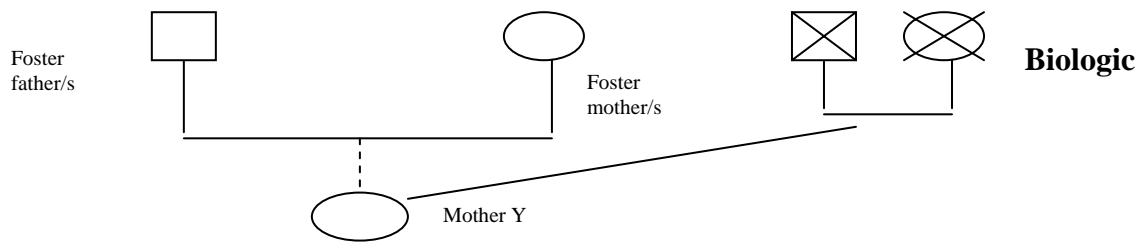

Mother Y was an only child. She was orphaned when very young and spent most of her life in foster homes. She may have been exposed to many different sibling constellations, and have had to adapt to her position in the various foster family systems. Due to the fact that mother Y is deceased and could not be interviewed, little information is available concerning the sibling constellations of the various foster families. Mr Y could also provide no information in this regard. Mr Y stated that “she [mother Y] probably felt shy about her circumstances...because she hardly ever spoke about her childhood...very little information from her...once she left them [her foster parents] she never had any further contact with her foster parents.”

The orphaning of mother Y at a very young age, with no biological siblings to share the loss with, may have contributed towards considerable feelings of insecurity and abandonment in mother Y. Her movement through a number of foster homes may have left mother Y with little sense of permanency or consistency, as well as personal shame and low self-esteem as stated by Mr Y in the quote above. With little information on the nature of the foster homes

that mother Y lived in, it is difficult to state the implications that the sibling constellations may have had on her.

The instability of sibling constellation in the early life of mother Y may have made her uncertain of her place or position with peers of her own age, younger and older peers. This may also explain her reluctance to socialize with others, and insecurity around people outside of the family system. Mr Y stated that “I think my mom was embarrassed due to the fact that she could not get on with people at all, she didn’t like people that much...she could never have, like, have a discussion with the next-door neighbour or anything like that, no way...”

- Implications of respective sibling positions of father Y and mother Y for their spousal relationship.

Father Y may have been used to taking a protective role in relation to the women in his life.

Mother Y may have been attracted to individuals that she felt could take care of her, given her experiences of being orphaned and her movement between foster homes. The spousal compatibility between these two individuals may have been high. Mr Y confirmed this when he stated that “I think my mother was not very happy most of her life, you see the only person she truly loved was my father...and she was happy.”

In much the same way as mother Y, Mr Y was exposed to different sibling constellations in the various households of which he was a part. This is one of many similarities possibly contributing towards a strong identification between Mr Y and mother. The two positions occupied by Mr Y in the sibling constellation appear to be:

- o the youngest child position (see figures 15 and 16); and
- o the only child position (see figure 17).

Although Mr Y was born into a family system where there were two older siblings already resulting in him occupying the youngest child position, he appears to have assumed the functional position of only child. This was on the basis of:

- o the considerable age difference between his half-siblings and himself, namely 10 years from his older half-brother and eight years in the case of his older half-sister. McGoldrick and Gerson (1985) stated that in cases where there is a considerable age gap between older siblings and a younger child, that younger child tends to take on the position of a functional only child;
- o mother Y's own attitude towards Mr Y. According to Mr Y, Mother Y seems to have treated Mr Y as if he was her only child, and this appears to have intensified when the two half-siblings left the household and nuclear family system at a later point, when Mr Y was eight years old. Mother Y may also have viewed her second marriage as an opportunity to start over, and may have possibly favoured Mr Y over his half-siblings. Additionally, in terms of the nuclear family system, namely father Y, mother Y, and Mr Y, Mr Y was the only child of father Y, and may have been treated in that light by father Y; and
- o finally, Mr Y's own attitude to his position in the family system appears to indicate an identification with the position of only child (as discussed in chapter 6).

Mr Y stated that "from childhood, I was always sort of like left out- they [the step-siblings] were much older than me, I mean, when I was seven years old, my brother was 15...my sister was only two years younger than him. I mean, there's a gap and it's also like it's not their father...so we were never close." In addition to occupying the functional position of only child in the households where there were other siblings present (namely, households one and

two), Mr Y was the only child in the nuclear family system from midway through the time period of household two and then for the duration of household three.

Mr Y's position as functional only child and preferential treatment in the households where there were other siblings present may have contributed towards his feelings of superiority and being special within the family system. Additionally, Mr Y was named after his father. He may have identified with father Y, as well as the family program for him to follow in his father's footsteps. This can be seen in his fascination with the supernatural and occult, as well as his criminal behaviour. The family program and identification with his father may also have coincided with considerable pressure on Mr Y to fulfill the expectations that had been placed on his father once father Y was deceased. This may also contribute towards understandings of Mr Y's assumption of a position of responsibility (thereby identifying with father Y's role) in relation to mother Y once father Y was deceased.

Additionally, his position as favoured child as well as the considerable amount of time that he spent as the only child in a single parent family system, and then a remarried family system where mother Y was particularly isolated from the external world, may have contributed towards the close relationship between Mr Y and mother Y. Mr Y's position as the only child in family systems that were relatively closed and lacked peers of his own age (as well as any other outsiders) to whom he could relate or with which he could communicate, may also reflect the closed nature of the nuclear family system of which he was a part.

Mr Y's independence and early development of adult-like behaviour may also be attributable to his position as only child (Toman, 1961).

- Unusual family configurations.

The genogram demonstrates three significant unusual structural configurations in the Y family system, namely in terms of:

- o number of households on the maternal side;
- o premature or early deaths; and
- o alcohol and other substance abuse.

The genogram demonstrates a greater number of households on the maternal side of the family system than on the paternal side of the family system. This configuration is both in terms of mother Y's exposure to numerous households during her youth as a foster child, and in terms of her attempts in later life to start a family of her own (which involved three different households). She may have been continuing with the same pattern she learnt in her youth, thus maintaining homeostasis. This may have impacted upon Mr Y's life in the sense that there is a repetition of this pattern in his own life with respect to the numerous serious relationships in which he was involved.

This structural aspect of the family system may also indicate that mother Y may have had trouble in her relationships with significant others, and her ability to successfully resolve conflict in these relationships as well as possibly indicating an inability to negotiate commitment successfully. This may have been passed on to Mr Y also as can be seen in his particular difficulties in his own relationships around trust, commitment and conflict.

The genogram indicates a number of premature or early deaths in the Y family system. These include the paternal uncle of Mr Y, father Y, and mother Y. Given that initially Mr Y received the death penalty for his crimes, he would also have followed this pattern in the family system. Premature or early death in a family system is frequently associated with high levels of stress, undifferentiation and anxiety in that system (Bowen, 1978). This will be discussed further in the section on emotional processes in the family system. However, the change in Mr Y's sentence may have provoked symptomatic behaviour or changes in the system to maintain the homeostasis that might have been triggered as a result of Mr Y's failure to follow in his father's footsteps and fulfill his role in the family system.

The information from the genogram highlights a number of instances of alcohol and substance abuse. These concern Mr Y's paternal uncle (who died of cirrhosis due to alcohol abuse), mother Y (dependency on Grand-Pa® headache powders), and Mr Y's step-father (alcohol abuse). Once again, the presence of a number of instances of alcohol and substance abuse in the family system may indicate an inadequate coping mechanism for high levels of stress and anxiety in the Y family system. Also significant is the fact that Mr Y did not follow this pattern. As a result he may have needed other outlets for anxiety that he experienced within the family system and this may have been one of the functions of his criminal behaviour.

- Summary of family structure.

The first category, family structure yielded the following notable aspects of the family system of Mr Y. In terms of household composition, three significant households emerged in the nuclear family system. These were the remarried family household (household one, into which Mr Y was born); single parent family household (household two, after the death of Mr Y's father); and the remarried family household (household three). Other significant households included the foster family household of mother Y and the first marriage family household of mother Y.

In terms of the sibling constellation of Mr Y, the Y nuclear family system consisted of an eldest, favourite child (father Y) together with an orphan (mother Y) as parents and a functional only child (Mr Y). Despite having two half-siblings from mother Y's previous marriage, Mr Y seems to have held the role of favoured child in the family. Mother Y had no other children with father Y (or with her third husband, Mr Y's step-father). As a result, Mr Y was made to feel special and superior to those around him, especially given that he was named after father Y. However, this position would also have placed a large degree of

pressure on him to assume the father role once father Y passed away and to follow in the footsteps of father Y after his death. Mr Y's sibling position as favourite son and functional only child would also have contributed to him identifying strongly with father Y.

Additionally, in terms of the implications of Mr Y's sibling constellation, the large age gap between himself and his half-siblings, together with his position as functional only child, may have resulted in his diminished ability to relate to others.

In terms of unusual family configurations, the genogram (figure 3) revealed a greater number of households on the maternal side of the family system; alcohol or substance abuse; and premature or early death. These areas all may be evidence of faulty coping mechanisms in response to the high levels of stress and anxiety in the family system, as well as possibly faulty conflict resolution strategies in relationships. The number of households on the maternal side may also have influenced Mr Y's own relationship history, namely in that he appears to have continued his mother's tradition of multiple serious adult relationships in his own life. In much the same way, Mr Y recounts his mother having truly loved his father, just as he recounts having truly loved his co-accused, Mr H.

- **Category two: life cycle fit.**

The genogram and interview data revealed the following significant areas in the life cycle of the Y family system, namely:

- non-normative stages;
- relationship history; and
- relationships between individuals at different stages in their life cycle.

- Non-normative stages.

There are four significant non-normative life cycle events in the family system of Mr Y, namely:

- o the early pregnancy of mother Y;
- o the lack of an available father figure in Mr Y's early life;
- o the lack of socialisation during Mr Y's adolescence; and
- o Mr Y's academic performance.

Mother Y was pregnant with her first child at the age of 18. Given her experiences as a foster child and the pressure that this may have placed on her to become independent and to grow up quickly in order to take care of herself, she may have had little time to experience and enjoy her youth. The early pregnancy might have ruled out any possibility of enjoying her youth in her early adult years and coincided with mother Y's entry onto a marriage that eventually failed. Additionally, her commitments and obligations as a parent may have prevented her from finding a job or developing skills that may have made her more independent in later life. Additionally, she was dependent on others (such as her spouses, or the state welfare department) for her financial well-being. Mr Y stated that "they were very, very, very, very poor...and since she was born, she went through hardship all the way...she [mother Y] didn't have any skills whatsoever...she wasn't going to be able to get a job anywhere and she was a little bit too old" and then "[her intelligence was] basic, very average...she couldn't understand one word of my schoolwork."

The early death of father Y meant that Mr Y lost his father at the age of two years . Additionally, mother Y isolated herself from any extended family on the maternal or paternal side of the family system at this time and attempted to care for her children on her own for a period of ten years. While Mr Y's half-brother was living in the household, Mr Y may have had an older male to identify with as a father figure. However, mother Y's emotional distance

from her two older children, together with the family system programme for Mr Y to follow in father Y's footsteps, would have meant that identification with the elder half-brother would have been weak at best. Due to the older age of the brother, he may have initially become the parentified child, however, he later left the household (1969). Systemically, this may have constituted another "loss" or psychological divorce in the system, continuing the patterns of change, possibly thus resulting in Mr Y moving into the parentified child position to maintain homeostasis until he, too, left the household.

Mr Y appears to have assumed the role of father or husband (or the parentified child position) for a large period of his early development (namely, the years two until twelve). This, together with mother Y's underparenting, would explain why he felt that he was independent and learnt to take care of himself quite early in his life. Mr Y may have perceived his stepfather as a rival to his position as head of the household when mother Y remarried in 1973. This may have been exacerbated by the youth of the stepfather, who was considerably younger than mother Y. This pattern can also be seen to have been repeated in Mr Y's later life where his early parentification may have been carried through to his relationship with his co-accused, Mr H (also considerably younger than Mr Y) where Mr Y felt an extreme sense of responsibility for caring for Mr H. Mr Y stated that "she [mother Y] wasn't very worried about my schoolwork and stuff like that because there they [mother Y and Mr Y's step-father] left me to go on my own...there was none of that support coming from them, so I mostly learnt from a young age to operate on my own."

The closed nature of the Y nuclear family system (specifically after the death of father Y) may be seen by virtue of mother Y's fear of outsiders and prohibition of any visitors to the family home, and the close, closed relationship between her and Mr Y. Mr Y may never have achieved the developmental objectives of adolescence, namely the development of social skills and close relationships with others outside of the family system. In much the same way,

this pattern may have been repeated in Mr Y's relationship with his co-accused, Mr H in that Mr Y could not tolerate the presence of another individual in their closed relationship system. This can be seen in Mr Y's murder of the first victim, a runaway who initially accompanied Mr H when he left to meet up with Mr Y at the start of their flight from authority. Even Mr Y's cannibalism of this victim may be seen as a systemic effort to deal with an outsider to the system by going to the extreme of making him part of that system by eating him (and thus controlling his influence on the system).

Mr Y stated that

I wasn't allowed to have friends at home- I could go and visit them...their houses were much better...I think my mom was embarrassed due to the fact that she could not get on with people...people of her own age group and all that kind of stuff...I actually inherited a similar condition as hers...I don't particularly like having people around me...I never encouraged people to come and visit me.

Finally, in terms of non-normative events within the context of the family system, Mr Y's achievement of a Matric [high school] certificate made him different from the other members of the family system in the sense that nobody else had achieved this. This event coincided with Mr Y's feelings of superiority in relation to the other members of the family system, as well as his feelings of being different. Mr Y stated that "I was the only one that made Matric...I lived in a higher bracket than my entire family."

- Relationship history and relationships between individuals at different stages of their life cycle.

In terms of life cycle fit, there appears to be a struggle on the part of mother Y to establish long-lasting relationships with significant individuals in her life. This can be seen in her

movement through numerous foster homes as well as her involvement in three marriages in later life. This also may explain her intense emotional investment in the adult relationships that she experienced. The fact that these later relationships also did not last very long could explain her close attachment to Mr Y when he was born, and the role of protector and caregiver that Mr Y assumed in relation to his mother from a very young age. Mr Y appears to have repeated this relationship pattern with many of the significant individuals in his adult life. This will be explored further in the section on emotional processes in the family system.

In the extended Y family system, there appear to be two instances of relationships between people at different life stages in their life cycle, namely between:

- o mother Y and Mr Y's step-father; and
- o Mr Y and Mr H.

In the case of mother Y and Mr Y's stepfather, Mr Y stated that there was a thirteen year age difference between the two. Given the ages at which they got married (as seen on the genogram, figure 3), Mr Y's stepfather may have been looking to start his adult life whereas mother Y would have been looking at settling down and moving into later adulthood.

Their relationship may have been quite incompatible and complicated by Mr Y's rivalry with his stepfather. Additionally, Mr Y's stepfather, as the youngest of the spousal couple, may have been unable or unwilling to perform the role of caretaker that mother Y may have required. She may have moved closer to Mr Y, who had been performing this role up until that point. Further conflict may have ensued between mother Y and Mr Y's stepfather. Mr Y's stepfather may also have looked outside the family system, after a period of marriage, for a partner closer to his own age, who could fulfill his requirements. Mr Y stated that "the things he did, the way he treated me and my mother...left a lasting impression...he was a creep towards my mother...he made her feel worse about herself than she usually did...it's that typical scenario of the abusive husband" and, after mother Y died, "I found that he's got

another woman there, living there, with her two children and everything...then I found out that he was seeing this woman long time already...on the side.”

Mr Y appears to have repeated this relationship pattern of mother Y, namely in that he chose a partner 12 years his junior in Mr H. Mr Y, at 29 years of age, may have been looking for a more serious relationship, whereas Mr H, at 15, may have been looking for someone who could look after him. Mr Y fulfilled this role for Mr H, and vice versa (in a manner which will be discussed further). These two may have been compatible for the time period in which they were together. One might hypothesize that as they approached further life cycle stages, this compatibility may have weakened, as may have occurred with mother Y and Mr Y's stepfather. Thus, the systemic pattern appears to have been repeated.

This pattern may have been further repeated with respect to Mr Y's feelings of jealousy and rivalry towards the first murder victim (Mr H's runaway companion) as well as other men that attempted to approach Mr H such as the attempted murder victim and third murder victim, who both made sexual advances towards Mr H, which repeated Mr Y's feelings of rivalry towards his step-father. Mr Y stated that “I felt so protective about him...I became the father, mother, the brother, the lover, everything to him [Mr H].” This may be another indication of the extent to which Mr Y was fused with mother Y, as well as the rigidity of his role as caretaker, which he assumed in relation to a younger partner.

- Summary of category two: life cycle events.

The second category, life cycle events revealed three main areas that had considerable impact upon the family system. These were non-normative stages, relationship history and relationships between individuals at different points in their life cycle.

In terms of non-normative stages, there appear to be four significant non-normative life cycle events. These are the early pregnancy of mother Y; the lack of an available father

figure in Mr Y's early life; the lack of socialization during Mr Y's adolescence; and Mr Y's academic performance. These events may illuminate some of Mr Y's attitudes to other persons outside of the family system, as well as his independence and early maturity, and rigid role as caregiver and protector that persisted with him through later life. They may also further illuminate characteristics such as mother Y's neediness and close relationship with Mr Y.

In terms of relationship history, there appears to be a repetition of systemic relationship patterns in mother Y and Mr Y. The relationship history of mother Y may contribute towards understandings of her neediness, close relationship with Mr Y, mistrust of individuals outside of the family system, and general insecurity. The repetition of this pattern in Mr Y may point towards his identification with mother Y.

In terms of relationships between individuals at different stages in the life cycle, there seems to be a repetition of systemic relationship patterns in mother Y and Mr Y. This area indicated a possible incompatibility between mother Y and Mr Y's stepfather, as well as the compatibility of Mr Y and Mr H. Once again, the repetition of patterns may be indicative of identification between Mr Y and mother Y. However, Mr Y's role in these relationships may point towards his identification with mother Y.

- **Category three: pattern repetition across generations.**

Discussion of pattern repetition across generations as seen in the genogram (Figure 3) of the Y family system will proceed with regards to:

- o patterns of functioning;
- o patterns of relationship; and
- o patterns of structure.

- Patterns of functioning.

In terms of patterns of functioning, the genogram (figure 3) demonstrates the following patterns being repeated across generations in the Y family system:

- o substance and alcohol abuse;
- o violence as a means of dealing with conflict or problem-solving;
- o difficulties in sustaining intimate relationships with significant others;
- o dependence on the supernatural and occult; and
- o failure.

The genogram demonstrated a number of examples of substance abuse in members of the Y family system. These occur at the second tier of the family system, in Mr Y's paternal uncle who abused alcohol and died of liver cirrhosis as a result; Mr Y's step-father who also abused alcohol; and in mother Y who was addicted to Grand-Pa® headache powders. Additionally, Mr Y stated that most of the paternal side of the family system used to consume large amounts of alcohol on regular occasions (see above quote).

In the third tier of the family system, this pattern of substance use does not appear to have been repeated in Mr Y. He may have found other ways to relieve stress or deal with problems such as violence or aggression towards others. However, despite this behaviour constituting a new coping method, this appears to have been as dysfunctional as previous methods adopted in the family system, and thus repeated the systemic pattern of faulty coping strategies. Mr Y stated that "I'm not a drug user...I'm a beer drinker basically...I'm an occasional drinker", and, in relation to his ability to cope with stress and problems, Mr Y stated that "the problem is, if someone irritates me [in prison] and I couldn't get away from that person, I'd wait until he sleeps...and then I'd probably kill him because at that point in time, in my mind I would have decided that the only way to get rid of this problem is to get rid of him."

The repetition of this pattern of substance and alcohol use may indicate that there was a lack of coping skills in the family system passed on from one generation to the next, with members using alcohol or other substances in order to deal with high anxiety or stress in the family system. Additionally, there appears to be a susceptibility to addiction within the family system, specifically when such behaviour results in an improvement in the family system or subjective state, possibly by temporarily reducing stress or anxiety as mentioned above. In this way, Mr Y may have compensated for his lack of coping skills, and reluctance to use substances to deal with this, by using violence to solve his problems, and may have become “addicted” to murder as a result, with the positive feedback (or rather lack of negative feedback) that he received as a result, reinforcing this pattern of murder.

Several members in the family system appear to have used violence as a means to solve problems or to deal with conflict. These members are father Y (who murdered his employer) and Mr Y’s stepfather (who physically abused mother Y) in the second tier of the family system, and Mr Y in the third tier of the family system. Importantly, father Y’s violent behaviour was criminal and resulted in the death of his employer – this pattern was repeated in Mr Y whose violent behaviour resulted in the deaths of three people. Mr Y stated that “my step-father was a bit of a boozier, then sometimes he’d have his freak out sessions, and then me and my mother would have to run.”

Once again, this repeated dysfunctional pattern may indicate a lack of skills in the family system to deal with conflict or to problem solve in a constructive manner. This lack of skills appears to have been passed down from one generation in the Y family system to the next. Additionally, the level of violent behaviour appears to have escalated from one generation to the next, as can be seen in the way that Mr Y engaged in more widespread and extensive criminal behaviour (with three murder victims) than father Y (with one murder victim). This

escalation in violent behaviour may have been in response to increasing feelings of isolation on the part of Mr Y.

The family system also seems to reflect a repeated difficulty in sustaining intimate relationships with significant others in mother Y (in the second tier) and Mr Y (in the third tier). Both individuals appear to have had a number of relationships in adulthood that failed to last for any considerable amount of time. Additionally, a pattern of forming a close emotional attachment to one individual and isolation from persons outside of the immediate nuclear family system is present in both of these individuals. This specific pattern of functioning appears to have been passed down from mother Y to Mr Y.

Both mother Y and Mr Y may have developed a significant mistrust of individuals around them and attempted to prevent anyone from entering their personal space thus creating a closed system. This can be seen in the way that mother Y would not allow anyone to visit the household, and in how Mr Y adopted the same attitude when he had his own home later on, only allowing those with whom he had a close intimate relationship to visit him at home. Ultimately, this pattern appears to have escalated to the point where Mr Y's world shrunk to rigidly including himself and Mr H (his gay partner) exclusively and being closed to any outsiders. This can again be seen with respect to the first murder victim, where the system of Mr Y and Mr H could not allow for another who had to be removed from the system as a result, yet at the same time, included via cannibalism.

Mr Y stated that

I think that's why I also only choose one friend and go out with them, you know, I'll spend all my energy – love and affection on that one person...this friend usually turns out to be a lover' and 'I lived basically on my own, when I left home...I was very happy, I don't need someone at home to come home to...the home was a sanctuary...a

person that I would allow into my home is a person I would have a sexual relationship with...but I would never encourage someone that I just knew as a friend to come visit.

The genogram and interview data showed that a number of members of the family system believed in the supernatural and occult, mostly on the paternal side of the family system. These members included the paternal aunt (who claimed that she could see father Y after he died); mother Y (who claimed to see poltergeists); and Mr Y. Mr Y stated that he had discovered the occult at the age of 15 and had continued to use the occult throughout his life to advance his own standing in relation to others. Mr Y stated that 'I was involved since about the age of fifteen with the occult.' Mr Y also stated that "Yes, I used it [the occult] and I think that's what actually gave us the edge on the fact that nobody could sense any danger when we were around...you can influence events around you, you can change it so it's in your favour" and that "my mother told me that, on my father's side of the family, they all had certain abilities, paranormal abilities...you see, my aunt could see my father, he apparently sat there and spoke to her then after his death."

This pattern appears to serve a number of functions in the family system. Firstly, this may have been another manner of dealing with the lack of coping skills in the family system. The use of the supernatural to communicate with father Y after his death may have allowed members in the system, specifically on the paternal side, to cope with the loss of a member. Additionally, Mr Y's discovery of the occult came at a time when the stepfather had started physically abusing mother Y, and consequently may have constituted a means by which Mr Y could have coped with the higher levels of stress and anxiety in the family system, in the absence of other coping skills. Mr Y stated that "my step-father was drunk the one night and he decided to park the car in front of the house instead of in the garage...so round about 10

o'clock...I went into the garage and I sat there and drew a circle...placed candles...not knowing what I was doing actually and it [the occult] just started coming.”

Secondly, the passing on of these “powers” from mother Y to Mr Y may have served to further strengthen their relationship, and to confirm Mr Y’s role as superior or different within the family system. Paradoxically, other than mother Y, this pattern was prevalent mostly on the paternal side of the family system. This pattern may have linked Mr Y to the paternal side of the system, despite his attempts to differentiate from it.

Finally, given what has been discussed previously in relation to mother Y’s locus of control and feelings of powerlessness as a result of her history of abandonment, this may have been a means by which she could rationalize the various events and experiences in her life.

The genogram (figure 3) seems to reflect a repeated pattern of failure in the Y family system across generations. Additionally, this repetition seems to have escalated as reflected by the extent of failure in the successive generation. In the second tier of the family system, there were two instances of failure, namely in father Y’s criminal behaviour and death penalty, and in mother Y’s relationships. In the third tier, there is a repetition of both of these patterns of failure in Mr Y, namely in his own criminal behaviour and death penalty, as well as his failed relationships. Additionally, Mr Y’s failure repeats the failure of father Y to fulfill the expectations of the family system, specifically on the paternal side.

This repeated pattern of failure may reflect two possibilities. Firstly, this pattern may serve a particular function within the family system in maintaining stability or homeostasis, which would explain why it is repeated across successive generations. Secondly, this pattern may reflect a deviation-amplification measure in the family system as a means of destroying the system in question. Both of these possibilities will be discussed and evaluated further in the sections on homeostasis and emotional processes in the family system.

- Patterns of relationships.

With respect to patterns of relationships, there appear to be two significant patterns that are repeated across generations in the family system of Mr Y. These are:

- o closeness with one person and isolation from others; and
- o isolation from the extended family system.

There is a repetition of this pattern of relationships across the second and third generations, namely from mother Y to Mr Y. Mother Y appears to have had a history of forming close attachments to one person and then attempting to fuse with this individual, isolating the dyad from other persons or individuals outside of the closed/fused dyad. These attempts can be seen in the genogram. This may have been a repetition of patterns of relationships developed during her early experience as an orphan and being moved from one foster home to another. This pattern seems to have been passed on to Mr Y who repeated it in his relationships with his first lover, Mr C, and then Ms T, and finally, most intensely with Mr H. This pattern may also explain the intensity with which Mr Y viewed persons outside of his fused dyad with Mr H as a threat and his need to protect the relationship at all costs. As with the violent behaviour above, there appears to have been an escalation in the intensity of the emotional investment in the dyadic relationship from one generation (namely, mother Y) to the next (namely, Mr Y).

The second relationship pattern that appears to have been repeated across generations in the family system is one of isolation from the extended family system. As with the first pattern, this pattern appears to have been passed on from mother Y to Mr Y. With mother Y, there is no relationship between her and an extended family system; her biological parents were deceased; there seems to have been inconsistent foster parentage; and an abrupt end to her relationship with her foster parents. With Mr Y, a similar pattern emerges in the way that he first emotionally isolated himself from the paternal side of the family system and then physically moved away from the paternal members of the extended family system.

This pattern of isolation from the extended family system appears to have intensified the relationships in the nuclear family system, as well as the relationship dyads that mother Y or Mr Y were a part of. Additionally, this pattern of isolation appears to have also been repeated in relation to the larger societal supra-system by virtue of Mr Y's sexual orientation as a homosexual as well as more recently, within the correctional and prison system amongst criminals as a person who has committed serial murder and who has engaged in cannibalism. It would appear that there is a consistent pattern of isolation from other systems with respect to Mr Y, which he may have inherited from his mother. The emotional content of the relationships in which Mr Y was involved may also have been heightened. This will be discussed further in the section on emotional processes in the family system.

- Patterns of structure.

With respect to repeated structural patterns, there appears to be one significant structural pattern that is repeated across generations in the family system of Mr Y. This is the pattern of multiple households, and can be seen in all three tiers of the family system, specifically on the maternal side of the family system.

In relation to the first tier of the family system, the genogram and interview data evidenced how mother Y lived in many different households while growing up as a result of her status as an orphan and foster child. In her adult life, in relation to the second tier of the family system, there seems to be a repetition of this structural pattern with mother Y living in four different households, in terms of geographical location and membership. In terms of the third tier of the family system, there is further repetition of this structural pattern with Mr Y, who lived in three different households growing up, and then as an adult lived in at least three different households over time. Mr Y stated that "my mother was married before, and she had two kids with this guy and then divorced him and then she got married to my father...she had

to basically look after three kids for several years until I was 12 years old and she met my step-father and then we moved.”

The effects of this repeated structural pattern may be evident in less dependency on the household as the emotional or psychological seat of the home and source of security, and greater dependency on a person/s with which one had a close emotional relationship. In light of the instability and lack of consistency in households or homes in the early youth of mother Y, she may have learnt to rely more on herself as well as a close emotional attachment to another person for a sense of security. This can be seen in the intensity of her relationship with father Y, and then later, with Mr Y. This strategy was passed on to Mr Y and can be seen in his relationship with his first lover, Mr C, and then Mr H. Mr Y stated that “...I also only choose one friend and go out with them...you know, I’ll spend all my energy, love and affection on that one person.”

Mr Y also stated that

I don’t ask for much in life, I don’t need much in life- I’m used to being a loner, that’s why I can concentrate all my energies and my emotions on one person- I can’t share it among several people...oddly enough...I realized that I’m more sociable with other people, just for the sake of the person that I’m involved with...otherwise I wouldn’t speak to those people, I have no desire to- now that’s typical antisocial behaviour but to me it’s normal because that’s the way I was outside- I’ve been totally on my own.

- Summary of category three: pattern repetition across generations.

In terms of the third category, pattern repetition across generations, the genogram (figure 3) demonstrates a number of patterns of functioning that are repeated across generations. These include substance and alcohol abuse; violence as a means of dealing with conflict or problem

solving; difficulties in sustaining intimate relationships with significant others; dependence on the supernatural and occult; and failure.

These repeated patterns of functioning appear to indicate a lack of coping skills, as well as a lack of ability to deal with conflict or to problem solve effectively in the family system. The family system appears to compensate via substance abuse and violence to achieve these ends. Mr Y's criminal behaviour was shown to be one such means of dealing with this shortage of skills in the family system.

In terms of patterns of relationships, the genogram and interview data revealed two significant patterns, namely, closeness with one person and isolation from others and isolation from the extended family system. These patterns occurred originally in mother Y and were repeated in Mr Y. This served to bring these two individuals closer together, and intensified in their repetition, escalating as in the case of the violent behaviour example above.

Finally, there was a repeated structural pattern in terms of multiple households. As with the above, this occurred first in mother Y and was passed on to Mr Y. Together with the above, these repeated patterns may shed some light on Mr Y's protectiveness of his relationship with significant others and his intense mistrust of outsiders and potential threats to this relationship.

- **Category four: life event and family functioning.**

Discussion of life events and family functioning as seen in the genogram of the Y family system will proceed with regards to:

- o coincidences of life events;
- o impact of life change, transitions and traumas; and
- o anniversary reactions.

- Coincidences of life events.

There are a number of co-occurring events that emerge from the genogram and which centre on certain key events in the family system of Mr Y. These can be arranged chronologically into five significant clusters, namely:

- o first cluster (1961);
- o second cluster (1963);
- o third cluster (1973);
- o fourth cluster (1983); and
- o fifth cluster (1989).

The first cluster appears to centre on the birth of Mr Y and start of the Y nuclear family system of Mr Y, father Y and mother Y. Prior to this, mother Y had divorced her first husband in 1960. Mr Y also stated that mother Y had told him that she was bitten by a “poltergeist” when 8 months pregnant with him in 1961, and that his heart stopped beating for 8 minutes when she was giving birth to him.

The second cluster of events appears to centre on the death of father Y. Prior to this, father Y had murdered his employer in a dispute in 1962 and was sentenced to death in 1963. After this, mother Y looked after her three children on her own and formed the single parent household (figure 16). In 1965, according to his mother, Mr Y had another supernatural experience when his mother and half-siblings found him suspended in the air in a corner of his room. Mr Y was never told the truth about the circumstances surrounding father Y’s death until he was 21 years of age.

The third cluster of events appears to centre on the marriage of mother Y to her third husband, Mr Y’s stepfather. Prior to this, both Mr Y’s half-brother and half-sister had left home (1969 and 1971, respectively). In 1973, Mr Y also discovered his sexual orientation,

namely homosexual, and started judo in 1974. In 1975, he was caught shoplifting and fined. In 1976, Mr Y discovered the occult and started bodybuilding in 1978.

The fourth cluster appears to centre on the death of mother Y. Prior to this, Mr Y had completed his compulsory national service (1978-1980). He also left home in 1980. In 1981, Mr Y was caught and fined for fraud. In 1981, Mr Y started working as a policeman in the railway police, as well as the anti-hijack division of the police force. In 1982, Mr Y found out the truth about the circumstances surrounding the death of father Y from mother Y. After the death of mother Y in 1983, Mr Y cut off contact with his stepfather and a year later, 1984, was the last time that he saw his half-siblings. In 1984, he suffered from depression and in 1985, Mr Y was fined for possession of pornography.

The fifth cluster appears to center around Mr Y's introduction to Mr H and the start of their relationship. Prior to this, Mr Y had lost his job as a policeman on account of his sexual orientation in 1987. Mr Y's relationship with his first lover, Mr C, ended in 1989. Mr Y moved to Kwazulu-Natal Province in 1989 and also got a job as a bouncer at a gay nightclub in this year. In the same year, Mr Y started a relationship with a woman, Ms T, which he ended after he met Mr H in the same year. In 1992, Mr Y had to serve a three month prison sentence for having committed an indecent act with a minor boy under the age of 19. Later that same year, Mr Y ran away with Mr H and committed the first murder. The remaining two murders were also committed in 1992 and he was arrested in the same year. In 1993, Mr Y was sentenced to death for his crimes.

- Impact of life change, transitions and traumas.

The above co-occurrences and clusters will now be examined with respect to the impact that these appear to have had on the family system.

The key event in the first cluster appears to have been the birth of Mr Y and formation of the Y nuclear family system. This event in the family system may have introduced new hope and potential for the success and advancement of the extended family system and for members of the Y nuclear family system respectively.

For father Y, and the paternal side of the Y family system, the birth of Mr Y may have signified the birth of an heir to the role of father Y in that family system. Given that father Y had the role of favourite child in his own family of origin and carried the hopes of that family for success and achievement, Mr Y may have been viewed as part of that achievement. Additionally, given that Mr Y was named after his father, it follows that his role within the Y family system may have been to follow in the footsteps of his father, and the paternal side of the Y family system.

For mother Y, the birth of Mr Y may also have been treated with much hope and expectation. Given the failures that she had encountered in previous relationships, namely, those with her foster parents and with her first husband, her marriage to father Y may have signified a new beginning. Mr Y stated that his father had been the most significant of all of mother Y's partners, and was the one for whom she cared the most. Mother Y may have treated Mr Y, as a product of this relationship, as special as well and his half-brother and half-sister from the previous marriage may have been excluded from the new nuclear family system. Mr Y stated that "I think my mother was not very happy most of her life, you see the only person she truly loved was my father...and she was happy" and that "we [Mr Y and his mother] used to talk- I was like a friend as well and that kind of thing."

The short period of time between the first and second marriages of mother Y may have meant that she did not have enough time to process the emotional material that remained from her first marriage before she started her new relationship. Additionally, the failure of her first marriage may have signified a possible repetition of patterns of abandonment from her youth.

Many of these fears and anxieties may have followed her into the new family system that she formed with father Y, and may explain the intensity of her fusion with both Mr Y and father Y. These will be elaborated upon in the later section on emotional processes in the nuclear family system.

Lastly, mother Y's attribution of supernatural elements to the birth of Mr Y may have signified another attempt to make his birth special and to flag Mr Y as significant and different within the family system. This supernatural label may also have signified an unsuccessful attempt on mother Y's part to alter the systemic pattern of loss or failure in the Y family system (in much the same way as has been shown by Selvini-Palazzoli *et al.* (1978) to occur with psychotic families). This, together with the family programme for him to follow in the footsteps of father Y, would have placed considerable pressure on Mr Y to live up to the expectations of other members of the family system, specifically on the paternal side of the family system.

Mr Y stated that

another odd thing happened, I don't know whether that would have had an effect on my psyche or not...when my mother was in labour with me, before I popped out...my heart apparently stopped for 8 minutes...and apparently, the way she told me, she ripped the oxygen mask off and my heart started beating- so I was basically clinically dead, I would have been brain dead- now I don't know if something happened...caused some future reaction you understand but it's difficult to determine...she [mother Y] said when the doctors told this to her- eight minutes, she was freaking out because the doctors were telling her this child is dead...I had this weird idea- it sounds ridiculous- that during the time period when my heart stopped, the soul that was in there, was kicked out and another one was stuck in there- that's

me. Maybe I was born- someone made a balls up somewhere along the line, that when I came, someone put the wrong card in the wrong spot there and then I got popped onto the scene and I wasn't supposed to be born.

The key event in the second cluster appears to have been the death of father Y. The impact of this event on the Y family system may have been an increase in anxiety in the nuclear and extended family system (specifically the paternal side of the system) due to fears of system failure as a result of the loss of the member who had been assigned the responsibility of system success, namely father Y; an attempt on the part of the system to find a suitable replacement; and the distancing of mother Y from the extended family system.

The death of father Y would have also possibly resulted in a vacancy in the family system with respect to the role of father Y for both the extended family system as well as for the nuclear family system. In the absence of other suitable substitutes, Mr Y may have taken on both of these roles. Initially Mr Y's paternal uncle may have also been turned to for this purpose. However, he may have been unable to withstand this pressure as can be seen in his alcohol abuse and early death from liver cirrhosis (1966). The next available male in the family system may have been turned to, namely Mr Y. Also, the fact that Mr Y was named after his father may have increased the likelihood of his selection for this purpose further.

In terms of father Y's role in the nuclear family system, mother Y may have turned to Mr Y to take over from his father as caretaker and protector. The dyad of mother Y and Mr Y may have become closer and more fused. This may have been further intensified by the fears and anxieties of mother Y. Having lost another significant person in her life unexpectedly, and not having ever dealt with her anxiety surrounding this issue, she may have attempted to fuse even more completely with the remaining significant person in her life, namely Mr Y, in an attempt to prevent the loss of another significant individual in her life.

Mother Y may have also feared that she would lose Mr Y to the extended family system, namely to the parental side of the extended family system, as a result of their need for a male heir to the role of father Y. This may explain mother Y's distancing from the extended family network after the death of father Y (and especially after the death of Mr Y's paternal uncle). This may also explain Mr Y's own distancing from the paternal side of the family system. Mr Y stated that

No, I didn't want to [be a part of the family]...ja, I didn't like them- their whole lifestyle and stuff- didn't fit in there and I always felt the outsider...I just simply did not fit in- I couldn't handle it...I was young, about 10 years old when I knew I didn't like this [his extended family]...I'm not like that- I couldn't stand my grandfather, when I was five years old, I couldn't stand my grandfather- I couldn't let him touch me, I'd freak out.'

The key event in the third cluster may have been the marriage of mother Y to her third husband (Mr Y's step-father). The impact of this event on the family system appears to have been the reorganisation of the nuclear family system to accommodate a new member. This may have been accompanied by considerable resistance, specifically on the part of Mr Y, as his assumed parentified role was usurped. The departure of two members of the family system (namely, Mr Y's two half-siblings) as well as mother Y's financial concerns, and fears of losing Mr Y as he grew up and made attempts to start his own family, may have necessitated the introduction of another member or partner with whom mother Y could form a relationship.

The introduction of a possible replacement seems to have been accompanied by a number of reactions in Mr Y. It may be the case that Mr Y felt challenged in his role as caretaker and protector of mother Y (parentified role) as well as the primary male in the nuclear family

system, when his stepfather arrived. He may have acted out in an attempt to assert himself in the nuclear family system, as can be seen in his criminal behaviour and conflict with his stepfather. This acting out may also have been a means of dealing with the considerable pressure he may have felt in terms of his loyalty to the memory of his father, and the fulfillment of the role that he had inherited in the family system after the death of father Y. Mr Y's need to feel special and powerful within the family system may explain his involvement in sports such as martial arts and bodybuilding, as well as the occult. This will be discussed further in the section on emotional processes in the family system. Mr Y stated that

she met this guy [the step-father] and we moved to [Eastern Johannesburg] because he worked on the mines...and I think that's where things started going wrong- well, in my mind it was wrong...he used to drink a lot, typical abusive parent scenario- you know, he'd chase us around with an axe and things like that...but from my mother's side, she looked after me very well...he was very abusive towards her...most of the time, he's get drunk at the local hotel- probably lost a fight there or whatever and then he'd come home and take it out.'

Mr Y also stated that "I was 13 years old, started judo till about 17, started bodybuilding."

Further, he said that

I just felt that, you know, I must no longer stay there because I knew that I was getting to a point in my life where I was going to kill this guy [his step-father]...by then [18 years of age] I already weighed more than him...I had been training for a year...two years and then I went to the army and I came out of the army and it was such a nice- I had the means [to kill the step-father].

The key event in the fourth cluster appears to be the death of mother Y. The impact that this event appears to have had on the Y family system was the collapse of the nuclear family system and the complete isolation and emotional distancing of Mr Y from the extended family system. Mr Y appears to have involved himself more in his work, and relationships with significant others, such as Mr C. Mr Y stated that “I joined the railway police at that time period and it was 6 months later that my mother died...that sort of knocked me and for a year I just went on the pot, fights in bars, stuff like that...I was involved with a guy [Mr C]...it was substantial.”

The key event in the fifth cluster appears to be Mr Y's introduction to Mr H and the start of their relationship. The impact that this event had was that Mr Y appears to have repeated the relationship pattern of the fused dyad and isolation that he had experienced with mother Y, and ultimately, completed his identification with father Y, including an escalation in violent behaviour. Mr Y stated that “I knew this was trouble...but I just went into it...two days after I met him, he knocks on the door of my flat, open the door, there he's standing with these big blue eyes, he says, ‘Can I stay?’ Bam, that's it...couldn't see it coming, I'm bugged...”

- Anniversary reactions.

There appears to be one significant anniversary reaction in the genogram of Mr Y. This took place in 1989 when Mr Y was close to the same age as his father had been when he murdered his employer and was sentenced to death. As has been discussed in previous sections, there appears to have been a lot of pressure on Mr Y within the extended and nuclear family system to fill the role vacated by father Y after his death in 1963 at the age of 27. As Mr Y approached the same age as his father had been when he was sentenced to death, he may have felt an inevitability that his life would take the same course, in line with the systemic pattern.

The supernatural and occult theme in the family system may have functioned to accentuated this belief on the part of Mr Y. Although not mentioned by Mr Y in the interviews conducted for the present study, the psychologist's report that stemmed from his evaluation after being arrested in 1991, makes mention of certain details in this regard. According to the report by the clinical psychologist for sentencing assessment,

he [Mr Y] was melodramatically informed by his mother that when his father was hanged for murder when he himself was 18 months old, he screamed terribly as his father's spirit passed into him...and was informed that he grew up to resemble his father exactly in physical appearance. He 'knew' he was doomed to follow in his father's murderous footsteps and dreaded the age of 27, when his father was hanged.

There may have been intense pressure within the family system for Mr Y to commit crime in the same manner as his father and also be sentenced to death as a result of a particular function that such an event would serve for the system as a whole. This will be discussed further in forthcoming sections.

Mr Y's start of a relationship with Mr H may have been similarly influenced by the fact that he was a similar age (namely, in his late twenties) as father Y had been when he had married mother Y (as can be seen on the genogram, figure 3). These two aspects, namely the criminal behaviour and relationship, appear to indicate the extent to which Mr Y appears to have identified with father Y in the family system.

- Summary of category four: life events and family functioning.

In terms of category four, life events and family functioning, the genogram of Mr Y seems to reveal five clusters of co-occurring events in the family system. These clusters appear to

centre around the following events: the birth of Mr Y (1961); the death of father Y (1963); the marriage of mother Y to her third husband (1973); the death of mother Y (1983) and the start of the relationship between Mr Y and Mr H (1989).

The implication and impact of these coinciding life events for the family system concerned the family programme for Mr Y and his assumption of his father's role in the family system; the greater fusion of the nuclear family dyad of Mr Y and his mother and their increased isolation from the extended family system; the intense rivalry that developed between Mr Y and his step-father; and the repetition of the relationship pattern between mother Y and father Y, and mother Y and Mr Y, in the relationship between Mr Y and Mr H.

In terms of anniversary reactions, the genogram appears to demonstrate one significant anniversary reaction in the family system of Mr Y. This involved the age at which father Y had been sentenced to death for murder. The implications of this anniversary reaction were a consolidation of Mr Y's identification with his father and assumption of his role in the family system, as well as a possible catalyst with regards to Mr Y's criminal behaviour and failure in the family system.

- **Category five: relational patterns and triads.**

A number of triads are evident in the genogram of Mr Y. The most significant triads with respect to the current analysis will now be discussed according to the particular types highlighted in McGoldrick and Gerson (1985). Triad patterns and structural configurations in the family system will be further elaborated upon in the section.

- Parent-child triads.

There are two significant parent-child triads, and one supplementary parent-child triad in the genogram of Mr Y, namely:

- o between father Y and the paternal grandparents (parent-child triad one);
- o between father Y, mother Y and Mr Y (parent-child triad two); and
- o between Mr H and his parents (parent-child triad three – supplementary).

Figure 20.

Parent-Child Triad One

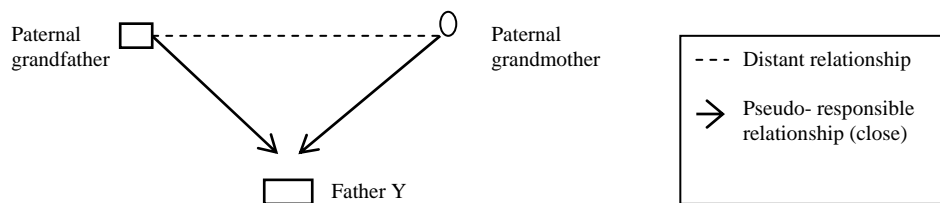

The first significant parent-child triad occurs between father Y and his parents (the paternal grandparents). As discussed previously, father Y was idolised greatly by his parents and much was expected from him in terms of success for the family. This parent-child triad appears to have involved a focusing on the child as the object of the parents' interest, and may have served to distract the parents from any conflicts that were present in the spousal relationship.

Father Y may have felt considerable pressure to fulfill the expectations of his family, in terms of a role in the family system, specifically from his parents (as seen in the quote above referring to father Y as the apple of his parents' eyes by Mr Y). Additionally, by placing their hopes in the hands of father Y and displacing their own responsibility for the success of the

family, it may have also assisted the parents from avoiding their own personal failures to elevate the status of the family.

Figure 21.

Parent-Child Triad Two

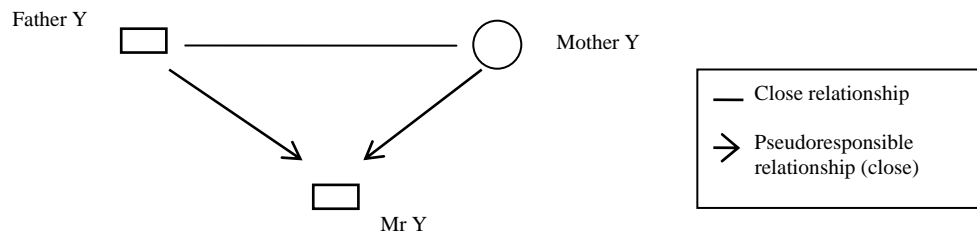

The second significant parent-child triad involved father Y, mother Y and Mr Y. After the death of father Y, a similar pattern as in parent-child triad one emerged, namely, in that Mr Y appears to have become the focus of the ambitions of both mother Y and father Y. Although deceased, father Y continued to exert his influence on the family system, and this particular triad, via his memory which was maintained by mother Y, as well as the extended family on the paternal side of the family system.

Mr Y may have felt systemic pressure to live up to the expectations of mother Y as well as to make his father proud and to succeed where father Y had failed. Additionally, Mr Y appears to have moved closer to his mother. Mother Y may have possessed details and memories about his father that Mr Y would not have been privy to, due to him being too young to remember – he was two years old when his father died (as indicated by the psychologist's report above, section). This closeness may have further intensified the pressure on Mr Y to fulfill the expectations of his mother due to fears of disappointing her and failing in terms of his role in the system. For example, Mr Y continued to attend school and complete his Matric [grade 12] in order to please his mother, despite the fact that his activities were not

monitored nor supervised by her. This aspect becomes even more significant when fusion and undifferentiation in the relationship are explored in the later section on emotional processes in the family system. Mr Y stated that “she [mother Y] made sure that I get my school clothes and whatever I need for school...but when I’m out of the house and go to school, I’m alone...I could’ve dropped out, I could’ve- for all they know, I could’ve walked away...what kept me going is the fact that my mother...okay, it probably would’ve broken her heart.”

Additionally, with the death of father Y, mother Y appears to have concentrated all of her attention on Mr Y with a fused dyadic relationship developing between the two of them. This fused relationship appears to have repeatedly functioned in opposition to a third member, with outsiders perceived as threats as part of a systemic pattern aimed at sustaining the close relationship between Mr Y and his mother and preventing a possible break-down in the fused relationship. This can be seen in Mr Y’s conflict with, and mother Y’s distance from Mr Y’s stepfather, as well as the negativity towards the paternal side of the extended family that emerged after father Y’s death (this will be discussed further under multi-generational triads).

Figure 22.

Parent-Child Triad Three - Supplementary

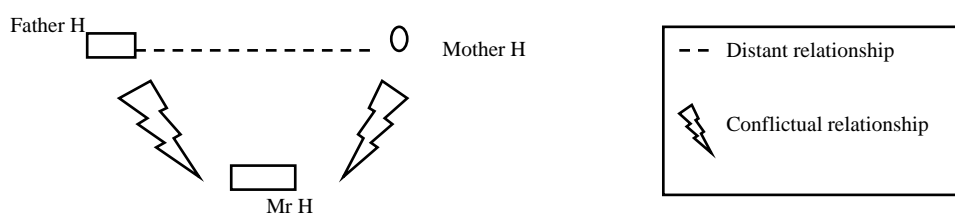

The third supplementary parent-child triad involves Mr H, Mr H’s father and Mr H’s mother. According to Mr Y, Mr H was the black sheep of the H family and was regularly intimidated and bullied by the other members of his family. It would appear that Mr H may

have functioned as a member around which father H and mother H could triangulate and thereby avoid conflict in their own relationship. This possibility seems to be supported by behavioural problems in Mr H such as early promiscuity, substance abuse and prostitution (Report by Clinical Psychologist, 1992), which may have signified attempts to act out both in terms of dealing with anxiety as a result of spousal projection (discussed in the section on emotional processes in the family system) and to fulfill his role as family scapegoat.

Mr Y stated that

he [Mr H] was still at school...well, he didn't want to go to school- that's where his problems were...he was also a loner- he had a similar background, you know...okay, he had sisters and brothers and that kind of thing but he was the odd one out...he didn't get the attention the others got from his mother and father...they wouldn't buy him things that they would buy the others, so he was the odd one out...he didn't fit in with his family at all so he was singled out.

Mr Y and Mr H appear to have been very compatible due to their respective membership of parent-child triad two and parent child triad three - supplementary. Mr Y, who was the focus of his parents' ambitions and looked to for success, appears to have been a complementary foil to Mr H, who was the focus of his parents' dissatisfaction and looked to as the family failure. This relationship may have also compounded the pressure on Mr Y to succeed however, in the sense that he now was responsible for the success of both his nuclear family system, and the relationship that he was a part of with Mr H. Mr Y stated that "his father [Mr H's father] even told me, he said that seeing as he only listens to me and not to them, then I must look after his son and make sure he's alright...I felt so protective about him...I became the father, mother, the brother, the lover, everything."

- Triads involving divorce or remarriage.

There appear to be two significant triads involving divorce or remarriage in the genogram of Mr Y (figure 3), namely:

- o between father Y, mother Y and the half-siblings of Mr Y (divorced/remarried triad one); and
- o between mother Y, Mr Y and Mr Y's stepfather (divorced/remarried triad two).

Figure 23.

Divorced/Remarried Triad One

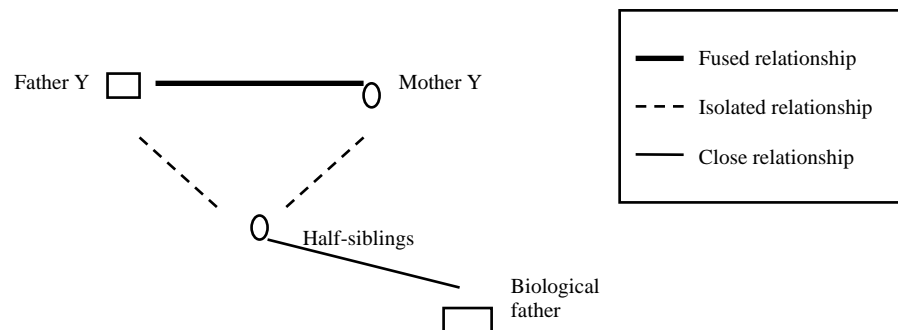

The first significant divorced/remarried triad appears to have involved a close relationship between mother Y and father Y and the isolation of the children from mother Y's previous marriage, namely Mr Y's half-siblings. The children from the previous marriage may also initially have attempted to remain closely attached to their other parent (namely their biological father), and further isolated themselves from their new step-parent, father Y. Mr Y's half-siblings may never have been fully integrated into the family systems that developed after the break-down of mother Y's marriage to her first husband. Mr Y stated that "they went out of the house earlier, I mean, for their ages – those years, if you were 16, you went to work, understand...if you were 16, you had to work- you didn't need to go to school...and then my sister got married when she was 16, so she left."

Additionally, if mother Y's second marriage signified a new beginning for her, the new family system may have resisted accommodating Mr Y's half-siblings as additional members. The new system may also have lacked resources (emotional and financial) to accommodate the additional members. Given what has been discussed in light of the other triads (parent-child triad two and couples triad one), and the relationship pattern exhibited by mother Y consisting of a fused dyad, united against an intrusive or threatening third party, this pattern may have been repeated in the new system with Mr Y's half-siblings. They may have served this function in her relationship with both father Y and Mr Y, filling the role of possible threats to the relationships respectively, which served to bring her closer to both her son (Mr Y) and his father (father Y). As a result, further isolation from the half-siblings would have taken place. Mr Y stated that "when my sister and her husband used to come and visit and things like that, it was fine and well and so on, but I could see that she started getting stressed out."

Figure 24.

Divorced/Remarried Triad Two

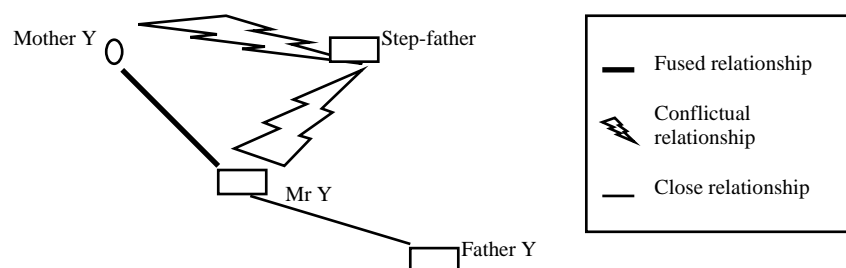

The second significant divorced/remarried triad appears to have involved Mr Y, mother Y and Mr Y's stepfather. In a similar pattern to divorced/remarried triad one, Mr Y continued to idealize the lost parent (father Y), just as Mr Y's half siblings had continued a close

relationship with their biological father, and Mr Y resented his mother's new spouse (the step-father), just as the half siblings had possibly distanced themselves from father Y. In this triad, there also appears to have been conflict between Mr Y and his stepfather, and, as a result, Mr Y may have formed a closer attachment to the memory of his biological father.

Mr Y's fused relationship with his mother, together with family pressure to honour the memory and name of father Y, accompanied Mr Y's protective attitude towards his mother after the death of his father and Mr Y increasingly filling the role of primary male in the single parent household that resulted as he grew older. When mother Y married Mr Y's stepfather (when Mr Y was 12 years old), Mr Y may have perceived him as a rival to his role and position in the family system. This may have contributed towards the ensuing rivalry and competition between Mr Y and his stepfather.

Mother Y may have been in a particularly stressful position as she attempted to negotiate dual loyalties to her new husband (Mr Y's step-father) and Mr Y. This may have contributed to the conflict in the spousal relationship (as evidenced by the physical abuse present in the relationship as well as mother Y's addiction to painkillers), as well as Mr Y and his mother drawing closer together as he consolidated his role as protector and primary male with regard to his mother. This may also explain Mr Y's involvement with the occult and bodybuilding as a possible attempt to intimidate and gain power over his stepfather and increase his power within the system. However, this may also have been a source of great shame for Mr Y in that he was ultimately powerless to stop the abuse or to protect his mother from harm. This guilt and need to compensate for his inability to intervene while his mother was alive, may have repeated itself in his relationship with Mr H, where he may have escalated attempts to correct the systemic outcome and protect his partner by resorting to extreme measures such as murder to maintain the relationship.

Mr Y stated that “the things he did, the way he treated my mother and myself left a lasting impression...I cannot handle anyone that’s dominating” and that “I don’t believe in assaulting women and I don’t believe- because you must understand, I grew up watching someone being assaulted...I have no time for that, I also have an incredible sense of protectiveness over someone that I like...sometimes that protectiveness becomes a bit overwhelming...for the person to handle.” Mr Y also stated that “I would have loved to [retaliate against his step-father when he was assaulting mother Y], yes, but the problem is logic told me that if I had to retaliate against him, he’d take it out on my mother.”

- Triads involving foster or adopted children.

There appears to be one significant instance of this type of triad in the genogram of Mr Y, namely:

- o between mother Y, her foster parents, and her biological parents (the maternal grandparents) (foster/adopted triad one).

Figure 25.

Foster/Adopted Triad One

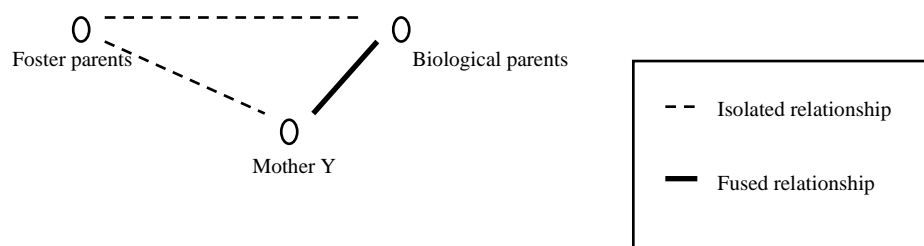

As stated in McGoldrick and Gerson (1985), triads involving foster or adopted children, frequently exhibit a pattern involving the triangulation of the memory or idea of the biological parents in the relationship between foster parents and the adopted or foster child. This appears to have been the case with mother Y, where she triangulated the idea of her biological parents,

idealising this relationship in the face of consistent rejection by a series of foster parents. Additionally, this pattern may have escalated as mother Y distanced herself from her various foster family systems, and fused more intensely with the idea of her biological parents and her idealised relationship with them. As a child, she may also have resented the foster parents who attempted to “replace” her biological parents, and inadvertently perceived these foster parents as responsible for the loss of her biological parents and her idealised relationship with them.

Mother Y may have attempted to replicate this idealised relationship with her significant others in later life (such as with her first husband, then father Y and ultimately, Mr Y), and perceived any outsider to this relationship as a potential threat. This may have contributed towards fusion with the significant other in question and distance, isolation or conflict with the external party. This can be seen in her relationship with Mr Y’s stepfather. Although she cared for him, it would appear that she married him more for material security than emotional bonding. Mr Y stated that

in the beginning she probably fell for him a bit but I think the way I looked at it, is now, I used to ask her, “Why don’t you just divorce the guy? Leave him”, and her words were always “What would happen to me?” Where would she go...she’d have nobody to look after her...she didn’t have any skills whatsoever, understand, she wasn’t going to be able to get a job.

Her fused relationship with Mr Y appears to have catered to her emotional needs. In addition to material security, Mr Y’s stepfather appeared to have been valuable to the system in the sense that he contributed towards the increased fusion between Mr Y and his mother, as she covertly united with Mr Y against the threat of his stepfather. This relationship pattern of a

fused dyad united against, and closed to outsiders was passed on to Mr Y in the following generation, as can be seen in his relationship with Mr Y.

- Multigenerational triads.

There appears to be one significant multigenerational triad in the genogram of Mr Y, namely:

- o between the paternal grandparents, mother Y and Mr Y (multigenerational triad one)

Figure 26.

Multigenerational Triad One

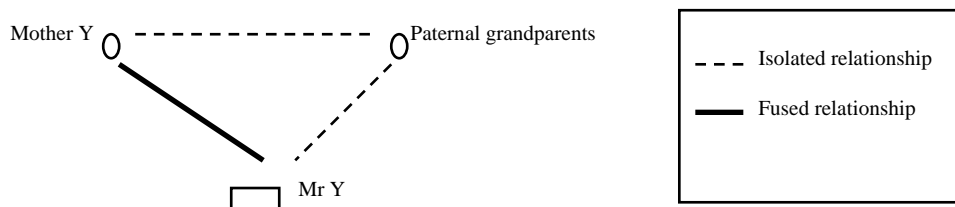

This triad consisted of a close relationship between mother Y and Mr Y and an isolated relationship between Mr Y and his mother respectively with the paternal grandparents. This took place after the death of father Y (1963).

As discussed previously, both the extended family in the form of the paternal side of the Y family system, and the nuclear Y family system, had expectations of Mr Y, in terms of his role in the system. However, while father Y was alive, he primarily filled the role of family hope for success. After the death of father Y, as well as the failure of the paternal uncle to take his role in the extended family system, however, Mr Y seems to have become the sole focus of both the paternal side of the extended family system as well as mother Y with respect to the role vacated by the former. Given mother Y's close, fused relationship with Mr Y (which appears to have intensified after father Y's death), she may have perceived any closeness between Mr Y and the paternal grandparents as a threat to her relationship with Mr

Y, and a potential loss of Mr Y as a member of the remaining nuclear family system. She appears to have drawn Mr Y closer to her and cut off from the paternal grandparents (as can be seen in figure 3).

Mr Y appears to have felt considerable pressure for a while as the paternal grandparents and mother Y involved themselves in a power struggle over him. He may have felt pulled between two interconnected (albeit increasingly distant) systems. Eventually, this would have shifted as Mr Y moved closer to his mother and assumed his father's role in the nuclear family system, distancing and eventually cutting off from his extended family. This cut-off and isolation would have further intensified the relationship between Mr Y and his mother.

This pattern seems to have been repeated with respect to Mr H, Mr Y and Mr H's parents, where Mr Y identified with his mother's position in multi-generational triad one, and fought Mr H's parents for ultimate control over and exclusive relationship with Mr H.

- Triads involving relationships outside the family.

Given the intensely closed and fused relationship between Mr Y and his mother, together with their fear of outsiders and nuclear family system rigidity, there seems to have been little opportunity or flexibility in the nuclear family system for relationships with persons outside of the family system.

Mother Y's relationship with her third husband would appear to be one example of a relationship that was permitted to occur within the framework of the nuclear family system and her relationship with Mr Y. Mr Y's step-father possessed certain resources which the system required in order to survive, such as money and material support, especially considering that mother Y was unemployed and unskilled. The emotional bond between mother Y and Mr Y remained intact in spite of the introduction of Mr Y's stepfather into the system. He also may have functioned to promote further cohesion between mother Y and Mr

Y on account of his role as persecutor (with regards to his physical abuse of mother Y) and family scapegoat (in the form of his alcohol abuse and suspected extramarital liaisons).

Mr Y only started having relationships outside of the family system after the death of his mother, and subsequent collapse of the nuclear family system (as illustrated in the genogram, Figure 3). These relationships took on the emotional content and intensity of his relationship with his mother, as he possibly tried to recreate the fused dyad. This possibly explains the intensity of his relationship with Mr H and the drastic extents that Mr Y went to in order to protect this against external threats, such as murdering potential threats to the relationship and dyadic system.

Additionally, freed of his obligation to fulfill his mother's expectations regarding his success and conduct, and to redeem his father's memory, Mr Y may have been left with only the impending sense that he was to follow in the failed footsteps of his father, and to end his life in the same way. This feeling of impending failure may have been heightened by guilt that he could have felt for not having been able to protect his mother or to prevent her death. Subsequent relationships where he tried to recreate the dyadic relationship may have been attempts to succeed where he had failed previously with his mother. For example, this is most evident in his relationship with Mr H, where in an attempt to make some success of his life, he was driven to desperate and violent measures, which may have been learned behaviour patterns within the family system of using violence to resolve relationship problems. Mr Y stated that "I was battling the fact that I'm killing people in order to survive, I mean, with my co-accused." Mr Y also stated that "I was madly in love at the time, completely in love- we were perfect for each other...and I wanted to keep him...at all costs." These issues will be dealt with further in the section on emotional processes in the family system specifically with respect to levels of differentiation.

- Triads: other.

There are two other significant triads in the genogram of Mr Y, namely:

- o between mother Y and her respective partners (as the dyad) and another entity (triad other: one); and
- o between Mr Y and Mr H (as the dyad) and another entity (triad other: two).

Figure 27.

Triad Other: One

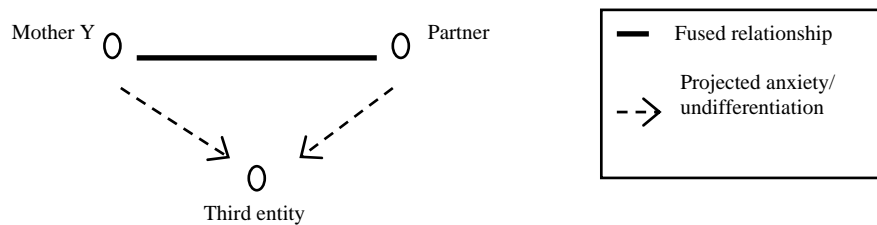

The first significant other triad appears to involve mother Y as the primary member and then the pattern of relationships in this triad repeats itself with each of her partners and another entity. This will be discussed with respect to:

- her relationship with her first husband;
- her relationship with father Y; and
- her relationship with Mr Y's stepfather.

More elaborate attention will be given to aspects such as differentiation and anxiety in the section on emotional processes in the family system. However, it is important to mention at this point that mother Y's previous life experiences in terms of her early orphaning by her biological parents as well as her lack of a consistent home environment growing up meant that she had a low level of differentiation. However, her isolation from her foster homes may have made her more inclined to fuse intensely with the partners she was involved with. This

relationship would have been characterised by high levels of anxiety and undifferentiation necessitating possible triangulation around other members or things.

In her relationship with her first husband, the role of the third entity or triangulated member may have been filled by her eldest children (Mr Y's half-siblings). The high level of anxiety in this relationship may have resulted in the eventual divorce. In her relationship with father Y, Mr Y may have filled this position in the short time that the marriage lasted. Finally, with respect to her relationship with Mr Y's step-father, mother Y's addiction to Grand-Pa® headache powder, and the step-father's alcoholism and suspected extra-marital affair would have possibly filled the third position in the triad to absorb some of the anxiety or undifferentiation in the relationship. Mr Y stated that "my mother was absolutely hooked on Grand-Pa® powders – she'd polish off a packet a day, I mean you can get addicted to it...without the Grand-Pa® powders, she was a nervous wreck." These aspects will all be elaborated upon in the section on emotional processes in the family system.

Figure 28.

Triad Other: Two

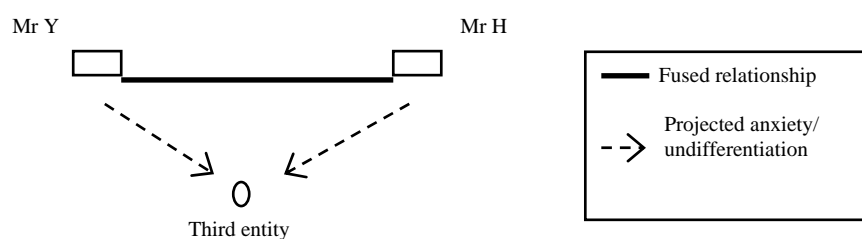

The second significant other triad appears to involve Mr Y, Mr H and another variable entity. In this couples triad, there appears to be a repetition of the pattern in couples triad one. This is not surprising given the high level of fusion and identification of Mr Y with his mother.

Mr Y's had a close relationship with mother Y, and may have also had a large amount of undifferentiation which needed to be absorbed in any relationship of which he was a part. His relationship with Mr H involved various entities in triadic relationships at different points in time, with these entities filling the role of triangulated member that could absorb surplus differentiation or anxiety in the relationship between Mr Y and Mr H. These included Mr H's family; the occult; the Child Protection Unit; as well as the murder victims and criminal activity.

As with his relationship with mother Y, the presence of an external threat or perceived aggressor served to strengthen the dyadic relationship between Mr Y and Mr H. This is because they could focus or project all of the anxiety within their own relationship (which may have caused the relationship to break down) onto this third entity. By uniting against an outsider, Mr Y and Mr H appear to have been drawn closer together.

- Summary of category five: relational patterns and triads.

In terms of category five, relational patterns and triads, the genogram demonstrates a number of triads. However, only those significant to the current analysis were selected for study.

With respect to parent-child triads, two significant and one supplementary parent-child triad emerged. These were between father Y and the paternal grandparents (parent-child triad one); between father Y, mother Y and Mr Y (parent-child triad two); between Mr H and his parents (parent-child triad three – supplementary). It was shown that parent-child triads one and two may have functioned to prevent conflict or disruption in the spousal relationship by focusing upon the child as an idealised object. This appears to have also been to avoid guilt or responsibility for lack of family success by placing this obligation on the child concerned. It was also shown that Mr Y and Mr H would have been very compatible due to their

positions in their respective parent-child triads, but that this may have meant additional pressure for success on Mr Y.

With respect to triads involving divorced or remarriage, there were two significant divorced/remarried triads in the genogram, namely, between father Y, mother Y and the half-siblings of Mr Y (divorced/remarried triad one); and between mother Y, Mr Y and his step-father (divorced/remarried triad two). In divorced/remarried triad one, it was shown that Mr Y's half-siblings appear to have remained distant and isolated from the remarried family system that included mother Y, father Y and Mr Y. Additionally, it was shown that in divorced/remarried triad two, Mr Y appears to have remained in conflict with his step-father due to his loyalty to his father's memory as well as his close relationship with his mother.

In terms of triads with foster or adopted children, it was found that mother Y appears to have idealised her relationship with her biological parents, resulting in her isolation and distance from her foster parents, as well as an attempt to mirror this idealised relationship in her adult relationships. Mr Y may have repeated this pattern of idealizing absent individuals in terms of his relationship with his biological father after he was deceased. Additionally, the loss of her biological parents and idealised relationship may have made her more sensitive to potential threats to any of her adult relationships.

In terms of multigenerational triads, there is one significant triad in the genogram, namely, between the paternal grandparents, mother Y and Mr Y (multigenerational triad one). It was shown that this triad appears to have intensified after the death of father Y, when mother Y and the paternal grandparents were involved in a struggle over Mr Y. Ultimately, mother Y appears to have won and this appears to have resulted in a closer, fused relationship between her and Mr Y, and a distancing and cutting off from the extended family and paternal grandparents. Possession appears to be a multigenerational theme in the Y family system with

the paternal grandparents wanting possession of Mr Y; Mother Y wanting possession of Mr Y; and Mr Y wanting possession of Mr H.

In terms of triads involving relationships with others outside of the Y family system, it was shown that the rigid, closed relationship between mother Y and Mr Y meant that outsiders were guarded against and seen as a potential threat. The only individual allowed into the nuclear family system appears to have been Mr Y's step-father and it was shown that this appears to have been mainly due to his provision of material resources as well as ensuring that the fused dyad (between Mr Y and his mother) remained closely attached. It was also shown that Mr Y appears to have only gotten involved in relationships with others after the death of his mother; however, these relationships appear to have repeated the pattern of his original relationship with his mother, namely fusion and isolation and defence against outsiders.

With respect to significant other triads, two significant other triads emerged from the genogram. These were between mother Y and her respective partners (triad other: one); and between Mr Y and Mr H (triad other: two). It was shown that mother Y's relationship pattern and previous childhood experiences of intimate or significant relationships may have meant that she tended towards fusion with her partner or significant other in relationships, and that the surplus of anxiety or undifferentiation that resulted appears to have necessitated the involvement of a third entity to absorb some of this surplus. In mother Y's relationships, some of these entities included children, substance abuse and extramarital affairs. In terms of other triad two, it was shown that Mr Y may have repeated this pattern in his own relationships, notably with Mr H.

- **Category six: family balance and imbalance.**

Discussion of family balance and imbalance as seen in the genogram of the Y family system will proceed with regards to:

- o family structure;
- o roles;
- o level and style of functioning; and
- o resources.

- Family structure.

The genogram of Mr Y reflects three main imbalances with regards to the structure of the family system, namely with regards to:

- o families of origin;
- o the number of marriages; and
- o Mr Y's status as only child.

The genogram demonstrates that father Y, or the paternal side of the external family system, consisted of one sole family of origin. By comparison, the maternal side of the extended family system demonstrates numerous and various families of origin, including biological parents and foster parentage.

This imbalance may have had implications for the nuclear family system. It may have contributed towards a degree of conflict in the spousal relationship with mother Y having to accommodate herself within a larger external family system, with its own expectations regarding her husband, father Y, as well as her son, Mr Y. Having grown up relatively independently, this may have been a challenge for her. Additionally, her mistrust of outsiders and insecurity in her close relationships, may have made this even more challenging and increased her anxiety or neuroticism within the nuclear family system, given that she was outnumbered by father Y's side of the family.

These tensions appear to have become more prominent after the death of father Y, when mother Y (and the nuclear family system) lacked father Y as an intermediary member who

filled a mediatory role between the nuclear and extended family system. She may have felt further threatened and distanced herself from the paternal side of the family system, possibly using her influence over Mr Y to ensure that she did not lose him to the paternal side of the family system. This appears to be evident in Mr Y's statement that he knew that he was different from his father's family of origin from an early age. Additionally, Mr Y spoke of the paternal side of the family system with disdain and superiority throughout the interviews.

Mr Y stated that

that's why I say that I don't fit in with my family at all...totally, totally, totally an outsider...I don't think like them, I don't act like them, I never lived like them outside...your average, low class, white characters are raw and mostly uneducated...common is the right word...it was something I couldn't stand.

The genogram demonstrates that mother Y had three marriages. In comparison, it appears that father Y had only one marriage. Additionally, mother Y appears to have been the only member of the entire family system (nuclear and extended family systems) to have been married more than once. As a result, there was an imbalance in the family system in this regard.

The implications of this appear to be that Mr Y may have attempted to address the imbalance in the system by having a number of relationships (five) himself. This may have also been the result of his close relationship with his mother and identification with her and her style of relationship, and reflective of her upbringing in foster homes. Additionally, this relationship patterns may have paradoxically increased insecurity about the nature of relationships in both Mr Y and his mother. Mr Y's relationships appear to have been characterised by fear of losing his partners and strong attempts to control the relationship as

well as the other partner to prevent this. Paradoxically, this behaviour may have contributed to the end of the relationship.

As with Mr X, the genogram demonstrates that Mr Y was functionally an only child in the family system. As discussed previously, the age gap between Mr Y and his half-siblings, together with his status as favourite in the nuclear family system, resulted in him growing up as an only child functionally. Additionally, Mr Y is the only reported instance of an only child in the entire family system.

The implications of this may have been that Mr Y had to absorb the full surplus of undifferentiation in the nuclear family system. This intensified after the death of father Y, when the nuclear family system was reduced to two members and the relationship between mother Y and Mr Y appears to have approached complete fusion, with the system becoming extremely closed and intolerant of outsiders. Fears of self-annihilation in the fused dyad may have been high. Responses to this will be dealt with further in the section on emotional processes in the family system. However, to prevent the breakdown of the fused relationship, much anxiety appears to have been projected onto extended family in the paternal system and other outsiders, who were seen as aggressors and threats to the nuclear family system. Additionally, Mr Y's loss of his father appears to have contributed towards an increased in mother Y's identification with Mr Y due to the fact that she had also lost her parents.

- Roles.

The genogram (figure 3) and interview information reveals two areas of imbalance with respect to roles in the family system, namely:

- o Mr Y; and
- o the role of "bad guy" or external threat.

As evidenced in the genogram, Mr Y appears to have been the one member of the Y family system who took on multiple roles within this system. Within the nuclear family system, he appears to have fulfilled the roles of son and heir to his father's legacy (evident in him being named after his father). After the death of his father, Mr Y appears to have had to perform the role of son, caretaker, father and husband within the nuclear family system, as he became the sole focus of mother Y's attention. He was appears to have been placed in the role of family rescuer or savior who would redeem father Y's name and succeed where he had failed in his duties as caretaker of the nuclear family system.

In his relationship with his mother, Mr Y appears to have also been cast in the role of the strong partner in order to balance the weakness of mother Y. Given her apparent underfunctioning in the role of parent or caregiver, Mr Y's assumption of the role of caretaker and protector in this relationship appears to have also been an attempt to redress the imbalance in mother Y's functioning in this capacity. This role as caregiver in the system may have been particularly overwhelming due to the considerable imbalance in the entire family system as a result of the considerable lack of caregiving in the maternal side of the family system. It may have been a particularly arduous responsibility for Mr Y to take on. Additionally, Mr Y's role as the strong one may have also impacted upon his criminal behaviour in that it may have made it necessary to introduce victims into the system to assert this position.

In this light, Mr Y's model for his role as caregiver appears to have been influenced by his own experiences at the hands of his mother, who was neurotic, paranoid and controlling, and yet under-responsible. Mr Y would have associated this pattern as that for a caregiving relationship style within the Y family system. This may explain his relationship style with his partners, such as Mr H, as well as his relationships while in prison. Mr Y stated that "there's

one thing that I actually managed to do...I managed to control my relationships [in prison]...in that sense I could control, I could let them go.” Mr Y also stated that

in all my relationships, I don't expect that much from the partner...except the honesty and loyalty...and when I choose to, I can let him go...like with one of my relationships in prison, after I allowed him to leave me, I felt terrible afterwards, for two days I couldn't eat...they were worried about me in the section there...they came at night, made sure I was alive, I didn't hang myself...

As discussed previously, within the external family system, specifically the paternal side, Mr Y appears to have had to also perform the role of saviour or redeemer for this system.

As discussed previously, when his mother died, Mr Y appears to have interpreted this event as a sign that he had failed to perform his roles in the family system, namely as a caregiver and protector. He appears to have felt that he had also failed his father in this light, namely in not successfully filling his position in the family system. This may explain Mr Y's depression and downward spiral after his mother's death, as well as his extreme need to protect and care for those who he cared for in later life, such as Mr H. Given that a large part of his self in the family system was tied up to his roles in that system, this experience may also have intensified fears of self-annihilation. Mr Y stated that “I was battling the fact that I'm killing people in order to survive, I mean, with my co-accused.” Mr Y also stated that “he [Mr H] was with me the whole time, I didn't allow him to do any of the killing or any of the crimes himself...he was with me, I didn't allow him to touch anything...I didn't want him to experience that, I took it upon myself to basically do what we did to survive.”

Mr Y's roles within the family system appear to also have influenced his relationships outside of the system. His choice of partner was always someone of a considerably younger age, and Mr Y appears to have always played the role of caregiver and strong one in the

relationship. Additionally, his plans for the person he is involved appear to always have involved helping them to improve themselves in some way, thereby perpetuating his role as saviour or redeemer. His repetition of the same kinds of relationships and similar choices in partner may also indicate an attempt to succeed where he failed in his past relationship with his mother, as well as his failed duty to bring success to the family system. Mr Y stated that “he’s [his ex-lover in prison] doing excellent...all kinds of courses that he’s done...so he’s going well and it makes me feel that I was at least an inspiration or instrumental in the time period he was with me...in a way I’m trying to heal myself by looking after somebody else.”

Finally, Mr Y’s job choices can also be seen as a manifestation of the roles that he played in the family, namely in the way of his police work (that is, protecting others) and later security work, as well as in his pastimes with sports such as bodybuilding reflecting his strength.

In the genogram, the role of the bad guy appears to be overwhelmingly assigned to individuals or entities outside of the nuclear family system. Entities fulfilling this role for the system appear to include the paternal side of the external family system and Mr Y’s stepfather. Later on, in Mr Y’s significant relationships as an adult, this pattern appears to have been repeated. The role of the bad guy at these stages appears to have been filled by the family of Mr H; the authorities at the Child Protection Unit; and finally, the murder victims (especially the first murder victim).

It would appear that this role served to strengthen the fused dyadic relationship within the system (initially between mother Y and Mr Y and then, in Mr Y’s intimate relationships) as well as to provide a target onto which tensions or anxiety in the relationship could be projected. It also appears to have assisted Mr Y in successfully performing his role as saviour, redeemer, success and caretaker, as he was never positioned in the role of bad guy as long as these other outsiders were available for this purpose.

- Level and style of functioning.

In terms of level and style of functioning, the genogram and interview data reveals imbalances in four main areas, namely:

- o orientation towards family;
- o emotional style;
- o success and failure; and
- o under- and over-functioning.

As discussed above with respect to family structural imbalances, the genogram demonstrates how father Y appears to have been positioned within an extended family network that was absent on the maternal side of the family system. This was due to the fact that mother Y was an orphan and had spent time in and out of various foster homes growing up, ultimately being forced to leave her last home at the age of 17.

The implications of this imbalance for the family system may have been that father Y and mother Y would have viewed family differently, and oriented themselves towards such a unit in different ways. Whereas father Y would have seen the family system as a place of constancy and stability, and would have tried mould the nuclear family system along similar lines, mother Y may have viewed a family system as unstable and unreliable. This may explain her focus on the “home” as opposed to the “family” as well as her prioritization of a dyadic person fused relationship over a two parent and child nuclear family grouping. This also may explain why she possibly was not constrained by any norms around family and marriage and felt free to form new households or families on four occasions.

As discussed previously, these differing styles of orientation towards family may have resulted in marital tension due to mother Y’s inability or reluctance to integrate herself with the extended nuclear family system on the paternal side. Additionally, mother Y’s style of

orientation towards family appears to have been passed on to Mr Y, who appears to have felt little connection to his extended family on either side, or to other systems.

In the nuclear family system, specifically with respect to the relationship between mother Y and Mr Y, there appears to have been an anxious and hysterical emotional style on the part of mother Y. In order to balance this as part of a complementary relationship with mother Y (discussed further in section), Mr Y may have developed a more controlled style, as can be seen in his behaviour and approach to committing the murders and the way he dealt with the effects of being on the run from the police, as well as in the clinical impressions of the interviewer.

Mother Y's emotional style appears to have influenced her choice of partner, as well as their quality of relationship. With respect to father Y, this appears to have taken the form of a complementary relationship with father Y balancing her hysterical style with a controlled manner of behaviour (in much the same way as Mr Y). In the case of Mr Y's step-father, mother Y appears to have chosen a partner who was less controlled and more emotional than her previous husbands, more in line with a symmetrical relationship. Escalated marital conflict appears to have ensued culminating in incidences of physical abuse. Mr Y stated that, in comparison to the abuse that his step-father unleashed on mother Y, "if she [mother Y] got angry with him [father Y]...he'd just hold her hands, you see, I mean she can't do anything because he held her...no, he would never lift his hands to her."

Mr Y's emotional style appears to have also influenced his choice of partner as can be seen in Mr H who was more emotionally expressive, and at times, anxious and neurotic. This appears to have also been the case with his partners in prison as well as friendships, all of which appear to repeat the complementary pattern of his original relationship with mother Y. Mr Y stated that he was attracted to someone who was "good-looking of course, very good looking...personality gentle, full of fun, not someone with a criminal mentality...very gentle

person, extremely soft, he cries...to me that's so sweet." In the clinical psychologist's report for sentencing on Mr H, Mr H is described as anxiously preoccupied, impulsive and jumpy in comparison to the more controlled presentation of Mr Y.

This pattern appears to have been carried through to the crimes themselves as reflected where Mr Y stated that during the time period of the murders,

I hardly ever slept...my co-accused he could just drop where we were and sleep...I was so full of adrenaline rush constantly...oddly enough I didn't feel physically out of it...I ate less food than I've ever eaten in my life ...I didn't seem to need it, I was running on full adrenaline...any chance that I could get hold of booze I took it, got motherlessly drunk but even in the drunken state that I was, I kept going...I was exactly the same as when I was sober.

Mr Y also stated that

there was still control, you understand, that's why I say the sentence that I received was appropriate because I wasn't insane at that time period [of the murders]...I knew exactly what I was doing...I was emotionally unstable, yes, but who isn't sometimes? But not in such a way that I couldn't control what I was doing.

As depicted in the genogram, there appears to be an overwhelming amount of failure in the Y family system, with almost no signs of success in the lives of respective members. This failure includes mother Y's biological parents; mother Y's foster parents; mother Y's first marriage; father Y; and the paternal uncle. The implications of the extent of failure in the system appear to have been twofold, namely that:

- o the degree of success needed to balance the failures in the system would have had to have been sufficiently large to achieve this; and

- o with each succeeding generation's lack of success, the pressure for this success would have increased in the family system.

Mr Y, as the chosen successor to his father, appears to have felt both incredibly pressurized under the weight of the expectations of members of the family system, as well as fatalistically doomed to repeat the failures of each successive generation. As will be discussed further in the section, Mr Y's failure to achieve the success demanded of him by the family system may have contributed towards him ultimately giving in to this fatalism, and committing the crimes that he did.

Another possible explanation of the predominance of failure in the family system may be that the system was attempting to destroy itself, due to lack of sustainability. The nature of the family system, as a closed system, and principle of homeostasis would have possibly resulted in the stagnation of that system (due to lack of new inputs) as well as an inability to deal effectively with change. Mr Y, as the final and only end product of a particular branch of the family system (namely, between father Y and mother Y), in effect, prevented that branch of the system from continuing, both in terms of his sexual orientation, as well as his criminal behaviour. In this way, the remaining parts of the extended family system may have grown stronger.

In terms of imbalances regarding levels of functioning, interview data indicate one significant area of imbalance, namely in the relationship between mother Y and Mr Y. In terms of this relationship, mother Y appears to have under-functioned in her capacity as a parent and caregiver. In order to compensate for this, Mr Y appears to have learnt to look after himself and over-functioned in this relationship in terms of reversing the roles so that he took care of his mother. As discussed in the section on roles, this style and level of functioning appears to have stayed with Mr Y throughout his adult life. Mr Y stated that

I never had parents that would come to athletic meetings or anything like that...because I mean I had no- all the others had their parents there and support and so on and here, you're on your own, you know...emotionally I had to start suppressing and realize that I'm on my own, and you have to do everything on your own...she [mother Y] tried her best to be a good parent but she was suffering continually...psychological problems and so on...I would say that my mother had a very low self-esteem...

Despite having learnt to be independent from a young age, mother Y appears to have been emotionally very needy. She appears to have under-functioned in this regard in her close relationships, namely in that she depended on the other party in the relationship for emotional support but did not reciprocate in this regard. Mr Y appears to have over-functioned in his emotional input into the relationship with his mother. This assumption of the adaptive position in the relationship may have contributed towards fears of self-annihilation in the context of the relationship.

- Resources.

In terms of the balance of resources in the family system, the genogram and interview data appear to indicate three main areas of disparity, namely:

- o occupational and financial resources;
- o coping skills; and
- o support systems.

With respect to occupational and financial resources, the family (extended and nuclear) appears to have been from a particularly low socio-economic background, and lacking considerably in financial resources. This appears to have been a source of great shame, as well

as frustration and resentment for Mr Y, especially when it stood in the way of his extramural activities as a child (as quoted in previous sections). He appears to have distanced himself further from his family background (especially after the death of his mother).

The lack of financial resources in the family system may also have increased the desperation and need for a member to address this imbalance through their own occupational success. This may have motivated Mr Y to succeed academically and start a career that was an advancement on the occupational pay level of the family system, namely as a policeman in a family of miners. Interestingly, due to his distance and cutting off, he appears to have withheld these resources from the extended family system and invested them in his nuclear family, and later relationships.

The nuclear family system appears to have been considerably depleted of occupational resources, especially after the death of father Y, due to the fact that mother Y was unskilled and unemployed. As a result, this imbalance appears to have necessitated continual correction by bringing in the necessary resources from outside of the system, in the form of her various spouses, or grants from the State.

In the case of State grants, these appear to have been insufficient to support mother Y's attempt at being a single parent with Mr Y, and as a result, she married her third husband. This may have resulted in resentment towards the State on the part of Mr Y for what he perceived as its failure to prevent the introduction of an outsider into the nuclear family system in the form of his stepfather. His resentment towards his stepfather may also have been increased by what he saw as the enslavement of mother Y on account of her lack of financial independence. Mr Y stated that

in the beginning she probably fell for him a bit but I think the way I looked at it, is now, I used to ask her, "Why don't you just divorce the guy? Leave him", and her words were always "What would happen to me?" Where would she go...she'd have

nobody to look after her...she didn't have any skills whatsoever, understand, she wasn't going to be able to get a job.

With respect to coping skills, the genogram demonstrates a considerable lack of these resources in the Y family system, specifically in relation to dealing with conflict. Members of the family system appear to have dealt with stress and conflict by:

- o escaping or running away when the adversary was too powerful. This occurred either by literally escaping (such as in the case of mother Y with Mr Y's step-father) or through substance use (such as in the case of mother Y and her addiction to painkillers). Stress appears to also have been dealt with in the same way, such as with Mr Y's paternal uncle and Mr Y's step-father's alcoholism, or father Y's smoking;
- o using violence. This can be seen in father Y's killing of his employer in a dispute over his wages as well as Mr Y's step-father's physical abuse of mother Y; or
- o developing emotional or behavioural problems. This appears to have occurred in mother Y, as evidenced by her hysteria and obsessive cleaning.

Many of these ways of dealing with stress and conflict appear to have been passed on to Mr Y, and thus, the system appears to have maintained its ineffective attempts at solutions and coping. With respect to escaping or running away as a tactic, this can be seen in relation to Mr Y's running away with Mr H when he felt that the authorities were too powerful to argue with. Additionally, Mr Y used to smoke to deal with stress, and drink while fleeing the police. With respect to the use of violence, this can be seen in Mr Y's general style of dealing with conflict and stress, as expressed in his crimes, as well as in his recounting of his experiences in prison. Mr Y stated that "I simply just decided that he [the first murder victim] was a problem...he would be a problem...and- but then I must admit I understand why I suppose, I

couldn't have a sensation, no hard feelings about killing him...I just went, strangled him...and that was the end of it."

In terms of support resources external to the family system, these appear to be notably absent from the nuclear family system, both in terms of extended family system support, and sources of support such as friends or areas of the community such as churches. This appears to be on account of the rigidly closed nature of the relationship between Mr Y and his mother, and their suspicion and mistrust of outsiders. Additionally, mother Y's experiences with organisations such as the welfare department in her time as a foster child may have increased her weariness in this regard due to her perception of the failures on their part (which was worsened by their perceived failure to support her adequately as a single parent).

The nuclear family system may have had to depend solely on its members (namely, mother Y and Mr Y) for support, and these two individuals may have been considerably strained in terms of their ability to provide this. This may be one motivating factor in Mr Y's discovery of the occult, in a possible attempt to obtain support resources from another area.

- Summary of category six: family balance and imbalance.

In terms of category six, family balance and imbalance, the genogram revealed a number of areas of imbalance in the family system.

With respect to family structure, these imbalances appear to have occurred in the areas of families of origin; the number of marriages; and Mr Y's status as an only child. The result of these imbalances appears to have been that there was conflict between father Y and mother Y concerning their respective attitude toward family, specifically integration with the extended family system of father Y. Additionally, the imbalance with regard to number of marriages may have resulted in Mr Y attempting to balance the system by emulating the relationship patterns of his mother, as well as contributing to his insecurity in relationships. Mr Y's status

as only child appears to have resulted in increased pressure on him as the sole target for anxiety in the nuclear family system as well as possible tension between him and Mr H on account of Mr H's more open relationship style and differing sibling position.

With respect to roles, two areas of imbalance emerged from the genogram, namely Mr Y and the role of the bad guy or external threat. It was shown that Mr Y appears to have had to perform multiple roles in the Y family system and that the role of the bad guy was frequently attributed to outsiders as a means of bringing the fused relationship dyad (mainly in the form of Mr Y and his mother, and then Mr Y and his partners, specifically Mr H) and nuclear family system closer together.

With respect to levels and styles of functioning, four areas of imbalance emerged, namely orientation towards family; emotional style; success and failure; and under- and over-functioning. Once again, this appears to explain mother Y's distancing from the external family system, as well as her favouring of the dyadic relationship as opposed to larger group system. Additionally, it was shown that Mr Y appears to have been frequently required to balance the level and style of functioning of his mothering a complementary interaction due to his position as her partner in the dyadic relationship. As a result, he appears to have generally over-functioned and developed a controlled emotional style. The overwhelming prevalence of failure in the family system was explored.

Finally, with respect to resources, imbalances emerged in three areas, namely, occupational and financial resources; coping skills; and support systems. It was shown that Mr Y may have developed shame and resentment towards the family system, as well as the larger social system on account of their inability to support the nuclear family system adequately. It was also shown that Mr Y's violent behaviour as well as some of his responses to stress and conflict such as smoking and running away appear to have been the result of a general lack of coping skills in the family system. Mr Y's discovery of the occult was shown

to have possibly resulted from this lack of support resources in the nuclear family system. This lack of support was also shown to have possibly placed great strain on both Mr Y and his mother.

7.2.2 Thematic content analysis

As discussed above, the clinical observations of Mr Y, the genogram of Mr Y and the interviews conducted yielded considerable information concerning the family system of Mr Y. This information was supplemented with interviews with the prison psychologist of the prison where Mr Y is being held, as well as the cellmate of Mr Y. Court reports and assessments were also consulted as a secondary source of information, together with a television documentary on Mr Y.

The above body of data was then analysed using the content analysis method and the resulting themes will now be elaborated upon in terms of the family systems theoretical framework discussed in the methodology section (chapter 5), namely in terms of emotional process, multigenerational patterns and relationship patterns.

- **Themes relating to emotional processes in the Y family system.**

In terms of emotional processes, the following themes emerge, namely:

- low levels of differentiation in the nuclear family system (Theme one);
- high anxiety levels in the nuclear family system (Theme two);
- emotional cut-offs,
 - specifically with respect to the isolation of a dyad from surrounding systems (Theme three); and
 - fears of loss of self due to extremely fused relationships (Theme four).

- Low levels of differentiation in the nuclear family system (theme one).

The Y family system demonstrated a low level of differentiation, specifically with respect to mother Y and the system variations that developed with each of her significant relationships. As discussed in previous sections, mother Y, although relatively differentiated from her foster parents and surrounding societal system and social welfare systems, appears to have been involved in a fused, closed relationship with the memory and fantasy of her deceased biological parents. This is a pattern that she appears to have repeated with father Y, after his death in 1965.

This relationship pattern of mother Y appears to have become the central point around which the subsequent nuclear formulations of Mr Y's family system developed. This involved a central, fused dyad together within a family system that may or may not have included other members (such as the half-siblings of Mr Y, as well as his step-father). The level of differentiation in the nuclear family system appears to have been very low. This would have influenced Mr Y in the sense that the low level of differentiation that characterized his relationship with his mother appears to have made him inclined to move towards fused relationships after her death, in line with the principle of homeostasis that would have characterized the family system. Mr Y appears to have repeated this pattern in his later life, with his co-accused, and the level of differentiation in this dyad appears to have also been very low, despite the isolation of the dyad from surrounding societal systems. Mr Y stated that "I think my mother was not very happy most of her life, you see the only person she truly loved was my father...and she was happy." He also described Mr H as "amazing...he was special...he never asked me for anything...he simply wanted to be with me, that was one of the best things I ever heard."

The nuclear family system appears to have also been very closed and rigid, preventing outsiders from entering. This can be seen in mother Y's attitude to the home and to visitors.

There appear to also have been few avenues by which some of the surplus undifferentiation and anxiety in the system could have been absorbed, and this may have taken its toll on the members of the system, namely Mr Y and his mother. Mr Y stated that

I wasn't allowed to have friends at home- I could go and visit them...their houses were much better...I think my mom was embarrassed due to the fact that she could not get on with people...people of her own age group and all that kind of stuff...I actually inherited a similar condition as hers...I don't particularly like having people around me...I never encouraged people to come and visit me.

Given that mother Y and Mr Y were so enmeshed and fused, it can be hypothesized that they would have had difficulty surviving without each other. This would have been compounded by mother Y's own fears regarding abandonment in significant relationships. There also appears to have been no room for conflict in this relationship to possibly prevent the breakdown of the relationship and system. Therefore, the two methods that were used to deal with the anxiety and undifferentiation in the nuclear family system appear to have been dysfunction in family members and projection.

It would appear that this pattern was repeated in the relationship between Mr Y and Mr H, although there appears to have also been an escalation in the level of undifferentiation and accompanying anxiety, as possibly reflected in the extremity of the above methods, namely to involving murder of others.

The premium on conflict avoidance in the fused relationship between Mr Y and his mother, as well as their distance from outsiders or members of the external family system at various points in time, may have inclined Mr Y and his mother towards developing behavioural symptoms to absorb some of the anxiety in the system. With respect to mother Y, this may have consisted of her hysteria, obsessive cleaning, as well as addiction to painkillers,

namely Grand-Pa® headache powders. With respect to Mr Y, this seems to have involved his early criminal behaviour such as shoplifting, and fraud, as well as involvement in the occult.

Mr Y and his mother also appeared to deal with anxiety and undifferentiation in the nuclear family system by projecting this onto a third entity. Paradoxically, however, this projection mechanism served to bring Mr Y and his mother closer together, and isolate them further from surrounding systems, contributing to even greater levels of undifferentiation that had to be absorbed in the nuclear family system, thus perpetuating the need to manage this anxiety in some manner that did not threaten the relationship (and thus maintaining system homeostasis). There are a number of examples of this in the Y family system.

In the early years of the nuclear family system, the extended family system appears to have served this function. Mother Y may have reduced her own anxiety levels by projecting them onto the extended family that were seen as an entity that needed to be avoided on account of their “simplicity” and “inferiority” to the nuclear family system. This also served the dual purpose of ensuring that Mr Y did not distance from her and move closer to father Y’s family.

The second significant target of projection mechanisms of the nuclear family system appears to have been Mr Y’s stepfather. By projecting the excess anxiety onto him and focusing on him as the aggressor or abuser, mother Y and Mr Y were able to get rid of some of the surplus anxiety in the nuclear family system. As a result, Mr Y’s stepfather may have developed problems such as heavy drinking, as a release for the system anxiety leveled at him.

Other possible targets for projection may have included Mr Y’s half-siblings and the memory of Mr Y’s father. In terms of Mr Y’s half siblings, they may have served a similar purpose to the extended family for mother Y and Mr Y and their departure from the household as soon as they were able to support themselves independently may reflect an

attempt to cut-off or distance themselves from the projected anxiety. With respect to the memory of Mr Y's father, by focusing on his probable wishes and desires for Mr Y, mother Y may have been able to project some of her own desires for Mr Y, and consequently, keep her dominant role in the fused relationship covert.

As with the development of dysfunction as a means of dealing with surplus anxiety and undifferentiation in the nuclear family system, Mr Y appears to have repeated this pattern of projection in his later relationships as an adult. This can be seen in his attitude towards Mr H's family who may have functioned as a target for excess anxiety in Mr Y's fused relationship with Mr H, in much the same way as Mr Y's mother had used father Y's extended family. This may have also been the role of the various murder victims, who served as targets through which excess anxiety in the relationship between Mr Y and Mr H could be managed, and the system could continue. For example, Mr Y stated that

because of all the crimes, everything started pouring out you understand, and because I basically crossed over from being a normal person to the person that did the crimes and I wanted to kill him [the step-father] because my mother had never been the same, the amount of abuse she went through, she just gave up.

- High anxiety levels in the nuclear family system (theme two).

As discussed previously, the Y nuclear family system had particularly low levels of differentiation. Bowen (1978) states that individuals frequently choose partners of a similar differentiation level. This may explain the low levels of differentiation that mother Y in particular brought to the various relationships that she was involved in within the and it may be hypothesized that father Y, as well as Mr Y's step-father may have also come from systems with low levels of differentiation and high anxiety or subjectivity. The violent behaviour and angry dispositions of both these individuals may be an indication of the above.

The levels of differentiation in the Y family system appear to have decreased even further after the death of father Y, when the nuclear family system was reduced to mother Y, Mr Y and his two half siblings, and mother Y attempted to substitute the loss of her close relationship with Mr Y with her relationship with Mr Y (which appeared to approximate almost complete fusion). In this way, the Y family system appears to have been exercising its principle of homeostasis; however, as a result of the considerable further decline in differentiation that would have occurred accordingly, there would have been a large amount of anxiety in the Y nuclear family system.

With regards to the high level of emotionality and subjectivity in the system, this can be seen in mother Y's high anxiety and hysteria, and father Y's violent outburst and inability to manage his anger as indicated in his crime. Mr Y described his mother as "totally emotional...I mean, she would freak out for the slightest thing" and his father as "he used to get angry very easily- he'd fly into a rage."

This low level of differentiation may have also been exacerbated by the fact that the Y family system appeared to grow even more rigid and closed after the death of father Y (1965) and particularly after the departure of Mr Y's siblings from the household (1969 and 1971 respectively). The system may have needed to find outlets for the accompanying increase in anxiety levels, which may have played an increasingly important role in influencing the actions and behaviour of both Mr Y and his mother, and possibly posing a threat to the fused relationship. Some of this tension may have been resolved via the introduction of a new member to the system in the form of Mr Y's stepfather, who could then serve as a target for the intense emotions on the part of Mr Y and anxiety of his mother.

The above, in turn, may have set up a pattern for Mr Y, and the systems of which he was a part, where outsiders to the fused, dyadic relationship may have been seen as means of reducing anxiety in the fused relationship. This can be seen in his criminal behaviour and

murder series, where the murder victims appear to have served as a focal point for intensely violent emotions on the part of Mr Y, which could then be kept from interfering with his relationship with Mr H.

The intensity of his jealousy and possessiveness in relation to Mr H may also be seen as a repeat of the above pattern, as a result of the low levels of differentiation that characterized the relationship between Mr Y and Mr H. Mr Y appears to have repeated this pattern in prison, in terms of his relationship with his cell-mate, Mr Z, as well as the various partners that he has had whilst in prison.

- Emotional cut-offs (theme three).

In the family system of Mr Y, it would appear that the mechanism of emotional cutting off or distancing and isolation functioned to preserve the fusion between two individuals involved in a close dyadic relationship, and isolate the dyadic system from surrounding systems and other members of these systems. Initially this relationship consisted of Mr Y and his mother, but later this pattern appears to have been repeated by Mr Y in his relationship with Mr H.

Mother Y's early experiences as a foster child may demonstrate patterns of developing emotional distance from foster caretakers and their families in order to prevent the trauma of separation that resulted when she was sent to a different home. This isolation and distance from those around her may have contributed further towards her apparent fusion with the idealized notion of her biological parents.

When mother Y started her adult relationships, she may have repeated this pattern, with her first and second husbands taking the place of her biological parents, and with her isolating herself from everyone else around them. When Mr Y was born, she became particularly close to him and developed a fused relationship with him, especially after the death of his father. Her relationship with Mr Y's step-father does not appear to have been of the same type as that

with her previous husbands, but he may have been important with regards to the Y family system, due to the resources that he added to the system in terms of money and financial support, as well as a form of outlet for the high levels of anxiety in the system (discussed in theme two). Mr Y stated that

in the beginning she probably fell for him [Mr Y's step-father] a bit but I think the way I looked at it, is now, I used to ask her, "Why don't you just divorce the guy? Leave him", and her words were always "What would happen to me?" Where would she go...she'd have nobody to look after her...she didn't have any skills whatsoever, understand, she wasn't going to be able to get a job.

The use of emotional cut-off is also evident in Mr Y's relationships. He appears to demonstrate a pattern of investing his emotions exclusively in a fused dyadic relationship with another individual (first his mother and then his subsequent partners in adult life such as Mr H), and isolate himself emotionally from everybody else. The extent of his emotional investment in the relationship can be seen in the way that Mr Y felt that he was not capable of sharing himself with more than one individual.

Mr Y stated that

I'm used to being a loner...that's why I can concentrate only all my energies and emotions on one person...I can't share it among several people – I find that extremely difficult, for the simple fact that it's difficult to actually- say you've got four people, four friends, how are you going to split up the amount of time that you have to spend with them? How are you going to be fair about who gets what? You know, dishing out your friendship to four people...

Mr Y's emotional isolation and cut-off from those around him may have also contributed towards his inability to empathize with those around him or to feel bound to any social responsibility towards the social or societal system of which he was a part. This inability to empathise with others may have influenced his criminal behaviour. When he committed the murders in his series, the emotional connection with Mr H appeared to consume all of Mr Y's available emotional investment (repeating the pattern of his mother). The system, in line with homeostasis and established patterns, may have satisfied established criteria for self-sustenance, and Mr Y may not have felt a need to form emotional connections with members outside of the dyad, or rigidly defended against this in order to prevent the dyad from being threatened. Mr Y may have felt little guilt or remorse over inflicting harm on outsiders, if such behaviour was perceived as ensuring the survival of the system. Any remorse he did feel appears to have been related exclusively to the possible negative effects that his actions may have had on his relationship with Mr H. Mr Y stated that "I'd never been so happy [when he met Mr H]...it was like you found your partner in life...the magic is there...but the emotional attachment to each other was far greater than anything I've experienced before in my life...it was unique" and that "I feel responsible for what happened, the fact that he ended up in prison as well...I need to speak to him, I need to get it off my chest, I need to ask his forgiveness." He also stated that

I was battling that fact that I'm killing people in order to survive...I mean, with my co-accused...and obviously, I know it's wrong [but] even to this day I don't feel...I don't think about, I don't think about the crimes unless somebody asks me...I don't have any nightmares about it, I don't have any guilt feelings about it.

- Fears of loss of self due to extremely fused relationships (theme four).

The centralized, fused relationship between Mr Y and his mother can be classified as pathological according to Ackerman's (1984) criterion, which stipulates that a pathological centralized family system occurs when all functions of the family are excluded except for one. This can be seen in the case of Mr Y and his mother, where the Y family system focused exclusively on emotional survival and support in one another, and other functions such as adequate parenting and socialization were excluded. Mother Y also assumed a position of pseudo-responsibility in relation to Mr Y. This changed as he grew older and took more of a one-up position. However, initially, mother Y spoke on Mr Y's behalf, decided that he would remain apart from the extended family, influenced him to believe that he was different from the extended family system, and shaped other perceptions of himself, notably in terms of his superiority.

Mr Y's involvement in the fused relationship with his mother appears to have contributed to fears of self-annihilation, or loss of self-identity in the fused relationship. In an attempt to assert himself and prove that he existed beyond the fused relationship with his mother, he may have developed behaviour and engaged in pastimes that defined him as different to the nuclear family system. Such behaviour may have included his academic achievements, sexual orientation, and involvement in pastimes such as bodybuilding and judo. His assertions that he was different from his family and that he felt that his soul had been swapped may all be attempts to prove that he existed as an entity independent to his mother, despite the fact that he could never reveal these parts of himself to her out of fear of conflict and the breakdown of the fused relationship. The need to be different appears to be a theme that runs quite strongly in Mr Y, as evidenced in his desire to also be different to the stereotypical homosexual male. Mr Y stated that "I don't look like your average gay guy...I don't react or think like that actually – or, I'm basically a straight guy that likes to go to bed with men."

Mr Y appears to have been caught in a paradox. Having fused with his mother, he was dependent on the relationship with her. However, the same relationship risked annihilating his distinct self identity completely. Mr Y appears to have developed ways of proving that a part of himself still remained, independent of the fused relationship, thus allaying fears of self-annihilation. However, because a large part of him depended on the fused relationship, he was forced to keep these ways covert from his mother, thus preventing conflict and a breakdown of the relationship. This pattern persisted with Mr Y throughout his later life in his relationships with others. This can be seen in the way that he had to take a complementary role to Mr H in their relationships, and this escalated as the relationship progressed and the two became closer. For example, Mr Y appears to have had to have been the strong, violent, aggressive, mature caretaker in relation to Mr H's role as the weak, dependent, submissive individual in the relationship.

To prevent the possible annihilation of the self in the relationship Mr Y may have asserted himself by taking the lead and controlling the relationship. Any situation in which he possibly felt that he was losing total control of the fused relationship may have triggered established patterns dealing with responses to fear over the annihilation of the self, such as distancing from other systems or individuals and fusing more intensely with one's partner. This may have sparked desperate attempts to retain control such as in the case of his relationship with Mr H, where the intervention of the Child Protection Unit members threatened to take control away from Mr Y. Consequently, he had to assume control in any way possible (to prevent what he viewed as self-annihilation) and ran away with Mr H, protecting the relationship from outside interference with violence and murder. Mr Y stated that "I think because of the fact that they wanted- they tried to split us up...that sort of- I had dreams and dreams and dreams about him and there I knew I changed...when I got out of there I was not the same person I was...I became more jealous there."

These patterns may be also seen at the higher tiers of the family system, such as with Mr Y's mother whose own early experiences in foster homes may have resulted in her developing emotional distance and isolation as a defence mechanism against growing too attached to temporary caregivers. Her fear of self-annihilation as a result of sharing herself with more than one individual may have been responsible for her fear of outsiders and her intense need to remain in her own house and to avoid other people. Mr Y stated that

I'm used to being a loner...that's why I can concentrate only all my energies and emotions on one person...I can't share it among several people – I find that extremely difficult, for the simple fact that it's difficult to actually- say you've got four people, four friends, how are you going to split up the amount of time that you have to spend with them? How are you going to be fair about who gets what? You know, dishing out your friendship to four people...

This statement is significant in that it illustrates the process by which fusion takes place in a relationship, namely, with the two individuals involved almost functioning as one self, but also accompanied by fears of self-annihilation, specifically in the individual who takes the adaptive role. This fear of self-annihilation may have been one of the reasons that Mr Y chose to leave home in 1981. The fact that his mother died soon after this can indicate the extent to which she was dependent on Mr Y in the fused relationship, and may have contributed towards Mr Y fearing a similar fate in his future relationships, if his partner were to leave him or the fused relationship was to be broken up by others (such as in the case of Mr H). Mr Y stated that "I couldn't stand staying at home, joined the railway police at that time period [after his compulsory national service] and it was six months later that my mother died."

- **Themes concerning multigenerational patterns in the Y family system.**

In terms of multigenerational patterns, the following themes emerged, namely:

- transmission of certain attitudes, beliefs and coping styles across generations as a means of homeostasis in the Y family system (Theme five);
- weak generational boundaries and poorly defined subsystems (Theme six); and
- a tendency towards periodic active intervention by the larger social system in an attempt at recalibration of the Y family system in line with social norms (Theme seven).

- Homeostasis mechanisms across generations of the Y family system (theme five).

It would appear that in order to allow the Y family system to sustain itself over a number of generations, certain aspects of the system had to be repeated across generations in line with the principle of homeostasis that characterizes systems in general (Bowen, 1978). These aspects may not necessarily appear to be beneficial to the individual members that make up a system; however, their repetition functions to sustain the overall system, and are consequently beneficial to it.

Some of the aspects that appear to have been repetitively passed on in the Y family system include the following attitudes, beliefs and coping styles, namely:

- anger management skills and violence;
- attitude towards relationships; and
- failure of individual members.

- o **Anger management skills and violence.**

The Y family system history appears to demonstrate a trend of violence and poor ability to manage violence across generations. The first reported incidence of this appears to be father Y, who bludgeoned his employer to death when he could not resolve a pay dispute with him. Given that Mr Y's extended family is either deceased or estranged, little detail could be obtained about whether these patterns were present in other areas of the extended family system. However, it would appear that this particular pattern was passed on to Mr Y. This may have formed part of Mr Y's inherited role and position in the Y family system as the successor to his father. Mr Y stated that "it [father Y's crime] was in a fit of anger. He had this argument with the employer- the guy owed him money for his pay and they had words and my father apparently became angry and hit the guy with a tyre iron, killed him..." He also described his own aggressive behaviour in the following way -

only after they [the hiking companions of the second victim] were away about an hour later, and after eating and I sort of started looking around and stuff and then, then it started affecting me- that reaction...and I became extremely aggressive, you know, because I was angry with myself...I thought to myself, this is completely unnecessary...it's messy, it's overkill.

The introduction of further violence and poor anger management skills with the arrival of Mr Y's stepfather (in the form of his physical abuse of mother Y) would have added to the presence of this behavioural trend in the family system as a means to resolve conflict and to express one's anger.

The implications of this for Mr Y were that, when the system of which he was a part was faced with possible change or perceived threats to the dyadic relationship, he may have defended against his fear of loss or change with anger and expressed this aggressively or

violently as a means to maintain the system. This can be seen in his criminal behaviour. When he was involved in conflict with the authorities at social welfare and the Child Protection Unit over his relationship with Mr H, and it seemed as if this relationship might end (and therewith the entire system) he responded with anger, and resorted first to escaping the threat by running away, and then actively preserving the system by murdering individuals that he perceived as further threats to the relationship. This can be seen particularly in the first and last murders, as well as the attempted murder, where Mr Y may have perceived Mr H's friend (the other runaway) as well as the other men that they attempted to con and manipulate as a threat to their relationship and solved this problem with violence, namely by murdering them. In this way, the system sustained itself, and was able to maintain (temporarily) its rigid and closed boundaries. Mr Y stated that "I simply just decided that he [the first murder victim] was a problem...he would be a problem...and- but then I must admit I understand why I suppose, I couldn't have a sensation, no hard feelings about killing him...I just went, strangled him...and that was the end of it."

o **Attitude towards relationships.**

Another behavioural trend that was passed down through the generations in the Y family system appears to have been a particular attitude towards relationships with significant others. Given mother Y's early abandonment and orphaning by her biological parents, as well as her movement through several foster homes, mother Y may have never truly felt like a member of the systems of which she was a part, viewing relationships as temporary and inconsistent. This may have been coupled with an insecurity and fear of abandonment and separation that had resulted from her loss of her biological parents. Mother Y may have aligned herself with alternative systems emotionally cutting off from the systems in which she was placed and fusing completely with a member of the new system, usually as part of a dyadic relationship.

This appears to have occurred firstly with her deceased biological parents, and then in her later relationships. However, each failed relationship in her life, appears to have been positive feedback in terms of the principle of fusion that operated in the various systems of which she was a member, resulting in fusion being more intense in each relationship that followed.

By the time that mother Y developed a fused relationship with Mr Y, her insecurity would have been particularly great. Perhaps her choice of Mr Y was based on the practicality that as her son, he was dependent on her, and would not abandon her. The fears and insecurities of mother Y, with respect to relationships, may have also resulted in her need to control and maintain the relationship at all costs in order to preserve the family system.

This attitude towards relationships appears to have been passed on to Mr Y in line with homeostasis. The trend of controlling the relationship and partner; fear of loss and abandonment; and dependency on the other in the relationship were all evident in Mr Y's relationship with Mr H as well as his partner in prison. Mr Y described his relationship with Mr H as

it was lovely, there was no- it was great, it felt like, you know, the feeling of actually having someone that needs you, you understand...being alone is I think- because you actually become blasé about having these feelings so you cut your own feelings down so now you meet someone that you actually fall in love with that person and then all those feelings that have always been packed away surface...and then...they are much more powerful...I think that's my biggest problem...controlling emotions.

Mr Y also stated that "I tend to get extremely jealous- I think it's that thing of worrying that someone else will take the person away, you understand."

To a similar extent, Mr Y's discomfort with his own independence or solitude may reflect the effects of the Y family system's imperative of homeostasis in terms of maintaining a rigid, closed system via a fused dyadic relationship –

I don't like being out of control, no control of myself, you understand...I have to be in control of myself because that's a scary feeling that you're on the outside, I mean being alone you have to- I mean, you're in charge of things around you...you don't have somebody else you can go to and they going to do the work for you now and that kind of thing, you understand, so you do everything yourself...so you have to control constantly.

o **Failure of individual members.**

Finally, there appears to be a repeated pattern of failure across generations in the Y family system. This failure appears to have occurred specifically in the area of money or financial security; adequate caregiving; occupational success; relationships; and respect of the law.

Mr Y appears to have attempted to escape this pattern by achieving his Matric [grade 12] and getting a good job; developing a good standard of living; getting involved in a stable, long-term relationship; and taking care of his mother. However, the principle of homeostasis in the Y family system appears to have resulted in the pattern of failure eventually repeating itself in the life of Mr Y, specifically after the death of his mother. Although he appears to have blamed his stepfather, he also felt that the death would not have occurred if he had remained at home. In Mr Y's opinion, he had failed in his primary relationship, and as a result, his subsequent relationships appear to have been attempts to succeed by applying "more of the same" where he perceived he had failed with his mother. To have failed with mother Y may have meant that he abandoned her in the same way as his father. Additionally, when his relationship with Mr H was threatened he may have resisted abandoning him at all

costs, resulting in his violent response. However, as a result of homeostasis in the Y family system, Mr Y's failure with regards to his significant relationships appeared imminent, given mother Y's own pattern with relationships, which was passed on to him.

The introduction of the occult into the Y family system as well as mother Y's reports concerning father Y's death and paranormal influence on Mr Y (Clinical Psychological Report on Mr H (17) and his relationship with Mr Y, 23 November, 1992), may have served to further consolidate Mr Y's role in the family system, as well as to ensure that Mr Y ultimately repeated his father's criminal and violent behaviour and failure in terms of also obtaining the death sentence and thereby ensuring the homeostasis of the system. Mr Y stated that

when I left home, I was worried leaving her [his mother] in the house...oddly enough, I knew it was not the right thing to do...but I had to make a choice, I had to think about my future, you understand...she made her choice...it seemed like things were alright there for a while...when I used to phone home and so on and go and visit, it seemed alright...because at that point in time I joined the police force and obviously, he started sort of behaving...but behind the scenes I was wrong.

Mr Y also stated that "I actually clapped my hands in court...I stood up and clapped my hands [when he received the death penalty]."

- Weak generational boundaries and poorly defined subsystems (theme six).

The Y family system appears to have been characterized by extremely permeable boundaries between the poorly defined parental and child subsystems. This is evident in the apparent parentification of Mr Y in relation to his mother, who became increasingly dependent on him for caregiving after the death of father Y. Mr Y may have struggled to develop the necessary

skills for developing relationships outside of the family system. Mr Y stated that “I wouldn’t say that she spoiled me but she had little things that she always bought and stuff to show me she loved me...and she had a miserable life...I mean she wasn’t a happy woman...the only happiness she had was me basically...”

Additionally, the lack of clearly defined boundaries between subsystems may have contributed further to the enmeshment between Mr Y and his mother. This enmeshment may have resulted in their over-involvement in each other’s lives, as well as a perception that separation from the system would constitute an act of betrayal. Mother Y’s death soon after Mr Y’s departure from the household appears to illustrate the extent to which the two were enmeshed, and that the survival of the family system depended on the dyadic relationship between the two.

The Y family system also appears to have been characterized by a rigid boundary between the parent-child subsystem and the grandparent subsystem. It would appear that members of the grandparent subsystem were prohibited from entering the parent-child subsystem consisting of mother Y and Mr Y to such an extent that there appears to have been disengagement of these two subsystems from each other. As parent and child became more enmeshed, this disengagement appears to have extended to include the larger societal system as well.

Given the lack of available supplementary information on the Y family system, due to the lack of other members of the system available for interviews, it is difficult to comment on the prevalence of the above structural pattern at other points in the system, and whether this may have been repeated as a means of maintaining homeostasis. However it does appear that this systemic structural pattern of enmeshment with a dyadic partner and disengagement from other systems was repeated in Mr Y’s other relationships, such as that with Mr H. For example, Mr Y described his relationship with Mr H as “perfect...I played the part...basically

I looked after him...we were perfect for each other...here's this kid that looked up towards me...I was looking after him- I was actually being a parent, lover, everything to him.”

It would also appear that the degree of fit between Mr H and Mr Y may have also been influenced by the extent to which the subsystems in each of their family systems complemented each other. It appears that in the H family system, the boundaries between parental and child subsystems were clearly demarcated; however, in contrast to the family system of Mr Y, where these boundaries were increasingly diffuse, in the case of Mr H, these boundaries were particularly rigid. Consequently, in the H family system, autonomy of the children may have been maintained, but at the expense of nurturance and involvement. It would appear that when Mr H and Mr Y formed their own system, Mr Y may have contributed resources to the system that were absent from the child subsystem of Mr H, namely nurturance and emotional involvement, which may have been very attractive to him.

This may have been compounded by the fact that Mr H is reported to have been isolated within his own sibling subsystem as well. The Clinical Psychological Report on Mr H (17) and his relationship with Mr Y (23 November, 1992) stated that “For her (mother H) it was obviously normal to give her craving son virtually nothing materially or emotionally despite repeated promises to do so” (p. 11) and that “the father (father H) was fundamentally uninterested in his son's conduct, and clearly ignorant of much long-established detail pertaining to the case and well known to his wife” (p. 13). Regarding the relationship between Mr H and Mr Y, the report states that “the relationship between the two accused is clinically termed symbiotic. Symbiosis...denotes a relationship of mutual interdependence in which each partner requires intimate interaction with the other literally for survival and development.”

- A tendency towards periodic active intervention by the larger social system in an attempt at recalibration of the Y family system in line with social norms (theme seven).

As indicated in the genogram (figure 3), two key events in the Y family system were the arrest and hanging of father Y for murder, and the criminal behaviour of, and serial murders committed by Mr Y. This would seem to imply that the social norms surrounding acceptable behaviour in society were not being integrated completely within the Y family system norms for behaviour. The larger external societal system may have had to intervene on two occasions to sanction members of the family system in an attempt to possibly bring about the recalibration of the Y family system to social norms via negative feedback.

In the case of father Y, this intervention was unsuccessful, specifically at the level of the nuclear family system. This may have been influenced by the isolation of mother Y and Mr Y from larger external systems on account of their fused, closed relationship. Mother Y may also have been skeptical of the broader societal system as a result of her experiences of social welfare as a foster child, the perceived injustice of the department of justice with regards to father Y's sentence, and her own difficulty with social welfare grants and support as a single parent. Any attempts to force compliance via negative feedback may have been lost on the nuclear family system, and distance from social norms may have increased with the greater isolation of the fused dyad of mother Y and Mr Y. This may explain the intensification of criminal behavior and deviance from social norms that occurred at the next level of the family system, namely with respect to Mr Y.

As expressed in interviews, Mr Y appears to have had little faith in the societal system and any accountability or allegiance to his membership of such a system appears to have been absent from him, even though he worked as part of an agency of such a system, namely the police force. This may have been more for his own sense of power and control, than a desire to espouse any social aims. Additionally, with little integration of norms and values of the

larger social system, mother Y may have been Mr Y's primary guide in terms of what behaviour was acceptable or permissible. In this regard, she was particularly under-responsible. Mr Y stated that

I never had parents that would come to athletic meetings or anything like that...because I mean I had no- all the others had their parents there and support and so on and here, you're on your own, you know...emotionally I had to start suppressing and realize that I'm on my own, and you have to do everything on your own...she [mother Y] tried her best to be a good parent but she was suffering continually...psychological problems and so on...I would say that my mother had a very low self-esteem...

Due to the fact that social norms appears to have played little part in influencing the nuclear family system, they may have played a minimal part in influencing Mr Y's role as a member of a family and social system. Norms with regard to acceptable social behaviour would consequently not possibly have placed a constraint on Mr Y's criminal behaviour. He would have most likely been more concerned about his mother's feelings on this matter. Due to the fact that she had passed away by this point, there may have been even less reason for him to check his decision to murder the victims, and may explain the coldness with which he approached his crimes, as well as his lack of restraint or hesitance in committing them.

Mr Y stated that

basically what it boils down to is that two overzealous policemen decide they want to arrest this gay guy and his younger lover and the two gay guys...decide well, no, this is not on and they start running and obviously, to their surprise, they commit one crime and it carries on, and gets worse and gets worse and gets worse...we were hunted...thing is, I needed to survive- I needed for us to stay together...oh well, I

knew it would be stopped...the odds were too great...but, we still tried, you see, we still tried to fight the system.

The pattern of the societal system attempting to force a recalibration of the family system via negative feedback appears to have been repeated in Mr Y's generation, when Mr Y received the death penalty, just as his father had. The system that he had formed appears to have collapsed (namely, with the separation of Mr Y from Mr H), and members of the societal system in the form of prison officials, as well as prison psychologists, continue to repeat and enforce societal attempts at recalibration by preventing the two from being reunited as well as monitoring Mr Y's relationships in prison, and preventing him from being released.

- **Themes concerning relationship patterns in the Y family system.**

Relationship patterns will be discussed with respect to the following themes, namely:

- the use of triads and triangulation to strengthen the dyadic relationship pattern in the Y family system (Theme eight); and
- the use of symmetrical and complementary patterns of interaction to negotiate power in the Y family system (Theme nine).

- The use of triads and triangulation to strengthen the dyadic relationship pattern in the Y family system (theme eight).

As discussed above, in the interpretation of the genogram, it would appear that a number of significant triads emerge. These will now be discussed in more elaborate detail, specifically with regard to their function within the Y family system, which appears to be mainly concerned with the preservation of the fused relationship.

It would appear that most of the triads in the family system functioned largely to preserve a fused, dyadic relationship between two members, triangulating around a third member who took the role of the bad guy in the family system or outsider against whom the fused members had to unite in order to protect the enmeshed relationship. This will now be illustrated with reference to a number of the significant triads that emerged in the genogram and interview details.

Figure 25. Foster/Adopted Triad One

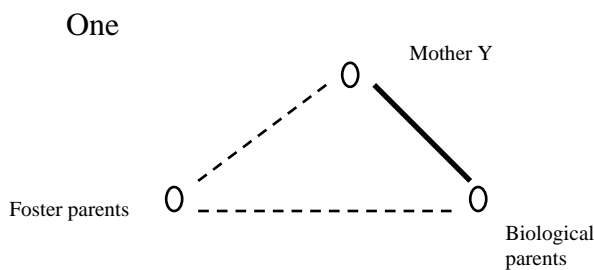
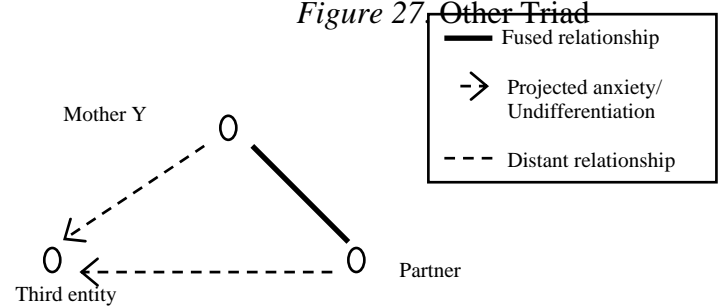

Figure 27. Other Triad



As discussed with respect to foster/adopted triad one, mother Y's experiences as an orphan and a foster child may have contributed towards her idealization of the relationship with her biological parents. She also appears to have resisted integrating herself in her various foster families, viewing her foster parents as possible threats to the idealized relationship, and resenting them for their perceived responsibility for the loss of her biological parents. Thus, in order for the maternal family system to be preserved, it may have been necessary for mother Y to sustain the relationship with the memory of her biological parents.

This patterns appears to have been repeated in later life as a means to sustain the other systems of which mother Y was a part, as can be seen in couples triad one. The high levels of undifferentiation that mother Y introduced into the systems that she entered may have overwhelmed the available resources of those systems possibly explaining the divorce with

her first husband, and conflict with her third husband. Additionally, her low level of differentiation in such a relationship and tendency towards fusion may have contributed towards increased anxiety in her partners, as evident in triads involving relationships with others, such as alcohol and extramarital affairs (as possible means of absorbing anxiety and asserting themselves in fear of self-annihilation). The pattern of the original triad, namely foster/adopted triad one, may have also contributed to the system needing one member (or alternatively an outsider to the system) to take the role of threat to the fused relationship, so that the system could preserve itself around the fused, central dyadic relationship. This can be illustrated in the various systems formed by mother Y such as:

- o mother Y's relationship with father Y, where the paternal grandparents took the role of threat to the system; and
- o mother Y's relationship with Mr Y, where both the where the paternal grandparents (multigenerational triad one) and Mr Y's stepfather (divorced/remarried triad two) took on the role of threat to the system.

Figure 23. Divorced/Remarried Triad One

Figure 24. Divorced/Remarried Triad

Two

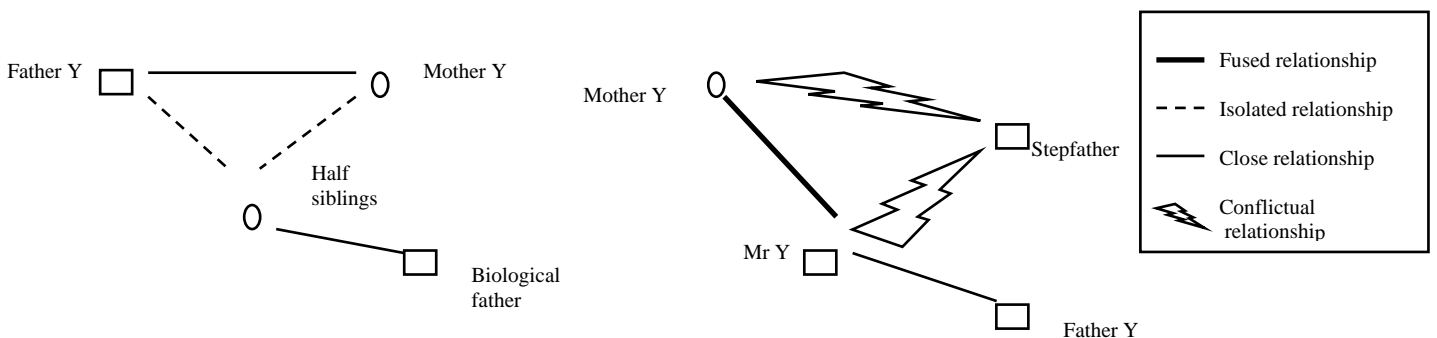

Mother Y's need to recreate the idealized, fused relationship of foster/adopted triad one in order to sustain the system of which she was a member, as well as the precarious nature of such a system, appeared to rigidify system boundaries and close the system to outsiders in order to preserve what resources were available. There also appears to have been a cutting off or distancing from other individuals within the system who did not form part of the fused, dyadic relationship or from members of other systems, outside the Y family system. This is evident in the isolation of Mr Y's half-siblings, when mother Y formed a new system together with father Y. This is also evident in the new system that resulted after the death of father Y, when Mr Y appears to have become the member who replaced father Y in the fused dyadic relationship, and together with mother Y, distanced himself from the extended family and other outsiders. For a while, this relationship drew strength and fusion at the expense of further isolation from Mr Y's half siblings as well as triangulation around these members of the immediate Y family system and the paternal grandparents in the extended family system. However, when the half-siblings left the system, a replacement would have been necessary to absorb some of the anxiety that otherwise might have overwhelmed the fused dyad. Additionally, the Y family system may have been depleted of some resources, mostly in the form of financial resources, and required a source for these. Mr Y's stepfather appeared to be the new member introduced into the Y family system to fill this position.

Figure 28.

Other triad two

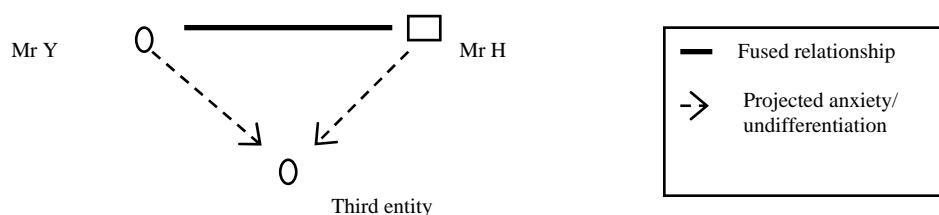

The above relationship pattern, which appeared to first be observable in the system in foster/adopted triad one, appears to be repeated as a means of sustaining the further systems of which Mr Y was a member. This is evident in his adult relationships with Mr C and Mr H. The fact that Mr Y's first relationship commenced the year in which his mother died illustrates the systemic principle of homeostasis which required a replacement for the deceased member in the Y family system, specifically in terms of the fused dyadic relationship to which Mr Y had become accustomed, and which appears to have been the structure around which the system sustained itself.

Additionally, due to the enmeshed nature of the relationship with his mother, Mr Y appears to have had a poorly developed sense of an autonomous self that could exist outside of a relationship with another. This may be reflected in Mr Y's apparent struggle with fears of his own annihilation after the death of his mother, possibly evidenced by his depression and heavy drinking after her death. Mr Y stated that "I joined the railway police at that time period and it was 6 months later that my mother died...that sort of knocked me and for a year I just went on the pot, fights in bars, stuff like that...I was involved with a guy [Mr C]...it was substantial"

Having discussed how triads within the Y family system functioned to maintain homeostasis within that system, it will be shown how the process of triangulation served a similar function within the system. Triangulation in the Y family system appears to have functioned to keep the dyadic relationship around which the system was centred fused in a coalition against a triangulated third member. This can be seen in the case of Mr Y and his mother, who formed the main fused dyad with the position of the triangulated third being taken by extended family members, the larger social system, as well as with Mr Y's step-father at various points in time respectively. These methods did not appear to be particularly

effective as can be seen in the way that the system eventually did collapse when Mr Y left the household.

As with the triads discussed above, this pattern appears to have been repeated in Mr Y's adult life and relationships, as in the case of Mr H, where the two formed a coalition against Mr H's family, possible rivals to the relationship, the social welfare system and Child Protection Unit, and ultimately, the murder victims. As with the original pattern, and in line with system principles such as homeostasis, this process of triangulation ultimately failed to sustain the system, as can be seen in the arrest and separation of Mr Y and Mr H in the end.

- The use of coalitions, alliances and complementary and symmetrical patterns of interaction to negotiate power in the Y family system (theme 9).

In terms of coalitions and alliances, the previous sections can be referred to for a discussion of how coalitions and alliances in the Y family system manifest themselves in the various triads and triangulation processes that occurred in the Y system. Suffice to say, the main coalitional pattern in the Y family system appears to have consisted of a fused relationship or coalition against other members of the system or other systems and outsiders to the Y family system.

Importantly, this coalition appeared to afford its members considerable power within the Y family system in terms of feelings of superiority and self-sufficiency, in spite of any marginal positions of powerlessness that these members of the fused relationship may have held respectively within other systems of which they were members. For example, mother Y held relatively little power as an individual member within the Y family system when she married father Y. It was only together with the heir to father Y, in the form of Mr Y, that her power increased in the system. Mr Y, held little power in the societal system as the son of a murderer or convicted and executed criminal, as well as a homosexual. However, in his fused

relationship with his mother (and together with Mr H at a later phase of his life), he appeared to have been made to feel superior and powerful.

With regards to interactional patterns, these can be discussed with reference to the pattern of complementary and symmetrical relationships in the Y family system.

- Complementary relationships.

There appear to be three significant complementary relationships in the Y family system, namely:

- between Mr Y and his mother;
- between Mr Y and Mr H; and
- between mother Y and Mr Y's stepfather.

These will now be discussed in turn with respect to how these impacted on power dynamics within the Y family system.

The complementary relationship between Mr Y and his mother initially consisted of mother Y in the one-up position, and Mr Y in the more dependent one-down position. However, as Mr Y grew older, he assumed the one-up position more regularly, with mother Y apparently becoming increasingly dependent on him for emotional support. As a result, a large proportion of Mr Y's role in the family system appears to have revolved around being in a one-up position as caregiver or provider in his close relationships (especially the fused dyad of which he was a part).

Additionally, mother Y's attempts to distance herself from the extended family system and develop a closer relationship with Mr Y in the form of a fused coalition against the extended family, may have influenced Mr Y's position in a complementary relationship with the extended family system, as well as all outsiders, and other systems. This relationship appears to have consisted of Mr Y assuming a one-up position of superiority in relation to

anyone outside of the fused, close relationship with his mother. The Y family system may have created an additional role for Mr Y, namely as being superior to, and more powerful than others.

In line with homeostasis, Mr Y may have felt impelled to continue performing this role, even with the death of his mother, in relation to the other fused relationships that he entered into with his partners. As this relationship was increasingly threatened, the system may have necessitated that this role be performed with increasing differential between one-up and one-down positions. In other words, as other systems impinged further on the viability of the fused relationship, it appears that it became more necessary that attempts to secure the one-up position of one of its members be more dramatic or extreme, which may explain the lengths that Mr Y went to secure this, namely by murdering members of external systems, thus apparently reducing their power. For example, when the Child Protection Unit members intervened in his relationship with Mr H, they threatened both his position of superiority (by portraying him as socially inferior on account of his sexuality), as well as his position as caregiver in the relationship. His sense of self may have been threatened on two levels, provoking the extreme actions that he took to reassert himself as powerful, dominant and able to take care of Mr H. This can be seen in the manner in which he committed the murders, as well as the desperation of his need to look after Mr H.

The fused nature of the relationship between Mr Y and his mother, and lack of any other significant relationships may have prevented a broader definition of Mr Y's roles as well as his self-identity in the system from developing. Mr Y's membership of the system appears to have been contingent on two very specific roles, namely, as superior or more powerful than others, as well as a successful caretaker and provider in his close relationships. Any experiences or relationships which may have questioned his capabilities in these two areas, may have been perceived as a disconfirmation of self and possibly aroused fears of self-

annihilation and loss of membership of the system in Mr Y, possibly provoking extreme measures to reassert himself as powerful and capable as a caretaker. This can be seen in his reaction to the arrival of his stepfather, which challenged his position as head of the household. Soon after the arrival of the stepfather, Mr Y took up bodybuilding and martial arts, as well as the occult. These may have all been attempts to reassert himself as a powerful and dominant member of the family system, out of fears of possible loss of his role and membership in the system.

The second instance where this pattern may be observed is after the death of his mother. Mr Y may have felt the threat of self-annihilation and collapse of the system due to his inability to fulfill the role of caregiver. This is evident in the depression that he suffered after the death of his mother. He may have attempted to reclaim this position in a number of other complementary relationships, in order to reclaim a sense of self, recreate the family system and prevent annihilation. This can also be seen in his choice of job, namely as a protector in the form of a railway policeman, and in his relationships, which all consisted of his partner occupying a one-down position of dependence.

Mr Y stated that

I regret the fact that I didn't manage to kill him [the step-father]...you see, it's almost like I owed my mother at least that for all the suffering and what she gave me, you understand...I wouldn't say that she spoiled me but she had little things that she always bought and stuff to show me she loved me...and she had a miserable life...I mean she wasn't a happy woman...the only happiness she had was me basically...and I felt that I sort of missed- I abandoned her at that difficult stage of her life by moving out of the house to stay on my own

As discussed above, the relationship between Mr Y and Mr H, appears to have satisfied Mr Y's need to be in a complementary relationship where he could occupy the one-up position as caretaker. This relationship also came at a time when Mr Y had lost his job with the police force, and with it, a source of confirmation of himself in the role of caretaker as well as the power and superiority that he drew from this occupational position. The ending of his relationship with Mr C, his first lover, also exacerbated this. As a result, the relationship may have been particularly intense due to Mr Y's increased need for self-confirmation with regards to his two roles.

As discussed in the previous section, the relationship with Mr H allowed Mr Y to perform both of his prescribed roles as caregiver and superior individual within the system that resulted. Attempts to preserve the power that he derived within the system as a result may have been particularly extreme, as in his evasion of being caught by police, as well as his violent behaviour while on the run - all possibly ways of demonstrating his superiority to others. Mr Y described the circumstances surrounding the third murder – "I decided to go to the toilet, I go to the toilet, come back, there this guy's got my co-accused there, now he's nice and pissed, you see and he's slobbering all over my co-accused and that makes me explode...and I attacked the guy, I immediately decided now I'm going to rob him and the whole trip."

The relationship between mother Y and Mr Y's step-father was complementary, with mother Y occupying the one-down position and Mr Y's step-father in the one-up position. Mother Y was submissive to Mr Y's stepfather. However, at times, when mother Y may have appeared to challenge his position in the relationship, Mr Y's step-father may have used physical abuse in order to reassert himself in the one-up position. This physical abuse may also have been intensified by possible competition for power in the family system on the part of Mr Y in relation to his stepfather and the role of primary caregiver. The use of physical

force to establish dominance and superiority may thus have been observed by Mr Y who used this method to assert himself at times when his one-up position was challenged in his future relationships.

Additionally, Mr Y may have been frustrated in this respect due to his limited ability to provide totally for his mother (that is, emotionally and financially) as a result of him still being at school and a minor. He may have developed a pattern of finding alternative ways to gain power over others and in the family system that did not involve financial means, such as may be seen in his discovery of the occult and introduction of this into the family system. This may be seen in his behaviour in the army where he would have been forced to assume the one-down position in relation to superiors. As a result, Mr Y found other ways in which he could reassert himself in the one-up position and feel superior or powerful in some way. This pattern can also be seen as a motivation for the murders that he committed in later life.

Mr Y stated that

18 months on the border- now there actually I should've known that something was wrong because something unusual started happening there...there was a bushman training camp...one sergeant said that if you see any dogs chasing horses...I must shoot the dog, because the horses are very important...and this somehow stuck in my head and every dog that I saw from then on, I shot...

- Symmetrical relationships.

There are two significant symmetrical relationships in the Y family system, namely:

- between Mr Y and his father; and
- between Mr Y and his stepfather.

These will now be discussed in turn with respect to how these impacted on power dynamics within the Y family system.

Given the pressure in the family system for Mr Y to follow in the footsteps of his father and take up father Y's role in the system, there appears to have been a symmetrical relationship between Mr Y and his father which consisted of Mr Y having to repeat and improve on the achievements of father Y. The failure of father Y to fulfill his role successfully in the family system appears to have affected this symmetry in that it escalated in the sense that Mr Y's achievements had to be considerably greater than those of his father in order for to compensate for the loss of resources and investment in the system. In other words, it appears that Mr Y had to outdo his father.

This appears to be evident in the way that Mr Y completed his Matric, and got a better job than his father had had. Ultimately however, the symmetry in the relationship appeared to revolve primarily around Mr Y's ability to successfully fulfill the role of caregiver for mother Y. Due to his early departure from the family system, father Y failed in this role. Mr Y may have felt pressure within the system (and specifically his subsequent fused relationship with his mother) to compensate for the loss of emotional resources in the system. This may also explain Mr Y's guilt after her death, which he felt was a direct consequence of his leaving the family household and not caring for her adequately.

This also explains the intense need that Mr Y may have had to look after Mr H in his later relationship. Mr Y may have viewed this as a second opportunity to prove himself better than his father, and as a result system pressure on his symmetrical relationship would have intensified, and attempt to outdo father Y increased in intensity similarly. This can be seen in the extreme nature of the measures taken by Mr Y to preserve the relationship such as going on the run, and committing crime to succeed in the role that father Y had failed in.

This symmetrical interaction between Mr Y and his father appears to also be reflected in the crimes that Mr Y committed. Whereas father Y murdered one individual, Mr Y murdered three individuals and committed other crimes such as assault and theft. Ultimately, the

societal system punished both in the same way for failing in their roles as members of society, namely, via the death penalty. This may provide further proof of the extent to which these individuals had isolated themselves from other systems, namely in that the symmetry in the relationship between Mr Y and his father, while operational in the Y family system, did not have a place within the societal system from which these individuals were detached.

Finally, there may have also been an escalation in the intensity of the consequences of failure in the sense that, when father Y died and ‘abandoned’ mother Y, she suffered a prolonged depression and withdrew further into the family system; however, when Mr Y left the household and “abandoned” his mother, she died.

The relationship between Mr Y and his stepfather appears symmetrical, largely on account of competition between the two to fill the role of primary male and head of the household in the Y family system.

As discussed in the section on complementary relationships, Mr Y was involved mostly in relationships that were complementary in the systems of which he was a member, with him occupying the one-up position, and another individual occupying a one-down position, whether this constituted a position of inferiority in the case of an outsider, or dependence, if in a close, fused relationship. When Mr Y’s step-father was introduced into the Y family system, he appears to have challenged the accepted relationship pattern, largely because he refused to occupy the one-down position with respect to Mr Y. Competition took place between the two, with Mr Y developing intense resentment for his step-father. However, being younger than his stepfather, and concerned for the well being of his mother, Mr Y could not express this resentment directly or challenge his step-father in anyway. Additionally, such a challenge may have possibly resulted in the collapse of the system, especially when the financial resources added to the system by the inclusion of Mr Y’s stepfather were necessary for the survival of the system. Mr Y could neither accept the one-down position in the interaction

with his stepfather however. As discussed previously, he may have drawn on other resources such as the belief that he was intellectually superior, gifted with supernatural powers, and a better emotional support for his mother, to make him feel that he was ultimately in the one-up position. Mother Y may have also had to take a more extreme one-down position in her interaction with Mr Y in order to maintain balance in the family system, through compensating for the possible loss of power that Mr Y may have experienced in his interactions with his stepfather.

In later life, when Mr Y did have the means to challenge similar symmetrical situations (such as with the Child Protection Unit, or other male individuals who he perceived to be challenging him to relinquish his relationship with Mr H), he may have been willing to resort to extreme measures to assert his physical and intellectual superiority in order to compensate for his relative powerlessness in his relationship with his step-father, in relation to mother Y. This may explain the excessive use of force and violence in the murders that he committed, and his motives behind many of the murders. One may argue that a significant motive behind the murder series that he committed, was ultimately to gain ultimate ascendancy in the symmetrical relationship with the stepfather by murdering him. Mr Y stated that "...that was the last one...that's when I decided well now...we're going to kill one more person – my step-father...so we go off to...[town in Gauteng Province] to get my step-father..."

- Summary of themes.

There appear to be a number of themes in the Y family system, with respect to emotional process, multigenerational patterns and relationships. It would appear that the Y family system was characterized by a large degree of anxiety (theme two) as partly a function of the low levels of differentiation in the system (theme one), reflected predominantly by the central point of the system being constituted of a fused dyadic relationship, detached from other

members of the system (theme three). This, in turn, appears to have contributed further to anxiety levels through fears of self-annihilation possibly experienced by members of the fused dyad in relation to the diffuse boundaries that characterized the relationship between them (themes four and six).

Additionally, there appear to be themes of homeostasis across generations of the Y family system maintaining patterns of anger management, attitudes to relationships and failure of individual members (theme five). Weak boundaries between poorly-defined subsystems (theme six) appears to be another theme that affected the Y family system, specifically in terms of further decreasing levels of differentiation (theme one) and increasing anxiety levels further (theme two) amongst other effects. Another important theme that seems to appear in the Y family system, is that of attempts of the surrounding societal system to recalibrate the Y family system with regards to societal norms on repeated occasions (theme seven). This also illustrates the homeostatic principle of the societal system.

In terms of relationships, triads and triangulation processes in the Y family system contributed to the strength of the fused, central relationship (theme eight), which also functioned as part of a repeated coalition pattern, as well as a number of complementary and symmetrical relationships that functioned to manage power within the family system (theme nine).

Mr Y's criminal behaviour appears to serve a function within all of these themes as has been reflected in the discussion above. Primarily, however, it would appear that the predominant role functions may have been concerned with:

- maintaining system homeostasis through attempts to maintain the superiority of the fused central dyad in relation to other systems;
- sustaining the Y family system through attempting to fulfill roles assigned by such a system and perceived as integral to the survival of that system;

- serving as a manner in which the Y family system could manage anxiety concerning the preservation of the fused central dyad and associated fears of annihilation or loss of identity of its members; and
- serving as a means via which the Y family system could prevent interference from outsiders or other systems into the fused, central relationship.

These are only a sample of possible functions that have been discussed in the above results, and many more may emerge from alternative perspectives on the data or repeated analysis in subsequent study. The sample highlighted in this discussion reflects those suggestions that the researcher feels are most strongly supported by the data. These will be addresses further in Chapter 8.

8. DISCUSSION OF FINDINGS, CRITIQUE AND RECOMMENDATIONS

To recapture, the focus of the study was to investigate serial murder from a family system point of view. To achieve this, the following question was proposed:

- “How does the family system of a person who commits serial murder function?”

That is, what is the family structure, who are the people in the family system and how do they maintain the family system.

This chapter will discuss the findings critically and then make suggestions or recommendations for future work. The two case studies of Mr X and Mr Y from Chapter 6 will now be compared and contrasted with regards to their similarities and differences according to their biographical data, genogram and the respective categories of thematic content analysis that were utilized, namely emotional processes, multigenerational patterns and patterns of relationships in the family systems.

8.1 COMPARISON OF MR X AND MR Y AND THEIR FAMILIES

8.1.1 Biographical information and genogram

In terms of biographical information, both Mr X and Mr Y are Afrikaans-speaking White South African males. They are of a similar age group, with both Mr X and Mr Y in their early forties. Both individuals trained as policemen, as part of the railway police. Mr X worked as part of the police force until his arrest, whilst Mr Y left the police and worked in various security firms and as a bouncer. Mr X has been involved in one significant heterosexual

relationship with Miss N while Mr Y has been involved in a number of homosexual relationships, the most significant of which appear to have been that with his co-accused, Mr H. Both individuals received the death penalty for their crimes, which was later revoked due to a change in the legislation. Both are currently serving life terms for their crimes. Mr X's victims were females of varying ages and races, while Mr Y's victims were predominantly white, homosexual males. Mr X's crimes involved rape and murder, whereas Mr Y's crimes involved murder predominantly. Mr X committed his crimes alone, whilst Mr Y committed his crimes together with his partner, Mr H.

With regards to family structure, both Mr X and Mr Y appear to be part of a nuclear family system that is relatively cut-off or isolated from the extended family system. Mr X appears to be part of a triadic structure, involving himself, mother X and father X, while Mr Y appears to be part of a predominantly dyadic relationship with mother Y. Both individuals appear to have occupied the position of functional only child. Despite having two half siblings it would appear that Mr Y speaks of his role in his family system as one as the only child, possibly on account of the short amount of time that the half-siblings were a part of the household and their isolation from the dyad involving Mr Y and his mother once they left the household.

Table 8.1

Comparison between Mr X and Mr Y (Biographical Information and Genogram)

	Mr X	Mr Y
Gender	Male	Male
Racial/ethnic background	White, Afrikaans-speaking	White, Afrikaans-speaking
Age (at time of research)	Early forties	Early forties
Occupational history	<ul style="list-style-type: none"> Trained as policeman (Railway police) 	<ul style="list-style-type: none"> Trained as policeman (Railway police) Security officer; bouncer
Sexual orientation	Heterosexual	Predominantly homosexual
Sentence	Death penalty (later changed to life terms)	Death penalty (later changed to life terms)
Victims	All female – various ages and races	All male – white and predominantly homosexual
Nature of crimes	<ul style="list-style-type: none"> Worked alone Mixed rape and murder 	<ul style="list-style-type: none"> Worked with co-accused, Mr H Mixed murder, attempted murder and assault
Education	Completed high school	Completed high school
<u>Family characteristics</u>	Traditionally nuclear	Single parent household; later introduction of step-parent
<ul style="list-style-type: none"> Structure 		
<ul style="list-style-type: none"> Primary relationship type 	Triadic, with mother and father	Dyadic, with mother
<ul style="list-style-type: none"> Sibling position 	Only child	Youngest, with two half-siblings but functional only child

- **Emotional processes.**

In terms of emotional processes, it would appear that both Mr X and Mr Y have family systems that seem to have exhibited low levels of differentiation. Both individuals also appear to have been involved in a dyadic, fused or enmeshed relationship while growing up and seem to have dealt with this in different ways. In both cases, the fused relationship appears to have served a central function in maintaining the family system and members of the respective family systems appear to have interacted with each other in manners that preserved the central fused relationship for this purpose. In the case of Mr X, this relationship involved him and mother X and appears to have persisted into his adult years. Mr X's murder and rape victims may have possibly functioned as a means to absorb some of the excess anxiety and other threatening emotions in the fused relationship so that this relationship could be maintained thus maintaining the homeostasis of the family system.

In the case of Mr Y, this fused relationship also involved Mr Y and his mother, but it would appear that Mr Y repeated this pattern with his co-accused, Mr H. It seems that in the same way as Mr X, Mr Y's murder victims may have also served as a means to absorb threatening emotions and anxiety that may have jeopardized the homeostasis of the dyadic relationship and family system created by Mr Y and Mr H. It would appear that the information above, namely close relationships with a maternal figure in the case of both Mr X and Mr Y, challenges much of the existing literature on individuals who commit serial murder (see Burgess *et al.*, 1986; Douglas & Olshaker, 2000; Ressler *et al.*, 1988).

It would appear that in both cases, anger as an emotional response was unacceptable within the respective X and Y family systems on the parts of Mr X and Mr Y, with only certain other members being able to engage in anger responses (such as father X and the maternal grandfather in the X family and the step-father in the Y family). As a result, Mr X and Mr Y may have been indirectly responsible for the management of anger within their

respective family systems, by refraining from adding to existing anxiety within the systems (via expression of their anger) and thereby maintaining emotional homeostasis of their family systems. Anger or other negative, anxiety-provoking emotions experienced by Mr X and Mr Y may possibly have been suppressed and accumulated over time until they were possibly expressed explosively outside of their family systems in the form of violence (or murder). The ensuing relief may have acted as positive feedback that encouraged the repetition of such behaviour as a means of relieving pressure from suppressed anger and maintaining homeostasis in the family system.

Figure 29. Emotional Processes in X and Y Family Systems

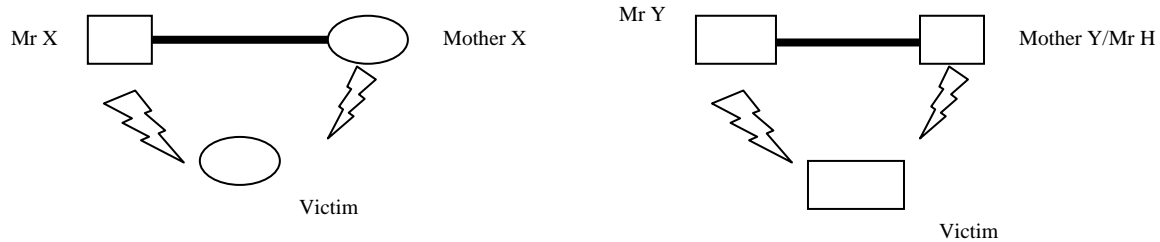

Due to their involvement in fused, enmeshed relationships, both Mr X and Mr Y may have feared a loss of self or identity in such relationships. However, both appeared to attempt to assert themselves in different ways. Mr X appears to have used the role of murderer or social deviant to achieve this, while Mr Y appears to have attempted to fill roles within his family system that deviated from the expected patterns associated with extended family such as Matriculant, intelligent and cultured man, and homosexual. Paradoxically, he ultimately repeated the behaviour pattern of his father by committing murder and being sentenced to death. Mr X also appears to have enacted a paradox in the sense that he ultimately repeated

his maternal grandfather's pattern of addictive behaviour (whereas his grandfather was addicted to alcohol) with regards to his murders.

The family systems of both Mr X and Mr Y also appear to have consisted of members that were emotionally cut-off from others in the system. In the case of Mr X, this appears to have been father X who was emotionally cut-off from Mr X and mother X, while with Mr Y, this appears to have been Mr Y and his mother who were emotionally cut-off from the extended family system (and later, Mr Y and Mr H who were cut-off from their respective family systems). Additionally, both Mr X and Mr Y appear to have been emotionally cut-off from the societal supra-system and positioned within rigidly closed family systems.

Figure 30.

Emotional Cut-Offs in the X and Y Family Systems

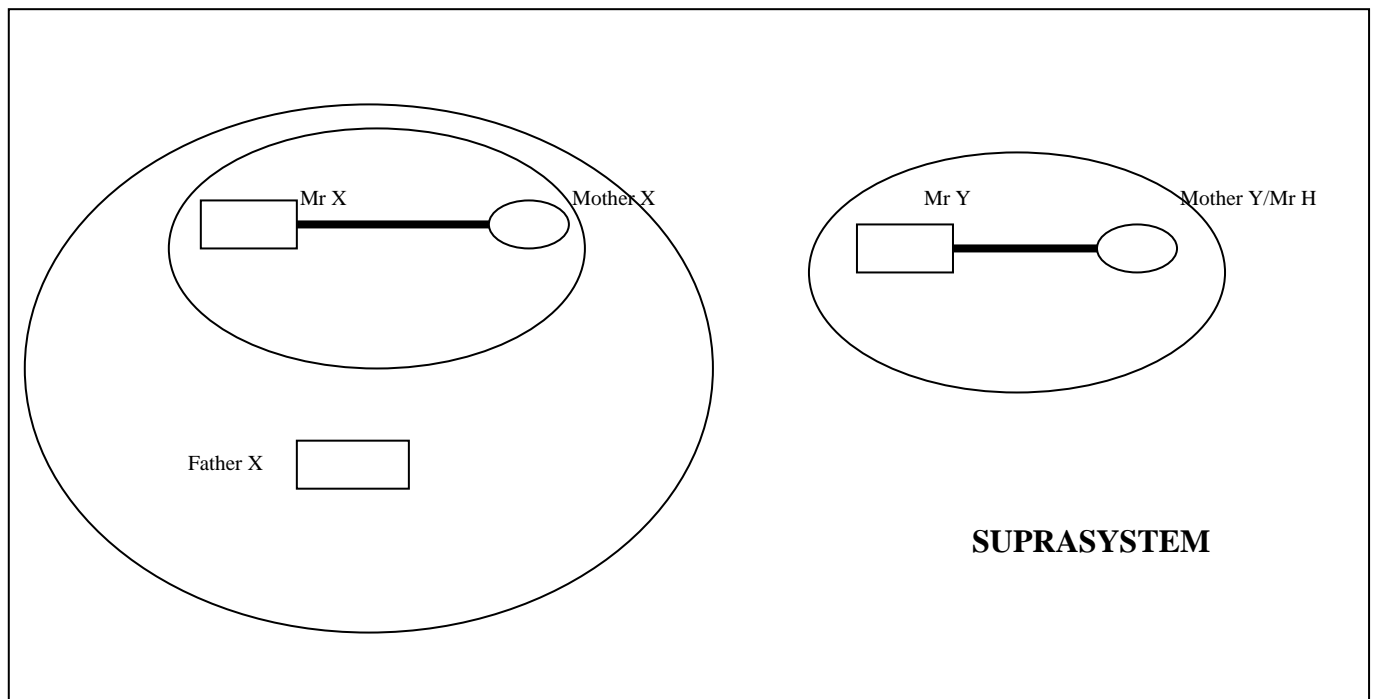

In terms of both Mr X and Mr Y, both of their respective family systems appear to have struggled to find effective ways of managing and expelling excess stress and anxiety that threatened homeostasis within the system. This may have been influenced by the paucity of

resources available to the respective systems, the rigid, closed nature of the family system boundaries as well as the 'symptomatic' patterns of behaviour passed down across generations of the family system, discussed in the following section. In both cases, Mr X and Mr Y appear to have assumed a particular role within the system with regards to managing anxiety and maintaining homeostasis by facilitating release points for excess emotion in the system. One way in which they achieved this function may have been via the introduction of new members to the system in the form of murder victims, onto which some of this emotion could be channeled. These were members who physically were also "cut-off" from the family; being the murder victims but into which some of the emotion could be channeled.

- **Multigenerational patterns.**

It would appear that both individuals were members of family systems consisting of parental and other sub-systems that were poorly defined with weak generational boundaries. In the case of Mr X, this appears to have been the case mainly in relation to his mother and maternal grandfather, where the parental and grandparental sub-systems had very diffuse boundaries with the maternal grandfather taking on the role of father to Mr X on many occasions. In the case of Mr Y, the parental and child subsystems appear to have had diffuse boundaries with Mr Y frequently taking on a parentified role in relation to his mother. Mr Y appears to have repeated this pattern in his relationship with Mr H as well.

Additionally, both individuals appear to have inherited the patterns of previous generations with regards to coping and management of anxiety and homeostasis in the family system. Mr X appears to have repeated the patterns of addiction (to murder in his case) and belligerence or aggression apparent at the grandparental level of the family system, as well as behavioural patterns of emotional cutting-off evident with regards to father X as well as the X nuclear family and the extended family system. Mr Y appears to have repeated patterns of

criminal behaviour and violence as seen at his father's level of the family system, as well as maternal patterns of relationship style. In this way, both individuals appear to have performed a role in maintaining the homeostasis of the family system, albeit in ways that were not necessary beneficial to individual members, including themselves.

- **Relationship patterns.**

In terms of relationship patterns, there appears to be evidence of the use of triangulation in the family systems of both Mr X and Mr Y. However, it would appear that the manner in which each individual was involved with triangulation processes in their respective family systems differed. Mr X appears to have played a more passive role in the triads of which he was a part, usually taking the position of the triangulated third. This appears to have taken place in relation to his father and mother, as well as his mother and grandfather. In these relationships, Mr X appears to have served as a means of preserving the relationship between the individuals concerned by absorbing some of the excess anxiety in these relationships in his role as triangulated third.

Mr Y, conversely, appears to have taken a more active role in the triads of which he was a part. In this sense, it would appear that he formed part of a dyadic relationship that frequently needed to introduce a third member in order to absorb excess anxiety in the dyadic relationship. This can be seen in Mr Y's relationship with his mother, where others such as his stepfather took the role of the triangulated third member, as well as in his relationship with Mr H where the victims of their crimes frequently took the role of triangulated third member. This also appeared to be evident in Mr Y's relationships whilst in prison, where prison staff such as warders and social workers, as well as other prisoners frequently took the role of triangulated third to preserve his dyadic relationships with individuals such as his cell-mate, Mr Z, as well as his various lovers.

In both case studies, it would appear that crime victims frequently took the role of triangulated third members as a means to possibly absorb excess anxiety in the family systems of Mr X and Mr Y, or in the relationships that they were involved in within the context of such systems. In this way, they also appear to have assisted the system in maintaining homeostasis with regards to levels of differentiation and relationship patterns. For example, in the case of Mr X, the spouses of his maternal grandfather appear to have functioned in a similar light, whilst with Mr Y, the spouses of his mother appear to have functioned in a similar way.

Another difference in the positions and relationships that characterized Mr X and Mr Y's participation in triads and triangulation within their family systems involves the manner in which threats to the relationships that characterized these triads were perceived. Whilst Mr X appears to have been part of triads where the threat to homeostasis within such triads came from one of the members of the family system, Mr Y appears to have had threats to homeostasis constituted by a blend of individuals from inside the family system and external to the family system. In the case of Mr X, the stability of the triadic relationship between himself, mother X and the maternal grandfather was frequently threatened by increased anxiety on the part of the maternal grandfather and mother X, whilst in Mr Y, threats to the stability of his dyadic relationship with mother Y appeared to come largely from his step-father, or extended family members, whilst with Mr H, these threats came from outside of the system in the form of members of the societal supra-system (such as other homosexuals, or members of the police force or social welfare).

In terms of coalitions and types of relationships within the family systems of Mr X and Mr Y, it would appear that there were some differences between the two individuals' involvement in such relationships. Mr X appears to have been involved predominantly in complementary relationships in his family system, with him predominantly taking the one-

down position, specifically in relation to his mother and maternal grandfather. It would appear that any attempt on Mr X to occupy a different, one-up position contributed further to anxiety in the family system and was prevented by homeostatic mechanism in the family system. This can be seen in Mr X's arguments with his mother while growing up and with his grandfather in later life. In relation to his victims however, Mr X appears to have taken a one-up position, thus lending weight to a possible hypothesis that these relationships with victims served possibly to balance the extent to which Mr X took the one-down position in his own family system. Additionally, Mr X's occupation of the one-down position in his complementary relationships in the family system appears to have repeated the patterns of father X, who appears to have also predominantly taken the one-down position in his relationships.

Mr X's relationship with his maternal grandfather appears to have been an important coalition within the family system, specifically with regards to regulating processes within the nuclear family system and with regards to empowering Mr X within the family system. His falling out with the maternal grandfather, and the death of this individual soon afterwards may have depleted Mr X's power and the stability of his position within the family system. The escalation in criminal behaviour of Mr X during this period may have served as an attempt to regain stability and power.

With regards to Mr Y, there is a variation in the character of his relationships within the family system with regards to symmetrical and complementary types. The fused dyads of which Mr Y was a part within his family system appear to have consisted of complementary relationships with Mr Y in the one-up position. In this way, he appears to have held considerable power within the family system. In terms of the symmetrical relationships of which he was a part, these appear to have been in relation to a specific type of individual, namely a powerful male, possibly in a competitive context. This can be seen with regards to Mr Y's relationship with his father (and the memory of his father), as well as his step-father.

In contrast to Mr X, Mr Y's relationship with his victims appears to have operated on a similar symmetrical premise, where many of the men were seen as threats to his relationship with Mr H, and escalated until Mr Y forced a complementary form of relationship by positioning himself in the one-up position by violent means.

In both cases, it may be that the individuals concerned committed murders to escape the homeostatic processes in the family in the sense that the experience of this was so destructive or annihilating that the individual concerned may have felt the need to perform some extreme act to voice his individuality or difference and prevent complete loss of self in fused or enmeshed relationships.

8.2 CONTRIBUTIONS TO THE GENERAL LITERATURE

As discussed in chapter 1, serial murder is a phenomenon that has been studied from a number of different perspectives, such as law enforcement in terms of developing profiling techniques and typologies or classification systems (Holmes & DeBurger, 1988; Leibman, 1989; Ressler & Schachtman, 1992); psychological perspectives in terms of attempting to understand factors such as personality and its impact on criminal behaviour (Douglas & Olshaker, 2000; Harbort & Mokros, 2001; Pinto & Wilson, 1990), as well as possible (or impossible) rehabilitation or offender management strategies (Pistorius, 1996; Ressler, 1997); and many other fields such as criminology, sociology and psychiatry.

This study has demonstrated that it is possible to understand the phenomenon of serial murder from another domain within the broader realm of the psychological approach, namely, via family systems theory. Additionally, this study has also indicated that adopting such an approach may yield novel possibilities in terms of contributions to the wider body of literature

on the topic as well as possible rehabilitative or management applications after such individuals have been apprehended and sentenced. These will be discussed in greater detail.

The application of family systems theory to the study of serial murder has also raised the possibility of using such an approach with other types of criminal behaviour in order to understand the role that the family system plays in maintaining such behaviour or patterns of relationship, as well as the role of this “symptom” within the family system. Findings could then be compared and contrasted across sub-types of criminal behaviour, as well as different family structures and individuals. The genogram, in particular, may be a powerful tool for achieving these objectives, as will be discussed below in terms of methodological developments.

Finally, this study makes a considerable contribution to the international body of literature on the topic of serial murder due to the accessibility of individuals who have been incarcerated for serial murder. In other countries, researchers are frequently unable to gain access to incarcerated individuals and hence lack the opportunity to explore related topics (Beyers, personal communication, 2005). As a result, the findings in this study may be of use to those who are not able to conduct similar research in their own countries.

8.3 DEFINITIONS

In terms of definitions of serial murder, the family systems perspective illuminates new possibilities for a framework that views serial murder as a function by which a system attempts to communicate a particular message; deal with a set of circumstances; manage disequilibrium or instability as part of negative and positive feedback mechanisms and homeostasis; or facilitate outlets for excess anxiety within the system. Such a definition may then focus explicitly on a definition of serial murder purely in terms of the behaviour involved

and thus preclude issues related to factors such as specification of gender, victim number, and sexual aspects to name some of those discussed in chapter two, as well as other demographic factors such as race, age, or socio-economic background. The generic definition specified in chapter two could still be maintained in terms of identifying an instance of serial murder; however, the above conceptualization of serial murder in terms of family systems and behaviour could then be added to the other definitional elaborations (such as Douglas & Olshaker, 2000; Labuschagne, 2001; Pistorius, 1996; Ressler *et al*, 1988, for example) as an alternative way of understanding the phenomenon.

8.4 HISTORY

In terms of the history of serial murder both internationally and in South Africa, a systemic view of serial murder raises a number of possibilities with regards to the perspectives from which the emergence of serial murder as a phenomenon and its development over time can be viewed. Firstly, it may be the case that different systemic configurations with regards to the larger societal supra-system influenced the role of serial murder within such a system. Consequently, this behaviour may have served different systemic purposes over time. This may also have altered with regards to emerging alternatives, as the family as a system has evolved, developed and changed over time. Changes in the historical, societal system may have impacted upon family types, and in turn, family systems may have found alternative ways of communicating messages; alternative types of relationship patterns and interactions; as well as alternative means of maintaining homeostasis. One of these alternative symptom presentations may have involved the development of serial murder. Therefore, over time, one may possibly be able to link the

“emergence” of serial murder to the emergence of changes in the societal supra-system and/or different family types.

With reference to discussion in chapter 2 regarding the history of serial murder, a systemic perspective challenges the predominant linear perspective that has been adopted by researchers (such as Anderson, 1994; Ferguson *et al.*, 2003) and would appear to make questions such as when was the first case of serial murder less important than those that explored the nature of societal systems that produce serial murder as a symptom or as a means to achieve a certain function. In this light, the systemic perspective would appear to extend understandings of serial murder from a historical aspect along the lines of researchers such as Jenkins (1994), Simpson (1999), Whitman and Agutagawa (2003), and Wilson (2000).

Secondly, the history of serial murder has traditionally examined such a phenomenon by focusing primarily on the individual. By viewing this phenomenon as a type of interaction or relationship pattern within a system (in line with a systemic view), an alternative history could be traced or documented to supplement existing historical data, and possibly illuminate different patterns or developments in the form and nature of serial murder over time.

Lastly, the history of serial murder viewed in a more systemic light may indicate when the systemic context (in terms of the type of family or larger societal supra-system) was amenable to reflect serial murder as a message or communication. In other words, what is it about a system that makes serial murder as a relationship pattern or message visible and communicable? And historically, what developments occurred to facilitate this?

8.5 CLASSIFICATION SYSTEMS AND TYPOLOGIES

With regards to the typologies discussed in chapter 2, many of the categories and classifications of serial murder could be interpreted via a more systemic view, in line with

certain theoretical principles. For example, the power/control serial murder type of Holmes and DeBurger (1988), could be viewed as an individual who frequently possibly repeats complementary patterns of relationship and finds it necessary to be in the one-up position. Consequently, the emphasis moves away from a focus on intrapsychic factors such as need for omnipotence to more systemic, interactional factors such as relationship. In terms of profiling initiatives, this could be used to predict other situations in which the individual would be able to repeat such a relationship pattern in other areas of his/her life such as work or social situations.

8.6 THEORETICAL ASPECTS

This study makes a considerable contribution to the body of traditional theoretical data that explores the phenomenon of serial murder, due to the fact that such a body is devoid of any attempts to examine serial murder from a systemic perspective. Consequently, not only does this study illuminate different ways of understanding serial murder, but it also produces novel opportunities for the further study and investigation of serial murder.

The systemic viewpoint does not exclude the possibility of other theoretical perspectives (such as psychodynamic, neurological and cognitive theories, for example, in chapter 3) but rather chooses to focus on a different aspect or contextual setting in which this phenomenon is explored, namely the family system (or societal system alternatively in future studies).

The systemic theoretical viewpoint also raises the question of whether serial murder should be viewed as an outcome of a certain personality type, or intrapsychic, individual characteristics of the individual concerned; or whether it should be viewed as the result of a particular type of interaction in a system. As discussed in chapter 3, traditional theories that have explored serial murder appear to have focused on the former approach, and have adopted

a largely linear causal model to explain serial murder (see Douglas & Olshaker, 2000; Holmes & Holmes, 1996; Pistorius, 1996; Ressler et al., 1988; Ressler & Schachtman, 1992; Whitman & Akutagawa, 2003, for example). To date, serial murder continues to evade comprehension and comprehensive explanation.

A systemic approach that allows for more circular notions of causality, together with a focus more on the behaviour or patterns of relationship concerned, may be able to explain the phenomenon more effectively, especially if used to supplement existing theories in a holistic framework, rather than being forced to situate itself on either side of the individual/behaviour theoretical dichotomy. Such applications can include extension to possible rehabilitation or management of incarcerated individuals who have committed serial murder if such behaviour is viewed within a systemic framework that understands serial murder behaviour as a symptom of instability or problems in the family system, and sees the development of the symptom as a possible attempt to enlist resources from the larger societal system with regards to restoring prior patterns of functioning. These resources could be seen as deriving from the criminal justice and/or correctional system. This would then contradict the proposals of both Pistorius (1996) and Ressler (1997), which state that rehabilitation is not a possibility for individuals who commit serial murder.

Related to the above suggestion, the question then arises as to the reason for the manifestation of serial murder as the particular symptom within a family system; explanations as to why some other symptom could not have possibly served the same purpose (for example, stealing or fraud); and why other family systems with similar circumstances do not “produce” serial murder. This may be a significant area that could be explored in further research studies and possibly yield answers that differ from traditional focus on genetic factors (such as Kumra *et al.*, 1998; Schroder *et al.*, 1981; and Stephenson, 1992) to explain

individual differences in manifestation of criminal behaviour (especially when environmental factors remain constant).

In the spirit of circularity, and second order cybernetic approaches, it may be hypothesized that systemic theory may in turn be influenced by its application to studies of criminal and deviant behaviour such as serial murder, and that further engagement in such areas may spur new theoretical concepts within the broader area of systemic theory. This reciprocal process does not appear to be possible with other theoretical approaches such as psychodynamic (Schwartz, 1999) and cognitive-behavioural and learning theory (Moorey, 1996) models where interpretation and application appears to operate in a top-down, linear fashion with respect to serial murder.

Finally, this study did not address possible systemic influences with regards to the larger societal supra-system. In a country such as South Africa, that has undergone considerable changes in the societal supra-system over the last 10 years, and where the emergence of serial murder appears on the surface to be related to such changes, it would be interesting to examine the possible impact of the societal system on family systems and the interaction between the two systems as well as their assimilation or resistance to assimilation which may have characterized, and possibly continues to characterize, such interactions. This is particularly salient also given the role that Bowen (1978) hypothesizes that societal regression may play in affecting anxiety levels and levels of differentiation within systems, as well as the permeability of system boundaries. Additionally, this would not limit the “emergence” of serial murder as a societal symptom to certain periods of time in South Africa’s history (such as post-1994), as has been postulated in existing theory (see Hodgskiss, 2003; Labuschagne, 2003; Pistorius, 1996, for example). It would rather view serial murder as a symptom that could emerge at any point in time given certain societal circumstances.

8.7 METHODOLOGY

A qualitative methodological approach also facilitates a more interpretative approach to serial murder, and its emphasis on relationship rather than causality made it very amenable to the systemic theoretical paradigm that informed the study. Given the important role that contextual factors play in understandings of family, as well as the flexibility required to appreciate and incorporate the nuances of different family systems and interactional style, the qualitative approach has shown potential for illuminating possible explanations for differences in the manifestation of instances of serial murder, and for exploring each instance in its entirety and its own right as opposed to searching for underlying commonalities that may be generalized across the phenomenon type.

In terms of methodological contributions, this study has demonstrated the usefulness of the genogram as a method for illustrating family systems and relationships diagrammatically. With regards to serial murder, this method could be applied to an individual who has committed serial murder once incarcerated in terms of his/her relationships within the correctional system. One might then be able to predict how such an individual may function in terms of his/her relationships with other inmates and staff based on repeating patterns in the family system genogram. In this way, the genogram may be a useful contribution to offender management and may inform possible interventions in this regard.

The qualitative research criterion of reflexivity with regards to the researcher also lends itself well to the systemic principle of second order cybernetics, or the importance given to how the therapist or researcher or individual (“outsider”) who interacts with the family system is assimilated into such a system, and transformed as part of such a system, in addition to making his/her own impact on the family system (Goldenberg & Goldenberg, 2004). In this sense, it was important for the researcher to assess how she may have been influenced by the

family system she was temporarily a part of; whether the system assimilated her easily or resisted; and how her observations, interview style, interactions with family members, and view of the study may have been shaped by such an interaction.

For example, conducting interviews at the family home (as was the case with Mr X's family) resulted in the researcher taking a one-down position due to her own concerns about intruding upon frequently rigid family systems who had little room for the introduction of outsiders. As a result, interviews may have been more social than initially intended, and potentially painful questions phrased carefully or avoided. It would possibly be interesting to conduct follow-up interviews at some point with families to assess how the system may have been affected by the brief participation of the researcher.

The study will now be evaluated in terms of its fulfillment of the four criteria for qualitative research.

8.7.1 Evaluation of qualitative research.

As discussed in chapter 5, qualitative research should be evaluated according to the principles of:

- credibility;
- transferability;
- dependability; and
- confirmability (Marshall & Rossman, 1995).

Credibility requires that the researcher must demonstrate that the study was conducted in such a manner that the subject was accurately identified and described. In line with the stipulated definition in chapter two, namely, multiple murders committed over a period of time by one or more individuals and difference between a generic definition and elaborations thereof, the

researcher made use of case studies that fulfilled these criteria and additionally, added an additional, alternative elaboration of the generic definition, namely that serial murder may reflect a pattern of behaviour that functions as a symptom within a family system; as a means to maintain homeostasis; or as an outlet for excess anxiety in the family system. Additionally, all families used for the purpose of the study (real and perceived) conformed to the stipulated definition in chapter four, namely the group of individuals or individual, biologically related or otherwise, with whom one is involved in intimate, interactional relationship/s over time; and whom one subjectively recognizes as playing a significant role in this regard.

Transferability refers to the question, how applicable or transferable are the findings to another setting or group of people? As discussed previously, the findings of this study could be transferred to the individual concerned in his current correctional setting to inform and predict relationship patterns that he may be involved in or repeat given those present in his genogram and family system. Findings could also be applied to different types of case studies (for example, individuals of different races or having committed different types of crimes) in order to compare and contrast family system processes and factors. Findings could also be applied to different contextual settings such as other countries or cities to examine differences and similarities in patterns.

Dependability refers to the degree to which one can be sure that the findings would be replicated if the study were conducted with the same participants in the same context. Given the rigidity and premium placed on homeostasis within the family systems involved in this study, there is considerable probability that the study would yield similar results in conducted with the same participants and the same context. Changes that might compromise dependability may consist of possible transformations or alterations of interactional patterns or introduction of new input in other systems in which participants are involved (for example, the researcher's own family system or the correctional system of which the individual who

commits serial murder is a member). Additionally, changes in theoretical aspects (in line with the continual evolution of epistemology) might result in different results if the study were to be conducted again.

Confirmability refers to the extent to which the findings are reflective of the subjects and the inquiry itself rather than being brought about by the researcher's own prejudices. To this end, it is important to address certain prejudices or biases that may have influenced the researcher's interpretations of the phenomena studied. In the current study, the researcher may have been influenced by preconceptions concerning the "types" of families that individuals who commit serial murder are members of. This may have been influenced by literature that has addressed the role of the "dysfunctional family" in serial murder as well as popular preconceptions. To this end, she attempted to compensate for any preconceptions by adopting a more neutral stance towards such families, and may have tended to overcompensate by emphasizing positive aspects related to such systems in her own mind and playing down, not noticing or rationalizing more negative (or less positive) aspects.

The researcher also comes from a background that has involved predominant work within linear causal, pathology-oriented and intrapsychic approaches. Consequently, she may have occasionally viewed processes and interactions within family systems in these terms as opposed to a more systemic, relational, circular approach, and have had to adjust accordingly on noting her alternative punctuation of events in the former manner.

The researcher's own ethnicity (namely, White, English-speaking) may have inclined her towards cases of individuals from a similar background (namely, White) that could speak the same languages (namely, English and Afrikaans). This may have resulted from an ease of communication as well as possible interest in personal commonalities. In light of the above, confirmability should be evaluated accordingly, with the stipulation that the researcher did

integrate the above into her analysis of the data and compilation of findings, as well as critique and recommendations below.

8.8 CRITIQUE

Firstly, the **sample** is relatively small albeit this is not a particularly salient concern given the qualitative nature of the research undertaken. However, one may argue that considerably different data and results may have been obtained with other individuals. This research did not aim to generalize to the population of individuals who have committed serial murder as a whole and it is understood that the findings obtained pertain specifically to a small segment of those individuals who have committed serial murder in South Africa, at a particular geographical and temporal point, and from a particular background, and should be applied and interpreted as such. It would be of interest to compare findings from possible future research that targeted other individuals who have committed serial murder from similar and different backgrounds to those individuals used in the current study.

Family information available also varied between case studies and it was not always possible to get the **desired quality or quantity of data**. For example, details surrounding the paternal side of the X family system were relatively vague and less elaborated than those for the maternal side of the family system due to the avoidant and guarded interpersonal style of father X. This style also appeared to have resulted in the X nuclear family members also being less able to discuss the paternal side of the family system. Consequently, statements proposed with regard to the family background and organization of family of origin of father X are particularly tentative. However, this aspect of data collection may be integrated as further information of the relational styles and interpersonal interaction between father X and other systems, as well as members of the X nuclear family, especially Mr X.

With regards to Mr Y, it was not possible to interview other members of the Y family system, other than Mr Y. Consequently, statements proposed with regard to the family background and organization of extended family are derived entirely from interviews with Mr Y, and may reflect a singular perspective on the family system. Steps were taken to guard against such an approach to limit a decrease in reliability (see chapter 5). However, this aspect of data collection may be integrated as further information of the isolation and detachment of Mr Y, together with the intensity that characterized the fused relationships of which he was a part.

The above is an indication of the difficulty of addressing serial murder from a family theory point of view. Families appear to be reluctant or “absent” seeing that murder and serial murder within a family system seems to defile other members of that system. This may explain some of the difficulties in obtaining full details from family members, or locating relatives of the individuals who commit serial murder.

With regards to **data analysis**, the themes obtained in this study for Mr X and Mr Y may vary with respect to the perspectives of other researchers who might examine the data in separate studies, informed by their own orientations, as well as with respect to the data obtained (with respect to alternative or additional sources) and method of analysis used.

The use of the family home as a **setting** for interviews with family members was also not ideal due to the lack of neutrality that characterizes such a setting. The researcher felt more inclined to adopt a social and obliging position with regards to interviewees in such settings which may have influenced the ways that interviews were conducted and data obtained accordingly. The families may also have felt intruded on and inhibited in their communication. In future studies, this may be an important consideration. On the other hand, viewing the family within a context where, as a family, they have developed over time (if so),

their interactions and interpersonal styles have developed and patterns have been formed, could prove to be equally valuable.

Like the researcher, researchers should be aware of their positions with regards to **gender**, culture/ethnicity, socio-economic status, education level, religion, and age and consequently should allow for influences by these particular aspects in their interpretations of the data as well as interaction with individuals and systems. In turn, the reciprocal nature of interactions between researchers and respondents should also be kept in mind.

The individuals interviewed in the current study are presently serving prison sentences for their crimes and are incarcerated. It may be the case, that individuals in **different circumstances** (such as those who have not yet been apprehended) would provide different responses and data. Consequently, once again, the specificity and particularity of the current sample and applicability of findings must be held in mind critically. Additionally, the changes in context that occur once a person has been incarcerated may possibly position such an individual within a different “family” system or social structure. Consequently, the processes or patterns of his incarcerated life may have contaminated the research.

One aspect of this process may be the **time lapse** between apprehension and incarceration. The family system may have been slightly different in terms of processes when the individual concerned was committing the murders or when apprehended. This emphasizes the contextual specificities of the current study, that is, that the cases concerned are located at a particular time, place and point in the family life cycle and should be interpreted as such when reviewing the results, findings and conclusions.

Whilst clinical observations, interviews and genogram method were selected as methods of data collection for the current study, a plethora of **alternative data collection methods** exist that could also have been used and which could supplement the existing methods. For example, although in this study, a participant was interviewed separate to his family,

interviewing individuals who have committed serial murder and their families together, and also utilize techniques such as family sculpting to supplement genogram compilation may prove useful. Alternatively, it may also have been of interest to study the family system over a longer period, stemming a number of sessions together with the family. Future work may address this and examine if additional findings yield novel insights.

8.9 RECOMMENDATIONS

Given the findings of the current study, future research may examine the following aspects with the aim of expanding the limited available literature on serial murder in South Africa as well as facilitating novel views and interpretations of the existing international body of work on the topic.

This study is the first to have investigated the phenomenon of serial murder from the perspective of the family system. It may be of interest that future studies also take the families of individuals who commit serial murder as their focus; possibly making use of alternative or similar paradigms to examine this facet further. It would be interesting to compare psychodynamic interpretations of the families of such individuals, for example, with the current study, or other studies that adopted a more systemic view.

Future studies may also attempt to elicit understandings of serial murder within other systems, such as the societal, welfare, justice or political (to name a few examples) systems. In this way, one could also examine the role of the individual who commits serial murder within the prison system, once incarcerated, and potentially compare this with the role of such an individual as a member of other systems. For this purpose, prison warders and fellow prisoners could be interviewed and their data analysed in a similar manner as the current study.

Along a similar vein, given South Africa's political history, it would be of interest to the current researcher to examine the extent to which changes in the surrounding societal supra-system of which the individual who committed serial murder (specifically those whose adult life spanned the transition from Apartheid to current government) is a part may have impacted in his role both as a member of the larger system, as well as processes within his individual family system, and the manner in which such changes may have impacted on his criminal behaviour.

Alternate types of criminal behaviour could also be examined in a similar way, in terms of the role of such behaviour in family systems in future research studies. This might facilitate novel suggestions with regards to proactive, preventative measures in reducing crime as well as suggestions for rehabilitative measures that operated at a systemic level. It would also be interesting to compare findings from studies focusing on one type of crime with others to note similarities and differences across criminal behaviours.

Future research may also want to collect data from a sample of individuals from different geographical, ethnic, racial, and cultural backgrounds. For example, this study made use of individuals from a predominantly White, Afrikaans-speaking background. It would be interesting to examine whether cultural differences in understandings of family (as well as with respect to other areas) impact upon the data and results obtained, and to compare such differences or similarities across variations.

A FAMILY SYSTEMS ANALYSIS OF SERIAL MURDER

BY

GIADA ALESSIA DEL FABBRO

**SUBMITTED IN PARTIAL FULFILLMENT OF THE REQUIREMENTS FOR
DEGREE**

PHILOSOPHIAE DOCTOR

IN THE FACULTY OF HUMANITIES

AT THE UNIVERSITY OF PRETORIA

MAY 2006

A FAMILY SYSTEMS ANALYSIS OF SERIAL MURDER

OPSOMMING

Die navorsing het op die fenomeen van reeksmoorde vanuit 'n sisteemteoretiese perspektief gefokus. Die doel was om gesinsistemiese insig te verkry met betrekking tot reeksmoorde in 'n Suid-Afrikaanse konteks. Deur gebruik te maak van 'n gesinsistemiese teoretiese raamwerk en die genogram-metode, is gegewens van gesinsisteme van individue wat reeksmoorde gepleeg het, ingesamel, kwalitatief ontleed en deur middel van 'n tematiese inhoudsanalise ondersoek. Die ondersoek het hoofsaaklik emosionele prosesse, multi-generasionele en verhoudingspatrone van gesinsisteme beklemtoon.

Inligting is uit verskeie bronne versamel. Onderhoude is onder andere gevoer met individue wat tans vonnisse uitdien vir reeksmoorde, sowel as met hul gesinslede, asook met professionele persone wat by hierdie persone betrokke was. Inligting is ook uit kliniese observasies en argiefdata verkry. Die resultate van die inhoudsanalise demonstreer aansienlike ooreenkomste, maar dui ook op verskille in die organisering en funksionering van gesinsisteme van individue wat reeksmoorde gepleeg het. Teoretiese insig is ook verkry aangaande die rol van reeksmoorde in gesinsisteme en wat die tans heersende teoretiese perspektiewe met die klem op die enkel individu en linieêre oorsaaklikheid uitdaag.

Hierdie studie bied die geleentheid vir verdere sisteemteoretiese navorsing, veral om die moontlikheid van die betekenis van reeksmoorde in relatief kleiner (bv. ouer-kind of portuurgroepsverhoudings) of groter kontekse (die politieke, kulturele en sosiale sisteme) te ondersoek. Verder bied dit ook geleentheid vir 'n alternatiewe kyk na die fenomeen van

reeksmoord in terme van teoretiese, definiërende, tipologiese, ondersoekende en korrektiewe benaderings.

ABSTRACT

The research aimed to explore the phenomenon of serial murder from a systems theory perspective. The purpose of the study was to develop an understanding of serial murder in a South African context from a family systems approach. Utilizing a family systems theoretical framework and the genogram method, the study, which was qualitative in nature, explored information about the family systems of individuals who committed serial murder via content analysis. The investigation focused mainly on emotional processes, multigenerational and relationship patterns in family systems.

Information was gathered from numerous sources and included interviews conducted *inter alia* with individuals currently incarcerated for serial murder and their family members, and with professionals involved with such individuals; as well as information obtained from clinical observations and archival data. The results of the content analysis demonstrated considerable similarities but also differences in the organization and functioning of the family systems of individuals who committed serial murder. Importantly, the analysis shed novel theoretical light on the role of serial murder within family systems and challenged established dominant theoretical perspectives on serial murder that have emphasized linear, causal and/or individual-focused explanations.

The study opened up considerable opportunities for further exploration of the phenomenon from a systemic perspective, specifically with the focus on the meaning of serial murder in

relatively smaller (e.g., parent-child or peer relationships) or larger (e.g., political, cultural and societal) systems. It also provided opportunities for alternative vistas from which the phenomenon of serial murder can be viewed in terms of theoretical, definitional, typological, investigative and correctional approaches.

10 KEY PHRASES: serial murder; family system; multigenerational patterns; emotional cut-offs; triads; genogram; case study; nuclear family system; violent crime; relationship patterns

AFFIDAVIT

I declare that **A Family Systems Analysis of Serial Murder** is my own work and that all references have been fully acknowledged in the text and the bibliography.

Opinions expressed and conclusions arrived at in this research are those of the author and not necessarily those of the Department of Psychology, Faculty of Humanities, South African Police Service or Department of Correctional Services.

GIADA A DEL FABBRO

Johannesburg

02 May 2006

TABLE OF CONTENTS**ACKNOWLEDGEMENTS****LIST OF TABLES****LIST OF FIGURES****Chapter**

1. INTRODUCTION	1
1.1 SERIAL MURDER AS PHENOMENON	2
1.2 MOTIVATIONS FOR THE STUDY	3
1.2.1 Interaction of popular and academic sources	3
1.2.2 Limited available research on serial murder in South Africa	7
1.2.3 The novelty of the systemic perspective	8
1.2.4 Applications to correctional and investigative systems	9
1.3 PURPOSE OF THE STUDY	10
1.4 RESEARCH FOCUS AND DESIGN	11
1.4.1 Research design	11
1.5 A NOTE ON THE PATHOLOGICAL MODEL	11
1.6 RESEARCH OUTLINE	12
1.7 CONCLUSION	12
2. LITERATURE REVIEW: HISTORY, DEFINITIONS AND CATEGORIES OF SERIAL MURDER	14
2.1 DEFINING SERIAL MURDER	14
2.1.1 Mass and spree murder	14

2.1.2 Serial murder	15
Definitions of serial murder: international	16
Definitions of serial murder: South Africa	20
2.1.3 Differences and similarities of definitions	23
Quantity of murders	24
The “cooling off” period	24
Motive	26
Sexuality and lust murder	30
Number of perpetrators	32
Gender	33
Victim/offender relationship	34
2.1.4 Concluding remarks of definitions	36
2.1.5 Definition of serial murder for the purposes of this study	40
2.2 HISTORICAL BACKGROUND OF SERIAL MURDER	41
2.2.1 History of serial murder: international	42
2.2.2 History of serial murder: South Africa	46
Muti murder	59
2.3 WAYS OF CATEGORIZING SERIAL MURDER	61
2.3.1 Topological classification schemes	61
The FBI’s disorganised/organised typology	62
Holmes and De Burger’s visionary, missionary, hedonist and power/control typology	65
Leibman’s ego-syntonic and ego-dystonic classification	70
2.3.2 Geographical classification	71
2.3.3 Concluding remarks on classification schemes	74

3. LITERATURE REVIEW: THEORETICAL FRAMEWORKS CONCERNING SERIAL MURDER	75
3.1 ORGANIC THEORIES	76
3.1.1 Neuroanatomy/neurology	76
3.1.2 Genetics	78
3.1.3 Critique of organic theories	79
3.2 PSYCHOLOGICAL THEORIES	81
3.2.1 Psychodynamic theories	82
The role of fantasy in psychodynamic theories of serial murder	84
The role of primary attachments in psychodynamic theories of serial murder	87
3.2.2 Critique of psychodynamic theories of serial murder	89
3.2.3 Cognitive-behavioural and learning theory models	92
Learning theory	92
Cognitive-behavioural theories	93
Rational choice models	94
An addiction model of serial murder	95
3.2.4 Critique of cognitive-behavioural and learning theory models of serial murder	96
3.2.5 Other theories emphasizing psychological factors	97
3.2.6 Critique of other theories emphasizing psychological factors	103
3.3 SOCIO-CULTURAL THEORIES	105

3.3.1 Sociological and criminological schools and crime	105
Socio-cultural theories focusing specifically upon	
serial murder	108
3.3.2 Seltzer's theory of serial murder and wound culture	112
3.3.3 Cameron and Frazer's social constructionist theory of	
serial murder	113
3.3.4 Holmes and DeBurger's socio-cultural interactionist approach	
to serial murder	114
3.3.5 Jenkins' social constructivist theory of serial murder	115
3.3.6 Simpson and the popular representation of serial murder	116
3.3.7 Feminist theories of serial murder	117
3.3.8 Hook's post-structuralist approach to serial murder	118
3.3.9 Du Plessis' grounded theory approach to serial murder	120
3.3.10 Critique of socio-cultural theories	121
3.4 THEORETICAL FRAMEWORK FOR THE CURRENT STUDY	122
4. FAMILY SYSTEMS THEORY	126
4.1 DEFINITION OF "THE FAMILY"	126
4.1.1 Dictionary definitions	126
Family as household	128
The family in terms of the function or role of its members	128
Family as ancestry or blood lineage	129
4.1.2 Summary of dictionary definitions	129
4.1.3 Contemporary view and definitions of the family	130
4.1.4 Summary of contemporary definitions of the family	132

4.1.5 A South African definition of the family	134
4.1.6 Conceptualisation of the family for this study	135
4.2 THE CONTEXT OF THE FAMILY	136
4.2.1 The post-modern family	137
4.2.2 The family and deviance	139
4.2.3 The family and larger systems	140
4.3 FAMILY SYSTEMS THEORY	141
4.3.1 Watzlawick, Beavin and Jackson's theory of communication and interaction	142
Wholeness	143
Circular or cybernetic causality	144
Feedback	144
Reflexivity	146
Equifinality	147
Types of interaction	147
Pathological communication	148
Definitions of self and other	150
Punctuation	152
4.3.2 Summary of Watzlawick, Beavin and Jackson's view	153
4.3.3 Bowen's family theory	154
Differentiation of self	155
Triangles	155
Nuclear family emotional system	162
Family projection process	163
Emotional cut-off	164

Multigenerational transmission process and sibling position	165
Emotional process in society	165
4.3.4 Summary of Bowen's family theory	166
4.3.5 The symptom in the family system	167
4.3.6 The individual in a family systems approach	168
4.4 KEY FAMILY SYSTEM CONCEPTS FOR THIS STUDY	170
4.4.1 Emotional processes	171
4.4.2 Multigenerational patterns	173
4.4.3 Relationship patterns	174
4.5 SUMMARY OF THE CHAPTER	177
5. METHOD OF RESEARCH	179
5.1 METHODOLOGY	179
5.1.1 Evaluating qualitative research	181
5.2 RESEARCH DESIGN	182
5.3 SAMPLING	183
5.3.1 Case study one: Mr X and family	185
5.3.2 Case study two: Mr Y and family	185
5.4 DATA COLLECTION	187
5.4.1 Clinical observations	187
5.4.2 Interviews	188
5.4.3 Genograms	189
Mapping the family structure	191
Recording family information	191

Showing family relationships	192
5.4.4 Archival data and other records	193
5.5 PROCEDURE	194
5.6 ETHICAL CONSIDERATIONS	197
5.7 DATA ANALYSIS	197
5.7.1 Discussion of the case study method	198
Yin's criteria for defining a case study	198
The unit of analysis	199
5.7.2 Content analysis	200
5.8 DATA INTEGRATION	201
5.9 CONCLUSION	202
6. RESULTS	203
6.1 CASE STUDY ONE – MR X AND FAMILY	203
6.1.1 Persons interviewed	203
6.1.2 Biographical information	204
6.1.3 Clinical observations	205
Mr X	205
Mr X's family	206
Interaction between mother X and father X	209
6.1.4 Genogram	210
Paternal side of the family system	212
Maternal side of the family system	212
Nuclear family	214
Additional family systems of friends	216

6.1.5 Archival data and supplementary interview data	216
Interview with prison psychologist	217
Interview with psychiatrist involved in Mr X's competency to stand trial assessment	217
Additional data sources	219
6.2 CASE STUDY TWO – MR Y AND FAMILY	219
6.2.1 Persons interviewed	219
6.2.2 Biographical information	221
6.2.3 Clinical observations	221
Mr Y	221
6.2.4 Genogram	225
Paternal side of the family system	227
Maternal side of the family system	228
Nuclear family system	228
Mr Y	231
Additional family system of Mr Y's co-accused, Mr H	235
6.2.5 Supplementary data sources	237
Interview with prison psychologist, Ms V	237
Interview with Mr Y's cellmate, Mr Z	238
Additional data sources	239
6.3 CONCLUDING REMARKS	241
7. DISCUSSION OF RESULTS	242
7.1 DISCUSSION OF RESULTS OF CASE STUDY ONE – MR X AND HIS FAMILY	242

7.1.1 Genogram interpretation	243
Category one: family structure	243
Category two: life cycle fit	251
Category three: pattern repetition across generations	255
Category four: life events and family functioning	261
Category five: relational patterns and triads	268
Category six: family balance and imbalance	279
7.1.2 Thematic content analysis	293
Themes relating to emotional processes in the X family system	294
Themes relating to multigenerational patterns in the X family system	307
Themes relating to relationship patterns in the X family system	312
Summary of themes	326
7.2 DISCUSSION OF RESULTS OF CASE STUDY TWO – MR Y AND FAMILY	327
7.2.1 Genogram interpretation	327
Category one: family structure	328
Category two: life cycle fit	339
Category three: pattern repetition across generations	345
Category four: life events and family functioning	354
Category five: relational patterns and triads	364
Category six: family balance and imbalance	381
7.2.2 Thematic content analysis	397
Themes relating to emotional processes in the Y family system	397
Themes concerning multigenerational patterns in the Y family	

system	409
Themes concerning relationship patterns in the Y family system	419
Summary of themes	432
8. DISCUSSION OF FINDINGS, CRITIQUE AND RECOMMENDATIONS	435
8.1 COMPARISON OF MR X AND MR Y AND THEIR FAMILIES	435
8.1.1 Biographical information and genogram	435
Emotional processes	438
Multigenerational patterns	441
Relationship patterns	442
8.2 CONTRIBUTIONS TO THE GENERAL LITERATURE	445
8.3 DEFINITIONS	446
8.4 HISTORY	447
8.5 CLASSIFICATION SYSTEMS OF TYPOLOGIES	448
8.6 THEORETICAL ASPECTS	449
8.7 METHODOLOGY	451
8.7.1 Evaluation of qualitative research	452
8.8 CRITIQUE	456
8.9 RECOMMENDATIONS	459
REFERENCES	461

ACKNOWLEDGEMENTS

Firstly, I would like to thank God for giving me strength and guidance at this time as well as throughout my professional and personal life journeys.

I would also like to thank my incredible family for the love, patience, support and care that they have given me. Dad, for understanding and questioning, helping me to develop my own understanding and clarity better; Mom, for bringing out the lighter side of this experience and always making sure I kept a balance; and Oriana, for your encouragement, empathy and endless cups of coffee. And to all of you, thanks for the proofreading!

My friends and colleagues - for their understanding, appreciation and encouragement.

My supervisor, Prof Dave Beyers, for his knowledge and insight, patience and inspiration, together with my co-supervisor, Dr Gerard Labuschagne, for his professional guidance, friendship and meticulous attention to detail.

Academic staff at the Department of Psychology at the University of Pretoria, particularly Prof Maria Marchetti-Mercer and Ms Annelies Cramer. Maria, thank you for being an incredible source of inspiration and for your support and advice; Annelies, your understanding and encouragement during my M1 year was priceless.

Lastly, I would like to dedicate this doctoral thesis to my late grandmother, Bruna Perrone, who was with me at the beginning of this journey and continues to inspire, guide and support me. Grazie, nonna!

LIST OF TABLES

Table 2.1.	South African serial murder cases 1936-2003	52
Table 2.2.	Disorganised/organised typology	64
Table 2.3.	Holmes and DeBurger typology of serial murder	69
Table 8.1.	Comparison between Mr X and Mr Y (biographical information and genogram).....	437

LIST OF FIGURES

Figure 1.	Diagrammatic Representation of a Family System.....	178
Figure 2.	Mr X's Genogram.....	211
Figure 3.	Mr Y's Genogram.....	226
Figure 4.	Maternal Grandfather's Remarriages.....	250
Figure 5.	Pattern of Relationships in X Family System.....	259
Figure 6.	Parent-Child Triad One.....	268
Figure 7.	Parent-Child Triad Two.....	269
Figure 8.	Parent-Child Triad Three.....	270
Figure 9.	Couples Triad One.....	272
Figure 10.	Multigenerational Triad One.....	273
Figure 11.	Multigenerational Triad Two.....	274
Figure 12.	Multigenerational Triad Three.....	274
Figure 13.	Triad: Other.....	276
Figure 14.	Roles in the X Family System.....	283
Figure 15.	Household One for Mr Y.....	329
Figure 16.	Household Two for Mr Y.....	329
Figure 17.	Household Three for Mr Y.....	330
Figure 18.	Father Y's Sibling Constellation.....	331
Figure 19.	Mother Y's Sibling Constellation.....	333
Figure 20.	Parent-Child Triad One.....	365
Figure 21.	Parent-Child Triad Two.....	366
Figure 22.	Parent-Child Triad Three –Supplementary.....	367
Figure 23.	Divorced/Remarried Triad One.....	369

Figure 24.	Divorced/Remarried Triad Two.....	370
Figure 25.	Foster/Adopted Triad One.....	372
Figure 26.	Multigenerational Triad One.....	374
Figure 27.	Triad Other: One.....	377
Figure 28.	Triad Other: Two.....	378
Figure 29.	Emotional Processes in X and Y Family Systems.....	439
Figure 30.	Emotional Cut-Offs in the X and Y Family Systems.....	440

1. INTRODUCTION

Crime and criminal behaviour have been studied and analysed since before the end of the nineteenth century (Stephenson, 1992). Disciplines as diverse as sociology, psychology, criminology, penology, medicine, psychiatry and philosophy have all studied crime, often focusing on the individuals who commit crime as well as criminal behaviour. A crime that has attracted some scientific and much popular attention for the greater part of the twentieth century is serial murder (Hickey, 2006).

Research in the field of crime and criminal behaviour has focused on its causes, prevalence, nature and impact, with the aims of enriching our understanding of crime and criminal behaviour; developing methods of preventing crime; apprehending individuals who commit such acts; assisting victims; as well as conceptualizing ways of punishing, managing or “treating” convicted individuals. As man’s way of understanding himself and his surroundings has changed with the particular *Zeitgeists* of the last centuries, so has man’s method of conducting social research. From a positivist view, man has expanded his research approach to include post-modern ways of conducting research, including systemic and social constructionist paradigms.

This research study has chosen to tap the above two areas, namely serial murder and post-modern research approaches, by exploring the phenomenon of serial murder from a systemic perspective, specifically with regards to the role played by serial murder in the family systems of individuals who commit such crimes. This chapter will briefly discuss serial murder as an international and local phenomenon and outline the motivation and purpose, as well as focus of the study.

1.1 SERIAL MURDER AS PHENOMENON

One of the academic issues regarding research on serial murder is the difficulty to determine a precise definition of the concept serial murder. The reason is probably that definitions differ with regard to various disciplines' views (e.g., criminology and psychology - these similarities and differences will be discussed in chapter two), despite overlapping to various degrees regarding their descriptions of serial murder. For the purpose of this study, a generic definition was developed, namely: multiple murders committed over a period of time by one or more individuals.

Serial murder constitutes a very specific category of criminal behaviour. After emerging and increasing rapidly in prevalence in the United States of America (USA) during the 1960s and 1970s, figures for serial murder prevalence in the USA show that 50% of the known cases of serial murder in the USA occurred during the time period 1975-2004 (Hickey, 2006). Gorby (2000) found the same pattern for most non-European countries in comparison to European countries that show a slight decrease from 1975-1995, after peaking in the period before this (1950-1974). Consequently, it would appear that serial murder, as a type of criminal behaviour, has been noticed and attended to largely during the last and current century.

South Africa has a particularly high crime rate, specifically in terms of violent crime. Between 1994 and 2004, South Africa's national rate of murder was 57.7 per 100 000 (http://www.saps.gov.za/statistics/reports/crimestats/2004/_pdf/crimes/Murder.pdf), while that of rape was 120.6 per 100 000 (http://www.saps.gov.za/statistics/reports/crimestats/2004/_pdf/crimes/Rape.pdf). Despite the fact that the above figures show a decrease in both murder (by 8.8%) and rape (by 2.8%)

over the last two years, South Africa's crime statistics are still comparatively high in relation to the rest of the world. For example, the USA recorded 7.1 homicides per 100 000 people for 2001 (<http://www.ojp.usdoj.gov/bjs/homicide/homtrnd.htm>), in comparison to South Africa's rate of 47.8 per 100 000 for the same year (http://www.saps.gov.za/statistics/reports/crimestats/2004/_pdf/crimes/Murder.pdf).

South Africa shows a similar pattern to the USA in terms of the proportion of murders accounted for by serial murder (namely, less than 1.0%, with 55 recorded cases of serial murder between 1994 and 2004). The obvious question to be posed is: why is there a crime such as serial murder; a crime that includes several victims, where it seems as if usually one person shows a repetitive pattern of killing people? Hickey (2001) has attempted to explain the USA data in relation to the proliferation of violence in the media; sado-masochistic and violent pornography; and the patriarchal societal system. In terms of the South African situation, Labuschagne (2001) and Gorby (2000) have argued that the less extensive infrastructure; less robust economy; and rapid urbanization and crowding that characterize developing societies may make them more vulnerable to serial murder. Given the large number of unanswered questions that remain concerning serial murder, it is evident that further research into this phenomenon is required.

1.2 MOTIVATIONS FOR THE STUDY

1.2.1 Interaction of popular and academic sources

Despite the general increase in serial murder cases over time in the USA during the latter part of the last century, this type of criminal behaviour accounts for less than one percent of the total homicide rate for the USA in any given year (Meloy, 2000). However, this

phenomenon attracts a large amount of attention and fascination from the general population. Public fascination with serial murder overseas/internationally has been reflected in, and sustained by, many fictional books and films on serial murder. Examples of these are the books of Thomas Harris, namely *Red Dragon* (1987), *Silence of the Lambs* (1991), and *Hannibal* (1999), as well as films such as *Copycat* (1995), *Se7en* (1995) and *Kiss the Girls* (1997). Hickey (2006) states that during the 1990s there were 150 films upwards with the theme of serial murder.

It would seem that serial murder has featured frequently in the popular media and that a large proportion of knowledge production and information dissemination on serial murder has taken place via this channel and possibly influenced academic or scientific exploration of the phenomenon. In South Africa, this popular media attention to serial murder has been in the form of newspapers, television programmes, non-fiction crime literature and fictional works.

With regards to newspaper sources, references and articles dealing with serial murder can be found across South African newspaper types. The following are examples of serial murder references in the press: Rapport (31 January, 1999) ran an article titled “Spanwerk los reeksmoord op” (team work solves serial murder); the Weekly Mail and Guardian (9 September, 1994) featured an article titled “Station Strangler – Who’s Fooling Whom”; City Press (7 December, 1997) featured an article titled “ ‘Electrician’ may be next serial killer”; Beeld (14 August, 1995) featured an article titled “Reeksmoordenaars nie ‘dieselfde mens’ ” (Serial murderers not the same person); and The Star (21 August, 1997) featured an article titled “18 murders linked in hunt for serial killer”. These form part of a considerably larger sample of articles on serial murder that have featured across newspapers in the past two decades.

Television programmes featuring serial murder have occurred on local series such as *Carte Blanche*, *Third Degree* as well as in the form of documentaries such as *Criminal Minds* (2003) and *Psycho Factory* (2004). *Carte Blanche* has aired episodes on Micki Pistorius, previous head of the Investigative Psychology Unit of the South African Police Services, on serial murder cases in South Africa, as well as episodes on forensic entomologist Mervyn Mansell and the serial murder case of Samuel Sidyno, the Capital Park serial murderer (“Crawling with evidence”, April, 13, 2003). The local actuality programme on e-tv, *Third Degree*, has also featured an episode on serial murder in South Africa (“Copy Cat Killers”, March 13, 2001).

Examples of popular non-fiction crime literature in South Africa include the works of Micki Pistorius, namely *Catch Me a Killer* (2000), *Strangers on the Street* (2002) and *Fatal Females* (2004). Local fictional works featuring serial murder include Deon Meyer’s *Dead Before Dying* (1999) and Amanda Patterson’s *I See the Moon* (2003).

In addition to popular sources of serial murder information, there are scientific or academic sources of information; but these seem to influence perceptions of the phenomenon to a lesser degree. International academic research has been conducted by David Canter, Kim Rossmo, Harold Smith, Al Carlisle, Steve Egger, Eric Hickey, Ronald Holmes and James DeBurger and Philip Jenkins, as well as John Douglas, Robert Ressler, and Robert Keppel; locally academic studies also exist and have been conducted largely as part of post-graduate studies by individuals such as Micki Pistorius, Gerard Labuschagne, Cobus Du Plessis, Jackie De Wet, Brin Hodgskiss, and Derek Hook.

The interaction between academic and popular sources of information on serial murder, both locally and internationally have led to certain problems. As described by Hook (2003), there seems to be a tension in the processes of knowledge production on the topic of serial murder, between “biases of popular opinion” (p. 6) as reflected in and by the popular media,

and scientific or academic fact. This would appear to be further complicated by the apparent frequency with which academics and professionals in South Africa feature in the popular realm on the subject of serial murder and make knowledge claims about the topic with limited experience or reference to sources of empirical support. For example, Robert Ressler, an ex-member of the FBI Behavioural Science Unit, chose the *Beeld* (17 July, 1995) to make his claim that the end of Apartheid ushered in a new era for serial murder in South Africa due to the lifting of tight police controls and the exposure of consequences relating to brutal, unfair and unjust practices of the 70's and 80's. His statements in this article featured no details about supporting arguments or evidence upon which such claims were based. Often these academics and professionals make opinions in the popular media without ever having consulted the investigator or seen the case file materials (Labuschagne, personal communication, 2006).

In the same vein, Pistorius (1996) attributed serial murder in South Africa to poverty, crime, violence and the disbanding of families in the press, despite her academic work that places emphasis on intrapsychic factors in the etiology of serial murder. Dr Mark Welman, previously of Rhodes University (*City Press*, 11 January, 1998), Dr Rika Snyman, a Unisa criminology researcher (*Independent Newspapers*, 1997), and Dr Irma Labuschagne, a criminologist (*Maxim*, August 2000) are individuals who have also been featured in newspaper articles on the topic of serial murder, in the context of more popular rather than scientific understandings of serial murder.

As a result, it would seem that some of the confusion surrounding understandings of serial murder, both locally and internationally, may be attributed to the blurring of popular and professional contexts, with professionals frequently failing to support their arguments or make claims in the way expected of them in the scientific community when they feature in the popular media. This may also be as a result of the manner in which the popular media

reports on the statements and arguments of the afore-mentioned professionals, as well as general lack of clarity on aspects such as definitions and psychological/investigative tensions. Thus the two systems of academia and popular media become interlinked often with problematic consequences for their “creations”.

In the absence of frequent productivity in the research and academic field with regards to serial murder, there is little evidence or support with which to challenge popular misperceptions, especially when voiced by “experts”, or to stem the sensationalism with which this topic may be covered. Hence, it would seem that an encouragement of valid and reliable productivity in this area is advantageous.

1.2.2 Limited available research on serial murder in South Africa

Despite a period of awakened interest in serial murder as a research topic in South Africa in the mid-nineties running through to the early part of the year 2000, there has been a tapering off of formal research into the area (possibly due to less media focus on serial murder that has also taken place during this period). Serial murder as a type of crime continues to sustain itself in South Africa, however, and, in the absence of a large volume of available local research, much still has to be done to understand South African serial murder, especially in light of its significant difference from international serial murder in areas such as offence, offender and victim characteristics (Hodgskiss, 2003). Consequently, this study’s exploration of South African understandings of serial murder would be useful in developing the existing pool of South African research on the topic of serial murder, and making novel contributions from a systemic perspective.

1.2.3 The novelty of the systemic perspective

Many approaches have been made to understand serial murder by theoretical contributions on the causes of serial murder (Jenkins, 1994; Meloy, 1988; Norris, 1988); geographical profiling techniques (Canter, 1994, 2000; Rossmo, 1995, 1997); and typologies (Holmes, 1990; Holmes & DeBurger, 1988; Ressler, 1985; Ressler, Burgess & Douglas, 1988). These will be discussed in further detail in chapter three. However, none of the above has attempted to understand serial murder from a systemic perspective, specifically with respect to the family system of each individual. Some theories on serial murder (Keeney & Heide, 2000; Ressler et al., 1988; Sears, 1991) have made reference to “dysfunctional” families in this context.

The dysfunctional family type has served as a means of attributing responsibility for the serial murder behaviour to experiences of abuse (sexual, physical or emotional) in the family settings of the individuals concerned. However, no prior study has attempted to directly interview members of the families of individuals who commit serial murder to elicit their interpretation of this behaviour; to understand the individual who committed serial murder as he sees himself in relation to his family; and to see the role of serial murder within such a system.

Family plays a big part in most of South Africa’s diverse cultures. Across the majority of cultures that make up South Africa’s ethnic demographic, the family system is an important source of support (financial, emotional or practical) for individual members. In terms of the form of South African families, the 1996 South African census demonstrated that the nuclear family is the most prominent household type (23, 89%) across all ethnic categories (Ziehl, 2001), with groups who traditionally displayed a more extended family form moving

increasingly towards the nuclear family form with greater urbanization and employment or financial opportunities (Amoateng, 1997; Moller, 1998).

Locally and internationally, the researcher is aware of no research that focuses on the family systems of individuals who commit serial murder, or which has interviewed family members of such individuals. The novel approach afforded by a family systems theory to serial murder would resist interpreting the phenomenon within the framework of linear causality, and as such, would provide unique input points at which change could be initiated at a systemic level to bring about changes in the behaviour of individuals who commit serial murder. In the literature, rehabilitation is frequently negated as an option for individuals who commit serial murder (Pistorius, 1996; Ressler, 1997). However, this has largely been based on linear notions of causality. Family systems' approaches, with their emphasis on "circular causality" (Bateson, 1979), would be of particular use to those groups and individuals who could play a role in effecting change in individuals who commit serial murder such as prison warders, psychologists, as well as family members.

Additionally, an individual can be recognized as a system within such a theoretical paradigm (Guttman, 1991; Kerr & Bowen, 1988) in the absence of other members of the family system of which he/she is a member. Although a social systems approach addresses family or groups of people, the individual in and part of the system is still recognized as a system: in itself as well as part of a specific group or family. This aspect will be discussed again in Chapter 4.

1.2.4 Applications to correctional and investigative systems

Locally and internationally, there is little research that has been conducted with actual offenders. Consequently, a research study that could add to the limited pool of research that

has managed to interview offenders directly would be advantageous, specifically with regards to understanding criminal behaviour.

This study of serial murder from the family perspective in South Africa may also assist with police investigations and the use of techniques such as offender profiling. By attending to the particular way in which serial murder exists in the South African context, police work can benefit from greater accuracy and consequently efficiency in the apprehension of individuals who commit serial murder in this country.

An exploration of a South African understanding of serial murder from a family perspective could reflect the degree to which the application of overseas theories to the above areas is applicable or not. The family systems approach to understanding serial murder adopted in this study might also illuminate certain patterns in family systems that increase the probability of serial murder occurring within a family system, and allow for proactive, preventative interventions based thereon, or even assist investigators by providing patterns of family behaviours they can look for in families of potential suspects in a serial murder investigation.

1.3 PURPOSE OF THE STUDY

Given the above discussion on the motivations for the current study, the purpose of this study is to:

- investigate serial murder from a systemic point of view with the aim of increasing local understandings of serial murder.

1.4 RESEARCH FOCUS AND DESIGN

In order to achieve the above ends, the following question is proposed as focus of the study:

- “How does the family system of a person who commits serial murder function?”

That is, what is the family structure, who are the people in the family system and how do they maintain the family system.

1.4.1 Research design

The research design will be exploratory and qualitative in nature, adopting a case study method to thoroughly investigate specific examples of individuals who have committed serial murder in South Africa and their particular family systems. Data will be analysed by means of a content analysis in line with the theoretical framework of family systems theory and interpreted with reference to the research focus above. It is hoped that this study will yield novel and useful findings about serial murder in South Africa, as well as the utility of the family systems approach in understanding such phenomena.

1.5 A NOTE ON THE PATHOLOGICAL MODEL

The so-called pathological model is not addressed in this study and seems to be overlooked. Models based solely on individual psychopathology (i.e. those focusing on intrapsychic factors or internal pathologies of an individual) seem to be a preferred way of

trying to understand crime in general. Many studies have already attempted to explore crime as well as serial murder specifically in a similar manner (see Douglas & Olshaker, 2000; Harbort & Mokros, 2001; Pinto & Wilson, 1990). However, for this study, pathology is defined from a systemic theoretical point of view, as explained by Watzlawick, Beavin and Jackson (1967). To these authors, it is essential to take into account interpsychic factors that play an important role towards the understanding of human behaviour. This needs to be applied in research; therefore the theoretical aim of this thesis is to study serial murder from an interpersonal, systemic perspective.

1.6 RESEARCH OUTLINE

The introductory part of the thesis will be followed by a discussion of the literature on serial murder; a review of the body of theoretical work on serial murder; as well as theories of family systems. The methodology chapter will discuss the research design and epistemology that will guide the study, as well as the research method, data collection techniques, sampling strategies and methods of analysis. This will be followed by the results for the cases used; a discussion of the results; and finally, a conclusion that will include an assessment of the limitations of the study as well as suggestions for possible future studies.

1.7 CONCLUSION

This chapter has briefly outlined the topic of the current study, namely serial murder in South Africa. The motivation and focus for the current study has also been provided, together with an outline of the proposed study procedure and thesis outlay.

To summarise, this study will attempt to investigate the topic of serial murder in South Africa from the perspective of family systems theory. It is hoped that this study will thereby develop an understanding of serial murder from a systemic perspective that may contribute a novel perspective on the subject and hopefully allow for better management of individuals who commit serial murder, and the prevalence of this type of criminal behaviour in larger society.

2. LITERATURE REVIEW: HISTORY, DEFINITIONS AND CATEGORIES OF SERIAL MURDER

For the past two decades, serial murder seems to have occupied an increasingly privileged place in the fascination of popular culture. Such fascination appears to have combined with academic and investigative endeavors to produce a plethora of historical and theoretical explorations of the subject. This literature review will investigate defining the concept of serial murder and outline the historical origins of the phenomenon of serial murder as well as the various ways in which serial murder has been classified and understood.

2.1 DEFINING SERIAL MURDER

There is much confusion, even in the scientific community, with regards to defining serial murder. In 2005 at the FBI's serial murder symposium, one of the symposium's objectives was to come to a consensus amongst professionals about the definition(s) of serial murder (Labuschagne, personal communication, 2006). In order to arrive at defining this concept, it is necessary to distinguish serial murder from other acts of multiple murder, such as mass murder and spree murder (Douglas & Olshaker, 2000; Dubner, 1992; Gresswell & Hollin, 1994; Lane & Gregg, 1992; Warren, Hazelwood & Dietz, 1996).

2.1.1 Mass and spree murder

Mass murder has been defined as "an act in which a number of people are slain by a single assassin during a short period of time in roughly the same location" (Lane & Gregg, 1992, p.1). Consequently, the murders all take place in the same location and are committed

quite closely after one another, if not simultaneously. An example of mass murder in South Africa would be Barend Strydom who in 1981 murdered a number of people in Strydom Square in Pretoria.

Spree murder involves “multiple killing [which] takes place over a marginally longer period of time – hours or days” (Lane & Gregg, 1992, p.1) usually at different locations. Consequently, it would seem that, on the continuum of multiple murder, spree murder is further along a distance dimension with regard to time and location with murders that are spaced out more than in the case of mass murder, yet within the context of one ongoing event. An example of spree murder in South Africa would be Charmaine Phillips and Peter Grundling who in 1983 murdered four victims over a three week period during which they moved from their starting point in Durban, to Melmoth, Secunda and ended in Bloemfontein (Labuschagne, 2003). Definitional commonalities between these two types of multiple murder, appear to lie in the act itself - that is, murder is committed - and the plurality of the act concerned – that is, two or more murders take place.

It would appear that the above differentiations are based primarily upon differences in temporal and spatial dimensions, with respect to the amount time passing between individual murders and the number of locations at which the murders are committed. All three forms of multiple murder can be seen as lying upon a continuum with respect to distance in space and time. Now, the definitions of the third type of multiple murder, serial murder, will be discussed.

2.1.2 Serial murder

Academics and law enforcement professionals have attempted to create a suitable definition for serial murder for the purposes of communication, research, and theoretical

understanding, as well as practical applications in the form of criminal investigation tools. As a result, there has been a proliferation of definitional postulates for serial murder that have varied greatly with regard to the fundamental elements stipulated as essential to classifications of serial murder. Whilst there are a number of communalities in almost all, there are considerable differences in opinion as to what serial murder entails and a few of these definitions will be discussed now. This discussion will first deal with international, predominantly US, definitions and then move on to South African definitions of serial murder. The pros and cons of each will briefly be highlighted.

- **Definitions of serial murder: international.**

Definitions of serial murder from the USA would appear to originate predominantly from the domain of law enforcement, specifically the Federal Bureau of Investigation (FBI) of the United States, which played a central role in defining and investigating serial murder in the 70's and 80's.

Ressler *et al.* (1988) from the Behavioural Science Unit of the FBI define serial murder as:

- three or more separate murders, with
- an emotional cooling-off period between homicides, and
- taking place at different locations.

This definition does not specify the number of suspects or perpetrators involved and does not make reference to motivation. It does, however, refrain from referring to gender, which allows for the possibility of both male and female perpetrators of serial murder.

John Douglas, a retired FBI behavioural scientist, together with Mark Olshaker, a journalist, defines serial murder in the following manner in his popular crime non-fiction piece *Anatomy of Motive* (2000):

- murders take place on at least three occasions,
- there is an emotional cooling off period between each incident (this cooling off period may last hours, days, weeks, months, or years), and
- each event is emotionally distinct and separate.

This definition makes no reference to location or to motivation and, as with the first definition, specifies three occasions as the minimum number. The duration of the cooling off period is also allowed to be short enough to possibly result in confusion with spree murder, and due to neglecting to specify separate locations, may result in confusion with mass murder. With regards to law enforcement, such a definition may prove difficult to apply in terms of its emphasis on emotional distinctness which can only be gathered from self-report on the part on the suspect, and hence, difficult to assess prior to the arrest of the suspect.

Holmes and De Burger (1988), who come from a primarily academic background in Professional Justice Administration and have provided the police with assistance on a consultant basis in numerous cases, provide a definition that is descriptive, namely:

- repetitive homicide;
- murders usually occur between two people - a victim and a perpetrator;
- the relationship between victim and perpetrator is usually that of stranger or slight acquaintance;
- apparent and clear-cut motives are typically lacking;
- motives originate within the individual and do not reflect passion, personal gain, or profit tendencies; and
- a common perception that all serial killers are lust killers in light of evidence or observations to indicate the murder was sexual in nature.

In this definition, once again, the notion of serial murder as stranger murder is evident, and the number of people involved in the crime is limited to two, namely, the perpetrator and

victim, and thereby seems to exclude teams of two or more perpetrators. As with previous definitions, the motive is situated within the psychological workings of the individual concerned and not externally available or obvious. The number of murders is not specified, and victimology (beyond “stranger”) is absent in this definition. Interestingly, this definition starts to introduce sexual aspects of serial murder, which have been elaborated in literature that will be discussed later. However, the introduction of a sexual element may limit other non-sexual cases from being included. Furthermore, labeling occurs and the person implicated in such a definition seems categorized with the “diagnosis” of “killer” ignoring the complexities of the person who commits murder.

Egger (1990), a professor of Criminal Justice at the University of Texas provides the following in a detailed definition of serial murder:

- the murders may involve one or more individuals.
- the murders are committed mostly by males.
- there must be at least two murders
- there is no apparent prior relationship between victim and attacker.
- the murders occur at different times and are unconnected.
- the murders are usually in different geographic locations.
- the motive is not for material gain.
- the motive is largely related to the murderer’s desire to have power over his victim.
- the victims have symbolic value and are perceived to be prestigeless and powerless given their situation in time, place or status within their immediate surroundings. For example, vagrants, prostitutes, migrant workers, homosexuals, missing children, and single and often elderly women

This definition mentions motive as well as victimology and defines the relationship between victim and perpetrator as one between strangers, as introduced by Holmes and DeBurger (1988) above. There is a more explicit reference to gender with an acknowledgement of the greater proportion of males committing serial murder. The previous definitions have allowed for the possibility of prior relationship between victim and perpetrator and have not elaborated upon victimology in the extensive manner of this definition. However, the definition of serial murder victimology above appears to be quite narrow, and inherently contradictory in that, as much as victims are proposed as having symbolic value, unique to the individual committing serial murder, their specification as vagrants, prostitutes and so on, is derived from socially marginalized groupings and hence, sources external to the psychological motivations of the individual concerned.

Lane and Gregg (1992), academic researchers, list six criteria for serial murderers in their *New Encyclopedia of Serial Murder*, namely,

- the murders are repetitive.
- the murders often escalate over a period of time, sometimes years and continue until the killer is taken into custody, dies or is himself killed.
- the murders tend to be one-on-one.
- there is no (or very little) connection between the perpetrator and the victim.
- individual murders within a series rarely display a clearly defined or rational motive.
- the perpetrators may move rapidly from one place to another often before a murder has been discovered.
- there is usually a high degree of redundant violence, or 'overkill', where the victim is subjected to a disproportionate level of brutality.

This definition repeats the absence of relationship between perpetrator and victim as well as notions of motive or apparent lack thereof and location. There is no specification of number of offences necessary to constitute serial murder. In this definition, there is an elaboration on modus operandi or manner in which the crime is committed, namely as “overkill”. Once again, the above definition avoids specifying gender of the likely perpetrator and does not explicitly specify the possibility of more than one individual committing serial murder.

Finally, Harbort and Mokros (2001), two German academic researchers, define serial murder in the following manner:

- the perpetrator may be fully or partially culpable. Consequently, severe mental disorder or disturbance would not render him/her accountable for his deed.
- serial murder may be committed alone or with accomplice(s).
- serial murder involves at least three completed murders.
- the murders have to be premeditated and characterized through a new, hostile intent.

Once again, the minimum number of murders appears to be set at three, and each event has been specified as having to be distinct from each other. Interestingly, the possibility of more than one perpetrator in serial murder is introduced as well as notions of insanity and mental disorders as precluding individuals from being classified as having committed serial murder. In other words, *menses rea* (or criminal intent) becomes an important criterion for serial murder.

• **Definitions of serial murder: South Africa.**

In terms of South African definitions, Pistorius (1996) defines serial murder in the following way in her doctoral thesis, *A Psychoanalytical Approach to Serial Killers*:

- A serial killer is a person (or persons) who murder/s several victims.

- These victims are usually strangers.
- The murders take place at different times.
- The murders are not necessarily committed at the same location
- There is usually a cooling-off period between murders.
- The motive for serial murder is intrinsic and consists of an irresistible compulsion, fuelled by fantasy that may lead to torture and/or sexual abuse, mutilation and necrophilia.

Similar to Holmes and DeBurger (1988), this definition appears to describe the person who commits serial murder solely in terms of the acts that they have engaged in, thereby reducing understandings of such a person to their criminal activity rather than encompassing the totality of the individual concerned, for example as someone's partner, son or daughter. Perhaps there needs to be a greater delineation between understandings of an individual who commits serial murder (in terms of personality and character structure for example), and definitions of what serial murder as a type of crime or behaviour entails. This is not clear in the above definition.

The label "serial killer" is additionally sensationalistic and used more by the popular media and fictional domain than academic and law enforcement areas. The definition also neglects the number of murders necessary, and is also too specific in terms of the paraphilias or sexual perversions that may accompany serial murder (but is not always the case). The definition however, is advantageous in its allowance for more than one perpetrator, as well as specification of motive nature and temporal and geographical distinctness.

Labuschagne (2001) in his doctoral thesis entitled *Serial murder revisited: a psychological exploration of two South African cases*, defined serial murder as involving:

- a person who is motivated to kill,

- a person who commits three or more murders occurring at different times, and in an ostensibly unconnected manner,
- a motive that is not primarily for material gain, revenge, or the elimination of a witness.

In this definition, neither victimology nor location are referred to. There is no specification of relationship between victim and perpetrator, nor clear discussion of the number of perpetrators who may be involved. However, temporal individuation of murders and motive are clearly delineated in as much as ulterior primary motives are immediately empowered to discount classification as serial murder.

This definition was subsequently revised in 2004 as the following, and appears to include a number of the excluded dimensions discussed above:

- The person(s) are intrinsically/psychologically motivated to kill.
- The murder of two or more victims.
- The murders occur at different times.
- The murders appear unconnected.
- The motive is not primarily for material gain, nor elimination of witness/es.
- The motive is not primarily for revenge. Revenge may play a role but more indirectly, as against a certain category of individuals such as prostitutes, as opposed to a specific person.
- The victims tend to be strangers (Labuschagne, 2004).

This definition appears to encapsulate the core elements involved in serial murder, and whilst not specifying a specific number of perpetrators, allows for the possibility of more than one perpetrator. However, it omits geographical aspects such as whether the murders have to occur at different geographical locations.

An important note with regards to terminology concerns distinctions between “murder” and “killing”. Whereas murder constitutes a crime punishable by law, killing refers to a more general action of taking life. Consequently, if definitions make reference to killing and killers, they may include many individuals who take life legitimately on a regular basis, or on at least two or more occasions. Such individuals may be military and law enforcement personnel or civilians working in places such as abattoirs or slaughterhouses, killing animals for commercial consumption. One is not indicted for killing, but for murder. To this end, it would seem that the use of the term murder is preferable.

2.1.3 Differences and similarities of definitions

As can be seen from the above definitions, all appear to have a number of factors that overlap, despite and in the presence of obvious variations and differences. These commonalities include number of victims, motive, temporal and geographical distinctions, number of perpetrators, relationship between victim and perpetrator and, in some cases, victimology. An exclusive emphasis on these factors may be disadvantageous however, in that it may prevent dialogue around alternative possibilities and factors that may be equally salient. In this way, novel understandings and definitions of serial murder may be silenced or prevented from emerging.

With regards to differences, these appear to concern the number of murders necessary to constitute serial murder, as well as the extent to which motive and victimology is elaborated upon. All definitions appear to be gender neutral, despite the fact that an overwhelming proportion of the literature operates under the assumption that serial murder is largely perpetrated by males and in some cases, holds that it is impossible for females to commit serial murder. These differences and similarities will now be discussed.

- **Quantity of murders.**

With respect to criteria regarding the number of murders necessary for a series of murders to qualify as serial murder, definitions vary between two or more (Egger, 1990; Labuschagne, 2003), and three or more (Douglas & Olshaker, 2000; Harbort & Mokros, 2001; Labuschagne, 2001; Ressler et al., 1988) while some definitions leave this number unspecified (Holmes & DeBurger, 1998; Lane & Gregg, 1992; Pistorius, 1996).

Merriem-Webster's (2005) dictionary defines the word "series" as - "a group of usually three or more things or events standing or succeeding in order and having a like relationship to each other" (p. 2073). However, any attempt to stipulate a specific number of murders is problematic for the following reason. Egger (1984) highlights problems with setting the number of murders for serial murder at three with reference to individuals who may have committed only two murders before being apprehended but for whom these two murders were the beginning of a "harvest of victims" (p. 5) as part of a serial murder sequence. However, this argument may also be applied to cases where individuals who would go on to commit additional murders are apprehended after the first offence. Hence, any definition that specifies a particular number of murders risks omitting part of its intended sample.

On the other hand, definitions that do not specify the number of murders involved risk loss of clarity, and place decisions to classify a case as serial murder at the discretion of any individual who uses such a definition. As a result the reliability and consistency with which such a definition can be applied uniformly is compromised, and one could argue that the validity with which it characterizes serial murder is also limited.

- **The "cooling off" period.**

Several definitions (Douglas, Burgess, Burgess & Ressler, 1992; Douglas & Olshaker, 2000; Pistorius, 1996; Ressler *et al.*, 1988), notably those from FBI behavioural science sources,

allude to a cooling off period to account for the temporal spacing between murders within a series and thereby, distinguish serial murder from other types of multiple murder such as spree and mass murder.

Such a period is described as emotional in nature (Douglas & Olshaker, 2000; Ressler *et al.*, 1988) and, as will be elaborated upon in discussion of the theories of serial murder, has been argued as constituting a time period in which the individual who commits serial murder temporarily satiates his/her need to murder or enact his/her fantasy of murder, and either regenerates such a fantasy and the desire to act upon it (Douglas & Olshaker, 2000) and/or plans his/her next murder (Hazelwood & Warren, 1995).

The inclusion of an emotional cooling off period in certain definitional criteria raises a number of salient issues. Firstly, despite the stipulation of a cooling off period, there is little detail as to how much time this period entails. Douglas *et al.* (1992) describe such a period as consisting of days, months, weeks or even years; however, this appears to be too broad, and as a result, may lead to confusion between types of multiple murder. For example, the recent Washington sniper in the United States, murdered several people over a spate of days and was classified as a serial sniper. The basis for this classification is unclear (possibly because of the nature of the murders), but the classificatory rationale in this case would certainly seem to omit considerations of time between murders or a cooling off period stipulation that, if adhered to, would have made the Washington sniper an individual who committed serial murder.

Secondly, if the cooling off period is stipulated too narrowly or specifically, it may overlook individual nuances in the psychological and emotional processing of the separate murders within a series by offenders, which may vary from one serial murderer to another. As a result, this may omit certain cases of serial murder or erroneously include others.

Additionally, little research has been done with respect to the qualitative aspects of the cooling off period. These aspects may include details such as whether the length of time period involved varies with age, temperament, gender and personality characteristics or differences between individuals in the ability to self-regulate; impulse control; fantasy life; or intensity of affective functioning. In this regard, the length of cooling off period may vary between individuals with regard to the above factors or within an individual across time in relation to developmental changes and progression, or even coinciding life events or situational factors. For example, one might hypothesize that the presence of stressful life events such as death of a loved one or end of a relationship might impact upon the cooling off period an individual who commits serial murder needs before committing another murder.

Finally, the choice of phrase used to describe such a period, namely, “cooling off” would appear to portray serial murder in a certain light. It seems to imply that murders take place as a result of an intense emotional outburst that overwhelms the capacity to normally contain such emotional material in the individual concerned, after which the individual requires a resting period during which those emotions reaccumulate. It would seem inadvisable to narrow understandings of serial murder in such a way, as it may exclude cases of serial murder where this does not occur, such as where the time lapses between murders may occur as a result of victim availability. Additionally, if police are unable to find bodies (because they have been buried or hidden or moved to another area), they may mistakenly believe that the suspect is in a cooling off period, instead of taking extra steps to find bodies.

- **Motive.**

Motives for crime can be classified as external and internal (Labuschagne, 2003). An example of external motives is a case where a witness is murdered. The motive in this case would be to conceal another crime, with the murder in question being a means to another end, that is, to

get away with the first crime. Internal motives or psychologically motivated crime refers to cases where there is no external benefit for the offender and there is frequently no obvious relationship between offenders and victims. The crime serves to satisfy a psychological need. For example, the kleptomaniac will steal to satisfy an internal drive or compulsion as opposed to the thief who steals for external profit. In some cases, internal and external motives may occur in combination. An example may be a case where a hijacker steals a motor vehicle for external profit in terms of payment but tortures the owner of the vehicle due to a personal sadistic need.

With reference to the above definitions, some do not make reference to motive specifically (Douglas & Olshaker, 2000; Harbort & Mokros, 2001; Ressler *et al.*, 1988), while those that do refer to motive specify this as being located internal to the individual concerned (Egger, 1990; Holmes & DeBurger, 1988; Labuschagne, 2001, 2004; Lane & Gregg, 1992; Pistorius, 1996). Definitions that include motive additionally do not classify it as related to profit, revenge, or passion (Egger, 1990; Holmes & DeBurger, 1988) but in one case, defined it as relating to power as a function of the interpersonal relationship between perpetrator and victim (Egger, 1990) and in others claim that motive in serial murder is not rational (Holmes & DeBurger, 1988; Lane & Gregg, 1992).

Definitions that do not refer to motive at all are problematic in that they may include individuals such as contract murderers, who murder for profit, or individuals involved in organized crime, which murder for personal gain, profit or religious or ideological reasons. There has been much debate around this particular point, namely whether those who commit multiple murders and derive some form of evident gain in the sense of material profit or professional kudos, such as the assassin, qualify as being individuals who commit serial murder (Pistorius, 1996; Wilson, 2000). However, by not specifying any details with regard to

motive, definitions may suffer the same threats to consistency as discussed above with reference to quantity of murders.

Definitions that do refer to motive appear to situate this motive intrinsically or internally to the individual concerned (Egger, 1990; Holmes & DeBurger, 1988; Labuschagne, 2004; Lane & Gregg, 1992; Pistorius, 1996). Serial murder is consequently frequently understood as being psychologically motivated (Labuschagne, 2003). Such definitions have implications for the manner in which such an individual is treated after being apprehended as well as investigative methods used to track and apprehend such a person. By defining serial murder as having motives that are internal, these same attempts to track and apprehend such an individual become very difficult, as there are limitations to the certainty with which future criminal behaviour can be assessed.

Additionally, by virtue of definitions of such motives as being psychological in nature, it seems as if an individual who commits serial murder is distinguished from the criminal population for whom motives are external, which may not always be an accurate assessment. This follows from the possibility that as much as motives may differ, offence behaviour and criminal decision-making may follow similar patterns. Additionally, by excluding cases where there is an obvious external motive, definitions may omit cases where, in spite of this external motive, there is a stronger internal motive that is less obvious but nevertheless, the primary motivation. This may occur in a case where an individual kills a young couple and steals their motor vehicle but where the murder of the two individuals satisfies the suspect's primary need.

Some definitions that refer directly to motive go as far as to specify what kinds of internal motives these are such as power (Egger, 1990; Holmes & DeBurger, 1988), lust (Holmes & DeBurger, 1988) and compulsion (Pistorius, 1996). Whereas a more detailed description of

motive in definitions may be helpful with respect to investigation of serial murder, motive-based definitions that are too specific may omit cases of serial murder where motives differ.

Additionally, given that such motives are internally located, there may be large differences in interpretation of such motives between those who apply the definition and those who are involved in serial murder. For example, definitions that emphasize the role of power motives in serial murder remain ambiguous in that power itself as a concept is defined and interpreted subjectively with respect to the nature of power - physical, psychological, emotional and/or financial - and relationship, in the sense that power involves a differential between the individual who is powerful in relation to another who is not. The perpetrator may select victims whose powerlessness is obvious to him/her in accordance to an internal set of values and norms but not obvious to those applying power motive-based definitions. As a result, such definitions may omit this individual or fail to link a series of murders. To combat this, Jenkins (1994) has suggested that motive should be included in definitions in as much as the murder is consistent with the perpetrator's internal set of values. This, however, holds little worth for investigative applications in that it would only be possible to establish this information post-arrest, and hence is not helpful in guiding searches for possible suspects. This can also be applied to motive-based definitions that emphasise compulsion or drive, and lust.

Motive-based definitions that are too specific may also often result in presumptive labeling or attributions in investigation. Should a motive-based definition be too exclusive, individuals who commit murder for the pure enjoyment of the act of killing are left out. Additionally, typology-based definitions such as that of Holmes and DeBurger (1988) that classify serial murder in terms of visionary, mission-oriented, hedonistic and power/control motivations, risk creating fixed serial murder types which do not allow enough flexibility for variation in motive or new kinds of motives.

Police investigation that utilizes such types may also narrow its focus to evaluate crime scenes and murder cases within the confines of the typology as opposed to deducing motive from crime scene details and case facts. Such inductive exposition is not entirely accurate and Turvey (1998) warns against the dangers of such inductive logic in terms of the inherent flaws in going beyond the available data with no justifiable ground from which to do so. Definitions which promote certain kinds of motives in serial murder may consequently not only tautologically confirm their definitional elements by reference to subsequent instances but also base their “evidence” on untenable and flawed causal links.

- **Sexuality and lust murder.**

Some definitions of serial murder appear to introduce a sexual component (Egger, 1990; Holmes & DeBurger, 1988; Pistorius, 1996). This may be with respect to motive, as with Holmes and DeBurger (1998) and to a lesser degree, Pistorius (1996); with respect to concomitant paraphilias or sexual deviance (Pistorius, 1996); or with regards to the type of victim selected, such as prostitutes and homosexuals in Egger’s (1990) definition.

Definitions such as that of Pistorius (1996), that includes reference to paraphilias such as necrophilia and components such as sexual abuse, risk omitting cases where those components are absent. In South Africa, the extent to which such elements have been seen in serial murder cases varies. Whereas individuals such as Stewart Wilken, engaged in some post-mortem mutilation, cannibalism and necrophilia (Labuschagne, personal communication, 2005), individuals such as the Saloon Killer, Velaphi Ndlangamandla, did not, and shot his victims from a distance with a .22 caliber rifle.

Additionally, there may not be consistency across murders in a particular case of serial murder with respect to sexual elements. For example, Samuel Sidyno strangled his male victims, and yet raped some of the females that he murdered. The case of David Mbengwa

illustrates another difficulty with including sexual components in a definition of serial murder. Much the same as with most motive-based definitions, what constitutes as sexual may vary between perpetrators as well as those applying definitions or interpreting crime scenes. David Mbengwa shot his victims and thus his modus operandi was not explicitly sexual in nature. However, his targets were young couples making love. Whether this constituted a sexual stimulus for Mbengwa or not will depend on his worldview, which may conflict with those of the individual applying a definition of serial murder with sexual components. This may also only be determined on apprehension. Much the same debate has occurred with international serial murderers such as David Berkowitz, the Son of Sam, who also shot his victims, which were young couples as well (Lane & Gregg, 1992). Douglas and Olshaker (2000) as well as FBI profilers such as Robert Ressler (1997) have argued that the gun in these cases represented a phallic object, and hence, the murders were sexual in nature. This would seem to be open to argument however.

Sexual homicide has been defined as “the intentional killing of a person during which there is sexual behaviour by the perpetrator” (Meloy, 2000, p. 2). Ressler *et al.* (1988) define sexual homicide as “...murders with evidence or observations that indicate the murder was sexual in nature.” (p. 13), which is not very helpful. Given that sexual homicide appears to refer to a separate kind of homicide or murder, it would appear that in cases where murders within an instance of serial murder conform to the above definitions in terms of displaying obvious sexual components, it would seem more appropriate to classify such an instance as a particular case of serial sexual homicide, as opposed to incorporating sexual elements into a standard definition of serial murder. In other words, serial sexual murder (or homicide) would constitute a sub-type existing within the broader category of serial murder, together with other subtypes such as serial murder as part of organized crime, which would encompass individuals working as contract killers.

- **Number of perpetrators.**

Definitions of serial murder appear to vary with respect to the number of perpetrators that they specify. Whereas some do not specify number at all (Douglas & Olshaker, 2000; Ressler *et al.*, 1988), others appear to be divided between specifying one perpetrator (Harbort & Mokros, 2001; Lane & Gregg, 1992) and more than one perpetrator (Egger, 1990; Holmes & DeBurger, 1988; Labuschagne, 2003; Pistorius, 1996).

Definitions that refer to single perpetrators risk omitting cases where serial murder involves two individuals such as the Moors murders in England (Ian Brady and Myra Hindley), Fred and Rosemary West in England, as well as Jacques Coetzee and John Frank Brown and the NASREC pair of Mazangkane and Motsegwa in South Africa. Those definitions that allow for more than one perpetrator generally appear to avoid specifying a maximum number of individuals that may be involved, or the ways in which aspects of serial murder may vary as a result. For example, in cases where more than two individuals appear to be involved in committing murders, such as the Manson murders in the 1970's in the United States, questions arise as to the apportioning of accountability and responsibility, as a result of group dynamics such as "mob thinking" (Asch, 1956; Janis, 1972). Additionally, definitions that include the possibility of more than two perpetrators appear to avoid specifying whether gangs of individuals who commit multiple murders would qualify as instances of serial murder. It also seems to be unclear whether the same individuals would have to be involved in every murder in a particular series, or whether each individual would have to carry out the same tasks in each instance.

- **Gender.**

With regards to gender, some definitions seem to directly frame serial murder as perpetrated by males (Egger, 1990; Harbort & Mokros, 2001; Lane & Gregg, 1992) while others avoid specifying a particular gender (Douglas & Olshaker, 2000; Holmes & DeBurger, 1988; Labuschagne, 2004; Pistorius, 1996; Ressler *et al.*, 1988).

Definitions that describe serial murder as perpetrated solely by males omit cases of serial murder where the perpetrator or co-perpetrator has been a female. These include, Myra Hindley (part of the Moors Murders team with Ian Brady – convicted of three murders) and Rosemary West (part of a team with Fred West – convicted of ten murders) in the United Kingdom, and Aileen Wuornos (convicted of six murders), Christine Falling (convicted of three murders), Janie Gibbs (convicted of five murders) and Gwendolyn Graham and Caroline Wood (convicted of six murders) in the USA. In South Africa, Daisy de Melker is argued to have committed serial murder in the 1930's on Johannesburg's East Rand by poisoning her two husbands and stepson (Lane & Gregg, 1992); however her motive is largely acknowledged to be financial.

Those definitions that do not explicitly refer to a particular gender, while leaving the possibility for a female perpetrator open, do not seem to go far enough by failing to explicitly stating that perpetrators can be male or female. This appears to be reflected by the inconsistent classification of females who commit multiple homicides as serial murderers - for example, individuals such as Daisy de Melker and Aileen Wuornos, as mentioned above.

On the topic of gender, the sexualisation of serial murder definitions (discussed above) has frequently been critiqued by feminist theorists such as Cameron and Frazer (1987) and Caputi (1992), in as much as this often limits the extent to which women can be subsumed under such a definition due to popular conceptions regarding the extent to which a woman can aggressively display her sexuality. As a result, these theorists feel that males who commit

multiple murders are frequently overrepresented in serial murder samples as opposed to women who commit the same crime. In fact, the number of female serial murderers increases by 10-15% in the USA if sexual motives are excluded from definitions of serial murder.

The effects of serial murder definitions that include sexual components can be seen in the recent debate over the classification of Aileen Wuornos, an American woman who murdered six individuals while working as a prostitute in the USA (Lane & Gregg, 1992). While writers such as Douglas and Olshaker (2000) consider her to be the only female American serial murderer, a researcher such as Blanchard (1995) critiques their selective application of serial murder definitions that have excluded other females involved in serial sexual murders such as Catherine Bundy, Karla Homolka and Judith Neely, or conceded their inclusion in classification of serial murder cases by framing female offenders as part of a team, in a more secondary role to their male counterpart (Geberth, 1998). This will be discussed further in the following chapter on theoretical understandings of serial murder.

- **Victim/offender relationship.**

Finally, the aspect of specified relationship between victim and perpetrator in definitions of serial murder will be examined. Some definitions do not make any reference to the details of such a relationship (Douglas & Olshaker, 2000; Harbort & Mokros, 2001; Ressler *et al.*, 1988) while others characterize this relationship as between strangers (Egger, 1990; Holmes & DeBurger, 1988; Labuschagne, 2004; Lane & Gregg, 1992; Pistorius, 1996) and between two people or one-on-one (Holmes & DeBurger, 1988; Lane & Gregg, 1992). Labuschagne (2003) allows for the possibility of more than one victim at a time.

Definitions that do not describe the nature of the relationship between offender and victim appear to be limited in the degree to which they can be useful for investigative purposes.

Those that describe such a relationship too explicitly, such as Egger (1990) in terms of his

description of victims as powerless and prestigeless and in terms of membership to certain social categories such as homosexuals, vagrants, and prostitutes, suffer the same criticism with respect to their possible omission of cases of serial murder where this is not the case such as in the case of Jacques Coetzee and John Frank Brown, who were homosexual themselves, Coetzee being a homosexual prostitute, and whose victims were male homosexuals. They also appear to be weakened by the many ways in which “power” and “powerlessness” can be defined and interpreted.

Definitions that characterize the relationship between victim and offender as one between strangers risk failing to link cases where there is an established connection between these two individuals. An example would be Nicolas Ncama in South Africa whose victims included the daughter of a family friend, a housemate and his stepdaughter (Pistorius, 1996) as well as Stewart Wilken who murdered his own daughter and neighbour’s son (Labuschagne, 2004). Definitions that characterize such a relationship as one-on-one are also challenged by cases where this is not the case such as South Africa’s Wemmer Pan killer, Cedric Maake, as well as David Mbengwa, who killed couples. The same criticism would apply on the grounds of cases where there is more than one perpetrator, such as the Moors murders or the Wests in the United Kingdom.

Definitions that emphasise a lack of relationship between victim and offender also appear to propose this as a core feature of victim selection in serial murder. However, frequently this is not the case, and victim selection operates primarily from personal motives of the individual concerned, to which the nature of relationship with the victim is incidental. For example, for John Wayne Gacy, the American serial murderer convicted of the murder of thirty three victims, his particular victim choice was young boys, regardless of whether a prior relationship existed or not (and in fact, in many cases, he was familiar with his victims who worked for him) (Lane & Gregg, 1992).

2.1.4 Concluding remarks on definitions

The Concise Oxford Dictionary (2004) defines a “series” as a “number of things each of which is similar to the preceding or related to it as it to its predecessor”. Serial murder consequently would refer to a series of murders with each element of the series related in some way to its precedent and antecedent. Definitions should consequently illuminate necessary connections between instances of murder. One would surmise that consistency of perpetrator would be sufficient to link instances of murder. However, this is challenged by the fact that this is evident only after the individual concerned has been apprehended and by cases where there is more than one individual involved such as serial murder teams or duos.

For investigative purposes, connections thereby come in the form of similarities in the way the murder is committed which results in extensive exploration of apparent modus operandi and elements such as signature, victim choice, location and time between murders, and motive which are assumed to be manifested consistently by an individual perpetrator or perpetrators. Assumptions of consistency cannot be reliably proven to withstand challenges and there have been many instances in which apprehended individuals have claimed responsibility for murders considerably different to the series for which the individual has been charged.

The choice of the term “serial” is of interest in that it reflected a need to create a distinct crime category as opposed to viewing a number of linked murders as a result of a compulsion or addiction on the part of the individual/s concerned, which would have been more in line with a psychological or medical model as opposed to a legal-investigative model. Consequently, when psychological concepts such as “emotional cooling off period” (Douglas & Olshaker, 2000), “motives...that originate within the individual” (Holmes & DeBurger, 1988) and statements such as “motive is intrinsic; an irresistible compulsion, fuelled by

fantasy...” (Pistorius, 1996) are included in definitions of serial murder, complications arise due to the fact that such concepts and statements are not always as empirically and veridically accessible as necessary for investigative applications. Tenuous links that are drawn between the two domains not only add to debates around definitions of serial murder but also frequently add to the confusion surrounding what constitutes serial murder. It would appear that, as much as psychological explanations and concepts might be utilized to inform definitions, should the purpose of accurate definitions of serial murder be largely for investigative purposes, they should be phrased in these terms.

Ferguson, White, Cherry, Lorenz and Bhimani (2003) argue that a clear definition of serial murder is essential in order to standardize reporting of prevalence statistics and to educate criminal justice professionals and the public. Different definitions not only result in general public confusion and misperceptions but also additionally mean that research frequently focuses upon different populations of offenders without acknowledging this difference.

In this light, it is necessary to highlight what appears to be an underlying tension with regard to definitions of serial murder, between psychological and investigative perspectives. Although it would seem that the two domains overlap frequently in understandings of serial murder, and are not essentially mutually exclusive, there are differences between their respective emphases that frequently result in competing tensions within serial murder definitions. For example, the inclusion of the notion of a cooling off period in definitions such as Douglas and Olshaker (2000) and Ressler *et al.* (1988) can be seen to constitute a reference to psychological interpretations of the temporal lapses between the various offences of the perpetrator.

If these definitions were to be strictly investigative oriented it would suffice to say that murders occurred at different times (days, weeks, months apart) such as Egger (1990).

Another example of this is descriptions of victims as having symbolic value (Egger, 1990) that also invokes a need for psychological interpretations of the individual in question.

This interplay is problematic in that it frequently obfuscates the absolute character with which investigative definitions and criteria need to be applied in order to make them as effective as possible. Due to the relativity and multiplicity of psychological approaches available with which to interpret definitional criteria, it is possible to conceive of a number of ways in which such criteria can be structured and applied. For example, psychodynamic approaches may interpret David Berkowitz's use of a gun to commit his crimes as a form of phallic affirmation, and consequently invoke the sexual criterion of serial murder in spite of the absence of overtly sexual elements in his crime scenes and modus operandi (Lane & Gregg, 1992). Other schools of psychology, such as cognitive-behavioural approaches, may not interpret actions in the same way and find no basis for a sexual interpretation and consequently not invoke the sexual criterion as essential for definitions of serial murder.

Such confusion and definitional relativity are counter-productive to investigative applications that necessitate greater clarity and certainty with which to make absolute pronouncements, despite being necessary for dialogue concerning psychological understandings and theories of serial murder. It is interesting to note that most of the above definitions have emerged from law enforcement backgrounds, and that a definitive theory or theories of serial murder are difficult to find (as will be discussed in sections to follow). It is the opinion of the author that there needs to be a greater awareness of these perspectives in serial murder definitions and a separation of their respective elements in definitional criteria so as to facilitate greater clarity.

One solution may lie in a distinction being drawn between definitional criteria and characteristics of serial murder, with the former relating more to law enforcement and investigative purposes, and the latter related more to psychological understandings of serial

murder. To elaborate, definitional criteria might include factors such as number of murders, and timing between murder instances, while characteristics would be more explicitly related to personality and psychological traits, allowing for individual variations within classifications based on the afore-mentioned criteria. These might include factors such as the nature of motive, and possible personality traits, such as disorganised/organised as conceptualized in Holmes and Holmes (1996) below. Until these aspects are distinguished more clearly, definitions of serial murder run the risk of inconsistency with respect to the manner in which cases of serial murder are classified. Consequently, the definitional criteria might be used after the fact, so to speak, to classify an individual as someone who had committed serial murder. Concurrently, a set of characteristics based on personality traits and psychological factors associated with individuals who commit serial murder could also be established and allow for more variation between individuals. Such a group of characteristics would then capture those exceptions that may not meet all the definitional criteria, and yet display personality traits or behavioural patterns characteristic of serial murder.

Labuschagne (personal communication, 2006) elaborates on the above and states that one of the most confounding problems with serial murder definitions is the creators' habit of mixing a criterion with a characteristic. If one looks at a parallel, the DSM diagnostic system (American Psychological Association, 1994), it has a few set criteria that are necessary to make the diagnosis. The DSM then goes on to discuss the characteristics of the disorder. In relation to serial murder, it can be said that to murder two or more victims is a criteria; the fact that they are often prostitutes or vagrants is a characteristic. If it is elevated to a criterion, then it becomes limiting, in that if the victims are middle-class, working people, can the crime not be classified as serial murder? A similar concern could be raised in relation to other characteristics/criteria such as the sexual element. It is a characteristic that the crimes are sexual in nature but if it is elevated to a criterion then a number of murders where the suspect

strangled women could not be classified as a series. Labuschagne further feels that this is in part due to the problem of some definitions defining the concept (serial murder) and some defining the person (serial murderer). Defining the concept might be more useful for investigators; defining the person might be more useful for the criminal justice system, researchers and psychologists.

2.1.5 Definition of serial murder for the purposes of this study

In light of the above discussion and critique, the following definition of serial murder is proposed for the current study, namely as:

- multiple murders committed,
- over a period of time
- by one or more individuals.

In this way, the broadness of many of the above definitions is avoided and a working definition is provided which may then be elaborated upon in terms of characteristics associated with serial murder, from different perspectives (such as psychology, law enforcement, sociology, and other disciplines). This study also chooses to use the term “serial murder” rather than “serial homicide” due to the fact that South African legal terminology for types of crime makes reference to murder and not homicide. Additionally, serial murder will be utilized rather than “serial killing” due to the previously discussed sensationalistic nature of the latter term, as well as the fact that one may kill but the act of killing does not necessarily constitute an illegal act. For example, killing in self-defence or as part of a national defence force in armed conflict. Finally, the phrase “individual/s who commit/s serial murder” will be used rather than “serial murderer/s” in an effort to view such individuals

holistically, and not to adopt a reductionist stance of viewing such individuals as consisting of the sum total of their criminal behaviour/activity.

As discussed above, definitions of serial murder have frequently lost precision due to an apparent attempt to satisfy both psychological and law enforcement or policing perspectives with regards to its usage. By formulating a basic definition such as that above, the author intends to provide a basis for identifying instances of serial murder, which then may be expanded to include exceptions or variations in associated characteristics (such as motive, number of perpetrators, gender and victim/offender relationship, for example). In this way, it is hoped that a clearer distinction is made between a definition of serial murder and the characteristics associated with instances of serial murder, two areas that previously have been less clearly distinguished in attempts to define serial murder.

The author will now discuss some of the ways in which serial murder has been classified. As will be illustrated, many of these classification schemes operate largely on assumptions about the type of individual/s who commit/s serial murder and have been developed predominantly to assist with profiling and investigative applications.

2.2 HISTORICAL BACKGROUND OF SERIAL MURDER

In the following section, the historical background of serial murder will be explored, taking into account the history of serial murder in an international and local South African context. As will be demonstrated in the ensuing discussion, it would appear that a debate concerning the origins of serial murder runs consistently through attempts to document the history of this phenomenon. This debate is concerned with whether serial murder is a recent phenomenon or whether it has existed for the greater part of contemporary history. This

debate together with the international and South African historical background of serial murder will now be discussed.

2.2.1 History of serial murder: international

Considerable contention surrounds the issue of when the first noted case of serial murder occurred. While some argue that serial murder is a recent phenomenon, having risen to prominence over the last three decades (Anderson, 1994; Ferguson *et al.*, 2003), others argue that serial murder has always been part of the human experience, and that the ways in which it has been understood and described have varied with different historical periods and the dominant understanding of human behaviour at that time (Jenkins, 1994; Simpson, 1999; Whitman & Agawa, 2003; Wilson, 2000).

Arguments for and against serial murder as a recent phenomenon may be subject to the effects of crime reporting. Generally, reported rates and statistics for serial murder are considered skeptically due to differences and variability in reporting (especially in light of the different definitions that are utilized) as well as linkage blindness or the lack of reliable linking of cases comprising the series of homicides in a single instance of serial murder (Stote & Standing, 1995). As a result, it is not always easy to assess, with sufficient certainty, whether reported increases or lack of increase are accurately reflecting the phenomenon of serial murder.

Within the literature, the earliest suggested instance of serial murder is claimed to be as early as 54 AD in the form of Locusta of Gaul - a woman who poisoned several members of the Roman royal family to assist others to usurp their positions (Whitman & Akutagawa, 2003). It is also thought that accounts of "monsters" such as werewolves and vampires like Vlad the Impaler in the early 17th and 18th centuries may have been early references to serial

murder (Jenkins, 1994; Simpson, 1999; Wilson, 2000). This sketchy history of serial murder is further elaborated upon by reports of individuals such as Gilles de Rais in the 15th century, Countess Elizabeth Bathory in the 18th century, and Dr Neill Thomas Cream in the 19th century, who are thought to have sadistically preyed upon the local peasants and innocent patients respectively, with postulated victim counts of up to thousands (Lane & Gregg, 1992; Wilson, 2000).

The earliest popular documentation of serial murder in the currently accepted format originates in the late nineteenth century, with accounts of Jack the Ripper (Wilson, 2000). This individual is believed to have terrorized the Whitechapel area of the East End of London from August to December 1888, violently murdering five female prostitutes (Douglas & Olshaker, 2000). Police were never able to apprehend the perpetrator and as such, Jack the Ripper's true identity remains a mystery, rendering this modern "antihero" to near mythological status (Lane & Gregg, 1992). Various modern theorists, novelists, profilers and investigators have attempted to identify the most likely candidate from a plethora of possible suspects, but Jack the Ripper's identity remains a case of speculation, ranging from links to royalty to a deranged local butcher.

The romanticization of the Jack the Ripper case in popular fiction can be seen in a multitude of fictional works such as the Sherlock Holmes novels of Arthur Conan Doyle and in several popular films such as *Edge of Sanity* (1989), *Deadly Advice* (1993) and recently, *From Hell* (2001). As a result, it would appear that serial murder has experienced a similar romanticization and elaboration in fictional and factual works, with the borders between these two realms blurred and the representations contained within each utilized interchangeably by the general public and popular understandings. The individual who commits serial murder seems to enjoy a similar elevation to mythical status as a consequence and certain elements of

the romantic in his portrayal in the various expressions of the popular culture in which he is situated.

Since Jack the Ripper in the late nineteenth century, serial murder appears to have attracted attention once again in the 1960's which saw an overwhelming volume of cases such as the Manson family, and Albert DeSalvo (the Boston Strangler) followed by Ted Bundy, Dean Corll, John Gacy and Randall Woodfield in the 1970's in the United States; the Moors murders (committed by Ian Brady and Myra Hindley) and the Yorkshire Ripper, John Sutcliffe, in the United Kingdom; Pedro Lopez, the "monster of the Andes" in South America; and Arthur Chikatilo, Citizen X, in Russia from the 1970's through to the 1990's (Lane & Gregg, 1992; Wilson, 2000).

The 1970's also saw the birth of the term "serial killer", allegedly penned by the Behavioural Science Unit of the Federal Bureau of Investigation (FBI) in the USA, as well as the emergence of the psychological profile and investigative science aimed specifically at the tracking and apprehension of this "new" criminal type (Wilson, 2000).

There appears to have been a lack of attention to serial murder during the period between the sensation that accompanied the case of Jack the Ripper at the turn of the century, and the re-emergence of such sensationalism with the serial murder cases of the 1960's. The available literature does not appear to suggest any explanations for this silence. One may postulate a number of possible explanations. One explanation may be that crime statistics and crime reporting failed to reflect incidences of serial murder.

Another explanation may be that the frequency of wars during this period in the form of the First (1914-1919) and Second World War (1939-1945), as well as the Korean War (1950-1953), masked incidences of serial murder that may have been noticeable at other times due to either deflection of media and criminal justice concerns to the war effort; absorption of potential serial murderers into a war effort that may have channeled their aggressive

tendencies in more sanctioned pursuits; or, with reference to a more systemic perspective, that a war-time society focused upon survival had no function for an individual working counter to the collective aims of that particular society (Wilson, 2000). However, one could argue that this theory is challenged by incidences such as the Vietnam War (1968-1972) that took place concurrently to the rise of the serial murder phenomenon in the USA and the United Kingdom and does not seem to have masked the serial murder phenomenon in a similar way.

Another explanation may be derived from the work of Jenkins (1994) in the sense that the emergence of serial murder may reflect a need for disciplining society at times when society moves away from conservatism towards a state of more flexible morals and norms. Both the end of the Victorian era (e.g., Jack the Ripper) and the 1960's represented eras where society adopted a more relaxed attitude to norms and values, reflecting a change in the social system. Through victim choice and representation as evil or other, the serial murderer prescribed acceptable behaviour. For example, Jack the Ripper targeted prostitutes, as did many of the 1960's group of serial murderers in the USA (together with homosexuals, vagrants, and other social deviants). In this way, certain ways of life were considered dangerous and made one vulnerable to victimization, encouraging a return to more conservative ways of life. This argument will be elaborated upon further in discussion of the theories that have attempted to explain serial murder (see Chapter 3).

To return to the debate surrounding the historical origins of serial murder, Wilson (2000) counters attempts to trace the historical origins of serial murder to the earliest parts of the history of the human race, by arguing that serial murder is a recent development in criminal history. He attributes the use and origin of the term "serial murder" in 1980's America to an increase in sex crime and "motiveless murder" in the previous twenty years. Conversely, Lane and Gregg (1992) hold that understandings of patterns of behaviour of individuals who

commit serial murder such as those of the Federal Bureau of Investigation (FBI) Behavioural Science Unit or the “psychologization” of serial murder are more recent developments.

Such developments are argued to have increased the attention bestowed upon serial murder over the last two decades (as an academic topic, psychological case study, media attraction, entertainment feature and fictional protagonist) and have contributed to a false perception of such a phenomenon as recent. Stote and Standing (1995) compared a number of newspaper and statistical sources reporting rates of serial murder in the USA from 1950 to 1990 and found that increases in serial murder had occurred proportionately to increases in general violent crime and homicide. Ressler (in Holmes & Holmes, 1996) supports the view that serial murder is a recent phenomenon and holds that serial murder did not exist in the United States before 1950. Once again, such a statement is arguable but does point to a certain viewpoint, which sees serial murder as a possible chronological benchmark in cultural development, although what constitutes such development remains unclear.

The author will now discuss how serial murder developed in South Africa, including local variations on the above debate concerning the origins of serial murder.

2.2.2 History of serial murder: South Africa

Serial murder in South Africa appears to have risen to prominence in the early nineties (Hodgskiss, 2003; Labuschagne, 2003; Pistorius, 1996). Available crime statistics demonstrate that over the last two decades, South Africa has accumulated a tally of over 50 cases of serial murder (Hodgskiss, 2003). The last decade in particular has contributed considerably to this total (Schonteich & Louw, 2001). In the last twelve years alone, only Russia and the USA surpassed this tally on an international level (Hodgskiss, 2002; Holmes & Holmes, 1996).

The apparent proliferation of serial murder in the early 1990s might be likened to the way that serial murder seemed to rise to prominence in the USA and the United Kingdom in the 1960s and 1970s (Wilson, 2000). In much the same way as debates surrounding international interpretations of the apparent proliferation of serial murder in the twentieth century could be divided roughly between those who view this phenomenon as recent (Anderson, 1994; Ferguson et al., 2003), and those who believe that serial murder has existed historically in some form (Jenkins, 2002; Simpson, 1999; Whitman & Agutagawa, 2003; Wilson, 2000), the considerable increase in awareness of serial murder in South Africa has been debated along similar lines.

In other words, these can be divided between a belief that serial murder is a recent phenomenon in South Africa (Ressler, 1997) and one that it is not a recent phenomenon (Marsh, 1999; Pistorius, 1996). With regards to the former, explanations proposed include the political transformation and social upheaval of the early nineties due to a change from Apartheid government to a democratic system in South Africa, as well as increased Westernization and influence of an apparently Western phenomenon such as serial murder (Ressler, 1997). With reference to socio-cultural explanations of serial murder, one may refer to theories such as that of *anomie* (Durkheim, 1897) and Strain Theory (Merton, 1968) to understand serial murder in South Africa. With regards to the former, the transition, and accompanying reassessment of societal norms and values, that affected South African society in the early nineties, after the end of Apartheid, may have created a climate that fostered an increase in serial murder. With regards to Strain Theory, the end of Apartheid ushered in a period of great expectation and hope amongst a majority population who had previously been denied opportunities for success, prosperity and achievement. One could argue that the apparent increase in serial murder in the early nineties may have been a response to the lack of immediate realization of such opportunities in a democratic South Africa, or the selective

availability of opportunities to realize such goals amongst certain sectors of the previously disadvantaged, and not others.

Individuals such as Marsh (1999) claim that a failure to notice serial murder before 1990 may reflect biases in crime reporting. For example, Elifasi Nsomi murdered 15 people in Kwazulu-Natal province over a period of 18 months in 1950. He blamed the tokoloshe (traditional African spirit) for his crimes but was sentenced to death (Labuschagne, personal communication, 2006). Pistorius (1996) explains the lack of attention to serial murder prior to 1990 as a result of a lack of awareness of such a phenomenon; poorer ability to link cases of murder; insufficient sensitivity or discrimination between crime types on the part of the South African media; and lack of specialized training on the part of South African law enforcement, which only began in the mid-1990s (Pistorius, 1996).

With reference to Marsh (1999), the lack of attention or popular awareness of serial murder in South Africa prior to the nineties may have been the result of differences in reporting of instances of serial murder pre- and post-1990. However, this is difficult to assess given general problems with the ability of crime records to accurately reflect patterns of crime (Stote & Standing, 1995) and problems with crime reporting in the South African context such as: a biased reporting and recording of criminal activity and violent crime during Apartheid, and poor availability and inconsistency in archive management (Marsh, 1999). Schonteich and Louw (2001) support the above and argue that due to the fact that South African Police crime figures during the Apartheid era excluded crimes committed and reported in the homelands and KwaZulu-Natal Province; official crime statistics prior to 1994 should therefore be interpreted cautiously.

With respect to media attention, it would appear that local media attention to South African instances of serial murder seemed to emerge during the early nineties. This can be evidenced in articles across the publication spectrum, such as “Verkrachter nie versteurd –

getuie” in the *Beeld* (22 September, 1993) about the Norwood rapist, Cobus Geldenhuys; “Spanwerk los reeksmoord op” in the *Rapport* (31 January, 1999) about the Capitol Hill serial murder case; “Still no end to serial killing” in the *Weekly Mail and Guardian* (22 September, 1995); and “2410 years on jail for ghoulish serial killer” in the *City Press* (7 December, 1997), both about Moses Sithole. Prior to this period, South Africa’s media and popular press were interested in, and aware of, true crime stories, particularly those of “sensational crimes” or crimes of passion such as William van der Merwe, the “screwdriver rapist” of the 1970s (Marsh, 1999) and cases such as the Suitcase Murder of 1964 (Kennaugh, 1968). However, references to serial murder appear to be absent in the popular media during this period. This may indicate a lack of awareness of, and/or a lack of interest in serial murder as a type of crime by media sources, or simply reflect the greater lack of awareness of this phenomenon in the wider police and socio-cultural context.

Although considerable skepticism appears to surround South African crime statistics prior to 1990, it is interesting to consider the third option, namely that serial murder did actually increase in prevalence post-1990. Ressler (1997) has attributed the seeming emergence of serial murder during this time period to larger socio-cultural and political developments such as the end of Apartheid and transition to an era of democracy as well as increased exposure to Western culture, which may have encouraged the assimilation of Western phenomena, such as serial murder, into African culture. Pistorius (1996) has argued that a combination of factors such as a highly mobile population and widespread poverty and unemployment appeared to aggregate at this particular point in time, possibly by virtue of socio-cultural developments and political change, creating an atmosphere conducive to the development of serial murder. Hodgskiss (2003) elaborates upon this, utilizing the work of Holmes and DeBurger (1988) and Hickey (2001), to argue that high rates of violent crime in South Africa post-1990, increased urbanization and overcrowding of urban areas resulting in anonymity and

depersonalization, and normalization of interpersonal violence may have created an environment that fostered the development and increase of serial murder in South Africa in the early nineties.

Given the above, it would appear that establishing serial murder prevalence prior to 1990 with considerable validity is difficult. However, individuals such as Pistorius (2002) and Labuschagne (2003), possibly due to their involvement in policing investigation initiatives directed at identifying, investigation, convicting and containing serial murder have attempted to outline a tentative chronology of serial murder in South Africa, based on their own experiences and case file material, which will be discussed now.

Pistorius (2002), in an attempt to historically document serial murder in South Africa in her source-book *Strangers on the Street*, holds that the first known case of South African serial murder actually occurred in Milnerton in the 1930s followed by sporadic incidences spread across the remaining pre-1992 period. Her attempt to retrospectively classify cases of apparent multiple murder as instances of serial murder can be critiqued on a number of levels, notably the possible lack of validity across time and availability of sufficiently detailed archival data on which to base such classifications, as well as on the basis of the general problems with South African crime records highlighted by Marsh (1999) above. Pistorius (1996) herself has highlighted that, prior to initiatives launched by the Investigative Psychology Unit (IPU) of the SAPS in specialized training in serial murder in the early 1990's, a majority of investigating officers were not specifically trained in serial murder investigation. In light of the above, it would seem that retrospective classification of cases of serial murder is flawed and potentially further complicated by disagreements concerning definitional stipulations around serial murder, as discussed previously.

It is consequently the position of this study that although serial murder may have been prevalent in South Africa prior to the nineties, it is only from 1990 onwards that it can be

documented with any arguable accuracy. Additionally, triangulation of data from numerous sources such as police case files, professional discussion and academic research publications, popular media sources, and court records has enabled a more grounded evaluation and confirmation of such cases (Labuschagne, 2001) as may be evidenced in the following table.

Table 2.1

South African Serial Murder Cases 1936-2003 (Adapted from Labuschagne, 2004)

Series name	Location	Suspect Name	Years	Victim number
None	Johannesburg	Cornelius Burger	1936-1937	5
None	Cape Town	Salie Lingeveldt	1940	5
None	Kwazulu-Natal	Elifasi Msomi	1953-1955	15
Pangaman	Pretoria	Elias Xitavhudzi	1960s	16
None	Atteridgeville	John Phukokgabi	1974-1978	16
None	Soweto	Joseph Mahlangu	1979	13
None	Pietermaritzburg	Phillip Magoso	1983	5
Station Strangler	Cape Town	Unknown	1986-1994	22
Vlakgrafte	Kuilsrivier	Zola Mqombuyi	1987-2001	5
Norwood Serial	Norwood	Cobus Geldenhuis	1989-1992	5
None	Port Elizabeth	Brydon Brandt	1989-1997	4
Boetie Boer	Port Elizabeth	Stewart Wilken	1990-1997	10
None	Cape Town	Wessels & Havenga	1991	4
None	West Rand	Moses Mokgeti	1991-1993	7
Kaap prostituut	Cape Town	Unknown	1992-1995	19
Eva Nosal	East Rand	Christiaan De	1993-1994	2

		Wet		
None	Witbank	Nolan Edwards	1993-1994	3
Cross Dressing	East Rand	Brown &	1993-1995	5
		Coetzee		
NASREC	Johannesburg	Mazankane &	1993-1998	17
		Motsegwa		
Cleveland	Cleveland, JHB	David Selepe	1994	14
Strangler				
Pinetown	Pinetown	Unknown	1994-1995	3
Strangler				
Atteridgeville	Atteridgeville,	Moses Sithole	1994-1995	38
Strangler	Boksburg,			
	Cleveland			
Donnybrook	Natal Midlands	Christopher	1994-1995	8
		Zikode		
Pheonix	Pheonix, Durban	Sipho Twala	1994-1997	17
None	Louis Trichardt	Willem Grobler	1995	2
None	Mdantsane, East	Vuyani Mpezo	1995	2
		London		
Kranskop	Newcastle	Bongani Mfeka	1995	4
Wemmerpan	Johannesburg	Cedric Maake	1995-1997	35
Lenyenye	Tzaneen	Unknown	1996-1997	5
Oos Kaap	Kwazakele	Nicolas Ncama	1996-1997	4
None	Carltonville	Unknown	1996-1998	6

None	Thohoyandou	David Mbengwa	1996-1998	10
Roadside	Northwest Province	Francois Potgieter	1996-2000	16
Langlaagte	Johannesburg	Unknown	1996-2000	2
Piromaan	Jeppe, JHB	Norman Hobkirk	1997	3
Saloon Killer	Piet Retief	V. Nglanamandla	1997-1998	16
Maize Field	Kroonstad	Daniel Ramayisa	1997-1998	3
None	Upington	JAC Nel	1997-1998	2
Skiereiland	Cape Town	Unknown	1997-	3
Nagmerrie				
Doringdraad	Empangeni	Unknown	1997-1998	16
Sleepy Hollow	Pietermaritzburg	Unknown	1997-1999	8
Capital Park	Pretoria	Samuel Sydino	1998	7
None	Vereeniging	Unknown	1998-1999	2
None	Natal	Juan Jordaan	1999	3
None	Barberton	Frank Ndebe	1999	4
Osizweni	Newcastle	Sidney Dlamini	1999-2000	5
Rioolplaas	Cape Town	Unknown	1999-2000	9
Riverman	Durban	Unknown	1999-2001	13
Kleine Fonteine	Pretoria West	Unknown	1999-2001	5
RDP Strangler	Potgietersrus	Ephraim Legodi	2000	4
Hospital View Strangler	Potgietersrus	Ephraim Legodi	2000	1

None	Kwa Dukuza	Unknown	2000-2001	4
None	Keiskammahoek	Mcpherson	2001	2
		Nyonga		
PE Prostitute	Port Elizabeth	Unknown	2001	4
None	Randfontein	Unknown	2001-2003	7
None	Mapelo Hans	Awaiting trial	2002	3
Highwayman	Pretoria	Elias Chauke	2002	5
Newlands East	Durban	Unknown	2002-2003	13
Johannesburg	Johannesburg	Awaiting trial	2003	7
Mine Dump				
Rustenburg	Rustenburg	Awaiting trial	2003	2
Child Killer				
Stellenbosch	Stellenbosch	Unknown	2001-2003	3
Child Murder				

Since the early nineties, and apparent rapid subsequent increment, serial murder has been approached in a manner that has seen considerable efforts made to improve investigation (and consequently apprehension) methods especially given the pervasive doubt in the rehabilitation capacity for the individuals who commit such crimes (Pistorius, 1996). One such measure was the creation of the Investigative Psychology Unit (IPU) as part of the South African Police Services' Serious and Violent Crime Component in 1995. The IPU has done considerable work to introduce training programmes for police officers and investigators of serial murder cases, provide investigative support; and conduct research, with the result that South Africa seems to hold the world record for the quickest apprehension time in a serial murder case (six

weeks from first murder and another within 48 hours of a task team being put together). The SAPS also has a hundred percent conviction rate for its serial murder cases brought to trial (Labuschagne, personal communication, 2003).

The IPU is also one of the few law enforcement units in the world with a full-time unit of functional members, albeit stretched in terms of resources given its small compliment of three members. Given its positioning at national level, it is able to centrally communicate with detective units across the country and consequently greatly limit linkage blindness. Each province has a co-coordinator of serial murder and serial rape investigations who also assists in detecting cases and monitoring investigations. The unit also possesses a mandate to be involved in all serial murder cases, which means that it is able to continually monitor serial murder in South Africa, as well as its interventions in relation to it. It is also the only unit in the SAPS allowed to do offender profiling.

Generally, the IPU is concerned with three roles – investigative support; training; and research. It is the only police service in the world with regular training on serial murder for: crime scene photographers; general detectives; serious and violent crimes detectives; family violence, child protection and sexual offences detectives; forensic science laboratory field workers; and facial identification unit members, and additionally, it has a specialized three week course in serial murder investigation (Labuschagne, 2003).

In addition to the IPU, investigative handling of serial murder in South Africa has been supplemented by crime mapping technology, which has allowed for greater ability in terms of linking crimes and offences within cases of serial murder. Such technology has allowed for better presentation in court cases, and has involved liaising with cellular network providers for itemized billing, transmission towers and maps of coverage in cases where cellular phones have been stolen or used by the offender. The SAPS first used computerized crime mapping in 1998 with a nationwide computerized crime mapping system in

development during the last quarter of 2000. Computerized crime mapping has allowed for greater ease of distribution of information within police areas as compared with previous wall maps. In this way, serial murder cases can be identified quickly and monitored effectively, as well as facilitating possible geographical profiling applications.

Many factors still need to be addressed in the realm of investigative police work however. The SAPS lack resources such as money and equipment in order to operate at an optimum level. The varied nature of the South African crime scene and its interaction with cultural factors additionally requires sensitivity to such factors so as to avoid confusion in classifying instances of serial murder. One such confound is muti murder which has may be frequently misattributed to serial murder on the basis of its surface presentation (Labuschagne, 2004). This will receive greater attention in later discussion.

In addition to the above considerations, a large population of mobile, migrant labour also constrains effective investigation and apprehension of criminals as well as surveillance of victims and tracing of missing persons. As such the victims of an individual who commits serial murder may only be discovered months after they have been murdered or abducted, and never identified. The significant amount of poverty which characterizes the South African context also hampers police investigation in terms of providing a large pool of potential victims as well as fostering conditions in which serial murder (according to international literature) may flourish (Hodgskiss, 2002).

To supplement arguments of the importance of law enforcement effectivity in the apprehension of individuals who commit serial murder, studies in the US and Canada (Collins, Johnson, Choy, Davidson & Mackay, 1998) have pointed to lack of/poor communication between law enforcement and criminal justice agencies as allowing for reduced detection of individuals who commit serial murder. Crime linkage techniques in these countries were seen to fail as a result of a lack of detail in reports compiled by investigators

concerned; subjective interpretations of crime scene information; as well as question formats that were too open-ended and broad. It may be safe to presume that some of these factors have also played a part in the South African context and influenced the perception of serial murder and consequently prevalence statistics. However, it appears that initiatives such as the development of an investigative psychology unit in the SAPS; better communication between provincial and regional police stations; and the IPU at national level, training of investigators and other SAPS members in the identification of serial murder, as well as technology such as crime mapping, may improve crime linkage in serial murder cases.

In conclusion, it would appear that South Africa has made considerable advances in a relatively short period of time to develop effective techniques for preventing and containing serial murder at an investigative level. However, many of these techniques require empirical verification and support in the form of a substantial base of research from which these techniques can be developed and informed. Keppel (1989) emphasizes the importance of the collection of physical evidence and interviewing techniques in serial murder cases. He advocates a standardization and clarification of procedure in order to demystify apprehension techniques and common popular perceptions of serial murder investigation which emphasise “luck”, hunches or intuitive practice as opposed to a more realistic and accurate emphasis on routine police procedure, something that the training offered by the IPU hopes to achieve.

Additionally, it would seem that psychological methods for dealing with and understanding serial murder, and working with individuals who commit serial murder after they are incarcerated, are to a large degree still lacking in South Africa. As will be discussed and shown in the following section, many of the research studies on serial murder in South Africa have touched on aspects of the psychology of serial murder (De Wet, 2005; Du Plessis, 1998; Labuschagne, 2001, 2003; Pistorius, 1996), but these have yet to be consolidated into a body of recommendations for dealing with serial murder both proactively and after

incarceration. Further research in the above areas, in a manner that takes the cultural nuances of the local context into account, may go a significant distance in assisting interventions at police, correctional services and psychological levels for dealing with serial murder in South Africa.

- **Muti murder**

Muti murder is defined as “a murder in which body parts are removed from a live victim for the sole purpose of using the victim’s body parts medicinally” (Labuschagne, 2004, p.191). These parts may or may not be mixed with other medicinal substances in the creation of the final end product or medicine (muti). The cause of death of the victim is usually due to the loss of blood from wounds inflicted in attaining the necessary body parts. Labuschagne (2004) also states that muti murder usually involves three role players (in addition to the victim), namely, the client; the traditional healer; and the murderer. These roles may be filled by three different individuals, or occasionally involve one individual performing more than one role.

Turrell (2001) demonstrates factors comprising muti murder which are useful in distinguishing this from serial murder. He states that firstly, muti murder is usually done on behalf of a chief seeking power, business advocate or doctor for powerful medicine. The victim may be related to the beneficiary in some way. Flesh is removed from the victim while they are still alive, and no blood must be spilt. Given the cultural dilution of pure traditionalism that has developed with the growing influence of Westernisation, this type of murder has been criminalized and developed increasingly along the lines of such influence with the result that capitalist competition has played a larger role in its manifestation. Such cases are important as they highlight the cultural particularities which colour the South

African criminal, investigative context and which necessitate a locally sensitive approach in dealing with the phenomena at hand.

Labuschagne (2004) states that muti murder can be confused with serial murder (and vice versa) and consequently mislead the way in which investigators approach the crime scene; compile suspect lists; and draw up profiles to assist with investigation. As a result, one needs to be cautious when encountering a series of murders involving mutilation of the body or removal of body parts. Labuschagne (2004) highlights a need to distinguish between muti murder and other types of murder such as sadistic mutilation and serial murder and discusses a number of ways in which this may be possible.

With regards to sadistic mutilation, there may be more wounds that are less severe as opposed to fewer, more functional wounds that would characterize muti murder. Additionally, in sadistic mutilation the aim of the wound is more about inflicting pain and suffering, whereas with muti murder, the aim is usually to remove the necessary organ. Mutilation or sadistic murders may also demonstrate evidence of sexual assault, including traces of semen, and may be guided by a fantasy being played out – two features which are not usually expected in muti murder (Labuschagne, 2004).

With regards to serial murder, muti murder differs in that it is often an isolated incident, as opposed to being part of a series of incidents. Serial murder may also demonstrate similar mutilation on bodies, whereas with muti murder body parts are specified and consequently, mutilation is unique to a particular victim. As with the above, serial murder may be guided by fantasy, thereby differing from muti murder, and finally, body parts may be kept as souvenirs in serial murder whereas they are usually handed over to traditional healers in muti murder (Labuschagne, 2004).

Despite the above distinctions, the presentation of muti murder continues to mislead investigations due to the subtlety with which the differences present themselves

(Labuschagne, 2004) and classification of serial murder series should proceed with caution to avoid including cases that are not part of the same series, or failing to recognize a series of murders committed by the same individual.

2.3 WAYS OF CATEGORIZING SERIAL MURDER

Throughout the literature, a number of ways of categorizing different variations of serial murder and individuals who commit serial murder have been proposed. These categories often appear to be based on the manner in which the murders comprising a series are committed. Some of these will now be discussed and critically commented upon.

2.3.1 Topological classification schemes

A review of the literature indicates a number of different classification schemes that have been devised to classify serial murder. Such schemes have been devised for investigative purposes, to assist police investigators in searching for possible suspects or devising offender profiles, interviewing suspects once arrested, and drawing up possible victim profiles (Turvey, 1998).

The FBI and their Behavioural Science Unit have devised a typological classification scheme for serial murder that draws distinctions between disorganised/organised offenders (Ressler & Schachtman, 1992). Such an effort stemmed from general work that was done by the FBI in devising crime classification schedules such as the *Crime Classification Manual* (Douglas, Burgess, Burgess & Ressler, 1992) to assist in investigative applications.

This has been followed by similar schemes such as the Holmes and DeBurger (1988) typology as well as Leibman's (1989) ego-syntonic and ego-dystonic classifications of serial

murder. Finally, a classification based on crime scene geography, as put forward by Canter (1994, 2000) and Rossmo (1995, 1997) will be discussed.

- **The FBI's disorganised/organised typology.**

The disorganised/organised typology of serial murder (Ressler & Shachtman, 1992) was constructed by a group of FBI agents in the 1970's and 1980's in the USA from interviews conducted with 36 individuals incarcerated for sexual murder. It consists of a classification scheme based upon the offender's manner of interpersonal interaction together with information about developmental and early life experiences. Such factors were used in conjunction with information about the individual's modus operandi and general crime planning. This also included details such as the way the offender committed a crime and left a crime scene, pre- and post-offence behaviour and lifestyle to classify such an individual as either disorganised or organised.

Ressler and Shachtman (1992) then extrapolated such information and typological links to isolate certain common characteristics or clusters of features that they believe were typical of disorganised and organised types of offenders. Consequently, they argue that when these clusters of features are encountered at a crime scene, investigators can then assess whether they are searching for a disorganised or organised individual and structure their search accordingly. The FBI is quick to stress that classification is often not either/or but often involves a mixed presentation with elements from different categories occurring simultaneously in one offender.

Scientifically, this typology lacks ecological validity due to its limited sample base, lack of falsifiability, and lack of empirically proven reliability (Turvey, 1998). Canter, Alison, Alison and Wentink (in press) hold that there is only one small-scale empirical test of this typological model and that such a test is open to many challenges. Despite the cursory lack of

scientific rigor, however, this typology is still widely used on the basis of anecdotal success. The introduction of a “mixed” classification additionally weakens the dichotomous basis for the disorganised/organised typology, especially if a large number of cases are found to fall into this type (Canter *et al.*, in press).

Turvey (1998) also criticizes inductive profiling applications such as the FBI disorganised/organised typology on the basis that they lack standardized terminology across investigative applications. He believes that the use of such typologies is dangerous especially when involved in the production of gross generalisations across offender type. Canter *et al.* (in press) tested the disorganised/organised typology using a multidimensional scaling procedure to see whether such discrete subsets of offence behaviour could be elicited from the frequency with which they co-occurred in crime scenes of serial murder cases. They found that such discrete subsets could not be supported, and that, rather, only organised clusters could be identified.

Table 2.2 (Adapted from Ressler & Schachtman, 1992)

Disorganised/Organised Typology

Disorganised, asocial offenders	Organised, nonsocial offenders
IQ below average, 80-95 range	IQ above average, 105-120 range
socially inadequate	socially adequate
lives alone, usually does not date	lives with partner or dates frequently
absent or unstable father	stable father figure
family emotional abuse, inconsistent	family physical abuse, harsh
lives and/or works near crime scene	geographically/occupationally mobile
minimal interest in news media	follows the news media
usually a high school dropout	may be college educated
poor hygiene/housekeeping skills	good hygiene/housekeeping skills
keeps a secret hiding place in the home	does not usually keep a hiding place
nocturnal (nighttime) habits	diurnal (daytime) habits
drives a clunky car or pickup truck	drives a flashy car
needs to return to crime scene for reliving memories	needs to return to crime scene to see what police have done
may contact victim's family to play games	usually contacts police to play games
no interest in police work	a police groupie or wannabe
experiments with self-help programs	doesn't experiment with self-help
kills at one site, considers mission over	kills at one site, disposes at another
usually leaves body intact	may dismember body
attacks in a "blitz" pattern	attacks using seduction into restraints
depersonalizes victim to a thing or it	keeps personal, holds a conversation
leaves a chaotic crime scene	leaves a controlled crime scene
leaves physical evidence	leaves little physical evidence
responds best to counseling interview	responds best to direct interview

- **Holmes and De Burger's visionary, missionary, hedonist and power/control typology.**

Holmes and DeBurger (1988) devised a typology to organise individuals who commit serial murder according to the nature of motivation for their crime - that is, with regard to whether the murders are committed because of:

- visions as with the visionary type;
- a particular mission;
- the pleasure derived from the crime and
- the power obtained in the act of murder.

These four types of serial murder stem from four aspects of the offence namely, the background of behaviour (psychological, sociogenic and biological); victimology (specific/non-specific, random/non-random and affiliative/stranger); pattern and method (act/process focused, planned/spontaneous and organised/disorganised); and finally, location (concentrated/dispersed).

- **The visionary type.**

Such an individual is motivated to murder by visions, godly messages, voices, demon possession, telepathic messages, and alter egos. He/she may experience hallucinations and, for example, believe that they hear a voice instructing them to murder blonde women. Certain theorists (Lane & Gregg, 1992; Leyton, 2001) believe that Charles Manson from the USA could be classified as a visionary type due to his belief that the Beatles' songs Helter Skelter and Blackbird were calls to take up arms and launch an offensive on elements of American society.

- **The missionary type.**

Such an individual believes that they have a special function to fulfill such as ridding society of “undesirables” such as prostitutes, homosexuals, and drug addicts. Peter Sutcliffe, the Yorkshire Ripper in England, believed it was his mission to rid the streets of prostitutes (Lane & Gregg, 1992).

- **The hedonist type.**

This category is divided into another three types based upon the nature of pleasure that is derived from the act of murder. The lust-oriented hedonist is thought to have sexual gratification as his primary motivation and is thought to inflict a considerable amount of mutilation on the sexual organs in the commission of the offence. The thrill-oriented hedonist has the thrill of the act of murder itself as primary motivation and any sexual pleasure as secondary. The comfort-oriented hedonist takes pleasure from the act of murder primarily, but also obtains a secondary benefit/profit such as financial gain.

This last type has been understood differently however by authors such as Lane and Gregg (1992) who hold that the act of murder is incidental to the gain obtained. Some such as Pistorius (1996) have argued that if such a definition is accepted than these individuals should not qualify as serial murderers as they are not motivated primarily by the act of murder.

- **The power/control seeker type.**

The feeling of power motivates such an individual over another life and control of the pain inflicted on the victim. Lane and Gregg (1992) postulate that such a type is reflective of low self-esteem and may manifest sadistic traits.

Holmes and DeBurger (1988) qualify their typology by stating that these “types” may be found in combination within an individual. This typology has additionally been grouped in terms of process/act distinctions. Process/act distinctions are based upon how important the

murder is for the individual concerned. A focus on act applies to individuals for whom the murder of a victim is less important than what is symbolized by that victim and consequently, the murder itself takes place relatively quickly. A focus on process signifies that the individual concerned prefers to draw out the act of murder – the victim is primarily a vehicle for the gratification obtained from the murder process and is recognized minimally for the particular characteristics they possess. Process-focused individuals are thought to engage in excessive violence and may mutilate the body post-mortem (Holmes & DeBurger, 1988). An example of this may be a sadist, who derives enjoyment from the suffering of the victim in the process of finally murdering him/her.

Process/act distinctions have also been interpreted in terms of their explanatory potential in conjunction with the disorganised/organised typology (Holmes & DeBurger, 1988). Frequently, act-focused types are thought to reflect the same characteristics as disorganised type serial murderers, and process-focused types with organised types. It is not clear whether this is advisable as process/act distinctions may represent a distinct alternate classification scheme for serial murder. It would also seem that for classification schemes to be robust, such interchangeability between overarching schematic structures and crime scene characteristics is not advisable and often results in a dilution of the relevance with which such schemes may be applied. This can be seen in articles such as Anderson (1994) that equate disorganised/organised distinctions with process/act-focused distinctions, ignoring subtle definitional distinctions originally stipulated.

Holmes and DeBurger (1988) additionally use disorganised and organised as criteria for their typological scheme. For example, the visionary type is thought to be disorganised whereas the remaining types are thought to be organised. This is problematic in that there is no elaboration upon which aspects of the disorganised and organised classifications should be evident in crime scenes, nor empirical support both for the inclusion of these types as criteria

and for the co-occurrence of their respective constituent elements in the classification types of Holmes and DeBurger (1988). As a result, there seems to be a set of assumed relationships between criteria based on anecdotal experience and theoretical speculation (Canter *et al.*, in press).

Table 2.3

Holmes and DeBurger Typology of Serial Murder

Serial murder type	Visionary (v)	Mission-oriented (m)	Hedonistic Lust (l)	Thrill(t)	Comfort(c)	Power/control(p)
Factors:						
Victim specific		m	l			p
Victim non-specific	v			t	c	
Random choice	v		l	t		
Non-random choice		m			c	p
Victims affiliative	v	m	l	t	c	p
Victims - Strangers						
Methods						
Process-focused	v	m	l	t	c	p
Act-focused						
Planned		m	l		c	p
Spontaneous	v			t		
Organised		m	l		c	p
Disorganised	v			t		
Location						
Concentrated	v	m	l		c	
Dispersed				t		p

(Adapted from Holmes & DeBurger, 1988)

- **Leibman's ego-syntonic and ego-dystonic classification.**

Leibman (1989) differentiates between ego-syntonic, ego-dystonic and psychotic serial murderers. Within this classification, the ego-syntonic type sees the act of murder as congruous with his/her beliefs and consequently does not experience conflict with his ego functioning or negotiation of reality. The ego-dystonic type experiences considerable conflict with regards to his/her actions of murder, which is not congruous with his/her beliefs. Consequently he/she will disassociate him/herself with the murder on a conscious level. Finally, the psychotic type is thought to murder due to a mental illness or symptoms such as hallucinations. As a result, the actions of such a type are not perceived to be based in reality.

Leibman (1989) holds that most serial murderers are ego-dystonic. Adopting a psychodynamic perspective, Pistorius (2002) suggests that ego-dystonic serial murderers may have a degree of super-ego functioning while those for whom murder is ego-syntonic may have very limited super-ego development.

Such a classification scheme may work towards enriching psychological understandings of individuals who commit murder/serial murder, and possibly methods for rehabilitation in terms of psychodynamic psychotherapy, but is not *prima facie* useful in terms of crime scene interpretation for investigative purposes. Additionally, the use of the term ego-dystonic/syntonic to refer to individuals is problematic - it would probably be more useful to refer to their relationship with the act of killing/murder as either ego-dystonic/syntonic. Finally, the literature indicates that psychosis is rarely found in individuals who commit serial murder (Meloy, 2000).

2.3.2 Geographical classification

Canter (1994, 2000) and Rossmo (1995, 1997) have attempted to classify individuals who commit serial murder, and other serial crimes, with regards to the geographical context in which such individuals operate. Within an environmental psychology paradigm, Canter (2000) has attempted to demystify serial murder by arguing that individuals who commit such a crime follow general patterns which can be applied to other crime categories as well. His classification method focuses predominantly on the geographical planning and situation of criminal activity as well as clusters of behavioural elements that have been found to repeatedly occur within a serial murder sample. As such, classifications which result in the creation of types of serial murderer are avoided and rather clusters of behavioural elements are grouped together to indicate which elements are likely to co-occur, on the basis of observed frequency of types of criminal actions (Canter, 2000). He also argues that this method is more reliable, empirically verifiable and scientific than deductive, inferential profiling approaches based on personal opinion and anecdotal evidence.

Lundrigan and Canter (2001) have applied their work to assisting investigative initiatives with regard to serial murder. They argue that despite the belief that serial murder is an outcome of heightened emotion and poor impulse control, choices involved in details of the various murders can be seen as guided by rational decision-making processes. Spatial patterns of disposal locations have been demonstrated to operate subject to a rational logic and vary according to the range over which the offender operates. It was found that offenders centred their criminal activity around their primary residence; that the location of each subsequent body disposal location was in a different direction to that directly preceding it; and that this process was strongest for individuals who traveled less than 10km on average, and weakest for those who traveled 30km or more on average. In this way, the geographical movements of

offenders can be modeled and assist in identification of a series, tracking an offender and predicting future offence disposal sites with an aim to apprehend the individual concerned. Canter (1994) distinguishes between two predominant types of criminal based on the geographical arrangement of their crimes, namely a commuter type and a marauder type. A commuter usually travels some distance from his/her home base to commit a crime, whereas a marauder will travel shorter distances from his/her home base. This approach has been critiqued due to its ambiguous nature – namely, Canter (1994) is vague in terms of describing what constitutes a short as opposed to long distance quantitatively, thus rendering application of such a model subjective to the investigator concerned and increasing difficulty of ultimately locating the suspect's home base.

Rossmo (1995) supports the notion that criminals tend to commit their crimes close to where they live, according to the “least efforts” or “nearness principle”. The area in which crimes are committed, specifically the first in a series, usually represents the individual's comfort zone, both in terms of physical or geographical factors and psychological elements. Rossmo (1995) additionally states that a number of factors have to be considered when establishing the comfort zone or geographical profile of an individual. These include area demographics with regard to types of victims selected and the geographical distribution of such victim types; arterial routes with respect to street patterns and transport methods such as bus routes; physical barriers such as highways, or rivers; mental barriers such as a lower socio-economic offender not wanting to go into a richer neighbourhood; and displacement, namely possible moves that result due to police activity or media reports. Geographical profiling may also differ if different aspects of the crime are considered. For example, if first point of contact with victims is taken into account, a different profile may emerge than if body disposal sites are focused upon (Rossmo, 1997).

In many ways, this system is less reductionist than schemes that create types of serial murderer. However, the statistical technique (Small Space Analysis) from which such clusters are derived possesses a degree of flexibility and variability that leaves much to the discretion of the researcher for its interpretation (Rosenthal & Rosnow, 1991). Consequently, factors may be grouped into different clusters by another researcher.

Rossmo's (1995, 1997) approach is useful, specifically in terms of suspect evaluation and crime prevention; however, Labuschagne (2003) has highlighted the importance of complete and accurate information for such approaches to be useful to police investigations. If any crimes are omitted or any irrelevant crimes are erroneously included or linked within a single series, the geographical profile may be skewed and consequently, inaccurate.

Labuschagne (2003) argues that in South Africa, there is little anecdotal evidence to support the claims of Canter (1994, 2000) and Rossmo (1995, 1997) consistently. For example, Cobus Geldenhuys, the Norwood serial murderer, and Moses Sithole, operated close to their homes; however, Elias Chauke, the Highwayman serial murderer, did not. This still requires empirical testing and validation to establish whether geographical classification methods would be useful in South Africa.

It may also be the case that due to the different nature of the South African geography as compared to the USA, Canada or United Kingdom, as well as the different transport systems and widespread mobility of people, and multiple households occupied by individuals at any one time, it may be difficult to successfully apply geographical profiling in its current format to the investigation of serial murder in South Africa. However, this may be used to inform further research into the applicability of existing methods to South Africa, or the formulation of a geographical profiling approach that is more suitable for South Africa.

2.3.3 Concluding remarks on classification schemes

Classification schemes seem problematic for a number of reasons. Many are largely unscientific in terms of empirical criteria of validation, falsifiability, standardisation and reliability; they run the risk of labeling and as such confining the individual in question to fitting his “type” with little scope for contradiction resulting in a tautological kind of argument; they ignore the psychological diversity and multiplicity of human beings; and they encourage inductive profiling of offender characteristics from crime scene data (Canter *et al.*, in press; Turvey, 1998).

Canter *et al.* (in press), criticize typological classification schemes on the basis that human beings rarely can be found to fall into distinct types, and hence, such schemes will struggle to find strong, consistent empirical support. Their optimal use may lie rather in identifying characteristics of the crime scene (i.e. disorganised/organised, process/act focus) without extrapolating grossly to offender characteristics/type.

As discussed with regard to definitions of serial murder, typological classification schemes incorporate many psychological principles despite having been devised primarily for law enforcement purposes. As a result, they may be seen to be characterised with similar tensions as discussed in relation to definitions. The interpretative relativity that results is not assisted by the fact that few of these typologies have been tested empirically, and tend to rely predominantly on anecdotal accounts of their successful or unsuccessful application. As a result, it is difficult to claim, with any certainty, that typological classification schemes aid or hinder understandings of serial murder, or their investigative analysis.

Additionally, none of the above typological schemes have been tested for their empirical validity in a South African setting (Labuschagne, 2003). As a result, it is not possible to state

whether individuals who commit serial murder in South Africa can be classified in the same manner, or require different schematic distinctions.

The following chapter will critically examine theories about serial murder from a number of different perspectives ranging from those that focus more on individual factors, to those that take the broader social context into account.

3. LITERATURE REVIEW: THEORETICAL FRAMEWORKS CONCERNING SERIAL MURDER

The author will now critically examine the different ways in which serial murder has been understood from various theoretical positions and paradigmatic orientations. Such theoretical positions mimic theoretical divisions relating to general violence and crime with different disciplines analyzing the causes of violence at different levels such as the structural, institutional, interpersonal and individual.

Generally, such theories frame the “creation” of serial murder as a manifestation of some dysfunction at any one of these levels. The basic viewpoints can be grouped under: individual focused theories and contextual viewpoints. The author will begin discussion of theories of serial murder with a review of the individual focused theories on serial murder. Due to the small amount of theories (both locally and internationally) that have attempted to explain serial murder specifically, this chapter will first outline theories addressing violent behaviour in general for each section and then move on to discussing any theories within the specific sub-category (e.g. individual and contextual) that have attempted to explain serial murder, in particular.

Individual-focused theories seem to argue for some nature of dysfunction either in the physical aspect and biology of the person involved or in the psychological development or functioning of the individual concerned. These positions will now be discussed under the headings of organic, psychological and socio-cultural theories.

3.1 ORGANIC THEORIES

Organic theories operate at the level of the individual, assuming that people have a neurological or genetic tendency towards violent behaviour (Reiss & Roth, 1993). These will be discussed with regards to approaches that focus more specifically on neuroanatomy/neurology and genetics respectively in relation to criminal behaviour and serial murder in particular.

3.1.1 Neuroanatomy/neurology

In terms of neuroanatomy, the limbic system has been drawn upon as an area that may affect the emotional processing of events by individuals who commit murder (Money, 1990). This part of the brain is responsible for the mediation of emotional states and regulation of emotional responses to the environment (specifically response to perceived threats from such an environment and decisions to attack), a lesion in, or damage to limbic system may affect the individual's ability to respond with accurate emotion to their environment (Ellis & Walsh, 2000; Hagan, 1996).

In the case of sexual sadism, Money (1990) argues that the aggressive signal is incorrectly coupled with the sexual drive, and hence violence is eroticised or sexually stimulating to the individual concerned. The difficulties in the processing of emotional stimuli mentioned above in terms of limbic system functioning have also been explained by investigating the differences in hemispheric processing in the brain. It has been suggested that individuals who commit serial murder may rely predominantly upon left, verbal-analytic hemispheric

processing than right hemispheric processing with the result that the “feeling” part of emotional interpretation is lacking resulting in a lack of empathy and callousness (Money, 1990). Little data exists however, indicating the number of cases in which such a neurological dysfunction has been present and accountable for the sexually sadistic behaviour.

Additionally, it is difficult to separate the influence of psychological and environmental factors on etiology in many of these biological theoretical arguments.

Research has also focused on the diencephalic structures of the thalamus and hypothalamus, which have been suggested as having a direct role in aggressive behavior, as well as a role in associating positive or negative emotions with incoming stimuli (Siegel, 2000). Abnormalities in the thalamus have been proposed to explain a serial murderer's inability to maintain personal relationships or display empathy for his victims (Sears, 1991).

The thalamus has also been associated with pathological activation of fearful and combative behavior (aversive experiences) along with oral and sexual functions (pleasant experiences). When one area is stimulated, arousal may extend to other areas, producing pleasurable feelings associated with violent acts. The hypothalamus plays a role in the reticular activating system, which may block otherwise stimulating activity from reaching the judgment-related cerebral cortex. It has been suggested that such a mechanism may be what is responsible for chronic underarousal in the psychopath, leading to antisocial behavior in an attempt to increase cortical levels of arousal (Bartol, 1980).

In some cases, specifically with respect to those serial murderers classified as disorganised types (Holmes & Holmes, 1996; discussed previously), it has been suggested that these individuals may suffer from a degree of mild to moderate mental retardation. This has been applied to individuals such as Edmund Kemper and Harrison Graham in the USA (Leyton, 2001). However, the link is not particularly tenuous for the reason that it has not

been consistently shown to be the case that individuals who are mentally retarded manifest a disorganised manner of committing murder.

Additionally, it is particularly dangerous to construct a link between mental retardation and violent crime, particularly serial murder, in the absence of reliable evidence, given the additional stigmatization that may be placed upon this group of individuals. Whereas mental retardation on the part of the individual who commits serial murder may influence the manner in which the murders are carried out, it may be inaccurate to go the further step of claiming that the mental retardation itself causes the offending behaviour.

3.1.2 Genetics

Genetic factors have also been implicated in arguments of causality with regards to criminality (Stephenson, 1992). One theory that has been applied increasingly to the category of sexual crimes and violence is that of the XYY chromosome (Kumra, Wiggs, Krasnewich, Meck, Smith, Bedwell, Fernandez, Jacobson, Lenane & Rapoport, 1998; Schroder, De la Chapelle, Hakola & Vikkunen, 1981). The XYY theory refers to a condition where a male individual has an extra Y chromosome as a result of irregular sperm propagation on the part of the biological father. Such individuals are usually considerably taller than average; have a greater amount of facial hair; and are thought to exhibit pronounced masculine traits and hypersexuality (Berner, Grunberger, Sluga, Schnedl, Wagenbichler & Herbich, 1977; Diego Nunez, Prieto Veiga, Rey Sanchez, Salazar Veloz, De Manueles Jiminez, Santos Borbujo, Martin Ruano, Alvarez Aparicio & Cedeno Montano, 1992).

During the 1960's, these individuals were found to be overrepresented in legally incarcerated populations, leading to widespread beliefs that XYY individuals were by nature more likely to commit crimes, specifically those involving considerable sex and violence

(Berner *et al.*, 1977). These beliefs have recently been dispelled (Delisi, Friedrich, Wahlstrom & Crow, 1994) however, and it appears that the mild learning and behaviour problems that may accompany the syndrome are responsible for those XYY individuals who do undertake criminal activity being apprehended more easily (Berner *et al.*, 1997).

With regard to serial murder, to date, no individual who has committed serial murder has been found to have been an XYY individual, although Edmund Kemper, an American serial murderer who, responsible for the “Co-Ed” series of murders in Santa Cruz in the 1970’s, was the subject of such speculation given his physical characteristics (above average height and build) and hypersexuality (Lane & Gregg, 1992; Leyton, 2001). However, it was later established that his chromosomes were normal (Leyton, 2001). Consensus on the XYY syndrome link to serial murder (and general criminal behaviour) appears to be that such links to the XYY syndrome are largely correlative at best with no solid causal links established (Faber & Abrams, 1975).

3.1.3 Critique of organic theories

Organic theories can be critiqued on several grounds in general. Firstly, samples upon which these theories or suggestions are based, frequently are contrasted by samples of serial murderers who either manifest the problem behaviour in question without the accompanying organic dysfunction or manifest no such behaviour in the presence of neurological dysfunctions (Kolb & Whishaw, 1996).

Samples of serial murderers upon which organic theories are based are additionally very small and often anecdotal in nature, often on account of these samples being limited to incarcerated serial murderers (Egger, 1984). This may not completely discredit these theories but samples are too small to discount the potential influence of other factors in the

manifestation of serial murder, be they biological or environmental or psychological. As a result, organic theories run the risk of being reductionist and eliminating the opportunity and need for change or amelioration of social/environmental conditions and factors that may play a part in “etiology”.

Causal direction in organic theories is also frequently unclear with uncertainty surrounding whether pathological behaviour alters brain functioning or vice versa (Kolb & Whishaw, 1996). This general critique of organic theories of neuropathology may be extended to organic theories that attempt to explain serial murder in the sense that the direction of causality may be queried with regard to brain or other organic abnormalities and serial murder offending.

A large proportion of the critical scrutiny and assessment of organic theories as related to violent behaviour has proceeded from the legal domain (Rice, Harris & Quinsey, 1990). Organic arguments have often been involved in legal applications in terms of assessing culpability of individuals committing murder and serial murder with the result that they are often viewed skeptically as attempts to exonerate such individuals and as such, divert the cause of justice (Litwack & Schlesinger, 1987). Such a context has resulted in research that has examined the thinking and feeling components of neurological functioning with the aim of establishing whether individuals who commit murder may “know” that their actions are wrong or immoral yet not feel the same way to support varying legal arguments.

Additionally, whereas aggression has largely been viewed as a biologically-based behaviour, violence is a social construction (Rivara, 2002). Much debate characterizes the literature with regards to defining and distinguishing these two concepts (Monahan, 1999; Rivara, 2002), however it would appear that whereas aggression refers to a biological factor present throughout the animal kingdom and related to ways of acting, violence is more man-made and dependent upon the consequences of an act of aggression, that is, involving

intentional harm to the object at which aggression is directed (Archer, 1994). Consequently, it may be argued that organic theories may be able to explain aggression, but necessitate an understanding of the social context, and relationship between actor/s and object/actor in order to explain acts of violence. Given that serial murder constitutes an act of violence, organic theories are limited in their ability to explain such a phenomenon independent of other violent acts.

Finally, organic theories frequently negate the possibility for rehabilitation of serial murderers or influence forms of rehabilitation that isolate an individual either physically or behaviourally (Vachss, 1993). These forms of rehabilitation are often accompanied by the neutralization of such an individual via medical technology either in the form of psychotropic drugs or psychosurgery. As a result, it remains to be seen whether rehabilitation of a serial murderer is a viable possibility.

3.2 PSYCHOLOGICAL THEORIES

Psychological theories that have been applied to the understanding and explanation of serial murder can be differentiated with respect to where they position themselves along a continuum of more intrapsychic or more interpersonal outlooks. Psychodynamic theories emphasise the intrapsychic and tend to focus upon phenomena that take place within the mind or psyche to explain human behaviour (Schwartz, 1999). These theories tend to place less emphasis on external factors in the person's context or environment. Interpersonal theories and cognitive psychology or behavioural theories tend to engage in less depth psychology, and rather place greater emphasis on the person's interaction with their environment or significant persons or elements within such an environment - that is, they appear to be more socially oriented. Psychological theories of serial murder will now be discussed with respect

to the psychodynamic position; the cognitive-behavioural and learning theory position; and then examine other psychological theories used to explain serial murder that do not fit into the above classifications.

3.2.1 Psychodynamic theories

As with organic theories above, psychodynamic theories focus on the individual in order to explain serial murder. Psychodynamic theories refer broadly to those theories that emphasise the unconscious as the primary element of intrapsychic processes together with elements such as conflicts and instinctual energies. These theories examine the interaction of these unconscious and conscious processes as they influence personality, behaviour and attitudes (Schwartz, 1999).

Psychoanalytic theories refer specifically to the theories of Sigmund Freud and fall within the broader category of psychodynamic theories. While maintaining an overarching emphasis on the role of the unconscious, psychoanalytic theory focuses more specifically on processes such as repression and concepts such as infantile sexuality and the psychosexual stages (oral, anal, phallic/oedipal and latency), resistance, transference and division of the psyche into the id, ego and superego (Harre & Lamb, 1983).

Within psychodynamic theory, serial murder is thought to be a reflection of the workings of inner drive processes and remnants of internalized developmental conflicts with significant care figures. Psychodynamic theories are considerably prevalent in theories exploring the psychological factors that influence serial murder (Douglas & Olshaker, 2000; Holmes & Holmes, 1996; Pistorius, 1996; Ressler et al., 1988; Ressler & Schachtman, 1992; Whitman & Akutagawa, 2003). These schools of thought have been thought to automatically lend themselves to explanations of serial murder by virtue of the fact that psychodynamics has

emphasized the role of both sexual and aggressive drives in its theoretical tenets and serial murder is frequently considered to have strong sexual and aggressive overtones.

Further, the concept of fantasy plays an important role in psychodynamic theories and serial murder (e.g. the oedipal complex). Due to emphasis on the role of fantasy and dysfunctional family in some theories (Holmes & DeBurger, 1988; Ressler *et al.*, 1988) of serial murder, and understandings of serial murder as a psychologically/internally motivated crime (as discussed in Chapter 2), psychodynamic theories with their emphasis on primary relationships and internal psychological fantasy life (Freud, 1966) appear well suited. These aspects will now be examined within a psychodynamic theoretical paradigm after a cursory note on the role of the dysfunctional family in theories of serial murder.

The role of the dysfunctional family in theories of crime has featured in both cognitive and social learning, and psychodynamic theories of serial murder (Douglas & Olshaker, 2000; Ressler *et al.*, 1988). The individual who commits serial murder is seen to have been affected developmentally by the dysfunction, which characterises his environment and so develops into an adult who repeatedly attempts to resolve such dysfunctional development or mimics the behaviour or conditioning such an environment has cultivated in him. Such an environment may consist of persistent abuse (physical, emotional or sexual) at the hands of caregivers or neglect. Lloyd (1995) found a link between violence and abuse in childhood, while Jehu (1991) found that up to 57% of sex offenders reported being sexually abused in childhood.

Supporting evidence for such theories in cases of serial murder is mixed however. Serial murderers such as Edward Gein and Albert DeSalvo in the United States, and Stewart Wilken in South Africa, report childhoods characterised by abuse and neglect (Lane & Gregg, 1992); however, individuals such as Jeffrey Dahmer and Ted Bundy in the United States, report happy childhoods (Lane & Gregg, 1992). As a result, references to the importance of the

dysfunctional family in the etiology of serial murder should be interpreted cautiously, especially as what constitutes dysfunctional has yet to be clearly specified.

- **The role of fantasy in psychodynamic theories of serial murder.**

The role of fantasy, specifically sexual and sadistic fantasy, has been postulated to play a strong role in serial murder, and serial sexual murder specifically (Claus & Lidberg, 1999; Myers, Burgess & Nelson, 1998). Psychodynamic perspectives have lent themselves easily to discussions of the role of fantasy in serial murder by virtue of their emphasis on internal processes, drives and sexual energy or libido (Smith, 1996), all of which can be used to explain different elements of fantasy.

Prentky, Burgess, Rokous, Lee, Hartman, Ressler and Douglas (1989) define fantasy as “an elaborated set of cognitions characterized by preoccupation anchored in emotion, and originating in daydreams” (p. 889). Johnson and Becker (1997) regard sexually sadistic fantasies to be indicators of future homicidal pathology and interviews with individuals who committed serial sexual murder in the USA by both Prentky et al. (1989) and Warren *et al.*, (1996) found violent sexual fantasies in at least 80% of the individuals interviewed.

The fantasy-based motivation model has further been supported by Burgess, Hartman, Ressler, Douglas and McCormack (1986) who found evidence for daydreaming and compulsive masturbation in 80% of their sample of 36 sexual murderers when this model was tested, as well as Prentky *et al.* (1989) who found a higher prevalence of fantasy as well as five paraphilias (compulsive masturbation, indecent exposure, voyeurism, fetishism and cross-dressing) in a sample of serial murderers when these were compared to a sample of single murderers. Similar models have been proposed by Norris (1988) as well as Abel and Blanchard (1974) who argue for social learning processes as pairing deviant fantasy with sexual arousal.

Burgess *et al.* (1986) developed a fantasy-based motivational model for serial sexual murder. This model consisted of five components, namely,

- impaired development of early attachments;
- formative traumatic events;
- patterned responses that serve to generate fantasies;
- private, internal world consumed by violent thoughts that leaves the person isolated and self-preoccupied; and
- a feedback filter that sustains repetitive thinking patterns.

Hazelwood and Warren (1995) elaborated upon the structure of sexual fantasy and also argued for five components, namely:

- relational (that is, involving a relationship between individuals);
- paraphilic (that is, involving some form of deviant sexual behaviour);
- situational (that is, taking place in a particular location);
- self-perceptual (that is, furthering the individual's sense of self in some manner);
- and
- demographic (that is, involving specific details about the other individuals involved such as age and/or race and/or gender).

Meloy (2000) argues that the manner in which a sexual fantasy is structured along the above lines, is useful in establishing the manner in which sexual murders will be carried out by a particular individual, as well as the types of victims that such an individual will search for.

This can be seen to have useful applicability for investigative operations in terms of guidance with regard to type of offender and victim. The fantasy may also be a useful guide in terms of gaining insight into developmental experiences of the offender that may have contributed to both the shaping of the fantasy as well as the serial murder behaviour.

The model of Burgess *et al.* (1986) above, is elaborated upon by Whitman and Akutagawa (2003) who detail the processes entailed in an acquired dependence upon fantasy in serial sexual murder. Whitman and Akutagawa (2003) argue that in the absence of secure attachment and affection from the primary caregiver, the individual concerned turns to fantasy as a pleasurable substitute. The emotional unavailability and distancing of the caregiver prevents the child from developing empathy for others as well as healthy means by which to channel and modify libido and aggression in appropriate manners (Money, 1990). The role of fantasy in serial sexual murder thus functions as a means of reducing the anxiety associated with rejection, or anticipated rejection, by significant others and a means of challenging libido and aggression that have remained relatively unmodified from their original, immature state (Whitman & Akutagawa, 2003) and a means of enacting power, domination, manipulation and control (Douglas & Olshaker, 2000; Holmes & Holmes, 1996).

Ressler *et al.* (1988) have attempted to explain how individuals move from fantasy to acts that attempt to fulfill their particular fantasies in reality. They argue that certain antecedent factors may provoke such a move. These include life stressors (such as loss of a job, end of a relationship), frame of mind (such as anger, hostility or frustration) and planning (such as details of where, and when the murder will occur) (Ressler *et al.*, 1988). Meloy (2000) states that an individual will also tend to act on the fantasy when the response tendency exceeds the intensity of the rehearsal fantasy, and a viable opportunity for such acting out is available.

Holmes and Holmes (1996) argue for a cyclical process with respect to the acting out of fantasy, both in terms of activity leading up to the first murder and then with respect to each subsequent murder. Initially, each attempt to begin to act out a fantasy (which may include voyeuristic activity, compulsive masturbation, or other paraphilic activity and rape) is thought to temporarily reduce anxiety or fulfill the particular fantasy of the individual concerned after which the cycle of frustration, subsequent and more detailed attempt and temporary

satisfaction gained thereby is repeated. Eventually, according to Holmes and Holmes (1996), a murder is committed, and the cycle continues with each subsequent murder an attempt to fulfill sadistic fantasy with greater accuracy.

To summarise, theorists who have emphasized the role of fantasy in serial murder appear to view fantasy as serving to empower the individual concerned in light of perceived abandonment or emotional neglect by the primary caregiver; traumatic experience; and subsequent anxiety in relation to these experiences (Burgess *et al.*, 1986; Hazelwood & Warren, 1995) as well as similar experiences in adulthood (Ressler *et al.*, 1988). Such a dependence upon fantasy appears also to be cyclical (Holmes & Holmes, 1996). As a result, interviewing the current and past girlfriends and wives of suspects in an investigation may yield considerable insights into the fantasies of that individual which can be used to further guide the investigation and interview potential suspects (Labuschagne, personal communication, 2004).

- **The role of primary attachments in psychodynamic theories of serial murder.**

Ressler *et al.* (1988) postulate that individuals who commit serial murder have ambivalent attitudes towards their mother as a result of mixed messages communicated towards the individual as a child and anger towards an absent or emotionally unavailable father. Whereas the above may be seen to draw more upon interpersonal than interpsychic relations, Ressler *et al.*, (1988) describe the role of fantasy, namely that serial murder involves a continued, repetitive attempt to enact the fantasy in reality, echoes Freud's repetition compulsion to resolve points of fixation in development. Such fantasy, and its constituent elements, is thought to be derived from developmental experiences and significant figures that featured during such a period, and is largely a manifestation of introjected, intrapsychic dynamics.

The attachment theory of Anna Freud (1966) has been used by Ressler and Shachtman (1992) who postulate that individuals who commit serial murder have been deprived of love in their primary attachments with their mothers. Such relationships are thought to be characterized as uniformly cool, distant, unloving and neglectful with little physical contact or emotional warmth. As a result, the innate aggressive impulses and drives of such individuals are left unmodified and the capacity for empathy vastly diminished. This lack of an emotionally fulfilling, warm relationship with the primary caregiver is thought to explain the individual's use of auto-eroticism (in the absence of pleasurable physical contact with the mother) as well as withdrawal and dependence on fantasy as a pleasurable substitute to the absent attachment relationship.

Pistorius (1996), develops Ressler *et al.*'s (1988) and Ressler and Schachtman's (1992) theoretical arguments further, and holds that a major causal agent of serial murder is a fixation at one or more of the stages of psychosexual development. This fixation is seen to fuel and shape the fantasies that characterize later life. Due to the emotional poverty that characterizes the relationship with both parents, Pistorius (1996) argues that super-ego development is limited and consequently, the relatively unmediated division between conscious and unconscious encourages fantasy life. The lack of super-ego would also explain a lack of guilt or fear of perceived punishment on the part of the individual concerned. This, and the lack of mediation between conscious and unconscious is thought to be responsible for the lack of repression of primitive sexual and aggressive impulses which result in a fixation at latency, characterized by an inability to socialize, empathize and develop positive interpersonal relationships.

Whitman and Akutugawa (2003) argue that anxiety related to feelings of inner emptiness and impotence in the serial murderer persists into later development and adulthood. As a result, compulsive masturbation, paraphilias and fantasy are used to relieve such anxiety. It is

thought that serial murderers defend against such underlying anxiety with reaction formations that transform feelings of impotence into omnipotence. The emotional starvation that exists as a result of failed early attachments is postulated to leave an intense, chronic state of emotional hunger and rage that is only temporarily satisfied by each murder. Whitman and Akutugawa (2003) argue that the relative rarity of serial murderers is a result of mediating biological factors which act as necessary conditions for factors such as failed attachments to contribute fully to the development of a serial murderer.

As can be seen from the above work, the physical or emotional absence of the primary caregiver appears to be a significant factor in psychodynamic and attachment theory perspectives on the etiology of serial murder (Pistorius, 1996; Ressler *et al.*, 1988). Its significance appears to be particularly prominent in accounting for the considerable rage, violence and anger with which some of the murders are committed (Whitman & Akutugawa, 2003).

3.2.2 Critique of psychodynamic theories of serial murder

With regards to psychodynamic theories of serial murder, these are problematic for the following reasons. They are largely anecdotal in nature, focusing upon intensive case studies that lack valid generalisability (Schwartz, 1999). They are not falsifiable, by virtue of their grounded tautological argumentation with regard to psychosexual stages and personality structure (Cooper, 1996). They are also too broad in their characterization of the “causes” of serial murder, which appear to be explicable with reference to a fixation at any stage that can be seen to match offending behaviour patterns post hoc (Smith, 1996). This is not really helpful for case investigation or guidelines when searching for suspects.

As with organic theories, psychodynamic theories negate the possibility for rehabilitation of serial murder due to the expense and duration of psychoanalysis; the limited number of therapists willing to practice such a therapy in the context of prison; and the ingrained permanence that is attributed to the fixations postulated. Additionally, no explanation is provided of what happens to these drives when an individual is incarcerated. Many individuals who have committed serial murder have been found to function adequately within a prison system without any aggressive behaviour (Stephenson, 1992). Intrapsychic theories appear to ignore the influence of contextual factors that may mediate and alter the behaviour and coping ability of such individuals (Labuschagne, 2001).

Psychodynamic theories also place considerable emphasis on the role of fantasy. Although present in a proportion of serial murderers, fantasy does not always play a role in serial murder. This is notably the case with South African serial murderers, who seldom reflect the central role of fantasy in relation to their offences, and seldom report engaging with a rich fantasy life (Hodgskiss, 2002; Labuschagne, personal communication). Additionally, there appears to be a lack of attention to non-sexual serial murder and the role that fantasy does or does not play in such a series. As a result, the overriding impression from the international (predominantly law enforcement FBI arena) seems to be that serial murder and serial sexual murder are one and the same thing, and that consequently, all serial murder is sexual in nature, when in fact, individuals such as Leyton (2001) argue that serial murder is frequently more about class inequality.

With respect to the “dysfunctional family” and its role in serial murder, another significant problem is the many occurrences of cases in which individuals who have committed serial murder such as Ted Bundy and Jeffrey Dahmer in the USA, who have reported relatively normal childhoods with no instances of significant dysfunctional developmental milestones such as failed attachments (Masters, 1993). In the case of these

individuals, no biological anomalies have been found either, and as a result the “necessary condition” qualification of psychodynamic theories such as those discussed in Whitman and Akutagawa (2003), does not save these theories from their evident weakness in accounting for certain cases of serial murder.

With regards to the applicability of Pistorius’ (1996) theory to the South African context, her work can be critiqued in that it appears to take limited cognizance of particularly South African aspects of serial murder and seems to reinforce dominant Western paradigms, and is based on a very small sample.

Most of her analyses are also based upon anecdotal evidence and lack verifiable empirical proofs. She draws frequently upon the work of Robert Ressler and other FBI behavioural science individuals such as John Douglas to substantiate her theory. As discussed previously, it has been shown that the work of such individuals is based upon samples that differ considerably from South African cases (Hodgskiss, 2004). Psychodynamic theory may also be limited to the extent to which it may inform investigative applications due to the variability in the manner in which aspects of crime scene and criminal behaviour can be interpreted within such a paradigm, as discussed previously (Smith, 1996).

Pistorius (1996) has also been inconsistent with respect to her explanations of serial murder - on the one hand, being cited as claiming that cultural context is not important with regards to serial murder in the press and on the other, attributing the incidence of serial murder in South Africa to poverty, crime, violence and the disbanding of families (Pistorius, 1996).

3.2.3 Cognitive-behavioural and learning theory models

Whereas psychodynamic theories of serial murder appear to emphasise sexual and aggressive drives and internalized representations of relationships with primary caregivers, cognitive and behavioural schools emphasize thought patterns and observational learning as factors that contribute to the development of criminal behaviour (Moorey, 1996).

- **Learning theory.**

Learning theory argues that individuals model their behaviour on what they observe in their environment (Weiten, 1995). Following from this, it has been argued that criminals “learn” their behaviour as a result of observing such behaviour in their immediate environment at early developmental stages and adolescence. Bandura (1973) conducted some of the foundational studies on aggression and observational learning, in which he established the increased likelihood of observers learning aggressive behaviour when that behaviour was seen to result in positive consequences for the modeling agent. Consequently, if an individual grows up in a family where violence is used as a means of achieving goals and resolving conflict, he/she may learn to behave in similar ways later on in life. A similar argument could possibly be made for the development of deviant sexual behaviour, specifically with reference to families or developmental environments where sexual abuse may have taken place.

Dollard and Miller’s (1950) social learning theory has been interpreted as indicating that individuals are socialized to seek affection and approval from those whom they love (Wright & Hensley, 2003). When such an interaction is mutually fulfilling, the individual in question learns trust and empathy in relation to interpersonal relationships and social interactions. However, in situations where the individual in question’s need for approval is frustrated, and he/she is prevented from retaliating towards the aggravating individual, he/she may seek out

other persons, animals or objects upon which to vent their anger. Wright and Hensley (2003) have used such theories to explain serial murder and the potential graduation link from cruelty to animals in childhood to serial murder in adulthood. Their theory may explain how an individual goes on to commit violent acts towards others, but there is nothing that specifically links this outcome to serial murder behaviour.

Hale (1993) goes further than Wright and Hensley (2003) by arguing that it is only individuals who internalize humiliation as a motive that go on to commit serial murder. Using Hull (1943) and Spence's (1936) theories of discriminant learning, Hale (1993) argues that the ability to discriminate between similar situations and behave in a way appropriate to the situation in question is based upon the presence of a reinforcement or rewarding stimulus. Hale (1993) states that in early caregiving relationships of individuals who go on to commit serial murder, there is an absence of a rewarding stimulus. Consequently, individuals who commit serial murder are unable to discriminate between the original and subsequent perceived humiliatory situations. In this way, the individual will displace the aggression and anger associated with the original humiliation in childhood, upon a new, weaker victim in the presence of a potentially humiliating situation. This approach may be critiqued by arguing that many individuals who witness similar interactions or relationships between others do not necessarily go on to commit serial murder. Additionally, this approach does not explain why individuals who commit serial murder go to the extent of murdering another individual as opposed to engaging in sadistic or humiliatory behaviour patterns with others.

- **Cognitive-behavioural theories.**

Other salient factors in cognitive theories of crime and criminals include distorted thinking patterns or cognitions; deviant conditioning; and lack of empathy. Developing the argument for the role of cognitions and thought processes in crime and criminality, Yochelson and

Samenow (1976) claim that criminal thinking patterns are characterized by different reasoning ability and a greater degree of irresponsible and erroneous thinking. Such thinking develops as a result of faulty social learning which results in unrealistic perceptions of the world as an arena for self-indulgence, and an inability to recognize the rights of others or personal responsibility (Stephenson, 1992). This theory has been applied to the area of psychopathy (Finkenbauer & Kochis, 1984; Launay & Murray, 1989), specifically to the frequent tendency towards rationalization of criminal behaviour evidenced in psychopathic behaviour. This could also be used to explain the traits of neutralization and compartmentalization discussed previously in relation to serial murder.

Cognitive-behavioural theories and interventions have been used specifically in relation to sex offenders (Jehu, 1991), who are understood as manifesting dysfunctional thinking patterns; deviant arousal and conditioning; lack of empathy; poor self-esteem; as well as overwhelming shame and guilt. The literature on serial murder does not seem to document any attempts to use similar interventions with individuals who have committed serial murder. It would be interesting to see if such interventions could be applied successfully and a deeper exploration of such thinking patterns in the individuals concerned, given previous arguments with regard to the frequently sexual nature of serial murder (Geberth, 1998; Holmes & DeBurger, 1988).

- **Rational choice models.**

Extending the cognitive argument that emphasizes the role of thought processes in governing criminal behaviour, is the rational choice model of crime. Rational choice theories of crime argue that the decision to commit a crime is subject to the same processes of reasoning that characterize non-criminal human behaviour (Stephenson, 1992). Tuck and Riley (1986) applied Ajzen and Madden's (1986) Theory of Reasoned Action to explain criminal

behaviour as the product of beliefs about the consequences of behaving in a particular way and evaluation of those consequences. Consequently, a decision to behave in a criminal manner is based upon attitudes towards the crime in question and evaluation of the pros and cons of behaving in that particular way. If the pros outweigh the cons, the crime is committed.

A rational choice to commit a crime involves an evaluation consisting of beliefs about the outcome of the crime; normative beliefs or attitudes and individual motivation to comply with such norms; and beliefs about resources and opportunities available (Ajzen & Madden, 1986). Once again, the literature on serial murder does not appear to document any attempts to explain serial murder as the product of rational choices on the part of the individual concerned. It would seem that any such attempt would still have to explain the deviant nature of the behaviour in question and questions of etiology. However, it may well be that planning of the murders in question operates along rational choice lines.

- **An addiction model of serial murder.**

Another variation on the cognitive-behavioural model of crime is one that argues that criminal behaviour may operate as a form of addiction. Pomerleau and Pomerleau (1988) defines addiction in the following way, namely, as

the repeated use of a substance/ or a compelling involvement in behavior that directly or indirectly modifies the internal milieu (as indicated by changes in neurochemical and neuronal activity) in such a way as to produce immediate reinforcement, but whose long-term effects are personally or medically harmful or highly disadvantageous to society. (p. 345).

Anderson (1994) holds that serial murder can be seen as an addiction to murder by virtue of the fact that the individual is driven to murder by an intrusive fantasy life. The act of

murdering temporarily (but incompletely) satisfies the fantasy with the result that the drive regenerates and eventually results in another murder. Shaped by a dysfunctional childhood and faulty learning, Anderson (1994) believes that the individual who commits serial murder develops fantasy as a coping mechanism. As a consequence, in times of stress in later life, fantasy is called upon in order to deal with such stress.

The murder component, for Anderson (1994), constitutes a related effect required to fuel the richness and power of the fantasy life. An addiction model of serial murder would seem appropriate in terms of capturing the apparent compulsive element that characterizes some instances of serial murder. However, Anderson's (1994) theory does not seem adequately supported in terms of establishing that murders occur in the service of fantasy. Given previous discussions, it would seem that stronger support is provided for the act of murder as the central component of serial murder (Harbort & Mokros, 2001; Holmes & Holmes, 1996), and that, rather, this is the addictive element. Additionally, the addictive element in the form of the act of murder appears to disappear once these individuals are incarcerated. This theory does not account for how this is transformed or what happens to the individual's need or dependency on the act of murder once he/she is in prison.

3.2.4 Critique of cognitive-behavioural and learning theory models of serial murder

Cognitive-behavioural theories of serial murder appear to hold considerable promise with regard to the potential for viable interventions and rehabilitation that they offer. Cognitive Behavioural Therapy (CBT) has demonstrated considerable effectiveness with sex offenders (Jehu, 1991) and is generally more cost-effective and efficient than psychodynamic alternatives (Moorey, 1996). Cognitive-behavioural and learning theories also potentially

provide more tangible, empirically testable elements (such as thought processes and behaviour) than psychodynamic theories (such as parental introjects) (Barkham, 1996).

As with theories of serial murder across the theoretical spectrum however, cognitive-behavioural and learning theories of serial murder are plagued by exceptions and inconsistencies. For example, social learning theory approaches to serial murder may be challenged by examples of individuals who report growing up in relatively healthy family backgrounds such as Jeffrey Dahmer (Lane & Gregg, 1992) or Ted Bundy (Leyton, 2001) and observational learning can be challenged by examples of individuals who have grown up in environments or families modeling violence as a means to achieve goals and who have not gone on to commit serial murder, or any other violent crime.

An example may be the sibling of an individual who has committed serial murder, such as Albert De Salvo who had sisters that did not go on to commit serial murder despite growing up amidst considerable physical abuse by their father. Theorists such as Wright and Hensley (2003), while providing useful and plausible theories of serial murder, are also weakened in the same way as some psychodynamic theories (such as Ressler *et al.*, 1988) by virtue of their use of anecdotal case studies and popular source material such as true crime novels.

3.2.5 Other theories emphasizing psychological factors

The discussion of serial murder will now review other theories that have attempted to explain the phenomenon with reference to psychological factors in a broader sense, with postulates derived from various paradigmatic orientations and blended in the theoretical explanations.

Ressler *et al.*'s (1988) theory of serial murder (specifically serial sexual murder) incorporates the family context; substance abuse; structural factors such as the community

and education system; and interpersonal skills. They argue that social bonding is affected in the development of serial murder due to the stifling of the formation of close contact or bonds within the family. The individual concerned is consequently limited in terms of his ability to form close bonds with individuals outside of the family. This may occur as a result of neglect on the part of the parents or as a result of the rationalization or normalization of unacceptable behaviour by parents or caregivers. Substance abuse within the family, as well as criminality and psychopathology in the family, may further contribute to the development of deviant behaviour patterns in the individual who will go on to commit serial murder.

Ressler *et al.* (1988) additionally postulate that there may be emotional, physical or sexual abuse present, resulting in distress which is ignored by the parents and consequently results in the individual concerned being desensitized, lacking the ability to empathise or display positive affect and forming negative interpersonal relationships. According to Ressler and Schachtman (1992):

In a situation where you find a distant mother, an absent or abusive father and siblings, a non-intervening school system, an ineffective social services system, and an inability of the person to relate sexually in a normal way to others, you have almost a formula for producing a deviant [not necessarily murderous] personality (p. 93).

Turvey (1998) incorporates the familial context; relationships with primary caregivers; and community or social intervention. According to him, there may be prevalent criminality, substance abuse and emotional abuse within families of individuals who commit of serial murder. He holds that in these individuals, the first formative years (birth to age six or seven) may be characterized by poor relationships with primary caregivers that lack warmth and love and demonstrate poor supervision. As a result the individual in question may lack empathy and display an abundant egocentricity in relation to the rest of the world.

Turvey (1998) holds that individuals who grow up in such conditions and do not go on to commit serial murder may receive some form of intervention in preadolescence. This may involve nurturing peer relationships or relationship with another significant adult or intervention by social services and removal from the household. In the absence of any intervention, the dysfunctional behaviour of pre-adolescence is thought to be consolidated. Adolescence may reflect some acting out and antisocial tendencies such as substance abuses and fire starting and the commencement of a criminal record.

As a result of poor interpersonal skills, the individual experiences considerable social isolation, cultivating a greater dependency upon fantasy and exclusively auto-erotic sexual experimentation – in Turvey's (1998) study, 79% of serial murderers engaged in compulsive masturbation, 72% voyeurism, 81% pornography and 72% fetishism. Turvey (1998) holds that there is possibility for further intervention during adolescence at the level of the school or social services that may encounter the individual concerned in relation to more minor offences.

Holmes and Holmes' (1996) theory of serial murder may also be seen as adopting an interactionist stance by virtue of its seeming blending of cognitive and psychodynamic psychological components. For these theorists, serial murder is a result of an individual trapped in a pattern of five cyclical phases. The first stage consists of distorted thinking patterns, which sees the individual, concerned overly aware of intrinsic or extrinsic rewards at the expense of an awareness of the consequences of his actions. The second stage is called "the fall" and involves a reality challenge to the ideals of the individual concerned by a real or imagined event. Such a reaction or experience leads on to the third stage where there is a negative inward response that necessitates a need to validate self status in the form of stage four or the negative external response (which frequently involves murder). Following this, potential dangerous consequences are realized which necessitates restoration or steps to

minimize personal risk. The cycle builds up again to the first stage as a result of fantasy and other possible intrapsychic mechanisms such as internalized primary relationships, or possible paraphilic traits.

Labuschagne (2001) adopted a systemic interactional approach to investigate serial murder. He described such an approach as attempting to investigate serial murder in as much as it is situated as part of a relationship between persons and manifests as part of the manner in which an individual interacts with his/her context. Interviews were conducted with two individuals incarcerated for serial murder and were supplemented with psychometric measures such as the Thematic Apperception Test (TAT).

Labuschagne's (2001) findings were that, within an interactional paradigm, serial murder may signify a communication or act against something. Further work by Labuschagne (2001) found that serial murder may be symptomatic of larger dysfunction in South African society. He stated that an increase in crime coupled with low effectiveness of government services equipped to deal with such a phenomenon may have resulted in a change in the social ecosystem which results in a mutation or new phenomenon, namely, serial murder. Within such an interactional perspective serial murder may be seen as a negative symptom possibly maintained by the system due to a perceived secondary gain. Labuschagne (2000b) acknowledged the limitation of his small sample of individuals and recommended research based on a larger sample as well as acknowledging the need for more work from a social constructivist perspective to supplement the existing research base.

Labuschagne's (2001) work is advantageous in that it takes the local South African socio-cultural system replete with its particular historical features into account and consequently, lays a more locally-specific platform from which to develop South African understandings and involved interviews with incarcerated serial murderers in South African prisons. The perspective adopted, namely an interactional approach, provides a novel way at understanding

serial murder, and would appear to be particularly advantageous in that it affords an opportunity to examine the manner in which an individual who commits serial murder might interact with other individuals, as well as his/her context, as well as the socio-cultural significance of serial murder as an act against something at a broader systemic level (Labuschagne, 2001). This may have possible applications for rehabilitation.

Hodgskiss (2001) conducted research on the offence behaviours of South African serial murderers for his Masters dissertation, also by interviewing incarcerated offenders. To this end, he attempted to create a multivariate model of serial murder offence characteristics in South Africa, using the technique of Multi-Dimensional Scaling (MDS) and Small Space Analysis (SSA), evidenced greatly in the work of David Canter at the University of Liverpool in the service of geographical profiling. Hodgskiss (2001) work would appear to be particularly useful in that it seems to be one of the first South African studies that draws specific attention to differences between South African serial murder and serial murder as it exists in the available literature. These differences will now be examined more closely.

Hodgskiss (2001) found the following differences in terms of developmental and psychiatric factors: an absence of the following: catathymia; cruelty to animals; violent fantasies and history of child conduct disorder; and Macdonald's behavioural triad (1961) components such as bed-wetting, fire-setting and as above, cruelty to animals in South African cases. Hodgskiss (2001) also found that the role of fantasy in instances of South African serial murder was considerably reduced, as well as the correlation between the content of fantasy and details of offences.

Hodgskiss (2003) additionally argues that due to the nature of the South African context and socio-economic composition, factors incorporated into international typologies like the Disorganised/Organised typology (Holmes and Holmes, 1996) such as vehicle ownership, level of education and employment history are of little use. Local offenders are more likely to

make use of public transport systems and educational requirements and desirable levels of attainment will differ; as well as types and profile of employment levels and opportunities in the country (Hodgskiss, 2003).

Hodgskiss (2001) also found differences with respect to ethnicity and age characteristics of offenders and their victims, as well as duration of serial murder cases. Ethnically, many US studies (Holmes & DeBurger, 1988; Ressler & Shachtman, 1992) have stated that serial murderers will choose victims from within their own ethnic group – in South Africa, five out of eight white offenders interviewed by Hodgskiss (2002) chose victims of a different ethnicity. Reasons for this are postulated to be more about victim availability than politics. In South Africa, the lower socio-economic grouping is comprised mainly of black individuals and this group is more available as potential victims of serial murder.

The USA sample of individuals who have committed serial murder consists of a dominant profile of white males between the ages of 25 and 34, with cases varying in duration from less than 1 year to 37 years (Gorby, 2000; Holmes & Holmes, 1996) contrasts sharply with a predominantly black male South African sample varying in age from 16 to 54 years of age, with cases varying from less than 1 year to 5 years (Hodgskiss, 2003).

In terms of offence characteristics, South African serial murder shows a greater degree of heterogeneity - murder is largely the central focus of the offence, and the victim, in most cases, is depersonalized and treated as object (Hodgskiss, 2002). In these terms, one could say that South African serial murder is predominantly act-focused, if interpreted with respect to the Holmes and DeBurger (1988) distinction.

South African offences also seem to be less sexually driven than postulated for international serial murder, and more about total control as the driving motivation with little attempt at interpersonal relationship development before the offence (Hodgskiss, 2001).

External events prior to offence also appear to play a large role in influencing offence characteristics during the offence.

In terms of offender characteristics, developmental and psychiatric factors in common between South African and international findings included mood disorders, anxiety, substance abuse, chronic interpersonal isolation, lack of sexual abuse, psychotic features but not serious enough to constitute psychotic disorder, paranoid and schizoid traits (Labuschagne, 2001).

In light of Hodgskiss' (2001) work, the validity of applying international research uncritically to the local context is evidently compromised and seems to necessitate a greater impetus on locally oriented research in order to aid the development of South African understandings of serial murder and investigative initiatives based thereon. Hodgskiss' (2001) research also appears to be particularly useful to investigative applications by virtue of its focus on offence and offender characteristics in South African cases of serial murder.

His research can be critiqued however in that it uses a methodology, namely Small Space Analysis (SSA) that may be interpreted in a number of different ways, each with equitable validity and support if provided (Wilson, 2000). In this way, his findings may be viewed as one of a number of ways in which the data on offence characteristics in South Africa can be interpreted. In order to consolidate Hodgskiss' (2001) findings, replication of the study would be advisable. This appears to be of even greater saliency given the lack of similar studies on serial murder in South Africa, which may provide confirmatory or supportive findings. As with Labuschagne's (1998, 2001) work, Hodgskiss' (2001) sample is small, consisting of interviews with thirteen individuals and archival data such as casefiles, and hence, generalization to South African serial murder as a whole, is limited.

3.2.6 Critique of other theories emphasizing psychological factors

The above theories may be challenged by examples of siblings of such individuals who have been raised in the same environment and not become serial murderers. In these cases, response to criticism often sparks reference to biological theories that are used to supplement such explanations.

With regard to theories or models such as that of Ressler *et al.* (1988), data on which their study was based was derived exclusively from self-report information from individuals incarcerated for sexual murder, who were prepared to participate in the study. Consequently, their model is only applicable to a limited sample of individuals who have committed and been apprehended for serial murder, neglecting those still at large or never detected. Additionally, this data may be subject to possible social desirability effects, which refer to when respondents attempt to answer in a manner that portrays them in a more favourable light or in accordance with how they assume society expects them to behave. Turvey's (1998) theory is more helpful in as much as it provides tangible entry points for possible interventions to proactively assist individuals who potentially may go on to commit more serious violent offences.

The above theories appear to hold the greatest promise with regard to their greater holistic interpretation of etiological factors in serial murder. In this way, the theories avoid reductionism and provide numerous points that could be targeted both in proactive prevention of serial murder and offender rehabilitation. Criticism, however, can be leveled at the etiological model that is applied (in much the same way as with intrapsychic and organic theories). There is an implicit assumption that serial murder is a condition, pathology or illness at an individual or social level, whereas it may be the case that it is a variation on general criminal behaviour patterns such as envisioned by economic models of crime (Stephenson, 1992).

3.3 SOCIO-CULTURAL THEORIES

Theories of crime frequently make reference to the socio-cultural context to explain its form and etiology. It is argued that the nature of criminal activity frequently reflects core tenets of the cultural and social networks in which it takes place, and is a manifestation of the dominant trends, values and philosophies of the time and place in which it occurs. Serial murder has not been immune to theoretical exploration with reference to socio-cultural developments, and such discussion will now be detailed, commencing with a general overview of criminological theory of deviance and progressing to more specific application of these theoretical positions.

3.3.1 Sociological and criminological schools and crime

Durkheim's (1897/1952) theory of *anomie* has often been used to account for criminal behaviour especially with respect to societies in transition. *Anomie* refers to a state where norms or expectations on behaviours are confused, unclear or absent. Durkheim (1897/1952) held that this state is particularly prevalent in societies that are undergoing or have undergone a transition period in which the norms and values are re-evaluated and assessed. For him, deviance could be explained with reference to states of *anomie*, where restrictions imposed by clearly defined norms are relaxed as a result of norm confusion. This theoretical position argues that crime or the criminal is a necessary component of society in terms of its role as an indicator of loosening social bonds and dilution of value systems.

According to Durkheim (1897/1952), the sophistication of a society is dictated by the degree to which its individual members are interdependent, although individually specialized. Morality is a means by which such interdependence is celebrated. During times in which there are great transitions in a relatively short space of time, “old ideals and the divinities which incarnate them are dying because they no longer respond sufficiently to the new aspirations of our days, and the new ideals which are necessary to orient our life are not yet born” (p. 47).

With South Africa having undergone significant political changes in the course of the last decade, this theoretical position has great potential for understanding crime in a South African context, specifically with regard to South Africa’s considerable increment in violent crime post-1994. Labuschagne (in Hodgskiss, 2004) argues that the increased diversity and broadening of parameters that occurred around 1994 may have contributed towards an increase in serial murder as part of a greater susceptibility to crime in general in society, together with a sense of anonymity created by ineffectiveness of government services to manage crime problems. Understandings of the place of serial murder within such a transition, and as a possible indicator of loosened societal norms and bonds, may provide insights into the character and nature of South Africa’s *anomie*, and possibly indicate which aspects of social cohesiveness require reinforcement.

Merton’s Strain Theory (1968) has also been made use of to explain crime as one of the ways tension between society and the individual is manifested. Strain Theory argues that the real problem is not created by a sudden social change, as Durkheim (1897) proposed, but rather by a social structure that holds out the same goals to all its members without giving them equal means to achieve them. It is this lack of integration between what the culture calls for and what the structure permits that causes deviant behaviour. Deviance then is a symptom of the social structure. With respect to serial murder, strain theory has not been used specifically to explain such a phenomenon. However Myers, Raccoppa, Burton and McElroy

(1993) found that a predisposition to resort to illegitimate means to obtain social goals was confirmed in 60 percent of serial murderers having previous criminal convictions. Despite such findings, it would appear that a relationship between serial murder and social opportunity or “strain” is spurious and may be influenced by a number of other factors such as individual characteristics of the person concerned.

In South Africa, changes in the political leadership and culture of the country ushered in a democratic era with the promise of many new opportunities for previously disadvantaged groups. Over the last decade, however, many of these opportunities remain out of reach for the majority of the population, and consequently, Strain Theory may be one way of explaining the apparent increase in general crime this country has experienced. However, this theory does not explain why certain types of criminal activity or deviance occur more frequently than others and hence, cannot really provide further insight into the relatively recent proliferation of serial murder.

The Chicago School of Criminology (Park, Burgess & McKenzie, 1925) has also lent considerable impetus to the development of understandings of crime and the criminal. It holds that structural and social factors are important in understanding crime and deviance, and focuses upon the surrounding community or ecology to explain the causes and form of criminal behaviour (Holmes & Holmes, 1996). Humans are viewed as social creatures and their behaviour as a product of their social environment. This environment provides values and definitions that govern behaviour. Frequently, urbanisation and industrialisation break down older and more cohesive patterns of values, thus creating communities with competing norms and value systems.

The breakdown of urban life results in basic institutions such as the family, friendships and other social groups becoming impersonal and almost anonymous. As values became fragmented, opposing definitions about proper behaviour arise and come into conflict with

other behaviour. Given South Africa's extensive history of migrant labour and generally high population mobility between and within urban areas, effects of urbanization and traditional value fragmentation could very well be causal factors in relation to South African crime. Once again, as with the above theory of crime, there is little scope for understanding the prevalence of certain types of crime such as serial murder.

Sutherland's (1937) theory of differential association asserts that criminal behaviour is learned in primary group relationships as opposed to secondary sources such as television and the press. Mitchell (1997) has attempted to apply this to serial murder by arguing that many offenders are incarcerated prior to their first murder, and may learn techniques and formally conceptualise their plans in prison stays. Holmes and Holmes (1996) have stated in this regard, features of *modus operandi* such as the application of duct tape as a restraining technique may be learnt in prisons. While such a theory may explain how certain elements involved in committing a crime may develop, it does not seem able to convincingly argue that differential association causes serial murder.

- **Socio-cultural theories focusing specifically upon serial murder.**

The following arguments are grounded in one or a combination of the above socio-cultural theories, but have focused specifically on serial murder. Reinhardt (1962) argues that individuals who commit serial murder lack a workable system of social or personal frames of reference due to never having experienced normal communication with a dependable, understanding part of the social world around them. Hazelwood and Douglas (1980) support such a view by arguing that a lack of socialization in the midst of a climate of conflict and neglect results in a lack of available positive ways of coping developing in the individual concerned.

While lack of socialization may explain some aspects of serial murder, particularly antisocial or psychopathic traits, it would appear to fail to explain causation of serial murder completely. As mentioned previously with respect to the dysfunctional family, a number of individuals grow up in similar environments and do not go on to commit serial murder (Mitchell, 1997). The above observations have also not been tested against suitable control groups and, just as discussed with regards to the dysfunctional family, it would seem that biological and personality factors may also play a part in the development of such individuals.

Wilson (2000) argues that the nature of prevalent crime or developments in the nature of criminal activity is frequently indicative of the cultural development of a society. He states that an increase in sex crime in the 1900's actually reflected a general improvement in the conditions of society that freed up a greater proportion of the population from concerns of work. The Industrial Revolution changed the nature of "work" or work activity so as to free up more leisure time. Within a Maslowian paradigm (Maslow, 1954), an increase in leisure time and relative security of the work proportion of one's life, meant that crime evolved to focus on intimacy and sex or love as opposed to previously focusing upon subsistence.

As views towards sexuality have become less conservative over the progression of the twentieth century, crimes have developed and centred more on resentment and a desire for recognition or acknowledgement than sex, progressing according to Maslow's next level of hierarchy. Serial murder, for Wilson (2000), constitutes a combination of a need for recognition together with sexual desire or need for intimacy and a deviant attempt via which to secure these ends in contrast to the more conventional means that usually characterize this level of development.

Marsh (1999) supports the Durkheimian view with respect to societies in transition, which he believes are more vulnerable to crime in general and serial murder due to the fact that they often involve a decay of social support structures resulting in a lack of healthy outlets for

success. Social messages advocating the importance and desirability of success continue however with the result that individuals seek such power by any other means, namely deviant ones, in line with Merton's Strain Theory (1968).

Tannahill (1992) also supports this by arguing that the sexual revolution of the 1960's resulted in complacency towards sex that inspired a desire for difference and ability to shock that encouraged more deviant sexuality. This coupled with desensitization to violence in the general media, and the representation of the individual who commits serial murder as quasi-celebrity in popular sources may have contributed to a cultural milieu that accommodated the serial murder phenomenon.

In this light, Gresswell and Hollin (1994) argue that the initial motivation for serial murder may be superseded by the need to generate and maintain public interest. Ressler *et al.* (1988) found that a proportion of their sample of individuals convicted of serial murder followed their crimes in the media, as a means to increase post-offence excitement.

Mitchell (1997) argues that the large amount of public and media interest surrounding serial murder serves to glorify it, and he believes that these frequently contribute towards copycat murders such as with Jack the Ripper, where newspaper coverage of the crimes is thought to have resulted in similar crimes being committed by another individual. Theories that emphasise the role of the media may explain part of the motivation for serial murder, particularly for individuals who may enjoy the attention. However, such theories still fail to reveal what the initial motivation consists of, or why many more people who are exposed to serial murder in the media and press do not go on to commit such offences.

Leyton (2001) argues that multiple murderers are "very much products of their time", their arrival "dictated by specific stresses and alterations in the human community" (*ibid.*) - "he is in many senses an embodiment of the central themes in his civilization as well as a reflection of that civilization's critical tensions" (p. 258). Leyton (2001) consequently divides

multiple murderers according to periods pre- and post-Industrial Revolution, much like Wilson (2000), in terms of their particular characteristics as well as those of their victims. He argues that the pre-Industrial Revolution multiple (or serial) murderer was an aristocrat who preyed on peasants while during the Industrial Revolution, the multiple (or serial) murderer was a new bourgeois who preyed upon prostitutes, homeless boys and housemaids. In the post-Industrial Revolution era, the murderer is more than likely a faded bourgeois who stalks middle class figures such as university women.

It seems that Leyton (2001) is postulating that individuals reflect the general issues of crisis affecting their class in their offences. One must wonder why multiple murder and not, say, theft would reflect this and Leyton (2001) does not provide answers to these questions. Additionally, despite their development within a post-Industrial Revolution era, many individuals who commit serial murder, such as Peter Sutcliffe in the United Kingdom, selected prostitutes as victims.

Similar to Leyton (2001), Ratner (1996) argues that serial murder represents an ideological leakage, in the sense that serial murder constitutes a rupture in the ideological status quo of society. Operating on the assumption that the early environment of individuals who commit serial murder involves a lack of adequate socialization, Ratner (1996) claims that such individuals lack ideological controls.

At a broader societal level, consequently, serial murder represents a means by which to homeostatically return society to a state in which conservative ideology is more firmly established. This would appear to apply aptly to the South African context, given that serial murder seemed to emerge at a time of great social upheaval and ideological uncertainty. However, this argument would seem to represent serial murder in a light that potentially frames it as a social necessity in times of uncertainty, with the individual who commits serial murder potentially framed as a martyr-like sacrifice for the benefit of society. As a result, this

argument would always border on potentially condoning serial murder, which one would think is not acceptable. Additionally, as with Leyton (2001) above, there is no justification as to why serial murder in particular assumes this social role.

3.3.2 Seltzer's theory of serial murder and wound culture

Seltzer (1998) sees serial murder as an artefact of a public wound culture of “addictive violence” (p. 1) characterized by public fascination with the wound or open body. The serial murderer as one aspect of such a culture forms one of many representations of a crossing point of private desire and public fantasy. For Seltzer (1998) the wound in the twentieth century, has become a fashion accessory, and hence one who inflicts the wound (and thereby displays his own) becomes fashionable especially with respect to the serial murderer who does so on such a grand scale.

Senseless murder, however, additionally represents the area where our basic senses of body and society, identity and desire, violence and intimacy are secured and brought to crisis. Seltzer (1998) believes that sex crime in particular elicits a postmodern fluidity between public and private spaces and identities, and as such, the individual who commits serial murder becomes iconic to the twentieth century and its postmodernism by tapping such a fluidity, specifically with regards to perception and identity. He also argues that as part of the growing culture of information, numerical data, repetition, number counts – the individual who commits serial murder conforms to such a culture by virtue of the seriality of his particular crime.

During the nineteenth century, Seltzer (1998) argues there was a cultural shift in ways of looking at crime and sexuality from the nature of the act, to the character of the actor. It is in the midst and intersection of such a shift, that the serial murder typology was created. He

identifies the following factors as contributing towards the creation of the serial murderer, namely:

- a pathological public sphere characterized by stranger-intimacy,
- an intricate rapport between murder and machine culture (enumeration, statistics, graphomanias, recording) and
- the mass in person as characterizing the form of the person who commits serial murder.

Seltzer's (1998) account may be a bit relativist but is a very competent post-modern, constructivist view of serial murder, which sees it as a phenomenon of the transformed 1800-present cultural milieu as opposed to an entity existing of its own accord.

3.3.3 Cameron and Frazer's social constructionist theory of serial murder

Cameron and Frazer (1987) see serial murder as a result of a number of historical, popular and cultural strands that have woven together to create the phenomenon concerned. The sex murderer of the late 19th and early 20th century was framed in either two ways, namely, either as someone outwardly repulsive or monstrous; or as a Jekyll/Hyde master of dual identity - one socially acceptable, the other deviant. Such an individual grew in the fascination of the public via the increasing attention paid to crime in broadside publications and true crime magazines. The voyeuristic public fascination with crime and the criminal is thought to have been coupled with a Gothic genre that encouraged a fascination with evil and terror as well as sex and death. Individuals such as the Marquis de Sade depicted the sadist as a rebel and martyr, challenging accepted convention and unrecognized by a repressed and ignorant society.

This followed the philosophical trend epitomized by existentialism that saw murder as the ultimate manner in which true essence and freedom could be embraced by one's liberation from the laws of both man and God. The third strand involved the development of a clinical model of the sexual deviant in the newly created disciplines of criminology and psychology as well as more established fields such as medicine.

Within such a model attempts were made to locate the source of the pathology or the pathology itself, which was causally linked to deviant sexual behaviour. Cameron and Frazer (1987) claim that these three strands cemented the sex murderer as a phenomenon of social awareness, public fascination and professional preoccupation, and can be seen to have laid the foundations for ideas surrounding modern day serial murder.

3.3.4 Holmes and DeBurger's socio-cultural interactionist approach to serial murder

Holmes and DeBurger (1988) argue that "violence-associated learning" (p. 43) plays a part in influencing the development of inclinations toward serial murder. The first source of such learning is to be found in a continuous culture of violence coupled with a continually changing relationship of the individual to his environment. With reference to American culture, they believe that the following factors are responsible for an increase and perpetuation of violence, namely – normalizing of interpersonal violence; emphasis on personal comfort; emphasis on thrills; extensive violence; magical thinking; unmotivated hostility and blaming of others; normalizing of impulsiveness; violent role models; anonymity and depersonalisation in overcrowded areas; extensive and accelerating spacious geographic mobility; and emphasis on immediate gratification of needs.

The second source involves patterns of interaction between the individual and their immediate family. Such a theory explains how serial murder is accommodated, promoted or

nurtured by the socio-cultural milieu but seems to depend on family dysfunction to explain how it may manifest itself in the individual.

Leibman (1989) elaborated upon the second source of violence by suggesting five factors that may characterize the dysfunctional family context. These include:

- a childhood marked by cruel and violent patterns;
- rejection by parents;
- rejection by a member of the opposite sex during adulthood;
- confrontation with the law during adulthood; and
- admittance to psychiatric hospitals.

The final factor may be more effect than cause though (as may the other factors). Leibman's (1989) study had a very limited sample however – four case studies – and there will be many cases of serial murder which can be shown to have none of these developmental factors as well as many individuals who have been subjected to similar childhood backgrounds and not committed serial murder.

3.3.5 Jenkins' social constructivist theory of serial murder

Jenkins (1994) has explored the social construction of serial murder and debates the functions that such a construction may serve in contemporary society. He argues that serial murder as a socially constructivist phenomenon emerged at a time in American history, namely the early 1980's, where there was a need to reinforce conservatism and social control after the liberalism and freedom of the 1960's and 1970's.

Jenkins (1994) argues that the serial murderer has been constructed as an individual who exercised no control over aggressive and sexual impulses and demonstrated no respect for criminal law or social convention. He also believes that the serial murderer has

simultaneously been constructed as extremely dangerous, evil and/or mentally disturbed. These two portrayals of the serial murderer, in turn, are thought to construct the serial murder as needing to be contained, thereby prescriptively reflecting the consequences of transgressing conservatism and societal norms and reinforcing agencies of law and order within such a society, such as the FBI, and conservative values. Jenkins (1994) argues that newspapers and the popular media served as vehicles through which such constructions were communicated and further elaborated so that the concept of serial murder developed through the interaction of the ostensible reality of criminal justice and popular culture.

3.3.6 Simpson and the popular representation of serial murder

Simpson (1999) describes serial murderers as immortal and profitable cultural icons that answer a human need to personify free-floating fears aggravated by the indeterminacy of the postmodern world. Adopting a strategy similar to that of Jenkins (1994) above, Simpson (1999) argues that serial murder encodes cultural phobias in terms of its victim selection and characterization. Simultaneously to the revulsion with which he/she is regarded, the individual who commits serial murder is also paradoxically elevated to hero status due to his/her ability to transcend societal norms.

Simpson (1999) supports Jenkins (1994) by arguing that the construction of serial murder serves to maintain the societal status quo and patriarchal dominance by diverting attention away from more pressing “evils” such as social or government policy, that actually affect a wider group of persons. Simpson (1999) analyzes the construction of serial murder in popular fiction and isolates the following dominant themes, namely, the coupling of murderous impulse and creative urge; the serial murderer as superb game player; the serial murderer as masculine hero; and the serial murderer as demonic messenger or punisher. He believes that

there is a significant interaction between constructions of serial murder in fiction and general perceptions of serial murder in the public domain.

3.3.7 Feminist theories of serial murder

Serial murder has invited considerable analysis and commentary from feminist theorists. This may be attributed to the overwhelming majority of male perpetrators and female victims that constitute the American, English and South African profiles of serial murder. As a result, serial murder has come to be viewed as a manner in which patriarchal dominance is reinforced and female subjugation ensured. These theories will now be examined in further detail.

Caputi (1992) views the serial murderer as one of many patriarchal agents responsible for enforcing female submission. Serial murder symbolizes an extreme patriarchal measure required increasingly as a result of the comparative increase in freedom and opportunities for women that threaten the dominant power imbalances. Caputi (1992) argues from a feminist perspective that the origins of violence against women, and consequently most serial murder, lie in systems of gender inequity – “they're actually performing a cultural function in enforcing misogyny in showing that women are prey, etc. and acting out masculinity in totally dominating the feminine” (p. 45). Serial murderers perform a cultural function in terms by disciplining women and reinforcing their subjugation via fear and behavioural inhibition.

Feminist views such as these have been extended by authors such as Cameron and Frazer (1987) in relation to serial murder. They hold that, other than feminist perspectives, all other theories of serial murder fail to address the question of gender directly. Victims of serial murder remain mostly female while the perpetrators of serial murder are increasingly male. Serial murder generally therefore constitutes violence against women with male sexuality

within such an act constructed as aggressive and predatory requiring unlimited access to the female.

The female consequently has to police her own sexuality to guard against potential attacks and sexual murder can consequently be perceived as sex terrorism on the female population. Additionally, sexual murder can be seen as masculine transcendence from the struggle to free oneself from the material constraints dictating human destiny (as discussed above with respect to the influence of existentialism). The subject of such transcendence is masculine however and consequently attempts to transcend one's objective nature that are lauded in the masculine subject are represented as "foolish" or "wicked" in the female subject. Serial murder consequently becomes an additional tool to limit the expression of female sexuality and further oppress the female under patriarchy (Cameron & Frazer, 1987).

3.3.8 Hook's post-structuralist approach to serial murder

Hook (2003) undertook a post-structural deconstruction of psychoanalytic narratives surrounding the life history of Cobus Geldenhuys, the individual labeled as the "Norwood serial murderer". He found that accounts of the life history of Geldenhuys and explanation of his criminal behaviour were influenced largely by popular representations of serial murder informed by popular psychoanalytic theory, reflected in an emphasis on aspects such as a domineering mother and absent father; prohibition on masturbation and early adolescent sexual experimentation or expression which manifested in a phallic fixation; ambivalent feelings towards women; and insufficient super-ego development.

Hook (2003) additionally perceived such accounts as being sensationalistic, sentimental and moralistic in tone and persistently adhered to in the face of alternative explanations and contradictory accounts. Hook (2003) explained such processes as necessary for the

objectification and othering of the individual who commits serial murder. He argues that this othering serves the purpose of distancing the individual who commits serial murder from those who talk of and observe such an individual so as to prevent identification with such a person and his criminal actions.

Hook's (2003) study provides insights into social processes and the social construction of serial murder, and demonstrates that post-structuralist work lends considerable qualitative richness to understandings of serial murder. Also, this work demonstrates the complex interaction of popular culture and psychology, as well as the politics of information and knowledge production.

This would appear to be an important factor to bear in mind when conducting research on serial murder, especially given the seemingly large amount of attention bestowed on this phenomenon in particular by the popular media. However, there seems to be a lack of grounded support for Hook's (2003) claims, and as a result this paper appears to be based on the anecdotal, personal interpretations of the writer. This may be due to Hook's (2003) lack of specialization in the field of serial murder or criminal psychology, and his primary specialization in discursive psychology. Hence, the topic of serial murder serves to increase understandings of popular cultural and socio-cultural constructive processes, as opposed to understandings of serial murder specifically.

Additionally, Hook's (2003) work would appear to bear little use for investigative applications, and does not contribute to a solid etiological explanation from a psychological perspective. Given the methodology utilized, a single case study does not appear problematic for the study in question; however, it is difficult to state whether similar processes may occur with different cases of serial murder. This is made more difficult by the absence of detail regarding Hook's (2003) sources. The detail that is provided would appear to situate such accounts as deriving from "expert" opinion such as that of the criminologist Irma

Labuschagne, and the third year psychology students taught by Hook (2003). This would have to be borne in mind when evaluating the reasons why narratives and interpretations may have been shaped in the way documented, and it may be interesting to conduct similar exercises in different contexts to establish whether the same themes and processes prevail.

3.3.9 Du Plessis' grounded theory approach to serial murder

In line with social constructionist attempts to study South African serial murder, Du Plessis (1998) explored the psychological themes in serial murder via a grounded theory approach as part of his thesis for a Masters degree in psychology from interviewing serial murderers incarcerated in South African prisons. He highlighted the following themes as the most salient: a dependent personality structure with underlying anxiety; presenting as reasonably normal without indications of severe pathology; an incapacity to form meaningful relationships; and a possibility of growing up in a psychologically deprived environment. He also clustered themes with respect to theoretical perspectives.

As a result, Du Plessis (1998) identifies ego-syntonic and ego-dystonic references (psychodynamic); cluster C personality traits (psychopathology); elements such as conditioned conscience and modeling (social learning theory); and evidence of neurological difficulties (neuropsychology). From a systemic perspective, Du Plessis (1998) interprets serial murder as serving a function within the system of the family from which the individual originates: for example, his behaviour may serve as a common problem that holds a family together. He also identifies themes that emerge that are in common with previous work in the literature such as an absent father figure; abused childhood; introversion, shyness and poor peer relations; inability to maintain meaningful relationships; self-centredness; and a

charming personality with an absence of hallucinations. These themes were found across the sample of two individuals interviewed as opposed to consistently in each case.

Du Plessis' (1998) study is useful from a psychological perspective in that, given the extent to which serial murder has been understood as the product of intrinsic motivation (Holmes & DeBurger, 1988; Labuschagne, 2001; Pistorius, 1996), a research approach such as grounded theory, which aims at ethnographically exploring the world view of the research participant from his/her perspective, seems particularly useful in understanding such the nature of the afore-mentioned motivation. His systemic interpretations are also useful in that the system in which an individual who commits serial murder functions, may be enlarged to apply to a particular society or at the level of culture.

As with Hodgskiss (2001) and Labuschagne (1998, 2001), the sample size was small (two individuals) and consequently, as mentioned above, generalization is limited. While restricting the extent to which Du Plessis' (1998) study might be useful for investigative purposes, the size of the sample might not pose as significant a challenge to the grounded theory approach as discussed above.

3.3.10 Critique of socio-cultural theories

Theories that focus upon sociogenic factors give a large volume of information on the etiology of serial murder in terms of the social forces and structures which produce such a phenomenon, but are limited in terms of their potential for investigative and rehabilitative application.

From an investigative perspective, socio-cultural theories do not provide any information that could be used pragmatically to guide investigations. Any insights that are provided are at an abstract level, framed in social processes, and are limited in their ability to provide

practical details necessary for serial murder investigation. They seem better suited at developing understandings of serial murder at a phenomenological level.

In terms of rehabilitation, sociogenic theories provide little input at the individual level, in terms of immediate interventions that could be used to help individuals who commit serial murder and prevent or limit future cases of serial murder. Rather they illuminate flaws in the broader social structure, which would require a longer spate of time in which any effects of modification in the character of social fabric could be monitored, assessed, or observed.

Finally, as has been mentioned in discussion of socio-cultural theories, as much as they explain and describe the roots of deviance and criminality in society with convincing argument, they do not appear to explain why certain types of crime or deviance occur. Even with reference to those that have attempted to focus specifically on serial murder, their argument may apply equally as well to other types of crime prolific in the twentieth century.

3.4 THEORETICAL FRAMEWORK FOR THE CURRENT STUDY

The current study has chosen to work from a systemic theoretical paradigm, focusing specifically on family systems theory in order to investigate serial murder. The systemic framework facilitates a focus on relationships and process as opposed to the content and individualistic focus of more intrapsychic approaches. Additionally, systemic theory provides an alternative to established linear ways of conceptualizing pathology by proposing a more circular approach to causality, and avoiding blaming or pathologizing individuals for symptomatic or problem behaviour (Goldenberg & Goldenberg, 2004). As a result, problems are viewed as interactional and situational, and as having a particular function within a system. In the case of serial murder, such an approach is useful, specifically in relation to

family systems, as it has not always been productive to blame specific family members (such as parents) for the occurrence of serial murder behaviour in another member.

An approach that focuses on relationships also taps an important aspect of serial murder, namely the relationship between perpetrator and victim which has frequently been fundamental in discerning serial murder from other types of crimes, mainly due to the fact that these two individuals are frequently strangers (i.e. the victim is not known to the perpetrator). Consequently, this would seem to point to the fact that it is the relationship between the two individuals rather than individualistic, personality factors that influence the manifestation of serial murder. An approach that focuses on this aspect, such as systemic theory, may yield productive findings as a result.

Importantly, the systemic view does not discount approaches that have a more intrapsychic, individual focus; rather it views such approaches as alternative ways of viewing phenomena. As a result it is possible to study serial murder from a systemic perspective and yet still integrate traditional literature into one's final understanding of the phenomenon. Given the lack of success that traditional approaches appear to have had in fully comprehending serial murder and the individuals who commit serial murder, an alternative approach that focuses more on process and patterns and family systems may yield information that could be used effectively either on its own or combined with existing data.

The systemic perspective's reluctance to engage in blaming and pathologizing of behaviour means that it may offer a novel approach to understanding criminal behaviour and challenging perceptions regarding the individuals who engage in such behaviour. It may free up such individuals as well as their families to be viewed as consisting of more than the criminal behaviour concerned in terms of public perceptions and opportunities for constructive work with such groups and individuals. This is not to say that the behaviour

should be condoned, but rather that individuals associated with such behaviour need to be viewed in their own right.

Consequently, the systemic theoretical perspective appears to provide an opportunity for a novel approach to studying serial murder and thus possess considerable potential for producing findings that may extend and elaborate understandings of such a phenomenon. In the following chapter, such an approach will be elaborated upon with regards to how it will be used to inform the current study.

4. FAMILY SYSTEMS THEORY

Discussion will now turn to the concept of the family. Firstly, the author will examine definitions of the family, as they have appeared in dictionaries, contemporary sources and the South African literature. The author will then discuss family systems theory and elaborate upon the aspects of this theoretical approach that will be utilized to interpret the data in the current study. Finally, the author will provide a summarized version of the definitions and theoretical perspectives that will be used to inform the present study.

4.1 DEFINITION OF “THE FAMILY”

Arriving at a solid and universally applicable definition of the family is the subject of much debate, given the proliferation of family structures that have emerged in the greater part of the last century (Bell & Vogel, 1968). The author consulted three dictionary sources for definitions of the family and will now discuss these in further detail.

4.1.1 Dictionary definitions

Merriam-Webster's Dictionary (2005), *The Concise Oxford English Dictionary* (2004) and the *Penguin Concise English Dictionary* (1992) were consulted for definitions of the family. *Merriam-Webster's Dictionary* (2005) defines family in three possible ways, namely, as

- “the collective body of persons who live in one house, and under one head or manager; a household, including parents, children, and servants, and, as the case may be, lodgers or boarders” (p. 541),

- “the group comprising a husband and wife and their dependent children, constituting a fundamental unit in the organization of society” (p. 541), and
- “those who descend from one common progenitor” (p. 541).

The *Concise Oxford English Dictionary* (2004) defines the family as:

- “members of a household, parents, children, servants, etc” (p. 436),
- “set of parents and children, or of relations, living together or not” (p. 436), and
- “all descendants of common ancestor, house or lineage” (p. 436).

The *Penguin Concise English Dictionary* (1992) defines the family as:

- “a household, including dependants and servants” (p. 278)
- “a group of parents and children” (p. 278), and
- “a group of persons interrelated by blood and marriage” (p. 278).

The three dictionary sources of definitions of the family, when examined together, all appear to have three common types of definitions for the family. Additionally, all three sources appear to argue strongly towards a conception of the family that is very similar to notions of the nuclear family (discussed below).

On examining the types of definitions in each source, the following three types of definitions would appear to emerge across the sources. The first type seems to focus on the family as a household; the second type appears to define a family more in terms of the roles that this group is expected to play in society such as “organizational” (Merriam-Webster’s Dictionary, 2005) and in terms of fixed roles of parents and children; and the third type seems to focus on blood lineage, or ancestry as definitional criteria for a family.

These types will now be discussed in terms of their suitability to contemporary notions of family, as well as to the present study.

- **Family as household.**

The first type of definition makes allowance for servants, lodgers and boarders, in addition to traditional family members such as father, mother and children. This is useful in that frequently a person's psychological conception of family may not refer member-for-member to one's biological family, in that many of the above non-biological household members may play integral parts in helping the biological family function as an organizational unit in society, as stipulated by the second definition. Additionally, if one looks at the roles within a family such as father or mother, individuals who are not necessarily the biological parents of the individuals concerned may perform these.

However, as will be demonstrated below, the first type seems to be referring more to a household than a family. It is important to distinguish a household which refers to a spatial category where a group of people, or one person, is bound to a particular place from a family which entails blood and marriage ties (Muncie & Sapsford, 1995). These two terms cannot be used interchangeably because a family may form part of a household, but that household may not be exclusive to that family. For example, a family may rent a room to a lodger, or a member of the extended family may come and stay for a while.

A single family may also be spread over two households. For example, a husband may leave a family temporarily to go and work elsewhere, in which case he would reside at another household for a while. The first type would appear to be more suited to censuses and household surveys, where the household is the primary focus for data collection (Nam, 2004).

- **The family in terms of the function or role of its members.**

The second type introduces an important facet of the family, namely that the family performs certain functions in society, however, these functions may not be exclusively limited to the organization of society, as stated in the definition. The family may also provide emotional

support for its members, or act as a refuge from the pressures of society (Muncie & Sapsford, 1995). This definition also seems to be too narrow as it excludes extended family members such as grandparents and aunts or uncles.

The definition seems to be referring to what has come to signify the “nuclear family”. The term nuclear family is laden with a number of normative assumptions, and has been mostly used to refer to a family type that consists of a married man and woman and their offspring (Murdock, 1968). This is distinguished from an extended family, which refers to two nuclear families affiliated through the extension of a parent-child relationship rather than that of husband-wife (Murdock, 1968). Unfortunately, studies that have limited their study of the family to the nuclear family have often missed out on the considerable impact that extended generations frequently have on the phenomenon of interest (McGoldrick & Gerson, 1985).

- **Family as ancestry or blood lineage.**

The third type of definition would appear to define membership of a family in terms of common genetic links. This is also a bit exclusive in the sense that it would omit cases where families consist of adopted members or fostered members, as well as cases where individuals have remarried and formed a new family unit with their children from the previous marriages.

4.1.2 Summary of dictionary definitions

It would seem that the above definitions, on their own, are unsuitable as criteria for what constitutes as a family, especially with the emergence of alternative family types such as single parenting, same sex parenting, cohabitation, fostering and extended family and kin networks (Murdock, 1968).

However, the three types above are of use in the sense that they do capture a number of common themes in general understandings of “family”, such as genetic or blood links, a common household and nuclear formation (father, mother and children). For this reason, the gestalt of the three definitions can be utilized with flexibility and awareness of the variations that may occur on this theme (such as those outlined above), as well as variations occurring on each definitional strand (such as a family with members living in two households). In other words, if used together with contemporary theoretical information concerning recent developments and alterations to notions of family, the gestalt of the three types can be of use in the present study, especially due to the fact that many of the individuals in the study sample grew up at a time when alternative family types were not recognized as prolifically in society.

Contemporary views and definitions of the family will now be examined, after a brief cautionary note about the temporal development of “the family”. Studies that focus upon the family have to also be aware that this grouping may change over time. For example, a family member may pass away, members may remarry or new members may be added via adoption or pregnancy. For this reason, definitions of family should allow for changes over time and be aware of their impact upon family organization (e.g. AIDS households headed by a child “parent”).

4.1.3 Contemporary view and definitions of the family

More contemporarily, that is, with the advent and progression of the twentieth century, the traditional family structure has undergone a number of changes. Some of these changes have been outlined by Ravanera and Rajulton (2000) and include the following:

- an increase in cohabitation with children;
- an increase in the amount of children that leave their home later;

- a change in the household division of labour, with females facing; responsibility as breadwinner and executor of household duties;
- changing family values which have seen cohabitation and divorce becoming more socially acceptable; as well as
- a reduction in the emphasis placed on marriage and an increase in preference for egalitarian spousal relationships and parent-child relationships.

Such changes have necessitated a re-examination and revision of traditional ways of defining the family.

The emergence of post-modernism has also influenced contemporary understanding and definition of the family (Hossfeld, 1991). With its emphasis on multiplicity and pluralism, as well as post-traditionalism, the concept of the family has been made more flexible with regard to the ways in which such a unit is understood and defined (Gubrium & Holstein, 1990). Contemporary definitions of the family are more interpretative and tend to refrain from viewing the family as an objectively knowable entity, but rather view it as a complex, contingent lived reality between members (Bernardes, 1997; Morgan, 1996).

Some examples of contemporary definitions of the family include:

- the family as a discursive construction with relationships constituted and maintained through routine dialogue and communication (Gubrium & Holstein, 1990);
- the family as an interactional process as opposed to a structure or set of social ties (Morgan, 1996, 1999); and
- the family as a system of negotiated intimacies (Gillies, 2003).

Family types have also been defined in terms of individualism and collectivism (Corder, 2001). Collectivism refers to a position encompassing co-operation and central planning, as well as a commitment to the values, norms or mores of a system or society (Hofstede, 1994).

Collectivist families are those families in which there is an emphasis on co-operation, resources are pooled, and social commitments (such as attendance at weddings and other family ceremonies) are of great importance (Corder, 2001). In these families, for example, members of the family who are employed would support unemployed members.

Individualism refers to a position encompassing independent thought and action, as well as the predominance of the rights of the individual within the social system. Individualistic families may consequently be understood as those families where loyalty to the family is secondary to the advancement of the individual members (Corder, 2001).

In collectivist families, Corder (2001) has argued that children will be influenced more greatly by others and their actions judged in a social environment where transgression signifies humiliation. In individualistic families, he argues that the independence of children is encouraged and transgression results in guilt. Consequently, persons growing up in these two types of families may develop different attitudes both towards their society and social setting as well as the systems of which they are members. Importantly, families may not fall into either extreme completely, but may position themselves at points along an individualistic/collectivist continuum (Corder, 2001).

4.1.4 Summary of contemporary definitions of the family

Such definitions are both advantageous and disadvantageous. In terms of their advantages, contemporary definitions allow for greater flexibility in terms of membership of the family unit. By avoiding references to household, conjugal relationships, or blood ties, these definitions avoid many of the problems discussed above with respect to the dictionary definitions, by not excluding many alternative family types that have emerged with the post-modern age.

Additionally, these contemporary definitions allow for the psychological perception and interpretation of an individual to play a greater role in defining the family unit of which he is a member. In other words, rather than a top-down prescription which states that the individual's family must consist of his biological parents and siblings or household, regardless of whether the individual himself felt any familial ties to these people, these definitions allow the individual to define his family for himself. This is of particular usefulness in South Africa, where many individuals are raised by individuals other than their biological kin, or distantly related family members, or where households have lost both parents to AIDS and the eldest child takes on the role of head of the household.

However, these definitions are still very broad and do not seem to illuminate clearly enough how (or whether) a family is different from other types of social groupings such as a workplace or sports-team, for example. Minuchin (1974) seems to accept this fact: "the theory of family therapy is predicated on the fact that man is not an isolate. He is an acting and reacting member of social groups" (p.2). Intuitively, it would seem that the family as a social grouping is different to the workplace, however these definitions do not go far enough in drawing distinctions between the different kinds of groups.

Finally, the South African literature was reviewed with respect to current definitions of the family in South Africa. The following definition was obtained from the South African Government's Department of Social Development and will be used to inform the present study (discussed further below).

4.1.5 A South African definition of the family

The South African Government's Department of Social Development (2003) defines the family in the following manner in its *Baseline Document for the Development of a National Policy for Families*:

- “as extended, multi-generational, nuclear or consisting of one or more parents and children, and single parent with children, recombined families with step-parents and step-children, or gay families” (p.24);
- “social units governed by family rules” (p.24);
- “individuals who either by contract and/or agreement, by descent and/or adoption, have psychological/emotional ties with each other and function as a unit within a social and/or economic system, not necessarily living together intimately” (p.24).

The first part of this definition seems to be more about family types, than providing a definition that can be applied to a group to thereby identify such a group as a family. In this way, it excludes family types such as unmarried, cohabiting individuals or families with adopted children. It is advantageous in that it includes many modern, alternative family types such as gay families, but doesn't specify that marriage is necessary.

The second part of the definition makes more progress in terms of providing a more practical, applicable definition. However, it is too broad and could refer to an organised crime syndicate, for example, where none of the members of this group are related to each other in the more traditional sense of family. Additionally, little further information is provided with regard to what constitutes the “family rule”.

The third part of the definition appears to be the most useful in terms of capturing what the family signifies and being applicable in terms of identifying such groups in wider society. This definition captures the psychological aspect and subjective perception of family (as

discussed above) by including psychological and emotional ties, as well as allowing the notion of family to extend beyond the household, by including members who may live elsewhere but who are still psychologically or emotionally linked to the family group. The definition also refrains from excluding any alternative family types, by acknowledging that families may emerge as a result of factors other than blood lineage or common genetic material (such as legal unions, or adoption).

A number of definitions for the family have been discussed above, largely with respect to dictionary and contemporary definitions of the family. The author's will now propose a definition of the family that will inform the present study.

4.1.6 Conceptualisation of the family for this study

Given the different ways of understanding the family outlined above, the study will attempt to use a combination of the two main approaches, namely, contemporary and more modern notions. While this study chooses will focus primarily on the immediate blood relatives of the individual concerned, specifically those with whom he has grown up, and secondarily on the extended family, such as grandparents, aunts, uncles and cousins, or significant others who may have performed roles usually associated with nuclear or extended family members, it will also allow for flexibility with respect to alternative family types and changes over time as well as the individual's own definition of what he considers to constitute his family. Hence, a family in this study is defined as:

- the group of individuals biologically related or otherwise, with whom one is involved in intimate, interactional relationship/s over time; and
- whom one subjectively recognizes as playing a significant role in this regard.

Extended family will refer to all those family members, related to the individual concerned, who do not fit into the category above. That is, those individuals to whom the individual is related or with whom that individual has interacted with on a basis that is not as intimate as the above.

This study will also investigate any attempts to begin a family of procreation (inclusive of alternative types such as gay couplings) by the individuals concerned. Prior to examining some of the core aspects of family system's theory, as well as discussing both how a symptom is understood within the family system, the author will shortly discuss the family system's relationship with other systems and the influence of society and culture.

4.2 THE CONTEXT OF THE FAMILY

The family does not exist in isolation, but rather is situated within particular social and cultural contextual settings – the supra-system (Bateson, 1979). Such contexts play an influential role in shaping the way in which a family perceives itself, as well as the form it may take (Connell, 1987). The socio-cultural context, in particular, frequently influences perceptions of what is acceptable with regards to how that family should function in that system (Dallos, 1995; Muncie & Sapsford, 1995). For example, if the socio-cultural context is dominated by conservative values, the traditional nuclear family may be perceived as the norm and as a result, any non-traditional forms, such as single parent or same-sex caregiver families, might be blamed for moral decay, increased crime, unemployment and drug-taking in society.

Muncie and Sapsford (1995) state that families are frequently shock absorbers of change in society. They argue that families absorb socio-cultural changes in various areas such as gender roles, intergenerational relationships, racial attitudes, politics, economics and science,

and as a result, may develop new family forms, relationships or functions. Within a systems framework, one could argue that families with particularly rigid interactions and who cling strongly to stability or homeostasis, might struggle to deal with changes in the socio-cultural milieu. As a result, one might expect these kinds of families to start to exhibit some degree of symptomatic behaviour.

Prior to commencing with the discussion of the theoretical background and conceptual framework that will guide the study, a short cursory discussion on the role of context will be conducted with an aim to illustrate the contextual issues that the author has utilized as part of her guiding frame of reference in the analysis of the data. The main areas discussed are the post-modern family, the role of deviance and the interaction of the family system with larger contextual systems.

4.2.1 The post-modern family

Sociologists such as Shorter (1975), Gergen (1991) and Hossfeld (1991) have detailed influences on the family unit of one such socio-cultural change and its influence on the relationship between family systems and the context in which they are situated: namely, the change from a modern to a post-modern society.

The modern (or post-industrial) family resembles the nuclear family unit and evolved in response to the needs of an industrial society (Parsons, 1956). The modern family exhibited some of the following characteristics:

- it consisted of definite sex role distinctions, with the man or husband as breadwinner and woman or wife as caretaker of the household;
- it acted as a lynch-pin of social cohesion; and

- it functioned as a fundamental building block of order and moral health in society, frequently reflecting the normative views of the particular society.

With the advent of post-modernism, Hossfeld (1991) states that many varieties of other family types (such as single parent families and same sex parent families) were ushered in. Shorter (1975) argues that these emerged out of:

- the economic liberation of women;
- the lack of faith in the previously established order due to the disillusionment in human progress; and,
- the influence of the electronic media, which reflects and legitimates family diversity.

The post-modern family has also become more permeable, specifically with regard to the last point, where the media has brought the global village with its multiplicity of viewpoints and perspectives, into the family living room. As a result, the boundaries between the family and other systems are more blurred (Shorter, 1975).

Gergen (1991) has elaborated on this point, labeling the post-modern family as the “saturated family” on account of the degree to which family members are exposed to different views, personalities and relationships. He argues that the post-modern family is more vulnerable to fragmentation and chaos due to this saturation, and that the home, no longer the refuge it symbolized in the modern age, becomes a site of confrontation between different views, ages, genders and ideologies.

Other sociologists such as Denick (1989) and Gillies (2003) adopt a more positive view. Denick (1989) argues that such variation (or saturation) encourages a child growing up in a post-modern family to become more flexible in terms of being able to adapt to different spheres and information, as part of his or her socialization process and individualization or identity formation. Gillies (2003) states that a post-modern family reflects post-traditionalism,

balancing individuality with love and intimacy and economic obligation with an emphasis on relationship together with intimacy and love.

The possible influence of socio-cultural changes on the family, as discussed above, will be an important consideration in the current study. Many of the individuals in the sample, together with their families, lived through a period of considerable social change in South Africa, both in terms of transitions from modern to post-modern trends, as well as the political transformations during, towards and after Apartheid.

Amoateng (1997) in his research on changes in the composition of the South African family from 1994 to 2001, has documented that contemporary South Africa is composed of two main family types, namely, the extended (mostly among African and Coloured racial groups) and nuclear (mostly among White and Asian racial groups) family types.

Additionally, he has documented an increase in cohabitation (and lower marriage rates) and female-headed households amongst families in South Africa. Additionally, the African family has traditionally placed considerable importance on descent lineages within the larger kinship network together with the nuclear family (Caldwell, Caldwell, Ankrah, Anarfi, Agyeman, Awusabo-Asare & Orubuloye, 1993). Consequently, the conceptualization of the family for the present study will take the above into account during the analysis and interpretation of the data.

4.2.2 The family and deviance

Another area that has been examined with respect to the relationship between the family and larger context, is that of deviance.

Hoffman (1981) states that deviance serves three purposes for social systems, namely:

- to promote cohesion;
- to keep an outmoded group functioning long after it should have collapsed; and
- to mediate where people are in conflict.

Deviance may occur at the level of the family, where a member who displays deviant behaviour serves to unite the family or keep the family from extinction, and/or at the level of society where a certain type of deviant behaviour may serve to achieve one or all of the aims outlined above by Hoffman (1981) for the society in question. This work is of particular interest in studies such as the present one that focuses on deviant or anti-social behaviour such as serial murder.

4.2.3 The family and larger systems

Finally, families have rules for interaction within larger systems. Involvement with representatives of such systems may be an attempt to fill voids left by cut-off members, divert attention from internal strife, or to support family myths (Imber-Black, 1988). For example, if the eldest sister of a family is the member to whom others go for advice or to talk about their problems, and she leaves, the family may then enlist the help of a psychologist or counselor when future problems arise, if no other member assumes that role within the family system.

The theoretical background of the study, namely family systems theory, will now be outlined, followed by a more detailed description of the conceptual framework that will be derived from family systems theory to guide the analysis and interpretation of the data.

4.3 FAMILY SYSTEMS THEORY

Family systems theory developed from the application of systemic theory, pioneered by individuals such as Bateson (1979) and Bateson, Jackson, Haley and Weakland (1956) to the family. This took place largely in the 1950's when the psychotherapeutic community working with families began looking for alternatives to the predominant psychoanalytic approaches that dominated practice (Nichols & Schwartz, 1991).

Family systems theory also developed from the considerable body of research that was being done during the 1950's time on the families of schizophrenic individuals, by individuals such as Gregory Bateson and Don Jackson at the Palo Alto Veterans Administration Hospital (Vorster, 2003). Their pioneering paper, together with Jay Haley and John Weakland, titled the "Theory of Schizophrenia", ascribed the source of the thought disorder in the patient to the form of communication exchanged between family members (Bateson *et al.*, 1956). This ushered in a new approach to working with families by applying the new science of cybernetics, or the regulation of self in a social or biological system, to the description of family pathology, and, later on, to devising methods of treatment (Guerin, 1976).

A system can largely be understood as consisting of a number of interconnected elements which mutually and continually influence each other (Dallos, 1995). Given this definition, it is evident how systemic theory could be applied to the family. The family is an organic unit that is made up of interconnected individuals who perform various tasks and fulfill various roles in relation to each other (Muncie & Sapsford, 1995). Consequently, the principles of a system should apply equally to the family, as to other systems. Within a systemic paradigm, the family may be defined as consisting of a number of interrelated members, whose behaviour (together with emotions, actions, thoughts, and beliefs) mutually influences each

other, together with the family as a whole. This view of the family provides pragmatic avenues of change, as well as new ways of understanding pathology and processes in a family, and individual members.

From a systems theoretical point of view, Guttman (1991) sees the family as:

- a cybernetic system (a system of interconnected parts, and as a system that governs itself through feedback);
- a homeostatic system (that is, that negative feedback maintains homeostasis in a system by reducing any deviation that results from the introduction of new information); and
- a rule-governed system (that the mechanisms maintaining homeostasis operate according to certain rules that condition or ‘set’ the range within which a given behaviour can vary)

This section will now look at aspects of family systems theory. It will first examine some core aspects of family systems theory, as outlined in Watzlawick, Beaven and Jackson (1967) and Bowen (1978), as well as Minuchin (1974) with respect to the structural organization of families, hierarchies within family systems and power. The discussion will then examine the genogram as a means of understanding and conceptualizing family systems, the role of the symptom in families, as well as the family’s position within other larger systems and society.

4.3.1 Watzlawick, Beavin and Jackson’s theory of communication and interaction

Watzlawick *et al.* (1967) describe objects of interactional systems as “persons-communicating-with-other-persons” (p. 120). An interactional system consists of ‘two or more communicants in the process of, or at the level of, defining the nature of their relationship’ (p. 121). They distinguish between two types of systems:

- open systems, and
- closed systems (Watzlawick *et al.*, 1967).

Open systems exchange materials and information with the environment, whereas closed systems do not permit the introduction of any novel stimuli from outside of the system.

Systems exhibit the following properties:

- wholeness,
- feedback, and
- equifinality (Watzlawick *et al.*, 1967).

- **Wholeness.**

The property of wholeness means that every part of a system is related to other parts so that a change in one part results in a change in the total system. Consequently, a system is not summative, but emerges from a combination of elements, and can be viewed as a gestalt of such elements, as opposed to a cumulative, linear aggregation of its various parts. As a result, parts are not unilaterally related, but rather demonstrate circularity with respect to the manner in which they interact. For example, the consequences of A's actions towards B are not limited solely to B, but rather impact on the way that B then reacts to A, and so on.

Applying this principle to family systems, wholeness means that a change in one member of the family, will affect the other members, as well as the family as a unit (Kilpatrick & Holland, 1999). For example, the departure of the eldest son of a family of four, may result in the other sibling having to assume additional responsibilities, and depression over the loss of a child from the household and anxiety over aging in the parents, together with the family having to redefine itself as a unit of three and potentially have to accommodate extension in the form of a new spouse and children from the eldest son who has now moved onto the next phase of his life.

A corollary to the principle of wholeness is circular or cybernetic causality, which will be discussed now.

- **Circular or cybernetic causality.**

Circular causality refers to the fact that, due to the principles of wholeness (where a change in one member of a system impacts upon the behaviour of other members) as well as homeostasis (or keeping levels of system activity within an acceptable range, discussed below), each member's behaviour in a system is maintained by the actions of the other/s. In other words, each person within a family is seen as influencing the other, and their responses, in turn, influence the first person, whose response influences the others, and so on.

Over time, many of these interactions, or circularities (Watzlawick *et al.*, 1967), may become more regular and repetitive, giving the impression that they serve as possible rules that are necessary for the functioning of the family (Jackson, 1957). For example, a father may shout at his son on account of his son's behaviour at school, to which the son may react by increasing aggressive behaviour at school as a way of getting back at his father. This then makes the father increase his disciplining of his son, which in turn may result in increased aggressive behaviour at school.

- **Feedback.**

Feedback is related to the principle of homeostasis. It means that part of the output of a system is fed back into that system as an input to modify system activity (Watzlawick *et al.*, 1967). For example, many of the systems on the human body operate according to feedback mechanisms and monitor if levels of hormones, excretory products, or neurotransmitters are at optimal levels. Feedback also operates in human systems, and especially families, where it serves to regulate processes and interaction within the family unit and between members.

Feedback usually occurs in relation to a system norm or set level (Watzlawick *et al.*, 1967). The system then decides on how to proceed as a result of how feedback input relates to the system norm, and the type of reaction it wants to achieve, that is, to amplify or reduce deviation from the norm. An example of such a norm in families may be rules around acceptable behaviour, within each individual has to operate. A system tends to calibrate itself around a norm so as to achieve constancy within a defined range. This principle has often been likened to a thermostat, in which there is a lower and higher limit within which the thermostat functions and adjusts itself to achieve the desired norm.

Consequently, there are two types of feedback (Watzlawick *et al.*, 1967). Positive feedback or escalation (Bateson, 1979; Jackson, 1957) results in an amplification of output deviation from a system norm, whereas negative feedback or stability results in the opposite, namely a reduction of output deviation from a system norm. In a human system, positive feedback usually results in change, whereas negative feedback tends towards stability or homeostasis. In the above example, an individual who deviated from a family norm may be disciplined or sanctioned so that he/she came back into line with the system norm, thus maintaining homeostasis.

This can frequently be seen in the case of families who seek help for a member displaying behavioural problems, and yet appear to frequently jeopardize attempts to bring about change in such a member. Such families and relationships can be seen as particularly rigid closed systems, where change is resisted on account of the threat posed to homeostasis and stability of the family unit (Jackson, 1957).

A system that is constantly threatening to exceed homeostatic limits frequently engages in “runs” (Hoffman, 1981). Normally, when a plateau is exceeded, a deviation-amplifying process sets in and destroys the system. However, less drastic runs frequently delay this process due to the fact that the imbalance in the nuclear family may be trying to correct an

imbalance in the larger kin system or other systems (Hoffman, 1981). As a result, the family pathology is stabilized. Should the stabilizing member leave, or other systems undergo certain changes, this process may break down.

Both stability and escalation are necessary for a family to function as a viable social unit: escalation or an open system, allows for adaptability to novel circumstances while stability allows a family to maintain a certain degree of constancy in the face of such change (Dallos, 1995). Either process, at its extreme, threatens the survival of the family: an overly rigid closed system not being able to adapt to changes, while a highly unstable, open system risking the fragmentation or dissolution of the family unit.

Watzlawick *et al.* (1967) were not the only theorists to view the family as a system that tends towards homeostasis. Both Jackson (1957) and Haley (1970) have also advanced this notion in the sense that they claim that the family system attempts to maintain equilibrium (Hoffman, 1981).

- **Reflexivity.**

Reflexivity refers to a system's capacity to monitor and reflect on its own actions. This operates in accordance with feedback. Watzlawick *et al.* (1967) argue that because a system can store and keep a record of previous adaptations and feedback patterns, a pattern of redundancies (although complex) within the system can be recognized and predictability is possible. As a result, family systems can begin to form rules or expectations concerning types of situations or challenges and ways of dealing with them, by grouping together past experiences of similar feedback patterns and responses.

- **Equifinality.**

The property of equifinality means that any alterations in state after a period of time in a system are not determined so much by initial conditions as by the nature of the process and system parameters (Von Bertalanffy, 1968; Watzlawick *et al.*, 1967). In other words, the same results in two systems may spring from different origins because of differences in parameters, interactions within the system, and informational exchanges with other systems. In closed systems, where there are no exchanges outside of the system, results may be determined by initial conditions. In open systems however, where this exchange does occur, equifinality is possible, both with respect to the above and its opposite, that is, different results from the same origins. For example, serial murder has often been problematically linked to nature or nurture explanations due to the fact that many individuals who commit serial murder have siblings who do not go on to commit such crimes. However, if serial murder is understood within the context of the family system, it becomes less problematic to understand how this may be possible.

- **Types of interaction.**

Watzlawick *et al.* (1967) describe two main types of interaction:

- symmetrical, and
- complementary.

In symmetrical interactions, the partners involved mirror each other's behaviour. In this way, each partner attempts to use his/her turn to minimize the extent to which the other partner may be one up on him/her, and thereby minimize any difference between the two. In this way, symmetrical relationships are based on equality but may become quite competitive (in order to prevent either partner from getting too far ahead of the other).

Watzlawick *et al.* (1967) have likened symmetrical interactions to a seesaw, where if one partner goes up a bit, the other adjusts to meet the movement. Symmetrical interactions and relationships may escalate into “runaways” where the stability of the relationship is lost and a quarrel or fight takes place. This may also lead to escalation, where the intensity of the behavioural responses increases with each adjustment in each partner.

In complementary interactions, one partner’s behaviour complements the other, and the pair are usually arranged in a one-up and one-down position (Watzlawick *et al.*, 1967). Who occupies which position may vary with each interaction between two partners, however, frequently complementary relationships will have one partner set in the one-up position and the other in the one –down position. For example, in a married couple, there may be one partner who is dominant or assertive, while the other is more submissive or passive.

Conflict may take place when one of the partners (frequently the partner in the one-down position) attempts to take the opposite position. Alternatively, one partner may want to change their position but be prohibited from doing so by a powerful partner or circumstantial factors which may lead to frustration and despair as well as self-estrangement, depression and acting out on the part of the dissatisfied partner.

- **Pathological communication.**

Watzlawick *et al.* (1967) see behavioural, emotional and psychological problems as an outcome of sustained pathological communication between individuals. With the concept “pathological” they mean ways of communication of which the effects and the process of these effects are ineffective. They argue that human beings cannot avoid communicating, for, even by choosing not to communicate with someone, they are, in fact, communicating a certain statement to that someone (namely, “I don’t want to communicate with you”). Given this condition, namely the impossibility of not communicating, and if an individual cannot

leave the field in which such interaction takes place, the following options may be available to the person, namely:

- rejecting communication;
- accepting communication;
- disqualifying communication; or
- manifesting a symptom as communication (Watzlawick *et al.*, 1967).

Rejecting communication may involve informing the individual directly that one has no desire to communicate with them, for example, by telling them so or leaving the room.

Accepting communication involves responding and starting an interaction with the person concerned, for example, by replying to their statement. Disqualifying communication involves disqualifying the communication of either oneself or the other person, and is frequently found in situations where the individual concerned does not want to communicate but is obligated to do so. Disqualification may be achieved by contradicting oneself, inconsistencies, subject switches, tangentializations, incomplete sentences, misunderstandings, literal interpretations of metaphors or metaphorical interpretations of the literal (as found frequently in people suffering from schizophrenia). Consequently, “crazy” communication may not be exclusively an indicator of mental illness, but rather, may be viewed as an indication of an individual who may be reacting to an absurd or untenable communication context, or both (Watzlawick *et al.*, 1967).

Lastly, communicating by means of a symptom involves non-verbally communicating certain information to one’s family or others. This differs from intentional feigning of an illness to avoid communicating or interacting with others. Here, when a symptom develops, the individual with the symptom is convinced that he or she is suffering from that particular problem or illness. In this way, the individual avoids the reproach of significant others as well as his or her own guilt. For example, one may become violently ill or suffer an upset stomach

before an important public speech or examination, or start to experience psychotic symptoms such as hearing voices.

The last two aspects of pathological communication are particularly relevant for the current study, in as much as they will be applied to understanding how serial murder may be a means of communicating certain information to the family of individuals who engage in this criminal behaviour. This theory is also useful to examine how communication in general takes place in the families of these individuals and if any common patterns emerge.

Ways of communicating do not only have implications for specific behavioural, emotional or psychological behaviour but also for the way in which an individual defines him/herself in relation to others (Watzlawick *et al.*, 1967). This will now be discussed with respect to the communication options outlined above, namely with respect to how rejecting, accepting or disqualifying communication, or communicating a symptom, are related to the way one defines oneself.

- **Definitions of self and other.**

When individuals communicate and interact with one another, one person, A, for example, will periodically indicate “This is how I see myself”, and the reaction of the other individual, B, will have implications (Watzlawick *et al.*, 1967). These reactions have been grouped into three types, mainly:

- confirmation;
- rejection; and
- disconfirmation (Watzlawick *et al.*, 1967).

If B chooses to confirm A’s statement, then communication is generally promoted. If B chooses to reject A’s statement, then A may experience the rejection as painful and the relationship may be strained for a while. However, given that B’s rejection involves a degree

of recognition of what is being rejected, namely A's self, rejection does not involve a negation of the reality of A.

In contrast with rejection, which involves a negation of A's statement, disconfirmation, involves a negation of the source of the statement, namely, A. For example, A makes a statement indicating, "This is A". Should B disconfirm A's perception of themselves, this may result in A assuming that B does not understand or love them, while B may remain totally oblivious to A's dissatisfaction and assume that A feels understood. This may result in an alienation of A.

Alternatively, B might disconfirm A's self perception but A may not register that his/her message has not gotten through. As a result, a vicious circle ensues in which A may be confused at how their behaviour continually does not achieve the ends that he or she intends. As a result, this individual may be perpetually mystified leading to despair and frustration and a sense that life does not make sense.

As indicated in the examples above, disconfirmation may result in persistent vicious circles, with great potential for pathological behavioural outcomes in the individuals concerned. This has been researched by individuals such as Laing (1961, 1965), who found that such communication is frequently found in families of individuals suffering from schizophrenia. This has been explored largely within the framework of the double bind (Hoffman, 1981; Watzlawick *et al.*, 1967). This refers to an instance of pathological communication where an overt demand at one level is covertly nullified or contradicted at another level (Hoffman, 1981).

Individuals caught in such communication patterns frequently have to find ways of communicating that satisfy the paradox, and consequently, appear to make no sense to other individuals outside of the paradox, as in the case of a person suffering from schizophrenia (Selvini-Palazzoli, Boscolo, Cecchin & Prata, 1978). A frequently used example of a

paradoxical communication such as the double bind is the command, “Be spontaneous!” (Watzlawick *et al.*, 1967). In this case, a person cannot obey the command without contradicting him or herself.

Haley (1970) argues that in a family where double bind communications are used frequently, there is a perpetual struggle for control. As a result, the members use disqualifications of meaning to control the behaviour of the other members and/or to prevent their behaviour from being controlled. Disqualifications may range from pretending one has not understood what another member has said, ignoring another member’s communication or changing the subject to taking the literal as metaphoric and vice versa, as is often exhibited by individuals with schizophrenia (Watzlawick *et al.*, 1967).

This aspect of Watzlawick *et al.*’s (1967) theory will also be utilized in the study to investigate how definitions of self have been negotiated in the families of individuals who commit serial murder and how this may have impacted upon the behaviour of the individual concerned.

- **Punctuation.**

Punctuation refers to the process whereby people develop a set of self-fulfilling perceptions or beliefs about their relationships that interlock to produce repetitive patterns (Watzlawick *et al.*, 1967). This process serves as a means to explain and predict, construct and maintain each other’s behaviour, another means by which to ensure the stability of the system.

Punctuation is how we frame our reality. For individuals in a system, it is nearly impossible to place oneself outside the system to observe the full cycle of interaction. Consequently, punctuation is a means by which the individuals attempts to define a cause-effect or beginning and end to his communication, due to the influence of linear thinking.

Once again, utilizing the example of the father and son, the father may perceive his son to be a “rebel without a cause” whereas the son may perceive the father to be pedantic and disciplinarian. On an occasion where the son stays out past his curfew, the father may reprimand him, confirming the son’s perception of his father. The son may then react by shouting at his father and protesting against his strong discipline, thereby confirming the father’s perception of his son as rebellious. This may then escalate his disciplining behaviour, which would confirm the son’s perceptions further.

4.3.2 Summary of Watzlawick, Beavin and Jackson’s view

Watzlawick *et al.* (1967) focus upon the nature of communication in the context of an interactional system between two or more people. They demonstrate how the nature of this communication can impact upon the nature of the system as well as individuals who function within such a system.

They classify two types of systems, namely open and closed systems, based on the degree of interaction and exchange systems undertake with other systems or elements. Further, they attribute three properties to open systems, namely, wholeness, feedback and equifinality. Feedback may be positive or negative, and operates in relation to system norms or relationship rules.

Watzlawick *et al.* (1967) also discuss various aspects of communication and types of relationships between persons in a system. These include symmetrical and complimentary relationships. In symmetrical relationships, the individuals involved aim to equalize differences between the two of them, whereas complementary relationships involve maximization of difference. As discussed, both of these types may have pathological outcomes when taken to their extremes.

Watzlawick *et al.* (1967) also discuss different types of response to situations in which one cannot avoid communicating. These are rejection, acceptance, disqualification and manifestation of a symptom.

Watzlawick *et al.* (1967) additionally address how perceptions of self and other may be negotiated in the context of interactions between two people in a system. These include confirmation, rejection and disconfirmation. Pathological outcomes may result in individuals caught up in vicious circles that are generated by incongruent or problematic communication that takes place about self and other.

4.3.3 Bowen's family theory

Bowen (1978) emphasises the family as an emotional system. He argues that the intense emotional interdependency in families makes interactions in families more predictable than in other groups, and that this interaction crystallizes in particular patterns through time. These patterns may be repeated in subsequent generations. Bowen's family theory (1978) has a number of basic concepts. These are:

- differentiation of self;
- triangles;
- nuclear family emotional system;
- family projection process;
- emotional cut off;
- multigenerational transmission process;
- sibling position; and
- emotional process in society (Hall, 1981).

These will now be dealt with separately.

- **Differentiation of self.**

This refers to the extent to which an individual is embedded in the emotional matrix of the family (Bowen, 1978). An individual that has a better differentiated self, will be able to have a more established notion of self, and make decisions independently of the family matrix of which that person is a member. Less differentiated individuals will be more fused to the identity of the family and depend on the common self of the family unit for direction and beliefs.

Bowen (1978) holds that families generally tend towards fusion. However, the greater flexibility that a particular family has, will enable its members to be sufficiently differentiated. Differentiation, taken to its pathological extreme, will result in isolation or cut-offs, but ideally, should allow for direct meaningful contact with one's family's emotional system but also being sufficiently outside to be objective about one's self and others.

Bowen (1978) also speaks of a *hard-core self* which refers to those parts of one's self that are non-negotiable with others or one's firmest held convictions and beliefs; as well as a *pseudo-self*, which refers to opinions of others that are absorbed as one's own despite having no personal commitment to the beliefs underlying these opinions. With increased differentiation, more use is made of one's hard-core self.

- **Triangles.**

To discuss this aspect of Bowen's theory, Ackerman (1984) will be made use of to supplement Bowen's theoretical discussion. The family as a system can be distinguished by its parts together with their relationships, and behaves as a whole, not as an aggregate (Ackerman, 1984). These relationships between members are often easier to understand when broken up into groups of threes, or triads. Depending on the number of members in the

family, there may be any number of these triads in operation at any one time. For example, in a family of three, there will be one triad; in a family of four, there may be up to four triads at any one time; and in a family of five, up to nine triads.

The relationship of any two entities in a triad, is largely conditional upon the state of the third, with the sum of the quantity of interaction of the three relationships that comprise a triad, remaining constant. For example, if A, B and C are members of a triad, if A increases interaction with B and C, then the interaction between B and C will decrease.

In a balanced triad, all three members have the same amount of interaction and take responsibility for their actions in the context of the relationship (Ackerman, 1984). Additionally, in a balanced triad, relationships between all three members are positive, or at times, there may be one positive relationship or coalition between two members who are both in conflict with a third (Hoffman, 1981).

An unbalanced triad occurs when all three relationships are negative or when there is one negative relationship, or conflict between two members, and two positive relationships, that is between each of the two who are in conflict, and a third member (Hoffman, 1981).

Balance or homeostasis does not necessarily imply harmony or health, but refers rather to the leveling out of positive and negative relationships in the triad (Hoffman, 1981). Additionally, as long as triads are relatively flexible they may stand a better chance of resisting pathological outcomes. As soon as triads are rigid with respect to the organization of their members and the coalitions within them, they are more likely to become pathological (Hoffman, 1981).

This can be illustrated by means of an example of a person suffering from schizophrenia. Such an individual is frequently situated within a closed, rigid family system where interactions are limited in number and set in quality (Selvini-Palazzoli *et al.*, 1978). Additionally, in line with the “double bind” theory of schizophrenia (Bateson *et al.*, 1956;

Searles, 1959; Sluzki & Veron, 1971), the person suffering from schizophrenia is usually the subject of a paradox, where communication at a digital or verbal level is negated at an analogue or non-verbal level.

This double bind is usually the result of a “game” that is being played out between the parents of the person suffering from schizophrenia, in which both partners covertly vie for control over the spousal relationship (Haley, 1959; Selvini-Palazzoli *et al.*, 1978). This is undertaken covertly as a result of the family system not being able to tolerate the breakdown of the spousal relationship, the loss of a spouse or change in general due to its closed and rigid nature as a system. Due to the contradictory messages received by the person suffering from schizophrenia, this person then attempts to behave in a manner that disobeys neither level of the message, resulting in the symptomatic behaviour associated with schizophrenia, and thus maintaining homeostasis in the closed system.

Processes within a triad may include progressive segregation, centralization, and triangulation (Ackerman, 1984). Progressive segregation refers to the process whereby parts that are interdependent differentiate so as to become more independent of one another (Ackerman, 1984). For example, in a family, as children grow older, they may find work and become less dependent on their parents for financial support. Consequently, the family may still be interdependent for emotional support, but more independent with respect to material provision.

Taken to its extreme form, progressive segregation may result in insulation. In a triad, this may be the result of one member being distanced/distancing to the point of being cut off, thereby losing relatedness to the other two members and becoming autonomous. Signs of insulation may include withdrawal and inability to relate to others on the part of the insulated member, as well as attempts by any of the other members to act in anticipation of, or to prevent, the response of the insulated member to any other person (Ackerman, 1984).

Centralization refers to the process whereby functions are assigned in a hierarchical manner so that the system becomes unified and efficient, and small changes in the large or dominant parts may result in larger changes in other parts (Ackerman, 1984). For example, in a family, the primary breadwinner (father or mother) may be assigned the function of providing for the family, with supplementary support from any other members who may be earning money.

Just as insulation would be the extreme end-point of progressive segregation, fusion is the extreme outcome of centralization. Fusion, within a triad, results in one member engulfing or overwhelming another member, with personal boundaries being blurred (Ackerman, 1984). A fused relationship between two members will frequently result in the exclusion of the other member (as well as many other outsiders) and is often based on a need in one member to aggrandize himself at the expense of the other. As a result, a fused relationship results in two members behaving almost as a single individual with one behaving exclusively for the other.

In systems, such as the family, both centralization and segregation are necessary for successful integration of members and efficient and effective functioning. It is important for a family to be united in common goals, and yet for members to be sufficiently differentiated in order to effectively achieve such goals, by performing diverse functions. Loss of differentiation results in a closed system and fusion, whereas loss of centralization results in fragmentation and isolation. Within triads also, fusion and insulation accompany each other, so that in cases where two members are fused, the third member will be insulated, and so forth.

It is important to remember that fusion and insulation, while properties of the system, or triad, are not properties of the individual concerned. For example, an insulated member within a family may be very involved in his/her community. In fact, individuals who insulate

themselves from their family of origin, frequently try to make a whole family out of another individual (Ackerman, 1984).

Triangulation (Haley, 1976; Minuchin, 1974) refers to the process in a triad where one individual stands in relation to two other in such a way as to be the focus of the relationship. The two latter members generally relate only by communicating about the third party and thus avoid direct, personal exchanges, which may result in open conflict as a result (Ackerman, 1984). For example, a mother and father may attempt to avoid relating to one another by becoming overly involved with a child. Triangulation can be observed every time a member of a family speaks on behalf of another, or about one member to another, or is involved in the middle of a conflict between two other members.

Bowen (1978) viewed triangulation as the basic building block of an emotional system, operating as safety valve for when emotional tension in a two-person system exceeded a certain level. In a two-person relationship, the tendencies of progressive segregation and centralization frequently result in power struggles, where greater interaction usually implies that increased centralization with one partner increasingly burdened, and the other humiliated while decreased interaction may result in the loss of the relationship. Consequently, the solution to this dilemma frequently involves the addition of a third member, or development of a triad, where distancing and closure of the dyad is prevented.

Frequently, however, such triads develop into triangulation patterns with barricading or incomplete personal communication between two members, and pseudo-responsibility (see below) with respect to the third party. An example of this process may be evident in a marriage when the decision to have a child is made to prevent the collapse of the dyadic relationship. The married couple can then avoid directly confronting each other about issues and concern themselves with the child. Ackerman (1984) argues that whereas fusion or

insulation often signals the demise of a family, triangulation is a means whereby to keep the system going, albeit not necessarily by “healthy” means.

Ackerman (1984) has identified three patterns of triangulation, namely:

- focused triangulation;
- triangulation with an intermediary; and
- shifting triangles.

Focused triangulation occurs when the third member is ignored as an independent member of the triad, and responsibility for that member is taken by the remaining two, such as in the example above.

Triangulation with an intermediary occurs when the third member is utilized as a go-between for the other two members. For example, parents communicate via a child in the case of a separation or divorce proceedings. Scapegoating is also an example of this type of triangulation, and involves one member being labeled as the “black sheep” of the family and consequently assuming responsibility for all the faults within such a system. This member consequently acts as a means for the other two to avoid self-blame as well as preventing more dangerous warfare between more powerful family members.

Shifting triangles involve intense open conflict, with frequent interruptions, so that different members occupy different positions within a triangulation at different times. For example, two parents triangulate around a child. When forced to confront one another, and their conflict is out in the open, the child may jump to the defence of the mother, and shift the triangle so that she and her father avoid direct conflict, and triangulate around the mother, and so forth.

Triangulation also involves the processes of pseudo-responsibility and barricading. Pseudo-responsibility refers the process whereby a member appears to take responsibility for another, but is actually using the other member for his or her own requirements, such as either

avoiding conflict with another member (such as in focused triangulation). The third member of a triangulated relationship is always in a pseudo-responsible relationship to the other two. An extreme form of pseudo-responsibility is fusion, where one member takes complete responsibility for the other.

Barricading refers to when communications between two members are not complete. This is usually the case between the two members of the triangulated triad who assume pseudoresponsibility with regard to the third member.

A consequence of triangles is a tendency to repeat behaviour patterns automatically, especially in stressful situations. For example, if a mother involves her mother in a triangle when experiencing tension with her child, this pattern will be repeated each time a stressful situation with the child occurs. Additionally, triangles may be multigenerational, both in their spread across the family system (that is, a triangle may involve members from different generations), and in the sense that triangling patterns can be passed on from one generation to the next. For example, if a parent was allied with his same sexed parent, against the parent of the opposite sex, this pattern may be repeated with his children in the subsequent generation.

Although many theorists have conceptualized types of triangles, this discussion will focus on the classifications as proposed by Minuchin (1974). Minuchin conceptualized four types of rigid triads that could lead to pathology, namely:

- triangulation;
- parent-child coalition;
- detouring-attacking; and
- detouring-supportive.

Triangulation has been discussed above and refers to a situation, for example, where two parents in overt conflict try to get the child's support against the other. A parent-child coalition triad refers to a triad where a coalition already is in place between one parent and a

child, and both are in conflict with the other parent. A detouring-attacking triad involves a coalition between the two parents who then scapegoat the child. The conflict with the child frequently serves as a means to keep the parents united, and usually manifests behavioural problems as symptoms.

In a similar vein, a detouring-supportive triad also serves to keep parents together by focusing on the child. However, in this instance, all relationships are positive as the parents focus on the child as an object of concern or to be protected. In this triad, the child will often manifest psychosomatic symptoms. For example, a detouring-attacking triad would have the parents uniting to discipline the child, whereas a detouring-supportive triad would have the parents uniting to look after a sick child. In both triads, the parents are avoiding dealing with the real issues in their relationship (which may result in open conflict) by focusing on the child, or detour.

- **Nuclear family emotional system.**

This refers to the inner core family processes as opposed to multigenerational processes (Hall, 1981). Going back to differentiation, the level of differentiation of the spouses generally determines the family level of differentiation. As will be discussed later, differentiation level tends to be perpetuated across generations due to the fact that an individual usually chooses a spouse having a similar level of differentiation. The lower the level of differentiation in a family, the more fused such a family will be, and as a result, this type of family will exhibit a greater degree of reactivity and tight interdependence between members, which restricts behavioural options.

Generally, an overload of anxiety between spouses is dealt with via

- marital conflict;
- dysfunction of a spouse; or

- projection to a child/children (Hall, 1981).

Symptoms normally develop in a family member when only one strategy is used. Marital conflict is usually the result of excessive fusion, where neither spouse will give in (Bowen, 1978). Dysfunction of a spouse usually occurs where there is a great degree of fusion and one spouse sacrifices their pseudo-self to the other, who then assumes a higher functioning level (Hall, 1981). Consequently, the couple operates in accordance with one common self, largely dictated by one of the spouses.

The adaptive spouse, who has given up their pseudo-self, generally will start to develop symptomatic behaviour such as physical or emotional illness, social acting out (such as alcohol abuse and promiscuity), as a result of having to bear the full load of anxiety of undifferentiation on their own. The dominant spouse is usually unaware of the problems of the adaptive spouse. The dysfunction, however, serves to absorb the undifferentiation or anxiety present in the couple. Consequently, the dysfunction is perpetuated, the other spouse gains strength, and marital conflict or projection to the children, is prevented. Projection to the child or children will be dealt with in the following section.

- **Family projection process.**

Family projection is a means for dealing with surplus undifferentiation in the nuclear family system (Hall, 1981). The level of differentiation of each spouse will influence the degree of fusion in his or her relationship (as discussed above). Should such fusion within the spousal relationship be inadequate to deal with the amount of undifferentiation present, then this residual undifferentiation will remain in the family system, and is usually projected onto a child or children, who absorb this. Family projection is usually accompanied by some marital conflict and dysfunction of a spouse. For example, in a relationship between a mother and child, a mother may reduce her own anxiety levels by projecting it onto the child, and seeing

the child as a problem or needing help or protection. The reader is reminded that Bowen's interpretation and use of the term "projection" does not correspond to psychodynamic conceptualizations and use of the same term. Rather, Bowen's projection signifies a manner in which the system attempts to distribute anxiety and intense emotional processes that may arise from enmeshed relationships along other avenues as a means of preserving homeostasis.

Factors influencing the selection of a child include the sibling position of the parents and the intensity of the parents' dependency on their own parents (that is, the level of differentiation of the parents). The child most trapped is the one who is the most emotionally attached to their parents (Bowen, 1978). This may be manifested as overt closeness or intense repulsion. Popular choices for children include children in the oldest, youngest or only child positions.

- **Emotional cut-off.**

Emotional cut-off is a means of dealing with intense fusion in the family system and signifies an attempt to achieve independence or prevent an annihilation of the self (Bowen, 1978). However, cut-offs generally do not result in greater differentiation but rather result in a gain in pseudo-self and a greater degree of fusion in other relationships.

A precondition for emotional cut-offs is a high level of anxiety in the self or family system (Hall, 1981). Triangles may result in emotional cut-offs where a distanced third person loses contact with the other two. The duration of the emotional cut-off is an indication of the investment of feelings each party has in continuing the distancing. Extreme forms of emotional cut-offs include psychotic symptoms, where the individual suffering these symptoms cuts him/herself off emotionally from the family system and invests these emotions 'outside' of the system, in fantasy (Selvini-Palazzoli *et al.*, 1978) as well as the most extreme form of emotional cut-off, namely, death (premature, suicide or from symptoms).

Emotional cut-offs may be multi-generational (Hall, 1981). When emotional cut-offs exist between parents and grandparents, children are more likely to be cut-off in their relationships as an interpersonal strategy (Haley, 1970).

- **Multigenerational transmission process and sibling position.**

As mentioned above, levels of differentiation, triangles, and emotional cut-offs patterns of behaviour may be transmitted between members of different generations of the same family (Bowen, 1978). Sibling position in a family system tends to influence vulnerability to projection and multigenerational transmission processes (Hall, 1981; Tolman, 1951). As mentioned, oldest, youngest and only children tend to be targets for projection. These positions do not necessarily have to be the chronological positions, but rather the functioning sibling positions. For example, the object of projection is often treated as the youngest, and the child concerned will behave accordingly, or in families where there are large gaps between siblings, the siblings may function as only children.

- **Emotional process in society.**

Bowen (1978) does not exclude the impact of social influence on family processes. In society, he argues that emotional processes move either towards extinction or towards adaptation. If togetherness in society predominates, then differentiation is impeded, and a society tends to stagnate, like a closed system. A society which is largely fused, and characterized by high anxiety levels will manifest “symptoms” such as high crime rates, violence and high rates of divorce, for example (Bowen, 1978).

When differentiation predominates, society generally improves and develops constructively, similar to an open system (Bowen, 1978). The level of anxiety in society (as with the family) generally determines the degree of differentiation in society, which in turn

influences family units (Bowen, 1978). In other words, the process is cyclic in nature. The greater the amount of anxiety in society, the greater the degree of togetherness or fusion, the greater the degree of problem behaviour, which results in societal regression and, over time, societal extinction. Well-differentiated and flexible families are better suited to withstand external impairment influences in society, while fused and brittle families may collapse or explode in response to additional stress from outside (Hall, 1981).

4.3.4 Summary of Bowen's family theory

Bowen (1978) views families as complex emotional systems with patterns of behaviour that are repeated and consequently, predictable. These repetitive patterns are particularly evident during times of stress.

The self emerges out of family interaction. The family tends towards fusion and a common self. Families may take a number of possible positions along a continuum of flexibility and rigidity. Flexible families respond better to stress and allow for greater differentiation of self in their members. Rigid families tend more towards fusion and do not respond as well to stress. The more fused a family is, the higher the level of anxiety within such a system.

Bowen's theory enables one to see how individual functioning and self-determination is a product of family processes, and one's emotional relationship with the family system. It also shows how behaviour may also be influenced by patterns that have been transmitted across generations, as well as in response to emotional processes in society.

4.3.5 The symptom in the family system

Within a systemic paradigm, a problem would be defined as any process that threatens the stability of the system. A system consequently develops its own solutions (Boscolo, Cecchin, Hoffman & Penn, 1987). For example, a family may be growing apart, so, in order to unite the members, the system may produce a solution in the form of a family member who develops a symptom. As a result, the family members will rally around and unite in the cause of the affected member. Further, on examining the history of the afore-mentioned problem or symptom, one might see that it often appears during crisis moments in family life; thus, the problem or symptom helps to restore stability. Symptomatic behaviour consequently may balance or unbalance the system, and not necessarily, by definition, signify pathology for the family concerned (Hoffman, 1981).

Consequently, within family systems theory, pathology in an individual member is secondary to what the presence of such pathology signifies for the system, that is the family, and the function it performs within such a system.

Minuchin (1974) argues that a symptom in a child, frequently indicates the presence or absence of stress in parents. He states that the executive dyad of the nuclear family (which is frequently the parents) may undergo a change or crisis, which exceeds the couple's usual coping mechanisms, and involve the child as a result. The child may then manifest symptomatic behaviour, and if the child is overwhelmed, the involvement may move onto another level, such as other members of the nuclear family, the extended family, or other systems in wider society.

In the case of a child whose problems keep the parents together, the marriage often seems uneven, with one partner appearing to have more power than the other, that is in a complimentary relationship. The couples may also be intensely clinging, intensely avoiding

conflict and/or have children who are disturbed. The child's behaviour influences the balance of power between parents, so that his behaviour may provoke the more powerful or one-up partner, but will be such that only the one-down partner is able to deal with it.

As a result, this couple functions according to what has been termed a "homeostatic seesaw" (Hoffman, 1981, p. 132). If the seesaw is too uneven, the parent/child may develop a symptom; if the seesaw is too even, the couple may split; and if the child's symptom disappears (Hoffman, 1981), a symptom may develop in another part of the system, such as with one of the parents or another child. With such a lot "invested" in a symptom, the system may resist any attempts to "cure" the symptom.

4.3.6 The individual in a family systems approach

It would appear that individual and systemic psychologies have generally been perceived as mutually exclusive. However, many theorists (Haley, 1978; Kerr & Bowen, 1988) have challenged this on the basis that a family system can be reflected in the psychology of the individual and vice versa, due to the circular nature of the impact that these two units of understanding have upon one another. Haley (1978) argues that "the smallest unit [of the family system] could be considered to be the individual" (p. 147). Kerr and Bowen (1988) challenge traditional notions of the psychology of the individual by advocating the placement of such a psychology within the larger systemic context of the family system. Consequently, an individual (although representing only one unit within the family system) can be understood as part of a network of interlinking relationships between members of a family system. It follows that the role that such an individual has performed within such a system and the relationships of which he has been a part will impact upon his psychology and that it

is possible to understand an individual by understanding the family system of which he is a part.

In discussing the place of the individual in a systemic point of view, Nardone and Watzlawick (1993) state that if you observe the behaviour of individuals from the systemic and cybernetic point of view, personal entities can be viewed as “not standing on their own and having their own ‘determined’ evolutive and behavioural scheme, but...interacting inside a system of relationships or a context characterized by a continuous and mutual exchange of information between single entities that influence one another” (p. 36). Similarly, McClendon and Kadis (1990) stress an important point. They base their assumption (from Miller, 1969) on their view of general systems theory (GST). Although every unit is made up of smaller units and the larger unit is more than the sum of its parts, the application of GST seems to focus entirely on the larger unit with the assumption that significant change in the family unit will necessarily result in change in the individual. They believe while this may be so, it misses an important point:

The family is made up of individuals and each person brings his or her own personal history to the party, perceives and interprets events in the context of his or her own personal history, makes decisions about him/herself and the world, and finally acts on the basis of this personalized processing (p. 137).

The authors quote several studies confirming their point: “that it may not be enough to focus on the system without attending to the individuals who compromise the system” (p. 137).

Following from the above, Kerr and Bowen (1988) state that the evaluation and treatment of families in systemically-oriented psychotherapy can involve any number of members, as

long as the therapist approaches the conceptualization, evaluation and treatment of the issues at hand from a systems perspective (i.e., he or she punctuates the issue hand in a systemic manner). Methods of evaluation include interviews with family members (Kerr & Bowen, 1978) and genograms (McGoldrick & Gerson, 1985). With regards to the latter, McGoldrick and Gerson specify that although interviews with clients and different members of the family may increase the reliability of information obtained, such a scenario is not always feasible and the interview can then be used with one member (usually the client). In such a case, Guttman (1991) points out that information obtained is as useful, and can be analysed by client and therapist to elicit adaptive and maladaptive patterns across generations. Beyers (personal communication, 2006) points to the caution with which an individual perspective in family psychotherapy and research should be approached but also argues that to exclude individual perspectives when additional family members are unavailable is to undermine the utility and value of an individual's perceptions, beliefs and knowledge of his own family and to diminish the scope of family and social research. The responsibility lies with the researcher in terms of carefully listening with openness to the individual's story about his family system, weighing and evaluating the manner of communication and personal involvement; of how the individual recalls his history; how the interactions between family members are described and communicated; and be aware of his own role in the process of research.

4.4 KEY FAMILY SYSTEM CONCEPTS FOR THIS STUDY

Prior discussion has included an elaboration on the definition of the family that will be used in this study as well as an overview of family systemic theory. Whereas the former will be utilized as a means by which to select the unit of analysis for this particular study (that is, the family system), the latter will be used to interpret the findings of the analysis. In terms of

achieving the latter, it is necessary to narrow down family systems theory to those theoretical elements that the researcher feels are of particular importance in understanding and interpreting family systems. These are:

- emotional processes;
- multigenerational patterns of structure and function; and
- patterns of relationship.

In line with the spirit of reflexivity that characterizes qualitative research, other researchers may have chosen to focus on other aspects of family systems theory, which would have influenced the results of the study in turn. Perhaps this may provide inspiration for future research where other aspects could be used and the results compared. This will be discussed further in chapter 6 however and the different elements selected for this study will now be elaborated upon further.

4.4.1 Emotional processes

Emotional processes form a significant component of family systems, specifically in terms of the manner in which members that are part of such a system encounter emotional processes as part of their relationships with other members, and ways of dealing with such emotional content and process are established at both individual and systemic level.

Emotional processes in the context of serial murder appear to have been dealt with in two predominant ways. On the one hand, serial murder has been portrayed as an act involving aggressive and violent emotional processes (Douglas & Olshaker, 2000; Holmes & De Burger, 1988; Ressler, 1997); while on the other, individuals who commit serial murder have frequently been portrayed as unemotional or detached from the affective component of their acts (Holmes & Holmes, 1996; Meloy, 2000). In this way, the author intends to investigate

the manner in which emotional processes have been negotiated within the family system of an individual who commits serial murder in order to make further sense of the above. This is also imported by the notion of the family as a homeostatic and cybernetic system (Guttman, 1991). Emotional processes interconnect the parts of the system; it also governs the system through feedback. Furthermore, emotional reactions (or not) within the family maintain homeostasis and reduce any deviation that results from the introduction of new information making it difficult to introduce “new” or other emotions into the system.

In terms of emotional processes, Bowen’s concept of differentiation as well as his discussion of the role that anxiety and stress play in the family system will be used. It will be of particular interest to see the manner in which the spousal sub-system of family systems deals with anxiety, specifically the impact that this has on the marital relationship, dysfunctions or symptoms in spouses or involvement/projection onto the child subsystem.

An examination of this aspect of family systems becomes important when one considers proposed classifications of individuals who commit serial murder that have been based on an individual’s ability to manage their emotions. For example, in terms of Eysenck and Eysenck (1977) who proposed classifying criminals into extroverts or thrill-seekers who actively seek out emotional stimulation, and introverts with little overt emotional expression or affectivity. Additionally, Hickey (2006) has also included suggestions in his work on serial murder that this type of criminal behaviour may result from an inability to control and manage internal emotion states such as anger, hurt, fear and anxiety which results in the externalization of these feelings onto outsiders.

Additionally, individuals such as Leyton (2001) have argued that serial murder frequently represents an attempt on the part of the individual who commits serial murder to assert himself and to be recognized as an important and distinct individual in society. By using Bowen’s concept of differentiation together with Ackerman’s (1984) concepts of fusion and

isolation, this study may illuminate interesting developments with regard to the manner and extent to which individuals who commit serial murder are a part of their family system.

4.4.2 Multigenerational patterns

The author has also chosen to focus on multigenerational patterns with regards to the family systems of individuals who commit serial murder mainly due to the large role attributed to multigenerational patterns by theorists such as Bowen (1978) and Minuchin (1974) in the perpetuation and escalation of faulty coping strategies and problem solving attempts within a family system. In this way, across generations the family system may develop ways of preserving homeostasis that ultimately may compromise the ability of certain individual members to function optimally. Consequently, the author intends to investigate the role of serial murder behaviour in an individual member within a family system may represent repetition of relationship and other patterns from previous generations, which may serve as a means to maintain homeostasis or perform other system functions.

In terms of Bowen, it will be of interest to see how levels of differentiation are transmitted through the extended family system as well as how stress and anxiety have been managed across generations. The effects of projection across generations will also be examined together with an investigation of repeated patterns of emotional processes in the family system and their impact on the system.

Sibling position and its effect on the family system (especially where sibling constellations are repeated in some manner) will be included in an investigation on multigenerational patterns also. Given that serial murder has frequently been linked to physical, sexual and other types of abuse during the early developmental period by individuals such as Cleary and Luxenburg (1993), and Hazelwood and Warren (1989), it will

be interesting to see what forms an inability to deal with stress and anxiety at other levels of the family system have taken; whether some of these forms include abuse; and whether some of these incidences reflect patterns that have been repeated in other parts and levels of the system.

Minuchin (1974) will lend a more structural interpretation to examination of multigenerational patterns. In this way, the study will examine the manner in which the family system is divided into sub systems, as well as the manner in which these subsystems interact and organize themselves with regards to membership rules and the way in which individual members adopt certain roles within different subsystems. The way in which boundaries are structured around family systems and subsystems will also be of interest with respect to the degree of flexibility or rigidity which characterizes these boundaries, and thereby mediates intra- and inter-system interaction (that is, how much do subsystems interact with each other, and how much does the family interact with outsiders).

As discussed in the literature review (see chapter 3), serial murder has been argued as being the result of the isolation of the individual member who commits serial murder, as well as the entire family system, from other systems or individuals (Hickey, 2006; Ressler *et al.*, 1988). In this way, it will be interesting to examine the extent to which rules and boundaries of sub-systems and the entire family system have influenced interaction between systems and consequently, the behaviour of individual members or sub-systems.

4.4.3 Relationship patterns

Serial murder involves an event between people, who usually do not know one another, and yet become connected by virtue of the criminal act that transpires between them.

Individuals who commit murder have often been thought to have a particular view of

interpersonal relationships and other people, which may necessitate, facilitate or contribute in some way to their serial murder behaviour (Holmes & DeBurger, 1988; Egger, 1990; Labuschagne, 2001; Lane & Gregg, 1992; Pistorius, 1996). Consequently, the author has chosen to focus upon relationship patterns within family systems of individuals who commit serial murder as the final component of her conceptualization of the family system for the current study. In this sense, she intends to examine how relationship patterns within the family system occur as well as the particular relationships within the family system in which the individual who commits serial murder has been involved, and whether some of these patterns are repeated in (or impact upon) the serial murder behaviour of the individual concerned.

Both Ackerman (1984) and Bowen (1978) ascribe the primary importance of the triad as the fundamental unit of relationships in family systems. Consequently, relationships within the family systems of individuals who commit serial murder will be examined with respect to their arrangement into triangles or triads, and the subsequent influence of these arrangements on the organization and functioning of the family system. In order to achieve this, Bowen's concept of triads, together with the more structural or hierarchical view of Minuchin (1974) in terms of his triads will be used in order to tap both the emotional processing implications (via Bowen) as well as the organizational or subsystem and boundary implications (via Minuchin).

Given the role of power that has frequently been mentioned with respect to serial murder (Prentky, Burgess & Carter, 1986; Ressler *et al.*, 1988), the aspects of family systems theory that deal with relationships in terms of hierarchy and power will be of particular interest in terms of interpreting the family systems of such individuals. The approaches used will thus include Watzlawick *et al.*'s (1967) concepts of symmetrical and complementary relationships, as well as Minuchin's (1974) concepts of hierarchy, coalitions and alliances in family systems.

The theoretical conceptualization above (namely, emotional process, multigenerational patterns and relationship patterns) is illustrated in the diagram (Figure 1 below). As can be seen, emotional processes within the nuclear family, as well as in extended family systems and larger external systems impact upon each other, as well as on individual members. Bowen's theory will be used to interpret these processes in the current study.

In addition to emotional processes, there are also multigenerational factors and processes that may impact upon the nuclear family. These can be seen in the arrows going from extended to nuclear family systems. Additionally, these arrows are bi-directional indicating that activity within the nuclear family system will in turn impact upon extended family systems. For example, if an eldest son refuses to follow in the footsteps of his father, this will have repercussions for the relationship of the son's nuclear family with the extended paternal family system. In order to understand this multigenerational activity, Bowen and Minuchin's theory will be used here.

Finally, the relationships between members within family systems as well as between systems can be seen in the diagram. Firstly, there are bi-directional arrows between members of the nuclear family depicting the relationships between these members. These will be interpreted via Watzlawick's theory as well as Bowen, Minuchin and Ackerman's theories of triangulation. Secondly, there are bi-directional arrows between both nuclear and extended family systems and the larger social milieu (as well as other external systems). The extent to which these arrows are able to operate and the predominant direction along which activity will flow (that is, from the family system outwards or from the outside in towards the family system) will vary from one family system to another.

4.5 SUMMARY OF THE CHAPTER

Family definitions have historically focused on the nuclear family and excluded alternative family types such as single parents and same-sex unions, as well as the manner in which families may change over time.

This study has chosen to interpret the concept of family more holistically, in terms of the nuclear and extended family, as well as allowing for variations along alternative lines.

Family systems theory applies the theory of cybernetics to the family, and examines how processes and outcomes within the family context occur in line with the principles of systemic theory. Within such a paradigm, the family can be viewed as consisting of a number of inter-related members, whose actions and behaviour influence the other members in the family as well as the family system as a whole.

The principles and concepts of family systems will be used to interpret the data in the current study and applied to understand the role that serial murder plays in the family system, specifically with reference to a conceptual framework that focuses upon emotional processes, multigenerational and relationship patterns in family systems. These different aspects are not mutually exclusive but rather influence each other in a circular manner.

The following chapter will examine the methodology for the current study, including aspects such as research design, data collection techniques, sampling strategies and methods of data analysis for the current study.

Figure 1. Diagrammatic Representation of a Family System

LARGER SOCIAL SYSTEM OR OTHER SYSTEMS

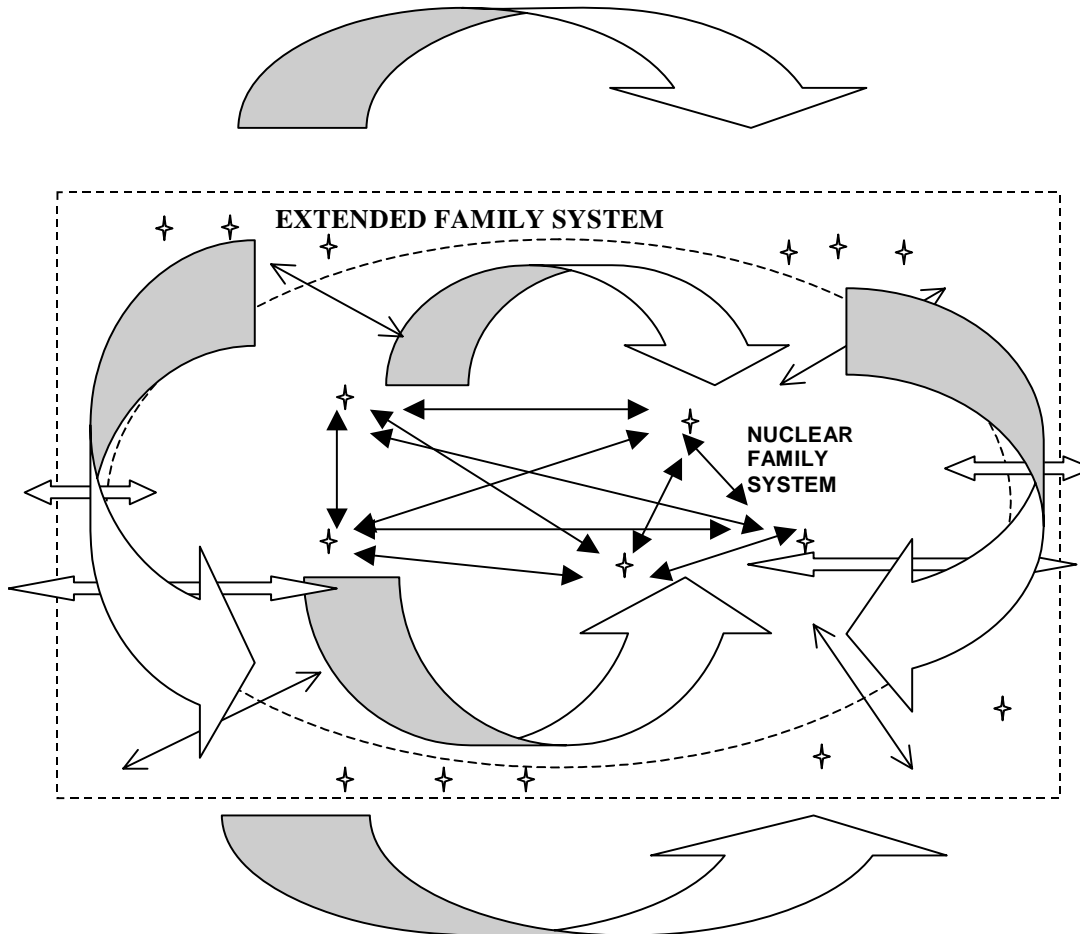

Key to diagram

- Boundary between systems (in systems with rigid structures)
- ↔ Relationships (between members)
- ↔ Relationships between nuclear and extended family systems
- ↔ Relationships between nuclear/extended family systems and larger systems
- ↪ Emotional processes
- ✦ Individual members

5. METHOD OF RESEARCH

Previous chapters have discussed the body of theoretical work on serial murder. The approach used to interpret the current findings, namely family systems theory, has also been discussed. In Chapter 1, the purpose of the study was spelt out, namely: to investigate serial murder from a systemic point of view. To achieve the above, the following question was proposed as focus:

- “How does the family system of a person who commits serial murder function?”

That is, what is the family structure, who are the people in the family system and how do they maintain the family system.

This chapter explains the methodology, research design, procedures, ethical considerations, data analysis and data integration of the study.

5.1 METHODOLOGY

This study is qualitative in nature. Qualitative research has been understood as “the interpretive study of a specified issue or problem in which the researcher is central to the sense that is made” (Banister, Burman, Parker, Taylor & Tindall, 1994, p.2). Qualitative research focuses on the meaning of experience, actions and events as they are interpreted through the eyes of certain researchers, participants and cultures or groups, and is sensitive to the particular contextual nuances of the study topic (Harre & Secord, 1972) as well as the impact that the relationship between researcher and the participant/s and context has on interpretation of the study topic. *Quantitative* research focuses on measuring, manipulating

and specifying relationships between certain variables in order to test causal hypotheses (Henwood, 1996).

Parker (1992) describes the differences between quantitative and qualitative research in terms of three “methodological horrors” (Woolgar, 1988). These are indexicality, inconcludability and reflexivity.

In terms of *indexicality*, an explanation is always tied to a particular context, and will change as the context changes. This is viewed as problematic in quantitative research and is addressed via reliability and validity. Qualitative research does not view this as a problem and instead it into the research process by focusing on specificity with respect to the topic of study. The qualitative researcher does not and cannot generalize his findings, but provides an understanding of the phenomenon as it occurs.

In the current study, the researcher focuses specifically on serial murder in the South African context and acknowledges that this phenomenon is subject to change as the South African political and socio-economic and cultural climate changes, or as policing initiatives targeting individuals who commit this crime become more sophisticated and accurate. Consequently, the current research is framed by specific contextual parameters, and findings will be interpreted with reference to those parameters.

In terms of *inconcludability*, an account can always be added to, and as more is added to it, so it will mutate. Quantitative research deals with this “problem” by having a representative sample size; however, in qualitative research, the inconcludable nature of research is accepted and therefore, methods such as single case studies are acceptable. In fact, much qualitative research treats each study as if it was a case study and aims to provide an in-depth examination of the different meanings at work within a different context.

As will be discussed further, this study will focus on case studies of individuals who have committed serial murder in South Africa and will attempt to develop an understanding of

these individuals and their family systems. The researcher acknowledges the sample size and findings that will be generated are by no means complete; and that these findings may be contradicted, elaborated or supplemented by other research on the same topic, or with the same individuals, for example. Yet, understanding and knowledge about serial murder within the context of family may shed light on aspects such as interpersonal familial patterns, emotional processes within the family and family structures.

Finally, *reflexivity* refers to the researcher's awareness of his own subjectivity in terms of the way that a topic is conceptualized, and findings are interpreted. The way in which a researcher characterizes a phenomenon will change how it operates for him and that will change the way that that phenomenon is perceived. Rather than attempting to eliminate subjectivity as quantitative research attempts to do, qualitative research includes the researcher's subjectivity as a resource in the research process.

In this study, the researcher has chosen to define the concepts under investigation in a certain way – see definitions of serial murder (Chapter 2) and family (Chapter 4). It is understood that these definitions impact upon the cases selected for analysis and data collection and that another researcher may have chosen different definitions, and obtained different findings possibly as a result. Additionally, the conceptual framework for family systems theory devised by the researcher will also impact upon the analysis of the data and findings generated, and will be kept in mind throughout the analysis and assessment of findings.

5.1.1 Evaluating qualitative research

As opposed to quantitative research, which focuses on validity and reliability to evaluate the strength and generalizability of a study, quantitative research has its own set of criteria by which a study can be evaluated.

These criteria are:

- credibility;
- transferability;
- dependability; and
- confirmability (Marshall & Rossman, 1995).

Credibility requires that the researcher must demonstrate that the study was conducted in such a manner that the subject was accurately identified and described.

Transferability refers to the question, how applicable or transferable are the findings to another setting or group of people? The burden of demonstrating transferability lies with the investigator who would make that transfer rather than the original investigator.

Dependability refers to the degree to which one can be sure that the findings would be replicated if the study were conducted with the same participants in the same context. In order to satisfy this criterion, the researcher has to account for changing conditions in the phenomenon.

Confirmability refers to the extent to which the findings are reflective of the subjects and the inquiry itself rather than being brought about by the researcher's own prejudices. This study will be evaluated by the researcher in relation to these four criteria, and this evaluation will be included in Chapter 8.

5.2 RESEARCH DESIGN

The research design is exploratory in nature. Exploratory or descriptive research does not concern itself directly with causal explanations but rather details empirical observations made by the researcher (Rosenthal & Rosnow, 1991). Consequently, the researcher does not specify research hypotheses prior to the study but rather generates findings that may be used in other

studies in ways that may or may not be causal. Exploratory research is frequently used when the topic under study is novel; when little research is available on the topic of interest; when a researcher wishes to test out methods or approaches that may be formalized in a future study; or when the researcher wishes to generate findings that may be tested in a more formal manner in another study (Rosenthal & Rosnow, 1991).

As discussed previously, although serial murder has not been researched extensively in South Africa, a few studies (Du Plessis, 1998; Hodgskiss, 2003; Hook, 2003; Pistorius, 1996; Labuschagne, 2001) have been conducted. Additionally, no prior study has assessed the role of serial murder within a family systems theoretical approach. Therefore, the topic of serial murder in South Africa is suited to an exploratory research design, which will be adopted for the current study, and which hopefully will yield findings that can be tested further in future research.

5.3 SAMPLING

Given the usual small population targeted by qualitative research, in this case individuals who have committed serial murder and are currently incarcerated in prisons in South Africa, the sampling strategy is a non-probability purposive sampling strategy. Non-probability sampling does not involve random sampling and consequently is limited with respect to how well it can be said to be representative of a particular population (Trochim, 2002). Given that qualitative research does not require representativeness in as strict a sense as quantitative research, and that the sample population is limited, non-probability sampling is suitable for this study.

There are two types of non-probability sampling, namely accidental and purposive sampling. This study will use a purposive sampling strategy. According to Trochim (2002)

purposive sampling is ideal when the researcher is seeking a certain predefined group; when a targeted sample is needed quickly; and where proportionality is not a primary sampling concern. The current study meets the first and third criteria, namely:

- individuals who have committed serial murder constitute a certain predefined group; and
- proportionality is not of primary importance given the small population size.

According to the various types of purposive sampling strategies proposed by Patton (1990), the strategy adopted by this study can be further classified as a criterion-based purposive sampling strategy. This means that cases are selected on the basis of meeting some criterion – in this case, the generic definition of serial murder discussed in chapter two. Patton also states that this sampling strategy allows for quality assurance in purposive sampling.

The selected sample for this study consists of individuals who are currently serving sentences in various prisons in South Africa. A case consists of instances of serial murder behaviour and the family systems of which they are a part. It was important to select cases from similar cultural and ethnic backgrounds (namely, White, Afrikaans-speaking) as opposed to others (such as Black and speaking an African language) due to the researcher's objective of obtaining a thorough, in-depth understanding of the phenomenon within a family system. In order to do this, the researcher selects the sample according to those with which she feels that she could communicate most adequately without potential contamination or influences that may have resulted due to lack of familiarity with linguistic practices. The introduction of a translator may also affect the system's response and may dilute the investigation further. Future research may possibly aim at extending the realm of cultural backgrounds with regards to serial murder.

Two individuals who meet the criteria for an offence of serial murder are chosen. A brief description of each and their family follows:

5.3.1 Case study one: Mr X and family

Mr X is a White, Afrikaans male in his early forties who is currently incarcerated in a prison in South Africa. He was convicted on five counts of murder, seven counts of rape and one count of attempted rape. His victims were all females, of various ages and ethnicities and he committed his crimes over a period of two years. His immediate family consists of a mother and father and no siblings. The mother and father are pensioners and are of the same ethnic background as Mr X. Mr X's mother still works in the catering industry whilst his father is retired.

5.3.2 Case study two: Mr Y and family

Mr Y is a White, Afrikaans male in his late forties who is also currently incarcerated in a prison in South Africa. He was convicted of three counts of murder, three counts of robbery and one count of attempted murder. His victims were all White males, of various ages and he committed his crimes over a period of ten months. Mr Y's family is estranged and both his mother and father are deceased. After extensive unsuccessful attempts to contact other members of Mr Y's family, it is decided to proceed and document the family of Mr Y via interviews conducted with him: the way he experiences his family.

The reasons to proceed with Mr Y, without having had any available support for the research from his family members are follows:

- He was one of only a few who fulfills the basic cultural criteria, namely from Afrikaans background and origin.
- He was from the White ethnic group.
- He is of male gender.
- He fulfills the criteria set for the definition of serial murder.
- From a theoretical point of view as explained in Chapter 4, the individual is still important in family theory. The individual can still be interviewed and evaluated especially where the genogram is applied as instrument to identify repetitions, adaptive and maladaptive interactional patterns across generations (Guttman, 1991). Given that the genogram information may lead to a decrease in reliability (McGoldrick & Gerson, 1985) the ethical responsibility now rests fully on the shoulders of the researcher to allow for this limitation. In effect, it means that the researcher should apply his/her clinical skills to the full. She should listen carefully, but with openness, weighing and evaluating the person's manner of communication, interpersonal style and involvement (Beyers, personal communication, 2006).

For both cases, the family system in each instance is defined in line with the operational definition of family in chapter 4, namely, as those individuals included by Mr X and Mr Y in their conceptualization of their "family". Where these individual are alive and give consent, interviews are conducted with them as outlined below. Alternatively, the individual's own description of their family and relationships within the family system is accepted, as with Mr Y.

5.4 DATA COLLECTION

This study uses four sources of data collection, namely:

- clinical observations of the participant/s;
- interviews with
 - individuals who have committed serial murder;
 - their family members; as well as
 - prison staff, investigating officers and/or other professionals involved in the cases of these individuals;
- genograms of the families of individuals who have committed serial murder; and
- archival records in the form of
 - police case files for the individuals concerned;
 - psychological reports or evaluations;
 - newspaper reports; and
 - recorded television interviews.

These four sources will now be discussed in further detail.

5.4.1 Clinical observations

Clinical observation refers to the direct observation of an individual in order to learn more about that individual's behaviour and, more specifically, their mental health or psychological functioning (Sadock & Sadock, 2003). Aspects of the individual that are focused upon may include appearance, body size, hygiene, eye contact, attention and concentration, speech and language, mood, thinking process, memory, ability to interact with others, problem-solving strategies, and repetitive behaviours such as tics. The context in which clinical observation

can take place ranges from more formal settings such as the psychiatric ward of a general hospital to less formal contexts such as casual conversation in a non-psychiatric setting.

This study uses clinical observations of the individuals interviewed (participants and their family members). These observations provide information regarding the behaviour of the individuals interviewed and their interaction with their immediate surroundings (including kinetic aspects such as tone of voice, posture, body language, and use of affect) as an additional data source.

5.4.2 Interviews

The interview used in this particular research study is a qualitative one. In line with the research design, the purpose of the interview method is exploratory as opposed to hypothesis testing and aims to elicit and explore the family and individuals who have committed serial murder. The intention is to allow the data and themes to emerge relatively unrestricted from the interviewees. The researcher conducts all the interviews personally and makes use of interpreters/translators where necessary. The potential influence of such a device on the narratives and themes drawn is noted and included in analysis. Informed consent and confidentiality are ensured.

The interviews are semi-structured and consist of open-ended questions about the family system. The interviews are structured only in the sense that the interviewer will keep the focus on serial murder, the family system, the views of family members about the occurrences and feelings towards the incarcerated member, and the subject's views or perceptions of his own family. The basic format of the interview follows the interviewee's interpretations, explanations, and sense/meaning-making of the topic (Breakwell, 1995). Effort is made to interpret and clarify meanings expressed by the interviewee throughout the interview so as to

ensure the quality of analysis. Sensitivity to the emotional well being of the interviewee is practiced throughout the interview process and is used to inform interview questions.

The semi-structured interviews are open ended, which means that the researcher listens carefully and proceeds by reacting to the cues given by the participant (Kvale, 1996). The researcher's actions are based on her own manner of communicating, the messages of meta-communication, and could be explained in a simple way as the constant phrasing of questions in her mind, such as:

- what is happening in the interview between researcher and participant?
- under what circumstances is it happening (what and where)?
- how does it happen?
- why does it happen?
- how is what is happening connected to what follows?
- how and with what can the researcher behave to intervene without contamination of the research process?

5.4.3 Genograms

The genogram is “a format for drawing a family tree that records information about family members and their relationships over at least three generations” (McGoldrick & Gerson, 1985, p.1). It provides an effective graphical representation of family patterns, which enables the researcher to view how problems within the family or affecting individual members may be related to these patterns across the system. A genogram is a flexible assessment instrument and can be used for research purposes, as well as a clinical tool to inform therapeutic interventions (McGoldrick & Gerson, 1985).

The genogram has traditionally been paired with Bowenian family systems theory but is not exclusive to it (Mauzey & Erdman, 1995). Within this framework, the genogram assists with formulating hypotheses about family systems and designing interventions into them. Additional clinical benefits of the genogram include organizing data in a graphical way; engaging a family in sessions; teaching systemic ideas; clarifying family patterns and characteristics; and developing intellectual understanding of issues in family systems (McGoldrick & Gerson, 1985; Wachtel, 1982). Consequently, it would appear that the genogram is useful as both a clinical intervention and tool for working with family systems, as well as from a research-oriented perspective in terms of understanding and representing family systems.

Most traditional approaches to genogram construction focus upon the basic structure of the family; demographic information; and relationships. However, it is possible to expand creatively on these bases (Mauzey & Erdman, 1995). Additionally, the genogram has been shown to have considerable usefulness in terms of developing cross-cultural understandings of family systems, as well as validity for application to multi-cultural groupings in studies conducted in South Africa (Marchetti-Mercer & Cleaver, 2000).

This study makes use of the genogram method to organize and interpret data gathered on the family systems of individuals who commit serial murder. The decision to use a genogram is based on its proven utility in organizing data related to family systems; graphically representing such systems and illuminating relationships between members; fit with theoretical approaches utilized for the current study (such as that of Bowen (1978)); and its proven cross-cultural suitability and applicability, especially given the multicultural composition of current South African society.

The standardised method for compiling a genogram as outlined in McGoldrick and Gerson (1985) is used. The standardized method consists of three steps, mainly:

- mapping the family structure;
- recording family information; and
- showing family relationships (McGoldrick & Gerson, 1985).

These will now be elaborated upon in turn.

- **Mapping the family structure.**

The graphic depiction of family relationship and structure involves constructing a map of how different family members are related (McGoldrick & Gerson, 1985). This map consists of figures, lines and symbols, representing people and their relationship to each other. The main information represented on the map includes marriages, deaths, divorce or separation, adoption or fostering of children, twins and households.

- **Recording family information.**

The family structure can be considered the “skeleton of the genogram” (McGoldrick & Gerson, 1985). Once compiled, further family information is added, namely:

- demographic information;
- functioning information; and
- critical family events.

Demographic information includes dates of birth and death, ages, locations, occupations and educational level. Functional information refers to the medical, behavioural and emotional functioning of family members. Critical family events refer to important events that may have impacted upon family functioning or the functioning of the individual concerned. These include transitions, migrations, failures and successes, demographic events such as births and deaths, and loss of job, for example.

McGoldrick and Gerson (1985) stress the importance of including housekeepers, extended family such as aunts, uncles, cousins, foster children and adopted children in the analysis of families for clinical or research purposes. They also state that ethnic groups may vary considerably in the structuring of their family trees and that for this reason godparents and other kinship networks should not be ignored in terms of the role that they might play for a particular family group. Stack (1974) states that when a close friend is especially important to a family, this individual may become a member of the informal extended kinship network and that he or she should be included in any analysis of the family.

- **Showing family relationships.**

The final step of creating the genogram involves delineating the relationships between family members. This process is largely inferential and is based on information gathered from family members as well as observation of the family members.

The definition of family discussed in chapter 4 will be used to designate the group of individuals that would be used to construct the genogram for each case. The genogram for each family system is compiled from interviews with, and direct observation of family members as well as the primary research participants in the study, and will go back three generations to the grandparents of the individuals concerned. Due to the fact that the index individuals are incarcerated, and as a result of strict Department of Correctional Services access regulations, it will not be possible to observe the interaction between them and their family members.

Analysis and interpretation of the genogram data takes according to the following categories, namely:

- Category one: Family structure, with respect to
 - household composition;

- sibling constellation; and
- unusual family configurations;
- Category two: Life cycle fit;
- Category three: Pattern repetition across generations, with respect to
 - patterns of functioning;
 - patterns of relationships; and
 - repeated structural patterns;
- Category four: Life events and family functioning, with respect to
 - the coincidences of life events;
 - the impact of life changes, transitions and traumas;
 - anniversary reactions; and
 - social, economic and political events;
- Category five: Relational patterns and triangles; and
- Category six: Family balance and imbalance, with respect to
 - the family structure;
 - roles;
 - levels and style of functioning; and
 - resources (McGoldrick & Gerson, 1985).

5.4.4 Archival data and other records

Archives are the “ongoing, continuous records of a society” (Rosenthal & Rosnow, 1991, p. 354). Archival records may include actuarial records of births, deaths, and marriages; political and judicial records; other government records (such as crime reports, and police

case files); the mass media; sales records; industrial and institutional records; and various other written documents.

This study uses archival records in the form of police records, and case files in order to select participants and psychological reports together with documentation in the form of newspaper reports as well as video interview footage as part of the data analysis.

It is hoped that by using multiple sources of data, the study will obtain a rich and complex interpretation of the topic of interest (Patton, 1990), and satisfy the criterion of credibility. By using interviews with individuals who have committed serial murder and their families, together with reports from psychologists who assessed them, and direct observation of family interaction, the consistency of the overall impression of the family system can be established and any contradictions can be included in the analysis and/or explored by accessing other sources of data, which may become available as the process of evidence enquiry develops.

To be able to review the drafts of participants, all information gathered is put together and assessments and analyses conducted with the aim of possibly determining if any new or additional information is needed. Additionally, the participants are asked to confirm the researcher's understanding of their beliefs, ideas and perceptions as expressed during interviews and in this way, key informants are allowed to review the information collected in the study and relative consistency in understandings between the researcher and participants is ensured, thus attempting to fulfill the criterion of reflexivity.

5.5 PROCEDURE

The procedure followed by the research study consists of the following steps, namely:

- review literature;

- choose approach and design;
- research media for possible cases;
- identify possible cases;
- get permission from University of Pretoria and Department of Correctional Services;
- review case files and other archival data; speak to experts;
- approach subjects for permission;
- interview individuals who have committed serial murder;
- interview family, prison staff and other professionals;
- compile genogram;
- examine data in light of theoretical approach (Family systems theory); and
- compile results.

All interviewees are briefed before interviews. Briefing consists of defining the situation for the subject, describing the purpose of the interview as well as allowing for any questions on the part of the interviewee. This includes a semi-formal social introduction, the sharing with the participant the aims of the research, as well as ethical and confidentiality issues. This also includes the participants' permission or willingness to participate. Confidentiality is stressed and anonymity guaranteed with regards to interview data, collection and publication of the research.

A statement is made that participation will possibly contribute to the understanding of violence in general and more specifically to serial murder. Initial questions in the interviews are unstructured and open-ended, aimed at developing a sense of rapport with participants. Later, more focused, semi-structured questions are introduced in order to gather information about the family, using circular questions and the genogram to further generate questions and

information for clarity. In addition to the above, some structured questions are also included to obtain biographical and chronological data about the family.

Debriefing after the interview(s) consists of summarizing the main points of the interview and allowing for feedback from the interviewee. Such feedback may go towards verification in later stages.

The above examples of how the interviews are to be introduced may differ depending on the immediate meta-communications and interactional/interpersonal cues in the researcher's relationship with the interviewee (Watzlawick *et al.*, 1967). The processes and interactions during the interviews are also described and analyzed.

The researcher conducts between three and five interviews of approximately two to three hours with each individual who has committed serial murder, and approximately one interview of one to two hours with family members. The idea is to continue until some form of saturation of information is reached before interview(s) are terminated.

Interviews with prison psychologists are used for both Mr X and Mr Y (approximately one interview of one hour each); in the case of Mr X, the psychiatrist who assessed him for competency to stand trial is also interviewed (one interview of approximately one hour); and with Mr Y, his cell-mate, Mr Z, is also interviewed (approximately five interviews of two hours each). These interviews are unstructured and are integrated into total data analysis, together with primary interviews (with participants and family members), as supplementary data sources. These interviews consist of semi-structured questions concerning the interviewees' perspectives on the individual concerned; the topic of serial murder and their impressions of the families of these individuals where is contact with these individuals.

5.6 ETHICAL CONSIDERATIONS

In order to safeguard the privacy of the family members interviewed, names of people and places are withheld in line with ethical considerations concerning confidentiality. This is done in spite of the fact that the details of the crimes committed, as well as identity of the individuals sampled for the case studies, are public record. Many of the family members interviewed have avoided public attention due to the sensitive nature of the crimes committed by a member of their family, and their wishes with regards to privacy in this respect are observed.

Additionally, all individuals interviewed are offered the opportunity for debriefing after every interview if they experienced stress or trauma as a result of recounting painful or other experiences. Informed consent is obtained from all individuals interviewed.

Permission to conduct the study is granted by the Research Ethics Committee of the University of Pretoria, and the Department of Correctional Services, after carefully scrutinizing the nature and conditions of the research.

5.7 DATA ANALYSIS

After data is collected via the various methods discussed above, analysis takes place in two ways, namely:

- a case study method; and
- content analysis.

5.7.1 Discussion of the case study method

The case study method selected for this study is a multiple case study exploratory research design, as described by Yin (1994). A case study approach is selected due to the fact that the author desires an in-depth, rich, descriptive conceptualization of the participant and the family system of the participant concerned. On account of the fact that the study does not wish to make any causal attributions about the phenomenon in question, namely serial murder, it is not necessary to use an experimental design with control groups or a quasi-experimental design (Nachmias & Nachmias, 1981). The case study approach is also amenable to the epistemology and theoretical framework of the study.

- **Yin's criteria for defining a case study.**

Yin (1994) has two main criteria for defining a case study, namely that the study must consist of “an empirical inquiry that investigates a contemporary phenomenon within its real-life context” (p. 13); and that “the boundaries between phenomenon and context are not clearly evident” (p. 13).

Serial murder is a contemporary phenomenon, especially in South Africa, where, as discussed in the literature review, it has been particularly prolific over the last ten years (Pistorius, 1996). It is the opinion of the author that serial murder is frequently linked to the context in which it is situated, which, for the purposes of this study, is the family, as well as broader social, cultural and political contexts, to a lesser degree. Additionally, in accordance with Yin's second principle, it is often difficult to draw definite lines between serial murder as a behaviour of one particular individual (as well as serial murder as a cultural phenomenon),

and the context in which this behaviour takes place. This can be seen in the numerous theories discussed in the chapter 3 that attribute serial murder to an individual's upbringing in a "dysfunctional family". Consequently, it would appear that Yin's (1994) two definitional criteria are satisfied, and that a case study methodology is appropriate for this study, and the topic of serial murder.

- **The unit of analysis.**

The unit of analysis is defined by establishing:

- what constitutes a case;
- the time boundaries of a case; and by
- distinguishing what is inside a case from what is outside (Yin, 1994).

A case in this study refers to an individual who has committed serial murder and meets sampling criteria, together with the available family members of this individual. This is because the author intends to study the role played by the family in contributing towards serial murder behaviour in the participant concerned. Family is defined according to the definition in chapter 4 (see p.133).

This study uses the two cases discussed above, taking into account that there are not many individuals incarcerated for serial murder in South Africa.

The time boundaries of the cases that are used in this study consist of the amount of time necessary to establish rapport with the participant concerned as well as their family, and the time necessary to complete enough interviews to reach saturation with the participants and their families.

5.7.2 Content analysis

This study uses a content analysis method to analyze the data collected. Content analysis is a technique whereby messages (in the form of written or oral statements) are studied via being exposed to criteria of selection (Holsti, 1968), after which statements are made about such messages with regard to frequency, grouping or other interpretative frameworks. As a technique, content analysis has been interpreted as both quantitative and qualitative in nature (Smith, 1975). Content analysis involves a consideration of what to count, the nature of levels and units of analysis and how to use coding frames or categories (Berg, 1995; Franzosi, 2004).

It is thought that seven major elements in messages can be counted in content analysis (Berelson, 1952; Berg, 1983; Merton, 1968; Selltitz, Jahoda, Deutsch & Cook, 1959). These are words or terms; themes; characters; paragraphs; items; concepts; and semantics. These elements can be considered types of units of analysis that are then organized in terms of coding frames (Berg, 1995). Coding frames or categories are used to sort cases or units of analysis into some specified special class according to certain criteria. Franzosi (2004) states that coding categories for content analysis have a number of properties, namely:

- the design of coding categories follows the theoretical interest of the researcher;
- coding categories are abstract, general and highly aggregated;
- since the coding categories follow the theoretical interest of the researcher, a researcher with different interests with respect to the texts used or subject matter may choose different categories;

- coder discretion plays a role in trying to fit concrete text into abstract coding categories and thus there may be ‘contamination’ of the measurement which needs to be addressed in terms of reflexivity;
- links and connections between categories are not specified, that is, causal statements are not usually made; and
- coded output bears little relationship to the original text.

This study adopts a qualitative approach to the content analysis method used. The unit of analysis for this study consists of themes that emerge from the collected data (namely, interviews, clinical observations, genograms and archival records) for each case study, and coding proceeds on the basis of theoretical classes based on the family systems conceptual framework discussed in chapter 4 (see p. 167), such as emotional process, multigenerational patterns and relationship patterns. These coding frames or categories are further structured with respect to their various constituent elements (as specified by the conceptual framework in chapter 4).

Therefore, emotional process are further subdivided into differentiation within the family system and differentiation in the social milieu, and themes coded on the basis of how they fit into the various categories. A similar procedure is repeated with multigenerational processes (in terms of Bowen’s projection and Minuchin’s sub-system or structural approach) as well as with relationship patterns (in terms of triangulation and triads, as well as interactions and hierarchies).

5.8 DATA INTEGRATION

Data collected and analysed as outlined above is integrated in order to explore the topic of serial murder as outlined in the research focus, namely: “How does the family system of a

person who commits serial murder function?" That is, what is the family structure, who are the people in the family system and how do they maintain the family system.

After data analysis, there should be an awareness of possible meta-patterns in the family system of each case, which illuminate the connections or relationships between the serial murder pattern of behaviour of one of the members of the family system and other patterns of behaviour in the family system.

5.9 CONCLUSION

This study investigates the role that serial murder plays within the family system via an exploratory qualitative research design. The various criteria for evaluating such a study have been outlined and will be referred to again in chapter 8, when assessing the limitations of the current study.

Importantly, analysis of data first examines each case individually, and then explores the patterns that emerge across cases. In this way, findings may reveal patterns that can be elaborated upon in future research by the addition of other cases or testing of particular patterns. The following chapter will examine the results of the current study.

Reference list

- Abel, G.G., & Blanchard, E.B. (1974). The role of fantasy in the treatment of sexual deviation. *Archives of General Psychiatry*, 30, 467-475.
- Ackerman, N. (1984). *A theory of family systems*. London: Gardner Press, Inc.
- Ajzen, I., & Madden, T.J. (1986). Prediction of goal-directed behaviour: Attitudes, intentions and perceived behavioural control. *Journal of Experimental Social Psychology*, 22, 453-474.
- American Psychiatric Association. (1994). *Diagnostic and statistical manual of mental disorders* (4th ed.). Washington, DC: Author.
- Amoateng, A.Y. (1997). The structure of urban Black households: New evidence from a Coloured and an African community on the Cape Flats in the Western Cape of South Africa. *African Sociological Review* 1(2), 22-40.
- Anderson, J. (1994). *Genesis of a serial killer: Fantasy's integral role in the creation of a serial killer*. Paper presented at Luther College, May 1994, Decorah, IA.
- Archer, J. (1994). *Male Violence*. London: Routledge.
- Asch, S.E. (1956). Studies of independence and conformity: A minority of one against a unanimous majority. *Psychological Monographs*, 70 (Whole no. 416)
- Bandura, A. (1973). *Aggression: A social learning analysis*. Englewood Cliffs, NJ: Prentice-Hall.
- Banister, P., Burman, E., Parker, I., Taylor, M., & Tindall, C. (1994). *Qualitative methods in psychology: A research guide*. Buckingham: Open University Press.
- Barkham, M. (1996). Individual therapy: Process and outcome findings across successive research generations. In W. Dryden (Ed.), *Handbook of Individual Therapy* [pp. 22-36]. London: Sage
- Bartol, C.R. (1980). *Criminal behaviour: A psycho-social approach*. Englewood Cliffs, NJ: Prentice Hall.
- Bateson, G. (1979). *Mind and nature: A necessary unity*. London: Bantam Books.
- Bateson, G., Jackson, D.D., Haley, J., & Weakland, J.H. (1956). Towards a theory of schizophrenia. *Behavioural Science*, 1, 251-264.
- Beeld. (1993). *Bloedverskynsel by 'Norwoodman' uifers seldsaam hoor hof*. 12 June.
- Beeld. (1993). *Verkragter nie versteurd – getuie*. 22 September.
- Bell, N.W., & Vogel, E.F. (1968). *A modern introduction to the family*. New York, NY: The Free Press.
- Berelson, B. (1952). *Content analysis in communications research*. Glencoe, IL: Free Press.
- Berg, B.L. (1983). *Jewish identity: Subjective declarations of objective life styles*. Unpublished doctoral dissertation, Syracuse University, Syracuse, NY.
- Berg, B.L. (1995). *Qualitative research methods for the social sciences* (2nd edition). Boston, MA: Allyn & Bacon.
- Bernardes, J. (1997). *Family studies: An introduction*. London: Routledge.
- Berner, W., Grunberger, J., Sluga, W., Schnedl, W., Wagenbichler, P., & Herbich, J. (1977). Catamnesis of YY carriers in prison. *Fortschritte der Neurologie, Psychiatrie und ihrer Grenzgebiete*, 45 (3), 194-205.
- Blanchard, G. (1995). Sexually addicted lust murderers. *Sexual Addiction and Compulsivity*, 2, 62-71.
- Boscolo, L., Cecchin, G., Hoffman, L., & Penn, P. (1987). *Milan systemic family therapy: Conversations in theory and practice*. Los Angeles, CA: Basic Books.
- Bowen, M. (1978). *Family therapy in clinical practice*. New York, NY: J Aronson.
- Breakwell, G.M. (1995). Interviewing. In G.M. Breakwell, S. Hammond & C. Fife-Schaw (Eds.), *Research methods in psychology* [pp. 45-54]. London: Sage.

- Brown, D. (Producer) & Fleder, G. (Director). (1997). *Kiss the Girls* (Motion picture). United States of America: Paramount Pictures.
- Burgess, A.W., Hartman, C.R., Ressler, R.K., Douglas, J.E., & McCormack, A. (1986). Sexual homicide: A motivational model. *Journal of Interpersonal Violence*, 13(3), 251-272.
- Caldwell, J., Caldwell, P., Ankrah, E.M., Anarfi, J.K., Agyeman, D.K., Awusabo-Asare, K., & Orubuloye, I.O. (1993). African families and AIDS: Context, reactions and potential interventions. *Health Transition Review*, 3 (supplementary edition), 1-14.
- Cameron, D., & Frazer, E. (1987). *The lust to kill: A feminist investigation of serial murder*. London: Polity Press.
- Canter, D. (1994). *Criminal shadows*. London: Harper Collins.
- Canter, D. (2000). Offender profiling and criminal differentiation. *Legal and Criminological Psychology*, 5, 23-46.
- Canter, D., Alison, L.J., Alison, E., & Wentink, N. (2003). The organised/disorganised typology of serial murder: Myth or model? Unpublished paper.
- Caputi, J. (1992). American psychos: The serial killer in contemporary fiction. *Journal of American Culture*, 3, 23-48.
- Carlyle, P. (Producer) & Fincher, D. (Director). (1995). *Se7en* (Motion picture). United States of America: Alliance Atlantis Communications.
- City Press. (1997). *2410 years in jail for ghoulish serial killer*. 7 December.
- Claus, C., & Lidberg, L. (1999). Serial murder as 'Schahriar syndrome'. *The Journal of Forensic Psychiatry*, 10(2), 427-435.
- Cleary, S., & Luxenburg, J. (1993). *Serial murders: Common background characteristics and their contribution to causation*. Paper presented at the annual meeting of the American Society of Criminology, Miami, Florida.
- Collins, P.I., Johnson, G.F., Choy, A., Davidson, K.T., & Mackay, R.E. (1998). Advances in violent crime analysis and law enforcement: The Canadian Violent Crime Linkage Analysis System. *Journal of Government Information*, 25(3), 277-284.
- Concise Oxford English Dictionary*. (2004). USA: Oxford University Press.
- Connell, R.W. (1987). *Gender and power: Society, the person and sexual politics*. Stanford, CA: Stanford University Press.
- Cooper, C. (1996). Psychodynamic therapy: The Kleinian approach. In W. Dryden (Ed.) *Handbook of individual therapy* [pp. 67-74]. London: Sage.
- Corder, C.K. (2001). *The identification of a multi-ethnic South African typology*. Unpublished doctoral dissertation, University of Pretoria, Pretoria, South Africa.
- Dallos, R. (1995). Constructing family life: family belief systems. In J. Muncie, M. Wetherell, R. Dallos & A. Cochrane (Eds.), *Understanding the family* [pp. 174-209]. London: Sage.
- De Wet, J.A. (2005). *A psychological perspective on the personality development of a serial murderer*. Unpublished Masters thesis, University of Pretoria, Pretoria, South Africa.
- Delisi, L.E., Friedrich, U., Wahlstrom, J., & Crow, T.J. (1994). Schizophrenia and sex chromosome anomalies. *Schizophrenia Bulletin*, 20, 495-505.
- Denick, L. (1989). Growing up in the post-modern age: On the child's situation in the modern family, and on the position of the family in the modern welfare state. *Acta Sociologica*, 32, 155-180.
- Diego Nunez, M.A., Prieto Veiga, J., Rey Sanchez, F., Salazar Veloz, J.F., De Manueles Jiminez, J., Santos Borbujo, J., Martin Ruano, A., Alvarez Aparicio, E., & Cedeno Montano, J. (1992). Clinical polymorphism of the XYY syndrome. *Annals Espanoles de Pediatria*, 37(2), 140-144.
- Dollard, J., & Miller, N. (1950). *Personality and psychotherapy*. New York, NY: McGraw-Hill.
- Douglas, J., Burgess, A.W., Burgess, A.G., & Ressler, R.K. (1992). *Crime classification manual: A standard system for identifying and classifying violent crimes*. New York, NY: Lexington.

- Douglas, J., & Olshaker, M. (2000). *The cases that haunt us*. New York, NY: Scribner.
- Du Plessis, J.J. (1998). *Towards a psychological understanding of serial murder*. Unpublished Masters Thesis, University of Pretoria, Pretoria, South Africa.
- Dubner, S.J. (1992). Portrait of a serial killer. *New York*, 25, 82-87.
- Durkheim, E. (1897/1952). *Suicide*. London: Routledge.
- Egger, S.A. (1984). A working definition of serial murder and the reduction of linkage blindness. *Journal of Police Science and Administration*, 12 (3), 348-357.
- Egger, S.A. (1990). Serial murder: A synthesis of literature and research. In S.A. Egger (Ed.), *Serial murder: an elusive phenomenon* [pp. 53-67]. New York, NY: Praeger Publishers
- Ellis, L., & Walsh, A. (2000). *Criminology*. Boston, MA: Allyn & Bacon.
- Eysenck, S., & Eysenck, H. (1977). Personality differences between prisoners and controls. *Psychological Reports*, 40, 1023-1028.
- Faber, R., & Abrams, R. (1975). Schizophrenia in a 47, XYY male. *British Journal of Psychiatry*, 127, 401-403.
- Ferguson, C.J., White, D.E., Cherry, S., Lorenz, M., & Bhimani, Z. (2003). Defining and classifying serial murder in the context of perpetrator motivation. *Journal of Criminal Justice*, 31, 287-292.
- Finkenbauer, J.O., & Kochis, D.S. (1984). Causal theory and the treatment of juvenile offenders: A case study. *Advances in Forensic Psychology and Psychiatry*, 1, 49-63. *First Draft Baseline Document for the Development of a National Policy for Families*. Department of Social Development, Pretoria, South Africa. July 2003.
- Franzosi, R. (2004). *From words to numbers: Narrative, data and social science*. Cambridge: University of Cambridge.
- Freud, A. (1966). *Normality and pathology in childhood*. *International Psychoanalytic Library No. 69*. London: The Hogarth Press.
- Geberth, V.J. (1998). Anatomy of a lust murder. *Law and Order Magazine*, 46 (5), 22-27.
- Gergen, K.J. (1991). The saturated family. *Networker*, September/October.
- Gillies, V. (2003). Family and intimate relationships: A review of the sociological research. *Families and Social Capital ESRC Research Group Working Paper No. 2*. London: South Bank University.
- Goldenberg, I., & Goldenberg, H. (2004). *Family therapy: An overview* (6th edition). Sydney: Brooks/Cole.
- Gorby, B. (2000). *Serial murder: A cross-national descriptive study*. Unpublished Masters thesis, California State University: Fresno.
- Gresswell, D.M., & Hollin, C.R. (1994). Multiple murder: A review. *British Journal of Criminology*, 34(1), 1-14.
- Gubrium, J., & Holstein, J. (1990). *What is family?* California: Mayfield.
- Guerin, P.J. (1976). Family therapy: The first twenty-five years. In P.J. Guerin (Ed.), *Family therapy: Theory and practice* [pp. 127-143]. New York, NY: Gardner Press.
- Guttman, H.A. (1991). Systems theory, cybernetics and epistemology. In A.S. Gurman and D.P. Kniskern (Eds.) *Handbook of Family Therapy Vol II* [pp. 43-44]. New York, NY: Brunner/Mazel.
- Hale, R. (1993). The application of learning theory to serial murder or "You too can learn to be a serial killer". *American Journal of Criminal Justice*, 17(2), 37-45.
- Haley, J. (1959). The family of the schizophrenic: A model system. *Journal of Nervous and Mental Diseases*, 129, 357-374.
- Haley, J. (1970). Family therapy. *International Journal of Psychiatry*, 9, 233-242.
- Haley, J. (1976). Problems of training therapists. In J. Haley (Ed.), *Problem-solving therapy* [pp. 92-103]. San Francisco, CA: Jossey-Bass.

- Haley, J. (1978). *Problem solving therapy*. London: Jossey-Bass Publishing.
- Hall, C.M. (1981). *The Bowen family theory and its uses*. London: Jason Aronson.
- Hamsher, J. (Producer) & Hugher, S. (Director). (2001). *From Hell* (Motion picture). United States of America: Fox.
- Harbort, S., & Mokros, A. (2001). Serial murderers in Germany: From 1945 to 1995. *Homicide Studies* 5(4), 311–334.
- Harre, R., & Lamb, R. (1983). *Encyclopaedic dictionary of psychology*. Cambridge, MA: MIT Press.
- Harre, R., & Secord, P.F. (1972). *The explanation of social behaviour*. Oxford: Basil Blackwell.
- Hazelwood, R.R., & Douglas, J. (1980). The lust murderer. *FBI Law Enforcement Bulletin*, April, 1-5.
- Hazelwood, R.R., & Warren, J. (1995). The relevance of fantasy in serial sexual crime investigation. In R.R. Hazelwood & A.W. Burgess (Eds.), *Practical aspects of rape investigation* (2nd ed) [pp. 127-138]. New York, NY: CRC Press.
- Henwood, K. (1996). Qualitative inquiry: perspectives, Methods and psychology, In J.T.E. Richardson (Ed.), *Handbook of qualitative research methods for psychology and the social sciences* [pp. 105-124]. Leicester: BPS Books.
- Hickey, E.W. (2001). *Serial murderers and their victims* (3rd edition). Belmont, CA: Wadworth.
- Hickey, E.W. (2006). *Serial murderers and their victims* (4th edition). Sydney: Thomson Wadworth.
- Hodgskiss, B. (2001). *A multivariate model of the offence behaviours of South African serial murderers*. Unpublished Masters thesis, Rhodes University, Grahamstown, South Africa.
- Hodgskiss, B. (2002). *Serial killing in South Africa*. Paper presented at the First International Conference on Criminal Analysis and Profiling. 3-5 June 2002, Institute of Criminology, Paris, France.
- Hodgskiss, B. (2004). Lessons from serial murder in South Africa. *Journal of Investigative Psychology and Offender Profiling*, 1 (1), 67-94.
- Hoffman, L. (1981). *Foundations of family therapy*. New York, NY: Basic Books.
- Hofstede, G. (1994). *Uncommon sense about organizations: Cases, studies and field observations*. Thousand Oaks, CA: Sage Publications.
- Holmes, R.M. (1990). *Profiling violent crimes*. Newbury Park, CA: Sage.
- Holmes, R.M., & DeBurger, J. (1988). *Serial murder*. Newbury Park, CA: Sage.
- Holmes, R.M., & Holmes, S.T. (1996). *Profiling violent crimes: An investigative tool*. London: Sage.
- Holsti, O.R. (1968). Content analysis. In G. Lindzey & E. Aaronson (Eds.), *The Handbook of Social Psychology* [pp. 203-248]. Reading, MA: Addison-Wesley.
- Hossfeld, K.J. (1991). Pondering the post-modern family. *Socialist Review*, 3-4, 187-194.
- Hook, D. (2003). Reading Geldenhuys: Constructing and deconstructing the Norwood killer. *South African Journal of Psychology*, 33(1), 1-10.
- Hull, C.L. (1943). *Principles of behaviour*. New York, NY: Appleton-Century-Crofts.
- Imber-Black, E. (1988). *Families and larger systems: A family therapist's guide through the labyrinth*. New York, NY: Guilford Press.
- Jackson, D.D. (1957). The question of family homeostasis. *Psychiatric Quarterly Supplement*, 31, 79-90.
- Janis, I.L. (1972). *Victims of groupthink: A psychological study of foreign policy decisions and fiascos*. Boston, MA: Houghton Mifflin Company.
- Jehu, D. (1991). Clinical work with adults who were sexually abused in childhood. In C.R. Hollin & K. Howells (Eds.) *Clinical approaches to sex offenders and their victims* [pp.23-40]. Chichester: John Wiley & Sons.
- Jenkins (1994). *Using murder: The social construction of serial homicide*. New York, NY: Aldine de Gruyter.

- Johnson, B.R., & Becker, J.V. (1997). Natural born killers? The development of the sexually sadistic serial killer. *Journal of American Academy of Psychiatry and Law*, 25(3), 335-348.
- Keeney, B., & Heide, K. M. (2000). Defining serial murder. In L. Gerdes (Ed.), *Serial killers* [pp. 15-21]. San Diego, CA: Greenhaven Press.
- Kennaugh, R.C. (1968). *Contemporary murder*. Johannesburg: Penguin.
- Keppel, R.D. (1989). *Serial murder: Future implications for police investigations*. Ohio, IL: Anderson Publishing Co.
- Kerr, M.E., & Bowen, M. (1988). *Family evaluation*. New York, NY: WW Norton & Co.
- Kilpatrick, A. & Holland, T.P. (1999). *Working with families: An integrative model by level of need* (2nd ed.). Boston, MA: Allyn & Bacon.
- Kolb, B., & Whishaw, I.Q. (1996). *Fundamentals of human neuropsychology* (4th ed.). Los Angeles, CA: WH Freeman & Co.
- Kumra, S., Wiggs, E., Krasnewich, D., Meck, J., Smith, A.C., Bedwell, J., Fernandez, T., Jacobson, L.K., Lenane, M., & Rapoport, J.L. (1998). Brief report: association of sex chromosome anomalies with childhood-onset psychotic disorders. *Journal of the American Academy of Child Adolescent Psychiatry*, 37 (3), 292-296.
- Kvale, S. (1996). *Interviews: An introduction to qualitative research interviewing*. Thousand Oak, CA: Sage.
- Labuschagne, G.N. (2001). *Serial murder revisited: A psychological exploration of two South African cases*. Unpublished doctoral thesis, University of Pretoria, Pretoria, South Africa.
- Labuschagne, G.N. (2003). Offender profiling in South Africa: Its definition and context. *Acta Criminologica: Southern African Journal of Criminology*, 16 (4), 67-74.
- Labuschagne, G.N. (2004). Features and investigative implications of muti murder in South Africa. *Journal of Investigative Psychology and Offender Profiling*, 1, 191-206.
- Laing, R.D. (1961). *Self and others*. London: Tavistock Publications.
- Laing, R.D. (1965). *The divided self*. Harmondsworth, Great Britain: Penguin.
- Lane, B., & Gregg, W. (1992). *The new encyclopaedia of serial killers*. Surrey: Headline.
- Launay, G., & Murray, P. (1989). Victim/Offender groups. In M. Wright & B. Galaway (Eds.), *Mediation and criminal justice* [pp. 34-47]. London: Sage Publishers.
- Leibman, F.H. (1989). Serial murderers: Four case histories. *Federal Probation, December*, 41-45.
- Leyton, E. (2001). *Hunting humans*. London: John Blake Publishing.
- Litwack, T., & Schlesinger, L. (1987). Assessing and predicting violence: Research, law and applications. In I. Weiner & A. Hess (Eds.), *Handbook of forensic psychology* [pp. 91-99]. New York, NY: John Wiley.
- Lloyd, S. (1995). The dark side of courtship: Violence and exploitation. In S. Stith & M. Straus (Eds.) *Understanding partner violence: Prevalence, causes, consequences and solutions* [pp.90-98]. Minneapolis, MN: National Council on Family Relations.
- Lundrigan, S., & Canter, D. (2001). A multivariate analysis of serial murderers' disposal site location choice. *Journal of Environmental Psychology*, 21, 423-432.
- MacDonald, J.M. (1961). *The murderer and his victim*. Springfield, IL: Charles Thomas.
- Marchetti-Mercer, M.C., & Cleaver, G. (2000). Genograms and family sculpting: An aid to cross-cultural understanding in the training of psychology students in South Africa. *The Counselling Psychologist*, 28(1), 61-80.
- Marsh, R. (1999). *With criminal intent: The changing face of crime in South Africa*. Cape Town: Penguin.
- Marshall, C., & Rossman, G.B. (1995). *Designing qualitative research* (2nd edition). Thousand Oaks, CA: Sage.
- Maslow, A. (1954). *Motivation and personality*. New York, NY: Harper.
- Masters, B. (1993). *The shrine of Jeffrey Dahmer*. London: Coronet.

- Mauzey, E., & Erdman, P. (1995). Let the genogram speak: Curiosity, circularity and creativity in family history. *Journal of Family Psychotherapy*, 6(2), 1-11.
- McClendon, R., & Kadis, L.B. (1990). In J.K. Zeig & S.G. Gilligan (Eds.). *Myths, Methods and Metaphors* [pp. 131-145]. New York, NY: Bruner/Mazel Publishing.
- McGoldrick, M., & Gerson, R. (1985). *Genograms in family assessment*. York: Norton.
- Meloy, R. (1988). *The psychopathic mind: Origins, dynamics and treatment*. London: Jason Aronson.
- Meloy, J.R. (2000). The nature and dynamics of sexual homicide: An integrative review. *Aggression and Violent Behaviour*, 5(1), 1-22.
- Merriam-Webster Dictionary*. (2005). USA: Merriam-Webster.
- Merton, R.K. (1968). *Social theory and social structure*. New York, NY: Free Press.
- Milchan, A. (Producer) & Amiel, J. (Director). (1995). *Copycat* (Motion picture). United States of America: Warner Bros.
- Minuchin, S. (1974). *Families and family therapy*. Cambridge, MA: Harvard University Press.
- Mitchell, E.W. (1997). *The aetiology of serial murder: Towards an integrated framework*. Unpublished doctoral dissertation, University of Cambridge, United Kingdom.
- Moller, V. (1998). Innovations to provide an intergenerational society for South Africa to promote the well-being of the Black elderly. *Society in Transition*, 29, 1-2.
- Monahan, J. (1999). Assessing violence risk among discharged psychiatric patients: Toward an ecological approach. *Law and Human Behaviour*, 23, 235-253.
- Money, J. (1990). Forensic sexology: Paraphiliac serial rape (blastophilia) and lust murder (erotophonophilia). *American Journal of Psychotherapy*, 44, 26-36.
- Moorey, S. (1996). Cognitive therapy. In W. Dryden (Ed.), *Handbook of individual therapy* [pp. 64-73]. London: Sage.
- Morgan, D.H.J. (1996). *Family connections: An introduction to family studies*. Cambridge, MA: Polity Press.
- Morgan, D.H.J. (1999). Risk and family practices: Accounting for change and fluidity in family life. In E. Silva and C Smart (Eds.), *The new family?* [pp. 127-142]. London: Sage.
- Muncie, J., & Sapsford, R. (1995). Issues in the study of 'the Family'. In J. Muncie, M. Wetherell, R. Dallos & A. Cochrane (Eds.), *Understanding the family* [pp.7-39]. London: Sage.
- Murdock, G.O. (1968). The universality of the nuclear family. In E.F. Vogel & N.W. Bell (Eds.) *A modern introduction to the family* (pp.34-53). New York, NY: The Free Press.
- Myers, W.; Burgess, A.; & Nelson, J. (1998). Criminal and behavioural aspects of juvenile sexual homicide. *Journal of Forensic Sciences*, 43, 340-347.
- Myers, W.C., Raccoppa, L., Burton, K., & McElroy, R. (1993). Malignant sex and aggression: An overview of serial sexual homicide. *Bulletin of the American Academy of Psychiatry and the Law*, 21(4), 435-451.
- Nachmias, D., & Nachmias, C. (1981). *Research methods in the social sciences* (2nd edition). New York, NY: St Martin's Press.
- Nam, C.B. (2004). The concept of the family: Demographic and genealogical perspectives. *Sociation Today*, 2(2), 22-25.
- Nardone, A. & Watzlawick, P. (1993). *The art of change: Strategic therapy and hypnotherapy without trance*. San Francisco, CA: Jossey-Bass Publishing.
- Nichols, M.P., & Schwartz, R.C. (1991). *Family therapy concepts and methods*. Boston, MA: Allyn & Bacon.
- Norris, J. (1988). *Serial killers*. New York, NY: Doubleday.
- Park, R., Burgess, E.W., & McKenzie, R.D. (1925). *The City*. Chicago, IL: University of Chicago, Press.

- Parker, I. (1992). *Discourse dynamics: Critical analysis for social and individual psychology*. London: Routledge.
- Parsons, T. (1956). *Family: Socialisation and interaction process*. London: Routledge and Keegan Paul.
- Patton, M.Q. (1990). *Qualitative evaluation and research methods* (2nd edition). Newbury Park, CA: Sage Publications.
- Penguin Concise English Dictionary*. (1992). USA: Godfrey Cave Associates.
- Pinto, S., & Wilson, P.R. (1990). *Serial murder*. Australian Institute of Criminology series on Trends and Issues in Crime and Criminal Justice, No. 25. Canberra, Australia.
- Pistorius, M. (1996). *A psychoanalytic approach to serial murderers*. Unpublished doctoral dissertation, University of Pretoria, Pretoria, South Africa.
- Pistorius, M. (2002). *Strangers on the Street*. Johannesburg: Penguin.
- Pomerleau, O., & Pomerleau, C. (1988). A bio-behavioural view of substance abuse and addiction. In S. Peele (Ed.), *Visions of addiction* [pp.23-36]. Lexington: DC Heath and Company.
- Prentky, R., Burgess, A.W., & Carter, D.L. (1986). Victim responses by rapist type: An empirical and clinical analysis. *Journal of Interpersonal Violence, 1*, 73-98.
- Prentky, R., Burgess, A., Rokous, F., Lee, A., Hartman, C., Ressler, R., & Douglas, J. (1989). The presumptive role of fantasy in serial sexual homicide. *American Journal of Psychiatry, 146*, 887-891.
- Rapport. (1999). *Spanwerk los reeksmoord op*. 31 January.
- Ratner, R.S. (1996). Ideological homicide. In T. O'Reilly Fleming (Ed.), *Serial and mass murder: Theory, research and policy* [pp. 67-82]. Toronto: Canadian Scholar Press.
- Ravanera, Z.R., & Rajulton, F. (2000). *Multiple levels of analysis: Prospects and challenges for the Family Transformation and Social Cohesion Project*. Paper presented at the Annual Meeting of the Canadian Population Society, Edmonton, Canada, May 29-31.
- Reinhardt, J.M. (1962). *The psychology of a stranger killer*. Springfield, IL: University of Chicago.
- Reiss, A., & Roth, J. (1993). *Understanding and preventing violence*. Washington, DC: National Academic Press.
- Ressler, R.K. (1985). *FBI Law Enforcement Bulletin, 54*, 1-53.
- Ressler, R.K. (1997). *I have lived in the monster*. New York, NY: St Martins Press.
- Ressler, R.K., Burgess, A.W., & Douglas, J. (1988). *Sexual homicide: Patterns and motives*. Lexington, CA: Heath & Company.
- Ressler, R.K. & Shachtman, T. (1992). *I have lived in the monster: Inside the minds of the world's most notorious serial killers*. Boston, MA: St Martin's Press.
- Rice, M.E., Harris, G.T., & Quinsey, V.L. (1990). A follow-up of rapists assessed in a maximum-security psychiatric facility. *Journal of Interpersonal Violence, 5*, 435-448.
- Rivara, F.P. (2002). Prevention of injuries to children and adolescents. *Injury Prevention, 8* (4), 5-8.
- Rosenthal, R. & Rosnow, R.L. (1991). *Essentials of behavioural research: Methods and data analysis* (2nd edition). New York, NY: McGraw-Hill.
- Rossmo, D. K. (1995). Geographical profiling: target patterns of serial murderers.
- Unpublished doctoral dissertation, Simon Fraser University, British Columbia.
- Rossmo, D.K. (1997). Geographic profiling. In J. Jackson and D. Bekerian (Eds.), *Offender profiling: Theory, practice and research* [pp. 154-173]. New York, NY: Wiley.
- Sadock, B.J., & Sadock, V.A. (2003). *Kaplan and Sadock's synopsis of psychiatry* (9th edition). Philadelphia, PA: Lippincott Williams & Wilkins.

- Schonteich, M., & Louw, A. (2001). *Crime in South Africa: A country and cities profile*. Institute for Security Studies Paper 49, April 2001 [Available online <http://www.iss.co.za/Pubs/Papers/49/Paper49.html>]
- Schroder, J., De La Chapelle, A., Hakola, P., & Vikkurnen, M. (1981). The frequency of XYY and XXY men among criminal offenders. *Acta Psychiatria Scandinavica*, 63, 272-276.
- Schwartz, J. (1999). *Cassandra's daughter: A history of psychoanalysis*. London: Penguin Books.
- Searles, H. (1959). The effort to drive the other person crazy: An element in the etiology and psychotherapy of schizophrenia. *British Journal of Medical Psychology*, 32, 1-18.
- Sears, D. (1991). *To kill again: The motivation and development of serial murder*. Wilmington, DE: Scholarly Resource Books.
- Selltiz, C., Jahoda, M., Deutsch, M., & Cook, S.W. (1959). *Research methods in social relations*. New York, NY: Holt, Rinehart & Winston.
- Seltzer, M. (1998). *Serial killers: Life and death in America's wound culture*. London: Routledge.
- Selvini-Palazzoli, M., Boscolo, L., Cecchin, G., & Prata, G. (1978). *Paradox and counterparadox: A new model in the therapy of the family in schizophrenic transaction*. New York, NY: Jason Aronson
- Shorter, E. (1975). *The making of the modern family*. New York, NY: Basic Books.
- Siegel, L. (2000). *Criminology*. Belmont, CA: Wadsworth.
- Simons, E. (Producer) & Kikoine, G. (Director). (1989). *Edge of Sanity* (Motion picture). United Kingdom: Metro Goldwyn Meyer.
- Simpson, P. (1999). Introduction: The serial killer in fiction. In P.Simpson (Ed.), *Psycho paths: Tracking the serial killer through contemporary American film and fiction* [pp. 1-11]. Carbondale, IL: Southern Illinois University Press.
- Sluzki, C., & Veron, E. (1971). The double-bind as a universal pathogenic situation. *Family Process*, 10, 397-417.
- Smith, D.L. (1996). Psychodynamic therapy: The Freudian approach. In W. Dryden (Ed.), *Handbook of individual therapy* [pp. 19-25]. London: Sage.
- Smith, H.W. (1975). *Strategies of social research*. Englewood Cliffs, NJ: Prentice Hall.
- Spence, K.W. (1936). The nature of discrimination learning in animals. *Psychological Review*, 43, 427-449.
- Stack, C. (1974). *All our kin*. New York, NY: Harper & Row.
- Stafford-Clark, N. (Producer) & Fletcher, M. (Director). (1993). *Deadly Advice* (Motion picture). United Kingdom: Castle Hill.
- Stephenson, G. (1992). *The psychology of criminal justice*. Oxford: Blackwell.
- Stote, R., & Standing, L. (1995). Serial and multiple homicide: Is there an epidemic? *Social Behaviour and Personality*, 23, 313-318.
- Sutherland, E. (1937). *The professional thief*. Chicago, IL: University of Chicago Press.
- Tannahill, R. (1992). *Sex in history: Revised and updated*. Oxford, UK: Scarborough House.
- Tolman, E.C. (1951). *Collected papers in psychology*. Los Angeles, CA: University of California Press.
- Toman, W. (1961). *Family constellation*. New York, NY: Springer Publishing Company.
- Trochim, W. (2002). *Non-probability sampling*. London: Routledge.
- Tuck, M., & Riley, D. (1986). The theory of reasoned action: A decision theory of crime. In D.B. Cornish & R.V. Clarke (Eds.), *The reasoning criminal* [pp. 34-48]. New York, NY: Springer.
- Turrell, R. (2001). Muti ritual murder in Natal: From chiefs to commoners (1900-1930). *South African Historical Journal*, 44, 21-39.
- Turvey, B. (1998). *Deductive criminal profiling: Comparing applied methodologies between inductive and deductive profiling techniques*. Scientific Offender Profiling Resource, Switzerland.

- Vachss, A. (1993). Sex predators can't be saved. *New York Times*, January 5.
- Von Bertalanffy, L. (1968). *General systems theory*. New York, NY: Braziller
- Wachtel, E. (1982). The family psyche over three generations: The genogram revisited. *Journal of Marital and Family Therapy*, 8, 335-343.
- Warren, J.I., Hazelwood, R.R., & Dietz, P.E. (1996). The sexually sadistic serial killer. *Journal of Forensic Science*, 41, 970-974.
- Watzlawick, P., Beavin, J.H., & Jackson, D.D. (1967). *Pragmatics of human communications: A study of interactional patterns, pathologies and paradoxes*. New York, NY: Norton.
- Weekly Mail and Guardian. (1995). *Still no end to serial killings*. 22 September.
- Weiten, W. (1995). *Psychology: Themes and variations*. Pacific Grove, CA: Brooks/Cole.
- Whitman, T.A., & Akutagawa, D. (2003). Riddles in serial murder: A synthesis. *Aggression and Violent Behaviour*, 23(1), 19-24 .
- Wilson, C. (2000). *The mammoth book of murder*. London: Robinson.
- Woolgar, S. (1988). *Science: The very idea*. Chichester: Ellis Horwood.
- Wright, J., & Hensley, C. (2003). From animal cruelty to serial murder: Applying the graduation hypothesis. *International Journal of Offender Therapy and Comparative Criminology*, 47 (1), 71-88.
- Yin, R.K. (1994). *Case study research: Design and methods*. Thousand Oaks, CA: Sage.
- Yochelson, S., & Samenow, S.E. (1976). *The criminal personality volume 1: A profile for change*. New York, NY: Jason Aronson.
- Ziehl, S.C. (2001). Documenting changing family patterns in South Africa: Are census data of any value? *African Sociological Review*, 5(2), 1-5.