

**THE STABILITY OF THE CURVE OF SPEE
AND THE OVERBITE
AFTER ORTHODONTIC TREATMENT**



**JOHANNES HATTINGH
BChD (Pret)**

2003

THE STABILITY OF THE CURVE OF SPEE
AND THE OVERBITE
AFTER ORTHODONTIC TREATMENT

by

JOHANNES HATTINGH
BChD (Pret)

Submitted in partial fulfilment of the
requirements for the degree of

MASTER IN DENTISTRY (ORTHODONTICS)

at the
Department of Orthodontics
in the
Faculty of Health Sciences
of the
University of Pretoria

Study leader: Professor S.T. Zietsman

May 2003

“Never regard study as a duty, but as the enviable opportunity to learn to know the liberating influence of beauty in the realm of the spirit for your own personal joy and to the profit of the community to which your later work belongs”

- Albert Einstein -

DEDICATION

**This dissertation is dedicated to my wife, Marina,
and my two children, Johné and Ruan.**

Thank you for understanding.

ACKNOWLEDGEMENTS

My sincerest thanks to the following people who contributed to this dissertation:

Prof ST Zietsman, my study leader, for his time and support during this study, but above all, for sharing his wisdom and sense of humour.

Prof AGH McCollum, for his willingness to act as external examiner. His involvement lends credibility to this project.

Dr Piet Becker of the Medical Research Council, for the statistical analysis, advice on the interpretation of the results, and for providing a human touch to statistics.

Drs Birgit Scherman, Pierre Ferreira, and their staff, for allowing me into their practices, and for going out of their way to collect, sort, and supply dental casts and other records for this study.

Dr Dharmesh Mistry, for sacrificing a lot of his time to assist me with the photography of the dental casts, and for expert advice on computer software and the electronic analysis during the project.

My co-registrars, and lecturers in the Department of Orthodontics, for assisting with the re-measurement of the curve of Spee to determine the inter-examiner reliability of the measuring procedure.

Mss Reinette de Wet and Antoinette Wolmarans, for their assistance with the scheduling of patients for the project, and for their involvement with the impression taking and manufacturing of the dental casts.

All the patients that took part in the study, for attending the follow-up appointment, and for giving consent that their records can be used for research purposes.

DECLARATION

I, Johannes Hattingh, declare that the dissertation I am herewith submitting for the degree MChD (Orthodontics) at the University of Pretoria, is my own work and has not previously been submitted for any other degree at any other university.

J. Hattingh

5 May 2003

CONTENTS

SUMMARY	x
OPSOMMING	xiii
LIST OF FIGURES	xvi
LIST OF TABLES	xviii

CHAPTER 1

INTRODUCTION

1.1 BACKGROUND	1
1.2 MOTIVATION	5
1.3 PURPOSE	6
1.4 HYPOTHESES	6
1.4.1 Null hypothesis (H₀₁)	6
1.4.2 Null hypothesis (H₀₂)	6
1.4.3 Null hypothesis (H₀₃)	6
1.4.4 Null hypothesis (H₀₄)	6

CHAPTER 2

REVIEW OF THE LITERATURE

2.1 THE CURVE OF SPEE	7
------------------------------	---

2.1.1	Definitions	7
2.1.2	Stability and relapse	10
2.1.3	The role of differential horizontal growth	13
2.1.4	Arch length considerations	14
2.2	THE CONCEPT OF FUNCTIONAL OCCLUSION	16
2.2.1	Definitions	16
2.2.2	The goals of an ideal functional occlusion	21
2.2.3	The relationship between static and functional occlusion	23

CHAPTER 3

MATERIALS AND METHODS

3.1	SAMPLE	25
3.2	MEASUREMENT OF THE CURVE OF SPEE	29
3.2.1	The photographic setup	31
3.2.2	Computerized analysis of the photographs	42
3.3	MEASUREMENT OF THE OVERBITE	48
3.4	EVALUATION OF THE FUNCTIONAL OCCLUSION	50
3.5	STATISTICAL ANALYSIS	54

CHAPTER 4

RESULTS

4.1	INTRACLASS REPEATABILITY AND INTERCLASS RELIABILITY	55
4.2	ANALYSIS OF THE RESULTS	57
4.2.1	Means, standard deviations and distributions	57
4.2.2	Determination of statistical significance (P values)	68

4.2.3 Determination of correlation coefficients	73
4.2.4 Relation between both the curve of Spee and overbite, and the presence of anterior guidance at T3	78

CHAPTER 5 DISCUSSION

DISCUSSION	86
-------------------	----

CHAPTER 6 CONCLUSIONS

CONCLUSIONS	104
--------------------	-----

LITERATURE REFERENCES	108
------------------------------	-----

ADDENDA

ADDENDUM A: EVALUATION OF FUNCTIONAL OCCLUSION	118
ADDENDUM B: CONSENT	119
ADDENDUM C: RAW DATA FOR MEASUREMENT OF THE CURVE OF SPEE	120
ADDENDUM D: RAW DATA FOR DETERMINATION OF INTRA-EXAMINER REPEATABILITY AND INTER-EXAMINER RELIABILITY	124

SUMMARY

THE STABILITY OF THE CURVE OF SPEE AND THE OVERBITE AFTER ORTHODONTIC TREATMENT

by

Johannes Hattingh

Department of Orthodontics

Faculty of Health Sciences

University of Pretoria

Study leader:

Professor S.T. Zietsman

BDS, HdipDENT (Wits); DTVG, MChD (Pret)

Research Consultant

Department of Orthodontics

Faculty of Health Sciences

University of Pretoria

Department:

Orthodontics

Degree:

MChD (Orthodontics)

The aim of orthodontic treatment is to provide the patient with a good static and functional occlusion. During research that was conducted to complete a seminar on the static and functional aspects of occlusion, the author discovered that there might be a discrepancy between the goals of an ideal static occlusion, and the goals of an ideal functional occlusion. An ideal static occlusion seemed to require a flat mandibular plane and a minimal amount of overbite after active orthodontic treatment, whereas an ideal functional

occlusion required a curved mandibular plane and an overbite of 4 mm to prevent cusp interferences during functional mandibular movements.

The rationale behind the excessively flat mandibular plane and minimal overbite after orthodontic treatment is to compensate for the tendency of the bite to deepen during the period following orthodontic treatment. This tendency to relapse causes uncertainty about the stability of orthodontic treatment. Little research has been dedicated to examining the long-term stability of the leveled curve of Spee. In addition, there seems to be a considerable amount of controversy surrounding the long-term stability of overbite correction after orthodontic treatment.

The aim of this study was to evaluate the stability of the curve of Spee and the overbite following orthodontic treatment. In addition, the relationship between the curve of Spee and the presence of anterior guidance after a period of orthodontic retention, was examined. The relationship between the overbite and the presence of anterior guidance was also examined, and the results were used to predict an ideal value for the overbite to avoid possible dental cusp interferences.

Standardized digital photographs of the dental casts of 40 subjects were taken at three different stages: before treatment (T1), after orthodontic treatment (T2), and three years (mean) post-treatment. Accurate electronic measurement of the curve of Spee, using computer software, was completed for all three stages. The overbite was measured with a dial caliper. Clinical evaluation of the functional occlusion, with special reference to anterior guidance, was performed on all the subjects. Statistical analysis was carried out in search of statistical significant changes between the various stages, and possible correlations between the different variables.

The results indicated that the leveling of the curve of Spee is a stable treatment procedure. The overbite was less stable than the curve of Spee,

and nearly half the amount of overbite correction obtained during treatment, relapsed in the three years (mean) post-treatment. No relationship was found between the curve of Spee and the presence of anterior guidance at T3. A highly significant relationship was found between the overbite and the presence of anterior guidance. Subjects with a small overbite seemed to be predisposed to posterior interferences during mandibular protrusion.

An overbite of not less than 3mm was found to be a desirable feature after orthodontic retention in order to reduce potentially interfering contacts. More research is necessary to clarify the relationship between dental interferences and temporomandibular disorders (TMD).

OPSOMMING

DIE STABILITEIT VAN DIE KURWE VAN SPEE EN DIE OORBYT NA ORTODONTIESE BEHANDELING

deur

Johannes Hattingh

Departement van Ortodonsie

Fakulteit van Gesondheidswetenskappe

Universiteit van Pretoria

Studie leier:

Professor S.T. Zietsman

BDS, HdipDENT (Wits); DTVG, MChD (Pret)

Navorsings Konsultant

Departement van Ortodonsie

Fakulteit van Gesondheidswetenskappe

Universiteit van Pretoria

Departement:

Ortodonsie

Graad:

MChD (Ortodonsie)

Die doel van ortodontiese behandeling is om die pasiënt van 'n goeie statiese en funksionele okklusie te voorsien. Gedurende navorsing wat gedoen is om 'n seminar oor die statiese en funksionele aspekte van okklusie te voltooi, het die skrywer ontdek dat daar moontlik 'n teenstrydigheid bestaan tussen die doelwitte van 'n ideale statiese okklusie, en die doelwitte van 'n ideale funksionele okklusie. 'n Ideale statiese okklusie vereis 'n plat mandibulêre vlak en 'n minimum oorbyt, terwyl 'n ideale funksionele okklusie 'n gekurfde

mandibulêre vlak en 'n oorbyt van 4mm vereis om kuspe struikelings tydens funksionele mandibulêre bewegings te voorkom.

Die rasionaal agter die plat mandibulêre vlak en minimale oorbyt na aktiewe ortodontiese behandeling is om te kompenseer vir die neiging van die byt om te verdiep gedurende die periode na ortodonsie behandeling. Hierdie neiging tot terugval veroorsaak onsekerheid oor die stabiliteit van ortodonsie behandeling. Min navorsing is tot dusver gedoen aangaande die langtermyn stabiliteit van die kurwe van Spee. Boonop bestaan daar baie kontroversie oor die langtermyn stabiliteit van oorbyt korreksie na ortodontiese behandeling.

Die doel van hierdie studie was om die stabiliteit van die kurwe van Spee en die oorbyt na ortodontiese behandeling te evalueer. Die verband tussen die kurwe van Spee en die teenwoordigheid van 'n anterior gidshelling na 'n periode van ortodontiese retensie is ook ondersoek. Die verband tussen die oorbyt en die teenwoordigheid van 'n anterior gidshelling is ondersoek, en die resultate is gebruik om 'n ideale waarde vir die oorbyt, waarby kuspe struikelinge moontlik verhoed sal kan word, te voorspel.

Gestandaardiseerde digitale fotos is geneem van die studie modelle van 40 pasiënte gedurende drie verskillende stadia: voor behandeling (T1), direk na ortodontiese behandeling (T2), en drie jaar (gemiddeld) na behandeling. Akkurate elektroniese meting van die kurwe van Spee is met behulp van rekenaar sagteware vir al drie stadia van ondersoek gedoen. Die oorbyt is met behulp van 'n meetpasser bepaal. Kliniese evaluasie van die funksionele okklusie, met spesifieke verwysing na anterior gidshelling, is gedoen op al die pasiënte. Statistiese analise is uitgevoer op soek na moontlike statisties betekenisvolle veranderinge tussen die onderskeie stadia, asook om potensiële korrelasies tussen die veranderlikes te identifiseer.

Die resultate bevestig dat die afplatting van die kurwe van Spee 'n stabiele behandelings prosedure is. Die oorbyt was minder stabiel as die kurwe van Spee, en byna die helfde van die oorbyt korreksie wat tydens behandeling verkry is, het teruggeval gedurende die drie jaar (gemiddeld) na behandeling. Geen verwantskap kon gevind word tussen die kurwe van Spee en die teenwoordigheid van 'n anterior gidshelling tydens T3 nie. 'n Hoogs betekenisvolle verwantskap tussen die oorbyt en die teenwoordigheid van 'n anterior gidshelling is gevind. Dit blyk dat 'n klein oorbyt aanleiding kan gee tot posterior struikelinge tydens mandibulêre protrusie.

'n Oorbyt van nie minder nie as 3mm is geïdentifiseer as 'n behandelingsdoelwit om die kans op kuspe struikeling na ortodontiese behandeling te verminder. Meer navorsing moet nog gedoen word om die verwantskap tussen kuspe struikelinge en temperomandibulêre patologie te verifieer.

LIST OF FIGURES

Figure 1:	Curves generated through (a) anterior border of condyle and occlusal surfaces of molars, and (b) through occlusal surfaces of molars and incisor tips	8
Figure 2:	Anterior guidance during mandibular movement	20
Figure 3:	Canine guidance during mandibular movement	20
Figure 4:	Group function guidance during mandibular movement	20
Figure 5:	The mandibular occlusal plane trimmed parallel to the base of the mandibular dental cast	32
Figure 6:	The dental surveyor	32
Figure 7:	Spirit-levels were used to standardize dental casts in the sagittal and transverse dimensions	33
Figure 8:	The spirit-level from an occlusal view	34
Figure 9:	The analysing rod of the dental surveyor was used to standardize the vertical height of the dental casts	35
Figure 10:	The positions of the dental surveyor and tripod of the camera marked on a black sheet of cardboard	36
Figure 11:	The dental surveyor (without mounting platform) and tripod with camera in position	36
Figure 12:	Illustration that the line of incidence of the camera was perpendicular to the midline through the dental surveyor	37
Figure 13:	Spatial orientation of the dental cast on the base of the dental surveyor (surveyor removed for demonstration purposes)	38
Figure 14:	An angle finder with millimetre ruler used for calibration of photographs	38
Figure 15:	The angle finder/ruler as part of the photographic setup	39
Figure 16:	Dental casts were numbered for easy identification	39
Figure 17:	Setup of the dental cast and surveyor	40
Figure 18:	Complete photographic setup (rear view)	40
Figure 19:	Complete photographic setup (side view)	41

Figure 20:	Complete photographic setup (occlusal view)	41
Figure 21:	Measurement of the curve of Spee	43
Figure 22:	A standard millimetre ruler (yellow) superimposed upon the image – before calibration	44
Figure 23:	A standard millimetre ruler (yellow) superimposed upon the image – after calibration	45
Figure 24:	Construction of reference and perpendicular lines in CorelDRAW®10	46
Figure 25:	Measurement of the curve of Spee (T1)	47
Figure 26:	Measurement of the curve of Spee (T2)	47
Figure 27:	Measurement of the curve of Spee (T3)	48
Figure 28:	Dial caliper used for measurement of the overbite	49
Figure 29:	Measurement of the overbite	50
Figure 30:	Graphic representation of the left side curve of Spee at T1, T2 and T3	64
Figure 31:	Graphic representation of the right side curve of Spee at T1, T2 and T3	64
Figure 32:	Graphic representation of the total curve of Spee at T1, T2 and T3	65
Figure 33:	Histogram of the mean overbite at T1, T2 and T3	67
Figure 34:	Histogram of relapse of the curve of Spee and overbite (%)	72
Figure 35:	Scatter diagram indicating the relative stability of the curve of Spee as a treatment procedure	77
Figure 36:	Scatter diagram indicating the relative stability of overbite correction as a treatment procedure	77
Figure 37:	Variation in mean values for the curve of Spee between the subgroups at T3	82
Figure 38:	Variation in mean values for the overbite between the subgroups at T3	82
Figure 39:	Prevalence of anterior guidance for overbite > 3mm	84
Figure 40:	Prevalence of anterior guidance for overbite < 3mm	84
Figure 41:	Fixed and variable determinants of the occlusion	99

LIST OF TABLES

Table 1:	General information of the study sample	27
Table 2:	Age distribution of the total sample	28
Table 3:	Age distribution of the subsample	28
Table 4:	Intraclass and interclass correlations for re-measurement of the curve of Spee	55
Table 5:	Intraclass and interclass reliability for measurement of the curve of Spee using actual differences between measurements	57
Table 6:	Measurement of the curve of Spee (CoS) at T1 (pre-treatment)	58
Table 7:	Measurement of the curve of Spee (CoS) at T2 (post-treatment)	59
Table 8:	Measurement of the curve of Spee (CoS) at T3 (follow-up)	60
Table 9:	Mean values for the curve of Spee at T1, T2 and T3	61
Table 10:	Means, standard deviations, and distributions for the curve of Spee at T1, T2 and T3	62
Table 11:	Mean values for individual measurements used to calculate the curve of Spee on the left side only	63
Table 12:	Mean values for individual measurements used to calculate the curve of Spee on the right side only	63
Table 13:	Mean values for individual measurements used to describe the total curve of Spee	65
Table 14:	Mean values for the overbite at T1, T2 and T3	66
Table 15:	Means, standard deviations, and distributions for the overbite at T1, T2 and T3	67
Table 16:	Means, standard deviations, and P values for the changes in the curve of Spee between the various stages for the total group	68

Table 17:	Means, standard deviations, and P values for the changes in the curve of Spee between the various stages for the two subgroups	70
Table 18:	Means, standard deviations, and P values for the changes in the overbite between the various stages for the total group	71
Table 19:	Correlation coefficients for the different parameters tested	73
Table 20:	Prevalence of anterior guidance at T3	79
Table 21:	Relationship between the presence or absence of anterior guidance, and the curve of Spee at T3	80
Table 22:	Relationship between the presence or absence of anterior guidance, and the overbite at T3	81
Table 23:	Mean values for the curve of Spee and overbite in two comparative studies	90

CHAPTER 1

INTRODUCTION

1.1 BACKGROUND

Edward H. Angle, the father of modern orthodontics, is credited with the definition of normal occlusion as well as the first classification of malocclusion. According to this definition, normal occlusion exists when the mesiobuccal cusp of the upper first permanent molar occludes in the groove between the mesial and middle buccal cusps of the lower first permanent molar (Proffit and Fields, 2000). This definition of occlusion, based on a static position of the teeth in closure, launched orthodontics as the specialty of dentistry dedicated to treating deviations from Angle's definition of normal occlusion (Aronowitz, 1996).

Clinical experience and observations of treatment results, however, had increasingly pointed to the fact that the positioning of the mesiobuccal cusp within the buccal groove alone could be inadequate in providing an ideal static occlusion. Too many models displaying that vital cusp-embrasure relationship had, even after orthodontic treatment, obvious inadequacies, despite an acceptable molar relationship as described by Angle.

The search to define more characteristics of normal occlusion continued and, after extensive research, Lawrence F. Andrews identified six characteristics that were present in 120 non-orthodontic models that displayed normal occlusion. More importantly, the absence of any one or more of the six characteristics resulted in a proportionally less normal or ideal static occlusion. Andrews described the six characteristics as 'The six keys to normal occlusion' and

concluded that, because nature's non-orthodontic normal models provide such a beautiful and consistent guideline, orthodontists should, when possible, use these guidelines as a measure of the ideal static occlusal relationship for successful orthodontic treatment (Andrews, 1972). Today, Andrews' six keys to normal occlusion are widely regarded as the treatment goal of an ideal static occlusion and orthodontists use them as a guideline for a well-finished orthodontic case.

The sixth key to normal occlusion relates to the occlusal plane. The planes of occlusion found on the non-orthodontic normal models ranged from flat to slight curves of Spee. Even though not all of the non-orthodontic normals had flat planes of occlusion, Andrews believes that a flat plane should be a treatment goal as a form of over-treatment.

According to Andrews (1972), there is a natural tendency for the curve of Spee to deepen with time, because the lower jaw's downward and forward growth is faster and continues longer than that of the upper jaw. As a result, the lower anterior teeth, which are confined by the upper anterior teeth and lips, are forced back and up, resulting in crowded lower anterior teeth, a deeper overbite and/or deepening of the curve of Spee.

In addition, intercuspatation of teeth is best when the plane of occlusion is relatively flat. A deep curve of Spee results in a more contained area for the upper teeth, making normal occlusion impossible. For these reasons, it seems reasonable to treat the mandibular plane of occlusion until it is flat or somewhat reverse, to ensure the best possible static occlusion after orthodontic treatment, and to compensate for the inherent relapse tendency of the curve of Spee after treatment (Andrews, 1972).

The concept of functional occlusion, which focuses on occlusal contacts during functional mandibular movements, is gaining popularity among orthodontists. The aim of functional occlusion is to coordinate the occlusion with TMJ function and thereby ensure maximum protection and long-term health of the TMJ, masticatory musculature, teeth and periodontium.

According to Roth (1981a), achieving functional occlusion may increase stability of post-treatment tooth positions and alignment, and ensure comfort, efficiency and longevity of the dentition, supporting structures, and the temporomandibular joints. Achievement of an ideal static occlusion remains important, but is now considered only part of the broader goal of an ideal final result. Roth (1981a) stated: "In dentistry and in the specialty of orthodontics, functional occlusion (or gnathologic considerations) should not just be an add-on or an afterthought. Providing a good functional occlusion should be a primary goal with definite, measurable criteria."

The first objective of a good functional occlusion is to obtain a stable centric relation of the mandible and have the teeth intercusp maximally at this mandibular position. Centric relation will permit seating of the condyles into the glenoid fossa at the most superior position, against the eminentia, and also centered in the transverse plane of space. In an ideal orthodontic finish, this condylar position should occur when the upper and lower teeth are closed into maximum intercuspation (Kasrovi, Meyer and Nelson, 2000).

The second objective of a good functional occlusion is to have a harmonious glide path of the anterior teeth working against each other to separate or disclude the posterior teeth immediately, but gently, as soon as the mandible moves out of centric closure. The glide path provided by the anterior teeth (anterior guidance) must be in harmony

with the way in which the mandible moves through its border excursions. In this way, a "mutually protective" occlusal scheme is established, where the anterior teeth protect the posterior teeth from lateral stress during movement, and the posterior teeth protect the anterior teeth from lateral stress during closure into centric relation occlusion (Roth, 1981b). Thus, in a mutually protective occlusal scheme, the mandible can execute its total range or envelope of motion without interference from the teeth. In turn, the teeth will direct and maintain centricity of the condyles in the fossae in closure.

A prerequisite for obtaining anterior guidance during protrusive mandibular movement is sufficient overbite and overjet at the maxillary incisor tips to allow for a gentle glide path against which the posterior teeth can be discluded. In addition, according to Klineberg (1992), a curved (not flat) occlusal plane is necessary to allow protrusive contact of incisor teeth without posterior tooth interferences.

Roth (1997) summarized the goals of an ideal functional occlusion by formulating an occlusal scheme. According to this scheme, the goals of an ideal functional occlusion include: Maximum intercuspation with condyles seated in centric relation, **4mm of vertical overbite**, 2 to 3 mm of overjet, slight clearance between the incisal edges and cusp tips of mandibular incisors and canines with the lingual surfaces of the maxillary canines and incisors and mesioaxial inclination of the maxillary canines to effect canine lift.

Roth (1997) continues: "On right and left lateral excursions the canines should engage and all posterior teeth should disengage or disclude. On protrusive excursions, the incisors should engage and all posteriors disclude. **The occlusal plane should have a gentle curve of Spee** and should diverge as much as possible from the slope of the eminentia. This is a mutually protected occlusal scheme for the

natural dentition and permits proper anterior and canine guidance with posterior disclusion. This scheme works well for the natural dentition.”

Where does this leave the orthodontist in terms of treatment goals set for his patients? According to Andrews' sixth key, a flat or even slight reverse occlusal plane should be a treatment goal, with the assumption that the curve of Spee will deepen with time. In addition, orthodontic patients usually display a small overbite after treatment to allow/compensate for the tendency of the bite to deepen during the period following orthodontic treatment.

On the other hand, according to the treatment goals for an ideal functional occlusion, a gentle curve of Spee and an overbite of 3-4mm are necessary to ensure anterior guidance without posterior tooth interferences during protrusive mandibular movement. A good functional occlusion, in turn, is believed to contribute to long-term health of the teeth, periodontium and TMJ.

1.2 MOTIVATION

At the end of orthodontic treatment, the occlusion usually resembles a "bilaterally balanced" occlusal scheme during mandibular excursions. In other words, there is often insufficient anterior guidance to ensure posterior disclusion during protrusive mandibular movement. This happens because the curve of Spee is levelled, and the overbite is overcorrected during orthodontic treatment, to compensate for the natural tendency of the bite and the curve of Spee to deepen with time.

This orthodontic treatment philosophy is therefore based upon the assumption that the curve of Spee and the overbite will deepen after appliance removal, to provide a more ideal anterior guidance.

The question is: (a) Does this deepening of the Curve of Spee and overbite occur after orthodontic treatment, and (b) if it does, will the changes be adequate to ensure that the goal of anterior guidance is met?

1.3 PURPOSE

The purpose of this study was to evaluate

- the stability of the curve of Spee after orthodontic treatment,
- the stability of the overbite after orthodontic treatment,
- the relationship between the curve of Spee and the presence of anterior guidance after a period of orthodontic retention, and
- the relationship between the overbite and the presence of anterior guidance after a period of orthodontic retention.

1.4 HYPOTHESES

1.4.1 Null hypothesis (H₀1)

The leveling of the curve of Spee during orthodontic treatment is not a stable treatment procedure.

1.4.2 Null hypothesis (H₀2)

The correction of the overbite during orthodontic treatment is not a stable treatment procedure.

1.4.3 Null hypothesis (H₀3)

No relationship exists between the curve of Spee and the presence of anterior guidance after a period of orthodontic retention.

1.4.4 Null hypothesis (H₀4)

No relationship exists between the overbite and the presence of anterior guidance after a period of orthodontic retention.

CHAPTER 2

REVIEW OF THE LITERATURE

2.1 THE CURVE OF SPEE

2.1.1 Definitions

The curve of Spee represents the alignment of the occlusal surface of the mandibular teeth according to their individual positions in the arch. According to De Praeter, Dermaut, Martens and Kuijpers-Jagtman (2002), the curve of Spee was first described by F. Graf von Spee in 1890. He used skulls with abraded teeth to define a line of occlusion. That line of occlusion lies on a cylinder that is tangent to the anterior border of the condyle, the occlusal surface of the second molar, and the incisal edges of the mandibular incisors. Spee located the center of this cylinder in the mid-orbital plane so that it had a radius of 6.5 to 7.0 cm (65 to 70mm).

After an English translation of Graf von Spee's original work became available, some of his hypotheses were tested on a group of Stone Age skulls (Spee, Biedenbach, Hotz and Hitchcock, 1980; Hitchcock, 1983). Hitchcock (1983) establishes that a circle through contact points on the anterior border of the condyle and the occlusal surfaces of the second and first mandibular molars generates a radius with an average length of 69.1mm, which is comparable in length to what Spee originally proposed. In most of the sample, however, the incisor tips could not be included along the arc generated from such a curve (Figure 1a).

Clinically, the curve of Spee is determined by the distal marginal ridges of the most posterior teeth in the arch and the incisal edges of the central incisors (Hitchcock, 1983). However, if the anterior border of

the condyle is excluded from the arc when measuring the curve of Spee, and the curve is constructed only from contact points on the occlusal surfaces of the molars and incisor tips, the radius of the arc will be very different. Using only occlusal landmarks to construct the curve of Spee, Hitchcock (1983) calculated an average radius of 225.2mm for the curve of Spee (Figure 1b).

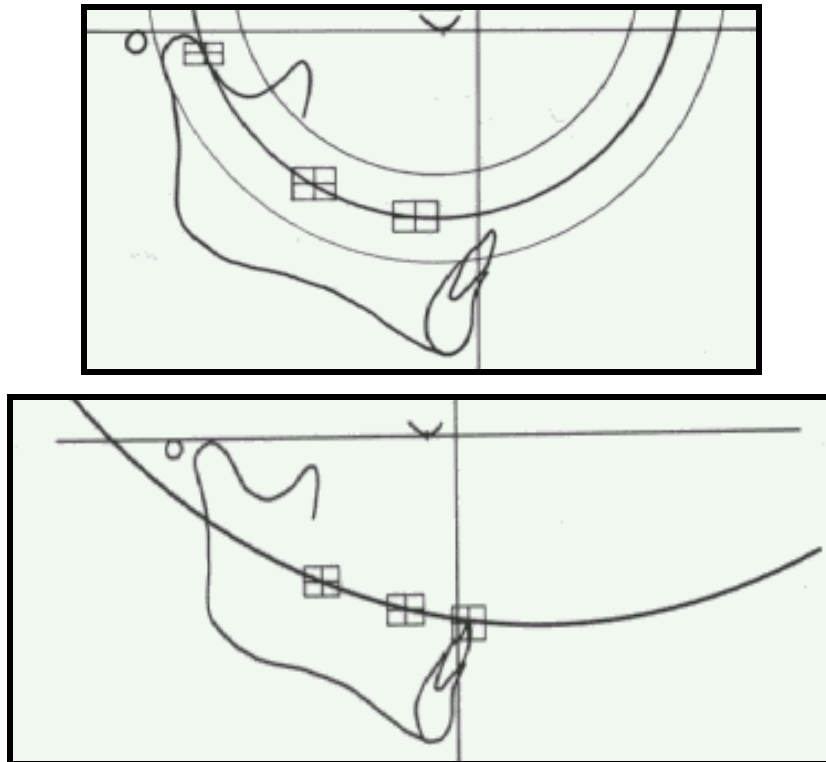

Figure 1: Curves generated through (a) anterior border of condyle and occlusal surfaces of molars, and (b) through occlusal surfaces of molars and incisor tips (Hitchcock, 1983)

According to the glossary of prosthodontic terms (1994), the curve of Spee is defined as the anatomic curve established by the occlusal alignment of the teeth, beginning with the cusp tip of the mandibular **canine** and following the buccal cusp tips of the premolar and molar teeth, continuing through the anterior border of the mandibular ramus, and ending at the anterior-most portion of the mandibular condyle. Similar definitions are given by Ramfjord and Ash (1971) and Okeson (2003).

Dawson (1989) proposes an identical radius of 4 inches (101.6 mm) for all patients undergoing occlusal reconstruction. Orthlieb (1997), however, determines a mean radius of approximately 80mm for the curve of Spee during a cephalometric analysis of 470 patients. In addition, there was extreme variability between the individual measurements, with the radius of the curve of Spee ranging between 40 and 150mm. The standard deviation between the measurements was greater than 20mm. Because of this large variability in the observed radius of the curve of Spee, Orthlieb (1997) questions the validity of a standard radius for all patients during extensive occlusal reconstruction.

Ferrario, Sforza, Poggio, Serrao and Colombo (1999) compared the curvature of the mandibular dental arch in healthy permanent dentitions of young adults and adolescents. Results indicate that the occlusal curvature of the mandibular arch is not significantly influenced by sex, but age has a significant effect on the radius of the curve of Spee. The radii of the left and right curves of Spee were about 101mm in adults, an about 80mm in adolescents. They conclude that the different curvatures of the occlusal plane in adolescents and adults may be explained by a progressive rotation of the major axis of the teeth, moving the occlusal plane toward a more buccal position.

From the available literature, it is evident that there isn't agreement on the precise definition and morphology of the curve of Spee. The "clinical" curve of Spee, as used in orthodontics, differs substantially from the "original" curve of Spee, as described by Von Spee, and the definition for the curve of Spee in the prosthodontic literature. For instance, if the anterior condylar border is included in the measurement of the curve, it will be impossible to obtain a "flat" curve of Spee during orthodontic treatment. A flat occlusal plane is certainly a more appropriate term to describe the goal of orthodontic treatment.

2.1.2 Stability and relapse

The human craniofacial skeleton and its associated dental arches undergo visible alterations as they grow, adapt, and age. Relatively rapid changes occur during the transitional dentition, and once a functional permanent dentition is established, smaller changes continue to be observed throughout life. Findings from a cephalometric study by Behrents (1985) provide indisputable evidence that craniofacial growth continues well into adulthood. Given these findings, it is reasonable to assume that changes also occur in the associated dental arches. An understanding of the mechanisms underlying these slowly occurring changes in supposedly non-growing adults is essential in the understanding of stability after orthodontic treatment.

Stability and long-term changes of the dental arches have been studied extensively in both orthodontically treated (Little, 1990; Rossouw, Preston and Lombard, 1999) and orthodontically untreated (Bishara, Treder and Jakobsen, 1994; Carter and McNamara, 1998) populations.

Carter and McNamara (1998) examined changes in the dental arches that occur in untreated persons between late adolescence and the fifth or sixth decade of life. Overjet, overbite, curve of Spee, and incisor irregularity were measured directly from the dental casts. Results indicate that, in general, overbite, overjet, and curve of Spee remain stable during adulthood (in an untreated population).

Bishara, Treder and Jakobsen (1994) studied the dentofacial changes occurring between 25 and 46 years of age in an untreated, normal sample. The findings indicate that both males and females exhibited statistically significant increases in antero-posterior and vertical skeletal facial dimensions. In addition, a statistically significant increase in overbite was noted in females, but not in males. However, all these changes were small in magnitude, and their clinical relevance are

rather limited, as generally, the results of the study will not significantly influence orthodontic treatment planning.

The long-term outcome of orthodontic treatment has traditionally been studied by recording measurements from study casts taken before treatment, at the end of active treatment, and a number of years post-treatment or post-retention. Most studies measure treatment outcome and stability in terms of changes in intra-arch dimensions such as intermolar distance, intercanine distance, arch depth and arch circumference. There has especially been a keen interest in mandibular incisor stability and the factors related to late lower incisor crowding in treated (Little, 1990) and untreated (Richardson, 1999) populations.

Some studies on long-term stability of orthodontic treatment also include measurements of the buccal segment relationships, overbite, overjet, and anterior and posterior crossbites (Sadowsky and Sakols, 1982; Sadowsky, Schneider, BeGole and Tahir, 1994). However, little research has been dedicated to examining the long-term stability of the leveled curve of Spee.

Sadowsky and Sakols (1982) examined the long-term stability of orthodontic treatment in a group of 96 patients who were treated between 12 and 35 years previously. Results indicate that 41% of patients had an excessive overbite (> 3.5 mm) at the long-term follow-up. In addition, in 16% of the cases, the overbite was worse at long-term follow-up than at pre-treatment. It appears that, even though an increased overjet (3.5 to 6.0 mm) was also present in many cases during the long-term follow-up, it was the overbite that relapsed more often. As a result, Sadowsky and Sakols (1982) suggest that more attention should be given to adequately correcting, or even

overcorrecting, deep overbite during orthodontic treatment in anticipation of the potential relapse after treatment.

Despite the tendency of many variables to return toward their pre-treatment dimensions, a certain amount of post-treatment change is quite acceptable and is often desirable to permit settling of the occlusion and the establishment of adequate incisal guidance. It is only when the dental relationships are outside a particular range that concern arises as to the success of treatment. According to Sadowsky and Sakols (1982), an excessive overjet (> 3.5 mm) or overbite (> 3.5 mm) can be esthetically and functionally acceptable by current gnathologic standards.

Sadowsky, Schneider, BeGole and Tahir (1994) evaluated long-term stability in a sample of 22 previously treated orthodontic cases in which a fixed mandibular lingual retainer was used for retention. All cases were treated non-extraction with fixed edgewise appliances and were without retainers a minimum of 5 years. Results indicate that, even though relapse of the overjet and overbite was statistically significant, the average postretention values were within normal limits, with much less relapse than in the study by Sadowsky and Sakols (1982). They conclude that the prolonged retention time may be an important factor in limiting the amount of relapse after orthodontic treatment.

Kuitert, van Ginkel and Prah-Andersen (2000) investigated the changes in form and depth of the curve of Spee during and after orthodontic treatment. Results indicate that 25% of the flat curves deteriorated after treatment. De Praeter, Dermaut, Martens and Kuijpers-Jagtman (2002) investigated the long-term stability of leveling of the curve of Spee, and conclude that the leveling of the curve of Spee is a relatively stable treatment procedure compared with the stability of incisor crowding and overbite.

2.1.3 The role of differential horizontal growth

The amount and direction of mandibular growth during the final stages of facial development are thought to be factors in the development of late mandibular incisor crowding, as well as the development of an increased anterior overbite. According to this theory, the mandible grows forward more than the maxilla, and the mandibular basal bone more than the alveolar bone after eruption of the second molars. Because the mandibular incisors are not free to move forward due to the restraining influence of the upper arch, they are forced backwards and upwards, and subsequently become retroclined and crowded.

Bjork and Palling (1954) find that mandibular prognathism increased relative to maxillary prognathism between 12 and 20 years in males, resulting in straightening of the profile and an average retroclination of 1.7° of the lower incisors. Siatowski (1974) finds an average increase in the interincisal angle of 7.4° in males and 4.6° in females between 13 and 18 years of age.

In addition, Andrews (1972) states that, because the lower jaw's downward and forward growth is faster and continues longer than that of the upper jaw, the lower anterior teeth are forced back and up, resulting in crowded lower anterior teeth, a deeper overbite and/or deepening of the curve of Spee.

Sinclair and Little (1985), however, were unable to show any relationship between lower anterior crowding and parameters expressing amount and direction of growth in 65 untreated 'normal' subjects. Richardson (1994) finds no significant differences in amount or direction of growth between the maxillary and mandibular teeth or jaws in subjects between 12 and 16 years of age. As a result, findings to support the differential growth theory are still inconclusive, and more long-term studies are needed to clarify the issue.

2.1.4 Arch length considerations

Several authors have suggested that leveling of the curve of Spee requires additional arch length. From a clinical point of view, the reduction in arch circumference that accompanies leveling is believed to lead to incisor protrusion. One popular rule of thumb for estimating the reduction in arch circumference that accompanies leveling is that 1 mm of arch circumference is needed for each millimeter of curve of Spee to be levelled, where the depth of the curve of Spee is taken as the sum of the right and left side measured to the deepest portion of the curve from a flat plane (Proffit and Ackerman, 1994).

However, Braun, Hnat and Johnson (1996) determined that the arch circumference reduction is considerably less than one-to-one, implying that the incisor protrusion often associated with leveling the curve of Spee is not primarily due to the aforementioned differential, but rather more directly due to the mechanics used during leveling the curve of Spee. They calculated that, for a severe curve of Spee with a total depth of 9 mm, the total arch circumference loss after leveling would be 2.04 mm. If this amount of arch circumference are added to the arch anterior to the canines, the incisal edges of the central incisors will be advanced by 0.78 mm, which corresponds to 3.2° of tipping of the mandibular incisors.

Germane, Staggers, Rubenstein and Revere (1992) also determined the relationship between arch circumference and the curve of Spee to be non-linear, and concluded that the clinical practice of allowing 1 mm of arch circumference for leveling each millimeter of curve of Spee overestimates the amount of arch circumference needed to flatten the curve of Spee. Clinically, this means that less than 1 mm of arch circumference is necessary to level each millimeter of the curve of Spee.

Woods (1986) indicates that incisor flaring may primarily be related to the mechanics of leveling the curve of Spee, and not necessarily due to the differential in arch circumference. He considers the lower incisors a separate segment that can be intruded or extruded independently of the buccal segments. He concludes that, as long as leveling of the curve of Spee is achieved through anterior teeth intrusion, flaring of the incisors can be avoided.

AlQabandi, Sadowsky and BeGole (1999) evaluated the effects of both round and rectangular continuous archwires on the axial inclination of lower incisors during leveling of the curve of Spee. The intention of rectangular archwires is to counteract the labial crown moment usually produced during leveling the curve of Spee with full arch mechanics.

No statistical significant difference in proclination was detected between the round and rectangular archwires. However, change in lower incisor inclination correlates significantly with relief of crowding, suggesting that the amount of crowding, and not the depth of the curve of Spee, determines the amount of incisor tipping. In addition, the lower incisor tipping can be attributed to the intrusive force being applied labial to the center of resistance of the lower incisors. The ability of rectangular archwires to control incisor proclination during leveling of the curve of Spee was not supported.

Arch length analysis should consider discrepancies not only within the sagittal plane but also within the vertical and transverse planes. The sagittal discrepancy is the amount of dental crowding. Transverse discrepancies take the form of posterior crossbites. The curve of Spee represents the vertical deviation of the occlusal plane from a flat plane of occlusion. By using appropriate biomechanics, the curve of Spee can be leveled successfully without excessive flaring of the mandibular incisors (Braun, Hnat and Johnson, 1996).

2.2 THE CONCEPT OF FUNCTIONAL OCCLUSION

2.2.1 Definitions

There is considerable confusion in the literature on various aspects of functional occlusion, and one of the reasons for this is the excessive number of definitions and their different interpretation.

According to Clark and Evans (2001), functional occlusion refers to the occlusal contacts of the maxillary and mandibular teeth during function, i.e. during speech, mastication and swallowing. During mastication and swallowing, tooth contacts occur posterior, lateral, and anterior to the intercuspal position.

Intercuspal position (ICP) is the occlusal position with the teeth in maximum intercuspatation. The term intercuspal position is synonymous with many other terms, including centric occlusion, habitual occlusion, acquired occlusion, and habitual centric (Clark and Evans, 2001). Thomson (1990) describes centric occlusion as the contact between the greatest number of opposing teeth (usually cusps and opposing fossae or marginal ridges) while the mandible is stationary.

Retruded contact position (RCP), in contrast, is the occlusal position when the first tooth contact/s occurs on the mandibular path of closure with the condyles in the retruded axis position (Clark and Evans, 2001). Alternatively, RCP can be defined as the first point of contact between the upper and lower teeth with the mandible in centric relation.

Centric relation (CR) describes the relationship between the mandible and maxilla when the condyles are placed in the most superiorly and posteriorly relaxed position in their respective glenoid fossae (Thomson, 1990). Alternatively, CR can be defined as the relationship

between the mandible and maxilla when the condyles rotate through the terminal hinge axis (retruded axis). The terminal hinge axis is an imaginary axis which runs through both condyles when the condyles rotate in the most posterior superior position in the glenoid fossa during opening and closing of the mandible. When the mandible hinge about the terminal hinge axis (retruded axis), it permits an incisal opening of 20-25mm with the condyles in the retruded axis position (RAP). Centric relation, terminal hinge axis and retruded axis position are therefore all terms to describe different aspects of the same relation.

Confusion arises from the lack of consensus on the exact location of the condyles in the glenoid fossa when they describe a pure hinge movement. The Academy of Prosthodontics (1994) describes the condyles as being located in the most superior-posterior position in the glenoid fossa. Roth (1981a) describes the location as the most superior position in the glenoid fossa with the condyles against the eminentia articularis and centered in the glenoid fossa in the transverse dimensions. Dos Santos (1998) states that, due to the irregular ovoid shape of the condyles, it may assume an uppermost and rearmost, uppermost and midmost, or an uppermost and anterior position in the glenoid fossa, when positioned in centric relation.

Okeson (2003) describes CR as the most orthopedically stable joint position as dictated by the muscles when the condyles are located in their most supero-anterior position in the articular fossae, fully seated and resting against the posterior slopes of the articular eminences. The controversy regarding the most physiologic position of the condyles will probably continue until conclusive evidence exists that one position is more physiologic than the others. The exact position of the condyles when the mandible is in centric relation is probably of little practical significance. The significance of centric relation is that it

is a border position of the mandible, and highly reproducible for several subsequent jaw registrations. As a result, it is an important reference point during occlusal diagnosis and treatment planning (Clark and Evans, 2001).

A protrusive mandibular movement occurs when the mandible moves forward from the ICP. Any area of a tooth that contacts an opposing tooth during protrusive movement is considered to be a protrusive contact (Okeson, 2003). During a lateral mandibular movement, the right and left mandibular posterior teeth move across their opposing teeth in different directions. The working side is the side that the mandible move towards during lateral excursions, while the opposite side that the mandible moves away from during lateral excursions, is called the non-working (balancing) side (Clark and Evans, 2001).

In a normal occlusal relationship, the predominant protrusive contacts occur on the anterior teeth, between the incisal and labial edges of the mandibular incisors and the lingual surfaces and incisal edges of the maxillary incisors. These are considered the guiding inclines of the anterior teeth. Therefore, **anterior guidance** (Figure 2) refers to the guidance provided by the lingual surfaces of the maxillary incisors and canines to disarticulate (disclude) the posterior teeth as the mandibular incisal edges contact them during protrusive mandibular movement (Thomson, 1990).

Three different types of posterior tooth relationship can occur during lateral excursion of the mandible (Clark and Evans, 2001):

- **Balanced occlusion:** During the entire lateral movement, posterior teeth on both the working side and the non-working side are in contact. This concept has been dismissed completely for restoring the natural dentition, although it is still useful in complete denture construction (for better stability).

- **Group function occlusion** (Figure 4): During the entire lateral movement, the buccal cusps of the posterior teeth on the working side are in contact. There is no contact between the teeth on the non-working side.
- **Canine protected occlusion** (Figure 3): During the lateral excursion, contact occurs only between the upper and lower canine, and the first premolar on the working side. There is no contact between the teeth on the non-working side.

When all the anterior teeth are examined, it becomes apparent that the canines are best suited to accept horizontal forces that occur during eccentric movements. They have the longest and largest roots and therefore the best crown/root ratio. They are also surrounded by dense compact bone, which tolerates the forces better than does the medullary bone found around posterior teeth (Okeson, 2003). In addition, according to D'Amico (1958), canine teeth have the greatest proprioception, resulting in lower levels of muscular activity during mastication and therefore decreased forces to the dental and joint structures. The shape of the palatal surface of the upper canine is also concave and suitable for guiding lateral movements.

Many patients' canines, however, are not in the proper position to accept the horizontal forces and therefore other teeth must contact during eccentric movements. The most favourable alternative to canine guidance is group function (Okeson, 2003). In group function, several teeth on the working side contact during laterotrusive movement. The most desirable group function consists of the canine, premolars and mesiobuccal cusp of the first molars. Any laterotrusive contacts more posterior than the mesial portion of the first molar are not desirable, because of the increased amount of force that can be created as the contact gets closer to the fulcrum (i.e., TMJ).

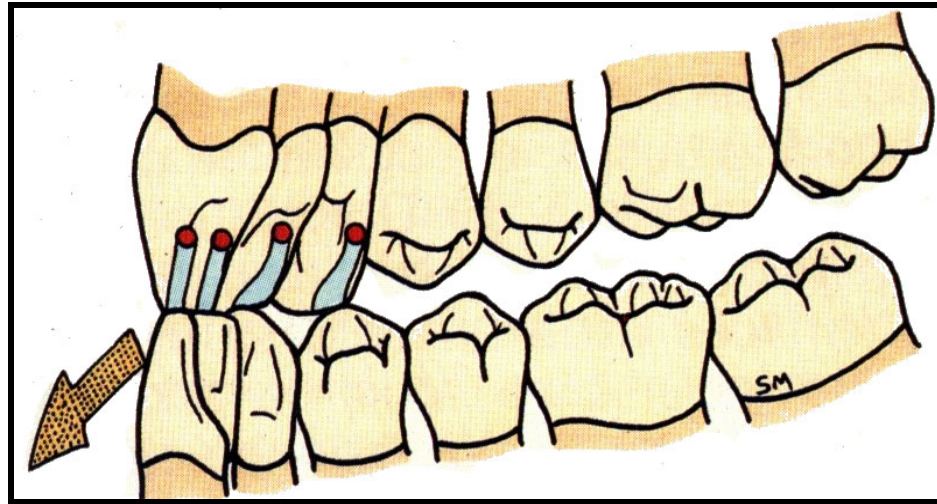

Figure 2: Anterior guidance during mandibular movement (Smukler, 1991)

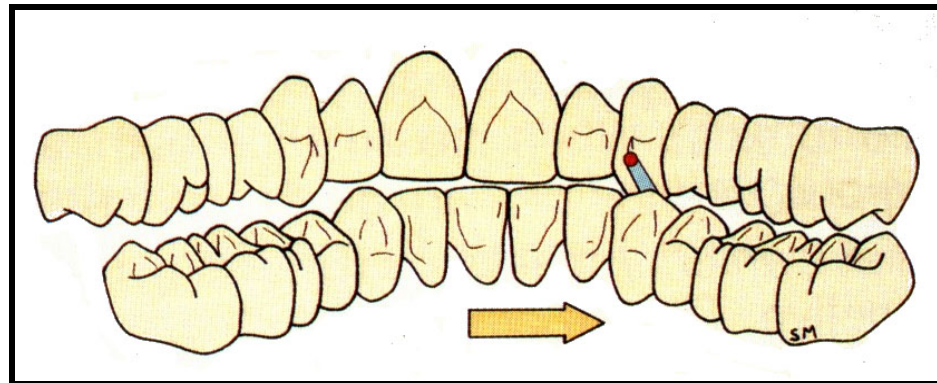

Figure 3: Canine guidance during mandibular movement (Smukler, 1991)

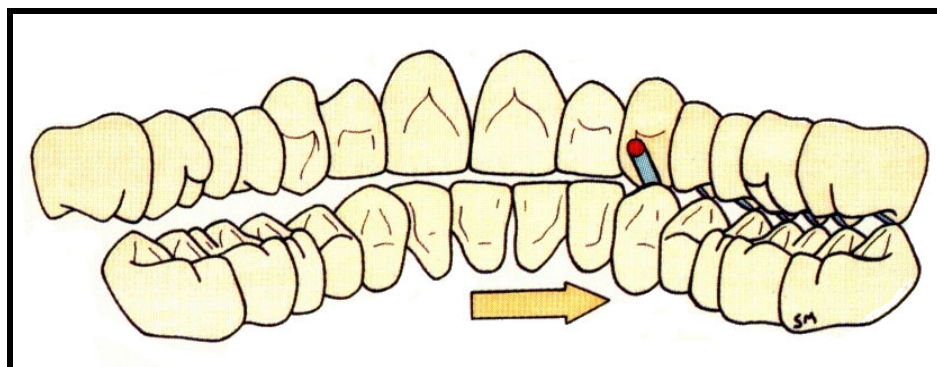

Figure 4: Group function guidance during mandibular movement (Smukler, 1991)

2.2.2 The goals of an ideal functional occlusion

Achieving a good functional occlusion is a treatment goal that has been talked about in orthodontics for years. Yet, the requirements of a good functional occlusion for the natural dentition have been rather vague. If we meet orthodontic goals and achieve the static occlusion that is acceptable in the orthodontic specialty, we are automatically supposed to have created good occlusal function. Yet, we know that this is not always, or even usually, the case (Roth, 1981b).

Kasrovi, Meyer and Nelson (2000) describe the two main goals of a good functional occlusion. Firstly, in an ideal orthodontic finish, maximum intercuspation should occur with the mandibular condyles in the retruded axis position. It has been shown that displacement of the condyles from this position caused by intercuspation of teeth (i.e. CRP-ICP discrepancy) should ideally be less than 1mm vertically and horizontally, and less than 0.5mm transversely (Williamson, Steinke, Morse and Swift, 1980). In other words, intercuspation position (ICP) should be equal to retruded contact position (RCP), or there should be less than 1mm slide from RCP to ICP.

Secondly, to achieve optimal functional occlusion, the teeth should be positioned in such a way that they create a mutually protected occlusal scheme. In this scheme, (a) posterior teeth protect anterior teeth from lateral stress at full closure (MI), and (b) anterior teeth protect posterior teeth from lateral stress during mandibular movements.

According to Okeson (2003), the anterior and posterior teeth function quite differently. The posterior teeth function effectively in accepting forces applied during closure of the mouth. They accept these forces well, primarily because their position in the arch is such that the force can be directed through their long axes and thus dissipated efficiently. The anterior teeth, however, are normally positioned at a labial angle

to the direction of closure, so axial loading is nearly impossible. Therefore, to enable the posterior teeth to protect the anterior teeth during closure, there should be a slight clearance detectable between the upper and lower incisors, with heavier contact between the posterior teeth during maximal intercuspation.

Conversely, anterior teeth, unlike posterior teeth, are in proper position to accept the forces of eccentric mandibular movements. Upon movement of the mandible in any direction from full closure (left and right lateral excursions and straight protrusion), the anterior teeth and canines should provide a gentle ramp that allows the condyles to traverse the eminentia, and disclude the posterior teeth on the balancing (non-working) side.

According to the goals of functional occlusion (Kasrovi, Meyer and Nelson, 2000), during protrusion of the mandible, the palatal surfaces of the upper incisors should act as an incline to guide the lower incisor tips and, at the same time, disclude the posterior teeth bilaterally (anterior guidance). In addition, during lateral mandibular movement, there should be contact between the canines on the working side only (canine guidance), or contact between more posterior teeth on the working side (group function). Any contacts on the non-working side (non-working interferences), however, should be avoided.

Ingervall (1976) suggests that orthodontic treatment is indicated in all young adults in whom the occlusion is not or will not be functionally optimal. According to Ingervall (1976), ICP (intercuspal position) should coincide with RCP (retruded contact position) or be within 1 mm of RCP, there should be no balancing side interferences, and there should be anterior guidance on protrusion and either canine guidance or group function on lateral excursion. Guidelines such as these are often referred to as 'treating to a functionally optimal occlusion.'

2.2.3 The relationship between static and functional occlusion

It is generally assumed that an ideal static occlusal relationship is compatible with an ideal functional occlusion. Andrews (1976) postulates that achieving an excellent result in terms of static occlusion is likely to lead to attainment of functional occlusal goals. Ramfjord and Ash (1971) state: "... good anatomic relationships provide the best background for functional harmony."

Tipton and Rinchuse (1991), however, find no statistically significant relationship between static occlusion and functional occlusion in a population of dental school students with no prior orthodontic treatment. A high natural occurrence of balanced occlusion (i.e., possessing bilateral non-working contacts) was found in subjects with 'normal' (ideal) static occlusion.

Ingervall (1972) studied 50 adults and 50 children with normal static occlusion and reports that at least 80% of the subjects possessed balanced occlusion. Rinchuse and Sassouni (1983) report that 85% of 27 normal static occlusion subjects had a balanced occlusion (bilaterally functional contacts) after orthodontic treatment.

Clark and Evans (1998) also demonstrate a group of patients whose static occlusion was good, yet their functional occlusal contact patterns were not ideal. They conclude that, if treatment is planned by considering static tooth relationships only, achievement of a functionally acceptable occlusion would be purely by coincidence.

Regarding the relationship between occlusion and temporomandibular disorders, data from most epidemiological studies have shown that morphological and/or functional occlusion play a minor role, or no role, in the etiology of TMD (Mohlin, Ingervall and Thilander, 1980; Pullinger, Solberg, Hollender and Petersson, 1987).

Sadowsky (1992) concludes that the prevalence and development of TM disorders is no greater in orthodontically treated patients than in untreated control subjects. A high prevalence of non-working side contacts were found in both groups. The study concludes that, although involvement of occlusal factors in the etiology of TMD appear to be mechanically logical, these conclusions are based on empirical, clinical observations and have not been proved by controlled studies.

Epidemiological studies have also shown that the presence of occlusal interferences are widespread in all population groups and that there are more people with non-ideal occlusal relationships than people with signs or symptoms of TMD (Heikinheimo, Salmi, Myllarniemi and Kirveskari, 1990). This, however, should not lead to a practice of disregarding basic functional principles during orthodontic treatment.

Sadowsky and Polson (1984) state: "However, non-functional contacts are generally considered unfavorable for a variety of reasons. Therefore, once the decision has been made to treat a particular malocclusion orthodontically, it seems prudent that one should strive to establish as ideal a functional occlusion as possible with well-planned and appropriate mechanotherapy."

The discussion on the relationship between functional occlusion and TMD will be continued in Chapter 5.

CHAPTER 3

MATERIALS AND METHODS

3.1 SAMPLE

The study material required for this project involved a sufficient number of dental study casts to evaluate the long-term stability of the overbite and the curve of Spee in patients treated with fixed upper and lower orthodontic appliances for the correction of their malocclusion. In similar studies, Braun, Hnat and Johnson (1996) evaluated dental casts of 27 patients, while Sadowsky, Schneider, BeGole and Tahir (1994) studied a sample of 22 cases to evaluate long-term stability.

Pre-treatment (T1), post-treatment (T2) and follow-up (T3) study casts of at least 30 subjects had to be obtained. A minimum period of two years between the completion of active orthodontic treatment (T2) and the follow-up (T3) was set to provide enough time for any post-treatment changes to occur. In addition, only patients whose post-treatment retention protocol included removable appliances (invisible retainers, Hawley-type appliances) were included in the study.

To ensure clinically relevant results, the study sample was obtained from an academic institution (Department of Orthodontics, School of Dentistry, Faculty of Health Sciences, University of Pretoria), as well as from private orthodontic offices. Several orthodontic practices in the Pretoria area were visited, and the possibility of obtaining records for the research was discussed. Eventually, two offices, in addition to the orthodontic department, were earmarked to supply the material for the research. From the pre- and post-treatment records, sixty (60) subjects were identified as possible participants in the study. Of the 60 subjects, 20 were selected from patients treated at the Department of

Orthodontics, University of Pretoria, and 20 each from the aforementioned private orthodontic offices. All the patients were treated with standard edgewise mechanics.

The following criteria were used during the random selection:

- Skeletal Class I, or moderate Class II malocclusion at the start of orthodontic treatment. Skeletal Class III malocclusions were excluded from the study.
- Comprehensive orthodontic treatment of the upper and lower dental arches, using standard edgewise mechanics. Surgically treated cases were excluded from the study.
- An acceptable static occlusion at the end of orthodontic treatment, as judged by the orthodontist.
- A minimum period of two years after active orthodontic treatment.
- Availability of acceptable pre- and post-treatment dental casts for measurement of the curve of Spee and overbite.

The selected patients were contacted telephonically and asked if a follow-up appointment could be attended. The aim of, and procedure during the follow-up appointment was explained. Of the 60 subjects, sixteen (16) subjects could either not be reached, or was not interested in attending the appointment. In addition, three subjects who did attend, had a fixed lingual retainer, and were excluded from the study. The study casts of one of the subjects were later deemed inadequate, and were also excluded from the study.

The final sample, therefore, consisted of forty (40) subjects, 14 males and 26 females. Sixteen (16) subjects were treated at the Department of Orthodontics and thirteen (13) and eleven (11) respectively at the two private orthodontic offices. The general information of the subjects comprising the total sample is summarized in Table 1.

Table 1: General information of the study sample (n = 40)

Subject number	Sex	Age at T1 (Pre-treatment)	Age at T2 (Post-treatment)	Age at T3 (Follow-up)
01	Female	14 Y 06 M	16 Y 07 M	19 Y 09 M
02	Female	14 Y 10 M	17 Y 03 M	20 Y 03 M
03	Female	16 Y 04 M	18 Y 06 M	20 Y 11 M
04	Male	16 Y 07 M	18 Y 05 M	21 Y 10 M
05	Male	12 Y 06 M	15 Y 00 M	17 Y 10 M
06	Female	12 Y 04 M	14 Y 10 M	17 Y 10 M
07	Female	13 Y 09 M	15 Y 07 M	18 Y 07 M
08	Female	14 Y 11 M	16 Y 02 M	18 Y 04 M
09	Male	15 Y 04 M	17 Y 05 M	20 Y 11 M
10	Male	15 Y 04 M	17 Y 06 M	20 Y 11 M
11	Female	12 Y 03 M	13 Y 09 M	17 Y 07 M
12	Female	14 Y 07 M	16 Y 11 M	20 Y 03 M
13	Female	15 Y 02 M	16 Y 05 M	18 Y 08 M
14	Male	15 Y 11 M	18 Y 00 M	21 Y 04 M
15	Female	12 Y 02 M	14 Y 10 M	17 Y 05 M
16	Male	13 Y 09 M	15 Y 11 M	19 Y 11 M
17	Female	13 Y 07 M	15 Y 01 M	17 Y 02 M
18	Female	16 Y 01 M	17 Y 06 M	20 Y 04 M
19	Female	11 Y 00 M	14 Y 00 M	16 Y 11 M
20	Male	11 Y 10 M	14 Y 09 M	18 Y 00 M
21	Female	12 Y 02 M	13 Y 08 M	16 Y 05 M
22	Female	12 Y 00 M	13 Y 06 M	16 Y 04 M
23	Female	10 Y 10 M	12 Y 10 M	14 Y 10 M
24	Female	10 Y 05 M	12 Y 03 M	15 Y 06 M
25	Male	13 Y 07 M	15 Y 08 M	17 Y 11 M
26	Female	29 Y 02 M	31 Y 00 M	33 Y 04 M
27	Male	12 Y 05 M	14 Y 06 M	17 Y 06 M
28	Female	13 Y 04 M	15 Y 03 M	17 Y 10 M
29	Female	12 Y 10 M	14 Y 03 M	17 Y 05 M
30	Male	11 Y 11 M	14 Y 06 M	18 Y 00 M
31	Female	13 Y 03 M	16 Y 02 M	19 Y 09 M
32	Male	15 Y 05 M	18 Y 03 M	21 Y 07 M
33	Male	15 Y 01 M	17 Y 03 M	20 Y 11 M
34	Female	14 Y 05 M	16 Y 02 M	19 Y 07 M
35	Female	10 Y 01 M	13 Y 08 M	17 Y 02 M
36	Male	16 Y 04 M	17 Y 11 M	20 Y 03 M
37	Male	27 Y 08 M	29 Y 02 M	33 Y 02 M
38	Female	11 Y 04 M	14 Y 08 M	17 Y 11 M
39	Female	10 Y 05 M	12 Y 09 M	16 Y 01 M
40	Female	15 Y 06 M	17 Y 06 M	20 Y 05 M

The age distribution of the total sample is presented in Table 2.

Table 2: Age distribution of the total sample (n = 40)

	Mean age (years)	Standard deviation	Range (years)
Pre-treatment (T1)	14.3	3.8	10.1 – 29.2
Post-treatment (T2)	16.4	3.6	12.3 – 31.0
Follow-up (T3)	19.4	3.7	14.8 – 33.3

Mean age at the start of treatment (T1) was 14.3 years, with a range of 10.1 to 29.1 years. Mean age at the completion of orthodontic treatment (T2) was 16.4 years, with a range of 12.3 to 31.0 years. Mean age at the follow-up appointment (T3) was 19.4 years, with a range of 14.8 to 33.3 years. The mean treatment time of the sample (T2 – T1) was 2.1 years, with a range of 1.2 to 3.6 years. In addition, the mean period between the end of active treatment and follow-up (T3 – T2) was 3.0 years, with a range of 2.0 to 4.0 years.

Two adult patients were included in the total sample of 40 subjects, which made the age range of the total sample seem rather large. However, if the two adult patients are excluded from the sample, the age distribution of the subsample is significantly smaller (Table 3).

Table 3: Age distribution of the subsample (n = 38)

	Mean age (years)	Standard deviation	Range (years)
Pre-treatment (T1)	13.5	1.9	10.1 – 16.6
Post-treatment (T2)	15.6	1.7	12.3 – 18.5
Follow-up (T3)	18.7	1.8	14.8 – 21.8

Since there was no statistical difference between the other variables in the total sample and the subsample, the results from the total sample (n = 40) were used for statistical analysis.

During the follow-up appointment (T3), all routine retention checks were carried out on the 40 subjects, including an update on the retention protocol used after treatment, evaluation of the third molars, and interdental enamel reduction where necessary. Specific patient queries were addressed, and information regarding the research was given where desired.

In addition, a thorough evaluation of the functional occlusion, with special reference to anterior guidance, was performed (see section **3.4**). Alginate impressions were taken of the upper and lower dental arches, and plaster dental casts were made for all the subjects. Written consent, to confirm that the data may be used for research purposes, was obtained from all the patients (ADDENDUM B).

3.2 MEASUREMENT OF THE CURVE OF SPEE

There is little consensus in the literature concerning the measurement of the curve of Spee. Clinically, the curve of Spee is determined by the distal marginal ridges of the most posterior teeth in the arch and the incisal edges of the central incisors (Hitchcock, 1983). The curve of Spee is “measured” clinically on dental casts by placing a flat object (such as the base of the maxillary dental cast) along the mandibular occlusal plane from the mandibular incisal edges to the posterior marginal ridges. The curve of Spee is then quantified by estimating the distance from the cusp tips of the mandibular premolars to the base of the maxillary dental cast.

For research purposes, however, a more accurate method for measuring the clinical curve of Spee had to be developed. Yen (1991) states that direct measurement of a three-dimensional object has a high potential for error and variability, and believes that the measurement of a two-dimensional transfer is easier and can provide

the same degree of accuracy. He introduced computer-aided space analysis, where a photocopy of the upper and lower study models can be used to analyse the dental cast electronically.

Champagne (1992) and Schirmer and Wiltshire (1997) indicate that accurate space analyses and arch length measurements cannot be made from photocopies of dental casts. This is especially true for the measurement of the curve of Spee, since increasing magnification errors will occur as the dental arch curve away from the glass surface of the photostat machine. Schirmer and Wiltshire (1997) conclude that three-dimensional orthodontic dental casts cannot accurately be reproduced on photocopies, and that an alternative method for analysis of dental casts must be used.

Sondhi, Cleall and BeGole (1980), and Bishara, Jakobsen, Treder and Stasi (1989) calculated the curve of Spee from standardized photographs of the mandibular dental casts. The actual procedure they used to standardize the photographs is not described in the literature. De Praeter, Dermaut, Martens and Kuijpers-Jagtman (2002) also used a photographic setup and a computer software program (SigmaScan Pro Version 5.0) to measure the curve of Spee. A millimetre ruler was incorporated in the photograph for calibration.

Braun, Hnat and Johnson (1996) used the Brown and Sharp Precision Coordinate measuring machine, a device used extensively in the precision machine tool industry, to record the XYZ coordinates of specific points along the mandibular occlusal plane. Unfortunately, similar equipment is not commonly available for research purposes.

During this research, standardized photographs of the dental casts of all 40 subjects were taken at three stages (T1, T2 and T3). The photographs were taken from both the left and right side of each

dental cast, which resulted in a total of 240 photographs taken and analysed to determine the stability of the curve of Spee.

The photographs of the mandibular dental casts were taken with a digital camera (Sony Cybershot DSC-F505V). The photographs were analysed using computer software (CorelDRAW[®]10) to measure the depth of the curve of Spee before treatment (T1), after orthodontic treatment (T2), and during the follow-up (T3), which was 3.0 years (mean) after active treatment.

3.2.1 The photographic setup

A reliable and repeatable photographic technique and setup is the key to obtain standardized photographs of the dental casts. Standardized photographs, in turn, are crucial to ensure accurate results during electronic analysis of the photographs. Therefore, much of the outcome of the research depends on a sound methodology during the gathering of data.

A great deal of thought and planning went into the design of the photographic setup to ensure the best possible repeatability of the technique and standardization of the photographs. The curve of Spee is measured to the nearest one-hundredth of a millimetre, which means that any slight variation in technique during the photographic process will result in large errors during measurement. An outline of the methodology used to obtain standardized photographs of the dental casts will now be presented.

The mandibular dental casts were trimmed specifically in such a way that the mandibular occlusal plane ran parallel to the base of the mandibular dental cast (Figure 5). The incisal edges of the central incisors and cusp tips of the most posteriorly positioned teeth present (either first or second molars) were used to define the occlusal plane.

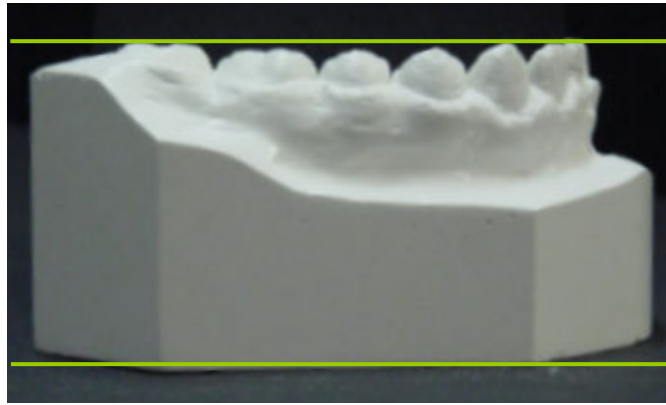

Figure 5: The mandibular occlusal plane trimmed parallel to the base of the mandibular dental cast

A dental surveyor (The J.M. Company) was used to assist during the photographic process. The dental surveyor (Figure 6) is normally used to analyse and record the extent and position of undercuts during the construction of removable partial dentures (Owen, 1998). For the purposes of this research, however, it was used only as a device upon which the dental casts could be suspended during the photographic process.

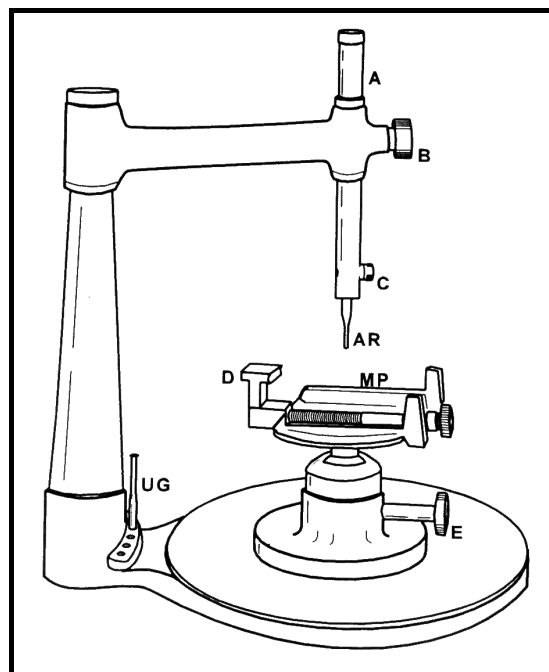

Figure 6: The dental surveyor (Owen, 1998)

A=vertical arm; **B&E**=locking screws; **C**=chuck; **AR**=analysing rod; **MP**=mounting platform; **D**=anterior holding arm; **UG**=undercut gauge

The surveyor has the advantage that the position of the study cast can be standardized in the vertical, sagittal and transverse dimensions. Moreover, as the dental cast is “suspended” in midair, it allows for easier and better photographic technique and quality than would be possible if the cast were placed upon a solid surface.

The study cast was placed on the mounting platform and fixated by the anterior holding arm. The platform is fully adjustable in the sagittal and transverse dimensions through a ball and socket joint, which is locked by a screw. To ensure that the mounting platform was leveled in the sagittal and transverse dimensions, four commercially available spirit-levels (Stanley Works) were attached to the base of the platform. The spirit-levels were attached to the front and rear end, as well as to the left and right side of the mounting platform (Figure 7).

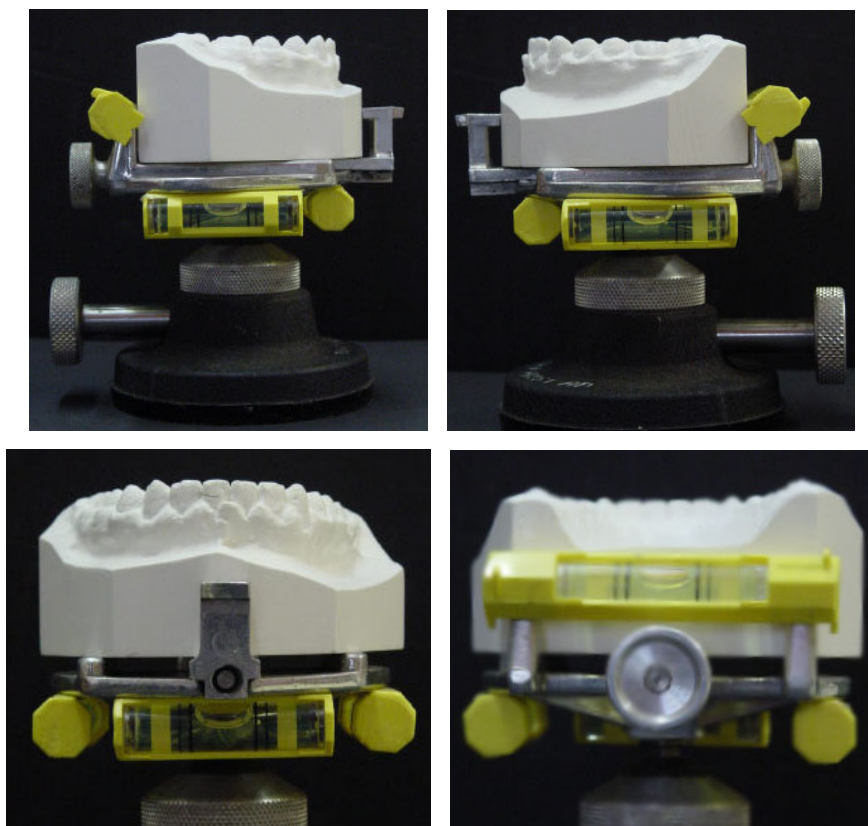

Figure 7: Spirit-levels were used to standardize dental casts in the sagittal and transverse dimensions

The spirit-level at the rear-end of the mounting platform could also be observed from occlusally, which simplified control over the platform during the mounting process (Figure 8).



Figure 8: The spirit-level from an occlusal view

Once it was determined that the mounting platform was levelled in the sagittal and transverse dimensions, the platform, with the fixed dental cast, was placed on the base of the dental surveyor. The base of the platform is smooth, and can slide on the flat base of the surveyor.

To ensure standardization of the height of the dental casts in the vertical dimension, the vertical arm and analysing rod of the surveyor were locked in a predetermined position. This vertical position was maintained throughout the photographic process. The mounting platform was placed in such a position on the base of the surveyor that the analysing rod just touched the buccal cusp tip of the second premolar on the dental cast (Figure 9).

The vertical height of successive dental casts was standardized by ensuring that the cusp tips of the second premolars of all the dental casts touched the analysing rod at the exact same position. Plastic clear retainer sheets (Orthotain), 0.5, 0.75 or 1mm thick, were used as spacers to ensure the correct vertical height. For instance, if the base

of a successive dental cast was thinner than that of the original dental cast, sheet/s were added between the base of the dental cast and the mounting platform, until the cusp tip of the second premolar touched the analysing rod. Conversely, if the base of a successive dental cast was thicker than a previous dental cast, sheets were removed. In this way, standardization of the vertical height of the dental casts was guaranteed throughout the photographic process.



Figure 9: The analysing rod of the dental surveyor was used to standardize the vertical height of the dental casts

In addition to the setup of the dental casts in the surveyor, the position of the digital camera was also standardized meticulously. The camera was mounted on a tripod, and positioned at a fixed distance from the dental surveyor. The height of the camera was also set in a fixed position that correlated with the height of the dental casts.

The camera and dental surveyor were placed on a black sheet of cardboard and the positions of the tripod and the surveyor clearly marked, as illustrated in Figure 10. As a result, photographs could be taken repeatedly without the risk of changing the setup, thereby standardizing the degree of enlargement of all the photographs.

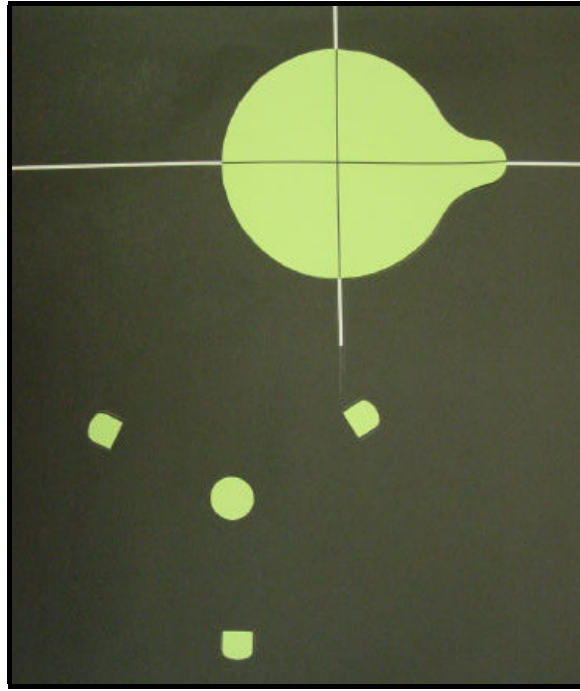

Figure 10: The positions of the dental surveyor and tripod of the camera marked on a black sheet of cardboard

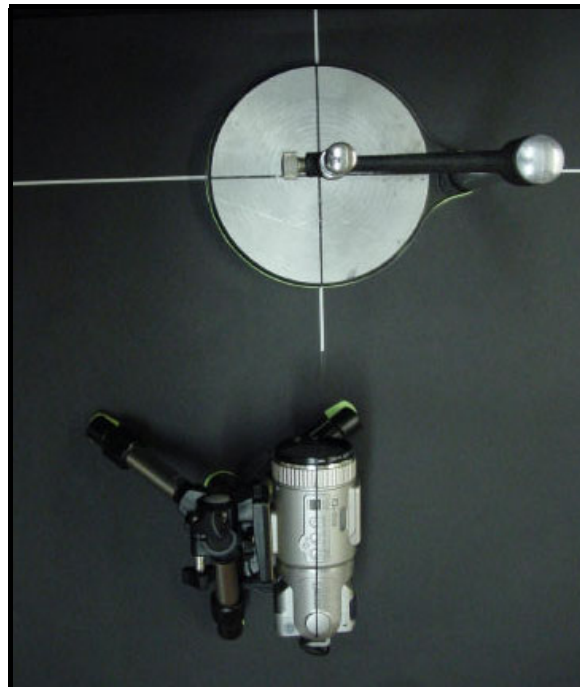

Figure 11: The dental surveyor (without mounting platform) and tripod with camera in position

As can be seen in Figure 12, the dental surveyor was positioned in such a way that a line drawn through its midpoints (in a left-to-right direction) was perpendicular to the line of incidence of the camera.

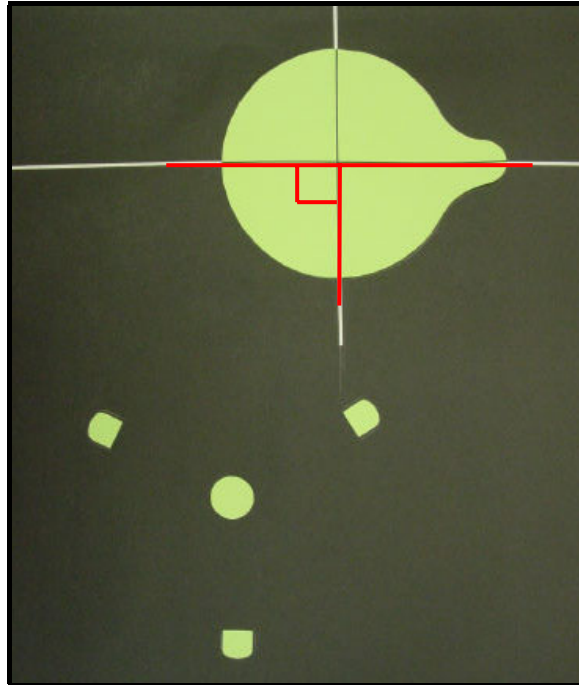

Figure 12: Illustration that the line of incidence of the camera was perpendicular to the midline through the dental surveyor

This line (in addition to the position of the analysing rod described earlier) was used to standardize the placement of the dental cast and the mounting platform on the base of the surveyor. The dental cast was placed in such a way that an imaginary line from the cusp tip of the canine to a point midway between the buccal and lingual cusps of the first molar on the mandibular occlusal plane, ran parallel to the midline through the surveyor (Figure 13).

By doing this, it was ensured that the angle of incidence between the camera and the line of occlusion (from canine to molar) on the dental casts was always 90°. The entire photographic setup could easily be reproduced for all the dental casts to guarantee standardization of all the photographs in all the dimensions.

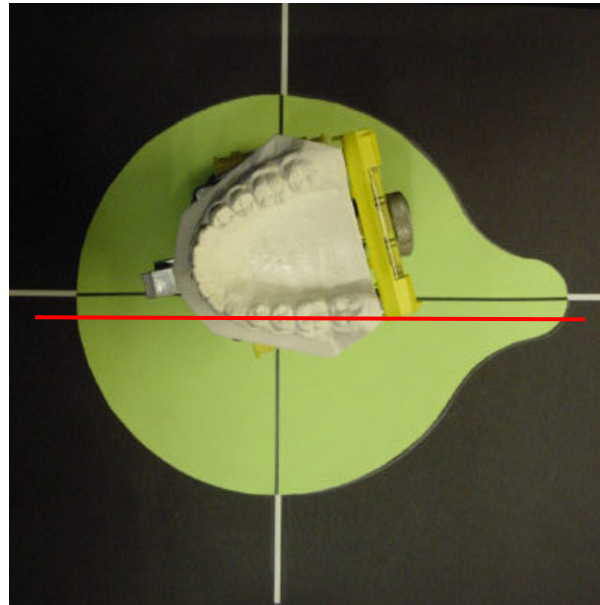

Figure 13: Spatial orientation of the dental cast on the base of the dental surveyor (surveyor removed for demonstration purposes)

Finally, a millimetre ruler was placed in front of the dental cast to enable calibration of the photographs during electronic measurement of the curve of Spee (see section **3.2.2**). The ruler was part of an angle finder (Raco Tools), and was placed on the base of the dental surveyor, right in front of the dental cast, with the ruler positioned slightly lower than the mandibular occlusal plane (Figure 14 & 15).



Figure 14: An angle finder with millimetre ruler used for calibration of photographs

The angle finder/ruler combination could additionally be used to confirm that the occlusal plane of the mandibular dental cast was level, and parallel to the base of the dental surveyor (Figure 15).

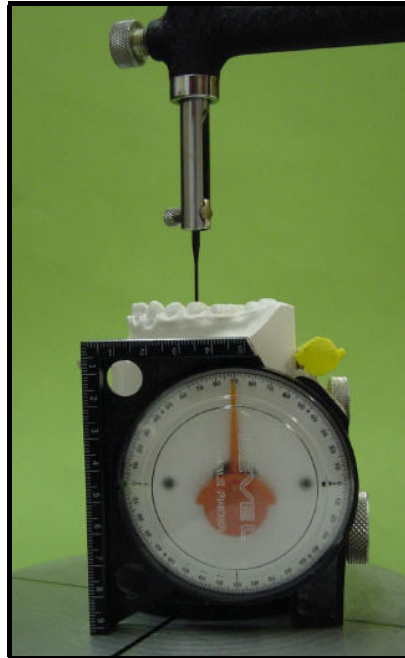

Figure 15: The angle finder/ruler as part of the photographic setup

Before the photographs were taken, the face of the angle finder was covered with black cardboard (for better contrast). In addition, all the dental casts were numbered, and the number was written on the cardboard and included in the photograph to facilitate dental cast identification during measurement (Figure 16).



Figure 16: Dental casts were numbered for easy identification

The complete photographic setup is illustrated in Figures 17 – 20. Using this setup, all the errors that could be foreseen during the photographic process was eliminated and the photographs could be standardized to a high degree of accuracy.



Figure 17: Setup of the dental cast and surveyor



Figure 18: Complete photographic setup (rear view)



Figure 19: Complete photographic setup (side view)

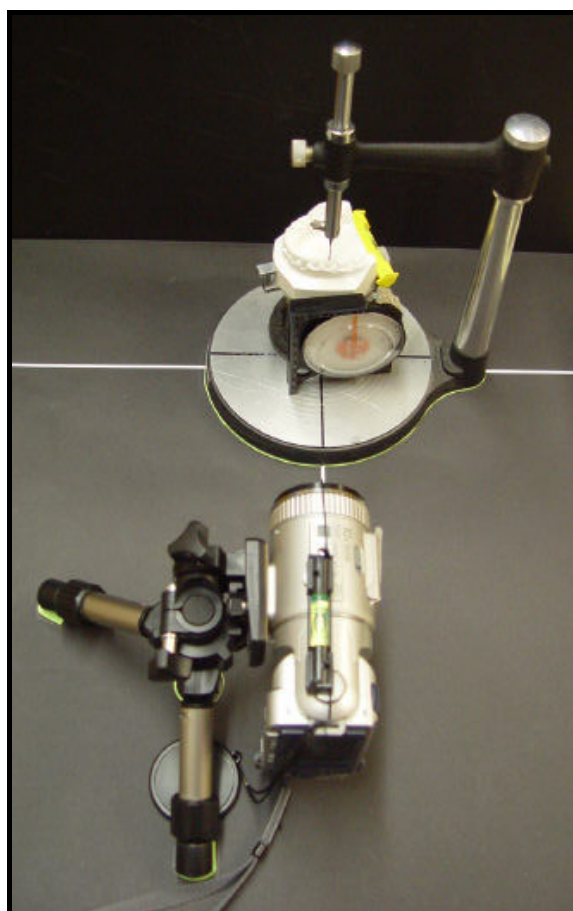

Figure 20: Complete photographic setup (occlusal view)

3.2.2 Computerized analysis of the photographs

The next crucial step to ensure that the research would produce accurate results involved the actual process of measurement of the curve of Spee. As stated earlier, accurate results can be anticipated if the measurements are done on standardized photographs, and an accurate measuring technique is used. The CorelDRAW[®]10 software (Corel Corporation, New York, NY) allows for uncomplicated measurement of the curve of Spee, while providing excellent accuracy to the nearest millionth (or even more) of a millimetre. For practical reasons, however, the curve of Spee was measured to the nearest hundredth of a millimetre during this research.

Again, different methods of measuring the curve of Spee are described in the literature. Bishara, Jakobsen, Treder and Stasi (1989) measured the curve of Spee in relation to a reference line that is drawn from the incisal edge of the central incisor to the distal cusp tip of the **second** molar. Perpendiculars were projected from this line to the cusp tips of the canine, first premolar, second premolar, and the mesiobuccal cusp of the first molar. The curve of Spee was quantified as the **average** of the sum of these perpendicular distances to each cusp tip.

Braun, Hnat and Johnson (1996) recorded the curve of Spee by summing the **right and left** side **maximum** depths from a flat plane formed by the tips of the mandibular incisors anteriorly and the distal cusp tips of the **second** molars posteriorly. De Praeter, Dermaut, Martens and Kuijpers-Jagtman (2002) used the **sum** of perpendicular lines constructed from a reference line from the incisal edge of the central incisor to the distal cusp tip of the **first** molar. Measurements were taken unilaterally only.

During this research, the curve of Spee was measured from a reference line that was drawn from the incisal edge of the central

incisor to the distal cusp tip of the **first** molar. The first molar was chosen instead of the second molar because, more often than not, the second molar was not yet erupted at T1 (pre-treatment).

Perpendicular lines were constructed from this line to the incisal edge of the lateral incisor, and the cusp tips of the canine, the premolars, and the mesiobuccal cusp of the first molar (Figure 21). The lengths of the perpendicular lines were measured, and the individual lengths of the five perpendicular lines added to calculate a total value for the curve of Spee on one side. These measurements were carried out **bilaterally** on the left and right side of the dental arches. The curve of Spee was eventually quantified as the **average** of the sums of the total value for the curve of Spee on **both sides** of the dental arches.

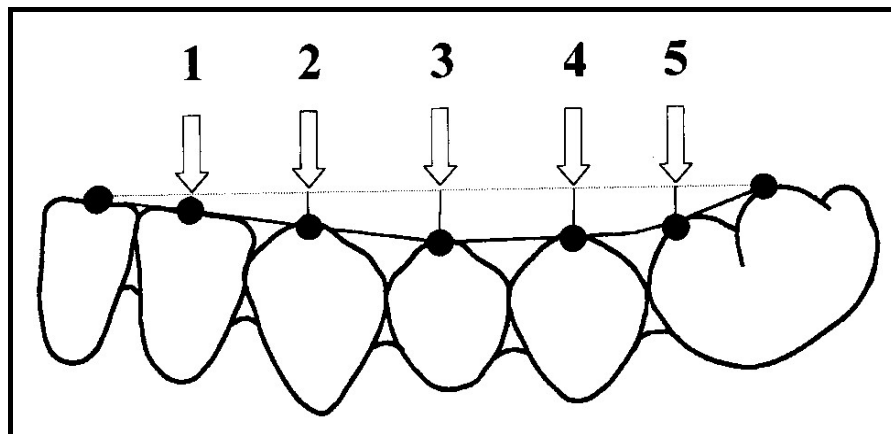

Figure 21: Measurement of the curve of Spee (De Praeter *et al*, 2002)

Example:

	Line 1	Line 2	Line 3	Line4	Line5	Total	Average
Left	0.5	1.0	1.5	1.2	0.8	5.0	-
Right	0.6	1.2	1.8	1.4	1.0	6.0	-
CoS	-	-	-	-	-	11.0	5.5

The total value for curve of Spee (CoS) for both sides in this example will be quantified as 11.0 mm with an average value of 5.5 mm.

The steps followed during the electronic measurement of the curve of Spee can be summarized as follows:

The photographs were all imported individually into CorelDRAW[®]10. A separate file was opened for each subject, containing all the photographs of that particular subject. The file consisted of six pages, each page containing one photograph out of the total of six photographs taken of each subject (left and right side before treatment (T1), left and right side after treatment (T2), and left and right side during follow-up (T3). Each of the photographs were analysed individually.

A standard millimetre ruler was superimposed on the photographs. The CorelDRAW software facilitates calibration of the photographs by allowing the user to resize the entire image according to need. During this research, the image was resized (where necessary) so that the millimetre ruler (on the angle finder) captured as part of the image during photography exactly coincided with the standard millimetre ruler superimposed upon the image (Figure 22 & 23). Calibration of images eliminates the risk of inaccurate results due to unequal magnification between the images.

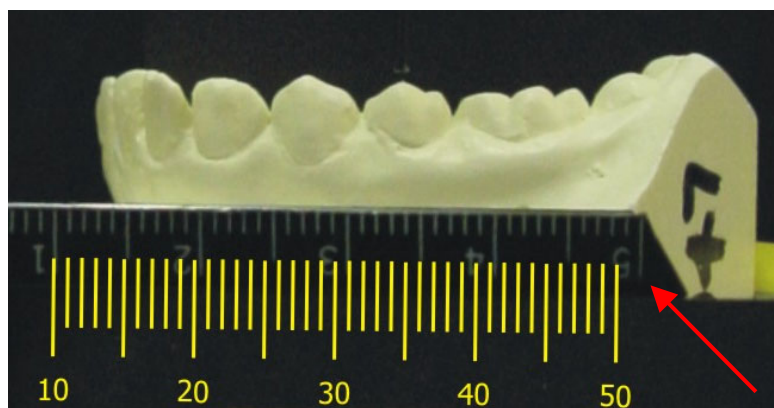

Figure 22: A standard millimetre ruler (yellow) superimposed upon the image – before calibration

The red arrow indicates that the two rulers do not concur

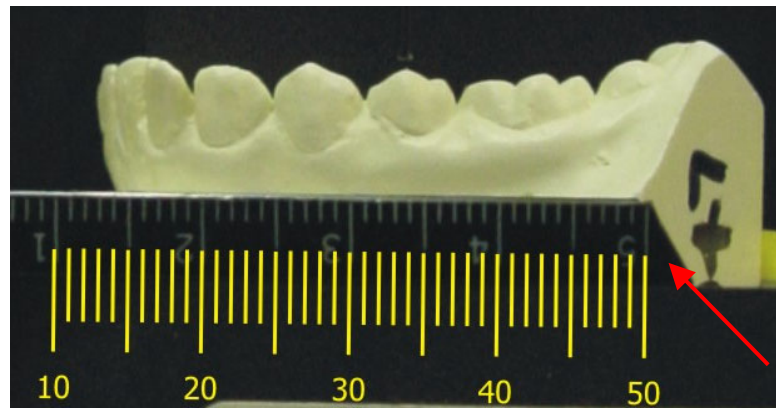

Figure 23: A standard millimetre ruler (yellow) superimposed upon the image – after calibration

All the images were enlarged to 1600% (one of the standard settings in CorelDRAW[®]10), and a reference line was drawn from the incisal edge of the central incisor to the tip of the distobuccal cusp of the first molar. CorelDRAW software enables construction of perpendicular lines to the incisal edge of the lateral incisor and the cusp tips of the canine, premolars and mesiobuccal cusp of the first molar. In addition, a “dimension tool” allows accurate measurement of the length of the perpendicular lines from the reference line to the cusp tip.

Similar to the method employed by De Praeter, Demaut, Martens and Kuijpers-Jagtman (2002), a positive value was given to measurements where the cusp tips were located beneath the reference line. Conversely, a negative value was given where the cusp tips were located above the reference line. In practical terms, this means that an excessive (deep) curve of Spee in the lower arch will have a large positive value, whereas a reverse curve of Spee in the lower arch will have a negative value (See Figures 25 – 27 for illustration).

The individual values of the lengths of the perpendicular lines were transferred to a spreadsheet (Microsoft[®] Excel 2000). All the necessary calculations were made in Microsoft[®] Excel, and the total and average values for the curve of Spee for each subject during each

stage (T1, T2 and T3) were calculated. It is important to clarify at this stage that the purpose of the research was not to determine a “normal” value for the curve of Spee before or after treatment, but rather to evaluate the changes that took place after levelling the curve of Spee. Therefore, the absolute value to describe the curve of Spee was of less importance than the relative changes that took place during the different stages.

A typical window display as seen in CorelDRAW[®]10 after construction of the reference and perpendicular lines is presented in Figure 24. During actual measurement, however, the reference and perpendicular lines were much thinner (hairline), but were enlarged here for demonstration purposes. The dimension tool (red arrow on the left of Figure 24) was used to measure the distance from the reference line to the various cusp tips as described earlier. The perpendicular lines were all constructed to a length of 3mm for uniformity.

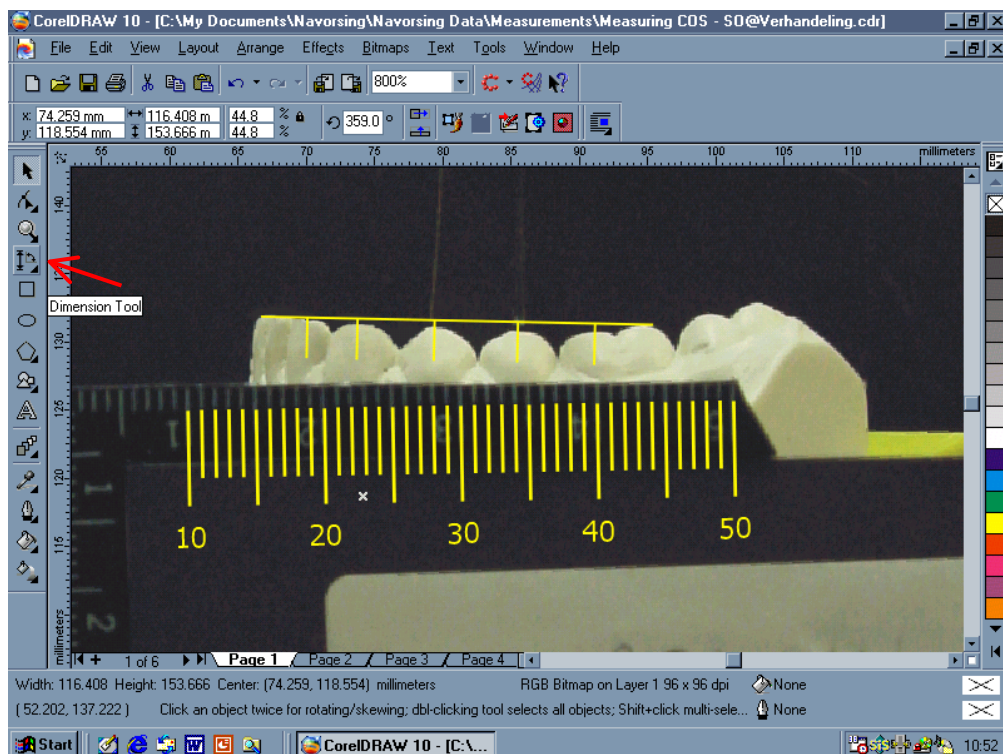

Figure 24: Construction of reference and perpendicular lines in CorelDRAW[®]10

The general tendencies observed during the measurement of the curve of Spee at all three stages (T1, T2 & T3) are illustrated in Figures 25 - 27.

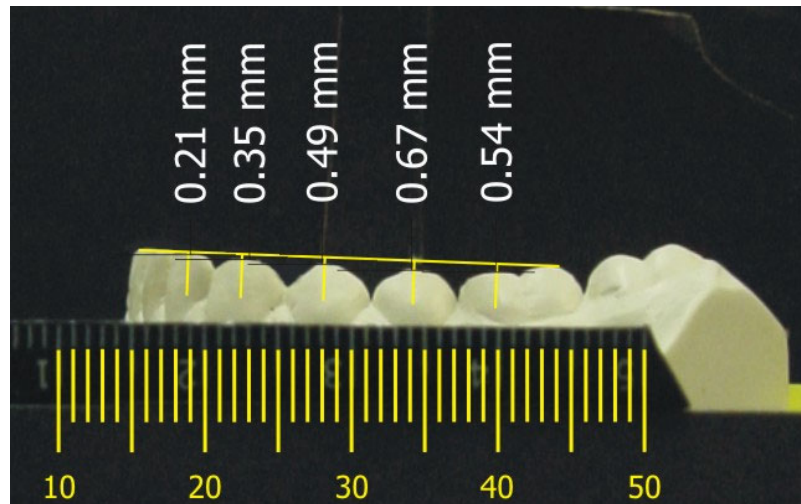

Figure 25: Measurement of the curve of Spee (T1)

Typically, a slight curve of Spee existed before treatment (T1), as indicated by the positive values measured for all five perpendicular lines in Figure 25. Orthodontic treatment often resulted in a reverse curve of Spee after treatment (T2), as indicated by the mostly negative values in Figure 26.

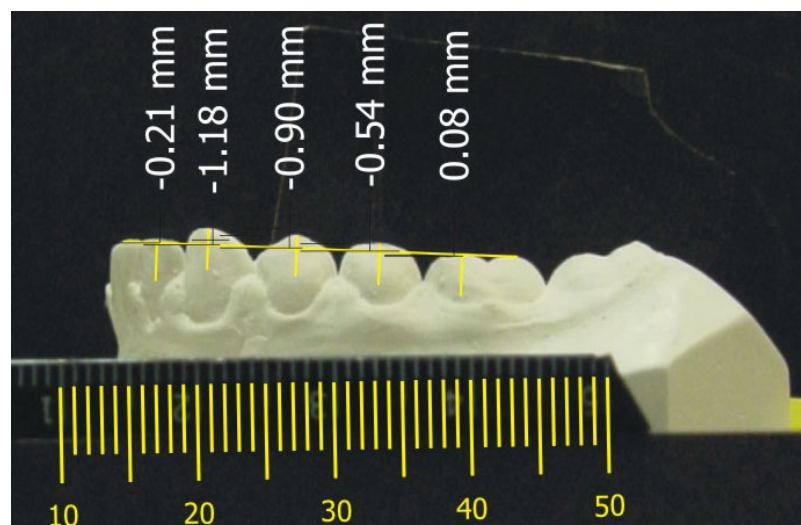

Figure 26: Measurement of the curve of Spee (T2)

A slight relapse of the overcorrected curve of Spee often occurred after treatment, as can be seen from the values obtained during the follow-up appointment (T3). Although most of the measurements were still negative during T3, the values tend to be less negative, while the positive values were more positive at T3 (Figure 27).

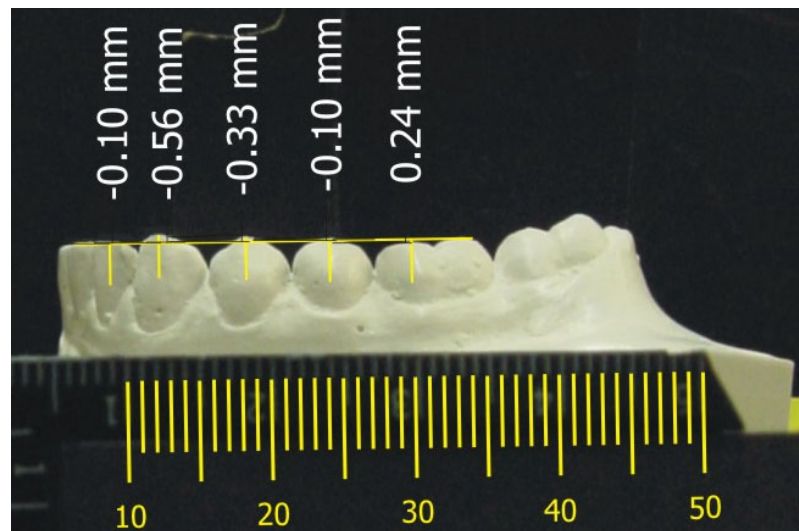

Figure 27: Measurement of the curve of Spee (T3)

The complete results, as well as the statistical analysis, will be presented later.

3.3 MEASUREMENT OF THE OVERBITE

The focus of post-retention studies has generally centered on the stability of mandibular incisor alignment, arch dimensions, overbite, and overjet. Mostly, these variables are measured directly from dental casts using standard or digital calipers.

Sadowsky and Sakols (1982) recorded overbite from study models using a Boley gauge, while Sadowsky, Schneider, BeGole and Tahir (1994) used an electronic dial caliper to measure overbite to the nearest 0.1mm. Little, Warren and Riedel (1981), and Little, Riedel and Årtun (1988) measured the overbite with dial calipers calibrated to read hundredths of a millimetre.

The overbite can also be measured from lateral cephalograms. Bishara, Jakobsen, Treder and Stasi (1989), and Gardner, Harris and Vaden (1998) measured overbite, overjet, and other variables from digitized lateral cephalograms. The availability of lateral cephalograms at the different stages before, during, and after treatment, however, may be problematic when using this approach.

For measurement of the overbite during this research, it was decided to use the conventional method of direct measurement from dental casts. As dental casts of the different stages (T1, T2 and T3) would be available for direct measurement, it was considered ethically wrong and unnecessary to take lateral cephalograms of all the patients during the follow-up appointment (T3). The cost of the radiographs would also have been a problem, since the facilities of private orthodontic practices were used during data gathering.

A dial caliper (TA Corp), capable of measuring to the nearest fiftieth (1/50) of a millimetre, was used to quantify the overbite (Figure 28). The round dial on the caliper makes reading and measurement of a fraction of a millimetre much easier, and certainly more accurate, than with a standard Boley gauge.



Figure 28: Dial caliper used for measurement of the overbite

For standardization of the technique used to measure the overbite, the upper and lower dental casts were positioned in maximum

intercuspatation. Incisor overbite was recorded as the amount of vertical incisal overlap of the upper and lower incisors in millimetres. A sharp pencil was used to mark the position of the incisal edge of the upper incisor on the labial aspect of the lower incisor on the dental casts. Care was taken to keep the pencil perpendicular to the incisal edge of the upper incisor during the process. The upper right central incisor was used in all cases to determine the overbite. The distance from the lower incisal edge to the lead marking was measured and used to quantify the overbite (Figure 29.)

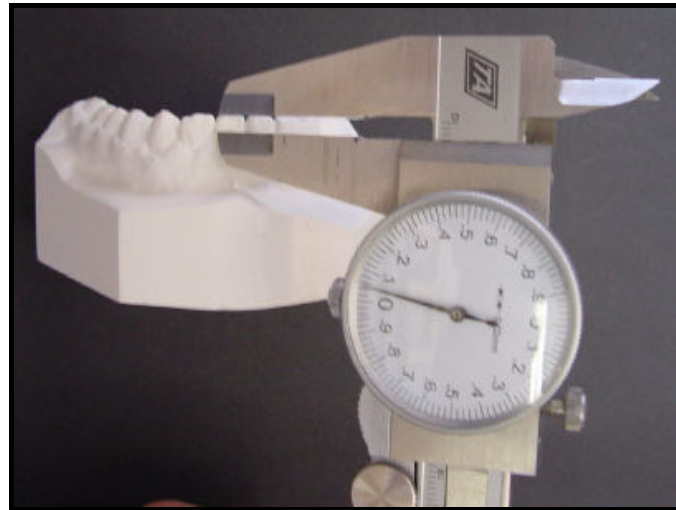

Figure 29: Measurement of the overbite

The overbite was measured for all the subjects (n=40) before treatment (T1), after active orthodontic treatment (T2), and during the follow-up appointment (T3). Therefore, a total of 120 measurements of the overbite at different stages were available for statistical analysis.

3.4 EVALUATION OF THE FUNCTIONAL OCCLUSION

During the follow-up appointment (T3), a thorough evaluation of the functional occlusion, with special reference to anterior guidance, was performed. Although no pertinent information on the status of the functional occlusion before treatment (T1) or after orthodontic

treatment (T2) was available, the aim of the research was to relate some of the goals of an ideal functional occlusion (anterior guidance) to some of the goals of static occlusion (curve of Spee, overbite) as it was standing during the post-retention stage (T3).

Different methods are employed to record and measure functional occlusion, and the sample and design of each study is unique. Therefore, one must be cautious about direct comparisons from one study to another, especially regarding the dynamic aspects of functional occlusion. Tipton and Rinchuse (1991) determine the presence of non-working side contacts directly and visually with the aid of articulating wax and dental floss. Lateral functional excursions were generated by the subjects from "habitual centric" to the lateral cusp tip-to-cusp tip relationship (usually 3mm lateral to habitual centric).

Milosevic and Samuels (1998) designate non-working side contacts as either absent or present, and, when present, non-working side contacts were confirmed by passing dental floss around the interfering cusp to confirm that the floss could not be pulled through. Similarly, Sadowsky and BeGole (1980) recorded the presence of posterior contacts during mandibular protrusion with two thicknesses of articulating ribbon. The rationale for using two thicknesses of ribbon was that one thickness might not record slight contacts during mandibular excursions (Sadowsky and BeGole, 1980).

Clark and Evans (1998) examined post-orthodontic functional occlusion using articulated study casts and articulating paper. A cusp tip impression of the maxillary teeth was made using two thicknesses of softened wax on a bite fork. In addition, a facebow registration was taken to ensure that the articulated study casts accurately represent the intra-oral occlusal contact patterns. They conclude that this technique of occlusal diagnosis represented an accurate picture of the

intra-oral occlusion and provided a permanent record that could be used by different operators in subsequent studies.

However, Clark, Hutchinson and Sandy (2001) admit that, if the use of articulator mounted study casts is to be advocated, the clinician must be able to carry the technique out accurately. Mounting study models on an articulator in the retruded condylar axis is an operator sensitive procedure, requiring skill and practice. Each stage involved in mounting study models on a semi-adjustable articulator is a potential source of error, and only if the technique is carried out with a high degree of accuracy, it is worth the additional chairside time.

To establish an appropriate protocol for evaluation of the functional occlusion during this study, several factors were considered. Firstly, both the amount of chairside time (to record a facebow registration), and laboratory time (to accurately articulate the dental casts), were considered. In addition, roughly two-thirds of the sample had to be evaluated in private orthodontic practices, further emphasizing the importance of efficient time management. Also, in a recent article, Celar, Tamaki, Nitsche and Schneider (1999) report that a semi-adjustable articulator duplicated only approximately 73% of intra-oral protrusive contacts, and 81% of lateral contacts.

Eventually, it was decided to evaluate the functional occlusion clinically. Both protrusive and lateral functional excursions were examined with the subject in an upright, seated position. Working and non-working side contacts were recorded, and the overall functional occlusal type (canine disclusion, group function or balanced occlusion) was noted. However, to keep the amount of variables as part of this study manageable, it was decided to concentrate on one or two aspects only. Anterior guidance was chosen, and it was decided to relate anterior guidance to the curve of Spee and the overbite.

Ideally, evaluation of functional contacts should consider the tooth contacts from the intercuspal position through the entire range of mandibular movement. However, according to Clark and Evans (2001) this is difficult to achieve clinically, and therefore, in most studies on functional occlusion, tooth contact patterns have been recorded at various static mandibular positions.

In order to satisfy the condition of evaluating anterior guidance through the entire range of mandibular protrusion during this research, the initial clinical evaluation was done non-visually. A strip of cellophane paper was placed between the upper and lower posterior teeth, and the patient was asked to close in maximum intercuspatation. The cellophane strip was gently pulled forward, while the patient was instructed to slowly glide the lower jaw forward, until the upper and lower incisors were in an edge-to-edge position. The process was executed separately for both the left and right side.

Immediate release of the cellophane strip indicated disclusion of the posterior teeth, with no non-working side interferences. In such cases, the functional tooth contacts were examined visually to confirm the presence of anterior guidance (and absence of posterior interferences). Delayed or no release of the cellophane strip indicated that occlusal contacts occur between the posterior teeth during protrusion. In such cases, the functional occlusal contacts were also examined visually to confirm and locate the presence of posterior (non-working side) interferences.

The evaluation form used during the follow-up appointment (T3) for examination of the functional occlusion is included as ADDENDUM A. Take note that the form was not designed as a complete analysis of functional occlusion, but rather to fulfil the requirement of gathering data for the current research project.

3.5 STATISTICAL ANALYSIS

The statistical analysis was carried out by a senior statistician at the Unit of Biostatistics of the Medical Research Council (MRC) in Pretoria. Means, standard deviations, distributions, and the 95% confidence intervals were calculated for all the variables at T1, T2 and T3.

The changes in the curve of Spee and the overbite between T1, T2 and T3 were calculated and compared, and statistical significance for these changes was determined using Student's paired t-tests. The Welch t-test was used to determine statistical significance for the variables between specific subgroups within the total group (e.g. for the subgroups with or without anterior guidance). The Welch t-test makes provision for unequal variances between the subgroups. Testing was done at the 0.05 level of significance. Correlation between all the variables at T1, T2 and T3 was determined using Pearson's product moment correlation coefficients.

In addition, intraclass and interclass correlations and the methodological error for the measurement of the curve of Spee were determined. To determine intraclass repeatability, the author re-digitized and re-measured the left side curve of Spee in ten randomly selected subjects. Only the pre-treatment photographs (T1) were re-measured for the repeatability test.

To determine interclass reliability of the measurements, five different investigators measured the left side curve of Spee for the same group of ten subjects. All five investigators are staff members of the Department of Orthodontics, University of Pretoria, and work as either researchers, lecturers or registrars in the department. A table containing the data of the measurements by the five investigators, as well as the original- and re-measurements by the author, is included as an addendum (ADDENDUM C).

CHAPTER 4

RESULTS

4.1 INTRACLASS REPEATABILITY AND INTERCLASS RELIABILITY

Intraclass repeatability and interclass reliability must be tested to determine the correlation of the measurements between the original measurement and subsequent measurements by the researcher (intraclass), and between the measurements of the researcher and the measurements of other examiners (interclass). A high correlation is mandatory before the data can be used for statistical analysis.

The mean values and correlation coefficients between the original measurement and re-measurements of the curve of Spee (intra- and interclass) for 10 subjects are summarized in Table 4. The complete set of data is listed as ADDENDUM C.

Table 4: Intraclass and interclass correlations for re-measurement of the curve of Spee (n = 10)

Investigator	Mean value for curve of Spee*	Mean difference with original measurement*	Correlation coefficient
Original measurement	2.121	-	1.00
Remeasurement (Intraclass)	2.126	0.005	0.998
Examiner 1 (Interclass)	2.129	0.008	0.996
Examiner 2 (Interclass)	2.108	0.013	0.994
Examiner 3 (Interclass)	2.112	0.009	0.996
Examiner 4 (Interclass)	2.127	0.006	0.997
Examiner 5 (Interclass)	2.087	0.034	0.984

* Measurements are in millimetres.

Intraclass differences were found to be minimal, with a mean difference of 0.005mm between the mean value for the curve of Spee during the original measurement, and the mean value during the re-measurement of the ten subjects. This amounts to a correlation coefficient of 0.998 between the measurements.

Interclass differences were also found to be minimal (0.006–0.034mm), with correlation coefficients between 0.984 and 0.997. Therefore, it can be concluded that both the intraclass repeatability and interclass reliability of the measurement of the curve of Spee, as utilized during this study, were high.

However, because the measurements involved are so small in magnitude, using mean values to determine reliability might give a false representation of the truth. For instance, if the curve of Spee is overestimated by 0.1mm for subject 1, and underestimated by the same amount for subject 2, the mean value would indicate complete reliability with the original measurement.

To further qualify the accuracy and reliability of the measurements, the mean values for the **actual** differentiation between the original measurement of the curve of Spee and the re-measurements done by **each** examiner for **each** of the ten subjects, were calculated. The results are summarized in Table 5.

Even when using this approach for statistical analysis, the magnitude of error for intraclass measurement of the curve of Spee was found to be only 0.03mm, whereas the magnitude of error for interclass measurements varied between 0.03 and 0.06mm (Table 5). The results confirm the accuracy with which measurements can be made when utilizing a computerized analysis and CorelDRAW[®]10 software.

Table 5: Intraclass and interclass reliability for measurement of the curve of Spee using actual differences between measurements (n=10)

Investigator	Actual difference with original measurements (mm)
Re-measurement (intraclass)	0.03
Examiner 1 (interclass)	0.05
Examiner 2 (interclass)	0.04
Examiner 3 (interclass)	0.05
Examiner 4 (interclass)	0.03
Examiner 5 (interclass)	0.06

In summary, the results from the repeatability and reliability tests confirmed that both the intraclass repeatability and the interclass reliability of the measurements obtained during the research were high. The results indicated that the accuracy of the measurements is more than sufficient to be used for statistical analysis.

4.2 ANALYSIS OF THE RESULTS

4.2.1 Means, standard deviations and distributions

A table containing the complete set of data obtained during the measurement of the curve of Spee is included as an addendum (ADDENDUM D). However, shorter versions of the table are included in the text for ease of reference. Tables 6 – 9 summarize the measurement of the curve of Spee for T1, T2 and T3 respectively. Table 10 shows the comparative mean values of the curve of Spee for the total group of 40 subjects during all three stages (T1, T2 and T3).

At the pre-treatment stage (T1), eight (8) of the 40 subjects were still in the mixed dentition phase. These eight subjects were excluded from the total group during determination of the mean value for the curve of Spee at T1.

Table 6: Measurement of the curve of Spee (CoS) at T1 (Pre-treatment)

Subject number	Sum CoS (left)	Sum CoS (right)	Total CoS (left & right)	Mean CoS
01	-1.01	-0.32	-1.33	-0.67
02	-1.20	2.09	0.89	0.45
03	0.27	0.48	0.75	0.38
04	-0.10	-1.57	-1.67	-0.84
05	*	*	*	*
06	*	*	*	*
07	1.55	-0.27	1.28	0.64
08	-1.21	-1.24	-2.45	-1.23
09	-0.37	2.40	2.03	1.02
10	0.14	-0.18	-0.04	-0.02
11	*	*	*	*
12	4.61	1.72	6.33	3.17
13	-1.29	-0.18	-1.47	-0.74
14	-0.14	0.60	0.46	0.23
15	*	*	*	*
16	4.11	2.51	6.62	3.31
17	2.22	3.56	5.78	2.89
18	1.27	0.18	1.45	0.73
19	0.18	0.37	0.55	0.28
20	*	*	*	*
21	5.69	3.78	9.47	4.74
22	1.17	0.83	2.00	1.00
23	1.81	1.21	3.02	1.51
24	3.18	5.11	8.29	4.15
25	0.93	1.29	2.22	1.11
26	3.25	2.94	6.19	3.10
27	1.46	0.31	1.77	0.89
28	2.08	2.87	4.95	2.48
29	2.86	0.14	3.00	1.50
30	*	*	*	*
31	4.29	7.37	11.66	5.83
32	*	*	*	*
33	1.22	2.63	3.85	1.93
34	0.46	0.87	1.33	0.67
35	*	*	*	*
36	-1.42	-2.76	-4.18	-2.09
37	-0.16	0.04	-0.12	-0.06
38	2.21	2.34	4.55	2.28
39	1.13	1.26	2.39	1.20
40	-1.96	-0.36	-2.32	-1.16

* Mixed dentition

Table 7: Measurement of the curve of Spee (CoS) at T2 (Post-treatment)

Subject number	Sum CoS (left)	Sum CoS (right)	Total CoS (left & right)	Mean CoS
01	-1.43	-1.99	-3.42	-1.71
02	-2.03	-1.59	-3.62	-1.81
03	-0.24	0.07	-0.17	-0.09
04	-0.52	-0.74	-1.26	-0.63
05	-1.45	-1.42	-2.87	-1.44
06	-1.24	-1.14	-2.38	-1.19
07	-0.86	-1.32	-2.18	-1.09
08	-0.64	-2.64	-3.28	-1.64
09	0.35	-1.96	-1.61	-0.81
10	-1.52	-0.66	-2.18	-1.09
11	-2.61	-1.33	-3.94	-1.97
12	-0.31	0.20	-0.11	-0.06
13	-0.52	-1.73	-2.25	-1.13
14	-0.56	-0.59	-1.15	-0.58
15	-0.38	-0.51	-0.89	-0.45
16	-0.64	-0.65	-1.29	-0.65
17	0.32	-1.75	-1.43	-0.72
18	-0.74	-1.49	-2.23	-1.12
19	-1.29	0.32	-0.97	-0.49
20	-1.51	-0.68	-2.19	-1.10
21	-2.23	-2.44	-4.67	-2.34
22	-1.42	-0.46	-1.88	-0.94
23	-0.65	-1.92	-2.57	-1.29
24	-1.63	-3.65	-5.28	-2.64
25	-2.06	-0.65	-2.71	-1.36
26	-1.16	-1.37	-2.53	-1.27
27	-0.48	0.27	-0.21	-0.11
28	-0.53	0.42	-0.11	-0.06
29	-2.71	-1.28	-3.99	-2.00
30	-2.19	-1.10	-3.29	-1.65
31	1.52	-0.56	0.96	0.48
32	0.78	-1.60	-0.82	-0.41
33	-1.99	-0.61	-2.60	-1.30
34	-1.46	-0.88	-2.34	-1.17
35	-0.17	-1.89	-2.06	-1.03
36	-0.75	-2.54	-3.29	-1.65
37	-1.27	-2.13	-3.40	-1.70
38	-1.23	-0.51	-1.74	-0.87
39	-1.06	-1.13	-2.19	-1.10
40	-2.48	-2.37	-4.85	-2.43

Table 8: Measurement of the curve of Spee (CoS) at T3 (Follow-up)

Subject number	Sum CoS (left)	Sum CoS (right)	Total CoS (left & right)	Mean CoS
01	-0.52	-1.37	-1.89	-0.95
02	-0.07	-0.14	-0.21	-0.11
03	0.15	0.50	0.65	0.33
04	-0.32	-0.4	-0.72	-0.36
05	-1.34	-0.89	-2.23	-1.12
06	-0.25	-0.97	-1.22	-0.61
07	-0.80	0.39	-0.41	-0.21
08	-1.10	-2.02	-3.12	-1.56
09	-0.71	0.00	-0.71	-0.36
10	-0.49	-0.18	-0.67	-0.34
11	-1.92	-1.29	-3.21	-1.61
12	-1.12	1.11	-0.01	-0.01
13	-0.41	-1.18	-1.59	-0.80
14	-0.32	0.74	0.42	0.21
15	0.07	1.70	1.77	0.89
16	1.33	0.61	1.94	0.97
17	-0.10	0.37	0.27	0.14
18	-0.56	-0.80	-1.36	-0.68
19	-0.60	-0.18	-0.78	-0.39
20	0.36	0.02	0.38	0.19
21	-1.25	-0.88	-2.13	-1.07
22	-0.79	0.22	-0.57	-0.29
23	-0.18	-1.09	-1.27	-0.64
24	0.09	-2.05	-1.96	-0.98
25	-1.97	-1.37	-3.34	-1.67
26	-0.82	-1.35	-2.17	-1.09
27	-0.64	0.92	0.28	0.14
28	-0.64	0.45	-0.19	-0.10
29	-1.00	-0.51	-1.51	-0.76
30	-0.99	0.43	-0.56	-0.28
31	3.04	-1.10	1.94	0.97
32	0.51	-1.14	-0.63	-0.32
33	-1.18	-0.25	-1.43	-0.72
34	0.17	-0.28	-0.11	-0.06
35	-0.02	-1.60	-1.62	-0.81
36	0.03	-2.65	-2.62	-1.31
37	-0.70	-0.92	-1.62	-0.81
38	-0.42	-1.53	-1.95	-0.98
39	-0.44	-0.59	-1.03	-0.52
40	-1.59	-1.44	-3.03	-1.52

Table 9: Mean values for the curve of Spee at T1, T2 and T3 (mm)

Subject number	Curve of Spee (Mean)		
	T1	T2	T3
01	-0.67	-1.71	-0.95
02	0.45	-1.81	-0.11
03	0.38	-0.09	0.33
04	-0.84	-0.63	-0.36
05	*	-1.44	-1.12
06	*	-1.19	-0.61
07	0.64	-1.09	-0.21
08	-1.23	-1.64	-1.56
09	1.02	-0.81	-0.36
10	-0.02	-1.09	-0.34
11	*	-1.97	-1.61
12	3.17	-0.06	-0.01
13	-0.74	-1.13	-0.80
14	0.23	-0.58	0.21
15	*	-0.45	0.89
16	3.31	-0.65	0.97
17	2.89	-0.72	0.14
18	0.73	-1.12	-0.68
19	0.28	-0.49	-0.39
20	*	-1.10	0.19
21	4.74	-2.34	-1.07
22	1.00	-0.94	-0.29
23	1.51	-1.29	-0.64
24	4.15	-2.64	-0.98
25	1.11	-1.36	-1.67
26	3.10	-1.27	-1.09
27	0.89	-0.11	0.14
28	2.48	-0.06	-0.10
29	1.50	-2.00	-0.76
30	*	-1.65	-0.28
31	5.83	0.48	0.97
32	*	-0.41	-0.32
33	1.93	-1.30	-0.72
34	0.67	-1.17	-0.06
35	*	-1.03	-0.81
36	-2.09	-1.65	-1.31
37	-0.06	-1.70	-0.81
38	2.28	-0.87	-0.98
39	1.20	-1.10	-0.52
40	-1.16	-2.43	-1.52

Means, standard deviations, and distributions for the curve of Spee were calculated for all the investigation times (T1, T2, and T3), and are summarized in Table 10.

Table 10: Means, standard deviations, and distributions for the curve of Spee at T1, T2 and T3 (mm)

	Mean	SD	Minimum	Maximum
T1	1.20	1.8	-2.09	5.83
T2	-1.10	0.7	-2.64	0.48
T3	-0.48	0.7	-1.67	0.97

SD, standard deviation

The general tendencies observed during the measurement of the curve of Spee, and mentioned earlier (section 3.2.2), are validated by the results presented in Table 10. The mean value for the curve of Spee at T1 had a positive value (1.20), indicating a slight curve of Spee before treatment. However, the mean value for the curve of Spee at T2 was negative (-1.10), indicating a reverse curve of Spee after orthodontic treatment.

The mean value for the curve of Spee during the follow-up (T3) was less negative (-0.48), indicating a slight relapse of the overcorrected curve of Spee that were present after orthodontic treatment (T2). This trend can also be observed in Table 9, which lists the mean values for the curve of Spee of all the subjects at T1, T2 and T3. The statistical significance of this trend, however, will be discussed later.

As can be expected, a considerable range was observed for the curve of Spee before treatment (T1). This is reflected in the minimum and maximum values, which ranged from -2.09 to 5.83 at T1. The range of distribution was considerably smaller for both T2 and T3, because orthodontic repositioning of the teeth had taken place.

The mean values for the measurements on all the individual teeth that were used during measurement of the curve of Spee (refer back to Figure 21) were calculated for all three stages of the study. Table 11 summarizes the results of these measurements for the left side only, while Table 12 summarizes the results for the right side only.

Table 11: Mean values for individual measurements used to calculate the curve of Spee on the left side only (n = 40)

	L2	L3	L4	L5	L6	Sum L
T1	-0.09	-0.18	0.35	0.59	0.49	1.16
T2	-0.15	-0.61	-0.24	-0.19	0.16	-1.02
T3	-0.12	-0.43	-0.13	0.01	0.22	-0.41

In Table 11, L2 represents the left side lateral incisor, L3 the left side canine, L4 the left side first premolar, L5 the left side second premolar, and L6 the mesiobuccal cusp of the first molar on the left hand side. For instance, the value of -0.09 (Table 11) represents the mean measurement of the left side lateral incisors for all the subjects at T1.

Table 12: Mean values for individual measurements used to calculate the curve of Spee on the right side only (n = 40)

	R2	R3	R4	R5	R6	Sum R
T1	-0.03	-0.01	0.31	0.54	0.44	1.25
T2	-0.25	-0.65	-0.25	-0.22	0.17	-1.20
T3	-0.14	-0.45	-0.14	0.00	0.20	-0.52

As can be seen from Tables 11 and 12, slight differences exist between the left and right side for some of the measurements. This observation supports the decision to measure the curve of Spee on both sides, and use the average (mean value) of the sum on the left and right side to quantify the curve of Spee. Moreover, using the data summarized in

Table 11 and 12, an accurate graphic representation of left and right side of the curve of Spee at T1, T2 and T3 can be constructed.

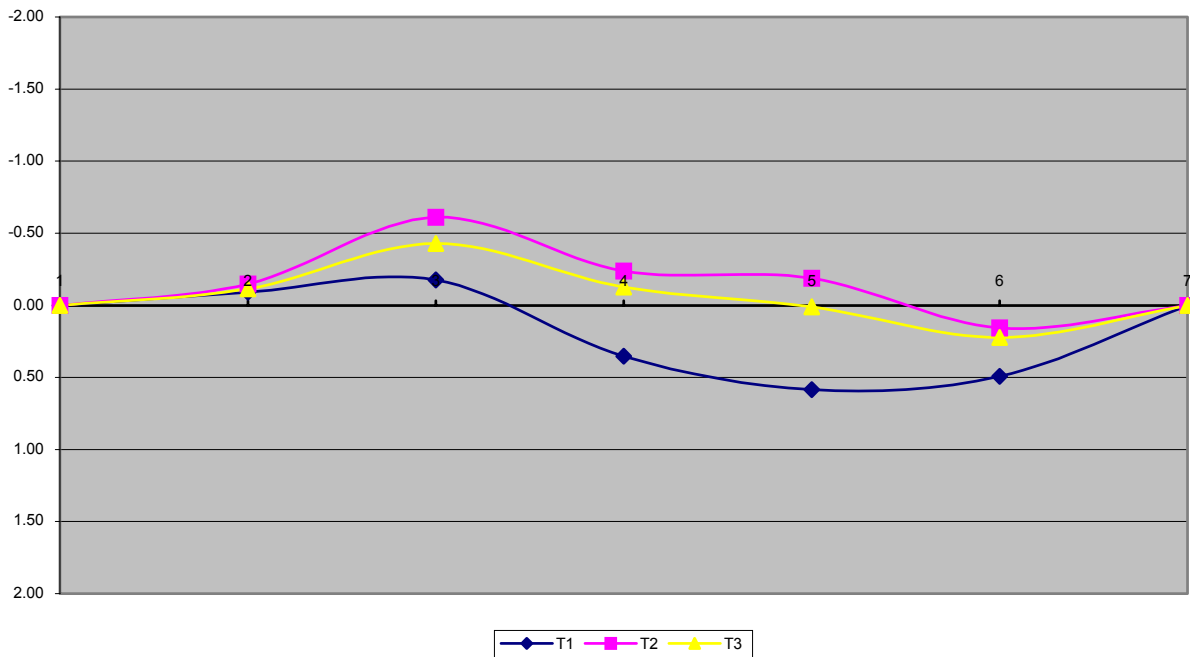

Figure 30: Graphic representation of the left side curve of Spee at T1, T2 and T3

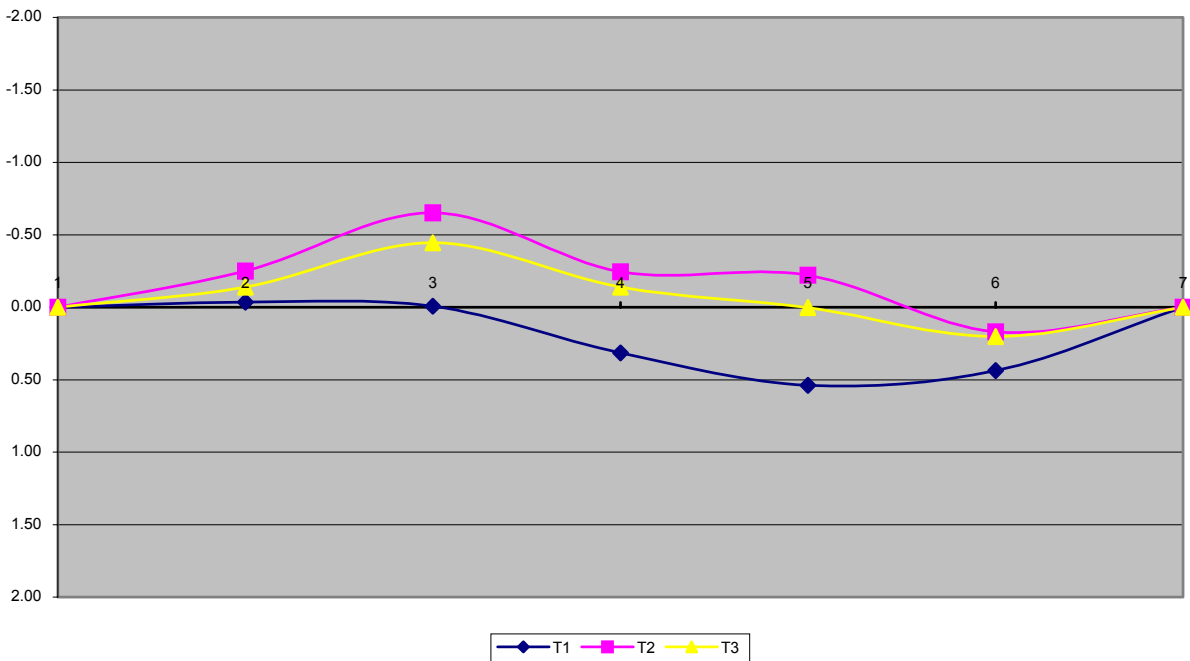

Figure 31: Graphic representation of the right side curve of Spee at T1, T2 and T3

Data from the left and right side were added and averaged, and a single set of measurements was obtained to represent the total curve of Spee. The results are summarized in Table 13, and the graphic representation is given in Figure 32.

Table 13: Mean values for individual measurements used to describe the total curve of Spee (n = 40)

	2 (L&R)	3 (L&R)	4 (L&R)	5 (L&R)	6 (L&R)
T1	-0.06	-0.09	0.33	0.56	0.47
T2	-0.20	-0.63	-0.24	-0.21	0.16
T3	-0.13	-0.44	-0.13	0.01	0.21

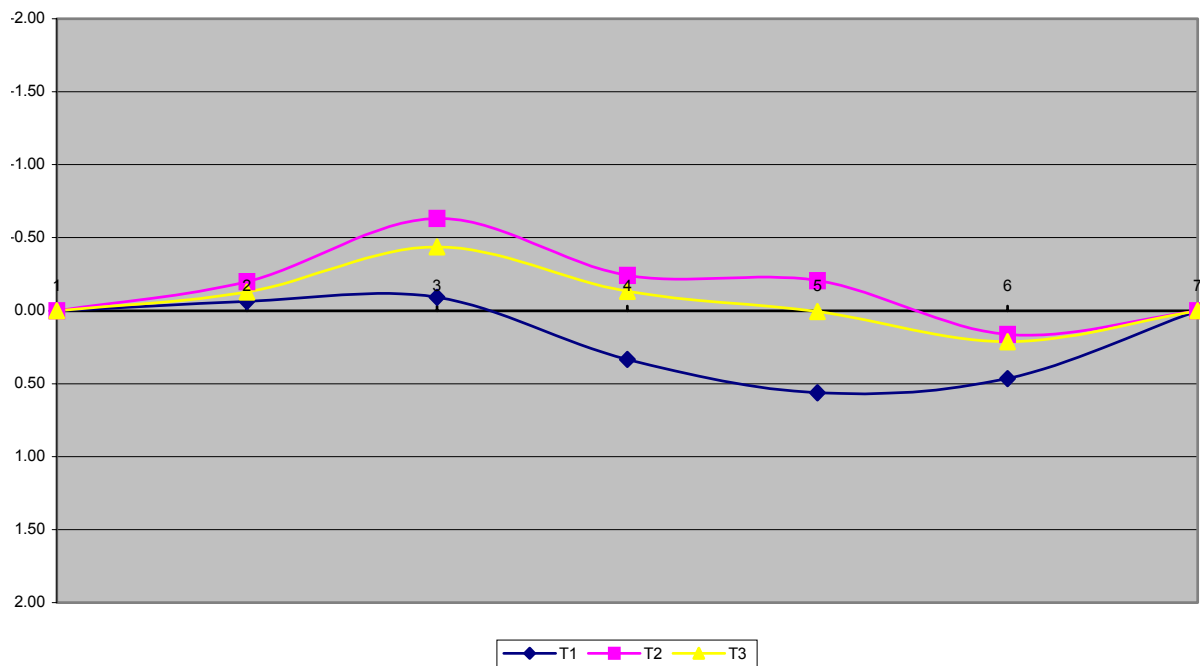

Figure 32: Graphic representation of the total curve of Spee at T1, T2 and T3

The general tendencies for the curve of Spee that took place over time are clearly illustrated in Figures 29-31: A predominant positive curve of Spee at T1 turned into a predominant negative (reverse) curve of Spee at T2, with some relapse to a nearly flat curve of Spee at T3.

Table 14: Mean values for the overbite at T1, T2 and T3 (mm)

Subject number	Overbite (Mean)		
	T1	T2	T3
01	2.94	1.52	2.46
02	5.96	1.36	2.96
03	3.40	2.78	3.12
04	4.04	2.66	2.92
05	1.80	1.92	3.42
06	4.14	3.44	3.78
07	2.82	2.96	3.24
08	2.70	1.48	1.96
09	0.82	1.16	1.58
10	0.74	1.40	0.66
11	2.80	1.76	2.68
12	3.48	2.42	2.98
13	0.58	1.26	0.36
14	-0.52	1.32	0.94
15	3.18	1.72	2.12
16	3.66	1.48	2.50
17	5.30	2.34	3.26
18	4.94	3.54	4.86
19	0.00	2.84	2.76
20	5.88	2.92	5.20
21	4.46	1.90	4.28
22	4.12	2.16	3.86
23	4.40	1.80	3.66
24	4.72	1.92	1.40
25	4.06	2.38	3.34
26	4.98	1.40	4.24
27	4.32	2.78	4.04
28	7.12	3.32	3.90
29	5.58	2.50	2.68
30	2.96	1.50	1.84
31	5.32	3.84	4.10
32	6.48	3.48	4.16
33	4.34	1.84	1.96
34	5.22	2.58	2.74
35	3.86	1.92	2.38
36	2.42	2.32	2.80
37	5.44	2.46	3.68
38	4.46	1.50	2.42
39	3.32	1.98	2.16
40	3.94	1.18	1.38

Table 14 lists the mean values for the overbite of all the subjects at T1, T2 and T3, while Table 15 summarizes the means, standard deviations, and distributions of the overbite at all three stages.

Table 15: Means, standard deviations, and distributions for the overbite at T1, T2 and T3 (mm)

	Mean	SD	Minimum	Maximum
T1	3.75	1.8	-0.52	7.12
T2	2.20	0.7	1.16	3.84
T3	2.90	1.1	0.36	5.20

SD, standard deviation

According to Tables 11 and 12, the general tendency for the overbite seems to be a decrease during treatment (except for the subjects with anterior open bites at T1), and an increase during the retention period (T2-T3). In fact, the overbite seems to have quite a high relapse tendency from T2 to T3, where roughly 50% of the correction gained during treatment seems to be lost again during the retention period. Again, the statistical significance of this relapse will be discussed later.

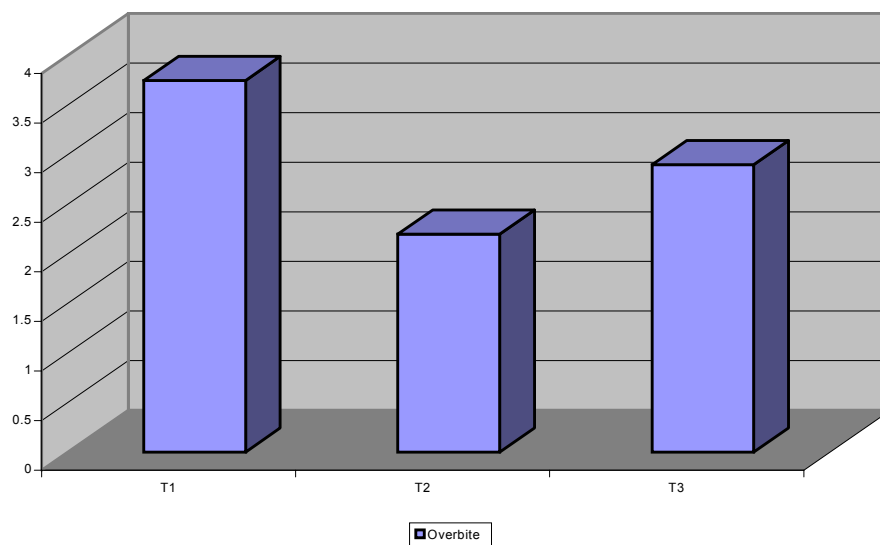

Figure 33: Histogram of the mean overbite at T1, T2 and T3

4.2.2 Determination of statistical significance (P values)

As stated earlier, it is not so much the actual values of the variables, but rather the changes that took place between the different stages (T1, T2 and T3) that will provide some valuable information on the stability of the variables. The mean values, standard deviations and P values of the changes in the curve of Spee between the different stages are summarized in Table 16.

Table 16: Means, standard deviations, and P values for the changes in the curve of Spee between the various stages for the total group (n = 40)

	Mean	SD	Minimum	Maximum	P
T2-T1	-2.30	1.8	-7.10	0.45	<0.0001
T3-T2	0.65	0.5	-0.30	1.70	<0.01
T3-T1	-1.70	1.7	-5.80	0.80	<0.0001

SD, standard deviation; P, level of significance

The variable T2-T1 represents the amount of leveling of the curve of Spee during orthodontic treatment. As can be expected, the mean value of 2.3mm (the negative sign indicates that the curve was leveled during treatment) was statistically significant (P <.0001). In addition, the curve of Spee was almost always leveled, not deepened, during treatment. (In Table 16, the 7.1mm is indicated as 'minimum' because of the negative sign, but it actually represents the maximum amount of leveling that took place during treatment). Very seldom was the curve of Spee deeper after treatment (T2) than before treatment (T1); the maximum amount for this to have happened was only 0.45mm.

The variable T3-T2 represents the amount of relapse that occurred during the follow-up period (mean 3.0 years after active treatment). The mean value for this relapse is 0.65mm, which represents less than 30% of the mean amount of leveling during treatment. Nevertheless the amount of relapse was still seen as significant (P<.01), although

not highly significant. Obviously, the relapse mostly tended to deepen the curve of Spee, but the extent of the relapse was less than expected, as indicated by a maximum value of 1.7mm of relapse.

The variable T3-T1 represents the amount of correction of the curve of Spee that was still present at the follow-up appointment (T3). A statistically significant value would show that most of the correction obtained during treatment (T2-T1) had been sustained, while a value that is not statistically significant would signify a high relapse tendency. A small (statistically insignificant) value would also suggest that the post-retention value (T3) is not much different from the pre-treatment value (T1), which would mean that most of the correction obtained during treatment, had been lost after treatment.

The mean value for the variable T3-T1 is 1.7mm, which represents nearly 75% of the mean total correction during treatment (T2-T1). Not surprisingly, this value was highly significant ($P < .0001$), which confirm that most of the correction of the curve of Spee obtained during orthodontic treatment was still present at T3.

Looking at the P values for the changes in the curve of Spee at the various intervals, it seems that the amount of relapse after leveling the curve of Spee, although statistically significant ($P < .01$), is clinically minimal. Therefore, it can be tentatively concluded that the curve of Spee is a relatively stable procedure. However, this statement still has to be confirmed after correlation coefficients had been calculated for all the variables (section 4.2.3).

To make matters even more interesting, it was decided to form two subgroups within the total group of 40 subjects: the first subgroup (n=26) consisted of subjects treated without extractions, while the second subgroup (n=14) consisted of subjects treated with extraction

of four premolars. The statistical analysis was repeated on the two subgroups to determine if extraction therapy would have a significant influence on the stability of the curve of Spee. The mean values, standard deviations and P values of the changes in the curve of Spee within the two subgroups are summarized in Table 17.

Table 17: Means, standard deviations, and P values for the changes in the curve of Spee between the various stages for the two subgroups

Subgroup 1: Non-extraction (n=26)					
	Mean	SD	Minimum	Maximum	P
T2-T1	-2.30	1.9	-6.80	0.45	<0.0001
T3-T2	0.65	0.5	-0.30	1.70	<0.1
T3-T1	-1.60	1.7	-5.10	0.80	<0.0001
Subgroup 2: Extraction (n=14)					
	Mean	SD	Minimum	Maximum	P
T2-T1	-2.40	1.8	-7.10	-0.80	<0.0001
T3-T2	0.60	0.4	-0.10	1.34	<0.01
T3-T1	-1.80	1.7	-5.80	-0.30	<0.0001

SD, standard deviation; P, level of significance

The results indicated similar changes in the curve of Spee for the two subgroups (extraction and non-extraction group) between the various intervals. In addition, the changes also correlate well with the changes observed for the total group of subjects (Table 16). The levels of significance for all the variables tested were similar between the two subgroups, and also similar to that of the total group already discussed.

In the light of these findings, it was concluded that there was no difference in the relapse tendency for the curve of Spee between extraction and non-extraction treatment. Because the two subgroups yield similar results to each other, and to the total group, and because

of the small sample size of the extraction group, it was decided to only use the total group (n=40) for all further statistical analysis.

An analysis of statistical significance was also performed for changes in the other major variable, the overbite. The mean values, standard deviations and P values of the changes in the overbite between the different stages are summarized in Table 18.

Table 18: Means, standard deviations, and P values for the changes in the overbite between the various stages for the total group (n = 40)

	Mean	SD	Minimum	Maximum	P
T2-T1	-1.60	1.7	-4.60	2.85	<0.0001
T3-T2	0.70	0.8	-0.90	2.85	<0.0001
T3-T1	-0.90	1.4	-3.30	2.75	<0.01

SD, standard deviation; P, level of significance

The mean amount of bite opening during orthodontic treatment (T2-T1) was 1.60mm, which is statistically significant ($P < .0001$). The mean amount of bite opening might seem to be quite small, but this is partly due to a fairly wide range of distribution of between 4.60mm bite opening and 2.85mm bite closure in subjects who started off with small overbites or open bites at T1. The overbite decreased in 33 out of the 40 subjects during treatment, while only seven (7) subjects had an increase in overbite during treatment (Table 14).

The mean amount of relapse in overbite (T3-T2) was 0.7mm. This amount may seem small, but it represents just less than 45% of the mean amount of bite opening during treatment. The level of significance ($P < .0001$) confirms that a statistically significant amount of relapse in overbite occurred between T2 and T3. Interestingly, the overbite decreased in only five (5) of the 40 subjects from T2 to T3; in four of those five subjects, the overbite was increased during

orthodontic treatment to close an open or partially open bite. Although it is a small sample, this result seems to support the theory that the overbite has a tendency to return to pre-treatment values after orthodontic treatment.

Just over 55% (0.9mm) of the mean correction in overbite was still present during the follow-up appointment (T3). Although this value is statistically significant, the level of significance ($P < .01$) is lower than the corresponding level of significance determined for the curve of Spee ($P < .0001$). Clinically this suggests that less of the correction obtained during orthodontic treatment was still present at T3 than was the case for the curve of Spee.

Careful analysis of the P values for the changes in overbite during the different stages (T1, T2 and T3) seems to indicate that the overbite has a higher relapse tendency than the curve of Spee. The possible relevance of this tendency in the eventual establishment of anterior guidance will be examined later.

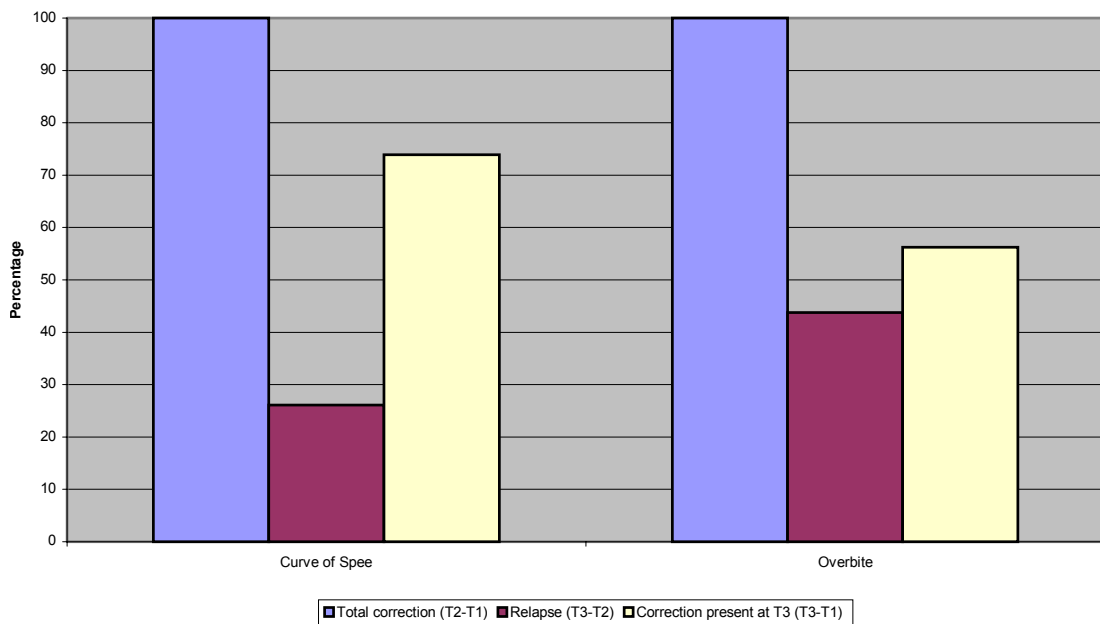

Figure 34: Histogram of relapse of the curve of Spee and overbite (%)

4.2.3 Determination of correlation coefficients

The purpose of this study was, amongst others, to examine the long-term stability of the curve of Spee and the overbite, and to relate changes in the curve of Spee to changes in the overbite. Therefore, correlation coefficients were calculated for the different parameters tested, and are summarized in Table 19.

Table 19: Correlation coefficients for the different parameters tested

Parameter	r	P
Spee T1		
Overbite T1	0.43	<0.05
Spee T2-T1	-0.92	<0.0001
Spee T3-T2	0.19	NS
Overbite T3-T2	0.14	NS
Spee T2-T1		
Spee T3-T1	0.96	<0.0001
Spee T3-T2	-0.39	<0.05
Overbite T3-T2	-0.33	NS
Overbite T2-T1	0.50	<0.01
Spee T3-T2		
Overbite T3-T2	0.03	NS
Overbite T1		
Overbite T2-T1	-0.92	<0.0001
Overbite T3-T2	0.50	<0.01
Spee T3-T2	0.19	NS
Overbite T2-T1		
Overbite T3-T1	0.76	<0.01
Overbite T3-T2		
Overbite T2-T1	-0.55	<0.01

r, Correlation coefficients; P, level of significance; NS, not significant

The general rule when evaluating correlation coefficients is that the closer the value of the correlation coefficient is to 1 or -1, the stronger the correlation between the variables. A correlation coefficient of 0 indicates no correlation between the variables.

Example: $r = 0.94$ - strong correlation;
 $r = 0.50$ - mild correlation;
 $r = 0.10$ - weak correlation.

The correlation coefficients must also be interpreted in accordance with the level of significance. A strong correlation should be accompanied by a high level of significance, indicated by a P value of $< .0001$. In this study, a P value $> .05$ was considered to be statistically insignificant.

Example: $P < 0.0001$ - highly significant
 $P < 0.01$ - significant
 $P < 0.05$ - low significance
 $P = 0.3$ - not significant (NS).

In Table 19, the parameter in the top left corner of each cell is correlated with all the variables listed in the centre of the same cell. As the curve of Spee and the overbite are correlated with themselves and with each other during different stages of observation, only one table was drawn up to display the results.

As can be expected, there was a highly significant ($P < .0001$) negative correlation between the depth of the curve of Spee at T1 and the amount of leveling of the curve ($r = -0.92$). Without stating the obvious, this means that significant leveling of the curve of Spee took place during orthodontic treatment. No correlation was found between the depth of the curve of Spee before treatment (T1), and the amount

of relapse for both the curve of Spee and the overbite, after treatment (T3-T2). This is a significant finding, because it indicates that the amount of relapse of the curve of Spee, and the amount of relapse of the overbite, cannot be predicted from the depth of the curve of Spee before treatment (T1).

As a matter of interest, a correlation coefficient was determined for the relation between the depth of the curve of Spee before treatment, and the overbite before treatment. Only a weak correlation ($r = 0.43$, $P < .05$) was found between the two variables. This indicates that a deep overbite before treatment is not necessarily associated with a deep curve of Spee before treatment, and *vice versa*. Clinically, this means that the arch responsible for the presence of a deepbite must be identified, before a decision is taken on the treatment mechanics to open the bite (e.g., intrusion of maxillary incisors, intrusion of mandibular incisors or extrusion of mandibular premolars and molars).

A highly significant ($P < .0001$) strong correlation ($r = 0.96$) was observed between the leveling of the curve (T2-T1) and the net result after the follow-up appointment (T3-T1), meaning that much of the treatment result was still present at T3. This strong correlation also confirms the tentative conclusion made earlier that the curve of Spee is a stable treatment procedure.

There was a weak negative correlation ($P < 0.05$; $r = -0.39$) between the amount of leveling of the curve of Spee and the relapse of the curve of Spee after treatment. In addition, there was no significant correlation between the amount of leveling of the curve of Spee and the relapse in the overbite after treatment. These findings seem to confirm that the amount of relapse after treatment of both the curve of Spee and the overbite cannot be predicted from the amount of leveling of the curve of Spee during orthodontic treatment.

There was no correlation between the amount of relapse of the curve of Spee (T3-T2) and the amount of relapse in the overbite (T3-T2). This suggests that deepening of the bite after treatment is not necessarily associated with deepening of the curve of Spee. Other factors, such as relapse of the maxillary incisors, instead of the mandibular incisors, might therefore be involved in the deepening of the bite after treatment.

Similar to the curve of Spee, there was a highly significant ($P < .0001$) negative correlation between the overbite at T1 and the correction in the overbite (T2-T1) during treatment ($r = -0.92$). This is an indication of the effectiveness of orthodontic therapy to alleviate anterior deepbites during treatment (The deeper the overbite before treatment, the more the correction obtained during treatment).

However, unlike the curve of Spee, there was some suggestion ($P < .01$) that the overbite before treatment (T1) can be used to predict the amount of relapse in overbite after treatment (T3-T2). Unfortunately, the correlation coefficient was only 0.50, indicating only a mild correlation between the variables. R^2 can be used as an indication to quantify this relationship; in this case, $R^2 = 0.25$, indicating that only 25% of the relapse in overbite can be connected to the pre-treatment overbite. The amount of the overbite before treatment, however, had no statistical significant correlation with the amount of relapse of the curve of Spee after treatment.

A significant correlation ($P < .01$; $r = 0.76$) was observed between the correction of the overbite (T2-T1) and the net result after the follow-up appointment (T3-T1). However, both the correlation coefficient and level of significance was lower than that of the same variables tested for the curve of Spee ($P < .0001$; $r = 0.96$). This seems to confirm that, although fairly stable, the overbite has a higher tendency for relapse

than the curve of Spee. The difference in stability between the curve of Spee and the overbite is beautifully illustrated in Figure 35 and 36.

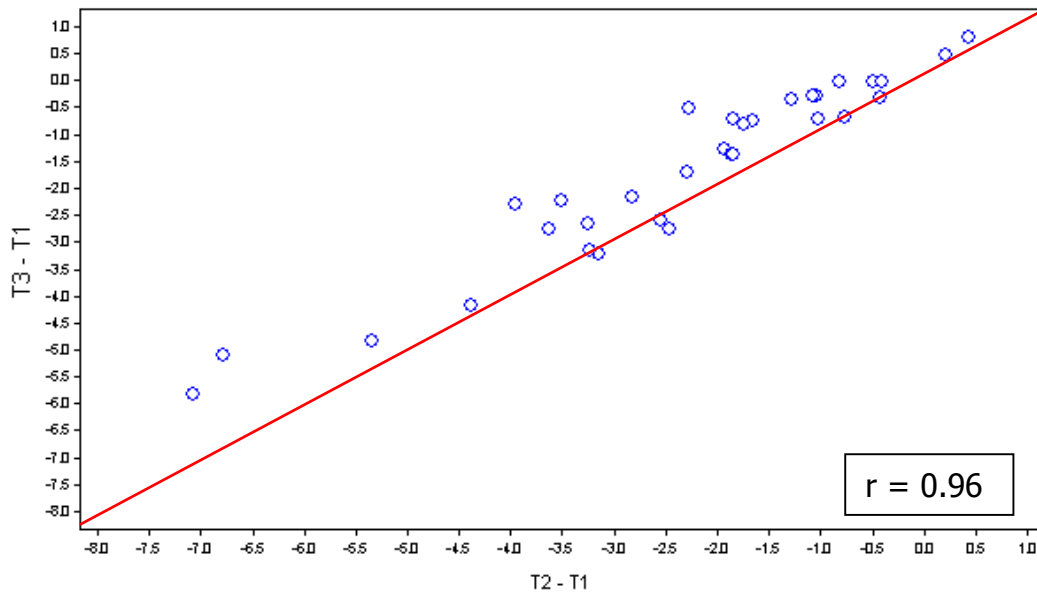

Figure 35: Scatter diagram indicating the relative stability of the curve of Spee as a treatment procedure

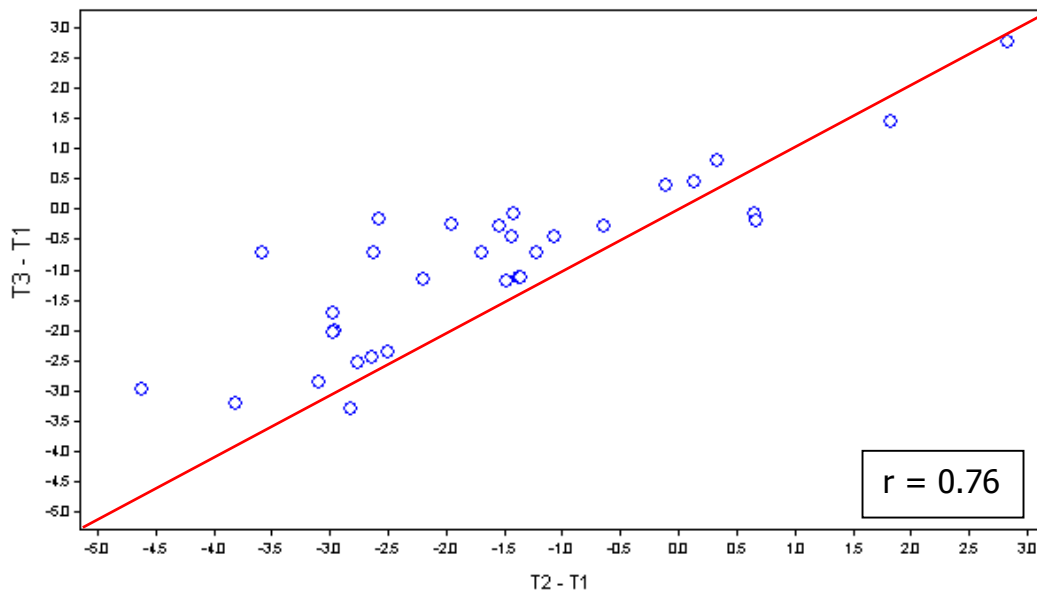

Figure 36: Scatter diagram indicating the relative stability of overbite correction as a treatment procedure

In Figure 35 and 36, the red line indicates the gradient of maximum stability, in other words, complete correlation between the correction during treatment ($T2-T1$) and the correction still present at $T3$ ($T3-T1$).

The closer the distribution of the blue dots around this line, the better the correlation between the variables, and therefore the better the long-term stability of the treatment procedure. As can be seen, the dots are more uniformly distributed among the red line in Figure 35 (curve of Spee) than in Figure 36 (overbite).

There was a mild negative correlation ($P < 0.01$; $r = -0.55$) between the amount of correction of the overbite (T2-T1) and the relapse in the overbite after treatment (T3-T2). Again, this seems to indicate that for the overbite, the amount of correction can be used as an indication of the amount of relapse that can be expected after treatment. Unfortunately, there was again only a mild correlation between the variables, allowing for limited clinical interpretation only. Nevertheless, both the amount of overbite before treatment, and therefore the amount of correction during treatment, should be considered potential risk factors in the relapse of overbite after treatment.

4.2.4 Relation between both the curve of Spee and overbite, and the presence of anterior guidance at T3

During orthodontic treatment, the natural arrangement of the teeth is changed. According to Klineberg (1992), any minor relapse in overbite after treatment might allow earlier protrusive contacts between the incisors, and thereby prevent posterior tooth interferences.

During the follow-up appointment (T3), a clinical evaluation of some of the properties of functional occlusion was performed. One of the more important aspects that were evaluated (from the perspective of this study at least), was an indication of the presence or absence of anterior guidance during mandibular protrusion (ADDENDUM A). Table 20 lists the results of this investigation, together with the values of the curve of Spee and the overbite at T3, to allow an analysis of possible correlation between these variables.

Table 20: Prevalence of anterior guidance at T3 (n=40)

Subject number	Curve of Spee (T3)	Overbite (T3)	Anterior guidance
01	-0.95	2.46	No
02	-0.11	2.96	Yes
03	0.33	3.12	Yes
04	-0.36	2.92	Yes
05	-1.12	3.42	Yes
06	-0.61	3.78	Yes
07	-0.21	3.24	Yes
08	-1.56	1.96	No
09	-0.36	1.58	No
10	-0.34	0.66	No
11	-1.61	2.68	Yes
12	-0.01	2.98	Yes
13	-0.80	0.36	No
14	0.21	0.94	No
15	0.89	2.12	No
16	0.97	2.50	No
17	0.14	3.26	Yes
18	-0.68	4.86	Yes
19	-0.39	2.76	No
20	0.19	5.20	Yes
21	-1.07	4.28	Yes
22	-0.29	3.86	Yes
23	-0.64	3.66	Yes
24	-0.98	1.40	No
25	-1.67	3.34	No
26	-1.09	4.24	Yes
27	0.14	4.04	Yes
28	-0.10	3.90	Yes
29	-0.76	2.68	No
30	-0.28	1.84	No
31	0.97	4.10	Yes
32	-0.32	4.16	Yes
33	-0.72	1.96	No
34	-0.06	2.74	No
35	-0.81	2.38	No
36	-1.31	2.80	Yes
37	-0.81	3.68	Yes
38	-0.98	2.42	Yes
39	-0.52	2.16	No
40	-1.52	1.38	No

From the total sample of 40 subjects, 22 subjects (55%) displayed anterior guidance during protrusive mandibular movement. In contrast, 18 subjects (45%) had no anterior guidance, but posterior interferences during mandibular protrusion.

In order to find a possible relationship between the variables, a two-sample t-test with equal variances and Welch t-test were performed on two subgroups within the total group of 40 subjects at T3. The t-tests allow determination of statistical significance for the variation in the curve of Spee and the overjet between the subgroups (with and without anterior guidance). The results of the t-test are summarized in Tables 21 and 22.

Table 21: Relationship between the presence or absence of anterior guidance, and the curve of Spee at T3

	N	Mean	SD	95% confidence	
				Min	Max
With AG	22	-0.43	0.6	-0.70	-0.15
Without AG	18	-0.55	0.7	-0.90	-0.20

AG, anterior guidance; n, number of subjects; SD, standard deviation

The mean value for the curve of Spee at T3 for the subjects with anterior guidance (n=22) was -0.43mm. The mean value for the curve of Spee at the same period for the subjects without anterior guidance (n=18), was slightly less (more reverse curve of Spee), with a mean of -0.55mm. The mean difference in the depth of the curve of Spee between the two subgroups was 0.12. Statistical analysis of the variation in the curve of Spee between the subgroups revealed a level of significance of 0.64, which is statistically insignificant ($P > .05$).

As a result, it can be concluded that the depth of the curve of Spee at T3 is not related to the presence or absence of anterior guidance. The

validity of this conclusion was also reflected by the 95% confidence intervals of the two subgroups, where the high degree of overlapping between the mean values of the two subgroups suggested that no difference regarding the curve of Spee exists between the two groups.

Table 22: Relationship between the presence or absence of anterior guidance, and the overbite at T3

	N	Mean	SD	95% confidence	
				Min	Max
With AG	22	3.60	0.7	3.2	4.0
Without AG	18	1.95	0.8	1.5	2.4

AG, anterior guidance; n, number of subjects; SD, standard deviation

The mean value for the overbite at T3 for the subgroup with anterior guidance (n=22) was 3.60mm. This was considerably more than the 1.95mm mean value for the subgroup without anterior guidance (n=18) at the same period. The mean difference in overbite between the subgroups is 1.65mm. Statistical analysis of the variation in overbite between the subgroups revealed a highly significant difference (P<.0001).

Therefore, it can be concluded that a statistically significant relationship existed between the overbite at T3, and the presence or absence of anterior guidance. It seems that the deeper the overbite at T3, the better the chance of having anterior guidance without protrusive interferences. Conversely, subjects with a small overbite at T3 seem to be more at risk for having posterior interferences during protrusive mandibular movement. In retrospect, it can be speculated that the relapse in overbite after orthodontic treatment might not be that bad after all – the mean overbite at T2 (2.2mm) might be associated with a higher percentage of posterior interferences than the mean overbite after relapse at T3 (2.90mm). The validity of this

suggestion, however, could not be tested, since data on the presence of anterior guidance at T2 was not available.

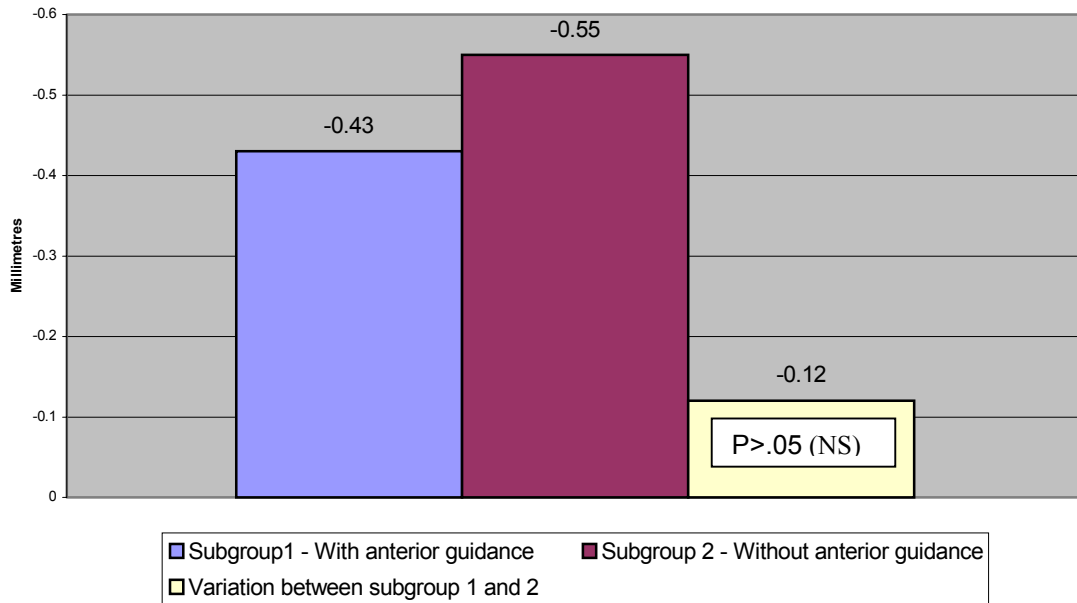

Figure 37: Variation in mean values for the curve of Spee between the subgroups at T3

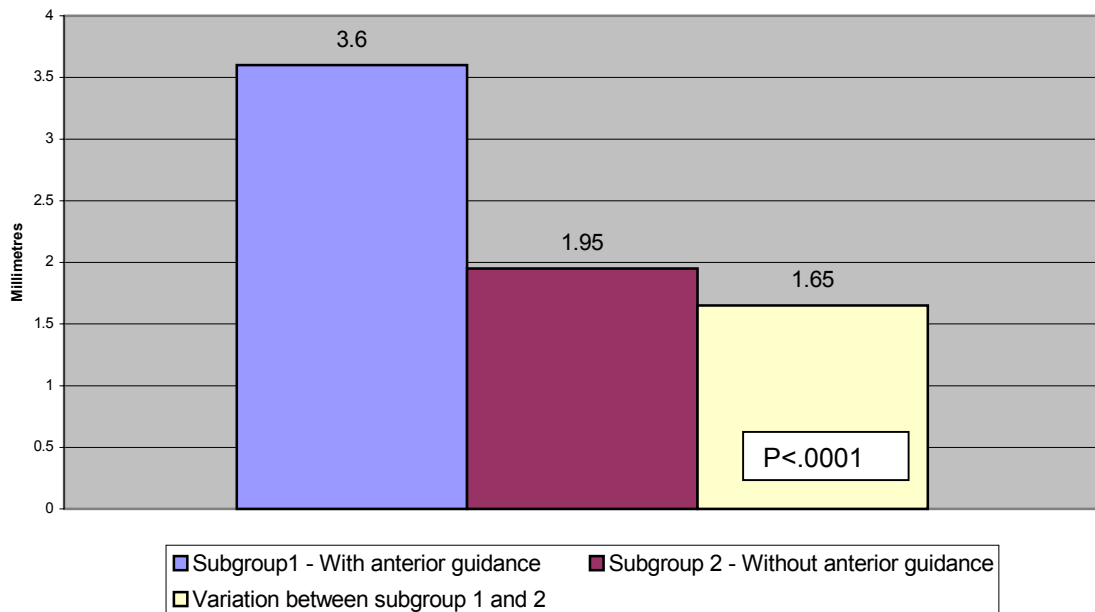

Figure 38: Variation in mean values for the overbite between the subgroups at T3

Figure 37 and 38 illustrate that the variation between mean values for subgroup 1 (anterior guidance) and subgroup 2 (no anterior guidance) is statistically significant for the overbite, but not for the curve of Spee.

The 95% confidence intervals of the 2 subgroups (Table 22) can be used to extrapolate the results of this study to a general population. The 95% confidence interval for the overbite in the group with anterior guidance was between 3.2 and 4.0mm. This confidence interval can be interpreted as follows: There is a 95% chance that the true, but unknown value for the overbite for any population in which anterior guidance is present, will be between 3.2 and 4.0mm.

Similarly, the 95% confidence interval for the overbite in the group without anterior guidance was between 1.5 and 2.4mm. This means that there is a 95% chance that the overbite for any population without anterior guidance (or with protrusive interferences), will be between 1.5 and 2.4mm.

However, the sample size of this study was probably too small to confidently apply the extrapolated results to a general population. In addition, the results are based on a sample of orthodontically treated patients, and can therefore only be applied to a general population of orthodontically treated subjects. The range in overbite in a population of non-treated subjects will probably be much larger than that for a sample of orthodontically treated subjects.

Nevertheless, the results of the 95% confidence interval were used to predict a cut off point for the overbite above which anterior guidance would most probably be present in a general, orthodontically treated population. A cut off point of 3mm was set, and an assumption was made that an overbite > 3mm will result in anterior guidance, while an overbite < 3mm will not result in anterior guidance. The assumption was tested for sensitivity and specificity against the results of the study. Of the 17 subjects with an overbite of > 3mm at T3, 16 had anterior guidance. Therefore, the hypothesis had a false positive outcome (predicted anterior guidance in a case with protrusive

interferences) in only 1/17 subjects (5.8%). In addition, of the 23 subjects with an overbite of < 3mm at T3, 17 did not have anterior guidance. Therefore, the hypothesis had a false negative outcome (predicted protrusive interference in cases with anterior guidance) in 6/23 subjects (26.1%).

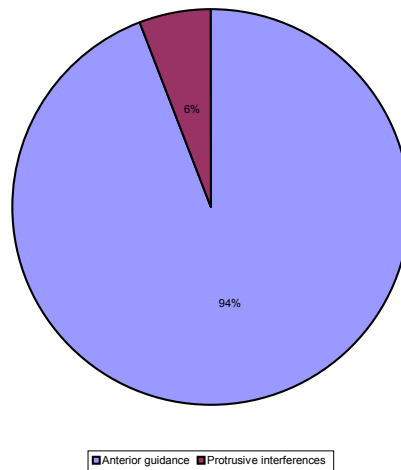

Figure 39: Prevalence of anterior guidance for overbite > 3mm

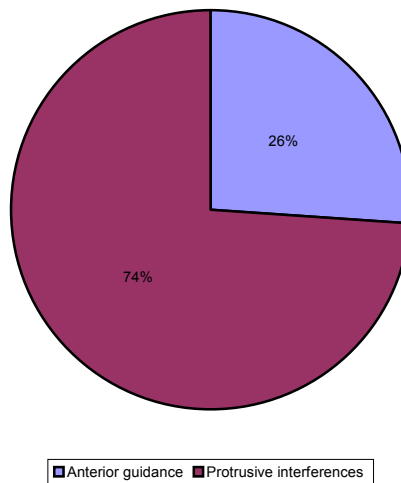

Figure 40: Prevalence of anterior guidance for overbite < 3mm

Figure 39 and 40 illustrate the prevalence of anterior guidance for overbites > 3mm, and < 3mm, respectively. If the assumption were 100% accurate, the circle in Figure 39 would have been completely blue, because the assumption stated that an overbite of > 3mm will

result in anterior guidance. Similarly, the circle in Figure 40 would have been completely red, because the assumption stated that an overbite < 3mm will result in protrusive interferences.

Ultimately, the statistical analysis indicated that the prediction that an overbite > 3mm would result in anterior guidance, was accurate in 16/17 subjects (94%). Prediction that an overbite < 3mm would not result in anterior guidance, but in protrusive interferences, was accurate in 17/23 subjects (74%).

In statistical terms, the hypothesis had a higher sensitivity than specificity, meaning that there was more false negative than false positive errors. However, a cut off point of 3mm for the overbite seems to be a fairly good compromise between sensitivity and specificity in terms of the prediction of anterior guidance in orthodontically treated patients.

CHAPTER 5

DISCUSSION

Obtaining enough study material for the collection of data for the research was more difficult than anticipated. Several of the orthodontists who were approached to provide study material, were unable to help, because study casts are not made routinely as part of their post-treatment records. Instead, intra-oral photographs (usually digital) are taken to record the post-treatment occlusion.

This trend was confirmed by the 2002 JCO study of orthodontic diagnosis and treatment procedures. According to Keim, Gottlieb, Nelson and Vogels (2002), there had been a gradual decline in routine usage of most of the diagnostic records surveyed since the 1986 study, the only notable exceptions being panoramic X-rays and digital records. According to the study, only 58.2% of the orthodontists surveyed make routine use of post-treatment study casts. That is a decline of 17.2% from the 1996 survey, when 75.4% of orthodontists reported routine usage of post-treatment study casts.

In addition, according to the 2002 survey, 78.1% of orthodontists make use of intra-oral photographs to capture the post-treatment occlusion (53.0% use digital photographs, 23.2% use 35mm intra-oral photographs, and 1.9% use Polaroid intra-oral photographs). This is very similar to the 77.6% that routinely took post-treatment photographs during the 1996 survey.

The two main explanations for not making post-treatment study casts routinely by local orthodontists seem to be shortage of storage space for the casts, and financial considerations. Patients, as well as medical

insurance companies, seem unwilling to pay for post-treatment records, placing the onus on the orthodontist to cover the costs for such expenses.

In contrast to the private practices, there is a fairly large database of pre-treatment and post-treatment records available in the departmental storeroom of the Department of Orthodontics, University of Pretoria. However, these patients are, in general, more difficult to locate, as their personal and contact details seem to change more regularly, making it often impossible to retrieve the patients for follow-up appointments or records.

Despite this, a total of 40 subjects (out of a possible 60 subjects that were initially identified) were retrieved, and the process of data collection could be administered. A sample of 40 subjects seem more than adequate, judging from the sample sizes of similar studies (Braun, Hnat and Johnson (1996) – 27 subjects; Bishara, Jakobsen, Treder and Stasi (1989) – 28 subjects; Little, Riedel and Årtun (1988) – 31 subjects; Sadowsky, Schneider, BeGole and Tahir (1994) – 22 subjects). In addition, the minimum proposed follow-up time of two years was exceeded by one year, resulting in a mean follow-up time of three years.

De Praeter, Dermaut, Martens and Kuijpers-Jagtman (2002) had a larger study sample (149 subjects), courtesy of the databank of the University of Nijmegen, The Netherlands. This emphasize the importance of continuity in a databank, and place a responsibility on local universities to built up and manage similar databanks more effectively, for the benefit of future research projects. The possibilities for research, if such a databank can be established, are nearly endless. In my opinion, one of the biggest drawbacks to local research, is the lack of **structured** study material.

Several studies have evaluated the difference in the curve of Spee between male and female patients. Orthlieb (1997) finds no statistical significant difference in the radius of the curve of Spee between a male and female sample. Ferrario, Sforza, Poggio, Serrao and Colombo (1999) report that the occlusal curvature of the mandibular arch is not significantly influenced by sex. Braun and Schmidt (1956) studied the differences in the curve of Spee between men and women and between the different Angle classifications. The shape of the curve for males and females seemed to be identical, and no significant differences could be found among Class I, Class II division 1, or Class II division 2 patients.

De Praeter, Dermaut, Martens and Kuijpers-Jagtman (2002) find no statistically significant differences between males and females for all the variables tested (including the curve of Spee and the overbite). The sample of 40 subjects used in the current research consisted of 26 females and 14 males. Since no differences seems to exist between the curve of Spee for male and female subjects, no distinction were made between the male and female subjects, and the data were pooled together during the statistical analysis of the results.

The photographic setup and computerized analysis of the photographs were explained in detail under "Materials and Methods" (Chapter 3). Judging by the high correlation obtained for both intraclass and interclass measurements, the process of electronic measurement of the curve of Spee seems to have been successful. The CorelDRAW[®]10 software is relatively easy to use, and can be applied in a variety of studies requiring accurate measurement of whatever variables needed. Even cephalometric radiographs can be traced and measured with a high degree of accuracy using the CorelDRAW[®]10 software.

Little research has been dedicated to examining the long-term stability of the leveled curve of Spee. Most previous studies regarding the curve of Spee in the orthodontic literature focussed on determining the radius for the curve of Spee (Hithchcock, 1983; Ferrario, Sforza, Poggio, Serrao and Colombo, 1999), or on arch length considerations due to the curve of Spee (Germane, Staggers, Rubenstein and Revere, 1992; Braun, Hnat and Johnson, 1996; Clifford, Orr and Burden, 1999). Chung, Sadowsky, Wallace and McCutcheon (1997) find no relationship between various arch perimeter variables (arch length, arch depth, arch width), and leveling of the curve of Spee.

In addition, the classic studies on stability in orthodontics usually refer to lower incisor crowding (Little, Riedel and Årtun, 1988; Little, 1990), arch length changes (Sadowsky and Sakols, 1982; Sadowsky, Schneider, BeGole and Tahir, 1994) and stability in the transverse dimension (Vanarsdall, 1999) after orthodontic treatment. Numerous studies have shown that transverse expansion across the mandibular canines is almost never maintained (Bowman, 1998). To date, there is no credible evidence that early intervention to 'prepare', 'develop', or expand arches has any efficacy in providing a less crowded permanent dentition at a substantial post-retention point in time (Proffit and Fields, 2000).

The purport of studies on the curve of Spee in the prosthodontic literature (Orthlieb, 1997; Lynch and McConnell, 2002) are also generally quite different from those in the orthodontic literature. In prosthodontics, the curve of Spee is seen as one of the variable determinants of the occlusion, which should be set up in harmony with condylar guidance to prevent protrusive interferences. As no teeth are actively moved during prosthodontic treatment, no mention regarding long-term stability of the curve of Spee is made in the prosthodontic literature.

As a result, few studies, regarding the stability of the curve of Spee, are available with which to compare the results of this research. The only notable exceptions are the studies by Kuitert, van Ginkel and Prah-Anderson (2000), and De Praeter, Dermaut, Martens and Kuijpers-Jagtman (2002). Unfortunately, the former of the two studies was never published in full, and is only available as an abstract of the research.

Despite using a completely different photographic setup and different computer software to measure the curve of Spee, the results of this study compare favourably with the results of the study by De Praeter, Dermaut, Martens and Kuijpers-Jagtman (2002). The mean values for both the curve of Spee and the overbite followed a similar trend from T1 to T2 and T3 in the two studies. The results of the two studies are summarized in Table 23.

Table 23: Mean values for the curve of Spee and overbite in two comparative studies (in millimetre)

	This study	De Praeter, <i>et al</i> (2002)
Curve of Spee		
T1	1.20	2.40
T2	-1.10	-0.70
T3	-0.48	-0.20
Overbite		
T1	3.75	3.0
T2	2.20	1.8
T3	2.90	2.7

The results of this study also indicate that slight differences exist between the left and the right side for some of the measurements of the curve of Spee. This tendency was also observed by Ferrario,

Sforza, Miani, Colombo and Tattaglia (1992). According to their study, the right and left sides showed different concavities, the right-hand side being flatter than the left. The results of this study support this finding for T2 and T3, but the mean curve of Spee was slightly deeper on the right than the left during T1. Whatever differences existed between the left and right sides were negated during this study by measuring both sides, and using the mean value between left and right sides to describe the curve of Spee for each subject.

Relapse of the curve of Spee during the period after orthodontic treatment was minimal. Less than 30% of the total amount with which the curve was leveled during treatment, relapsed in the 3 years (mean) after orthodontic treatment. In addition, a highly significant ($P < .0001$) strong correlation ($r = 0.96$) was found between the leveling of the curve (T2-T1) and the net result after treatment (T3-T1), indicating that much of the treatment result was still present after retention (T3). It was therefore concluded that the leveling of the curve of Spee is a stable treatment procedure, with little post-treatment relapse.

Similar results were recorded by De Praeter, Dermaut, Martens and Kuijpers-Jagtman (2002), and by Carter and McNamara (1998). However, the sample examined by Carter and McNamara (1998) consisted of **untreated subjects** evaluated from late adolescence to the fifth or sixth decade of life. The curve of Spee, in general, was stable during adulthood. De Praeter, Dermaut, Martens and Kuijpers-Jagtman (2002) conclude that leveling the curve of Spee was a relatively stable treatment procedure – there was less than 20% relapse in the curve of Spee during the post-treatment period of 6 years.

No correlation was found between the depth of the curve of Spee before treatment (T1) and the relapse in the curve of Spee after

treatment. In addition, only a weak correlation ($r=0.39$) was found between the amount of leveling of the curve of Spee during treatment and the relapse in the curve of Spee after treatment. This indicates that the amount of relapse of the curve of Spee cannot be predicted from either the depth of the curve before treatment, or the amount of leveling during treatment. Similar conclusions were drawn by Kuitert, van Ginkel and Prah-Anderson (2000), and De Praeter, Dermaut, Martens and Kuijpers-Jagtman (2002).

A higher tendency for relapse was observed for the overbite – 45% of the correction obtained during orthodontic treatment was lost again during the post-treatment period. A lower level of significance ($P<.01$) and a lower correlation coefficient ($r=0.76$) between the correction during treatment (T2-T1) and the net result after retention (T3-T2) were obtained for the overbite than for the curve of Spee. This indicates that the overbite, although relatively stable, has a higher relapse tendency than the curve of Spee.

This finding was confirmed by the fact that no correlation could be established between the amount of relapse of the curve of Spee and the amount of relapse in the overbite. A possible mechanism for the tendency for relapse in overbite, but not for the curve of Spee, could be that the bite is deepened by eruption of the upper incisors, rather than eruption of the lower incisors, during the post-treatment period. This would result in deepening of the overbite, without concomitant deepening of the curve of Spee.

Deepening of the overbite through relapse of the upper incisors would presume that the upper incisors were intruded during orthodontic treatment. According to Sarver (2001), a serious mistake commonly made in orthodontic practice, is 'overintrusion' of the maxillary incisors. In most cases, this will tend to hide the maxillary incisors behind the

upper lip during normal conversation, and thereby create a flat smile arc. Not only will this contribute to a less attractive facial appearance, but it may also be associated with an increase in relapse of the upper incisors after treatment.

In light of this finding, a future research project may investigate the stability of the curve of Spee in the maxillary arch, to validate or invalidate the possibility that the relapse in overbite after orthodontic treatment is mostly due to eruption of the upper incisors, and not to eruption of the lower incisors. At the same time, a clinical evaluation of the smile arc, which is a very relevant topic in orthodontics at present, can be done to evaluate the effects of maxillary incisor intrusion during orthodontic treatment. According to Zachrisson (1998), parallelism between the smile arc and the curvature of the lower lip should be a treatment goal during all forms of oral rehabilitations, including orthodontic treatment, to ensure an optimal esthetic treatment result.

There seems to be a considerable amount of controversy in the literature surrounding the stability of overbite correction after orthodontic treatment. Glenn, Sinclair and Alexander (1987) report excellent long-term stability in the overjet, overbite and intermolar widths in 28 non-extraction cases who had been out of retention for at least 3 years.

Sadowsky, Schneider, BeGole and Tahir (1994) also estimate overbite correction to be fairly stable – only 26% of the overbite correction obtained during orthodontic treatment was lost through relapse during the post-treatment period. However, in their study, all the subjects evaluated had a fixed lingual retainer placed after treatment, and were under retention for an average period of 8.4 years after active orthodontic treatment. As a result, the relapse in overbite appeared to

be due mainly to maxillary incisor eruption. Sadowsky, Schneider, BeGole and Tahir (1994) conclude that prolonged retention might be an important factor to ensure long-term stability of the overbite after orthodontic treatment.

Shields, Little and Chapko (1985) report a 55% relapse in the overbite during a period of ten years post-retention. They also identify cephalometric measures that were associated with a higher risk of relapse in overbite - subjects who had lower occlusal and mandibular plane angles, as well as higher SNA and SNB angles (suggestive of the heavy musculature of a Class II division 2 patient), were more likely to have significant post-retention bite deepening. The practical use of these predictions, however, is of limited clinical value, for it is a well-known fact that Class II division 2 patients have a higher tendency towards post-treatment relapse.

De Praeter, Dermaut, Martens and Kuijpers-Jagtman (2002) report a 75% relapse in overbite after treatment – this meant that the initial overbite almost completely returned after treatment. The amount of overbite correction during treatment, however, was not correlated with the amount of relapse in overbite after treatment. Sadowsky and Sakols (1982) also report that the overbite often relapsed back to pre-treatment values, and that the overbite can sometimes even become worse than the pre-treatment value over the long-term.

Treatment mechanics are also believed to influence the stability of overbite correction after orthodontic treatment. Ricketts (1955) believes that intrusion of incisors is the only way to achieve a stable reduction of deep overbites, while Schudy (1966) advocates molar extrusion as the treatment of choice for overbite reduction. Sondhi, Cleall and BeGole (1980), however, find no significant difference in the stability of overbite correction between cases that underwent intrusion

of incisors and those that did not, and conclude that no single type of treatment mechanics can be deemed superior in terms of the stability of overbite correction.

Unlike the curve of Spee, there was some suggestion that both the overbite before treatment (T1), and the amount of overbite correction during treatment (T2-T1), can be used as indicators to predict the amount of relapse that can be expected after treatment. The bigger the overbite before treatment, and the bigger the correction in overbite during treatment, the greater the risk of relapse in the overbite after treatment. However, the correlation coefficients between the variables were relatively low ($r=0.50$), and any interpretation of a correlation between variables should be made with caution.

The 45% relapse in overbite obtained during this study seems to be midway within a wide range of relapse tendencies reported in the literature. From a clinical perspective, however, it is probably safe to accept that the overbite, together with lower incisor alignment, are the two variables that are most likely to change after orthodontic treatment. Whether these changes are entirely due to orthodontic relapse (the slip back or fall back to a former condition after temporary improvement), or part of a normal process of developmental changes and growth recovery, are still being debated.

Long-term stability after orthodontic treatment seems to be an elusive goal. However, according to Rossouw (1999), a stable orthodontic result can be achieved when the physiologic changes that occur naturally in the dentition are considered as part of the long-term result, and all post-treatment changes are not necessarily seen as orthodontic relapse. A multiplicity of factors, not only post-orthodontic relapse, are involved in the changes or "adjustments" that occur after orthodontic treatment.

The relationship between the curve of Spee and overbite, and the presence of anterior guidance at T3, provided interesting results. Only 55% of the sample displayed anterior guidance at T3, while 45% had posterior interferences during mandibular protrusion. This seems to be a worrying statistic, especially since anterior guidance is strongly advocated to be one of the goals of an ideal functional occlusion.

Nonetheless, similar results are reported in the literature. Sadowsky and BeGole (1980) indicate that 52% of a sample of orthodontically treated subjects (n=75) had posterior contacts on protrusion 10 to 35 years post-treatment. Sadowsky and Polson (1984) also report a high prevalence of protrusive contacts (50%) in a group of orthodontically treated patients. Milosevic and Samuels (1998) record a slightly smaller prevalence of posterior contacts on protrusion, with 23% of their sample displaying protrusive interferences.

Most of these studies included a control group of untreated subjects, to evaluate the functional occlusal status in a general population of untreated subjects. According to Sadowsky and BeGole (1980), 55% of an untreated sample presented with protrusive interferences, while Sadowsky and Polson (1984) report protrusive contacts in 51.5% of an untreated group.

Klineberg (1992) states that the curve of Spee is necessary to allow contact between the upper and lower incisor teeth, and to prevent posterior tooth interferences during mandibular protrusion. However, the results of this study revealed no statistical significant difference in the depth of the curve of Spee in a sample with, and a sample without anterior guidance. While a relation between the depth of the curve of Spee, and the presence of anterior guidance during mandibular protrusion seems theoretically likely, the presence of such a relation could not statistically be demonstrated during this study.

In contrast, a highly significant difference existed between the overbite in a group of subjects with anterior guidance (3.60mm), and a group of subjects without anterior guidance (1.95mm). A subject with a relatively small overbite may therefore be predisposed to protrusive interferences, and all the potential negative effects so often associated with such interferences. These negative effects include excessive dental attrition, increased tooth mobility, parafunctional activities such as bruxism, periodontal breakdown, muscle fatigue and pain, and temporomandibular disorders (TMD). The validity of these claims, is controversial, and will be discussed later.

In orthodontics, there is a tendency to 'overtreat' the overbite, often resulting in a small overbite at the end of active orthodontic treatment. This tendency was reflected during this research by the mean value of just 2.2mm for the overbite after orthodontic treatment. This value is quite close to the mean value of the overbite for the group of subjects with protrusive interferences after retention (1.95mm). As a result, it can be speculated that a high percentage of the subjects might have had protrusive interferences directly after active orthodontic treatment, a statement that cannot be verified since no data is available on the status of the functional occlusion directly after treatment (T2).

Nevertheless, in light of the significant relationship between the overbite and anterior guidance established during this study, the results seem to agree with an earlier statement by Sadowsky and Sakols (1982): "... a certain amount of posttreatment change is quite acceptable and is often desirable to permit settling of the occlusion and also to permit the establishment of adequate incisal guidance. It is only when the dental relationships are outside a particular range that concern arises as to the success of treatment."

The cut off point of 3mm established for the overbite as an indication of the probability of the presence of anterior guidance, proved to be quite accurate. Subjects with an overbite $> 3\text{mm}$, had a 94% chance of having anterior guidance during mandibular protrusion, while 74% of subjects with an overbite $< 3\text{mm}$, had protrusive interferences. This suggest that an overbite between 3 and 4 mm (as recommended by Roth, 1997), is likely to result in anterior guidance during protrusive mandibular movement, and that one of the goals of an ideal functional occlusion will be met.

From a clinical perspective, an overbite of 3mm is easy to measure, and it is my intention to clinically test this theory (that an overbite $>3\text{mm}$ will result in anterior guidance) in future on all my patients after treatment. Only by applying the results of studies such as this clinically on a broader spectrum of patients, will the *real* significance (clinical versus statistical significance) of the results be verified.

It was interesting to note that a study with similar objectives had previously been published in the literature. Milosevic and Samuels (1998) demonstrate that a moderate, but significant association exists between the end of treatment overbite, and dynamic excursive movements. By setting a cut-off point of 2.4mm for the overbite, the frequency of functional interferences with an overbite of $<2.4\text{mm}$, was significantly higher than interferences with an overbite of $>2.4\text{mm}$, especially with respect to protrusive tooth contacts.

The deeper overbite provides longer incisor and canine guidance on protrusion and lateral excursions respectively, which in turn discludes the remaining dentition. Milosevic and Samuels (1998) conclude: "It would seem that an overbite of not less than 2mm is a desirable feature in order to reduce potentially interfering contacts and should be considered an orthodontic treatment goal."

Naturally, the overbite and the curve of Spee are not the only factors that will have an influence on the presence or absence of protrusive interferences. Other factors, such as the angle of condylar guidance (CG), the angle of incisal guidance (IG), the angle of the plane of occlusion (PO), and the cusp heights of the posterior teeth, can all directly or indirectly influence development of posterior contacts during protrusive mandibular movements (Figure 41).

For instance, to ensure posterior disclusion during protrusive mandibular movement, the angle of incisal guidance must be greater than the angle of condylar guidance (Figure 41). The angle of condylar guidance is a fixed factor, determined by the morphology of the temporomandibular joints (Kasrovi, Meyer and Nelson, 2000). This emphasizes the importance of adequate torque of the maxillary incisors during orthodontic treatment, as inadequate buccal root torque will result in a small angle of incisal guidance, which may result in protrusive interferences during functional mandibular movements.

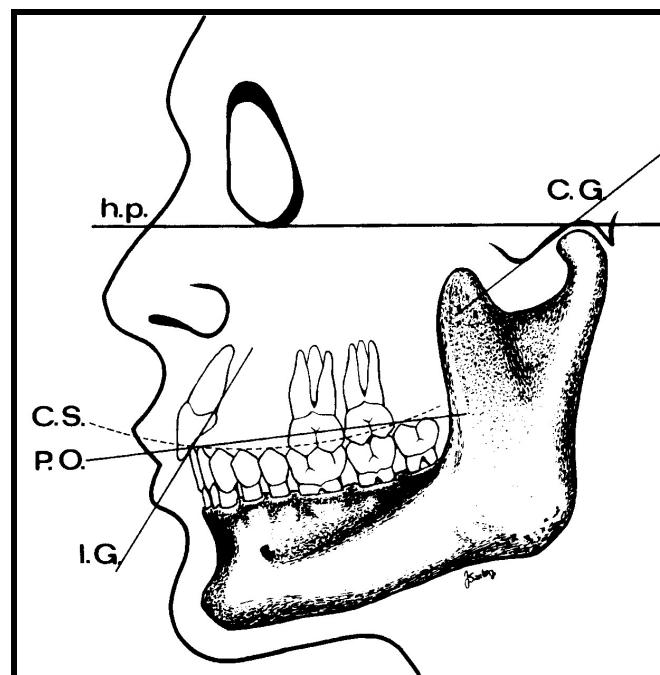

Figure 41: Fixed and variable determinants of the occlusion (Dos Santos, 1998)

In addition, anterior guidance is not the only goal of an ideal functional occlusion. Other goals, such as canine guidance/group function during lateral mandibular movement, RCP/ICP equality, an interocclusal distance of 2 – 4 mm between rest position and intercuspal position, and no deflective contacts between the teeth of the maxillary and mandibular arches, are equally important from a functional occlusal point of view (Thomson, 1990).

Unfortunately, not all of these variables can be examined during a single study. Therefore, for this research, two of the goals of an ideal functional occlusion (anterior guidance during mandibular protrusion, and no posterior interferences during mandibular protrusion), were examined. In addition, the possible relationship between two variables (the curve of Spee and the overbite) and the presence of anterior guidance, was evaluated. The overall results of this study must be reviewed in the context of the bigger picture outlined above.

Finally, what is the importance of obtaining an ideal functional occlusion? The argument usually put forward is that a non-ideal functional occlusion (RCP/ICP differences, occlusal interferences, etc.) is associated with temporomandibular disorders (TMD). If occlusion does play a significant role in the etiology of TMD, the orthodontist can and should play an important role in the management of these disorders. On the other hand, if occlusion plays no role in TMD, any attempt by the orthodontist to alter the occlusal condition is misdirected and should be avoided (Okeson, 2003).

The prevalence of signs and symptoms associated with TMD can best be appreciated by examining epidemiological studies. A high natural occurrence of balanced occlusion (i.e. possessing bilateral non-working contacts) was found in populations studied by Gazit and Liberman (1985), Rinchuse and Sassouni (1983), and others. The type of

functional occlusion some have considered the worst type, i.e. balanced occlusion with non-working contacts bilaterally, may be the norm as regards to prevalence, rather than the exception. Woda, Vigneron and Kay (1979) state: "...pure canine protection or pure group function rarely exists and balancing contacts seem to be the general rule in the populations of contemporary civilization."

Despite the high prevalence of functional interferences in the general population, only 25% of the general population is likely to report some awareness of TMD symptoms, while less than 10% of the population is likely to believe that their symptoms are severe enough to seek treatment (Okeson, 2003). There are more people with non-ideal occlusal relationships than people with signs or symptoms of TMD.

Sadowsky and BeGole (1980) investigated the long-term status of temporomandibular joint function and functional occlusion after orthodontic treatment. A high prevalence of non-functional occlusal contacts occurred in both the orthodontically treated and the control groups (e.g. 91% of the orthodontically treated group had a balanced occlusion with non-working side interferences). Also, a high prevalence of mandibular shift from the retruded contact position (RCP) to the intercuspal position (ICP) was evident in both groups, with the shift being significantly greater in the control group than in the orthodontic group.

In the same study (Sadowsky and BeGole, 1980), the prevalence of TMJ signs/symptoms was similar between the orthodontically treated group and a control group of subjects with untreated malocclusions. More importantly, no relationship was evident between the presence of non-functional occlusal contacts or mandibular shifts, and the subjects who exhibited signs or symptoms of TMJ dysfunction. The results of this and other epidemiological studies indicate that a cause-effect

relationship cannot be demonstrated between the functional occlusion and TM disorders.

Despite this finding, Sadowsky and BeGole (1980) caution that it is difficult to anticipate when the limits of physiologic tolerance in the masticatory system of any particular patient will be exceeded to cause dysfunctional problems. The gradual adaptation of muscles and joints which occurs during the slow development of a specific (mal)occlusion during growth, may not occur following the much quicker change related to orthodontic treatment. They conclude that it will be careless of the orthodontist not to attempt to establish as ideal a functional occlusion as possible that is in harmony with the masticatory musculature and temporomandibular joints.

At present, the majority of individuals undergoing orthodontic treatment are adolescents, most of whom have considerable remaining growth potential at the end of active treatment. In addition, following removal of appliances, small tooth movements occur in a process described as 'settling'. It is likely that these two factors will alter functional occlusal relationships with time, although there are currently no data to support this.

As no long-term studies exists to measure the impact of non-ideal occlusal relationships on the dentition, it is debatable whether orthodontic treatment should be prolonged in order to ensure that 'ideal' occlusal contacts are achieved. Clark and Evans (2001) conclude: "As the occlusion tends to 'settle' in the period following appliance removal, we propose that it may be more appropriate to examine the functional occlusal relationships after retention has ceased rather than prolong active orthodontic treatment to achieve 'ideal' functional occlusal goals."

In summary, what will the repercussions be if an ideal functional occlusion is not achieved? Based on current literature, the mere presence of occlusal interferences in a patient does not necessarily mean that the patient will develop TMD. Conversely, it is apparent that all individuals do not respond in the same manner to the same event. This variation reflects what might be thought of as the individual's physiologic tolerance (Okeson, 2003). Each patient has the ability to tolerate certain events without any adverse effects. The level of the physiologic tolerance for any individual patient, however, is not known.

Although there are conflicting views on the role of malocclusion as a potential risk factor for TMD, there are other reasons for the orthodontist to be concerned with functional occlusion. Collision of cusps, if allowed to occur, will cause trauma with potential sequela of pulpitis, tooth mobility, attrition, and periodontal breakdown. Muscles can fatigue if the neuromuscular protection mechanism must restrict mandibular movement to avoid cusp collision.

Luther (1998) concludes: "Based on currently available evidence, it seems that neither the possession of a malocclusion nor orthodontic treatment can be said to cause or cure TMD." Despite this, achievement of an excellent static and functional occlusion should always be the treatment goal for all orthodontic patients, in the interest of stability, health, and longevity of the dentition.

CHAPTER 6

CONCLUSIONS

The term 'flat curve of Spee' is often used in the orthodontic literature to describe one of the treatment goals of the first stage of comprehensive orthodontic therapy (leveling and alignment). While it may be possible to level the "clinical" curve of Spee, it certainly would not be possible to level the curve of Spee as originally defined by Von Spee in 1890. A more appropriate term to describe the goal of leveling during the first stage of orthodontic treatment will be to generate a flat dental arch, or a flat occlusal plane.

A flat mandibular occlusal plane is one of the keys to an ideal static occlusion (Andrews, 1972). According to Heusdens, Dermaut and Verbeeck (2000), an excessive curve of Spee will result in poor interdigitation, and, in a study on features affecting ideal occlusion, a deep curve of Spee had the biggest negative effect on the final occlusion of all the variables (tooth size discrepancy, curve of Spee, extraction therapy) tested.

It is said that a picture can paint a thousand words. The graphic representation of the changes in the curve of Spee (Figures 30-32) does exactly that – the original excessive curve of Spee before treatment changed to a reverse curve after orthodontic treatment, just to relapse ever so slightly to a nearly flat curve of Spee after retention.

The purpose of this study was to evaluate the stability of the curve of Spee and the overbite in a group of subjects following orthodontic treatment. The results indicated that the relapse of the curve of Spee after orthodontic treatment was minimal. It can be concluded that

leveling of the curve of Spee is a treatment procedure with a stable result in the long-term. A higher tendency for relapse was observed for the overbite, and it was concluded that correction of the overbite was less stable than leveling of the curve of Spee. Eruption of the upper incisors after orthodontic treatment is a possible explanation for the difference in stability between the curve of Spee and the overbite.

The results of this study also indicated that the amount of relapse in the curve of Spee could not be predicted from either the depth of the curve of Spee before treatment, or the amount of leveling during treatment. Conversely, both the overbite before treatment, and the amount of overbite correction during treatment, was weakly correlated with the relapse in overbite after treatment, suggesting that these variables might be used to predict the amount of relapse in overbite after treatment.

The relationship between both the curve of Spee and the overbite, and the presence of anterior guidance after a period of orthodontic retention, was also examined. The results of this study revealed no statistical difference in the depth of the curve of Spee between a sample with, and a sample without anterior guidance. As a result, no relationship could be established between the depth of the curve of Spee and the presence of anterior guidance after orthodontic retention.

In contrast, a highly significant difference existed between the overbite in a group of subjects with anterior guidance, and a group of subjects without anterior guidance. A significant relationship was established between the overbite and the presence of anterior guidance after orthodontic retention – the bigger the overbite, the higher the possibility of anterior guidance during mandibular protrusion. Subjects with a small overbite may be predisposed to posterior interferences during mandibular protrusion.

Null hypothesis (H_01) stated that the leveling of the curve of Spee during orthodontic treatment is not a stable treatment procedure. In light of the findings of this study, null hypothesis (H_01) was rejected. Instead, an alternative hypothesis (H_11), which states that the leveling of the curve of Spee during orthodontic treatment is a stable treatment procedure, can be accepted.

Null hypothesis (H_02) stated that the correction of the overbite during orthodontic treatment is not a stable treatment procedure. In light of the findings of this study, null hypothesis (H_02) was also rejected. Instead, an alternative hypothesis (H_12), which states that the correction of the overbite during orthodontic treatment is a **fairly** stable treatment procedure, can be accepted. It is important to add that the correction of the overbite was less stable than the leveling of the curve of Spee.

Null hypothesis (H_03) stated that no relationship exists between the curve of Spee and the presence of anterior guidance after a period of orthodontic retention. In light of the findings of this study, null hypothesis (H_03) was accepted. No alternative hypothesis (H_13) needs to be formulated.

Null hypothesis (H_04) stated that no relationship exists between the overbite and the presence of anterior guidance after a period of orthodontic retention. In light of the findings of this study, null hypothesis (H_04) was rejected. Instead, an alternative hypothesis (H_14), which states that a highly significant relationship exists between the overbite and the presence of anterior guidance after a period of orthodontic retention, can be accepted.

An overbite of 3mm was established as an indication to predict the presence of anterior guidance during mandibular protrusion. The

results indicated that subjects with an overbite > 3mm were more likely to have had anterior guidance during mandibular protrusion, while protrusive interferences were more likely to be present in subjects with an overbite < 3mm. It was speculated that a moderate relapse in overbite after treatment might be desirable, as it might be useful in the establishment of a higher percentage of anterior guidance after retention.

The results indicated that 55% of the subjects had anterior guidance, while 45% of the subjects displayed posterior interferences during mandibular protrusion. These findings are similar to epidemiological studies published in the literature. The confusion and controversy concerning the relationship between occlusion and TMD continues. The general message is that no simple cause-and-effect relationship explains the association between occlusion and TMD. The etiology of TMD is complex and multifactorial. Numerous factors, such as occlusal interferences, parafunctional activities (bruxism), emotional stress, and systemic factors, can contribute to the development of TMD.

Future research may re-examine the results of this study after a longer post-treatment time. In fact, a wide range of future research projects can arise from the various topics covered during this study. Clinical experience suggests that incorporation of the second molars into the arch can play a significant role during orthodontic treatment – not only does it assist in the leveling of the curve of Spee, but it also contributes toward overbite correction. The long-term benefits of banding/bonding the second molars, in terms of its influence on the stability of arch leveling and overbite correction, should be examined. A structured approach to future research is necessary to supplement the results and conclusions from this study, until an integrated database of knowledge is accumulated, that can be used to enhance our understanding of the intricacies of orthodontic treatment.

LITERATURE REFERENCES

AlQabandi, AK; Sadowsky, C and BeGole, EA (1999). A comparison of the effects of rectangular and round arch wires in leveling the curve of Spee. *Am J Orthod Dentofac Orthop*, **116**: 522-529.

Andrews, LF (1972). The six keys to normal occlusion. *Am J Orthod*, **62**: 296-309.

Andrews, LF (1976). The straight-wire appliance: origin, controversy, commentary. *J Clin Orthod*, **10**: 99-114.

Aronowitz, HI (1996). Orthodontics and occlusion: a historical perspective. *J Cal Dent Assoc*, **24**: 16-18.

Behrents, RG (1985). Growth in the aging craniofacial skeleton. Monograph No 17, Craniofacial Growth Series, Center for Human Growth and Development, The University of Michigan, Ann Arbor.

Bishara, SE; Jakobsen, JR; Treder, JE and Stasi, MJ (1989). Changes in the maxillary and mandibular tooth size-arch length relationship from early adolescence to early adulthood. *Am J Orthod Dentofac Orthop*, **95**: 46-59.

Bishara, SE; Treder, JE and Jakobsen, JR (1994). Facial and dental changes in adulthood. *Am J Orthod Dentofac Orthop*, **106**: 175-186.

Bjork, A and Palling, M (1954). Adolescent age changes in saggital jaw relation, alveolar prognathly and incisal inclination. *Acta Odont Scand*, **12**: 201-232.

Bowman, SJ (1998). One-stage versus two-stage treatment: Are two really necessary? *Am J Orthod Dentofac Orthop*, **113**: 111-116.

Braun, ML and Schmidt, WG (1956). A cephalometric appraisal of the curve of Spee in Class I and Class II, Division 1 occlusions for males and females. *Am J Orthod*, **42**: 255-278.

Braun, S; Hnat, WP and Johnson, BE (1996). The curve of Spee revisited. *Am J Orthod Dentofac Orthop*, **110**: 206-210.

Carter, GA and McNamara, JA (1998). Longitudinal dental arch changes in adults. *Am J Orthod Dentofac Orthop*, **114**: 88-99.

Celar, AG; Tamaki, K; Nitsche, S and Schneider, B (1999). Guided versus unguided mandibular movement for duplicating intraoral eccentric tooth contacts in the articulator. *J Prosthet Dent*, **81**: 14-22.

Champagne, M (1992). Reliability of measurements from photocopies of study models. *J Clin Orthod*, **26**: 648-650.

Chung, TS; Sadowsky, PL; Wallace, DD and McCutcheon, MJ (1997). A three-dimensional analysis of mandibular arch changes following curve of Spee leveling in nonextraction orthodontic treatment. *Int J Adult Orthod Orthog Surg*, **12**: 109-121.

Clark, JR and Evans, RD (1998). Functional occlusal relationships in a group of post-orthodontic patients: preliminary findings. *Eur J Orthod*, **20**: 103-110.

Clarke, JR and Evans, RD (2001). Functional occlusion: I. A review. *J Orthod*, **28**: 76-81.

Clark, JR; Hutchinson, I and Sandy, JR (2001). Functional occlusion: II. The role of articulators in orthodontics. *J Orthod*, **28**: 173-177.

Clifford, PM; Orr, JF and Burden, DJ (1999). The effects of increasing the reverse curve of Spee in a lower archwire examined using a dynamic photo-elastic gelatine model. *Eur J Orthod*, **21**: 213-222.

D'Amico, A (1958). The canine teeth – normal functional relation of the natural teeth of man. *J Cal Dent Assoc*, **26**: 6-23, 49-60, 127-142, 175-182, 194-208, 239-241.

Dawson, PE (1989). *Evaluation, diagnosis and treatment planning of occlusal problems*. 2nd edition. St Louis: CV Mosby; pp 85-91, 365-381.

De Praeter, J; Dermaut, L; Martens, G and Kuijpers-Jagtman, A (2002). Long-term stability of the leveling of the curve of Spee. *Am J Orthod Dentofac Orthop*, **121**: 266-272.

Dos Santos, J (1998). *Occlusion: Principles and concepts*. 2nd edition. St Louis: Medico Dental Media International, Inc. Publishers, p 1-60.

Ferrario, VF; Sforza, C; Miani, A; Colombo, A and Tartaglia, G (1992). Mathematical definition of the curve of Spee in permanent healthy dentitions in man. *Arch Oral Biol*, **37**: 691-694.

Ferrario, VF; Sforza, C; Poggio, CE; Serrao, G and Colombo, A (1999). Three-dimensional dental arch curvature in human adolescents and adults. *Am J Orthod Dentofac Orthop*, **115**: 401-405.

Gardner, RA; Harris, EF and Vaden, JL (1998). Postorthodontic dental changes: A longitudinal study. *Am J Orthod Dentofac Orthop*, **114**: 582-587.

Gazit, E and Liebermann, MA (1985). Occlusal contacts following orthodontic treatment. *Angle Orthod*, **55**: 316-320.

Germane, N; Stagers, JA; Rubenstein, L and Revere, JT (1992). Arch length considerations due to the curve of Spee: A mathematical model. *Am J Orthod Dentofac Orthop*, **102**: 251-255.

Glenn, G; Sinclair, PM and Alexander, RG (1987). Nonextraction orthodontic therapy: posttreatment dental and skeletal stability. *Am J Orthod Dentofac Orthop*, **92**: 321-328.

Heikinheimo, K; Salmi, K; Myllarniemi, S and Kirveskari, P (1990). A longitudinal study of occlusal interferences and signs of craniomandibular disorder at the ages of 12 and 15 years. *Eur J Orthod*, **12**: 190-197.

Heusdens, M; Dermaut, L and Verbeeck, R (2000). The effect of tooth size discrepancy on occlusion: An experimental study. *Am J Orthod Dentofac Orthop*, **117**: 184-191.

Hitchcock, HP (1983). The curve of Spee in Stone Age man. *Am J Orthod*, **84**: 248-253.

Ingervall, B (1972). Tooth contacts of the functional and non-functional side in children and young adults. *Arch Oral Biol*, **17**: 191-200.

Ingervall, B (1976). Functionally optimal occlusion: The goal of orthodontic treatment. *Am J Orthod*, **70**: 81-90.

Kasrovi, PM; Meyer, M and Nelson, GD (2000). Occlusion: an orthodontic perspective. *J Cal Dent Assoc*, **28**: 780-790.

Keim, RG; Gottlieb, EL; Nelson, AH and Vogels, DS (2002). 2002 JCO study of orthodontic diagnosis and treatment procedures. Part 1: Results and trends. *J Clin Orthod*, **36**: 553-568.

Klineberg, I (1992). *Occlusion: principles and assessment*. Oxford: Butterworth-Heinemann.

Kuitert, RB; van Ginkel, FC and Prah-Andersen, B (2000). Development of the curve of Spee during and after orthodontic treatment [abstract]. *Eur J Orthod*, **22**: 596-597.

Little, RM (1990). Stability and relapse of dental arch alignment. *Br J Orthod*, **17**: 235-241.

Little, RM; Riedel, RA and Årtun, J (1988). An evaluation of changes in mandibular anterior alignment from 10 to 20 years postretention. *Am J Orthod Dentofac Orthop*, **93**: 423-428.

Little, RM; Wallen, TR and Riedel, RA (1981). Stability and relapse of mandibular anterior alignment – first premolar extraction cases treated by traditional edgewise orthodontics. *Am J Orthod*, **80**: 349-365.

Luther, F (1998). Orthodontics and the temporomandibular joint: Where are we now? Part 2. Functional occlusion, malocclusion, and TMD. *Angle Orthod*, **68**: 305-318.

Lynch, CD and McConnell, RJ (2002). Prosthodontic management of the curve of Spee: use of the Broadrick flag. *J Prosthet Dent*, **87**: 593-597.

Milosevic, A and Samuels, RHA (1998). Functional occlusion after fixed appliance orthodontic treatment: a UK three-centre study. *Eur J Orthod*, **20**: 561-568.

Mohlin, B, Ingervall, B and Thilander, B (1980). Relationship between malocclusion and mandibular dysfunction in Swedish men. *Eur J Orthod*, **2**: 229–237.

Okeson, JP (2003). *Management of temporomandibular disorders and occlusion*. St Louis: Mosby, Inc, p 67-179.

Orthlieb, JD (1997). The curve of Spee: understanding the sagittal organization of mandibular teeth. *Cranio*, **15**: 333-340.

Owen, CP (1998). *Fundamentals of Removable Partial Dentures*. University of Cape Town: UCT Press, p 59-92.

Proffit, WR and Ackerman, JL (1994). Diagnosis and treatment planning in orthodontics. In: Graber, TM and Vanarsdall, RL (editors). *Orthodontics: current principles and techniques*. 2nd edition. St. Louis: Mosby-Year Book, p 3-95.

Proffit, WR and Fields, HW (2000). *Contemporary Orthodontics*. 3rd edition. St Louis: Mosby, Inc., pp 200-203, 240-293, 526-551.

Pullinger, AG; Solberg, WK; Hollender, L and Petersson, A (1987). Relationship of mandibular condylar position to dental occlusion factors in an asymptomatic population. *Am J Orthod Dentofac Orthop*, **91**: 200-206.

Ramfjord, SP and Ash, MM (1971). *Occlusion*. Philadelphia: WB Saunders Company.

Richardson, ME (1994). Late lower arch crowding: The role of differential horizontal growth. *Brit J Orthod*, **21**: 379-385.

Richardson, ME (1999). A review of changes in lower arch alignment from seven to fifty years. *Semin Orthod*, **5**: 151-159.

Ricketts, RM (1955). Facial and denture changes during orthodontic treatment as analyzed from the temporomandibular joint. *Am J Orthod*, **41**: 163-179.

Rinchuse, DJ and Sassouni, V (1983). An evaluation of functional occlusal interferences in orthodontically treated subjects. *Angle Orthod*, **53**: 122-130.

Rossouw, EP (1999). Terminology: Semantics of postorthodontic treatment changes in the dentition. *Semin Orthod*, **5**: 138-141.

Rossouw, PE; Preston, CB and Lombard, C (1999). A longitudinal evaluation of extraction versus nonextraction treatment with special reference to the posttreatment irregularity of the lower incisors. *Semin Orthod*, **5**: 160-170.

Roth, RH (1981a). Functional occlusion for the orthodontist: Part 1. *J Clin Orthod*, **15**: 32-51.

Roth, RH (1981b). Functional occlusion for the orthodontist: Part 3. *J Clin Orthod*, **15**: 174-198.

Roth, RH (1997). Gnathologic considerations for orthodontic therapy. In: McNeill, C (editor). *Science and practice of occlusion*. Chicago: Quintessence Publishing Company; pp 502-514.

Sadowsky, C (1992). The risk of orthodontic treatment for producing temporomandibular disorders: a literature overview. *Am J Orthod Dentofac Orthop*, **101**: 79-83.

Sadowsky, C and BeGole, EA (1980). Long-term status of temporomandibular joint function and functional occlusion after orthodontic treatment. *Am J Orthod*, **18**: 201-211.

Sadowsky, C and Polson, AM (1984). Temperomandibular disorders and functional occlusion after orthodontic *treatment*: Results of two long-term studies. *Am J Orthod Dentofac Orthop*, **86**: 386-390.

Sadowsky, C and Sakols, EI (1982). Long-term assessment of orthodontic relapse. *Am J Orthod*, **82**: 456-463.

Sadowsky, C; Schneider, BJ; BeGole, EA and Tahir, EJ (1994). Long-term stability after orthodontic treatment: Nonextraction with prolonged retention. *Am J Orthod Dentofac Orthop*, **106**: 243-249.

Sarver, DM (2001). The importance of incisor positioning in the esthetic smile: The smile arc. *Am J Orthod Dentofac Orthop*, **120**: 98-111.

Schirmer, UR and Wiltshire, WA (1997). Manual and computer-aided space analysis: a comparative study. *Am J Orthod Dentofac Orthop*, **112**: 676-680.

Schudy, FF (1966). The association of anatomical entities as related to clinical orthodontics, *Angle Orthod*, **36**: 190-203.

Shields, TE; Little, RM and Chapko, MK (1985). Stability and relapse of mandibular anterior alignment: a cephalometric appraisal of first premolar extraction cases treated by traditional edgewise orthodontics. *Am J Orthod*, **87**: 27-38.

Siatowski, RE (1974). Incisor uprighting: mechanism for late secondary crowding in the anterior segments of the dental arches. *Am J Orthod*, **66**: 398-410.

Sinclair, PM and Little, RM (1985). Dentofacial maturation of untreated normals. *Am J Orthod*, **88**: 146-156.

Smukler, H (1991). *Equilibration in the Natural and Restored Dentition*. Chicago: Quintessence Publishing Co, Inc, p 75-107.

Sondhi, A; Cleall, JF and BeGole, EA (1980). Dimensional changes in the dental arches of orthodontically treated cases. *Am J Orthod*, **77**: 60-74.

Spee, F; Biedenbach, MA; Hotz, M and Hitchcock, HP (1980). The gliding path of the mandible along the skull. *J Am Dent Assoc*, **100**: 670-675.

The Academy of Prosthodontics: Glossary of prosthodontic terms (1994). *J Prosthet Dent*, **71**: 50-112.

Thomson, H (1990). *Occlusion*. 2nd edition. London: Butterworth & Co (Publishers) Ltd, pp 68-91, 276-283.

Tipton, RT and Rinchuse, DJ (1991). The relationship between static occlusion and functional occlusion in a dental school population. *Angle Orthod*, **61**: 57-66.

Vanarsdall, RL (1999). Transverse dimension and long-term stability. *Semin Orthod*, **5**: 171-180.

Williamson, EH; Steinke, RM; Morse, PK and Swift, TR (1980). Centric relation: A comparison of muscle-determined position and operator guidance. *Am J Orthod*, **77**: 133-145.

Woda, A; Vigneron, P and Kay, D (1979). Non-functional and functional occlusal contacts: a review of the literature. *J Prosthet Dent*, **42**: 335-341.

Woods, M (1986). A reassessment of space requirements for lower arch leveling. *J Clin Orthod*, **20**: 770-778.

Yen, C-H (1991). Computer-aided space analysis. *J Clin Orthod*, **25**: 236-238.

Zachrisson, BU (1998). Esthetic factors involved in anterior tooth display and the smile: Vertical dimension. *J Clin Orthod*, **32**: 432-445.

ADDENDUM A

EVALUATION OF FUNCTIONAL OCCLUSION

Date:

1. Patient information

Surname: Initials:

Date of Birth:

Age: Y M

Date of Debanding:

Retention protocol: Maxilla:

Mandible:

2. Occlusal Analysis

Overjet:

Overbite:

RC-IC difference:

Protrusive interferences:

Lateral interferences: Left: Right:

Functional occlusal type:

ANTERIOR GUIDANCE YES / NO	PATIENT NUMBER:
--------------------------------------	------------------------

ADDENDUM B

CONSENT

UNIVERSITY OF PRETORIA
UNIVERSITEIT VAN PRETORIA

DEPARTMENT OF ORTHODONTICS
DEPARTEMENT ORTODONSIE

CONSENT (Research)
TOESTEMMING (Navorsing)

I herewith give my consent for all examination materials (x-rays, photo's, models, etc) and examination reports of myself/my wife/my child, to be used for research and publication, with the understanding that names will remain anonymous and that all material will be handled in the strictest confidence.

Hiermee gee ek toestemming dat alle ondersoek materiaal (röntgenbeelde, fotos, modelle, ens) en ondersoekverslae van myself/my vrou/my kind, gebruik mag word vir navorsings- en publikasiedoeleindes, met dien verstande dat name anoniem gehou sal word en dat alles streng vertroulik hanteer sal word.

.....
Date / Datum

.....
Signature / Handtekening

ADDENDUM C

RAW DATA FOR MEASUREMENT OF THE CURVE OF SPEE															
Subject	Number	L2	L3	L4	L5	L6	Sum L	R 2	R 3	R 4	R 5	R 6	Sum R	Total L+R	Mean
1	T01-1	-0.88	-1.00	-0.03	0.45	0.45	-1.01	-0.17	-0.31	0.02	0.02	0.12	-0.32	-1.33	-0.67
	T01-2	-0.39	-0.74	0.00	-0.60	0.30	-1.43	-0.48	-0.66	0.00	-0.91	0.06	-1.99	-3.42	-1.71
	T01-3	-0.39	-0.59	0.00	0.05	0.41	-0.52	-0.31	-0.63	0.00	-0.59	0.16	-1.37	-1.89	-0.95
2	T02-1	-0.78	-1.06	-0.18	0.27	0.55	-1.2	0.38	0.49	0.47	0.3	0.45	2.09	0.89	0.45
	T02-2	-0.30	-0.90	-0.60	-0.30	0.07	-2.03	-0.36	-0.65	-0.36	-0.11	-0.11	-1.59	-3.62	-1.81
	T02-3	-0.04	-0.33	-0.10	0.18	0.22	-0.07	-0.53	-0.13	0.1	0.21	0.21	-0.14	-0.21	-0.11
3	T03-1	-0.73	-1.05	0.31	0.87	0.87	0.27	-0.46	-0.78	0.31	0.6	0.81	0.48	0.75	0.38
	T03-2	-0.31	-0.21	0.17	0.21	-0.10	-0.24	-0.21	-0.17	0.03	0.21	0.21	0.07	-0.17	-0.09
	T03-3	-0.18	-0.01	0.08	0.18	0.08	0.15	-0.29	0.25	-0.14	0.43	0.25	0.5	0.65	0.33
4	T04-1	-0.13	-0.82	0.13	0.27	0.45	-0.1	-0.46	-1.61	-0.14	0.18	0.46	-1.57	-1.67	-0.84
	T04-2	0.10	-0.35	-0.06	-0.24	0.03	-0.52	-0.14	-0.22	0.04	-0.28	-0.14	-0.74	-1.26	-0.63
	T04-3	0.35	-0.53	-0.14	-0.14	0.14	-0.32	0.15	-0.47	-0.19	-0.11	0.22	-0.40	-0.72	-0.36
5	T05-1	*	*	*	*	*	*	*	*	*	*	*	*	*	*
	T05-2	-0.14	-0.71	-0.28	-0.53	0.21	-1.45	-0.17	-0.61	-0.36	-0.14	-0.14	-1.42	-2.87	-1.44
	T05-3	-0.21	-0.74	-0.28	-0.32	0.21	-1.34	0.10	-0.39	-0.39	-0.14	-0.07	-0.89	-2.23	-1.12
6	T06-1	*	*	*	*	*	*	*	*	*	*	*	*	*	*
	T06-2	-0.53	-0.96	0.00	-0.25	0.50	-1.24	-0.85	-0.71	0.00	-0.64	1.06	-1.14	-2.38	-1.19
	T06-3	-0.18	-0.39	0.00	-0.07	0.39	-0.25	-0.25	-0.57	0.00	-0.36	0.21	-0.97	-1.22	-0.61
7	T07-1	0.13	0.32	-0.25	0.53	0.82	1.55	-0.21	-0.56	-0.13	0.46	0.17	-0.27	1.28	0.64
	T07-2	0.00	-0.68	-0.53	0.14	0.21	-0.86	-0.5	-0.85	0.00	0.17	-0.14	-1.32	-2.18	-1.09
	T07-3	-0.15	-0.48	-0.45	0.13	0.15	-0.8	0.07	-0.21	0.00	0.32	0.21	0.39	-0.41	-0.21
8	T08-1	-0.36	-0.50	-0.45	-0.22	0.32	-1.21	-0.25	-0.53	-0.35	-0.25	0.14	-1.24	-2.45	-1.23
	T08-2	0.25	-0.03	-0.25	-0.71	0.10	-0.64	-0.21	-0.71	-0.79	-0.93	0.00	-2.64	-3.28	-1.64
	T08-3	0.14	-0.14	-0.57	-0.60	0.07	-1.1	-0.22	-0.54	-0.65	-0.65	0.04	-2.02	-3.12	-1.56
9	T09-1	-0.43	-1.01	-0.36	0.64	0.79	-0.37	-0.54	0.97	0.79	0.64	0.54	2.40	2.03	1.02
	T09-2	-0.14	-0.57	0.00	0.60	0.46	0.35	-0.67	-1.00	0.00	-0.50	0.21	-1.96	-1.61	-0.81
	T09-3	-0.28	-0.82	0.00	0.00	0.39	-0.71	-0.10	-0.39	0.00	0.14	0.35	0.00	-0.71	-0.36
10	T10-1	-0.18	-0.18	-0.31	0.22	0.59	0.14	-0.32	0.07	-0.75	0.11	0.71	-0.18	-0.04	-0.02
	T10-2	-0.67	-0.89	0.00	-0.35	0.39	-1.52	-0.35	-0.67	0.00	-0.28	0.64	-0.66	-2.18	-1.09
	T10-3	-0.17	-0.71	0.00	0.25	0.14	-0.49	-0.21	-0.43	0.00	0.21	0.25	-0.18	-0.67	-0.34

University of Pretoria etd – Hattingh, J (2003)

11	T11-1	*	*	*	*	*	*	*	*	*	*	*	*	*	*
	T11-2	-0.22	-1.00	-0.75	-0.68	0.04	-2.61	-0.18	-0.47	-0.5	-0.47	0.29	-1.33	-3.94	-1.97
	T11-3	-0.14	-0.86	-0.71	-0.39	0.18	-1.92	-0.24	-0.42	-0.63	-0.38	0.38	-1.29	-3.21	-1.61
12	T12-1	0.59	0.08	0.82	1.42	1.70	4.61	-0.07	-0.43	0.29	1.18	0.75	1.72	6.33	3.17
	T12-2	-0.17	-0.07	-0.53	0.14	0.32	-0.31	-0.17	-0.42	-0.13	0.21	0.71	0.2	-0.11	-0.06
	T12-3	-0.03	-0.53	-0.85	-0.17	0.46	-1.12	0.11	-0.25	0.14	0.36	0.75	1.11	-0.01	-0.01
13	T13-1	0.17	-0.82	-0.96	-0.08	0.40	-1.29	0.18	-0.39	-0.46	0.03	0.46	-0.18	-1.47	-0.74
	T13-2	-0.03	-0.21	-0.39	0.01	0.10	-0.52	-0.17	-0.71	-0.64	-0.49	0.28	-1.73	-2.25	-1.13
	T13-3	-0.10	-0.24	-0.17	-0.07	0.17	-0.41	0.1	-0.6	-0.46	-0.57	0.35	-1.18	-1.59	-0.80
14	T14-1	-0.41	-0.59	0.09	0.41	0.36	-0.14	-0.18	-0.36	0.07	0.61	0.46	0.6	0.46	0.23
	T14-2	-0.42	-0.42	0.02	0.13	0.13	-0.56	-0.35	-0.1	-0.21	-0.14	0.21	-0.59	-1.15	-0.58
	T14-3	-0.25	-0.21	-0.10	0.14	0.10	-0.32	-0.18	0.07	0.5	0.25	0.1	0.74	0.42	0.21
15	T15-1	*	*	*	*	*	*	*	*	*	*	*	*	*	*
	T15-2	-0.10	-0.46	0.00	-0.18	0.36	-0.38	-0.32	-0.57	0.00	0.1	0.28	-0.51	-0.89	-0.45
	T15-3	-0.14	-0.21	0.00	0.21	0.21	0.07	-0.13	0.42	0.00	0.67	0.74	1.7	1.77	0.89
16	T16-1	0.13	0.18	1.51	1.56	0.73	4.11	0.13	0.04	0.87	0.87	0.6	2.51	6.62	3.31
	T16-2	-0.04	-0.55	-0.14	0.00	0.09	-0.64	-0.19	-0.51	-0.09	0.09	0.05	-0.65	-1.29	-0.65
	T16-3	0.00	0.04	0.69	0.46	0.14	1.33	0.05	0.00	0.23	0.28	0.05	0.61	1.94	0.97
17	F01-1	-0.18	-0.18	1.06	0.97	0.55	2.22	0.05	0.09	1.02	1.43	0.97	3.56	5.78	2.89
	F01-2	-0.19	-0.23	0.28	0.09	0.37	0.32	-0.18	-0.23	-0.6	-0.46	-0.28	-1.75	-1.43	-0.72
	F01-3	-0.32	-0.60	0.18	0.23	0.41	-0.1	0.05	-0.37	-0.14	0.55	0.28	0.37	0.27	0.14
18	F02-1	0.50	-0.13	0.59	-0.01	0.32	1.27	0.98	-0.19	-0.47	-0.19	0.05	0.18	1.45	0.73
	F02-2	-0.09	-0.69	0.00	-0.32	0.36	-0.74	-0.42	-0.84	0.00	-0.51	0.28	-1.49	-2.23	-1.12
	F02-3	-0.19	-0.47	0.00	-0.37	0.47	-0.56	-0.19	-0.61	0.00	-0.24	0.24	-0.8	-1.36	-0.68
19	F03-1	0.22	-0.09	-0.13	-0.04	0.22	0.18	-0.09	-0.09	-0.18	0.32	0.41	0.37	0.55	0.28
	F03-2	-0.41	-1.37	0.00	0.22	0.27	-1.29	-0.04	-0.41	0.00	0.5	0.27	0.32	-0.97	-0.49
	F03-3	-0.09	-0.87	0.00	0.09	0.27	-0.6	-0.04	-0.32	0.00	0.04	0.14	-0.18	-0.78	-0.39
20	F04-1	*	*	*	*	*	*	*	*	*	*	*	*	*	*
	F04-2	-0.32	-0.82	-0.26	-0.03	-0.08	-1.51	-0.04	-0.55	-0.09	-0.23	0.23	-0.68	-2.19	-1.10
	F04-3	-0.32	-0.22	0.22	0.55	0.13	0.36	-0.16	-0.51	0.23	0.23	0.23	0.02	0.38	0.19
21	F05-1	0.55	1.01	2.16	1.24	0.73	5.69	0.28	0.28	1.47	1.01	0.74	3.78	9.47	4.74
	F05-2	-0.18	-1.10	0.00	-0.50	-0.45	-2.23	-0.46	-1.15	0.00	-0.6	-0.23	-2.44	-4.67	-2.34
	F05-3	-0.14	-0.60	0.00	-0.37	-0.14	-1.25	-0.41	-0.88	0.00	0.18	0.23	-0.88	-2.13	-1.07

University of Pretoria etd – Hattingh, J (2003)

22	F06-1	0.18	0.22	0.18	0.32	0.27	1.17	-0.09	0.41	-0.18	0.46	0.23	0.83	2.00	1.00
	F06-2	-0.18	-1.19	0.00	-0.18	0.13	-1.42	-0.27	-0.69	0.00	0.27	0.23	-0.46	-1.88	-0.94
	F06-3	-0.55	-0.87	0.00	0.27	0.36	-0.79	-0.23	-0.23	0.00	0.27	0.41	0.22	-0.57	-0.29
23	F07-1	-0.11	-0.02	0.80	0.66	0.48	1.81	0.02	-0.2	0.66	0.57	0.16	1.21	3.02	1.51
	F07-2	-0.16	-0.80	0.00	0.20	0.11	-0.65	-0.85	-1.35	0.00	-0.2	0.48	-1.92	-2.57	-1.29
	F07-3	-0.07	-0.48	0.00	-0.11	0.48	-0.18	-0.16	-0.89	0.00	-0.2	0.16	-1.09	-1.27	-0.64
24	F08-1	0.57	0.80	0.99	0.71	0.11	3.18	0.71	0.99	1.17	2.04	0.2	5.11	8.29	4.15
	F08-2	-0.02	-0.48	-0.71	-0.53	0.11	-1.63	-0.39	-1.26	-1.4	-0.62	0.02	-3.65	-5.28	-2.64
	F08-3	0.00	0.16	-0.30	-0.02	0.25	0.09	-0.11	-0.76	-0.99	-0.39	0.2	-2.05	-1.96	-0.98
25	F09-1	-0.04	-0.04	-0.22	0.78	0.45	0.93	0.01	-0.18	0.41	0.5	0.55	1.29	2.22	1.11
	F09-2	-0.22	-0.87	-0.78	-0.41	0.22	-2.06	-0.04	-0.55	-0.41	0.13	0.22	-0.65	-2.71	-1.36
	F09-3	-0.31	-1.05	-0.96	0.04	0.31	-1.97	-0.31	-0.87	-0.59	0.22	0.18	-1.37	-3.34	-1.67
26	F10-1	-0.73	1.47	1.33	0.87	0.31	3.25	-0.82	1.47	1.24	0.78	0.27	2.94	6.19	3.10
	F10-2	-0.41	-1.14	0.00	0.08	0.31	-1.16	-0.13	-0.91	0.00	-0.41	0.08	-1.37	-2.53	-1.27
	F10-3	-0.64	-0.73	0.00	0.09	0.46	-0.82	-0.74	-0.74	0.00	0.04	0.09	-1.35	-2.17	-1.09
27	F11-1	-0.18	0.41	0.69	0.41	0.13	1.46	-0.01	0.45	-0.22	-0.04	0.13	0.31	1.77	0.89
	F11-2	0.19	-0.80	0.00	-0.30	0.43	-0.48	0.18	-0.5	0.00	0.13	0.46	0.27	-0.21	-0.11
	F11-3	-0.09	-0.69	0.00	-0.13	0.27	-0.64	0.36	-0.22	0.00	0.37	0.41	0.92	0.28	0.14
28	S01-1	0.20	-0.16	0.99	0.57	0.48	2.08	0.37	0	1.02	1.02	0.46	2.87	4.95	2.48
	S01-2	0.19	-0.18	-0.40	-0.33	0.19	-0.53	0.14	-0.18	0.23	0	0.23	0.42	-0.11	-0.06
	S01-3	0.23	-0.46	-0.32	-0.27	0.18	-0.64	0.14	-0.14	0.18	0.09	0.18	0.45	-0.19	-0.10
29	S02-1	0.46	0.32	0.60	0.88	0.60	2.86	-0.09	-0.37	0	0.28	0.32	0.14	3.00	1.50
	S02-2	-0.18	-1.15	-0.97	-0.55	0.14	-2.71	-0.23	-0.87	-0.32	-0.04	0.18	-1.28	-3.99	-2.00
	S02-3	-0.13	-0.64	-0.37	-0.09	0.23	-1	-0.18	-0.51	-0.28	0.14	0.32	-0.51	-1.51	-0.76
30	S03-1	*	*	*	*	*	*	*	*	*	*	*	*	*	*
	S03-2	-0.18	-0.64	-0.92	-0.32	-0.13	-2.19	-0.27	-0.6	-0.27	-0.05	0.09	-1.1	-3.29	-1.65
	S03-3	-0.18	-0.41	-0.36	-0.13	0.09	-0.99	-0.23	0.19	0.19	0.23	0.05	0.43	-0.56	-0.28
31	S04-1	-0.64	-0.32	1.38	2.72	1.15	4.29	0	0.6	2.12	2.72	1.93	7.37	11.66	5.83
	S04-2	-0.18	-0.13	0.87	0.46	0.50	1.52	-0.32	-0.42	0	-0.28	0.46	-0.56	0.96	0.48
	S04-3	0.37	0.23	0.83	1.15	0.46	3.04	-0.55	-0.6	0	-0.18	0.23	-1.1	1.94	0.97
32	S05-1	*	*	*	*	*	*	*	*	*	*	*	*	*	*
	S05-2	0.14	0.04	0.23	0.60	-0.23	0.78	-0.32	-0.78	-0.46	0.14	-0.18	-1.6	-0.82	-0.41
	S05-3	-0.23	0.05	0.23	0.55	-0.09	0.51	-0.23	-0.5	-0.46	0.09	-0.04	-1.14	-0.63	-0.32

University of Pretoria etd – Hattingh, J (2003)

33	S06-1	-0.20	-0.53	0.62	0.85	0.48	1.22	0.07	0.89	0.8	0.57	0.3	2.63	3.85	1.93
	S06-2	-0.25	-0.80	-0.66	-0.39	0.11	-1.99	-0.11	-0.53	0.3	-0.16	-0.11	-0.61	-2.60	-1.30
	S06-3	-0.30	-1.17	0.07	0.11	0.11	-1.18	-0.11	-0.66	0.43	0.16	-0.07	-0.25	-1.43	-0.72
34	S07-1	-0.50	-0.46	0.32	0.46	0.64	0.46	0.13	-0.36	0.09	0.32	0.69	0.87	1.33	0.67
	S07-2	-0.09	-0.73	0.00	-0.73	0.09	-1.46	-0.23	-0.55	0.00	-0.51	0.41	-0.88	-2.34	-1.17
	S07-3	-0.09	0.09	0.00	-0.01	0.18	0.17	-0.09	-0.83	0.00	0.09	0.55	-0.28	-0.11	-0.06
35	S08-1	*	*	*	*	*	*	*	*	*	*	*	*	*	*
	S08-2	0.12	-0.07	-0.17	-0.12	0.07	-0.17	-0.21	-0.9	-0.58	-0.29	0.09	-1.89	-2.06	-1.03
	S08-3	0.21	-0.06	-0.17	-0.12	0.12	-0.02	-0.17	-0.78	-0.45	-0.25	0.05	-1.6	-1.62	-0.81
36	S09-1	-0.08	-0.17	-0.45	-0.50	-0.22	-1.42	-0.15	-0.68	-1.01	-1.10	0.18	-2.76	-4.18	-2.09
	S09-2	-0.06	-0.31	-0.50	-0.01	0.13	-0.75	0.08	-1.1	-1.01	-0.5	-0.01	-2.54	-3.29	-1.65
	S09-3	0.04	-0.04	-0.27	0.13	0.17	0.03	-0.04	-1.05	-0.96	-0.55	-0.05	-2.65	-2.62	-1.31
37	S10-1	0.04	-0.82	0.18	0.13	0.31	-0.16	-0.41	-0.36	0.41	0.32	0.08	0.04	-0.12	-0.06
	S10-2	0.05	-0.22	-0.73	-0.50	0.13	-1.27	-0.13	-0.36	-1.01	-0.5	-0.13	-2.13	-3.40	-1.70
	S10-3	0.08	-0.27	-0.41	-0.27	0.17	-0.7	-0.05	-0.14	-0.46	-0.18	-0.09	-0.92	-1.62	-0.81
38	S11-1	-0.14	0.28	0.83	1.29	-0.05	2.21	-0.04	0.5	0.87	1.06	-0.05	2.34	4.55	2.28
	S11-2	-0.18	-0.91	0.00	-0.01	-0.13	-1.23	-0.04	-0.59	0.00	0.04	0.08	-0.51	-1.74	-0.87
	S11-3	-0.13	-0.41	0.00	0.06	0.06	-0.42	-0.08	-0.87	0.00	-0.36	-0.22	-1.53	-1.95	-0.98
39	S12-1	0.18	0.32	-0.09	0.13	0.59	1.13	0.13	0.09	0.18	0.36	0.5	1.26	2.39	1.20
	S12-2	0.08	-0.23	-0.31	-0.68	0.08	-1.06	-0.13	-0.78	-0.36	-0.04	0.18	-1.13	-2.19	-1.10
	S12-3	0.13	-0.22	-0.04	-0.36	0.05	-0.44	0.04	-0.64	-0.18	0.01	0.18	-0.59	-1.03	-0.52
40	S13-1	-0.13	-1.10	-0.87	-0.04	0.18	-1.96	-0.18	-0.18	-0.32	0.09	0.23	-0.36	-2.32	-1.16
	S13-2	-0.23	-0.87	-1.10	-0.64	0.36	-2.48	-0.27	-0.96	-0.82	-0.59	0.27	-2.37	-4.85	-2.43
	S13-3	-0.13	-0.64	-0.82	-0.45	0.45	-1.59	-0.22	-0.59	-0.54	-0.31	0.22	-1.44	-3.03	-1.52

ADDENDUM D

RAW DATA FOR DETERMINATION OF INTRA-EXAMINER REPEATABILITY AND INTER-EXAMINER RELIABILITY							
Subject	Examiner	L2	L3	L4	L5	L6	Sum L
1	Measure1	-0.73	-1.05	0.31	0.87	0.87	0.27
	Measure2	-0.73	-1.05	0.36	0.82	0.87	0.27
	Examiner1	-0.77	-1.05	0.31	0.82	0.87	0.18
	Examiner2	-0.73	-1.07	0.33	0.87	0.89	0.29
	Examiner3	-0.73	-1.07	0.31	0.82	0.87	0.2
	Examiner4	-0.73	-1.05	0.31	0.82	0.87	0.22
	Examiner5	-0.73	-1.05	0.31	0.78	0.82	0.13
2	Measure1	0.59	0.08	0.82	1.42	1.70	4.61
	Measure2	0.59	0.08	0.78	1.42	1.74	4.61
	Examiner1	0.64	0.08	0.82	1.42	1.72	4.68
	Examiner2	0.59	0.08	0.78	1.42	1.70	4.57
	Examiner3	0.55	0.08	0.78	1.42	1.74	4.57
	Examiner4	0.55	0.08	0.82	1.42	1.74	4.61
	Examiner5	0.55	0.13	0.78	1.42	1.74	4.62
3	Measure1	-0.41	-0.59	0.09	0.41	0.36	-0.14
	Measure2	-0.41	-0.59	0.09	0.46	0.36	-0.09
	Examiner1	-0.41	-0.59	0.13	0.41	0.41	-0.05
	Examiner2	-0.41	-0.64	0.09	0.41	0.36	-0.19
	Examiner3	-0.41	-0.59	0.04	0.41	0.36	-0.19
	Examiner4	-0.41	-0.64	0.09	0.41	0.36	-0.19
	Examiner5	-0.41	-0.64	0.09	0.41	0.41	-0.14
4	Measure1	-0.18	-0.18	1.06	0.97	0.55	2.22
	Measure2	-0.22	-0.18	1.06	0.97	0.55	2.18
	Examiner1	-0.23	-0.21	1.13	0.97	0.58	2.24
	Examiner2	-0.23	-0.18	1.06	0.97	0.55	2.17
	Examiner3	-0.23	-0.14	1.06	1.01	0.55	2.25
	Examiner4	-0.23	-0.14	1.06	1.01	0.50	2.2
	Examiner5	-0.23	-0.18	1.06	0.97	0.50	2.12
5	Measure1	0.55	1.01	2.16	1.24	0.73	5.69
	Measure2	0.55	1.06	2.16	1.24	0.73	5.74
	Examiner1	0.55	1.04	2.20	1.21	0.73	5.73
	Examiner2	0.55	1.06	2.16	1.24	0.73	5.74
	Examiner3	0.55	1.01	2.21	1.24	0.73	5.74
	Examiner4	0.50	1.01	2.21	1.29	0.78	5.79
	Examiner5	0.55	1.01	2.16	1.24	0.78	5.74
6	Measure1	-0.20	-0.53	0.62	0.85	0.48	1.22
	Measure2	-0.22	-0.55	0.64	0.82	0.50	1.19
	Examiner1	-0.22	-0.55	0.59	0.87	0.50	1.19
	Examiner2	-0.22	-0.55	0.59	0.87	0.50	1.19
	Examiner3	-0.22	-0.59	0.59	0.87	0.50	1.15
	Examiner4	-0.22	-0.55	0.64	0.87	0.50	1.24
	Examiner5	-0.22	-0.55	0.59	0.82	0.50	1.14

7	Measure1	0.46	0.32	0.60	0.88	0.60	2.86
	Measure2	0.42	0.32	0.60	0.88	0.65	2.87
	Examiner1	0.46	0.34	0.57	0.90	0.65	2.92
	Examiner2	0.42	0.32	0.60	0.88	0.65	2.87
	Examiner3	0.46	0.32	0.60	0.79	0.65	2.82
	Examiner4	0.42	0.32	0.65	0.83	0.65	2.87
	Examiner5	0.42	0.32	0.60	0.79	0.69	2.82
8	Measure1	-0.14	0.28	0.83	1.29	-0.05	2.21
	Measure2	-0.14	0.32	0.83	1.34	-0.09	2.26
	Examiner1	-0.14	0.28	0.83	1.29	-0.07	2.19
	Examiner2	-0.18	0.28	0.83	1.29	-0.05	2.17
	Examiner3	-0.14	0.32	0.88	1.29	-0.05	2.3
	Examiner4	-0.18	0.32	0.83	1.29	-0.05	2.21
	Examiner5	-0.14	0.32	0.83	1.29	-0.09	2.21
9	Measure1	-0.50	-0.46	0.32	0.46	0.64	0.46
	Measure2	-0.50	-0.46	0.32	0.46	0.64	0.46
	Examiner1	-0.53	-0.49	0.32	0.49	0.64	0.43
	Examiner2	-0.50	-0.46	0.36	0.46	0.64	0.5
	Examiner3	-0.50	-0.46	0.36	0.46	0.64	0.5
	Examiner4	-0.50	-0.46	0.36	0.46	0.64	0.5
	Examiner5	-0.50	-0.46	0.41	0.46	0.59	0.5
10	Measure1	-0.11	-0.02	0.80	0.66	0.48	1.81
	Measure2	-0.12	-0.03	0.76	0.67	0.49	1.77
	Examiner1	-0.12	-0.05	0.78	0.70	0.47	1.78
	Examiner2	-0.12	-0.03	0.76	0.67	0.49	1.77
	Examiner3	-0.12	-0.02	0.76	0.67	0.49	1.78
	Examiner4	-0.12	-0.03	0.76	0.72	0.49	1.82
	Examiner5	-0.12	-0.02	0.76	0.67	0.44	1.73

- Measure 1 refers to the original measurement by the author
- Measure 2 refers to the re-measurement by the author
- Examiner 1 – 5 represent the measurements of 5 different operators