

**CONTRIBUTION OF RESPIRATORY HEAT LOSS TO HEAT
BALANCE IN THOROUGHBRED HORSES PERFORMING NEAR
MAXIMAL EXERCISE UNDER THERMONEUTRAL AND HOT-
HUMID CONDITIONS**

A THESIS

SUBMITTED TO THE
FACULTY OF VETERINARY SCIENCE
OF THE
UNIVERSITY OF PRETORIA
IN FULFILMENT OF THE REQUIREMENTS
FOR THE DEGREE OF
DOCTOR OF PHILOSOPHY

IN
PHYSIOLOGY

BY

RAYMOND JOHN LUND

BACHELOR OF SCIENCE (ENGINEERING), UNIVERSITY OF CAPE TOWN, 1989

MASTER OF SCIENCE (PHYSIOLOGY) UNIVERSITY OF PRETORIA, 1996

JANUARY 2000

DEDICATION

To all those who encouraged me to complete this thesis,
Particularly my wife, Bernice,
And parents, Howard and Jessie

ACKNOWLEDGEMENTS

I wish to acknowledge and express my sincere appreciation to the following people:

PROFESSOR ALAN GUTHRIE, my promoter and director of the Equine Research Centre, for the insight, patience, guidance and wisdom. Thank you for the enthusiasm and for the friendship.

PROFESSOR ROY MEINTJES, my co-promoter from the Department of Veterinary Physiology, for his help and guidance.

JANE NURTON, colleague at the Equine Research Centre, for providing the positive stimulating help, motivation, enthusiasm and friendship.

HENNING MOSTERT, fellow student at the Equine Research Centre, for providing the positive stimulating and happy environment in which we work.

I am grateful to the following organisations whose generous financial assistance enabled the experimental work described in this thesis to be undertaken: The **TRANSVAAL/GAUTENG PROVINCIAL ADMINISTRATION**, the **HIGHVELD RACING AUTHORITY**, the **EQUINE RESEARCH CENTRE** and the **UNIVERSITY OF PRETORIA**.

The experiments described in this thesis would not have been possible without the excellent co-operation and patience of the subjects, the horses, who took part in the experiments.

DECLARATION

I, *Raymond John Lund*, do hereby declare that the experiments presented in this thesis were conceived and executed by myself and, apart from the normal guidance from my supervisor, I have received no assistance.

Neither the substance nor any part of this thesis has been submitted in the past, or is being, or is to be submitted for a degree in the University or any other university.

This thesis is presented in fulfilment of the requirements for the degree of PhD.

Signed:.....



Date:.....

20 AUGUST 2000

ABSTRACT

The purpose of the studies presented in this thesis was to develop a greater understanding of the contribution of respiratory heat loss to the thermal balance of exercising horses.

In the first experiment the effect of three different warm-up regimens on the thermal balance of Thoroughbred horses was investigated. The experiments showed that a low intensity warm-up was most beneficial aiding heat dissipation during subsequent exercise. The study also showed the heat loss by sweating is not restricted by the rate of sweat production, but by the evaporation rate of the sweat.

In the second experiment, horses were exercised to fatigue in thermoneutral and hot-humid environments. The evaporative heat dissipation from sweating and from the respiratory tract was severely impaired during the hot humid exercise protocol. There was a significant increase in the heart rate and the metabolic rate during the hot humid protocol, thus indicating the additional work done by the horse in an effort to dissipate the rapidly accumulating heat. The significantly shorter time to fatigue may be a mechanism to protect the horse from circulatory collapse as the circulatory demands for cardiac output exceed its capacity.

In the third experiment adaptations that the horse is able to make to alleviate the compromised evaporative heat loss were identified. These experiments showed that the horse is able to shorten its stride, increase minute ventilation and the velocity of the air in the conducting airways. The results presented also indicate that the horse is able to modify the evaporative area of the airways to enhance evaporative heat loss from the respiratory tract. The experiments also showed that during exercise in hot-humid environments, small changes in the evaporating surface vapour pressure have a significant effect on the vapour pressure gradient thus having a significant effect on the evaporating heat loss.

Finally, the lessons gained during the experiments presented in this thesis were used to revise and refine a mathematical model of the thermal balance of exercising horses. The resulting model is more accurate and easier to apply to use in the field.

SAMEVATTING

Die doel van die studie was om 'n beter begrip te verkry van die bydrae van asemhalings-hitte-verlies tot die termiese balans van die volbloed renperd.

In die eerste eksperiment is die effek van drie verskillende opwarmings oefening roetines op die termiese balans van volbloed perde ondersoek. Die eksperimente het getoon dat 'n lae intensiteit opwarming die mees voordeligste is en hitte verspreiding gedurende die daaropvolgende oefening fase fasiliteer. Die studie het verder getoon dat hitte-verlies deur sweet nie beperk is deur die produksie van sweet nie, maar deur die tempo van die verdamping van sweet.

In die tweede eksperiment is die perde geoefen tot moegheid in 'n termoneutraal en 'n warm hoë humiditeit klimaat. Die verdampingshitte verbruik van sweet en van die asemhaling streek was baie benadeel gedurende die warm humiditeit oefening protokol. Daar was 'n merkende toename in die hartklop sowel as die metaboliese spoed tydens die warm hoë humiditeit omstandighede, wat daaropdui dat die perd addisionele werk moet doen in 'n poging om die vinnig opbouende hitte te verminder. Die heelwat korter tyd tot moegheid kan dalk 'n meganisme wees om die perd te beskerm teen

sirkulerende ineenstorting wanneer die sirkulêre vereistes van die vraag vir kardio uitset die kapasiteit daarvan oorsky.

In die derde eksperiment is die aanpassing wat deur die perd gemaak kan word, aangaande verdampingshitte-verlies geïdentifiseer. Hiedie eksperiment het getoon dat die perd oor die vermoë beskik om die spoed van lug in die lugweg te vertraag sowel as die spoed van die lug in die geleidingslugweg. Die resultate toon ook dat die perd oor die vermoë beskik om die asemhalingsarea te bevorder. Die eksperiment het ook getoon dat gedurende oefening in 'n warm humiede klimaat, minimale veranderinge in die verdampsarea 'n merkwaardige impak het op die verdampingshitte-verlies.

Ten slotte is die resultate van die studie gebruik om die wiskundige model van termiese balans van renperde aan te pas. Die aangepaste model is meer akuraat en is ook maklike om in die pratyk te gebruik.

PUBLICATIONS EMANATING FROM THIS THESIS

1. Guthrie, A.J., Lund, R.J., (1997) Thermoregulation - Base Mechanisms and Hyperthermia. Veterinary Clinics of North America: K Hinchcliff – Extracted from the literature review presented in Chapters 2 and 3 :Appendix B.
2. Lund, R.J., Guthrie, A.J., Mostert, H.J., Travers, C.W., Nurton, J.P. and Adamson, D.J. (1996) Effect of three different warm-up regimens on heat balance and oxygen consumption of Thoroughbred horses. J. Appl. Physiol. 80: 2190-2197
3. Mostert, H.J., Lund, R.J., Guthrie, A.J., Cilliers, P.J. (1996) An Integrative Model for Predicting Thermal Balance in the Exercising Horses. Equine Veterinary Journal 22:7-15: Appendix A
4. Lund, R.J., Guthrie, A.J., Nurton, J.P., Mostert, H.J., Travers, C.W. and Hodgson, D.R. (XXXX) Respiratory Heat Loss from Horses in Extreme Hot-Humid and Thermoneutral Environments :Chapter 5
5. Lund, R.J., Guthrie, A.J. and Lyon, Q (XXXX) Design of a simplified Ultrasonic Air Flowmeter : Chapter 6
6. Lund, R.J., Guthrie, A.J., Nurton, J.P. and Meyer, C (XXXX) Respiratory Adjustments During Exercise in Hot-Humid Environments to Aid Heat Loss in Thoroughbred Horses: Chapter 7

7. Lund, R.J. and Guthrie, A.J. (XXXX) Refinements to a Mathematical Model of the Thermal Balance of Exercising Horses: Chapter 8

TABLE OF CONTENTS

Dedication	ii
Acknowledgements	iii
Declaration	iv
Abstract	v
Samevatting	vii
Publications emanating from this Thesis	ix
Table of Contents	xi
List of Tables	xx
List of Figures	xxii
Chapter 1	1—1
General Introduction	1—1
Chapter 2	2—4
Review of Literature	2—4
Total Energy Balance, Metabolism and Heat Stress	2—4

1. Introduction	2—4
2. Total Body Energy Balance	2—9
Basic Concepts of Energy Expenditure and Caloric Balance	2—9
3. Heat Production.....	2—13
Mechanisms.....	2—13
Regulation of Heat Production	2—14
4. Thermoregulation.....	2—17
Observations in the Field.....	2—17
Control Mechanisms.....	2—20
Thermoregulation and work	2—20
5. Endocrinology and Heat.....	2—26
Thyroid Function.....	2—26
Adrenal Function	2—28
Pituitary Hormones.....	2—31
6. Thermal Environment	2—33
Abiotic Environmental Factors	2—33
7. The Animal and the Environment.....	2—36
Heat Exchange Between Animal and Environment.....	2—36
8. Heat Stress.....	2—42
Circulatory Changes In Heat-Stressed Animals.....	2—42
Effect of exercise in the Heat-stressed animal	2—45
Central Cardiovascular Changes	2—46
9. Effects on Respiration.....	2—48

Moisture Loss from the Respiratory Tract	2—48
Disturbance of respiration and blood gas concentrations.....	2—49
10. Thermal Stress and The Horse	2—53
Exercise Stress.....	2—53
Transport Stress	2—53
Thermal Stress	2—54
Medical Problems Associated with Heat Stress and Exercise ...	2—57
Management of Horses in Potentially Stressful Environments..	2—61
Calculation of metabolic heat production	2—64
Measurement of Heat Loss	2—65
12. Summary	2—67
Chapter 3	3—69
Review of Physical Chemistry and Water Vapour Thermodynamics	3—69
1. Review of Thermodynamics, Gas Laws and Psychrometrics	3—69
Fundamental Parameters	3—69
Adiabatic Saturation	3—72
Calculation of Heat Transfer by Moist Gasses.....	3—75
Heat Transfer During Evaporation.....	3—77
Equine Sweat	3—81
Chapter 4	4—89

The Effect of Three Different Warm-up Regimens on Heat Balance of Thoroughbred Horses.....	4—89
Abstract	4—89
Introduction.....	4—91
Materials and Methods.....	4—93
Experimental animals:.....	4—93
Experimental protocols.....	4—93
Determination of temperatures.....	4—94
Determination of metabolic response to exercise.....	4—96
Statistical analyses:.....	4—98
Results.....	4—99
Exercise time.....	4—99
Metabolic responses to the different warm-ups.....	4—99
Temperature responses to warm-up and exercise.....	4—100
Heat Production.....	4—103
Heat Storage.....	4—105
Heat Dissipation.....	4—105
Discussion.....	4—105
Acknowledgements.....	4—112
Chapter 5.....	5—113

Respiratory Heat Loss from Horses Performing Maximal Exercise in Hot - Humid and Thermoneutral Environments	5—113
Abstract	5—113
Introduction	5—115
Materials and methods	5—117
Experimental animals	5—117
Experimental protocols.....	5—117
Measurement of Oxygen consumption.....	5—119
Measurement of respiratory heat loss.....	5—119
Measurement of metabolic responses to exercise	5—119
Measurement of temperatures	5—120
Measurements of laboratory conditions	5—120
Statistical analyses.....	5—121
Results	5—123
Exercise time.	5—123
Metabolic responses to exercise	5—123
Temperature responses to warm-up and exercise.....	5—123
Heat Gain.....	5—124
Respiratory Heat Dissipation.....	5—124
Discussion	5—126
Acknowledgements	5—134
Chapter 6	6—135

Design and Construction of a Simplified Ultrasonic Air Flowmeter⁶—135

Abstract	6—135
Introduction	6—136
Principle of operation	6—139
Operation of the system	6—140
Construction of the Flowhead	6—143
Measuring Results and Discussion.....	6—149
Conclusions	6—152
Chapter 7	7—153

Respiratory Adjustments During Exercise in Hot-Humid Environments to Aid Heat Loss in Thoroughbred Horses

7—153

Abstract	7—153
Introduction	7—155
Materials and Methods	7—157
Experimental animals	7—157
Experimental protocols.....	7—158
Measurement of Oxygen consumption.....	7—159
Measurement of respiratory heat loss.....	7—159
Measurements of temperatures.....	7—159
Measurements of laboratory conditions	7—160
Measurement of tidal volume and minute volume	7—160

Measurement of end expiratory gas temperature and respiratory frequency	7—161
Calculation of the changes of the evaporative area and the vapour pressure at the evaporating surface of the respiratory tract.....	7—162
Calculation of respiratory tract mean flow velocity and evaporative heat loss	7—163
Statistical analyses.....	7—163
Results	7—166
Oxygen consumption.....	7—166
Respiratory heat dissipation	7—166
Temperature responses to warm-up and exercise.....	7—166
Changes in respiratory dynamics	7—167
End Expired Gas Temperatures.....	7—168
Estimate of the relative change in the Evaporative Surface Area and Vapour pressure.....	7—169
Calculation of Respiratory Heat Loss	7—169
Discussion	7—179
Acknowledgements	7—191
Chapter 8	8—191
Refinements to a Mathematical Model of the Thermal Balance of Exercising Horses.....	8—192
Abstract	8—192

Introduction	8—194
Model	8—197
Heat Losses.....	8—197
Comparison of model with experimental data	8—204
Results	8—205
Discussion	8—213
Conclusion.....	8—216
Chapter 9	9—218
General Conclusions	9—218
Chapter 10	10—220
References	10—220
Appendix A	A—257
An Integrative Model for Predicting Thermal Balance in the Exercising Horses	A—257
Abstract	A—257
List of Symbols and the Units of the Corresponding Variables.....	A—259
Introduction	A—261
Methodology	A—264
Heat Gain.....	A—265
Heat Losses.....	A—270

Comparison of model with experimental data	A—277
Results	A—281
Discussion	A—290
Effects of increasing humidity:	A—292
Conclusion.....	A—294
Appendix B.....	B—297
Thermoregulation - Base Mechanisms and Hyperthermia.....	B—297
Heat Balance	B—298
Heat Gain	B—299
Heat Transfer.....	B—303
Thermoregulation.....	B—306
Heat balance of horses	B—308
Hyperthermia.....	B—310
Clinical signs of hyperthermia	B—311
Management of hyperthermic horses	B—312
Prevention of hyperthermia.....	B—316
Summary	B—319

LIST OF TABLES

Table 2-1: Summary of effector mechanisms in temperature regulation	2—6
Table 2-2 : Exhaustive Disease Syndrome	2—60
Table 4-1. Means and standard errors of various variables measured in 6 horses at rest, following warm-up, at fatigue and following 20 minutes recovery in response to 3 different warm-up regimens.	4—101
Table 5-1: Means and standard errors of variables measured in 5 horses at rest, prior to a warming up, following warming up, at the point of fatigue and 1 minute after fatigue whilst performing a standardised exercise to fatigue test under thermoneutral (TN) (20°C, 50% RH) and under hot humid conditions (HH) (35°C, 85% RH). * indicates means are significantly different at P<0.05.	5—122
Table 7-1: Means and standard errors of variables measured in 5 horses at rest, prior to a warming up, following warming up, after 5 minutes at 9.1 m/s and after 5 minutes recovery. Exercise was performed under hot dry (HD) (30°C, 35% RH) and under hot humid conditions (HH) (30°C, 85% RH). * indicates that means are significantly different at P<0.05.	7—165
Table 8-1: Characteristics of a typical Thoroughbred horse.....	8—205
Table A-1: Characteristics of a typical Thoroughbred horse.....	A—279
Table A-2: Summary of data defining the three work intensities used in the validation of the model	A—280

Table A-3: Comparative summary of the time duration calculated for the horse to reach a critical temperature of 42 C and that reported by Hodgson *et al.* (1993) for different exercise intensitiesA—280

Table A-4: Comparison of the respiratory heat loss predicted by by the model with the heat loss from the lungs reported by Hodgson *et al.* (1993) for a laboratory temperature of 22°C and a humidity of 40% for 3 different exercise intensities.A—281

LIST OF FIGURES

Figure 2-1: Body temperature as a balance of heat loss and heat gain	2—8
Figure 2-2: Streams of energy between the animal and environment	2—38
Figure 2-3: Conceptual model of environmental effects on the metabolism of animals	2—40
Figure 3-1: The Adiabatic Saturation process. Air enters the ‘saturator’ at point 1, moves over a pan of water and leaves at point 2 saturated with water vapour. There is no heat transfer during the process and the temperature of the mixture at point 2 is defined as the wet bulb temperature.	3—74
Figure 3-2: Sensible heating and cooling process described by a psychrometric chart	3—76
Figure 3-3: Schematic of a heating or cooling device	3—76
Figure 3-4: Boiling heat transfer coefficients for a heating surface in water at atmospheric pressure.....	3—78
Figure 4-1 Temperature in the pulmonary and carotid arteries and the rectum during no warm-up (X;A), race warm-up (R;B), and comprehensive warm-up (W;C) trials.....	4—102
Figure 4-2 Heat production (A) during different stages of the experiments and heat dissipation (B) via various avenues during the X, R and W trials.	4—104
Figure 5-1: Metabolic heat production and respiratory heat exchange during each phase of the standard exercise to fatigue tests under thermoneutral (TN) and hot-humid (HH) conditions. Respiratory heat exchange was	

significantly lower ($P < 0.05$) during all phases of exercise in the hot-humid environment.....5—125

Figure 6-1 Block diagram of the ultrasonic air flowmeter system6—144

Figure 6-2 Relation of output voltage and air flow.....6—145

Figure 6-3 Respiratory gas flow trace from a horse galloping on a treadmill6—146

Figure 6-4 Cross section through the flowhead. Diameter of the respiratory tube is 110 mm.....6—147

Figure 6-5: Oscilloscope image of the output of 1. the signal received by the transducer; 2. the non-retriggerable monostable flipflop output preventing multi-triggering of the multivibrator; and 3. the burst triggering the multivibrator.6—148

Figure 7-1: Means and SE of oxygen consumption of five horses during warm-up, near maximal exercise and recovery under hot dry (HD) and hot humid (HH) conditions.7—170

Figure 7-2: Means and SE of respiratory heat loss of five horses during warm-up, near maximal exercise and recovery under hot dry (HD) and hot humid (HH) conditions. * indicates values significantly different ($P < 0.05$)7—171

Figure 7-3: Means and SE of pulmonary artery temperature and rectal temperature of five horses during warm-up, near maximal exercise and recovery under hot dry (HD) and hot humid (HH) conditions. Long dash lines indicate lines used to determine the temperature lag between the pulmonary artery and the rectal temperatures.....7—172

- Figure 7-4: Means and SE of tidal volume (A), respiratory frequency (B) and minute volume (C) of five horses during warm-up, near maximal exercise and recovery under hot dry (HD) and hot humid (HH) conditions. * indicates a significant difference ($P < 0.05$).7—173
- Figure 7-5: Means and SE of the tracheal air velocity of five horses during warm-up, near-maximal exercise and recovery under hot dry (HD) and hot humid (HH) conditions. * indicates values significantly different ($P < 0.05$).7—174
- Figure 7-6: Means and SE of the temperature of the gas in the trachea measured at the end of the expiratory phase of the respiratory cycle in five horses during warm-up, near maximal exercise and recovery under hot dry (HD) and hot humid (HH) conditions. * indicates values significantly different ($P < 0.05$).7—175
- Figure 7-7: Vapour pressure of the respiratory tract evaporative surface calculated from the temperature of the saturated evaporative surface and the change in evaporative surface area relative to the area 1 minute after start of warm-up during exercise in hot-dry (HD) and hot-humid (HH) conditions.7—176
- Figure 7-8: Comparison of the percent reduction from the HD (30°C & 35% RH) to the HH condition (30°C & 85% RH) of the vapour pressure capacity of the environment and the respiratory heat loss with each phase of exercise. (Vapour Pressure Capacity = $(p_{\text{Sat}} - p_{\text{Amb}})$)7—177

- Figure 7-9: Comparison of measured respiratory heat loss from horses exercising during hot dry and hot humid conditions with the respiratory heat loss is calculated from tracheal air velocity and the relative surface areas of the evaporating surfaces. The calculated respiratory heat loss for the HH environment overestimated the heat loss when compared to the experimental data. This heat loss was corrected by applying a constant to the calculated data.....7—178
- Figure 8-1: Graphic presentation of the relative proportions of the avenues of heat loss from horses during exercise. 8—207
- Figure 8-2: Plot of predicted core temperature from the revised model, the Mostert model and carotid artery temperature reported by Hodgson *et al.* (1993) at three different work intensities in Thoroughbred horses. The predicted values were calculated for a temperature of 22°C and a relative humidity of 40% to simulate the laboratory conditions under which the experiments were done.8—208
- Figure 8-3 : Comparison between the rate of change in core temperature as predicted by the Mostert model and the Revised model at the onset of exercise, the rate of change in pulmonary artery temperature reported by Jones and Carlson (1995), and the rate of change in carotid artery temperature reported by Hodgson *et al.* (1993) at three different work intensities in horses.8—209

Figure 8-4: Comparison of the respiratory heat loss measured experimentally (Chapter 7) with the respiratory heat loss predicted by the model in hot-humid and hot dry conditions8—210

Figure 8-5: Plot of the heat loss by evaporation of sweat estimated using the Mostert model [153] and the Kerslake model [112]. Regression $r^2 = 0.9999$ 8—211

Figure 8-6 : Comparison of the pulmonary artery temperature presented in Chapter 7 and the core temperature predicted by the model during exercise in hot-humid and hot dry conditions.....8—212

Figure A-1 : Plot of predicted core temperature and carotid artery temperature reported by Hodgson *et al.* (1993) at three different work intensities in Thoroughbred horses. The predicted values were calculated for a temperature of 22°C and a relative humidity of 40% to simulate the laboratory conditions under which the experiments were done.A—283

Figure A-2 : Comparison between the rate of change in core temperature as predicted by the model ($\Delta\dot{T}$), the rate of change in pulmonary artery temperature reported by Jones and Carlson (1995), and the rate of change in carotid artery temperature reported by Hodgson *et al.* (1993) at three different work intensities in horses.A—284

Figure A-3: The predicted effect of increasing humidity on the rate of change of core temperature of an average Thoroughbred horse exercising at 90% of $\dot{V} O_2\text{max}$ in ambient temperatures of 22 and 30°C.....A—285

Figure A-4 : Plots summing the predicted effects of varying humidities at two temperatures and two air speeds on heat loss by evaporation of sweat for a typical Thoroughbred horse exercising at 90% of $\dot{V} O_2\text{max}$A—286

Figure A-5: The predicted effect of solar radiation on the rate of change of core temperature ($\Delta\dot{T}$) at different humidities for a typical Thoroughbred horse exercising at 90% of $\dot{V} O_2\text{max}$A—287

Figure A-6: The predicted effect of long wave absorptivity due to different coat colours on the rate of change of core temperature ($\Delta\dot{T}$) for a typical Thoroughbred horse exercising at 90% of $\dot{V} O_2\text{max}$ at a temperature of 22°C, relative humidity of 40%, long wave irradiance of 0.94 kW/m² and short wave irradiance of 0.18kW/m²A—288

Figure A-7: The predicted effect of different long wave absorptivities due to different coat colours on solar heat gain (\dot{H}_{solar}) for a typical Thoroughbred horse assuming a long wave irradiance of 0.94 kW/m² and a short wave irradiance of 0.18kW/m².....A—289

CHAPTER 1

GENERAL INTRODUCTION

The thermoregulatory system is probably one of the most important control systems in the athletic horse. The horse has a tremendous aerobic capacity that gives the horse the elite athletic qualities that man has exploited in his endeavours for personal gain - be it monetary or pleasure. However it is the same physiologic capacity that can lead to its demise. The horse generates tremendous heat as a result of oxygen metabolism that unless adequately dissipated, can challenge the welfare of the performance horse. The studies described may benefit the welfare of the horse, and probably the trainer in the quest for improved performance.

The studies reported in chapters 3, 4, 5, 6, 7 and 8 represent research efforts aimed at understanding and evaluating various aspects of thermoregulation and thermodynamics of exercising horses. The thermal balance of exercising horses was modelled by Mostert, Lund and co-workers [153] and is presented in Appendix A. The thermal model, although fairly comprehensive, does have shortcomings and does not truly reflect the thermal behaviour of exercising horses in the field, particularly with extended exercise periods.

The role of the pre-exercise warm up has been well described in humans. It has not been discussed in the horse, and it is also thought that a warm-up can place the body in a state of thermoregulatory readiness prior to maximal exercise. A study evaluating the role of the pre-exercise warm up on subsequent thermoregulation during maximal exercise was thought to be necessary to improve understanding of the thermoregulatory mechanisms in the horse and provide the insight to the shortcomings of the models discussed in Chapter 4.

The study discussed in Chapter 4 did highlight that the major shortcomings of the model of Mostert *et al.* [153] were in the quantification of respiratory heat loss. Furthermore, other workers have discussed respiratory heat loss without adequate understanding of the mechanisms involved in the process. Two studies were carried out, discussed in Chapters 5 and 7, in order to provide data to describe the thermoregulatory processes.

The study described in Chapter 5 demonstrated how hot-humid environments compromise respiratory heat dissipation (and any other form of evaporative heat loss). The study also indicated that the horse is able to make adaptations to its respiratory function in order to alleviate the constraint heat dissipation.

The study described in Chapter 7 illustrated the adaptations the horse is able to

make when evaporative heat loss is compromised by hot-humid environment. The data generated in these studies was used to validate a revised mathematical model. The revised model was also incorporated into an MS-Excel based program thus providing the equine sports physiologist with a useful field tool.

The specific objectives of these studies can be summarised as follows:

1. To refine a previously developed mathematical model of the heat balance of horses exercising at near maximal intensities.
2. To evaluate the role of warm-up on subsequent thermoregulation and thermal balance.
3. To measure the respiratory heat dissipation from horses exercising at near-maximal intensities in thermoneutral and hot-humid environments.
4. To identify the adaptations the horse is able to make in order to increase respiratory heat dissipation when heat dissipation by sweat evaporation is compromised.
5. To use the data generated from the studies presented to rework and simplify the mathematical model of Mostert *et al.* [153], thus making the model easier to apply to field conditions.

CHAPTER 2

REVIEW OF LITERATURE

TOTAL ENERGY BALANCE, METABOLISM AND HEAT STRESS

1. INTRODUCTION

Most mammals are homeotherms and to live they must keep their body temperature within a narrow range (35 to 42°C) despite wide variation in the environmental temperature and differences in levels of physical activity. Poikilotherms (most fish and insects), on the other hand, have close to a perfect 1:1 relation between body temperature and environmental temperature [160]. It is interesting however, to observe that fast-swimming species of fish (tuna, marlin and sailfish; i.e. performance fish) and flying insects are able to elevate the temperature of their locomotory muscles to temperatures similar to those found in the muscles of homeotherms during intense exercise [160].

The energy balance of the homeotherm is constantly being disturbed by environmental and/or physical activity and is dependent on the dissipation or retention of metabolic heat. There is temperature zone that is species, breed, climate, and coat dependent, at which the animal can maintain a constant core temperature with minimal energy consumption. This temperature zone, which

is termed the thermoneutral zone, is where the basal metabolic rate is lowest [197]. Conversion of chemical energy to mechanical energy that allows exercise is extremely inefficient - a large proportion of the total chemical energy used during muscular contraction is released as heat rather than as physical work [159].

The surface of the body exchanges heat with the external environment by radiation, conduction, convection and by water evaporation (evaporation of sweat.). Table 2-1 [197] summarises the mechanisms regulating temperature, none of which are all-or-nothing responses, but which show a progressive increase or decrease in activity. Heat production via skeletal muscle activity becomes extremely important at the cold end of the spectrum whereas increased heat loss via sweating is critical at the hot end.

Central to thermoregulation is consideration of afferent input. These temperature-regulating reflexes require receptors capable of detecting changes in the body temperature. There are two groups, one (peripheral) in the skin and the other (central) in the core of the body.

Table 2-1: Summary of effector mechanisms in temperature regulation

Desired Effect	Mechanism
	Stimulated by cold
Decreased heat loss	Vasoconstriction of the skin vessels; reduction of surface area (curling up, etc.); Behavioural response (put on warmer clothes, etc.)
Increased heat production	Increased muscle tone; shivering and increased voluntary activity; increased secretion of thyroid hormone and adrenaline; increased appetite
	Stimulated by heat
Increased heat loss	Vasodilatation of skin vessels; sweating; behavioural response (cooler clothes)
Decreased heat production	Decreased muscle tone and voluntary activity; decreased secretion of thyroid hormone and adrenaline; decreased appetite

The objective of this chapter is to gain a greater understanding of the sensitive balance between heat production and heat loss (Figure 2-1), the homeotherm's response to thermal stress and the homeotherms mechanisms of thermoregulation. In order to gain this understanding, the various techniques required to measure and evaluate these responses must also be reviewed.

Figure 2-1: Body temperature as a balance of heat loss and heat gain

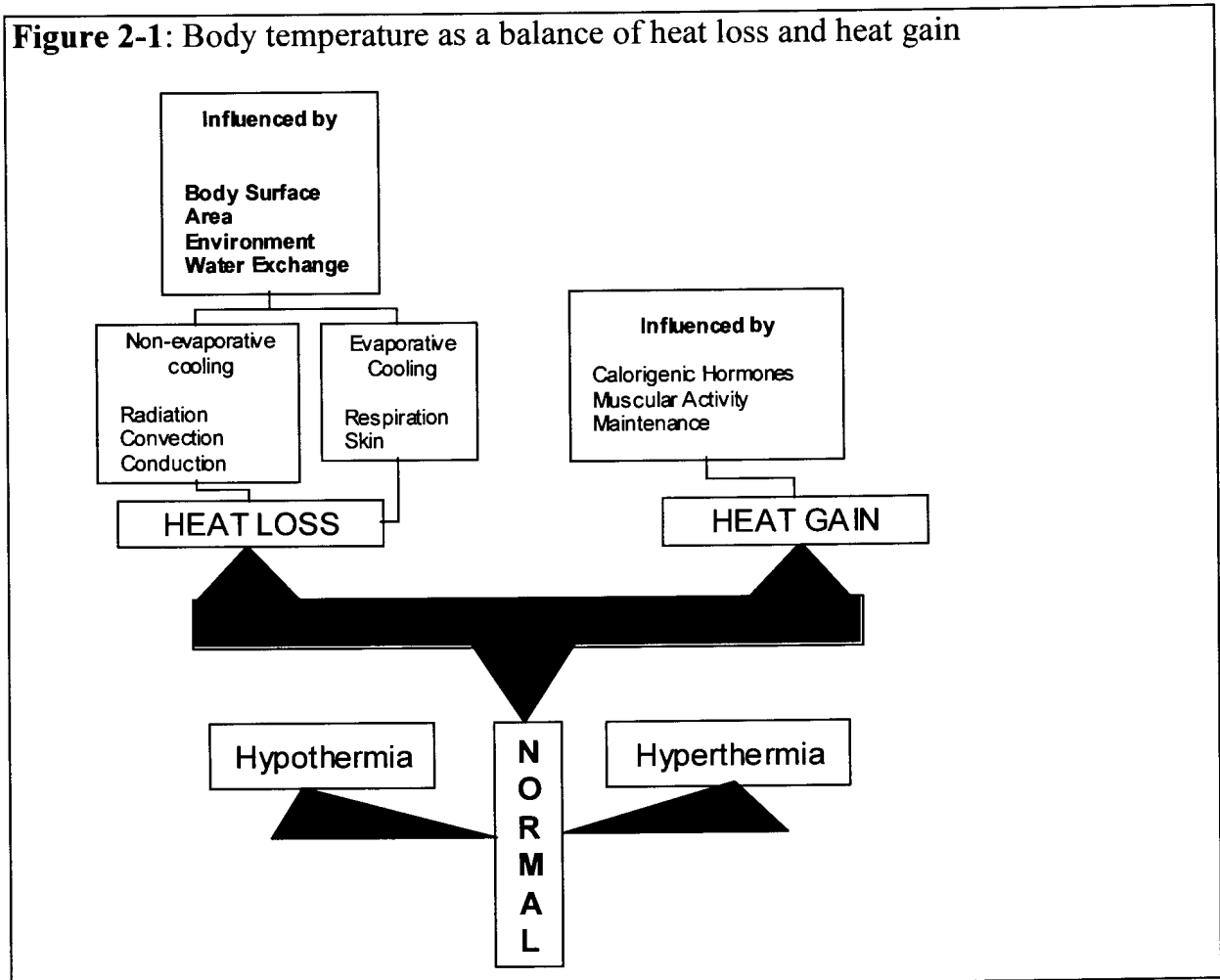

2. TOTAL BODY ENERGY BALANCE

Basic Concepts of Energy Expenditure and Caloric Balance

The breakdown of organic molecules liberates the energy locked in their intramolecular bonds. This is the source of energy utilised by cells in their performance of various forms of biological work (muscle contraction, active transport, synthesis of molecules). The first law of thermodynamics states that energy can neither be made nor destroyed but can be converted from one form to another. Thus, internal energy liberated (ΔE) during breakdown of a organic molecule can either appear as heat (H) or be used for performing work (W).

$$\Delta E = H + W$$

During metabolism, as much as 70 % of the energy appears immediately as heat and the rest is used for work. The body is not a heat engine since it is totally incapable of converting heat into work, but that heat is vital for maintaining body temperature.

Biological work can be divided into two categories: (1) external work, i.e., movement of external objects by contracting skeletal muscles; and (2) internal work, which includes all other forms of biological work. All internal work is

ultimately transformed into heat except during periods of growth. One of several examples of this point is the internal work that is performed during cardiac contraction ultimately appears as heat generated by the resistance to flow through the blood vessels.

Thus, the total energy liberated when cells catabolize organic nutrients may be transformed into body heat, appear as external work, or be stored in the body in the form of organic molecules (fat deposition during obesity). The total body energy expenditure of the body is therefore given by the equation

$$\begin{aligned} \text{Total energy (from food intake and the environment)} &= \text{Internal heat produced} \\ &+ \text{External work} + \text{Energy storage} \end{aligned}$$

In the above equation there is no term representing loss of fuel from the body via excretion of nutrients. In a normal person/animal, almost all the carbohydrate and amino acids filtered at the glomerulus are reabsorbed by the tubules, so that the kidneys play no significant role in the regulation of energy balance.

The units for energy are kilocalories or kilojoules, and total energy expenditure per time unit is called the metabolic rate. The methodology involved in the measurement of metabolic rate will be discussed later in this paper, but briefly, metabolic rate can be measured either directly or indirectly.

The direct method requires the subject to be placed in a calorimeter, and heat production measured by changes in temperature within the calorimeter. The indirect method simply requires measuring the subject's oxygen consumption per unit time. From this value heat production is calculated from the principle that the catabolism of nutrients inside and outside the body must produce the same amount of energy. The amount of heat liberated from 1 litre of oxygen in the oxidation of fat, carbohydrate or protein is therefore known to be 21 kilojoules. [197]

Metabolic Rate

Many factors influence the body's metabolic rate. In the measurement of basal metabolic rate (BMR), standardised test parameters must be maintained. The subject must not have eaten for 12 hours, be at a state of physical and mental rest and be at a comfortable temperature. These conditions are termed basal, but the BMR is not the minimum metabolic rate. The subject's metabolic rate may be lower during sleep. BMR as defined is difficult to achieve and measure in animals. Metabolic rate can be elevated by a number of factors including body temperature and environmental temperature. Any form of stress, including illness will also raise metabolic rate [197].

The ingestion of food causes an increase in metabolic rate of between 10 and 20 %. This is known as the specific dynamic action (SDA). It has been shown that the increase is not only due the digestion of the food but also the processing of the nutrients by the liver. The greatest influence on the

metabolic rate is the altered state of the skeletal muscle. During severe exercise the metabolic rate can increase by as much as twenty fold.

Metabolic rate is also strongly influenced by adrenaline and thyroid hormone. Adrenaline has powerful calorogenic properties, i.e. heat producing, which may be related to its stimulation of glycogen and triacylglyceride catabolism, since adenosine-tri-phosphate (ATP) splitting and energy liberation occur in both the breakdown and the subsequent resynthesis of these molecules. An increase in the plasma concentration of adrenaline may increase heat production by 30 %. Thyroid hormone (TH) also increases the oxygen consumption and heat production of most body tissues (except the brain). Further details on the effects of these hormones on the thermoregulatory system are discussed in section 5, page 2—26.

3. HEAT PRODUCTION

Metabolic processes yield energy that is used for synthesis of new molecules, for work, and/or liberated as heat. In an organism, energy is transformed from one form to another form in various biochemical stages and in accordance with its needs by means of cellular oxidation where carbon skeletons are oxidised to CO₂, hydrogen to water, and potential energy is converted to other forms of energy. Heat production is a measure of the sum of energy transformation taking place in the animal per unit time.

Mechanisms

The rate of heat production (HP) in mammals is controlled by the nervous and endocrine systems. These two systems regulate HP directly by modifying the animal's appetite and its digestive processes, and/or indirectly by alterations of the activity of the respiratory enzymes and synthesis of proteins.

Neurocontrol

The neurocontrol of HP was first recognised in 1866. Moore [152] noted that Tscherniak had discovered that injury to part of a rabbit's brain increased body temperature. In general, studies have shown that the rate of HP is influenced by the environmental temperature stimulating peripheral receptors and by internal body temperature changes. The output signals from the central

nervous system that change HP are directed either to promote shivering or nonshivering thermogenesis.

Localised cooling of the hypothalamus or spinal cord increased HP in the pig when it was maintained at a cool or thermoneutral ambient temperature [32]. Heating the hypothalamus tended to decrease heat production. Hypothalamic heating decreased shivering in an ox in a cold environment [101].

Regulation of Heat Production

Measurement of BMR in ungulates is not practical since it is difficult to attain measurements from animals at rest and in the postabsorptive state. The rate of O_2 consumption ($\dot{V} O_2$) under thermoneutral ambient temperature is called "resting" or "standing" and is commonly accepted as a convenient baseline for measuring various energy increments, such as heat increments of muscular work, feeding and thermoregulation. Some factors affecting "resting" HP in ungulates are discussed:

Size

The mammalian resting HP has been discussed at length by Brody [26] and Kleiber [116] and they concluded a relation of resting HP/kg^x of body weight, where x is approximately 0,73 or 0,75, which is relatively constant across many species. They developed the physiological term "physiological weight" or "metabolic body size", i.e., body weight^{0,75}. In other words a 100% increase in body weight constitutes a 75% increase in metabolic rate. This has

shown to be constant in adults, but is still questioned in growing animals [26]. Resting HP per unit body weight of cattle, horses, and goats is known to decline exponentially with age [26].

Species and breeds

The resting HP of different ungulates vary from species to species [216]. For example the camel living in the desert and its relative, the llama, inhabiting high mountains, have different HP per unit metabolic body weight than is expected from the predicted values of Brody [26] and Kleiber [116].

The resting HP per unit metabolic weight in cattle is higher than in sheep [75]. Among domestic cattle, Zebu breeds have lower resting HP than the European and Afrikander breeds [198,212].

Environmental Factors

Sudden or acute exposure to heat causes a rise in HP, but chronic or continuous heat stress results in a decrease in HP. Under natural climatic conditions, the average rate of HP declines about 18 to 20% from spring to summer in Holstein heifers [18].

Exposures of ungulates to cold in climatic chambers for short and long periods cause the resting HP to increase. Exposure to naturally occurring cold climates had a similar effect, however, the bison decreased its HP at temperatures down to -30°C and the HP only started increasing when a wind

was superimposed on the extremely low ambient temperature [44]. In other words there is a species dependent thermal environment where the HP is increased in order to prevent hypothermia.

Feed and Water

For resting animals with a given body weight in a thermoneutral environment, the HP depends largely on the quality and quantity of feed intake. Fasting decreases HP, but the previous nutritional level can influence the fasting HP [74]. The rate of HP in sheep at thermoneutral temperatures was found to be directly related to the level of the feed intake [76].

Restriction of water intake and dehydration decreased the HP of many animals exposed to hot and cold environments [54,206,215].

4. THERMOREGULATION

Any exposure to an environmental temperature outside the thermoneutral zone involves an animal in a response which aims to maintain deep body temperature within set limits. The extent to which such an exposure can be regarded as a stress is at least partly a matter of definition. A small departure from thermoneutrality is perhaps not "stressful", whereas a severe hot or cold exposure is certainly regarded as "stress". For the homeotherm there are three responses to conditions that depart from thermoneutrality; (1) An autonomic nervous response, i.e. shivering or panting, (2) a hormonal response i.e. thyroid hormone and adrenaline secretion and (3) a behavioural response i.e., avoiding cold winds and wallowing in water in hot conditions.

Observations in the Field

The simplest form of thermoregulatory behaviour (in homeotherms and poikilotherms) involves the thermocline in which the animal can select a temperature from a range of possibilities. Such behaviour may involve avoidance of adverse or stressful conditions.

Heat

A thermocline is available to birds since they are able to select an air temperature from a vertical gradient [176]. Large, soaring birds are able to

soar to altitudes of a few thousand metres during the hottest parts of the day. Migratory behaviour over long distances may also be related to easing the thermoregulation in small birds. Other animals make use of the temporal thermocline over a 24-hour period. Cattle have been observed to spend most of hot days under shady trees and graze at night. The air temperature may be only slightly lower, but the absence of solar radiation drops the heat load considerably.

The jack rabbit often finds a place which is not only shaded from the sun but also provides an opening to the blue sky [176]. The significance of this behaviour is that the large, vascularized ears, which have a surface temperature of 38°C, are exposed to the sky. A blue sky acts as a solid sheet at a temperature 20°C below the ambient temperature, which may be above 40°C in the desert. The animal can thus lose heat by radiation as well as shelter from the short-wave radiation from the sun.

In contrast, the antelope ground squirrel actually uses heat stress to its advantage. The small animal runs around the desert allowing its body temperature to approach lethal limits before scurrying back to its burrow to lose heat by conduction to the cool ground. When its body temperature returns to normal, it repeats the cycle. In exchange for this apparently hazardous lifestyle, the creature searches for food when all other desert creatures are avoiding the heat.

Animals that are unable to sweat or pant efficiently are liable to become severely stressed if the environmental temperature approaches their body temperature, because under these conditions heat cannot be lost by evaporation. The pig does not sweat, but it is known to wallow in mud during hot weather. The evaporative heat loss by this avenue was measured by Ingram [98], who found that applying water to a pig's skin achieved the same cooling rate as humans, but the effect only last 15 minutes, whereas with the application of mud, the evaporation continued for nearly 2 hours.

Cold

Protection from wind and driving rain becomes important to avoid excessive heat loss. In most adult farm animals the environmental conditions seldom present severe thermal stress. Protection of the young is however critical. The smaller and younger the animal is, the closer the environmental temperature has to be to the animal's body temperature. Often huddling together can be a matter of life and death.

Another way in which the animal can thermoregulate is by orientation of the body to the rays of the sun. The effect is most easily observed by the size of the animal's shadow; the larger the shadow, the greater the area exposed to the sun.

Control Mechanisms

Among the factors that influence the thermoregulatory behaviour of animals is nutritional status. It is known that animals that have been given a high-energy intake also have a high metabolic rate and, as may be expected, these animals demand less heat than their controls on low energy intake.

Role of Thermoreceptors

The effect of heating and cooling the preoptic region of the hypothalamus has already been discussed. In another approach, the neural control of behavioural and autonomic thermoregulation of genetically obese and lean mice was observed. In the obese mouse there is an impaired response of the autonomic system controlling heat production.

Thermoregulation and work

Thermoregulation of Working Animals

Performance of animals in stressful environments is limited by their physiological and behavioural abilities to thermoregulate. The environmental heat load becomes much more severe whenever the animal works or its activity level increases. Bonsma [23] was the first to publish a significant paper assessing the working performance of animals in hot conditions. On the whole, there is limited data on animals working in thermally stressed environments.

Dissipation of heat in the horse during work

Horses are capable of prolonged exercise at high metabolic rates ($\dot{V}O_2$ in excess of $100 \text{ ml} \cdot \text{kg}^{-1} \cdot \text{min}^{-1}$), but have relatively low surface area-to-mass ratio. Estimates of surface area-to-mass ratio in humans are 1:35-40, whereas values in the horse are 1:90-100.

Hodgson and co-workers [92] did work evaluating the efficiency and performance of the sweating mechanism in the horse. They calculated the metabolic heat load from the horse's oxygen consumption, assuming that 80% of the energy was liberated as heat and oxygen had an energy equivalent of $21 \text{ kJ} \cdot \ell^{-1} O_2$. Heat dissipated from the lung was estimated by considering the temperature difference between the pulmonary and carotid arteries, the cardiac output at the time and the specific heat capacity of blood. The equation $\text{heat} = \Delta T_{(\text{pulmonary artery-carotid artery})}(\text{°C}) \times Q(\ell/\text{min}) \times 3,77 \text{ kJ} \cdot \ell^{-1} \cdot \text{kg}^{-1} \cdot \text{°C}^{-1}$ was used. The specific heat of vaporisation of sweat was taken as $2428 \text{ kJ}/\ell$ at room temperature. Body surface area was calculated by taking $1.09 + 0.008 \times \text{body wt (kg)}$.

The resulting responses to exercise were as follows: The gluteal muscle

temperature, the rectal temperature and the temperature in the pulmonary circulation all increased markedly. However, the temperature of the blood in the superficial thoracic vein, the vein which predominantly drains the skin, was $>2^{\circ}\text{C}$ less than that of the central circulation and with exercise the difference increased to as much as 3.3°C . The temperatures at all sites had returned to resting values within 10 minutes of the cessation of exercise. This clearly illustrates the magnitude of the evaporative mechanisms cooling blood perfusing the skin.

Evaporation of sweat under a thin layer of insulating hair is probably the best physical compromise for allowing the skin to lose heat while providing protection from heavy solar loads, i.e., insulation from solar radiation [130].

The Sweating Response

The role of the blood circulation in the transport of heat from the interior to the surface of the body is often overlooked. Venous return from the extremities takes place through superficial veins, thus increasing heat conductance of the tissues. The increased heat flow increases the skin temperature, thus facilitating heat loss. If the heat load is sufficiently large the sweat glands are activated. Sweating induced by exercise occurs in response to both circulating adrenaline and the sympathetic nervous system, but only the latter is involved in thermal sweating. Adrenaline-induced sweating in the horse is mediated by β_2 -receptors. Following protracted exposure to catecholamines, the sweat

glands of the horse may become unresponsive to this stimulus, thus limiting evaporative cooling.

Sweat promotes heat loss only when sweat water is evaporated. A horse working at moderate intensity, with an oxygen consumption of 30 to 40 litres/min could have a heat production of 628 kJ/min. If this pace is maintained for an hour, the total metabolic heat production would be 37,6 MJ. To dissipate this amount of heat by evaporative processes alone would require the complete evaporation of just over 15 litres of water.

Noakes [159] states that with human athletes, particularly in the heat, as the skin temperature rises it causes blood to pool in the veins of the arms and legs. This is apparently because the veins become progressively more dilated as the skin temperature rises. The veins soon fill with a large volume of blood that is effectively lost from the circulation and can only be returned to the circulation when the skin temperature is again lowered. This is achieved in human athletes by cooling the skin by sponging.

The fine hair coat of the horse is easily saturated with sweat when conditions do not allow complete sweat evaporation. This saturated coat effectively insulates the horse from further heat loss and there is currently no reasoning that the pooling of blood in the human athlete cannot occur in the equine athlete. The average horse sportsman/trainer is of the opinion that spraying or

sponging a horse with water will cause vasoconstriction at the skin surface and limit the heat loss from the horse. It is the opinion of the author that cooling the skin of the horse with water will cause vasoconstriction, thus returning the blood pooled at the skin to the circulation and further stimulating the circulation of blood to the skin surface. The elevated core temperature results in peripheral vasodilatation promoting peripheral circulation. The cooling at the skin surface as a result of application of water could cause local vasoconstriction, returning the blood pooled at the skin to the central circulation which could result in more efficient cooling, and improved athletic performance.

The commonly observed practice of horses rolling in cool sand following exercise may have to do with the dissipation of heat. Much in the same way as pigs roll in mud, the horse can probably conserve water and prolong the evaporative cooling effect while at rest following exercise. This conclusion has not been drawn previously and may be an aspect that requires further investigation.

While sweating is the principle means of evaporative cooling in horses, the respiratory tract also contributes to heat and water loss. Horses do not normally pant. However, panting may occur when high humidity or anhydrosis compromises the effectiveness of evaporative sweat loss. The pulse respiration inversion represents a form of panting and is common in

endurance horses during post-exercise recovery in hot humid environments.

5. ENDOCRINOLOGY AND HEAT

The homeotherm's thermoregulation is best described in control system terminology, i.e., sensor, controller, and controlled elements. The maintenance of normal body temperature requires adjustments and feedback signals between controlled and controlling elements. Endocrine glands are essential of both the controlling elements and the feedback signals. Therefore, hormonal responses to the environment are seen as vital to maintaining homeostasis.

There is a close association between the calorogenic hormones, i.e., thyroxine (T_4), triiodothyronine (T_3), growth hormone (GH), and glucocorticoids and the metabolic rate of mammals.

Thyroid Function

Thyroxine and triiodothyronine (T_4 and T_3) are recognised as powerful metabolic agents in animals [190].

Thompson [190] concluded that heat acclimation and/or acclimatisation causes an increase in body temperature and a decrease in thyroid activity. High ambient temperatures seem to have a direct influence on decreasing thyroid activity, and this effect is probably initiated at the hypothalamic level.

The effect of exposure to heat on thyroid function takes at least 60 hours to take effect, and its readjustment to normal levels after removal from the heat requires about 108 hours. The slow response of this gland indicates the small role it plays in acclimation, but the major role it plays later in "compensation" stages.

Conversely, cold temperatures increase thyroid function in most animals. The increased thyroid activity appears to depend on the severity and duration of the cold stress and upon the availability of food. Animals kept outdoors in Alberta, Canada in winter had higher plasma T_4 than animals kept indoors at $<15^\circ\text{C}$ [43,139,213]. Increasing feed intake of the outdoor animals tended to increase the plasma T_4 to the levels of the indoor animals.

Feed restriction is known to decrease thyroid function in farm animals. Dehydration of llamas and donkeys for 72 hours during exposure to heat caused significant decrease in plasma T_4 and T_3 . In the camel, dehydration in winter caused an increase in plasma T_4 and no change in T_3 , but dehydration in summer saw the same response as the llama and donkey.

Hyperthyroidism induces a number of side effects secondary to hypermetabolism. The increased metabolic demands increase hunger demands and food intake; the feed intake is often still inadequate and leads to

catabolism of endogenous protein and fat that leads to weight loss. The requirement for vitamins increases, and vitamin deficiency diseases may occur; respiration is increased to supply additional oxygen; cardiac output is also increased; the animal ultimately suffers intolerance of warm environments.

Thyroidectomy decreased HP, and administration of iodinated casein increased HP in cattle and sheep [20,27,135,155]. Injection of thyroxine in Holstein cattle increased HP in animals in a thermoneutral environment (18°C) and a hot environment (32°C) [219]. The calorigenic effect of a single dose of T₄ lasted for up to 6 days.

Adrenal Function

Hormones of the adrenal cortex and the medulla control many vital physiological and biochemical events to maintain homeostasis under different environment stresses.

While much work has been done on the role of the adrenal cortex in the maintenance of metabolic rate in small animals, not much has been done on large animals. Yousef and Johnson [220] showed that injection of hydrocortisone increased HP of cattle acclimated to thermoneutral and hot environments. The effective time of a single dose was about 4 hours. Intravenous infusion of noradrenaline in cattle had no effect on HP, while

adrenaline significantly increased HP.

Glucocorticoids

Cortisol is known to be a calorogenic agent in many animal species. Changes in glucocorticoid activity in animals in response to environmental heat and cold have been studied by looking at plasma levels, turnover rate and hormonal excretion rate. The initial rise in cortisol level was suggested to be a result of a stress reaction rather than specifically heat exposure [42]. Long term exposure to heat decreased cortisol turnover rate and plasma levels. If heat acclimated animals are returned to a thermoneutral environment, the cortisol levels returned to normal within 9 days. Yousef and Johnson [220] suggested that the reduced cortisol levels during heat acclimation probably aid the regulation of heat production.

There appears to be seasonal changes in cortisol secretion. The winter season was associated with higher adrenal cortical activity. Data collected over a year showed lower plasma corticoids in the hot season.

Mineralocorticoids

Thermally induced changes in water and mineral metabolism are hormonally controlled. The mineralcorticoid, aldosterone, and the pituitary ADH are involved in homeostasis of body fluid volume and concentration. Temperature

acclimation is associated with significant disturbances in body fluid homeostasis. Cattle exposed to heat (35°C) showed significant decrease in plasma aldosterone level after only 24 hours [53]. The reduction in plasma aldosterone was associated with a decrease in serum Na⁺ and K⁺ levels. The possibility that reduced aldosterone levels in heat-exposed cattle may be related to higher extracellular fluid volume and plasma ADH levels was suggested [53]. Other suggestions include (1) low plasma K may be a dominant factor in regulation of aldosterone secretion in cattle, and (2) Na⁺ regulation in cattle is probably controlled mainly by other hormones.

An interesting paradox occurs with aldosterone concentrations in sheep. Dehydration in sheep causes an increase concentration in plasma Na⁺ and renin and a decrease in plasma aldosterone, while in the camel, dehydration causes an increase in plasma Na⁺, renin and aldosterone [58,124]. This paradox is as yet unexplained.

Catecholamines

The importance of catecholamines i.e., adrenaline, noradrenaline, dopamine, serotonin, and histamine in animal thermoregulation has been widely demonstrated. Changes in catecholamines during exposure of animals to heat are outlined below.

There seems to be a general consensus across all species that short-term exposure to cold and heat increased plasma levels of noradrenaline. However

this does not hold for adrenaline. Adrenaline increased in only some species and did not change in others. Long term exposure to cold in pigs had no effect on the levels of noradrenaline and adrenaline [12], while long term heat significantly increased plasma levels of noradrenaline and adrenaline [2]. It appears that the changes blood levels of noradrenaline are as a result of adrenal medullary activity rather than increased sympathetic response.

Pituitary Hormones

Growth Hormone

Administration of growth hormone (GH) elevates heat production and simultaneously increased thyroxine turnover rate. Conversely, increased environmental heat caused a significant decrease in plasma GH and GH secretion rate.

Cattle acclimated to a thermoneutral and hot temperatures were injected with GH and HP measured [218]. The HP increased 30 to 40% at 18°C and 50 to 60% at 38°C. The latent period was 10 to 24 hours at 18°C and 4 to 10 hours at 38°C; and the effective time was 40 to 50 hours.

ADH

Little work on the effect of ADH on thermal changes in water balance appears to have been done. Changes in environmental temperatures (-5° to 35°C) gave no change in plasma ADH or urine flow in the pig [60]. However, when the

rectal temperature reached 41°C, ADH increased and urine flow decreased. Cooling sensitive regions of the central nervous system prevented the increase in ADH. Data collected in cattle showed that exposure to heat caused an increase in ADH, urine volume was unchanged and plasma osmolality decreased. The temperature changes inducing these effects were moderate (<1°C change in rectal temperature) [53].

6. THERMAL ENVIRONMENT

In its broadest sense, the environment can be classified into two main components: (1) abiotic, or the physical and chemical factors, and (2) biotic, or all interactions between biological entities such as food, water, predation, diseases, and social and sexual interactions [217]. The abiotic environmental factors are the primary factors in stress physiology and it is the influence of these factors, particularly the thermal factors, on the animal that is being reviewed here.

Abiotic Environmental Factors

The abiotic factors that affect the animals include air temperature, humidity, solar radiation, and wind.

Temperature

Environmental temperature is a measure of heat intensity in degrees Celsius. Ambient temperature (T_a) is the average temperature of a gaseous or liquid environment surrounding a body. The air temperature, the dry bulb temperature (T_{db}), is defined as the temperature of a gas indicated by a thermometer shielded from radiation [22].

Humidity

The amount of water vapour in the air is humidity. Relative humidity (RH) is the ratio of the mol fraction of water vapour present in a volume of air to the mol fraction present in saturated air, both at the same temperature and pressure [22]. The RH is usually expressed as a percentage. The intensity of the thermal environment is dependent upon T_{db} and %RH. The humidity controls the animal's evaporative heat loss from the skin and the respiratory tract.

Solar Radiation

The sun emits radiation of different wavelengths. The part of the spectrum of significance to the thermal stress physiologist is divided into the following wave bands: i. ultraviolet, ii. visible, and iii. infrared. The infrared waves provide the earth with warmth at high altitudes, and the visible light contributes most of the warmth that the earth receives and is the main source of energy.

Measurement of radiant energy should be considered as an important part of the thermal environment. A simple measure of the average surrounding radiant heat is the globe (T_g), or black body temperature which is defined as the temperature of a blacked hollow sphere of thin copper as measured by a thermometer inside at its centre.

Wind

Wind is generated by broad pressure patterns in the atmosphere which

themselves are related to heat sources and sinks. Wind speed in a given location slows down as one gets nearer the ground. Thus wind speeds should always be measured at the animal's height. Heat transfer by convection and evaporation between the animal and its environment is influenced by wind speed.

Thermal Environment of Animals

The thermal environment for animals can be classified according to radiation, air temperature, wind speed and water vapour pressure [217]. Mammals survive, and may thrive, in an unfavourable thermal environment depending on their ability to utilise efficient physiological and behavioural mechanisms to maintain a heat balance between their bodies and the environment.

7. THE ANIMAL AND THE ENVIRONMENT

Heat Exchange Between Animal and Environment

One of the primary means by which the environment affects animals is through the exchange of energy. If the animal takes in more energy than it gives out, it will get warmer, overheat, and die. If the animal loses more than it gains, it will cool and not survive. An animal can warm or cool for a limited period, but on average it must be in energy balance. For survival, maximum growth and performance, animals need an environment most compatible with their physiological requirements for energy.

The factors responsible for the energy flow to an animal are the thermal environment variables (air temperature, sky temperature, solar and thermal radiation, wind speed and humidity) and geometric structural properties of the animal coat such as hair density, diameter, length, colour, hair transmissivity, and absorptivity. The four independent environment variables - radiation, wind speed, air temperature, and humidity - act simultaneously and are each time dependent.

The energy exchange between the animal and its environment affects the body temperature of the animal. The rate of water loss, both cutaneous and respiratory, are in part determined by the environmental conditions and in part by the animal's physiology. The metabolic rate, a physiologic property of the

animal involving chemical energy, may also depend on the environment. Hence, in working with the interaction of the animal with the environment, one is faced with a further three independent variables (metabolic heat, body temperature and water loss). Thus the problem of evaluating the interaction of the animal with the environment tends towards a seven-dimension problem. The variables of body temperature, rate of moisture loss, metabolic heat, radiation, air temperature, wind speed, and humidity all have one common denominator and that is energy.

The outer-most layer of the animal, the skin, fur or feathers, acts as a transducer between the external environment and the internal physiology. The interaction between the internal and external environments is illustrated in Figure 2-2. All seven of the independent variables affect the animal's energy balance and the interaction of the animal with the environment determines the animal's energy balance.

Energy is also lost by vaporising water within the respiratory tract and from the skin surface of the animal. The amount of water lost in grams per unit time when multiplied by the latent heat of vaporisation of water at the appropriate temperature ($W/g^{\circ}C$) gives the rate of water loss in energy units of W/cm^2 -sec. In addition, defecation and urination also lose energy.

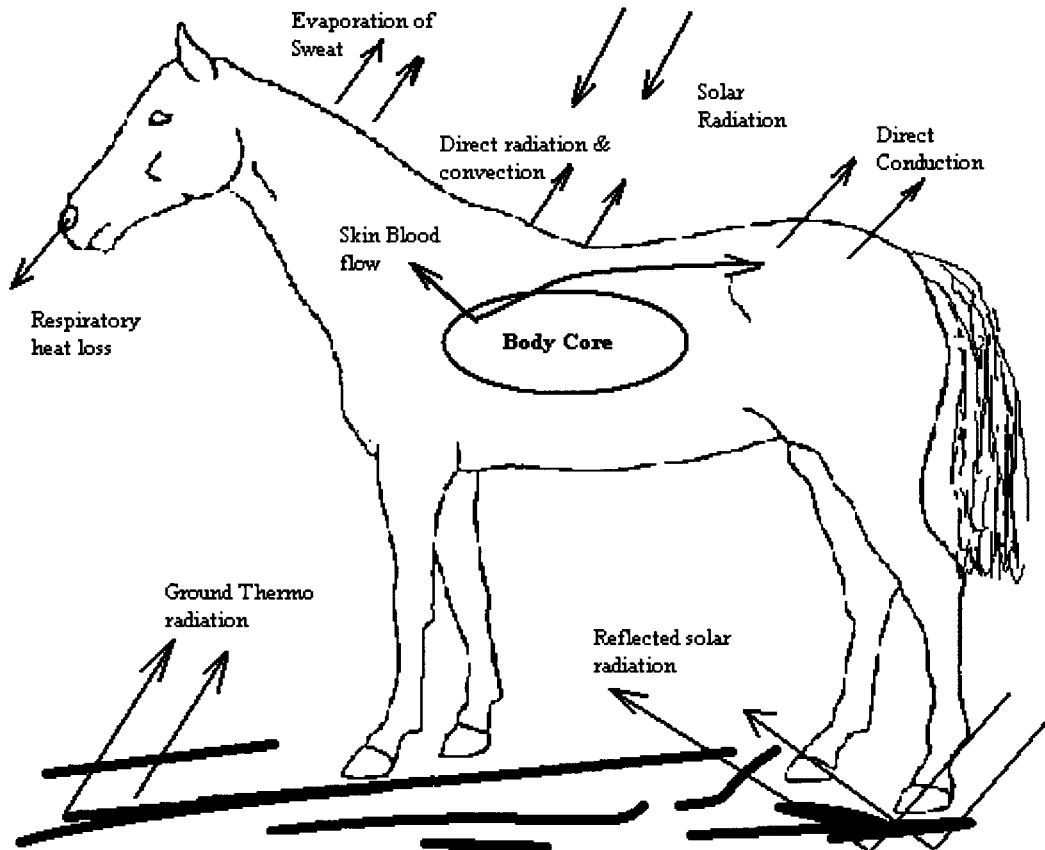

Figure 2-2: Streams of energy between the animal and environment

Conceptual model of the environmental effects on heat transfer in animals

A general model that predicts one-dimensional heat loss through a fibrous media was developed by Kowalski [119] and used by other workers [64]. The inputs to the model include air temperature, sky temperature, skin temperature, solar radiation, and air velocity; and measured structural properties of the coat - hair colour, hair density, diameter, length, reflectivity and transmissivity. With these inputs, the model describes the energy transport through the animal's coat and predicts the heat loss of the animal. Heat loss is directly related to metabolism and, therefore, to food requirements for survival, growth, and reproduction.

The basic concepts of the model and some of its implications are illustrated in Figure 2-3, which is essentially "hammock" shaped. The axes of the graph are solar radiation and air temperature on the horizontal axes, and metabolic rate on the vertical axis. The cold corner is upper left and the hot corner is lower right. The diagonal and curving surface from the hot to the cold corner shows air temperature equal to radiant temperature, the usual metabolic chamber environment. There is a high metabolic rate when the environment is cold. As temperatures increase, metabolism decreases and reaches a minimum in the flat bottom, which is the thermoneutral zone. Then metabolism increases as temperatures climb. The complete picture presented is characteristic of the species and breed of the animal, but the concept of the curve is empirical physiology.

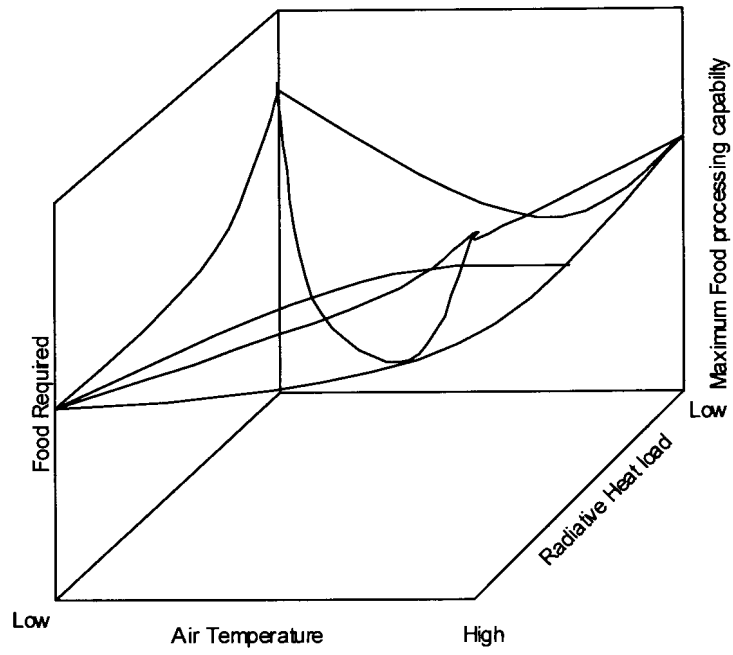

Figure 2-3: Conceptual model of environmental effects on the metabolism of animals

The effect of the thermoneutral zone on the energy balance is illustrated in Figure 2-3. The top of the box is taken as the animal's maximum food processing rate; the area below the metabolic curve is the energy requirement for maintenance; and that above the metabolic curves the energy available for growth. Disease and chemicals can move the metabolic curve; for example fever would raise body temperature and thus lift the entire curve. Chemicals could alter the animal's physiology and behaviour.

It is interesting to note that the thermoneutral zone illustrated in Figure 2-3 also includes an area of low air temperature with high solar radiation. In the absence of sunlight, the skin temperature is always higher than the temperature of the hair coat and, thus, the animal loses heat to the environment, which means more food is required for maintenance at colder temperatures. However, when solar radiation is present, the temperature profiles through the hair coat becomes parabolic and the hair, in effect, acts as a heat source and heat flows toward the skin of the animal. In work done by Gebremedhin *et al.* [63] on Holstein calves in different environments, the hair coat temperature was almost 60% above the skin temperature.

8. HEAT STRESS

Circulatory Changes In Heat-Stressed Animals

The cardiovascular system is a major role player in the thermoregulatory mechanism, allowing rapid and efficient control of deep-body temperature by varying heat flow between the body core and superficial tissues ('the shell'). Under thermoneutral conditions, the balance between vasoconstriction and vasodilatation of the peripheral blood vessels is sufficient to maintain thermal stability. As the heat balance tilts one way or the other, and efficiency of non evaporative heat loss declines, it is supplemented by evaporative processes. These processes require augmented blood flow of both heat and water to the skin to subserve sweating [83,187]. As can be seen, the circulatory system is imperative for transport of heat and thermal information between sites of the body.

Blood flow to the superficial tissues is significantly enhanced during exposure to a warm environment. The increase in peripheral blood flow following thermal stimulation is not restricted to the skin of the trunk - in evaporative tissues of the tongue and respiratory tract of panting animals capillary blood flow can increase 500%. Significant changes in the shell blood flow can be attributed to the action of the high-volume, low-resistance bypass channels provided by arteriovenous anastomoses (AVAs)(non-nutrient channels). It has been found that hypothalamic, spinal cord, or direct skin heating can

specifically dilate these AVAs [86]. It appears that it not possible to increase capillary blood flow (under experimental conditions), but an eight-fold increase in AVA flow in response to spinal warming or α -receptor blockade was achieved [173]. Surprisingly, when sheep are exposed to a 40°C environment, the AVAs close again and there is a threefold increase in capillary blood flow. Similarly, with intense heating of a region, skin capillary blood flow increased and AVA flow in that region decreased significantly. It is thought that this is a mechanism to reduce heat flow *into* the body by increasing thermal resistance.

These findings indicate that heat stress does not simply increase blood flow to all peripheral vascular beds. There is an additional mechanism that may contribute to modify the level of heat loss independent of changes in total peripheral blood flow and irrespective of the metabolic requirements of individual tissues.

Changes in Cardiac Output

The significant increase in peripheral blood flow during heat stress requires compensatory actions to avoid a fall in arterial blood pressure. The two compensatory solutions are as follows (1) an increase in cardiac output, (2) a blood flow redistribution between the different body regions according to the thermoregulatory requirements. Most animals, including man, use both of these mechanisms and they are closely linked by the reflex control of arterial blood pressure.

Heat stress of varying degrees results in redistribution of cardiac output to tissues essential for heat dissipation [16]. The sheep has been extensively researched in this regard. In mild heat, the blood flow to the skin, nasal region, and respiratory muscles increased, while blood flow to non-respiratory muscles and abdominal organs decreased. Under severe heat stress causing the deep body temperature to rise significantly, blood flow decreased to the large intestine as well and further increased to the tongue and adrenals. Blood flow to the internal organs was maintained better in dogs than in sheep, but the dog has to increase cardiac output during heat stress while the sheep does not.

Local adjustment of blood flow through AVAs occurs under heat stress. This blood flow which comprises from 2% of cardiac output under thermoneutral conditions can increase to 9% under moderate heat stress and 11% under severe heat stress in sheep; corresponding values in the dog are 1, 5, and 4%, respectively.

Cutaneous vascularity is known to increase during heat acclimation of horses [80]. The density of capillaries near hair follicles and sweat glands of temperate breeds of cattle is higher during summer than winter, and AVAs are at a much more shallow location in the skin of the heat-adapted *Bos indicus* than the relatively nonadapted *Bos taurus* cattle. All of the above observations indicate that acclimation or adaptation to heat involves enhanced blood flow in

the body shell. The decreased blood supply to skeletal muscle and gut could quite conceivably be a factor in body growth rate, poorer appetite (often seen in racehorses in summer in the PWV region of South Africa (Personal Communication: Guthrie, A.J. :1993), less efficient use of foodstuffs and compromised performance.

Effect of exercise in the Heat-stressed animal

The cardiovascular responses to exercise of man are well-documented [159], consisting of an increase in O₂ consumption accompanied by redistribution of a higher cardiac output. The combination of both stress factors, heat and exercise, with their many conflicting requirements of blood flow, must lead to a situation where either work has to be terminated or the control of deep-body temperature has to be abandoned.

Work done on sheep has shown that while an ambient heat load of 40°C dry bulb and 27°C wet bulb could be tolerated at rest, once exercise was superimposed no thermal balance could be achieved. The body core temperature thus rose continuously until one or both stresses were removed [17]. There is a significant increase in blood flow to the limb muscles, but this is compromised under heat stress compared with thermoneutral conditions. Likewise, skin blood flow did not increase as much during exercise in the hot environment as it did during exercise in the thermoneutral environment. Thus, there are competing drives for increased blood flow to muscle and skin;

neither tissue receives its optimum flow requirement and therefore both exercise performance and body temperature regulation are sub optimal.

The skin blood flow in humans during strenuous exercise is estimated to be ~15% of cardiac output [171]. Horses rely primarily on sweating and therefore skin blood flow for dissipation of heat. No data is available for the proportion of cardiac output directed to the skin in horses during exercise. If a similar proportion of a horse's cardiac output was redirected to the skin, it would shift ~480 kJ/min of heat to the skin and would need to evaporate 200 mℓ/min sweat in order to dissipate that heat [92].

Central Cardiovascular Changes

The essential regulation of blood pressure within "normal" limits depends on cardiac output and resistance of peripheral vascular beds to blood flow. The blood pressure depends on the heart and the blood vessels, which are influenced by the autonomic nervous system. Other factors that affect blood pressure may included renal function and actions involved in body fluid and electrolyte balance.

The most obvious effect of heat stress on cardiovascular function is an increase in heart rate. There is an increase in cardiac output reported in most species, but not in the sheep [81]. The situation in sheep may indicate a mechanism of adaptation to high environmental temperatures. Arterial blood

pressure decreases in the ox under mild heat stress as a consequence of the decrease in total peripheral resistance¹ [205], but does not change in sheep.

An increase in blood volume is an adaptive mechanism to meet the increased circulatory requirements. It has been reported that there are definite volume increases in both plasma and whole blood in animals exposed over several days to 45°C dry bulb for 5hr/day [19].

In defence of a heat load on the body, whether due to warm ambient air, exercise, fever, or some other metabolic disturbance, the first response by the animal is to increase blood flow through the body shell. The consequential decrease in tissue insulation and increased skin temperature therefore increases heat loss. An increase in blood flow to skin, nasobuccal tissues, and respiratory muscles is achieved by redistribution of blood away from the splanchnic bed and possibly the non respiratory muscles or fat, and by increasing cardiac output.

¹ Total peripheral resistance = (arterial – venous pressure)/(cardiac output)

9. EFFECTS ON RESPIRATION

In some species of mammals the control of respiration appears to be directed only toward elimination of carbon dioxide from tissues of the body and provision of oxygen. In other species this control system is modified in high environmental temperatures and respiration is also directed toward evaporation of moisture from the respiratory tract and prevention of hyperthermia.

Moisture Loss from the Respiratory Tract

Panting can increase the rate at which moisture is evaporated from the respiratory tract, because of rapid replacement of moist air over the evaporative surface with dry fresh air maintains a large gradient of vapour pressure between surface and air.

In order to calculate heat loss by measurement of respiratory moisture loss it is usually assumed that: i. the moisture is initially at deep-body temperature. ii. all the moisture lost is evaporated. iii. that all heat of evaporation is taken from the body and none from the air, and iv. and that the latent heat of vaporisation of respiratory fluid is the value which has been determined for water.

Sheep lose about 20% of total body heat via respiratory moisture loss when they are in a thermoneutral environment. This moisture loss increases and

accounts for about 60% of heat loss at higher temperature (35°C) [25].

There is evidence from experiments in dogs that a flow circuit can occur in their upper respiratory passages during panting, with inspired air preferentially entering the nose and expired air preferentially leaving the mouth; however sheep and cattle seem to pant with their mouth closed for most of the time.

There is increased secretion from salivary glands and from lateral nasal glands in the dog [104]. The upper respiratory tract of the dehydrated camel can produce the opposite effect. It can cool expired air and extract water from it, in this case defence against dehydration appears to be most important for survival and hyperthermia is permitted.

Disturbance of respiration and blood gas concentrations

Exposure to both high and low temperatures will disturb blood gas concentrations and respiration.

During Cold Exposure

At low temperatures, tissues such as shivering muscle, and to a lesser extent, liver, increase their oxygen consumption and carbon dioxide production, causing the total oxygen consumption and carbon dioxide production of the animal to increase. The respiratory control system accommodates this by

increasing tidal volume and pulmonary extraction of oxygen from the air, and there is little effect on the respiration rate [107]. At the same time cardiac output may or may not increase, but pulmonary artery pressure increases, suggesting increased resistance to blood flow through the lungs. Raising the oxygen content of the inspired air almost eliminates the change of pulmonary artery pressure, while lowering the concentration of oxygen enhances the change, suggesting that cold exposure produces an hypoxic constriction of pulmonary vessels [41,207]. It appears that similar observations have yet to be carried out in horses, and one questions the effect in horses because of the apparent improvement in performance of the athletic horse in cold environments.

During Rapid Shallow Panting in a Hot Environment

At high environmental temperatures, when panting begins, respiratory rate increases but tidal volume decreases; the former far outweighs the latter and the net effect is an increase of respiratory minute volume [87]. The amount by which the tidal volume changes varies between species (cattle it decreases to about 50% and the pig to about 25%). Reductions in the tidal volume determine the extent to which the extra pulmonary ventilation is confined to the "dead space" of the respiratory passages or extends to alveoli, where over ventilation produces changes in pulmonary gas exchange and alkalosis. It appears that occasional deeper breaths interspersed between shallow breaths bring about alveolar ventilation in a controlled fashion, firstly, and secondly

by small inequalities between inspired and expired volumes that progressively add to, and then take from, the reserve volume in the lungs during panting [87]. Panting wildebeest increase their minute volume by as much as fourfold (the tidal volume does not change significantly). It appears that the wildebeest has paranasal sinuses, which are ventilated during panting, thus increasing the functional dead space [186].

Cardiac output, and therefore pulmonary blood flow, may or may not increase during rapid shallow panting, while pulmonary arterial pressure may fall suggesting dilation of the pulmonary vessels. The changes in the intrathoracic pressure that causes panting also produce large changes in transmural pressure in the pulmonary artery and the heart.

While panting dissipates body heat, one would question the heat production by the effort of panting. Measurements in cattle and sheep indicate that the oxygen consumption during panting were no different from those measurements in oxygen consumption of the controls, indicating a zero effect [82]. Shunting blood flow away from the non-respiratory skeletal muscles attains this effect. Measurements in pigs and goats indicate a significantly increase their oxygen consumption during panting [99].

During slow, Deep Panting in Extreme Heat

In extremely hot environments, when the body temperature rises, slow deeper panting in cattle [85] and sheep supersedes the rapid panting discussed

previously. This type of panting occurs with the mouth open, the tidal volume increases to almost normal values, but the respiration rate remains elevated. The resulting minute volume is even greater than the minute volume that occurred during the shallow rapid panting, and it is not confined to the respiratory "dead space". Alveolar ventilation increases by as much as five times normal values, causing a respiratory alkalosis; arterial blood paCO_2 may fall below 10 mmHg, pH may exceed 7.7, and paO_2 increases [87].

Slow deep panting appears to involve movement of the thorax, while the diaphragm produces the rapid panting. The total oxygen consumption of the animal increases during slow deeper panting. The alkalemia that prevails during this type of breathing will not favour normal dissociation of oxygen and haemoglobin in the tissues and will tend to reduce their oxygen supply and thus produce tissue hypoxia.

10. THERMAL STRESS AND THE HORSE

Before discussing the direct implications of thermal stress on the horse, it is necessary to mention the other effects of stress per se. It is felt that the effects seen in other forms of stress like mental, transport, confinement and exercise stress, will be seen, although as yet the observations have yet to be made in heat stressed horses.

Exercise Stress

Stress is believed to induce immunosuppression, which can lead to an increase in susceptibility to diseases. In horses, athletic performance or other physical exertion has been implicated in microbial infections, especially those of the respiratory tract [210]. Intense exercise in horses may have a detrimental impact on bronchoalveolar macrophages and their role in pulmonary defence.

The effects of a 6-week interval-training program were investigated [121]. Broncholavage was performed and the results indicate a progressive decrease in the total number of alveolar macrophages collected.

Transport Stress

It is apparently fairly common that acute pleuropneumonia can develop during

transport of horses over fairly long distances. Attempts to repeat these observations under laboratory conditions have been unsuccessful and it has been suggested that there may be a heat stress component that allows the proliferation of bacteria resulting in the development of pleuropneumonia [4]. In other words, clinically significant pneumonia will rarely develop in a normal, non-stressed animal challenged via the respiratory tract [193].

Thermal Stress

Environmental stress may influence nutrient requirements and productivity of the animal by affecting heat exchange, rate of feed intake, average daily gain, and dietary nutrient concentration required per unit of digestible energy. Of the dietary factors, energy and protein have been investigated the most.

In thermoneutral conditions, heat production depends mostly on feed intake and metabolic body size. By definition, ambient temperature does not affect heat production when within the thermoneutral zone. Factors influencing critical temperatures (lower and higher ends of the thermoneutral zone) need further research in order to quantify effects of ambient temperature. Lower critical temperature (LCT) is assumed to be the lowest effective ambient temperature for optimal production/performance of animals.

Cold Stress

The LCT varies with many factors. Metabolic size and level of feed intake are

known, as discussed earlier, to affect the LCT. Draft, airspeed, type of flooring and radiant temperature can also influence LCT. Increasing airspeed from 2,4 to 5,5 km/hr increased LCT by 6°C in pigs [154].

In the past very little attention has been given to horses. Brody [26] did not mention critical temperatures for horses other than concluding that horses do not require elaborate barns - merely open sheds for protection from the snow, rain and wind. McBride *et al.* described environmental conditions as low as -40°C in Alberta, Canada where horses were wintered outdoors without injury. They reported that a 500-kg cold-stressed horse requires an additional 1534 kJ metabolisable energy intake for every 1°C that the air temperature falls below the LCT to support an increased level of heat production. They measured the LCT to be at -15°C in winter acclimatised horses in Canada. Young and Coote [214] concluded that mature horses in reasonable condition have a critical temperature of about 0°C during early winter, but this lowered with acclimation and development of a winter coat. They also suggested that horses housed in heated barns do not develop any winter hardiness and may have a LCT above 4°C.

Heat Stress

Heat stress can cause reduced feed intake and thus reduce the rate of gain. Sweating animals can withstand much higher temperatures than non-sweating animals. The upper critical temperature (UCT) is defined as the effective ambient temperature above which the total heat production rate at a given feed

intake will rise [3].

Because heat stress decreases total feed intake, concentrations of nutrients may need to be increased to ensure adequate intake of individual nutrients. For example the daily feed intake of the pig decreases 40 g/°C of heat stress. Thus 10° of stress would result in a reduction of 400 g of intake. Therefore the pig requiring 378 g of protein per day would require feed with an increased protein concentration. Heat stress also causes a depression in the daily gain and therefore the growth rate resulting in a decrease in the daily protein requirement. Therefore the increase in the protein requirement may not be as great as indicated above.

Heat stress in horses may increase the nutrient requirements by increasing the amount of nutrients lost in sweat. The total excretion of calcium and phosphorus in the sweat of polo horses was determined to be 80 to 145 mg Ca and 11 to 17 mg P after a 20-min period of exercise [180]. The higher the temperature, the greater the sweat losses. Long distance riding may decrease plasma electrolyte levels, probably because of increased sweat losses. [36] It has been concluded that intravenous administration of balanced electrolyte solutions could improve performance and speed of recovery of exhausted horses. [123] Few studies have been conducted to determine the optimal level of electrolytes to be used.

Much of the work been done in equines is on dehydration and food deprivation. For example Dill *et al.* [49] reported that donkeys deprived of food and water at ambient temperatures of $>40^{\circ}\text{C}$ chose to eat hay before drinking water when the increase in osmotic pressure was less than 10%. When the increase was 17%, the donkeys chose water first.

Medical Problems Associated with Heat Stress and Exercise

Heat stroke or heat exhaustion may also occur in resting horses confined to hot, poorly ventilated stables. More often the problem develops in horses that are poorly conditioned and overexerted in hot and humid climates. The clinical signs are depression, weakness, lack of appetite, and refusal to go on. Pulse and respiratory rates increase and rectal temperature may increase. The capillary refill time is prolonged and the sweating response is inadequate. The most important and effective treatment is to reduce the body temperature.

Anhydrosis

Anhydrosis is defined as the inability to sweat in response to an appropriate stimulus. Clinical signs develop over time; some horses have initially normal exercise-associated sweating response, but subsequently develop a gradual failure to sweat. The disorder is common in horses maintained in hot and humid areas.

Clinical signs include the inability to sweat normally, tachypnea (panting),

diminished exercise tolerance, excessive exercise-associated pyrexia, and, in some cases, alopecia. The only effective remedy at this stage is to remove the horse to a more temperate climate.

Exhaustive Disease Syndrome

Fatigue or exhaustion results from relatively brief maximal exercise or protracted submaximal exercise. During maximal exertion, energy is primarily generated by anaerobic metabolism of carbohydrates. Muscles energy stores deplete rapidly, and exhaustion correlates closely with the development of a severe metabolic lactic acidosis.

Protracted exercise at the pace of endurance rides may require energy expenditures of 10 to greater than 20 times that of the basal metabolic rate. This rate of energy expenditure results in a massive metabolically generated heat load that must be dissipated to maintain thermal balance. It is not unusual for endurance horses to develop rectal temperatures of 42°C. The avenues of heat loss have been discussed previously, the evaporative cooling process being the most effective for the horse. The relative electrolyte losses in horses' sweat are as follows. For each 100mEq of sodium, approximately 40 mEq of potassium and 130 mEq of chloride are lost in sweat. Significant amounts of calcium and magnesium are also lost.

The combination of dehydration and sodium depletion results in increased blood viscosity and decreased blood volume, inadequate tissue perfusion, and

inefficient oxygen and substrate transport. This may contribute to impaired renal function and lead to partial renal shutdown as part of the overall cardiovascular effects. Chloride depletion may contribute to the development and persistence of metabolic alkalosis. This acid-base disturbance associated with depletion of potassium, calcium, and magnesium may alter membrane potential and neuromuscular transmission and contribute to gastrointestinal stasis, cardiac arrhythmias, and muscle cramps and spasms, including synchronous diaphragmatic flutter.

Table 2-2 lists the clinical signs of exhaustion. The severity of these signs varies in individual horses. In most normal horses, rectal temperatures begin to return to normal 15 to 30 minutes after cessation of exercise. Horses with markedly elevated rectal temperatures (in excess of 41°C) or persistently elevated rectal temperatures should be cooled with a spray of cold water in an open space with free air movement. Cold water enemas may be beneficial in severe cases of hyperthermia. Rapid cooling is essential in horses with marked hyperthermia and signs of altered central nervous function.

Horses with signs of severe exhaustion require prompt and vigorous fluid therapy to restore adequate volume, correct electrolyte deficits, and provide ready sources of glucose for metabolism. Horses with synchronous diaphragmatic flutter generally respond well to intravenous calcium solutions [34].

Synchronous diaphragmatic flutter (SDF) is seen frequently in endurance horses performing in hot climates. It is the result of a contraction of the diaphragm that is synchronous with the heartbeat. It is apparent as a twitch or spasm in the flank. The twitch is not related to normal respiratory movements and may become sufficiently violent to produce an audible thumping sound, hence the descriptive term "thumps". By itself, SDF is probably not dangerous but it is an index of significant electrolyte imbalances [34].

Table 2-2 : Exhaustive Disease Syndrome

-
1. Severe depression and anorexia
 2. Dehydration with lack of thirst
 3. Persistently elevated temperature, pulse, and respiratory rates
 4. Increased capillary refill time, decreased pulse pressure
 5. Atonic bowel, dilated anus, occasional colic
 6. Cardiac irregularities
 7. Muscle cramps and spasms
 8. Synchronous diaphragmatic flutter
-

Muscle Problems

Exercising horses frequently develop muscle problems, which are traditionally considered to be tying-up syndrome, a milder form of azoturia or "Monday morning disease". Treatment in the past has generally been geared toward an anticipated metabolic acidosis. However, most horses with exertional myopathies do not have significant metabolic acidosis, and many are mildly

alkalotic [34].

Management of Horses in Potentially Stressful Environments

Dissipation of heat from exercising horses has been discussed previously, but the dissipation of heat when the ambient conditions reach those where the evaporative dissipation of heat is severely impaired has not been discussed and does warrant discussion.

McConaghy *et al.* [192] demonstrated selective brain cooling in horses. Horses exposed to warm environments and also exercising in hot humid conditions were able to maintain the hypothalamus temperatures below that of the body core (pulmonary circulation). Whether the horse is specifically cooling the brain; or whether the observed brain cooling is merely a result of the increased respiratory gas flows and evaporative cooling in the cavernous sinus is matter of debate. (It is possible the horse is able to manage the vapour pressure of the sinus mucosa in order to modify the evaporative cooling within the respiratory tract. This is discussed further in subsequent chapters). However, the fact remains that brain temperature is below that of the deep body temperature and thus the often suggested safe maximum body temperature of the exercising horse of 42.5°C may be conservative.

Under conditions the evaporative dissipation of heat is severely impaired, exercise induced hyperthermia occurs rapidly as the rate of metabolic heat production by the body far exceeds the rate of dissipation. The rapid onset of fatigue can easily culminate in stroke, collapse and death when the core temperature exceeds a critical value [84,92,120,129].

Effective body cooling has been shown to prevent exercise induced heat stroke [113], and shown to benefit humans and dogs [129]. In this light and with the 1996 Equine Olympiad been scheduled for Atlanta where the conditions are particularly stressful, a study was initiated to investigate the effect of body cooling procedures on horses [208].

Williamson [208] looked at the effect of cooling horses with cold water over the entire body, and whether or the treatment caused any evidence of myopathy. They used forty-two horses in the study under environmental conditions where the temperature and humidity were often above 30°C and 80% respectively.

The cooling procedure involved sponging and pouring water of 9°C onto the entire body at 5 minute intervals, and scraping the water plus sweat off between each application of water. This technique was compared to the conventional technique of applying tap water to the neck, shoulders and underside of the torso, avoiding the large muscle groups.

Their results showed that the rectal temperatures were significantly lower at all post exercise temperature measurements following the proposed cooling technique and there was no evidence of any post exercise myopathy. These cooling techniques proved to be the method of choice by veterinarians and competitors at the Olympic games held in Atlanta during July 1996.

These techniques also show that the most significant reduction in temperature was ten minutes after the cessation of exercise, which they indicate as an added benefit when such techniques are employed during the 10-minute breaks in the endurance phase of the 3 day eventing competition. Work on other species [103,120,129] has shown that a lower body temperature at the onset of exercise allows longer duration of exercise before a critical temperature is reached. The mathematical model of Mostert *et al.* [153] further supports this where the increase in body temperature is directly related to the work done and the heat dissipation. This increase in body temperature is thus incremental to the temperature of the body prior to the commencement of work.

11. EXPERIMENTAL METHODS

Calculation of metabolic heat production

Energy expenditure can be estimated from the volume of O₂ consumed. The energy expenditure is computed from O₂ consumption ($\dot{V}O_2$) and CO₂ production ($\dot{V}CO_2$) [217]:

Calculations:

1. Volume of expired air, STD/min = Volume.(STPD factor) = R

Where

$$STPD\ factor = \left(\frac{P_B - PH_2O}{760(1 + 0,00367)T} \right)$$

2. Calculate true O₂, true CO₂, and RQ

$$\% \text{ True } O_2 = (\% N_2 \text{ in expired air} \cdot 0,2651) - (\% O_2 \text{ in inspired air})$$

$$\% N_2 \text{ in expired air} = 100 - (\%O_2 + \%CO_2 \text{ in expired air})$$

3. Volume of O₂ consumed/min = (vol. STPD) (% true O₂)

4. % True CO₂ = (%CO₂ in expired air - %CO₂ in inspired air)

5. Volume of CO₂ produced = (vol. STPD)(% true CO₂)

- 6.

$$RQ = \frac{Vol\ CO_2\ produced}{Vol\ O_2\ consumed}$$

7. Energy expenditure in kJ/min = (Volume O₂ consumed/min)(thermal equivalent of 1 ℓ of O₂) Thermal equivalents of O₂ for different RQ can be obtained from tables (McLean and Tobin) [148]. If the RQ is 1.00, the heat per litre of oxygen is 21.13 kJ
8. The conversion factors to express energy in terms of calories or watts are as follows: 1 kJ = 239 cal = 0,278 W/hr
9. The calculation overestimates energy expenditure in ruminants since no consideration has been given to CH₄ production. If the volume of CH₄ produced is calculated, then its calorific equivalent should be subtracted from the total heat production.

Measurement of Heat Loss

In order to maintain equilibrium, a mammal must lose heat at a rate proportional to changes in its heat production. The relative importance of evaporative heat loss increases in a hot environment and diminishes in a cold environment.

Evaporative Heat Loss

Water evaporation is an effective channel of heat loss since, at 25 °C, for every gram of water evaporated 2,44 kJ of heat is lost. For example, a 100 kg animal with a metabolic heat production of 590 kJ/hr can maintain its thermal equilibrium solely by dissipating all of its heat production by evaporating 240 g of water per hour from the body surface.

Measurement of Skin Vaporisation

If air of a known moisture content is passed over an enclosed skin site, the change in the moisture content of the air is dependent upon cutaneous vaporisation, assuming that the air flow is constant and that water vapour content is low enough to maintain complete and rapid evaporation. The amount of water evaporated is calculated from the change in humidity, the flow rate, and the temperature of the air. [181,217].

There are other techniques for measuring cutaneous vaporisation, the method of choice depends on the goal of the experiment. In exercising horses the method described above is probably the best and has been used in horses previously [92] [181]. Sweating and panting are complementary in the sense that animals with low capacity for sweating normally have a high capacity for panting.

12. SUMMARY

The concepts of energy balance, thermoregulation and thermal stress have been introduced and discussed. The environmental factors affecting the mammal's metabolism and behaviour have been discussed. Mechanisms of heat production and regulation via both neuro and hormonal systems were discussed. The difference mechanisms used by different breeds and species of animal have been summarised. Observations of the behavioural responses to heat and cold were discussed.

Exercise has the most powerful destabilising influence on the energy balance of the mammal. The energy expended in work and empirical formulae for calculating the energy cost of locomotion is presented. Since a high proportion of the energy expended during work is liberated as heat, the dissipation of the excess body heat is of utmost importance. The evaporative cooling mechanism of the horse is discussed. A concept of assisting heat loss and possibly improving athletic performance in the horse is proposed. This may significantly help the horse unacclimatised to work in thermally stressful environments. Research in this field could be of considerable value to equine sportsman.

The effect of the endocrine function on the homeotherm's thermoregulation

and the effect of the environment on the endocrine function were discussed. It appears that long term exposure to heat significantly increases plasma noradrenaline and adrenaline, although there is limited data available.

Very little work on the effect of heat stress on the equine had been done prior to the announcement that the Equine Olympiad would be staged in Atlanta, Georgia in 1996. This announcement, however, initiated a number of laboratories commencing related and complementary work on the equine species at a similar time to the start of this work.

Much of the equine thermal stress research over the past few years has been associated with the effects of hot humid environments on horses performing endurance type events where the intensity of the exercise is relatively low. The research presented in the subsequent chapters of this thesis has concentrated on the thermal balance of horses exercising at near-maximal intensities. This research has contributed to the world-wide greater understanding of *how* the exercising equine is able to dissipate the extreme heat loads when the environmental thermal stress is particularly severe.

CHAPTER 3

REVIEW OF PHYSICAL CHEMISTRY AND WATER VAPOUR

THERMODYNAMICS

1. REVIEW OF THERMODYNAMICS, GAS LAWS AND PSYCHROMETRICS

Fundamental Parameters

Gas Laws

Moist air up to about 3 atmospheres pressure obeys the perfect gas law with sufficient accuracy for the engineering and physiologic calculations that we encounter when studying the behaviour of exercising horses. The Gibbs Dalton law [195] for a mixture of perfect gases states that the mixture pressure is equal to the sum of the partial pressures of the constituents.

Because the various constituents of dry air are considered one gas, it follows that the total pressure of moist air is the sum of the partial pressures of the dry air and the water vapour. Each constituent behaves as though the others were not present.

Based on the composition of air, the molecular mass M_a of dry air is 28.965, and the gas constant R_a is

$$R_a = \frac{\bar{R}}{M_a} = \frac{8314}{29.965} = 287 \text{ J/(kg.K)}$$

Where \bar{R} is the universal gas constant. Most systems involve a combination of dry air and water vapour. The amount of water vapour may vary from zero to a maximum determined by the temperature and pressure of the mixture. The latter is called saturated air, a state of neutral equilibrium between the moist air and the liquid or solid phases of water. The molecular mass of water is 18.015 and the gas constant for water vapour is

$$R_v = \frac{8314}{18.015} = 462 \text{ J/(kg.K)}$$

Humidity Ratio, ω is the ratio of the mass of water vapour m_v to the mass of the dry air m_a in the mixture

$$\omega = \frac{m_v}{m_a}$$

Relative Humidity ϕ is the ratio of the mole fraction of the water vapour x_v in a mixture to the mole fraction x_s in a saturated mixture at the same temperature and pressure.

$$\phi = \left| \frac{x_v}{x_s} \right|_{t,p}$$

For a mixture of perfect gases, the mole fraction is equal to the partial pressure ratio of each constituent. The mole fraction of the water vapour is

$$x_v = \frac{p_v}{P}$$

Thus if we let p_s stand for the partial pressure of water vapour in a saturated gas, the relative humidity may be expressed as

$$\phi = \left[\frac{\rho_v}{\rho_s} \right]_{t,p}$$

Where the densities ρ_v and ρ_s are referred to as the absolute humidities of the water vapour (mass of water per unit volume of gas mixture). Values for ρ_s are calculated using the Goff Gratch Equation [70,72]. The perfect gas law is used to derive a relation between the relative humidity and the humidity ratio to give

$$\omega = \frac{M_v p_v}{M_a p_a},$$

Which, for the air-water vapour mixture reduces to

$$\omega = \frac{18.015 p_v}{28.965 p_a} = 0.6219 \frac{p_v}{p_a}$$

Which gives

$$\phi = \frac{\omega p_a}{0.6219 p_s}$$

Enthalpy

Under a constant-pressure system, where no work is done on the substance, the amount of heat added or removed per unit mass is the change in the enthalpy of the substance. Enthalpy values are always based on some arbitrarily chosen datum plane. The datum plane for water and steam is an enthalpy value of

zero for liquid water at 0°C. Based on that datum plane, the enthalpy of liquid water at 100°C is 419 kJ/kg and of water vapour at 100°C is 2676 kJ/kg. The enthalpy property can also express the rates of heat transfer for processes where there is vaporisation or condensation.

The enthalpy h of a mixture of perfect gases is equal to the sum of the enthalpies of each constituent and for the air-water vapour mixture is usually referenced to dry air. This is because the amount of water vapour may vary, but the amount of dry air typically remains constant. On the assumption of perfect gas behaviour, enthalpy is a function of temperature only. If zero Celsius is selected as the Reference State where the enthalpy of dry air is zero, and if the specific heat c_{pa} and c_{pv} are assumed to be constant, the following expressions are derived

$$h_a = c_{pa}t$$

$$h_v = h_g + c_{pv}t$$

Where the enthalpy of saturated water h_g at 0 °C is 2501.3 kJ/kg. Using these equations, with c_{pa} and c_{pv} taken as 1.0 and 1.86 kJ/(kg.°C), [184] respectively, becomes

$$h = 1.0t + \omega(2501.3 + 1.86t)\text{kJ/kg}_{\text{air}}$$

Adiabatic Saturation

The equations presented above show that at a given pressure and dry bulb

temperature of an air-water vapour mixture, one additional property is required to completely specify the state, except at saturation. Any of the parameters discussed (ϕ , ω or h) would be acceptable; however there is no apparent means to measure any of them. The concept of adiabatic saturation provides a solution.

Referring to Figure 3-1, the air leaving at point 2 is saturated. The temperature t_2 , where the relative humidity is 100 percent, is then defined as the adiabatic saturation temperature t_2^* , or thermodynamic wet bulb temperature. If we assume the device operates in a steady-flow-steady-state manner, an energy balance on the control volume yields

$$\omega_1(h_{v1} - h_{l2}) = C_{pa}(T_2 - T_1) + \omega_2 h_{fg2}$$

One is now led to ask, is this apparatus described above not analogous to a horse inspiring and expiring air, where the air expired from the exercising horse is at a temperature t_{exp} and the relative humidity is often considered to be 100 percent? It appears so, however the expired gas relative humidity has been shown to be closer to 85% [179] and the temperature of the air increases to about 28°C [31]. The adiabatic process, by definition, means that no heat transfer takes place; thus $q=0$ [184]. As heat transfer certainly takes place during the horse's respiratory cycle, respiratory heat loss in the horse cannot be reduced to the simple algorithms describing adiabatic saturation of air.

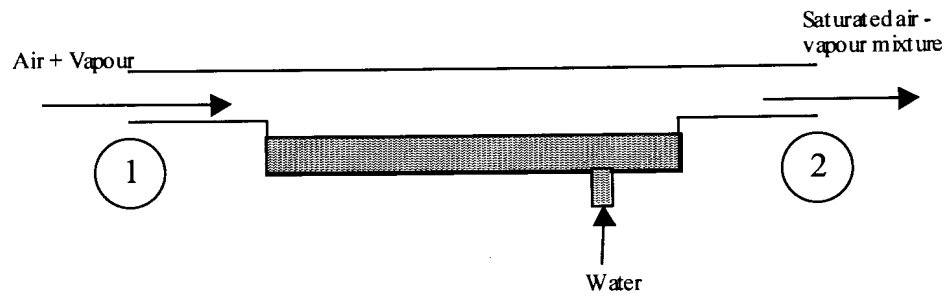

Figure 3-1: The Adiabatic Saturation process. Air enters the ‘saturator’ at point 1, moves over a pan of water and leaves at point 2 saturated with water vapour. There is no heat transfer during the process and the temperature of the mixture at point 2 is defined as the wet bulb temperature.

Calculation of Heat Transfer by Moist Gasses

The first law of thermodynamics and the conservation of mass or mass balance are the basis for the analysis of moist air processes. Although the properties may not be uniform across the flow area, it is customary to analyse these processes by using the bulk average properties at the inlet and the outlet of the device (or in the case of respiratory physiology, the animal).

Heating of Moist Air

The specific heat capacity of air changes according to the moisture content of the air and its temperature. During inspiration, air is warmed and saturated with water vapour, a process that, on average doubles the heat carrying capacity of that air. When air is heated without loss or gain of moisture, the process yields a straight horizontal line on the psychrometric chart because the humidity ratios are constant. Under steady state conditions, the energy balance of Figure 3-3 becomes

$$\dot{m}_a i_2 + \dot{q} = \dot{m}_a i_1$$

The enthalpy of the moist air, per unit mass of dry air, at sections 1 and 2 can be obtained from the following:

$$i_1 = i_{a1} + W_1 i_{v1} \quad \text{and} \quad i_2 = i_{a2} + W_2 i_{v2}$$

Alternatively the enthalpy can be obtained from the psychrometric chart. The equations above can be rearranged and written as follows

$$\dot{q}_s = \dot{m}_a c_p (t_1 - t_2) \quad \text{where} \quad c_p = c_{pa} + W c_{pv}$$

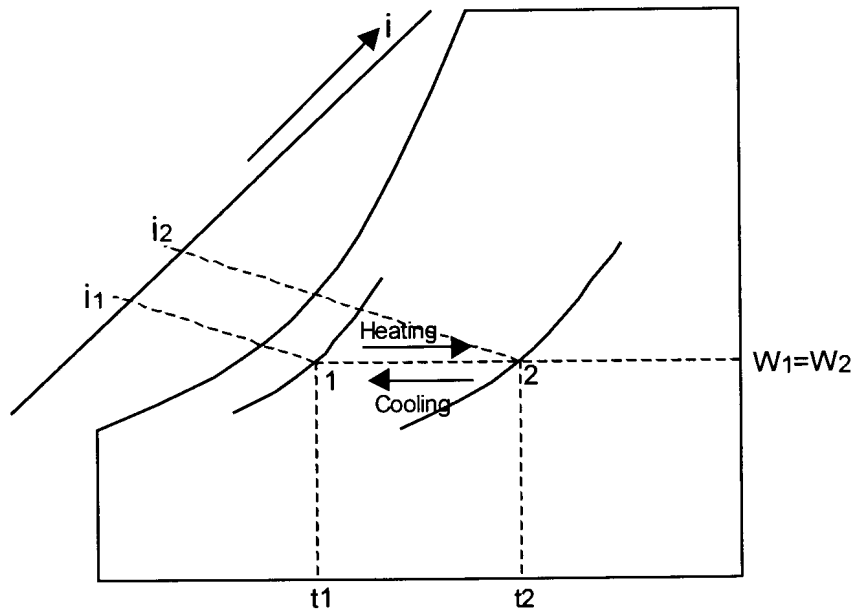

Figure 3-2: Sensible heating and cooling process described by a psychrometric chart

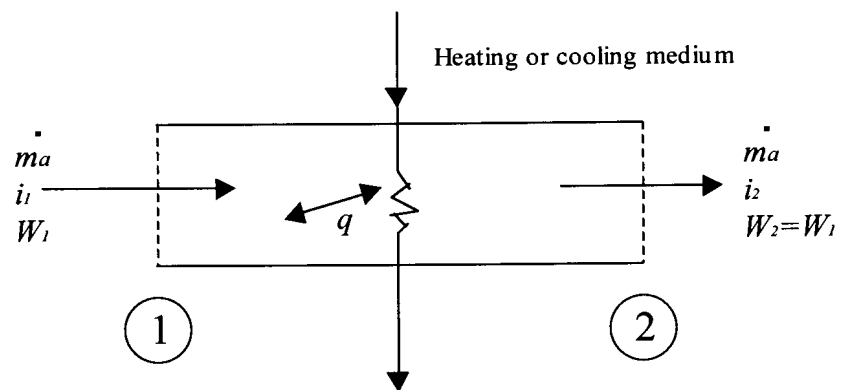

Figure 3-3: Schematic of a heating or cooling device

HEAT TRANSFER DURING EVAPORATION

As in convective processes, the quantity of heat transferred during evaporation is expressed in terms of a heat transfer coefficient h defined as

$$\dot{Q} = h(T_w - T_s) A_s$$

However, the heat transfer coefficient is itself a function of the difference between heating surface and saturation temperature. The variation of h for water in a container boiling at atmospheric pressure is shown Figure 3-4. At low temperature difference (less than 3°C) the coefficient is small and is determined only by free convection occurring in a single-phase liquid. In this region, the heat is transferred by liquid that was in contact with the heated surface, was superheated there, and rose to the liquid-vapour interface, where it changed into vapour. In the region of moderate temperature difference (from 3°C to about 30°C), the heat transfer is determined by increased convection of the liquid resulting from the growth and movement of vapour bubbles. These vapour bubbles form at discrete locations on the heating surface. The heat transfer coefficient increased rapidly with increase in temperature difference, reaching a maximum value at about 30°C temperature difference. This mode of boiling is called nucleate or ordinary boiling.

After reaching the maximum value the heat transfer coefficient decreased sharply with increase in temperature difference ΔT . In the nucleate

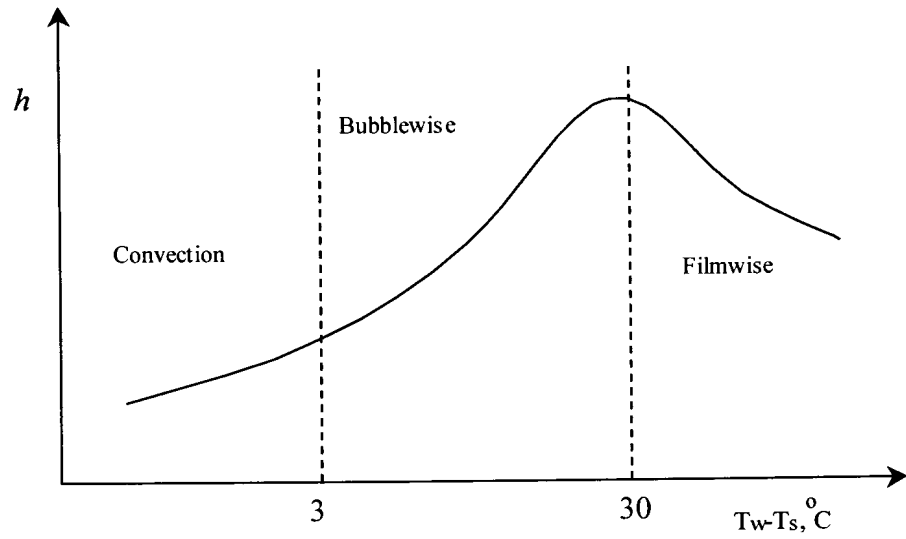

Figure 3-4: Boiling heat transfer coefficients for a heating surface in water at atmospheric pressure

boiling regime, the number of starting points or nuclei increased with increase in ΔT ; At the point of maximum h value, the vapour bubbles cover less to form a continuous vapour film which separates the liquid from the heating surface. This mode is therefore called film boiling. Vapour bubbles continue to separate from the vapour film, with new film forming on the free surface. In general, the maximum value of h will depend on the physical properties of the boiling liquid [79].

In the free convection evaporative region, the heat transfer coefficient h is determined from equation with the physical properties of the liquid evaluated at the mean temperature $T_m = \frac{1}{2}(T_w + T_s)$. In the bubble-wise evaporative region, the relation gives h :

$$h = C\mu_l \sqrt{\frac{g(\rho_l - \rho_v)}{\sigma}} \frac{c_{pl}^3 (T_w - T_s)^2}{h_{fg}^2 (\text{Pr}_l)^4}$$

Where the constant C depends on the roughness and wettability of the boiling surface. Its value must be obtained for each surface-fluid combination. The surface tension (σ) with units of N/m is proportional to the force tending to retain a vapour bubble on the heating surface during evaporation. The buoyancy force (which is proportional to the density difference between liquid and vapour tends to separate the vapour bubble from the heating surface. The above relationship has been determined from experimental measurements of heat transfer on a variety of liquids over a range of saturation temperatures. The subscript l (or f) refers to the liquid phase and the subscript v (or g) refers

to the vapour phase. T_s is the saturation temperature, while T_w is the wall temperature. All thermal properties are taken at saturation temperature. In the filmwise evaporative region, an experimentally determined relation for h for laminar motion within the film is

$$h = 3.52k_v \left[\frac{g\rho_v(\rho_l - \rho_v)}{\mu_v^2 D} \text{Pr}_v \left(\frac{h_{fg}}{c_{pv}(T_w - T_s)} + 0.4 \right) \right]^{1/4}$$

The practical application of the above equations is difficult because some of the values in these equations are not easily determined. Less complex equations were needed to satisfy the practical requirements. Fritz [62] determined the following simple equation in 1963, which showed good correlation with experimental results

$$\alpha = A \left(\frac{\dot{q}}{\dot{q}_0} \right)^{0.72} \cdot \left(\frac{p}{p_0} \right)^{0.24}$$

In which A has the value $1.95 \text{ W}/(\text{m}^2\text{K})$ for water. \dot{q}_0 is a heat flux of $1 \text{ W}/\text{m}^2$ and p_0 is a pressure of 1 bar. The equation can be applied to other liquids if the value of A is selected from tables. The value for a 24% NaCl solution in water is $1.18 \text{ W}/\text{m}^2\text{K}$.

In boiling mixtures the heat transfer coefficient is smaller than it is in pure liquids and the value of the heat transfer coefficient must be determined experimentally for each case [89].

It is interesting to note that Wenzel [89] observed that the heat transfer coefficient for evaporation can be considerably enhanced by attaching a very thin, porous layer to the heating surface area. The analogies to the horse are immediately apparent with the fine hair coat on the horse. Furthermore, the often-observed practice of covering the sweaty horse with a light sweat rug may actually be beneficial to the heat dissipation.

Evaporative heat loss from the horse is more complex than it appears above. Air temperature, wind velocity, and relative humidity influence this process and have led to the concept of 'effective temperature'. At extremely high environmental temperatures evaporative heat loss may not be able to keep pace with the exercise-induced heat load and heat gain from the environment. Incomplete evaporation of sweat results in little or no heat transfer. Conditions of high environmental temperature and humidity thus pose a serious risk to the equine athlete, particularly when performing protracted submaximal exercise.

Equine Sweat

One is easily led to assume that the evaporative characteristics of equine sweat are similar to those of water. However there are a number of observations that indicate otherwise. Equine sweat contains a surfactant, a protein called latherin [15,51,52], that aids the wetting characteristics of the coat thus presenting a larger wetted area and therefore more effective heat dissipation.

Latherin, as indicated by name generates a lather. This lather, if one considers it empirically, is in effect boiling. The mere occurrence of the boiling indicates that the vapour pressure of the liquid has exceeded the atmospheric pressure. From the discussion above, boiling is the essence of evaporative heat transfer. This observation gives us an indication of probably one of the most critical attributes of equine sweat. A vapour pressure higher than that of water at a given temperature implies that the rate of evaporation at that temperature is greater, and thus the heat transfer rate is therefore higher for equine sweat than for water. All models that have discussed the evaporation of equine sweat have assumed the evaporative heat transfer rate of equine sweat to be the same as water.

This lathering characteristic of equine sweat also has negative connotations for heat dissipation under certain conditions. As described in the previous section, where evaporative heat dissipation is described in terms of boiling, the optimum heat transfer rate is achieved when the vapour bubbles are released from discrete sites. However, with the formation of a lather, the vapour bubbles are trapped and the lather that is easily observed forms an insulating blanket over the animal. The evaporative surface then moves away from the skin surface and the efficiency of heat transfer plummets.

Observations of the composition of equine sweat have shown that horses that are conditioned to work in warm environments have lower protein

concentrations than unconditioned horses. The latherin content has also been shown to decrease with exercise duration - an indication that the latherin may only be present initially to improve the wettability of the coat [15,37,110,111,114,115,143,144,147].

The electrolytes typically found in equine sweat are:

Mg ⁺⁺	~	3 mmol/ℓ
Na ⁺	~	160 mmol/ℓ
K ⁺	~	40 mmol/ℓ
Cl ⁻	~	195 mmol/ℓ
Ca ⁺⁺	~	5 mmol/ℓ

Thus the salts would be NaCl, KCl, CaCl₂ and MgCl₂ in approximately the following ratio 53:13:2:1, respectively. Adding up the electrolyte concentrations above gives a total concentration of 402 mmol/ℓ. According to the Handbook of Physics and Chemistry [201], the vapour pressure characteristics of a liquid can also be modified with the addition of salts. The following list indicates salts that are common to the list and the known compositions of equine sweat.

Salt	Effect of 500 mmol/ℓ
NaCl	12.3 mmHg reduction of Vapour Pressure at boiling point
KCl	12.2 mmHg reduction of Vapour Pressure at boiling point
CaCl ₂	17.0 mmHg reduction of Vapour Pressure at boiling point
MgCl ₂	15.0 mmHg reduction of Vapour Pressure at boiling point

According to the data presented by Weast [201], there is a linear relationship between the increase in salt concentration and the reduction in the vapour pressure.

Therefore it can be deduced that the approximate effect of the salt content of equine sweat will be to reduce the vapour pressure (at 100°C) as follows:

$$\frac{403}{500} * \frac{(53 \times 12.3) + (13 \times 12.2) + (2 \times 17) + (15)}{69} = \pm 10 \text{ mmHg Reduction in vapour pressure (at } 100^\circ\text{C)}$$

To date no quantitative data on the effect of the protein present in the sweat on the vapour pressure is available. There are experimental techniques that can be used to evaluate the vapour pressure of a liquid. The simplest being that by measuring the temperature of the liquid and the pressure above it at which the liquid boils. By definition, when water boils at sea level, the vapour pressure of the water exceeds the atmospheric pressure of 760 mmHg.

The concentration of protein in sweat varies with exercise duration (Initially 7 g/l to 3g/l after 40 minutes [144]). Kerr *et al.* [110] reported an exponential decrease of protein content over 3.5 to 4 hr from 10 g/l to 1.3 g/l.

The data presented by McCutcheon *et al.* [147] show changes in the protein content over time and also with different atmospheric conditions. The protein is a surfactant to improve the wetting of the skin and hair coat (discussed previously). A surfactant is a phospholipid chain with a hydrophobic end and

a hydrophilic end [131]. The hydrophilic end of the chain attaches to the water and reduces the surface tension, the hydrophobic end of the chain creates a water 'free' layer on the surface of the water, thus retarding evaporation [131]. The action of lipids on evaporation of physiologic fluids has been described. The eye has a lipid layer, removal of this lipid layer increases tear evaporation by fourfold [46]. The observed decrease in the protein content of horse sweat during endurance exercise and when exercising in warm environmental conditions is thus probably an adaptation to increase the evaporation rate from the skin. The initial higher protein content ensures adequate wetting of the skin, once the skin is wet, the surfactant content reduces to improve evaporation.

Determining Vapour pressure of an unknown liquid

The effect of salts on vapour pressure has been discussed, however equine sweat, as is well known, is a physiologic substance and therefore probably contains a number of other substances (protein as discussed above). It is difficult to estimate the vapour pressure at a given temperature of such a liquid.

Hass and Newton in [201] developed an algorithm that can be reworked (below) to calculate vapour pressure at a temperature when the boiling temperature of the liquid is known.

$$2.8808 - \log p = \frac{\phi \Delta t}{273.1 + t - 0.15 \Delta t}$$

3—85

Where p is the vapour pressure, t is the boiling temperature, Δt is the difference between the observed boiling point and the unknown vapour pressure temperature, ϕ is the entropy of vaporisation at 760mmHg.

Therefore, equine sweat that boils at 89°C, at 30°C will have a vapour pressure as follows (p):

$$2.8808 - \log p = \frac{5.75 \times 59}{303.1 - (.15 \times 59)} = 1.1529$$

$$\log p = 2.8808 - 1.1529 = 1.7278$$

$$p = 53.44 \text{ mmHg.}$$

The vapour pressure of sweat at 30°C is thus 53.44 mmHg, whereas the vapour pressure of pure water at the same temperature would be 31.13 mmHg. Thus the protein component of the sweat increases the vapour pressure by ~22mmHg. Referring to the former discussion on the effect of the salt content of the sweat, the 10mmHg reduction in vapour pressure at boiling point is reduced to a 0.6 mmHg reduction in the vapour pressure at 30°C.

This technique described above may produce incorrect results due to the boiling of a liquid containing protein. The boiling may denature the protein, the effects of which would be unknown. Thus drawing any conclusions from this result would not be wise.

However the results presented indicate that the protein may have a far greater effect on the evaporating characteristics of sweat than the salts. Previous modelling that assumed that the vapour pressure properties of sweat are equal to that of water may underestimate the evaporative cooling component of the energy balance equation.

The evaporative cooling via the respiratory tract therefore generates a further debate. The lungs, as it is well known, contain a surfactant [108,174]. The action of this surfactant, primary composition being a phospholipid, has been well described [55,108,109,174].

Changes in the lung surfactant secretion with changes in exercise has been described [196]. Surfactant has a high turnover rate and is replaced with a half life of about 10 hours [131]. Work in human subjects has shown increases in surfactant production following a single large breath or hyperventilation but the biochemical mechanism has not been fully described [131]. Pronounced shifts in the percentages of the phosphatidylcholine (PC) and phosphatidylglycerol (PG) fractions were found to occur as a result of adrenergic influences during physical exercise [196]. The PC/PG quotient was observed to decrease with exercise in healthy horses, thus indicating a greater percentage of the phosphatidylglycerol. An investigation of the differences of the vapour pressures of these two substances would indicate whether or not this observation aids heat dissipation.

The first assumption of modelling respiratory heat loss by way of evaporative heat transfer is that the evaporative body is pure water, or perhaps physiological saline. The action of salts has been described above to indicate that there is virtually no difference between the two scenarios, however they are both incorrect. The predominantly phospholipid base of the surfactant secretions in the lung and respiratory airways indicates that similar vapour pressures to that found in sweat may form in the respiratory tract, however the specific mechanisms underlying any vapour pressure adaption has not been described. The variation of the secretion of the respiratory tract surfactants would alter vapour pressure gradients and thus alter heat dissipation.

CHAPTER 4

THE EFFECT OF THREE DIFFERENT WARM-UP REGIMENS ON HEAT BALANCE OF THOROUGHBRED HORSES

ABSTRACT

Horses were exercised at 105% of their maximal $\dot{V}O_2$ uptake ($\dot{V}O_{2,max}$) until fatigued following three different warm-up regimens (no warm-up, a light warm-up, and a warm-up until the central venous temperature $> 39.5^\circ\text{C}$) to assess the effect of the warm-up on the various avenues of heat loss. Approximately 12.79, 15.10 and 18.40 MJ of heat were generated in response to the warm-up and exercise following the three different warm-up regimens, respectively. Of this, 17.5, 17.2 and 17.4% remained as stored heat after 20 min of active recovery. Heat loss from the lower respiratory system, estimated from the temperature difference between blood in the pulmonary and carotid arteries and the cardiac output, was 63.6, 33.7, 40.3% of the heat produced during and following the three warm-up intensities. The balance of the heat loss was assumed to be via the evaporation of sweat. On this basis, the heat loss by sweating was 14.9, 49.1 and 42.3% of the heat produced during and following the three warm-up intensities. This represented evaporation of 0.8, 3.1 and 3.0 ℓ of sweat, respectively, which

highlights the role of the warm-up in initiating sweating in horses. The similarity between the latter two evaporated sweat volumes, despite obvious visible differences in the sweating rate, indicates that the environmental conditions limit evaporative heat loss.

INTRODUCTION

The dissipation of metabolic heat by evaporation of sweat is the most critical avenue of heat loss in exercising horses [141]. This is commonly observed by the intolerance to work in anhidrotic horses [137]. The magnitude of the heat loss by vaporisation of sweat has been assumed to be the same as vaporisation of water which has been reported to be 2,415 kJ per litre [92]. Horses are adrenergic sweaters [183], as opposed to humans who are cholinergic sweaters. The implication is that the horse requires a period of submaximal exercise in order to activate the sweating process [92]. It is proposed that if a horse should commence intense exercise without a prior warm-up, blood is directed to the locomotory muscles while foregoing heat dissipation through the peripheral circulation [141]. If this occurs in the feral horse, the duration of the intense exercise is probably brief and heat accumulation during the exercise is dissipated when sweating commences during the recovery period. The exercising horse appears to accommodate metabolic heat accumulation and initiate sweating more effectively when its body temperature rises slowly [92].

Extensive research has been conducted on the effect of pre-competition warm-up on subsequent performance in human athletes and many researchers consider prior physical activity (warm-up) essential for optimal performance [48,61]. Human athletes competing in events lasting 2 - 15 minutes at 90-120% of $\dot{V}O_2\text{max}$, often

follow a warm-up consisting of a mild, longer duration component followed by several high intensity, short duration repetitions at race pace [95]. Grodjinovsky and Magel [77] observed that adding short duration, high intensity repetitions significantly improved performance over a mild, longer duration warm-up. There is also evidence from Grodjinovsky and Magel [77] and others that warm-up does not necessarily improve [47,61,182] and may even harm [48,61,65] performance. Furthermore, it has been reported that the warm-up in human athletes increases muscle and tendon suppleness, stimulates blood flow, increases body temperature, and enhances free, co-ordinated movement thus minimising injuries [167,194,211]. Rodenburg *et al.* [167] reported that warm-up decreases delayed muscle soreness following eccentric exercise. Worrel and Perrin [211] reported that preconditioning (warm-up) significantly increases the force required to induce muscular injury. Warm-up has a beneficial effect on thermoregulation in human athletes [45] and increases peripheral circulation [95,167].

When exercise is performed in a hot humid environment, the skin blood flow increases to assist heat dissipation [170]. Competition between active skeletal muscle and the subcutaneous circulation for cardiac output has often been suggested [161].

The aim of this study was to compare the thermoregulatory responses of

Thoroughbred horses during maximal exercise following three different intensities of warm-up.

MATERIALS AND METHODS

Experimental animals:

Six Thoroughbred mares, aged 3 - 14 years and weighing 432 - 514 kg [478 ± 11.7 (SE) kg] were used in the study. The horses were maintained in box stalls at night and conditioned with a program of walking, trotting, cantering and galloping for at least 3 months prior to the commencement of the study. For the final six weeks of the conditioning program the horses were exposed to standardised high intensity treadmill exercise three times a week. Initially this consisted of exercise for 5 min at 7 m/s, 5 min at 8.5 m/s and 5 min at 10 m/s. The intensity and duration was gradually increased until the horses were exercising 5 min at 7 m/s, 5 min at 9.5 m/s and 8 min at 12 m/s by the sixth week of training. The maximal $\dot{V}O_2$ uptake ($\dot{V}O_{2\max}$) of each horse was determined using a step-wise incremental protocol [126] on three occasions during the last two weeks prior to commencing the experiments. The mean $\dot{V}O_{2\max}$ was 159.6 ± 4.28 (SE) $\text{m l} \cdot \text{kg}^{-1} \cdot \text{min}^{-1}$.

Experimental protocols.

Three different warm-up experiments were conducted with horses running on a

treadmill until fatigued at a load that elicited 105% of $\dot{V}O_{2\max}$. Each experiment consisted of a warm-up phase followed immediately by an exercise to fatigue phase and a 20-min active cool down and recovery phase. The three warm-up regimens employed were; i. no warm-up at all (X); ii. A warm-up simulating the warm-up used in horse racing in South Africa (R - this warm-up consisted of a 5 min walk followed by 400 metres of cantering followed by walking for a further 5 min); and iii. a warm-up consisting of 5 min of trotting followed by a canter until the central venous temperature exceeded 39.5°C followed by trotting for a further 5 min (W). During the experiments $\dot{V}O_2$, heart rate, cardiac output (\dot{Q}), heat loss from the respiratory system, and heat storage by the body were measured. The experiments were conducted in an air-conditioned laboratory (19.5-21.0°C). All exercise was performed on a treadmill (Mustang, Switzerland) set at a 7% slope. A fan was used to maintain an air velocity of 7.5 m/s over the anterior and dorsal aspects of the animals. When expressed as a percentage of running speed during the fatigue test phase of the experiment, the air speed values were between 62 and 73% of the running speed.

Determination of temperatures.

Copper-constantan thermocouples (Teflon insulated, Type TT-T-40, OMEGA Engineering, Stamford, USA) were passed through the lumens of the pulmonary and carotid artery catheters. The thermocouple placed in the carotid artery, which

had been translocated to a sub-cutaneous [185] location three months prior to commencing the present study, was introduced through the lumen of an 18-gauge 40 mm catheter (Intraflon-2, Vygon, France). Hodgson *et al.* [92] reported no effect of translocation of the carotid artery on the temperature of the blood in the vessel. The thermocouple was sealed into the side branch of a Y-type Luer fitting to enable blood samples to be drawn through the same catheter. The catheter was placed in the relocated carotid artery using aseptic techniques. The thermocouple and catheter placed in the pulmonary artery was introduced via a 12-GA intravenous cannula (Medicut, Sherwood Medical, Ireland). This cannula was introduced into the right jugular vein 25 cm cranial to the thoracic inlet. The custom catheter (2000mm long and $\text{\O}1.70$ mm polyethylene tubing, Portex, England) was introduced and its tip was advanced toward the heart and pulmonary artery using aseptic techniques. Catheter position in the pulmonary artery was estimated by observing reference markings on the catheter. The catheters were held in place with adhesive (Thixotrop, Sichel-werke GmbH, Germany) and the Y-junction Luer fittings were attached to the mane of the subjects.

Thermocouples were placed in the mixing chamber of the calorimeter system and in close proximity to the head of the horse in order to measure the mixed expired and the inspired gas temperatures. All thermocouples were connected to a 486DX33 computer via a 16-channel thermocouple interface board with cold

junction compensation (EXP-20, Keithley Metrabyte, USA). Temperatures were sampled at 20 Hz, averaged and recorded every 2 seconds. Data was stored in a Lotus123® spreadsheet.

Determination of metabolic response to exercise.

A telemetric ECG (Nihon Kohden) was applied using a base-apex lead configuration to record heart rate. The horse was walked onto the treadmill, and resting baseline arterial and mixed venous blood samples were collected simultaneously, via previously placed catheters, into heparinised syringes under anaerobic conditions. The O₂ content of these samples was measured using a haemoximeter (OSMJ3, Radiometer, Copenhagen, Denmark). An open-flow mask system was used to measure $\dot{V}O_2$ and CO₂ production during all phases of the experiment by use of techniques previously described [126]. \dot{Q} was calculated using the direct Fick method.

After baseline sample collection, one of three randomly assigned warm-up regimens was commenced. This was followed by the exercise test where the treadmill speed was increased to a predetermined speed equivalent to 105% of the $\dot{V}O_{2max}$. This speed was calculated individually for each subject and ranged between 10.3 and 12.2 m·s⁻¹. Exercise was terminated when the horse

demonstrated signs of impending fatigue as reflected by its inability to keep pace with the treadmill belt despite verbal encouragement.

Heart rate was measured, and arterial and mixed venous blood samples were collected during the last 15 seconds of each minute of the intense exercise test. $\dot{V}O_2$ and expired gas temperature and humidity were measured continuously throughout the test and the recovery phase. Blood samples were also collected after 1, 5, 10, 15 and 20 min of recovery. The rectal temperature was measured prior to the start of each test and once the treadmill had stopped after the first 20 minutes of active recovery following fatigue.

Metabolic heat load was estimated by assuming that 80% of the energy utilised was liberated as heat and that each litre of O_2 had a calorific value of 21 kJ. Therefore the metabolic heat load (MH) was estimated by $MH = \dot{V}O_2(\ell / \text{min}) \times 0.8 \times \text{exercise duration}(\text{min}) \times 21 \text{kJ} / \ell O_2$. The total oxygen consumed during the entire experiment was calculated by integration of the individual $\dot{V}O_2$ with respect to time. The portion of heat dissipated during the experimental period was estimated by subtracting the stored heat from the total MH. An estimate of the stored heat was calculated from the elevation in rectal temperature 20-min post exercise, the specific heat capacity of tissue and body weight (kg). The specific heat capacity of the horse has not been reported and

thus the human value ($3.48 \text{ kJ}\cdot\text{kg}^{-1}\cdot^{\circ}\text{C}^{-1}$) was used.

Heat dissipated from the lung throughout the duration of the experiment was estimated by integration from the pulmonary — carotid arterial blood temperature difference, the cardiac output and the specific heat capacity of blood. The difference between the temperature and humidity of the laboratory air and expired gas flowing through calorimeter was used to calculate the heat loss from the respiratory tract by convective and evaporative means. The low specific heat capacity of air ($1 \text{ kJ}\cdot\text{kg}^{-1}\cdot^{\circ}\text{C}^{-1}$) compared to the latent heat of vaporisation of water ($2415 \text{ kJ}/\ell$ at 34°C) indicated that the convective heat loss from the respiratory tract was insignificant and could thus be ignored. The non-respiratory heat loss was determined algebraically and assumed to be the balance of the heat produced following the subtraction of the measured heat dissipation and storage. The sweat volume required to dissipate the remaining heat was taken as the quotient of the balance of the heat and the specific heat of vaporisation of sweat, which at the laboratory temperature was taken as $2436 \text{ kJ}/\ell$.

Statistical analyses:

Results were analysed by an analysis of variance for repeated measures [156] (RM ANOVA) using SigmaStat (Jandel Scientific Software, California, USA). Where means were different, post-hoc multiple comparison analyses were made

by the Student-Newman-Keuls (SNK) test [156]. Differences were considered significant when $P < 0.05$. Proportions of the total metabolic heat load were compared using the z-Test [156]. The means and standard errors (SE) of results were reported.

RESULTS

Exercise time.

The run time to fatigue for the horses was 4.24 ± 0.58 min following no warm-up (X), 3.56 ± 0.75 min following the race (R) warm-up, and 3.18 ± 0.55 min following the comprehensive (W) warm-up. The total duration of the respective trials was 27.61 ± 0.68 , 38.75 ± 0.89 and 39.6 ± 0.67 min.

Metabolic responses to the different warm-ups.

There were rapid increases in heart rate, \dot{Q} and $\dot{V}O_2$ at the onset of the exercise to fatigue phase of each experiment. Values for these variables during the fatigue phase and the recovery phase of the experiment are presented in Table 4-1. The maximal oxygen consumption during the R and W trials was significantly lower than during the X trial.

Temperature responses to warm-up and exercise.

There were increases in rectal, carotid artery and pulmonary artery temperatures in the horses in response to the R and W warm-ups and in response to the intense exercise that followed all warm-up regimens. Values of these variables during all phases of the experiment are presented in Table 4-1 and Figure 4-1. There were no differences in the rectal temperatures after the first 20 minutes of active recovery following fatigue.

Both the pulmonary and carotid artery post warm-up temperatures in the W regimen were significantly higher than those following the X and the R warm-up regimens. The W arterial temperature at fatigue was significantly higher than both the X and R temperatures at fatigue.

Table 4-1. Means and standard errors of various variables measured in 6 horses at rest, following warm-up, at fatigue and following 20 minutes recovery in response to 3 different warm-up regimens.

Warm-up Regimen	Resting	Post warm-up			Fatigue			20 min Post Fatigue		
		X	R	W	X	R	W	X	R	W
HR, beats/min	28±5	119±13	138±10	141±8	194±20	208±2	210±3	118±7	113±8	116±7
\dot{Q} , ℓ /min	*	132±21 ^a	145±17 ^a	212±43 ^b	348±13	348±9	354±11	156±10	110±13	130±16
$\dot{V} O_2$, ml·kg ⁻¹ ·min ⁻¹	*	33±4	40±5	48±2	158±8 ^a	152±9 ^b	153±11 ^b	34±4	32±3	34±3
Pulmonary artery, °C	38.1±0.5 ^a	38.1±0.1 ^a	38.8±0.4 ^b	39.9±0.5 ^b	41.5±0.6 ^c	41.8±0.6 ^c	42.2±0.4 ^c	38.7±0.2	38.7±0.7	38.7±0.3
Carotid artery, °C	38.0±0.5	38.0±0.2	38.5±0.4	39.6±0.4	40.9±0.6 ^a	41.4±0.8 ^a	41.9±0.4 ^b	38.7±0.2	38.7±0.2	38.6±0.3
Pul-Car difference, °C	0.1	0.1	0.3	0.3	0.6 ^a	0.4 ^b	0.3 ^b	0.0	0.0	0.1
Rectum, °C	37.4±0.1 ^a	*	*	*	*	*	*	39.1±0.2 ^b	39.2±0.2 ^b	39.5±0.3 ^b
Heat Production, kJ	*	364±53 ^a	3850±182 ^b	7840±599 ^c	4387±796	3850±894	3160±720	8049±615	7390±592	6970±491
Heat Storage, kJ	-	-	-	-	-	-	-	2228±331 ^a	2591±393	3207±380 ^b
Heat Dissipation (Respiratory), kJ	-	213±88 ^a	1902±291 ^b	2961±710 ^b	3552±1375 ^c	1095±269 ^d	1366±455 ^d	4896±1718 ^c	2097±284 ^f	3094±500 ^g
Total heat dissipated by other mechanisms, kJ	-	-	-	-	-	-	-	1910±310 ^a	7405±415 ^b	7343±550 ^b
[Lactate], mmol· ℓ^{-1}	2.2±0.4 ^a	2.2±0.4 ^a	4.9±1.6 ^a	15.6±6.0 ^b	37.7±3.7 ^c	29.9±4.9 ^d	28.6±1.4 ^d	18.3±4.6 ^e	16.8±3.2 ^e	23.8±7.6

HR, heart rate; \dot{Q} , cardiac output; $\dot{V} O_2$ max, O₂ uptake; X, no warm-up; R, racing warm-up; W, full warm-up; *, measurements not taken; -, data not determinable; values with different superscripts are significantly different from each other.

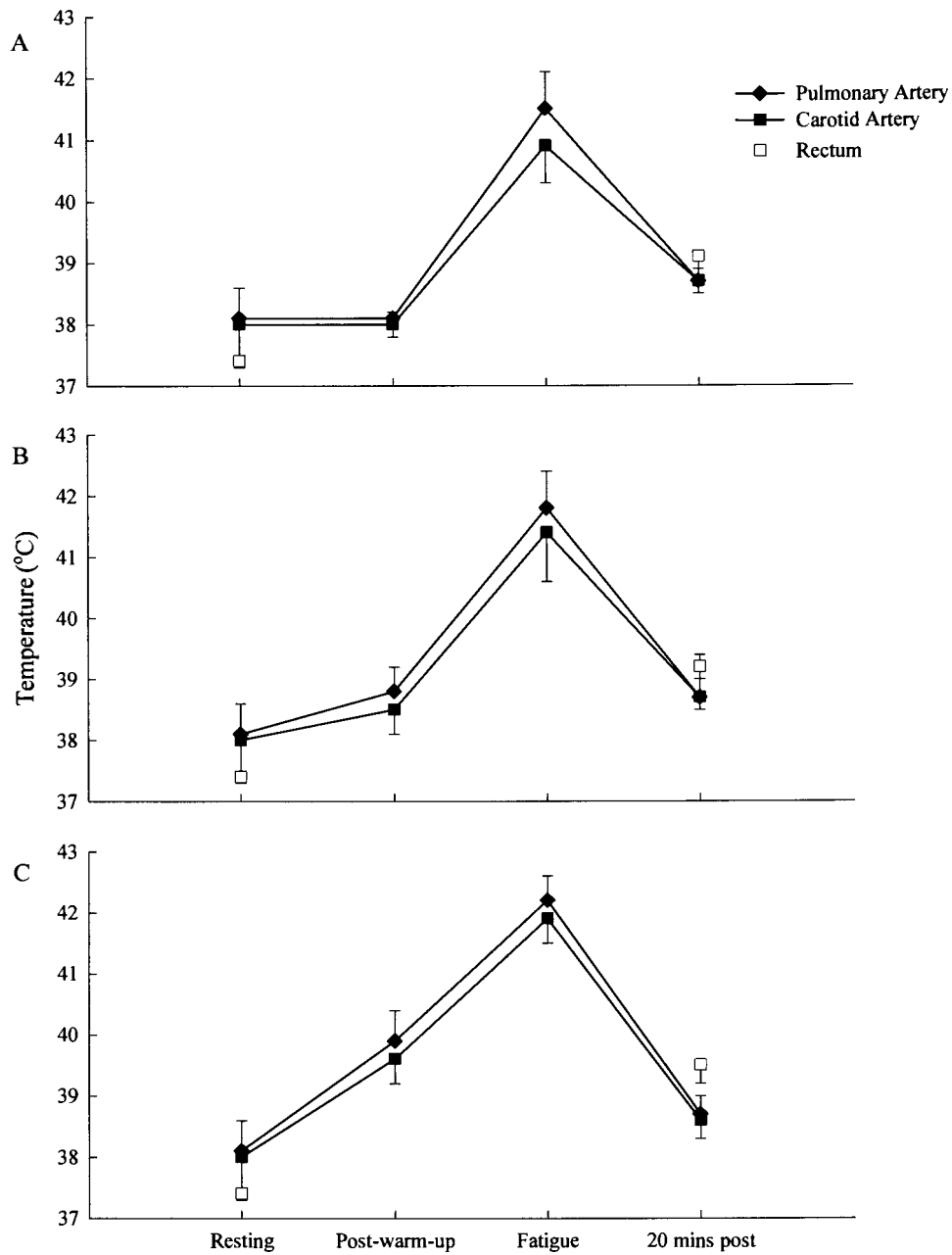

Figure 4-1 Temperature in the pulmonary and carotid arteries and the rectum during no warm-up (X;A), race warm-up (R;B), and comprehensive warm-up (W;C) trials.

The temperatures in the carotid and pulmonary arteries dropped during the post fatigue exercise. There were no differences between the carotid and pulmonary blood temperatures in the three warm-up regimens following 20 minutes recovery. The temperatures of the blood 20 minutes post fatigue were not significantly different to the pre-exercise temperatures. The decline in the arterial blood temperature was significantly greater in the W warm-up group (3.6°C) than the X warm-up group (2.3°C).

Heat Production

The total heat production from the start of exercise prior to warm-up to the completion of 20 minutes post fatigue active recovery was $12\,794 \pm 1\,464$, $15\,103 \pm 2\,900$ and $18\,404 \pm 2\,786$ kJ for the X, R and W warm-ups, respectively. The total heat production was significantly different in each of the 3 warm-up regimens. The proportion of the heat produced during each phase of the exercise tests is presented in Table 4-1 and Figure 4-2. The warm-up accounted for 3.0, 25.6 and 42.6% of the total heat production during the X, R and W warm-up conditions, respectively. The heat production during each of the three warm-up phases was significantly different. The 20-minute recovery phase represented 62.9, 48.9 and 37.9% of the total heat production for the X, R and W warm-ups, respectively. There was no significant difference between the heat produced during the exercise test and the 20-minute recovery following the three different warm-up regimens.

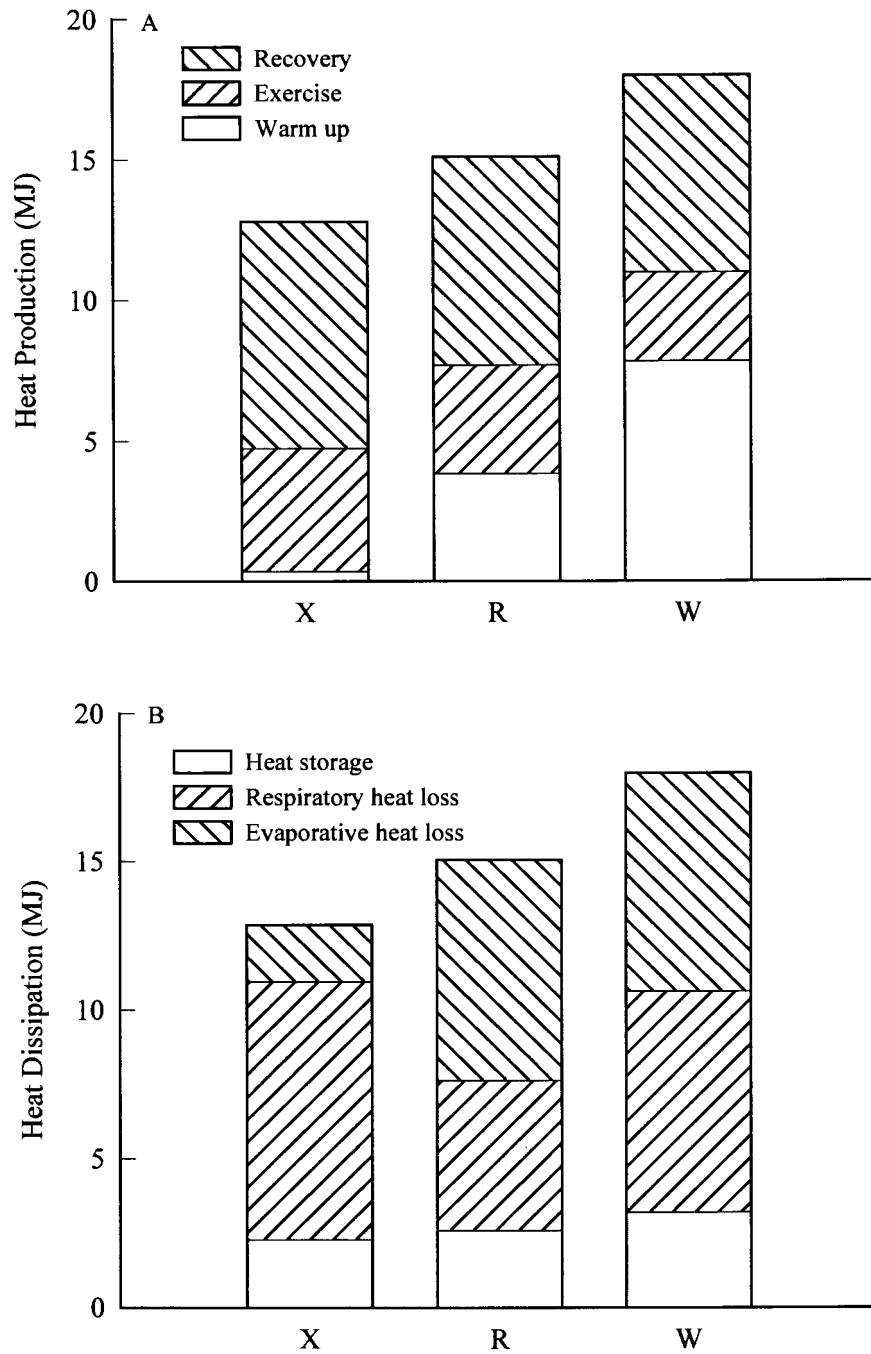

Figure 4-2 Heat production (A) during different stages of the experiments and heat dissipation (B) via various avenues during the X, R and W trials.

Heat Storage

The calculated magnitude of the heat storage is presented in Table 4-1 and Figure 4-2. Of the heat produced, 17.4, 17.1 and 17.4% remained as stored heat at the conclusion of the post-exercise recording period following the X, R and W warm-ups, respectively. The heat stored following the W warm-up was significantly higher than that following the X warm-up.

Heat Dissipation

On the basis of measurements of \dot{Q} and the pulmonary arterial-to-carotid artery temperature difference, 67.7, 33.7 and 40.3% of the total heat load was dissipated from the respiratory system during exercise following the X, R and W warm-ups, respectively. The respiratory heat dissipation was significantly higher during the exercise test to fatigue test and recovery phase of the X test (Table 4-1 and Figure 4-2).

DISCUSSION

When considered alongside other mammalian athletes, the horse is an elite athlete ($\dot{V}O_{2\max}$ of 120-180 ml·kg⁻¹·min⁻¹) [169]. It is however limited in that its thermoregulatory capacity, particularly in a warm, humid environment, is inadequate. The horse has a small skin surface area-to-body mass ratio (approximately one third of that of human athletes) [92] which often results in compromised evaporative heat loss and therefore poor athletic performance

[141]. The primary purpose of this study was to establish whether warming-up prior to maximal exercise would influence the horse's thermoregulation and performance.

The results presented here indicate that a low intensity warm-up, similar to that used at South African racecourses, is adequate to activate the thermoregulatory mechanisms. Warm-up was also shown to significantly reduce the oxygen consumption at a given intensity of work.

Metabolic heat produced during submaximal exercise prior to maximal exercise produced substantial changes in the metabolic status of horses. Hodgson *et al.* [92] reported rectal, arterial and pulmonary blood temperatures of 38.3, 38.9 and 39.2°C, respectively, in horses after 3 minutes of exercise at 65% of $\dot{V}O_2\text{max}$. In the present study, the R warm-up produced arterial and pulmonary blood temperatures of 38.9 and 38.7°C, respectively. The W warm-up produced temperatures of 40.0 and 39.4°C, respectively, with the highest individual values being 41.1°C in both the arterial and pulmonary blood following the W warm-up. The increase in pulmonary and carotid artery temperatures from post warm-up to fatigue was significantly different in each of the three conditions. In the X trial the increase was greatest (3.1°C) compared to 2.9°C and 2.3°C under the R and W conditions, respectively. Conversely, the decline in the pulmonary and carotid artery temperatures during the first 20 minutes of recovery was the greatest in the W trial (3.6°C)

compared to 2.9°C and 2.4°C in the R and X conditions, respectively. This indicates the increased rate of heat dissipation from the horse following warm-up. Although the core temperature was higher following a warm-up, the rate of heat accumulation was not as great during the intense exercise, and the subsequent post fatigue recovery was quicker.

Evaporative cooling represents a major route for the dissipation of heat in most 'athletic' mammals [141]. The extent of cooling has not been quantified, but Hodgson *et al.* [92] made estimations of this by measuring the temperature of the blood in the superficial thoracic vein, which carries efflux from the skin. The volume carried by the vessel has not been determined, but Rowel [170] estimates the maximal skin blood flow in man is ~15% of the \dot{Q} during strenuous exercise. Assuming the horse can divert a portion of its cardiac output to the subcutaneous circulation, any increase in \dot{Q} will also aid heat dissipation.

Sweating in the equine species is mediated by stimulation of β_2 adrenergic receptors [78]. Hodgson *et al.* [92] showed a close positive relationship between the temperature in the carotid artery and sweat rate. During this study the sweat rate itself was not measured, however, at the point of fatigue of the X trial, sweat was not visible on the horse's coat and was only just noticeable after the first 20 minutes post fatigue. During the R trial, sweat was visible on the neck and the flanks of the horses following the warm-up and horses were

covered in an even layer of sweat over their entire body at the point of fatigue. However, during the W warm-up, the horses were sweating considerably at the start of the high intensity exercise test following warm-up, and sweating prodigiously by the end of the test. It can therefore be assumed from the observation of sweat saturating the animal's body at the end of both the R and W trials that the warm-up had had a significant effect on the sweat secretion rate. Much of the excess sweat dripped onto the treadmill belt during the W regimen, therefore not contributing to the evaporative heat loss from the animal.

It has been postulated that the horse commencing strenuous exercise without a prior warm-up probably diverts most of its cardiac output to the locomotory muscles rather than the skin and other organs [123]. In contrast, the horse that warms up prior to strenuous exercise probably place its cardiorespiratory system in a state of readiness and would therefore be able to increase its cardiac output more readily in order to accommodate the demand for increased peripheral circulation required for thermoregulation. This has been demonstrated in human athletes following warm-up [45,95].

The heat loss via the ventilatory system was estimated on the basis of the pulmonary artery-to-carotid artery temperature difference, a technique previously described by Hodgson *et al.* [92]. These results were verified by observing the difference in the temperature and humidity of the gas flowing

through the calorimetry system and that of the laboratory air, and by the flow rate through the system. On this basis it was determined that 1.3, 0.7 and 0.9 ℓ water had evaporated from the respiratory tract during the X, R and W trials respectively. These volumes relate favourably to the 0.8 ℓ of water that Hodgson *et al.* [92] estimated had evaporated from the lung during exercise eliciting 90% of $\dot{V}O_2\text{max}$ for a similar time period.

The remaining heat (1.91, 7.41, and 7.34 MJ, produced in response to and following the X, R and W warm-ups, respectively) was lost via radiation, convection and evaporation of sweat. Since the experiments were conducted in an environmentally controlled laboratory, we assumed that the heat loss by radiation and convection was similar and insignificant in all trials (when compared to evaporative heat loss) and could thus be ignored. Therefore, if evaporative cooling from the skin lost all this heat, 0.8, 3.1 and 3.0 ℓ of water would have evaporated for the three exercise conditions, respectively. It was apparent from the observations made during the experiments, that most of the sweat secreted during the X trial evaporated, whereas an excess of sweat was secreted during the R and W trials.

However, the present studies not only demonstrated how warm-up enhances the onset of sweating, it also illustrated how the cooling capacity of sweating is limited by the environmental conditions. It was evident from observations during the R and W trials, that the horses were producing considerably more

sweat during the W trial, however, similar quantities of sweat were estimated to have evaporated during the two trials. The estimated sweat volumes, 3.1 and 3.0 ℓ , respectively, were both equivalent to a sweat evaporation rate of 15.9 $\text{m}\ell \cdot \text{m}^{-2} \cdot \text{min}^{-1}$. The laboratory conditions were maintained at 20°C, 55% relative humidity and an air speed over horse of 7.5 $\text{m} \cdot \text{s}^{-1}$. It was therefore apparent that the maximum rate of sweat evaporation, under the laboratory conditions described, was 15.9 $\text{m}\ell \cdot \text{min}^{-1} \cdot \text{m}^{-2}$ irrespective of the sweat secretion rate. Thermodynamic models have illustrated how the environmental conditions affect evaporation rate [153]. When these thermodynamic models are applied to the present study, they predict a sweat evaporation rate of 16 $\text{m}\ell \cdot \text{min}^{-1} \cdot \text{m}^{-2}$ under the described laboratory conditions.

The estimates and calculations of the relative heat loss via different mechanisms during the present study were based on a number of assumptions. The heat storage by the body was calculated from the specific heat capacity of the body and the mean body temperature and body weight. The specific heat capacity of the horse is unknown, and the human value (3.48 $\text{kJ} \cdot \text{kg}^{-1} \cdot ^\circ\text{C}^{-1}$) which we used may underestimate the specific heat capacity of the horse. The large hind gut, which also serves as a large water reservoir and heat sink, probably has a specific heat capacity closer to that of water (4.18 $\text{kJ} \cdot \text{kg}^{-1} \cdot ^\circ\text{C}^{-1}$) [201]. The rectal temperature after the first 20 minutes of active recovery was used as an estimate of mean body temperature. Hodgson *et al.* [92] showed that the rectal temperature was an acceptable estimation of mean body

temperature although the rectal temperature lagged the carotid artery blood temperature.

The calculated heat loss across the pulmonary circulation relied upon consistent and repeatable measurements of the respective artery temperatures. It was assumed that the heat dissipated across the pulmonary circulation was ultimately lost from the body via the respiratory tract. Given the low specific heat capacity of air, the heat was probably lost by evaporation of water from the mucous membranes of the conducting airways as the inspired air is saturated with water vapour. The saturated air, in the lung at $\pm 40^{\circ}\text{C}$, has a specific heat capacity at least twice that of dry air [201]. On this basis, thermodynamic calculations of the energy required to heat the inspired air and saturate it with water (≈ 200 kJ/min at fast gallop and ≈ 90 kJ/min at a trot) equate reasonably well with the heat loss estimates from the pulmonary circulation. Hodgson *et al.* [92] reported values of ≈ 84 kJ/min and ≈ 188 kJ/min at the onset and after 35 mins of exercise eliciting 40% of $\dot{V}O_{2\text{max}}$, respectively.

Savard *et al.* [175] and Nielsen *et al.* [158] did not, however, find any difference in muscle blood flows during exercise in hot environments. This may further support the postulation that the preparation for exercise, i.e. warm-up under any environmental condition, determines locomotory muscle and peripheral perfusion and the rate of response of the cardiovascular circulation at the onset intense exercise. It also indicates the importance of the warm-up

prior to intense exercise in the heat when both peripheral and muscular perfusion are essential for optimal performance.

In summary, we found that a low intensity warm-up prior to maximal exercise has a beneficial effect on heat balance of Thoroughbred horses. It was shown that despite the higher mean body temperatures at the onset of maximal exercise, the subsequent accumulation of heat is not as rapid. A low intensity warm-up prior to the event appears to be sufficient to initiate sweating and promote better thermoregulation. However, this study has also showed that ultimately evaporative heat loss is not restricted by sweating rate but by evaporation of the sweat which is determined by environmental conditions.

ACKNOWLEDGEMENTS

We acknowledge the technical assistance of Robyn Morris, Annemarie Koekemoer, Karin Kruger and Clifford Matjiane. We must also thank Cordelia, Escarpment, Hula Hula, On the Day, Silkwood and Zola Zee for their contribution to the study. This project was conducted under the auspices of the Equine Research Centre as project number ERC 94/02 and we would like to thank the Equine Research Centre, the Gauteng Provincial Administration, the Highveld Racing Authority and the University of Pretoria for their support.

CHAPTER 5

RESPIRATORY HEAT LOSS FROM HORSES PERFORMING MAXIMAL EXERCISE IN HOT - HUMID AND THERMONEUTRAL ENVIRONMENTS

ABSTRACT

The present study was undertaken to investigate the respiratory heat loss from horses exercising in hot humid environments and thermoneutral environments. The horses were exercised at a speed equivalent to 90% of $\dot{V}O_2\text{max}$ and data were collected to assess the effect of environmental conditions on respiratory heat loss. The ambient temperature during the thermoneutral tests was set at 20°C and the relative humidity was set 45% in an environmentally controlled laboratory. During the hot humid trials the temperature set point was 35°C and the relative humidity set point was 85%. Mean heart rate was significantly higher during the hot humid tests. The time to fatigue was significantly shorter during the hot humid tests. There was a significant difference in the heat loss between the two different exercise conditions. At the start of the hot humid trials the expired air from the horses was cooler than the inspired air. There was an increase in the temperature of the expired air and therefore an increase in the heat loss from the respiratory tract. The rate of heat dissipation from the respiratory tract during the thermoneutral trials was dependent on the work rate

of the animal. During the hot-humid trials the respiratory heat dissipation was not apparently affected by the work rate and was close to zero due the absence of any thermal and vapour pressure gradient between the respiratory tract and the environment.

INTRODUCTION

It is well known that the dissipation of metabolic heat from exercising horses is compromised when they are exercising in hot humid environments. The development of heat stress is common under such circumstances [132,204].

Under thermoneutral ambient conditions, inspired air is warmed and humidified in the respiratory tract [69] [168] until it is close to deep body temperature and saturated with moisture [202]. Some heat and moisture may be recovered from the expired air under certain environmental conditions, but the respiratory cycle plays a significant role in maintaining thermal balance [127]. McConaghy *et al.* [142] have shown that the horse can selectively regulate the temperature of the brain. Baker [10] discussed the complementary role of hyperventilation to sweat evaporation, thus allowing body temperature to rise while the brain temperature is regulated. The contribution of the respiratory system to heat balance, particularly heat dissipation in hot-humid environments, is of interest in this study.

Numerous studies in humans have illustrated that several factors determine respiratory heat dissipation. The condition of the inspired air with regard to the temperature and water vapour content, the physical properties of the respiratory gases and the respiratory minute volume all have an effect on respiratory heat dissipation [96]. Work in human subjects has involved both the effect of

altered temperature and humidity of the inspired air and breathing gas mixtures of varying density and conductivity [88].

Previous studies by Lund *et al.* [127] (Chapter 4) have indicated that when heat dissipation by evaporation of sweat from the skin is compromised, the heat loss from the respiratory system can compensate to aid heat dissipation. The question is thus raised of how the horse is able to mediate this heat dissipation. The higher temperature of the lung creates a greater vapour pressure gradient from the evaporating surface to the atmosphere than that from the skin to the atmosphere. This increased gradient may increase evaporation from the respiratory tract when the sweat evaporation is compromised by environmental relative humidity.

The aim of the study was to compare the respiratory heat loss of horses exercising in thermoneutral environments and extreme hot humid conditions where the ambient temperature and moisture content was close to that found in the respiratory tract. This comparative study, which has not been previously reported in horses, was done in order to identify any adaptive strategy that the horse may be able to recruit to dissipate heat via the respiratory system when the temperature and humidity prevent sweat evaporation.

MATERIALS AND METHODS

Experimental animals

Five Thoroughbred mares aged 6 to 13 years and weighing 481.2 ± 16.0 (SE) kg were used in the study. The horses were maintained in box stalls at night and were fed a maintenance ration of alfalfa and *Eragrostis teff* hay and a commercial concentrate mix plus molasses meal according to NRC guidelines for working horses. The horses were conditioned on a treadmill for at least 3 months with a program of walking, trotting, cantering and galloping prior to the start of the experiments. During the final 6 weeks of the conditioning program the horses were exposed to standardised high intensity treadmill exercise three times a week. Initially this consisted of exercise for 5 mins at 7 m/s, 5 mins at 8.5 m/s and 5 mins at 10 m/s. The intensity was gradually increased until the horses were exercising 5 mins at 7.5 m/s, 5 mins at 9.5 m/s and 8 mins at 12 m/s by the sixth week of training. The maximal oxygen uptake ($\dot{V}O_{2\max}$) of each horse was determined using a step-wise incremental protocol [126] on three occasions during the last two weeks prior to commencing the experiments. The mean $\dot{V}O_{2\max}$ of the 5 horses was 171.4 ± 2.5 (SE) $\text{ml}\cdot\text{kg}^{-1}\cdot\text{min}^{-1}$.

Experimental protocols

A randomised crossover experimental design was used. This involved the horses being exposed to each of 2 different environmental protocols with at

least 7 days between treatments. The protocols involved the horses performing the exercise test under: i. thermoneutral (TN) conditions (20°C/40%RH) and ii. hot-humid (HH) conditions (35°C/85%RH). Environmental conditions in the laboratory were maintained using a combination of an electric heater bank (36kW capacity; Fifty Two Engineering, Johannesburg, South Africa), air-conditioner (Apache, South Africa) and humidifier (Defensor Mark 4 steam humidifier; Axair AG, Pfäffikon, Switzerland). Each experiment commenced with a two-hour acclimatisation phase, where each horse was housed in a stall in the exercise laboratory in order to acclimate with the environmental conditions prior to the exercise phase of the experiment. This was followed a warm-up phase of trotting at 40% of $\dot{V}O_{2\max}$ (range 66-72 $\text{m}\ell\cdot\text{kg}^{-1}\cdot\text{min}^{-1}$) for 1000 metres. The speed was immediately increased to a speed eliciting 90% of $\dot{V}O_{2\max}$ (range 149-161 $\text{m}\ell\cdot\text{kg}^{-1}\cdot\text{min}^{-1}$) with the horses being run until fatigue. Fatigue was defined as the point when the horses were unable to keep pace with the treadmill belt despite verbal encouragement. Exercise to fatigue was followed by a 15 minute cool down and recovery phase. The recovery phase was conducted at 30% of $\dot{V}O_{2\max}$ during the thermoneutral experiments. During the hot humid trials the horses were removed from the treadmill immediately following fatigue and sprayed with cool water until the body temperature dropped close to normal again. During exercise the air speed over the dorsal aspects of the horse was maintained at 7.5 m/s.

During each of the trials the following variables were recorded: $\dot{V}O_2$, respiratory heat loss, heart rate, laboratory temperature and humidity, central venous temperature and rectal temperature.

Measurement of Oxygen consumption

The oxygen consumption ($\dot{V}O_2$) was measured using an open circuit flow-through calorimeter described by Lund *et al.* [126]. The horses were acclimated to wearing the mask at least 3 months prior to the commencement of the study. $\dot{V}O_2$ was computed continuously in real-time from data collected and stored to a data file (MSExcel®) every 2 seconds.

Measurement of respiratory heat loss

The temperature and humidity of the air flowing through the calorimeter and the temperature and humidity of the inspired air was recorded in the data file as described above. The enthalpy of the inspired air (laboratory air) and the calorimeter gas were calculated using known algorithms [195]. The change in enthalpy, measured in kilojoules per kilogram of air ($\text{kJ/kg}_{\text{air}}$), and the mass flow rate through the system, measured in kilograms per second ($\text{kg}_{\text{air}}/\text{s}$), were used to calculate the sensible and insensible respiratory heat loss from the exercising horse.

Measurement of metabolic responses to exercise

A telemetric ECG (Nihon Kohden) was used to record heart rate. The electrodes (Electrospyres™) were applied in a base-apex lead configuration and secured with superglue (SICOMET Thixatrop™ superglue). The horse was

walked onto the treadmill, and resting baseline arterial and mixed venous blood samples were collected simultaneously, via previously placed catheters, into heparinised syringes under anaerobic conditions. The O₂ content of these samples was measured using a haemoximeter (OSM3™ Hemoximeter, Radiometer, Copenhagen, Denmark). Cardiac output, \dot{Q} , was calculated using the direct Fick method.

Measurement of temperatures

The pulmonary artery temperature was measured using a thermocouple that was passed into a catheter that had been previously placed with the aid of a pressure transducer. The rectal temperature was measured using a custom made probe placed 30cm into the rectum, and the muscle temperature was measured by inserting a custom-made thermocouple probe into the gluteus muscle. The site for the muscle temperature measurements was aseptically prepared and a small stab incision was made through the skin using a No. 10 scalpel blade. The area was anaesthetised using a local anaesthetic (Lignocaine) and the probe was inserted through the stab insertion. The temperatures were measured using a hand-held instrument and recorded manually to a data sheet.

Measurements of laboratory conditions

An automatic weather data logger recorded all the laboratory environmental data. (Weather Monitor II, Davis Instruments, Hayward, CA, USA). The data

was downloaded to a computer and incorporated into an Excel® spreadsheet for post-trial analysis.

Statistical analyses

Results were analysed using an analysis of variance for repeated measures [156] (RM ANOVA) using SigmaStat (Jandel Scientific Software, California, USA). Where means were different, post-hoc multiple comparison analyses were made using the Tukey test [156]. Differences were considered significant when $P < 0.05$. The means and standard errors (SE) of results were reported.

Table 5-1: Means and standard errors of variables measured in 5 horses at rest, prior to a warming up, following warming up, at the point of fatigue and 1 minute after fatigue whilst performing a standardised exercise to fatigue test under thermoneutral (TN) (20°C, 50% RH) and under hot humid conditions (HH) (35°C, 85% RH). * indicates means are significantly different at P<0.05.

Environment	Before Warm Up		Following Warm Up		At Fatigue		After Fatigue (1 min)	
	TN	HH	TN	HH	TN	HH	TN	HH
HR, beats/min	◆	◆	129.1±7.4	132.8±6.5	200.4±2.3*	204.4±2.9*	190.0±5.1	192.0±5.1
\dot{Q} , l/min	◆	◆	209.4±19.5	224.8±20.6	323.4±14.7	318.4±12.3	147.8±23.7	176.2±22.2
$\dot{V}O_2$, l/min	◆	◆	26.8±2.1	30.6±2.2	72.66±1.99*	76.80±2.1*	31.8±3.3	34.0±2.7
Pulmonary artery, °C	37.2±0.1	37.7±0.2	38.0±0.2	38.4±0.4	41.6±0.4*	42.5±0.3*	40.8±0.4*	41.6±0.3*
Rectum, °C	36.8±0.1	37.6±0.2	37.9±0.2	37.7±0.3	39.2±0.3	38.9±0.2	39.5±0.3	39.1±0.1
Heat Production, kJ	◆	◆	1767±316	1847±212	7755±1506	5686±1058	832±150	1044±73
Respiratory Heat Dissipation, kJ	◆	◆	205±29*	-332±76*	878±141*	-137±95*	125±21*	4±7*

TN, Thermoneutral; HH, Hot-Humid; HR, Heart rate; \dot{Q} , Cardiac Output; $\dot{V}O_2$, O₂ uptake; ◆, Data not collected

RESULTS

Exercise time.

The run time to fatigue for the horses was 419 ± 51 seconds in the thermoneutral environment (TN), whereas under the hot-humid (HH) conditions, the run time to fatigue was 270 ± 28 seconds. The run-time to fatigue was significantly shorter under the HH conditions. The horses did not follow an active cool-down phase on the treadmill following the HH trials; rather, exercise was stopped 1 minute after fatigue and they were removed from the laboratory and sprayed with water to assist cooling and recovery.

Metabolic responses to exercise

There were rapid increases in heart rate, \dot{Q} and $\dot{V}O_2$ at the onset of the high intensity exercise phase of each experiment. Values for heart rate and \dot{Q} after warm-up, at fatigue and 1 minute post fatigue for each environment protocol are presented in Table 5-1. Heart rates at fatigue were significantly higher during the HH trial than during the TN trial. There were no differences in the cardiac outputs between the two protocols. The $\dot{V}O_2$ at fatigue was significantly higher during the HH protocol (Table 5-1).

Temperature responses to warm-up and exercise.

There were increases in rectal and pulmonary artery temperatures in the horses in response to exercise under both environmental conditions. Values for these variables after warm-up, at fatigue and 1 minute post fatigue for each

environmental protocol are presented in Table 5-1. The rectal temperature was significantly elevated prior to the warm-up in the HH trial, however during exercise the rectal temperature was elevated, although not significantly, in the TN trial. The pulmonary artery temperature at fatigue and 1-minute post-fatigue in the HH protocol were significantly higher than that during the TN protocol.

Heat Gain

The total heat gain as a result of aerobic metabolism of oxygen from the start of exercise prior to warm-up to 1 minute post fatigue active recovery was $10\,354 \pm 657$ kJ during the TN environmental protocol, which was significantly higher than the $8\,577 \pm 448$ kJ during the HH environmental protocols. ($P < 0.05$). However, the work rates during the exercise to fatigue phases were similar (19.9kW and 20.1kW for the TN and the HH trials respectively). The heat produced during each of the environmental protocols is presented in Table 5-1 and the rates of heat exchange are presented in Figure 5-1.

Respiratory Heat Dissipation

On the basis of measurements of the change in enthalpy of the air drawn through the calorimetry system, there were significant differences in the heat dissipated from the respiratory system at each stage of exercise under the HH environment. The rate of respiratory heat exchange was significantly lower during all phases of exercise under the HH environment. (Table 5-1 and Figure 5-1).

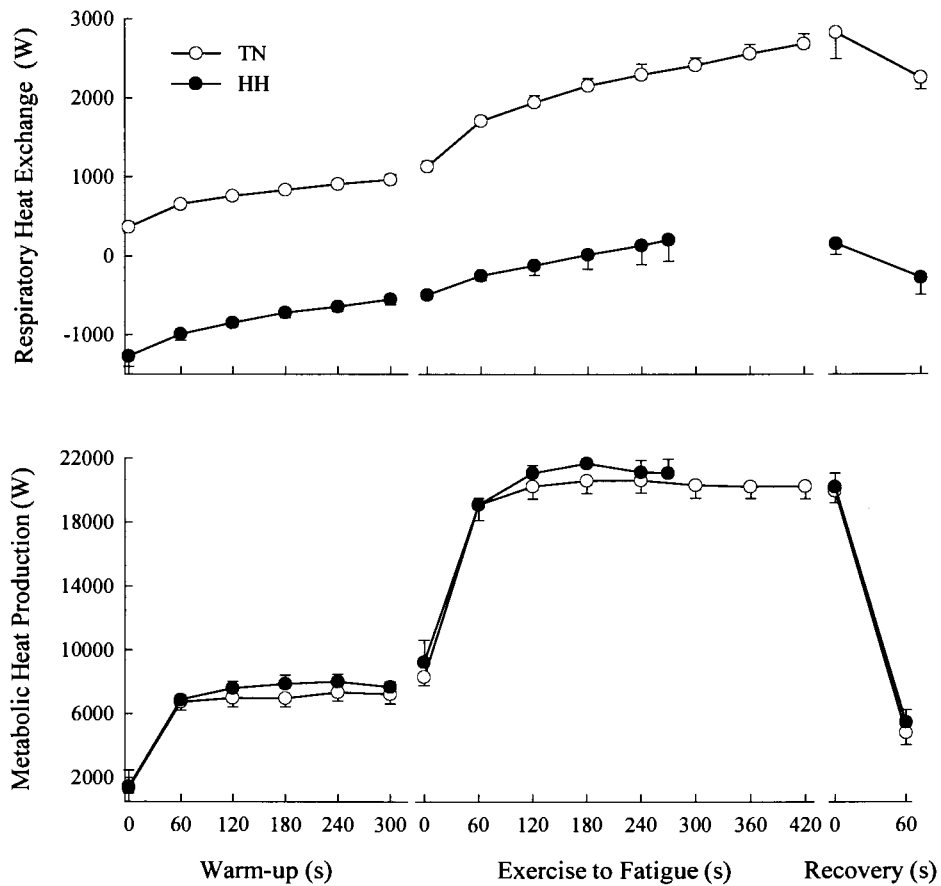

Figure 5-1: Metabolic heat production and respiratory heat exchange during each phase of the standard exercise to fatigue tests under thermoneutral (TN) and hot-humid (HH) conditions. Respiratory heat exchange was significantly lower ($P < 0.05$) during all phases of exercise in the hot-humid environment.

DISCUSSION

The horse has long been classed as the supreme elite athlete, and its rate of oxygen consumption certainly confirms its status ($\dot{V}O_{2\max}$ of 120-180 ml·kg⁻¹·min⁻¹) [169]. It is this high oxidative capacity which is not balanced with a comparable heat dissipation mechanism that predisposes the equine athlete to thermal distress. The horse has its origins in cool northern climes of Asia and Europe and is ‘designed’ to conserve metabolic heat rather than dissipate it. The modern equine athlete performs in conditions far removed from its origin and although it, as do human athletes, uses well-developed sweat mechanisms for dissipating heat, the horse is ill adapted to warm, humid environments. The horse has a small skin surface area-to-body mass ratio (approximately one-third of that of human athletes) [92]. The equine athlete is often expected to travel to foreign climes to compete (and perform) under adverse environmental conditions where the normal evaporative avenues of heat dissipation are compromised. The primary purpose of this study was to identify adaptive strategies the horse may employ in order to overcome the heat accumulation during exercise under hot humid environments.

The results presented here indicate that respiratory heat loss is significantly impaired when the environmental heat and humidity prevents evaporation. The results also indicate that the rate of heat exchange between the respiratory tract and the environment changes as core body temperature increases (pulmonary

artery temperature). The heat gain from the environment decreases, approaching zero and eventually the horse begins to dissipate heat from the respiratory tract. The increased core temperature raises the vapour pressure of the evaporating surface, thus creating a greater vapour pressure gradient from the evaporating surface to environment air, the increased vapour pressure gradients promotes greater heat dissipation. Heart rate and central venous temperature were significant elevated during exercise under the HH environment. Rectal temperature was elevated at the start of the exercise in the HH environment due to the 2 hour acclimation period prior to the start of the exercise protocol, but during the exercise test the rectal temperature was below that measured during exercise protocol in the TN environment.

The exercise to fatigue phase of these trials were performed at approximately 90% of the intensity that elicited $\dot{V}O_{2max}$. Sub-maximal exercise allowed observation of changes in the $\dot{V}O_2$. The $\dot{V}O_2$ during the exercise to fatigue during the HH protocol was significantly higher than the $\dot{V}O_2$ at the same point of the TN trial (Table 5-1) indicating increased work required in order to dissipate metabolic and environmental heat accumulation. Conversely, Lund *et al.* [127] have shown that near maximal exercise elicited a lower $\dot{V}O_2$ following warm-up when compared to no warm-up, probably indicating that the warm-up improved efficiency. The difference between the trials however is that the environmental conditions inhibited heat dissipation in the current study, whereas in the former study the warm-up initiated heat dissipation in a

thermoneutral environment.

The exercise time to fatigue was significantly shorter during the HH trials. The core body temperature at fatigue during the HH trial was significantly elevated (42.5°C), this elevated temperature was probably the reason for the horse terminating the high intensity exercise despite verbal encouragement. During exercise in the HH environment the metabolic heat production significantly exceeds the heat dissipation. There is thus substantial heat storage and therefore a rapid unchecked increase in the core body temperature. The onset on clinical problems in horses subjected to significant heat loads can be rapid depending on the level of conditioning of the horse. Better conditioned horses can often maintain thermoregulatory function when subjected to thermally stressful conditions [141]. It has been recommended that horses showing rectal temperatures in excess of 40.5°C be cooled as quickly as possible. The lag between the rectal temperature and the core body temperature [92] implies that when the rectal temperature is above 40.5°C , the core body temperature is probably in excess of 42°C . This temperature is generally considered as the critical maximum temperature [142]. Work done in humans [122] has shown that by precooling the body exercise duration is increased. This implies that the precooling delays the onset of the physiologically critical maximum body temperature. Cooling strategies during equine events [208] have been effective in delaying or preventing the effects of thermal distress when the environmental conditions compromise

evaporative heat loss [117].

The role evaporative cooling plays in maintaining the thermal balance in 'athletic' mammals have been discussed previously [141]. The capability of evaporative cooling in any environmental situation is governed by the vapour pressure gradient from the evaporating surface to the microclimate of the environment surrounding the body. The environmental conditions were altered in the HH trials in order to minimise the evaporative heat loss via sweating in order to observe changes in the respiratory heat dissipation. The ambient temperature was set at 35°C, similar to the resting skin temperatures reported by Naylor *et al.* [157] and similar to the expired air temperature of 34°C estimated by Hodgson *et al.* [92]. The set point of the laboratory humidifier was set as high as possible in order to maximise the relative humidity and therefore prevent sweat evaporation. Measured relative humidity in the laboratory was in excess of 85%.

There were significant differences in the respiratory heat loss between the TN and HH environmental protocols. The primary reason being the reduced vapour pressure gradient between the respiratory tract and the atmosphere in the HH conditions. During the warm-up and the initial part of the exercise to fatigue stage of the HH trials, the horse was gaining heat from the environment, thus indicating a negative vapour pressure gradient despite the pulmonary artery temperature (central venous temperature) being higher than

that of the environment. (Pulmonary artery – environmental temperature = ΔT = 3.4° at the start of the high intensity exercise). As exercise progressed, and the central venous temperature increased, the rate of heat gain reduced until there was equilibrium. With further exercise and temperature elevation, sufficient vapour pressure gradient mediated respiratory heat loss. Schroter and Watkins [179] indicated that the expired air is at least 85% saturated, and Hodgson *et al.* estimated the expired air temperature to be approximately 34°C [92]. The HH trial was conducted in conditions where the environmental relative humidity of 85% and the temperature was 35°C. These data indicate that the evaporating surfaces of the respiratory tract may be in the conducting airways and not the lung itself, the lung temperature would be very similar to the temperature measured in the pulmonary artery. Heat exchange has been previously described as occurring in the upper respiratory tract [100] as opposed to the lung. Evaporation from the lung surface would upset the fluid balance of the lung surfactant and mucosa and therefore the gas exchange. Evaporation occurring in the upper airways humidifies the inspired air prior to the air reaching the lung.

The heart rate at fatigue was significantly elevated in HH compared to TN. Cardiac output was slightly depressed, but due to high variability in measurements, was not significant. The increased heart rate with the cardiac output unchanged implied that the stroke volume is decreased. The animal subjected to heat stressed conditions is shunting blood to other parts of the

body to aid heat dissipation. As a result the venous return would be depressed, but the animal responds with a need to maintain cardiac output by increasing heart rate with a decrease stroke volume. The shunting of blood has been described by McConaghy *et al.* [145]. They reported increased blood flows to tissues for heat dissipation in resting ponies when exposed to heat without compromising the perfusion of other tissue beds. Similar observations have been made in human athletes, Noakes [159] described blood pooling in the large vascular beds of the locomotory muscles in endurance athletes performing in the heat. McConaghy *et al.* [145] also indicated that animals with a high exercise capacity have capacity to increase cardiac output to aid heat dissipation without compromising the perfusion of other tissues. However, as the temperature of the cutaneous tissue increases, the reduction in cutaneous vasomotor state reduces the total peripheral resistance and therefore the blood pressure. The reduction in blood pressure, observed by McConaghy *et al.* [145] reduces the venous return and ultimately there is a reduction in cardiac output. Whittow [205] also described a reduction in the arterial blood pressure of the ox during heat stress as a result of a decrease in total peripheral resistance. The horse's ability to increase its cardiac capacity to meet its metabolic, locomotory and heat dissipative needs has been described [141,145]. These studies however, describe ponies at rest in mildly hot environments and horses exercising in low heat stress conditions. Rowell [172] indicated that the skin must be relatively vasoconstricted during intense exercise in the heat because of insufficient blood volume to perfuse the

cutaneous and locomotory tissue beds adequately. The present study was conducted on horses exercising near maximally in an extreme hot-humid environment. Without the responses described by Rowell, the central blood volume could decrease to levels resulting in circulatory collapse. The responses described could be a further reason for fatigue, where the fatigue is a mechanism to restore the metabolic circulatory demands to within the limits of cardiac capacity.

The lower rectal temperature during the HH trial is probably further indication of inadequate blood volume in circulation. The concept that the hindgut of the horse is a heat sink has been described previously [92,127]. The initial elevated rectal temperature was probably due to the 2-hour acclimatisation period the horses spent in the laboratory at the elevated temperature prior to the start of the exercise tests, however the depressed rectal temperature during the subsequent exercise could be ascribed to sympathetic shunting of blood away from the gastro-intestinal tract.

The significantly elevated pulmonary artery temperature during the HH trial is an indication of the heat storage as a result of the compromised heat loss. The increased temperature does, however, increase the vapour pressure of the evaporating surfaces of the respiratory tract. During exercise the temperature of the respiratory tract is generally higher than the temperature of the skin, thus creating a greater vapour pressure gradient and therefore creating an

avenue of heat dissipation when all other avenues are compromised.

The heat exchange by other avenues (radiation, convection and conduction) and storage by the body was not considered in this trial. The radiative, convective and conductive avenues of heat exchange are relatively insignificant when compared to the metabolic heat loads and the evaporative components of heat exchange. Since the experiments were conducted in an environmentally controlled laboratory, it was assumed that the heat loss by radiation and convection was similar and that there were no differences between the trials. Estimates of the heat storage were not made in this study due to the short duration of the exercise protocol. Previous heat storage estimates [92,127] have used rectal temperatures after at least 20 minutes of exercise when the rectal temperature has equilibrated with the core body temperature.

The method used for calculating heat loss from the respiratory system was simpler and less invasive than the carotid – pulmonary artery temperature difference technique described previously [92]. Respiratory heat loss during the high intensity exercise phase of the trials under thermoneutral conditions published by Lund *et al.* using the invasive technique was 1095 ± 269 kJ which was not significantly different to the 878 ± 141 kJ in the current study.

In conclusion, respiratory heat loss from horses exercising in TN and HH

environments was measured and compared. Respiratory heat loss was significantly compromised during the exercise in the HH trials. The rate of heat dissipation did, however, increase as exercise progressed during both environmental conditions. Metabolic rate was significantly higher during exercise in the HH trials which may indicate a higher work-load required to dissipate the heat in stressful conditions. Measurements of heart rate and cardiac output indicate that the horse is redistributing blood flow in order to aid heat dissipation.

ACKNOWLEDGEMENTS

We acknowledge the technical assistance of Robyn Morris, Kim Stevens, Patrick Martin, Gavin Collyer and Clifford Matjiane. We must also thank Cassandra, Escarpment, Hula Hula, Silkwood and Zola Zee for their contribution to the study. This project was conducted under the auspices of the Equine Research Centre as project number ERC 96/03 and we would like to thank the Equine Research Centre, the Gauteng Provincial Administration, the Highveld Racing Authority and the University of Pretoria for their support.

CHAPTER 6

DESIGN AND CONSTRUCTION OF A SIMPLIFIED ULTRASONIC AIR FLOWMETER

ABSTRACT

The design and construction of an ultrasonic flowmeter are described. The mean velocity of the airflow through the flow tube is determined from the interval between successive pulses being transmitted from the transmitting transducer to the receiving transducer. The frequency of transmission is dependent on the diameter of the flow tube and the velocity of the airflow through the tube. The flowmeter system consists of the control electronic circuitry and the flow tube. The former consists of the power supply, the logic control circuit and the signal-processing computer. The flow tube consists of a constant diameter tube (length 300mm, diameter 110mm) and a sound transmission channel with two capacitive ultrasonic wide-band transducers. The air flowmeter had an extremely fast response and was accurate over a wide flow range (bi-directional from 0 to 150 ℓ /s).

INTRODUCTION

Flowmeters are instruments that measure the instantaneous flow rate in gas streams. Although the flowmeter measures flow rate, they can also be used for measuring absolute volume changes (in the case of respiratory physiology, changes in lung volume) by integrating the flow signal. In contrast to systems like mechanical spirometers, the open flowmeter systems are relatively non-obstructive to the respiratory flow. Furthermore in the case of horses, even the more commonly used Fleisch heated pneumotachographs are relatively restrictive to the large respiratory flow volumes.

Horses can typically generate respiratory gas flows of the range of 80 ℓ/s [7], this is significantly above the range of conventional flowmeters. The respiratory frequency of exercising and thermally stressed horses can typically exceed 120 breaths per minute (2 Hz) [209]. Further complications to the accuracy of pneumotachometers is the variation in the viscosity and density of the inspiratory and expiratory gases.

For an accurate computation of volume changes, the sensitivity and the flow meter system have to be stable over long periods. This demands bi-directional flowmeters that are not influenced by changes of gas temperature, gas composition, humidity and viscosity. Furthermore, the system should have large dynamic range. In addition, the demand for a good frequency response

becomes apparent. Experiments with high frequency ventilation, the measurement of breathing dynamics, and the measurement of acoustical impedance of the lung thorax system by spectral analysis of forced random noise, need a flow metre with a linear frequency response up to 50 - 100 Hz.

The most popular flowmeters for physiological research are the following devices.

Linear resistance or Fleisch pneumotachograph: A fixed resistance in the gas flow causes a pressure drop related to the value of the volume flow. The dynamic range of the devices is limited by the requirement of laminar gas flow. Turbulent flow results in a non-linear relationship between pressure drop and flow. Owing to the requirement of a dynamic range up to 150 ℓ/s per second for measurements in horses and the resistance that these flowmeters present this system is not suitable.

Mechanical vane or turbine devices: Owing to the significant mass of turbines and vanes, the latter tend to react rather slowly on changes in gas velocity. Moreover, they depend strongly on the density, viscosity, and humidity of the gases respired.

Thermal dissipation devices: they are based on thermistors or heated resistance wires that are convectively cooled by the flowing gas. The computation of the gas flow is based on complicated time functions of the sensor's temperature, gas temperature, gas density, humidity, and specific heat. The velocity of the gas flow is only registered at a single point of the cross-

section and has to be extrapolated to the mean velocity. To measure bi-directional flows, two thermistors in a tandem arrangement are required.

In addition to these types of flowmeters there exist two different ultrasonic devices.

Vortex shedding: Vortexes are waves which may be generated in a fluid stream they are caused by a fixed vortex shedding object (bluff body) in the path of the flow stream. As the air passing off the bluff body moves down the flow tube, vortexes are created. An ultrasonic beam detects the rate of vortexes generated. The vortex principle is only suitable for unidirectional flow measurement.

Time of flight measurement: The velocity of the airflow is calculated by measuring the changes in transit time of an ultrasonic signal propagated across a respiratory tube. Various ultrasonic devices of this type have previously been presented [28,209]. Beadle *et al.* [13] characterised a density corrected ultrasonic pneumotachometer for horses. The principle of operation was by measuring the time of flight both upstream and downstream directions. The density of the air is determined from the average time of flight, and the flow, determined from the difference between the up and downstream times of flight can be corrected for changing air density. This solution thus overcomes the earlier discussed shortcomings of other flow measuring devices with an inability to compensate for changes in gas density.

The flowmeter presented here belongs to the latter type of ultrasonic devices. However, this flowmeter is used in conjunction with an open circuit flow through calorimeter [126]. The calorimetry system has an overall bias flow of approximately 100 ℓ/s , thus the flow through the ultrasonic flowmeter (situated at the intake to the horse's mask) would be unidirectional, and therefore have a continuous gas density (laboratory air) flowing through it. The density correction component of the flowmeter described by Beadle *et al.* [13] could thus be eliminated. The flowmeter described below is thus simpler in design and construction than similar ultrasonic devices, however in simplifying the design the operation and frequency response has not been compromised. In evaluation we compared our ultrasonic flowmeter to a differential pressure flowmeter.

PRINCIPLE OF OPERATION

Ultrasonic flowmeters of this class are based on the principal that sound, travelling through a streaming medium, is sped up or slowed down by the movement of the medium. This causes, for a fixed distance across the medium, a decrease in the down stream transit time and an increase in the up stream transit time. The changes in transit time can be related to the flow velocity.

For the measurement of “direct time of flight,” the flowmeter presented uses two ultrasonic transducers, T1 and T2 (Figure 6-1). The transducers are mounted in recessed wells on the opposite sides of the tube. The angle of incidence of the transducers to the flow axis is 45°. An ultrasonic pulse is emitted from one of the transducers. The pulse is received by the second transducer and processed which initiates the emission of the next pulse from the first transducer. The frequency at which pulses are emitted from the first transducer is related to the flow velocity. The inverse of the frequency, the interval, is therefore the time of flight of the ultrasonic wave across the flow tube. The downstream and upstream transit times (t_d , t_u) are

$$t_d = \frac{L}{c + u \cdot \cos(\beta)}; \quad t_u = \frac{L}{c - u \cdot \cos(\beta)}$$

where L is the length of the sound transmission path, u is the mean flow velocity along the sound path, c is the sound velocity, and β is the angle between the transducer- and the flow-axis.

OPERATION OF THE SYSTEM

The flowmeter consists of a control system and a separate flow head. The operation can be explained with the aid of a block diagram (Figure 6-1) and description of the operations that are executed during one measuring cycle of <1 ms: a burst of ultrasonic noise initiates the operation of the whole system. The initial noise is received by the receiving transducer, T2 and starts a cycle

by triggering the digital pulse generator. The latter consists of two non-retriggerable monostable multivibrators with individually adjustable time constants. The first of these non-retriggerable monostable multivibrators is used to create a window preventing extraneous noise and subsequent signals from the transducer from triggering the signal generator. The time constant of this multivibrator is set longer the transducer ringing decay and to less than half the estimated time of flight of the signal across the flow tube. The second multivibrator controls a timer/pulse generator that supplies the signal via a transformer to the transmitting transducer. The two multivibrators are connected in series, however operate in parallel, i.e. the incoming signal causes both the multivibrators are activated simultaneously and prevents multiple triggering of the signal generator until the front of the transmitted burst is expected by the receiving transducer (Figure 6-1). The output signal is a square wave pulse train with a duration of $20\mu\text{s}$ and having a centre frequency of 120 kHz. After the third pulse, the signal generator is switched off. The resulting amplified pulse train (burst) is transmitted to the flow head via a screened cable that connects the flow head to the control unit.

The burst is emitted from T1 across the flow tube to T2. The incoming signal retriggers the two multivibrators thus creating a singing of the transducers. The frequency at which the signal generator is triggered is directly proportional to the flow velocity in the tube.

The pulse train generated and transmitted arrives at the receive transducer. An operational amplifier amplifies the received signals. This amplifier is protected against the high voltage pulses by a clamp circuit with a current limiting resistor.

The signal at the output of the amplifier has a couple of parts; firstly, the received pulse (Trace 1: Figure 6-5); approximately 600 μ s after the emission at the opposite transducer (Trace 3: Figure 6-5), and secondly, the spurious reflections of the ultrasonic pulses (Trace 1). The non-retriggerable monostable multivibrators (Trace 2: Figure 6-5) prevent these reflections and echoes from having a deleterious effect on the performance of the flowmeter by creating a silent window once the front of transmitted signal has been received.

The sampling frequency is governed by the singing frequency of the transducers across the flow tube. The flow tube diameter is 110 mm, and the transducer's angle of incidence to the tube is 45°. Therefore the ultrasonic path length is approximately 160mm. Thus the time of flight for the burst of ultrasound is 1 mS, and the baseline firing frequency of the signal generator will be approximately 1 kHz.

The frequency is measured with a counter timer. A counter timer board (DAS20, Keithley Metrabyte, USA) was installed into a PC. The period of the

signal was averaged over 5 pulses, thus the sampling frequency was approximately 200 Hz and the measured frequency was converted to a voltage (0-10V).

CONSTRUCTION OF THE FLOWHEAD

A cross-section of the flowhead-constructed of PVC plastic-is shown in Figure 6-4. The two ultrasonic transducers (Sensor Technology, Mattek, CSIR, Pretoria, South Africa) *T1* and *T2* (diameter 20mm, length 25mm) are mounted in the obliquely attached tubes. The transducers are acoustically isolated from the body of the flow tube by mounting with two 20mm diameter O-rings (see Figure 6-4). The control circuitry is contained in a metal shielded case which is attached the body of the flowhead.

The inner diameter of the flow tube was lined with fine plastic gauze (1.5mm mesh), thus covering the transducer wells and maintaining a circular cross-section of the tube over its length. This prevented turbulence of the airflow and thus minimised any spurious ultrasonic sound reflections. An absorbing layer of polyester felt attenuated multiple reflections of the ultrasonic pulses. (Smith-Kline Beecham, South Africa)

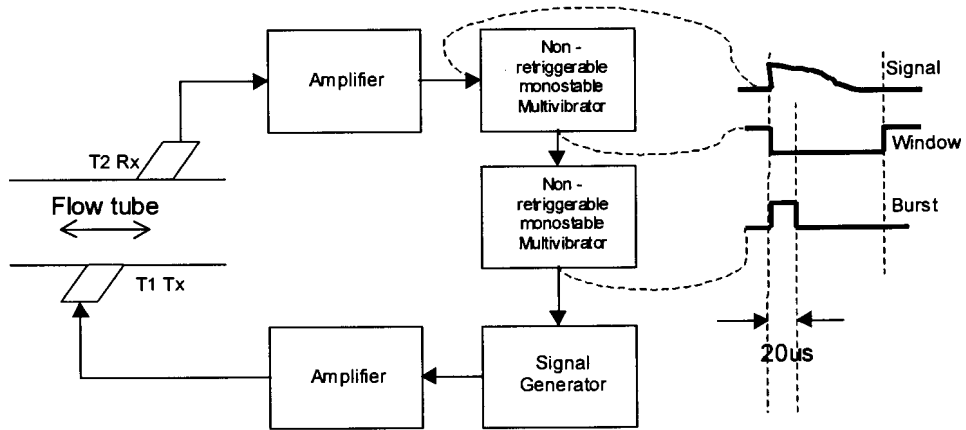

Figure 6-1 Block diagram of the ultrasonic air flowmeter system

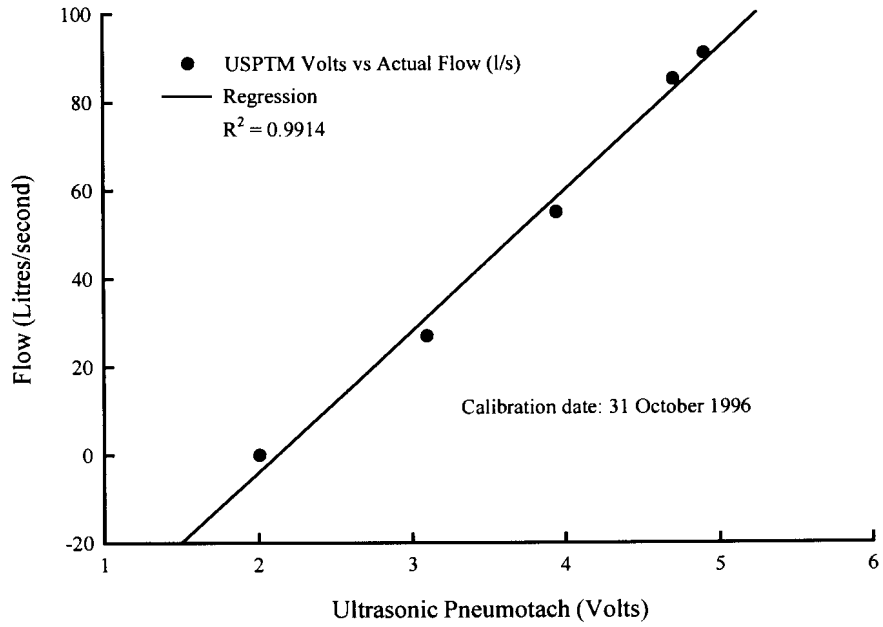

Figure 6-2 Relation of output voltage and air flow

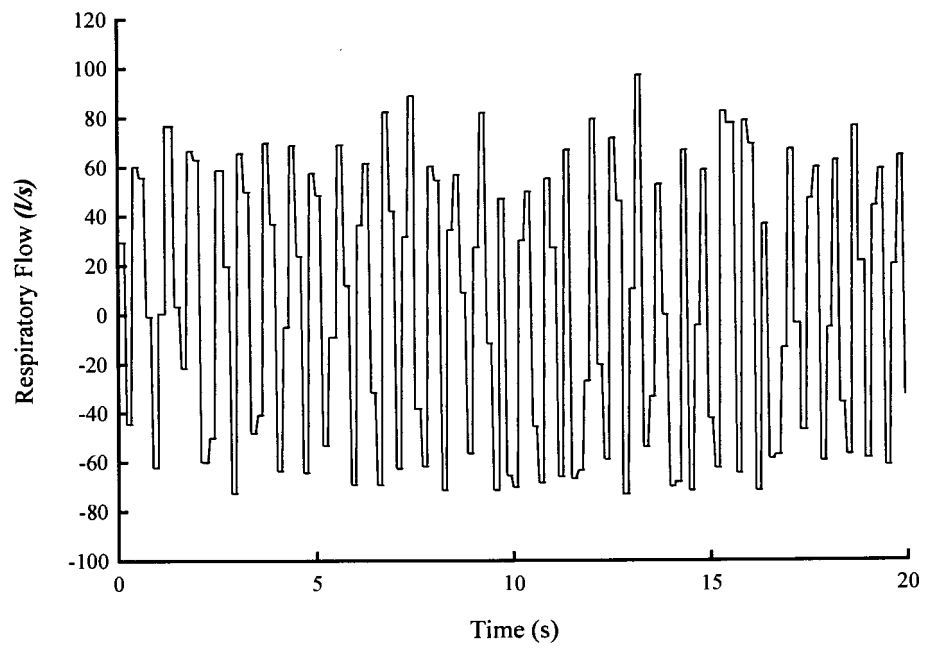

Figure 6-3 Respiratory gas flow trace from a horse galloping on a treadmill

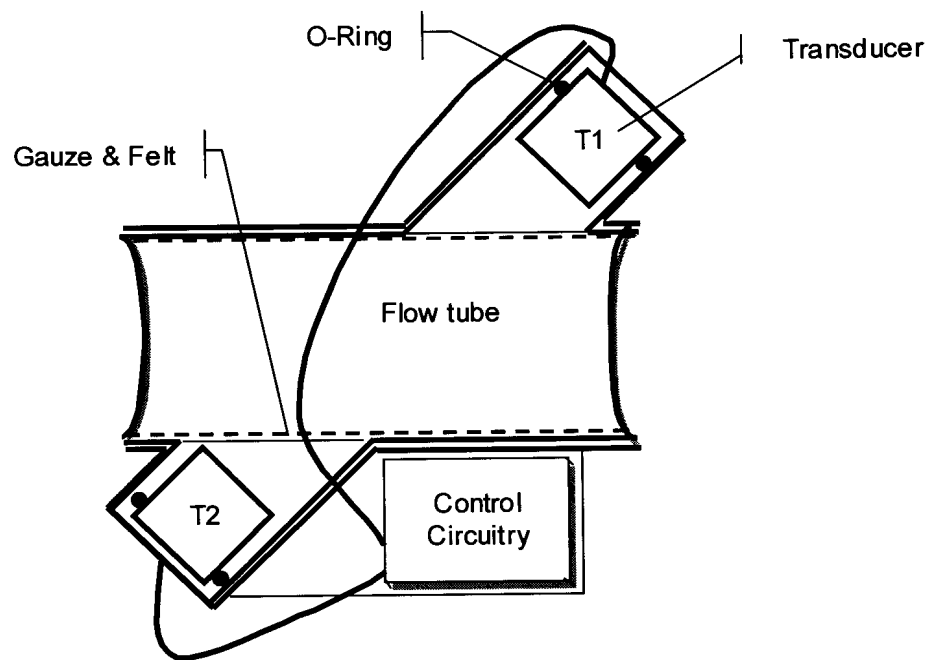

Figure 6-4 Cross section through the flowhead. Diameter of the respiratory tube is 110 mm.

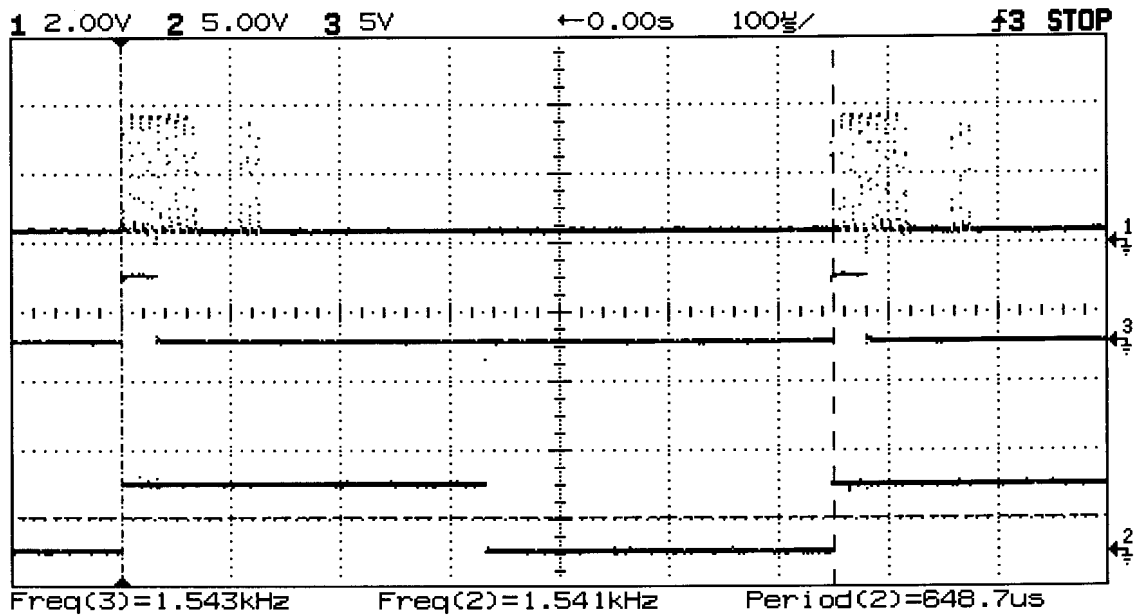

Figure 6-5: Oscilloscope image of the output of 1. the signal received by the transducer; 2. the non-retriggerable monostable flipflop output preventing multi-triggering of the multivibrator; and 3. the burst triggering the multivibrator.

MEASURING RESULTS AND DISCUSSION

The ultrasonic flowmeter was evaluated in comparison to a differential pressure pitot tube flowmeter (Model No. 11A, Meriam, USA). The differential pressure was measured using a piezoresistive transducer (Model No. 163PC01D48, Honeywell Microswitch, USA). The sampling rate of the microcomputer interfaced with the ultrasonic flowmeter was 200Hz. The sampling rate of the ultrasonic flowmeter itself is governed by the time of flight of the signal across the flow tube and not related to the microcomputer sampling rate. (It was approximately 1 kHz.)

Linearity

The linearity of the flowmeter was measured by connecting the ultrasonic flowmeter in series with the pitot tube flowmeter. The Pitot tube flowmeter had been previously calibrated [126]. Air was drawn through the two flowmeters using a centrifugal fan; the flow of which could be restricted by means of a ball valve. The airflow incremented in a step-wise manner with increments of 25 ℓ/s . The output voltage from the ultrasonic flowmeter were plotted against the calibrated readings from the pitot tube flowmeter and is presented in Figure 6-2.

The ultrasonic flowmeter described in this chapter showed a linear response over the tested range ($R^2=0.99$).

Frequency Response

The frequency response of the ultrasonic flowmeter presented here was not specifically measured. However, the frequency response of other similar flowmeters has been described and we can draw conclusions from those.

Beadle *et al.* [13] investigated the frequency response of an ultrasonic flowmeter to sinusoidal variations of flow with frequencies from 2 to 32 Hz using techniques described by Jackson and Vinegar [102] and Renzi *et al.* [165]. They reported an increase in the phase angle difference and a decrease in the amplitude as the frequency was increased. They were able to correct the response digitally. The ultrasonic transmission frequency (measuring cycle frequency) of their ultrasonic frequency was 122 Hz.

Buess *et al.* [29] reported a linear frequency response up to frequencies of 30 Hz, which is above the expected maximum working respiratory frequency of the flowmeter. The measuring cycle frequency of their flowmeter was between 500 and 625 Hz.

The measuring cycle frequency of the flowmeter that is presented here is the same as the singing frequency of the transducers, which is approximately 1kHz. This frequency is above the cycle frequency of Beadle *et al.* by more than 8 fold and above that of Buess *et al.* by nearly two fold. Since the flowmeter of Buess *et al.* reported a frequency response that was improved

over that of Beadle *et al.*, one could safely assume that the frequency response of the ultrasonic flowmeter presented here is linear.

Stability and Reliability

Absolute respiratory gas volumes, tidal volumes and minute ventilation are computer by digital integration of the flow signal. Stability of the flowmeter output signal is essential for the reliability of these computations. A drifting baseline leads to errors in the volume computations with increasing time duration. The design of the flowhead is important to avoid temperature drifts. The control circuitry can cause heat accumulation and therefore lead to errors.

The baseline (zero flow) of the flowmeter is stable within 1 bit (corresponding to a flow of 200 ml/s), when the flowhead temperature is stabilised. There was a shift of the baseline of between 3 and 5 bits as the temperature of the flow head stabilised from room temperatures of 20°C to laboratory working temperatures of 30 °C. The changes with the change in temperature are probably due to the thermal expansion of the flow head and variation in the response of the transducers.

A typical respiratory flow trace from a galloping horse is shown in Figure 6-3. The signal of the trace is remarkably clean and free spurious spikes. Data collected during the flow measuring cycle is written to a data file for integration of volumetric flow data.

CONCLUSIONS

In comparison to other ultrasonic flowmeters, the design and operation of flowmeter presented in this chapter is simple and robust. The simple design allows scaling of the flowhead according to the application without any change to the control circuitry.

Despite the simplicity of the design, it has been shown the performance and accuracy of the flowmeter is comparable with other more complex units.

CHAPTER 7

RESPIRATORY ADJUSTMENTS DURING EXERCISE IN HOT-HUMID ENVIRONMENTS TO AID HEAT LOSS IN THOROUGHBRED HORSES

ABSTRACT

The present study was undertaken to quantify the means that the horse is able to recruit in order to mediate greater respiratory heat loss when other avenues of heat loss are compromised. The horses performed repeated bouts of exercise at 550 metres/minute under two environmental protocols (30°C - 35%RH and 30°C - 85%RH). This intensity was below $\dot{V}O_{2\max}$, therefore allowing a sustained steady bout of near-maximal exercise. There were significant increases in the stride frequency, respiratory frequency and minute volume, and a significant decrease in respiratory heat loss during the exercise under the hot-humid conditions. The end expired gas temperature, oxygen consumption and pulmonary artery blood temperature were also elevated during the exercise under the hot humid conditions.

This study showed that during identical bouts of near maximal exercise under environmental conditions where only relative humidity was increased, the horse is able to shorten stride length to increase respiratory frequency and

therefore increase minute volume. The increased minute ventilation is associated with an increase in the gas flow in the airways, which results in a greater rate of evaporation and therefore heat loss. The higher trachea gas temperature, probably as a result of the increased systemic blood temperature helps create a vapour pressure gradient to allow increased heat dissipation.

INTRODUCTION

The balance between the rate at which heat is generated metabolically, and the rate at which heat can be exchanged with the environment [153] governs body temperature of any animal. Thermoregulation is probably the most important regulatory mechanism in homeothermic animals [141]. Physical work has the greatest influence on the metabolic production of heat. Metabolically produced heat is primarily dissipated to the environment by evaporation of sweat, and via the respiratory tract of the animal [92]. Exchange of heat with the environment is determined by the prevailing ambient conditions. Hot and humid conditions, particularly, can markedly affect the dissipation of heat to the environment [133,134,153,177].

The equine athlete is capable of sustaining high metabolic rates for prolonged periods [126,169], and combined with its relatively low surface area to body weight ratio [92] (one third of that of the human athlete), the horse is predisposed to thermal distress. When the climatic conditions begin to differ markedly from the cooler climates of the horse's origin, its thermoregulatory function is challenged to extremes [127,153]. The modern equine athlete (racing or sporting) is often expected to travel the world to compete under climatic conditions that could lead to life threatening hyperthermia [6,203].

Mostert *et al.* [153] (Appendix A) developed a mathematical model of the thermal response of the exercising horse. This model, although thorough, deviated from experimental data when exercise progressed longer than a few minutes. Lund *et al.* [127] (Chapter 4) have presented studies reporting the role of warm up on thermoregulation. This study and the mathematical model have shown that the two most significant heat dissipation mechanisms in the horse are evaporation from the respiratory system and evaporation of sweat. Respiratory heat loss has been reported to increase with prolonged exercise [92], yet the respiratory component of the model, which was derived from human data [88], does not allow for this trend. The deviations of the mathematical model from the observed experimental data indicate that the shortcomings of the model may be due to the respiratory component of the model being inadequately described. The means by which the horse mediates respiratory heat loss mechanism has not been fully described previously.

It has been suggested that the horse can make adaptations to enable increased respiratory heat loss when the environmental conditions compromise the evaporation of sweat. It is thought that the reported increase in respiratory heat dissipation observed during prolonged exercise is due to heat accumulation as a result of inadequate heat loss by evaporation of sweat.

The objective of this study was to quantify the means that the horse is able to recruit in order to mediate greater respiratory heat loss when other avenues of heat loss are compromised.

MATERIALS AND METHODS

Experimental animals

Five thoroughbred mares aged 5 to 15 years and weighing 432 -514 kg [478 ± 11.7 (SE) kg] were used in the study. The horses were maintained in box stalls at night and conditioned with a program of walking, trotting, cantering and galloping for at least 3 months prior to the start of the study. For the final six weeks of the conditioning program the horses were exposed to standardised high intensity treadmill exercise three times a week. Initially this consisted of exercise for 5 mins at 7 m/s, 5 mins at 8.5 m/s and 5mins at 10 m/s. The intensity was gradually increased until the horses were exercising 5 mins at 7.5 m/s, 5 mins at 9.5 m/s and 8 mins at 12 m/s by the sixth week of training. The maximal oxygen uptake ($\dot{V}O_{2\max}$) of each horse was determined using a step-wise incremental protocol [126] on three occasions during the last two weeks prior to commencing the experiments. The mean $\dot{V}O_{2\max}$ of the 5 horses was 159.6 ± 4.28 (SE) $\text{ml}\cdot\text{kg}^{-1}\cdot\text{min}^{-1}$.

Experimental protocols

Two different environmental protocols were used for the experiments conducted with horses running on a high speed treadmill (Mustang, Switzerland) inclined at 7° at a near maximal speed of 9.1 m/s for 5 minutes. Each experiment consisted of a 5 minute warm-up phase of trotting at 3.3 m/s, followed immediately by the exercise at 9.1 m/s followed by 5 minutes of trotting at 3.3 m/s that represented a cool down and recovery phase. Immediately following the recovery phase, the horses were removed from the treadmill and sprayed with cool water until the body temperature dropped close to normal again. The environmental protocol was randomly assigned. The environmental conditions were i. hot dry (HD), where the laboratory was maintained at 30°C and relative humidity of 35% and ii. hot-humid (HH), where the temperature of the laboratory was maintained at 30°C and 85% relative humidity. During the exercise the air speed over the dorsal aspects of the horse was maintained at 7.5 m/s.

During each trial the following variables were recorded: $\dot{V}O_2$, respiratory heat loss, central venous temperature, rectal temperature, respiratory frequency, tidal volume, minute volume, end expiratory gas temperature, and laboratory temperature and humidity. Vapour pressure at the evaporating surface of the lung was calculated.

Measurement of Oxygen consumption

The oxygen consumption ($\dot{V}O_2$) was measured using an open circuit flow-through calorimeter described by Lund *et al.* [126]. The horses were acclimated to wearing the mask at least 3 months prior to the commencement of the study. $\dot{V}O_2$ was computed continuously in real-time from data collected and stored to a data file (MSExcel®) every 2 seconds.

Measurement of respiratory heat loss

The temperature and humidity of the air flowing through the calorimeter and the temperature and humidity of the inspired air was recorded by a computer. The enthalpy of the inspired and the calorimeter gases were calculated using known algorithms [195]. The change in enthalpy (kJ/kg) and the mass flow rate (kg/s) through the system were integrated with respect to time to determine the sensible and insensible respiratory heat loss.

Measurements of temperatures

The pulmonary artery temperature was measured using a thermocouple that was passed into a catheter that had been previously placed with the aid of a pressure transducer. The rectal temperature was measured by a custom made probe placed 30cm into the rectum. The thermocouples were connected via a series of signal amplifiers (Burr Brown, USA) to an Analogue-to-Digital board (Eagle Technologies, Cape Town) installed in a microcomputer (IBM-PC

compatible). Measured thermocouple voltages were converted to temperatures and stored to a database using purpose written software (Test Point, Capital Equipment Corporation, USA).

Measurements of laboratory conditions

An automatic weather data logger recorded all the laboratory environmental data. (Weather Monitor II, Davis Instruments, Hayward, CA, USA). The data was downloaded to a computer and incorporated into an MS-Excel® spreadsheet.

Measurement of tidal volume and minute volume

In order to determine the respiratory gas volumes while using an open circuit flow through calorimeter, a second flowmeter was required at the inlet of the mask on the horses' face. An ultrasonic flowmeter was designed and characterised for the purpose (Chapter 6). The existing mask used on the calorimetry system [126] was modified in order to i. have a single inlet and single outlet to accommodate the flowmeter, and ii. seal well onto the face of the horse in order to prevent air bypassing the flowmeter. Although the mask sealed onto the horse's face, the calorimeter was still an open circuit flow through. The output signal from the ultrasonic flowmeter was connected to the data recording system described above.

Measurement of end expiratory gas temperature and respiratory frequency

A purpose design cannula was manufactured from a 16-gauge needle. A suitable flange was brazed onto the Luer fitting of the needle in order to facilitate attachment to the horses' neck and the end of the needle was ground off to minimise irritation to the horse during exercise while the cannula was in place. The shaft of the needle (cannula) was curved in such a manner that the tip would be positioned in the centre of the lumen of the trachea.

The point of insertion was approximately 30 cm from the thoracic inlet of the animal. The site was aseptically prepared and a small stab incision was made through the skin using a No. 10 scalpel blade. A hole was made between the cartilage rings of the trachea wall using a 16-gauge needle. The cannula was inserted and strapped around the horses' neck in order to keep the cannula from moving. Once the cannula had been fastened, a 40-gauge thermocouple was inserted into the lumen of the cannula. The tip of the thermocouple protruded beyond the end of the cannula. The position of the thermocouple was verified by monitoring the thermocouple temperature with reference to the horses' respiratory rate while the horse was at rest.

The thermocouple was connected to the data recording equipment described above. Respiratory frequency was determined from analysis of the trachea temperature data following the experiments.

Calculation of the changes of the evaporative area and the vapour pressure at the evaporating surface of the respiratory tract

Respiratory heat loss is a function of vapour pressure gradient from the evaporating surface, air velocity over the surface and the area of the evaporating surface [153,177]:

$$\text{Respiratory Heat Loss (W)} = \text{Vel(m/s)} \cdot (p_s - p_a)(\text{mmHg}) \cdot A (\text{m}^2) \cdot (\text{J} \cdot \text{m}^{-3} \cdot \text{mmHg}^{-1})$$

where Vel is the tracheal air velocity, A is the area of the evaporative surface, p_s is the evaporating surface water vapour pressure and p_a is the ambient environmental water vapour pressure.

The vapour pressure of the evaporative surface was assumed to be equivalent to the vapour pressure of water and was calculated using techniques described by Goff and Gratch [71,72]. The evaporative surface temperature was assumed to be equal to the temperature of the pulmonary circulation and saturated. Any effects of the surfactants found in the lung and conducting airways were ignored. The area of the evaporative airways is unknown, however the relative changes of the evaporative area were determined from the equation presented above. Calculated values representing areas were corrected

to unity at 1 minute of the warm-up. The changes relative to this reference were presented.

Calculation of respiratory tract mean flow velocity and evaporative heat loss

Mostert *et al.* [153] described heat loss by evaporation of sweat from the skin of a subject as being related to the vapour pressure gradient and the velocity of the airflow over the subject, as follows:

$$H = 4.8 \cdot A \cdot (3.2127 + 1.922u) \cdot (p_{sk} - p_a)^{0.88} \text{ W}$$

Where A is the surface area, u is the air speed, p_{sk} is the skin water vapour pressure, p_a is the ambient water vapour pressure (mmHg). This relation to velocity has not been previously used to describe the evaporative heat loss from the respiratory tract. The mean velocity of the air in the trachea was calculated from the minute volume, assuming the trachea was 40 mm in diameter. The evaporative area of the conducting airways of the respiratory tract is unknown. The measured respiratory heat loss was compared to calculations of respiratory heat loss using the air velocity and the relative changes in evaporative area. A constant, determined from the error between the calculated and measured heat loss, was applied to the heat loss calculated during HH conditions to correct it to measured data.

Statistical analyses

Results were analysed by an analysis of variance for repeated measures [156] (RM ANOVA) using SigmaStat (Jandel Scientific Software, California, USA).

Where means were different, post-hoc multiple comparison analyses were made using the Tukey test [156]. Differences were considered significant when $P < 0.05$. The means and standard errors (SE) of results were reported.

Table 7-1: Means and standard errors of variables measured in 5 horses at rest, prior to a warming up, following warming up, after 5 minutes at 9.1 m/s and after 5 minutes recovery. Exercise was performed under hot dry (HD) (30°C, 35% RH) and under hot humid conditions (HH) (30°C, 85% RH). * indicates that means are significantly different at P<0.05.

Environment	Before Warm Up		Following Warm Up		At 5 min exercise		After 5 min recovery	
	HD	HH	HD	HH	HD	HH	HD	HH
$\dot{V}O_2$, ml/kg/min	54.6±1.0	55.4±2.5	60.1±1.3	68.1±2.4	154.7±8.0	161.6±7.0	73.1±0.7	73.1±6.9
Resp. Heat Loss, kJ	◆	◆	334.9±5.4*	73.8±6.9*	655.9±6.35*	277.9±5.65*	703.0±9.4*	278.4±12.8*
Pul. Artery temp, °C	38.59±0.21	38.65±0.35	38.92±0.20	38.94±0.23	41.18±0.33	41.82±0.15	40.29±0.61	40.99±0.68
Δ Pul. Art Temp, °C/min	-	-	0.12±0.08	0.07±0.36	0.40±0.08	0.59±0.02	-0.11±0.09	-0.23±0.11
Rectal Temp., °C	37.06±0.15	37.39±0.18	37.36±0.04	37.63±0.12	37.77±0.23	38.13±0.21	38.94±0.30	39.35±0.27
Resp. Frequency, /min	64.20±3.74	67.20±7.56	74.40±4.96	78.60±6.10	111.60±2.58*	115.2±1.80*	111.60±5.33*	137.40±4.59
Tidal Volume, ℓ	11.08±0.81	11.22±1.60	11.16±0.48	11.82±1.16	12.30±0.81	13.02±0.66	7.70±0.59	8.42±0.89
Minute Vent., ℓ/min	699.8±20.6	710.6±28.1	820.6±31.2	900.7±23.5	1407.1±131.2	1501.9±88.8	871.9±61.6*	1165.8±54.2*
End Exp. Temp., °C	35.46±1.42	35.60±0.90	35.13±1.04	36.50±0.42	34.69±0.83	35.2±0.47	34.30±1.34	36.23±0.63

Values are means ± SE. HD, Hot-Dry; HH, Hot-Humid; $\dot{V}O_2$, Oxygen uptake; Pul, Pulmonary; Resp, Respiratory; Vent., Ventilation; Temp., Temperature; Exp, Expiratory; ◆, Data not collected

RESULTS

Oxygen consumption.

There was rapid increase in $\dot{V}O_2$ at the onset of the near maximal exercise phase of each protocol. Although there was no significant difference in the $\dot{V}O_2$ values between the two environmental protocols, the hot humid $\dot{V}O_2$ measurements were elevated following the warm-up and at each stage of the near maximal exercise. Data for $\dot{V}O_2$ are presented in Table 7-1 and Figure 7-1.

Respiratory heat dissipation

On the basis of measurements of the change in enthalpy of the air drawn through the calorimetry system, there were significant differences in the heat dissipated from the respiratory system during each stage of exercise between the HD and HH environment. The total respiratory heat dissipated was significantly lower during all phases of exercise under the HH environment. (Table 7-1 and Figure 7-2).

Temperature responses to warm-up and exercise.

There were increases in rectal and pulmonary artery temperatures in the horses in response to exercise under both environmental conditions. These data after warm-up, during near maximal exercise and during recovery for each

environment protocol are presented in Table 7-1 and Figure 7-3. The rectal temperature was consistently elevated during the HH trial when compared to the HD trial, however there were no significant differences in the rectal temperatures between the two protocols.

The rate of increase of the pulmonary artery temperature is presented in Table 7-1. During the near-maximal exercise, the rate of increase during the HH protocol was elevated above that of the HD protocol, although this was not significant. During the recovery (cool-down) phase there was no difference in the rate of decrease between the two environmental protocols.

Changes in respiratory dynamics

There were significant changes in the respiratory frequency, minute volume and the respired air velocity. Values for these variables are presented in Table 7-1 and in Figure 7-4 and Figure 7-5.

The respiratory frequency, which during the near maximal phase of exercise is coupled with the stride frequency, was significantly elevated during the last two minutes of the near-maximal exercise under the HH conditions. During the recovery phase (3.3 m/s trot) the respiratory frequency was significantly elevated during the 3rd, 4th and 5th minutes and the trend was upward, while the trend during the last two minutes of the HD recovery was downward.

The tidal volume was elevated during the HH trial, and remained elevated above that measured during the HD trial for the entire trial duration. The minute volume was also elevated during every phase of the exercise protocol performed under the HH conditions. The minute volume was significantly elevated during the last three minutes of the recovery under the HH conditions.

The mean airway air velocity was significantly elevated during the last three minutes of the recovery phase of the HH protocol. The airway air velocity was also elevated during the last three minutes of near-maximal exercise, although this was not significant.

End Expired Gas Temperatures

The end-expired gas temperatures measured during each of the protocols are presented in Table 7-1 and Figure 7-6. At the end of warm-up phase the expired gas temperature was approximately 3°C below the pulmonary artery temperature. As minute volume increased during the near-maximal exercise, the end-expired gas temperature dropped markedly. During the near-maximal exercise the difference between the end expiratory gas temperature and the pulmonary artery temperature increased to greater than 6°C with the greatest increase being observed during the HH conditions.

Estimate of the relative change in the Evaporative Surface Area and Vapour pressure

The estimates of the vapour pressure of the evaporating surface under the HD and HH environments calculated from the pulmonary artery temperature are presented in Figure 7-7. The relative changes in the evaporative surface area are presented in Figure 7-7. The data presented indicated that during the exercise in the HH environment, the evaporative area increased earlier in the bout of exercise than during the HD environment.

Calculation of Respiratory Heat Loss

The respiratory heat loss calculated from the application of the formula presented by Mostert *et al.* [153] is presented in Figure 7-9 and compared to the measured respiratory heat loss (Figure 7-2).

The respiratory heat loss was calculated from the respired air velocity and the relative surface areas. The respiratory heat loss calculated during HH conditions overestimated the measured data by a factor of 2.4. After applying this factor, the heat loss calculated during the HH condition was similar to the measured data.

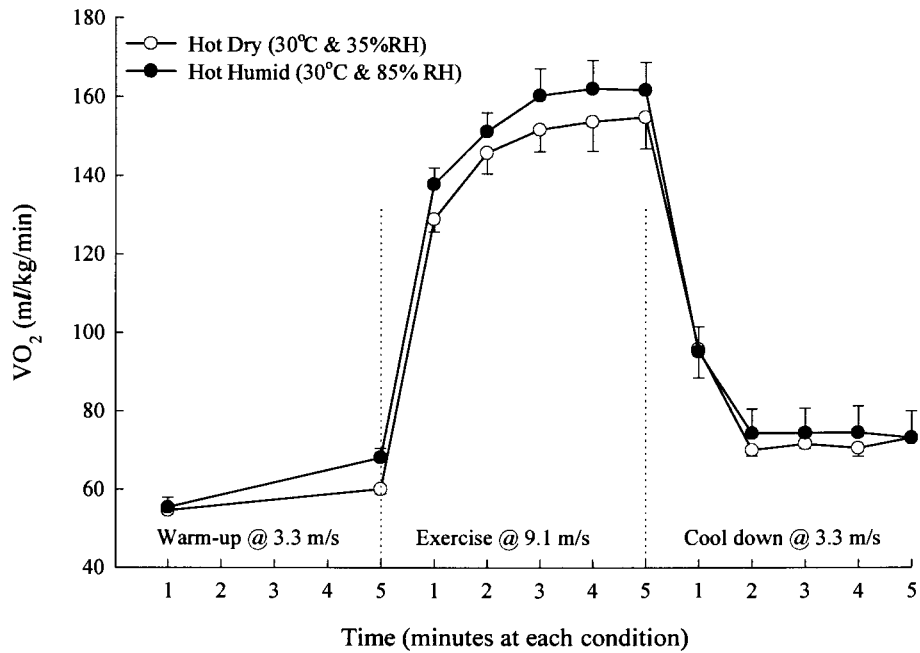

Figure 7-1: Means and SE of oxygen consumption of five horses during warm-up, near maximal exercise and recovery under hot dry (HD) and hot humid (HH) conditions.

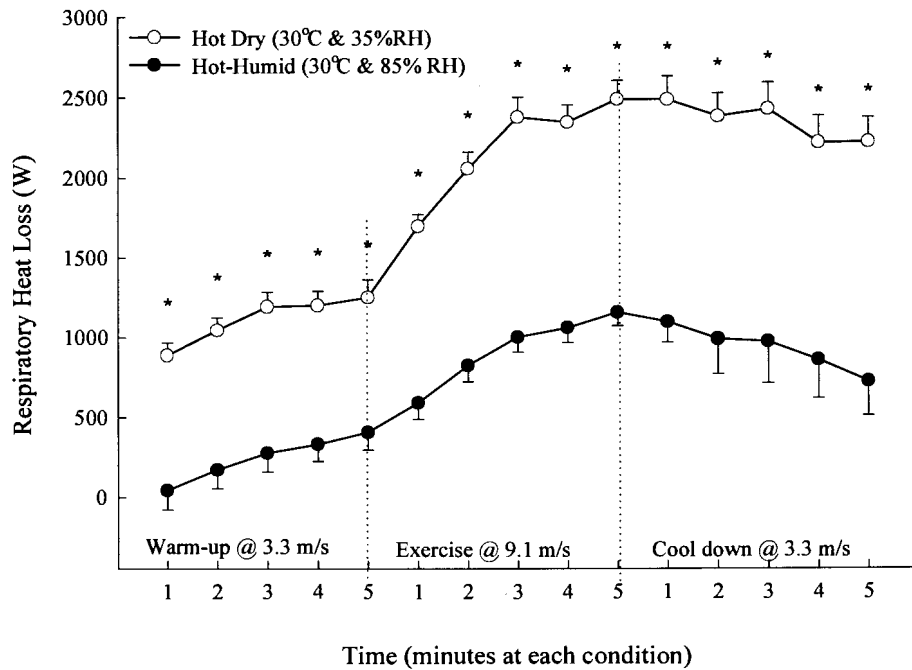

Figure 7-2: Means and SE of respiratory heat loss of five horses during warm-up, near maximal exercise and recovery under hot dry (HD) and hot humid (HH) conditions. * indicates values significantly different ($P < 0.05$)

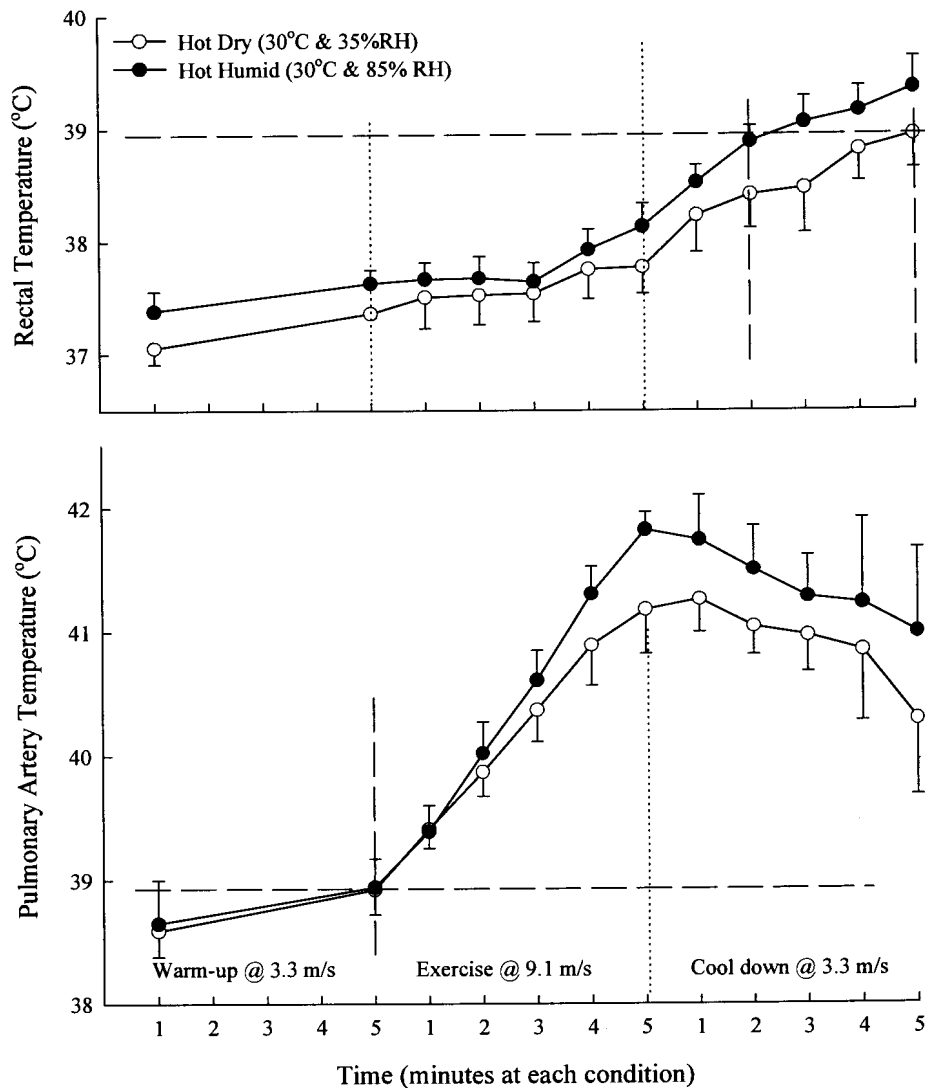

Figure 7-3: Means and SE of pulmonary artery temperature and rectal temperature of five horses during warm-up, near maximal exercise and recovery under hot dry (HD) and hot humid (HH) conditions. Long dash lines indicate lines used to determine the temperature lag between the pulmonary artery and the rectal temperatures.

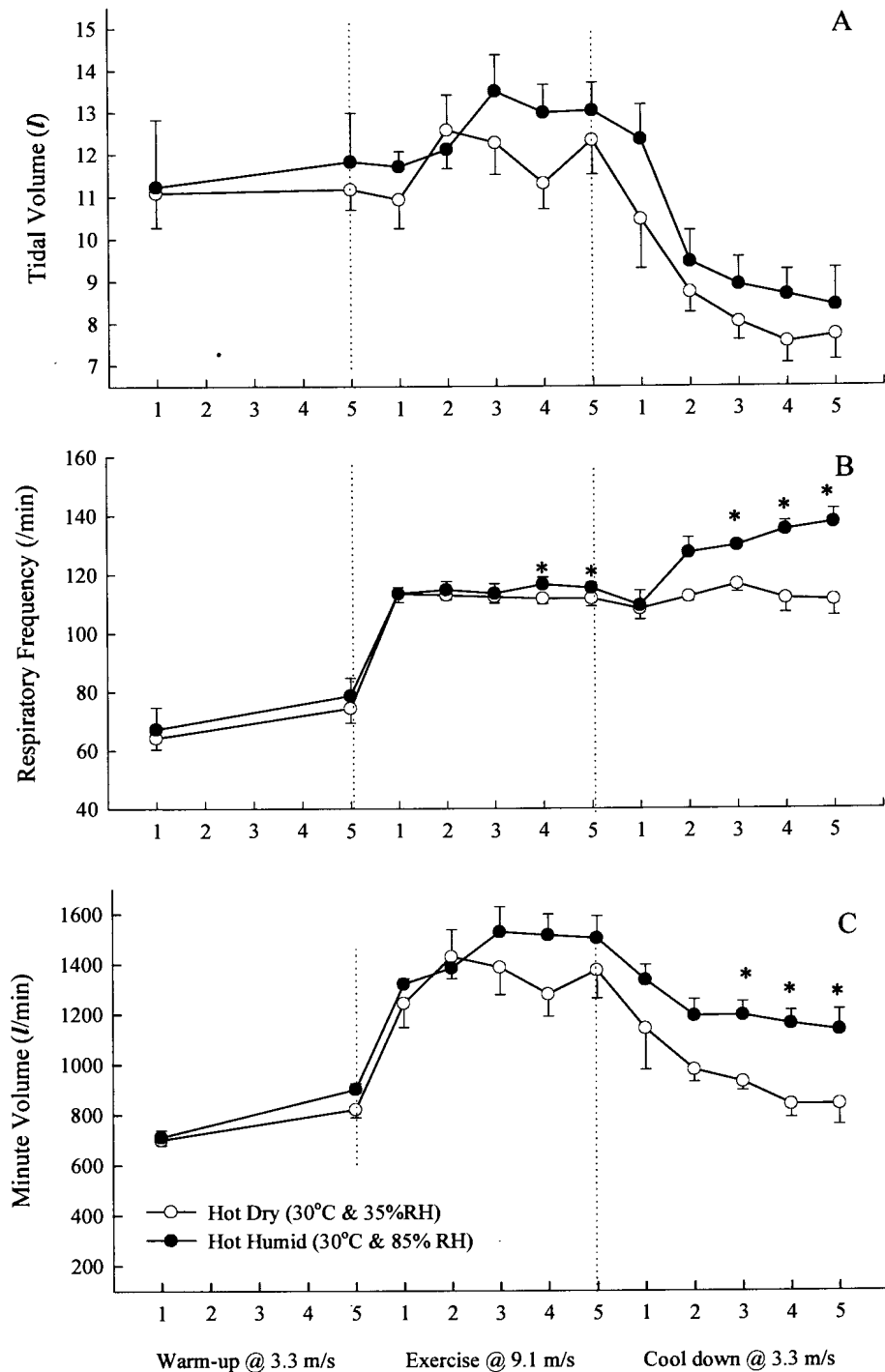

Figure 7-4: Means and SE of tidal volume (A), respiratory frequency (B) and minute volume (C) of five horses during warm-up, near maximal exercise and recovery under hot dry (HD) and hot humid (HH) conditions. * indicates a significant difference ($P < 0.05$).

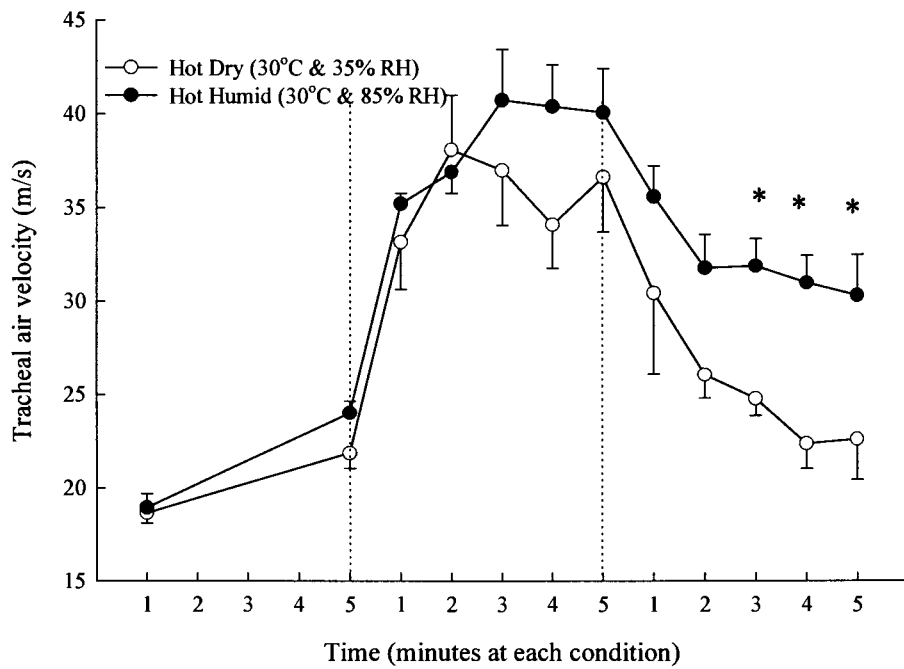

Figure 7-5: Means and SE of the tracheal air velocity of five horses during warm-up, near-maximal exercise and recovery under hot dry (HD) and hot humid (HH) conditions. * indicates values significantly different ($P < 0.05$).

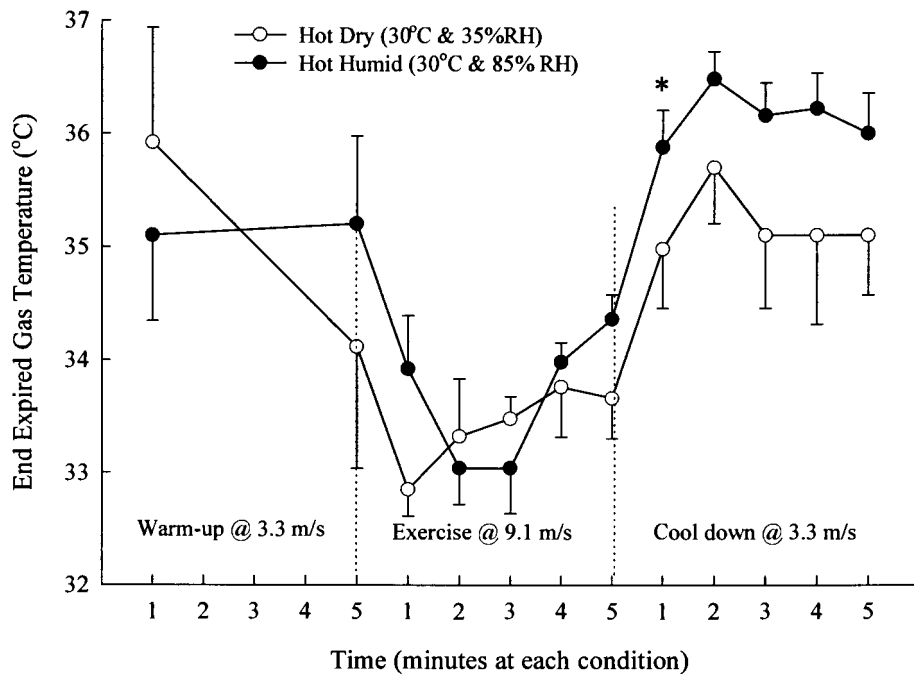

Figure 7-6: Means and SE of the temperature of the gas in the trachea measured at the end of the expiratory phase of the respiratory cycle in five horses during warm-up, near maximal exercise and recovery under hot dry (HD) and hot humid (HH) conditions. * indicates values significantly different ($P < 0.05$).

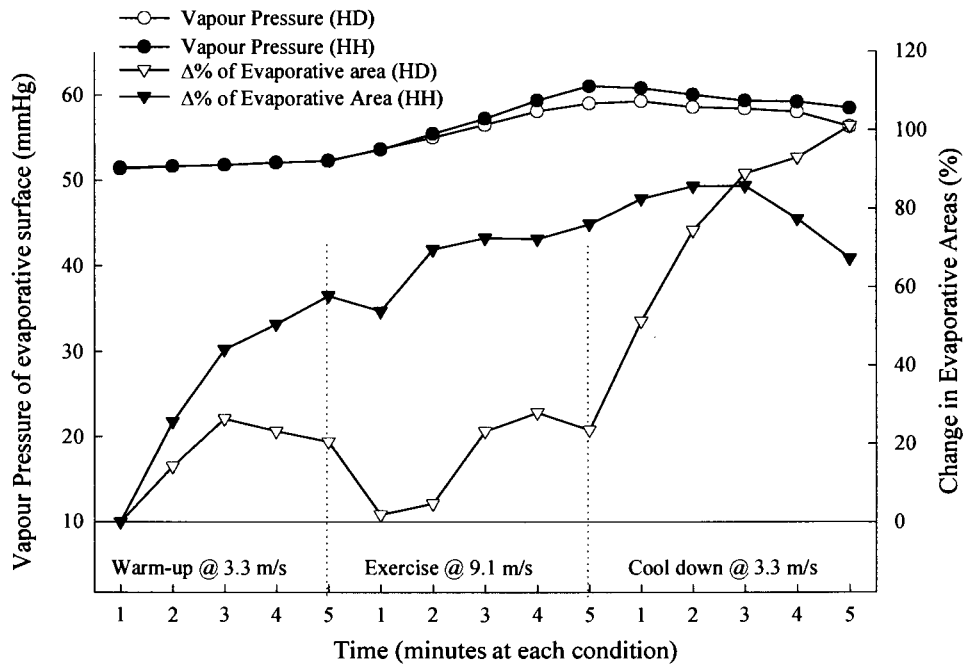

Figure 7-7: Vapour pressure of the respiratory tract evaporative surface calculated from the temperature of the saturated evaporative surface and the change in evaporative surface area relative to the area 1 minute after start of warm-up during exercise in hot-dry (HD) and hot-humid (HH) conditions.

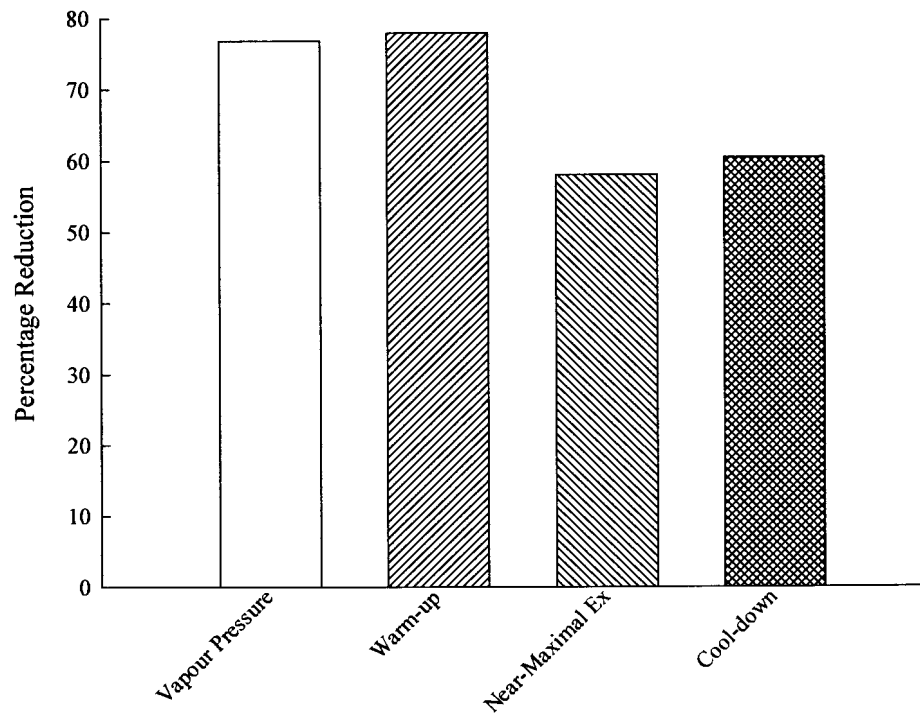

Figure 7-8: Comparison of the percent reduction from the HD (30°C & 35% RH) to the HH condition (30°C & 85% RH) of the vapour pressure capacity of the environment and the respiratory heat loss with each phase of exercise. (Vapour Pressure Capacity = $(p_{\text{Sat}} - p_{\text{Amb}})$)

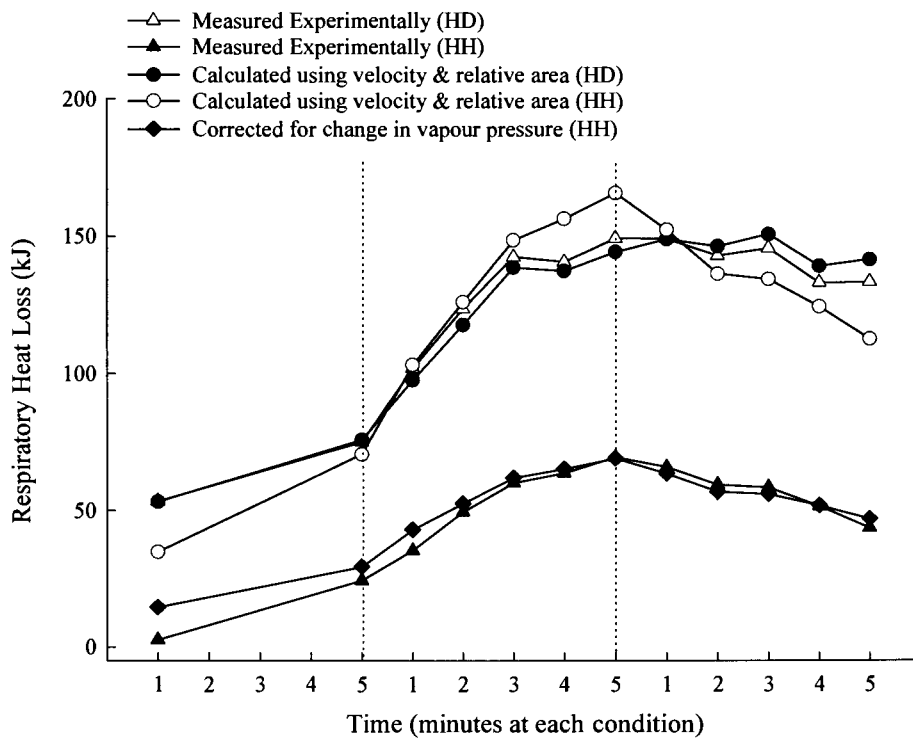

Figure 7-9: Comparison of measured respiratory heat loss from horses exercising during hot dry and hot humid conditions with the respiratory heat loss is calculated from tracheal air velocity and the relative surface areas of the evaporating surfaces. The calculated respiratory heat loss for the HH environment overestimated the heat loss when compared to the experimental data. This heat loss was corrected by applying a constant to the calculated data.

DISCUSSION

All athletic species are characterised by their high capacity for aerobic exercise. However, as the metabolic rate increases there is a concomitant release of metabolic heat. Unless this heat is adequately dissipated, life-threatening hyperthermia can develop. Evaporative heat loss is known to be the most significant avenue of heat dissipation. Sweat evaporation is the primary means, but evaporation from the respiratory tract is also significant. Thiel *et al.* [188] estimated that up to 20% of metabolic heat may be dissipated from the respiratory tract. Lund *et al.* [127] suggested that the respiratory heat loss component may change depending on the environmental conditions. The primary purpose of this study was to identify adaptations the horse may employ in order to increase respiratory heat dissipation when evaporative heat loss is compromised by hot-humid environments.

The results presented here indicate that under hot-humid environmental conditions, the athletic horse is able to significantly increase respiratory frequency in order to increase minute volume, thereby aiding the dissipation of heat via the respiratory tract. Although the respiratory heat dissipation was significantly reduced from the levels measured during HD conditions, the reduction observed was not as great as the reduction in the vapour pressure capacity (Figure 7-8). (Vapour Pressure Capacity = Saturation Vapour Pressure –

Ambient Vapour Pressure at the same temperature) This indicates the exercising horse may, to a limited degree, be able to adapt to the compromised evaporative heat loss found in hot-humid environments.

The intense exercise phase of each exercise test was performed at intensities below $\dot{V}O_{2max}$. This enabled each animal to complete this phase of the exercise test in a standard time and without severe fatigue thus enabling comparative analysis. The elevated oxygen consumption during the HH conditions, albeit not significant, is consistent with previous findings (Chapter 5). This elevation in oxygen consumption confirms the previously discussed [140] energetic cost of maintaining the body within its normal homeothermic limits. Thus under the stressful conditions present in the HH trial, the horse had to expend energy to dissipate the accumulated heat. There was a metabolic cost to increasing respiratory frequency. McConaghy *et al.* [145] showed that when ponies are subjected to stressful environmental conditions, they redistribute more blood to the respiratory muscles, indicating the metabolic cost of losing heat.

Respiratory heat loss changed with changes in exercise intensity. As the core temperature increased, along with the minute volume, there was an increase in the respiratory heat loss. Hanson [88] reported similar findings in human subjects where the evaporative and convective heat loss increased as minute volume and core temperature increased. The trials in the hot-humid environment, where the

vapour pressure gradient from the animal's respiratory tract to the environment was significantly reduced, resulted in significantly reduced respiratory heat loss. This heat loss was, however, significantly greater than the respiratory heat exchange reported in Chapter 5 where the ambient temperature was 35°C and the relative humidity was 85%. Lund *et al.* [127] postulated that when the environmental conditions limit evaporative heat loss from the skin (sweat evaporation), other evaporative means of dissipation may be enhanced, namely the respiratory function. The changes in the respiratory heat loss during each phase of the exercise during the two environmental protocols are presented in Figure 7-8. The change in the vapour pressure deficit between the two conditions is presented in the same figure. The decrease in the vapour pressure deficit was substantially greater than the decrease in the respiratory heat loss between the two environmental conditions.

The vapour pressure capacity of the environmental air during the HD trial (30°C & 35% RH) was 20.7 mmHg. During the HH trial (30°C & 85% RH) it was 4.7 mmHg. This equates to a 77% reduction in the evaporative heat loss 'capability' to the environment, all other variables being equal (Figure 7-8). This study indicates that the reduction in respiratory heat dissipation matched the change in environmental conditions during the warm-up, however, during near-maximal exercise and recovery the horse was able to adjust physiologically to improve respiratory heat loss. The reduction was 57% and 60% during the near-maximal

and recovery phases, respectively.

Metabolic heat produced during all intensities of exercise produced substantial changes in the metabolic status of horses. The warm-up phase of exercise in this study was conducted at approximately 40% of $\dot{V}O_{2 \max}$. Hodgson *et al.* [92] reported rectal and pulmonary artery temperatures following warm-up at 65% of $\dot{V}O_{2 \max}$ of 38.3 and 39.2°C, respectively. Lund *et al.* [127] reported a pulmonary artery temperature of 38.7°C following a South African racing warm-up of walking and cantering 400 metres. In the present study, the post warm-up temperatures were 38.92 and 38.94°C in the HD and HH trials, respectively. The rise in the pulmonary artery temperature during the near-maximal exercise has been reported previously [127] to be between 3.1 and 2.3°C depending on exercise duration. In the present study the increases during the near-maximal exercise were 2.3 and 2.9°C during the HD and HH trials, respectively. In the post exercise recovery the drop in the pulmonary artery temperature during the 1st five minutes were 0.89 and 0.83°C, respectively. This indicates that during the initial low intensity exercise the impaired heat dissipation under the HH conditions does not have a significant effect on heat accumulation, whereas during the near-maximal exercise the rate of heat accumulation is affected by the restricted heat dissipation.

The rectal temperature lagged the central venous circulation temperature during

the present study. Similar findings have been previously reported by Hodgson *et al.* [92]. The difference in the lag time was markedly different between the two environmental protocols (Figure 7-3). The rectal temperature reached a temperature approximately 10 minutes later than the pulmonary circulation during the HD conditions, whereas the lag time was approximately 7 minutes under the HH conditions (Figure 7-3). McConaghy *et al.* [145] showed that during heat stress, blood is redistributed to other heat dissipative tissue beds. The hindgut of the horse has a large heat storage capacity and heat can probably be shunted by means of the peripheral circulation when heat dissipation is compromised. The shorter lag time observed during the HH trials may indicate this phenomenon.

The changes observed in the respiratory dynamics, i.e. the respiratory frequency, the tidal volume and the minute volume, (Figure 7-4) may explain the higher than expected respiratory heat loss during the HH trial. The product of the frequency and the tidal volume produces the minute volume. There are two basic respiratory patterns that can be recognised and described by these two variables, thermal tachypnoea and thermal hyperpnoea. Thermal tachypnoea is characterised by high frequency and small tidal volume, in other words shallow breathing. This breathing pattern is similar to that observed during the recovery phase of exercise while the horse was trotting. It is generally confined to the respiratory dead space as the tidal volumes are small. By confining the

respiration to the dead space, the high minute volumes don't affect the blood-gas status of the horse, thus preventing the development of respiratory alkalosis. Thermal hyperpnoea is associated with moderate frequencies, but a larger tidal volume [136] and is normally observed in resting animals. In the galloping horse, however, the respiratory frequency is governed by the coupling with the stride frequency [68] and is relatively moderate when compared to the frequencies observed during the trotting recovery phase. The tidal volume, on the other hand, is significantly elevated during this mode of exercise, and these observations can be likened to thermal hyperpnoea. Although a significant increase in frequency was observed in this study, tidal volume changes have a greater influence on minute volume adjustments. Butler *et al.* [30] showed that the horse is able to control its tidal volume in response to metabolic demands independent of running speed. Art and Lekeux [8] reported the effect of environmental temperature and relative humidity on breathing patterns in ponies. They assumed a value of 85, the sum of the temperature (°C) and relative humidity (%), as the threshold between hot humid and cold dry conditions. (In the present study the HD environmental condition would be defined as cold-dry ($30^{\circ}\text{C} + 35\%\text{RH} = 65$). They did not find significant differences during the exercise phase, however during the recovery phase the tidal volume was lower, and the respiratory frequency and minute volume were higher in their study [8]. The exercise intensity and the thermal stress were significantly lower than during the present study, and therefore probably insufficiently stressful to generate the

responses observed in the present study. Later work by Art *et al.* [9] done under conditions similar to that of the present study indicated similar hyperventilation during the recovery phase following near maximal exercise.

Apart from aiding the respiratory heat loss when sweat evaporation is compromised, other arguments for hyperventilation have been published. Baker [10] discussed that when panting aids sweating, water loss is decreased, and probably more significantly, keeps the brain cool while allowing the body core temperature to rise. Baker has discussed the phenomenon of brain cooling in several species where the animal has a carotid rete. In the horse, a species without a carotid rete, the internal carotid artery runs through the cavernous sinus on its way to the circle of Willis. During exercise and heat stress, the increased respiratory airflow increases evaporative cooling in these regions thus supplying cooled blood to the cranial cavity [10]. McConaghy *et al.* [142] have demonstrated that the horse can selectively cool the brain during exercise or heat exposure. Baptiste *et al.* [11] showed that the guttural pouches cool the blood in the internal carotid artery on its way to supply the brain.

The end-expired gas temperature measured during exercise has not been reported previously. Hodgson *et al.* [92] did, however, estimate the temperature of expired air to be 34°C, which is similar to the measurements reported in this study. At the onset of the near-maximal exercise, the end-expired gas

temperature during both environmental conditions dropped markedly and remained so until the end of the near-maximal exercise. At the start of the recovery phase, the end-expired temperature rapidly increased to levels higher than that post warm-up. During the initial part of the recovery during the HH trial the end-expired air temperature was significantly elevated above that measured in the HD trial. The elevated end-expired air temperature during the recovery phase of the trials can be ascribed to the low tidal volume but elevated minute volume, and therefore low alveolar ventilation resulting in a slower wash out of air from the lung. During the near maximal exercise, the high air velocity and tidal volume through the conducting airways results in substantial evaporative cooling of the air by an adiabatic saturation process. The air is not fully saturated even when expired [179] and thus still cooled adiabatically during expiration. As the tidal volume decreases, and therefore the alveolar ventilation decreases, the end-expired air is closer to saturation and the end-expired air is not cooled to the same extent.

Heat dissipation by evaporation, whether by sweat evaporation from the hair coat or from the respiratory tract can be described in terms of the vapour pressure gradient from the evaporative surface to the environment, the air velocity over the evaporating surface and the area of the evaporative surface. The comparison of the measured respiratory heat loss with the calculations using the formula described by Mostert *et al.* [153] show remarkable correlation (Figure 7-9). The

use of air velocity in the conducting airways to estimate respiratory heat loss has not been reported previously, however it is generally accepted that the evaporation rate from the hair and skin coat is closely related to the air speed over the evaporative surface [191]. At the onset of exercise, there is a marked increase in the velocity through the conducting airways. During the recovery phase of the HH trials the air velocity was significantly elevated above that during the HD trial. The evaporation rate and therefore the heat dissipated via the respiratory tract increases markedly with the increased air velocity. The relative changes in the evaporative surface area of the respiratory tract presented in Figure 7-7 may indicate that the horse is able to change the ventilated surface areas according to the heat dissipative requirements. During the HD conditions there appeared to be fluctuations in the surface areas as the horse demanded respiratory heat dissipation. Observations by Baptiste *et al.* [11] of the role of the guttural pouch in brain temperature regulation may indicate the guttural pouch is ventilated as required, which may be the fluctuations seen in the present study. During the recovery phase of the exercise, the evaporative surface area appears to increase markedly. During the HH trials, the evaporative surface increased earlier in the bout of exercise, probably as a result of the compromised sweat evaporation.

The data calculated and presented in Figure 7-9 indicated that the respiratory heat loss calculation overestimated the heat loss during the HH conditions by a factor of 2.4. This error may indicate a marked change in one to the factors of the

equation between the two environmental conditions, and/or an incorrect assumption. The vapour pressure of the environment change by a factor of 2.4, however this change was included in the calculations presented. The vapour pressure of the evaporative surface used in the calculations had been normalised for changes in the pulmonary artery temperature, but the assumption that the vapour pressure was related to the pulmonary artery temperature may be incorrect. During the near maximal exercise in the HH trials, the minute volume and therefore the trachea air velocity was higher and the end-expired trachea temperature was generally lower. This drop in temperature drops the vapour pressure by 25%, but more significantly, drops the vapour pressure gradient by 55%, a factor of 2.2, which is similar to the error presented above.

During the recovery phase of the exercise, the dead space / alveolar ventilation ratio increases to approximately 90% [163]. The bulk of the heat dissipation during this phase thus occurs from the upper airways. McConaghy *et al.* have described how the large surface areas of the nasal turbinates have four and five fold increases in blood flow during exercise and heat exposure respectively [142,145], thus indicating how heat is transported to sites of heat dissipation. Baptiste *et al.* [11] have also described that the guttural pouch can be ventilated as required to regulate the temperature of the brain. As described as occurring during the near-maximal exercise, the higher airflow rates and therefore lower surface temperatures would have a more marked effect on the heat dissipation

during HH conditions than HD conditions.

Changes in lung surfactant secretion with exercise have been described [196]. The changes have been demonstrated in human subjects are rapid in response to a single large breath and hyperventilation [131], but the biochemical mechanism has not been described. There are four known proteins that make up the pulmonary surfactants [131]. The primary composition of these surfactants is phospholipid [55,131]. The effect of the lung and airway surfactant on the evaporating surface vapour pressure has not been previously described, however the phospholipid, a polar molecule, does reduce surface tension and therefore surface energy. The reduced surface energy implies that the vapour pressure of the surface is reduced and thus evaporation would be retarded. Furthermore, polar substances have lower vapour pressures than non polar substances [164] and lower evaporation rates.

The increase in the pulmonary surfactant secretions during increased respiratory flow rates may be a mechanism to retard the evaporation from the lung and conducting airways. The primary function of the surfactant is to maintain lung and alveolar inflation. The observed two-fold increase in the airway velocity from 1-minute into the warm-up through to the near maximal exercise would result in at least a two-fold increase in the evaporation from the conducting airways. Drying out of the lung mucosa would significantly affect the

compliance, and therefore the performance of the lung. While the increased evaporation rate is desirable for heat loss, there may be an underlying protective mechanism to maintain the quality of the mucosa.

In summary, we found that the horse is, to a limited degree, able to enhance the heat loss from the respiratory tract when evaporative heat loss is compromised by a high ambient humidity. Respiratory heat dissipation increases with increased body core temperature. The core body temperature probably determines adjustments to the respiratory mechanics, and the core temperature also increases the vapour pressure of the evaporating surfaces, thus improving the gradient promoting heat loss. It was shown that the horse is able to shorten its stride to increase respiratory frequency, and furthermore increase the tidal volume and therefore the minute volume. The increased minute volume and therefore the increased mean airway air velocity does aid the respiratory heat loss, without which the horses' performance would be further compromised. Calculations presented indicate that the area of the evaporative surfaces of the airways does change with differing levels of heat stress. The changes in the vapour pressure of the evaporating surface have a more significant effect during the HH environment than it does during the HD conditions. The mechanism of action of surfactants and the knowledge of increased surfactant secretions with hyperventilation may indicate that apart from its primary role of maintaining lung inflation, it may reduce evaporation from the airways and the lung in order to maintain lung

compliance.

The following conclusions can be drawn from this study: The horse is able to adapt its respiratory function in an effort to overcome the compromised evaporative heat loss when subject to near-maximal exercise under hot-humid conditions. This modification is not sufficient to dissipate all the metabolic heat and life-threatening hyperthermia may occur unless the animal is adequately managed.

ACKNOWLEDGEMENTS

We acknowledge the technical assistance of Kim Stevens and Clifford Matjiane. We must also thank Cassandra, Hula Hula, On the Day, Silkwood and Zola Zee for their contribution to the study. This project was conducted under the auspices of the Equine Research Centre as project number ERC 96/04 and we would like to thank the Equine Research Centre, the Gauteng Provincial Administration, the Highveld Racing Authority and the University of Pretoria for their support.

CHAPTER 8

REFINEMENTS TO A MATHEMATICAL MODEL OF THE THERMAL BALANCE OF EXERCISING HORSES

ABSTRACT

A theoretical mathematical model developed to determine the heat balance of horses working in a given environment was developed and published by Mostert *et al.* This model included all parameters known to affect heat balance, namely: metabolic heat gain, solar heat gain, evaporative heat loss due to sweating, respiratory tract heat loss, radiation from the body and heat gain or loss due to convection and conduction. The resulting model gave a reasonable correlation of the temperature of the exercising horse in the field during short duration exercise, however as exercise duration was increased, the model deviated substantially from the field data.

Adverse environmental conditions (hot and humid) compromise the horse's ability to dissipate heat. The model presented by Mostert *et al.* does not allow for the limited physiological adjustments that the horse is able to make in order to compensate for the compromised heat loss.

Using data collected during various studies reported in Chapters 5 and 7, the model has been simplified and refined to give closer approximations to the horses' body temperature during exercise. The heat index described by Schroter and Marlin [177] has been incorporated in order to have a better representation of environmental conditions in the model.

INTRODUCTION

A theoretical integrative model was developed by Mostert *et al.* [153] (Referred to as the Mostert model in this Chapter and appended in Appendix A) to predict the heat balance of the horse under given weather conditions and exercise intensities. This model, although comprehensive in including all known factors, did have deviations from field measured data, particularly during endurance exercise.

The energy liberation during the metabolic activity requires that an equal amount of heat is lost by means of convection, radiation, and evaporation otherwise body temperature will rise. This is simply described by the energy balance equation:

$$E_{\text{metab}} - E_{\text{work}} = H_{\text{conv}} \pm H_{\text{rad}} \pm H_{\text{evap}} \pm H_{\text{Storage}}$$

Where E_{metab} = Metabolic energy released, E_{work} = External work done, H_{conv} = convective heat loss or gain, H_{rad} = radiative heat loss or gain, H_{evap} = evaporative heat loss ($H_{\text{evap}} = H_{\text{resp}} + H_{\text{sweat}}$), and H_{storage} = storage of body heat. The difference between E_{metab} and E_{work} is the heat liberated by the body. E_{work} is assumed to be 20% of E_{metab} .

Heat dissipation by convection and radiation requires a thermal gradient from the body to the environmental air temperature and radiant temperature, respectively.

The evaporative heat loss depends on the vapour pressure gradient from the evaporating surface and the environment. Evaporating surfaces are either the skin and hair coat or the respiratory tract. Air velocity and volumes also play a role in the convective and evaporative heat exchange.

Review of the Mostert model, which included all known mechanisms that effect thermal balance, indicates that the evaporative components account for up to 98% of the heat dissipation. According the model as it is presented, heat loss by sweat evaporation accounts for 84% of the heat loss and respiratory heat loss accounts for approximately 14% of the heat loss.

McConaghy [141] described the horses' reliance on the evaporation of sweat as its primary means of heat dissipation. The respiratory heat loss, which appears to be species dependent, varies between 14 and 38 percent of the total heat dissipation – varying according to the ambient conditions and the state of exercise. The well described exercise intolerance of horses suffering from anhidrosis [128,137] also demonstrates the importance of the sweat mechanism in maintaining thermal equilibrium during exercise.

Hodgson *et al.* [92] described respiratory heat loss increasing as exercise progresses, although did not describe the means that allows this increase. Studies in human subjects [88] showed increased respiratory heat loss with increased

minute volume. The study presented in Chapter 7 showed that respiratory heat loss increases with the exercise duration. The observed increase in the respiratory heat loss is associated with an increase in the minute volume, airway velocity and the core body (pulmonary artery) temperature. The model presented by Mostert *et al.* does not illustrate similar observations.

The radiative, convective and conductive avenues of heat loss may be significant in the sedentary animal and during exercise at low ambient temperatures. However, as the body surface temperatures rise toward 35°C these components become less significant and in the exercising animal the heat dissipated by these means is insignificant by comparison (Figure 8-1). The solar heat gain is also significant in the resting animal, whereas when compared to the metabolic heat loads during exercise is insignificant and can probably be ignored in the evaluation of the thermal balance of the exercising horse.

The Mostert model, while being complete, does rely on a number of assumptions and measurements that are not easily determined in field conditions. The aim of this chapter is to firstly improve the accuracy of the body temperature estimates during prolonged exercise. Secondly, to simplify the model by eliminating components that have little effect on the thermal balance of exercising horses and thirdly rework the model such that it may be easily used and applied in field conditions.

MODEL

The change in core body temperature can be estimated from the following equation:

$$\Delta \dot{T} = \frac{\text{Heat Storage (J} \cdot \text{s}^{-1})}{\text{Specific Heat capacity of the horse (J} \cdot \text{°C}^{-1} \cdot \text{kg)} \cdot \text{Body Weight (kg)}} \text{ (°C} \cdot \text{s}^{-1})$$

This equation can be rearranged to determine the exercise time to increase to the body temperature by 1°C, and therefore the time reach a critical temperature of 42°C .

$$\text{Time} = \frac{\text{Heat Capacity (J} \cdot \text{°C}^{-1} \cdot \text{kg)} \cdot \text{Bodyweight (kg)}}{\text{Heat Storage (J} \cdot \text{s}^{-1})} \text{ (s)}$$

Heat Losses

Respiratory heat loss

Mostert *et al.* calculated respiratory heat loss from the sum of the convective and evaporative components as shown in equation:

$$\dot{H}_{\text{resp}} = \dot{V}_E \cdot \rho_{\text{CP}} \cdot (T_e - T_i) + L_a \cdot (W_e - W_i) \text{ (J/min)}$$

Where, \dot{V}_E is the minute volume, ρ_{CP} the volumetric specific heat capacity of air, T_e and T_i the temperatures of the expired and inspired air, respectively, L_a is the

latent heat of vaporisation of water, and $W_e - W_i$ is the difference between expired and inspired water vapour. Mostert *et al.* assumed that the inspired air temperature is the same as the ambient temperature and used Hodgson *et al.*'s [92] estimated an expired air temperature of 34°C. The water vapour loss was taken as 33.9 g/min (Lund *et al.* [127] (Chapter 4)).

While the equation above does give reasonable approximations of respiratory heat loss, there are improvements that could give more accurate estimates of heat loss. The rate of evaporation from any surface is closely related to the velocity of the air movement over the surface. The velocity of the air in the airways has not been previously considered in modelling of the respiratory heat loss. The equation presented in the Mostert model for sweat evaporation does include a relation between the air speed over the horse (running speed). This equation can be applied to the respiratory tract and the airway air velocity can be estimated from the minute volume and the mean airway diameter.

The minute volume, V_E , is described the expression by Evans *et al.* [57] relating it to metabolic rate. This is however flawed since it makes no provision for the effect ambient conditions, the type of exercise (speed) and the core body temperature have on the respiratory rate of horses. The study presented in Chapter 7 illustrated the differences in minute volumes with changes in ambient conditions, speed of exercise and body core temperature.

Each of the factors indicated above (body temperature, speed of locomotion and ambient conditions) appear to have thresholds where they become significant. Firstly, the transition between trotting, cantering and galloping does not have a linear effect on the oxygen consumption and therefore the minute ventilation. The minute ventilation does not drop with the oxygen consumption during the post canter period of exercise. The speed, v , is thus used with a threshold of 9 m/s to magnify to minute ventilation during the trotting phase of the recovery phase. Secondly, when the body core temperature, T , exceeds an apparent critical temperature, T_{crit} , the respiratory frequency is elevated and the horse increases its minute ventilation to aid heat dissipation. T_{crit} is taken as 40.5°C, which was determined from experimental data presented in Chapter 7. The third factor accounts for the environmental conditions. The WBGT (Wet Bulb Globe Temperature) Index presented by Schroter and Marlin [177] describes the ambient conditions in the simplest complete way. The WBGT (below) consists of the wet bulb temperature and the black globe temperature.

$$WBGT = 0.7 T_{wb} + 0.3 T_g$$

Experimental data [177] has shown that when the WBGT index exceeds 32.5°C, the environmental conditions are stressful and the animal responds in order to increase heat loss.

Thus

$$\dot{V}_E = 214.804 + 7.39 \dot{V}O_2 \quad (\ell / \text{min})$$

becomes

$$\dot{V}_E = \left(\frac{9}{v}\right)^{\frac{1}{3}} \cdot \left(\frac{T}{T_{\text{crit}}}\right)^3 \cdot \left(\frac{\text{Index}}{32.5}\right)^{\frac{1}{2}} \cdot (214.804 + 7.39 \dot{V}O_2) \quad (\ell / \text{min})$$

Where v is the velocity in m/s, T is the body core temperature, T_{crit} is the respiratory frequency critical temperature ($^{\circ}\text{C}$), Index is the WBGT ($^{\circ}\text{C}$) and $\dot{V}O_2$ is the oxygen consumption in ml/kg/min.

The minute volume, V_E , can now be used to estimate airway air velocity. The mean airway velocity was assumed to be 40mm. Therefore the air velocity is given by the following equation:

$$\text{Velocity} = u = 2 \cdot \left(\frac{V_E \cdot 4}{60 \cdot 1000 \cdot \pi \cdot d^2} \right)$$

Where u is the mean airway velocity, V_E is the minute volume and d is the mean diameter of the airway.

Thus the equation for respiratory heat loss becomes:

$$\dot{H}_{\text{resp}} = \frac{L_a \cdot [3.2127 + 1.922u] \cdot (P_s - P_a)^{0.88} \cdot A}{86.4} \quad \text{W}$$

Where, L_a is the latent heat of vaporisation of water, u the air speed over the horse, p_s the saturated water vapour pressure of air at ambient temperature (kPa), p_a the actual water vapour pressure of air ($p_s \cdot [\text{humidity of air}]$) (kPa) and A the

surface area of the conducting airways (Assumed to 2.5m length and 40mm diameter = 0.3m²). The vapor pressures can be determined from temperature and atmospheric pressure using the equations of Grof and Gratch [71].

Evaporation heat loss due to sweating

The importance of evaporative heat loss (\dot{H}_{sweat}) in the horse is well recognised. Exercise intolerance demonstrated by anhidrotic horses highlights the role that sweat evaporation plays in maintaining thermal balance of exercising horses [137]. Horses with compromised sweating capabilities overheat easily, often with severe clinical implications [137].

In the Mostert model it was assumed that a body of water adequately represents the skin surface of a sweating horse and that there is a convectively stable atmosphere. The equation describing the molecular diffusion of water vapour into free atmosphere [94] was used as a basis of the equation to estimate heat loss due to sweating. The equation below, incorporating the latent heat of vaporisation of sweat and the surface area of the horse was the equation used in the Mostert model.

$$\dot{H}_{\text{sweat}} = \frac{La \cdot [3.2127 + 1.922 u] \cdot (p_s - p_a)^{0.88} \cdot \rho_{\text{sweat}} \cdot A}{86400} \quad \text{W}$$

Where, La is the latent heat of vaporisation of sweat, u the air speed over the

horse, p_s the skin water vapour pressure of air at ambient temperature (kPa), p_a the actual water vapour pressure of air ($p_s \cdot [\text{humidity of air}]$) (kPa), ρ_{sweat} the density of sweat (g/l), and A the surface area of the horse (m^2). For this study, the relation of surface area of the horse to body weight described by Hodgson *et al.* [92] was used. The skin surface area (A) is related to body weight by equation:

$$A = 1.09 + 0.008 \cdot \text{BW} \quad (\text{m}^2)$$

Where, BW is the body weight of the horse in kg.

Kerslake [112] published equations for heat exchange, the equation for the evaporation of sweat in watts is shown in following equation:

$$H_{\text{resp}} = 16.53 \sqrt{u} (p_{\text{sk}} - p_a) W \cdot \text{mmHg}^{-1} \cdot \text{m}^{-2}$$

Where u is the speed, p_{sk} is the skin water vapour pressure, p_a is the ambient water vapour pressure (mmHg). The Mostert model equation was derived from the evaporation of water from a land pan over 24 hours, whereas Kerslake's equation was derived from laboratory experimentation.

Heat Gain

Solar Heat Gain

The Mostert model used an equation for solar heat gain that had the following form:

$$\dot{H}_{\text{solar}} = A_{\tau} \left[L_i \cdot a_L + S_i \left[a_s + \left(\frac{\left(\frac{\rho c_p}{h} \right) - r_e}{r_e} \right) \cdot \left(\frac{1}{pt} \right) \cdot (2 - a_s) \right] \right] \cdot 60 \quad (\text{J/min}) \quad (4)$$

where, A_{τ} is the exposed surface area of the animal (this area was assumed to be 85% of total surface area of the animal [59]), a_L the long-wave absorptivity for the animal, L_i the average long wave irradiance of the sun, S_i the average short wave irradiance of the sun, a_s the short-wave absorptivity for the animal, ρc_p the volumetric specific heat capacity of air, h the coat thermal conductance, r_e the external resistance to convective and radiative heat transfer and pt the probability that a penetrating ray will strike a coat element with thickness t .

This is an extremely complex equation and can be reduced to the following without introducing any significant errors:

$$H_{\text{solar}} = A \cdot (L_i \cdot a_i + S_i \cdot a_i)$$

The long and short wave irradiation can be approximated to the following:

$$L_i + S_i = (\text{Mean Radiative Temperature, K})^4 \approx (T_g + 273.16)^4$$

Therefore the equation for solar radiation can be reduced to:

$$H_{\text{solar}} = a_i \cdot A \cdot (T_g + 273.16)^4$$

Where a_i is the average absorptivity, A is the surface area and T_g is the black globe temperature

Comparison of model with experimental data

The predictions generated by the revised model were compared to data published by Mostert *et al.* [153] and data presented in Chapters 4, 5 and 7. The variables describing the typical Thoroughbred horse are presented in Table 8-1 and were the basis of the calculations.

Comparison with treadmill laboratory data:

The conditions within treadmill laboratories are generally controlled and therefore easily determined. Much of the published data used in the publication of Mostert *et al.* described heat balance of horses working in similar laboratories [92,157]. The Mostert model used an ambient temperature of 22 °C and the relative humidity of 40%. Changes in skin temperature published by Naylor *et al.* [157] for similar ambient conditions and used by Mostert *et al.* were very similar to the core body temperature during prolonged exercise. This is understandable since the horses' skin is highly vasculised and perfused with warm blood in order to dissipate heat. The core body temperature was therefore used as the skin temperature for exercise lasting longer than 10 minutes. The revised model relies on environmental data (dry bulb temperature, relative humidity, black globe temperature and atmospheric pressure) and the size and work intensity of the horse.

Parameter	Value
Body Weight, BW	474 kg
VO _{2max}	150 ml/kg/min
Running speed 3.5 m/s	40% of VO _{2max}
Running speed 7 m/s	65% of VO _{2max}
Running speed 9.1 m/s	95% of VO _{2max}
Latent heat of H ₂ O vaporisation	2 428 kJ/ℓ

Table 8-1: Characteristics of a typical Thoroughbred horse

RESULTS

Data generated by the revised model presented here was overlaid data presented by Mostert *et al.* [153] and experimental data presented by Hodgson *et al.* [92]. The data generated by the revised model was similar to the experimental data presented by Hodgson *et al.* and is presented in Figure 8-2. Details of relation of running speed on a 10% slope to work intensity (% of VO_{2max}) are presented in Table 8-1. The air speed generated by fans in the laboratory, and not the running speed of the horse, was taken as the air speed over the horse.

The comparison between the rate of change of the core temperature as predicted by the revised model and the data previously published by Mostert *et al.* [153] is presented in Figure 8-3. The rate of change of the core temperature was closer to the values reported by Hodgson *et al.* and lower than that predicted by Mostert *et al.* [153].

The predicted core temperature and measured pulmonary artery temperature in response to the exercise protocol described in Chapter 7 are compared in Figure 8-6. The exercise protocol comprised a 5 minute warm-up at 3.5 m/s followed by 5-minutes of near-maximal exercise of 9.1 m/s and the 5-minute recovery at 3.5 m/s under hot dry and hot humid conditions. The respiratory heat loss predicted by the model is compared with the experimental data reported in Chapter 7 in Figure 8-4.

The correlation of the heat loss by sweat evaporation as determined by the Mostert model and the equation presented by Kerslake [112] is presented in Figure 8-5. The Mostert model and the Kerslake equation had a regression of $r^2 = 0.9999$. The Mostert model did however give higher estimations of the evaporative heat loss.

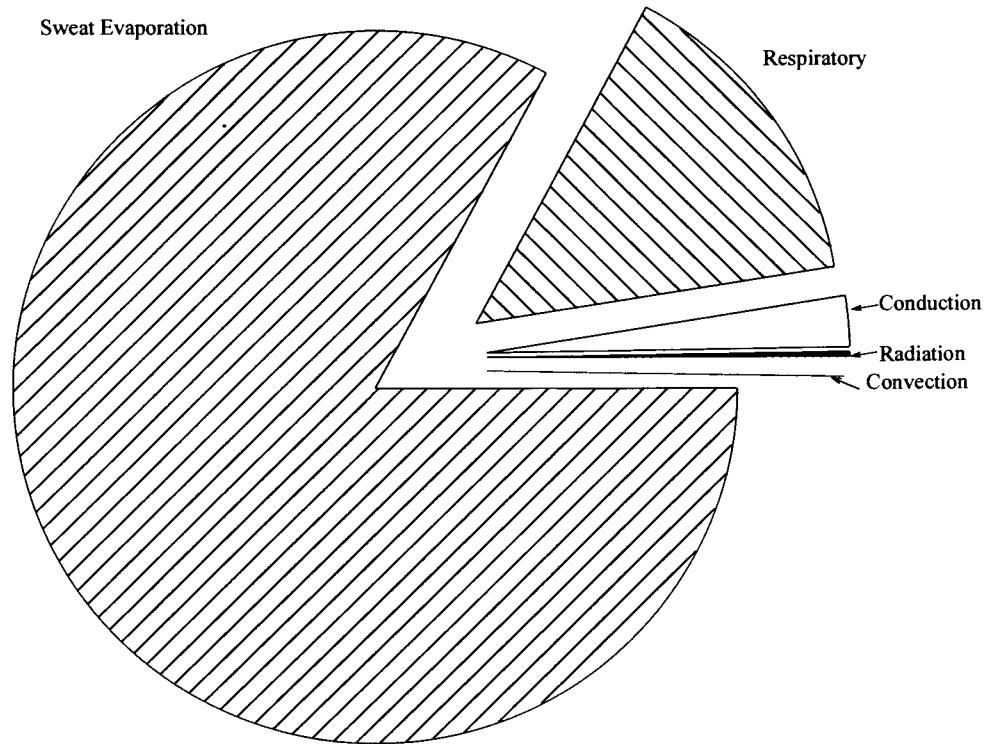

Figure 8-1: Graphic presentation of the relative proportions of the avenues of heat loss from horses during exercise.

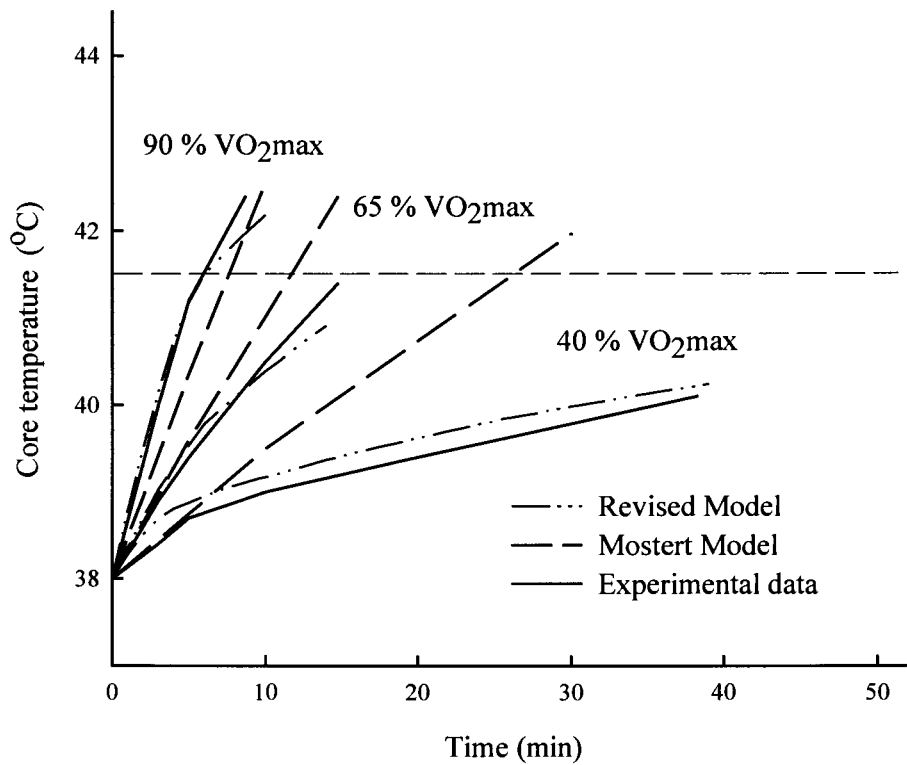

Figure 8-2: Plot of predicted core temperature from the revised model, the Mostert model and carotid artery temperature reported by Hodgson *et al.* (1993) at three different work intensities in Thoroughbred horses. The predicted values were calculated for a temperature of 22°C and a relative humidity of 40% to simulate the laboratory conditions under which the experiments were done.

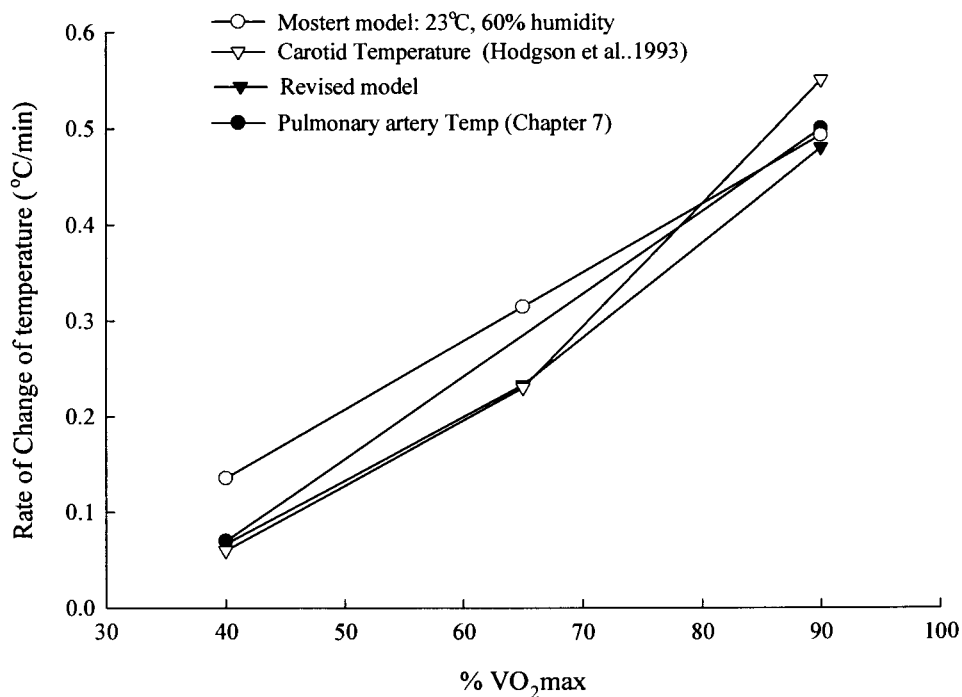

Figure 8-3 : Comparison between the rate of change in core temperature as predicted by the Mostert model and the Revised model at the onset of exercise, the rate of change in pulmonary artery temperature reported by Jones and Carlson (1995), and the rate of change in carotid artery temperature reported by Hodgson *et al.* (1993) at three different work intensities in horses.

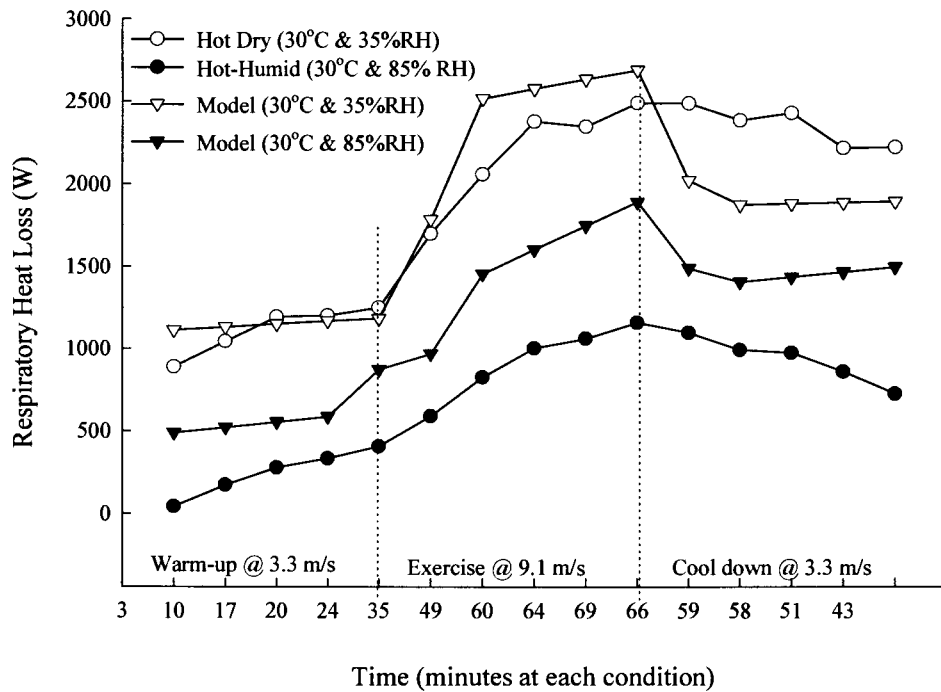

Figure 8-4: Comparison of the respiratory heat loss measured experimentally (Chapter 7) with the respiratory heat loss predicted by the model in hot-humid and hot dry conditions

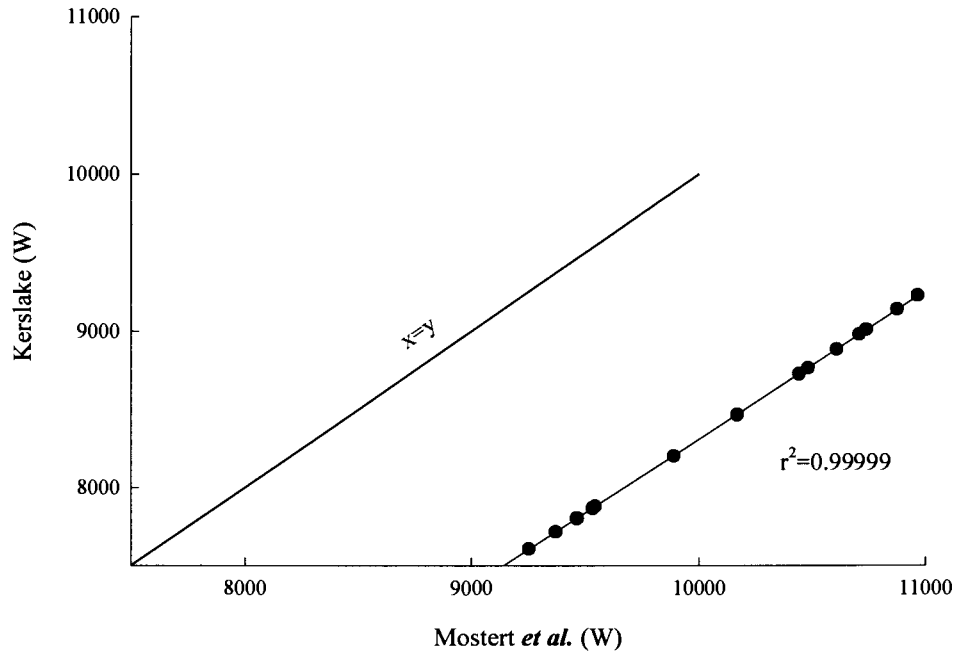

Figure 8-5: Plot of the heat loss by evaporation of sweat estimated using the Mostert model [153] and the Kerslake model [112]. Regression $r^2 = 0.99999$

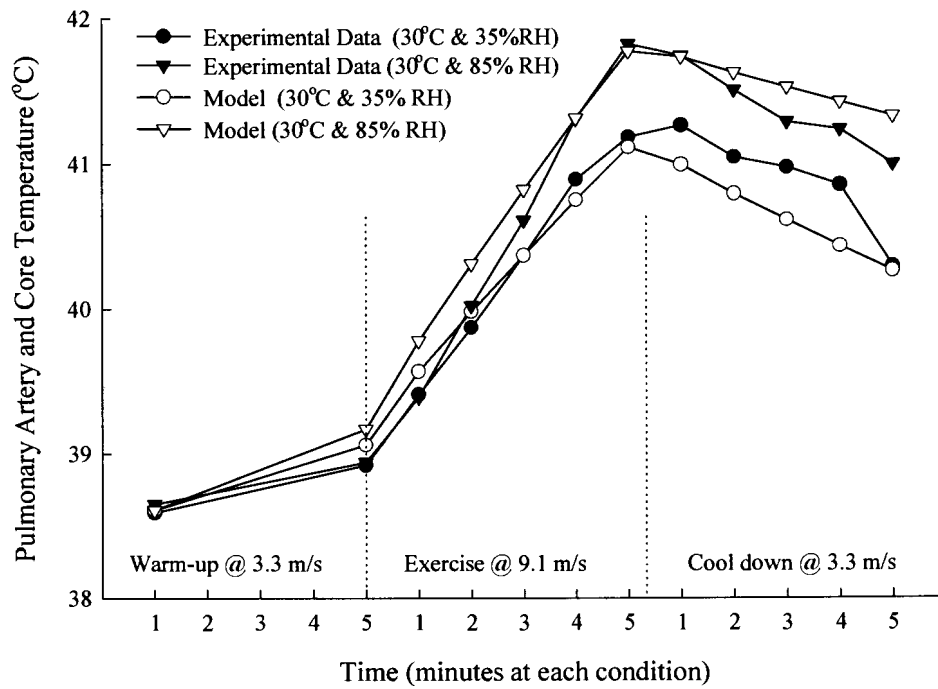

Figure 8-6 : Comparison of the pulmonary artery temperature presented in Chapter 7 and the core temperature predicted by the model during exercise in hot-humid and hot dry conditions.

DISCUSSION

It is clear that the revisions to the Mostert model presented in this chapter have improved the accuracy of the estimations of the body core temperatures of exercising horses. At 90% of $\dot{V}O_{2\max}$, the approximations of core body temperature followed similar trends to the experimental data presented by Hodgson *et al.* [92]. At the two lower work intensities (65 and 40%), the predicted data and the experimental data are very similar for the first 5 minutes as the hair coat became saturated with sweat. Beyond 5-minutes, when the hair coat was fully saturated with sweat, the predictions of the core temperature followed the pulmonary temperature closely.

Respiratory heat loss has been reported to increase as exercise progresses at all intensities [92] (Chapters 5 and 7) [88]. The Mostert model did not describe the trend described in Chapters 5 and 7. Furthermore, the studies presented in these Chapters indicated that the environmental conditions affect the horses' response to the mediating of respiratory heat loss.

The study reported in Chapter 7 showed respiratory frequency and tidal volume increased with body temperature and the speed of exercise. High ambient heat loads and high ambient humidity also affect the way the horse responds to dissipating heat. Schroter and Marlin [177] devised a WBGT

index that described the environment in terms of the wet bulb temperature and the black globe temperature. This index along with a factor representing the critical core body temperature that initiates increased respiratory frequency and a factor representing the speed of locomotion were incorporated in the equation presented by Evans [57] for the estimation of minute volume. The incorporation of these factors gave estimations of the minute volume that was a lot closer to that reported in Chapter 7.

This estimate of the minute volume was used to estimate the trachea air velocity, which in turn was used in the equation for the respiratory heat loss. The respiratory heat loss calculation using the air velocity in trachea to determine the evaporation rate gave good approximations of the respiratory heat loss when compared to the data presented in Chapter 7.

Mostert *et al.* [153] expressed doubt about the equation they developed for the evaporation of sweat. Their equation was based on the evaporation of water from a land pan over 24 hours. The comparison with the equation presented by Kerslake [112] presented in this Chapter indicated a strong correlation between the results of the two models, however the results of the Mostert model were elevated above the results determined from the Kerslake model. When incorporating these data into the complete model, the data from the Mostert equation for evaporative heat loss gave approximations of the core body temperature closer to the experimental data.

The balance of the heat was assumed to be lost via sweat evaporation, radiation and convection, of which evaporation of sweat was most significant. We assumed that the horse had a layer of sweat over its entire body 5 minutes after commencing exercise. The evaporative heat loss is dependant on the environmental conditions and assuming the temperature, humidity and air speed were constant, the model predicted the evaporative heat loss under the laboratory conditions to be similar at all work intensities. Air speed over the entire surface of the horse is important for maintenance of core temperature. When exercising on a track, increases in speed result in greater air movement over the body, allowing more heat to be lost via the evaporation of sweat.

The comparison presented in Figure 8-3 shows that the rates of change of core temperature predicted by the revised model are similar to the results reported by Hodgson *et al.* [92] and presented in Chapter 7. The close relationship between pulmonary artery trends generated during the exercise protocol described in Chapter 7 and the estimates of the model (Figure 8-6) indicates the improved accuracy of the revised model.

The solar heat load equation presented by Mostert *et al.* [153] contained a number of factors relating to the penetrance of solar ray on the hair coat. These factors have a very small effect on the final result of the equation. These components could thus be excluded from the equation without any

significant effect on the result. The use of the mean ambient radiative temperature (in Kevlin) gave very close approximations to the combined long and short wave irradiance levels to the reported local weather stations.

CONCLUSION

The correlation of the predictions of the revised model with published experimental data [92,105,157] and the data generated in Chapter 7 indicates the mathematical model has been significantly improved. The model describing evaporative heat loss, which was derived from evaporation from a water pan, gives good approximations of the evaporative heat loss. When the same equation is applied to the evaporative heat loss from the respiratory tract, the results were closely related to the measures of respiratory heat loss presented in Chapter 7. The solar heat gain calculated using the mean ambient radiative temperature gave results that were closely related to the results using the long and short wave radiation levels. This equation for solar heat load would be simpler to apply to field conditions, where the only required data is the black globe temperature.

The correlation between the predictions of the revised model presented here and data of other researchers shows that the thermal balance of working horses can be accurately modelled. This model as it is presented is easily applied to work in the field. The only environmental data required for input to the model is the dry bulb ambient temperature, relative humidity, black globe

temperature and the atmospheric pressure.

This study has focussed on the parameters in the model that have the greatest influence on the heat balance of the exercising horse. Ultimately, the model should reasonably predict the intensity and duration of work a horse should be able to maintain under specific environmental conditions before experiencing thermal distress.

CHAPTER 9

GENERAL CONCLUSIONS

The following conclusions were drawn from these studies:

1. The effect of different warm-up regimens on heat balance of exercising horses was determined. It was found that a warm-up similar to that used in racing in South Africa was sufficient to activate the heat dissipation mechanisms.
2. Evaporative heat loss is not restricted by sweating rate but by evaporation of the sweat which is determined by environmental conditions
3. Respiratory heat loss from horses exercising in extreme hot humid environments is reduced to the extent the horse actually gains heat through the respiratory tract.
4. Respiratory heat loss increases with increasing exercise duration.
The increase in heart rate may represent an attempt to shunt warm blood to heat dissipative tissue beds in response to exercise in heat stressful conditions.
5. Severe circulatory demands during exercise in heat stressful environments could lead to circulatory collapse. The shorter time to

fatigue during the exercise in the hot-humid environments, may indicate a protective mechanism to prevent circulatory collapse.

6. A simplified ultrasonic pneumotachometer was designed and presented.
7. The simple design allows scaling of the flowhead according to the application without any change to the control circuitry.
8. The flowmeter's performance and accuracy was comparable with other more complex units despite the simplicity of the design.
9. The horse is able, to a limited degree, to enhance the heat loss from the respiratory tract when evaporative heat loss is compromised.
10. The horse is able to shorten its stride length to increase respiratory frequency and therefore increase its minute ventilation.
11. The horse is able to change the size of the evaporative area of the respiratory tract in order to increase heat loss.
12. The revised mathematical model presented in Chapter 8 gives accurate estimations of an exercising horse's core body temperature.
13. The model has been simplified for ease of use in field applications, the only data required other than that describing the horse is the ambient dry bulb temperature, the relative humidity, the black globe temperature and the atmospheric pressure.
14. This thesis has contributed to the greater understanding of the heat balance of horses exercising in thermoneutral and hot-humid environments.

CHAPTER 10

REFERENCES

1. Allen, T. E., J. W. Bennett, S. M. Donegan, and J. C. D. Hutchinson. Moisture, its accumulation and site of evaporation in the coats of sweating cattle. *J.Agric.Sci.Camb.* 74: 247, 1970.
2. Alvarez, M. B. and H. D. Johnson. Environmental heat exposure on cattle: plasma catecholamine and glucocorticoids. *J.Dairy Sci.* 56: 189-189, 1973.
3. Ames, D. R., S. E. Curtis, G. L. Hahn, R. E. McDowell, D. Polin, and B. A. Young. Effect of environment on nutrient requirements of domestic animals. Washington, D.C., National Research Council-National Academy Press. 1981, 96.
4. Anderson, N. V., R. M. DeBowes, K. A. Nyrop, and A. D. Dayton. Mononuclear phagocytes of transport-stressed horses with viral respiratory tract infection. *Am.J.Vet.Res.* 46: 2272-2277, 1985.

5. Andrews, F. M., S. L. White, L. H. Williamson, P. L. Maykuth, D. R. Geiser, E. M. Green, S. L. Ralston, and R. A. Mannsman. Effects of shortening the steeplechase phase (*Phase B*) of a 3-day-event. *Equine Vet.J.Suppl.* 20: 64-72, 1995.
6. Anon. Air transport of horses. *Aust.Equine Vet.* 7: 30-31, 1989.
7. Art, T., L. Anderson, A. J. Woakes, C. Roberts, P. J. Butler, D. H. Snow, and P. Lekeux. Mechanics of breathing during strenuous exercise in thoroughbred horses. *Respir.Physiol.* 82: 279-294, 1990.
8. Art, T. and P. Lekeux. Effect of environmental temperature and relative humidity on breathing pattern and heart rate in ponies during and after standardised exercise. *Vet.Rec.* 123: 295-299, 1988.
9. Art, T., D. Votion, and P. Lekeux. Physiological measurements in horses after strenuous exercise in hot, humid conditions. *Equine Vet.J.Suppl.* 20: 120-124, 1995.
10. Baker, M. A. Influence of Dehydration on Thermoregulation in Panting animals. 407-412, 1984.

11. Baptiste, K. E., J. M. Naylor, J. Bailey, E. M. Barber, K. Post, and J. Thornhill. A function for the Guttural Pouches in the horse. *Nature* 403: 382-383, 2000.
12. Barrand, M. A., M. J. Dauncey, and D. L. Ingram. Changes in plasma noradrenaline and adrenaline associated with central and peripheral thermal stimuli in the pig. *J.Physiol.(Lond.)* 316: 139-139, 1981.
13. Beadle, R. E., A. J. Guthrie, and A. H. Kou. Characterization of a density-corrected ultrasonic pneumotachometer for horses. *J.Appl.Physiol.* 78: 359-367, 1995.
14. Beadle, R. E., G. L. Norwood, and V. A. Brencick. Summertime plasma catecholamine concentrations in healthy and anhidrotic horses in Louisiana. *Am.J.Vet.Res.* 43: 1446-1448, 1982.
15. Beeley, J. G., R. Eason, and D. H. Snow. Isolation and characterization of latherin, a surface-active protein from horse sweat. *Biochem.J.* 235: 645-650, 1986.
16. Bell, A. W. and J. R. S. Hales. Cardiovascular, Respiratory and Thermoregulatory Function During Exercise. Armidale, University of New England Press. 1982.

17. Bell, A. W., J. R. S. Hales, R. B. King, and A. A. Fawcett. Influence of heat stress on exercise induced changes in regional blood flow in sheep. *J.Appl.Physiol.* 55: 1916-1916, 1983.
18. Berman, A. Nychthermal and seasonal patterns of thermoregulation in cattle. *Aust.J.Agric.Res.* 19: 181-181, 1968.
19. Bianca, W. The effect of repeated short exposures to heat on the volume and hydration of the blood of the calf. *Br.Vet.J.* 113: 227-227, 1957.
20. Blaxter, K. L. The effect of iodinated casein on the basal metabolism of the sheep. *J.Agric.Sci.Camb.* 38: 207-207, 1948.
21. Bligh, J. The thermosensitivity of the hypothalamus and thermoregulation in mammals. *Biol.Rev.* 41: 317, 1966.
22. Bligh, J. and K. G. Johnson. Glossary of terms for thermal physiology. *J.Appl.Physiol.* 35: 941-942, 1973.
23. Bonsma, J. C. Breeding cattle for increased adaptability to tropical and sub-tropical environments. *J.Agric.Sci.Camb.* 39: 204-204, 1949.

24. Brinnel, H., M. Cabanac, and J. R. S. Hales. Critical upper levels of body temperature, tissue thermosensitivity and selective brain cooling in hyperthermia. In Hales, J. R. S. and D. A. B. Richards, eds., *Heat Stress: Physical Exertion and Environment*. Amsterdam, Elsevier Scientific. 1987, 209.
25. Brockway, J. M., J. D. McDonald, and J. D. Pullar. Evaporative heat-loss mechanisms in sheep. *J.Physiol.* 179: 554-554, 1965.
26. Brody, S. *Bioenergetics and Growth*. New York, Reinhold. 1945.
27. Brody, S. and R. F. Frankenbach. Age changes in size, energy metabolism and cardio-respiratory activities of thyroidectomized cattle. *Mo.Agric.Exp.St.Res.Bull.* 349-349, 1942.
28. Buess, C., P. Pietsch, W. Guggenbühl, and E. A. Koller. A pulsed diagonal-beam ultrasonic airflow meter. *J.Appl.Physiol.* 61: 1195-1199, 1986.
29. Buess, C., P. Pietsch, W. Guggenbühl, and E. A. Koller. Design and construction of an ultrasonic air-flowmeter. *IEEE Trans.Biomed.Eng.* BME-33: 768-774, 1986.

30. Butler, P. J., A. J. Woakes, L. S. Anderson, C. A. Roberts, and D. J. Marlin. Stride length and respiratory tidal volume in exercising Thoroughbred horses. *Resp.Physiol.* 93: 51-56, 1993.
31. Cain, J. B., S. D. Livingston, R. W. Nolan, and et al. Respiratory heat loss during work at various ambient temperatures. *Respir Physiol* 79: 145, 1990.
32. Carlisle, H. J. and D. L. Ingram. The influence of body core temperature and peripheral temperatures on oxygen consumption in the pig. *J.Physiol.* 231: 341-341, 1973.
33. Carlson, G. P. Thermoregulation and fluid balance in the exercising horse. In Snow, D. H., S. G. B. Persson, and R. J. Rose, eds., *Equine Exercise Physiology*. Cambridge, Granta Editions. 291-309, 1983.
34. Carlson, G. P. Medical problems associated with protracted heat and work stress in horses. *Comp.Contin.Educ.* 542-550, 1985.
35. Carlson, G. P. Medical problems associated with protracted heat and work stress in horses. *Compend.Cont.Educ.Pract.Vet.* S542-S550, 1985.

36. Carlson, G. P. and R. A. Mansmann. Serum, electrolyte and plasma protein alterations in horses used in endurance rides. *J.Am.Vet.Med.Assoc.* 165: 262, 1974.
37. Carlson, G. P. and P. O. Ocen. Composition of equine sweat following exercise in high environmental temperatures and in response to intravenous Epinephrine administration. *J.Equine Med.Surg.* 3: 27-32, 1979.
38. Cena, K. and J. A. Clark. Thermal radiation from animal coats: Coat structure and measurements of radiative temperature. *Phys.Med.Biol.* 18: 432-443, 1973.
39. Cena, K. and J. L. Monteith. Transfer processes in animal coats I. Radiative transfer. *Proc.R.Soc.Lond.B.* 188: 377-393, 1975.
40. Cena, K. and J. L. Monteith. Transfer processes in animal coats II. Conduction and convection. *Proc.R.Soc.Lond.B.* 188: 395-411, 1975.
41. Chauca, D. and J. Bligh. An additive effect of cold exposure and hypoxia on pulmonary artery pressure in sheep. *Res.Vet.Sci.* 21: 123-123, 1976.

42. Christison, G. I. and H. D. Johnson. Cortisol turnover rate in heat-stressed cows. *J.Anim.Sci.* 35: 1005-1005, 1972.
43. Christopherson, R. J., H. W. Gonyou, and J. R. Thompson. Effects of temperature and feed intake on plasma concentration of thyroid hormones in beef cattle. *Can.J.Anim.Sci.* 59: 655-655, 1979.
44. Christopherson, R. J., R. J. Hudson, and M. K. Christopherson. Seasonal energy expenditure and thermoregulatory responses of bison and cattle. *Can.J.Anim.Sci.* 59 : 611-611, 1979.
45. Chwalbinska-Moneta, J. and O. Hanninen. Effect of active warming-up on thermoregulatory, circulatory, and metabolic responses to incremental exercise in endurance-trained athletes. *Int.J.Sports Med.* 10: 25-29, 1989.
46. Craig, J. P. and Tomlinson A. Importance of the lipid layer in human tear film stability and evaporation. *Optometry and Visual Science* 74: 8-13, 1997.
47. De Bruyn-Prevost, P. and F. Lefebvre. The effects of various warming-up intensities and durations during a short maximal anaerobic exercise. *Eur.J.Appl.Physiol.* 43: 93-100, 1980.

48. De Vries, H. A. Effects of various warm up procedures on 100 yard times of competitive swimmers. *Res.Q.Am.Assoc.Health Phys.Educ.* 30: 110-122, 1959.
49. Dill, D. B., M. K. Yousef, C. R. Cox, and R. G. Barton. Hunger vs. thirst in the burro (*Equus asinus*). *Physiol.Behav.* 24: 975, 1980.
50. Eaton, M. D., R. J. Rose, D. L. Evans, and D. R. Hodgson. Assessment of anaerobic capacity using maximal accumulated oxygen deficit in fit Thoroughbreds. *Equine Vet.J.Suppl.* 18: 29-32, 1995.
51. Eckersall, P. D., J. G. Beeley, D. H. Snow, and A. Thomas. Characterisation of glycoproteins in the sweat of the horse (*Equus caballus*). *Res.Vet.Sci.* 36: 231-234, 1984.
52. Eckersall, P. D., M. G. Kerr, and D. H. Snow. An investigation into the proteins of horse sweat (*Equus caballus*). *Comp.Biochem.Physiol.* 73B: 375-378, 1982.
53. El-Nouty, F. D., I. M. Elbanna, T. P. Davis, and H. D. Johnson. Aldosterone and ADH response to heat and dehydration in cattle. *J.Appl.Physiol.* 48: 249-249, 1980.

54. El-Nouty, F. D., M. K. Yousef, A. B. Magdub, and H. D. Johnson. Thyroid hormones and metabolic rate in Burros, *Equus asinus*, and Llama, *Lama glama*: Effects of environment temperature. *Comp.Biochem.Physiol.* 60(A): 235-235, 1978.
55. Espinosa, F. F., A. H. Shapiro, J. J. Fredberg, and R. D. Kamm. Spreading of exogenous surfactant in an airway. *J.Appl.Physiol.* 75: 2028-2039, 1993.
56. Evans, C. L., D. F. G. Smith, and H. Weil-Malherbe. The relationship between sweating and the catechol content of the blood in the horse. *J.Physiol.* 132: 542, 1956.
57. Evans, D. L. and R. J. Rose. Maximum oxygen uptake in racehorses: Changes with training state and prediction from submaximal cardiorespiratory measurements. In Gillespie, J. R. and N. E. Robinson, eds., *Equine Exercise Physiology 2*. San Deigo, ICEEP Publications. 1987, 52-67.
58. Finberg, J. P. M., R. Yagil, and G. M. Berlyne. Response of the renin-aldosterone system in the camel to acute dehydration. *J.Appl.Physiol.* 44: 926-926, 1978.

59. Finch, V. A., R. Dmi'El, R. Boxman, A. Shkolnik, and C. R. Taylor. Why black goats in hot deserts? Effects of coat color on heat exchanges of wild and domestic goats . *Physiol.Zool.* 53: 19-25, 1980.
60. Forsling, M. L., D. L. Ingram, and M. W. Stalzier. Effects of various ambient temperature and of heating and cooling the hypothalamus and cervical spinal cord on antidiuretic hormone secretion and urinary osmolality in pigs. *J.Physiol. (Lond.)* 257: 673-673, 1976.
61. Franks, B. D. Physical warm-up. In Williams, M. H., ed., *Ergogenic Aids in Sport*. Champaign, IL, Human Kinetics Publishers. 1983, 340-375.
62. Fritz, W. Grundlagen der Wärmeübertragung beim Verdampfen von Flüssigkeiten. *Chem.Ing.Tech.* 35: 753-764, 1963.
63. Gebremedhin, K. G., C. O. Cramer, and W. P. Porter. Predictions and measurements of heat production and food and water requirements of Holstein calves in different environments. *Trans.Am.Soc.Agric.Eng.* 24(3): 715-715, 1981.
64. Gebremedhin, K. G., W. P. Porter, and C. O. Cramer. Quantitative analysis of heat exchange through the fur layer of Holstein calves. *Trans.Am.Soc.Agric.Eng.* 26(1): 188-188, 1983.

65. Genovely, H. and B. A. Stamford. Effects of prolonged warm-up exercise above and below anaerobic threshold on maximal performance. *Eur.J.Appl.Physiol.* 48: 323-330, 1982.
66. Geor, R. J., L. J. McCutcheon, G. L. Ecker, and M. I. Lindinger. Thermal and cardiorespiratory response of horses to submaximal exercise under hot and humid conditions. *Equine Vet.J.Suppl.* 20: 125-132, 1995.
67. Geor, R. J., L. J. McCutcheon, and M. I. Lindinger. Adaptations to daily exercise in hot and humid ambient conditions in trained Thoroughbred horses. *Equine Vet.J.Suppl.* 22: 63-68, 1996.
68. Geor, R. J., H. R. Staempfli, J. McCutcheon, J. Pringle, and S. Young. Effect of gas collection system on respiratory and stride frequency and stride length. *Equine Vet.J.Suppl.* 18: 53-57, 1995.
69. Gillespie, J. R. and J. R. Pascoe. Respiratory function in the exercising horse: a review. In Snow, D. H., S. G. B. Persson, and R. J. Rose, eds., *Equine Exercise Physiology*. Cambridge, Granta Editions. 1983, 1-6.
70. Goff, J. A. Saturation pressure of water on the new Kelvin scale. *Trans.Am.Soc.Heat.Air-Cond.Eng.* 63: 347-354, 1957.

71. Goff, J. A. Saturation pressure of water on the new Kelvin scale. In Wexler, A. and W. A. Wildhack, eds., *Humidity and Moisture: Measurement and Control in Science and Industry*. New York, Reinhold Publishing Corporation. 1965, 289-300.
72. Goff, J. A. and S. Gratch. Low-pressure properties of water from -160 to 212 F. *Trans.Am.Soc.Heat.Vent.Eng.* 52: 95-122, 1946.
73. Gordon, M. S., G. A. Bartholomew, A. D. Grinnell, C. Barker Jorgensen, and F. N. White. Chapter 8: Body temperature and energy metabolism. In Gordon, M. S., G. A. Bartholomew, A. D. Grinnell, C. Barker Jorgensen, and F. N. White, eds., *Animal physiology*. New York, Macmillan publishing Co., Inc. 1982, 333-406.
74. Graham, N. M. The metabolic rate of fasting sheep in relation to total lean body weight and the estimation of maintenance requirements. *Aust.J.Agric.Res.* 18: 127-127, 1967.
75. Graham, N. M. Units of metabolic body size for comparisons among adult sheep and cattle. *Proc.Aust.Soc.Anim.Prod.* 9: 352-352, 1972.
76. Graham, N. M., F. W. Wainman, K. L. Blaxter, and D. C. Armstrong. Environmental temperature, energy metabolism and heat regulation in

- sheep. I. Energy metabolism in closely clipped sheep. *J.Agric.Sci.Camb.* 52: 13-13, 1959.
77. Grodjinovsky, A. and J. R. Magel. Effect of warm-up on running performance. *Res.Q.Am.Assoc.Health Phys.Educ.* 41: 116-119, 1970.
78. Guthrie, A. J., J. S. Van den Berg, V. M. Killeen, and E. Nichas. Use of a semi-quantitative sweat test in Thoroughbred horses. *J.S.Afr.Vet.Assoc.* 63(4): 162-165, 1992.
79. Haberman, W. L. and J. E. A. John. Fundamentals of Engineering Heat Transfer. In Haberman, W. L. and J. E. A. John, eds., Engineering Thermodynamics with Heat Transfer. Boston, Allyn and Bacon. 1999, 489-492.
80. Habermehl, K. H., B. Vollmerhaus, and H. Wilkens. Textbook of the anatomy of domestic animals. Volume III. The circulatory system, skin and cutaneous organs. German Fed. 1984.
81. Hales, J. R. S. Effects of exposure to hot environments on the regional distribution of blood flow and on cardiorespiratory function in sheep. *Pflugers Arch.* 344: 133-133, 1973.

82. Hales, J. R. S. Effects of heat stress on blood flow in respiratory and non- respiratory muscles in sheep. *Pflugers Arch.* 345: 123-123, 1973.
83. Hales, J. R. S. Physiological responses to heat. MTP International Reviews of Science, Physiology, Vol 7. London, Butterworths. 1974, 107-107.
84. Hales, J. R. S. Proposed mechanisms underlying heat stroke. In Hales, J. R. S. and D. A. B. Richards, eds., Heat Stress: Physical Exertion and Environment. Amsterdam, Elsevier Science Publishers. 1987, 85-102.
85. Hales, J. R. S. and G. D. Brown. Net energetic and thermoregulatory efficiency during panting in the sheep. *Comp.Biochem.Physiol.* 49A: 413-413, 1974.
86. Hales, J. R. S., A. A. Fawcett, J. W. Bennett, and A. D. Needham. Thermal control of blood flow through capillaries and arteriovenous anatomoses in skin of sheep. *Pflugers Arch.* 372: 157-157, 1977.
87. Hales, J. R. S. and M. E. D. Webster. Respiratory function during thermal tachypnoea in sheep. *J.Physiol.* 190: 241-241, 1967.
88. Hanson, R. d. G. Respiratory heat loss at increased core temperature. *J.Appl.Physiol.* 37: 103-107, 1974.

89. Hausen, H. Heat Transfer by Heat conduction and Convection Together with Condensation and Evaporation. In Willmott, A. J., ed., Heat Transfer in Counterflow, Parallel Flow and Cross Flow. New York, McGraw Hill. 1999, 11-94.
90. Heilemann, M., A. J. Woakes, and D. H. Snow. Investigations on the respiratory water loss in horses at rest and during exercise. *Adv.Anim.Physiol.Anim.Nutr.* 21: 52-59, 1990.
91. Hodgson, D. R., R. E. Davis, and F. F. McConaghy. Thermoregulation in the horse in response to exercise. *Br.Vet.J.* 150: 219-235, 1994.
92. Hodgson, D. R., L. J. McCutcheon, S. K. Byrd, W. S. Brown, W. M. Bayly, G. L. Brengelmann, and P. D. Gollnick. Dissipation of metabolic heat in the horse during exercise. *J.Appl.Physiol.* 74: 1161-1170, 1993.
93. Hodgson, D. R., R. J. Rose, T. B. Kelso, L. J. McCutcheon, W. M. Bayly, and P. D. Gollnick. Respiratory and metabolic responses in the horse during moderate and heavy exercise. *Pflugers Arch.Eur.J.Physiol.* 417: 73-78, 1990.
94. Holman, J. P. Heat transfer. Singapore, McGraw-Hill Book Company. 1989.

95. Houmard, J. A., R. A. Johns, L. L. Smith, J. M. Wells, R. W. Kobe, and S. A. McGoogan. The effect of warm-up on responses to intense exercise. *Int.J.Sports Med.* 12: 480-483, 1991.
96. Hörnicke, H., R. Meixner, and U. Pollmann. Respiration in exercising horses. In Snow, D. H., S. G. B. Persson, and R. J. Rose, eds., *Equine Exercise Physiology*. Cambridge, Granta Editions. 1983, 7-16.
97. Hutchinson, J. C. D. and G. D. Brown. Penetrance of cattle coats by radiation. *J.Appl.Physiol.* 26: 454-464, 1969.
98. Ingram, D. L. Evaporative cooling in the pig. *NATL* 207: 415-415, 1965.
99. Ingram, D. L. and K. F. Legge. The effect of environmental temperature on respiratory ventilation in the pig. *Respir.Physiol.* 8: 1-1, 1969.
100. Ingram, D. L. and L. E. Mount. *Man and Animals in Hot Environments*. Berlin, Springer-Verlag. 1975.
101. Ingram, D. L. and G. C. Whittow. The effect of heating the hypothalamus on respiration in the ox (*Bos Taurus*). *J.Physiol.* 163: 200-200, 1962.

102. Jackson, A. C. and A. Vinegar. A technique for measuring frequency response of pressure, volume, and flow transducers. *J.Appl.Physiol.* 47: 462-467, 1979.
103. Jessen, C. Hyperthermia and its effect on exercise performance. In Hales, J. R. S. and D. A. B. Richards, eds., *Heat Stress: Physical Exertion and Environment*. Amsterdam, Elsevier Science Publishers. 241-249, 1987.
104. Johnson, K. G. and M. Peaker. Studies of the lateral nasal (Steno's) glands of the sheep. *J.Physiol.* 242 : 7P, 1974.
105. Jones, J. H. and G. P. Carlson. Estimation of metabolic energy costs and heat production during a 3-day event. *Equine Vet.J.Suppl.* 20: 23-30, 1995.
106. Jones, J. H., C. R. Taylor, A. Lindholm, R. Straub, K. E. Longworth, and R. H. Karas. Blood gas measurements during exercise: Errors due to temperature correction. *J.Appl.Physiol.* 67: 879-884, 1989.
107. Joyce, J. P. and K. L. Blaxter. Respiration in sheep in cold environments. *Res.Vet.Sci.* 5: 506-506, 1964.

108. Kaup, F. J. and W. Drommer. Surfactant system of the lung. I. Morphology, composition and function of the surfactant system in humans and animals. *Berl.Muench.Tieraertztl.Wochenschr.* 98: 73-80, 1985.
109. Kaup, F. J. and W. Drommer. Surfactant system of the lung. II. Disorders of the surfactant system and their importance for veterinary medicine. *Berl.Muench.Tieraertztl.Wochenschr.* 99: 77-85, 1986.
110. Kerr, M. G., C. D. Munro, and D. H. Snow. Equine sweat composition during prolonged heat exposure. *Proc.Physiol.Soc.* 52-53, 1980.
111. Kerr, M. G. and D. H. Snow. Composition of sweat of the horse during prolonged epinephrine (adrenaline) infusion, heat exposure, and exercise. *Am.J.Vet.Res.* 44: 1571-1577, 1983.
112. Kerslake, D. *The Stress of Hot Environments.* Cambridge, Cambridge University Press. 1972.
113. Kielblock, A. J. Strategies for the prevention of heat disorders with particular reference to efficacy of body cooling procedures. In Hales, J. R. S. and D. A. B. Richards, eds., *Heat stress: Physical exertion and environment.* Amsterdam, Elsevier Science Publishers. 1987, 489-497.

114. Kingston, J. K., R. J. Geor, and L. J. McCutcheon. Rate and composition of sweat fluid losses are unaltered by hypohydration during prolonged exercise in horses. *J.Appl.Physiol.* 83: 1133-1143, 1997.
115. Kingston, J. K., R. J. Geor, and L. J. McCutcheon. Use of dew-point hygrometry, direct sweat collection and measurement of body water losses to determine sweating rates in exercising horses. *Am.J.Vet.Res.* 58: 175-181, 1997.
116. Kleiber, M. *The Fire of Life: An Introduction to Animal Energetics.* New York, John Wiley & Sons. 1961.
117. Kohn, C. W. and K. W. Hinchcliff. Physiological responses to the endurance test of a 3-day-event during hot and cool weather. *Equine Vet.J.Suppl.* 20: 31-36, 1995.
118. Kohn, C. W., K. W. Hinchcliff, L. J. McCutcheon, R. J. Geor, J. Foreman, A. K. Allen , S. L. White, P. L. Maykuth, and L. H. Williamson. Physiological responses of horses competing at a modified 1 star 3-day-event. *Equine Vet.J.Suppl.* 20: 97-104, 1995.

119. Kowalski, G. J. An Analytical and Experimental Investigation of Heat Loss Through Animal Fur. Mechanical Engineering Department, University of Wisconsin , 1978
120. Kozlowski, S., Z. Brzezinska, B. Kruk, H. Kaciuba-Uscilko, J. E. Greenleaf, and K. Nazar. Exercise hyperthermia as a factor limiting physical performance: temperature effect on muscle metabolism. *J.Appl.Physiol.* 59: 766-773, 1985.
121. Laegreid, W. W., L. J. Huston, R. J. Basaraba, and M. V. Crisman. The effects of stress on alveolar macrophage function in the horse: An overview. *Equine Pract.* 10: 9-16, 1988.
122. Lee, D. T. and E. M. Haymes. Exercise duration and thermoregulatory responses after whole body precooling. *J.Appl.Physiol.* 79: 1971-1976, 1995.
123. Lucke, J. N. and G. N. Hall. Further studies on the metabolic effects of long distance riding: Golden Horseshoe ride 1979. *Equine Vet.J.* 12: 189-192, 1980.
124. Lund-Larsen, T. R., J. Kofstad, and A. Aakvaag. Seasonal changes in serum levels of aldosterone, cortisol, and inorganic ions in the reindeer (*Rangifer tarandus*). *Comp.Biochem.Physiol.* 60: 383-383, 1978.

125. Lund, R. J. The effect of three different warm-up regimens on the oxygen consumption of Thoroughbred horses. MMedVet Dissertation, University of Pretoria 1-71 1996
126. Lund, R. J. and A. J. Guthrie. Measurement of maximal oxygen consumption of Thoroughbred horses at an altitude of 1250m using open-circuit flow-through calorimetry. *J.S.Afr.Vet.Assoc.* 66: 239-243, 1995.
127. Lund, R. J., A. J. Guthrie, H. J. Mostert, C. W. Travers, J. P. Nurton, and D. J. Adamson. Effect of three different warm-up regimens on heat balance and oxygen consumption of Thoroughbred horses. *J.Appl.Physiol.* 80: 2190-2197, 1996.
128. MacAlpine, L. My horse won't sweat. *EQUUS* 176: 18-20, 1992.
129. MacDougall, J. D., W. G. Reddan, C. R. Layton, and J. A. Dempsey. Effects of metabolic hyperthermia on performance during heavy prolonged exercise. *J.Appl.Physiol.* 36: 538-773, 1974.
130. Macfarlane, W. V. Terrestrial animals in dry heat: ungulates. In Dill, D. B., E. F. Adolph, and C. G. Wilber, eds., *Handbook of Physiology: Adaptation to the Environment*. Washington, D.C., American Physiological Society. 1964, 509-509.

131. Maddison, I. (1 October 1999). Surfactant. <http://www.skiagram.com/surfactant.html>, Jan. 25, 2000.
132. Marlin, D. J. and F. Barrelet. Animal Health Trust - Study aims to keep horses running in the heat of Atlanta. *Vet.Rec.* 133: 126-127, 1993.
133. Marlin, D. J., P. A. Harris, R. C. Schroter, R. C. Harris, C. A. Roberts, C. M. Scott, C. E. Orme, M. Dunnet, S. J. Dyson, F. Barrelet, B. Williams, C. M. Marr, and I. Casas. Physiological, metabolic and biochemical responses of horses competing in the speed and endurance phase of a CCI**** 3-day event. *Equine Vet.J.Suppl.* 20: 37-46, 1995.
134. Marlin, D. J., C. M. Scott, R. C. Schroter, P. C. Mills, R. C. Harris, P. A. Harris, C. E. Orme, C. A. Roberts, C. M. Marr, S. J. Dyson, and F. Barrelet. Physiological responses in nonheat acclimated horses performing treadmill exercise in cool (20°C/40%RH), hot dry (30°C/40%RH) and hot humid (30°C/80%RH) conditions. *Equine Vet.J.Suppl.* 22: 70-84, 1996.
135. Marston, H. R. and A. W. Peirce. The effects following thyroidectomy in Merino sheep. *Aust.J.Exp.Biol.Med.Sci.* 19: 205-205, 1932.

136. Maskrey, M. Metabolic and Acid-Base Implications of Thermal Panting. In Hales, J. R. S., ed., Thermal Physiology. New York, Raven Press. 1984.
137. Mayhew, I. G. and H. O. Ferguson. Clinical, clinicopathologic, and epidemiologic features of anhidrosis in central Florida Thoroughbred horses. *J.Vet.Intern.Med.* 1: 136-141, 1987.
138. McArthur, A. J. Thermal interaction between animal and microclimate: a comprehensive model. *J.theor.Biol.* 126: 203-238, 1987.
139. McBride, G. E., R. J. Christopherson, and W. Sauer. Metabolic rate and plasma thyroid hormone concentrations of mature horses in response to changes in ambient temperature. *Can.J.Anim.Sci.* 65: 375-382, 1985.
140. McBride, G. E., R. J. Christopherson, and W. C. Sauer. Metabolic responses of horses to temperature stress. *Can.J.Anim.Sci.* 106-108, 1985.
141. McConaghy, F. Thermoregulation. In Hodgson, D. R. and R. J. Rose, eds., The Athletic Horse: Principles and practice of equine sports medicine. Philadelphia, W.B.Saunders Company. 181-202, 1994.

142. McConaghy, F. F., J. R. S. Hales, R. J. Rose, and D. R. Hodgson. Selective brain cooling in the horse during exercise and environmental heat stress. *J.Appl.Physiol.* 79: 1849-1854, 1995.
143. McConaghy, F. F., D. R. Hodgson, D. L. Evans, and R. J. Rose. Effect of two types of training on sweat composition. *Equine Vet.J.Suppl.* 18: 285-288, 1995.
144. McConaghy, F. F., D. R. Hodgson, D. L. Evans, and R. J. Rose. Equine sweat composition: effects of adrenaline infusion, exercise and training. *Equine Vet.J.Suppl.* 20: 158-164, 1995.
145. McConaghy, F. F., D. R. Hodgson, R. J. Rose, and J. R. S. Hales. Redistribution of cardiac output in response to heat exposure in the pony. *Equine Vet.J.Suppl.* 22: 42-46, 1996.
146. McCutcheon, L. J. and R. J. Geor. Sweat fluid and ion losses in horses during training and competition in cool vs. hot ambient conditions: implications for ion supplementation. *Equine Vet.J.Suppl.* 22: 54-62, 1996.
147. McCutcheon, L. J., R. J. Geor, M. J. Hare, G. L. Ecker, and M. I. Lindinger. Sweating rate and sweat composition during exercise and

- recovery in ambient heat and humidity. *Equine Vet.J.Suppl.* 20: 153-157, 1995.
148. McLean, J. A. and G. Tobin. Animal and human calorimetry. Cambridge, Cambridge University Press. 24-29, 1987.
149. Mitchell, D. Convective heat transfer from man and other animals. In Monteith, J. L. and L. E. Mount, eds., Heat Loss from Animals and Man. London, Butterworths. 59, 1973.
150. Mitchell, D., C. H. Wyndham, and T. Hodgson. Emissivity and transmittance of excised human skin in its thermal emission wave band. *J.Appl.Physiol.* 23: 390-394, 1967.
151. Mitchell, J. W., E. R. Nadel, and J. A. J. Stolwijk. Respiratory weight losses during exercise. *J.Appl.Physiol.* 32: 474-476, 1972.
152. Moore, L. M. Experimental studies on the regulation of body temperature. II. Relation of the corpus striatum to the regulation of body temperature. *Am.J.Physiol.* 46: 253-253, 1918.
153. Mostert, H. J., R. J. Lund, A. J. Guthrie, and P. J. Cilliers. Integrative model for predicting thermal balance in exercising horses. *Equine Vet.J.Suppl.* 22: 7-15, 1996.

154. Mount, L. E. The assessment of thermal environment in relation to pig production. *Livest.Prod.Sci.* 2: 381, 1975.
155. Mukherjee, R. and H. H. Mitchell. The basal energy and nitrogen metabolism of dairy calves in hyperthyroidism induced by thyroprotein administration. *J.Anim.Sci.* 10: 149-149, 1951.
156. Myers, J. L. and A. D. Well. Research Design and Statistical Analysis. New York, HarperCollins. 1991.
157. Naylor, J. R. J., W. M. Bayly, P. D. Gollnick, G. L. Brengelmann, and D. R. Hodgson. Effects of dehydration on thermoregulatory responses of horses during low-intensity exercise. *J.Appl.Physiol.* 75: 994-1001, 1993.
158. Nielsen, B., G. Savard, E. A. Richter, M. Hargreaves, and B. Saltin. Muscle blood flow and muscle metabolism during exercise and heat stress. *J.Appl.Physiol.* 69: 1040-1046, 1990.
159. Noakes, T. D. Lore of Running. Cape Town, Oxford University Press. 101-124, 1985.
160. Oke, T. R. Climates of animals. Boundary Layer Climates. London, Methuen & Co Ltd. 160-196, 1978.

161. Oyono-Enguelle, S., A. Heitz, J. Marbach, C. Ott , A. Pape, and H. Freund. Heat stress does not modify lactate exchange and removal abilities during recovery from short exercise. *J.Appl.Physiol.* 74: 1248-1255, 1993.
162. Palmer, S. E. Effect of ambient temperature upon the surface temperature of the equine limb. *Am.J.Vet.Res.* 44: 1098-1101, 1983.
163. Pelletier, N., D. Blais, A. Vrins, and N. E. Robinson. Effect of sub-maximal exercise and training on dead space ventilation in the horse. In Gillespie, J. R. and N. E. Robinson, eds., *Equine Exercise Physiology 2*. San Deigo, ICEEP Publications. 225-234, 1987.
164. Perona, M. (22 September 1999). Vapour Pressure, Enthalpy of Vaporization and Intermolecular Forces. California State University, Stanislaus. <http://wwwchem.csustan.edu/chem112/1112vap2.htm>, Jan. 25, 2000.
165. Renzi, P. E., C. A. Giurdanella, and A. C. Jackson. Improved frequency response of pneumotachometers by digital compensation. *J.Appl.Physiol.* 68: 382-386, 1990.

166. Robertshaw, D. Contributing factors to heat stroke. In Khogali, M. and J. R. S. Hales, eds., *Heat Stroke and Temperature Regulation*. Sydney, Academic. 13,1983.
167. Rodenburg, J. B., D. Steenbeek, P. Schiereck, and P. R. Bar. Warm-up, stretching and massage diminish harmful effects of eccentric exercise. *Int.J.Sports Med.* 15: 414-419, 1994.
168. Rose, R. J. and D. L. Evans. Cardiovascular and respiratory function in the athletic horse. In Gillespie, J. R. and N. E. Robinson, eds., *Equine Exercise Physiology 2*. San Deigo, ICEEP Publications. 1-24, 1987.
169. Rose, R. J., D. R. Hodgson, T. B. Kelso, L. J. McCutcheon, T.-A. Reid, W. M. Bayly, and P. D. Gollnick. Maximum O₂ uptake, O₂ debt and deficit, and muscle metabolites in Thoroughbred horses. *J.Appl.Physiol.* 64: 781-788, 1988.
170. Rowell, L. B. Human cardiovascular adjustments to exercise and thermal stress. *Physiol.Rev.* 54: 75-159, 1974.
171. Rowell, L. B. Cardiovascular adjustments to thermal stress. *Handbook of Physiology. The Cardiovascular System. Peripheral and Organ Blood Flow*. Bethesda, American Physiological Society. 967-1023,1983.

172. Rowell, L. B. Circulatory adjustments to dynamic exercise and heat stress: competing controls. *Human Circulation: Regulation During Physical Stress*. New York, Oxford University Press. 1986, 363-407.
173. Rubsamen, K. and J. R. S. Hales. Role of AVAs and capillaries in determining transfer across extremity skin of sheep. In Hales, J. R. S., ed., *Thermal Physiology*. New York, Raven Press. 1983, 259-259.
174. Sanderson, R. J., G. W. Paul, A. E. Vatter, and G. F. Filley. Morphological and physical basis for lung surfactant action. *Respir.Physiol.* 27: 379-392, 1976.
175. Savard, G. K., B. Nielsen, J. Laszczynska, B. E. Larsen, and B. Saltin. Muscle blood flow is not reduced in humans during moderate exercise and heat stress. *J.Appl.Physiol.* 64: 649-657, 1988.
176. Schmidt-Nielsen, K. *Desert Animals*. Oxford, Oxford University Press. 1964.
177. Schroter, R. C. and D. J. Marlin. An index of the environmental thermal load imposed on exercising horses and riders by hot weather conditions. *Equine Vet.J.Suppl.* 20: 16-22, 1995.

178. Schroter, R. C., D. J. Marlin, and L. B. Jeffcott. Use of the wet bulb globe temperature (WBGT) index to quantify environmental heat loads during three-day-event competitions. *Equine Vet.J.Suppl.* 22: 3-6, 1996.
179. Schroter, R. C. and N. V. Watkins. Respiratory Heat exchange in mammals. *Respir Physiol* 78: 357, 1989.
180. Schryver, H. F., H. F. Hintz, and J. E. Lowe. Calcium metabolism, body composition and sweat losses of exercised horses. *Am.J.Vet.Res.* 39: 245, 1978.
181. Scott, C. M., D. J. Marlin, and R. C. Schroter. Modified ventilated capsule for the measurement of sweating rate in the exercising horse. *Equine Vet.J.Suppl.* 22: 48-53, 1996.
182. Smith, J. L. and M. F. Bozymoswski. Effect of attitude toward warm-ups on motor performance. *Res.Q.Am.Assoc.Health Phys.Educ.* 36: 78-85, 1965.
183. Snow, D. H. Identification of the receptor involved in adrenaline mediated sweating in the horse. *Res.Vet.Sci.* 23: 246-247, 1977.
184. Stoecker, W. F. and J. W. Jones. Refrigeration and Air Conditioning. New York, McGraw-Hill Book Company. 1999.

185. Tavernor, W. D. Technique for the subcutaneous relocation of the common carotid artery in the horse. *Am.J.Vet.Res.* 30: 1881-1883, 1969.
186. Taylor, C. R., D. Robertshaw, and R. Hofmann. Thermal panting: a comparison of wildebeest and zebu cattle. *Am.J.Physiol.* 217: 907-907, 1969.
187. Thauer, R. Circulatory adjustments to climatic requirements. In Hamilton, W. F. and P. Dow, eds., *Handbook of physiology*, Vol 3. Washington, D.C., American Physiological Society. 1921-1921, 1965.
188. Thiel, M., G. Tolkmitt, and H. Hörnicke. Body temperature changes in horses during riding: Time course and effects on heart rate and respiratory frequency. In Gillespie, J. R. and N. E. Robinson, eds., *Equine Exercise Physiology 2*. San Deigo, ICEEP Publications. 1987, 183-193.
189. Thomas, D. P. and G. F. Fregin. Cardiorespiratory and metabolic responses to treadmill exercise in the horse. *J.Appl.Physiol.* 50: 864-868, 1981.
190. Thompson, G. E. Review of the progress of dairy science. Climatic physiology of cattle. *J.Dairy Res.* 40: 441-441, 1973.

191. Tregear, R. T. Hair density, wind speed, and heat loss in mammals. *J.Appl.Physiol.* 20: 796-801, 1965.
192. Van den Berg, J. S. Effect of transportation on horses. *Fourth Biennial Equine Stud Managers Course* 4: 20-31, 1996.
193. Van den Berg, J. S., A. J. Guthrie, R. A. Meintjes, J. P. Nurton, D. A. Adamson, C. W. Travers, R. J. Lund, and H. J. Mostert. Water and electrolyte intake and output in conditioned Thoroughbred horses transported by road. *Equine Vet.J.* 30: 316-323, 1998.
194. Van Mechelen, W., H. Hlobil, H. C. G. Kemper, W. J. Voorn, and H. R. De Jongh. Prevention of running injuries by warm-up, cool-down, and stretching exercises. *Am.J.Sports Med.* 21: 711-719, 1993.
195. Van Wylen, G. J. and R. E. Sonntag. Fundamentals of classical thermodynamics. Singapore, John Wiley and Sons. 1985.
196. Vanden-Bossche, G. and M. Dörwald. Exercise induced alterations in the tracheobronchial secretion of surfactant phospholipids in respiratory healthy horses and in horses with chronic pulmonary disease. *Wien.Tieraerztl.Monatsschr.* 78: 145-152, 1991.

197. Vander, A. J., J. H. Sherman, and D. S. Luciano. Human Physiology: The mechanisms of body function. New York, McGraw-Hill. 533-550, 1985.
198. Vercoe, J. E. The fasting metabolism of Brahman, Africander and Hereford X Shorthorn cattle. *Br.J.Nutr.* 24: 559-559, 1970.
199. Walsberg, G. E. Coat color and solar heat gain in animals. *Biosci.Rep.* 33: 88-91, 1983.
200. Walsberg, G. E., G. S. Campbell, and J. R. King. Animal coat color and radiative heat gain: a re-evaluation. *J.Comp.Physiol.* 126: 211-222, 1978.
201. Weast, R. C. Handbook of Chemistry and Physics. Boca Raton, Florida, CRC Press Inc. 1988.
202. West, J. B. and P. D. Wagner. Pulmonary gas exchange. In West, J. B., ed., Bioengineering aspects of the lung. New York, Marcel Dekker Inc. 361-457, 1977.
203. White, A., A. Reyes, A. Godoy, and R. Martinez. Effects of transport and racing on ionic changes in Thoroughbred race horses. *Comp.Biochem.Physiol.* 99: 343-346, 1991.

204. White, S. L. and L. Williamson. Management of horses in extreme heat and humidity. Proc.14th ACVIM For.: 408-409, 1996.
205. Whittow, G. C. The effect of hyperthermia on the systemic and pulmonary circulation of the ox (*Bos Taurus*). *Q.J.Exp.Physiol.* 50: 300-300, 1965.
206. Whittow, G. C. Ungulates. In Whittow, G. C., ed., *Comparative Physiology of Thermoregulation, Volume 2*. New York, Academic Press. 191-191, 1971.
207. Will, D. H., I. F. McMurtry, J. T. Reeves, and R. F. Groves. Cold-induced pulmonary hypertension in cattle . *J.Appl.Physiol.* 45: 469-469, 1978.
208. Williamson, L., S. White, P. Maykuth, F. Andrews , C. Sommerdahl, and E. Green. Comparison between two post exercise cooling methods. *Equine Vet.J.Suppl.* 18: 337-340, 1995.
209. Woakes, A. J., P. J. Butler, and D. H. Snow. The measurement of respiratory airflow in exercising horses. In Gillespie, J. R. and N. E. Robinson, eds., *Equine Exercise Physiology 2*. San Deigo, ICEEP Publications. 1987, 194-205.

210. Wong, C. W., S. E. Smith, Y. H. Thong, J. P. Opdebeeck, and J. R. Thornton. Effects of exercise stress on various immune functions in horses. *Am.J.Vet.Res.* 53: 1414-1417, 1992.
211. Worrell, T. W. and D. H. Perrin. Hamstring muscle injury: The influence of strength, flexibility, warm-up and fatigue. *J.Orthop.Sports Phys.Ther.* 16: 12-18, 1992.
212. Worstell, D. M. and S. Brody. Comparative physiological reactions of European and Indian cattle to changing temperature. *Mo.Agric.Exp.St.Res.Bull.* 515, 1953.
213. Young, B. A. Cold stress as it affects animal production. *J.Anim.Sci.* 52: 154-154, 1981.
214. Young, B. A. and J. Coote. Some effects of cold on horses. *Univ.Alberto Feed.Rep.* 21: 1973.
215. Yousef, M. K. Thermoregulation in wild ungulates. In Johnson, H. D., ed., *Progress in Animal Biometeorology*, Volume 1. Amsterdam, Swets & Zeitlinger, B.V. 1976.

216. Yousef, M. K. Adaptive responses of ungulates to environment. In Tromp, S. W. and J. J. Bouma, eds., *Biometeorological Survey*, Volume 1. London, Heydon & Son. 90-90, 1979.
217. Yousef, M. K. Measurement of heat production and heat loss. In Yousef, M. K., ed., *Stress physiology in Livestock: Volume I*. Boca raton, Florida, CRC Press, Inc.. 1984, 35-46.
218. Yousef, M. K. and H. D. Johnson. Calorigenesis of cattle as influenced by growth hormone and environmental temperature. *J.Anim.Sci.* 25: 1089-1089, 1966.
219. Yousef, M. K. and H. D. Johnson. Calorigenesis of dairy cattle as influenced by thyroxine and environmental temperature. *J.Anim.Sci.* 25: 150-150, 1966.
220. Yousef, M. K. and H. D. Johnson. Calorigenesis of cattle as influenced by hydrocortisone and environmental temperature. *J.Anim.Sci.* 26: 1087-1087, 1967.

APPENDIX A

AN INTEGRATIVE MODEL FOR PREDICTING THERMAL BALANCE IN THE EXERCISING HORSES

ABSTRACT

A theoretical integrative model was developed to determine the heat balance of horses working in a given environment. This model included the following parameters: metabolic heat gain, solar heat gain, evaporative heat loss due to sweating, respiratory tract heat loss, radiation from the body and heat gain or loss due to convection and conduction.

The model developed in this study includes a unique approach for estimating heat loss via evaporation of sweat from the animal's skin surface. Previous studies modelling evaporative heat dissipation are based on the volume of sweat loss. While it is known that the ambient conditions affect evaporation rate, these effects have not been adequately described. The model assumes a body of water adequately represents the horse's skin surface, and it describes the interaction of that water body with the atmosphere.

It is assumed that sweat has thermodynamic characteristics equivalent to distilled water. Sweat, however, has high electrolyte and protein

concentrations and anecdotal evidence has shown that the thermodynamic characteristics may be significantly affected. Further research is therefore required to confirm these characteristics for equine sweat.

The model describes all factors known to affect the thermal balance of the horse working in a given environment. The relative significance of the various variables on the whole integrative model has been illustrated. The effect of ambient temperature and humidity on the evaporative heat loss, the most significant and critical avenue of heat dissipation, is defined and quantified. The model clearly illustrates how increasing relative humidity limits evaporative heat loss, which can be further compromised when horses exercise on treadmills with no air movement.

LIST OF SYMBOLS AND THE UNITS OF THE CORRESPONDING VARIABLES

A	Surface area (m^2).
A_τ	Area of animal emitting to long wave radiation (m^2).
a_L	Long-wave absorptivity of animal coat (dimensionless).
a_s	Short-wave absorptivity of animal coat (dimensionless).
BW	Body weight of animal (kg).
c_p	Specific heat capacity of air ($J/g/^\circ C$).
c_{pf}	Specific heat capacity of air at film temperature ($J/g/^\circ C$).
D	Characteristic diameter of the horse (m).
d	Mean diameter of individual hair (m).
h	Coat thermal conductance ($W/m^2/^\circ C$).
h_c	Heat transfer coefficient at film temperature ($W/m^2/^\circ C$).
\dot{H}_{cond}	Heat loss via conduction through the hair coat (J/min).
\dot{H}_{conv}	Heat loss via forced convection from surface (J/min).
\dot{H}_{metab}	Metabolic heat gain (J/min).
\dot{H}_{rad}	Heat loss via radiation from animal (J/min).
\dot{H}_{resp}	Respiratory heat loss (J/min).
\dot{H}_{sweat}	Heat loss via the evaporation of sweat from the surface (J/min).
\dot{H}_{solar}	Solar radiation heat gain (J/min).
\dot{H}_{total}	Total heat absorbed by animal (J/min).
k_a	Thermal conductivity of air at film temperature ($W/m/^\circ C$).
k_c	Thermal conductivity of animal coat ($W/m/^\circ C$).
La	Latent heat of sweat (kJ/ℓ).
L_i	Long wave irradiance (W/m^2).
ℓ_s	Length of hair (m).
n	Number of hair per unit area of skin ($/m^2$).
Nu	Nusselt number (dimensionless).
Pr	Prandl number (dimensionless).
p	Probability per unit coat depth that a penetrating ray will strike a coat element (m^{-1}).
p_w	Ambient water vapour pressure (kPa).

p_s	Saturated vapour pressure of air (kPa).
p_a	Actual vapour pressure of air (kPa).
Rey	Reynolds number (dimensionless).
r_e	External resistance of animal coat (s/m).
S_i	Short wave irradiance (W/m^2).
t	Coat thickness (m).
T_{air}	Air temperature ($^{\circ}C$).
T_e	Expired air temperature ($^{\circ}C$).
T_i	Inspired air temperature ($^{\circ}C$).
T_s	Coat surface temperature ($^{\circ}C$).
T_{skin}	Skin temperature ($^{\circ}C$).
u	Air speed \approx travel speed of horse (m/s).
\dot{V}_E	Minute volume of horse (ℓ/min).
$\dot{V}O_2$	Oxygen uptake ($m\ell/kg/min$).
W_e	Expired water vapour (g/min)
W_i	Inspired water vapour (g/min)
x	Length of horse (m).
ΔT	Change in temperature of animal ($^{\circ}C$).
$\Delta \dot{T}$	Rate of change of temperature ($^{\circ}C/min$).
ϵ	Emissivity of coat (dimensionless).
μ	Dynamic viscosity of air (g/s/m).
μ_f	Dynamic viscosity of air at film temperature (g/s/m).
ξ	Convection constant of the airflow ($s^{1/2}/m$).
ρ	Density of air (g/ ℓ).
ρc_p	Volumetric specific heat of air ($J/m^3/^{\circ}C$).
ρ_f	Density of air at film temperature (g/ ℓ).
ρ_{sweat}	Density of sweat (g/ ℓ).
σ	Stefan Boltzman constant = 5.67×10^{-8} ($W/m^2/^{\circ}C^4$).

INTRODUCTION

The environmental conditions at Atlanta, USA, the site of the 1996 Summer Olympics has generated questions concerning the welfare of the participating horses, particularly from countries with markedly different weather conditions to those expected in Atlanta. To address this, and similar issues concerning thermoregulation in horses, a theoretical integrative model was developed to predict the heat balance of the horse under given weather conditions and exercise intensities.

Thermoregulation is the most important regulation system in the homeothermic animal [73]. The animal must keep its body temperature within a very narrow range (37 - 40 °C) despite extreme variations in its metabolic rate and in environmental conditions [141]. Physical work has the greatest effect on the metabolic rate and the resultant metabolic heat is the most significant source of heat in the exercising horse. Environmental factors such as solar radiation, ambient temperature and humidity and wind speed also play a role in the total heat gain of the horse.

Evaporation of sweat and water from the respiratory tract are the most important heat loss mechanisms in the exercising horse [141]. The rate of evaporation is almost totally dependent on ambient conditions. Other less significant mechanisms of heat loss include radiation to the environment,

convection and conduction. All these factors are time and species dependent.

Several mathematical models have been formulated to describe whole body heat balance in homeotherms. According to the first law of thermodynamics, the total heat gain of the body can be expressed as:

$$\dot{H}_{\text{total}} = \dot{H}_{\text{metab}} + \dot{H}_{\text{solar}} - \dot{H}_{\text{rad}} \pm \dot{H}_{\text{conv}} \pm \dot{H}_{\text{cond}} - \dot{H}_{\text{resp}} - \dot{H}_{\text{sweat}}$$

This equation includes all the internal and environmental factors that have an influence on thermoregulation of the body. These factors include the heat generation due to basal metabolism and muscle activity (\dot{H}_{metab}), heat gain due to solar radiation (\dot{H}_{solar}) and heat exchange by means of radiation (\dot{H}_{rad}), convection (\dot{H}_{conv}), conduction (\dot{H}_{cond}), evaporation from the airways (\dot{H}_{resp}), and evaporation of sweat from the animal's skin surface (\dot{H}_{sweat}). This total heat balance model can be applied to any animal subject by alteration of a few of the parameters.

The structure and extent of the hair coat is primarily responsible for differences between thermoregulation in humans and animals. It is therefore necessary to consider coat structure and colour for application of models to animals. Several authors have described the influence of the coat structure and colour on the solar radiation, conduction and convection components of the heat balance equation. [38,39,97,199,200].

Heat loss through evaporation of sweat remains the most poorly defined parameter in the complete heat balance model. Evaporative heat loss has previously been estimated on the basis of sweat losses, and while it is understood that the environmental conditions significantly affect evaporation of sweat, these have not been quantified. This avenue of heat loss is the most significant parameter in terms of heat dissipation in the working horse [141]. It is therefore essential to quantify heat loss via this route. In the model described, we have assumed the skin surface of a sweating horse is adequately described as a body of water with a given surface area. We have described the interaction of the body of water with the prevailing environmental conditions.

When an animal expends energy, approximately 80% of that energy (in excess of 1.4 MJ per minute during maximal effort in a typical Thoroughbred horse) is released as heat [73]. This results in an increase in the animal's body temperature at a rate proportional to its work intensity. Horses are capable of high intensity work for prolonged periods and this has been exploited in various forms of competition. The horse has been expected to perform in climates vastly different from its northern cooler origins. Although there has been a degree of adaptation to warmer climates, the modern competitive equine athlete is often vulnerable to thermal distress [141]. The model described enables prediction of changes in the core temperature of horses working at a specific intensity under specific environmental conditions. This information may also be of use to predict the limits of work intensity and duration that an

exercising horse can endure without experiencing thermal distress.

METHODOLOGY

If the core body temperature of most mammals rises uncontrollably from its normal resting value of $\approx 37^{\circ}\text{C}$ clinical signs of, and even life-threatening, hyperthermia may become apparent [141]. During exercise, metabolic heat load increases in proportion with metabolic consumption of oxygen. Environmental conditions influence the degree to which this heat accumulates in the animal's body. Many mammalian species do, however, have some anatomical adaptations to maintain the brain temperature within closer tolerance of its normal body temperature [176].

Heat storage, or heat accumulation, can be defined as the imbalance resulting from an excess of heat gain over heat loss. It is the difference between the sum of the heat gains from all sources and the sum of heat sinks via all loss avenues. Heat storage, which is dependent on the heat dissipation, results in an increase in the animal's core temperature. The resultant increase is dependent on the body's specific heat capacity and its size, as described in equation (2). The model therefore predicts the rate of change of core temperature ($\Delta \dot{T}$).

$$\Delta \dot{T} = \frac{\text{Heat Storage (J/ min)}}{\text{Specific Heat capacity of the horse (J/ kg /}^\circ\text{C)} \cdot \text{Body Weight (kg)}} \quad (^\circ\text{C/ min)} \quad (2)$$

Although the rate of increase of the core temperature is mirrored by the rate of increase of the horse's deep rectal temperature, the changes in rectal temperature lag behind core temperature [92]. This should be considered when changes in rectal temperature are used as an indication of heat storage under field conditions.

Heat Gain

Metabolic heat gain ($\dot{H}_{\text{metab.}}$) and heat gain due to solar radiation (\dot{H}_{solar}) are the two most significant sources of heat. As the horse's work rate increases, the metabolic heat gain becomes more significant.

Metabolic heat

The metabolic heat production of the animal (\dot{H}_{metab}) can be estimated from the rate of metabolic oxygen consumption ($\dot{V}O_2$). The value of \dot{H}_{metab} is dependent on the animal's work intensity and duration. During work, the metabolic rate increases due to increased muscular activity. Horses are capable of high metabolic rates, consuming in excess of 150 mℓ O₂/kg/min. It has been assumed that 80% of the calorific value of oxygen consumed doing work is released as heat, rather than mechanical work, and that each mℓ of O₂

consumed has an energy equivalent of 21 J [92]. The metabolic heat, \dot{H}_{metab} can be calculated from equation (3).

$$\dot{H}_{\text{metab}} = 21 \cdot 0.8 \cdot \dot{V} O_2 \cdot BW \quad (\text{J/min}) \quad (3)$$

where, 21 is the energy equivalent of O_2 in $\text{J/m} \ell$, 0.8 is the fraction of the calorific value of oxygen released as heat, $\dot{V} O_2$ is the oxygen consumption in $\text{m} \ell / \text{kg/min}$ and BW is the body mass in kilograms.

Solar Heat

Heat gain due to solar radiation (\dot{H}_{solar}) depends mainly on the animal's coat structure and colour. The darker the coat, the higher the radiant heat gain [199]. It has also been shown that with an increase in wind speed, the radiant heat gain of a dark coat decreases more rapidly than that of lighter coats [199]. There are no known reports of the relation between solar radiant heat gain and the coats of horses. Research done on pigeons [200] and other animals [38,39] have shown that \dot{H}_{solar} can be calculated from equation (4):

$$\dot{H}_{\text{solar}} = A_r \left[a_L \cdot L_i + S_i \left[a_s + \left(\frac{\left(\frac{\rho c_p}{h} \right) - r_e}{r_e} \right) \cdot \left(\frac{1}{\text{pt}} \right) \cdot (2 - a_s) \right] \right] \cdot 60 \quad (\text{J/min}) \quad (4)$$

where, A_r is the exposed surface area of the animal (this area is assumed to be 85% of total surface area of the animal [59]), a_L the long-wave absorptivity

for the animal, L_i the average long wave irradiance of the sun, S_i the average short wave irradiance of the sun, a_s the short-wave absorptivity for the animal, ρc_p the volumetric specific heat capacity of air, h the coat thermal conductance, r_e the external resistance to convective and radiative heat transfer and p_t the probability that a penetrating ray will strike a coat element with thickness t .

The coat thermal conductance of the flank and belly of the horse have been reported by Tregear [191]. This study used coats removed from the torsos of freshly killed horses. Wind was blown over the coat in the same direction as occurs in the naturally running horse. The thermal conductance through the coat was found to be highly dependent on the hair density and on the speed of the air passing over the animal's surface. For the present study it was assumed that 70% of a horse's body surface is covered with the same hair density as the flank, while 30% of the body is covered with belly type coat. A value for the thermal conductance of the horse coat was calculated using this 70% -30% relationship between the data obtained by Tregear for the belly and the flank at different wind speeds .

The external resistance of the animal coat (r_e) can be calculated using equation (5).

$$\frac{1}{r_e} = \frac{4\varepsilon\sigma T_{\text{air}}^3}{\rho c_p} + \frac{1}{\xi \left(\frac{D}{u}\right)^{\frac{1}{2}}} \quad (5)$$

where, ε is the emissivity of the coat (assumed to be equal to 1 [150]), σ is the Stefan Boltzman constant, T_{air} is the ambient temperature, ρc_p the volumetric specific heat capacity of air and ξ the convection constant for a specific air flow. Assuming laminar flow across the body of the horse, the value of ξ can be taken as $307S^{1/2}/m$ [199,200]. D is the characteristic diameter measured across the trunk of the animal, and u the travelling speed of the horse (or the net sum of travel and wind speeds). Mitchell *et al.* [150] showed in humans that the emissivity is independent of skin colour. They obtained a value for emissivity of 0.997 for all skin colours. In most studies on animals, an emissivity of 1.0 was assumed for the coat [38,39]. Therefore, the horse coat emissivity was taken as 1.0 for the purposes of this study.

The actual values for the absorptivities a_L and a_S of the horse coat are unknown. Hutchinson and Brown performed a study on samples of cattle coats of differing colour and structure [97]. The absorptivity of the coats was measured using spectrophotometric techniques. This study showed that radiation absorptivity of cattle coats varies with different coat colours. In the present study, it was assumed that horses have a similar coat structure to cattle. From data described previously by Hutchinson and Brown [97], the

wavelength dependence of absorptivity can be divided into two ranges: a short wave range from 0.3 μm to about 1.3 μm and a long wave range from 1.3 μm to 2 μm . In these two ranges a mean value for white, black and brown coat colours can be estimated individually. Hutchinson and Brown [97] showed that for short wave radiation, the mean absorptivity for the different coat colours were: $a_s(\text{white}) = 0.68$, $a_s(\text{brown}) = 0.72$ and $a_s(\text{black}) = 0.8$. They also showed that for long wave radiation, the mean absorptivity for all three colours was $a_L=0.6$.

The probability that a penetrating ray will strike a coat element with thickness t , namely pt , is dependent on the time of day. In previous studies, only one value of pt was assumed for the specific kind of skin surface used in each particular study [39,199]. According to Cena and Monteith [39], a general value for pt for a specific coat can be calculated from equation (6):

$$pt = nd \cdot \tan[\arccos(t/\ell_s)] \quad (6)$$

Where, n is the number of hairs per m^2 of coat, d the mean diameter of the individual hair, t the coat thickness, and ℓ_s the mean length of the hair. For the purposes of this study, the long wave irradiance (L_i) was taken as 0.94 kW/m^2 and the short wave irradiance (S_i) as 0.18 kW/m^2 , which are typical of a clear summer's day in Pretoria, South Africa.

Heat Losses

Respiratory heat loss

Hodgson *et al.* [92] concluded in their study conducted on horses that heat loss from the pulmonary circulation (\dot{H}_{resp}) increases as exercise progresses. Furthermore, this progressive increase in heat loss may be related to increase in alveolar ventilation that occurs with increasing exercise duration in horses. Recent studies on human subjects [88] showed that increased respiratory heat loss can be affected by increased minute volume (\dot{V}). This is directly related to evaporative and convective heat loss from the respiratory tract. Both these variables are dependent on an increase in the core temperature of the subject. Evaporative heat loss is a major component of the respiratory heat loss and increases with increasing \dot{V} [88]. The role of respiratory heat loss in maintaining thermal balance varies from species to species, and has been shown to be the primary route for heat dissipation in some species.

The total respiratory heat loss can be calculated from the sum of the convective and evaporative components as shown in equation (7):

$$\dot{H}_{\text{resp}} = \dot{V}_E \cdot \rho_{\text{CP}} \cdot (T_e - T_i) + La \cdot (W_e - W_i) \quad (\text{J/min}) \quad (7)$$

Where, \dot{V}_E is the minute volume, ρ_{CP} the volumetric specific heat capacity of air, T_e and T_i the temperatures of the expired and inspired air, respectively, La

is the latent heat of vaporisation of water, and $W_e - W_i$ is the difference between expired and inspired water vapour [88]. In exercising horses one can assume that the inspired air temperature is the same as the ambient temperature. Hodgson *et al.* [92] estimated an expired air temperature of 34°C in exercising horses. This value was used in the predictions made in the present study. It should be noted that the specific heat capacity of air is not constant and is dependent on its density, temperature and water vapour content.

Convective heat exchange from the lungs is dependent on the pulmonary ventilation and the difference between the temperature of the expired air and ambient air temperature and humidity. Pulmonary ventilation is related to metabolic rate and this effect is accounted for by the first term of equation (7). The equation for respiratory heat loss derived by Mitchell *et al.* [151] cannot be used on horses because respiratory heat loss in horses is likely to be more significant than in humans. Calculating respiratory heat loss from metabolic heat production alone is therefore not accurate and the evaporative water loss from the respiratory system must be included in the calculation.

Evans *et al.* [57] concluded that the minute volume (\dot{V}_E) is linearly related to sub-maximal exercise intensity. They derived an equation for the relationship between the minute volume and oxygen consumption; equation (8):

$$\dot{V}_E = 214.804 + 7.39 \dot{V}O_2 \quad (\ell / \text{min}) \quad (8)$$

Where, $\dot{V}O_2$ is in $m\ell/kg/min$.

Evaporation heat loss due to sweating

The importance of evaporative heat loss (\dot{H}_{sweat}) in the horse is well recognised. Exercise intolerance demonstrated by anhidrotic horses highlights the role that sweat evaporation plays in maintaining thermal balance of exercising horses [137]. Horses with compromised sweating capabilities overheat easily, often with severe clinical implications [137].

In most previous studies, heat loss due to sweating is estimated from the change in body mass during the period of work. This probably overestimates effective evaporative heat loss as excess sweat is often lost as it drips from the horse. If one assumes that the skin surface of a sweating horse is adequately represented by a body of water and that there is a convectively stable atmosphere then the equation (9) describing the molecular diffusion of water vapour into free atmosphere [94] can be used to estimate heat loss due to sweating.

$$\dot{H}_{sweat} = \frac{La \cdot [3.2127 + 1.922 u] \cdot (P_s - P_a)^{0.88} \cdot \rho_{sweat} \cdot A}{1440} \quad (\text{J/min}) \quad (9)$$

Where, La is the latent heat of vaporisation of sweat, u the air speed over the horse, p_s the saturated water vapour pressure of air at ambient temperature, p_a the actual water vapour pressure of air ($p_s \cdot [\text{humidity of air}]$), ρ_{sweat} the density of sweat, and A the surface area of the horse. Due to the lack of data

describing the thermodynamic properties of equine sweat, it is assumed that sweat has thermodynamic properties similar to water. Further research is required to determine how the latent heat of evaporation and vapour pressure of horse sweat varies with changes in composition. For this study, the relation of surface area of the horse to body weight described by Hodgson *et al.* [92] was used. The skin surface area (A) is related to body weight by equation (10):

$$A = 1.09 + 0.008 \cdot BW \quad (\text{m}^2) \quad (10)$$

Where, BW is the body weight of the horse in kg.

Radiative heat loss

Any heated body can radiate heat to the environment. Heat loss due to radiation (\dot{H}_{rad}) is dependant on the surface area of the horse. The most important variable in this equation is the surface temperature. This surface temperature is dependent on the metabolic heat of the animal and the ambient conditions, which include ambient temperature and humidity, and cloud conditions. In the horse, heat loss due to radiation (\dot{H}_{rad}) can be calculated from equation (11) [59]:

$$\dot{H}_{\text{rad}} = 60(A_r \varepsilon \sigma T_s^4) \quad (\text{J/min}) \quad (11)$$

where, A_r is the area emitting long wave radiation, ε is the emissivity of coat, σ the Stefan Boltzman constant, and T_s is the coat surface temperature.

Convective heat transfer

When there is air movement around a body, convection (\dot{H}_{conv}) occurs. Free convection occurs in still air decreasing the boundary-layer resistance as the temperature difference increases between the coat surface and the air [138]. Forced convection occurs when the body is exposed to moving air. Heat gain or loss due to forced convection can be calculated using equation (12). In this equation, the heat transfer rate is related to the total temperature difference between the surface of the horse and the air, and the surface area [94].

$$\dot{H} = 2 h_c A (T_s - T_{\text{air}}) \cdot 60 \quad (\text{J / min}) \quad (12)$$

Where, A is the surface area, T_s is the coat surface temperature, T_{air} the air temperature and h_c is the heat transfer coefficient at film temperature which can be calculated from equation (13):

$$h_c = \text{Nu} \cdot \frac{k_a}{x} \quad (13)$$

where, Nu is the Nusselt number, k_a is the thermal conductivity of air at film temperature, and x the length of the horse measured from the point of the shoulder to the tuber sacrale. The film temperature is the mean of the animal's surface temperature and the air temperature. Assuming the horse has a constant temperature over its entire body surface, the Nusselt number can be calculated from equation (14):

$$\text{Nu} = 0.332 \text{Rey}^{1/2} \text{Pr}^{1/3} \quad (14)$$

where, Rey is the Reynolds number and Pr is the Prandl number. The

Reynolds number, which includes air speed and certain characteristics of the airflow across the animal's body, can be calculated using equation (15):

$$\text{Rey} = \frac{\rho_f u x}{\mu_f} \quad (15)$$

Where, ρ_f the density of air at film temperature, u the air speed over the horse, x the length of the horse and μ_f the dynamic viscosity of air at the film temperature [138].

The Prandl number relates the relative thicknesses of the hydrodynamic and thermal boundary layers and can be calculated from equation (16):

$$\text{Pr} = \frac{c_{pf} \mu_f}{k_a} \quad (16)$$

Where, c_{pf} is the specific heat capacity of air at the film temperature, μ_f the dynamic viscosity of air at film temperature, and k_a is the thermal conductivity of air at film temperature. These parameters were obtained from heat transfer tables for particular ambient conditions [94].

The Nusselt number describes the air layer and laminar airflow over the body. The effect of turbulence generated by the hairy coat of the horse is unknown and as in previous studies [138] was ignored.

Conductive heat transfer

Heat transfer due to conduction (\dot{H}_{cond}) plays a minor role in the heat balance of the horse. Conduction can cause either heat gain or heat loss, depending on the temperature differences between the animal and the environment [40]. The effect of this mechanism of heat exchange is not significant when compared to other factors described, and can probably be ignored [138]. The conductive heat loss factor may play a more significant role in the total heat balance when the different thicknesses and structures of summer and winter coats are considered. The conductive heat transfer is given by:

$$\dot{H}_{\text{cond}} = -\frac{k_c A}{t}(T_s - T_{\text{skin}}) \cdot 60 \quad (\text{J/ min}) \quad (17)$$

Where k_c is the thermal conductivity of the animal coat, A the surface area, t the thickness of the coat, T_s the coat surface temperature and T_{skin} the skin temperature. A value of 0.036 W/m/°C for k_c of felt and hair was given by Holman [94] and was used for predictions made in this study. No values for the surface temperature of the horses during exercise were available. In a study done by Naylor *et al.* [157], subcutaneous temperatures of the neck and back of the horse were measured during low-intensity exercise (40% of $\dot{V}O_2\text{max}$, speed range 3.6 - 4.1 m/s) on a treadmill in a temperature-controlled laboratory (21-22°C). These temperatures were assumed to be similar to skin temperatures, and thus were used in verifying the model in the present study.

In South Africa the thickness of the sweat saturated coat of Thoroughbred horses is approximately 1 mm during summer and 3 mm during winter. The difference between skin and surface temperatures is so small for coats of this thickness that the heat loss due to conduction is negligible.

In all the models used in this study where air speed was a variable, it was assumed that air speed was equivalent to the actual travel speed of the horse and that the direction was opposite to the direction of travel of the horse. When applying these equations to field conditions the wind and travel components can be summed using component vectors in the travel direction.

Comparison of model with experimental data

The predictions generated by the described integrative model were compared to data reported by a number of workers. The variables describing the typical Thoroughbred horse are presented in Table A-1 and were the basis of the calculations.

Comparison with treadmill laboratory data:

The conditions within treadmill laboratories are generally controlled and therefore easily determined. Much data has been published describing heat balance of horses working in such laboratories [92,157]. Under these conditions solar radiation can be eliminated from the model. The thermodynamic characteristics were obtained from various thermodynamic

steam tables [195,201]. The ambient temperature was 22 °C and the relative humidity was 40%. Changes in skin temperature were obtained from data published by Naylor *et al.* [157] for similar ambient conditions. Since the effect of work intensity on skin temperature kinetics has not been reported, the same skin temperature profile was used at all work intensities. Initial predictions were made at 10-minute increments. The skin temperatures used in this study were 35.8, 37.5, 39.2, 39.6, 39.7 °C at 0, 10, 20, 30, and 40 minutes of exercise, respectively [157]. The coat thermal conductivity was taken from data published by Tregear [191]. The difference between expired and inspired water vapour for the analysis was taken as 33.39 g/min [127].

Effect of solar radiation:

The effect of solar radiation on the heat balance of the animal as determined by lab the model was studied by adding the solar radiation components to the laboratory conditions presented above.

Table A-1: Characteristics of a typical Thoroughbred horse

Parameter	Value
Body Weight, BW	474 kg
Characteristic diameter, D	1.6 m
Length of horse, x	1.8 m
Coat Thickness, t	0.001 m
Length of hair, ℓ_s	0.03 m
Mean diameter of hair, d	0.0001 m
Number of hair/m ² , n	12 x 10 ⁶
Thermal conductivity of coat, k_c	0.036 W/m/°C
Long wave absorptivity, a_L	0.6
Specific heat capacity of air, c_p	3 470 J/g/°C
Emissivity of coat, ϵ	1
Latent heat of H ₂ O vaporisation	2 428 kJ/ℓ
Stefan Boltzman constant, σ	5.67x10 ⁻⁸ W/m ² /°C ⁴
Convection constant of airflow, ξ	307 S ^{1/2} /m
Short wave absorptivity, a_s	0.72

Table A-2: Summary of data defining the three work intensities used in the validation of the model

Work intensity		Speed (m/s) at 10% slope	Coat thermal conductance, h (W/m ² /°C)
% of max.	$\dot{V} O_2$ (m l/kg bwt/min)		
40	50	4	11.51
65	86	6.8	14.45
90	117	8.5	15.59

Table A-3: Comparative summary of the time duration calculated for the horse to reach a critical temperature of 42 C and that reported by Hodgson *et al.* (1993) for different exercise intensities

Running speed (m/s) at 10% slope	% of $\dot{V} O_2$ max	Time to reach critical temperature	
		Predicted	Experimental data
4	40	30	N/C
6.8	65	13.5	17.7
8.5	90	8.8	7.5

N/C, the time to reach the critical temperature was not reported in this study for this specific exercise intensity. From extrapolation of the plots presented in this study the time was estimated to be greater than 38 min.

Table A-4: Comparison of the respiratory heat loss predicted by the model with the heat loss from the lungs reported by Hodgson *et al.* (1993) for a laboratory temperature of 22°C and a humidity of 40% for 3 different exercise intensities.

Running speed(m/s) at 10% slope	% of $\dot{V} O_2\text{max}$	Respiratory heat loss (\dot{H}_{resp}) (kJ/min)		
		Predicted	Experimental data	
4	40	89.539	60.5 after 3 min	198.5 after 38 min
6.8	65	93.394	151.2 after 3 min	259.5 after 15 min
8.5	90	96.179	166.3 after 3 min	408.2 after 9 min

RESULTS

Comparisons were made between published data [92,105] and predicted data at 40, 65 and 90% of $\dot{V} O_2\text{max}$. Further details of the exercise conditions are summarised in Table A-2. The air speed generated by fans in the laboratory, and not the running speed of the horse, was taken as the air speed over the horse. Results predicted by the model and the carotid artery blood temperature data presented by Hodgson *et al.* [92] are compared in Figure A-1. The predicted and measured times for the horse's core temperature to reach a temperature of 42°C (nominated as the critical core temperature for the purposes of this study) are presented in Table A-3. The respiratory heat loss predicted by the model is compared with the experimental data reported by Hodgson *et al.* [92] in Table A-4. Figure A-2 shows a comparison between

the rate of change of core temperature predicted by the model, that of the pulmonary artery reported by Jones and Carlson [105], and that of the carotid artery reported by Hodgson *et al.* [92].

The relationship between the predicted rate of change in core temperature and ambient humidity is presented in Figure A-3. These data were calculated at a work intensity eliciting 90% of $\dot{V}O_{2\max}$ and ambient temperatures of 22°C and 30°C, other variables were taken from Table A-1. The effects of humidity and air speed over the horse on \dot{H}_{sweat} are presented in Figure A-4.

The effect of solar radiation on the rate of change in core temperature ($\Delta\dot{T}$) at various humidities is presented in Figure A-5. Figure A-6 presents $\Delta\dot{T}$ for the absorptivities corresponding to different coat colours. The relationship between the solar heat gain and the coat absorptivity is presented in Figure A-7

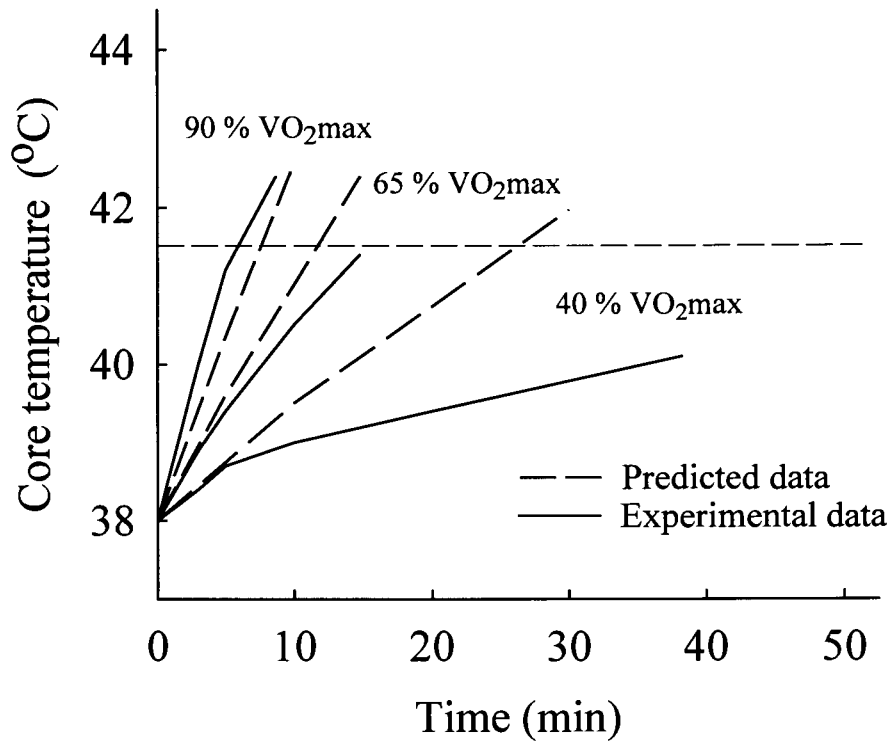

Figure A-1 : Plot of predicted core temperature and carotid artery temperature reported by Hodgson *et al.* (1993) at three different work intensities in Thoroughbred horses. The predicted values were calculated for a temperature of 22°C and a relative humidity of 40% to simulate the laboratory conditions under which the experiments were done.

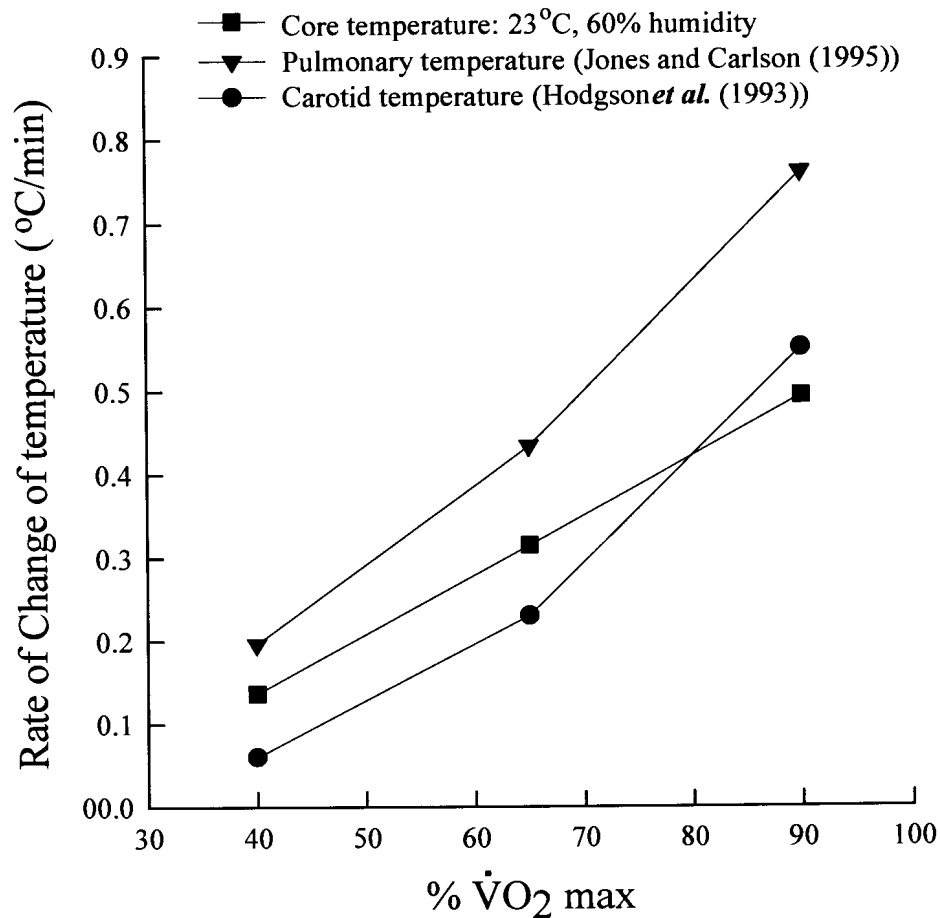

Figure A-2 : Comparison between the rate of change in core temperature as predicted by the model (ΔT), the rate of change in pulmonary artery temperature reported by Jones and Carlson (1995), and the rate of change in carotid artery temperature reported by Hodgson *et al.* (1993) at three different work intensities in horses.

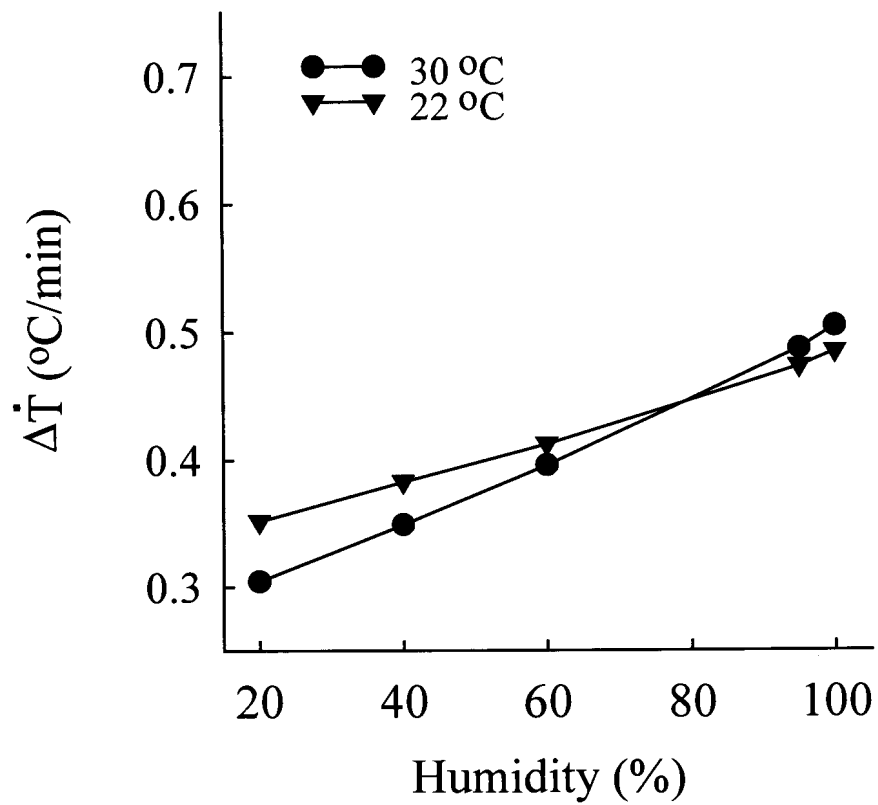

Figure A-3: The predicted effect of increasing humidity on the rate of change of core temperature of an average Thoroughbred horse exercising at 90% of $\dot{V} O_{2max}$ in ambient temperatures of 22 and 30°C.

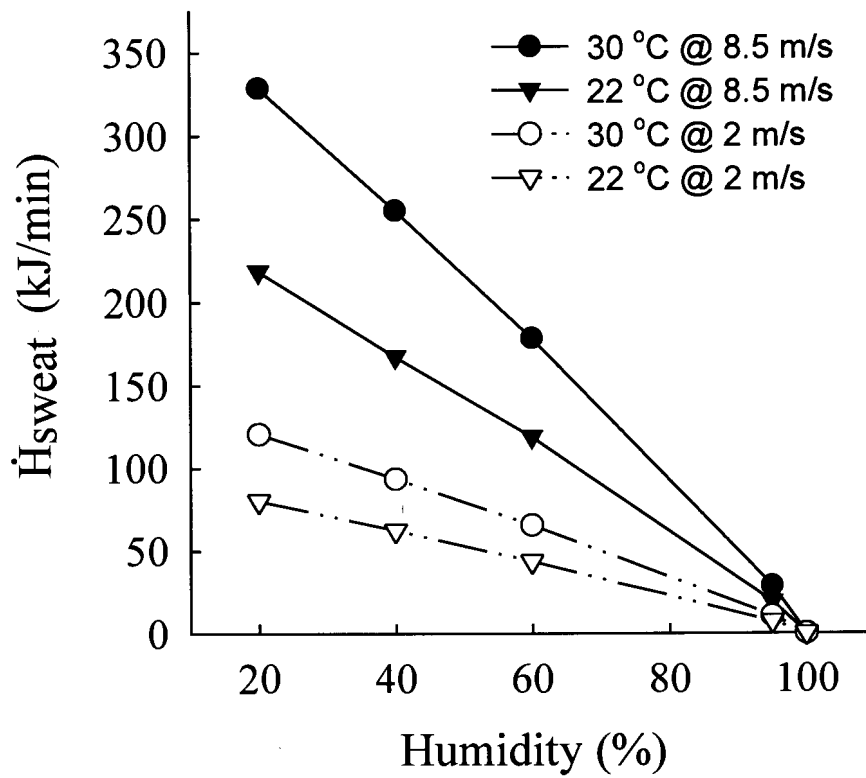

Figure A-4 : Plots summing the predicted effects of varying humidities at two temperatures and two air speeds on heat loss by evaporation of sweat for a typical Thoroughbred horse exercising at 90% of $\dot{V} O_2\text{max}$.

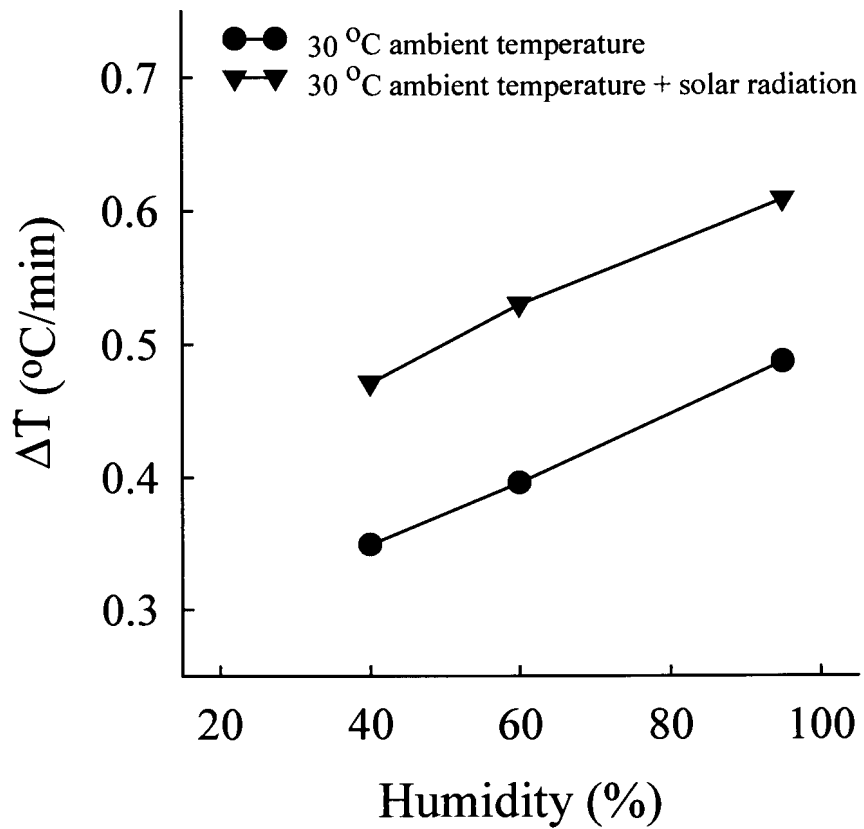

Figure A-5: The predicted effect of solar radiation on the rate of change of core temperature ($\Delta\dot{T}$) at different humidities for a typical Thoroughbred horse exercising at 90% of $\dot{V} O_2\text{max.}$.

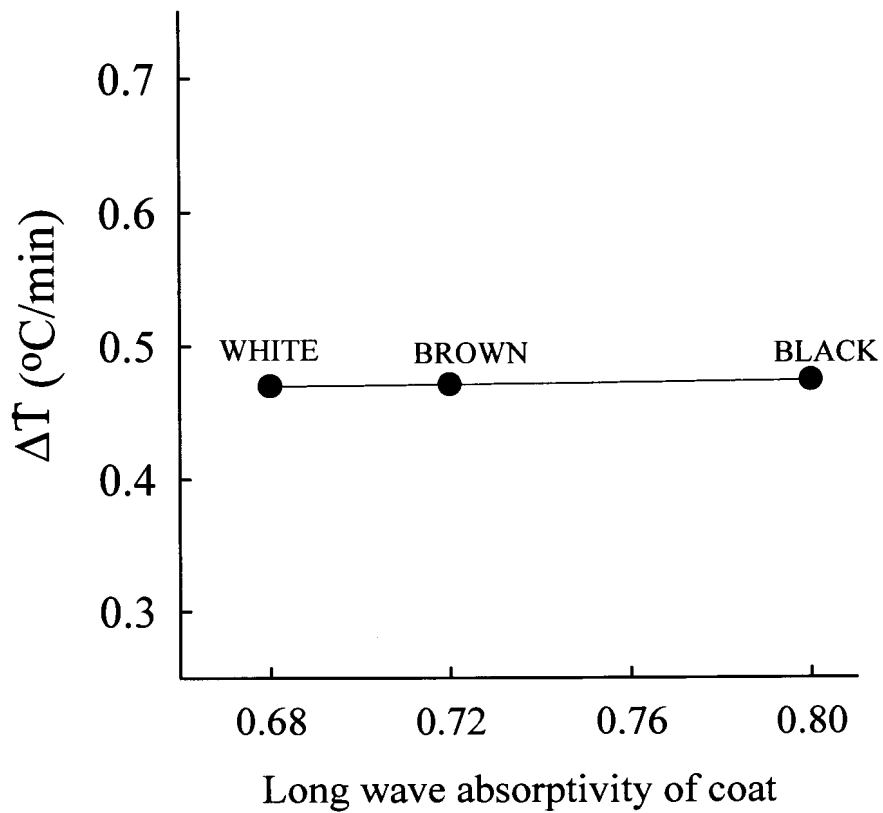

Figure A-6: The predicted effect of long wave absorptivity due to different coat colours on the rate of change of core temperature ($\Delta\dot{T}$) for a typical Thoroughbred horse exercising at 90% of $\dot{V}O_2\text{max}$ at a temperature of 22 $^{\circ}\text{C}$, relative humidity of 40%, long wave irradiance of 0.94 kW/m² and short wave irradiance of 0.18kW/m²

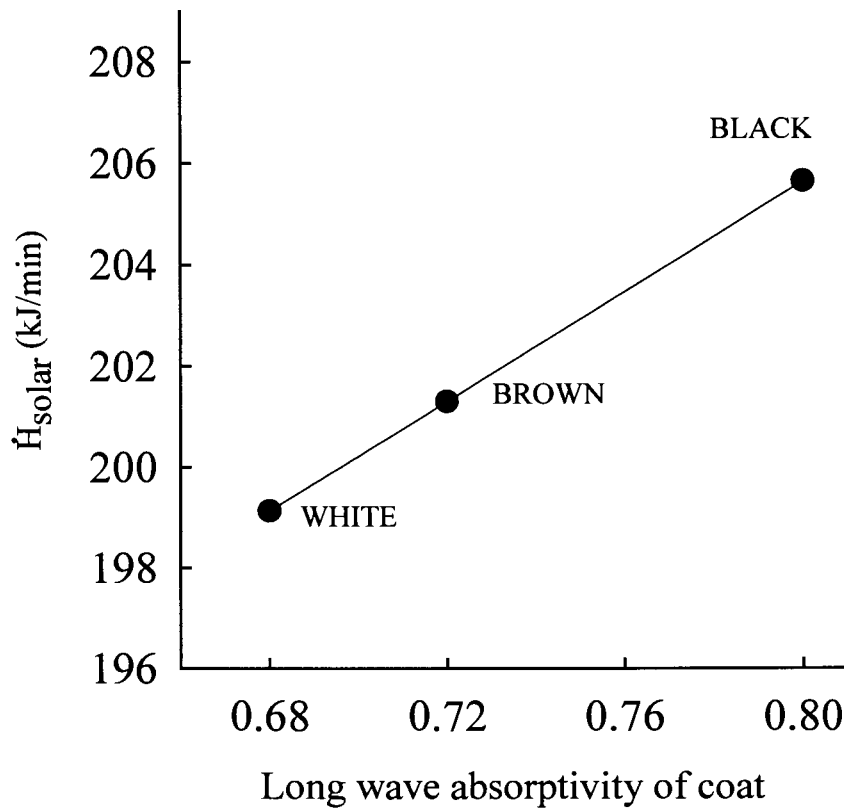

Figure A-7: The predicted effect of different long wave absorptivities due to different coat colours on solar heat gain (\dot{H}_{solar}) for a typical Thoroughbred horse assuming a long wave irradiance of 0.94 kW/m^2 and a short wave irradiance of 0.18 kW/m^2 .

DISCUSSION

It is apparent that as the work duration increases, the disparity between the predicted core temperature and the measured temperature increases. This is most easily illustrated during low intensity exercise where the exercise duration exceeds 30 minutes, however, at higher intensities, the respective data are also divergent as exercise progresses. At 90% of $\dot{V}O_{2\max}$, the model initially underestimates the core temperature. As exercise progresses, the predicted data approaches the experimental data and if exercise progressed beyond 9 minutes, the model would probably overestimate the core temperature. At the two lower work intensities, the predicted data and the experimental data are very similar for the first 5 minutes. Estimations of core temperature beyond 5 minutes increasingly exceed the experimental data as exercise progresses.

Respiratory heat loss has been reported to increase as exercise progresses at all intensities [88,92]. However, the mechanism by which this occurs has not yet been explained nor modelled. The model presented therefore does not describe a similar trend. If these trends (presented in Table A-4) were superimposed on the data described by the model, the deviations of the model data from the experimental data at all work intensities would be smaller.

The balance of the heat was assumed to be lost via sweat evaporation, radiation and convection, of which evaporation of sweat was most significant. We assumed that the horse had a layer of sweat over its entire body 5 minutes after commencing exercise. The evaporative heat loss is dependant on the environmental conditions and assuming the temperature, humidity and air speed were constant, the model predicted the evaporative heat loss under the laboratory conditions to be similar at all work intensities. Lund *et al.* [127] showed that respiratory heat dissipation can compensate when evaporative heat dissipation reaches its maximum rate for the given conditions. Air speed over the entire surface of the horse is important for maintenance of core temperature. When exercising on a track, increases in speed result in greater air movement over the body, allowing more heat to be lost via the evaporation of sweat. In contrast if the speed of air movement over the body is lower than the running speed, which may occur when a horse exercises on a treadmill, inadequate evaporative heat loss is likely to occur, thereby dramatically increasing the risk of thermal stress if exercise is continued.

In our model, heat loss via convection accounted for about 5% of the total heat load during the first 10 min. Heat loss via radiation was the least significant, accounting for less than 1% of the total load. Although heat loss due to convection and radiation increased with increasing skin temperature and time, their contribution to overall heat balance was small.

The comparison presented in Figure A-2 shows that the rates of change of core temperature predicted by the model are closer to the results reported by Hodgson *et al.* [92] than to those calculated using the equations reported by Jones and Carlson [105]. The exercise test used by Jones and Carlson was conducted on the flat while that of Hodgson *et al.* was performed at a treadmill inclination of 10 %. Jones and Carlson did not report maximal oxygen uptake of their experimental subjects and did not relate any of their data to maximal oxygen uptake. These differences in experimental design makes direct comparison of the results difficult. The large fluctuation in laboratory temperature and humidity reported by Jones and Carlson further complicates these comparisons. These limitations highlight the need to perform comparative studies using similar experimental protocols and under controlled conditions.

Effects of increasing humidity:

Figure A-3 clearly shows that humidity has a major effect on thermal balance of the exercising horse. The air temperature determines the quantity of water vapour that the air can hold. The environmental ambient temperature and humidity are therefore interdependent in determining the evaporative heat loss of the exercising horse, which led us to conclude that the heat loss by sweating is independent of sweat rate. The elevated core temperature experienced during hot, humid conditions is a consequence of decreased evaporative heat

loss (\dot{H}_{sweat}). The evaporative heat loss decreases with increasing humidity. Figure A-4 shows that as relative humidity tends toward 100%, the air becomes totally saturated with water vapour and evaporative heat loss tends toward zero. Heat can then only be lost via the respiratory system, convection, radiation and conduction. The respiratory heat loss will, however, be compromised as it depends, to an extent, on evaporation from the airways. The effect of air speed over the horse on evaporative heat loss at different humidities is also shown. These results show the importance of creating sufficient air movement over the horse when it is exercising at different exercise intensities on a treadmill. Failure to do so may result in unnecessary exposure of the horse to conditions that could result in heat stress.

Research by Hodgson *et al.* [92] has shown that the sweat rate of horses is closely related to the temperature of the blood in the carotid and pulmonary arteries. Kerr and Snow [111] investigated the sweat rate of horses during endurance exercise and concluded that the sweat rate gradually increased during the first 2 to 3 kilometres and was then maintained at a constant rate throughout the ride.

It could be proposed that evaporation from a saturated hair coat is not as effective as from the skin surface. Hodgson *et al.* [92] have shown that evaporation from the skin cools the subcutaneous blood flows, a hair coat saturated with sweat could behave as an insulating layer between the

evaporative surface and the skin. The clipping of the hair coat of cattle has been shown to aid evaporative heat loss [1].

Figure A-5 shows solar radiation does affect the rate of increase of the core temperature of the horse. Cloud cover and the altitude determine the intensity of solar radiation. There is evidence that cities with high temperatures combined with high humidity (e.g. Hong Kong and Durban, South Africa) generally experience high cloud cover under such conditions. This therefore reduces the overall heat gain when evaporative heat loss is compromised. The absorptivity of the coat, which is determined by the colour of the hair, is often considered to significantly affect the heat gain [97]. Figure A-6 shows that coat colour does not significantly affect the rate of change of the core temperature. The component of heat gain as a result of the coat colour, shown in Figure A-7, compares well with results presented by Finch *et al.* [59] for white and black goats.

CONCLUSION

The deviations of the predictions of our model from the published experimental data [92,105,157] may be partially explained by incomplete data describing the environmental conditions under which the reported trials were carried out. However, the comparisons indicate that aspects of the model do not completely describe the behaviour of the mechanisms involved in dissipating metabolic heat. The predicted respiratory heat dissipation is lower than the experimental data and does not describe a similar ramping trend as

exercise duration progresses. This ultimately results in an overestimation of the rate of change in core temperature during exercise. The model describing evaporative heat loss was derived experimentally from evaporation from a water pan, and the air flow over such a pan and the horse may be significantly different. The thermodynamic characteristics of horse sweat are unknown. Previous studies have assumed water and sweat have similar thermodynamic characteristics. It has been shown, however, that horse sweat contains protein, the concentration of which is higher at the onset of sweating [52] and has high salt concentrations [111]. The protein in horse sweat is known to reduce surface tension, enabling the sweat to wet the hair coat rather than forming droplets that can run off. Salts added to liquids are known to reduce vapour pressure [201]. Reducing vapour pressure reduces evaporation rate, and may also effect the latent heat of vaporisation. The effect of protein and salt on these characteristics of horse sweat warrants further investigation.

The reasonable correlation between the predictions of the integrated mathematical model presented and data of other researchers shows that the thermal balance of working horses can be modelled. However, the model, as it is presented here, requires refining before it can be applied with confidence to predict the thermal status of the equine athlete.

The study has shown which of the parameters in the model have the greatest influence on the heat balance of the exercising horse. It has also illustrated

shortcomings in the current model. It has shown that the respiratory heat loss model is inadequate and warrants further experimental work in order to establish the mechanisms behind the reported increase in respiratory heat loss with exercise duration. Evaporative heat loss via sweating has been modelled with a reasonable degree of confidence, it should, however, be refined with experimental verification. Ultimately, the model should reasonably predict the intensity and duration of work a horse should be able to maintain under specific environmental conditions before experiencing thermal distress.

APPENDIX B

TERMOREGULATION - BASE MECHANISMS AND HYPERTHERMIA

Thermoregulation is the most important regulation system in homeothermic animals. [73] Such animals must maintain their body temperature within a very narrow range (37 - 40°C) despite extreme variations in metabolic rate and environmental conditions. [141] Physical work has the greatest effect on the metabolic rate and the resultant metabolic heat is the most significant source of heat in exercising horses. Environmental factors such as solar radiation, ambient temperature, humidity and wind speed also play a role in heat balance of the horse. Evaporation of sweat and water from the respiratory tract are the most important heat loss mechanisms in the exercising horse and the rate of evaporation is almost totally dependent on ambient conditions. [141]

When an animal expends energy, approximately 80% of that energy (in excess of 1.4 MJ/min during maximal effort in a 500 kg horse) is released as heat. [73] This results in an increase in the animal's body temperature at a rate proportional to its work intensity. Horses are capable of high intensity work for prolonged periods and this has been exploited in various forms of competition. Horses are also often expected to perform in climates substantially different from those to which they are acclimatized. Although there has been a degree of adaptation to warmer climes, the modern equine athlete is often vulnerable to hyperthermia and heat stress. This is further exacerbated by the fact that elite equine athletes are often

required to travel to distant locations where the environment may be significantly different from that to which they are acclimatized. The staging of major international competitions under particularly stressful environmental conditions has highlighted awareness of heat balance of equine athletes recently. This has prompted research in the field and therefore an increase in the depth of knowledge of this aspect of equine athletics.

HEAT BALANCE

In homeotherms, energy balance is related to the maintenance of body temperature within a narrow range and is dependent on the dissipation and retention of metabolic heat. There is thus an environmental temperature range, which is (1) species, (2) breed, (3) climate, and (4) 'clothing or coat' dependent within which the animal can reduce its energy consumption and still maintain energy balance. This temperature zone, termed the thermoneutral zone, is the temperature range where the basal metabolic rate is lowest. The basal metabolic rate of a sedentary animal is often referred to as the cost of living. [197]

Conversion of chemical energy to mechanical energy is extremely inefficient with approximately 80% of the total chemical energy used during muscular contraction released as heat rather than physical work. [26] The balance between heat gain and heat loss is continually disturbed, either by changes in metabolic rate (exercise being the most powerful influence) or by changes in the external

environment. Heat is produced by virtually all chemical reactions occurring in the body, and thus metabolism sets the basal level of heat production, which can be increased by skeletal muscular contraction or the action of several hormones. [197] Heat gain due to solar radiation can also be significant but as a horse's work rate increases, the metabolic heat gain becomes more significant.

HEAT GAIN

The breakdown of organic molecules liberates energy from intramolecular bonds. This energy is utilized by cells in their performance of various forms of biological work (muscle contraction, active transport, synthesis of molecules). The first law of thermodynamics states that energy can neither be made nor destroyed but can be converted from one form to another. Thus, internal energy liberated during breakdown of organic molecules can either appear as heat or be used to perform work. The body is incapable of converting heat into work, but heat is vital for maintaining body temperature.

Biological work can be divided into two categories: (1) external work, i.e., movement of external objects by contracting skeletal muscles; and (2) internal work, which includes all other forms of biological work. All internal work is ultimately transformed into heat except during periods of growth. One of several examples of this is the internal work that is performed during cardiac contraction that ultimately appears as heat generated by the resistance to flow through the

blood vessels. Thus, the total energy liberated when cells catabolize organic nutrients may be transformed into body heat, appear as external work, or be stored in the body in the form of organic molecules (fat or glycogen). The total energy expenditure of the body is therefore summarized by the equation:

Total energy = internal heat produced + external work performed + energy stored

Many factors influence the body's metabolic rate. In the measurement of basal metabolic rate (BMR), standardized test conditions must be maintained. The subject must not have eaten for 12 hours, must be in a state of physical and mental rest and be at a comfortable temperature. These conditions are termed basal, but the BMR is not the minimum metabolic rate. The subject's metabolic rate may be lower during sleep. BMR, as defined, is extremely difficult to achieve and measure in animals. Metabolic rate can be elevated by a number of factors including, body temperature and environmental temperature. Any form of stress, including illness, can also raise metabolic rate. [197] The ingestion of food causes an increase in metabolic rate of between 10 and 20%. It has been shown that this increase is not only due the digestion of the food but also the processing of the nutrients by the liver. Measurement of BMR in ungulates is not practical since it is difficult to attain a postabsorptive state and complete rest. The rate of O₂ consumption (V_{O₂}) under thermoneutral ambient temperature of a resting animal is commonly accepted as a convenient baseline for measuring various energy increments, such as heat increments of muscular work, feeding and thermoregulation. Some factors affecting "resting" heat production (HP) in ungulates include body size, species, breed and feed intake.

The relationship between mammalian body weight and resting HP has been extensively studied by Brody [26] and Kleiber. [116] Their studies revealed that resting HP is proportional to the animal's body mass to the power of 0.75 (i.e. a 100% increase in body weight is equivalent to a 75% increase in metabolic rate). Based on this finding, they proposed the term "physiological weight" or "metabolic body size" (i.e., body weight^{0.75}). They also showed that while this relationship is constant for adults of many species, it may not hold true for growing animals. [26] While this relationship is generally true, it has been shown that the resting HP per unit metabolic weight of cattle is higher than that of sheep. [75] Furthermore, Zebu cattle have a lower resting HP than the European and Afrikander breeds. [198,212] Although no studies have reported similar differences in horses, one could expect that lighter breeds may have a significantly lower resting HP than the heavier breeds that originate from northern Europe.

Under thermoneutral conditions, HP also depends on the quality and quantity of feed intake. [76] In horses, it has been shown that the replacement of dietary hay with grains reduces HP, [116] which can be further reduced by dietary fat supplementation. [63] Fasting also decreases HP but its effect is dependent on previous nutritional level. [74] Restriction of water intake and dehydration also decrease HP of many animals exposed to hot or cold environments [54,206,215]. The calorogenic hormones, (epinephrine, thyroid hormone (TH), growth hormone (GH), and glucocorticoids) all influence the metabolic rate of mammals. An

increase in the plasma concentration of epinephrine may increase heat production by 30 %. Thyroid hormone (TH) also increases the oxygen consumption and heat production of most body tissues. [20,135] Administration of GH to cattle acclimated to a thermoneutral and a hot temperature increases HP by 30 to 60%. [218] Injection of hydrocortisone has also been shown to increase HP of cattle acclimated to thermoneutral and hot environments. [220]

The resting oxygen consumption of adult horses is between 2.2 and 4.2 ml/kg/min. [189] During maximal exercise the oxygen consumption may increase 40 to 60-fold to between 140 and 187 ml/kg/min. [50] Metabolic heat production of horses exercising at this intensity can exceed 1.4 MJ/min and would result in an increase in body temperature of approximately 1°C per minute if no heat was dissipated. The metabolic heat load of an endurance horse exercising at a mean speed of 8 m/s is approximately 0.6 MJ/min and would result in an increase in body temperature of approximately 21°C per hour if no heat was dissipated. Thoroughbred horses race over distances that require maximal effort for between 1 and 3 minutes and if the total heat load generated during such exercise were to accumulate it would result in an increase in temperature of approximately 4°C. Horses can tolerate acute changes in body temperature of this magnitude [66,92] provided the stored heat can be dissipated following cessation of exercise. The magnitude of the heat that accumulates during endurance exercise in horses can only be tolerated if adequate heat loss occurs throughout the event.

HEAT TRANSFER

Heat is transferred to or from a body by means of thermal gradients. There are four prime mechanisms whereby heat exchange can occur: radiation, convection, conduction and evaporation. Homeothermy requires a balance between heat produced by an animal, or gained from the environment, and that dissipated to the environment. Conductive, convective and radiative heat loss are of minor importance while evaporation of sweat and water from the respiratory tract are vital heat loss mechanisms in the exercising horse. [141]

Conduction refers to the direct transfer of heat between surfaces that are in contact and results in either heat gain or heat loss, depending on the temperature differences between the animal and the environment. [40] In exercising horses, most of this transfer is to air which has a very low thermal conductivity and thus conductive heat loss plays an insignificant role when compared to other mechanisms and can therefore be ignored. [138] Conductive heat loss is directly proportional to skin temperature and is inversely proportional to coat thickness. The limbs, head and neck of animals have a very high surface area to mass ratio and thus the majority of conductive heat loss occurs from these parts of the body. Shunting of blood away from the skin of the extremities limits conductive heat loss in animals exposed to low environmental temperatures while local vasodilation enhances heat loss from the extremities in animals exposed to high temperatures. [162] The increased thickness of winter coats reduces conductive

heat loss and plays an important role in reducing heat loss from horses exposed to low environmental temperatures.

Convection occurs when there is heat transfer between two media at different temperatures. Free convection occurs in still air decreasing the boundary-layer resistance as the temperature difference increases between the coat surface and air. [138] Forced convection occurs when the body is exposed to moving air, as occurs during exercise [149]. Heat loss due to convection depends on the temperature difference between the surface of the horse and the air, surface area of the horse and the air speed over the horse. Free convection at the skin can contribute significantly to heat loss when ambient air temperatures are low. Convective heat exchange also occurs in the respiratory system and is dependent on pulmonary ventilation and the temperature difference between inspired and expired air.

Radiative heat transfer occurs when electromagnetic radiation is absorbed or emitted at the body surface. Any object exposed to sunlight absorbs solar, or short wave, radiation. Long-wave radiation is absorbed or emitted from the skin surface whenever there is a temperature difference between the animal and its environment. Heat loss due to radiation is primarily dependent on the skin surface temperature of the horse, but is also influenced by the skin surface area of the horse. The metabolic heat of the animal and ambient conditions, which include ambient temperature and humidity, and cloud conditions, determine surface

temperature. The heat load from solar radiation can exceed 15% of the maximal metabolic heat production when animals are exposed to bright sunlight. [166]

In exercising horses, evaporation of sweat is the most important mechanism whereby heat is lost. [141,153] Evaporation of 1 liter of water can dissipate 2.4 MJ of heat. This is equivalent to the heat produced in approximately 6 minutes of endurance exercise or 2 minutes of high intensity exercise. The rate of evaporation is dependent on the water vapor pressure gradient between the body surface and the environment and on the rate of air movement over the body surface. During exercise in environments with a low humidity, evaporation is very efficient and can account for up to 65% of total heat loss. [153] When the humidity is very high the vapor pressure gradient between the body surface and the environment is smaller and less evaporation occurs. Under such conditions, sweat production usually exceeds the rate at which sweat can evaporate and sweat drips from the skin, thus losing the benefit of evaporative heat loss.

Significant evaporative heat loss also occurs when inspired air is almost fully saturated with water at a temperature similar to core temperature as it passes over the moist surfaces of the upper respiratory tract. Heat lost via this mechanism is dependent on ambient humidity and minute ventilation. It has been estimated that between 15 and 25% of total heat loss can occur via respiratory heat loss. [90] It has also been shown that increased respiratory heat loss can be used as a

compensatory mechanism when evaporative heat dissipation from sweating reaches its maximum rate for the ambient environmental conditions. [127,145]

THERMOREGULATION

Thermoregulatory mechanisms maintain the homeotherm's core body temperature within a narrow range by regulating heat accumulation and heat dissipation. In exercising horses, metabolic heat is produced in the working muscles and is lost from the body surface. These mechanisms are therefore responsible for distributing blood to the working muscles and subcutaneous vascular beds thus facilitating convective transfer of heat to the body surface. Peripheral thermoreceptors located in the skin, skeletal muscle, abdomen, spinal cord and hypothalamus detect changes in thermal load and produce a proportional output. The output of these peripheral temperature sensors is integrated in the hypothalamus and results in appropriate thermoregulatory effector activity [21]. In exercising horses, the primary thermoregulatory effectors are the circulatory system and the sweat glands.

Blood flow provides a very efficient means of transferring heat by convection and by altering blood flow to various organs, the circulatory system acts as a major thermoregulatory mechanism. The circulatory system plays its role as a thermoregulatory effector by increasing cardiac output and by redistribution of cardiac output, particularly blood flow to the skin. These adjustments in blood

flow are so effective that thermal stability can be maintained under thermoneutral conditions by balancing peripheral vasodilation and vasoconstriction. Blood flow to the skin increases on exposure to heat resulting in conduction of heat to the body surface that increases skin temperature and convective heat loss from the body. As the heat load increases, increased blood flow to the skin also provides the latent heat for vaporization of sweat and supplies fluid for sweat production. When exposed to low environmental temperature, blood flow to the skin is reduced thus reducing skin temperature and limiting heat loss from the body.

Arteriovenous anastomoses (AVAs) connect arteries directly to veins in the skin thereby bypassing capillary beds. The opening of these vessels greatly increases blood flow through the skin thereby increasing heat loss. Skin blood flow is primarily controlled by the sympathetic nervous system. Response to heat results in vasodilation of arterioles and AVAs, while vasodilation of arterioles and veins occurs in response to cold. Heat exposure in horses results in an increase in blood flow to the skin, which is achieved by increasing cardiac output without a reduction in blood flow to other tissue vascular beds. [145]

During exercise, metabolic heat production is proportional to the intensity of exercise and heat is transferred from the working muscles to the body core, thus increasing core temperature. Sweating is initiated at a certain core temperature and continues at a rate proportional to the increase in core temperature. Under most environmental conditions, heat loss from the surface matches the rate of

metabolic heat production and body temperature stabilizes at a temperature higher than resting core temperature. In horses, while sweating is under sympathetic nervous control there does not appear to be direct innervation of equine sweat glands. Sweating therefore occurs due to the humoral stimulation of β_2 -adrenergic receptors on the sweat glands. During exercise, increased circulating epinephrine concentration is sufficient to cause sweating. [56]

HEAT BALANCE OF HORSES

Horses are capable of performing exercise at maximal metabolic rates that are twice those of elite human athletes and therefore the mass specific heat load of performance horses is double that of man. [91] Despite this, horses have a surface area to mass ratio that is approximately half that of man (Man - 1:35-40 and horse 1:90-100). Therefore, during maximal exercise, horses may be required to dissipate approximately 4 times more heat per unit of body surface area than man.

At the onset of exercise the accumulation of heat by the body is relatively rapid. As the various heat dissipation mechanisms are activated, the rate of heat accumulation decreases and the core body temperature reaches a plateau and remains relatively stable if heat production and heat dissipation are balanced. This increased core body temperature does have the advantage of improving muscle performance, facilitating the release of oxygen from the red blood cells and increasing maximum heart rate. The relatively slow rate of the increase of core body temperature is an indication of the body's capacity for heat storage. It

has been shown that changes in deep rectal temperature lag significantly behind changes in core body temperature and that as the large hind gut of the horse has a high capacity to store heat, it probably plays an important role in heat storage during high intensity exercise of short duration. [92] The ability of the horse to compete successfully in short duration events when the conditions are thermally stressful is relatively good as a result of the body's capacity to store heat that is dissipated after the event. This allows the horse to perform at a high intensity for a short duration, without the danger of developing hyperthermia. The conditions experienced during high intensity exercise of short duration are probably similar to those that wild equids experience in 'fright or flight' thus allowing the animal to escape danger and restore heat balance once the danger has been averted.

A horse working at moderate intensity, with an oxygen consumption of 30 to 40 liters/min produces approximately 628 kJ of heat per minute. If this workload is maintained for an hour, the total metabolic heat production would be 37,6 MJ. In order to dissipate this amount of heat by evaporative processes alone would require the complete evaporation of approximately 15 litres of water. The rate of evaporation of this water depends on the environment's capacity to absorb the evaporated water vapor. The environment's capacity to absorb evaporated water vapor is dependent on the temperature and water vapor pressure (humidity) gradient between the skin surface and the environment and the air velocity over the skin surface. The combination of these factors has led to the development of the concept of 'effective temperature'. This concept has been extended by the use

of the Wet Bulb Globe Temperature (WBGT) which includes total radiation and therefore provides an extremely useful index for quantifying environmental heat load. [177,178]

When the environmental heat load is high, evaporative heat loss may not be able to keep pace with the exercise-induced heat load and heat gain from the environment and may thus pose a serious risk to the equine athlete, particularly when performing protracted submaximal exercise. Under these conditions, the sweat rate often exceeds the rate at which sweat can evaporate. This results in sweat dripping from the horse and contributes to the large fluid losses which can occur under these conditions. [33] With continued exercise, where fluid losses are sufficiently large (<5% of bodyweight) heat dissipation by evaporative cooling from the skin is compromised either by decreased conduction of heat from the core or subsequent to reduction in cardiac output and sweat rate [91]. Under such conditions, the heat storage capacity of the body can easily be exceeded [105] and the horse's temperature may exceed the critical temperature resulting in hyperthermia.

HYPERTHERMIA

During moderate to high intensity exercise under experimental conditions, fatigue occurs in horses when central blood temperature approaches 42.5°C. [92,93] Since heat balance is under the control of the thermoregulatory center in the

hypothalamus, critical upper temperature limits have been proposed for the central nervous system. [24] A recent study in horses [142] demonstrated that fatigue occurs when hypothalamic temperature approaches 41.5°C. This study also reported that hypothalamic temperature was consistently more than 1°C less than central blood temperature and therefore provides evidence to show that horses have a mechanism that allows selective cooling of the brain. During high intensity exercise in horses, muscle temperature increases rapidly and may reach 45°C. [106] Above this temperature, some enzymes have been shown to denature, thus altering metabolism, [24] and therefore 45°C probably represents the safe upper limit for muscle temperature.

CLINICAL SIGNS OF HYPERTHERMIA

Hyperthermia occurs most commonly in poorly conditioned horses that are required to exercise for prolonged periods under adverse ambient conditions (high temperature and humidity). Thermoregulatory failure in horses is commonly referred to as the “exhausted horse syndrome” [33,35]. Affected horses show fatigue, hyperthermia and profound fluid and electrolyte losses. Clinical signs include depression, weakness, reduced exercise capacity, increased heart and respiratory rate and elevated rectal temperature (often >42°C). Mucous membranes are often congested and capillary refill time is increased. Fluid and sodium loss associated with excessive sweating result in hypotonic dehydration [33] and affected horses often lose the desire to drink, due to insufficient osmotic

stimulus. Sweating response is often reduced resulting in the skin being hot and dry. Serious metabolic disturbances including exertional rhabdomyolysis, synchronous diaphragmatic flutter, gastrointestinal stasis, colic and renal failure may also develop. Severe cases may progress to show ataxia, collapse and convulsions. Coma and death are rare consequences of extreme heat stress.

MANAGEMENT OF HYPERTHERMIC HORSES

Early recognition and medical intervention are critical in the management of patients suffering from heat exhaustion. Management includes immediate termination of exercise and application of simple cooling methods that take advantage of the immediate environment. All these strategies should be aimed at dramatically increasing radiant, convective and evaporative heat loss. The horse should be removed from direct sunlight if possible and placed in a shady area. Utilization of fans may be extremely beneficial to provide increased air movement over the horse's body surface. Repeated application of cool water to the horse's body also enhances heat dissipation. While this can be accomplished using sponges dipped in cold water, more aggressive cooling may be required if the horse is very hot. In such cases, water with a temperature of 2 to 8°C should be used and repeatedly applied using sponges, hoses or by pouring it directly on to the horse. Water applied in this fashion will become warm almost immediately and should thus be scraped off and fresh cool water applied. While the application of iced water was thought to result in reflex vasoconstriction of

cutaneous vascular beds thereby reducing conduction of heat to the surface of the body, recent studies have shown that this aggressive approach to cooling is effective and is not associated with any adverse side-effects. [118,208] In these studies, rectal temperatures following use of iced water were significantly lower at all post exercise temperature measurements and the largest reduction in temperature occurred within 10 minutes of cessation of exercise. For this reason, this aggressive approach to cooling was widely employed by attending veterinarians and competitors during the 10 minute breaks in the endurance phase of the 3-day event competition of the Olympic games held in Atlanta during July 1996.

The horse's temperature should be monitored during the cooling process and the body temperature should be lowered as rapidly as possible to prevent damage to the central nervous system or other tissues. Cooling should start as soon as possible and should continue until body temperature is reduced to normal. Horses with severe heat stress are often dehydrated and usually require rehydration. As the dehydration is usually hypotonic, most of these cases will not drink voluntarily and it is therefore often necessary to administer sodium-containing fluids intravenously and/or orally if gut function is adequate. It is often necessary to administer 20 to 40 liters of fluid over a few hours. Isotonic solutions are recommended for intravenous administration. Normal saline (0.9% NaCl) supplemented with potassium chloride (approximately 20 mmol/l) is useful for replenishment of the most important ionic deficits. Administration of fluids by

stomach tube is extremely useful when attempting to rehydrate horses, although care must be taken to ensure that ileus is not present. There are many commercially available oral replacement fluids that can be used. Some of these fluids contain glucose and glycine that enhance the uptake of fluids and electrolytes from the small intestine. As simple replacement fluid for oral administration can be made up by dissolving 20g of common salt (sodium chloride) and 20g of “Litesalt” (sodium and potassium chloride) in 5 liters of water. This results in an electrolyte composition of approximately 107, 28 and 132 mmol/l of sodium, potassium and chloride, respectively. [33] In horses with normal gut function, one can usually administer large volumes of fluid (up to 8 liters) and this can be repeated approximately every hour.

Synchronous diaphragmatic flutter (SDF) is seen most frequently in endurance horses performing in hot, humid climates. By itself, SDF is probably not dangerous but it is an index of significant electrolyte imbalances. [34] Such horses require prompt and vigorous fluid therapy to restore volume and correct electrolyte deficits. Horses with SDF generally respond well to the administration of intravenous solutions containing calcium. [34]

While heat stress is most common following prolonged exercise, hyperthermia can occur in horses in training for racing or performing high intensity exercise of short duration. This is most common in horses resident in areas with hot, humid tropical climates and is commonly associated with partial or complete anhidrosis.

Sweat production in response to an appropriate stimulus is decreased in anhydrotic horses, probably as a result of prolonged stimulation of sweat glands by circulating catecholamines. [14] Clinical signs of anhidrosis include the inability to sweat normally, diminished exercise tolerance and performance, tachypnea following exercise, and, in some cases, alopecia. At this stage, the only effective remedy is to move the horse to an area with a more temperate climate. The increased metabolic rate that results from increased circulating catecholamine concentrations observed in horses that become excessively excited, may predispose such animals to development of heat stress when they are exposed to adverse environmental conditions. The confinement of horses in poorly ventilated stables or transport vehicles in hot, humid environments can also induce heat stress. While horses that develop heat stress following high intensity exercise of short duration may occasionally collapse and even die, the clinical signs of heat stress of this type are generally mild when compared to those observed following endurance events. Clinical signs include unsteadiness, tachycardia, tachypnea, muscle cramping and a rectal temperature of up to 41°C. Dehydration is not common in these cases and application of iced water to the entire body surface following termination of exercise is usually sufficient to reduce the body temperature to normal.

PREVENTION OF HYPERTHERMIA

Recognition of the potentially harmful effects of high environmental heat load is vital to allow horses to train and compete safely under such conditions. The implementation of measures to minimize thermoregulatory demands and optimize fluid balance, helps reduce the impact of stressful environmental conditions. Such measures include estimation of the environmental heat load expected during the event, acclimatization of horses to the expected environmental conditions and dietary supplementation.

The Wet Bulb Globe Temperature (WBGT) Index [177] provides a means of quantifying the effective environmental heat load. In addition to the effects of ambient temperature and humidity, it also accounts for wind speed and radiative heat load. A retrospective study in which the WBGT Index was compared with the veterinary assessment of the degree of thermal stress experienced by the horses during a number of national and international competitions has clearly demonstrated the value of WBGT Index in quantifying local environmental thermal load. [178] In January 1996, the Fédération Equestre Internationale (FEI) officially adopted the WBGT Index to ensure that local climatic conditions at the competitions site were accounted for in the design and management of competitions. Environments with a WBGT Index below 28 are suitable for the Speed and Endurance phase of 3-day-events, while environmental conditions giving a WBGT Index of above 33 may not be compatible with safe competition. When WBGT Index is between 28 and 33, it is essential that the competition

proceeds with extreme caution and it may be necessary to modify the conditions of the competition. While these limits probably provide a realistic basis for planning of 3-day-event competitions further refinement of the WGBT Index is essential for its use to be expanded to other equestrian sports, e.g. endurance rides.

Regular exposure to high ambient heat loads result in a number of physiological adaptations that decrease the negative effect of environmental conditions on subsequent performance. This improved ability to thermoregulate is achieved by a combination of thermal and circulatory adaptations and is referred to as acclimatization. [125] In man, acclimatization is characterized by adaptations to circulatory and sweating responses which occur within 3 to 14 days of regular exposure to, and exercise under, thermally stressful conditions. These adaptations include; a reduced heart rate at the same exercise intensity, increased plasma volume, cardiac output, blood flow to the skin and sweating rate, onset of sweating at a lower core temperature which combine to result in a reduced core temperature at the same exercise intensity. [125] A recent study in horses has demonstrated that 3 weeks of daily exposure to, and exercise in, thermally stressful conditions results in a reduction in heart rate and core temperature at the same exercise intensity. [67] It is therefore advisable to ensure that the conditioning program of horses includes sufficient time, approximately 3 weeks, for acclimatization if horses are going to be expected to compete under hot, humid conditions. This acclimatization period is of particular importance for horses that are transported from cool to warm environments.

SUMMARY

Metabolic heat production is extremely high during exercise in horses. Thermoregulation in horses is primarily dependent on evaporative heat loss from sweating in particular. Under thermoneutral conditions these mechanisms are sufficient to allow horses to perform high intensity exercise for long periods. Under thermally stressful conditions, particularly high ambient humidity, the efficiency of evaporative heat loss mechanisms is compromised and may result in horses developing hyperthermia. Early recognition and vigorous treatment are essential to limit the consequences of heat stress in horses. Meticulous planning and management of equestrian events that are held under thermally stressful conditions are essential to ensure the welfare of competing horses and their riders. The conditioning program of horses expected to compete under thermally stressful conditions must also make adequate provision for acclimatization to the hot, humid conditions.