

CLAIM USE ADAPT

Cohousing Community in the Old Poynton's Building, Church Street

By Raymund König

submitted in fulfillment of part of the requirements for the degree of

BACHELOR OF INTERIOR DESIGN

In the Faculty of Engineering, The Built Environment and Information
Technology, University of Pretoria, Pretoria

November 2002

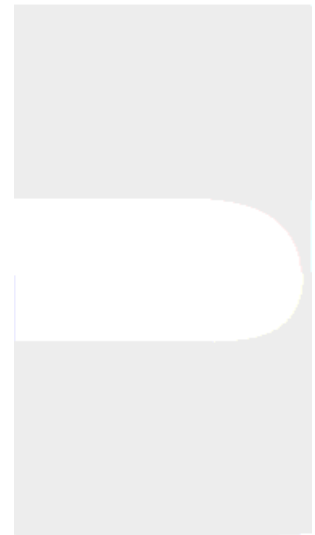

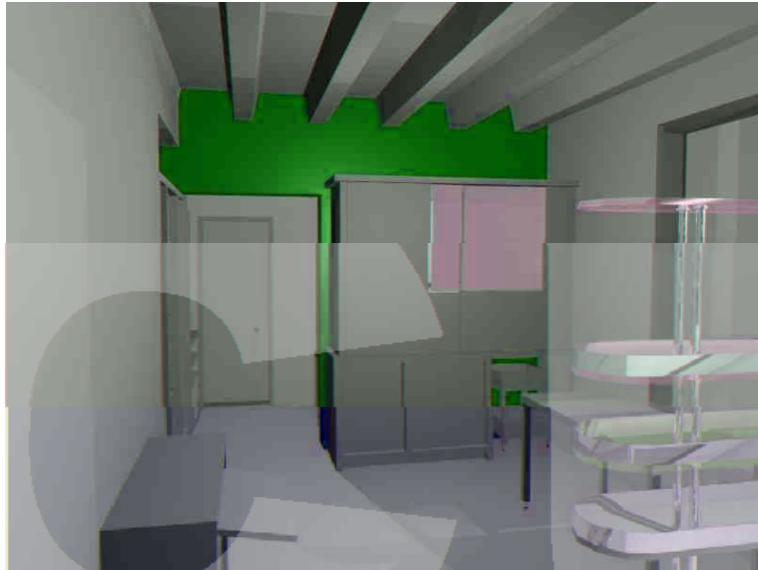

CLAIM USE ADAPT

Cohousing Community in the Old Poynton's Building, Church Street

RAYMUND KÖNIGK

Mentor: Professor S.W. le Roux

Bachelor of Interior Design

Collective or communal housing (Cohousing) is housing featuring joint facilities available to all residents, while the residents also maintain autonomous, self sufficient housing units. The communal spaces form a central characteristic of the housing complex and is not just an added amenity. The shared facilities should encourage and accommodate social interaction, group activities and the coordination and cooperation between residents to carry out common tasks.

A distinct infill level in buildings is gradually emerging. This level contains all the equipment, non load-bearing partitions and a substantial amount of services. The infill level restores the building as provider of space and shelter and facilitates the specific needs and preferences of the inhabitants more directly. Traditional notions of the family is being challenged, placing increasing demand on homes to be flexible and responsive to changes in family structure.

Since the long-range benefits of a stable community is jeopardised if residents have to move when their spatial requirements change, transformable interiors were used to reduce this risk. Flexibility is largely used in the housing units, relying on advanced computed aided manufacture that is able to fabricate components for easy assembly on site.

For the purposes of this thesis an under utilised office building in the Pretoria central business district was chosen to illustrate a cohousing complex in an urban environment. Design energy was focused on design ing the communal facilities and a sample housing unit, illustrating the support system and investigating the unit's versatility.

CONTEXT STUDY	1	
Thoughts on Design	3	
Pretoria Culture	4	1.1 View down Pretorius Street, looking west
Character	5	1.2 Walkway in Church Street, looking west
Old Poynton's Building	6	1.3 Pretoria Central CBD (Information supplied by Capital Consortium) 1.4 Pretoria (/information supplied by Capital Consortium)
	7	1.5 Old Poynton's Building, showing position of Café Riche. 1.6 Northern offices 1.7 Atrium 1.8 Old Poynton's Building, Church Street facade 1.9 Offices on atrium
	8	1.10 Position of Old Poynton's Building in central CBD 1.11-1.12 View from northern offices 1.13 Typical floor plan, not to scale (Aquired from the Department of Public Works, Gauteng. 2 April 2002)
Social Ideas Gentrification Cohousing	9	1.14 Queens, Church Street 1.15 Tribeca, Vermeulen Street
Client Profile	10	
The dream of Prefabrication	11	1.16-1.17 The BACH provides flexible, user-defined, prefabricated housing (www.bachkit.com).
Design Problem		1.18-1.19 Example of proposed Design, illustrating a one-person unit with bed in closet and fold-away table and stackable chairs. The entire housing unit occupies 18m ² and is prefabricated and modular to be used in under-utilised buildings.

PRECEDENTS STUDY	13	
Japanese Interiors	15	2.1-2.2 Kitchen with dining table cantilevered into the living room in Koshino House (Slesin; 1987,40).
Koshino House, Tadao Ando		
Chine House, Kenji Hongo	16	2.3 The five storey house has no windows on the street facade (Slesin; 1987,92). 2.4 The atrium wall allows free penetration of light and air while restricting views (Slesin; 1987,98).
Tower House, Takamitsu Azuma		2.5 Tower House is a small concrete building in central Tokyo (Slesin; 1987,220). 2.6-2.7 The cluttered interiors of the bedroom and kitchen is juxtaposed to large panes of glass (Slesin; 1987,221).
Early Mine- and Railway Housing	17	2.8 Bachelor Quarters, Class D - Kenilworth (Wasserfall; 1989,152) 2.9 Bachelor Quarters - Kenilworth (Wasserfall; 1989,152).
Bachelor Quarters, Sydney Stent	18	2.10 Portable staff quarters Type P108 (Wasserfall; 1989,235).
Type P108 Portable Quarters, South African Railways		
Self-build House	19	2.11 Brookes-Coombes House (Allen; 2001,22). 2.12 Ground Floor Plan (Allen; 2001,23). 2.13 First Floor Plan (Allen; 2001,23).
Burd Haward Marston Architects		
	20	2.14 Longitudinal Section (Allen; 2001,23). 2.15 View from the closed courtyard, towards the living space (Allen; 2001,25). 2.16 The staircase is situated in the closed courtyard (Allen; 2001,24). 2.17 Storage zones are placed at uniform height to allow for future expansion without spoiling the proportions (Allen; 2001,28).

Transformable Interiors	21	2.18 Hinged space housing, Fukuoka by Steven Holl (Holl; 2000,51).
Graphic Designer's Apartment, Roger Hirsh	22	2.19 Floor plan of apartment (Conran; 2001,214). 2.20 View of office with door closed (Conran; 2001,213). 2.21 View of Office from the bedroom (Conran; 2001,216). 2.22 The folding action of the door reveals the office inside the central wall panel (Conran; 2001,214).
House in the Outskirts, Vicente Gullart	23	2.23-2.24 A wall panel folds down to form a table (Gullart; 1996,205).
Naked House, Shigeru Ban		2.25 The interior of Naked House with boxes removed (Tiry; 2001,19) 2.26 The interior of Naked House with boxes added (Tiry; 2001,19).
Jernstoberiet Cohousing Community Jan Gudmand-Hoyer	24	2.27 General section (McCamant; 1988,94). 2.28 Residents converted an old iron foundry to a 21-household cohousing community (McCamant; 1988,90). 2.29 The main entrances of the dwellings open onto a central court (McCamant; 1988,93).
	25	2.30 The comon house at the end of the central court (McCamant; 1988,97). 2.31 The central hall provides a covered courtyard for socialising (McCamant; 1988,95). 2.32 Residents preparing dinner in the common house (McCamant; 1988,96).
Penthouses, Melrose Arch OMM Design Workshop	26	2.33 Penthouses, Melrose Arch 2.34 Storage underneath the staircase seperates two bedrooms 2.35 A mezzanine level is provided in the living area. 2.36 View of uncompleted mezzanine and bathroom.

DESIGN PREVIEW	27	
Schedule of Accommodation	29	3.1 General section, indicating functions accommodated on different storeys.
	30	3.2 Floor Layout of Common Facilities
Common Facilities	31	
	33	3.3 Floor Layout of Infill Levels
Infill Levels	34	
Open Building System	35	3.4 Evolution of Service wall
	36	3.5 Section through service wall, indicating provision of services
Infill Sites	37	
	38	3.6 Typical Infill site.
Common House	39	
Environmental Impact of Materials	40	
Cement and Concrete		
Plastics		
Boards		
Glass		
Metals	41	
Timber		
Paints and Finishes		
Performance Mandates	42	

DESIGN REPORT	43	
Product and Process	45	
Common House	46	4.1 Concept perspective: central, linear kitchen in Common House
		4.2 Common House, first draft layout
	47	4.3 Common House, second draft layout
	48	4.4 Common House, final layout
Sample Apartment	49	4.5-4.6 The design of the sample apartment was based on a Bachelors Apartment occupying a single module.
		4.7 Concept plan, Bachelors Apartment
	50	4.8-4.9 Perspectives of bottom and top floors of Two-bedroom Apartment.
Sleeper Couch	51	4.10 Perspective, Sleeper Couch
	52	4.11-4.12 Front- and back leg details and exploded axonometrics
LIST OF REFERENCES	53	
APPENDIX A		
Technical Documentation not included in main text.		

CONTEXT STUDY



Thoughts on Design

Cultures originate when individual spirits disassociate themselves from pragmatic problems of everyday life and begin the contemplation of spiritual and materialistic concerns (Lesnikowski: 1982,2). "The Designer" as cultural phenomenon finds himself in the dualistic position between intuition and intellect. Heraclitus argues that the essence of reality is the union between opposites (Lesnikowski: 1982,5). The designer is thus the creator of new realities by existing between science, which concerns itself with measurable phenomenon, and theology, which deals with the immeasurable.

The greatest art is achieved by managing a fine balance between these two extremes. Since art is composition and not adapted to a particular end, and life is functional and therefore not art, design as "the emotional act of the artist" is without justification (Hannes Meyer in Mira; 1992,9). The "Designer as Artist" leads to self-indulgent aesthetics (Papanek; 1995,53).

Good design should respond to real needs, there is a strong pragmatic approach to my design philosophy. However I share Louis Kahn's view that knowledge without intuition is lifeless (Lesnikowski: 1982,4). The intellect cannot understand the whole without breaking it into uniform parts and analysing these. This is the doctrine of abstract ideas, to think about a feature without attending to all the other features that are connected with it, ideas are formed that are devoid of change and life. Aristotle argues that thinking comprises two elements, contemplation and deliberation (Lesnikowski: 1982,4). Contemplation should terminate in conclusion, while deliberation should produce a decision. Contemplation deals with theory while deliberation deals with practice. Thinking is not an abstract dialogue but an act of the intellect that affects the intellect. Thinking is a

sequence of images tied to customs and habits. Behaviour is determined by the changing series of functional and emotional positions.

The world is in constant flux, space-time and matter-energy is constantly changing and the universe is comprised of events not elements. Permanent values do not exist; there are no frontiers, bounds or commitments. The birth of pluralism that follows the creation of the Global Village leaves people feeling free, but uncertain and longing for better times. Every person is exposed to a plurality of cultures and can make choices and discriminations from a wide body (Jencks; 1987,95). Great architecture has diverse historical and cultural influences even while responding to a specific time and place (Curtis; 1996,636).

Hanson (1998,217) states that it is the nature of architecture to search for novelty at the expense of the transmission of cultural values. This reflects the global interest in regionalism that reveals anxiety about the homogenizing forces of development. Novelty should increase heterogeneity, flux and contradiction. This does not advocate disorder and originality for its own sake.

Kurokawa (1991,13) states that the 21st century will be the age of the individual, of pluralism and diversification, it would be difficult to make new discoveries or to be creative compared to conformist times. The intellect cannot cope with the amount of analysis that would be needed to make sense of such a richly creative society; a greater understanding of intuition would be required.

I am an intuitive designer and regard form as superior to function, since form is permanent and universal while function is of temporary and casual aspect. However design must still respond to dynamic function. Design should facilitate the reconciliation between form and unpredictable

changes in function to balance the importance of both these aspects.

Design is thus the result of synthesis between intuitive actions and intellectual conclusions and - decisions.

Pretoria

Culture

By deconstructing South African history as it is reflected in Pretoria a layering of styles and materiality is discernable. These layers reflect the contexts in which they were created. The Pretoria central business district (CBD) may be considered as the hybrid metropolis, where new realities were added to the existing, creating a richer more complex reality.

When moving west in the walkway created in Church Street, a progression from Boer identity at Church Square, through the Apartheid years up to recent times of tolerance may be observed. This must be considered a single hybrid culture. Multi-culturalism is destroyed when the structures created by individual cultures are joined to form a single city fabric that forms the backdrop of contemporary Pretoria culture. Although different contexts are superimposed, older contexts were not destroyed and they held their importance and identity.

The brick tradition inherited from the Dutch played a fundamental role in the construction of ZAR-buildings on Church Square (e.g. the Nederlandsche Bank and the Palace of Justice). The square's aesthetic was altered as British buildings, from the Baker School, were erected to illustrate British identity and power (e.g. Standard Bank, the Old Reserve Bank). The British buildings are characterized by monumental styles and the use of heavy materials, e.g. stone blocks.

When the Afrikaner gained power in 1948 a new materiality evolved, the Nationalists were ready to embrace the International Style. An Afrikaner Modernist aesthetic was created incorporating the Dutch brick tradition into modernist facades (e.g. the Nedbank building in Church street). This was done in rebellion against British buildings (e.g.

Tudor Chambers) and due to the Afrikaner's fascination with Avant-garde movements. (Fisher, 1998:124) The bricks can be attributed to a nostalgic remembrance of the ZAR. These buildings were progressive in style, if not in material use. This proved to be a positive point as these buildings aged well, especially when compared with early concrete buildings.

Administrative buildings in Pretoria have a similar aesthetic, although less traditional materials were used as the Nationalists grew more self-assured and newer materials had proven their use over time (e.g. wall cladding and curtain walls).

Post-modern buildings of recent time with new and old materials used in combination are present in the city centre (e.g. Sammy Marks Square with its red brick, concrete blocks, copper sheeting and IBR roofing).

The close proximity of these divergent structures informs the plurality of contemporary Pretoria culture. Tolerance and respect for the past is characteristic of this culture.

Character

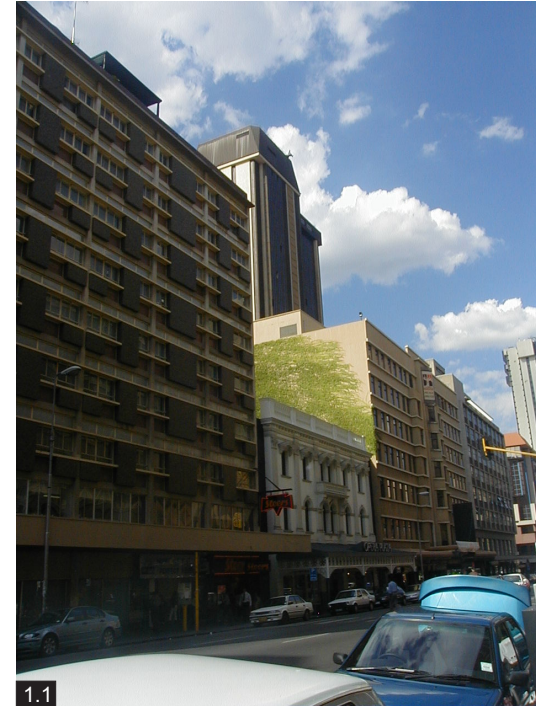

1.1 View down Pretorius Street, looking west

1.2 Walkway in Church Street, looking east

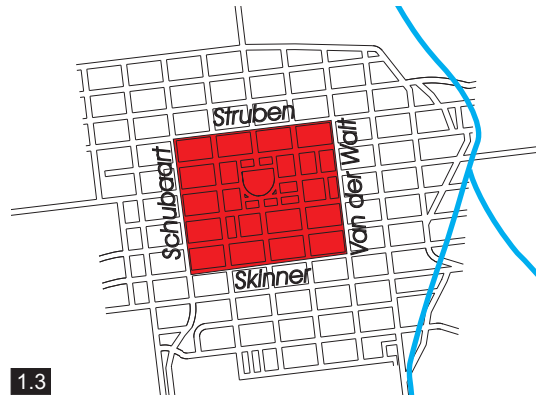

1.3

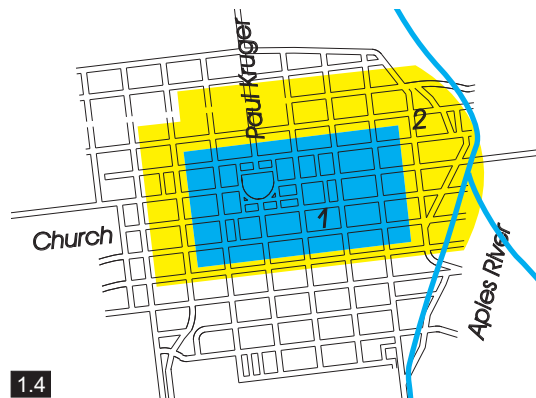

1.4

1.3 Pretoria Central CBD (Information supplied by Capital Consortium)

1.4 Pretoria
1.CBD Core Precinct
2.CBD Support Precinct
(Information supplied by Capital Consortium)

The tendencies of urban sprawl and decentralization are apparent in the current development of Pretoria. The central business district is acknowledged as a primary metropolitan activity node, with decentralization of offices and retail from the (CBD) to Brooklyn, Hatfield and Menlyn (Capital Consortium, 1999:5).

Pretoria exhibits typical characteristics of an Apartheid City with residential areas for the lower income black population far from job opportunities and economic activities (Capital Consortium, 1999:5; Chipkin, 1998:149-74). In the past residents of these areas utilised local retail facilities, but in recent years a greater utilisation of the CBD by these residents has occurred. They have to travel long distance daily and a greater percentage of regular users are dependent on public transport. There is a continuous movement of pedestrians in the precinct making the CBD a vibrant area by day. The lack of accommodation causes the area to be quiet at night and over weekends (Bothma 2000, 14).

Poor market conditions and trends of urban decline resulted in low demand for commercial space in the Inner City. The move of the provincial government to Johannesburg and other government departments to nodal areas (e.g. the offices of the Auditor-General to Brooklyn and the Receiver of Revenue to Menlyn) has increased uncertainty in the property sector and created large areas of under-utilised office space (Capital Consortium, 1999:5).

The Central CBD (See Figure 1.3) is bound by Skinner Street, Schubart Street, Struben Street and Van der Walt Street. It contains retail-, offices- and service land uses and mixed activity areas. There is major motorised and pedestrian movement in areas of formal- and informal retail and offices. It is predominantly high density and contains strong government and municipal functions (Capital Consortium, 1999:8).

The Capital Consortium envisages the introduction

of mixed land use with a larger residential component to ensure a sustainable working and living environment (Capital Consortium, 1999:3). To achieve this goal the Inner City was divided into 22 precincts based on an Integrated Development Framework. The precincts give a focused approach to future developments. Two of the precincts fall within the Central CBD (See Figure 1.4). The Capital Consortium propose improving the quality of the environment of the CBD Core Precinct by encouraging high quality office-, retail- and residential land use. The CBD Support Precinct should facilitate land use that will support the CBD Core Area. The CBD Support Area should act as a spill over area and accommodate additional land uses needed to sustain the CBD Core. These areas should provide a hierarchical road network, pedestrian friendly routes and sidewalks, and efficient public transportation (Capital Consortium, 1999:69).

The Capital Consortium propose the establishment and redevelopment of inner city housing stock. Development should be considered holistically to include social infrastructure (Capital Consortium, 1999:97). Housing locations should be close to social amenities (schools, churches, shops etc.) and public transport routes (UBIC 2000, 1). The Capital Consortium further propose the investigation into the residential conversion of existing structures within the CBD (Capital Consortium, 1999:97).

Old Poynton's Building

The Old Poynton's is a typical example of an under-utilised office building. It is situated in Church Street, to the west of Rafé Riche, and is bordered by the Capitol Theatre to the south and the Gauteng Provincial Government Building to the west.

Its position close to Church Square and within the Central CBD makes it an ideal site for the investigation of urban renewal. For the purposes of this study the building will be discussed as typical site to be considered for residential conversion. The building is suitable to be used as test site for a prefabricated housing system that can be used in a number of under-utilised buildings.

Although the building was chosen to serve an illustrative purpose, it offers design opportunities and -problems specific to this site (e.g. large western windows, a dark atrium - figure 1.7). The problems of this site will guide the use of an infill-system that is not site specific.

The entrance to the building is situated on the western half of the northern facade between shops. The threshold to private space is at the end of a corridor at the main stairway and elevators on the south side of the building (See plan Figure 1.13). The creation of private residential space within an urban context is the main focus of this study with buildings used as example only.



1.5 Old Poynton's Building, showing position of Café Riche.

1.6 Northern offices

1.7 Atrium

1.8 Old Poynton's Building, Church Street facade

1.9 Offices on atrium

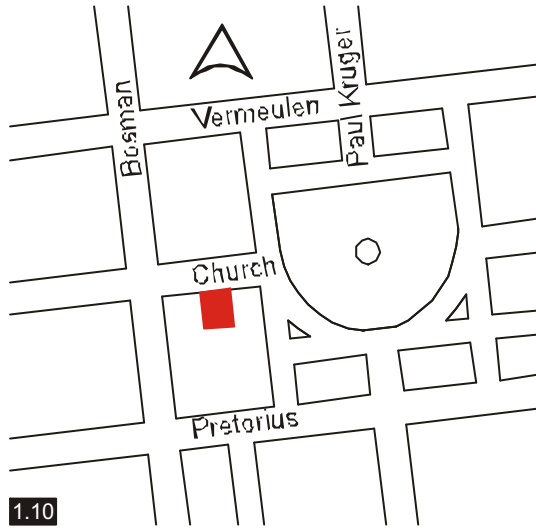

1.10



1.11



1.12

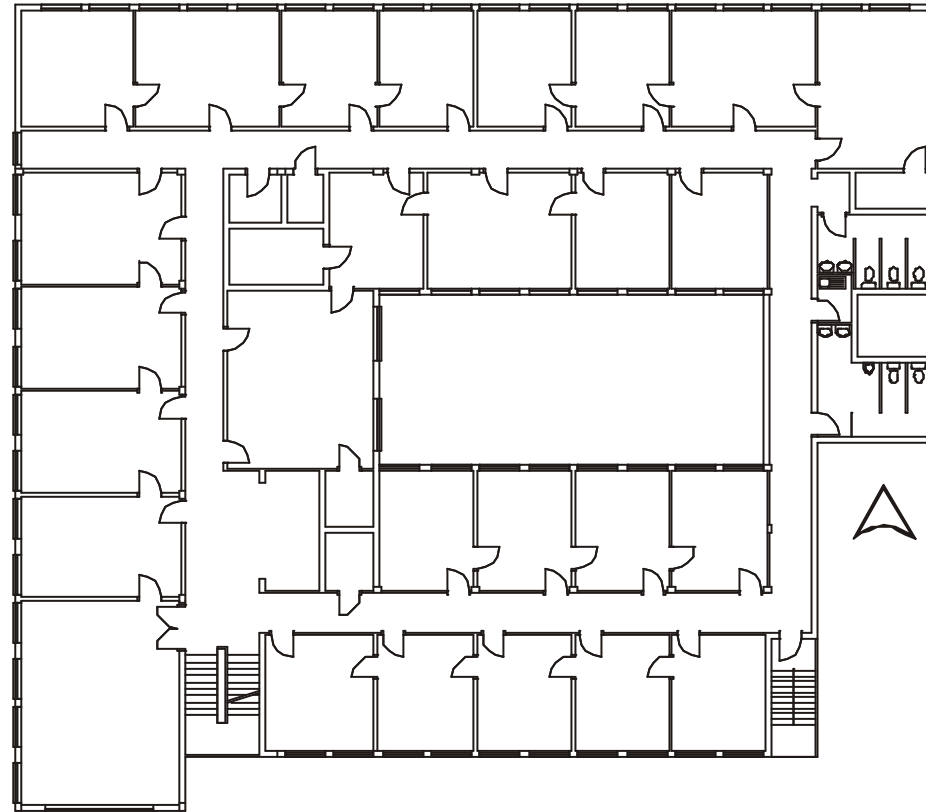

1.13

1.10 Position of Old Poynton's Building in central CBD

1.11-1.12 Views from northern offices.

1.13 Typical floor plan, not to scale. (Acquired from the Department of Public Works, Gauteng. 2 April 2002)

Social Ideas

Gentrification

The Central CBD (See Figure 1.2) is suitable for the process of gentrification. The term refers to the economic and cultural growth of young individuals and households in formerly low-income areas (Lang, 1990:158). The Webster Comprehensive Dictionary (1998,527) defines gentrification as the restoration of deteriorating city properties for purchase by middle class buyers. Gentrification is based on newly formed households that are introduced to the city for the first time. Gentrifiers are typically highly educated, affluent individuals in their twenties or thirties. Their impact is often rapid, transforming areas that are considered undesirable due to commercial under-utilisation and abandonment into desirable residential enclaves supported by a strong local economy. Gentrification is the process of returning market demand and private capital to inner city housing markets.

There is signs of gentrification in the Inner City. This is evident in the creation of the Church Street walkway, the development of the Museum Mall precinct, the presence of high-quality lifestyle retail outlets (e.g. "Queens" in Church Street and "Tribeca" in Vermeulen Street - figures 1.14-1.15) and the Capital Consortium's encouragement of high quality retail-, office- and residential uses in the Central CBD.

The Inner City contains a number of buildings of historic-, cultural- or architectural value waiting to be utilised and enhanced (Bothma, 2000:17). A great number of these buildings are found on Church Square (e.g. The Raadsaal, the Palace of Justice, Café Riche, the Capitol Theatre and The Old Reserve Bank). Church Square is also the most important public open space in the city centre. Church Square forms the geometric centre of the Central CBD. Attractive natural vistas and notable

architecture are the most frequent characteristics of gentrified areas (Lang, 1990:158). The area surrounding Church Square (i.e. the Central CBD) is the most favourable area for gentrification in Pretoria.

Gentrification may cause the displacement of low-income residents by high-income residents and cause a decline in security of tenure (Treanor, 2002). Gentrifiers are not interested in social mix.

The process of gentrification should be controlled to ensure that the economic benefits of urban renewal will accrue to low-income residents. Certain areas should be targeted for gentrification while others is protected from it. For instance the local authority should enact anti-displacement ordinances and protect long-time residents from future property tax increases (Lang, 1990:159).

The problem is to achieve a balance between continued gentrification and the protection of original residents.

Cohousing

"The luxury of having community and privacy with spaces designed for both extremes should be a more frequent design consideration in all kinds of housing."

Karen A. Frank (1991:17)

Collective- or Communal housing (Cohousing) is housing featuring joint facilities available to all residents, while those residents also maintain autonomous, self-sufficient housing units (Frank, 1991:3). The communal spaces form a central characteristic of the housing and are not just an added amenity. Woodward (1991:74) defines the communal model as a multigenerational, multifamily housing complex that includes extensive communal facilities and facilitates the preparation of common meals. The shared facilities should encourage and accommodate



1.14



1.15

1.14

1.15

social interaction, group activities and the coordination of- and cooperation between residents to carry out common tasks.

The residents in these complexes are liable to vote for an alternative political party (e.g. the Green Party) or to have been actively involved in an alternative political movement (e.g. the women's movement). The residents are typically those people that value social values above material values (Woodward, 1991:85).

McCamant and Duret (1988:36-41; 1991:100-1) identifies the following characteristics of cohousing:

- Participatory Process: Residents initiate the project and organize and participate in the design process. Typically the residents will be active in the initial planning stages while delegating greater control to the architect as the process develops, most participants recommends leaving technical- and aesthetic decisions to the architect and advocates standardization of expensive details (e.g. kitchens and bathrooms) between units (McCamant and Duret; 1988:165).
- Intentional Neighbourhood Design: The site layout encourages and facilitates social interaction and a sense of community by incorporating seating areas close to walkways and central parking.
- Extensive Common Facilities: The common house is designed for daily use by all residents, to supplement autonomous living units. Typically the common house would incorporate a kitchen to prepare meals for the whole community, a large dining room, single rental rooms and children's rooms. The functions incorporated depend on the needs of the residents and should be

designed for mixed usage to accommodate the changing needs of the community.

- Complete Resident Management: Residents remain responsible for the management of the complex after completion. Tasks (e.g. cooking common dinners or cleaning the common house) is divided among work groups in which all adults participate, these duties are rotated. In most cases the community duties become more informal as the residents develop their interpersonal relationships.

Cohousing developments espouse no ideology, but a sincere desire to create more practical and social home environments based on democratic principles.

Client Profile

The social phenomena of Cohousing and Gentrification require a specific user profile. As discussed above these people should be highly educated, affluent, politically liberal and active, gentrifiers are typically in their twenties and thirties, cohousing demands of these people a vested interest to stay in the community.

It can be assumed that the user's circumstances will change while living in the community (e.g. getting married or starting a family), but that the user will want to remain living in the community. The user would participate in the planning process (specifically requiring adaptable amenities) but leave most aesthetic- and technical decisions to the designer.

The dream of prefabrication

Pre-cut houses originated from the popularity of mail order catalogues in the late nineteenth century. Typically the consumer would buy his house from a catalogue, the supplier delivered detailed technical documentation and pre-cut material, usually staggered to provide material when needed in the construction cycle (Stevenson and Jandl, 1990:127). The vision was to provide well-designed, affordable homes at every socio-economic level in both urban and rural areas.

Applied technology was seen as the means by which the American Dream could be achieved in the 1920's. This led to the dream of prefabricating houses (Jensen, 1990:128). From the economic depression that began in 1929 an intellectual and financial commitment to industrialise housing followed.

Prefabricated housing did not provide a radical improvement on traditional built houses (a requirement for the success of any innovation). Four cost factors influence the life-cycle cost of establishing and living in a home, construction, finance, terrain and maintenance. Prefabrication addresses only construction fully and maintenance partially. Solutions to the high cost of housing would be found in social- and political spheres (Jensen, 1990:129).

Prefabricated houses did not provide consumers with enough freedom of choice and possibility. Consumers found them boring. Wortman states that the buyer of a catalogue house does so because he has no clear ideas and no need to express anything (1999, 11). The main cause of the American failure in prefabricated housing was the lack of choice and expression. Home-owners

wanted to express their individuality through their houses.

Sophisticated and profitable prefabricated houses (e.g the Bach from Nieu-Zealand - figures 1.16-1.17) offer the user flexibility and choice (McMahon, 2001:91). The foundation to successful prefabrication is understanding the user's need to express his identity through his dwelling.



1.16-1.17 The BACH provides flexible, user-defined, prefabricated housing (www.bachkit.com)

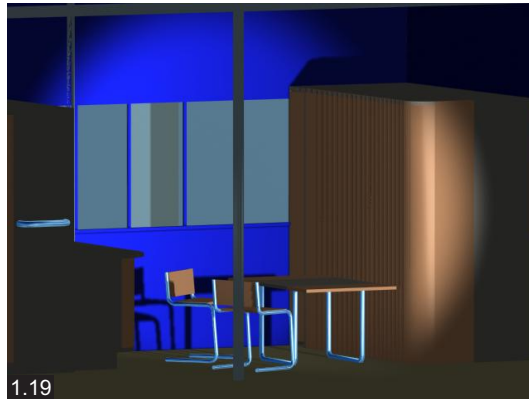
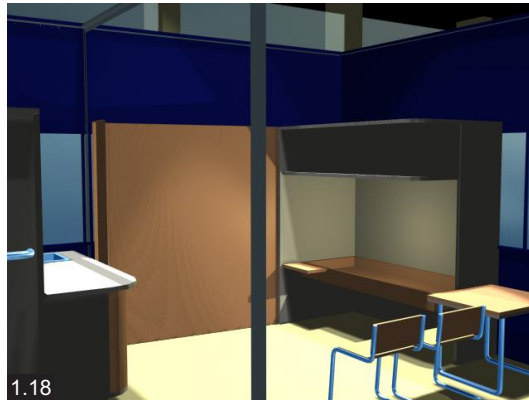

1.18-1.19 Example of proposed Design, illustrating a one-person unit with bed in closet and fold-away table and stackable chairs. The entire housing unit occupies 18 m² and is prefabricated and modular to be used in under-utilised buildings.

Design Problem

"... a little reflection suggests that the house is perhaps the most complex building of all."

Julienne Hanson (1998:2)

Housing is an ideal vehicle for exploring the formal and experiential aspects of architecture. This is the attraction of houses for the great twentieth century architects whose continued interest in creating housing prototypes illustrates that the intellectual challenge of housing is limitless. At the same time the familiarity of the house makes it so innocuous that the design for a house is located early in many Design courses (Hanson, 1998:2).

Hanson states that knowledge of both the internal laws of form and the social logic of space are required to generate the concurrence of formal rigour with functional simplicity that is observed in the houses of great architects (1998:242).

Housing occurs within a complex social-, political-, economic- and physical context. Often housing policy (in particular the references to integration and empowerment through community building) is in discord with the delivery of environments. The most damning effect of policy-practice discord is housing that is disconnected from broader metropolitan opportunities (Du Toit, 2002:41). An integrated spatial framework is needed to establish social networks that support a wide range of functions; the focus is therefore on collective spatial networks and not on isolated objects of architecture (Du Toit, 2002:42).

Cohousing limits the individual housing unit, placing more emphasis on community life outside the dwelling. Cohousing contests the isolation of the single house without sacrificing its autonomy. I envisage cohousing as the first step to an

integrated framework. My design will be positioned within the context of cohousing, the Capital Consortium's integrated spatial development framework and the current development of gentrification within the Central CBD.

I foresee a housing system that can be used in a number of under-utilised buildings in the Central CBD. The system should be largely prefabricated to allow for disassembly when the building changes its function. Prefabrication would allow for adaptability to the inhabitant's changing needs (e.g. fast remodelling of rooms to suit the change from couple to family) and to different sites.

The adaptable housing unit will be investigated to establish and demonstrate its versatility. The unit should be pliable without being all things to all people. It should be specifically developed for cohousing in gentrified urban areas.

PRECEDENTS STUDY





2.1



2.2

Japanese Interiors

Usually the Japanese interior is restrained and orderly (Slesin; 1987,61). Discipline, neatness and the willingness to live with only the essentials in multipurpose rooms are common characteristics of Japanese city dwellers (Slesin; 1987,191). Japanese interiors suggest a conflict between traditionalism (e.g. sitting directly on the floor) and western influence (e.g. the incorporation of chairs in contemporary interiors). Privacy of the home is maintained and many houses are devoid of the decorative possessions that fill western interiors (Slesin; 1987,61). Depending on how the occupants use a space, the atmosphere may be refined or disorderly. If the residents fail to reflect the elegance of the environment in their daily life the house will lose its original beauty (Itoh; 1969,8).

Traditionally load-bearing walls are not used in Japanese architecture (Itoh; 1969, 77). This is due to the preference of the Japanese to open their houses to nature and to permit the free circulation of air. The post and beam system and straight-line composition forms the basis of traditional architecture (Itoh; 1969, 77). The use of straight-line composition does not mean that rooms are arranged to follow square or rectangular plans. The love of asymmetry originated in the tea ceremony where any square or rectangular arrangement of tea utensils was considered unoriginal and unaesthetic (Itoh; 1969,80). The appreciation of asymmetry enabled the Japanese to create design capable of arousing curiosity and pleasure.

For the purposes of this study only contemporary Japanese interiors are discussed. The chosen examples illustrate synthesis between traditional principles (uncluttered space, asymmetry, openness to nature, discipline of the residents and privacy of the home), modern materials and western influence (concrete, glass, chairs and western kitchens).

Koshino House
Tadao Ando
1981
Curtis; 1996,640-641
Slesin; 1987,34-43

In the house designed for Japanese fashion designer Hiroko Koshino, Ando uses the conflict between western- and oriental traditions to achieve successful synthesis. A western kitchen is used in combination with Japanese open floor areas and unity with nature. Harmony and timelessness are seen as important elements in the perception of the physical world (Slesin; 1987,2). Natural material (e.g. grass matting and wood cabinetry) are meant to change with age, creating a sensual contrast to concrete walls (Slesin; 1987,34). The house is turned towards the interior, creating tranquil spaces detached from the outside world (Curtis; 1996,641).

2.1-2.2 Kitchen with dining table cantilevered into the living room in Koshino House by Tadao Ando (Slesin; 1987, 40). Note the penetration of space with the use of furniture.



Chine House
Kenji Hongo
Undated
Slesin; 1987,92--99

The architect uses a windowless street facade to isolate the interior from the urban surroundings. Behind the closed facade, the different floors are open to a narrow atrium that rises from the ground floor parking space to the roof. The use of material and the bunkerlike isolation of the interior reflects a Japanese view of the house as a bulwark against the industrial city (Slesin; 1987,34). Of special importance is the measurements taken to maintain visual privacy.



2.3 The five story house has no windows on the street facade (Slesin; 1987,92).

2.4 The atrium wall allows free penetration of light and air while restricting views (Slesin; 1987,98).

Tower House
Takamitsu Azuma
1967
Slesin; 1987,220-221

The density of the population and high real estate prices have forced Japanese city dwellers to live in small spaces (Slesin; 1987, 191). An innovative way of dealing with small spaces is stacking rooms atop each other with a single space to each floor. A narrow spiral stair connects the five levels. All the objects of daily life are crammed into a tiny vertical space. A cluttered feeling is avoided by using large windows. Privacy is maintained by placing windows away from the street. The house is an example of the inventive discipline required to live in such tight quarters.

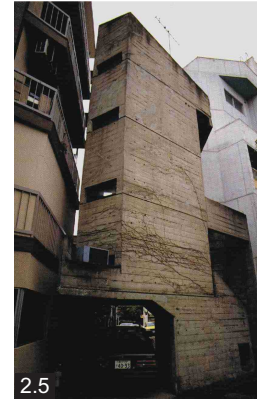

2.5 Tower House is a small concrete building in central Tokyo (Slesin; 1987,220).



2.6-2.7 The cluttered interiors of the bedroom and kitchen is juxtaposed to large panes of glass (Slesin; 1987,221).

Design influence

The importance of user participation and discipline is noted although the designer has little control over the residents' actions. The designer should assist the resident in achieving discipline and elegance by juxtaposing potentially cluttered areas (e.g. open shelves) with flat planes (e.g. blank walls and open windows).

The potential of asymmetry to create interest, pleasure and beauty should be exploited.

The maintenance of privacy in urban areas by the creation of introverted space and the celebration of the macrocosm (that which lies beyond the threshold) from these sanctities is promoted by the control of visual access (e.g. by the placement of windows to control views and layering to restrict views).

It is noted that Japanese residences are collections of living spaces and not compartmentalised boxes.

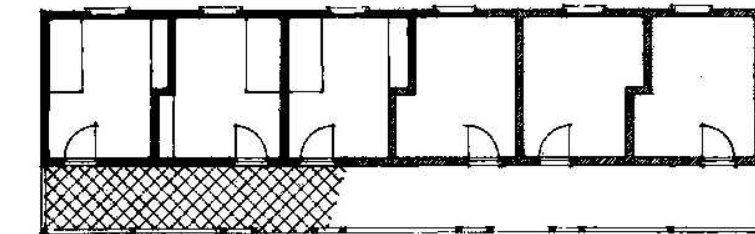
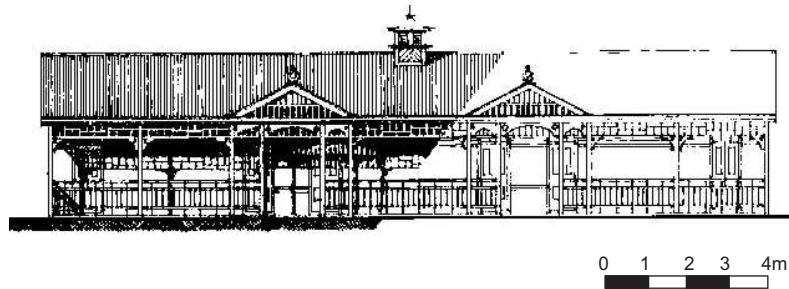

2.8

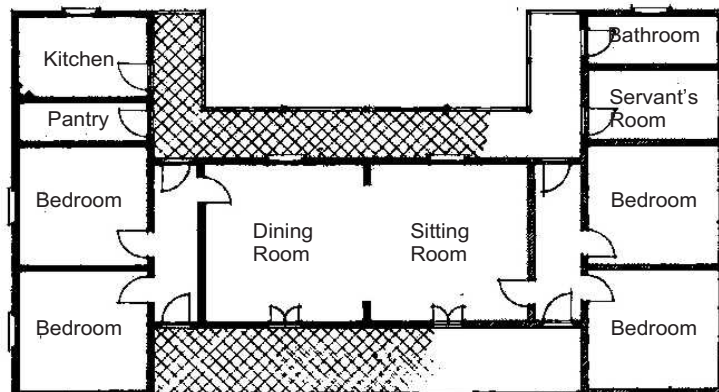

2.9

Early Mine and Railway Housing

The communal nature of early singles quarters for mine and railway labourers is central to the discussion. Workers' housing serves as a historical precedent that indicates that separate sleeping quarters with communal living spaces can be successfully utilised.

Gentrification in its physical manifestation is the taking over of previously working class areas by the professional middle class (Tulloch; 1991, 129). The definition can be expanded to include the reuse of working class typology. The majority of cohousing residents are young, two income families (McCamant and Durrett; 1991, 101) that view the communal facilities as an important aspect of community life (McCamant and Durrett; 1991, 95). Workers' housing serves a symbolic purpose to illustrate gentrification as the reuse of working class typology by the professional middle class.

2.8 Bachelor quarters, Class D - Kenilworth (Wasserfall; 1989, 152).

2.9 Bachelor quarters - Kenilworth (Wasserfall; 1989, 152).

Bachelors' Quarters
Sydney Stent
Undated (Kenilworth Village construction from 1889)
Wasserfall; 1989,151-152

Kenilworth was built in Kimberley to render the white labour force dependent on De Beers Consolidated Mines for their livelihood and thereby submitting them to strict industrial discipline (Wasserfall; 1989,162). The economic reasons for its construction was disguised by marketing the village as a philanthropic gesture (Wasserfall; 1989,168). De Beers attached an ideological function to Kenilworth. It was to serve as visual evidence that a new era for white labour has arrived at Kimberley and would improve the workers approach to life and their efficiency (Wasserfall; 1989,168-169).

Kenilworth Village had a clubhouse with a reading room and a billiard room. Its kitchen provided single men of the village with three meals daily at a fixed rate (Wasserfall; 1989,145-149). Main meals were taken in the dining room, while breakfast and lunch were sent to the workplaces.

Two types of bachelors' quarters were constructed. The simpler type consisted of a row of six rooms opening onto a verandah. The other type was H-shaped and accommodated four men. Its facilities included large dining and sitting rooms, a kitchen, pantry, bathroom and servant's room. This arrangement facilitated the conversion to married quarters (Wasserfall; 1989,151).

Kenilworth serves as an example where design was used to create and control a community. The village was so successful that when white wages reached an all time low in 1893, labourers remained loyal to De Beers despite pressure from trade unions (Wasserfall; 1989,169).

The improvement of living standards by the

2.10 Portable staff quarters
Type P108 (Wasserfall;1989, 235).

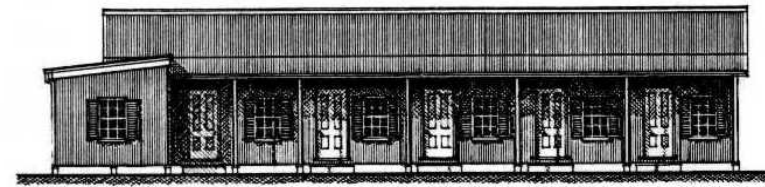

0 1 2 3 4m

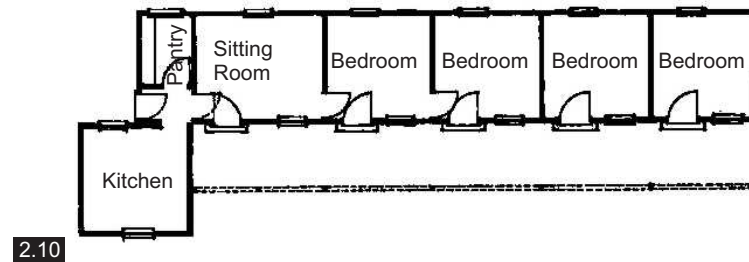

2.10

creation of communities and not the control of the labour force is the objective of the author. Kenilworth's facilitation of this process is noted.

Type P108 Portable Quarters
South African Railways
1913
(Wasserfall; 1989,234-235)

Housing assistance by the Railways after the Anglo-Boer War (1899-1902) was ad hoc, with housing provided where it was needed (Wasserfall; 1989,225). A large proportion of housing was of portable type, derived from standard design adapted to suit different requirements (Wasserfall; 1989,226).

The Type P108 portable quarters for single or married labourers were utilised alongside the track (Wasserfall; 1989,234). As with all rai-side quarters, an earth closet, fuel store and servant's room were provided in an outbuilding near the house (Wasserfall; 1989, 235).

Design Influence

In the precedents discussed, communal facilities were used as an economical measure to reduce housing cost and as an economic measure to control the workforce (by forcing total dependency on the employer). It is noted that communal facilities were detached from sleeping quarters (e.g. Class D Bachelors' Quarters and Type P108 portable quarters) or when attached used to facilitate future conversion (e.g. H-Plan Bachelors' Quarters with the inclusion of communal facilities to facilitate conversion to married quarters).

Kenilworth offered a way of making the workforce more contented, and therefore more productive (Wasserfall; 1989,168). In Kenilworth Village design was used intentionally to create a community. It is argued that it was this and the provision of high quality affordable housing that inspired this contentment.

It is noted that while Japanese residences are collections of spaces, working class housing was collections of rooms, this is to be avoided.

Self-Build House

Architect: Burd Haward Marston Architects
 Structural Engineer: Elliot Wood Partnership
 Services Engineer: Max Fordham and Partners
 Client/Contractor: John Brooke and Carol Coombes
 1999
 Allen; 2001,22-31

Self-build housing is ideally suited to prefabrication and adaptability. Conceptionally the design of the house was influenced by the clients' requirements to build it themselves (Allen; 2001,23). The planning is kept simple with the accommodation as compact as possible and on one side of the site. This leaves room for a glazed courtyard on the other. The courtyard contains the staircase and a mezzanine seating area.

The structural system is simplified. The building elements are reduced to their essentials to obtain economy of material and effort, making construction quick and economical. Otherwise the designer-client relationship becomes confused. In this way the decision to use a steel framed construction was an effort by the architect to limit the extent to which the clients could use their own initiative (Allen; 2001,27).

The construction process facilitates the future adaptation or structural alteration of the house. The Brooke Coombes house has been designed with storage zones at uniform height in the bedrooms to allow storage to be added when necessary, without disrupting its proportions. Partition walls between the children's bedrooms can be removed as they leave home (Allen; 2001,27).

The self-build process produces buildings that are not monumental, they encourage a feeling of lightness (Allen; 2001,28). The house maintains privacy with distinct separation between living- and sleeping spaces. The staircase is placed outside the accommodation zone, marking the transition from public to private space in the house with semi-outdoor space.



2.11

2.11 Brookes-Coombes House (Allen; 2001,22).

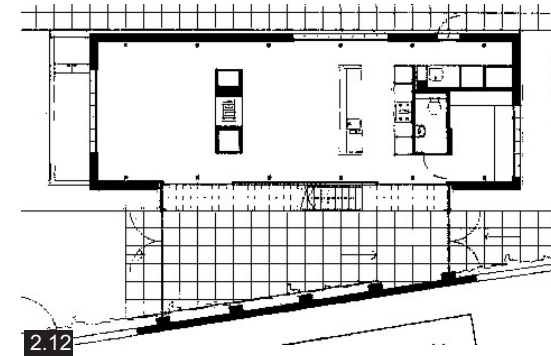

2.12

2.12 Ground Floor Plan (Allen; 2001,23).

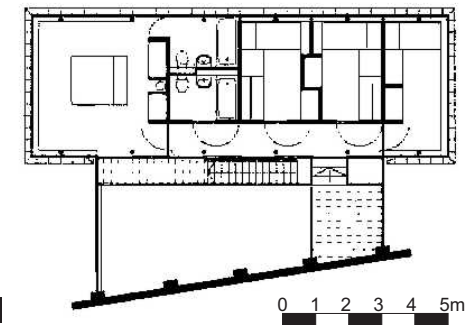

2.13

2.13 First Floor Plan (Allen; 2001,23).

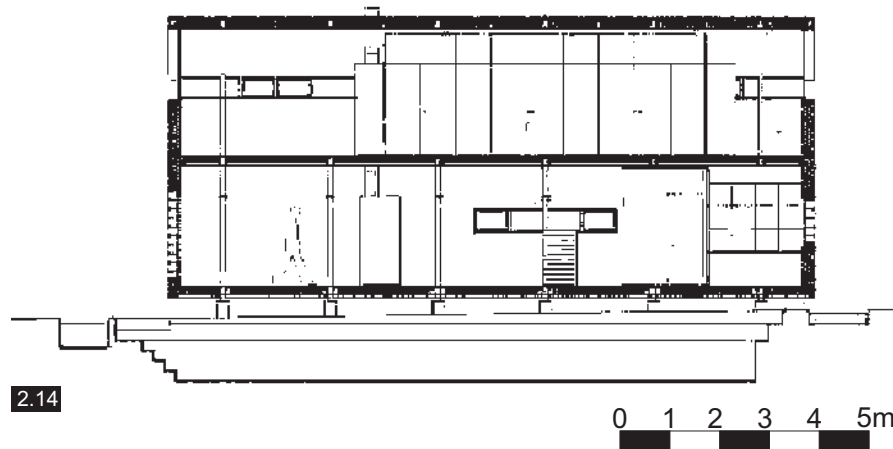

2.14 Longitudinal Section (Allen; 2001,23).

2.15 View from the closed courtyard, towards the living space (Aleen; 2001,25).



2.16 The staircase is situated in the closed courtyard (Allen; 2001,24).

Design Influence

An integrated approach to simplicity creates comprehensible construction and planning that promotes prefabrication and future adaptations. The same approach resulted in a feeling of lightness and led to the choice of materials that can be easily installed (e.g. steel columns, chipboard wall panels and clip-on tile cladding).

Private and public spaces are clearly separated by the placement of the staircase and by keeping the accommodation compact and on one side of the site.



2.17 Storage zones are placed at uniform height to allow for future expansion without spoiling the proportions (Allen; 2001,28).

Transformable Interiors

"Transformable" means the integration of technology in the home, the use of modular systems to facilitate construction and planning or the development of devices for modifying and customising space on a daily basis (Bell; 2000,5). During the twentieth century architecture's power to revolutionise social conventions through the rejection of the rigid floor plan and the subsequent separation and fragmentation of the domestic sphere was recognised (Bell; 2000,5). Beyond autonomous room-by-room space is interactive space (Holl; 2000,50). Domestic environments can be reordered and space becomes dynamic and unpredictable.

A distinct infill or fit-out level in buildings is gradually emerging (Dekker; 1998,312). This level contains all the equipment, non-loadbearing partitions and a substantial part of the services. These parts are removed from the building level and given their own employment. The infill level restores the building as provider of space and shelter and facilitates the specific needs and preferences of the inhabitants more directly. The designer may, by controlling this level, add the benefits of transformability to existing buildings.

Contemporary practice offers new approaches to modular and prefabricated construction (Bell; 2000,9). The concept of a flat-pack, flexible house that accommodates a number of arrangements and conditions is more commonplace (Bell; 2000,6).

Traditional notions of the family are being challenged (more young people live together, the elderly population is increasing and multiple marriages are increasing) (Bell; 2000,5). An increasing demand is placed on homes to be flexible and responsive to changes in family structure, work patterns and technological

development (Richardson 2000,44).

The precedents discussed will consider the use of modular units and foldable partitions. Transformable space dynamics allows an interactive reformation of the entire domestic sphere. Interactive space can be exact in one variation and suddenly evolve into energetic composite space (Holl 2000,52).



2.18

2.18 Hinged space housing, Fukuoka by Steven Holl (Holl; 2000,51).

Graphic Designer's Apartment
 Roger Hirsch
 Undated
 Conran; 2001,212-217

The client wanted to work from home while maintaining separate living and working quarters. This was to avoid the clutter of living spaces detracting from his professional image. The apartment was too small to house both functions separately. Housing the office within the separating wall between living and sleeping space solves the problem.

A foldable door covers the office at night and over weekends. During office hours the door is opened. The daily use of the door required an easy, simple application. The simplicity in planning required a high level of detailing to ensure that the use of the door does not become burdensome.

Important features of the scheme are the simplicity of planning and high levels of detailing. The daily transformation of space with a simple action is noted.

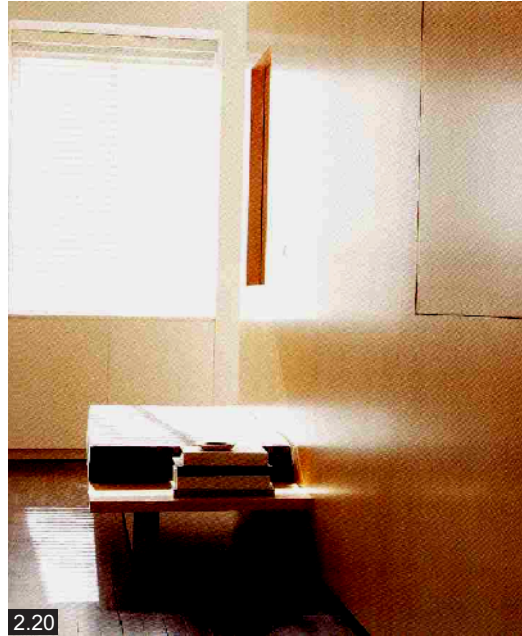
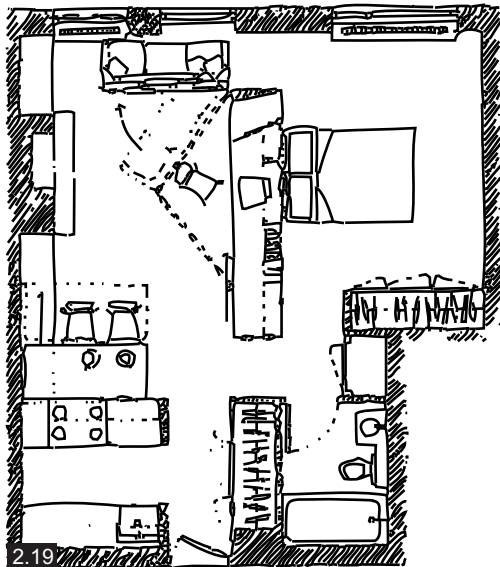

2.19 Floor plan of apartment, not to scale (From Conran; 2001, 214).

2.20 View of office with door closed (Conran; 2001,213).

2.21 View of the office from the bedroom (Conran; 2001,216).

2.22 The folding action of the door reveals the office inside the central wall panel (Conran; 2001, 214).

House in the Outskirts
Vicente Gullart
1994-1996
Gullart; 1996,202-206

The house was designed on the principle that the beauty of a place is dependant on its spatial qualities and not on the quality of its materials (Gullart; 1996,202). Concentration of resources provided efficient use of materials. The wall panel that lowers to provide a table illustrates that transformability is an economical measure taken to reduce the amount of material and space required in fulfilling a function.



2.23



2.24

2.24-2.25 A wall panel folds down to form a table (Gullart; 1996,205).

Naked House
Shigeru Ban
2000
Tiry; 2001 18-20

Movable boxes form rooms in an open space. The boxes are treated as loose pieces of furniture and can be taken out of the large living space to create a single uncluttered volume. Wet services are fixed and can be closed by curtains suspended from the ceiling.

This precedent serves as an example of the ultimate freedom of space. Here rooms can be used and discarded as needed and only the positions of wet services are fixed.



2.25

2.25 The interior of Naked house with boxes removed (Tiry; 2001,19).

Design influence

The use of transformable infill systems to accommodate the changing functions of buildings and to be responsive to changing family structures and work patterns is recognised. It is the intention of the author to use a similar system to transform the function of an existing building and to provide for the adaptation of the new use.

Transformability is used to reduce spatial and material requirements without restricting living space.

It is noted that the successful transformation of space is not burdensome or complicated. Simplified planning and a high level of attention to detail facilitate simple transformability.



2.26

2.26 The interior of Naked house with boxes added (Tiry; 2001,19).

Jernstoberiet Cohousing Community

Architects: Jan Gudmand-Høyer, Jes Edwards, Helge Christiansen
1981

McCamant and Durret; 1988,90-97

McCamant and Durret; 1991,98,116,121-122

Cohousing was chosen as a study theme since it facilitates the creation of a more convenient and sociable home environment (McCamant; 1991,96). Cohousing provides a context for the design of transformable housing units and offers opportunities to explore the meaning of threshold and the relationships between public and private space. It is these relationships and the possibilities they offer to the design of the residence's interiors that will be examined.

Cohousing is generally new construction due to the difficulty in creating the desired relationships between spaces in existing buildings (McCamant; 1991,97-98). Jernstoberiet was chosen as precedent because it converted an iron foundry (dated 1946) to accommodate 21 residences and a common house, using the large central hall as a courtyard (McCamant; 1988,91). Jernstoberiet

was the first cohousing community to combine all residences and common facilities under one roof (McCamant; 1988,93).

The attention paid to the design of transitions between private and common realms affect the ease of movement between these areas and define the relationship between the community

members (McCamant; 1991,111). In cohousing communities there is less need for territorial definitions and the relationships between private and community areas can be more relaxed (McCamant; 1991,111). Visual access to the common areas allow people to see activities they might want to join. In Jernstoberiet all residences have their main entrance in the closed courtyard and visual access is provided with the use of windows.

McCamant and Durret propose the creation of a soft edge between the residence and the common area to increase the opportunities for casual socialising (1991,112). The soft edge was not properly developed in Jernstoberiet, although residents use the space in front of their dwellings as storage, there is no area specifically separate from general circulation in front of the dwellings. The use of interior streets and courts reduces the transition area (McCamant; 1991,112) and makes the transition from public to private space more informal. The interior courtyard makes transition in

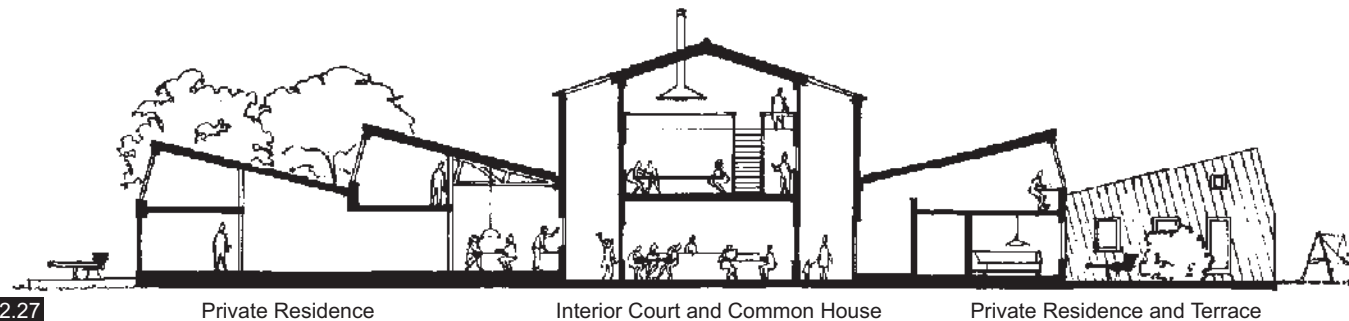

2.27 General Section, not to scale (From McCamant; 1988,94)..



2.28 Residents converted an old iron foundry to a 21-household cohousing community (McCamant; 1988,90).

2.29 The main entrances of the dwellings open onto a central court (McCamant; 1988,93).



2.30

Jernstoberiet more successful although it is still not optimised.

The Jernstoberiet common house has a large community "family room" providing a library, newspapers and tables for crafts. Many residents leave their equipment (e.g. sewing machines) and materials here. It is noted that the closed courtyard (i.e. not having to go outside to reach the common house) encourages the use of the common facilities (McCamant; 1988,96). By providing common facilities the common house re-establishes the residence as private enclosure while encouraging the formation of communities.



2.31

By reusing an existing building the size and form of the residences was determined by the concrete structure. The residents had considerable flexibility in the planning of their interiors (McCamant; 1988,96). This indicates the need for construction allowing flexible and transformable interiors. If residents have to move from the community as their spatial requirements change, the long-range benefits of a stable community is at stake (McCamant; 1991,120).

2.30 The common house at the end of the central hall (McCamant; 1988,97).

2.31 The central hall provides a covered courtyard for socialising (McCamant; 1988,95).

Design influence

Cohousing offers the designer the opportunity to reduce the size of the individual housing unit by placing craft-, hobby, reading and other sociable relaxation material inside the common areas. This facilitates casual socialising and the building of communities.

The relaxed transition between private and common areas should be ensured with the use of soft edges and interior courts and streets. Without a soft transition residents cannot move informally from one to the other (McCamant; 1991,112).

Transformable interiors reduces the risk to long-term stability if residents have to move out of the



2.32

2.32 Residents preparing dinner in the common house (McCamant; 1988,96).

Penthouses, Melrose Arch

OMM Design Workshop
Under construction
Visited by author on 24 May 2002

Melrose Arch is a constructed urban place with little connection to the rest of the city (Bremner; 2002). Although the penthouses are located in an artificial urban setting, it serves as example of residential units in urban surroundings.

The penthouses are located on the top two storeys of a multi-functional building (functions include offices and restaurants). Private areas (bedrooms and bathrooms) are compact and clustered on the lower storey to provide large, open plan living and mezzanine levels. This does not conform to the logical order of locating living and reception areas at the entrance, and bedrooms at a deeper level.

Design Influence

The value of clustering functions to free space for open areas is noted.

Although city development was simulated at Melrose Arch (Bremner; 2002) it illustrates the importance of integrating functions (housing, retail and offices) in the creation of successful urban areas. It is the intention of the author that the Old Poynton's Cohousing community facilitates this process in an authentic urban setting.



2.33



2.34

2.33 Penthouses, Melrose Arch.

2.34 Storage underneath the staircase separates two bedrooms.



2.35



2.36

2.35 A mezzanine level is provided in the living area.

2.36 View of uncompleted mezzanine and bathroom.

DESIGN PREVIEW

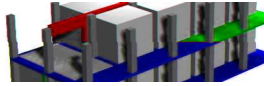

Schedule of Accomodation

The Old Poynton's Cohousing community is accommodated in the top three storeys of the building. The common facilities are housed on the lowest of these three and serves as a threshold between the urban surroundings and the residences. Due to its role in community formation it is important that residents pass the common facilities when entering or leaving the community.

The walls to the existing courtyard are removed and a roof added to create an atrium. The atrium should serve as interior open space and facilitate visual access between the three storeys.

Two infill levels, to accommodate transformable residences, is located on the top two storeys.

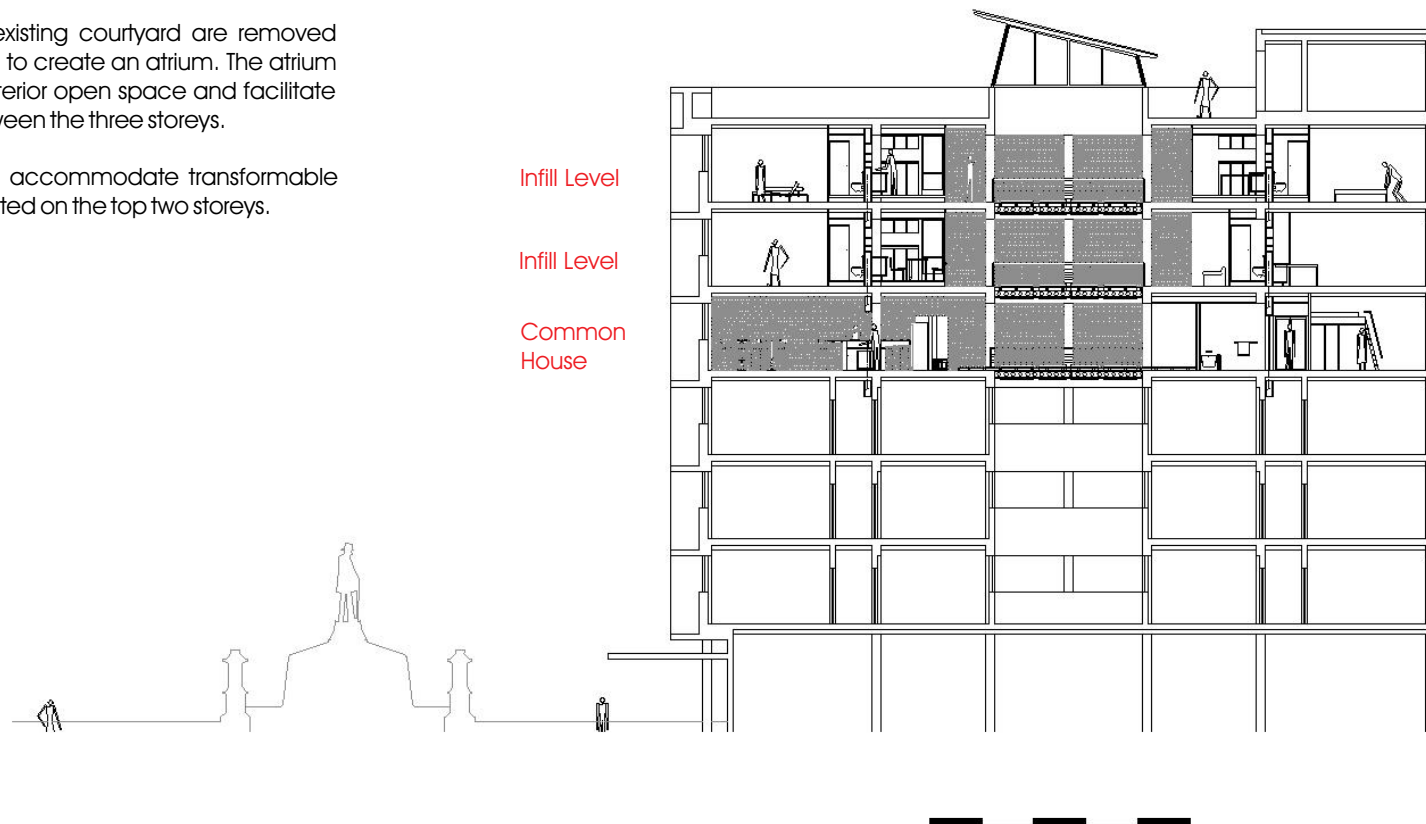

3.1 General Section, indicating functions accommodated on different storeys, scaled to fit.

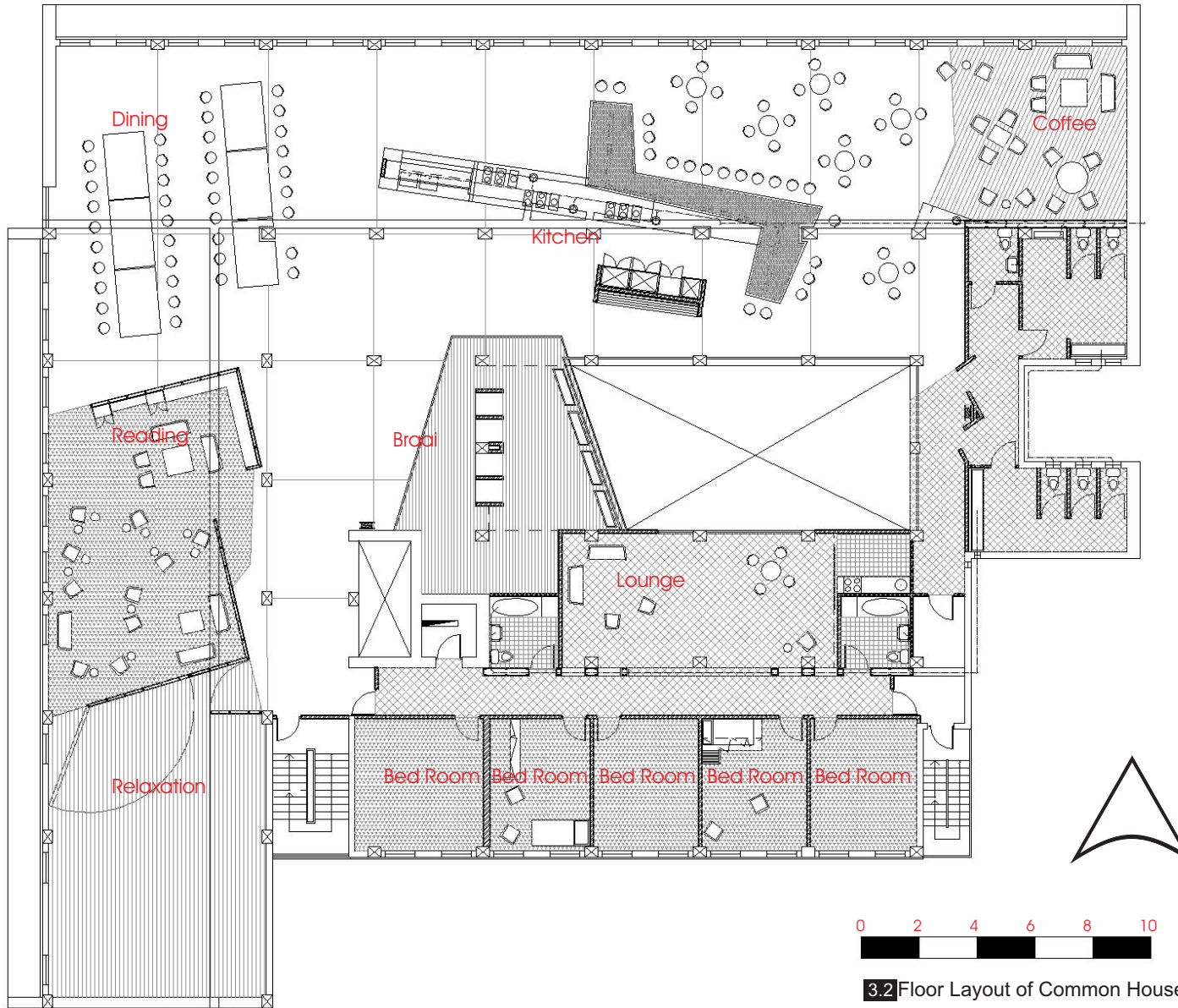

3.2 Floor Layout of Common House, scaled to fit.

Based on the recommendations of McCamant and Durrett (1988,182-184) and to allow for open building systems, the following amenities are provided:

1 Common Facilities

The common facilities should allow residents to become acquainted, share experiences and discover mutual interests. The primary role of common facilities is to contribute to the formation of communities (McCamant; 1988,40).

1.1 Dining Area

1.1.1 Kitchen

The kitchen is to the north of the atrium and unenclosed to allow residents to see activity in the kitchen and dining room. The kitchen should accommodate the following functions:

1.1.1.1 Preparation

Equipment: Preparation bowls
Moveable tables
Fridges
Shelving
Storage for utensils
Trolleys to transport utensils to scullery

1.1.1.2 Cooking

Equipment: Preparation bowls
Moveable tables
Electric hobs
Electric ovens
Shelving
Storage for utensils
Trolleys to transport utensils to scullery

1.1.1.3 Serving

Equipment: Counters with storage for crockery
Moveable tables from cooking area is used to enlarge serving area

1.1.1.4 Scullery

Equipment: Wash trough
Sink
Storage for detergents
Trolleys to transport utensils
Separate bins for organic and inorganic waste.

1.1.1.5 Braai Area

Equipment: Built in braai
Fuel storage
Moveable tables

1.1.2 Dining Room

To avoid creating an institutional character and to foster a residential atmosphere, the dining room is not separate from the kitchen.

Equipment: Tables
Chairs

1.1.3 General Circulation

1.2 Lounges

The lounges include a reading room and relaxation room. Based on the principles discussed in this document they are separated with operable partitions to facilitate transformation based on the community's needs.

1.2.1 Reading Room

1.2.2 Relaxation Room

1.3 Guest Rentable Rooms

Single rentable rooms are available to guests of the cohousing inhabitants. These residents have a higher need for privacy than cohousing residents and their facilities are appropriately planned.

1.3.1 Sitting and Dining Area

Equipment: Moveable tables
Chairs
Lounge chairs

1.3.2 Kitchenette

Equipment: Electric Stove
Sink
Under counter fridge
Storage for dry food and utensils

1.3.3 Bathrooms

1.3.4 Bedrooms

Bedrooms are large to provide ample space for private retreat to residents not accustomed to living in cohousing.

1.3.5 General Circulation

1.4 Ablutions

1.4.1 Disabled

Equipment: Water closet
Hand wash basin
Grab rails

1.4.2 Male

Equipment: 1 x slab urinal
2 x wc
3 x whb

1.4.3 Female

Equipment: 3 x wc
3 x whb

1.5 General Circulation

1.6 Atrium

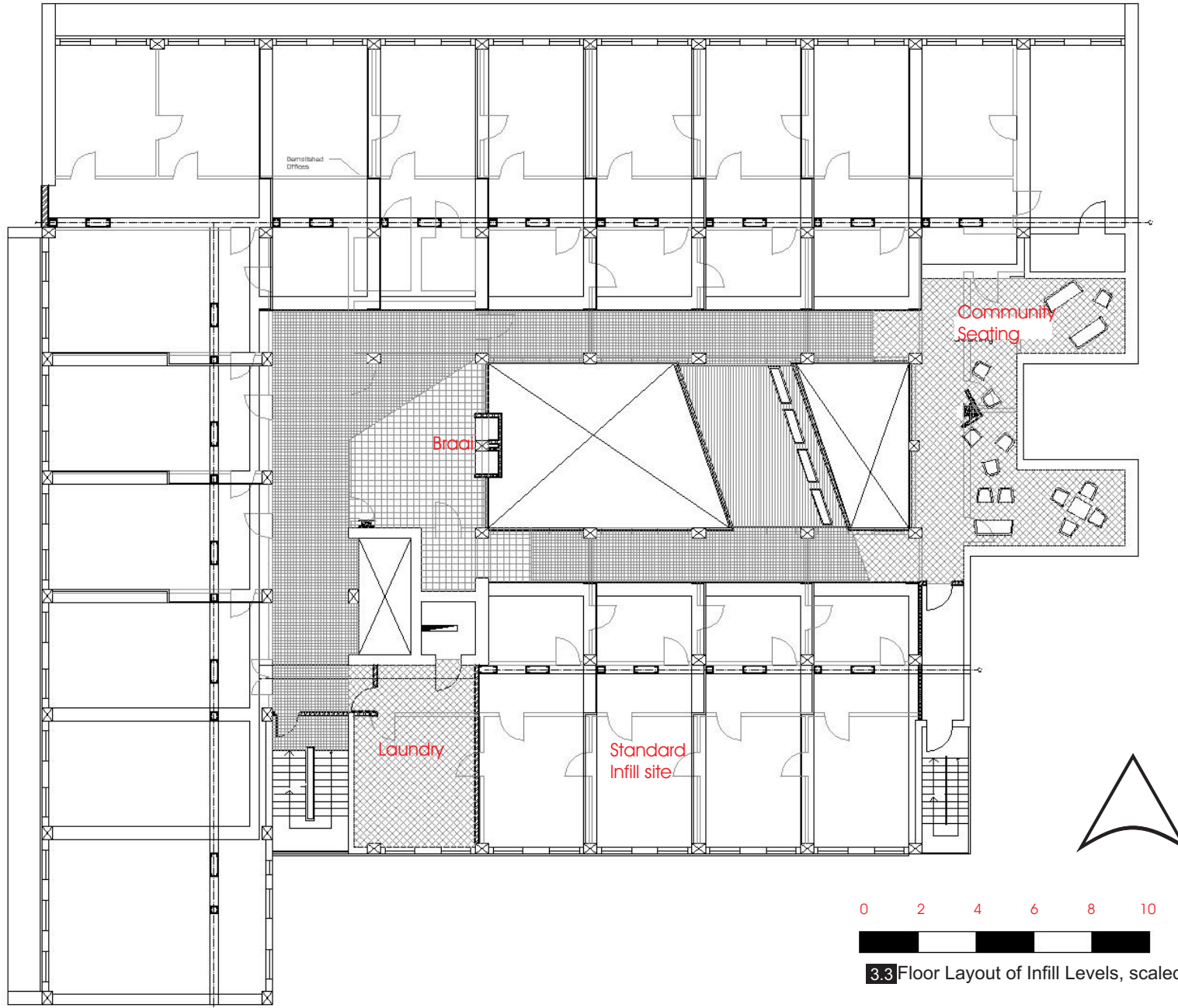

0 2 4 6 8 10



3.3 Floor Layout of Infill Levels, scaled to fit.

2 Infill Levels

Due to their flexible nature, the layout and size of the dwellings will be user defined. General floor layout is predetermined with infill sites available for occupation. Only the support system (electrical and sanitary services) is provided.

2.1 Braai Area

Equipment: Built in braai
Fuel storage
Moveable tables

2.2 Community Seating

Seating areas are provided in circulation areas to facilitate random meetings between residents

Equipment: Benches
Chairs
Tables

2.3 Atrium

2.4 Distribution Board Room

2.5 General Circulation

2.6 Infill Sites

Infill sites may be occupied individually, or more than one adjoining site may be utilised to provide a larger residential unit. Each infill site is provided with a sanitary connection, a cold water connection and an electrical connection.

Open Building System

The basic concept of Open building is to find principles of ordering systems to minimise interference between them (Dekker; 1998,311). This allows for efficient building and creates the possibility to redesign or replace a system without interference to the others.

The development of comprehensive open systems for the interior infill level is important. This development is of great importance considering that about 50% of the value of refurbishment work is carried out at the infill level (Dekker, 1998,313). Flexibility is the measure of a building's ability to accommodate changing functions and occupancies (Rush; 1986,238). To facilitate flexibility new design methods, improved installation skills and new products that allow streamlined inspection and review processes should be developed (Dekker; 1998,313). Flexibility is dependant on the relative independence of building systems (Rush; 1986,238).

To facilitate flexibility in the infill housing of this study the building systems are separated into:

- The existing building (structure and envelope): Interference to the existing building is limited to removing the existing internal partitions, removing the courtyard walls from the three cohousing levels and converting the courtyard to an atrium.
- Service wall: The service wall provides the wet support for the housing units and common facilities. It accommodates water supply, sanitary services and mechanical ventilation for the ablutions.

- Electrical services: The electrical services (electricity, telephone and data lines) are housed in ducts that indicate the boundaries of infill sites.
- Interior infill systems: The infill system would consist of modular partitions (to facilitate construction and planning) and devices for customising space on a daily basis. It is this system that must provide for the residents' need to change their dwellings as their requirements change.

The systems have separate lives with varying degrees of transformability. The existing building provides a base building that should accommodate different uses. The electrical and wet services can be upgraded when technology improves, but are considered fixed entities. The infill system allows the resident to improve the interior or choose a complete new infill (Dekker; 1998,315). Although the systems are separated they are always interdependent (Rush; 1986,10).

In the planning of the dwellings, the service wall would act as a barrier between private (e.g. bedrooms) and semi-private (e.g. diningroom) areas. In this regard the service wall is integrated with the infill system without impeding its flexibility. To facilitate integration the service wall is visually sized and coloured and its position determined by the need to have a threshold between semi-private- and private space in the dwelling.

3.4 Evolution of Service Wall. (1) The service wall (blue) developed from the need to provide wet services to the infill sites (gray boxes). (2) To allow access to the dwelling the wall is reduced to stubs dependent on a duct below the floor slab. (3) The stubs is extended to the duct above. The duct below a stub accommodates sanitary services and the one above plumbing- and mechanical ventilation services. (4) The wall is not integrated with the interior system and is moved to a position where it will serve as threshold between private- and semi-private areas.

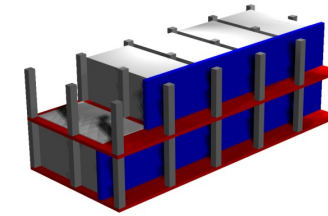

1

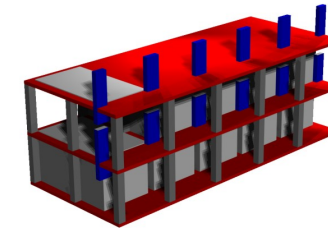

2

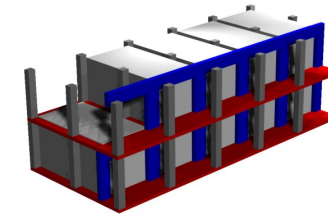

3

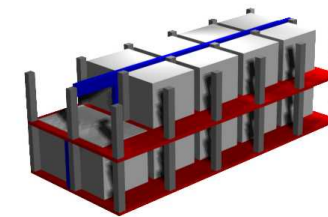

4

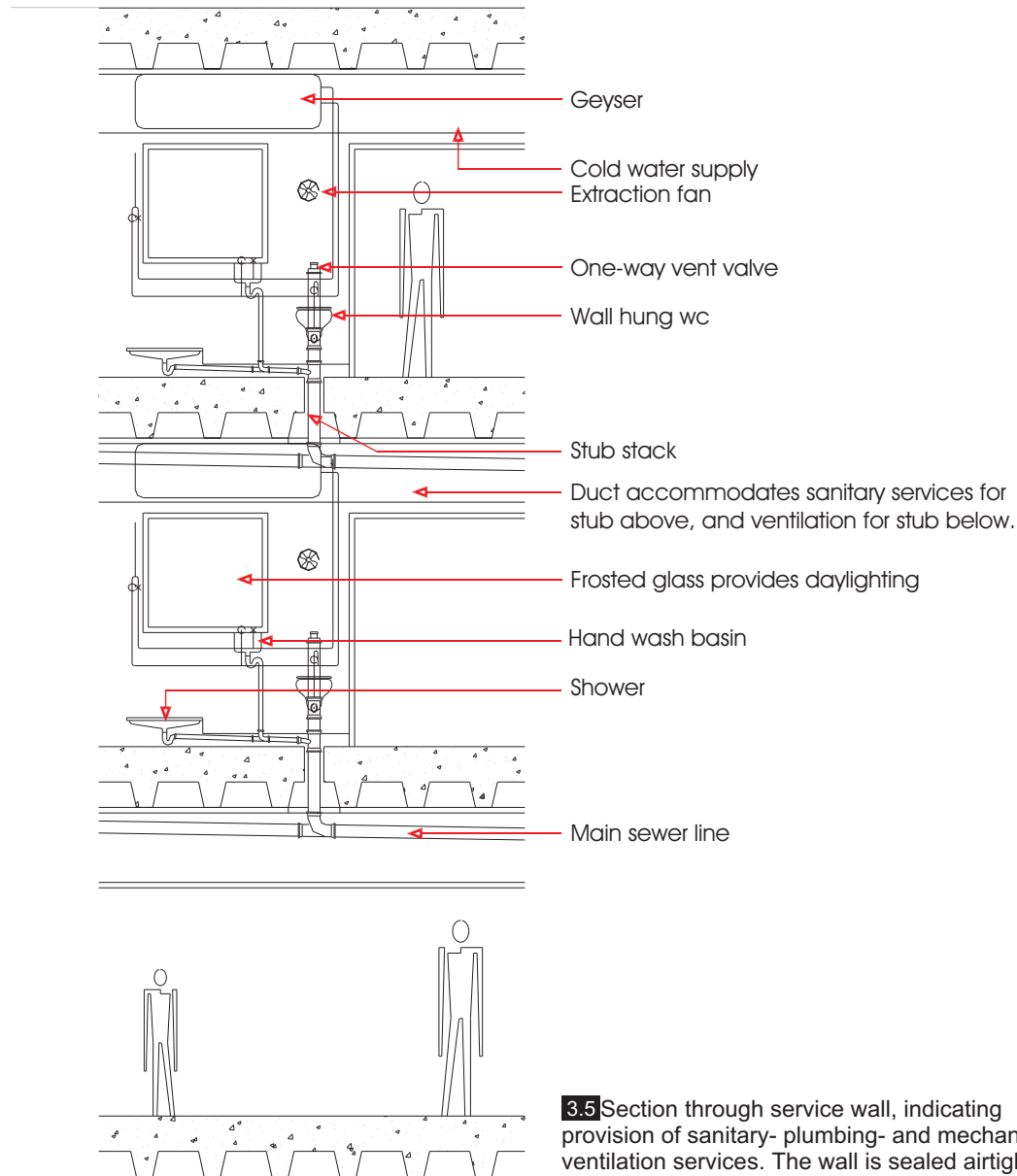

3.5 Section through service wall, indicating provision of sanitary- plumbing- and mechanical ventilation services. The wall is sealed airtight with free ventilating openings piercing the building envelope, to provide ventilation to the stub stacks. Scaled to fit.

Dekker (1998,317) states that flexible infill systems have the following advantages:

- It is possible to completely fulfil the individual requirements of a resident.
- There is flexibility in timing the individual dwelling renovation.
- The residents are completely free in their decisions and are not obliged to accept renovation against their will.
- It is a flexible way to upgrade housing estates, related to the latest technological possibilities.

Infill Sites

To facilitate open building in the Old Poynton's Building, a chassis and infill system is proposed based on the principles established by House_n researchers at the Massachusetts Institute of Technology (MIT). House_n is a research initiative that is currently developing methods to integrate digital and building technologies within architecture (Hart; 2002,149). House_n is fueled by criticism (shared by the author) that the housing industry is antiquated, labor intensive and inflexible. House_n is developing a new component based building system (Chassis and Infill) that is a determined effort to produce construction that is more flexible. Chassis and Infill is an integrated assembly based on the automotive industry's method of rapidly installing integrated parts (Hart; 2002,154).

Under the provisions of the Chassis and Infill system the chassis will be composed of columns and beams that will provide structure, insulation, sensors arrays, lighting, signal and power cables and ductwork. The infill components will include integrated wall/floor assemblies, speciality millwork, display systems and networked appliances and devices. Theoretically the infill components can be altered, upgraded or replaced without disruption to the chassis (Hart; 2002,154).

It is the author's intent to design within the possibilities and restrictions of such a building system and not to design the system. Infill sites are provided for occupation, the boundaries determined by the position of the chassis component. The chassis is separated into two independent but integrated systems. The wet services wall (as discussed earlier) and beams running between columns carrying electrical and telecommunications systems and lighting (figure 3.6). These systems would provide mechanical fixing points for the infill component. The infill component will not be modular but is dependant on a manufacturing system that is able to fabricate components for easy assembly on site. Advanced computer aided design/manufacture (CAD/CAM) (e.g.. Computerised Numerically controlled Machines, already in use in large millwork and metal plants) allow for custom parts to be manufactured as fast and economically as identical ones (Hart; 2002,154). The sample apartment is designed withing the paradigm of low-labor, prefabricated, mass-customised housing.

Duct Construction

Duct construction is specified to reduce the possibility of ducts spreading fire quickly through the building. The acoustic problems associated with ducts are also to be addressed.

Ducts are to be constructed from wood wool slabs fixed to a mild steel framework. Wood wool slabs are chosen because they are not easily ignited and have a low spread of flame (Everett; 1994,77). The natural surface provides good sound absorption and the open texture is a good base for plaster.

The wood wool slabs on the interior of the duct is to be unfinished while the outside is to be plastered with gypsum plaster since its continuous surface are free of joints through which flames can pass. Gypsum plasters are non-combustable and can resist fire for considerable periods (Everett; 1994,23). The gypsum also provides a suitable surface to be painted.

To prevent spread of flame along ducts, site boundaries are fitted with fire and air stops. Expanded metal panels painted with intumescent paint is fixed in the duct. When heated the paint expands forming an insulating porous char (Everett; 1994,24). Intumescent paint will also be used to protect the mild steel framework from structural weakening in the event of fire.

Each infill site is provided with a stub stack with a two way vent valve, ventilating into the duct. Extraction fans in all the bathrooms will provide positive pressure inside the duct. To assist ventilation the duct terminates in free ventilating openings at the building skin.. The main sewer line is fitted with a free ventilating vent pipe, since a closed sewer system is not permitted.

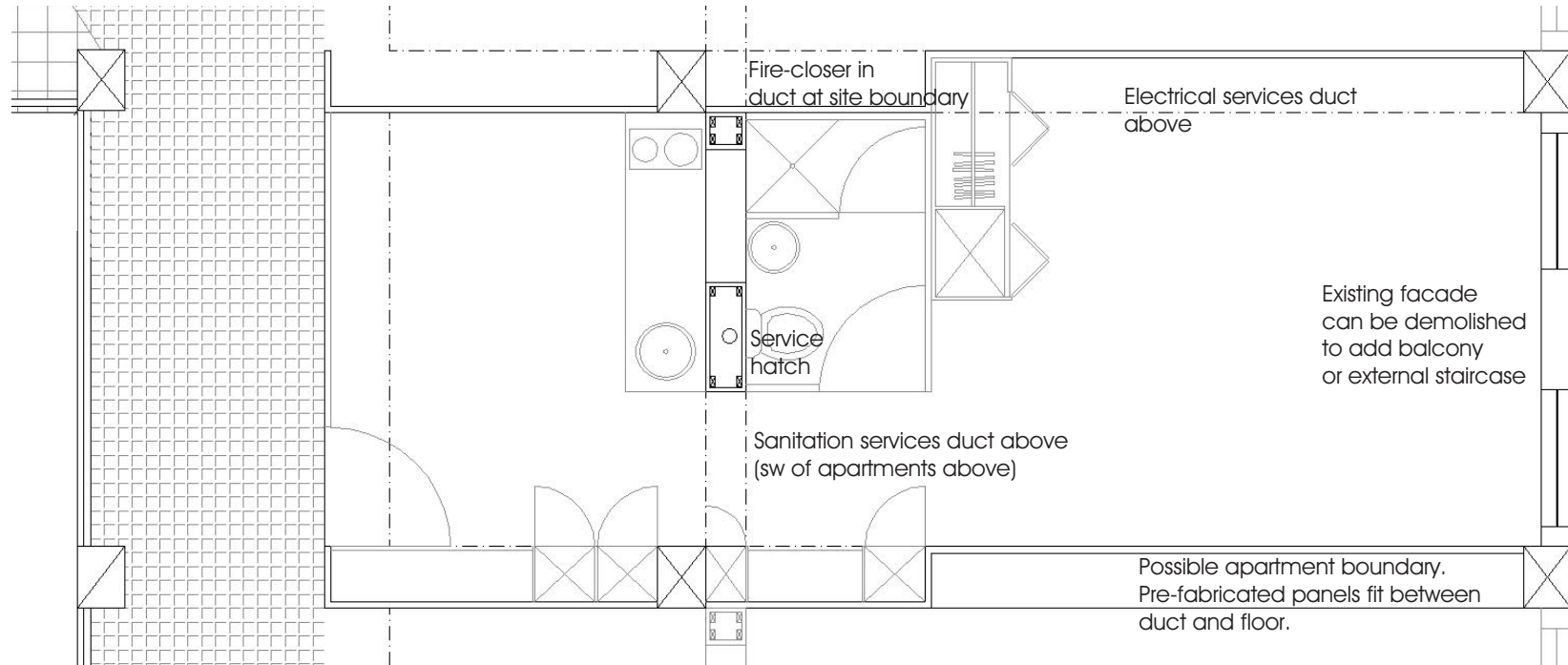

Common House

The Common House does not need the same degree of flexibility as is required in the infill units. Although spaces were still designed to be malleable, more traditional building materials will be employed (e.g. dry wall construction, in-situ concrete and masonry).

The occupational difference between the communal facilities (kitchen, dining room, reading room) and the rentable rooms require separation by occupational separating elements that has a fire resistance of at least 60 minutes (Government Gazette; 1985,108). Two fire hose reels are required and CO₂ fire extinguishers are used in the kitchen, since they will not contaminate food not damaged by fire.

Light from highly illuminated areas (e.g. the kitchen and reading room) is used as atmospheric/effect lighting in closely situated areas where lower illumination is required (e.g. the lounge and dining area). Light areas are not separated from dim ones to allow visual access and excitement in the common house. Privacy can be achieved (in the recreation area) by closing pivoted partitions.

The position of the kitchen is determined by the service wall. The sinks and preparation bowls are serviced by a single branch and require a one way vent valve. The hobs are serviced by an extraction canopy with two extraction units, steam and vapours are expelled through a flexible duct situated in the service wall (in-line fans may be needed).

Kitchen Surfaces

The kitchen is to be built from in situ concrete, treated with a damp-proofing admixture to offer higher resistance to the absorption of water (Everett; 1994,120). The entire island is to be plastered in water-repellant, acid resistant, blue-pigmented plaster.

To avoid the blunting of knives on the concrete worktop, loose wooden cutting boards are supplied. The cutting boards are sanded smooth, but left untreated (it is assumed that the residents will oil them with sunflower oil and disinfect them with salt on regular intervals).

A joint free, continuous surface was required for the countertop. PG Bison's Surinno (a composite acrylic flat sheet product) is non-porous, hygienic and impact and stain resistant. Colour matched seaming compounds creates a continuous surface. Since colour is distributed through the whole thickness of the product, scratches and stains can be removed by polishing the surface (which is not the case in standard laminated worktops).

Environmental Impact of Materials

The use of open building systems reduces the need for wet construction and the subsequent damage that the extraction and manufacture of lime and cement has on the environment. It is considered highly undesirable to use lime in constructions designed to have a short life (Fox; 1989,67).

Flexible buildings systems demand structures that can be erected or dismantled with the minimum use of energy and waste of material. This calls for the use of composite materials or boards that can be screwed, bolted or clipped into position. The use of lightweight structures often accommodates a high quality function fulfillment with more net usable floor area (Beukers; 2001,111).

While the recyclability of composite materials is limited (Beukers; 2001,112), their use reduces the reliance upon environmentally undesirable materials that involve mining and quarrying (Fox; 1989,46). Further composite materials can be obtained ready finished and have inherent decorative qualities that reduce maintenance (Everett; 1994,24).

For the purposes of this study the environmental impact of possible materials to be used (either singular or as components of composite materials) will be listed:

Cement and Concrete:

Although wet construction methods are to be excluded in all flexible applications they will not be disregarded for elements with a permanent nature (e.g. as plaster in the ducts or in the use of certain partitions in the common facilities). Where cement is suitable as a component in composites and its properties make it more suitable than other materials its use would not be excluded (e.g. particle boards bonded with cement have a higher sound reduction and better dimensional stability than resin bonded particle boards (Everett; 1994,74)).

Cement extraction damages the environment and its manufacture causes dust in the surrounding area (Fox; 1989,31-32).

Plastics

Plastics will largely be used as a component of composite materials (e.g. formaldehyde in chipboard).

Due to the easy recycling and reuse of plastics they are theoretically ecologically benign (Fox, 1989,84). It is the lack of adequate recycling facilities that prevent them from becoming a renewable resource.

Although petroleum based products are the main raw material employed in plastics manufacture, it can be manufactured from any organic compound (Fox 1989,84). There is an increasing trend to manufacture plastics from renewable resources (e.g. Formaldehyde from slaughterhouse waste, casein from milk and cellulose from wood (Fox, 1989, 86)).

In many building applications plastics provide a low-energy, long-lasting, lightweight alternative to traditional material (Fox 1989,86).

Boards

Composite materials manufactured in flat sheets are considered. They would typically include resin or cement bonded fibers or particles and resin bonded laminates.

The environmental impact of boards depends partly on their composition and in the potential for being eco-friendly alternatives for more destructive construction methods. Building boards can be used to extend the possibilities of timber-frame construction, but their limited potential for recycling is an environmental disadvantage (Fox, 1989, 25).

It is important to lessen the environmental impact of boards by ensuring that only wood from sustainable sources are specified and that the bonding agent is obtained from renewable resources (e.g. formaldehyde). The reusability of boards is determined by the construction methods employed and the decorative surface laminates specified. It is the intention of the author to reduce the use of decorative laminates and specify materials with inherent decorative qualities.

Glass

Glass is considered to be used as fibres in composites (e.g. glass fibre reinforced concrete), as fenestration and for decorative purposes (e.g. shelves, shower doors and luminaries).

Glass manufacture is a high-energy industry, but it is easily recycled when separated from other materials (Fox; 1989,51). The high energy demand of glass manufacture and its ability to increase the cooling load of the interior by solar heat gain (Bradshaw; 1993,101) should be considered in its application.

Metals

Nearly all metals are derived from non-renewable resources, the extraction of the raw material is destructive and large amounts of energy is used in the refinement and transport of metals (Fox; 1989,67). The environmental impact of metals can be reduced by using larger amounts of recycled metals and reducing the use of metal in the building process to essential elements only.

Timber

Grown and harvested in a sustainable manner, timber is a renewable resource, and thus the ultimate environmentally friendly building material (Fox; 1989,123). In terms of indoor comfort and health aspects, timber is one of the most acceptable materials (Stulz; 1993,101).

The concern over rapid deforestation has led to research in rationalised timber utilisation (Stulz; 1993,101). Only timber from sustainable managed sources should be specified, and when the use of tropical hardwoods is inevitable ensure that it is refined as close to the source as possible. The production and processing of timber requires less energy than most other building materials. Demolished timber structures can be recycled as building materials or burned as fuel (and the ash used as fertiliser) (Stulz; 1993,109).

Fast growing timber species (mainly grown in plantations to preserve slow growing tropical hardwoods) have low natural durability that has to be improved with appropriate seasoning and timber preservatives (Stulz; 1993,103). By their nature to kill organisms all timber treatments are toxic to some degree (Fox; 1989,131). Fox (1989,106-107; 131-132) argues that the use of timber preservatives arises solely from bad design practice. Timber of suitable type and quality, correctly conditioned and correctly utilised in a properly maintained building is very unlikely to suffer from biological attack. Timber should be mechanically protected from moisture and good

ventilation should be provided, or microporous paints should be preferred to impervious coatings that do not allow timber to breathe (Fox; 1989,107).

Well built and tested timber structures are energy efficient, flexible for later additions and respond organically to outside conditions (Fox; 1989,130).

Paints and Finishes

Most paints incorporate solvents, dyes and other materials of petrochemical origin (Fox; 1989,79). Paints are developed that are based on vegetable oils, or rely on emulsion techniques that do not release toxic vapours when drying.

Organic solvents pose a health hazard and a green policy should be to eliminate all solvents that release vapour into the atmosphere (Fox; 1989,99-100).

Conclusion

It is the intent of the author to rely on sustainable materials in all applications where they are suitable. The amount of renewable materials used should be controlled, because such resources are limited even if they continue to be available (Bradshaw; 1993,2).

The use of high embodied energy or non-renewable materials cannot be excluded but their application should be limited to where they are absolutely necessary.

Although composite materials are in an environmental difficulty their use would not be excluded, due to their performance in acoustic and thermal applications and their ability to facilitate more functions with a reduction in the amount of material used.

Wet construction processes would not be excluded, but limited to applications which do not need to be transformable (e.g. in the structures providing the support level).

The use of purely decorative paints and finishes will be reduced by specifying materials with inherent decorative qualities (e.g. timber and concrete), materials that are resistant to environmental impact (e.g. Stone and stainless steel) or material that age well (e.g. copper, stone and wood).

Performance Mandates

The interior must resolve the direct demands that people make on the building to provide comfort in supporting activity (Rush;1986,318). Rush (1986,232) outlines six performance mandates: spatial performance, acoustical performance, visual performance, air quality and building integrity. These performance mandates is defined by physiological, psychological, sociological and economic needs.

Based on this, Rush (1986,234) determines that the following objectives should be met:

Spatial Performance

- Physiological needs: Ergonomic comfort, disabled access and functional services.
- Psychological needs: Habitability, calm, beauty and excitement.
- Sociological needs: Functional adjacencies and navigation.
- Economic needs: Space conservation.

Thermal Performance

- Physiological needs: No numbness, nausea or heatstroke.
- Psychological needs: Sense of warmth and individual control.
- Sociological needs: Flexibility in deciding on clothing items.
- Economic needs: Energy conservation.

Air Quality

- Physiological needs: No lung problems, rashes or cancers.
- Psychological needs: Not closed in or stuffy and individual control over ventilation.
- Sociological needs: No smoke or smells from neighbours.

Acoustic Performance:

- Physiological needs: Speech intelligibility and musical enjoyment .
- Psychological needs: Quiet, soothing or exciting.
- Sociological needs: Privacy and easy communication.

Building Integrity

- Physiological needs: Fire safety, structural strength and stability and weathertightness.
- Psychological needs: Durability and a sense of stability.
- Sociological needs: Quality of construction.
- Economic needs: Material and labour conservation.

The performance mandates should be used to determine a strategy to prioritise certain mandates based on the client and specific building function. The building must perform adequately over time. It should be immediately suitable and yet be reliable and flexible enough to adapt to future changes in function and occupancy (Rush; 1986,233). For the purposes of cohousing acoustic performance (especially privacy between dwellings) is important. Spatial comfort is most significantly affected by the interior (Rush 1986,243).

Prioritising certain performance mandates does not imply that the others would be neglected. Decisions must be made with the full understanding of the available resources (Rush; 1989,235) and to ensure that the building performs as an integrated whole (Rush; 1986,232).

DESIGN REPORT

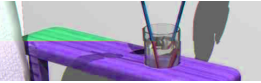

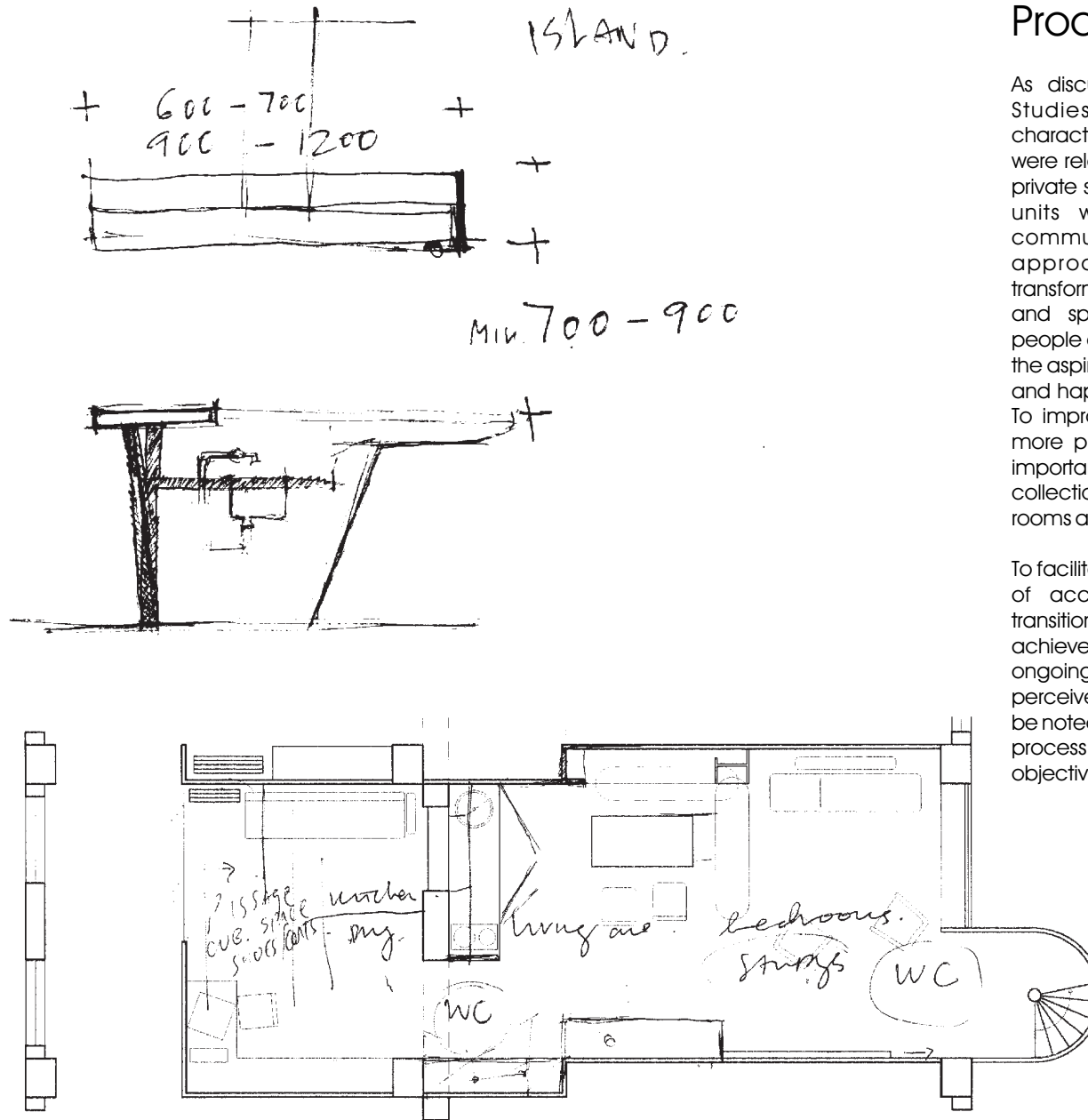

Product and Process

As discussed in the Context and Precedents Studies, certain design objectives and characteristics were established. The main criteria were relaxed transitions between communal and private spaces, preserving the autonomy of living units while establishing opportunities for community formation and an integrated approach to simplicity that facilitates transformable interiors while reducing material and spatial requirements. Design must offer people an alternative way of living - it must answer the aspirations of the people in terms of well-being and happiness (Cristophe Pillet in Fiell; 1998,386). To improve the lifestyle of residents by creating more practicable and social environments it is important that the product act as an integrated collection of spaces and not as a collection of rooms and functions.

To facilitate all functions described in the schedule of accommodation while ensuring relaxed transition between these, the final product was achieved by critically reviewing all decisions on an ongoing basis. While the product may be perceived as a result of the design process it must be noted that the author exercised control over this process to ensure that the product met the objectives set at the outset.

Common House

Since conceptually and symbolically the kitchen and dining room are the most important elements in a cohousing community, it was decided that the kitchen should be the focal area with the dining area clustered around it.

Separate lounges were provided for children, teenagers and adults. This created a disconnected layout with formal transitions between functions. The entrance into the communal area lacked gradual transition from the infill levels.



4.1

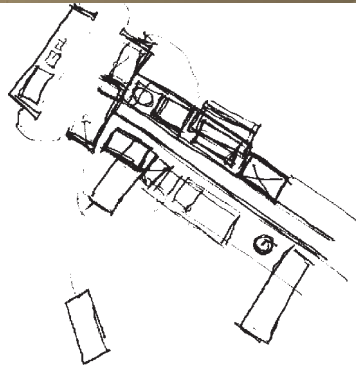

4.1 Concept perspective: central, linear kitchen in Common House.

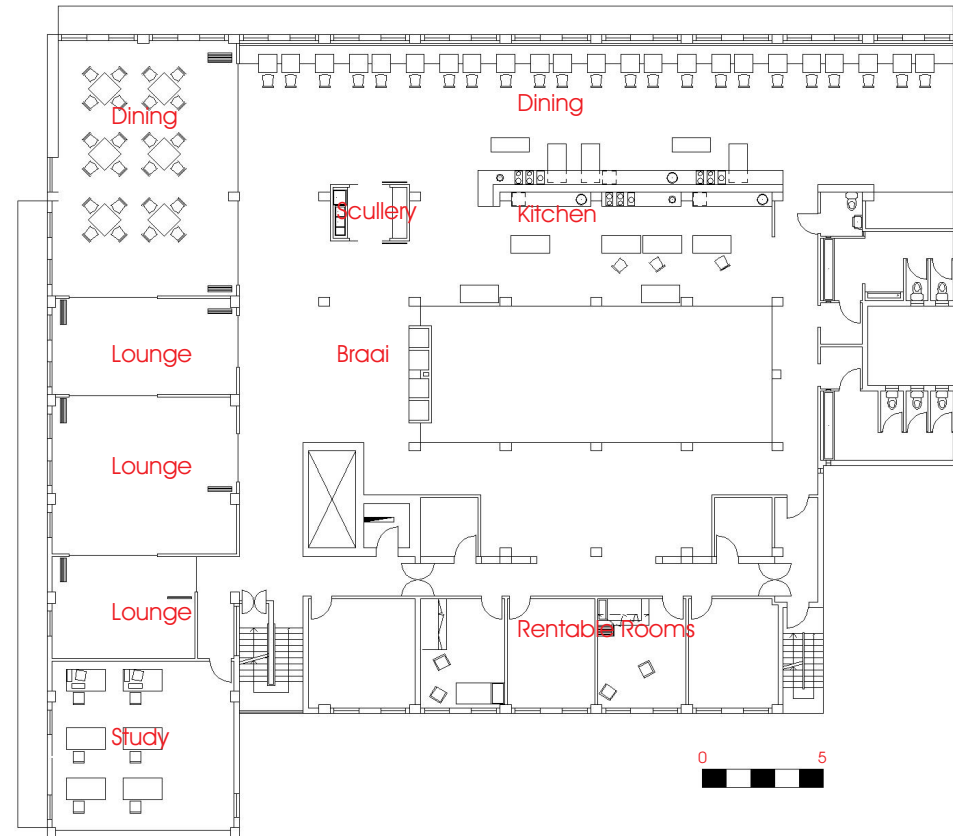

4.2 Common House, first draft layout.

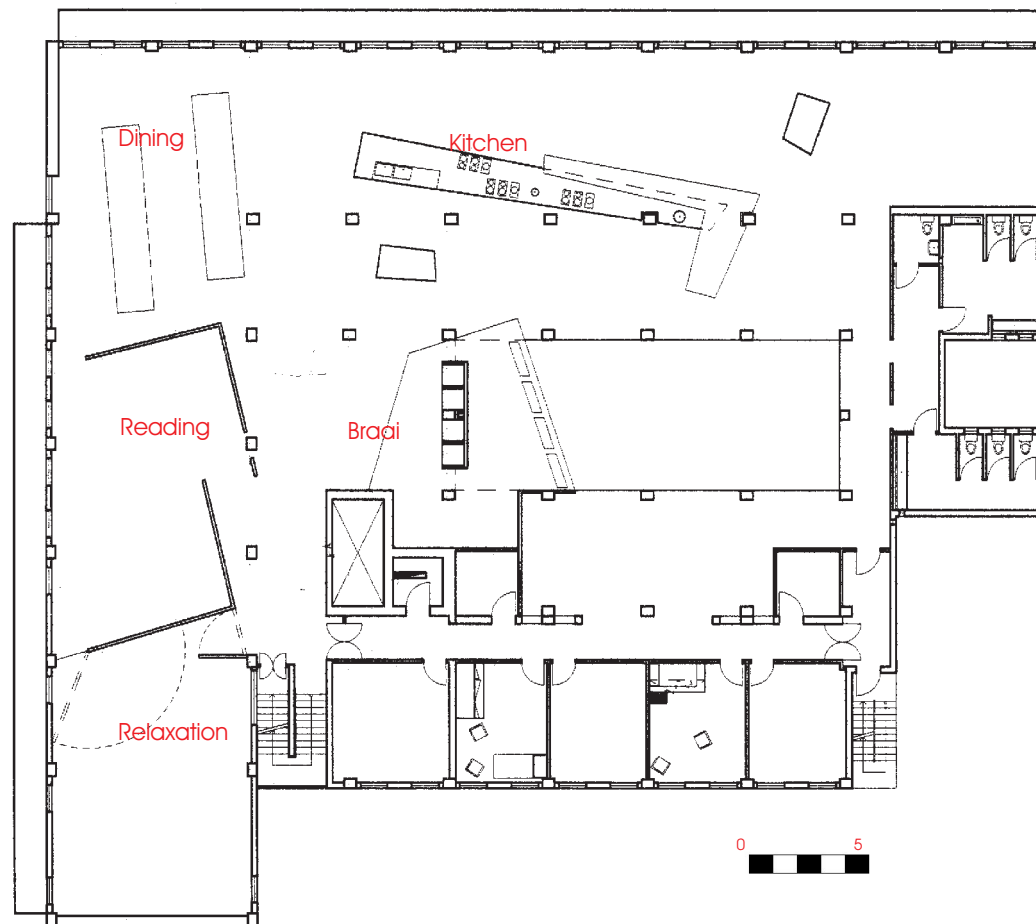

It was decided that the social function of the kitchen should be improved. This was achieved by adding a bar counter, allowing residents to socialise while cooking. The kitchen was rotated and moved away from the columns to forsake the strong Cartesian order established by the first concept layout.

The separate lounges were substituted with a reading room (defined by dry walls stopping short of the ceiling) and a relaxation room (to be used as art or yoga studio). These rooms are separated by a pivoting partition, rendering the space more flexible.

Relaxed transitions were enhanced by establishing visual access between different functions. The atrium is partially decked, to establish visual access between the Common House and infill levels.

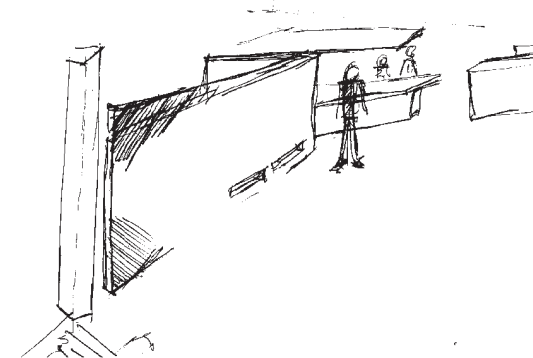

4.3 Common House, second draft layout.

To facilitate conversation at the bar counter an extra bend was added to create more seating. The bend defines the space by separating the formal dining tables from bar tables and a coffee area. The asymmetrical kitchen heightens the sense of interest, beauty and pleasure.

Floor finishes are used to define different spaces and relax thresholds. With the use of lighting (higher illumination at the kitchen and reading room with dimmer lights in the dining and conversation areas) the floor finishes will assist gradation between spaces.

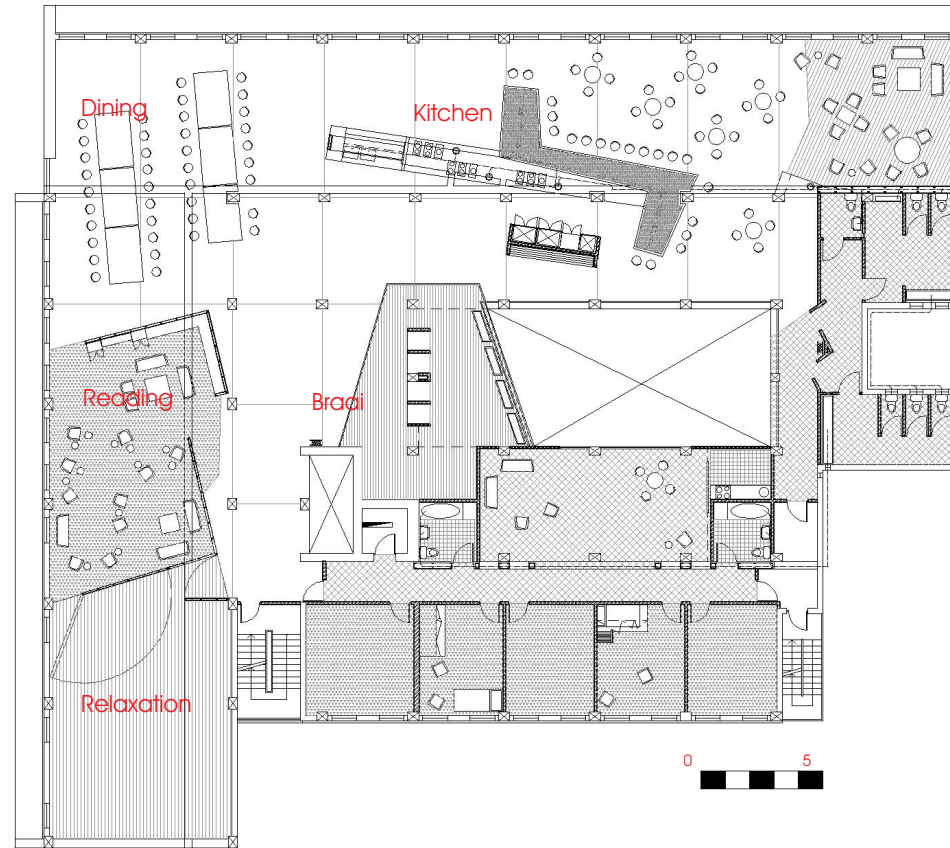
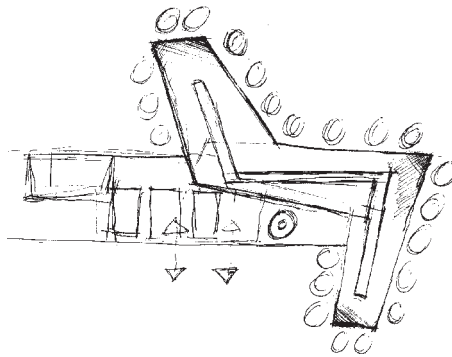

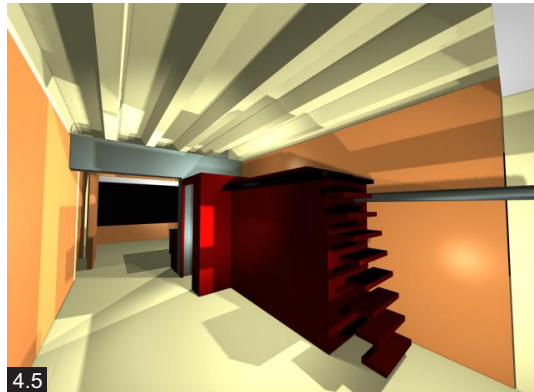

4.5

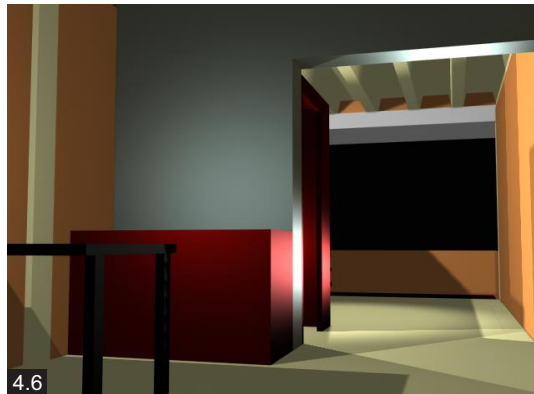

4.6

4.5-4.6 The design of the sample apartment was based on a Bachelor's Apartment occupying a single module. Design emphasis was placed on compact, transformable spaces and products.

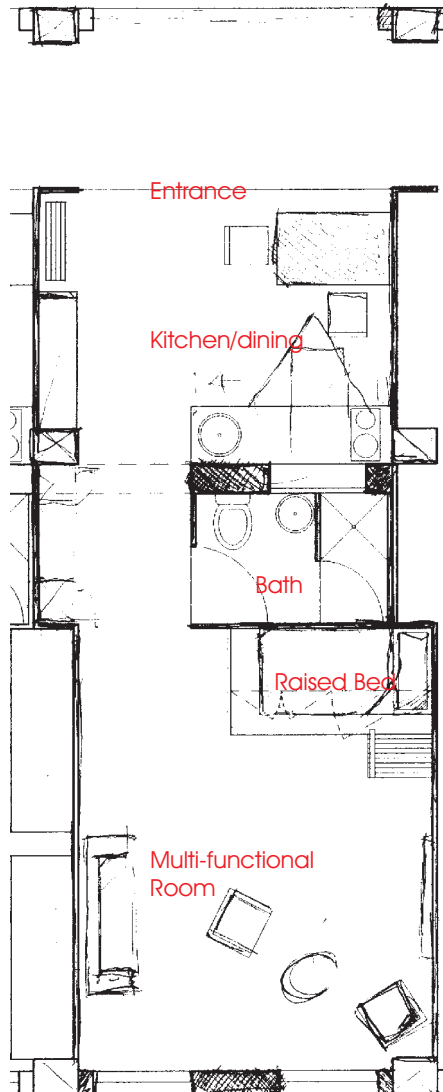

4.7 Concept plan, Bachelor's Apartment.

Sample Apartment

It was determined that the living units should be autonomous and independent, therefore design effort was concentrated on establishing the unit as a sanctuary. To preserve privacy the sensitive design of thresholds was of primary concern.

A bachelor's apartment occupying a single infill module was designed. The bachelor's apartment determined the unit's relationship with its neighbours and the communal areas and the position and extent of the support system. The provision of communal facilities allowed the designer to concentrate on creating compact, multi-functional spaces.

Since the bachelor's apartment was impersonal and did not fulfill the resident's need to express his identity through his dwelling, it was decided to redesign the apartment for a more specific client. Standardised details (e.g. the bathroom and kitchen) and general proportions (determined by the position of the services) was reused but the abrupt threshold was withdrawn in the design of a two-bedroom apartment.

Two-bedroom Apartment

The apartment was designed to fulfill the needs of a couple with one child. It is assumed that a space to work from home will be needed occasionally.

The accommodation of the apartment is divided into public- (dining, lounge and work spaces) and private (bedrooms) spheres. These functions are located on different levels, with a prefabricated external staircase forming a ritual barrier between them. Entrances are provided on both levels, but the main threshold to the apartment is on the bottom (public) level. The public space was designed with a high degree of flexibility to allow the residents to change the character and function of their apartment on an ongoing basis. Flexibility is an impairment in creating comfortable spaces of retreat, therefore the bedrooms were designed to be compact spaces of personal sanctuary.

The threshold of the apartment was improved by allocating an outside transitional area and with the use of an entrance lobby. To remove the possibility that guests would need to enter the private sphere, a guest toilet was provided on the lower level.

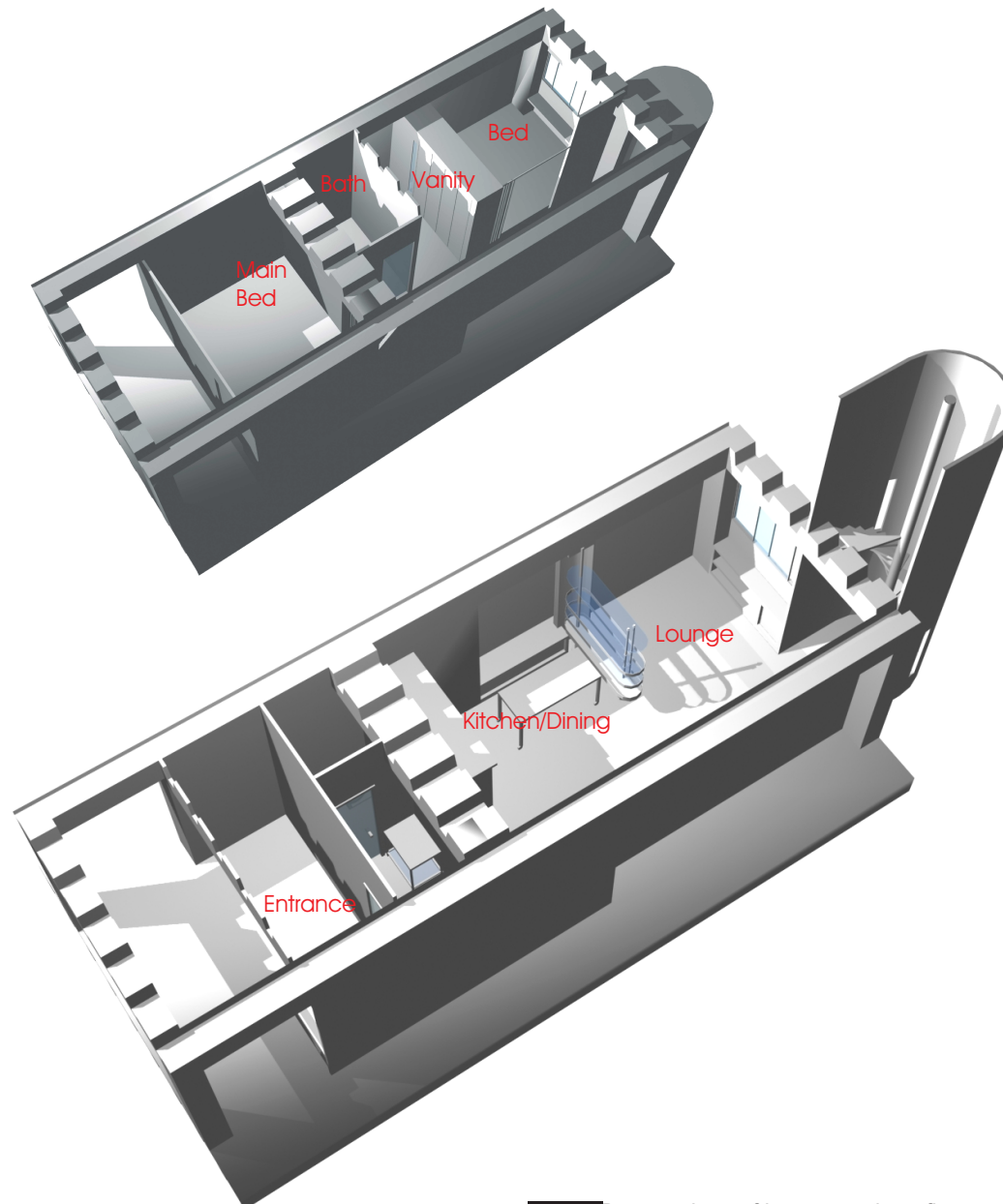
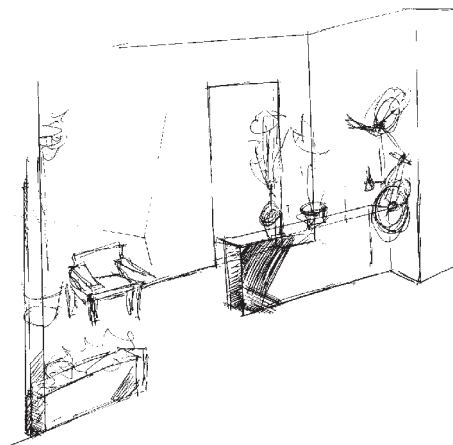

4.8-4.9 Perspectives of bottom and top floors of Two-bedroom Apartment.

Sleeper Couch

The main objective in the design of this product was to design a piece of furniture that was both simple and honest in aesthetics, construction and function.

A clear and understandable object is created by celebrating the relationship between the object and its use. The aesthetic is inseparable from the function, as it was informed and determined by a tectonic desire to expose all joints.

To ensure simple legible function, the most elementary unfolding procedure was determined (a single person, lifting and pulling the seat of a couch to create a single bed). It was established that it was necessary to perform this sequence from the front of the object since the sides and back might be inaccessible if the couch was placed in a corner, against a wall or used with side tables. These criteria determined the evolution and reduction processes that established the product in its current manifestation.

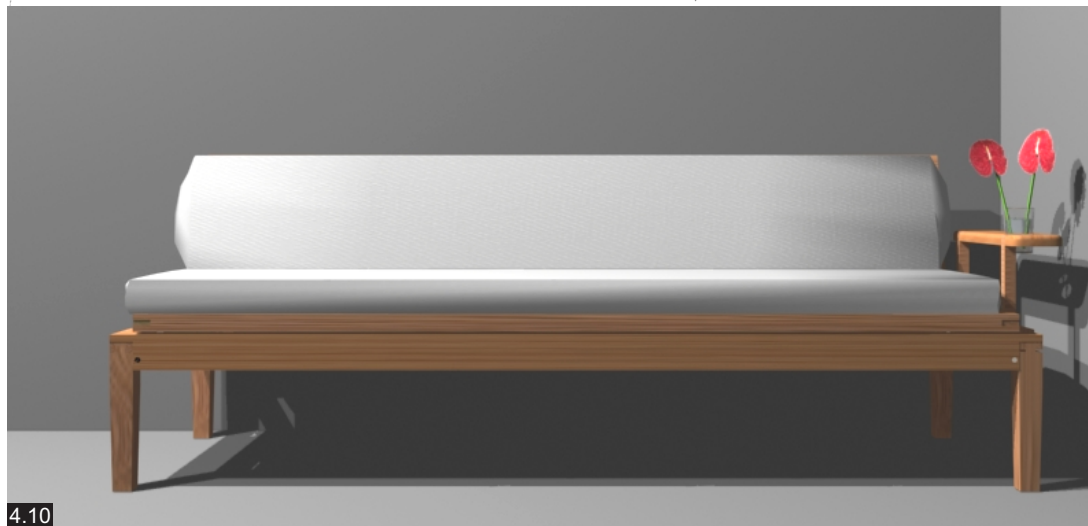
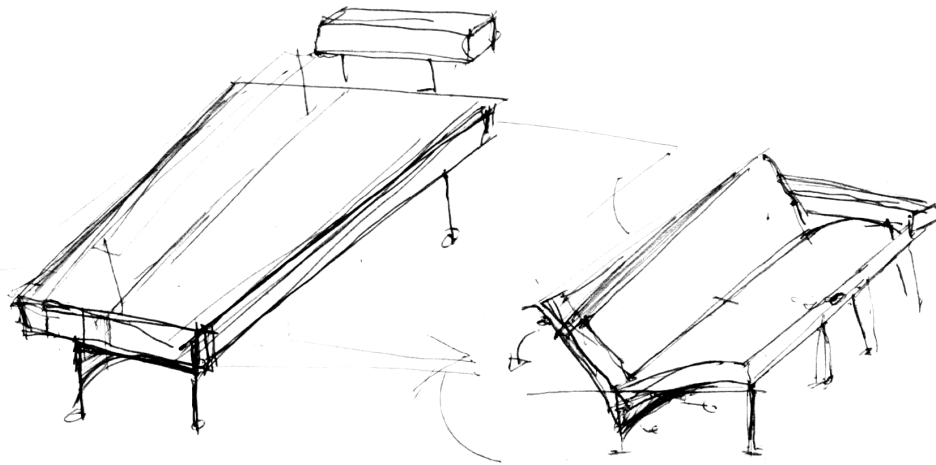

4.10

4.10 Perspective, Sleeper Couch.

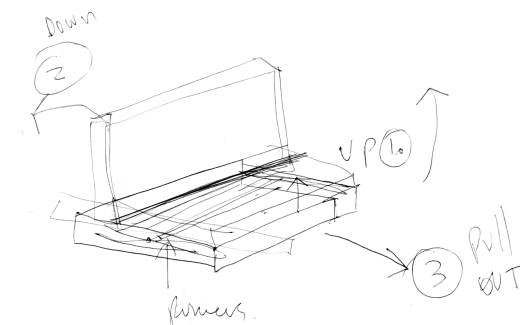

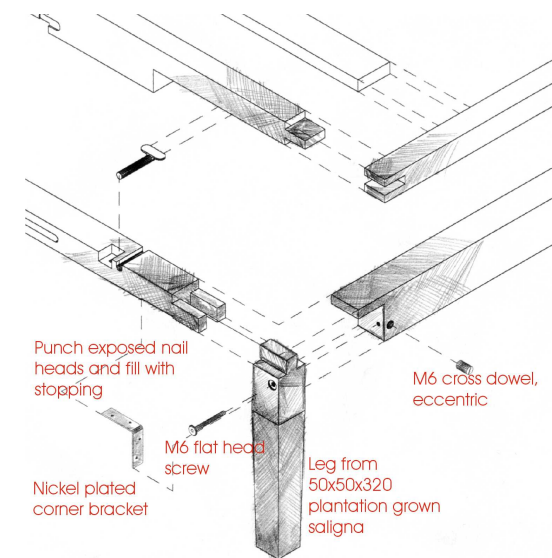
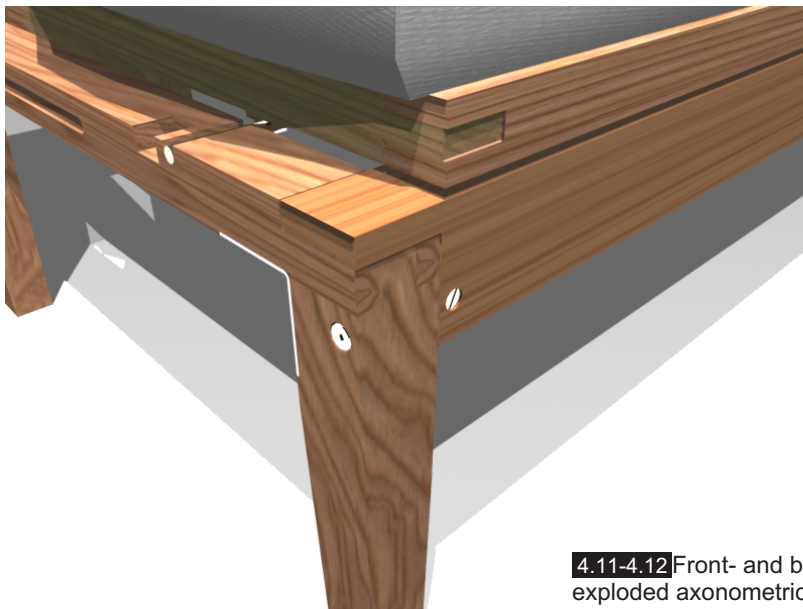
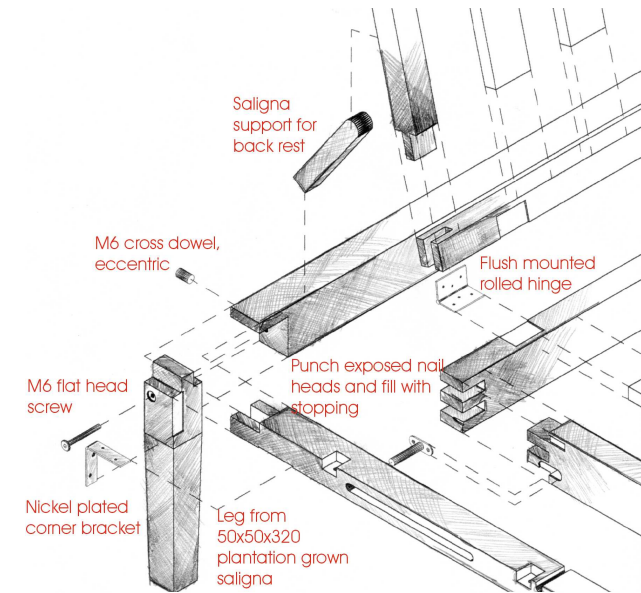
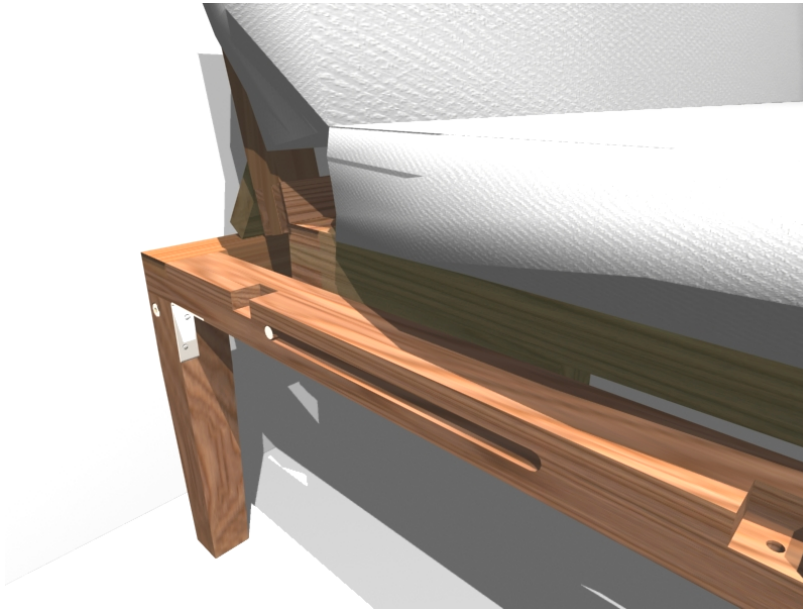

4.11-4.12 Front- and back leg details and exploded axonometrics.



CLAIM USE ADAPT
Cohousing Community in the Old Poynton's Building, Church Street
RAYMUND KÖNIGK
Mentor: Professor S.W. le Roux

LIST OF REFERENCES 

List of References

- Allen, I (2001): Trying it at home. In The architects journal (214/7) p. 22-31.
- Bachkit. www.bachkit.com. 1 April 2002.
- Bell, J (2000): Introduction. To Architectural design: The transformable house (70/4) p. 5-9.
- Beukers, A and van Hinte, E (2001): Lightness. The inevitable renaissance of minimum energy structures. Rotterdam: 010 Publishers.
- Bothma, B (2000): Film school and related facilities. Unpublished thesis. University of Pretoria.
- Bradshaw, V (1993): Building control systems. New York: John Wiley.
- Bremner, L (2002): Theme park city. www.sundaytimes.co.za. 2 June 2002.
- Capital Consortium (1999): The spatial framework. Pretoria
- Chipkin, CM (1998): Preparing for Apartheid. In Architecture of the Transvaal. Editors Fisher, RC; Le Roux, S; Marè, E. Pretoria: Unisa.
- Conran, T (2001): Small spaces. London: Conran Octopus.
- Curtis, WJ (1996): Modern Architecture since 1900. Saddle River: Prentice Hall.
- Dekker, K (1998): Open building systems, a case study. In Building research and information (26/5) p. 311-318.
- Du Toit, S (2002): Foregrounds and backgrounds to public housing. In SA Architect (January/February) p. 41-44.
- Everett, A (1994): Materials. Essex: Longman.
- Fiell, C and Fiell, P (2001): Designing the 21st century. Köln: Taschen.
- Fisher, RC (1998): The third vernacular. In Architecture of the Transvaal. Editors Fisher, RC; Le Roux, S; Marè, E. Pretoria: Unisa.
- Fox, A and Murrel, R (1989): Green Design. A guide to the environmental impact of building materials. London: Architecture Design and Technology Press.
- Frank, KA (1991): Overview of collective and shared housing. In new households, new housing. Editors Frank, KA and Ahrentzen, S. New York: Van Nostrand Reinhold.
- Government Gazette (1985): National Building Regulations and Building Standards Act, Act 103 of 1977. (237/9613).
- Guallart, V (1996): House in the outskirts. In El croquis, arquitectura Espanola. p. 202-206
- Hanson, J (1998): Decoding homes and housing. Cambridge: University Press.
- Hart, S (2002): The house of the future has arrived. In Architectural Record (190/7) p. 149-158.
- Holl, S (2000): Hinged space. In Architectural design: The transformable house (70/4) p. 50-51.
- Itoh, T (1969): The elegant Japanese house. New York: Weatherhill.
- Jencks, C (1987): The language of Postmodern Architecture. 5th ed. London: Academy Editions.
- Jensen, R (1990): Industrial housing. In Housing, symbol, structure, site. Editor Lisa Taylor. New York:

Cooper-Hewitt Museum.

Kurokawa, K (1991): Intercultural Architecture. The philosophy of symbiosis. London: Academy Editions.

Lang, MH (1990): Gentrification. In Housing, symbol, structure, site. Editor Lisa Taylor. New York: Cooper-Hewitt Museum. .

Lesnikowski, G (1982): Rationalism and Romanticism in Architecture. London: McGraw-Hill.

McCament, K and Durrett, C (1988): Cohousing. A contemporary approach to housing ourselves. Berkeley: Habitat.

McCament, K and Durrett, C (1991): Cohousing in Denmark. In New households, new housing. Editors Frank, KA and Ahrentzen, S. New York: Van Nostrand Reinhold.

McMahon, T (2001): Kitskloor. In Visi. Somer uitgawe. p.86-95.

Mira, PJR (1992): Block Housing. A contemporary Perspective. Barcelona: Gustavo Gili.

Papanek, V (1995) The green imperative. London: Thames and Hudson.

Richardson, H and Harris, J (2000): A house for the future. In Architectural design (70/4) p. 42-47.

Rush, RD (1986): The building systems integration handbook. Boston: Butterworth-Heinemann.

Slesin, S; Cliff, s; Rozenstroch, D (1987): Japanese style. London: Thames and Hudson.

Stevenson, KC; Jandl, HW (1990): Mail-order residences. In Housing, symbol, structure, site. Editor Lisa Taylor. New York: Cooper-Hewitt Museum.

Stulz, r and Mukerji, K (1993): Appropriate building materials. A catalogue of potential solutions. St. Gallen: SKAT.

Tiry, C (2001): Naked House, case study10. In L'architecture d'aujourd'hui (334) p. 18-20.

Treanor, P. Brownfield gentrification in Europe. <http://web.inter.nl.net/users/Paul.Treanor/gasfab.html> 30 March 2002.

Tulloch, S (1991): The Oxford dictionary of new words. Oxford: University Press.

UBIC: Utilization of vacant buildings in the Pretoria inner city. Minutes of meeting 6 March 2000.

Wasserfall, JC (1989): Early mine and railway housing in South Africa. Unpublished dissertation for Doctor Of Philosophy. University of Cambridge.

Webster Comprehensive Dictionary (1998). Chicago: Ferguson.

Woodward, A (1991): Communal housing in Sweden. In new households, new housing. Editors Frank, KA and Ahrentzen, S. New York: Van Nostrand Reinhold.

Wortman, A (1999): An architecture governed by viewing figures. In Archis (1999/10) p. 8-14.

THANK YOU

...for your nurture, support, sacrifice and contribution to who I am, Mamma en Pappa

...for your love, enthusiasm and understanding, Cobus

...For ciabatta and olives in all its manifestations, Lisl

...because you were a teacher, John

...because you told me to be myself, Schalk

...for your encouragement, Katarina

...because the planning and deadlines and your high expectations pushed me further, Nico

...for my talent, my Lord