

**ΔΟΞΑ AND RELATED CONCEPTS
IN THE FOURTH GOSPEL:
AN INQUIRY INTO THE MANIFESTATION OF ΔΟΞΑ
IN JESUS' CROSS**

By

SOO KEUM JIN

Dissertation

Submitted in fulfilment of the requirements
for the degree:

Philosophiae Doctor

New Testament Studies
In the Faculty of Theology
Pretoria University

Supervisor: Prof. Jan G. van der Watt

October 2006

“The heavens declare the glory of God;
The skies proclaim the work of His hands”

Psalm 19:1

ACKNOWLEDGMENTS

I, first of all, thank my God the Father, who has been my great helper and Lord in the whole process of writing the dissertation.

I wish to acknowledge my deep gratitude to Professor Jan G. van der Watt for his professional guidance, exemplary scholarship, unfailing enthusiasm and heartwarming support as well as for his Christian care and encouragement.

I wish to thank my parents, my parents-in-law, my brother Soo-Mok, my sister Sun-Mi, my sister-in-law Moon-Suk, and other family members for their patient understanding, support, and help in many ways. Specially, my brother-in-law Chang-Soon who has cheered me on and given me financial support, I say a hearty thank you.

To my beloved wife In-Sook and my sons Yee-Chan and Chan-Young – thank you for your patience, cooperation, love and prayer. Without my wife's help, encouragement and confidence in me, the completion of this thesis would not have been possible.

Above all I must thank Ian and Veronica who encourages, spiritual support, and comforts me in the whole process of this dissertation.

Soo-Keum Jin
Pretoria, RSA
October 2006

SUMMARY

Dissertation Title: Δόξα and Related Concepts in the Fourth Gospel: An Inquiry into the Manifestation of Δόξα in Jesus' Cross

Researcher: Soo-Keum Jin

Supervisor: Professor Jan G. van der Watt

Department: New Testament Studies

Degree: Doctor of Philosophy

Many commentators have ably dealt with the concept of glory in the Fourth Gospel and there is consequently an abundance of literature available regarding this topic. These writers have suggested a relatively wide range of concepts associated with the term indicating that the meaning of δόξα, as used by John, is multidimensional in character. In spite of the profusion of literature relatively little has been written on the manifestation of δόξα in the events of the cross and the conclusions of those who have essayed to do so differ considerably. Crucifixion was a painful, humiliating and degrading death reserved for criminals, murderers and rebels and the questions that arise are: Why does John link the crucifixion of Jesus with δόξα? What is the concept behind John's use of the word δόξα? Both questions may be summed up as: What does John expect or want his readers to understand by his use of this word in relation to the events of the cross? In order to answer this question an initial review of several classic writings on the Fourth Gospel dealing with δόξα from different perspectives was undertaken to establish these writers' perceptions of the concepts inherent in the use of δόξα in the Fourth Gospel. This was followed by a survey of the lexicographical background of δόξα. This is focused on its use in the LXX, since NT usage usually follows that of the LXX. The concept of δόξα in the LXX, however, is partly dependent on its meaning in extra-biblical Greek and partly on the concepts of the Hebrew words which are translated as δόξα in the LXX. This consideration of the concepts of δόξα in the Greek Old Testament is supplemented by an inquiry into its use in extra-Biblical literature, particularly the writings of Philo and Josephus. John's use of δόξα in

the Fourth Gospel is examined as are other passages which point to the inherent δόξα of Jesus. Emphasis is placed on the Prologue, Jesus' relationship with the Father, the demonstration of Jesus' power and authority in the σημεῖα, the impact of the Ἐγώ εἰμι statements and the way some people, such as Thomas, reacted to Jesus' words and works. A review of other words which, in some contexts, have similar connotations to that of δόξα is presented. Among these the prime terms are Τιμή / Τιμάω, Ἀναβαίνω, Ἐξουσία, Βραχίων and Φῶς. A more detailed analysis of the Greek word Ὑψίω follows. The use of δόξα in relation to events of the cross is considered in detail. A discussion of the manifestations of δόξα evident in the events of the cross, either expressly or indirectly by what is said or done concludes the examination of the use of δόξα in the Fourth Gospel. This study does not attempt to discuss every text in the Fourth Gospel that speaks of δόξα or δοξάζω, but those that are most closely associated with the events of the cross are studied and discussed.

KEY TERMS

- | | | | |
|------------------------|---------------|--------------|----------|
| 1. Glory | 2. Lifting up | 3. The cross | 4. Signs |
| 5. The prayer of Jesus | 6. Father | 7. Honour | 8. I AM |
| 9. Authority | 10. Power | | |

ABBREVIATIONS

A. General Abbreviations

AD	Anno Domini
Ant.	Antiquities
BC	Before Christ
BHS	Biblia Hebraica Stuttgartensia
Cf.	Confer
CD	Cairo-Damascus Document
Ch(s).	Chapter(s)
DSS	Dead Sea Scrolls
Ed(s)	Editor(s)
e.g.	For example
En.	English
esp.	Especially
i.e.	That is
LXX	Septuagint
mss	Manuscripts
MT	Massoretic Text
NASB	New American Standard Bible
NIV	New International Version
NRSV	New Revised Standard Version
NT	New Testament
Ode	Odes of Solomon
OT	Old Testament
1 QS	Qumran Rule of the Community (Manual of Discipline)
Tg. Onq.	Targum Onqelos
trans.	translation
Vol (s).	Volume(s)

B. Abbreviation of the Bible

Old Testament		New Testament	
Gen.	Genesis	Mt.	Matthew
Ex.	Exodus	Mk.	Mark
Lev.	Leviticus	Lk.	Luke
Num.	Numbers	Jn.	John
Deut.	Deuteronomy	Acts	Acts
Jos.	Joshua	Rom.	Romans
Jdg.	Judges	1 Cor.	1 Corinthians
Ruth	Ruth	2 Cor.	2 Corinthians
1 Sam.	1 Samuel	Gal.	Galatians
2 Sam.	2 Samuel	Eph.	Ephesians
1 Ki.	1 Kings	Phil.	Philippians
2 Ki.	2 Kings	Col.	Colossians
1 Chr.	1 Chronicles	1 Thess.	1 Thessalonians
2 Chr.	2 chronicles	2 Thess.	2 Thessalonians
Ezr.	Ezra	1 Tim.	1 Timothy
Neh.	Nehemiah	2 Tim.	2 Timothy
Est.	Esther	Tit.	Titus
Job	Job	Phlm.	Philemon
Ps.	Psalms	Heb.	Hebrews
Prov.	Proverbs	Jas.	James
Eccl.	Ecclesiastes	1 Pet.	1 Peter
Cant.	Song of Songs	2 Pet.	2 Peter
Isa.	Isaiah	1 Jn.	1 John
Jer.	Jeremiah	2 Jn.	2 John
Lam.	Lamentations	3 Jn.	3 John
Ezek.	Ezekiel	Jude.	Jude
Dan.	Daniel	Rev.	Revelation
Hos.	Hosea		
Joel	Joel		
Amos	Amos		

Obad.	Obadiah	
Jon.	Jonah	
Mic.	Micah	
Nah.	Nahum	
Hab.	Habakkuk	
Zeph.	Zephaniah	
Hag.	Haggai	
Zech.	Zechariah	
Mal.	Malach	

c. Abbreviations of Reference Works

<i>ABD</i>	<i>The Anchor Bible Dictionary</i> . Ed. D. N. Freedman. Vols. 6. New York: Doubleday, 1992
<i>ATR</i>	<i>Anglican Theological Review</i>
<i>ATRS</i>	<i>Anglican Theological Review Supplement</i>
<i>BT</i>	<i>The Bible Translator</i>
<i>BTB</i>	<i>Biblical Theology Bulletin</i>
<i>BZNW</i>	<i>Beiheft zur Zeitschrift fur die neutestamentliche Wissenschaft</i>
<i>CBQ</i>	<i>Catholic Biblical Quarterly</i>
<i>DCH</i>	<i>Dictionary of Classical Hebrew</i>
<i>EDNT</i>	<i>Exegetical Dictionary of the New Testament</i> . Ed. H. Balz & G. Schneider. Grand Rapids: Eerdmans. 1994
<i>EmJ</i>	<i>The Emmaus Journal</i>
<i>ET</i>	<i>Expository Times</i>
<i>HALOT</i>	<i>The Hebrew and Aramaic Lexicon of the Old Testament</i>
<i>IDB</i>	<i>The Interpreter's Dictionary of the Bible</i> . Ed. G. A. Buttrick Vols. 4. New York: Abingdon Press. 1962
<i>Int</i>	<i>Interpretation</i>
<i>ISBE</i>	<i>The International Standard Bible Encyclopedia</i> . Ed. G. W. Bromiley. Vols. 4. Grand Rapids: Eerdmans. 1982

<i>JBL</i>	<i>Journal of Biblical Literature</i>
<i>JETS</i>	<i>Journal of the Evangelical Theological Society</i>
<i>LTJ</i>	<i>Lutheran Theological Journal</i>
<i>NBD</i>	<i>The New Bible Dictionary</i> . Ed. J. D. Douglas. London: Inter-Varsity Press. (1962) 1974
<i>NIDNTT</i>	<i>New International Dictionary of New Testament Theology</i> . Ed. C. Brown. Vols. 4. Cumbria: Paternoster Press. 1986
<i>NIDOTTE</i>	<i>New International Dictionary of Old Testament Theology & Exegesis</i> . Ed. W. A. VanGemeren. Vols. 4. Cumbria: Paternoster Press. 1997
<i>NovT</i>	<i>Novum Testamentum</i>
<i>NovTSup</i>	<i>Supplements to Novum Testamentum</i>
<i>NTF</i>	<i>Neutestamentliche Forschungen</i>
<i>NTS</i>	<i>New Testament Studies</i>
<i>NTSSA</i>	<i>Journal of the New Testament Society of South Africa</i>
<i>RSR</i>	<i>Religious Studies Review</i>
<i>SBLSP</i>	<i>Society of Biblical Literature Seminar Papers</i>
<i>TDNT</i>	<i>Theological Dictionary of the New Testament</i> . Ed. G. Kittel and G. Friedrich. Eng. Trans. G. W. Bromiley. Vols. 10. Eerdmans: Grand Rapids. 1964-1976
<i>TDOT</i>	<i>Theological Dictionary of the Old Testament</i> . Ed. G. J. Botterweck & H. Ringgren & Heinz-Josef. Fabry. Eng. Trans. E. G. David. Vols. 7. Eerdmans: Grand Rapids. 1995/1978/2001
<i>ThE</i>	<i>Theological Educator: A Journal of Theology and Ministry</i>
<i>TLNT</i>	<i>Theological Lexicon of the New Testament</i> . By Ceslas Spicq. Ed. & Trans. Ernest, J. D. Vols. 3. Peabody: Hendrickson Publishers.
<i>TLOT</i>	<i>Theological Lexicon of the Old Testament</i>
<i>TS</i>	<i>Theological Studies</i>

<i>TWOT</i>	<i>Theological Wordbook of the Old Testament</i> . Ed. R. L. Harris. et al., Vols. 2. Chicago: Moody Press. 1980
<i>VKGNT</i>	<i>Vollständige Konkordanz zum Griechischen Neuen Testament</i> . Vols. 2. (Spezialübersichten). Berlin: Walter de Gruyter. 1978
	<i>Vollständige Konkordanz zum Griechischen Neuen Testament</i> . Vols. 2. Berlin: Walter de Gruyter. 1983.
<i>WBC</i>	Word Biblical Commentary
<i>WTJ</i>	<i>Westminster Theological Journal</i>
<i>ZNW</i>	<i>Zeitschrift für die Neutestamentliche Wissenschaft</i>
<i>ZPEB</i>	<i>The Zondervan Pictorial Encyclopedia of the Bible</i> . Ed. Tenney, M.C. Vols. 5. Michigan: Grand Rapids. 1975

TABLE OF CONTENTS

SUMMARY	i
KEY TERMS	ii
ABBREVIATIONS	iii
TABLE OF CONTENTS	viii

CHAPTER 1. INTRODUCTION

1.1. The Question: “How does the Cross reveal Δόξα?”	1
1.2. Current views of the Relationship between Δόξα and the Cross	3
1.2.1. Bultmann on δόξα in the Fourth Gospel	3
1.2.2. Käsemann’s view of δόξα in the Fourth Gospel	6
1.2.3. Schnachenburg on δόξα in the Fourth Gospel	10
1.2.4. Brown on δόξα in the Fourth Gospel	10
1.2.5. Morris on δόξα in the Fourth Gospel	12
1.2.6. Neyrey on honour and shame in the Fourth Gospel	14
1.2.7. Van der Watt on δόξα and cross in the Fourth Gospel	18
1.3. Methodology	19
1.3.1. Some fundamental principles of semantic analysis	20
1.3.2. Some of the more important basic assumptions about methodology in analyzing the meanings of lexemes	21
1.3.3. Methodology applied in this study	23
1.4. Definition of Terms	26
1.5. The Investigative Procedure	27

CHAPTER 2. A LINGUISTIC AND LITERARY ECOLOGY SURVEY OF ΔΟΞΑ

2.1. Introduction	29
2.2. The Meanings of Δόξα	29
2.3. Δόξα in the Classical Greek	33

2.3.1. Extra-Biblical usage of the word δόξα	33
2.3.2. Δόξα in the writings of Philo and Josephus	34
2.3.2.1. Philo	35
2.3.2.2. Josephus	39
2.4. διῶκ: in the Hebrew Bible	41
2.4.1. Other Hebrew words used to convey the concept of δόξα	45
2.5. The Use of Δόξα in the Septuagint (LXX)	49
2.6. Δόξα in the New Testament excluding John's writings	56
2.7. Concluding Summary	65

CHAPTER 3. AN OVERVIEW OF ΔΟΞΑ IN THE FOURTH GOSPEL

3.1. Introduction	67
3.2. Δόξα (Δοξάζω) in the Fourth Gospel	68
3.2.1. Lexical meaning of δόξα (δοξάζω) in the Fourth Gospel	68
3.2.2. The concepts of δόξα (δοξάζω) in the Fourth Gospel	71
3.3. Jesus' Inherent Δόξα	77
3.3.1. Δόξα in the Johannine Prologue	77
3.3.2. Literary aspects of Johannine Prologue	78
3.3.2.1. Proposed sources	78
3.3.2.2. Structure analysis	80
3.3.2.3. Thematic analysis	82
3.3.3. Exegetical perspective on Jn. 1:14-18	86
3.3.4. Theological perspective on Jn. 1:14-18	93
3.3.5. Summary and conclusion	95
3.4. Relationship with the Father	96
3.4.1. Eternal Life (ζωή αἰώνιος)	96
3.4.2. Sent by the Father	99
3.4.3. Witness of the Father	100
3.4.4. Judgement given to the Son	101
3.4.5. The Son of God (ὁ Υἱὸς τοῦ Θεοῦ)	102

3.4.6. Conclusion	105
3.5. Jesus' Δόξα Demonstrated	107
3.5.1. Δόξα demonstrated in the σημεία	107
3.5.1.1. Direct use δόξα on σημεία	112
3.5.1.1.1. Water into wine (2:1-11)	112
3.5.1.1.1.1. Literary aspects of this passage	112
3.5.1.1.1.2. Exegetical perspective on this passage	114
3.5.1.1.1.3. Conclusion	118
3.5.1.1.2. The story of Lazarus' resurrection (11:1-53)	119
3.5.1.1.2.1. Literary aspects of this passage	120
3.5.1.1.2.2. Exegetical perspective of this passage	122
3.5.1.1.2.3. Conclusion	123
3.5.1.2. Inferred δόξα in the σημεία	124
3.5.1.3. Summary and Conclusion	126
3.5.2. Δόξα demonstrated in the "Ἐγώ εἰμι" statements	128
3.5.2.1. The use of Ἐγώ εἰμι as a title	130
3.5.2.2. The use of Ἐγώ εἰμι as identification	136
3.5.2.3. Conclusion	138
3.6. Jesus' Claims to Δόξα	140
3.6.1. The Prayer of the Lord	140
3.6.1.1. Literary aspects on the Prayer of the Lord	141
3.6.1.2. Exegetical perspective on the Prayer of the Lord	145
3.6.1.3. Conclusion	150
3.7. Recognition of Jesus' Δόξα by people	151
3.7.1. Nathanael	152
3.7.2. Disciples	152
3.7.3. Samaritans	153
3.7.4. Mary and Martha	154
3.7.5. Entrance to Jerusalem (Jn. 12:12–18)	154
3.7.6. The chief priests and Pharisees	156
3.7.7. Conclusion	156

3.8. Jesus' Lowly Service and Δόξα	157
3.9. Other Words used to convey the concept of Δόξα in the Fourth Gospel	160
3.9.1. Introduction	160
3.9.2. Honour in the Fourth Gospel	161
3.9.2.1. The honour (δόξα) of Jesus and the Father	161
3.9.2.2. Honour (τιμή / τιμάω) of Jesus and Father	164
3.9.2.3. Jesus' greater honour (αὐξάνω)	166
3.9.2.4. Summary and conclusion	167
3.9.3. Exaltation in the Fourth Gospel	168
3.9.3.1. Τιμάω in the ultimate eschatological salvation	169
3.9.3.2. Ἀναβαίνω of Jesus	169
3.9.3.3. Summary and conclusion	172
3.9.4. Power (Authority) in the Fourth Gospel	173
3.9.4.1. Ἐξουσία of Jesus from the perspective of δόξα	173
3.9.4.1.1. Lexical and Literary aspects of ἐξουσία	173
3.9.4.1.2. Exegetical perspective of the use of the term ἐξουσία	174
3.9.4.1.3. Conclusion	177
3.9.4.2. Βραχίων of the Lord as δόξα	178
3.9.4.3. Φῶς of Jesus as δόξα	179
3.9.4.3.1. Lexical and Literary aspects of φῶς	179
3.9.4.3.2. Exegetical perspective of the use of the term φῶς	180
3.9.4.3.3. Conclusion	182
3.10. Concluding Summary	183

CHAPTER 4. JESUS' CLIMACTIC GLORY: ΔΟΞΑ AND THE CROSS

4.1. Introduction	190
4.2. Ὑψόω-phrases and the Crucifixion of the Son of Man	190
4.2.1. Introduction	190

4.2.2. Lexical and Literary aspects of the use of ὑψόω	191
4.2.3. Exegetical perspective of the use of the term ὑψόω	193
4.2.4. Summary and conclusion	195
4.3. Δόξα and the Events of the Cross	196
4.3.1. Δόξα and the Ἐγώ εἰμι statements	196
4.3.1.1. Ἐγώ εἰμι the Good Shepherd	197
4.3.1.2. Ἐγώ εἰμι the Resurrection and the Life	198
4.3.1.3. Ἐγώ εἰμι in the Passover Supper	201
4.3.1.4. Ἐγώ εἰμι in the Gethsemane	201
4.3.1.5. Conclusion	203
4.3.2. The events of the cross and recognition of Jesus' δόξα by people	203
4.3.2.1. The captors	204
4.3.2.2. Pilate	204
4.3.2.3. Thomas	205
4.3.2.4. Summary and conclusion	206
4.4. The Events of the Cross and Jesus' Δόξα	207
4.4.1. The events of the cross in relation to Jesus' δόξα	207
4.4.2. Exegetical perspective of the events of the cross and Jesus' δόξα	211
4.4.3. Summary and conclusion	219
4.5. Concluding Summary	221

CHAPTER 5. CONCLUSION

5.1. Summary and Discussion	227
5.1.1. Introduction	227
5.1.2. Methodology	228
5.1.3. Intended readers	230
5.1.4. Δόξα in the Fourth Gospel	231
5.1.5. Δόξα and the events of the cross	232
5.2. Suggestions for Future Research	235

APPENDIX A	238
APPENDIX B	240
APPENDIX C	242
APPENDIX D	246
BIBLIGRAPHY	261

CHAPTER 1. INTRODUCTION

1.1. The Question: “How does the Cross reveal Δόξα?”

“הַשָּׁמַיִם מְסַפְּרִים כְּבוֹד־אֱלֹהִים וּמַעֲשָׂה יְדֵי מַנְיָד הַרְקִיעַ:” (BHS, Ps. 19:2); “οἱ οὐρανοὶ διηγούνται δόξαν Θεοῦ ποίησιν δὲ χειρῶν αὐτοῦ ἀναγγέλλει τὸ στερέωμα” (LXX, Ps. 18:2); “The heavens declare the glory of God; the skies proclaim the work of His hands” (Ps. 19:1).

The Bible is full of references to the glory of God.¹ These range from the vivid, poetical imagery cited above, through the perceived revelations recorded by the prophets,² to the physical manifestation of God’s power.³ In the New Testament the Greek word for glory, δόξα, and the related verb, δοξάζω, occur frequently⁴ and in the Fourth Gospel these terms are used more frequently than in any of the other Gospels. This repeated use in the Fourth Gospel alone warrants close examination of what the author intended his readers to understand by his use of

¹ The phrase “glory of God” (הַשָּׁמַיִם מְסַפְּרִים) appears thirty-six times in the Hebrew Bible (Ex. 16:7, 10; 24:16, 17; 40:34, 35; Lev. 9:6, 23; Num. 14:10, 21; 16:19, 42[17:7]; 20:6; 1 Kin. 8:11; 2 Chr. 5:14; 7:1, 2, 3; Ps. 104:31; 138:5; Isa. 35:2; 40:5; 58:8; 60:1; Ezek. 1:28; 3:12, 23; 8:4; 10:4 (x2); 10:18; 11:23; 43:4, 5; 44:4; Hab. 2:14). Seven times מְסַפְּרִים is linked with names for God other than הַשָּׁמַיִם (Six times with אֱלֹהִים: Ps. 19:2; 29:3; Ezek. 9:3; 10:19; 11:22; 43:2; and once with מַלְאָכָא: Prov. 25:2). The contexts indicate that אֱלֹהִים מְסַפְּרִים possesses the same semantic value as הַשָּׁמַיִם מְסַפְּרִים (cf. Ezek. 10:18 with 10:19 and Ezek. 11:22 with 11:13).

Aalen (1986, 2:46) states that, God is “Ὁ θεὸς τῆς δόξης” (Acts 7:2), “ὁ Πατὴρ τῆς δόξης” (Eph. 1:17), “τῆς μεγαλοπρεποῦς δόξης” (2 Pet. 1:17). The expression “the glory of God” is frequent (Mt. 16:27; Acts 7:55; Rom. 1:23; 6:4; Eph. 3:16; 1 Tim. 1:11; Rev. 15:8). The power of God is mentioned along with His glory (Mt. 5:13; Col. 1:11; 2 Thess. 1:9; Rev. 19:1). The term glory is also applied to Christ: to His earthly life (Lk. 9:32; Jn. 1:14; 2:11; 1 Cor. 2:8), His exalted existence (Lk. 24:26; Jn. 17:5; Rom. 8:17; Phil. 3:21; 2 Thess. 2:14; 1 Tim. 3:16), His return (Mt. 16:27 par. Mk. 8:38; Lk. 9:26; Mt. 24:30 par. Mk. 13:26; Lk. 21:27; Tit. 2:13; 1 Pet. 4:13; Jude 24 [but this latter probably refers to the Father]), to His pre-existence (Jn. 12:41; 17:5) and also as an all-embracing epithet (Jn. 17:22, 24; 2 Cor. 3:18; 4:4, 6; 2 Thess. 2:14; cf. 1 Cor. 2:8).

² Isa. 6:1-3; Ezek. 1:28.

³ Ex. 24:16-17.

⁴ Aland (1978:333) established that δόξα is used 166 times in the New Testament, of which 77 occur in the Pauline epistles. It also figures in the Petrine letters (15 times), the Johannine writings (Jn. 19 times, Rev. 17 times), Synoptics and Acts (27 times), the Epistle to the Hebrews (7 times), James (once) and Jude (3 times). The verb δοξάζω occurs 61 times in the New Testament, 23 of which are found in John’s Gospel. Kittel (1974, 2:242) states that, in the LXX, δόξα is widely used and occurs some 280 times in the canonical books.

these words. Of particular interest is the way in which John⁵ links δόξα with the death of Jesus on a cross.⁶ Crucifixion was a horrific punishment reserved for criminals⁷ and the association of such a death with glory in any form seems contradictory, if not absurd. Yet this is just what John does in the Fourth Gospel and so this linking of δόξα and an ignominious death is a further important reason for an examination of the concept John intended to convey by his use of the words δόξα and δοξάζω.

Many scholars⁸ have discussed the meaning and significance of the use of δόξα and δοξάζω in the Fourth Gospel. Some have done this in relatively broad general terms while others have narrowed their focus, in some cases to a single verse.⁹ A modern trend is to recognise that, as shown by Louw and Nida (1993, 1:xvi-xx), a word can have several meanings depending on the context within which it is used. This also raises the question as to what concept or concepts of glory are in John's mind as he uses δόξα and δοξάζω in the context of Jesus' crucifixion.

The tremendous change that took place in the meanings associated with these

⁵ Hegermann (1994, 1:347-348) suggests that this is done in three ways: I. In contrast to Paul the consistent view of the pre-existence of δόξα is distinctive (Jn. 1:14, 18; 3:35; 5:20; 17:24; 16:32, cf. 5:17; 17:5, cf. 1:1f.). II. In Jesus' deeds of power the glorious nature of God becomes manifest (Jn. 11:4, 40). Thus Jesus has glorified the Father on earth (17:4) in His works (Jn. 2:11) and His death (13:31f.; 17:4). III. Δόξα in the sense of reputation, honour appears in two contexts: i. Christological-apologetic (Jn. 7:18; 8:50, 54). ii. Soteriological (Jn. 5:44; 12:43). The verb δοξάζω also is used in a corresponding sense, especially in John's Gospel. Its meaning oscillates between transfigure, cause to share in God's glory (Jn. 7:39; 12:16) and make the glory of God or of the Son effective (Jn. 11:4; 13:31 f.; 17:1, 4 f.).

⁶ Jn. 12:23-28; 13:31f.; 17:1f.. John also links ὑψόω with the death of Jesus which was by being lifted up in crucifixion (3:14 [x2]; 8:28; 12:32, 34).

⁷ New Testament authors reflect the general perception of crucifixion in the Greco-Roman world as "shame" (Heb. 12:2). As Neyrey (1999:153-154) has pointed out, the crucifixion process was marked by a progressive public humiliation of the victim with an associated deprivation of honour. Also, he notes that crucifixion was considered the appropriate punishment for slaves (Cicero, In Verrem 2.5.168), bandits (Josephus War 2.253), prisoners of war (Josephus War 5.451) and revolutionaries (Josephus Jewish Antiquities 17.295; see Hengel 1977:46-63).

⁸ Forster (1929:311-316); Schneider (1932); Lloyd (1932:546-548); Ramsey (1949); Ramn (1963); Thüsing (1960); Hill (1967:281-285); Caird (1968/1969:265-277); Decreus (1974/1975:117-185); Pamment (1983:12-16); Cook (1984:291-297); Robertson (1988:121-131); Bratcher (1991:401-409); Joong-Suk (1995) and others.

⁹ Wong (2005) considered on Jn. 17:22 in her dissertation, "The Δόξα of Christ and his followers in the Fourth Gospel."

words when they were used to translate the Hebrew דָּבָר ; by the compilers of the LXX is a fascinating study in itself and constitutes a vital background to our comprehension of what $\delta\acute{o}\xi\alpha$ and $\delta\omicron\xi\acute{\alpha}\zeta\omega$ can mean.

Our understanding of the significance of the Greek words $\delta\acute{o}\xi\alpha$ and $\delta\omicron\xi\acute{\alpha}\zeta\omega$ would be further enhanced by examining those passages in the Fourth Gospel where, while these words are not used as such, the concept of $\delta\acute{o}\xi\alpha$ is portrayed by other words, or by the reaction of people to what Jesus said or did.¹⁰

1.2. Current views of the Relationship between $\Delta\acute{o}\xi\alpha$ and the Cross

There are many commentaries and texts dealing with the concept of $\delta\acute{o}\xi\alpha$ and it is beyond the scope of this thesis to deal with them all. However there are several classic writings on the Fourth Gospel which deal with $\delta\acute{o}\xi\alpha$ from different perspectives, and these were given priority in examining the concepts inherent in the use of $\delta\acute{o}\xi\alpha$ in the Fourth Gospel.

1.2.1. Bultmann on $\delta\acute{o}\xi\alpha$ in the Fourth Gospel

While the general tenor of Bultmann's thesis regarding the origin and development of the Fourth Gospel is rejected, his view that the Greek $\delta\acute{o}\xi\alpha$ of the New Testament is, in some contexts, equivalent to the Hebrew דָּבָר ; with all that this implies is correct.

When dealing with $\delta\acute{o}\xi\alpha$ in his book, *Theology of the New Testament 2*, Bultmann (1967:49-59) considers that the identification of Jesus with God the Father as being one, is expressed in terms of Gnostic myth and he further views the various biblical descriptions of this unity as being derived from mysticism¹¹

¹⁰ An example is the Samaritan woman's recognition of Jesus as the Messiah.

¹¹ As the people from the East moved westwards they brought with them their various religious beliefs. These contained mystical elements which were to varying degrees accepted by and assimilated into Western religious thought. The emerging concepts gave rise to what is generally termed mysticism. Tannehill (1966:4) indicates that the core belief was that "the individual can come into immediate contact with God through subjective experiences which differ essentially from the experiences of ordinary life" (McGinn, 1991:23-61; Laansma, 2000:725-737). Whether or not there is mysticism in the Bible is mainly a matter of definition. The personal concept of God in biblical religion does not allow for a sense of unification, which

and considers that mythological language is often used. This view is true to his thinking that John is influenced by Gnostic philosophy but this stance is questionable as the clear intention of John's writing is that God Himself uses these terms to describe the relationship between Jesus and the Father.

Bultmann (1967:50) says that God Himself encounters men in Jesus, a man like other men except "his bold assertion that in him God encounters men." He goes on to say that this constitutes the paradoxical nature of the concept of Revelation and that John was the first to see this with any distinctness. He then comments that "it never occurs to Paul to reflect about the revelation which took place in the human figure of Jesus and his work and fate." In this statement Bultmann reveals serious flaws in his approach. The first issue is that Bultmann claims to know what Paul did or did not reflect on. We may not have any letter written by Paul in which he deals with this issue but that does not entitle anyone to assume that he did or did not reflect on such issues. Paul is very clear as to the work that Jesus accomplished on the cross – the salvation of men and women from the consequence of their sin.¹²

is more characteristic of pantheistic religion (Ringgren, 1992, 4:945-946). Ringgren (1992, 4:945) says that visions are mentioned several times in the New Testament, but nowhere do we get information that would enable us to describe them as mystical.

The danger in this approach is the dependence on subjective experience by an individual. Paul clearly cautions that this can lead to dangerous deviations from "the faith" (Col. 2:16-23). Brown (1978:cxxii) indicates that the Fourth evangelist saw in Jesus the culmination of a tradition that through the Wisdom Literature of the Old Testament, which shared much in common with the writings of sages in Egypt, Sumeria, and Babylon. The blend of Oriental mysticism and mythology with Greek philosophy, found in the Wisdom Literature, had an influence that continued even after the biblical period.

These views are radically opposed to Christian belief but did not have any apparent significant impact on the Johannine Christian community or its view of glory as they do not contain an inherent concept of glory. They would, therefore, have no impact on the concept of δόξα in the Fourth Gospel (Dupre, 1986:245-251).

¹² In claiming that Paul does not see Jesus bearing "heavenly glory and riches," Bultmann forgets Paul's first letter to the Corinthians where he writes in 2:6-8, "Yet we do speak wisdom among those who are mature; a wisdom, however, not of this age, nor of the rulers of this age, who are passing away; but we speak God's wisdom in a mystery, the hidden wisdom, which God predestined before the ages to our glory; the wisdom which none of the rulers of this age has understood; for if they had understood it, they would not have crucified the Lord of glory." Also in 2 Corinthians 4:3-4, Paul refers to Jesus' glory: "And even if our gospel is veiled, it is veiled to those who are perishing, in whose case the god of this world has blinded the minds of the unbelieving, that they might not see the light of the gospel of the glory of Christ, who is the image of God." Then in the Ephesian letter Paul writes in 3:14-19, "For this reason, I bow my knees before the Father, from whom every family in heaven and on earth derives its name, that

Bultmann (1967:51) comments that the work of Jesus is to “accomplish the task enjoined upon him by the Father ... which he does, not to His own glory but for the sake of the Father’s glory. As for Jesus’ own δόξα, the Father sees to that” Bultmann makes a valid point that when Jesus speaks of His doing what the Father wants Him to do; He is not stressing His humility but rather His authority.

Bultmann (1967:52) comments that the works that Jesus does are in fact just one work and quotes 4:34 (“My food is to do the will of Him who sent Me, and to accomplish His work”) and 17:4 (“I glorified You on earth, having accomplished the work which You have given Me to do”) to substantiate his view. He then says that in the Hellenistic church Jesus’ death and resurrection are the facts of salvation and might be called the work of Jesus. He says that for Paul the “incarnation of Christ is a part of the total salvation-occurrence, for John it is the decisive salvation-event.” This claim is not elaborated and is in contrast to Jesus’ statement that “And I, if I am lifted up from the earth, will draw all men to Myself” (12:32).

Bultmann (1967:53) emphasises that for Paul the stress is on the “cross” and “suffering”, terms that are not found in John where the emphasis is on “elevation” (being lifted up) and “glorification”. He appears to imply that the two have different theologies but in reality they are simply stressing different aspects of the same event. Bultmann strives to present the viewpoint of John’s Gospel as being different to the other Christian perspectives in which Jesus’ death is seen as an atonement for sins.¹³ He spends time on trying to negate the witness of John the Baptist; “behold the Lamb of God that takes away the sin of the world.” He also tries to negate references to the blood in John’s letters

He would grant you, according to the riches of His glory, to be strengthened with power through His Spirit in the inner man; so that Christ may dwell in your hearts through faith; and that you, being rooted and grounded in love, may be able to comprehend with all the saints what is the breadth and length and height and depth, and to know the love of Christ which surpasses knowledge, that you may be filled up to all the fullness of God.” In Philippians Paul writes; 3:21, “who will transform the body of our humble state into conformity with the body of His glory, by the exertion of the power that He has even to subject all things to Himself.” And in 4:19, “And my God shall supply all your needs according to His riches in glory in Christ Jesus.”

¹³ The fact that Bultmann uses the plural rather than the singular indicates that he might have missed the purpose of the Lord’s death – the atonement for the sinful nature of mankind rather than the resultant plethora of sinful deeds.

as being redactional glosses. A betrayal of his mind-set – what does not fit his theory is rejected as a gloss or redaction.

The third point raised by Bultmann (1967:56) in the section on δόξα is that “If Jesus’ death on the cross is already His exaltation and glorification, His resurrection cannot be an event of special significance. No resurrection is needed to destroy the triumph which death might be supposed to have gained in the crucifixion.” This statement seems to miss the point that the resurrection proves the claims that Jesus made. Without it there is no confidence that what the Lord said was in fact true.

In Bultmann’s view, John’s concepts of light and darkness, truth and falsehood, freedom and bondage come from Gnostic dualism¹⁴ and “take on their specific Johannine meaning only in their relation to the idea of creation.” His commentary is based on this approach but is only tenable if the inspiration of the scriptures is set aside and John branded as a liar.

1.2.2. Käsemann’s view of δόξα in the Fourth Gospel

In his study “The Testament of Jesus” Käsemann (1968:4-26) uses terminology

¹⁴ Gnosticism was a religio-philosophical movement current in the Graeco-Roman world. It comprised many sects located in various places and under various leaders. Despite many differences of presentation and imagery these Gnostic sects merited their designation by virtue of claiming a secret γνῶσις (knowledge) about the constitution of universe, human nature and the ultimate destiny of mankind (Brown, 2003:116-120).

Gnostic doctrine is that knowledge is the way to salvation, especially for human spirits who are thought of as particles of light or sparks from the upper world which have fallen into prison-houses of flesh. In addition to this, cosmological dualism was an essential feature of Gnosticism – an opposition between the “good” spiritual world and the “evil” material world. This basic scheme was variously elaborated in the Gnostic schools of the second century, most, but not all, of which had associations with Christianity. Gnosticism was attacked in the writings of the church fathers, who regarded the various Gnostic groups as heretical perversions of Christianity. Modern scholars believe that Gnosticism was a religious phenomenon which was in some cases independent of Christianity. There is as yet no consensus as to when and how it originated, though many scholars have recently sought to trace the roots of Gnosticism to Jewish fringe elements. One problem that faces this view is the need to explain the anti-Jewish cast given to the Old Testament by Gnostics, an example of which is the caricature of Jehovah as a foolish demiurge (Brandon, 1970:302; Brodie, 1993:7-8; Yamauchi, 1993:350-354; Hinnells, 1995:190; Smith, 1997:12-16).

One of the basic tenets of Gnosticism – that matter is evil and spirit is good – does have a potential impact on the concept of δόξα in that nothing in the flesh can ever have an inherent δόξα or manifest the δόξα of God.

strongly suggestive of a docetic view of Jesus and was therefore chosen as a representative of a docetic understanding of δόξα in the Fourth Gospel. His view is indicated in a typical passage “In what sense is he flesh, who walks on the water and through closed doors, who cannot be captured by his enemies, who at the well of Samaria is tired and desires a drink, yet has no need of drink and has food different from that which his disciples seek?”¹⁵ Another passage suggesting a docetic view is Käsemann’s (1968:12) comment that “He (Jesus) does not really change himself, but only his place.” This suggests that the physical body of Christ is less than real. The letter to the “Hebrews” sets out the divinity of Jesus very clearly in chapter 1 and in chapter 2 goes on to emphasize His humanity. The fact that Christ was God manifest in real human flesh is generally accepted amongst scholars and the early Christian leaders, and is the view adopted in this thesis.

Käsemann (1968:7) discerns a tension in the affirmations of the prologue “We beheld His glory (δόξα)” and the future δόξα which will be perfected in His death. This tension disappears if the δόξα beheld by the author and disciples is taken to be the δόξα of Jesus’ total submission to the will of the Father and the δόξα of Jesus’ death is viewed as the ultimate fulfilment of all God’s Old Testament promises of a saviour followed by the resumption of the δόξα He has always had in heaven.

In keeping with many scholars, Käsemann takes the view that John is not the author of the fourth Gospel and that the author (or redactor) of the gospel takes great liberties with the underlying “tradition” breaking it up “when his viewpoint demands it.” This approach is refuted elsewhere.¹⁶ His view is thus that the author is basing his writing on what records he has but is creating a story which is shaped by his personal views and therefore is not necessarily a true record of real events and sayings. This view affects his entire approach to the record of

¹⁵ In this passage Käsemann confuses several issues. He does not distinguish between the pre-crucifixion and the post-resurrection body of Jesus. He also apparently does not see that the language of Jn. 4:32 alludes to a satisfaction in fulfilling His mission rather than a need for sustenance.

¹⁶ See Westcott (1890:v-xxxii); Bruce (1983:1-6); Carson (1991:68-81); Morris (1995:4-25).

Christ's discourses with His disciples in the Fourth Gospel.

Käsemann (1968:9) writes that “The problem of the divine glory (δόξα) of the Johannine Christ going about on earth is not yet solved, but rather most strikingly posed when we hear the declaration of the prologue ‘The Word became flesh’”. His understanding of δόξα in this gospel is, therefore, that it is the view of an unknown author or redactor and is determined by that person's theology, a personal theology developed over time and not necessarily consistent with the views of other Christian leaders.

In Käsemann's (1968:12) view, the δόξα may be hidden in lowliness and goes on to point out that lowliness and δόξα are not two separate stages of a journey but are united with each other in the “earthly Christ” who enters the world of suffering and death but does not lose his unity with the Father. This unity demands that Jesus has an intrinsic δόξα which may be hidden but is nevertheless always present. He (1968:13) considers that the combination of humiliation and δόξα is not paradoxical because “the humiliation makes the epiphany and presence of δόξα possible and represents its concretion. Only the exclusive, absolute claim through which Jesus binds salvation to his message and person is offensive and paradoxical.” Thus though he apparently accepts the inherent δόξα in Jesus he denies that the accompanying message of a unique salvation in Jesus is valid. One may say that, from an orthodox perspective, this view tends to the heretical.

Käsemann (1968:10) states that “obedience is the form and concretion of Jesus' δόξα during the period of his incarnation.” It is true that the obedience of Jesus led to his being highly exalted and receiving a name that is above every name¹⁷ but the ultimate end of this exaltation is “the glory of God the Father” the first person of the triune God. Jesus' δόξα was from the beginning that which he had as God¹⁸ and while on earth this δόξα was hidden, in that it was not overtly manifested, it was demonstrated in all that was recorded of what Jesus

¹⁷ Phil. 2:5-11.

¹⁸ Jn. 17:5.

said and did and for a short moment was demonstrated to human perception during the transfiguration.

The miracles recorded in the Fourth Gospel are intended to be a manifestation of the δόξα of Jesus. The significance of these miracles extends beyond the immediate physical needs that are met and reflect a spiritual reality. They are, according to Käsemann (1968:53), also proofs of “divine power in the sphere of the transitory.” According to the author of the Gospel, however, the miracles selected go beyond this demonstration of power and are intended to lead the reader or hearer to a belief in Jesus as the incarnate Son of God and that, flowing from this belief, they would have eternal life.¹⁹

The sole purpose of references to the love of God in the Fourth Gospel is, according to Käsemann, seen as stressing the δόξα of Jesus’ mission, which is the miracle of the incarnation. This falls short of the majestic concept that Jesus’ mission was not just the incarnation and becoming the revealer of God, but that he came to die as a propitiating sacrifice for the sin of the world. Käsemann’s (1968:11) view that the author of the Fourth Gospel considers that “Jesus has no other function and authority apart from being the revealer of God” falls far short of the reality and also negates the sacrificial aspect of Jesus’ death.

According to Käsemann the manifestation of δόξα that takes place during the passion and death of Jesus is that, at this time, he leaves the world and returns to the Father. In this view Jesus resumes the manifested δόξα He always had with the Father. While this is, in a sense, true, it is far short of the concept of δόξα which recognises that, in that death, there was the fulfilment of the promises and purpose of God to re-establish communion between God and man. It is the recognition that, that death, was the ultimate sacrifice for sin and that because man could not, because of his sinful nature, offer such a sacrifice himself, God stepped in to do so on his behalf.

Käsemann (1968:20) considers that, in the mind of the writer or redactor of the

¹⁹ Jn. 20:30.

Fourth Gospel, Jesus' δόξα is perfected through His death since limitations cease and the realm of lowliness is left behind.²⁰ This view is consistent with a docetic viewpoint but misses the concept of δόξα being vested in the fulfilment of God's promises, the once for all sacrifice for sin and Christ's triumph over sin.

1.2.3. Schnackenburg on δόξα in the Fourth Gospel

According to Schnackenburg the idea of lifting up enables John to "glorify" the appalling death of crucifixion. He (1984:398-399) considers that this is an "individual Johannine conception which could only be developed relatively late, only on the basis of the primitive Christian kerygma of the death and resurrection of the Jesus and on the basis of a characteristic Christology."

Schnackenburg seems to miss the point that the significance of the "lifting up" is intimately tied up with the "looking and living." He focuses on the link between the lifting up and the eventual ascension but not the faith required to 'look and live'. John, however, repeatedly uses the words 'believe' (πιστεύω) in 'the Son of Man' thus emphasising the element of faith in Jesus as the Christ.

Schnackenburg considers that the typological use of the lifting up of the serpent was "probably his own (John's) idea" but that he was using an existing resurrection kerygma.

Some of what Schnackenburg has to say reveals a right understanding of the Word. His passage on the glorification of the Lord Jesus Christ (1984:402) tying δόξα and δῶκε together in reference to the δόξα of God is correct. However he seems to miss the real point of the cross in his later paragraphs (1984:403) where he does not mention Christ being made sin or bearing the sin of the world – an integral part of understanding what the cross and glorification really means.

1.2.4. Brown on δόξα in the Fourth Gospel

²⁰ See Käsemann (1968:20).

Brown comments in his book, *The Gospel according to John*,²¹ that in the Old Testament the δόξα of God implies a visible and powerful manifestation of God to men and that there is a constant connection of the δόξα of God and His presence in the tabernacle and the temple. This is then linked with the comment in John that “we beheld His glory (δόξα).” Based on the Old Testament record of God’s visible presence residing in the temple and then leaving it just before the destruction by the Babylonians, coupled with the fact that God’s δόξα will fill the restored temple, Brown rightly says that it is appropriate that, after referring to the Word setting up a Tabernacle in the flesh of Jesus, John should record that God’s δόξα became visible.

Brown (1978:503) considers that δόξα equals “glory” and “honour.” Here Brown writes of the Old Testament concept of *dwbk*: being the “visible manifestation” of God’s majesty “in acts of power.” These may take place in the realm of nature such as a thunderstorm, in God’s provision for His people such as manna or in the cloud which lead them in the wilderness. Brown rightly comments that, as Jesus is the incarnate Word of God, the same two aspects, the visible divine presence and the manifestation of power in the miracles are present in Him.

Using his interpretation of *dwbk*: to mean the “visible manifestation” of God’s majesty “in acts of power” Brown states that both qualities “are verified in Jesus’ death and resurrection” which are actions of His own power. Thus Jesus honoured God by His obedience and God revealed His δόξα in Jesus by the mighty power shown in the resurrection. This view is in line with that taken in this thesis.

Brown suggests that, based on the records in the Synoptic Gospels and 2 Peter, this reference may be to the transfiguration of the Lord Jesus Christ. He (1978:35) spoils the picture by further commenting that “it remains no more than a possibility that the Johannine writers knew of the Transfiguration scene.” Brown goes on to quote two scholars with different approaches to the

²¹ See Brown (1978).

understanding of the passage but does not give a clear verdict as to how he sees their ideas.

The conclusion is that Brown has some clear insights into the meaning of $\delta\acute{o}\xi\alpha$ - the visible presence of God manifested in works of power – and applies these to the Lord Jesus Christ. He sees the $\delta\acute{o}\xi\alpha$ of Christ being manifested in the signs that Jesus did which showed the power of God and in His obedience to the Father. He seems to accept that Jesus is indeed the revelation of God to man in a humanly comprehensible form, the visible $\delta\acute{o}\xi\alpha$ being veiled but shining through on the mount of transfiguration. The $\delta\acute{o}\xi\alpha$ of the cross is, in his view, not only Christ's obedience to God's will but also the demonstration of His power as shown in the resurrection.

1.2.5. Morris on $\delta\acute{o}\xi\alpha$ in the Fourth Gospel

Morris (1989:56-59; 2000:17-26) comments that a surprising feature of the Fourth Gospel is that, in spite of the author's showing, by repeated references, that $\delta\acute{o}\xi\alpha$ is an important element in the life of Jesus, there is no reference to the transfiguration. He considers that while the prologue clearly records that "the Word became flesh, and dwelt among us, and we beheld His glory ($\delta\acute{o}\xi\alpha$), glory as of the only begotten from the Father, full of grace and truth" (Jn.1:14) this should not be taken to mean that this is a reference to the transfiguration. He argues that this idea is foreign to the purpose of the author which is to show $\delta\acute{o}\xi\alpha$, not just in one incident but rather everywhere in Jesus' life.

Morris stresses the reality of the incarnation emphasising that Jesus became flesh and "lived among us." The Greek word used by John for live or dwell, $\sigma\kappa\eta\nu\acute{o}\omega$, is connected with the word $\sigma\kappa\eta\nu\acute{\eta}$ a tent or tabernacle. This is seen to refer to a temporary dwelling but while the incarnation was temporary in that Jesus did not live on earth forever, it cannot be used to suggest that Jesus' body was anything but real in every sense of the word.

John's use of σκηνώ would lead his readers to think of the tent in the wilderness and the record that, at the inauguration of the tabernacle, "the cloud covered the tent of meeting, and the glory of the Lord filled the tabernacle" (Ex. 40:34). This was the evidence of God dwelling amongst His people and in using this language John was not only accurately recounting the reality of the incarnation but also showing that the δόξα that had been manifest in the tabernacle was now evident in the life of Jesus.²²

The δόξα of God is also revealed in the way in which He allows man to approach Him. The way into the Holy of Holies and the related restrictions on access showed the greatness and majesty of God. The message is that it is true that God dwells amongst us but that we are to approach Him as He chooses and not as we may consider appropriate. We may not presume on the revealed δόξα, we need to maintain a proper reverent awe.

John wrote that we beheld His δόξα. The question that Morris (2000:21) poses is, "What, then, did they see?" In answering this he points out the many ways in which Jesus' life was ordinary. There were obviously many moments of δόξα manifest during the three years of His ministry on earth – a δόξα associated with the signs that he performed, but we are told that "He was despised and forsaken of men, A man of sorrows, and acquainted with grief; And like one from whom men hide their face, He was despised, and we did not esteem Him. Surely our griefs He Himself bore, And our sorrows He carried; Yet we ourselves esteemed Him stricken, Smitten of God, and afflicted" (Isa. 53:3). In commenting on this Morris says that God does not need the outer trappings of majesty and pomp for God's purposes to be carried out. The δόξα inherent in Jesus was that He did the Father's will, meeting the real need of those He encountered. True δόξα is seen in lowly service and John's Gospel shows this at every turn.²³

²² See Morris (1995:91-93; 2000:19-20).

²³ See Morris (1989:12, 56-59, 94).

In respect the δόξα associated with the cross Morris (2000:24-26) points out that while the cross today has become a symbol of piety and is incorporated in artwork and adornment, it was, in Jesus' day, an extremely painful way of dieing. The humiliation was even worse – it was regarded as an utterly shameful way to die. John, however, presents the cross of Jesus as glorious and Morris (2000:25) quotes Barclay “Jesus did not mean by glorified what they meant. By glorified they meant that the subjected kingdoms of the earth would grovel before the conqueror's feet; by glorified He meant crucified.” They defined δόξα as triumph; Jesus defined it as service. John shows that by His lowly death Jesus dealt with man's sin – and this is true δόξα for by it people are brought into salvation.²⁴

The approach taken in this thesis is that Morris' view is representative of sound exegetical scholarship and is academically valid.

1.2.6. Neyrey on honour and shame in the Fourth Gospel

Neyrey's (1998:1-34) approach to the concepts of honour and shame in the New Testament context, is based on a sociological and anthropological assessment of the social climate in and around the Mediterranean in those days. He (1999:155) says that at that time the acquisition of “honour” was a pivotal driving force and “men lived and died in quest of honour, reputation, fame, approval and respect.” Ascribed honour was an honour ascribed to a person on the basis of their lineage, public roles, authority or wealth. Achieved honour was a public recognition of what a person had succeeded in achieving by their own efforts. Such achieved honour could be in the realm of benefaction, military prowess, and athletic achievements in the various games or some other notable performance. He (1998:28) comments that honour is also viewed as “living up to the values of and social expectations into which individuals were socialized. Shame is the antithesis of honour and Neyrey (1999:154) points out that crucifixion is the ultimate shameful experience as it publicly and systematically

²⁴ See Morris (1989:128).

deprived the one being crucified of all honour, whether ascribed or associated and heaped shame on his head.

Another aspect of Neyrey's (1998:16) social analysis is that society in the New Testament was male dominated and that it was agonistic in character. He (1998:19) cites Dover saying that conflict, competition and combat were pervasive elements in the social dynamics of antiquity.²⁵ According to Neyrey's (1998:20) analysis of the competitive nature of the society, the ancients considered that the availability of "honour" was fixed and thus gaining honour would result in someone else losing honour. This led to a well defined pattern of dealing with honour claims namely (1) a claim, (2) a challenge to that claim, (3) a riposte or response and (4) the public verdict of success either to the claimant or the challenger. Using this pattern of claim, challenge, riposte and verdict, Neyrey analysed the Gospel of Matthew,²⁶ and showed how many of the interactions between Jesus and the authorities followed this paradigm.

In line with the formal pattern for an encomium Matthew deals with Jesus' origins and birth, education and training, public life and death. In this record he shows how Jesus was repeatedly challenged by the Jewish leaders and how He successfully answered every challenge, shaming the challengers and gaining increasing honour.²⁷ One outcome of his success was a growing swell of envy and hatred that resulted in His accusers plotting how they could kill Him.

A similar pattern of claim, challenge, riposte and public verdict is evident in the Fourth Gospel where, as in Matthew, it culminates in the events of the cross. The author of the Fourth Gospel shows how Jesus' enemies set out to shame, publicly humiliate and kill Him but how the ultimate riposte, His resurrection, confirmed every claim He had ever made and brought Him great honour and glory.

Neyrey's (1999:151-175) thesis is wide ranging and will only be considered as it

²⁵ See Dover (1974:229-234).

²⁶ See Neyrey (1998).

²⁷ See Neyrey (1998:1-68).

impacts on a deeper understanding of the δόξα inherent in the events of the cross and how they redounded to the glory and honour of Jesus as a result of His resurrection and ascension.²⁸

While the physical agony of death by crucifixion is horrific Neyrey (1999:154) reminds us that in the prevalent culture of the day “mockery, loss of respect and humiliation were the bitter parts.” Endurance of pain was a mark of manly courage; silence during torture was seen as a mark of honour and in these Jesus was triumphant. What His enemies desired was to dishonour Him even as they killed Him. This is evident by their public acts as detailed in the Synoptic Gospels. They mocked Him, spat on Him, ridiculed Him, heaped insults on Him and treated Him as a thief and robber. Also the process of crucifixion was intended to demean and dishonour the victims who were stripped naked, scourged and had their arms pinioned to the cross.

While all this was done to Jesus and the spectators would interpret the events from their perspective as the ultimate shame and loss of honour, John presents the events from a different viewpoint and shows how Jesus really gains honour at each stage of the events.

Being arrested is a shaming experience but John describes how Jesus’ takes the initiative and first questions the intent of the crowd. The questioner is, in the context of claim and challenge, the challenger – the one in a commanding position. Then at his “Ἐγώ εἰμι” the soldiers are forced back to the ground leaving Jesus erect. This is a demonstration, firstly of power and authority and therefore honour, and secondly the relative positions of being erect and lying on their backs is a signal of greater honour for Jesus.

Peter’s bold of cutting off the servant’s ear is corrected as Jesus explains that obedience to the Father’s will is an act of greater honour than responding honourably by resistance to the challenge of arrest.

²⁸ See Malina & Neyrey (1988:95-131).

While to the crowd it seems that Jesus has now been deprived of power and honour as He is interrogated he answers the challenging questions boldly even responding to the affront of being struck in the face by a counter challenge that leaves Him the victor in the exchange.

At the formal, secular trial we can find evidence of the general procedure of challenge and riposte between Jesus' accusers and Pilate and this is evident in 18:29-31, 39-40 and 19:6, 12-16. These confrontations occur in the public domain. The interaction between Jesus' accusers and Pilate are in the open forum and, while those between Jesus and Pilate are "private" they take place in the public forum of the Roman praetorium in presence of the soldiers.

The interaction between Jesus and Pilate follows, in measure, the challenge riposte form. Pilate challenges Jesus with his questions and He responds with questions and explanations that demonstrate His honour. During the trial, Pilate says on three occasions that he finds no fault in Jesus but, in the end, accedes to the crowd's demands that Jesus be crucified.

It must be noted that the prime reason for the trial is that the Jewish leaders were envious, a result of having been repeatedly bested in the challenge riposte encounters with Jesus. Also, Jesus' chief claim was that he was the Son of God, and this was anathema to them. They therefore wanted to discredit Him absolutely and heap shame on Him.

From this point on the things done to Jesus are intended shame Him to the utmost and from the human perspective it appears that they succeeded. He was mocked, scourged, crowned with thorns, beaten about the face, stripped naked and crucified. The degradation and shame was extreme. John however shows Jesus as honourable to the end. He cares for His mother, committing her to the care of the beloved disciple. It is noble to lay down one's life for another and that is what Jesus does. He says "It is finished" and then dismisses His spirit. He is not killed by the crowd but rather He lays down His life voluntarily, a token of honour.

There are other marks of honour in the scene as presented by John, His legs were not broken and, in contrast to the general practice, He was given an honourable burial. Above all, however, is the fact that on the third day Jesus rose from the dead indicating that He had the greatest honour ever possible – approval by God.

Thus while the Jewish leaders were trying to shame Jesus, the end result of their efforts was the public vindication of His great honour and glory by His resurrection.

1.2.7. Van der Watt on δόξα and cross in the Fourth Gospel

Van der Watt's (2002:606) view is that the cross is the focus point of early Christian documents and, because it was unexpected and contrary to the general concept of what the Messiah would do, the events surrounding the crucifixion of Jesus were constantly reviewed in order to gain greater understanding of their significance. This reflection on the full meaning of what transpired is referred to as the reinterpretation of the events of the cross which embrace the death, resurrection and ascension of Jesus.

He (2002:610-611) points out that the author of the Fourth Gospel presents the entire narrative not only from a perspective which regards the cross historically and theologically necessary but also in order to achieve a specific purpose. This was to show that the events of the cross revealed how glorious and important Jesus is.²⁹

The reason for presenting the events of the cross in this way was that the Christian community desired to convince the Jews that Jesus was the Messiah but this raised the question of why then did he die on a cross – an emblem of shame and suffering? The challenge was to present Jesus' death in a way that was positive and John chose to do so by pointing to the δόξα that it revealed.

In identifying the meaning of the terms δόξα and δοξάζω van der Watt (2002:608-

²⁹ See van der Watt (2002:611-614).

610) reviews the semantic range of the terms and goes on to point out that in order to comprehend the author's intended meaning it is necessary to recognise that the context within which they are used must be taken into account.

A brief review of the use of δόξα and δοξάζω is given and the focus is then on the use of the terms in relation to the cross. Here van der Watt (2002:611-614) identifies a series of events which illustrate the glorification of Jesus. These include His use of Ἐγὼ Εἰμί and the crowd being forced to the ground, the healing of the cut off ear, the recognition of His kingship by Pilate. But above and beyond these is Jesus' resurrection.

In this Jesus is seen as the cosmic king, the victor over the prince of the world, the one who fulfilled the Messianic scriptures. His δόξα lies in who He is, what he did and the acknowledgement of this by others.

Van der Watt (2005:472-481) considers that in using δόξα and δοξάζω John is adopting a stylistic feature in which a word has a double sense and is used to convey an indelicate or improper meaning. In the case of the Fourth Gospel this double meaning is not so much indelicate or improper but rather unpalatable – referring as it does to death on a cross.

According to van der Watt (2005:468) the use of δόξα and δοξάζω in this way occurs in six passages (Jn. 7:39; 12:16, 23; 13:31, 32; 17:1) in which glory is linked with the cross of Jesus. The lexicographical meanings of these terms do not include "cross" or "cross events" nor does John link them syntactically. The linkage is, in each case, contextual. He makes the point that "This is not just by chance. Semantic interaction opens a powerful way to theological reinterpretation of two concepts that would otherwise have been difficult to link, namely the cross-events and the glory of the Son."³⁰ He goes on say that "linked with the resurrection, the cross becomes an inherent part of a larger

³⁰ See van der Watt (2005:472).

event which proves that the divinity makes His glory apparent.”³¹

The ultimate result is that the cross is finally presented as a glorious triumph as proved by the resurrection.

1.3. Methodology

The methodology of this study is based on the principles and approaches set forth by Louw and Nida in their Greek-English Lexicon of the New Testament Based on Semantic Domains (1993), Nida and Louw’s Lexical Semantics of the Greek New Testament (1992), and Louw’s Semantics of New Testament Greek (1982).

1.3.1. Some fundamental principles of semantic analysis

In ascertaining the meaning of any word an acceptable semantic framework for the determination and analysis of the word must be used. In this thesis the framework suggested by Louw and Nida (1993:xvi-xx) has been selected as the most appropriate for the task. The principles they use in their lexicon are briefly set out below.

Firstly, no two words have completely the same meanings in all contexts in which they occur (“there are no synonyms”). Secondly, a word outside a context does not have meaning but only “possibilities of meaning.” Differences in the meaning of a word are marked by the context in which it is used. This context may be either the sentence or the entire paragraph in which it occurs. In addition, the extra textual context, the way in which the author uses the word in other writings, can give additional insight as to the intended meaning the author wishes to convey. Thirdly, the set of distinctive features associated with the word being considered has an impact on the meaning of the word. In their introduction Louw and Nida (1993:xvi) use *πατήρ* as an example and point out that it can have the meaning father, parent or ancestor but that with reference to God the supplementary features such as authority and provident care come to

³¹ Ses van der Watt (2005:480).

the fore. In addition words may have designative and associative meanings. The former are readily established but associative meanings depend on a wide range of factors such as the persons who use the terms, the physical contexts in which they are used, the literary contexts in which the terms are used, the level of formality of the content and other, similar, issues. Fourthly, figurative meanings occur often and, according to Louw and Nida (1993:xviii) may differ from their bases in respect of three key factors viz. – the diversity in domains, the differences in the degree of awareness of the relationship between literal and figurative meanings, and the extent of conventional use. Fifthly, the different meanings of the word under consideration and the related meanings of different words tend to be multidimensional resulting in irregularly shaped groupings rather than formal, well defined structures.

While fitting in category three,³² “words are defined by a set of distinctive features,” the fact that the meanings of words tend to change significantly over time as evidenced by the marked difference between the English in common use today and that of Shakespeare’s era, is of particular interest in that the LXX was translated about 200 years before the Johannine era. The possibility that the meanings associated with δόξα in the LXX had changed over this period was also explored.

The foregoing general principles were used in establishing the meaning of δόξα in each of the relevant documents – the LXX, the writings of Philo and Josephus³³ (used as examples of the “standard” Greek word usage and meaning of their era) with particular emphasis on the Fourth Gospel.

1.3.2. Some of the more important basic assumptions about methodology in analyzing the meanings of lexemes

Nida and Louw in their book, *Lexical Semantics of the Greek New Testament* (1992:17-20), suggest a number of basic assumptions about methodology in

³² See Louw & Nida (1993:xvi).

³³ Soderlund (1988:400) notes that the impact of the special translation-Greek vocabulary created by the LXX can be seen in the writings of Philo and Josephus.

analyzing the meanings of lexemes. It may be useful to summarize briefly some of them and the prime relevant aspects are mentioned here.

1. Multiple meanings for many lexemes are inevitable. The lexemes in the Greek of the New Testament do not have one single meaning in all their contexts, as do the words in mathematical or logical language.

2. Languages consist of open systems, since lexemes may be added or dropped and the range of their meanings may enlarge or contract.

3. There is no such thing as an absolute definition of the meaning of any word, although there may be practical definitions.

4. In analyzing the meaning of a combination of lexemes, it is important to consider not only the lexical meanings of the individual words, but also their meaningful syntactic and rhetorical relations. Nida and Louw (1992:12) consider that the meaning of a combination of words “is not merely the sum of the meanings of individual words, because any combination of words also involves the meaning of the grammatical constructions and, in many cases, one must also consider various rhetorical features (e.g. parallelism, contrast, hyperbole, etc.).” The setting of the passage within the discourse must also be taken into account.

5. The meanings of lexemes in the Greek of the New Testament are not equivalent to reality, but only represent the manner in which the speakers of a language perceive reality.

6. Allusions in the Greek of the New Testament must enter into the semantic analysis in some contexts. Nida and Louw (1992:20) indicate that in the Gospel of John, where “Ἐγώ εἰμι” occurs frequently, the phrase must reflect the Old Testament declaration “I am that I am.” Also, they say that when considering associative meanings of words it is essential to look constantly to the cultural setting. The phrases “δοῦλος Χριστοῦ Ἰησοῦ” (Rom. 1:1 and elsewhere) and “δοῦλος Θεοῦ” (Tit. 1:1 and elsewhere) should not be understood with the same

associative meaning that 'slave' has in English. In the Old Testament times 'Servant of the King' or 'Slave of the King' was a person of high position. They (1992:20) point out that "An important aspect of this associative meaning of the Hebrew expression undoubtedly carries over into the New Testament usage." Therefore the meanings attached to δόξα in the Fourth Gospel will have many of their roots in the Old Testament.

1.3.3. Methodology applied in this study

A study of lexical semantics is a complicated field.³⁴ The purpose of this study is not to develop, expand, or enter into discussion on a methodological level, but to use appropriate categories of analysis of words. These categories will be formulated on a functional level, so that they will be characterized by both functionality and accessibility.

The theory that this dissertation follows is that words and ideas are structurally interrelated, and one should read the detailed remarks in the light of the larger whole and vice versa. The meaning of a word is developed not only in the immediate context, but also within the larger framework of the book which consists of paragraphs, chapters, and the book as a whole. This interrelation will be taken seriously in this study. This is in line with the semantic theory as it is presented *inter alia* by Nida and Louw.³⁵

Nida and Louw (1992:31) say that lexemes not only acquire designative meanings but also acquire associative meanings. As explained above, designative meanings come from their use in representing phenomena in the real and linguistic worlds, while associative meanings are acquired from the people who characteristically use them, from the settings or circumstances in which they normally occur, from their associations with a well-known literary discourse, and from the nature of the referents. The associative meanings in the Fourth Gospel are derived primarily from the Hebrew Scripture and LXX. Both

³⁴ See Nida & Louw (1992:1-20).

³⁵ See Nida and Louw's (1992) *Lexical Semantics of the Greek New Testament* and Louw & Nida's (1993) *Greek-English Lexicon of the New Testament Based on Semantic Domains*.

the designative meanings and the associative meanings of δόξα will be carefully considered in this study. I will look for the range of lexical meanings of the word and I will also consider the contexts, both within the Fourth Gospel and in related writings. The objective is to find the potential of the word, not to write a traditional history of δόξα or to analyze the different documents individually. Therefore this study will examine each of the various documents as a whole (e.g. the NT, the OT, the LXX, etc.), rather than consider individual authors or specific historical developments within each document.

They (1992:18) state that in the study of any NT writing, one must keep in mind the nature of the Hellenistic Greek of the New Testament, which should be treated in the same way as any other language, while at the same time recognizing that the vocabulary is restricted and the communication has a special purpose. This is especially true of the vocabulary of the Fourth Gospel.³⁶ Also, they (1992:18) consider that many of the lexemes in the Greek of the New Testament have multiple meanings. Any given lexeme may not have a single meaning in all its contexts, and lexemes do not have rigid boundaries, but they sometimes seem to be quite elastic. Since the meanings of words often overlap with one another, an author may use two or more terms or expressions interchangeably. This will be kept in mind in studying the meaning of δόξα.

The concept designated by the term δόξα may be conveyed by words other than δόξα and δοξάζω. As an example the fifth chapter of the Fourth Gospel records Jesus' claims that the Father has put all judgement under His authority and goes on to say that He has also given Jesus life in Himself. Both these claims carry the implicit concept that whoever has this authority must of necessity have a certain δόξα. In the context of these claims Jesus refers to honour indicating, in this instance, that there is a semantic relationship between the words honour and glory. Passages where this similarity of concept occurs are reviewed and a lexicographical review of the words used in this way is undertaken.

³⁶ See Barrett (1978:5-11); Carson (1991:23).

The Fourth Gospel cites several instances where the reaction of people to Jesus' deeds or words is an implicit acknowledgement of the δόξα due to him because of what he had said or done. Typical of these is the encounter with the Samaritans recorded in chapter four of the Fourth Gospel. Here the outcome is an acknowledgement that Jesus is the expected Messiah with all the δόξα implied in that office. These instances will be examined in order to gain further insights into the concept of δόξα as used in relation to the crucifixion as recorded in the Fourth Gospel.

Finally the use of δόξα in relation to the events of the cross in the Fourth Gospel will be examined in detail. Van der Watt (2002:606) reminds us that the events of the cross are in conflict with the general expectations of that time as to what a Messiah should be and do.

The δόξα motif is helpful to view various texts together to be able to see a complete picture, whether or not the word δόξα actually occurs in those texts. Not all passages that are relevant to δόξα contain the word δόξα. The theme of δόξα may be present even though the word δόξα is absent. For example, John uses 'ὑψόω' a semantically related word³⁷ (interchangeable in some contexts, also the ὑψόω pronouncements are central to the Fourth Gospel as it deals with the cross³⁸), to say the same thing as making the word synonymous with δοξάζω (LXX, Ex. 15:2; Isa. 33:10; Sir. 43:30). In the Fourth Gospel, the verb ὑψόω can refer both to Jesus being lifted up on the cross (3:14; 8:28; 12:32-34; cf. 18:32) and to His exaltation in δόξα.

In the face of confirmed death Jesus said the statement, Ἐγώ εἰμι the resurrection and the life, the phrase (11:25-26) show us the δόξα of God shining through Christ who has power over death.

Also, Ἐγώ εἰμι the good shepherd (10:11), this line of thought inevitably leads on to the reason for the necessity of the Shepherds death. We realise that

³⁷ See Hooker (1994:94-96); Carroll & Green (1995:102); Liddell and Scott (1996:1910).

³⁸ See Schnackenburg (1984, 2:399-401).

Jesus' death was entirely voluntary, He laid down His life for "the sheep." With the realisation that Jesus was prepared to die for the sheep, comes a dawning wonder at His amazing love and we recognise the inherent δόξα in His death.

The δόξα and δοξάζω word group does not occur in the story of the cross. But when John tells of the events of cross, Jesus is sketched throughout as the One who has all power and is in control (cf. 10:17-18). We find His δόξα in the events of the cross. For example, Judas is described as the traitor but he does not kiss Jesus (John departs from that of the Synoptic Gospels) – it is not necessary to identify Jesus in this way, Jesus Himself comes to meet the group and asks them what they were looking for (18:4). Then, Jesus says "Ἐγώ εἰμι" the soldiers fell to the ground (18:6). The story of the cross is also interspersed with other references to the kingship of Jesus (chapter 18-19).³⁹ In the resurrection narratives in chapter 20-21 the power of Jesus is equally seen.

1.4. Definition of Terms

Throughout the study "the Fourth Gospel" is used to designate the writing of the person or persons responsible for the material as it now appears. No argument is posited for or against authorship by the Apostle John.

The term "Johannine literature" is used to refer to the Gospel of John, the three Epistles of John and the Revelation of John. It is accepted that they were produced sometime during the last part of the first century as a direct result of the needs of the Christian community and the influence of the environment in which it operated.

The term "Johannine Christian community"⁴⁰ is used to refer to the Christian group or Christian community existing at the time when the Johannine literature was written. This community is not restricted to one locality but is composed of all believers wherever they might be found. It is assumed that the life of the

³⁹ See Barrett (1978:530, 536-537, 549); Morris (1995:678).

⁴⁰ Further see Appendix B.

community is reflected accurately in its literature.⁴¹

1.5. The Investigative Procedure

The purpose of chapter 1 is to discuss introductory matters of this dissertation, which deals with the question: “How does the Cross reveal Δόξα?” and current views of the relationship between δόξα and the cross (Bultmann, Käsemann, Schnachenburg, Brown, Morris, Neyrey, van der Watt). It sets out the methodological argument, especially in respect of some fundamental principles of semantic analysis covering some of the more important basic assumptions about methodology in analyzing the meanings of lexemes. Finally it details the methodology applied in this study.

The search for the concepts of δόξα and the manifestation of δόξα in Jesus’ cross necessitates a survey of its use in the Greek Old Testament, since New Testament usage usually follows that of the Greek Old Testament. However, the concept of the word in the Greek Old Testament is dependent partly on its concept in extra-biblical Greek and partly on the concepts of the Hebrew words that δόξα represents in the LXX. Chapter 2 will therefore begin with a brief study of the meanings of δόξα in Classical (extra-biblical) Greek as exemplified by Philo and Josephus who follow the customary Greek usage of δόξα.⁴² This is followed by an examination of the meanings of דָּבָר which is most often translated by δόξα, and closely related nouns in the Hebrew Old Testament (Chapter 2.3). Chapter 2.4 is a study of the use of δόξα in the Greek Old Testament. The New Testament is the immediate cultural setting for the Fourth Gospel. Therefore Chapter 2.5 is a study of δόξα in New Testament books other than those authored by John.

Chapter 3 is an overview of δόξα and δοξάζω in the Fourth Gospel. The key

⁴¹ For further discussion of this assumption, along with arguments for its defence, see Brown (1979), *The Community of the Beloved Disciple*; Culpepper (1975), *The Johannine School*; Martyn (1978), *The Gospel of John in Christian History: Essays for Interpreters*, (2003), *History and Theology in the Fourth Gospel*.

⁴² See TDNT 2:236-237.

aspects dealt with are: Jesus' inherent δόξα (δόξα in the Johannine Prologue), the multi-dimensional relationship He has with the Father, the demonstration of Jesus' δόξα in the σημεῖα, the implication of divinity in the "Ἐγώ εἰμι" statements, Jesus' claims to δόξα in the Prayer of the Lord, the recognition of Jesus' δόξα by various individuals and groups of people and the δόξα manifested in Jesus' lowly service. This is followed by an analysis of other words used to convey the concept of δόξα in the Fourth Gospel: prime among these are the Greek words translated by honour, exaltation and power. Also of some significance in this analysis is the Greek word φῶς.

Because of its importance in understanding the δόξα of the cross the ὑψόω-phrases occurring in John are analysed in detail in Chapter 4. In addition the Ἐγώ εἰμι statements are specifically examined in relation to the events of the cross and their influence on our understanding of δόξα. This is followed by a review of people's reaction to Jesus during the events of the cross. In particular attention is given to those sent to arrest Jesus, Pilate and Thomas. Finally attention is focused on Jesus' δόξα as displayed in the events of the cross.

In the last chapter (Chapter 5), the findings of the study are summarised the results of this investigation discussed and possible avenues for future research on δόξα suggested.

CHAPTER 2. A LINGUISTIC AND LITERARY ECOLOGY SURVEY OF ΔΟΞΑ

2. 1. Introduction

The main focus of this study is the meaning and use of δόξα and related terms in describing the crucifixion, resurrection and ascension⁴³ of Jesus as recorded in the Fourth Gospel. Because the word δόξα is so prominent in the Fourth Gospel, it will be necessary to investigate the lexicographical potential of the word δόξα within the social ecology of the world in which the Gospel was written giving attention to both in its extra-biblical as well as in its biblical usage.

2.2. The Meaning of Δόξα

This chapter first lays out a semantic survey דְּבָרִים, the δόξα equivalent in the Hebrew Bible (add. raP, rdh; and d/h). Next, focus is placed on the contemporary understanding of the term δόξα, concentrating on its use in the Septuagint (LXX) and then paying attention to its extra-biblical usage as exemplified in the writings of Philo and Josephus. After exploring the linguistic and literary ecological significance of these meanings of δόξα, a brief review of its use in the New Testament is presented.

This chapter is, therefore, mainly concerned with a linguistic and literary ecology survey of δόξα. Centralization on this term is inevitable since δόξα is one of the most common and significant words in the Septuagint, and was also widely used in ordinary Greek in New Testament times.⁴⁴ The Hebrew Bible uses many terms which relate to the concept of glory, and which were translated into Greek using the term δόξα. In carrying into effect a survey, the main aim of which is to provide the linguistic background to John's usage of δόξα and related terms, a synchronic approach ordinarily would be given priority, since what we mainly need to know are the regular senses and conventional associations of these words in contemporary usage. However, a large part of the discussion of δόξα in this chapter is conducted from a diachronic point of view. This approach can be justified on the basis of the historical and social-scientific significance of the term.

The word δόξα is used to translate virtually all the Hebrew words relating to glory and this develops the term (δόξα) to a remarkable degree. Forster (1929:312-

⁴³ Van der Watt (2002:607) points out that John presents the cross, resurrection and ascension of Jesus as a single event. These three events are interlinked and have been termed "the events of the cross." I want follow that this dissertation is referred to as "the events of the cross." See Koester (1995:213).

⁴⁴ See Forster (1929:312); Kittel (1974:242).

314) and Kittel (1974:242) make the point that $\delta\acute{o}\xi\alpha$ is very widely used in the LXX, about 280 times in the canonical books and altogether it occurs about 445 times.⁴⁵ In fact, Hatch & Redpath (1975:341) say that 25 different Hebrew words are translated as $\delta\acute{o}\xi\alpha$ although some of these are very rarely used in the Hebrew Scripture.⁴⁶ Forster (1929:312-314) lists the Hebrew words translated as $\delta\acute{o}\xi\alpha$ in the LXX as follows

I . Eight Hebrew words are translated by $\delta\acute{o}\xi\alpha$ in Isaiah and not elsewhere. (1) 'לִוּוּ', Isa. 6:1; (2) 'חַלְמָה' [חַלְמָה] Isa. 11:3; (3) 'רַב־ב' Isa. 17:4; (4) 'אֶפְמֵם' Isa. 22:25; (5) 'צַבְיָה' Isa. 28:1; (6) 'חֶסֶד' Isa. 40:6; (7) 'אוֹנִי' Isa. 40:26; (8) 'חֲאָרָה' Isa. 52:14. In these eight instances in Isaiah, $\delta\acute{o}\xi\alpha$ as the translation of the Hebrew words is unique.

II . Other unique translations of Hebrew words by $\delta\acute{o}\xi\alpha$ are. (1) 'הוֹן' Ps. 111(112):3; (2) 'זָבַל' Ps. 48(49):15; (3) 'יָד' 2 Chr. 30:8; (4) 'קִרְשָׁי' Jer. 23:9; (5) 'גֵּס' Ezek. 27:7; (6) 'חֹעֲפֹת' Num. 23:22; 24:8; (7) 'טוֹב' Ex. 33:19. Thus in 15 out of the 25 cases $\delta\acute{o}\xi\alpha$ is used only once to translate the particular word. There are other cases where a Hebrew word is represented by $\delta\acute{o}\xi\alpha$ only two or three times. (8) 'עוֹ' in Isa. 12:2; 45:25 and in Ps. 67:35; (9) 'יָקָר' in Esth. 1:4; 6:3; (10) 'חֲמִנָה' in Num. 12:8; Ps. 16:13; (11) 'יָפִי' in Isa. 33:17; Lam. 2:15; Ps. 44:(2)3; (12) 'תְּהִלָּת' Ex. 15:11; Isa. 61:3; Ps. 145(146):1; (13) 'נֶאֱוִן' Ex. 15:7; also 3 times in Isaiah 14:11; 24:14; 26:10, once in Micah 5:4.

III. In the three following cases $\delta\acute{o}\xi\alpha$ is a frequent translation of the Hebrew words. (1) 'חֲפָאֲרָה' Ex. 28:2, 40; also in Isa. 3:18; 4:2; 10:12; 20:5; 28:1; 52:1; 60:19; 63:12, 14; 3 times in Jer. 13:11, 18, 20; and in 1 Chr. 22:5; 2 Chr. 3:6; (2) 'הוֹד' in Ps. 20(21):6;

⁴⁵ See Hatch & Redpath (1975: 341-344).

⁴⁶ Wong (2005:24) reports 27 in her dissertation "The $\Delta\acute{o}\xi\alpha$ of Christ and his followers in the Fourth Gospel" includes two more: 'עָרִי' in Ex. 33:5 and 'מִלְכוּת' in Est. 5:1.

also in Job 37:22; 39:20; 40:5; in Isa. 30:30; in 1 Chr. 16:27; 29:25; and Dan. 11:21; (3) 'דָּבָר' in Ps. 149:9; Prov. 14:28; 20:29; Isa. 2:10; 19:21; 53:2; Dan. 4:27; Ezek. 27:10. the latter is the second of the two cases in Ezekiel where δόξα is not used to translate d/bK. As shown above, in the case of the foregoing 24 words, δόξα with few exceptions, is used to translate Hebrew words the potential meanings of which include strength, wealth, beauty. Δόξα seems, therefore, to connote to the translators of the LXX external manifestation of male and female power and position whether it is manifest by money or clothes or appearance. This connotation brings us close to the Hebrew word 'd/bK,' which is represented by δόξα about 180 times in the LXX.

IV. In more than one third of the total occurrences of δόξα in the LXX it is used to translate d/bK. To illustrate: δόξα is found 3 times in Genesis, twice it represents d/bK, in the third, there is no underlying Hebrew word. Of 15 places in Exodus, 9 represent d/bK, 2 out of 2 in Leviticus, 7 out of 11 in Numbers, 1 out of 1 in Deut., 2 out of 2 in Haggai, 2 out of 2 in Zechariah, 2 out of 2 in Malachi, 51 out of 57 in the Psalms, 19 out of 21 in Ezekiel...The question of the meaning of δόξα becomes essentially therefore the question of the meaning of d/bK.

It is apparent that the word most frequently translated as δόξα in the LXX is דָּבָר.⁴⁷ This occurs 181 times and thus דָּבָר is the true and dominant equivalent of the word δόξα in the Septuagint, the others either having the same, or much the same, meaning as דָּבָר. Thus the usual meaning of the word δόξα in classical literature is no longer a generally valid concept in the LXX and is replaced by the rich Hebrew concept of God's glory as reflected in the meaning of דָּבָר. In

⁴⁷ Schneider (1932:36-37) points out that but d/bK has been translated differently in only a few verses (ἔνδοξος, Isa. 22:24; 59:19; Prov. 25:27. δοξάζειν, Isa. 24:23; 1 Chr. 17:18; Ex. 28:2. τιμή, Isa. 11:10; 14:18; Prov. 26:1. καλός, Isa. 22:18. βαρύνεσθαι, Nah. 2:9. γλῶσσα).

commenting on the Hebrew word-group translated by the term $\delta\acute{o}\xi\alpha$ in the Septuagint, Kittel (1974:244) writes:

The primary meaning of the LXX word, however, does not emerge except with reference to God. In this sense, of course, it may simply refer to “God’s honour” or “power,” like dwbk . But to isolate individual senses can only be a help to understanding. In reality, the term always speaks of one thing. God’s power is an expression of the “divine nature,” and the honour ascribed to God by man is finally no other than an affirmation of this nature. The $\delta\acute{o}\xi\alpha$ $\Theta\epsilon\omicron\upsilon$ is the “divine glory” which reveals the nature of God in creation and in His acts, which fill both heaven and earth. Again, the “form of the divine manifestation or revelation” of d/bk , as this controls certain parts of the OT, is for the translator the disclosure or self-revelation of this nature. Thus the “divine radiance” at the giving of the Law, or in the tabernacle or the temple, is very properly to be rendered $\delta\acute{o}\xi\alpha$. In the LXX and therefore in the Bible generally $\delta\acute{o}\xi\alpha$ acquires its distinctive sense as a term for this divine nature or essence either in its invisible or its perceptible form.

It will be helpful, therefore, in view of the theme of this thesis, not only to set out the understanding of the linguistics and literary ecology associated with $\delta\acute{o}\xi\alpha$ but also to sketch its development and perpetuation. It is not the intention here to offer a comprehensive review of $\delta\acute{o}\xi\alpha$ in contemporary Greek usage. The profuseness of $\delta\acute{o}\xi\alpha$ in Greek writings renders such an investigation impossible within these present confines. The intention is rather to ascertain the various prime potential meanings attached to the term $\delta\acute{o}\xi\alpha$ as far as contemporary Greek usage is concerned. Following this the meaning of the various Hebrew words rendered $\delta\acute{o}\xi\alpha$ when translating the Hebrew Bible are examined. In so doing the focus will be on the most frequently occurring Hebrew words translated by $\delta\acute{o}\xi\alpha$ in the Septuagint. This meaning would have become well established and generally understood by all those exposed to the Septuagint at the time of Christ’s life, death and resurrection. It is sufficient that the survey is representative and serves to establish the main issues in respect of the usage of $\delta\acute{o}\xi\alpha$ in the Fourth Gospel.

2.3. $\Delta\acute{o}\xi\alpha$ in the Classical Greek

2.3.1. Extra-Biblical usage of $\delta\acute{o}\xi\alpha$

As one traces the meaning of $\delta\acute{o}\xi\alpha$ one is impressed first of all with the fact that the biblical usage of the word does not correspond fully with its extra-biblical usage.

The noun δόξα derived from δοκέω (imperfect ἐδόκουν, future δόξω, aorist ἔδοξα),⁴⁸ which means “to believe, to think;” “to appear, to have the appearance;” “to count for something, to be of repute.”⁴⁹ Δόξα is part of the word-group that includes δοκέω, δόξα, δοξάζω, συνδοξάζω, ἔνδοξος, ἐνδοξάζω, and παράδοξος.⁵⁰ The noun δόξα in extra-biblical Greek has had a double basic meaning. First, that of opinion, meaning the view or opinion that I may have myself, second, the view or opinion that others may have of me, that is, my standing or reputation with others.⁵¹

The most frequent meaning of δόξα in extra-biblical usage is ‘view, opinion,’ but this meaning is not present in the New Testament.⁵² Thus the word remains in the realm of subjective opinion. It may also carry the sense of ‘expectation, notion, judgement, philosophical maxims, conjecture, imagine, suppose, fancy, vision.’⁵³

The other basic meaning of δόξα in extra-biblical usage is an objective sense, which is mostly used favourably for ‘reputation, renown, value, or honour.’⁵⁴ In this objective sense δόξα, with the Homeric κλέος and later τιμή, became of central significance for the Greeks.⁵⁵ Kittel (1964, 2:235) says that the term δόξα expresses the concept of supreme and ideal worth.⁵⁶

2.3.2. Δόξα in the writings of Philo and Josephus

Philo and Josephus were selected as being representative of scholarly writers of the early Christian era. Philo is typically Greek in his approach while Josephus writes from a typically Hebrew perspective. Both authors follow the

⁴⁸ Liddell & Scott (1996:441-442); TLNT 1:362.

⁴⁹ TDNT 2:232-234; EDNT 1:340.

⁵⁰ TDNT 2:232.

⁵¹ Kittel (1934:1). Molin (1970:295) agree with the above statement when he says, among ancient writes δόξα is used with two meanings: first, ‘the opinion which I have,’ and second, ‘the opinion which others have of me.’

⁵² EDNT 1:345; TLNT 1:362-363.

⁵³ TDNT 2:234; Liddell & Scott (1996:444).

⁵⁴ TDNT 2:234-235; EDNT 1:345; TLNT 1:363-364; Liddell & Scott (1996:444); NIDNT 2:44.

⁵⁵ TDNT 2:2354.

⁵⁶ Forster (1929:311) says that “this (δόξα) is the commonest meaning of the word throughout Greek literature.”

customary, contemporary Greek usage of δόξα.⁵⁷ In Philo, δόξα is used to convey the thought of a right or wrong ‘opinion’ or ‘philosophical tenet,’ for example, of Aristotle or the Pythagoreans,⁵⁸ or of Heraclitus.⁵⁹ In Josephus, δόξα is used to denote the concept of ‘view’⁶⁰ for example, δόξαν περὶ Θεοῦ.⁶¹ Both Philo and Josephus, use the term δόξα in respect of the ‘honour’ or ‘glory’ which accrues to man.⁶²

While not an exhaustive or detailed account of the use of δόξα in the Greek Literature of Philo and Josephus, what follows is a broad outline of this usage, giving particular attention to the development of the related concepts linked with these terms.

2.3.2.1. Philo

Philo’s (c. 20 B.C. - c. A.D. 50) writings are an important example of Hellenistic Judaism⁶³ in the Second Temple period.⁶⁴ He was a Jewish interpreter of the Old Testament, and provides useful insights as to the extra-biblical usage of the

⁵⁷ See TDNT 2:236-237.

⁵⁸ Philo (2002:708, *De Aeternitate Mundi*, 12).

⁵⁹ Philo (2002:50, *Legum Allegoriae*, 3, 7).

⁶⁰ It can be English translation ‘proposition,’ ‘notion.’

⁶¹ Josephus (2001: 805, 810, *Contra Apionem*, 2, 179, 254, 256).

⁶² TDNT 2:236; Philo (2002:12, *De Opificio Mundi*, 79; 2002:49, *Legum Allegoriae*, 2, 107); Josephus (2001:17, *Vita* 273; 2001:134, *Antiquitates*, 5, 115; 2001: 435, *Antiquitates*, 16, 158; 2001:71, *Antiquitates*, 2, 268; 2001:166, *Antiquitates*, 6, 200; 2001: 300, *Antiquitates*, 11, 217).

⁶³ The influence of Judaism on the concept of δόξα in the Fourth Gospel is to be found in the Jewish belief and practices of the first century and not in later developments such as those that occurred after the destruction of the temple in A.D. 70. During this period there were many Jewish religious groups holding different doctrines, which were at variance with one another. The Pharisees and Sadducees are typical of the different sections of Judaism. Another, much smaller group, were the Essenes who lived in many cities in Palestine, but were concentrated in a major settlement on the west bank of the Dead Sea, with Engedi below them, and Masada even further south. The Pharisees were the dominant group as far as numbers are concerned and their distinguishing characteristics were a belief in life after death, a spiritual world and angels. Sadducees, many of whom were priests and scribes, believed in none of these but were meticulous in keeping the minutiae of the Law. Based on their Scriptures the Jews were, as a nation, looking for a Messiah who would deliver them from foreign domination, and establish the promises of a Davidic kingdom. Their basic concept of δόξα was thus focused on a material kingdom which would display physical and spiritual glory though the latter was, in the majority of cases, relegated to a place of secondary importance. A crucified Messiah or Redeemer is far removed from this concept and thus the Christians had to show how a crucified Messiah fitted in to the Jewish sacred writings and how it was a manifestation of δόξα.

⁶⁴ See Belleville (1991:31-35); Sterling (2000:789).

word δόξα. He used the Greek word δόξα 250 times in his writings.⁶⁵ In Philo's usage it means either right or wrong "opinion."⁶⁶ For example, he refers to his ideas about the perfect king by using the term δόξα. Philo writes that "Kings are called shepherds of their people, not by way of reproach, but as a most especial and pre-eminent honour. And it appears to me, who have examined the matter, not with any reference to the opinions (δόξα) of the many, but solely with regard to truth (and he may laugh who pleases), that that man alone can be a perfect king who is well skilled in the art of the shepherd."⁶⁷ Not only opinions about man but also opinions concerning God are regarded as δόξας. In his book on husbandry, Philo writes "and yet to allow the opinions (δόξα) which are held concerning God to be in confusion in the soul of each individual."⁶⁸ And he mentions in Allegorical Interpretation III, "In the wicked man the true opinion (δόξαν) concerning God is overshadowed."⁶⁹ Furthermore, the importance of the object that has to be defined here demands "the correct ... the true and becoming opinion (notion) of God."⁷⁰ The word δόξα is also used of the doctrine (creed) or pagan beliefs in which Abraham had been raised. Philo says of him, "The man who had been raised in this doctrine (δόξα), and who for a long time had studied the philosophy of the Chaldaeans."⁷¹ But the term is also used to express the "honour" or "glory" which accrues to man and which we may receive from others. In his writing on Abraham, Philo uses δόξα when he speaks of "the younger things are wealth, and authority, and glory (δόξα), and nobility."⁷² In his essay on the Creation, Philo warns against the dangers of seeking

⁶⁵ See Kittel (1974:236). Schneider (1932:81) states that δόξα with the meaning opinion occurs approximately 180 times in Philo's writings, and approximately 60 times with the meaning praise.

⁶⁶ TDNT 2:236; TLNT 1:366; Philo (2002: 51, τοῖς δόξαν πρὸ Ἀληθείας τετιμηκόσι; 64, πολλάκις συνεισέρχεται μὲν ὁ νοῦς εἰς ἱερὰς καὶ ὀσίους καὶ κκαθαρμένας δόξας; 120, ἦν μὲν δοκεῖς ἀνηρηκέναι φιλόθεον δόξαν; 136, ἀσεβῆ καὶ ἄθεον εἰσηγούμενοι δόξαν γένει τῷ Καίῳ προσκεκληρώσθωσαν).

⁶⁷ See Philo (2002:465, *De Vita Moses*, 1, 62).

⁶⁸ See Philo (2002:185, *De Agricultura*, 130).

⁶⁹ See Philo (2002:50, *Legum Allegoriae*, 3, 7).

⁷⁰ See Philo (2002:50, 233). Also, we find that the true opinion (notion) of God must first of all acknowledge Philo's monotheistic character is revealed in his book *The Works of Philo* where he writes: 'the first commandment of the obligations towards God thus implies that man must protest against the polytheistic doctrine.' Philo (2002: 24, 259, 290, 524, 680). This perception has an impact on his intention in using the word δόξα in relation to God.

⁷¹ See Philo (2002:417, *De Abrahamo*, 70).

⁷² See Philo (2002:429, *De Abrahamo*, 219).

renown by saying, “nor desires of glory (δόξα), or power, or riches, to assume dominion over life.”⁷³ Also, in Allegorical Interpretation II 107 he refers to, “gold and silver, and glory (δόξα) and honours (τιμαί), and powers and the objects of the outward senses.” Likewise, in his writing on the Giants he refers to those who “have not been eager in the pursuit of glory (δόξα) have been thought worthy of public praises and honours.”⁷⁴

Of special interest is the way Philo speaks of the glory that came upon the face of Moses when he returned from Mount Sinai (Ex. 34). He does not explain the δεδόξασται of LXX as the reflection of the divine δῶκ; but he regards this glory (δόξα) as the reflection of the spiritual inner purity and beauty of Moses (ἐβελτιοῦτο).⁷⁵ Likewise, in Philo’s the Special Laws I 45-47, Moses says to God, “δόξαν δε σην ειναι νομίζω τας περι δε δορυφορούσας δυναάμεις, ων διαψεύγουσα η χατάληψις αχρι του παρόντος ου μιχρον ἐνεργάζεταί μοι πόθον της διαγνώσεως.”⁷⁶ Philo describes how Moses became convinced that he could not gain a clear image of God’s being. Therefore it seems that Moses wants at least to see the glory surrounding God, in other words, powers that are not usually seen. Equally striking is the way in which Philo deals, in Questions and Answers on Exodus II, 45, with the Old Testament record of the descent of the δόξα of God on Sinai (Ex. 24:16); where he compares it with the δόξα and δύναμις of an earthly monarch.⁷⁷

⁷³ See Philo (2002:12, *De Opificio Mundi*, 79, αἱ δόξης ἢ ἔρημάτων ἢ ἀρχῆς ἐπιθυμία).

⁷⁴ See Philo (2002:154, *De Gigantibus*, 36).

⁷⁵ See Philo (2002:497, *De Vita Mosis*, 2, 69) “He was inspired from above from heaven, by which also he was improved in the first instance in his mind, and, secondly, in his body, through his soul, increasing in strength and health both of body and soul, so that those who saw him afterwards could not believe that he was the same person.... Being much more beautiful in his face than when he went up, so that those who saw him wondered and were amazed, and could no longer endure to look upon him with their eyes, inasmuch as his countenance shone like the light of the sun.”

⁷⁶ “I am persuaded by thy explanations that I should not have been able to receive the visible appearance of thy form. But I beseech thee that I may, at all events, behold the glory (δόξα) that is around thee. And I look upon thy glory (δόξα) to be the powers which attend thee as thy guards.” Cf. Ex. 33:18. This usage has given to the term the sense of the divine radiance which Moses saw.

⁷⁷ See Kittel (1974:236).

In Philo's writings, the honour of God (τιμὴ Θεοῦ) and the honour of parents (τιμὴ γονέων) come to the fore. Philo mentions in his writings that honour and respect are due to God (τιμὴ Θεοῦ) because He is the one true living God,⁷⁸ the Creator of the universe,⁷⁹ the Emperor (αὐτοκράτωρ),⁸⁰ the great King.⁸¹ Parents (τιμὴ γονέων) have a claim to honour and respect on the basis of the fifth commandment cited in Ex. 20:12 (Philo, Who is the Heir of Divine Things).⁸² The elders, too, are worthy of highest honour.⁸³ Philo also associated honour with the Passover.⁸⁴ He also indicated that often the word (τιμὴ) is also used where the meaning is 'dignity,'⁸⁵ 'value,'⁸⁶ or 'price.'⁸⁷

In his writings Philo primarily uses the word δόξα to convey the concept of a right or wrong opinion but he also uses it to express the idea of the honour (glory) due to God. In his writings, τιμὴ is used of the honour due to a person because of their position, power or authority such as is given to a king or ruler. He also

⁷⁸ Philo (2002:788, *De Virtutibus Prima Pars, Quod Est De Legatione Ad Gaium*, 347), "that in all the vast circumference of the world there may be no visible trace or memorial to be found of any honour (τιμὴ) or pious worship paid to the true real living God?"

⁷⁹ Philo (2002:783, *De Virtutibus Prima Pars, Quod Est De Legatione Ad Gaium*, 293), "established at the beginning, as tending to the honour (τιμὴ) of the Creator and Father of the universe."

⁸⁰ Philo (2002:784-785, *De Virtutibus Prima Pars, Quod Est De Legatione Ad Gaium*, 305), "The honour (τιμὴ) of the emperor is not identical with dishonour to the ancient laws," "both for the honour (τιμὴ) due to the emperor, and for the preservation of the ancient customs of the city."

⁸¹ Philo (2002:523, *De Decalogo*, 61), "if any one were to assign the honours (τιμὴ) of the great king to his satraps and viceroys."

⁸² Philo (2002:290, *Quis Rerum Divinarum Heres*, 171), "The fifth commandment is about the honour (τιμὴ) due to parents;" Philo (2002:509, *De Vita Mosis*, 2, 207), "for those persons who have a proper respect (τιμὴ) for their parents do not lightly bring forward the names of their parents;" Philo (2002:522, *De Decalogo*, 51), "to paying honour (τιμὴ) to parents both separately to each;" Philo (2002:527), "which concerns the honour (τιμὴ) to be paid to parents;" Philo (2002:529, *De Decalogo*, 121), "about the honour (τιμὴ) to be paid to parents;" Philo (2002:532, *De Decalogo*, 165), "that about the honour (τιμὴ) due to parents;" Philo (2002:593, *De Specialibus Legibus*, 2, 261), "In the same way let not him who honours (τιμὴ) his parents dutifully seek for any further advantage;" Philo (2002:596, *De Specialibus Legibus*, 3, 21), "because of the respect (τιμὴ) which he feels towards both his parents" etc.

⁸³ See Philo (2002:104, *De Sacrificiis Abelis et Cain*, 77), "But by an elder is meant one who is worthy of honour, and respect, and of pre-eminence." Cf. Lev. 19:32; Num. 11:16.

⁸⁴ See Philo (2002:582, *De Specialibus Legibus*, 2, 149), "And this universal sacrifice of the whole people... in order that nothing which is accounted worthy of honour (τιμὴ) may be separated from the number seven."

⁸⁵ See Philo (2002:497, *De Vita Mosis*, 2, 67).

⁸⁶ See Philo (2002:571, *De Specialibus Legibus*, 2, 32, 33, 36; 2002: 590, *De Specialibus Legibus*, 2, 233).

⁸⁷ See Schneider (1974:173); Philo (2002:571, *De Specialibus Legibus*, 2, 33).

uses this word in respect of the honour due to God. This typical Greek usage gives us a valuable insight into the common Greek usage and meaning of the words δόξα and τιμή.⁸⁸

2.3.2.2. Josephus

Flavius Josephus, was a first-century Jewish politician, soldier, and historian, whose writings constitute important sources of our understanding of biblical history and of the political history of Roman Palestine in the first century.⁸⁹

It is Josephus who tells us almost everything we know about the non-Christian figures, groups, institutions, customs, geographical areas and events mentioned in the New Testament.⁹⁰ Scott (1992:391) asserts that this first-century Jewish writer is significant in any study of Jesus, a prime reason being that Josephus provides the major (virtually the only) contemporary Jewish account of the history and conditions of the period leading up to and including the New Testament era. Also, Feldman (2000:590) points out that in particular Josephus' work is useful in confirming the historicity of Jesus. Josephus also points out that the destruction of the temple was in fulfilment of the prophecies of Jesus and was inflicted by God upon the Jews for their rejection of Jesus.

Josephus follows the customary Greek usage of δόξα. The word δόξα is used of 'opinion (notion, view, proposition)' in his book 'Flavius Josephus against Apion.' As long as 'the opinion (notion) about the gods' is not integrated into a strict religious framework it means only the image that man has formed for himself of the gods, the opinion (notion) that he has of them.⁹¹ We also find the term (δόξα) is used in Josephus' writings for the "honour" or "glory" which is attributed to man. Josephus writes in *The Antiquities of the Jews*, "they were

⁸⁸ Philo speaks often of honour, glory, fame, high reputations, being adorned with honours and public offices, noble birth, the desire for glory, and honour in the present and a good name for the future (*De Migratione Abrahami* 172; *Legum Allegoriae*. 3:87; *Quod Deterius Potiori Insidiari Soleat* 33, 157; *De Posteritate Caini* 112; *De Abrahamo* 185, 263).

⁸⁹ See Feldman (1992:981).

⁹⁰ See Mason (2000:596).

⁹¹ See Josephus (2001:773, *Bellum Judaicum*, 1, 6; 2001:789, *Bellum Judaicum*, 1, 805, 810).

advanced to so great a degree of glory (δόξης) and plenty,⁹² “accustomed to prefer righteousness (δίκαιον) to glory (δόξαν),”⁹³ “he should have glory (δόξα) and honour (τιμή) among men,”⁹⁴ “without any glory (δόξα) or honour (τιμή),”⁹⁵ “the first in my esteem, and in dignity.”⁹⁶ And he notes in his autobiography, *The Life of Flavius Josephus*, “they congratulated me upon the honours.”⁹⁷ In *The Antiquities of the Jews*, the word δόξα is also used of fame or reputation, “out of a desire to purchase to himself a memorial and eternal fame (δόξα αἰώνιος),”⁹⁸ and “and obtain an everlasting reputation (δόξα αἰώνιος).”⁹⁹ Furthermore, we can see a transition to the sense of splendour in a few passages. The Queen of Sheba came to Jerusalem “with great splendour (δόξης) and rich furniture” (*The Antiquities of the Jews*).¹⁰⁰ Josephus also indicates, in *The Wars of the Jews*, an admiration for the temple “as well as for the glorious splendour (δόξης) it had for its holiness.”

Schneider (1974:173) says that, in his book *The Wars of the Jews*, Josephus used the noun term (τιμή), which means predominantly “honour, honouring (honour of being)”¹⁰¹ especially of prominent people and not infrequently in association with gifts, titles, or possessions.¹⁰² Then there is a reference to the “cultic honour (opinion)” shown to God (Josephus, *The Antiquities of the Jews*, I, 156).¹⁰³ And in *The Antiquities of the Jews*, Josephus also speaks of the goal of

⁹² See Josephus (2001:134, *Antiquitates*, 5, 115, εἰς τοῦτο δόξης προελθοῦσι).

⁹³ See Josephus (2001:435, *Antiquitates*, 16, 158, τὸ δίκαιον ἀντὶ τοῦ πρὸς δόξαν ἡγαπηκέναι).

⁹⁴ See Josephus (2001:71, *Antiquitates*, 2, 268, δόξα καὶ τιμή).

⁹⁵ See Josephus (2001:166, *Antiquitates*, 6, 200, δόξα καὶ τιμή).

⁹⁶ See Josephus (2001:300, *Antiquitates*, 11, 217, δόξα καὶ τιμή).

⁹⁷ See Josephus (2001:17, *Vita*, 273, κόσμον ἑαυτῶν εἶναι τὴν ἐμὴν δόξαν).

⁹⁸ See Josephus (2001:339, *Antiquitates*, 13, 63, δόξα αἰώνιος).

⁹⁹ See Josephus (2001:422, *Antiquitates*, 15, 376, δόξα αἰώνιος).

¹⁰⁰ See Josephus (2001:224, *Antiquitates*, 8, 166, μετὰ πολλῆς δόξης καὶ πλοῦψου παρασκευῆς).

¹⁰¹ Josephus speaks of honours bestowed by Caesar, Vespasian, David, Saul, Jonathan, Augustus, Claudius, and the city of Athens (*Bellum Judaicum* 1:194, 199, 358, 396, 607; 3:408; *Vita* 423; *Antiquitates* 6:168, 251; 7:117; 13:102; 14:152; 19:292). Also, he tells of the honour that belongs to consuls, governors, priests, village judges, and prophets (*Bellum Judaicum* 4:149; 7:82; *Antiquitates* 4:215; 10:92; 11:309; 15:217).

¹⁰² See Josephus (2001:559, *Bellum Judaicum*, 1, 207; 2001:558, *Bellum Judaicum*, 1, 194; 2001:580, *Bellum Judaicum*, 1, 461; 2001:611, *Bellum Judaicum*, 2, 208).

¹⁰³ See Josephus (2001:38, *Antiquitates*, 1, 156, νενομισμέναι τομαί).

piety (εὐσέβεια) being the “honour” (veneration) of God.¹⁰⁴ The word (τιμῆ) is used specially by Josephus for the “dignity” of the high priesthood.¹⁰⁵ Josephus usually uses the term τιμάω (‘to honour,’ ‘to show honour’), in respect of the honour of God, men, parents and king.¹⁰⁶ However, in his book, *The Antiquities of the Jews*, he mainly uses this word to describe the honour due to God.¹⁰⁷ Josephus also used the term (τιμάω) in the sense of ‘to reward, to make presentations,’¹⁰⁸ ‘to stand in honour.’¹⁰⁹

To sum up, as demonstrated by its use by both Philo and Josephus, in common Greek usage the word δόξα conveys various related but different ideas including those of “opinion,” “honour” and “glory.” Within the context of its usage, these nuances of meaning would be understood by those familiar with the Greek language and literature.

2.4. דבכ; in the Hebrew Bible

The first objective of this examination is to trace the lexicographical possibilities that the various dictionaries¹¹⁰ give in respect of דבכ. It will be helpful to set out some syntagmatic, semantic data concerning דבכ; as it is typically used in the Hebrew Bible, before commencing the paradigmatic analysis. This historical survey relies on Collins’ survey (1997:577) and concentrates on the fact that the root of דבכ; is widely found in the Semitic language family.¹¹¹

¹⁰⁴ See Josephus (2001:227, *Antiquitates*, 8, 208; 2001:293-294, *Antiquitates*, 11, 120).

¹⁰⁵ See Josephus (2001:311, *Antiquitates*, 12, 42; 2001:318, *Antiquitates*, 12, 157).

¹⁰⁶ See God: Josephus (2001: 50, *Antiquitates*, 1, 316; 2001:153, *Antiquitates*, 6, 21), Men: Josephus (2001:61, *Antiquitates*, 2, 123), parents: Josephus (2001:85, *Antiquitates*, 3, 92), king: Josephus (2001:157, *Antiquitates*, 6, 80; 2001:255, *Antiquitates*, 9, 153).

¹⁰⁷ See Josephus (2001:153, *Antiquitates*, 6, 21).

¹⁰⁸ See Josephus (2001:584, *Bellum Judaicum*, 1, 511; 2001: 595, *Bellum Judaicum*, 1, 646).

¹⁰⁹ See Josephus (2001:82, *Antiquitates*, 3, 49, ὁ ὑπὸ τοῦ Θεοῦ τετιμημένος; 2001:544, *Bellum Judaicum*, 1, 16; 2001:589, *Bellum Judaicum*, 1, 576; 2001:598, *Bellum Judaicum*, 2, 7, οἱ ὑφ’ Ἡρώδου τετιμημένοι).

¹¹⁰ See Decreus (1974/1975:117-185); Dohmen (1995, 7:13-17); Stenmans (1995, 7:22); Weinfeld (1995, 7:22-38); Collins (1997, 2:577-587); Oswald (1980, 1:426-428).

¹¹¹ The root (dbk), with its derivatives, occurs 376 times in the Hebrew Bible. It is especially prominent in Psalms (sixty-four occurrences) and Isaiah (sixty-three), as well as Exodus (thirty-three), Ezekiel (twenty-five) and Proverbs (twenty-four). Of the total number of occurrences, 114 are verbal. (Oswald, 1980:426). Dohmen (1995:13) mentions that the root dbk (*kbd*) is widely encountered in Semitic languages. Moreover, his detailed examination found that in the Old Testament, the root dbk (*kbd*) encompasses a wide range of meaning, and this multiple usage of dbk (*kbd*) is especially common in declarative statements. In the Old Testament, there are 114 occurrences’ of the verb, plus 26 in Sirach. The adjective appears 40 times, plus 5 in Sirach. In

From this survey it appears that “δόξα” most frequently corresponds to the Hebrew דְּבָרָה .¹¹² Owing to the difference between Hebrew and Greek idiomatic expressions several other Hebrew words are also sometimes translated by “δόξα” (glory). In its theological meaning δόξα is not only the translation of דְּבָרָה , but also of 25 different Hebrew equivalents that are all, in one way or another, used to convey the concept of דְּבָרָה . Some of these only occur once or twice. Thus we find that δόξα occurs in the LXX, 181 times as a translation of דְּבָרָה .¹¹³ This chapter therefore focuses on דְּבָרָה , and its Greek equivalent δόξα . The meaning of the word δόξα , as used in the New Testament, is based on its meaning in the Septuagint, which, as we have noted, is a translation of the Old Testament Hebrew word דְּבָרָה . Another focus of this chapter is to consider the important ideas expressed by the word “glory” and the phrase “the glory of God.”

As we seek to determine the meaning of דְּבָרָה in the Old Testament we note the following.¹¹⁴ Firstly, the original meaning of the word was that of weight. Hence it could be used for the honour or prestige that might be given to men. When דְּבָרָה was used of persons, it reflected noteworthy elements such as dignity of character, sometimes it might be due to the outward tokens of his prosperity, such as silver and gold, or the splendour of his appearance; sometimes his reputation, the esteem in which he is held.¹¹⁵ Secondly, the concept of דְּבָרָה is employed mainly in the Old Testament as a characteristic attribute and possession of God.¹¹⁶ The word דְּבָרָה has a special meaning when it refers to God where it used as a technical term for God’s manifest presence. The transcendent God reveals Himself on earth, in His sanctuary, in His city, by means of sacred paraphernalia in the tabernacle and in meteorological phenomena. God’s

addition, Stenmans (1995:22) notes that the word group (dbk) occurs 30 times in the Dead Sea Scrolls where its usage closely follows that of the Hebrew Bible.

¹¹² Gordon (1975:730) comments that an historical survey of this topic indicates that several words such as the Hebrew רָדָה , רָדַח , דָּבַח , רָחַף , הִרְאָה ; and the Aramaic arqy , have been translated “glory.” In fact, we find that twenty-five different Hebrew words are translated δόξα in the LXX.

¹¹³ See Hatch & Redpath (1975:341-343).

¹¹⁴ See von Rad (1974:238-242).

¹¹⁵ References; rich (Gen. 13:2); desirable things of all nations (Hag. 2:7, 9); splendour of his riches (Esth. 5:11, cf. Ps. 49:16; Isa. 16:14; 17:4; 61:6; 66:11); fame and glory (1 Chr. 22:5; cf. Isa. 60:7); for glory and for beauty (Ex. 28:2); all glorious (Ps. 45:13); honour as a crown (Job 19:9); reputation (2 Sam. 6:20; Job 29:20; Ps. 4:2; 73:24; Prov. 21:21; Eccl. 10:1); armies or people (Isa. 8:7; Prov. 14:28; Isa. 17:3; 21:16); splendour and dignity (1 Kin. 10:5); the glory of Lebanon (Isa. 60:13, cf. Isa. 35:2); splendour (Gen. 45:13, cf. 31:1); wealth (Nah. 2:9); weight (Job 6:3; Prov. 27:3).

¹¹⁶ I. Glory, majesty, honour, power, and authority as attributes of God (DCH 4:353; ISBE 2:478; HALOT 3:457; TDNT 2:241); II. God’s self-manifestation, God’s presence, God’s dwelling (DCH 4:353; HALOT 3:457; ISBE 2:478; TDNT 2:238; NIDOTTE 2:581-2); III. God’s essence and character (DCH 4:353; HALOT 3:458; TDNT 2:239, 244); IV. Acknowledgment of God’s majesty and glory (TLOT 2:596-7; HALOT 3:457; NIDOTTE 2:580-1; TDNT 2:241); V. God Himself (דְּבָרָה as another word for God); God as source of דְּבָרָה (NIDOTTE 2:581, 582; TDNT 2:241); VI. Glory, splendour, and magnificence of heaven (NIDOTTE 2:580; ISBE 2:480). See Collins (1997:581).

דְּבָרָא: implies His power, and consequently Isaiah saw God's self-manifestation in דְּבָרָא: as bringing judgement upon human pride and power (Isa. 2:10, 19, 21). But whatever the manifestation, it was through this type of revelation that divine glory became a factor in human consciousness.

Whenever דְּבָרָא: is used in connection with God – this occurs frequently in the phrase “Glory of God,” הַיְהוָה דְּבָרָא: – it means the ‘impact of the divine appearance.’¹¹⁷ It seems that the major use of the word (דְּבָרָא:) is to describe God's glory. The phrase “Glory of God” (הַיְהוָה דְּבָרָא:) is used as a technical term for the manifest presence of God's divinity with His people. In this connection it occurs thirty-six times in the Hebrew Bible.¹¹⁸ Seven times דְּבָרָא: is linked with names for God other than הַיְהוָה.¹¹⁹

Newman (1992:20) notes that the occurrences of the phrase הַיְהוָה דְּבָרָא: can be divided into two mutually exclusive syntagmatic profiles, which are, firstly, movement terminology and secondly appearance terminology.¹²⁰ The term הַיְהוָה דְּבָרָא:, though customarily associated with a closely circumscribed set of words,¹²¹ is used a few times with other syntagma. Other linguistic analyses note similar semantic usages of הַיְהוָה דְּבָרָא:, however, which indicate that the pronominal and nominal constructions behave quite differently.¹²² Nevertheless, this does not mean that God is to be regarded as some natural god, because His דְּבָרָא: is also manifested in other ways besides in meteorological phenomena. Actually, we see that the דְּבָרָא: of God is the essence of the nature of God, independent even of the way it is manifested (Isa. 42:8; 48:11).

¹¹⁷ See Molin (1970:296).

¹¹⁸ Ex. 16:7, 10; 24:16, 17; 40:34, 35; Lev. 9:6, 23; Num. 14:10, 21; 16:19, 42[17:7]; 20:6; 1 Kin. 8:11; 2 Chr. 5:14; 7:1, 2, 3; Ps. 104:31; 138:5; Isa. 35:2; 40:5; 58:8; 60:1; Ezek. 1:28; 3:12, 23; 8:4; 10:4 (x2); 10:18; 11:23; 43:4, 5; 44:4; Hab. 2:14.

¹¹⁹ Six times with הַיְהוָה: Ps. 19:2; 29:3; Ezek. 9:3; 10:19; 11:22; 43:2; and once with מַלְאֲכָא: Prov. 25:2.

¹²⁰ The first profile is found in such passages (Ex. 40:34, 35; Num. 14:21; 1 Ki. 8:11; 2 Chr. 5:14; 7:1, 2; Ezek. 10:4; 43:5; 44:4). The phrase הַיְהוָה דְּבָרָא: is said to have “filled” the tabernacle, earth, house/temple, or the court (of the temple). Also, הַיְהוָה דְּבָרָא: is said to ‘settle,’ ‘rise, go up’ over people and places, ‘come, arrive,’ ‘enter/depart’ or merely to ‘stand still, be over’ something or somewhere (Ex. 24:16; Isa. 60:1; Ezek. 3:23; 9:3; 10:18; 11:23; 43:2, 4). In the second profile the same Hebrew verb is employed in each of the following fourteen references: Ex. 16:7, 10; 24:17; Lev. 9:6, 23; Num. 14:10; 16:19, 42; 20:6; 2 Chr. 7:3; Isa. 35:2; 40:5; Ezek. 1:28; 8:4 when הַיְהוָה דְּבָרָא: is said to have appeared. We find that דְּבָרָא: may also be revealed by outward manifestations such as ‘in a cloud,’ ‘on top of Mount Sinai,’ ‘at the door of the Tent of Meeting,’ ‘over the temple,’ and appears to the ‘whole assembly’ or ‘congregation,’ ‘all the children of Israel,’ to others outside of Israel, or, more generally, to ‘all flesh.’

¹²¹ Ps. 29:3, cf. Ps. 104:31; Isa. 58:8; Ps. 19:1; Ex. 24:17; Ezek. 1:28.

¹²² In Exodus 29:43, דְּבָרָא: means “consecrates,” דְּבָרָא: is something God “gives” in Isaiah 42:8 and 48:11, דְּבָרָא: is something for which man is “created” in Isaiah 43:7, דְּבָרָא: is to be “feared” in Psalm 102:16 and in Isaiah 59:19, דְּבָרָא: is depicted as a canopy of cloud, smoke and fire. In Isaiah 4:5 and דְּבָרָא: is the object of proclamation in 1 Chronicles 16:24, Psalm 96:3 and Isaiah 66:19.

In addition, the theological point of view, according to Martin-Achard (1973:137), is that the idea of glory is an important part of the theology of the Old Testament. God acts for His own glory, and when He creates (Ps. 19:1-6), punishes or saves, the fundamental motive of His action is the glorification or, as it may also be described, the sanctification of Himself or of His holy name. Even though, as everywhere attested in the Old Testament, God is intrinsically invisible, nevertheless, when He reveals Himself, or declares Himself, His glory has intrinsic worth and permanence. Also, as von Rad (1974:238-239) indicates, in meteorological phenomena, one may rightly speak of the *hwhy dwbk* as a manifestation, which makes a highly significant impression on man. The more seriously religious consideration took the idea of God's invisibility and transcendence, the more this phrase for the powerful element in God (*hwhy dwbk*) became an important technical term in Old Testament theology. Thus the whole biblical record unites to manifest this glory. We can define this power and glory as essentially belonging to God alone (1 Chr. 29:11-13).

The same features are repeated in the various descriptions of eschatological glory. God's glory will be most openly displayed in the consummation of His purposes, whether depicted as a golden age on earth (Hab. 2:14; Isa. 4:5) or in a heavenly setting (Ps. 73:24). The glory of God also has eschatological associations (Isa. 58:8; 59:19), as we should expect, for in the eschaton He will manifest Himself to all flesh (Isa. 40:5). Isaiah 24:23 speaks of the future kingdom of God upon Mt. Zion, when "before his elders He will manifest His glory." Also, the Lord will build up Zion, and will appear in His *dwbk* (Ps. 102:16; cf. 97:6). Further, the New Jerusalem will possess an abundant glory (Isa. 66:11; Zech. 12:7), which will be seen and proclaimed among the people of the world (Isa. 66:18-19). The idea of God's glory filling the whole earth is present in Isaiah 6:3, but it is more frequently an expectation of an event still to be realized. It appears that this *dwbk* fills the earth as universal salvation (Ps. 72:19; Num. 14:21 cf. 57:5, 11). Consequently, von Rad (1974:242) says that it will be seen that the *dwbk*, understood as the act of salvation to which these eschatological expressions refer, is finally so all inclusive that it does not seem to make much difference if it is said that God will become *dwbk* for Israel or that Israel is created for the *dwbk* of God.

2.4.1. Other Hebrew words used to convey the concept of *δόξα*

It is also necessary to examine other typical Hebraic expressions of glory in the Hebrew Bible (*raP*, *rdh*; *d/h*), which are related to the use of *δόξα* in the Fourth Gospel, especially, those that deal with expressions of *δόξα* in relation to God.

Firstly, the term *raP*, is used in two main ways in the Hebrew Bible. Some texts using this term refer to God's glory being bestowed on His people. Deut. 26:19, mentions God's promise to set

Israel high above all nations in praise (תהלה), fame (שם), and glory (תפארה). Other texts focus on the glory and honour of God. Ps. 71:8 praises the glory of God (hLhiT and תפארתך)¹²³, as a result of God's deliverance in the context of the Psalmist's call for help. In Ps. 96:6, לפניו עז ותפארת במקדשו, ¹²⁴ תפארת appears in conjunction with rdhAd/h and תפארתו z[0 a reference to God's appearing in His sanctuary. Ps. 78:61 describes God as delivering his glory to captivity,¹²⁵ a reflection of 1 Sam 4:21-22. God is the subject of raP' in Isa. 44:23; 49:3; 60:21; 61:3, where its usage refers to God's gaining for Himself ascriptions of glory and dignity. As with d/bK;, this specialized usage is valid because God's presence with his people in the tabernacle reveals His own inherent glory and importance. The semantic relationship can be seen from Isa. 60:7; 63:12, 15. The semantic variety of the root raP as demonstrated in the Septuagint is represented by a wealth of different translations, among which derivatives of δόξα stand out.¹²⁶

Secondly, rdh; is another frequently used word meaning majesty, honour, glorify, adorn, splendour and which is used in relation to God¹²⁷ and the king.¹²⁸ God's rdh; is a sign of the royal dignity of the universal ruler. The term rdh; is used to describe God in passages such as Ps. 29:4; Ps. 90:16; Ps. 96:6;¹²⁹ Ps. 104:1; Ps. 111:3; and Ps. 145:5, 12. In Ps 29:4 His voice is depicted as thundering in rdh; "full majesty" as an expression of His power. We also often find the word pair rdh; d/h "majesty and splendour," applied to God.¹³⁰ In Ps. 90:16 God's impressive or imposing character is in view when this word is used of Him.¹³¹ Thus Warmuth (1978:337) says that in Ps. 104:1 rdh; (majesty) is the reason given for praising God and the term rdh; (splendour, honour) when used in songs of praise refers especially to God's might and glorious deeds in Israel's history (Ps. 111:3). Also, rdh; belongs to the group of terms denoting God's works in history (Ps. 145:4, 5). Thus Ps. 145:12 (להודיעו לבני האדם גבורתיו וכבוד ה' מלכותו),¹³² mentions that "the glory of the majesty of Your kingdom" (וכבוד ה' מלכותו) is manifest in God's mighty works. The Psalm goes on to declare that God's kingdom is everlasting. In Isa. 2:10, "גאון"

¹²³ "My mouth is filled with Your praise and with Your glory all day long." Also, praise of God's glory stands in the foreground in 1 Chr. 29:11, 13.

¹²⁴ "Splendour and majesty are before Him, strength and glory are in His sanctuary."

¹²⁵ "And gave up His strength to captivity and His glory into the hand of the adversary." Also, the same combination appears in Ps. 89:17, which speaks the power and might that God is to His people.

¹²⁶ See Hausmann (2001:464-467); Collins (1997:572-574); Hamilton (1980:207-209).

¹²⁷ Ps. 21:6 [5]; 45:4, 5 [3, 4]; 145:5, 12; etc.

¹²⁸ Ps. 21:6 [5]; etc.

¹²⁹ For background see 1 Chr. 16:27. rdh; d/h in Ps. 96:6, Delitzsch (1952:91) points out that this is the usual pair of words for royal glory.

¹³⁰ Job 40:10; Ps 96:6 (= 1 Chr. 16:27); 104:1; 111:3; cf. 145:5 (the splendour of the glory of Your majesty), 12 (the glory of the splendour of His kingdom).

¹³¹ Delitzsch (1952:60) points out here, "in the work of the Lord the bright side of His glory unveils itself, hence it is called rdh;."

¹³² "To make known to the sons of men Your mighty acts And the glory of the majesty of Your kingdom"

צִרִים וּבְמִחְלֹת עֵפֶר מִפְּנֵי פֶחַד יְהוָה וּמִתְהַרֵר גְּאוֹנוֹ בְּקִוְמוֹ לַעֲרֹץ הָאָרֶץ”¹³³ v. 19 “בּוֹא בַצֹּר וְהִטְמֵן בְּעֵפֶר מִפְּנֵי פֶחַד יְהוָה וּמִתְהַרֵר”¹³⁵ the parallel connection between the phrases “the glory (splendour) of His majesty (/n/ɑgʹ rdh)” and “the terror (dj P) of the Lord” is of special interest as it declares that the majestic splendour of God creates terror in the hearts of the unrighteous. Isa. 35:1-2 (cf. Lev 23:40) indicates that the Arabah (desert) will blossom as the crocus, that it will have the same glory as Lebanon and the same majesty as Carmel and Sharon (mountain and plain). This transformation in the natural world will reflect the glory (d/bK) and majesty (rdh) of God.¹³⁶

Thirdly, d/h is a further frequently used word meaning majesty, splendour, honour, glorify, adorn, and which is attributed to God,¹³⁷ the king,¹³⁸ individuals,¹³⁹ the people,¹⁴⁰ animals,¹⁴¹ and plants.¹⁴² The term d/h is also used to describe Daniel’s usual appearance.¹⁴³ This term, d/h, occurs 24 times in the Old Testament.¹⁴⁴ God’s d/h is manifest in His lordship in creation and the history of His people.¹⁴⁵ When used of God, this term, d/h, often denotes the revelation of His majesty to people.¹⁴⁶ Several times we find the parallel terms of rdhwʹ d/h (splendour and majesty) used in conjunction with each other.¹⁴⁷ In Ps. 96:6 this combination is used to describe His sanctuary. In Job 40:10, “עֲדָה נָא גְאוֹן וְנִבְהָה יְהוָה וְהִדְרַת תְּלַבֵּשׁ”¹⁴⁸ he is challenged to clothe himself with d/h and rdhwʹ and if he can do so God will praise him in that Job can save himself (v. 14), From the context this is something Job cannot do as these are attributable to God alone.

Thus Hamilton (1980:207) points out that this glory (הוֹד וְהִדְרָה) is part of God’s wardrobe (Ps. 104:1) and His majestic voice (אֶת־הוֹד קוֹלוֹ) can be heard (Isa. 30:30). In Ps. 145:5 these words

¹³³ “Enter the rock and hide in the dust From the terror of the Lord and from the splendour of His majesty”

¹³⁴ “Men will go into caves of the rocks And into holes of the ground before the terror of the Lord and the splendour of His majesty, When He arises to make the earth tremble.”

¹³⁵ “In order to go into the caverns of the rocks and the clefts of the cliffs Before the terror of the Lord and the splendour of His majesty, When He arises to make the earth tremble.”

¹³⁶ See Collins (1997:1014).

¹³⁷ Ps. 8:2[1]; 96:6; 111:3; 145:5; 148:13; Hab. 3:3; Job 37:22; 1 Chr. 16:27; 29:11.

¹³⁸ Jer. 22:18; Ps. 21:6[5]; etc.

¹³⁹ Num. 27:20; Prov. 5:9; etc.

¹⁴⁰ Hos. 14:7[6].

¹⁴¹ Zech. 10:3; etc.

¹⁴² Hos. 14:7[6].

¹⁴³ Dan. 10:8.

¹⁴⁴ Appearing most frequently (8 times) in the Psalter, 3 times each in Job and 1 Chr., twice each in Zech. and Dan., and once each in Num., Isa., Jer., Hos., Hab., and Prov.

¹⁴⁵ See Warmuth (1978:353). Ps. 104:1, 2 describes God’s majesty, and His manifest power (Ps. 148:13).

¹⁴⁶ Isa. 30:30 speaks of the majesty of His voice (/l/q d/h), Hab 3:3 describes His majesty as covering the heaven (cf. Ps. 8:1; 1 Chr. 29:11).

¹⁴⁷ Ps. 21:5; 45:3; 96:6 (= 1 Chr. 16:27); 104:1 (cf. Job 40:10); 111:3 (cf. 145:5).

¹⁴⁸ “Adorn yourself with eminence and dignity, And clothe yourself with honour and majesty”

refer to God's helping acts, they speak of the הַהֲרַר בְּבוֹר הַהֲרַר (the glorious splendour of Your majesty). The Term רְדָה׀ d/h (splendid and majestic) in Ps. 111:3 speaks of God's rule.¹⁴⁹ The 'majesty' that surrounds God at His appearing is terrible (Job 37:22), it is an expression of God's incomprehensibility by man (v. 37:23). As a result the LXX used a number of words to translate d/h, the most frequent and probably most important being δόξα, glory (9 times).¹⁵⁰

As we look at the concept of δόξα in the LXX translation of the Hebrew Bible we find that it is used to translate several Hebrew words and word groups. The most important of these, based on the frequency with which δόξα is used to translate them are דָּבָר; raP, rdh; and d/h. The range of Hebrew meanings conveyed by these Hebrew words and phrases gives a rich depth of meaning to the word δόξα, glory, and conveys the current English concept of glory, majesty, splendour, power, authority, and dignity in one single word, a word always associated with God, the God of creation and Israel. That which is characteristic of דָּבָר; raP, rdh; d/h, at all times is the majestic, the unapproachable, and the numinous.¹⁵¹ We find that the LXX uses a number of Greek words to translate words from these groups (raP, rdh; d/h), of which the most common is δόξα, glory (which it shares with parts of the dbk – group).

To sum up, we may say that as outlined previously, the Hebrew word דָּבָר; is used, in the Hebrew Scriptures, to convey various concepts such as δόξα, honour, majesty. In the Old Testament the prime concepts conveyed by דָּבָר; relate to the majesty and glory of God. When interpreting the Old Testament the interpreters would seek to use a word or words which convey these concepts.

2.5. The Use of Δόξα in the Septuagint (LXX)

In order to understand the concept of δόξα in the Fourth Gospel and New Testament, it is important not only to know the concept of δόξα as it is presented in classical Greek and explore the meaning of דָּבָר; in the Hebrew Bible but also to look at the concept of δόξα in the Septuagint. We saw in chapter 2.3. that in classical Greek, δόξα had the meanings "opinion" and "reputation, renown, honour." We also studied the concepts of דָּבָר; in the Hebrew Bible in chapter 2.4. and looked at nouns semantically related to it. Other Hebrew words

¹⁴⁹ See Warmuth (1978:354).

¹⁵⁰ See Collins (1997:1016-1017).

¹⁵¹ HALOT 1:239-240; 2:457-458; 3:908; DCH 4:353-357; NIDOTTE 2:586; TWOT 1:207-209; ZPEB 2:730; TDOT 7:22-28.

used to convey the concept of $\delta\acute{o}\xi\alpha$ were reviewed in chapter 2.4.1. In this section we shall examine the concepts of $\delta\acute{o}\xi\alpha$ as used in the Septuagint.

Soderlund (1988:400) says that the LXX was the Bible for most of the New Testament authors. The majority of their direct quotations of Scripture was taken from the LXX.¹⁵² Silva (1983:66) considers that most Biblical scholars would agree that, in researching the meaning of New Testament words and phrases, the LXX is the place to begin. Hill (1967:26) writes that “When we seek the meaning of a Greek word the meaning of the Heb. word it renders on many occasions in the LXX is an important guide.”

John would be well acquainted with the Septuagint and so to gain further insight into John’s use of $\delta\acute{o}\xi\alpha$, we briefly examine the Septuagintal usage of the term. Vermeulen (1956:11) reviews the history of $\delta\acute{o}\xi\alpha$ of the Septuagint. This historical survey shows that $\delta\acute{o}\xi\alpha$ generally occurs in general Greek use from the sixth century B.C. in the sense of opinion both in its subjective meaning, that is the opinion which I myself hold (*opinio*) and in its objective meaning, that is the opinion which others have of me (repute, fame). Thereafter, in the sense of *opinio* it becomes a technical term in philosophical and sophistic writings and generally denotes our unreliable, sensory knowledge. Its precise meaning has to be defined for each thinker individually. In the sense of fame it has the nuance of ‘Good fame, good repute, honour or renown.’ Sometimes, especially since the fourth century B.C., the ethical value of $\delta\acute{o}\xi\alpha$, in the sense of fame, came to be studied critically. Afterwards, in the Septuagint $\delta\acute{o}\xi\alpha$ received an entirely new life, for the Alexandrian translators of the Hebrew Bible used it as a rendering of the Hebrew דְּבָרָא ; even in its most sacred meanings.¹⁵³

Referring to $\delta\acute{o}\xi\alpha$ in the Septuagint, Kittel (1974:242-245) maintains that where for the first time a translator of the Old Testament had the idea of rendering דְּבָרָא ; with $\delta\acute{o}\xi\alpha$, he made an intervention in the development of the meaning of the word, which was of unusual importance. A greater change in the meaning of the Greek word could hardly be imagined. It seems that from the idea of thought and opinion, to which belong all the subjectivity and all the uncertainties of human thought and conjecture, the word became an expression of the objective divine reality.¹⁵⁴

¹⁵² See Soderlund (1988:400).

¹⁵³ See Vermeulen (1956:12).

¹⁵⁴ Kittel (1974:245): “When the translator of the OT first thought of using $\delta\acute{o}\xi\alpha$ for דְּבָרָא ; he initiated a linguistic change of far-reaching significance, giving to the Greek term a distinctiveness of sense which could hardly be surpassed. Taking a word for opinion, which implies all the subjectivity and therefore all the vacillation of human views and conjectures, he made it express something absolutely objective, i.e. the reality of God.”

The meaning of the Septuagint word has become identical with the דְּבָרִים of the Old Testament. Kittel (1938:22) writes: “Much greater in number, however, are words which have, so to speak, been re-created by the Septuagint, and which have thereby become new words, and as such have then passed into the New Testament.” Let us consider $\delta\acute{o}\xi\alpha$ again. The most important meaning of $\delta\acute{o}\xi\alpha$ in classical Greek is “opinion” (Latin *opinio*). This sense of the word completely vanishes in Biblical language the moment the Septuagint uses $\delta\acute{o}\xi\alpha$ as the equivalent of the Hebrew דְּבָרִים ; $\Delta\acute{o}\xi\alpha$ henceforth no longer stands for “the personal opinion of an individual,” the most subjective thing there is; but, in complete contrast, it now stands for God’s Glory, God’s Own Essence, the most objective thing there is.”

In connection with the Septuagint (Kittel, 1974:242-245) it should be noted¹⁵⁵ that, first, the meaning of $\delta\acute{o}\xi\alpha$ as *opinio* is missing almost completely, because דְּבָרִים , cannot be used with this meaning.¹⁵⁶ Second, the meaning of $\delta\acute{o}\xi\alpha$ as *gloria* or honour given to man is not often used in the Old Testament.¹⁵⁷ $\Delta\acute{o}\xi\alpha$ is used less often in this meaning than דְּבָרִים ; for which the only other important Greek word which is at all common is $\tau\iota\mu\acute{\eta}$.¹⁵⁸ So strong is the change in the use of

¹⁵⁵ The usual meaning of the word $\delta\acute{o}\xi\alpha$ in classical literature is no longer valid and is replaced by the rich Hebrew concept of God’s glory as reflected in the meaning דְּבָרִים . In introducing the Hebrew word-group translated by the term $\delta\acute{o}\xi\alpha$ in the Septuagint, Kittel (1974:244) comments:

The primary meaning of the LXX word, however, does not emerge except with reference to God. In this sense, of course, it may simply refer to “God’s honour” or “power,” like דְּבָרִים . But to isolate individual senses can only be a help to understanding. In reality, the term always speaks of one thing. God’s power is an expression of the “divine nature,” and the honour ascribed to God by man is finally no other than an affirmation of this nature. The $\delta\acute{o}\xi\alpha$ $\Theta\epsilon\omicron\upsilon$ is the “divine glory” which reveals the nature of God in creation and in His acts, which fill both heaven and earth. Again, the “form of the divine manifestation or revelation” of דְּבָרִים , as this controls certain parts of the OT, is for the translator the disclosure or self-revelation of this nature. Thus the “divine radiance” at the giving of the Law, or in the tabernacle or the temple, is very properly to be rendered $\delta\acute{o}\xi\alpha$. In the LXX and therefore in the Bible generally $\delta\acute{o}\xi\alpha$ acquires its distinctive sense as a term for this divine nature or essence either in its invisible or its perceptible form.

It will be helpful, therefore, in view of the thesis, not only to set out the understanding of the linguistics and literary ecology associated with $\delta\acute{o}\xi\alpha$ but also to sketch its development and perpetuation. It is not the intention here to offer a comprehensive review of $\delta\acute{o}\xi\alpha$ in contemporary Greek usage.

¹⁵⁶ Kittel (1974:242): “Here, and in biblical and biblically influenced Greek as a whole, we hardly ever find $\delta\acute{o}\xi\alpha$ used for opinion. The term דְּבָרִים cannot bear such a sense, and it is extremely rare for $\delta\acute{o}\xi\alpha$ in the Bible.”

¹⁵⁷ Kittel (1974:243): “‘ $\delta\acute{o}\xi\alpha$,’ glory or honour ascribed to someone, ‘reputation.’ This is very rare in the Old Testament books.”

¹⁵⁸ Another typical Greek expression of glory ($\tau\iota\mu\acute{\eta}$) in the LXX, is related to $\delta\acute{o}\xi\alpha$ in the Fourth Gospel. Aalen (1986:44) says that “two different Greek word-groups are represented by the English words glory and honour. From classical Greek onwards $\tau\iota\mu\acute{\eta}$ denoted recognition of another’s work by giving him the position and honours he merited.” $\Delta\acute{o}\xi\alpha$ is in fact the regular translation of דְּבָרִים ; though $\tau\iota\mu\acute{\eta}$ is used a few times, as in Prov. 26:1 and Isa. 11:10. Also, Aalen

δόξα that rather strangely there is very little urge to equate d/bK; with δόξα in this original sense of the Greek term. Nevertheless, there are a few instances of this meaning (Gen. 45:13; Ps. 8:5; Job 19:9; Hos. 4:7; Prov.11:16; 20:3; 26:8; Wis. 8:10; Sir. 3:11; 5:13). Third, since d/bK; may have the meaning of power, splendour and human glory, we also find this meaning given to δόξα in the Septuagint. Since power and splendour often bring recognition and honour from men, we find that these two meanings often flow into one another (Isa. 17:4; Isa. 28:1; Hag. 2:3).¹⁵⁹ The Septuagint emphasizes the idea of power in its use of the word δόξα. This is shown by the fact that it translates Hebrew words meaning power and strength with δόξα.¹⁶⁰ Fourth, the main meaning of the Septuagint δόξα appears when it is used to refer to God. The traditional meaning of the word in classical literature drops out and is replaced by the rich Hebrew concept of the glory of God.¹⁶¹ Thus, as a result of this wide use, the δόξα of God is more prominent in the Septuagint than is the d/bK; of God in the Hebrew Bible, and the doctrine of the divine glory is presented with a greater unity and impressiveness. The divine glory which reveals God's being in creation and in his deeds is called δόξα Θεοῦ.¹⁶² Likewise also the divine appearance and forms of manifestation of the d/bK; of God as they appear in various parts of the Old Testament are for the Septuagint translator, a becoming visible or a self revelation of the glory of God.

(1986:49) says that in contrast to its use of δόξα, the Septuagint seldom uses τιμή for God's honour (Isa. 29:13; Prov. 3:9). As we thoroughly research the use of τιμή in LXX, it seems that it normally applies τιμή to human honour, although both τιμή and δόξα are used to translate the Hebrew d/bK;. Furthermore, Schneider (1974:172) comments that this is the honour which is due to God and which is to be and is shown Him; men are commanded to bring Him δόξα and τιμή (LXX Ps. 28:1; 95:7; cf. Job 34:19). Then it is the honour which comes to man from God. God has crowned "with glory and honour" (δόξη καὶ τιμῆ) the man whom He created in His image (LXX Ps. 8:6). Earthly goods are almost always connected with honour. "Value" (τιμάς λαμβάνοντες) in Ezek. 22:25, the unlawful taking of valuables; in Sir. 45:12 (καύχημα τιμῆς). "Price" in Gen. 44:2; Num. 20:19. "Payment" in Job 31:39; Sir. 38:1 (τίμα ἰατρῶν), honorarium for service (the doctor). Honour should be shown to parents (Ex. 20:12; Deut. 5:16; Sir. 3:3-16), old men (Lev. 19:32), the doctor (Sir. 38:1), the temple (2 Macc. 3:2, 12; 13:23; 3 Macc. 3:16), to kings and the mighty (Dan. 2:37; Job 34:19 LXX; Wis. 14:17). Also, we find that in contrast, no positive value was given to shame (4 Macc. 1:10; 17:20; Wis. 3:14-5:5; Sir. 10:19; Isa. 53), it reveals the godless experience (Isa. 10:16 LXX; Jer. 23:40; cf. αἰσχύνη, Dan. 12:2), faithlessness to God (Jer. 6:15), and this had to be recognized (Ezek. 16:63) (Aalen, 1986:49).

¹⁵⁹ Kittel (1974:243): "Since d/bK; can have the sense of 'power,' 'splendour,' 'human glory,' δόξα takes on the same meaning. Yet this does not involve any great transition from the previous sense, since power and splendour usually bring honour and renown. They are often the outward manifestation and even the cause of being honoured. Thus the meanings often merge into one another."

¹⁶⁰ Ps. 67:35; Hab. 3:4; Isa. 30:30; 40:26; 45:24; 62:8; 63:12.

¹⁶¹ Also, Ramsey (1949:23-24) says that "by far the most frequent use of δόξα in the Septuagint is as a translation of the d/bK; of God, both in the sense of His character and might and in the sense of the radiance of His presence. Δόξα is above all else the glory of God, and the Greek word has found an employment far removed from its original human and man-centred connotation."

¹⁶² Kittel (1974:244): "The δόξα Θεοῦ is the 'divine glory' which reveals the nature of God in creation and in His acts, which fill both heaven and earth."

Hence the divine-light splendour as it appears at the time of the giving of the law and also in the tabernacle and temple are rightly translated by the word δόξα.¹⁶³ The Septuagint δόξα has been used to designate the divine being both in His invisible and in His perceptible form. In this way it has given the biblical terminology its true meaning. God is θεός and βασιλεὺς τῆς δόξης (Ps. 29:3; 24:7; 57:5).¹⁶⁴ Vermeulen (1956:13) says that in this sense it gets a more concrete character, because the concrete features of the δόξα are clearly expressed in the context. Its great usage from the formalization of the Septuagint onward, as is already now apparent, lies in its use and development as a theological concept, or rather as a religious term.

Ramsey (1949:23) points out that by so using it the Septuagint translators gave it a sense totally different from its original meaning in Greek literature. He says that no word in the Biblical language has a more fascinating history. And he insists that for a word which meant human opinion or human reputation to come to express the greatest theological ideas both of the Old Testament and of the New, is one of the most signal instances of the impact of theology upon language.¹⁶⁵ As δόξα could have the meaning of 'splendour,' 'brightness,' 'amazing might,' 'praise,' 'honour,' 'greatness,' 'glorious being,' 'heaven,' 'pride' (Louw & Nida, 1993:66) it could serve as a suitable rendering of *דְּבָרָא* in cases where *דְּבָרָא* conveyed one of those meanings. It seems that the meaning of δόξα in the Septuagint was determined by the fact that it was mainly used to translate the *d/bk*; of the Old Testament.¹⁶⁶ But the Septuagint, indeed, uses δόξα more frequently than the Hebrew uses *דְּבָרָא*; because other Hebrew words for honour, majesty and dignity are also rendered by δόξα in the Septuagint. Furthermore it is added to the text in a number of passages by way of interpretation.¹⁶⁷ This chapter surveys the Septuagint's use of the word δόξα in order to understand the full significance of its meanings in the Fourth Gospel.

¹⁶³ Kittel (1974:244): "Again, the "form of the divine manifestation or revelation" of *d/bk*;, as this controls certain parts of the OT, is for the translator the disclosure or self-revelation of this nature. Thus the "divine radiance" at the giving of the Law, or in the tabernacle or the temple, is very properly to be rendered δόξα." Also, see Schneider, "Doxa" 1932:36-70.

¹⁶⁴ Kittel (1974:244): "Thus the 'divine radiance' at the giving of the law, or in the tabernacle or the temple, is very properly to be rendered δόξα. In the LXX and therefore in the Bible generally δόξα acquires its distinctive sense as a term for this divine nature or essence either in its invisible or its perceptible form."

¹⁶⁵ Ramsey (1949:23), who is supported by Kittel (1974:233-234) analyses the normal meaning of δόξα thus;

In Greek literature the word δόξα has two familiar meanings. With its roots in the verb δοκέω, 'to think' or 'to seem,' it means opinion and also distinction or fame, what a man himself thinks, and what other people think about him. The Latin *opinio* and *gloria* serve well to express the two uses. There is no evidence for thinking that the word is originally connected with light or radiance.

¹⁶⁶ Kittel (1974:242): "The LXX word (δόξα) receives its distinctive force from the fact that it is used for *d/bk*; It has become identical with *d/bk*;"

¹⁶⁷ See Brockington (1967:1). Cf. 2 Chr. 2:6; Isa. 4:2-6; Ex. 33:19.

Without attempting to resolve the debate concerning the character of Septuagintal Greek, what can be said about $\delta\acute{o}\xi\alpha$? First, Kittel (1934:33-68), Harrison (1982:477-483) and Mohrmann (1954:321-328), consider that the translators mechanically used $\delta\acute{o}\xi\alpha$ to convey the meanings of d/bK ; . They thought that the translation of d/bK ; by $\delta\acute{o}\xi\alpha$ exemplifies such a linguistic missionary process. Second, in contrast, Schneider and Deissmann maintain that the Septuagint is not the sacred bearer of divine language.¹⁶⁸ They accept that the Greek of the Septuagint is simply *Koiné* Greek. Another scholar Decreus (1974/1975:117-185), argues that $\delta\acute{o}\xi\alpha$ and d/bK ; not only share a range of meanings, but also that the two words ($\delta\acute{o}\xi\alpha$ and d/bK ;) possess a structural similarity as well. In other words, both $\delta\acute{o}\xi\alpha$ in classical literature and d/bK ; in the Hebrew bible possessed double semantic fields (subjective and objective connotations).¹⁶⁹ When these two words, $\delta\acute{o}\xi\alpha$ and d/bK ;, are considered together it seems that Decreus' argument becomes more plausible.

By sketching the semantic field of $\delta\acute{o}\xi\alpha$, it seems that the Septuagint translators probably chose it so that the manifestation of pagan deities would not be confused with the revelation of God as Newman's (1992:152) assertion. The choice of $\delta\acute{o}\xi\alpha$ to render d/bK ; thus bears an indirect witness to the development of Glory,¹⁷⁰ and as will be seen, an unforeseen process of semantic change which can be detected in the New Testament use of $\delta\acute{o}\xi\alpha$.¹⁷¹ While $\delta\acute{o}\xi\alpha$ in the New Testament continued to relate to the same

¹⁶⁸ Deissmann (1903:165-166) says "As far as I know up to now, we do not have a sure proof outside the biblical texts for $\delta\acute{o}\xi\alpha$ in the realistic meaning of *Lichtglanz* (brilliance of light). The supposition however that translators of the Old Testament – who translated the Hebrew d/bK by $\delta\acute{o}\xi\alpha$ – have forced onto this word a realistic meaning which it had not before is more unlikely as the other supposition that they simply used the old still existing realistic basic meaning in the common language of that environment."

¹⁶⁹ Decreus (1974/1975:175-176) says that "when we compare these last stipulations with the classification of the d/bK ; Jahweh, two fundamental structural similarities are apparent: first, $\delta\acute{o}\xi\alpha$ as well as d/bK ; are determined by a polar structure, an inner and outer aspect, and by a tension that makes them both dependent on each other all the time. Second, the d/bK ; Jahweh refers to the essence of God in as far as it reveals itself; $\delta\acute{o}\xi\alpha$ indicates how something makes itself known to the outside world, how it appears. In both cases one may say that an essence reveals itself, appears."

See Decreus, " $\delta\acute{o}\xi\alpha$ - d/bK ;" (1974/1975:121-163): About subjective and objective scenes in the Greek concept $\delta\acute{o}\xi\alpha$.

¹⁷⁰ In terms of semantics, we find that a semantic change took place when $\delta\acute{o}\xi\alpha$ acquired the technical meanings of glory of God ($\eta\lambda\iota\omega\delta\eta\delta\eta\delta\eta\delta\eta$ d/bK).

¹⁷¹ $\Delta\acute{o}\xi\alpha$ and its cognates, appear some 227 times in the New Testament and scholars generally begin any discussion of $\delta\acute{o}\xi\alpha$ in the New Testament with the observations that Kittel (1974:237) says "the old meaning 'opinion' has disappeared completely" and he (1974:247) goes on to comment that "it is obvious that the New Testament use of $\delta\acute{o}\xi\alpha$ follows the Septuagint rather than Greek usage."

lexical field of words, the semantic range of δόξα had in fact been altered.¹⁷² Also, we find that though explaining much of δόξα in the New Testament, the semantic change enacted by the translation process fails to account for the way in which the New Testament authors, and John in particular, connected Christ and δόξα as strongly as they did.

This latter assertion is addressed in part three, the analysis of δόξα and related terms in the Fourth Gospel.

The essence of the foregoing is that, when the translation of the Hebrew Scriptures into Greek was undertaken the translators were faced with the question of how to adequately translate the Hebrew word *דְּבָרָא* and related terms, giving it its full significance and conveying all its wealth of meaning, into Greek. The Hebrew scholars decided to use the Greek word δόξα and in so doing gave the word a whole new meaning. From that point on the meaning of δόξα, within the Hebrew Scriptures, came to mean not the usual Greek thought of opinion or honour but the word was now imbued with all the significance of the Hebrew concept of *דְּבָרָא*.

2.6. Δόξα in the New Testament excluding John's writings

The New Testament understanding of glory has its roots in the Old Testament concept of *דְּבָרָא*, and also the Septuagint meaning of δόξα. The Greek word δόξα, is often difficult for translators of the New Testament to handle. To some extent this is because it is hard to determine what the word is intended to mean in certain places. Further when translating the Greek δόξα into other languages no single word is able to express its meaning in all of its various uses. However, having now completed a review of the broad linguistic and literary ecology of δόξα, in this section we will consider the semantic range of δόξα (*δοξάζω*), as used in the Fourth Gospel. This term, as indicated at the outset of the chapter, will be treated in the light of its range of usage in the New Testament and in particular as it applies to the crucifixion, resurrection and ascension of Jesus Christ.

Δόξα is used 166 times in the New Testament,¹⁷³ of which 77 occur in the Pauline epistles. It also figures in the Petrine letters (15 times), the Johannine writings (Jn. 19 times,¹⁷⁴ Rev. 17 times), Synoptics and Acts (27 times), the Epistle to the Hebrews (7 times), James (once) and

¹⁷² See Bauer (2000:256-258).

¹⁷³ Aland (1978:333) established that, in the New Testament, δόξα occurs 36 times, δόξαν occurs 58 times, δόξας occurs 3 times, δόξη occurs 21 times and δόξης occurs 48 times.

¹⁷⁴ Aland (1978:333), δόξα and the cognate words δόξαν occurs 16 times, and δοξάσω, δόξης, δόξασόν each appear once.

Jude (3 times). The verb δοξάζω occurs 61 times in the New Testament,¹⁷⁵ 23 of which are found in John's Gospel.¹⁷⁶

When considering the semantic range of δόξα, Fry (1976:422-425) suggests that there are three major components to its meaning namely brightness or splendour, great power and strength, and majesty and honour.¹⁷⁷ However in his Lexicon, Bauer (2000:256-258) states that there are four major divisions in the semantic range of the noun 'δόξα' in the New Testament:

- I. The condition of being bright or shining, brightness, splendour, radiance (a distinctive aspect of Hebrew דְּבָרָה):
 - i. of physical phenomena (Acts 22:11; Lk. 9:32; 1 Cor. 15:40f);
 - ii. of humans involved in transcendent circumstances and also of transcendent beings - cherubim (Heb. 9:5), angels (Lk. 2:9; Rev. 18:1), especially of God's self (Acts 7:2; 2 Thess. 1:9; 2 Pet. 1:17^b; Rev. 19:1; 21:11, 23; Eph. 1:17), of those who appear before God: Moses (2 Cor. 3:7-11, 18), Christians in the next life (1 Cor. 15:43; Col. 3:4), the δόξα τοῦ Θεοῦ as it relates to the final judgment (Rom. 3:23; 5:2), of Jesus Himself σῶμα τῆς δόξης (Phil. 3:21), Christ is the Κύριος τῆς δόξης (1 Cor. 2:8). The concept has been widened to denote the glory, majesty,

¹⁷⁵ According to Aland (1978:333), δοξάζω and the cognate words which occur in the New Testament are as follows: δεδοξασμαι, δεδοξασμενη, δεδοξασμενον, δεδοξασται, δοξαζειν, δοξαζεται, δοξαζεταιω, δοξαζεταιαι (x2), δοξαζητε, δοξαζομενος, δοξαζοντες (x2), δοξαζω, δοξαζων (x4), δοξασαι, δοξασατε, δοξασει (x5), δοξαση, δοξασθη (x3), δοξασθωσιν, δοξασον (x3), δοξασω (x2), δοξασωσιν (x2), εδοξαζειν (x2), εδοξαζον (x6), εδοξασα (x2), εδοξασαν (x4), εδοξασειν (x4), εδοξασθη (x6).

¹⁷⁶ Jn. 7:39; 8:54 (x2); 11:4; 12:16, 23, 28 (x3); 13:31 (x2), 32 (x3); 14:13; 15:8; 16:14; 17:1 (x2), 4, 5, 10; 21:19.

¹⁷⁷ Fry (1976:422-425), referring to the entire New Testament, suggests that there are three main components to the meaning of the word glory (δόξα) as used of God and Christ. 1. Brightness or splendour, Mt. 16:27; 24:30; Mk. 8:38; 13:26; Lk. 2:9; 9:26, 31-32; 21:27; Acts 7:55; Rom. 9:4; 2 Cor. 4:6; 2 Thess. 1:9; Tit. 2:13; 2 Pet. 1:17; Rev. 15:8; 21:11, 23. When used in this way the emphasis seems to be on God's presence. 2. Great power and strength, Jn. 2:11; 11:40; 12:41; Rom. 6:4; Eph. 3:16. The emphasis here is on His action. 3. Majesty and honour, Mt. 25:31; Mk. 10:37; Lk. 24:26; Jn. 1:14; 17:1, 5, 24; Eph. 1:12, 14; Heb. 2:9; 1 Pet. 1:11, 21; 4:11; Rev. 1:6; 7:12; 19:1. It is position that is in view in these passages.

sublimity of God in general (Rom. 1:23; Jude 24; Jn. 2:11) - power, might (Rom. 6:4; cf. Mt. 16:27; Mk. 8:38; Col. 1:11), the wealth of His glory (Rom. 9:23; Eph. 1:18; cf. Eph. 3:16; Phil. 4:19; Col. 1:27), glory of His grace (Eph. 1:6), glory of virtue (2 Pet. 1:3), radiance of God's glory (Heb. 1:3), glorious appearing of God (Tit. 2:13), the glory of God transferred to Christ (Mt. 19:28; 24:30; 25:31; Mk. 10:37; 13:26; Lk. 9:26; 21:27; 2 Cor. 4:4; cf. 4:6); iii. the state of being in the next life described as participation in the radiance or glory - with reference to Christ (Lk. 24:26; 1 Tim. 3:16; cf. 1 Pet. 1:11; 4:13), with reference to his followers (Rom. 8:18, 21; 1 Cor. 2:7; 2 Cor. 4:17; 1 Thess. 2:12; 2 Thess. 2:14; 2 Tim. 2:10; Heb. 2:10; 1 Pet. 1:7; 4:14; 5:1, 4); iv. of reflected radiance reflection (1 Cor. 11:7; cf. Rom. 3:23; 5:2; 2 Cor. 8:23).

II. A state of being magnificent, greatness, splendour, anything that catches the eye: i. fine clothing of a king (Mt. 6:29; Lk. 12:27); ii. of royal splendour in general (Mt. 4:8; Rev. 21:24, 26); iii. general human splendour of any sort (1 Pet. 1:24).

III. Honour as enhancement or recognition of status or performance, fame, recognition, renown, honour, prestige: i. of public approbation (Lk. 14:10); ii. of God (Rev 4:11); iii. of the Lamb (Rev 5:12); iv. divine approbation (Rom 3:23; 5:2); v. of persons who bestow renown through their excellence - of Jesus (Lk. 2:32; cf. Rom. 9:4), of Paul's epistolary recipients (1 Thess. 2:20); vi. praise be to God (Luke 2:14. Cf. 19:38; Rom 11:36); vii. *τιμὴ καὶ δόξα* (1 Tim 1:17; Rev 5:13); viii. Doxologies to Christ (2 Pet

3.18; Rev 1.6); ix. to the praise of God (Rom 15.7; 1 Cor 10.31); πρὸ δ (2 Cor 1.20); for the glory of the Lord (Christ) (2 Cor 8.19).

IV. A transcendent being deserving of honour, majestic being, δόξα majestic (heavenly) *beings* (Jude 8; 2 Pet 2.10).

According to Bauer, the noun 'δόξα' can indicate first, 'brightness,' 'splendour' or 'radiance,'¹⁷⁸ second, 'magnificence,' 'greatness' or 'splendour,' third, 'fame,' 'recognition,' 'renown,' or 'honour,' and fourth, an 'office,' 'a transcendent being deserving of honour,' 'majestic (heavenly) being.' In his analysis of the verb 'δοξάζω,' Bauer also makes two major divisions in the semantic range, first, 'to influence one's opinion about another so as to enhance the latter's reputation,' 'praise,' 'honour,' or 'extol,' second, 'to cause to have splendid greatness,' 'clothe in splendour,' or 'glorify.' Interestingly, we find that among Bauer's major four categories in respect of the noun 'δόξα,' the third category, fame, recognition, renown and honour, is especially prominent in the Fourth Gospel.¹⁷⁹ Louw and Nida's lexicon (1993:66) has eleven different semantic domains under which they classify δόξα; one domain for the middle/passive δοξάζομαι (1 Pet. 1:8 "to be wonderful, to be glorious"); and three domains for the active δοξάζω.¹⁸⁰

- I. The quality of splendid, remarkable appearance (Mt. 6:29; 1 Pet. 1:24);
- II. The state of brightness or shining (Jn. 12:41; Acts 26:13);
- III. A manifestation of power characterized by glory – glorious power, amazing might (Jn. 2:11; 11:40; Rom. 6:4);
- IV. To speak of something as being unusually fine and deserving honour – to praise, to glorify (Jn. 5:41, 44; 7:18; 12:43; Mt. 6:2; Lk. 17:18);
- V. Honour as an element in the assignment of status to a person – honour, respect, status (Jn. 4:44; 5:41, 44; 7:18; 12:43; Lk. 14:10);
- VI. A state of being great and wonderful – greatness, glory (Jn. 2:11; 7:18; 11:40; Mt. 4:8; Lk. 12:27);
- VII. A benevolent supernatural power deserving respect and honour – glorious power, wonderful being (2 Pet. 2:10);
- VIII. A place which is glorious and as such, a reference to heaven –

¹⁷⁸ According to Bauer (2000:256-258), the category with the greatest use of occurrences is by far the first – δόξα as "radiance." Furthermore, Bauer subdivides the use of δόξα as "radiance" as follows: first, a literal reference to "light" of physical phenomena, including everything in heaven and in the sky, second, the radiance of human involvement in transcendent circumstances and beings, third, the state of being in the next life is thus described as participation in the radiance or glory, and fourth, a reflection of divine glory.

¹⁷⁹ Jn. 5:41, 44(x2); 7:18; 8:50, 54; 9:24; 11:4; 12:43(x2);

¹⁸⁰ Praise (Mt. 6:2; Lk. 17:18); honour (Mt. 6:2; 15:4; Jn. 5:23; 8:54); glorify (Jn. 17:5).

glory, heaven (1 Tim. 3:16); IX. The reason or basis for legitimate pride – pride (2 Cor. 7:4); X. A formula used in placing someone under oath to tell the truth – promise before God to tell the truth, swear to tell the truth (Jn. 9:24); XI. Sublime glory, majestic glory (2 Pet. 1:17).

In considering the meaning which should be attached to δόξα in the various passages where it occurs in the New Testament it must be remembered that the meaning of the word δόξα is based on the underlying Hebrew concept it is used to translate in the Septuagint. Besides conveying the concept of power and δόξα it is also used as an expression of the divine mode of being.

Kittel (1974:247-248) says that, as in the Septuagint, the various meanings of δόξα in the New Testament, 'divine honour,' 'divine splendour,' 'divine power' and 'visible divine radiance' flow into one another in such a way that they can only be artificially separated.¹⁸¹ These expressions all point to the divine mode of being. However, at times the visible manifestation receives little or no emphasis, while at other times it is strongly emphasized. In contrast to Kittel, Brockington (1967:3-8) classifies four ways in which δόξα is used in the New Testament and which may be said to be directly due to corresponding usage in the Septuagint. First, there is the concept of brightness.¹⁸² This was present in Hebrew usage, not so much in the etymological significance of the word *דְּבָרִים*; as in its use in describing theophanies.¹⁸³ In the New Testament the light of God's δόξα is often associated with Jesus Christ as the saviour of mankind (Heb. 1:3; 2 Cor. 4:6). A rapid glance over the passages already mentioned will show that the New Testament, like the Septuagint, does not use δόξα merely to convey the idea of the brightness of God's presence but also as a word representing a larger whole of which the major element is that of the salvation of men. The second concept is that of the power and wonder-working activity of God. This is the use of δόξα and cognate words in the Septuagint to express the power and activity of God, especially as displayed in His 'wonderful acts' on behalf of His people. Some of the evidence here is to be found in the use of the adjective *ἐνδοξος* and the verb *δοξάζω*.¹⁸⁴ The saving power of God is the third concept.¹⁸⁵ In this respect the New Testament continues the emphasis

¹⁸¹ Kittel (1974:237) says that even a cursory survey of the position of δόξα in the New Testament reveals a totally different picture. In the New Testament, δόξα meanings are 'repute, honour (Lk. 14:10; 1 Cor. 11:15; 1 Thess. 2:6, 20; Eph. 3:13; Phil. 3:19),' 'radiance, glory (Mt. 4:8; cf. Lk. 4:6; Mt. 6:29; Lk. 12:27; Rev. 21:24, 26; 1 Pet. 1:24; 1 Cor. 15:40)' and 'reflection (1 Cor. 11:7)' in the sense of image.

¹⁸² Ex. 34:29 (LXX). Cf. Lk. 2:9; Acts 22:11. Ezek. 43:2 (LXX). Cf. Rev. 18:1; 21:23.

¹⁸³ The LXX emphasis on the radiance of God's presence may be seen in the narrative of Exodus (Moses face). But it is in the LXX of Isaiah that this trait emerges clearly (Isa. 2:10, 19, 21; 4:2; 30:27; 40:5; 58:8; 60:1).

¹⁸⁴ Ex. 15:1, 11, 21; Deut. 10:21; 28:59; Job 5:9; 9:10; Isa. 12:4; 48:9 (LXX). Cf. Lk. 2:20; 5:25, 26; 13:13, 17; 17:15; 18:43; 23:47; Acts 3:13; 4:21; 11:18; 13:48; 21:20; Rom. 3:23; 6:4. Cf. Mt. 9:8; 15:31; Mk. 2:12; Jn. 2:11; 11:4, 40; 17:2, 4, 22.

¹⁸⁵ Isa. 40:5 (LXX); cf. Rom. 8:30; 9:23. Lk. 2:14; 19:38.

already made by the Septuagint, namely that the *δόξα* of God includes the salvation of men, particularly the salvation of Israel. In the New Testament this is virtually put the other way round. Fourth, is the concept of God-likeness. According to Brockington (1967:7), there are a few places in the Septuagint where the word *δόξα* seems to bear the meaning of 'form' or 'image.'¹⁸⁶ Several New Testament passages need to be reconsidered in the light of the possibility that, as in these four passages in the Septuagint, *δόξα* may mean 'image,' or 'likeness' (1 Cor. 11:7; Rom. 1:23; 2 Cor. 8:23). Therefore, we should be aware of the relationship of the New Testament and the Septuagint and in particular how the Septuagint has influenced New Testament usage of *δόξα*. This influence on the use of *δόξα* may readily be shown by reference to the various Septuagint passages, in which *δόξα* occurs, quoted in the New Testament.¹⁸⁷

Δόξα has clearly come to denote something sacred, it has come to be used as a biblical concept for the intrinsic majesty of God.¹⁸⁸ It is owing to this almost exclusive use of *δόξα* in this way that lead to its becoming the technical term for *δόξα Θεοῦ*. It is with regard to this concept that the New Testament usage closely follows the pattern of Jewish thought. For instance, God is "the God of *δόξα*,"¹⁸⁹ "the Father of *δόξα*,"¹⁹⁰ "the majestic *δόξα*."¹⁹¹ The expression "the *δόξα* of God"¹⁹² is used frequently, and the power of God is mentioned along with His *δόξα*.¹⁹³

The New Testament usage takes a further decisive step in the development of the meaning of *δόξα* in so far as it links the word to Christ as well as to God. We find that the relationship of God and Christ can be expressed in many ways, and the whole dynamism of the relationship is reflected in the use of *δόξα*. *Δόξα* in the sense of God's glory is also applied to Christ: He is the outshining of the divine *δόξα*.¹⁹⁴ It is also revealed in His *σημεῖον*,¹⁹⁵ and at His transfiguration,¹⁹⁶ which is the hour of dedication to death. In the Fourth Gospel, this death is essentially the hour of His *δόξα*.¹⁹⁷ Also the resurrection and ascension are seen as manifestations of the *δόξα* of God

¹⁸⁶ Num. 12:8; Ps. 16:15 (LXX). Cf. 1 Cor. 11:7; Rom. 1:23 (Jer. 2:11; Ps. 105:20 LXX); Rom. 9:4; 2 Cor. 8:23. Jn. 1:14; 17:5, 22, 24.

¹⁸⁷ 1 Pet. 1:24; cf. Isa. 40:8; 2 Thess. 1:9; cf. Isa. 2:10, 19, 21; Jn. 9:24; cf. Jos. 7:19; Rom. 1:23; cf. Jer. 2:11 & Ps. 106:20; Ps. 62:3 LXX cf. Mt. 6:13 & 24:30 & Mk. 13:26 & Lk. 21:27 & Rev. 4:11 & 7:12 & 15:8; Dan. 7:14; cf. Lk. 4:6; & Jn. 17:2, 22, 24.

¹⁸⁸ But we find that only in a few instances is it used in its profane sense of honour, fame (1 Thess. 2:20; Jn. 5:41), magnificence (Mt.4:8; 6:29) or splendour (1 Cor. 15:40-41), and never once does it mean 'opinion.'

¹⁸⁹ Acts 7:2.

¹⁹⁰ Eph. 1:17.

¹⁹¹ 2 Pet. 1:17.

¹⁹² Mt. 16:27; Acts 7:55; Rom. 1:23; 6:4; Eph. 3:16; 1 Tim. 1:11; Rev. 15:8.

¹⁹³ Col. 1:11; 2 Thess. 1:9; Rev. 19:1.

¹⁹⁴ Heb. 1:3.

¹⁹⁵ Jn. 2:11.

¹⁹⁶ Mt. 17:1-8; Mk. 9:2-8; Lk. 9:28-36.

¹⁹⁷ Jn. 7:39; 12:23-28, 41; 13:31; 17:5; cf. Heb. 2:9.

in Christ.¹⁹⁸ But above all it is revealed in its fullness at the παρουσία.¹⁹⁹ In the light of the above, the comments of Brockington (1945:24) may be relevant here.

The glory of Christ is identified with the glory of God. This identification is so fully made that John speaks of Isaiah as having seen the glory of Christ, and the Epistle to the Hebrews speaks of Christ as the 'effulgence of his glory'... Of much greater significance, however, than the identification of the glory of Jesus with that of God is the experience of being participators in that glory. No longer is it the privilege of the few, and of Moses in particular, to be allowed to see God in His majesty.

Of particular interest is the connection of suffering with δόξα. Jesus the incarnate Son of God, must enter into His δόξα by suffering and death, as He Himself had with such difficulty taught His disciples.²⁰⁰ It seems that John especially stresses that the hour of Jesus Christ's crucifixion is the 'hour' of His glorification.²⁰¹ Also, Peter speaks of the suffering of Jesus Christ and the δόξα that should follow.²⁰²

Furthermore when we consider the doxologies in the New Testament, we find that they assume a more definite form and do not add anything to God that he does not already possess.²⁰³ They are recognition of praise of that which already exists.²⁰⁴ This is also true of the expression "to give glory to God (δόξαν τῷ θεῷ)."²⁰⁵ Also, the New Testament doxologies are in the indicative, they state a truth. In this respect they are closely related to those of the Old Testament. We find that in these passages δόξα is contextually coordinated with other nouns used in the veneration of God in the New Testament; 'honour (τιμὴ),'²⁰⁶ 'power (δύναμις),'²⁰⁷ 'might (κράτος),'²⁰⁸ 'blessing (εὐλογία),'²⁰⁹ 'thanksgiving (εὐχαριστία),'²¹⁰ 'wisdom (σοφία),'²¹¹ 'strength (ἰσχύς),'²¹² 'salvation (σωτηρία),'²¹³ 'praise (ἑπαινος),'²¹⁴ and 'riches (πλοῦτος).'²¹⁵ Similarly when θεός or its semantic

¹⁹⁸ Lk. 24:26; Acts 3:13; 7:55; Rom. 6:4; 1 Tim. 3:16; 1 Pet. 1:21.

¹⁹⁹ Mt. 16:27 par. Mk. 8:38, Lk. 9:26; Mt. 24:30 par. Mk. 13:26, Lk. 21:27; Tit. 2:13; 1 Pet. 4:13.

²⁰⁰ Mk. 8:31; 9:12; 10:32-45; Lk. 12:50.

²⁰¹ Jn. 7:30; 12:16, 23, 27; 17:1, 5.

²⁰² 1 Pet. 1:11, 21.

²⁰³ See Vermeulen (1956:17).

²⁰⁴ Lk. 2:14; 19:38; Rom. 11:36; 16:27; Eph. 3:21; Phil. 4:20; 1 Tim. 1:17; Rev. 4:9; 7:12.

²⁰⁵ Acts 12:23; Rom. 4:20; Rev. 11:13; 14:7; 16:9; 19:7.

²⁰⁶ 1 Pet. 1:7; Rev. 4:9, 11; 5:12, 13; 7:12.

²⁰⁷ Rev. 4:11; 5:12; 7:12; 19:1.

²⁰⁸ 1 Pet. 4:11; Rev 1:6; 5:13.

²⁰⁹ Rev. 5:12, 13; 7:12.

²¹⁰ Rev. 4:9; 7:12.

²¹¹ Rev. 5:12; 7:12.

²¹² Rev. 5:12; 7:12.

²¹³ Rev. 19:1.

²¹⁴ 1 Pet. 1:7.

equivalent is the object of the verb $\delta\omicron\zeta\acute{\alpha}\zeta\omega$ or when its semantic equivalent is the subject of a verb in the passive voice, then $\delta\omicron\zeta\acute{\alpha}\zeta\omega$ without fail means to 'praise,' 'worship' or 'venerate': 'glorify God' or 'God be glorified.'²¹⁶ Therefore, we can say that the real intention of a New Testament doxology is the recognition of God's power and sanctity.

Ramsey's (1949:28) note, on this, defines the $\delta\acute{o}\xi\alpha$ of Christ, as follows.

In so far as $\delta\acute{o}\xi\alpha$ means the power and character of God, the key to that power and character is found in what God has done in the events of the Gospel. Hence new possibilities of language emerge: such is the place of Jesus Christ in relation to the divine glory that it is possible to speak of the glory of Christ, and by those words to mean no less than the glory of God Himself. It follows that the word $\delta\acute{o}\xi\alpha$ both reflects and expresses the pattern of the apostolic faith. This faith has as its groundwork the glory of God in creation, in nature and in the history of Israel; it has as its centre the glory of God in the birth, life, death and exaltation of Jesus, and as its goal the participation of mankind and of all creation in the eschatological glory of the Messiah. Creation, redemption, eschatology form a single pattern; and to separate them is to render each of them unintelligible and to distort the theology of the apostolic age.

In all these nuances of meaning $\delta\acute{o}\xi\alpha$ still implies something concrete, even in the New Testament, though here it indicates an extra-terrestrial and extra-sensory reality rather than one perceptible to human senses. $\Delta\acute{o}\xi\alpha$ comprises the elements of power and glory and honour.

In typical Hebrew theological thinking, $\delta\acute{o}\xi\alpha$ is equivalent to דְּבָרָה and related terms of the Old Testament scriptures. Their concepts and meanings, rather than the classical concept of opinion, would therefore be foremost in the minds of all the New Testament authors and, when writing the Fourth Gospel, John would have used $\delta\acute{o}\xi\alpha$ within this semantic range.

2.7. Concluding Summary

The methodology described in chapter 1 was used to determine the potential meanings of the Hebrew word דְּבָרָה as it occurred in the Hebrew bible. The same technique was used in examining the meaning and use of $\delta\acute{o}\xi\alpha$ and related terms, such as $\tau\iota\mu\eta$ in contemporary Greek literature and in the Fourth Gospel and other writings by John. The use of $\delta\acute{o}\xi\alpha$ to translate the

²¹⁵ Rev. 5:12.

²¹⁶ Acts 4:21; 11:18; 13:48; 21:20; 1 Pet. 2:12; 4:11, 16; Rev. 15:4; 18:7.

Hebrew כבוד in the LXX was reviewed and the most probable intended meaning determined by direct comparison of the relevant with the Hebrew bible and LXX passages.

The original meaning of כבוד in the Hebrew bible was that of weight and so it could be used in respect of the honour or prestige that might be given to men. When used in this way it could be intended to mean dignity of character, the outward tokens of wealth, the splendour of the person's appearance, his reputation or the esteem in which he is held. In the Hebrew Scriptures it has a special meaning where it is used in conjunction with הוֹדוּת (glory of God, הוֹדוּת כבוד) as a technical term for God's manifest presence. The term כבוד is also frequently used in the sense of majesty, splendour, honour, glorify and adorn. However the concept of $\delta\acute{o}\xi\alpha$ goes beyond this and includes the thought that the $\delta\acute{o}\xi\alpha$ of God will be displayed in the consummation of His purposes. These purposes include the fulfilment of His promises to Israel and the ultimate blessing of all nations.

The writings of Philo and Josephus were selected as being adequately representative of Greek literature of the early Christian era contemporary with the Johannine Christian community. Philo's writings are an important example of Hellenistic Judaism and provide insights as to the extra-biblical use of $\delta\acute{o}\xi\alpha$ and $\tau\iota\mu\acute{\eta}$. In his writings $\delta\acute{o}\xi\alpha$ is used in the sense of opinion, notion (of God), the creed or doctrine of pagan beliefs, the honour or glory which is bestowed on man and also the honour (glory) due to God. He uses $\tau\iota\mu\acute{\eta}$ in the sense of dignity, value or price. Josephus follows the customary contemporary Greek usage of $\delta\acute{o}\xi\alpha$ in the sense of opinion, the honour or glory that applies to man, especially to prominent people. He also uses $\tau\iota\mu\acute{\eta}$ in this context.

When the translation of the Hebrew Scriptures into Greek was undertaken the translators were faced with the question of how to adequately translate the Hebrew word כבוד and related terms giving them their full significance and conveying all their wealth of meaning, into Greek. When the Alexandrian Hebrew scholars decided to use the Greek word $\delta\acute{o}\xi\alpha$ as the correct translation for there Hebrew terms כבוד . They gave the word a whole new range of meanings. Instead of the concept of thought and opinion, to which belong all the subjectivity and all the uncertainties of human thought and conjecture, the word became an expression of the objective divine reality and assumed the meaning of the כבוד of the Old Testament. From that point on the meaning of $\delta\acute{o}\xi\alpha$, within the Greek version of the Hebrew Scriptures came to mean to the not the usual

Greek thought of opinion or honour but the term was now imbued with all the significance of the Hebrew concept of דָּבָרָא.

The meaning of δόξα within Hebrew religious thought would thus lose the concept of opinion and take on the rich concept of דָּבָרָא and related words. These nuances would dominate the use of δόξα within the Hebrew religious context and this concept would be carried over into New Testament usage.

As just noted, in Greek usage δόξα is overlap in the דָּבָרָא and related terms (רָאָה, רָחַם, דָּחַ, etc.) of the Hebrew Bible. This meaning of δόξα would have been foremost in the minds of all the New Testament authors and when writing the Fourth Gospel, John would have used δόξα within this semantic range.

The forgoing survey thus provides a broad linguistic and literary ecology against which to relate John's specific use of the term δόξα and, in so doing, provide a basis for determining – as far as possible – John's intention when using the term δόξα in the Fourth Gospel and his known other writings.

CHAPTER 3. AN OVERVIEW OF ΔΟΞΑ IN THE FOURTH GOSPEL

3.1. Introduction

This chapter explores the various ways in which John uses the term δόξα in the Fourth Gospel. The understanding of δόξα so gained will be used in analysing the concept of glory in relation to the events of the cross. It therefore, deals with the literary and exegetical treatment of the theme “δόξα of Christ” in the Fourth Gospel. It analyses John's use of δόξα in the Fourth Gospel in general and then specially δόξα in relation to Jesus' death. Related words (glorified, δοξάζω) themes, and emphases are also considered. Also use of δόξα in the Fourth Gospel will be analysed using an inductive approach rather than one based on a word study or deductive reasoning.

Lloyd (1932:546) states that ζωή, φῶς, and ἀλήθεια are the key words of the Fourth Gospel. To them we should add “δόξα,” which is used again and again and, towards the end of the gospel, with an increasing frequency. In the latter part of the Fourth Gospel it has a special significance giving us insights and a deeper understanding of Johannine Christology.

Scott (1966:267-268) commented upon the “history of the word δόξα” as follows.

The history of the word δόξα in the Bible has still to be written. When it is written it will probably be found that, like many other Scriptural expressions, it starts from a conception which is physical or material, something which appeals to the senses, and ends as a conception which is predominantly ethical in character. ‘We beheld his glory, full of grace and truth’ (Jn. 1:14). The word owes its significance in many passages of the New Testament to the fact that ... it stands to the Jewish conception of the Shekinah, ... which can be seen though He Himself is not visible, and which marks the place of His dwelling.

Scott’s comments that the history of δόξα in the Bible is still to be fully written are challenging and, as set out in the introduction to this thesis, the intention is to examine the significance of δόξα in New Testament book where its frequent use gives rise to a greater understanding of both its history and meaning.

The themes selected for detailed examination were chosen on the basis of their importance in the life and ministry of Jesus and their pivotal role in leading to a fuller understanding of the concept of δόξα as used in the Fourth Gospel.

3.2. Δόξα (Δοξάζω) in the Fourth Gospel

3.2.1. Lexical meaning of δόξα (δοξάζω) in the Fourth Gospel

In order to establish the Lexical meaning of ‘δόξα’ and ‘δοξάζω’ in the New Testament three prime lexicons were consulted, Kittel, Bauer and Thayer. Kittel

(1974, 2:233-247) asserts that the usage of $\delta\acute{o}\xi\alpha$ in the New Testament usually follows the LXX, where the meanings of $\delta\acute{o}\xi\alpha$ include divine honour, divine splendour, divine power, and visible divine radiance. These meanings are derived from customary, contemporary, Greek usage and the meanings of קְבוֹד and other Hebrew words (פָּאָר , קִבְּר , עֲרֹךְ , יָקָר) signifying glory, greatness, power, majesty, splendour, praise, exaltation, beauty, brightness, form and semblance which, in the LXX, are translated by the Greek word $\delta\acute{o}\xi\alpha$.

God's power is a manifestation of God's nature, and the honour people give to God is an acknowledgement of this nature. The emphasis on God's power, God's saving activity, Godlikeness, and brightness in the LXX is also found in the New Testament. The range of concepts of ' $\delta\acute{o}\xi\alpha$ ' and ' $\delta\omicron\acute{o}\xi\acute{\alpha}\zeta\omega$ ' as used in the Fourth Gospel, however, is somewhat different from that in the New Testament in general, being less broad, since the Fourth Gospel has a distinct and particular focus on the theme of revelation. Bultmann (1971:429) comments that "the glory which God received through the work of the Son in truth consists in the fact that God became manifest" (cf. 17:4, 6)." Also, Carson (1991:406) considers that the $\delta\acute{o}\xi\alpha$ of God in the Fourth Gospel more often than not refers, not to the praise that people ought to give him, but to the revelation of His being and nature.

Bauer (2000:257-258) gives the following concepts of ' $\delta\acute{o}\xi\alpha$ ' as found in the Fourth Gospel:

- I. The condition of being bright or shining, brightness, splendour, radiance (a distinctive aspect of the Hebrew קְבוֹד) especially of God's self (Jn. 12:41 [Isa 6:1]).
 - i. The concept has been widened to denote the sublime glory and majesty, of God in general; power, might (Jn. 2:11; 11:4, 40) and the $\delta\acute{o}\xi\alpha$ of God transferred to Christ (Jn. 1:14; 2:11).
 - ii. The state of being in the next life is described as participation in the radiance or glory - referring to Christ's pre-existence (Jn. 17:5, 22, 24).

II. Honour as enhancement or recognition of status or performance, fame, recognition, renown, honour, prestige (Jn. 5:41, 44^a; 8:54 [= make high claims for myself]; 12:43^a [cf. 8:50]); of enhancement of divine prestige as an objective (Jn. 7:18); Lazarus' illness redounds to God's honour (Jn. 11:4); of divine approbation of persons (Jn. 5:44^b; 12:43^b); as an adjuration - Δὸς δόξαν τῷ θεῷ· give God praise by telling the truth (9:24).

He also (2000:258) gives the following concepts for 'δοξάζω' in the Fourth Gospel: to cause to have splendid greatness, clothe in splendour, glorify, of the glory that comes in the next life (Jn. 7:39; 12:16, 23, 28; 13:31, 32; 17:1, 5, 10). It is a favourite term in the Fourth Gospel, in which the whole life of Jesus is depicted as a glorifying of the Son by the Father (Jn. 8:54; 12:28; 13:31; 17:1, 4), and at the same time, of the Father by the Son (Jn. 13:31f; 14:13; 17:1). The glorifying of the Son is brought about by the miracles (Jn. 11:4), through the working of the Paraclete (Jn. 16:14), and through 'His own' (Jn. 17:10), who also glorify the Father (Jn. 15:8), especially in martyrdom (Jn. 21:19).

Although some of the Fourth Gospel's usages of δόξα imply 'brightness, splendour, radiance' (the first category),²¹⁷ they may also be interpreted from the perspective of the third category (honour, reputation, renown). Instead of the noun δόξα, δοξάζω, with the meaning specified by Bauer (2000:256-258) in his second category (glorify), is frequently used in the Fourth Gospel.²¹⁸

According to Thayer's lexicon (1914:155-156), in the Fourth Gospel 'δόξα' can be used for the following meanings:

I . In the sacred writings always, good opinion concerning one, and as resulting from that, praise, honour, glory (Jn. 5:41, 44; 7:18; 8:50, 54; 9:24; 11:4; 12:43);

II . As a translation of the Hebrew כְּבוֹד (splendour, brightness) -

²¹⁷ Jn. 1:14; 2:11; 11:40; 12:41; 17:5, 22, 24.

²¹⁸ Jn. 7:39; 12:16, 23, 28; 8:54; 11:4; 12:28; 13:31, 32; 14:13; 15:8; 16:14; 17:1, 4, 5, 10; 21:19.

i . the majesty of God as exhibited in deeds of power (Jn. 11:40), the absolutely perfect inward or personal excellence of Christ (Jn. 1:14; 12:41), of which majesty he gave tokens in the miracles he performed (Jn. 2:11; cf. Jn. 11:40). ii. a most glorious condition, most exalted state - of that condition with God the Father in heaven to which Christ was raised after he had achieved his work on earth (Jn. 17:5, 22, 24).

Also, Thayer lists (1914:157) the following concepts for 'δοξάζω' in the Fourth Gospel:

I . To praise, extol, magnify, celebrate, to glorify Himself (Jn. 8:54);

II . To honour, do honour to, hold in honour, to undergo death for the honour of God (Jn. 21:19);

III. To make glorious, adorn with lustre, clothe with splendour -
i . to cause the dignity and worth of some person or thing to become manifest and acknowledged: Christ, the Son of God (Jn. 8:54; 11:4; 16:14; 17:10); God the Father (Jn. 13:31f; 14:13; 15:8; 17:1, 4; 12:28). ii. to exalt to a glorious rank or condition - of God exalting, or rather restoring, Christ His Son to a state of glory in heaven (Jn. 7:39; 12:16(23); 13:31f; 17:1, 5).

From the foregoing it is clear that there are many perceived nuances to the meaning of $\delta\acute{o}\xi\alpha$ in the Fourth Gospel. These depend on the context within which the term is used but the overarching concept is that of the revelation or manifestation of God's being, nature, power and authority.

3.2.2. The concepts of $\delta\acute{o}\xi\alpha$ ($\delta\omicron\acute{\xi}\acute{\alpha}\zeta\omega$) in the Fourth Gospel

While the Synoptic Gospels speak more of Jesus' earthly existence, the Fourth Gospel views the whole of Jesus' incarnate life as one continuous

demonstration of His δόξα.²¹⁹ Having said this, references to His δόξα are not lacking elsewhere such as in Lk. 9:28-36, and in Paul's view, which emphasizes the power and glory of the risen Jesus Christ. Instead, the Fourth Gospel insists that Christ's δόξα was already being revealed while He was here on earth.²²⁰ Thus we find that John makes striking use of the words δόξα and δοξάζω in the Fourth Gospel.

The use of δόξα in the Fourth Gospel reflects certain peculiarities. In this Gospel Jesus' δόξα is always associated with God's δόξα.²²¹ This agrees with the Jewish usage, where "glory (Hebrew *dhbk*; Aramaic *arqy*, Greek δόξα)" is especially characteristic of God. Brown (1978:34) comments that "In the OT the glory of God implies a visible and powerful manifestation of God to men." In the Targums, 'glory' also became a surrogate, like *memra* and *shekinah*, for the visible presence of God among men. He (1978:503) states that God's δόξα "is a visible manifestation of His majesty in acts of power." Both these elements, the manifestation of God to men and the demonstration of divine power, are present in Jesus. Thus Brown says that "He (Jesus) represents the visible divine presence exercising itself in mighty acts."²²²

In the case of the Fourth Gospel, we find that the divine power or honour as a "divine mode of being" is prominent in the concept of δόξα.²²³ Cook (1984:292)

²¹⁹ See Morris (2000:17-18).

²²⁰ John says, "And the Word became flesh, and dwelt among us, and we saw His glory, glory as of the only begotten from the Father, full of grace and truth" (Jn. 1:14).

²²¹ See Barrett (1978:166); Carson (1991:128).

²²² Schnackenburg's (1984, 2:402) view is that, "Jesus' δόξα in the Fourth Gospel is that 'John has created a linguistic instrument which brings under a particular concept the whole of Jesus' saving work, as it continues and is completed in the action of Christ with God through the Spirit, in the disciples.' Moreover, he comments on the concept of δόξα as follows, 'The concept of 'glorification' thus subsumes the saving revelation of Jesus Christ, which takes place symbolically in His works and with full effect in His lifting up, under the concept of the revelation of God's δόξα,'" comes short of this accurate focus.

²²³ Pamment (1973:12) interprets the meaning of δόξα in terms of "selfless generosity and love" rather than "power." She notes that, "in the Fourth Gospel, God's δόξα is manifested in the suffering and death of the Son of man on the cross. The forceful effecting of salvation through God's power, pictured in the Old Testament, is replaced in John by the effecting of God's salvation through the Son of man's voluntary self-surrender: the gift of God's Son." Pamment seems to interpret δόξα in the Fourth Gospel using a similar approach to that of Paul who puts an emphasis on the fact that Jesus "emptied Himself, taking the form of a bond-servant, and

underlines the thought that “in the Johannine literature, with but few exceptions it (the main aspect of δόξα’s meaning) is used predominantly of the glory of God or the glory of Christ.” His note is correct as far as the primary meanings of δόξα are concerned, but he comes short of explaining why John uses the term in this fashion, and what sort of social milieu this fashion reflects.

Unlike the other New Testament writers, John’s usage of δόξα makes it stand out. He presents the term in an apparently distinctive fashion. Hegermann (1990:347) explains the peculiarities of its use as follows:

In contrast to Paul the consistent view of the pre-existence of δόξα is distinctive. Just as God’s δόξα is prior to all created existence, so also is the δόξα of the Son, who was always “with God” (Jn. 17:5; cf. 1:1f.). At death He returns to the δόξα “with the Father” (17:5), but on earth He never departs from the δόξα of the Father, for the Father is always “with Him” (16:32; cf. 5:17). In His revelation in the world the glory as of the only begotten from the Father (1:14) is characteristic of him. The Father gives Him a share of His δόξα in love (1:18; 3:35; 5:20; 17:24).

Hegermann’s explanation is quite satisfactory as far as the δόξα of Jesus is concerned. What has not yet been recognized by him is John’s notion of the δόξα of the Johannine Christian community.

We find on the one side reference to the visible δόξα, wholly in the sense of the Hebrew *dhbK*: (Jn. 12:41; cf. Jn. 12:16, 23, 28), on the other, δόξα is used in the sense of the human honour or glory which is sometimes given by men and sometimes by God (Jn. 12:43; cf. Jn. 5:41, 44; 7:18; 8:50, 54).²²⁴ Also, John speaks of the connection between dying and the fruit-bearing of the seed.

being made in the likeness of men ... He humbled Himself by becoming obedient to the point of death, even death on a cross” (Phil. 2:7-8), whereas John’s emphasis is on the inherent δόξα that Jesus retained and manifested in His the fleshy life.

²²⁴ See Kittel (1974, 2:248).

According to Jn. 13:31, Jesus' δόξα arises out of His death while, at the same time, His suffering is a proceeding by which God is glorified.²²⁵

The following are briefly some thoughts on the use of δόξα in the Fourth Gospel. They are not based on a word study or deductive reasoning but rather on an inductive approach.²²⁶

The first reference to glory in the Gospel is in 1:14. "And the Word became flesh, and dwelt among us, and we beheld His glory, glory as of the only begotten of the Father, full of grace and truth." This could be a general reference to all the recorded manifestations of the Lord's δόξα but may also be a more specific reference to the transfiguration referred to in Mt. 17:1-8. Peter certainly considers this event with to be the manifestation of the Lord's δόξα and τιμή – 2 Pet. 1:17-18. Morris (2000:17-18), however, suggests that in the Gospel, John wants to show that "δόξα" is evident in the whole early life of Jesus and is not just manifested in one brief episode.²²⁷

In chapter 2 John records the first of the specific "σημεῖα" or miracles he selected for inclusion in his record in order to support his declared purpose in writing "but these have been written that you may believe that Jesus is the Son of God; and that believing you may have life in His name" (20:31). The σημεῖον, turning water to wine, was directed towards His disciples and His mother. As such it demonstrated His authority and ability to His immediate intimate circle.

²²⁵ See Nixon (1974:472). Kittel (1974:249) posits as follows. "The turning-point, the entry into δόξα is the cross, the dying of the corn of wheat (12:23ff.). This emphasis is itself Johannine to the extent that John has a particularly strong sense of the causal connection between dying and bringing forth fruit, or between the death and the resurrection of Jesus, between the suffering and the glorification of the Son of Man. The δόξα derives from His death. At the same time, what Jesus does in His passion is a process through which ὁ θεὸς ἐδοξάσθη ἐν αὐτῷ (13:31). It is acknowledgment of the divine δόξα in the sense already mentioned, and it carries with it certainty of participation in the same δόξα: ὁ θεὸς δοξάσει ἐν αὐτῷ (v. 32). In this sense to have regard to the passion is to see δόξα even in the earthly life of Jesus."

²²⁶ In these comments the term "Gospel" is to be taken as the Gospel of John. Quotations are from the NASB.

²²⁷ Morris (2000:17) says that "it would be intelligible if John had included the transfiguration story with its revelation of Jesus' glory (δόξα), ... for all his (John) emphasis on glory (δόξα), omits it."

The references to δόξα in 7:18 and 8:50 are not pertinent to these comments as they do not specifically apply to a manifestation of the Lord's δόξα though they clearly emphasize that all the Lord Jesus Christ does is, ultimately, for the δόξα of His Father. As we later learn, His Father in turn glorified (δοξάζω) Jesus.

Jn. 7:39 indicates that the Lord was to be glorified (δοξάζω) at some time in the future. This was to be after the Spirit was given. From our standpoint this means after the event recorded in Jn. 22:22 where Jesus “breathed on them and said to them “Receive the Holy Spirit” and the later outpouring of the Holy Spirit at Pentecost. Another reference to a future glorification is found in 12:16 where we are told that the disciples missed the importance of the crowd's reaction to Jesus' entrance to Jerusalem and that they only came to comprehend its significance once He had been glorified (δοξάζω). This appears to refer to His ascension.

The next use of δόξα in the gospel is in 11:1-46 which is the well known record of the illness, death and resurrection of Lazarus. This event was for the “τῆς δόξης τοῦ θεοῦ, ἵνα δοξασθῇ ὁ υἱὸς τοῦ θεοῦ δι' αὐτῆς” (v. 4). Here Jesus' δόξα is demonstrated to His disciples, His friends (Mary, Martha and Lazarus) and the wider community in which His friends lived. Its fame reached to Caiaphas – the high priest – the chief priests and the Pharisees who, from then on, planned to kill Him.

In Jn. 12:23-33 the δόξα of Jesus Christ is manifested through the audible intervention of God before a crowd of people in response to the Lord's words regarding His impending death, verse 28, “Πάτερ, δόξασόν σου τὸ ὄνομα.” There came a voice out of heaven: “καὶ ἐδόξασα καὶ πάλιν δοξάσω.” This may be a reference to all the σημεῖα that Jesus had performed up to that point. Jn. 12:40 is a quotation from Isa. 6:10, “וְשִׁנְיָ הַשָּׁמַיְמָה בְּעֵינָיו וּבְאָזְנוֹ יִשְׁמַע וּלְבָבוֹ יִבְיֹן וְשָׁב וְרָפָא לוֹ:” (BHS);” “ἐπαχύνθη γὰρ ἡ καρδία τοῦ λαοῦ τούτου καὶ τοῖς ὠσίν αὐτῶν βαρέως ἤκουσαν καὶ τοὺς ὀφθαλμοὺς αὐτῶν ἐκάμμυσαν μήποτε ἴδωσιν τοῖς ὀφθαλμοῖς καὶ τοῖς ὠσίν ἀκούσωσιν καὶ τῇ καρδίᾳ συνῶσιν καὶ ἐπιστρέψωσιν

καὶ ἰάσομαι αὐτούς (LXX)” and verse 41 states “These things Isaiah said because he saw His δόξα, and he spoke of Him.” The record of Isaiah’s vision of the Lord is given in Isa. 6:1-13. The δόξα (דּוֹכָא) that Isaiah saw is not described in the same detail as Ezekiel does in the first three chapters of his prophecy but is clearly of the same magnificence. Therefore there appears to be a difference in the visible presentation of the δόξα of God (as far as human beings can perceive it) and the δόξα inherent in the σημεῖα, miracles and events recorded in the Fourth Gospel.

John goes on to record the last supper and Judas’ betrayal. As soon as Judas leaves the room Jesus says: “Ὅτε οὖν ἐξηλθεν, λέγει Ἰησοῦς· νῦν ἐδοξάσθη ὁ υἱὸς τοῦ ἀνθρώπου καὶ ὁ Θεὸς ἐδοξάσθη ἐν αὐτῷ· [εἰ ὁ Θεὸς ἐδοξάσθη ἐν αὐτῷ,] καὶ ὁ Θεὸς δοξάσει αὐτὸν ἐν αὐτῷ, καὶ εὐθὺς δοξάσει αὐτόν” (13:31-32). This whole incident seems to relate to the imminent supreme obedience of Christ to God’s plan of salvation through His atoning death on the cross. The Lord was irrevocably committed to enduring the death of the cross and, in so doing, bearing the penalty for sin due to man. By following this route He would glorify (δοξάζω) God - cause men and women of all ages to praise Him for His love and mercy. In doing so the Lord would also be glorified (δοξάζω) by the Father – evidenced by His resurrection, ascension and eternal δόξα in heaven.

Believers will in future glorify (δοξάζω) the Father in the Son (14:13) when they pray in line with God’s will and their prayers are answered. This puts great pressure on believers to ensure that they seek the leading of the Holy Spirit and the guidance of God in those things for which they pray.

Following Judas’ betrayal John records the prayer of the Lord in 17:1-26. A key element of this prayer is for the Father to glorify (δοξάζω) the Son so that the Son might glorify (δοξάζω) the Father. The reference is to His coming death and for a manifestation of the glory that Christ had with the Father “before the world was.” What was to follow in the lives of the disciples would indeed bring δόξα to God. This has been carried on through all the intervening ages. Where simple men

and women boys and girls believing in Christ have endured trials, martyrdom, scoffing and scorn without flinching and have “kept the faith” in spite of persecution – even to the death. As an example of this we have 21:19: “signifying by what kind of death he (Peter) would glorify God” (σημαίνων ποίῳ θανάτῳ δοξάσει τὸν Θεόν).

In summary δόξα in the Fourth Gospel is manifest in increasingly wider circles. First there is the manifestation of His δόξα to His intimate friends, His disciples and His mother by the first miracle. Then there is a widening of the evidence of His divinity by the signs and miracles performed in the community. These were of such a nature that to the unbiased mind there could be no doubt that Jesus was the Christ. However as the Gospel progresses there is an increasing emphasis on the fact that the δόξα of God and of Jesus Christ is not just in what is seen and done in the realm of the miraculous but rather in the obedience of the Lord to the will of the Father and His preparedness to “become sin” for believers. The death of Jesus Christ on the cross is therefore presented as being a victory opening up the way in which man can be reconciled to God, it reveals His climactic δόξα, to those who realise the full extent of what was achieved. It is the ultimate purpose of the Lord’s birth, life and witness and so reflects the δόξα of God in the One who died on the cross. The final cry of the Lord – “It is finished” brings into being the way back to God for fallen man and so brings δόξα to God and Christ. The penalty of sin has been met and Satan defeated.

3.3. Jesus’ Inherent Δόξα

Compared to general New Testament usage, Jesus’ δόξα in the Fourth Gospel is rather different in that we find more references to the glory (δόξα) of the Incarnate Word (Λόγος). This δόξα is manifested in the works and the words of Jesus’ ministry upon earth. This undoubtedly corresponds to the distinctive Johannine characteristic of describing the earthly life of Jesus from the standpoint of His exaltation.

In the prologue John explains the theological significance of the story he is about to recount. In this section he introduces numerous key themes that will recur throughout the Gospel: the pre-existence and divinity of Jesus, Jesus as the source of eternal life, Jesus as a fulfilment of an eschatological reality, Jesus as the climactic revelation of God, light versus darkness (vv. 4-5, 7-9), belief and unbelief (vv. 7, 12), God's glory and Christ's glorification (v. 14), grace and truth (vv. 14, 16-17), the rejection of the gospel by Israel, and the role of John the Baptist as a witness to Jesus.²²⁸

The main themes introduced in the prologue to the Fourth Gospel culminate in the concept of δόξα which is later developed in the body of the Gospel.²²⁹ These themes are, successively, the Word, life, light, witness, belief in the Word (Λόγος) and in "His name," incarnation and finally a revealed δόξα.²³⁰

3.3.1. Δόξα in the Johannine Prologue

The Word (Λόγος) is presented as being the Creator and the very embodiment of God. He is also presented as having inherent life and therefore being a light for men. This light shone in the darkness but was not comprehended.²³¹ John the Baptist is presented as being a witness to the nature of the "true" light and this is followed by a declaration that those who believe in the Word or true light have the right to become "children of God" (τέκνα Θεοῦ)²³² with all the implied privileges and responsibilities associated with this standing.

John, the writer of the Fourth Gospel, goes on to proclaim that this Word, this inherent life, this light, that God Himself, became flesh and dwelt amongst men. He further states that men, he and others, beheld the glory (δόξα) of the incarnate God.

²²⁸ See Blomberg (2001:71).

²²⁹ See Hooker (1974:55).

²³⁰ See Carson (1991:128-130).

²³¹ The Greek word is καταλαμβάνω and carries the thought of laying hold of or possessing for one's own.

²³² Jn. 1:12; 11:52.

In introducing the Fourth Gospel in this way John clearly establishes the theme of $\delta\acute{o}\xi\alpha$ as being one of the dominant concepts of this Gospel. This understanding is reinforced by the recurrent emphasis of Christ's $\delta\acute{o}\xi\alpha$ in this Gospel.

3.3.2. Literary aspects of Johannine Prologue

This section will briefly evaluate recent surveys of source and structural analyses of the prologue, and will then propose a thematic analysis of Jn. 1:14-18, based on an understanding of the literary structure of the Johannine prologue.

3.3.2.1. Proposed sources

According to Bultmann's (1971:14-18) analysis, the Johannine prologue has a literary character, which is that of a hymn, and that the hymn is a hymn of a community. That is to say that on the one hand, the original hymn was composed in a poetical style which used metaphorical terms, whereas, on the other hand the additional sections were written in prose.²³³

Bernard (1948:1) claims that the prologue to the Fourth Gospel is in the form of a hymn, whose theme is the Christian doctrine of the Logos, explanatory comments being added at various points. He (1948:cxliv) gives the basic criteria used for this type of literary analysis and which are applicable to all Biblical literary reconstructions. They are: I. in accordance with the character of Semitic poetry, the verse-lines must be short, roughly the same in length, and fall into parallel clauses; II. as the unit is a hymn, it must consist of statements, hence the argumentative verses (1:13, 17 and perhaps 18) are to be excluded; and III. as it is an abstract statement proper names (John, Moses, Jesus Christ) are to be excluded (i.e. 1:6-8, 15, 17).²³⁴

Schnackenburg (1984:224) accepts that the prologue is based on a song or

²³³ Bultmann (1971:17) claims that the Evangelist has made a cultic community hymn the basis for the prologue, and has developed it with his own comments.

²³⁴ See Brown (1978:21-23); referred to by Lindars (1982:80-81).

hymn which was used for the beginning of the Gospel.²³⁵ Haenchen (1984:127-130) argues that the original hymn was composed on the basis of an old myth of wisdom, and that this hymn was taken over by Judaism and put in the service of the Torah. Dodd (1998:292-296), as elsewhere in his study of the Fourth Gospel, takes the possibility of a Greek background into account. He uses both the word 'proem' and the word 'prologue.' Thus he (1998:292) indicates that "Chapter 1 forms a proem to the whole gospel. It falls into two parts: 1:1-18, commonly designated the Prologue, and 19-51, which we may, from the nature of its contents, conveniently call the Testimony."

Robinson (1963:120-129) believes that the Johannine prologue was written at a later stage than the composition of the Gospel, and therefore could not be held to have shaped and controlled what follows. Brown (1978:22-23) proposes that, based on recent redaction analyses, two additions have been incorporated into this hymn: I. The explanatory expansions of some of the lines of the hymn (1:12c-13, 17-18); II. The material pertaining to John the Baptist (1:6-9, 15). However, scholars' opinions differ as to the point where the original hymn should be located in the Johannine prologue.

At the opposite pole is Barrett (1971:26-28), who, on literary grounds, rejects the view that a poetic structure underlies the Johannine prologue. In his view there is no evidence here of Greek poetry, which was written in recognizable metres. Barrett argues that the Greek in the prologue is in prose rhythm, the content determining the length of the lines, and verses 1:6-8 are not to be distinguished as prose from the rest which is supposedly in verse.

We agree with Barrett's opinion regarding the analysis of the prologue, even though his point cannot be systematically tested. That is, the Johannine prologue 'is not a jig-saw puzzle but one piece of solid theological writing,' and that it is 'as necessary to the gospel, as the Gospel is necessary to the prologue.'

²³⁵ Schnackenburg (1984, 1:225-226) gives the following reasons: I. The differences between the poetical sentences and the prose elements (1:6-8, 12, 13, 15, 17); II. The breaks and sudden switches of structure and the movement of thought (1:6-8, 15); III. The stylistic differences; and IV. The terminological and conceptual differences (e.g. ὁ λόγος σκῆνω ἴδιος).

The history explicates the theology, and the theology interprets the history.²³⁶

3.3.2.2. Structure analysis

Culpepper (1998:116) points out the single chiastic structure of the Johannine prologue.²³⁷

1-2	18	The Word with God
3	17	What came through the Word
4-5	16	What was received from the Word
6-8	15	John announces the Word
9-10	14	The Word enters the world
11	13	The Word and His own people
12a	12c	The Word is accepted
12b		The Word's gift to those who accepted Him (children of God, τέκνα Θεοῦ)

He argues that the pivot of the Johannine prologue is the conferring of the status “children of God” on those who believed in Jesus. He defines their status and identity as being the true community of the children of God. But even so he does not succeed in linking all the sections of this chiastic structure of the Johannine prologue in the same convincing way.

Furthermore, some scholars insist that the prologue presents two different scenes at the same time. Masanobu (2002:186) says that it seems possible to assume that it is a literary device as shown below:

The Witness of John the Baptist in John 1:1-18

- A: The Logos statement (1-5)
- B: The Baptist's Witness (6-8)
- A: The Logos (the Son) statement (9-14)
- B: The Baptist's Witness (15)
- A: The Son statement (16-18)

Based on her structural understanding of the prologue, Hooker (1969/1970:355-

²³⁶ See Barrett (1971:27-28).

²³⁷ Another scholar Schmithals (1979:31, 41-42) finds a symmetrical parallel correspondence between two clearly defined sections namely verses 1:1-13 and verses 1:14-18 (Masanobu 2002:191). In his analysis he sees the following correspondences: verses 1:1-5 parallel verse 1:14; verses 1:6-8 parallel verse 1:15; verses 1:9-11 parallel verse 1:16; verse 1:12^{ab} parallels verse 1:17; verses 1:12^c-13 parallel verse 18. This symmetric parallelism is based on agreements in content, but is problematic, especially because his structure does not pay enough attention to syntactical cohesion of the text.

357) argues that references to John the Baptist occur as the turning-point of the context:

A: The Logos in relation to God; active in creation; as life which is light (1:1-5)

B: Reference to John the Baptist (1:6-8)

C: The Light lightens men; but the world [created by Him] did not accept Him; those who did were made children of God through Him (1:9-13)

A': The incarnate Logos – His glory, full of grace and truth (1:14)

B': Reference to John the Baptist (1:15)

C': Men have received of His fullness, and grace and truth have come through Him; God, whom no one has seen, has been made known through Him (1:16-18)

Verses 1:6-8 are intended to focus on the event of the coming of light, by making a clear distinction between true light and the witness to it.²³⁸ In verse 1:15 reference to John the Baptist's words is designed to remind the readers of the divine identity of the incarnated Λόγος (the pre-existence of the Son (πρωτός μου ἦν)).²³⁹ Van der watt (1995:319-320) rightly comments that the historical-critical interpreter might have interpreted the structural break between verses 1:5 and 1:6, because verses 1:1-5 focus on the period between creation and incarnation, while the evangelical interpreter might have seen it as an indication of a shift in emphasis or as an indication of a dramatic event which is about to start.²⁴⁰ Barrett (1971:22-27) also emphasizes the important theological function of the witness of John the Baptist.

The prologue contains a theological evaluation of the historical figure of the Baptist; it places the narrative that is to follow in the setting in which it can be understood. This means that the 'Baptist' verses were not an afterthought, thrown in to injure the rival Baptist group, but part of a serious, connected, thought-out, theological purpose.

It is therefore apparent that the function of the witness of John the Baptist is

²³⁸ See van der Watt (1995:319-326).

²³⁹ See van der Watt (1995:327).

²⁴⁰ Van der watt (1995:319) indicates that it might be that with this structural break, the author wants to emphasize the beginning of an important next period within the history of salvation.

very important in the Johannine prologue because his witness is to the coming of the true light and the Word (Λόγος) of God.

3.3.2.3. Thematic analysis

We now deal with a thematic analysis of Jn. 1:14-18. At this point John focuses on the incarnation in which Jesus completely took on our human nature but without the taint of sin. These verses show the Son as the incarnate Λόγος.

- I The Logos was shining in a pre-existent stage (Jn. 1:5).
- ↓
- II The Logos as the true Light was coming to His world (Jn. 1:9).
- ↓
- III The Logos dwelt in the world as the Son of God (Jn. 1:14).

This passage indicates that the Logos, which was pre-existent with God (1:1-2) and created the world (1:3, 10-11), historically came into the world (1:9) and dwelt among the people (1:14).

Also, the coming of the Logos (the Son) is described as a fulfilment of the eschatological reality of the dwelling of God amongst men. The reality of the restoration of God's people (children of God, τέκνα Θεοῦ), is, in the Hebrew prophetic scriptures, often linked to the reality that God will dwell in the midst of His people: "I will dwell () among the children of Israel, and will be their God. And they shall know that I am the Lord their God" (Ex. 29:45-46); "So shall ye know that I am the Lord your God dwelling in Zion" (Joel 3:17); "For behold I am coming and I will dwell in your midst declares the Lord. Many nations will join themselves to the Lord in that day and will become My people" (Zech. 2:10-11). "My dwelling place also will be with them; and I will be their God, and they will be My people" (Ezek. 37:27). Interestingly, the verb σκηνώω, occurs only five times in the New Testament (once in John, four times in Rev.); Rev. 7:15 and 21:3 mention the dwelling of God in the midst of His people in the end time.

Finally, verses 17^b-18 reveal one of the roles of the Son as the Revelation of God. The prologue mentions the revelation of glory (1:14^b), of grace and truth'

(1:14^c; 16-17), and the name through which the restoration of God’s people is made (1:12). Bruce (1983:42) comments that the glory seen in the incarnate Word was the glory which was revealed to Moses, and that it has been manifested on earth as the fullness of grace and truth.

Van der Watt (1995:326-329) indicates that in this passage (Jn. 1:14-18) there is a thematic parallelistic progress. He points out that in Jn. 1:14-18 the focus centres on important historical figures and their relationship to divine qualities which became an eschatological reality through the revelatory actions of Jesus Christ.

Thematic Parallelistic Progress in 1:14-18

Historical events and figures	Jesus’ incarnation	John the Baptist’s testimony	the Law through Moses	Jesus’ true presence (pre-existence)
	Jn. 1:14	Jn. 1:15-16	Jn. 1:17	Jn. 1:18
Divine qualities	grace, truth, divine glory	Jesus’ grace and truth	grace and truth	To make known God (revelation)

Actually, it seems that the focus of this passage is on the divine dimensions and implications of Jesus as the revealer (Λόγος).

Carson (1991:112) points out that the suggestion that the prologue, though written by the Evangelist, was composed later than the rest of Fourth Gospel is realistic, but speculative. The following parallels between this passage in the prologue and the rest of the book immediately stand out, although there are many others of a more subtle nature.

P R O	Beheld His glory (εθεωρούμεθα)	The only begotten (μονογενοῦς) (1:14)	The truth through Jesus Christ (ἡ	No one has seen God, the only
-------------	--------------------------------	---------------------------------------	-----------------------------------	-------------------------------

L O G U E	τὴν δόξαν αὐτοῦ) (1:14)	The only begotten Son (ὁ μονογενὴς Υἱός) (1:18)	ἀλήθεια διὰ Ἰησοῦ Χριστοῦ) (1:17)	begotten Son (θεὸν οὐδέ τις ἑώρακεν πώποτε ἄμωγενῆς Υἱός) (1:18)
	Seeing His glory	The 'one and Only' Son	Truth in Jesus Christ	No one has seen God, except the One
G O S P E L	Saw His glory (εἶδεν τὴν δόξαν) (12:41)	Only begotten Son (Υἱόν αὐτοῦ τὸν μονογενῆ) (3:16)	I am the truth (Ἐγώ εἰμι ἡ ἀλήθεια) (14:6)	No one has seen the Father except the One (οὐχ ὅτι τὸν Πατέρα ἑώρακεν) (6:46)

Furthermore, according to Carson, verses 14 and 18, deal with the revelation of the Father through the ministry of the Son. In the Johannine prologue, the δόξα of the Son, as of the only Son from the Father (δόξαν ὡς μονογενοῦς παρὰ Πατρός) was witnessed by believers, and the only Son of God (ὁ μονογενῆς Υἱός) was said to have revealed the Father.

In the rest of the Fourth Gospel, we find that the ministry of the Son carries out the work of the Father on earth (5:19, 20, 30; 6:38; 8:29; 10:32). He is always doing the Father's work (5:17-20; 8:16), and the Father is working in the Son (5:22, 27, 36; 8:28; 12:49; 17:4), the Son's work reveals the Father (14:10; 15:24). Also, the earthly ministry of the Son was to reveal the Father's δόξα (11:40). Christ's works revealed His δόξα (2:11), and through them the Father was also glorified (11:4, 40; 13:31, 32). The Fourth Gospel proclaims that Christ's δόξα had been climactically revealed at the cross and through His exaltation (7:39; 12:16, 23, 28; 13:31-32; 17:1), and that this glorification was not only of the Son, but also of the Father (13:31-32; 17:1, 4).

In conclusion some commentators regard the Johannine prologue as a hymn or poem which has been taken over by the author of the Fourth Gospel, and have thought that this section was originally separate, perhaps being composed by

someone other than the Evangelist.²⁴¹ The references to John the Baptist in verses 1:6-8 and 1:15, are generally regarded as interpolations but there is a considerable variety of opinion.²⁴² These commentators see the prologue as having no real connection with the Gospel, but as being adapted more or less successfully to its present situation. Interestingly, Barrett (1962:125-126) rightly points to the lack of agreement among those who seek to remove the ‘interpolations’ as an indication that the original poetic structure which they are attempting to recover never in fact existed. Furthermore, “the whole passage shows, on careful exegesis, a marked internal unity, and also a distinct unity of theme and subject-matter with the remainder of the gospel.” Therefore, the Johannine prologue stands before us as a prose introduction which was specially written to introduce the gospel and is not a modified hymn or later insertion.

3.3.3. Exegetical perspective on Jn. 1:14-18

<p>14 Καὶ ὁ λόγος σὰρξ ἐγένετο καὶ ἐσκήνωσεν ἐν ἡμῖν, καὶ ἐθεασάμεθα τὴν δόξαν αὐτοῦ, δόξαν ὡς μονογενοῦς παρὰ πατρός, πλήρης χάριτος καὶ ἀληθείας.</p>

The Gospel of John speaks of Christ’s δόξα as already being revealed while he was here on earth. Jn. 1:14 is a specially important passage in connection with the exegesis of this section, “The Word (Λόγος) became flesh and tabernacled (evskh,nwsen) among us (pitched his tent), and we beheld His δόξαν (cf. Ex. 40:34f.), the δόξαν as of the only begotten of the Father, full of grace and truth.” This passage indicates the pre-incarnate glory of Christ and affirms that it is of one piece with the incarnate δόξα of Christ. The divine glory of Jesus was manifest in His obedience to the Father and in all He did and said. On account

²⁴¹ Brown (1978:1) describes it as “An early Christian hymn, probably stemming from Johannine circles, which has been adopted to serve as an overture to the Gospel narrative of the career of the incarnate Word.”

²⁴² See Brown (1978:21-23).

of this Jesus could say, “He who has seen Me has seen the Father” (Jn. 14:9).²⁴³

We agree with Ramsay (1949:57-58) that Jn. 1:14 cannot be separated from Jn. 1:1 any more than it can be separated from the glory (δόξα) of the cross and the resurrection. According to Jn. 1:1, 14, 18 we know that the manifestation of the δόξα of the Son of God is the climax of the activity of the Word (Λόγος) who was in the beginning with God. However, in the beginning was Jesus Christ and Jesus Christ was the Word (Λόγος). Ridderbos (1966:191) defines it neatly when he says: “Jesus Christ is, in essence, the subject of the Prologue, the Logos the predicate. And not the reverse.”

With reference to “And the Word became flesh (καὶ ὁ Λόγος σὰρξ ἐγένετο),” du Toit (1968:15) points out that the Word “Λόγος” is used here again for the first time since verse 1 and preceded by a significant καὶ.

Ἐν ἀρχῇ ἦν ὁ Λόγος Καὶ ὁ λόγος ἦν πρὸς τὸν Θεόν Καὶ Θεὸς ἦν ὁ Λόγος (1:1)	Καὶ ὁ Λόγος σὰρξ ἐγένετο Καὶ ἐσκήνωσεν ἐν ἡμῖν (1:14)
---	---

Because of this du Toit is convinced that the Johannine prologue should be divided into two sections, in verse 1 the divinity of the Λόγος stands at the focal point, in verse 14 His incarnation. He therefore identifies verses 1 and 14 as the respective focal points in the Johannine prologue.

Λόγος is a Greek word having many meanings, most of which can be summarized under the two headings; that of inward thought, and that of the outward expression of thought in speech. It seems that in a theistic system it could therefore naturally be used in an account of God’s self-revelation. Also, Λόγος is naturally a very frequent word in the Greek translation of the Hebrew scripture; here, special attention may be drawn to two categories of usage. In the first the word of God is creative

²⁴³ Alan Richardson (1961:65) says that the Fourth Gospel “regards the whole of Christ’s incarnate life as an embodiment of the δόξα of God, though the glory is revealed only to believing disciples and not unto the world.”

(cf. Gen. 1:3, 6, 9; Ps. 33(32):6, “by the word of the Lord (בְּדִבְרֵי יְהוָה) the heavens were made, (τῶ λόγῳ τοῦ κυρίου οἱ οὐρανοὶ ἐστερεώθησαν, LXX).” In the second, the word of the Lord is the prophet’s message, that is, the means by which God communicates His purpose to His people (cf. Jer. 1:4, “Now the word of the Lord came to me, (καὶ ἐγένετο λόγος Κυρίου πρὸς με λέγων, LXX; cf. Ezek. 1:3; Amos 3:1). In all the passages the word is not abstract concept but is spoken and active. Actually, in the Johannine prologue, both creation and revelation are in mind, and the rest of the gospel encourages us to suppose that the influence of the Hebrew scripture may be found here.²⁴⁴ Flesh (Σὰρξ) here is a form of metonymy, indicating the full humanity (cf. Ps. 145:21; Jer. 32:27) which the divine Logos assumes, humanity in the totality of all that is essential to manhood.²⁴⁵ In contrast to σωμα, which indicates the body only, the word σὰρξ defines the whole human being in Christ’s earthly existence as a bodily and spiritual entity. It represents human nature as distinct from God. This being so Käsemann (1968:65, 76-77) is certainly wrong to regard John as docetic. John specially refers to the enfleshment, and the verb indicates the enfleshment of his whole being, not a temporary or partial adoption of it as an envelope or covering (cf. 4:6; 18:37). Keener (2003:408) comments that “σὰρξ” depicts Christ’s humanity and His solidarity with all humanity; it is valueless in itself for perceiving truth (3:6; 6:63; 8:15), but it is only in His flesh – His sharing of human mortality – that people may be saved (6:51, 53, 54, 55, 56). It seems that ἐγένετο cannot simply mean “became,” since the Word continues to be the subject of further statements – it was the Word who “dwelt among us,” and whose glory “we beheld;” the Word continued to be the Word. Du Toit (1968:15-16) maintains that the verb “bridges the enormous distance between the divine Logos and the “σὰρξ,” that it “states the solid, the ‘crude’ fact of the incarnation,” and that it “entirely cuts off the possibility of any docetic misinterpretation.” The combination of the verb ἐγένετο and the noun σὰρξ points irresistibly to a genuine incarnation, Jesus really became man and accepted all the limitations and

²⁴⁴ See Barrett (1963:127-128).

²⁴⁵ See Vine (1956:107-108).

suffering and experiences that that involves.²⁴⁶ Also, John indicated that this passage is the supreme revelation. Carson (1991:127) comments that even the revelation of antecedent Scripture cannot match this revelation, as the Epistle to the Hebrew also affirms in strikingly similar terms: “God, after He spoke long ago to the fathers in the prophets in many portions and in many ways, in these last days has spoken to us in His Son, whom He appointed heir of all things, through whom also He made the world” (Heb. 1:1-2).

In “And dwelt (tabernacled) among us” (καὶ ἐσκήνωσεν ἐν ἡμῖν), the verb used σκηνοῶ could mean simply ‘to dwell’ or ‘to live,’ and it seems that the word σκηνοῶ was chosen here with special reference to the word δόξα. This is demonstrated in the following passages: the Hebrew verb יָשַׁב is used of the dwelling of God with Israel (Ex. 25:8; 29:46; Zech. 2:14), and a derived noun (שְׁכִינָה) is used for the name of God Himself. Further, the cloud settled down upon the tabernacle (Ex. 24:16; 40:35), and since it was the visible manifestation of the presence of God, the abiding presence of God suggested His glory (δῶκ; δόξα).²⁴⁷ The word “tabernacled” (σκηνοῶ) has rich connotations for the reader of the Old Testament.²⁴⁸ Here it seems that John has in mind the Tent of Meeting during the wilderness sojourn with the *Shekinah* presence of God filling the tabernacle (Ex. 40:34). The tent, with the glory of God as a bright cloud filling and covering it, was the visible symbol of God’s abiding presence. Ezekiel saw the “glory of God” or this luminous *Shekinah*, leave the temple of Solomon because of the sins of the people, the visible evidence that God had left His people to their own destruction (Ezek. 10:18, 19; 11:23). The climax of the

²⁴⁶ Du Toit (1968:18) rightly comments as follows:

The incarnation means, according to verse 14, that the divine Logos substituted His heavenly way of existence for the frail, broken, earthly, human way of existence. This human existence of the Word is not to be understood in a docetic way, a mere being “in the flesh,” but as a becoming flesh,” and yet without sacrificing His essential being as Logos.

²⁴⁷ See Barrett (1962:138); Brown (1978:32-35).

²⁴⁸ Marshall (1902:488-489) notes that “the word *Shekinah* is used very often in the Jewish Targums... The conception of *Shekinah* the appears in Greek dress under the word δόξα. In several instances δόξα is used of deity or a manifestation-form of deity, and thus shows itself to be the equivalent of *Shekinah*... In the New Testament there are several instances in which δόξα is used as more or less the equivalent of *Shekinah*.” See Brown (1978:32-33); Carson (1991:127-128).

drama of redemption is seen in Rev. 21:3, “Behold, the tabernacle of God is among men ...” Also, the Johannine Christian community probably understood this as the ideal, eschatological state (Rev. 7:15; 21:3; cf. Heb. 8:2). His dwelling “among us” (ἐν ἡμῖν), most probably refers to those who, like the evangelist, were eye-witnesses of Jesus’ life. It could also possibly be the experience of a believing Christian community that can further claim to have gazed upon His glory (τὴν δόξαν αὐτοῦ).²⁴⁹

In “We beheld His glory” (καὶ ἑθεασάμεθα τὴν δόξαν αὐτοῦ), the reference to the glory of the Word (Λόγος) should also be seen against the background of the tabernacle (Ex. 40:34), which is filled with the $\delta\omega\beta\kappa$ of God. Ridderbos (1966:194) rightly points out that the incarnation of the Word (Λόγος) in verse 1:14 is not the concealment of the δόξα in the flesh, but rather in fact its revelation. This “we” should not be misunderstood, because it is the same “we” as that of 1 John 1:1, where the purport of it becomes still clearer: “What was from the beginning, what we have heard, what we have seen with our eyes, what we have looked at and touched with our hands, concerning the Word (Λόγος) of life.” It is not simply the “we” of the believers, or the “we” of the ecclesia.²⁵⁰ For not all who believe, or will believe, have also seen. It seems that “we” means John and his fellow disciples. In “we beheld,” John uses the past tense, it was in the ministry, the loving service and sacrifice of Jesus, in which “we” beheld His glory. Furthermore, John will have had in mind the δόξα of the Christ which the witnesses saw in the signs He gave (2:11), in His being lifted up on the cross (19:35), and in the Easter resurrection (20:24-29). “His δόξα,” John asserts, is thus dependent upon both His essential relation with God and His obedience.

In the phrase “The glory as of the only begotten of the Father” (δόξαν ὡς μονογενοῦς παρὰ Πατρός), the term ‘only begotten (μονογενής)’ is used in John only

²⁴⁹ See Ridderbos (1966:195; 1997:51-52); Du Toit (1971:17).

²⁵⁰ Barrett (1978:143) says that it should mean ‘we, the church,’ ‘we Christians’: “we beheld the glory of Christ when he abode with us.” cf. Ridderbos (1997:51-52). Haenchen (1980:119) says that the “we” that praises His deed is a Christian community.

of Christ (Jn. 1:18; 3:16, 18; 1 Jn. 4:9) to indicate uniqueness. The term does not refer to birth (γεννάω) but to uniqueness of kind (γένος).²⁵¹ Verses 1:1 and 1:2 describe the relationship between “the Word” and “God,” but this relationship is later described as being between “Son” and “Father.” These terms are those which Jesus uses throughout to narrative to speak of the relationship that exists between Himself and God. The δόξα in this passage, which is seen in the Son, is the glory of the Father, yet is uniquely the Son’s. It is the δόξα, that the Son had with the Father before all time (17:5) and is unknown and unknowable to the human situation unless revealed by God (1:18). John states that what the human story of Jesus reveals of the divine, is seen in the incarnation of the Word, the only Son sent from the Father to reveal Him to us.

When dealing with the phrase “full of grace and truth” (πλήρης χάριτος καὶ Ἀληθείας), in verse 1:14 it should be noted that the phrase should be considered in relation to verses 1:16 and 1:17. Taken in the context of the Hebrew of Ex. 34:6 (הַחַסֵּד וְהַרְחִמֵנוּ), we find that the δόξα which Christ manifests is full of grace (χάρις) and truth (ἀλήθεια). Χάρις only occurs three times in the Fourth Gospel, all in the prologue, and can mean outward grace, as when we say that someone is well or ill favoured. It can also mean an inward grace or graciousness or kindness on the part of the doer and gratitude on the part of the receiver. Here, in verse 1:14, it signifies God’s free kindness towards us and, reciprocally, our free gratitude towards Him. Ἀλήθεια occurs twenty-five times in John’s Gospel, and is of obvious importance for the author who uses it to affirm that God really is revealed in Jesus.²⁵² Thus, according to its components,²⁵³ truth means to be unconcealed or not-hidden. We would suggest that the word “full” (πλήρης) probably indicates an abundance of grace and truth. When God revealed His character at Sinai, the revelation was incomplete; Moses saw only part of God’s δόξα (Ex. 33:20-23). But what was an incomplete revelation through Moses was completed through the revelation of His abundant grace and truth in Christ (1:17).²⁵⁴ Therefore, when John says that full

²⁵¹ See Keener (203:412-413).

²⁵² See Bernard (1948:25-26); Schnackenburg (1984, 2:225-237).

²⁵³ Mensch (1992:50) says that this noun closely related to this is ἀληθής. It is ἀ (not) + ληθω (λανθάνω, hidden or conceal).

²⁵⁴ See Keener (2003:417).

of grace and truth are the δόξα, he is asserting that the unconcealed reality of God which shines through His presence in the flesh is His free kindness or good will towards us. It should be noted that this term (full of grace and truth) is connected with verses 16 and 17.

As far as δόξα is concerned, the glory that Jesus reveals is referred to at the outset in Jn. 1:14. The δόξα as of the only begotten of the Father (δόξαν ὡς μονογενοῦς παρὰ Πατρός) speaks of the unique revelation of the Father's δόξα in Jesus. The next clause, full of grace and truth (πλήρης χάριτος καὶ ἀληθείας), indicates the nature of this δόξα, that it, 'δόξα, is full of grace and truth.' Alternatively it may taken as 'His δόξα, He who was full of grace and truth.'²⁵⁵

John introduces his readers to the incarnation with a statement regarding Christ's δόξα (Jn. 1:14), which was to some degree dimmed by His being in flesh (Jn. 17:5). While it was not perceived as δόξα at all by some to whom He came because of the cloud of moral darkness that surrounded them (Jn. 1:5, 9-11; 12:40-41), it was both seen and recognized for what it really was by others (Jn. 1:14). Furthermore, this δόξα was not only observable but also shareable (Jn. 17:22).²⁵⁶

According to verse 15, John the Baptist refers to the pre-existence of Jesus (1:1-2) as Christ's superiority, while verse 18 dwells on the pre-existent relationship between Jesus and God. Also, this functional description of John the Baptist is consistent with the thoughts expressed in 1:19-34.

In verse 1:16, the fullness (plenitude, πλήρωμα), the full measure of all the Christ's divine powers and graces which were concentrated absolutely in Jesus, was revealed in the incarnate Word. The term πλήρωμα occurs only here in John's writings; but it is found five times in the two Epistles of Paul to the Colossians and Ephesians (Col. 1:19; 2:9; Eph. 1:23; 3:19; 4:13).

²⁵⁵ Painter (1975:58) comments that Jn. 1:14 is a crux verse. Thus John first states that the glory was seen ("we beheld [aorist tense]", not "we now see"), he then indicates the origin of the glory (the Father whose glory is expressed in His unique Son) and finally expounds the character of glory ("full of grace and truth").

²⁵⁶ See Cook (1984:294-295).

Referring to verse 1:17, deSilva (1999:75) points out that Jesus' special honour (δόξα) is underscored by the comparison with Moses. He insists that, not only is Jesus "full of grace," but also He is "full of truth," that is, reliable knowledge upon which true evaluations of honour and dishonour can be made. Considerable emphasis is placed throughout the Fourth Gospel on the superior knowledge Jesus brings and on the ignorance and error of those who do not receive His revelation of truth.

Verse 1:18 has associations with Exodus. The phrase "No one has ever seen God" has in view not only deliverers of the Old Testament generally, but most especially Moses. Beasley-Murray (1987:15) comments that he witnessed the theophany at Sinai, but his request to look directly on the δόξα of God ("καὶ λέγει δειξόν μοι τὴν σεαυτοῦ δόξαν" Ex. 33:18, LXX) was denied. The term ἐξηγήσατο in Jn. 1:18 is related to the English term "exegesis." It seems that ἐξηγήσατο is peculiarly authoritative by virtue of the unity of the Son with God, expressed in the phrase "who is in the bosom of the Father," that is, in closest fellowship with him (cf. 13:23). Actually, this passage means that the δόξα, grace, and truth of the invisible God is now being manifested in Christ.

The Logos became Incarnate, not as a momentary Epiphany of the Divine, but as an abiding and visible manifestation of the Christ's divine δόξα, even as the Son reveals the Father (1:14). Thus does the incarnate Word reveal the invisible God (1:18).

3.3.4. Theological perspective on Jn. 1:14-18

It seems that in any case Jn. 1:14 and 2:11 indicate that this δόξα, carefully introduced in respect of the divine Logos-Son relationship to a Father, who is the God of the Jews, is clearly visible to all from the beginning, and there is here nothing corresponding to the messianic secret of Mark's Gospel.²⁵⁷ Jn. 1:14 could be a general reference to all the recorded manifestations of the Lord's δόξα but may also be a more specific reference to the transfiguration referred to

²⁵⁷ See Hooker (1974:40-58).

in Mt. 17:1-8. Peter certainly considers this event to be the manifestation of the Lord's δόξα (2 Pet. 1:17-18). This is a revelation of the δόξα of the Lord in a physical way that could be seen and, to a limited extent, comprehended and appreciated by the selected disciples. It is a manifestation of His δόξα to an intimate select group of men who were commissioned to report on the event after "the Son of Man is risen from the dead."

According to 1:14 and 1:17, it follows that, in John's theological view, the Word is the manifestation of God; whenever God has been described as appearing in Israel's history, it has always been the Word (Λόγος) who appears. Consequently, far from disparaging or denying the reality of the revelation on Sinai, John regards it as a genuine revelation of God's character (δόξα) as full of grace and truth, but it is a revelation, as all revelation must be, mediated by Jesus Christ.

We find that the Johannine prologue is full of abundant Christological events with the Christological climax being recorded in verse 1:14. The Logos becomes flesh and "We have seen His glory, glory as the only begotten from the Father, full of grace and truth," in spite the fact that the Logos has assumed the ambiguity of fleshly existence. Δόξα is a biblical term for revelation. To see the δόξα of the enfleshed Logos is to perceive the true reality of the Logos. But since that δόξα is of the "only begotten" of the Father, they²⁵⁸ confess that, through the enfleshed Logos, they have seen the revelation of God themselves. It is that the δόξα is full of grace (χάρις) and truth (ἀλήθεια). Grace means that the revelation of God is a gift to the world, it has to be a gift, for the world cannot of itself know or perceive this glory. Truth is the reality of an entity, here, the reality is that of God Himself. Although there is no clear mention of the cross in the Johannine prologue, the passage, "grace and truth came through Jesus Christ" (1:17), may allude to the completion of the revelation of the Father's δόξα, that is the cross. Actually, if this is the case, then the Johannine prologue and the rest of the Fourth Gospel share an important motif of the Johannine Christology.

²⁵⁸ John and his fellow disciples.

According to Barrett (1962:138) Jn. 1:14 means no more than that the Logos took up a temporary dwelling; however, John links the Jewish eschatological hope to the reign of the Logos. In the passage there are several allusions to the narrative of the theophany in chapters 33 and 34 of Exodus.²⁵⁹

The Exodus Theophany	John 1:14-18
The glory of the Lord (δόξαν Κυρίου) filled the tabernacle (ἡ σκηνή), when God came down to the tent of meeting (Ex. 40:34-35)	They beheld the glory as the Son of God (δόξαν ὡς μονογενοῦς παρὰ Πατρός) when the Word (Λόγος) came and dwelt among the people (Jn. 1:14)
God declared that he was full of grace and truth (τὸ ἄω δόξα βρῶ) in the revelation (Ex. 34:6)	The Son was full of grace and truth (πλήρης χάπλήρης χάριτος καὶ ἀληθείας) (Jn. 1:14); out of his fullness (πληρώματος) believers received grace upon grace (χάριν ἀντί χάριτος) (Jn. 1:16)
The Law was given through Moses (Ex. 34:28)	Grace and truth (ἡ χάρις καὶ ἀλήθεια) came through Jesus Christ (Jn. 1:17)
Moses was allowed to see God, but partially (Ex. 33:20; cf. 33:11)	The only Son, who is in the bosom of the Father, he has made him known (Jn. 1:18)

As the people of Israel saw the glory of God (Ex. 40:34) and bore witness to His fullness of grace and truth in Exodus 34:6, they now saw Christ's do,xa (Jn. 1:14) and the fullness of grace and truth (Jn. 1:16) in the Logos, the Son of God. Christ's appearance is a climactic full revelation of the nature of God whom no one has ever seen (Jn. 1:18) and it is contrasted with Moses' wilderness experience where he was allowed a partial revelation of God (Ex. 33:20; cf. 33:11). Thus, the coming and the dwelling of the Son of God amongst men is, in this passage, depicted against the background of the epiphany of God in Mount Sinai.²⁶⁰

3.3.5. Summary and conclusion

The prologue to the Fourth Gospel starts: "In the beginning was the Word, and the Word was with God, and the Word was God. He was in the beginning with

²⁵⁹ See Hanson (1976/1977: 90-101). Cf. Bernard (1948:21) insists on Ps. 85:7-10 rather than Ex. 34 as the main scriptural inspiration behind Jn. 1:14-18. Collins (1990:198-209) indicates that Jn. 1:14 has an eschatological connotation.

²⁶⁰ Further see, The Son of God, Chapter 3.4.5.

God” (1:1-2). Later in verse 1:14 the author writes: “And the Word became flesh, and dwelt among us, and we saw His glory, glory as of the only begotten from the Father, full of grace and truth.” From this point on there are abundant references to God’s δόξα being manifest in Jesus Christ. These are seen in the signs He performed, the completion of the work God had given Him to do, the fulfilment of God’s promises of a Messiah and Jesus’ obedience in all things. While many writers see veiled references to the transfiguration in the Fourth Gospel, it seems that Morris’ view (2000:17-18), that direct reference to it is withheld so as to focus on the inherent δόξα in all the life of Jesus, is correct.

While this theme is strongly developed in the Fourth Gospel other New Testament writers also refer to Jesus’ δόξα notably Paul, Peter and the writer of Hebrews.²⁶¹ The theological perspective of the prologue is simply that Jesus is the Word and the Word is the visible manifestation of God.

Jn. 1:14 summarises the whole message of the Fourth Gospel – the δόξα of God, which is the δόξα of Christ, is manifest among men. In the first twelve chapters John presents δόξα as being, as it were, diffuse: manifest in sign and word; in the next nine chapters he presents δόξα as being focussed: concentrated in the keenness of a love that loved to the end.²⁶²

3.4. Relationship with the Father

3.4.1. Eternal Life (ζωή αἰώνιος)

²⁶¹ There have been a variety of suggestions relating to the composition of the prologue. Many scholars consider that it had its origin in a hymn that was adapted by the author of the Fourth Gospel who modified it by interspersing it with prose commentary. After a review of the various proposals the view in this thesis is that the prologue is a prose introduction which was specially crafted to introduce the Fourth Gospel and that it is not a modified hymn.

The closest conceptual parallels to the Johannine prologue in the New Testament (especially 1:14-18) are probably the so-called “Christological hymns,” for instance, Phil. 2:6-11, Col. 1:15-20, 1 Tim. 3:16, and Heb. 1:1-3. Phil. 2:6-11, is particularly important as a parallel because it contains a clear pattern of descent and ascent, God highly exalted Him and gave Him a name that was above every name, so that every creature should bow and confess that Jesus is Lord to the δόξα of God. This foregoing material is almost universally dated very early and is certainly referred to by widely scattered authors.

²⁶² See Brown (1978); Moloney (1998a).

Eternal life (ζωὴ αἰώνιος) is one of the major theological themes of the Fourth Gospel. It occurs 17 times in the Fourth Gospel, and 6 times in 1 John.²⁶³ Van der Watt (2000:203) commenting, on this, says quite definitely, “Eternal life (ζωὴ αἰώνιος) is of a divine quality and since death is something which breaks down and indeed ends the possibility of relating to the living God, death is not a possibility in the realm of eternal life.” When compared with the other Gospels, John gives “eternal life (ζωὴ αἰώνιος)” the prominence that they accord to “kingdom of God.”²⁶⁴

According to Jn. 6:57, God is the primary source of eternal life (ζωὴ αἰώνιος). Van der Watt (2000:205) says that the verse gives a description of how eternal life for mankind is derived from its prime source God.

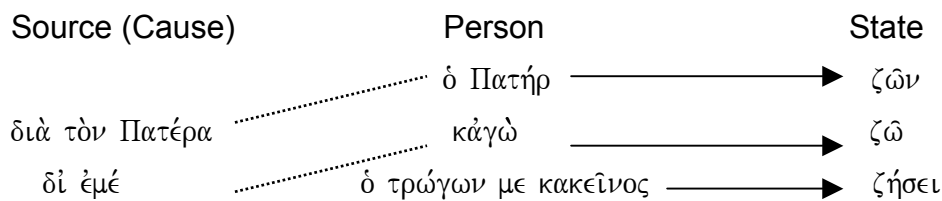

The structure of Jn. 6:57 shows that the Father is the origin of life, and gives it to Jesus, who in turn gives life to believers. Brown (1978:283) indicates that the relationship between the Father, His Son and those who believe in Him is expressed as a chain of the source of life. The diagram clearly shows that the Father and the Son have life in themselves (ζῶν, ζῶ) and that they are thus the source of preserving alive (ζήσει) those who come to them, giving to them a divine quality (eternal) of life. We may also conclude that the titles “Father” and “Son” are interchangeable with the terms “God” and “Jesus.”²⁶⁵ Jn. 3:16, reveals the ultimate purpose of God’s sending His only Son which is said to be: “that whoever believes in Him should not perish, but have eternal life” (ζωὴ αἰώνιος).

²⁶³ See Brown (1978:505-506). Ζωὴ and ζάω are found much less frequently in the Synoptic Gospels (ζωὴ: Mt. 7 times; Mk. 4 times; Lk. 5 times; ζάω: Mt. 6 times; Mk. 3 times; Lk. 9 times).

²⁶⁴ See Thompson (1992:380).

²⁶⁵ See van der Watt (2000:205-206).

In 10:22-42, Jesus contrasts the unbelieving Jews with His sheep which listen to His voice and follow Him (10:278; cf. 10:3-4), affirms that He gives them ζωὴ αἰώνιος (10:28) and declares: “I and the Father are one” (10:30) Jesus goes on and reproves the Jews urging them to “believe the works, that you may know and understand that the Father is in Me, and I in the Father” (10:38). These sayings of Jesus reveal His divine identity and unity with God. Interestingly, these passages seem to be similar to those of the parallel discourse in Jn. 5:17-38. In this passage the argument is that, because Jesus has a unique relationship with the Father (10:30, 38; cf. 5:26), does His works (10:32, 37-38; cf. 5:36), and gives eternal life (10:28; cf. 5:21) He must be the Son of God (10:36; cf. 5:17, 19-30).

Verses 12:49-50 reveal the relationship between eternal life (ζωὴ αἰώνιος) and the words which Jesus speaks at the command of the Father. Schnackenburg (1984, 2:424) points out that their central idea in the context of 12:49-50 may be expressed as: “The words which Jesus speaks at the Father’s command are a source of eternal life to those who accept them.”

Jesus describes eternal life in terms of knowing Him and the Father: “αὕτη δὲ ἐστὶν ἡ αἰώνιος ζωὴ ἵνα γινώσκωσιν σὲ τὸν μόνον ἀληθινὸν θεὸν καὶ ὃν ἀπέστειλας Ἰησοῦν Χριστόν” (17:3). This is the eternal life that the Father has authorized the Son to communicate to all men and women (17:2)

We may conclude that eternal life (ζωὴ αἰώνιος) in the Fourth Gospel means not only everlasting life as opposed to earthly life which ends with death but also a qualitatively new life through Jesus’ unity with God.²⁶⁶ Because of Jesus’ death and resurrection, the possession of eternal life is already a reality for those who believe in Him. The divine eternal life of the Father and the Son is shared by the believers here and now through the mediation of Jesus, the incarnate, divine

²⁶⁶ Dodd (1998:145-150) indicates that the Jewish idea of eternal life is “the life of the Age to come,” and that it is qualitatively as well as quantitatively different from this life. This phrase occurs occasionally in the Talmud (cf. IV Ezra 7:12-13; 8:52-54), with ‘death’ according to Jewish usage, as its antithesis.

Son.²⁶⁷ Mlakuzhyil (1987:298) points out that

The present possession of eternal life (ζωή αιώνιος) through an active faith in Jesus is insisted upon by the frequent repetition of ὁ πιστεύων (εἰς τὸν Υἱὸν / εἰς αὐτόν) ἔχῃ ζωὴν αἰώνιον (3:15, 16, 36; 5:24; 6:40, 47; 20:31). The Christocentric character of the eternal life (ζωή αιώνιος) of the believers is underscored also by presenting Jesus as the life (ἡ ζωὴ, 11:25; 14:6).

3.4.2. Sent by the Father²⁶⁸

The two verbs for send; 'ἀποστέλλω' and 'πέμπω' seem to be used synonymously in the Fourth Gospel.²⁶⁹ The former (ἀποστέλλω) suggests an official or authoritative sending whereas the latter (πέμπω) suggests a more general activity.²⁷⁰ The sending of the Son into the world by the Father is a constant theme of the Fourth Gospel. Beasley-Murray (1987:379) comments that verses 20:21 and 17:18 reflect in measure the principle of Jewish authorization "One who is sent is as he who sends him." In the person of the Son, in His words and deeds, the Father Himself is present, His words declared and His actions performed.

According to 10:36, Jesus is the One uniquely consecrated by the Father and sent by Him into the world to bring to the world the revelation of the Father and His saving sovereignty (cf. 17:18).

In 11:41-42 we find that the purpose of Jesus' prayer in the record of Lazarus' resurrection is that the people will believe that the Father sent Him. Moreover Jesus is not concerned to show people that He is a miracle worker, but rather to reveal through His miracles the δόξα of God (vv. 4, 40) active in Him. However

²⁶⁷ See Dodd (1998:144-150).

²⁶⁸ Jn. 6:57; 13:20; 16:5, 28, 30; 17:8, 18, 23, 25; 20:21.

²⁶⁹ See Barrett (1978:569).

²⁷⁰ When dealing with Christ's being sent by the Father; ἀποστέλλω is used in 3:17, 34; 5:36, 38; 6:29, 57; 7:29; 8:42; 10:36; 11:42; 17:3, 8, 18, 21, 23, 25. Whereas πέμπω is used in 4:34; 5:23f., 30, 37; 6:38f., 44; 7:16, 18, 28, 33; 8:16, 18, 26, 29; 9:4; 12:44f., 49; 13:20; 14:24; 15:21; 16:5.

this sign also revealed the δόξα of Jesus (v. 4^c).

Two different verbs (ἀπέσταλκέν, πέμπω) meaning 'send' occur in 20:21. It seems that the first ἀπέσταλκέν (perfect active), emphasizes completion of Christ's mission to earth together with its continuing effects; the second πέμπω (present active) emphasizes that the authoritative commission is now being given to the disciples, by the Son of God. In 20:21 Jesus speaks of their mission in immediate connection with His own mission from the Father, which is again related to the unity of the Father and the Son, a unity in which the disciples participate (cf. 17:21ff.). Ridderbos (1997:642) says that it is as if the Father in sending His Son continues to stand behind Him and to take part in His work (cf. 8:16, 29). The purpose of Jesus' being sent by the Father remains in force in the mission of His disciples (20:21) who continue His work on earth (cf. 14:12ff.).

From the prologue onwards John also accentuates the fact that Jesus was sent by the Father and that, as the sent One, He only sought to present the Father's δόξα and to do His will fully and completely. Further the prevalent Jewish concept of authorisation that the "one who is sent is as he who sends him" would endorse Jesus' authority and His claim to be equal with the Father. Ultimately, as the sent One, Jesus' purpose was to accomplish God's mission of revelation and salvation and to ensure the continuation of that mission through those who believe in Him.

We may conclude that Jesus' proclamation reiterates that He has been sent by the Father and that the origin of His message is in God. This is a constant theme of the Gospel from the prologue on (cf. 1:14-18; 3:31-36; 7:14-17; 8:26-29). Jesus is presented as having a wholly divine nature and whose purpose in coming to earth is to reveal God's δόξα.

3.4.3. Witness of the Father²⁷¹

In the context of Jesus' ministry, the most important witnesses to the veracity of

²⁷¹ Jn. 3:36-37; 7:16-18; 8:13; 12:49-50.

His teaching were the witness borne by the Father to Jesus' works and His own testimony.

According to 3:31-36, the testimony of the One from above (v. 31), derives from "what He has seen and heard" (v. 32). The language appears to include reminiscence of His pre-incarnate existence; yet such passages as 5:19-20, 30 speak of a continuous fellowship between Father and Son as the source of all Jesus' speech and action. Jesus bears witness to what God has given Him to say (3:34^a), and this the Son can do since the Father has given Him the Spirit without measure (3:34^b).

In Jn. 5:36 we find Jesus referring to the witness of the Father through the works (ἔργα) He was doing. Painter (1993:239-240) comments that the witness to which Jesus appeals are the works (τὰ ἔργα) which the Father has given Him to complete (τελειώσω; cf. 4:34; 17:4). Indirectly it is the witness of the Father because the works (τὰ ἔργα) done are those commissioned and authorized by the Father. According to 5:19-20, the works done by the Son are those which He sees the Father doing and, because the works of the Son are the works of the Father they bear witness "that the Father has sent Me" (ὅτι ὁ Πατήρ με ἀπέσταλκεν) in verse 5:36^d; cf. 14:11. In 5:37 Jesus appeals to the witness of the Father "And the Father who sent Me, He has testified of Me" (καὶ ὁ πέμψας με Πατήρ ἐκεῖνος μεμαρτύρηκεν περὶ ἐμοῦ).

In 7:16-17, Jesus says that His teaching comes from God and not from Himself. The same thought is implied in 5:30 and is stated explicitly in 8:28; 12:49; 14:10, 24. These references introduce the real source of Jesus' teaching and then show that His teaching is a work of witness to the Father.

According to 8:16-19, the Father who sent Jesus is present (v. 18; μαρτυρῶν, μαρτυρεῖ) with Him and confirms His witness (vv. 16-17). When challenged by the Jews to say where His Father was, Jesus replied that the refusal to acknowledge Him as the One sent by the Father, arose from their failure to

know the Father who sent Him (v. 19).²⁷²

3.4.4. Judgement given to the Son²⁷³

The Old Testament teaching is that on the last day God will raise the dead (cf. 1 Sam. 2:6; Deut. 32:39; Isa. 25:8; Wis. 16:13; 2 Ki. 5:7), and that at that time all men shall be judged (cf. Deut. 1:17) and this is referred to in Jn. 5:23. In 5:22 John records that Jesus says that God has handed over the office of judgement to the Son that the Son may receive equal honour (τιμάω) with the Father (5:23).²⁷⁴ It is by honouring the Son that we honour the Father. Verse 21 indicates that the Son exercises a sovereign power and δόξα in giving life (ὁ Υἱὸς οὓς θέλει ζωοποιεῖ), then “τὴν κρίσιν πᾶσαν δέδωκεν τῷ Υἱῷ” (v. 22) shows all authority (δόξα) to judge has been given to Him (cf. v. 27). Beasley-Murray (1987:76) points out that the inclusive language of verses 21-23 embraces resurrection (v. 21), judgement (κρίσιν, v. 22), and honour (τιμάω, v. 23) due to the Son, both in the present and in the future.²⁷⁵

“I do not seek My own will, but the will of Him who sent Me;” ὅτι οὐ ζητῶ τὸ θέλημα τὸ ἐμὸν ἀλλὰ τὸ θέλημα τοῦ πέμψαντός με (5:30^c), this verse indicates that the judgement of the Son is based upon His unity with the Father and His perfect knowledge of His Father’s thoughts and will (cf. 8:16). The action of the Son is based upon the perfect vision of His Father’s works (cf. 5:19).²⁷⁶ Jn. 5:30 specifically applicable to Jesus’ authority (δόξα) in judgement.

3.4.5. The Son of God (ὁ Υἱὸς τοῦ θεοῦ)

The full title ὁ Υἱὸς τοῦ θεοῦ is found 47 times in the New Testament, 9 of which occur in the Fourth Gospel.²⁷⁷ This is significant in comparison with the other

²⁷² See Painter (1993:299).

²⁷³ Jn. 5:19-23.

²⁷⁴ See Barrett (1978:260). Barrett states that a fundamental Jewish belief is ‘raising the dead’ and ‘judgement’ on the last day through God.

²⁷⁵ See Barrett (1978:260).

²⁷⁶ See Westcott (1890:88).

²⁷⁷ Jn. 1:34, 49; 3:18; 5:25; 10:36; 11:4, 27; 19:7; 20:31.

New Testament books,²⁷⁸ Jesus is called “the Son of God” (ὁ Υἱὸς τοῦ Θεοῦ), while Christians are called “children of God” (τέκνα Θεοῦ) in the Fourth Gospel. This distinction highlights the unique relationship of Jesus to the Father, which is further underscored by the Gospel’s designation of Jesus as “the only begotten Son.” In fact, it seems that the Father – Son relationship appears as one of the most constitutive and significant features in the Fourth Gospel. Moreover, John expressly states that the purpose of his Gospel is to confirm believers in the belief that “Jesus is the Christ, the Son of God” (20:31).

“And I have seen, and have borne witness that this is the Son of God” (1:34), here the Christological title “the Son of God” (ὁ Υἱὸς τοῦ Θεοῦ) seems to be the whole content of John the Baptist’s testimony to Jesus, since μεμαρτύρηκα in 1:34 forms a literary inclusion with ἡ μαρτυρία at 1:19, it is an assertion of the deity of the Messiah.²⁷⁹

In the first chapter of the Fourth Gospel four people, John the Baptist, Andrew, Philip and Nathanael, acknowledge, in different ways, that Jesus is the Messiah. Both John the Baptist and Nathanael use the phrase “ὁ Υἱὸς τοῦ Θεοῦ.” This phrase would have been understood in the Messianic sense by Nathanael, because he confesses the combination of “ὁ Υἱὸς τοῦ Θεοῦ” with “Βασιλεὺς εἶ τοῦ Ἰσραήλ.” Schnackenburg (1984, 1:306) comments that on the lips of John the Baptist (1:34), Nathanael (1:49) and Martha (11:27) the phrase would have the deeper “metaphysical” meaning of Sonship of God (cf. 20:31).

Jn. 3:18, Jesus refers to Himself as “the Son of God,” towards the end of His dialogue with Nicodemus. Since it is part of the full title “the only begotten Son of God” (τοῦ μονογενοῦς Υἱοῦ τοῦ Θεοῦ) and is immediately preceded both by “the only begotten Son” (τὸν Υἱὸν τὸν μονογενῆ) in 3:16 and by “the Son” (τὸν Υἱὸν)

²⁷⁸ The Son of God (ὁ Υἱὸς τοῦ Θεοῦ) applied to Jesus occurs only 47 times in the entire NT (Mt. 9 times; Mk. 4 times; Lk. 7 times; Jn. 9 times; Acts 2 times; Rom. once; 2 Cor. once; Gal. once; Eph. once; Heb. 4 times; 1 Jn. 7 times; Rev. once).

²⁷⁹ Brown (1978:67) notes the Christological abundance of this section of the Fourth Gospel: “When we look back on the wealth and depth of the material contained in the intervening verses (i.e. vv. 19-34), we appreciate John’s genius at incorporating a whole Christology into one brief scene.”

in 3:17, it certainly refers to Jesus' unique divine Sonship of God. But the context and content of 3:16-18 make it clear that the stress is on soteriology, namely, on salvation or condemnation, on sharing in the eternal life through faith in the only beloved Son of God or condemning oneself by refusing to believe in Him, the Saviour and giver of eternal life.²⁸⁰

In the context of a controversy with the Jews (5:19-30), Jesus implicitly applies the title "the Son of God" to Himself (5:25). Because of His violation, as the Pharisees perceived it, of the Sabbath in curing a cripple and on account of His claim to divine status by calling God His own Father (5:16-18) He faced murderous persecution by the Jewish authorities. Also, He shares in the Father's life in a unique manner (5:26) and therefore mediates eternal life for those who believe in Him (5:24-25). "The Son of God" in this context seems to be used to denote Jesus' divine Sonship.

In 10:22-39, a similar situation of hostility is manifested as that recorded in 5:19-30. Here the Jews attempt to stone Jesus (10:31) because of His claim to perfect unity with the Father (Ἐγὼ καὶ ὁ Πατήρ ἓν ἐσμεν, v. 10:30); this claim was, to the Jews a clear blasphemy (ὅτι σὺ ἄνθρωπος ὦν ποιεῖς σεαυτὸν θεόν, v. 10:33^c). In this record Jesus defends His divinity and by citing a line from Ps. 82:6 (LXX) demonstrating from Scripture,²⁸¹ and His own works (10:37-38), that He has not blasphemed in calling Himself "Υἱὸς τοῦ θεοῦ εἰμι" (10:36). As in 5:25, Jesus employs the title "the Son of God" to reveal both His divine identity as the Son of the Father and His unique union with Him. In this instance Jesus also manifests Himself as more than the Jewish Messiah (cf. 10:24), for He is the divine "Υἱὸς τοῦ θεοῦ" intimately united and in constant communion with the Father. It is in this unity with the Father in exercising the divine prerogatives of vivifying and judging mankind that the unique Sonship of Christ is manifested.

²⁸⁰ See Mlakuzhyil (1987:259).

²⁸¹ See Brown (1978:409-410); Dodd (1998:254-255). Beasley-Murray (1987:25) comments that the phrase "Son of God" was more prevalent in Judaism than has generally been allowed. In the Old Testament we find that Israel is called God's first-born son (Ex. 4:22 f.); David's progeny is owned by God as His son in 2 Sam. 7:14, a deeply influential passage (cf. Ps. 2:7; 89:26 f.) which came to be interpreted in a Messianic perspective.

Howton (1963/64:236) asserts that in verse 10:38 Jesus concludes with another unequivocal statement of the reality of His Sonship.

In the record of raising Lazarus (Jn. 11), the title “ὁ Υἱὸς τοῦ Θεοῦ” is found twice, once on the lips of Jesus (11:4) and once in the confession of Martha (11:27). Jesus uses the title to refer to His divine Sonship in 11:4, therefore His δόξα as the Son of God is interchangeable with the glory ascribed to God.²⁸² Martha uses the phrase as a Messianic title in 11:27; linking the Messianic title “the Christ” with the expression “He who comes into the world.” By raising His friend Lazarus from death, Jesus shows that He is not simply a man, but that He is the Lord of life and death, that He is God Himself who can bring to life whomsoever He wills (5:21, 25f.).²⁸³ The record of the raising of Lazarus underlines and further confirms this Christology: Jesus is truly the Christ, the Son of God.

During Jesus’ trial before Pilate the Jews accuse Him of having made Himself “Υἱὸν Θεοῦ, (19:7^c)” and hence of deserving death (19:7^b) for blasphemy (cf. 5:18; 10:33). It is clear that in the Fourth Gospel, Jesus is put on trial on account of His claim to divine Sonship.

Since the statement that “Jesus is the Christ, the Son of God” (Ἰησοῦς ἐστὶν ὁ Χριστὸς ὁ Υἱὸς τοῦ Θεοῦ, 20:31), follows immediately after Thomas’ confession of the divinity and lordship of the risen Jesus (ὁ Κύριός μου καὶ ὁ Θεός μου, v. 10:28), it is not being used in a mere Messianic sense as a conclusion to the Fourth Gospel. Rather this passage is a confession of Christian belief in the divine Sonship of Jesus Christ (cf. 1 Jn. 4:15; 5:5).

Therefore, we can say that the use of the title “the Son of God” (ὁ Υἱὸς τοῦ Θεοῦ) reflects an established confessional position and gives clear expression to the faith conviction that Jesus is One with God.²⁸⁴ Dodd (1998:253), in commenting on the phrase “the Son of God” (ὁ Υἱὸς τοῦ Θεοῦ) says that “certainly there is no other writing known to me in which the idea of divine Sonship is treated with

²⁸² See Appold (1976:57).

²⁸³ See Panackel (1988:189-190).

²⁸⁴ See Appold (1976:57).

anything like such fullness and precision.”

3.4.6. Conclusion

Jesus' relationship with the Father is a major theme of the Fourth Gospel. The author demonstrates this by constant referral to concepts such as “eternal life.” This eternal life originates with the Father, and the disposition of this life, as far as mankind is concerned, is the sole prerogative of the Son who gives it to those who receive or believe in Him. The portrayal of the source of life, and the way in which it is mediated to man, gives insight into the relationship between the Father and the Son.

Jesus is not alone in claiming to be sent by the Father as the Father bears witness to what Jesus says and does, giving Him the Spirit without measure. This witness by God is manifest in the works which Jesus does. These works are authorised and commissioned by the Father. On one occasion (Jn. 12:28) the witness was by way of an audible voice from heaven.

As part of His ministry, Jesus has had all judgement entrusted to Him by the Father. The proclaimed purpose of this is that He may receive equal honour with the Father. Further Jn. 5:30 indicates that the judgement exercised by the Son is based upon unity with the Father in all things. All Jesus' judgments are in perfect accord with the will of the Father. Not only this but as the Son of Man Jesus has experienced all the physical limitations and temptations of mankind and He is therefore able to judge fairly and righteously.

Among all the passages in the Fourth Gospel which give insight into Jesus' relationship with the Father the more telling are those in which He is addressed as the Son of God or uses the title to describe Himself. John says explicitly that “many other signs therefore Jesus also performed in the presence of the disciples, which are not written in this book; but these have been written that you may believe that Jesus is the Christ, the Son of God; and that believing you may have life in His name.” and so it is not strange to find this title used of Jesus on key occasions: John the Baptist at Jesus' baptism, Nathanael's

confession, His dialogue with Nicodemus, the healing of a paralytic on a Sabbath day, His claim that He and the Father are one, the raising of Lazarus and His trial before Pilot. All these points to a latent δόξα that, if recognised, shows Jesus to be divine.

John shows a genuine distinction not only in the terminology for Jesus as Son of God, or the Son of the Father, and believers as children of God, but also in the terminology used of God in each instance. The obverse of the uniqueness of Jesus' filial relationship to God is the uniqueness of God's paternal relationship to Jesus. Thompson (2001:71) asserts that John emphasizes the unique character of the relationship between the Son and the Father in such a way that it is not unreasonable to ask whether it is even possible to talk about God as Father apart from talking about Jesus as the Son. Also, Meyer (1996:255) comments that "The unity of Father and Son, a prominent motif in the evangelist's Christology, seems to preclude any talk about God apart from the Son, or at least to render highly problematic any venture to devote a separate chapter on Johannine theology to 'the Father.'"

It is clear that Jesus' relationship with the Father is that of Sonship, that He is divine and possess equal executive δόξα with God in respect of eternal life and judgement.

3.5. Jesus' Δόξα Demonstrated

3.5.1. Δόξα demonstrated in the σημεῖα

In the LXX σημεῖον is predominantly a translation of the Hebrew word *מוֹפֵת*, and, it used by itself for sign, miracle, mark or token, between man and man, or between God and man; sometimes it means a token of things to come, an omen. It is applied in particular to symbolic acts performed by the prophets.²⁸⁵ Hence in this Gospel, to those who believed, a σημεῖον performed by the Lord is a visible pointer to the invisible truth about Him who gives the sign and the

²⁸⁵ See Hofius (1986:626); Rengstorf (1975:219-221).

teaching which often accompanies the σημεῖα is designed to make this clear.²⁸⁶ Therefore, it seems that the word ‘sign’ in the Fourth Gospel usually implies more than the word ‘symbol.’²⁸⁷

John records seven specific “σημεῖα” which he selected for inclusion in his record in order to support his purpose in writing his gospel; “but these have been written that you may believe that Jesus is the Son of God; and that believing you may have life in His name (Jn. 20:31).” These are followed by an eighth σημεῖον, that of the miraculous draught of 153 large fish. This last recorded σημεῖον in the Fourth Gospel has a different purpose. It took place after the resurrection of Jesus and it appears to be directed towards reminding the disciples of the Lord’s power and authority over nature and in a gentle way, reminding them of their original commission when Jesus told them that they would become fishers of men. It would also demonstrate that, while He was no longer with them, He was still aware of their needs and that He was still caring for their physical needs. This assurance of ongoing care would be an anchor for them in the difficult days of persecution that followed. Another important aspect of the eighth σημεῖον is that it formed the basis for His reassuring and re-commissioning talk with Peter. Peter had denied Jesus on three occasions – now Jesus gives him three opportunities to declare his affection for him. But before doing so He sets the scene by performing a σημεῖον that would evoke memories of all His care and teaching demonstrated so clearly during His public ministry.

Many scholars²⁸⁸ think that σημεῖα were indispensable to and played a dominant role in the public ministry of Jesus as recorded in the Fourth Gospel. In John’s Gospel, σημεῖα are presented as a manifestation of the δόξα of Christ.²⁸⁹ Smith

²⁸⁶ See Rengstorf (1975:243-257).

²⁸⁷ See Lightfoot (1956:21-23). Also, Louw & Nida (1993, 1:443) indicate that a σημεῖον is not simply a miraculous occurrence but in the Fourth Gospel something which points to a reality with even greater significance.

²⁸⁸ See Schnackenburg (1984, 1:515); Brown (1978:529); Barrett (1962:63); Blackburn (1992:555).

²⁸⁹ Hofius (1986:632) says that the Fourth Gospel shows the purpose of the eschatological reference of Jesus’ miracles (σημεῖα) is to highlight His δόξα.

(1997:107-108) says that the very designation of mighty works or miracles as σημεῖα suggests that they are intended to signify who Jesus is, and this is indeed the case. The σημεῖα of the Fourth Gospel thus play a positive theological role in calling attention to Jesus' origin, power, and purpose.²⁹⁰

The δόξα of the earthly Jesus' ministry is characterized by a series of miraculous σημεῖον. We might define a disciple as one who sees the manifestation of the divine δόξα of the Son in the miraculous σημεῖον of Jesus' ministry.²⁹¹ If the Synoptists show the implied relation of the miraculous σημεῖον to the Kingdom of God,²⁹² John shows their explicit relation to the δόξα of Christ. In the greatness of these signs Jesus manifests His divinity. The emphasis on the miraculous as such and the presentation of Jesus as having an unlimited δόξα is clear in every miracle story.²⁹³ But we find that the δόξα which the miraculous σημεῖα manifest is not a δόξα of Christ in Himself. It is the δόξα which the Father gives to Him as He works with the Father's δόξα as His motive.²⁹⁴ According to Schnackenburg (1984, 1:517), the concept of the Johannine σημεῖα has "a distinctive theological contour and which leads us to the heart of Johannine theology."²⁹⁵ It is a Christological notion. For John, it seems that the σημεῖα and the person who does them cannot be separated. In the Fourth Gospel, the σημεῖα pose

²⁹⁰ Blackburn (1992:556) points out that the Johannine σημεῖα are significant, for in very concrete, physical ways they point to the deep and crucial truth about Jesus (and God), that is, that He is the absolutely unique Son of God who descended from heaven to reveal the Father and through whose "lifting up" on the cross, resurrection and return to the Father believers receive the Holy Spirit and thus eternal life. The σημεῖα, in other words, point to the present δόξα of the exclusive mediator of eschatological salvation and also portend the salvation to be enjoyed by the beneficiaries of the completion of His messianic work.

²⁹¹ See Jn. 1:14.

²⁹² Brown (1978:527) points out that in the Synoptics, "σημεῖον" is used in an eschatological setting, in reference to the signs of the last times and *parousia* (Mt. 24:3, 24, 30), as well as when non-believers demand a miracle of Jesus as an apologetic proof (Mt. 12:38-39; 16:1-4; Lk. 23:8).

²⁹³ I. The turning of water into wine (2:1-11), II. The healing of the nobleman's son (4:46-54), III. The curing the impotent man at Bethesda (5:2-9), IV. The feeding of the five thousand (6:4-13), V. The walking on the sea (6:16-21), VI. The giving sight to a man blind from birth (9:1-7), VII. The raising of Lazarus from the dead (11:1-44), VIII. The miraculous catch of fishes, after His resurrection (21:1-6).

²⁹⁴ See Jn. 7:18; 5:41, 44; 8:50, 54; 9:24; 12:43.

²⁹⁵ Barrett (1962:63) also indicates that the Johannine σημεῖον is "one of the most characteristic and important words of the gospel."

questions about Jesus' identity (Jn. 6:14) and call for a decision. They are a means of revealing Jesus' true nature, His δόξα (Jn. 2:11; 11:4, 40). In all 17 occurrences of the word σημεῖα in the Fourth Gospel,²⁹⁶ Schnackenburg (1984, 1:515) quite definitely says, "The σημεῖα are important works of Jesus, performed in the sight of His disciples, miracles, in fact, which of their nature should lead to faith in 'Jesus the Messiah, the Son of God.'" With the miracles, John has seized the Christological interpretation which is implicit in the Synoptic Gospels, clarified it, and stamped it upon the material in such a way that the reader is not allowed to escape it. The σημεῖα of the Fourth Gospel are a function of its Christology.²⁹⁷

Van Belle (1994:380) notes that in the Fourth Gospel the miracles can be called either σημεῖον or ἔργα; and regards both terms as largely synonymous.²⁹⁸ Brown (1978:528) however describes σημεῖον as being "a somewhat narrower term" than ἔργον. This ἔργον is only an alternative word for σημεῖον in the Fourth Gospel. Nicol (1972:116) points out that it does not occur in σημεῖα material, and it usually seems to have a wider meaning than σημεῖον, but in a number of instances it means no more than 'miracle' (7:3, 21; 19:32, 33), perhaps John himself chose it and used it according to his own theological ideas about the σημεῖα. Rengstorf (1974:248) says that "when the Johannine Jesus Himself refers to what John calls σημεῖον he consistently uses the word ἔργον" the use of

²⁹⁶ The use of σημεῖα in the Fourth Gospel may be divided into four groups: firstly, seven times from the lips of Jews: 2:18; 3:2; 6:30; 7:31; 9:16; 10:41; 11:47; secondly, four times as an object of somebody's perception: 2:23; 6:2, 14; 12:18; thirdly, four times in the commentary of the narrator (not as the object of anybody's perception): 2:11; 4:54; 12:37; 20:30; fourthly, twice in the mouth of Jesus: 4:48; 6:26.

²⁹⁷ See Barrett (1962:62).

²⁹⁸ See Mlakuzhyil (1987:271-279). Most of the 27 ἔργα passages in the Fourth Gospel are clearly related to the σημεῖα of Jesus (Jn. 5:20, 36; 6:29; 7:3, 21; 9:3; 10:25, 32, 37; 14:10; 15:24; 17:4). Moreover they establish a close connection between the ἔργα of Jesus as σημεῖα and the work of God effected in the ἔργα. Van Belle (1994:384) notes that the miracles as works of Jesus have revelatory quality as well as a legitimizing function and are clear expressions of the unity of the Father with the Son (Jn. 4:34; 5:36; 6:28-29; 9:4; 10:25, 32, 37; 14:10; 17:4). Also, the Son fulfils the ἔργα τοῦ Θεοῦ, doing the will of the One who sent Him. Thus, the works (ἔργον) testify that the Father has sent the Son. Rengstorf (1974:235) notes that, "in the Synoptic Gospels the current term for the miracles of Jesus is δύνάμεις, σημεῖον is never used for them. There are in the tradition reminiscences of the fact that the δύνάμεις of Jesus are not regarded as σημεῖα in the sense of the demand for a sign; indeed, the miracles give rise to the demand."

σημείον is a specifically Johannine characteristic. Interestingly, Nicol also (1972:122) points out that each one of the three concepts σημείον, ἔργον and δόξα lead us to the same insight: the surprising unity of event and meaning. They illustrate this unity from three different points of view. Somewhat schematically it may be said that σημείον illuminates the unity from below, δόξα from above, and ἔργον from the side.²⁹⁹

The σημείον is clearly linked to δόξα and πιστεύω, two key themes of the Fourth Gospel.³⁰⁰ Δόξα and πιστεύω are brought together at three other crucial points in the Fourth Gospel. The Johannine prologue brings them together (Jn. 1:12-14), believing (πιστεύω) in the name of Jesus is to behold His δόξα, to perceive the

²⁹⁹ See Brown (1978:528-529); Rengstorf (1974:247-252). Ἔργον usually seems to have a wider meaning than σημείον, but in a number of instances it means no more than ‘miracle’: there can at least be no doubt about 7:3, 21; 10:32, 33. The setting for the full meaning of the word is provided by 4:34 and 17:4. In both case, it denotes the total life-work of Jesus, the revelation of the Father.

³⁰⁰ John’s Gospel is noted for its author’s distinctive development of and penchant for new phrases in place of old ones, for using many different words to describe the same activity (cf. Malina & Rohrbaugh, 1998:4). These words and phrases were specially selected by John to enhance the understanding of the Gospel by the Johannine Christian community and also to meet their specific spiritual needs. The distinctive feature of the Fourth Gospel is the emphasis on “believe,” and “witness (testify).”

John tells us explicitly, what he was aiming to do in writing his gospel (Jn. 20:30-31) namely to bring people to believe in Jesus, and in believing to have life (cf. Hermission & Lohse, 1981:160). This means that believing is very important for him and the Johannine Christian community, and in fact this idea rings throughout his whole book. When he wants to express the thought of “faith in Jesus Christ,” Paul speaks of “faith (πίστις) in Jesus Christ,” but John uses the phrase “to believe (πιστεύω) in Jesus” – John never uses the noun “faith” or “belief,” but always and only the verb “to believe” and the gerund “believing” (Jn. 1:7, 12, 50; 4:21, 42, 48; 6:29, 30, 36; 7:5; 8:24, 30; 11:15, 40; 12:11, 37; 13:19; 14:10; 16:30; 20:25, 27, 31).

It seems that for John belief is always an active matter. John describes faith as a continuing dynamic, not a state of being. Rather, by using the verb form of the word, John emphasizes the act and ongoing activity of faith, an activity that constantly endorses the original decision. This emphasis is deliberate and is directed to the prevailing circumstances and needs of the Johannine Christian community. Interestingly, Whitehouse (1950:75-76) comments,

The efficacy of faith for salvation and for right relationship with God is not to be sought in the act itself, but rather in that to which a man holds firm by believing. The Fourth Gospel, by the very fact of not using the noun, makes this plain.

This understanding of faith implicit in the use of the verb instead of the noun indicates that John’s fundamental concept of faith is that of personal relationship. It is as if John wishes to emphasize the act of believing. Because of this emphasis the Johannine Christian community can make certain affirmations about Christ that structure a sense of identity and community solidarity (See Kysar, 1993:94; Blomberg, 2001:62). The conclusion is that the specific words and phrases used by John are specially chosen by him to direct the thoughts of the Johannine Christian community to an active, ongoing faith in Jesus Christ.

fullness of grace and truth that are in Christ, and in receiving Him to receive that fullness (1:16). The raising of Lazarus also ties πιστεύω to δόξα, thus completing the sign cycle in unity with the first sign (11:40-44). The sign is also connected with the Christ's purpose that the spectators may believe that the Father sent Him. This leads into the Lord's prayer (Jn. 17) which again links πιστεύω and δόξα, it is Jesus' own summary-in-prayer of His ministry, His final report to the Father.³⁰¹

In the Fourth Gospel we find that the σημεία are of primary importance in finding the key to the relationship between the ministry of Jesus on earth and the exalted Christ in heaven. Nicol (1972:124-125) comments that the central definition of what happened in the σημεία is that they were revelation of δόξα; the usual word for Jesus' exaltation is δοξάσθαι³⁰² – the concept of δόξα is the hinge on which the Johannine Christology turns.

In this chapter, I will not deal with the entire texts relating to the σημεία, but I will limit the exegesis and analysis of the σημεία texts to passages which are connected with the term δόξα.

3.5.1.1. Direct used δόξα on σημεία

3.5.1.1.1. Water into wine (2:1-11)

In commenting on this first σημείον in the Fourth Gospel, Suggit (1987:141) says that it might be described as marking the end of the introduction. Just as the Johannine prologue proper (1:1-18) introduces the whole gospel, as it indicates themes which are to be developed throughout the gospel, so this σημείον foreshadows the future δόξα to be revealed in Jesus. This claim is to be substantiated by His works (5:36) which are seen as σημεία of His true work on

³⁰¹ cf. Jn. 1, 4-5, 8, 10, 20-26. See Cooper (1979:376).

³⁰² Jesus' departure from the world and return to the Father is usually referred to as His glorification (7:39; 11:4; 12:16, 23, 28; 13:31 f.; 17:1, 5). Jesus is glorified because He re-enters into the glory which He had in His pre-existence (17:5). Jesus is also glorified in His departure because His laying down His life is the completion of His earthly work by which He glorified the Father (17:4).

the cross.³⁰³

3.5.1.1.1.1. Literary aspects of this passage

In dealing with the miracle of turning water into wine at Cana 2:1-11, Menken's (1985:73) analysis is that this story displays a succession of five elements: introduction (2:1-2), exposition (2:3-4), the word directed by Jesus' mother to the servants has, it seems, a connecting function (2:5), preparation for the miracle (2:6-8), demonstration (2:9-10) and conclusion (2:11). The miracle begins with an introduction (2:1-2), in which the setting for what will be told is given, and in which the characters are introduced. The exposition follows in 2:3-5: there is a deficiency of wine, and Jesus' mother draws Jesus' attention to it. The preparation for the miracle (2:6-8), begins with information which is necessary to understand what follows, this relates to six stone water jars standing near by. The preparation for the miracle is followed by its demonstration (2:9-10): the steward tastes the water which has become wine, and praises the bridegroom for having on the superior quality of the wine. The miracle story proper is followed in 2:11 by an interpretative comment: the sign at Cana was the beginning of Jesus' signs, He revealed His glory in it, and His disciples believed in Him.³⁰⁴ It seems that the five elements of the miracle of turning water into wine at Cana 2:1-11, are indications which suggest some kind of concentric structure. Menken's (1985:74) describes that schematically, the concentric structure of 2:1-11 can be pictured as follows:

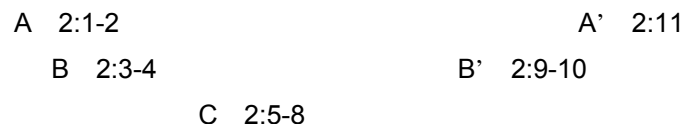

He (1985:73) says that the first stage (2:1-2) and the last stage (2:11) together constitute an inclusion. Also, the exposition in 2:3-4 corresponds to the demonstration in 2:9-10. The position of 2:5-8 is perhaps defined in this way: in

³⁰³ The events of the cross are those linked with the cross, resurrection and ascension.

³⁰⁴ We find that the positive conclusion is even more evident from a comparison with similar passages from John (12:37-43; 20:30-31).

the sequence of elements it belongs with what precedes. The miracle of turning water into wine at Cana displays both a linear and a concentric structure.³⁰⁵ It should be noted, however, according to element A' (Jn. 2:11), John gives us explicit and useful guidance concerning his intention for the Fourth Gospel. According to Olsson (1974:99), this concentrates, not on the situation or the speeches, but on Jesus' actions, indicated as a σημεῖον, even as an ἀρχὴν τῶν σημείων and as a revelation of Jesus' δόξα.

The linear structure follows the following pattern: in 2:3-4, a tension is evoked; the need is highlighted by Jesus' apparent refusal to do something about it. The tension is resolved in 2:9-10, when the removal of the need is described; there is wine again, even of a better quality than before.

This first sign, water into wine, was directed primarily towards His disciples and His mother. The group of servants who drew the water and later distributed the wine would of course be included. Taken overall it was a "private sign" demonstrating His authority, power and ability to His immediate intimate circle and to the 'lowly' servants.

All these textual features appear to be included as a prelude to the structure of the whole Gospel. The main reason for the comprehensive detail of the miracle seems to be that this story reveals part of the true concepts of Jesus' δόξα.

3.5.1.1.1.2. Exegetical perspective on this passage

In Jn. 2:1-2, a wedding feast is used as a parable to describe of the kingdom of God.³⁰⁶ In Mk. 2:19 (Mt. 9:15; Lk. 5:34) the presence of the disciples with Jesus is likened to that of guests at a wedding feast.³⁰⁷ The contrast of Jesus'

³⁰⁵ See Menken (1985:73-74).

³⁰⁶ Mt. 22:1-14; 25:1-13; Rev. 19:7-9; cf. Lk. 12:36.

³⁰⁷ According to Stauffer (1974:648-657), the phrase "a wedding" (γάμος) acquires its greatest religious significance where it is used in connection with the union or close connection between God and the people of Israel in the world of Israel and Judah, as well as in the ancient world. When John uses the term γάμος, the reader can without any difficulty relate this occasion to the eschatological banquet between God and His people (cf. Isa. 25:6; see Olsson 1974:26; Lindars 1982:125; Pryor 1992:17; Dodd 1998:297; van der Watt 2000:392-393).

message with Judaism is illustrated by the parable of wine and the wineskins.³⁰⁸ In the Fourth Gospel the Johannine narrative may have been influenced by these elements, for there can be little doubt that John meant to show the supersession of Judaism by the δόξα of Christ. Morris (1995:155), in discussing the wedding in Cana, suggests that Jesus changes the water of Judaism into the wine of Christianity, the water of Christlessness into the wine of the richness and the fullness of eternal life in Christ, the water of the law into the wine of the Gospel (cf. Jn. 2:10).³⁰⁹ There are already indications of this motif in Jn. 1:17, ὁ νόμος διὰ Μωϋσέως ἐδόθη, ἡ χάρις καὶ ἡ ἀλήθεια διὰ Ἰησοῦ Χριστοῦ ἐγένετο.³¹⁰ Ridderbos (1997:11) views the story of water into wine at Cana (Jn. 2:1-11) as linking up with various expressions and phrases in the giving and accepting of the Law in Sinai (Ex. 19). The similarities are set out as follows:³¹¹

On the third day (Jn. 2:1)	The third day (Ex. 19:11)
Jesus was invited (Jn. 2:2)	The Lord call Moses ...and Moses went up (Ex. 19:20)
Do whatever He says to you (Jn. 2:5)	All that the Lord has spoken we will do (Ex. 19:8; cf. 24:3, 7)
He manifested His δόξα (Jn. 2:11)	See I will reveal myself to you in the cloud of glory (אֲרָאָה אֲנִי בְּעָנָן וְעָנָן) (Ex. 19:9 [Targum]; cf. Ex. 24:17; Deut. 4:11)
His disciples believed in Him (Jn. 2:11)	So that the people may believe in you forever (Ex. 19:9)

³⁰⁸ Mk. 2:22; Mt. 9:17; Lk. 5:37f..

³⁰⁹ Olsson (1974:107-109) believes that this story has a number of hidden allusions, for example, the wine does not function as an eschatological symbol but stands for the law, which is now replaced by something new; the disciples are the people of the New Covenant, already manifest in the obedience of the servants; the miracle is therefore the fundamental "beginning" because the Son transforms the old into the new; and from this new perspective Mary's role can also be understood.

Also, this sign suggests that John mentions the following ministries of Jesus that are subtly linked together in theme: this sign indicates the changing of the old order into new; the cleansing of the temple (2:12-25); the introduction of the new life (3:1-36); the mention of the new worship (4:1-45). Blomberg (2001:106) denotes that "chapters 2-4 stress the newness of what Jesus is bringing: a new joy, a new temple, a new birth and a new universal offer of salvation."

See Lindars (1982:131); Morris (1989:24); Ridderbos (1997:108-110). Cf. Painter (1993:191). Culpepper (1998:131) says that the new (good) wine is Israel's hope and eschatological expectation.

³¹⁰ See Olsson (1974:19-20).

³¹¹ Further see Olsson (1974:102-109); Moloney (1993:91-92).

The story of water into wine at Cana is to be understood, Olsson (1974:107) says, against this Sinaitic background, because Jewish tradition often speaks of the Sinai tradition as the Lord's marriage to Israel.³¹²

The phrase "on the third day" (τῆ ἡμέρᾳ τῆ τρίτῃ), is our starting point, as the same expression can be found twice in Ex. 19:10-19. God instructs Moses on the preparation of the people for the gift of the Law as "on the third day the Lord will come down upon Mount Sinai in the sight of the people (Ex. 19:16)."³¹³ It seems that in the gift of the Law, God manifested His glory among His people. In the Fourth Gospel, John refers to Jesus' knowledge of the Hebrew scriptures that God's δόξα would be manifested on the third day. Also, this reference seems to have a symbolic meaning, Dodd (1998:300) describes it is an allusion to Easter – the miracle anticipates the manifestation of Christ's δόξα³¹⁴ in the resurrection from the dead.³¹⁵

In Jn. 2:4 as in the rest of the Fourth Gospel Jesus always refers to His mother (cf. 19:26) as "woman" (γύναι) not "mother" (μήτηρ). Jesus' ministry is not a family matter; indeed it is a matter in which Jesus must disengage Himself from His physical family and any parental authority Mary may have over Him, in order to establish the family of faith.³¹⁶ Van der Watt (2000:261) indicates that in this

³¹² See Knight (1959:218). Olsson (1974:107) indicates that it would not be too "farfetched, from a Sinai perspective, to allow events at a village wedding to carry a message of something that, according to the narrator, replaces the old wedding at Sinai."

³¹³ Cf. In Ex. 19:16, the term "δόξα" would accurately describe of the physical scene, the visible presence of God among His people. When Deuteronomy makes reference to Sinai, it is with this moment in mind. This reflects the awareness in Israel of the central importance of the event of Sinai as a revelation of "the δόξα of God:" "Behold, the Lord our God has shown us His glory (δῶκε) and His greatness, and we have heard His voice from the midst of the fire" (Deut. 5:24).

³¹⁴ See Caird (1968:265-277).

³¹⁵ Cf. Mt. 16:21; 17:23; 20:19; 27:64; Lk. 9:22; 18:32; 24:7, 46; Acts 10:40; 1 Cor. 15:4. Also Culpepper (1998:130) says that the miracle is to be understood from a post-Easter perspective. See Lindars (1982:128); Bruce (1983:68); Schnackenburg (1984, 1:325); Kysar (1986:44); Beasley-Murray (1987:36); Stibbe (1993:46); Koester (1995:77); Ridderbos (1997:102). Most commentators think that John's attempt is an effort to deliver the symbolic allusion of the Resurrection.

³¹⁶ In the Fourth Gospel, Jesus' mother is mentioned only three times: in this episode, in 6:42, and in 19:25-27. In these instances, she is constantly addressed as 'woman.' The reason for this anonymity differs according to various scholars. Some representative suggestions in this regard are as follows: Barrett (1978:190) infers that it is certain that John has in mind a historical character and that he intends no veiled allusion to Israel, from which the Messiah sprang. On the other hand, Lindars (1982:128) & Kitzberger (1995:564-586) think that the

passage the will of His heavenly Father and not that of His earthly family determines Jesus' actions. Here the priority of adherence to the heavenly family is stressed.

In this connection “my hour has not yet come” (οὐπω ἦκει ἡ ὥρα μου), in Jn. 2:4, is of special importance. The saying ἡ ὥρα, occurs over and over in the Fourth Gospel.³¹⁷ As a rule the coming of this “ἡ ὥρα” refers to the beginning of Jesus' suffering, His going to the Father, and His glorification. It refers to that decisive time in the crucifixion and resurrection when He is glorified by the Father.³¹⁸ In this Gospel there is thus a focus on Jesus' ὥρα – ἡ ὥρα for decisive action that manifests Christ's δόξα and fulfils God's will.³¹⁹ Here, it seems that “ἡ ὥρα” refers to all this future δόξα. It will be the time for the full revelation of δόξα. Therefore “ἡ ὥρα” of 2:4 indicates that the Johannine evaluation of the miracle “ἐφανέρωσεν τὴν δόξαν αὐτοῦ” (2:11) is a prolepsis of the final glorification of Jesus. Also, ἡ ὥρα with δόξα, σημεῖον and πιστεῦειν, are concepts which, according to verse 11, express the real meaning of what takes place. Ridderbos (1997:106) comments that this hour never came until the last days of the life of Jesus, and in verse 11 scholars say there is only the prophetic mention of Jesus' δόξα. In this way John may indicate that the full significance of Jesus' δόξα must be sought not in His σημεῖα but in His subsequent glorification by the Father.³²⁰

In this miracle, Jesus revealed His divine being, His glory (ἐφανέρωσεν τὴν δόξαν). Fortna (1988:53) comments that it recalls the characteristic Johannine and important use of this word in the prologue, “We saw His glory, glory as of the Only begotten from the Father, full of grace and truth” (Jn. 1:14). Jesus' δόξα would be revealed in greatest measure in His cross, resurrection and exaltation,

reason for the mentioning of this unnamed woman is to distinguish her from Mary of Bethany (Mary Magdalene). However, Malina & Rohrbaugh (1998:66; cf. Williams 1997:685) plausibly suggest that in the Mediterranean world the names of respectable woman were never mentioned in public. Therefore, ‘mother of Jesus’ is the customary honorific title, which is the respectful way of referring to a woman who has born a son; the birth of a son accordingly defines the woman as a complete, adult person.

³¹⁷ cf. 7:30; 8:20; 12:23; 13:1; cf. 16:21; 17:1; cf. also 7:6, 8.

³¹⁸ See Kysar (1986:45).

³¹⁹ See Witherington (1995:79).

³²⁰ See Nicol (1972:129).

but we find that every step along the course of His ministry is an adumbration of the δόξα shown in this first sign.³²¹ The δόξα was not apparent to all who saw the miracle; the δόξα cannot be identified with the miraculous display (cf. Jn. 1:14), because the servants saw the σημεῖον, but not the δόξα. The disciples by faith perceived Jesus' δόξα behind the σημεῖον, and they put their faith in Him (ἐπίστευσαν εἰς αὐτόν). It seems that σημεῖα in the Fourth Gospel consist of significant displays of power that point beyond themselves to the deeper realities that could only be perceived with the eyes of faith.³²² Also, the Johannine use of ἐφάνηρωσεν, shows that it is Jesus Himself (1:31; 7:4; 21:1, 14), Jesus' δόξα (2:11), God's ἔργα (9:3; 3:21), and God's name (17:6), which are revealed. Schnackenburg (1984, 1:335-337) indicates that this verb is closely associated with the Johannine idea of Jesus' revelation of God.

Schnackenburg (1984, 1:335) considers that the three clauses of Jn. 2:11 are a programmatic statement of what the “σημεῖα” essentially are and should be, namely, the unveiling of the “δόξα” of the Word made flesh (cf. Jn. 1:14); the Son of Man who dwells on earth and remains linked with heaven; and a δόξα which can be grasped by in faith and can thus lead to full faith “in Jesus,” the Messiah and Son of God (Jn. 20:31). The story of water into wine at the Cana feast revealed the δόξα of Jesus. In connection with Jn. 1:14 and 1:51 Beasley-Murray (1987:35) comments that the Word made flesh, the only Son of the Father, who is also the Son of Man, manifested His creative power. It seems that John's main emphasis is the eschatological δόξα which Jesus revealed as the fulfilment of Jewish expectations.

3.5.1.1.1.3. Conclusion

³²¹ Brown (1978:104) properly states that “what shines through is His glory (δόξα), and the only reaction that is emphasized is the belief of the disciples.”

³²² Cooper (1979:376) indicates that this σημεῖον is also connected with the purpose of Jesus namely that the spectators may believe that the Father sent Him as Jn. 2:11, links faith and δόξα. According to Jn. 17, the purpose of Jesus' ministry was to reveal His δόξα, which is the δόξα and the name of the Father, to the disciples, to the end that they might believe; that they might be glorified (δοξάζω) with the Father and the Son and that others might believe and be glorified (δοξάζω).

In respect of the miracle of water changed into wine at Cana, we take our point of departure from the statement in Jn. 2:11, “This beginning of His signs Jesus did in Cana of Galilee, and manifested His glory, and His disciples believed Him.” In exegetical discussions of this text, Schnackenburg, Smith, and Brown each read this text in light of the John’s symbolic theology. Schnackenburg (1984, 1:323) states, “The interest of the evangelist is restricted to its ‘theological’ impact in Cana, to the faith of the disciples, in which the revelation of Jesus’ glory bears fruit.” Likewise, Smith (1976:12) views the σημεῖον as an epiphany, and Brown (1978:103) reads it as the first of the σημεῖα that progressively reveal Jesus’ identity.³²³ Collins (1995:106) states that this focus has led, among other things, to an overtly theological reading of the entire passage, particularly with reference to Jesus’ δόξα. This focus dwells on the theological or Christological connotations in terms of Jesus reflecting the image of God.³²⁴

The significance of the miracle of changing water into wine at Cana is seen as a revelation of the δόξα of Jesus, and is primarily a revelation of His divine and creative power.³²⁵ In this σημεῖον there may be a symbolic presentation of God’s saving work of revelation through Christ, and a prophecy of something in Jesus’ work which would only be understood after His glorification. Moreover, in terms of the Christological significance of this story, the focus is on the deed of Jesus, which manifests His divine power and presence.³²⁶ Also, the centre of this story in terms of action is obviously the turning of water into wine, which gives His disciples an invitation to exercise faith in Jesus.³²⁷ We also find that this σημεῖον is said to reveal Jesus’ δόξα, that is, that God’s life-giving and joyful presence can be found in Him.³²⁸

³²³ Hughes (1933:19) considers that in this σημεῖον Jesus is revealed as the Creator-God.

³²⁴ See Smith (1997:109).

³²⁵ Cf. Jn. 3:2; 9:16; 10:21; 11:37.

³²⁶ See Brown (1978:107).

³²⁷ See Brown (1978:103-104); Ashton (1991:271).

³²⁸ Brown (1978:104) points out that the significance of the wedding-feast is the most natural possible symbol of joy, fulfilment, and the promise of new life through throughout the Old

3.5.1.1.2. The story of Lazarus' resurrection (11:1-53)

The story of Lazarus' resurrection is the climactic sign of Jesus' public ministry. This sign furnishes additional evidence that Jesus had the authority, power and δόξα not only to give healing but also to give life to whomever He chose.³²⁹ This sign is, apart from the resurrection of the Lord, the most significant and dramatic of all the miracles recorded in the Bible. The Jewish leaders could have argued that the raising the son of the widow in Nain (Lk. 7:11-17) and the restoration of Jairus' daughter (Mk. 5:21-24, 35-43; Lk. 8:40-42, 49-56) were natural because they had fainted or were unconscious but in the case of Lazarus there was absolutely no doubt that he had been dead for four days and that decay had therefore set in.

This record of Lazarus' resurrection and the δόξα that came to Jesus as a result of this miracle, point to the greater δόξα that would be His after His death on the cross. Thus Jesus says: "This sickness is not to end in death, but for the glory of God, so that the Son of God may be glorified by it" (11:4), a saying which Jesus repeats again in 11:40. Beyond its immediate reference to the glory inherent in the miracle, this is doubtless a prediction that the miracle would ultimately lead to Jesus' death and so to His departure to the Father.³³⁰ As such this σημεῖον left the Jewish leaders and those present with no choice but to believe Him or reject Him. While many of the people chose to believe Him those who should have recognized Him, the leaders, chose to reject Him and set

Testament background. Further see, Malina & Rohrbaugh (1998:70-71) for comments on the wedding-feast.

³²⁹ Culpepper (1998:184) comments that the story of Lazarus' resurrection serves to underscore the visual effect of the grandest divine power of Jesus who gives life as follows. The Johannine prologue opened the Gospel affirming that 'in Him was life' (1:4). The theme of Jesus as giver of life is highlighted in the exposition of chapter 2-4 (cf. Mlakuzhyil 1987:199). In chapter 5, John intensifies Jesus as the giver of life, therein John declares that the Father has given the authority to Jesus to raise the dead and give life, and thus the one who hears Jesus' word and believes in Him has eternal life and has already passed from death into life (5:21, 24). Van der Watt (2000:216-228) indicates that chapter 6 identifies Jesus as the eschatological life-giver through His miraculous feeding as well as the associated discourse on the bread of life. The symbolism of 'the living water' (ch.7), 'the the light of the world' (ch. 8) and through the performance of the miracle (ch. 9), Jesus declares that whoever follows Him will never walk in darkness but will have the light of life. In chapter 10, Jesus claims that He gives His sheep eternal life (v. 28). Further see 'chapter 3.4.1. Eternal Life (ζωὴ αἰώνιος).'

³³⁰ See Barrett (1962:324); Carson (1991:406); van der Watt (2000:215).

about plotting His death – and that of Lazarus.

3.5.1.1.2.1. Literary aspects of this passage

The story of Lazarus' resurrection (11:1-53), the most striking miracle record in the Fourth Gospel, is narrated in the plainest and most matter-of-fact style. The difference of form and structure in chapter 11 compared to that in the earlier sections of the Gospel has been remarked on frequently; in Jn. 5, 6, and 9, the sign (σημείον) was reported briefly and followed by a discourse on its meaning, but in Jn. 11, three conversations interpret the meaning of the sign before the record of Lazarus' resurrection is actually narrated. Kysar (1986:182-184) comments that the story of Lazarus' resurrection is one of the most dramatic and impressive of the compositions, not just in the Fourth Gospel but also in all of the four Gospels, particularly the scene where Jesus raises Lazarus from the tomb (11:38-44). Culpepper (1998:185-186) suggests the following analysis of the narrative of Lazarus' resurrection (11:1-53):

- I . A supplicant presents Jesus with a request (11:3)
- II . Jesus rebuffs the request (11:4)
- III. The supplicant persists (11:7)
- IV. Jesus gives instructions that will grant the request
(11:39, 43, 44)
- V . The other person complies with Jesus' order, and the sign
is accomplished (11:44)
- VI. The sign is verified: many of the Jews saw what Jesus did
(11:45)
- VII. There is a response of faith (11:45-46)

The story of Lazarus' resurrection shows forth Jesus as Lord over death, before whose majesty death must depart. The emphasis in this σημεῖον can be seen in verse 11:4, namely that Lazarus' illness is for the glory (δόξα) of God and the Son. In this regard, Beasley-Murray (1987:186) correctly asserts that the story

of Lazarus' resurrection, as the last of the signs of Jesus, brings to a climax all that preceded it and precipitated His own death and subsequent resurrection.³³¹

3.5.1.1.2.2. Exegetical perspective on this passage

The phrase “ὑπὲρ τῆς δόξης τοῦ θεοῦ” (11:4), has the meaning ‘to reveal God’s glory.’ “The Son of God may be glorified by it” (11:4), ‘glorified’ is specifically a reference to the revelation of Jesus Christ’s power to give life. Beasley-Murray (1987:187) exactly comments on the meaning of this phrase saying that the illness of Lazarus is not for the purpose of death (for the disciples it is a temporary illness, for Jesus it is a temporary death), but for the purpose of God’s manifesting His δόξα in powerful and compassionate action through the Son (cf. 9:3).³³²

According to Jn. 11:4, Jesus has announced that God’s δόξα will be seen and the Son of God will be glorified in the resurrection of Lazarus. Bultmann (1971:397) says this “is meant to affirm that this deed will also glorify Jesus who, in that He seeks the δόξα of the Father (7:18), at the same time acquires His own δόξα (8:54), for the δόξα of the Father and the Son form a unity.”

According to Jn. 11:40, to see God’s δόξα in Jesus’ works presupposes faith. Jesus recalls verse 4 as He informs Martha of the results of belief. However, Newman & Nida (1980:375) indicate that in the equivalent of “glory (δόξα) would be the thought ‘how wonderful God is,’ which may prove more meaningful and accurate than merely a reference to ‘God’s power.’ In Jn. 11:43-44, the resurrection of Lazarus is an anticipation of what is to take place at the last day, it means that the believer not only has eternal life, but also has passed from death into true life.

The Glory of God ⇄ The Glory of the Son of God
--

³³¹ Staley (1988:67) comments that the connection between the story of Lazarus’ resurrection and Jesus’ death is obviously suggested from the outset.

³³² See O’Day (1987:81). Moloney (1998a:326) comments that the reader recognizes that Jesus always decides in response to God’s designs, not to human need (cf. 2:4; 7:2-10. see van der Watt 2000:261; Lightfoot 1956:220).

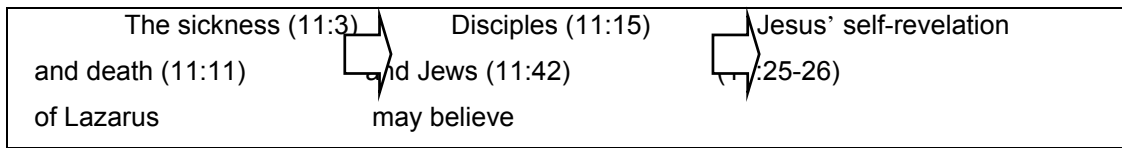

This figure shows that through the resurrection of Lazarus, Jesus had declared that God's glory would be seen and the Son of God would be glorified (11:4) by means of the events associated with the sickness and death of Lazarus (11:3, 11). Jesus would raise Lazarus from the sleep of death so that both His disciples and the Jews might believe (11:15, 42). Then Jesus' self-revelation (11:25-26) would continue so that the promise of verse 11:4 would be fulfilled.

The phrase "the glory of God" (11:40) means that the real significance of what He would do would be accessible only to faith (cf. 11:26-27). We know that the crowd would see the miracle, but only believers would perceive its real significance, the δόξα.³³³

5.1.1.2.3. Conclusion

The miracle of the raising of Lazarus from the dead underlines the ultimate human defeat by death while, at the same time, it reveals Jesus as the resurrection and the life.³³⁴ This miracle therefore clearly demonstrated the divine authority of Jesus and left no doubt that He is who He claimed to be – the Son of the living God. Morris (1967:164) says that the miracle of the raising of Lazarus sets forth Christ as the great Giver of life, as the One supreme over death. In logical sequence this miracle story leads on to the council at which Caiaphas, speaking in his official capacity as the high priest, laid down the principle that one man should die for the people (11:50). Jesus had clearly said that the purpose of Lazarus' sickness and death was "for the glory (δόξα) of God, that the Son of God maybe glorified (δοξαζω) by it" (11:4). Koester (1995:106) indicates that the statement points to two interrelated facets of meaning in the record of Lazarus' resurrection. Firstly, it discloses the δόξα of God by

³³³ See Morris (1995:497).

³³⁴ Van der Watt (2000:215) states that "only in the light of the death event of Jesus does the Lazarus event find its full meaning." See Barrett (1978:396).

manifesting the power of God to give life to the dead. Since Jesus, the Son of God, is the one through whom God's power is exercised, He shares in the divine δόξα revealed by the sign. Secondly, the record of Lazarus also presages Jesus' final glorification through His own death and resurrection. The sign solidified the resolve of Jesus' opponents to kill Him. Yet through His death, Jesus would reveal the δόξα of the love of God that gives life to the world, and by rising He would triumph over death to resume the δόξα He had with God before the foundation of the world. Jesus conquered physical death by being raised from the dead. He also conquered spiritual death and consequently offers spiritual life to all who believe in Him. Jesus' action in this sign has revealed τῆς δόξης τοῦ θεοῦ (cf. 11:4, 40) so that the disciples (cf. 11:15), and the people, including 'the Jews', might believe. The greater transformation would be acceptance on the part of all who witnessed the miracle that Jesus was the Son of the Father, the Sent One of God (cf. 11:42).

The story of Lazarus' resurrection is clearly associated with the manifestation of God's δόξα in Jesus at the beginning (11:4) and at the end (11:40), and serves to instruct the believer that Jesus Himself is the resurrection and the life. The resurrection of Lazarus foreshadows Jesus' own victory over death. Only in the light of the events of cross on Jesus does the story of Lazarus' resurrection find its full meaning. Therefore, this investigation of what the exact meaning of 'δόξα of the Father and the Son' is in this context provides the interpretative key factor for the understanding of the story of Lazarus' resurrection. Commenting on the story of Lazarus' resurrection, Newman & Nida (1980:356) says that it is literally correct that the 'δόξα' here is specially a reference to the revelation of the Son's power to give life. Theologically this σημεῖον will glorify Jesus, not so much in the sense that people will admire it and praise Him, but in the sense that it will lead to His death, which is a stage in His glorification.

3.5.1.2. Inferred δόξα in the σημεῖα

The healing of the nobleman's son (4:43-54) points to Jesus as the Life, and life came to the nobleman and his house (4:53). Along with the emphasis on Jesus'

Word of power, we find that the narrative reveals a corresponding progression in the nobleman's faith (4:48, ⇒ 4:50, ⇒ 4:53).

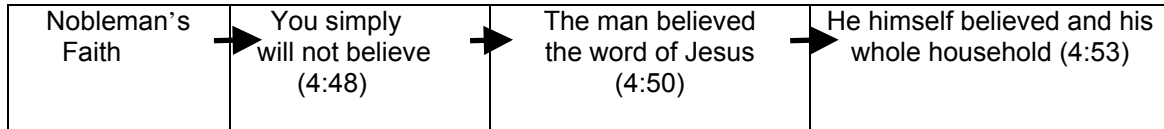

Therefore, the second miracle at Cana has a twofold significance: first, it stresses faith, and second, it stresses the power of Jesus' word to give life.³³⁵

The healing at the Bethesda (5:1-47) is a σημεῖον of the life-giving power of Christ.³³⁶ The Jews focused on the fact that the man was carrying his pallet on the Sabbath and, as a result, persecuted Jesus. This led to the discourse in which the Jews rightly understood Him to claim equality with God the Father. In this record, John shows that this healing is a witness to Jesus' equality with God, His mission, and His δόξα. This σημεῖον of healing at the pool of Bethesda underlines the inherent δόξα of the One who had such power and authority. This σημεῖον would reinforce His claims and points to His divinity (5:19-24).

The σημεῖον of the feeding of 5000 (6:1-15) points to a deeper Christological interpretation: Jesus is not merely a new Moses providing a sample of new manna (τὸν ἄρτον ἐκ τοῦ οὐρανοῦ τὸν ἀληθινόν, Ἐγώ εἰμι ὁ ἄρτος τῆς ζωῆς, 6:31-35^a), but He is heaven's supply (καταβέβηκα ἀπὸ τοῦ οὐρανοῦ, 6:38) for the greatest need of humanity (6:39-40). Van der Watt (2000:223), in referring to "the bread of life," says that Jesus as bread functions as the sustainer of life, because the person who wants to sustain eternal life, needs Jesus.

The miraculous provision of food for the multitude is in itself a reflection of Jesus' power and authority and therefore an indication of His δόξα. In the narrative it is also linked with the Passover and thus with His death and the δόξα

³³⁵ See Brown (1978:197-198). Hughes (1933:20) says that this σημεῖον proves Jesus as the Great Sustainer.

³³⁶ Hughes (1933:21) considers that John presents the healing at the pool to us in order to prove Christ as the Great Empowerer.

John always associates with that event.

The σημεῖον of walking on the water (6:16-21), there is more than a general demonstration of Jesus' power and authority over nature. It suggests that Jesus is God because He is doing more than controlling nature. He is coming to His followers aid just as Jehovah did in the Old Testament. As such it points to Jesus' inherent δόξα. Culpepper (1998:157-158) considers that this sign is once more a revelatory event that demonstrates Jesus' sovereignty over the created order as the incarnate creative Λόγος.³³⁷

The healed man who was born blind (9:1-41) acknowledges Jesus' authority, power saying “Well, here is an amazing thing, that you do not know where He is from, and yet He opened my eyes. We know that God does not hear sinners; but if anyone is God-fearing and does His will, He hears him. Since the beginning of time it has never been heard that anyone opened the eyes of a person born blind. If this man were not from God, He could do nothing” (Jn. 9:30-33). This σημεῖον shows Jesus as “the Light of the world” and leaves the man with light for his body and light for his soul (9:38). This miracle is not only a divine function, a function of God's own Messiah, which Jesus fulfils when He gives sight to the blind man, but also speaks of His character as the light of the world. All of this speaks of the intrinsic δόξα that resides in Jesus and is manifest in His deeds. Jesus also states the awful outcome of His mission where men refuse to recognise the sign (cf.9:39).³³⁸

A plentiful catch of fish (21:1-17) is shown to be an integral part of the Fourth Gospel. It was written in order to show believers how Jesus dealt with the apostles after His resurrection. In particular it demonstrates His authority in the paternal realm – the plentiful catch of fish. It also shows the way in which He re-commissions Peter in spite of His thrice repeated denial, thus confirming his position as an apostle in spite of his lapse under threat. Finally it shows Jesus' sovereignty in dealing with each individual believer as He chooses.

³³⁷ Hughes (1933:23) indicates that here our Lord presents Himself as the Great Protector.

³³⁸ See Morris (1995:422).

3.5.1.3. Summary and Conclusion

The purpose of the Fourth Gospel is, according to Jn. 20:30-31, that people might believe that Jesus is God's Messiah and that in believing they might have life.

Each of these eight selected signs not only point to Jesus as the Christ but also reveal to an ever increasing extent, the δόξα of God. This δόξα is, on occasion, clearly indicated as in the miracle of turning water to wine and the final sign before Jesus' death and resurrection was the raising of Lazarus from the dead. Other signs are recorded without specific reference to δόξα but the δόξα of God is inherent in them. There is also a discernable development in the revelation of that δόξα in terms of the nature of the sign and the audience to which it was directed. The signs also give rise to a reaction or response by those present.

Specially, the turning of water to wine, the δόξα is related to Jesus' divine, creative power, to His ability to intervene in the physical world and change the nature of a substance to that of something different. Wine is a variable commodity whose quality and bouquet, the aroma and flavour, is dependant on a highly complex blend of sugars, aromatic substances and alcohol derived by the fermentation of grapes. Given the variable quality of the original grapes and the natural processes through which they are put it is not surprising that the end product exhibits a wide range of characteristics. The wine which Jesus created was of such a standard that the "good wine" usually served first at weddings seemed to be "poorer" in quality.

It is also of significance that the miracle was directed to Jesus' disciples and observed only by them and the servants. This introduction to the miraculous power of Jesus would have focused their thoughts on who and what He truly was. The response of the disciples was to acknowledge Jesus' miraculous power and His "δόξα."

The final sign before Jesus' death and resurrection was the raising of Lazarus from the dead after four days in the tomb. The reality of the sign could not be

mistaken – Lazarus was not in a faint or coma – but was unmistakably dead. There can be no greater demonstration of the authority, power and δόξα of Jesus than the giving of life to the dead.

This sign is perhaps the most significant of all in that it reflects the essence of Jesus' mission – to provide, for all who believe in Him, the way to eternal life (Jn. 11:25; cf. 3:16; 14:6). A significant result of this sign is the markedly different response of those who witnessed it. Many believed that Jesus was truly who He said He was – the Son of God, while others, while acknowledging that a remarkable miracle had taken place sought to put Him and Lazarus to death.

Furthermore, each of the signs recorded in the Fourth Gospel show varying aspects of Jesus' δόξα and each calls forth different responses on the part of those who witnessed or heard about them. Each was directed to a particular audience who had to respond either with belief and entrance to eternal life or rejection of the witness of the sign and spiritual death.

Moreover, in the Fourth Gospel the σημεῖα are of primary importance as the key to the relationship between the earthly Jesus and the exalted Christ. The central definition of in the σημεῖα is that they were revelations of δόξα. In the Fourth Gospel, the revelation of δόξα is parallel to the performance of the σημεῖον, or miracle so that the δόξα cannot be separated from the miracle. John simply links the manifestation of Christ's δόξα to the σημεῖα He performs. The σημεῖα reveal Jesus' power and thus the disciples could see His δόξα, could recognize Him to whom God has given this δόξα, as the true Son of God.

3.5.2. Δόξα demonstrated in the “Ἐγώ εἰμι” statements

In Greek the pronoun “I” is generally incorporated in the Greek verb form itself and so it is not necessary to use a separate word for the “I.” Where the pronoun Ἐγώ is added to a Greek verb it is almost entirely emphatic. This construction is found in the Greek translation of the Old Testament where the translators used this emphatic form of speech when translating words spoken by God. Thus

when Jesus used the phrase Ἐγώ εἰμι he was adopting phraseology associated with deity in the Greek Hebrew Scriptures. While there are parallels of this usage of Ἐγώ εἰμι in Greek history and culture, its use in designating the words spoken by God in the LXX should be given precedence as this is the “Bible” that was in use by Christian believers at the time John wrote the Fourth Gospel. The phrase Ἐγώ εἰμι is a clear expression of John’s Christological evaluation of Jesus. We find that the “Ἐγώ εἰμι” statements are distinctive and typical of the Fourth Gospel, contrasting strongly with the sayings tradition in the Synoptic Gospels, according to which Jesus was quite reticent in discussing His own dignity and role.³³⁹ Neyrey (1988:213) considers that, as a result of investigation into both the popular interpretations of the divine name in the Old Testament and the general background concerning God’s being, the Johannine “Ἐγώ εἰμι” sayings refer to past eternity and future imperishability.³⁴⁰ In the central event of deliverance in the Exodus scenario of the Old Testament, God reveals Himself to Moses at the burning bush as “I am who I am” (BHS. אֲנִי אֶהְיֶה אֲנִי, Ex. 3:14; LXX. Ἐγώ εἰμι ὁ ὢν). Another is the recurring refrain of Isaiah in which the Lord identifies Himself as the redeemer of Israel, evoking the atmosphere and imagery of the Exodus tradition.³⁴¹

³³⁹ Bernard (1948:cxix) lists the “Ἐγώ εἰμι” sayings and proceeds, “This is clearly the style of Deity....Its force would at once be appreciated by any one familiar with the LXX version of the O.T.” Schnackenburg (1984, 2:88) says that the Ἐγώ εἰμι sayings of Jesus indicate expressions of Himself as “God’s eschatological Revealer in whom God utters Himself,” and “the Johannine Ἐγώ εἰμι sayings are completely and utterly expressions of John’s Christology and doctrine of salvation.”

³⁴⁰ Smith (1997:112-113) says that two Old Testament books (Exodus & Isaiah) have been proposed as the background to Jesus’ Ἐγώ εἰμι statements as, God identifies Himself by the statement “I am” (LXX. Ἐγώ εἰμι) in each of them. Further see Harner (1970:iii, 6-36).

³⁴¹ LXX, Isa. 41:4 (τίς ἐνήργησεν καὶ ἐποίησεν ταῦτα ἐκάλεσεν αὐτήν ὁ καλῶν αὐτήν ἀπὸ γενεῶν ἀρχῆς ἐγὼ θεὸς πρῶτος καὶ εἰς τὰ ἐπερχόμενα ἐγὼ εἰμι); 43:10 (γένεσθέ μοι μάρτυρες κἀγὼ μάρτυς λέγει κύριος ὁ θεός καὶ ὁ παῖς ὃν ἐξελεξάμην ἵνα γνῶτε καὶ πιστεύσητε καὶ συνῆτε ὅτι ἐγὼ εἰμι ἔμπροσθέν μου οὐκ ἐγένετο ἄλλος θεὸς καὶ μετ’ ἐμὲ οὐκ ἔσται), 25 (ἐγὼ εἰμι ἐγὼ εἰμι ὁ ἐξαλείφων τὰς ἀνομίας σου καὶ οὐ μὴ μνησθήσομαι); 45:18 (οὕτως λέγει κύριος ὁ ποιήσας τὸν οὐρανὸν οὗτος ὁ θεὸς ὁ καταδείξας τὴν γῆν καὶ ποιήσας αὐτήν αὐτὸς διώρισεν αὐτήν οὐκ εἰς κενὸν ἐποίησεν αὐτήν ἀλλὰ κατοικεῖσθαι ἐγὼ εἰμι καὶ οὐκ ἔστιν ἕτι); 47:10 (τῇ ἐλπίδι τῆς ποιηρίας σου σὺ γὰρ εἶπας ἐγὼ εἰμι καὶ οὐκ ἔστιν ἕτέρα γνῶθι ὅτι ἡ σύνεσις τούτων καὶ ἡ πορνεία σου ἔσται σοι αἰσχύνη καὶ εἶπας τῇ καρδίᾳ σου ἐγὼ εἰμι καὶ οὐκ ἔστιν ἕτέρα); 48:12 (ἄκουέ μου Ἰακωβ καὶ Ἰσραὴλ ὃν ἐγὼ καλῶ ἐγὼ εἰμι πρῶτος καὶ ἐγὼ εἰμι εἰς τὸν αἰῶνα); 51:12 (ἐγὼ εἰμι ἐγὼ εἰμι ὁ παρακαλῶν σε γνῶθι τίνα

The extent to which the use of Ἐγώ εἰμι would have been recognized by Jesus' hearers as being the language of deity is difficult to assess as the construction was occasionally used in ordinary conversation.³⁴² For John, however, the use of the phrase is a rendering, not only of the force of the words used by Jesus, but also a revelation of His deity.³⁴³ Jesus frequently quoted the Old Testament and it is not unlikely that He used this particular word combination to focus attention on His claims. That He was successful is evidenced by the response of the Jewish rulers who wanted to stone Him because of His claim that Before Abraham was “Ἐγώ εἰμι” (8:58).

The author of the Fourth Gospel records Jesus' use of the phrase Ἐγώ εἰμι twenty four times.³⁴⁴ On one occasion its use by Jesus could be regarded as part of a normal conversation. However thirteen instances of the use of Ἐγώ εἰμι are associated with the seven “discourses” and the balance are occasions when Jesus uses the phrase as identification reminiscent of the great “Ἐγώ εἰμι” of God in the Old Testament. The usage of Ἐγώ εἰμι as a title is dealt with in the following section, 3.5.2.1. and the others in section 3.5.2.2. Given the focus of the study, the Ἐγώ εἰμι statements connected with the events of cross (Ἐγώ εἰμι the Good Shepherd, Ἐγώ εἰμι the Resurrection and the Life, Ἐγώ εἰμι in the Passover Supper and Ἐγώ εἰμι in the Gethsemane) are dealt with in detail in chapter 4, and the following sections present only a brief overview of the relevant verses showing how they relate to Jesus' claim to be the Christ and thus reflect His inherent δόξα.

3.5.2.1. The use of Ἐγώ εἰμι as a title

John uses “Ἐγώ εἰμι” as a title in the great “I am” discourses recorded in the

ἐυλαβηθεῖσα ἐφοβήθη ἀπὸ ἀνθρώπου θνητοῦ καὶ ἀπὸ υἱοῦ ἀνθρώπου οἱ ὡσεὶ χόρτος ἐξηράνθησαν); cf. 46:9; 48:17.

³⁴² In Jn. 9:9, used by the man born blind, and in 12:26, Jesus promising His followers that they would be where He was. Another possible normal usage occurs in Jn. 8:23.

³⁴³ See van der Watt (2000:414-422).

³⁴⁴ Jn. 4:26; 6:20, 35, 41, 48, 51; 8:12, 18, 24, 28, 58; 10:7, 9, 11, 14; 11:25; 12:26; 13:19; 14:6; 15:1, 5; 18:5, 6, 8.

Fourth Gospel.³⁴⁵ This usage is found in the following passages: Jn. 6:35, 41, 48, 51; 8:12, 18, 23; 10:7, 9, 11, 14; 11:25; 14:6; 15:1, 5.³⁴⁶

According to “Ἐγώ εἰμι the bread of life,” John records that, as a result of Jesus’ healing of the sick, a great multitude followed Him. On this day He went up a mountain and, as He saw the crowd coming to Him, He asked Philip where they were going to buy bread to feed the multitude. Philip’s response was that “Two hundred denarii worth of bread is not sufficient for them, for everyone to receive a little” (6:7). Andrew said that there was a lad who had five barley loaves and two fish but this was obviously not enough for the five thousand gathered there.

Jesus then gave thanks for the food and distributed it to the people and all were not only filled but there were twelve baskets of pieces left as well. As a result the people wanted to “make Him a king” and followed Him to the other side of the sea of Galilee. Jesus pointed out that they had followed Him because they had been fed and told them not to work for food which perishes but rather for “food which endures to eternal life which the Son of Man will give to you” (6:27). In the ensuing discussion Jesus says “I am the bread of life” (6:35). The phrase “ὁ ἄρτος τῆς ζωῆς” could mean either ‘the bread that is alive’ or ‘the bread that gives life.’ Of importance is the use of the article with the word life which could point to eternal life rather than life in general.

In spite of having participated in the miraculous meal, the crowd then asks for a sign and referred to the bread which Moses had given their fathers. Jesus corrects them pointing out that God, not Moses, gave them bread in the wilderness, He goes on to say that God continues to give them the true bread from heaven (Jn. 6:32-33, 50-51). John’s record of these events clearly establishes that Jesus is able to meet the physical needs of the people but more than that, Jesus and Jesus alone, is able to meet the deep spiritual hunger in the hearts of the people. The God who met the needs of their fathers is still at work and in Jesus will meet their deep spiritual hunger. It is important

³⁴⁵ Harris (1994:136) expresses the use of the formula Ἐγώ εἰμι with a predicate.

³⁴⁶ Cf. Ex. 3:6, 14; 20:2; Isa. 44:6, 24; 51:12; Prov. 8; Rev. 1:17; 2:23; 22:16.

for us to realise that, while we today have a vast variety of foods available to us, in the time of Jesus bread was the main article of food and that bread was regarded as the essential foodstuff that supported the whole of life. The “bread from heaven” can therefore be taken to refer to what is essential for eternal life.³⁴⁷

The claim by Jesus is repeated with variation three times (vv. 6:35, 48, 51) underlining the importance of the claim. Jesus is stressing His heavenly origin and that it is in Him alone that the people will find the answer to their spiritual hunger. Beasley-Murray (1987:92) considers that verse 6:35 means that Jesus is the Bread which gives the life of the kingdom of God. This He bestows on those who “ἐρχόμενος to Him” and who “πιστεύων in Him,” it seems that the synonymous parallelism is unmistakable (cf. 7:37-38). Verse 35 asserts strongly that one who so “comes” and “believes” will “never hunger” and “never, never thirst.” But Carson (1991:288) says in addition, that this does not mean there is no need for continued dependence upon Jesus, for feeding upon Him continually; it does mean there is no longer that core emptiness that the initial encounter with Jesus has met. John’s approach is fundamentally Christological, and, so far as these Christological claims awaken echoes of Old Testament backgrounds (cf. Isa. 55:1ff.; Prov. 9:5),³⁴⁸ the connections are in terms of prophecy and fulfilment.³⁴⁹

According to “Ἐγώ εἰμι the Light of the world,” ‘light’ is ever a symbol for that which is good and darkness for that which is evil. In the context of the Fourth Gospel, John uses the term φῶς 19 times and the significance of its use is stressed at the very outset when, in the prologue John writes of Jesus, “In Him was life, and the life was the light of men. And the light shines in the darkness, and the darkness did not comprehend it (1:4-5).” The phrase “I am the Light of the world” and related terms conveying similar concepts, occur in various

³⁴⁷ See Lightfoot (1956:159-160); Morris (2000:229).

³⁴⁸ We find that the connection with Isaiah 55:1 is more likely, not only is Isaiah the most frequently quoted Old Testament book in the Fourth Gospel, but also Isaiah 55 deals explicitly with the dawning of eschatological salvation and fulfilment.

³⁴⁹ See Carson (1991:289).

passages (Jn. 8:12; 9:5; 12:46) but the use of Ἐγώ εἰμι is recorded in John 8:12. In verses 8:12-30, we are told that Jesus spoke these words in the treasury and since chapter 7 informs us that Jesus was in Jerusalem for the Feast of Tabernacles it reasonable to assume that this event was the background to this “I am” (Ἐγώ εἰμι) saying. The illumination of the great candelabra was a feature of the celebration and so Jesus’ comments would have a particular relevance to His audience. There is also the thought that His audience would connect Jesus’ words with the pillar of fire which protected and lead their forefathers in the wilderness.

In Jn. 8:12, the “again” (πάλιν) indicates that this discourse by Jesus was a continuation of 7:37-39, and is therefore to be considered in the context of the feast of Tabernacles. The phrase “Ἐγώ εἰμι τὸ φῶς τοῦ κόσμου” is one of His self-declarations in the Fourth Gospel. The light metaphor is steeped in Old Testament allusions (Ps. 27:1).³⁵⁰ The focus in 8:12 is on the fact that Jesus is the light of the world and that the person who follows Him as disciple will never walk in darkness (cf. 1:5, 9; 3:19-21; 12:35, 46) but will have the light of life (cf. Ps. 36:9).³⁵¹

Simmons (1988:100) writes that “The Pharisees understood the association (of Jesus’ claim to be the light of the world and the divine Shekinah which illuminated the wilderness trek) and they challenged Jesus’ affirmation.” In its potential association with the Shekinah δόξα of the Old Testament, this Ἐγώ εἰμι saying of Jesus conveys the most explicit reference to δόξα of all the Ἐγώ εἰμι sayings.

According to “Ἐγώ εἰμι the Door,” twice in chapter 10 John records that Jesus said that He was the door. In 10:7 Jesus says that He is “the door of the sheep”

³⁵⁰ Conzelmann (1975:320) says that “Light is Yahweh in action” (Ps. 44:3). God’s light shining for their salvation at the Exodus encouraged prayers for the like shining of his face in the predicaments of the faithful (Ps. 80:1-7, 14-19). Isaiah tells us that the servant of the Lord was appointed as a light to the Gentiles, that he might bring God’s salvation to the ends of the earth (Isa. 49:6), and was matched by their expectation of that same light shining for their salvation in the coming eschatological age (Isa. 60:19-22; cf. Rev. 21:23-24).

³⁵¹ See Ridderbos (1997:292-293); Carson (1991:338).

and in 10:9 He simply says He is “the door.” The context of these statements is a discussion about shepherds and their sheep. The hearers had not understood the comments Jesus’ had made about sheep, the sheepfold, the door and the shepherd in verses 1 to 6 and so He elaborates claiming that He is the door to the sheep. This affirmation of being the door emphasises the fact that Jesus is stating that there is only one door to eternal life and that is through Him alone. Using the door leads to salvation (v. 9^b)³⁵² and as a result the sheep will be able to “go in and out and find pasture” (10:9^c).³⁵³ Morris (1989:114) points out that the sheep go in for safety and come out for food.

This specific term points beyond pasture and security to the sort of salvation Jesus provides those who follow Him, the eschatological salvation God promised the flock of His people (cf. Ezek. 34:22; Zech. 9:16).³⁵⁴

This “Ἐγώ εἰμι” saying brings us face to face with the claim of an exclusive salvation available only through Jesus and this leads us on to realise that He is claiming divinity and divinity is, in itself, glorious.

According to “Ἐγώ εἰμι the Way, the Truth and the Life,” this Ἐγώ εἰμι saying was voiced in the upper room in response to Thomas’ statement “Lord, we do not know where You are going, how do we know the way?” (14:5) Jesus said to him, “I am (Ἐγώ εἰμι) the way, and the truth, and the life; no one comes to the Father, but through Me” (14:6). Jesus is affirming that there is no other way to God other than through Himself. It is significant that in the early days of Christianity the faith was referred to as ‘The way’ (ἡ ὁδός), a name based, no doubt, on this statement by Jesus. This affirmation is in line with the same implicit claim in His statement that He is the door. But not only is Jesus the way but He is the truth (ἡ ἀλήθεια). In the Fourth Gospel, truth means not only reliable and accurate information but deeds commensurate with absolute honesty. Thus Jesus is not only claiming that all that He taught is true but that

³⁵² Cf. 14:6; Mt. 7:13-14; 25:10; Lk. 24-25.

³⁵³ Cf. Ps. 23:2 (22:2 LXX); Jer. 23:3; 50:19; Ezek. 34:14; Mic. 2:12.

³⁵⁴ See Keener (2003:811).

all His deeds are governed by truth. We can therefore rely entirely on what He says about Himself, the Father and the way to eternal life. Jesus goes on to say that He is the life (ἡ ζωή) and this takes us into the same realm as the statement Ἐγώ εἰμι the resurrection and the life with all that this means.

Beasley-Murray (1987:252) asserts that the syntactical coordination of the three terms the way (ὁδός), the truth (ἀλήθεια), and the life (ζωή), in Jn. 14:6 is such that the principal theme clearly falls on the first word, for the statement explains the assertion of verse 4 (“you know the way”), and concludes with a deduction from the main clause: “no one comes to the Father but through Me” (14:6^c). Despite this emphasis on the first term – the way – the second and third terms are also of importance, in that they explain how it is that Jesus is the way: He is the way to God because He is the truth of God (cf. 1:14; the supreme revelation of God), and because the life of God resides in Him (cf. 1:4; 3:15; 5:26). The Word (Λόγος) became flesh and dwelt among us in order to supply such an avenue of approach. Bruce (1983:298-299) comments that “Jesus’ claim, understood in the light of the prologue to the Gospel, is inclusive, not exclusive. All truth is God’s truth, as all life is God’s life; but God’s truth and God’s life are incarnate in Jesus.

Uttered as it was on the eve of Jesus’ atoning death on the cross this emphatic threefold statement would linger in the minds of the disciples and remind them that Jesus claimed to be the exclusive way to God, that all that He taught was accurate and reliable and that in Him alone is eternal life to be found.

In the Old Testament, the vine is used as a symbol for Israel (Ps. 80:8-16; Isa. 5:1-7; Jer. 2:21; Ezek. 15; Hos. 10:1). In some cases the picture is one of an unproductive vine (Jer. 2:21) suggesting that Israel had not lived up to its high calling and had not been fruitful for God. In the same way as Israel had to be faithful to God, the children of God (Jn. 1:12; 11:52) are to abide in Jesus and draw their life from Him. They are one, just as He and the Father are one. The force of the passage in John 15 is not only on the fact that Jesus was the true vine and would accomplish God’s purposes but also on the fruitfulness of His

followers. This fruitfulness may be interpreted in different ways but the prime issue appears to lie in producing fruit for God and here we are reminded of the passage in Gal. 5:22-23 which describes the fruit of the Spirit. Fruitfulness may also be taken as the positive outcome of being diligent to implement the command of Mt. 28:16-20. Whatever the view taken, the key thought is that Jesus' followers are to bear fruit. The imagery of the vine is continued as Jesus goes on to teach that this fruitfulness can only be achieved in close relationship to Himself. Apart from Jesus we can do nothing.

We find that Jesus' theme as recorded in this chapter is the union between believers and Christ as manifested in His whole work in life, death, and resurrection.³⁵⁵ The fruitfulness of His disciples will redound to the δόξα of Jesus as people believe in Him and show the evidence of this in their changed behaviour and lifestyle.

3.5.2.2. The use of Ἐγώ εἰμι as identification

The instances where Jesus uses the term Ἐγώ εἰμι as identification³⁵⁶ occur in Jn. 4:26; 6: 20; 8: 24, 28, 58; 13:19; 18: 5, 6, 8.

According to "Ἐγώ εἰμι in Samaria," the first use of Ἐγώ εἰμι as a simple statement of identity in the Fourth Gospel occurs at Jacob's well in Samaria during Jesus' conversation with a Samaritan woman, "I who speak to you am He" (4:26^b). As noted by Simmons (1988:97) the Samaritans did not carry the Jewish "baggage" of political expectations regarding the Messiah and Jesus therefore freely revealed His identity to her after demonstrating superhuman knowledge of her past and present life. The nature of the conversation and His detailed knowledge of her life persuaded the woman that Jesus was indeed the Messiah (cf. 6:29).

This phrase "I who speak to you am He" (4:26^b) may be read as "I am Christ (Messiah) speaking to you." Here Jesus uses "Ἐγώ εἰμι" in an absolute sense,

³⁵⁵ See Westcott (1890:216); Barrett (1978:470).

³⁵⁶ Harris (1994:131) says that this is the use of the absolute formula Ἐγώ εἰμι expression.

He is identifying Himself with God and thus the glory (δόξα) associated with God.

After a strenuous day, which included the feeding of 5000 people with the multiplied “five barley loaves and two fish,” the disciples had left Jesus on the mountain and were rowing to the other shore. It was already dark and the sea was stormy because of a strong wind, when they saw Jesus walking on the sea towards them and they “were frightened.” To reassure them Jesus said “Ἐγώ εἰμι μὴ φοβεῖσθε, It is I; do not be afraid” (6:20). This may be no more than a way of self-identification as Barrett (1978:281) thinks, but the style of expression is the style of divine authority and it is in accordance with this that Jesus came walking on the water. The disciples were frightened at the remarkable sight of a man walking on the water and, in order to calm their fear, Jesus’ response was to identify Himself as their beloved Lord while at the same time reminding them of His claims to divinity by using the phrase “Ἐγώ εἰμι.” Ridderbos (1997:217) interestingly comments that “this occurs in a context – and that is where the emphasis lies in this self-revelation – that should convince them that, in virtue of the δόξα given Him by God, no darkness was too deep, waves too high, or sea too wide for Him to find them and be with in the midst of that tumult.”

While this may have been a simple identifying statement the next sentence records that after taking Jesus on board the boat was immediately at the land to which they were going. The linkage of the Ἐγώ εἰμι and the miraculous arrival at their destination would not have been lost on the disciples.

During the feast of Tabernacles recorded in John chapter 8 Jesus used the Ἐγώ εἰμι construction in presenting Himself as the “Light of the world” but also used it as a title three times during the discourse that followed.

In Jn. 8:24 Jesus said “I said therefore to you, that you shall die in your sins; for unless you believe that I am He (Ἐγώ εἰμι), you shall die in your sins.” There is little doubt that in this pronouncement His audience heard echoes of Isa. 43:10, “So that you may know and believe Me and understand that I am He.” “I am He” in 8:24 occurs after Jesus’ claim that He is going away, an allusion to His death

and return to the Father (8:21; cf. 7:33-35; 13:33). The connection between Jesus' claim to divinity through the use of this idiom and His exaltation as the Son of Man becomes explicit a few verses later: "When you lift up the Son of Man, then you will know that I am He (Ἐγώ εἰμι), and I do nothing on My own initiative, but I speak these things as the Father taught Me" (8:28). Culpepper (1999:82-83) considers that Jn. 8:28 comprises both Christological and soteriological aspects; life comes only by believing in Jesus as the one who can say, "Ἐγώ εἰμι," in the absolute sense. As pointed out by most of scholars, being lifted up and being glorified are closely associated in the Fourth Gospel.³⁵⁷ When this happens there would be no doubt that Jesus is identical with the "I am" of the Hebrew Scriptures.³⁵⁸

In Jn. 8:58 Jesus uses the term Ἐγώ εἰμι in such a way as to be an unmistakable claim to deity. John records the following: "Your father Abraham rejoiced to see My day, and he saw it and was glad. ... Jesus said to them, Truly, truly, I say to you, before Abraham was born, Ἐγώ εἰμι" (8:56-58). The claim to have been in existence before Abraham is a statement that shows that Jesus was sovereign over time.³⁵⁹ The Gospel narrative goes on to say that the listeners wanted to stone Jesus (cf. 10:30f.), a clear indication that they recognised the "Ἐγώ εἰμι" to be an echo from the Greek version of the Hebrew Scriptures³⁶⁰ and understood His words to be a claim to deity, implying as they did Jesus' pre-existence and changelessness.

3.5.2.3. Conclusion

Ἐγώ εἰμι is the phrase used by the LXX translators when translating words spoken by God and when Jesus used this emphatic form of I am he was

³⁵⁷ This analysis of lift up (ὑψώω) in Jn. 8:28 is developed further in chapter 4.2.

³⁵⁸ With reference to 8:28, Dodd (1998:96) asserts, "The Ἐγώ εἰμι carries with it the solidarity of Christ with God." However, Barrett (1978:342) finds the expression to mean no more than "Jesus is the obedient servant of the Father, and for this reason perfectly reveals Him. Ἐγώ εἰμι does not identify Jesus with God, but it does draw attention to Him in the strongest possible terms."

³⁵⁹ Furthermore, as in 13:19, it seems that the Ἐγώ εἰμι in 8:58 expresses the unity of the Father and the Son.

³⁶⁰ Cf. Deut. 32:39; Isa. 41:4; 43:10, 13; 46:4; 48:12.

adopting phraseology associated with deity in the Greek Hebrew scriptures. John records Jesus using this construction 24 times, once when it could be regarded as part of normal conversation, thirteen times when it occurs in relation to the seven great I AM discourses while the other occasions are instances where Jesus uses it as a title reminiscent of the Ἐγώ εἰμι of God in the LXX Old Testament.

The Ἐγώ εἰμι discourses point to various aspects of the person and ministry of Jesus:

As the Bread of Life, He is presented as the source of eternal life, providing His own with spiritual sustenance just as God provided the children of Israel with Manna in the wilderness.

As the Light of the World, Jesus is presented as a clear guide to those who wish to follow God's will just as the Shekinah δόξα directed the path of the Israelites in the wilderness. Of all the I AM sayings, it is also the most explicit pointer to the δόξα of Jesus.

As the Door, Jesus is presented as the one and only way to eternal life and, as the exclusive provider of salvation, it shows Him to be divine and to have all the δόξα associated with divinity.

As the Way, the Truth, and the Life, Jesus is presented in multiple guise. He is the sole way of access to God, All that He taught and did was governed by absolute honesty and so His disciples can have confidence that what He said of Himself, God the Father and eternal life is true.

As the True Vine, Jesus is presented as the source of fruitfulness for His followers in all its many aspects.

Jesus used Ἐγώ εἰμι as identification when talking to the Samaritan woman, the disciples as He came to them walking on the water, the crowd at the Feast of Tabernacles, the twelve at the Passover supper and to the mob in the garden of Gethsemane.

Where Jesus uses Ἐγώ εἰμι as identification far more than simple acknowledgement of who He is takes place. To the Samaritan woman He uses the phrase in a context which clearly demands that she understands He is claiming to be the Messiah that both Jew and Samaritan were expecting. After using Ἐγώ εἰμι to identify Himself to the storm tossed, frightened disciples He goes on to show His authority over the raging forces of nature.

At the Feast of Tabernacles Jesus, in speaking of His existence before Abraham, revealed His sovereignty over time and something of His eternal existence. There is no doubt that His hearers understood that that His words and the use of Ἐγώ εἰμι were a claim to divinity.

In all these instances, the use of the term Ἐγώ εἰμι by Jesus is reminiscent of the Old Testament divine “I am” used by God to identify Himself to Moses and the children of Israel. They demonstrate Jesus’ foreknowledge of coming events, His power over the forces of nature, the fulfilment of prophecy and His claim to an eternal existence. In doing so they reflect His deity and the implicit δόξα that is His as God.

3.6. Jesus’ Claims to Δόξα

3.6.1. The Prayer of the Lord

Δόξα is a key theme in Jesus’ prayer as recorded in John 17 and it is therefore important to review this prayer in the light of the insight it gives into the concept of δόξα as used within the Fourth Gospel. A key element of the Prayer of the Lord recorded in Jn. 17:1-26 is Jesus’ request for the Father to glorify (δοξάζω) the Son so that the Son might glorify (δοξάζω) the Father (v. 1). The reference is to His coming death and a request for the manifestation of the δόξα that Christ had with the Father “before the world was.” What was to follow in the lives of the disciples would indeed bring δόξα to God. This reflection of δόξα has been carried on through all the intervening ages where ordinary men and women boys and girls believing in Christ have endured trials, martyrdom, scoffing and scorn

without flinching and have “kept the faith” in spite of persecution – even to the death. As an example of this we have Jn. 20:19: “Now this He said, signifying by what kind of death he (Peter) would glorify God.”

In 2 Cor. 8:23, Paul speaks of brethren who are messengers of the churches and a δόξα to Christ representing Him in the churches. In 17:22 and 24, John writes that Jesus said that the glory (δόξα) which He received from God He passed on to His disciples. Jesus had a glory before the world was (17:5) and gave this glory to His immediate followers (17:22, 24).³⁶¹

In the Prayer of the Lord (Jn. 17), we find that the purpose of Jesus’ ministry was to reveal His δόξα, and the name of the Father, to the disciples, to the end as Cooper (1979:376) indicates, that they might believe (17:8, 20-21); that they might be glorified (17:22) with the Father and the Son; that others might believe and be glorified (17:20). In the prayer of the Lord we can discern three movements, prayer for His own glorification, prayer for His disciples and finally prayer for those who will, in the future, believe in Him through the ministry of His disciples.³⁶² In praying for His own glorification Jesus refers to eternal life, which is knowing the only true God, and which He gives to those given to Him. For His disciples He prays that they will be sanctified and that they will be kept from the “evil one.” There follows a plea for all those who will “believe in Me through their word” all those who, through the ministry of His disciples, come to believe in Him, that is believe that He is the only begotten Son of the Father.

3.6.1.1. Literary aspects on the Prayer of the Lord

The Prayer of the Lord in chapter 17 is conditioned by its position at the conclusion of the farewell discourse of Jesus. Dodd (1998:417) notes that almost every verse in the Prayer of the Lord contains echoes of chapters 14-16. The inclusion of a prayer in descriptions of farewell discourses is not uncommon in the Old Testament and Jewish writings. The book of Deuteronomy is similar

³⁶¹ Further see Jesus’ Lowly Service and Δόξα, Chapter 3.8.

³⁶² See Morris (1995:634).

in form including a series of farewell discourses, concluding with the Song of Moses in Deut. 32. This passage honours God's rule in the history of His people and records Moses' blessings of the tribes in Deut. 33 as a kind of prophetic prayer.³⁶³ In Jewish apocalyptic literature we find the prayer of Baruch in 2 Bar. 48, and in the book of Jubilees the prayers ascribed to Moses (1:19-21), Noah (10:3-6), Abraham (chaps. 20-22) and Isaac (36:17), coupled with admonitions and blessings (36:17).

The Prayer of the Lord in chapter 17, however, emphasizes Jesus' obedience to the Father, obedience even unto death and summarises Jesus' purpose and ministry. It also highlights the fact that His death is the means by which the δόξα of God is manifested; the choosing of the disciples out of the world; the revealing to them of God in the person of Jesus; their mission to the world; their ultimate unity in love, and their dwelling in Christ and in God. It consummates the movement of Christ to God, and anticipates His being lifted up on the cross, therefore, Dodd (1998:419) rightly comments that "the spiritual and ethical reality of that ἀνάβασις (go up) or ὑψωσις (lift up) of the Son of Man which is hereafter to be enacted in historical actuality on the cross." Also, Westcott (1890:237) has rightly pointed out, that the prayer of the Lord (Jn. 17:1-26) is "at once a prayer and a profession and a revelation, is the consummation of the glory (δόξα) of God through Christ."

The structure of the prayer of the Lord has been much discussed. Westcott (1890:237) proposed the threefold division (the Son and Father vv. 1-5; the Son and His immediate disciples vv. 6-19; the Son and the church vv. 20-26), which has been widely adopted.³⁶⁴ Breck (1994:215) considers that Jn. 17 reflects a

³⁶³ See Brown (1978:744-755).

³⁶⁴ Bernard (1948:559) and Brown (1978:749-750) adopt a slightly different threefold division (vv. 1-8; vv. 9-19; vv. 20-26). Dodd (1998:417) suggests a fourfold division (vv. 1-5; vv. 6-8; vv. 9-19; vv. 20-26). Lindars (1982:515) adopts a different fourfold division vv. 1-5; vv. 6-19; vv. 20-23; vv. 24-26, and Barrett (1978:499) also adopts a slightly different fourfold division vv. 1-5, vv. 6-19, vv. 20-24, and vv. 25-26.

chiastic structure according to the A:B:C:B':A' model.³⁶⁵

A (1-5): Jesus prays to the Father to glorify Him with the *glory*

He had *before the world was made*.

B (6-8): Jesus speaks about His apostles,

to whom He has given the Father's word.

C (9-13): Jesus prays for His apostles.

B' (14-19): Jesus again prays for His apostles,

to whom He has given the Father's word.

A' (20-26): Jesus prays for all believers and concludes by speaking about the *glory* the Father gave Him *before the foundation of the world*.

Interestingly, we find that the Prayer of the Lord (17:1-26) recalls many themes which were dealt with in the farewell discourse. Counet (2000:241-242) notes that there are similarities between the prayer of the Lord and the farewell discourse. He tries to show that there is a strong link in content between Jn 13-16 and Jn. 17 no matter whether or not this was intended. The similarities are noted below.

Farewell Discourse	Linking elements and themes	The prayer of the Lord
13:31-35	δοξάζω / glorifying	17:1-5
13:36-14:7	ὑπάγω / departure-stay	17:11-13 (17:8)
14:8	δεῖξον-ἐφανερώσα: name of the Father	17:6, 26
14:9-14	Unity	17:11 ^b & 17:21-26
14:10	Father : Jesus	17:21 ^b
14:14	Disciples : Jesus and the Father	17:23
14:15-16	ἔρωτῶ / ask-pray	17:6, 9 ^a
14:17-19	Inferiority of the cosmos	17:9 ^b -16
14:20-21	Love and unity (presence of Jesus in those He loves)	17:22-26
14:22-24	Not from the cosmos	17:14-16
14:23-24	τηρέω / keeping the Logos	17:6, 8
14:26-31	To be with you – go away	17:12-13
15:1-17	Remain in each other/ love each other	17:21-26
15:18-16:4	Hatred of the cosmos	17:14-16
16:5-15	Lead within / sanctify in truth	17:17-19
16:16-28	χαρά / joy (go to the Father)	17:13
16:29-33	Hour; stay in the cosmos; Victory over the cosmos	17:1 & 17:14-16

³⁶⁵ Ellis (1984:239-240) and Howard-Brook (1994:358) adopt the same chiastic structure but differ on the verse content of each section.

Similarities have occasionally been noted between the Prayer of the Lord in the Fourth Gospel and the Lord's Prayer as found in Luke and, more particularly, in Matthew.³⁶⁶ Brown (1978:747), comparing the Prayer of the Lord in Jn. 17 to the Lord's Prayer says:³⁶⁷

There are definite parallels to the petitions of the Lord's Prayer: compare the petition "May Your name be glorified [hallowed]" to the themes of glorification of the Father and the use of the divine name in xvii 1, 11-12; the petition "May Your will be done" to the theme of completing the work that the Father gave Jesus to do in xvii 4; the petition "Deliver us from the evil one" to the theme expressed almost in the same words in xvii 15.

There are places where the Prayer of the Lord in chapter 17 of the Fourth Gospel appears to echo the language of the Lord's Prayer in Matthew:³⁶⁸

The Lord's Prayer (Mt. 6:9-13)	The Prayer of the Lord (Jn. 17)
Πάτερ ἡμῶν ὃ ἐν τοῖς οὐρανοῖς (6:9)	Πάτερ (17:1, 5, 21, 24); Πάτερ ἅγιε (17:11); Πάτερ δίκαιε (17:25)
Πάτερ ... ἁγιασθήτω τὸ ὄνομά σου (6:9)	Πάτερ ἅγιε, τήρησον αὐτοὺς ἐν τῷ ὀνόματί σου (17:11); ἐτήρουν αὐτοὺς ἐν τῷ ὀνόματί σου (17:12)
Ῥῦσαι ἡμᾶς ἀπὸ τοῦ πονηροῦ (6:13)	τηρήσης αὐτοὺς ἐκ τοῦ πονηροῦ (17:15)

It seems that such parallels almost inevitably suggest the possibility of some type of literary relationship, either direct or indirect, between the two recorded prayers. Walker (1982:248) points out that Jn. 17:1-8 is for the most part, a midrashic expansion of the phrase "Your will be done, on earth as it is in heaven" (γενηθήτω τὸ θέλημά σου, ὡς ἐν οὐρανῷ καὶ ἐπὶ γῆς. Mt. 6:10; cf. Lk. 11:2^c), while Jn. 17:9-19 relates primarily to the phrase "And do not lead us into temptation, but deliver us from evil" (καὶ μὴ εἰσενέγκῃς ἡμᾶς εἰς πειρασμόν, ἀλλὰ

³⁶⁶ Lk. 11:2-4; Mt. 6:9-13.

³⁶⁷ Further see Dodd (1963:333).

³⁶⁸ See Walker (1982:238-248).

ῥῶσαι ἡμᾶς ἀπὸ τοῦ πονηροῦ. Mt. 6:13; cf. Lk. 11:4^b); thus far, the structure of the Prayer of the Lord (Jn. 17) reflects that of the Jesus' Prayer (Mt. 6:9-13; Lk. 11:2-4). Jn. 17:20-26 is essentially a recapitulation of the themes developed earlier in the prayer.

It should be noted that another possible reason for the similarities between the two prayers is that the same person, Jesus, is their originator. In the first, the "Lord's Prayer," He is teaching His disciples to pray and in the second He is engaged in prayer Himself and, as aspects of the prayers overlap,³⁶⁹ it is not strange to find similarities of thought and expression.

3.6.1.2. Exegetical perspective on the Prayer of the Lord

Jn. 17:1 begins with the statement that "the hour (ἡ ὥρα) has come," this phrase means that the whole life and mission of Jesus has moved into its final phase - contrast verses 2:4; 7:6, 8, 30; 8:20 with intimations of the arrival of the hour (ἡ ὥρα) in verses 12:23, 27-28, 31-32; 13:1, 31. It also means that Jesus' work of redemption of the world was ready for the climactic act. It is the hour of His δόξα - the hour (ἡ ὥρα) of His death.

The prayer opens with the request "Glorify Your Son, that the Son may glorify You" (δόξασόν σου τὸν Υἱόν, ἵνα ὁ Υἱὸς δοξάσῃ σέ) in 17:1, Beasley-Murray (1987:296) indicates that this petition strikes the keynote of the prayer of the Lord.³⁷⁰ He rightly comments that "its significance is complex; in the context it expresses the desire of Jesus that His life, now to be devoted to God in death (v. 19), may be an acceptable sacrifice; that God may raise Him to the throne of His glory (cf. 13:31-32); that the honour that comes from God alone may be His, and that all may recognize it." "That the Son may glorify You" (ἵνα ὁ Υἱὸς δοξάσῃ σέ, v. 1^c), means that if the Father glorifies the Son by accepting His obedient suffering and death and through it exalting Him to heaven, it is in order that the

³⁶⁹ As noted these similarities include obedience to the Father's will and protection from evil.

³⁷⁰ Bultmann (1971:490) says that the first petition of the prayer of the Lord is in fact its whole content. Also, Thüsing (1960:191) indicates that the thought of the glorification of Jesus in those who belong to Him is absolutely central in the prayer of the Lord (Jn. 17).

Son may by His obedience, thus corroborated, glorify the Father.³⁷¹ In verse 1, the prayer of the Lord makes it clear, moreover, that not only are the δόξα of the Son and the δόξα of the Father closely connected (ἵνα), and but also that to glorify the Son is to glorify the Father thus showing that the two are one.

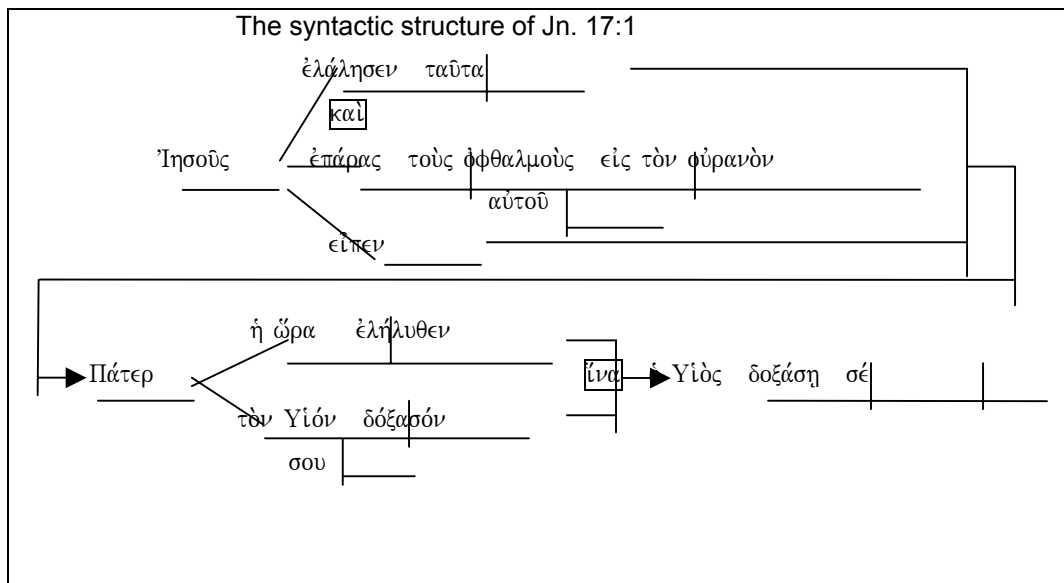

Carson (1991:554) comments that verse 2 seems to establish the ground for the petition of verse 1^b through the use of the term/word καθὼς (such as), and does so by establishing an analogical pattern.³⁷² This can be schematized as follows:

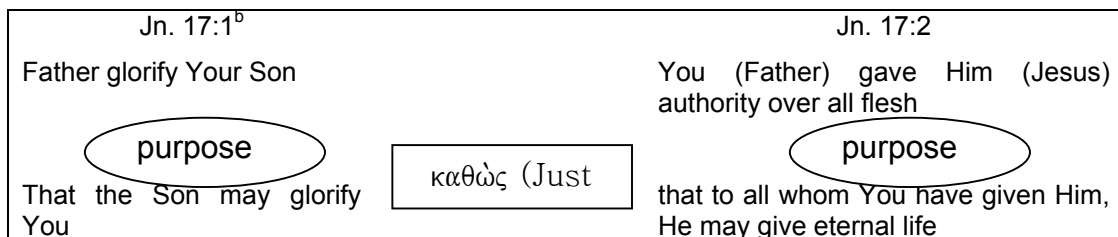

All of Jn. 17:2 is the ground for verse 1^b, but there are important horizontal parallels that can be observed in this schematization. Verse 2^a (ἔδωκας αὐτῷ ἐξουσίαν πάσης σαρκός) is understood as referring to God's pre-creation decision to give His Son authority over all flesh. Whereas, verse 2^b (ἵνα πᾶν ὃ δέδωκας

³⁷¹ See Barrett (1978:502).

³⁷² See Carson (1980:174-176).

αὐτῷ δώσειν αὐτοῖς ζωὴν αἰώνιον) refers to the Father’s gift of authority over all humanity, on the basis of the Son’s prospective obedient humiliation, death, resurrection and exaltation. It is nothing less than the redemptive plan of God, for 17:2^b declares the purpose; it is that the Son might give eternal life to those the Father has given to Jesus. Also with reference to verse 1^b (δόξασόν σου τὸν Υἱόν), Jesus utters this prayer on the basis of the Father’s pre-creation plan to give all authority to the Son as a outcome of the Son’s triumphant cross-work and exaltation. Then Jesus asks that He might be glorified in order that He might in turn glorify the Father (ἵνα ὁ Υἱὸς δοξάσῃ σέ); which is harmonious with the purpose clause in verse 2. The extent of authority is ‘over all flesh,’ the purpose is that those whom the Father has given to the Son might have eternal life. Therefore, according to verses 1 and 2, we find that the completed work of Jesus means; firstly, the glorifying of the Father (1^b), and secondly, the gift of eternal life to men (2^b).

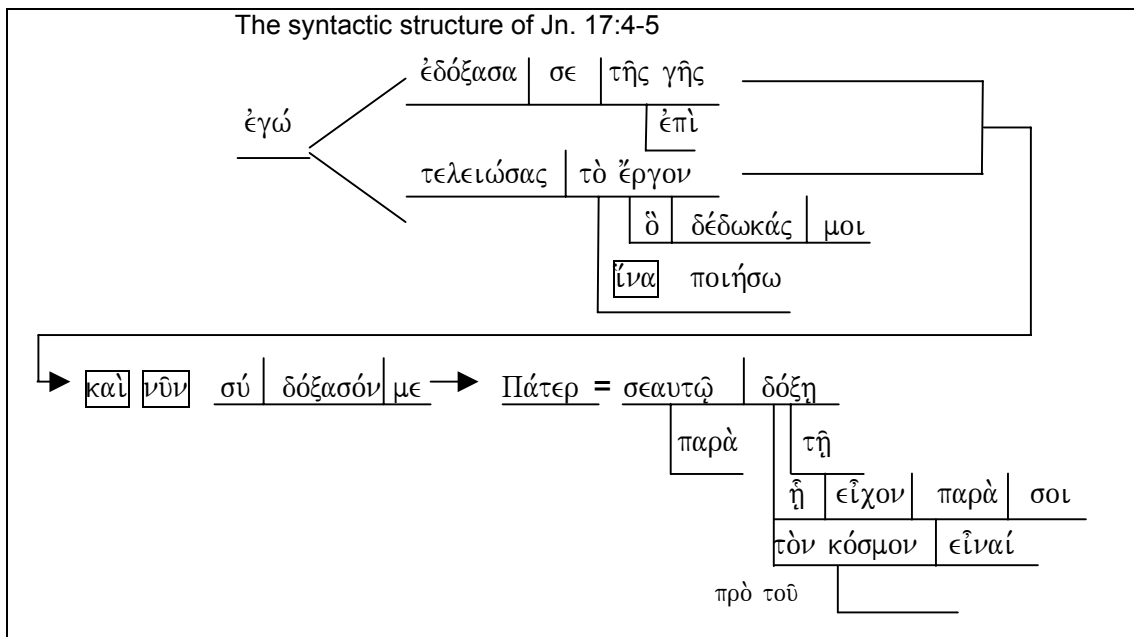

The meaning of δόξα in Jn. 17:4 is brought out in the phrase “having accomplished the work” (τὸ ἔργον τελειώσας), which mean that Jesus has glorified the Father by His complete obedience and faithful fulfilment of His mission. It seems that this phrase refers not only to what Jesus had already

done while on earth but also the future work He would accomplish on the cross, speaking of it as already having been done because of His determination to complete all that was in the mind and heart of God “from the foundation of the world.” This too, lends a glory to the events of the cross. The term *τελειώσας* looks forward to the completed life of Jesus, and upon His death (cf. 19:30).

In Jn. 17:5, the request of Jesus is expanded in that the *δόξα* for which He prays is linked to His pre-incarnate *δόξα* with the Father (Col. 1:15-17; cf. Jn. 1:1; 8:58; 16:28). The *δόξα* in this verse seems to be no less than the eternal *δόξα* of the Godhead. Beasley-Murray (1987:297) says that the prayer for *δόξα* in verse 5, is accordingly for a restoration of that which the Son enjoyed with the Father prior to creation (cf. 1:1-5).³⁷³ The implication seems to be that Jesus did not manifest on earth the full *δόξα* which belonged to Him from the beginning.³⁷⁴ Thus, throughout His entire ministry Jesus glorified the Father - but death sets the seal on His obedience and dedication and therefore supremely glorifies the Father, and, at the same time, leads to the resumption by Jesus of His full manifest *δόξα*. Moreover, John, unlike Paul, does not set Jesus' coming exaltation in contrast to the disgrace of the cross (cf. Phil. 2:6-11), but considers the cross as the essential stage towards that *δόξα*.

The term “glorify” (*δοξασματι*) in Jn. 17:10, also occurs in verses 14:13, 15:8 and 16:14. In 17:10 Jesus formally pronounces that He would be glorified in His disciples, “καὶ τὰ ἐμὰ πάντα σὰ ἐστὶν καὶ τὰ σὰ ἐμὰ” (17:10^a). It seems that between the Father and Son there exists a perfect unity of possession, which always expresses itself in the unity of mission as well, since both have perfect right of disposal over one another.³⁷⁵ To make clear that all these verses refer to His disciples (as clearly shown by the pronoun ‘them’ at the end of verse 17:10), it may be necessary to expand verse 17:10^a, “All those disciples who

³⁷³ Schnackenburg (1984, 3:174) comments that the glory of Jesus ‘before the world was made’ characterizes not the pre-mundane, but the supra-mundane existence of the Logos, and therefore ultimately the superiority of the divine Revealer to and His transcendence over the world.

³⁷⁴ See Strachan (1941:106).

³⁷⁵ See von Speyr (1987:328-329).

belong to Me, belong to Father, and all who belong to Father belong to Me (my trans.).” “Καὶ δεδόξασμαι ἐν αὐτοῖς” (17:10^b), the term δεδόξασμαι is in the perfect tense, used to indicate the continuing revelation of Jesus’ δόξα through His disciples.

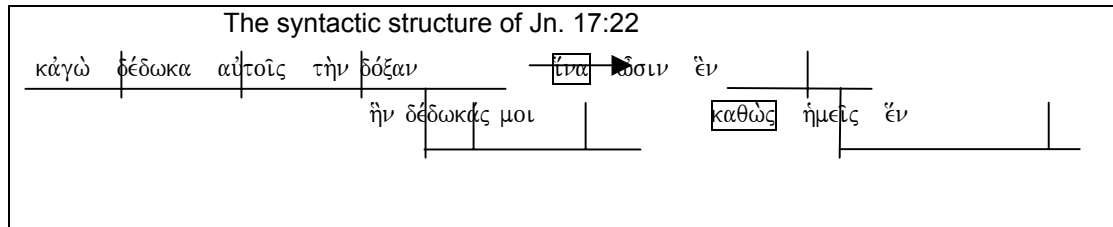

“Κἀγὼ τὴν δόξαν ἣν δέδωκάς μοι δέδωκα αὐτοῖς, ἵνα ᾧσιν ἐν καθὼς ἡμεῖς ἕν” (17:22), speaks of Jesus having passed on His δόξα to the disciples so that they may be one. Verse 22 means that, the participation in the unity of the Father and the Son which He gives to the disciples is nothing less than their participation in the δόξα which the Father gives to Jesus. From a theological perspective, Beasley-Murray (1987:302) comments that the δόξα is plainly the gift of the Revealer, the Son of God, who by His incarnation, death, and resurrection brings to humankind the saving sovereignty of God.³⁷⁶ Robertson (1988:126) indicates that the δόξα given to the disciples is the same δόξα Jesus had – the presence and power of God – the manifestation of the divine in man. Moreover, “κἀγὼ τὴν δόξαν ἣν δέδωκάς μοι δέδωκα αὐτοῖς” (17:22^a), means that after Jesus’ departure His followers are to represent Him in the world; it means that the “history” of Jesus will not become an episode in the past, but will remain continually present in the world as the eschatological event in the eschatological community.³⁷⁷ The meaning of this phrase seems to be that Jesus has conveyed to them the divine presence and life so that they can be spiritually united with each other and with God (cf. 17:23).³⁷⁸ It is therefore by virtue of this that sinful men and women may attain a unity with God and with their fellows such as that which exists within the Godhead. Lindars (1982:530) comments

³⁷⁶ See Bultmann (1971:514-518).

³⁷⁷ See Bultmann (1971:516).

³⁷⁸ Van der Watt (2000:353-354) describes unity in the spiritual family.

that “He has passed this on to the disciples not only by entrusting to them the message of salvation, but also by creating in them a form of life which bears witness to it.” As person in faith unites with the life of Jesus, God’s δόξα is transferred to that person.

The meaning of Jn. 17:24, is that Jesus desires not only that the disciples be with Him as long as He is living in the world; but He also wants them to have a share in His eternal life in the Father (14:3). Ramsey (1949:80) comments that there is in store for Jesus’ disciples the vision of δόξα, not only the vision of the δόξα of Christ which was manifested in His earthly ministry, but the vision of the eternal δόξα of the Son in union with the Father. The Father had given Jesus both the disciples and Jesus’ own glory (17:24), and Jesus desired the disciples to dwell in His presence, beholding His δόξα.³⁷⁹ Westcott (1890:248) says that here the “δόξα” referred to is the δόξα of a restored and consummated harmony of God and man, which is made the final object of the contemplation of believers, even as it is already potentially given to them (17:22). It is also possible that Jesus is praying that they will have the insight to know what the true glory really is, that is, that they may see lowly service as truly glorious. Paul gives us a somewhat similar thought when he says that “but we all, with unveiled face, beholding as in a mirror the glory of the Lord, are being transformed into the same image from glory to glory” (2 Cor. 3:18). Morris (1995:652) says that the δόξα that the Father gave the Son arose out of the love with which He loved Him before this universe came into existence (πρὸ καταβολῆς κόσμου).³⁸⁰

3.6.1.3. Conclusion

In Jn. 17 the Lord prays that the course on which He is embarked will bring δόξα

³⁷⁹ Keener (2003:1063) writes that the image in verse 24 is eschatological (cf. Rev. 21:11, 23), but in John’s emphasis on realized eschatology and especially in the light of 14:1-3, the focus is on disciples beholding Jesus’ δόξα in the present.

³⁸⁰ Godet (1912:219) comments that “πρὸ καταβολῆς κόσμου (before the foundation of the world),” means, “among all the sayings of Jesus, that which leads us farthest into the depths of Deity. It points out to Christian speculation the road by which it must seek the solution of the Trinitarian relations; love is the key of this mystery.”

to His Father, and that His followers, in consequence of His own death and exaltation, will be preserved from evil and have the priceless privilege of seeing Jesus' δόξα, all the while imitating in their own relationships the reciprocity of love displayed by the Father and the Son.³⁸¹

In this Prayer of the Lord, John gives us to understand that Jesus had revealed the Father to them in order to provide them an intimate, loving relationship with Him and with one another in the family of God. The love that unites them will reveal to the world the love that unites the Father and the Son and continues to make known that Jesus is the sent One of God. Carson (1988:206) comments as follows:

Jesus' departure does not have as its goal the abandonment of the disciples to solitary isolation. Far from it: His goal is to sweep up those the Father has given Him into the richness of the love that exists among the persons of the triune God.

The Prayer of the Lord reaches beyond the limits of the time and place of the prayer into the proximate glorification of Jesus (17:24), and the desired future glorification of the disciples.

The δόξα of Christ is wonderfully shown in the Prayer of the Lord (Jn. 17). Because this prayer of Jesus reveals the intimate, close and loving relationship within the majestic triune Godhead it also reveals something of the true extent and wonder of His δόξα. Carson (1988:205) asserts that Jesus chose to walk among us with a rather paradoxical δόξα of humiliation, in order to save us and raise us to heaven's heights, enabling us to see the unqualified brilliance of the divine δόξα which is rightfully His.

3.7. Recognition of Jesus' Δόξα by people

There are several instances where individual people have an experience,

³⁸¹ See Cullmann (1995:106-111).

recorded in the Fourth Gospel, which leads them to recognise Jesus' divinity and acknowledge His position, power, authority and δόξα. These instances are reviewed and the way in which they contribute to the manifestation of δόξα of Jesus is assessed.

3.7.1. Nathanael

In this record Jesus tells Nathanael that before Philip called him, while he was under the fig tree, he saw him. Whatever Nathanael was doing under the fig tree he clearly recognises that no human not present with him at the time, could have specific knowledge of where he was and what he was doing. Philip had already prepared the way by claiming that Jesus was "Him of whom Moses in the Law and also the Prophets wrote" (1:45) and Jesus' revelation of superhuman knowledge leads Nathanael to exclaim "Rabbi, You are the Son of God; You are the King of Israel" (1:49). The confession of Nathanael would have been made in the Messianic sense.

3.7.2. Disciples

The term "disciples" (μαθηταί) refers to those who were followers of Jesus and is used in both general and specific ways. In the Fourth Gospel, it is significant that John uses the term "disciples" (78 times)³⁸² much more frequently than "the twelve" (4 times) or "the apostles" (never). In general it refers to all those who followed Jesus but it is also used to designate the twelve chosen by Jesus to be apostles. Andrew, Peter's brother, was a disciple of John the Baptist who heard him say of Jesus "Behold, the Lamb of God!" (Jn. 1:36) and spent the night with Him. As a result of that meeting he told Peter "We have found Him of whom Moses in the Law and also the Prophets wrote, Jesus of Nazareth, the son of Joseph" (Jn. 1:42).

In the second chapter of the Fourth Gospel the disciples accompanied Jesus to

³⁸² It is also noteworthy that 74 out of the 78 times the term μαθητής refers to the disciples of Jesus. Only on four occasions does it refer to other disciples either those of John the Baptist (1:35, 37; 3:25) or of Moses (9:28).

a wedding in Cana of Galilee where Jesus turned water into wine. The stress made in this incident is not on the knowledge that they gained about Jesus' ability to change water into wine, but on faith in the person of Jesus. Moreover, as a result of that miracle His disciples were confirmed in their belief that He was the one of whom the prophets wrote.

After this first σημεῖον the author of the Fourth Gospel does not comment on the impact on the disciples of the various attesting signs that Jesus performed but simply records the σημεῖον and the related discourse leaving the reader to make the obvious conclusion that Jesus was indeed the Son of God and that by believing in Him they would enter into eternal life (Jn. 20:31). He also goes on to say that the σημεῖα he records are simply a selection from the many that Jesus performed in the presence of His disciples (Jn. 20:30).

Jesus' disciples are mentioned frequently at significant places in the overall plan of the Fourth Gospel. The disciples with their qualities and defects seem to be presented as types of Christian believers of all times. As the disciples presented in the Fourth Gospel exhibit a growing realisation of who Jesus really is and what His mission is, in the same way true disciples must grow in their personal knowledge of Jesus. Mlakuzhyil (1987:287) asserts dynamic and committed faith in Jesus to be the most essential quality of discipleship. Also he points out that the most fundamental characteristic of discipleship in the Fourth Gospel is its Christocentrism.

3.7.3. Samaritans

In 4:1-42 a Samaritan woman and Jesus have a profound discussion on water, and where true worship should take place, Jesus goes on to demonstrate a detailed knowledge of the Samaritan woman's past and present circumstances. As result she went into the city saying "Come, see a man who told me all the things that I have done; this is not the Christ, is it?" In essence her reaction is similar to that of Nathanael, a recognition that Jesus' knowledge of her is beyond human ability and she advances to the recognition that Jesus is also the

Μεσσίας / Χριστός (vv. 25, 29). In contrast to Nicodemus she is led by the claim of Jesus into a deeper understanding of who He is. In contrast to the disciples, who went into the city only to get bread, she hurried in to spread the good news of the arrival of the Messiah. Jesus' words had a profound effect on her fellow citizens leading them to the realization and acknowledgement that He is ἀληθῶς ὁ Σωτὴρ τοῦ κόσμου, ὁ Χριστός (v. 42).

3.7.4. Mary and Martha

In Lk. 10:38-42 we read of the first contact of Mary and Martha with Jesus. This contact was renewed from time to time and a special bond developed between Jesus and Lazarus and his sisters. In the passage in John we have the well known record of Lazarus' death and his resurrection by Jesus after four days in the grave. During the conversation that Jesus had with Martha prior to the raising of Lazarus she says, in response to Jesus' statement "I am the resurrection and the life; he who believes in Me shall live even if he dies, and everyone who lives and believes in Me shall never die. Do you believe this?" "Yes, Lord; I have believed that You are the Christ, the Son of God, even He who comes into the world" (11:25-27). During the intervening period she had clearly come to understand that Jesus was divine.

Mary's word to Jesus was "Lord, if You had been here, my brother would not have died" (11:32). While not an affirmation of Jesus' divinity this statement reveals a total conviction that Jesus had the power to control any illness. This assurance would have come as a result of hearing, and possibly witnessing, many of the attesting signs that Jesus performed. All of which would have indicated His divine power, authority and δόξα.

3.7.5. Entrance to Jerusalem (Jn. 12:12–18)

The key verses in this passage are 12–15 and 17-18. On the next day the great multitude who had come to the feast, when they heard that Jesus was coming to Jerusalem, took the branches of the palm trees, and went out to meet Him, and began to cry out, "Hosanna! Blessed is He who comes in the name of the

Lord, even the King of Israel.” And Jesus, finding a young donkey, sat on it; as it is written, “Fear not, daughter of Zion; behold, your King is coming, seated on a donkey’s colt.” The multitude who were with Him when He called Lazarus out of the tomb, and raised him from the dead, were bearing Him witness and, because the crowd had heard of the σημεῖον of the miraculous raising of Lazarus, they went out to meet Him. Robinson (1985:234) says that the meaning of the entry into Jerusalem can only be really grasped as being to ‘enter upon His δόξα,’ as the fulfilment of the words in Zechariah concerning the arrival of Zion’s king (Zech. 9:9).³⁸³

The reason for the honour bestowed on Jesus was directly a result of his raising Lazarus from the dead. This σημεῖον had been witnessed by many and they were testifying to this miraculous deed. A vital aspect of this incident is recorded in Lk. 19:41-44, “And when He approached, He saw the city and wept over it, saying, If you had known in this day, even you, the things which make for peace! But now they have been hidden from your eyes. For the days shall come upon you when your enemies will throw up a bank before you, and surround you, and hem you in on every side, and will level you to the ground and your children within you, and they will not leave in you one stone upon another, because you did not recognize the time of your visitation.”³⁸⁴ Dodd (1998:370-371) points out that the triumphal entry of Jesus into Jerusalem has the idea of Christ’ kingship, it is a σημεῖον of the universal sovereignty of Christ as conqueror of death and Lord of life.

³⁸³ See Hooker (1994:102).

³⁸⁴ See Baxter (1964:83-86); Anderson (1969:67-87). Daniel 9:25–27 states “So you are to know and discern that from the issuing of a decree to restore and rebuild Jerusalem until Messiah the Prince there will be seven weeks and sixty-two weeks; it will be built again, with plaza and moat, even in times of distress. Then after the sixty-two weeks the Messiah will be cut off and have nothing, and the people of the prince who is to come will destroy the city and the sanctuary. And its end will come with a flood; even to the end will be war; desolations are determined. And he will make a firm covenant with the many for one week, but in the middle of the week he will put a stop to sacrifice and grain offering; and on the wing of abominations will come one who makes desolate, even until a complete destruction, one that is decreed, is poured out on the one who makes desolate.” Based on this prophecy there were to be sixty nine sevens of years and after this the messiah would be cut off. This is a period of 173 880 days. Counting these days from the issuing of the decree (Neh. 2:1-6) takes us to Nissan 10 AD 32 – 6th April a Sunday, the very day of Jesus’ entry to Jerusalem to the acclamation of the crowds.

3.7.6. The chief priests and Pharisees

After the raising of Lazarus (Jn. 11:38-44) the Chief Priests and the Pharisees acknowledged that Jesus was performing many σημεῖα. Their reaction was not an honest attempt to determine how or through what power or authority Jesus performed the σημεῖα but rather they feared for their own position. A secondary concern was that the Romans might “remove the nation” (Jn. 11:48). As a result they decided to put Jesus and Lazarus to death (Jn. 12:10).

During the debate as to how to handle the situation the high priest, Caiaphas, put forward the idea that “one man should die for the people, and that the whole nation should not perish” (Jn. 11:47-53). John sees this as an unwitting prophetic pronouncement by the high priest that Jesus was going to die for the nation.

Not all the rulers were antagonistic as is evidenced by Nicodemus’ night visit to Jesus and the subsequent deep spiritual conversation. We also read that after Jesus’ resurrection “many of the priests were becoming obedient to the faith” (Acts 6:7).

3.7.7. Conclusion

In different ways and for different reasons many people recognised that Jesus had and exercised great power and authority. For some it was His character and teaching, for others it was the obvious demonstration of a super human authority that He exercised over natural events. For still others it was the miraculous power to heal the sick of whatever disease they had, even restoring sight to the blind and in particular a man born blind. In this realm the supreme demonstration of His power was the raising of the dead on more than one occasion, the most dramatic being the raising of Lazarus after he been in the tomb for four days. Even His antagonists acknowledged that Jesus was doing “many signs (σημεῖα).”

It is significant that the exercise of His authority had a divisive effect on people.

They either accepted Jesus' claim that He was from God and responded accordingly, or they attributed His power to some other source such as "Beelzebul, the ruler of the demons" (Lk. 11:15). As Jesus' ministry progressed this division became more pronounced until the Jewish rulers resolved to kill Him. The prime reason for their antagonism was that they refused to recognise that the signs Jesus was doing were messianic in character and that He did not conform to their expectations of what the Messiah would be like or how He would act. Another factor was their envy – "all men will believe in Him" – which would mean a lessening of their authority, power and importance. Finally they feared the reaction of the Roman authorities.

In recognising Jesus' power and authority there was also an inherent acknowledgement of the δόξα associated with the performance of the signs and in the power of His words.

3.8. Jesus' Lowly Service and Δόξα

Jn. 13:1-20, refers to service of special nature, the disciples' Lord and Master washing their disciples' feet. Van der Watt comments in his article, ethics and ethos in the gospel according to John, that although there are numerous efforts to explain the significance of the washing feet, two possibilities stand out; firstly, Jesus' lowly service and the other on Jesus' unquestionable love, secondly, Jesus wanted to give His disciples the example of unrestricted, unrestrained, lowly service to the point of humiliation. Washing feet defines lowly service to one another as a fundamental value. Neyrey (1995:201) says that washing the disciples' feet stands perhaps the climax of these transformation rituals. Malina and Rohrbaugh (1998:217) indicate that according to the washing of the feet of the disciples, as Jesus approaches His δόξα, He addresses the need for disciples to love one another as He loves them.

Jesus' action in washing their feet expresses the very essence of Christian authority. It consists of a humbleness of mind that puts others first even though a person has an authority based on spiritual gift or is an acknowledged leader such as an elder or deacon. The washing of the feet of the disciples was a concrete illustration of such authority being exercised in humility.

Moreover, John says, "If you know these things, you are blessed if you do them" (v. 17), The thought is that it is not enough for His disciples to be familiar with His teachings but that they are required to put them into practice. The essence of the teaching relating to the washing of the feet of the disciples is the theme of mutual love and interdependence which in turn is the essence of the service of the church.³⁸⁶

John intends us to see the δόξα of Jesus in His whole life. The underlying concept of the lowly service exemplified in this passage is also reflected in the Jesus' admonition that the disciples were to "love one another."³⁸⁷ Other incidents in the earthly life of Jesus in which He exhibits the same lowliness of service, and which are not referred to in the Fourth Gospel, include His willingness to go to a centurion in order to heal his servant (cf. Mt. 8:7), healing a Canaanite woman's daughter and His focus on the poor and needy (cf. Mt. 11:5). There is no record of Jesus ever asking for anything in the way of payment or gift for the gracious healings that He performed.

Morris (1995:650) commenting on the prayer of the Lord in John 17 (v. 22) says that "just as His true glory was to follow the path of lowly service culminating in the cross, so for them (His disciples) the true glory lay in the path of lowly service wherever it might lead them." He goes on to equate being right with God as having the true δόξα.

In conclusion, the lowly service evidenced by Jesus is a further reflection of δόξα and is to be reflected in the lives and deeds of His followers who are not to seek

³⁸⁶ See Hoskyns (1947:440); Pryor (1992:59).

³⁸⁷ See Jn. 13:34-35; 15:12, 17.

positions of power and authority over fellow believers (cf. Gal. 5:13).

3.9. Other Words used to convey the concept of Δόξα in the Fourth Gospel

3.9.1. Introduction

While the focus of this thesis is δόξα in the Fourth Gospel, the author, John, also uses other Greek words which are semantically closely related to it in his Gospel. These words include, in their potential range of meanings, concepts similar to some of those covered by δόξα and are therefore interchangeable with it in some, but not all, contexts. Therefore, in order to fully explore the meaning and significance of δόξα, it is necessary to examine those Greek words which are used in this way and determine how their use gives greater insight into the concept of glory in the Fourth Gospel. In this regard the prime related words in the Fourth Gospel are honour (τιμή and τιμάω) and authority (ἐξουσία). Other Greek words which are closely associated with the Johannine concept of glory and are therefore of importance in exploring the concept of δόξα in the Fourth Gospel, are increasing (αὐξάνω), lifting up (ὑψόω), ascension (ἀναβαίνω), and light (φῶς).

In the Fourth Gospel the concept of the δόξα of Jesus is not only conveyed by the actual words John uses, but also by the way in which he chooses to present Jesus. The emphases here are on Jesus' claims to divinity, both direct and indirect, and His claims regarding Himself, His Father and His Mission, and the recognition of His person, position, power and authority by various individuals and groups of people. Of importance in this regard are the relatively detailed records of Jesus' verbal statements and prayers, the specific signs (σημεῖα) selected for inclusion in the Gospel and the reactions of people to what Jesus said and did. These aspects are explored in detail in this chapter with particular reference as to how they impinge on the concept of δόξα.

As the concept of lifting up (ὑψόω) is intimately connected with the events of the cross it is dealt with in detail in chapter 4.

3.9.2. Honour in the Fourth Gospel

3.9.2.1. The honour (δόξα) of Jesus and the Father

Jesus' disputes with the Jews often centre on the theme of honour (δόξα) due to Himself. In this respect there are three passages which interweave similar statements (Jn. 5:41-47; 7:18; 8:49-59). Jesus does not receive honour Himself (7:18; 8:54), but Jesus honours the Father (7:18; 8:49; cf. 17:5) and the Father honours Jesus (8:54; cf. 17:5^a, 22; 16:14), because Jesus has come in the Father's name (5:43ff; cf. 12:28; 17:6; τῷ ὀνόματι τοῦ Πατρὸς). For instance, in 8:54 the context (cf. 49-50) shows that the immediate meaning of δόξα in this passage is 'honour,' and this reflects the meaning of a number of verb combinations with δόξα rendered as honour Jn. 5:41, 44. In 7:18 and 8:50 the term conveys the sense of honour. It seems that all statements with the verb 'δοξάζω,' even those which perhaps invite a translation with 'honour,' form part of the conceptual field of Jesus' δόξα.

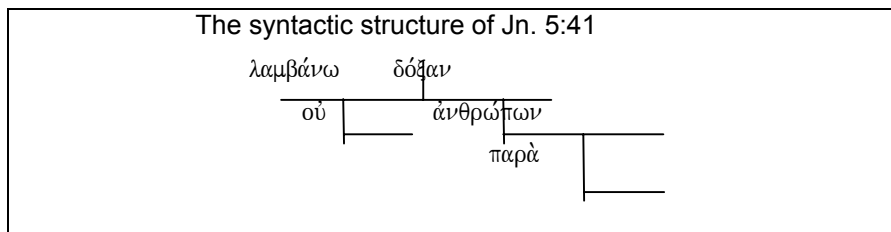

In the first-century Mediterranean world with its competing value systems, people had to choose the groups whose honour mattered to them; but Jesus did not receive honour from people (5:41).³⁸⁸ In this context verse 5:41 indicates that the source of Jesus' honour depended not on human testimony, but on His entire commitment to please His Father (5:19ff.), receiving the honour that only the Father can bestow (5:23), enjoying the honour (δόξα) due to the one and only Son from the Father (5:32, 36; cf. 1:14).³⁸⁹ Meanwhile we find that His opponents seek human honour or glory rather than seeking the honour which

³⁸⁸ See deSilver (2000:519-520).

³⁸⁹ See Carson (1991:264).

comes from God alone (5:44; cf. 4:44; 12:43).³⁹⁰

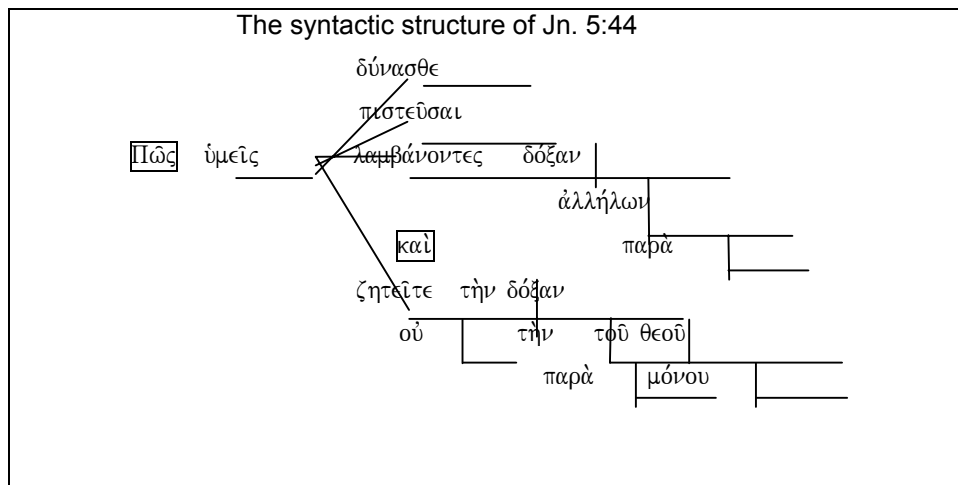

Witherington (1995:144) considers that verse 5:44 can mean that Jesus must be seen as the manifestation of the One true God on earth, God in human form. Actually, in this passage we know that the only honour (δόξα) worth having is that which comes from “τοῦ μόνου θεοῦ” (1:14; 17:3; cf. 1 Tim. 1:17). In referring to the phrase “τοῦ μόνου θεοῦ,” Ridderbos (1997:206) notes that Jesus alludes to the great principle on which Israel’s religion was founded namely that the Lord, Israel’s God, is one and as such commanded the people to love Him with undivided love (cf. Deut. 6:4ff.).

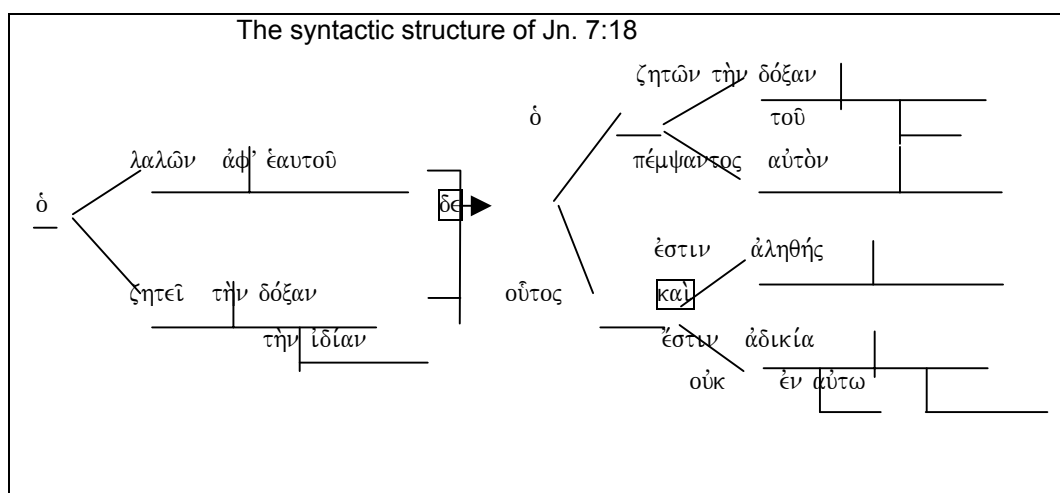

In verses 7:16-18 Jesus reveals the divine origin of His teaching.³⁹¹ The theme

³⁹⁰ See Keener (2003:660).

of seeking honour in verse 7:18 is an echo of 5:41-47. Interestingly Lindars (1972:289) suggests that the first half of the statement in 7:18 refers to “the blinding ambition of the rabbis” (cf. 5:44), in contrast to which the unselfishness of Jesus’ own motive is the proof of the integrity of His teaching (7:18). Schnackenburg (1984, 2:133) comments that “This is the irreducible claim of the true revealer, and the believer finds it authenticated” (cf. v. 17). Van der Watt (2000:299-300) comments that according to verse 7:18 Jesus also seeks the honour (δόξα) of the One who has sent Him. Jesus is not concerned about honour being given to Himself, He is totally focused on honouring the One who sent Him.

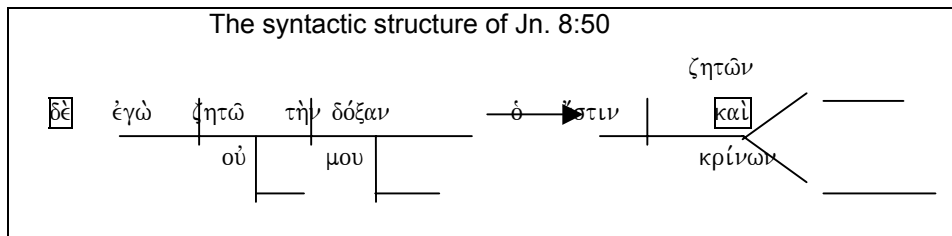

Chapter eight of the Fourth Gospel contains a record of the controversy, in the temple between Jesus and the Jews following His claim to be “the light of the world.” Here, Jesus concluded the ensuing discourse with reference to the honour (δόξα) which the Father gives the Son (8:49-50). However, deSilva (1999:75) notes that God desires that the Son be honoured by all, and guarantees the honour of Jesus in verses 8:49-50 “but I honour My Father, and you dishonour Me. But I do not seek My glory; there is One who seeks and judges” (He is the One who strives for it and evaluates it). It seems that this remark (8:49-50) echoes verse 5:23, where it is stated that God seeks Jesus’ honour and will hold the Johannine world accountable for it. That is, God will “judge” in this regard, even though all judgement has been put in Jesus’ hand.³⁹² Jesus stated that He did not seek His own honour (δόξα), but the Father seeks the honour (δόξα) of the Son (8:54). There is no explicit statement as to how the Father honoured Jesus, but it does not have to be stated explicitly. The

³⁹¹ See Panackel (1988:112).

³⁹² See Neyrey (1988:56).

Jews did not see Jesus' δόξα because they did not know the Father. They did not understand that in His works He honoured the Father for they did not know the Father. Jesus pursues only the honour (δόξα) that comes from God. Neyrey (1988:56) points out that verses 49-50 show an essential element of Jesus' eschatological power in that it was His right to an honour equal to that given to God.

According to 8:54, Jesus answers that, if He is seeking His own honour (δόξα), it would be worthless (8:54^a; cf. 8:50); but it is the Father who honours Him (8:54^b). The Fourth Gospel makes it clear how this will happen (3:14; 12:23-24, 31-33); Beasley-Murray (1987:138) rightly comments that "God's mode of glorifying Jesus, through self-sacrifice in shameful death, is as distant from self-glorification as heaven is from hell." It is this incomprehension of God's ways that makes Jesus say, "you have not come to know Him" (8:55^a), and to affirm, "I do know Him and keep His word" (8:55^b).

3.9.2.2. Honour (τιμή / τιμάω) of Jesus and Father

The meanings of 'δόξα' and 'δοξάζω' include 'honour' and 'to honour,' and the meanings of 'τιμή' and 'τιμάω' also include 'honour' and 'to honour.' In their lexicons, Louw and Nida (1993, 1: 576, 620) indicate that other meanings of 'τιμή' are:

- I . The worth or merit of some object, event, or state - 'worth, value;'
- II . The amount of money or property regarded as representing the value or price of something - 'amount, price, cost;'
- III. Compensation given for special service, with the implication that this is a way by which honour or respect may be shown - 'compensation, pay, honorarium.'

They (1993, 1:571, 576) explain that supplementary meanings of 'τιμάω' are:

- I . To determine an amount to be used in paying for something

– ‘to set a price on, to determine the cost;’ II. To provide aid or financial assistance, with the implication that this is an appropriate means of showing respect - ‘to give assistance to, to provide for the needs of as a sign of respect, to support and honour.’

In certain contexts, when both ‘δόξα,’ ‘δοξάζω’ and ‘τιμή,’ ‘τιμάω’ can have the meaning ‘honour’ and ‘to honour,’ and it therefore that these words are interchangeable.³⁹³

The phrase “a prophet has no honour (τιμὴν) in his own country” (ἐν τῇ ἰδίᾳ πατρίδι) in 4:44 finds parallels with Mt. 13:57; Mk. 6:4; and Lk. 4:24, but John uses it with a distinct focus. In the Synoptic Gospels it is used in connection with the rejection of Jesus in Galilee; in the Fourth Gospel it explains the reception of Jesus by the Galileans after He was rejected in Jerusalem (4:45).

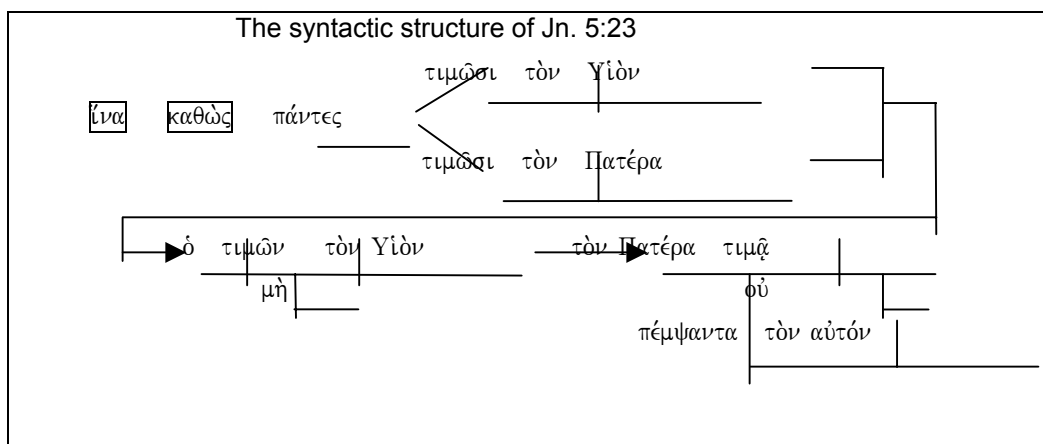

Verse 5:23 indicates that it is the Father’s will that the Son be honoured (τιμάω) just as the Father is honoured (τιμάω). Those who serve Jesus will be honoured by the Father (cf. 12:26). Ridderbos (1997:197) rightly comments that the point at issue in verse 5:19-23 is that the only God can be known and honoured (τιμάω) in no other way than in the Son and that only in the revelation of the Son is the oneness of God manifest in its utter uniqueness. Further, again from

³⁹³ See Moxnes (1996:23).

Jesus' self-justification it is clear that the oneness of the Son with the Father, of Christ with God, is the fundamental motif of Jesus' entire self-pronouncement. It reveals the unity of the Father and the Son, God is not two but one.

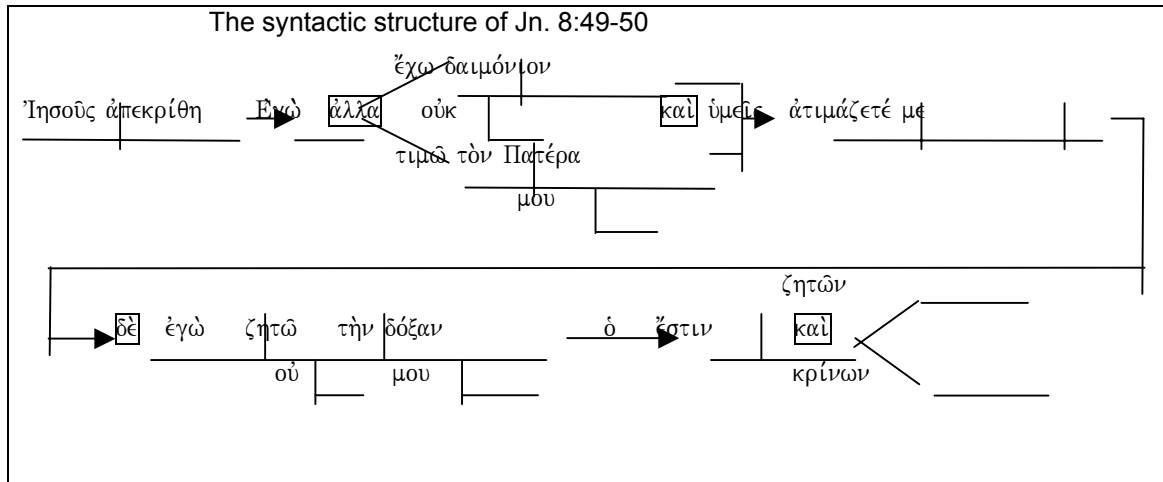

From Jn. 8:49-50, it is evident that, in certain contexts, 'δόξα / δοξάζω' and 'τιμή / τιμάω' may be used interchangeably as 'τιμάω' and 'ἀτιμάζω' (8:49) are used alternately with 'ζητέω τὴν δόξαν μου' (8:50). This may refer simply to honour (τιμάω) from God; or it may possibly refer directly to Jesus as the embodiment of δόξα. According to 8:49, Jesus' claims and behaviour are simply due to His obedience to the Father (cf. 3:34; 5:19ff.; 8:38; 17:8, 14).

The phrase "τις ἔμοι διακονῆ τιμήσει αὐτὸν ὁ Πατήρ" in 12:26, indicates that the Father will give honour to those who serve Jesus. Newman and Nida (1980:407) comment that the honour (τιμάω) that the Father shows to the believer in 12:26 is a reward for his faithful service to Jesus. It also suggests that a mutual relationship exists between the Father and the believer, in a way similar to that which exists between the Father and the Son. Moreover, Carson (1991:439) says that "as Jesus' crucifixion is the path to His glorification, so the believer's 'death' is the path to vindication."

3.9.2.3. Jesus' greater honour (αὐξάνω)

Louw and Nida (1993, 1:737-738) give the meaning of 'αὐξάνω' in the Fourth

Gospel as being ‘to become more important, to enjoy greater respect or honour.’³⁹⁴ In comparing himself to Jesus, John the Baptist says that “He must become more important while I become less important” (3:30). Louw and Nida (1993, 1:738) point out that for the increase or decrease of respect or honour to be correctly understood in some languages, the concept must be expressed idiomatically rather than literally.

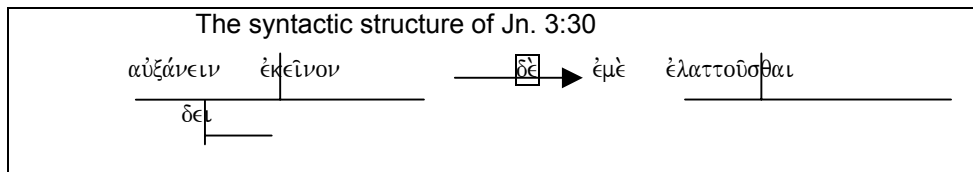

“He (Jesus) must increase (ἐκεῖνον δεῖ αὐξάνειν), but I must decrease (ἐμὲ δὲ ἐλαττοῦσθαι),” Ridderbos (1997:147) notes that this is the divinely ordered, salvation-historical “must (δεῖ)” to which John refers (cf. 3:14), Carson (1991:212) indicates that “must (δεῖ)” is nothing less than God’s determined plan that the Messiah must continually increase. This lesson is something that must be learned in every age.³⁹⁵ In 3:29-30 John the Baptist finds his joy in wholeheartedly embracing God’s will, and the supremacy it assigns to Jesus. Bultmann (1971:174) considers that coming from the last of the prophets, this expression means that “the old epoch of the world has run its course, the eschatological age is beginning.”

3.9.2.4. Summary and conclusion

Jesus does not seek His own honour but that of the Father and in turn the Father honours Him. The source of Jesus’ honour is not based on human testimony but on His commitment to pleasing the Father and receiving the honour the Father bestows on Him. This is in contrast to His opponents who seek human glory rather than that which comes from the one and only God.

In stressing that He is not seeking His own δόξα Jesus refers to the integrity of

³⁹⁴ Bauer (2000:151), Friberg (2000:81), and Thayer (191484) consider that ‘αὐξάνω’ means ‘to become greater, grow, increase.’

³⁹⁵ See Morris (1995:214).

His teaching which is directed to honouring His Father.

Ultimately Jesus will be lifted up on the cross and in this offering up of Himself He will honour the Father who in turn honours Him. It is the inability of the Jews to grasp the significance of Jesus' teaching and of the δόξα that is inherent in His life of obedience to the Father that results in Jesus saying that "you have not come to know Him."

The meaning of the noun and verb forms of 'δόξα' and 'τιμή' include the concept of 'honour' and so, in certain contexts, these words are interchangeable. The use of 'τιμή,' 'τιμάω' in the sense of δόξα occurs in several passages such as Jn. 4:44, 5:23 and 8:49-50.

While the word 'τιμάω' in the first reference is used simply to explain Jesus' reception by the Galileans after His rejection in Jerusalem the record shows that the motif of Jesus' statements about Himself is the oneness of the Son with the Father. This augments the concept of the latter phrase of 5:44 which refers to the one and only God – the dominant Old Testament thought that God is One.³⁹⁶

The honour 'τιμάω' the Father will show believers is as a reward for faithful service to Jesus and the relationship between the Father and the believer is, in a way, similar to the relationship between the Son and the Father.

When speaking of Jesus (Jn. 3:30) John the Baptist used the word 'αύξάνω' which has the meaning of 'to become more important, to enjoy greater respect or honour.' This is linked with "must" (δεῖ) and this indicates that it is God's determined plan that the Messiah must continually increase. Because John the Baptist is the last of the Old Testament prophets the phrase has been viewed as having the meaning that the old way God dealt with mankind has come to its end and the "eschatological age is beginning."

3.9.3. Exaltation in the Fourth Gospel

³⁹⁶ Deut. 6:4ff.

3.9.3.1. Τιμάω in the ultimate eschatological salvation

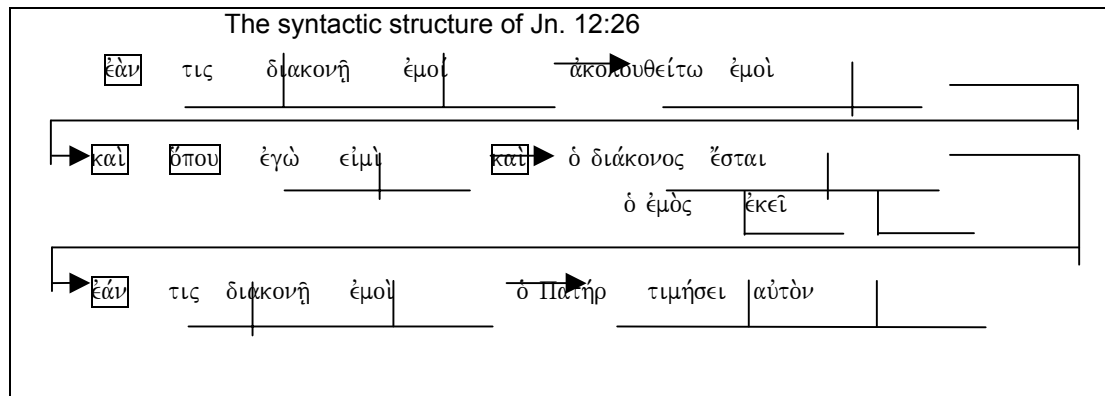

According to 12:26, this verse describes discipleship to Jesus as servant hood. The phrase “where I am (ὅπου εἰμὶ ἐγὼ), there My servant will be also” (cf. 14:3; 17:24) was used by Jesus in the days of ‘the hour’ that lead to His cross (cf. 12:23-25) and to His Father (cf. 14:3; 17:24). The phrase “if anyone serves Me, the Father will honour him” indicates that as crucifixion is the path to His exaltation (glorification), so believer’s service is the path to honouring by God. Furthermore, Ridderbos (1997:433) comments that it is a statement referring to Jesus’ future δόξα, and that the Father will honour those who serve Jesus by letting such a disciple share in the honour and glory of the Son (cf. 14:21, 23; 16:24; 17:22-23). Here the honour (τιμήσει, means ‘exaltation’) that the Father shows to the believer is a reward for his faithful service to Jesus.

3.9.3.2. Ἀναβαίνω of Jesus

The verb ἀναβαίνω³⁹⁷ may be said to be part of a field of verbs associated with the departure of Jesus.³⁹⁸ But since the other verbs are explicit only in the matter of departure or movement and merely imply ascent, the verb closest to ἀναβαίνω can be said to be ὑψόω (“lift up, exalt”).

³⁹⁷ The verb ἀναβαίνω is used thirteen times in John. In seven instances it refers to going up to Jerusalem (2:13; 5:1; 7:8, 10, 14; 11:55; 12:20), twice it carries the meaning of getting up or climbing over (10:1; 21:11). On only four occasions does it bear any theological meaning related to Jesus (1:51; 3:13; 6:62; 20:17).

³⁹⁸ Nicholson (1983:58) indicates that Jesus’ words of departure of Jesus in the Fourth Gospel are ἀναβαίνω, ἔρχομαι, μεταβαίνω, ὑπάγω, πορεύομαι and ἀπέρχομαι.

The term ἀναβαίνω used in Jn. 1:51; 3:13; 6:62 is associated with the phrase Son of Man.³⁹⁹ It is characteristic of the difference in the emphases of the Gospels that, while the synoptists give prominence to the future revelation of the Son of Man,⁴⁰⁰ the Fourth Evangelist stresses the revelation of the divine sovereignty in the incarnate life of the Son of Man, culminating in His exaltation to heaven via the crucifixion.

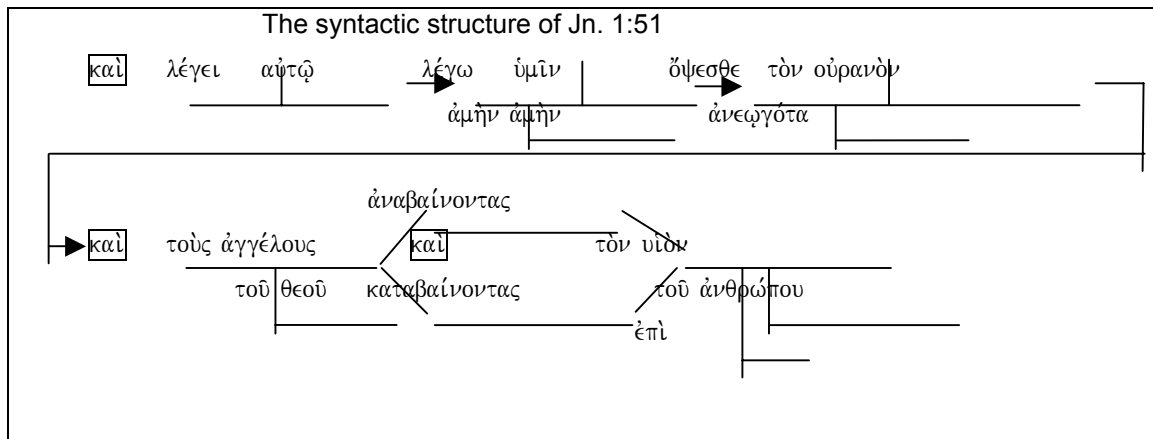

Jesus employs the term “truly, truly” (ἀμὴν ἀμὴν) using it before an utterance to confirm and emphasize its trustworthiness and importance. Lindars (1982:120) takes the “ἀμὴν ἀμὴν” in these sayings to be a special feature of Jesus’ authoritative style.

Beasley-Murray (1987:28) commenting on the phrase “you will see (ὄψεσθε),” says that it;

relates not to a future beyond the death of Jesus (as in Mark 14:62), but to the entire gamut of the action of the Son of Man for the kingdom of God: from the heaven that became open at His baptism, the blessings of the saving sovereignty will be poured out through Him – in the signs He performs, the revelation of His word, the life that He lives, the death and resurrection that He accomplishes (His “lifting up”), till the goal

³⁹⁹ See Pryor (1991:341-351).

⁴⁰⁰ See Mt. 16:27f.; 19:28; 25:31-46; Mk. 13:26; 14:62; Lk. 9:26; 12:8, 40; 17:22ff.. etc.

is attained when the Son of Man welcomes the redeemed to the Father's house (14:3).

The phrase “the angels of God ascending and descending on the Son of Man” (1:51), shows that an explicit parallel is drawn between Jacob and Jesus: the angels ascend and descend on the Son of Man, as they ascended and descended on Jacob (cf. Gen. 28:12). Every Jew honoured Jacob/Israel, the father of the twelve tribes; and 1:51 indicates that everyone must recognize that this same God has appointed Jesus as his Messiah.

Carson (1991:164) says that the fulfilment of the promise of 1:51, the culmination of the Father's attestation of the Son and the privilege of seeing the exaltation (glory) of the Son of Man – occur throughout the Fourth Gospel, and are climaxed by Jesus' death and resurrection. Verse 1:51 provides for Nathanael and the other disciples, as for countless followers of Jesus since then, the most powerful fulfilment of the promise (cf. 8:28).⁴⁰¹

Jn. 3:13 emphasizes the heavenly origin of the Son of Man. Jesus affirms the uniqueness of the revelation of the Son of Man; no one (οὐδεὶς) has ever ascended into heaven (v. 13^a), but only the one who can authoritatively reveal the heavenly things – the Son of Man who has come down from heaven (v. 13^b). The verse is constructed carefully and has a three-part chiasm that hinges on εἰ μὴ:

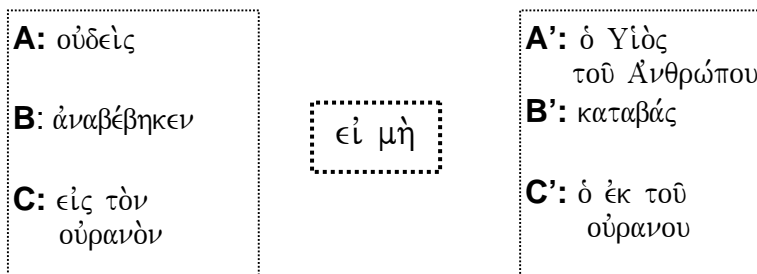

Moloney (1978:56) outlines this structure in order to claim that with the

⁴⁰¹ See Carson (1991:165).

subsequent contrast between “no one” (οὐδείς) and “the Son of Man” (ὁ Υἱὸς τοῦ Ἄνθρώπου) John wants to say that “there is only one who can reveal the truth with ultimate authority, the one who descended, the Son of Man.”⁴⁰² Jesus proclaims what has already been said in the Johannine prologue: “No one has seen God at any time; the only begotten God who is in the bosom of the Father, He has explained Him” (1:18). Therefore, we know that only Jesus, the Word become flesh (1:14), the Son of God (1:18), the Son of Man (1:51; 3:13) reveals the heavenly things. Bultmann (1971:151) points out that the ascent (ἀναβαίνω) of the Son of Man in Jn. 3:13 is that “His exaltation, His δόξασθηναί, is the fulfilment of the work of salvation, by which He draws His own to Himself.”

Ridderbos (1997:245-246) comments that in 6:62 the entire focus of Jesus' question affirms His pre-existence and the future δόξα of the Son of Man, with an implied reference to the δόξα with which He, precisely as the Son of Man was clothed “before” as the one sealed by the Father (cf. 6:27; 17:5, 24) and thus to the unity of “descending” and “ascending” as the great mystery of the Gospel (cf. 3:13ff.).

3.9.3.3. Summary and conclusion

The word τιμάω is used in referring to the honouring, by the Father of those who serve Jesus. This honour is thus a reward for faithful service to Jesus.

Ascending, ἀναβαίνω is considered to be part of a range of verbs associated with the departure of Jesus. In the Fourth Gospel, in contrast to the Synoptic Gospels, the stress is on the revelation of Jesus' divine sovereignty in His incarnate body culminating in His exaltation to heaven via crucifixion. In Jn. 1:51 there is an explicit parallel between Jacob (Israel) and Jesus indicating that as the Hebrews honoured Israel so they must now recognise that God has appointed Jesus as Messiah.

The structure of Jn. 1:51 is considered to be carefully constructed and has a

⁴⁰² See Westcott (1890:53); Carson (1991:199-201); Moloney (1998:95).

three part chiasm emphasising the contrast between “no one” and “the Son of Man.” The intent being to emphasise that the only one who can reveal the truth with authority is the one who descended from heaven – the Son of Man.

3.9.4. Power (Authority) in the Fourth Gospel

3.9.4.1. Ἐξουσία of Jesus from the perspective of δόξα

3.9.4.1.1. Lexical and Literary aspects of Ἐξουσία

According to Liddell and Scott (1996:599) ‘Ἐξουσία’ has the following range of meanings: ‘power, authority to do a thing, right and might.’⁴⁰³ Kittel (1974, 2:242-245) states that an important meaning of δόξα in the LXX and the New Testament is power. The sense of power is conveyed by several terms, including ‘Ἐξουσία’ and ‘δόξα.’⁴⁰⁴

The Father has given the Son Ἐξουσία to execute judgment (5:27) and Ἐξουσία to give life (17:2; cf. 5:21, 26). The Son also has Ἐξουσία to lay down His life and to take it up again (10:18). To those who receive Him and believe in Him, He gives Ἐξουσία to become children of God (1:12). Pilate would have no Ἐξουσία over Jesus unless it had been given him from above (19:11). Ἐξουσία is a gift imparted by God to the Son, to believers, and to rulers (e.g. Pilate).⁴⁰⁵

In Num. 27:20, the LXX translators used δόξα to translate the Hebrew which is the term for authority (honour, dignity). In this passage, the Lord tells Moses that since he would soon depart this life, he should “give [Joshua] some of your authority (δώσεις τῆς δόξης σου ἐπ’ αὐτόν), so that all the congregation of the Israelites may obey.” In John 17:1-5, there is a close correlation between the glory and glorification of the Son, and the authority and power that the Father has given Him (v. 2). There is a possible parallel between Moses’ giving δόξα (authority, power) to Joshua before his death so that Joshua could carry on

⁴⁰³ Louw and Nida (1993, 2:92) write that Ἐξουσία has the meanings “authority to rule, jurisdiction, symbol of authority ruler, control, power, supernatural power and right to judge.”

⁴⁰⁴ See Thayer, 1914:225; Bauer, 2000:352-353; Friberg, 2000:157.

⁴⁰⁵ See Bultmann (1971:662); Beasley-Murray (1987:339-340).

the work Moses had been doing and Jesus, as He is about to leave this world, giving δόξα (with the possible meaning of authority and power) to His followers (Jn. 17:22) so that they could perform His works, which are the works of God (cf. 14:12). In both the Old Testament and the New Testament, δύναμις and δόξα are closely correlated.⁴⁰⁶ In John there are no occurrences of the Greek noun for power (δύναμις), but there are many occurrences of the verb δύναμαι.⁴⁰⁷ The Son can do nothing on His own (5:19), meaning in His own power, it is the Father in Him who does His works (14:10). In the same way believers can do nothing apart from Christ (15:5).⁴⁰⁸ Those who believe in Jesus will do the same works He does, because Christ who dwells in them, is the ἐξουσία that does the works in answer to their requests (14:12-14). Ridderbos (1997:498) comments that “Jesus is pledging to His disciples that He is not withdrawing from them by His departure but will be able, because of His heavenly glory, to give them everything they will need for the continuation of His work on earth.”

3.9.4.1.2. Exegetical perspective of the use of the term ἐξουσία

In Jn. 1:12 ἐξουσία is used in parallel with the verbs ἔλαβον and πιστεύουσιν:

ὅσοι δὲ ἔλαβον αὐτόν to those who received Him	τοῖς πιστεύουσιν εἰς τὸ ὄνομα αὐτοῦ to those who believed in His name
---	--

This verse might be understood to mean that receiving the Word (Λόγος), believing in His name – whatever that may mean, and whoever the Word (Λόγος) in history might be – gave the recipients and the believers power to become children of God (ἔδωκεν αὐτοῖς ἐξουσίαν τέκνα θεοῦ γενέσθαι).⁴⁰⁹ The verb ἔδωκεν is in the aorist and so the power (ἐξουσία) given is not a promise, a mere possibility, but an achieved fact in the lives of those who received and believed

⁴⁰⁶ Ps. 63:3 (BHS)/ 62:3 (LXX); 145:12 (BHS)/ 144:12 (LXX); Mt. 24:30; Mk. 13:26; Lk. 21:27; Rom. 6:4; 1 Cor. 15:43; Eph. 3:16; 1 Pet. 4:11; Jude 1:25; Rev. 4:11; 5:12; 7:12; 15:8; 19:1.

⁴⁰⁷ Jn. 5:19, 30, 44; 6:44, 52, 60, 65; 7:7, 34, 36; 8:21; 9:16; 10:21; 14:17; 15:4, 5.

⁴⁰⁸ For apart from the power of Christ the disciples can do nothing, but by abiding in Christ, who has power, they can bear much fruit (Jn. 15:5, 16).

⁴⁰⁹ Carson (1991:126) says that those who receive the Word and those who believe in His name are identical with those who are born of God.

it (cf. 10:18; 17:2). Ridderbos (1997:45) comments that the power (ἐξουσία) in 1:12, is the right and the freedom “to become children of God.” The ability to confer this right marks Jesus’ exclusive relationship to God (cf. 3:35; 20:17) and His utterly unique position as the only way to the Father (14:6).

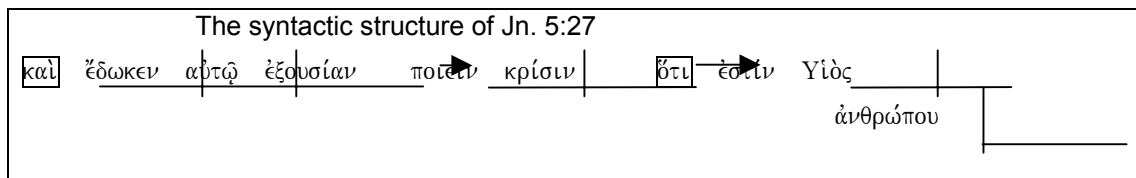

As the Father has given the Son the authority to have life in Himself so has He also given Him authority to execute judgment (v. 27^a; cf. vv. 21-22). The Father has granted this authority (ἐξουσία as δόξα) to Jesus because He is the Son of Man (v. 27^b).

Jn. 5:27	Dan. 7:13-14 (LXX)
ὅτι Υἱὸς Ἀνθρώπου ἐστίν (v. 27 ^b)	ὡς Υἱὸς Ἀνθρώπου ἦρχετο (v. 13)
καὶ ἐξουσίαν ἔδωκεν αὐτῷ (v. 27 ^a)	καὶ ἐδόθη αὐτῷ ἐξουσία (v. 14)

This title, Son of Man in Jn. 5:27 is an allusion to the apocalyptic Son of Man of Daniel 7:13-14, the one who comes on the clouds of heaven and is clothed with divine δόξα and unlimited power.⁴¹⁰ Morris (1995:283) comments that this is Jesus’ favourite self-designation and, moreover, it gives an excellent reason for judgment being committed to Him. Therefore, “the Son of Man” (Υἱὸς Ἀνθρώπου) is the heavenly figure to whom is given “dominion, glory and a kingdom, that all the peoples, nations and men of every language might serve Him. His dominion is an everlasting dominion which will not pass away; and His kingdom is one which will not be destroyed” (Dan. 7:14).⁴¹¹

Ridderbos (1997:200-201) notes that it is from within His self-identification with this eschatological figure and the divine qualities attributed to it that Jesus traces His authority as the Son to call the dead to life and His authority as the

⁴¹⁰ See Moloney (1978:81-82); Ashton (1991:357-363).

⁴¹¹ Carson (1991:257) says that in other uses in Ezekiel, it is God’s way of addressing a very human prophet.

Son of Man, to execute judgment.⁴¹² In Jn. 5:27 it seems that the figure of the Son of Man is advanced to express the transcendent character of Jesus' messiahship and the all-embracing, present-and-future-encompassing mission of Jesus as the Son of God.

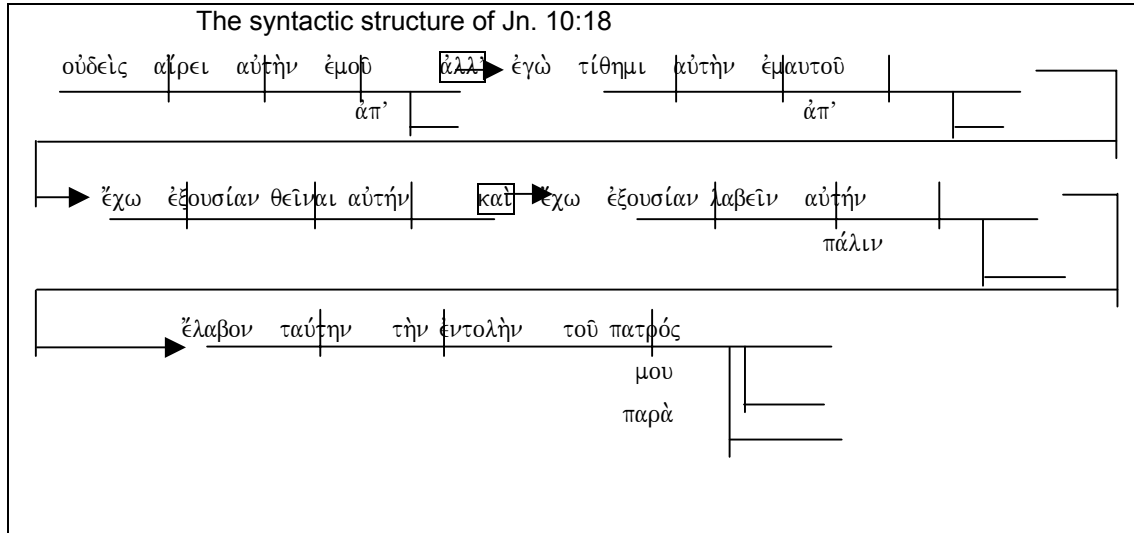

In Jn. 10:18, Jesus disavows that He would be a victim and claims power even over death: “No one has taken it away from Me, but I lay it down on My own initiative. I have authority to lay it down, and I have authority to take it up again. This commandment I received from My Father” (10:18). Since power is one of the public faces of δόξα (honour), Jesus' power to protect His sheep as well as His power to lay down His life shows that He suffers no shame whatever here. The power/authority (ἐξουσία) He has received from His Father sanctions not only His power to protect His own, but also to effect His own resurrection.

We know that the Lord Jesus' death does not take place as the result of misadventure or the might of His foes or the like. No one takes His life from Him. The Lord Jesus Himself lays it down, and does so completely of His own volition. Carson (1991:389) says that in Jn. 10:18 we see the complete identification of the Father and the Son in this plan. Schnackenburg (1984, 2:302) comments that “When, in rising from the dead, Jesus takes up His life again, nothing occurs other than that the Father glorifies Him (cf. 12:16; 13:31f.; 17:1).”

⁴¹² Cf. Mt. 19:28; 24:39f.; 25:31f.; 26:64; Mk. 8:38; 13:26f.; Lk. 21:27.

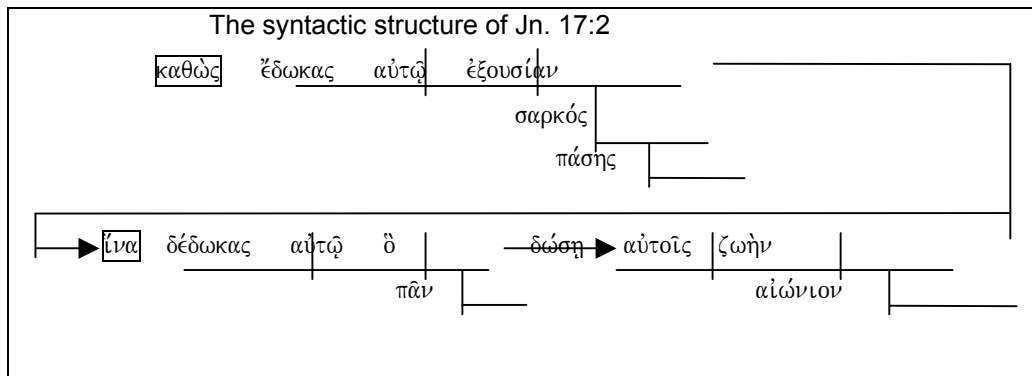

Moloney (1998:109) comments that according to Jn. 17:2, Jesus' having ἐξουσία over all mankind so that He might give eternal life to all (πᾶν) that God has entrusted to Him (v. 2^b; cf. 6:37), conjures up memories of the Johannine prologue (1:12-13), and that this is further developed in Jesus' discourse on His authority (ἐξουσία) as life-giver and judge in 5:19-30. Moreover, it is an authority given for the express purpose of conferring eternal life on those who believe in Him (3:15, 35-36; 10:28). Ridderbos (1997:548) notes that Jn. 17:2 describes a function and authority (power, ἐξουσία) of the eschatological Son of Man, the Son of God who came down from heaven (cf. 3:13). He came from heaven, to exercise that authority (power, ἐξουσία) in an unrestricted sense (cf. 7:39), an exercise to which He was predestined by the Father and for which He now prays. Moreover, the Father has clothed Jesus with the authority (power, ἐξουσία), to grant eternal life to all (people), who do not possess this life in themselves (cf. 3:16; 5:26f., etc.) – specifically “to all whom You (the Father) have given Him (17:2^b; cf. 6:39, 44).”

3.9.4.1.3. Conclusion

Ἐξουσία has a range of meanings including ‘power, authority to do a thing, right and might’ and power is an important meaning of δόξα in both the LXX and the New Testament. The Father has given the Son authority ἐξουσία in a wide range of activities such as judgement, to give life, to lay down His life and take it again, to give believers the authority to become children of God and, from the conversation with Pilate, we find that no one had authority over the Son unless

this was given from above.

The LXX translators used $\delta\acute{o}\xi\alpha$ to convey the sense of the Hebrew word for authority when translating the record of Moses' passing authority on to Joshua. There is a possible parallel in the record of Jesus giving His disciples authority to continue His works as they ask for this in Jesus' name. Apart from Jesus believers can do nothing.

Receiving Jesus is equated to believing in Him and this act confers on those who do so the power to become the children of God. In Jn. 1:12 "received" is an aorist and so this power is a reality. That Jesus has the authority to confer this power endorses His later statements that He is the exclusive way to the Father.

The title Son of Man is given to the prophet Ezekiel. It is also the title given to the apocalyptic figure of Dan. 7:14 who receives $\delta\acute{o}\xi\alpha$ and an everlasting dominion. In using this title Jesus identifies Himself with the prophetic character of Ezekiel by giving witness to God's view of people's thoughts, motives and deeds and also with Daniel's Son of Man and the divine qualities attributed to him.

Another aspect of the manifestation of Jesus' authority is His ability to lay down His life and to take it again. He can thus lay down His life for His sheep in the secure knowledge that He will take it again and be able to confer the same right to eternal life to those who receive Him. Jesus does not lose His life due to circumstances, He lays it down deliberately in response to His Father's pre-determined will. He takes it again and exercises His right to give this quality of life to all believers.

3.9.4.2. $\beta\rho\alpha\chi\acute{\iota}\omega\nu$ of the Lord as $\delta\acute{o}\xi\alpha$

Louw and Nida (1993, 1:681) write that ' $\beta\rho\alpha\chi\acute{\iota}\omega\nu$ ' is literally 'exalted arm' or 'lifted up arm.' In Semitic thought, the use of ' $\beta\rho\alpha\chi\acute{\iota}\omega\nu$ ' (arm) in such a context is an expression of great power, exalted power, and marvellous power (cf. Acts 13:17).

In Jn. 12:38, John correctly cites Isa. 53:1 from the LXX (κύριε τίς ἐπίστευσεν τῇ ἀκοῇ ἡμῶν καὶ ὁ βραχίων κυρίου τίνι ἀπεκαλύφθη, cf. Rom. 10:16). This rendering represents the current Hebrew text with sufficient accuracy. Ridderbos (1997:444) says that the question in Isa. 53:1 is that the prophet complains to God that hardly anyone has believed what the people have heard and what has been revealed to them as proof of God’s great power. In John’s context, Carson (1991:448) comments that verse 12:38 focuses on the teaching of Jesus, while “the arm of the Lord” (ὁ βραχίων Κυρίου) refers to divine activity, the power of almighty God (cf. Isa. 40:10; 52:10; 63:5) through the signs which Jesus performed.

3.9.4.3. Φῶς of Jesus as δόξα

3.9.4.3.1. Lexical and Literary aspects of φῶς

In the Fourth Gospel John employs ‘φῶς’ nineteen times to express the Hebraic thought⁴¹³ that in bringing δόξα to God, Jesus ushers a divine light into the world. Under the action of the light the truth (τὸ φῶς τὸ ἀληθινόν) is seen in Jesus as δόξα (Jn. 1:9). Jesus as, “the Light of the world” (τὸ φῶς τοῦ κόσμου, Jn. 8:12; 12:46), is seen by the believer to be the manifested δόξα of God.⁴¹⁴

Φῶς is a primary symbol in the Fourth Gospel. Culpepper (1983:190) describes φῶς in the Johannine prologue as follow. “The prologue links Λόγος, life, and light so powerfully that the cluster dominates the symbolic system of the entire narrative. The Λόγος incarnate in Jesus, is ‘the life [that] was the φῶς of men’ (Jn. 1:4) and where there is φῶς there is life and the perception of Life.”

Dodd (1998:202) states that in the Old Testament φῶς used to express that ultimate blessedness or salvation which is God’s gift to people and it was especially the sign of the manifestation of God. In this sense, God may be said

⁴¹³ Dodd (1998:204-205) indicates that the word φῶς reflects a Hebraic pattern in the Hellenistic thought. And Culpepper (1983:191) points out that the symbols of φῶς and darkness have deep roots both in Hellenism and in Judaism.

⁴¹⁴ Van der Watt (2000:258) comments that the concept of light (φῶς) focuses on Jesus as the revealer of God and the source of eternal life. See Westcott (1890:xlvii).

to be His people's φῶς.⁴¹⁵ In the Septuagint δόξα and φῶς are found in parallelism referring to the manifestation of the power of God for the salvation of His people (Isa. 60:1-3; cf. Isa. 58:8, LXX).

The determining fact of the Fourth Gospel, as far as φῶς is concerned, is that the light (φῶς) was manifested as the power evident in Jesus Christ. In Johannine literature the contrast between light (φῶς) and darkness (σκοτία) is stark and emphatic:

Light	God	Truth	Holiness	Life
Darkness	Satan	Falsehood	Sin	Death

Turner and Mantey (1964:58) comments that the darkness in John's writings, always stands in direct antithesis to light. John is not describing a dualistic universe in which light and darkness, the good and the evil, are matched opposites; he wants to describe the victory of the powerful light (1:5).⁴¹⁶ Carson (1991:119) indicates that "light and darkness are not simply opposites; darkness is nothing other than the absence of light." We find that John is largely interested in 'light' as it relates to salvation; the 'light' is revelation which people may receive by an act of faith and be saved.

3.9.4.3.2. Exegetical perspective of the use of the term φῶς

In Jn. 1:9 the true Light is affirmed to be the Word (Λόγος) who illumines the existence of every man (cf. 3:19-21). Moreover, Hendriksen (1969:77) notes that Christ, who is the powerful light coming into the world, actually grants spiritual illumination, in the highest and fullest sense of the term, to every human being dwelling on earth, without any exception. In this passage John's point is that the Word who came into the world is the light (φῶς), the true light (τὸ

⁴¹⁵ "τοῦ χρησθῆναι κύριος φωτισμός μου καὶ σωτήρ μου" (Ps. 26:1 [LXX]); "ὅτι παρὰ σοὶ πηγὴ ζωῆς ἐν τῷ φωτί σου ὁψόμεθα φῶς" (Ps. 35:10 [LXX]); "כִּי־עַמְךָ מְקוֹר הַיַּיִם בְּאוֹרֶךָ יִרְאֶה־אוֹר" (Ps. 36:10 [BHS]).

⁴¹⁶ Jn. 1:5; 8:12; 12:35, 46; 1 Jn. 1:5; 2:8; cf. Jn. 3:19; 1 Jn. 1:6.

Further see van der Watt (2000:246-248).

φῶς τὸ ἀληθινόν),⁴¹⁷ the genuine and ultimate self-disclosure of God to man.

The phrase “the Light has come into the world” (3:19) means that with the incarnation of the Word, the light shone in the darkness (cf. 1:4-5) even more brightly than at the creation. Carson (1991:207) comments that the phrase “Jesus is the light of the world” (8:12), means that Jesus is the revelation of God and the objectification of divine holiness and purity. Because “their deeds were evil” and they “loved the darkness rather than the light” men chose to live without the knowledge of God as the power of Light, and preferred to live as servants of the power of darkness.

“But he who practices the truth comes to the Light, so that His deeds may be manifested as having been wrought in God” (3:21), this expression makes it clear that the lover of Light’s authority (power) is not some intrinsically superior person. They are those who have chosen to acknowledge and obey the authority of God and, as a result, their deeds are said to have been “wrought in God” – Westcott (1890:57) comments that the phrase means that “in union with Him, and therefore by His power.”⁴¹⁸

The light metaphor “I am the Light of the world” (8:12),⁴¹⁹ is steeped in Old Testament allusions. In the Old Testament God is His people’s light (Ps. 27:1); in the light of His presence they enjoy grace and peace (Num. 6:24-26). Also, the word or law of God is described as a light to guide the path of the obedient (Ps. 119:105; Prov. 6:23). God’s light is shed abroad in revelation (Ezek. 1:4, 13, 26-28) and salvation (Hab. 3:3-4).⁴²⁰ So here Jesus, as the Son of the Father,

⁴¹⁷ Ladd (1974:167) says that “the Johannine use of ἀληθινός does carry something of the Greek meaning of ‘real,’ but it is the real because it is the full revelation of God’s truth.”

⁴¹⁸ See Carson (1991:208).

⁴¹⁹ This analysis of “I am the light of the world” (Jn. 8:12) is developed further in chapter 3.5.2.1. See Pancaro (1975:485-487).

⁴²⁰ Light is so common a religious symbol that scholars (Bultmann, 1971:40-45, 342-344; Barrett, 1978:335-338; Dodd, 1998:201-206) can find roughly parallel passages in a wide diversity of religious backgrounds and John may well have been exposed to these, Carson (1991:338) rightly comments that “insofar as some of his readers have been reared in one or more of these religious context, John would not be adverse to pointing out the ways in which Jesus is the true light.”

the Servant of the Lord and the Word incarnate, embodies this Old Testament language. “He who follows Me will not walk in the darkness, but will have the Light of life” (8:12) this passage makes plain its soteriological and eschatological dimensions. Also it gives to the believer the assurance of avoiding the perils and snares of the darkness and the promise of possessing “the Light of life” (τὸ φῶς τῆς ζωῆς), that is, liberation from the realm of death and translation to the domain of life and Light which is Jesus’ δόξα and power (cf. Ps. 36:9).⁴²¹ Marsh (1991:351) makes the important point that “light, in a sense, bears witness to itself, though every other object in the world requires light in order to bear witness to itself. Light always illuminates, is never illuminated.” Light is unique. Furthermore, Bultmann (1971:343) sees the emphasis not only in the fact that Jesus is distinguished from others who claim to give light, but also from that human certainty that it already has the light. Beasley-Murray (1987:128) rightly comments that as Jesus is the Light of life (cf. Jn. 1:4), the promise carries the reality in anticipation of its fullness in the δόξα of the kingdom of God still to be revealed (cf. 11:25).

3.9.4.3.3. Conclusion

Jesus said that He is the light of the world and this phrase epitomises the place light (φῶς) has in the Fourth Gospel where it is closely linked with Logos and life. Light (φῶς) is also strongly contrasted with darkness throughout this gospel where light is the true revelation of God’s character and will and darkness the absence of that light. Darkness is also seen as the deliberate putting aside of the knowledge of God.

The metaphor “I am the light of the world” has deep roots in the Old Testament. God is a light to His people, His word is a light to path of the obedient and God’s light is shed abroad in revelation and salvation. So in using this phrase Jesus

Elsewhere in the New Testament, we read that God is light (1 Jn. 1:5), and Jesus Himself said that His followers are “the light of the world” (Mt. 5:14). Paul can also speak of Christians as “lights in the world” (Phil. 2:15).

⁴²¹ Van der Watt (2000:249) says that the Light of life (τὸ φῶς τῆς ζωῆς) means light for those who have eternal life (ζωὴν αἰώνιον), who belong to God.

links His ministry with what has gone before in the Old Testament. He assures His followers that they will not walk in darkness but in the light of life and so avoid the perils and snares of darkness.

3.10. Concluding Summary

The Greek word δόξα has a wide range of potential meanings relating to both physical or material elements, those which appeal to the senses, and a conception which is predominantly ethical in character. In order to determine the sense in which δοξα is used in passages associated with the events of the cross in the Fourth Gospel various lexicons⁴²² were consulted. These give a very wide range of potential meanings for δόξα ranging from attributes such as brightness, splendour, radiance, power, might, the sense of honour as enhancement or recognition of status or performance, fame, recognition, renown, honour, prestige to the sublime glory and majesty of God in general. The verb form, δοξάζω carries a similar range of meanings. There are thus many perceived nuances to the meaning of δόξα and δοξάζω in the Fourth Gospel and understanding these depends on the context within which the terms are used. The overarching concept of δόξα, however, is that of the revelation or manifestation of God's being, nature, power and authority.

The LXX translation of the Hebrew Bible used δόξα to convey the sense of the Hebrew words אֱלֹהִים, פֶּאֶר, קָדוֹר, עֲרֹךְ, יָקָר. The range of meanings of these words includes the sense of glory, greatness, power, majesty, splendour, praise, exaltation, beauty and brightness. This further group of potential meanings, while similar to those already noted, must also be considered when evaluating the intended meaning of δόξα and δοξάζω in the Fourth Gospel.

Tracing the broad use of δόξα in the Fourth Gospel we find that the prologue introduces the concept of δόξα and that this theme is a constantly recurring refrain throughout the rest of the Gospel. It is seen in the semeia John selected for inclusion in the Gospel, first at the wedding feast and then at the raising of

⁴²² Kittel, Bauer and Thayer.

Lazarus. Jesus' δόξα is attested to by the audible voice of God in chapter 12:28. It is often mentioned in Jesus' discourses and He refers to His glorification the moment Judas leaves the upper room. This whole incident seems to relate to the imminent supreme obedience of Christ to God's plan of salvation through Jesus' atoning death on the cross. In doing so the Lord would also be glorified (δοξάζω) by the Father as evidenced by His resurrection, ascension and eternal δόξα in heaven. Finally in the prayer recorded in chapter 17 Jesus asks that He be glorified so that He might glorify the Father.

Because of the importance of the prologue to the Fourth Gospel, it was considered in detail with particular attention to references to δόξα. The keynote of this passage is that the Λόγος was God, that the Λόγος became flesh and dwelt among men and that they beheld His δόξα. This δόξα was "as of the only begotten of the Father, full of grace and truth." Some authors⁴²³ consider that the prologue to the Fourth Gospel is a modified hymn but the view taken in this thesis is that it is not a partial amalgam of a hymn interspersed with comments but that it is a carefully constructed single piece of theological writing intended to introduce the prime themes of the Gospel. The first section has as its focal point verse 1 of chapter 1 and deals with the divinity of the Λόγος, the second section has its focal point in verse 14 and deals with the incarnation. The prologue says that Jesus' δόξα was manifested while He was on earth and the rest of the Fourth Gospel deals with how that δόξα was manifested.

Jesus' relationship with the Father is a source of δόξα in that, if God has a δόξα – and He undoubtedly has – then the Son, too, has a δόξα. In the Fourth Gospel John presents Jesus' relationship with the Father in several ways. The most striking of these is Jesus' recorded statement that "I and the Father are One" indicating a divine identity and unity with God. This complete identity with the Father enables Jesus to give those who believe in Him eternal life. This eternal life is not to be thought of quantitatively but rather as a quality of life, a spiritual life that endures after physical death. John shows that Jesus is the "sent One"

⁴²³ Bultmann, Bernard, Schnackenburg, Haenchen and Brown.

and as the sent One he is, according to Jewish understanding, “as the One who sends Him.” Thus the Father is present in Jesus, He speaks in what Jesus says, and He is active in what Jesus does. At the raising of Lazarus Jesus prays that those present may, as a result of that σημεῖον believe that He is sent by the Father. John also records that, not only is Jesus the sent One, but in addition the Father witnesses to Jesus’ relationship with Himself by an audible voice at His baptism and again in response to Jesus’ prayer. The Father also witnesses to Jesus by the manifold works that Jesus did. This relationship was evident to any unbiased mind as shown by Nicodemus’ acknowledgement that “no one can do these signs that You do unless God is with him.” The Father not only witnessed to His relationship with Jesus but He put all judgement under His authority, power and δόξα. John refers to Jesus as “the Son of God” and Jesus Himself makes this claim when told of Lazarus’ illness. Mary and Nathanael both call Jesus the “Son of God” and Pilate, whether in derision or in contempt of the Jews put this title on Jesus’ cross. The oneness with the Father, as shown in all these different facets of Jesus’ ministry, demonstrates that Jesus has the same δόξα that the Father has.

In the Fourth Gospel John refers to Jesus’ deeds as σημεῖα, while Jesus refers to them as works (ἔργα). We can accept that, in this Gospel, the two are synonymous. Thus, whether we are considering works or signs they both pose questions as to Jesus’ identity and authority and require a decision as to who He is. They point beyond themselves to the deeper significance of what was done, a significance that is perceived by faith. While John states that the reason for including the σημεῖα is that his readers “may believe that Jesus is the Christ, the Son of God; and that believing you may have life in His name” they also reveal the δόξα of Jesus.

Jesus’ δόξα is specifically revealed in two of the eight recorded σημεῖα in the Fourth Gospel, changing water to wine and raising Lazarus from the dead. Turning water to wine occurred at the beginning of Jesus’ public ministry and raising Lazarus from the dead at the end. These two σημεῖα enclose the other

recorded signs and, while these other signs do not specifically refer to δόξα, we find that they too, reveal a power and authority that speaks of δόξα.

While both the changing of water to wine and the raising of Lazarus specifically mention Jesus' δόξα there are interesting differences. The first sign is private, only the disciples, Jesus' mother and the servants are aware of the σημεῖον and only His disciples are said to have "believed." In the second the σημεῖον is public. Mary, Martha, their friends and the Jews who had come to Mary all heard and saw what transpired and John records that they "believed." However "some" told the Pharisees what had taken place and the result was that they did not believe but rather plotted Jesus' death. The divergent responses to the σημεῖον highlight the fact that σημεῖα are always linked with πιστεῖν. People either believe or they reject the significance of the sign. Lazarus' resurrection, the last climatic σημεῖα before His crucifixion, reveals Jesus as having supreme authority over life and death, as being the resurrection and the life. It reveals His δόξα in an unmistakable and unmatched way.

The other signs Jesus performed, healing a nobleman's son, curing a paralytic, feeding five thousand, walking on the sea and giving sight to man born blind, although they do not refer to δόξα, all point in the same direction as the two discussed. They demand a response either of belief in Jesus' claims and all that that means or a rejection and the terrible destiny that follows.

Ἐγὼ εἰμι may be used as a title but is predominantly the name for divinity. Jesus uses this phrase on twenty four occasions but there are seven where its use is coupled with a striking metaphor which illustrates His relationship with mankind. He presents Himself as the "bread of life" reminiscent of the manna in the wilderness and indicating that He will sustain His followers materially and spiritually. He is "the light of the world" reminiscent of the shekinah δόξα that filled the tent of meeting and suggesting that He reveals God. He is the "Door of the sheep" the only way to God. He is the "Good Shepherd" caring for His flock and prepared to lay down His life for the sheep. He is the "Resurrection and the

Life” providing eternal life for believers. He is “the Way, the Truth and the Life” claiming again the He is the only way to God and that all that He taught was true and that in Him and in Him alone is eternal life to be found. He is “the True Vine” and as such the only source of fruitfulness for His followers.

The prayer of the Jesus recorded in chapter 17 reveals a great deal about His δόξα. It is linked with the δόξα that He had before His incarnation, and therefore is the δόξα of the Godhead. Jesus’ prayer is that He might be glorified so that the Father might be glorified. The basis for the prayer is that “the hour” had come. This was the hour of His crucifixion and death but also the hour of His glorification. It was the culmination of Jesus’ mission and purpose in the world. He had manifested the Father to those whom God had given Him, He had given them the words that the Father had given Him, He had completed the work which God had given Him to do and had glorified the Father by His complete obedience to the Father’s will. Although the cross still lay before Him Jesus was in control of all the events leading to the cross and completely determined to fulfil that final requirement. In doing so he obtained salvation and eternal life for those who believe in Him.

Jesus’ δόξα was recognised by many. Among the individuals who acknowledged His power, authority and δόξα were Nathanael, Mary and Martha, His special friends, and the Samaritan woman. In each case the acknowledgement was based on what can be termed a personal encounter with the Lord. Various groups of people also recognised His power, authority and δόξα. There were His disciples who, from the wedding in Cana “believed in Him”, the Samaritan citizens who heard Jesus speak during His brief stay there, the crowds that had heard of the raising of Lazarus and gathered to welcome Him as He entered into Jerusalem and finally the chief priests and the Pharisees who knew of Jesus’ σημεῖα but chose to reject the evidence of divinity and set about planning how to kill Him. Whether as individuals or as groups all acknowledged that Jesus had super natural power, authority and δόξα but only some saw beyond the immediate signs and realised the divine δόξα resident in Jesus.

Jesus taught His disciples some important lessons when He washed their feet. The first is not that we should literally wash believer's feet but rather that His followers should serve one another and imitate His humility and love in their dealings with one another. Another is that he has unquestionable love for those who believe in Him. Moreover, according to the washing of the feet of the disciples, as Jesus approaches His δόξα, He addresses the need for disciples to love one another as He loves them. A further lesson is that His death is totally effective in securing their purification.

Δόξα sometimes carries the sense of honour. The context of 8:54 shows that the immediate meaning of δόξα in this passage is 'honour. Thus we find that in certain contexts both 'δόξα,' 'δοξάζω' and 'τιμή,' 'τιμάω' can have the sense of 'honour' and 'to honour,' and it therefore seems that these words are interchangeable in some instances.

In Jn. 8:49-50 Jesus appears to equate honour with glory saying "I honour My Father, and you dishonour Me. But I do not seek My glory; there is One who seeks and judges." Jesus consistently seeks the honour of the Father and the Father, in turn, honours Jesus. He, the father, is the one who seeks for Jesus' honour and will hold those who do not honour Him accountable. Whereas Jesus' opponents seek their own honour and recognition by men rather than by God, Jesus' focus is on honouring the One who sent Him.

The ἀναβαίνω of Jesus is indicative of δόξα. He has triumphed over Satan's forces, He has shown His divine δόξα by the resurrection and now He is ascending to the Father and to the δόξα He had with the Father "before the world was."

A prime meaning of ἐξουσία is power and the sense of power can, in some cases be conveyed by both 'ἐξουσία' and 'δόξα.' Another important meaning is authority to do something. In the Fourth Gospel Jesus demonstrates both power, authority and δόξα. He is operating at the Father's behest and is empowered by Him to say what He says and to do what He does. As the Father works through

Him, He reflects the δόξα of the Father in all His words and deeds. Jesus' εξουσία is awesome in its extent. He has εξουσία to do all the works and to make all the statements recorded in John and the other Gospels. This alone demonstrates great δόξα but Jesus' εξουσία extends beyond this, He has εξουσία to execute all judgement, to give life, to lay down His life and to take it again. In addition Jesus has the εξουσία to give those who believe Him the right to become the children of God and this implies an eternal life. In that He has the power to lay down His life and to take it again He has the power to protect His sheep. Having such great εξουσία is surely a great δόξα. Another aspect of Jesus' εξουσία is that He exhibits the powerful βραχίων or arm of the Lord.

Jesus said "I am the light (φῶς) of the world." This statement carries with it allusions to some Old Testament incidents such as the Light shed at night by the column that lead the children of Israel on their way and the shekinah δόξα that filled the tabernacle and later the temple. The term light also speaks of God's word acting as guide to the obedient and points to the visible manifestation of God. In the New Testament light is seen as spiritual illumination and the revelation of God and Jesus as the "light of the world" is shown to be the revealer of spiritual truth and God to men.

CHAPTER 4. JESUS' CLIMACTIC GLORY: ΔΟΞΑ AND THE CROSS

4.1. Introduction

In this chapter the focus is on the events of the cross as they reflect Jesus' δόξα. The ὑψόω-phrases word cross only occurs four times (3:14; 8:28; 12:32, 34) in the Fourth Gospel but there are many indirect allusions to it. In this context the word ὑψόω is of particular importance as it is often used by Jesus and John when referring to the events of the cross. This word is therefore considered in detail. Also of importance are Jesus' "Ἐγώ εἰμι" statements that have direct bearing on the events of the cross and these are therefore evaluated specifically with the events of the cross in mind.

The δόξα of the events of the cross is also apparent in the reaction of some people to these events and so these are reviewed briefly. Finally the δόξα evidenced in the events of the cross is examined in depth.

4.2. Ὑψόω-phrases and the Crucifixion of the Son of Man

4.2.1. Introduction

In John, the cross is softened or expressed in figurative language in the case of the ὑψόω-phrases (3:14; 8:28; 12:32, 34). Van der Watt (2005:476) comments that the ὑψόω-phrases are central to the Fourth Gospel as it deals with the cross.⁴²⁴ He (2002:610) indicates that the use of this verb ὑψόω falls into the category of 'double meanings': firstly, the ὑψόω means to be lifted up – Jesus was literally lifted up on the cross; secondly, there is a figurative meaning, it is that He is lifted up above this evil world to 'above' (heaven), which is naturally an allusion to His divine status.

John wants readers to see the events of the cross as the visible manifestation of divine power and δόξα by referring three times to the crucifixion as the

⁴²⁴ See also Schnackenburg (1984, 2:398-401).

moment when the Son of Man was “lifted up” (ὑψόω). Koester (1995:210) considers that the term ὑψόω holds together the physical and transcendent dimensions of the crucifixion because it refers both to physical elevation and exaltation in δόξα.

4.2.2. Lexical and Literary aspects of the use of ὑψόω

According to Thayer (1914:647), Friberg (2000:394-395), and Bauer's (2000:1045-1046) lexicons 'ὑψόω' in the Fourth Gospel, can mean 'to lift up spatially, lift up, raise high.' Also, Liddell and Scott (1996:1910) consider that 'ὑψόω' has the meanings 'lift high, raise up,' and metaphorically to 'elevate, exalt.' Since 'δοξάζω' can also mean 'to exalt, to enhance someone's honour, fame, position, or power,' these two words are interchangeable in certain contexts. It is therefore easy to see that, in the Fourth Gospel, the verb ὑψόω can refer both to Jesus being lifted up on the cross and to His exaltation in δόξα.⁴²⁵ Jesus compares the lifting up of the serpent by Moses in the wilderness (3:14; Num. 21:9) and His being lifting up on the cross (3:14; 12:32-33). The purpose of the lifting up of the serpent on the pole was that snake-bitten people might be healed and live. The purpose of the lifting up of Jesus on the cross was that sin-afflicted people might not perish but have eternal life (3:16; 8:21, 24, 36).⁴²⁶ Schnackenburg (1984, 2: 393) considers that John takes advantage of the double dimension of ὑψόω to indicate both the physical lifting up of Jesus on the cross and His exaltation by God to His former heavenly world and soteriologically toward His δόξα and His saving power (cf. Jn. 3:14-15).⁴²⁷ In 3:14-16, the Son is lifted up in order to give eternal life to all who believe in Him. In 17:1-2, the Son is glorified in order to give eternal life to all those whom the Father has given Him.

⁴²⁵ See Hooker (1994:94-96). Ὑψόω is used to describe exaltation in the New Testament Christological tradition of Jesus' exaltation to God's right hand or to heavenly lordship (Acts 2:33; 5:31; cf. Phil. 2:9).

⁴²⁶ Carroll & Green (1995:102) comment that the ὑψόω motif builds upon a complex pattern of intratextual and intertextual echoes; both of Scripture (Num. 21:9; cf. 3:14) and of Jesus' own words (3:14; 8:28; 12:32-34; cf. 18:32).

⁴²⁷ Barrett (1962:356) indicates that Jesus was lifted up in execution on the cross and thereby exalted in δόξα.

The verb ὑψόω occurs 5 times in John (3:14 [x2]; 8:28; 12:32, 34) in connection with Jesus' public teaching about the Son of Man. The term ὑψόω is an apt image for the death of Jesus, for in four of them, Jesus is speaking about His return or ascent and this return is to be understood in connection with the death of Jesus which was by being lifted up in crucifixion. The term ὑψόω used in these verses constantly embraces the divine revelation, exaltation and the obedient suffering of the Son. Not only does the term ὑψόω suggest to the reader the lifting-up of the crucified one on the cross, but it also expresses the exaltation that the death of Jesus, described as His hour of glory, entails. However, John is able to express the idea that that lifting-up is also Jesus' exaltation, making the word synonymous with δοξάζω (LXX, Ex. 15:2; Isa. 33:10; Sir. 43:30). Brown (1978:146) asserts that its usage was probably influenced by Isaiah's depiction of the Servant of the Lord in Isa. 52:13,⁴²⁸ who suffered and was exalted and greatly glorified.⁴²⁹ We find that the Septuagint version of Isa. 52:13 which combines ὑψόω and δοξάζω at the beginning of the Song of the Servant's suffering, and some have suggested that John's choice of phrase was influenced by the vocabulary of this verse (also LXX Isa. 4:2).⁴³⁰

Any charge that 12:32 breaks this rule is soon dispelled when one bears in mind that, firstly, it draws the puzzled response from the crowd concerning the lifting up of the Son of Man (8:34), and secondly, the phrase "the Son of Man must be lifted up" (δεῖ ὑψωθῆναι τὸν Υἱὸν τοῦ Ἄνθρώπου) in 12:34, though it responds to 12:32, is so framed that it takes us back to 8:28 and in particular to 3:14.⁴³¹ Irrespective of the precise nuance in John's use of ὑψόω, whether it refers to the

⁴²⁸ Although a similar conjunction, together with the idea of vindication, is found also in Isa. 5:16; 33:10; 45:25.

⁴²⁹ See Schnackenburg (1984, 1:397).

⁴³⁰ See Schnackenburg (1984, 2:405); Brown (1978:146, 478); Barrett (1978:427); Bruce (1983:267); Carson (1991:444). However, Pamment (1983:16) considers that many commentators have not gone on to draw attention to the use of δόξα in Is. 52:14 and 53:2, where the word is used in the sense of 'appearance' and stresses the servant's marred δόξα. In other words, a contrast is made between the servant's want of glory in his suffering and his future glorification.

⁴³¹ Bultmann (1971:354-355) has attempted to resolve what he takes to be a problem by having 12:34 follow immediately after 8:28, an attempt roundly criticized by Brown and Schnackenburg. See Brown (1978:478); Schnackenburg (1984, 2:395)

lifting up to heaven in glorification that also involves the crucifixion or whether it refers primarily to the crucifixion (which is also His glorification to heaven),⁴³² it is clear that it includes the exaltation of the Son of Man in δόξα. Schnackenburg (1995:264) says that the lifting up (exaltation) in the Fourth Gospel means a Christological assertion of majesty and a soteriological promise (cf. Dan. 7:13-14). It is noteworthy, then, that both verbs (ὑψώω, δόξα) in the Johannine vocabulary that speak of the lifting up/ascending of Jesus are framed almost exclusively in terms of Son of Man thinking.

4.2.3. Exegetical perspective of the use of the term ὑψώω

The first reference (3:14-15) to the exaltation of the Son of Man explicitly connects the necessity of this exaltation with the gift of eternal life through faith, “And as Moses lifted up the serpent in the wilderness, even so must the Son of Man be lifted up; so that whoever believes may in Him have eternal life” (3:14-15). According to 3:14 the Son of Man is to be lifted up as Moses lifted up the serpent in the wilderness; this is a typological interpretation of Num. 21:4-9, and points quite clearly to a literal meaning that the Son of Man’s exalting comes about when Jesus is lifted up on the pole of a cross.⁴³³ It is plain enough that at one level of meaning this denotes the exaltation of Jesus to the position of divine δόξα appropriate to the apocalyptic Son of Man.⁴³⁴

Jn. 3:14-15	Jn. 17:1-2
ὑψωθήναι δεῖ τὸν Υἱὸν τοῦ ἀνθρώπου	δόξασόν σου τὸν Υἱόν
ἵνα πᾶς ὁ πιστεύων ἐν αὐτῷ ἔχη ζωὴν αἰώνιον.	ἵνα πᾶν ὃ δέδωκας αὐτῷ δώσῃ αὐτοῖς ζωὴν αἰώνιον.

Also, we find that the literary aspects of Jn. 3:14-15 and Jn. 17:1-2 have a parallel pattern as follows; in 3:14-15, the Son is lifted up (ὑψώω) in order to give eternal life (ζωὴν αἰώνιον) to all who believe in Him while in 17:1-2, the Son is glorified (δοξάζω) and gives eternal life (ζωὴν αἰώνιον) to all those whom the

⁴³² The question is well studied by Thüsing (1960:174-249); cf. also Nicholson (1983:75-144).

⁴³³ Loader (1989:117) comments that this would give the meaning either that the actual death, itself, is the basis for the promise of the eternal life, namely death understood as a vicarious sacrifice.

⁴³⁴ See Lindars (1977:77-78).

Father has given Him.

The use of the verbal form $\delta\epsilon\iota$ in Jn. 3:14 and 12:34 indicates that the lifting up ($\upsilon\psi\acute{\omega}$, passive) of the Son of Man was a fulfilment of Scripture (Isa. 52:13-53:12) and thus an expression of God's will.⁴³⁵ Some might say that, characteristically for John, it is precisely the exaltation that is willed by God. Schnackenburg (1984, 1:395; 2:401) says that, in the Fourth Gospel, the $\delta\epsilon\iota$ of the passion becomes a God-determined way to the exaltation and glorification of the Son of Man because John turns the humility statement about the passion (cf. Phil. 2:8) into an exaltation statement. Also, John presents Jesus going to His death not at the hands of His opponents in this world; nor at the behest of the prince of this world; but in accordance with God's decision in 18:11, 12:27-28, and 14:30-31.

Carson (1991:202) comments that "even so must the Son of Man be lifted up, οὕτως ὑψωθῆναι δεῖ τὸν Υἱὸν τοῦ ἀνθρώπου" (3:14), is the determined purpose of God. Morris (1995:200) points out that Jesus showed forth His $\delta\acute{o}\xi\alpha$ not in spite of His earthly humiliations, but precisely because of those humiliations, which, in the case of crucifixion are extreme. Also verse 3:14 reveals that to the eye of faith that it was, and is the greatest $\delta\acute{o}\xi\alpha$.

"When you lift up the Son of Man, then you will know that I am He" (8:28), Jesus' true identity as One who comes from the Father and is One with the Father will come to the fore clearest on the cross. Kysar (1993:42) expounds verse 8:28 as "When you execute Me as a common criminal in the most demeaning way, you will bring about my exaltation, the revelation of my true identity." Lindars (1982:322) comments that as with 3:14 this phrase in 8:28 shows John's technical expression of the story of the crucifixion of Jesus as the manifestation of the divine $\delta\acute{o}\xi\alpha$. In contrast to the other passages (3:14; 12:32-34), the $\upsilon\psi\acute{\omega}$ in 8:28 is actively asserted to the Jews. This verse states that the Jews responsible for the death of Jesus will afterwards know who He is, His

⁴³⁵ See Schnackenburg (1984, 1:397, 2:399); Brown (1978:146); Bruce (1983:89); Nielsen (1999:237-239).

relation to the Father, and the character of His ministry, for verse 8:29 continues the flow of thought in verse 8:28.⁴³⁶ “I speak these things as the Father taught Me” (8:28^d), Jesus repeats what He said earlier (8:26) that His message to the people is what God has spoken to Him.

In Jn. 12:32-34, the lifting up (ὑψόω) of Jesus refers not only to His crucifixion but also to His resurrection and ascension,⁴³⁷ and the exalted and glorified Christ draws all people,⁴³⁸ to Himself and to heaven.⁴³⁹ Moreover, in contrast to the expulsion of the ruler of this world (12:31), Ridderbos (19976:439) notes that Jesus draws all people to Himself from within this new centre of power, that is, by bringing them under His saving rule. In respect of the phrase “And I, if I am lifted up from the earth, will draw all men to Myself (κάγω ἐὰν ὑψωθῶ ἐκ τῆς γῆς, πάντας ἐλκύσω πρὸς ἑμαυτόν)” (12:32), Beasley-Murray (1987:214) comments that in virtue of Jesus’ crucifixion and resurrection the Son of Man brings saving sovereignty to the world, and He exercises that sovereignty by drawing all peoples (πάντας) without distinction to Himself in the kingdom. Also, it seems that the ideas of judgement and salvation in Jn. 12:31-32 are brought together in the glorification of Jesus.⁴⁴⁰

4.2.4. Summary and conclusion

‘Ὑψόω’ can have the metaphorical meaning ‘to elevate, exalt’ and, since ‘δοξάζω’ can have a similar meaning in some contexts, it is easy to see how, in the

⁴³⁶ See Beasley-Murray (1987:131).

⁴³⁷ Nicholson (1983:132) says that “κάγω ἐὰν ὑψωθῶ ἐκ τῆς γῆς” speaks about the time when Jesus has returned above to the Father rather than about the time when He draws near to the crucifixion. But it seems that this phrase does not only simply refer to the crucifixion, but also via the cross to the throne of heaven.

⁴³⁸ See Lindars (1972:434); Bruce (1983:267-268); Carson (1991:444). The phrase all people indicates that Gentiles as well as Jews, all without distinction will be drawn to Jesus. Beasley-Murray (1987:214) says that the term “all men (πάντας)” indicates the universal scope of the eschatological event disclosed in ὑψωθῶ (“if I be lifted up, ἐὰν ὑψωθῶ;” the saving sovereignty is for all humankind.

⁴³⁹ See Schnackenburg (1984, 2:393); Barrett (1978:427); Lindars (1972:434); Bruce (1983:267); Carson (1991:444).

⁴⁴⁰ Commenting on Jn. 12:41, Ferreira (1998:157) writes that John saw that burning altar as anticipating the sacrifice of Jesus on the cross, for herein, he says the prophet saw His δόξα. This imagery of the background (Isa. 6:9-10) may have provided John’s association of Jesus’ cross with His δόξα.

Fourth Gospel, it can refer both to Jesus being lifted up on the cross and to His exaltation in δόξα. Jesus links His lifting up on the cross to the lifting up of the serpent in the wilderness, the one to give life to those threatened by death from poisonous bites, the other to give eternal life to those under the penalty of death because of sin.

The verb ὑψόω is used 5 times in the Fourth Gospel in connection with Jesus' teaching about the Son of Man and His exaltation. This usage may well have been influenced by the language and thought of Isaiah 52 which speaks of the Servant of the Lord who suffered but was later exalted and given great δόξα. While the precise nuances of ὑψόω intended by John may be debated, it is clear that they include the exaltation of the Son of Man in δόξα.

The lifting up of the Son of Man referred to in John 3 is a typological interpretation of the incident in Numbers 21 pointing to the truth that the Son of Man's exalting occurs when Jesus is lifted up on a cross. He is lifted up to give eternal life to those who believe in Him and there is a parallel thought in John 17 where the Son is glorified and gives eternal life to all those whom the Father has given Him. These two passages clearly link the verbs lifting up and glorification as a single concept. It is important to note that the lifting up of Jesus on the cross was a fulfilment of Scriptures, it was the determined purpose of God. When this lifting up took place those who did so would come to know His true identity.

The lifting up of Jesus is also linked with His exaltation and His ascension and as this is the fulfilment of the work of salvation, flowing out of that ascension He will draw all peoples, without distinction, to Himself. Jesus' comments on His ascension also point to His pre-existence.

4.3. Δόξα and the Events of the Cross

4.3.1. Δόξα and the Ἐγώ εἰμι statements

4.3.1.1. Ἐγώ εἰμι the Good Shepherd

Further in chapter 10 verse 11 Jesus says; “I am the good shepherd” and this phrase is repeated in verse 14. This affirmation tells us much about Jesus. Morris (1989:115) says that “it is important that the word for ‘good’ here is one that represents not the moral rectitude of goodness, nor its austerity but its attractiveness.”

Not only was Jesus attractive, He was prepared to lay down His life for the sheep. Shepherds were to protect the sheep from the hazards of the open country and not to die for them. The task of a shepherd is well set out in Psalm 23. He is to lead them to pasture and water, to protect them from danger. Thus the statement that the good shepherd would lay down his life for the sheep would arrest the attention of all His hearers. The fact that the expression is repeated indicates that it is a central, important aspect of Jesus’ work on earth.

This line of thought inevitably leads on to the reason for the necessity of the Shepherds death. This in turn leads to a realisation of man’s estrangement from God and our need for salvation. Then too, there is the realisation realise that Jesus’ death was entirely voluntary, He laid down His life for “the sheep.”

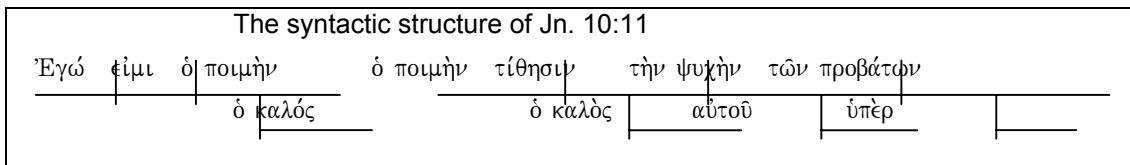

In the phrase “I am the good shepherd” (10:11^a), the word “good (καλός)” may suggest in the sense of “nobility” or “worth,” that is, “the noble shepherd” or “the worthy shepherd.”⁴⁴¹ Carson (1991:386) notes that Jesus is not contrasting Himself with temporal types, successful or otherwise, but with hired hands who have no real attachment to the sheep (cf. 10:12-16). Over against their deep self-interest, He is the noble shepherd who places an extremely high value on caring for the sheep. In Zechariah (11:17), we have a description of the

⁴⁴¹ Newman and Nida (1980:329) consider that the word good (καλός) may be understood “dedicated” or “devoted.”

worthless shepherd, in contrast to this Old Testament picture, here we have Jesus presented as the worthy shepherd.⁴⁴²

The phrase “the good shepherd lays down His life for the sheep,” means that Jesus distinguishes Himself from the hireling by risking His life for the sheep. Van der Watt (2000:78-79) says that the notion that the shepherd (Jesus) should die for His sheep is, however, strange and it is a question of what will actually happen to His sheep after His death. He (2000:79-80) considers that it is not a death in despair, but that in Jesus’ death in which the power of God will be illustrated. Carson (1991:386) comments that Jesus’ death is precisely what qualifies him to be the good shepherd – a point presupposed in Heb. 13:20, which acknowledges Jesus to be ‘that great Shepherd of the sheep.’ And by His death, far from exposing His flock to further ravages, He draws them to Himself (12:32). Moreover, Morris (1989:116) points out that this is another way in which John brings out the truth that Jesus’ death was no tragic accident, but the divinely appointed way whereby salvation would be brought to those who trust Him (cf. v. 14).⁴⁴³ With the realisation that Jesus was prepared to die for the sheep, comes a dawning wonder at His amazing love and a recognition of the inherent δόξα in His death.

Up to this point in the Fourth Gospel, the Ἐγώ εἰμι statements have been made to the populace in general. From now on, however, Jesus’ Ἐγώ εἰμι affirmations are made to His followers, those who had come to recognise who and what He truly was – the Son of God.

4.3.1.2. Ἐγώ εἰμι the Resurrection and the Life

In the face of confirmed death Jesus said “I am the resurrection and the life; he who believes in Me will live even if he dies, and everyone who lives and believes in Me shall never die” (11:25-26). This is one of the most startling of

⁴⁴² See Moloney (1998a:301).

⁴⁴³ Lightfoot (1956:207) says that the good shepherd (Jesus’) laying down of His life, “is His right and is in no way forced upon Him.” This striking way of putting it emphasizes the voluntary nature of what the good shepherd (Jesus) does for His sheep.

the *Ἐγώ εἰμι* statements. Jesus does not say that he will raise Lazarus from the dead nor is He referring to the general resurrection of the dead but that He is the resurrection and the life. The context of the passage is that Lazarus had been dead for four days and Jesus had said that His death was for the *δόξα* of God. He then demonstrated this by raising Lazarus from the dead. We all face death but Jesus claims that those who believe in Him have an eternal life (cf. 20:30-31).

The phrase “I am the resurrection and the life,” means that Jesus is thoroughly involved in the bringing of life, and He identifies Himself with it. Morris (1989:117) says that the phrase means that death, which to us appears so final, is no obstacle, and that the quality of life that He imparts to us here and now never ceases.⁴⁴⁴ Jesus’ claim to be both the resurrection and the life means that all hope for life with God, both in the present and the future⁴⁴⁵ is vested in Him and Him alone.

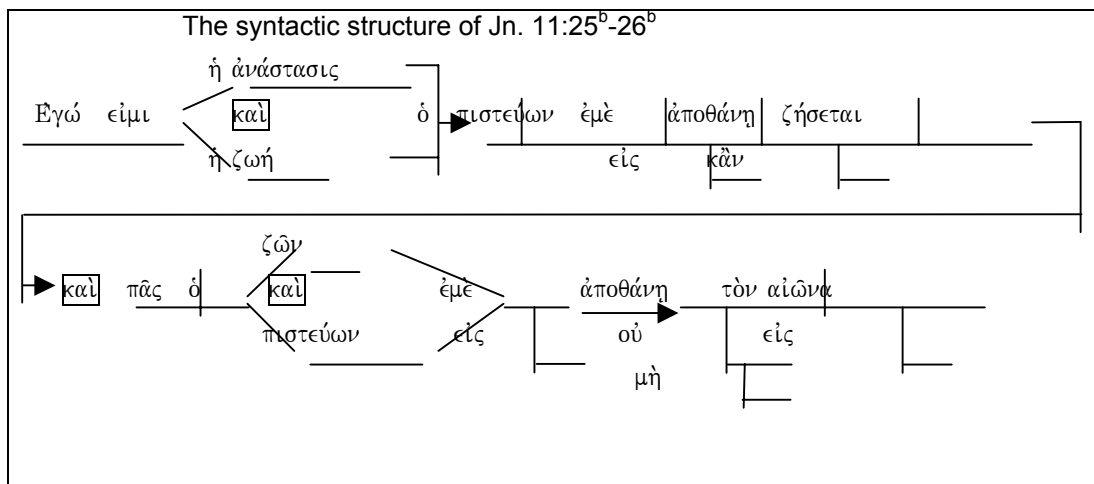

Jesus said “I am the resurrection and the life” (11:25), and where He is, there victory over the power of death, and belief in Him transforms the reality of death into a life that is not bounded by death. The meaning of the phrase “he who

⁴⁴⁴ Cf. Beasley-Murray (1987:191) comments that “the revelation to Martha thus is an assurance of resurrection to the kingdom of God in its consummation through him who is the Resurrection, and of life in the kingdom of God in the present time through him who is the Life. Both aspects of the “life” are rooted in the understanding of Jesus as the Mediator of the divine sovereignty in the present and in the future.”

⁴⁴⁵ See Turner & Mantey (1964:233); Koester (1995:109).

indicate that God alone had the power to give life to the dead, and by exercising that same power, Jesus revealed His unity with the God who had sent Him (cf. 5:21). Moreover, these verses show us the δόξα of God shining through Christ who has power over death.

4.3.1.3. Ἐγώ εἰμι in the Passover Supper

During the last meal before the crucifixion Jesus told His disciples of His impending betrayal saying (13:18^b-20): “I know the ones I have chosen; but it is that the Scripture may be fulfilled, ‘He who eats My bread has lifted up his heel against Me.’ From now on I am telling you before it comes to pass, so that when it does occur, you may believe that I am (Ἐγώ εἰμι) He. Truly, truly, I say to you, he who receives whomever I send receives Me; and he who receives Me receives Him who sent Me.” Not only was Jesus demonstrating His omniscience in knowing who was to betray Him but in quoting Ps. 41:9 Jesus was directing their thoughts to the fulfilment of the prophetic content of this Psalm. Also, Jn. 13:19 seems related to Isa. 42:8-9. Once Jesus had been betrayed, crucified and had risen again, the memory of Jesus’ prediction of His betrayal, His foreknowledge of His betrayer’s identity and His use of the phrase I am (Ἐγώ εἰμι) He would confirm His deity.

Harnier (1970:38) comments that John indicates that the meaning of the phrase “I am He (Ἐγώ εἰμι)” in 13:19 will be known only to faith and only after the death and glorification of Jesus (cf. 8:28). The phrase “that I am He (Ἐγώ εἰμι)” in verse 13:19, is a way of identifying Jesus with God (cf. 8:24; LXX Isa. 43:10). It reveals that Jesus is Christ, the Son of God (20:31).⁴⁴⁸

4.3.1.4. Ἐγώ εἰμι in the Gethsemane

Verses 5, 6 and 8 of chapter 18 of the Fourth Gospel record the last use of the term Ἐγώ εἰμι by Jesus. Up to now the use of the term has had an intellectual effect on His hearers and they have either accepted His claims or, as so

⁴⁴⁸ Harnier (1970:39) says that the absolute “I am He” (Ἐγώ εἰμι) in 13:19 with 8:58, expresses the unity of the Father and the Son.

frequently done by the Jewish leaders, rejected them. Now, for the first time there is a physical outcome as the band sent to arrest Jesus are thrown to the ground when He says Ἐγώ εἰμι – I am. In this passage, even the world could sense the δόξα of God through an encounter with the divine “Ἐγώ εἰμι.”

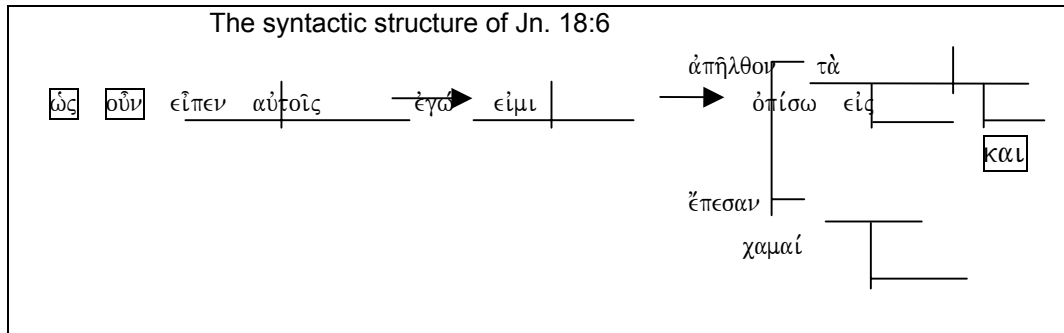

In this passage, Ἐγώ εἰμι is good Greek for “I am the One” or “It is I,” which echos the divine name, but throughout the Fourth Gospel John has played on Ἐγώ εἰμι without an expressed predicate giving voice to Jesus’ divine claim: “Before Abraham was born, I am” (8:58; cf. 8:24, 28; 13:19). While in the hymn of Phil. 2:6-11, “the name which is above every name (Phil. 2:9)” is bestowed on Jesus after His death on the cross and His exaltation, in John we find that before His death Jesus speaks to the Father saying “Your name which You have given Me” (Jn. 17:11). To use God’s name, “Ἐγώ εἰμι,” might be considered an act of power; and honour is always attached to power. There the name seems to have the power to keep the disciples safe (Jn. 17:6, 11-12); in Jn. 18:6 the name seems to have the power to paralyze His enemies; for as soon as He speaks the arresting party “drew back (εἰς τὰ ὀπίσω)” and “fell (ἔπεσαν)” to the ground (χαμαί).⁴⁴⁹ Falling to the ground characterizes human reactions in the presence of the δόξα of God (Ezek. 1:28; 44:4) or at least an honour-bestowing posture in the presence of a superior person (Dan. 2:46; Rev. 1:17). As in Jn. 6:20 the term may be taken as simply an identifying statement but the effect on the mass of Roman soldiers and Jewish religious officers is an

⁴⁴⁹ See Brown (1994:260-261). Brown (1994:261) comments that Old Testament antecedents for this reaction have been proposed: drew back (εἰς τὰ ὀπίσω, Ps. 56:9; 35:4); fell (ἔπεσαν, Ps. 27:2; and as a reaction to divine revelation in Dan. 2:46; 8:18; Rev. 1:17).

indication that it was far more than just an identifying statement and was a declaration and demonstration of Jesus' divine authority and δόξα.

4.3.1.5. Conclusion

Ἐγώ εἰμι is the phrase used by the LXX translators when translating words spoken by God and when Jesus used this emphatic form of I am he was adopting phraseology associated with deity in the Greek Hebrew scriptures.

As the Good Shepherd, Jesus is presented as the one who, in contrast to hired hands, really cares for the sheep. He is prepared to die for them and thus reflects something of God's incredible love for those He created.

As the Resurrection and the Life, Jesus is presented, not just as having eternal life and being able to mediate it to others, but rather as the source and spring of eternal life.

During the Passover supper Jesus predicted His betrayal and His death with the explicit intention that His disciples might believe He truly was the I AM, the Ἐγώ εἰμι.

In the garden of Gethsemane Jesus used the phrase Ἐγώ εἰμι to identify Himself to those sent to arrest Him. At His words, however, the crowds drew back and fell to the ground, showing that, on Jesus' lips, these words are more than a statement of identity, they become a declaration of His true being, power and authority and they reflect something of the δόξα that was, for a while, veiled in His flesh.

They demonstrate Jesus' foreknowledge of coming events, His power over the forces of nature, the fulfilment of prophecy and His claim to an eternal existence. In doing so they reflect His deity and the implicit δόξα that is His as God.

4.3.2. The events of the cross and recognition of Jesus' δόξα by people

4.3.2.1. The captors

When the crowd said they were seeking Jesus the Nazarene, Jesus responded Ἐγώ εἰμι the “I am” title of God. These words of Jesus, which implied His deity, had a force and power that stopped the mass of people in their tracks and drove them to the ground. Here (19:11) Jesus shows how powerless before him are the troops of the Roman cohort and the police attendants from the chief priest.⁴⁵⁰ As in 6: 20 the term may be taken as simply an identifying statement but the effect on the mass of Roman soldiers and Jewish religious officers is an indication that it was far more than just an identifying statement and was a declaration and demonstration of His divine δόξα and power.

4.3.2.2. Pilate

The events of the cross are interspersed with other references to the kingship of Jesus.⁴⁵¹ Chapter 18-19 indeed deal with a court case in which Jesus is tried by Pilate. Much has been written about the interaction between Jesus and Pilate. John records Pilate’s fear as the character and nature of Jesus emerges during the interrogation. In his interrogation of Jesus Pilate asks Him whether He is the king of the Jews and in His response Jesus says that “My kingdom is not of this world. If My kingdom were of this world, then My servants would be fighting, that I might not be delivered up to the Jews; but as it is, My kingdom is not of this realm” (18:36). Jesus’ affirmation of His kingship is reiterated in the following verse where He says “You say correctly that I am a king. For this I have been born, and for this I have come into the world, to bear witness to the truth. Everyone who is of the truth hears My voice.” John treats Jesus’ kingship as a major messianic motif. The kingship of Jesus does not have its origin, in and therefore does not receive its character from, this world (18:36),⁴⁵² and the royal power exercised by Pilate on Caesar’s behalf is only possible because it had been given “from above” (19:11).⁴⁵³ The vindicator of His kingship, then, must

⁴⁵⁰ See Brown (1994:261).

⁴⁵¹ The term βασιλεύς is employed 12 times (Jn. 18:33, 37, 39; 19:3, 12, 14, 15, 19, 21). Cf. Jn. 1:49; 6:15; 12:13, 15.

See Morris (1967:179); Barrett (1978:547, 549); Panackel (1988:238); Koester (1995:200-206).

⁴⁵² See Meeks (1967:63-67).

⁴⁵³ See Richard (1988:208).

be a most powerful person also ‘not of this world,’ namely God.⁴⁵⁴ Pilate become aware of Jesus’ declaration commenting: “So You are a king?” (11: 37). Moreover, it is significant that Pilate seems to recognise the otherworldliness of Jesus and on three occasions when talking to the leaders of the Jews refers to Him as their king (Jn. 18:39; 19:14, 15) and goes on to put this title on the inscription on the cross. Pilate also declares Jesus to be innocent on three occasions (Jn. 18:38; 19:4, 6) but because of the political situation allows an innocent man to be crucified.

According to Jn. 19:11, Pilate would not have any authority over Jesus unless it had been given to him from above (οὐκ εἶχεξ ἐξουσίαν κατ’ ἑμοῦ οὐδεμίαν εἰ μὴ ἦν δεδομένον σοι ἄνωθεν) thus Jesus’ present situation was not because of the power Caesar wielded but because it was God’s predetermined will. The development within the narrative demonstrates that this statement of Pilate’s authority is not an incidental remark about his political power.

While the Pharisees and the high priests could not appeal the superscription beyond the authority of Pilate, Jesus could appeal directly to God Himself. Thus the final judge of the ministry of Jesus is not Pilate, but the Father. Still, in spite of the fact that the judgement of Pilate is not the final judgement of Jesus; his statement is the final and unconditional commitment of his witness to Jesus, a witness which is to the whole world and which stands as one of the supreme examples of the irony of the Fourth Gospel. Rome, though it did not believe, witnessed to Jesus in the action of its representative, Pontius Pilate. Consequently Pilate was used as a tool for the manifestation of Jesus’ δόξα in the Fourth Gospel. Van der Watt (2002:613) comments that Jesus’ cross is and becomes His throne – the title (“Jesus of Nazareth, the King of the Jews,” 19:19) testifies to this. Thus to ascend your throne as king is indeed glorifying.

4.3.2.3. Thomas

John records just four appearances of Jesus after His resurrection. They were,

⁴⁵⁴ See Neyrey (1999:163-166).

in order, Mary Magdalene (20:11-18), the disciples (20:19-23) in hiding, Thomas with disciples (20:26-29) and finally the fishing party (21:1-23) consisting of Simon Peter, Thomas, Nathanael, the sons of Zebedee and two other disciples.

The significance of the resurrection and the associated δόξα was not immediately understood by those who saw Jesus but there was a growing awareness of this during the days that followed.

In John it is Thomas who truly acknowledges the δόξα of the resurrected Jesus. After emphatically rejecting the claims of his fellow disciples that they had seen Jesus and setting his requirements for believing that the resurrection had really happened it is Thomas who, when he sees Jesus says “My Lord and my God!” (20:28).⁴⁵⁵ This confession reveals that a central aspect of the δόξα of Jesus lies in the public confession of the disciples on the ground of their understanding of who Jesus is and what He did.⁴⁵⁶ Also, in that short statement there is an unreserved acknowledgement of Jesus’ divinity and a full submission to His authority. It also implies all the δόξα and majesty one would associate with divinity.⁴⁵⁷ This will be further developed eschatologically when the disciples see the eschatological δόξα of Jesus where He now is (17:24).

4.3.2.4. Summary and conclusion

In different ways and for different reasons many people recognised that Jesus had and exercised great power, authority and δόξα. It is significant that the exercise of His authority had a divisive effect on people. They either accepted Jesus’ claim that He was from God and responded accordingly, or they attributed His power to some other source such as “Beelzebul, the ruler of the

⁴⁵⁵ Senior (1991:139) points out that this phrase is one of the Gospel’s most profound confessions of Jesus’ true identity.

⁴⁵⁶ Cf. Jn. 20:31.

⁴⁵⁷ Kistemaker (2004:129) says that Thomas fully understood Jesus’ teaching of the unity of Father and Son, that is, as the Father is divine, so is the Son. Schnackenburg (1984, 3:333) comments that “The evangelist is not yet thinking from the point of view of the teaching of the two natures, he combines the Godhead of Jesus with the revelatory and saving function of the Son: he is the *Messiah*, the Son of God, that is, he is the messiah to the extent that he is the Son of God, and the Son of God in his messianic ministry. This functional understanding can be found expressed likewise in the personal confession formula: ‘My Lord and my God.’”

demons” (Lk. 11:15).

In recognising Jesus’ power, authority and δόξα there was also an inherent acknowledgement of the δόξα associated with the performance of the signs and in the power of His words.

4.4. The events of the cross and Jesus’ Δόξα

4.4.1. The events of the cross in relation to Jesus’ δόξα

In the Fourth Gospel, the events of the cross actually reveal Jesus’ oneness with God, manifest His δόξα, and signal the triumph of the Son of God over the forces of Satan.⁴⁵⁸ A key thought in the Fourth Gospel is that of sin and that the sacrificial death of Jesus dealt in full with the penalty of sin. The author notes John the Baptist’s designation of Jesus as “the Lamb of God who takes away the sin of the world!” (1:29, 36) and that the Baptist also recognizes Him as “the Son of God” (1:34). John the Baptist regards sin in an extremely serious light as is reflected in 3:36 “He who believes in the Son has eternal life; but who does not obey the Son will not see life, but the wrath of God abides on him.” In 8:24, Jesus is recorded as saying “therefore I said to you that you will die in your sins; for unless you believe that I am He, you will die in your sins.” These are the dire but unspecified consequences of sin. Similar thoughts are expressed in Jn. 3:18-21. The righteous removal of the consequences of sin indicates the need for a divine intervention and would reflect the intrinsic δόξα of the One who could and did make this possible. According to John this is just what took place at Calvary.

While “exaltation and glorification in abasement” is the most widely known and understandable of the leading motifs of Jesus’ crucifixion in the Fourth Gospel,⁴⁵⁹ in the times in which John wrote, crucifixion was the punishment for criminals – those who had committed heinous crimes. This cruel punishment was handed out to robbers, murderers and rebels. As a result one of the key

⁴⁵⁸ See Koester (1995:206).

⁴⁵⁹ See Panackel (1988:235-238).

questions in the early days of the era of grace was “How can there be any ‘δόξα’ in dying such a death?” This is one of the questions that John set out to answer in the Fourth Gospel.

John’s method of dealing with the perceived problem is to present the intrinsic δόξα of the Lord as manifested in His person, His deeds, His obedience to the Father in all things and in the response of people who, because of what was said or done, recognized Him as the Messiah or the Son of God. This presentation of the Lord’s δόξα takes place throughout the Gospel.

In the Fourth Gospel the concept of δόξα is closely related to Jesus’ death. The death of Jesus is thus a central feature of John’s Son of Man emphasis, but it will be noted that for Him the death of Jesus is at the same time His δόξα. It seems that John understands Jesus’ death to represent at once His plunge into the depths of humanity and at the same time to be the beginning of His ascent to the δόξα of the Father. Only John among the Gospel writers sees the death of Jesus as His ‘glorification,’⁴⁶⁰ because the cross was not the end.

The cross is the means by which Jesus obtained salvation for all men.⁴⁶¹ This deed of salvation for all is full of δόξα and while men did not see any δόξα in His ignominious death on a cross it was nevertheless glorious in what it gained for man. Jesus Himself speaks of being “glorified (δοξάζω)” by His crucifixion, “The hour has come for the Son of Man to be glorified” (Jn. 12:23. cf. Jn. 13:31-32). According to John the crucifixion itself was a self-evident glorification – an enthronement, a ‘lifting up,’ which carried with it exaltation. It would seem that at one level the ‘descent’ of Jesus to earth and to crucifixion is itself the beginning of His ‘ascent’ in δόξα.⁴⁶²

⁴⁶⁰ When John records, that “for the Spirit was not yet given, because Jesus was not yet glorified” (Jn. 7:39), and that after Jesus had been ‘glorified’ His disciples applied to Him Zechariah’s prophecy regarding the triumphant arrival of the messianic king in Jerusalem (Jn. 12:16; cf. Zech. 9:9), he is referring to the crucifixion of Jesus, which he sees as also being His exaltation.

⁴⁶¹ 2 Cor. 5:14, 15 “for all”; Rom. 8:32 “for us all”; Heb. 2:9 “for us all,” 9:28 “many.”

⁴⁶² See Rahner & Thüsing (1980:84).

In terms of the integration of Jesus' death with the Johannine Christology as a whole, the most widespread motif is that of "lifting up" or "exaltation (glorification)." In Jn. 3:14, Jesus says "As Moses lifted up the serpent in the wilderness, even so must the Son of Man be lifted up." This thought of being "lifted up" occurs again in 12:32 "And I, if I am lifted up from the earth, will draw all men to Myself" John goes on to say that, in using this phraseology, Jesus was indicating the type of death He would die. The thought of being lifted up is carried forward in 8:28 where Jesus is speaking to His enemies, those who would put Him to death. While it may be thought that this "lifting up (ὑψόω)" is an exaltation of Christ, it really refers to the act of crucifixion.⁴⁶³ In crucifying Jesus, however, His divinity, character and the very nature of His being, as the Lamb of God, were demonstrated and in doing so, would, of necessity, reflect His δόξα. The glorious deed of bearing the penalty of sin redounds to the δόξα of the One who was not only able to do so but actually did the deed. John therefore understood the intimate connection between Jesus' crucifixion and His exaltation (glorification), and this suggests that Jesus' death must be set within the larger Johannine portrait of Jesus' earthly career. According to John, the life of the Son of God is best understood as a journey: He comes from His pre-existent state in heaven, dwells among women and men, and then returns to heaven. He who descended from δόξα must ascend to δόξα (Jn. 3:13, 31; 6:38; 8:23; 13:1–3).

The Lord Jesus Christ uses the term δόξα and related words in connection with His death, claiming that, in His death, He and God would be glorified. The underlying thought relates to the fact that His death would be the fulfilment of all God's promises regarding the salvation of mankind and the culmination of God's work in relation to that universal salvation. In His death Jesus fulfilled many of the prophetic details regarding the promised Messiah as recorded in the Old Testament (19:24, 28, 36-37).⁴⁶⁴ Thus one aspect of the "δόξα" of the

⁴⁶³ This analysis of exaltation (ὑψόω) is developed further in chapter 4.2.

⁴⁶⁴ Isa. 52:13-53:12; Gen. 3:15; Ps. 69:9 (cf. Jn. 2:17); Num. 21:9 (Jn. 3:14); Ps. 41:9 (Jn. 13:18); Ps. 35:19/69:4 (Jn. 15:25); Ps. 22:18 (Jn. 19:24); Ps. 22:15 (Jn. 19:28); Ex. 12:46 (Jn. 19:36); Zech. 12:10 (Jn. 19:37).

cross is due to the fact that in the crucifixion the repeated promises of salvation made by God in the Old Testament were fulfilled.⁴⁶⁵

A further “δόξα” of the cross comes from the events that followed. The burial was a fulfilment of Isa. 53:9 and the resurrection a fulfilment of Jesus’ own statements that He would rise on the third day. These events clearly demonstrated the divinity of Jesus and, viewed in retrospect, shed a δόξα on the crucifixion.

Unlike the emphasis in the Synoptic Gospels, we find that the emphasis of the crucifixion record in the Fourth Gospel is different. Jesus is not led to a humiliating and degrading death on the cross where He is despised and rejected by men and abandoned by God. The Fourth Gospel does not tell the story of the crucifixion in terms of a movement through suffering and death to exaltation and glory (e.g. Mk. 8:31; 9:31; 10:33f.). Rather, the Johannine record of Jesus’ death on the cross is presented in terms of victory and δόξα. Jesus gives Himself up to His arrestors, He becomes the judge, and when He is ready to die (and not before), having cared for His earthly mother’s future and having now paid in full the penalty of sin on behalf of mankind, He lays down His life – no one takes it from Him (cf. Jn. 10:17f.). Smith (1997:42) says that it is the distinctively Johannine Jesus who moves toward death as one who wills and controls His own destiny in obedience to God.

Moreover, as Morris (1989:56) points out, there is a paradox that real δόξα is to be seen in lowliness rather than in a display of majesty.⁴⁶⁶ He notes that throughout the Fourth Gospel Jesus takes a lowly place, and it is one of John’s great paradoxes that the true δόξα is to be seen in this lowly service and especially in the death of Jesus on the cross (Jn. 12:23-24; 13:31). Therefore,

⁴⁶⁵ See further, resurrection as glory, Newman (1998:59-89).

⁴⁶⁶ Barrett (1982:51) describes the glory in the Fourth Gospel as follows: “The story of Jesus can be told in terms of glory – He had laid aside but will resume the glory He had with the Father before creation; He seeks not His own glory but the glory of the Father, yet in His voluntary humiliation and obedience, and pre-eminently in the disgrace of the cross, He is glorified and manifests His glory (Jn. 2:11; 8:50; 12:23; 17:5). There is a characteristic Johannine paradox here”

when John tells of the events of the cross, Jesus is sketched throughout as the One who has all power and is in control (18:1-11; cf. 10:17-18; 19:28) from beginning to end. In the Fourth Gospel Jesus speaks about His death from the beginning. As early in 2:4, He says that His hour has not yet come; so, too, in 7:6, 8, 30; but finally, in Jerusalem, He announces that His hour has come (12:23, 27).⁴⁶⁷ But we find that Jesus controls His own destiny, since in the Fourth Gospel it is called His hour. Jesus knows that Judas will betray Him (6:70), and the Jews are plotting His death (7:1, 19f.; 8:37, 40): but no one can do anything to Him until His hour arrives. According to the Fourth Gospel's account of the crucifixion, instead of the horror, the taunts, the cry of dereliction and the darkness presented in the other Gospels, we have an atmosphere, a scene of calm. Jesus is presented as still majestic and in control of what is happening.⁴⁶⁸

4.4.2. Exegetical perspective of the events of the cross and Jesus' δόξα

Koester (1995:212-213) rightly comments that the cross events are the moment of δόξα that brings Jesus' ministry to its climax as well as the visible sign of the δόξα of the exalted Lord. Also, the cross events revealed the scope of divine δόξα by revealing the depths of divine love.

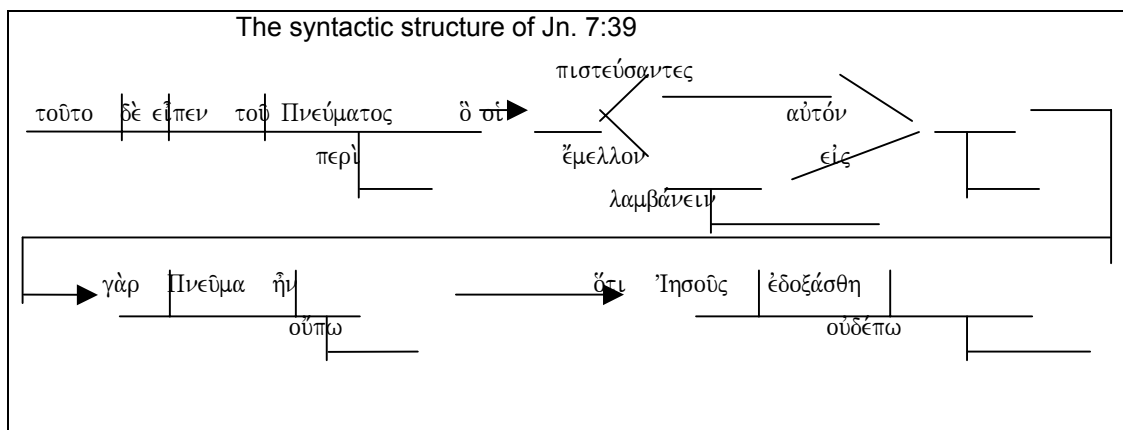

“Οὕτως γὰρ ἦν Πνεῦμα, ὅτι Ἰησοῦς οὐδέπω ἐδοξάσθη” (7:39), here the giving of the

⁴⁶⁷ Cf. 8:20; 13:1; 17:1.

⁴⁶⁸ See Hooker (1994:107). Jesus' words to His mother and to the beloved disciple (19:25-27) show that He is in control of the situation.

Holy Spirit is related to the *δοξάζω* of Jesus, which is to take place sometime in the future.⁴⁶⁹ In the Fourth Gospel, Jesus is glorified in His crucifixion and death (13:31); therefore, Jesus gave the Spirit in connection with His crucifixion and death. Moreover, John sees the source of the promised Holy Spirit to be Jesus Himself (1:32; 3:34), once He had been ‘glorified;’ once He had been crucified, died, risen and ascended to His Father. The verb *δοξάζω* also occurs in 12:16, where after the *δοξάζειν* of Jesus the disciples’ comprehension of events is deepened and they recall “that these things were written of Him.” The verb *ἐδοξάσθη* links 7:39 and 12:16 together.

οὕτω γὰρ ἦν Πνεῦμα, ὅτι Ἰησοῦς οὐδέπω <u>ἐδοξάσθη</u> (Jn. 7:39)	ἀλλ’ ὅτε <u>ἐδοξάσθη</u> Ἰησοῦς τότε ἐμνήσθησαν ὅτι ταῦτα ἦν ἐπ’ αὐτῷ γεγραμμένα καὶ ταῦτα ἐποίησαν αὐτῷ. (Jn. 12:16)
--	---

The concept of the giving of the Spirit also ties them together. Although the Spirit is not mentioned in 12:16; it is possible, however, for a reader to make the connection, since the reader knows that the presence of the Spirit is what enables believers to understand what they did not understand before the coming of the Spirit (16:12-13). One gift of the Spirit was given on the day of Jesus’ resurrection after His crucifixion and death,⁴⁷⁰ and a subsequent outpouring took place at Pentecost (20:22).⁴⁷¹ John himself recognizes clearly the dependence of the gift of the Spirit upon the completed work of Jesus, and in this recognition he is in close touch with the eschatological roots of the Christian proclamation.

According to Jn. 12:16, the disciples understood the meaning of “ὅτε ἐδοξάσθη Ἰησοῦς” (12:16) after His death and resurrection (cf. 2:22; 7:39). It means that they grasped the nature of the kingship of Jesus: the king of peace and salvation brought to the world the messianic kingdom of peace and salvation

⁴⁶⁹ Jonggil (1992:177) says that here John speaks not of the absolute existence of the Holy Spirit, but ‘comparatively.’

⁴⁷⁰ Bruce (1983:261) asserts that it is one continuous movement of which Jesus’ crucifixion (His being ‘lifted up’), resurrection and ascension are phases. Cf. Jn. 2:22.

⁴⁷¹ See Morris (1995:744, 747).

precisely through His death and resurrection.⁴⁷²

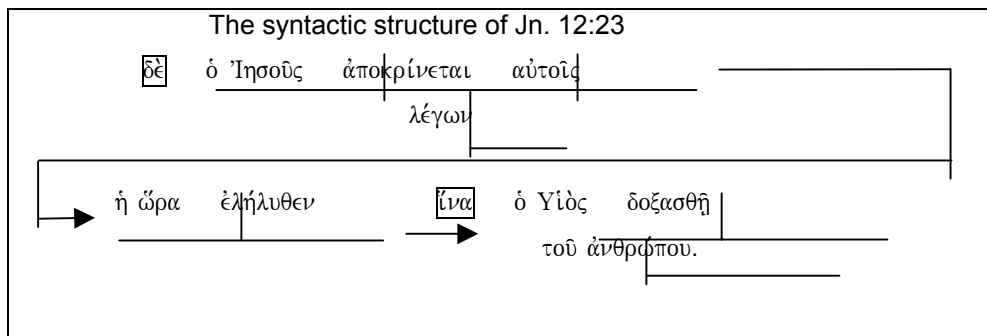

“ἐλήλυθεν ἡ ὥρα ἵνα δοξασθῆ ὁ Υἱὸς τοῦ ἀνθρώπου” (12:23), is a clear reference to His impending death. Jesus’ glorification in Jn. 12:23 is associated in the context with the mission to the entire world, the Greeks (12:20-22), the seed bearing fruit (12:24), and the Son of Man drawing all to Him through His exaltation (12:32). The meaning of *μόνος μένει* (12:24) would seem to be that without His death His life will have been in vain. It seems that the Son of Man’s glorification by the Father will lead to the spread of the gospel, through the gift of the Spirit, the sending of the disciples and their bearing fruit.⁴⁷³ 12:23 to 12:28 show that the hour (ἡ ὥρα) of the *δόξα* of Jesus relates to His death;⁴⁷⁴ also 13:31-32 and 17:1, 5 clearly indicate that the concept of *δόξα* includes His exaltation and return to the Father.⁴⁷⁵ We understand that the death of Jesus Christ on the cross is not regarded as the depth of shame from which He is raised to glory and honour, but the death itself is His moment of *δόξα* wherein God is glorified (12:28) and one with His exaltation to the throne of God.

Though Ferreira (1998:155) has noted that Jesus’ *δόξα* does not only refer to His death on the cross, the cross nevertheless remains the primary revelation of His

⁴⁷² See Beasley-Murray (1987:210).

⁴⁷³ See Loader (1989:109).

⁴⁷⁴ The noun *ὥρα* occurs 26 times in the Fourth Gospel, in 8 instances it is used for the “hour (*ὥρα*)” of Jesus (2:4; 7:30; 8:20; 12:23, 27; 13:1; 17:1).

⁴⁷⁵ Neyrey (1988:59-80) comments that Jesus’ death in Jn. 10:17-18 and 28-38 assert that Jesus has God’s eschatological power over death, and demonstrates the earlier claim of eschatological power whereby Jesus is equal to God.

δόξα.⁴⁷⁶

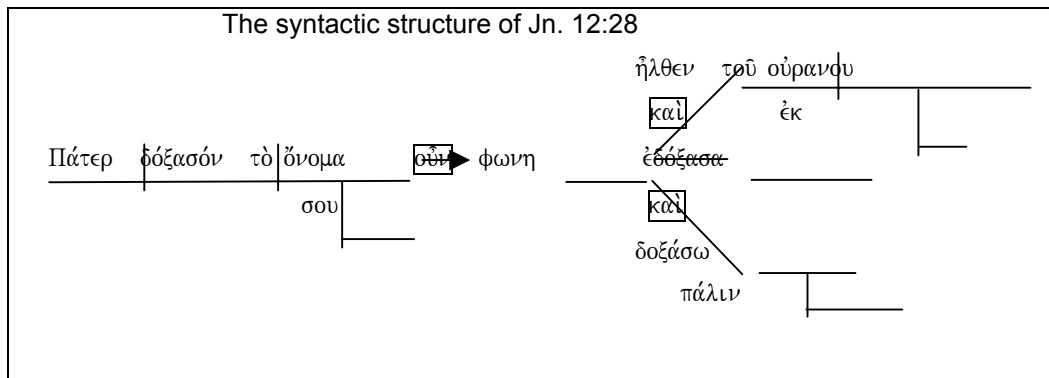

At the same time we have the Lord Jesus Christ saying, in 12:28^a; “Father, glorify Thy name.” Jn. 12:28^a gives us the Johannine form of the petition in the Prayer of the Lord (cf. 17:1). The verb (δόξασόν) is in the aorist tense, and as such indicates a single act, and if so it will be on Jesus’ willing obedience (cf. 7:18; 8:29, 50), to the death on the cross. Then, in response to Jesus’ prayer there came a voice out of heaven “I have both glorified it, and will glorify it again” (12:28^c).⁴⁷⁷ This is God’s response to His beloved Son. It seems that “I have glorified (ἐδόξασα) it,” includes the entire earthly ministry of Jesus and especially in the powerful signs; “I will glorify (ἔδοξα) it,” relates to the death by crucifixion, resurrection, and exaltation of Jesus and the results that flow from this. Jn. 12:28 again involves the distinctive Johannine language of glorification.

Suggit (1985:65) comments that the hour had now come (13:1). Anticipated from 2:4 the hour is the hour of the exaltation of the Son of Man, on the cross and in δόξα. 12:23 makes it quite clear that the exaltation on the cross is the exaltation in δόξα. According to 13:1, we find that it is the cross which gives meaning to the whole ministry and work of Christ from the conception to the

⁴⁷⁶ See Pamment (1983:12-16). She understood that Jesus’ δόξα only refers to His death on the cross.

⁴⁷⁷ According to the Synoptic Gospels a voice spoke from heaven at Jesus’ baptism (Mt. 3:17; Mk. 1:11; Lk. 3:22) and from a cloud at His transfiguration (Mt. 17:5; Mk. 9:7; Lk. 9:35), and also Acts 11:7 and Rev. 10:4. In each one of these New Testament instances, the voice from heaven is understood as the directly heard voice of God.

ascension.⁴⁷⁸

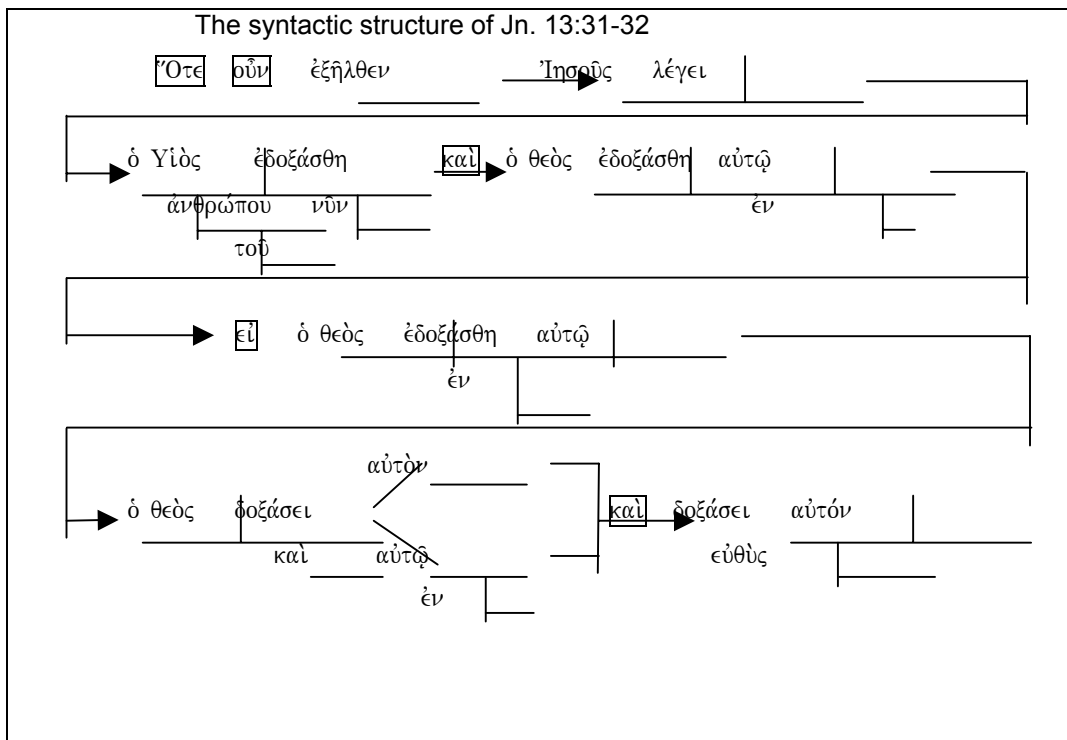

The theme of the glorification of the Son of the Man recurs in the words spoken by Jesus at Judas' departure from the last supper: "Now is the Son of Man glorified, and God is glorified in Him; if God is glorified in Him, God will also glorify Him in Himself, and will glorify Him immediately" (Jn. 13:31-32). The departure of Judas to betray the Lord set in motion the events which would culminate in Jesus' death on the cross. Jesus could have prevented this step but by His willing acceptance of the initiation of this train of events He signalled His total obedience to God's will and He could therefore speak of His being "glorified." This δόξα is referred to again and again in the following chapters of the Fourth Gospel, especially in the prayer of the Lord in chapter 17 (14:13; 15:8; 16:14; 17:1-5, 10, 22, 24).⁴⁷⁹ Moreover, Carson (1991:482) has shown that the now (νῦν), brings to a climax a theme developed throughout this

⁴⁷⁸ Although Bultmann (1967:53-55) notes the close connection between the cross and the whole of ministry, as John represents it, he refuses to assign to the cross the importance.

⁴⁷⁹ See Caird (1968/1969:265-277); de Boer (2005:12-13).

Gospel,⁴⁸⁰ John makes it clear that the supreme moment of divine self-disclosure, the greatest moment of displayed δόξα, was in the shame of the cross. In 13:31, the hour which has “now” (νῦν) struck is both the hour of Jesus’ departure in death (cf. Jn. 12:23), and the hour of His δόξα. Caird (1968/1969:268-277) refers to the aorist passive of δοξάζω (‘to glorify’), used twice in 13:31 and once in the first clause of 13:32, as being the expected way to translate the niphal tense of the Hebrew verb נִכְבַּד, used of the revelation of God’s splendid activity.⁴⁸¹ Since the verb in 13:31 is in the aorist tense, we should take the strictest sense and consider that the glorification refers to the whole life of Jesus right down to the present time.⁴⁸² The shift to the future tense of the verb δοξάζω in 13:32^b enables one to see the ongoing nature of glorification, and it points beyond the crucifixion to the eternal δόξα of the Father that the Son will share. In 13:32, the δόξα achieved by Jesus through His death on the cross is sealed by His exaltation to the δόξα which He had with the Father before the world was (17:5). Barrett (1978:450-451) comments that “ὁ θεὸς δοξάσει αὐτὸν ἐν αὐτῷ” (13:32^b), means that “God was glorified in Jesus’ temporal act of self-consecration; Jesus is glorified in the eternal essence of God the Father, which, in a sense, He re-enters at the resurrection and ascension.” “Ἐν αὐτῷ” (12:32^b) means “in God,” Plummer (1891:271) comments that “as God is glorified in the Messianic work of the Son, so the Son shall be glorified in the eternal blessedness of the Father (cf. Jn. 17:4-5; Phil. 2:9).” “Ἐὐθὺς δοξάσει αὐτόν” (13:32^c), indicates that God will resurrect and glorify the Son of the Man immediately and not wait until the general resurrection.⁴⁸³ Marsh (1991:495-496) says that the account in Jn. 13:31-32 highlights the unity between the two;

⁴⁸⁰ Also, Bruce (1983:293) describes 13:31 as indicating the climax of the δόξα revealed in the Son of Man.

⁴⁸¹ Ramsey (1949:71) indicates that the first clause in 13:31 speaks of a past event and that in Hebrew idiom the aorist can be used in anticipation of a future action (cf. Gen. 15:18). Burkett (1991:125) comments that the aorist tense is equivalent to a ‘prophetic perfect,’ and the past tense here is an anachronism.

⁴⁸² See Johnson (1993:47-49).

⁴⁸³ Barrett (1978:450-451) contends that this mention of an immediate glorification is intended as a contrast to the Synoptic idea of the glorification of the Son of Man at the *parousia*.

He wants to make it perfectly plain that it was not the case that Jesus died in shame and ignominy and was afterwards restored to honour and glorified, as if the cross were dishonour and shame, and the resurrection for the first time the moment of victory and glory. To John the whole story was the glorification....The real issue concerns God who has come to man in the form of man in the Person of Jesus Christ. So the real actor in the drama is God Himself, and so God will be glorified in the Son, as the Son will glorify the Father.

Loader (1989:109) commenting on 13:31 and 13:32 says that there is a mutuality (cf. 17:4): the Son of Man will glorify God (13:32^c) through His obedience in fulfilling His commission by facing crucifixion and death, and then, in response, the Father will 'glorify the Son of Man' (13:32^b), God's glorifying adding weight, as it were, to the honouring, for it is the restoration of δόξα in the divine heavenly presence. As Christ is glorified, the Father too is glorified.

The references in Jn. 17:1, 4, 5, are to Jesus' glorification and this is to be seen in His crucifixion and death. It is a prayer that the Father's will may be done in Him. Westcott (1890:238) says that the δόξα of the Son resting upon His perfect work issues in the δόξα of the Father; for to know God is to give Him honour. In 17:1, it is significant that with the cross in view Jesus prays that God will glorify Him. Jn. 17:4 could be said to look back on the finished work of Christ on the cross (cf. 19:30), especially in view of the phrase "on the earth." "Now, Father, glorify Me" (17:5) might mean 'Father let Me go through the events of the cross (glorification).' Therefore, in 17:5 it seems that Jesus now prays God to glorify Him. He looks for δόξα in the last place that people would look for it, namely in the cross.⁴⁸⁴

The title on the cross (*titulus* Latin) in Jn. 19:19-22, followed the custom of the

⁴⁸⁴ Smith (1997:122) comments that John speaks of Jesus' death revealing God's δόξα; the revelatory manifestation of God, and that this δόξα has existed from the foundation of the world (17:5, 24).

times whereby a placard or tablet stating the reason for a person's execution was affixed above the criminal's head or tied it round his neck.⁴⁸⁵ The title on Jesus' cross is in fact the revelation and proclamation of who Jesus of Nazareth really is: Jesus of Nazareth, King of the Judeans (for Romans, "Judean" referred to all Israelites).⁴⁸⁶ The wording of the title on the cross shows Jesus' kingship, Schnackenburg (1984, 3:271-272) says that "Pilate becomes a witness to Jesus' kingship, the inscription an honorific title. ... its validity strengthened by Pilate, proves this: Jesus is the King who rules from the cross." Therefore, the real story of the Jesus' crucifixion reveals that the Lord Jesus is indeed the King of the Israel; the cross is the means of His exaltation and the very manner of His δόξα.

Jesus' cry "It is finished!" (τετέλεισται, perfect passive) in Jn. 19:30 confirms John's preceding statement in verse 28 that He knew that "all things had already been accomplished."⁴⁸⁷ It means that Jesus' work was done, not only 'to the end' but to the full extent mandated by His mission. Dauer (1972:20) rightly comments that "So the last word of Jesus interprets His suffering and dying as the crowning conclusion and high point of the work that He has performed in obedience – the obedience of the Son finds here its most radical expression – and enables the believing eye to see the glorifying of the Son through the Father."

In Jn. 19:31-37 the breaking of the legs (*crurifragium*, Latin) was an established custom when it was desired to hasten the death of a crucified person; they were never killed by a spear.⁴⁸⁸ Jesus' bones are not broken but His side is pierced, both events take place in order to fulfil the prophecies of Scripture. The fact that Jesus' bones were not broken might be a reference to Ps. 34:20, but Hooker (1994:108) says that here certainly there is a reference to Ex. 12:46 or Num. 9:12, where instructions are given about the Passover lamb. The piercing of

⁴⁸⁵ See Bruce (1983:368); Beasley-Murray (1987:346).

⁴⁸⁶ See Malina & Rohrbaugh (1998:268-269).

⁴⁸⁷ Cf. Jn. 4:34; 17:4 (Ἐγώ σε ἐδόξασα ἐπὶ τῆς γῆς τὸ ἔργον τελειώσας ὃ δέδωκάς μοι ἵνα ποιήσω).

⁴⁸⁸ See Barrett (1978:555); Bruce (1983:375); Beasley-Murray (1987:353-354); Ridderbos (1997:618).

Jesus' side is a clear reference to Old Testament passages such as Ps. 22:16, Isa. 53:5 and Zech. 12:10.

These two differences in the usual crucifixion procedure fulfil prophecy precisely and confirm that, not only is Jesus the promised one, the Messiah, but also that God was glorifying Himself in the fulfilment of the manifold details of the way of salvation given to the prophets hundreds of years earlier.

According to Jn. 21:19, Jesus' death was not the end of His being glorified on earth; Jesus continues to be glorified in the lives of those who are united with Him in faith. As believers commit themselves to the will of God, they increasingly reflect the nature of God and thereby glorify God. The result may be that they encounter the same kind of antagonism and hatred that Jesus experienced and that this may lead to a physical death. In Jn. 21:19, this is reflected in John's comment on Jesus' statement to Peter, "Now this He (Jesus) said, signifying by what kind of death he (Peter) would glorify God," where it refers to the martyr's death by which Peter would glorify God (for death as a glorifying of God, cf. 12:23; 15:8; 1 Pet. 4:16). The phrase "Follow Me (ἀκολουθήτω μοι)," seems to indicate that Peter who had denied that he was a disciple is given the opportunity to begin again on the path of discipleship and is warned that following Jesus will mean that he, like Jesus, will glorify God through martyrdom.⁴⁸⁹

4.4.3. Summary and conclusion

John's view that the crucifixion was Jesus' departure to the Father underscored the positive aspects of the cross. Jesus' death is viewed as "δόξα" rather than shame. Neyrey (1999:154) indicates that despite all the shameful treatment of Jesus,⁴⁹⁰ He is, in the Fourth Gospel, portrayed not only as maintaining His honour, but even gaining δόξα and prestige. In the Fourth Gospel the crucifixion and death of Jesus is never referred to as something humiliating or degrading,

⁴⁸⁹ See Hooker (1994:111).

⁴⁹⁰ See Patterson (1998:80).

but a triumph to be celebrated. Moreover, it must be underlined that John does not want to say that Jesus' death did not include suffering. By specifying some details relating to the cross, what John is saying is that he wants to highlight certain aspects which point to the δόξα of Jesus. Moreover, Carroll and Green (1995:82) comment that in the historical highlights surrounding Jesus' death, which still deprive Him of honour in the public eye; John celebrates what only faith can see, the lifting up in δόξα of the Son of God.

We may say that the Fourth Gospel views the cross as the visible sign of the exaltation and glorification of the Son of Man in the presence of God. Those who are properly disposed and drawn by the Father, go beyond what is visible in Jesus' works and see the glory of God revealed in Him. Those who view the cross with faith are able to see beyond it the risen and ascended Lord who has manifested God's δόξα by revealing His love. The crucifixion is an elevation of the Son of Man as a means of salvation for those who view it with faith, just as the Hebrews of old had to look to the brazen serpent for healing (Num. 21:6-9). It is also the hour of Jesus' glorification whereby He in turn glorifies the Father. This glorification is a visible manifestation of the power and presence of God among men.

Vermeulen (1956:17) indicates that the record of Christ's crucifixion given in the Fourth Gospel is not only the strongest evidence of His δόξα, but also meant the beginning of the heavenly δόξα for Him. In the same way, where the faith of a believer leads to his or her death at the hands of unbelievers, there is, in that death, a reflection of the δόξα inherent in Jesus' death on the cross. Beyond this the 'death' of any believer is simply a transition from an earthly life to the δόξα of Jesus' eternal presence. To the Christian, Christ's death was no σκάνδαλον, but δόξα.

Although caution must be exercised in laying too much stress on the change in the Fourth Gospel's record of the crucifixion, it is true that there is more stress on the element of victory and completion in its account than is found in the Synoptic Gospels. In this respect the actual crucifixion and death of Jesus in the

Fourth Gospel is a witness to His power, authority and His δόξα. John presents Jesus firmly in control: knowing all that will happen, asking questions, controlling the events, and giving commands. In his trial Jesus shows up the vindictiveness of the Jewish leaders and uncovers the moral flaws in His judge, Pilate. Therefore, Ashton (1991:489) comments that in the case of the Fourth Gospel, “‘passion’ is a misnomer; Jesus controls and orchestrates the whole performance.”⁴⁹¹

Finally, the δόξα motif in the crucifixion and death of Jesus in the Fourth Gospel helps to communicate several truths. Firstly, the idea of δόξα suggests a form of revelation; hence, Jesus’ true character of grace was most clearly revealed in His glorification on the cross. Secondly, Christ’s δόξα in the crucifixion was the commencement of the renewal of the divine δόξα He had before creation and suggests that the divine life always had been characterized by self-giving.⁴⁹² Thirdly, God’s people can share Jesus’ δόξα and this implies their victory over the world (16:33). Therefore, Jesus is glorified in and through His death (12:23; 17:1, 5; cf. 2:21f.; 3:14; 12:16; 13:31f.).⁴⁹³

4.5. Concluding Summary

Unlike the synoptic Gospels, which tend to focus on the outward, visible humiliation of crucifixion, the Fourth Gospel presents the cross as being the glorification (δοξάζω) of Jesus. John makes only limited direct reference to the cross but alludes to it frequently often using words and phrases that have potential double meanings.⁴⁹⁴

One of the words used in this way is ὑψόω which has the prime, direct meaning of being physically lifted up as well being a metaphorical reference to being

⁴⁹¹ Cassidy (1992:52) indicates that according to the crucifixion and death of Jesus in the Fourth Gospel, Jesus’ dignity, Jesus’ sovereign bearing, Jesus’ autonomy remain untarnished even though He undergoes all of the specific aspects of Roman crucifixion.

⁴⁹² Pfitzner (1976:9) says that the features of the passion narrative serve to picture Christ’s passion as the glorification of the King.

⁴⁹³ Morris (1995:379) comments that John invariably uses it (δοξάζω) of the glorifying of the Son or the Father, and he sees this glorifying particularly in the cross.

⁴⁹⁴ See van der Watt (2005:463-481)

exalted. An additional dimension comes into play via Jesus' reference to the Old Testament incident where a brazen serpent was lifted up on a pole so that those bitten by a serpent might look at it and be healed. The result is that in the Fourth Gospel the word ὑψόω, being lifted up, takes on a multidimensional character and simultaneously presents the concepts of Jesus' death by crucifixion, salvation for those who understand the reality of what is transpiring and believe in Him and the first phase of His return to the Father.

The δόξα of ὑψόω is found in the significance of what it entailed, the complete obedience of the Jesus to the father's will, the fulfilment of the Old Testament promises and prophecies regarding salvation and the complete triumph over the forces of darkness.

A further unique feature of the Fourth Gospel is John's record of Jesus' repeated use of the phrase Ἐγώ εἰμι. This phrase is clearly associated with the Old Testament language of divinity and is used by Jesus on several occasions when the implication is that He is divine. Of particular interest are those discourses where the phrase is used in a context that has relevance to the events of the cross. Using the phrase Ἐγώ εἰμι Jesus says that he is the good shepherd and that the good shepherd lays down his life for the sheep. This is a clear reference to His death and, though not necessarily a death by crucifixion, certainly the death of One who is divine. At the Passover supper Jesus uses the phrase as an absolute claim to divinity and links it to His betrayal. In the garden of Gethsemane Jesus uses Ἐγώ εἰμι to identify Himself to the armed band sent to arrest Him and at His words they were forced to the ground – a demonstration of His power, authority, δόξα and a clear indication that He is control of the situation. Far from being a helpless victim the whole incident shows His superiority – Jesus is going to the cross but of His own volition and at the time determined by God. Again using the term Ἐγώ εἰμι He claims that He is the resurrection and the life. Here the claim refers not to the cross but to the subsequent events. The promise is that those who believe in Him will experience a similar resurrection and participate in a similar eternal life. In all

these incidents Jesus uses Ἐγώ εἰμι and in that use there is a pointer to δόξα.

In the Fourth Gospel the reaction of some people to the events of the cross is singled out and in their response there is a reflection of δόξα. As mentioned those sent to capture Jesus are forced to the ground. Pilate finds that, in his interrogation of Jesus, it is he that is on trial and that Jesus is not only in control but is the judge. Thomas, who wanted proof that Jesus had in fact been raised from the dead, was given that proof in full and acknowledged that Jesus was God.

John does not see the events of the cross from the perspective of the Synoptic Gospels. His view is that every aspect of Jesus' life reflects His δόξα whether it be His heavenly origin, His humility and lowly service, His complete obedience to the Father, the gracious words that He spoke, the challenging teaching He gave, the manifold mighty signs that He performed or the events of the cross.

John presents Jesus' crucifixion as His glorification and does so by highlighting the spiritual aspects of the events of the cross. Early in the Fourth Gospel there is the record of Jesus' prophetic statement that as the serpent was lifted up in the wilderness He, too, must be lifted up so that whoever believes Him would not perish but have eternal life. While there is no mention of δόξα the promise of eternal life points to the unlimited value of Jesus' sacrifice and the δόξα of one who could and did secure eternal life for those who believe in Him.

John returns to this motif again in chapter eight where He states that when Jesus is lifted up His opponents will know that Ἐγώ εἰμι a clear claim to divinity. In chapter twelve the thought of being lifted up is again prominent as Jesus says that if He were "lifted up" He would draw all men to Himself.

The way this eternal life could be made available to mankind would be by the righteous removal of the consequences of sin. This would have to be by a sacrificial, substitutionary death of someone who was able and willing to die for mankind. This indicates the need for divine intervention and that, that death,

would reflect the intrinsic δόξα of the One who could and did die in order to make this possible. John maintains that this is precisely what happened when Jesus was crucified at Calvary hence his view that, in that death, Jesus was glorified.

Crucifixion was the punishment for murderers, robbers and rebels. The indignities heaped on the felon were designed to strip him of all dignity and honour and to cause intense pain and suffering. John does not gloss over this aspect of crucifixion but counters it by pointing to the hidden δόξα implicit in the person of Jesus and the events of the cross. He points to the δόξα inherent in Jesus as revealed by His penetrating words, His powerful works, His purposeful willingness to obey the Father's will in every detail. John also records the reaction of those who encountered Jesus and saw beyond the physical and temporal to the reality of who He was, the Messiah – the Son of God. John develops this theme further by pointing to messianic prophecies that were fulfilled in Jesus' death, the underlying thought being that if these were fulfilled then Jesus' must be the Messiah and therefore must have an intrinsic δόξα.

John records that, when Jesus died he said "It is finished" and gave up His spirit. This was a fulfilment of His statement in 10:17-18 that the Father loves Him, "because I lay down My life that I may take it again. No one has taken it away from Me, but I lay it down on My own initiative. I have authority to lay it down, and I have authority to take it up again. This commandment I received from My Father." Jesus accurately predicted that the timing of His death would be His decision not that of others. The cry "It is finished" also indicates that the penalty for sin had been fully met and that His work on earth was now complete in every detail. It also meant that the repeated promises of salvation made by God were now fulfilled.

John continues the theme of fulfilled prophecies both in the Old Testament and those made by Jesus by recording details of the way His body was treated on the cross. It was customary for the legs of the crucified to be broken in order to hasten their death but, because Jesus was already dead, His legs were not broken and this fulfilled Old Testament prophecies and types (Ps. 34:20; Ex.

12:46; Num. 9:12). It was not customary to use a sword or spear to ensure the death of a person crucified but that is what happened to Jesus' (Jn. 19:34). This is regarded as the fulfilment of passages such as Ps. 22:16, Isa. 53:5 and Zech. 12:10. This theme is developed further by John's account of Jesus' burial showing that it was in accordance of Isa. 53:9. Jesus' resurrection on the third day is a fulfilment of His words in Jn. 2:19. Once again the underlying thought is that the fulfilled prophecies point to the δόξα of the one who so completely fulfilled them. The death of Jesus led to the disciples understanding what had been previously obscure to them. In 12:12-19 John records Jesus' entrance into Jerusalem. This was a fulfilment of Zech. 9:9 but the significance of the event only dawned on the disciples after Jesus had been "glorified." The same was true of His resurrection (2:19-22).

John presents Jesus' crucifixion as a step in a series of events that culminate in His ascension to heaven and the δόξα He had with the Father "before the world was." While Jesus' whole life was directed towards the events of the cross the final movement started with Judas leaving the Paschal supper on his way to betray the Lord. The moment he had left Jesus says "Now is the Son of Man glorified, and God is glorified in Him; if God is glorified in Him, God will also glorify Him in Himself, and will glorify Him immediately." (Jn. 13:31-32). Jesus could easily have prevented Judas from reaching the Jewish leaders but He was totally committed to accomplishing the Father's will and so allowed Judas to set in motion the events that would lead to His crucifixion and His δοξάζω.

John's whole record of the crucifixion presents Jesus as being totally in control. He knows beforehand what is to happen, He questions the questioners, He shows up the vindictiveness of His accusers and uncovers the moral flaws in the Roman judge, He endures the rigors of the cross and in the end it He who dismisses His spirit. In all that He did Jesus honoured the Father and was totally obedient to His will. In doing all this He also secured for mankind the only way to eternal life and δόξα with the Father and Himself in heaven.

CHAPTER 5. CONCLUSION

5. 1. Summary and Discussion

5.1.1. Introduction

The prologue to the Fourth Gospel includes the following arresting phrase; “And the Word became flesh, and dwelt among us, and we beheld His glory, glory as of the only begotten from the Father, full of grace and truth” (Jn. 1:14). This theme of δόξα recurs throughout the Gospel and, given the frequency with which the author uses the term and its related verb glorified (δοξάζω), particularly in relation to Jesus and God, it is evident that the concept which he wishes to

convey by its use is important. The question that arises is “What is the author’s intended meaning when he uses these words?”

In today’s usage δόξα usually conveys the thought of great honour or praise given to a person, fame or renown; radiant beauty, brightness, magnificence and splendour; finally, in a religious context, it carries the thought of adoring praise and thanksgiving. As one reads the Fourth Gospel these meanings do not seem to relate aptly to Jesus. The only recorded instance of a manifestation of δόξα, which fits current thinking, is that of the transfiguration and there is no direct reference to this event in the Fourth Gospel. Another startling factor is that the Fourth Gospel is the only Gospel which associates the concept of glory (δόξα and δοξάζω) with the events of the cross in relation to Jesus.⁴⁹⁵ This occurs in several passages and leads to a further question “How can there be any δόξα in Jesus’ ignominious death by crucifixion?”

It is evident that, in understanding the meaning of δόξα and δοξάζω, the intended readers of this Gospel would be influenced by the then current concepts associated with these words. These concepts would be based on the prevailing secular use of δόξα and δοξάζω in ordinary conversation, in the literature extant in that era and, of great importance because of its intended purpose, its use in the Greek versions of Jewish religious records.

Therefore, in order to determine the significance of δόξα and δοξάζω in the Fourth Gospel, the most likely meanings associated with these words at the time of its composition were determined. The meanings and use of other Greek terms used to convey the sense of δόξα within the Fourth Gospel were also explored. In doing this it was necessary to establish for whom the Gospel was intended, when it was written and who the author was. A further consideration is the content of this Gospel itself, of all that Jesus did and said, what was included and what was left out and what seems to be the reason for this selection by the author. Finally, this broad framework is used to establish the intention of the

⁴⁹⁵ Jn. 7:39; 12:16, 23; 13:31-32; 17:1-5.

author of the Fourth Gospel when he used δόξα and δοξάζω in his writing.

5.1.2. Methodology

The method used in this study is based on the principles and approaches set forth by Nida and Louw in their Greek-English Lexicon of the New Testament Based on Semantic Domains, Louw's Semantics of New Testament Greek, and in Nida and Louw's Lexical Semantics of the Greek New Testament. According to Louw (1982:40), a word outside a context does not have a concept, but only 'possibilities of concept.' In order to determine the concept of any word, it is necessary to look at its context, since the context will indicate, from the list of possible concepts, the particular potential of the word to be realized in that particular case. A concept depends on the relationships among words, their grammatical structure, and the occasion or situation in which the utterance was made. Everything that contributes to the concept of a word must be explored in order to truly comprehend the meaning intended by its use.

A survey of the lexicographical background of δόξα focused on the use of δόξα in the LXX, since NT usage usually follows that of the Septuagint (LXX). The concept of δόξα in the Greek OT, however, is partly dependent on the concepts communicated by it in extra-biblical Greek and partly on the concepts associated with the Hebrew words that were translated as δόξα in the LXX. The survey therefore began with an examination of δόξα in extra-biblical Greek as exemplified by Philo and Josephus, followed by an examination of the concepts of קְבוֹד and closely related words in the Hebrew Bible. The survey of the lexicographical background of δόξα concluded with a discussion of the concepts conveyed by the use of δόξα in the NT.

It is not an easy task to discover the precise meanings of δόξα and δοξάζω, and an equally hard task to formulate definitions for the two words. Lexicons and commentaries are often at variance with each other. Brown (19768:268) defines δόξα as (I) "praise,' 'honour,' that can sometimes be gained on a purely natural level," and (II) "a visible manifestation of (God's) majesty in acts of power."

Kittel (1974, 2:243-244) offers this definition for the word: (I) “glory or honour ascribed to someone,” “reputation,” and (II) the “divine nature or essence either in its invisible or its perceptible form.” Perhaps the issue here is what is meant by the words “visible,” “invisible” and “perceptible.” Brown’s definition also needs revision, not only on this point, but also on his second point regarding “acts of power.” Barrett (1978:167) writes that the δόξα of God “is shown by His acting in faithfulness to His own character, and by His character’s revealing itself in mercy.” Furthermore, he adds (1978:168-169): “Glory (δόξα) means to be full of grace and truth” and “is expressed not so much in deeds of power as in acts of grace and in the communication of truth...” These statements by Brown and Barrett present somewhat contrasting views of δόξα, with Brown emphasizing “mighty acts” and Barrett stressing “acts of grace” and “the communication of truth.”

Taken overall, the primary concepts of δόξα in the Fourth Gospel are (I) human glory, honour, reputation, prestige, and (II) divine glory, including the six aspects of divine glory (i . glory, honour, majesty, power, authority as attributes of God; ii . God’s self-manifestation, God’s presence, God’s dwelling; iii . God’s essence and character; iv . praise, acknowledgement of God’s majesty and glory; v . God Himself, God as source of דבִּרָה; vi . glory, splendour, and magnificence of heaven). As with דבִּרָה, the most important concept of δόξα in the LXX is divine glory, i.e. any of the six concepts listed above that are related to God (i -vi), although δόξα may also represent the concepts power, splendour, human glory, brightness, honour, majesty, magnificence, and greatness in general.

In writing about the meaning of δόξα, Caird (1968/1969:277) states that it seems reasonable

to suppose that a Jew, searching for a Greek word to express the display of splendid activity by man or God, which in his

native Hebrew could be expressed by the niph'al נִכְבַּד, might have felt justified in adapting the verb δοξάζεσθαι to this use, with every expectation that his Greek neighbour would correctly discern his meaning. Thus when John put into the mouth of Jesus the words ὁ θεὸς ἐδοξάσθη ἐν αὐτῷ, he could confidently expect his readers, whether Jews or Greeks, to understand that God had made a full display of his glory in the person of the Son of Man.

5.1.3. Intended readers

Many recent scholars have postulated the existence of a Johannine Christian Community, separate from the general church, and undergoing a series of progressive developments in belief and emphasis in teachings brought about by changes in the religious environment of the day. The differences in the suggested reconstructions indicate that the process of “reconstruction” is inexact and speculative and there is considerable doubt as to whether the Johannine Christian Community is a reality or simply a construct of fertile imaginations. “The question is not how many bricks in this or that wall are solid, but rather whether there is any solidity to the foundation of the entire edifice.” After a careful appraisal of the literature, the view taken in this thesis is that the postulated Johannine Christian community is a figment of the imagination and that the intended readers of the Fourth Gospel are the general Christian community, not only of John’s day, but every successive generation.

5.1.4. Δόξα in the Fourth Gospel

An overall review of the use of δόξα in the Fourth Gospel was done and a more detailed analysis of its use in specific arenas was undertaken. These arenas included the Prologue, Jesus’ inherent δόξα, His relationship with the Father, the σημεῖα, the Ἐγὼ εἰμι statements, Jesus’ prayer (Jn.17), Jesus’ claims to δόξα, the recognition of Jesus’ δόξα by people and His lowly service. In addition the use of other Greek words used to convey the sense of “glory (δόξα)” was explored.

One aspect of the δόξα of Jesus is His awesome power and authority. He has the power to change water into wine of a superior quality and He has the power to raise the dead. Both these demonstrations of power are linked by John to the δόξα of Jesus. There are, however, other many other instances where Jesus reveals His power, He heals leprosy with a word and touch, and diseases with just a word. He restores sight to the blind and in one memorable case He gives the man born blind, not only his sight, but also the ability to understand what he is seeing for the very first time. He multiplies food and feeds thousands. The cohort of Roman soldiers and the officers of the chief priests and Pharisees sent to arrest Him are forced to the ground by His use of the words Ἐγώ εἰμι.

In His discourses with the disciples Jesus' use of the Greek Old Testament Ἐγώ εἰμι associated with the divine pronouncements of God, is a clear claim to divinity and the implicit accompanying δόξα. John records seven such claims in which Jesus presents Himself as the Bread of Life, the Light of the world, the Door of the sheep, the Good Shepherd, the Resurrection and the Life, the Way and the Truth and the Life, and the True Vine. Each of these arresting claims points to an aspect of power implicit in Jesus' divinity.

The record of Jesus' works continues and the evidence of Jesus' supra natural great power grows more and more impressive and so does the understanding of His δόξα.

The vast sweep of Jesus' authority, as recorded in John, creates a sense of reverential fear. The judgement of all mankind has been entrusted to Him. He has the authority to lay down His life and to take it again. He has authority over all mankind and can give eternal life to all those the Father has given Him. A person with such authority must, of necessity, have great δόξα.

At Jesus' trial Pilate claims to have authority ““You do not speak to me? Do You not know that I have authority to release You, and I have authority to crucify You?” Jesus answered, “You would have no authority over Me, unless it had been given you from above; for this reason he who delivered Me up to you has

the greater sin.”” Thus confirming that there is only one with greater authority than Jesus and that is the Father. But this statement must be considered in the light of Jn. 10:30 where Jesus says that: “I and the Father are one.” The implication is that Jesus is allowing Pilate to exercise His temporal authority, but that in the end, the Father’s will would be done.

Finally there is the thought, introduced by Morris,⁴⁹⁶ that John wants his readers to see the δόξα of Jesus in every aspect of His life, not just in the remarkable events and demonstrations of power and authority. This has been ably argued and is regarded as a valuable insight into John’s intentions. Jesus’ obedience to the Father’s will is another source of δόξα, as is His fulfilment of the many Old Testament prophecies regarding the Messiah.

5.1.5. Δόξα and the events of the cross

In the Fourth Gospel John makes only a few references to the cross, but alludes to it frequently using words which have potential double meanings. A key word used in this way is ὑψόω which, in John, takes on a multidimensional character in that it simultaneously presents concepts of Jesus’ death by crucifixion, salvation for those who look to him in faith and the first phase of His return to the father. The δόξα associated with ὑψόω is in the significance of what it pointed to, Jesus’ complete obedience to every aspect of the Father’s will, the fulfilment of Old Testament prophecy and His triumph over the forces of darkness.

The Greek words Ἐγώ εἰμι are used to translate the I AM of the Hebrew Bible and carry with them the force of divine pronouncements. John records Jesus’ use of these words on several notable occasions. Some of these are particularly relevant to the events of the cross as they give insight into John’s perception of the δόξα of the cross. Jesus says that He is (Ἐγώ εἰμι) the good Shepherd and as such He lays down His life for the sheep. This points to His death and, while crucifixion is not suggested in any way, it is the death of One who is divine.

⁴⁹⁶ Morris (2000:17).

At the Passover supper Jesus tells His disciples that He is to be betrayed and explains that when this happens they will know that “Ἐγώ εἰμι.” A direct claim to divinity with all the δόξα inherent in the claim. Jesus uses the words Ἐγώ εἰμι when claiming to be ‘the Resurrection and the Life.’ This is an indirect pointer to the resurrection that would only become clear after Jesus was raised from the dead. In Gethsemane Jesus uses Ἐγώ εἰμι to acknowledge that He is the One the Roman cohort and Jewish officers sought. At the use of those words the whole crowd were forced to the ground. This incident, in leading up to the events of the cross, is a clear indication that Jesus is divine and therefore has an intrinsic δόξα.

The reaction of some people to the events of the cross reflects Jesus’ δόξα. Prominent among these is Thomas’ confession that Jesus is Lord and God.

John presents Jesus’ crucifixion as His glorification and does so by drawing attention to the fulfilment of Old Testament, and Jesus’ own, prophecies in the events of the cross. He records Jesus’ reference to the serpent being lifted up in the wilderness. In chapter eight John records Jesus’ own prophecy that He would be lifted up and that, at that time, those who did so would know that Ἐγώ εἰμι. In chapter 10 Jesus declares that He had the authority to lay down His life and to take it again accurately predicting that the timing of His death would be by His decision and not that of His opponents.

The way in which Jesus’ body was treated is also a fulfilment of prophecy. In contrast to customary practice no bones were broken but He was pierced by a spear. Again this was in fulfilment of Old Testament prophecy. His burial was in accordance with Isa. 53:9, and His resurrection on the third day was as He predicted in 2:19. John pictures Jesus’ crucifixion as a step that culminates in His ascension to heaven and the δόξα He had with the Father “before the world was.”

In the end it seems that, while the concept of δόξα in John carries with it all the connotations reviewed above, such as power, authority, and obedience to God,

there is another less recognised element. Rather than physical or material demonstrations of $\delta\acute{o}\xi\alpha$, this relates to the moral or ethical characteristics shown by Jesus. It relates, as it were, to the character of God as revealed by Jesus.

Jesus had the power to destroy His enemies, but he did not. He could have assumed the title of King, but He did not. He could have commanded prestige, honour and reverence, but He did not. He could have demanded that He be served by His disciples, but He did not. Instead He displayed all the attributes of God as recorded by the prophet Jeremiah⁴⁹⁷ “Let not a wise man boast of his wisdom, and let not the mighty man boast of his might, let not a rich man boast of his riches; but let him who boasts boast of this, that he understands and knows Me, that I am the LORD who exercises lovingkindness, justice, and righteousness on earth; for I delight in these things,” declares the LORD. Jesus also reflected the characteristics claimed by God Himself.⁴⁹⁸ “Then the LORD passed by in front of him (Moses) and proclaimed, “The LORD, the LORD God, compassionate and gracious, slow to anger, and abounding in lovingkindness and truth; who keeps lovingkindness for thousands, who forgives iniquity, transgression and sin; yet He will by no means leave the guilty unpunished, visiting the iniquity of fathers on the children and on the grandchildren to the third and fourth generations.”” Lovingkindness, compassion and ‘slow to anger’ were characteristics evident in all that Jesus did and could be summed up in a single word “Love.” Forgiving iniquity, sin and transgression demanded sacrifice and this is precisely what Jesus did at Calvary. Truly in Jesus we see that God so loved the world that He gave His Son.

The true $\delta\acute{o}\xi\alpha$ of Jesus, then is that He reflected of the character of God in all that He did and said and this is what John wants us to comprehend as we read the Fourth Gospel.

5. 2. Suggestions for Future Research

⁴⁹⁷ Jer. 9:23-24.

⁴⁹⁸ Ex. 34:6-7.

This study into the significance and meaning of δόξα in the Fourth Gospel's account of the events of the cross lays a foundation for future research into a deeper study of the concepts conveyed by the use of the term. In particular there appears to be a gap in the study of δόξα in the letters of Paul as compared with its use in John.

In the letters by Paul, as in the Fourth Gospel, δόξα takes its place with important key Christological terms.⁴⁹⁹ Scott (1966:263-270) and others⁵⁰⁰ appear justified in considering δόξα as a Christological term: Paul closely connects Christ with δόξα. He entitles Christ “the Lord of glory” (1 Cor. 2:8) and declares “that the God of our Lord Jesus Christ” (Eph. 1:17^a) is the “Father of glory” (Eph. 1:17^b), thereby paralleling Jesus and δόξα.

Paul connects key events in Jesus' life with δόξα. Jesus was raised from the dead through the glory of God (Rom. 6:4; 1 Tim. 3:16). As the resurrected and exalted Lord, Jesus possesses a body of δόξα (Phil. 3:21). The future parousia of Jesus will be an apocalypse in δόξα (Col. 3:4; cf. Tit. 2:13), in which sinners will be judged and believers transformed (2 Thess. 1:9-10). Paul also argues the δόξα possesses a final, eschatological character (2 Cor. 3:10).

Jesus reveals and mediates δόξα. The knowledge of δόξα is discovered in Jesus (2 Cor. 4:6). The saving deeds of Jesus make known the mystery of δόξα, hidden from the ages past, to all the nations (Rom. 9:23; Col. 1:27^a). The gospel which Paul preaches – a Gospel which features the death, resurrection and future coming of Jesus – is a “gospel of glory” (2 Cor. 4:4; cf. 1 Tim. 1:11).

Incorporation into Christ transfers δόξα to the believer. In salvation, God calls the believer to δόξα (1 Thess. 2:12; cf. 2 Tim. 2:10). Paul defines the eschatological goal of salvation as obtaining the δόξα of the exalted Christ (Rom. 8:30; 2 Thess.

⁴⁹⁹ By books, the order of frequency is as follows: Romans and 2 Corinthians (22 times each), 1 Corinthians (15 times), Ephesians (9 times), Philippians (7 times), 2 Thessalonians (5 times), Colossians (4 times), Galatians, 1 Thessalonians and 1 Timothy (3 times each), 2 Timothy (2 times) and Titus (1 times).

See Kittel (1934:191-221); Ramsey (1949:46-52, 148-151).

⁵⁰⁰ See Kittel (1974, 2:232-237, 242-255); Aalen (1986, 2:44-52); Hegermann (1994, 1:344-348).

2:14).⁵⁰¹

Paul characterizes the spiritual life of transformation into the resurrection likeness/image of Christ as a metamorphosis of δόξα (2 Cor. 3:18). God enables and sustains transformational progress by the δόξα of Christ (Eph. 3:16; Phil. 4:19; Col. 1:11). At the parousia of Jesus, God will culminate the transformation of believers by conforming their earthly bodies to Christ's resurrection body of δόξα (Phil. 3:21). The believer, as does all creation, longs for this final transformation into the δόξα of Christ (Rom. 8:21).

The indwelling of the exalted Jesus confirms the future glorification of all believers: the Christian therefore lives in the certain hope of a future δόξα (Rom. 5:2; Col. 1:27^b). Despite present suffering, God certifies that sharing Christ's δόξα will eclipse any suffering experienced in the earthly life (Rom. 8:18); indeed, present suffering produces future δόξα (Rom. 8:17; 2 Cor. 4:17).

An inquiry into the δόξα of Jesus in Paul's letters, like the Fourth Gospel, would be a worthwhile undertaking. But John differs from Paul, John focuses less upon issues having to do with how the specific mode of Jesus' cultic sacrificial death effected salvation, and more upon the nature of that salvation as a revelation of God made possible through Jesus' death. In the Fourth Gospel, John expresses and underscores the events of the cross of Jesus as being important, because, for him, they are the moment of Jesus' glorification; according to Paul, the believer is justified, but must await the final δόξα to be revealed at the resurrection (Rom. 6:5; cf. 1 Cor. 15:12-28).

This study of the δόξα in relation to the events of the cross according to the Fourth Gospel has come to a close. I have offered a fresh, focused, and methodical inquiry into the concepts of δόξα as evidenced in the events of the cross. The Fourth Gospel is not only about the confrontation of the world by the δόξα of Jesus, but also the continued manifestation of His δόξα in His disciples

⁵⁰¹ Newman (1992:245) says that Paul also identifies Jesus as the one who mediated the eschatological δόξα of God as revealed in the coming, life, death and resurrection of Jesus.

after the events of the cross, so that the world, through His disciples in every age, might continue to be confronted with the challenge of the demonstration of Jesus' δόξα.

APPENDIX A

1. Miracles in the Fourth Gospel

Miracle	1. Cana Wedding	2. Nobleman's Son	3. Lame Man	4. Feeding 5,000	5. Walking on Water	6. Blind Man	7. Lazarus	8. Catch of Fish
Text	2:1-11	4:46-54	5:2-9	6:4-13	6:16-21	9:1-7	11:1-44	21:4-14
Synoptic Parallel		Mt. 8:5ff. Lk. 7:1-10		Mt. 14:13-21 Mk. 6:32-44 Lk. 9:10-17	Mt. 14:22-33 Mk. 6:45-52			
Σημεῖον "sign"	2:11 first sign	4:48, 54 Second sign		6:14, 26		9:16	11:47	
Ἔργον Ἐργάζομαι "work"			5:17, 20	6:27ff.		9:3, 4		
Δόξα "glory"	2:11						11:4, 40	
Jesus as subject			5:19, 30	6:52		9:4, 16, 33; 10:21	11:37	
"I am" saying				6:35		8:12 9:5	11:25	
Associated Discourse				Bread of Life 6:25ff.		Light of the World 8:12ff.		

2. Vocabulary statistics of the Miracles in the Fourth Gospel

Term	1	2	3	4	5	6	7	8	9	10	11	12	13	14	15	16	17	18	19	20	21
Σημεῖον 17 occurrences (1 reference to Jesus)		11 18 23	2	48 54		2 14 26 30	31		16	41	47	18 37								30	
Σημαίνω 3 occurrences (all references to Jesus)												33						32			19
Ἔργον 27 occurrences (19 references to Jesus)			19 20 21	34	20 36 ^a	28 29	3 7 21	39 41	3 4	25 32 ^a 33 37 38				10 11 12	24		4				
Ἔργον 8 occurrences (5 references to Jesus)			21		17 ^a	27 28 30			4 ^a												
Δόξα 19 occurrences	14 ^a	11			41 44 ^a		18 ^a	50 54	24		4 40	41 43 ^a					5 22 24				
Δοξάζω 23 occurrences							39	54 ^a			4	16 23 28 ^b	31 ^a 32 ^b	13	8	14	1 ^a 4 5 10				19
Δύναμις 36 occurrences (7 references to Jesus)	46		2 3 4 ^a 5 9 27		19 30 44	44 52 60 65	7 34 36	21 22 43	4 16 33	21 29 35	37	39	33 36 37	17	4 5	12					
Δύναμις No occurrences																					
Ἐξουσία 8 occurrences (4 references to Jesus)	12				27					18 ^a							2		10 ^a 11		

(1) **Bold** verse numbers indicates reference to Christ.

(2)^a Term occurs twice in this verse.

(3)^b Term occurs three times in this Gospel.

APPENDIX B

Johannine Christian Community

In New Testament Studies there has emerged, in recent decades, a preoccupation with the development of what is termed “the Johannine Christian Community.” This is postulated as a community, separate from the general church, and undergoing a series of progressive developments in belief and emphasis in teachings, brought about by changes in the religious ecology of the day. These developments in belief and emphasis in teaching are thought to be reflected in various passages in the Fourth Gospel, which are thought by some to have been specifically included to counter perceived erroneous beliefs. The Fourth Gospel is thus postulated as having been modified and adapted in successive stages in order to counter incorrect doctrine or react to outside religious influences. Eventually the Gospel took the form in which we have it today.

That the process of “reconstruction” is inexact and speculative is evident from the differences in the reconstructions offered by various proponents of this view. There is considerable doubt as to whether the Johannine Christian Community is a reality or simply a construct of fertile imaginations. Generally the theory has developed out of a desire to show the relationship among the five writings traditionally associated with the Apostle John.

It is generally accepted that John spent his later years in Ephesus, the fourth largest city in the Roman Empire and the home of the temple of the goddess Artemis, who was sometimes referred to as Diana. At one time Ephesus was a centre of trade between East and West but the harbour became stilted and unserviceable. From that time the worship of Artemis became the city’s main means of economic survival. The ambiance of the city was thus one of gentile paganism and idolatry and Eastern mysticism. In addition all sorts of magic and sorcery were conjured up and documented. The city was also influenced by the various philosophies of the day, notably those from Greece and Rome. Within

this mixture of philosophic speculation, mysticism and pagan practice there was also a Jewish religious community.

It was within this climate of strongly contrasting belief systems that Paul and his companions planted the church that was later cared for by John. While it is true that, because of the existing climate of thought and practice, the churches in and around Ephesus faced a difficult situation, it would be wrong to suggest that this gave rise to a separate Christian Community so strongly influenced by the surrounding circumstances that it was different to the main body of believing Christians. It is also incorrect to imagine that within these churches there was a separate “Johannine Christian Community” as this would be a negation of the very teaching of the apostles that all believers are one in Christ. Neither should the relatively limited group of Christian believers in the Ephesian geographical area, made up of converted Jews and gentiles, be considered the Johannine Christian Community and seen as separate or distinct from other Christians.

In this thesis the “Johannine Christian Community” is viewed in the widest context and is considered to be composed, not only of the immediate circle of Christian believers under the general care and guidance of John in Ephesus and other believers in the same general geographic area but rather of all believers in all the ages and in all places.

The message of the Fourth Gospel has a timelessness that is directed to all people of all ages and all circumstances. It fills in what is left out of the three Synoptic Gospels and presents us with valuable insights into the intensely personal relationship that Jesus had with His disciples, a relationship which points to that relationship that He desires with all who are truly His own.

APPENDIX C

Views on the Origin and Development of Johannine Christian Community History

This survey briefly summarises the theories of representative scholars who have engaged in a reconstruction of the Johannine Christian community and highlights the substantially different conclusions reached. These conclusions tend to be based on the subjective views of the authors rather than on firm, objective facts. Brown, one of the leading scholars in this field, says “I warn the reader that my reconstruction claims at most probability; and if sixty percent of my detective work is accepted, I shall be happy indeed.” It would perhaps have been better for him to have used the word ‘possibility.’

Several writers have addressed the issue and the following is a brief review of their basic approaches.

1. J. L. Martyn

Martyn (2003:35-143) attempted to link the growth of a “Johannine Christian community” with the experience of a particular Christian community working its way through the final breach between the synagogue and the church. It is significant that in a later edition of this work⁵⁰² he (2003:145) attempted an elaborate reconstruction of Johannine church origins based on the following principle: “The literary history of a single community which maintained over a period of some duration its particular and somewhat peculiar identity.” Martyn’s reconstruction proposes a three-staged development of the Johannine Christian community. In the first stage the emphasis is on Jesus as the Messiah and Jewish converts fit in easily with living the new faith within the Torah and the synagogue. It postulated that at this time the sermons and traditions about Jesus are gathered into a form of the gospel. The second stage is marked by divisive, midrashic debates over the claims of Jesus, the expelling of heretics

⁵⁰² See Martyn (2003:145-167).

(from the synagogues) and by having some of them tried and executed. This, it is suggested, led to those expelled rewriting the account of Jesus. He is now seen as the One who, although from above is rejected by His own.⁵⁰³ In the third stage the expelled Christians again revise their position and adopt the view that there can be no middle way, a Christian could not continue in both camps. They also saw the Jewish Christians, scattered by persecution as being “other sheep” and part of the promise that they would become one flock under one Good shepherd.

2. G. Richter⁵⁰⁴

Richter argues for an original basic written gospel with varying Christologies, arising within the Johannine Christian community. On this basis he finds traces of four different communities in the Fourth Gospel. His categories are I. The Mosaic-Prophet Christians, II. The Son-of-God Christians, III. The Docetic Christians and IV. The anti-docetic redaction. This categorisation is based on a perceived evolution of the gospel through the various stages.

*** R. A. Culpepper**

The existence of a Johannine school is defended using three lines of reasoning. First, it is claimed that the similarities and dissimilarities of style and unity can best be explained by the existence of a Johannine Christian community. Second, as Stendahl (1968:20-35) points out that, from the use of Old Testament quotations in the Gospel, that this Christian community might be described as a school. Third, Culpepper’s analysis of the characteristics shared by the Johannine Christian community with other ancient schools is offered as final proof that this Christian community was indeed a school. Culpepper (1975:287-289) demonstrated how each one of the nine characteristics of a

⁵⁰³ This view was caused by the threat of physical persecution and death (Jn. 1:11; 10:28-29; 15:18; 16:2). In this situation the community began to see itself as “not of this world” (Jn. 17:1-26), and hated by the world (Jn. 15:18-16:33).

⁵⁰⁴ See Mattill (1977:294-315).

school were also found in the Johannine Christian community. These characteristics are as follows:

I. The Johannine Christian community was a fellowship of disciples; II. The Christian community gathered around, and traced its origins to, a founder – the Beloved Disciple; III. The Christian community valued the teachings of its founder and the traditions about him; IV. Members of the Christian community were disciples or students of the founder – the Beloved Disciple; V. Teaching, learning, studying, and writing were common activities of the Christian community. VI. The Christian community observed a communal meal; VII. The Christian community had rules or practices regulating admission and retention of membership; VIII. The Christian community maintained some distance from the rest of society; IX. The Christian community developed organizational means of insuring its perpetuity.

He (1975:289) indicates that “these characteristics, which describe ancient schools, also describe the Johannine community. The Johannine community, therefore, was a school.”

3. O. Cullman

Cullman (1976:93-94) considers that the Johannine Christian community consisted of people who, from the beginning, were on the margin between Judaism and Hellenism. They were heterodox Jews who had a profound fidelity to the historical Jesus and to the beloved disciple’s understanding of Jesus. The differences between the synoptic gospels and John’s Gospel are in part explained by the fact that Jesus had two different styles of teaching.

4. R. E. Brown

Brown (1979:25-169) is aware that the analytical form of scholarship used in determining the development of the Johannine Christian community is hypothetical but nevertheless considered himself able to trace four stages in the community's growth. In his analysis he classifies the first stage as covering the same time frame as Martyn's first stage but he sees it as the rapid coming together of Christians from a variety of different backgrounds – followers of John the Baptist, Samaritan converts, Jews of an anti-temple view and Gentiles. The second stage (ca A.D. 90) sees the composition of the Gospel and this leads to a "higher" Christology eventuating in the absolute "Ἐγώ εἰμι" and the idea of the pre-existence of Jesus. Using the Fourth Gospel, Brown identifies six groups with which the Johannine community had contact during this period. The third stage is set ca A.D. 100 when, according to Brown the community split into two. One group moved toward unity with the great church and the other towards Gnosticism. Finally in the second century, after the letters of John were written, the final moment in the history of the community is its separation and dissolution. This, he claims, can already be seen in the writings of Ignatius of Antioch (ca A.D. 110)

5. A Review of the suggested Reconstructions

Each of these reconstructions is based on the Johannine literature, as well as other external writings. Consequently each has its own plausibility but, given the diversity of views and conclusions, it is clear that the actual process of reconstruction is hazardous and extremely subjective.

The various theories relating to the development of the Johannine Christian community are not enhanced by saying that such a reconstruction need not be exact and that a limited percentage of accuracy is acceptable. While such qualifying statements reflect an appropriate caution they do not help the discussion; on the contrary they confuse the issues. When one considers these various reconstructions, these interesting buildings, the question is not how many bricks in this or that wall are solid, but rather whether there is any solidity to the foundation of the entire edifice.

APPENDIX C

The Socio-Cultural Ecology of the First century Related to the Johannine Christian Community

In this section an attempt will be made to analyse the atmosphere of religious thought in the socio-cultural ecology that prevailed in the Graeco-Roman world, particularly in Asia Minor, about the time when the Fourth Gospel was written.

Reviewing the alternative contexts which allegedly have affinities with the Fourth Gospel, is like reviewing the entire range of religious and cultural movements in the Greco-Roman world in the first century.⁵⁰⁵

The explicit purpose of the Fourth Gospel as stated in Jn. 20:30-31, is to convince readers that this Jesus is the Messiah of Jewish expectation (the Christ) and that He came to reveal God the Father in His person. The Evangelist contributed to the defence of the Christian community by addressing his writing primarily to members of that community. Also, it was an intra-church (intra-Christian community) document, a Gospel intended for the family.⁵⁰⁶

1. The Johannine Christian Community and its Religious Phraseology

⁵⁰⁵ Dodd's book, *The Interpretation of the Fourth Gospel*, is a fine example of traditional New Testament scholarship's painstaking concern to examine socio-cultural influences which converge in the first century related Johannine Christian community. Dodd (1998:4-6) writes in his introduction:

In order to work towards a sound interpretation of the Fourth Gospel it is necessary to consider the work in its true context of thought, so far as that is possible for us at this date. If we approach it without regard to any such context, we are in danger of imposing upon it a subjective interpretation of our own, for we shall in fact be placing it in the context of our preconceived notions, which may be foreign to the intention of the evangelist...The fact is that the thought of this gospel is so original and creative that a search for its 'sources,' or even for the 'influences' by which it may have been affected, may easily lead us astray. Whatever influences may have been present have been masterfully controlled by a powerful and independent mind...Nevertheless, its thought implies a certain background of ideas with which the author could assume his readers to be familiar.

⁵⁰⁶ Van der Watt (2000:161) refers to the frequently used family language (e.g. father, son, brother, house, birth, and life) in the Fourth Gospel.

John's Gospel is noted for its author's distinctive development of and penchant for new phrases in place of old ones,⁵⁰⁷ for using many different words to describe the same activity. These words and phrases were specially selected by John to enhance the understanding of the Gospel by the Johannine Christian community and also to meet their specific spiritual needs. The distinctive feature of the Fourth Gospel is the emphasis on "believe," and "witness (testify)."

John tells us explicitly, what he was aiming to do in writing his gospel (Jn. 20:30-31) namely to bring people to believe in Jesus, and in believing to have life.⁵⁰⁸ This means that believing is very important for him and the Johannine Christian community, and in fact this idea rings throughout his whole book. When he wants to express the thought of "faith in Jesus Christ," Paul speaks of "faith (πίστις) in Jesus Christ," but John uses the phrase "to believe (πιστεύω) in Jesus."⁵⁰⁹ It seems that for John belief is always an active matter. John describes faith as a continuing dynamic, not a state of being. Rather, by using the verb form of the word, John emphasizes the act and ongoing activity of faith, an activity that constantly endorses the original decision. This emphasis is deliberate and is directed to the prevailing circumstances and needs of the Johannine Christian community. Interestingly, Whitehouse (1950:75-76) comments,

The efficacy of faith for salvation and for right relationship with
God is not to be sought in the act itself, but rather in that to

⁵⁰⁷ Malina & Rohrbaugh (1998:4) mention that for example, when Paul wants to speak of faith in Christ, he speaks of "faith in Christ Jesus." But John uses the phrase "believing (to believe) into Jesus."

⁵⁰⁸ Hermission & Lohse (1981:160) link this passage with that which tells us that John the Baptist was sent by God to bear witness to the light "so that all might believe through him" (Jn 1:7), and draw the conclusion that "Jesus' effect is thus represented from the beginning to the end as a proclamation which calls one to faith."

⁵⁰⁹ John never uses the noun "faith" or "belief," but always and only the verb "to believe" and the gerund "believing" (Jn. 1:7, 12, 50; 4:21, 42, 48; 6:29, 30, 36; 7:5; 8:24, 30; 11:15, 40; 12:11, 37; 13:19; 14:10; 16:30; 20:25, 27, 31). Also, Malina & Rohrbaugh (1998:4) say of "believing in Jesus" that when John expresses this reality, he has recourse to terms such as: following Him (Jn. 1:38; 18:15), abiding in Him (Jn. 5:38; 14:10, 25), living in Him (Jn. 6:51, 57), having Him (Jn. 3:21; 4:45; 7:9; 13:1; 17:4), or seeing Him (Jn. 21:21). These expressions point to items and objects affecting areas of central concern to the Johannine Christian community. Also, we know that John's descriptions derive from the interests and activities of the Johannine Christian community.

Turner & Mantey (1964:3) indicate that the verb (πιστεύω) occurs about 96 times in the Fourth Gospel; about 34 times in the three Synoptics.

which a man holds firm by believing. The Fourth Gospel, by the very fact of not using the noun, makes this plain.

This understanding of faith implicit in the use of the verb instead of the noun indicates that John's fundamental concept of faith is that of personal relationship. It is as if John wishes to emphasize the act of believing. Because of this emphasis the Johannine Christian community can make certain affirmations about Christ that structure a sense of identity and community solidarity.⁵¹⁰

Also, we find that many have called attention to the prominence of the theme of "witness" (testify). This term occurs thirty-three times in verb form (μαρτυρέω) and fourteen times as a noun (μαρτυρία) in the Fourth Gospel.⁵¹¹ This emphasis on witness is noteworthy. It is incompatible with hearsay or with a romantic elaboration of a theological kind based on the barest minimum of fact (Morris, 1969:121). John bears witness to the things he has seen and heard concerning the Lord Jesus Christ and he wants the Johannine Christian community to have a reliable first hand account of those aspects of his experiences of Christ which will meet their prevailing spiritual needs. John is convinced that, while it is a great privilege to be a first-hand witness, an even greater blessing is in store for those who believe on the basis of the testimony of the apostolic witnesses (20:29). As others believe they share fully in the gift of eternal life.

The conclusion is that the specific words and phrases used by John are specially chosen by him to direct the thoughts of the Johannine Christian community to an active, ongoing faith in Jesus Christ. To do this John uses the

⁵¹⁰ See Kysar (1993:94). Also, Blomberg (2001:62) indicates that John is writing that Johannine Christian community might hopefully grow in their faith.

⁵¹¹ The witness to Christ which John records is therefore manifold, and extends over the whole range of possible attestation of divine things. Westcott (1890:xlvi-xlvii) says that in due succession there is, " I . The witness of the Father (Jn. 5:31f., 34, 37; 8:18); II . The witness of Christ Himself (Jn. 3:11, 32f.; 8:14, 18; 18:37); III . The witness of works (Jn. 5:36; 10:25); IV . The witness of Scripture (Jn. 5:39); V . The witness of the John the Baptist (Jn. 1:7, 8, 15, 19ff., 32ff.; 3:26; 5:33f., 36); VI . The witness of disciples (Jn. 15:27; 19:35; 21:24) ; VII . The witness of the Spirit (Jn. 15:26; 16:14)." Cf. see Morris, 1969:121-122; Bernard, 1948:xc-xcii.

verb forms of key words, such as “believe” and “witness” (testify) rather than the nouns.

2. The Johannine Christian community and followers of John the Baptist

A variety of theories, which differ significantly from one another, have been suggested to ‘explain’ the relationship between the disciples of John the Baptist and the Christian Community associated with John, the writer of the Fourth Gospel. It has been suggested, for example, that there was a group of John the Baptist’s disciples who claimed that he, and not Jesus, was the Messiah and that the Fourth Gospel was written to refute this error. On the basis of this view the relationship between the two groups is regarded as antagonistic. One reason for this view is the supposed unfavourable contrast between John the Baptist and Jesus in the prologue.

This view does not adequately take into account that the Synoptic gospels all show that John the Baptist pointed to someone who would come after him and who would be greater. These passages in the Synoptic Gospels (Mt. 3:1-17; Mk. 1:2-11; Lk. 3:1-22) clearly indicate that John the Baptist recognised that Jesus was the person to whom he had been referring to and that he, Jesus, was the greater. There was thus no doubt in John the Baptist’s mind that Jesus was the promised Saviour. His view of what the Saviour would accomplish was obviously based on his understanding of the Old Testament passages relating to the Messiah. Jesus did not meet all his expectations of a Saviour as is evident from the message he sent Jesus while in prison (Mt. 11:1-22) “Are you the Coming One, or shall we look for someone else?” Jesus’ reply directed John to the miracles that no human could perform and let him draw his own conclusions from how these fitted in with what the scriptures said about the Messiah. The passages in the Fourth Gospel which are regarded as an apologetic to reveal the distortion of truth by the disciples of John the Baptist (1:8, 15, 19-24, 30; 3:28-30; 10:41) really direct the reader, not to any supposed inferiority, but rather to the pre-eminent position he occupied as the witness to Jesus being the Christ – he is not the Light, but he is the witness; he

is not the Messiah, but, like Isaiah, he is a voice proclaiming the Messiah; he is not the bridegroom, but he is the bridegroom's friend.

Brown (1978:lxx) recognises that John acknowledges the position of honour that John the Baptist held amongst the witnesses to Jesus and concludes that "the view of John the Baptist in the Fourth Gospel is no less complimentary than that of the Synoptics." Brown's view is, like that of many scholars, that the Fourth Gospel is a compilation of traditional records of Jesus' sayings and activities edited and emended by a series of editors and redactors. Because of this he does not accept the clear statement in 20:30-31 that the intention of the single writer was to select specific signs which pointed to the divinity of Jesus and provide followers of Jesus with a firm basis for belief – a belief which is foundational to faith and salvation. He also does not accept that the Fourth Gospel is written by an eyewitness who is filling out the record of Jesus' acts by giving a record of the very words used by him.

Lindars (1982:60) considers that "the relation between the Baptist and Jesus needed explanation in the early days of the church; cf. Mt. 11:2-19." He goes on to say that "It is probable that behind this explanation there lies the embarrassing fact that Jesus had broken away from the Baptist, whom many regarded as the Messiah. This embarrassment shows through in Matthew's version of the baptism of Jesus (Mt.3:14f.)." There is nothing in either of these passages to suggest that Jesus was ever a "disciple" of John the Baptist or that he broke away from him. Objective consideration of these passages shows clearly that there is no indication of any embarrassment whatever. The attempt to claim that the disciples of John the Baptist used Mt. 11:11 to justify the claim that he was the Messiah is negated by the preceding verses in which John the Baptist indicates that there is a "Coming One" for whom he and his disciples were looking.

3. The Johannine Christian Community and Gnosticism

The term 'Gnosticism' is used to describe a wide range of schools of philosophy which, during the first Christian centuries, sought to provide an answer to the basic problem of man and the world by concentrating on salvation through a secret *gnōsis*, or 'knowledge.' Gnosticism is in fact more a philosophy than a religious system; and, whereas the early fathers saw Gnostic teachings solely as heretical corruptions of Christianity, modern scholarship views Gnosticism as a religious and philosophical outlook which may be completely independent of Christianity.⁵¹² It is true to say, however, that not all scholars agree about the origins of Gnosticism (whether its sources are pre-Christian, and indeed Jewish, as well as Christian), or even about its precise definition. For this very reason it is important to be flexible in any approach to this subject; and even if, for the sake of convenience, we shall here consider Gnosticism in connection with possible Hellenistic influences on the Johannine Christian community, this does not imply that Gnosticism is to be regarded as a purely Greek phenomenon.

Christian Gnosticism in its developed form is entirely intellectual and speculative. Using mythical ideas which drew on a philosophical background, it was an attempt to express the Christian gospel in terms which would be appreciated by those who were nurtured in a Hellenistic environment. But a cursory glance at Christian Gnostic books (e.g. The Gospel of Truth) is sufficient, however, to show how far Gnostic Christianity eventually travelled from its apostolic and New Testament origins. Basic to the outlook of the Gnostics was a dualistic view of the world, in which the upper world of spirit or mind contrasted with the lower world of evil matter.⁵¹³

We briefly survey the relationship between the Johannine Christian community and Gnosticism, examining the view of Bultmann, who is typical of the history of religions school of biblical scholarship, which considers that 'pre-Gnosticism' was an eclectic tradition of thought which infiltrated Judaism and Hellenistic paganism, as well as Christianity, from the orient. We then deal with John's

⁵¹² See Smalley (1978:49).

⁵¹³ See further Brown (1978:liv).

writings, refuting Bultmann's view that John's concepts originally come from a Gnostic sect.

In his commentary, Bultmann (1971:7-9) argues that the evangelist responsible for the redaction of the Fourth Gospel was a convert to Christianity from a Gnostic sect. He works on the premise that the thought patterns in the Johannine literature and theology are neither Greek nor Jewish, but Gnostic. He contends that the literature of the Mandaeans, a Gnostic sect which traces its origins to a migration from Palestine, preserves echoes of the pre-Christian Gnosticism from which the evangelist emerged. The most likely point of contact between the Fourth Gospel and the literature of the Mandaeans lies in the existence among the Gnostics of a so-called 'redeemer myth.' In Mandaeism this takes the form of a divine being (the most important is Manda *d'Hayye* = 'Knowledge of life'), who descends into the lower realms, conquers the powers of darkness, and victoriously ascends to the realm of light. His action thereby guarantees to the faithful the living efficacy of their myth and ritual.⁵¹⁴ It seems that Bultmann believes that the writer of the Fourth Gospel was himself a one-time Gnostic, who wanted to restate the kerygma in line with Gnostic concepts which had been "Christianised." Bultmann insists that John used a source which was Gnostic in tendency as a basis for the Gospel discourses in the Fourth Gospel. Also, in the formation of the discourse material, Bultmann sees the Evangelist as dependent above all on the 'redeemer myth,' a form of which has already been described. Bultmann (1971:8) claims that support for this reconstructed Gnosticism in John is found in the Mandaean literature.⁵¹⁵ He also seeks support for his view in the Gnostic Odes of Solomon which are especially closely related to the discourses of John in their thought and language.⁵¹⁶

⁵¹⁴ See Smalley (1978:46).

⁵¹⁵ Brown (1978:liv) mentions that the charge of circular reasoning has been hurled against Bultmann. "He (Bultmann) presupposes that there was a Gnosticism in the background of John, and then uses John as his main source for reconstructing this Gnosticism. However, Bultmann claims that pre-Christian Gnosticism has survived in the Odes of Solomon, and particularly in the Mandaean literature."

⁵¹⁶ Schnackenburg (1984, 1:144-145) mentions that many texts of the Odes of Solomon tell in favour of acquaintance with the Fourth Gospel:

Furthermore, the view of John's background taken by Bultmann is in fact open to question at several points. It is difficult to regard John as a 'Gnostic' in any real sense, because John's basic, Christian outlook differs from the mystical, philosophical approach of Gnosticism and its earlier manifestations.⁵¹⁷ The Evangelist not only has a real concern for the historical basis of salvation, he also has what Gnosticism lacks – a theology of salvation which involves deliverance from sin by means of a cross. The Johannine Soteriology is historical and Christocentric; that of the Gnostics is mystical and speculative. Therefore, however many parallels may be drawn between the Fourth Gospel and the supposed Gnosticising tendencies of John's day, it cannot be maintained that John was deeply influenced by Gnostic thought-forms, or indebted to them for his theology. The two are literally worlds apart. Also, we cannot accept that the Odes of Solomon are a valuable example of Gnostic themes and imagery, they can hardly be considered a concrete background of the Johannine Christian community.⁵¹⁸

Beasley-Murray (1987:1vi) states that there are sober scholars who are ready to acknowledge positive relationships of the Fourth Gospel to the contemporary religious movements that inspired the Gnosticism of the second century without

Ode 6:11f.; 30:1f. (thirst-assuaging source) cf. Jn. 4:14; 7:37. Ode 7:4ff. (He appeared like me...he is my grace) cf. Jn. 1:14, 16. Ode 8:14 (mine, whom I know) cf. Jn. 10:14. Ode 8:22 (pray...abide in the love of the Lord) cf. Jn. 15:7, 10. Ode 10:5 (the scattered gentiles gathered) cf. Jn. 11:52. Ode 11:16 (coming from darkness to light) cf. Jn. 8:12. Ode 12:7, 12 (the Word is light to the mind, its dwelling-place is man) cf. Jn. 1:4. Ode 15:2; 18:6 (his light has driven all darkness from before my face; the enlightened shall not be conquered by darkness) cf. Jn. 1:5; 12:35. Ode 16:19 (the worlds were made through his Word) cf. Jn 1:3. Ode 28:17f. (they aimed at my death but did not succeed, because I was older than their memory) cf. Jn. 8:57f. Ode 31:4 (he lifted up his voice to the Most High, and offered him the sons that were in his hands) cf. Jn 17:11-16. Ode 31:5 (his person was justified, as his holy Father had granted him) cf. Jn 17:1, 5; 12:28. Ode 31:7 (they accused me...who was guiltless) cf. Jn. 8:46. Ode 33:4 (he drew to himself all who heard him) cf. Jn. 12:32. Ode 39:11ff. (the footsteps of our Lord as bridge and way) cf. Jn. 14:2-6. Ode 41:13 (the Son of the Most High has appeared in the perfection of his Father) cf. Jn. 1:14. Ode 41:15 (the anointed...was known before the foundation of the world) cf. Jn. 1:1; 17:5, 24.

⁵¹⁷ Richardson (1961:41) says that "when scholars like Bultmann describe a Gnostic doctrine they take their first century 'evidence' from the New Testament itself. But this is a question-begging proceeding, since the New Testament is susceptible of a very different interpretation."

⁵¹⁸ See Schnackenburg (1984, 1:145).

the one-sided emphasis some enthusiasts for Gnosticism are making. Barrett (1962:55) rightly notes⁵¹⁹:

It is difficult to resist the view that the Gnostics used John because out of it, by exegesis sound or unsound, they were able to win support and enrichment for preconceived theories and mythologies. We should certainly not be justified in speaking of second-century Gnosticism as in any sense a creation of John.

Therefore, we reject the notion of any direct literary dependence of the Fourth Gospel on Gnostic sources. Also, we do not find Bultmann's complex literary source analysis convincing. Furthermore, we are compelled to acknowledge the correctness of those who have criticized the hypothesis of Johannine dependence on pre-Christian Gnosticism on the grounds of the chronology of the sources. While there are motifs which are later incorporated in the developed Gnostic systems of the second century, there is to date no substantial textual support for the existence of pre-Christian Gnosticism.

John asserted the primacy of history, and John's Gospel is a reaffirmation of history. John wrote his gospel as a whole, in order to bring out with the utmost clarity a single presentation, an interpreted history, of Jesus. Also, we find that in spite of many affinities between Gnosticism and the Fourth Gospel there remains a decisive difference: the Gnostic claims that what saves is knowledge, knowledge of the origins of the world, of man in the world and of the way for man to escape from the world to union with God. But for John the knowledge that will save is knowing that Jesus Christ is the only begotten Son of God, that He died as an atonement for sin, and was raised on the third day. Belief in these facts confers on the believer eternal life.⁵²⁰ Therefore, there is a real,

⁵¹⁹ Also, Barrett's comment (1982:63), is worthy of note: "It is difficult to doubt that John detected real theological appropriateness in the words he used, that in fact he was giving a Christianized - and that meant often an inverted - and always historicized version of a way of thinking that was not simply too popular but also too near to and too far from the truth to be ignored. Gnosticism raised questions that the theologian could not ignore"

⁵²⁰ See Marsh (1991:34).

significant difference between the Johannine Christian community and Gnosticism.

4. The Johannine Christian Community and Qumran Community

Under this heading we shall consider briefly the likelihood of connections between John and the Qumran community. The affinities between John's Gospel and the Dead Sea Scrolls both of which have deep roots in the Old Testament⁵²¹ are obviously of great interest. There are real differences between the Qumran sectaries and the early Christians.⁵²² But at the same time there are striking points of contact, notably in the attitude taken by both towards prophecy, eschatology and scriptural interpretation.⁵²³ Above all, the similarity

⁵²¹ The discovery of the Dead Sea Scrolls (DSS) in 1947 greatly increased our knowledge of Judaism in first-century Palestine. Among the whole or partial remains of some 800 manuscripts is the literature of the group that settled at Qumran on the northwest corner of the Dead Sea ca. 150 B.C. The fact that the Essene community at Qumran was destroyed in A.D. 68 means that with rare exceptions its documents antedate Christian literature (Brown, 1978:lxiii).

⁵²² Smalley (1978:32-33) mentions that John's Gospel is a Christian document and the Scrolls are Jewish. The incarnation is not just that John sees the end as already upon us, whereas in the War Scroll the incarnation is still in the apocalyptic future. In John's theology eternal life is achieved not through the Law as interpreted by the community of Qumran, but through belief in the Word (Jesus) (Jn. 3:15, 16, 36; 5:24; 6:40, 47, 54; 10:28; 17:2, 3), also the final victory is not achieved through the intervention of an angel of light, but by the victorious Messiah, Jesus. He is identified with the truth of which the Scrolls speak, and for which the Qumran community was searching. John's Gospel teaches clearly that knowledge of the truth derives uniquely from the knowledge of God through Christ and by the Spirit (Jn. 1:17; 14:6; 15:26; 16:13).

⁵²³ There are obvious literary parallels between the Scrolls and John's Gospel. These are particularly evident in the Manual of Discipline (or Community Rule), although they also exist in other documents from Qumran. In 1 QS 1:5, 9f (1 QS 5:19-21), there is reference to 'practising truth,' and loving the 'sons of light' while rejecting the 'sons of darkness,' in a way that is reminiscent with Jn. 3:21 and Jn. 12:35f. Again, the concept of knowledge in association with the existence and activity of God, and man's relationship to him, is present in both the community Rule and John (See cf. Jn. 1:2; 17:3). In the English translation of "The Complete Dead Sea Scrolls" Vermes (1997:101-102) says. "From the God of Knowledge comes all that is and shall be...He...has appointed for him two spirits in which to walk until the time of His visitation: the spirits of truth and injustice. Those born of truth spring from a fountain of light, but those born of injustice spring from a source of darkness. All the children of righteousness are ruled by the Prince of Light and walk in the ways of light, but all the children of injustice are ruled by the Angel of Darkness and walk in the ways of darkness...But the God of Israel and His Angel of Truth will succour all the sons of light." Similarly, the Scrolls and John's Gospel both contain references to the wisdom of God, and his enlightenment of the worshipper in answer to faith (See cf. 1 QS 9:23f. with Jn. 3:33-36; 5:31f.; also 1 QS 17:26-28; with Jn. 12:44-50; 16:25-27).

On these Charlesworth (1968/69:415) comments that,

These similarities, however, are not close enough nor numerous enough to prove that John directly copied from 1QS. But on the other hand, they are much too close to conclude that John and 1QS merely evolved out of the same milieu... there is no closer parallel to John's dualistic mythology either in contemporary or in earlier Jewish or Hellenistic literature.

of language and even ideas exhibited by the Fourth Gospel and the Scrolls reveal an early setting previously unknown in Judaism itself, where Hellenistic thinking lay intertwined with Jewish. As Brown (1978:lxiii) indicates, none of this suggests that John depends directly on the literature from Qumran. But it clearly seems that John was familiar with Qumranic patterns of thought, and may even have been influenced by the sect itself, either through personal contact or through John the Baptist. Also, we find that the Johannine Christian community is constituted, not by faith in an interpretation of the Law which is truth for Qumran, but by faith in Jesus who embodies truth.

The relationship between the documents discovered in the vicinity of Khirbet Qumran and the Fourth Gospel must be assessed in a rather different light than the alleged association of John and the Gnostic texts. In the first place, the historical footing upon which the discussion is carried out is considerably more substantial in the case of John's relationship to Qumran. The Qumran texts can be dated with relative precision on the basis of palaeography, certain historical allusions in the texts themselves and their relationship to the community centre at Khirbet Qumran. Archaeological work on the ruins of the monastery, comparisons of pottery found in the caves with that of the community centre, numismatic evidence, and details drawn from classical writers such as Josephus, Philo, and Pliny the Elder, permit us to identify the documents as products of a separatist Jewish sect known commonly as Essenes.

The Qumran literature is antecedent to the Fourth Gospel and as it is derived from Judaism of the same period it is probable that there will be some relationship between the Qumran sectarians' views and the thought pattern of the Fourth Gospel. On the basis of chronological proximity, one could expect that there ought to be a degree of correspondence in some areas.

Kümmel (1975:221), quite definitely says.

It must be adjudged that both John and Qumran presuppose a common background, but the thought world of Qumran cannot be the native soil of the Johannine thought forms.⁵²⁴

Morris (1969:352-353) considers that there is a tremendous gap between the Johannine Christian community and Qumran community but that the language and thought within this “common background” are striking.⁵²⁵ Even where John and the Johannine Christian community are using similar language and dealing with similar concepts, there are vast differences. Again it is too much to assume, that John had the Qumran writings before him, and that, as he borrowed their language and concepts, he systematically distorted their sense.⁵²⁶

The conclusion is that the Qumran community and the Johannine Christian community have common roots in the teaching of the Hebrew Bible. Although the Qumran community anteceded the Johannine Christian community they both existed within the same general time frame and would be exposed to the religious thinking of their day. It is therefore not surprising that their literature shows similarities. The differences however are profound.

5. The Johannine Christian Community and the “Jews”

One of the strange facts about this Gospel is that, whereas the term Ἰουδαῖς appears several times in the Synoptic Gospels (six in Mark, five in Matthew, and five in Luke), in John’s Gospel it is used seventy times. The difference is dramatic especially since it reflects John’s independent usage rather than

⁵²⁴ Also, Kümmel (1980:264) says that “it is true that ethical dualism...in the Qumran writings present actual parallels to the Johannine theology; yet in Qumran these conceptions occur in the context of a radical cultic legalism and of the demand for adherence to the group of unity, which detaches itself from the rest of Judaism, while in Qumran also the message of the sending of the Son from above, especially characteristic of John, has no analogy of any sort.”

⁵²⁵ We find that the Qumran and Johannine literature are alike also in their emphasis on unity in the community. In both cases they were not “of the world” and were dedicated to God. Because of the sharp disjunction between them and the world their sense of unity was intensified (cf. 1QS 5:2, 7 and Jn. 11:52; 17:11, 21, 23). Also, in both there was a strong emphasis on brotherly love, a strong sense of community (Turner & Mantey, 1964:10).

⁵²⁶ See Beasley-Murray (1987:1xi).

derivatives from Synoptic traditions.⁵²⁷ It seems that the term Ἰουδαῖς as used in the Fourth Gospel carries a variety of meanings and nuances, which may be determined from the context.⁵²⁸ The use of the term gives an indication of the then relationship between the Johannine Christian community and the Jews.

Because the Jewish synagogue was the regular Jewish assembly for prayer and worship. We briefly deal with the historical relationship between the Johannine Christian community the Jews and the Jewish synagogue.

The term “Jews” as used in the Fourth Gospel refers primarily to the Jewish religious leaders. These men were responsible for the interpretation and implementation of the Hebrew Scriptures. Because of their narrow views of the intention of the Law and their reliance on the traditions based on rabbinical teaching rather than on the spirit and intention of the actual Hebrew Scriptures, there was an increasing conflict between them and Jesus, a conflict that continued and escalated after Jesus’ resurrection and ascension. This conflict was fuelled by their jealousy of Jesus’ acceptance by the populace. We find that a conflict between the Johannine Christian community and the Jewish synagogue is reflected in the Fourth Gospel. The unusual word ἀποσυναγωγούς, which means to be expelled from the synagogue, appears three times in the Fourth Gospel.⁵²⁹ Based on this many scholars argue that the Gospel’s negative comments about Jews are not a reflection of anti-Judaism but rather an expression of a prolonged and violent controversy between the Johannine Christian community and the Jews in the wake of the community’s traumatic

⁵²⁷ Correspondingly, the Synoptic Gospels present a picture of Judaism that includes scribes, Pharisees, Sadducees, Herodians, even Zealots, and Jesus and His disciples. The Gospel of John tends to reduce these groups to Jesus and His disciples, on the one hand, and the Jews, who are also called Pharisees, on the other. Also, See Cohen (1987:224). The fact that Sadducees, the high priestly party, Zealots, Herodians, and Essens, along with scribes, are not found in the Gospel of John, tells us something about the time and circumstances of its origin. After the disastrous Roman war (66-70) and the destruction of the Jerusalem temple, most of the Jewish parties or groups that are not mentioned in the Fourth Gospel would have disappeared from the scene.

⁵²⁸ The Johannine usage supports an understanding of Ἰουδαῖος that includes firstly, Jewish leaders or Jewish authorities (Jn. 9:22; 19:38; 20:19), secondly, ethnic-geographic, political, and a religious elements (Jn. 1:47; 2:6, 13; 4:9; 5:1; 6:4, 59; 7:2; 11:55; 18:20; 19:40, 42 etc.).

⁵²⁹ Jn. 9:22; 12:42; 16:2.

expulsion from the synagogue.⁵³⁰ Also, we may safely assume that Jesus' warning in the farewell discourse (Jn.16:1-3) prepared the Johannine Christian community for conflict and persecution from the Jewish synagogues.⁵³¹

It appears that originally the Johannine Christians were part of the Jewish synagogue but that at some point they were excluded from the synagogue and formed a separate community. The synagogue's conflict with, and expulsion of members of the Johannine Christian community is the background to the many references of the "Jews'" hostility to Jesus and His disciples in the Gospel of John. The Gospel of John seems to look back on Jesus from the perspective of a time after the split between Jews and Christianity had become irreversible (cf. Acts 18:6). However, within the Gospel of John, it is clear, as we shall see, that not all Jews opposed Jesus. Jn. 11:1-44 and 12:11, imply an incompatibility between believing Jesus to be the Christ and maintaining membership in the Jewish community (synagogue), yet they do not attribute this separation to an official Jewish policy of expulsion.⁵³²

Culpepper (1998:44-45) thinks that, in various contexts in John's Gospel, those referred to as οἱ Ἰουδαῖοι seem to be the religious authorities in Jerusalem, or the Judeans, but do not refer to all Jews.⁵³³ Accordingly, Kysar (1993:68) considers that the Jews referred to are stylised types of those who reject Christ, and that John's usage illuminates this category. According to this view the Fourth Evangelist has used the term simply as a type, and is not referring to

⁵³⁰ See Kysar (1983:316).

⁵³¹ Martyn (2003:56-66) considers that the twelfth Benediction of the standard Eighteen Benedictions of the synagogue service was composed, or amended, to facilitate the dismissal of such troublesome sectarians, particularly Christians, from the synagogue. The Twelfth Benediction, or the *Birkath ha-Minim* as it is called, was composed at Jamnia late in the first century or early in the second century. Culpepper (1998:44) rather than seeing in Jn. 9:22 a reference to the *Birkath ha-Minim*, considers that it may be better to view the sequence in the opposite direction and understand the persecution echoed in John 9 as the kind of practice that was formalized by the *Birkath ha-Minim*

⁵³² See Reinhartz (1998:121).

⁵³³ Also, Fortna (1974:92) indicates that "while John's use of Judea and the Jews is not wholly negative, it is rarely unambiguously positive."

specific persons. There is no interest in them as a people, the interest in them is restricted to the role they play as types of unbelief.⁵³⁴

Therefore, some scholars consider that the Fourth Evangelist is writing during a ferocious dispute between Christian believers and the synagogue. The immediate problems for the Johannine Christian community are the charges levelled against them by their former brothers and sisters in the synagogue. For this reason, the Fourth Evangelist selects the Gospel's antagonists from the original readers' environment and portrays the Jews as a type of unbelief. Those who fail to see that in Christ there is a fulfilment of the heritage of the Hebrew Bible, who cling to their pride in the Hebrew Scriptures, who cannot accept that the self-understanding presented in the revelation of God in Christ – these are the persons represented in the term “the Jews.”

However this view neglects the position of John as an eye-writers of the events described. The Jews are better seen as those Jewish leaders, and their supporters who, in spite of the clear evidence presented to them, decided to reject Jesus as the Messiah and set about persecuting those who accepted His claims. In this sense they become types of the many who also refuse to believe and are antagonistic to faith in Him.

⁵³⁴ See Kysar (1993:68-69).

BIBLIOGRAPHY

- Aalen, S. 1986. Glory in *NIDNTT* Vol. 2, 44-52.
- Abrahams, I. 1925. *The Glory of God*. Oxford: Oxford University Press.
- Aland, K. 1978. *Vollständige Konkordanz zum Griechischen Neuen Testament*,
Vols. 2. (Spezialübersichten). Berlin: Walter de Gruyter.
1983. *Vollständige Konkordanz zum Griechischen Neuen Testament*,
Vols. 2. Berlin: Walter de Gruyter.
- Anderson, R. (1957) 1969. *Coming Prince*. Grand Rapids: Kregel Publications.
- Appold, M. L. 1976. *The Oneness Motif in the Fourth Gospel: Motif Analysis and
Exegetical probe into the Theology of John*. Tübingen:
Mohr.
- Ashton, J. 1991. *Understanding the Fourth Gospel*. Oxford: Clarendon Press.
- Aune, D. E. 1972. *The Cultic Setting of Realized Eschatology in Early
Christianity*. Leiden: E. J. Brill.
- Baldensperger, W. 1898. *Die Prolog des vierten Evangeliums*. Freiburg
- Barr, J. (1961) 1983. *The Semantics of Biblical Language*. London: SCM Press.
- Barrett, C. K. (1955) 1962. *The Gospel According to St John: An Introduction
with Commentary and Notes on the Greek Text*.
London: SPCK.

1971. *The Prologue of St John's Gospel*. London: The Athlone Press.

1978. *The Gospel According to St John: An Introduction with Commentary and Notes on the Greek Text*. 2nd Ed. London: SPCK.

1982. *Essays on John*. London: SPCK.

Bauer, W. (1957) 2000. *A Greek-English Lexicon of the New Testament and other Early Christian Literature*. 3rd Ed. Eng. Ed. Arndt, W. F. & Gingrich, F. W. & Danker, F. W. Chicago: The University of Chicago Press.

Baxter, J. S. (1952) 1964. *Explore the Book*. Vols 6. London: Marshall, Morgan and Scott Ltd.

Beall, T. 2000. Essenes in *Dictionary of New Testament Background*, ed. Evans, C. A. & Porter, S. E. Leicester: Inter Varsity Press. 342-348.

Beasley-Murray, G. R. 1987. *John*. WBC 36. Waco, Texas: Word Books.

Belleville, L. L. 1991. *Reflections of Glory: Paul's Polemical Use of the Moses-Doxa Tradition in 2 Corinthians 3.1-18*. Sheffield: Sheffield Academic Press.

Berger, P. L. & Luckmann, T. (1966) 1975. *The Social Construction of Reality*. Middlesex: Penguin Books Ltd.

Bernard, J. H. (1928) 1948. *A Critical and Exegetical Commentary on the*

Gospel according to St. John. 2 vols. Edinburgh:

T & T Clark.

Blackburn, B. L. 1992. Miracles and Miracle Stories in *Dictionary of Jesus and the Gospels*. Ed. Green, J. B. & McKnight, S. & Marshall, I. H. Leicester: Inter Varsity Press. 549-560.

Blomberg, C. L. 2001. *The Historical Reliability of John's Gospel*. Illinois: Inter Varsity Press

Bratcher, R. G. 1991. What does "glory" mean in relation to Jesus? *BT* 42:4. 401-409.

Breck, J. 1994. *The Shape of Biblical Language: Chiasmus in the Scriptures and Beyond*. New York: St. Vladimir's Seminary Press.

Brockington, L. H. 1945. The Presence of God: A study in the Use of the Term 'Glory of Yahweh.' *ET* 57. 21-25.

1967. The Septuagintal Background to the New Testament use of $\Delta\text{O}\epsilon\text{A}$ in *Studies in the Gospels*. Ed. Nineham, D. E. Oxford: Basil Blackwell.

Brodie, T. L. 1993. *The Quest for the Origin of John's Gospel: A Source-Oriented Approach*. Oxford: Oxford University Press.

1993a. *The Gospel according to John: A Literary and Theological Commentary*. Oxford: Oxford University Press.

Brown, R. E. (1966) 1978. *The Gospel according to John*. Vols. 2. London:

Geoffrey Chapman.

1979. *The Community of the Beloved Disciple*. London: Geoffrey Chapman.

1994. *The Death of the Messiah: From Gethsemane to the Grave*. Vols. 2. New York: Doubleday.

2003. *An Introduction to the Gospel of John*. Edited, updated, introduced, and concluded by Moloney, F. J. New York: Doubleday.

Bruce, F. F. 1979. *Peter, Stephen, James, and John: Studies in Early Non-Pauline Christianity*. Grand Rapids: Eerdmans.

1983. *The Gospel of John: Introduction, Exposition, and Notes*. Grand Rapids: Eerdmans.

Bühner, J. A. 1997. The Exegesis of the Johannine "I-Am" Sayings in *The Interpretation of John*. Ed. Ashton, J. Edinburgh: T & T Clark. 207-218.

Bultmann, R. (1951) 1967. *Theology of the New Testament*. Eng. Trans. Kendrick Grobel. 2 Vols. London: SCM Press Ltd.

1971. *The Gospel of John: A Commentary*. Eng. Trans. Beasley-Murray, G. R. Oxford: Basil Blackwell.

Burkett, D. 1991. *The Son of Man in the Gospel of John*. Sheffield: Sheffield Academic Press.

- Cadman, W. H. 1969. *The Open Heaven: The Revelation of God in the Johannine Saying of Jesus*. Ed. Caird, G. B. Oxford: Basil Blackwell.
- Caird, G. B. 1968/1969. The Glory of God in the Fourth Gospel: An Exercise in Biblical Semantics. *NTS* 15. 265-277.
1980. *The Language and Imagery of the Bible*. London: Gerald Duckworth & Co. Ltd.
- Carroll, J. T. & Green, J. B. & van Voorst, R. E. & Marcus, J. & Senior, D. 1995. *The Death of Jesus in Early Christianity*. Peabody: Hendrickson Publishers.
- Carson, D. A. (1980) 1988. *The Farewell Discourse and Final Prayer of Jesus: An Exposition of John 14-17*. Grand Rapids: Baker Book House.
1991. *The Gospel according to John*. Grand Rapids: Eerdmans.
- Cassidy, R. J. 1992. *John's Gospel in New Perspective: Christology and the Realities of Roman Power*. New York: Orbis Books
- Charlesworth, J. H. 1968/69. A Critical Comparison of the Dualism in 1Qs III, 13-IV, 26 and the 'Dualism' contained in the Fourth Gospel. *NTS* 15. 389-418.
- Chilton, B. D. 2000. Judaism and the New Testament in *Dictionary of New Testament Background*, ed. Evans, C. A. & Porter, S. E.

Leicester: Inter Varsity Press. 603-616.

Cohen, S. J. D. 1987. *From the Maccabees to the Mishnah*. Philadelphia: The Westminster Press.

Collins, C. J. 1997. rdh *NIDOTTE* Vol. 1, 1013-1015.

1997. d/h *NIDOTTE* Vol. 2, 1016-1017.

1997. dbk *NIDOTTE* Vol. 2, 577-587.

1997. raP *NIDOTT* Vol. 3, 572-574.

Collins, M. S. 1995. The Question of Doxa: A Socioliterary Reading of the Wedding at Cana. *BTB* 25. 100-109.

Collins, R. F. 1990. *These Things Have Been Written: Studies on the Fourth Gospel*. Louvain: Peeters Press.

Conzelmann, H. 1975. φῶς *TDNT* Vol. 9, 310-358.

Cook, W. R. 1984. The "Glory" Motif in the Johannine Corpus. *JETS* 27/3. 291-297.

Cooper, K. T. 1979. The Best Wine: John 2:1-11. *WTJ* 41. 364-380.

Counet, P. C. 2000. *John, A Postmodern Gospel: Introduction to Deconstructive Exegesis Applied to the Fourth Gospel*. Leiden: Brill.

Cullmann, O. 1953. *Early Christian Worship*. Philadelphia: Westminster.

(1975) 1976. *The Johannine Circle*. Eng. Trans. Bowden, J.

London: SCM Press LTD.

1995. *Prayer in the New Testament: With Answers from the New Testament to Today's Questions*. Eng. Trans. Bowden, J. London: SCM Press Ltd.

Culpepper, R. A. 1975. *The Johannine School: An Evaluation of the Johannine School Hypothesis based on an Investigation of the Nature of Ancient Schools*. Missoula: Scholars Press.

1983. *Anatomy of the Fourth Gospel*. Philadelphia: Fortress.

1998. *The Gospel and Letters of John*. Nashville: Abingdon Press.

1999. The Christology of the Johannine Writings in *Who Do You Say that I am?* Ed. Powell, M. A. & Bauer, D. R. Louisville: Westminster John Knox Press.

Dauer, A. 1972. *Die Passionsgeschichte im Johannesevangelium: Eine traditionsgeschichtliche und theologische Untersuchung zu Joh 18, 1–19, 30*. Munich: Kösel.

Decreus, F. 1974/1975. *Doxa-Kabod: Schematische Transposite of struktuurgelijkheid?* Sacris Erudiri: Jarrboek voor Godsdienstwetenschappen 22. 117-185.

Delitzsch, F. 1952. *Biblical Commentary on the Psalms*. Eng. Trans. Bolton, F. Grand Rapids: Eerdmans.

- deSilva, D. A. 1999. *The Hope of Glory: Honor Discourse and New Testament Interpretation*. Minnesota: The Liturgical Press.
2000. Honor and Shame in *Dictionary of New Testament Background*, ed. Evans, C. A. & Porter, S. E. Leicester: Inter Varsity Press. 518-522.
- De Waard, J. & Nida, E. A. 1986. *From One Language to Another: Functional Equivalence in Bible Translating*. Nashville: Thomas Nelson.
- Dillon, J. M. 2000. Philosophy in *Dictionary of New Testament Background*. Ed. Evans, C. A. & Porter, S. E. Leicester: Inter Varsity Press. 793-796.
- Dodd, C. H. (1953) 1998. *The Interpretation of the Fourth Gospel*. Cambridge: Cambridge University Press.
1963. *Historical Tradition in the Fourth Gospel*. Cambridge: Cambridge University Press.
- Dohmen, C. 1995. dbk *TDOT* Vol. 7, 13-17.
- Dupre, L. 1986. Mysticism in *The Encyclopedia of Religion*. Ed. Eliade, M. Vol. 10. New York: Macmillan Publishing Company.
- Du Rand, J. A. 1997. *Johannine Perspectives: Introduction to the Johannine Writings*. Orion: Johannesburg.
- Du Toit, A. B. (1968) 1971. "The incarnation word: a study of John 1:14" in *The*

Christ of John: Essays on the Christology of the Fourth Gospel. *Neotestamentica* 2. 9-21.

Ellis, P. F. 1984. *The Genius of John: A Composition-Critical Commentary on the Fourth Gospel*. Collegeville, Minn.: Liturgical Press.

Eusebius (1926) 1992. *The Ecclesiastical History*. Vol 1. Eng. Trans. Lake, K. London: Havard University Press.

Evans, C. A. 1997. Judaism, Post-A.D. 70 in *Dictionary of the Later New Testament & Its Developments*. Ed. Martin, R. P. & Davids, P. H. Leicester: Inter Varsity Press. 605-611.

Feldman, L. H. 1992. Josephus (person) in *The Anchor Bible Dictionary*. Ed. Freedman, D. N. New York: Doubleday. 981-998.

2000. Josephus: Interpretive Methods and Tendencies in *Dictionary of New Testament Background*. Ed. Evans, C. A. & Porter, S. E. Leicester: Inter Varsity Press. 590-596.

Ferguson, E. (1987) 1993. *Backgrounds of Early Christianity*. Grand Rapids: Eerdmans.

Ferreira, J. 1998. *Johannine Ecclesiology*. Sheffield: Sheffield Academic Press.

Forster, A. H. 1929. The Meaning of $\Delta\acute{o}\xi\alpha$ in the Greek Bible. *ATR* 12. 311-316.

Fortna, R. T. 1974. Theological Use of Locale in the Fourth Gospel, in *Gospel Studies in Honor of Sherman Elbridge Johnson*. Ed. by Massey H. S. and Edward C. H. *ATRS* 3. 58-95.

1988. *The Fourth Gospel and Its Predecessor: From Narrative Source to Present Gospel*. Philadelphia: Fortress Press.
- Friberg, T. & Friberg, B. & Miller, N. 2000. *Analytical lexicon of the Greek New Testament*. Grand Rapids: Baker Books.
- Friesen, I. I. 1971. *The Glory of the Ministry of Jesus Christ*. Basel: Friedrich Reinhardt Kommissionsverlag.
- Gaventa, B. R. 1996. The Archive of Excess: John 21 and the Problem of Narrative Closure in *Exploring the Gospel of John*. Ed. Culpepper, R. A. & Black, C. C. Louisville: Westminster John Knox Press.
- Ginsburger, M. (ed) 1903. *Pseudo-Jonathan (Thargum Jonathan ben Uziel zum Pentateuch)*. Berlin: S. Calvary & Co.
- Godet, F. 1912. *Commentary on the Gospel of St. John*. Vols. 3. Trans. Cusin, M. D. Edinburgh: T & T Clark.
- Gordon, M. R. 1975. Glory in *ZPEB* Vol. 2, 730-735.
- Grant, F. C. 1957. *The Gospels: Their origin and growth*. London: Faber and Faber.
- Grant, R. M. 1997. *Irenaeus of Lyons*. London: Routledge.
- Guilding, A. 1960. *The Fourth Gospel and Jewish Worship*. Oxford: Clarendon Press.

- Haenchen, E. (1980) 1984. *A Commentary on the Gospel of John*. En. Trans.
Funk, R. W. Ed. Funk, R. W. & Busse, U. 2 vols.
Philadelphia: Fortress.
- Hamilton, V. P. 1980. הָרַר TWOT Vol. 1, 207-208.
- הוּר TWOT Vol. 1, 209.
- Hanson, A. 1976/1977. John 1:14-18 and Exodus XXXIV. NTS 23. 90-101.
- Harner, P. B. 1970. *The "I Am" of the Fourth Gospel: A Study in Johannine Usage and Thought*. Philadelphia: Fortress Press.
- Harris, E. 1994. *Prologue and Gospel: The Theology of the Fourth Evangelist*.
Sheffield: Sheffield Academic Press.
- Harrison, E. F. 1982. Glory in ISBE Vol. 2, 477- 483.
- Harrison, R. K. 1982. Glory in ISBE Vol. 2, 478.
- Hartley, J. E. 1980. רָגַר TWOT Vol. 1, 398-399.
- Hatch, E. & Redpath, H. A. 1975. *A Concordance to the Septuagint and the other Greek Versions of the Old Testament (Including the Apocryphal Books)*. Vols. II.
Graz: Akademische Druck- u.
Verlagsanstalt.
- Hausmann, J. 2001. רַאֵר TDOT Vol. 11, 464-467.
- Hegermann, H. 1994. δόξα EDNT Vol. 1, 344-348.

Hendriksen, W. (1954) 1969. *The Gospel of John*. London: The Banner of Truth Trust.

Hill, D. 1967. The Request of Zebedee's sons and the Johannine DOXA Theme. *NTS* 13. 281-285.

1967a. *Greek Words and Hebrew Meanings: Studies in the Semantics of Soteriological Terms*. Cambridge: Cambridge University Press.

Hinnells, J. R. (1984) 1995. *A New Dictionary of Religions*. Oxford: Blackwell Publishers Ltd. 190.

Hofius, O. (1971) 1986. σημείον *NIDNTT* Vol. 2, 626-627.

Hooker, M. D. 1969/1970. John the Baptist and the Johannine Prologue. *NTS* 16. 354-358.

1974. The Johannine Prologue and the Messianic Secret. *NTS* 21. 40-58.

1994. *Not Ashamed of the Gospel: New Testament Interpretations of the Death of Christ*. Grand Rapids: Eerdmans.

Hoskyns, E. C. 1947. *The Fourth Gospel*. Ed. Davey, F. N. London: Faber & Faber Limited.

Howard, W. F. 1943. *Christianity according to St. John*. London: Duckworth.

Howard-Brook, W. 1994. *Becoming Children of God: John's Gospel and Radical Discipleship*. New York: Orbis Books.

Howton, D. J. 1963/64. 'Son of God' in the Fourth Gospel. *NTS* 10,227-237.

Hughes, A. 1933. *The Glory of the God-Head in the Gospel of John*. Philadelphia: The Mutual Press.

Jeremias, J. 1966. *The Eucharistic Words of Jesus*. En. Trans. Norman Perrin. Philadelphia: Fortress.

Johnson, S. L. Jr. 1993. The Eleventh Commandment. *EmJ*. Vol 2:1. 45-53.

Jonggil, B. 1992. *The Holy Spirit was not yet*. Kampen: Uitgeversmaatschappij.

Joong-Suk, S. 1995. *The Glory in the Gospel of John: Restoration of Forfeited Prestige*. Oxford: M. P. Publications.

Käsemann, E. 1968. *The Testament of Jesus: A Study of the Gospel of John according to John 17*. Eng. Trans. Krodel, G. Philadelphia: Fortress Press.

Kee, H. C. 1977. *Community of the New Age: Studies in Mark's Gospel*. Philadelphia: The Westminster Press.

Keener, C. S. 1993. *The IVP Bible Background Commentary: New Testament*. Illinois: Intervarsity Press.

2003. *The Gospel of John*. Peabody: Hendrickson Publishers.

Kistemaker, S. J. 2004. *The Conversations of Jesus: Learning from His*

Encounters. Grand Rapids: Baker Books.

Kittel, H. 1934. Die Herrlichkeit Gottes, Studien zu Geschichte und Wesen eines.
BZNW 16.

Kittel, G. 1938. Lexicographia Sacra: Two Lectures on the Making of the
Theologisches Wörterbuch zum Neuen Testament.
“Theology” *Occasional Papers* 7. London: SPCK.

(1964) 1974. δόξα *TDNT* Vol. 2, 232-237, 242-255.

Kitzberger, I. R. 1995. Mary of Bethany and Mary of Magdala – two female
characters in the Johannine passion narrative. *NTS* 41.
564-586.

Koester, C. R. 1995. *Symbolism in the Fourth Gospel: Meaning, Mystery,
Community*. Minneapolis: Fortress Press.

Köstenberger, A. J. 1999. *Encountering John: The Gospel in Historical, Literary,
and Theological Perspective*. Grand Rapids: Baker
Books.

Kümmel, W. G. 1975. *Introduction to the New Testament*. En. Trans. Kee, H. C.
London: SCM Press Ltd.

1980. *The Theology of the New Testament*. En. Trans. Stealy J.
E. London: SCM Press Ltd.

Kysar, R. (1976) 1993. *John The Maverick Gospel*. Louisville: Westminster
John Knox Press.

1983. The Gospel of John in Current Research. *RSR* 9. 314-323.

1984. *John's story of Jesus*. Philadelphia: Fortress Press.

1986. *John*. Mannesota: Augsburg Publishing House.

Laansma, J. 2000. Mysticism in *Dictionary of New Testament Background*. Ed. Evans, C. A. & Porter, S. E. Leicester: Inter Varsity Press. 725-737.

Ladd, G. E. 1974. *A Theology of the New Testament*. Revised edition by Hagner, D. A. With new material by Wenham, D. & France, R. T. Cambridge: The Lutterworth Press.

Lee, D. 2002. *Flesh and Glory: Symbolism, Gender and Theology in the Gospel of John*. New York: The Crossroad Publishing Company.

Liddell, H. G. & Scott, R. (1843) 1996. *Greek-English Lexicon with a revised supplement*. Oxford: Clarendon Press.

Lightfoot, R. H. 1956. *St. John's Gospel: A Commentary*. Ed. By Evans, C. F. London: The Clarendon Press

Lindars, B. (1972) 1982. *The Gospel of John*. London: Marshall, Morgan & Scott Publ. Ltd.

1977. The Passion in the Fourth Gospel in *God's Christ and His People*. Ed. Jervell, J. & Meeks, W. A. Oslo: Universitetsforlaget.

- Lloyd, R. B. 1932. The Word 'Glory' in the Fourth Gospel. *ET* 43. 546-548.
- Loader, W. R. G. 1989. *The Christology of the Fourth Gospel: Structure and Issues*. New York: Verlag Peter Lang.
- Louw, J. P. 1982. *Semantics of New Testament Greek*. Semeia Studies. Atlanta: Scholars Press.
- Louw, J. P. & Nida, E. A. (1989) 1993. *Greek-English Lexicon of the New Testament based on Semantic Domains*. Vols. 2, Cape Town: Bible Society of South Africa.
- Macgregor, G. H. C. 1928. *The Gospel of John*. London: Hodder and Stoughton.
- Malina, B. J. & Rohrbaugh, R. L. 1998. *Social-Science Commentary on the Gospel of John*. Minneapolis: Fortress Press.
- Mansoor, M. 1961. *The Thanksgiving Hymns*. Leiden: E. J. Brill.
- Marrow, S. B. 1995. *The Gospel of John: A Reading*. New York: Paulist Press.
- Marsh, J. (1968) 1991. *Saint John*. London: Penguin Books.
- Marshall, J. T. 1902. Shekinah in *A Dictionary of the Bible dealing with its Language, Literature, and Contents including the Biblical Theology*. Ed. Hastings, J. Edinburgh: T & T Clark. 487-489.

Martin-Achard, R. 1973. *Glory in Vocabulary of the Bible*. Ed. von Allmen J. J.;
Eng. Trans. Ed. Hilda M. Wilson, London: The Trinity
Press. 137-139.

Martyn, J. L. (1968) 2003. *History and Theology in the Fourth Gospel*. 3rd ed.
Louisville: Westminster John Knox Press.

1978. *The Gospel of John in Christian History: Essays for
Interpreters*. New York: Paulist Press.

Masanobu, E. 2002. *Creation and Christology: A Study on the Johannine
Prologue in the Light of Early Jewish Creation Accounts*.
Tübingen: Mohr Siebeck.

Mason, S. 2000. Josephus: Value for New Testament Study in *Dictionary of
New Testament Background*. Ed. Evans, C. A. & Porter, S. E.
Leicester: Inter Varsity Press. 596-600.

Mattill, A. J. 1977. Johannine Communities behind the Fourth Gospel: Georg
Richter's Analysis. *TS* 38. 294-315.

McGinn, B. 1991. *The Foundations of Mysticism*. New York: Crossroad.

Meeks, W. A. 1967. *The Prophet-King: Moses Traditions and the Johannine
Christology*. Leiden: Brill.

1972. The Man From Heaven In Johannine Sectarianism. *JBL*
91. 44-72.

Menken, M. J. J. 1985. Numerical Literary Techniques in John: The Fourth

Evangelist's Use of Number of Words and Syllables.

NovTSup 55. Leiden: Brill.

Mensch, J. R. 1992. *The Beginning of the Gospel According to Saint John: Philosophical Reflections*. New York: Peter Lang.

Meyer, P. W. 1996. "The Father": The Presentation of God in the Fourth Gospel in *Exploring the Gospel of John: In Honor of D. Moody Smith*. Ed. Culpepper, R. A. & Black, C. C. Louisville: Westminster/John Knox. 255-273.

Michaels, J. R. 1975. The Johannine Words of Jesus and Christian Prophecy. *SBLSP*, 233-264.

Mlakuzhyil, G. 1987. *The Christocentric Literary Structure of the Fourth Gospel*. Roma: Editrice Pontificio Istituto Biblico.

Molin, G. 1970. Glory in *Encyclopedia of Biblical Theology*. Ed. Bauer J. B. London: Sheed and Ward. 295-298.

Moloney, F. J. 1978. *The Johannine Son of Man*. 2nd ed. Biblioteca di Scienze Religiose 14. Rome: LAS.

1993. *Belief in the Word: Reading the Fourth Gospel, John 1-4*. Minneapolis: Fortress Press.

1996. *Signs and Shadows: Reading John 5-12*. Minneapolis: Fortress Press.

1998. *Glory Not Dishonor: Reading John 13-21*. Minneapolis:

Fortress Press.

1998a. *The Gospel of John*. Minnesota: The Liturgical Press.

Morris, L. (1965) 1967. *The Cross in The New Testament*. Exeter: The Paternoster Press.

1969. *Studies in the Fourth Gospel*. Grand Rapids: Eerdmans.

1989. *Jesus is the Christ: Studies in the Theology of John*. Leicester: Inter-Varsity Press.

1995. *The Gospel according to John*. Grand Rapids: Eerdmans.

(1986) 2000. *Reflections on the Gospels of John*. Peabody: Hendrickson Publishers.

Moxnes, H. 1996. Honour and Shame in *The Social Sciences and New Testament Interpretation*. Ed. Rohrbaugh, R. Peabody: Hendrickson Publishers.

Navone, J. J. 1968. "Glory" in Pauline and Johannine Thought. *Worship* 42. 48-52.

Newman, B. M. & Nida, E. A. 1980. *A Translator's Handbook on the Gospel of John*. London: United Bible Societies.

Newman, C. C. 1992. *Paul's Glory-Christology: Tradition and Rhetoric*. Leiden: E.J. Brill.

1998. Resurrection as Glory in *The Resurrection*. Ed. Davis, S.

& Kendall, D. & O'Collins, G. Oxford: Oxford University Press.

Neyrey, J. H. 1988. *An Ideology of Revolt*. Philadelphia: Fortress Press.

1995. The Foot Washing in John 13:6-11; Transformation Ritual or Ceremony? in *The Social World of the First Christians*. Essays in Honor of Wayne A. Meeks. Eds. White, L. M. & Yarbrough, O. L. Minneapolis: Fortress. 198-213.

1998. *Honor and Shame in the Gospel of Matthew*. Louisville: Westminster John Knox Press.

1999. 'Despising the Shame of the Cross:' Honour and Shame in the Johannine Passion Narrative in *Social-Scientific Approaches to New Testament Interpretation*. Edinburgh: T & T Clark Ltd.

Nicol, W. 1972. *The Semeia in the Fourth Gospel: Tradition and Redaction*. Leiden: Brill.

Nida, E. A. & Louw, J. P. 1992. *Lexical Semantics of the Greek New Testament: A Supplement to the Greek-English Lexicon of the New Testament Based on Semantic Domains*. Atlanta: Scholars Press.

Nielsen, H. K. 1999. John's Understanding of the Death of Jesus in *New Reading in John*. Ed. Nissen, J. & Pedersen, S. Sheffield: Sheffield Academic Press. 232-254.

- Nixon, R. E. 1974. Glory in *The New Bible Dictionary*, ed. Douglas, J. D. London: Inter-Varsity Press. 472-473.
- O'Day, G. R. 1987. *The Word Disclosed: John's Story and Narrative Preaching*. St. Louis: CBP Press.
- Olsson, B. 1974. *Structure and Meaning in the Fourth Gospel: A Text Linguistic Analysis of John 2:1-11 and 4:1-42*. Trans. by Gray, J. Sweden: CWK Gleerup Lund.
- Oswalt, J. N. 1980. dbk *TWOT* Vol. 1, 426-428.
- Painter, J. 1975. *John: Witness & Theologian*. London: SPCK.
- (1991) 1993. *The Quest for the Messiah: The History, Literature and Theology of the Johannine Community*. Edinburgh: T & T Clark Ltd.
- Pamment, M. 1983. The meaning of δόξα in the Fourth Gospel. *ZNW* 74. 12-16.
- Panackel, C. 1988. *ΙΔΟΥ Ο ΑΝΘΡΩΠΙΟΣ: An Exegetico-Theological Study of the Text in the Light of the Use of the Term ΑΝΘΡΩΠΙΟΣ Designating Jesus in the Fourth Gospel*. Roma: Editrice Pontificia Universita Gregoriana.
- Pancaro, S. 1975. *The Law in the Fourth Gospel: The Torah and the Gospel Moses and Jesus, Judaism and Christianity according to John*. Leiden: Brill.
- Patterson, S. J. 1998. *The God of Jesus: The Historical Jesus & the Search for*

Meaning. Harrisburg: Trinity Press International.

Pfitzner, V. C. 1976. The Coronation of the King – Passion Narrative and Passion Theology in the Gospel of St John. *LTJ* 10. 1-12.

Philo, J. (1993) 2002. *The Works of Philo*. Trans. Yonge, C. D. Peabody: Hendrickson Publishers.

Plummer, A. 1891. *The Gospel according to St. John, with Maps, Notes and Introduction*. Cambridge: Cambridge University Press

Price, S. R. F. 1984. *Rituals and power: The Roman imperial cult in Asia Minor*. Cambridge: Cambridge University Press

Pryor, J. W. 1991. The Johannine Son of Man And The Descent-Ascent Motif. *JETS* 34:3. 341-351.

1992. *John Evangelist of the Covenant People: The Narrative and Themes of the Fourth Gospel*. London: Darton, Longman and Todd.

Rahner, K. 1975. *Encyclopedia of Theology: A Concise Sacramentum Mundi*. London: Burns & Oates.

Rahner, K. & Thüsing, W. 1980. *A New Christology*. En. Trans. Smith, D. & Green, V. New York: A Crossroad Book.

Ramn, B. 1963. *Them He Glorified: A Systematic Study of the Doctrine of Glorification*. Grand Rapids: Eerdmans.

- Ramsey, A. M. 1949. *The Glory of God and the Transfiguration of Christ*.
London: Longmans, Green and Co. Ltd.
- Raney, W. H. 1933. *The Relation of the Fourth Gospel to the Christian Cultus*.
Giessen: Alfred Töpelmann.
- Reinhartz, A. 1998. The Johannine Community and its Jewish Neighbors: A
Reappraisal in *What is John?* Ed. Segovia, F. F. Vol. 2:
Literary and Social Reading of the Fourth Gospel, Atlanta:
Scholars Press. 111-138.
- Rengstorf, K. H. (1964) 1974. σημείον *TDNT* Vol. 7, 200-269.
- Richard, E. 1988. *Jesus: One and Many: The Christological Concept of New
Testament Authors*. Wilmington: Michael Glazier.
- Richardson, A. (1958) 1961. *An Introduction to the Theology of the New
Testament*. London: SCM Press LTD.
- Ridderbos, H. 1966. The Structure and Scope of the Prologue to the Gospel of
John. *NovT* 8. 180-201.
- (1987) 1997. *The Gospel according to John: A Theological
Commentary*. Trans. by John Vriend. Grand
Rapids: Eerdmans.
- Ringgren, H. 1992. Mysticism in *The Anchor Bible Dictionary*. Vol 4. Ed.
Freedman, D. N. New York: Doubleday. 945-946.
- Robertson, P. E. 1988. Glory in the Fourth Gospel. *ThE* 38. 121-131.

- Robinson, J. A. T. 1960. The Destination and Purpose of St. John's Gospel. *NTS* 6. 117-131.
1985. *The Priority of John*. Ed. Coakley, J. F. London: Meyer Stone Books.
- Schnackenburg, R. (1968) 1984. *The Gospel according to St John*. Vols 3. Eng. Trans. Smyth, K. Kent: Burns & Oates.
1995. *Jesus in the Gospels: A Biblical Christology*. Eng. Trans. by Dean, O. C. Louisville: Westminster John Knox Press.
- Schneider, J. 1932. *Doxa: Eine bedeutungsgeschichtliche Studie*. *NTF* 3. Gütersloh: C. Bertelsmann.
- Schnelle, U. 1992. *Antidocetic Christology in the Gospel of John: An Interinvestigation of the Place of the Fourth Gospel in the Johannine School*. Eng. Trans. Maloney, L. M. Minneapolis: Fortress.
- Scott, C. A. A. (1927) 1966. *Christianity According to St. Paul*. Cambridge: Cambridge University Press.
- Scott, E. F. (1908) 1943. *The Fourth Gospel: Its Purpose and Theology*. Edinburgh: T & T Clark.
- Scott, J. J. 1992. Josephus in *Dictionary of Jesus and the Gospels*. Ed. Green, J. B. & McKnight, S & Marshall, I. H. Leicester: Inter Varsity

Press. 391-394.

Senior, D. 1991. *The Passion of Jesus in the Gospel of John*. Collegeville: The Liturgical Press.

Silva, M. 1983. *Biblical Words & their Meaning: An Introduction to Lexical Semantics*. Grand Rapids: Academie Book.

Simmons, B. E. 1988. A Christology of the "I Am" Sayings in the Gospel of John. *ThE* 38. 94-103.

Smalley, S. S. 1973/1974. The Sign in John XXI. *NTS* 20. 275-288.

1978. *John: Evangelist and Interpreter*. Exeter: The Paternoster Press.

Smith, D. M. 1976. *John*. Philadelphia: Fortress.

(1995) 1997. *The Theology of the Gospel of John*. Cambridge: Cambridge University Press.

Soderlund, S. K. 1988. Septuagint in *ISBE*. Vol. 4. 400-409.

Staley, J. L. 1988. *The Print's First Kiss: A Rhetorical Investigation of the Implied Reader in the Fourth Gospel*. Atlanta: Scholars Press.

Stauffer, E. (1964) 1974. γάμος *TDNT* Vol. 1, 648-657.

Stendahl, K. 1968. *The School of St. Matthew: and its use of the Old Testament*. Lund, Gleerup.

Stenmans, P. 1995. dbk *TDOT* Vol. 7, 22.

Sterling, G. E. 2000. Philo in *Dictionary of New Testament Background*. Ed. Evans, C. A. & Porter, S. E. Leicester: Inter Varsity Press. 789-793.

Stibbe, M. W. G. 1993. *John*. Sheffield: Sheffield Academic Press.

Strachan, R. H. 1941. *The Fourth Gospel: Its Significance and Environment*. 3rd ed. London: SCM Press.

Suggit, J. N. 1985. John 13:1-30: The mystery of the incarnation and of the eucharist in *Neotestamentica* 19. Pretoria: NTSSA.

1987. John 2:1-11: The sign of great things to come in *Neotestamentica* 21. Pretoria: NTSSA

Sullivan, R. 1988. Jesus' Suffering, Death, and Resurrection in the Fourth Gospel. *ThE* 38. 145-153.

Tannehill, R. C. 1967. *Dying and Rising with Christ: A Study in Pauline Theology*. Berlin: Töpelmann.

Taylor, V. 1945. *The Gospels*. London: The Epworth Press.

Teeple, H. M. 1962. Methodology in source analysis of the Fourth Gospel. *JBL* 81. 279-286.

Tenney, M. C. 1965. *New Testament Times*. London: Inter-Varsity Fellowship.

1981. The Gospel of John in *The Expositor's Bible Commentary*

9, ed. Gaebelein, F. E. Grand Rapids: Zondervan Publishing House.

Thayer, J. H. (1901) 1914. *Greek-English Lexicon of the New Testament: being Grimm's and Wilke's Clavis Novi Testamenti*. Trans. Revised, and Enlarged by Joseph Henry Thayer. Edinburgh: T & T Clark.

Theissen, G. 2003. *The New Testament*. Eng. Trans. Bowden, J. London: T & T Clark A Continuum imprint.

Thom, J. C. 2000. Stoicism in *Dictionary of New Testament Background*. Ed. Evans, C. A. & Porter, S. E. Leicester: Inter Varsity Press. 1139-1142.

Thompson, M. M. 1992. John, Gospel of in *Dictionary of Jesus and the Gospels*. Ed. Green, J. B. & McKnight, S & Marshall, I. H. Leicester: Inter Varsity Press. 368-383.

2001. *The God of the Gospel of John*. Grand Rapids: Eerdmans.

Thüsing, W. 1960. *Die Erhöhung und Verherrlichung Jesu im Johannesevangelium*. Munster Westfalen: Aschendorffsche Verlagsbuchhandlung.

Turner, G. A. & Mantey, J. R. 1964. *The Gospel of John: An Evangelical Commentary*. Grand Rapids: Eerdmans.

- Van Belle, G. 1994. *The Signs Source in the Fourth Gospel: Historical Survey and Critical Evaluation of the SEMEIA Hypothesis*. Belgium: Leuven University Press.
- Van der Watt, J. G. (1986) 1995. The Composition of the Prologue of John's Gospel: The Historical Jesus Introducing Divine Grace. *WTJ* 57:2. 311-331.
2000. *Family of the King: Dynamics of Metaphor in the Gospel according to John*. Leiden: Brill.
2002. Verheerliking en die kruis? Die Johnniese herinterpretasie van die kruis as δόξα in *Ned Geref Theologiese Tydskrif* 43. 606-615.
2005. Double Entendre in the Gospel according to John in *Theology and Christology in the Fourth Gospel*. Ed. van Belle, G. & van der Watt, J. G. & Maritz, P. Leuven: Leuven University Press.
- Vermes, G. (1962) 1997. *The Complete Dead Sea Scrolls in English*. Middlesex: Penguin Books Ltd.
- Vermeulen, A. J. 1956. *The Semantic Development of Glory in Early-Christian Latin*. *Latinias Christianorum Primaeva*. Utrecht: Dekker & van de Vegt.
- Vine, W. E. (1940) 1956. *An Expository Diction of New Testament Words*. London: Oliphants LTD.

- Von Rad, G. (1964) 1974. *dwbk TDNT* Vol. 2, 238-242.
- Von Speyr, A. 1987. *The Farewell Discourses: Meditations on John 13-17*. En.
Trans. Nelson, E. A. San Francisco: Ignatius Press.
- Walker, W. O. Jr. 1982. The Lord's Prayer in Matthew and in John. *NTS* 28.
237-256.
- Wagner, S. 1990. *rqy TDOT* Vol. 6, 279-287.
- Warmuth, G. 1978. *rdh; TDOT* Vol. 3, 335-341.
1978. *d/h TDOT* Vol. 3, 352-356.
- Weinfeld, M. 1995. *dwbk TDOT* Vol. 7, 22-38.
- Westcott, B. F. 1890. *The Gospel according to St John: The Authorized Version with Introduction and Notes*. London: Murray.
- Williams, R. H. 1997. The mother of Jesus at Cana: A social-science interpretation of John 2:1-11. *CBQ* 59. 679-692.
- Windisch, H. 1926. *Johannes und die Synoptiker*. Leipzig: Heinrichs.
- Witherington, B. III. 1995. *John's Wisdom: A Commentary on the Fourth Gospel*.
Louisville: Westminster John Knox Press.
- Wong, C. H. S. 2005. *The Δόξα of Christ and his followers in the Fourth Gospel: An inquiry into the meaning and background of Δόξα in John 17:22*. University of Pretoria.
- Yamauchi, E. M. 1993. Gnosticism in *Dictionary of Paul and his Letters*. Ed.

Hawthorne, G. F. & Martin, R. P. & Reid, D. G.
Leicester: Interscience Press. 350-354.