

Roof Plan D- Discovery Haven

Scale 1:100

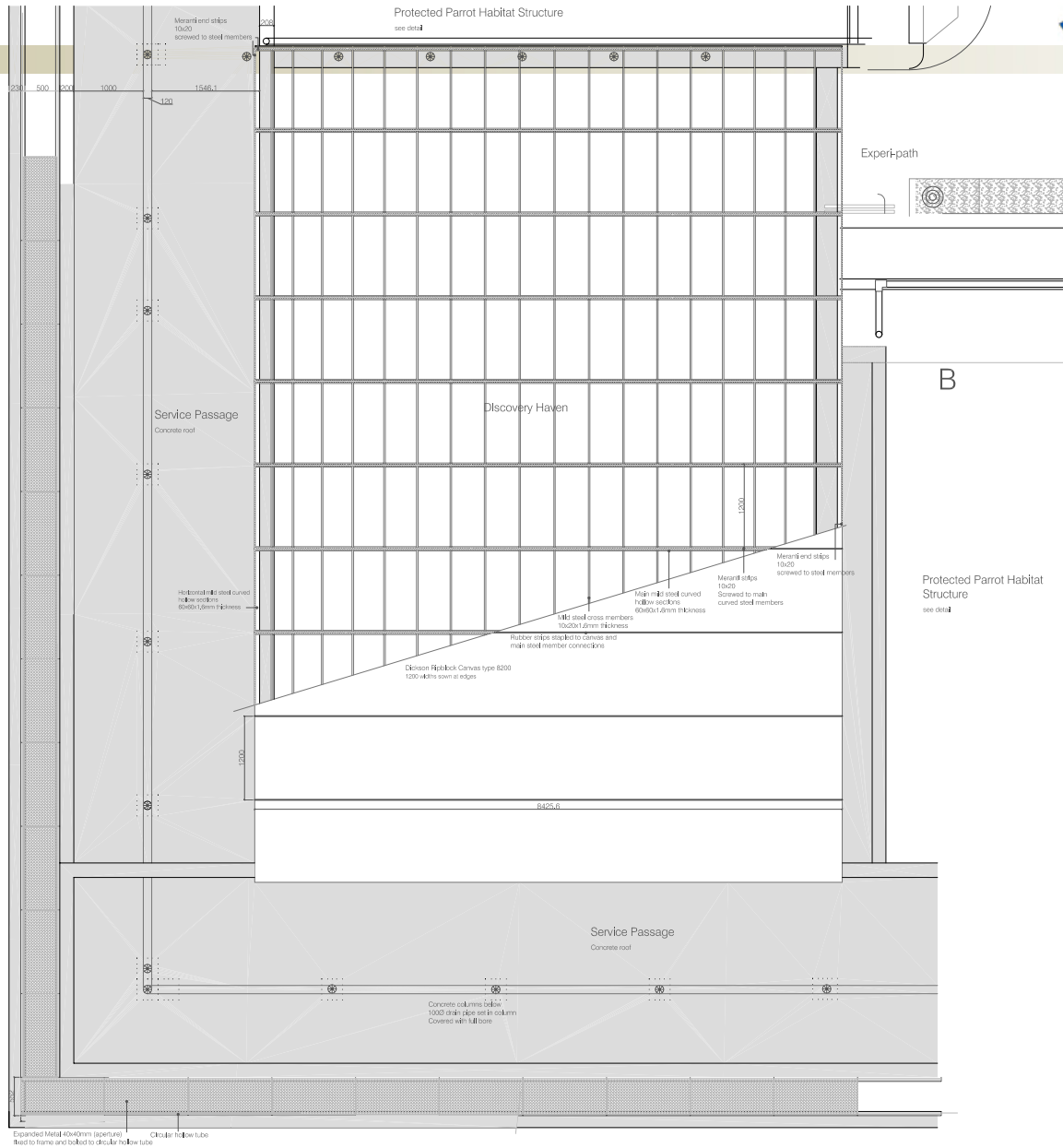
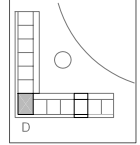

Roof Plan D- Discovery Haven

Scale 1:100

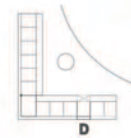
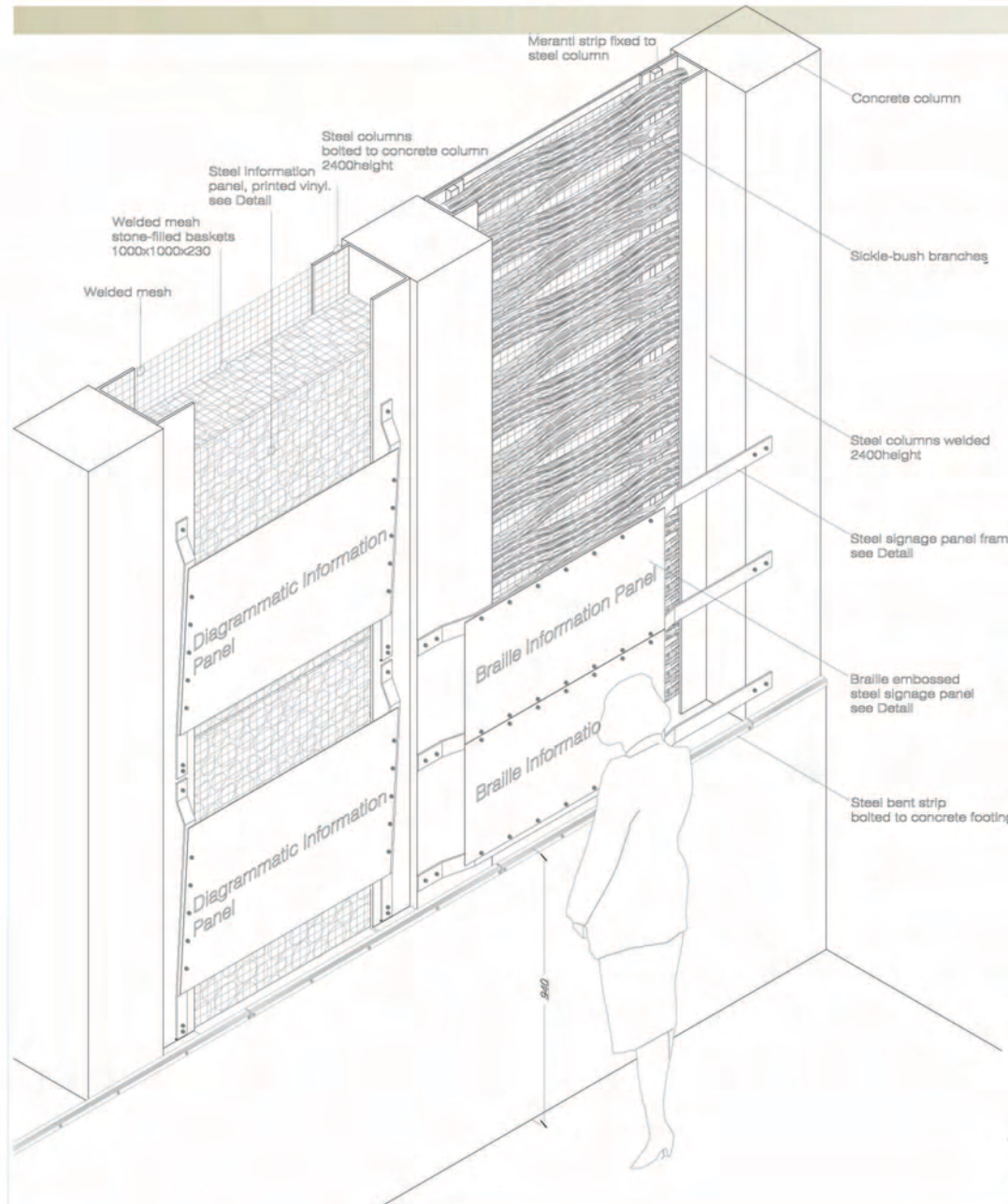

Isometric Detail D4 - Information Wall system
Scale 1:20

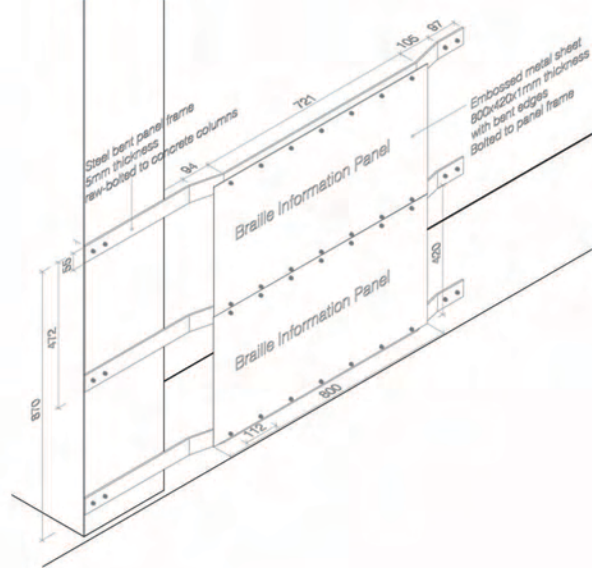

Isometric Detail D5 - Braille Information Panels
Scale 1:20

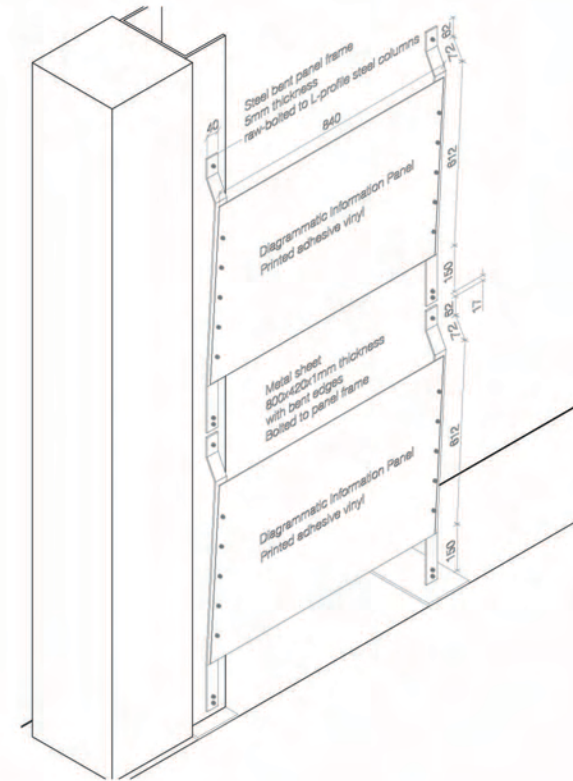

Detail Section D6 - Diagrammatic Information Panel
Scale 1:20

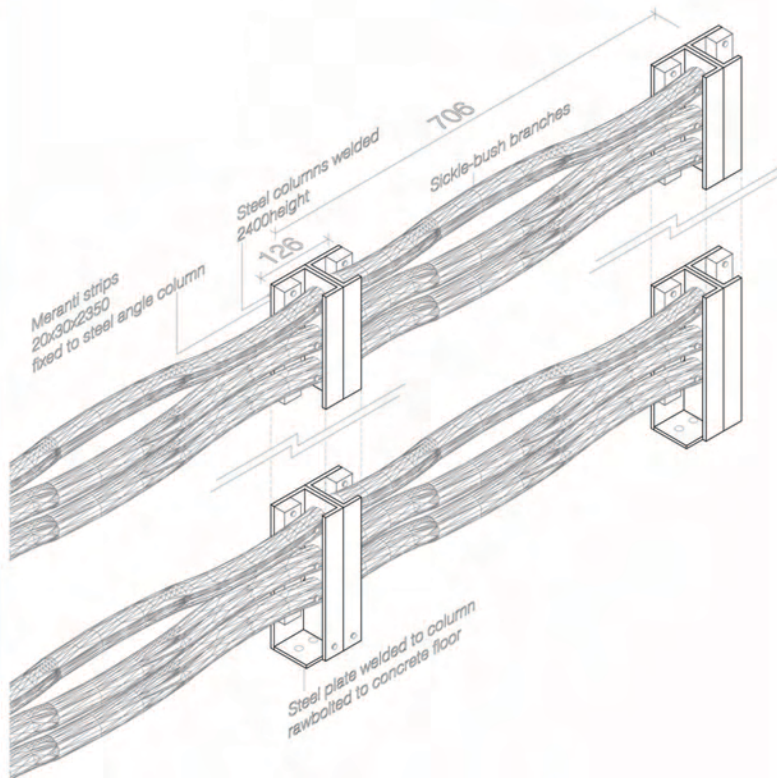

Isometric Detail D7 - Gum-pole Partition
Scale 1:10

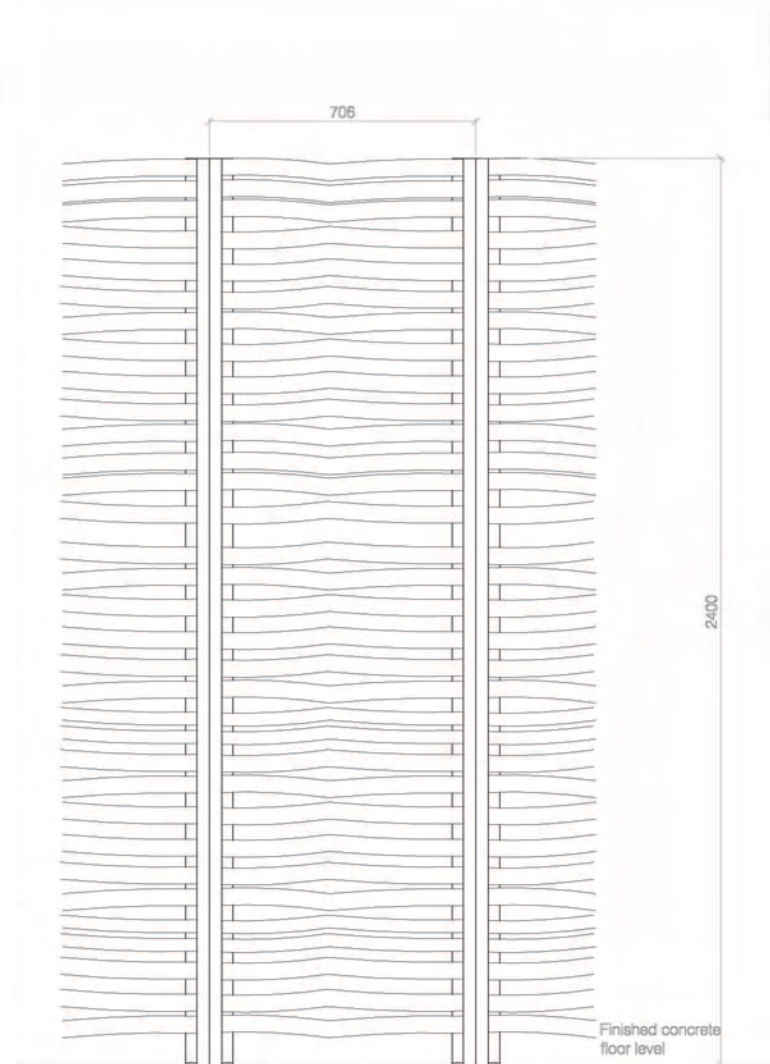

Detail Section D8 - Sickle-bush branch Partition
Scale 1:20

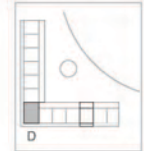
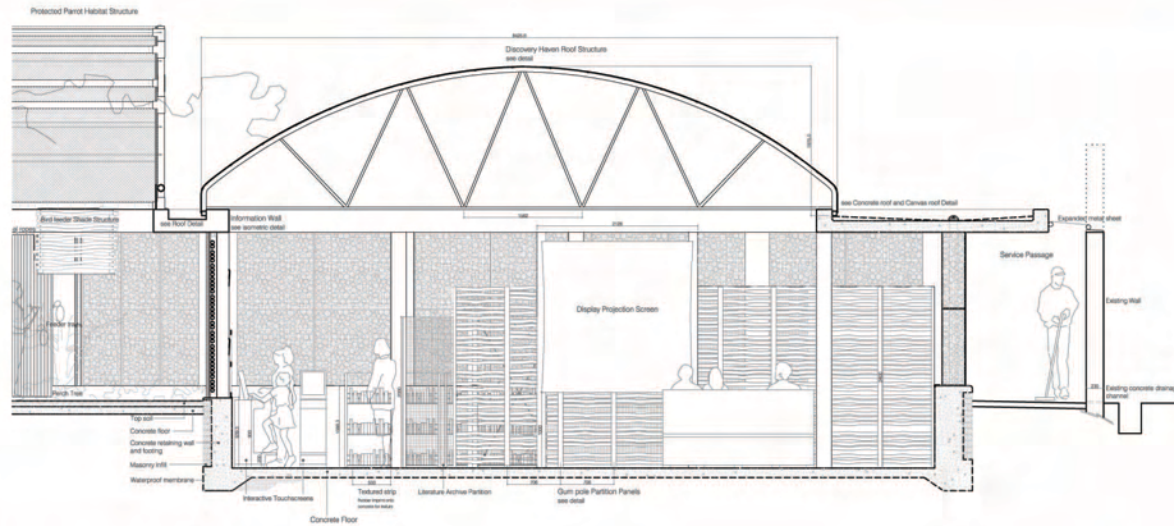

Section B-B
Discovery Haven Scale 1:100

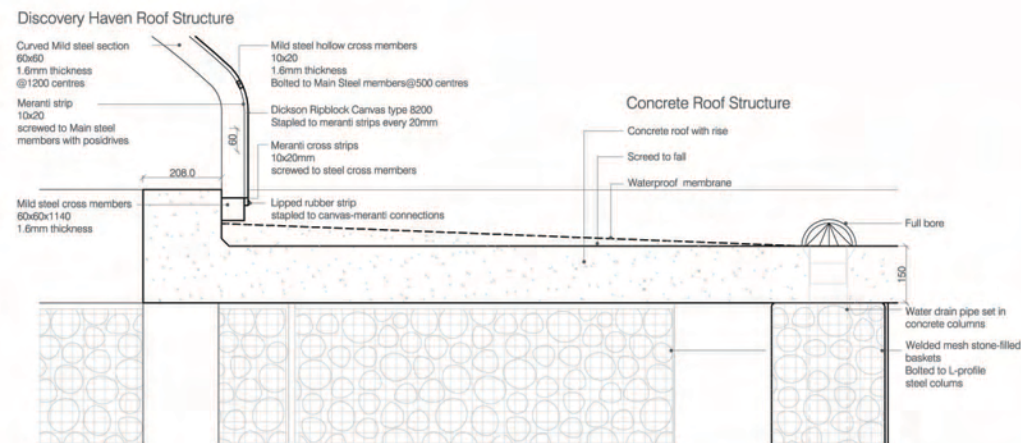

Concrete roof and Canvas roof Detail
Discovery Haven Scale 1:100

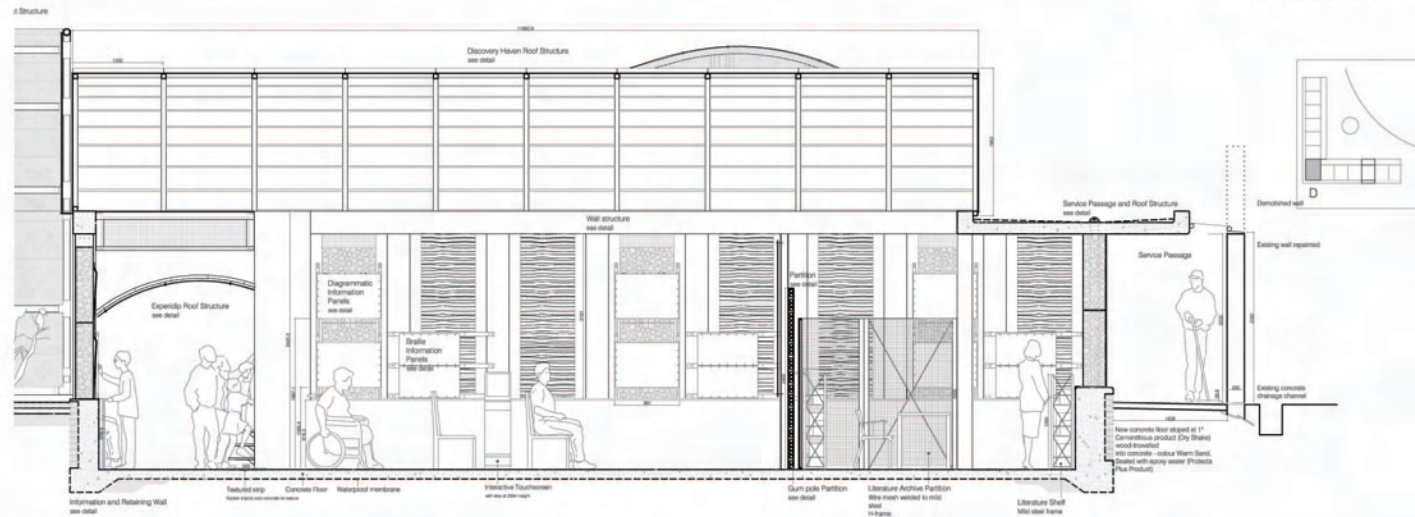

Protected Parrot
Habitat Structure

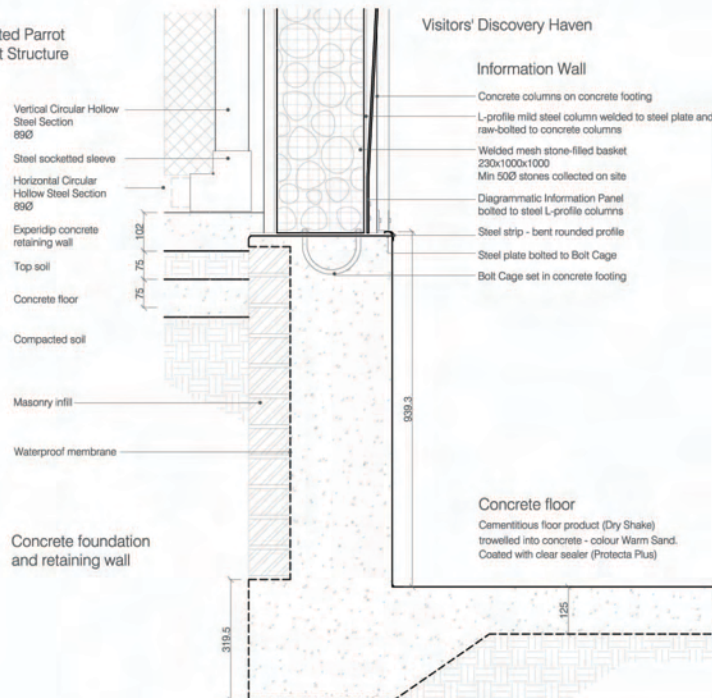

Section A-A
Discovery Haven Scale 1:100

Detail - Information and Retaining Wall
Scale 1:20