

**Learning difficulties involving volumes of solids
of revolution: A comparative study of
engineering students at two colleges of Further
Education and Training in South Africa**

by

Batseba Letty Kedibone

Mofolo-Mbokane

Submitted in partial fulfilment for the
Degree

Philosophiae Doctor

in the Department of Mathematics and Applied Mathematics
in the Faculty of Natural and Agricultural Sciences

University of Pretoria

Pretoria

September 2011

DECLARATION

I, the undersigned, declare that the thesis which I hereby submit for the degree Philosophiae Doctor to the University of Pretoria contains my own, independent work and has not previously been submitted by me for any degree at this or any other tertiary institution.

Signature:

Name: Batseba Letty Kedibone Mofolo-Mbokane

Date:

ABSTRACT

This study investigates learning difficulties involving volumes of solids of revolution (VSOR) at two FET colleges in Gauteng province, in South Africa. The research question for this study was: **Why do students have difficulty when learning about volumes of solids of revolution?** In order to answer the research question five skill factors were identified as the conceptual framework, subdivided into 11 elements. The five skill factors are: I. Graphing skills and translating between visual graphs and algebraic equations/expressions, II. Three-dimensional thinking, III. Moving between discrete and continuous representations, IV. General manipulation skills and V. Consolidation and general level of cognitive development.

Before collecting the main data for this study, a preliminary study and a pilot study were conducted. The data for the main study were then collected in six different investigations. The investigations consisted of two runs of a questionnaire, classroom observations, examination analysis; detailed examination responses and an interview with one student.

The results from the questionnaire runs as well as the pilot study reveal that students performed poorly in tasks involving three-dimensional thinking (Skill factor II), moving between discrete and continuous representations (Skill factor III), and consolidation and general level of cognitive development (Skill factor V). Students' performance was satisfactory in tasks involving graphing skills and translating between visual graphs and algebraic equations/expressions (Skill factor I) and general manipulation skills (Skill factor IV). Students were also more competent in solving problems that involved procedural skills than those that required conceptual skills. The challenges that students were faced with in class, evident from the classroom observations allude to the fact that the topic of VSOR is difficult to teach and to learn.

It is recommended that VSOR be taught and assessed more conceptually in line with the five skill factors; that curriculum developers must communicate with other stakeholders like industries and other institutions of higher learning and that the Department of Education must provide adequate training for these teachers and liaise with industry in this regard. It is also recommended that the suitability of this topic for the particular cohort of students be reconsidered as it appears to be of too high cognitive demand.

DEDICATION

This study is dedicated to my family for walking this long path with me. I dedicate this study to my husband Majagaodwa Mbokane, my daughter Mmamonkwe, my son Umalusi, my mother Mmamonkwe Mofolo and in soul my father Malebye Mofolo who inspired me throughout this journey. Perseverance is what kept me going. I can now sing and praise GOD, who lifted me up when I was tripping.

“Praise the LORD with the harp; make melody to Him with an instrument of ten strings. Sing to Him a new song; play skilfully with a shout of joy”.

PSALM 33: 2-3

ACKNOWLEDGEMENTS

I wish to thank my supervisor Prof Johann Engelbrecht and my co-supervisor Prof Ansie Harding for their hard work in continuously guiding and supporting me in the writing of this thesis. Their constructive criticism and feedback led to the improved versions of this report. Thank you for your patience, your encouragement and your motivation when I felt that the road was difficult.

I wish to thank the following people and organisations for their support during my research journey.

- All the lecturers and the students at the three FET colleges who were participants in this study for the time they spent to make this report possible.
- Many thanks to the national department of education for allowing me to analyse the examination scripts.
- I wish to thank my SMTE HODs Prof Onwu, Prof Braun and all my colleagues in the mathematics department for encouraging me to carry on with my studies and sharing my work load. Thank you Dr Gaigher and Mrs Randall for your sweet words of motivation when I was downcast. I wish to thank Mr Mnguni also for helping me with technical aspects when I got stuck, my colleague Mrs Kazeni for her words of encouragement and Mrs Alison Kitto for sharing my working load.
- Thank you Dr Lizelle Fletcher for the statistical analysis and interpretation of the data in this thesis.
- I wish to thank the language editor A.K. Welman for ensuring that the correct standards are maintained.
- I appreciate the financial support I received from the University of Pretoria and the NRF in terms of funding my research fully.
- Many thanks to the Almighty for making this possible.

TABLE OF CONTENTS

Declaration	i
Abstract	ii
Dedication	iii
Acknowledgements	iv
Table of contents	v
Appendices	xi
Index of tables	xii
Index of figures	xiv
List of acronyms	xviii

CHAPTER 1: CONCEPTUALISATION OF THE STUDY

1.1	Setting	1
1.1.1	The country	1
1.1.2	The education system	2
1.1.3	Structure of FET colleges	4
1.1.4	FET colleges and entry requirements	6
1.2	Motivation for the study	9
1.2.1	My involvement	9
1.2.2	Teaching experience	10
1.2.3	Criteria for selecting this topic	10
1.2.4	Calculating the area bounded by the graphs	11
1.2.5	Generating the volume of a solid of revolution	12
1.2.5.1	The disc method	13
1.2.5.2	The washer method	14
1.2.5.3	The shell method	15
1.3	The problem description	16
1.4	Research question	17
1.5	Significance of the study	20
1.6	Conclusion	21
1.7	Overview of the chapters	22

CHAPTER 2: LITERATURE REVIEW

2.1	Graphing skills and translation between visual graphs and algebraic/expressions	23
2.1.1	Visual learning and symbols	24
2.1.2	Transferring between mathematics and applications	31

2.2	Translation between 2D and 3D diagrams	36
2.3	Translation between continuous and discrete representations	39
2.4	General manipulation skills	42
2.5	General level of cognitive development	44
2.6	Contextual factors affecting learning	50
2.6.1	Writing to learn mathematics and effect of language	50
2.6.2	Scaffolding learning	54
2.6.3	Teaching approach	56
2.6.4	Curriculum level and assessment	60
2.6.5	Use of technology	62
2.7	Conclusion	65

CHAPTER 3: CONCEPTUAL FRAMEWORK

3.1	The three modes of representations	66
3.2	My conceptual framework involving the five skill factors	67
3.2.1	Skills factor 1: Graphing skills and translating between visual graphs and algebraic equations/expressions	68
3.2.2	Skills factor II: Three dimensional thinking	70
3.2.3	Skills factor III: Moving between continuous and discrete representation	71
3.2.4	Skill factor IV: General manipulation skills	73
3.2.5	Skills factor V: Level of cognitive development	73
3.3	The three modes of representations and the level of cognitive development	75
3.4	Procedural and conceptual knowledge	76
3.5	Procedural and conceptual knowledge within the five skill factors	77
3.5.1	The VSOR model	77
3.6	Related frameworks	79
3.6.1	Bernstein's framework	79
3.6.2	Kilpatrick's et al framework	80
3.7	Conclusion	84

CHAPTER 4: RESEARCH DESIGN AND METHODOLOGY

4.1	Research strategy	85
4.1.1	Research methods	85
4.1.2	The research sample	94
4.2	Data collection and analysis	96
4.2.1	Phase I: Data collection process and analysis	96
4.2.1.1	Part 1: The preliminary study (July 2005)	96
4.2.1.2	Part 2: The pilot study (October 2006)	98

4.2.2	Phase II: The main study	100
4.2.2.1	Investigation 1: April 2007 as the Questionnaire 1st run	100
4.2.2.2	Investigation 2: October 2007 and April 2008 as the Questionnaire 2nd run	107
4.2.2.3	Investigation 3: Analysis of 151 examination scripts for August 2007 Examinations	108
4.2.2.4	Investigation 4: Detailed examination analysis	109
4.2.2.5	Correlating the elements	109
4.2.3	Phase III	110
4.2.3.1	Investigation 5: Classroom observations	110
4.2.3.2	Investigation 6: Student interview	110
4.2.4	Final remarks	111
4.3	Validity	111
4.3.1	Validity in tests	112
4.3.2	Validity in observations and interviews	114
4.3.3	Threats of validity	114
4.3.4	Validity for the claims made	114
4.4	Reliability	115
4.5	Generalisation	116
4.6	Ethical consideration	116
4.7	Delineation of the study	117
4.8	Limitations of the study	117
4.9	Summary	118

CHAPTER 5: PRELIMINARY AND PILOT STUDIES

5.1	Part 1: Preliminary study in July 2005	120
5.1.1	The results from the seven students	121
5.1.1.1	Overall responses	122
5.1.1.2	Individual responses	125
5.1.1.3	The graphing skills	127
5.1.2	Discussion of the results	127
5.1.3	Conclusions	128
5.2	Part 2: The pilots study in October 2006	129
5.2.1	Lessons observations at College C	129
5.2.2	The results for the 21-item questionnaire	129
5.2.2.1	Responses for Element 1: Translation from algebraic to visual (2D)	130
5.2.2.2	Responses for Element 2: Translation from visual to algebraic (2D)	131
5.2.2.3	Responses for Element 3: Translation from algebraic to visual (3D)	132

5.2.2.4	Responses for Element 4: Translation from visual to algebraic (3D)	133
5.2.2.5	Responses for Element 5: Translation from 2D to 3D	135
5.2.2.6	Responses for Element 6: Translation from 3D to 2D	136
5.2.2.7	Responses for Element 7: Translation from continuous to discrete (visual 2D)	137
5.2.2.8	Responses for Element 8: Translation from continuous to discrete (visual 3D)	137
5.2.2.9	Responses for Element 9: Translation from discrete to continuous and continuous to discrete (algebraic) in 2D to 3D	139
5.2.2.10	Responses for Element 10: General manipulation skills	141
5.2.2.11	Responses for Element 11: Consolidation and general level of cognitive development	142
5.3	Conclusion from the results	144

CHAPTER 6: QUESTIONNAIRE AND EXAMINATIONS

6.1	Presentation and analysis of the results from the 23-item instrument (questionnaire)	145
6.1.1	Skill factor I: Graphing skills and translating between visual graphs and algebraic equations/expressions	146
6.1.2	Skill factor II: Three-dimensional thinking	167
6.1.3	Skill factor III: Moving between discrete and continuous	175
6.1.4	Skill factor IV: General manipulation skills	181
6.1.5	Skill factor V: Consolidation and general level of cognitive development	185
6.1.6	Overall responses per question, per element and per skill factor for the questionnaire runs	190
6.1.7	Total responses for all categories	197
6.1.8	Performance in the five skill factors classified in terms of procedural and/or conceptual knowledge	198
6.1.9	General observations from the five skill factors for the questionnaire runs	199
6.1.10	Discussion and conclusion	202
6.2	Examination analysis and the detailed written examinations responses	204
6.2.1	Examination analysis	204
6.2.1.1	Analysis of the examination scripts for 151 students	204
6.2.1.2	Quantitative analysis of five elements that were tested directly from the question paper	208
6.2.2	Detailed written examination responses	211
6.2.2.1	Actual written responses from the seven students	211
6.2.2.2	Summary for the detailed written examination responses	215
6.2.3	Discussion and conclusion	216
6.3	Summary of the examination analysis	216
6.4	A model question paper	217

CHAPTER 7: CORRELATING THE ELEMENTS

7.1	Non-parametric tests: Kendall tau (τ)	221
7.1.1	Correlations for the questionnaire 1 st run	222
7.1.1.1	Correlating the skill factor consolidation and general level of cognitive development and the other elements	223
7.1.1.2	Correlating general manipulation skills to other elements	224
7.1.1.3	Correlating translation from discrete to continuous and from continuous to discrete algebraically to other elements	224
7.1.1.4	Correlating translation from continuous to discrete (visually) to other elements	224
7.1.1.5	Correlating translation from 3D to 2D to other elements	225
7.1.1.6	Correlating translation from 2D to 3D to other elements	225
7.1.1.7	Correlating translation from visual to algebraic in 3D to other elements	225
7.1.1.8	Correlating translation from algebraic to visual in 3D to other elements	226
7.1.1.9	Correlating translation from visual to algebraic in 2D to other elements	226
7.1.1.10	Correlating translation from algebraic to visual in 2D to other elements	226
7.1.1.11	Summary for the Questionnaire 1 st run	226
7.1.2	Correlations for the Questionnaire 2 nd run	227
7.1.2.1	Summary for the Questionnaire 2 nd run	228
7.1.3	Conclusion for the correlations from the questionnaires	228
7.1.4	Correlations for the examinations analysis	229
7.1.5	Summary for the examination correlations	230
7.2	Parametric tests: Pearson (r)	230
7.2.1	The histogram for students' performance	231
7.2.2	The scatter plot for students' performance	232
7.3	The Pearson's correlation and the level of significance for the 151 students	234
7.3.1	Conclusion on the parametric tests	235

CHAPTER 8: OBSERVATIONS AND AN INTERVIEW

8.1	Classroom observations	236
8.1.1	The first lesson	236
8.1.1.1	Observing the lecturer and the students in Lesson 1	236
8.1.1.2	The five skill factors for the first lesson	250
8.1.2	Observing the second lesson	250
8.1.2.1	Observing the students in Lesson 2	251
8.1.2.2	Observing the lecturer in Lesson 2	253
8.1.2.3	The five skill factors for the second lesson	256

8.1.3	Observing the third lesson	258
8.1.3.1	Observing the students and the lecturer in Lesson 3	258
8.1.3.2	The five skill factors for the third lesson	262
8.1.4	Observing the fourth lesson	262
8.1.4.1	Observing the lecturer in Lesson 4	262
8.1.4.2	Observing the students in Lesson 4	263
8.1.4.3	The five skill factors for the fourth lesson	264
8.1.5	Observing the fifth lesson	265
8.1.5.1	Lesson 5: Group work	265
8.1.5.2	The five skill factors for the fifth lesson	271
8.1.6	Summary of the classroom observations	272
8.2	Interview with one student	272
8.2.1	Presentation of the interview results	272
8.2.2	Analysis of the interview results	276
8.3	Conclusion	276
CHAPTER 9: INTERPRETATIONS AND CONCLUSIONS		
9.1	Overview of this research	278
9.2	Addressing the research questions for this study	279
9.2.1	Skill factor I: How competent are students in graphing skill?	280
9.2.2	Skill factor II: How competent are students in translating between 2D and 3D diagrams?	283
9.2.3	Skill factor III: How competent are students in translating between continuous and discrete representations visually and algebraically in 2D and in 3D?	284
9.2.4	Skill factor IV: How competent are students in general manipulation skills?	285
9.2.5	Skill factor V: How competent are the students in dealing with the general cognitive demands of the tasks?	286
9.2.6	Teaching and assessment	289
9.2.7	Correlations	290
9.3	Answering the research question for this study	291
9.4	Recommendations of the study	293
9.4.1	Teaching the VSOR content	293
9.4.2	Assessing the VSOR content	294
9.4.3	The role of curriculum developers	295
9.4.4	Duties of the Department of Education and the industry	295
9.5	Limitations of the study and directions for further research	296
REFERENCES		297

APPENDICES

Appendix 1A	Syllabus on application of the definite integral	313
Appendix 1B	Preliminary study 2005	314
Appendix 2A	Pilot (2006) before reshuffled	318
Appendix 2B	Pilot administered 2006	320
Appendix 3A	Changed instrument	324
Appendix 3B	Main instrument administered	328
Appendix 4A	Main results for the Questionnaire 1 st run	334
Appendix 4B	Overall response percentage per skill factor	335
Appendix 4C	Average scores per element from the Questionnaire 1 st run	336
Appendix 4D	Skill factors percentage of responses and procedural and conceptual classification	337
Appendix 5A	Main results for the Questionnaire 2 nd run (Test 1 & 2)	338
Appendix 5B	Average scores per element from the Questionnaire 2 nd run	341
Appendix 5C	Main results for the Questionnaire 2 nd run (Test 3)	343
Appendix 6A	Detailed memorandum of the examination questions	344
Appendix 6B	Examination analysis for 151 responses	346
Appendix 6C	Average scores per element from the examination analysis	349
Appendix 6D	Responses from the seven students	354
Appendix 7A	Consent form for students	353
Appendix 7B	Consent form for classroom observations	355
Appendix 7C	Consent form for institutions	356
Appendix 7D	Consent form for the national examination	357

INDEX OF TABLES

Table 1.1	NQF (www.saqa.org.za/show.asp?include =focus/ld.htm)	2
Table 3.1	The five skill factors	67
Table 4.1	The <i>p</i> -value table	90
Table 4.2	11 elements from the 21-item instrument	98
Table 4.3	The 11 elements	101
Table 4.4	Question 2A modified to be Question 3A	102
Table 4.5	Question 3A modified to be Question 4A	103
Table 4.6	Question 5A modified to be Question 1A	103
Table 4.7	Modified Question 11B	103
Table 4.8	Criteria for performance level	106
Table 4.9	Classification of skill factors	107
Table 5.1	The schematic process in the presentation and analysis of the results	119
Table 5.2	Classification of students' written responses	122
Table 5.3	The graphs drawn	127
Table 5.4	Responses for Element 1	130
Table 5.5	Responses for Element 2	131
Table 5.6	Responses for Element 3	132
Table 5.7	Responses for Element 4	133
Table 5.8	Responses for Element 5	135
Table 5.9	Responses for Element 6	136
Table 5.10	Responses for Element 7	137
Table 5.11	Responses for Element 8	137
Table 5.12	Responses for Element 9	139
Table 5.13	Responses for Element 10	141
Table 5.14	Responses for Element 11	142
Table 6.1	Element 1 for the Questionnaire 1 st run as Question 1	146
Table 6.2	Element 1 questions	146
Table 6.3	Element 2 and 3 questions	150
Table 6.4	Element 2 and 3 for the Questionnaire 1 st run as Question 2 and Question 3	151
Table 6.5	Element 2 and 3 for the Questionnaire 2 nd run as Question 2A and Question 3A	151
Table 6.6	Element 2 and 3 for the Questionnaire 2 nd run as Question 2B and Question 3B	152
Table 6.7	Element 4 and 5 questions	158
Table 6.8	Element 4 and 5 for the Questionnaire 1 st run as Question 4 and Question 5	158
Table 6.9	Element 4 for the Questionnaire 2 nd run as Question 4	159

Table 6.10	Element 5 for the Questionnaire 2 nd run as Question 5A	159
Table 6.11	Element 5 for the Questionnaire 2 nd run as Question 5B	160
Table 6.12	Element 6 and 7 questions	167
Table 6.13	Element 6 and 7 for the Questionnaire 1 st run as Question 6 and Question 7	168
Table 6.14	Element 6 for the Questionnaire 2 nd run as Question 6A	168
Table 6.15	Element 6 for the Questionnaire 2 nd run as Question 6B	169
Table 6.16	Element 7 for the Questionnaire 2 nd run as Question 7	169
Table 6.17	Element 8 and 9 questions	175
Table 6.18	Element 8 and 9 for the Questionnaire 1 st run as Question 8 and Question 9	176
Table 6.19	Element 8 and 9 for the Questionnaire 2 nd run as Question 8B and Question 9A	176
Table 6.20	Element 8 and 9 for the Questionnaire 2 nd run as Question 8A and Question 9B	177
Table 6.21	Element 10 for Questionnaire 1 st run as Questions 10	181
Table 6.22	Element 10 for Questionnaire 2 nd run as Questions 10	182
Table 6.23	Element 11 for the Questionnaire 1 st run as Question 11	185
Table 6.24	Element 11 for the Questionnaire 2 nd run as Question 11A	186
Table 6.25	Element 11 for the Questionnaire 2 nd run as Question 11B	186
Table 6.26	All 11 elements for the Questionnaire 1 st run	190
Table 6.27	All 4 elements for the Test 1 and 2; and other questions from the Questionnaire 2 nd run	195
Table 6.28	Responses for Test 3 from the Questionnaire 2 nd run	195
Table 6.29	The responses for all questions	197
Table 6.30	Procedural and conceptual skills from the Questionnaire 1 st run	198
Table 6.31	Students' responses in five elements	208
Table 6.32	The composition of the paper	220
Table 7.1	Kendall tau for the Questionnaire 1 st run	222
Table 7.2	Kendall tau for overall 122 responses	227
Table 7.3	Correlations from Kendall's tau	229
Table 7.4	Displaying performance in the four quadrants	233

INDEX OF FIGURES

Figure 1.1	Population density in South African provinces (Statistics South Africa, 2006)	1
Figure 1.2	South African Map (www.southafrica.to/provinces/provinces.htm)	2
Figure 1.3	Approximating the area	11
Figure 1.4	The disc method	13
Figure 1.5	The washer method	14
Figure 1.6	The shell method	15
Figure 2.1	Students' visualisation of an integral (Rösken and Rolhka, 2006, p. 459)	32
Figure 2.2	Potter Wheel construction (adapted from Christou et al., 2008, p. 6)	38
Figure 2.3	Discrete approximation of velocity (Gravemeijer & Doorman, 1999, p. 125)	41
Figure 2.4	Questions on evaluating an integral (Mahir 2009, p. 203)	46
Figure 3.1	The Riemann sum	72
Figure 3.2	The VSOR model	77
Figure 4.1	Examples of scatter plots (Adapted from Willemse, 2004, p. 116)	89
Figure 4.2	The interactive model of research design (Adapted from Maxwell, 2005, p. 11)	91
Figure 4.3	The mixed method research design model	93
Figure 4.4	Gowin's knowledge Vee (Novak & Gowin, 1984)	93
Figure 5.1	S6 interpreting a Δx strip a Δy strip	125
Figure 5.2	S1 written response	126
Figure 5.3	Straight lines as parabolas	130
Figure 5.4	A parabola without limits	130
Figure 5.5	A disc and a parabola	133
Figure 5.6	A shell and a parabola	133
Figure 5.7	A line representing a solid	135
Figure 5.8	An ellipsoid	135
Figure 5.9	A cross-section of a washer	138
Figure 5.10	Misconceptions about the strips	138
Figure 5.11	Errors with integration rules	141
Figure 5.12	Incorrect limits used	143
Figure 5.13	Incorrect region shaded	143
Figure 6.1	Questionnaire 1 st run for Question 1	146
Figure 6.2	Questionnaire 2 nd run for Question 1	147
Figure 6.3	A line passing through $y = 3$	148
Figure 6.4	A line with a negative gradient	148
Figure 6.5	Half an ellipse below the x -axis	149

Figure 6.6	Half an ellipse above the x -axis	149
Figure 6.7	Questionnaire 1 st run for Question 2 and Question 3	151
Figure 6.8	Questionnaire 2 nd run for Question 2A and Question 3A	151
Figure 6.9	Questionnaire 2 nd run for Question 2B and Question 3B	152
Figure 6.10	A line with a negative slope	155
Figure 6.11	A parabola $y = x - x^2$	155
Figure 6.12	Δx with y limits	157
Figure 6.13	Formula for moment of inertia	157
Figure 6.14	A hyperbolic Equation	157
Figure 6.15	An exponential equation	157
Figure 6.16	Questionnaire 1 st run for Question 4 and Question 5	159
Figure 6.17	Questionnaire 2 nd run for Question 4	159
Figure 6.18	Questionnaire 2 nd run for Question 5A	160
Figure 6.19	Questionnaire 2 nd run for Question 5B	160
Figure 6.20	A positive parabola	163
Figure 6.21	A negative parabola	163
Figure 6.22	A complete parabola	164
Figure 6.23	Half a parabola	164
Figure 6.24	$\cos x$ and a Δy strip	166
Figure 6.25	Integration by parts	166
Figure 6.26	Questionnaire 1 st run for Question 6 and Question 7	168
Figure 6.27	Questionnaire 2 nd run for Question 6A	168
Figure 6.28	Questionnaire 2 nd run for Question 6B	169
Figure 6.29	Questionnaire 2 nd run for Question 7	169
Figure 6.30	The graph of $y = x$ and the Δy strip	171
Figure 6.31	The same graph and the Δx strip	171
Figure 6.32	A hemisphere about the x axis	172
Figure 6.33	Rotation about the x -axis	172
Figure 6.34	An exponential function	173
Figure 6.35	The parabolic diagram	173
Figure 6.36	A circular shape	174
Figure 6.37	A circle and a rod	174
Figure 6.38	Questionnaire 1 st run for Question 8 and Question 9	176
Figure 6.39	Questionnaire 2 nd run for Question 8B and Question 9A	176
Figure 6.40	Questionnaire 2 nd run for Question 8A and Question 9B	177
Figure 6.41	One rectangle	178
Figure 6.42	Four rectangle	178
Figure 6.43	The first ring	179
Figure 6.44	The second ring	179

Figure 6.45	Unequal rectangles	180
Figure 6.46	A rectangle of area 12	180
Figure 6.47	The thin circles	181
Figure 6.48	A circle of radius 1.5	181
Figure 6.49	Questionnaire 1 st run for Questions 10	182
Figure 6.50	Questionnaire 2 nd run for Questions 10	182
Figure 6.51	Incorrect solution 1	184
Figure 6.52	Incorrect solution 2	184
Figure 6.53	Questionnaire 1 st run as Question 11	186
Figure 6.54	Questionnaire 2 nd run for Question 11A	186
Figure 6.55	Questionnaire 2 nd run for Question 11B	187
Figure 6.56	Correct graph with a Δy strip	189
Figure 6.57	Inverse function manipulation	189
Figure 6.58	Comparing the 11 elements for the Questionnaire 1 st run	190
Figure 6.59	The five skill factors compared	193
Figure 6.60	All responses represented	197
Figure 6.61	Comparing the five elements	208
Figure 6.62	The performance from the seven students	211
Figure 6.63	The incorrect approximation with a Δx strip	212
Figure 6.64	Incorrect substitution in the equation for volume	213
Figure 6.65	A cosine graph without the strip	214
Figure 6.66	Incomplete manipulation	215
Figure 6.67	The proposed VSOR assessment model	217
Figure 7.1	Performance in Question 5	231
Figure 7.2	Performance in the whole paper	231
Figure 7.3	Scatterplot on Question 5 and the whole paper	232
Figure 8.1	Example 1 graphs	238
Figure 8.2	Transformation	239
Figure 8.3	The disc method for example 1	239
Figure 8.4	The shell method for example 2	240
Figure 8.5	The disc method for example 3	242
Figure 8.6	The washer method for example 4	243
Figure 8.7	The annulus	244
Figure 8.8	The parabola using a Δx strip	246
Figure 8.9	The exponential graph	251
Figure 8.10	Rotating anti-clockwise	252
Figure 8.11	Cross-section of a shell	252
Figure 8.12	The rectangular hyperbola	253



Figure 8.13	The first quadrant	253
Figure 8.14	The second quadrant	256
Figure 8.15	The cubic and straight line graphs	259
Figure 8.16	The intersection points	259
Figure 8.17	The two parabolas	259
Figure 8.18	The parabolas drawn	260
Figure 8.19	Locating the centroid	261
Figure 8.20	The 1 st attempt	263
Figure 8.21	The 2 nd attempt	263
Figure 8.22	The last attempt	263
Figure 8.23	The graphing skills	266
Figure 8.24	Straight line	267
Figure 8.25	The incorrect graphs	268
Figure 8.26	The correct graphs	268
Figure 8.27	The centroid	270
Figure 8.28	A decreasing exponential graph	271

LIST OF ACRONYMS

- ABET - Adult Basic Education and Training
- ACE - Advanced Certificate in Education
- ARIRE - Average Ranking for Individual Responses per Element
- CAS - Computer Algebra System
- DoE - Department of Education
- DoL - Department of Labour
- FET - Further Education and Training
- FTC - Fundamental Theorem of Calculus
- GET - General Education and Training
- HE - Higher Education
- MMA - Mixed methods approach
- NC(V) - National Certificate (Vocational)
- NQF - National Qualification Framework
- SAQA - South African Qualifications Authority
- TIMSS - Third International Mathematics and Science Study
- VSOR - Volumes of solids of revolution (VSOR)
- ZPD - Zone of Proximal Development
- 2D - Two-dimensional
- 3D - Three-dimensional

CHAPTER 1: CONCEPTUALISATION OF THE STUDY

This chapter introduces the study on investigating learning difficulties involving volumes of solids of revolution amongst engineering students at two colleges for further education and training in South Africa. Section 1.1 introduces the setting: the country, its educational system, the structure of the colleges for further education and training and their entry requirements. Section 1.2 presents the motivation for this study in relation to my involvement in teaching and learning. Section 1.3 presents the problem description in relation to learning about volumes of solids of revolution leading to the formulation of the research questions in Section 1.4. Section 1.5 presents the significance of this study for the colleges relating to the learning, teaching and assessment of volumes of solids of revolution. Section 1.6 presents the conclusion to summarise the important ideas and arguments discussed in this chapter and finally the overview of the chapters is presented in Section 1.7.

1.1 SETTING

1.1.1 The country

This study was conducted in South Africa, which comprises nine provinces: Gauteng, Free State, Eastern Cape, Western Cape, North West, Northern Cape, Mpumalanga, Limpopo and Kwa-Zulu Natal. These provinces were established in 1994, when South Africa was liberated from minority rule. The focus for this study is on Gauteng province, the richest province and the industrial hub of South Africa. Gauteng is the smallest province geographically but the second largest demographically with a population of 9 525 571 in 2006 (Statistics South Africa, 2006), since many people migrate to it for employment and educational opportunities. This tiny province is contributing 33.3% to the national gross domestic product. The population density for Gauteng is 576 people per square kilometre, as shown in Figure 1.1.

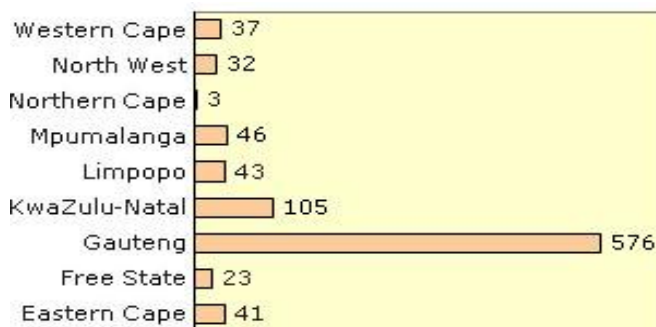

Figure 1.1: Population density in South African provinces (Statistics South Africa, 2006)

Most of the people moving to Gauteng are from the provinces surrounding it; Limpopo, Mpumalanga, North-West and Free State as displayed on the map in Figure 1.2.



Figure 1.2: South African Map (www.southafrica.to/provinces/provinces.htm)

1.1.2 The education system

The system of education in South Africa is classified into three bands in line with the National Qualification Framework (NQF) established in the early 1990s as shown in Table 1.1.

Table 1.1: NQF (www.saqa.org.za/show.asp?include=focus/ld.htm)

NQF LEVEL	BAND	QUALIFICATION TYPE	
8	HIGHER EDUCATION AND TRAINING	<ul style="list-style-type: none"> • Post-doctoral research degrees • Doctorates • Masters degrees 	
7		<ul style="list-style-type: none"> • Professional Qualifications • Honours degrees 	
6		<ul style="list-style-type: none"> • National first degrees • Higher diplomas 	
5		<ul style="list-style-type: none"> • National diplomas • National certificates 	
FURTHER EDUCATION AND TRAINING CERTIFICATE			
4	FURTHER EDUCATION AND TRAINING	<ul style="list-style-type: none"> • National certificates: Grade 10-12 	
3			
2			
GENERAL EDUCATION AND TRAINING CERTIFICATE			
1	GENERAL EDUCATION AND TRAINING	Grades 0 - 9	ABET Level 4
		<ul style="list-style-type: none"> • National certificates 	

The three bands within the NQF are as follows:

- (a) *General Education and Training* (GET) at NQF level 1. GET caters for students from Grade 0 to Grade 9, aged between 6 and 15 years as well as the *Adult Basic Education and Training* (ABET) qualification catering for adults. In South Africa education is compulsory from age 7 to 15 years (McGrath, 1998).
- (b) *Further Education and Training* (FET) is at NQF levels 2 to 4. FET caters for students from Grades 10 to 12 in schools (technical and normal), students mainly aged between 16 and 18 as well as students who left school after Grade 9 or Grade 12 to join FET colleges for vocational training.
- (c) *Higher Education* (HE) offered by universities of technology (previously technikons) and comprehensive or academic universities at NQF level 5 to 8.

It was asserted that

the NQF was introduced to South Africans through the education policies and debates within the trade union movement, and more broadly within the broader liberation movement. Partly because of this, many have seen the NQF as driven by a strongly egalitarian social project (Allais, 2003, p. 306).

This was done to transform the education system that was bound by apartheid law through the Congress of South African Trade Unions, and its affiliates who engaged in intensive discussions on education and training in South Africa. Lomofsky and Lazarus (2001, p. 303) point out that the previous education system in South Africa, under central government control led to discriminatory practices and that educational institutions (schools, colleges and universities) were segregated along racial lines.

The education and training policy which emerged was designed with the intention of doing away with the racial segregation and preventing workers from getting stuck in unskilled or semi-skilled jobs (Allais, 2003, p. 306). Finally, the recommendation for a national vocational qualifications system fully integrated with formal academic qualifications, thus integrating education and training to prepare students for the work environment (Ensor, 2003; McGrath, 1998; NECC, 1992), was made. In 1995 the South African Qualifications Authority (SAQA) Act, the first education and training legislation of the new democratic parliament, was passed. It brought the NQF legally into being, with SAQA as the body responsible for developing and implementing it (Allais, 2003, p. 309). Young (2003, p. 230) highlights that the NQF offered opportunities to employers to have a bigger say in the kind of skills and knowledge that 16 to 18-year-olds were expected to acquire.

This study focuses on FET colleges that prepare its students for different vocations. The terms used variously in different countries to refer to vocationally oriented education that takes place in vocational colleges/institutions are ‘Further Education’, ‘Further Education and Training’ (FET) and ‘Technical and Vocational Education and Training (Papier, 2008, p .6). In South Africa such vocational colleges are called FET colleges. During 1999-2002, the enrolments of students after school were highest in numbers at universities, followed by technikons (universities of technology) and then FET colleges (DoE & DoL, 2001; Powell & Hall, 2002, Powell & Hall, 2004).

1.1.3 Structure of FET colleges

In the past the FET colleges were called technical colleges, which were initiated in response to the mineral discoveries like gold in the nineteenth century and apprentices were trained (Behr, 1988; Akoojee, McGrath & Visser, 2008; Malherbe, 1977). The first technical colleges, the Cape and the Durban technical colleges were established in 1923 in line with the Apprenticeship Act of 1922 (Malherbe, 1977, p. 170). The technical colleges were mainly training artisans as apprentices from companies, not students coming straight from schools with no experience from the industry. The large technical colleges were transformed into universities of technology during the 1960s, to do more advanced technical training than what the technical colleges were doing (Fisher, Jaff, Powell & Hall, 2003).

During the 1960s to 1980s, technical colleges were obtaining their students from industry. Students were sent by the employers for the ten week ‘block release’ course (Malherbe, 1977) to do theory. These ten week courses, which were completed in a trimester, were called ‘N’ courses. That means that students came to the colleges with work experience, hence they would incorporate theory into the practical component of their work to complete an N course. The courses were done in six block releases, hence called N1, N2, N3, N4, N5 and N6. This system was beneficial to the companies as the then government was giving the employers a tax incentive for sending their employees to the colleges. With the scrapping of this arrangement, employers were no longer sending their employees to the colleges. Most employees would take the courses part-time in the evenings. FET colleges in South Africa came into existence after a merger of 152 technical colleges into 50 FET colleges in 2002, each with two or more campuses (college sites) in terms of the FET Act, No 98 of 1998 (Akoojee, 2008; Akoojee & McGrath, 2008; Fisher, Jaff, Powell & Hall, 2003; McGrath, 2004, McGrath, & Akoojee, 2009; Papier, 2008; Powell & Hall, 2004), with the initiative

from the National Committee on Further Education, which presented their draft report highlighting the lack of identity of an FET level (McGrath, 2004).

Both the Department of Education (DoE) and the Department of Labour (DoL) were engaged in a legislative process (McGrath, 2000), in which skills development was regarded as important in FET colleges. Akoojee (2008, p. 297) argues that the national attention on the role of skills development has focused on the role of FET colleges in providing intermediate-level education and training necessary to meet the South African national development challenge. In this regard attention has been focused on the reorganisation and rationalisation of college structures through the merger. The reasons for the merger were to help the weaker colleges financially, and in terms of resources, to share with the stronger colleges. Presently, the FET colleges are the responsibility of the Department of Higher Education and Training in terms of salary payments for the staff but governed and controlled by the college councils which also control students' fees. The role of college councils is critical to the success of the devolved staffing arrangement (Akoojee, 2008, p.308).

After the merger in 2002, a survey was made of South African FET college lecturers' qualifications. The qualifications of the 7088 teaching staff were as follows: 15% had higher degrees, 28% had degrees or higher diplomas, 43% had diplomas and 7% were unqualified or under-qualified (Powell & Hall, 2004). The presented qualifications revealed that the highest percentages of the lecturers have diplomas, recruited from universities of technology and the FET colleges themselves and that some lecturers are under qualified or unqualified. This analysis raised serious concerns about the quality of teaching at the colleges. A concern by Akoojee (2008, p. 311) is that increasing student numbers and diversifying programme offerings needed to be matched by improvements in the quantity and quality of teaching staff.

College lecturers in technical fields have in the past been recruited from industry and usually possessed technical qualifications and wide experience and knowledge from the industry, which is not the case presently, where the majority of the lecturers are recruited from the universities of technologies, with diplomas in engineering. According to Papier (2008, p. 7), many lecturers in academic subjects such as language, mathematics or science entered colleges with school teaching qualifications but little industry experience. Papier further attests that the national Ministry of Education is currently designing a framework of recognised qualifications for lecturers in FET colleges, which will usher in a new era of

curriculum development for those higher education institutions that wish to offer them. The quality of FET college lecturers has been a matter of concern, as highlighted by Papier that

College lecturers in the old dispensation were not required to have specific teaching qualifications. Their technical qualifications and years of experience were given equivalence for remuneration purposes, using pay-scales applicable to school-teachers. Where provincial departments of education made it a requirement for lecturers to obtain a teaching qualification, a few higher education institutions offered diploma programmes which have since become outdated. The national Department of Education indicated in 2007 that it would shortly publish a new framework of qualifications recognised for teaching in FET colleges (Papier, 2008, p. 7).

1.1.4 FET colleges and entry requirements

The FET colleges in South Africa are mainly located in the peri-urban areas (townships), and industrial (commercial) areas, scattered all over the nine provinces. Only black students attend colleges in the peri-urban and rural areas. The majority of students in the industrial areas are predominately black even though the colleges are non-racial. The FET colleges are seen to boost the economic mobility of the country. The economy needs artisans in engineering fields and specialists in fields that require mathematics as a basic subject. As a result mathematics has become compulsory in many study fields in South Africa, especially in engineering.

The curriculum in the FET colleges is vocationally inclined, preparing students for industry. FET colleges predominately offer qualifications for engineering studies and business studies, which comprises 90% of the total enrolment (Powell & Hall, 2004). The predominant courses in the engineering studies (the focus for this study) are mechanical engineering and electrical engineering where students take mathematics (which is compulsory) and three other subjects and civil engineering. The passing mark for subjects in the FET colleges is 40%. The courses for the engineering studies are taken at N1 to N6 levels.

Many students at the colleges do not normally reach the N6 level as companies start to recruit them with N3, N4 or N5 certificates. N1 to N6 levels are classified in terms of the trimester system (studying three times a year). For example, a student at an FET college could complete N1, N2 and N3 in one year spending ten weeks on each level, with external examinations written in April, August and November and N4, N5 and N6 in the following year. When a student completes a level, a certificate is awarded by the national DoE in Pretoria. The N1 to N6 courses are called national technical education programmes, examined by the national DoE (Akoojee, McGrath & Visser, 2008, p. 263). The examinations for N1 to N6 courses are moderated, marked and the results processed nationally, with Umalusi (Council for General and Further Education and Training Quality Assurance) and

experts in specific disciplines as quality assurers for N1 to N3 and N4 to N6, respectively (DoE, 2006, p.15). The national pass rate at the FET colleges is around 58%, with pass rates higher at N4 to N6 level than that at N1 to N3 level (Fisher, Jaff, Powell, & Hall, 2003, p. 338).

N1 to N3 fall under NQF level 2 to 4, while N4 to N6 fall under the NQF level 5 within the Higher Education and training level (Powell & Hall, 2004; Akoojee, McGrath & Visser, 2008). On completion of the N6 level a student receives a National Certificate that converts to a National Diploma (awarded by the national DoE) after completion of the necessary practical component for 18 months with an approved employer. After completion of the practical component, students may choose to join industry or a university of technology where they are normally given credit for some first semester courses. The universities do not recognise any qualifications from the FET colleges.

In 2007, a new qualification, the National Certificate (Vocational) abbreviated NC(V) offered at NQF level 2, 3 and 4 was introduced in order to gradually phase out the N1, N2 and N3 courses (DoE, 2006), which are believed to be outdated and obsolete (Sonn, 2008, p. 191). Unfortunately this new curriculum is being criticised as it is not recognised by universities (academic and comprehensive), universities of technology or the industry. According to Van Rooyen (2009, p. 1) “the National Certificate (Vocational) is too academic and pitched at a very high academic level, making it almost impossible for those on NQF level 2 and 3 to master”. As a result she argues that a decision was taken that the level 2 intake for NC (V) would be restricted to Grade 12 students. This decision implies that a student has to do NQF level 2 to 4 twice, with no academic benefit. In 2010 qualifications of those students who have completed NC (V) level 4 were not recognised by universities, universities of technology or the industry. These students cannot be accommodated in N4 to N6 courses either due to the curriculum mismatch from the NC (V). With the introduction of the NC (V), it is possible that the N4 to N6 courses may fade away, or may still continue with some students from the technical high schools or from industry.

The quality of students enrolled at the FET colleges varies. Some students in FET colleges spend a lot of time repeating N level subjects, even carrying subjects from lower levels. For example, you could find that a student is enrolled for N6 but still doing Mathematics N4 or/and Power Machines N5 (from mechanical engineering). In that case some students spend more than two years at the FET colleges. These problems where students do not complete

their studies on time at the FET colleges can be attributed to the fact that in many instances, students struggled to complete Grade 12 or joined the FET colleges at Grade 9 level because they had difficulties with the normal school subjects (particularly mathematics and science), and hence find the mathematics content at the college difficult. The other reason in some instances may be the superficial knowledge base of lecturers in teaching the content as some of them may not be adequately qualified and also lack experience from industry. Another important aspect may be the fact that students do not have a practical component from industry, as most of their courses require preknowledge from the industry.

Students join FET colleges for different reasons and in different ways. We find students who join FET colleges after having completed Grade 12, who could not get access to universities and universities of technology as they did not acquire the required points (no endorsement in the Senior Certificate); especially in engineering and science fields that require a minimum of 50% for Grade 12 mathematics. As a result these students end up taking courses at the FET colleges, either to upgrade their marks by enrolling for mathematics N3 and/or engineering science N3 so that they can enrol at the universities of technology if they obtain a minimum of 60% for both mathematics and engineering science, or simply joining the FET college to do the full curriculum offered by the college. Students who come from technical high schools are normally allowed to continue with the N3 courses or N4 courses depending on what they have passed, because the technical schools curriculum offers courses similar to N1, N2 and N3. The students who come from normal schools are required to start from N1 since the Grade 10 to Grade 12 curricula do not offer theoretical subjects that are vocationally inclined.

Other students who join the FET colleges enter with a minimum of a Grade 9 pass and take N1 to N6 courses in their chosen fields of study. In this case students who normally join the colleges after completing Grade 9 are better off, since they realised their potential for joining the vocational fields in time. These students would be admitted for N1 straight away. The important point to be noted is that students who normally join the FET colleges, whether after Grade 12 or after Grade 9, normally have problems with mathematics and science. Anecdotal evidence suggests that these low achieving students join the FET colleges probably hoping that the mathematics and science offered at the colleges are easier than that offered in schools, perhaps also thinking that they will only be learning skills where they use their hands. Parents who bring their children to the colleges would often say: "I think my child can work well with his/her hands since he/she is struggling with the school subjects". With this misconception, the colleges attract students who normally performed badly at schools and did

not excel in mathematics and science. However, there are those students who enrol at the colleges because of low fee structure and accelerated qualification times, as well as employment opportunities from industry that normally recruits students even at lower levels for example an N3 or an N4 certificate.

This study focuses on two colleges in the Gauteng province where there are eight colleges. One campus from College A with three campuses and one campus from College B with four campuses were sampled for this study. The campuses selected were the biggest engineering campuses from the two colleges used. In 2006 (during the pilot for this study), the number of FET engineering mathematics N6 students for all colleges in South Africa was 1771, 1778 and 2125 respectively for the April, August and November examinations (DoE, 2006, p. 23).

1.2 MOTIVATION FOR THE STUDY

1.2.1 My involvement

My experience of six years with the school mathematics curriculum and five years with the college mathematics curriculum (from 1993-2003) is twofold. Firstly, when comparing mathematics from Grade 10 to Grade 12, which I was fully involved with in normal schools before joining the FET colleges, I could attest to the fact that the mathematics offered at N1 to N3 levels is on a lower level than that offered in normal schools (both normal and technical). Many topics are omitted in N levels, such as euclidean geometry, linear programming, calculus applications (involving areas and volumes of right prisms). I believe that these difficult topics (that are omitted in N levels) help students in their critical and logical thinking as the main emphasis in these topics is more on conceptual thinking than procedural thinking. Secondly, I realised that a huge conceptual jump exists from the N3 to the N4 and N5 curricula (which prepare students for N6). The students are suddenly exposed to abstract mathematics in *algebra* at N4 level and abstract *calculus* at N5 and N6 level, without a proper foundation from N1 to N3 levels in terms of developing their conceptual understanding. These students might not be in a position to meet the challenges in the calculus content.

1.2.2 Teaching experience

During five years of lecturing at College A and as a marker of the N6 national examinations for three years during the five-year period, I encountered problems in that a large number of students from all nine provinces struggled with the section of calculating areas and volumes of three-dimensional rotational objects. I experienced the same problem at the university of technology, with the engineering mathematics students as a lecturer for three years on VSOR. At both institutions you would hear students who are repeating the course saying: “here comes a problem”, when you start teaching the topic on areas and volumes of solids of revolution and they become very attentive.

I wanted to investigate where these difficulties emanate from. In order to do that, I studied the section on areas and volumes of solids of revolution (VSOR) in-depth. I decided to observe my own teaching and that of other lecturers, analyse the assessment methods used for this section as well as analyse the examination scripts of college students and to give students different tasks that focus on areas and volumes to assess their in-depth knowledge.

1.2.3 Criteria for selecting this topic

In learning about VSOR, the students are expected to calculate the area and volume generated and also to extend this idea to finding the *centroid* and the *distance of centre of gravity* from a certain axis as well as finding the *second moment of area* and the *moment of inertia* (refer to Appendix 1A). Finally the idea of area moments would be extended to calculating the depth of fluid pressure. The concepts above, though done in mathematics, are also applicable in subjects such as Fluid Mechanics, Thermodynamics and Strength of Materials in the fields of mechanical and civil engineering, where they deal with channel flow of fluids, heat transfer and beams applicable to industry.

When learning VSOR, the students are expected to draw graphs (in the XY- plane), shade the region bounded by the graphs, interpret the drawn graphs (in terms of points of intersection and limits of integration) and translate from the graphical representation (drawing) to the algebraic representation (formula) in order to come up with numerical representation (calculation) of areas and volumes using integration techniques. In my experience while teaching VSOR and marking students examination scripts, all these processes involve procedural and conceptual understanding with conceptual understanding as the main focus for development of cognitive skills.

1.2.4 Calculating the area bounded by graphs

In this study problems relating to VSOR are being considered, involving the Fundamental Theorem of Calculus (FTC) originating from Leibniz's and Newton's work. The FTC involves using Riemann sums to find areas of regions enclosed by graphs of continuous functions defined on an interval $[a, b]$. When using Riemann sums the area bounded by the drawn graphs is approximated by partitioning it into thin rectangular strips (horizontal or vertical) of equal width that are joined to each other. The areas of these thin rectangular strips are added to approximate the area bounded by graphs between the limits. Increasing the number of strips improves the approximation. The area therefore becomes

$$A = \lim_{n \rightarrow \infty} [f(x_1)\Delta x + f(x_2)\Delta x + f(x_3)\Delta x + \dots + f(x_{n-1})\Delta x + f(x_n)\Delta x]$$

The area of each thin rectangular strip is calculated from the formula of area of a rectangle, $A = L \times B = f(x_i) \Delta x$, where $f(x_i)$ represents the height of the rectangle and $\Delta x = x_r - x_l$ represents the breadth of the rectangle. x_r is the x -value on the right of the rectangle while x_l is the x -value on the left of the rectangle. Figure 1.3 displays five vertical strips that approximate the area bounded by the graph of $f(x) = -x^2 + 5$, $x=0$, $x=2$ and $y=0$.

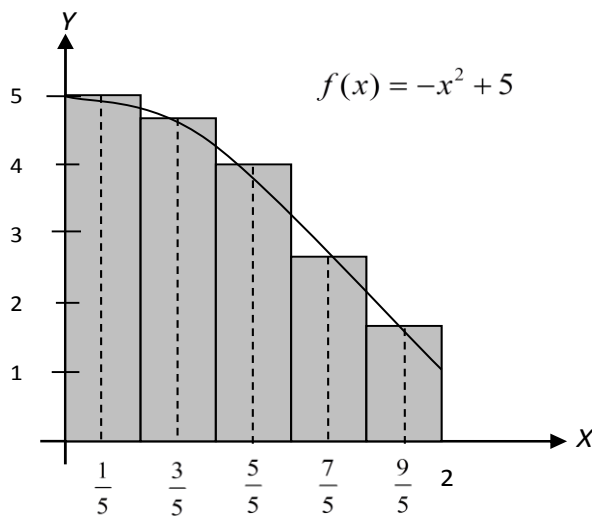

Figure 1.3: Approximating the area

According to the FTC, this area can be represented as

$$A = \int_a^b f(x) dx = F(b) - F(a), \text{ where } F(x) \text{ is an anti-derivative of } f(x), \text{ if a vertical}$$

rectangular strip is used.

1.2.5 Generating the volume of a solid of revolution

In order to understand VSOR students must be able to draw different types of graphs, identify correctly the area of the region bounded by those graphs, draw one rectangular strip that will be rotated, perform the necessary rotation and identify the correct formula for volume based on the rotated strip. In order to come up with the correct formula for volume students must have proper knowledge of figures such as a circle, an annulus and a cylinder (and their different orientations), be able to identify and draw two-dimensional and three-dimensional objects as well as rotations in general, be able to use imaginative skills and be able to do applications and calculations based on the definite integral.

In solving VSOR problems, the area bounded by drawn graphs in the XY - plane is rotated about the x -axis or about the y -axis, called an axis of revolution to form a solid (called solid of revolution) from the rotated figure. In order to form a solid, each point of the figure is rotated in a circle. If you slice the solid perpendicular to the axis of rotation, you will see a cross-section (the area revealed by many thin slices) that either resembles a coin (a full disc) or a washer (where the area between two circles in the bounded area is at a certain distance from the axis of rotation).

When learning about VSOR the emphasis would be on instruction that improves visual learning skills and development of the three formulae (disc/washer/shell). These formulae are derived from the idea of the volume of the solid as the integral of the area bounded by the given graphs. The volume in this case is found from the idea that volume = area \times height, so

$V = \int_a^b A(x) dx$ or $V = \int_c^d A(y) dy$. In the given formulae, $A(x)$ or $A(y)$ is the area rotated

which gives rise to a disc, a washer or a shell (cylinder) after rotation, depending on the selected rectangular strip. Δx (or dx) in the integral can be seen as the thickness of the selected vertical rectangular strip while Δy (or dy) can be seen as the thickness of the selected horizontal rectangular strip. In these formulae, $A(x)$ or $A(y)$ represents the area of a circle for the disc method, the area of a circle with a hole in the centre for the washer method and the surface area of a cylinder for the shell method. In all calculations for volume, the volume generated with different rotations (about the x -axis or about the y -axis) is different and gives different answers since the solids generated are different. The rotations form a revolution of 360° .

1.2.5.1 The disc method

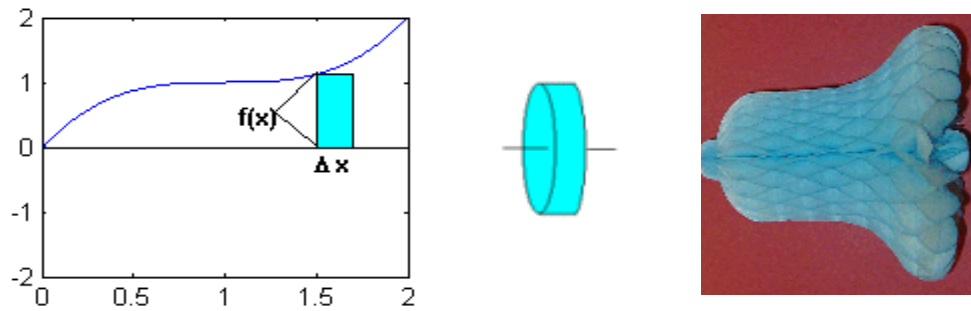

Figure 1.4: The disc method

The example given in Figure 1.4 is for a vertical strip (Δx), rotated about the x -axis. If a rectangular strip chosen to be *perpendicular* to and *touching* the x -axis is rotated about the x -axis, a circular three-dimensional diagram is formed. The circular three-dimensional diagram formulated resembles a flat cylinder with radius $y = f(x)$ and height Δx ; hence it is termed the *disc* method. Since the rotated diagram is circular the formula for the area of a

circle (πr^2) is used. The volume in this case is given by the formula $V = \pi \int_a^b [f(x)]^2 dx$ or

$V = \pi \int_a^b y^2 dx$, and a (the lowest x -value) and b (the highest x -value) are the limits of

integration for the bounded area.

If a rectangular strip chosen to be *perpendicular* to and *touching* the y -axis is rotated about the y -axis, a circular three-dimensional diagram is formed. The circular three-dimensional diagram formulated resembles a flat cylinder with radius $x = f(y)$ and height Δy . The

volume in this case is given by the formula $V = \pi \int_c^d [f(y)]^2 dy$ or $V = \pi \int_c^d x^2 dy$, and c (the

lowest y -value) and d (the highest y -value) are the limits of integration for the bounded area.

1.2.5.2 The washer method

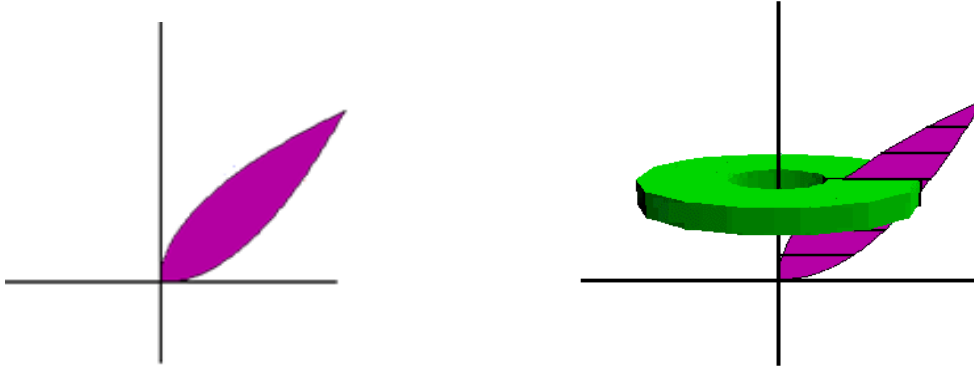

Figure 1.5: The washer method

The example given in Figure 1.5 is for a horizontal strip (Δy), rotated about the y -axis. If a rectangular strip chosen to be *perpendicular* to the y -axis and *not touching* it is rotated about the y -axis, a circular three-dimensional diagram with a *circular hole* from the y -axis is formed. The hollow circular three-dimensional diagram formulated resembles an annulus; hence it is termed the *washer* method. Since the rotated diagram is circular, with a hole in the middle, the formula for area of such a circle is $\pi[(r_o)^2 - (r_i)^2]$, where r_o is the radius of the outer circle and r_i is the radius of the inner circle.

Since different graphs are used $V = \pi \int_c^d [f(y)]^2 dy$ or $V = \pi \int_c^d x^2 dy = V = \pi \int_c^d (x_1^2 - x_2^2) dy$,

where x_1 represents the graph on the right and x_2 represents the graph on the left and c (the lowest y -value) and d (the highest y -value) are the limits of integration for the bounded area.

If a rectangular strip chosen to be *perpendicular* to the x -axis and *not touching* it is rotated about the x -axis, a circular three-dimensional diagram with a *circular hole* from the x -axis is formed.

Since different graphs are used $V = \int_a^b y^2 dx$ can be used as $V = \pi \int_a^b (y_1^2 - y_2^2) dx$,

where y_1 represents the top graph and y_2 represents the bottom graph, and a (the lowest x -value) and b (the highest x -value) are the limits of integration for the bounded area.

1.2.5.3 The shell method



Figure 1.6: The shell method

The example given in Figure 1.6 is for a vertical strip (Δx), rotated about the y -axis. If a rectangular strip chosen to be *parallel* to the y -axis is rotated about the y -axis, a cylindrical three-dimensional diagram is formed. The cylindrical three-dimensional diagram formulated resembles a shell; and thus it is termed the *shell* method. Since the rotated diagram is cylindrical, the formula for surface area of a cylinder ($2\pi rh$) is used, where r is the radius of the cylinder and h is the height of the cylinder.

Since different graphs are used $V = 2\pi \int_a^b x f(x) dx$ or $V = 2\pi \int_a^b x y dx$ can be used as

$V = 2\pi \int_a^b x(y_1 - y_2) dx$, where y_1 represents the top graph and y_2 represents the bottom graph, and a (the lowest x -value) and b (the highest x -value) are the limits of integration for the bounded area.

If the rectangular strip chosen is parallel to the x -axis and rotated about the x -axis, a cylindrical three-dimensional diagram is again formed. In this case the volume is given by

$V = 2\pi \int_c^d y f(y) dy$ or $V = 2\pi \int_c^d y(x_1 - x_2) dy$ where x_1 represents the graph on the right and

x_2 represents the graph on the left and c (the lowest y -value) and d (the highest y -value) are the limits of integration for the bounded area.

The formulae (disc/washer/shell) respectively if the radius is y and thickness is Δx are as

follows: $V = \pi \int_a^b y^2 dx$; $V = \pi \int_a^b (y_1^2 - y_2^2) dx$ and $2\pi \int_a^b xy dx$

1.3 THE PROBLEM DESCRIPTION

This study is on difficulties experienced by N6 engineering students when solving problems relating to VSOR, involving the FTC and its application to integration in calculating areas and volumes. The concept of the integral in VSOR is an important part of undergraduate mathematics and the FET college curriculum in South Africa. The integral concept, along with the derivative constitutes a mathematical domain that is a language, a device, and a useful tool that is very important for other fields: physics, engineering, economy, and statistics (Kouropatov, 2008, p. 1). In order to understand it better, it is advisable to study it through accumulation, such as in Riemann sums. The concept of accumulation is central to the idea of integration, and therefore is at the core of understanding many ideas and applications in calculus (Thompson & Silverman, 2008).

Students at the FET colleges are introduced to Riemann sums in N4 level focusing on vertical rectangles only and VSOR in N5 to N6 level, focusing on both vertical and horizontal rectangles. At N5 level the students use differentiation and integration techniques including calculating areas and volumes (only with *disc* and *washer* methods) using vertical and horizontal rectangles from the Riemann sums. The section on areas and volumes constitutes about $\pm 12\%$ of the final N5 examination paper. At N6 level a student comes with prior knowledge from N1 to N4 on drawing graphs such as straight lines, parabolas, circles, ellipses, cubic functions, exponential functions, logarithmic functions, trigonometric functions, hyperbolas and rectangular hyperbolas, which are applied in calculus. When students enrol for N6, one can assume that they come equipped with the necessary basic knowledge from previous levels for learning VSOR. In N6 the section on application of areas and volumes (including the *shell* method) constitutes 40 % of the examination paper.

In this study, I investigated the problems that the students encounter when learning VSOR. In order to do that, I explored how students draw graphs, how they use the Riemann sum on the drawn graphs, how they interpret those graphs, how they interpret questions that require procedural and conceptual understanding, how they perform calculations in evaluating areas and volumes (using the disc, washer or shell methods), and also how they translate from area (two-dimensions) to volume (three-dimensions). I was interested in investigating the difficulties that students come across when solving problems related to the definite integral, where the area or volume to be calculated is restricted within certain x -values or y -values. In particular I wanted to know what students produce in writing (both procedural and

conceptual), what they think and how they defend their mathematical content knowledge. I investigated the nature of the content learnt in VSOR and how the nature of the content learnt impacts on learning. I wanted to know what is actually happening in the classrooms in imparting this content to the students. What kind of teaching and assessments are these students exposed to? Are they taught and assessed properly? How do the teaching styles and the nature of assessment impact on the learning of VSOR? Are textbooks available for learning VSOR? If so, how useful are these textbooks in enabling them to learn a section of VSOR in terms of presentation of the content? The problem to be investigated in this study is why the students have difficulty in learning VSOR and where these difficulties emanate from.

Another aspect that may affect learning of VSOR but is not the focus of this study involves the use of language. Many students have learning difficulties caused by the use of language in mathematics (Amoah & Laridon, 2004; Howie & Pieterse, 2001; Howie 2002; Maharaj, 2005; Setati, 2008; White & Mitchelmore, 1996). Studies such as the Third International Mathematics and Science Study (TIMSS) revealed that South African students are performing badly in mathematics (Howie & Pieterse, 2001). Part of the results show that most South African students lacked the basic mathematical skills and failed to solve word problems, reason being, having to deal with English which is not the mother tongue for many students.

From the motivation for this study and the problem description discussed above, the following research question based on students' difficulties with VSOR was formulated.

1.4 RESEARCH QUESTION

The major research question for this study is:

Why do students have difficulty when learning about volumes of solids of revolution?

In order to address the major research question, seven subquestions were established, relating to what type of knowledge students display when solving problems on VSOR, revealing what they have learnt in relation to VSOR, how it is taught and how it is assessed. In selecting the sub-questions, the researcher identified aspects from literature, as well as from own experience, that can make the learning of the VSOR content successful or that could be problematic.

The subquestions are as follows:

Subquestion 1: *How competent are students in graphing skills? How competent are students in translating between visual graphs and algebraic equations/expressions in 2D and 3D?*

VSOR requires students to be in a position to draw correct graphs. Lack of students' competency in drawing graphs could therefore be a source of a problem when learning VSOR. After drawing the graphs, the students must be able to interpret them. They must be able to locate their points of intersection, their intercepts with the axis, identify the area bounded by these graphs by shading it as well as identifying the limits of integration and using them in the correct formula for area and volume. This is influenced by the way in which students visualise and is evident from what they produce in writing (graphically or in a form of equations/expressions) or what they verbalise. VSOR requires that students be able to visualise and use their imaginative skills, in order to translate from visual to algebraic and back.

Subquestion 2: *How competent are students in translating between two-dimensional and three-dimensional diagrams?*

The drawn graphs representing area are in two-dimensions and in rotating them, three-dimensional diagrams representing volume are formed. Learning difficulties arise if students cannot translate between the different dimensions, in terms of rotating properly about the given axis (x or y). The difficulties may also emanate from the selected rectangle, whether vertical or horizontal. If an incorrect rectangle is used, an incorrect formula to calculate area in two-dimensions and volume in three-dimensions will be selected. The inability to imagine rotations may also hinder or impact on correct translations and the formulae used.

Subquestion 3: *How competent are students in translating between continuous and discrete representation visually and algebraically in 2D and in 3D?*

This requires the application of the Riemann sums in terms of slicing the area bounded by the drawn graphs into thin rectangular strips (vertical or horizontal) which are summed to give the approximation of the area bounded and to calculate the volume generated when this area is rotated about either the x -axis or the y -axis. If the rectangles are not correctly selected, the area and the volume to be calculated will also be incorrect.

Subquestion 4: *How competent are students in general manipulation skills?*

Students may encounter difficulties in VSOR if they lack general manipulation skills. When given an integral, students should be able to calculate/evaluate it, or even to do calculations required in drawing graphs, including calculating the point of intersection of the given graphs.

Subquestion 5: *How competent are students in dealing with the consolidation and general level of cognitive demands of the tasks?*

The VSOR content is abstract. The way in which students interpret and internalise this content may result in difficulties in learning VSOR. What is the nature of abstraction with this content? Are the students able to meet the challenges to internalise this content? How do students interpret the symbols and notations used in VSOR? This may be evident from what students produce in writing or during their discussions and how familiar students are with the terminology used in VSOR.

Subquestion 6: *How do students perform in tasks that require conceptual understanding and those that require procedural understanding?*

I believe that VSOR requires both conceptual and procedural understanding with conceptual knowledge as the basis for proper learning of VSOR. I want to investigate how students conceptualise when learning VSOR and how they perform in tasks that require imagination when rotating. Conceptual understanding focuses on in-depth learning of VSOR and how students engage meaningfully with it. That will be evident from students' deliberations, the questions they ask and what they produce in writing and verbally as they construct knowledge.

Subquestion 7: *How is VSOR taught and assessed and how does that impact on learning?*

The way in which students are being taught and assessed may result in problems in learning VSOR. How are the six subquestions above integrated in class? What kinds of methods are used in teaching and assessing VSOR? VSOR requires that students be able to visualise and imagine, and as a result methods used in teaching might require the *visual/animated exposure* in order to enhance conceptual understanding as a basis for procedural understanding. The aim is finding out whether learning difficulties are as a result of students' inadequate exposure to visual aids during the learning process or not. It is also necessary to investigate the way in which the students are being assessed, as well as finding out if perhaps there are any other learning obstacles involved.

1.5 SIGNIFICANCE OF THE STUDY

The significance of this study is threefold. It is significant in that it aims to impact on the nature of the content; how it is learnt, taught, and assessed and how it could be improved.

Firstly, the difficult aspects in VSOR are made public and simplified to both the lecturer and the student. Suggestions are given as to what the content of VSOR entails, in a way of simplifying the content to both the lecturer and the student from an expert perspective. The importance and the relevance of the Riemann sums and all other subparts that are crucial in understanding the VSOR is made public. The implications and the importance of the procedural and the conceptual concepts (the roots of VSOR) are differentiated for the student and the lecturer.

Secondly, as a mathematics lecturer, I am interested in improving the standard of learning, teaching and assessment in our country, in particular at the FET colleges. This study is significant in that it may lead to exposure of different methods of learning, teaching and assessment of VSOR that could be beneficial to both students and lecturers. Consequently, there is an attempt to make the section on VSOR accessible and relevant. Lecturers need to improve on their *pedagogical content knowledge*, which is the kind of knowledge that “goes beyond knowledge of the subject matter per se to the dimension of subject matter knowledge for teaching” (Shulman, 1986, p. 9). Shulman argues that teachers need to know the content they teach in-depth, understand what makes learning of specific topics easy or difficult and understand it better than others since teaching entails transformation of knowledge into a form that students can comprehend. If lecturers’ pedagogical content knowledge is improved, their confidence in dealing with a section like VSOR may be improved and proper learning will take place.

This study may lead to the improvement of teaching where lecturers use appropriate methods that build the students’ conceptual understanding as a basis for procedural understanding. Appropriate learning strategies used may assist in equipping students with lifelong learning that could benefit them in their working environments. The industry and the economic status as a whole could be improved by such changes, as they might receive students with a good conceptual understanding and critical thinking skills. Students may benefit from what is learnt at the colleges and its application to industry, if its relevance to the industry is made

explicit in the classroom. This could lead to high awareness of the curriculum status at the colleges as it is popularised as being of high quality and not to be undermined.

Lastly, if lecturers' pedagogical content knowledge is improved, they will also have confidence in applying different methods of assessment. If lecturers know what to teach and how to teach it, proper ways of learning, teaching and assessment of VSOR which constitutes $\pm 12\%$ (at N5 level) and 40% (at N6 level) of the examination paper will take place. I anticipate that assessment procedures laid by the national DoE on assessment of VSOR may change. This may lead to curriculum change in that students will be assessed in better ways that are beneficiary to both the students and the lecturers and education in general. Improvements in N6 mathematics will be made and may be enjoyed by all the stakeholders. Lecturers' pedagogical content knowledge may be improved if teacher training courses are implemented at the colleges, mainly on addressing the content to be learnt and different ways of assessing it from the expert position.

When investigating the development of secondary mathematics teachers in Auckland Barton and Paterson (2009) reported that increasing the depth of understanding of mathematical knowledge may promote effective teaching of secondary mathematics. Another study conducted by Akkoç, Yeşildere and Özmantar (2007) on prospective teachers' pedagogical knowledge revealed that the teachers had difficulty in applying the concept of the limit process when teaching the definite integral. These teachers were not able to use the limit process to address how increasing the number of strips improves the approximation for area under a curve, due to their lack of pedagogical content knowledge.

This study can shed light on what is happening in classrooms when students are taught and assessed, and what could be done in order to improve it, the aim being to help all parties involved to benefit from the system, and to be empowered.

1.6 CONCLUSION

In Chapter 1 the setting of the country and its education system was discussed and extended to the FET colleges. The structures of the FET colleges, where they are located as well as the entry requirements were also discussed. My involvement in teaching in schools, FET colleges and university of technology were discussed. The problem description for this study was presented, in particular, how Riemann sums affect learning of VSOR as well as its

implications to two-dimensional and three-dimensional representations for areas and volumes. In the motivation for the study, I highlighted the important factors involving learning, teaching and assessment of VSOR from my experience. In the problem statement, I pointed out the crucial aspects that will be investigated in VSOR. That involved how students draw graphs, identify the rectangular strip, interpret the drawn strip, rotate the area bounded by the graphs from two-dimensions to three-dimensions, how they translate from the drawn graph to algebraic equations, as well as how the students apply the disc, washer or shell methods. The role of language and its effect on VSOR were also discussed. From the problem description, the research question and its subquestions were established. The research question for this study will be expanded further in the literature to find out what was done to date in relation to the subquestions established. The significance of this study was also discussed in terms of curriculum innovation, relating to the VSOR content, how it could be learnt, taught and assessed, in a way of improving it.

1.7 OVERVIEW OF THE CHAPTERS

Chapter 1 presents the context of the study in relation to the education system in South Africa and the way the FET colleges operates. It also presents the motivation for the study, the problem statement, the research questions as well as the significance of the study. Chapter 2 presents the literature review for the study in order to know what has been done or not done in relation to the VSOR topic. Chapter 3 presents the conceptual framework that locates this study. Chapter 4 presents the research design and methods including the instrument for data collection. In Chapter 5 the results from the preliminary and the pilot studies are presented and analysed. In Chapter 6 the results from the first and the second runs of the questionnaire and the August 2007 examination results are presented and analysed in terms of the five skill factors. Chapter 7 presents the correlations from the questionnaire runs and the examination analysis discussed in Chapter 6. Chapter 8 presents the summaries and narratives from the classrooms observations and interviews. Chapter 9 presents the interpretations and conclusions for the whole study as well as the limitations and the recommendations.

CHAPTER 2: LITERATURE REVIEW

In this chapter, the literature related to the way in which students learn mathematics in general and concepts related to VSOR, how they are taught and how they are assessed are discussed. In particular, the way in which the students draw graphs and diagrams (based on their external representations) and interpret them (based on the internal representations) are discussed, hence relating to the cognitive obstacles they come across. In the interpretation of the graphs, literature related to the way in which the students translate between the visual graphs and algebraic equation from the Riemann's sums and the rotations formulated (from 2D to 3D) are discussed, revealing the effect of visual and algebraic approach to learning and the concept images formulated. The discussion also extends to how the students solve problems that are conceptual and procedural in nature. Contextual factors that affect the learning of VSOR, and learning mathematics in general are discussed in order to strengthen the focus of this study. The discussion is done under the following headings:

- *Graphing skills and translation between visual graphs and algebraic equations/expressions in 2D and 3D.*
- *Translation between two-dimensional and three-dimensional diagrams.*
- *Translation between continuous and discrete representations.*
- *General manipulation skills.*
- *Consolidation and general level of cognitive development.*

Contextual factors that affect learning are discussed under the following headings

- *Writing to learn mathematics and effect of language.*
- *Scaffolding learning.*
- *Teaching approach.*
- *Curriculum level and assessment.*
- *Use of technology.*

2.1 GRAPHING SKILLS AND TRANSLATION BETWEEN VISUAL GRAPHS AND ALGEBRAIC EQUATIONS/EXPRESSIONS

In the learning of VSOR students draw graphs and interpret them, visually or algebraically. In translating between visual graphs and algebraic equations/expressions, students' visual ability and algebraic abilities are involved. The way in which students visualise the graphs affect the

way in which they translate to equations and the way in which the students manipulate algebraic equations affect the way in which they translate those equations to visual graphs. When performing these forms of translations, algebraic equations/expressions are justified visually using diagrams. Visual justification in mathematics refers to the understanding and application of mathematical concepts using visually based representations and processes presented in diagrams, computer graphics programs and physical models (Rahim & Siddo, 2009, p. 496).

2.1.1 Visual learning and symbols

According to Duval (1999, p. 13) “visualization refers to a cognitive activity, that is intrinsically semiotic, that is, neither mental nor physical”. Also such expressions as ‘mental image’, ‘mental representation’, ‘mental imagery’, are equivocal”. A mental image in terms of Gutiérrez (1996, p. 9) is “any kind of cognitive representation of a mathematical concept or property by means of visual or special elements”. Gutiérrez (1996, p. 9) considers visualisation as “a kind of mathematical reasoning activity based on the use of spatial or visual elements, either mental or physical performed to solve problems and or prove properties” and to mean the same thing as spatial thinking (Gutiérrez, 1996, p. 4). Haciomeroglu, Aspinwall and Presmeg, (2010, p. 159) and Jones (2001, p. 55) regard visualisation as a process involved in forming and manipulating images whether with pencil and paper or computers in order to understand the mathematical relations. Jones (2001, p. 55) further attests that “visualisation is essential to problem-solving and spatial reasoning as it enables people to use concrete means to grapple with abstract images”. Visualisation is

the ability, the process and the product of creation, interpretation, use of and reflection upon pictures, images, diagrams, in our minds, on paper or with technological tools, with the purpose of depicting and communicating information, thinking about and developing previously unknown ideas and advancing understandings (Arcavi, 2003, p. 217).

Spatial visualisation ability is a skill and a necessity in the engineering related areas since diagrams are used quite often. Menchaca-Brandan, Liu, Oman, and Natapoff (2007, p. 272) defined spatial ability as the “ability to generate, visualize, memorize, remember and transform any kind of visual information such as pictures, maps, 3D images, etc”. Spatial ability according to Wikipedia free encyclopaedia refers to **spatial visualisation ability** or **visual spatial ability** which is the ability to mentally manipulate two-dimensional and three-dimensional figures. Menchaca-Brandan et al. (2007) use subcomponents on spatial ability as perspective-taking and mental rotations. They argue that perspective-taking (also known as spatial orientation) is the ability to imagine how an object or scene looks from different perspectives and that mental rotation (also known as *spatial relations*) refer to the ability to

mentally manipulate an array of objects. Spatial visualisation is also seen by others as “the ability to imagine the rotation of a depicted object, to visualize its configuration, to transform it into a different form and to manipulate it in one’s imagination.” (Ryu, Chong & Song, 2007, p. 140). According to Deliyianni, Monoyiou, Elia, Georgiou and Zannettou (2009, p. 98) “students’ competence in generating pictures in mathematical tasks appears to be related to their spatial ability”. Such skills are concerned with manipulating, reorganising, or interpreting relationships visually (Tartre, 1990, p. 216). It is highlighted that “children who have a strong spatial sense do better at mathematics” (Clements, 2004, p. 278). It is also emphasised that spatial visualisation abilities are important for individuals who are developing and designing the three-dimensional environment and for those working in the field of engineering (Leopold, Gorska, & Sorby, 2001, p. 82).

Kozhevnikov, Hegarty and Mayer (2002), refer to those students who use visualisation as visualisers who process visual-spatial information, in a form of visual imagery and spatial imagery. Kozhevnikov et al. (2002, p. 48) argue that “*Visual imagery* refers to a representation of the visual appearance of an object, such as its shape, size, color, or brightness, whereas *spatial imagery* refers to a representation of the spatial relations between parts of an object, the location of objects in space, and their movements”. They further assert that some individuals may construct vivid, concrete, and detailed images of individual objects in a situation (the iconic type: visualisers with low spatial ability), whereas others create images that represent the spatial relations between objects that facilitate the imagination of spatial transformations such as mental rotation (the spatial type: visualisers with high spatial ability). The results of their study reveal that when dealing with graphs of motion, the iconic types tend to generate images by looking for a pattern with the closest match to the stimulus, for an example the downward motion, while the spatial types visualise overall motion by breaking the graph down into intervals and visualising changes in the object’s velocity from one interval to another successively (Kozhevnikov et al., 2002, p. 64). They characterised high-spatial visualisers (spatial type) as those who engage the spatial-schematic imagery system in solving problems, and low-spatial visualisers (iconic type) as those who engage the visual-pictorial imagery system in solving problems (Kozhevnikov et al., 2002, p. 69). It is argued that

Visual-spatial representations were classified as being either primarily schematic, representations that encoded the spatial relations described within the problem, or primarily pictorial representations that encoded objects or persons described in the problem. Schematic representation was positively correlated with success in mathematical problem solving, whereas pictorial representation was negatively related to success in mathematical problem solving (Van Garderen, 2003, p. 252).

Chmela-Jones, Buys and Gaede (2007, p. 630) believe that visual learning is an approach to “helping learners communicate with imagery”. They further affirm that the visual learning style is useful for learners who prefer the visual modality of learning in order to better recall what has been observed or read. This kind of learning is important in VSOR since it involves imagination as its foundation. When students engage in visual learning, the external representation and the internal representations are involved in the learning process. External representation refers to mathematics that can be visualised in terms of concrete objects while the internal representation refers to how the external representation is interpreted in the student’s mind as a mental image. Dreyfus (1995) discusses the external representations in terms of diagrams and internal representations in terms of mental images. He discusses how external images and discourse interact with students’ approaches to solving mathematics problems with the aid of diagrams.

Dreyfus (1995, p. 3) believes that one cannot think without mental images. He believes that for mathematics in particular, the most important type of visual information is diagrammatic (static or dynamic) which is the external representation and it plays a role in making meaning, understanding and mathematical reasoning. The mental images that students construct enable them to succeed or fail to succeed in learning mathematics. In solving mathematical problems, Dreyfus (1995, p. 13) believes that students avoid using diagrams and diagrammatic reasoning because of cognitive obstacles related to the diagrams. He points out that in one high school classroom, diagrams played a central part of students’ activities and lecturer explanations, but students were observed drawing diagrams only when they were explicitly directed to do so. In that case students did not see the significance of using diagrams to express what they were thinking. Dreyfus argues that in problem-solving, students connect the external representation with the internal representation that corresponds with the diagrams. This internal representation, which he calls the *visual imagery*, is not possible to access, as it can only be made public by the individuals themselves as they experience it, unless they talk it out by writing down or drawing. According to Dreyfus (1991, p. 32), “to be successful in mathematics, it is desirable to have rich mental representations of a concept” that would enable students to interpret the external representations (diagrams) appropriately.

The impact of visual imagery was evident in the study conducted by Duval (1999), which revealed that students were able to draw graphs when given equations and to read coordinates, but could not discriminate between the drawn graphs of $y = x + 2$ and $y = 2x$.

These students were able to translate from algebraic equations/expressions to visual graphs, but failed to translate from visual to algebraic. In this case there was a mismatch between the representations.

Dettori and Lemut (1995) discuss the role of external representation in arithmetic problem-solving. Their study was aimed at the acquisition of arithmetic concepts of number and elementary operations. Their students were working in a pen-and-paper environment and a computer hypermedia environment. They also experienced that students lacked the external representation (use of diagrams), and they attributed that to some blockages (referred to as *cognitive obstacles* by Dreyfus). Students in this case were found not to be in a position to solve problems or even to relate them to what was previously learnt. They used the computer to develop representations that could assist them as a cognitive help in arithmetic problem-solving (Dettori & Lemut, 1995, p. 29). According to Dettori and Lemut (1995) a computer is a powerful means for manipulating verbal, symbolic and pictorial representations. It can also provide a rich interactive source of possible imagery, both visual and computational (Tall 1995, p. 52). The external and internal representations discussed above are significant in learning mathematics, but different students have their own preferences in terms of representations.

In their study on understanding the concept of area and the definite integral, Camacho and Depool (2003) used Calculus I students after learning with the computer software programme DERIVE. Analysing the results obtained, the study revealed that DERIVE allows students to progress slightly in their use of graphic and numerical aspects of the concept of definite integral. However, one of the students interviewed was seen to prefer to work more with algebraic than with graphic representations, while the other student was able to work in both representations. In general from the questions given graphically, the students were not fully successful in interpreting the graphs as well as translating them to algebraic equations. In another study, Maull and Berry (2000) designed a questionnaire to test engineering students on differentiation, integration, differential equations and their application to simple physical cases. The results of the study reveal that engineering students prefer verbal representations and that their individual visualisations are idiosyncratic and do not coincide with the diagrams presented to them (Maull & Berry, 2000, p. 914).

An example from Haciomeroglu et al. (2010) study showed that when presented with a derivative graph in the interviews, sometimes students sketched its antiderivative graph on

paper while describing how it changed. Sometimes they described how they transformed the derivative graph into an antiderivative graph before sketching it on paper. From the students' behaviour, the authors believe that students form visual mental images guiding their thinking and employed imagery as they transform the derivative graph on paper or in their minds. Their study revealed that understanding of mathematics is strongly related to the ability to use visual and analytic thinking, as it was evident from the students' performance. They considered students' solutions as analytic (equation-based) or visual (image-based) when they translate into symbolic representations or graphic representations respectively. The results of Haciomeroglu et al. (2010) study regarding graphical tasks reveal that the one student demonstrated a strong preference for analytic thinking and relied on symbolic representations without the use of the visual representation. The results of the other two students showed that both students were more comfortable when using the y values on the derivative graphs to visualise the changing slopes at various points and used these to draw the antiderivative graphs. They both used visualisation as the primary method in their work. For one of these students it was concluded that dynamic visual images, without significant support from analytic thinking, prevented his complete understanding. The other student was able to draw precise sketches with the help of analytic support of his visual images. The conclusion for their study is that the ability to synthesise analytic and visual thinking is vital in the complete understanding of differentiation and integration.

According to Aspinwall and Shaw (2002), reform efforts promote an understanding of both the analytic and the graphic representations of functions. They claim that analytic representation is in the form of symbols and is easier to manipulate, analyse or transform, whereas graphic representation conveys mathematical information visually. Tall (1991) and Habre and Abboud (2006) in their study showed that students' understanding of functions in calculus is rather algebraic (analytic) than visual. Aspinwall, Shaw and Presmeg (1997) argue that calculus courses in colleges in USA are designed to put more emphasis on the graphical approach on learning calculus as students tend to prefer the algebraic approaches, at times using graphing technology. They further argue that even if it is believed that graphs improve students' conceptual understanding, they may also serve as a source of barriers to constructing meaning through mental imagery.

Observation made by Neria and Amit (2004) from a written test (on optimisation, rate of change and area and circumference of a rectangle) based on students' solutions on mathematical problems regarding different mode of representations, indicated that students

who preferred the algebraic mode achieved higher scores in the test than those who preferred the graphical mode. The results of another study by Nilklad (2004), who investigated 24 college algebra students' understanding, solution strategies, and algebraic thinking and reasoning used as they solved mathematical function problems, revealed that algebraic thinking and reasoning are lacking in students' problem-solving strategies. The study also revealed that in some instances none of the students used diagrams or pictures to clarify their examples when solving problems. However, from five students who were interviewed it was evident that the symbolic and graphical representations were used more often than any other representations while these students solved problems. The students were able to change from one representation to another, such as changing a verbal to a graphical representation or to a symbolic representation, moving from the external representation to the internal representation. An external representation, according to Gutiérrez (1996, p. 9) can be a verbal or graphical representation in a form of pictures, diagrams or drawings that helps to create or transform mental images and to reason visually. The internal representation (concept images) is what is in the mind of the learner. Students' concept images (which are enriched by the students' ability to visualise mathematical concepts) are often based on prior knowledge which they acquire through different experiences, including their daily experiences (Harel, Selden & Selden, 2006).

For her PhD study Rouhani (2004) conducted a case study of students' knowledge of functions using technology. Her study revealed that students were more knowledgeable about the recognition of functions than its interpretation and translation. The students had more difficulty with the interpretation of functions in algebraic form than in graphical representation. However, when coming to translations, the translation of functions from a numerical to a graphical representation was easy for all the participants. On the other hand, the translation of functions from a symbolic to a graphical representation was less frequent (Rouhani, 2004, p. 120). Farmaki, Klaoudatos and Verikios (2004) argue that a function is a central concept around which school algebra can be meaningfully organised.

When translating between visual graphs and algebraic equations/expressions, symbols are used. In the study of VSOR the symbols used include the *integral sign*, Δx and Δy . White and Mitchelmore (1996) point out that in some cases students operate with symbols without relating to their possible contextual meanings. If students do not contextualise what they are learning, they end up learning without proper understanding. According to Maharaj (2005)

many students perform poorly in mathematics because they are unable to handle information given in symbolic form adequately.

Maharaj (2008) conducted a study focusing on the outcomes and implications of research on (a) use of symbols in mathematics, (b) algebraic/trigonometric expressions, (c) solving equations, and (d) dealing with functions and calculus. He argues that it is important that attention be focused on establishing the meaning of symbols when teaching mathematics as they appear in different contexts. He points out that

Mathematics makes use of symbolic notation, which serves a dual role as an instrument of communication and thought. This special language makes it possible to represent in coded form mathematical concepts, structures and relationships (Maharaj, 2008, p. 411).

He argues that students should be encouraged to seek meaning when dealing with symbolic notation representing algebraic expressions, equations, and functions as well as get involved in verbalisation, visualisation, and appropriate mathematical questions which all contribute to sense-making (Maharaj, 2008, p.412). Another study by Samo (2009, p. 11) gives evidence that students' difficulties in algebra could be related to their difficulties and misinterpretation of symbolic notations as well as translating word problems to equations.

In her PhD study Montiel (2005) observed a Calculus II class and interviewed four students. Her study is strongly oriented towards the understanding of how learning, when applied to integral calculus, is affected by the dual nature of the integral symbol. She relates to the integral symbol as an instruction to carry out an operational process, as well as the embodiment of a specific object which is produced by that process, representing the mathematical concept of accumulation (Montiel, 2005, p. 3). Among other questions, students were given equations of graphs and were expected to set up the integrals that would permit them to find the volume of the solid generated by revolving the region bounded by the graphs of the equations about the indicated lines. In this case they were expected to translate from algebraic to visual (by drawing the graphs of the given equations) and then expected to translate from visual to algebraic as they set up integrals that would enable them to calculate the volume (involving disk, washer and shell methods). They were also given integrals (for area and volume) and asked to sketch them. In that way they were translating from algebraic to visual where the use of symbols in integration was tested. Most students in Montiel's study were able to draw graphs, but there were cases where students had problems, for example, two of the interviewed students were seen to express a certain function algebraically in terms

of y , but drew it in terms of x . In another study, Yasin and Enver (2007, p. 23) found that students had difficulty in drawing the graphs of functions except of polynomial type.

The symbolic language used in calculus was also explored where students were presented with volumes and areas (given below) expressed in terms of integrals, and were asked to

make sketches $V = \pi \int_0^4 (\sqrt{x})^2 dx$, $A = \pi \int_0^4 (\sqrt{x})^2 dx$ (Montiel, 2005, p. 103). Two students

identified the disc method (by the π) from the formula for volume, and used the boundaries correctly to sketch the two graphs. The other two students struggled with the area concept, confused by the π on the formula for area. They failed to see it as a constant. The findings were that a “cognitive obstacle” prevailed as students translated from equations to areas and solids of revolutions and back. Some students were seen to confuse the methods for calculating areas and volumes, and using incorrect rectangles for approximation of the area, as well as translating to volume. These problems that were evident in Montiel’s study were investigated in my study with more than a 100 students who solved 23 questions (classified in five categories) and another group more than a hundred, who wrote the final N6 examinations. In this study I analysed qualitatively in-depth the students’ thinking processes in written form. I did not interfere with their thinking processes. In a way of getting involved in their thinking processes, I used scaffolding for a group of eight students who were observed for five days while learning VSOR.

2.1.2 Transferring between mathematics and applications

In some instances students are translating from graphs to other contexts. Ubuz (2007) conducted a study where students were interpreting graphs and constructing derivatives. In my study students were translating from graphs to graphs or to the integral formula. For example students translated from area to volumes graphically and algebraically. Hjalmarson, Wage and Buck (2008) conducted a study with electrical engineering students who had completed advanced calculus or differential equations. They believe that graphical representations play a significant role in conceptual understanding within upper-level applied mathematics and that students need to be able to interpret and generate graphs as part of their mathematical reasoning. The challenge for instructors in this class was helping students learn to transfer knowledge from their mathematics class to applications in signals and systems. Students did not always connect their mathematics knowledge with the signals and systems problems. There were also representational challenges in two forms: the symbols unique to

signals and systems used for representing equations and a heavy use of graphical representations (Hjalmarson et al., 2008, p. 1). Their students were asked to make an interpretation from a graph (or graphs), for periodic functions and then to select another graph based on their interpretation.

Students did periodic functions and Fourier transformations in their mathematics course, but had problems transferring that knowledge to the electrical component of the course. Students were seen to struggle to balance their conceptual and procedural knowledge. Some of the students believed that they could do the mathematics but they did not understand it. Some students expressed fear, confusion or dislike of the Fourier transformations. In a few cases, students had trouble beginning to reason through a problem because of the association with the Fourier transform. While the majority of the students interviewed could successfully interpret and analyse the graphical representations associated with the Fourier transform, it still presented a conceptual challenge to them in that they felt a bit frustrated because of their lack of confidence with the concept associated with Fourier transformations. Their discomfort with the Fourier transform is particularly notable as no computations or manipulations of equations were required in order to successfully complete the problems (Hjalmarson et al., 2008, p. 13-14).

In their study Rösken and Rolhka (2006) report on some research into what students do know with a special focus on visual aspects of the integral in relation to mental representations. In one of the questions students were asked to illustrate the geometric definition of an integral (from words to visual). The results of the study reveal that 77% of the students' illustrations were restricted to the 1st quadrant only, which represent a positive area as shown in Figure 2.1.

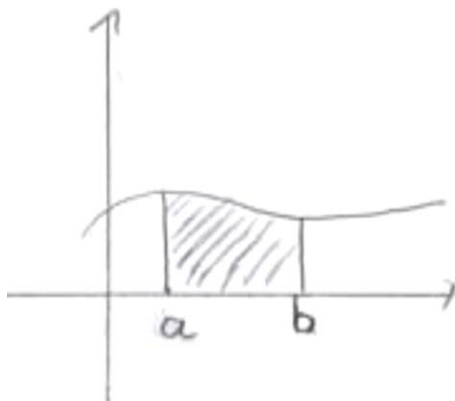

Figure 2.1: Students' visualisation of an integral (Rösken and Rolhka, 2006, p. 459)

In other instances the students in the Rösken and Rolhka (2006) study were unable to name the limits of integration and to use visualisation approaches. They preferred algorithmic approaches even if a visual approach was necessary for some problems. In their interpretation Rösken and Rolhka (2006, p. 463) believe that the students in their study are “cognitively fixed on algorithms and procedures instead of recognizing the advantages of visualizing”.

In another study Haciomeroglu et al. (2010) aimed to analyse the thinking processes of high-achieving calculus students as they attempted to sketch antiderivative graphs when presented with derivative graphs. They developed graphical tasks to evoke imagery and probe students’ thinking. Their study focussed on understanding of students’ difficulties and strengths associated with visualisation as well as the types of mathematical imagery utilised by students while interpreting the derivative graphs. They assert that individuals can create different internal representations of a concept that is presented as an external instructional representation such as a diagram or graph. As it is the case in my study, students translate from graphs to other contexts within mathematics itself. They transfer what they have learnt in areas to volumes (graphically) and do the same using symbols. In my study the transfer is within, that is from mathematics to mathematics. As it is the case in Hjalmarson et al. (2008) study, where students struggled to balance their conceptual and procedural knowledge, I also investigate the relationship of students’ conceptual and procedural knowledge as they transfer from areas to volumes. That is in a form of how they visualise and translate from visual to algebraic as well as how they do calculations of areas and volumes. Visualisation plays an important role in the development of algebraic skills discussed below.

Students’ algebraic skills in functions were also evident in the following two similar studies done by Knuth (2000) and Santos (2000) on the *Cartesian Connection*¹, relating to how students translate from algebraic to graphical representations and vice versa. Knuth (2000) conducted a study with 178 students enrolled for calculus. The students’ understandings of the connection between algebraic and graphical representation of functions were explored. He examined the abilities of students to employ, select and move between the different representations. He did that by examining how the students used a particular aspect of the Cartesian Connection, where the coordinates of any point on a line would satisfy the equation of the line (Knuth, 2000, p. 2). Students were given six tasks to work on, where both the

¹ Cartesian Connection is the way in which students are able to see how points plotted on a Cartesian plane can be joined to resemble a particular graph, as well as drawing graphs on the Cartesian plane when points are given.

algebraic representation of a function and a corresponding graphical representation were indicated. All the problems required the use of the Cartesian Connection in determining the solution. Knuth (2000, p. 3) hypothesised that if students understood the Cartesian Connection, for these problems in particular, they would then tend to use the graphical solution method (using graphs), as it was the most suitable one in responding to these problems. However, students used the algebraic solution method (using equations). The students in Knuth's study were not aware that when asked to find a solution to an equation, the answer might be represented graphically.

The findings from Knuth's study revealed that many students were able to connect between the algebraic and the graphical representations of functions when dealing with familiar routine tasks, where a table of values is used to satisfy a given equation, thereafter plotting the values on a coordinate graph, but failed to use this connection to move from a graph to an equation (Knuth, 2000, p. 4). However Knuth argues that

students' reliance on algebraic-solution methods is due to their failure to recognise the points used in calculating a slope as solutions to an equation-recognition of which should make a graphical-solution method a viable option rather than to a perceived need for precision (Knuth, 2000, p. 4).

Students failed to connect when they were unable to realise that the selection of any point on the graph of a line would not be a solution to the line (Knuth, 2000, p. 4). Knuth (2000) further suggests that in making the connections, students normally experience problems as a result of the interactions between their internal representations with the external representations, which were discussed above. Knuth (2000, p. 4) points out that the students' preferences might be due to the curricular and instructional emphasis, which is dominated by a focus on algebraic representations and their manipulations.

Santos (2000) on the other hand conducted a study where 40 Grade 12 high school students worked on mathematical tasks, where they were asked to examine the connections between graphical and symbolic representations, on *variation*, *approximation* and *optimisation*, through graphic, table and algebraic representations. The students were using dynamic software (Cabri-Geometry), which enabled them to examine variation among main parameters attached to the problem they were engaged with as well as visualisation of mathematical relationships. Students were asked to justify and explain their arguments to support their responses relating to the different representations in written form, which were presented to the whole class later to defend their arguments. They were tape-recorded throughout the tasks. The students' work was assessed in four episodes.

In the first episode students were asked to graph on the Cartesian system, $y = -2x + 8$ in the first quadrant and to examine the relationships between co-ordinates and the algebraic representations. Initially students in this study did not recognise that they could substitute the corresponding value of x in the expression $y = -2x + 8$ to determine the value of y , but they finally recognised this (Santos, 2000, p. 1999). In the second episode the students were expected to make use of a table, in which they showed calculations in terms of length of the sides of the rectangle, as well as the corresponding areas and perimeters. They were able to represent that if one side of the rectangle (the one that rests on the x -axis) had the value x , then the other side b could be expressed as $b = -2x + 8$. In this exercise the table became a powerful tool in enabling the students to observe variation in terms of area and perimeter (Santos, 2000, p. 203).

In the third episode the students were connecting three registers of representations, the *graphic*, *algebraic* and *numeric* with regard to the initial task. Students were asked to draw a graph which corresponds to the expression of area $A(x)$, as well as to describe the behaviour of the graph in terms of the side and area of the rectangle (Santos, 2000, p. 203). Cabri-Geometry was used in graphing the area. The students were asked to reflect on connections or relationships between the graph of the area and the type of the rectangle. They were asked to observe what the expression $A(x)$ becomes if $x = 1$, which is $A(1) = 6$. They were also asked to calculate the dimensions of the rectangle whose area is 8, and to justify if there was a rectangle with an area of 10 square units. In the fourth episode students were asked to find a rectangle of maximum area with fixed perimeter.

In Santos's study, students were given the opportunity to conceptualise, ask questions, argue and defend their arguments to develop mathematical understanding. The use of technology (Cabri-Geometry) provided a learning environment where students were able to analyse main parameters associated with the tasks (Santos, 2000, p. 210). Santos argues that even if the task was routine, it could be used as a platform to discuss and introduce the use of different representations, hence transforming the task to non-routine.

Much can be learnt from the above two studies by Knuth and Santos. The studies reveal that the task given to students might help them to work in different levels of representation even if it is a routine one. It is important that the task must be designed in such a way that it engages the students in critical thinking. The students in Santos's study were more successful in

working in different levels of representation than those in Knuth's study, possibly because they used dynamic software (Cabri-Geometry) to help them visualise the graphical relationships. The design and development of these two studies is used as a starting point in designing the tasks for my study, focussing on different levels of representations.

2.2 TRANSLATION BETWEEN 2D AND 3D DIAGRAMS

Translation between 2D and 3D diagrams requires a special kind of visualisation that involves imagery. Cube construction tasks, engineering drawing and mental rotation tasks were used to test whether manipulation and sketching activities could influence spatial visualisation ability in civil engineering students from Malaysian polytechnics (Alias, Black & Gray, 2002). The results of the study revealed that implicit teaching of mental rotation skills could be the cause for the lack of gain in mental rotation and that spatial activities (to be emphasised during teaching) enhance students' spatial visualisation ability (Alias et al., 2002). A study that focused on examining deaf and hearing students' ability to see, generate, and use relationships in mathematical problem-solving was conducted by Blatto-Vallee, Kelly, Gaustad, Porter, J and Fonzi (2007). According to Blatto-Vallee et al. (2007, p. 444), hearing students across the board generally utilised visual-spatial schematic representations to a greater degree than the deaf students in mathematical problem-solving, whereas deaf students used visual - spatial pictorial representations to a greater degree than hearing students. For that reason, hearing students were more successful in problem-solving than the deaf students.

A task designed by Ryu et al. (2007) for seven mathematically gifted students which could be solved by mentally manipulating, rotating or changing the direction of depicted objects in involving spatial visualisation abilities yielded the following results.

Though 2 out of the 7 subjects displayed characteristic spatial visualization ability carrying out all the tasks in this research, most of the other 5 students had some difficulty in mentally manipulating an object depicted in a plane as a spatial object. The spatial visualization abilities mainly found in the students' problem-solving process are the ability to mentally rotate a 3-dimensional solid figure depicted in 2-dimensional representation and thus change the positions of its constituents, to transform a depicted object into a different form by mentally cutting it or adding to it, to see a partial configuration of the whole that is useful to solve the problem, and to mentally arrange or manipulate a 3-dimensional object depicted in 2-dimensions (Ryu et al., 2007, p. 143).

The majority of the students from Ryu et al. (2007) study, though mathematically gifted, had difficulty in imagining rotations. Leonhard Euler, the great Swiss mathematician of the eighteenth century (1707-1783) was known for his power of imagining things through which he continued to do complicated mathematics calculations in his head even when he was blind.

This power of imagining things can be useful in imagining rotations in VSOR even including the diagrams that students are confronted with for the first time.

Duval (2006, p. 119) point out the fact that there are persistent difficulties that students encounter with figures as misunderstanding of the mathematics represented. That is as a result of the fact that what one sees in a figure depends on factors of visual organisation, that is the recognition of certain one-, two- and three-dimensional forms in a figure. According to Duval, seeing in geometry requires that a student is able to recognise these dimensions. In VSOR students do not only have to see, they should be in a position to look at different orientations of these figures, for an example, by rotating them.

One topic in geometry where students deal with different orientation of figures is transformation geometry. In transformation geometry, a given figure in 2D or 3D can be reflected, translated or rotated. In order to perform these reflections, translations and rotations of given figures, imagination becomes the main skill. In their study on transformational geometry problems, Boulter and Kirby (1994) classified students' problem-solving approaches as being *holistic* (involving mental rotations of shapes) or *analytic* (involving analysing an assembling shapes). They refer to transformations in their study as *slides* (translations), *flips* (reflections) and *turns* (rotations). Most of the students succeeded in solving a question involving translating a trapezoid and a question involving rotating an arrowhead using analytic strategies and succeeded in solving a question describing the transformations from a new shape to the original shape using holistic strategies. A similar study was done by Clements, Battista, Sarama and Swaminathan (1997) using Computer Algebra Systems (CAS). In one question students were given two shapes and asked whether the first shape would have to be flipped and rotated or just rotated to be superimposed on the second shape to the other side of the given vertical line. The use of CAS increased students' awareness and conceptualisation of slides, flips, and turns. Before the use of CAS some students were seen to use trial and error to argue about the slides, flips and turns.

An example to demonstrate how a solid of revolution (Potter's Wheel, shown in Figure 2.2) could be formed was given by Christou, Jones, Pitta, Pittalis, Mousoulides, and Boytchev (2008/9, p. 5-6). In generating a Potter's Wheel, a 2D object (a square) is rotated in 3D around a vertical axis to generate a 3D rotational object. Figure 2.2 (b) can be given as an intermediated step to help students 'perceptually construct' the solid, whereby they imagine the rotation. This intermediated step enhances students to visualise the revolution procedure

by identifying the fundamental 2D shape. They argue that alternatively, this didactical situation can be the other way round, where students can be given a constructed solid, Figure 2.2 (c) and asked to figure out the 2D object used. In this case students are expected to translate from 2D to 3D and from 3D to 2D.

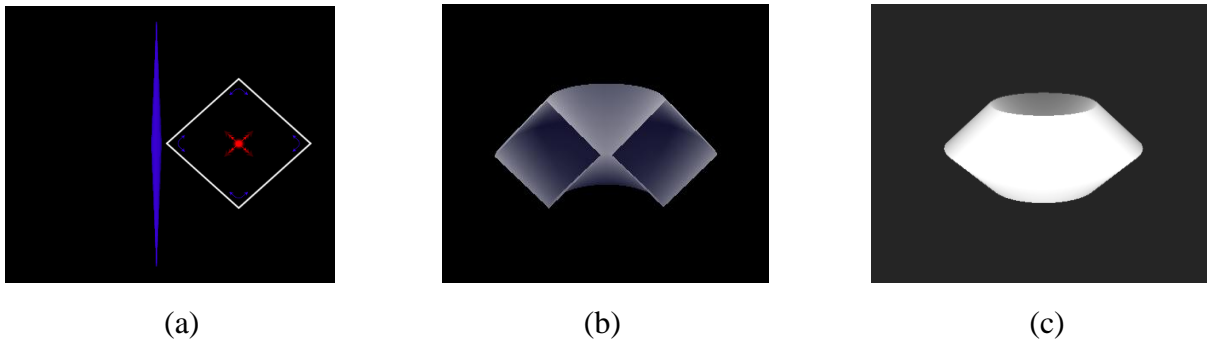

Figure 2.2: Potter Wheel construction (adapted from Christou et al., 2008, p. 6)

Gorgorió (1998), focused on spatial rotations, where students were given geometric tasks using 2D representations of 3D objects. The results reveal that there were difficulties and errors that obstructed or hindered the students' solving processes. Some students' difficulties and errors were observed relating to their interpretation of 2D representations of 3D objects, to the use of 2D drawings to represent 3D objects, and to the use of verbal codes which refer to spatial facts. For example when talking about 3D objects, they talked about sides instead of faces. Gorgorió (1998, p. 227) attests that the "individual's spatial orientation ability depends on his/her capacity to make successful use of structuring, processing and approaching strategies". It is highlighted that the ability of individuals to visualise and manipulate mental images has been recognised as an important cognitive ability (Güven, 2008, p. 100).

Montiel (2005, p. 91) reported that one student could not visually relate the perpendicular rectangles to the slender cylinders (disks), and the parallel rectangles to the 3D shells when required to calculate the volume. This lack of mathematical fluency relates to the lack of sufficient solid schemas, which would have permitted this student to formulate the mental models of 'disks' and 'shells'. For another student, it was noted that while saying 'rotating', the student actually performed a written rotation about the line $x = y$, as is done in geometry. This, I suppose, was assisting this student to imagine the rotation about a particular axis.

Learning about 2D) and 3D objects begins at the elementary level. The investigations of Kotzé (2007, p. 33) on Grade 10 learners and the teachers enrolled for the Advanced Certificate in Education (ACE) programme indicated that space and shape were problematic

areas for both teachers and learners. The following were some of the problems experienced in space and shape in geometry classes.

- Respondents had difficulty in representing characteristics of and relationships between 2D and 3D objects. 3D activities were specifically experienced as more problematic.
- If geometric objects were placed in different orientations and positions, respondents experienced problems in analysing and solving problems, especially related to viewing objects from different angles.
- In-depth knowledge into volume and surface area needed attention: respondents did not perform well in analysing a 3D problem and being able to calculate its surface area correctly.

VSOR use space and shape as well as formulae for areas of 2D and 3D objects as prior knowledge. The circle relates to the disc method which relates to the equation for the area of a circle, the washer that related to two circles, the small circle inside the big circle and the shell that relates to formula for area of a cylinder. If students lack knowledge of space and shape, especially involving 2D and 3D objects, it may become difficult to deal fully with problems related to volumes of solids of revolutions.

2.3 TRANSLATION BETWEEN CONTINUOUS AND DISCRETE REPRESENTATIONS

This translation normally occurs when students learn about areas bounded by continuous graphs and volume generated. Orton (1983, p. 4) discusses the results of calculus students who were given a number of items to solve. The students had great difficulty with the explanations required in the item that involved integration of sums and volume of revolution and in other comparable items concerned with areas. The results revealed and suggested that most students had little idea of the procedure of dissecting an area or volume into narrow sections, summing the areas or volumes of the sections, and obtaining an exact answer for the area or volume by narrowing the sections and increasing their number, making use of a limiting process. In translating between continuous and discrete, the Riemann sum is used. The bounded area is partitioned using vertical or horizontal rectangles, which will be used to set up the formulae for area and volume if the bounded area is rotated. One student from Montiel's (2005) study was trying to memorise the disk and shell methods according to the formulas (especially the ' π ' or ' 2π ' attached to one or the other) and the rectangles being

parallel or perpendicular. This attempt at rote memorisation caused this student to mention statements that hint at her lack of fluency in basic geometric concepts such as height, radius and the difference between parallel and perpendicular (Montiel, 2005, p. 91).

Gerson and Walter (2008) conducted a study in which students were given a task aimed at engaging them with calculus concepts (interpreting rates, antiderivatives, concavity, extremas, points of inflection, area between curves, and average rate of change) that they had not yet learnt, providing that require high-level thinking. They were interested in studying how students collaboratively built connected understanding of the quantity of water in a reservoir. In particular they were interested in studying students' development over time of the fundamental theorem of calculus. After having drawn graphs to represent the amount of water in the tank, students made different interpretations of their results. Some students were seen to determine the quantity of water discretely as they compared quantities at different levels. Other students compared areas between curves to generate a comparison of quantities. In that way they were operating with continuous graphs, and did not see discrete entities.

The studies by Orton (1983), Montiel (2005) and Gerson and Walter (2008) above relate to my study on VSOR in that students are calculating the area under the curve and translating that to volume. In my study students are expected to start by representing area under the curve by using a number of rectangles (discrete) and to later represent it using one strip that accommodates the whole area (continuous) in terms of integration. In another study Santos (2000) points out that the use of table or numeric representations was useful to explore the *discrete behaviour* of a particular property, while the graphic representation became a visual tool and the algebraic representation allowed students to examine general cases and *continuous behaviour*. Students in Santos's study discussed in Section 2.1.2 were able to move from discrete to continuous when performing the Cartesian Connection, which did not happen in Knuths's (2000) study.

The difference in performance in the above studies might be as a result of the fact that the students in Santos's study, though at a lower level (Grade 12) used dynamic software (Cabri-Geometry), while those in Knuths's study learnt traditionally. The implication of these results to my study may be that the lack of CAS, which enabled the students in Santos's study to operate in different levels of representations, may hamper students' understanding of concepts involving translation from discrete to continuous as it was the case in Knuths's study, despite the fact that the students were at a higher level.

Farmaki and Paschos (2007) reports on the case study of Peter (with excellent results in mathematics), involving the study of motion via graphic representation of velocity versus time in a Cartesian axes system. He used the visual representation of velocity (drawing a straight line $y = 2x$ continuous in a closed interval $x \in [a, b]$ and used step functions in a form of vertical rectangles of equal heights by partitioning of the time interval $[0,1]$ in equal subintervals) as a step to abstract mathematical thought and to full mathematical justification (Farmaki & Paschos, 2007, p. 361). The partitioning used in (Farmaki & Paschos, 2007, p. 361), may be regarded in one way where Peter was moving from continuous to discrete without being aware of it. Looking back at the origins of calculus it is asserted that

from a modeling perspective, we see a development of calculus that starts with modeling problems about velocity and distance. Initially these problems are tackled with discrete approximations, inscribed by discrete graphs. Later, similar graphs - initially discrete and later continuous - form the basis for more formal calculus (Gravemeijer & Doorman, 1999, p. 122).

A discrete approximation of a constant changing velocity is shown in Figure 2.3.

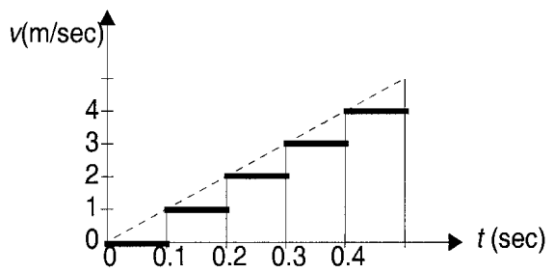

Figure 2.3: Discrete approximation of velocity (Gravemeijer & Doorman, 1999, p. 125)

According to Gravemeijer, and Doorman (1999) a central problem is when students use the small rectangles above through the coordination of the height and the width of the bars when they visualise a discrete approximation of a movement, as well as extending the idea to investigating the ‘area of the graph’, and the total distance covered over a longer period of time and extending that to integration. In another study by Camacho and Depool (2003), some students were seen to be in a position to draw a certain number of rectangles to approximate the area. The problem was that maybe some of them did perhaps not realise that the more the number of rectangles one uses, the better the approximation of area gets, since some were seen to use two rectangles while other used seven or eight rectangles. In some instances students were drawing rectangles to approximate the area for a region that is not bounded.

In their study on students’ understanding of limits and integrals, Pettersson and Scheja (2008, p. 776) interviewed a student who stated that “integral is the area ... and when you compute

the area you often ... get an approximation ... the smaller strips [the better]”. This student’s understanding was that the strips are just an explanation of how to find the area and that in order to find the area, you compute an integral by using the antiderivative. This approximation involved a Riemann sum. Another study on Riemann sums was conducted by Seally (2006), who investigated the use of Riemann sums to calculate area under a curve as well as the definite integrals. The conclusion reached in this study was that not all functions have an antiderivative that can be expressed in terms of elementary functions. For example, the antiderivative of $f(x) = e^{x^2}$ cannot be expressed in terms of elementary functions. With such functions, the FTC cannot be applied, and other methods for evaluating the definite integral, such as Riemann sums would be needed (Seally, 2006, p. 46).

2.4 GENERAL MANIPULATION SKILLS

A study by Cui, Rebello, Fletcher and Bennett (2006), on transfer of learning from college calculus to Physics II courses with engineering students, revealed that students had difficulties which they also acknowledged in setting up calculus-based physics problems. They could not decide on the appropriate variable and limits of integration and in most cases tend to avoid using calculus but used oversimplified algebraic relationships in problem-solving. This occurs as a result of students’ shallow knowledge of calculus and graphs in particular. In other instances the reason might be that what needs to be learnt is presented above students’ cognitive abilities. In their study Yasin and Enver (2007, p. 23) found that students had difficulty in calculating the area bounded by curves. From the written responses given, students only indicated the shaded area and did not draw the rectangular strip. Most of the students had problems calculating area especially if the area was below the x -axis and at times used incorrect limits.

Huntley, Marcus, Kahan and Miller (2007) investigated what high school mathematics students would use to solve three linear equations. They assert that the dominant strategy used by students is symbol manipulation (while checking their solutions by substituting back in the original equation) with graphical solution being the less dominant strategy. They used symbol manipulation even when given parallel lines which could be more easily solved graphically. The problem with general manipulation was also evident in Montiel’s (2005) study. Some students had problems expressing the functions ‘in terms of x ’ or ‘in terms of y ’, as well as confusing the line $x = -1$ with the line $y = -1$.

Some of the students also did not as well know when to use Δx and when to use Δy . This is what one student said:

“Mm, I have a question. In the disk method, the x ... is what we’re revolving about, if it’s x it’s dx , if it’s y , it’s dy in the disk and washer method. Now the shell method, if it is revolving about the x it is dy , and about y is dx (Montiel, 2005, p. 101).

This student also did not know which method to use for trigonometric functions such as $y = \sin x$.

Gonza 'Lez-marti'n and Camacho (2004) designed a teaching sequence for improper integrals using a computer algebra system. Their study identifies difficulties, obstacles and errors experienced by first-year mathematics students in Spain while they were learning integration. Students responded to questions from a questionnaire relating to algebraic and graphic representations. The authors focused on difficulties that students have when carrying out non-routine tasks related to improper integrals in order to discover the level of students' understanding (Gonza 'Lez-marti'n and Camacho, 2004, p. 74). They highlight that students' difficulties arise from errors that students make when doing conversions between algebraic and graphic registers. From their analysis one can conclude that there are students who have difficulty in articulating the different systems of representation, and have problems in connecting and relating this knowledge as a generalisation of previous concepts. Gonza 'Lez-marti'n and Camacho (2004) assert that even 'simple' calculation of integrals causes problems for the students. This may be as a result of students seeing integration as cognitively demanding and they develop a negative attitude even for the simple exercises.

Students in the study by Camacho and Depool (2003) were in some instances unable to translate from visual to algebraic, but they performed well in calculating arithmetic and manipulating the integrals they were working with. A study done by Neria and Amit (2004) indicated that the vast majority of their students preferred verbal mode (44%) and numerical mode (37%). When solving algebraic problems, students in the study by Pugalee (2004, p. 37) actually used guess and check most frequently followed by logical reasoning and diagrams/tables/other visuals. An analysis of students' written responses revealed that the majority of students' errors were procedural (66.2% of all errors) followed by computation (23%) and algebraic (10.8%).

2. 5 GENERAL LEVEL OF COGNITIVE DEVELOPMENT

Learning concepts that are above the students' cognitive level are often regarded as abstract but sometimes possible if the students are given enough time to deal with such concepts. Eisenberg (1991) argues that the abstraction of the new mathematical knowledge and the pace with which it is presented often becomes the downfall of many students. When learning abstract mathematical concepts, both conceptual knowledge and procedural knowledge are involved. In learning of VSOR, both procedural and conceptual knowledge feature predominately. There are many definitions of procedural knowledge and conceptual knowledge. According to Hiebert and Lefevre (1986), procedural knowledge involves symbols, rules, algorithms, syntax of mathematics while conceptual knowledge involves individual pieces of information and their relationships. According to Haapasalo and Kadjevich (2000, p. 141), procedural knowledge often calls for unconscious steps, while conceptual knowledge requires conscious thinking.

In this study I used questions that are procedural, as they could be answered by simplistic rehearsal of a rule method as well as conceptual questions as they require the use of some thought and rules or methods committed to memory (Berry, Johnson, Maull and Monaghan 1999, p. 110). The questions are structured in such a way that the students have an opportunity to reason since reasoning skills are necessary to advance from a procedural to a conceptual approach (Kotzé, 2007, p. 23).

It has been argued that,

conceptual knowledge has been described as being particularly rich in relationships and can be thought of in terms of a connected web of knowledge. Procedural knowledge has been defined in terms of knowledge of rules or procedures for solving mathematical problems (Pettersson & Scheja , 2008, p. 768).

According to Star (2005) conceptual knowledge involves 'knowledge of concepts' and procedural knowledge involves 'knowledge of procedures'. In my own interpretations, if one knows procedures only, I refer to that as procedural knowledge but if one knows procedures with reasoning, I refer to that as conceptual understanding (deep understanding of procedures and concepts behind that). According to Skemp (1976), that kind of understanding is instrumental understanding (knowing procedures) and relational understanding (knowing why certain procedures are done).

One of the reasons why students have difficulty in learning a subject like calculus is the deficiency in conceptual understanding (Mahir, 2009, p. 201). As it is the case in most calculus classrooms from my previous students, conceptual learning requires serious mental activity, and to avoid this, students prefer to memorise procedural rules and algorithms (Mahir, 2009, p. 201-202). Research has shown that success amongst students who memorise procedural knowledge without proper understanding of the underlying concepts is not possible (Mahir, 2009). Procedural and conceptual learning can involve routine and non-routine problems. A non-routine problem can become routine if an individual solves the same problem more than once. This is supported by Engelbrecht, Harding and Potgieter (2005) when stating that a problem that is conceptual in nature becomes procedural if it is done repeatedly.

Cognitive skills include visual skills since “our perceptions are conceptually driven” (Arcavi, 2003, p. 234). In addition to that Arcavi (2003, p. 235) comments that “visualization is no longer related to the illustrative purposes only, but is also being recognized as a key component of reasoning (deeply engaging with the conceptual and not the merely perceptual), problem-solving, and even proving”. According to Sabella and Redish (1996), studies involving students’ understanding of calculus reveals that they have superficial and incomplete understanding of many of the basic concepts of calculus. Garner and Garner (2001) suggest that when teaching calculus, instructors should focus more on conceptual teaching, since calculators and computers can be used to perform mathematical calculations.

A study by Pettersson and Scheja (2008) explores the nature of 20 engineering students’ conceptual understanding of calculus on the concepts of limit and integral. The results revealed that students’ understanding of the limit and integral concepts was algorithmic, emphasising procedures and techniques for problem-solving, rather than pointing at conceptual connections between concepts (Pettersson and Scheja, 2008, p. 781). In that case, it means that students did not have a thorough understanding of the concepts of limit and integral, hence lacked conceptual understanding. These concepts, limit and integral are regarded by Pettersson and Scheja (2008, p. 768) as ‘threshold concepts’ since they are ‘conceptual gateways’ or ‘portals’ that lead to a new way of thinking about a particular subject area. They further argue that threshold concepts have the potential to open up understanding of a topic in important ways, even though students may initially find them difficult to grasp.

In my study, threshold concepts include the ‘*rectangular strip*’, ‘*boundaries*’, ‘*solids of revolution*’, the ‘*disc method*’, the ‘*washer method*’ and the ‘*shell method*’. I focus on how students deal with these concepts, with the hope that students must have grasped the notion of an integral as limit of a sum. According to Pettersson and Scheja (2008, p. 770), students may experience difficulties in understanding the relationship between a definite integral and area under a curve and sometimes seen integration just as a rule, as antidifferentiation, thus students find integration difficult (Pettersson & Scheja., 2008 & Yost, 2008). Students, according to Pettersson and Scheja (2008) seemed to be thinking about limits and integrals within an algorithmic context, emphasising procedures and techniques for problem-solving, rather than pointing at conceptual connections between concepts.

Mahir (2009) conducted a study with a sample of 62 first-year calculus students on topics including functions, limits and continuity, differentiation, transcendental functions, and some applications of differentiation including sketching graphs of functions covered in the 1st semester and topics including integration, techniques of integration, application of integration, sequences, series and power series covered in the 2nd semester. The questions given in Figure 2.4 used in Mahir’s (2009) study are to a certain extent related to my study.

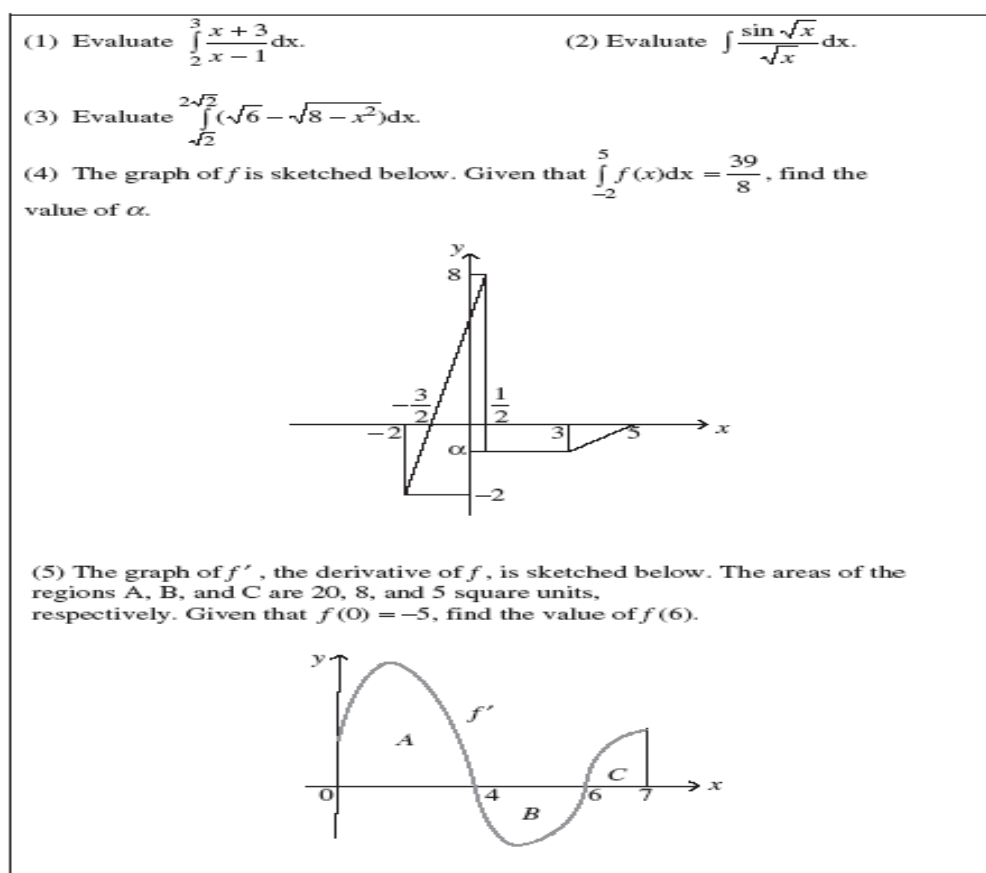

Figure 2.4: Questions on evaluating an integral (Mahir 2009, p. 203)

From the five questions given, the first and the second questions were procedural since they could be solved by using integral formulas and integration techniques. The third and fourth questions were both procedural and conceptual. They could be solved either by using the integral-area relation (indicating the presence of conceptual knowledge) or by using integral techniques (indicating the presence of procedural knowledge), while the fifth question was conceptual since it incorporates many concepts including the fundamental theorem of calculus, integral-area relation and the fact that the integral of a function is the algebraic sum of areas. For this reason, the ability to solve the fifth question strongly indicates the presence of conceptual knowledge (Mahir, 2009, p. 204).

The students' interpretations were interesting. Mahir (2009, p. 204-207) reported that the first and second questions were correctly solved by 92% and 74% of the students, respectively, which implies that students possess procedural knowledge of integration. For the third question, it was found that 73% of the participants tried to solve this question by using trigonometric substitution, whereas only 8% tried to make use of the integral-area relation and 19% of the students did not respond to this question at all. It was found that all the students who followed the conceptual approach correctly, solved this question by using a few simple calculations, whereas only 11% of the students who applied trigonometric substitution managed to obtain the correct solution. The remaining 89%, although successfully applying trigonometric substitution, delved into lengthy and complicated calculations and could not obtain the correct answer.

The results for the fourth question are not different from those of the third question. What is important is that the number of students that used procedural knowledge was significantly higher than the students who used conceptual knowledge. As in the third question, the number of students that used procedural knowledge is significantly higher than those who used conceptual knowledge. Most importantly only 16% of the students that used procedural knowledge were able to obtain the correct answer, whereas 71% of the students that used conceptual knowledge obtained the correct answer. This reveals that students who have a thorough understanding (conceptual knowledge) of content are better equipped to solve problems than those who have a shallow understanding (procedural knowledge) of concepts. As for the fifth question, 40% of the students did not respond, since they did not have the conceptual understanding of the fundamental theorem of calculus. Moreover, 36% of the students responded incorrectly. What was found to be problematic in most cases was that for the area below the x -axis the students took it as positive and did not subtract it.

In the above study, to evaluate the integral, one student calculated the area of an incorrect region. Although this student was aware of the integral-area relation, he did not know that the ‘area’ refers to the area of the region between the graph of the function and the x -axis. What was revealed again in Mahir (2009, p. 209) was that students were seen to successfully apply the fundamental theorem of calculus when the integrand is explicitly given to them as in Questions 1 and 2. On the other hand, if the integrand is not explicit, as in Question 5, they mostly failed. In his conclusion, Mahir (2009, p. 210) acknowledged that their students did not have satisfactory conceptual understanding of the integral and integral-area relation, that the integral of a function is algebraic sum of areas and of the fundamental theorem of calculus. They finally recommended among other reasons that in order to improve conceptual understanding, various graphical, algebraic and real-life examples should be given when a new concept is taught in class. Another aspect that is important in mathematics learning, especially calculus, is preknowledge. For example, the concepts of the Riemann sum must be understood well to succeed in integration as that enables a student to move from discrete to continuous.

Mahir (2009:202) is of the opinion that “one cannot understand differentiation without knowing limits and one cannot understand integration without knowing differentiation”. In FET colleges, before doing integration (at N5 and N6 level), students are expected to have preknowledge of differentiation from N3 and N4 levels and from Grade 12. However, there are different beliefs of what should be taught first (differentiation or integration) or whether they should be taught simultaneously. For example Harman 2003 and Parrott 1999 believe that teaching of integration must precede teaching of differentiation.

Other studies on conceptual and procedural knowledge were done on interpretations of functions (Evangelidou, Spyrou, Elia, & Gagatsis, 2004; Hähkiöniemi, 2006; Juter, 2006; Sierpiska, 1992; Tall, 2000). Among them, Juter (2006) reports on a study involving the limits of functions with 112 first-year university students. She asserts that students encounter difficulty with definitions when they learn limits. Most students did not improve, despite the fact that their teacher displayed graphical proofs of the limits and followed the textbook. She argues that the students struggled because they learnt limits as facts (Juter, 2006, p. 426). She further pointed out that the students had an algebraic approach to limits, where they used unknown and unsuitable procedures to compute limits. The study exposes the most crucial aspects of rote learning and lack of conceptual understanding. The fact that students were

seen to use unknown and unsuitable procedures, justifies that they lacked proper understanding of the concepts learnt.

In learning functions at undergraduate level, it is argued that if algebraic and procedural methods were closer connected to conceptual learning, students would be better equipped to apply their algebraic techniques appropriately in solving novel problems and tasks (Oehrtman, Carlson, & Thompson, 2008, p. 151). As students move through their school and undergraduate mathematics curricula, they are frequently asked to manipulate algebraic equations and compute answers to specific types of questions. This strong emphasis on procedures without accompanying activities to develop deep understanding of the concept has not been effective for building students' foundational function conceptions that allow for meaningful interpretation and use of functions in various representational and novel settings.

Cognitive obstacles experienced in mathematics understanding may be a result of the abstract nature of mathematics. Eraslan (2008) shows how the notion of reducing abstraction can be used for analysing mental processes of students studying quadratic function in high school mathematics. The results reveal that when students solve problems related to quadratic functions, they tend to change the given form from a less familiar form to a more familiar and manageable one, hence reducing abstraction (Eraslan, 2008, p. 1055). In most cases, when students try to reduce abstraction, they tend to change the whole meaning of the question and end up not getting the solution correct. Abstraction in most cases is possible in problems that are conceptual in nature, and that pose a challenge to both learners and their teachers. It is important that teachers assist learners to link new knowledge to existing knowledge and develop instructional techniques that would facilitate cognitive growth and change (Kotzé, 2007) in a way of promoting conceptual understanding.

In Montiel's (2005) study, cognitive obstacles were encountered in some questions. For example, when asked to sketch the region and the volume generated by this region of a

particular set, say, $V = \pi \int_0^4 (\sqrt{x})^2 dx$, students would evaluate the integral. This relates to

procedural knowledge of the integral. Another student was seen to multiply by π when asked to calculate area, not knowing exactly what the π was for, also indicating procedural knowledge of the concepts learnt. In this case the symbol becomes the cognitive obstacle. In some instances, it was difficult for the students to picture revolving about, say, the vertical axis, and setting up the integral in terms of the horizontal axis. Students were also seen to use

the disc method even if the question required the use of the shell method, pointing to the lack of conceptual understanding.

A study by Joffrion (2005) involving seventh grade teachers and their learners, revealed that

The students of the teacher who delivered conceptual instruction improved their algebra skills from the beginning of the year to the end. The students who received more procedural instruction without the support of the conceptual network showed little improvement over the course of the year. Their knowledge stood alone as individual pieces and they were not able to apply it in new situations. These students were not well equipped to solve problems or apply algebraic reasoning. The students of the more conceptual teacher, on the other hand, were significantly better prepared to answer questions requiring algebraic reasoning (Joffrion, 2005, p. 57-58).

The above studies all point to the important fact that knowing why certain procedures should be performed when solving mathematical problems is the foundation for conceptual understanding. These concepts are relevant to my study as success in learning VSOR requires use of procedures after reasoning at a conceptual level. In that way students will be able to solve problems that are abstract in nature. In relation to other studies discussed above, concurrent validity will be ensured where the results of the tests administered in my study concur with the results of the other tests or instruments that were testing the same construct (Cohen, Manion & Morrison, 2001, p. 132), in this case learning difficulties with VSOR.

2.6 CONTEXTUAL FACTORS AFFECTING LEARNING

2.6.1 Writing to learn mathematics and effect of language

According to Duval (2006), mathematics register is produced verbally or symbolically in written form. The special symbols used in mathematics are a way of communicating it. It is through this verbal or written form that success in mathematics can be measured. It is highlighted that “research about the learning of mathematics and its difficulties must be based on what students do really by themselves, on their productions, on their voices” (Duval, 2006, p. 104). In this research, the focus is on the students’ productions through their written work and in some instances their verbal interpretations.

In VSOR the issues of writing and language are relevant as students are expected to write and at the same time be confronted with the language of assessment. What students have learnt is evident from their written responses and what they verbalise individually or as they work in groups. Writing to learn mathematics was related to conceptual understanding and procedural ability of students in an introductory calculus course by Porter and Masingila (1995).

Students were seen using incorrect procedures, for example when asked to find the derivative of a function, they would then find the limit of the function. This shows that in this case language and interpretation of concepts is a problem. Students were seen to make procedural, conceptual and indeterminate errors. Students were at times asked to reflect in writing on their study habits and performance in the course. They were also asked to explain the following concepts in writing: function, derivative, Rolle's Theorem, the Mean-value Theorem and so on. Such explanations in written form improve conceptual understanding and not only knowledge of procedures (Porter and Masingila, 1995)

Writing has benefits for both the learner and the teacher. A study by Kågesten and Engelbrecht (2006) with engineering students in technical universities in Sweden reveals some interesting results. They argue that the students in their study and in many other countries tend to treat mathematics as a mechanical subject in which you do calculations and manipulations with very little explanation. They forced the students in their study to reflect and re-think the answers they gave in writing (during examinations) and comments from their teachers to clarify their explanations. Students were forced not to limit themselves to methods of calculations and manipulations when solving problems, but to reflect on the actual concepts involved. It was decided:

Students would not be given full marks for a question (if they do not fully explain why they used the manipulations they did, or if there are any deficiencies in the linguistics of the explanation. After the marked script has been given back to the student, (s)he takes the script home and revises and appends it according to the comments and questions listed by the teacher that marked the script (Kågesten and Engelbrecht , 2006, p. 709).

This practice forced each and every student to re-construct what he/she did. During the interview that they conducted, some students admitted that they could not explain their calculations, arguing that at the time of the examination they did not understand what they were doing to a 'sufficient depth', while other students did not want to expose their understanding too much, probably because of a lack of confidence about their understanding of the concepts learnt (Kågesten & Engelbrecht, 2006, p. 711). What was significant in this study is that almost all students interviewed, emphasised the importance of having to reflect on their work. They commented that "the additional time that they spent at home, attempting to address the comments from the teacher that marked the test, contributed largely to deeper understanding of the particular concept" (Kågesten & Engelbrecht, 2006, p. 712). The students interviewed also acknowledged that in having to think about the relevant concept again, they discovered their previous misconceptions. The students reported that they were used to using mathematical symbols and avoiding verbal language.

These comments clearly allude to the view that writing improves critical thinking, and it is important to improve on one's conceptual understanding. Smith (2010) concurs with Kågesten and Engelbrecht (2006) above when they assert that computations without any writing or explanation *contain no mathematics*. In their study on science literacy, students of McDermott and Hand (2010, p. 55) clearly indicated that the writing tasks they participated, in encouraged a type of "learning" that was in-depth, personal, and went beyond mere memorisation or recall. Writing can also be a tool for supporting a metacognitive framework (Pugalee, 2004).

In my study, writing is used in order to evaluate students at FET Colleges, in the classroom and during examinations. If during the class assessments, students are given the opportunity to reflect on their writing (Kågesten & Engelbrecht, 2006), critical thinking and better understanding of the concepts involved in VSOR may be reached. It is for the teacher to create an environment that stimulates explanations of what is written by the students (Kågesten & Engelbrecht, 2006, p. 713). At the university undergraduate level, writing is the dominant, if not exclusive language mode through which learning is evaluated (Gambell, 1991). Writing is seen as one way to encourage critical thinking (Indris 2009; Kieft, Rijlaarsdam & Van den Bergh, 2008; Klein, Piacente-Cimini & Williams, 2007; Zohar & Peled, 2008) and reflection and evaluation of understanding in students (Indris, 2009, p. 36). Indris (2009) conducted a study, where students were given an opportunity to use writing activities to explore calculus materials, concepts and ideas freely, to assist them to develop their own intuitive ideas. In learning mathematics the meanings of some concepts need to be understood for proper learning, especially problems that are conceptual in nature. Writing helps students to gain conceptual understanding of such scientific topics (Gunel, Hand & McDermott, 2009).

Another aspect that affects learning is the language used. It may be language of instruction or language of assessment. The problems that involve language include word problems. In a number of studies, language was a barrier for proper learning of mathematics (Bell, 1995; Eiselen, Strauss & Jonck, 2007; Howie, 2002; Inoue, 2008; Pettersson et al., 2008; Setati, 2008). In the study of Pettersson et al. (2008), students' understanding of the concept of limit seemed to be deeply intertwined with everyday language use, where the everyday meaning of the word 'limit' induces conceptions of the limit as a barrier or as the last term of a process. As it was the case in Montiel's (2005) study, when solving problems that are given in words, students tend not to relate the problem to its meaning. They rather tend to focus on how to do

calculations, without understanding what is being asked. When asked to sketch the region and

the volume generated by this region $V = \pi \int_0^4 (\sqrt{x})^2 dx$, the students were seen to evaluate the

given integral. Studies including TIMSS have shown that English seems to be a problem especially with learners whose home language is not English. It was evident from the TIMSS study that the poor performance of most South African learners was a result of their English language proficiency (Howie, 2002).

Some terminology in integration was seen to be problematic. According to Montiel (2005, p. 89), students understood terminology such as ‘bounds’, ‘boundaries’ and, ‘region’ incorrectly. Montiel (2005) believes that spoken mathematics is the most direct way to detect metaphors that are used by students. She believes that in mathematics, unlike foreign or native language (where students do creative writing), metaphors do not usually appear as such in students’ writing, although they are present in their mental structures. She argues that the actual names of the disk and shell methods correspond to extra-mathematical metaphors. It was evident from her study that the “disk” metaphor was much more helpful for the majority of students in the class than the “shell” metaphor.

According to Duval (2006, p. 121) students encounter problems with simple “translation” of the terms of a word problem into symbolic expressions. In Rouhani’s (2004, p. 120) study, the task of translating functions from a verbal representation to an algebraic description was the most difficult task for all but one participant. The results of a study conducted by Swangrojn (2003), indicate that unsuccessful problem solvers had difficulty translating and representing word problems into equations using variables and symbols. While lecturing to first-year students at the University of KwaZulu-Natal, Maharaj (2008; 411) found that a significant number of students were unable to interpret the structures of mathematical objects, and to solve word problems. He suggests that there should be a focus on formulating the problem statement and transforming it into the relevant equation in order to give students a deeper insight into the structural features of equations, and the need for transforming them into equivalent equations.

The above studies are relevant to my study of VSOR where students are assessed in writing and the language they use will be evident in their written responses and discussions. The language used in VSOR is the everyday and the mathematical language. In this study I focus on how students interpret the language used in questions given in VSOR.

2.6.2 Scaffolding learning

Scaffolding takes place when a teacher or one in possession of knowledge assists learners to attain knowledge through explanations and clarifications of concepts. While teachers teach

... pupils make sense of teachers' instructions in their own ways, sometimes very different from those of the teacher. With *cognitive structuring* teachers assist pupils to organise their own experience either by providing explanations or by suggesting meta-level strategies to help pupils organize their work (Bliss, Askew & Macrae, 1996, p. 41).

In a learning environment the classroom should be considered as a social environment which involves complex exchanges that support learning (Anghileri, 2006, p. 35). Anghileri found that teachers are most effective if they can scaffold pupils' learning by employing a range of teaching approaches in their classrooms in an environment that encourages active involvement working in groups. Scaffolding has been found to be very important in mediating learning (Anghileri, 2006; Bliss et al., 1996). During scaffolding, the *Zone of Proximal Development* (ZPD) is enabled. The ZPD is the "the distance between the actual development as determined by independent problem-solving and level of potential development as determined through problem-solving under adult guidance or in collaboration with more capable peers" (Vygotsky, 1978, p. 86).

Bliss et al. (1996) refer to two types of scaffolds in a way of cueing. They are the *Alpine guide: step-by-step* or *foothold scaffolds*; and *hints and slots scaffolds*. With the former, arguments in teaching are sometimes a little difficult. One way to keep going is to lead step by step in a series of questions. Each step in the argument is turned into a question, and each question expects an answer which in turn, will permit the next question. The latter type of scaffold refers to those occasions when it is difficult to ask open-ended questions. Questions such as 'What is ...?' often lead to one specific answer (Bliss et al., 1996, p. 47).

In mathematics classrooms scaffolding can take place when students learn individually or cooperatively. Various studies focus on individual learning (Brijlall & Maharaj, 2009; Ebert & Mwerinde, 2002; Gagatsis & Patronis, 1990) as well as cooperative learning where students share knowledge during their interactions (Brijlall & Maharaj, 2010; Brijlall & Maharaj, 2009; Chmela-Jones et al., 2007; Ebert & Mwerinde, 2002; Juter, 2006; Walter, Barros & Gerson, 2008). When students learn individually, they are able to use their imaginative skills in order to accomplish the necessary learning. With cooperative learning, there is a set of processes or step-by-step methods that help students interact with each other in order to accomplish a task (Chmela-Jones et al., 2007, p. 631). When students learn

mathematics, they require engagement in conscious reflection (a metacognitive skill), on their own mental processes (Gagatsis & Patronis, 1990), which may be activated when students work cooperatively. When students work together in a group, collective understanding is possible (Martin, Towers & Pirie, 2006), as they share meaning. These authors argue that group work enables students to make, hold, and extend particular images in growing their mathematical understanding about a particular concept. The students in this case act together; they are involved in *coacting*, which is

a process through which mathematical ideas and actions, initially stemming from an individual learner, become taken up, built on, reworked, and elaborated by others, and thus emerge as shared understanding for and across the group, rather than remaining located within any one individual (Martin et al., 2006; 156).

During group interactions, students construct individual mental representations. It is argued that, “as children model and represent their strategies, and as they develop generalized mental models of the part/whole relations for situations and operations, they construct *mental maps* that can eventually become tools to think with” (Fosnot & Dolk, 2003, p. 14). They believe that learning requires assimilation, accommodation and reflective abstraction. They further highlight that if the problems given to students promote progressive schematisation, the development of big ideas and the construction of models, learning will occur provided the pedagogic strategies are aligned with the process of learning rather than with transmission and or activity (Fosnot & Dolk, 2003, p. 14).

Zimbardo, Butler and Wolfe (2003) looked at reasons why teams arrive at better answers than individuals. It was argued that it is possible that team members may stimulate and encourage each other through their discussion. Additionally error correction procedures may occur in groups to effectively help the student get rid of incorrect answers. Through active participation such as verbalising a reason for one’s answer, a student’s misconception of the content learnt may be clarified by fellow students with more knowledge. It is possible that by using a group testing approach instructors are structuring their courses so that students assist each other in mastering the course content as they collaborate as peers. During group interaction the student’s misunderstanding of questions may be corrected by others through scaffolding. When group members support each other (positive affect) their motivation may be boosted, thus foster learning (Desrochers, Fink, Thomas, Kimmerling, & Tung, 2007, p. 294).

When a student is working alone it is possible that such a student carelessly reads an item and thus misinterprets it, resulting in failure to answer the question correctly. It should however

be noted that group work is only important to enable students during the learning process to pick on their errors and misconceptions and to develop confidence. In the end every student should be able to work independently, since examinations are not written in groups. In one study, as students worked cooperatively, some students demonstrated the ability to apply symbols, language, and mental images to construct internal processes as a way of making sense of the concepts of monotonicity and boundedness of sequences (Brijlall et al., 2010, p. 61).

The above studies have shown how scaffolding and cooperative learning are significant in the development of critical thinking in students, since students discuss (and are guided) and come to know what they do not know, from their peers or their teachers. This aspect is not of great importance in my study but it cannot be ignored since if students learn a topic like VSOR cooperatively, there are more opportunities that they might come to know what they do not know and may succeed in counteracting the cognitive conflicts that they may have. As students learn cooperatively it is important that the teacher also interact with them in a way of scaffolding to help students deal with their cognitive conflicts.

2.6.3 Teaching approach

According to Maharaj (2008, p. 411) teaching should focus on and emphasise the structural features of mathematical objects such as expressions, equations and functions. Maharaj (2008) argues that teaching should not neglect the role of ordinary English in developing the symbolic notation, and suggests that word problems should be used to introduce linear, quadratic and possibly cubic equations. He pointed out that instruction should not ignore the links between arithmetic and algebra, algebra and geometry, and the teaching implications from research studies in mathematics. He believes that

An educator who functions at the structural level, and ignores the fact that concepts in mathematics are first conceived operationally, is unlikely to meaningfully develop in learners an understanding of mathematical concepts. Furthermore, the educator is unlikely to appreciate the cognitive obstacles experienced by learners with regard to the formation of concepts and the achieving of understanding (Maharaj, 2008, p. 411).

In exploring children's algebraic thinking and generalisation through instruction that involves visual/spatial representation of a geometric growing pattern made of square tiles, it was asserted that

children's full understanding of and ability to engage in mathematical generalization may in fact rely on a critical integration of more than one form of representation of a mathematical idea. This may more specifically be described as involving children's ability to move fluidly and fluently back and forth across multiple representations in both interpreting and applying a mathematical generalization (McNab, 2006).

Adler (2002) argues that educators must relearn mathematics to develop conceptual understanding, in order to be better equipped to develop learners' conceptual understanding. Such teachers will be able to teach for understanding (Mwakapenda, 2004). Vaughn, Klinger, and Hughes (2000, p. 169) believe that teachers must have "deep knowledge about a practice" in order to sustain their use of that practice. The question that one might ask is: "Do we have teachers who have good conceptual understanding of mathematics?" According to Setati (2008, p. 114) procedural teaching is dominant in South African classrooms and it is seen as being a function of the teachers' lack of or limited knowledge of mathematics.

Procedural teaching will continue to dilute down the mathematical knowledge if teachers do not encourage deep learning for achieving high levels of reasoning and thinking (Kasonga & Corbett, 2008). Some official conceptions of mathematics teaching according to Hoz and Weizman (2008, p. 908) are that "mathematics teaching stresses the learners' construction of mathematical knowledge ... and that mathematical teaching must emphasise conceptual understanding". Bossé and Bahr (2008) on the other hand suggest that in teaching, there must be a balance between conceptual understanding and procedural knowledge. Another aspect that should not be ignored in teaching is students' abilities to solve problems. According to Clark, James, and Montelle (2009, p. 59), instructors may not take for granted what academically-able students have acquired in terms of employing their different methods with regard to problem-solving. Students' different methods must be taken into consideration for proper learning to take place, as long as they are mathematically correct.

Fricke, Horak, Meyer and Van Lingen (2008, p. 75) believe that there should be teacher development programmes on-site, focusing on individual teacher needs. The programmes should encompass both content knowledge and teaching strategies and should entail regular follow-up to ensure that there has been successful implementation of new strategies. In teaching mathematical knowledge, Rasmussen and Marrongelle (2006, p. 389) argue that teachers use a pedagogical content tool such as a graph, diagram, equation, or verbal statement intentionally to connect to students thinking while moving the mathematical agenda forward. They further attest that the use of pedagogical content tool requires blending of specific content knowledge, general pedagogical expertise and knowledge of subject matter for teaching.

A study by Bingolbali, Monaghan and Ropers (2007) on the understanding of the derivative involving a group of first-year students in Turkey reveals that mechanical engineering

students considered the derivative in terms of rate of change while mathematics students considered the derivative in terms of tangent. This was influenced by the way in which they were taught. In introducing the derivative concept, on the one hand the mechanical engineering calculus lecturer was seen to spend about ten minutes on ‘tangent’, ‘slope of the tangent line’ and ‘equation of the tangent line to the curve at a particular point’ without solving any tangent examples, while spending 133 minutes on rate of change aspects of the derivative followed by nine examples, focusing more on practical mathematics. This lecturer introduced the idea of rate of change through velocity, distance and acceleration. On the other hand, the mathematics course lecturer used tangent ideas to introduce the derivative, attending to the ‘slope of the line’, ‘equation of line’ and ‘tangent line and secant line’. This lecturer spent eleven minutes on rate of change ideas and 85 minutes on tangents followed by seven examples on tangents, focussing more on theoretical mathematics. The rate of change was only mentioned when he talked about the physical meaning of the derivative and later mentioned rate of change when he attended to acceleration with regard to the second derivative. This lecturer did not solve any examples on rate of change (Bingolbali et al., 2007, p. 771-772). According to Bingolbali and Monaghan (2008, p. 31), you get what you teach.

The way in which students were taught in the above study, shaped their developing concept images of the derivative. Bingolbali and Monaghan (2008, p. 23) investigated first-year mechanical engineering and mathematics students’ conceptual development of the derivative with particular reference to rate of change and tangent aspects through tests (pre-, post- and delayed post-tests), questionnaires, interviews observations and discussions. The test questions addressed ‘rate of change’ and ‘tangent’ aspects of the derivative in graphic, algebraic and application formats. The results for the tests revealed that students’ concept images of the derivative changed as they progressed from entry to the end of the first year, where mechanical engineering students’ concept images of the derivative developed in the direction of rate of change orientations and mathematics students’ concept images developed in the direction of tangent orientations (Bingolbali and Monaghan, 2008, p. 30). The results also revealed that students’ developing concept images and the way they build relationships with its particular forms are closely related to teaching practices and the department they come from (Bingolbali and Monaghan, 2008, p. 32).

According to McCormick (1997, p. 148) the schemata, which is the knowledge structures that exist in memory that the individual constructs from experience and instruction, need to be

taken into account by teachers when they want students to learn a new concept or theory. Bjuland (2007, p. 27) suggests that “teacher education must stimulate metacognitive training in combination with cooperative learning among the students in order to develop problem-solving skills”.

Allowing students to develop visual skills and to be able to translate to different representations in learning may also affect the way they learn. Kreminski (2009) proposes a visual approach that helps students with the chain rule formulae, by drawing functions of functions and showing them also how these formulae generalise. In this way the symbolic representation of the chain rule was shown graphically for better understanding. Aspinwall and Shaw (2002) encourage teachers to create a learning environment where students become fluent with a variety of representations. They attest that “teachers can enhance students’ understanding by continuing to demonstrate how different representations of the same mathematical concept provide additional information” (Aspinwall & Shaw, 2002, p. 439). Neria and Amit (2004, p. 414) believe that the use of algebraic representation should be integrated into the teaching of algebra from the first stage, and students should gain experience in using algebra for argumentation and justification. In teaching functions, Nilklad (2004) noticed that the instructor did not provide examples that used more than two mathematical representations to display the same data, as well as spending time translating one representation into another.

The ways in which students are taught have an influence on how they learn. Cai (2004) conducted a study on how teaching, the teacher’s beliefs, and curriculum emphases influence the way students solve problems in algebra. The results of the study reveal that the way in which students solved problems was influenced by the way in which they were taught, the teacher’s beliefs, and curriculum emphases. It was found that Chinese students rarely used visual representation whereas the United States (US) students did. That was due to the fact that

U.S. and Chinese teachers not only hold different learning goals, but also place different emphases on their teaching of problem solving. In particular, U.S. teachers hold a much higher value for responses involving concrete strategies and visual representations than do Chinese teachers (Cai, 2004, p. 158).

Woolner (2004) reports on a survey of the thinking styles of 36 students in Year 7 (aged 11 to 12) in a verbally taught class and a visually taught class where the verbal lessons and the visual lessons covered the same content area, also ensuring that the same questions, investigations and identical teaching materials were used. The intervention lessons were

taught once a week for ten weeks. Woolner categorised students into those who prefer to be given a formula (taught verbally) and work without a diagram and those who prefer to use a diagram (taught visually) to conceptualise. The students worked on mathematics questions requiring literacy skills.

The study revealed that students who were taught verbally scored significantly higher than students who were taught visually, with a good correlation ($r = 0.669$) between the pre and the post intervention scores. Woolner postulated that the contrasting results (those taught visually scoring less) could be as a result of a “mismatch between their preferred learning style and the predominance of verbal teaching and assessment” (Woolner 2004, p. 450). Even though Woolner’s study is on small kids, it highlights important aspects that if learners’ preferences are contradicted in the learning process, the mismatch can lead to poor performance. Haciomeroglu, Aspinwall and Presmeg (2009) argue that in learning, calculus concepts should be represented numerically, algebraically, graphically, and verbally in order that students develop a deeper understanding of the concepts.

2.6.4 Curriculum level and assessment

There is no research done on mathematics assessment at the FET colleges, where students’ written responses of content learnt was explored. Only examination policies and reports from the national examination are available. The reports hint on the general performance for different subjects in relation to the national average.

De Villiers (2004, p. 706) uses Van Hiele’s theory to argue that the reason for failure of the geometry curriculum in high schools is that the curriculum is presented at a higher level than that of the students. In geometry it is essential to engage students at some stage in the process of defining of geometric concepts (De Villiers, 2004, p. 708). The levels are presented below.

Level 1 (Visualisation) Students represent figures by appearance only, often by comparing them to a known prototype. The properties of a figure are not perceived. At this level, students make decisions based on perception, not reasoning.

Levels 2 (Analysis) Students see figures as collections of properties of geometric figures, but they do not see relationships between these properties. When describing an object, a student operating at this level might list all the properties the student knows, but not discern which properties are necessary and which are sufficient to describe the object.

Level 3 (Abstraction) Students perceive relationships between properties and between figures. At this level students can create meaningful definitions and use informal arguments to justify their reasoning. Logical implication and class inclusions, such as squares being a type of a rectangle are understood. The role and significance of formal deductions, however, are not understood.

Level 4 (Deduction) Students can construct proofs, understand the role of axioms and definitions, and know the meaning of necessary and sufficient conditions. At this level, students should be able to construct proofs such as those typically found in a high school geometry class.

Level 5 (Rigour) Students at this level understand the formal aspects of deduction, such as establishing and comparing mathematical systems. Students at this level can understand and use indirect proof and proof by contrapositive, and can understand non-Euclidean systems.

The levels above are crucial not only to geometry, but they can be used in other areas. Levels 1, 2 and 3 fit well in the learning of VSOR and are useful in that regard. The levels focus on what is happening in mathematic classrooms in a real sense and can be evident from classroom discussions and from students' writings. The use of circle, washer and shell stems from these levels as they are geometric figures.

In order to ensure that the curriculum was implemented correctly, students must be assessed. Assessment can be used to verify if proper teaching and learning took place. According to Vandeyar and Killen (2007, p. 102), educators who view assessment as a useful means of gathering data upon which to base decisions about learning and their own teaching will attempt to make assessment an integral part of teaching, by emphasising formative rather than summative assessment. In my study students were assessed from classroom exercises, tests, examination and the designed 23-item instrument which includes both formative and summative assessments. Beets (2007, p. 578) argue that *conventional assessment* is an approach in which assessment normally follows teaching. Beets (2007) believes that assessment in higher education is still dominated by summative assessment practices. In the FET colleges, students are assessed by summative assessments, which may have an impact on their success. Kasonga & Corbett (2008, p. 603) argue that the quality of assessment tasks is a very important determinant of the students' learning approach (surface or deep learning), except for those students who are intrinsically motivated by the subject.

2.6.5 Use of technology

Technology has been found to assist in the development of concepts (Berger, 2007; Pierce & Stacey, 2008; Smith & Shotsberger, 2001; Tall, 1991), especially those technologies that are conceptual in nature and aid visualisation. It is important to note that not only is CAS important to improve on students' conceptual understanding. Advice from various researchers is that shallow learning can be overcome if blended learning (mixing online and face to face learning) is used. The results of Groen and Carmody (2006) indicate that first-year mathematics students benefited positively from blended learning as deep learning was encouraged. The blended learning method introduced students to diverse environments. The results indicated a positive correlation between the average score on deep learning and the average score for blending.

It is believed that "CAS offers pedagogical opportunities for teaching mathematics better and for learning mathematics better" (Pierce & Stacey, 2008, p. 6) in that in some cases it creates possibilities of access to different mathematical representations such as numeric, symbolic and graphic. Berger (2007) and Tall (2000) share the sentiments of Pierce and Stacey (2008) about different mathematical representations with the use of CAS. Computer algebra systems such as Derive, Maple, Mathematica, Micromedia's Flash and others have recently been utilised to enhance the learning of mathematics in the form of animations. Animations have been found to be a successful tool in the learning and modelling of graphical data (Bakhoun, 2008).

Poohkay and Szabo (1995) conducted a study with 147 undergraduate education major students in a mathematics teaching methods course. They compared animations, still graphics and text only for their effects on the acquisition of the mathematics skill of using a compass to create triangles. They found that students, who studied through animations, performed better than students who used still graphics who in turn performed better than the students who used text only (Poohkay & Szabo, 1995, p. 4). In this study, the effects of such animations will be explored, focussing on calculus instruction with the engineering students, where learning through visualisation is an important aspect to be researched.

The birth of new mathematical software, CAS, was realised around the 90s. Among others: Maple (1990), Mathematica (Wolfram 1995), Matlab (Moler 1995) or Derive (1994) were released. According to (Balacheff & Kaput, 1996, p. 6) CAS "enable students to define, combine, transform, compare, visualize and otherwise manipulate functions and relations".

They further emphasise the importance of computers, that of providing ways of doing and experiencing mathematics that was not possible before through ‘chalk and talk’. It is important to ensure that while all that is possible, conceptual learning should not be hampered whereby the students, who end up being dependent to the computer, see everything that could be learnt using the computer as being procedural.

A study by Palmiter (1991) involving 78 subjects was carried out in order to investigate whether there was a significant difference between students who have been taught calculus using a CAS (MACSYMA) to compute limits, derivatives and integrals and students who used standard paper-and-pencil procedures focussing on knowledge of calculus concepts; knowledge of calculus procedures as well as grades in subsequent calculus course (Palmiter 1991, p. 151). The control group and the experimental group were each assigned one lecturer and one teaching assistant, who collaborated regularly to ensure that the topics presented were overlapping; the same examples were used and the same materials presented. The techniques for integration were not presented to the MACSYMA group; they had access to MACSYMA for both homework and examinations to compute integrals. Most of the work was covered in a form commanding MACSYMA to compute a limit, sum, derivative, integral, solving an equation or plotting a graph. The rest of the work was done on paper. In the end both groups were given the same conceptual and computational exams created by both lecturers. The results of this study reveal that the score on conceptual knowledge and computational examinations of the students who were taught calculus using a computer algebra system was higher than that of those who were taught using paper and pencil computations.

Rochowicz (1996) administered and analysed 89 questionnaires from calculus instructors and innovators from engineering and pre-engineering schools pertaining their perception on the impact of using computers and calculators on calculus instruction based on ‘calculus, student motivation, student learning, and the role of the lecturer’. He reported that there appeared to be a shift in the focus of learning, “from symbolic algebraic and skills to more interpretation, approximation, graphing, and modelling of realistic situations” (Rochowicz, 1996, p. 390), which is an important aspect for deep learning to be possible. The impact on student motivation was uncertain. In relation to student learning, it was revealed that learning improves as a more active environment is created with the use of technology and that visualisation enhances learning (Rochowicz, 1996, p. 392), even though in relation to the

impact on the lecturer, the use of the computer requires more time from the instructor which is more creative and meaningful (Rochowicz 1996, p. 3).

In his study, Meagher (2005) conducted qualitative case studies focusing on college students learning calculus using Mathematica. The results of his study reveals that the most significant representations in mathematics, numerical, graphical, and algebraic can now be instrumentalised with technology, and pedagogy aiming to use technology can take advantage of this instrumentalisation (Meagher, 2005, p. 177). However, some of the students felt that the computer was doing the mathematics for them since they were giving it instructions and they sometimes felt that they want to do the mathematics on their own without the computer. They complained that instead of learning calculus, they learnt how to use Mathematica which was making the calculations easier. Students felt that too much time was spent on Mathematica not mathematics and that too many of their questions were technical (about Mathematica) rather than conceptual (about mathematics) (Meagher, 2005, p. 182).

In contrast to this study some advantages are reported on using technology. Nilklad (2004, p. 212) highlights that “the incorporation of graphing tools in the curriculum does support students’ visualisation of functions because the graphing tools help them understand more abstract views of functions”. Noinang, Wiwatanapataphee and Wu (2008) also assert that the use of CAS help in developing students’ logical/analytical reasoning by visually supporting calculus concepts like integration to be learnt with graphics. Clements et al. (1997) point out that learning by CAS creates an environment that is motivating and meaningful to the students as well as allowing students of different abilities to use a variety of approaches to solve problems. CAS also improves spatial skills (Kaufmann & Schmalstieg, 2003).

Bressoud (2001), talks about the debates that took place (around 1980) in order to come up with innovative approaches to calculus instruction in undergraduate mathematics. One of the suggestions was that when learning using a computer, key ideas should be treated graphically, numerically and symbolically and that writing should be used to foster *critical thinking* (Bressoud, 2001, p. 579). Presently Autograph and Geogebra (available online) are used during mathematics lessons to enhance visualisation including drawing different graphs and demonstrations of the Riemann sum. A comment from a teacher was that Autograph enabled learners to visualise how a “2D shape can rotate to generate a 3D shape” (McMahon, 2012, p. 3). Autograph’s unique 3D interface was also found to be useful in aiding students aged 16 -19 to visualise a volume of revolution (Barton, 2009).

2.7 CONCLUSION

Since the focus of this study is on students' learning difficulties involving VSOR, the importance of visual learning was discussed. The literature survey done was based on the five categories and the contextual factors affecting learning of VSOR. What one can gather from the debates and studies above and reflecting on my study is that in learning a topic such as VSOR, students have to develop critical thinking. Diagrams are seen as a starting point to aid students to learn visually. However, most students tend to avoid using diagrams and prefer to use algebraic representation where they tend to calculate even if the solution to the problem given does not require calculation or can be interpreted visually. The majority of students were seen to perform better in problems that require procedural skills, and failed when they had to visualise, requiring conceptual skills. With VSOR the students are expected to draw graphs, interpret the graphs (from the Riemann sums and after rotating them). The use of the Riemann sum and the translation from 2D to 3D were difficult aspects for most students. The threshold concepts in integration were also seen as problematic to most students. In some studies, students struggled to understand how different rotations give rise to different methods for calculating volume as well as drawing the 3D diagrams formulated.

The importance of writing and language used was also shown. In this study in particular, students are assessed in writing in order to investigate their thinking processes. The importance of the use of CAS has also been discussed to show its merit in visual learning. The debates and studies above emphasise the importance of making mathematics real and accessible, using different levels of representation, also highlighting a shift from *verbal*, *symbolic* and *numerical* representation towards visual learning, especially when learning using the CAS. Visual instruction was seen to provide room to engage students with meanings, which are not always possible when they learn symbolically and verbally. In my study the use of CAS can be useful, but there is reluctance in using it due to shortage of resources at most colleges. Even though some of the studies discussed in this section involve younger children, their mathematical foundation might affect performance at higher levels.

In sections that follow, the conceptual framework, the methods of data collection and analysis are discussed, followed by the presentation, analysis and interpretation of the results in order to answer the research question of this study. Finally the conclusions and recommendations are made.

CHAPTER 3: CONCEPTUAL FRAMEWORK

Having discussed the background, defined the research question and discussed the literature for this study, this chapter aims at establishing the conceptual framework (my own model based on my experience) and the theoretical orientation (the work of others) that frames this study. The different modes of representations (visual/graphical; algebraic/symbolical and numerical) that affect the learning of Volumes of Solids of Revolution (VSOR) are explored and used to develop the five skill factors of knowledge that constitute the learning of VSOR as the framework for this study. The five skill factors are: (I) Graphing skills and translation between visual graphs and algebraic equations/expressions (both in 2D and in 3D); (II) translation between 2D and 3D diagrams; (III) translation between continuous and discrete representations; (IV) general manipulation skills and (V) consolidation and general level of cognitive development. It is identified whether the different skill factors require procedural and/or conceptual knowledge. Finally the conceptual framework is partially positioned within other related frameworks.

3.1 THE THREE MODES OF REPRESENTATIONS

A conceptual framework is a system of concepts, assumptions, expectations, beliefs and theories that supports and informs research (Maxwell, 2005, p. 33). The conceptual framework of this study is rooted in the following representation of knowledge:

Visual/graphical – where students' interpretations are analysed from the graphs, diagrams (both in 2D and in 3D), or other forms of pictorial illustration they produce.

Algebraic/symbolical – where students' interpretations of the visual/graphical are analysed from the equations/expressions, symbols and notations they use.

Numerical – where students' interpretations are analysed from the calculations they use (points of intersection, intercepts with the axes and other important points) when drawing graphs, computations and manipulation of the given integrals (using equations/expressions and symbols) to calculate area and volume, and their further applications.

3.2 MY CONCEPTUAL FRAMEWORK INVOLVING THE FIVE SKILL FACTORS

This research focuses on students' difficulties involving VSOR. In learning about VSOR, students are expected to sketch graphs, shade the region bounded by the graphs, show the representative strip for the shaded region, rotate the graphs (focusing on the shaded region) and calculate the volume generated. In so doing the students are expected to use visualisation as a tool for learning in order to translate the visual graphs to algebraic equations and to do the manipulations that follow. Based on these premises and also relating to literature, a theoretical framework was developed.

The theoretical framework is based on five skill factors given in Table 3.1. The five skill factors were developed from the analysis of the section based on VSOR from the N6 textbooks, to determine which skills students need for competency. Each skill factor is categorised according to elements (that clarify the skill factor in detail), as shown in Table 3.1 below, 11 elements in total. In order to investigate the difficulties, students' written and verbal interpretations were analysed in line with the five skill factors. The use of writing in this study helped the researcher monitor the students' conceptual understanding level required for VSOR. According to McDermott and Hand (2010, p. 519), writing in the science classroom is viewed as a communication tool as well as an epistemological tool to develop conceptual understanding.

Table 3.1: The five skill factors

Skill Factors	I Graphing skills and translating between visual graphs and algebraic equations/expressions in 2D and 3D	II Three-dimensional thinking	III Moving between discrete and continuous representations	IV General manipulation skills	V Consolidation and general level of cognitive development, incorporating Skill factors I, II, III and IV
Elements	1: <i>Graphing skills</i> 2: <i>Algebraic to Visual (2D).</i> 3: <i>Visual to Algebraic (2D).</i> 4: <i>Algebraic to Visual (3D).</i> 5: <i>Visual to Algebraic (3D).</i>	6: <i>2D to 3D.</i> 7: <i>3D to 2D</i>	8: <i>Continuous to discrete (Visual 2D and 3D)</i> 9: <i>Discrete to continuous and continuous to discrete (Algebraic)</i>	10: <i>General manipulation skills</i>	11: <i>Consolidation and general level of cognitive development</i>

The five skill factors and elements are now discussed individually in order to motivate the framework for this study, with the subsequent elements under each skill factor.

3.2.1 Skill Factor I: Graphing skills and translating between visual graphs and algebraic equations/expressions in 2D and 3D

Skill factor I involves visual learning and consists of Elements 1, 2, 3, 4 and 5. Visual learning involves the learning process whereby students can make sense of what they can visualise. The assumption is that if students learn visually they can reflect on pictures and diagrams mentally, on paper or with technological tools. In calculating VSOR, students are expected to visualise the area bounded by the drawn graphs between certain values (along the y -axis) and between certain values (along the x -axis) that serve as boundaries/limits for integration.

Elements 1, 2 and 4: Graphing skills and translating algebraic equations/expressions to visual graphs in 2D and 3D

Element 1 refers to the skills required when students are given the equations of one or more graphs that they have to draw, or in words. In Elements 2 and 4 the equations/expressions are given to represent a 2D or a 3D diagram or in the form of an integral formula. In drawing those graphs the students must show the intercepts with the x -axis and the y -axis and other important points including the parameters, turning points, points of inflection and the points of intersection if any.

Elements 3 and 5: Translating visual graphs to algebraic equations/expressions in 2D and 3D

Students translate the drawn graph(s) (given in 2D or 3D) to the algebraic formula in order to compute the area (skill required in Element 3) and the volume of the rotated area (skill required in Element 5). In so doing, they are translating between the visual graphs and the algebraic equations/expressions, which involve the use of equations or formulae in order to calculate the volume of the solid generated, after rotation of the shaded area about the x -axis or the y -axis. Students are expected to demonstrate what they have visualised or imagined from the shaded area by translating that into correct equations, in order to further calculate the value of the integral that represents the area or the volume of the shaded area upon rotation. Using integration the volume can be calculated by using the correct formula related to the selected strip (the Δx or the Δy strip), which results in a different method upon rotation, being the disc/washer or shell method. The Δx and the Δy represent the width of each selected rectangular strip. Depending on the selected strip, the students also need to calculate the necessary parameters if not given as coordinates, representing the x -value and the y -value. The substitution to the algebraic formula involves all three representations. As students do the

substitution, they are at the same time translating from the visual graphs to the algebraic equations. The general manipulation skills are also used after selection of the formula for area or volume resulting from the translation from the graphical representation to the algebraic representation. Students are also working in the visual/graphical representation as they use the selected strip (Δx or Δy) during the substitution of the different graphs in terms of top graph minus bottom graph or right graph minus left graph which can be done from interpreting the drawn graph for calculating area or volume.

The area and the volume to be calculated are integrals. Hence area could be expressed as

$A = \int_a^b y dx$ and the volume of the solid could be given as $V = \int_a^b A(x) dx$. The formulae

respectively if the radius is y and the strip width is Δx (or dx), are as follows:

$$V = \pi \int_a^b y^2 dx ; V = \pi \int_a^b (y_1^2 - y_2^2) dx \quad \text{and} \quad V = 2\pi \int_a^b xy dx$$

The first formula represents the disc method, the second represents the washer method and the last one represents the shell method. In order to use the correct formula, the student must relate to the drawn graph to the correct strip.

Depending on how the students are taught or how they prefer to learn, students may tend to portray some kind of preferences and capabilities. In one question from the FET National examination paper, students were asked to *calculate the volume described* which refers to a drawn graph. In this question students were required to translate the visual graphs to the algebraic equations, with an emphasis on graphs being the starting point in translating to algebraic from what one sees as the formula for the disc, washer and shell methods respectively. The numerical representation is also evident when students use the FTC after integration for evaluating the definite integral. In calculating area and volume, students may in some instances guess the correct formula without the correct reasoning.

In learning about VSOR students make mental pictures as they imagine rotations for disc, washer or shell methods respectively. The mental pictures are referred to by Dreyfus (1995) as *concept images*. Visualisation is a key component in mathematical problem-solving (Deliyianni et al., 2009). Christou et al. (2008, p. 2) and Gutiérrez (1996, p. 9) clarifies visualisation as integrated by four main elements: mental images, external representations, processes of visualisation, and abilities of visualisation. Thornton (2001, p. 251) argues that

visual thinking should be an integral part of students' mathematical experiences. He argues that visualisation plays a significant role in developing *algebraic* understanding (an important aspect to be explored in this study) and that it is also seen as valuing a variety of learning styles as well as providing a powerful problem-solving tool. According to Thornton, "powerful algebraic thinking arises when students attach meaning to variables and visualise the relationship in a number of different ways" (Thornton, 2001, p. 252). In this study I investigate those relationships, with the main focus on the development of algebraic thinking as students translate the visual (rotation of graphs after selection of an appropriate strip) to the algebraic manipulations (of equations) as they compute the volume using integration.

Under the Skill factor I, all three modes of representations overlap. As students draw graphs, they use general manipulation skills to calculate the intercepts with the axis and other important points; hence they operate in the numerical representation. At the same time they are translating between the given equations/symbols and the visual/graphical representation.

3.2.2 Skill Factor II: Three-dimensional thinking

Skill factor II also involves translation from 2D diagrams to 3D diagrams (Element 6) and translation from 3D diagrams to 2D diagrams (Element 7). In learning of VSOR students draw graphs, giving rise to two-dimensional shapes. The two-dimensional shapes are given in terms of the region within the given parameters, which upon rotation result in three-dimensional objects. The strip drawn approximates the area within the given parameters. The drawn strip for the area selected (in 2D) is used to calculate area from integration. If the selected area is rotated, students should use integration to compute the volume generated using the disc, washer or shell methods. In order to compute the volume generated as a result of rotating the region bounded by those graphs, students are expected to work in one dimension to identify the points that serve as parameters to these graphs. Students are then expected to relate (transfer) to prior knowledge regarding Riemann² sums when working in two-dimensions to compute the generated volume in three-dimensions as a solid of revolution.

In generating a solid of revolution, the students have to argue that when a 2D object (e.g. a segment, a circle, a square, a triangle, a sinusoidal curve or a free shape curve) is rotated in 3D around a vertical axis it can generate a variety of 3D rotational objects (Christou et al.,

² Using a number of rectangular strips (slicing vertically or horizontally) to calculate the area bounded by curves and summing them up using integration.

2008, p. 5). If the students fail to make such connections, it may be because their mental schemes do not recognise what they see. This may be due to their *internal representations* which conflict with the *external representations* (Knuth, 2000). For example, a student may not have the necessary tools (preknowledge or cognitive skills) to deal with the data presented by the external representation (diagram/graph) and internalise it. With Skill factor II, as it was with Skill factor I, all three modes of representations overlap. As students draw graphs or diagrams (in 2D or 3D), they use general manipulation skills to calculate the intercepts with the axis and other important points, hence they operate in the numerical representation. At the same time they are translating between the given equations/symbols and the visual/graphical representation, both in 2D and in 3D.

3.2.3 Skill Factor III: Moving between continuous and discrete representation

Skill factor III involves only visual/graphical representation. It focuses on Element 8, where translation is from continuous to discrete representations involving 2D and 3D diagrams and Element 9 where translation is from discrete to continuous representation and from continuous to discrete representation involving algebraic expressions. After drawing the graphs or when interpreting the drawn graphs, the students are expected to draw the representative strip (Δx or Δy) that would be used to compute the area or the volume from the shaded region bounded by the graphs, with or without using the Riemann sums. They are expected to see the shaded region and the volume generated as a result of rotating this region as being *continuous* and not as *discrete* isolated parts in order to use integration to compute the area and volume generated. In this study moving between discrete and continuous representation is possible when the shaded region bounded by graphs is approximated from the Riemann sums for area into thin rectangular strips which are summed to give an approximation of the area, as well as sliced into thin discs or washers or approximated with nested shells. Three rectangles are used in Figure 3.1 to demonstrate Riemann sums for the bounded area.

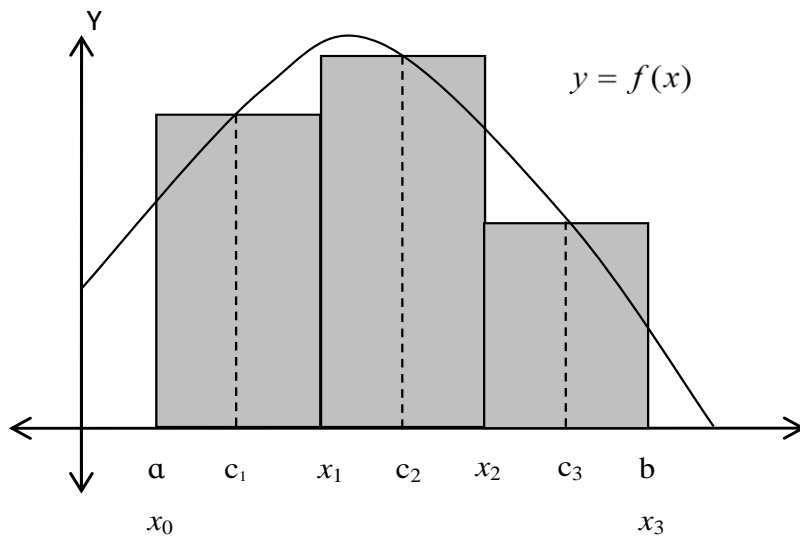

Figure 3.1: The Riemann sum

The area of the shaded region in Figure 3.1 above is an approximation of the area below the graph of $y = f(x)$ given as follows:

$$\int_a^b f(x) dx \approx f(c_1)(x_1 - x_0) + f(c_2)(x_2 - x_1) + f(c_3)(x_3 - x_2)$$

Students are expected to be in a position to use the widths of these rectangles as Δx (or Δy if roles of x and y are switched), which is represented on the diagram above as $x_1 - x_0$ and $x_2 - x_1$ and $x_3 - x_2$ and their given heights $f(c_1)$, $f(c_2)$ and $f(c_3)$ respectively to compute the area, depending on the number of rectangular strips selected. The more the number of rectangular strips within a given area are used, the better the approximation of the shaded area by summing the areas of those rectangular strips.

If the area for the region to be calculated is identified and the correct strip is drawn (where only one strip is required), students may be in the position to compute the volume generated as this region is rotated. Students are not in all cases required to sketch the exact solid of revolution that is generated, but they are expected to sketch the rotated strip that represents the method that will be used as either the *disc/washer* or *shell*. With Skill factor III, the visual/graphical representation is used, as students draw the selected strip and use it to approximate the area or the volume.

3.2.4 Skill Factor IV: General manipulation skills

General manipulation skills regarding Element 10 fall under the numerical representation as well as the algebraic/symbolic representation, where different equations/expressions are solved, including integration techniques. If the integral equation/ formula is given, the students are expected to compute the integral from the given equation or to calculate area or the volume of the given definite integral with respect to x or with respect to y . The numerical representation is also evident when students use the FTC after integration for evaluating the definite integral.

Within the numerical representation and the algebraic/symbolic representation under Element 10, procedural knowledge is involved. When using procedural knowledge, calculations done are based on the rules and algorithms used in learning VSOR. General manipulation skills used while calculating the value of the integral to find the area or volume generated can be regarded as being procedural since it involves applications of rules and algorithms. Finding the value of the integral does not only involve general manipulation skills, but require proper knowledge of integration rules. The numerical representations in this case involve the way in which the students do calculations and general manipulations. How do they solve problems and how do they perform during the process? How do they use general manipulation skills in solving problems involving calculation of the necessary points of intersection of the graphs, calculating the intercepts of the graphs with the axes and other important points? How do they use general manipulation skills in solving problems involving area and volume from integration and using integration techniques? What are their successes or failures during the manipulation process?

3.2.5 Skill Factor V: Consolidation and general level of cognitive development

This skill factor only involves Element 11, with the focus on the cognitive demands of the content learnt. The level of cognitive development may be affected by aspects such as the nature of difficulty of the content learnt as well as the time taken to learn a particular content.

Students' cognitive abilities and time constraints

Regarding learning about VSOR, I wanted to investigate whether failure is a result of the subject being of too high level of difficulty. Is the topic of VSOR maybe too high in terms of the students' cognitive abilities? If a new concept that is to be learnt is cognitively high for

the student's internal representation to comprehend, it is argued that students normally fail to make sense of such a concept or understand it conceptually (Tall, 1991).

Learning aspects that are above students' cognitive level becomes accessible if the students are given enough time to deal with such new concepts. Unfortunately that is not always possible with the FET College students due to the volume of work that needs to be completed within ten weeks, thus affecting the pace at which learning takes place. Eisenberg (1991, p. 148) argues that the abstraction of the new mathematical knowledge and the pace with which it is presented often becomes the downfall of many students. He further argues that in most cases the instructor had already internalised the topic, but this is not the case with the students who normally struggle to make sense of the new knowledge to be learnt.

It is argued that

As meaningful learning proceeds, new concept meanings are integrated into our cognitive structure to a greater or lesser extent, depending on how much effort we make to seek this integration, and on the quantity and quality of our existing, relevant cognitive structure (Novak, 2002, p. 552).

It is therefore the responsibility of both the lecturer and the student to ensure that meaningful learning occurs as they negotiate and re-negotiate meaning during the learning process. The way in which the lecturer integrates the content knowledge and the pedagogical knowledge during the teaching process also impact tremendously on meaningful and in-depth knowledge.

One does not know how different instructors approach the VSOR section. The question is do they start with simple graphs, like for an example rotation of a circle or a straight line before using the complicated graphs or do they just introduce the section without much order (haphazardly)? Do the instructors help the students to understand the relationship between area and volume and rotations in general? To what extent is their prior knowledge taken into consideration? What is actually happening in the classroom? It is anticipated that students will be taught traditionally and via technology with the emphasis on integrating the three representations in relation to the 5 skill factors discussed above.

3.3 THE THREE MODES OF REPRESENTATIONS AND THE LEVEL OF COGNITIVE DEVELOPMENT

In teaching calculus teachers use graphical, symbolic and numerical representations (Tall, 1996; Habre & Abboud, 2006). As is the case in my study, the use of graphical, symbolic and numerical representations will be required both in teaching and in learning of VSOR. According to Amoah and Laridon (2004, p. 6), the use of multiple representations is expected to increase students' understanding, even though students struggle to move comfortably among the different representations. To improve students' performance in calculus, it is necessary that teaching focuses also on concepts, not only the techniques. Concepts should be introduced graphically, algebraically and numerically (Serhan, 2006). This study suggests that practices of teaching calculus concepts should change to achieve a comprehensive concept image of the derivative concept that includes all the different representations. Students' concept images can be enriched if instruction is aimed at helping students to acquire the ability to visualise mathematical concepts (Harel et al., 2006, p. 149).

In his study Cheng (1999) investigated the critical role that representations have on conceptual learning in complex scientific and mathematical domains. Cheng (1999, p. 115) argues that approaches to conceptual learning should ensure that concepts are organised in a specific order. Cheng (1999, p. 116) writes: "building the conceptual network clearly does not occur by simply transmitting the knowledge of the domain to the learner", but that consideration must be given to "the role of the external representation used for the domain" as well as to "the role of individual concepts". By external representations he refers to charts, graphs, diagrams, equations, tables and all sorts of formal and semi-formal notations and by individual concepts he refers to schemas, sets of related propositions or groups of rules (Cheng, 1999, p. 116). With the use of computers in learning (Cheng, 1999, p. 117) argues, "there appears to have been no dramatic improvement in conceptual learning because programs typically support just a few of the processes". In this study the use of computers will only be addressed during the preliminary phase. The focus will be on the teaching and learning involving the five skill factors of knowledge identified, also focusing on conceptual knowledge and procedural knowledge.

3.4 PROCEDURAL AND CONCEPTUAL KNOWLEDGE

In teaching and learning of VSOR, students are expected to use procedural knowledge (involving algorithmic use) as well as conceptual knowledge (involving cognitive abilities and critical thinking), which complement one another. Students' cognitive abilities in VSOR are measured in the way in which students are capable of solving problems that translate from conceptual knowledge to procedural knowledge and vice versa and integration of conceptual knowledge to procedural knowledge.

In Haapasalo's (2003) terms conceptual knowledge is

Knowledge of and a skilful drive along particular networks, the elements of which can be concepts, rules (algorithms, procedure, etc) and even solved problems (a solved problem may introduce a new concept or rule) given in various representation forms (Haapasalo, 2003, p. 3).

While procedural knowledge is

dynamic and successful utilisation of particular rules, algorithms or procedures within relevant representation forms. This usually requires not only the knowledge of the object being utilised, but also the knowledge of format and syntax for the representational system(s) expressing them (Haapasalo, 2003, p. 4).

Engelbrecht et al. (2005) pointed out that along the process of learning, conceptual knowledge that is repeatedly taught might end up being procedural knowledge, in that students might not be thinking about what they are doing when presented with repeated problems, since the problems might have been done many times in class. In this study, I observed which aspects were learnt procedurally, and which ones were learnt conceptually.

According to Rittle-Johnson and Koedinger (2005, p. 317), students need to develop conceptual knowledge in a domain that can be flexibly applied to new tasks. They further argue that visual representations such as pictures and diagrams are one potential scaffold for eliciting conceptual knowledge and facilitating integration. In that way, students can instead of rote learning of rules, justify their knowledge from what they see. In the learning of VSOR, the visualisation of the graphical representation and the translation to algebraic can be regarded as the conceptual learning since it involves critical thinking to enable the student to use a particular method. For the different given graphs, the region bounded may be different; hence one cannot procedurally proceed without proper conceptual understanding of what is being visualised. The students must engage with the drawn graph, analyse what region need to be rotated, what parameters are given and how the selected region must be rotated.

If students in this study possess the cognitive abilities, they should be in a position to succeed in problems that require the use of procedural knowledge and in a problem that has a conceptual base. In that regard, students will succeed in solving problems involving *level of cognitive development*, as it is required under the Skill factor V. Interpreting graphs and diagrams and translation from visual to algebraic or other forms of translations would also not be problematic.

Below, a VSOR model is proposed where the extent to which the skill factors require conceptual knowledge and / procedural knowledge or both are shown.

3.5 PROCEDURAL AND CONCEPTUAL KNOWLEDGE WITHIN THE FIVE SKILL FACTORS

The VSOR model as a concept mapping is presented by the researcher to show where the five skill factors fit, in relation to conceptual understanding and procedural understanding.

3.5.1 The VSOR model

The VSOR model is presented in Figure 3.2 showing all five skill factors.

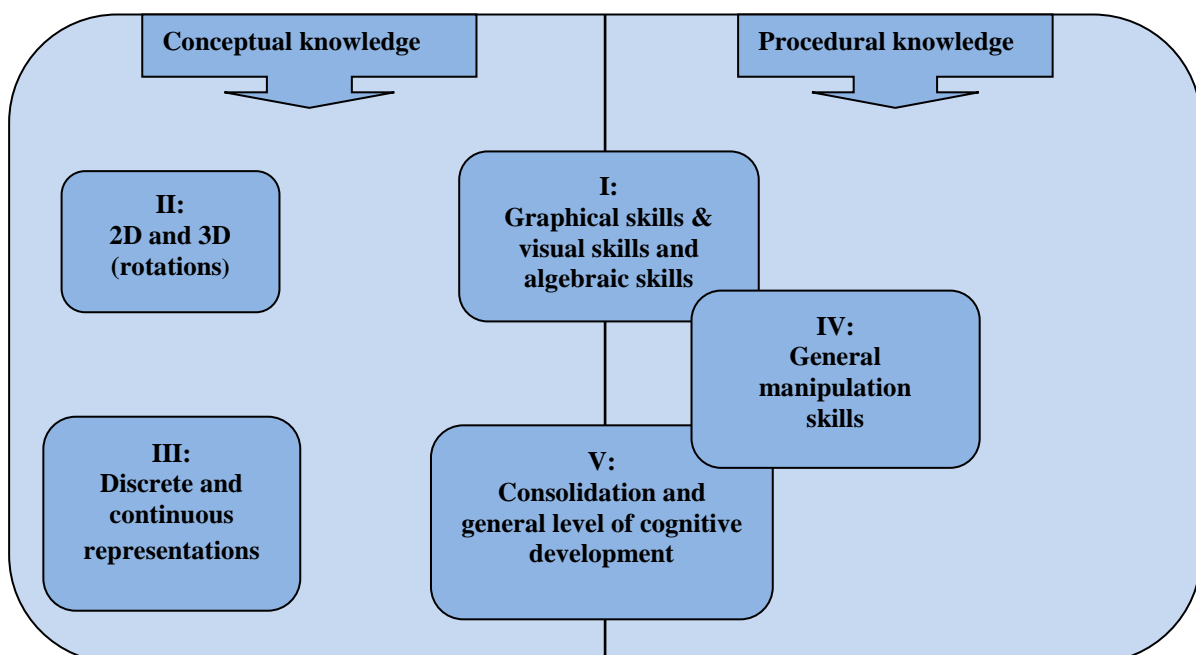

Figure 3.2: The VSOR model

Any skill factor can be performed to measure different aspects of competency in VSOR, whether procedural or conceptual or both, without any order. One does not have to always start by drawing a graph in order to calculate the area or the volume. The instrument designed is such that one can start anywhere. For example, there are cases where a graph (diagram) is given and students are asked to interpret it, either by coming up with the formula for area or volume; to represent on it the Riemann sums or the disc, washer or shell; or to translate it between 3D and 2D algebraically or in a form of a diagram. The VSOR model suggests that all the different skill factors individually affect the learning of VSOR, with Skill factor IV being incorporated in Skill factors I and V.

The model further shows that different factors of knowledge require different skills. For example, **Skill factor I** involves drawing graphs (translating from an algebraic equation to a visual graph), which requires the use of procedural skills while interpreting the drawn graphs (translating from the visual graph to an algebraic equation) requires conceptual skills. **Skill factor II** involves rotating 2D diagrams that result in 3D diagrams and interpreting a given problem from 3D to 2D, thus requiring conceptual skills. **Skill factor III** involves selection of the correct representative strip and interpreting an equation that relates a continuous graph to discrete form, thus requiring conceptual skills. **Skill factor IV** involves general manipulation skills where the calculations depend on algorithmic usage, which is procedural in nature, while Skill factor V involves level of cognitive development where a student is able to succeed in all first four skill factors which involve both procedural and conceptual skills.

The above VSOR model is adapted in this study focusing on the individual components of the model and the way in which they affect the learning of VSOR. Any explicit relationships that the elements from the five skill factors may have on each other were also investigated through correlations. For an example, do students who fail to draw graphs always fail to translate from 2D to 3D or fail to exhibit general manipulation skills and vice versa?

The VSOR model discussed above is further incorporated within Bernstein's (1996) theories of *knowledge transmission* and *knowledge acquisition* and Kilpatrick, Swafford and Findell (2001) five strands of *mathematical proficiency* as a theoretical framework.

3.6. RELATED FRAMEWORKS

In dealing with students' difficulties, it is necessary to study students' thinking processes and how these hamper or enhance learning. Do these students possess what is necessary for learning to take place or is learning just not possible? Using students' written and verbal interpretations, one can investigate their ways of thinking.

The way in which the students construct knowledge, interpret and make sense of what they have learnt about VSOR, is located within the two theoretical frameworks below, by Bernstein (1996) and Kilpatrick et al. (2001). The students' ways of learning is discussed and located within Bernstein's (1996) rules of knowledge acquisition as well as within the five strands of mathematical proficiency of Kilpatrick et al. (2001), while teaching practices are discussed using Bernstein's (1996) rules of knowledge transmission. The VSOR model is discussed in each case where relationships are possible for each framework.

3.6.1 Bernstein's framework

The other theoretical framework that is used in this study is that of Bernstein (1996) involving knowledge transmission and acquisition. Knowledge transmission relates to the *teaching process* while knowledge acquisition refers to the *learning process*. In this study the two processes are explored, with the main focus being on how learning takes place. In the process of learning, knowledge acquisition occurs when students are able to interpret the question and to give the correct answer. Bernstein (1996) refers to that process as involving the recognition and the realisation rules. He refers to the *recognition rules* as the means by which 'individuals are able to recognise the speciality of the context that they are in' (Bernstein 1996, p. 31) during a learning situation, while the *realisation rules* allow the production of the 'legitimate text' in giving the correct answer. If one considers what is happening in the classroom, the recognition rules enable the necessary realisations, while the realisation rules determine how meaning is being put together and made public (Bernstein, 1996, p. 32). In terms of this study the recognition and the realisation rules are related to the students' ability to link their internal representations (mental image) properly with the external representation (visualising and interpreting the graphs correctly) in volumes of solids of revolution. The ability to recognise and realise in a learning context, using procedural knowledge flexibly may be influenced by the way in which instruction occurred (knowledge transmission) or what the students believe mathematical knowledge to be.

The way in which the students construct knowledge, interpret and make sense of what they have learnt in class is located within Bernstein's (1996) rules of knowledge acquisition as our theoretical framework. Since one is dealing with students' difficulties, it is necessary to study students' thinking processes and how they impact on their ways of learning. Using students' written and verbal interpretations, one can investigate their ways of thinking. Under Skill factors I, II, III and V, are the students able to interpret the drawn graph(s) correctly? Or are they able to translate the given equations/expressions to graphs/diagrams or correct calculations. If they are able to, we say that they recognised the drawn graph (from its characteristics) and were as well able to realise, by translating the drawn graph to the correct equation for area or volume.

The ability to recognise and realise in a learning context, is also possible with problems that require the use of procedural knowledge such as Skill factors, I, IV and V. Are students able to recognise what is given and solve it accordingly. How is the integral sign interpreted? Are the students able to use general manipulation skills to solve problems and to get correct points that can be used to draw graphs like, for an example, the points of intersection?

Using conceptual knowledge and procedural knowledge flexibly in order to recognise and realise what students have learnt, may be influenced by the way in which instruction occurred, knowledge transmission according to Bernstein (1996), or what the students believe mathematical knowledge to be. In this study students are asked to sketch graphs, interpret graphs, interpret the drawn graphs, calculate from a given equation or even justify how a certain graph could be drawn. In so doing, the way in which the students recognise and realise is interpreted according to Bernstein's framework verbally and in written form.

3.6.2 Kilpatrick's et al. framework

Using Kilpatrick's et al. (2001) five strands of Mathematical Proficiency (MP), students' verbal interpretations were explored and scaffolding was used during group interactions. The way in which the students construct knowledge, interpret and make sense of what they have learnt is located within the theoretical framework involving the five strands of Mathematical Proficiency (MP), listed below. These five strands are not independent, they are interwoven and interdependent in the development of proficiency in mathematics (Kilpatrick et al., 2001, p. 116). MP is used to explain what is believed to be necessary for anyone to learn mathematics successfully. They argue that the way in which "learners represent and connect pieces of knowledge is a key factor in whether they will understand it deeply and can use it in

problem-solving” (Kilpatrick et al., 2001, p. 117). The fact that the five strands are interwoven relates to the way in which students connect the pieces of knowledge in problem-solving situations. They also highlight the importance of the central role of mental representations in enhancing learning with understanding as opposed to memorisation.

The five strands are discussed as follows:

- *Conceptual understanding* involves comprehension of mathematical concepts, operations and relations (understand).
- *Procedural fluency* involves skill in carrying out procedures flexibly, accurately and appropriately (compute).
- *Strategic competence* involves ability to formulate, represent, and solve mathematical problems (solve).
- *Adaptive reasoning* involves capacity for logical thought, reflection, explanation and justification (reason).
- *Productive disposition* involves habitual inclination to see mathematics as sensible, useful, and worthwhile, coupled with a belief in diligence and one’s own efficacy (attitudes).

The five strands are discussed below from the point of view of (Kilpatrick et al., 2001)

a) *Conceptual understanding* refers to an integrated and functional grasp of mathematical ideas. They argue that students with conceptual understanding know more than isolated facts and methods as they understand why a mathematical idea is important as well as its use in the context relevant to it. They further argue that with conceptual understanding one is able to represent mathematical situations in different ways as well as knowing how different representations can be useful for different purposes. With conceptual understanding students may discuss the similarities and differences of representations and the way in which they connect. These connections are found to be useful if related concepts and methods are related appropriately. They argue that

when students have acquired conceptual understanding in an area of mathematics, they see the connections among concepts and procedures and can give arguments to explain why some facts are consequences of others. They gain confidence, which then provides a base from which they can move to another level of understanding (Kilpatrick et al., 2001, p. 119).

b) *Procedural fluency* refers to knowledge of procedures, knowledge of when and how to use them appropriately, and skill in performing them flexibly, accurately and efficiently. When

students study algorithms as general procedures, they can gain insight into the fact that mathematics is well structured, that is highly organised and filled with patterns. They argue that a certain level of skill is required to learn many mathematical concepts with understanding and that using procedures can help and develop that understanding. According to Boaler (1997), knowledge that cannot be used flexibly is said to be inert.

If students learn procedures that they do not understand, they will fail to use them in new or different contexts when solving activities. They will also fail to understand the reasons underlying the applications of such procedures. If no emphasis is made on procedural fluency, students would have trouble deepening their understanding of mathematical ideas or solving mathematics problems. The problem with learning incorrect procedures is that the incorrect procedures make it difficult for them to learn correct ones.

c) *Strategic competence* refers to the ability to formulate mathematical problems, represent them and solve them. Strategic competence is evident if students build mental images of the essential components of a problem during problem-solving situations. In so doing, students should be able to generate a mental representation like diagrams and equations/expressions that capture the core mathematical elements of the question, whereby the students are able to detect mathematical relationships in the given problem. Strategic competence can be used in both routine where a known procedure is reproduced and used, and non-routine tasks where one does not immediately know the procedure but has to invent some rule or reconstruct. The way in which challenging mathematical problems are solved depends on the ability to carry out procedures readily.

d) *Adaptive reasoning* refers to the capacity to think logically about the relationships among concepts and situations. It involves informal explanation and justification when making conclusions given reasons for assumptions or conclusions made. With adaptive reasoning students are given the opportunity to use new concepts and procedures to explain and justify by relating them to already known concepts and procedures, hence adapting the old to the new. With strategic competence, students draw on their strategic competence to formulate and represent a problem using heuristic approaches that may provide a solution strategy leading to adaptive reasoning where a student will be determining whether an appropriate procedure is used in solving a problem. When solving the problem strategic competence is used, but if a student is not satisfied with the solution plan, adaptive reasoning is used to change the plan to another method that will be suitable by reasoning and justification.

e) *Productive disposition* refers to the tendency to see sense in mathematics, to perceive it as both useful and worthwhile, to believe that steady effort in learning mathematics pays off, and to see oneself as an effective learner and doer of mathematics. If students see themselves as capable of learning mathematics and using it to solve problems, they become able to develop further their procedural fluency or their adaptive reasoning abilities. Educational success in mathematics can also be affected by one's disposition. Failure to develop productive disposition is seen when students avoid challenging mathematics courses. Students who have developed a productive disposition are found to be confident in their knowledge and ability, with perception of mathematics as both reasonable and intelligible. These students have a belief that with appropriate effort and experience, they can learn.

Mathematical Proficiency in that regard goes beyond being able to understand, compute, solve and reason, but also involves one's attitude towards mathematics. Since these five strands are interwoven, they influence each other. For example, conceptual understanding and procedural fluency continually interact. As one gains conceptual understanding one will be able to compute, as a result of being able to use the correct and relevant procedures flexibly, irrespective of whether the problem at hand is new or challenging. If conceptual understanding is achieved, new understanding may develop. It is believed that to become mathematically proficient, students need to spend sustained periods of time doing mathematics that involve solving problems, reasoning, developing understanding, practising skills and building connections between previous knowledge and new knowledge. Problems in this study will require the use of the first four strands relating to content, with the last strand captured during the interviews.

Within the VSOR model, students are asked to sketch graphs and draw diagrams, interpret graphs, come up with the correct equations and use them to calculate from the given graphs, calculate from a given equation or even justify how a certain graph or diagram could be drawn both in 2D and in 3D. The five skill factors can be located within this model. The first strand involves conceptual understanding which is possible under the Skill factors I, II, III and V when students solve problems that are conceptual in nature. The second strand involves procedural fluency which is possible under Skill factors I, IV and V, where the problems require the use of general manipulation skills and use of rules. The third strand involves strategic competence which is possible under Skill factor I and IV where general manipulation skills are involved. The fourth strand, adaptive reasoning, is applicable in all the five skill factors where logical thought, justification and reflection are required. The fifth

strand, productive disposition, involves attitude towards mathematics that can be evident from the way students behave in class during the observations and from the interview conducted with one previous student.

3.7 CONCLUSION

In this chapter, the conceptual framework has been developed based on the 5 skill factors. The 5 skill factors include graphing skills and translating between visual graphs and algebraic equations/expressions; three-dimensional thinking, moving between continuous and discrete representations, general manipulation skills and consolidation and general level of cognitive development. The 5 skill factors were as well categorised as requiring procedural knowledge or conceptual knowledge or both and used towards the design of the VSOR model for this study. Other factors affecting the teaching and learning of VSOR in general, including students' thinking processes and the role of representations in learning were also discussed. The designed model opts for the interrelation between the five factors affecting VSOR and its 11 elements. The conceptual framework has also been located within the related theoretical framework and the work of others, focussing on the five skill factors. The theoretical frameworks discussed above relate to how students learn and how they go about showing that learning has occurred. The thinking processes are evident from their written and verbal interpretations. Bernstein's framework also extends to how knowledge is transmitted (teaching). The five strands of mathematical proficiency in mathematics by Kilpatrick et al. (2001) are used to explain successful learning in mathematics from the way in which the students represent and connect knowledge.

The chapter that follows presents a discussion on the research design and methodology for this study. Issues pertaining to ethical considerations governing this research are also discussed.

CHAPTER 4: RESEARCH DESIGN AND METHODOLOGY

This chapter outlines the research design and methodology regarding the investigation of learning difficulties involving volumes of solids of revolution (VSOR). In Section 4.1 the research strategy, involving the research methods and the sampling procedures is discussed for both qualitative and quantitative approaches. In Section 4.2 the mode of data collection and analysis including the instruments used for data collection in three different phases are discussed. Phase I involves the preliminary study and the pilot study, Phase II involves four different investigations, while Phase III involves two different investigations. The validity and reliability of the study are discussed in Section 4.3 and 4.4, respectively, for both quantitative and qualitative methods. In Section 4.5 the way in which generalisation of this study was done is discussed. The ethical considerations are discussed in Section 4.6. The delineation and limitations of the study are discussed in Section 4.7 and Section 4.8, respectively to shed light on what this research could or could not achieve and where it was restricted. The summary for this chapter is done in Section 4.9.

4.1 RESEARCH STRATEGY

4.1.1 Research methods

The research design for this study includes a number of strategies. This research is *empirical* since it focuses on data collection through observation and evidence (Bassey, 2003; Blaikie, 2003; Cohen et al, 2001) and *applied* since it is aimed to answer questions based on programs and organisations (Mason & Bramble, 1989) to produce recommendations in relation to organisational practices and change (Denscombe, 2002). This research is also *interpretive*, focussing on interpreting students' actual written and verbal interpretations and *descriptive*, since it reports information on the frequency or the extent at which something happens (Mertler, 2006). The research is *comparative* since the data collected from six different investigations are compared. This research also involves *correlation methods*. In correlational studies a researcher is interested in knowing whether variations in one trait correspond with variation in another (Mason & Bramble, 1989, p. 43), by finding a statistical relationship between variables (Brown & Dowling, 2001; Mertler, 2006). In this study, the correlation between variables was found using *scatter plots* as well as *Pearson's product moment* and *Kendall's tau* correlation coefficients.

Both qualitative and quantitative approaches are used. In the qualitative approach, I collect data through observation of what people do or say and interpret data as it occurs in the natural setting of the participants and explain it without numbers (Blaikie, 2003; Gelo, Braakmann, & Benetka, 2008; Mertler, 2006; Taylor-Powell & Renner, 2003). The qualitative approach is about what was said or done, while the quantitative approach is about numbers and ratings used (Blaikie, 2003; Gelo et al., 2008; Mertler, 2006). In this study tables, graphs and any form of statistical analysis will be used for the quantitative data. While quantitative researchers are interested in whether and to what extent variance in x causes variance in y , qualitative researchers are interested in finding out how x plays a role in explaining change in y and why (Maxwell, 2005, p. 23).

Maxwell (2010) does not support the idea that a qualitative approach is about words (verbally or written) and a quantitative approach is about numbers. He believes that using numbers in qualitative research is quasi-statistics, which correlates variables. According to Maxwell, with quasi-statistics, conclusions of qualitative studies have implicit quantitative components. He uses the terms “variance theory” and “process theory”. Variance theory on the one hand

“deals with variables and the correlations among them; it is based on an analysis of the contribution of differences in values of particular variables to differences in other variables. The comparison of conditions or groups in which a presumed causal factor takes different values, while other factors are held constant or statistically controlled, is central to this approach to understanding and explanation and tends to be associated with research that employs experimental or correlational designs, quantitative measurement, and statistical analysis (Maxwell, 2010, p. 477).

Process theory on the other hand

“deals with *events* and the processes that connect them; its approach to understanding relies on an analysis of the *processes* by which some events influence others. It relies much more on a local analysis of particular individuals, events, or settings than on establishing general conclusions and addresses “how” and “why” questions, rather than simply “whether” and “to what extent.” This aspect of qualitative research has been widely discussed in the methodological literature but has rarely been given prominence in works on the philosophical assumptions of qualitative research” (Maxwell, 2010, p. 477).

As a qualitative researcher, I adhere to the conventionalist view, that knowledge is constructed symbolically, and as a quantitative researcher, I adhere to the positivist view that “order exists among elements and phenomenon ... regardless of whether humans are conscious of order” (Mason & Bramble, 1989, p. 36). A conventionalist view is similar to the interpretative view and the constructivist view that there is no reality out there (Bassey, 2003), but it needs to be constructed in a social environment. The conventionalist or the interpretive or the constructivist researcher believes in finding meaning from what is being observed and also believes that the world is viewed differently depending on the observer and avoids general statements (Bassey, 2003; Cohen et al., 2001 & Denscombe, 2002). Positivists

make discoveries about realities of human actions and express it as factual statements also with expectations that other researchers handling similar data must come up with the same conclusions that they found (Bassey, 2003, p. 42), they also observe patterns in the social world empirically in order to explain it (Denscombe, 2002). The interpretive view focuses on qualitative methods interested in narrative data (verbal or written) while the positivists view focuses on quantitative methods interested in numerical data (Brown & Dowling, 2001; Denscombe, 2002; Mertler, 2006; Teddlie & Tashakkori, 2009). In this research both methods are used as they complement one another.

Using both qualitative and quantitative approaches is regarded as a *mixed method* approach (Bazeley, 2009; Creswell & Tashakkori, 2007; Christ, 2007; Morgan, 2007; Gelo et al., 2008; Hall & Howard, 2008; Hancock & Algozzines, 2006; Mertler, 2006; Teddlie & Tashakkori, 2009). The use of purely qualitative methods or purely quantitative methods can be overcome by integrating the two methods. Morgan (2007) refers to integration of qualitative and quantitative methods as a pragmatic approach. As it is the case in my study, “a strong mixed methods study starts with a strong mixed methods research question or objective” (Tashakkori & Creswell, 2007, p. 207) involving a ‘why’ research question. The research question for this study: **Why do students have difficulty when learning about Volumes of Solids of Revolution?** can be addressed from a mixed methods approach (MMA). Students’ performance on how they approached the problem can be analysed qualitatively relating to what written responses they actually produced and quantitatively as to which questions they did better in. It is also important to ensure that the writing up of MMA findings is integrated when reporting on the research done (Bryman, 2007).

My research involves *action research* since it is aimed at improving ways of teaching, learning and assessing VSOR. The important aspects that are neglected or not emphasised when teaching, learning and assessing VSOR are made public. Action research leads to innovation and change, but not necessarily to generalisation of the results to other settings (Cohen et al., 2001; Mason & Bramble 1989). Action research enables the researcher to understand the current practice, evaluate it and change it (Bassey, 2003; Mertler, 2006). In the data collected, action researchers qualitatively analyse data inductively (as they start from the observation of phenomena in order to build up theories about those phenomena) analysing patterns and similarities and quantitatively analyse data deductively (as they observe specific phenomena on the base of specific theories of reference) using descriptive statistics or inferential statistics (Mertler, 2006; Gelo et al., 2008). Analysing data both inductively and

deductively is referred to by Cohen et al. (2001, p. 4) as the *inductive-deductive* approach, which is referred to by Morgan (2007) as *abduction*, where results of the study can only be transferable, not generalised. This action research used multiple case studies during the data collection process in order to triangulate the data.

During a case study a researcher can use multiple sources of information (Cresswell, 2007; Mertler, 2006; Teddli & Tashakkori, 2009). In this study, the different sources of information included administration of different tests, direct observations, an interview and documentary analysis in order to determine the quality of events in the participants' natural setting as well as testing the theory designed in the conceptual framework presented in Chapter 3. Case studies address a particular event studied in its natural context to get a rich description of the event from a participant point of view (Gelo et al., 2008; Hancock & Algozzine, 2006). As a case study, I looked in-depth at individual student's written responses in class from the given tests and during examinations and observed group work in the classroom on how teaching and learning took place.

Case studies are seen as intensive investigations of the factors that contribute to characteristics of the case (Mason & Bramble, 1989, p. 40) as well as collecting sufficient data (Bassey, 2003) during the research process. Bassey (2003, p. 65) further advises that if a case study is conducted, the researcher will be able to:

- explore the significant features of the case;
- create plausible features of what is found;
- test for trustworthiness of this interpretation;
- construct a worthwhile argument or a story;
- relate the argument or the story to any relevant research in the literature;
- convey convincingly to an audience this argument or story;
- provide an audit trail by which other researchers may validate or challenge the findings, or construct alternative arguments.

After the case study investigations, correlations were also used to determine the association of the different elements from the students' performance. In this study I wanted to correlate variables (x and y) in order to determine any association between the variables as well as its direction and magnitude (Cohen et al., 2001). A correlation is a measure of the linear association between variables (Field, 2005). A scatterplot was used to determine such an

association as well as its direction and its magnitude (r). A scatter plot was used to display any association between the given variables from students' performance. Scatter plots can be useful in helping one understand how, and to what extent the variables are related (Myers, & Well, 2003, p. 40).

Examples of correlations using a scatterplot are given in Figure 4.1.

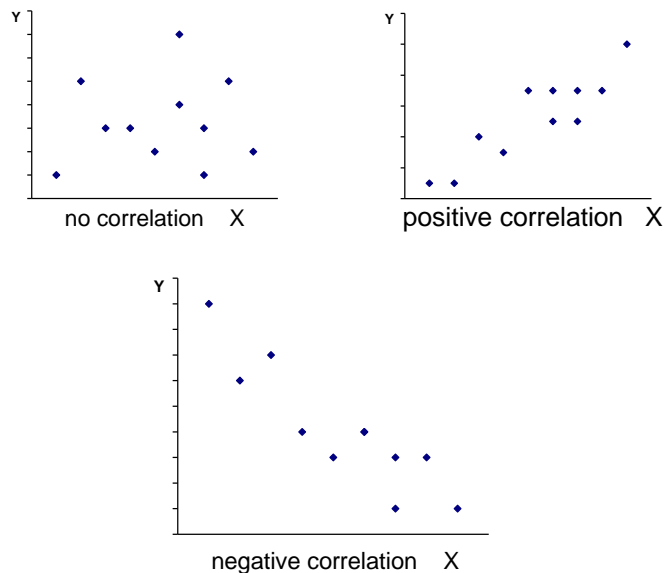

Figure 4.1: Examples of scatter plots (Adapted from Willemse, 2004, p. 116)

A correlation coefficient r , range between the values -1 and 1 , which is $-1 \leq r \leq 1$. The closer the correlation coefficient is to -1 or 1 , the more the linear association between the two variables. If r is close to 0 , there is little or no linear association between the two variables, the variables compared do not show any related pattern and the points are scattered around, not forming anything like a straight line. When the slope of the scattered points is positive, the r -value is positive and when it is negative, the r -value is negative. The sign of r indicates the direction of the association between the variables x and y . The strength of the correlation is not dependent on direction, that is $r = 0.84$ and $r = -0.84$ are equal in strength. The value of the coefficient reflects the strength of the correlation; a correlation of -0.84 is stronger than a correlation of 0.23 and the correlation of -0.44 is weaker than a correlation of 0.67 .

However, a correlation of 0.23 for a sample of 100 students and for a sample of 2000 students is interpreted differently. In order to determine the different interpretations of such correlations, we use the level of significance of the correlations. The level of significance of the correlations refers to the confidence that one has about the conclusion based on the

association of the elements being correlated by using the null hypothesis represented as H_0 which is either rejected or not rejected based on the p -value (Fields, 2005; Cohen et al., 2001). A p -value according to Keller (2005, p. 333) is a “test of probability of observing a test static at least as extreme as the one computed given that the null hypothesis is true”.

According to Cohen et al. (2001, p. 194-295), if an association occurs 95 times out of a 100 observations, then we can say with some confidence that there is less than 5% probability that an occurrence happened by chance, reported as ($p < 0.05$) for a statistically significant correlation. If the association occurs 99 times out of a 100 observations, then we can say with some confidence that there is less than 1% probability that an occurrence happened by chance, reported as ($p < 0.01$). In both cases ($p < 0.05$ and $p < 0.01$), the null hypothesis is rejected and we can conclude that there is a statistically significant association between the elements correlated. According to Field (2005), in showing the level of significance, $p < 0.01$ is represented by two asterisks (**), $p < 0.05$ with one asterisk (*) and $p > 0.05$ by no asterisk.

In Table 4.1, Keller (2005, p. 335) describes the p -value in terms of the rejection region. For an example, if the p value is less than 0.01, there is overwhelming evidence (highly significant) to reject the null hypothesis.

Table 4.1: The p-value table

p-value	Evidence	Interpretation	Conclusion
$p < 0.01$	Overwhelming	Highly significant	Reject H_0
$0.01 < p < 0.05$	Strong	Significant	Reject H_0
$0.05 < p < 0.1$	Weak	Not significant	Fail to reject H_0
$p > 0.1$	None	No evidence	Fail to reject H_0

After having determined the correlation using a scatter plot and finding the association between the variables, as well as the direction of that association and the magnitude, I determined the level of significance for those correlations using Pearson’s correlation coefficient (r) and Kendall’s tau correlation coefficient (τ) (Field, 2005). For the test statistic to be valid, Pearson’s correlation coefficient, a parametric static was used to correlate the marks obtained in Question 5 to the whole examination paper since the marks obtained were numerical (Field, 2005, p. 125). I presumed that there might be an association between the variables, but did not predict any direction between the associations of such variables; as a result, a null hypothesis was set up. Kendall’s tau correlation coefficient is a non-parametric statistic that was used since the data was ranked. Kendall’s tau correlation coefficient in

particular, was used since some of the data had tied ranks (Field, 2005). The coefficient of determination (R^2) is also determined to account for the amount of variability in one variable that is explained by the other (Fields, 2005), since other factors might have been involved.

The research design that was followed in this research is based on the three models discussed below, the *interactive model*; the *mixed method* model and *Gowin's Vee* model. The interactive model is mainly qualitative while the mixed method model integrates the qualitative and the quantitative approaches, and the Gowin's Vee integrates the conceptual framework and the methodology of this study.

The interactive model is the qualitative research design that follows Maxwell's (2005) model.

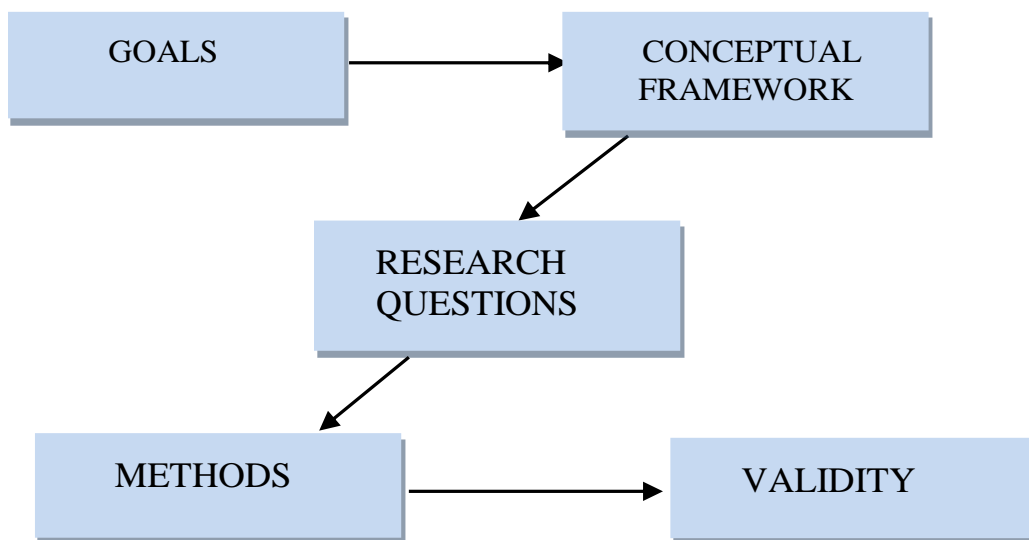

Figure 4.2: The interactive model of research design (Adapted from Maxwell, 2005, p. 11)

The model shown in Figure 4.2 has five components: *Goals*, *conceptual framework*, *research questions*, *methods* and *validity* (starting from the goals and ending up with issues of validity).

- The goals for this study include outlining challenges faced by students when learning VSOR. In particular, what are their learning difficulties? The significance of this study includes why is it important to research this area, which factors contribute towards improving learning and improved teaching and assessment practices. The goals include what practices the researcher wants to inform or change, for example, teaching or assessment and who will benefit from those changes.

- The conceptual framework for this research refers to specially designed elements in VSOR that I wish to build my research on as well as other theories that may be influential.
- The main research question for this study is: **Why do students have difficulty when learning about Volumes of Solids of Revolution?** The research question and subquestions are classified as the hub of the model as they connect all other components of the model and inform all other components, shown in Figure 4.2.
- The methods used are informed by the type of data that I want to collect, who the participants are, how I collected such data and how the analysis was done.
- The validity relates to the correctness of the results obtained, why other people should believe them, including interpretations that other people might have.

The strength of qualitative research according to Maxwell (2005) derives primarily from its inductive approach, focussing on what people do or say and the meanings they bring about as well as understanding their context to explain their behaviour.

With the mixed method research design (refer to Figure 4.3), the qualitative data collection involved written responses through tests and examinations; documentary analysis; classroom observations and an interview, in Phases I, II and III, while quantitative data collection involved assigning *rank scores* to the students' written responses in tests and examinations in Phase II. In Phase I the preliminary study was conducted through Test 1 and Test 2 and the pilot study was administered after content analysis of the textbooks and the examinations. In Phase II, the main data collection for this study was conducted through six *investigations*. Investigation 1 involved the administration of the 23-item instrument (questionnaire), called the Questionnaire 1st run whereas Investigation 2 involved the Questionnaire 2nd run in a different trimester including an analysis of the examination results (Investigation 3) and detailed written responses (Investigation 4) by students. The results from the questionnaire runs and the examination responses are as well compared. In Phase III classroom observations (Investigation 5) and an interview (Investigation 6) with a former N6 student were conducted. Even if a mixed method design is used, initially, the intention of the research was mainly qualitative, based on the interpretation and meaning of the data collected (Cresswell, 2009:4). The inclusion of quantitative methods is in order to make statistical inferences where necessary and to validate the qualitative data collected, where variables are related to one another (Cresswell, 2009:4).

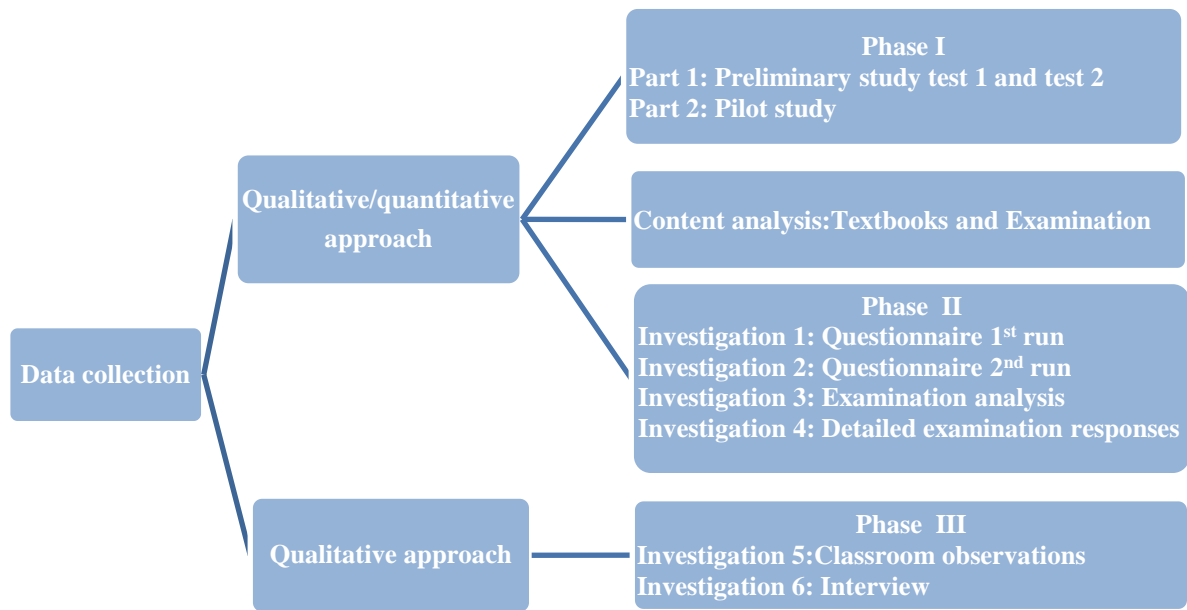

Figure 4.3: The mixed method research design model

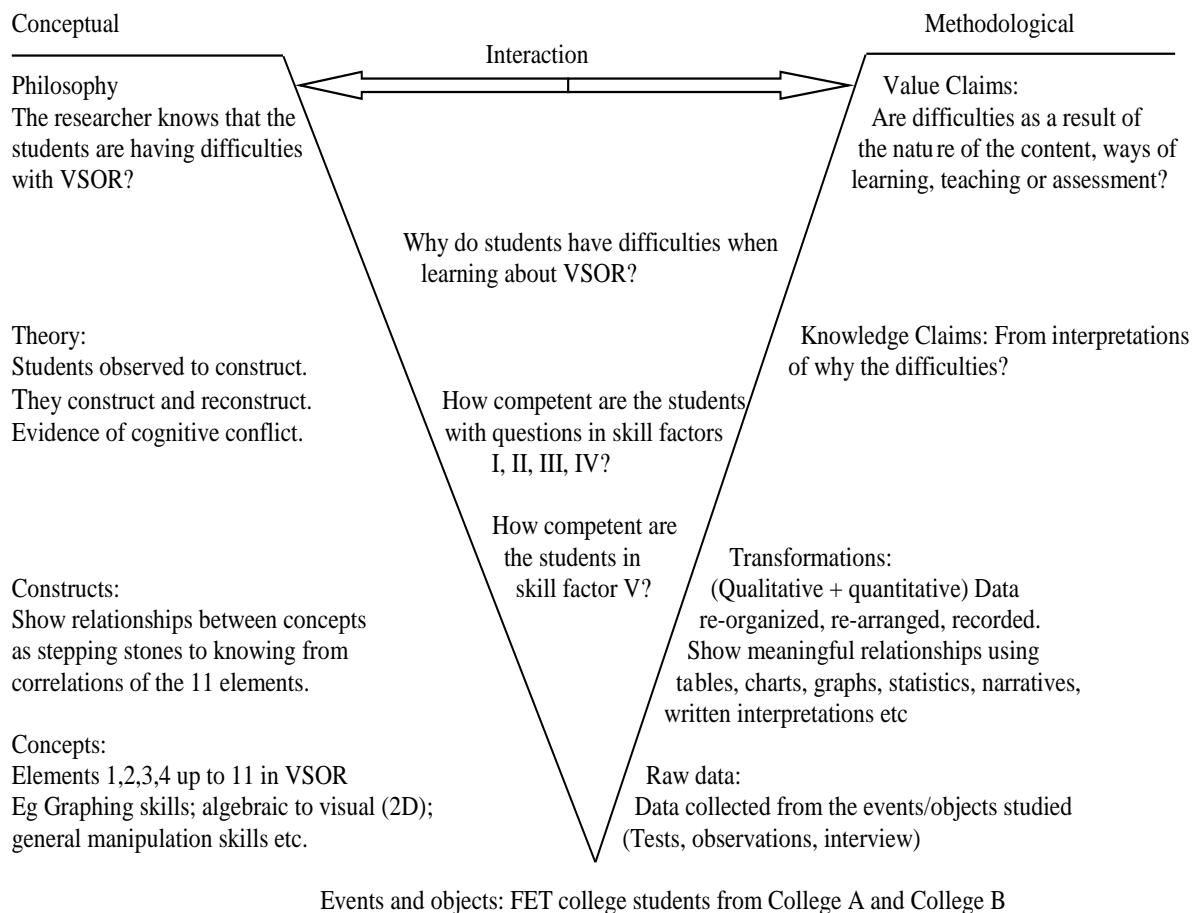

Figure 4.4: Gowin's knowledge Vee (Novak & Gowin, 1984)

In this research the V model starts from the bottom, with events or objects to be studied. In this case the objects to be studied are FET college students taking mathematics at N6 level. The conceptual framework follows upwards on the left while the methods follow upwards on the right. On the left the *concepts* to be learnt are the elements established throughout the three phases of data collection up to the 11 elements established from the 23-item instruments for learning VSOR. The *constructs* refer to how the relationships between these concepts are shown as a way of revealing how learning takes place. The theory involves constructivism as students construct knowledge. The philosophy relates to what the researcher knows about learning VSOR and what is guiding the enquiry in order to answer the research question. On the right, raw data are collected, rearranged and interpreted to establish how students perform in different elements. Data are interpreted (qualitatively and quantitatively) in order to answer the research question. Finally the value of knowledge found is established, be it in terms of validity and reliability and the trustworthiness of the results. The inside part of the Vee diagram involves the research question: Why do students have difficulties when learning about VSOR as the interaction of the conceptual ideas and the methodology. The other aspects that follow inside the Vee shape include how students address questions based on the Elements 1 up to 10 and how that relates to the performance with Element 11. The interaction of the left (with the order: concepts, constructs, theory and philosophy) and the right (with the order: raw data, transformations, knowledge claims, value claims), from the bottom of the Vee to the top, is an attempt to answer the research questions of this study, inside the Vee.

4.1.2: The research sample

The participants for this study are students from three FET colleges (aged 17 and more) enrolled for N6 mathematics. The colleges used are, College A in a township with students coming predominately from rural areas; College B and College C, both in industrial areas with students coming predominately from urban areas. All three colleges are in the Gauteng province. The number of students enrolled per trimester for N6 mathematics in each of these colleges is ± 40 for College A, ± 140 for College B and ± 70 for College C. Initially, all three colleges were used for the pilot study. For the main study, due to poor participation from College C, only the two remaining colleges (College A and B) were used, using different students from the pilot study.

The data collected for this study from the sample is presented in three different phases as Phase I (the preliminary and the pilot studies), Phase II (the main study as four investigations) and Phase III (the main study as two investigations), discussed in detail below.

Phase I: Data was collected through the preliminary and the pilot studies.

Part 1: For the preliminary study in July 2005, fifteen mathematics N6 students from one class from College A and their lecturer participated in this study, with only seven final responses, for those students who wrote all tests.

Part 2: For the pilot study in October 2006, three different FET colleges, College A; College B and College C, were sampled where finally only 15; 29 and 10 students respectively participated in the study.

Phase II: The main data collection was done in four investigations. All classes from College A and College B were sampled, using different students from the pilot study.

Investigation 1: Questionnaire 1st run, done in April 2007, with 37 final responses (17 students from College A and 20 students from College B).

Investigation 2: Questionnaire 2nd run, done in October 2007 with 122 students (30 students from College A and 92 students from College B) and in April 2008 with 54 students (15 students from College A and 39 students from College B) respectively.

Investigation 3: Examination analysis of the August 2007 mathematic N6 examinations results, done in November 2007 with 151 students (25 students from College A and 126 students from College B).

Investigation 4: A detailed examination analysis of the students' written responses from College A only (seven students).

Phase III: Classroom observations and an interview.

Investigation 5: Classroom observations from College A with \pm 40 students in October 2007. One focus group with eight students was observed during the classroom observations.

Investigation 6: An interview with one former student from College A.

The colleges were selected purposively for convenience (using the nearest colleges), since they were all accessible to the researcher and all were willing to participate (Cohen et al., 2001; Gelo et al., 2008; Maxwell, 2005) in terms of proximity. Purposive sampling is associated with qualitative approaches (Teddlie & Tashakkori, 2009). In purposive sampling,

some members of the broader population will definitely be excluded and others will definitely be included (Cohen et al., 2001). In this study only N6 students taking mathematics were chosen.

In this study more than one college was used to increase the sample size of this study and not to compare the students' performance from the colleges used. All students from the sampled colleges participated in this study.

4.2. DATA COLLECTION AND ANALYSIS

4.2.1 Phase I: Data collection process and analysis

In this research I used paper-and-pencil tests as a measurement technique to assess students' performance. The data collection process and analysis of this study, done in three different phases (Phase I, II and III) is discussed in that order.

4.2.1.1 Part 1: The preliminary study (July 2005)

- **Data collection process**

The preliminary study was done as an attempt to improve my own teaching relating to VSOR. After observations that many students were experiencing difficulty with this section, I introduced teaching of VSOR through technology, using Mathematica to aid students with visualisation of the rotations (for the disc, washer and shell methods). I also wanted to share my experience involving teaching VSOR with other lecturers.

Data for the preliminary study was collected in July 2005. A class of 15 students were participants in this study. Students were taught VSOR for four periods of 80 minutes each, focussing on calculating areas and volumes only. In the first two periods their lecturer taught them in a traditional verbal way (using chalk and talk), and then Test 1 was administered. In the last two periods, two days later, the students were taught by the researcher with the aid of a Mathematica through visualisation and verbalisation, where visualisation was the main method, with verbalisation being used for clarification of ideas and to highlight conceptual understanding portrayed visually with Mathematica with the main emphasis on rotations of the selected rectangular strip to show how a disc, a washer and a shell are formed. The animations and the graphics were displayed via a data projector. Students did not have access to computers. The intention was that after the lesson the students would be in a position to

draw the graph if it is not given, select the bounded area and the correct strip as well as to illustrate the correct method for rotation (disc/washer/shell) to calculate volume. After the lesson, Test 2 was administered. The use of Mathematica was explored by investigating the way in which students responded after being taught, relating to the performance level in two tests.

The students were given four questions in Test 1 and six questions in Test 2 (refer to Appendix 1B). The questions in Test 1 and Test 2 were discussed with their lecturer to ensure compliance with the required level as well as the level of difficulty. In the questions designed by the researcher, graphs were not given in two questions in both Test 1 and Test 2, but in the rest of the questions graphs were given. The students responded in writing in both Test 1 and Test 2. Only seven out of the 15 students wrote both Test 1 and Test 2. Some students were excluded because they wrote Test 1 only or Test 2 only whereas others wrote Test 1 and Test 2 but did not receive instruction via Mathematica. Students' names were written at the back of each test paper so that I could identify who wrote Test 1, Test 2 or both. Whether the names were correct or not was not important. What was important was that the students wrote the same name throughout the tests. During Test 2 students were also asked to indicate whether they were taught using Mathematica or not, also at the back of their written responses from the test paper. All the students who were present during the Mathematica demonstration lesson were asked to give written comments about how Mathematica impacted on their visual and algebraic thinking and whether they had benefited from the program or not.

- **Data analysis**

For the analysis of the data, the seven students' written responses were marked and discussed with their lecturer and an expert (the researcher) validating the analysis and the interpretations before the scripts were given back to the students. The written responses for only seven students from Test 1 and from Test 2 were therefore analysed and discussed in this study to give the actual students' interpretations. The written responses were analysed qualitatively for students' interpretations and summarised in tables in terms of comparing the students' visual and algebraic abilities. Students' actual written responses are also presented and analysed to identify any response patterns. One example of students' written responses for questions that reveal some interesting trends is used to show what students actually did. Students' comments on the lesson presented using Mathematica were also analysed and discussed in relation to the two teaching methods used.

- **Conclusion**

The low number of questions used in the preliminary study (ten) and the few students (seven) used make claims questionable as to how valid and reliable they are. Generalisation of the results was also not possible. I therefore decided to design more questions also focussing on all aspects that influence learning VSOR in terms of all skill factors of knowledge involved and using a bigger sample. That was possible after revising the whole VSOR content from textbooks and previous question papers in order to design an instrument that covers the main aspects that affect learning of VSOR. In the preliminary study, only four aspects were looked at. The aspects involved how students draw graphs, how they select the strip and rotate it, how they translate from the drawn graphs to the algebraic equations and to a lesser extent how they use general manipulation skills. The preliminary study did give an indication of what the focus of the research should be and how to strengthen it.

4.2.1.2 Part 2: The pilot study (October 2006)

- **Data collection process**

The data for the pilot study was collected in October 2006 at College A; College B and College C, using the 21-item instrument (refer to Appendix 2A) as a written test. The 21-item instrument was subcategorised into 11 different *elements* on VSOR with a maximum of two questions per element. In addition to the written test, I observed the lessons for five days at College C (with \pm 23 students), before the 21-item instrument was administered on the sixth day (with 10 students), after their lecturer covered the section on areas and volumes. The lessons were approximately 80 minutes long.

Table 4.2: 11 elements from the 21-item instrument

Elements
1. Algebraic to visual (2D)
2. Visual to algebraic (2D)
3. Algebraic to visual (3D)
4. Visual to algebraic (3D)
5. 2D to 3D
6. 3D to 2D
7. Continuous to discrete (Visual 2D)
8. Continuous to discrete (Visual 3D)
9. Discrete to continuous and continuous to discrete (Algebraic)
10. General manipulation skills
11. Consolidation and general level of cognitive development

The questions from the 21-item instrument that were given to students were randomised without being arranged according to the designed elements so that questions from the same element were not recognised by the students. Spaces were provided on the question paper

where students had to write down their responses, to ensure that the students do not remove the question papers since the questions were to be used in the next phases. The designed questions were discussed and verified with experts to ensure that proper standards were maintained throughout. The students responded to the questions individually in a class test setting with the researcher moving around to handle questions and to help when students needed clarification. The reason for using the pilot was that it could be used to assess the likelihood of errors in the test (Viswanathan, 2005), before conducting the main study. The pilot was also useful in enabling the researcher to find out if questions were clear and not ambiguous and if enough time was given to finish writing the test.

- **Data analysis**

The students' written responses were marked and then reorganised in the 11 elements for further analysis and interpretation. The results are presented in tables and the total scores are summarised in terms of the raw scores and the percentage for how many students responded to a particular question falling under a particular element. It is clearly indicated for each and every question how many students responded *correctly* (C), *partially correct* (PC), *incorrect* (I) or *not done* (ND). A response was done correctly if everything is correct, a partially correct response would be where part of the solution would be given (what is deemed legitimate by the researcher), an incorrect response would be where nothing is correct and not done would be where the student had left a blank space. The performance in questions within each element was compared, and the performances from the 11 elements were also compared. Table 4.8 (p. 108), which is discussed in the main study was adapted, where the performance levels were based on the total percentage from the raw scores, for both correct and partially correct responses, regarded as *acceptably correct* responses. One or two examples of students' written responses are given for selected questions (where interesting trends are found) for partially correct responses and incorrect responses only, since the study is on learning difficulties.

After conducting the pilot study, I realised that most of the students were unable to finish writing the test because it was too long. According to Cohen et al. (2001), the length of the test may have an influence on students' performance. In preparation for the main data collection instrument, the test was therefore broken up into three different sections (to ensure that students finish writing), Section A (Test 1), Section B (Test 2), and Section C (Test 3) where questions were randomly assigned to sections.

4.2.2 Phase II: The main study

Phase II of the main study was done in four separate investigations, Investigation 1 Investigation 2, Investigation 3 and Investigation 4.

4.2.2.1 Investigation 1: April 2007 as the Questionnaire 1st run

From the results of the pilot study it was evident that some questions were not clear to students. This was picked up from the responses given by students in such questions. Some questions from the pilot instrument were changed and modified, some were replaced while two more questions were added and an instrument with 23 questions under 11 different *elements* on VSOR was designed (refer to Appendix 3A). There is a maximum of two questions per element, except Element 10 with three questions. The 11 elements are categorised into five *skill factors*. The main instrument for data collection, the 23- item instrument is given Table 4.3.

Table 4.3: Classification of questions under the 11 elements

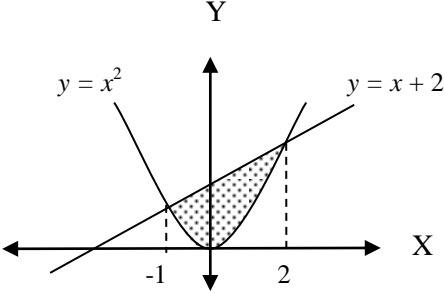
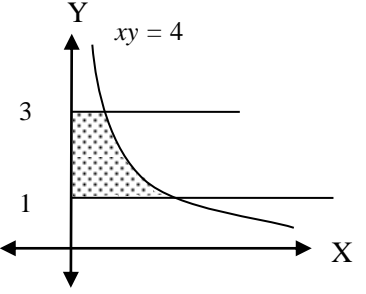
1. Graphing Skills	
1 A: Draw a line with a positive gradient passing through the origin for $x \in [0, 3]$	1 B: Sketch the graphs and shade the first quadrant area bounded by $x^2 - y^2 = 9$ and $x = 5$
2. Algebraic equations/expressions →	Visual graphs (2D)
2A: Represent $x^2 + y^2 \leq 9$ by a picture.	2B: Sketch the area represented by $\int_0^1 (x - x^2) dx$
3. Visual graphs →	Algebraic equations (2D)
3A: Substitute the equations of the given graphs in a suitable formula to represent the area of the shaded region. 	3B: Substitute the equations of the given graphs in a suitable formula to represent the area of the shaded region. 
4. Algebraic equations →	Visual graphs (3D)
4A: Draw the 3-D solid of which the volume is given by $V = \pi \int_0^1 (1 - x)^2 dx$ and show the representative strip.	4B: Draw the 3-D solid of which the volume is given by $V = 2\pi \int_0^1 x(1 - x^2) dx$ and show the representative strip.

5. Visual graphs → **Algebraic equations (3D)**

5A: The figure below represents the first quadrant area bounded by the graphs of $x^2 + y^2 = 5$ and $xy = 2$. Using the selected strip, substitute the equations of the given graphs in a suitable formula to represent the volume generated if the selected area is rotated **about the x-axis**. Do not calculate the volume.

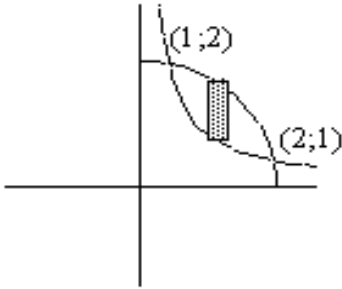

5B: The figure below represents the area bounded by the graphs of $y = \cos x$, the x-axis and the y-axis. Using the selected strip, substitute the equations of the given graphs in a suitable formula to represent the volume generated when this area is rotated **about the y-axis**. Do not calculate the volume.

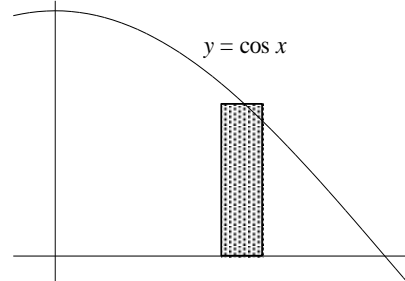

6. 2D → **3D**

6A: Draw the 3-dimensional solid that is generated when the shaded area below is rotated about the **x-axis**.

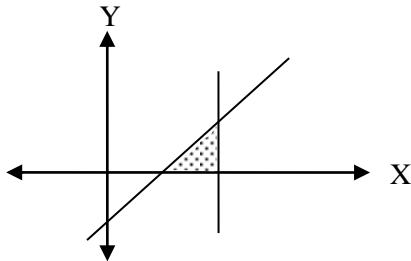

6 B: Draw a 3-dimensional solid that will be generated if you rotate the circle below about the **y-axis**.

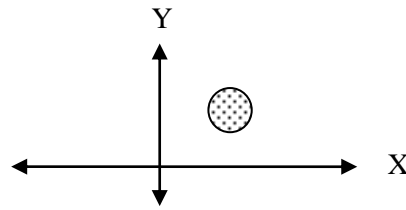

7. 3D → **2D**

7 A: Sketch a graph that will generate half a sphere when rotated about the **y-axis**.

7 B: A hole is drilled through the centre of the sphere as in the picture. Sketch the graphs that were rotated to generate the solid as in the picture below.

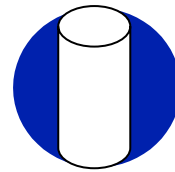

8. Continuous → **discrete (Visual) 2D and 3D**

8 A: Sketch three additional rectangular strips (similar to the given rectangle) so that the total area of the rectangles approximates the area under the graph.

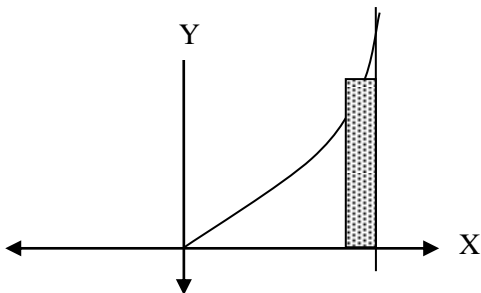

8B: When the plane region (a) on the left is rotated, the 3-dimensional solid of revolution (b) on the right is generated. Show using diagrams how you would cut the solid of revolution (b) in appropriate shapes (discs, shells or washers) to approximate its volume.

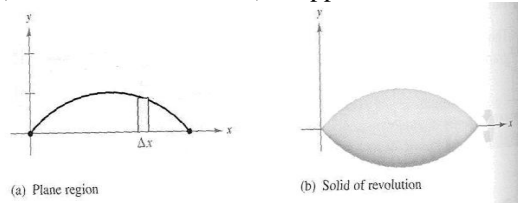

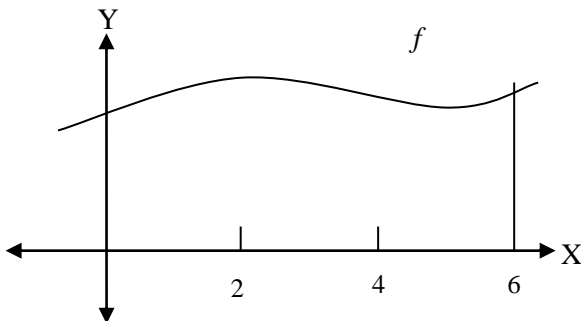
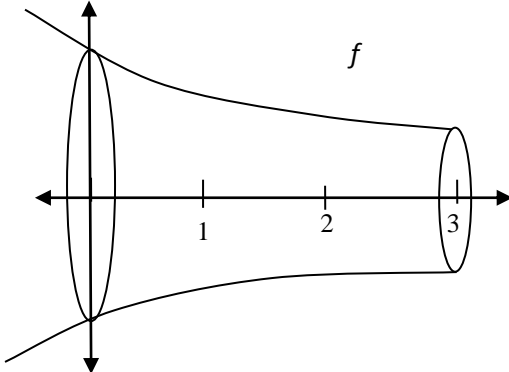
9. Discrete → continuous and continuous → discrete (Algebraic)		
<p>9 A: Show in terms of rectangles what the following represent with a sketch: $2f(0) + 2f(2) + 2f(4)$</p> 	<p>9 B: If the volume of the given solid of revolution is approximated by discs, sketch the discs that would give the volume: $\pi(f(0))^2 + \pi(f(1))^2 + \pi(f(2))^2$</p> 	
10. General manipulation skills		
<p>10 A: Calculate the point of Intersection $4x^2 + 9y^2 = 36$ and $2x + 3y = 6$</p>	<p>10B : Calculate $\int_0^1 \pi(1-x^2)^2 dx$</p>	<p>10 C: Calculate $\int_0^1 2\pi x(1-\sin x) dx$</p>
11. Consolidation and general level of cognitive development		
<p>11 A: Given: $y = \sin x$ where $x \in \left[0, \frac{\pi}{2}\right]$ and $y = 1$</p> <p>(i) Sketch the graphs and shade the area bounded by the graphs and $x = 0$</p> <p>(ii) Show the rotated area about the y-axis and the representative strip to be used to calculate the volume generated.</p> <p>(iii) Calculate the volume generated when this area is rotated about the y-axis.</p>	<p>11 B: Use integration methods to show that the volume of a cone of radius r and height h is given by $\frac{1}{3} \pi r^2 h$.</p>	

In Table 4.4 examples of the questions that were changed from the pilot study (on the left) to the main study (on the right) are given as follows:

- (a) Question 2A was modified to be Question 3A.

Table 4.4: Question 2A modified to be Question 3A

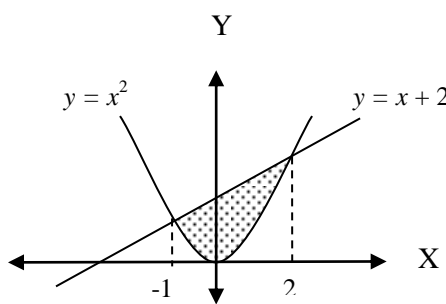
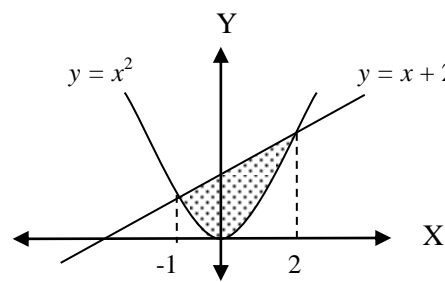
2. Visual → Algebraic (2D)	3. Visual → Algebraic (2D)
<p>2A. Give the formula for the area of the shaded region.</p> 	<p>3A: Substitute the equations of the given graphs in a suitable formula to represent the area of the shaded region.</p> 

For Question 2A students were asked to give the formula for the shaded region. Some students responded by giving the formula for area as $\int_{-1}^2 (y_1 - y_2) dx$ without continuing to substitute the given graphs for y_1 and for y_2 . Apparently the question was not that clear to the students as they showed the first step only. I expected that they would give the formula for area by substituting with the equations for the given graphs. The question was modified to make explicit that the equations for the given graphs must be substituted as in Question 3A.

(b) Question 3A was modified and made easier to be Question 4A. The original question seemed more difficult for the students.

Table 4.5: Question 3A modified to be Question 4A

Algebraic \longrightarrow Visual (3D)	Algebraic \longrightarrow Visual (3D)
3A: Draw the 3-D solid of which the volume is given by $V = \pi \int_0^1 (1 - x^2)^2 dx$	4A: Draw the 3-D solid of which the volume is given by $V = \pi \int_0^1 (1 - x)^2 dx$ and show the representative strip.

(c) Another element, the graphing skills, was added by changing one question from 2D \longrightarrow 3D to graphing skills, since it seemed difficult for the students. The question was as follows:

Table 4.6: Question 5A modified to be Question 1A

5A: Draw the solid that will be formed if a line with a positive gradient passing through the origin is rotated about the x-axis , where $x \in [0, 3]$	1 A: Draw a line with a positive gradient passing through the origin for $x \in [0, 3]$
--	---

(d) Another example, Question 11B in Table 4.7, was also modified, where the formula to be found was now given

Table 4.7: Modified Question 11B

11. Consolidation and general level of cognitive development	
11 B: Use integration methods to derive the formula of a volume of a cone of radius r and height h .	11 B: Use integration methods to show that the volume of a cone of radius r and height h is given by $\frac{1}{3} \pi r^2 h$.

In this question students were asked to derive the formula of volume of a cone with radius r and height h using integration. From the inappropriate responses that the students made, it was evident that the students had no clue about what the question was asking for. The question was therefore modified to be Question 11B where the formula for volume that they had to derive was given (stated in the question).

- **Data collection process**

Data was collected over the period of one week during the first trimester (April) of 2007 using the adapted 23-item instrument given above as the Questionnaire 1st run.

The questions that were given to the students were randomised and split into three different shorter tests (Section A, B and C) that were written in three consecutive days without being arranged into elements so that similar elements were not recognised by the students. There were eight questions in Section A, eight in Section B and seven in Section C, without any order or preference. As in the pilot study spaces were provided on the question paper where students had to write down their responses, to ensure that the students do not remain with the questions since the questions papers were to be used again. The students at College A and College B responded to the questions individually.

- **Data analysis**

There were 37 responses overall for this period (the Questionnaire 1st run) for those students who wrote all three tests, thus students who did not write all the tests were excluded. The data analysis was done qualitatively and quantitatively. The students' responses were marked and were coded according to *ranking* as follows: FC:4 if the answer is *Fully Correct*; AC:3 if the answer is *Almost Correct*; TU:2 if there were some *traces of understanding*; NU:1 if there was *no indication of understanding* and ND;0 if there was no attempt in answering the question, hence *not done*. It is highlighted that: "Codes or elements are tags or labels for allocating units of meaning to the descriptive or inferential information compiled during a study" (Basit, 2003, p. 144).

For the qualitative part of the data, students' written responses were shown per question for different individuals. A summary of written responses for all the students are given in every question from the 23 questions according to the different rankings. Examples of the actual solutions for the written responses are given from the selected students for some of the 11 elements (one or two examples) under the five factors of knowledge for the responses showing traces of understanding and no indication of understanding responses only. The written responses provide a better justification of what was done and more clarity.

For the quantitative analysis, the marked responses were reorganised under the elements for further analysis and presented in tables (using raw scores and percentages) and *multiple bar graphs*. Multiple bar graphs are a result of the use of two or more bar graphs, which are

grouped together in each category (Willemse, 2004). In this study multiple bar graphs are used since there are five rank scores (FC, AC, TU, NU and ND) grouped together under 23 categories, being the 23 questions.

It is indicated using tables and multiple bar graphs, how the students' responses were classified as fully correct, almost correct, showing traces of understanding, no understanding and not done per question (comparing the questions) and the percentage thereof. The 11 elements were also compared under the five skill factors of knowledge and classifying the skill factors in terms of requiring conceptual or procedural skills, or both.

The shapes of the multiple bar graphs are discussed in terms of the *symmetry* and *skewness* of the *distribution* in relation to the position of the mode on the bar graphs, being where the number of responses is the highest. Data are symmetric (normally distributed), if when a vertical line is drawn in the centre of the distribution, the two sides of the distribution are identical in shape and size; skewed if the mode is to the far left, with the data *skewed to the right*, or to the far right, with the data *skewed to the left* of the distribution and bi-modal if the data have two modes which are not necessarily equal in height (Keller, 2008).

If the data are symmetric (normally distributed), we conclude that the number of responses that are correct are equal to the number of responses that are incorrect; if the data are *positively skewed*, we conclude that most responses are correct and if the data are *negatively skewed*, we conclude that most responses are not correct. For the data that have two modes (bi-modal), the position of the mode is the one that determines whether there are more correct responses or few correct responses.

After the presentation of data involving the comparison of the different elements and the skill factors, the total number of responses per question in the Questionnaire 1st run (from all 37 respondents), showing fully correct and almost correct responses are added and discussed in terms of percentages from the raw scores. It is also indicated how students performed overall in individual questions per element and for each of the 11 elements.

The *performance criteria* used (set by the researcher) as in Table 4.8 (adapted from 2008 DoE Assessment standards) is used as follows: If the proportion of *acceptably correct* responses (the sum of fully correct and almost correct responses) for individual questions, per element and per skill factor) is in the interval [0, 20), the performance is regarded as *poor*, if

it is in the interval [20, 40), it is regarded as *not satisfactory*, if it is in the interval [40, 60), it is regarded as being *satisfactory*, if it is in the interval [60, 75), it is regarded as *good*, while performance in the interval [75, 100] is regarded as excellent.

Table 4.8 Criteria for performance level

Range in %	Description of performance
[0, 20)	Poor
[20, 40)	Not satisfactory
[40, 60)	Satisfactory
[60, 75)	Good
[75, 100]	Excellent

The sections where less than 40% of the students get acceptably correct responses (performance that is poor and not satisfactory) are regarded by the researcher as critical areas and issues for concern, since the majority of the students experience difficulty in such sections. These areas are highlighted as sections where students lack the necessary skills, resulting in poor performance in learning VSOR due to their incompetency. The incompetency may be due to the fact that the sections are difficult for the students as they require high cognitive abilities, which they do not possess or because the students are not properly taught or not taught at all.

After comparing the performance in the 11 elements in terms of the percentages of acceptably correct responses in the Questionnaire 1st run, performance in the 11 elements is compared in terms of the five skill factors. The same performance criteria as in Table 4.8 are used. Finally, individual student's responses are added and compared for the whole instrument for all response categories. All fully correct responses, almost correct responses, responses showing traces of understanding, responses showing no understanding and where there were no responses are added separately per category and compared. It is shown what percentage all the fully correct responses are in relation to other categories. In total since there are 23 questions and 37 individual responses per question, there are 851 total responses from the Questionnaire 1st run.

After comparing the performance in the skill factors in terms of percentages, performance in the five skill factors were classified and compared in terms of conceptual or procedural skills and both in terms of tables and multiple bar graphs, based on the performance in terms of

percentage. The comparison is done in order to determine how students performed in elements that require conceptual or procedural skills and both. It is determined in which skill factor the students performed poorly or excellently and also how they performed, be it good, satisfactory or not satisfactory.

As highlighted before, Skill factor I is composed of Elements 1;2;3;4 and 5 . Skill factor II composed of Elements 6 and 7; Skill factor III composed of Elements 8 and 9; Skill factor IV composed of Element 10 while Skill factor V is composed of Element 11 questions. The skill factors are classified as being composed of questions that require procedural skills, conceptual skills and both (Table 4.9) as discussed in Chapter 3, and given here again.

Table 4.9: Classification of skill factors

Skill Factors	I: Procedural and Conceptual Graphing skills and translating between visual graphs and algebraic equations/expressions in 2D and 3D	II: Conceptual Three-dimensional thinking	III: Conceptual Moving between discrete and continuous representations	IV: Procedural General manipulation skills	V: Procedural and Conceptual Consolidation and general level of cognitive development incorporating some elements in Skill factors I, II,III and IV
Elements	1: <i>Graphing skills</i> 2: <i>Algebraic to Visual (2D).</i> 3: <i>Visual to Algebraic (2D).</i> 4: <i>Algebraic to Visual (3D).</i> 5: <i>Visual to Algebraic (3D).</i>	6: <i>2D to 3D.</i> 7: <i>3D to 2D</i>	8: <i>Continuous to discrete (Visual 2D and 3D)</i> 9: <i>Discrete to continuous and continuous to discrete (Algebraic)</i>	10: <i>General manipulation skills</i>	11: <i>Consolidation and general level of cognitive development</i>

4.2.2.2 Investigation 2: October 2007 and April 2008 as the Questionnaire 2nd run

In Investigation 2, the 23-item instrument was administered for the second time with a different group of students using only Test 1 and Test 2 with 8 questions for each test from 122 respondents (in October 2007) and Test 3 with 7 questions from 54 respondents (in April 2008), called the Questionnaire 2nd run.

- **Data collection**

The process of data collection was the same as in the Questionnaire 1st run. Test 1 and Test 2 from the 23-item instrument were administered to 30 students from College A and 92 students from College B after the classroom observations (discussed in Chapter 8). Overall 122 students responded to the 16 questions individually. For Test 3 15 students from College A and 39 students from College B responded to the questions individually.

- **Data analysis**

The process for data analysis for the 23 questions involved marking and interpretation of data using tables and multiple bar graphs as in the Questionnaire 1st run. The process of data analysis was the same as in the Questionnaire 1st run. Examples of the responses that revealed interesting interpretations are discussed. The results for the Questionnaire 2nd run are compared to the results for the Questionnaire 1st run to establish if there were any trends.

4.2.2.3 Investigation 3: Analysis of the 151 examination scripts for August 2007 examinations

Before doing the analysis of the 151 scripts, the question involving VSOR (Question 5) from the August 2007 question paper was analysed according to the five skill factors used in the 23-item instrument (refer to appendix 6 for the questions as well as a detailed memorandum of the question). Out of the 11 elements from the main instrument only five elements were examined in Question 5. Question 5 had subquestions, from which the five elements were identified. Question 5 contributes 40% to the overall examination and seems very difficult for students.

- **Data collection**

The data were collected from 25 students from College A and 126 students from College B. In total 151 examination scripts were analysed, obtained from the National Department of Education for students who wrote the August 2007 examinations, focussing on the question based on VSOR only. These students were not participants in any of the questionnaire runs.

- **Data analysis**

The analysis for the 151 examination scripts is descriptive and inferential. I re-marked the 151 examination scripts in line with the classifications FC:4; AC:3; TU:2; NU:1 and ND:0 used in the main instrument of this research and average ranking per subquestion falling under the same element were calculated. The data were summarised in tables and multiple bar graphs to display the level of performance per element in percentage, under each element and compared. After comparing the elements in terms of the rank scores, the elements in Question 5 were correlated using the Kendal tau correlation coefficient.

After comparing the elements in terms of the rank scores, the actual marks obtained in Question 5 were correlated with the actual marks obtained in the whole examination paper. Analysis of the marks obtained in Question 5 and the whole examination paper is conducted

by using histograms, scatter plots, and correlation coefficients Pearson for numerical data. The marks that the students obtained in Question 5 (out of 40%) are correlated to the marks they obtained in the whole examination (out of 100%). Since this question contributes 40 per cent of the whole examination paper, the correlation coefficient was calculated to determine how the marks obtained in this question correlate with the marks that the students obtain overall. These results are displayed in four different quadrants to show this association.

4.2.2.4 Investigation 4: Detailed examination analysis

To obtain actual written responses of the August 2007 examination paper, the seven students' written responses from the group of eight students that was observed in class in November 2007 were analysed and discussed qualitatively. These students wrote the same examination question paper that was written by the 151 students in class as a formal test individually. One student out of these eight students did not write the test. The results were interpreted qualitatively after marking in line with the rank scores used in the questionnaire runs. Examples of the actual written responses are displayed under each element where possible.

4.2.2.5 Correlating the elements

Correlations for the 11 elements were done in terms of the average of the rankings from the questions under each element, called the *Average Ranking for Individual Responses per Element* (ARIRE). Correlations were calculated by comparing elements (from the average rankings) to determine association between the elements and the level of significance of those correlations. The correlations were used to determine whether students' responses within questions in one element correlate with other elements. Performance in all 11 elements was correlated with the Questionnaire 1st run, four for the Questionnaire 2nd run and five for the examination analysis with the 151 students. The correlations were therefore done only if all questions under each element were given to students to respond to. The average rank for elements from the questionnaire runs and the examination were then correlated to determine the level of significance using the Kendall tau correlation coefficient. For the Questionnaire 1st run all elements were correlated, since students were given all questions under each element to respond to. For the Questionnaire 2nd run only four elements (1; 4; 7 and 10) were correlated since students were given all questions from those elements. The elements correlated were therefore for the 122 students only. For the 54 students no correlations were done since the students were given only one question from each element. The correlation from the 151 examinations responses were for five elements only since the analysis of the examination questions resulted in five elements only.

4.2.3 Phase III

In addition to data collected in Phase II, the data collection process in Phase III (October 2007) involved classroom observations and the interview with a previous N6 student as the fifth and the sixth investigations respectively.

- **Data collection**

4.2.3.1 Investigation 5: Classroom observations

I observed and documented how students were being taught VSOR in their natural setting for five days in terms of addressing the 11 elements under the five skill factors. A video recorder was used in observing the lessons, with the main focus on the lecturer. I wanted to find out how students are taught and what preknowledge students had regarding all the different types of graphs. I also wanted to find out how students were assessed regarding different graphs, how they drew them and how they shaded the region bounded by these graphs. I wanted to investigate how the rectangular strip was selected on the shaded region and rotated about a given axis, what the strip would result in upon rotation and sometimes the diagram of the possible new solid and how they compute the area and volume generated. After the lesson, I identified one group comprising eight students (from Investigation 5) randomly to document the actual written responses. They agreed to be observed for five days. The group selected was assessed in writing from what the lecturer did in class during the observations. I was involved in observations as a participant observer, scaffolding during the group interactions. The group members were also assessed individually through a test (from the August 2007 examination paper) and the 23-item instrument on separate days.

4.2.3.2 Investigation 6: Student interview

I did not initially plan to interview students. After the first classroom observation, one former N6 student approached me, wanting to share her experiences regarding VSOR. The student was interviewed immediately using a video recorder. Even if interviews are time-consuming, they provide rich data. The interview was based on the student's impressions about the ways of learning and assessment of VSOR. The interview was open-ended and lasted for about 15 minutes. The interview focused on learning difficulties with VSOR in relation to Skill factor V. Excerpts from the interviews were transcribed, analysed and reported on.

- **Data analysis**

- (i) **Observations**

The five lessons observed were transcribed. The lecturer's ways of presenting the lesson and the relationship with the students were analysed and interpreted, with the focus on the way in which the content learnt was introduced, the use of procedural knowledge and conceptual knowledge, the level of difficulty of the content and the assessment strategies. The chosen group's written work during the five days of observation was analysed and interpreted. Extracts of the students' written responses are presented in Chapter 6. The chosen group's written work done individually during the last classroom observation (as a test) was marked first by their lecturer before I could analyse and interpret it.

- (ii) **Student interview**

The interview data with the previous N6 student was transcribed and analysed. The interview transcripts were discussed and interpreted to reveal what impression this student had about how VSOR is being taught, learnt and assessed.

4.2.4 Final remarks

In this study the tests and examinations were used to assess the students in writing. As McDermott and Hand (2010, p. 519) wrote: "Written composition provides a record of thought that can be read by an outside audience, as well as the author". Tests in this study were analysed qualitatively by looking at what students exactly wrote as well as looking at patterns, and quantitatively looking at how many students responded in which ways in different elements used as well as finding correlations.

4.3 VALIDITY

Validity is the degree to which the data collected measures accurately what it is supposed to measure (Mason & Bramble, 1989; Mertler, 2006). In this section the validity of the assessments used (Test 1 and Test 2, the 21-item instrument, the 23-item instrument, the August 2007 examination) in the data collection process; their interpretation and their analysis are discussed. The validity of the classroom observations and the interviews are also discussed as well as threats for validity.

4.3.1 Validity in tests

Validity concerns the accuracy of the questions asked, the data collected and the explanations offered (Denscombe, 2002, p. 100). During Test 1 and Test 2 (Phase 1), I tried to control threats to internal validity (the relationship between cause and effect), by making use of the same students when Test 1 and Test 2 were conducted to avoid different abilities and in case some students withdrew or were absent; making sure that Test 1 and Test 2 are conducted two days apart to avoid maturation (Brown & Dowling, 2001); making sure that the questions in Test 1 are not the same as those in Test 2 to avoid familiarity, except one question. For the analysis of the data, students' written responses were marked and discussed with their lecturer and with an expert. This was done in order to validate the analysis and the interpretations before the scripts were given back to the students.

There are three types of validity: *content validity*, which is the degree to which the test items represent the domain of the property being measured (where subject matter tested is relevant), *construct validity*, which is the degree of the relationship between the measure and the construct being measured (where performance on the test is fairly explained by particular appropriate constructs or concepts) and *criterion-related validity*, which is the ability of the test to predict or estimate a criterion by correlating it with other tests (Cohen et al., 2001; Mason & Bramble, 1989).

With regard to content validity in this study, VSOR was identified and the aim was to measure students' difficulties with it. The questions in Test 1 and the Test 2 were discussed with their lecturer to ensure compliance with the required level of the syllabus in terms of the content tested. Students' written responses were as well marked and discussed with their lecturer before the scripts were given back to the students. Questions in the main 21-item and the 23-item instrument were validated through scrutiny by experts in the field of VSOR. Experts were used to make sure that the elements that I defined were correct and that the marking memorandum was also correct. Subjective judgement of content was done to ensure that the items make sense (Viswanathan, 2005). This is also called member validation with the informed people (Denscombe, 2002).

The validity of the study was promoted since a statistician and various experts (including the supervisors and the researcher) in the field of VSOR were consulted throughout the study. In that way, the instrument used for data collection was carefully designed. The researcher in this case is more knowledgeable about the domain for the task to ensure that all aspects

relating to content to be tested are covered (Nitko, 2004). It was therefore anticipated that the questions designed for the students will enable me to get valid data through their written responses. Since the tests given to the students and the programme used (on visualising solids of revolution) focussed on the problematic aspect of their N6 syllabus, an assumption made was that the students were serious about their studies involving VSOR. The students would feel that being part of the research would benefit them since they would be able to achieve their goal of scoring higher on VSOR in their N6 examinations. As for the August 2007 examinations, content validity was ensured by the National DoE since experts in that level (from Umalusi) were used to assure the quality of the content that was tested. Throughout all the three phases the students' successes or failures were validated by their written responses. All the responses were marked, analysed and summarised, and discussed with experts in the field to validate the interpretations and the analysis.

Another method of ensuring validity was that I conducted all the tests and that the students were given the same tests with the same instructions and the same length of time to complete the tests under the same conditions (Nitko, 2004, p. 385). The results are also valid since the test was given to the mathematics N6 students after completing the section on VSOR in all colleges sampled for this study.

In construct validity VSOR is designed to measure the construct it was designed to measure (Viswanathan, 2005), which is *drawing graphs, solving problems that involve general manipulation skills, cognitive skills, reasoning* among others. To ensure that construct validity is supported, I compared the results of the designed tests with other studies done elsewhere (in Chapter 6). If there are similar trends, then the results of the designed tests are convergent (to ensure internal consistency) with the results from other studies (Mason & Bramble, 1989 and Viswanathan, 2005), provided the results from those tests that comparison is applied for, are also valid.

Finally, criterion-related validity in this study was done in terms of finding the relationship of the test and the students' difficulties in different elements by administering the pilot study and restructuring the questions. The responses in different elements were also compared.

To ensure validity of the results, the analysis of students' written responses is "descriptive, interpretive and theoretical" (Maxwell, 1992, p. 284-285). The main aim is to avoid false claims. In that way, an expert or any other person would see the students' written responses

presented as factual and allowing possibilities for verification if the need arises. For the quantitative part of the data, validity was improved through appropriate instrumentation (the 23-item instrument and the examination paper administered) and the statistical treatment of data (Cohen et al., 2001, p. 105). The Pearson and Kendall measures of correlations are used (with advise from a statistician) to ensure validity of the results and the claims that are made.

4.3.2 Validity in observations and interviews

The data that were collected for the observation was 'rich data' since the video recorder was used, and same data were collected more than once (Maxwell, 2005), to ensure validity of the claims made. By using the video recorder I was able to observe more than what could have been observed without it, and having to remember or document all that was observed since the video can be rewound (Brown & Dowling, 2001). The use of interviews in this research was another way in which valid data were collected. Interviews allowed me to probe further in order to get clarifications of what was not clear (Brown & Dowling, 2001).

4.3.3 Threats for validity

There are two threats for validity, researcher bias and reactivity, and the effect that I have on individuals studied (Maxwell, 2005). I controlled for bias by ensuring that the elements used were designed from the N6 examination question paper that the students write at the end of the year, and from the VSOR content in general, not from my existing theory. In relation to controlling reactivity, I tried to keep the respondents relaxed and encouraged them to view the data collection period as another learning stage.

4.3.4 Validity for the claims made

The validity and credibility for the whole data collection phase and analysis was controlled through triangulation, where different methods of data collection (observations, tests, examinations and interviews) and analysis (Brown & Dowling, 2001; Denscombe, 2002; Kimchi, Polivka & Stevenson, 1991; Mertler, 2006; Teddlie & Tashakkori, 2009,) for the same item were used as indicated in the three phases with different respondents to ensure that the results were trustworthy (Cohen et al., 2001; Mertler, 2006; Schumacher & McMillan, 1993). In this research using a mixed method approach also led to triangulation as the use of both methods (qualitative and quantitative) complements one another (Creswell, 2007; Robson, 2002). The results were also verified by collecting data more than once using the 23-item instrument. Data triangulation in this research was ensured by collecting data using

different students, during different times (three different trimesters) also in different phases, referred to by Denzin (1978) as person and time triangulation from his three types of data triangulation. In data triangulation the results are valid if similar findings were found from the different students (person), who wrote the same assessments during different periods (times) in different social settings (space). However, in this study, space triangulation was not done since the results of the students from the different colleges were not compared. As mentioned earlier, more than one college was used to increase the sample size, and not for comparative purposes.

4.4 RELIABILITY

Reliability involves the consistency, dependability or stability of the results or a coding process, and if the test is repeated or used many times by a different researcher; the same results are achieved (Bassey, 2003; Brown & Dowling, 2001; Cohen et al., 2001; Denscombe, 2002; Mason & Bramble, 1989; Mertler, 2006). According to Cohen et al. (2001, p. 117), reliability is concerned with precision and accuracy. Reliability was ensured by making available the instructions and the solutions for the tests as clear as possible so that they could be used by another person for marking the test. To ensure reliability, it was necessary that the tests be administered more than once (for the main data collection with the 23-item instrument) so that the reliability could be established from the proportion of individuals who consistently met the set criteria for the test. It was also important for me to make sure that the respondents did not get copies of the tests by providing blank spaces on the instrument, since the tests were conducted more than once to ensure that all the respondents would see the instrument for the first time. The students who were repeating the course were also excluded for the test. That was verified with the lecturer. Such procedures were necessary to ensure the reliability of the responses.

Reliability of the instrument used in the main data collection process was also ensured by administering the 21-item instrument as a pilot study and reviewing, modifying, as well as adding some questions depending on the responses given by the students to avoid ambiguity, in designing the 23-item instrument. Reliability of the tests used was ensured by making sure that more questions were used in the main data collection instrument (23 items) as shorter tests are less reliable (Nitko, 2004). Caution must be taken in designing tests that accurately

measure students' performance by ensuring that they are valid, reliable and unbiased (Zucker, 2003).

For the classroom observation and the interview, member checking was not done after the data collection process since the video recorder was used to collect accurate data. Reliability was ensured by making use of two observers to review the video recorder for analysis of the interpretations in order to code the same sequence of events (Brown & Dowling, 2001, p. 53). This is also called 'inter-rate reliability' (Jacobs, Kawanaka, & Stigler, 1999, p. 720).

4.5 GENERALISATION

Generalisation involves making conclusions about the selected sample or element of things on the basis of information drawn from particular examples or instances from the sample or from the element of things studied (Denscombe, 2002). The results of this study cannot be generalised to other settings, since the sample comprised of two colleges only for the data collection phase and only three colleges with very few students for the pilot study. I can rather infer how the findings might relate to different situations by transferring the results of this study to other similar settings. Qualitative researchers talk about transferability (a process in which the researcher and the readers infer how the findings might relate to other situations) rather than generalizability (Denscombe, 2002, p. 149).

4.6 ETHICAL CONSIDERATION

Ethics relate to the rights and the interests of the participants in the research. For ethical considerations, students and lectures were given consent forms for willingness to participate in the study and this also ensured that the results will be treated with confidentiality without their names and their institutions' names being revealed elsewhere and during publishing of the results (Bassegy, 2003; Cohen et al., 2001). The participants were also reassured that their faces would never be revealed from the video recordings. The students should be non-traceable unless they give consent (Cohen et al., 2001, p. 335). Permission was also granted from the National DoE.

In this research the respondents were not paid. They participated voluntarily. In that way, there would not be any possibility of research bias in terms of responses that the students

would give compared to if they were paid. Instead students were encouraged to participate by emphasising on how the designed instrument was relevant to their syllabus. They were also encouraged to develop trust based on my background and in-depth knowledge of VSOR. The respondents were assured that they would not be harmed during their participation, and that the research was solely based on improving their knowledge on VSOR.

For ethical considerations in this research, I ensured that there was respect for democracy, for truth and for persons (Bassey, 2003, p. 73) during data collection, analysis and reporting.

Care was taken that:

researchers should be committed to discovering and reporting things as faithfully and as honestly as possible, without allowing their investigations to be influenced by considerations other than what is the truth of the matter (Denscombe, 2002, p. 177).

Since observations were used and I had contact with the participants, it was also important that I made the participant feel at ease.

4.7 DELINEATION OF THE STUDY

The main study (Phase II and III) focussed on only two FET colleges, where only mathematics N6 students were sampled. The learning difficulties were not explored on the whole content studied for the N6 curriculum. Only a section that constitutes 40 per cent of the mathematics N6 syllabus, VSOR was used. The research was based on students' written responses interpretations, with less focus on their verbal responses interpretations.

4.8 LIMITATIONS OF THE STUDY

The results of this study could not be generalised to all the FET colleges in South Africa, because of the sample size. Only two FET colleges were used for the main study. The colleges sampled for this study were those accessible to the researcher and were limited to one township college with black students only and one industrial area college with predominantly black students. Even if all students at these colleges were sampled, some were either absent in other phases of the data collection process or did not complete all the questions asked. The other limitations for this study are that only one class was observed and that the students who completed the questionnaire from the two colleges were not the same students whose written responses were analysed in the 151 examination scripts. However all

students from this colleges were used, for the questionnaires, observations and examination analysis.

In addition the research was conducted a week or two prior to the examinations, which may have been stressful to some students or lectures like this could be time-consuming for the lecturers who did not complete the required syllabus. Some students were therefore absent on the day of data collection.

4.9 SUMMARY

In the above discussion I attempted to present and clarify the research design and methods used in this study in order to do research on students' difficulties involving VSOR. The research strategy used involved the MMA for data collection, analysis and reporting, where multiple case studies were used to ensure triangulation of the results. Mathematics N6 college students were sampled for this study. The research is interpretive and descriptive, following the interpretive and the positivists' view. As action research it aims to lead to innovation and change, but not necessarily to generalisation of the results to other settings (Cohen et al., 2001; Mason & Bramble 1989).

The data collected was analysed using MMA and reported, with qualitative approach as the dominant method. The issues regarding the validity and reliability of the study were discussed for both qualitative and quantitative methods. The issue of validity and credibility for the whole data collection phase and analysis was controlled through triangulation. The use of tests as the main mode for data collection was discussed in-depth. The ways in which the results could be transferable in qualitative research and generalised in quantitative research were also discussed. Ethical considerations were discussed in relation to respect towards participants and confidentiality. The delineation of the study clarified the focus of the study while the limitations of the study were associated with the small sample used, the exclusion of other racial groups and the time constraints when teaching N6 mathematics.

CHAPTER 5: PRELIMINARY AND PILOT STUDIES

The results of this study are presented in Chapters 5, 6, 7 and 8. The presentation is done in three different phases. Chapter 5 presents Phase I being the preliminary study in July 2005 as Part 1; and the pilot study in October 2006 as Part 2. Chapter 6 presents Phase II, being the main results from the developed instrument in April 2007 (the Questionnaire 1st run) and in October 2007 and in April 2008 (both as Questionnaire 2nd run) and the analysis of the students' responses from the 2007 August mathematics N6 examinations scripts (examination response analysis and detailed selected written examination responses). Chapter 7 presents the correlations of the elements from the questionnaire runs in Chapter 6, while Chapter 8 presents Phase III: the classroom observations and the interview with one student. The data collected are described qualitatively and quantitatively where possible. The qualitative data are presented in terms of students' written responses which were marked and classified into five different skill factors as discussed in Chapter 3 as the conceptual framework of this study, narratives (verbal or written) and tables. The quantitative data are presented in terms of tables, diagrams and graphs. In Chapter 4, the mode of data collection was discussed for both the qualitative and the quantitative data that are presented in Chapters 5, 6, 7 and 8. The interpretation of the data presented and analysed in these chapters is done in Chapter 9 and all the phases are consolidated. It is positioned within the conceptual framework of this study which was discussed in Chapter 3 and related to previous studies done, discussed in Chapter 2.

Table 5.1 indicates a schematic process that will be followed in the presentation of the results.

Table 5.1: Schematic process in the presentation and analysis of the results

Chapter 5: Phase I	Chapter 6: Phase II	Chapter 7: Correlations	Chapter 8: Phase III
Part 1: Preliminary study	Investigation 1: Questionnaire 1 st run in April 2007 (37 respondents) and Investigation 2: Questionnaire 2 nd run in October 2007 (122 respondents) and April 2008 (54 respondents).	Correlating the elements from the questionnaire runs and the examination analysis from Phase II.	Investigation 5: Classroom observations (± 40 students) and Investigation 6: An interview with a former N6 student.
Part 2 : Pilot study	Investigation 3: Examination analysis (151 respondents) and Investigation 4: Detailed examination responses (7 respondents).	Correlating the elements from the examination analysis from Phase II.	

5.1 PART 1: PRELIMINARY STUDY IN JULY 2005

The preliminary study was conducted at College A to investigate students' difficulties through the interplay between the visual and algebraic skills when learning volumes of solids of revolution (VSOR) through visualisation using Mathematica. Mathematica was used to illustrate (visually) how a given region may be rotated to formulate a solid of revolution (through graphics and animations), with an attempt to make the concept concrete for the students. Students' written responses, as they translated from a *visual* representation to an *algebraic* representation (from the *diagram* to the correct *formula* for computing volume) after the correct rotation of the selected strip, were explored. What was investigated here was that after identifying the rectangular strip that approximates the bounded region as Δx or as Δy , are the students able to rotate the selected rectangular strip and to use it to generate the formula for volume (be it disc, washer or shell), which was then evaluated. At this stage of the research, there was less focus on the evaluation of volume, the focus was on how the students translate from the drawn graphs to the algebraic formula for volume, which involves rotating the strip correctly and using the correct formula for volume from the given graphs.

Two tests (Test 1 and Test 2) were written (refer to Appendix 1B). In some questions, the graphs were given, while in other questions only equations were given where the students were expected to first draw the graphs. Test 1 was written after a verbal instruction presented by their lecturer (chalk and talk) and Test 2 was written after a visual instruction presented by the researcher using Mathematica. The two tests were not at the same level of difficulty. The graphs in Test 1 were much easier than those in Test 2, except for Question 2(a), which was the same in both tests. However, as mentioned earlier, the focus of the tests was on students' written responses, as they translated from a *visual* representation to an *algebraic* representation (from the *diagram* to the correct *formula* for computing volume) after the correct rotation of the selected strip, and not on how the students draw graphs as it was anticipated that the students were competent in drawing graphs. The assumption was that if students are able to translate from a *visual* representation to an *algebraic* representation when given a region bounded by more difficult graphs after being taught using Mathematica, then Mathematica would be regarded as having an effect on the enhancing of learning rotations visually and enhancing students' imagination skills from what was demonstrated to new situations, even with the difficult graphs.

Fifteen students participated in the preliminary study. In the section that follows, seven students' written responses are presented. Responses for only seven students out of the fifteen students (who participated in the study) are presented since these seven students wrote both tests. Test 1 had four questions, resulting in 28 responses (7×4), while the Test 2 had six questions, resulting in 42 responses (7×6). The rest of the students were excluded because some of them wrote Test 1 only or Test 2 only.

The results for the preliminary study are presented in three stages. Firstly the overall responses for Test 1 and Test 2 are presented in tabular form in Table 5.2 to reveal the emerging patterns from the responses. Secondly, selected individual students' written responses are presented, described and interpreted giving examples where possible. The existing trends between the visual skills and the algebraic skills are displayed. Finally, Table 5.3 is used to show students' competencies in drawing graphs, in questions where graphs were not given.

5.1.1 The results from the seven students

In the section that follows, responses for Test 1 and Test 2 are presented in tabular form. The focus is on how the strip is rotated and used to come up with the formula for volume. Even if the strip was drawn incorrectly, I focused on how the strip was interpreted further in relation to how it is rotated and used to select the correct formula for volume.

The students' responses are classified in the following categories:

- Rotating the strip correctly and using the correct formula (*able and able*)
- Rotating the strip correctly but using the incorrect formula (*able but unable*)
- Rotating the strip incorrectly but using the correct formula (*unable but able*)
- Rotating the strip incorrectly and using the incorrect formula (*unable and unable*)

Since this research focuses on students' difficulties with the VSOR, it was necessary to investigate the interplay between the visual (from the drawn graphs) and algebraic (using the selected strip to come up with the correct formula for volume) with the emphasis on the correct rotation of the strip selected and the solid of revolution generated and the selection of the correct formula. The focus was on the first steps of the calculation only, where the students were to show the correct method, whether disc, washer or shell. So even if a student made a mistake, the student is regarded as *able and able*, as long as he/she managed to rotate the strip correctly as well as using the correct formula for volume.

5.1.1.1 Overall responses

In Table 5.2 the four categories are denoted as follows: able and able is denoted by *aa* with the sum of all the *aa* students per question denoted by Σaa , for both the Test 1 and Test 2. The same applies to the other three categories, able but unable; unable but able and unable and unable denoted by *au*, *ua* and *uu* respectively, with the total number of students as Σau , Σua and Σuu respectively. The categories for responses from both tests are presented, with the sum of the total responses given in bold. The individual responses given for the seven students are denoted as S1, S2, S3, S4, S5, S6 and S7, while NG denotes questions without drawn graphs. In Table 5.2, the strip that is easy to work with upon rotation by the *x*-axis or the *y*-axis is identified, as well as the formula to be used, whether disc (D), washer (W) or shell (Sh).

Table 5.2: Classification of students' written responses

	Test 1 results					Test 2 results						
	Q1a	Q1b-NG	Q2a	Q2b-NG	Σ	Q1a	Q1b	Q1c-NG	Q2a	Q2b	Q2c-NG	Σ
Strip	Δx	Δx	Δx	Δy		Δx	Δx	Δy	Δx	Δx	Δy	
Rotation	Rx	Rx	Ry	Ry		Rx	Rx	Rx	Ry	Ry	Ry	
Formula	D	D	Sh	D		W	D	Sh	Sh	Sh	W	
S1	aa	aa	aa	au		aa	aa	au	au	au	au	
S2	ua	ua	ua	uu		uu	ua	uu	uu	uu	uu	
S3	aa	ua	uu	au		uu	ua	uu	ua	uu	uu	
S4	ua	uu	au	uu		au	au	uu	au	uu	au	
S5	aa	uu	au	uu		au	aa	au	aa	au	au	
S6	aa	aa	ua	aa		au	aa	uu	au	au	uu	
S7	aa	ua	uu	uu		uu	uu	uu	au	au	uu	
Σaa	5	2	1	1	9	1	3	0	1	0	0	5
Σau	0	0	2	2	4	3	1	2	4	4	3	17
Σua	2	3	2	0	7	0	2	0	1	0	0	3
Σuu	0	2	2	4	8	3	1	5	1	3	4	17
					28							42

From Table 5.2, Test 1 results indicate that students performed better in Question 1(a) involving the rotation of the region bounded by the drawn graph of $y = \cos x$ about the *x*-axis in comparison with other questions. Five students were able to rotate the strip correctly and used the correct formula, where a disc method was appropriate. Question 1(b) and Question 2(b) required that the students start by drawing the graphs of $y = x^2$ and $x = 3$; and the first quadrant area of $x^2 + y^2 = 9$ respectively. The rotation for the region bounded by the graphs for Question 1(b) was about the *x*-axis, resulting in a disc, whereas for Question 2(b), rotation was about the *y*-axis, also resulting in a disc. From the drawn graphs for Question 2(b), more than half of the students (4) were unable to rotate the strip correctly and to use the correct formula for volume. For Question 1(b), only 3 students were unable to rotate correctly but

used the correct formula for volume. For Question 2(a), where the region bounded by the graphs of $y = \sqrt{x}$ and $y = x^2$ was to be rotated about the y -axis, seemingly students encountered problems since most of them used a Δx strip but could not rotate it accordingly to give rise to a shell. Students were seen to use the washer method even if a Δx strip which was supposed to be rotated about the y -axis, was drawn. In most instances the students gave the formula for volume without drawing the strip.

The conclusions that could be drawn from Test 1 are that students avoid using a Δy strip and cannot rotate properly if rotation is about the y -axis. The students find it easy to work with a Δx strip when rotated about the x -axis, resulting in a disc or a washer. The number of responses where students were able to rotate the strip correctly and used the correct formula (9 out of 28) was more or less the same as the number of responses where students were unable to rotate the strip correctly and unable to use the correct formula (8 out of 48). However, the Σ_{ua} total of 7 out of 28 responses revealed that students were unable to rotate the strip correctly, but were able to use the correct formula based on the strip they selected. The lowest number of responses, was Σ_{au} with 4 out of 28 responses where students were able to rotate the strip correctly but unable to use the correct formula for volume. In general the performance was not very good since only 9 out of 28 (32%) of the responses were fully correct.

In Test 2 after instruction in Mathematica, students had more difficulties with Questions 1(c) and 2(c) with the highest of 5 students and 4 students respectively unable to rotate the strip correctly and to use the correct formula for volume. Question 1(c) required that they start by drawing the graph of $y = x^2 + 1$, $y = 2$ and $y = 4$ which most students could not draw, while for Question 2(c) they had to draw the graph of $y^2 = 4x$ and $y = 2x - 4$ before calculating the volume. For both questions, a Δy strip was appropriate, with a shell resulting after rotation of the graphs in Question 1(c) about the x -axis and a washer resulting after rotation for the graphs in Question 2(c) about the y -axis. For Questions 2(a) that was similar to Test 1 and Question 2(b), many students (4), were able to rotate the strip correctly but were unable to select the correct formula for volume from the rotated strip. Both questions required rotation of about the y -axis and the use of the shell method where a Δx strip was mostly appropriate. The students in this case were unable to translate the visual graph to the algebraic formula for volume.

The responses for Question 2(a) in both tests which required rotation of the region bounded by the drawn graphs of $y = \sqrt{x}$ and $y = x^2$ about the y -axis were interesting. The performance in Test 1 for Question 2(a) was better than the performance in Test 2 even though the students were doing this question for the second time. In Test 1 two students were able to rotate correctly, but failed to come up with the correct formula for volume, with only one student (S1) able to rotate correctly and coming up with the correct formula for volume. In Test 2 four students were able to rotate correctly, but failed to come up with the correct formula for volume, with only one student (S5) able to rotate correctly and coming up with the correct formula for volume. Student S1 who was able to rotate correctly, and able to come up with the correct formula for volume in Test 1 as a shell without substituting the equations of the graphs, was now only able to rotate correctly, but did not write down any formula to calculate the volume in Test 2. This student only calculated the point of intersection of the two graphs.

Even though the performance for Question 2(a) was better in Test 1 than in Test 2, some students improved in the way in which they rotated the strip. In addition to the three students who were able to rotate in both tests, two students S6 and S7 who were unable to rotate in Test 1 were now able to rotate after instruction using Mathematica in Test 2.

Test 2 results were remarkably different and worse than in Test 1, indicating Σ_{au} as the highest number of 17 and Σ_{uu} as the highest number of 17. The 17 Σ_{au} responses were of students who were able to rotate the strip correctly, but unable to use the correct formula and the 17 Σ_{uu} were responses where students were unable to rotate the strip correctly and unable to use the correct formula. A very low number of responses (5) revealed that the students were able to rotate the strip correctly and to use the correct formula. Even if the performance in Test 2 was bad, 17 out of 42 responses (40%) indicated that the students were now able to rotate correctly even if they failed to come up with the formula for volume compared to 4 out of 28 (14%) of the responses in Test 1.

I wanted to analyse these categories further to explore the students' written responses. One example of students' responses for the four questions from Test 1 and one example from the six questions in Test 2 were then analysed further. Question 2(a) from Test 1 was analysed further because it was the same in both tests. It was used to reveal students' ability to translate from the visual strip to the algebraic equation, even if the selected strip was rotated incorrectly. Question 1(c) from Test 2 was analysed further because that is where many

students were unable to rotate the strip correctly and unable to come up with the correct formula for volume, which was the category revealing the highest sum of 17 (17 Σuu).

5.1.1.2 Individual responses

- **Test 1 results for S6**

In Figure 5.1 a written response for Question 2(a) from Test 1 for category *ua* is presented. In this question Figure 5.1 shows the response for S6 where the strip was correct, the rotation was *incorrect* but the formula for volume used was *correct* (unable but able) based on the rotated strip.

QUESTION 2

Find the volume generated when the area bounded by given graphs is rotated about the Y-axis

(a) $y = \sqrt{x}$ and $y = x^2$

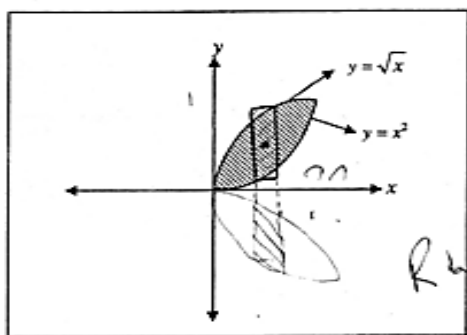

Handwritten student work:

$$\begin{aligned} \sqrt{x} &= x^2 \\ x^{\frac{1}{2}} &= x^2 \\ x &= x^4 \\ 1 &= x^3 \\ x &= 1 \\ y &= 1 \end{aligned}$$

$$V_y = \pi \int_0^1 (x_1^2 - x_2^2) dy \quad (4)$$

$$= \pi \int_0^1 (y - y^4) dy$$

$$= \pi \left(\frac{y^2}{2} - \frac{y^5}{5} \right) \Big|_0^1$$

$$= \pi \left(\frac{1}{2} - \frac{1}{5} \right) - 0$$

$$= 0.3 \pi 4^3 \text{ or } \frac{3}{10} \pi 4^3$$

Figure 5.1: S6 interpreting a Δx strip as a Δy strip

This student (and some of the other students) drew the strip correctly but rotated incorrectly about the x -axis instead of the y -axis, hence ended up with the washer method. The washer method used was not translated correctly from the drawn strip, since the student used a Δy in the formula, even though a Δx was drawn on the diagram. The student referred to the washer

method as $\pi \int_a^b (x_1^2 - x_2^2) dy$ instead of $\int_a^b (y_1^2 - y_2^2) dx$, failing to translate from the given graph,

where a Δx strip was used. In many instances, even if the correct strip was selected, some students failed to translate from the drawn graph to the correct formula for volume. The students in most cases were able to do the calculations correctly.

- Test 2 results for S1

In Figure 5.2 a written response to Question 1 (c) for element *au* is presented.

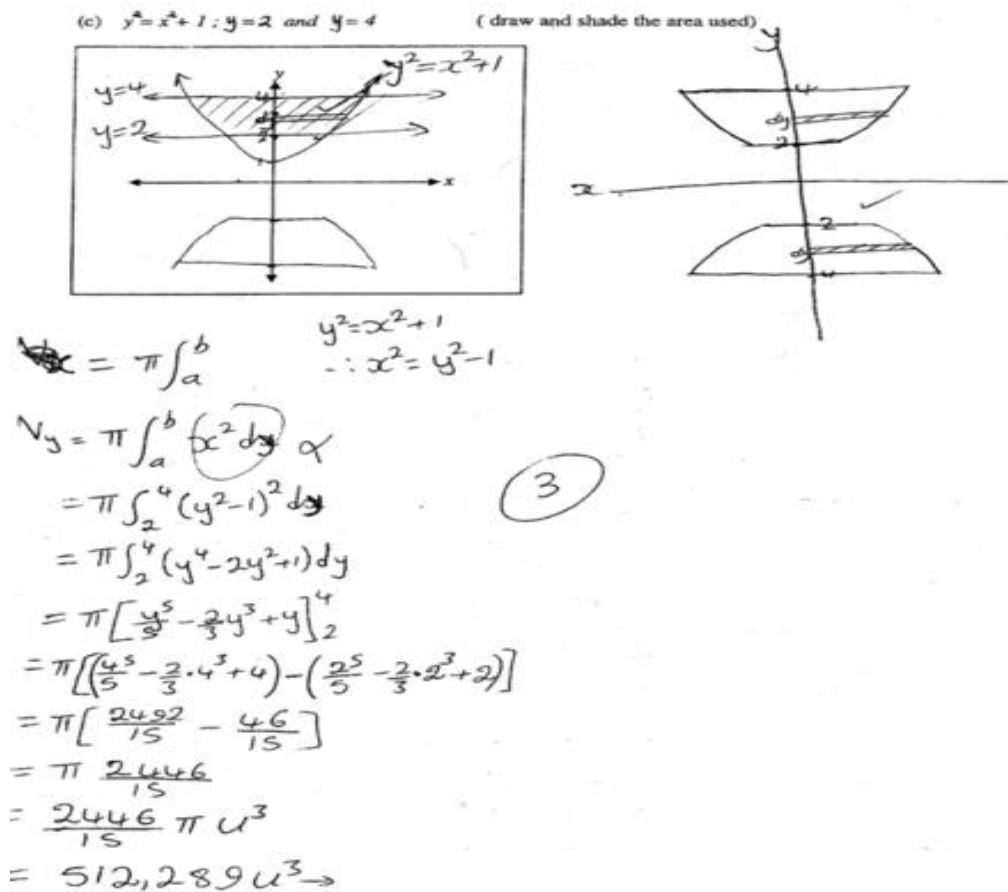

Figure 5.2: S1 written response

Question 1(c), shown in Figure 5.2 was very difficult for the majority of the students. The rest of the students could not draw the correct graphs, nor draw the strip. Only one student (S1) out of the seven managed to draw the correct graph, rotate correctly but used an incorrect formula when translating from visual to algebraic representation (able but unable). The student used the disc method, upon rotation about the x -axis instead of using the shell method, even though a correct strip after rotation was drawn below the x -axis, without showing that it was shell. Another mistake was substituting the x^2 for the disc method with $(y^2 - 1)^2$, instead of $y^2 - 1$ without a square. However, the steps that followed in manipulation of the incorrect method used were correct, with correct limits used. With the standard marking of the N6 examinations, this student will not be given any marks for the correct manipulation after the substitution with $(y^2 - 1)^2$ instead of $y^2 - 1$, even though all steps in calculating the volume are fully correct including the integration techniques used.

5.1.1.3 Graphing skills

Another aspect that was seen to be important in the preliminary study was the way in which students drew graphs. Table 5.3 gives a summary of how students drew graphs, in combination with the data presented in Table 5.2 for *aa*, *au*, *ua* and *uu* categories. In Table 5.3, F refers to fully correct, A refers to almost correct, P refers to partially correct, I refers to incorrect and N refers to not drawn. The ΣF ; ΣA ; ΣP ; ΣI ; and ΣN . are also given.

Table 5.3 The graphs drawn

	Test 1		Sum	Test 2		Σ
	Q1b	Q2b		Q1c	Q2c	
	NG	NG		NG	NG	
S1	Faa	Fau		Fau	Fau	
S2	Pua	Auu		Iuu	Nuu	
S3	Nua	Fau		Iuu	Nuu	
S4	Fuu	Auu		Nuu	Fau	
S5	Puu	Auu		Aau	Fau	
S6	Faa	Faa		Iuu	Auu	
S7	Iua	Fuu		Iuu	Puu	
ΣF	3	4	7	1	3	4
ΣA	0	3	3	1	1	2
ΣP	2	0	2	0	1	1
ΣI	1	0	1	4	0	4
ΣN	1	0	1	1	2	3

The results reveal that the students were most successful in drawing the graphs for Test 1 with 7 fully correct responses and 3 almost correct responses out of 14 responses. The 3 almost correct responses involved the first quadrant area of the circle $x^2 + y^2 = 9$, where the students drew a full circle. Four students drew this graph fully correct and there were no students who struggled with this graph. The graphs in Test 2 were difficult for the students. The graph that seemed most problematic to draw was a hyperbola with two straight lines, Question 1(c), $y^2 = x^2 + 1$; between $y=2$ and $y=4$, with the highest number of four incorrect responses. Only one student managed to draw this graph fully correctly.

5.1.2 Discussion of the results

The results of this study reveal that a significant number of students were able to identify the proper method used to compute the required volume (by rotating the region bounded by the given graphs) but tend to abandon the drawn graphs when they had to calculate algebraically or to select the correct formula. Some students were able to do what was expected by rotating the strip correctly but failed to make proper connections between the visual representation

and the algebraic manipulations. The students performed better in Test 1 than in Test 2. The conclusion to be made is that Mathematica did not assist the students in improving visualisation in learning the content, or that perhaps Test 2 was more difficult. The lesson within Mathematica might have confused these students as they could not recall what they saw during the lesson since Mathematica was used for two consecutive days only. Another reason might be the fact that the students could not go back to the computer lab and practice for revision, since Mathematica was only used as a demonstration tool in class for illustration.

5.1.3 Conclusions

The focus of the preliminary study was to investigate students' difficulties with VSOR through investigating the interplay between the visual and algebraic skills with the emphasis on the correct rotation of the graph from the selected strip and being in a position to use the correct formula through visualisation using Mathematica. The results reveal that after visual illustrations using Mathematica, a significant number of students were able to rotate the strip correctly for the region bounded by the given graphs, but tended to abandon the drawn graphs when they had to calculate algebraically, as they chose the incorrect formula. As a result they failed to use the rotated strip for the selection of the formula for volume. Mathematica in this study only became useful during the lesson as was evident from the students' comments. When working on their own, most of the students could not recall what they had learnt through Mathematica. Not all students improved in the way in which they rotated the strip. Even if the strip was rotated correctly, the students could not identify the new shape after rotation of the strip as a disc washer or shell, particularly because the new shape was not drawn. The results of this experiment revealed that even if most students were able to select the correct strip, it was found that when coming to rotating the selected strip, students prefer the method that results in a disc or a washer method, hence ending up rotating the strip incorrectly. Most students avoided using the shell method. Mathematica is regarded as having little effect if any in the enhancing of learning rotations visually and enhancing students' imagination skills from what was demonstrated for new situations, especially with the difficult graphs.

The number of questions in Test 1 (four questions) and Test 2 (six questions) and the number of participants in the preliminary study (seven participants) were too limited to allow for transferability of the results to other settings. The results of the pilot study below, with more questions, testing different aspects of VSOR and more participants, are presented to allow for transferability to other settings.

5.2 PART 2: THE PILOT STUDY IN OCTOBER 2006

The pilot for this study was done at three different FET colleges using the 21-item instrument. The colleges were College A with 15 students, College B with 29 students and College C with 10 students. All students participated in the study voluntarily. At College C the lessons were also observed for six days before administering the 21-item instrument.

5.2.1 Lesson observations at College C

Students were taught areas and volumes for six days. The lecturer was the author of the textbook that the students used. The examples, exercises and short test questions were taken from the textbook. At the beginning of every lesson, students were given blank papers to write a short test based on the work done the previous day. The students worked individually for about 30 minutes and then the papers they wrote on were given to other students to mark. The lecturer presented the marked solutions on the board in the form of a lesson involving the students actively. The lecturer then continued to introduce the next section, also involving the students actively. Thereafter students were given classwork to do, which they extended as homework to prepare for the short test the following lesson. In the end the lecturer recorded the marks for the short test and the students papers were returned to them. Most of the students were performing very well even though the lecturer was complaining about their efforts. One is not sure whether the good performance was based on the fact that the questions were familiar to the students or whether they did the questions beforehand, since the questions were selected from the textbook, or whether the students knew their work very well. The examples of written responses given below are from College C since the students were observed being taught.

5.2.2 The results for the 21-item questionnaire

The results of the 21 questions are discussed per element using tables. Each element is discussed individually. The total scores obtained by the students are summarised in terms of raw scores and percentages for a particular question under a particular element and discussed. The participants were 15 students from College A, 29 students from College B and 10 students from College C. It is clearly indicated for every question in the tables how many students responded *correctly*, *partially correct*, *incorrectly* or *not done*. A *correct* response would be if everything is correct, a *partially correct* response would be where part of the solution is correct, an *incorrect* response would be where everything is incorrect, and not

done would be where the student left a blank space. Examples of students' written responses are scanned in from College C only, where lessons were observed. For some questions one or two examples are given of either partially correct or incorrect responses. The percentage of *acceptably correct* responses (sum of correct and partially correct responses) is given in Table 5.4.

5.2.2.1 Responses for Element 1: Translation from algebraic to visual (2D)

Table 5.4: Responses for Element 1

Questions	College	Correct	Partially Correct	Incorrect	Not Done
1A: Represent $x^2 + y^2 \leq 9$ by a picture.	A	10	4	0	1
	B	25	2	1	1
	C	8	1	0	1
	ALL	43	7	1	3
	%	80 %	13 %	2 %	6 %
1B: Represent $\int_0^1 (x - x^2) dx$ by a picture.	A	4	0	9	2
	B	12	3	6	8
	C	3	0	3	4
	ALL	19	3	18	14
	%	35 %	6 %	33 %	26 %
Acceptably correct responses %		67%			

From Table 5.4 we see that the performance in Question 1A was very good, 80% correctly drawn graph as compared to 35% in Question 1B, with a fairly high percentage 33% and 26% respectively for those students who drew incorrect graphs or did not respond to the question. For Question 1A, an ordinary graph (a circle), had to be drawn, whereas for Question 1B a graph involving the definite integral was to be drawn. For Question 1B, seemingly the students did not recognise the possibility of two different graphs (straight line and a parabola) or one graph (a parabola) for the given interval. In this element we investigated students' skills in translating from an algebraic expression to visual graphs. The students were expected to draw a graph from the given algebraic expression. One can therefore assume that for Question 1A the students were able to translate from algebraic to visual whereas for Question 1B it was problematic. Figure 5.3 and 5.4 give two examples of written responses for Question 1B revealing the *incorrect responses*.

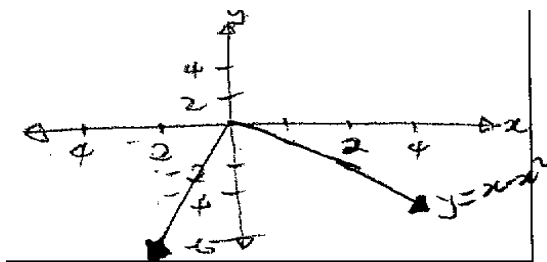

Figure 5.3: Straight lines as parabolas

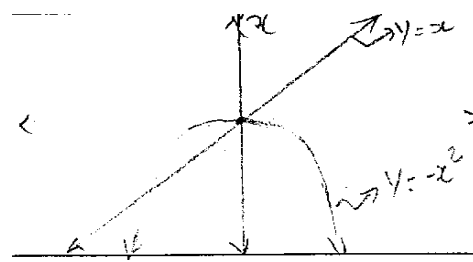
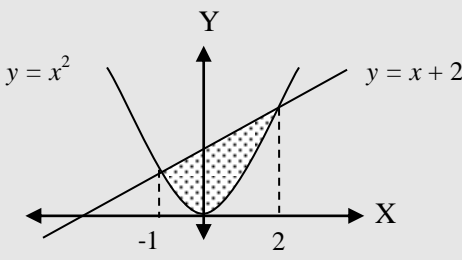
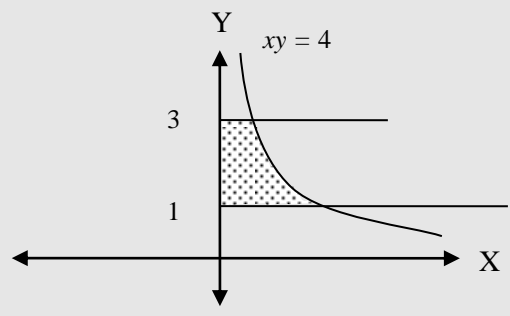

Figure 5.4: A parabola without limits

5.2.2.2 Responses for Element 2: Translation from visual to algebraic (2D)

Table 5.5: Responses for Element 2

Questions	College	Correct	Partially Correct	Incorrect	Not Done
2A: Give the formula for the area of the shaded region. 	A	3	5	6	1
	B	8	19	2	0
	C	3	7	0	0
	ALL	14	31	8	1
	%	26 %	57 %	15 %	2 %
2B: Give a formula for the area of the shaded region. 	A	2	6	6	1
	B	6	13	10	0
	C	3	3	3	1
	ALL	11	22	19	2
	%	20 %	41 %	35 %	4 %
Acceptably correct responses %		72%			

For Question 2A and 2B the graphs were given and students were expected to give the formula that describes what was drawn. Most of the students did the questions partially correct, 57% in Question 2A and 41% in Question 2B. The partial correct response to this question was when the formula for area was given without substituting with the given graphs

as $\int_{-1}^2 (y_1 - y_2) dx$ for Question 2A and $\int_1^3 (x_1 - x_2) dy$ for Question 2B.

In this element students worked from visual to algebraic. Seemingly the question was not that clear to the students as they showed the first step only. One is therefore not sure whether the students were going to substitute the graphs correctly or not as they did not proceed to the next step, except the fact that the first step was correct. One can therefore not make any claims or assumptions. In other instances students did not use the integral sign. The responses to Question 2 reveal that the questions were not clear to students since many students did not continue to do the substitution after using the formula for area.

Discussion on Element 1 and Element 2

If one compares Elements 1 and 2 it is evident that the large number of students got the *correct response* in Element 1, 80% for Question 1A and 35% for Question 1B, whereas for Element 2 the percentages were 26% and 20% respectively for Questions 2A and 2B. But overall, when considering the proportion of acceptably correct responses in Tables 5.4 and 5.5, many students (72%) were able to translate from visual to algebraic in 2D, while 67% were able to translate from algebraic to visual in 2D. This means that performance was good in translation from algebraic to visual and from visual to algebraic in 2D.

5.2.2.3 Responses for Element 3: Translation from algebraic to visual (3D)

Table 5.6: Responses for Element 3

Questions	College	Correct	Partially Correct	Incorrect	Not Done
3A: Draw the 3-D solid of which the volume is given by $V = \pi \int_0^1 (1 - x^2)^2 dx$.	A	0	6	5	4
	B	0	5	12	12
	C	0	3	4	3
	ALL	0	14	21	19
	%	0%	26%	39%	35%
3B: Draw the 3-D solid of which the volume is given by $V = 2\pi \int_0^1 x(1 - x^2) dx$.	A	5	1	5	4
	B	4	1	10	14
	C	1	3	3	3
	ALL	10	5	18	21
	%	19%	9%	33%	39%
Acceptably correct responses %		27%			

From Table 5.6 the performance for Questions 3A and 3B was fairly poor. Many students (39%) got the answer incorrect and 35% did not respond to Question 3A, whereas 33% got the answer incorrect and 39% did not respond to Question 3B. Both questions required that students draw graphs in three dimensions, with Question 3A deriving from the washer method and Question 3B deriving from the shell method. For both questions the graphs that were drawn by students were in two-dimensions, mostly incorrect parabolas. For Question 3A no student managed to draw the correct graph. The students were not aware that they had to draw the parabola $1 - x^2$ on the interval $[0,1]$, which represents half a parabola when rotated about the x -axis. For Question 3B a fair number of students (19%) managed to draw the graph. The students were not aware that they had to draw the parabola $1 - x^2$, on the interval $[0,1]$, which represents a parabola when rotated about the x -axis, where the x next to $1 - x^2$ is part of the formula for the shell method and need not be drawn.

The conclusion that could be made from Element 3 is that a large number of students (more than 70%) are unable to translate from an algebraic equation to a visual diagram in three-

dimensions. The students are also unable to recognise that the formula given derives from the disc method (Question 3A) from the πr^2 of the given equation from the circle and the other formula from the shell method (Question 3B) from the $2\pi r$ as the surface area of the cylinder.

Examples of students' *incorrect responses* are shown in Figures 5.5 and 5.6.

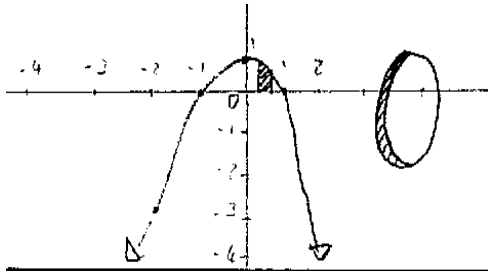

Figure 5.5: A disc and a parabola

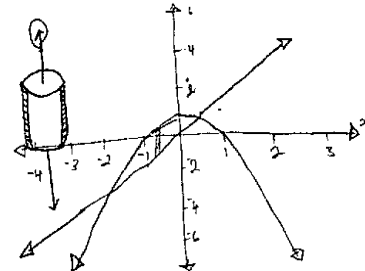
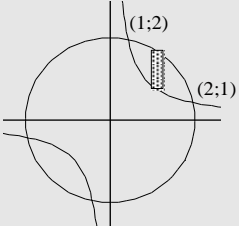
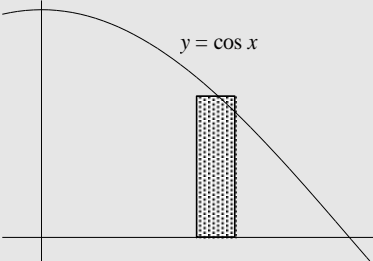

Figure 5.6: A shell and a parabola

5.2.2.4 Responses for Element 4: Translation from visual to algebraic (3D)

Table 5.7: Responses for Element 4

Questions	College	Correct	Partially Correct	Incorrect	Not Done
4A: Below the 1 st quadrant region bounded by graphs of $x^2 + y^2 = 5$ and $xy = 2$ is selected using the given strip. Give the formula for the volume generated if this region is rotated about the x-axis . Do not calculate the volume. 	A	3	9	3	0
	B	8	16	5	0
	C	1	4	5	0
	ALL	12	29	13	0
	%		22%	54%	24%
4B: Below the region bounded by the graph of $y = \cos x$, the x-axis and the y-axis is selected by the given strip. Give the formula for the volume generated when this region is rotated about the y-axis . Do not calculate the volume. 	A	1	7	6	1
	B	0	3	25	1
	C	0	7	3	0
	ALL	1	17	34	2
	%		2%	31%	63%
Acceptably correct responses %		55%			

As indicated in Table 5.7 for Questions 4A and 4B, different response patterns were found. For Question 4A, most students (54%) had the answer partially correct. The partially correct response was if the student managed to give the correct formula of the washer as

$\pi \int_1^2 (y_1^2 - y_2^2) dx$, which can also be classified as incorrect as one is not sure if the students were

going to substitute correctly using the given equations of the graphs. If the partial responses were to be classified as incorrect, the highest percentage would be 78% for the incorrect response. Few students (22%) gave the correct response. For Question 4B the highest number of students (63%) got the answer incorrect. 31% of the students got the answer partially correct, while only 2% got the correct answer. The partial response for Question 4B was

when the equation given was that of a shell as $2\pi \int_0^{\frac{\pi}{2}} xy dx$. If we also consider the partial

correct response as incorrect the total number for the incorrect responses would be 94%. The incorrect responses given included instances where limits for integration were incorrect, for example the limits were given as between 0 and 1 or not given at all. In other instances, the formula given did not represent a shell method. It at times represented a disc or a washer. In general the performance was not good. The students were not able to translate from visual to algebraic in three-dimensions, since a low percentage got the correct answer.

Discussion on Element 3 and Element 4

A large number of students (more than 70%), were unable to translate the given equations for volume to diagrams (from algebraic representation to visual representation). The students performed better when translating the visual diagram to algebraic equations when a washer method was required and failed (more than 60%) when they had to use a shell method.

Considering the proportion of acceptably correct responses in Tables 5.6 and 5.7, only 27% of the students were able to translate from algebraic to visual in 3D, regarded as performance that is not satisfactory, while 55% of the students were able to translate from visual to algebraic in 3D, regarded as satisfactory performance. Overall, the students were struggling to translate from algebraic to visual, than from visual to algebraic in 3D.

The average of proportion of acceptably correct responses as 55.25%, from Elements 1, 2, 3 and 4 (72%, 67%, 55% and 27%) from Tables 5.4, 5.5, 5.6 and 5.7, reveal that overall, performance was satisfactory in translation between algebraic and visual in 2D and in 3D.

5.2.2.5 Responses for Element 5: Translation from 2D to 3D

Table 5.8: Responses for Element 5

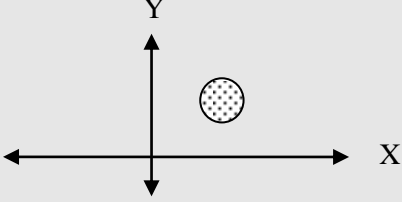
Questions	College	Correct	Partially Correct	Incorrect	Not Done
5A: Draw the solid that will be formed if a line with a positive gradient passing through the origin is rotated about the x -axis, where $x \in [0, 3]$.	A	2	2	8	3
	B	0	8	21	0
	C	1	1	6	2
	ALL	3	11	35	5
	%	6%	20%	65%	9%
5B: What solid do you get if you rotate the circle below about the y -axis? 	A	0	0	9	6
	B	0	0	17	12
	C	3	0	6	1
	ALL	3	0	32	19
	%	6%	0%	59%	35%
Acceptably correct responses %		16%			

In this element the questions required that the students had to analyse critically. More insight was needed in order to deal with these questions properly. Students had to imagine and to draw or explain their solutions. As seen in Table 5.8, for Questions 5A and 5B, the same small percentage (6%) of students got the answer correct and the majority of students responded incorrectly (65% and 59% respectively). It seemed as if most of the students did not know what a line with positive gradient means. For some of those who drew a correct line, y intervals were used instead of the given x intervals. The students moreover did not recognise that the given circle for Question 5B was not lying on any of the axis. Examples of the *incorrect responses* for Question 5A are given in figures 5.7 and 5.8, where a line with a negative gradient with the y -intercept as 3 and a solid similar to an ellipsoid were drawn.

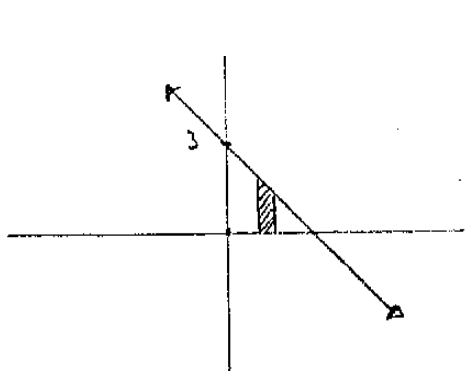

Figure 5.7: A line representing a solid

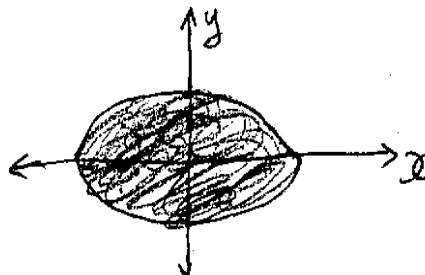
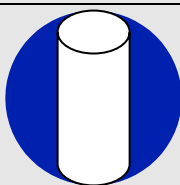

Figure 5.8: An ellipsoid

5.2.2.6 Responses for Element 6: Translation from 3D to 2D

Table 5.9: Responses for Element 6

Questions	College	Correct	Partially Correct	Incorrect	Not Done
6A: Discuss how a hemisphere is generated as a solid of revolution.	A	0	0	4	11
	B	0	0	2	27
	C	0	0	3	7
	ALL	0	0	9	45
	%	0%	0%	17%	83%
6B: A hole with radius 2cm is drilled through the centre of the sphere of radius 5 as in the picture. Describe the curves that are rotated to generate this solid.	A	0	1	4	10
	B	0	4	5	20
	C	0	2	2	6
	ALL	0	7	11	36
	%	0%	13%	20%	63%
Acceptably correct responses %		7%			



As displayed in Table 5.9, Questions 6A and 6B seemed to be quite difficult since none of the students got the answer correct and most of the students did not respond to the questions at all (83% and 63% respectively). Question 6A fared the worst with no single student even getting it partially correct. The problem might have been that both questions were given as word problems even though for Question 6B a diagram was given. The students did not only fail to translate from 3D to 2D, but they also failed to analyse and comprehend the questions.

Discussion on Element 5 and Element 6

From the questions that were asked by the students as they were writing while I was walking around, it was clear that the students had problems in interpreting and understanding the terminology used in these elements. The question that some students asked based on Element 5 was that they did not know what a *solid of revolution* was. For Element 6, it seemed as if students did not know what a *hemisphere* was. In general, the students failed to give the correct response, whether a diagram was given or not. In fact, the performance was lower if the diagram was given when they had to translate from 2D to 3D and much lower if the diagram was not given when they had to translate from 3D to 2D. The high percentage of incorrect responses and no responses (between 74% and 100%) in total, alludes to that. It seems as if the majority of the students had no idea what the questions entailed. The students failed to translate from 2D to 3D and from 3D to 2D.

The average percentage of the acceptably correct responses (11.5%) from table 5.8 as 16% and from Table 5.9 as 7% reveals that the performance in translating between 2D and 3D was poor.

5.2.2.7 Responses for Element 7: Translation from continuous to discrete (visual 2D)

Table 5.10: Responses for Element 7

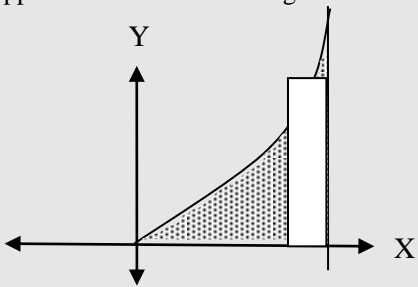
Questions	College	Correct	Partially Correct	Incorrect	Not Done
7A: Sketch three additional rectangles (similar to the given rectangle) so that the total area of the rectangles approximates the shaded region. 	A	2	3	5	5
	B	1	7	8	13
	C	0	5	2	3
	ALL	3	15	15	21
	%	6%	28%	28%	39%
Acceptably correct responses %		34%			

Question 7 in Figure 5.10 involved the approximation of the area under the curve using *rectangles*. The students were expected to translate to discrete, what was given as continuous. A high number of students (39%) did not respond to the question, with only 6% responding correctly. A large number of students failed to approximate the area with 28% partially correct responses and the same number of incorrect responses. Some students drew rectangles but there were spaces between them. These students failed to translate from continuous to discrete in 2D.

5.2.2.8 Responses for Element 8: Translation from continuous to discrete (visual 3D)

Table 5.11: Responses for Element 8

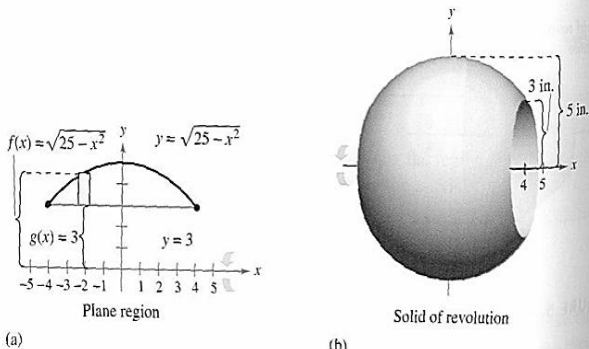
Questions	College	Correct	Partially Correct	Incorrect	Not Done
8A: When the graph below is rotated, the solid on the right is generated. Show how you would cut the solid in appropriate shapes (discs, washers or shells) to approximate the volume of the solid. 	A	0	3	5	7
	B	0	7	7	15
	C	0	6	2	2
	ALL	0	16	14	24
	%	0%	30%	26%	44%

Questions	College	Correct	Partially Correct	Incorrect	Not Done
8B: When the graph below is rotated, the solid on the right is generated. Discuss how you would cut it to generate either discs, washers or shells	A	4	2	3	6
	B	0	7	12	10
	C	1	2	4	3
	ALL	5	11	19	19
	%	9%	20%	35%	35%
Acceptably correct responses %		29.5%			

In Table 5.11, Question 8A involved approximation of the volume using washers, while Question 8B used discs. Seventy per cent of the students failed to approximate the volume with no correct responses for Question 8A and 9% of the correct responses for Question 8B. In this question the students were expected to translate from a continuous representation to a discrete representation. Apparently they did not succeed, based on what was evident from the students' responses. Some students only drew the slices (washers or discs) without the order that would give rise to the given solid of revolution. The responses from the students reveal that most of them were confused or they had no idea what the question was about. The students did not make any connections about the whole figure and breaking it down into smaller pieces that would still resemble the original diagram. These students failed to translate from continuous to discrete (3D). In Figures 5.9 and 5.10, one example of a partially correct response for Question 8A and an *incorrect response* for Question 8B is given.

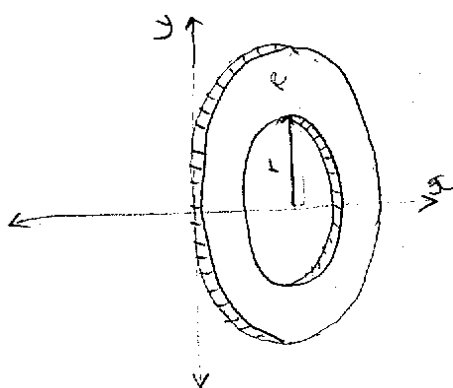

Figure 5.9: A cross-section of a washer

If you want to generate a disc you will have to use one strip (dx) and rotate it about the x -axis. For a shell you have to change the strip to (dy) and rotate it about the x -axis.

Figure 5.10: Misconceptions about the strips

Discussion on Element 7 and Element 8

In Questions 7, 8A and 8B, the questions were given including the diagrams, with Question 7 focusing on area and Question 8 focusing on volume. Most students failed to approximate the area and the volume from the given 2D and 3D diagrams. They had to translate from continuous representation to discrete representation. The responses from the students reveal that most of the students were confused since they had no idea how to do the approximations, irrespective of the problem given in 2D or in 3D. Students did not make any connections about the whole figure and breaking it down into smaller pieces that would still resemble the original diagram (moving from continuous to discrete representations).

5.2.2.9 Responses for Element 9: Translation from discrete to continuous and continuous to discrete (algebraic) in 2D and 3D

Table 5.12: Responses for Element 9

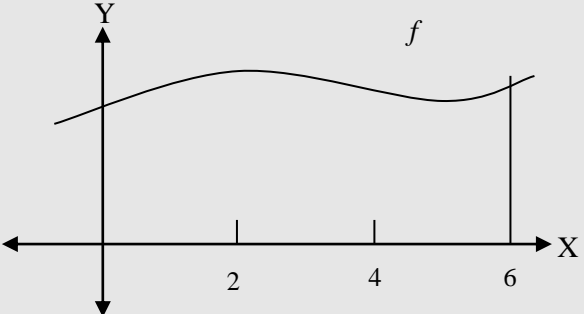
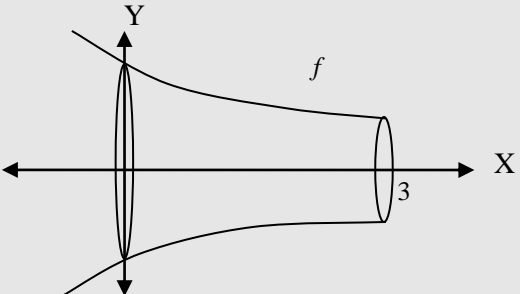
Questions	College	Correct	Partially Correct	Incorrect	Not Done
9 A: Show what the following represent with a sketch. $2f(0) + 2f(2) + 2f(4)$ 	A	1	0	4	10
	B	0	1	7	21
	C	0	0	4	6
	ALL	1	1	15	37
	%	2%	2%	28%	69%
9B: If the volume of the given solid of revolution is approximated by discs, sketch the discs that would give the volume. $\pi(f(0))^2 + \pi(f(1))^2 + \pi(f(2))^2$ 	A	0	1	7	7
	B	0	2	6	21
	C	0	3	5	2
	ALL	0	6	18	30
	%	0%	11%	33%	56%
Acceptably correct responses %		7.5%			

In Question 9A and 9B an expression and a diagram were given. Question 9A involves a 2D diagram and Question 9B involves a 3D diagram. The majority of the students did not respond to this question, 69% for Question 9A and 56% for Question 9B, and many of the other students got the answer incorrect, 28% and 33% respectively. Only one student (2%) out of the 54 students produced a correct response for Question 9A and none of the students gave a correct response for Question 9B. The students were unable to relate the given expressions to rectangles and discs respectively. The expressions given were not related to the graphs drawn. In this element students failed to translate from discrete to continuous and from continuous to discrete. The results here also reveal that most of the students had no idea about what the question required.

Discussion on Elements 7, 8 and 9

Questions 7, 8A and 8B, 9A and 9B are about the translation between discrete and continuous representations, involving area and volume. The questions given all included diagrams, with Question 7 and Question 9A focusing on area and Question 8 and Question 9B focusing on volume. Approximately 90% of the students failed to approximate the area and the volume, more so if given in a form of an area formula or a formula for volume as it was the case in Questions 9A and 9B, where the students had to translate from discrete to continuous and from continuous to discrete. The responses from the students reveal that most of the students were confused or they had no idea what these formulae in Question 9 were all about, they could not recognise an area formula or a disc formula. Translation between 2D and 3D was also problematic, with no connections made in relation to the given diagrams.

The proportion of acceptably correct responses in Table 5.10 as 34% for translation from continuous to discrete (visually) in 2D and in Table 5.11 as 29.5% translation from continuous to discrete (visually) in 3D, both reveal that performance is not satisfactory. For translation from discrete to continuous and continuous to discrete (algebraic) in 2D and 3D, the performance was poor, with only 7.5% of the responses acceptably correct as shown in Table 5.12. Overall, the average for the proportion of acceptably correct responses (19.5%) in translation from continuous to discrete (visually) in 2D and in 3D and translation from discrete to continuous and continuous to discrete (algebraic) in 2D and 3D, reveal that the performance in these elements was poor.

5.2.2.10 Responses for Element 10: General manipulation skills

Table 5.13: Responses for Element 10

Questions	College	Correct	Partially Correct	Incorrect	Not Done
10A: Calculate $\int_0^1 \pi(1-x^2)^2 dx$	A	9	3	3	0
	B	19	3	7	0
	C	6	1	2	1
	ALL	34	7	12	1
	%	63%	13%	22%	2%
10B: Calculate $\int_0^1 2\pi x(1-\sin x) dx$	A	0	2	12	1
	B	2	5	21	1
	C	1	0	8	1
	ALL	3	7	41	3
	%	6%	13%	76%	6%
Acceptably correct responses %		47.5%			

Questions in Table 5.13 are similar to some of the questions in the mathematics N6 examination paper, involving a definite integral. Question 10A involved basic rules for integration, whereas Question 10B involved integration by parts. The highest number of students (63%) got the correct answer for Question 10A while the highest number (76%) failed to give the correct response for Question 10B. The students failed to use integration by parts properly. Those who tried to use it got confused along the way. Question 10A involved direct integration and pure manipulation skills.

The proportion of acceptably correct responses, given as 47.5% in Table 5.13, reveals that the students' performance in the case of general manipulation skills was satisfactory.

In Figure 5.11, one example is given for Question 10B of an *incorrect response*.

$$\begin{aligned}
 &= 2\pi \int_0^1 x - \sin x^2 dx \\
 &= 2\pi \left[\frac{x^2}{2} - \frac{\cos x^3}{3} \right]_0^1 \\
 &= 2\pi \left(\left[\frac{(1)^2}{2} - \frac{\cos 1^3}{3} \right] - \left[\frac{0^2}{2} - \frac{\cos 0^3}{3} \right] \right) \\
 &= 2\pi (0,167 + 0,333) \\
 &= \cancel{2\pi} \pi (1,007) \text{ unit}^3.
 \end{aligned}$$

Figure 5.11: Errors with integration rules

5.2.2.11 Responses for Element 11: Consolidation and general level of cognitive development

Table 5.14: Responses for Element 11

Questions	College	Correct	Partially Correct	Incorrect	Not Done
11A: Given the graphs of $y = \sin x$ and $y = 1$ (i) Draw the graphs and shade the area bounded by the graphs and $x = 0$	A	12	0	3	0
	B	15	2	12	0
	C	7	0	3	0
	ALL	34	2	18	0
	%	63%	4%	33%	0%
(ii) Show the rotated region about the y-axis and the strip used	A	4	0	10	1
	B	3	0	24	2
	C	6	0	3	1
	ALL	13	0	37	4
	%	24%	0%	69%	7%
(iii) Write down a formula to find the volume when the region between $y = \sin x$ and $y = 1$ is rotated about the y-axis .	A	0	5	8	2
	B	0	1	27	1
	C	1	8	0	1
	ALL	1	14	35	4
	%	2%	26%	65%	7%
11B: Use integration methods to derive the formula of a volume of a cone of radius r and height h .	A	0	0	8	7
	B	0	0	13	16
	C	0	0	7	3
	ALL	0	0	28	26
	%	0%	0%	52%	48%
Acceptably correct responses %		29.8%			

Questions in Table 5.14 are also similar to the question on application of VSOR in the mathematics N6 examination paper, where the students are expected to start by drawing the graph(s), indicate the representative strip that they would use and to calculate the area of the bounded region or the volume generated when this region is rotated about the x -axis or about the y -axis. Question 11A is subdivided into three subquestions, whereas Question 11B involved one question only. For Question 11 A (i), the majority of the students (63%) managed to draw correct graphs, while about 33% failed. Most students were able to draw the graphs given and those who failed to draw the proper graphs did not draw the line $y = 1$ as well; they only drew the graph of $y = \sin x$. For Question 11A (ii), 69% of the students were unable to show the rotated region about the **y-axis** from the strip used, whereas about 65% failed to give the correct formula to calculate volume for Question 11A (iii). For Question 11B, it seems as if the students did not have any clue as to what the question entailed. None of the students got the answer correct or partially correct. Nearly half of the students gave an incorrect response and about half did not respond to the question, 52% and 48% respectively. The performance in consolidation and general level of cognitive development was not satisfactory, with 29.8% of the responses shown in Table 5.14 as nearly correct.

For Element 11, the students' performance raises questions as to how students cope with the final N6 examinations. Even if the students had some capabilities in drawing graphs, they were seen to struggle to interpret them. The implication here is that if the students fail to carry out one step, then the chances are that they might fail to give the correct solution for the questions that follow if the questions are not independent. The students cannot cognitively cope with the section of VSOR.

The difficulties that the student had in Element 11 were evident from the fact that the majority of students failed in Elements 5 and 6 (translation between 2D and 3D) involving three-dimensional thinking and Elements 7, 8 and 9 (translation between continuous and discrete representations in 2D and 3D), where the performance was poor. For an example, in Question 11A, even though a large number of students (63%) were able to draw the correct graphs, 69% failed to show the rotated graph about the y -axis. Some of the reasons for failure were that the representative strip selected was not correct or rotated incorrectly.

Examples are given in Figures 5.12 and 5.13 for Question 11A. The first example shows how the graph was drawn correctly but not interpreted correctly from the Δy strip, while the second example shows how the graph was drawn *incorrectly* and the *partially correct* formula for volume was given from the formula sheet without being adapted to the drawn graphs. In both cases, the equations were not interpreted further.

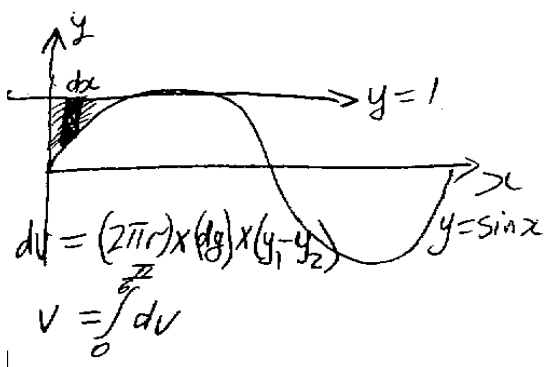

Figure 5.12: Incorrect limits used

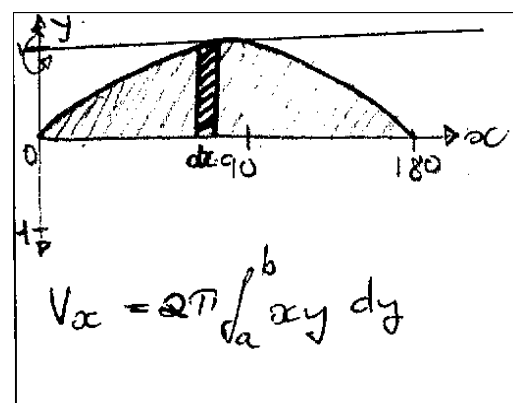

Figure 5.13: Incorrect region shaded

5.3 CONCLUSIONS FROM THE RESULTS

The results of this study reveal that, even though in general the performance in the pilot study was not satisfactory (32.7%), there were instances where students' performance was satisfactory and good. The conclusions that could be made from the proportion of acceptably correct responses in all the 11 elements are that the students are struggling with VSOR. At times they manage to show some competency, but mostly they seem to give solutions that are incorrect. For most of the elements the performance was not satisfactory. The students were unable to solve problems that involved translation between two-dimensions and in three-dimensions (poor performance). In particular the students failed to select the representative strip and to interpret graphs (poor performance). The poor performance in both Skill factors II and III, might have led to the very poor performance in VSOR. The results from students at the College C, where I observed lessons for six days were poor. Even though these students appeared to be performing well in class, taught by the author of the N6 textbook, their performance using the 21-item questionnaire was nonetheless the same as that of other students who were not observed, at times even outclassed by them, given from the way in which they responded to the questions: correctly, partially correct, incorrectly or not done.

The results for both the preliminary study and the pilot study reveal that even though the students have some capabilities in drawing some graphs, they cannot interpret them properly. For the pilot study it was further revealed that students are finding it difficult to solve problems where they need to translate between two and three dimensions and those involving the selection of the representative strip as well as translating between the algebraic and the visual representations in 3D. However, since it was evident that some questions from the pilot study were not clear to the students, the instrument was modified and used for main data collection in Phase II that is presented in Chapter 6.

CHAPTER 6: QUESTIONNAIRE AND EXAMINATIONS

This chapter presents Phase II, being the main study. Section 1 consists of the students' written responses that were gathered through two investigations from the developed 23-item instrument (the questionnaire), with 11 elements grouped under the five skill factors. The first investigation involves the first run of the questionnaire that was administered in April 2007 to 37 respondents, while the second investigation involves the second run of the questionnaire that was administered in October 2007 to 122 respondents and later again in April 2008 to 54 respondents. Section 2 consists of two investigations from the August 2007 mathematics N6 examinations. The first investigation involves the analysis of the examination results for 151 respondents while the second investigation involves detailed written examination responses with seven respondents from College A. The students' written responses were marked according to the rank scores and classified into 5 elements under Skill factor V. The data are presented in tables and multiple bar graphs and described quantitatively and qualitatively. The skill factors are further classified as requiring conceptual skills or procedural skills or both. The interpretation of the data presented and analysed in this chapter is done in Chapter 9. It is located within the conceptual framework of this study discussed in Chapter 3 and related to existing studies, discussed in Chapter 2.

6.1 PRESENTATION AND ANALYSIS OF THE RESULTS FROM THE 23-item INSTRUMENT (QUESTIONNAIRE)

The presentation and analysis of the responses for the 23 questions are classified and discussed under the 11 elements and the five skill factors and summarised. Similar elements, for example, Elements 6 and 7, both relating to translation between 2D and 3D, are discussed together. Tables and multiple bar graphs are used to display rank scores for the responses as *fully correct* (FC:4), *almost correct* (AC:3), *traces of understanding* (TU:2), *no understanding* (NU:1) and *not done* (ND:0), shown in Appendix 4A for the Questionnaire 1st run and Appendix 5A and 5C for the Questionnaire 2nd run. The response percentage per rank score with the raw score in the brackets for the Questionnaire 1st run in April 2007 with 23 questions and 37 respondents; the Questionnaire 2nd run in October 2007 with 16 questions and 122 respondents and again in April 2008 with 7 questions and 54 respondents is given. The description of performance is discussed in terms of the proportion of the acceptably correct responses (sum of fully correct and almost correct responses) at different performance

levels. A summary of students' written responses are presented under the rankings, almost correct; traces of understanding and no understanding, with some examples of students' actual written responses showing traces of understanding and no understanding.

6.1.1 Skill factor I: Graphing skills and translating between visual graphs and algebraic equations/expressions in 2D and 3D

- **Element 1: Graphing skills**

Two questions were given:

1 A: Draw a line with a positive gradient passing through the origin for $x \in [0, 3]$.

1 B: Sketch the graphs and shade the first quadrant area bounded by $x^2 - y^2 = 9$ and $x = 5$.

Questionnaire 1st run

Table 6.1: Element 1 for the Questionnaire 1st run as Question 1

RESPONSES	Q1A	%	Q1B	%
Fully correct	4	10.8	9	24.3
Almost correct	6	16.2	10	27.0
Traces of understanding	0	0	8	21.6
No understanding	17	46	10	27.0
Not done	10	27.0	0	0
% (FC + AC)		27		51.3

N = 37

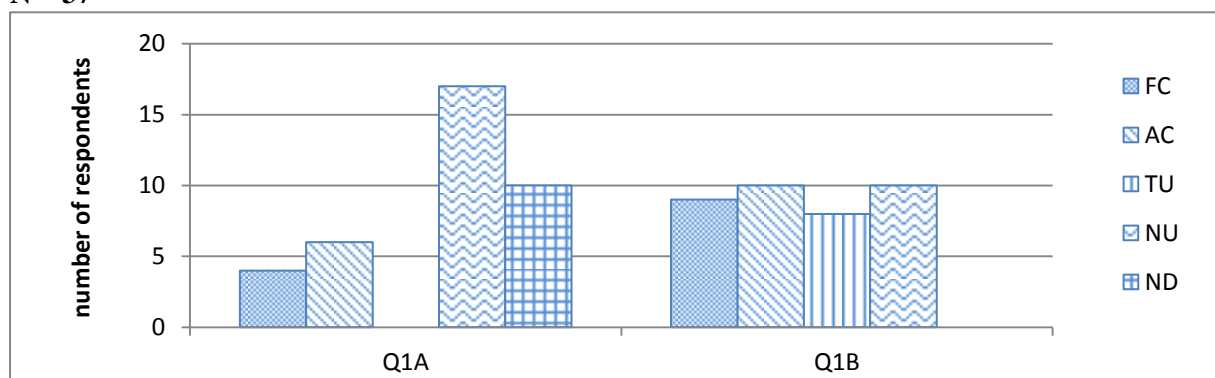

Figure 6.1: Questionnaire 1st run for Question 1

Questionnaire 2nd run

Table 6.2: Element 1 questions

RESPONSES	Q1A	%	Q1B	%
Fully correct	8	6.6	54	44.3
Almost correct	17	13.9	16	13.1
Traces of understanding	32	26.2	19	15.6
No understanding	58	47.5	31	25.4
Not done	7	5.7	2	1.6
% (FC + AC)		20.5		57.4

N = 122

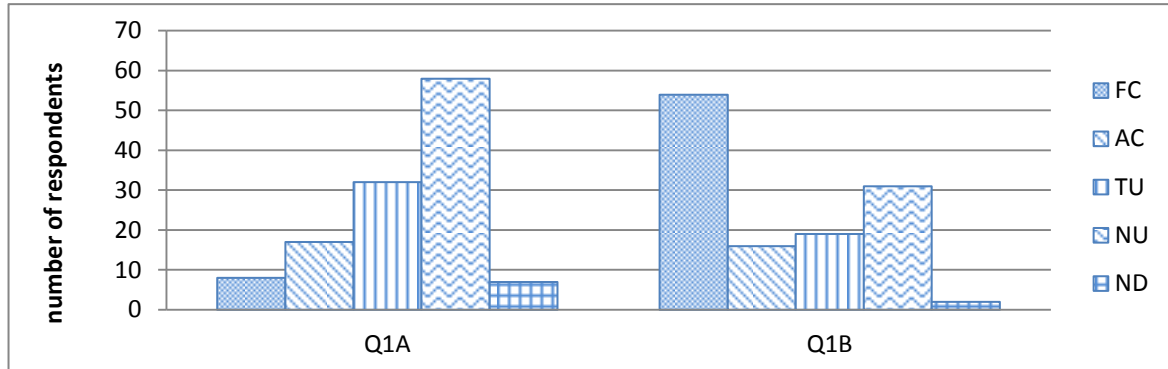

Figure 6.2: Questionnaire 2nd run for Question 1

From Tables 6.1 and 6.2 as well as Figures 6.1 and 6.2 for both questionnaire runs, it is evident that the performance was low for Question 1A (drawing a line with a positive gradient), with a large proportion of responses, 46 % (17) and 47.5% (58), for the Questionnaire 1st run and for the Questionnaire 2nd run respectively, showing no understanding. There was no student from the Questionnaire 1st run that showed traces of understanding in this question, while for the Questionnaire 2nd run, only 26.2% (32) of the responses revealed some traces of understanding. It is also evident from both bar graphs (Figures 6.1 and 6.2), which are negatively skewed that most responses are not acceptably correct, 27% (10) and 20.5% (25) for the Questionnaire 1st run and for the Questionnaire 2nd run respectively (given in Tables 6.1 and 6.2). This proportion of responses that are not acceptably correct indicates that the performance in drawing a line with a positive gradient passing through the origin for a certain interval in both runs of the questionnaire was not satisfactory.

In Question 1B for the Questionnaire 1st run, there was the same trend in the responses, 24.3%; 27%; 21;6% and 27% (9, 10, 8 and 10) respectively for all categories, fully correct; almost correct; traces of understanding and no understanding, with all students attempting this question. The students were required to draw a hyperbola and a straight line. The same trend in responses is represented from the nearly symmetric bar graph (Figure 6.1), where 51.3% (19) of the responses were acceptably correct. However, for the Questionnaire 2nd run, 44.3% (54) of the responses were fully correct while 25.4% (31) of the responses revealed that the students did not understand the question, with only 1.6% (2) of the responses not done. It is also indicated from the bar graph (Figure 6.2), which is positively skewed, that a large proportion of the responses 57.4% (70) were acceptably correct. The results reveal that the performance in drawing a rectangular hyperbola and a straight line graph, as well as shading the bounded area in both runs of the questionnaire was satisfactory.

Below some examples of what students actually did in Question 1A and 1B are given.

Question 1A: Typical students' errors when drawing a line with a positive gradient

Almost correct responses: Students drew

- A line $y = x$ and $y = 1$ with a Δy strip labelled Δx
- A line $y = x$ and $y = 3$

Traces of understanding: Students drew

- A line with a positive gradient passing through the negative x -axis and passing through the y -axis at 3

No understanding: Students drew

- A vertical line on the y -axis ending at point 3
- A vertical line on the y -axis with an arrow passing point 3 and going down below pointing down below zero
- A vertical line pointing up on the y -axis with an arrow at point 3
- A line $y = 3$ showing coordinates $(0;3)$
- Point 3 on the y -axis
- A line with a negative gradient intersecting the y -axis and the x -axis
- Point 3 on the x -axis
- A line $x = 3$ drawn going up starting from the x -axis
- A line $x = 3$
- A line with a negative gradient passing through the y -axis at 3
- A number line from 0 to 3
- A line $y = 3$

The responses given above reveal that the students did not know what a positive gradient means. The students drew different kinds of lines including those with a negative gradient as well as horizontal and vertical lines passing through 3. The students were also not able to use the given interval of $x \in [0, 3]$. The lines passing through 3 might be an indication that the students were not able to interpret and use the given interval of $x \in [0, 3]$, which was seemingly interpreted to mean the x and the y intercepts.

In Figures 6.3 and 6.4, examples of actual written responses are given for the responses showing *no understanding*. Figure 6.3 shows an example of a horizontal line passing through 3, while Figure 6.4 shows a line with a negative gradient.

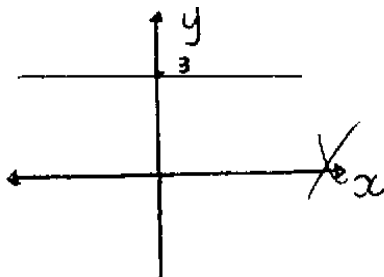

Figure 6.3: A line passing through $y = 3$

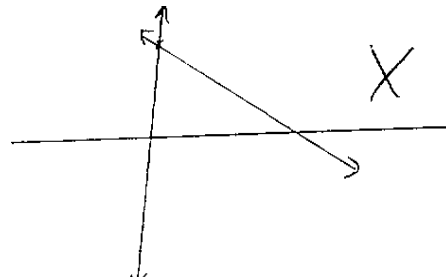

Figure 6.4: A line with a negative gradient

Question 1B: Typical students' errors when drawing a hyperbola $x^2 - y^2 = 9$ and $x = 5$

Almost correct responses: Students drew

- Both graphs correctly, but did not shade anything
- Both graphs correctly, but shaded quadrant 1 and 2
- Both graphs correctly with a Δy strip in the 1st quadrant
- Both graphs correctly with a Δy strip in the 1st and the 4th quadrants

Traces of understanding: Students drew

- $x = 5$ correctly, but had problems with the graph of $x^2 - y^2 = 9$, which was represented differently as half an ellipse with intercepts on the y -axis as ± 3
- A circle with intercepts on the y -axis and on the x -axis as ± 3 , with a Δx strip in the circle's 1st quadrant
- The graphs $x = 5$ and $x^2 - y^2 = 9$ not intersecting since the hyperbola was not extended
- A circle with intercepts on the y -axis as ± 3
- Half a circle with intercepts on the y -axis as 3 and on the x -axis as ± 3
- A full rectangular hyperbola with both x -intercepts
- A semicircle or a quarter of a circle

No understanding: Students drew

- Half an ellipse intersecting the x -axis at ± 5 and the y -axis at -3
- Different graphs like a parabola or an incorrect rectangular hyperbola
- An ellipse with x -intercepts as ± 3 and y -intercepts as ± 4
- An ellipse with x -intercepts as ± 5 and y -intercepts as ± 4
- Half a circle and the line $y = x$
- A line passing through $x = -3$ and $y = 3$

The responses given above reveal that most of the students were able to draw the line $x = 5$, but had problems drawing the graph of $x^2 - y^2 = 9$. Some students were seen to draw ellipses, circles, even semicircles when attempting to draw the hyperbola. The students also had problems in showing the correct intercepts of the hyperbola on the x -axis only. In many instances the x -intercepts were incorrect. The y -intercepts were also given even though they were supposed to be non-real roots. Figures 6.5 and 6.6 are examples of actual written responses showing *no understanding*, showing half of an ellipse with both intercepts on both axes.

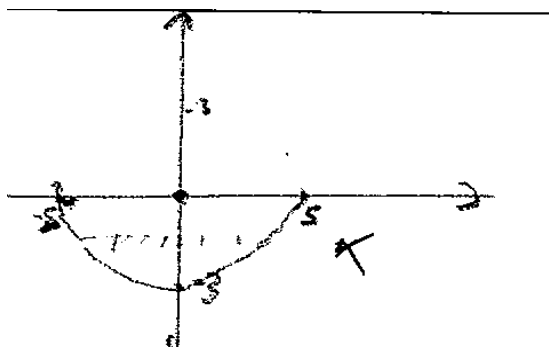

Figure 6.5: Half an ellipse below the x -axis

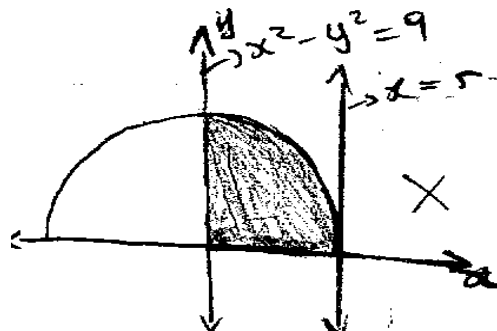

Figure 6.6: Half an ellipse above the x -axis

Discussion on Element 1

From Question 1A, drawing a straight line graph given as word problem, seemed simpler than Question 1B where a graph of a hyperbola $x^2 - y^2 = 9$ and a straight line $x = 5$ were required, yet a large proportion of the students, 51.3% (19) and 57.4% (70) respectively from Questionnaire 1st run and Questionnaire 2nd run were able to draw both graphs in Question 1B, regarded as satisfactory performance, compared with only 27% (10) from Questionnaire 1st run and 20.5% (25) from Questionnaire 2nd run who could not draw the straight line in Question 1A, resulting in performance that is not satisfactory for this question. This might be because Question 1B was familiar since it is similar to some questions in past examination papers, unlike Question 1A which was given as a word problem. In drawing a line with a positive gradient passing through the origin for $x \in [0, 3]$ some students drew vertical lines ending at 3 or lines $y = 3$ or $x = 3$ and other different lines. Those who tried to draw lines with a positive gradient had their lines not through the origin, sometimes passing through 3 on the x -axis or on the y -axis. The students who drew a line $y = 3$, may have done that because they misinterpreted $x \in [0, 3]$ to mean the coordinates (0;3) which means that the y value is 3 while the x value is 0. The students had difficulty in interpreting a verbal description such as “a line with a positive gradient” and did not know what $x \in [0, 3]$ means.

- **Element 2: (algebraic to visual in 2D) and Element 3 (visual to algebraic in 2D)**

The questions for Elements 2 and 3 were as follows:

Table 6.3: Element 2 and 3 questions

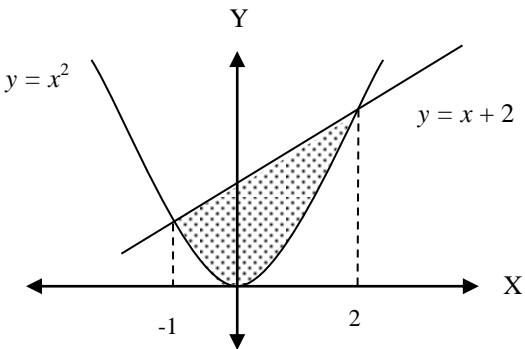
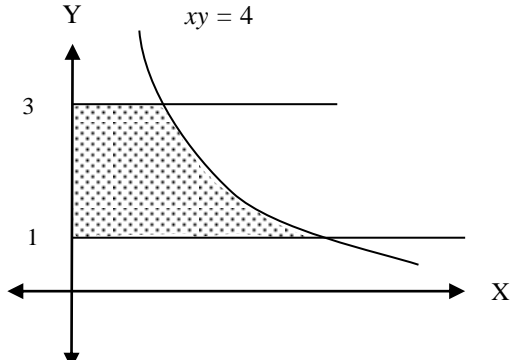
<p>2A: Represent $x^2 + y^2 \leq 9$ by a picture.</p>	<p>2B: Sketch the area represented by $\int_0^1 (x - x^2) dx$.</p>
<p>3A: Substitute the equations of the given graphs in a suitable formula to represent the area of the shaded region.</p> 	<p>3B: Substitute the equations of the given graphs in a suitable formula to represent the area of the shaded region.</p> 

Questionnaire 1st run

Table 6.4: Element 2 and 3 for the Questionnaire 1st run as Question 2 and Question 3

RESPONSES	Q2A	%	Q2B	%	Q3A	%	Q3B	%
Fully correct	3	8.1	13	35.1	31	83.8	16	43.2
Almost correct	28	75.7	8	21.6	2	5.4	4	10.8
Traces of understanding	4	10.8	4	10.8	3	8.1	8	21.6
No understanding	1	2.7	10	27.0	1	2.7	8	21.6
Not done	1	2.7	2	5.4	0	0	1	2.7
%(FC + AC)		83.8		56.7		89.2		54

N = 37

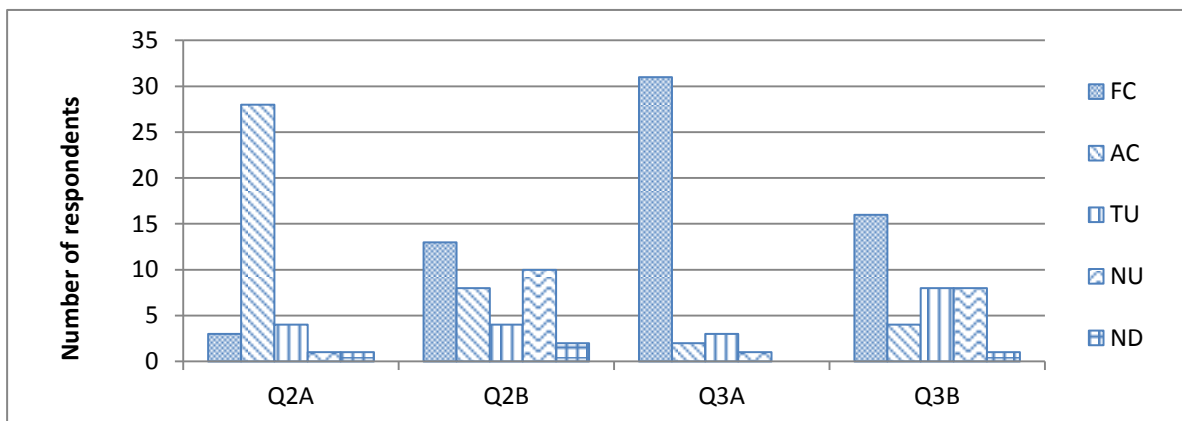

Figure 6.7: Questionnaire 1st run for Question 2 and Question 3

Questionnaire 2nd run

Table 6.5 Element 2 and 3 for the Questionnaire 2nd run as Question 2A and Question 3A

RESPONSES	Q2A	%	Q3A	%
Fully correct	0	0	30	55.6
Almost correct	29	53.7	17	31.5
Traces of understanding	18	33.3	0	0
No understanding	5	9.3	5	9.3
Not done	2	3.7	2	3.7
%(FC + AC)		53.7		87.1

N = 54

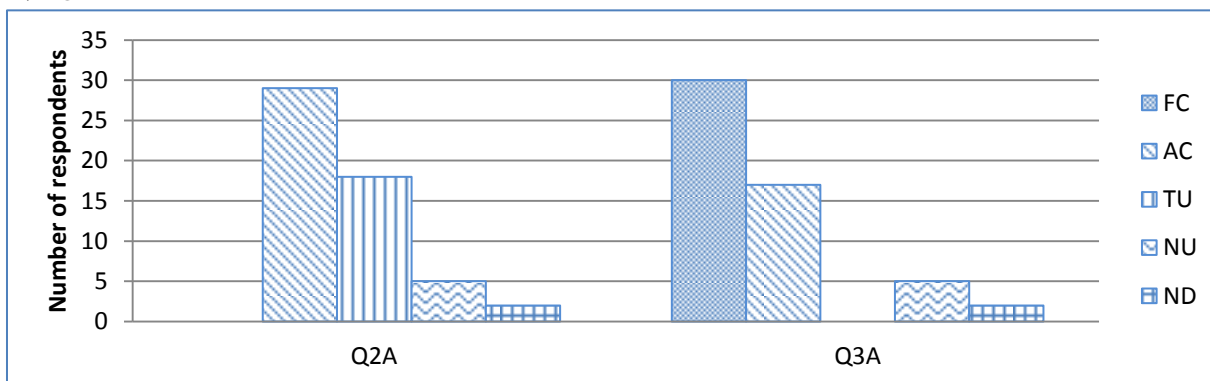

Figure 6.8: Questionnaire 2nd run for Question 2A and Question 3A

Table 6.6 Element 2 and 3 for the Questionnaire 2nd run as Question 2B and Question 3B

RESPONSES	Q2B	%	Q3B	%
Fully correct	9	7.4	43	35.3
Almost correct	28	23	11	9.0
Traces of understanding	30	24.6	44	36.1
No understanding	48	39.3	23	18.9
Not done	7	5.7	1	0.8
% (FC + AC)		30.4		44.3

N = 122

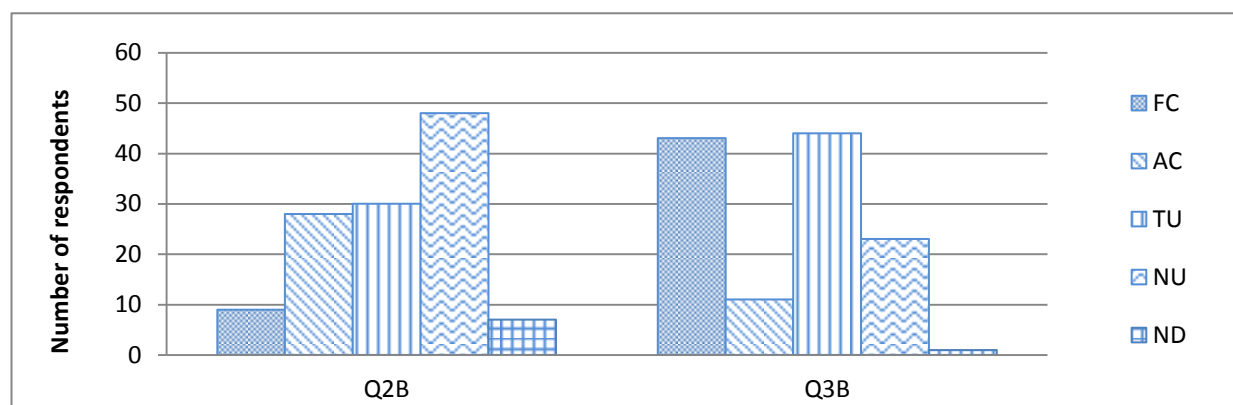

Figure 6.9: Questionnaire 2nd run for Question 2B and Question 3B

Tables 6.4, 6.5 and 6.6 and Figures 6.7, 6.8 and 6.9 display the pattern of responses for the four questions, Question 2A, 2B, 3A and 3B. In Question 2A from Questionnaire 1st run, a large proportion of almost correct responses, 75.7% (28) were the students who were able to in draw a circle but did not shade inside it to represent the inequality. For the Questionnaire 2nd run, 53.7% (29), was the highest proportion of almost correct responses, in relation to the other rank scores, being those students who did not shade inside the circle to represent the inequality. The results reveal that from the proportion of acceptably correct responses, the performance was excellent, 83.8% (31) for the Questionnaire 1st run, and satisfactory for the Questionnaire 2nd run 53.7% (29), evident from the positively skewed bar graph in Figures 6.7 and 6.9.

For Question 2B, the highest proportion of responses, 35.1% (13), from the Questionnaire 1st run, showed that the responses were fully correct, with only 7.4% (9) from the Questionnaire 2nd run. Despite the fact that most of the responses from the Questionnaire 1st run were fully correct, there was also a higher proportion of responses, 27% (10), indicating that the students did not understand the question. From Questionnaire 2nd run, most of the responses, 39.3% (48), reveal that the students struggled with this question, showing no understanding. The students were expected to sketch a graph represented by an integral formula for area

representing a parabola $y = x - x^2$ or a straight line $y = x$ and a parabola $y = x^2$. The results reveal that the performance was satisfactory, with 56.7% (13) of the responses being acceptably correct in the Questionnaire 1st run, evident from the positively skewed bar graph in Figure 6.7. For the Questionnaire 2nd run, the performance was not satisfactory, with only 30.4% (37) of the responses being acceptably correct, evident from the negatively skewed bar graph in Figure 6.8. Overall, in answering Question 2, the students performed better in the Questionnaire 1st run than in the Questionnaire 2nd run, where none of the students were able to give fully correct responses for Question 2A, with only 7.4% (9) of the responses being fully correct in Question 2B.

For Question 3A a large proportion of the responses, 83.8% (31) from the Questionnaire 1st run were fully correct, where all the students responded to the question. The students were successful in substituting correctly from the drawn graphs when representing area as an integral where a Δx strip was appropriate. For the Questionnaire 2nd run, even if most of the responses, 55.6% (30) are fully correct, this percentage is very low when compared with the 83.8% from the Questionnaire 1st run. However, both graphs representing Question 3A (Figures 6.7 and 6.9) from the questionnaire runs are positively skewed. The performance in this question was excellent, with 89.2% (33) and 87.1% (47) of the acceptably correct responses in the Questionnaire 1st run and Questionnaire 2nd run respectively.

For Question 3B, which required the use of a Δy strip when representing the formula for area, the highest proportion of responses, 43.2% (16) for the Questionnaire 1st run represent fully correct responses, with equal proportion of responses, 21.6% of the responses showing traces of understanding and no understanding. However, as represented from the bar graph (see Figure 6.7), the data are positively skewed, where most of the responses, 54% (20) are acceptably correct, indicating satisfactory performance. For the Questionnaire 2nd run, almost the same proportion of responses, 35.3% (43) and 36.1% (44) respectively were fully correct and showing traces of understanding, evident from the bi-modal graph in Figure 6.8. The performance from the Questionnaire 2nd run was also satisfactory, with 44.3% (54) of acceptably correct responses.

All four positively skewed graphs in Figure 6.7 from the Questionnaire 1st run reveal that overall, most of the responses were acceptably correct, 83.8% (31), 56.7% (21), 89.2% (33) and 54% (20) in Questions 2A, 2B, 3A and 3B respectively. For the Questionnaire 2nd run, the graphs are also positively skewed as in Figure 6.9, indicating that there were most

acceptably correct responses, 53.7% (29) and 87.1% (47) in Questions 2A and 3A respectively. However, from all bar graphs for Question 2 and 3 (Figures 6.7, 6.8 and 6.9), the lowest bar is for not done, representing that the majority of the students, more than 94% (Tables 6.4, 6.5 and 6.6) attempted Question 2 and 3.

Below some examples of what students actually did in Question 2A and 2B are given.

Question 2A: Typical students' errors in representing an inequality for a circle

Almost correct: Students drew

- A circle with intercepts ± 3 for x and y

Traces of understanding: Students drew

- A circle with intercepts ± 9 for x and y
- Semicircle with x intercepts ± 3 and y intercept of 3

No understanding: Students drew

- A quarter of a circle in quadrant 1

The responses reveal that the majority of students were able to draw the graph but did not use the inequality by shading inside the circle. The performance was relatively good.

Question 2B: Typical students' errors in drawing the graph represented by an integral

Almost correct: Students drew

- A correct graph but shaded even below the x -axis
- $y = 1 - x^2$ and shaded the first quadrant
- $y = 1 - x^2$ with a Δy strip and labelled it as $y = x - x^2$
- $y = x$ and the Δx strip
- A correct graph with one x -intercept incorrect
- $y = x$ and $y = x^2$ a Δx strip
- The parabola $y = x^2 - x$
- The opposite of the correct graph

Traces of understanding: Students drew the graph of

- $y = x$ and $y = -x^2$ and interpreted – sign incorrectly
- $y = x$ and part of a circle in the 1st quadrant only
- $y = x$ and $y = x^2 - x$

No understanding: Students drew

- A graph similar to $x = \sqrt{y}$ and shaded above the x axis for $y \in (0; 2)$
- $y = -x^2$ with the shading below it in the 4th quadrant
- $y = -x^2$ in the 3rd and the 4th quadrant with a Δx strip selected on top of the graph between 0 and 1
- A line having the x intercept as 1 and the y intercept as 1
- $y = x + 1$ with a Δx strip
- A line having the x intercept as 1 and the y intercept as 1
- $y = -x + x^2$ with a Δx strip

Even if the performance for Question 2B was not satisfactory, most of the students had some idea about what the question entailed, that of drawing a parabola facing downwards and shading the first quadrant area between the x values of 0 and 1. However, most of the students who succeeded in this question did not identify the integral given to relate to the region bounded by the straight line $y=x$ and the parabola $y=x^2$. The integral was in most cases identified to represent the parabola $y=x-x^2$, the way in which it was asked. The students did not interpret the formula to identify the region bounded by the two graphs, being the straight line $y=x$ and the parabola $y=x^2$. They interpreted the question as if they were asked to draw the parabola, which means that the integral formula representing the region bounded by the two graphs was not identified. In Figures 6.10 and 6.11, examples of actual written responses are given showing *no understanding*, where in some cases straight lines and parabolas facing upwards were drawn.

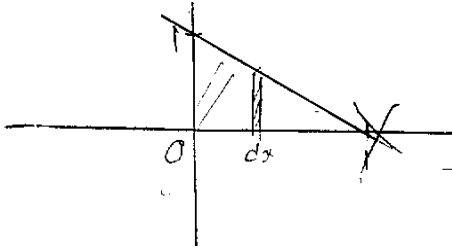

Figure 6.10: A line with a negative slope

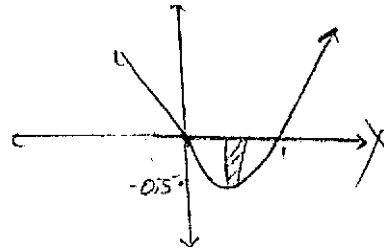

Figure 6.11: A parabola $y = x - x^2$

Discussion on Element 2

In Question 2A, most of the students with acceptably correct responses, 75.7% (28) from Questionnaire 1st run and 53.7% (29) from Questionnaire 2nd run, were able to draw the required circle but did not indicate the inequality involved by shading the inside of the drawn circle. However, the performance in the Questionnaire 1st run was excellent, 83.8% (31) while the performance in the Questionnaire 2nd run was satisfactory, 53.7% (29). The performance in both questionnaire runs was lower in Question 2B requiring that the students must sketch the area represented by an indefinite integral formula, representing a parabola, or a straight line and a parabola. This might be as a result of students being familiar to the way in which this question is assessed in past examination papers and in their textbooks, where they are used to writing down the formula that represents the area of the region bounded by the graphs and not the other way round. The performance in the Questionnaire 1st run in Question 2B was satisfactory, 56.7% (21), while the performance in the Questionnaire 2nd run was not satisfactory, 30.4% (37). The successes in Question 2, was mainly based on the responses, showing traces of understanding, and not on the fully correct responses.

Below some examples of what students actually did in Question 3A and 3B are given

Question 3A: Typical errors when performing the substitution requiring a Δx strip

Almost correct: Students

- Made mistakes with one graph from correct limits
- Substituted correctly but did not specify the limits used

Traces of understanding: Students

- Wrote the correct equation but did not substitute
- Integrated incorrectly

No understanding: Students

- Took moments about the x – axis as if they were calculating the centroids

The students performed extremely well in this section, no actual written examples are given.

Question 3B: Typical errors when performing the substitution requiring a Δy strip

Almost correct: Students

- Chose a correct formula and a Δy strip but did not substitute
- Chose a correct formula and substituted correctly, but drew a Δx strip which was labelled incorrectly as Δy and did not substitute the limits

Traces of understanding: Students

- Drew a Δy strip but used an incorrect formula as $\int (y_1 - y_2) dy$, then $\int_4^3 \left(3 - \frac{4}{x}\right) dy$
- Drew a Δy strip but used an incorrect formula $\int_1^3 3^2 - \left(\frac{4}{y}\right)^2 dy$
- Drew a Δx strip but used y values as boundaries
- Drew a Δy strip but used Δx incorrectly in the formula as $\int_1^3 \frac{4}{x} dx$
- Drew a Δy strip and the correct formula but did not substitute in the formula
- Used formula as $\int_1^3 \left(\frac{4}{x}\right) dx$ with limits for y
- Used formula as $\int_1^4 \left(\frac{4}{x}\right) dx$

No understanding: Students

- Did not substitute nor draw the strip
- Only wrote down equations as $y = \frac{4}{x}$; $y = 3$ and $y = 1$
- Wrote only $y = \frac{4}{x}$
- Wrote $y = 0$, $x = y$ and $y = e^{2x}$
- Used moment about the x – axis and formula $\int \left(\frac{4}{x}\right) - 3 - 1 dx$

Despite the fact that on the graph, the y values that would serve as limits were given, some students abandoned them and did not use them or used them with Δx instead of Δy . Some students drew a Δy strip, but could not represent it correctly when translating from the graph (visual) to an algebraic equation for area, especially when having to make x the subject of the formula in order to substitute. However, in some cases, the students were successful in making x the subject of the formula, in expressing $x = \frac{4}{y}$ and substituted with it correctly, to give the expression for area, with incorrect limits, while in most cases the incorrect formula for substitution, was used as $y = \frac{4}{x}$ with a Δx strip, which reveals the preference of these students in using a Δx strip even if it is not possible.

In Figures 6.12, 6.13, 6.14 and 6.15, examples actual written responses are given for the responses showing *no understanding* and *traces of understanding*.

$$\begin{aligned} \bar{A} &= \int_1^3 y_2 - y_1 \, dx \\ &= \int_1^3 \left(\frac{4}{x} - 3 - 1 \right) dx \\ &= \int_1^3 \left(\frac{4}{x} - 4 \right) dx \\ &= \int_1^3 [4 \ln x - 4x] \end{aligned}$$

Figure 6.12: Δx with y limits

$$\begin{aligned} I_x &= \int y^2 x \, dy \\ &= \int 2y \cdot \frac{x}{4} dx \\ &= \int 2y \cdot \frac{x^2}{4} \end{aligned}$$

Figure 6.13: Formula for moment of inertia

$$y = \frac{4}{x}$$

Figure 6.14: A hyperbolic equation

between

$$\begin{aligned} y &= 0 \\ x &= y \\ y &= e^{2x} \end{aligned}$$

Figure 6.15: An exponential equation

Discussion on Element 3

In Element 3 the questions required that students must substitute the equations of given graphs into a suitable formula for area. Most of the students, 89.2% (33) from the Questionnaire 1st run and 87.1% (47) from the Questionnaire 2nd run were successful in Question 3A, which reveals that they could substitute correctly from the correct formula for area when a Δx strip was appropriate, regarded as excellent performance. The students successfully translated from the visual graph to the algebraic equation for area. However, the level of success was lower in Question 3B, in the Questionnaire 1st run with only with 54% (20) successes and 44.3% (54) successes in the Questionnaire 2nd run, regarded as satisfactory performance. The reason might perhaps be based on the fact that the students were now in Question 3B required to use a Δy strip, which they do not normally prefer to work with.

Summary for Element 2 and 3

The results for Element 2 and 3 reveal that in some instances the students were able to translate from algebraic equations/expressions to visual graphs (Element 2) to a lesser extent than when translation from visual graphs to algebraic equations (Element 3). It seems as if the students are not good at drawing graphs, that represent integral formula for area, but if a graph is drawn, they are able to translate appropriately to the formula for area, using integrals, preferably if the Δx strip is required. The reason for using a Δy strip for those who used it might be because the y values were given in the question, as it was for Question 3A where the x values were given.

- **Element 4 (algebraic to visual in 3D) and Element 5 (visual to algebraic in 3D)**

The questions for Element 4 and 5 were as follows:

Table 6.7: Element 4 and 5 questions

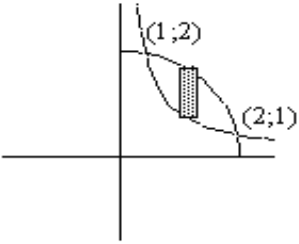
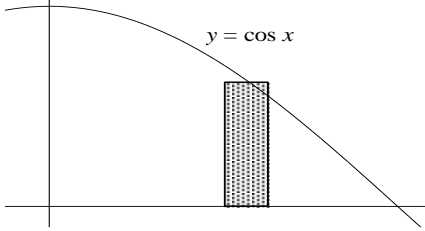
<p>4A: Draw the 3-D solid of which the volume is given by $V = \pi \int_0^1 (1-x)^2 dx$ and show the representative strip.</p>	<p>4B: Draw the 3-D solid of which the volume is given by $V = 2\pi \int_0^1 x(1-x^2) dx$ and show the representative strip.</p>
<p>5A: The figure below represents the first quadrant area bounded by the graphs of $x^2 + y^2 = 5$ and $xy = 2$. Using the selected strip, substitute the equations of the given graphs in a suitable formula to represent the volume generated if the selected area is rotated about the x-axis. Do not calculate the volume.</p> 	<p>5B: The figure below represents the area bounded by the graphs of $y = \cos x$, the x-axis and the y-axis. Using the selected strip, substitute the equations of the given graphs in a suitable formula to represent the volume generated when this area is rotated about the y-axis. Do not calculate the volume.</p> 

Questionnaire 1st run

Table 6.8: Element 4 and 5 for the Questionnaire 1st run as Question 4 and Question 5

RESPONSES	Q4A	%	Q4B	%	Q5A	%	Q5B	%
Fully correct	4	10.8	4	10.8	23	62.2	4	10.8
Almost correct	8	21.6	18	48.7	6	16.2	6	16.2
Traces of understanding	3	8.1	10	27.0	5	13.5	0	0
No understanding	11	29.7	2	5.4	3	8.1	18	48.7
Not done	11	29.7	3	8.1	0	0	9	24.3
% (FC + AC)		32.4		59.5		78.4		27

N = 37

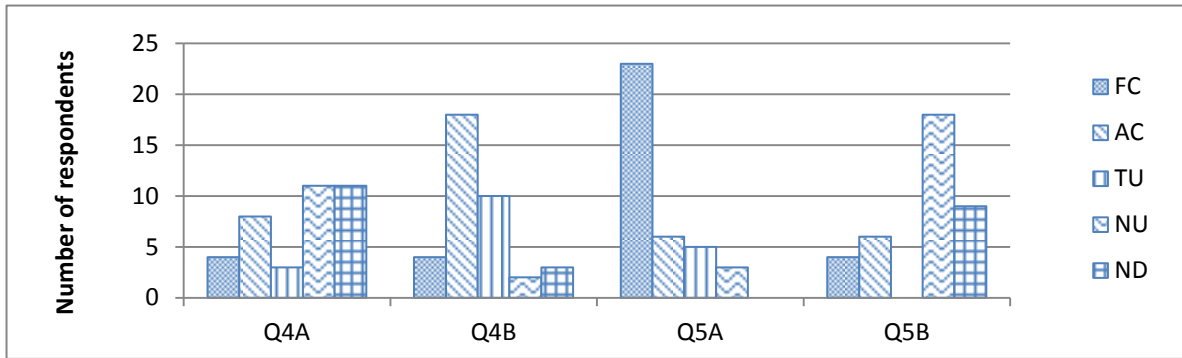

Figure 6.16: Questionnaire 1st run for Question 4 and Question 5

Questionnaire 2nd run

Table 6.9: Element 4 for the Questionnaire 2nd run as Question 4

RESPONSES	Q4A	%	Q4B	%
Fully correct	0	0	2	1.6
Almost correct	5	4.1	16	13.1
Traces of understanding	25	20.5	15	12.3
No understanding	61	50	75	61.5
Not done	31	25.4	14	11.5
% (FC + AC)		4.1		14.7

N = 122

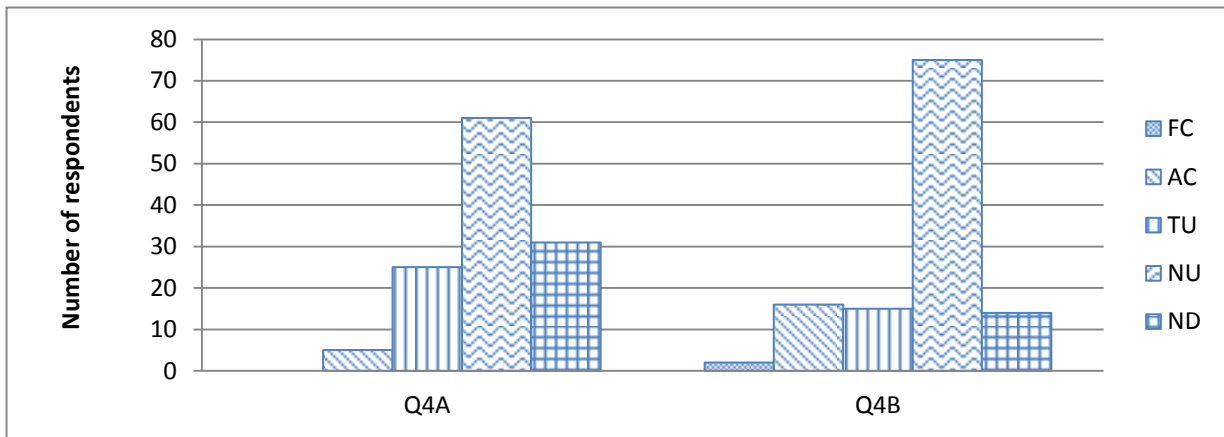

Figure 6.17: Questionnaire 2nd run for Question 4

Table 6.10: Element 5 for the Questionnaire 2nd run as Question 5A

Responses	Q5A	%
Fully correct	32	59.3
Almost correct	4	7.4
Traces of understanding	9	16.7
No understanding	9	16.7
Not done	0	0
% (FC + AC)		66.7

N = 54

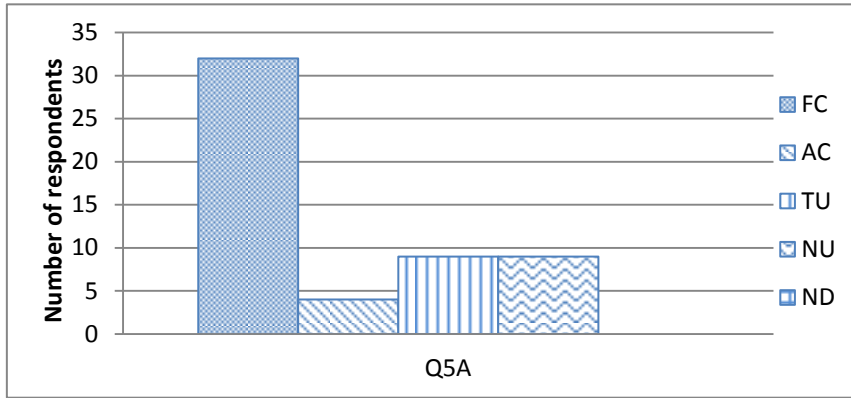

Figure 6.18: Questionnaire 2nd run for Question 5A

Table 6.11: Element 5 for the Questionnaire 2nd run as Question 5B

RESPONSES	Q5B	%
Fully correct	18	14.8
Almost correct	23	18.9
Traces of understanding	14	11.5
No understanding	57	46.7
Not done	10	8.2
% (FC + AC)		33.7

N = 122

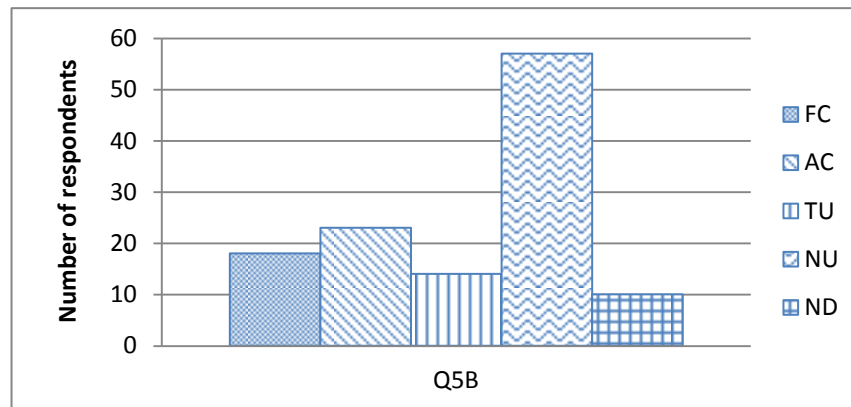

Figure 6.19: Questionnaire 2nd run for Question 5B

All the questions under Elements 4 and 5 involve 3D solids resulting from rotation of 2D graphs. The results for Question 4 (the translation from algebraic to visual) in both runs of the questionnaire are discussed from Tables 6.8 and 6.9 as well as Figures 6.16 and 6.17. In the Questionnaire 1st run, students performed better in Question 4B where they were expected to draw a 3D solid (representing a shell method) from the formula for volume given as an integral, compared with Question 4A where they were expected to draw a 3D solid (representing a disc method) from the formula for volume given as an integral. In Question 4A the highest proportion of the responses 29.7% (11) showed no understanding and not

done, with only 10.8% (4) of the responses being fully correct and 21.6% (8) showing almost correct responses, while for Question 4B, 10.8% (4) of the responses were fully correct and 48.7% (18) showing almost correct responses. For the Questionnaire 2nd run, the performance for Questions 4A and 4B was poor. In Question 4A, only 4.1% (5) of the responses were almost correct, 50% (61) showing no understanding with no fully correct responses. In Question 4B only 1.6% (2) of the responses were fully correct, with most of the responses 61.5% (75) showing no understanding.

A higher proportion of acceptably correct responses (59.5%) to Question 4B from the Questionnaire 1st run reveals that the students were able to relate the graph from the 2π to the shell method, regarded as satisfactory performance, compared to Question 4A, where only 32.4% of the responses were acceptably correct, regarded as performance that was not satisfactory. The problem encountered by most of the students in Question 4A and in Question 4B, as it was evident from the Questionnaire 2nd run was that the students were not able to draw a 3D solid, evident from the low proportion of acceptably correct responses in these questions as 4.1% (5) and 14.7% (18) respectively, revealing that the performance was poor. Few acceptably correct responses in Question 4A (32.4%) in the Questionnaire 1st run and Question 4 (4A: 4.1% and 4B: 14.7%) in the Questionnaire 2nd run are displayed from all three negatively skewed graphs in Figures 6.16 and 6.17 respectively.

The results for Question 5 (the translation from visual to algebraic) in both runs of the questionnaire are discussed from Tables 6.8, 6.10 and 6.11 as well as Figures 6.16, 6.18 and 6.19. From both questionnaire runs, it is evident that the students did better in Question 5A, than in Question 5B. In Question 5A, most of the responses were fully correct, 62.2% (23) for Questionnaire 1st run and 59.3% (32) for Questionnaire 2nd run, with all students attempting this question. The students did not do well in Question 5B with the highest proportion of responses, 48.7% (18) showing no understanding and 24.3% (9) of the students not responding for the Questionnaire 1st run, while for the Questionnaire 2nd run, the highest proportion of responses, 46.7% (57) showed that the students did not understand this question. In Question 5A, a Δx strip was drawn on the bounded region by the graphs of a circle and a hyperbola and students were asked to come up with a formula for volume upon rotation of this region about the x -axis, resulting in a washer. In Question 5B, a Δx strip was drawn on the bounded region by the graph of $y = \cos x$ and students were asked to come up with a formula for volume, resulting in a shell upon rotation about the y -axis.

In Question 5A the performance was excellent in the Questionnaire 1st run, with 78.4% (29) of the acceptably correct responses and good in the Questionnaire 2nd run with 66.7% (36) of the acceptably correct responses, as shown in Figures 6.16 and 6.18 from the positively skewed graphs. For Question 5B the performance was not satisfactory with 27% (10) of the responses being correct from the Questionnaire 1st run and 33.7% (41) of the responses being correct for the Questionnaire 2nd run, as shown in Figures 6.16 and 6.19 from the negatively skewed graphs. The results in Question 5 reveal that most of the students were able to translate from visual graphs to algebraic equations in 3D when rotating a Δx strip (drawn on the diagram) about the x -axis (Question 5A), resulting in a washer, but encountered difficulties when rotation was about the y -axis (Question 5B), resulting in a shell. A large proportion of acceptably correct responses in both questionnaire runs reveal that the students were able to come up with the correct formula for the volume and they also substituted correctly.

Overall, from both runs of the questionnaires, the students had difficulty with Questions 4A and 5B. For the Questionnaire 2nd run the results reveal that the students had difficulty in translating from algebraic equations to visual graphs in 3D, where a solid of revolution was to be drawn as required in Question 4A and 4B, than having to translate from visual graphs to algebraic equations in 3D resulting in a washer method. For the Questionnaire 2nd run, all the graphs representing Questions 4A, 4B and 5B are negatively skewed (Figures 6.17 and 6.19).

Below some examples of what students actually did in Question 4A and 4B are given.

Question 4A: Typical students' errors in drawing a 3D-solid represented by a disc from an equation

Almost correct: Students drew the graph of

- $y = 1 - x$ with a Δx strip but not a 3D solid
- $y = 1 - x$ without a strip also not a 3D solid

No understanding: Students drew

- A line with a positive gradient passing through the origin
- A parabola $y = x - x^2$ with a Δx strip labelled Δy
- A parabola $y = 1 - x^2$ with a Δx strip
- A parabola $y = 1 - x^2$ with a Δy strip
- A parabola similar to $y = x^2 - 1$ and the other one as $y = 1 - x^2$
- $y = x$ and Δx strips below it
- $y = x$ and $y = 1$, then selected a Δx strip, similar to washer as $V = \pi \int_0^1 (1^2 - x^2) dx$
- A parabola $y = (x-1)^2$ with a Δx strip between 1 and 0
- A line with x - intercept of -1 and y - intercept of 2
- A line with x - intercept of -1 and y - intercept of 1

The responses in the above examples reveal that the students did not understand Question 4A. It seems as if many students did not recognise the disc method in the formula, and therefore did not recognise that the straight line $y=1-x$ in this case was rotated about the x -axis, resulting in a disc. These students were not relating the square to the disc formula but instead they used it to draw different types of parabolas. One student related the given formula to a washer by drawing the graphs $y=x$ and $y=1$, that represented a washer upon rotation about the x -axis. A 3D solid was not drawn as required to represent a solid of revolution from the integral equation given. Instead graphs given in 2D were drawn. Ordinary graphs, passing through the x -axis, sometimes even graphs that did not resemble a parabola or a straight line were drawn.

In Figures 6.20 and 6.21, actual written responses showing *no understanding* are indicated.

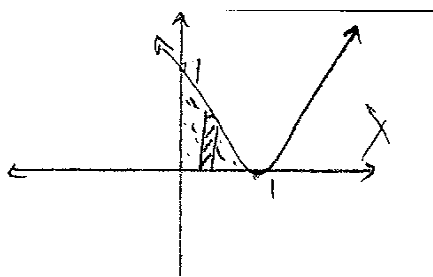

Figure 6.20: A positive parabola

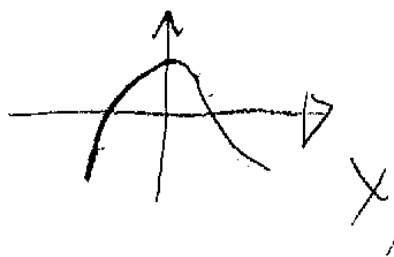

Figure 6.21: a negative parabola

Question 4B: Typical students' errors in drawing a 3D-solid represented by a shell from an equation

Almost correct: Students drew

- A correct graph, but passing down below the y -axis, showing a Δx strip and showing a disc
- A correct graph drawn, but not representing a 3D solid

Traces of understanding: Students drew

- Graphs of $y=1-x^2$ and $y=x$

No understanding: Students drew

- A graph similar to $y=-x^3$ with a Δx strip in the 4th quadrant
- A parabola with y intercepts only and a Δx strip below it between limits 1 and 0

The above actual responses give examples of the incorrect graphs showing how some of the students failed to draw a 3D solid from the integral equation (formula) for volume given. The students were not able to interpret the given equation appropriately. This was evident from the 2D graphs that were drawn. Some of the students drew two graphs separately as $y=x$ and $y=1-x^2$, since they saw them as separate graphs, while some drew the graph of $y=-x^3$, probably because they multiplied the expression $x(1-x^2)$ from the given integral formula.

In Figures 6.22 and 6.23 examples of actual written responses are given showing *traces of understanding*.

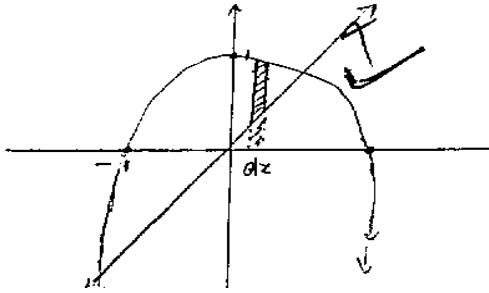

Figure 6.22: A complete parabola

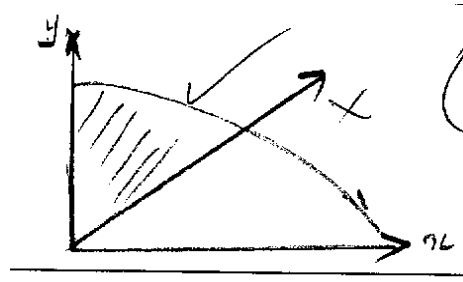

Figure 6.23: Half a parabola

Discussion on Element 4

In Element 4 the students were required to draw a 3D solid from the given formula for volume. Students in Questionnaire 1st run performed better than those in the Questionnaire 2nd run in Question 4B, with mainly almost correct responses. Question 4B employed a shell method. The success (mainly from the almost correct responses) might probably be because the 2π was related to the shell method. However the students were unable to draw a 3D solid, but were seen to draw ordinary parabolas passing through the x -axis. There were also some instances where some students misinterpreted the x in the formula, and in addition to the correct parabola, drew a graph of $y=x$ as well. In Question 4A most of the students did not associate the square on $1-x$ with a disc. They interpreted the question incorrectly by drawing parabolas, instead of drawing the graph of a straight line $y=1-x$, which was rotated about the x -axis using a Δx strip on the interval $[0,1]$. Other students did not use this interval when drawing their graphs. Again, same as in Question 2A, where the formula for area was given as an integral, the students were given the formula for volume as an integral, and asked to represent it as a solid of revolution, which they were possibly not familiar with, since they are more familiar with finding the formula for volume after drawing the graphs and not the other way round.

Those students, who drew parabolas instead of straight lines, had difficulty in translating the given algebraic equation to the visual 3D graph, which represents a solid of revolution. The students failed to relate the given equations in 3D (one as a disc and the other one as a shell) to the graphs in 2D that they represent, perhaps because they are normally asked to come up with the equation for volume from the rotated region bounded by graphs, which is the opposite of the Questions 4A and 4B. The incorrect graphs drawn by students reveal that the students were not familiar with this type of questions.

Below some examples of what students actually did in Question 5A and 5B are given.

Question 5A: Typical students' errors in substituting, when rotation is about the x -axis

Almost correct: Students

- Substituted one equation correctly, with correct boundaries, at times π missing
- Substituted one equation correctly, but the integral sign and boundaries were missing

Traces of understanding: Students

- Wrote the correct formula for a washer with limits as 1 and 0, but did not substitute into it; while the other students used the limits as b and a , but did not substitute into it
- Solved the substituted equations incorrectly

No understanding: Students

- Redrew the graph and changed the strip into the Δy strip
- Used the formula $\pi \int_0^1 y^2 dx$
- Calculated area instead of volume

Those students, who failed in this question, were in most cases using an incorrect strip or the disc method instead of the washer method.

Question 5B: Typical students' errors in substituting, when rotation is about the y -axis

Almost correct: Students used

- Correct formula as $2\pi \int_0^{\frac{\pi}{2}} xy dx$ but did not finish
- Incorrect upper limits $\frac{\pi}{3}$ and $\frac{\pi}{4}$
- Wrote $2\pi \int_a^b x \cos x dx$

No understanding: Students

- Used formula for a disc using Δy in the formula even if a Δx strip was given in the diagram and continued to substitute, representing an inverse of a cosine $\pi \int_a^b x^2 dy = \pi \int_0^1 \cos^{-1} y dy$
- Used formula for a disc $\pi \int_a^b x^2 dy = \pi \int_0^{\frac{\pi}{2}} \cos^{-1} y dy$ even if a Δx strip was given
- Used $V = \pi \int_a^b \cos x dy$; $\pi \int_a^b \cos^2 x dx$; $\pi \int_{-1}^1 \cos^2 x dy$ or $\pi \int_0^{\frac{\pi}{2}} x \sin x + \cos x dx$;
- Drew the graph with a Δy strip
- Used different formulae were used for volume as $\int_a^b y^2 dx$; $\pi \int_0^1 \cos^2 x dx$; $\pi \int_{-\frac{\pi}{2}}^{\frac{\pi}{2}} \cos x dx$;
- Used $V = \pi \int_a^b x^2 dy$ then $V = \pi \int \sec x dy$ while other used $2\pi \int_a^b y \cos^{-1} y dx$

In Figures 6.24 and 6.25, some examples of actual written responses are given where there was *no understanding*. The majority of the students were unable to evaluate the integral.

$$\begin{aligned} dV &= \pi \cos x \, dy \\ dy &= \pi \int \cos x \, dy \\ \underline{dy} &= \pi \sin x \, dy \end{aligned}$$

Figure 6.24: $\cos x$ and a Δy strip

$$V = \pi \int_0^{\pi/2} x \sin x + \cos x \, dx$$

Figure 6.25: Integration by parts

Discussion on Element 5

From the Questionnaire 1st run, a large proportion of students (78.4%) were able to substitute correctly for Question 5A that did not require the use of a shell method, while a large proportion of students (73%) failed in Question 5B where a Δx strip resulted in a shell upon rotation. With the Questionnaire 2nd run, similar results were found with 66.7% of the responses being acceptably correct for Question 5A and only 33.7% of the responses being acceptably correct for Question 5B. In responding to Question 5B, a large number of students used a Δy in the formula along with a disc method (probably because they find it easy to work with), squaring the $\cos x$ and using other methods including the inverse of a $\cos x$ graph having a π (used for a disc method) outside the integral sign instead of a 2π (used for a shell method). The upper and lower limits were incorrect in most cases or not given.

Summary for Element 4 and 5

The results for these elements reveal that the students do not know what a 3D solid is and that they prefer to use a disc method or washer method despite the strip that is used. Students showed competency in questions that required the straight forward substitution, especially if the question required the use of a washer method. It is evident from the substitutions that a Δx strip is preferred, and that students avoid using the shell method even if the given strip results in a shell upon rotation.

Discussion on Skill factor I (Elements 1-5)

The conclusion to be made on Skill factor I is that students struggle to draw graphs that they are not familiar with. If a graph that they are familiar with for an example, the graph of $y = x$ is asked differently, given as a word problem (using the mathematics register), most of them fail. In other instances it was also revealed that the students prefer using a Δx strip as well as

a disc or washer method, avoiding a shell method even if the region bounded by the drawn graphs results in a shell upon rotation. It was also evident that even if the graphs obviously required the use of Δy strip, some students were seen to use Δx in the formulae but using the y values as limits for integration. Most of the students were able to substitute the given equations into the formula for area or volume, but failed in most cases to interpret the visual graphs and to translate the information from the drawn graphs to the algebraic equations. There were instances where a Δx strip was drawn for the students and some students translated it correctly if it resulted in a disc or washer method upon rotation, but used a Δy in their formulae (with a disc) if upon rotation the drawn Δx strip resulted in a shell.

In discussions with students as they were solving problems, it appeared that most students had problems understanding what a 3D-diagram means. Many students also believe that when asked to rotate about the y -axis one must use a Δy strip and when rotating about the x -axis, one must use a Δx strip. This conception justifies why students use the disc method often. If one rotates a Δx strip about the x -axis one will always get a disc or a washer and the same applies if a Δy strip is rotated about the y -axis. Overall the results reveal that the students avoid using a shell. The results also reveal that the students cannot draw 3D solids.

6.1.2 Skill factor II: Three-dimensional thinking

- **Element 6 (2D to 3D) and Element 7 (3D to 2D)**

The questions for Element 6 and 7 were as follows:

Table 6.12: Element 6 and 7 questions

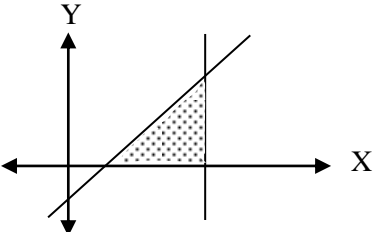
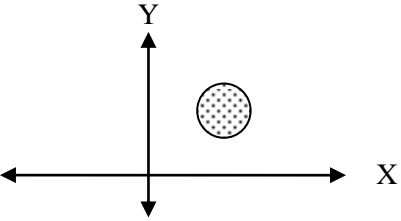
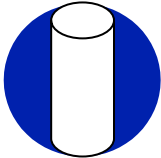
<p>6A: Draw the 3-dimensional solid that is generated when the shaded area below is rotated about the x-axis.</p> 	<p>6 B: Draw a 3-dimensional solid that will be generated if you rotate the circle below about the y-axis.</p> 
<p>7 A: Sketch a graph that will generate half a sphere when rotated about the y- axis.</p>	<p>7 B: A hole is drilled through the centre of the sphere as in the picture. Sketch the graphs that were rotated to generate the solid as in the picture below.</p> 

Questionnaire 1st run

Table 6.13: Element 6 and 7 for the Questionnaire 1st run as Question 6 and Question 7

RESPONSES	Q6A	%	Q6B	%	Q7A	%	Q7B	%
Fully correct	15	40.5	3	8.1	21	56.8	3	8.1
Almost correct	1	2.7	2	5.4	4	10.8	2	5.4
Traces of understanding	2	5.4	10	27	2	5.4	14	37.8
No understanding	8	21.6	19	51.4	7	18.9	4	10.8
Not done	11	29.7	3	8.1	3	8.1	14	37.8
% (FC + AC)		43.2		13.5		67.6		13.5

N = 37

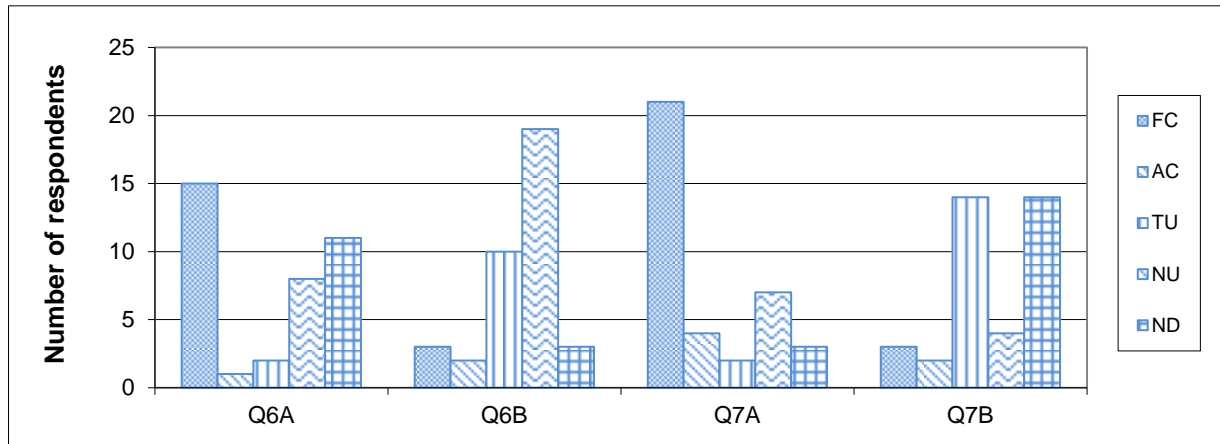

Figure 6.26: Questionnaire 1st run for Question 6 and Question 7

Questionnaire 2nd run

Table 6.14: Element 6 for the Questionnaire 2nd run as Question 6A

RESPONSES	Q6A	%
Fully correct	0	0
Almost correct	15	12.3
Traces of understanding	19	15.6
No understanding	66	54.1
Not done	22	18
% (FC + AC)		12.3

N = 122

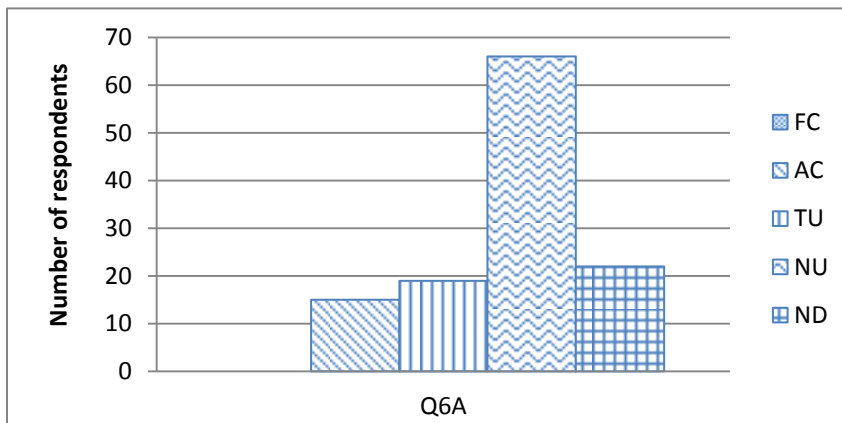

Figure 6.27: Questionnaire 2nd run for Question 6A

Table 6.15: Element 6 for the Questionnaire 2nd run as Question 6B

RESPONSES	Q6B	%
Fully correct	9	16.7
Almost correct	8	14.8
Traces of understanding	18	33.3
No understanding	18	33.3
Not done	1	1.9
% (FC + AC)		31.5

N = 54

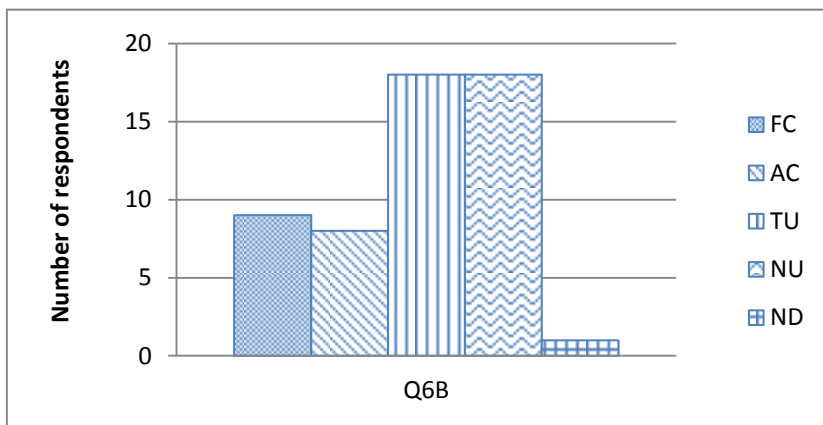

Figure 6.28: Questionnaire 2nd run for Question 6B

Table 6.16: Element 7 for the Questionnaire 2nd run as Question 7

RESPONSES	Q7A	%	Q7B	%
Fully correct	28	23.0	4	3.3
Almost correct	8	6.6	1	0.8
Traces of understanding	13	10.7	32	26.2
No understanding	57	46.7	46	37.7
Not done	16	13.1	39	32
% (FC + AC)		29.6		4.1

N = 122

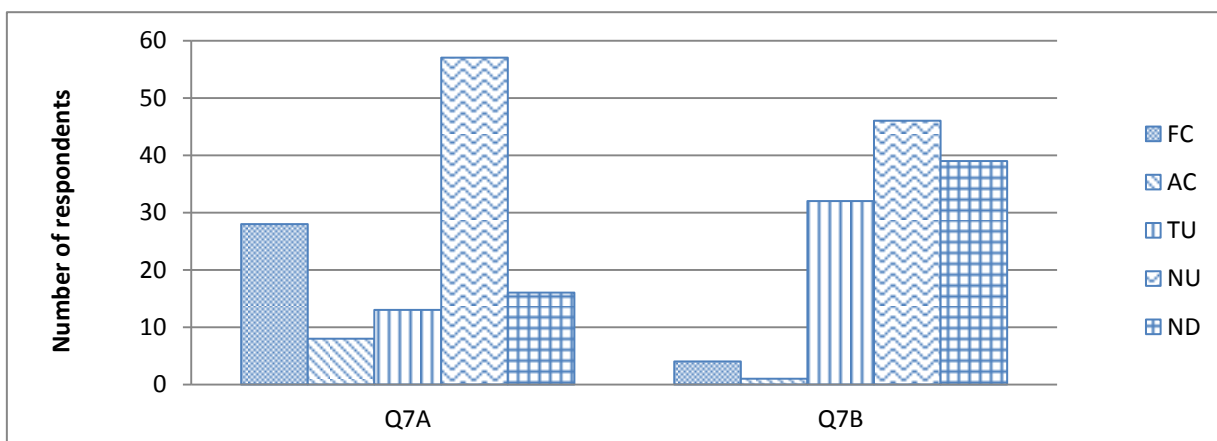

Figure 6.29: Questionnaire 2nd run for Question 7

From Tables 6.13, 6.14, 6.15 and 6.16 as well as Figures 6.26, 6.27, 6.26 and 6.29 the performance was different for the two questionnaire runs. For Question 6A a large proportion of responses in the Questionnaire 1st run, 40.5% (15), reveal that the students understood the question producing fully correct responses, even though there was also a higher percentage (29.7%) of responses showing that the students did not respond to this question with 21.6% (8) of the responses showing no understanding, evident from the bi-modal graph. In contrast, for the Questionnaire 2nd run, a large proportion of responses, 54.1% (66), reveal that the students did not understand the question with no fully correct responses, evident from the negatively skewed graph. In Question 6A, the students were expected to draw a 3D solid from a given 2D diagram after rotation of a region bounded by straight line graphs. In overall, 43.2% (16) of the responses for the Questionnaire 1st run were acceptably correct, regarded as satisfactory performance with only 12.3% (15) of the acceptably correct for the Questionnaire 2nd run, regarded as poor performance.

For Question 6B, a large proportion of responses in the Questionnaire 1st run, 51.4% (19), reveal that the students did not understand the question. In the case of the Questionnaire 2nd run the same proportion of responses, 33.3% (18) showed that the students had traces of understanding and no understanding respectively. In Question 6B a torus was an outcome after rotation of the given circle that was a certain distance from the axis. Only 13.5% (5) of the responses were acceptably correct from the Questionnaire 1st run, regarded as poor performance, evident from the negatively skewed graph. For the Questionnaire 2nd run, 31.5% (17) of the responses were acceptably correct, regarded as performance that is not satisfactory, evident from the negatively skewed graph. In both runs of the questionnaire, students performed better in Question 6A compared to Question 6B.

In Question 7A the students were expected to translate from 3D to 2D by drawing a graph that generates a sphere when rotated about the y-axis. The results from the Questionnaire 1st run reveal that a higher proportion of responses, 56.8% (21) were fully correct. For the Questionnaire 2nd run, a higher proportion of responses, 46.7% (57) were for the responses showing no understanding, with only 23% (28) of the responses being fully correct. Based on 67.6% (25) of the acceptably correct responses in the Questionnaire 1st run, evident from the positively skewed graph in Figure 6.26, the performance was regarded as being good. In the Questionnaire 2nd run, with only 29.6% of the responses being acceptably correct, evident from the negatively skewed graph as in Figure 6.29, the performance was regarded as not satisfactory.

In Question 7B the students were expected to sketch graphs of the given the solid of revolution. In the Questionnaire 1st run the same highest proportion of responses (37.8%) showed traces of understanding and those that were not done (37.8%). In the Questionnaire 2nd run, a higher proportion of the responses, 37.7% (46) was for no understanding and 32% (39) for traces of understanding. For both runs of the questionnaire, the performance was poor, with 13.5% (5) and 4.1 % (5) of the acceptably correct responses for the Questionnaire 1st run and for the Questionnaire 2nd run respectively. As in Figures 6.26 and 6.29, both graphs were negatively skewed.

In both runs of the questionnaire, performance in Question 7A was better than in Question 7B. In Questions 6 and 7, the overall impression is that for the Questionnaire 2nd run, there were few acceptably correct responses, evident from all four negatively skewed graphs in Figures 6.27, 6.28 and 6.29, compared to the Questionnaire 1st run.

Below some examples of what students actually did in Question 6A and 6B are given.

Question 6A: Typical students' errors when drawing a 3D solid resembling a cone

Traces of understanding: Students drew

- Only a disc from a Δx strip showing rotation about the x – axis
- A rotated graph about the y -axis with a Δx strip rotated about the x – axis

No understanding: Students drew

- Only a Δx strip on the drawn graph
- A graph of $y = x$ and $x = c$ with a Δy strip in the 1st quadrant
- A Δy strip on the drawn graph

The examples above reveal that students are not familiar with drawing 3D diagrams, representing solids of revolution. The rotation was only shown with a rotated strip, not a solid of revolution. The students were rotating the graphs, but in most cases the 3D shapes that arise as a result of rotation remained the original graphs. In Figures 6.30 and 6.31, examples of actual written responses are given showing *no understanding*.

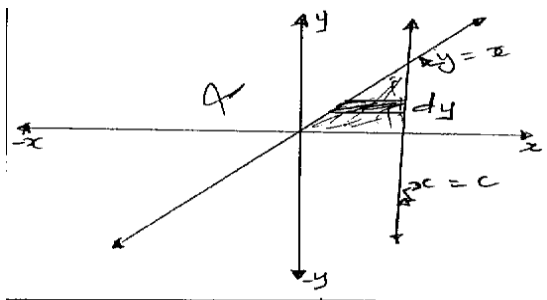

Figure 6.30: The graph of $y = x$ and the Δy strip

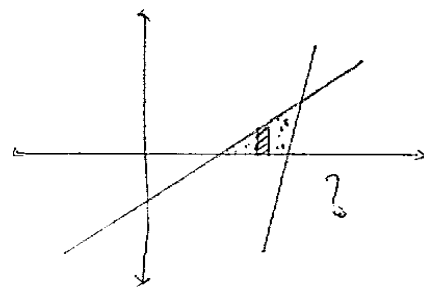

Figure 6.31: The same graph with Δx strip

Question 6B: Typical students' errors when drawing a 3D solid resembling a torus

Almost correct: Students drew

- A torus even if it was not an accurate one

Traces of understanding: Students drew

- A torus, but rotated about the x -axis
- A horizontal cylindrical pipe away from the x -axis, in the 1st and 2nd quadrant
- A horizontal cylindrical pipe away from the x -axis in the 1st quadrant

No understanding: Students drew

- A Δy strip on the given diagram
- A circle in the 1st quadrant away from the origin, with a Δx and a Δy strip
- A semicircle in the 1st and the 4th quadrant with a Δx strip
- A semicircle in the 1st and the 2nd quadrant with a Δy strip
- The same given diagram in the 4th quadrant with a Δx strip
- Three quarter circles in quadrants 1, 2 and 3
- A quarter circle in quadrant 1
- Something like a leaf on the y -axis
- Two big circles in quadrant 1 and 4
- A rectangular hyperbola rotated about the y -axis

Very few students managed to draw a torus. Students drew cylinders and other nonsensical diagrams. Students did not see the significance of the distance of this circle from both axes and did not realise that such a distance could give rise to a hole after rotation.

In Figures 6.32 and 6.33 examples of actual written responses are given showing *no understanding* and *traces of understanding*.

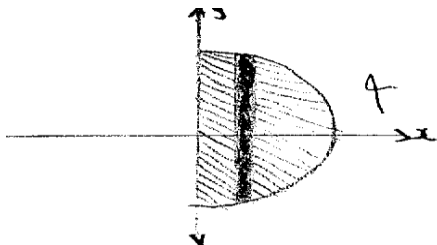

Figure 6.32: A hemisphere about the x axis

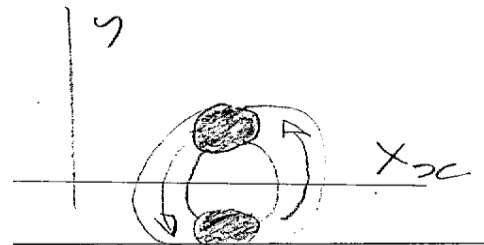

Figure 6.33: Rotation about the x -axis

Discussion on Element 6

In the Questionnaire 1st run, students performed satisfactorily (43.2%), in Question 6A where the region bounded by straight lines was rotated, and poorly (13.5%) in Question 6B involving rotation of a circle that was a certain distance from the origin, probably because it was unfamiliar. The majority of the students drew vertical or horizontal rectangles and rotated them, instead of the whole diagram as a solid of revolution. In the Questionnaire 2nd run the students' performance was not satisfactory in Question 6B with 31.5% of acceptably correct responses and poor in Question 6A with only 12.3% of acceptably correct responses.

Below some examples of what students actually did in Question 7A and 7B are given.

Question 7A: Typical students' errors when drawing a graph that could generate a hemisphere after rotation about the y -axis

Almost correct: Students drew

- Half a circle in quadrant 1 and 2, with a Δy strip in quadrant 1
- Half a circle in quadrant 1 and 4 with a Δx strip in both quadrants, in other cases without a strip.

Traces of understanding: Students drew

- A graph of $y = 1 - x^2$

No understanding: Students drew

- Different graphs, for example the graph of $y = e^x$, in other cases different strips Δx strip or Δy
- Different diagrams including a cylinder and a parabola facing down without the x intercepts and other different parabolas including a horizontal parabola $x = y^2$

The different graphs drawn reveal that some of the students did not know what a sphere was.

Figures 6.34 and 6.35 display actual written responses showing *no understanding*.

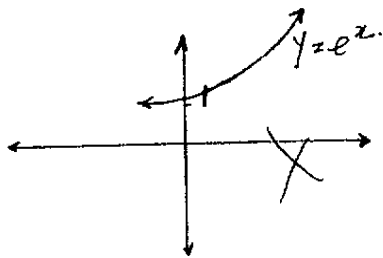

Figure 6.34: An exponential function

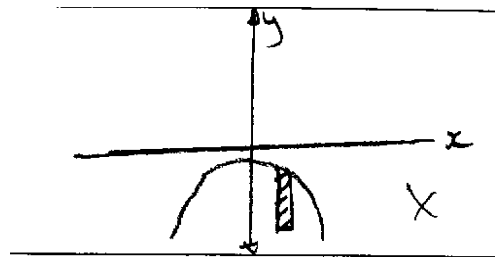

Figure 6.35: The parabolic diagram

Question 7B: Typical students' errors when drawing a graph that could generate a sphere with a cylindrical hole in the centre

Almost correct: Students drew

- Half a cylinder was drawn to show a hole in the 2nd quadrant

Traces of understanding: Students drew

- A circle and two rectangles crossing at the origin, one vertical and one horizontal
- Half a circle on the Cartesian plane with a hole
- A circle on a Cartesian plane
- A circle on a Cartesian plane with a hole like a pipe
- A circle with a Δy strip in quadrants 1 and 2
- A line $x = c$ and rotated about the y -axis, showing a cylinder
- A circle with intercepts $\pm r$; a circle with a Δy strip in quadrants 1 and 2 like a cylinder
- A cylinder with the x -axis and the y -axis intersecting at its center
- A circle and a cylinder to show a hole

No understanding: Students drew

- A cone on the Cartesian plane
- An exponential graph with a Δy strip
- A rectangular hyperbola rotated about the y -axis.

In Figures 6.36 and 6.37, examples showing *traces of understanding* are given.

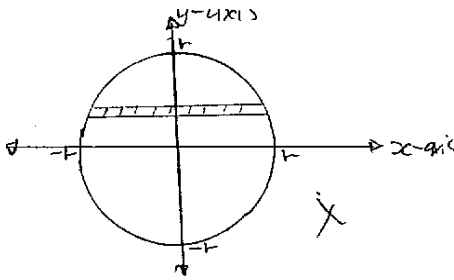

Figure 6.36: A circular shape

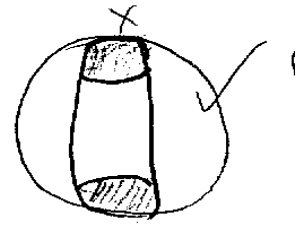

Figure 6.37: A circle and a rod

Discussion on Skill factor II

In the Questionnaire 1st run, students' performance was good when translating from 3D to 2D, when drawing a graph that could generate half a sphere after rotation and performed satisfactorily when translating from 2D to 3D, where the given straight line results in a cone after rotation. Students struggled mainly with the questions that require more imaginative skills at a higher level, when translating between 2D and 3D. Most students failed to comprehend a question where a given 2D diagram resulted in a torus after rotation (translation from 2D to 3D), regarded as poor performance. Most students did not respond to a question when they were expected to draw the graphs that could give rise to a sphere with a cylindrical hole in the centre (translation from 3D to 2D). This was also regarded as poor performance. The student partially managed to work in 2D and in 3D. Therefore translation from 2D to 3D and from 3D to 2D was partially achieved only for simple diagrams, such as a straight line that gave rise to a cone and a semicircle that gives rise to half a sphere, mainly in the Questionnaire 1st run. Most students failed when the diagrams involved more imaginative skills at a higher level of conceptualising.

The result from the Questionnaire 2nd run revealed that many students struggled with most of the questions in this element. The performance was poor when the students were expected to draw the graphs that could give rise to a sphere with a cylindrical hole in the centre (translation from 3D to 2D) and when translating from 2D to 3D, where the given straight line results in a cone after rotation. The performance was not satisfactory in the remaining two questions. For the one question, the students solved a problem where a given 2D diagram resulted in a torus after rotation (translation from 2D to 3D), while for the other question the students were expected to draw a graph that could generate half a sphere after rotation.

6.1.3 Skill factor III: Moving between discrete and continuous

- **Element 8: Continuous to discrete (visual) in 2D and 3D and**
Element 9: Discrete to continuous and continuous to discrete (algebraic) in 2D and 3D

The questions for Element 8 and 9 were as follows:

Table 6.17: Element 8 and 9 questions

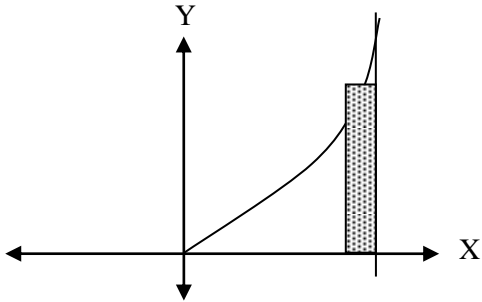
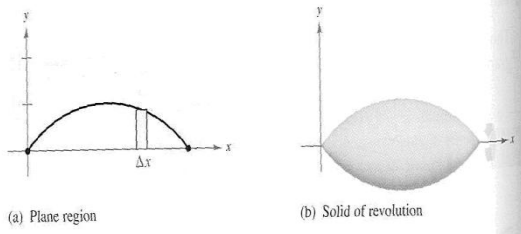
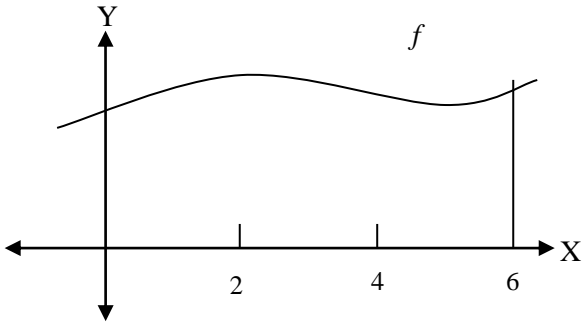
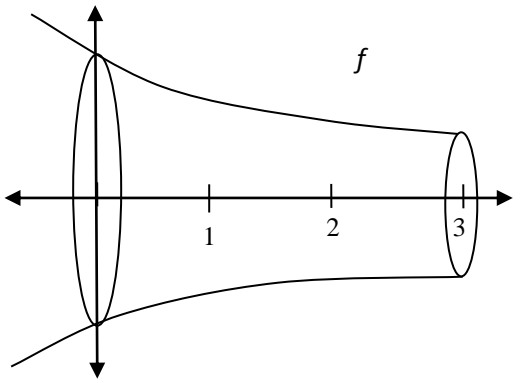
<p>8A: Sketch three additional rectangular strips (similar to the given rectangle) so that the total area of the rectangles approximates the area under the graph.</p> 	<p>8B: When the plane region (a) on the left is rotated, the 3-dimensional solid of revolution (b) on the right is generated. Show using diagrams how you would cut the solid of revolution (b) in appropriate shapes (discs, shells or washers) to approximate its volume.</p>  <p>(a) Plane region (b) Solid of revolution</p>
<p>9 A: Show in terms of rectangles what the following represent with a sketch: $2f(0) + 2f(2) + 2f(4)$</p> 	<p>9 B: If the volume of the given solid of revolution is approximated by discs, sketch the discs that would give the volume: $\pi(f(0))^2 + \pi(f(1))^2 + \pi(f(2))^2$</p> 

Questionnaire 1st run

Table 6.18: Element 8 and 9 for the Questionnaire 1st run as Question 8 and Question 9

RESPONSES	Q8A	%	Q8B	%	Q9A	%	Q9B	%
Fully correct	8	21.6	2	5.4	1	2.7	0	0
Almost correct	3	8.1	1	2.7	2	5.4	0	0
Traces of understanding	15	40.5	12	32.4	2	5.4	17	46
No understanding	10	27	6	16.2	12	32.4	9	24.3
Not done	1	2.7	16	43.2	20	54.1	11	29.7
% (FC + AC)		29.7		8.1		8.1		0

N = 37

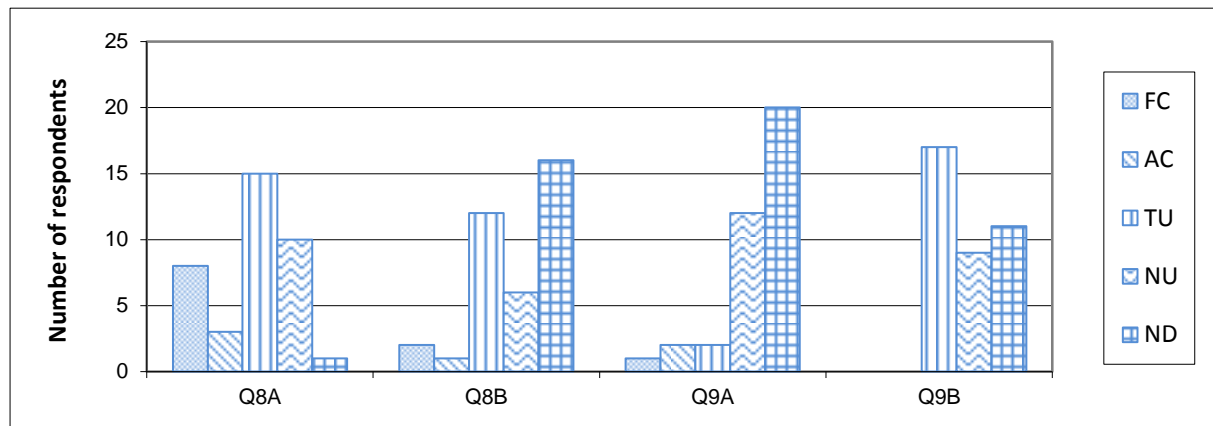

Figure 6.38: Questionnaire 1st run for Question 8 and Question 9

Questionnaire 2nd run

Table 6.19: Element 8 and 9 for the Questionnaire 2nd run as Question 8B and Question 9A

RESPONSES	Q8B	%	Q9A	%
Fully correct	0	0	0	0
Almost correct	0	0	15	12.3
Traces of understanding	14	11.5	19	15.6
No understanding	47	38.5	33	27.1
Not done	61	50	55	45.1
% (FC + AC)		0		12.3

N = 122

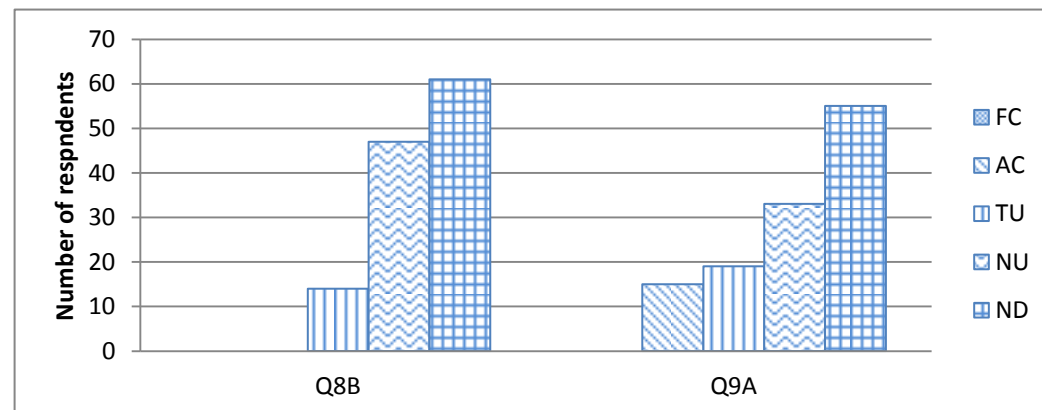

Figure 6.39: Questionnaire 2nd run for Question 8B and Question 9A

Table 6.20: Element 8 and 9 for the Questionnaire 2nd run as Question 8A and Question 9B

RESPONSES	Q8A	%	Q9B	%
Fully correct	4	7.4	0	0
Almost correct	2	3.7	0	0
Traces of understanding	38	70.4	44	81.5
No understanding	10	18.5	6	11.1
Not done	0	0	4	7.4
% (FC + AC)		11.1		0

N = 54

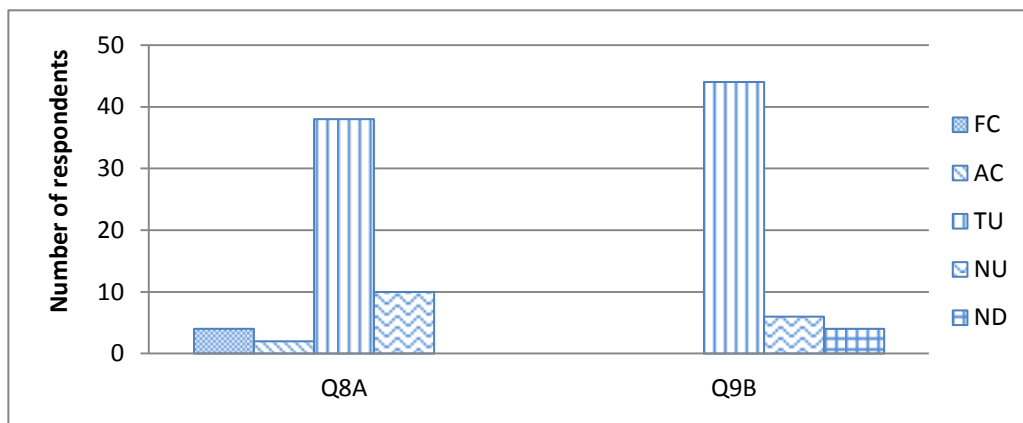

Figure 6.40: Questionnaire 2nd run for Question 8A and Question 9B

The performance in this element was poor for all questions. For both runs of the questionnaire, the highest responses in Questions 8A and 9B revealed traces of understanding, 40.5% (15) and 46% (17) respectively for the Questionnaire 1st run and 70.4% (38) and 81.5% (44) for Questionnaire 2nd run. The proportion of acceptably correct responses in Question 8A, 29.7% (11) for Questionnaire 1st run reveals that the performance was not satisfactory. In the Questionnaire 2nd run, the performance in this question was poor, with only 11.1% (6) of the responses being acceptably correct. The graphs representing these questions (as in Figures 6.38 and 6.40) are negatively skewed. None of the students obtained fully correct or almost correct responses in Question 9B, represented by the first and the longest bar for traces of understanding as in Figures 6.38 and 6.40. In Question 9B the students were expected to represent the three discs from the given formula on the given diagram. In Question 8A the region bounded by graphs was to be approximated using three additional rectangles.

Most of the students did not respond to Questions 8B and 9A, 43.2% (16) and 54.1% (20) respectively for Questionnaire 1st run and 50% (61) and 45.1% (55) respectively for the Questionnaire 2nd run. There were only 8.1% (3) acceptably correct responses for Questions

8B and 9A for the Questionnaire 1st run and 0% and 12.3% (15) for the Questionnaire 2nd run, all regarded as poor performance. The graphs representing these questions (as in Figures 6.38, and 6.39) are negatively skewed. Question 8B involved the approximation of the rotated region bounded by graphs using discs and Question 9A involved a representation of three rectangles from the given formula on the given diagram.

Question 8 involved operating visually in 2D and 3D and approximating area and volume by slicing based on the concepts of the Riemann sums, whereas Question 9 involved approximating area and volume algebraically in 2D and in 3D.

Below some examples of what students actually did in Question 8A and 8B are given.

Question 8A: Typical students' errors when approximating area using rectangular strips

Almost correct: Students drew

- Three additional rectangles correctly, but not well on scale.

Traces of understanding: Students drew

- Two additional rectangles correctly
- Three additional rectangles but separated them
- Seven additional rectangles
- Two additional separated rectangles, not joint

No understanding: Students drew

- An image of the rotated given graph about the x -axis
- The image of the rotated given graph about the y -axis using a Δx strip
- Some vertical lines separately
- Mirror images of the original graph when reflected about the x and the y -axis separately
- A rectangle along the x -axis

Question 8A required that the students must approximate the area bounded by a curve using rectangles that are joined to each other, originating from Riemann sums. In Figures 6.41 and 6.42 examples of actual written responses for students showing *no understanding* and *traces of understanding* are given.

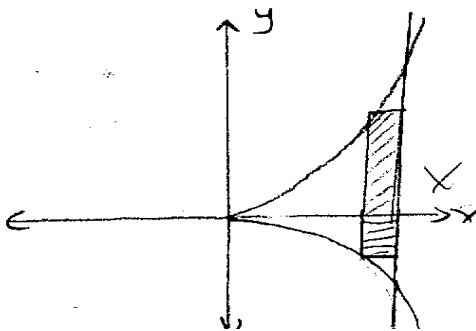

Figure 6.41: One rectangle

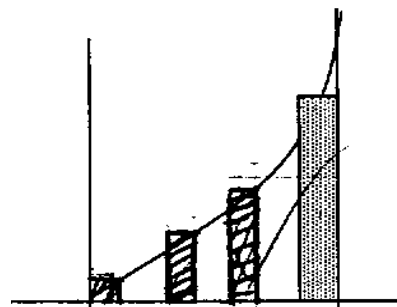

Figure 6.42: Four rectangles

Question 8B: Typical students' errors when approximating volume using discs

Almost correct: Students drew

- Two discs

Traces of understanding: Students drew

- A vertical disc, but labelled it Δy
- One disc in the middle of the diagram
- One strip in quadrants 1 and 4 in the middle of the diagram

No understanding: Students drew

- A Δy strip on the x – axis in the middle of the diagram; cut it in the middle leaving an open disc; a rectangular hyperbola rotated about the x – axis.

In Question 8B students were required to approximate the volume of a given solid using discs. Figures 6.43 and 6.44 give examples of actual written responses showing *traces of understanding*.

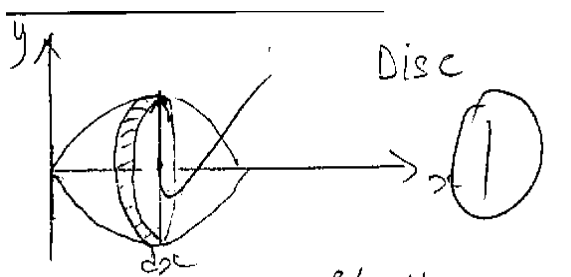

Figure 6.43: The first ring

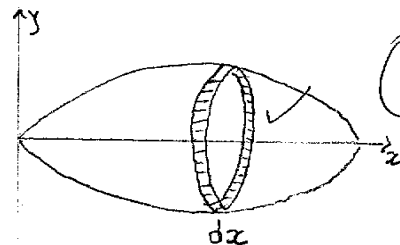

Figure 6.44: The second ring

Below some examples of what students actually did in Question 9A and 9B are given.

Question 9A: Typical students' errors when representing area from the given equation

Almost correct: Students drew

- Rectangles, where the middle rectangle, $f(2)$ not properly done

Traces of understanding: Students drew

- 4 vertical lines without joining the top
- 3 rectangles not corresponding to the given function
- Rectangles drawn, without drawing the function

No understanding: Students drew

- A rectangle of length 4 and breadth 2 separately
- A rectangle of unspecified breadth and length 6 separately
- A rectangle of unspecified length and breadth 2 separately
- A rectangle of unspecified breadth and length 4 separately
- A line $y = 2$ from the y – axis
- A rectangle of length 6 and breadth 2 separately
- A rectangle of length 6 and breadth 12 separately
- A rectangle of length $2f(4)$ and breadth $2f(2)$ separately
- A trapezium

The performance in Question 9A was disappointing. Students could not interpret the given expressions and could not relate it to the given function. They did not recognise that the

width (relating to the x values) of all the rectangles is 2 and that $f(0)$, $f(2)$ and $f(4)$ represented the length (relating to the y values) of the rectangles, hence the length times the width represented by, $2f(0)$, $2f(2)$, and $2f(4)$ respectively which need to be summed, as in Riemann sums. Despite the fact that the question stated explicitly that the rectangles should be drawn, the students had no idea where the rectangles should be located on the given diagram as an approximation for area. In Figures 6.45 and 6.46 examples actual written responses display *no understanding*.

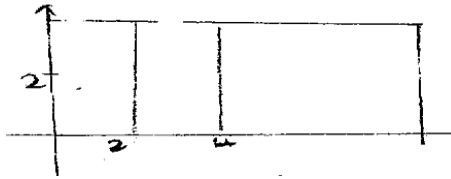

Figure 6.45: Unequal rectangles

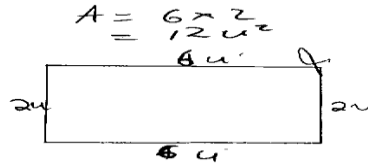

Figure 6.46: A rectangle of area 12

Question 9B: Typical students' errors when representing volume from the given equation

Traces of understanding: Students drew

- Vertical then discs at the given x -intercepts of 1 and 2
- 2 vertical half discs at the given x -intercepts of 1 and 2
- One disc in the middle of the diagram
- 2 discs anywhere

No understanding: Students drew

- A horizontal disc around the y – axis
- The same given diagram upside down
- A cylinder
- The top half of the given graph
- A semicircle
- The same graph reduced from 0 to 2 for the x values

In Question 9B rather than using rectangles, students were asked for an approximation of volume using discs of the same thickness, to approximate the volume on the given diagram. Even though it was explicitly asked that the volume should be represented by discs, also in the formula πr^2 , from the given formula where in each case r is represented as $f(0)$, $f(1)$ or $f(2)$ respectively, the majority of the students struggled to use the formula to translate to the appropriate discs. None of the students responded correctly to this question. The students simply failed to interpret the question, even though there were traces of understanding in most instances. The students drew discs which did not have the same thickness, as it was required from the given x - intercepts on the diagram where three discs of thickness 1 could be drawn.

In Figures 6.47 and 6.48, examples of actual written responses showing *traces of understanding* are given.

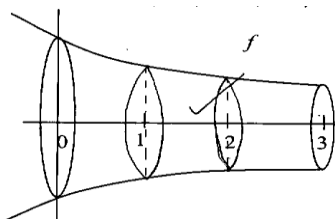

Figure 6.47: The thin circles

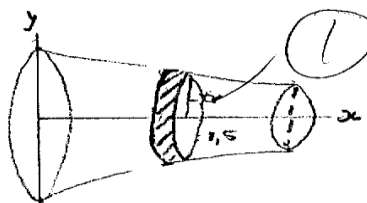

Figure 6.48: A circle of radius 1.5

Discussion on Skill factor III

In Skill factor III, performance was very low for both runs of the questionnaire. Students approximated the given area or volume, for other questions by using disjoint rectangles of the same width or slices of the same thickness, not showing any continuity of points on a continuous function. It was evident that students were not familiar with the concept of Riemann sums. Students were certainly not able to translate from continuous to discrete representations and from discrete to continuous representations in 2D and in 3D, where the given equations represented rectangles and discs.

6.1. 4 Skill factor IV: General manipulation skills

Skill factor IV comprises Element 10 only.

The questions for Element 10 were as follows:

10A: Calculate the point of intersection of $4x^2 + 9y^2 = 36$ and $2x + 3y = 6$

10B: Calculate $\int_0^1 \pi(1-x^2)^2 dx$

10C: Calculate $\int_0^1 2\pi x(1-\sin x) dx$

Questionnaire 1st run

Table 6.21: Element 10 for Questionnaire 1st run as Questions 10

RESPONSES	Q10A	%	Q10B	%	Q10C	%
Fully correct	10	27.1	15	40.5	2	5.4
Almost correct	3	8.1	7	18.9	22	59.5
Traces of understanding	1	2.7	2	5.4	9	24.3
No understanding	22	59.5	4	10.8	3	8.1
Not done	1	2.7	9	24.3	1	2.7
% (FC + AC)		35.2		59.4		64.9

N = 37

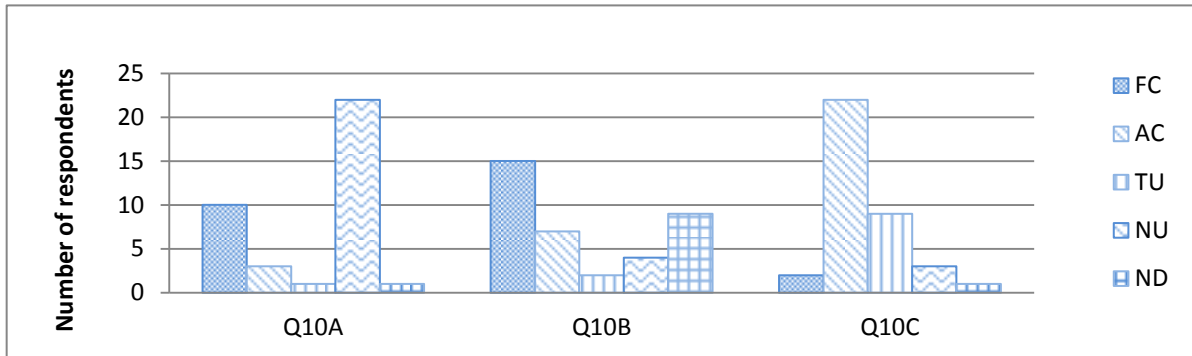

Figure 6.49: Questionnaire 1st run for Questions 10

Questionnaire 2nd run

Table 6.22: Element 10 for Questionnaire 2nd run as Questions 10

RESPONSES	Q10A	%	Q10B	%	Q10C	%
Fully correct	8	6.6	55	45.1	4	3.3
Almost correct	5	4.1	25	20.5	28	23
Traces of understanding	7	5.7	15	12.3	32	26.2
No understanding	97	79.5	12	9.8	58	47.5
Not done	5	4.1	15	12.3	0	0
% (FC + AC)		10.7		65.6		26.3

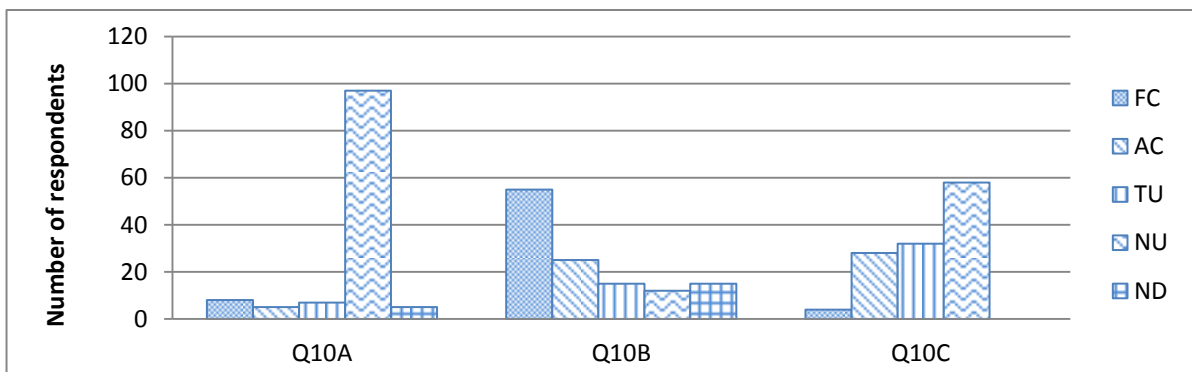

Figure 6.50: Questionnaire 2nd run for Questions 10

From Tables 6.21 and 6.22 as well as Figures 6.49 and 6.50, for both questionnaire runs, the performance was low in Question 10A, where students were expected to calculate the point of intersection of $4x^2 + 9y^2 = 36$ and $2x + 3y = 6$. A higher proportion of responses, 59.5% (22) in the Questionnaire 1st run and large proportion of responses 79.5% (97), for Questionnaire 2nd run showed that most of the students were unable to calculate the point of intersection. It is also evident from the bar graphs (Figures 6.49 and 6.50) for Question 10 A, which are negatively skewed, that few responses were acceptably correct, 35.2% (13) in the Questionnaire 1st run and 10.7% (13) in the Questionnaire 2nd run. The performance was not satisfactory (35.2%) for the Questionnaire 1st run and poor (10.7%) in the Questionnaire 2nd run.

In relation to the other questions, the performance was better in Question 10B for both Questionnaire 1st run and Questionnaire 2nd run, where most of the responses were fully correct, 40.5 % (15) for Questionnaire 1st run and 45.1% (55) for Questionnaire 2nd run. In Question 10B, the students were expected to evaluate a definite integral involving basic power rules, with all students in the Questionnaire 1st run responding to this question. Performance in this question was satisfactory in Questionnaire 1st run with 59.4% (22) of the responses being acceptably correct and good in the Questionnaire 2nd run with 65.6% (80) of the responses being acceptably correct, also shown in Figures 6.49 and 6.50 which are positively skewed for Question 10B.

In Question 10C a higher proportion of responses, 59.5% (22) in the Questionnaire 1st run were almost correct responses, and 24.3% (9), showed some traces of understanding. In the Questionnaire 2nd run, there was a higher proportion of non-responses, 47.5% (58) with only 3.3% (4) of fully correct responses. In the Questionnaire 1st run, as evident from the positively skewed graph (Figure 6.49), there were a large proportion of acceptably correct responses (64.9%). In contrast, as evident from the negatively skewed graph (Figure 6.50) in Questionnaire 2nd run, there were few acceptably correct responses (26.3%). In this question, students were expected to evaluate a definite integral involving integration by parts. Even though there was an indication of some manipulation skills, some of the mistakes that students made were because they used incorrect algorithms.

The results reveal that from both questionnaire runs, students were less successful in solving Question 10A, where they had to calculate the point of intersection, which seemed simpler than the other two questions, where they had to evaluate the definite integral.

Below some examples of what students actually did in Question 10A, 10B and 10C are given.

Question 10A: Typical students' errors when calculating the point of intersection

Almost correct: Students

- Substituted correctly but manipulated incorrectly

Traces of understanding: Students

- Substituted correctly but made a mathematical error when simplifying the roots, since they did not square them

No understanding: Students

- Solved for the x -intercept and the y -intercept for each equation
- Equated some graphs in an incorrect way
- Only made y the subject of the formula in the linear equation and did not proceed
- Took square roots incorrectly like $\sqrt{36 - 4x^2}$ as $6 - 2x$
- Differentiated the two equations representing the two graphs

Some of the students were able to solve problems in general manipulation skills, even though there were substantial mathematical errors in some cases. Such errors occurred mostly in Question 10A, for example when some students were finding the x - and the y -intercepts for the graphs, some equated the equations representing the two graphs incorrectly while others took square roots incorrectly: $\sqrt{36-4x^2} = 6-2x$. Figures 6.51 and 6.52 present examples of actual written responses *showing no understanding*. In Figure 6.51 the solution is incomplete and in Figure 6.52 the solution is completely incorrect.

$$y = 2 - \frac{2x}{3} \dots \textcircled{1}$$

$$y = 2 - \frac{2x}{3} \dots \textcircled{2}$$

Figure 6.51: Incorrect solution 1

$$y \Rightarrow$$

$$\frac{2}{3}x^2 + 2 = 2 - \frac{2}{3}x$$

$$-\frac{2}{3}x + \frac{2}{3}x = 0$$

$$-\frac{2}{3}x(x-1) = 0$$

$$x = 0 \text{ or } x = 1$$

$$(0, 2) \text{ \& } (1, \frac{4}{3})$$

Figure 6.52: Incorrect solution 2

Question 10B: Typical students' errors when evaluating the integral

Almost correct: Students

- Calculated incorrectly after correct integration and substitution

Traces of understanding: Students

- Integrated incorrectly

No understanding: Students simplified $(1-x^2)^2$ as follows

- $(1-x^2)^2 = 1-x^4$
- $(1-x^2)^2 = 1+x^4$

Question 10C: Typical students' errors when using the integration by parts

Almost correct: Students

- Used integration by parts, but made mistakes with signs
- Integrated by parts correctly, but made mistakes at the end of the calculation

Traces of understanding: Students

- Used integration by parts, but lost the other part
- Did not use integration by parts correctly

No understanding: Students

- Made a mathematical error by multiplying $x \sin x$ to be $\sin^2 x$
- Made a mathematical error by multiplying $x \sin x$ to be $\sin x^2$

For questions such as in Question 10C, although some students made mathematical errors such as shown above, most students were able to solve the integral even if they were making errors with the signs.

Conclusions from Skill factor IV

Students are fairly proficient with general manipulation skills, especially in the Questionnaire 1st run. They mainly make mistakes in applying the integration techniques, like the integration by parts. In other instances they take square roots incorrectly or make mathematical errors. However, as they continue to calculate, they showed proficiency in the general manipulation skills. It can be argued that students were reasonably successful in this element.

6.1.5 Skill factor V: Consolidation and general level of cognitive development

Skill factor V comprises Element 11 only.

In this element there were 2 questions. The aim of the questions was to test whether students can do an entire problem correctly, in this way consolidating the individual skills tested from five different elements: graphing skills, general manipulation skills, moving from continuous to discrete (visual 2D and 3D), translation from visual to algebraic in 2D and translation from visual to algebraic 3D combined, from Skill factors I, II, III and IV.

The questions for Element 11 were as follows:

11A: Given: $y = \sin x$ and $y = 1$, where $x \in \left[0, \frac{\pi}{2}\right]$

- (i) Sketch the graphs and shade the area bounded by the graphs and $x = 0$.
- (ii) Show the rotated area about the y -axis and the representative strip to be used to calculate the volume generated.
- (iii) Calculate the volume generated when this area is rotated about the y -axis.

11B: Use integration methods to show that the volume of a cone of radius r and height h is given by

$$V = \frac{1}{3} \pi r^2 h.$$

Questionnaire 1st run

Table 6.23: Element 11 for the Questionnaire 1st run as Question 11

RESPONSES	Q11A	%	Q11B	%
Fully correct	0	0	1	2.7
Almost correct	6	16.2	4	10.8
Traces of understanding	24	64.9	2	5.4
No understanding	4	10.8	17	46
Not done	3	8.1	13	35.1
% (FC + AC)		16.2		13.5

N = 37

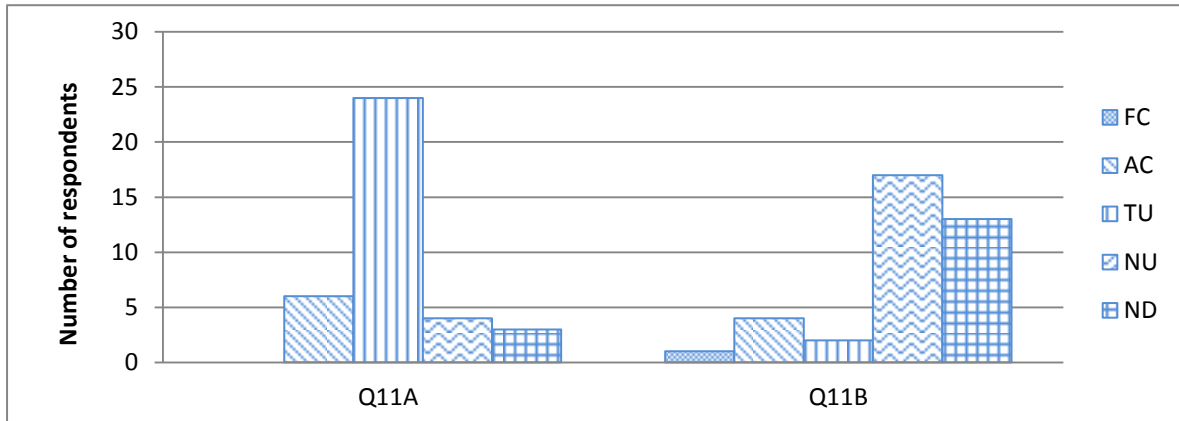

Figure 6.53: Questionnaire 1st run as Question 11

Questionnaire 2nd run

Table 6.24: Element 11 for the Questionnaire 2nd run as Question 11A

RESPONSES	Q11A	%
Fully correct	0	0
Almost correct	4	3.3
Traces of understanding	63	51.6
No understanding	52	42.6
Not done	3	2.5
% (FC + AC)		3.3

N = 122

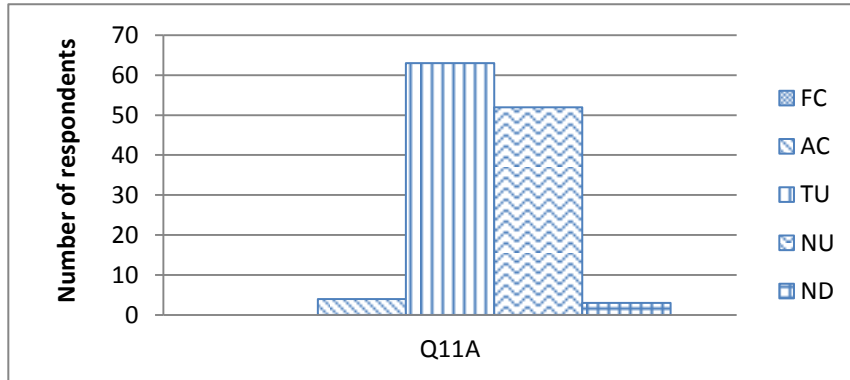

Figure 6.54: Questionnaire 2nd run for Question 11A

Table 6.25: Element 11 for the Questionnaire 2nd run as Question 11B

RESPONSES	Q11B	%
Fully correct	0	0
Almost correct	0	0
Traces of understanding	2	3.7
No understanding	39	72.2
Not done	13	24.1
% (FC + AC)		0

N = 54

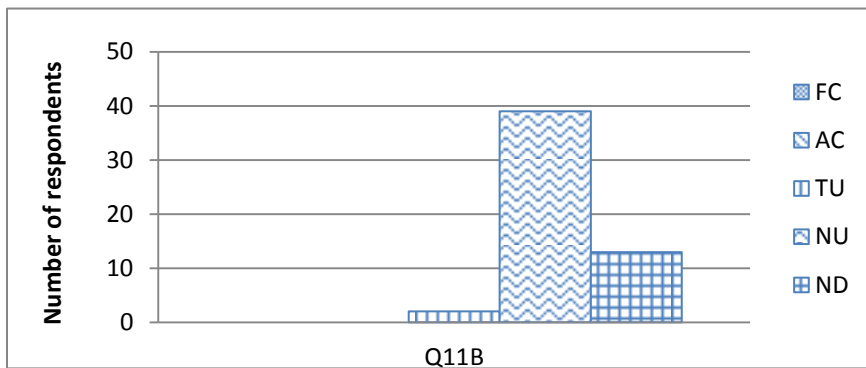

Figure 6.55: Questionnaire 2nd run for Question 11B

From Tables 6.23, 6.24 and 6.25 and Figures 6.53, 6.54 and 6.55 it is evident that the students did not do well in this element. In the Questionnaire 1st run, none of the students produced fully correct responses in Question 11A, with a large proportion of responses 64.9% (24), showing traces of understanding, as displayed from Figure 6.53. The responses showing traces of understanding reveal that the students had an idea on how to approach the question but were confused at times. In Question 11A, 16.2% (6) of the responses were acceptably correct, regarded as poor performance. In the Questionnaire 2nd run, a large proportion of responses 51.6% (63) and 42.6% (52) were for traces of understanding and no understanding respectively, as shown in Figure 6.54. As it was in the Questionnaire 1st run, there were no fully correct responses. Only 3.3% (4) of the responses were acceptably correct.

In Question 11B, from the Questionnaire 1st run, the highest proportion of responses, 46% (17), was an indication of no understanding, with 35.1% (17) of non-responses and only 2.7% (1) of the responses being fully correct. The proportion of acceptably correct responses in this question is 13.5% (5), revealing that there were few acceptably correct responses, as indicated in Figure 6.63, which is negatively skewed. The performance for Question 11B was worse than for Question 11A, with the highest number of responses showing no understanding or not done at all. For the Questionnaire 2nd run, the performance was the lowest in Question 11B with no fully correct or almost correct responses. Most of the responses, 72.2% (39) was an indication of no understanding. There were no acceptably correct responses, as shown in Figure 6.55.

The performance in both questionnaire runs in Question 11 was poor (less than 20% of acceptably correct responses). This question, structured in the same way as the final N6 examinations portrays the students' level of cognitive development as very low or not developed.

Below are some examples of what students actually did in Question 11A and 11B.

Question 11A: Typical students' errors in drawing the graphs, shading the bounded region, selecting the strip and selecting the formula for volume

Traces of understanding: Students

- Drew correct graphs, shaded correctly, drew a disc using a Δy strip, but used formulas for disc and shell in same equation used $2\pi \int_0^1 y (\sin^{-1} y)^2 dy$
- Drew a Δx strip but used a washer method when substituting, which was incorrect
- Drew two Δx strips on separate graphs, but labelled them as Δy , one incorrectly (i) then (ii) correctly
- Drew a Δy strip and used the formula $x = \int \sin^{-1} y dy$ or $\pi \int_0^{\frac{\pi}{2}} (\sin^2 x) dx$ or $\pi \int_0^{\frac{\pi}{2}} (\sin^2 x - 1) dx$
- Drew a Δy strip and used an incorrect formula as $\pi \int_0^1 x (\sin x) dx$, after substituting in the correct formula
- Used a Δy strip and shaded below, used formula, even if a Δy strip was drawn
- Selected a Δx strip incorrectly under the sine graph, drew a disc as if a Δy strip was rotated about the y -axis and used an incorrect formula as $\pi \int_0^{90} x (\sin x) dx$, after substituting in the correct formula

No understanding: Students

- Drew an incorrect sine graph and selected a Δx strip below it, using a the formula $\int_0^{\frac{\pi}{2}} x^2 (\sin x) dx$
- Drew a correct sine graph and selected a Δy strip below it

The variety of different attempts in this question reveals how confused the students were, and how failure in one facet of the problem can make them fail in the rest of the problem. A vast number of students were seen to use different formulae to calculate volume despite the fact that they might have chosen the correct strip and perhaps also rotated it correctly. None of the responses were correct. All the students struggled to come up with the correct formula for a

shell as $2\pi \int_0^{\frac{\pi}{2}} x(1 - \sin x) dx$, despite the fact that some of them managed to draw the correct graph and the correct strip. It seems as if students do not have a clue about how different strips results in different solids leading to a disc, a washer or a shell method. A significant number of students were seen to use the boundaries as 1 and 0, instead of seeing the graph of $y=1$ as the top graph and the graph of $y = \sin x$ as the bottom graph. The results also reveal that students avoid the shell method; they tend to use the disc method or the washer method.

In Figures 6.56 and 6.57, examples of actual written responses are given, showing *traces of understanding*.

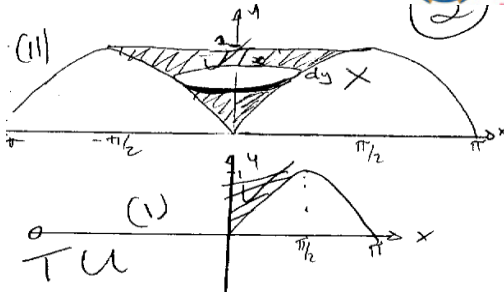

Figure 6.56: Correct graph with a Δy strip

$$\begin{aligned}
 (ii) \quad V_x &= 2\pi \int_a^b x y \, dy \\
 V &= 2\pi \int_0^{\pi/2} y (\sin^{-1} y)^2 \, dy \\
 &= 2\pi \left\{ y \cdot (\sin^{-1} y)^2 - \int y \cdot 2 \sin^{-1} y \cdot \frac{1}{\sqrt{1-y^2}} \, dy \right\}
 \end{aligned}$$

Figure 6.57: Inverse function manipulation

Question 11B: Typical students' errors when deriving the formula for volume of a cone

Almost correct: Students

- Used $y = \frac{r}{h}x + c$ and integrated correctly with the shell method, but lost h on the way.
- Drew a line similar to $y = x$, labelled it $y = mx + c$ and rotated about the y -axis formulating a cone with radius r and height h , and used the formula $V_y = \pi \int_0^r \left(\frac{h}{r}x\right)^2 dy$, but erased the square on h and r in the next step, working towards the formula

Traces of understanding: Students

- Drew a correct straight line in the 2nd quadrant, but did not give its equation nor integrate
- Wrote the formula $y = \frac{r}{h} + c$, without the graph and integrated using the formula $V = 2\pi \int_0^r (h-x)y \, dy$

No understanding: Students

- Did not draw graphs, the equation $\frac{1}{3}\pi h$ and $\frac{1}{3}\pi r^2$ were integrated with no limits of integration
- Calculated volume as $\frac{dV}{dr}$, also $\frac{dV}{dh}$ same as in rate of change
- Integrated $\int_a^b \frac{1}{3}\pi r^2 dx$ but still failed, some without limits
- Integrated $\frac{1}{3}\pi r^2 h$ to be, $\frac{1}{3}\pi x \frac{r^3}{3} \frac{h^2}{2}$ or $\frac{1}{3}\pi \frac{r^3}{3} \frac{h^2}{2}$, or $\frac{1}{9}\pi r^2 h$ and $\frac{1}{6}\pi r^2 h^2$ as in rate of change

Discussion on Skill factor V

The majority of the students lacked the broader cognitive skills required to solve Question 11A. Students in this case did not display the possibility of cognitive development. They were actually performing poorly. Students were in most cases seen to use a Δx strip and a disc or a washer method. At times a disc or washer method was used with a Δy strip. Those who tried to use the shell method struggled when having to substitute using the two graphs or from the correct limits. For Question 11B, most of the students were seen to integrate the given expression. It seems as if most of the students do not know that the given expression can be derived from the 1st principles as formula for volume of a cone which is formulated when a straight line with a positive or negative gradient is rotated about the x -axis or the y -axis, depending on how the line is drawn and how the strip is selected.

6.1.6 Overall responses per question, per element and per skill factor for the questionnaire runs

Table 6.26 and the Figures 6.58 and 6.59 display the sum of individual rank scores (from Appendix 4A) of the responses from the Questionnaire 1st run under each question. Overall performance is presented, to indicate performance in terms of the proportion of fully correct and almost acceptably correct responses in questions, elements and skill factors.

Table 6.26: All 11 elements for the Questionnaire 1st run

RESPONSES	GR		AV2D		VA2D		AV3D		VA3D		2D-3D		3D-2D		CD(V)		DC-CD(A)		GMNP			CGLCD	
	1A	1B	2A	2B	3A	3B	4A	4B	5A	5B	6A	6B	7A	7B	8A	8B	9A	9B	10A	10B	10C	11A	11B
FC	4	9	3	13	31	16	4	4	23	4	15	3	21	3	8	2	1	0	10	15	2	0	1
AC	6	10	28	8	2	4	8	18	6	6	1	2	4	2	3	1	2	0	3	7	22	6	4
TU	0	8	4	4	3	8	3	10	5	0	2	10	2	14	15	12	2	17	1	2	9	24	2
NU	17	10	1	10	1	8	11	2	3	18	8	19	7	4	10	6	12	9	22	4	3	4	17
ND	10	0	1	2	0	1	11	3	0	9	11	3	3	14	1	16	20	11	1	9	1	3	13
(FC+AC)	10	19	31	21	33	20	12	22	29	10	16	5	25	5	11	3	3	0	13	22	24	6	5
Questions %	27.0	51.4	83.8	56.8	89.2	54.1	32.4	59.5	78.4	27.0	43.2	13.5	67.6	13.5	29.7	8.1	8.1	0.0	35.1	59.5	64.9	16.2	13.5
ELM%(FC+AC)	39.2%		70.3%		71.6%		45.9%		52.7%		28.4%		40.5%		18.9%		4.1%		53.2%			14.9%	
SKF %(FC+AC)	55.9%										34.5%				11.5%				53.2%			14.9%	
OVERALL%	40.5%																						

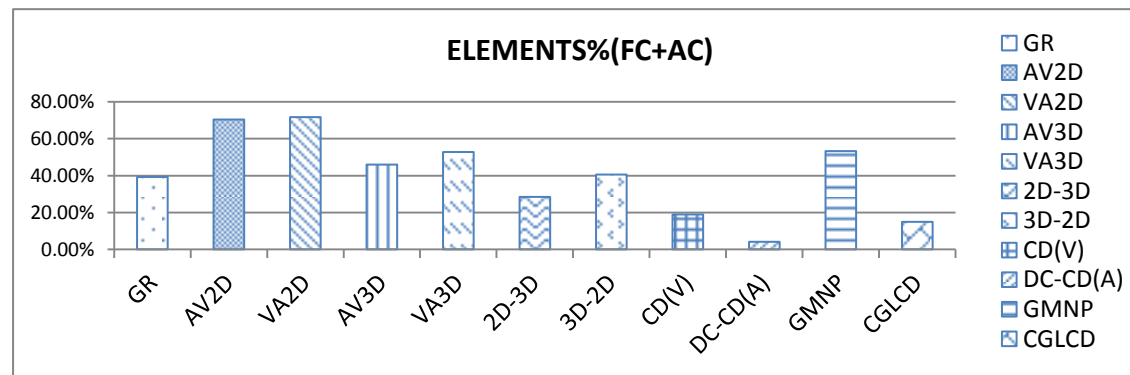

For the tables in this section, the following acronyms are used

GR: Graphing skills
 AV2D: Translation from algebraic to visual in 2D
 VA2D: Translation from visual to algebraic in 2D
 AV3D: Translation from algebraic to visual in 3D
 VA3D: Translation from visual to algebraic in 3D
 2D-3D: Translation from 2D to 3D
 3D-2D: Translation from 3D to 2D
 CD(V): Translation from continuous to discrete (visually)
 DC-CD(A): Translation from discrete to continuous and continuous to discrete (algebraic)
 GMNP: General manipulation skills
 CGLCD: Consolidation and general level of cognitive development

Figure 6.58: Comparing the 11 elements for the Questionnaire 1st run

From Table 6.26, it is evident that the performance was poor in 7 questions falling under 5 elements (translation from 2D to 3D, translation from 3D to 2D, translation from continuous to discrete (visually), translation from discrete to continuous and continuous to discrete (algebraic) and consolidation and general level of cognitive development), not satisfactory in 5 questions falling under 5 elements (graphing skills, translation from algebraic to visual in 3d, translation from visual to algebraic in 3D, translation from continuous to discrete (visually) and general manipulation skills), satisfactory in 6 questions falling under 6 elements (graphing skills, translation from algebraic to visual in 2D, translation from visual to algebraic in 2d, translation from algebraic to visual in 3D, translation from 2D to 3D and general manipulation skills), good in 2 questions falling under 2 elements (translation from 3D to 2D and general manipulation skills), and excellent in 3 questions falling under 3 elements (translation from algebraic to visual in 2D, translation from visual to algebraic in 2D and translation from visual to algebraic in 3D). The discussion that follows is based on the difficulties that the students have from the 11 elements regarding VSOR (refer to Table 6.26 and Figure 6.58) in terms of performance level from the average of the questions under each element.

Students' performance was poor (less than 20%) in three elements (Elements 8, 9 and 11), evident from the shortest bars. The proportion of acceptably correct responses under these three elements were 4.1% for the translating from discrete to continuous and continuous to discrete, where the students were expected to represent the equations using the rectangular strips and discs on the given diagram; 14.9% for consolidation and general level of cognitive development, where the students were expected to do skills required in the five different elements as one question and 18.9% for translation from continuous to discrete (visually), where the students were expected to represent the rectangular strips and discs on the given diagram. These reveal that the students have major difficulties in these three elements.

For the two elements (Elements 8 and 9), translating from discrete to continuous and continuous to discrete (algebraic) and for translation from continuous to discrete (visually), using the representative strip, stemming from the Riemann sum, is the main aspect. If students lack knowledge of the main concepts of the Riemann sum, selection and interpretation of the representative strip becomes problematic, even if a correct graph might be drawn. In regard to Element 11, consolidation and general level of cognitive development, the students were required to consolidate what was done in five elements (graphing skills; translation from

visual to algebraic in 2D; translation from visual to algebraic in 3D; translation from continuous to discrete (visually) and general manipulation skills) as one question. All these elements consolidated, result in skills that require a certain level of cognitive development. The students are expected to first draw graphs. The correctness of the graphs that are drawn depends on the general manipulation skills, from the calculations for the important points for the graph. The students are then asked to select the representative strip (translation from continuous to discrete (visually)), representing the region bounded by the drawn graphs, which is also affected by the correctness of the graph. Based on the drawn graph and the representative strip selected, the students are then required to interpret the drawn graph so as to come up with the formula for area, (translation from visual to algebraic in 2D) or for volume, (translation from visual to algebraic in 3D) after rotation of the bounded region, where the strip has been selected. Students are then expected to calculate the area or volume from the selected strip which again requires general manipulation skills. It is clear from the above results, based on the proportion of the acceptably correct responses (14.9%), that most of the students did not reach the required cognitive level when solving VSOR problems.

Students' performance was not satisfactory in Elements 1, involving graphing skills and Element 6 involving translation from 2D to 3D, with 39.2% and 28.4% respectively as the proportion of acceptably correct responses. This reveals that even though the students have difficulties in drawing graphs as well as rotating the 2D diagrams to 3D diagrams (solids of revolution), the difficulties are not major as compared with the selection of the strip and the questions that require consolidation and general cognitive development.

However, despite the difficulties, the students' performance was satisfactory in four elements (translation from algebraic to visual in 3D, translation from visual to algebraic in 3D, translation from 3D to 2D, general manipulation skills), and good in only two elements, translation from algebraic to visual in 2D involving representation of area in a form of a diagram, with 70.3% of acceptably correct responses and translation from visual to algebraic in 2D, involving representation of area in a form of an equation with 71.6% of acceptably correct responses. The results reveal that even if students' performance was excellent in individual questions (three questions only) from different elements (translation from algebraic to visual in 2D, translation from visual to algebraic in 2D and translation from visual to algebraic in 3D), overall there were no elements where the average performance in all questions was excellent. This is an indication that generally VSOR is difficult for the students.

When grouping the 11 elements into five skill factors, Table 6.26 and Figure 6.59 are used to display students' performance from the Questionnaire 1st run.

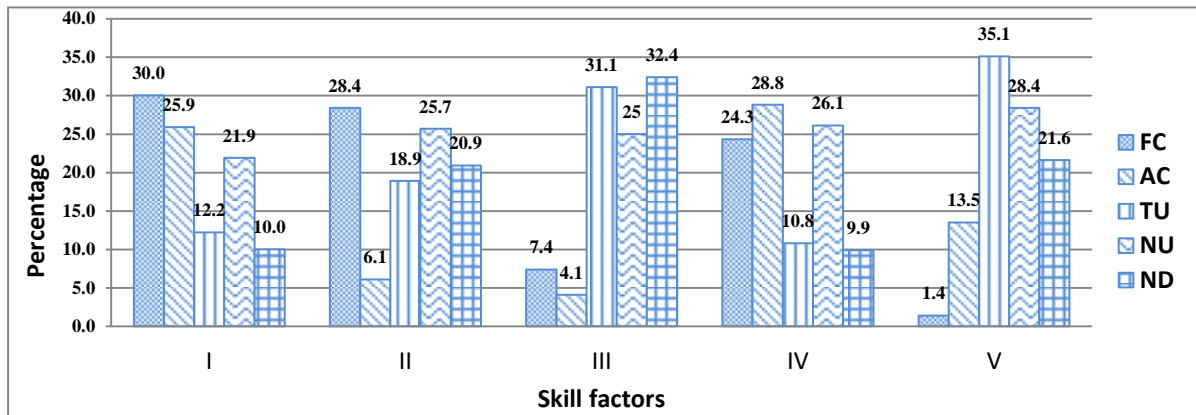

Figure 6.59: The five skill factors compared

As indicated in Table 6.26 and Figure 6.59 it is clear that most of the students are performing satisfactorily (55.9%) in the skill factor where students are drawing graphs and translating between the visual graphs and algebraic equations/expressions both in 2D and in 3D (Skill factor I). The performance in skill factor involving questions where students' general manipulation skills were tested was also satisfactory, where 53.2% of acceptably correct responses were produced (Skill factor IV).

In the other three skill factors, a large proportion of the responses were incorrect. Most of the students struggled mainly with the skill factor involving moving between discrete and continuous representations (Skill factor III). Only 11.5 % of the responses were acceptably correct, regarded as poor performance, with a large proportion (32.4%) of responses being where the students did not respond to the question. This skill factor has the highest proportion of non-responses in relation to the other four skill factors. In this skill factor, the selection of the representative strip which approximate the region bounded by the drawn graphs and the Riemann sum are the main concepts.

Another skill factor where the performance was poor, with 14.9% of acceptably correct responses, is the skill factor involving questions that require that students be at a certain level of cognitive development (Skill factor V), namely consolidation and general level of cognitive development. With general level of cognitive development, students use manipulation skills to draw graphs, select the representative strip, rotate it in terms of volume, translate the drawn graph to represent formula for area or volume and perform

manipulation skills based on the selected formula. With this skill factor, students are expected to possess the necessary skill from all the other four skill factors. Only 14.9 % of the responses were acceptably correct, with the lowest of 1.4 % fully correct responses compared to the other skill factors, also with higher proportion (21.6%) of non-responses.

Finally only 34.5 % (performance that was not satisfactory) of the responses were acceptably correct for the skill factor with questions of a conceptual nature, where students were translating between two-dimensional and three-dimensional diagrams (Skill factor II), where solids of revolution are drawn. This low performance in the three skill factors (II, III, and V) discussed above reveal that students are having difficulties with VSOR.

In Table 6.27 (results for Test 1 and 2 from one group of students) and Table 6.28 (results for Test 3 from a different group of students), the responses from the Questionnaire 2nd run are indicated and discussed. Individual questions and mainly elements, where all questions were written are compared.

Table 6.27: All 4 elements for the Test 1 and 2; and other questions from the Questionnaire 2nd run

RESPONSES	GR		AV2D	VA2D	AV3D		VA3D	2D-3D	3D-2D		CD(V)	DC-CD(A)	GMNP			CGLCD
	1A	1B	2B	3B	4A	4B	5B	6A	7A	7B	8B	9A	10A	10B	10C	11A
FC	8	54	9	43	0	2	18	0	28	4	0	0	8	55	4	0
AC	17	16	28	11	5	16	23	15	8	1	0	15	5	25	28	4
TU	32	19	30	44	25	15	14	19	13	32	14	19	7	15	32	63
NU	58	31	48	23	61	75	57	66	57	46	47	33	97	12	58	52
ND	7	2	7	1	31	14	10	22	16	39	61	55	5	15	0	3
	122	122	122	122	122	122	122	122	122	122	122	122	122	122	122	122
FC+AC	25	70	37	54	5	18	41	15	36	5	0	15	13	80	32	4
Questions %	20.5	57.4	30.3	44.3	4.1	14.8	33.6	12.3	29.5	4.1	0.0	12.3	10.7	65.6	26.2	3.3
ELM(FC+AC)	38.9%				9.4%				16.8%				34.2%			

Table 6.28: Responses for Test 3 from the Questionnaire 2nd run

RESPONSES	AV2D	VA2D	VA3D	2D-3D	CD(V)	DC-CD(A)	CGLCD
	2A	3A	5A	6B	8A	9B	11B
FC	0	30	32	9	4	0	0
AC	29	17	4	8	2	0	0
TU	18	0	9	18	38	44	2
NU	5	5	9	18	10	6	39
ND	2	2	0	1	0	4	13
	54	54	54	54	54	54	54
FC+AC	29	47	36	17	6	0	0
Questions %	53.7%	87.1%	66.7%	31.5%	11.1%	0.0%	0.0

From Tables 6.27 and 6.28 the results reveal that less than 20% (regarded as poor performance) of the students got acceptably correct responses in 10 questions, 7 in Test 1 and Test 2, under seven elements (translation from algebraic to visual in 3D; translation from 2D to 3D; translation from 3D to 2D; translation from continuous to discrete (visually); translation from discrete to continuous and continuous to discrete (algebraic); general manipulation skills and consolidation and general level of cognitive development) and three questions in Test 3 under three elements (translation from continuous to discrete (visually); translation from discrete to continuous and continuous to discrete (algebraic) and consolidation and general level of cognitive development). From these 10 questions, where performance was poor, there were three questions, where none of the students answered the questions. One of these three questions is Question 8B from Test 1 and 2, requiring an approximation of the given 3D diagram using discs where translation is from continuous to discrete (visual). The other two questions, both from Test 3 are Questions 9B and 11B, respectively requiring the use of a given formula for volume to represent it on a given 3D diagram to represent discs where translation is from discrete to continuous and continuous to discrete (algebraic) and the derivation of the formula for volume of a cone from the first principles, possible if one has competency in the skills for the consolidation and general level of cognitive development.

Similar to the results of the Questionnaire 1st run, poor performance in the Questionnaire 2nd run was mainly for the same three elements, namely translation from continuous to discrete (visually), translation from discrete to continuous and continuous to discrete (algebraic) and the consolidation and general level of cognitive development. In the Questionnaire 1st run, the average response percentage for the questions under these three elements were calculated since both questions were given to the same group of students, but were not calculated in the Questionnaire 2nd run since the questions were given to two different groups of students, thus resulting in two separate response percentages.

The proportion for the acceptably correct responses under the three elements are given, respectively for the Questionnaire 1st run and for the Questionnaire 2nd run as 18.9%, 0% and 11.1% under translation from continuous to discrete (visually), 4.1%, 12.3% and 0% under translation from discrete to continuous and continuous to discrete (algebraic) and 14.9%, 3.3% and 0% under the consolidation and general level of cognitive development. The performance was poor in Questionnaire 1st run for the element where translation is from discrete to continuous and continuous to discrete with 4.1%, while for the Questionnaire 2nd run, performance was poor for the element requiring consolidation and general level of cognitive

development with 3.3% and 0% from both groups. As argued above, for these three elements, the representative strip, stemming from the Riemann sum, is the main aspect.

Looking at the four elements (graphing skills, translation from algebraic to visual in 3D, translation from 3D to 2D and general manipulation skills) in the Questionnaire 2nd run where the same group of students wrote all questions, different results were found. In contrast, to the results of the Questionnaire 1st run, it is evident that the performance in Test 1 and 2 (Questionnaire 2nd run) was poor in the elements, translating from algebraic to visual in 3D and translating from 3D to 2D with the proportion of acceptably correct responses as 9.4% and 16.8% respectively, while for the Questionnaire 1st run, the response percentages were 45.9% and 40.5% respectively. However, for the graphing skills, the performance in both Questionnaire 1st run and Questionnaire 2nd run were not satisfactory, with the proportion of acceptably correct responses as 38.9% and 39.2% respectively nearly equal.

6.1.7 Total responses for all categories

In Table 6.29 and Figure 6.60, the overall responses are given for all 23 questions from the 37 responses. The total number of fully correct responses, almost correct responses, responses showing traces of understanding, no understanding and not done are given for the 37 students for the 23 questions, resulting in $37 \times 23 = 851$ responses in total.

Table 6.29: The responses for all questions

RESPONSES	Total	%	Total %
Fully correct	192	22.6	40.5
Almost correct	153	18	
Traces of understanding	157	18.4	59.5
No understanding	206	24.2	
Not done	143	16.8	
Σ	851		

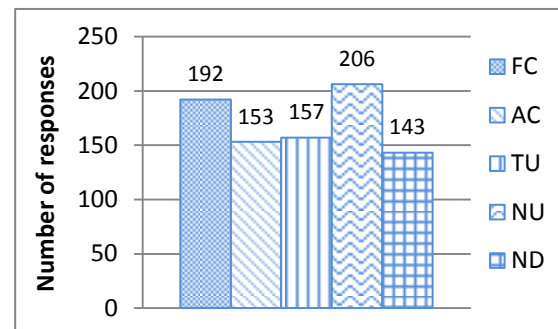

Figure 6.60: All responses represented

There were 192 (22.6%) fully correct responses; 153 (18%) showing almost correct responses; 157 (18.4%) responses showing traces of understanding; 206 (24.2%) responses showing no understanding and finally 143 (16.8%) where the students did not attempt to answer the questions, categorised as not done, shown in Figure 6.60, which is bi-modal. It can be argued that in general the students had problems with VSOR, with the highest percentage (24.2%), revealing that the students showed no understanding of the questions given. Even though the fully correct responses also show a higher percentage (22.6%), it is mainly because most of the

problems in the instrument involved general manipulation skills. Overall, students struggled with the problems that required higher order thinking skills, where general manipulation skills were not used. Overall the performance was satisfactory (40.5%), yet nearly below 40%.

6.1.8 Performance in the five skill factors classified in terms of procedural and/or conceptual knowledge

In Table 6.30 (adapted from Appendix 4D), the five skill factors are classified as either requiring the use of procedural and conceptual skills, conceptual skills or procedural skills.

Table 6.30: Procedural and conceptual skills from the Questionnaire 1st run

	Procedural and conceptual Skills % Skill factors I and V	Conceptual skills % Skill factor II and III	Procedural Skills % Skill factor IV
FC	49.1	23	53.1
AC			
TU	50.9	77	46.9
NU			
ND			

Questions that are procedural and conceptual in nature are found in Skill factor I, where students draw graphs and solve problems where they translate between the visual graphs and algebraic equations/expressions and in Skill factor V, where students perform skills required after consolidation of five elements from Skill factors I, II, III and IV, requiring a certain level of cognitive development. The performance with questions that were procedural and conceptual in nature was satisfactory (49.1% of the acceptably correct responses).

Questions that are conceptual in nature are found in Skill factor II, where students were translating between two-dimensional and three-dimensional diagrams and Skill factor III involving moving between discrete and continuous representations. In these questions, the students' performance was poor (23% of the acceptably correct responses). This performance was the lowest compared to the other skills.

The performance in Skill factor IV, involving questions that are more procedural in nature where students' general manipulation skills were tested, was also satisfactory (53.1% of the acceptably correct responses). In general the students were partially competent in skill factor IV that involved procedural knowledge, and not fully competent in the skill factors that involve both procedural and conceptual skills and not competent in the skill factors that involve conceptual skills only.

In the section that follows, general observations are made based on the five skill factors.

6.1.9 General observations for the five skill factors from the questionnaire runs

Skill factor I: *Graphing skills and translating between visual graphs and algebraic equations/ expressions in 2D and 3D*

The results of the Questionnaire 1st run and the Questionnaire 2nd run reveal that students' performance in drawing graphs was not satisfactory. Students were in most cases able to draw graphs that they were familiar with or completely failed to draw the graphs that they had not seen before or worded differently. Students had difficulty mainly in answering a question requiring that a line with a positive gradient passing through the origin on a given interval be drawn. In most cases the interval was interpreted as coordinates, where $x=0$ and $y=3$. By contrast, in drawing the graphs of $x^2 - y^2 = 9$ and $x=5$ that were expected to be more difficult to draw than a line with a positive gradient, the performance was good. It seems as if students had difficulty in interpreting this problem since it was presented as a word problem, they did not know what "a line with a positive gradient" is, but could easily draw a line $y=x$ as was seen in other questions. The students struggled to interpret the symbolic notation representing an interval.

When translating from algebraic representation to visual representation, where an integral formula for area was to be translated to a diagram, most students in the Questionnaire 2nd run were not successful. In the Questionnaire 1st run, the performance was good when translating from algebraic to visual, involving the integral formula for area. In both questionnaire runs, more students succeeded in translating from visual graphs to algebraic equations in 2D, especially if a Δx strip was appropriate, compared to having to draw the graphs.

When students solved the problems that relate to translation between algebraic and visual representations in 3D, the performance in the Questionnaire 1st run was satisfactory while not satisfactory in the Questionnaire 2nd run. Even if the performance in the Questionnaire 1st run was satisfactory, students in both runs of the questionnaire were seen to struggle with the formula that involves the translation from algebraic to visual when the formula for a disc was used, compared to when a shell was used. The disc in the disc method was not interpreted correctly. Most students used it as if it related to a parabola that was to be drawn and not to a straight line that was squared as a result of the formula for a disc (refer to Question 4A). For the

other formula, probably the presence of 2π may have triggered some form of awareness to them that it represents a shell. Many students were seen to draw the parabolas as they appear in 2D without drawing the 3D solids from the 2D rotations.

The translation from visual graphs to algebraic equations in 3D was seen to be simpler only when a disc method was appropriate. A fair number of students managed to come up with the correct formula for volume for a disc. They failed when it resulted as a shell. Most students ignored the Δx strip drawn and used a Δy in the formula that represented a disc method or a washer method for the cosine graph. For those students who tried to use a shell method, errors were found as the students used incorrect limits of integration.

Overall the results from the Questionnaire 1st run reveal that the students' performance was satisfactory (55.9%) in graphing skills and translating between visual graphs and algebraic equations/expressions (composed of five elements).

Skill factor II: *Three-dimensional thinking*

In both questionnaire runs students find it easier to translate when simple diagrams like a straight line were rotated to formulate 3D solids, involving translation from 2D to 3D. They found it difficult to rotate when given diagrams that required more imaginative skills at a higher level of conceptualising like when a torus had to be formed after rotation of a circle that was a certain distance away from the x -axis and from the y -axis. Generally, students had difficulty in drawing solids of revolution, involving translation from 2D to 3D, where 2D diagrams were given. Instead of drawing solids of revolution, 2D diagrams were drawn. The students' performance in the Questionnaire 1st run, when translating from 2D to 3D was not satisfactory.

When a 3D solid or its description was to be represented as a 2D diagram, where translation from is 3D to 2D, students also encountered difficulties. The performance in the Questionnaire 1st run was satisfactory, while poor in the Questionnaire 2nd run.

Overall, the performance in the Questionnaire 1st run in three-dimensional thinking (composed of two elements) was not satisfactory (34.5%).

Skill factor III: *Moving between discrete and continuous representations*

The questions involved the approximation of area and volume from rectangles and discs that represented a bounded region. The results revealed that many students struggled mainly with the translation from the algebraic expressions to the approximation of area or volume on the given diagram, involving translation from discrete to continuous and continuous to discrete (algebraic). It was quite clear that most of the students were not familiar with the concept of Riemann sums algebraically as representing the area of rectangles for a 2D diagram and the area of the circle for a 3D diagram on a bounded region. The students also struggled to approximate the area of the region bounded by graphs using rectangles and discs involving translation from continuous to discrete (visually).

The results of both Questionnaire runs reveal that students were not competent in approximating the area of the region bounded by graphs and in translating from the algebraic expressions to the approximation of area or volume on the given diagram, using rectangles and discs. Evidence from the students' responses points to the students' lack of in-depth knowledge about the Riemann sums. Overall, the performance in the Questionnaire 1st run in moving between discrete and continuous representations was poor (11.5%) and very low compare to the other four skill factors. The results reveal that the students do not have in-depth knowledge about the significance of the representative strip. This calls for serious interventions so that the learning of VSOR becomes meaningful to students who will not just want a formula to substitute in, but think carefully about the selection of the representative strip, which is where the formulae come from. In that way conceptual understanding may be enforced.

Skill factor IV: *General manipulation skills*

The results from the Questionnaire 1st run revealed that most of the students were fairly fluent with regard to general manipulation skills. In some cases errors were made as students solved problems that involved the evaluation of an integral involving integration by parts. Mathematical errors were also made when students calculated the point of intersection of graphs. Many students were seen to make y the subject of the formula from the ellipse by seeing $\sqrt{36 - 4x^2}$ as $6 - 2x$, hence making the whole solution incorrect after substitution. The results from the Questionnaire 1st run reveal that students' performance was satisfactory (53.2%) with general manipulation skills. In regard to the Questionnaire 2nd run, students' performance was not satisfactory (34.2%).

Skill factor V: *Consolidation and general level of cognitive development*

In the Questionnaire 1st run it was found that the majority of the students lack the general cognitive skills required to solve problems that involve five elements from Skill factors I, II, III and IV, when consolidated, since they lack in-depth understanding of VSOR. Students' partial competency in drawing graphs; failure in identifying the strip correctly and drawing the 3D diagram represented by the rotated strip after rotation, impacts heavily on the consolidation and general level of cognitive development. This leads to difficulty in learning about VSOR, which leads to poor performance. If the students' performance in the five elements from Skill factors I to IV is so low, how do they then manage to solve problems that address these skill factors all at once, when consolidated? The poor performance in Question 11A and 11B give evidence of that. In some instances students drew the graphs correctly, but gave incorrect limits for integration, meaning that they failed to translate from a visual graph to an algebraic equation. It was also found that the students struggled to use integration techniques. The students' performance in Skill factor V was also poor (14.9%), same as that from skill factor III (11.5%).

In the Questionnaire 2nd run the results were similar to those from the Questionnaire 1st run. The students also partially managed to draw the graphs and failed to interpret them correctly. From the responses given by students, it seems as if tasks similar to those in Skill factor V are cognitively demanding for these students. Cognitive obstacles were encountered when dealing with such tasks, as the ones under Skill factor V. The majority of these students lacked skills in the general level of development. They could not meet the cognitive demands of the tasks. The students' cognitive abilities are not at a level that enables them to solve the tasks that involve the consolidation and general level of cognitive development.

6.1.10 Discussion and conclusion

From the discussion on the five skill factors above, it seems as if students struggled mostly with Skill factor III, involving questions that are conceptual in nature where students were translating between continuous and discrete, which relates to the use of the Riemann sums. The results reveal that students are not competent in the concept of the Riemann sums. Students do not know how to approximate the bounded region or the volume generated from the rectangles or the discs from the Riemann sums. What emerges from these results is that even if students manage to draw correct graphs, or graphs are given, most of them struggle to locate the rectangular strip that approximates the area or the volume after rotation of the bounded region.

The general conclusion after these investigations is that although students perform better in some of the elements, their overall performance (40.5%), which is very close to being not satisfactory (below 40%) indicates that this section of the syllabus involving VSOR, is perhaps cognitively more demanding than other topics (those that constitute the other 60% of the paper). Students are seen to rely on types of problems that they have been exposed to before, so they fail if the problems in examinations differ from what they have seen before. The same applies to the 23-item instrument where most of the questions were somewhat different from the format of the examination. However performance seems to be higher in certain questions, especially those questions where a graph is given to students. It was also found that the students cannot draw properly where graphs are not given. At times they tend to abandon the drawn graphs when they do the translations, especially if the graph is a bit complicated. The skill factors that the students seem to be partially competent in are the general manipulation skills as well as graphing skills and translating between visual graphs and algebraic equations/expressions, where the students' performance was satisfactory.

Overall, from both runs of the questionnaire, even though different students were used at different times and different results were obtained, some similar trends were evident. More attention, in terms of areas where learning should be improved needs to be on the three skill factors of knowledge where the students are not competent in and where performance is not satisfactory and poor namely:

- Moving between discrete and continuous representations (poor performance).
- Three-dimensional thinking (performance that is not satisfactory).
- Consolidation and general level of cognitive development (poor performance).

6.2 EXAMINATION ANALYSIS AND THE DETAILED WRITTEN EXAMINATION RESPONSES

The discussion of the results includes a quantitative analysis of the examination and a qualitative analysis of the detailed examination responses from seven students. Before presenting the results, the analysis of the questions that students responded to, is presented.

6.2.1 Examination analysis

In the section that follows, Question 5 from the August 2007 examination paper, contributing 40% of the whole examination is analysed in terms of the five skill factors.

6.2.1.1 Analysis of the examination scripts of 151 students

Below the subquestions of Question 5 are given (refer to a detailed marking memorandum of the Question 5 in Appendix 6A). Each subquestion is discussed in relation to the given classified elements from the skill factors.

Question 5.1

- 5.1.1 Calculate the points of intersection of: $y = -4x^2 + 4$ and $y = -x^2 + 4$
Sketch the TWO graphs and show the representative strip/element that you will use to calculate the volume of the solid generated when the area bounded by the graphs is rotated about the y -axis. (3)
- 5.1.2 Calculate the volume described in QUESTION 5.1.1 by means of integration. (4)
- 5.1.3 Calculate the volume moment of the solid about the x -axis as well as the y -ordinate of the centre of gravity of the solid. (5)

In Question 5.1.1 three subsections were evident. Students were required to

- Firstly, calculate the point of intersection of two graphs, which involves *general manipulation skills* (Skill factor IV).
- Secondly, sketch the two graphs, which involve *graphing skills* (Skill factor I).
- Thirdly, show the representative strip/element to be used in calculation of volume, which involves *translation from continuous representation to discrete representation* (Skill factor III).

In Question 5.1.2 students were required to

- Calculate the volume generated by means of integration, which involves the *translation between 2D and 3D* (Skill factor II); *the translation between visual graphs and*

algebraic equations (Skill factor I) as well as the *general manipulation skills* (Skill factor IV), as the calculation is performed. In the marking memorandum, there is no mention as to how the drawn graph in 5.1.1 is *translated between 2D and 3D* (Skill factor II), in order to show the new solid generated as well as the resulting *disc, washer or shell*, whichever is applicable. It was anticipated that in calculating the volume the visual representation would also be shown.

In Question 5.1.3 students were required to

- Calculate the volume moment as well as the y -ordinate of the centre of gravity, which also involves the *translation between the visual graphs and algebraic equations for volume* (Skill factor I) as well as the *general manipulation skills* (Skill factor IV), when calculating volume.

Question 5.2

- 5.2.1 A vertical sluice gate in the form of a trapezium is 7 m high. The longest horizontal side is 8 m in length and in the water level. The shorter side is 4m in length and 7 m below the water surface. Make a neat sketch of the sluice gate and calculate the relationship between the two variables x and y . (3)
- 5.2.2 Calculate the first moment of area of the sluice gate about the water level. (4)
- 5.2.3 Calculate the second moment of area of the sluice gate about the water level as well as the depth of the centre of pressure of the sluice gate by means of integration. (5)

In Question 5.2.1 two subsections were evident. Here students were required to

- Firstly, sketch the sluice gate, which involves the *graphical skills* (Skill factor I).
- Secondly, calculate the relationship between x and y , which involve *general manipulation skills* (Skill factor IV), but *translating between visual graphs and algebraic equations* (Skill factor I).

In Question 5.2.2, the students were required to

- Calculate the first moment of area which involves the *translation between visual graphs and algebraic equations* (Skill factor I), from the solution in 5.2.1 as well as *general manipulation skills* (Skill factor I).

In Question 5.2.3 they are required to

- Calculate the second moment of area as well as the depth of the centre of pressure which involves the *general manipulation skills* (Skill factor I) and incorporating the solution in 5.2.2.

Question 5.3

- 5.3.1 Make a neat sketch of the curve $y = 3\cos x$ and show the area bounded by the curve and the lines $x = 0$ and $y = 0$. Show the representative strip/element that you will use to calculate the volume, by using the SHELL METHOD only, if the area bounded is rotated about the y -axis. (2)
- 5.3.2 Calculate the volume described in QUESTION 5.3.1. Use the SHELL METHOD only. (5)

In Question 5.3.1 two subsections were evident. Here students were required to

- Firstly, sketch the graph and show the area bounded, which involves the *graphical skills* (Skill factor I) as well as the integration of the *general manipulation* (Skill factor IV) and *visual skills* (Skill factor I).
- Secondly, show the representative strip/element using SHELL METHOD only that will be used in the calculation of volume, which involves *translation between continuous and discrete representations* (Skill factor III).

In Question 5.3.2 the students were asked to

- Calculate volume, which involves *translation between visual and algebraic* (Skill factor I) as well as the *general manipulation skills* (Skill factor IV). In the marking memorandum, there is no mention as to how the drawn graph in 5.3.1 is *translated between 2D and 3D* (Skill factor II), in order to show the new solid generated as well as the resulting *shell*. It was anticipated that in calculating the volume the visual representation would also be shown, in a form of a solid of revolution.

Question 5.4

- 5.4.1 Calculate the coordinates of the points of intersection of: $y - 2x = 0$ and $x = \frac{1}{4}y^2$.
Sketch the graphs and show the representative strip/element that you will use to calculate the area bounded by the graphs. (3)
- 5.4.2 Calculate the area described in Question 5.4.1 (3)
- 5.4.3 Calculate the second moment of area described in Question 5.4.1 with respect to the y -axis. (3)

In Question 5.4.1 three subsections were evident. Here students were required to

- Firstly, calculate the point of intersection of two graphs, which involves the *general manipulation skills* (Skill factor I).
- Secondly, sketch the two graphs, which involve *graphing skills* (Skill factor I).
- Thirdly, show the representative strip/element to be used in calculation of the area, which involves part of *translation between continuous and discrete representations* (Skill factor III). In the marking memorandum the 2D diagram is shown.

In Question 5.4.2 students were required to

- Calculate the area generated by means of integration, which involves the *translation between visual graphs and algebraic equations* (Skill factor I), as well as *general manipulation skills* (Skill factor IV) as the calculation is performed.

In Question 5.4.3 students were required to

- Calculate the second moment of area from Question 4.1 with respect to the *y-axis*, which also involves *general manipulation skills* (Skill factor IV) and *translation between visual graphs and algebraic equations* (Skill factor I).

Total Marks for the section [40]

In the examination paper, only five elements were assessed explicitly, the other six elements were assessed implicitly. In this section, the discussion will centre only on these five elements. The other six elements were indirectly embedded in the assessment.

The five elements are

- General manipulation skills (Skill factor I)
- Graphing skills (Skill factor IV)
- Translation from continuous to discrete (visually) (Skill factor III)
- Translation from visual to algebraic in 2D (Skill factor I)
- Translation from visual to algebraic in 3D (Skill factor I)

In all the tables and figures, abbreviations were used as follows, GMNP: general manipulation skills, GR: graphing skills, CD(V): translation from continuous to discrete representation (visually) from the selected strip, VA2D: translation from visual to algebraic in 2D and VA3D: translation from visual to algebraic in 3D.

6.2.1.2 Quantitative analysis of five elements that were tested directly from the question paper

- The response for Question 5

In this section performance of 151 students is discussed based on Table 6.31 and Figure 6.61 from the 17 subquestions. The responses were coded as follows: FC if the answer is fully correct; AC if the answer is almost correct; TU if there were some traces of understanding; NU if there was no indication of understanding and ND if there was no attempt in answering the question, drawn from Appendix 6B.

Table 6.31: Students' responses in five elements

	GMNP	GR	CD(V)	VA3D	VA3D	GR	VA2D	VA2D	VA2D	GR	CD(V)	VA3D	GMNP	GR	CD(V)	VA2D	VA2D
	1.1	1.1	1.1	1.2	1.3	2.1	2.1	2.2	2.3	3.1	3.1	3.2	4.1	4.1	4.1	4.2	4.3
FC	70	63	32	17	10	38	33	16	9	89	31	21	38	50	52	45	6
AC	13	26	19	21	10	15	12	31	38	25	2	41	37	12	4	28	8
TU	22	8	21	18	14	66	65	56	51	6	3	29	24	23	23	20	6
NU	28	29	33	67	57	12	19	17	17	9	81	29	17	27	20	18	74
ND	18	25	46	28	60	20	22	31	36	22	34	31	35	39	52	40	57
% FC+AC	54.9	58.9	33.8	25.2	13.2	35.1	29.8	31.1	31.1	75.5	21.9	41.1	49.7	41.1	37.1	48.3	9.3
% FC+AC	GMNP: 52.3%		GR: 52.6%			CD(V): 30.9%			VA2D: 29.9%			VA3D: 26.5%					
% FC+AC	OVERALL: 37.5%																

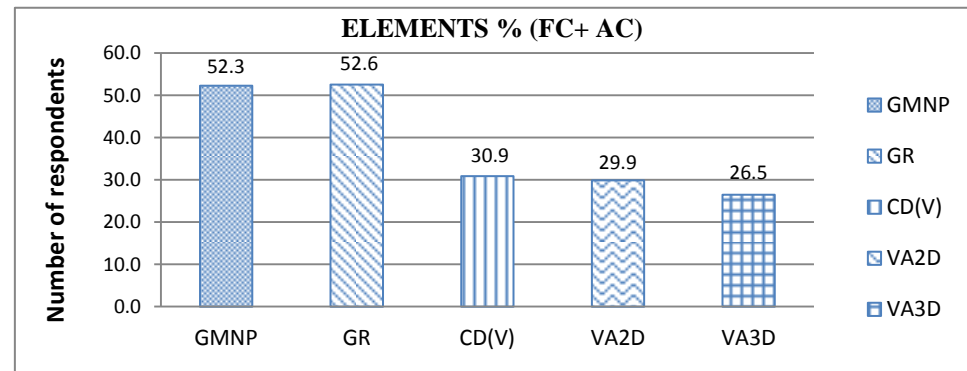

For the tables in this section, the following acronyms are used
 GMNP: General manipulation skills
 GR: Graphing skills
 CD(V): Translation from continuous to discrete (visually)
 VA2D: Translation from visual to algebraic in 2D
 VA3D: Translation from visual to algebraic in 3D

Figure 6.61: Comparing the five elements

Questions 5.1.1 to 5.4.3 were classified under the five elements, depending on whether they involve graphing skills, general manipulation skills (only for calculation of points of intersection or intercept points or any other points necessary for drawing the graphs), moving from continuous to discrete (visual 2D and 3D), translation from visual to algebraic in 2D or translation from visual to algebraic 3D, leading to 17 subsections in line with the five elements. In the presentation and discussion of the results the general manipulations involving integration (evaluation of area, volume, centroid, centre of gravity and so on) that occurred after translation from visual to algebraic in 2D or in 3D are excluded. The reason for excluding them is that there were many different solutions based on the previous parts on the questions since the students were expected to start by drawing graphs, selecting the representative strip and translating from visual to algebraic in 2D or in 3D and errors made would affect the final general manipulations required.

In Table 6.31 and Figure 6.61 the data revealed that, out of the 17 questions, the question in which students performed well in involved graphing skills, where a graph of the curve $y = 3\cos x$, bounded by the lines $x = 0$ and $y = 0$ (graphing skills 3.1) was to be drawn, where 75.5% of the responses were correct and regarded as excellent performance. Question 3.1 indicated some interesting trends. The majority of the students did well in this question with 89 fully correct responses. Surprisingly most of the students were unable to draw the correct strip, a huge jump to only 31 fully correct responses, which means that the interpretation for the question that follows might be incorrect. In this question, it was evident that even if the students were able to draw the proper graph, the idea of translating the area of the graph in accordance with the Riemann sum, to show the strip that approximates the area correctly, was not well understood. These results are also confirmed from a huge jump in Question 1.1 with 63 fully correct responses for graphing skills 1.1, followed by 32 fully correct responses for a question involving translation from continuous to discrete (visually) 1.1. Clearly students have huge problems in selecting the correct strip, whether it should be a Δx strip or a Δy strip.

The results also indicate that in most cases, students' responses deteriorated from the first question to its subquestions. If one considers Question 5.1 for example, one will observe some trends for the fully correct responses. For the general manipulation skills 1.1, there were 70 fully correct responses, followed by 63 fully correct for graphing skills 1.1, followed by 32 fully correct responses for translation from continuous to discrete (visually) 1.1 followed by 17 fully correct responses for translation from visual to algebraic in 3D 1.2 and finally 10 fully correct responses for translation from visual to algebraic in 3D 1.3. That may imply that even if

students get the first answer correct, they may fail to interpret it correctly to get to the next question. It may also mean that the incorrect response from the first question may affect the rest of the questions in such a way that the performance deteriorates.

The above analysis shows that there were more or less same patterns for Questions 5.1.1 and Questions 5.3.1. The question that may be asked is, if these questions are similar in some ways. Most students were able to draw the parabolas and a cosine graph asked in these two questions respectively. However, on the one hand a large number of students who chose a Δx strip in Question 5.1.1 indicated such a preference, even if it does not approximate the chosen area correctly. On the other hand, in Question 5.3.1, only a few students drew the correct Δx strip, which was different than in Question 5.1.1. The choice of a strip in this case was not well justified.

There was no question where the students' performance was good. The performance was satisfactory in six questions. The questions that need serious attention are the eight questions (Translation from continuous to discrete (visually), 1.1; Translation from visual to algebraic in 3D, 1.2; Graphing skills, 2.1; Translation from visual to algebraic in 2D, 2.1; Translation from visual to algebraic in 2D, 2.2; Translation from visual to algebraic in 2D, 2.3; Translation from continuous to discrete (visually), 3.1 and Translation from continuous to discrete (visually), 4.1) where performance was not satisfactory and two questions (Translation from visual to algebraic in 3D, 1.3 and Translation from visual to algebraic in 2D, 4.3) where performance was poor. Most of the questions where the students are having difficulty involve the selection of the representative strip and the translation from a visual graph to an algebraic equation in 2D and in 3D. The results also reveal that overall students' performance in general manipulation skills and in some of the graphing skills is satisfactory. Overall, from Table 6.34, the performance in Skill factor V was not satisfactory, where only 37.5% of the responses were acceptably correct.

It was found that even if the students were able to draw the correct graphs and sometimes the correct strip, the problem arose when the students had to translate from the graph to the algebraic formula for area or volume. The chosen strip was in most cases not considered when writing down the algebraic formula. The average mark that students obtained for Question 5 is 15.4 out of 40 and for the whole examination paper, it is 45.5 out of 100, which is satisfactory performance (refer to Appendix 6B).

In the next section written responses for seven students in Question 5 are presented.

6.2.2 Detailed written examination responses

6.2.2.1 Actual written responses from the seven students

Some students from College A (who were part of the group that was observed for 5 days) were given Question 5.1, 5.3 and 5.4 (as well as some other questions) to respond to as a test. Only seven scripts from this group were collected and analysed qualitatively. The percentages of acceptably correct responses (given in Figure 6.62) are calculated for each of the five elements so as to know how the seven students performed overall (Refer to Appendix 6D), in each element, for an example in graphing skills and in other elements.

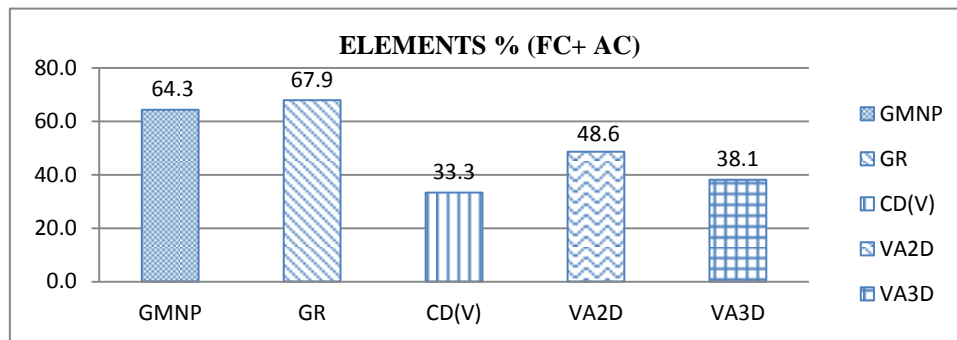

Figure 6.62: The performance from the seven students

The results from Figure 6.62 reveal that students' performance was good in graphing skills (67.9%) and in general manipulation skills (64.3%). Students' performance was satisfactory (48.6%) in translation from visual to algebraic in 2D. The performance was not satisfactory in translation from visual to algebraic in 3D (38.1%) and translation from continuous to discrete representations (33.3%). Overall, from the average of the 5 elements (50.2%), the performance in Skill factor V was satisfactory. However, even if the overall performance was satisfactory, the results reveal that most students had difficulty when selecting the strip and when interpreting the rotated strip so as to come up with the formula for volume.

Some of the examples from students' written responses are presented below.

- **Responses for Question 5.1**

In Question 5.1 students were asked to

5.1.1 Calculate the points of intersection of $y = -4x^2 + 4$ and $y = -x^2 + 4$.

Sketch the TWO graphs and show the representative strip/element that you will use to calculate the volume of the solid generated when the area bounded by the graphs is rotated about the y-axis. (3)

5.1.2 Calculate the volume described in QUESTION 5.1.1 by means of integration. (4)

5.1.3 Calculate the volume moment of the solid about the x-axis as well as the y-ordinate of the centre of gravity of the solid. (5)

Of the seven responses, five students were able to draw the correct graphs, but were unable to draw the proper Δy strip, hence failed to solve the problem correctly. The sixth student drew straight lines and not parabolas. The seventh student drew the graph correctly and drew the correct Δy strip for rotation. In Figure 6.63, written responses for one of the five students are given.

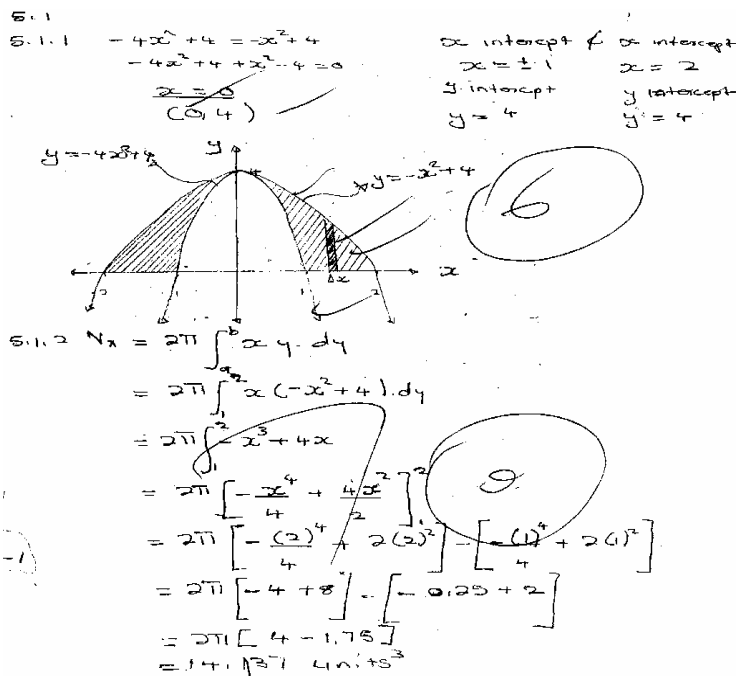

Figure 6.63: The incorrect approximation with a Δx strip

The results reveal that this student was able to draw the graphs correctly. The student drew a strip that does not accommodate all of the bounded area. This raises questions about the in-depth knowledge about the Riemann sum and the idea of slicing the area to touch all graphs used. What was interesting from the above example was that this student, compared to the other students used a Δx strip but in solving the problem referred to it as a Δy strip. The other four students also used a Δx strip and carried on solving the problem using the Δx strip, but did not get the solution correct since instead of the ‘washer method’, they used the ‘shell method’. Even if the first step was incorrect, based on the formula used, the general manipulation skills that were required from this student were correct. The student carried on to simplify and integrate correctly, until the final step. What is disappointing is that despite the other steps being correct, the student forfeits all the marks because the steps that follow are not in accordance with the marking memorandum, which is followed when marking this question. The reason behind this is that the formula used for the first step was incorrect. The wrong interpretation of the drawn graph raises questions as to whether the students refer to their drawn diagrams when they select the equations. This student also did not relate to the correct point of intersection that was calculated, which relates to the Δy strip.

The written responses given in Figure 6.64 are for the seventh student who drew the graph correctly, drew the correct strip, but failed to substitute in the formula correctly.

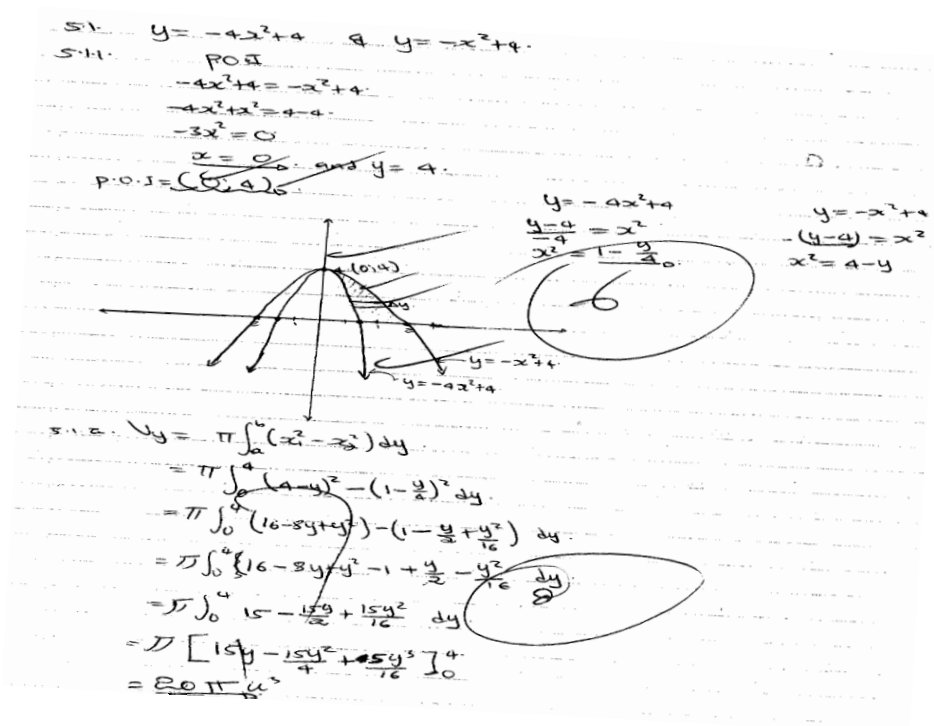

Figure 6.64: Incorrect substitution in the equation for volume

What is evident from the above answer is that this particular student was able to calculate the correct points of intersection, to draw the correct graph and to select the correct strip. This student could not substitute correctly, hence failed to transfer. The student used the correct formula to integrate volume as given in Figure 6.64 but failed to substitute correctly. The equations used to calculate the point of intersection were correctly given as $x^2 = 1 - \frac{y}{4}$ and $x^2 = 4 - y$. When substituting these equations in the formula for a washer as x_1^2 and x_2^2 , the student failed to use them. The student continued with the squares again as if x was not squared already. The student wrote $\pi \int_0^4 (4-y)^2 - \left(1 - \frac{y}{4}\right)^2 dy$ instead of $\pi \int_0^4 (4-y) dy - \left(1 - \frac{y}{4}\right) dy$.

From the responses given above, this student was able to draw the proper graph and the proper strip. The problem was the second step of the substitution where the squares were not necessary in the equation. The steps that followed were mathematically correct but the correct volume was not found. Of the seven scripts, five were able to draw the correct graphs, but were unable to draw the proper Δy strip, and thus failed to solve the problem correctly. The sixth student drew straight lines and not parabolas. The seventh student drew the graph correctly and drew the correct Δy strip for rotation.

• Responses for Question 5.3

In Question 5.3 students were asked to

- 5.3.1 Make a neat sketch of the curve $y = 3 \cos x$ and show the area bounded by the curve and the lines $x = 0$ and $y = 0$. Show the representative strip/element that you will use to calculate the volume, by using the SHELL METHOD only, if the area bounded is rotated about the y-axis. (2)
- 5.3.2 Calculate the volume described in QUESTION 5.3.1. Use the SHELL METHOD only (5)

For this question most of the students managed to draw the correct graphs, and the correct strip, but struggled to use the formula for the shell method correctly. There was one student who nearly got the correct answer for the volume, but did not use radians when evaluating the definite integral. Overall, most students were unable to use integration by parts when integrating $x \cos x$. Students were seen to use incorrect rules for integration including adding 1 and writing $\cos x$ as $\frac{\cos x^2}{2}$ even if they used the correct formula for the shell.

In Figure 6.65, an example is given of a student who drew the graph correctly, without drawing a strip (the strip on the diagram was drawn by the lecturer when he was marking). In the interpretation of the graph, this student used a Δy strip when substituting in the formula for volume where incorrect limits were used as 0 and 3 instead of being 0 and $\frac{\pi}{2}$, hence the student failed to translate from visual to algebraic in 3D. The volume to be calculated was therefore incorrect. This student was unable to calculate the volume correctly because of the incorrect formula for integration and incorrect integration techniques as shown in Figure 6.65.

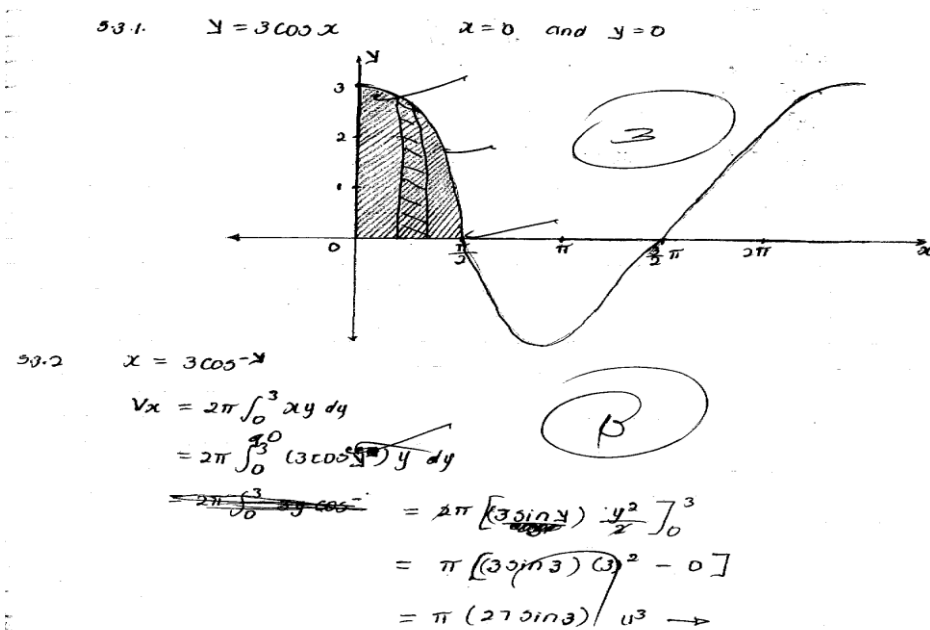

Figure 6. 65: A cosine graph without the strip

• **Responses for Question 5.4**

In Question 5.4, students were asked to

5.4.1 Calculate the coordinates of the points of intersection of $y - 2x = 0$ and $x = \frac{1}{4}y^2$.

Sketch the graphs and show the representative strip/element that you will use to calculate the area bounded by the graphs. (3)

5.4.2 Calculate the area described in Question 5.4.1 (3)

5.4.3 Calculate the second moment of area described in Question 5.4.1 with respect to the y-axis. (3)

In Figure 6.66 the student was trying to calculate the points of intersection of the graphs before drawing them, but failed and no graph was drawn. In that case the whole question was never answered. This student failed to manipulate at the step where cross multiplication was to be used. The student solved $x = \frac{1}{4}y^2$ incorrectly as $y^2 = \frac{x}{4}$ in stead of $y^2 = 4x$, hence could not find the correct solution. This student failed in all five elements and as a result failed in the consolidation and general level of cognitive development.

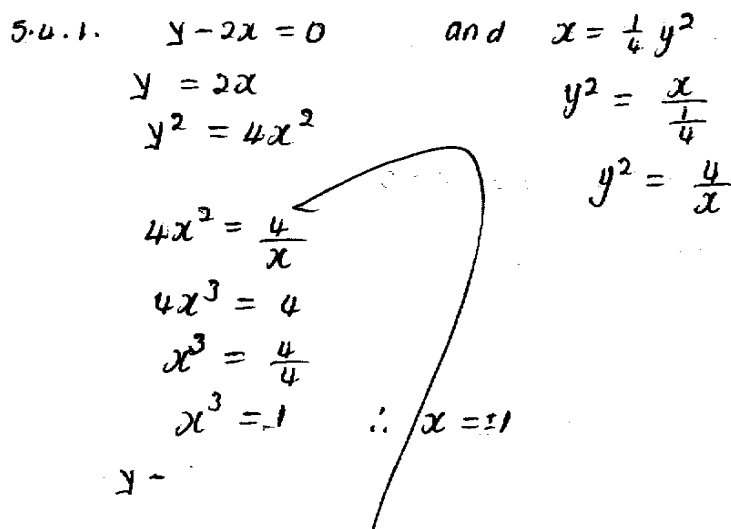

5.4.1. $y - 2x = 0$ and $x = \frac{1}{4}y^2$

$y = 2x$ $y^2 = \frac{x}{4}$

$y^2 = 4x^2$ $y^2 = \frac{4}{x}$

$4x^2 = \frac{4}{x}$

$4x^3 = 4$

$x^3 = \frac{4}{4}$

$x^3 = 1 \quad \therefore x = 1$

Figure 6.66: Incomplete manipulation

6.2.2.2 Summary for the detailed written examination responses

In this section in particular students did not fail because they got everything incorrect, they failed because the questions are accumulative in nature. In answering the questions, the solution for the first step is used in order to answer the second step. If the graph is drawn incorrectly, then the strip drawn will not be correct. Again if the strip is incorrect, the other steps as well as the rotations will be affected.

6.2.3 Discussion and conclusion

The results from the examination reveal that Question 5 may be problematic for students since the questions are asked in a hierarchical order. One must start by drawing graphs first, at times calculating the points of intersection before calculating area, volume and so on. These may create problems if the graphs drawn are not correct. In other instances students who draw correct graphs fail to interpret the drawn graphs in relation to the selection of the correct strip that approximates the area of the bounded region and rotating that drawn strip in cases where the volume is to be calculated.

6.3 SUMMARY OF THE EXAMINATION ANALYSIS

Special trends can be established from the discussions on the examination analysis in relation to the students' difficulties with VSOR. Students' performance was satisfactory in general manipulation skills and in drawing graphs, but they were unable to interpret the drawn graphs. In cases where graphs are drawn correctly, there are many instances where the students could not select the strip correctly, interpreting it to calculate the area as well as rotating it properly to calculate the volume generated. Similar to the results of the questionnaire runs, more attention needs to be on the three skill factors of knowledge where performance is not satisfactory namely:

- Moving between discrete and continuous representations.
- Three-dimensional thinking.
- Consolidation and general level of cognitive development.

Overall for the examination analysis of the 151 respondents, performance in Skill factor V was not satisfactory, revealing how challenging the VSOR content is.

In the section that follows, a model question paper for the August 2007 paper is designed in line with the five skill factors as a guide on how Question 5 analysed above could be assessed.

6.4 A MODEL QUESTION PAPER

In Figure 6.67, a proposed model on how VSOR should be assessed is presented, in an attempt to reduce the cognitive constraints brought about by the consolidation of the four skill factors as one question. The model proposes that VSOR be assessed in line with the five skill factors where most of the questions are broken down. The reason is that it is evident that students have problems with the consolidation of the four skill factors since some of the skill factors require conceptual understanding of the VSOR content which these students do not have.

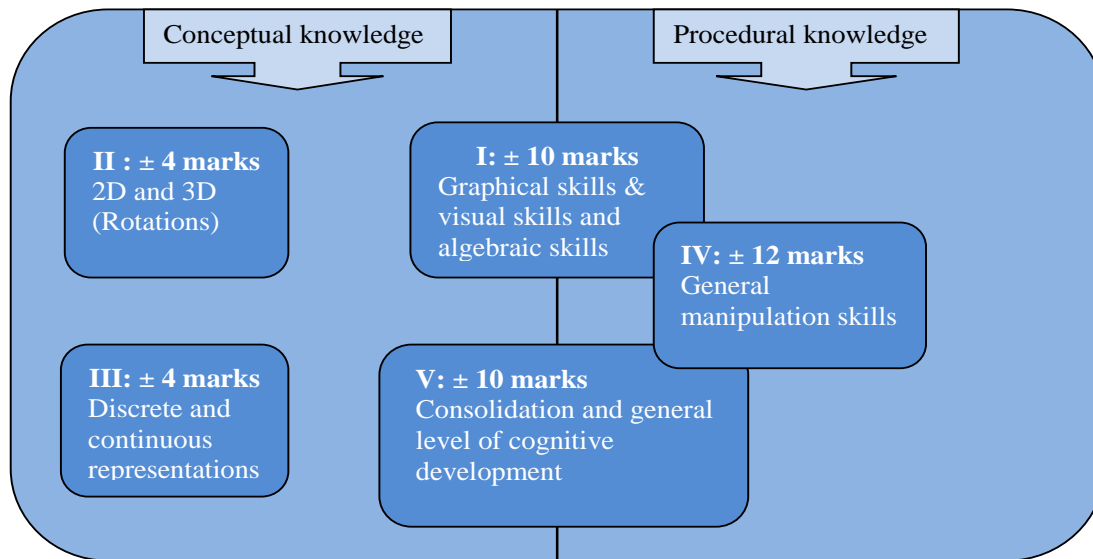

Figure 6.67: The proposed VSOR assessment model

In the above model, the 40 marks of Question 5 will be separated into 15 marks of the conceptual knowledge and 25 marks of the procedural knowledge from the five skill factors. Below an example of how Question 5 should be assessed using questions from the August 2007 examination paper is designed as four separate questions.

Question 5.1 tests for both conceptual and procedural knowledge (12marks), from Skill factors I and IV. Question 5.2 tests for conceptual knowledge from Skill factor II and their applications (5marks), where Skill factor IV is required. Question 5.3 tests for conceptual knowledge and their applications from Skill factor III (11 marks), where Skill factor IV is required, while Question 5.4 tests for consolidation of all four skill factors (12 marks). The total marks allocated is still 40 but the VSOR content is assessed differently, using the same questions as it was from the August 2007 examination paper, where most of the elements are tested explicitly.

A. With this approach, 12 marks tests for both conceptual and procedural knowledge as it is with Skill factor I.

Question 5.1

5.1 Below the area bounded by the graphs of $y = -4x^2 + 4$ and $y = -x^2 + 4$ is represented. A representative strip is also indicated in first quadrant area.

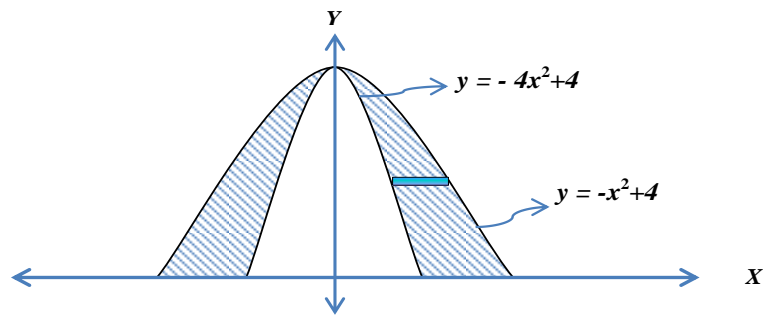

- 5.1.1 Calculate the intercepts as well as the coordinates of the point of intersection of the graphs. (2)
- 5.1.2 Draw the 3D representation of the rotated strip about the y-axis, and the solid of revolution formulated. (2)
- 5.1.3 Using the selected strip, substitute the equations of the given graphs in a suitable formula to represent the volume generated when the area bounded is rotated about the y-axis. (2)
- 5.1.4 Calculate the volume generated when this area is rotated about the y-axis. (2)
- 5.1.5 Calculate the volume moment of the solid about the y-axis as well as the co-ordinates for the centre of gravity of the solid. (Hint: Show the position of the centre of gravity on the solid.) (4)

[12]

B. The next 5 marks are for Skill factor II, when translating from 3D to 2D as well as some general manipulation skills from Skill factor I as the given integral will be evaluated.

Question 5.2

5.2.1 Draw a 2D diagram from which the volume is given by $V = 2\pi \int_0^{90^\circ} x(3 \cos x) dx$ (2)

5.2.2 Evaluate the integral $V = 2\pi \int_0^{90^\circ} x(3 \cos x) dx$ (3)

[5]

C. The next 11 marks focus on the questions that test for conceptual knowledge and their applications as it is with skill III as well as some from Skill factor I as students will be calculating the area.

Question 5.3

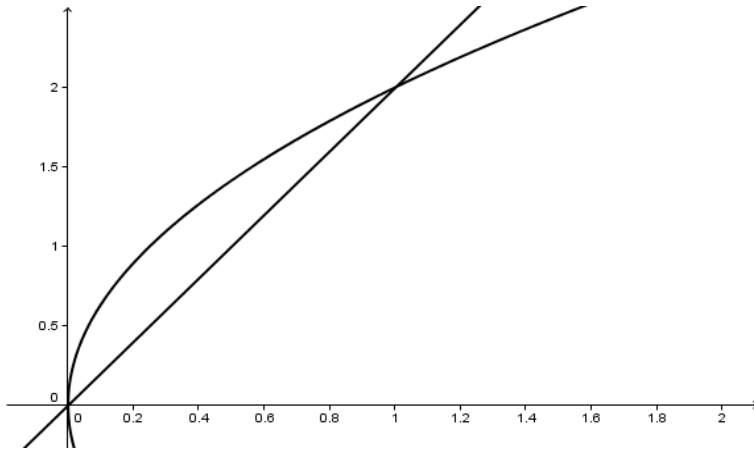

5.3.1 Above the graphs of $y - 2x = 0$ and $4x = y^2$ are drawn. Use five rectangles to **approximate** the area bounded by the drawn graphs.

(NB: Highlight the representative strip) (4)

5.3.2 Calculate the area bounded by the graphs using integration methods. (3)

5.3.3 Show the coordinates of the centroid of the strip and calculate them. (4)

[11]

D. The last 12 marks use questions where the next questions depend on the graph(s) drawn testing both conceptual and procedural knowledge as it is with Skill factor V. Students are expected to calculate area, volume, centroid, centre of gravity, moment of inertia and second moment of area. An example given below is for fluid pressure on sluice gates.

Question 5.4

5.4.1 A vertical sluice gate in the form of a trapezium is 7 m high. The longest horizontal side is 8 m in length and in the water level. The shorter side is 4 m in length and 7 m below the water surface. Make a neat sketch of the sluice gate and calculate the relationship between the two variables x and y . (3)

5.4.2 Calculate the first moment of area of the sluice gate about the water level. (4)

5.4.3 Calculate the second moment of area of the sluice gate about the water level as well as the depth of the centre of pressure of the sluice gate by means of integration. (5)

[12]

The general manipulation skills for Skill factor IV should not be tested separately since ± 15 marks of it are tested in Skill factors I and V as students are calculating points of intersection, other important points of the graphs, the equations of the sluice gates and other necessary calculations before drawing the graphs, as well as evaluating the integrals after selecting the correct formula and calculating the centroids and others. The general manipulation skills are also tested in most of the questions that constitute the remaining 60 marks of the examination paper. It is suggested that in alternative trimesters, some of the concepts including the centroid, centre of gravity, second moment of area, the moment of inertia and the application of fluid pressure be tested in Skill factor I where the diagram and the strip are given and the students interpret them. The way of questioning in Skill factor I enables one to determine whether the students are competent in these concepts or not. The assessment in Skill factors II and III, the focus is mainly on the development of the conceptual understanding. In Skill factor V, a concept that was not tested in Skill factor I may now be tested, where the focus is now on the level of cognitive development. The table 6.32 summarises the composition of the paper.

Table 6.32: The composition of the paper

QS	GMNP	GR	CD(V)	VA3D	VA2D	AV3D	2D-3D	Marks
5.1	7			3			2	= 12
5.2	3					2		= 5
5.3	5		4		2			= 11
5.4	7	3			2			CGLCD = 12
	22	3	4	3	4	2	2	TOTAL=40
	25		15					



CHAPTER 7: CORRELATING THE ELEMENTS

This chapter presents the correlation of the elements from the first and the second runs of the questionnaire with 37 students and 122 students respectively, as well as from the examination analysis with 151 students that were analysed qualitatively in Chapter 6. Kendall tau and Pearson correlation coefficients are used to determine the level of significance of the correlations. The null hypothesis H_0 in this study is that: there are no associations in performance between the different elements. Depending on the p-value, relating to the significance level, the null hypothesis is either rejected or not rejected. The ranked marks for each respondent (0 to 4) obtained for the 11 elements, from the 37 responses from April 2007 results; and four elements from the 122 responses from the October 2007 results and five elements from the 151 responses from August 2007 examination analysis are correlated using a non-parametric test, Kendall tau correlation coefficient. The marks obtained by the 151 students from Question 5 out of 40 are correlated with the overall examination marks out of 100 using scatter plots and the Pearson correlation coefficient as a parametric test. A histogram is used to display the distribution of the students' marks and the scatter plot is used to identify students' performance in terms of four quadrants before the correlations are done.

7.1 NON-PARAMETRIC TESTS: KENDALL TAU (τ)

When using non-parametric tests, the rank scores obtained by the students are correlated. The correlations are done based on the average ranks that each student got for all questions under each of the 11 elements. For example, the average rank of the two questions under graphing skills is correlated to the average rank of the two questions under consolidation and general level of cognitive development. In the Questionnaire 1st run, all the students were given all 23 questions to respond to. For the Questionnaire 2nd run, two groups of students were given different questions. It was only for one group where all questions under four elements were given. In other elements, students were given only one question to respond to. For the examination analysis, the questions that the students responded to could only be classified under five elements. The students' performance based on the elements from the Questionnaire 1st run with 37 responses, the Questionnaire 2nd run with 122 responses and the examination analysis with 151 responses are correlated separately using Kendall tau (τ) correlation coefficients. Kendall tau is used since most of the results contained tied ranks between 0 and 4, with more than one student having the same score.

The data are presented in tables where the pairs of correlations are indicated. The level of significance shown by no asterisk is not significant (p -value is > 0.05); one asterisk (*) indicates significance where $0.01 < p < 0.05$ and two asterisks (**) indicates where the p -value is < 0.01 as highly significant. The diagonal row gives a correlation of 1, since the averages from the same elements are correlated, e.g. graphing skills is correlated with graphing skills. The correlation discussed here is below the diagonal. In correlating the elements the direction of the association of the elements is not known. My research hypothesis (H_0) is: *There are no associations in performance between the different elements*. It does not state the direction of the difference or association among the elements. Therefore I used a two-tailed test of significance. The null hypothesis is either rejected or not rejected, depending on the p value, relating to the significance level at 0.01 (1%) or at 0.05 (5%) levels.

7.1.1 Correlations for the Questionnaire 1st run

Table 7.1: Kendall tau for the Questionnaire 1st run

	GR	AV2D	VA2D	AV3D	VA3D	2D-3D	3D-2D	CD(V)	DC-CD(A)	GMNP	CGLCD
GR Correlation Coefficient	1.000										
Sig. (2-tailed)	.										
AV2D Correlation Coefficient	.112	1.000									
Sig. (2-tailed)	.407	.									
VA2D Correlation Coefficient	.028	-.071	1.000								
Sig. (2-tailed)	.834	.607	.								
AV3D Correlation Coefficient	.168	-.029	.324*	1.000							
Sig. (2-tailed)	.201	.833	.016	.							
VA3D Correlation Coefficient	.416**	.174	.084	.294*	1.000						
Sig. (2-tailed)	.002	.202	.536	.026	.						
2D-3D Correlation Coefficient	.291*	.227	.275*	.144	.271*	1.000					
Sig. (2-tailed)	.025	.091	.039	.268	.039	.					
3D-2D Correlation Coefficient	.384**	.207	.206	.198	.248	.463**	1.000				
Sig. (2-tailed)	.003	.127	.123	.131	.060	.000	.				
CD(V) Correlation Coefficient	.314*	.048	-.040	.178	.319*	.437**	.407**	1.000			
Sig. (2-tailed)	.018	.724	.769	.180	.017	.001	.002	.			
DC-CD(A) Correlation Coefficient	.180	.161	.209	.368**	.261	.314*	.328*	.450**	1.000		
Sig. (2-tailed)	.174	.237	.122	.005	.051	.017	.013	.001	.		
GMNP Correlation Coefficient	.145	.081	-.174	.224	.252	-.135	-.183	.071	-.079	1.000	
Sig. (2-tailed)	.269	.547	.192	.087	.055	.295	.161	.592	.547	.	
CGLCD Correlation Coefficient	.374**	.306*	.069	.319*	.436**	.455**	.444**	.593**	.502**	.138	1.000
Sig. (2-tailed)	.006	.027	.615	.018	.001	.001	.001	.000	.000	.303	.

** Correlation is significant at the 0.01 level (2-tailed).

* Correlation is significant at the 0.05 level (2-tailed)

From Table 7.1, the correlations for the 11 elements are displayed and interpreted from Kendall's tau correlation coefficient. All correlations in Table 7.1, which are significant at 0.01 and 0.05 levels, are positive, while none of the negative correlations are significant.

7.1.1.1 Correlating the skill factor consolidation and general level of cognitive development and the other elements

The two highly significant correlations $\tau = 0.593, p < 0.001$, and $\tau = 0.502, p < 0.001$ are correlating the consolidation and general level of cognitive development to two different elements, translation from continuous to discrete (visually) and translation from discrete to continuous and from continuous to discrete (algebraically). Such an association between the consolidation and general level of cognitive development and elements in the continuous to discrete representations, points out to how important the selection of representative strip is to the ability to perform better in a question that requires consolidation and general level of cognitive development.

The correlation of the consolidation and general level of cognitive development is also highly significant to four other elements: graphing skills, $\tau = 0.374, p = 0.006$; translation from visual to algebraic in 3D, $\tau = 0.436, p = 0.001$; translation from 2D to 3D, $\tau = 0.455, p = 0.001$; and the translation from 3D to 2D, $\tau = 0.444, p = 0.001$. Such an association between the consolidation and general level of cognitive development and graphing skills; translation from visual to algebraic in 3D; translation from 2D to 3D and translation from 3D to 2D also points out the strong correspondence between consolidation and general level of cognitive development and performance in these elements. The performance in these elements is related to how graphs are drawn and interpreted. It relates to how the region bounded by the drawn graphs or a given diagram is rotated about any axis, especially in three-dimensions. It also relates to having to draw a 2D diagram from the given 3D solid.

The correlation of the consolidation and general level of cognitive development is significant to the two elements: translation from algebraic to visual in 2D and translation from algebraic to visual in 3D, and not significant to the two elements: translation from visual to algebraic in 2D and general manipulation skills. Overall, consolidation and general level of cognitive development is strongly associated with these six elements, graphing skills, translation from visual to algebraic in 3D, translation from 2D to 3D, translation from 3D to 2D, translation from continuous to discrete (visually) and translation from discrete to continuous and from continuous to discrete (algebraically).

7.1.1.2 Correlating general manipulation skills to other elements

The element, general manipulation skills is the only element which does not show any significant correlations to the other elements. It also has a high number (4) of negative correlations in relation to other elements. General manipulation skills correlates negatively to the elements: translation from visual to algebraic in 2D; translation from 2D to 3D; translation from 3D to 2D and translation from discrete to continuous and from continuous to discrete algebraically. The non-significant correlations of manipulation skills to the other elements reveals that lack of manipulation skills does not impact on the skills in the other elements.

7.1.1.3 Correlating translation from discrete to continuous and from continuous to discrete algebraically to other elements

In addition to the consolidation and general level of cognitive development, the element translation from discrete to continuous and from continuous to discrete algebraically is highly correlated to translation from continuous to discrete (visually) with $\tau = 0.450$, $p = 0.001$ and translation from algebraic to visual in 3D with $\tau = 0.368$, $p = 0.005$, respectively. Both elements and use the strip as the main focus, visually and algebraically. This shows that algebraic thinking is related to visual thinking when translating from continuous to discrete and vice versa.

The element translation from discrete to continuous and from continuous to discrete algebraically has significant correlations between the elements translation from 2D to 3D and translation from 3D to 2D.

7.1.1.4 Correlating translation from continuous to discrete (visually) to other elements

Apart from the element consolidation and general level of cognitive development and the element translation from discrete to continuous and from continuous to discrete algebraically, the element translation from continuous to discrete (visually) is highly correlated to the two elements, translation from 3D to 2D with $\tau = 0.407$, $p = 0.002$ and translation from 2D to 3D $\tau = 0.437$, $p = 0.001$. This reveals that the selection of the strip and approximating the bounded region impacts on how one translates between 2D and 3D, be it from area to volume or from volume to area. The element translation from continuous to discrete (visually) shows significant correlations with the two elements, graphing skills and translation from visual to algebraic in 3D with non-significant correlations to the other remaining elements.

7.1.1.5 Correlating translation from 3D to 2D to other elements

In addition to the elements consolidation and general level of cognitive development and translation from continuous to discrete (visually), the element translation from 3D to 2D is highly correlated to the two elements, translation from 2D to 3D with $\tau = 0.463$, $p < 0.001$ and graphing skills with $\tau = 0.384$, $p = 0.003$. This reveals that the ability to translate from 3D to 2D is associated with the skills that one has in drawing graphs and how the drawn 2D diagrams are rotated to 3D. Earlier on we observed that this element was significantly correlated to the element translation from discrete to continuous and from continuous to discrete algebraically. It also shows no significant correlations with the other elements.

7.1.1.6 Correlating translation from 2D to 3D to other elements

As previously discussed, the element, translation from 2D to 3D, was highly correlated to the three elements, translation from 3D to 2D, translation from continuous to discrete (visually) and consolidation and general level of cognitive development. This means that translation from 2D to 3D is associated with translation from 3D to 2D, to the way in which the strip is being selected and requires a level of cognitive development.

In addition to the element translation from discrete to continuous and from continuous to discrete (algebraically), this element is significantly correlated to the three elements graphing skills; translation from visual to algebraic in 2D and translation from visual to algebraic in 3D. There is no significant correlation of this element to the elements, translation from algebraic to visual in 2D translation from algebraic to visual in 3D and general manipulation skills.

7.1.1.7 Correlating translation from visual to algebraic in 3D to other elements

In addition to being highly correlated with the element consolidation and general level of cognitive development, this element is also highly correlated to graphing skills with $\tau = 0.416$, $p = 0.002$. This reveals the relationship between the skills that one has in drawing graphs with the skill of interpreting the drawn graphs, resulting in the formula for volume. Apart from the translation from 2D to 3D and translation from continuous to discrete visually translation from visual to algebraic in 3D has a significant correlation to translation from algebraic to visual in 3D. The rest of the correlations (translation from algebraic to visual in 2D, translation from algebraic to visual in 3D, translation from 2D to 3D, translation from discrete to continuous and from continuous to discrete algebraically and general manipulation skills are non-significant.

7.1.1.8 Correlating translation from algebraic to visual in 3D to other elements

Looking at the remaining correlations for this element, it is highly correlated with translation from discrete to continuous and from continuous to discrete algebraically. These two elements are highly associated because the equations given are to be translated and represented visually in both elements.

This element is significantly correlated to the translation from visual to algebraic in 3D, the translation from visual to algebraic in 2D and the consolidation and general level of cognitive development.

7.1.1.9 Correlating translation from visual to algebraic in 2D to other elements

This element is not highly associated with any elements. It does not have any significant correlation with 8 elements. It only has significant correlations with the elements translation from algebraic to visual in 3D and translation from 2D to 3D. Of the eight non-significant correlations that this element has with the other elements, three are negative. These correlations reveal that the ability to solve problems involving translation from visual to algebraic in 2D is not associated with the other elements.

7.1.1.10 Correlating translation from algebraic to visual in 2D to other elements

Similar to the element translation from visual to algebraic in 2D, this element does not have any significant correlations with many elements. It also has a high number of non-significant correlations (9) of which two are negative. This element is only significantly correlated to consolidation and general level of cognitive development. The correlation here reveals that drawing diagrams in 2D is associated with the cognitive demands of the task.

7.1.1.11 Summary for the Questionnaire 1st run

The conclusions that can be drawn from Kendall's tau correlation coefficient suggest that the consolidation and general level of cognitive development as well as the translation from continuous to discrete visually has the highest significant correlations with most of the elements. The element involving general manipulation skills shows all correlations that are not significant in relation to all 9 elements. These non-significant correlations mean that performance in general manipulation skills does not have any impact on how one performs in VSOR. Similarly all the correlations for the translation from algebraic to visual in 2D, except consolidation and general level of cognitive development has non-significant correlations to the other elements.

The conclusions above imply that in order to do well in VSOR, the students must be competent in the skill that involves the consolidation and general level of cognitive development as it is strongly associated with other elements as well as translation between discrete and continuous (the proper identification of the correct strip). The results also reveal that the skills that involve general manipulation do not have any impact on other elements, while the translation from algebraic to visual in 2D have an impact only on the element consolidation and general level of cognitive development.

In the section that follows, the results involving the Questionnaire 2nd run (122 respondents) are presented and analysed, again using Kendall tau to establish similar or different trends from the Questionnaire 1st run (37 respondents) discussed above.

7.1.2 Correlations for the Questionnaire 2nd run

Table 7.2: Kendall tau for overall 122 responses

		GR	AV3D	3D-2D	GMNP
GR	Correlation Coefficient	1.000			
	Sig. (2-tailed)	.			
AV3D	Correlation Coefficient	.228**	1.000		
	Sig. (2-tailed)	.002	.		
3D-2D	Correlation Coefficient	.106	.129	1.000	
	Sig. (2-tailed)	.139	.074	.	
GMNP	Correlation Coefficient	.140	.284**	.099	1.000
	Sig. (2-tailed)	.050	.000	.158	.

** Correlation is significant at the 0.01 level (2-tailed).

In Table 7.2 all correlations are seen to be positive. An element that has highly significant correlations to other elements is the element, translation from algebraic to visual in 3D, with the highest correlation of $\tau = 0.284$, $p < 0.001$ with general manipulation skills and the correlation of $\tau = 0.228$, $p = 0.002$ with graphing skills. The correlations obtained imply that translation from algebraic to visual in 3D is strongly associated with general manipulation skills and with graphing skills. In both cases the association between translation from algebraic to visual in 3D to these other elements is statistically significant at the 1% level ($p < 0.01$). The correlations between graphing skills and the other two elements translation from 3D to 2D and general manipulation skills are not significant. This means that a skill in drawing graphs appears not to be associated with how one performs calculations or how one translates from 3D to 2D.

7.1.2.1 Summary for the Questionnaire 2nd run

The conclusions can be drawn that overall the translation from algebraic to visual in 3D has a high correlation with general manipulation skills and graphing skills in relation to other elements that are correlated. The conclusions above imply that in order to do well in VSOR, the students must be competent in the skill that involves the translation from algebraic to visual in 3D, general manipulation skills and graphing skills.

7.1.3 Conclusion for the correlations from the questionnaires

In the Questionnaire 2nd run the element translation from algebraic to visual in 3D was highly correlated to the elements graphing skills and general manipulation skills, but in the Questionnaire 1st run the correlations were not significant. In the Questionnaire 1st run, the elements graphing skills and the elements translation from 3D to 2D were highly correlated, whereas in Questionnaire 2nd run, their correlations were not significant. Similar results were found between the following correlations:

- Translation from algebraic to visual in 3D and translation from 3D to 2D.
- General manipulation skills and graphing skills.
- General manipulation skills and translation from 3D to 2D.

The general conclusion that could be made is that general manipulation skills do not have any impact on most of the elements, whereas graphing skill does.

It must however be noted that in the Questionnaire 1st all 11 elements were correlated and that in the Questionnaire 2nd run only four elements graphing skills, translation from algebraic to visual in 3D, translation from 3D to 2D and general manipulation skills were correlated. In both runs of the questionnaires the students were different, the lecturers who taught them were different and probably their level of preparedness were different. However, one can make some inferences about the recurring trends in the correlations despite their different circumstances, as it is evident from similar results that were found above from the correlations of the elements.

7.1.4 Correlations for the examinations analysis

In Table 7.3 the five elements from the 11 elements used in the main instrument are correlated.

Table 7.3: Correlations from Kendall's tau

		GMNPav	GRav	CDav	VA2Dav	VA3Dav
GMNPav	Correlation Coefficient	1.000				
	Sig. (2-tailed)	.				
	N	151				
GRav	Correlation Coefficient	.444**	1.000			
	Sig. (2-tailed)	.000	.			
	N	151	151			
CDav	Correlation Coefficient	.366**	.561**	1.000		
	Sig. (2-tailed)	.000	.000	.		
	N	151	151	151		
VA2Dav	Correlation Coefficient	.342**	.575**	.415**	1.000	
	Sig. (2-tailed)	.000	.000	.000	.	
	N	151	151	151	151	
VA3Dav	Correlation Coefficient	.412**	.480**	.428**	.370**	1.000
	Sig. (2-tailed)	.000	.000	.000	.000	.
	N	151	151	151	151	151

** . Correlation is significant at the 0.01 level (2-tailed).

In Table 7.3 the correlations of the five elements, general manipulation skills, graphing skills, translation from continuous to discrete, translation from visual to algebraic in 2D and translation from visual to algebraic in 3D are given and based on Kendall's tau coefficient of correlation (τ). Kendall's coefficient of correlation takes into account the ranks that have ties (more than one student having the same score). The correlations found in Table 7.3 show a highly significant association between the five elements from Question 5 at 1% level. The highest correlations are for the element graphing skills to the elements translation from visual to algebraic in 2D with $\tau = 0.575$, $p < 0.001$ and translating from continuous to discrete visually with $\tau = 0.561$, $p < 0.001$.

The correlations in Table 7.3 mean that for all the elements, the higher a student scores in one element, the higher a student will score in the other element since all correlations are positive. The lower a student scores on graphing skills, the lower a student will score on problems requiring the translation from visual to algebraic in 2D and vice versa. This reveals that the examination paper is assessed in such a way that the responses to the five different elements are strongly associated with one another.

7.1.5 Summary for the examination correlations

Interpretations of the Kendall's tau correlation coefficient for the 151 students for the 5 elements reveals that, overall, the graphing skills and translation from visual to algebraic in 2D are highly correlated as well as the association of the graphing skills and translating from continuous to discrete. The other correlations are highly significant as well. One can therefore conclude that in learning VSOR, the consolidation and general level of cognitive development appears to be significant as it depends on all five elements correlated. The five elements being correlated (graphing skills, translation from visual to algebraic in 2D, translation from visual to algebraic in 3D, translating from continuous to discrete visually and general manipulation skills) are therefore fundamental in learning VSOR in relation to the way in which the final N6 mathematics examination paper is prepared.

7.2 PARAMETRIC TESTS: PEARSON (r)

In the section that follows, the marks obtained by 151 students in Question 5 (out of 40 with a passing mark of 16) are correlated to the marks that they obtained for the whole paper (out of 100 with a passing mark of 40). The parametric tests are used, using graphs and tables. Under the parametric tests, histograms; a scatter plot; the Pearson correlation coefficient (r) and the level of significance are discussed based on the overall numerical value that each student obtained for Question 5 and comparing it to the mark for the whole paper. The five elements are: general manipulation skills; graphing skills; translation from continuous to discrete; translation from visual to algebraic in 2D and translation from visual to algebraic in 3D.

My research hypothesis does not state the direction of the difference or association among variables. Therefore I used a two-tailed test of significance. The null hypothesis H_0 in relation to the examination analysis and the elements is that: *There are no associations in performance between Question 5 and the whole paper.* The null hypothesis is either rejected or not rejected depending on the p -value, relating to the significance level.

Before correlating the scores obtained by students in Question 5 to those in the whole paper and determining the level of significance using Pearson's correlation coefficient, a histogram is used to display the distribution of the students' marks. Thereafter a scatter plot is used to identify where each student lies in terms of the marks obtained for Question 5 and the whole paper. The distribution of the results is shown for Question 5 in Figure 7.1 and for the whole paper in Figure 7.2 for the 151 students. The data are almost symmetrically distributed.

7.2.1. The histogram for students' performance

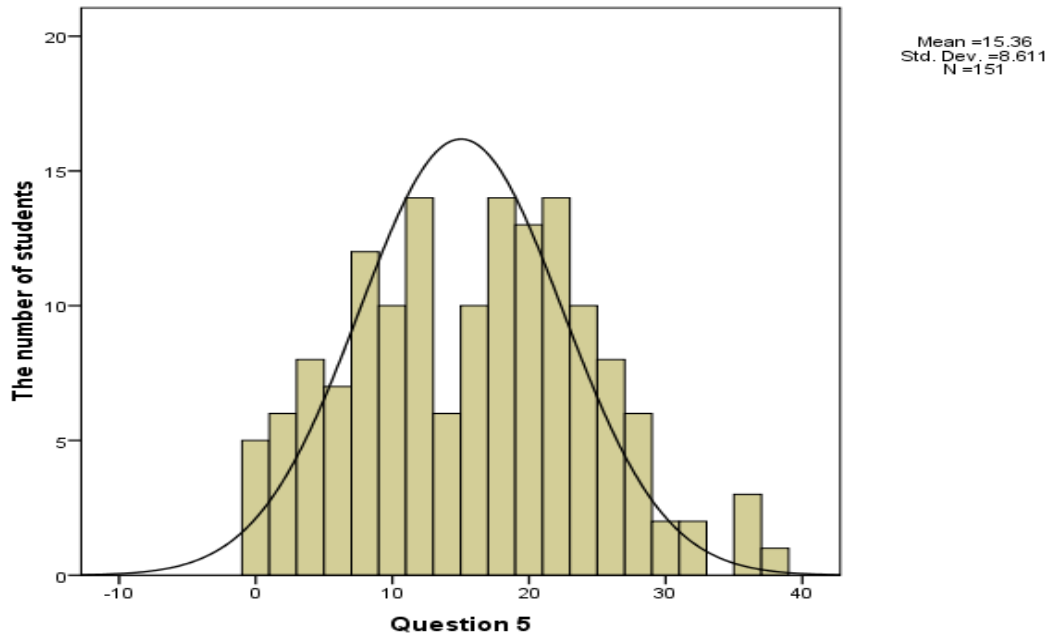

Figure 7.1: Performance in Question 5

Figure 7.1 shows how many students obtained a particular score, ranging from zero to 40. It is evident from the histogram that 5 students scored zero for Question 5 whereas none of the students scored the total mark of 40. The highest number of students (from the bars) scored 12; 18 and 24 respectively with no students scoring 34. Ten students got 16 marks, the passing mark for Question 5 and 78 (51.6%) students passed the Question 5. The mean for Question 5 is 15.4 (below 16), resulting a mean percentage of 38.5%, with the standard deviation of 8.611.

The coefficient of variation for this data is $\frac{8.611}{15.36} \times 100 = 56.1\%$.

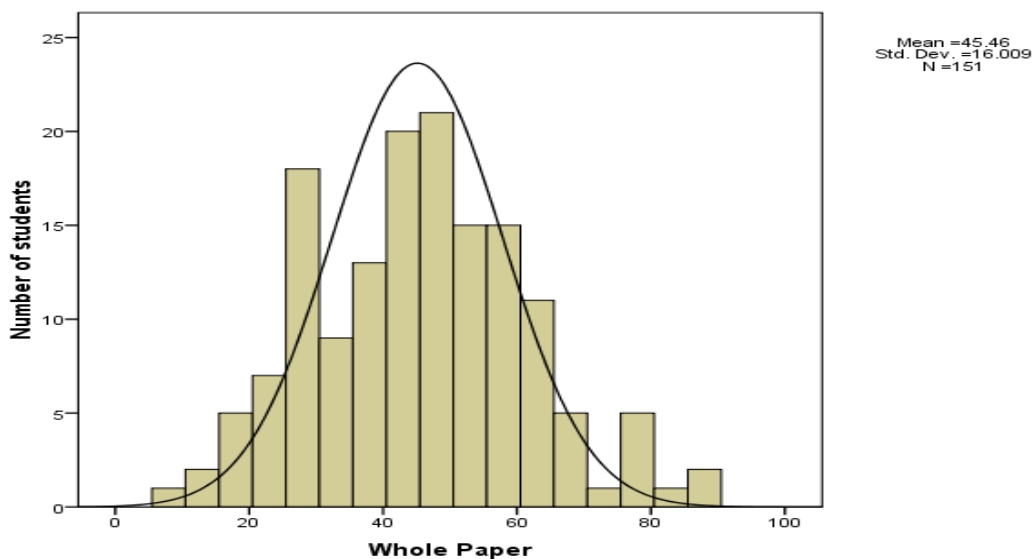

Figure 7.2: Performance in the whole paper

Figure 7.2 shows how many students obtained a particular score for the whole paper, ranging from zero to 100. It is evident from the histogram that no students scored zero for the whole paper whereas none of the students scored the total mark of 100. The lowest mark is below ten (8) obtained by one student and the highest mark is 90, also obtained by one student. The highest number of students (21) scored between 45 and 50 with no students scoring below 5 and above 90. The majority of the students, 99 (65.6%) passed the whole paper. Students performed better in the whole examination (65.6%) than in Question 5 (51.6%). The low percentage obtained in Question 5 in relation to the whole examination implies that Question 5 was difficult.

The mean for the whole paper is 45.5, resulting in a mean percentage of 45.5% (higher than that of question 5) with a standard deviation of 16.009. The coefficient of variation for this is $\frac{16.009}{45.46} \times 100 = 35.2\%$. Compared to the coefficient of variation obtained in Question 5, it shows that there is less variability (data less dispersed) 35.2% in the marks obtained in the whole paper compared to those obtained in Question 5 with the coefficient of variation being 56.1%.

7.2.2 The scatter plot for students' performance

In Figure 7.3 a scatterplot is used to show the association between the marks obtained in Question 5 (out of 40 with a passing mark of 16) and the marks obtained in the whole papers (out of 100 with a passing mark of 40) which are presented in Appendix 6B. The passing mark is used to separate the students according to specified quadrants A, B, C and D.

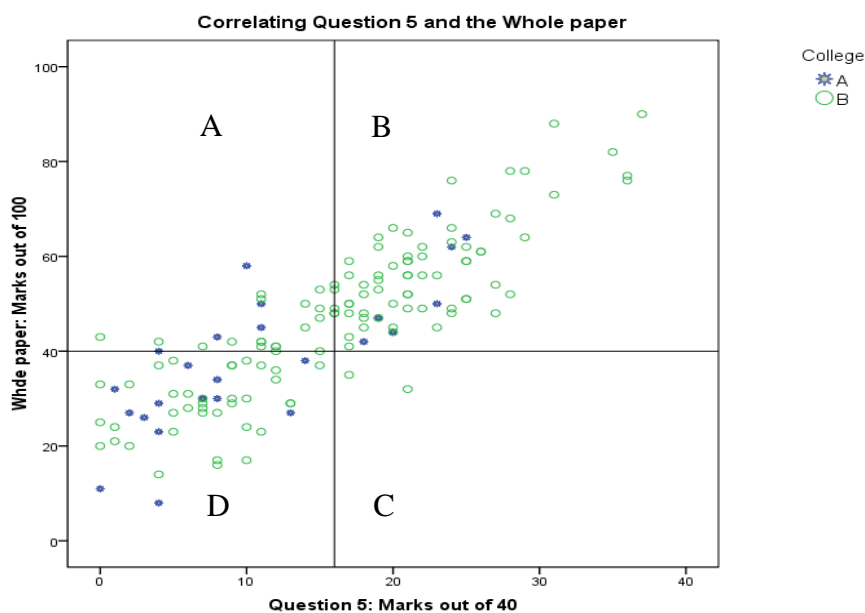

Figure 7.3: Scatterplot on Question 5 and the whole paper

Comments on the performance in terms of the quadrants A, B,C and D are made in Table 7.4

(* representing students from College A and o representing students from College B).

Table 7.4: Displaying performance in the four quadrants

Quadrants	Students performance	Ratio and % of students
A	Those who failed Question 5 and passed the whole paper.	$23 = \frac{23}{151} \times 100 = 15.2\%$
B	Those who passed Question 5 and passed the whole paper.	$76 = \frac{76}{151} \times 100 = 50.3\%$
C	Those who passed Question 5 and failed the whole paper.	$2 = \frac{2}{151} \times 100 = 1.3\%$
D	Those who failed Question 5 and failed the whole paper	$50 = \frac{50}{151} \times 100 = 33.1\%$
		100%

The majority of the students (76), that is 50.3%, fall in quadrant B, which means that there is a tendency that those who pass Question 5 tend to pass the whole paper and vice versa. The second group, comprising 50 students, that is 33.1% fall in quadrant D, which means that there is again a tendency that those who fail Question 5 tend to fail the whole paper and vice versa. The third group is in quadrant A (23) that is 15.2% representing those students who failed Question 5, yet passed the whole paper. In quadrant C there are two outliers, about 1.3% (a very small percentage), who passed Question 5 but failed the whole paper, scoring less than 40 per cent in the whole examination.

On the scatter plot there are scores that lie on top of one another and cannot be identified individually on the scatter plot as some students obtained the same marks. For example two students obtained 25 out of 40 in Question 5 and 51 out of 100 in the whole paper from quadrant B and two students obtained 12 out of Question 5 and 41 out of the whole paper from quadrant A (refer to Appendix 6B). There are also those students that lie on the border line. There are four students that are on the border line of quadrant A and B, representing about 3%. These students are included in quadrant B since they obtained 16 marks for Question 5 and passed the whole paper. The two students that lie on the border of quadrant A and D representing about 1% are included in quadrant A because they failed Question 5, yet scored 40% for the whole paper, which is regarded as a passing mark.

The majority of the students in quadrants B and D (83.4%) justifies that performance in Question 5 and performance in the whole paper are related. That means those who perform well in in this question are likely to perform well in the whole paper and vice versa. The

opposite is also true in that those who perform poorly in this question are likely to perform poorly in the whole paper and vice versa. Only in exceptional cases, like the two outliers, was it found that such students passed Question 5 but failed the whole paper. In addition to that, those outliers scored very low marks, 17 and 21 respectively out of 40 for Question 5 (refer to Appendix 6B). The marks obtained by the best performing student, 37 for Question 5 and 90 for the whole paper and the worst performing student, 0 for Question 5 and 11 for the whole paper, also justifies the association between Question 5 and the whole paper. Up to this point the direction of this association of Question 5 and the whole paper is not known, until tests for causality are done.

In the section that follows, the marks obtained by the individual students in Question 5 are correlated with the whole paper and the level of significance of that correlation is discussed.

7.3 The Pearson's correlation and the level of significance for the 151 students

In correlating the marks obtained by a student out of 40 in Question 5 and the marks out of 100 obtained in the whole paper, it was found that there was a very strong positive correlation, $r = 0.852$, $p < 0.001$ between the marks obtained in Question 5 and the whole paper, which is highly significant. What this correlation means is that high marks obtained in Question 5 are associated with high marks obtained in the whole paper. It also means that low marks obtained in Question 5 are associated with low marks in the whole examination paper.

This correlation means that performance in Question 5 is strongly positively correlated to the performance in the whole paper, hence their association is statistically significant at the 1% level. There is therefore convincing evidence against the null hypothesis that the correlation coefficient is zero. We have confidence that such a big correlation coefficient for the 151 students did not occur by chance, hence such an association is genuine. An assumption that could be made based on the above correlation and its significance is that the majority of the students who pass Question 5 tend to pass the whole paper and that the majority of the students who fail Question 5 tend to fail the whole paper, rejecting the null hypothesis that: *There are no associations in performance between Question 5 and the whole paper.* We can conclude that there is a strong association between Question 5 and the whole paper. There is overwhelming evidence against the null hypothesis.

In order to measure how much variability in the performance in the whole paper may be explained by the performance in Question 5, the coefficient of determination is used. The coefficient of determination (R^2) is a measure of the amount of variability in one variable that is explained by the other variable (Field, 2005: 128), which is always positive. In this case it is $(0.852)^2$, which is equal to 0.73. This value (converted to percentage) means that performance in Question 5 accounts for 73% of the variability in the performance for the whole paper. The other 27% may be accounted for by other variables that do not relate to performance. For an example, the socio-economic factors that affect the student might affect how one performed during the examination.

7.3.1 Conclusion from the parametric tests

Conclusions can be made for the analysis of the 151 responses from the above sections. It can be concluded from the scatter plots, from the correlations of Question 5 and the whole paper, where $r = 0.852$, $p < 0.001$ and the correlation of the five elements as well from their significance level, that there is convincing evidence that (a) There are associations in performance between Question 5 and the whole paper and that (b) There are associations in performance between the different elements, from Question 5. The findings are that the performance in Question 5 accounts for 73% of how one performs in the whole paper. Half of the students, 50.3% who passed Question 5 passed the whole paper and 33.1% of the students who failed Question 5 failed the paper as evident from the four quadrants. This justifies without any doubt that 83.4% of the associations results in a strong positive linear relationship.

This justification is further emphasised through the correlation of Question 5 to the whole paper using Pearson's correlation coefficient and the average ranks of the five elements from Question 5 using Kendall's tau correlation coefficients, which also showed statistically significant correlations at 1% level. These highly significant correlations are as result of the subquestions in question 5 where solution for the first subquestion is used in finding the solution for the subsequent questions. As a result, failure in the first question, which in most cases involves drawing graphs, leads to failure in the subsequent questions, relating to interpretations of the drawn graphs.

CHAPTER 8: OBSERVATIONS AND AN INTERVIEW

This chapter presents the description and analysis of the data collected from the classroom observations focusing mainly on the lecturer and a group of students selected, including an interview with a former N6 student. The results of the observations and the interview confirm or contrast the results obtained in Chapter 6. The data collected is described qualitatively in terms of what was said or done (narratives, verbal or written) by the lecturer and the selected group of students as well as the single interviewed student in relation to the five skill factors discussed in Chapter 3. The results are presented with selected extracts from the classroom observations and excerpts from the interview. For the classroom observations, the way in which the content learnt was introduced, the use of procedural knowledge and conceptual knowledge, the level of difficulty of the content and the assessment strategies are discussed. The interpretations of these results are presented in Chapter 9.

8.1 CLASSROOM OBSERVATIONS

One N6 classroom with about 40 students from College A was observed for 5 days from Monday 15th October to Tuesday 23 October 2007, focusing on what was said and done. In the presentation of the results, extracts from the classroom observations are used and analysed in terms of the five skill factors. In-depth discussions are presented for lessons one and five only, since they are regarded as the main lessons. In the first lesson the foundation for VSOR was laid and in the fifth lesson students were working in groups throughout the lesson, thus indicating what was learnt from the previous lessons. Lessons 2, 3 and 4 are discussed with few extracts where necessary to corroborate, justify, contradict or augment what happened in the first lesson. The lecturer is referred to as L, students as STs and single students as S₁, S₂, ... and the researcher as R. In the extracts that follow, for example, 01:44 indicates that an event occurred 1minute 44 seconds after the lesson was introduced. The words used by the lecturer and the researcher appear in normal font. The students' responses are in italic format, while the reactions and comments for all participants are in square brackets.

8.1.1 The first lesson

8.1.1.1 Observing the lecturer and the students in lesson 1

- **Introducing the content to be learnt**

The lesson was introduced with the topic 'Application of integration' written on the board.

Below an extract of the introduction of the lesson is presented.

00:00 to 01:44 (74 seconds)

L: ...you did application of integration. You apply integration to calculate the 'area under a curve' [repeats] a curve... you did that at the previous level [referring to N5 level] ... at N1 at N2 level, you did the chapter called mensuration ... you were measuring, calculating, perimeter, area, volume, and distance around the figure ... volume = Area x height. That is the sequence, you do perimeter, area, and you do volume ... but please allow me to start with volume, we will do area after volumes, neh!

The lecturer referred the students to the graphical and visual representation when saying that "you apply integration to calculate the area under a curve". The curve refers to what has being drawn, and can be visualised. The lecturer referred the students to a section on mensuration from the previous year, elaborating on the formula for volume, as volume = Area x height, hence emphasising the procedural skills.

The lecturer introduced a section on volume by introducing students to shapes.

01:44 to 02:40 (56 seconds)

L: Now, for us to can do this section on volumes ... we need to understand just few things, 'the shapes' [repeats three times]... we will be doing volumes, since we apply this on graphs, it will be a volume of a solid which is rotating about the x -axis or the y -axis. But as this area is rotating it formulates a particular shape, hence I want us to look at the shapes first, because those shapes inform us of the formula to use when we calculate the volume.

The lecturer emphasised that the students must understand shapes, pointing to the fact that shapes are important in learning volumes and that the formulae that the students will use in calculating the volumes will be derived from those shapes. The shapes in this case relate to the visual representation and they can be presented as diagrams. The lecturer mentioned that, rotating the area about the x -axis or the y -axis gives rise to a particular shape. During this rotation the translation is from 2D to 3D. From his statement: "shapes inform us of the formula to use when we calculate the volume", the lecturer was relating to the translation from the visual graphs to the algebraic equations for volume.

The lecturer also made use of the terminology and concepts required in this section, such as 'application of graphs', 'volume of a solid' and 'rotation' about the x -axis or the y -axis. The lecturer did not ask students how volumes are formulated, but explained to them that the shapes that one gets after rotation are important. The word, 'volume of a solid' was used but was not explained to the students, nor demonstrated. Application of graphs may be related to the way in which students interpret graphs (translating them from visual to algebraic or translating them from continuous to discrete). The volume of a solid is related to a 3D diagram that could be formulated by translating from 2D to 3D, while rotation refers to a skill that the students can use when they translate a 2D diagram to formulate a 3D diagram visually or by imagining it.

The lesson continued with the lecturer writing ‘Disc’ on the board. An example used involved a graph of a parabola and a straight line graph on the same Cartesian plane drawn on the board with a Δy representative strip as shown in Figure 8.1. During this lesson the lecturer was asking questions and the students were responding. The students’ responses as a chorus are given in the normal brackets in italic format followed by the lecturer’s responses in regular font if he repeats what the students said, while the reactions and comments for either the students or the lecturer are given in the square brackets.

02:40 to 04:36

L: [Write on the board ‘Disc’ and draw the two graphs with a horizontal strip, Δy]. If we have this two functions, $f(x)$ and $g(x)$ [facing the class] ...what type of graph is the ... $g(x)$? (*parabola*) parabola...and $f(x)$? (*straight line*) straight line graph... what are the co-ordinates of the turning point of the parabola (*4 and zero, [4;0]*), 4 and zero [4;0] neh!? [lecturer not puzzled] ... hhh!, (*zero and zero, [0;0]*) zero and zero [0;0]. Is this turning point having a minimum or maximum value? (*minimum*), [pointing on the graph’s turning point] is the a value positive or negative? (*positive*) positive.

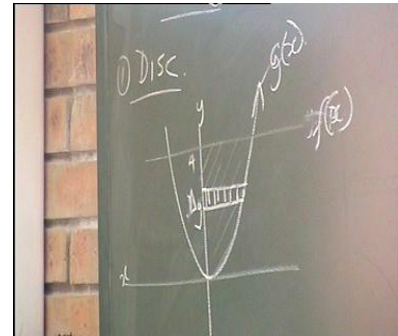

Figure 8.1: Example 1 graphs

The drawn graphs represent the graphing skills even though the equations of the graphs were not given; hence there was no translation from algebraic to visual in 2D. The Δy strip (drawn to represent the shaded area) indicates the translation from continuous to discrete representations. The reason why a Δy strip was drawn was also not discussed with the students. It was impossible in this case to detect whether the students were able to draw those graphs or either identify the correct strip. The lecturer did not start by giving the equations of the graphs and translating from algebraic to visual skills in 2D or using the general manipulation skills to find the important points on the graphs. It is not explicit whether the students still remembered what the word ‘disc’ meant as the lecturer did not explain what it meant or revising it since it is a concept that was learnt from the previous level. The general manipulation skills were applied when students gave the coordinates of the turning point of the parabola as 4 and 0 before a correct answer of 0 and 0 was given. A question relating to visual skills in 2D was also asked when the students were asked to determine whether the turning point of the given parabola was a minimum or maximum value.

In relation to the representative strip, representing the shaded area, the lecturer asked the students whether the representative strip drawn, is parallel or perpendicular to the y -axis. The lecturer referred to it as a Δy strip and related it to transformation as it rotates. The use of transformation was to enhance the visual skills and translation from 2D to 3D for the strip only and encouraging a form of imagination.

04:36 to 05:36

L: ...if we have the area bounded by the graphs $f(x)$ and $g(x)$ and the y -axis, this is the ... in the 1st quadrant ...and we have a representative strip [show them on the board]. This representative strip, is it parallel or perpendicular to the y -axis? (*perpendicular to the y -axis*); we call it a Δy strip. If it is perpendicular to the x -axis we call it? ... (Δx) Δx , ok. Now if this representative strip, which is representing this area is rotating [demonstrate with a finger pointing up, and rotating anticlockwise] about the y -axis we talk about transformation, do you know transformation. [No response from students].

The lesson continued with the lecturer demonstrating transformation to the students as shown in Figure 8.2.

05:36 to 06:40

L: If for an example, this hyperbola, [shown alongside]. A hyperbola is made up of two curves [pointing to the top graph and the bottom graph] this curve [pointing to the bottom one] is the mirror image of this one [pointing to the top graph]. Meaning that this reference line [referring to a dotted line passing through the origin] is the mirror image line, meaning that the distance from this point [showing points on the top graph and the bottom graph] up to this point will be the same to the distance from this point to that point ... we have equal distance... now, that is transformation.



Figure 8.2: Transformation

From the above extract the lecturer was trying to emphasise the visual representation using transformation of the hyperbola showing the line $y = x$ as an axis of rotation as well as the graphing skills, without starting with the equation for the hyperbola.

In Figure 8.3, the lecturer reverted to the first example.

06:38 to 07:30

L: Now when we rotate for example a representative strip [back to the drawn graphs], if you rotate it about the y -axis, it means that the length of this representative strip from the ... this point [finger pointing at the origin as in the diagram], will be the same. Now if it is rotating, it is rotating like this, [with a finger moving anticlockwise and pointing up]. What are we going to have (*a circle*), [many students whispering] circle ...but this axis [pointing on the y -axis] as our reference line, we will be having sort of a hole like this [pointing at the strip on the y -axis] ... it will form sort of a ... [no response, lecturer finishes up] ... sort of a disc [lecturer draws a disc alongside]. It rotates about our reference line.

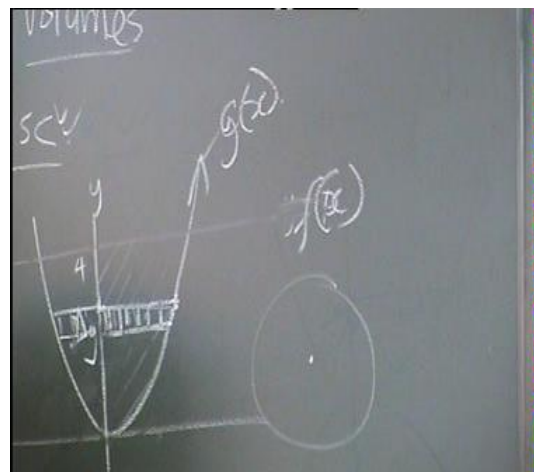

Figure 8.3: The disc method for example 1

The formation of the disc resulting from rotating (demonstrating with the finger) the given Δy strip about the y -axis relates to the translation from 2D to 3D, where visual skills are used to aid imagination in order to demonstrate a 'circle' referring to a disc in relation to the length of the representative strip.

In the section that follows the lecturer continued with the same graphs and the same Δy strip but then rotated about the x -axis, as the second example as in Figure 8.4.

07:30 to 10:50

L: ... if we can take this parabola and this other function [draw the original graphs with a Δy strip] this representative strip, we rotated it about the y -axis [referring to the first example] and a disc, was formed. What then happens if the same representative strip is rotated now about the x -axis? ...if it is rotating about the x -axis [lecturer demonstrates a cylinder shape with fingers being horizontal and rotating, both left and right fingers pointing towards one another and drew a Δy strip below the x -axis]. Do you see what will happen? The distance from ... [showing distance from the strip to the bottom of the parabola at turning point (0;0)] ... we are having our mirror image line, our reference line is our x -axis, meaning that this graph [draw a parabola facing downwards] ... the distance from this point to that point [pointing on the top graph and then on the bottom graph, are equal distances from the graph to the y -axis], ... the distance from the strip to the x -axis must be equal distance [shows below the x -axis] and the length of the representative strip must also be the same. Now it must rotate. What is going to be formed here? (a cylinder) a cylinder [also demonstrating with a glass and a diagram].

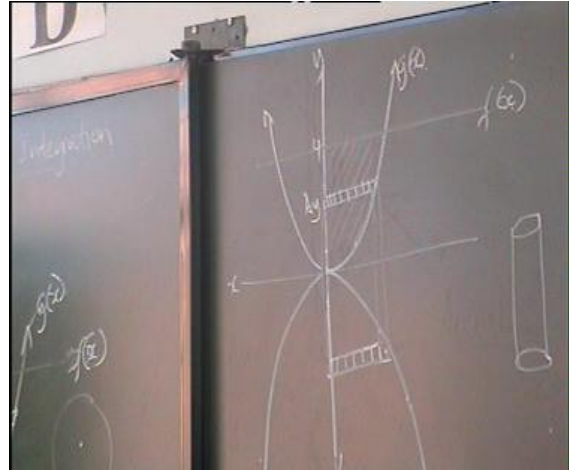

Figure 8.4: The shell method for example 2

The lecturer related the first example, about rotation of the Δy strip about the y -axis to the second example, about rotation of the same strip about the x -axis. The lecturer demonstrated the rotation by hands and through transformations and mirror images. When asking students what shape would be formed (emphasising the visual skills), they shouted out ‘cylinder’, while translating from 2D to 3D. An error was picked up as the lecturer drew the rotated cylinder on the board. Rightfully, the lecturer was supposed to have drawn a cylinder lying horizontally, not vertically, as if a Δx strip was rotated about the y -axis. The students were then referred to the question papers that were given to them in the previous lesson to refer to the formulae from the formula sheet that would be used in this section. The fact that the students were given question papers before the lesson justifies why some students were able to shout out the correct answers. Probably, the students prepared before the lesson, hence knew the answers. The lecturer emphasised that the shape that is generated after the rotation of the strip, informs the students on which formula to choose from the formula sheet.

10:50 to 12:59

If you went through the question papers you were always finding the question: Use the so called shell method to calculate the volume generated when the area bounded by ... so so so ... and the graph ... so ... is rotating about the x -axis or the y -axis, what then will be that shell method, it will be the method that we use to calculate the volume generated when rotating [refers to strip in the second example]. This means that same graph, you can calculate the area, you can calculate the volume generated ... if it is rotating about the y -axis, the disc is formed [relating to the first example]. From page no. 3 of your formula sheet (students are paging) there are lists of formulae, for volume... so that we must know, where to get what? Now if the question says, calculate the volume generated ... you must pick up the formula, what informs you what formula you must choose, must be the shape after drawing the graph.

The lecturer referred the students to the way in which the questions are asked and in conjunction with the students chose the formula from the formula sheet to be used to calculate the volume. From the second example he referred to rotating a Δy strip about the x -axis resulting in a shell and in the first example related to rotating a Δy strip about the y -axis resulting in a disc method from the shape formed, hence emphasising the visual skills. The lecturer advised the students to draw the graph(s), relating to the graphing skills, and then rotated the area bounded by the drawn graphs after having drawn the representative strip, relating to translating from visual 2D to 3D, before they could choose the formula from the shape formulated after rotation, relating to the translation of the shape (visual) to the algebraic equation (for volume) in 3D. In this case, the lecturer was leading the students to get engaged in the graphical representation and the algebraic representations. Below an example of how the equation was selected from the formula sheet when translating from the visual graphs (not drawn in 3D) to the algebraic equation for volume is given.

13:23 to 14:13

L: ... if the question says, calculate the volume generated when the representative strip is rotated about, one the y -axis [referring back to the first example] ... $V_y = \pi \int_a^b x^2 dy$ [from the students]. Why Δy ?
Because your representative strip is perpendicular to the y -axis, neh!. Are you fine with that? (yes)

The lecturer used the first and the second examples to demonstrate rotation from a Δy strip about the y -axis and about the x -axis respectively, relating to translation from 2D to 3D only visually from the rotated strip without drawing the solid of revolution generated. The formula

given, $V_y = \pi \int_a^b x^2 dy$ illustrating the translation from visual to algebraic in 3D, was

demonstrated by the lecturer as a circle drawn next to the graph as in Figure 8.3. When identifying a representative strip, it is not explicit whether the students knew when to use a Δy strip or a Δx strip, or both or when a certain strip cannot be used.

These differences were not clarified to the students during the lesson that was done on the previous level. Perhaps the lecturer could have used the same graphs (as in the first and the second examples), to demonstrate what happens if a Δx strip was rotated about the y -axis and about the x -axis, stemming from the Riemann sums, hence enhancing the translation from continuous to discrete representations visually in approximating the shaded area. If a Δx strip was rotated, from the graphs based on the first example, students could have probably been introduced nicely to the washer method upon rotation about the x -axis, since the strip does not touch any axis. They could also relate to the cylinder upon rotation about the y -axis. This type

of in-depth way of teaching by using different strips on the same graphs and using different rotations might help students in knowing why a certain strip might fail in certain graphs and that the way you choose and rotate a strip determines which method you will use to calculate the volume generated, be it disc, washer or shell.

When using a Δx strip, the lecturer used a different example, an exponential function given below in Figure 8.5 as the third example. The third example was used to aid students in selecting a formula for volume using a Δx strip upon rotation about the x -axis, resulting in a disc method.

14:14 to 16:32

L: Now ... when the representative strip is parallel to the y -axis or is perpendicular to the x -axis, ... see what our formula will be like. If it were an exponential function [draws an exponential function]. Now, look at this figure. If this representative strip [referring to the drawn Δx strip] ... are we going to write Δy or Δx ? (Δx), why Δx ?... because the representative strip is perpendicular to the ...[student finish up] (x -axis), then we have Δx . If representative strip is rotated about y -axis, what shape will be formed? (*cylinder*) ... and which method will you use to calculate volume (*shell method*). If the representative strip is rotated about the x -axis, which shape will be formed? (*disc*). It will be a disc. Then what will be the formula? You are calculating the volume which will be generated when the representative strip is rotated about the x -axis. The formula to calculate volume, it will be V_x because the representative strip will be

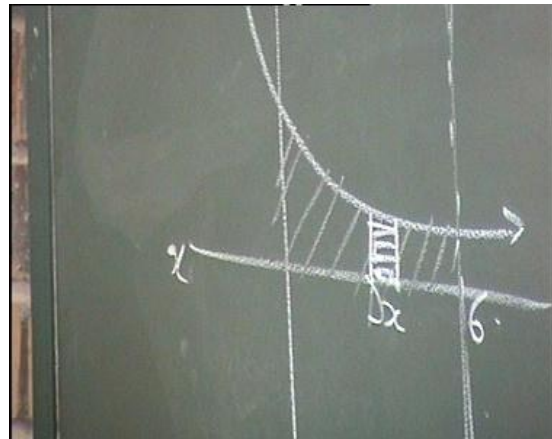

rotating about the x -axis it will be $V_x = \pi \int_a^b y^2 dx$...

Δx lower limit (a) upper limit (b). Why Δx , ... ok ... now why y here? ... the length of the representative strip, why x here, the length of the representative strip (referring to the first example).

Figure 8.5: The disc method for example 3

From the above extract, again graphical skills were displayed by the lecturer for drawing the two graphs (the exponential function and the line $x = 6$) and again without the translation from algebraic to visual in 2D since no equations were given. The Δx representative strip drawn indicates the translation from continuous to discrete representations. The lecturer emphasised the location of this particular strip in relation to the x -axis or the y -axis. That is, if the strip is parallel to the y -axis, it is at the same time perpendicular to the x -axis, hence enhancing the visual skills. Further emphasis on what shape was to be formed as the representative strip is rotated about the y -axis and about the x -axis, relates to translation from 2D to 3D also enhancing the visual skills. It was never mentioned why a Δy strip was not used and what it

means in terms of approximating the bounded region. The formula $V_x = \pi \int_a^b y^2 dx$ for a disc was

used to represent rotation about the x -axis, hence translating from the visual graph to an algebraic equation in 3D.

The lecturer reverted to the second example (Figure 8.4) to select a formula for volume using a Δy strip rotated about the x -axis, resulting in a shell method after rotation, hence translating from visual to algebraic in 3D.

16:40 to 18:48

L: To calculate volume here [referring to the second example] you will use shell method, which formula

are you going to use? ... If it is rotating about the (x -axis) the volume will be $V_x = 2\pi \int_a^b xy dy$ why

Δy ...because the representative strip is parallel to the y -axis [an error from the lecturer]. If this strip [referring to the third example] is rotated about the y -axis, to calculate the volume, what will be the formula

$$V_y = 2\pi \int_a^b xy dx \dots$$

In introducing the washer method, the lecturer referred the students to the distance between the strip and the other axis and not touching a particular axis.

L: For all ... graphs ... the representative strip is on the axis [showing students examples 1, 2 and 3 used that the representative strip is, either on the x -axis or on the y -axis].

The fourth example involving the 1st quadrant region bounded by a hyperbola of the form $xy = k$ and a straight line $y = mx + c$ was used, where the Δx strip drawn does not touch the x -axis or the y -axis, resulting in a washer method after rotation about the x - axis, as shown in Figure 8.6.

18:49 to 19:46

L: Sometimes, the representative strip can be lifted, it can be on the Cartesian plane, not on the axis, neh!... [Draw two graphs]. We have our area there [pointing on the shaded area]. Then we can draw our representative strip either perpendicular to the x -axis or parallel to the x -axis. Let's do it this way...we are going to have here [drew a Δx strip on the graph perpendicular to the x -axis] Δx neh! [pauses].

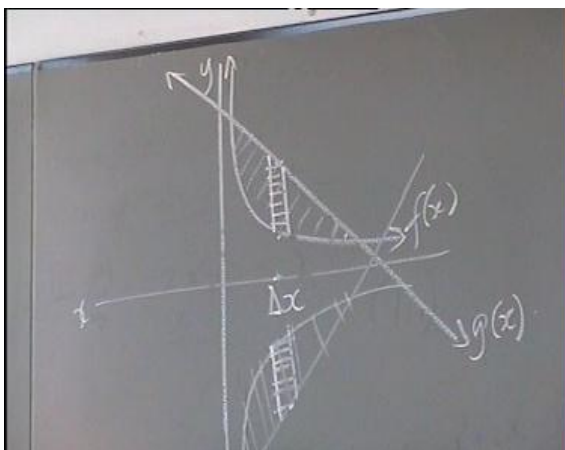

Figure 8.6: The washer method for example 4

The lecturer articulated that the drawn representative strip can be rotated about any axis, also emphasising the new shape to be formed.

19:50 to 21:25

L: ... this representative strip can be rotated either about x -axis or y -axis. What will be the shape formed when ... rotated about the y -axis? (*cylinder*), a cylinder ... meaning that it will be the shell method, neh!. Now, if it rotates about the x -axis? [as shown in the figure, demonstrating with a finger], which shape will be formed? (*washer*) washer. Meaning that the distance from here up to here [x -axis to the bottom of the strip] will be the same as the distance from the ... [pointing below the x -axis, and draws the rotated graph]. This is the mirror image as it is rotating.

The lecturer demonstrated how an annulus (a disc with a hole), shown in Figure 8.7 is formed, when a strip is lifted, enhancing the visual skills and translation from 2D to 3D.

21:28 to 22:25

Somewhere ... there is this very small hole [referring to the first example for the disc] ...but what then happens... because it rotates this way [demonstrating rotation about the x -axis with hands], that means that there will be a bigger hole [repeats] ... is the length of the representative strip. Meaning that [shade] this is our area [pointing at the shaded area], what do we call this shape [no response] this shape is called an 'Annulus' ok.



Figure 8.7: The annulus

The drawn annulus was further used to come up with the formula for a washer, discussed below, hence translating from the visual graph to the algebraic equation in 3D.

22:42 to 24:08

... how do we get the magnitude of this area [referring to the shaded area] we get the of the area of the bigger circle, minus the area of the smaller circle. The area of the annulus is ... area is pie r squared [πr^2] = area of bigger circle – minus area of smaller circle ... [$\pi R^2 - \pi r^2$] you take out pie as a common factor ... and we say $V = \pi (R^2 - r^2)$, that volume is area multiplied by the perpendicular height, where in the perpendicular height in this case will be the length of the representative strip ... that will be Δy or Δx . That is where you do the volume. But this is a constant [referring π] we take it out of the integral sign, when we do the volume. If it is rotating about the x axis, it will be upper limit, lower limit,

$$V = \pi \int_a^b (y_1^2 - y_2^2) dx$$
 ... the length of the representative strip [referring to $R^2 - r^2$] ... can be, change in the y value or change in the x value.

The lecturer worked towards the formula for volume of a washer in conjunction with the students and explained what the different variables in the formula meant, by interpreting the drawn graph. In interpreting the graph, they translated from visual graph to an algebraic equation. The lecturer was referring the students to the different types of graphs (the top as y_1 and the bottom as y_2) relating to the representative strip and the names of the graphs, hence translating from the visual graph to the algebraic equation resulting in the formation of the annulus as a result of rotating the representative strip from 2D to 3D. The annulus was later referred to as a washer. As it was the case in the previous exercises, the lecturer emphasised the axis of rotation as the reference line. Students were referred to the formula sheet on a regular

basis to choose the formula to use relating to the washer. The lecturer explained the washer method by demonstrating the location of the strip in relation to the top graph and the bottom graph, hence translating from the visual graph to the algebraic equation in 3D as discussed in the extract below.

24:10 to 27:32

L: So it can be $V_x = \pi \int_a^b (y_1^2 - y_2^2) dx$... which one is y_1 ... which one is y_2 , you are going to say the top minus bottom ...you subtract the smaller one from the bigger one ... if it is rotating about the x -axis, it means that the x -axis must be your reference line ... you are going to move from the x -axis you going up ... the 1st graph you are going to meet will be the smaller one , so it will be the top one minus the bottom one [referring to example 4, top being straight line and bottom being hyperbola] ... so it will be top minus bottom. That formula is it on page 3? or 4? (page 5) page 5 [moves toward the students].. [the lecturer looks at the formula sheet and pauses].If... if [moves back to the board] this representative strip is perpendicular to the y -axis [drawing a Δy strip on the diagram used for example 4]. If it rotates about the x -axis, which shape is going to be formed? ... (cylinder) cylinder. Which method do we use? (shell method) shell method. But, if it is rotating about the y -axis are we going to have a shhhh, a disc or cylinder? [no response, lecturer repeats] (none of the above) none of the above, neh! What are we going to have? (annulus) We are going to have an annulus, which is also called (washer) [few students responded] a washer , are you fine with that. What will be the formula, if it is rotating about the y -axis.

$V_y = \pi \int_a^b (x_1^2 - x_2^2) dy$ [students telling the lecturer what to write].You have this formula on page no5

[moving towards the students]. I think this are the basics that you have to know to answer the questions, on this section, the volumes [pause, and moves towards the board].

An example was given (from the question paper), where the graph had to be drawn first before calculating the volume (graphing skills). The representative strip had to be selected first before rotation (translation from continuous to discrete). The lecturer worked with the students to find the intercepts and the turning points of the graph (general manipulation skills).

27:53 to 30:50

L: If we have the question which goes [writes the question on the board]. Determine the volume of a solid generated when the curve $y = 2x - x^2$ and the x -axis rotates ... when area between the curve , this one and this one [pointing at the given equations, on the board] rotates about one(a) the x -axis and two (b) the y -axis ... where do you start? (draw the graph) you draw the graph [emphasising]. You all know how to draw a parabola, neh!...is that a parabola [students hesitant, not clear what they say]. Is it a parabola? (yes) ...are you sure (yes) yes it is a parabola. Now, what do we then do, to determine your intercepts, x -intercepts and y -intercepts? y intercept:0, x -intercept: you let $y = 0$ therefore you take it to the right and take out the common factor, meaning that your intercepts will be (x -intercept: 0 and 2) [students and lecturer responded simultaneously]. Coordinates of the turning points? There are about 2 methods which you can

use; one, you find the derivative of a function, you let $\frac{dy}{dx} = 0$ and then you find the value of x and you

substitute in the original equation. Or you can use the formula $-\frac{b}{2a}$ and $f\left(-\frac{b}{2a}\right)$. What you get ... x -axis

$\left(\frac{1}{2}\right) x$ is 1?, $\left(\frac{1}{2}\right)$ and 2) [another student] 2 ...1; and what? $\left(\frac{1}{2}\right)$ [One student says it loudly, female], x is $\frac{1}{2}$?

(1 and 1) [the argument with turning point carried on for about 37 seconds, then it was finally agreed that $x = 1$ and $y = 1$] turning point at (1;1). So basically, we try and draw the graph.

The lecturer drew the graph shown in Figure 8.8 on the board without involving the students. The whole class contributed towards the calculation of volume, before the students could work individually or in groups. That was done from 31:30 to 35:42 (4 minutes 12 seconds)

L: So this area between this curve and the x -axis ... we can have our representative strip Δx neh? [no explanation why Δx is used and not Δy]. Now the first question is (a) if it rotates about the x -axis ... what will be the volume it will be $V_x =$ [the students and the lecture together] it will be ... what will be the shape formed ... (a *disc*) a disc. Then you choose the formula. What will be the formula? What are our limits? $[0, 2]$

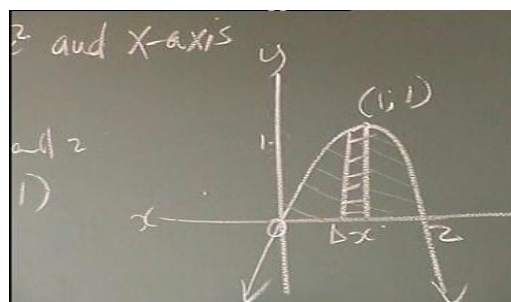

Figure 8.8: The parabola using a Δx strip

The lecturer explained to the students how the y value from the formula is replaced through substitution (translating from visual to algebraic). The lecturer in conjunction with the students used general manipulation skills while squaring the y in order to evaluate the whole integral, replacing y by x .

L: The fact of the matter is that we cannot integrate this y with respect to the variable x , ... $y\Delta x$ but only if we have x here [meaning substitute y for x]. Now it will be pie into f (upper limit) – f (lower limit). F of (lower limit will be zero because of this 0 [referring to the x -axis]. Then ... we have (a) $V_x = \pi \int_0^2 y^2 dx$ can you square that y ?, $2x - x^2$ all squared [lecturer writes, while it is not clear what the students says], $\pi \int_0^2 (4x^2 - 4x^3 + x^4) dx$, the fact of the matter is that we cannot integrate this y , with the variable x , meaning that we have to express this y in terms of x .

The lecturer in conjunction with the students continued to solve the problem (using general manipulation skills), applying the rules of integration. The application was done successfully until the volume was obtained using the disc method for problem (a), as in Figure 8.8.

L: Then lets integrate [students shout] = $\pi \left[\frac{4}{3}x^3 - x^4 + \frac{x^5}{5} \right]_0^2 =$ now ... upper limit minus lower limit ...

Can someone do it for us? ... you should get the answer as 3.351, did you get it? 3.351 neh! after multiplying by pie (yes) ... it is volume the unit must be cubed, if it is area it was going to be squared.

The lecturer started the second question (b) where the shell was formed after rotation (translating from 2D to 3D), but did not complete it. The students had to substitute for y (translating from visual to algebraic) as they were shown in Question (a) with the disc method. One is not sure whether they succeeded or not since the solution was not done in class.

L: The next question [b] says calculate volume when this representative strip is rotating about the y -axis.

What is the shape that is going to be formed? (*Cylinder*), cylinder neh! the formula? $V_y = 2\pi \int_0^2 xy \, dx$, but

the points at y , must be expressed in terms of x , so there is where you are going to put in this $2x - x^2$ and multiply then integrate, you use upper limit minus lower limit, you find the volume, and it must be in cubic units, neh!

In the section that follows, other aspects that were evident during the lesson and had an impact on the 11 elements are discussed as follows: procedural knowledge; conceptual knowledge and the level of difficulty of the content and assessment strategies.

- **The use of procedural and conceptual knowledge, level of difficulty of the content and assessment strategies**

All problems relating to procedural knowledge involved general manipulation skills and graphing skills. The lecturer in conjunction with the students had to find the x and the y intercepts as well as the coordinates of the turning points in cases where a parabola was used. After selecting the formula from the formula sheet, the substitution method was used when replacing x by y or replacing y by x , before evaluating the integral. The last part of the lesson was based on evaluating the integral, with the lecturer taking a leading role. For graphing skills, everything was procedural in nature since the graphs used during the lesson were ready made. The graphs used were familiar graphs like parabolas, straight lines and an exponential graph which are easy to draw without complex calculations. However, one cannot comment whether students would have drawn them correctly or not, since the lecturer drew them on the board.

Problems relating to conceptual knowledge involved graphing skills, translating from continuous to discrete, translating from 2D to 3D and translating from visual to algebraic in 3D. It was not possible to comment about the graphing skills and the translation from continuous to discrete (visually) since the lecturer drew the graphs and identified the strip without involving the students. There were many instances where the lecturer emphasised visual skills when relating to the position of the strip, whether the strip was parallel or perpendicular to a particular axis, and how it rotates about a certain axis, hence enhancing the conceptual understanding in relation to the representative strip by translating from 2D to 3D.

In more than two thirds of the lesson, the lecturer demonstrated the conceptual ideas through rotation from 2D to 3D by showing them a disc (circle), a shell (cylinder) and a washer

(annulus); even though the students were not given an opportunity/time to think critically about the different shapes after rotation and to draw a solid of revolution generated. The lecturer emphasised how the formula was derived, resulting from the diagram (translating from visual to algebraic), only for the washer. In other cases, the lecturer explained to the students without deriving the formulae visually that after rotating a representative strip, a formula can be selected from the formula sheet based on the shape formulated, for a disc and for a shell.

From the way in which the students responded to questions posed by the lecturer, an assumption was made that the students understood the lesson. From the way in which the lesson was presented, it seemed as if the lesson was not cognitively demanding, even though some gaps were evident. The gaps that I picked up during the lesson were that the lecturer did not involve students in drawing the first four graphs as well as explaining why a Δx strip or a Δy strip was used. While students were working in groups and individually, it was evident that some students had problems with the selection of the strip. Drawing of graphs and identifying the representative strip might have impacted on the level of cognitive difficulty in learning VSOR. One student asked the lecturer a question, in Setswana, translated in brackets in italic, relating to how a strip is selected, revealing the difficulties encountered. Comments are given in square brackets.

36:54 to 40:21

S: (*how do I know that*) this [pointing at the strip on his diagram] ... (*what do you call it ... that the strip that I use, is like this or like this?*) [demonstrating with hands, vertical or horizontal]. What is it that is going to tell me (*that my representative strip is*) perpendicular to the x -axis or to the y -axis?

L: I gave you a bundle of question papers. I was telling you ... can you take out one.

S: No I do not have one [this student did not look at, or use question papers before the lesson like other students did].

The lecturer moved away [apparently looking for question papers, and came back later]. I approached the student, in order to find out what exactly transpired.

R: You are worried about this question? Both of them?

S: (*My stress is the strip*), how do I know (*that the strip that I use, will be positioned like this or like this?*) [show with hands again, vertical and horizontal]. [Lecturer is back with the question paper and read the question to the student]

L: Make a neat sketch of the graph ... and show the representative strip that you will use to calculate the area. Now after drawing this two graphs, then your strip will either be perpendicular to the y -axis or to the x -axis: If you draw ... and rotates about y -axis and then about x -axis you will find two different values, but if you draw it perpendicularly, if you rotate about the y -axis, when you rotate about the x -axis, you will find two values, these two values, rotate by x [referring to rotations with different strips, Δx or Δy] and these two values, rotate by y [referring to rotations with different strips, Δx or Δy] will be the same.

S: (*it is up to me how I position the strip*) unless stated

L: Yes, unless otherwise stated but usually they don't state.

The lecturer made it explicit to the student what the question entails, but still did not relate to the shaded region on how a strip is selected in order to approximate it. The lecturer continued

to explain the difference between the strip being parallel or perpendicular to a certain axis (visual skills) as he did during the lesson and how it is rotated (translating from 2D to 3D) and the different values that one will obtain when calculating volume as a result of different rotations. The advice given to this student was that one can decide which strip one wants to use (meaning that any representative can be used, be it vertical or horizontal), hence ignoring the translation from continuous to discrete (visually) based on the approximation of the shaded region stemming from the Riemann sums. The lecturer did not relate the strip to be the one that would best approximate the area (the region bounded by the graphs) that would result in volume after rotation about a particular axis based on how the graphs are drawn or on the given equations, but rather emphasised the order in which the questions are asked. The lecturer also emphasised that when calculating area, using Δy or Δx strip, area remains the same, but if you rotate (translating from 2D to 3D), there will be different answers for volume. In this case the lecturer was coaching the students on how to attend to the examination questions. Below an extract is given.

L: What the question will say, it will ask you to indicate the representative strip, after drawing the graph. ...you find there are the 3 questions: One [1], the first question, will say calculate the point of intersection. Two [2], draw the graph, draw the sketch indicating the two graphs, clearly ... indicate the representative strip that you will use to calculate the volume generated as it rotates about the y -axis or the x -axis. Let's go through this one, sketch the graph, 'show the representative strip or element that you will use' [emphasised and repeated]...to calculate the volume generated when the area bounded by the graph or x -axis ...rotates about the y -axis: In other words you draw your own representative strip, so they do not indicate whether it is perpendicular to the x -axis or to the y -axis, hence they say: you will use. Area stays the same. But with volume is different, if it rotates this way [referring to rotation about the x -axis] is different shape, then it will have its own volume.

Despite the fact that the students were given the question papers before the lesson and were shouting out the answers, some students were not participating and seemed puzzled during the lesson. That could have emanated from the fact that some of the students did not know why a strip was drawn as Δy or as Δx . This was not discussed and clarified during the lesson. The emphasis was that the representative strip should be perpendicular or parallel to a certain axis. The emphasis was on the shape that the chosen strip generates after rotation about a particular axis, representing a disc, shell or washer, rather than how a particular strip approximates the region bounded by the graphs. The solid of revolution generated after rotating the bounded region was not drawn. Even if the lecturer showed in-depth knowledge of the content and explained this section properly, it was evident after the lesson that not all students had a proper basic knowledge from the previous levels.

The lesson ended while the students were working independently on four questions, while the lecturer was moving around to monitor their work. I observed that many students used a table

method to plot graphs, which demonstrates the use of procedural skills. The lecturer gave students activities to work on in groups, but did not wrap up the lesson to summarise what was done. As a result there was no evidence of feedback and reflection.

In lesson one the students were taught for 36 minutes and 30 seconds in English only before they could work independently. The lecturer took an authoritative role and the students were very attentive in class. That was the same throughout the other lessons. The students were only able to speak in other languages, mainly Setswana, when they worked in groups.

8.1.1.2 The five skill factors for the first lesson

The first skill factor involving graphing skills and translation between visual graphs and algebraic equations was addressed only when the lecturer drew graphs on the board (graphing skills) without involving the students hence there was no opportunity for graphing skills to develop and translation from algebraic equations to visual graphs in 2D. The translation from visual graphs to algebraic equations in 3D was evident when the lecturer worked with the students to select the equations to use when calculating volume based on the different shapes, disc, washer or shell. The second skill factor, three-dimensional thinking involving the translation from 2D to 3D was addressed from the strip that was rotated to form different shapes, disc, washer or shell, which were drawn on the graphs without drawing a solid of revolution formed. The third skill factor, moving between discrete and continuous, was not well addressed since the lecturer drew the representative strip on the board without relating to the Riemann sums. The reason why a Δy or Δx strip was used was not explained or reinforced. The fourth skill factor involving general manipulation skills was used minimally. It was only evident when the students calculated the turning points of the parabolas. The fifth skill factor, the consolidation and general level of cognitive development, which involves all the four skill factors was not high enough, since for example most of the students failed to draw strips correctly.

8.1.2 Observing the second lesson

At the beginning of this lesson students were working in groups for about 14 minutes. The lecturer then taught for about 48 minutes. A problem was encountered during this lesson, where the lecturer could not solve a question that required integration from the substitution method and ended up asking the researcher to intervene.

8.1.2.1 Observing the students in lesson 2

The students were evaluating volume based on the graphs $y = e^{2x}$ and $x = 1$. They were seen to draw the graph of $y = e^{2x}$ using a table method. When I asked, they said that they find the table method easier and that they prefer it. From the use of the table method, it seems as if these students did not know the general characteristics of such an exponential graph, hence resorted to the use of procedural knowledge, by using the table method. Even though the students drew the two graphs, the graph of an exponential function $y = e^{2x}$ was not correct. As you can see in Figure 8.9, the graph drawn does not show exponential growth. It starts at the origin instead of intercepting the y -axis at 1. The graph drawn resembles half of a parabola, having a maximum turning point and facing downwards. However, it can still be used for evaluation of area or volume correctly.

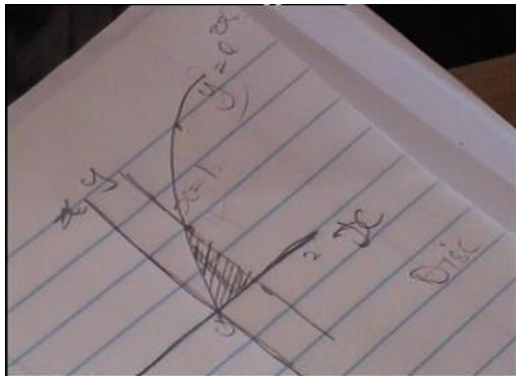

Figure 8.9: The exponential graph

After drawing the two graphs, relating to graphing skills and translation from algebraic to visual, the area was shaded (visual skills) and a Δx strip was selected (translation from continuous to discrete (visually)) as shown in Figure 8.9. The strip was then rotated about the x -axis (translating from 2D to 3D). It seemed as if the students understood what the strip would form after rotation as well as the formula to be used, since they wrote a disc next to the graph. The formula was selected from the worksheet that their lecturer gave them as a summary for the section on rotation of strips and the formulae to be used.

In translating from the visual graph to the algebraic equation for volume after rotation of the drawn strip, a disc method was used. The students were able to substitute correctly from the equations of the two graphs (translation from visual to algebraic in 3D and using general manipulation skills) and to evaluate the volume. The students evaluated the integral correctly and demonstrated good manipulation skills. The volume was evaluated correctly as 13.399.

When the students were asked why they did not use the cylinder method, one student said:

10:32 to 10:35

S1: I think the disc is simpler than the cylinder

Even though some students were able to use the correct methods upon rotation of the selected strip, some students were still asking for clarity as to how one knows which method to use, pointing out to the problems they had in translating from 2D to 3D.

11:14 to 13:29

S4: How do you know that this is a disc and this a cylinder and this is a washer?

S1: This thing, when you look at it like this... this is your strip ... If you rotate this thing you'll rotate this way (rotating anti-clockwise ... the strip will rotate forming a circle, and in case of the cylinder you'll see the y-axis ... Since this part (the strip) it rotates that means it's no longer a straight line it's a cylinder.

The dominant student (S1) explained to the other students using a demonstration, of a disc method (refer to Figure 8.10) and a shell method by rotating a pen and using the diagram as shown in Figure 8.11. A circle was drawn and a cross section of a shell was drawn upon rotation of a Δx strip about the y-axis (calling it a cylinder) as follows:

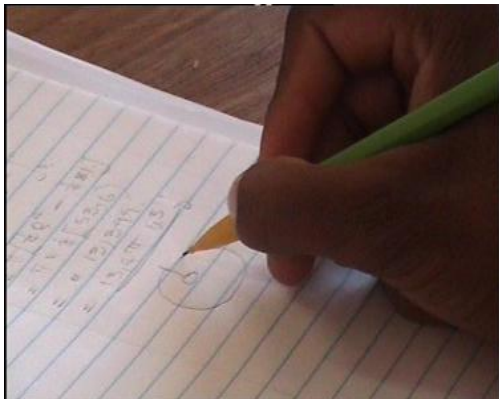

Figure 8.10: Rotating anti-clockwise

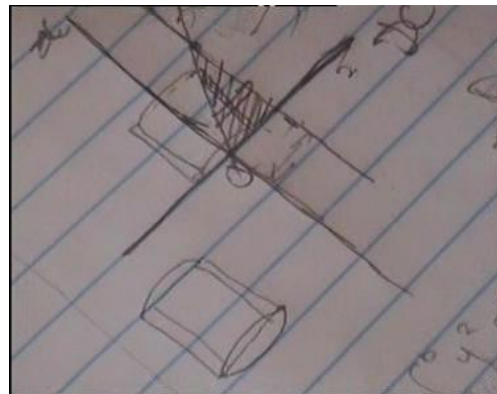

Figure 8.11: Cross section of a shell

S1 emphasised the importance of the sketch (graphing skills) as a starting point of knowing what needs to be rotated and the role of visualisation of the different methods from the graphs. However, some students mentioned that they have problems when it comes to drawing graphs. This is what S1 said:

13:31 to 13:42

S1: Obviously if you want to solve it you have to have a sketch.

R: If you don't have the sketch?

S4: You can't see if it's a cylinder or a shell, you can't see.

S1: If you can work with things on your mind then it's okay but it will be easier if you draw it or work with something that you see.

8.1.2.2 Observing the lecturer in Lesson 2

- **Introducing the content to be learnt**

After observing the students working in groups, the lecturer introduced the lesson by emphasising how different hyperbolas are drawn. A hyperbola $\frac{x^2}{25} - \frac{y^2}{16} = 1$ was drawn while discussing it with the students. The students were shown how to find the intercepts and the asymptotes (using general manipulation skills) and to represent them graphically as shown in Figure 8.12, hence emphasising the graphing skills. Later a line $x = 7$ was drawn (graphing skills) on the same set of axes as shown in Figure 8.13 with a Δx strip (translating from continuous to discrete) located on the shaded region. In drawing both graphs, the lecturer involved students critically based on the shape of the graphs and their intercepts. The question required that a shell method be used to find the volume generated if the area bounded by the graphs in the 1st quadrant is rotated about the y-axis.

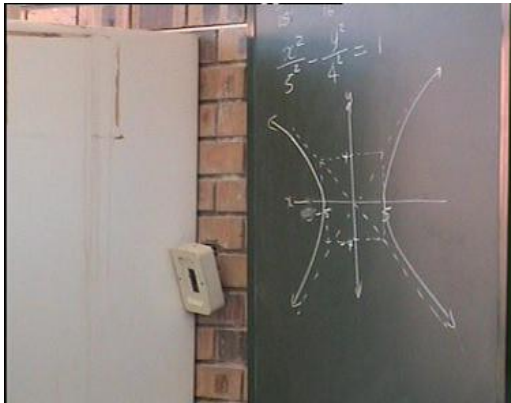

Figure 8.12: The rectangular hyperbola

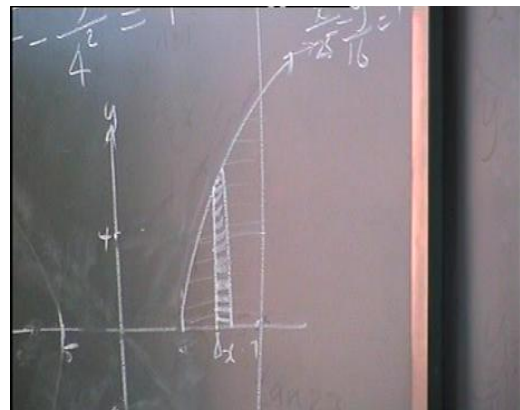

Figure 8.13: The first quadrant

The lecturer explained to the students how the graph will be drawn, and how a strip will be selected.

25:39 to 26:34

L: It means that you're going to ignore the curves in the 4th quadrant. So we're going to concentrate in the 1st quadrant. Now the question is saying use shell method. How are we going to draw a representative strip? Is it going to be perpendicular to the y-axis or to the x-axis?

Sts: ... to the y-axis

L: If your representative strip is perpendicular to the y-axis. If it rotates which shape will that going to be? ... it will not be perpendicular to the y-axis but perpendicular to the x-axis. So that when it rotates it will form a shell.

The problem that they had to solve stipulated that a shell method was to be used. The students were saying that the representative strip must be drawn perpendicular to the y-axis, referring to a Δy strip. The lecturer discussed with the students why a Δy strip could not be used since upon rotation about the y-axis a shell will not be formed but that a Δx strip would be used since upon

rotation about the y -axis, it gives rise to a shell. Since a shell was not drawn, there was no translation from 2D to 3D. In translating from visual to algebraic in 3D, a formula for the shell

method $2\pi \int_5^7 xy \, dx$ was selected from the formula sheet. When evaluating this formula in order

to calculate the volume upon rotation about the y -axis (V_y), the lecturer got stuck at this step

$V_y = 2\pi \int_5^7 x \sqrt{\frac{16x^2}{25} - 16} \, dx$ after substituting for the y value, using general manipulation skills. This

is as a result of the complexity of some problems involving integration techniques in VSOR.

Suggestions were given from the students as to how to simplify before integrating. One student

said that the inside of the square root becomes, $\frac{4x}{5} - 4$ (taking the square roots of each term).

The lecturer explained to the students that if they take square roots like that, it means that

$\left(\frac{4x}{5} - 4\right)^2$ must give back what is inside the square root sign, which is not possible. There was a

pause for some time while the lecturer was asking for more suggestions. I probed the chosen

group as a way of scaffolding in order to provoke the students' thinking processes in relation to

the given suggestion of $\sqrt{\frac{16x^2}{25} - 16}$ simplifying to become $\frac{4x}{5} - 4$.

33:24 to 33:49

R: What is it that makes it not to be possible to say whatever he was saying? (referring to $\frac{4x}{5} - 4$)

What is the main thing? ... What makes his answer incorrect?

S1: ... there is a negative sign

R: and what if it wasn't a negative, what was supposed to be there?

S1: multiplication or division

In that way I was trying to draw attention to the very important basic rules of mathematics (the

mathematics register), that one can take the square root only if what is inside the square root is

to be multiplied or divided, and that one cannot take the square root if it involves the sum or

the difference. Another suggestion from the students was that they have to multiply the inside

of the square root with x from the step $x \sqrt{\frac{16x^2}{25} - 16}$. The lecturer explained to them that it would

not be possible since there is an exponent $\frac{1}{2}$. The errors that were made here relate to the

students' failure to use general manipulation skills.

As the lesson continued, there was a pause for a long time and the lecturer asked students for

further suggestions. There were no suggestions and the lecturer suggested that they try the

product rule (asking students to do it on the board but nobody volunteered). It seemed as if no

one knew what needs to be done next as they struggled for about 4 minutes. The lecturer ended up asking the researcher to assist in solving the problem and I solved the whole problem on the board in collaboration with the whole class. In this case, I temporarily relinquished my role after being asked to assist in solving the problem, from that of the researcher to being a lecturer.

36:30 to 38:01

L: How do we integrate that? Mam how can we integrate that one? [referring to the researcher]

R: You know I am hearing interesting things here. They wanted to multiply x and he was explaining it that we cannot ...

L: There is an exponent

R: ... those are the common errors that you always do ... you cannot multiply x if there's a power $\frac{1}{2}$

I explained to the students that if it was $2\pi \int \sqrt{\frac{16}{25}x^2 - 16} dx$, they would use the formula $\sqrt{x^2 - b^2}$ (identified by the students) from the formula sheet, since there is no x outside the square root sign. I further explained that, because there is an x outside the square root sign, then the substitution method would be used in order to eliminate that x after substitution, before evaluating the integral. I solved the problem on the board in collaboration with the whole class showing them how the x will be eliminated as $\frac{16}{25}x^2 - 16$ is equated to u and then differentiated to be $\frac{32}{25}x = \frac{du}{dx}$, so as to replace $\frac{16}{25}x^2 - 16$ in the formula by u and to integrate further with respect to u . From the way in which the students were responding, it seemed as if the students followed what I was doing. They finally calculated the volume as 196.996 cubic units. The skills involved here were the general manipulation skills, where integration rules were used and calculations were done.

The lecturer then continued with the second problem where it was expected that the point of intersection be calculated (general manipulation skills) before the graphs of $y = x + 4$ and $xy = -3$ were drawn (graphing skills) in collaboration with the students. The students suggested that they wanted to use a Δy strip (translating from continuous to discrete) as in the Figure 8.14 that would be rotated about the y -axis. The use of a Δy strip, upon rotation about the y -axis, resulted in a washer being formed. The students avoided using the shell method and opted for the washer method as a result of rotating a Δy strip about the y -axis. When substituting into the formula for volume, students had problems identifying the limits of the Δy strip as the y values from the points of intersection as 3 being the upper limit and 1 being the lower limit, hence failed to translate from visual to algebraic. Through the lecturer questioning

and directing, the students finally managed to use the correct limits for integration. The correct formula was used and the volume evaluated correctly to be 8.388 cubic units. The washer used was not drawn and there was no evidence of translation from 2D to 3D. However, the translation from visual to algebraic in 3D was done successfully from the representative strip and the correct formula for the washer was used. The students demonstrated the ability to use general manipulation skills throughout as they solved the problem.

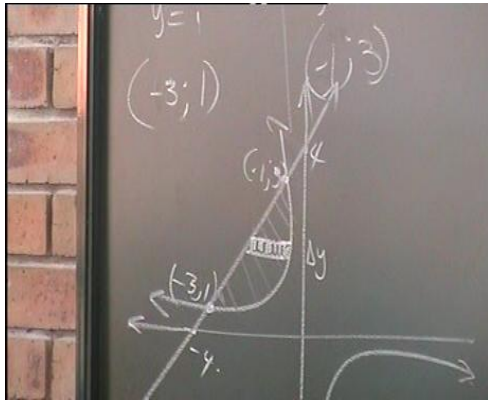

Figure 8.14: The second quadrant

- **The use of procedural and conceptual knowledge, level of difficulty of the content and assessment strategies**

The lecturer emphasised the drawing of graphs and on calculations as well as on how to use the formulae when solving problems. The conceptual knowledge was not displayed. The lecturer taught the students how to calculate and how to draw graphs also selecting a strip, without thorough explanation. The level of difficulty was evidently too high as it was evident when the lecturer asked the researcher to intervene (relinquishing roles and assisting for a short period of time). It was clear that the lecturer was unable to solve the problem involving a certain integration technique, called the substitution method. The lecturer gave students questions and they worked in groups to solve problems given from the previous lesson before the lesson began.

8.1.2.3 The five skill factors for the second lesson

The first skill factor involving graphing skills and translation between visual graphs and algebraic equations was addressed when the students drew the graphs of $y = e^{2x}$ and $x = 1$ (graphing skills) even if the exponential function was not fully correct; drew the graphs as a result of the translation from the algebraic equations to visual graphs and selected the correct formula for disc from the formula sheet, addressing the translation from visual graphs to

algebraic equations in 3D. The third skill factor, moving between discrete and continuous, was evident when the students selected a Δx strip, which was problematic to most of the students. The Δx strip selected was rotated about the x -axis to form a disc (translation from 2D to 3D), addressing the second skill factor, three-dimensional thinking. The fourth skill factor, general manipulation skill, was evident when students used a table method in plotting graphs as they calculated the coordinates. It was also evident when the students calculated the volume correctly after substituting the equations of the two graphs correctly in the formula they selected from the formula sheet. The performance in the fifth skill factor, the consolidation and general level of cognitive development, which involves all the four skill factors, was fair since the problem was solved fully correct but some of the students still did not know which strip to use. Only as a result of working as a group, the students were competent in the skill, level of cognitive development.

In relation to the lecturer, the first skill factor involving graphing skills and translation between visual graphs and algebraic equations was addressed when the lecturer drew a hyperbola $\frac{x^2}{25} - \frac{y^2}{16} = 1$ on the board (graphing skills) involving the students, mainly on how the intercepts (x and y) are plotted. In that way there was an opportunity for graphing skills to develop critically and translation from algebraic to visual in 2D. In the second problem, the lecturer involved the students in drawing the graphs. The translation from visual graphs to algebraic equations in 3D was evident when the lecturer worked with the students to select the equation for volume to substitute based on the shell method as requested from the question, and for the washer method as requested for the second question, but students struggled to use the y values as the limits of integration for the second question, hence failed partially to translate from visual to algebraic. The second skill factor, three-dimensional thinking (translation from 2D to 3D), was not addressed since the cylinder that could be formed through the rotation of the selected Δx strip and the washer for the second question were not drawn. The solids of revolution formed for both graphs were also not drawn. The third skill factor, moving between discrete and continuous, was addressed when the students suggested that a Δy strip be used and rotated about the y -axis to form a cylinder, which was incorrect, revealing that the students had problems in translating from continuous to discrete. For the second question, the selected Δy strip was correct.

Addressing the fourth skill factor, general manipulation skills was evident when the lecturer in conjunction with the students calculated the intercepts of the hyperbola and the asymptotes.

General manipulation skills were also not adequate, as became evident when students made mathematical errors in solving problems involving a square root, where $\sqrt{\frac{16x^2}{25}-16}$ was simplified as $\frac{4x}{5}-4$. The whole class also failed in general manipulation skills when a problem involving integration through the substitution method was difficult to solve. General manipulation skills were only achieved when the students gave correct answers to the solution to evaluate the volume after the substitution method was used properly. In the second problem the students were able to manipulate correctly. Due to the problems encountered in solving the first problem based on the hyperbola in relation to failure to the selection the correct strip, absence of the cylinder formulated after rotation, failure to use general manipulation skills in finding the square root and failure to use the substitution method for integration, one can argue that there was no competency with consolidation and general level of cognitive development since the tasks were too difficult for the students. However, in the second problem, the students achieved the desired level of cognitive development except that they did not show the solids formed as they translated from 2D to 3D.

8.1.3 Observing the third lesson

8.1.3.1 Observing the students and the lecturer in Lesson 3

The students were solving problems before their lecturer came in. The graphs of $y = 3x$ and, $y = 7x - x^3$, were drawn, successfully displaying graphing skills by students. They started by finding the intercepts of the graph of $y = 3x$ (general manipulation skills). In drawing the graph of $y = 7x - x^3$, they used the table method for points on the graph and used the first derivative to find the coordinates of the turning points (general manipulation skills). In substituting the x values from the turning points in order to find the coordinates of the turning points some students made errors as the answers they gave from their calculators were different. Students made errors in calculating the coordinates of the turning points, before they could get the correct answer. Initially they used the y values 7.128 and -7.126 they found after substituting the x values of the turning points $\pm\sqrt{\frac{7}{3}}$ in the original equation incorrectly as the coordinates (7.128; -7.126) of the turning points (general manipulation skills). The students made an error when trying to draw the graphs before they could calculate the x and the y intercepts (graphing skills). I intervened and they ended up calculating the intercepts. Finally the students used the correct points (intercepts and turning points) and the graphs were drawn correctly as shown in Figure 8.15.

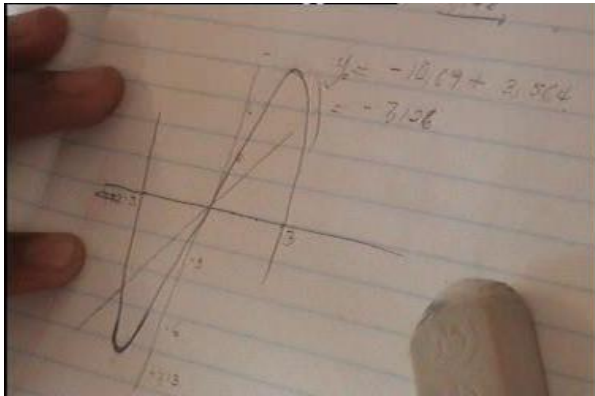

Figure 8.15: The cubic and straight line graphs

The next graphs to be drawn were the graphs of $y = x^2$ and the graph of $y^2 = 8x$.

The students did not know how to show the points of intersection graphically as the points where the two graphs meet, but rather used them as turning points on the graphs, hence drawing something like a cubic function graph as shown in Figure 8.16. The misconception of drawing a cubic graph might have emanated from a step $x^3 = 8$ (after substitution), where they were calculating the point of intersection. When realising that they are failing to draw the graphs properly, some students suggested that they use the table (refer to Figure 8.17) to draw the graph of $y^2 = 8x$, which displays the use of procedural knowledge and general manipulation skills. Finally, the graphs of $y = x^2$ and the graph of $y^2 = 8x$ were drawn as in Figure 8.17. One of the students called the graph of $y^2 = 8x$ exponential graph and $y = x^2$ parabola. The other students did not respond. It seems as if the students were not aware that that the graph of $y^2 = 8x$ is also a parabola.

07:40 to 08:42

S1: ... the graph will be looking like this [turning point shown on the graph, as in Figure 8.16, the graph looks like a cubic function]. [One student disagreed and erased the part that turns after the point [2; 4], ... it has a minimum turning point [referring to the graph of $y = x^2$], for the second graph, it says $y^2 = 8x$, it will be simple if we use the table, we will have to make y the subject of the formula ... so let us do the table. By the way there is no square root of a negative number so we start at 0. [a table drawn].

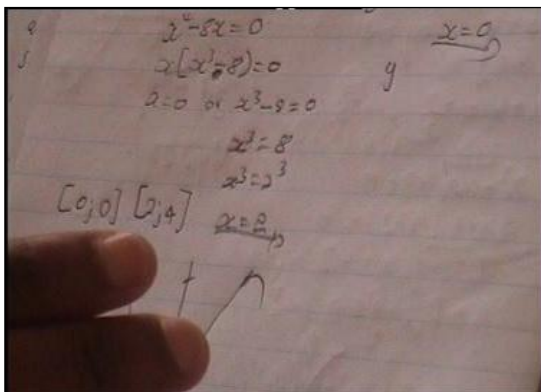

Figure 8. 16: The intersection points

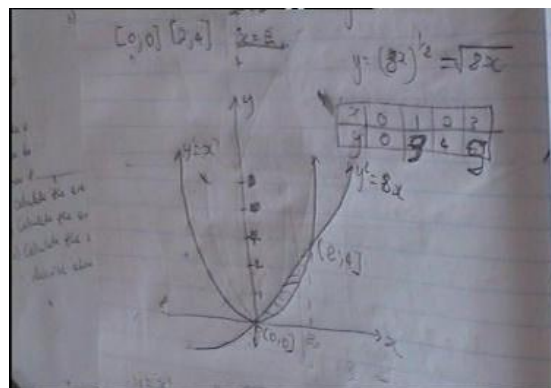

Figure 8.17: The two parabolas

In the section that follows, the lecturer carried on the third lesson after the group work.

- **Introducing the content to be learnt**

The lecturer solved the same problem on the board in collaboration with the students. The lecturer was asking questions about the point of intersection and the students responded.

11.46 to 14:48

Sts: ... coordinates of the points of intersections are (0; 0) and (2;4) [lecturer writes on the board]

L: What type of graph is this [referring to $y = x^2$]

Sts: Parabola

S: What type of graph is it? [referring to $y^2 = 8x$]

Sts: Exponential graph

L: exponential graph? Exponential graph? [puzzled]
Exponential goes this way, goes this way demonstrating using hands]

S: I don't know its name but it's not hyperbola. I don't know its name.

L: Usually you may find this function $y^2 = 8x$, written as $y = \sqrt{8x}$... this ...it's like a parabola neh? This 'side way parabola', it's either it opens to the right or to the left neh!

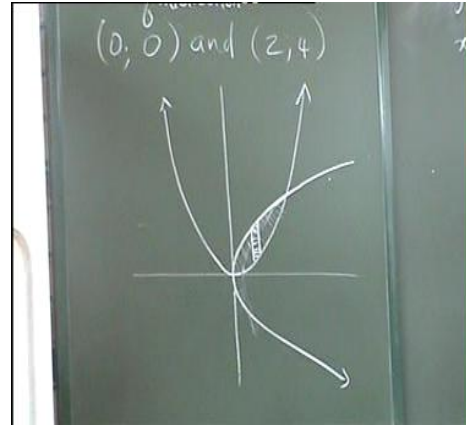

Figure 8.18: The parabolas drawn

The lecturer drew the graphs on the board also showing the points of intersections as shown in Figure 8.18, hence enhancing graphical skills and general manipulation skills. The lecturer showed the students a different equation of the graph of $y^2 = 8x$ as $y = \sqrt{8x}$, also referred to as a horizontal parabola. However, in the selection of the strip, the lecturer did not collaborate with the students. As a result, the translation from continuous to discrete (visually) was compromised. He simply drew a Δx strip on the shaded area.

The lecturer continued working with the students for about 25 minutes teaching them what the coordinates of the centroid are. This was done visually on the graph, translating from the visual graph to the algebraic equation in 2D. Both coordinates were calculated collaboratively, enhancing general manipulation skills, with full participation from the students and guidance from the lecturer. The equation to determine the x co-ordinate \bar{x} was given, relating to the distance from the y -axis and was calculated to be $\frac{2.4u^3}{0.667u^2} = 0.899u$. Even if some errors were made before the correct answer was obtained. The students had to finish up the last steps in order to find \bar{y} , the distance from the x -axis. Below, the lecturer coached the students on how to approach these problems.

L: ... so you get 9 marks for that. It is important that even if you cannot calculate the coordinates of that centroid, you must get marks for points of intersection. You must get points for drawing the graphs neh!

From the above statement, it is clear that there was an emphasis on marks, rather than on learning. After the lesson presentation, the students were able to demonstrate the coordinates of the centroid visually and algebraically on the other graphs they have as shown in Figure 8.19.

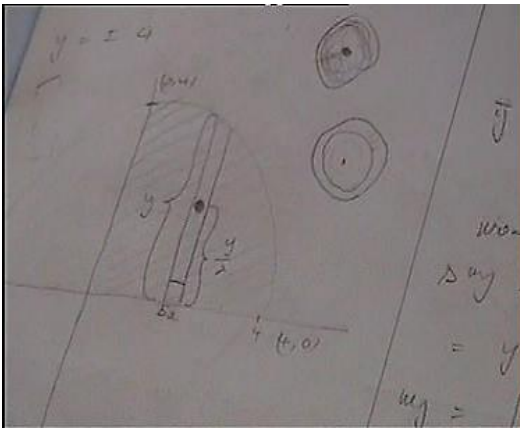

Figure 8.19: Locating the centroid

The students were also able to calculate the y or the x ordinates of the centroid, displaying general manipulation skills from the given graphs, hence also translating from visual to algebraic in 2D, resulting in the coordinates of the centroid as $(\bar{x}; \bar{y})$. The substitution method was used correctly in the problem that they solved, since it involved the equation of the circle, where y was made the subject of the formula. In this case students demonstrated the ability to use general manipulation skills.

- **The use of procedural and conceptual knowledge, level of difficulty of the content and assessment strategies**

The lesson is based on calculations, and the use of table method in plotting graphs. The derivation of formulae was emphasised. The lesson involved conceptual knowledge to a lesser extent, only with the selection of the representative strip, where some visual skills were used as well as demonstration of the coordinates of the centroid on the selected strip. The problem involved integration of roots and was a bit long. The lecturer as well made some errors at the end of the second co-ordinate of the centroid, leaving out some multiplications. The lecturer ended asking the students to complete the problem on their own. These kinds of errors are also common with students. The lecturer gave students feedback from the previous activities, but he did not complete the second part of the problem. In most cases, students were solving problems as a group.

8.1.3.2 The five skill factors for the third lesson

The first skill factor involving graphing skills and translation between and algebraic equation and visual graphs in 2D and 3D, was addressed when the students drew graphs (graphing skills) and translating from algebraic to visual in 2D, even though errors were made before the students could draw the correct graphs. The translation from visual graphs to algebraic equations in 3D was evident when the lecturer worked with the students to select the equations of the centroid based on the location of the centroid of the strip. The second skill factor, three-dimensional thinking (translation from 2D to 3D), was not addressed since the centroid does not involve three-dimensional thinking. The third skill factor, moving between discrete and continuous, was not well addressed since the lecturer drew the representing strip on the board without relating to the Riemann sums, even explaining his choice to the students. The reason why a Δx strip was used was not explained or reinforced. The fourth skill factor general manipulation skill was evident when students were calculating the intercepts of the graphs, the points of intersection and the coordinates of the centroid in collaboration with the lecturer. The fifth skill factor, the consolidation and general level of cognitive development, which involves five elements from the four skill factors was not as yet attained as the tasks require a higher level of cognitive development. Most of the students struggled to draw graphs correctly, the choice of the strip was not well clarified and errors were made in calculating the coordinates of the centroid.

8.1.4 Observing the fourth lesson

8.1.4.1 Observing the lecturer in Lesson 4

- **Introducing the content to be learnt**

The lecturer began the lesson by writing the topic ‘centre of gravity’ on the board and an activity as follows:

00:00 to 00:40

L: Calculate the distance of the centre of gravity from the x -axis of a solid generated when the area bounded by $y^2 = 4ax$, $x = 0$ and $y = b$ is rotated about the y -axis.

The lecturer continued to explain the difference between the centre of gravity and the centroid. The lecturer did not demonstrate the difference visually from graphs but referred the students to the formula sheet. The emphasis was on using the formula sheet to select the formula and then calculating the centre of gravity required, hence promoting procedural knowledge.

01:05 to 01:49

L: Eh centre of gravity. The only difference between centre of gravity and the centroid is that the centroid is ... the area about the x -axis ... over the area. So with centre of gravity it will be the volume about eh

volume multiplied by moment about eh ... a particular axis above the volume. In the formula sheet the page that I've just gave out.

The lecturer continued to draw the graphs and selecting the strip without justifying why such a strip was used. That might have impacted on in-depth knowledge, especially based on the Riemann sum relating to how a chosen strip approximates the given area.

- **The use of procedural and conceptual knowledge, level of difficulty of the content and assessment strategies**

The lecturer emphasised the derivation of formulae for the centre of gravity procedurally. The lesson did not cater for conceptual knowledge. The lesson was more on calculations, with less focus on the development of visual skills. The content introduced was difficult. The centre of gravity was not well demonstrated. Students were given problems that they solved as a group.

8.1.4.2 Observing the students in Lesson 4

There was an interesting situation when the students struggled to draw the graphs of $\frac{x^2}{9} - \frac{y^2}{4} = 1$ without showing the asymptotes until they finally succeeded as shown from Figure 8.20 to Figure 8.22 in the next page when a Δy representative strip was chosen. The question required that they shade the region bounded by the graphs of $\frac{x^2}{9} - \frac{y^2}{4} = 1$, the x -axis and $y = 3$ as well as showing the strip that would be used when rotating about the y -axis. In selecting the strip, a Δy strip was drawn. When I asked why a Δy strip was used, one of the students argued that a Δy strip is used because rotation is about the y -axis and that if rotation was about the x -axis, a Δx strip would be used. This misconception points to the fact that the students do not have in-depth knowledge on how the strip is selected, it is shallow.

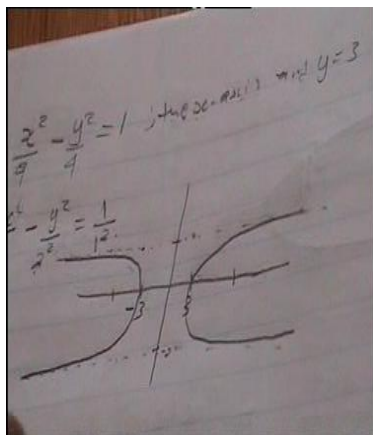

Figure 8.20: The 1st attempt

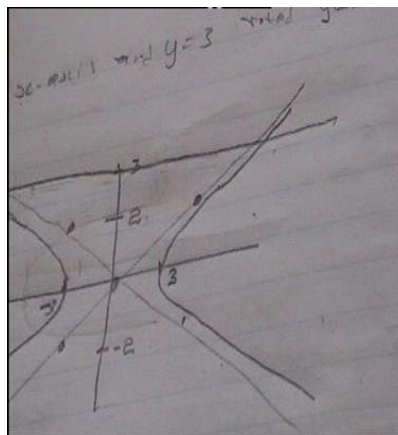

Figure 8.21: The 2nd attempt

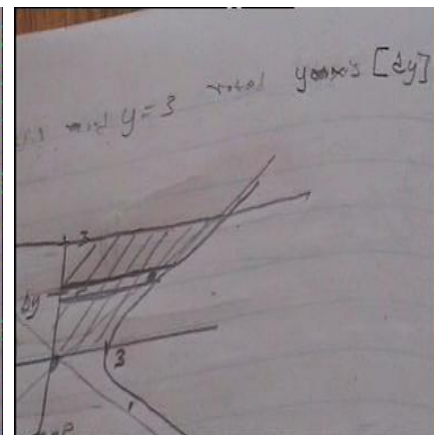

Figure 8.22: The last attempt

The extract below justifies what transpired during the selection of the representative strip.

35:30 to 35:51

R: why are you choosing that one? [referring to a Δy strip]?

S1 and S2: ... it rotates about the y-axis

R: So when they say rotated about the y-axis. You're going to choose Δy ?

S1: yah, the strip must be ...

S3: with respect to y

R: then what if we change the question and say rotates at the x-axis

S1: we must change the strip

R: and put it like?

S1: like this (referring to Δx strip)

R: Okay

During the group work, when finding the intercepts of the hyperbola, the students had problems in interpreting $\sqrt{-4}$ as being undefined, to justify that the hyperbola did not have the y intercepts. They were also not sure on how the representative strip should be selected. The other problem encountered was that the students were struggling to solve this activity when expected to evaluate the integral even if it was the same as the one that I did in class involving the use of the substitution method. The errors that these students made until they obtained the correct answer revealed that the student had made mathematical errors (due to lack in manipulation skills). They were a bit confused. Their work was not logical and in an orderly manner. They later obtained it right with my assistance through scaffolding. Generally the students lacked the skills of drawing graphs as well as interpreting those graphs. During the group discussions, it was evident that the students still struggled to draw the correct graphs and made errors in calculations. The students lacked the graphical skills and the general manipulation skills.

8.1.4.3 The five skill factors for the fourth lesson

The first skill factor involving graphing skills and translation between visual graphs and algebraic equations in 2D and 3D, was addressed when the students drew graphs (graphing skills) and translating from algebraic equations to visual graphs in 2D. Students' performance in drawing graphs improved, even though they were in some instances still making errors before they could draw the correct graphs. The translation from visual graphs to algebraic equations in 3D was evident when the lecturer worked with the students to select the equations of the centre of gravity even though it was done procedurally. The lecturer explained the formula to calculate the distance of the centre of gravity from a particular axis from the formula sheet, explaining the relationship between moments of volume and volume. The second skill factor, three-dimensional thinking (translation from 2D to 3D), was not addressed since the 3D diagrams were not drawn. The third skill factor, moving between discrete and continuous, was not well addressed since the lecturer drew the representing strip on the board

without relating to the Riemann sums. The reason why a Δx or a Δy strip was used was not explained or reinforced.

The fourth skill factor general manipulation skill was evident when students were evaluating moments of volume and volumes from the integrals in collaboration with the lecturer. The fifth skill factor, the consolidation and general level of cognitive development, which involves five elements from the four skill factors, was not attained since the tasks were cognitively demanding. There was an improvement in drawing graphs and translation from visual graphs to algebraic equations from 2D to 3D was not achieved. Most the students struggled to do general manipulation skills properly, since they struggled in most cases with problems that involved the substitution method even if it was explained by the researcher in one lesson. This indicates that the students find VSOR challenging and need more time to grasp the concepts.

8.1.5 Observing the fifth lesson

8.1.5.1 Lesson 5: Group work

In this lesson, the students were working in different groups. The discussion that follows is of a group of eight students who were working on four activities from one of the previous question paper during the fifth lesson, with the researcher scaffolding. During this lesson, students were working as a group to consolidate what was done throughout the past four lessons. During their discussion, I asked students questions to justify what they were doing as well as probing their responses. S1 was dominant and the one who was writing the solutions down during this discussion. The students managed to solve the first three problems out of four before the end of the lesson. A detailed discussion of the first two questions is given with a summary for the third question.

- **The first question**

The first question that the students answered was as follows:

5.1.1 Make a neat sketch of $\frac{x^2}{25} - \frac{y^2}{16} = 1$ and show the area bounded by the graph and the line $x=7$.

Show the representative strip/element that you will use to calculate the volume (by using the SHELL-METHOD only) of the solid generated when the area in the first quadrant is rotated about the y -axis.

5.1.2 Use the SHELL-METHOD to calculate the volume described in QUESTION 5.1.1 above.

The students started by drawing the graphs correctly in the first quadrant showing all the important points as shown in Figure 8.23, as well as identifying a Δx strip. The students were

competent in graphing skills. The discussion below follows from the drawn graph, which was correct. It involves both students and the researcher in with the conservation translated from Setswana.

$$S's: \text{From, } \frac{x^2}{25} - \frac{y^2}{16} = 1 \text{ we have } \frac{y^2}{16} = \frac{x^2}{25} - 1,$$

$$\text{then } y = \sqrt{\frac{16x^2}{25} - 16}$$

$$V_y = 2\pi \int_5^7 x y dx = V_y = 2\pi \int_5^7 x \sqrt{\frac{16x^2}{25} - 16} dx$$

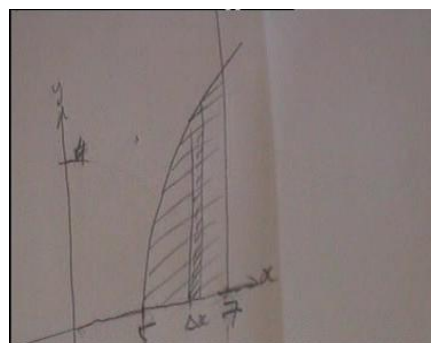

Figure 8.23: The graphing skills

$$S3: \text{Let } u = \frac{16x^2}{25} - 16, \text{ then } \frac{du}{dx} = 32x, \text{ then } \Delta x$$

R: $32x$? How did you get $32x$?

S1: We differentiated $16x^2$ and we get $32x$...and 16 is 0.

R: Then 25. Is it lost...where is it?

S1: No, it is not lost. I think we differentiated in terms of x

S2: ...where is 25?

R: By the way what is the answer when you differentiate $3x^2$

S1: $3x^2$ becomes $6x$...ok $\frac{16x^2}{25}$ becomes $2 \times \frac{16x}{25}$, then $\frac{32x}{25}$

S1: ... we want Δx so $\frac{du}{dx} = \frac{32x}{25}$ and $dx = \frac{25}{32} du$

R: mmh! where is x ?

S2 & S3: where is x ?

S1: Oh, $dx = \frac{25x}{32} du$, I forgot

S2: This x is for 32; it must be written below so as to see that it is $\frac{1}{x}$ not x .

S1; So what next?

S3: Now we use the formula $2\pi \int_5^7 x \sqrt{u} dx$ (students stuck)

R: Say u to the power half [scaffolding].

S5: We get $2\pi \int_5^7 x \cdot u^{\frac{1}{2}} \frac{25}{32x} du$

$$S3: \frac{50\pi}{32} \left[\frac{(u)^{\frac{3}{2}}}{\frac{3}{2}} \right]_5^7$$

$$S2: \frac{50\pi}{32} \left[\frac{2}{3} u^{\frac{3}{2}} \right]_5^7 \quad [\text{some students were saying multiply by } \frac{2}{3} \text{ instead of division}]$$

$$S1: \frac{100\pi}{96} \left[\left(\frac{16x^2}{96} - 16 \right)^{\frac{3}{2}} \right]_5^7 =$$

$$S1: \frac{100\pi}{96} [60,199 - 0] = 198u^3$$

In the above extract students were seen helping one another, while I was helping out only when they got stuck, in a way of cuing or leading step-by-step. Some students were seen in some

instances helping step-by-step when others got stuck like S1 and S3. These students were able to recognise when they went astray, and had good manipulation skills. The students were able to solve the problem through scaffolding, until they reached the final solution. They were able to draw the graphs properly and by helping one another they were able to evaluate the integral correctly. When using the definite integrals, the students substituted x by u with boundaries of 8 and 5. However, this did not affect the answer as they substituted back the u value with the x value.

- **The second question**

5.2.1 Calculate the point of intersection of the graphs of $y = 2x + 2$ and $y = x^2 + 2$

Sketch the graphs and show the representative strip/element that you will use to calculate the area bounded by the graphs.

5.2.2 Calculate the area described in QUESTION 5.2.1.

5.2.3 Calculate the area moment of the bounded area about the x -axis as well as the distance of the centroid from the x -axis described in QUESTION 5.2.1.

In the second question that they solved, they were asked to first calculate the point of intersection of the graphs of $y = 2x + 2$ and $y = x^2 + 2$ before they could draw the graphs, which were calculated to be (0,2) and (2,6). After drawing the graphs, they realised that the drawn graphs do not intersect at the points they found as intersection points. They finally realised that for one of the graphs $y = 2x + 2$, the x and the y intercepts were swapped, as indicated in Figure 8.24. These students lacked graphing skills.

S1: If intersection is at (0,2) and (2,6) so why the graph is like that (referring to the first picture below), it means that this graph is on the incorrect position.

S5: y is 2, not $x = 2$

S3: You mean that $y = 2$ and $x = -1$, so graph is ...

S: So graph must be like this (drawing the correct graph figure 8.26)

S3: ..any way this graph(referring to the incorrect graph) is the symmetrical graph of the other one (meaning the correct one as in the middle picture below).

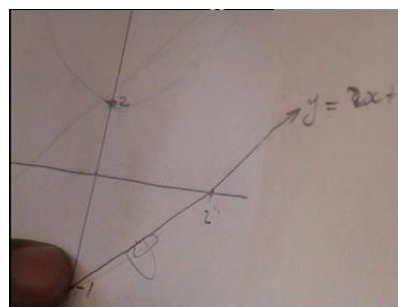

Figure 8.24: The straight line

The other graph of $y = x^2 + 2$ also gave them problems as they could not show or understand that it does not have the x -intercepts, they failed to understand what $\sqrt{-2}$ becomes as they solved $x^2 = -2$. They argued that it gives an error as indicated from their calculator, without interpreting what that really meant. Only after scaffolding through probing from the researcher, they realised that the roots were non-real, and as a result there would not be any x -intercepts.

The discussion that follows justifies what happened.

14: 48 to 16:52

S3: ... we are dealing with the shell method, then what is rotating?

S1: Whoop!! whoop! Where are the x -intercepts? [the student asks the researcher] ... Mam, do we have x intercepts?

S3: It is 0 and 2

R: x intercepts? For what?

S1: For the graph $y = x^2 + 2$. For x -intercept this is zero (referring to 0) then we will have x^2 equals to (pause)...2 will be this side, ... becomes negative, there way that we can get the square root, unless!

S3: Let's factorise $y = x^2 + 2$.

S2: How are we going to factorise that; it can't be factorised

S1: Maybe if it was negative maybe [referring that if it was $y = x^2 - 2$]

S1: Then we calculate area with the formula [they want to avoid] the problem $y = x^2 + 2$

R: Please continue, you said if you take 2 to the other side?

S1: Whoop! If there is $x^2 = -2$, then root -2 is error.

R: Then what does that mean?

S1: It means that it won't touch the x -axis, so we leave it like that

R: [smiling] so you were opposing that?

S1: No, I want to know whether it will touch the x -axis. So if it is like that it won't touch.

R: So what does it mean?

S1: It means that there is error ...

S2: So let it not touch

S: So it faces up without touching the x -axis. [referring to the graph $y = x^2 + 2$.]

Students continued to solve the question but got confused in the process of drawing the second graph, $y = x^2 + 2$, on the same set of axis. They knew that the parabola faces upwards, but struggled to draw it. The students lacked graphing skills. Initially students started by drawing an incorrect graph. Refer to Figure 8.25 and the correct graph Figure 8.26.

16:55 to 18:58

S5: So why does it pass there?

S1: No, this is not the turning point, it turns at (0, 2) [Graph erased].

S2: You may draw an absolute value.

S1: No

S2: Our points of intersection are (2,6) [finally the correct graph was drawn]

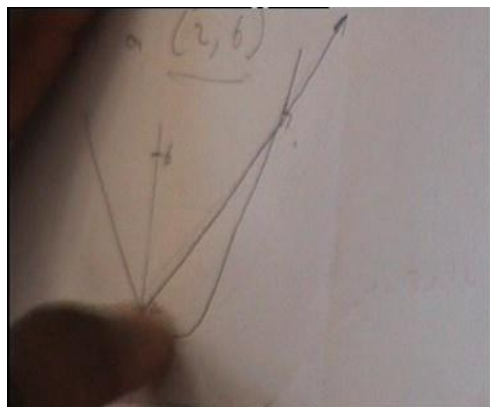

Figure 8.25: The incorrect graphs

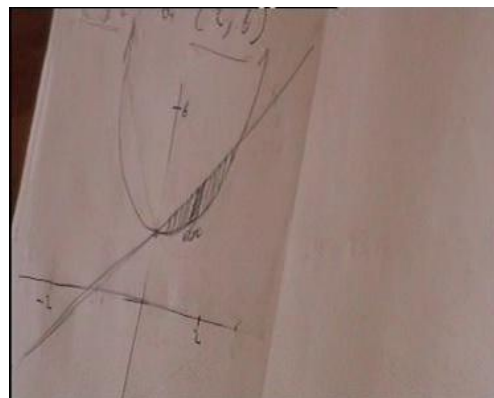

Figure 8.26: The correct graphs

The problem then arose when students had to select the strip to use. The students continued to read the question and progressed as follows

19: 05 to 20:42

S2: Question says calculate the area

S3: The next question says calculate the moment of the area ...

S1: So this one will be rotating about which axis?

S2: You just choose

R: Mmh! [surprised]

S1: It won't be the same if we chose the y axis they won't be the same.

S2: Then lets choose ...

R: What is your question?

S2: Calculate the area bounded

R: Ya! And you [referring to S1]? what were you saying

S1: I was saying they will be equal [referring to answers] if we rotate about the y-axis and about the x-axis?

R: Read the question ... is there anywhere where they talk about rotating?

S1: [read the Question 5.2.3], they say calculate the area moment of the bounded area about the x-axis, as well as the distance of the centroid from the ... axis, so before you start you must read the whole question?

R: I think it is important.

S1: Then, we will rotate it about the x-axis [student confused again].

R: Do they say rotate?

S2: We will rotate it, about the x – axis [another student also confused].

S1: It means that we do not have to rotate

R: They say area moment

S1: There is no way that it won't rotate

R: But the question says area moment, do you rotate in area moment? If they say area, do you rotate?

Sts: [Argue about which strip to use] Lets find the formula

S3: Lets chose the x one (as shown in Figure 8.39)

S1: Let's use Δx strip

The discussion above highlights that the students do not know how to select the strip and neither when to rotate. They do not know that with area one does not rotate. They seem to prefer the Δx strip as shown in Figure 8.26. They fail to explain the translation from continuous to discrete (visually) based on the strips used. The terminology use in the question does not make sense to them.

After selection of the strip, the students selected the formula to use and continued with the calculation. Through continuous scaffolding, step-by-step and through hints, they managed to get the solution correct. When calculating area, the students wanted to use the centroid formula, I advised them to use the area formula not that of the centroid. When I asked them what the formula for area is this is what one student said.

22:04 to 26:55

S1: The formula for area is length times breadth that will be a change the x multiply by a change in y

R: Why do you go back there, what did you do in the first lesson?

S3: We will use $A = \int_c^d (x_2 - x_1) dy$

S2: It is the formula for the washer

S3: The washer – the washer

S1: The question says area of this strip ok? ... this is our

strip, which formula do we use? We use $A = \int_a^b (y_2 - y_1) dx$

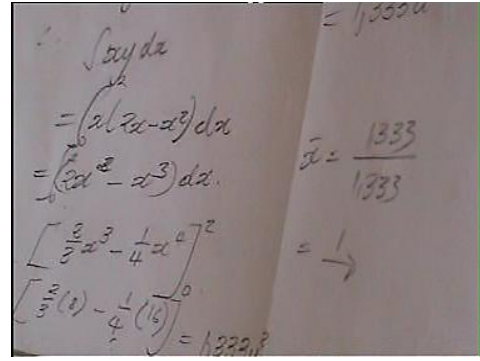

Handwritten work showing the calculation of the area and centroid of a region bounded by $y = 3e^{2x}$ and the lines $x = 0$, $y = 0$, and $x = 2$. The work includes the integral for area, the integral for the centroid \bar{x} , and the final numerical results.

$$\int_0^2 3e^{2x} dx = \frac{3}{2} [e^{2x}]_0^2 = \frac{3}{2} (e^4 - 1) \approx 1.333$$

$$\bar{x} = \frac{\int_0^2 x \cdot 3e^{2x} dx}{\int_0^2 3e^{2x} dx} = \frac{\frac{3}{4} [2xe^{2x} - e^{2x}]_0^2}{\frac{3}{2} (e^4 - 1)} = \frac{\frac{3}{4} (2 \cdot 2 \cdot e^4 - e^4 - 1)}{\frac{3}{2} (e^4 - 1)} = \frac{\frac{3}{4} (3e^4 - 1)}{\frac{3}{2} (e^4 - 1)} = \frac{3e^4 - 1}{2(e^4 - 1)} \approx 1$$

Figure 8.27: The centroid

The students substituted correctly, integrated correctly and obtained the answer for area as 1.333, demonstrating appropriate general manipulation skills as shown in Figure 8.27. They continued with the second part of the question and calculated the centroid correctly as $(1; \frac{y}{2})$ as shown in the calculation.

- **The third question**

5.3.1 Make a neat sketch of the graph of $y = 3e^{2x}$ and show the area bounded by $y = 3e^{2x}$ and the lines $x = 0$, $y = 0$ and $x = 2$. Show the representative strip/element that you will use to calculate this area.

5.3.2 Calculate the area described in QUESTION 5.3.1.

5.3.3 Calculate the second moment of area about the y -axis of the area described in QUESTION 5.3.1

The third question was solved in a similar way through scaffolding. The students drew graphs as shown in Figure 8.28 but the exponential graph was drawn as a decreasing function. Throughout the problem-solving situation, if students experience problems, I probed until they reflected on their work and exchanged ideas to reach the correct solution. The discussions helped the students to reflect critically on their work in order to make informative decisions. Some of the problems encountered were that students drew incorrect graphs and mainly used a Δx strip. However, in some instances the incorrect graph did not make the solution incorrect. In terms of integration techniques the students were doing well, with minor errors especially in calculations after substitutions from the limits as well as using integration by parts. That was perhaps due to the fact that some students were not able to use the calculators properly. Throughout the recording process, student one was dominating the discussions and able to pick up many errors, with scaffolding from the researcher and assistance from other students.

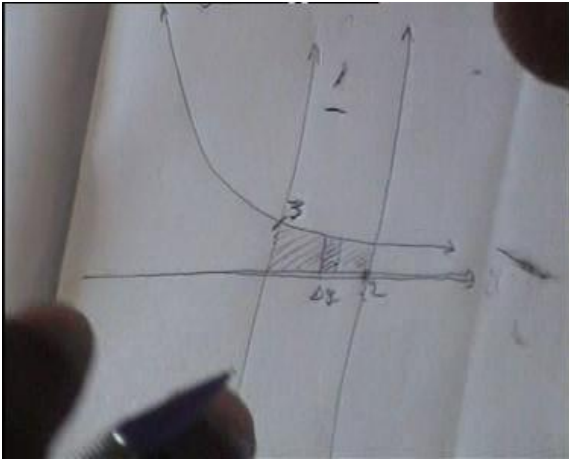

Figure 8.28: A decreasing exponential graph

From the above discussion one can conclude that the students were not fully competent in drawing graphs (failing to translate from algebraic to visual). They were also not competent in translating from continuous to discrete since they did not know why a particular strip was used and failed to translate from 2D to 3D as they did not draw such diagrams after rotation. They, however, demonstrated some capabilities in translating from visual to algebraic both in 2D and 3D, as they were always able to select the correct formula (disc, washer or shell) and substituted correctly from the graphs. The general manipulation skills in most cases were affected by the errors that they made, but besides those errors, one could say that they were partially competent.

8.1.5.2 The five skill factors for the fifth lesson

The fifth lesson can be summarised in terms of the five skill factors. The first skill factor involving graphing skills and translation between and algebraic in 2D and 3D, was not adequately developed as the students struggled to draw most of the graphs, unless I assisted.

The only graph that the students were able to draw without problems was $\frac{x^2}{25} - \frac{y^2}{16} = 1$, probably because they did it in class during the second lesson, even if they could not remember completely. The students were seen to rely on the formula sheet to get their formula and not from their drawn graphs, hence that did not improve on their ability to translate visual to algebraic in 2D and 3D. The 3D solids generated when translating from 2D to 3D were not drawn. The students were not competent in the second skill factor, three-dimensional thinking (translation from 2D to 3D). The different shapes, disc, washer or shell, were not drawn. The third skill factor, moving between discrete and continuous, was not well addressed since the strips drawn were drawn without relating to the Riemann sums. The reason why a Δy or Δx

strip was used was not clear to most students. The fourth skill factor, general manipulation skill was developed even though some errors were made when calculating points of intersections and other important points as well as and when evaluating the integrals. The fifth skill factor, the consolidation and general level of cognitive development, was not well developed, since for example most of the students failed to draw strips correctly, they could not interpret those graphs. They could not identify the correct representative strip and they did not draw the 3D solids.

8.1.6 Summary of the classroom observations

For the lessons observed, the lecturer did not teach the students how to draw graphs and how to select the rectangular strip, probably because they had been dealt with at previous levels. The lecturer focused mainly on finding the important points of the graphs like the turning points and the intercepts, the rotation of the strip and using the strip to select the formula from the formula sheet and to do calculations for area, volume, centroid and the centre of gravity. The students were somewhat competent in calculating the necessary points and drawing graphs, but had problems in selecting the correct representative strip and rotating it. In cases where the strip was rotated correctly, a correct formula was selected and substituted correctly. However, when having to evaluate the integral, students' performance was merely satisfactory. They struggled at times to use integration techniques (especially the substitution method) and showed good performance only when using simple rules for integration. What was also observed was that students were not using textbooks in class. They used notes and questions compiled by the lecturer as hand-outs.

8.2 INTERVIEW WITH ONE STUDENT

8.2.1 Presentation of the interview results

The student was interviewed based on her general perceptions about the mathematics at N6 level. The interview was done in Setswana and translated into English. Excerpts from the interview are used in the discussion. In the following excerpts R refers to the researcher and S refers to the student being interviewed.

The discussion reveals that the student interviewed is very much aware that in order to do well in VSOR, one should be able to draw the graphs and that in order to calculate the volume, one needs to interpret the drawn graph. What the student emphasised is that without the correct

graph, one will not be able to calculate the volume. According to this student, drawing graphs for her was never a problem.

R: ...My interview is on the section of areas and volumes. ...just tell me your experience from N5, maybe starting from N4 as well.

Int: Oh...basically...what can I say...I got lecturers who taught me ...I was satisfied. And I did not have problems with areas and volumes. I knew them and I liked them...because as you draw number one, you will get number 2.

R: What do you mean, if you draw number one, you will get number 2

S: Is like if they give you something like, they ask you about volume. You have to draw 1-sketch ok! ... then from that sketch is where you will be able to see that you will have to calculate something like what..., so that is why I like it. It is different from if you are given a question and asked to solve it. That means that this one (referring to the question on areas and volumes) can be solved by looking at the sketch ... that is why I like them. You can answer the question based on the sketch. So if you fail to draw the sketch, you won't get it. That is why I like them, because they give you an idea, themselves, by just drawing you can see how to get this length

R: So let's say you fail to draw the sketch.

S: I fail to draw the sketch?

R: Mm

S: Eish! ... that never occurred to me, where I failed to draw the sketch...in most cases I can draw.

The student also believes that most of the students think that this section is difficult and that prevents them from doing well in this section, and believes that you can still get the answer (by just writing) even if the graph is not drawn.

R: ... and then... what is your experience from other students about that section?

S: They say that it is difficult... and my belief is that if you say that something is difficult ... and tell your mind that, you will believe that ... that thing is difficult. I believed that they will be simple despite what other student told us, making us to believe that they are difficult. But they are interesting ... and what thing else ... if you can fail to draw the graph you can still get the answer.

R: How?

S: If you fail to draw the sketch ... what can you do... you can just write... but is not always that you fail to draw the sketch.

The student stated that they did not have a lecturer at N5 level and that they studied on their own. The difficulty that the students had with VSOR might be because the students from her class studied on their own at N5 level and that they carried on to the N6 level without the proper foundation from N5, since this section on VSOR starts at N5 level where they use the disc method and the washer method. However, the student believed that there was an improvement at N6 level as they had a good lecturer.

R: ...and what is the relationship, between N5 and N6, based on that section?

S: At N5, I struggled a bit, because we did not have a class lecturer. Basically we worked in groups to assist one another.

R: Is it possible?

S: ...there were other students who were bright, then they would come with information from other places, maybe from brothers... and we worked in the afternoon, or during maths period. With N5, I struggled a bit.

R: ...and N6?

S: At N6...that is where I started to know them.

R: ..and, were they interesting?

S: Yes:

This student pointed out a form of advice to other students, that in order to do well in this question, their lecturer emphasised that the students work from the graphs that they have drawn. No questions are given with graphs. They have to draw before they calculate the area or the volume, they must have a sketch.

R: Then what is your advice to other students, for that section, you know how much it weighs? That is why it is my concern as well.

S: Yes, ... you know eish! That one! I advise them to draw a sketch, even if they do not have a clue. But at least somebody might see what you want to say, that is where the idea come from.

R: So, what if you cannot draw a sketch.

S: But there is no way that you can avoid to draw.

R: So how did other students managed... to draw sketches in general.

S: They taught us from the beginning of the block... telling us that you have to draw a sketch, if you cannot (shake head disagreement), you must know that you are lost, and we put that in our heads, that you have to draw a sketch, so as to find the answer. Even if it is incorrect, but that could be better because maybe graph was supposed to be here, or here, that is where we see that the sketch helps. That is sketch, sketch, sketch.

The student believes that the question is graded according to the N6 level.

R: So, the way the question is asked, I mean Question 5, what can you say about the way in which they ask? Are you happy about the way this question is being asked, especially at N6 level?

S: Yes, it goes according to the standard.

R: Which standard?

S: The N6 standard, ... it suits the N6 level.

The interviewed student had a strong belief that most students cannot draw graphs, they can select the strip correctly if the graph is given and are proficient when doing calculations. The student believes that if the graph is given, most students will be able to select the strip correctly and do the calculations correctly. This student also pointed to the fact that some students do not draw graphs because they are lazy and believe that the graphs waste their time. She also pointed out that that she believes in sketching graphs and that failing to draw a graph will lead to failure in answering the question correctly. The message is that students must sketch.

R: Let's talk about the graph, you have been emphasising that if you do not have a sketch, you cannot do anything. Now my question is what if the sketch is given?

S: You will be able to get it right, and then, you also know your area.

R: Then, what if the question comes with a sketch.

S: (looks excited) If they give me the, sketch, ... in that case I will finish quickly... that means if they can improve and give us sketches, it will be much better, because other students are lazy to draw sketches, they say that the sketch waste their time.

R: Lets us say that they are not lazy, what if they do not have a background on graphs. By the way at which level did you do the graphs?

S: From N1

R: What if others are not good in drawing sketches?

S: Eish! There forget ... I don't know, because I believe in sketches, you have to draw a sketch.

After probing from the researcher to find out how the student feels if a graph is given and students are asked to calculate the area and volume, the student convincingly highlighted that that would be a bonus, and that every student would pass N6 mathematics. That is what the

student believed in, which is not the real situation, since the students struggle even when graphs are drawn. In addition to that it becomes easy since the formulae are given and they can use the knowledge they have from other subjects. In general, she highlights that selection of the strip might sometimes be a problem to other students, if they cannot put it in the right place, or they draw it on the graph that is drawn incorrectly. The student also believes that the paper is too long.

R: So what I am saying is that, what if the question is changed a little bit. By the way that question has about five subquestions. If part of the questions comes with a sketch?

S: It will be much better, we will succeed. All the people will manage to pass the N6 maths, because the 3 hours allocated is not enough.

R: So, if the sketch is given, what becomes a problem now?

S: ..if you do not know your formula, you do not how to calculate area and volume... normally the challenge is there but normally, they give formulae on the formula sheet, but sometimes they expect you to have done it in mechanical or electrotechnics. You have to know it, you have to know about area and volume... and about the strip. So you see if you did not draw a sketch. So it's hard to say you can't.

R: So, how would that improve, you have said it in a way, so according to you, what is the problem with this section, is it the graph or the strip or the calculation?

S: It is the strip. If you can't put it in the right place, you won't get the right, answer.

R: Then what if you have drawn the incorrect graph? Can you put it in the right place?

S: No.

The student believes that in order to do well in this section, one must practise enough. It was also pointed out that the error that you make at the beginning, like drawing the incorrect graph and selecting the strip incorrectly, affects everything that you do thereafter, resulting in incorrect responses. According to the student, the selection of the strip and the calculations based on formulae from the formula sheet will be correct based on the incorrect graph drawn.

R: What is the main problem here?

S: The main problem is with the question itself. ... the way in which they ask, but if you practise. ...

R: Let us say that you make an error with the graph?

S: What? Everything will be incorrect, let us say 4.1 ;4.2 and 4.3

R: And what is that? What does it tell you if it is like that?

S: That tells me that I have failed.

R: And, in reality, did you fail or not?

S: I won't fail because this question has 40 marks, and I still have 60 on the other side.

R: Now the question where you say 4.1; 4.2; 4.3

S: Those ones I won't get correct, so you see if I fail to draw the graph, I won't get it.

R: So what will your calculation be based on?

S: On the graph ...the one drawn incorrectly.

R: Is it incorrect?

S: Mm

R: So, you cannot calculate.

S: No, in my mind I will be telling myself that this graph, is right.

R: ... let us say that I check your incorrect graph, and your calculation based on your incorrect graph, what do I get?

S: Incorrect answer.

R: I am talking about the answer; I am talking about your calculation based on the incorrect drawn graph. ...are you going to be able to select the strip correctly on you graph, even if that graph is incorrect?

S: Yes, I am going to put the strip correctly and calculate based on that strip, whether it will be in the y-axis or in the x-axis and calculate according to my mind. I will take the formula sheet, and chose the formula.

R: So what is the main problem?

S: Is the graph, calculation is not a problem, the graph is a problem.

When asked about the different formulae for washer, cylindrical shell or disc, the interviewed student believed that the students were competent in that, since they would have practised, and that the style in which the questions are asked must be changed, so that the students could do well.

R: Will the students be able to see the washer...the cylinder?

S: Yes, plus because one would have practised, basically the problem is the graph.

R: What can be done to improve this section; is the problem with the students, or the section or the question paper:

S: Question paper ... the way in which the examiner asks questions, like give us more information like at matric level, they give you a lot of information that helps you, like if the graph is given, even if the strip is not given. If you are asked to calculate this and this and put the strip on the given graph, we will be more encouraged ... I wish that the person whose doing the question paper can realise that and improve it.

8.2.2 Analysis of the interview results

In terms of the five skill factors, the interviewed student emphasised the importance of graphing skills, where the students must be competent in drawing graphs. She pointed out that some students do not like drawing graphs and that graphs are crucial since the drawn graphs are starting points to calculating areas and volumes. That was captured from her statement as she said: “You can answer the question based on the sketch. So if you fail to draw the sketch, you won’t get it”. She also emphasised that the students must select the correct strip (translation between continuous and discrete) and be able to rotate the selected strip correctly (pointing at the translation from 2D to 3D. She argued that what one calculates will be incorrect if the graphs were drawn incorrectly and the strip selected and rotated incorrectly relating to the general manipulation skills and the consolidation and general level of cognitive development. From what is gathered from the interview, graphing skills, selection of the strip and rotation thereof are prerequisites in calculating areas and volumes as one has to comply with them first before choosing the formula sheet and do the manipulations.

8.3 CONCLUSION

The conclusions that can be made from the classroom observations and the interview are that students in general lack graphing skills. The students make many errors in calculating the intercepts and turning points of the graphs, pointing also to a lack of general manipulation skills. In other instances even if the intercepts are correct, they fail to use them to draw graphs. Another problem that arises after having drawn the graphs (that they also struggle with) relates to selection of the representative strip. The students tend to draw the strip based on what they prefer, not based on what the question requires, hence failing to translate from continuous to discrete. Some students relate the position of the strip to how it rotates. For example, if they are

asked to rotate about the x -axis they draw a Δx strip. Some students also talk about the disc method and rotation even when they are asked to find the centroid which depends on area only, without rotation.

Even if the graph was drawn, the students in most cases failed to show the diagrams when translating the drawn strip from 2D to 3D after rotation. The students were successful in translating from visual graphs to algebraic equations as they were able to select the correct equations from the formula sheet and substituted correctly, for disc washer, shell centroid and centre of gravity. The difficulties that these students have, might emanate from the way in which they were taught. The lecturer drew graphs without involving the students and without translating from algebraic equations to visual representation and identified the strips on those graphs without making any link to the approximation of the bounded region, hence failing to translate from continuous to discrete. The students in this case did not know why a particular strip was used. The lecturer only emphasised that the strip had to be either parallel or perpendicular to a certain axis and how it rotated as well as which formula was used upon rotation. Even though the lecturer was adequately qualified and knew most of the VSOR content well, procedural skills were more emphasised during the lesson, rather than the conceptual skills. It was also evident that most students, including the lecturer had problems in solving problems that involved the use of the substitution method, hence pointing to the complexity added to VSOR through integrating techniques. The fact the students observed did not have a lecturer at N5 level and that they had to do the VSOR content on their own, adds to the complexity since they lack the adequate background knowledge. It is therefore necessary that the preknowledge required for the VSOR content be revised at N6 level, emphasising the development of conceptual skills. That should be done despite the fact that the concepts to be learnt were done at previous levels. In that case the content may be accessible to the students.

CHAPTER 9: INTERPRETATIONS AND CONCLUSIONS

*In this chapter, the results for the investigation into students' learning difficulties involving VSOR are interpreted in terms of the five skill factors of knowledge, consisting of 11 elements, as discussed in the conceptual framework in Chapter 3. The research question for this study: **Why do students have difficulty when learning about volumes of solids of revolution?**, is answered based on performance in the five skill factors of knowledge, being*

- *the graphing skills and translation between visual graphs and algebraic equations/expressions*
- *translation between two-dimensional and three-dimensional diagrams*
- *translation between continuous form and discrete form*
- *general manipulation skills and*
- *the consolidation and general level of cognitive development*

The interpretations are extended to categorising the skill factors in terms of procedural knowledge and conceptual knowledge, how VSOR is taught and assessed, how the different elements correlate and related to the studies discussed in Chapter 2. Finally, the recommendations, the limitations and the conclusions are discussed.

9.1 OVERVIEW OF THIS RESEARCH

The aim of this study was to investigate students' learning difficulties with VSOR. From the motivation of this study, discussed in Chapter 1, I highlighted the problem I experienced in teaching VSOR for eight years and marking the N6 examinations for three years. I argued that one of the problems experienced in VSOR might be as a result of the lack of in-depth knowledge of the Fundamental Theorem of Calculus (FTC) and its application to calculus. The question that I established was: **Why do students have difficulty when learning about volumes of solids of revolution?** In an attempt to address the research question for this study, I focused on three issues. I identified what the VSOR content entailed from the textbooks and the previous examination papers to aid in the development of the assessment instrument under five skill factors which were subdivided into 11 elements, comprising 23-items; observed how the content was taught (own teaching and that of others), learnt and assessed so as to establish where the difficulties emanate from and to suggest possible ways of improving learning of VSOR.

The three modes of representation of knowledge, visual/graphing; algebraic/symbolical and numerical (Tall, 1996; Habre & Abboud, 2006) were used to develop the conceptual

framework for this study, discussed in Chapter 3 under the five skill factors that became the subquestions for this study. In Chapter 4 the methods of data collection and analysis for this study were discussed using a mixed method approach. In Chapter 5, the results for the preliminary and the pilot studies were discussed and modified in order to design the main data collection instrument for this study.

For the main data collection, six investigations, on why students have difficulty when learning about VSOR were carried out as follows:

- Questionnaire 1st run with 37 respondents for 23 questions (Chapter 6).
- Questionnaires 2nd run with 122 and 54 respondents for 16 questions and 7 questions respectively (Chapter 6).
- Examination response analysis with 151 respondents (Chapter 6)
- Detailed selected written examination responses with seven students (Chapter 6).
- Classroom observations of one class with about 40 students (Chapter 8).
- Interview with a previous N6 student (Chapter 8).

The average rank scores obtained from the 11 elements, were correlated to determine if they were associated with one another (discussed in Chapter 7). With the results from the preliminary and the pilot studies, the six investigations and the correlations, the results were triangulated.

9.2 ADDRESSING THE RESEARCH QUESTIONS FOR THIS STUDY

The aim of this study was to investigate students' learning difficulties with VSOR, resulting in the main research question as follows: **Why do students have difficulty when learning about volumes of solids of revolution?**

In order to address the main research question in this study, the following subquestions were established under the five formulated skill factors, also relating to conceptual understanding and procedural understanding as well as how VSOR was taught and assessed.

1. **Skill factor I: How competent are students in graphing skills? How competent are students in translating between visual graphs and algebraic equations/expressions in 2D and 3D?**
2. **Skill factor II: How competent are students in translating between two-dimensional and three-dimensional diagrams?**
3. **Skill factor III: How competent are students in translating between discrete and continuous representations visually and algebraically in 2D and in 3D?**

4. **Skill factor IV: How competent are students in general manipulation skills?**
5. **Skill factor V: How competent are students in dealing with the consolidation and the general cognitive demands of the tasks?**
6. **Teaching and assessment: How is VSOR taught and assessed and how does that impact on learning?**

In the section that follows the main research question in this study is addressed under the six headings. The results for the six different investigations as well the preliminary and the pilot studies are compared and contrasted where they are applicable under each heading in terms of the different performance levels. The performance levels discussed are for the different skill factors and/or elements where applicable. The result of an interview with a previous N6 student is discussed only under the subquestion that focuses on how VSOR is taught and assessed and how that impacts on learning. Finally the correlations are discussed.

9.2.1 Skill factor I: *How competent are students in graphing skills? How competent are students in translating between visual graphs and algebraic equations/expressions in 2D and 3D?*

In order to address the research question, students' performance in graphing skills as well as translating between visual graphs and algebraic equations/ expressions were explored. Graphing skills require procedural understanding while translating between visual graphs and algebraic equations/expressions require conceptual understanding. The results of the Questionnaire 1st run revealed that the students' performance in graphing skills and in translating between visual graphs and algebraic equations/expressions in 2D and 3D was satisfactory. This performance implies that the students have some ability in graphing skills and in translating between visual graphs and algebraic equations/expressions in 2D and 3D. However, in both runs of the questionnaire, the students' performance in drawing graphs was not satisfactory. Failure to draw graphs could imply that the students might have forgotten what they learnt in previous levels or that they were not properly taught or that they have learnt it without understanding.

Under Skill factor I, most of the students were struggling when translating from algebraic to visual in 3D, especially in the Questionnaire 2nd run, where the performance was poor and the students were not competent. The results of the questionnaire runs, the preliminary study and pilot study, revealed that the majority of the students were only able to draw simple graphs. The students were only able to draw graphs that they were familiar with, but struggled to draw

the graphs that they were unfamiliar with or given as word problems. The students struggled more when the questions from the questionnaire runs involved the symbolic representation of integrals, like drawing a graph(s) or object(s) that represents $V = \pi \int_0^1 (1-x)^2 dx$, where they had to translate from algebraic to visual. Students' failure in responding to questions similar to this one revealed that the students did not comprehend the disc method conceptually. They could only translate a given visual graph to represent a formula for a disc but could not revert to the original graph if an equation representing a disc was given. The students do not have conceptual understanding of the integral formula for area and volume; they can only use it as given from the formula sheet, without interpreting it critically.

Similar to the results of my study, a study by Samo (2009) gives evidence that students' difficulties in algebra could be related to their difficulties and misinterpretation of symbolic notations. In Montiel's (2005) study, similar to the results from all the questionnaire runs, most of the students were not able to interpret the given integral notation. They failed to translate from algebraic to visual, except in cases where simple or familiar equations were given. When asked to draw the 3D solids from the equations of volume, given as an integral for a disc or a shell, students were seen to draw 2D diagrams. These results reveal that perhaps the students were not familiar with drawing solids of revolution or that they operate with symbols without relating to their possible contextual meanings (White & Mitchelmore, 1996). The results of this study supports the findings by Maharaj (2005) that many students perform poorly in mathematics because they are unable to handle information given in symbolic form adequately.

Despite the difficulties encountered, a large majority of students were seen, from the questionnaire runs and the pilot study, to succeed in translating from visual graphs to algebraic equations in 2D, especially if a Δx strip was appropriate and in 3D if the rotation resulted in a disc or a washer. Most of the students avoided using a Δy strip as well as the shell method. For those students who tried to use a shell method, errors were found as the students failed to use correct limits of integration, when applying the Fundamental theorem of Calculus. The results also revealed that most of the students were more able to translate from visual to algebraic representation than from algebraic to visual representation, especially in 3D. This means that the students were more competent in interpreting the drawn graphs, resulting in a formula for volume, rather than drawing the graphs from an equation of a 3D representation (volume) of a certain graph. Similar results were found when working in 2D. Contrary to the above results the results of the preliminary study revealed that the students were, in most cases, unable to

translate from visual graphs to algebraic equations, when they calculated volume, since they abandoned the drawn graphs.

The results from the examination response analysis revealed that students' performance in drawing graphs was satisfactory. From the detailed selected written examination responses, students' performance was good. In contrast, during the classroom observations, it appeared as if in some instances, students' performance in drawing graphs was satisfactory, whereas in other cases they had difficulties, evident from their reliance on the table method when drawing graphs. The students' performance in drawing graphs was satisfactory (examination responses analysis) and good (detailed examination responses) probably because simple graphs were tested. However, the performance was not satisfactory when the students were required to translate from the drawn graphs to algebraic representation, when using the selected strip to give rise to the algebraic formula for volume. From the classroom observations it appeared that the lecturer did not teach the students how to draw graphs as it was expected that they had done them in-depth at previous levels, but focussed more on the translation of the drawn strip to algebraic equations for volume (disc, washer or shell), which students were seen to be partially competent in during the classroom discussions. When working on their own, most of the students had difficulties when translating from visual to algebraic, especially in 3D.

There were no instances during the examinations and the classroom observations where students were expected to translate from algebraic equations to visual graphs where integral equations were used. It appears as if these students were not adequately competent in Skill factor I, probably because they could not interpret their drawn graphs, or at times abandon them, since they lacked spatial abilities involving three-dimensional thinking. If students have spatial abilities they will be able to "generate, visualize, memorize, remember and transform any kind of visual information such as pictures, maps, 3D images" (Menchaca-Brandan, Liu, Oman, & Natapoff, 2007, p. 272), without any problem. The result of a study by Dettori and Lemut (1995) concurs with my results. Their study also revealed that students could not use diagrams and they attributed that to some blockages, referred to as *cognitive obstacles*.

From the above discussions, a conclusion can be made that students have difficulty in learning VSOR in part because they are not fully competent in graphing skills and translating between visual graphs and algebraic equations/expressions in 2D and 3D. Overall from all the investigations, generally students have difficulty in interpreting the drawn graphs. They also have difficulty especially when translation is between visual and algebraic in 3D.

9.2.2 Skill factor II: *How competent are students in translating between two-dimensional and three-dimensional diagrams?*

Translating between 2D and 3D diagrams requires conceptual understanding. From the Questionnaire 1st run, it appears that students were able to translate between 2D and 3D when simple diagrams were given, but struggled to rotate when given diagrams that required that they imagine the rotations, which requires conceptual skills. For example most students failed to draw a torus that could result after rotation of a circle that was a certain distance away from the x -axis and from the y -axis, involving translation from 2D to 3D. The ability to translate properly depends on the students' visualisation ability, a kind of mathematical reasoning activity based on the use of spatial or visual elements (Gutiérrez, 1996) that can assist a student to imagine the rotations. The results from the study conducted by Gorgorió (1998) revealed that students used 2D drawings to represent 3D objects when interpreting 2D representations of 3D objects.

From the Questionnaire 1st run, most of the students' performance was not satisfactory in translating from 2D to 3D when they were expected to draw solids of revolution. When the tasks involved translation from 3D to 2D, in cases where the students were expected to represent 2D diagrams from the given 3D diagrams, the performance was satisfactory. In contrast, the results from the Questionnaire 2nd run reveal that the students' performance was poor when translating from 3D to 2D. As for the pilot study, the results reveal that the students' performance in translating between 2D and 3D was poor. The results of the preliminary study revealed that only after using Mathematica, more students were able to rotate the strip correctly, even though its 3D representation was not drawn. Overall, from Questionnaire 1st run, the performance in three-dimensional thinking, where the students were required to translate between 2D and 3D was not satisfactory.

The classroom observations did not include problems where 2D diagrams were rotated to form 3D diagrams or where 3D diagrams were used to determine which 2D diagrams they originated from. The rotations that were demonstrated were when representative strips were rotated about a particular axis, resulting in a shell, washer or disc, without drawing the exact solids of revolution. The lecturer gave a clear explanation about the strip being parallel or perpendicular to a certain axis and the shape it would generate after rotation, hence enhancing visual skills. Alias et al., (2002) point out that if spatial activities are emphasised during teaching, then students' spatial visualisation ability is enhanced. From the solutions for the written examination and most of the examination analysis, in most cases, strips were indicated on the

diagram but they were not drawn after rotation as representing a disc, a washer or a shell. The solids of revolution formulated were never drawn. Failure to draw the translated diagram from 2D to 3D in this case interferes with the ability to develop visual and imaginative skills, necessary if mental images are made about rotations (Dreyfus, 1995), and to derive the formula for volumes from the diagrams and not from the formula sheet.

From the above discussions, a conclusion can be drawn that students' performance was not satisfactory in Skill factor II, which involves translating between two-dimensional and three-dimensional diagrams. Even if at times the students drew the strip correctly, they could not rotate it correctly as a result of failing to translate between 2D and 3D, or even interpret a 3D diagram to determine which 2D diagram it originated from. If students have difficulty in solving problems that involve three-dimensional thinking, then learning VSOR can be problematic.

9.2.3 Skill factor III: *How competent are students in translating between continuous and discrete representations visually and algebraically in 2D and in 3D?*

The performance on translating between continuous and discrete representations visually and algebraically in 2D and in 3D (both requiring conceptual understanding) in the first and the second run of the questionnaire and the pilot study was poor, revealing that the students lacked competency in this area. It was revealed that almost all of the students struggled with the translation from the algebraic expressions to the discrete approximation of area and volume, as a result of students not being familiar with the concept of Riemann sums. Only a few students managed to approximate the area by using rectangles and volume by using discs. Similar to the results of my study, students in Montiel's (2005) study were also seen to use the rectangles for approximation of the area inappropriately. The results from a study by Orton (1983) also concur with the results from my study. It was revealed that most students had little idea of the procedure of dissecting an area or volume into narrow sections, summing the areas or volumes of the sections. From a study by Camacho and Depool (2003), some students were seen to be in a position to use the Riemann sums. The lack of competency in translation between continuous and discrete representations visually and algebraically in 2D and 3D, as it was the case in my study, can be as a result of an absence of proper concept images (Harel et al., 2006).

During the classroom observations and the examinations, the concept of Riemann sums was never dealt with as it was assumed that the students had done them on the previous levels. However, from the responses that students produced, it seems that even if the concept of

Riemann sums had been done, it might have been at a more procedural level, without relating the continuous to the discrete representations. From the examination response analysis, the detailed selected written examination responses and during the classroom observations, many students had problems when they had to select the representative strip. They did not know when the strip should be vertical or when should it be parallel to a certain axis. For that reason, the students were unable to translate between continuous and discrete representations. In all three investigations, the students' performance in selecting the representative strip was not satisfactory. Similarly to Montiel's (2005: 101) study, as during the classroom observations, some students did not know when to use a Δx strip and when to use a Δy strip. In that case the difficulties in learning VSOR arise from the fact that the students cannot translate between the continuous and the discrete representation. Based on the overall poor performance, it means that the concept of Riemann sums, which is crucial to the learning of VSOR, is lacking. In order for the students to do well with VSOR, the concept of Riemann sums should be dealt with at a level where conceptual understanding is reinforced starting from N4 to N6.

9.2.4 Skill factor IV: *How competent are students in general manipulation skills?*

General manipulation skills require procedural understanding. The results from the questionnaire runs, the examination response analysis, the classroom observations, the pilot study and the preliminary study showed that the students performed satisfactorily in problems that required general manipulation skills. Even if the performance was satisfactory, errors were made when students solved problems that involved evaluation of integrals using integration techniques. From the classroom observations, it was observed that generally, the students struggled with integration by parts and the substitution method involving a square root. Even if the integral to be evaluated is not difficult to calculate, students already had a negative attitude towards integration. Gonza 'Lez-marti'n and Camacho (2004) assert that even 'simple' calculation of integrals causes problems for the students since most of them perceive integration as cognitively demanding to the extent that they even develop a negative attitude even towards the simple exercises.

Errors were also made when calculating the point of intersection of graphs, where in some instances students were unable to interpret the square root of negative numbers. The nature of errors made may be as a result of the students' lack of the mathematics register and probably because their knowledge in mathematics rules is superficial. The problem with general manipulation skills was also evident in Montiel's (2005) study. Similar to the results of my study, some students in Montiel's (2005) study had problems expressing the functions "in

terms of x ” or “in terms of y ”. Students encounter difficulties in problems requiring general manipulation skills because their mathematics content knowledge is too low. They lack the necessary mathematics register. However, in a study by Hacımeroglu et al. (2010), students succeeded without difficulties with procedural tasks that involved the computation of an integral.

In contrast, the results from the detailed selected written examination responses reveal that the students’ performance in general manipulation skills was good. Not so many errors were made, as it was the case during the classroom observations.

9.2.5 Skill factor V: *How competent are students in dealing with the consolidation and general cognitive demands of the tasks?*

This skill factor involves problems that require both procedural and conceptual understanding included in Skill factors I, II, III and IV. The results from all the investigations as well as the pilot study, reveal that students lack the cognitive skills required to solve problems under Skill factor V, since they lack conceptual understanding of the VSOR content required in Skill factor II and Skill factor III. Students’ failure in identifying the strip correctly and drawing the 3D diagram of the strip resulting after rotation to show the solid of revolution formulated, may hamper success in dealing with the problems that require the consolidation ability and general level of cognitive development, hence leading to poor performance when tested on the threshold concepts (Pettersson et al., 2008) in learning VSOR.

The results reveal that from the other skill factors, students’ performance was poor in Skill factors II and III, and satisfactory in Skill factors I and IV. If the students’ performance in the Skill factors II, and III is so poor, how do they then manage to solve problems that require application using these skill factors? The students have difficulties in Skill factor II and Skill factor III, since they require conceptual understanding, which they lack. The students also have difficulties since they have to start by calculating the important points on the graphs and drawing the graphs, which they perform satisfactorily in and at times make errors; select the representative strip and continue to rotate the selected strip which they are not competent in (in cases where the volume is to be calculated) and to interpret it so as to come up with the formula to calculate volume. These results reveal that the main reason that students struggle with Skill factor V is because they cannot select the correct representative strip as well as rotating it properly. The fact that they do not usually draw the solid of revolution generated

reduces their chances of interpreting what is visual accordingly. The students' failure in this case is because they have not developed cognitively to the correct level.

The results of the examination response analysis revealed that in most cases, students' performance deteriorated from the first question, where they were asked to draw graphs, to its subquestions, when they were asked to interpret the drawn graphs, as in the performance from the written examination responses. Students managed in some instances to draw graphs but failed to interpret those graphs after the selection of a rectangular strip. These students tended to abandon the drawn graphs and the drawn strip when selecting the formula for area or volume. The general conclusions that could be made from the examination analysis are that students' performance in drawing graphs was satisfactory, but were unable to interpret the region bounded by such graphs, as is evident from their incompetency in selecting the representative strip, translating from visual to algebraic in 2D and in translating from visual to algebraic in 3D, which was performance that was not satisfactory.

The problem is that if a student fails to draw the graphs correctly and select the strip correctly and fails to interpret it correctly in selecting the correct formula, then the rest of the answers that follow from the drawn graphs are likely to be incorrect. In that way the general manipulation skills performed thereafter would also be incorrect as it depends on the preceding steps. The majority of these students were unable to deal with the cognitive demands of the task, hence lacked the skills in the consolidation and general level of cognitive development. The performance in the examination response analysis was not satisfactory.

From the classroom observations, one can conclude that students were not mathematically adequately proficient (Kilpatrick et al., 2001), as they struggled to draw graphs, failed in most cases to select the proper strip, had problems in translating from a visual representation to an algebraic representation and made many errors in their calculations, but succeeded only through scaffolding. These students struggled because they lacked conceptual understanding, had limited procedural fluency, limited strategic competence and no adaptive reasoning. The results from the classroom observations also revealed how problematic VSOR can be in terms of the consolidation and general level of cognitive development required. This was evident during the classroom observations as even the lecturer could not solve a problem that required the use of the substitution method in evaluating an integral derived from an equation of a hyperbola. VSOR requires more time for students to conceptualise the cognitively demanding aspects. Eisenberg (1991) argues that the abstraction of the new mathematical knowledge and

the pace with which it is presented often become the downfall of many students. The content at the N6 level seem to be too abstract for students, hence they cannot meet the cognitive demands of the VSOR content. It seems as if a reason why students have difficulty is that their background level is not at an appropriate level, or that the VSOR content is too abstract for them. The results discussed above make explicit the fact that competencies in all other four skill factors hinder or prohibit success in solving VSOR problems. As a result students encounter difficulties in learning VSOR. Students' difficulty may also be as a result of the lack of the recognition and the realisation rules or failing to realise the speciality of the context that one is in (Bernstein, 1996), because VSOR is above the students' cognitive abilities.

The difficulty in VSOR can as well be explained from the average mark that the students scored in Question 5, from the examinations analysis, falling under the consolidation and general level of cognitive development. It appears that students' performance, with a mean of 15.4 (38.5%) for Question 5 which was marked out of 40 was not satisfactory. This mean percentage for question 5 is less than the mean percentage (45.5%) of the whole examination, implying that question 5 was difficult.

The results of this study raise questions about the level of difficulty of content that the N6 students must study and the career paths they must follow. If most of these students did not meet the requirements of being at the university of technology, then why do they have to study this difficult content at the FET college, which does not even qualify them to be accepted at universities. Only a few of these students who get above 50% per subject including mathematics qualify to write the government certificate of competency which qualifies them as certificated engineers.

The mathematics content learnt at the FET colleges from N5 to N6 levels is more advanced and more abstract as compared to the school mathematics learnt in Grade 11 to 12. They do complex differentiation and integration which should qualify them to be accepted at universities, as they come with a proper background, provided they pass it with high marks. In this regard, students who completed N6 mathematics with high marks are more competent than those students with a matric qualification who even fail the National Benchmark Test (NBT) at universities for entrance into engineering and science fields because of the lack of in-depth knowledge about basic engineering concepts which the FET college students have. However, the fact that there was no instance during this study where the students' performance was good

or excellent in any of the five skill factors, imply that most of the students at the FET colleges lack the necessary mathematics background, only a few may qualify to be at universities.

9.2.6 Teaching and Assessment: *How is the VSOR content taught and assessed and how does that impact on learning?*

The question on how VSOR is taught has already been addressed in the six subquestions above when classroom observations were discussed.

The way in which the VSOR content is assessed create a huge burden for lecturers who are expected to teach new concepts required for the application of areas and volumes including centroids and centre of gravity. The burden here is that these lecturers are compelled to start by reinforcing concepts that were done previously including drawing graphs and using the Riemann sums (based on the prior knowledge that these students have) in a very short space of time. The new concepts that are to be taught can only be done properly if the students draw correct graphs, which they normally manage to draw if they are familiar with them and to select the representative strip with which they struggle extremely.

When assessing VSOR in the final N6 examinations, the VSOR content assessed in Question 5 focuses on five elements only namely: general manipulation skills; graphing skills; translation from continuous to discrete (visually); translation from visual to algebraic in 2D and translation from visual to algebraic in 3D. It is clear from the N6 examination question paper and the memorandum that questions where translating between two-dimensional and three-dimensional diagrams, where students are given marks for drawing a solid of revolution generated are not assessed. For that reason, the lecturers do not normally teach this section properly. From the classroom observations it was evident that the lecturer did not emphasise that students should draw the solids of revolution generated, even if it is shown in textbooks. In that way the rotation of the strip is not learnt in-depth and used visually as a starting point to generate the formula for volume. Students are influenced to rely on the formula sheet instead of visualising the formula for the disc, washer or shell from the drawn diagram, also the one for area.

As highlighted under Skill factor V, in order to do well in Question 5 one must be competent in graphing skills. Students must draw graphs first and then interpret them based on the requirements of the questions that follow. The high correlation of students' performance in graphing skills to the other elements reveals that the way in which the students are assessed in Question 5 is problematic as it starts by requiring the students to draw graphs which they may

fail to draw. Hence the students may fail to respond to the questions that follow, based on the drawn graphs and how they interpret them. So the question is, do we teach the drawing of graphs and interpretations of the drawn graphs properly again as these students' capabilities are very low, or do we change the way of assessment that can accommodate the students who cannot draw or interpret graphs? Advice for teachers is that they must assist students to link new knowledge to their prior knowledge and develop instructional techniques that would facilitate cognitive growth and change (Kotzé, 2007), and not to focus on general manipulation skills. A study by Pettersson et al. (2008:781) reveal that students should be taught threshold concepts of calculus like the concepts of limit and integral in order to develop conceptual understanding. In in this study the threshold concepts involve the interpretation of graphs, based on three-dimensional thinking and the Riemann sums.

Another aspect that may impact on learning difficulties is the attitude that students have towards VSOR, the fifth strand of mathematical proficiency called *productive disposition* (Kilpatrick et al., 2001). The interviewed student showed a productive disposition. This student really enjoyed learning VSOR and appreciated the way in which it applies to other subjects and its meaning. She pointed out that that the other students should not be discouraged that VSOR is difficult, because if they agree to that, they will never succeed. The student interviewed highlighted that it is important that the students be able to draw a graph properly, to select a correct strip and to rotate it properly in order to do well in VSOR. She mentioned that without a sketch (graph) you are lost, as the formula that one uses is derived from the sketch. According to the student interviewed, one must visualise the bounded region and interpret it. However, she also mentioned that if questions were given where graphs were drawn, without students having to start by drawing graphs, then VSOR would be easy, especially for those students who struggle to draw graphs. The results from the interview reveal that students have difficulty with VSOR because they struggle to draw graphs and mainly to interpret them. The student also stated that students' attitude may also hamper success in learning VSOR.

9.2.7 Correlations

Most of the correlations from the questionnaire runs were not statistically significant. From the Kendall tau correlation coefficient, the correlations that were highly significant at 1% level, were those correlating the consolidation and general level of cognitive development to other six elements, namely: translation from continuous to discrete (visually); translation from discrete to continuous and from continuous to discrete algebraically; graphing skills; translation from visual to algebraic in 3D; translation from 2D to 3D and the translation from

3D to 2D. Such an association between the consolidation and general level of cognitive development to these six elements points out the strong association between consolidation and general level of cognitive development and performance in these elements. This performance is related to how graphs are drawn and interpreted, for example, selecting a strip and translating it to an equation for area or volume, also involving three-dimensional thinking. Such an association between the consolidation and general level of cognitive development and for example the translation from continuous to discrete representations, points out how important the selection of representative strip is to the ability to perform better in a question that requires consolidation and general level of cognitive development. However, the element involving general manipulation skills shows correlations that are not significant in relation to the rest of the elements. What this implies is that being capable of solving problems requiring general manipulation skills has no association with how one performs in the other elements.

In contrast, from the examination analysis, also using Kendall tau correlation coefficient, the correlations of the five elements, general manipulation skills; graphing skills; translation from continuous to discrete (visually); translation from visual to algebraic in 2D and translation from visual to algebraic in 3D are all highly significant at 1% level. These results reveal that the way in which Question 5 is assessed is problematic, compared to the 23-item instrument, since all other five elements correlate significantly to each other. For example, as performance in graphing skills, increases, then the performance in all other elements also increases, which is affected by the way in which question 5 has been assessed. The correlation of 0.852, using Pearson correlation coefficient, alludes to the significance of these correlations from the examinations.

9.3 ANSWERING THE RESEARCH QUESTION FOR THIS STUDY

From the interpretations of the results discussed under the subquestions in Section 9.2 above, I attempt to answer the research question for this study: **Why do students have difficulty when learning about volumes of solids of revolution?**

It was found that students lack graphing skills. They only manage to draw simple graphs, many at times using the table method to plot the points. Hjalmarson et al. (2008) argue that graphing representations play a significant role in conceptual understanding within upper-level applied mathematics. They believe that students need to be able to interpret and generate graphs (which the students in my study struggled with) as part of their mathematical reasoning. In that way

they may develop some cognitive skills. If students are not taught the characteristics of a graph and are rather taught to rely on the table method, then they waste time and will most probably fail in identifying the important characteristics of the particular graph. In this case, the use of a table method becomes procedural and a source of the difficulty for students. Due to the scope of the VSOR content, the use of the table method becomes too time consuming; hence students might not be able to finish answering all the questions.

Students do not learn about solving VSOR problems conceptually, hence perform better when they translate from visual graphs to algebraic equations (which was emphasised in class when they chose formulae from the formula sheet) and struggled to translate from algebraic equations/expressions to visual graphs (the reverse of the first process) because they were never taught to deal with such problems when they had to draw a diagram represented by an integral formula. The use of a formula sheet is an additional source of difficulty, since instead of students learning to develop the formula for area or volume from the drawn graphs or diagrams (conceptually) they rely on the formula sheet. In that case, the development of visual skills is compromised, serving as a source of learning difficulties. Students experience difficulties because instead of lecturers focusing on developing conceptual skills, they tend to concentrate on general manipulation skills, which students do not have major difficulty in, evident from all investigations.

Students struggle to solve problems that involve three-dimensional thinking. The main reason might be because three-dimensional thinking requires spatial visualisation abilities, which these students do not seem to have. Students had difficulty in learning about VSOR because they were not able to deal with problems in which they were required to imagine the rotations as well drawing solids of revolution. The most critical aspect that students struggled with was to identify the strip that would be best to approximate the region bounded by the graphs. This failure resulted in failing to use Riemann sums and applying the FTC, also failing in rotating the selected strip correctly and representing the rotated strip as a 3D diagram. If some students did not have a lecturer at N5 level, as it was stated during the interview and the classroom observations, then these students were not taught the basic concepts that involve three-dimensional thinking regarding the VSOR, and the basic knowledge of what a solid of revolution is, hence the difficulties. Seemingly, these students did also not learn the basic skills necessary for selecting a representative strip. The content that students do at lower levels before they do N5 and N6, does not prepare them adequately in three-dimensional thinking, to meet the challenges of the complex VSOR content. Due to the limited time that the N6

lecturers have to complete the syllabus in, the topic of VSOR is learnt procedurally, hence making it difficult for these students who come with the poor mathematics background, to cope. Such students are not given enough time to develop cognitively to be in a position to deal with the complex VSOR content.

With regard to general manipulation skills, many mathematical errors led to students' inability to obtain the final answer correctly, including drawing the correct graphs, which led to the steps that follow being incorrect. Students also at times encountered difficulties because they do not know the techniques of integration and do not possess a sufficient mathematics register, due to their poor mathematics background. The difficulties that students have with VSOR are as a result of the errors that they make when performing calculations and not being familiar with using correct integration techniques. The fact that lecturers also at times find it difficult to use some techniques of integration, add to the difficulties that students have. Such lecturers are unable to reach out to students and make the VSOR content accessible for students.

Perhaps the main problem that students experience is that the topic of VSOR is of too high a general cognitive level for these students. Students find it difficult to deal with questions in which all four other skill factors are consolidated in one question, possibly because the content that students do at lower levels before they do VSOR, does not prepare them adequately in three-dimensional thinking, critical and logical thinking, complex problem solving techniques and basic mathematics content to meet the challenges of the complex VSOR content.

9.4 RECOMMENDATIONS OF THE STUDY

Some recommendations resulting from this study are subsequently indicated for lecturers, examiners, curriculum developers and the department of education.

9.4.1 Teaching the VSOR content

Lecturers should teach the topic of VSOR more conceptually and design questions that encourage students to engage with problems more conceptually. Lecturers must encourage students to draw graphs or diagrams from the given equations/expressions, including formulae given as integrals representing areas and volumes of the shaded region and the limits of integration, that is, work in the opposite direction to the usual way of the examination paper. The focus should be on how the formulae derive from the diagrams (2D and 3D) rather than calculating areas or volumes. That is, translate the given graphs or diagrams from visual to

algebraic as well as from visual to visual in 2D and in 3D to make students conceptually capable, not just procedurally.

Students should be encouraged to draw a solid of revolution after rotating a given diagram (region bounded by graphs) from 2D to 3D and to show a 3D diagram formed after rotating the representative strip, as it is in Skill factor II. Students should also be encouraged to draw graphs from the given formula in integral form that represent area and volume of a disc, washer or shell, as the students translate from 3D to 2D. Most importantly, students should be encouraged to use Riemann sums to approximate the bounded region to justify whether the rectangular strip should be vertical or horizontal as it is tested in Skill factor III. In that way, they are not just choosing any strip that they prefer to work with, but have to justify their choice. In teaching VSOR, emphasis should not be on performing the calculations for area and volume, but on development of conceptual skills, where mainly solids of revolution are drawn. As was evident from the correlations between the different elements, calculations performed are not associated with the skills required in the other elements. Even if a student performs excellently with general manipulation skills, it does not imply that such a student will perform well in any of the other elements, since the correlations found were non-significant.

9.4.2 Assessing the VSOR content

It is suggested that the five skill factors of VSOR content be assessed using two complementating modes of assessment. The first mode may follow the current format in which the first four skill factors are consolidated where students are firstly asked to draw the graph before solving the question based on the drawn graph, either to calculate area, volume, centroid or centre of gravity. I would advise that the marking memorandum be designed in such a way that a student who has drawn an incorrect graph is not penalised for the rest of the question, as is done presently. The marking memorandum should have all the possible alternative solutions taking into account the errors that students make. The selection of the strip and the rotation thereof must be marked based on students' drawn graphs. Further general manipulation skills, for example calculating the area, volume, centre of gravity and so on should as well be marked in the same way.

I suggest that in the second mode students should be given drawn graphs that they can interpret. In that way, the incorrect graph that the student might have drawn (similar to the current method of assessment as it is in this question in the examination paper) may not affect the solution to the problem. The main focus of these questions should therefore be on how

students interpret the drawn graphs (which is the main focus at N6 level). The focus should also be on how students identify the representative strip for the bounded region, how they translate the visual graph (the bounded region) by drawing the solid of revolution formed and the diagram representing the 3D rotation of the selected strip. The questions must encourage students to derive an algebraic equation from the strip (in 2D or in 3D) that they have drawn in order to calculate area or volume. Another recommendation is that students should get credit for showing the location of the coordinates of the centroid of the strip and the centre of gravity of the solid from the drawn graphs (in 2D and in 3D) before they could calculate them, since that will help them to approximate the coordinates in relation to the limits of integration before performing the calculation of those points. In that way students are encouraged to come up with their formulae visually in a way of enhancing conceptual understanding instead of just relying on the formula sheet.

9.4.3 The role of curriculum developers

Curriculum developers must design the curriculum in line with the capabilities of the students registered at the FET colleges as this content seems to be too complex for these students and a hurdle for entrance into universities of technology. My experience in teaching at the universities of technology is that the VSOR content that the university of technology students learn is cognitively less demanding than what FET students are exposed to. This raises a concern as to whether there is any communication between the college curriculum developers and those from the universities of technology, in order to address the career paths that these students may follow.

I suggest that the VSOR content that is learnt at the FET colleges at N6 level be made less cognitively demanding by perhaps moving some of the concepts to the university of technology level, where these concepts can be addressed in-depth. As mentioned earlier, in the past, FET colleges (then technical colleges) were mainly training artisans as apprentices from companies, not students coming straight from school with no experience from the industry. The VSOR content at this stage is not in line with students' capabilities, since they come straight from schools and have no industrial background.

9.4.4 Duties of the Department of Education and the industry.

An alternative approach would be for the Department of Education to design programmes in which lecturers who teach mathematics at the FET colleges, especially from N4 to N6 level, are thoroughly trained in teaching VSOR as it requires that they teach more conceptually, an

aspect that most of the lecturers lack, perhaps due the fact that most of them are not adequately qualified and specialists in their fields. Another aspect is that this section is more closely related to the industrial experience in engineering which most of the present lecturers at the FET colleges do not have. This topic is meaningful to mechanical and electrical engineering students since it is applicable in subjects such as Fluid Mechanics, Thermodynamics and Strength of Materials that deal with channel flow of fluids, heat transfer, beams, etc. These topics are applicable to e.g. civil engineering, hence cannot be removed from the curriculum. Perhaps computer programmes e.g. Mathematica, if used regularly, can be beneficial for students doing VSOR as it will enable them to visualise the rotations (from 2D to 3D).

According to Tall (1995: 52) computer programmes can also provide a rich interactive source of possible imagery, both visual and computational as well as allowing students to progress in their use of graphic and numerical aspects of the concept of definite integral (Camacho & Depool, 2003). Visualising these rotations is important since understanding and application of mathematical concepts using visually based representations and processes presented in diagrams, computer graphics programmes and physical models is essential (Rahim & Siddo, 2009). In developing curricula for FET colleges, the Department of Education must also involve employers. Young (2003:230) mentioned that the NQF offers opportunities to employers to have a bigger say in the kind of skills and knowledge that 16 to 18-year-olds are expected to acquire. Presently these 16 to 18-year-olds are studying at the FET colleges.

9.5 LIMITATIONS OF THE STUDY AND DIRECTIONS FOR FURTHER RESEARCH

This study has some limitations in that its results cannot be generalised since it was conducted in two colleges only, on a small sample of students. The lesson observations conducted were for one lecturer only, and one class only at one college. The classroom observations might have influenced teaching and learning styles. Other factors might have contributed to the results of this study since the students were taught by different lecturers and used different textbooks. However, the results can be transferrable to similar settings.

The strong positive correlation between the results in the questions on VSOR and the entire examination paper raises serious concerns about causation, which could be investigated further. The question is, does performance in these questions affect the performance in the whole examination paper or vice versa? This fact could be researched further.

REFERENCES

- Adler, J. (2002) Inset and mathematics teachers' conceptual knowledge in practice. In *Proceedings of the 10th Annual Conference of the Southern African Association for Research in Mathematics, Science and Technology*, 2, 1– 8.
- Akkoç, H., Yeşildere, S., & Özmantar, F. (2007). Prospective mathematics teachers' pedagogical content knowledge of definite integral: the problem of limit process. In *Proceedings of the British Society for Research into Learning Mathematics*, 27 (3), 7-12.
- Akoojee, S. (2008). FET college lecturers: the 'devolving' link in the South African skills development equation, *Journal of Vocational Education & Training*, 60(3), 297-313.
- Akoojee, S., & McGrath, S. R. (2008). Skills development for poverty reduction: Can FET colleges deliver? In S. Maile (2008). *Education and poverty reduction strategies. Issues of policy coherence*. Colloquium proceedings. HSRC.
- Akoojee, S., McGrath, S., & Visser, M. (2008). Further education and training colleges. In A. Kraak, & K. Press (2008). *Education, employment and skills in South Africa*. Human Resource Development (HRD) Review (pp. 254-277). Cape Town: HSRC.
- Alias, M., Black, T.R., & Gray, D.E. (2002). Effect of instructions on spatial visualisation ability in civil engineering students. *International Education Journal*, 3(1), 1-12.
- Allais, S. M. (2003). The national qualifications framework in South Africa: a democratic project trapped in a neo-liberal paradigm? *Journal of Education and Work*, 16(3), 305-323.
- Amoah, V., & Laridon, P. (2004). Using multiple representations to assess students' understanding of the derivative concept. McMara, O. (Ed.) *Proceedings of the British society for the research into learning mathematics*, 24(1), 1-6.
- Anghileri, J. (2006). Scaffolding practices that enhance mathematics learning. *Journal of Mathematics Teacher Education*, 9, 33-52.
- Arcavi, A. (2003). The role of visual representations in the learning of mathematics. *Educational Studies in Mathematics*, 52, 215-241.
- Aspinwall, L., Shaw, K.L., & Presmeg, N.C. (1997). Uncontrollable mental imagery: graphical connections between a function and its derivative. *Educational Studies in Mathematics* 33, 301-317.
- Aspinwall, L., & Shaw, K.L. (2002). Connecting Research to Teaching. Representations in Calculus: Two Contrasting Cases. *Mathematics Teacher*, 95(6), 434-439.
- Bakhoum, E.G. (2008). Animating an equation: a guide to using FLASH in mathematics education. *International Journal of Mathematical Education in Science and Technology*, 39(5), 637-655.
- Balacheff, N., & Kaput, J.J. (1996). Computer-based learning environments in mathematics, *International Handbook of Mathematics Education*. <http://scholar.google.com/scholar> . Retrieved 12 January 2006.

Barton, C.N. (2009). Autograph activities. Student investigations for 16-19. [http://www.autograph-math.com/downloads/Contents\(Students\).pdf](http://www.autograph-math.com/downloads/Contents(Students).pdf). Retrieved 25 January 2012.

Barton, B., & Paterson, J (2009). Teachers Learning Mathematics: Professional development research. *Teaching & Learning Research Initiative*. New Zealand: Crown. http://www.tlri.org.nz/assets/A_Project-PDFs/9256-FinalReport.pdf. Retrieved 25 January 2012.

Basit, T.N. (2003) Manual or electronic? The role of coding in qualitative data analysis. *Educational Research* 45 (2), 143–154.

Bassey, M. (2003). *Case study research in educational settings*. England: Open University Press.

Bazeley, P. (2009). Editorial: integrating data analyses in mixed methods research. *Journal of Mixed Methods Research*, 3(3), 203-207.

Beets, P. A.D. (2007). (Re)positioning assessment in higher education: the case of geography in South Africa. *South African Journal of Higher Education*, 21 (4), 577-584.

Behr, A.L. (1988). *Education in South Africa. Origins, issues and trends: 1652-1988*. Pretoria: Academica.

Bell, A. (1995). Purpose in school algebra. *Journal of Mathematical Behaviour*, 14, 41-73.

Berger, M. (2007). CAS as a tool for learning mathematics at undergraduate level: some aspects of its use. *African Journal of Research in SMT Education*, 11(1), 17-28.

Bernstein, B. (1996). *Pedagogy, symbolic control and identity: theory, research, critique*. London: Taylor & Francis.

Berry, J., Johnson P., Maull, W., & Monaghan J. (1999). Routine questions and examination performance. In O, Zaslavsky, (Ed.), *Proceedings of the 23rd Conference of the International Group for the Psychology of Mathematics Education (PME23)* (2, pp. 105-112). Haifa, Israel.

Bingolbali, E., Monaghan, J., & Roperz, T. (2007). Engineering students' conceptions of the derivative and some implications for their mathematical education. *International Journal of Mathematical Education in Science and Technology*, 38(6), 763-777.

Bingolbali, E., & Monaghan, J. (2008). Concept image revisited. *Educational Studies in Mathematics*, 68, 19-35.

Bjuland, R. (2007). Adult students' reasoning in geometry: teaching mathematics through collaborative problem solving in teacher education in Sriraman, B (2007). *The Montana Mathematics Enthusiast*, 4 (1), 1-30.

Blaikie, N. (2003). *Analysing quantitative data: From description to explanation*. London: Sage.

- Blatto-Vallee, G., Kelly, R.R., Gaustad, M.G., Porter, J., & Fonzi, J. (2007). Visual-spatial representation in mathematical problem solving by deaf and hearing students. *Journal of Deaf Studies and Deaf Education* 12 (4), 432-448.
- Bliss, J., Askew, M., & Macrae, S. (1996). Effective teaching and learning: scaffolding revisited. *Oxford Review of Education*, 22 (1), 37-61. Vygotsky and Education.
- Boaler, J. (1997). *Experiencing school mathematics: Teaching styles sex and setting*. Buckingham, England: Open University Press.
- Bossé, M.J., & Bahr, D.L. (2008). The state of balance between procedural knowledge and conceptual understanding in mathematics teacher education. *International Journal for Mathematics Teaching and Learning*, www.cimt.plymouth.ac.uk/journal/bossebahr.pdf.
- Boulter, D.R., & Kirby, J.R. (1994). Identification of strategies used in solving transformational geometry problems. *The Journal of Educational Research*, 87 (5), 298-303.
- Bressoud, D. M. (2001). What's been happening to undergraduate mathematics. *Journal of Chemical Education*, 78 (5), 578-581.
- Brijlall, D., & Maharaj, A. (2010). An APOS analysis of students' constructions of the concepts of monotonicity and boundedness of sequences. *Proceedings of the Eighteenth Annual Meeting of the Mathematics, Science and Technology - Crossing the boundaries*. Volume 1. University of Kwazulu-Natal. Edited by Vimolan Mudaly.
- Brijlall, D., & Maharaj, A. (2009). An APOS analysis of students' constructions of the concept of continuity of a single-valued function. *Proceedings of Delta '09*, 36-49. Gordon's Bay.
- Brown, A., & Dowling, P. (2001). *Doing research: A mode of interrogation for education*. London: Falmer Press.
- Bryman, A. (2007). Barriers to integrating quantitative and qualitative research. *Journal of Mixed Methods Research*, 1(1), 8-22.
- Cai, J. (2004). Why do U.S. and Chinese students think differently in mathematical problem solving? Impact of early algebra learning and teachers' beliefs. *Journal of Mathematical Behavior*, 23 (2004). 135-167.
- Camacho, M., & Depool, R. (2003). Using *derive* to understand the concept of definite Integral. *International Journal for Mathematics Teaching and Learning*, 1-16.
- Cheng, P.C.H. (1999). Unlocking conceptual learning in mathematics and science with effective presentational systems. *Computers and Education*, 33, 109-130.
- Chmela-Jones, K.A., Buys, C., & Gaede, R.J. (2007). Visual learning and graphic design: a cooperative strategy *SAJHE*, 21 (4), 628-639.
- Christ, T.W. (2007). A recursive approach to mixed methods research in a longitudinal study of post secondary education disability support services. *Journal of Mixed Methods Research*, 1(3), 226-241.

- Christou, C., Jones, K., Pitta, D., Pittalis, M., Mousoulides, N., & Boytchev, P. (2008). Developing student spatial ability with 3-dimensional applications. <http://www.elica.net/download/papers/DevStudSpatAbil3D.pdf>. Retrieved 05 May 2010.
- Clark, K.M., James, A., & Montelle, C. (2009). "Expert" vs. "Advanced": Investigating differences in problem-solving practices. *Proceedings of Delta '09*, 50-60. Gordon's Bay.
- Clements, D.H. (2004). Geometric and spatial thinking in early childhood education. In D.H. Clements, J. Sarama & A. DiBiase. *Engaging young children in mathematics: Standards for early childhood mathematics education*. (pp. 267-298). United States of America: Lawrence Erlbaum Associates.
- Clements, D.H., Battista, M.T., Sarama, J., & Swaminathan, S. (1997). Development of students' spatial thinking in a unit on geometric motions and area. *The Elementary School Journal*, 98 (2), 171-186.
- Cohen, L. Manion, L., & Morrison, K. (2001). *Research Methods in Education* (5th ed). London: Routledge Falmer.
- Creswell, J.W. (2009). *Research design: Qualitative, quantitative, and mixed methods approaches*. (3rd ed). London: Sage.
- Creswell, J.W. (2007). *Qualitative inquiry and research design: Choosing among 5 approaches*. (2nd ed). London: Sage.
- Creswell, J. W., & Tashakkori, A. (2007). Differing perspectives on mixed methods research. *Journal of Mixed Methods Research*, 1(4), 303-308.
- Cui, L., Rebello, N.S., Fletcher P.R., & Bennett, A. G. (2006). Transfer of learning from college calculus to physics courses. National Association for Research in Science Teaching (NARST). *The proceedings of the NARST 2006 annual meeting*, 3-6. United States of America: CA.
- Deliyianni, E., Monoyiou, A., Elia, I., Georgiou, C., & Zannettou, E. (2009). Pupils' visual representations in standard and problematic problem solving in mathematics: their role in the breach of the didactical contract. *European Early Childhood Education Research Journal*, 17(1), 95-110.
- Denscombe, M. (2002). *Ground rules for good research: a 10 point guide for social researcher*. Buckingham: Open University Press.
- Denzin, N. K. (1978). *The research act: A theoretical introduction to sociological methods*. New York: McGraw-Hill.
- Desrochers, M.N., Fink, H.C., Thomas, A., Kimmerling, J., & Tung, W. (2007). Student assessment: a comparison of solitary, cooperative, and competitive testing. *International Journal of Teaching and Learning in Higher Education*, 19 (3), 289-96. <http://www.isetl.org/ijtlhe/> ISSN, 1812-9129.
- Dettori, G., & Lemut, E. (1995). External representations in arithmetic problem solving. In Sutherland, R., & Mason, J. *Exploiting Mental Imagery with computers in Mathematics Education*. Series F: Computers and Systems Sciences, 138, 20-33. Berlin: Springer-Verlag.

De Villiers M. (2004). Using dynamic geometry to expand mathematics teachers' understanding of proof. *International Journal of Mathematics Education in Science and Technology*, 35 (5) 703-724.

DoE (Department of education)(2006). *Further Education and Training Colleges: Report on 2006 national examination results. Natural Sciences studies and General studies*. Pretoria.

DoE (Department of education) & DoL (Department of Labour) (2001). *Human Resource Development Strategy for South Africa: A Nation at Work for a Better life for All*. Pretoria

Dreyfus, T. (1991). Advanced mathematical thinking processes. In D.Tall. *Advanced Mathematical Thinking*. (pp. 25-41) .London: Kluwer Academic Publishers.

Dreyfus, T. (1995). Imagery for diagrams. In Sutherland, R., & Mason, J. *Exploiting Mental Imagery with computers in Mathematics Education*. Series F: computers and systems sciences, 138, 3-19. Berlin: Springer-Verlag.

Duval, R. (2006). A cognitive analysis of problems of comprehension in a learning of mathematics. *Educational Studies in Mathematics 61*: 103-131.

Duval, R. (1999). Representation, vision and visualization: cognitive functions in mathematical thinking. Basic issues for learning. *In proceedings for the annual meeting of the North American Chapter of the International group for the Psychology of Mathematics Education*, 3-26. France.

Ebert, C., & Mwerinde, P. (2002). Delineating the relationship between problem solving behaviors and achievement of students in cooperative-learning groups. In M. H. Ahmadi (Ed.) *Readings in Innovative Ideas in Teaching Collegiate Mathematics*. (pp. 43-55). University Press of America: Lanham, MD.

Eiselen, R., Strauss, J., & Jonck, B. (2007). A basic mathematical skills test as predictor off performance at tertiary level. Unisa Press. *South African Journal of Higher Education*, 21(1), 38-49.

Eisenberg, T (1991) Functions and associated learning difficulties. In Tall, D. (1991) *Advanced Mathematical Thinking*.

Engelbrecht, J., Harding, A., & Potgieter, M. (2005). Undergraduate students' performance and confidence in procedural and conceptual mathematics. *International Journal of Mathematics Education*, 36 (7), 701-712.

Ensor, P. (2003). The national qualifications framework and higher education in South Africa: some epistemological issues. *Journal of education and work*, 16 (3), 325-346.

Eraslan, A. (2008). The notion of reducing abstraction in quadratic equations. *International Journal of Mathematical Education in Science and Technology*, 39(8), 1051-1060.

Euler, L. <http://www.usna.edu/Users/math/meh/euler.html>. Retrieved 20 July 2010.

Evangelidou, A., Spyrou,P., Elia, I., & Gagatsis, A.(2004). University students' conceptions of function. *Proceedings of the 28th Conference of the International*, 2, 351-358. Group for the psychology of mathematics education.

- Farmaki, V., Klaoudatos, N., & Verikios, P. (2004). From functions to equations: Introduction of algebraic thinking to 13-year-old students. *Proceedings of the 28th Conference of the International Group for the Psychology of Mathematics Education*, 4, 393-400.
- Farmaki, V., & Paschos, T., (2007). The interaction between intuitive and formal mathematical thinking: a case study. *International Journal of Mathematical Education in Science and Technology*, 38 (3), 353-365.
- Field, A. (2005). *Discovering statistics using SPSS*. (2nd ed.). London: Sage.
- Fisher, G., Jaff, R., Powell, L., & Hall, G. (2003). *Public further education and training colleges*. Human Resource Development (HRD) Review. 327-51. <http://hrdreview.hsrc.ac.za>
- Fosnot, C., & Dolk, M. (2003). Mathematics in the city. *Phythagorus*, 57. The Association for Mathematics Education of South Africa.
- Fricke, I., Horak, E., Meyer, L., & Van Lingen, N. (2008). Lessons from a mathematics and science intervention programme in Tshwane township schools. *South African Journal of Higher Education*, 22 (1), 64-77.
- Gagatsi, A., & Petronis, T. (1990). Using geometrical models in a process of reflective thinking in learning and teaching mathematics, *Educational Studies in Mathematics*, 21(1), 29-54.
- Gambell, T.J. (1991). University education students' self-perceptions of writing. *Canadian Journal of Education*, 16(4), 420-433.
- Garner, B., & Garner, L. (2001). Retention of concepts and skills in traditional and reformed applied calculus. *Mathematics Education Research Journal*, 13 (3), 165-184.
- Gelo, O., Braakmann, D., & Benetka, G. (2008). Quantitative and qualitative research: beyond the debate. *Integrative psychological and behavioral science*, 42, 266-290.
- Gerson, H., & Walter, J.G. (2008). How Blending Illuminates Understandings of Calculus. *Proceedings for the Eleventh Special Interest Group of the Mathematical Association of America on Research in Undergraduate Mathematics Education Brigham Young University*. sigmaa.maa.org/rume/crume2008/Proceedings/Proceedings.html-106k.
- Gonza' Lez-Marti' n, A.S., & Camacho, M. (2004). What is first-year Mathematics students' actual knowledge about improper integrals? *International Journal of Mathematics Education Science and Technology*, 35, (1), 73-89.
- Gorgorió, A. (1998). Exploring the functionality of visual and non-visual strategies in solving rotation problems. *Educational Studies in Mathematics* 35, 207-231.
- Gravemeijer, K., & Doorman, M. (1999). Context problems in realistic mathematics education: A calculus course as an example. *Educational Studies in Mathematics*, 39, 111-129. Netherlands: Kluwer Academic Publishers.
- Groen, L., & Carmody, G. (2006). Blended learning in a first year mathematics subject. *Uniserve Science Blended Learning Symposium Proceedings*.

Gunel, M., Hand, B., & McDermott, M.A. (2009). Writing for different audiences: effects on high-school students' conceptual understanding of biology. *Learning and Instruction, 19*, 354-367.

Gutiérrez, A. (1996). Visualization in 3-dimensional geometry: in search of a framework. in L. Puig., & A. Gutierrez (eds.) *Proceedings of the 20 th conference of the international group for the psychology of mathematics education 1*, 3-19.

Güven, B. (2008). The effect of dynamic geometry software on student mathematics teachers' spatial visualization skills. *The Turkish Online Journal of Educational Technology, 7* (4) Article 11, 100-107.

Haapasalo, L. (2003). The conflict between conceptual and procedural knowledge: Should we need to understand in order to be able to do, or vice versa? In L. Haapasalo., & K. Sormunen (Eds.), *Towards meaningful mathematics and science education. Proceedings on the IXX. symposium of the Finnish mathematics and science education research association* (86, pp. 1-20). University of Joensuu. Bulletins of the Faculty of Education.

Haapasalo, L., & Kadjevich, D. (2000). Two types of mathematical knowledge and their relation. *Journal für Mathematik-Didaktik, 21*(2), 139-157.

Habre, S., & Abboud, M. (2006). Students' conceptual understanding of a function and its derivative in an experimental calculus course. *Journal of Mathematical Behavior, 25*, 57-72.

Haciomeroglu, E. S., Aspinwall, A., & Presmeg, N. (2009). Visual and analytic thinking in calculus. *Mathematics Teacher, 103*, 140-145.

Haciomeroglu, E. S., Aspinwall, A., & Presmeg, N. (2010). Contrasting Cases of Calculus Students' Understanding of Derivative Graphs. *Mathematical Thinking and Learning, 12*, 152-176.

Hähkiöniemi, M. (2006). Associative and reflective connections between the limit of the difference quotient and limiting process *Journal of Mathematical Behavior, 25*, 170-184.

Hall, B., & Howard, K. (2008). A synergistic approach: conducting mixed methods research with typological. *Journal of Mixed Methods Research, 2*(3), 248-269.

Harman, C. (2003). Reform calculus – Yesterday, today, and tomorrow. In M.O.J. Thomas and G. Oates (Eds.), *New Zealand Journal of Mathematics: Proceedings of Remarkable Delta '03 Fourth Southern Hemisphere Symposium on Undergraduate Mathematics and Statistics Teaching and Learning* (pp. 89-96). Auckland: New Zealand Mathematical Society and The University of Auckland.

Hancock, D. R., & Algozzine, B. (2006). *Doing case study: A practical guide for beginning researchers*. London: Teachers College Press.

Harel, G., Selden, A., & Selden, J. (2006). In A. Gutiérrez & P. Boero (Eds.). *Handbook of research on the psychology of mathematics education: past, present and future* (pp. 147-172). United Kingdom: Sense.

- Hiebert, J., & Lefevre, P. (1986). Conceptual and procedural knowledge in mathematics: An introductory analysis. In J. Hiebert (Ed.) *Conceptual and procedural knowledge: The case of mathematics* (pp.1-27). Hillsdale, N.J: Lawrence Erlbaum Associates.
- Hjalmarson, M.A., Wage, K.A., & Buck, J.R. (2008). Translating information from graphs into graphs: systems and signals.
<http://mathed.asu.edu/crume2008/Proceedings/Hjalmarson%20LONG.pdf>.
- Howie, S., & Pieterse, J. (2001). Mathematics literacy of final year students: South African realities. *Studies in Educational Evaluation*, 27, 7-25.
- Howie, S. (2002) *English Language Proficiency and Contextual Factors Influencing Mathematics Achievement of Secondary School Pupils in South Africa*. Den Haag: CIP- Gegevens Koninklijke Bibliotheek.
- Hoz, R., & Weizman, G. (2008). A revised theorization of the relationship between teachers' conceptions of mathematics and its teaching. *International Journal of Mathematical Education in Science and Technology*, 39(7), 905-924
- Huntley, M.N., Marcus, R., Kahan, J., & Miller, J.L. (2007). Investigating high-school students' reasoning strategies when they solve linear equations. *Journal of Mathematical Behavior*, 26, 115-139.
- Indris, N. (2009). Enhancing students' understanding in calculus Trough writing. *International Electronic Journal of Mathematics Education*, 4 (1), 36-55.
- Inoue, N. (2008). Minimalism as a Guiding Principle: Linking Mathematical learning to everyday knowledge. *Mathematical Thinking and Learning*, 10, 36-67.
- Jacobs, J. K, Kawanaka, T., & Stigler, J. W. (1999). Integrating qualitative and quantitative approaches to the analysis of video data on classroom teaching. *International Journal of Educational Research*, 31, 717 -724
- Jaworski, B. (2004). Grappling with complexity: Co-learning in inquiry communities in mathematics teaching development. *Proceedings of the 28th Conference of the International group for the Psychology of Mathematics Education*, 1, 17-36.
- Joffrion, H. K. (2005). *Conceptual and procedural understanding of algebra concepts in the middle grades*. Master of science thesis. Graduate studies of Texas A&M University.
- Jones, K. (2001). Appendix 8: Spatial thinking and visualisation. *Teaching and Learning Geometry*, 11-19. The Royal Society.
- Juter, K. (2006). Limits of functions as they developed through time and as students learn them today. *Mathematical Thinking and Learning*, 8(4), 407-431.
- Kågesten, O., & Engelbrecht, J. (2006). South Africa supplementary explanations in undergraduate mathematics assessment: a forced formative writing activity. *European Journal of Engineering Education*, 31(6), 705-715.
- Kasonga, R.A., & Corbett, A.D. (2008). An assessment model for improving student learning. *South African Journal of Higher Education*, 22(3), 602-614.

- Kaufmann, H., & Schmalstieg, D. (2003). Mathematics and geometry education with collaborative augmented reality. *Computers and Graphics*, 27, 339-345.
- Keller, G. (2005). *Statistics for management and economics*. Duxbury: Thompson Brooks/Cole.
- Keller, G. (2008). *Managerial statistics* (2nd ed.). United States of America: South-Western Cengage Learning.
- Kieft, M., Rijlaarsdam, G., & Van den Bergh, H. (2008). An aptitude-treatment interaction approach to writing-to-learn. *Learning and Instruction*, 18(4), 379-390.
- Kilpatrick, J., Swafford, J., & Findell, B. (Eds.) (2001). *Adding it up: Helping Children Learn Mathematics*. Washington DC: National Academy Press.
- Klein, P. D., Piacente-Cimini, S., & Williams, L. A. (2007). The role of writing in learning from analogies. *Learning and Instruction*, 17, 595-611.
- Kimchi, J., Polivka, B., & Stevenson, J.S. (1991). Triangulation: Operational definitions. *Nursing research*, 40 (6), 364-366.
- Knuth, E.J. (2000). Student understanding of the cartesian connection: An exploratory study. *Journal of Research in Mathematics Education*, 31 (4), 500-508.
- Kotzé, G. (2007). Investigating shape and space in mathematics: a case study. *South African Journal of Education*, 27(1), 19-35.
- Kouropatov, A. (2008). Approaches to the integral concept: The case of high school calculus. *Paper for YESS-4*, 1-12, Israel.
- Kozhevnikov, M., Hegarty, M., & Mayer, R.E. (2002). Revising the visualizer verbalizer dimension: evidence for two types of visualizers. *Cognition and instruction*, 20(1), 47-77.
- Kreminski, R. (2009). Visualizing the chain rule (for functions over R and C) and more. *International Journal of Mathematics Education science and technology*, 40 (2), 277-287.
- Leopold, C., Gorska, R. A., & Sorby, S.A. (2001). International experiences in developing the spatial visualization abilities of engineering students. *Journal for Geometry and Graphics*, 5 (1), 81- 91.
- Lomofsky, L., & Lazarus, S. (2001). South Africa: first steps in the development of an inclusive education system. *Cambridge Journal of Education*, 31(3), 303-317.
- Maharaj, A. (2005). *Investigating the Senior Certificate Mathematics Examination in South Africa: Implications for Teaching*. PhD thesis In Mathematics Education: Unisa.
- Maharaj, A. (2008). Some insights from research literature for teaching and learning mathematics. *South African Journal of Education*, 28, 401-414.
- Mahir, N. (2009). Conceptual and procedural performance of undergraduate students in integration. *International Journal of Mathematical Education in Science and Technology*, 40(2), 201-211.

Malherbe, E.G. (1977). *Education in South Africa, 2, 1923-75*. Cape Town: Juta Publishers.

Martin, L., Towers, J., & Pirie, S. (2006). Collective mathematical understanding as improvisation. *Mathematical Thinking and Learning*, 8(2), 149-183.

Mason, E.J., & Bramble, W.J. (1989). *Understanding and conducting research. Applications in education and the behavioural sciences* (2nd ed.). New York: McGraw-Hill.

Mauil, W., & Berry, J. (2000). A questionnaire to elicit the mathematical concept images of engineering students, *International Journal of Mathematical Education in Science and Technology*, 31 (6) , 899-917.

Maxwell, J. A. (1992). Understanding and validity in qualitative research. *Harvard Educational Review*, 62 (3), 279-300.

Maxwell, J.A. (2005). *Qualitative research design: An interactive approach* (2nd ed.). Applied social research methods series, Volume 41. London: Sage.

Maxwell, J.A. (2010). Using numbers in qualitative research. *Qualitative Inquiry*, 16(6), 475-482.

McCormick, R. (1997). Conceptual and procedural knowledge. *International Journal of Technology and Design Education*, 7, 141-159.

McDermott, M.A., & Hand, B. (2010). A secondary reanalysis of student perceptions of non-traditional writing tasks over a ten year period. *Journal of Research in Science Teaching*, 47(5), 518-539.

McGrath, S. (1998). Questioning education and training in South Africa: the challenge of moving from policy to practice. In W. Morrow & K.King (Eds.), *Vision and Reality. Changing education and training in South Africa* (Cape Town, University of Cape Town Press).

McGrath, S. (2000). Coming in from the Cold? Further education and training in South Africa, *Compare: A Journal of Comparative and International Education*, 30(1), 67-84.

McGrath, S (2004). Reviewing the development of the South African further education and training college sector ten years after the end of apartheid, *Journal of Vocational Education & Training*, 56(1), 137-160.

McGrath, S. & Akoojee, S. (2009). Vocational education and training for sustainability in South Africa: The role of public and private provision, *International Journal of Educational Development*, 29, 149-156.

McMahon, P. (2012) Using Autographs in the mathematics classroom. 21 century learning conference Hong Kong. *Leading & Learning in Digital Schools*.
<http://ning.21clhk.com/group/usingautographinthemathsclassroom>. Retrieved 25 January 2012.

McNab, S.L. (2006). Supporting algebraic thinking and generalizing about functional relationship through patterning in a second grade classroom. *PME-NA 2006 Proceedings*, 2, 118-122.

- Meagher, M. (2005). *The processes of learning in a computer algebra system (CAS) environment for college students learning calculus*. PhD dissertation, The Graduate School of The Ohio State University.
- Menchaca-Brandan, M.A., Liu, A. M., Oman, C. M., & Natapoff, A. (2007). Influence of perspective-taking and mental rotation abilities in space teleoperation. *Proceedings of the ACM/IEE international*. Virginia, USA:HRI'07.
- Mertler, C. A. (2006). *Action Research: Teachers as Researchers in the Classroom*. London: Sage.
- Montiel, M. (2005). *Mathematical Fluency measured with the Four Parameters of Foreign Language Learning: Applications of the Integral*. PhD dissertation. University of New Hampshire.
- Morgan, D.L. (2007). Paradigms lost and pragmatism regained: methodological implications of combining qualitative and quantitative methods. *Journal of Mixed Methods Research*, 1(1), 48-76.
- Mwakapenda, W. (2004). Understanding student understanding in mathematics, *Pythagoras*, 60, 28-35.
- Myers, J.L., & Well, A.D. (2003). *Research design and statistical analysis Volume 1*. United states of America: Lawrence Erlbaum Associates.
- National Curriculum statement Grade 10-12, general (2008). Department of Education. *Subject assessment guideline*.
- National Technical Certificate N6 Syllabus: August (1996). *Department of Education and Training*.
- National Technical Certificate N6 Examination and memorandum: August (2007). *Department of Education and Training*.
- NECC (The National Education Coordinating Committee) (1992). *National Education Policy Investigation. Report of the NEPI Human Resources Development Research Group* (Cape Town, Oxford University Press/NECC).
- Neria, D., & Amit, M. (2004). Students preference of non-algebraic representations in mathematical communication. *Proceedings of the 28th Conference of the International Group for the Psychology of Mathematics Education*, 3, 409 – 416.
- Nilklad, L. (2004). *College algebra students' understanding and algebraic thinking and reasoning with functions*. PhD dissertation. Oregon State University.
- Nitko, A.J. (2004). *Educational assessment of students* (4th Ed.). New Jersey: Pearson Prentice Hall.
- Noinang, S., Wiwatanapataphee, B., & Wu, Y.H. (2008). Teaching-learning-tool for integralcalculus. *Proceedings of the 13th Asian Technology Conference in Mathematics*, 525-533. Thailand, Bangkok: Suan Sunandha Rajabhat University.

- Novak, J., & Gowin, D.B. (1984). *Learning how to learn*. New York: Cambridge University Press.
- Novak, J. (2002). Meaningful learning: the essential factor for conceptual change in limited or inappropriate propositional hierarchies leading to empowerment of students. *Science Education*, 86 (4), 548-571. Wiley Periodicals, Inc.
- Oehrtman, M. C., Carlson, M. P., & Thompson, P. W. (2008). Foundational reasoning abilities that promote coherence in students' understandings of function. In M. P. Carlson & C. Rasmussen (Eds.), *Making the connection: Research and practice in undergraduate mathematics*, 27-42. Washington, DC: Mathematical Association of America.
- Orton, A. (1983). Students' understanding of integration, *Educational Studies in Mathematics*, 14, 1-18.
- Palmiter, J.R. (1991). Effects of computer algebra system on concept and skill acquisition in calculus. *Journal for Research in Mathematics Education*, 22 (2), 151 – 156.
- Papier, J. (2008). *England-Africa partnerships in higher education supporting accelerated and shared growth in South Africa: Report on the training of FET college lecturers in South Africa, England and other international contexts*.
- Parrott, D. (1999) Integration first? *The challenge and diversity*. Delta 1999. 155-159.
- Pettersson, K., & Scheja, M. (2008). Algorithmic contexts and learning potentiality: a case study of students' understanding of calculus. *International Journal of Mathematical Education in Science and Technology*, 39(6), 767-784.
- Pierce, R., & Stacey, K. (2008). Using pedagogical maps to show the opportunities afforded by CAS for improving the teaching of mathematics. *Australian Senior Mathematics Journal*, 22 (1), 6-12.
- Poohkay, B., & Szabo, M. (1995). Effects of animations and visuals on learning high school mathematics. Paper presented at the *Annual meeting of the Association for Educational Communications and Technology*.
- Porter, M.K., & Masingila, J.O. (1995). Effects of writing to learn mathematics on the types of errors students make in college calculus class. *Paper presented at the annual meeting of the North American chapter of international group for Psychology of Mathematics Education*, 17th PME-NA, 1-8, Columbus.
- Powell, L., & Hall, G. (2002). *Quantitative overview of the further education and training college sector: The new landscape*. Pretoria: DoE.
- Powell, L., & Hall, G. (2004). *Quantitative overview of the further education and training college sector: A sector in transition*: Pretoria: DoE.
- Pugalee, D.K. (2004). A comparison of verbal and written descriptions of students' problem solving processes. *Educational Studies in Mathematics* 55, 27-47.

- Rahim, M.H., & Siddo, R. (2009). *The use of visualization for learning and teaching mathematics*. math.unipa.it/~grim/21_project/Rahim496-500.pdf Retrieved 29 June 2010.
- Rasmussen, C., & Marrongelle, K. (2006). Pedagogical content tools: integrating students reasoning and mathematics in instruction. *Journal for Research in Mathematics Education*, 37 (5), 388-420.
- Rittle-Johnson, B., & Koedinger, K.R. (2005). Designing knowledge scaffolds to support mathematical problem solving, *Cognition and Instruction*, 23 (3), 313-349.
- Robson, C. (2002). *Real world research*. (2nd ed.). Blackwell: Oxford.
- Rochowicz, J.R. (1996). The impact of using computers and calculators on calculus instruction: various perceptions. *International Journal of Computers in Mathematical and Science Teaching*, 15(4), 387-399.
- Rösken, B., & Rolka, K. (2006). A picture is worth a 1000 words - the role of visualization in mathematics learning. In J. Novotná, H. Moraová, M. Krátká, & N. Stehlíková, (Eds.), *Proceedings 30th Conference of the International Group for the Psychology of Mathematics Education*, 4, 457-464. Prague: PME.
- Rouhani, B. (2004). *A case study of students' knowledge of functions in an online college algebra course*. PhD dissertation. University of Georgia.
- Ryu, H., Chong, Y., & Song, S. (2007). Mathematically gifted students' spatial visualization ability of solid figures. In J.H. Woo, H.C. Lew, K.S. Park & D.Y. Seo (Eds.), *Proceedings of the 31st Conference of the International Group for the Psychology of Mathematics Education* (4, pp. 137-144). Seoul: PME.
- Sabella, M.S., & Redish, E.F. (1996). Student understanding of topics in calculus. www.physics.umd.edu/perg/plinks/calc.htm. Retrieved 13 August 2008
- Samo, M.A. (2009). Students' perceptions about the symbols, letters and signs in algebra and how do these affect their learning of algebra: a case study in a government girls secondary school, Karachi. *International Journal for Mathematics Teaching and Learning*, 335-370.
- Santos, M. (2000). The use of representations as a vehicle to promote students' mathematical thinking in problem solving. *The international Journal of Computers Algebra in Mathematics Education*, 7 (3), 193-212.
- Schumacher, S., & McMillan, J. (1993). *Research in Education* (3rd Ed.). New York: Harper Colins College Publishers.
- Seally, V. (2006). Definite integrals, Riemann sums, and area under a curve: What is necessary and sufficient? In Alatorre, S., Cortina, J.L., Sáiz, M., and Méndez, A.(Eds) (2006). *Proceedings of the 28th annual meeting of the North American Chapter of the International Group for the Psychology of Mathematics Education*. Mérida, México: Universidad Pedagógica Nacional.
- Serhan, D. (2006). *The effect of graphing calculators use on students' understanding of the derivative at a Point*. <http://www.cimt.plymouth.ac.uk/journal/serhan.pdf>.

- Setati, M. (2008). Access to mathematics versus access to the language of power: the struggle in multilingual mathematics classrooms. *South African Journal of Education*, 28, 103-116.
- Shulman, L.S. (1986). Those who understand: knowledge growth in teaching. *Educational researcher*, 15 (2), 4-14.
- Sierpinska, A. (1992). On understanding the notion of function. In G. Harel and E. Dubinsky (Eds.), *The Concept of Function, Aspects of Epistemology and Pedagogy*, 25, 25-58. USA: Mathematical Association of America.
- Skemp, R. (1976). Relational understanding and instrumental understanding, *Mathematics Teacher*, 77, 20-26.
- Smith, K., & Shotsberger, P. (2001). *Web-based teacher education: Improving communication and professional knowledge in preservice and inservice teacher training*. Available [online]. Eric Document #ED459161.
- Smith, D.A. (2010). *Mathematics survival guide*. Mathematics Subject Classification. Primary 97Dxx, Secondary 97D30.
South African Map. www.southafrica.to/provinces/provinces.htm.
- Sonn, R. (2008). Poverty, unemployment and education: strategies to address the disservice of modern development. In S. Maile. (2008). *Education and poverty reduction strategies. Issues of policy coherence*. Colloquium proceedings. HSRC.
- Statistics South Africa (2006). <http://www.statssa.gov.za>.
- Star, J. (2005). Reconceptualizing procedural knowledge, *Journal of Research in Mathematics Education*, 36, 404-411.
- Swangrojn, P. (2003). *Solving Algebra Word Problems: Solution Strategies Thai Students Used and Potential Connections with Teachers' Instructional Strategies*. PhD dissertation. Oregon State University.
- Tall, D. (1991). *Advanced Mathematical Thinking*. London: Kluwer Academic Publishers.
- Tall, D. (1995). Visual organisers for formal mathematics. In Sutherland, R., & Mason, J. *Exploiting Mental Imagery with computers in Mathematics Education*. Series F: Computers and Systems Sciences, 138, 52-70. Springer-Verlag Berlin Heidelberg.
- Tall, D. (1996). Calculus and functions. In A. Bishop et al. (Eds.), *International handbook of mathematics education*, Part 1, 289-324. Dordrecht: Kluwer Academic Publishers.
- Tall, D. (2000). Cognitive development in advanced mathematics using technology. *Mathematics Education Research Journal*, 12(3), 210-230.
- Tartre, L.A. (1990). Spatial orientation skill and mathematical problem solving. *Journal for Research in Mathematics Education*. 21 (3), 216-229.
- Tashakkori, A., & Creswell, J.W. (2007). Exploring the nature of research questions in mixed methods research. *Journal of Mixed Methods Research*, 1(3), 207-211.

- Taylor-Powell, E., & Renner, M. (2003). Analyzing qualitative data. *Programme development and evaluation*. Madison.
- Teddlie, C., & Tashakkori, A. (2009). *Foundations of mixed methods research: integrating quantitative and qualitative approaches in the social and behavioural sciences*. London: Sage.
- Thompson, P. W., & Silverman, J. (2008). The concept of accumulation in calculus. In M. P. Carlson., & C. Rasmussen (Eds.), *Making the connection: Research and teaching in undergraduate mathematics*, (pp. 43-52). Washington, DC: Mathematical Association of America. Available at <http://pat-thompson.net/PDFversions/2008MAA Accum.pdf>.
- Thornton. (2001). A picture is worth a thousand words. Accessed 27/07/2005 Math.unipa.it/~grim/Athornton251.pdf.
- Ubuz, B. (2007). Interpreting a graph and constructing its derivative: stability and change in students' conceptions. *International Journal of Mathematical Education in Science and Technology*, 38(5), 609-637.
- Vandeyar, S. & Killen, R. (2007). Educators' conceptions and practice of classroom assessment in post-apartheid South Africa. *South African Journal of Education*, 27(1),101-115.
- Van Garderen, D. (2003). The division for learning disabilities of the council for exceptional children visual-spatial representation, mathematical problem solving, and students of varying abilities. *Learning Disabilities Research & Practice*, 18(4), 246-254.
- Van Rooyen, L.(2009). Cutting the edge newsletter. *FET colleges: What is the solution?* South Africa. <http://www.assess.co.za/newsletter/200908/readmore01.htm>
- Vaughn, S., Klinger, J., & Hughes, M. (2000). Sustainability of research-based practice. *Exceptional children*, 66 (2), 163-171.
- Viswanathan, M. (2005). *Measurement error and research design*. London: Sage.
- Vygotsky, L.S. (1978). *Mind in society, the development of higher psychological processes*. (Eds) Cambridge, Harvard University Press.
- Walter J.G., Barros, T.R., Gerson, H. (2008). Semantic warrants, mathematical referents, and personal agency in theory building. <http://www.rume.org/crume 2008/walter-LONG.pdf> Accessed 30/01/2009.
- White, P., & Mitchelmore, M. (1996). Conceptual knowledge in introductory calculus, *Journal for research in Mathematics Education*, 27 (1), 79-95.
- Wikipedia free encyclopedia, http://en.wikipedia.org/wiki/Spatial_visualization_ability.
- Willemse I. (2004). *Statistical Methods for business and Basic Calculations* (2nd Edition). South Africa: Juta & Co.
- Woolner, P. (2004). A comparison of a visual-spatial approach and a verbal approach to the teaching of mathematics. In Høines, M.J. & Fugelstad (Eds.). *The Psychology of Mathematics Education*,4 (28), 449-456.

- Yasin, S., & Enver, T. (2007). Students' difficulties with application of definite integration 1. *Educația Matematică* 3(1-2), 15-27.
- Young, M. F. D. (2003). National qualifications frameworks as a global phenomenon: a comparative perspective, *Journal of Education and Work*, 16 (3), 305-324.
- Yost, D. (2008). Integration: reversing traditional pedagogy. *Australian Senior Mathematics Journal*, 22 (2), 37-40.
- Zimbardo, P.G., Butler, L.D., & Wolfe, V. A. (2003). Cooperative college examinations: more gain, less pain when students share information and grades. *The Journal of Experimental Education*, 71 (2), 101-125.
- Zohar, A., & Peled, B. (2008). The effects of explicit teaching of metastrategic knowledge on low- and high-achieving students. *Learning and Instruction*, 18(4), 337-353.
- Zucker, S. (2003). *Assessment report. Fundamentals of Standardized Testing*. Pearson.

APPENDICES

APPENDIX 1A: SYLLABUS ON APPLICATION OF THE DEFINITE INTEGRAL

The section to be covered on volumes on application of the definite integral is indicated below as stipulated in the syllabus, so that the researcher can ensure that the proper standards are maintained in terms of how students are taught and assessed in class. Other sections can be referred to in the Syllabus for Mathematics N6 (1996).

√ MODULE 5: APPLICATIONS OF THE DEFINITE INTEGRAL

All the applications in this module must be done as follows:

- Draw a neat sketch of the relevant curves and clearly indicate the relevant points of intersection after suitable calculations.
- Indicate the representative strip and the relevant limits, as well as the distance to the reference axis when moments are to be determined.
- Give the equation for the volume, centroid, moment etc. of the representative strip.
- Apply the operation for summation (Determine the correct definite integral.)

NB Only curves prescribed in the N1 to N6 Syllabi will be examined.

√ Volumes

On completion of this topic, the student should be able to calculate the volume developed when an area enclosed between a given curve and an axis, or between two given curves is rotated about a reference axis, with the specific application of the representative strip being parallel to the axis about which the area is rotated (the tin effect). (Syllabus for N6, 1996:10)

APPENDIX 1B: PRELIMINARY STUDY 2005

RESEARCH ON SOLIDS OF REVOLUTION: MATHEMATICS N6

RESEARCHER: BLK MOFOLO

04 JULY 2005: TEST 1

ANSWER ALL QUESTIONS ON THE WORKSHEET

Instructions: In all the questions show the solid of revolution, the method used and the strip.

Question 1

Find the volume generated when the area bounded by the graphs is rotated about the X-axes.

(a) $y = \cos x$

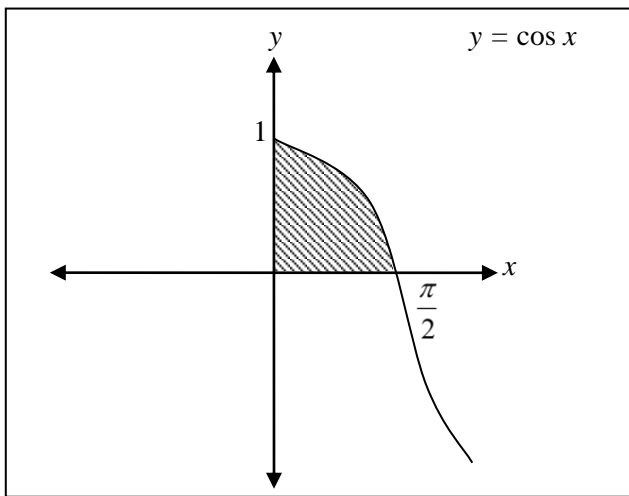

(b) $y = x^2$ and $x = 3$. (Draw the graph and shade the area used)

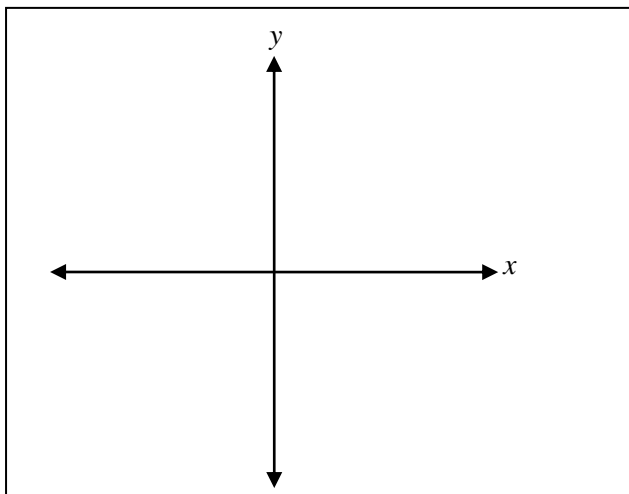

Question 2

Find the volume generated when the area bounded by the graphs is rotated about the Y-axes.

(a) $y = \sqrt{x}$ and $y = x^2$

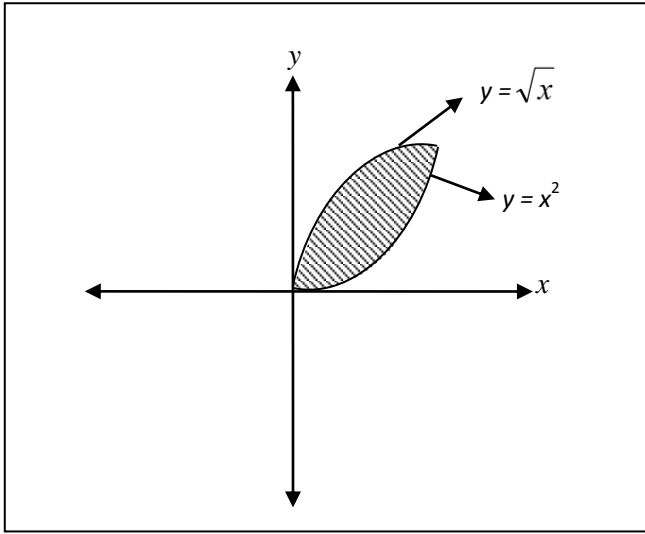

(b) The first quadrant area of $x^2 + y^2 = 9$. (Draw the graph and shade the area used)
 $y = x^2$ and $x = 3$. The first quadrant area of $x^2 + y^2 = 9$.

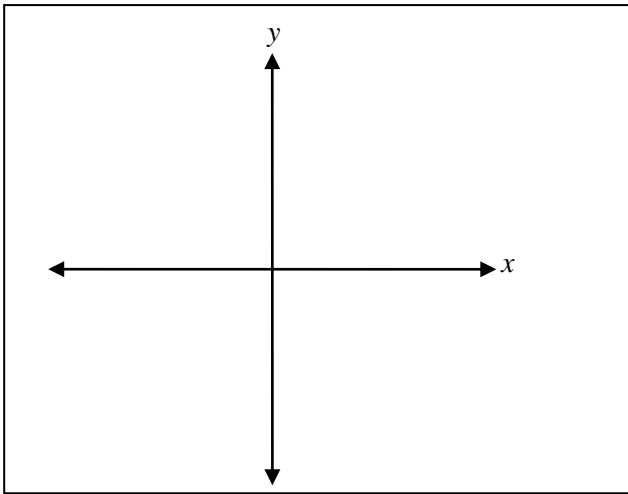

RESEARCH ON SOLIDS OF REVOLUTION: MATHEMATICS N6

RESEARCHER: BLK MOFOLO

07 JULY 2005: TEST 2

ANSWER ALL QUESTIONS ON THE WORKSHEET

Instructions: In all the questions show the solid of revolution, the method used and the strip.

Question 1

Find the volume generated when the area bounded by the graphs is rotated about the X-axis.

(a)

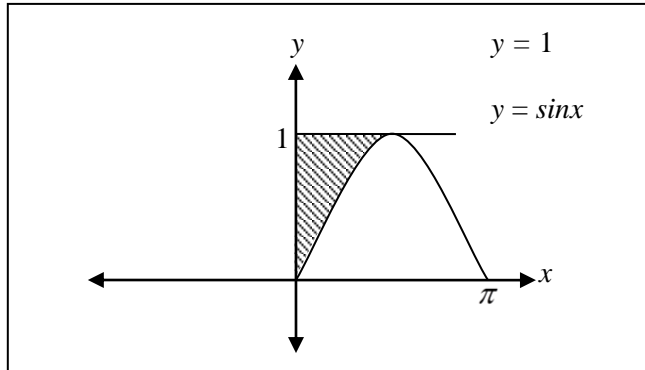

(b) $x = 1$; $x = 3$ and $y = e^x$

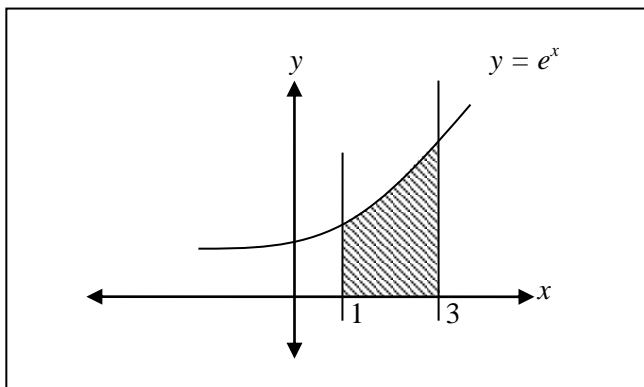

(c) $y^2 = x^2 + 1$; $y = 2$ and $y = 4$. (Draw the graph and shade the area used)

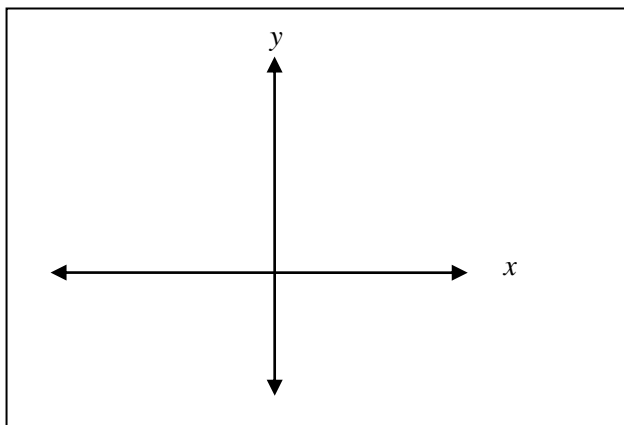

Question 2

Find the volume generated when the area bounded by the graphs is rotated about the Y-axes.

(a)

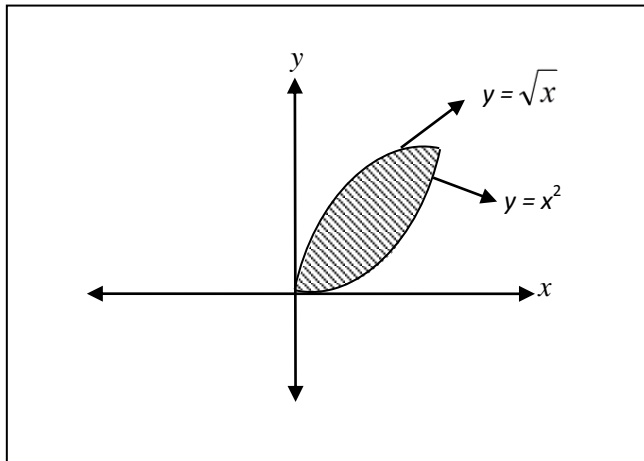

(b)

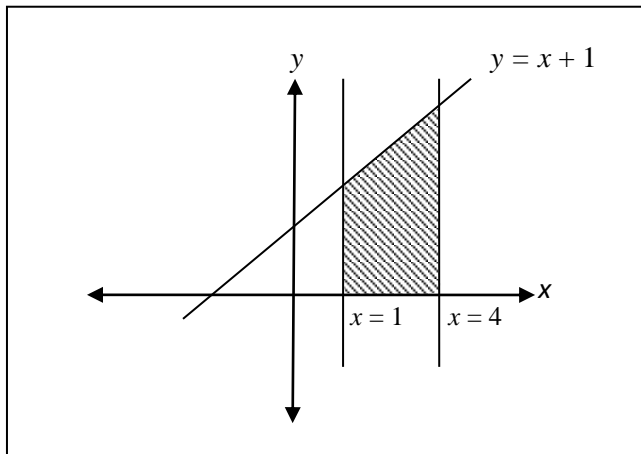

(c) $y^2 = 4x$ and $y = 2x - 4$. (Draw the graph and shade the area used)

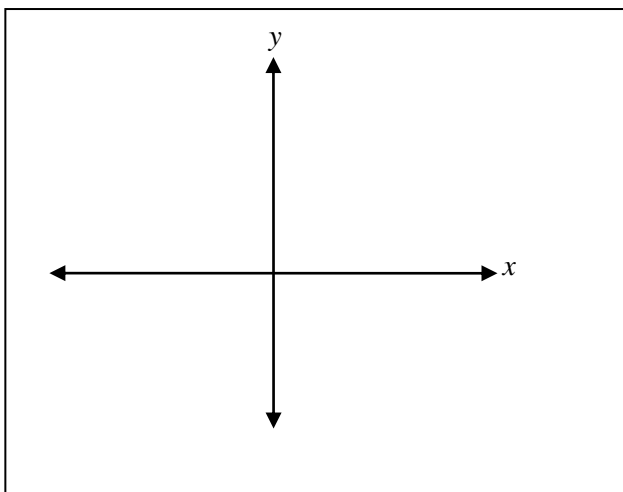

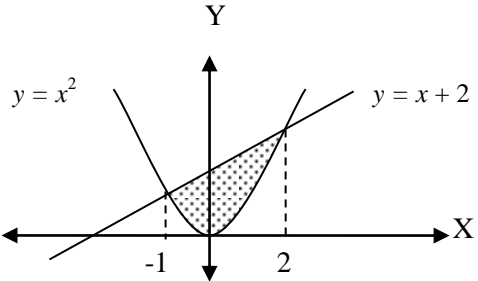
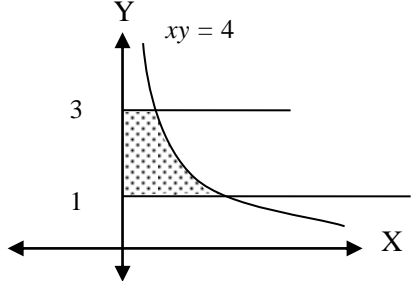
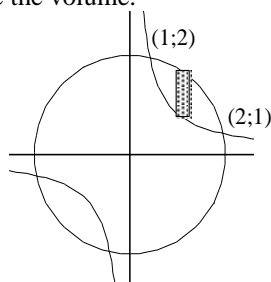
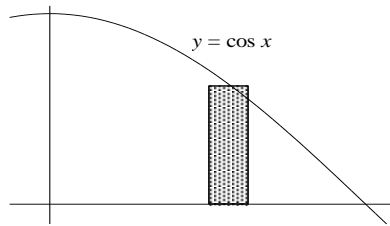
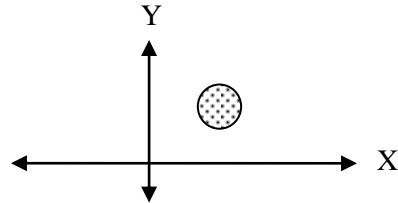
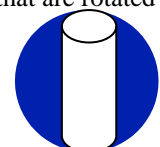
<p>1. A LG \longrightarrow VS (2D)</p>	
<p>1A. Represent $x^2 + y^2 \leq 9$ by a picture.</p>	<p>1B. Represent $\int_0^1 (x - x^2) dx$; by a picture</p>
<p>2. VIS \longrightarrow ALG (2D)</p>	
<p>2A. Give the formula for the area of the shaded region.</p> 	<p>2B. Give a formula for the area of the shaded region.</p> 
<p>3. A LG \longrightarrow VS (3D)</p>	
<p>3A: Draw the 3D solid of which the volume is given by $V = \pi \int_0^1 (1 - x^2)^2 dx$</p>	<p>3B: Draw the 3D solid of which the volume is given by $V = 2\pi \int_0^1 x(1 - x^2) dx$</p>
<p>4. VIS \longrightarrow ALG (2D)</p>	
<p>4A: Below the 1st quadrant area bounded by graphs of $x^2 + y^2 = 5$ and $xy = 2$ is selected using the given strip. Give the formula for the volume generated if this area is rotated about the x-axis. Do not calculate the volume.</p> 	<p>4B: Below the region bounded by the graph of $y = \cos x$, the x-axis and the y-axis is selected by the given strip. Give the formula for the volume generated when this area is rotated about the y-axis. Do not calculate the volume.</p> 
<p>5. 2D \longrightarrow 3D</p>	
<p>5A: Draw the solid that will be formed if a line with a positive gradient passing through the origin is rotated about the x-axis, where $x \in [0, 3]$.</p>	<p>5B: What solid do you get if you rotate the circle below about the y-axis?</p> 
<p>6. 3D \longrightarrow 2D</p>	
<p>6 A: Discuss how a hemisphere is generated as a solid of revolution.</p>	<p>6 B: A hole with radius 2 cm is drilled through the centre of the sphere of radius 5 as in the picture. Describe the curves that are rotated to generate this solid.</p> 

7. CONTINUOUS → DISCRETE (VIS) 2D

7 A: Sketch three additional rectangles (similar to the given rectangle) so that the total area of the rectangles approximates the shaded area.

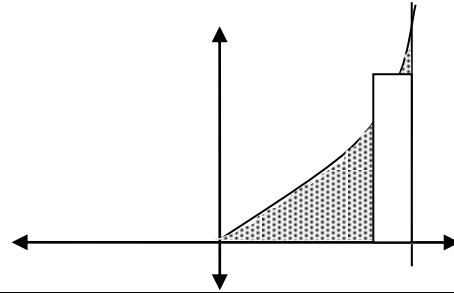

8. CONTINUOUS → DISCRETE (VISL) (3D)

8A: When the graph below is rotated, the solid on the right is generated. Show how you would cut the solid in appropriate shapes (discs, shells or washers) to approximate the volume of the solid.

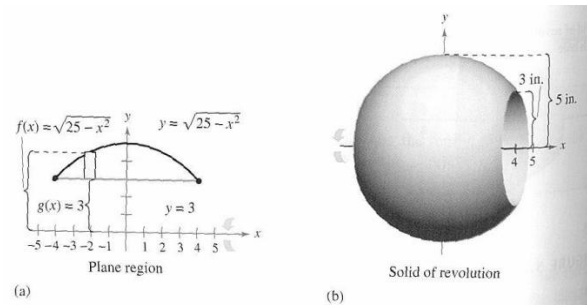

8 B: When the graph below is rotated, the solid on the right is generated. Discuss how you would cut it to generate either (discs, shells or washers).

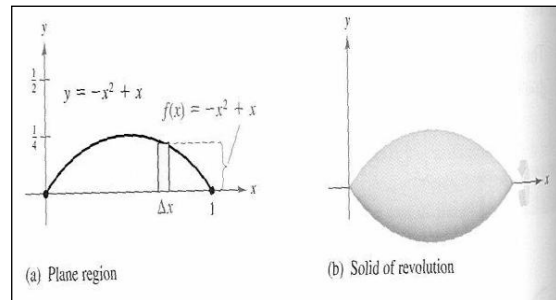

9. {DISCRT → CONTNS and CONTS → DISCRT } (ALG)

9 A: Show what the following represent with a sketch.

$$2f(0) + 2f(2) + 2f(4)$$

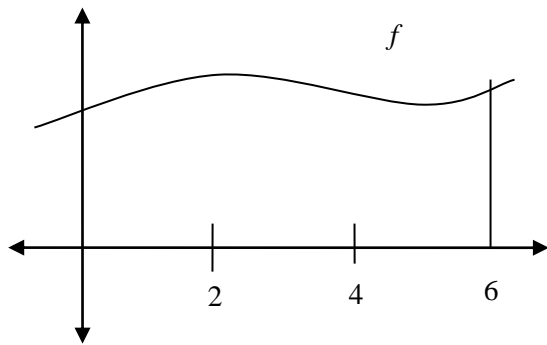

9 B: If the volume of the given solid of revolution is approximated by discs, sketch the discs that would give the volume.

$$\pi(f(0))^2 + \pi(f(1))^2 + \pi(f(2))^2$$

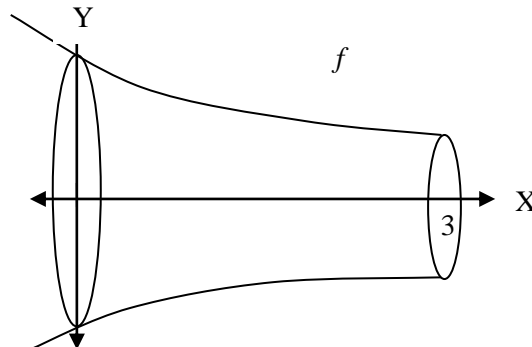

10. ALGEBRAIC SKILLS

10 A : Calculate $\int_0^1 \pi(1-x^2)^2 dx$

10 B: Calculate $\int_0^1 2\pi x(1-\sin x) dx$

11. COGNITIVE SKILLS

11 A: Given the graphs of $y = \sin x$ and $y = 1$

- Draw the graphs and shade the area bounded by the graphs and $x = 0$
- Show the rotated area about the **y-axis** and the strip Used
- Write down a formula to find the volume when the region between $y = \sin x$ and $y = 1$ is rotated about the **y-axis**.

11 B: Use integration methods to derive the formula of a volume of a cone of radius r and height h .

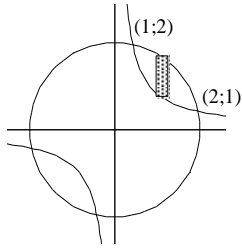
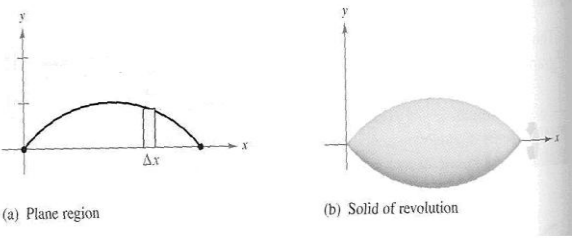
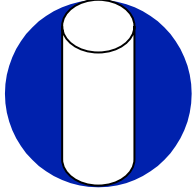

<p>1: Below the 1st quadrant area bounded by graphs of $x^2 + y^2 = 5$ and $xy = 2$ is selected using the given strip. Give the formula for the volume generated if this area is rotated about the x-axis. Do not calculate the volume.</p> 	
<p>2: Calculate $\int_0^1 \pi(1-x^2)^2 dx$</p>	
<p>3: When the graph below is rotated, the solid on the right is generated. Discuss how you would cut it to generate either discs, shells or washers.</p>  <p>(a) Plane region (b) Solid of revolution</p>	
<p>4: Draw the solid that will be formed if a line with a positive gradient passing through the origin is rotated about the x-axis, where $x \in [0, 3]$.</p>	
<p>5: Represent $x^2 + y^2 \leq 9$ by a picture.</p>	
<p>6: A hole with radius 2cm is drilled through the centre of the sphere of radius 5cm as in the picture. Describe the curves that are rotated to generate this solid.</p> 	
<p>7: Draw the 3D solid of which the volume is given by: $V = \pi \int_0^1 (1-x^2)^2 dx$</p>	



8: Give the formula for the area of the shaded region.
Do not calculate the area

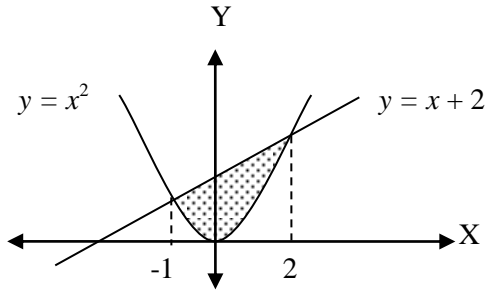

9: Given: $y = \sin x$ and $y = 1$

- (i) Draw the graphs and shade the area bounded by the graphs and $x = 0$
- (ii) Show the rotated area about the **y-axis** and the strip used to find the volume.
- (iii) Write down a formula to find the volume when the region bounded by $y = \sin x$ and $y = 1$ is rotated about the **y-axis**. Do not calculate the volume.

10: Draw the 3D solid of which the volume is given

by: $V = 2\pi \int_0^1 x(1-x^2) dx$

11: When the graph below is rotated, the solid on the right is generated. Show how you would cut the solid in appropriate shapes (discs, shells or washers) to approximate the volume of the solid.

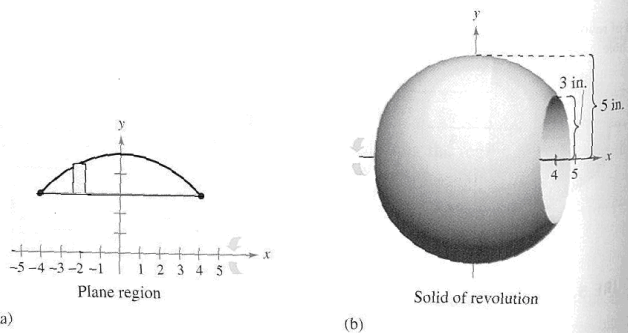

12: If the volume of the given solid of revolution is approximated by discs, sketch the discs that would give the volume: $\pi(f(0))^2 + \pi(f(1))^2 + \pi(f(2))^2$

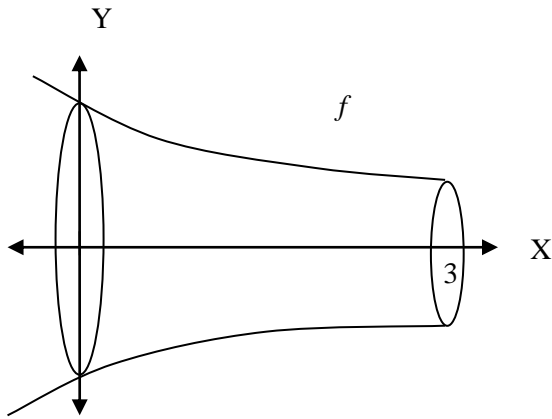

13. Represent $\int_0^1 (x - x^2) dx$; by a picture

14: Below the region bounded by the graph of $y = \cos x$, the x -axis and the y -axis is selected by the given strip. Give the formula for the volume generated when this area is rotated **about the y -axis**. Do not calculate the volume.

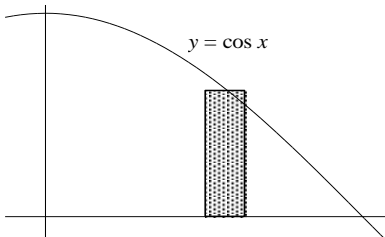

15: Show in terms of rectangles what the following represent with a sketch:

$$2f(0) + 2f(2) + 2f(4)$$

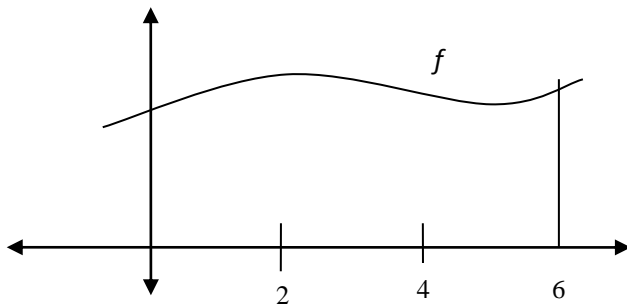

16: Calculate $\int_0^1 2\pi x(1 - \sin x) dx$



17: What solid do you get if you rotate the circle below about the **y-axis**?

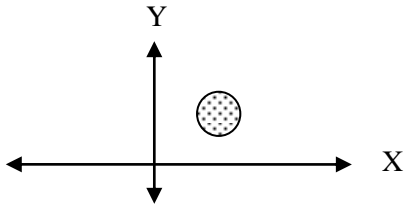

18: Use integration methods to derive the formula for the volume of a cone of radius r and height h .

19: Give a formula for the area of the shaded region.

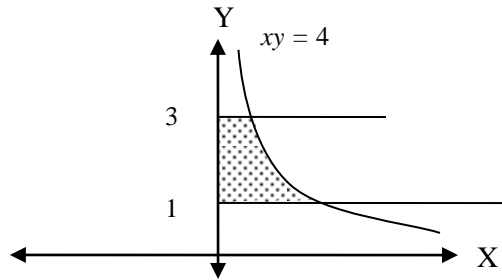

20: Sketch four additional rectangles (similar to the given rectangle) so that the total area of the rectangles approximates the area under the graph.

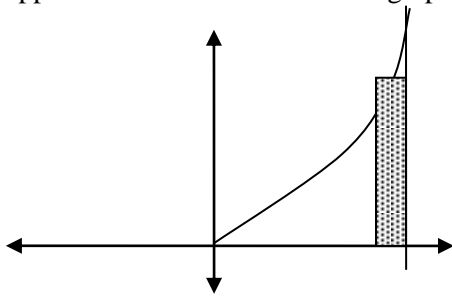

21: Discuss how a hemisphere is generated as a solid of revolution.

APPENDIX 3A: CHANGED INSTRUMENT

The questions were changed as follows from the pilot to the main study:

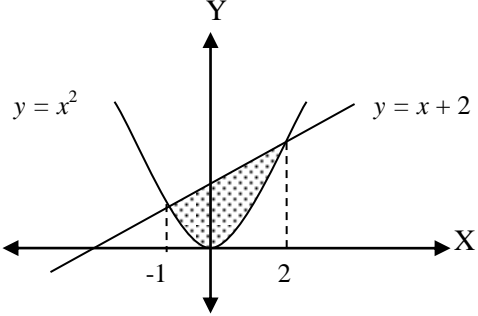
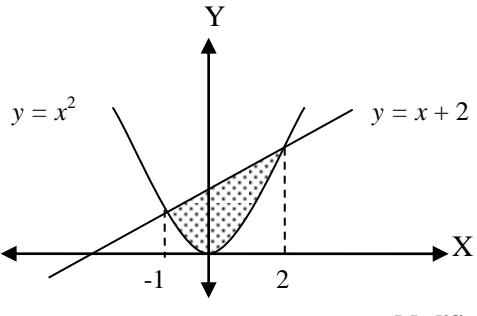
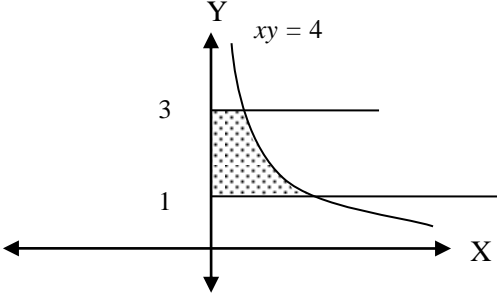
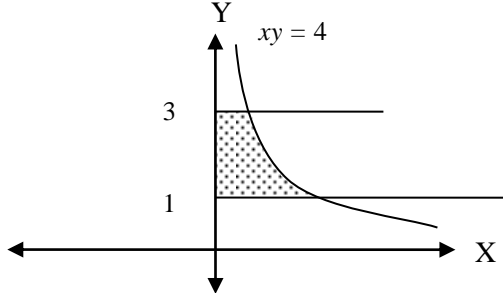
PILOT STUDY	MAIN STUDY
	1. Graphing Skills
Was changed and modified from 5A 5A: Draw the solid that will be formed if a line with a positive gradient passing through the origin is rotated about the x -axis, where $x \in [0, 3]$.	1 A: Draw a line with a positive gradient passing through the origin for $x \in [0, 3]$ Changed
New question	1 B: Sketch the graphs and shade the first quadrant area bounded by $x^2 - y^2 = 9$ and $x = 5$ New
1. A LG \longrightarrow VS (2D)	2. A LG \longrightarrow VS (2D)
1A. Represent $x^2 + y^2 \leq 9$ by a picture.	2A: Represent $x^2 + y^2 \leq 9$ by a picture. Same
1B. Represent $\int_0^1 (x - x^2) dx$; by a picture	2B: Sketch the area represented by $\int_0^1 (x - x^2) dx$ Modified
2. VIS \longrightarrow ALG (2D)	3. VIS \longrightarrow ALG (2D)
2A. Give the formula for the area of the shaded region. 	3A: Substitute the equations of the given graphs in a suitable formula to represent the area of the shaded region. 
2B. Give a formula for the area of the shaded region. 	3B: Substitute the equations of the given graphs in a suitable formula to represent the area of the shaded region. 
3. A LG \longrightarrow VS (3D)	4. A LG \longrightarrow VS (3D)
3A: Draw the 3D solid of which the volume is given by $V = \pi \int_0^1 (1 - x^2)^2 dx$	4A: Draw the 3D solid of which the volume is given by $V = \pi \int_0^1 (1 - x)^2 dx$ and show the representative strip. Modified and made easier
3B: Draw the 3D solid of which the volume is given by $V = 2\pi \int_0^1 x(1 - x^2) dx$	4B: Draw the 3D solid of which the volume is given by $V = 2\pi \int_0^1 x(1 - x^2) dx$ and show the representative strip. Modified

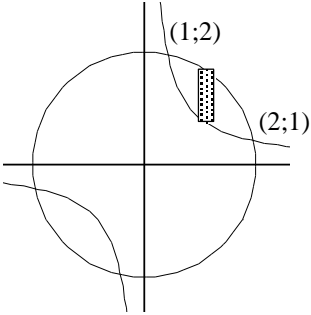
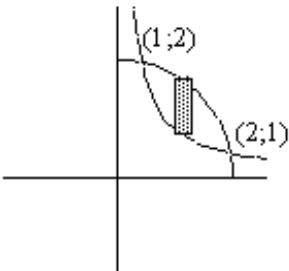
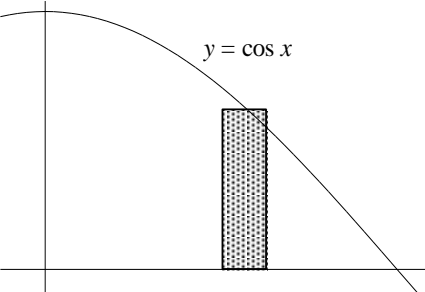
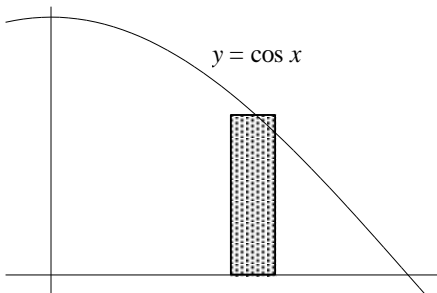
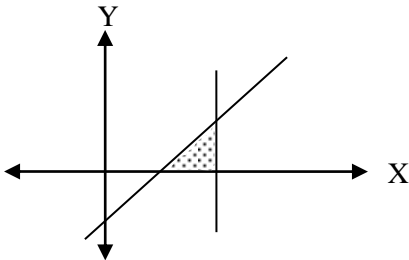
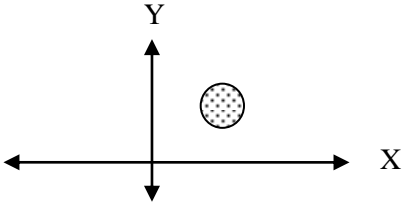
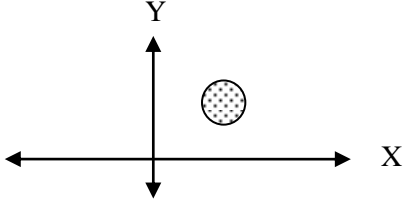

<p>4. VIS → ALG (2D)</p> <p>4A: Below the 1st quadrant area bounded by graphs of $x^2 + y^2 = 5$ and $xy = 2$ is selected using the given strip. Give the formula for the volume generated if this area is rotated about the x-axis. Do not calculate the volume.</p> 	<p>5. VIS → ALG (3D)</p> <p>5A: The figure below represents the first quadrant area bounded by the graphs of $x^2 + y^2 = 5$ and $xy = 2$. Using the selected strip, substitute the equations of the given graphs in a suitable formula to represent the volume generated if the selected area is rotated about the x-axis. Do not calculate the volume.</p>  <p style="text-align: right;">Modified</p>
<p>4B: Below the region bounded by the graph of $y = \cos x$, the x-axis and the y-axis is selected by the given strip. Give the formula for the volume generated when this area is rotated about the y-axis. Do not calculate the volume.</p> 	<p>5B: The figure below represents the area bounded by the graphs of $y = \cos x$, the x-axis and the y-axis. Using the selected strip, substitute the equations of the given graphs in a suitable formula to represent the volume generated when this area is rotated about the y-axis. Do not calculate the volume.</p>  <p style="text-align: right;">Modified</p>
<p>5. 2D → 3D</p> <p>5A: Draw the solid that will be formed if a line with a positive gradient passing through the origin is rotated about the x-axis, where $x \in [0, 3]$. Changed to be 1A</p>	<p>6. 2D → 3D</p> <p>Changed to be 1A above for the main study and replaced by 6A: Draw the 3-dimensional solid that is generated when the shaded area below is rotated about the x-axis.</p> 
<p>5B: What solid do you get if you rotate the circle below about the y-axis?</p> 	<p>6 B: Draw a 3-dimensional solid that will be generated if you rotate the circle below about the y-axis.</p>  <p style="text-align: right;">Modified</p>
<p>6. 3D → 2D</p>	<p>7. 3D → 2D</p>

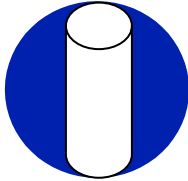
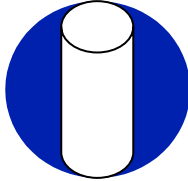
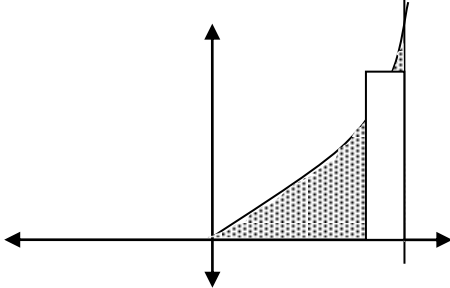
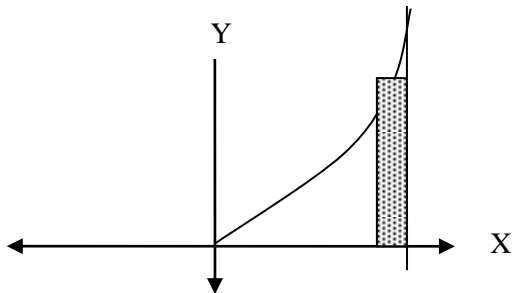
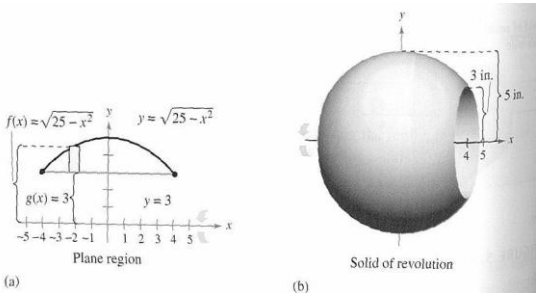
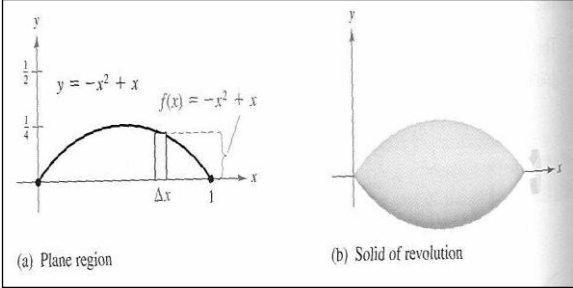
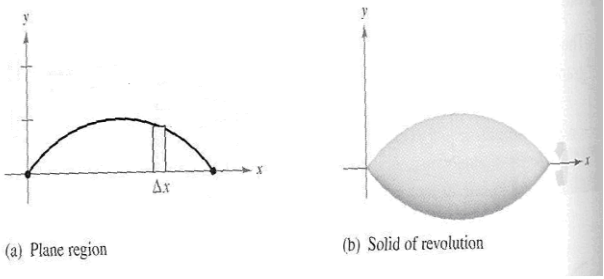

<p>6 A: Discuss how a hemisphere is generated as a solid of revolution.</p>	<p>7 A: Sketch a graph that will generate half a sphere when rotated about the y- axis. Modified</p>
<p>6 B: A hole with radius 2 cm is drilled through the centre of the sphere of radius 5 as in the picture. Describe the curves that are rotated to generate this solid.</p> 	<p>7 B: A hole is drilled through the centre of the sphere as in the picture. Sketch the graphs that were rotated to generate the solid as in the picture below.</p>  <p style="text-align: right;">Modified</p>
<p>7. CONTINUOUS \longrightarrow DISCRETE (VIS 2D) 8. CONTINUOUS \longrightarrow DISCRETE (VIS) 2D and 3D</p>	
<p>7 A: Sketch three additional rectangles (similar to the given rectangle) so that the total area of the rectangles approximates the shaded area.</p> 	<p>8 A: Sketch three additional rectangular strips (similar to the given rectangle) so that the total area of the rectangles approximates the area under the graph.</p>  <p style="text-align: right;">Modified</p>
<p>8. CONTINUOUS \longrightarrow DISCRETE (VISL 3D)</p>	
<p>8A: When the graph below is rotated, the solid on the right is generated. Show how you would cut the solid in appropriate shapes (discs, shells or washers) to approximate the volume of the solid.</p> 	<p>Removed</p>
<p>8 B: When the graph below is rotated, the solid on the right is generated. Discuss how you would cut it to generate either (discs, shells or washers).</p> 	<p>8B: When the plane region (a) on the left is rotated, the 3-dimensional solid of revolution (b) on the right is generated. Show using diagrams how you would cut the solid of revolution (b) in appropriate shapes (discs, shells or washers) to approximate its volume.</p>  <p style="text-align: right;">Modified</p>



9. {DISCRT → CONTNS and CONTS → DISCRT } (ALG)	
<p>9 A: Show what the following represent with a sketch. $2f(0) + 2f(2) + 2f(4)$</p>	<p>9 A: Show in terms of rectangles what the following represent with a sketch: $2f(0) + 2f(2) + 2f(4)$</p> <p style="text-align: right;">Modified</p>
<p>9 B: If the volume of the given solid of revolution is approximated by discs, sketch the discs that would give the volume. $\pi(f(0))^2 + \pi(f(1))^2 + \pi(f(2))^2$</p>	<p>9 B: If the volume of the given solid of revolution is approximated by discs, sketch the discs that would give the volume: $\pi(f(0))^2 + \pi(f(1))^2 + \pi(f(2))^2$</p> <p style="text-align: right;">Same</p>
10. GENERAL MANIPULATION SKILLS	
	<p>10 A: Calculate the point of intersection of $4x^2 + 9y^2 = 36$ and $2x + 3y = 6$</p> <p style="text-align: right;">Added</p>
<p>10 A: Calculate $\int_0^1 \pi(1-x^2)^2 dx$</p>	<p>10B : Calculate $\int_0^1 \pi(1-x^2)^2 dx$</p> <p style="text-align: right;">Same</p>
<p>10 B: Calculate $\int_0^1 2\pi x(1-\sin x) dx$</p>	<p>10 C: Calculate $\int_0^1 2\pi x(1-\sin x) dx$</p> <p style="text-align: right;">Same</p>
11. COGNITIVE SKILLS	
<p>11 A: Given the graphs of $y = \sin x$ and $y = 1$</p> <p>(i) Draw the graphs and shade the area bounded by the graphs and $x = 0$</p> <p>(ii) Show the rotated area about the y-axis and the strip used</p> <p>(iii) Write down a formula to find the volume when the region between $y = \sin x$ and $y = 1$ is rotated about the y-axis.</p>	<p>11 A: Given: $y = \sin x$, where $x \in \left[0, \frac{\pi}{2}\right]$ and $y = 1$</p> <p>(i) Sketch the graphs and shade the area bounded by the graphs and $x = 0$</p> <p>(ii) Show the rotated area about the y-axis and the representative strip to be used to calculate the volume generated.</p> <p>(iii) Calculate the volume generated when this area is rotated about the y-axis.</p> <p style="text-align: right;">Modified</p>
<p>11 B: Use integration methods to derive the formula of a volume of a cone of radius r and height h.</p>	<p>11 B: Use integration methods to show that the volume of a cone of radius r and height h is given by $\frac{1}{3} \pi r^2 h$.</p> <p style="text-align: right;">Modified</p>



APPENDIX 3B: MAIN INSTRUMENT ADMINISTERED

Data collecting Instrument for VSOR: Administered

March, 2007

Researcher: Mofolo BLK

SECTION A

1. Draw the 3D solid of which the volume is given by $V = 2\pi \int_0^1 x(1-x^2) dx$ and show the representative strip.	
2. Calculate the point of intersection of $4x^2 + 9y^2 = 36$ and $2x + 3y = 6$	
3. Sketch the graphs and shade the first quadrant area bounded by $x^2 - y^2 = 9$ and $x = 5$	
4. Calculate $\int_0^1 2\pi x(1 - \sin x) dx$	
5. Sketch a graph that will generate half a sphere when rotated about the y- axis.	



6. Substitute the equations of the given graphs in a suitable formula to represent the area of the shaded region.

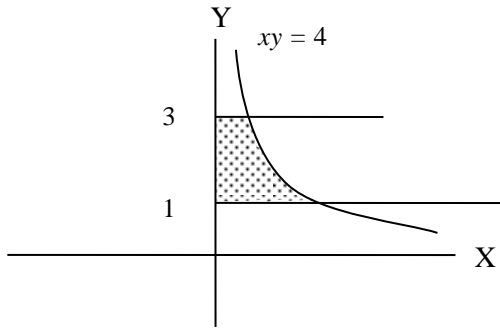

7. Show in terms of rectangles what the following represent with a sketch:
 $2f(0) + 2f(2) + 2f(4)$

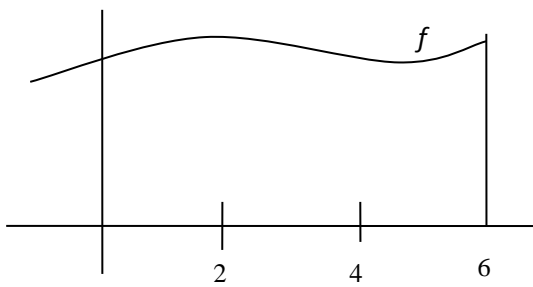

8. Draw the 3-dimensional solid that is generated when the shaded area below is rotated about the **x-axis**.

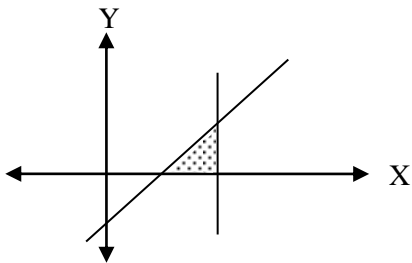

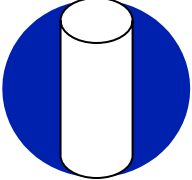
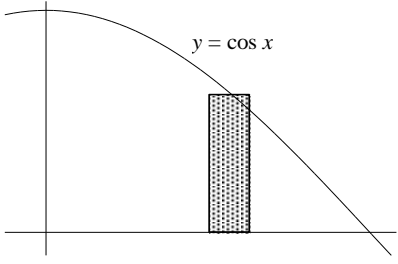

SECTION B

<p>9. Sketch the area represented by $\int_0^1 (x - x^2) dx$</p>	
<p>10. A hole is drilled through the centre of the sphere as in the picture. Sketch the graphs that were rotated to generate the solid as in the picture below.</p> 	
<p>11. Given: $y = \sin x$, where $x \in \left[0, \frac{\pi}{2}\right]$ and $y = 1$</p> <p>(i) Sketch the graphs and shade the area bounded by the graphs and $x = 0$</p> <p>(ii) Show the rotated area about the y-axis and the representative strip to be used to calculate the volume generated.</p> <p>(iii) Calculate the volume generated when this area is rotated about the y-axis.</p>	
<p>12. Draw a line with a positive gradient passing through the origin for $x \in [0, 3]$</p>	
<p>13. The figure below represents the area bounded by the graphs of $y = \cos x$, the x-axis and the y-axis. Using the selected strip, substitute the equations of the given graphs in a suitable formula to represent the volume generated when this area is rotated about the y-axis. Do not calculate the volume.</p> 	



14. When the plane region (a) on the left is rotated, the 3-dimensional solid of revolution (b) on the right is generated. Show using diagrams how you would cut the solid of revolution (b) in appropriate shapes (discs, shells or washers) to approximate its volume.

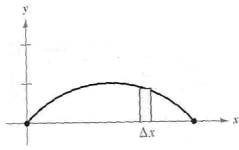

(a) Plane region

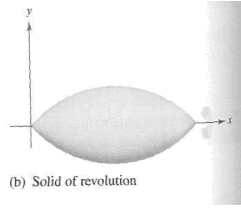

(b) Solid of revolution

15. Draw the 3D solid of which the volume is given by $V = \pi \int_0^1 (1-x)^2 dx$ and show the representative strip.

16. Calculate $\int_0^1 \pi (1-x^2)^2 dx$



SECTION C

17. If the volume of the given solid of revolution is approximated by discs, sketch the discs that would give the volume: $\pi(f(0))^2 + \pi(f(1))^2 + \pi(f(2))^2$

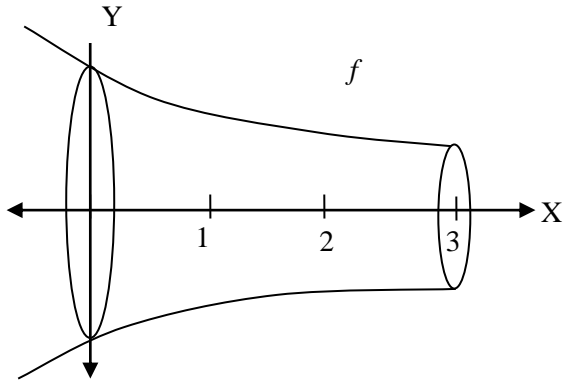

18. Use integration methods to show that the volume of a cone of radius r and height h is given by $\frac{1}{3}\pi r^2 h$.

19. Substitute the equations of the given graphs in a suitable formula to represent the area of the shaded region.

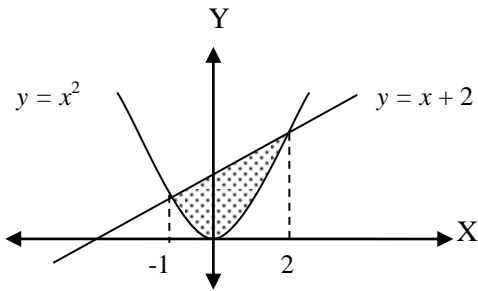

20. Draw a 3-dimensional solid that will be generated if you rotate the circle below about the **y-axis**.

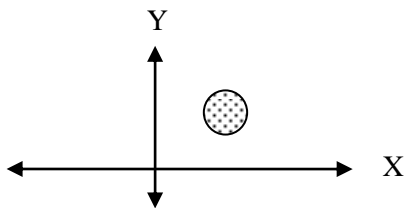

21. Sketch three additional rectangular strips (similar to the given rectangle) so that the total area of the rectangles approximates the area under the graph.

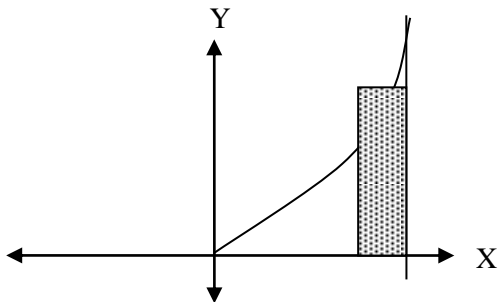



22. Represent $x^2 + y^2 \leq 9$ by a picture.	
23. The figure below represents the first quadrant area bounded by the graphs of $x^2 + y^2 = 5$ and $xy = 2$. Using the selected strip, substitute the equations of the given graphs in a suitable formula to represent the volume generated if the selected area is rotated about the x-axis . Do not calculate the volume.	

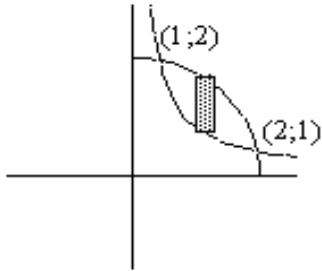

APPENDIX 4A: MAIN RESULTS FOR THE QUESTIONNAIRE 1st RUN

College	Students	1A	1B	2A	2B	3A	3B	4A	4B	5A	5B	6A	6B	7A	7B	8A	8B	9A	9B	10A	10B	10C	11A	11B
		ELM1		ELM2		ELM3		ELM4		ELM5		ELM6		ELM7		ELM8		ELM9		ELM10			ELM11	
		GR		AV2D		VA2D		AV3D		VA3D		2D-3D		3D-2D		CD(V)		DC-CD(A)		GMNP			CGLCD	
B	1	NU	AC	AC	FC	FC	FC	ND	FC	AC	AC	FC	FC	FC	FC	FC	ND	AC	TU	NU	ND	AC	AC	ND
B	2	FC	FC	AC	NU	FC	FC	AC	AC	AC	FC	FC	ND	FC	NU	TU	TU	NU	TU	FC	FC	AC	AC	AC
B	3	NU	FC	TU	TU	AC	FC	ND	AC	FC	ND	NU	NU	FC	ND	TU	ND	ND	NU	FC	ND	NU	TU	ND
B	4	NU	TU	AC	AC	FC	TU	NU	AC	AC	NU	FC	TU	FC	TU	TU	FC	TU	TU	NU	ND	ND	TU	NU
B	5	NU	AC	AC	TU	FC	FC	NU	AC	FC	NU	TU	FC	AC	TU	TU	TU	AC	TU	NU	ND	TU	TU	NU
B	6	ND	AC	AC	AC	FC	FC	AC	AC	FC	NU	FC	FC	FC	TU	TU	TU	NU	TU	NU	ND	AC	AC	AC
B	7	NU	AC	AC	AC	FC	AC	NU	AC	AC	NU	NU	ND	FC	ND	NU	ND	ND	TU	FC	NU	AC	TU	ND
B	8	ND	AC	AC	FC	FC	FC	ND	AC	FC	ND	FC	AC	FC	ND	TU	ND	ND	TU	FC	ND	AC	ND	AC
B	9	NU	FC	AC	NU	FC	TU	NU	AC	FC	NU	TU	NU	TU	TU	NU	TU	NU	NU	FC	FC	NU	TU	NU
B	10	NU	AC	AC	AC	FC	AC	NU	AC	FC	NU	ND	NU	FC	NU	AC	NU	NU	NU	FC	AC	AC	TU	NU
B	11	ND	AC	AC	FC	FC	FC	ND	AC	FC	ND	FC	NU	FC	ND	NU	ND	NU	ND	FC	ND	AC	TU	NU
B	12	ND	FC	AC	NU	FC	TU	ND	FC	FC	ND	FC	NU	FC	ND	AC	ND	NU	ND	AC	AC	AC	TU	NU
B	13	NU	AC	AC	FC	FC	AC	ND	FC	FC	FC	AC	NU	TU	ND	AC	ND	TU	ND	NU	FC	AC	TU	NU
B	14	AC	TU	AC	FC	FC	TU	ND	NU	TU	NU	FC	NU	FC	ND	FC	ND	ND	ND	NU	FC	AC	TU	NU
B	15	FC	FC	AC	NU	FC	FC	AC	TU	FC	FC	FC	NU	FC	TU	FC	FC	FC	TU	NU	FC	AC	AC	TU
B	16	FC	AC	AC	FC	FC	NU	AC	TU	AC	AC	NU	NU	AC	TU	NU	NU	ND	TU	AC	AC	AC	TU	NU
B	17	NU	TU	AC	FC	FC	NU	AC	TU	FC	AC	NU	NU	NU	TU	NU	AC	NU	TU	FC	FC	AC	TU	TU
B	18	AC	NU	AC	AC	AC	ND	NU	TU	FC	NU	ND	AC	NU	TU	TU	TU	ND	NU	NU	FC	AC	TU	ND
B	19	NU	AC	AC	FC	FC	NU	AC	TU	FC	NU	NU	NU	NU	TU	NU	TU	NU	TU	FC	FC	AC	TU	AC
B	20	NU	NU	AC	AC	TU	NU	NU	TU	NU	NU	ND	NU	NU	TU	NU	TU	NU	TU	AC	AC	AC	TU	ND
A	21	FC	TU	AC	FC	NU	FC	FC	NU	FC	FC	FC	TU	NU	FC	FC	TU	ND	NU	NU	FC	AC	AC	FC
A	22	AC	NU	AC	AC	FC	FC	AC	AC	AC	ND	ND	TU	FC	NU	TU	ND	ND	ND	NU	FC	TU	TU	ND
A	23	AC	TU	TU	TU	FC	TU	ND	ND	FC	NU	ND	NU	FC	ND	TU	ND	ND	ND	NU	NU	AC	NU	NU
A	24	ND	FC	AC	NU	FC	FC	FC	FC	NU	AC	FC	NU	FC	TU	FC	TU	NU	TU	NU	FC	TU	AC	NU
A	25	NU	FC	FC	AC	TU	NU	ND	ND	FC	NU	FC	TU	FC	AC	FC	ND	ND	NU	NU	ND	AC	TU	NU
A	26	NU	FC	FC	ND	FC	NU	ND	AC	FC	NU	FC	TU	FC	FC	FC	TU	ND	NU	NU	ND	AC	TU	NU
A	27	ND	NU	AC	NU	FC	FC	NU	AC	FC	NU	NU	NU	AC	ND	NU	NU	ND	ND	NU	TU	TU	NU	ND
A	28	NU	NU	NU	FC	FC	TU	NU	TU	NU	NU	NU	NU	FC	NU	NU	TU	ND	TU	FC	NU	FC	TU	NU
A	29	NU	FC	AC	NU	FC	FC	FC	TU	AC	FC	TU	AC	FC	TU	NU	AC	FC	TU	NU	AC	TU	TU	NU
A	30	ND	NU	TU	NU	FC	TU	NU	AC	TU	NU	ND	ND	NU	TU	TU	NU	ND	TU	NU	NU	NU	NU	NU
A	31	NU	TU	FC	FC	FC	AC	NU	AC	FC	NU	ND	TU	FC	TU	TU	NU	ND	NU	NU	FC	TU	TU	NU
A	32	AC	TU	AC	FC	FC	FC	FC	AC	FC	NU	FC	NU	FC	TU	TU	ND	NU	TU	NU	AC	AC	TU	ND
A	33	ND	NU	TU	TU	FC	FC	ND	TU	FC	ND	ND	TU	ND	ND	TU	ND	ND	ND	ND	AC	TU	ND	ND
A	34	AC	NU	AC	NU	FC	FC	AC	AC	FC	ND	NU	TU	AC	ND	TU	ND	ND	NU	NU	FC	TU	TU	ND
A	35	ND	NU	AC	NU	FC	NU	TU	TU	TU	ND	ND	NU	ND	ND	NU	NU	ND	ND	NU	TU	TU	NU	ND
A	36	ND	TU	ND	FC	TU	NU	TU	ND	TU	ND	ND	NU	ND	ND	ND	ND	ND	ND	NU	FC	AC	ND	ND
A	37	NU	NU	AC	ND	FC	TU	TU	AC	FC	AC	ND	TU	FC	ND	TU	ND	ND	ND	NU	FC	FC	TU	ND

APPENDIX 4B: OVERALL RESPONSE PERCENTAGE PER SKILL FACTOR

(i) Skill factor I

	Q1A	Q1B	Q2A	Q2B	Q3A	Q3B	Q4A	Q4B	Q5A	Q5B	Σ	%	%
FC	4	9	3	13	31	16	4	4	23	4	111	30.0	55.9
AC	6	10	28	8	2	4	8	18	6	6	96	25.9	
TU	0	8	4	4	3	8	3	10	5	0	45	12.2	
NU	17	10	1	10	1	8	11	2	3	18	81	21.9	
ND	10	0	1	2	0	1	11	3	0	9	37	10.0	
Σ	37	37	37	37	37	37	37	37	37	37	370	100	

(ii) Skill factor II

	Q6A	Q6B	Q7A	Q7B	Σ	%	%
FC	15	3	21	3	42	28.4	34.5
AC	1	2	4	2	9	6.1	
TU	2	10	2	14	28	18.9	65.5
NU	8	19	7	4	38	25.7	
ND	11	3	3	14	31	20.9	
Σ	37	37	37	37	148	100	

(iii) Skill factor III

	Q8A	Q8B	Q9A	Q9B	Σ	%	%
FC	8	2	1	0	11	7.4	11.5
AC	3	1	2	0	6	4.1	
TU	15	12	2	17	46	31.1	88.5
NU	10	6	12	9	37	25.0	
ND	1	16	20	11	48	32.4	
Σ	37	37	37	37	148	100	

(iv) Skill factor IV

	Q10A	Q10B	Q10C		Σ	%	%
FC	10	15	2	FC	27	24.3	53.1
AC	3	7	22	AC	32	28.8	
TU	1	2	9	TU	12	10.8	46.9
NU	22	4	3	NU	29	26.1	
ND	1	9	1	ND	11	9.9	
Σ	37	37	37	37	111	100	

(v) Skill factor V

	Q11A	Q11B	Σ	%	%
FC	0	1	1	1.4	14.9
AC	6	4	10	13.5	
TU	24	2	26	35.1	85.1
NU	4	17	21	28.4	
ND	3	13	16	21.6	
Σ	37	37	74	37	



APPENDIX 4C: AVERAGE SCORES PER ELEMENT FROM THE QUESTIONNAIRE 1st RUN

College	Students	ELM1 GR	ELM2 AV2D	ELM3 VA2D	ELM4 AV3D	ELM5 VA3D	ELM6 2D-3D	ELM7 3D-2D	ELM8 CD(V)	ELM9 DC-CD(A)	ELM10 GMNP	ELM11 CGLCD
B	1	2	3.5	4	2	3	4	4	2	2.5	1.5	1.5
B	2	4	2	4	3	3.5	2	2.5	2	1.5	3.5	3
B	3	2.5	2	3.5	1.5	2	1	2	1	0.5	0.5	1
B	4	1.5	3	3	2	2	3	3	3	2	0	1.5
B	5	2	2.5	4	2	2.5	3	2.5	2	2.5	1	1.5
B	6	1.5	3	4	3	2.5	4	3	2	1.5	1.5	3
B	7	2	3	3.5	2	2	0.5	2	0.5	1	2	1
B	8	1.5	3.5	4	1.5	2	3.5	2	1	1	1.5	1.5
B	9	2.5	2	3	2	2.5	1.5	2	1.5	1	2.5	1.5
B	10	2	3	3.5	2	2.5	0.5	2.5	2	1	3	1.5
B	11	1.5	3.5	4	1.5	2	2.5	2	0.5	0.5	1.5	1.5
B	12	2	2	3	2	2	2.5	2	1.5	0.5	3	1.5
B	13	2	3.5	3.5	2	4	2	1	1.5	1	3.5	1.5
B	14	2.5	3.5	3	0.5	1.5	2.5	2	2	0	3.5	1.5
B	15	4	2	4	2.5	4	2.5	3	4	3	3.5	2.5
B	16	3.5	3.5	2.5	2.5	3	1	2.5	1	1	3	1.5
B	17	1.5	3.5	2.5	2.5	3.5	1	1.5	2	1.5	3.5	2
B	18	2	3	1.5	1.5	2.5	1.5	1.5	2	0.5	3.5	1
B	19	2	3.5	2.5	2.5	2.5	1	1.5	1.5	1.5	3.5	2.5
B	20	1	3	1.5	1.5	1	0.5	1.5	1.5	1.5	3	1
A	1	3	3.5	2.5	2.5	4	3	2.5	3	0.5	3.5	3.5
A	2	2	3	4	3	1.5	1	2.5	1	0	3	1
A	3	2.5	2	3	0	2.5	0.5	2	1	0	2	1
A	4	2	2	4	4	2	2.5	3	3	1.5	3	2
A	5	2.5	3.5	1.5	0	2.5	3	3.5	2	0.5	1.5	1.5
A	6	2.5	2	2.5	1.5	2.5	3	4	3	0.5	1.5	1.5
A	7	0.5	2	4	2	2.5	1	1.5	1	0	2	0.5
A	8	1	2.5	3	1.5	1	1	2.5	1.5	1	2.5	1.5
A	9	2.5	2	4	3	2.5	3	2	3	1.5	2.5	1.5
A	10	0.5	1.5	3	2	1.5	0	1.5	1.5	1	1	1
A	11	1.5	4	3.5	2	2.5	1	3	1.5	0.5	3	1.5
A	12	2.5	3.5	4	3.5	2.5	2.5	3	1	1.5	3	1
A	13	0.5	2	4	1	2	1	0	1	0	2.5	0
A	14	2	2	4	3	2	1.5	1.5	1	0.5	3	1
A	15	0.5	2	2.5	2	1	0.5	0	1	0	2	0.5
A	16	1	2	1.5	1	1	0.5	0	0	0	3.5	0
A	17	1	1.5	3	2.5	3.5	1	2	1	0	4	1

APPENDIX 4D: SKILL FACTORS PERCENTAGE OF RESPONSES AND PROCEDURAL AND CONCEPTUAL CLASSIFICATION

(i) Responses for Skill factor I & V: Procedural and conceptual questions

	Q1A	Q1B	Q2A	Q2B	Q3A	Q3B	Q4A	Q4B	Q5A	Q5B	Q11A	Q11B	Σ	%	%
FC	4	9	3	13	31	16	4	4	23	4	0	1	112	25.2	49.1
AC	6	10	28	8	2	4	8	18	6	6	6	4	106	23.9	
TU	0	8	4	4	3	8	3	10	5	0	24	2	71	16.0	50.9
NU	17	10	1	10	1	8	11	2	3	18	4	17	102	23.0	
ND	10	0	1	2	0	1	11	3	0	9	3	13	53	11.9	
Σ	37	37	37	37	37	37	37	37	37	37	37	37	444	100	

(ii) Responses for Skill factor II & III: Conceptual

	Q6A	Q6B	Q7A	Q7B	Q8A	Q8B	Q9A	Q9B	Q9B	Σ	%	%
FC	15	3	21	3	8	2	1	0	0	53	17.9	23
AC	1	2	4	2	3	1	2	0	0	15	5.1	
TU	2	10	2	14	15	12	2	17	17	74	25.0	77
NU	8	19	7	4	10	6	12	9	9	75	25.3	
ND	11	3	3	14	1	16	20	11	11	79	26.7	
Σ	37	37	37	37	37	37	37	37		296	100	

(iii) Responses for Skill factor IV: Procedural

	Q10A	Q10B	Q10C	Σ	%	%
FC	10	15	2	27	24.3	53.1
AC	3	7	22	32	28.8	
TU	1	2	9	12	10.8	46.9
NU	22	4	3	29	26.1	
ND	1	9	1	11	9.9	
Σ	37	37	37	111	100	



APPENDIX 5A: MAIN RESULTS FOR THE QUESTIONNAIRE 2 - KUN (TEST 1 & 2)

College	Students	Q1A	Q1B	Q2B	Q3B	Q4A	Q4B	Q5B	Q6A	Q7A	Q7B	Q8B	Q9A	Q10A	Q10B	Q10C	Q1
B	1	NU	FC	TU	FC	ND	NU	ND	NU	NU	NU	ND	ND	NU	TU	NU	NU
B	2	ND	FC	AC	FC	ND	NU	ND	ND	NU	ND	ND	ND	NU	TU	TU	TU
B	3	NU	NU	NU	TU	ND	NU	NU	NU	NU	NU	ND	NU	NU	FC	NU	NU
B	4	NU	TU	AC	FC	ND	ND	AC	NU	FC	ND	TU	TU	NU	ND	NU	NU
B	5	NU	TU	FC	FC	NU	ND	TU	NU	FC	FC	TU	TU	NU	FC	NU	TU
B	6	NU	FC	ND	FC	TU	ND	NU	NU	ND	FC	ND	AC	ND	TU	TU	AC
B	7	TU	NU	ND	NU	TU	NU	NU	TU	ND	NU	TU	ND	NU	TU	TU	NU
B	8	TU	NU	NU	FC	ND	NU	ND	TU	FC	TU	TU	ND	NU	FC	TU	TU
B	9	NU	FC	FC	FC	NU	NU	AC	TU	TU	ND	ND	ND	FC	FC	AC	NU
B	10	TU	FC	FC	FC	NU	NU	TU	TU	AC	TU	NU	ND	NU	AC	AC	TU
B	11	NU	FC	NU	TU	NU	NU	FC	NU	NU	TU	NU	AC	NU	FC	TU	TU
B	12	NU	FC	NU	NU	ND	ND	TU	ND	ND	TU	ND	TU	ND	AC	NU	TU
B	13	NU	FC	TU	TU	ND	NU	ND	ND	ND	ND	ND	TU	NU	ND	NU	TU
B	14	NU	FC	NU	FC	TU	NU	FC	TU	FC	NU	NU	NU	NU	TU	TU	TU
B	15	TU	FC	NU	FC	ND	NU	FC	NU	TU	NU	ND	ND	NU	FC	TU	TU
B	16	AC	TU	TU	FC	NU	AC	AC	NU	TU	TU	ND	ND	NU	AC	TU	NU
B	17	NU	FC	FC	TU	TU	NU	AC	NU	FC	NU	ND	TU	NU	FC	TU	TU
B	18	ND	NU	NU	NU	ND	ND	FC	ND	AC	ND	ND	ND	NU	AC	TU	NU
B	19	AC	AC	TU	TU	ND	ND	AC	ND	ND	ND	ND	ND	TU	ND	AC	TU
B	20	NU	AC	TU	AC	ND	NU	NU	NU	NU	NU	ND	ND	NU	ND	NU	TU
B	21	NU	NU	TU	AC	ND	NU	NU	NU	NU	TU	ND	NU	NU	ND	NU	NU
B	22	NU	FC	TU	FC	NU	NU	NU	NU	NU	NU	TU	NU	NU	FC	TU	NU
B	23	NU	TU	NU	TU	NU	NU	NU	AC	FC	NU	TU	NU	FC	NU	AC	TU
B	24	NU	FC	TU	TU	ND	AC	TU	NU	AC	TU	NU	AC	NU	AC	NU	TU
B	25	NU	FC	NU	TU	NU	AC	FC	ND	TU	TU	ND	ND	NU	FC	FC	AC
B	26	TU	FC	AC	NU	TU	AC	NU	AC	FC	NU	NU	AC	AC	AC	AC	NU
B	27	NU	TU	TU	FC	NU	NU	NU	NU	FC	ND	NU	NU	NU	TU	TU	NU
B	28	NU	TU	AC	TU	NU	NU	NU	NU	NU	NU	NU	NU	NU	FC	AC	NU
B	29	AC	AC	TU	TU	ND	ND	FC	NU	NU	ND	ND	ND	ND	FC	NU	TU
B	30	NU	FC	NU	TU	NU	NU	NU	NU	NU	NU	NU	NU	NU	FC	AC	NU
B	31	FC	TU	NU	TU	ND	NU	TU	NU	NU	ND	ND	TU	NU	FC	NU	NU
B	32	NU	NU	NU	NU	NU	NU	NU	AC	NU	NU	NU	NU	NU	AC	NU	NU
B	33	AC	NU	NU	TU	NU	NU	NU	NU	NU	NU	NU	TU	NU	FC	NU	NU
B	34	NU	FC	NU	TU	NU	NU	NU	NU	NU	TU	TU	TU	NU	NU	AC	TU
B	35	NU	FC	AC	FC	ND	NU	ND	NU	NU	TU	ND	ND	NU	AC	TU	TU
B	36	NU	AC	TU	FC	TU	NU	TU	NU	NU	TU	NU	AC	NU	NU	NU	TU
B	37	TU	FC	AC	FC	ND	NU	NU	ND	NU	TU	ND	NU	NU	NU	AC	TU
B	38	NU	AC	TU	FC	TU	NU	AC	NU	NU	TU	NU	TU	NU	FC	NU	TU
B	39	NU	FC	TU	FC	NU	NU	TU	NU	NU	TU	NU	TU	NU	FC	NU	TU
B	40	NU	NU	AC	FC	ND	NU	NU	ND	NU	NU	ND	ND	NU	AC	NU	TU
B	41	NU	TU	NU	TU	NU	NU	ND	ND	NU	TU	ND	ND	NU	FC	TU	NU
B	42	AC	AC	AC	FC	ND	NU	AC	NU	FC	ND	ND	NU	NU	ND	AC	TU
B	43	AC	TU	AC	TU	ND	NU	AC	NU	NU	TU	ND	ND	NU	ND	AC	TU
B	44	TU	FC	TU	NU	NU	TU	FC	NU	AC	TU	NU	NU	FC	TU	TU	TU
B	45	NU	AC	TU	FC	ND	AC	FC	TU	ND	ND	ND	ND	FC	ND	AC	TU



B	46	AC	FC	NU	FC	ND	TU	FC	NU	ND	ND	ND	TU	NU	ND	NU	TU
B	47	TU	NU	NU	TU	NU	ND	NU	NU	NU	ND	ND	ND	NU	FC	NU	NU
B	48	NU	FC	NU	FC	TU	NU	AC	NU	TU	TU	ND	ND	NU	AC	NU	NU
B	49	TU	FC	AC	FC	NU	NU	FC	NU	TU	NU	ND	NU	NU	AC	TU	TU
B	50	ND	FC	AC	TU	ND	NU	ND	ND	FC	ND	ND	ND	NU	ND	FC	ND
B	51	NU	FC	TU	FC	NU	NU	NU	NU	FC	TU	ND	ND	NU	FC	NU	TU
B	52	ND	AC	TU	FC	ND	NU	ND	ND	FC	NU	ND	ND	ND	ND	NU	NU
B	53	NU	TU	NU	TU	NU	NU	AC	NU	FC	NU	TU	NU	NU	TU	TU	TU
B	54	NU	FC	FC	FC	TU	NU	AC	TU	FC	NU	NU	TU	NU	NU	TU	TU
B	55	NU	FC	AC	NU	NU	NU	NU	NU	FC	NU	ND	NU	NU	AC	FC	TU
B	56	TU	FC	NU	TU	TU	AC	NU	NU	NU	TU	TU	ND	NU	AC	AC	TU
B	57	TU	TU	NU	TU	ND	NU	NU	AC	ND	TU	ND	TU	NU	AC	NU	NU
B	58	NU	FC	NU	FC	ND	NU	NU	TU	NU	TU	ND	TU	NU	FC	AC	TU
B	59	NU	FC	AC	TU	TU	TU	AC	NU	ND	TU	ND	ND	NU	TU	NU	TU
B	60	TU	FC	AC	AC	NU	NU	FC	NU	FC	NU	ND	NU	NU	ND	AC	TU
B	61	TU	FC	TU	FC	NU	AC	TU	NU	TU	TU	ND	NU	NU	TU	FC	TU
B	62	NU	FC	TU	AC	NU	NU	AC	NU	NU	TU	NU	NU	NU	FC	NU	TU
B	63	NU	FC	TU	AC	NU	NU	FC	NU	NU	TU	NU	NU	NU	TU	TU	TU
B	64	TU	TU	NU	TU	TU	TU	AC	NU	ND	ND	NU	ND	NU	FC	NU	ND
B	65	TU	NU	NU	NU	ND	ND	NU	NU	NU	ND	ND	ND	ND	FC	NU	NU
B	66	TU	NU	FC	AC	NU	NU	NU	AC	NU	NU	ND	ND	NU	FC	NU	NU
B	67	FC	NU	NU	TU	NU	ND	NU	NU	NU	ND	TU	AC	NU	FC	NU	NU
B	68	ND	NU	NU	TU	ND	ND	NU	NU	ND	ND	ND	ND	NU	FC	NU	NU
B	69	TU	NU	AC	TU	NU	ND	NU	NU	ND	ND	ND	ND	NU	AC	NU	NU
B	70	TU	NU	NU	TU	NU	AC	NU	TU	NU	NU	NU	TU	NU	AC	NU	NU
B	71	TU	NU	NU	ND	NU	NU	NU	TU	NU	ND	ND	NU	NU	FC	NU	NU
B	72	ND	FC	NU	TU	NU	NU	AC	ND	AC	NU	NU	ND	NU	ND	AC	TU
B	73	NU	FC	NU	TU	NU	NU	TU	NU	FC	ND	ND	ND	NU	NU	NU	TU
B	74	NU	FC	TU	TU	ND	NU	FC	NU	FC	AC	NU	TU	NU	FC	AC	NU
B	75	TU	NU	NU	TU	NU	NU	NU	ND	NU	NU	NU	ND	NU	FC	NU	NU
B	76	TU	NU	AC	TU	NU	NU	NU	NU	AC	TU	NU	AC	NU	AC	AC	TU
B	77	TU	NU	ND	NU	NU	NU	NU	NU	ND	NU	ND	TU	ND	AC	FC	TU
B	78	TU	NU	ND	FC	NU	NU	NU	NU	NU	ND	TU	ND	NU	FC	NU	NU
B	79	NU	FC	NU	FC	NU	NU	NU	NU	FC	NU	ND	AC	NU	FC	AC	TU
B	80	AC	NU	NU	TU	NU	NU	NU	TU	NU	ND	NU	AC	NU	AC	TU	NU
B	81	FC	NU	AC	NU	TU	NU	FC	TU	NU	ND	ND	ND	NU	FC	AC	TU
B	82	AC	NU	AC	TU	NU	ND	NU	NU	NU	ND	ND	ND	AC	NU	FC	NU
B	83	NU	ND	NU	NU	TU	AC	NU	ND	ND	ND	ND	ND	NU	FC	NU	NU
B	84	TU	NU	ND	NU	NU	NU	NU	NU	NU	NU	ND	AC	NU	NU	NU	NU
B	85	TU	AC	AC	TU	TU	NU	NU	NU	FC	ND	ND	ND	NU	ND	TU	NU
B	86	ND	TU	NU	AC	ND	NU	NU	ND	FC	ND	ND	ND	TU	ND	NU	TU
B	87	NU	TU	NU	TU	TU	NU	NU	NU	AC	ND	ND	ND	NU	NU	AC	NU
B	88	NU	NU	NU	NU	NU	NU	NU	ND	TU	ND	ND	ND	NU	NU	NU	NU
B	89	TU	FC	AC	NU	NU	TU	NU	NU	AC	ND	ND	ND	AC	FC	AC	TU
B	90	NU	FC	TU	AC	TU	NU	NU	NU	TU	NU	ND	NU	NU	TU	TU	TU
B	91	NU	FC	NU	TU	NU	NU	FC	AC	NU	NU	NU	TU	NU	TU	TU	TU
B	92	AC	FC	NU	FC	TU	TU	NU	AC	NU	NU	ND	AC	TU	FC	TU	TU
A	93	FC	AC	FC	FC	NU	TU	TU	AC	NU	NU	NU	AC	FC	FC	TU	TU



A	94	NU	TU	TU	FC	NU	NU	AC	NU	TU	NU	ND	ND	NU	FC	NU	TU
A	95	AC	TU	TU	NU	TU	NU	AC	NU	TU	NU	NU	TU	NU	FC	TU	TU
A	96	AC	NU	TU	NU	TU	TU	NU	NU	FC	NU	ND	AC	NU	FC	NU	NU
A	97	NU	NU	AC	NU	NU	TU	NU	AC	NU	NU	NU	ND	AC	AC	NU	NU
A	98	NU	FC	NU	FC	AC	NU	NU	AC	FC	ND	NU	ND	AC	FC	AC	TU
A	99	TU	FC	NU	NU	NU	TU	NU	TU	FC	ND	NU	ND	NU	FC	NU	TU
A	100	AC	AC	TU	NU	NU	AC	TU	NU	FC	TU	NU	NU	TU	FC	TU	TU
A	101	FC	TU	TU	NU	AC	FC	NU	NU	NU	TU	NU	NU	FC	TU	NU	TU
A	102	TU	FC	NU	AC	NU	NU	TU	ND	NU	NU	NU	NU	NU	FC	NU	TU
A	103	NU	FC	AC	FC	NU	TU	NU	NU	NU	NU	NU	NU	NU	FC	TU	NU
A	104	NU	AC	AC	NU	AC	AC	AC	NU	FC	NU	NU	NU	NU	FC	AC	TU
A	105	NU	FC	AC	FC	NU	FC	AC	AC	ND	ND	NU	ND	NU	FC	TU	AC
A	106	FC	TU	ND	TU	ND	AC	AC	ND	NU	NU	ND	AC	NU	AC	NU	TU
A	107	NU	AC	TU	TU	NU	AC	NU	TU	NU	TU	NU	ND	FC	AC	AC	TU
A	108	AC	FC	AC	TU	NU	AC	AC	NU	NU	TU	NU	NU	NU	FC	NU	TU
A	109	TU	TU	FC	FC	NU	NU	AC	AC	NU	NU	NU	ND	TU	AC	AC	NU
A	110	NU	FC	AC	AC	TU	TU	AC	NU	NU	ND	ND	ND	NU	FC	NU	NU
A	111	NU	FC	NU	NU	NU	NU	ND	ND	ND	ND	ND	ND	NU	FC	TU	ND
A	112	FC	FC	FC	FC	AC	TU	AC	AC	FC	FC	NU	NU	FC	FC	AC	AC
A	113	FC	NU	AC	AC	NU	NU	NU	NU	NU	NU	NU	NU	NU	NU	NU	NU
A	114	TU	AC	NU	FC	AC	TU	FC	AC	NU	FC	NU	NU	TU	FC	AC	NU
A	115	TU	AC	NU	FC	TU	NU	NU	NU	TU	ND	NU	NU	NU	TU	NU	NU
A	116	AC	NU	NU	TU	TU	NU	FC	TU	NU	NU	TU	NU	NU	AC	NU	NU
A	117	NU	AC	NU	TU	NU	NU	NU	TU	NU	NU	NU	ND	NU	NU	NU	NU
A	118	NU	FC	AC	FC	NU	AC	ND	ND	ND	ND	ND	ND	NU	FC	NU	NU
A	119	NU	ND	ND	TU	NU	ND	NU	TU	FC	NU	NU	ND	NU	AC	TU	NU
A	120	TU	NU	TU	NU	NU	TU	FC	NU	NU	TU	TU	ND	NU	AC	NU	NU
A	121	AC	FC	TU	TU	TU	TU	NU	AC	NU	NU	NU	NU	NU	NU	NU	TU
A	122	AC	NU	NU	FC	TU	AC	FC	TU	TU	NU	NU	TU	TU	FC	NU	TU
		Q1A	Q1B	Q2B	Q3B	Q4A	Q4B	Q5B	Q6A	Q7A	Q7B	Q8B	Q9A	Q10A	Q10B	Q10C	Q1



**APPENDIX 5B: AVERAGE SCORES FOR ELEMENT FROM THE QUESTIONNAIRE
2ND RUN**

Test 1 & 2 College	Correlating the 4 elements for Questionnaire 2 nd run.			October 2007	
	Students	ELM 1	ELM 4	ELM 7	ELM 10
B	1	2.5	0.5	1.0	1.3
B	2	2.0	0.5	0.5	1.7
B	3	1.0	0.5	1.0	2.0
B	4	1.5	0.0	2.0	0.7
B	5	1.5	0.5	4.0	2.0
B	6	2.5	1.0	2.0	1.3
B	7	1.5	1.5	0.5	1.7
B	8	1.5	0.5	3.0	2.3
B	9	2.5	1.0	1.0	3.7
B	10	3.0	1.0	2.5	2.3
B	11	2.5	1.0	1.5	2.3
B	12	2.5	0.0	1.0	1.3
B	13	2.5	0.5	0.0	0.7
B	14	2.5	1.5	2.5	1.7
B	15	3.0	0.5	1.5	2.3
B	16	2.5	2.0	2.0	2.0
B	17	2.5	1.5	2.5	2.3
B	18	0.5	0.0	1.5	2.0
B	19	3.0	0.0	0.0	1.7
B	20	2.0	0.5	1.0	0.7
B	21	1.0	0.5	1.5	0.7
B	22	2.5	1.0	1.0	2.3
B	23	1.5	1.0	2.5	2.7
B	24	2.5	1.5	2.5	1.7
B	25	2.5	2.0	2.0	3.0
B	26	3.0	2.5	2.5	3.0
B	27	1.5	1.0	2.0	1.7
B	28	1.5	1.0	1.0	2.7
B	29	3.0	0.0	0.5	1.7
B	30	2.5	1.0	1.0	2.7
B	31	3.0	0.5	0.5	2.0
B	32	1.0	1.0	1.0	1.7
B	33	2.0	1.0	1.0	2.0
B	34	2.5	1.0	1.5	1.7
B	35	2.5	0.5	1.5	2.0
B	36	2.0	1.5	1.5	1.0
B	37	3.0	0.5	1.5	1.7
B	38	2.0	1.5	1.5	2.0
B	39	2.5	1.0	1.5	2.0
B	40	1.0	0.5	1.0	1.7
B	41	1.5	1.0	1.5	2.3
B	42	3.0	0.5	2.0	1.3
B	43	2.5	0.5	1.5	1.3
B	44	3.0	1.5	2.5	2.7
B	45	2.0	1.5	0.0	2.3
B	46	3.5	0.5	0.0	0.7
B	47	1.5	0.5	0.5	2.0
B	48	2.5	1.5	2.0	1.7
B	49	3.0	1.0	1.5	2.0
B	50	2.0	0.5	2.0	1.7
B	51	2.5	1.0	3.0	2.0
B	52	1.5	0.5	2.5	0.3
B	53	1.5	1.0	2.5	1.7
B	54	2.5	1.5	2.5	1.3
B	55	2.5	1.0	2.5	2.7
B	56	3.0	2.5	1.5	2.3
B	57	2.0	0.5	1.0	1.7
B	58	2.5	0.5	1.5	2.7
B	59	2.5	2.0	1.0	1.3
B	60	3.0	1.0	2.5	1.3



B	61	2.0	2.0	2.0	2.3
B	62	2.5	1.0	1.5	2.0
B	63	2.5	1.0	1.5	1.7
B	64	2.0	2.0	0.0	2.0
B	65	1.5	0.0	0.5	1.7
B	66	1.5	1.0	1.0	2.0
B	67	2.5	0.5	0.5	2.0
B	68	0.5	0.0	0.0	2.0
B	69	1.5	0.5	0.0	1.7
B	70	1.5	2.0	1.0	1.7
B	71	1.5	1.0	0.5	2.0
B	72	2.0	1.0	2.0	1.3
B	73	2.5	1.0	2.0	1.0
B	74	2.5	0.5	3.5	2.7
B	75	1.5	1.0	1.0	2.0
B	76	1.5	1.0	2.5	2.3
B	77	1.5	1.0	0.5	3.0
B	78	1.5	1.0	0.5	2.0
B	79	2.5	1.0	2.5	2.7
B	80	2.0	1.0	0.5	2.0
B	81	2.5	1.5	0.5	2.7
B	82	2.0	0.5	0.5	2.0
B	83	0.5	2.5	0.0	2.0
B	84	1.5	1.0	1.0	1.0
B	85	2.5	1.5	2.0	1.0
B	86	1.0	0.5	2.0	1.0
B	87	1.5	1.5	1.5	1.7
B	88	1.0	1.0	1.0	1.0
B	89	3.0	1.5	1.5	3.3
B	90	2.5	1.5	1.5	1.7
B	91	2.5	1.0	1.0	1.7
B	92	3.5	2.0	1.0	2.7
A	93	3.5	1.5	1.0	3.3
A	94	1.5	1.0	1.5	2.0
A	95	2.5	1.5	1.5	2.3
A	96	2.0	2.0	2.5	2.0
A	97	1.0	1.5	1.0	2.3
A	98	2.5	2.0	2.0	3.3
A	99	3.0	1.5	2.0	2.0
A	100	3.0	2.0	3.0	2.7
A	101	3.0	3.5	1.5	2.3
A	102	3.0	1.0	1.0	2.0
A	103	2.5	1.5	1.0	2.3
A	104	2.0	3.0	2.5	2.7
A	105	2.5	2.5	0.0	2.3
A	106	3.0	1.5	1.0	1.7
A	107	2.0	2.0	1.5	3.3
A	108	3.5	2.0	1.5	2.0
A	109	2.0	1.0	1.0	2.7
A	110	2.5	2.0	0.5	2.0
A	111	2.5	1.0	0.0	2.3
A	112	4.0	2.5	4.0	3.7
A	113	2.5	1.0	1.0	1.0
A	114	2.5	2.5	2.5	3.0
A	115	2.5	1.5	1.0	1.3
A	116	2.0	1.5	1.0	1.7
A	117	2.0	1.0	1.0	1.0
A	118	2.5	2.0	0.0	2.0
A	119	0.5	0.5	2.5	2.0
A	120	1.5	1.5	1.5	1.7
A	121	3.5	2.0	1.0	1.0
A	122	2.0	2.5	1.5	2.3
		ELM 1	ELM 4	ELM 7	ELM 10

APPENDIX 5C: MAIN RESULTS FOR THE QUESTIONNAIRE 2nd RUN (Test 3)

College	Students	Q9B	Q11B	Q3A	Q6B	Q8A	Q2A	Q5A
		DC-CD(A)	CGLCD	VA2D	2D-3D	CD(V)	AV2D	VA2D
B	1	TU	NU	FC	TU	TU	AC	FC
B	2	TU	NU	FC	NU	TU	TU	FC
B	3	TU	NU	AC	TU	TU	TU	FC
B	4	TU	NU	FC	NU	TU	TU	TU
B	5	TU	NU	FC	NU	TU	AC	FC
B	6	TU	NU	FC	TU	FC	AC	TU
B	7	TU	NU	AC	AC	NU	ND	AC
B	8	TU	NU	FC	ND	AC	TU	NU
B	9	NU	NU	FC	TU	TU	AC	TU
B	10	ND	NU	AC	TU	TU	NU	AC
B	11	TU	NU	FC	FC	TU	AC	FC
B	12	TU	TU	FC	FC	TU	AC	FC
B	13	TU	TU	NU	AC	NU	NU	FC
B	14	TU	NU	FC	FC	TU	TU	FC
B	15	TU	ND	AC	NU	TU	TU	TU
B	16	TU	NU	FC	FC	TU	AC	FC
B	17	TU	NU	FC	AC	TU	TU	FC
B	18	TU	ND	FC	TU	TU	AC	FC
B	19	TU	ND	FC	TU	TU	AC	TU
B	20	TU	NU	AC	FC	NU	AC	AC
B	21	TU	NU	AC	AC	NU	NU	TU
B	22	TU	ND	FC	AC	TU	TU	FC
B	23	TU	ND	NU	NU	NU	AC	TU
B	24	TU	NU	AC	TU	TU	TU	NU
B	25	TU	NU	FC	NU	TU	AC	NU
B	26	TU	NU	AC	FC	NU	ND	FC
B	27	TU	NU	NU	FC	TU	TU	FC
B	28	TU	NU	AC	TU	TU	AC	FC
B	29	TU	NU	FC	AC	TU	TU	FC
B	30	NU	NU	AC	NU	NU	TU	NU
B	31	TU	NU	NU	NU	NU	TU	FC
B	32	TU	NU	FC	TU	TU	AC	FC
B	33	TU	NU	FC	NU	TU	TU	FC
B	34	TU	ND	AC	NU	NU	AC	FC
B	35	ND	ND	AC	AC	TU	TU	NU
B	36	TU	ND	FC	NU	FC	AC	FC
B	37	ND	ND	ND	TU	TU	AC	FC
B	38	TU	NU	AC	TU	TU	NU	NU
B	39	ND	ND	ND	TU	TU	AC	FC
A	40	TU	NU	AC	NU	TU	AC	
A	41	NU	NU	FC	NU	TU	AC	NU
A	42	NU	NU	FC	NU	TU	NU	FC
A	43	TU	NU	AC	NU	TU	AC	FC
A	44	TU	ND	FC	TU	NU	AC	FC
A	45	TU	NU	FC	TU	FC	AC	NU
A	46	TU	NU	FC	NU	TU	TU	FC
A	47	TU	ND	AC	TU	FC	AC	TU
A	48	NU	NU	FC	NU	TU	AC	TU
A	49	TU	NU	FC	TU	TU	AC	FC
A	50	TU	NU	AC	FC	AC	AC	AC
A	51	NU	NU	FC	FC	TU	AC	FC
A	52	TU	ND	FC	TU	TU	AC	FC
A	53	TU	NU	FC	NU	TU	TU	NU
A	54	TU	NU	NU	AC	TU	TU	FC
		Q9B	Q11B	Q3A	Q6B	Q8A	Q2A	Q5A

APPENDIX 6A: DETAILED MEMORANDUM OF THE EXAMINATION QUESTIONS

Solution 1

S.1.1. $y = -4x^2 + 4$ $y = -x^2 + 4$
 $-4x^2 + 4 = -x^2 + 4$
 $\therefore x = 0, y = 4$ ✓

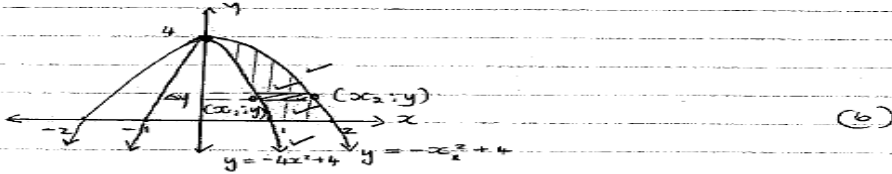

S.1.2. $\Delta y = \pi (x_2^2 - x_1^2) \Delta y$ ✓
 $V_y = \pi \int_0^4 (4 - y - (-1 + \frac{y}{4})) dy$ * $\frac{4-y}{4} = 4-y$
 $= \pi \int_0^4 (3 - \frac{3}{4}y) dy$ ✓
 $= \pi [3y - \frac{3}{8}y^2]_0^4$ ✓
 $= \pi [3(4) - \frac{3(4)^2}{8}]$ ✓
 $= 6\pi \text{ units}^3 \quad (18,85 \text{ m}^3)$ ✓ (8)

S.1.3. To find \bar{y} take moments about x -axis

$$\Delta m_x = \pi (x_2^2 - x_1^2) \Delta y \times y$$

$$M_{x0} = \pi \int_0^4 (4 - y - (-1 + \frac{y}{4})) y dy$$

$$= \pi \int_0^4 (3y - \frac{3}{4}y^2) dy$$

$$= \pi [\frac{3}{2}y^2 - \frac{3}{12}y^3]_0^4$$

$$= \pi [\frac{3(4)^2}{2} - \frac{3(4)^3}{12}]$$

$$= 8\pi \text{ units}^4 \quad (25,133 \text{ m}^4)$$

$\therefore \bar{y} = \frac{25,133}{18,85}$ ✓ $(\frac{8\pi}{6\pi})$
 $= 1,333 \text{ units}$ ✓ (10)

Solution 2

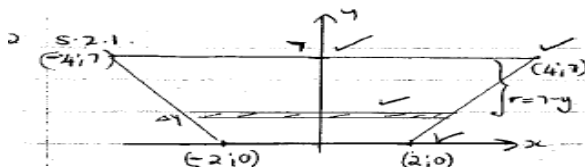

$$\frac{y-7}{x-4} = \frac{0-7}{-2-4}$$

$$y = \frac{7}{2}x - 7$$
 ✓
 $x = \frac{2}{7}(y+7)$ ✓ (6)

$$dA = 2 \left[\frac{2}{7}(y+7) \right] dy$$

$$dA = \frac{4}{7}(y+7) dy \quad / \quad \left(\frac{4}{7}y + 4 \right) dy$$

or $dA = (0,571y + 4) dy$

S.2.2. $\int_0^7 (7-y) \cdot \frac{4}{7}(y+7) dy$
 $= \frac{4}{7} \int_0^7 (49 - y^2) dy$ ✓
 $= \frac{4}{7} [49y - \frac{y^3}{3}]_0^7$ ✓
 $= \frac{4}{7} [49(7) - \frac{7^3}{3}]$ ✓
 $= 130,667 \text{ units}^3$ ✓ (8)

S.2.3. $\int_0^7 (7-y)^2 \cdot \frac{4}{7}(y+7) dy$
 $= \frac{4}{7} \int_0^7 (343 - 7y^2 - 49y + y^3) dy$
 $= \frac{4}{7} [343y - \frac{7y^3}{3} - \frac{49y^2}{2} + \frac{y^4}{4}]_0^7$
 $= \frac{4}{7} [343(7) - \frac{7(7)^3}{3} - \frac{49(7)^2}{2} + \frac{7^4}{4}]$ ✓
 $= 571,667 \text{ units}^4$ ✓

$\bar{y} = \frac{571,667}{130,667}$ ✓
 $= 4,375 \text{ units}$ ✓ (10)

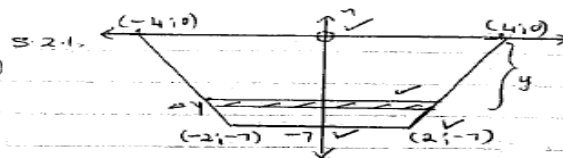

$$\frac{y-0}{x-4} = \frac{-7-0}{-2-4}$$

$$y = \frac{7}{2}x + 14$$
 ✓
 $x = \frac{2}{7}(y+14)$ ✓ $x = \frac{2}{7}(y+14)$

$$dA = 2 \left[\frac{2}{7}(y+14) \right] dy$$

$$dA = \frac{4}{7}(y+14) dy \quad / \quad \left(\frac{4}{7}y + 8 \right) dy$$

(6)

S.2.2. $\int_{-7}^0 y \left[\frac{4}{7}(y+14) \right] dy$
 $= \frac{4}{7} \int_{-7}^0 [y^2 + 14y] dy$ ✓
 $= \frac{4}{7} \left[\frac{y^3}{3} + \frac{14y^2}{2} \right]_{-7}^0$ ✓
 $= \frac{4}{7} \left[0 - \left(\frac{(-7)^3}{3} + 7(-7)^2 \right) \right]$ ✓
 $= -130,667 \text{ units}^3$ ✓ (8)

$$\int_{-7}^0 y^2 \left[\frac{4}{7}(y+14) \right] dy$$

$$= \frac{4}{7} \int_{-7}^0 (y^3 + 14y^2) dy$$

$$= \frac{4}{7} \left[\frac{y^4}{4} + \frac{14y^3}{3} \right]_{-7}^0$$

$$= \frac{4}{7} \left[0 - \left(\frac{(-7)^4}{4} + \frac{14(-7)^3}{3} \right) \right]$$

$$= 571,667 \text{ units}^4$$
 ✓

$\bar{y} = \frac{571,667}{-130,667}$ ✓
 $= -4,375 \text{ units}$ ✓ (10)

Alternative Solution 2

S.2.2 $\int_0^7 (7-y) \left(\frac{4}{3}y + 4\right) dy$
 $= \int_0^7 (4y + 28 - \frac{4}{3}y^2 - 4y) dy$
 $= \int_0^7 (28 - \frac{4}{3}y^2) dy$
 $= \left[28y - \frac{4}{9}y^3 \right]_0^7$
 $= 28(7) - \frac{4}{9}(7)^3$
 $= 130,667 \text{ u}^3 \quad (8)$

S.2.3 $\int_0^7 (7-y)^2 \left(\frac{4}{3}y + 4\right) dy$
 $= \int_0^7 (28y + 196 - 8y^2 - 56y + \frac{4}{3}y^3 + 4y^2) dy$
 $= \int_0^7 (-28y + 196 - 4y^2 + \frac{4}{3}y^3) dy$
 $= \left[-\frac{28}{2}y^2 + 196y - \frac{4}{3}y^3 + \frac{4}{12}y^4 \right]_0^7$
 $= \left[-14(7)^2 + 196(7) - \frac{4}{3}(7)^3 + \frac{1}{3}(7)^4 \right]$
 $= 571,667 \text{ u}^4$

$y = \frac{571,667}{130,667}$
 $= 4,375 \text{ u} \quad (10)$

Solution 3

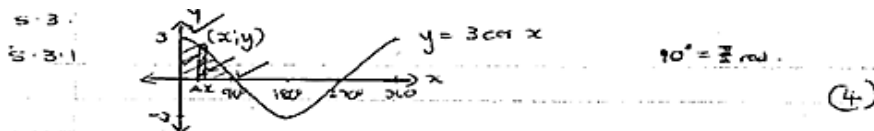

S.3.2 $\Delta y = 2\pi x \times y \times \Delta x$
 $= 2\pi \int_0^{\pi/2} x (3 \cos x) dx$
 $= 2\pi \left[3x \sin x - \int 3 \sin x dx \right]_0^{\pi/2}$
 $= 2\pi \left[3x \sin x + 3 \cos x \right]_0^{\pi/2}$
 $= 2\pi \left[\left[3\left(\frac{\pi}{2}\right) \sin \frac{\pi}{2} + 3 \cos \frac{\pi}{2} \right] - \left[3\left(\frac{\pi}{2}\right) \sin 0 + 3 \cos 0 \right] \right]$
 $= 2\pi \left[\left[\frac{3\pi}{2} \right] - [3] \right]$
 $= 10,759 \text{ u}^3 \quad (10)$

Solution 4

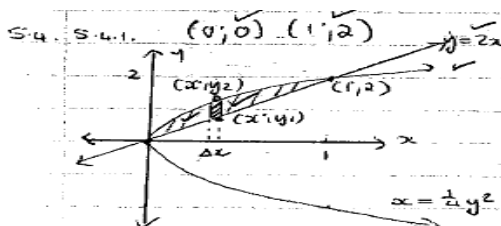

S.4.2 $\Delta A = (y_2 - y_1) \Delta x$
 $A = \int_0^1 (2\sqrt{x} - 2x) dx$
 $= \left[\frac{2 \cdot 2}{3} x^{3/2} - \frac{2x^2}{2} \right]_0^1$
 $= \frac{4}{3} (1)^{3/2} - (1)^2$
 $= \frac{1}{3} \text{ units}^2$

S.4.3 $I_y = \int_0^1 (y_2 - y_1) x^2 dx$
 $= \int_0^1 (2\sqrt{x} - 2x) x^2 dx$
 $= \int_0^1 (2x^{5/2} - 2x^3) dx$
 $= \left[\frac{2 \cdot 2}{7/2} x^{7/2} - \frac{2x^4}{4} \right]_0^1$
 $= 0,071 \text{ u}^4$

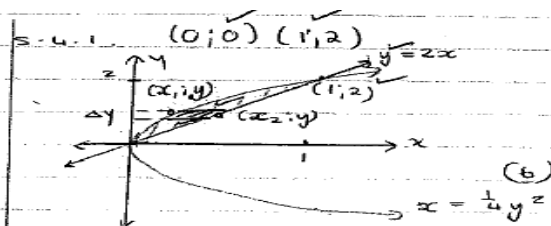

S.4.2 $\Delta A = (x_2 - x_1) \Delta y$
 $A = \int_0^2 \left(\frac{1}{4}y - \frac{1}{4}y^2 \right) dy$
 $= \left[\frac{1}{8}y^2 - \frac{1}{12}y^3 \right]_0^2$
 $= \left[\frac{1}{8}(2)^2 - \frac{1}{12}(2)^3 \right]$
 $= \frac{1}{3} \text{ units}^2 \quad (6)$

$I_y = \int_0^2 y x^2$

(6)



APPENDIX 6B: EXAMINATION ANALYSIS FOR 151 RESPONSES

	GMNP	GR	CD	VA3D	VA3D	GR	VA2D	VA2D	VA2D	GR	CD	VA3D	GMNP	GR	CD	VA2D	VA2D	MARKS	
	1.1	1.1	1.1	1.2	1.3	2.1	2.1	2.2	2.3	3.1	3.1	3.2	4.1	4.1	4.1	4.2	4.3	40	100
1	FC	FC	FC	NU	ND	FC	FC	AC	AC	FC	NU	FC	AC	FC	FC	AC	NU	25	64
2	NU	NU	NU	NU	ND	TU	NU	NU	ND	AC	FC	NU	ND	NU	NU	NU	ND	2	27
3	ND	NU	FC	TU	TU	TU	TU	AC	AC	AC	FC	AC	AC	FC	FC	FC	NU	20	44
4	NU	NU	TU	NU	NU	ND	NU	TU	TU	ND	ND	ND	ND	ND	ND	ND	ND	7	30
5	FC	AC	TU	FC	TU	TU	NU	ND	ND	AC	NU	TU	TU	TU	TU	TU	ND	11	50
6	ND	NU	ND	NU	ND	AC	TU	TU	TU	NU	NU	NU	AC	FC	ND	AC	NU	13	27
7	NU	ND	ND	ND	ND	TU	TU	AC	AC	ND	ND	ND	NU	ND	ND	TU	NU	8	30
8	FC	ND	ND	AC	ND	ND	ND	ND	ND	AC	ND	ND	AC	TU	ND	ND	ND	6	37
9	ND	ND	ND	ND	ND	ND	ND	ND	ND	ND	ND	ND	ND	ND	ND	ND	ND	0	11
10	AC	AC	FC	FC	FC	FC	FC	FC	AC	AC	ND	TU	NU	NU	NU	TU	NU	24	62
11	FC	FC	ND	FC	NU	FC	FC	AC	AC	FC	NU	NU	FC	FC	FC	FC	NU	23	69
12	FC	ND	ND	NU	ND	ND	ND	ND	ND	FC	ND	ND	TU	TU	TU	ND	ND	4	8
13	NU	NU	FC	NU	NU	ND	ND	ND	ND	ND	ND	ND	ND	ND	ND	ND	ND	1	32
14	FC	FC	AC	TU	NU	AC	AC	AC	AC	FC	NU	NU	AC	AC	FC	TU	AC	19	47
15	ND	ND	ND	ND	ND	AC	AC	AC	AC	AC	FC	AC	TU	AC	TU	FC	NU	18	42
16	TU	NU	TU	TU	NU	AC	AC	FC	FC	AC	NU	NU	TU	AC	TU	FC	NU	23	50
17	NU	NU	FC	NU	NU	ND	NU	NU	NU	NU	NU	TU	AC	NU	TU	AC	NU	8	34
18	NU	FC	ND	NU	ND	FC	FC	AC	AC	ND	ND	ND	ND	ND	ND	ND	ND	10	58
19	FC	FC	ND	NU	NU	NU	NU	ND	ND	AC	FC	AC	AC	NU	NU	NU	NU	4	40
20	FC	FC	AC	TU	NU	TU	ND	NU	NU	FC	NU	TU	TU	TU	TU	FC	NU	14	38
21	FC	FC	NU	NU	NU	ND	ND	ND	ND	FC	TU	TU	ND	FC	TU	AC	ND	11	45
22	ND	ND	ND	TU	ND	TU	TU	AC	AC	ND	ND	ND	ND	ND	ND	ND	ND	8	43
23	NU	NU	NU	NU	NU	NU	NU	ND	ND	TU	TU	ND	NU	NU	NU	NU	NU	4	29
24	ND	FC	NU	NU	ND	TU	NU	NU	ND	ND	ND	ND	ND	ND	ND	ND	ND	4	23
25	FC	NU	NU	NU	ND	ND	ND	ND	ND	TU	NU	ND	NU	NU	NU	ND	ND	3	26
26	FC	FC	FC	FC	FC	FC	FC	FC	AC	FC	NU	FC	FC	FC	FC	FC	NU	36	76
27	FC	NU	NU	NU	ND	TU	TU	TU	TU	ND	ND	ND	ND	ND	ND	ND	ND	5	31
28	TU	FC	FC	NU	NU	TU	TU	TU	TU	FC	NU	NU	NU	AC	TU	TU	ND	16	53
29	FC	FC	FC	NU	NU	FC	FC	AC	AC	AC	AC	NU	FC	AC	AC	FC	AC	26	61
30	FC	FC	NU	NU	ND	TU	TU	TU	TU	FC	FC	AC	FC	FC	FC	FC	AC	21	56
31	ND	ND	ND	ND	ND	ND	ND	ND	ND	ND	ND	ND	ND	ND	ND	ND	ND	0	33
32	FC	FC	FC	FC	AC	TU	TU	TU	TU	FC	FC	FC	TU	TU	TU	TU	NU	25	59
33	FC	FC	FC	NU	NU	ND	ND	ND	ND	ND	ND	ND	AC	TU	TU	TU	TU	24	49
34	TU	ND	ND	ND	ND	TU	TU	TU	TU	FC	NU	TU	FC	TU	TU	FC	NU	17	35
35	FC	AC	TU	NU	NU	TU	TU	TU	TU	AC	FC	TU	TU	NU	TU	NU	NU	12	34
36	FC	FC	FC	NU	TU	FC	FC	TU	TU	NU	NU	AC	FC	FC	FC	ND	ND	25	51
37	FC	FC	AC	NU	NU	FC	FC	FC	AC	NU	NU	TU	FC	FC	FC	FC	AC	25	59
38	FC	AC	FC	NU	NU	NU	NU	ND	ND	NU	NU	NU	NU	ND	ND	ND	ND	5	38
39	FC	AC	AC	AC	ND	TU	TU	TU	TU	FC	NU	TU	NU	NU	NU	ND	ND	17	43
40	FC	AC	AC	AC	ND	NU	NU	ND	ND	FC	NU	NU	AC	NU	NU	NU	NU	11	42
41	FC	AC	AC	AC	AC	AC	TU	NU	NU	FC	FC	AC	TU	NU	NU	AC	NU	18	45
42	NU	ND	ND	NU	NU	TU	TU	TU	TU	FC	NU	FC	FC	ND	ND	FC	NU	19	56
43	FC	FC	AC	AC	AC	TU	TU	TU	TU	FC	NU	AC	FC	ND	ND	FC	NU	24	66
44	NU	FC	ND	ND	ND	ND	ND	ND	ND	FC	ND	TU	NU	ND	ND	ND	ND	5	27
45	ND	ND	ND	ND	ND	FC	FC	FC	FC	FC	NU	TU	FC	TU	FC	NU	ND	18	47
46	FC	FC	AC	AC	TU	TU	TU	TU	TU	FC	NU	FC	FC	FC	FC	AC	NU	27	54
47	ND	ND	ND	ND	ND	TU	TU	TU	TU	FC	FC	AC	FC	TU	ND	FC	NU	16	48
48	NU	FC	AC	AC	NU	TU	TU	TU	TU	FC	NU	AC	NU	NU	NU	TU	NU	22	56
49	FC	FC	NU	TU	TU	FC	FC	AC	AC	AC	TU	AC	FC	AC	TU	TU	TU	20	45
50	FC	TU	TU	TU	TU	FC	FC	FC	FC	FC	NU	AC	FC	AC	TU	AC	TU	28	68
51	FC	FC	AC	NU	NU	FC	FC	AC	AC	FC	NU	NU	TU	TU	FC	FC	NU	19	47
52	FC	FC	FC	AC	AC	TU	TU	TU	TU	FC	NU	AC	FC	FC	FC	FC	FC	24	63
53	NU	ND	ND	ND	NU	FC	FC	NU	NU	AC	FC	NU	ND	FC	FC	NU	NU	6	31
54	FC	AC	NU	NU	ND	TU	TU	ND	ND	NU	NU	TU	TU	TU	ND	NU	NU	9	37
55	ND	ND	ND	ND	ND	TU	TU	TU	TU	FC	FC	ND	FC	FC	FC	FC	NU	14	50
56	FC	FC	FC	FC	FC	TU	TU	TU	TU	FC	NU	FC	TU	FC	FC	AC	NU	28	78



57	FC	FC	FC	FC	FC	TU	TU	TU	TU	FC	FC	FC	NU	ND	ND	TU	NU	27	48
58	FC	AC	AC	NU	NU	FC	FC	FC	FC	FC	NU	TU	FC	NU	NU	FC	NU	23	56
59	FC	FC	FC	FC	FC	AC	FC	AC	AC	FC	FC	FC	FC	FC	FC	AC	FC	36	77
60	FC	FC	FC	NU	NU	TU	TU	TU	TU	FC	NU	AC	FC	FC	FC	FC	ND	21	56
61	ND	FC	FC	AC	NU	TU	TU	TU	TU	FC	ND	FC	AC	FC	FC	FC	NU	25	62
62	FC	FC	FC	AC	FC	FC	FC	FC	FC	FC	NU	AC	FC	FC	FC	AC	FC	35	82
63	NU	AC	NU	NU	NU	TU	TU	TU	TU	FC	ND	TU	ND	TU	NU	ND	ND	9	30
64	FC	FC	AC	NU	NU	TU	TU	TU	NU	FC	NU	TU	AC	AC	AC	TU	NU	10	30
65	NU	AC	NU	NU	NU	FC	FC	TU	TU	FC	NU	NU	AC	FC	FC	AC	NU	18	52
66	TU	NU	ND	NU	ND	FC	AC	AC	AC	FC	FC	TU	AC	FC	FC	AC	ND	16	49
67	TU	TU	ND	ND	ND	TU	TU	TU	TU	AC	FC	AC	TU	FC	FC	AC	NU	15	47
68	FC	FC	FC	FC	FC	FC	FC	FC	FC	FC	NU	FC	FC	FC	FC	FC	NU	37	90
69	TU	ND	ND	NU	NU	TU	TU	NU	NU	AC	FC	ND	ND	ND	ND	ND	ND	4	14
70	FC	AC	ND	ND	ND	ND	ND	ND	ND	ND	ND	ND	ND	ND	ND	ND	ND	2	33
71	FC	NU	ND	NU	NU	NU	NU	NU	NU	FC	ND	AC	TU	TU	TU	NU	NU	12	41
72	FC	FC	AC	NU	NU	NU	ND	ND	ND	NU	ND	NU	NU	FC	NU	NU	TU	7	29
73	AC	FC	ND	NU	NU	ND	ND	ND	ND	FC	FC	TU	ND	ND	ND	ND	ND	7	41
74	ND	NU	TU	NU	NU	FC	FC	FC	AC	FC	FC	NU	ND	ND	ND	ND	ND	15	37
75	TU	NU	ND	NU	ND	TU	TU	TU	TU	AC	FC	TU	AC	NU	ND	TU	NU	11	23
76	TU	NU	NU	ND	ND	TU	ND	TU	TU	ND	ND	ND	ND	ND	ND	ND	ND	4	42
77	TU	ND	ND	NU	ND	TU	TU	NU	NU	ND	ND	AC	AC	ND	ND	AC	NU	7	27
78	FC	NU	NU	FC	NU	TU	TU	AC	AC	FC	NU	TU	FC	FC	FC	FC	NU	21	52
79	TU	NU	NU	NU	NU	NU	NU	NU	NU	AC	NU	NU	ND	NU	NU	TU	ND	8	17
80	FC	FC	NU	AC	AC	TU	TU	TU	TU	AC	NU	AC	TU	FC	NU	AC	NU	20	44
81	TU	ND	ND	ND	ND	TU	ND	NU	ND	ND	ND	ND	ND	ND	ND	ND	ND	1	21
82	FC	FC	TU	NU	ND	FC	NU	AC	AC	ND	ND	ND	ND	ND	ND	ND	ND	12	40
83	ND	ND	ND	ND	ND	ND	ND	ND	ND	ND	ND	ND	ND	ND	ND	ND	ND	0	43
84	FC	FC	NU	AC	TU	TU	TU	AC	AC	FC	ND	TU	ND	ND	ND	ND	ND	21	59
85	TU	FC	NU	NU	NU	TU	TU	TU	TU	TU	NU	TU	NU	ND	ND	TU	ND	12	36
86	FC	FC	NU	AC	AC	TU	TU	TU	TU	FC	NU	AC	AC	FC	FC	AC	AC	19	62
87	FC	FC	NU	AC	AC	AC	AC	AC	AC	FC	FC	AC	FC	FC	FC	FC	ND	29	64
88	FC	FC	ND	NU	ND	AC	AC	AC	AC	FC	NU	FC	FC	NU	FC	FC	NU	21	60
89	AC	AC	TU	NU	NU	TU	TU	NU	NU	FC	NU	TU	TU	NU	FC	AC	NU	11	52
90	FC	FC	NU	FC	TU	FC	AC	AC	AC	AC	NU	ND	ND	ND	ND	ND	ND	17	41
91	FC	FC	FC	TU	TU	FC	FC	NU	NU	FC	NU	TU	ND	ND	ND	ND	ND	16	48
92	FC	NU	FC	FC	NU	NU	NU	TU	TU	FC	NU	AC	FC	FC	FC	TU	NU	14	45
93	FC	FC	ND	NU	ND	AC	AC	TU	TU	FC	NU	AC	FC	FC	ND	AC	NU	17	48
94	AC	NU	TU	FC	TU	TU	TU	ND	ND	FC	NU	TU	FC	NU	FC	FC	FC	18	48
95	FC	FC	FC	NU	ND	AC	AC	AC	AC	FC	NU	FC	TU	ND	ND	ND	ND	20	58
96	TU	AC	TU	NU	NU	FC	AC	AC	AC	FC	NU	AC	TU	FC	FC	AC	NU	17	50
97	FC	AC	TU	FC	AC	TU	TU	TU	AC	FC	NU	AC	TU	FC	FC	AC	NU	22	62
98	FC	FC	FC	NU	NU	AC	TU	AC	AC	AC	NU	AC	FC	FC	FC	FC	NU	21	65
99	TU	ND	ND	NU	ND	AC	TU	AC	AC	FC	NU	NU	TU	FC	ND	NU	ND	11	42
100	AC	FC	FC	TU	ND	TU	TU	TU	TU	AC	AC	TU	ND	ND	ND	ND	ND	10	17
101	FC	FC	AC	AC	NU	TU	TU	TU	TU	ND	ND	ND	ND	ND	ND	ND	ND	9	42
102	AC	FC	AC	NU	NU	FC	FC	FC	AC	FC	NU	FC	AC	FC	FC	FC	NU	26	61
103	AC	AC	FC	AC	AC	FC	FC	FC	AC	FC	NU	AC	AC	AC	FC	FC	NU	28	52
104	FC	FC	ND	NU	NU	TU	TU	TU	TU	FC	NU	TU	AC	FC	FC	FC	NU	18	54
105	AC	FC	NU	AC	FC	TU	TU	TU	TU	FC	NU	AC	ND	FC	FC	AC	NU	22	49
106	NU	FC	FC	NU	NU	TU	TU	TU	TU	FC	NU	FC	TU	TU	TU	NU	NU	15	53
107	FC	NU	TU	FC	FC	TU	TU	TU	TU	AC	ND	AC	FC	FC	FC	FC	NU	24	76
108	FC	AC	TU	NU	TU	TU	TU	TU	TU	FC	NU	FC	AC	FC	FC	AC	NU	17	59
109	NU	NU	ND	NU	NU	FC	FC	AC	AC	FC	NU	AC	AC	TU	TU	FC	TU	17	50
110	ND	AC	FC	ND	ND	TU	TU	ND	ND	AC	FC	NU	ND	NU	ND	ND	ND	5	23
111	AC	AC	NU	NU	NU	TU	TU	TU	ND	FC	FC	ND	ND	ND	ND	ND	ND	11	41
112	TU	FC	ND	TU	TU	TU	TU	TU	TU	FC	FC	AC	AC	ND	ND	FC	NU	22	60
113	TU	AC	TU	NU	NU	FC	FC	NU	NU	FC	NU	TU	TU	NU	ND	ND	ND	9	37
114	AC	AC	TU	ND	ND	FC	FC	TU	ND	FC	NU	NU	AC	TU	TU	AC	AC	15	49
115	FC	FC	FC	NU	NU	FC	FC	FC	FC	FC	NU	FC	AC	AC	FC	FC	FC	31	88
116	TU	AC	NU	NU	ND	TU	TU	TU	TU	FC	NU	AC	ND	ND	ND	ND	ND	11	51



117	AC	FC	NU	NU	ND	FC	FC	FC	AC	FC	FC	FC	FC	FC	FC	FC	FC	29	78
118	ND	ND	ND	ND	ND	ND	ND	ND	ND	ND	ND	ND	ND	ND	ND	ND	ND	0	20
119	FC	FC	ND	TU	ND	ND	ND	ND	ND	FC	ND	ND	AC	NU	ND	AC	NU	9	29
120	ND	ND	ND	ND	ND	ND	ND	ND	ND	ND	ND	ND	ND	ND	ND	ND	ND	0	25
121	NU	ND	ND	ND	ND	ND	ND	ND	AC	ND	ND	NU	NU	NU	ND	ND	1	24	
122	FC	FC	AC	FC	ND	FC	AC	AC	NU	FC	FC	AC	NU	TU	FC	FC	NU	21	32
123	AC	AC	NU	NU	NU	TU	TU	TU	NU	TU	NU	TU	NU	NU	TU	NU	ND	8	27
124	NU	FC	AC	NU	ND	FC	FC	FC	FC	FC	FC	AC	FC	FC	FC	FC	NU	27	69
125	FC	TU	ND	ND	ND	TU	TU	TU	TU	FC	NU	AC	FC	FC	FC	FC	NU	20	66
126	NU	FC	FC	AC	AC	FC	FC	AC	AC	FC	NU	AC	AC	FC	FC	FC	NU	23	45
127	NU	NU	NU	ND	ND	TU	TU	ND	ND	ND	ND	ND	ND	ND	ND	ND	ND	2	20
128	NU	NU	NU	TU	NU	FC	FC	AC	AC	FC	NU	AC	AC	AC	AC	TU	NU	17	56
129	NU	NU	NU	ND	ND	TU	TU	NU	NU	AC	NU	NU	FC	TU	FC	AC	ND	7	30
130	TU	FC	FC	NU	NU	TU	TU	TU	TU	FC	NU	NU	AC	TU	TU	TU	NU	10	24
131	NU	NU	NU	ND	ND	AC	NU	AC	AC	FC	NU	AC	AC	TU	TU	FC	NU	21	59
132	AC	AC	TU	FC	FC	TU	TU	TU	TU	FC	FC	FC	AC	FC	FC	FC	NU	31	73
133	TU	ND	ND	ND	ND	TU	TU	TU	TU	FC	FC	AC	AC	ND	ND	NU	NU	16	54
134	FC	NU	ND	ND	ND	FC	FC	FC	AC	FC	FC	AC	FC	TU	AC	FC	ND	21	49
135	FC	FC	FC	AC	NU	AC	NU	ND	ND	ND	ND	ND	FC	FC	ND	NU	NU	12	41
136	NU	AC	TU	TU	ND	NU	NU	ND	ND	TU	NU	NU	AC	NU	NU	AC	ND	7	28
137	NU	TU	TU	TU	TU	FC	AC	AC	AC	AC	NU	FC	AC	NU	NU	FC	NU	24	48
138	TU	TU	NU	NU	NU	AC	NU	TU	TU	FC	NU	NU	TU	NU	NU	FC	NU	13	29
139	ND	ND	ND	ND	ND	FC	FC	AC	AC	FC	NU	FC	AC	FC	FC	AC	AC	21	52
140	NU	TU	ND	NU	ND	NU	NU	NU	NU	FC	NU	NU	NU	NU	ND	NU	NU	8	16
141	FC	NU	TU	AC	NU	TU	TU	ND	ND	FC	NU	NU	ND	ND	ND	ND	ND	10	38
142	NU	TU	TU	NU	NU	TU	TU	TU	TU	FC	NU	TU	AC	FC	FC	AC	AC	19	64
143	FC	FC	NU	TU	NU	TU	TU	NU	NU	NU	FC	NU	TU	FC	NU	TU	TU	13	29
144	NU	FC	ND	TU	NU	TU	TU	TU	TU	TU	NU	NU	AC	FC	ND	FC	NU	15	40
145	ND	ND	ND	NU	NU	TU	TU	TU	TU	FC	FC	AC	AC	AC	FC	FC	FC	19	53
146	TU	FC	AC	TU	ND	ND	ND	TU	TU	FC	NU	NU	FC	FC	FC	TU	ND	19	55
147	TU	NU	AC	AC	ND	ND	ND	ND	ND	FC	NU	NU	TU	TU	TU	TU	ND	4	37
148	NU	ND	ND	ND	ND	FC	FC	AC	FC	FC	NU	NU	FC	FC	FC	FC	NU	20	50
149	FC	TU	NU	TU	TU	NU	TU	TU	TU	FC	NU	FC	FC	TU	TU	NU	NU	25	51
150	FC	AC	NU	NU	NU	TU	TU	TU	TU	ND	ND	ND	ND	ND	ND	ND	ND	11	37
151	FC	NU	TU	NU	ND	NU	NU	ND	ND	NU	NU	AC	NU	NU	NU	NU	NU	6	28
AVRG																		15.4	45.5
	GMNP	GR	CD	VA3D	VA3D	GR	VA2D	VA2D	VA2D	GR	CD	VA3D	GMNP	GR	CD	VA2D	VA2D		
	1.1	1.1	1.1	1.2	1.3	2.1	2.1	2.2	2.3	3.1	3.1	3.2	4.1	4.1	4.1	4.2	4.3		
FC	70	63	32	17	10	38	33	16	9	89	31	21	38	50	52	45	6		
AC	13	26	19	21	10	15	12	31	38	25	2	41	37	12	4	28	8		
TU	22	8	21	18	14	66	65	56	51	6	3	29	24	23	23	20	6		
NU	28	29	33	67	57	12	19	17	17	9	81	29	17	27	20	18	74		
ND	18	25	46	28	60	20	22	31	36	22	34	31	35	39	52	40	57		
	151	151	151	151	151	151	151	151	151	151	151	151	151	151	151	151	151		
% FC+AC	54.9	58.9	33.8	25.2	13.2	35.1	29.8	31.1	31.1	75.5	21.9	41.1	49.7	41.1	37.1	48.3	9.3		



APPENDIX 6C: AVERAGE SCORES PER ELEMENT FROM THE QUESTIONNAIRE 2ND RUN

Students	GMNP	GMNP	GMNP	GR	GR	GR	GR	GR	CD	CD	CD	CDav	VA	VA	VA	VA	VA	VA	VA	VA	VA	VA2D	VA3D
	1.1	4.1	av	1.1	2.1	3.1	4.1	av	1.1	3.1	4.1	ELM 8	3D	3D	2D	2D	2D	3D	2D	2D	av	ELM 3	av
1	4	3	3.5	4	4	4	4	4.0	4	1	4	3.0	1	0	4	3	3	4	3	1	2.4	2.8	1.7
2	1	0	0.5	1	2	3	1	1.8	1	4	1	2.0	1	0	1	1	0	1	1	0	0.6	0.6	0.7
3	0	3	1.5	1	2	3	4	2.5	4	4	4	4.0	2	2	2	3	3	3	4	1	2.5	2.6	2.3
4	1	0	0.5	1	0	0	0	0.3	2	0	0	0.7	1	1	1	2	2	0	0	0	0.9	1.0	0.7
5	4	2	3.0	3	2	3	2	2.5	2	1	2	1.7	4	2	1	0	0	2	2	0	1.4	0.6	2.7
6	0	3	1.5	1	3	1	4	2.3	0	1	0	0.3	1	0	2	2	2	1	3	1	1.5	2.0	0.7
7	1	1	1.0	0	2	0	0	0.5	0	0	0	0.0	0	0	2	3	3	0	2	1	1.4	2.2	0.0
8	4	3	3.5	0	0	3	2	1.3	0	0	0	0.0	3	0	0	0	0	0	0	0	0.4	0.0	1.0
9	0	0	0.0	0	0	0	0	0.0	0	0	0	0.0	0	0	0	0	0	0	0	0	0.0	0.0	0.0
10	3	1	2.0	3	4	3	1	2.8	4	0	1	1.7	4	4	4	4	3	2	2	1	3.0	2.8	3.3
11	4	4	4.0	4	4	4	4	4.0	0	1	4	1.7	4	1	4	3	3	1	4	1	2.6	3.0	2.0
12	4	2	3.0	0	0	4	2	1.5	0	0	2	0.7	1	0	0	0	0	0	0	0	0.1	0.0	0.3
13	1	0	0.5	1	0	0	0	0.3	4	0	0	1.3	1	1	0	0	0	0	0	0	0.3	0.0	0.7
14	4	3	3.5	4	3	4	3	3.5	3	1	4	2.7	2	1	3	3	3	1	2	3	2.3	2.8	1.3
15	0	2	1.0	0	3	3	3	2.3	0	4	2	2.0	0	0	3	3	3	3	4	1	2.1	2.8	1.0
16	2	2	2.0	1	3	3	3	2.5	2	1	2	1.7	2	1	3	4	4	1	4	1	2.5	3.2	1.3
17	1	3	2.0	1	0	1	1	0.8	4	1	2	2.3	1	1	1	1	1	2	3	1	1.4	1.4	1.3
18	1	0	0.5	4	4	0	0	2.0	0	0	0	0.0	1	0	4	3	3	0	0	0	1.4	2.0	0.3
19	4	3	3.5	4	1	3	1	2.3	0	4	1	1.7	1	1	1	0	0	3	1	1	1.0	0.6	1.7
20	4	2	3.0	4	2	4	2	3.0	3	1	2	2.0	2	1	0	1	1	2	4	1	1.5	1.4	1.7
21	4	0	2.0	4	0	4	4	3.0	1	2	2	1.7	1	1	0	0	0	2	3	0	0.9	0.6	1.3
22	0	0	0.0	0	2	0	0	0.5	0	0	0	0.0	2	0	2	3	3	0	0	0	1.3	1.6	0.7
23	1	1	1.0	1	1	2	1	1.3	1	2	1	1.3	1	1	1	0	0	0	1	1	0.6	0.6	0.7
24	0	0	0.0	4	2	0	0	1.5	1	0	0	0.3	1	0	1	1	0	0	0	0	0.4	0.4	0.3
25	4	1	2.5	1	0	2	1	1.0	1	1	1	1.0	1	0	0	0	0	0	0	0	0.1	0.0	0.3
26	4	4	4.0	4	4	4	4	4.0	4	1	4	3.0	4	4	4	4	3	4	4	1	3.5	3.2	4.0
27	4	0	2.0	1	2	0	0	0.8	1	0	0	0.3	1	0	2	2	2	0	0	0	0.9	1.2	0.3
28	2	1	1.5	4	2	4	3	3.3	4	1	2	2.3	1	1	2	2	2	1	2	0	1.4	1.6	1.0
29	4	4	4.0	4	4	3	3	3.5	4	3	3	3.3	1	1	4	3	3	1	4	3	2.5	3.4	1.0
30	4	4	4.0	4	2	4	4	3.5	1	4	4	3.0	1	0	2	2	2	3	4	3	2.1	2.6	1.3
31	0	0	0.0	0	0	0	0	0.0	0	0	0	0.0	0	0	0	0	0	0	0	0	0.0	0.0	0.0
32	4	2	3.0	4	2	4	2	3.0	4	4	2	3.3	4	3	2	2	2	4	2	1	2.5	1.8	3.7
33	4	3	3.5	4	0	0	2	1.5	4	0	2	2.0	1	1	0	0	0	0	2	2	0.8	0.8	0.7
34	2	4	3.0	0	2	4	2	2.0	0	1	2	1.0	0	0	2	2	2	2	4	1	1.6	2.2	0.7
35	4	2	3.0	3	2	3	1	2.3	2	4	2	2.7	1	1	2	2	2	2	1	1	1.5	1.6	1.3



36	4	4	4.0	4	4	1	4	3.3	4	1	4	3.0	1	2	4	2	2	3	0	0	1.8	1.6	2.0
37	4	4	4.0	4	4	1	4	3.3	3	1	4	2.7	1	1	4	4	3	2	4	3	2.8	3.6	1.3
38	4	1	2.5	3	1	1	0	1.3	4	1	0	1.7	1	1	1	0	0	1	0	0	0.5	0.2	1.0
39	4	1	2.5	3	2	4	1	2.5	3	1	1	1.7	3	0	2	2	2	2	0	0	1.4	1.2	1.7
40	4	3	3.5	3	1	4	1	2.3	3	1	1	1.7	3	0	1	0	0	1	1	1	0.9	0.6	1.3
41	4	2	3.0	3	3	4	1	2.8	3	4	1	2.7	3	3	2	1	1	3	3	1	2.1	1.6	3.0
42	1	4	2.5	0	2	4	0	1.5	0	1	0	0.3	1	1	2	2	2	4	4	1	2.1	2.2	2.0
43	4	4	4.0	4	2	4	0	2.5	3	1	0	1.3	3	3	2	2	2	3	4	1	2.5	2.2	3.0
44	1	1	1.0	4	0	4	0	2.0	0	0	0	0.0	0	0	0	0	0	2	0	0	0.3	0.0	0.7
45	0	4	2.0	0	4	4	2	2.5	0	1	4	1.7	0	0	4	4	4	2	1	0	1.9	2.6	0.7
46	4	4	4.0	4	2	4	4	3.5	3	1	4	2.7	3	2	2	2	2	4	3	1	2.4	2.0	3.0
47	0	4	2.0	0	2	4	2	2.0	0	4	0	1.3	0	0	2	2	2	3	4	1	1.8	2.2	1.0
48	1	1	1.0	4	2	4	1	2.8	3	1	1	1.7	3	1	2	2	2	3	2	1	2.0	1.8	2.3
49	4	4	4.0	4	4	3	3	3.5	1	2	2	1.7	2	2	4	3	3	3	2	2	2.6	2.8	2.3
50	4	4	4.0	2	4	4	3	3.3	2	1	2	1.7	2	2	4	4	4	3	3	2	3.0	3.4	2.3
51	4	2	3.0	4	4	4	2	3.5	3	1	4	2.7	1	1	4	3	3	1	4	1	2.3	3.0	1.0
52	4	4	4.0	4	2	4	4	3.5	4	1	4	3.0	3	3	2	2	2	3	4	1	2.5	2.2	3.0
53	1	0	0.5	0	4	3	4	2.8	0	4	4	2.7	0	1	4	1	1	1	1	1	1.3	1.6	0.7
54	4	2	3.0	3	2	1	2	2.0	1	1	0	0.7	1	0	2	0	0	2	1	1	0.9	0.8	1.0
55	0	4	2.0	0	2	4	4	2.5	0	4	4	2.7	0	0	2	2	2	0	4	1	1.4	2.2	0.0
56	4	2	3.0	4	2	4	4	3.5	4	1	4	3.0	4	4	2	2	2	4	3	1	2.8	2.0	4.0
57	4	1	2.5	4	2	4	0	2.5	4	4	0	2.7	4	4	2	2	2	4	2	1	2.6	1.8	4.0
58	4	4	4.0	3	4	4	1	3.0	3	1	1	1.7	1	1	4	4	4	2	4	1	2.6	3.4	1.3
59	4	4	4.0	4	3	4	4	3.8	4	4	4	4.0	4	4	4	3	3	4	3	4	3.6	3.4	4.0
60	4	4	4.0	4	2	4	4	3.5	4	1	4	3.0	1	1	2	2	2	3	4	0	1.9	2.0	1.7
61	0	3	1.5	4	2	4	4	3.5	4	0	4	2.7	3	1	2	2	2	4	4	1	2.4	2.2	2.7
62	4	4	4.0	4	4	4	4	4.0	4	1	4	3.0	3	4	4	4	4	3	3	4	3.6	3.8	3.3
63	1	0	0.5	3	2	4	2	2.8	1	0	1	0.7	1	1	2	2	2	2	0	0	1.3	1.2	1.3
64	4	3	3.5	4	2	4	3	3.3	3	1	3	2.3	1	1	2	2	1	2	2	1	1.5	1.6	1.3
65	1	3	2.0	3	4	4	4	3.8	1	1	4	2.0	1	1	4	2	2	1	3	1	1.9	2.4	1.0
66	2	3	2.5	1	4	4	4	3.3	0	4	4	2.7	1	0	3	3	3	2	3	0	1.9	2.4	1.0
67	2	2	2.0	2	2	3	4	2.8	0	4	4	2.7	0	0	2	2	2	3	3	1	1.6	2.0	1.0
68	4	4	4.0	4	4	4	4	4.0	4	1	4	3.0	4	4	4	4	4	4	4	1	3.6	3.4	4.0
69	2	0	1.0	0	2	3	0	1.3	0	4	0	1.3	1	1	2	1	1	0	0	0	0.8	0.8	0.7
70	4	0	2.0	3	0	0	0	0.8	0	0	0	0.0	0	0	0	0	0	0	0	0	0.0	0.0	0.0
71	4	2	3.0	1	1	4	2	2.0	0	0	2	0.7	1	1	1	1	1	3	1	1	1.3	1.0	1.7
72	4	1	2.5	4	1	1	4	2.5	3	0	1	1.3	1	1	0	0	0	1	1	2	0.8	0.6	1.0
73	3	0	1.5	4	0	4	0	2.0	0	4	0	1.3	1	1	0	0	0	2	0	0	0.5	0.0	1.3
74	0	0	0.0	1	4	4	0	2.3	2	4	0	2.0	1	1	4	4	3	1	0	0	1.8	2.2	1.0
75	2	3	2.5	1	2	3	1	1.8	0	4	0	1.3	1	0	2	2	2	2	2	1	1.5	1.8	1.0



76	2	0	1.0	1	2	0	0	0.6	1	0	0	0.3	0	0	0	2	2	0	0	0	0.5	0.8	0.0
77	2	3	2.5	0	2	0	0	0.5	0	0	0	0.0	1	0	2	1	1	3	3	1	1.5	1.6	1.3
78	4	4	4.0	1	2	4	4	2.8	1	1	4	2.0	4	1	2	3	3	2	4	1	2.5	2.6	2.3
79	2	0	1.0	1	1	3	1	1.5	1	1	1	1.0	1	1	1	1	1	2	0	1.0	1.0	1.0	
80	4	2	3.0	4	2	3	4	3.3	1	1	1	1.0	3	3	2	2	2	3	3	1	2.4	2.0	3.0
81	2	0	1.0	0	2	0	0	0.5	0	0	0	0.0	0	0	0	1	0	0	0	0	0.1	0.2	0.0
82	4	0	2.0	4	4	0	0	2.0	2	0	0	0.7	1	0	1	3	3	0	0	0	1.0	1.4	0.3
83	0	0	0.0	0	0	0	0	0.0	0	0	0	0.0	0	0	0	0	0	0	0	0	0.0	0.0	0.0
84	4	0	2.0	4	2	4	0	2.5	1	0	0	0.3	3	2	2	3	3	2	0	0	1.9	1.6	2.3
85	2	1	1.5	4	2	2	0	2.0	1	1	0	0.7	1	1	2	2	2	2	2	0	1.5	1.6	1.3
86	4	3	3.5	4	2	4	4	3.5	1	1	4	2.0	3	3	2	2	2	3	3	3	2.6	2.4	3.0
87	4	4	4.0	4	3	4	4	3.8	1	4	4	3.0	3	3	3	3	3	4	4	0	2.8	2.6	3.0
88	4	4	4.0	4	3	4	1	3.0	0	1	4	1.7	1	0	3	3	3	4	4	1	2.4	2.8	1.7
89	3	2	2.5	3	2	4	1	2.5	2	1	4	2.3	1	1	2	1	1	2	3	1	1.5	1.6	1.3
90	4	0	2.0	4	4	3	0	2.8	1	1	0	0.7	4	2	3	3	3	0	0	0	1.9	1.8	2.0
91	4	0	2.0	4	4	4	0	3.0	4	1	0	1.7	2	2	4	1	1	2	0	0	1.5	1.2	2.0
92	4	4	4.0	1	1	4	4	2.5	4	1	4	3.0	4	1	1	2	2	3	2	1	2.0	1.6	2.7
93	4	4	4.0	4	3	4	4	3.8	0	1	0	0.3	1	0	3	2	2	3	3	1	1.9	2.2	1.3
94	3	4	3.5	1	2	4	1	2.0	2	1	4	2.3	4	2	2	0	0	2	4	4	2.3	2.0	2.7
95	4	2	3.0	4	3	4	0	2.8	4	1	0	1.7	1	0	3	3	3	4	0	0	1.8	1.8	1.7
96	2	2	2.0	3	4	4	4	3.8	2	1	4	2.3	1	1	3	3	3	3	3	1	2.3	2.6	1.7
97	4	2	3.0	3	2	4	4	3.3	2	1	4	2.3	4	3	2	2	3	3	3	1	2.6	2.2	3.3
98	4	4	4.0	4	3	3	4	3.5	4	1	4	3.0	1	1	2	3	3	3	4	1	2.3	2.6	1.7
99	2	2	2.0	0	3	4	4	2.8	0	1	0	0.3	1	0	2	3	3	1	1	0	1.4	1.8	0.7
100	3	0	1.5	4	2	3	0	2.3	4	3	0	2.3	2	0	2	2	2	2	0	0	1.3	1.2	1.3
101	4	0	2.0	4	2	0	0	1.5	3	0	0	1.0	3	1	2	2	2	0	0	0	1.3	1.2	1.3
102	3	3	3.0	4	4	4	4	4.0	3	1	4	2.7	1	1	4	4	3	4	4	1	2.8	3.2	2.0
103	3	3	3.0	3	4	4	3	3.5	4	1	4	3.0	3	3	4	4	3	3	4	1	3.1	3.2	3.0
104	4	3	3.5	4	2	4	4	3.5	0	1	4	1.7	1	1	2	2	2	2	4	1	1.9	2.2	1.3
105	3	0	1.5	4	2	4	4	3.5	1	1	4	2.0	3	4	2	2	2	3	3	1	2.5	2.0	3.3
106	1	2	1.5	4	2	4	2	3.0	4	1	2	2.3	1	1	2	2	2	4	1	1	1.8	1.6	2.0
107	4	4	4.0	1	2	3	4	2.5	2	0	4	2.0	4	4	2	2	2	3	4	1	2.8	2.2	3.7
108	4	3	3.5	3	2	4	4	3.3	2	1	4	2.3	1	2	2	2	2	4	3	1	2.1	2.0	2.3
109	1	3	2.0	1	4	4	2	2.8	0	1	2	1.0	1	1	4	3	3	3	4	2	2.6	3.2	1.7
110	0	0	0.0	3	2	3	1	2.3	4	4	0	2.7	0	0	2	0	0	1	0	0	0.4	0.4	0.3
111	3	0	1.5	3	2	4	0	2.3	1	4	0	1.7	1	1	2	2	0	0	0	0	0.8	0.8	0.7
112	2	3	2.5	4	2	4	0	2.5	0	4	0	1.3	2	2	2	2	2	3	4	1	2.3	2.2	2.3
113	2	2	2.0	3	4	4	1	3.0	2	1	0	1.0	1	1	4	1	1	2	0	0	1.3	1.2	1.3
114	3	3	3.0	3	4	4	2	3.3	2	1	2	1.7	0	0	4	2	0	1	3	3	1.6	2.4	0.3
115	4	3	3.5	4	4	4	3	3.8	4	1	4	3.0	1	1	4	4	4	4	4	4	3.3	4.0	2.0



116	2	0	1.0	3	2	4	0	2.3	1	1	0	0.7	1	0	2	2	2	3	0	0	1.3	1.2	1.3
117	3	4	3.5	4	4	4	4	4.0	1	4	4	3.0	1	0	4	4	3	4	4	4	3.0	3.8	1.7
118	0	0	0.0	0	0	0	0	0.0	0	0	0	0.0	0	0	0	0	0	0	0	0	0.0	0.0	0.0
119	4	3	3.5	4	0	4	1	2.3	0	0	0	0.0	2	0	0	0	0	0	3	1	0.8	0.8	0.7
120	0	0	0.0	0	0	0	0	0.0	0	0	0	0.0	0	0	0	0	0	0	0	0	0.0	0.0	0.0
121	1	1	1.0	0	0	3	1	1.0	0	0	1	0.3	0	0	0	0	0	0	0	0	0.0	0.0	0.0
122	4	1	2.5	4	4	4	2	3.5	3	4	4	3.7	4	0	3	3	1	3	4	1	2.4	2.4	2.3
123	3	1	2.0	3	2	2	1	2.0	1	1	2	1.3	1	1	2	2	1	2	1	0	1.3	1.2	1.3
124	1	4	2.5	4	4	4	4	4.0	3	4	4	3.7	1	0	4	4	4	3	4	1	2.6	3.4	1.3
125	4	4	4.0	2	2	4	4	3.0	0	1	4	1.7	0	0	2	2	2	3	4	1	1.8	2.2	1.0
126	1	3	2.0	4	4	4	4	4.0	4	1	4	3.0	3	3	4	3	3	3	4	1	3.0	3.0	3.0
127	1	0	0.5	1	2	0	0	0.8	1	0	0	0.3	0	0	2	0	0	0	0	0	0.3	0.4	0.0
128	1	3	2.0	1	4	4	3	3.0	1	1	3	1.7	2	1	4	3	3	3	2	1	2.4	2.6	2.0
129	1	4	2.5	1	2	3	2	2.0	1	1	4	2.0	0	0	2	1	1	1	3	0	1.0	1.4	0.3
130	2	3	2.5	4	2	4	2	3.0	4	1	2	2.3	1	1	2	2	2	1	2	1	1.5	1.8	1.0
131	1	3	2.0	1	3	4	2	2.5	1	1	2	1.3	0	0	1	3	3	3	4	1	1.9	2.4	1.0
132	3	3	3.0	3	2	4	4	3.3	2	4	4	3.3	4	4	2	2	2	4	4	1	2.9	2.2	4.0
133	2	3	2.5	0	2	4	0	1.5	0	4	0	1.3	0	0	2	2	2	3	1	1	1.4	1.6	1.0
134	4	4	4.0	1	4	4	2	2.8	0	4	3	2.3	0	0	4	4	3	3	4	0	2.3	3.0	1.0
135	4	4	4.0	4	3	0	4	2.8	4	0	0	1.3	3	1	1	0	0	0	1	1	0.9	0.6	1.3
136	1	3	2.0	3	1	2	1	1.8	2	1	1	1.3	2	0	1	0	0	1	3	0	0.9	0.8	1.0
137	1	3	2.0	2	4	3	1	2.5	2	1	1	1.3	2	2	3	3	3	4	4	1	2.8	2.8	2.7
138	2	2	2.0	2	3	4	1	2.5	1	1	1	1.0	1	1	1	2	2	1	4	1	1.6	2.0	1.0
139	0	3	1.5	0	4	4	4	3.0	0	1	4	1.7	0	0	4	3	3	4	3	3	2.5	3.2	1.3
140	1	1	1.0	2	1	4	1	2.0	0	1	0	0.3	1	0	1	1	1	1	1	1	0.9	1.0	0.7
141	4	0	2.0	1	2	4	0	1.8	2	1	0	1.0	3	1	2	0	0	1	0	0	0.9	0.4	1.7
142	1	3	2.0	2	2	4	4	3.0	2	1	4	2.3	1	1	2	2	2	2	3	3	2.0	2.4	1.3
143	4	2	3.0	4	2	1	4	2.8	1	4	1	2.0	2	1	2	1	1	1	2	2	1.5	1.6	1.3
144	1	3	2.0	4	2	2	4	3.0	0	1	0	0.3	2	1	2	2	2	1	4	1	1.9	2.2	1.3
145	0	3	1.5	0	2	4	3	2.3	0	4	4	2.7	1	1	2	2	2	3	4	4	2.4	2.8	1.7
146	2	4	3.0	4	0	4	4	3.0	3	1	4	2.7	2	0	0	2	2	1	2	0	1.1	1.2	1.0
147	2	2	2.0	1	0	4	2	1.8	3	1	2	2.0	3	0	0	0	0	1	2	0	0.8	0.4	1.3
148	1	4	2.5	0	4	4	4	3.0	0	1	4	1.7	0	0	4	3	4	1	4	1	2.1	3.2	0.3
149	4	4	4.0	2	1	4	2	2.3	1	1	2	1.3	2	2	2	2	2	4	1	1	2.0	1.6	2.7
150	4	0	2.0	3	2	0	0	1.3	1	0	0	0.3	1	1	2	2	2	0	0	0	1.0	1.2	0.7
151	4	1	2.5	1	1	1	1	1.0	2	1	1	1.3	1	0	1	0	0	3	1	1	0.9	0.6	1.3
	GMNP	GMNP	GMNP av	GR	GR	GR	GR	GR av	CD (V)	CD (V)	CD (V)	CDav	VA 3D	VA 3D	VA 2D	VA 2D	VA 2D	VA 3D	VA 2D	VA 2D	VA av	VA2D av	VA3D av

APPENDIX 6D: RESPONSES FROM THE SEVEN STUDENTS

Elements	GMNP	GMNP	GR	GR	GR	GR	CD(V)	CD(V)	CD(V)	VA2D	VA2D	VA2D	VA2D	VA2D	VA3D	VA3D	VA3D
Question	1.1	4.1	1.1	2.1	3.1	4.1	1.1	3.1	4.1	2.1	2.2	2.3	4.2	4.3	1.2	1.3	3.2
S1	4	0	4	4	4	0	1	4	0	4	3	2	0	0	3	3	2
S2	4	4	4	4	4	0	1	4	0	4	4	4	0	0	3	2	3
S3	4	1	1	2	1	1	1	0	2	1	1	1	1	1	1	1	0
S4	4	2	4	4	4	0	1	0	2	4	4	4	0	0	3	1	0
S5	4	0	4	4	4	2	1	4	0	4	2	2	0	0	1	1	2
S6	4	0	4	4	0	4	1	0	4	4	4	4	2	1	3	1	0
S7	4	4	4	4	4	4	4	4	4	4	3	3	4	4	3	1	3
	GMNP		GR				CD(V)			VA2D					VA3D		
FC	9		19				7			14					0		
AC	0		0				0			3					8		
TU	1		2				2			4					3		
NU	1		3				6			6					7		
ND	3		4				6			8					3		
TOTAL	14		28				21			35					21		
% (FC+ AC)	64.3		67.9				33.3			48.6					38.1		

APPENDIX 7A: CONSENT FORM FOR STUDENTS

RESEARCH ON APPLICATION OF CALCULUS INVOLVING VISUALISATIONS: FROM AREAS TO VOLUMES

RESEARCH TO BE CONDUCTED BY: BLK MOFOLO

A PhD STUDY

MARCH 2007

As a Mathematician and a Mathematics Instructor for the past **13 years**, I have been mostly worried about the way in which mathematics students in general battle with a section on **application of calculus including areas and volumes**. Most students in High schools, Technical Colleges (now referred to as College for FET) and Technikons (now referred to as Universities for Technology or Comprehensive Universities) are struggling with this section, they take time to learn what is required, some do not even manage to get it right. Most students nationally do not attempt questions under this section during the examination (if they attempt them they do not perform well). I decided to conduct a study, where I investigate how students learn this section with a particular focus on visualization, either dynamic (animations and graphics) with software or static with pictures.

I am doing research to promote the teaching and learning of calculus. **Students participating in this research do so voluntarily. Their names will not be revealed, only their written and verbal comments will be used.**

To be completed by students

Surname:

Course:

Subject and level:

Signature:

Date:

I voluntarily participated to be part of this research. I am aware that the results from this research will be used to promote teaching and learning of calculus and for publications.

APPENDIX 7B: CONSENT FORM FOR CLASSROOM OBSERVATIONS

RESEARCH ON APPLICATION OF CALCULUS INVOLVING VISUALISATIONS: FROM AREAS TO VOLUMES

RESEARCH TO BE CONDUCTED BY: BLK MOFOLO: OCTOBER 2007

A PhD STUDY: University of PRETORIA

As a Mathematician and a Mathematics Instructor, I have been mostly worried about the way in which Mathematics students in general battle with a section on **application of Calculus on Areas and Volumes**. Most students in High schools, at the FET Colleges and at Universities battle with this section. Most students do not attempt examination questions under this section. My study is aimed at investigating some of these difficulties, where students' written and verbal interpretations will be recorded. A video recorder will be used to record all classroom interactions as teaching and learning takes place. Participation in this research is voluntary. All the recordings will be used for research only. The students' names, faces and their lecturer's name will not be revealed, only their interpretations as they solve problems will be used.

The results of this research will be shared by the Colleges and the Department of Education in order to promote teaching and learning in this section.

I(Surname and Initials)

Voluntarily participate in this research

Signature.....

Date.....

Subject.....

Institution.....

APPENDIX 7C: CONSENT FORM FOR INSTITUTIONS



Pretoria 0002, South Africa

<http://www.up.ac.za/academic/maths/>

Department of Mathematics and Applied

Mathematics

School for Mathematics

01 October 2007

This is to certify that Ms BLK Mofolo is registered at our university for the PhD degree in Mathematics Education under my supervision with prof AF Harding as co-supervisor.

She requests permission from the department to analyse students' scripts at the department for previous as well as forthcoming examinations. She would also like to have the statistics of the mathematics results for all 50 FET Colleges in South Africa which she will use in her research. The aim with her research is to investigate difficulties encountered by students as they solve problems on the section on solids of revolution which constitutes about 20%-40% of the final examinations.

Prof JC Engelbrecht

DEPARTMENT OF MATHEMATICS AND APPLIED MATHEMATICS

Ms Mofolo BLK

UNIVERSITY OF JOHANNESBURG

0825941271

APPENDIX 7D: CONSENT FORM FOR THE NATIONAL EXAMINATION



Pretoria 0002, South Africa

<http://www.up.ac.za/academic/maths/>

Department of Mathematics and Applied

Mathematics

School for Mathematics

01 October 2007

This is to certify that ms BLK Mofolo is registered at our university for the PhD degree in Mathematics Education under my supervision with prof AF Harding as co supervisor.

She requests permission from your institution to administer a research instrument on volumes of solids of revolution. The aim of her research is to investigate difficulties encountered by students as they solve problems on the section on solids of revolution which constitutes about 20%-40% of the final examinations.

The research will involve students completing a questionnaire consisting of mathematics questions and interviews with students and lecturers.

Prof JC Engelbrecht

DEPARTMENT OF MATHEMATICS AND APPLIED MATHEMATICS