

**Investigation of mobility of trace elements in river sediments using
ICP-OES**

by

Mr Paul Johannes Botes

Submitted in partial fulfilment of the requirements for the degree

MAGISTER SCIENTIAE

In the Faculty of Natural and Agricultural Science

University of Pretoria

Pretoria

December 2003

Table of Content

Synopsis	i
Acknowledgements	ii
1 Introduction	1
1.1 The scope of this thesis	1
1.2 The study area	2
1.2.1 Blesbokspruit (Sample Point No 1)	3
1.2.1.1 Land Use	3
1.2.1.2 Geology and Vegetation	3
1.2.2 Crocodile River (Sample Point No 2)	5
1.2.2.1 Land Use	5
1.2.2.2 Geology and Vegetation	5
1.2.3 Olifants River (Sample Point No3)	7
1.3 Inductively Coupled Plasma Spectroscopy as an analytical method	10
1.4 References	13
2 Inductively Coupled Plasma Atomic Emission Spectroscopy (ICP-OES)	14
2.1 The theory and principles of ICP-OES	14
2.2 The various components of an ICP-OES	16
2.2.1 Sample Introduction System for samples in solution	16

2.2.1.1	Peristaltic pump	16
2.2.1.2	Nebulizers	16
2.2.1.3	Spray chambers	21
2.2.2	The inductively coupled plasma, ICP torch and gas supply	22
2.2.2.1	The inductively coupled plasma (ICP)	22
2.2.2.2	The ICP torch	23
2.2.2.3	Gas supply	24
2.2.3	Radio Frequency Generator (RF)	25
2.2.4	Spectrometer	26
2.2.4.1	General requirement of a spectrometer	26
2.2.4.2	Main spectrometers used in ICP-OES	28
2.2.4.3	Simultaneous ICP-OES Polychromator	28
2.2.4.4	Sequential ICP-OES Monochromator	30
2.2.5	Detection of emission	32
2.2.5.1	Photo multiplier tubes	32
2.2.5.2	Charged Transfer Devices	33
2.2.6	Requirements of the data collection system	33
2.3	Interferences in ICP-OES	34
2.3.1	Matrix effects	34
2.3.1.1	Physical interference	34
2.3.1.2	Chemical interference	35

2.3.1.3	Ionization interference	35
2.3.2	Spectral overlap	35
2.3.2.1	Direct overlap	36
2.3.2.2	Wing overlap	36
2.3.2.3	Continuum radiation	37
2.3.2.4	Stray light	38
2.3.2.5	Spectral lines and molecular bands from discharge atmosphere	39
2.3.3	Inter-element interference correction	40
2.4	References	41
3	Characteristics of sediments and soils	42
3.1	Adsorption in soils and sediments	42
3.1.1	Forces of Adsorption	42
3.1.1.1	Physical forces	42
3.1.1.2	Hydrogen bonds	43
3.1.1.3	Electrostatic bonding	43
3.1.1.4	Coordination reactions	43
3.2	Factors Influencing Metal Ion Adsorption	44
3.2.1	Adsorption of cations by sediment colloids	44
3.2.2	Cation exchange reactions	44

3.2.3	Specific adsorption	45
3.2.4	Organic complexation	45
3.2.5	Selectivity of absorbents for different metals	46
3.3	Sediment Capacity for Trace Elements	46
3.3.1	Sediment pH	46
3.3.2	Cation Exchange Capacity (CEC)	47
3.3.3	Organic Matter	47
3.3.4	Amount and type of clay	48
3.3.5	Oxides of iron, manganese and aluminium	48
3.3.6	Redox potential	49
3.4	References	49
4	Characteristics and sources of trace elements in the environments	51
4.1	Sources of trace elements in sediment and soil	51
4.1.1	Sediment and soil parent rock material	51
4.1.2	Agricultural and commercial fertilizer materials	52
4.1.3	Mining and smelting processes and metallurgical industries	53
4.1.4	Land disposal of sewage sludge and municipal wastes	54
4.1.5	Electronics industries	55
4.1.6	Chemical and other industries	55
4.1.7	Coal residues and combustion of fossil fuels	56

4.2	Trace elements and their characteristics	56
4.2.1	Arsenic (As)	56
4.2.1.1	General characteristics	56
4.2.1.2	Application and possible pollution contributors	57
4.2.1.3	Natural occurrence in the environment	57
4.2.1.4	Factors influencing the mobility of arsenic in sediments and soil	58
4.2.1.5	Toxicity of arsenic	58
4.2.2	Barium (Ba)	59
4.2.2.1	General characteristics	59
4.2.2.2	Application and possible pollution contributors	59
4.2.2.3	Natural occurrence in the environment	60
4.2.2.4	Factors influencing the mobility of barium in sediments and soil	60
4.2.2.5	Toxicity of barium	60
4.2.3	Cadmium (Cd)	61
4.2.3.1	General characteristics	61
4.2.3.2	Application and possible pollution contributors	61
4.2.3.3	Natural occurrence in the environment	62
4.2.3.4	Factors influencing the mobility of cadmium in sediments and soil	62

4.2.3.5	Toxicity of cadmium	62
4.2.4	Chromium (Cr)	63
4.2.4.1	General characteristics	63
4.2.4.2	Application and possible pollution contributors	63
4.2.4.3	Natural occurrence in the environment	64
4.2.4.4	Factors influencing the mobility of chromium in sediments and soil	64
4.2.4.5	Toxicity of chromium	64
4.2.5	Cobalt (Co)	65
4.2.5.1	General characteristics	65
4.2.5.2	Application and possible pollution contributors	65
4.2.5.3	Natural occurrence in the environment	65
4.2.5.4	Factors influencing the mobility of cobalt in sediments and soil	66
4.2.5.5	Toxicity of cobalt	66
4.2.6	Copper (Cu)	66
4.2.6.1	General characteristics	66
4.2.6.2	Application and possible pollution contributors	67
4.2.6.3	Natural occurrence in the environment	67
4.2.6.4	Factors influencing the mobility of copper in sediments and soil	67

4.2.6.5	Toxicity of copper	68
4.2.7	Iron (Fe)	68
4.2.7.1	General characteristics	68
4.2.7.2	Application and possible pollution contributors	68
4.2.7.3	Natural occurrence in the environment	69
4.2.7.4	Factors influencing the mobility of iron in sediments and soil	69
4.2.7.5	Toxicity of iron	70
4.2.8	Mercury (Hg)	70
4.2.8.1	General characteristics	70
4.2.8.2	Application and possible pollution contributors	71
4.2.8.3	Natural occurrence in the environment	71
4.2.8.4	Factors influencing the mobility of mercury in sediments and soil	71
4.2.8.5	Toxicity of mercury	72
4.2.9	Manganese (Mn)	72
4.2.9.1	General characteristics	72
4.2.9.2	Application and possible pollution contributors	73
4.2.9.3	Natural occurrence in the environment	73
4.2.9.4	Factors influencing the mobility of manganese in sediments and soil	73

4.2.9.5	Toxicity of manganese	74
4.2.10	Molybdenum (Mo)	74
4.2.10.1	General characteristics	74
4.2.10.2	Application and possible pollution contributors	75
4.2.10.3	Natural occurrence in the environment	75
4.2.10.4	Factors influencing the mobility of molybdenum in sediments and soil	75
4.2.10.5	Toxicity of molybdenum	76
4.2.11	Nickel (Ni)	76
4.2.11.1	General characteristics	76
4.2.11.2	Application and possible pollution contributors	77
4.2.11.3	Natural occurrence in the environment	77
4.2.11.4	Factors influencing the mobility of nickel in sediments and soil	77
4.2.11.5	Toxicity of the nickel	78
4.2.12	Lead (Pb)	78
4.2.12.1	General characteristics	78
4.2.12.2	Application and possible pollution contributors	78
4.2.12.3	Natural occurrence in the environment	79
4.2.12.4	Factors influencing the mobility of lead in sediments and soil	79

4.2.12.5	Toxicity of lead	80
4.2.13	Vanadium (V)	80
4.2.13.1	General characteristics	80
4.2.13.2	Application and possible pollution contributors	80
4.2.13.3	Natural occurrence in the environment	81
4.2.13.4	Factors influencing the mobility of vanadium in sediments and soil	81
4.2.13.5	Toxicity of vanadium	81
4.2.14	Zinc (Zn)	82
4.2.14.1	General characteristics	82
4.2.14.2	Application and possible pollution contributors	82
4.2.14.3	Natural occurrence in the environment	82
4.2.14.4	Factors influencing the mobility of zinc in sediments and soil	83
4.2.14.5	Toxicity of zinc	83
4.2.15	Zirconium (Zr)	84
4.2.15.1	General characteristics	84
4.2.15.2	Application and possible pollution contributors	84
4.2.15.3	Natural occurrence in the environment	84
4.2.15.4	Factors influencing the mobility of zirconium in sediments and soil	85

4.2.15.5	Toxicity of zirconium	85
4.3	References	85
5	Experimental Procedures	89
5.1	Sampling procedure	89
5.1.1	Preparation of sampling equipment	89
5.1.2	River sediment sampling	89
5.1.3	River water sampling	90
5.2	Sample preparation	91
5.2.1	River sediment sample preparation	91
5.2.2	River water preparation	93
5.2.3	Extract solutions	93
5.3	Experimental Procedure	94
5.3.1	Sediment digestion procedure	94
5.3.2	Tube experiment procedure	95
5.3.3	Shaker experiment procedure	97
5.3.4	Trace element spiking procedure	97
5.3.5	Preparation of dilutions of samples	98
5.4	ICP-OES parameters	98
5.4.1	Instrument parameters for analysis	98
5.4.2	Wavelength and limit of detection (LOD)	99

5.4.3	Quality Assurance	100
5.5	References	102
6	Analytical Results and Discussion	105
6.1	River water analytical result	105
6.2	Digestion analytical results of the different fractions of the river sediments	106
6.2.1	Digestion results of Blesbokspruit	106
6.2.2	Digestion results of the 3 fractions of the Crocodile River	106
6.2.3	Digestion results of Olifants River sand layer	107
6.2.4	Digestion results of Olifants River clay layer	107
6.2.5	Digestion results of the certified reference material NCS DC 73317	108
6.3	Blank sediment column extract and shaker extract test	108
6.4	Discussion on the results of the Blesbokspruit samples	109
6.4.1	Results of the Blesbokspruit water sample	109
6.4.2	Blesbokspruit sediment digestion results	109
6.4.3	Blesbokspruit sediment column leaching tests results	110
6.4.4	Blesbokspruit sediment shaker method leaching tests results	114
6.4.5	Blesbokspruit sediment spiking results	119
6.5	Discussion on the results of the Crocodile River samples	121

6.5.1	Results of the Crocodile River water sample	121
6.5.2	Crocodile River sediment digestion results	122
6.5.3	Crocodile River sediment column leaching tests results	122
6.5.4	Crocodile River sediment shaker method leaching tests results	124
6.5.5	Crocodile River sediment spiking results	126
6.6	Discussion on the results of the Olifants River sand layer samples	127
6.6.1	Results of the Olifants River water sample	127
6.6.2	Olifants River sand layer sediment digestion results	128
6.6.3	Olifants River sand layer sediment column leaching tests results	128
6.6.4	Olifants River sand layer sediment shaker method leaching tests results	130
6.6.5	Olifants River sand layer sediment spiking results	131
6.6.6	Olifants River clay layer sediment digestion results	133
6.6.7	Olifants River clay layer sediment column leaching tests results	133
6.6.8	Olifants River clay layer sediment shaker method leaching tests results	134
6.6.9	Olifants River clay layer sediment spiking results	136
7	Conclusion and Recommendations	138
7.1	Conclusion on the results obtained from this study	138
7.1.1	Blesbokspruit sediment results	138
7.1.2	Crocodile River sediment results	139

7.1.3	Olifants River sediment results	140
7.1.4	Sediment fractions	141
7.1.5	Analytical procedures	142
7.1.5.1	Column method of leaching trace elements	142
7.1.5.2	Shaker method of leaching trace elements	142
7.1.5.3	Digestion of sediment samples	143
7.1.5.4	ICP-OES and quality control parameters	143
7.2	Recommendations	144

Appendixes

List of Maps

Map 1: Map showing location of sample points	2
Map 2: Map showing land use in the Blesbokspruit area	4
Map 3: Map showing land use in the Crocodile River area	6
Map 4: Map showing land use in the Olifants River area	8
Map 5: Map showing the geology in the vicinity of the three sample points	9

List of Figures

Figure 1: Schematic diagram of an inductively coupled plasma optical emission spectrometer	15
Figure 2: The geometry of a typical Meinhard nebulizer and different tip designs	18
Figure 3: Typical cross flow type nebulizer	19

Figure 4: Typical Babington type nebulizer	20
Figure 5: Schematic diagram of a double pass Scott type spray chamber	21
Figure 6: Schematic representation of the different zones in the ICP	23
Figure 7: An illustration of a Scott-Fassel type torch for ICP-OES	24
Figure 8: Multi-channel simultaneous spectrometer using the Paschen-Runge mounting	29
Figure 9: Typical side-window photomultiplier tube	32
Figure 10: Example of direct overlap	36
Figure 11: Example of wing overlap	37
Figure 12: Example of continuum radiation	38
Figure 13: Experimental set up of the tube experiment	96
List of Photographs	
Photograph 1: Sampling at the Olifants River sampling point	90
Photograph 2: Sediment tubes from the Olifants River sampling point	91
List of Tables	
Table 1: Percentage sample representivity of the river sediment samples	92
Table 2: Preparation of the mobile phases	94
Table 3: Instrument set-up and operating parameters	98
Table 4: Analysis wavelength, LOD and calibration range of determinants	100

Table 5a: River water analytical results using ICP-OES (Spectroflame Modula)	105
Table 5b: River water pH results using Knick pH meter	105
Table 6a: Results of the different fractions after digestion (Blesbokspruit)	106
Table 6b: Results of the different fractions after digestion (Crocodile River)	106
Table 6c: Results of the different fractions after digestion (Olifants River sand layer)	107
Table 6d: Results of the different fractions after digestion (Olifants River clay layer)	107
Table 6e: Results of the certified reference material (CRM) NCS DC 73317	108

Lists of Graphs

Graph 1: Mobility of elements present in Fraction 1 (column method) of Blesbokspruit sediment	114
Graph 2: Mobility of the elements present in Fraction 1 (shaker method) of Blesbokspruit sediment	118
Graph 3: Recovery results if the spiked elements in fraction 1 (column method) of Blesbokspruit sediment	120
Graph 4: Recovery results if the spiked elements in fraction 1 (shaker method) of Blesbokspruit sediment	121
Graph 5: Mobility of elements present in Fraction 1 (column method) of Crocodile River sediment	124

Graph 6: Mobility of the elements present in Fraction 1 (shaker method) of Crocodile River sediment	125
Graph 7: Recovery results if the spiked elements in fraction 1 (column method) of Crocodile River sediment	126
Graph 8: Recovery results if the spiked elements in fraction 1 (shaker method) of Crocodile River sediment	127
Graph 9: Mobility of elements present in Fraction 1 (column method) of Olifants River sand layer sediment	129
Graph 10: Mobility of the elements present in Fraction 1 (shaker method) of Olifants River sand layer sediment	131
Graph 11: Recovery results if the spiked elements in fraction 1 (column method) of Olifants River sand layer sediment	132
Graph 12: Recovery results if the spiked elements in fraction 1 (shaker method) of Olifants River sand layer sediment	132
Graph 13: Mobility of elements present in Fraction 1 (column method) of Olifants River clay layer sediment	134
Graph 14: Mobility of the elements present in Fraction 1 (shaker method) of Olifants River clay layer sediment	135
Graph 15: Recovery results if the spiked elements in fraction 1 (column method) of Olifants River clay layer sediment	136
Graph 16: Recovery results if the spiked elements in fraction 1 (shaker method) of Olifants River clay layer sediment	137

Synopsis

This study focused on the pH dependant mobility of 15 trace elements in river sediments in South Africa. These river sediments originated from the Blesbokspruit (near Witbank in the Mpumalanga Province), the Crocodile River (near Hartebeespoort Dam in the Gauteng Province) and the Olifants River (near Ohrigstad in the Northern Province). A theoretical discussion on the properties of the measured trace elements and the ICP-OES technique were included in this study for the sake of completeness. Three different fractions of river sediment (smaller than 0.2 mm, bigger than 0.2 mm and unsieved) were investigated using two different leaching techniques and a digestion procedure to determine the total trace element content. The sediment was subjected to simulated pollution by trace element through the addition of standard solutions in know concentrations. These results it were evaluated to determine the possible behaviour of trace elements that is not presently present in the river sediment. The results obtained from this study were used to determine the impact that trace elements may have in the pollution of the underground water resources.

Acknowledgements

I would like to thank my wife, Bianca, for her encouragement, assistance and patience throughout the study period.

Thanks to my supervisor, Professor J. F. van Staden, for all his assistance and inputs to complete this study.

I would like to thank the Department of Water Affairs and Forestry for allowing me to complete this study, the financial assistance and the opportunity to use the laboratory facilities to produce reliable and good quality results.

Special thanks go to all my colleagues that assisted me and made suggestion to improve the work produce.

Finally, thanks to my parents for always believing in me and supporting me.

Chapter 1

Introduction

1.1. The scope of this thesis

In the past, water quality assessment techniques were the main tool used to assess the impact that humans have on the environment. However, soil and river sediments are also prone to contamination from atmospheric and hydrological sources. In South Africa, this indicator of pollution is not that intensively investigated in comparison to the water resource component.

The purpose of this study is to establish ambient concentration values of trace metals in the chosen river sediments. These river sediments originated from the Blesbokspruit (near Witbank in the Mpumalanga Province), Crocodile River (near Hartebeespoort Dam in the Gauteng Province) and Olifants River (near Ohrigstad in the Northern Province). The sediments were investigated to establish their ability to adsorb trace metals. The mobility of the trace metals was also investigated to establish the possibility that trace metals present in the sediments can be mobilised under certain environmental conditions. Two different methods were used to extract the trace metals and these methods were evaluated to determine their suitability. The river sediments were also subjected to a total digestion procedure to determine the total trace metal content. After sample preparation, all of the samples were analysed using an inductively coupled plasma spectrometer.

1.2. The study area

In this study, two main catchments were identified to investigate the trace metals levels in the sediments and the water components of the selected rivers (Map 1). The rivers were selected according to the type of land use activities found within the catchment area and the importance of the water quality and integrity of the water resources. The two river catchments that were chosen were the Olifants River (Mpumalanga and Northern Province) and the Crocodile River (Gauteng Province) to be investigated. The sample area covers land use activities ranging from predominantly coal and iron mining to agriculture and forestry [1].

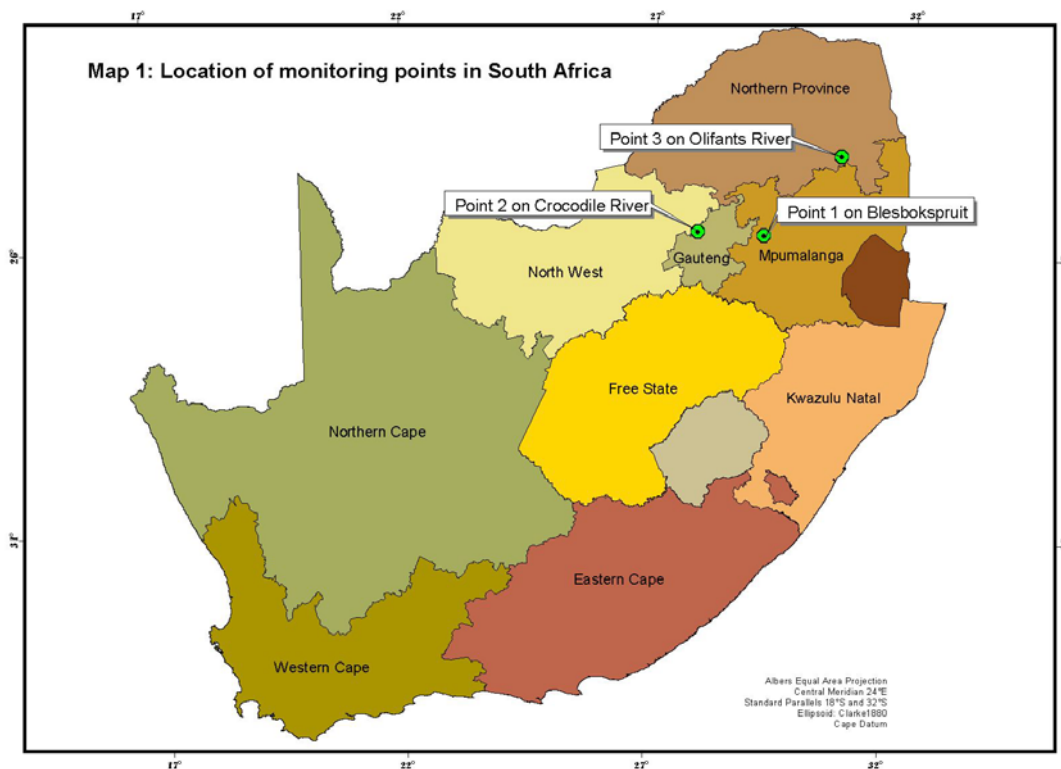

Map 1. Map showing location of sample points

1.2.1. Blesbokspruit (Sample Point No 1)

1.2.1.1 Land Use (Map 2) [2]

This tributary of the Olifants River is classified as part of the Upper Olifants River catchment. This area is heavily impacted upon by point and non point source discharges. The main land use activities are mining, especially coal and ferrometal mines. Acid mine drainage problems are found especially in the case of abandoned coalmines. Urban developments including Middelburg, Witbank and Bronkhorstspuit have also a role to play in the overall impact on the environment and the water quality. Large industries and power stations can also have a significant impact on the environment. Farming is not practised extensive in the area, but the main farming activities that are encountered are temporary dryland and livestock farming [3]. If the abovementioned activities go ahead without careful monitoring, they can influence the water quality and have an impact on the river sediments.

1.2.1.2 Geology and Vegetation

The geology in the area is mainly described as sandstone, shale, coal and carbonaceous shale (Map 5) [4]. With deposits of coal and iron, it is common to find high deposits of sulphur or sulphates, mainly in the form of pyrite (FeS_2). This can in turn be oxidised in the presence of oxygen, water and bacteria. The end product of this process is the production of sulphuric acid (H_2SO_4) [5]. This has a major impact on the pH of the water, with increase in acidification and this in turn causes trace metals to be more soluble. When the pH value increases, the solubility of the trace metals decrease and the metals are

deposited in the river sediments. With the increased levels of sulphate and nutrients in the water and in turn stimulate aquatic vegetation growth, resulting in encroachment of the water bodies [6].

The most widespread soil group is the Hutton horizon; these are well-drained red apedal soils. These soils range from loams to clays; from deep to shallow.

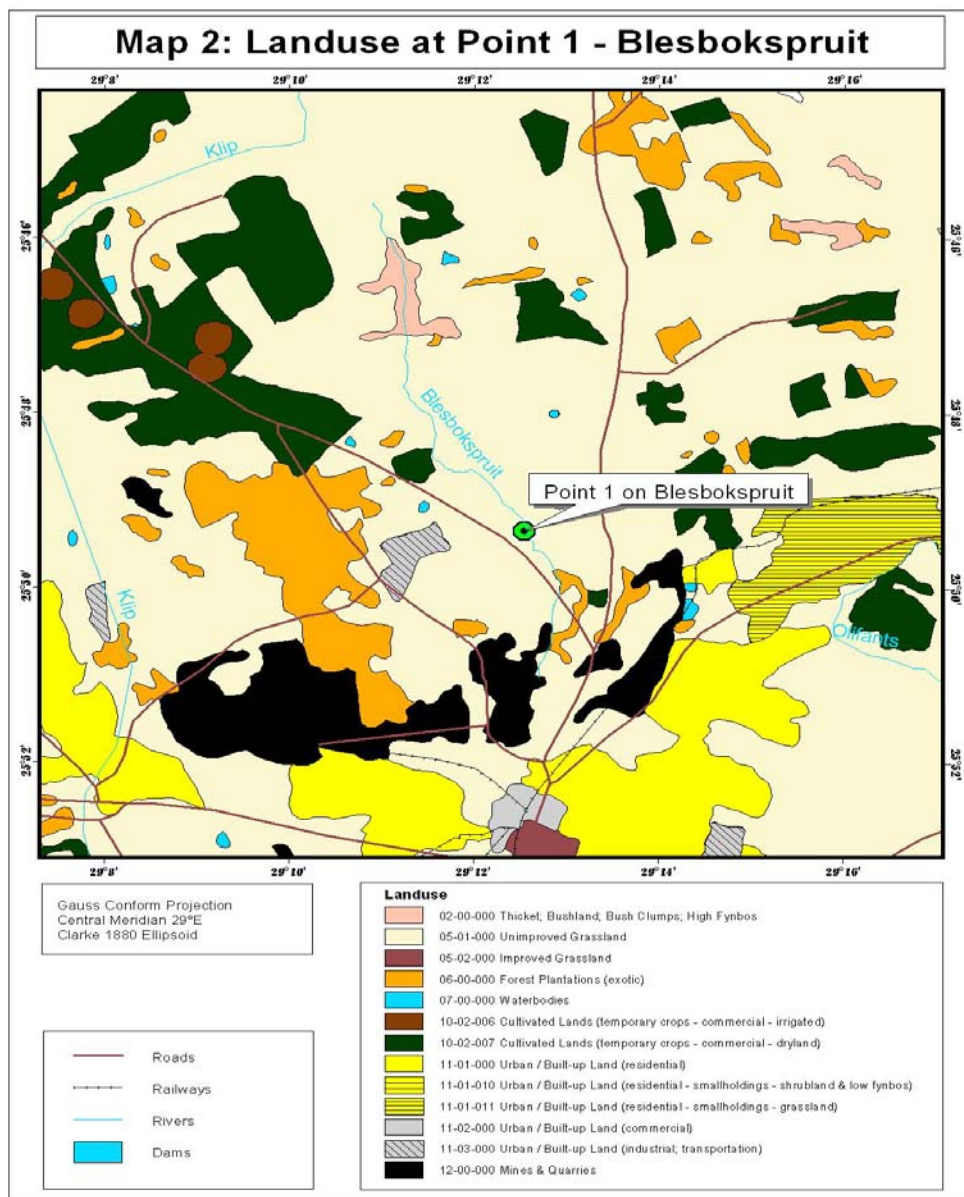

Map 2. Map showing land use in the Blesbokspruit area

1.2.2 Crocodile River (Sample Point No 2)

1.2.2.1 Land Use (Map 3) [2]

The land use in this catchment centres mainly on agriculture and forestry. Commercial forestry comprises 16.5% of the catchment area. Agriculture is divided into two parts, which consist of dry land and irrigation agriculture. Dry land agriculture produces crops like maize, sub-tropical fruits, citrus and nuts. The most important of the crops cultivated under irrigation are citrus and sugar cane. Both types of agriculture may lead to increased levels of nutrients in the water and soils if fertilisers are used in excess of the crop's requirements and if there is irrigation return flows. The main mining activities in the area consist of chromium, platinum and vanadium mining. Urban development and informal settlements have a detrimental influence on the quality of the environment in this area due to industrial and domestic wastes. Smaller game farming and cattle ranching activities when properly managed have a lesser impact on the state of the catchment, from a water quality perspective [3].

1.2.2.2 Geology and Vegetation

The geology in the area consists mainly of the following: quartzite, shale, basalt, andesite, conglomerate, iron, jaspilite, dolomite, chert, porphyritic and amygdaloidal rocks. (Map 5) [4]. The soils are shallow to deep sandy, loam to sandy clay in the Highveld plateau, while in the higher altitudes the dominant type is lithosols. The vegetation in the catchment is mainly in the savanna biotope with grasslands dominating the western parts thereof [4].

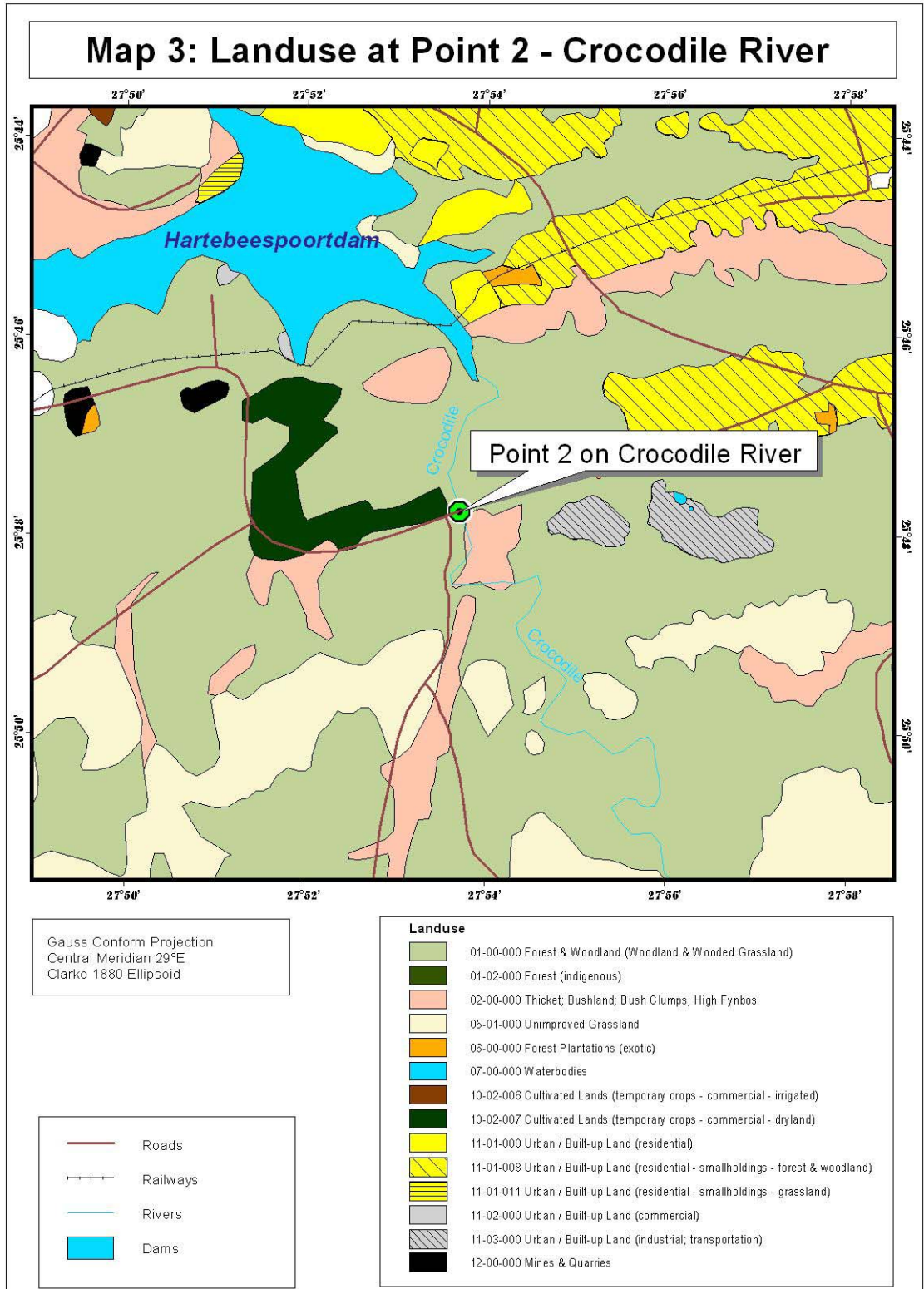

Map 3. Map showing land use in the Crocodile River area

1.2.3 Olifants River (Sampling Point No 3)

1.2.3.1 Land Use (Map 4) [2]

The sample point on the Olifants River is in the mountain to lower catchment. The most important land use activities in the mountain region are small and large scale irrigation farming, afforestation, stock watering and urban developments e.g. Lydenburg, Steelpoort and Burgersfort. In the lower part of the catchment the following land use activities are of importance: precious and base metal mining, small-scale irrigation farming and urban development e.g. Phalaborwa. The mining activities are mainly concentrated in the Steelpoort River valley and at Phalaborwa (phosphate mining) [3]. The Olifants catchment is experiencing an extreme demand for natural resources. This is closely associated with land modification and pollution [7].

1.2.3.2 Geology and Vegetation

The geology in the area is mainly consisting of the following: Iron, jaspilite, syenite, hornblende granite, potassic granite, foskorite and diorite. (Map 5) [4]. The soil is mainly the Hutton horizon and consists of well-drained red apedal soils. These soils vary from loams to clays, from deep to shallow and covers all the trophic ranges. The vegetation in the catchment is mainly in the savanna biotope with perennial woody plant, which is well adapted to withstand both drought and fire. A very small portion of the catchment is classified in the forest biome and is mainly along the Escarpment. This vegetation is primarily consisting of evergreen woody plants [1].

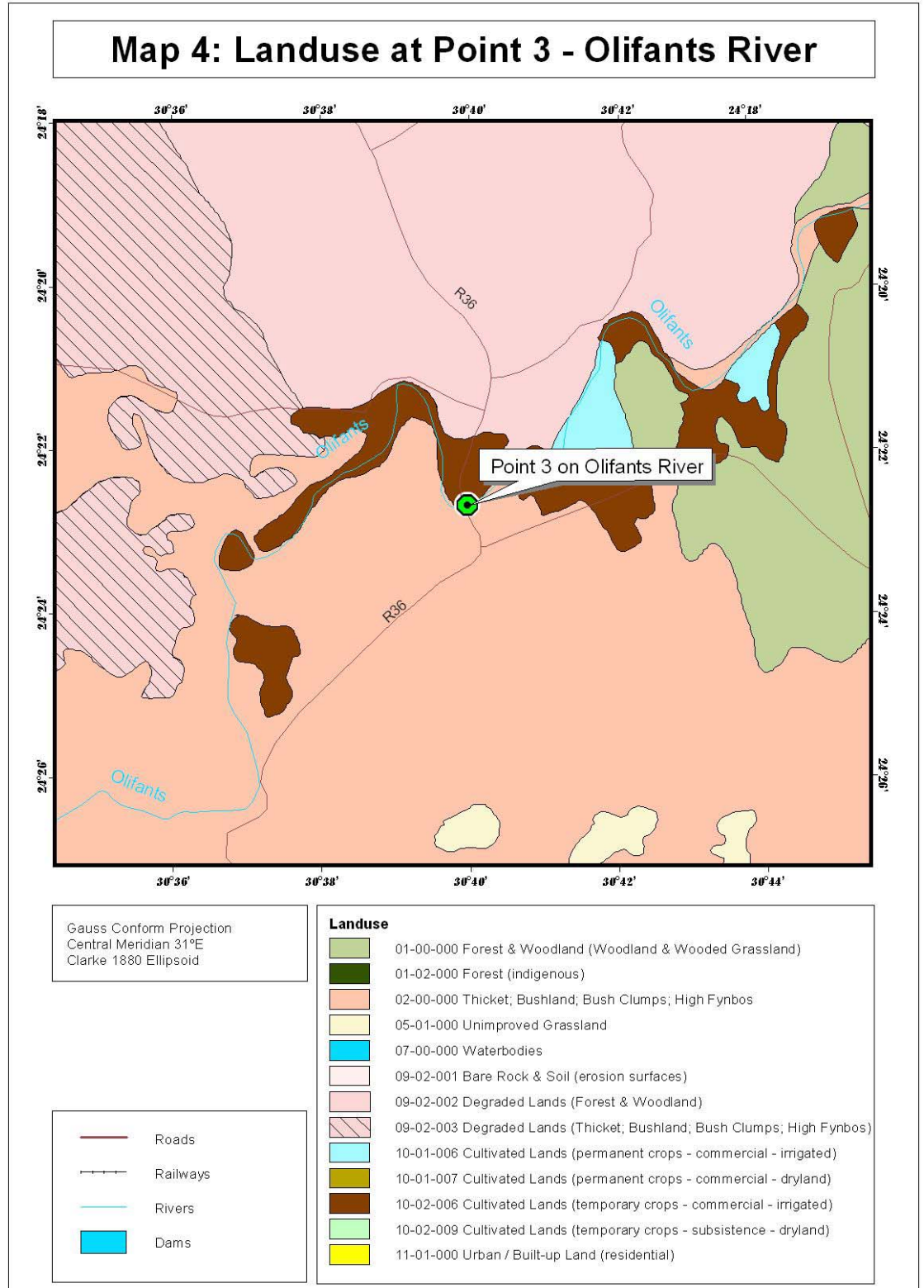

Map 4 Map showing land use in the Olifants River area

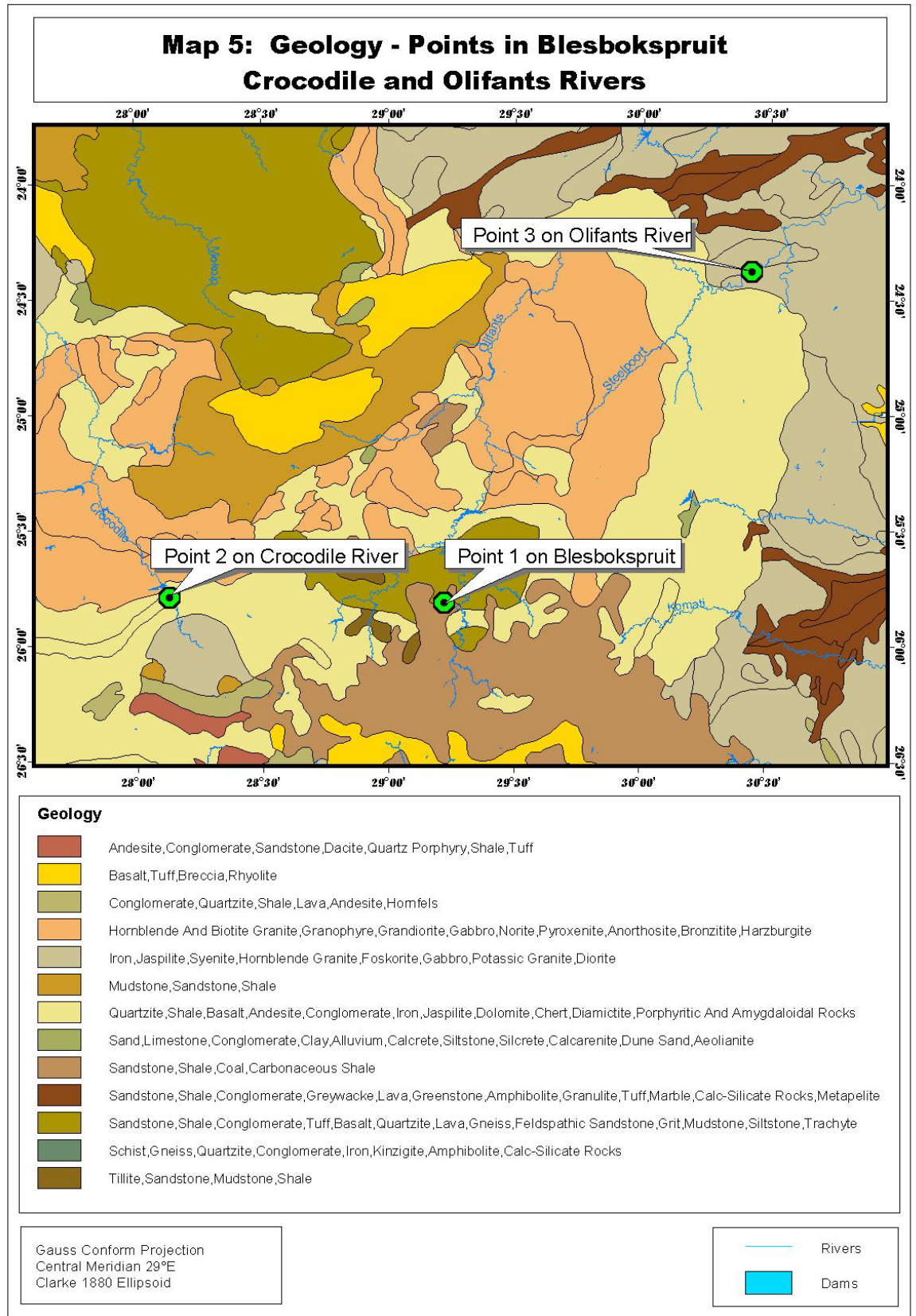

Map 5 Map showing the geology in the vicinity of the three sample points

1.3 Inductively Coupled Plasma Spectroscopy as an analytical method

In the past, Atomic Absorption Spectrometry (AAS) was used to ascertain the concentration of specific elements. This technique was very reliable, but very time consuming due to the limitation to only one element determination that could be conducted at a time. Recent developments have produced multi-element hollow cathode lamps that are able to analyse more than one element using the same lamp. This, however, when compared to the Inductively Coupled Plasma Optical Emission Spectrometry (ICP-OES) technique is still not at the same performance level when it comes to sensitivity and sample throughput.

Interest in the ICP-OES stems not only from the high sensitivity of the ICP-OES sources, but also the increasing realisation of the advantages to effectively quantify multi-elements in solution for a variety of samples [8]. These mentioned samples range from biological, geological and environmental materials to high viscosity and flammable organic compounds. As geological material is generally very complex in composition, several sources of interferences are expected. There are several ways of eliminating or minimalising these interferences, which will be discussed in more detail in the next chapter of this thesis. Organic compounds have caused some analytical difficulties, however, a number of innovative solutions have been developed to overcome these problems and have been used with success [9].

For ICP-OES, additional energy is required for the flame to excite the emission of the atomic spectra. This emission spectrum is characteristic of the element whose intensity is not only a function of the atomic concentration in the flame, but also of

the temperature of the flame. The extremely high temperatures attained by the radio-frequency plasma sources are sufficient to produce emission spectra with excellent sensitivity for trace elements whose spectral lines lie well below 200 nm [8]. The main advantage of this technique is that it has a high dynamic range. Thus means that in the same sample, the concentrations of major elements and trace concentrations of elements can be determined together. These concentrations range from the upper mg/L down to the $\mu\text{g/L}$ with minimum difficulty. The concentration from the upper mg/L can be easily determined using adequate calibration procedures and standardisation, before the sample is measured.

In the case of trace element analyses, the abovementioned interferences can cause problems. These can be classified under spectral and/or physical interferences. The spectral interferences are mainly due to overlapping of spectral lines from concomitant elements this problem can be overcome by choosing another analytical line for the interfered analyte, if possible. The physical interferences, such as insufficient nebulization of the sample, or changes in the plasma conditions due to matrix effects, can also play a role in the effectiveness of the analysis. These physical interferences can easily be controlled by using either an internal standard addition technique or by using a control standard to check the performance of the instrument at set intervals.

There are two basic systems available on the market for ICP-OES, namely: Simultaneous and sequential. The simultaneous system's advantage is that the analytical lines are already installed at assembly of the instrument and this mean shorter analysis time and greater sample throughput. However, a complete

investigation must be done before purchasing this type of instrument. The decision on which elements and which analytical line to be installed is critical. The disadvantage of this system is that the user is limited to the installed lines. If there are concomitant elements that interfere on a specific analytical line, one cannot readily analyse for the specific element. The sequential system scans through the wavelength using the monochromator. This system presents more versatility to analyse elements using a variety of analytical lines. As mentioned, the lines are scanned using the monochromator, but this process is time consuming. The analysis is confined to one element at a time. The advantage on this system is the flexibility of wavelength selection. If there is an interferant present in the sample, the user is not restricted to a particular emission line, unlike with the simultaneous system.

At the heart of the ICP-OES system is the spectrometer. This component must comply with the following capabilities to perform adequately for the method. Firstly, the spectrometer must have a high resolution to achieve good separation of the spectral lines, which will reduce the effect of inter-element interference. The spectrometer must exhibit high sensitivity and have adequate light gathering capabilities. The spectrometer must be stable both thermally and mechanically. This will ensure that the instrument has good repeatability and accuracy. The mechanical stability will ensure that the correct wavelength is used to determine the concentration of the analyte. Another advantage of the ICP-OES is with the highly excited species in the plasma the light that is emitted is very intense. This ensures that there is a large difference in the intensity of the line and the background intensity. These detection limits are sample-matrix dependant, and with the use of a new sample type the detection limit must be calculated for it.

1.4 References

1. L Hill, P Vos, J Moolman and M Silberbauer, Inventory of the River Health Programme monitoring sites on the Olifants, Sabie and Crocodile Rivers, Water Research Commission Report no. 850/2/01 (2001)
2. Arc View 3.2, Land cover for South Africa from Landsat images, Forestek (1999)
3. DWAF Mpumalanga, Proposal for the establishment of a catchment management agency for the Olifants Water Management Area: Appendix C. Version 2.2, (2002)
4. Arc View 3.2, Geology map of South Africa, Lesotho and Swaziland (1984)
5. N. N. Greenwood and A Earnshaw, Chemistry of the elements, Pergamon Press, New York (1984), pp 798-805
6. G Quibell and A Belcher, Status report: Monitoring the impact of saline mine water from the Grootvlei mine on aspects of the water environmental quality of the Blesbokspruit wetlands system, Water Research Commission Report no. N/C210/RMQ/1196 (1997)
7. A Balance, L Hill, D Roux, M Silberbauer and W Strydom, State of the Rivers report, Water Research Commission Report no. TT 147/01 (2001)
8. K Smith, Soil Analysis Modern Instrumental Techniques Second Edition, Marcel Dekker Inc, New York (1990), pp 1-3
9. A Montaser and D. W Golightly, Inductively Coupled Plasmas in Analytical Atomic Spectrometry Second Edition, VCH Publishers, New York (1992), pp 489-490.

Chapter 2

Inductively Coupled Plasma Optical Emission Spectroscopy (ICP-OES)

2.1 The theory and principles of ICP-OES

The ICP-OES plasma is an effective source of atomic and ionic emission, which can in principle be used for the determination of all the elements other than argon and helium. Despite the theoretical scope of the method, not all the elements can be conveniently determined using the ICP-OES without additional specific modifications to the instrument. The principle of the method is to use optimal conditions to excite the atoms into the higher energy level. This state is only temporary, because of the atom's natural tendency to return to the ground state. For the atom to move back to the ground level state it must release the additional energy. This energy is observed as emission radiation, which is characteristic to the element emitting. A single element has a number of emission lines that can be used for analytical determination. However, the most commonly used lines for an element, depend on the sensitivity of the line and if there is possible interferences [1; 2].

A typical ICP-OES system is comprised of the following components (Figure 1).

- A sample introduction system, which is comprised of a peristaltic pump, nebulizer, spray chamber and drain assembly.
- The plasma, ICP torch and gas supply.
- A source to produce a stable radio frequency.
- Transfer optics and an optical spectrometer.

- Detectors and other electronics.
- Computerised instrument control and data collection unit.
- Additional accessories that can be of use are an auto sampler and a hydride generation unit. These, however, are not essential and are only used to solve possible restrictions that may be experienced.

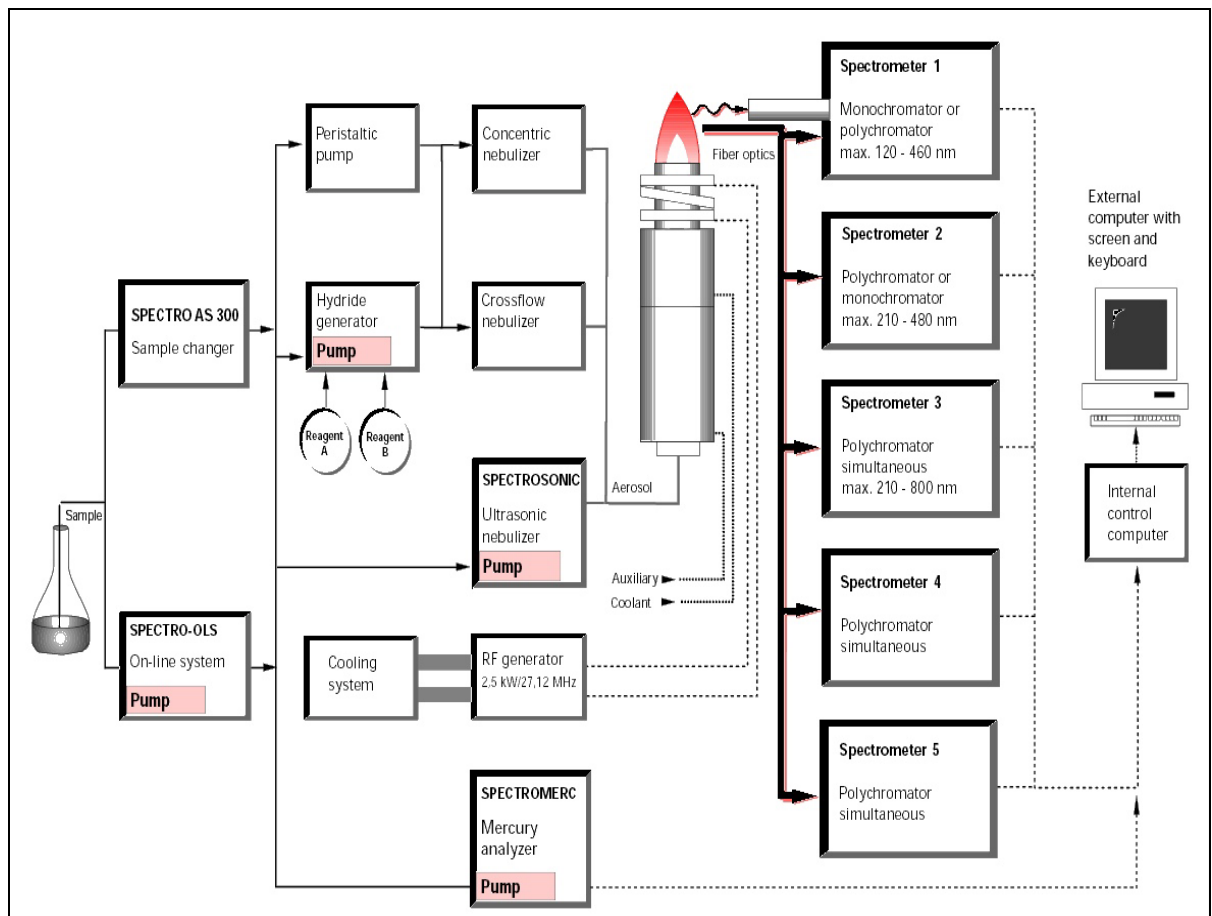

Figure 1. Schematic diagram of an inductively coupled plasma optical emission spectrometer [2]

2.2 The various components of an ICP-OES

2.2.1 Sample Introduction System for samples in solution

The sample introduction system consists of the peristaltic pump for sample uptake, nebulizer to aspirate the sample and the spray chamber to separate the smaller and bigger droplets. There are different instrument designs and the selection of the ideal one is dependent upon the type of sample to be analysed and the sensitivity required.

2.2.1.1 Peristaltic pump

The peristaltic pump is used for the transport of the sample from the sample container to the nebulizer's sample inlet connection. The pump used must have minimum variations in feed rate; this means that surges in feed rate must be avoided. This is achievable through the use of a multiroller type pump with 10 or more rollers in the roller head. Using a peristaltic pump it is possible to control the sample flow independently of the gas flow rate. The peristaltic pump also provides the ability to rinse the system and wash in the sample much quicker. This aspect saves on analysis time without compromising stability of the instrument.

2.2.1.2 Nebulizers

There is wide agreement that the sample introduction into the ICP-OES is a very critical area. The majority of analyses carried out on an ICP-OES are carried out in solution form, with the sample being converted into an aerosol. The lighter part of the aerosol is transferred to the plasma by the injector gas and the larger droplets are

removed in the spray chamber. The general droplet size of the aerosol is in the region of a few microns in diameter [3, 4].

There are two main categories of nebulizers: pneumatic and non-pneumatic or ultrasonic. The pneumatic nebulizers rely on a high gas flow to generate an adequate aerosol from the introduced sample. Changing the gas flow to produce smaller or bigger droplets can control the droplet's size. Nebulizers belonging to this group are as follows: concentric (e.g. Meinhard type), cross flow and Babington-type [3,4].

Concentric nebulizers rely on the Venturi effect to produce the aerosol. The reduced pressure resulted from the fast moving gas jet cause the solution to be drawn into the gas jet and aspirated (Figure 2). This causes the solution to be broken into droplets of various sizes. The advantage of this nebulizer is that it has very high sensitivity. This is the reason why it is the most widely used nebulizer and is setting the standard to which other nebulizers are compared. The disadvantage of this nebulizer is the fact that blockage of the central capillary is common when analysing samples containing high concentrations of salts. This is due to the central capillary's inner diameter being typically 0.3 mm. This disadvantage is minimised when using the Type C Meinhard nebulizer [2, 3, 5].

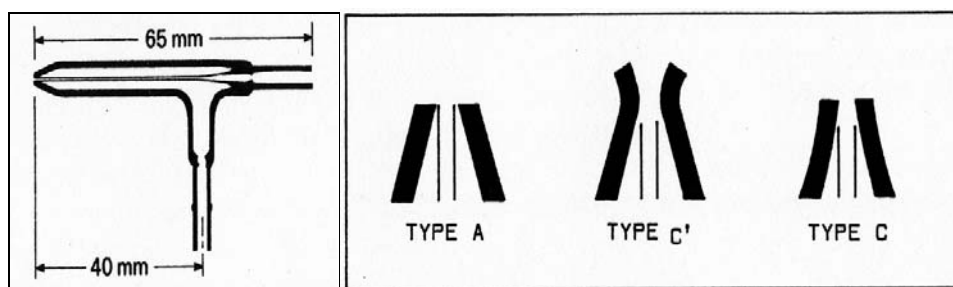

Figure 2. The geometry of a typical Meinhard nebulizer and different tip designs [3]

The cross flow nebulizer's design makes it much more tolerant of solutions with high salt contents than the concentric nebulizers. These two types use the same principle in achieving the aerosol and transport to the spray chamber. As the name suggests, the design relies that the sample solution and the gas flow are 90° to each other. The most crucial mechanical feature of this nebulizer is the alignment of the sample uptake capillary and the gas orifice. With any small shift in alignment, the performance of the nebulizer will suffer. A rigid design is essential. The gas connection is typically horizontal and the sample inlet capillary vertical (Figure 3). However, the sample uptake capillary's inner diameter for the cross flow nebulizer is in the region 0.5mm compared to the Meinhard nebulizer of 0.3 mm. This is the reason why the cross flow nebulizer is seen as a more rugged nebulizer and can handle samples with higher salt content than the concentric nebulizer. The disadvantage of this nebulizer is with the added capability to handle higher salt content a certain degree of sensitivity is relinquished. This type of nebulizer was used in the experimental set-up of this study to quantify the concentration of trace metals in solution.

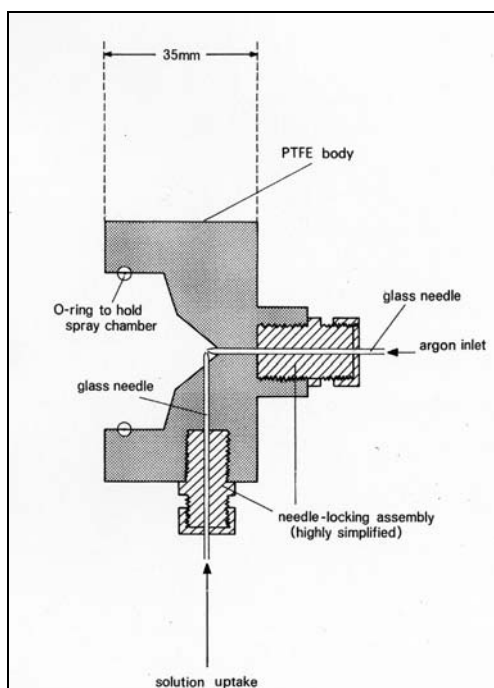

Figure 3. Typical cross flow type nebulizer [3]

The last of the pneumatic nebulizer types to be discussed is the Babington nebulizer (Figure4). This nebulizer is commonly used for sample with high salt contents (10% sodium or more) such as found in seawater, digestions of geological material or slurries of solid powders. A film of sample flows over the surface of a sphere in the V groove of the nebulizer through which the gas is forced. This in turn ruptures the film of sample and produces an aerosol that will be transported to the plasma through the spray chamber. The difference between this nebulizer type and the previous two is that the liquid flows over the gas orifice rather than through it. This is the reason why this type can tolerate high amounts of salts and suspended matter. For higher levels of suspended solids this nebulizer is undoubtedly the best choice. The main disadvantage of the nebulizer is the fact that it tends to have an extended memory effect, meaning that the rinsing time between samples will have to be longer to guard against possible carry over from one sample to another.

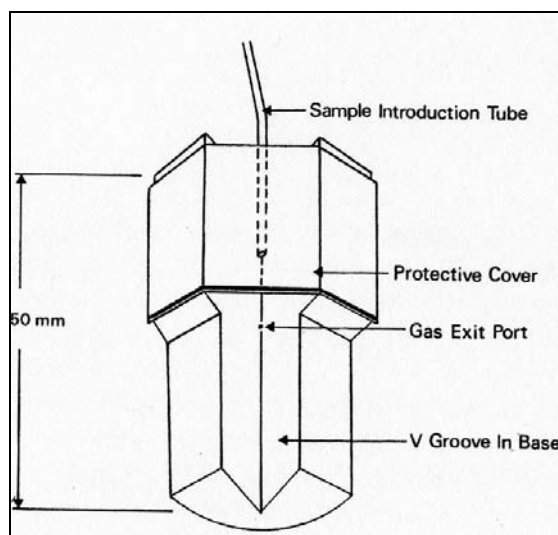

Figure 4. Typical Babington type nebulizer [3]

Non-pneumatic or ultrasonic nebulizers are less common in practice, however, this nebulizer's sensitivity can be up to 4 times better than the pneumatic type. The sample solution is pumped into the vibrating transducer (1-10 MHz) that produces the aerosol. [4. 5] A major drawback in this type of nebulizer is the fact that often a desolvation step is required to reduce water loading in the aerosol. If this step is not used, it is possible that the plasma will not remain in an ignited state. This desolvation step increases the analysis time and memory effect. Ultrasonic nebulizers also suffer from poor long-term stability, and their performance is easily influenced by small operational parameter changes. The cost of this nebulizer is also much higher than the pneumatic nebulizers. The major advantage of the ultrasonic nebulizer is the fact that the detection limits achievable with it are at least an order of magnitude better than the pneumatic nebulizers. This better detection limit is attributed to the smaller particles produced in the nebulization process.

2.2.1.3 Spray chambers

The spray chamber's main function in the sample introduction system is to remove the larger droplets from the nebulizer. These droplets are condensed in the spray chamber and are led to the waste container. This is achieved by sharp changes in the gas flow direction or direct collision of the droplets onto an internal surface. A small positive pressure is necessary to drive the aerosol into the injector tube. This can be achieved by simply dipping the drain tube into the waste container. This however can lead to a change in pressure as the container fills. Using either a drain loop or intermediate trap with a constant head usually eliminates this factor. An ideal spray chamber will have the best separation capabilities and the shortest memory effect for the particular samples that must be analysed. The most widely used spray chamber is the double pass Schott type and this was also the type used in the instrument set-up [3].

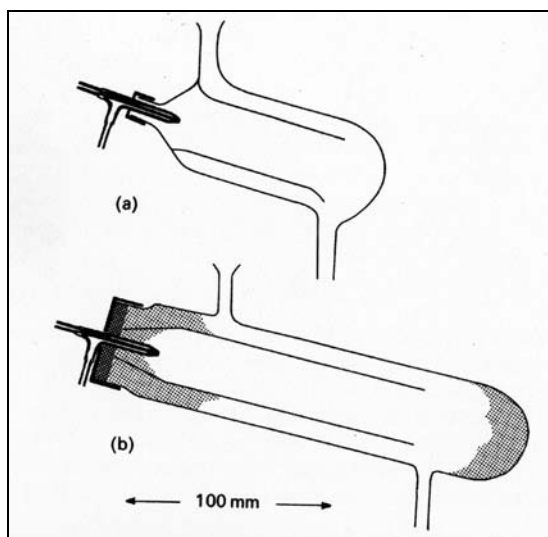

Figure 5. Schematic diagram of a double pass Scott type spray chamber [3]

2.2.2 The inductively coupled plasma, ICP torch and gas supply

2.2.2.1 The inductively coupled plasma (ICP)

An ICP is formed during the coupling of free electrons from a suitable gas (usually argon) to the energy radio frequency (RF) magnetic field, which is produced by the radio frequency generator (1-3 kW power at 27-50 MHz). The gas is contained in a plasma torch, which is constructed from materials that are resistant to high temperature and is transparent to the RF radiation. The most common material used for this purpose is quartz. The magnetic field is generated by 2 to 3 turn silver plated copper coil, that is placed around the upper part of the torch. The initial electrons needed to ignite the plasma are provided by an internal spark discharge. In the plasma, the electrons are accelerated by the magnetic field oscillation. This in turn results in effective energy transfer from the field to the electrons. When equilibrium is reached between the rate of electrons production and the loss resulting from recombination and diffusion, the plasma is stable and can then be used for analytical measurements. [2]

In the produced plasma there is different zones of importance. These zones are: Preheating zone, initial radiation zone, induction, and the hotter normal analytical zone (6000-8000 K).

The mentioned zones are not fixed in position and are influenced by the operating conditions. The parameters that play a role in the position of the different zones in the plasma are as follows:

- Applied power and sample carrier gas flow

- Quantity and particle size distribution of the aerosol.
- Matrix component of the sample.

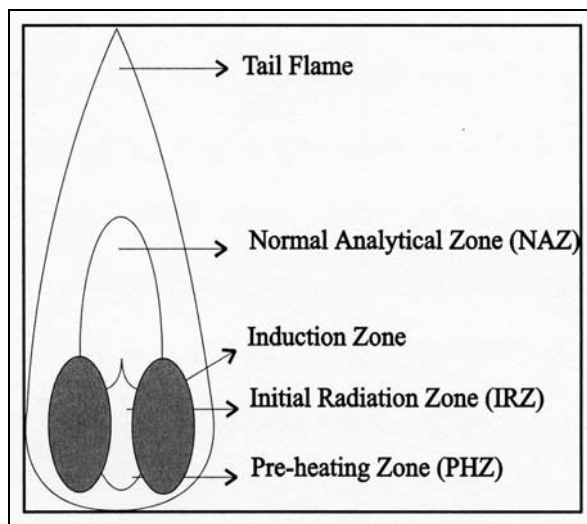

Figure 6. Schematic representation of the different zones in the ICP [5]

2.2.2.2 The ICP torch

The plasma is sustained in the torch of the ICP-OES. The torch consists of three concentric quartz tubes arranged to provide suitable gas flow geometry. There are two types of torches. The first is a fixed torch that has many designs, but the most commonly used is the Scott-Fassel type (Figure7). This type of torch that is in a radial position, was used in experimental set-up of this study. This type of torch requires a high degree of concentricity and is mostly fabricated in one piece from fused silica. The disadvantage of this design is that when the injector tube or outer tube in the vicinity of the plasma is damaged, the whole torch has to be replaced. To replace the torch is costly.

The second type of torch is the demountable type. The torch can be fully disassembled and the damaged parts can be replaced individually. The torch consists of the inner, outer and injector tube. The inner and outer tubes are housed in normally housed in a body made of a ceramic-loaded Teflon (PTFE) for thermal stability. The sample introduction tube and injector mounting are made of normal PTFE. The orientation of the torch can be radial or axial. Both of these orientations have their advantages

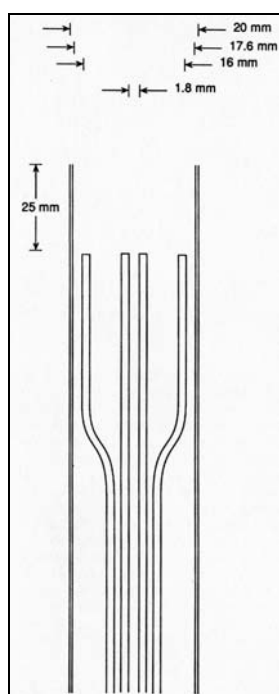

Figure 7. An illustration of a Scott-Fassel type torch for ICP-OES [2]

2.2.2.3 Gas supply

In ICP-OES there are three gas flows which is necessary for plasma formation and instrument operation. Firstly, the coolant gas flow is used to avoid melting of the torch. This gas flow is the largest and at the outer tube of the torch. The coolant gas

is also commonly named the “plasma gas”, because it forms the bulk of gas used to form the plasma. Secondly, the main function of the auxiliary or intermediate gas is to lift plasma. The third and central gas flow is called injector or nebulizer gas. This is the gas flow that is needed to drive the nebulizer and to transport the sample to the plasma.

2.2.3 Radio Frequency Generator (RF)

The radio frequency (RF) generator provides a high frequency current in the induction or load coil, producing the oscillating magnetic field that sustains the plasma discharge. A number of different generators are available on the commercial market. These can mainly be divided into two categories for example, if the generator uses a crystal oscillator and power amplifier to drive the load coil. The first type of generator uses a piezoelectric crystal to produce an output at a constant frequency. This crystal usually operates in the low milliwatt output range, as it cannot carry large currents. The second type uses a load coil and is part of a free running RF oscillator. The performance of the analytical instrument is not very reliant on which type of RF generator they use and there is no clear evidence that the one is superior to the other. When using the crystal controlled oscillator, it must be fitted with automatic tuning. If the conditions rapidly change in the coil due to solvent or technique change and the generator cannot adjust fast enough, the plasma will be extinguished. The other requirement for the RF generator is that the power unit must be well shielded to meet legal requirements. This is simpler at the industrial standard frequencies of 27.12 and 40.68 MHz. It has been found that the

RF generator using the 40.68 MHz provided a higher signal to background ratio, but there is not a major difference in performance [3, 6].

2.2.4 Spectrometer

2.2.4.1 General requirement of a spectrometer

The function of the spectrometer is to select a given line in the emission spectrum and isolate it from the other lines [4]. The most important features the spectrometer must provide are the following: High resolution, light throughput and stability. The other factor that must be taken into account is to minimise the factor for stray light in the spectrometer. It is, however, not always possible to have high light throughput and high resolution, and a compromise between the two is often necessary [2].

- **The wavelength range** is usually in the range of 200-800nm in air-path spectrometers. The poor sensitivity of the spectral lines ranging below 200 nm is due to the absorption of the emission of the lines in the UV region. In this case the performance of the spectrometer is reduced. To solve this problem, systems were designed to either have a vacuum or purge gas system in the spectrometer to allow analysis under 200 nm [3].
- **The resolution** of a spectrometer must be at maximum for optimum sensitivity. The resolution of the spectrometers may be increased by using the following: (i) higher dispersion gratings (more grooves per mm), (ii) higher spectral orders, (iii) narrow slits and (iv) longer focal lengths. In the analyses of environmental samples, however, it is not that

important for the spectrometer to have the highest resolution. Moderate resolution is adequate for these analyses [2, 3].

- **Light throughput** is an important aspect when analysing for environmental samples due to the matrix effects. The parameters that play a role in the improvements of the resolution of the spectrometer are as follows: Use of larger gratings, shorter focal length, wider slit widths or lower dispersion gratings. When you look at the different components that play a role in improved light throughput, it is noticeable that it is in direct conflict with the requirement of better resolution. This is why it was mentioned previously that compromises must be made to ensure that the spectrometer perform optimally [3].
- **Stability** in a spectrometer is needed to provide the wavelength reproducible on the variable wavelength instruments. For the fixed wavelength instruments the wavelength must remain on the determine point. The factors that ensure that the spectrometer is stable are as follows: The materials used to produce the spectrometer are rigid and have a low coefficient of expansion; the spectrometer is also usually mounted on shock absorbing supports and this area is temperature controlled above ambient temperature (30-40°C) [3].
- **Stray light** is produced by elements that produce relatively high levels of light. These are caused mainly by the presence of alkaline earths. The light will enter the spectrometer and with scattering thereof it might cause problems in isolating the light of the required element. This will in turn cause a shift in background due to the scattering effect. Factors that can improve and minimalise this effect are: The use of holographic

gratings and blackening of the internal spectrometer components. These should produce the lowest stray light levels [3].

2.2.4.2 Main spectrometers used in ICP-OES

There are typically three types of ICP-OES systems available that are categorized according to the method that they use for analysis.

- The multi-element analysis systems consists of a polychromator that has fixed lines of analysis and is mainly used for high sample throughput.
- The single channel or sequential system uses a monochromator to analyse the samples. This system has no fixed lines and can theoretically analyse any element using any of the lines.
- The third type of instrument is the simultaneous / sequential system. This system provides the advantages of both previously discussed systems. However, the cost is not quite equivalent to two spectrometers but close to and noticeably higher than the single spectrometer systems [6].

2.2.4.3 Simultaneous ICP-OES Polychromator

The most widely used mounting for polychromator systems is the Paschen-Runge and uses a concave grating. This mount is based on the Rowland circle the detectors are mounted on this circle (Figure 8) [6]. The points on the circle are all in focus. A great advantage of this system is the lack of components that are potentially light absorbing. The system is also very simple in its layout. The main components of the system are: Lens, primary slit, diffraction grating and secondary slit [3].

The advantage of the Paschen-Runge mounting is that wavelength coverage is wide on the focal plane; photomultiplier tubes can be installed with ease. Other advantages of this system are listed as follows:

- Speed of analyses is fast because all the elements analyses are done simultaneously. The speed is mainly limited by the speed of the sample-changeover.
- Minimal sample volume is required due to the speed of the analyses.
- Ease of internal standardization and applying matrix corrections.
- Accuracy and stability of wavelength settings. The use of fixed slits helps in this regard and the stability of the wavelength setting has precision of between 0.5-1.0% relative standard deviation (RSD) [2].

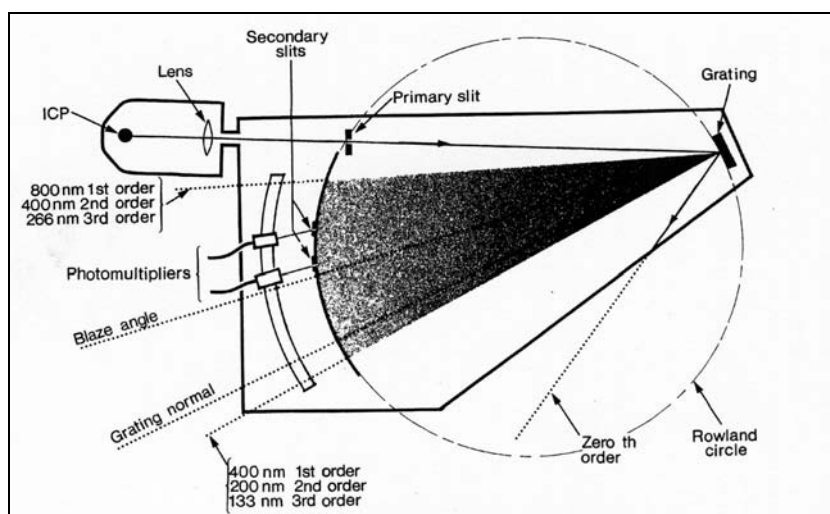

Figure 8. Multi-channel simultaneous spectrometer using the Paschen-Runge mounting [2]

The main disadvantages of this system are the high cost, inflexibility in analysing unknown elements and moderate resolution. The latter two can be

improved by using an ICP-OES with more than one polychromator. Spectro Analytical Instruments improved this by the use of optical fibres to transmit the emission to the different entrance slits of the polychromator. The elements with the same characteristics and wavelengths are grouped together. This makes it possible to analyse two spectral lines close to each other using different spectrometers [7].

2.2.4.4 Sequential ICP-OES Monochromator

The mostly used monochromator used in sequential system is Czerny-Turner. In the case of the Spectroflame Modula used in the analytical measurements of the samples in this study, the monochromator is of the Paschen-Runge type. Both of the spectrometers mentioned will be discussed briefly in this thesis.

The Czerny-Turner spectrometer's primary optics considerations are the same as the polychromator, to be as simple a system as possible. In this system, the light is focussed on the grating by a concave mirror. This mirror is moved by a stepper motor to move the spectrum across the secondary slit where the detection system is usually a single photomultiplier tube with associated electronics [3].

The Paschen-Runge type is very much the same as for the polychromator set-up. In this instance the exit slits on the Rowland circle are fixed on the selected wavelengths. The radiation is directed to the exit slits by mirrors and passes through the exit slits to a single photomultiplier tube for detection. The radiation

can be sequentially determined by sequentially opening the shutters in the optical system [7].

The advantage of the sequential spectrometer Paschen-Runge mounting is that wavelength coverage is wide on the focal plane; photomultiplier tubes can be installed with ease. Other advantages of this system are listed as follows:

- Flexibility. All spectral lines are theoretically available for analysis and thus make it possible to analyse for any element.
- Higher resolution is possible due to the narrower slits that can be used. This in turn reduces spectral interference and has improved detection limits.
- Ease of background correction is possible; because background and signal are determined independently and is calculated as the difference between them.
- The spectrometer's cost is much lower compared to that of a polychromator.
- The spectrometer makes it easier to perform survey analysis because the whole spectrum can be analysed for.

The main disadvantages of this system are the speed of analysis, higher sample consumption and the inability to perform matrix correction. The speed of the analysis is proportional to the number of elements to be analysed. That is, the more elements being analysed; the longer the analysis time is going to be. This is also the reason why more sample is needed for the sequential analysis. When spectral or matrix interferences are a problem, it is necessary to analyse other

spectral lines of the require element. This will only be accomplished with additional analysis time [2].

2.2.5 Detection of emission

2.2.5.1 Photo multiplier tubes

Photomultiplier tube (PMT) has no rivals when it comes to their light measurement capabilities at this stage. The PMT in the spectrometer is used to convert the light intensity into an electrical signal that can be quantified and, therefore, related to the concentration of the analyte in solution. The PMT is under vacuum and consists of a photocathode from which photoelectrons are generated when by incident photons. The quantum efficiency of the tube depends on the material it is made of. The major disadvantage of the tube is the presence of a “dark current”. This is the current in the absence of radiation. These electrons get sufficient energy to leave the photocathode thermally, by cosmic or radioactive rays (Figure 9) [6]. The photomultiplier tubes are also chosen to have the lowest dark current possible.

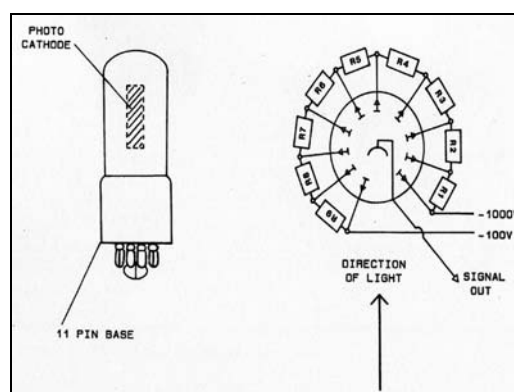

Figure 9. Typical side-window photomultiplier tube

2.2.5.2 Charged Transfer Devices

One of the other detection devices that are becoming more popular in recent times is the charge transfer device (CTD). These devices have high sensitivity and dynamic range. There are two main types: Charged Coupled Device (CCD) and the Charge Injection Devices (CID). The CTDs are multi channel photon-integrating detectors that accumulate signal information rather in the same manner to the way in which the light strikes the photographic film. All CTDs must be cooled to reduce the “dark current”.

The CCD can be thought of as a large number of photodetecting analog shift registers. After the photon-generated charges have been stored, they are recorded horizontally, row-by-row, through a high-speed shift register to a preamplifier. A computer stores the resulting signal. Conversely for the CID, the light strikes a row-column structure of discrete pixels, each of which is composed of a pair of semi-conductor capacitors. These two mentioned CTDs have the highest efficiency and very low noise levels.

2.2.6 Requirements of the data collection system

The currently used data collection system is that of a microprocessor computer with the manufacturer’s software package installed developed exclusively for the particular ICP-OES. This software controls the spectrometer’s functions and is where the raw data is stored on. The system must provide the ability to require data fast and effectively. The software usually provides the capabilities to reprocess data, as well as do background and drift correction. In many cases the removal of

interferences are possible from the raw data. The processing unit must also make it possible to calibrate, standardize and use the calibration values to calculate the concentration of the elements of interest.

2.3 Interferences in ICP-OES

There are several sources of possible error in the determination of an analyte in solution. The main contributors to this error can be categorised into classes, namely: Matrix and spectral interferences. The matrix effects are divided into physical, chemical and ionization interferences. The spectral interferences are associated with the capabilities of the spectrometer used [5].

2.3.1 Matrix Effects

2.3.1.1 Physical interference

Changes in the acid concentration or dissolved solids content and sample solution can lead to changes in the nebulization rate. This rate change is due to changes in the density, viscosity and surface tension of the solution. These effects can change the droplet size, which can have an influence on the sensitivity of the measurement. Significant amounts of sulphuric or phosphoric acid can suppress the analyte signal. Some elements introduced in the plasma can have an effect on analyte lines with high excitation potentials. These elements are mainly part of the alkali elements [2, 3, 5, 6, 7].

2.3.1.2 Chemical interference

Chemical interference occurs when a compound is formed that prevents quantitative atomisation of the element. In ICP-OES, however, this does not play a major part as interference due to the extreme conditions in the plasma [2, 3, 5, 6, 7].

2.3.1.3 Ionization interference

This interference cause a reduction in sensitivity, which depends on the following:

- Temperature of the plasma
- Ionization potential of the element
- Concentration of the element [3].

2.3.2 Spectral overlap

Spectral overlap is one of the biggest problems of ICP-OES. This is a direct result of high temperatures required to minimise vaporisation and to maximise the emission. As many species are injected into the plasma, high levels of interference can be expected. In the case of major elements it is not that significant, but in the case of trace or weakly emitting elements, the wavelength is dependant on other spectral features near to that wavelength. There is an average of 294 lines emitted per element, and overall there are more than 100 000 wavelengths. The abundance of these lines can cause the following spectral line overlaps: Direct spectral and wing overlap [2, 3, 5, 6, 7].

2.3.2.1 Direct overlap

Direct overlap occurs when two elements emit light at exactly the same wavelength. An increase in resolution will not offer a solution to the problem.

These lines would not be able to be resolved (Figure 10).

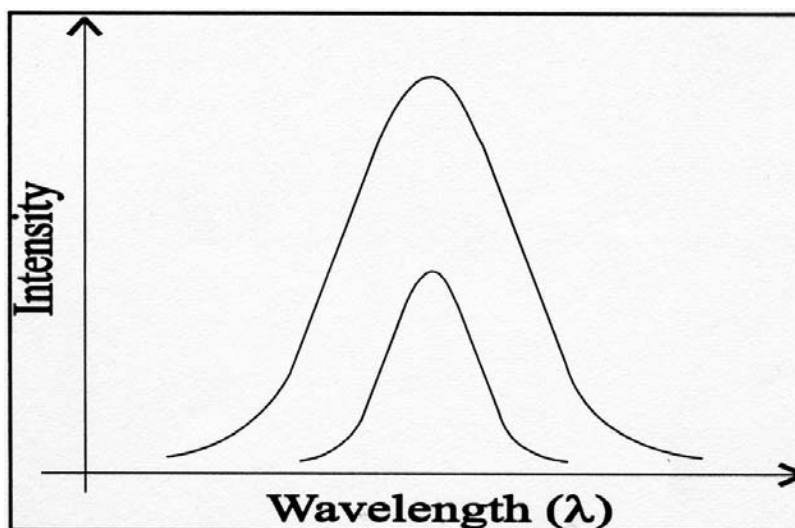

Figure 10. Example of direct overlap [3, 5]

2.3.2.2 Wing overlap

Wing overlap occurs through Doppler broadening, caused by the high temperatures of the plasma. This overlap can be rectified through the use high-resolution spectrometer. In other cases the selection of an alternate analytical line will be necessary. One example of this type of interference is the influence of Ca (393.37 nm and 396.85 nm) on the analytical lines of Al (394.4 nm or 396.2 nm). Ca will severely affect the analysis of Al in the mentioned example (Figure 11).

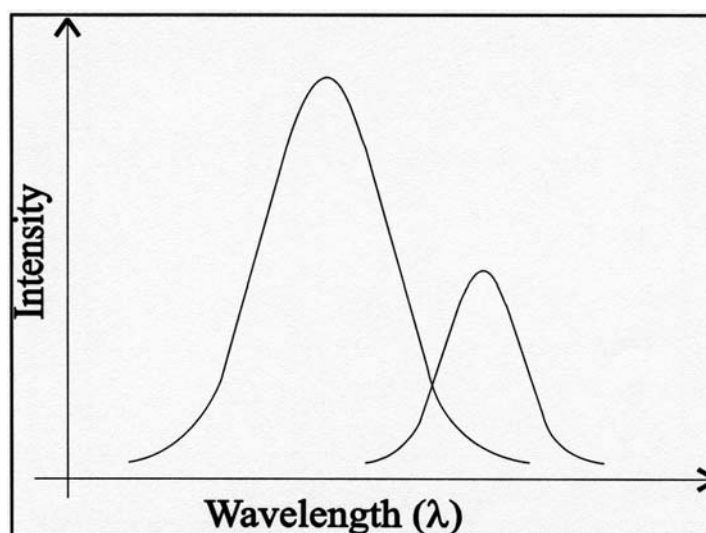

Figure 11. Example of wing overlap [3, 5]

2.3.2.3 Continuum radiation

Throughout an ICP spectrum there is broad-band background beneath the line radiation. This adds to the offset to the signal measured. The continuum originates from a number of sources. These sources include: Electrons, argon gas and matrix species (both atomic and molecular). The operating parameters of the instrument also play a role in the profile of the continuum and several levels of overlap can occur (Figure 12). Small changes in the argon gas flow can alter the background radiation considerably. This effect can be removed mathematically by using blanks, however it is often necessary to use a dynamic background correction method to eliminate this occurrence sufficiently.

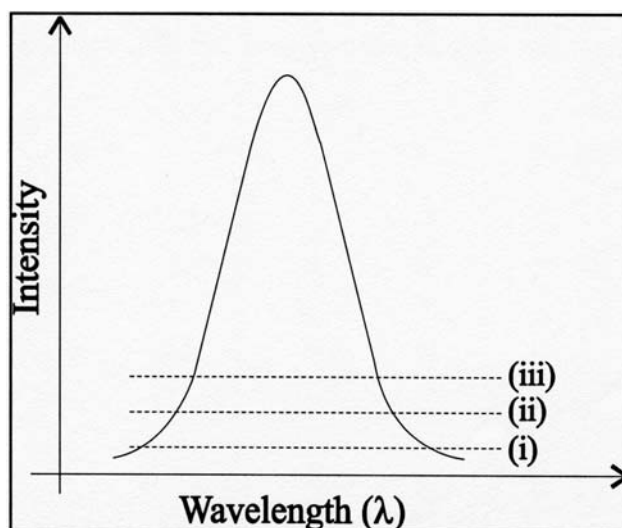

Figure 12. Example of continuum radiation [3, 5]

2.3.2.4 Stray light

Stray light is radiation that reaches the detector unintentionally. This stray light can have a number of causes. One of them is imperfection in the optical system and to a greater extent, the grating. No optical system is perfect, but the manufacturers strive to minimise this effect through better-designed spectrometers. The ruled gratings have improved considerably, but the best grating to use in the spectrometer to minimise the stray light effect is the use of a holographic grating spectrometer. Another cause of stray light is elements that have very intense emission lines (mainly alkaline earth elements). The light enters the spectrometer and in cases can interfere with spectral lines of the analyte many band-passes away (“far-scatter”). An example of this is the influence of Ca 393.37 nm and 396.85 nm on the Zn 213.68 nm line. This phenomenon is well documented in the literature. There is a number of ways to try and minimise this problem such as the use of solar blind PMTs, which will not respond to radiation above 350 nm. The use of double monochromators and

correction coefficients can help to solve this problem. The best however is to investigate the performance of the spectrometer and decide which ones performance is the best [3, 5].

2.3.2.5 Spectral lines and molecular bands from discharge atmosphere

Argon spectrum. (Plasma gas)

Argon gas produces 294 lines in the region between 317 and 877 nm. There are no bright argon lines between 200 and 300 nm. The most intense lines are in the region of 420-440 nm and can play a role when analysing for elements in the mentioned region [6].

Hydrogen and Oxygen Spectrum.

The hydrogen and oxygen lines originate from atomic hydrogen and oxygen formed by the dissociation of water molecules. The hydrogen 397.007 nm line interferes with the Ca 396.85 nm line. Atomic oxygen lines interfere in the region of 436 and 845nm [6].

Carbon and Silicon Spectrum.

The carbon lines that can play a role in the spectrum are the C 193.091, 199.362 and 247.856 nm lines. The carbon originates mainly from trace amounts of organic compounds in the compressed argon cylinders. The silicon lines are commonly found due to erosion of silica torches, etching of glass spray chamber by hydrofluoric acid and/or solvent blanks. To eliminate these interferences silicon-free materials must be used in the analysis method [6].

Molecular bands: OH, NO, N₂⁺ and NH.

Hydroxyl (OH) radicals resulting from the dissociation of water emit spectra in the 281 to 295 nm and 306 to 325nm regions. The NO bands are most prominent at 195 to 300 nm and the N₂⁺ from about 329-590 nm. The NH band at 336 and 337 nm are rather strong. Bands of molecules containing nitrogen can be eliminated by the use of extended torches. These are specially applied to measure the nitrogen concentration using the atomic nitrogen lines [6].

Absorption bands of O₂

In the air-path spectrometers the absorption of O₂ is a major problem. The O₂ band produces a background below 200 nm. The use of a vacuum system or purged nitrogen system will eliminate this background effect [6].

2.3.3 Inter-element interference correction

The inter-element interference corrections coefficients on the polychromator were calculated as discussed in [8]. The coefficients for the polychromator were determined as follows. The net intensities for the programmed elements were recorded on aspiration of pure single element standard solutions. The intensities are then converted to concentrations. These positive concentrations for the elements not present are then taken as interferences. This process is crucial because the end concentration reported will be influence by the applied correction factor and this factor needs to be acc correction must be correct.

2.4 References

1. D. A. Skoog and J. J. Leary, Principles of instrumental analysis, Fourth edition, Harcourt Brace College Publishers (1992), pp 233-244.
2. K Smith, Soil Analysis Modern Instrumental Techniques Second Edition, Marcel Dekker Inc, New York (1990), pp 63-96.
3. M. Thompson and J. N. Walsh, Handbook of Inductively Coupled Plasma Spectrometry Second Edition, Blackie and Son Ltd, Glasgow (1989), pp26-32, 43-82.
4. H. H. Willard, L. L. Merritt Jr. and J. A. Dean, Instrumental methods of analysis, Fifth edition, D. Van Nostrand Company, New York (1987), pp 350-389.
5. A. E. S. Whaley, The determination of arsenic in soil by ICP-OES (2000), pp 18-30, 42-47.
6. P. W. J. M. Boumans, Inductively Coupled Plasma Emission Spectrometry. Part 1. Methodology, instrumentation and performance, John Wiley and Sons, New York (1989), pp 1-45, 69-81; 258-328; 358-393, 466-483, 538-541.
7. A Montaser and D. W Golightly, Inductively Coupled Plasmas in Analytical Atomic Spectrometry Second Edition, VCH Publishers, New York (1992), pp 122-124, 277-317.
8. P. L. Kempster, Application of inductively coupled plasma emission spectrometry in the analysis of environmental samples (1986), pp 226-230.

Chapter 3

Characteristics of sediments and soils

3.1 Adsorption in soils and sediments

3.1.1 Forces of Adsorption

Adsorption can be defined as the concentration of constituents at the colloidal surface. In this study the main emphasis is on the adsorption of trace metals onto the sediment particles and their remobilisation. In the case of river sediments, the sediment is saturated with water and the water moves freely through the pores of the sediment by gravity and capillary action. This movement is called drainage and can have a number of negative effects, such as the leaching of nutrients and trace metal pollutants. This can later pose a problem in the pollution of underground water resources [1].

3.1.1.1 Physical forces

The most important of the physical forces act on the saturated sediment zone is the Van der Waals force. This force is the result of short-range dipole-dipole interactions. This type of bond is formed when two atoms approach each other and their electron clouds interpenetrate. The electrons of the one atom repel the electrons of the other and the same happens with the nuclei. If the atoms come closer still, the attraction forces can offset the repulsive forces. At this stage the energy of the two atoms will decrease. The bond that is formed is called a Van der

Walls bond. These bonds, however, are only important at close distances, since these types of bonds decrease significantly with increased distance [1-3].

3.1.1.2 Hydrogen bonds

This type of bond forms when a hydrogen atom acts as the connecting linkage with other atoms. Through the dipolar properties of water, it may be possible to adsorb substitutes through the hydrogen bond mechanism. This hydrogen bond is a special form of dipole-dipole attraction. This is when a hydrogen atom (H) is attached to a very electronegative atom (X); the interaction between other molecules and the H-X bond dipole is significantly greater than expected for ordinary dipole-dipole interactions [1,3].

3.1.1.3 Electrostatic bonding

This type of bond occurs when ions are attracted to each other by electrostatic force. The bond is the result of the electrical charge on the clay particle surface of the sediment or soil. This is the main reason for the cation exchange reactions on the surface of the clay and these types of reactions will be discussed in greater detail later in this thesis [1].

3.1.1.4 Coordination reactions

This reaction involves coordinate covalent bonding. The process occurs when a ligand donates electron pairs to the metal ion and, in turn, a compound is formed. These compounds can be either of metal complexes when it is an inorganic ligand, or organo-metal complexes, when the ligand is organic in nature [1,3].

3.2 Factors Influencing Metal Ion Adsorption

3.2.1 Adsorption of cations by sediment colloids

Clay colloids carry a negative charge and thus make it possible for cations to be attracted by the clay particles. The cations are adsorbed onto the clay particles electrostatically. Most of the cations are in liquid phase and this makes it easier for the cations to move into the pores of the sediment and find binding points onto the clay particles. The density of the adsorbed cations is the highest close to the surface of the clay particles. A general rule to use in assessing preference of adsorption of a cation is, the smaller the hydrated size of the ions the better chance they will have to be adsorbed. In literature there is evidence of lyotropic series that give the preference of the clay particles to adsorb certain ions. These series are dependent on the type of clay present in the soil or sediment [1, 4].

3.2.2 Cation exchange reactions

The most heavy metals (with certain exceptions, including the metalloids As, Sb and Se and the metals Mo and V) exist in the form as cations in sediments and soils. Their adsorption depends on the density of the negative charge on the clay particles. Ion exchange refers to the process where the counter ions balancing the surface charge on the clay particles exchange with other ions in the soil solution. This process is reversible and if this process is reversed it can eventually lead to metal ions migrating to the ground water resource. The requirement for an ion to displace the H^+ is that it must have higher valency. The higher the valency of the ion the greater ability it will have to displace the H^+ . The negative charge on the soil

particles is due to either a permanent charge or a pH dependent charge. This charge is a result of the dissociation of protons from, for example, the OH group on the edge of the clay particles. The cation exchange properties of sediment and soil make it good in adsorbing pollution, for example, metals, but if the cation exchange capacity (CEC) of the sediment is reached, the pollution will migrate through it without being adsorbed. This process sometimes takes a long time to reach this stage, but when the pollution is no longer acceptable it will be too late to rectify the situation. Assorted effort needs to be taken to avoid this stage at all costs [1, 4].

3.2.3 Specific adsorption

Specific adsorption involves the exchange of heavy metal cations with most anions with the surface ligands to form covalent bonds with the particles. It results in the adsorption of the metal ions to be much higher than expected from the CEC of the sediment or soil. Specific adsorption is also highly pH dependent and is related to the hydrolysis of the heavy metal ions. The metals that easily form hydroxy complexes are specifically adsorbed to a greater extent. In some types of soil, adsorption can take place in three different steps: Surface adsorption, diffusion into the particles, and thirdly adsorption and fixation at positions in the structure of the mineral particles [4].

3.2.4 Organic complexation

In addition to being involved in the cation exchange reaction, the metals can form complexes in the presence of organic substances. These are predominantly originating from the solid-phase humic substances such as humic acid. Low molecular weight organic ligands, not necessarily of humic origin, can form soluble

complexes with the metals and this will prevent them from being adsorbed or precipitated. The main group that is involved in metal binding is the carbonyl group. There is a direct relationship between the carbonyl groups present and the number of metal bindings formed [4].

3.2.5 Selectivity of adsorbents for different metals

Metals vary in the extent to which they are adsorbed by the mechanisms described above. Adsorbents show different affinities to bind the different metals. The main aspects that play a role in the selectivity are the parent rock material and the properties it has, and the amount of iron oxides, II and III, that is present.

3.3 Sediment Capacity for Trace Elements

3.3.1 Sediment pH

In general, the capacity of soil to bind most trace elements is increased with increasing pH up to a maximum capacity at neutral or slightly alkaline conditions. Exceptions on this statement are: As, Mo, Se and some oxidation states of Cr, which are more mobile in alkaline conditions. The pH of the sediments, however, may not be that precise due to the heterogeneity of the certain sediments. The determination of pH in solution gives a much more accurate estimation than in the case of sediments. The soil pH is affected by a change in the redox potential; this is common in soil that becomes waterlogged and in sediments. Reducing conditions generally cause the pH of the sediment to increase and under oxidation conditions bring about a decrease in pH. Soil and sediments have mechanisms to buffer pH to

varying extents, including hydroxylaluminium ions, CO₂, carbonates and cation exchange reactions. These buffering effects can vary significantly through localised variations in the sediment [4-6].

3.3.2 Cation Exchange Capacity (CEC)

The cation exchange capacity (CEC) of sediments and soil is largely dependent upon the amount of organic matter, amount and type of clay and the amount of iron, manganese and aluminium oxide present. All the mentioned components have different cation exchange properties. The CEC is reported as meq/100 g sediment. If the CEC of the sediment is high it generally shows that it can accept trace elements without becoming potentially hazardous [1,5, 7-9].

3.3.3 Organic Matter

In soil there are two categories that organic matter can be divided into. The first is “non-humic” substances, which mainly comprise of amino acids, carbohydrates, waxes, organic acids and fats. These compounds are in the original form they were synthesised in. Alternatively, the humic substances are a series of acidic yellow to black compounds, which have moderate molecular weight. Sediments and soils mainly comprise of humic substances, but there are to a lesser degree a number of biochemicals bound to humic polymers. Trace elements like Co, Cu, Mn, Ni, Pb, Zn and others exhibit the characteristics of high affinity for soil organic matter. This organic matter is commonly known as humus and the compound formed with trace elements can influence in the solubility and stability of the species formed. Thus it

can play a definite role in the concentration of trace elements in sediments and soils [4, 5].

3.3.4 Amount and type of clay

The amount and type of clay plays a distinct role in the determination of the CEC value of the sediment. Generally soils and sediments with higher amounts of clay have a higher CEC. It has also been shown in studies that the CEC is dependent on the texture, clay (content and type), surface area and the concentration of iron oxide present. Trace elements like Cu and Pb have shown to be reasonably immobile in most soils and sediments. On the other hand, Hg is relatively more mobile than the previously mentioned elements. With the increase of the surface area, the soil also has a larger area to bind the trace elements and a higher CEC is expected [5].

3.3.5 Oxides of iron, manganese and aluminium

The oxides of Fe, Mn and Al are commonly referred to as the hydrous oxides. In the case of Fe and Al, these elements play an important role in the chemical behaviour of metals in sediments. The oxides are mainly present in the clay fraction smaller than 2µm in size. These oxides play a role in the control of fixation of other trace elements in the sediments. With regard to the dynamics of trace elements in soil, Fe and Mn oxides co-precipitate and adsorb cations including the following elements: Co, Cr, Cu, Mn, Mo, Ni, V and Zn. Anions such as HPO_4^{2-} and AsO_4^{3-} can also undergo the mentioned processes [4, 5, 7-9].

3.3.6 Redox potential

High water content in soils and sediments influence the capacity for trace element adsorption. This capacity is influenced through biological and chemical oxidation-reduction reactions. Reduction reactions are where the substance gains electrons resulting in a decrease in the oxidation state. The oxidation reactions on the other hand are where the substance loses electrons resulting in an increase in oxidation state. Under reducing conditions sulfides can form compounds with for elements like Cd, Zn, Ni, Co and others. These sulfides are partially insoluble and their mobility and bioavailability decrease. This is much lower than in well-oxidised soils. Mn and Fe however are exceptions on the rule and their compounds are much more soluble in reducing conditions than oxidizing conditions [4, 5]

3.4 References

1. K. H. Tan, Principles of Soil Chemistry, Marcel Dekker INC, New York (1982), pp 148-171.
2. F Cotton, G. Wilkinson and P. L Gaus, Basic Inorganic Chemistry, Second Edition, John Wiley & Sons, New York (1987), pp92-94, 270-271.
3. J. C. Kotz and K. F. Purcell, Chemistry & Chemical Reactivity, Saunders College Publishing, Philadelphia (1991), pp363-367, 504-507.
4. B. J. Alloway, Heavy Metals in Soils, Second, Blackie Academic & Professional, London (1990), pp 12-25.
5. D. C. Adriano, Trace Elements in the Terrestrial Environment, Springer-Verlag, New York (1986), pp14-18.

6. S. Van Herreweghe, R. Swennen, V. Cappuyns and C. Vandecasteele, *Journal of Geochemical Exploration* **76** (2002), pp 113-138
7. K. C. Yu, L. J. Tsai, S. H. Chen and S. T. Ho, *Wat Res* Vol **35**, No **17** (2001), pp 4086-4094.
8. H. M. V. M. Soares, R. A. R. Boaventura, A. A. S. C. Machado and J. C. G. Esteves da Silva, *Environmental Pollution* **105** (1999), pp 311-323.
9. K. C. Yu, L. J. Tsai, S. H. Chen and S. T. Ho, *Wat Res* Vol **35**, No **10** (2001), pp 2417-2428.

Chapter 4

Characteristics and sources of trace elements in the environments

4.1 Sources of trace elements in sediment and soil

All the investigated trace elements are present in the sediment or soil in some way. Below all the processes contributing to their abundance will be discussed. The only process that is not anthropogenic in nature is the contribution through natural weathering of parent rock sources. All the other channels of enrichment are mainly due to human activities.

4.1.1 Sediment and soil parent rock material

In nature the natural process of weathering of parent rock plays a part as a source of trace elements. This weathering of minerals in parent rocks is needed to form new soil and is an important natural process. The weathering process relies on many reactions to form the end product (soil). These include: Hydrolysis, ion exchange, oxidation and reduction and others reactions. It is generally accepted practice that the older the soil or sediment, the less likely the parent rocks will play a major role in the addition of trace elements [1, 2].

4.1.2 . Agricultural and commercial fertiliser materials

Farming is a very important non-point source of trace element enrichment. This enrichment depends on the intensity and type of farming in an area. Plants need micronutrients to grow optimally. In the 1960's a micronutrient study in the United States show that the soils commonly lacked plant available forms of the following microelements: Zinc, manganese, iron, copper, molybdenum and boron.

The main sources of concern from a water resource perspective are listed below:

- Impurities in the fertilisers consist mainly of the trace elements: Cd, Cr, Mo, Pb, U, V, and Zn.
- When sewage sludge is used for fertilisation and irrigation. This sludge contains a number of trace elements and can vary drastically in composition.
- Manures from intensive animal farming, especially pig and poultry farming can contain Cu, As and Zn. These trace elements are added to the feed to improve the food conversion capacity of the animals.
- Pesticides used to control pests may contain one or more of the following trace elements: Cu, As, Hg, Pb, Mn, and Zn. The main compounds for the mentioned trace elements are: Hg from methyl mercurials, Pb and As mainly originating from lead arsenate. Products to preserve wood in lumber farming also fall in this category and consist mainly of: As, Cr and Cu.
- Corrosion of metal objects is not only encountered with farming, but still plays a very small part in the cumulative effect.

The main contributor of elevated Cd concentrations in soil is phosphate fertiliser. The trace elements in the fertiliser are impurities in the phosphate rock used. The impurities are mainly caused by co-precipitation with phosphate at the time of deposition. The type of impurities is also related to where the rock is mined. Lime addition is also widely used in agriculture to correct soil acidity and to optimise nutrient uptake. The same applies to lime as with phosphate fertiliser. Impurities in the dolomite or calcite can cause a deposition of unwanted trace elements [1, 2].

4.1.3 Mining and smelting processes and metallurgical industries.

Mining of minerals have become more and more worthwhile through the larger demand in the resources explored. Today the processes used for mining are generally much better equipped to extract minerals from lower grade ore. This extraction of minerals from lower grade ore bodies, however, leaves much more waste product in the form of tailings. Modern dressing techniques have improved to minimise the amount of trace elements in the tailings, but earlier mining activities produced much more waste products with higher concentration of trace elements. This was the direct result of ineffective ore separation techniques employed in the nineteenth and early twentieth century. These tailing particles can be transported though wind and water and accidental flooding of tailing dams has caused serious pollution incidents in the past.

The metallurgical industries suffer from the same pollution potential as with mining. There are three major routes of pollution when it comes to these industries. Firstly, the pollution originates from aerosols and dust particles that can be

transported in air and eventually be deposited onto soil and vegetation. Secondly, by polluted effluent and can pollute the soil in times of flooding. Lastly, when waste dumps become “corroded” or oxidised and the metals leach into the nearby soil [1].

4.1.4 Land disposal of sewage sludge and municipal wastes

The primary objective in the disposal of waste is to get rid of it in the most environmentally acceptable and economical way. Sewage sludge is the residue produced in the treatment of domestic and industrial wastes and the general composition of the sludge is organic in nature and contains a number of plant nutrients. These components make it very advantageous to use for fertiliser and irrigation. Some sludge techniques use lime in the treatment stages and this can be used instead of “plain” lime for soil pH correction. The disadvantage of using sludge for agricultural purposes is that the concentration of trace elements and organic micro pollutants can vary drastically. These trace elements can have a detrimental effect on plant growth, which will negate the reason for adding nutrients. The trace elements of concern are Cd, Zn, Cu, Pb and Ni, which at elevated levels can cause depression of crop yield and degradation of crop quality.

In general, wastes originating from industrial areas contain higher concentrations of trace elements than those from suburban domestic waste. Nevertheless, domestic waste cannot be ignored as a pollution source. The main contributions from domestic wastes are from corrosion of metal plumbing fittings, the excretion of heavy metals by humans, and metals present in domestic cleaning agents [1, 2].

In recent times, however, the trace metal load on the sewage system is becoming more regulated and a decline in the concentrations of trace elements has been seen. This is a positive step, but much more must be done to lessen the impact even further [1].

4.1.5 Electronics industries

In the manufacture of semi-conductors, a number of heavy metals are used to produce the end product. The main concern in this industry is the treatment of the waste generated in the manufacturing process. Accidental contact of the raw material and end products can cause pollution and must be avoided at all costs.

4.1.6 Chemical and other industries

Other significant sources of pollution of soils and the environment can either be the use and disposal and/or production of the following products:

- Chlorine manufacture: Hg.
- Batteries: Pb, Sb, Zn, Cd, Ni and Hg.
- Additive in fuels and lubricants: Se, Te, Pb, Mo and Li.
- Pigment and paints: Pb, Cr, As, Sb, Se, Mo, Cd, Ba, Zn and Co.
- Medical uses: Ag, As, Ba, Cu, Hg, Sb, Se, Sn, Pt and Zn [1].

4.1.7 Coal residues and combustion of fossil fuels

The combustion of fossil fuels results in a wide range of heavy metal pollution. The metals present are, however, not at significant levels in all coal and petroleum products. The heavy metals originally accumulated in the coal and petroleum deposits at the time of their formation. The main two ways it contributes to pollution are through airborne particles or ash, which can be leached by water or be distributed through wind action. The combustion of leaded fuel can contribute to pollution and has been shown to be the largest source of pollution of this metal. With the switch to unleaded fuel, the problem has decreased with respect to lead, but there are still heavy metals present in fuel and in the long term they can also have a detrimental effect on the environment [1, 2].

4.2 Trace elements and their characteristics

4.2.1 Arsenic (As)

4.2.1.1 General characteristics

Arsenic (As) is a steel-gray, brittle and crystalline metalloid. In dry air it is stable but in moist air it oxidises, and when heated it rapidly oxidises to form As_2O_3 with the odour of garlic, which is highly poisonous. This metalloid's position on the periodic table is element 33 in the V-A group with an atomic weight of 74.92. It also falls in the group together with bismuth and antimony. The gray arsenic is the most stable form in nature and has a melting point of 817°C . The more general oxidation states of arsenic are $-III$, 0 , $+III$ and $+V$. This gives arsenic characteristics

to bind with metals and non-metals to form stable organic compounds both in the trivalent and pentavalent states [1-4].

4.2.1.2 Application and possible pollution contributors

The major use of arsenic is attributed to its toxic characteristics. The main use of the element is the active ingredient in pesticides, fungicides, algicides, and herbicides. Other uses of arsenic are the production of wood preservatives, dyes and animal dip ingredients. The main forms used in the production of these products are calcium and lead arsenates, copper acetoarsenite and monosodium methanearsonate. The use of organo arsenic is also becoming more and more common for the abovementioned uses. Arsenic is also used as an additive in poultry feed to control coccidiosis and to promote chick growth, it is also added to alloys to promote hardness. As seen from the main uses, the most probable pollution sources will be in the agricultural and industrial sectors [1, 4].

4.2.1.3 Natural occurrence in the environment

Arsenic is found in all soils in detectable amounts in both inorganic and organic forms. General occurrence of arsenic in soil is said to be at 1.5-2 mg/kg. The main forms that arsenic is found in nature are sulphides (As_4S_4), arsenic oxides (AsO_4^{3-}) and arsenides (As^{3-}). The main source of arsenic is as by product with lead and copper ores. The form that comprises 97% of the arsenic produced is arsenic trioxide (As_2O_3) [1,2].

4.2.1.4 Factors influencing the mobility of arsenic in sediments and soil

Arsenic in neutral pH soils is not very mobile and the measured values in mobility experiments show it to be very low. The conditions where the best adsorption of arsenic takes place in soils are at pH 3.5, 5.3 and 7. The condition under which arsenic is the most mobile is under higher pH values due to the anionic form of arsenic being dominant. With addition of lime to soils, it is possible to increase the solubility through the formation of $\text{Ca}_3(\text{AsO}_4)_2$. This compound, compared to the aluminium and iron complexes that form is much more soluble and thus much more mobile in the soil. Other factors that play a role in the mobility of arsenic are the presence of free Fe and Al oxides. This is the main reason why arsenic is more mobile in sandy soils; in clay soils there are considerably more Fe and Al oxides that can bind the arsenic. Redox potential also plays an important role in the mobility of the arsenic. Reduced arsenic in the III oxidation state is 4 to 10 times more soluble than the V form. This can also be closely linked to the reduction of the Fe (III) to Fe (II) with subsequent dissolution of the ferric arsenate [1, 2 and 4].

4.2.1.5 Toxicity of arsenic

Arsenic has been notorious for its toxic properties from the earliest times. It can have a detrimental health effect on humans and animals both when ingested and by inhalation. Characteristic effects of arsenic poisoning are perforation of the nasal septum, skin changes and peripheral neuritis. The fatal dose of ingested arsenic trioxide for humans is reported to be between 70-180 mg. Depending on the form of arsenic ingested, it can be eliminated via urine, but the excess arsenic can be found in skeleton, hair and nails. This element exhibits chronic and acute health effects when the individual is exposed to it. Other adverse effects are that it is carcinogenic

(cancer forming or inducing agent), teratogenic (substance effecting foetuses) and mutagenic (inducing chromosomal abnormalities) [4, 5, 6].

4.2.2 Barium (Ba)

4.2.2.1 General characteristics

Barium (Ba) is the heaviest stable alkaline earth metal in Group IIA together with beryllium (Be), calcium (Ca), magnesium (Mg) and strontium (Sr). Ba has an atomic weight of 137.3 and is element 56 in the periodic table. The density of Ba is 3.5 g/cm^3 , with a melting point of 725°C and a yellow-silver metallic colour. Ba is present in nature in the +II oxidation state. The free element oxidises readily in moist air and reacts with water and dilute acid. [3, 4, 6].

4.2.2.2 Application and possible pollution contributors

Barium enjoys a number of industrial applications. In the medical field barium sulphate is used as a contrast medium in X-ray examinations. Barium acetate is used in lubricants and in the fabrics printing industries. Barium bromate is used as a corrosion inhibitor for low carbon steel and barium carbonate is used in a number of manufacturing processes for ceramics, glass, and electrodes. Barium containing compounds are used in photocells, television tubes and explosives. Barium's greatest significance is due to its toxicological properties, thus it is widely used in rodenticides and insecticides. The most likely source of Ba pollution will be from industrial wastes [3, 4, 6].

4.2.2.3 Natural occurrence in the environment

Barium occurs mainly as the mineral barite (BaSO_4) and is mined in over 40 countries. Much smaller amounts are also mined as witherite. The United States is the largest producer of Ba at an estimated 4 million tons per year. Through chemical analysis, it has been found that Ba is very much present in all biological material analysed [4, 6].

4.2.2.4 Factors influencing the mobility of barium in sediments and soil

A number of barium compounds are highly soluble and this characteristic gives it great mobility properties. The adsorption is also dependant on the clay particles and the amount of organic matter present. Barium compounds that are very soluble in water are the chloride and nitrate; with carbonate only being soluble in dilute acid. The sulphate form, however, is the least soluble in any medium. The mobility of barium is pH dependent, the lower the pH of the soil the more mobile the element. With an increase in pH the adsorption of barium will increase [4, 6].

4.2.2.5 Toxicity of barium

Barium does not play a role in any metabolic processes, but it is highly toxic to humans and animals. Barium poisoning is characterised by very intense stimulation of muscles and muscle tremors. With high exposure, the respiratory muscles can be paralysed and cardiac arrest will soon follow. The threshold toxic dose of Ba is 0.2-0.5 g and lethal, 3-4g in untreated cases [4, 6].

4.2.3 Cadmium (Cd)

4.2.3.1 General characteristics

Cadmium is a soft, silver white electropositive metal. Cadmium is element 48 and a member of Group IIB in the periodic table. The density of the metal is 8.6 g/cm^3 (at 20°C) and has a melting point of 320.9°C . The metal is not abundant in the environment and is found together with zinc-containing ores. Like zinc, the metal occurs in the divalent form. The most commonly found cadmium compound is CdS. Cadmium easily forms complexes with ammonia and cyanide ($\text{Cd}(\text{NH}_3)_6^{4+}$ and $\text{Cd}(\text{CN})_4^{2-}$) and can also form organic complexes. Although cadmium oxidises easily, it is very resistant to rusting [1, 2, 4, 6].

4.2.3.2 Application and possible pollution contributors

Cadmium is mainly used in the production of alloys (especially low melting point alloys) and is also used in electroplating industries. Its resistance to rust makes it a very good metal to electroplate other metals that are susceptible to rust. Cadmium is much better than zinc (galvanised) in this regard. Cadmium is also used in the production in nickel-cadmium batteries. Cadmium sulfides are commonly used as pigment in the manufacture of paints and plastics, and cadmium stearate is used as a stabiliser in plastics. Possible pollution sources are zinc and lead mining practices, phosphate fertiliser, sewage sludge, industrial wastes and atmospheric deposits. Phosphate fertiliser can have high concentrations of cadmium depending on the composition of the parent rock used; with long term fertilisation the concentration of cadmium can be elevated [1, 2, 4, 6 and 7].

4.2.3.3 Natural occurrence in the environment

Cadmium crustal abundance is around 0.2 mg/kg and is closely related to the zinc-lead and zinc-lead-copper carrying ores. The percentage of cadmium present in these ores differ significantly, but it is in the range of 0.02–1.4%. The principle mineral for cadmium is hexagonal CdS (greenockite). In unpolluted areas that have higher than normal cadmium levels, the source will most likely be of the weathering of parent rocks [2, 7].

4.2.3.4 Factors influencing the mobility of cadmium in sediments and soil

Generally cadmium's solubility increases when the pH of the soil decreases. On the other hand, under neutral and reducing conditions, the element is relatively immobile. The property of being quite soluble makes it much easier to be bio-available for plants and living organisms. Another factor that plays a role in the mobility of cadmium is the cation exchange capacity. This parameter is the most important factor for adsorption of cadmium and others to a much lesser degree. Another factor that has an affect on the adsorption of cadmium is the ionic strength; an increase in ionic strength decreased the amount of cadmium adsorbed [2, 8].

4.2.3.5 Toxicity of cadmium.

Cadmium may give rise to both acute and chronic poisoning. The main symptoms are nausea, vomiting, abdominal cramps and headaches. The dose that will give rise to vomiting is in the order of 15 mg/L in water and for protein-containing food somewhat higher concentrations. The chronic effects of cadmium exposure are: Kidney and liver damage, anaemia, hypertension and negative effects on bone

formation. Cadmium is also classified as a carcinogen, teratogen and a mutagen [4, 6].

4.2.4 Chromium (Cr)

4.2.4.1 General characteristics

Chromium is a steel-gray, lustrous, hard and brittle metal. It is element 24 in the periodic table and is a member of Group VI-B. The element has an atomic weight of 51.996, a density of 7.18 g/cm³ (at 20°C) and a melting point of 1903°C. Chromium dissolves readily in non-oxidising mineral acids, but not in cold aqua regia or nitric acid [2, 6, 9 and 10].

4.2.4.2 Application and possible pollution contributors

World production of chromite (FeCr₂O₄) has been increasing in the last number of years, with South Africa being the largest producer of chromite. The main users of Cr are the metallurgical, refractory and chemical manufacturers. Metallurgic-grade chromite is converted into ferrochromium or alloys with iron, nickel or cobalt. Chromium is also used in the manufacturing process of stainless steel. The chemical industry uses ore that contains 45% chromic oxide for the preparation of sodium chromate and sodium dichromate. These compounds in turn are used as a tanning agent, catalyst, pigment and an ingredient of wood preservatives. The main pollution sources of chromium are mining and industrial wastes [2, 11].

4.2.4.3 Natural occurrence in the environment

Chromium is generally present in the environment, found in varying levels in air, soil, water and all biological materials. Chromium in most types of rocks is generally in oxidation states from $-II$ to $+VI$, but the most common states are 0 , $+III$ and $+VI$. Chromium mostly occurs as chromite in rocks. The reported value for chromium concentrations in soils varies considerably, but the range is between 100-300 mg/kg. The trivalent form is the most stable and occurs in two forms e.g. Cr^{3+} and CrO_2^- ; while the VI form is usually as $Cr_2O_7^{2-}$ (dichromate) and CrO_4^{2-} (chromate). Chromium under reducing conditions is in the trivalent form and under oxidising condition in the hexavalent form [2, 4 and 6].

4.2.4.4 Factors influencing the mobility of chromium in sediments and soil

The immobilisation of chromium depends on a number of factors, e.g., oxidation state, pH, clay minerals, competing ions and complexing agents. The movement of Cr (VI) was found to be better under higher pH conditions. Cr (III) solubility on the other hand decreases with the increase of pH. Its solubility in soil is less above pH 2.5 and it precipitates at pH 4.5 [2, 6 and 13].

4.2.4.5 Toxicity of chromium

Chromium in the hexavalent form is much more toxic than the trivalent form and is easily absorbed via lungs and gastrointestinal tract. Chromium in the trivalent form is essential to humans and animals. It plays an important part in insulin metabolism, however, the daily requirement of Cr (III) has not been established. Acute poisoning can occur with Cr (VI). Chromium (VI) is also classified as: Carcinogen, mutagen and teratogenic [4, 6].

4.2.5 Cobalt (Co)

4.2.5.1 General characteristics

Cobalt is a silver gray metal and is element 27, Group VIII, on the periodic table. The metal has an atomic weight of 58.9, a melting point of 1495°C and a density of 8.9 g/cm³ (at 20°C). The pure metal is hard and brittle and has magnetic properties. The oxidation states the metal occurs in are usually in the +II or +III. The compounds generally found are cobalt oxide, cobalt tetra oxide, cobalt chloride, cobalt sulfide and cobalt sulfate [4, 6].

4.2.5.2 Application and possible pollution contributors

Cobalt is used in the production of alloys with high melting points and also in magnets. The salts of the metal are very colourful and are commonly used as a pigment in the manufacturing processes. Radioactive Co is used in the medical field for the treatment of cancers and certain iron resistant anemias. Cobalt is also an ingredient of fertilisers, livestock feed, and is an essential integral component of the vitamin B₁₂. The most likely pollution source will be industrial waste products and excessive use of fertilisers in agriculture. To a smaller extent, medical waste can also add increase Co levels to the environment [4, 6].

4.2.5.3 Natural occurrence in the environment

Cobalt is a relatively rare metal comprising about 0.001% of the earth's crust. The most important minerals of cobalt are arsenites: Smaltites, cobaltite, sulfides and oxides. In recent times the production of the metal has increased due to the increase in demand. [6, 14 and 15].

4.2.5.4 Factors influencing the mobility of cobalt in sediments and soil

In general, the metal shows an increase in mobility with a decrease of pH. The adsorption of the element in soils is dependant in the organic matter present, soil type and the CEC of the soil [6, 16].

4.2.5.5 Toxicity of the cobalt

Cobalt ingested in very low concentrations will not have adverse effects on the health of humans and animals. In higher concentrations, however, it can induce vomiting and nausea through localised irritation of the gastric tract. Other known adverse effects to man are to the: Pancreas, kidney, thyroid gland and heart. The metal is also a mutagen, teratogen and carcinogen [6].

4.2.6 Copper (Cu)

4.2.6.1 General characteristics

Copper is one of the most important metals to man. It is element 29 and a member of Group I-B of the periodic table. The metal's atomic weight is 63.54, it has a melting point of 1083°C and a density of 8.96 g/cm³ (at 20°C). Copper is reddish in colour and takes on a brilliant metallic lustre when polished. Copper in nature usually occurs in +I or +II oxidation states. In the II form its properties are very similar to that of Zn²⁺, Mg²⁺ and Fe²⁺. Copper reacts with halogens, but not with non-oxidising acids. Copper is readily dissolved with nitric and concentrated sulphuric acid. It can also be dissolved in ammonium and sodium cyanide in the presence of oxygen [1-3, 17].

4.2.6.2 Application and possible pollution contributors

The metal is a very good conductor of heat and electricity. This is also the reason for its main use in the production of electrical wires and alloys. These alloys also include metals like: Tin, lead, zinc, nickel, aluminium and manganese. The metal's properties of very effective heat conduction and relative inertness make it very suitable for the construction of boilers, steam pipes and cooking utensils. The element is also widely used in agriculture through bactericides, fungicides and algicides in water purification processes. The major contributors of possible pollution are thus the industrial processes and agriculture [1,2].

4.2.6.3 Natural occurrence in the environment

Copper is found in nature as mainly sulfides, sulfates and carbonates. The major mineral that contains copper is chalcopyrite (CuFeS_2), which constitutes 34% copper. It is widely dispersed in rocks and is concentrated in large Cu ore deposits. By estimation, copper's average concentration in the earth crust is 24-55mg/kg and is ranked as being the 26th most abundant metal [2, 18 and 19].

4.2.6.4 Factors influencing the mobility of copper in sediments and soil

Copper in soil is very strongly adsorbed and is one of the most immobile metals found in soil. Factors that influence the adsorption of copper are: Organic matter, manganese and iron oxides and the type of clay present in the soil. The solubility, mobility and bioavailability of copper is very much dependent on the pH of the soil. Copper availability is the highest at lower pH values and is at an optimum at pH values lower than 5. When Cu^{2+} and Cd^{2+} mobility is compared, it is seen that Cd shows a much better mobility than Cu in the soil profile [2, 20].

4.2.6.5 Toxicity of copper

The major impact of copper on plants is the reduction on growth, poorly developed root system and reduced branching of branches. Copper is also part of the essential required by plants and animals elements and is part of all materials analysed. Elevated concentrations of copper have been found in epilepsy sufferers, but there is still no agreement that it causes the condition. Excessive levels of ingested copper can lead to chronic and acute poisoning [4, 6].

4.2.7 Iron (Fe)

4.2.7.1 General characteristics

Iron is element 26 and a member of Group VIII in the periodic table. The metal has an atomic weight of 55.85, a density of 7.9 g/cm³ (at 20°C) and a melting point of 1535°C. The oxidation states Fe occurs in nature are: +II, +III, +IV and +VI. The +II (Fe²⁺ ferrous) and +III (Fe³⁺ ferric) states are the most abundant of the mentioned states. Iron is a silver-white metal and is highly reactive. Ferrous chloride and ferrous sulfate are water-soluble and iron carbonate, iron oxide, iron hydroxide and sulfides have limited solubility in water. The metal oxidises readily in the presence of oxygen and moisture (rusting) [1, 6 and 21].

4.2.7.2 Application and possible pollution contributors

Iron is used in the production of many alloys. Iron compounds are widely used as catalysts, pigments in paints and electronic products. Iron is mainly used in the production of steel with treatment with coal, phosphorous, silica, and sulphur. Other elements that are used in this process are chromium, nickel, manganese and

molybdenum. Iron salts are also used as a flocculent in water purification process. Iron is also the main part of haemoglobin that is primarily used for the transfer of oxygen in the human body. Iron is used in medicine and as a dietary supplement. The main pollution sources of iron are mining (acid mine drainage) and industries converting iron into other products [6, 21].

4.2.7.3 Natural occurrence in the environment

Iron is the fourth most abundant metal in the earth's crust with an average concentration of 50 000 mg/kg. Abundant iron minerals in nature are: Hematite (Fe_2O_3), magnetite (Fe_3O_4), limonite ($\text{Fe}_2\text{O}_3 \cdot \text{H}_2\text{O}$) and siderite (FeCO_3). Iron occurs also in clay particles in the oxide form and is very important in the adsorption qualities of the soil [3].

4.2.7.4 Factors influencing the mobility of iron in sediments and soil

The factors that play a role in the mobility of iron are: Redox potential, pH and chelation. Inorganic iron compounds can be hydrolysed to form Fe^{3+} , FeOH^{2+} , $\text{Fe}(\text{OH})_2^+$, $\text{Fe}(\text{OH})_3(\text{aq})$ and $\text{Fe}(\text{OH})_4^-$. The Fe^{3+} , FeOH^{2+} and $\text{Fe}(\text{OH})_2^+$ forms are predominantly found in soil or solutions of low pH (acidic). Whereas the $\text{Fe}(\text{OH})_3(\text{aq})$ and $\text{Fe}(\text{OH})_4^-$ will be found in pH conditions higher than 7. The following equation indicates that with the oxidation of Fe(II) to Fe(III) contributes to the lowering of pH:

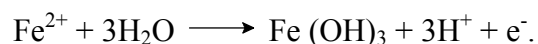

Bacterial conversion of Fe can produce soluble forms of iron in water [21, 23].

4.2.7.5 Toxicity of iron

Iron is an important micronutrient in humans and animals for the production of haemoglobin. A deficiency of this element will cause insufficient oxygen transportation in the body. Iron, however, can also be toxic in all forms and at moderate concentrations fatal poisoning is not uncommon. The amount of iron poisoning increased with the increased use of Fe in medicine. Severe poisoning will occur with amounts of 0.5 g especially in children. Symptoms of poisoning usually occur 1 to 2 hours after ingestion and include vomiting and ulceration of the gastric tract. Frequently the stool and vomit may become bloody from bleeding ulcers. It is also documented that iron is a carcinogen and with localised exposure can cause sarcomas [4, 6 and 24].

4.2.8 Mercury (Hg)

4.2.8.1 General characteristics

Mercury is element 80 and is a member of Group IIB in the periodic table. The metal has an atomic weight of 200.59, a density of 13.55 g/cm³ (at 20°C) and a melting point of -38.9°C. It is the only metal that is a liquid at room temperature. Mercury is a heavy, glistening, silvery-white metal with poor heat conduction properties but fair electrical conducting properties. Mercury in nature mainly occurs in the 0, +I and +II oxidation states. The metal form occurs in nature, but it is not very common. Other mercury compounds that are of importance are: Mercury sulfides, inorganic and organic complexes [2, 6].

4.2.8.2 Application and possible pollution contributors

Mercury has widespread applications in science, industry and agriculture. The biggest user of Hg is the chlor-alkali industry. In this industry mercury is used in the production of chlorine and caustic soda. Being the largest user of mercury, it is also the biggest possible pollution source. In agriculture the main use of mercury is in foliar spray to control plant diseases, however, the metal is very toxic and is not preferred as an element in the food chain. Other smaller users include: Pharmaceutical and electrical instrument manufacturing, dentistry (dental fillings), and laboratory products. Other contributing pollution sources are mining and smelting of Cu and Zn ores (associated with mercury) and burning of fossil fuels (mainly coal) [1, 2 and 6].

4.2.8.3 Natural occurrence in the environment

Mercury is not that abundant in the earth's crust and its concentration is on average about 50 µg/kg. This concentration is mainly due to the sulfide form and generally occurs in all types of parent rocks. Shales with high organic content are particularly enriched with mercury. Mercury minerals mainly consist of cinnabar and metacinnabar, with large deposits found in Spain [1,2].

4.2.8.4 Factors influencing the mobility of mercury in sediments and soil

The amount of mercury that mobilises in soil is dependent on the redox potential, characteristics of the organic and inorganic particles in the soil, the pH and the form in which mercury is present. The sorption of mercury (II) onto aluminium silicates, iron and manganese oxides and organic matter has been documented by a number of researchers. The pH of the soil determines the type and stability of solid mercury

species. A pH study showed that soil values between 4.5 and 5.5 showed increased adsorption of mercury in certain soil types [1, 2 and 25].

4.2.8.5 Toxicity of mercury

There is no documented evidence that mercury has any biological function. In spite of this, mercury is one of the most toxic metals known to man. All chemical forms of mercury are toxic and exhibit severe acute poison properties. The symptoms and damage vary according to the type of mercury compound the individual was exposed to. The metal is also shown to have teratogenic, mutagenic and carcinogenic properties. It does not seem that mercury has any phytotoxic characteristics, but with the impact it has on humans and higher animals, it is not advisable to use in foodstuff production [1, 2 and 6].

4.2.9 Manganese (Mn)

4.2.9.1 General characteristics

Manganese is a transition metal and is element 25 and a member of Group VII-A in the periodic table. The atomic weight of the metal is 54.938, with density of between 7.21-7.44 g/cm³ (at 20°C) and melting point of 1244°C. Manganese is a whitish-gray metal and it is harder than iron but quite brittle. The metal's natural oxidation states are: +II, +III, +IV, +VI and +VII. The salts in the +II, +IV, +VI and +VII are the most stable forms of manganese. The metal's chemical properties closely resemble that of Fe and it oxidises easily in the presence of moisture and oxygen. Mn (II) form salts with most of the anions found in water and these salts are usually soluble in water [1, 2, 3 and 21].

4.2.9.2 Application and possible pollution contributors

Manganese is primarily used in the metallurgical industries. It is used in the manufacture of steel where it neutralises the harmful effect of sulphur in the steel and serves as an antioxidant. Manganese is also used in the production of aluminium and copper alloys for the abovementioned reasons. This metal and its compounds are also widely used in alkaline batteries, glass, pigments and driers in paint, disinfectants and animal food additives. The most likely sources of pollution are in industrial and smelting processes, agriculture and combustion of fossil fuels (mainly coal) [1, 2 and 6].

4.2.9.3 Natural occurrence in the environment

Manganese ore deposits are widespread in the tropical and subtropical zones of the world and the average amount of Mn in the earth's crust is 1000 mg/kg. There are about 100 minerals that contain Mn as an essential element. The most common of the Mn compounds are: Oxides, carbonates and silicates. Manganese ion size is very much the same as that of magnesium and calcium and this makes it easier for the metal to displace these elements and be incorporated into the structure of the parent rocks. Manganese is mainly in the divalent state in water and soil [1, 2, 6 and 21].

4.2.9.4 Factors influencing the mobility of manganese in sediments and soil

Manganese is very mobile in soil with a pH value of less than 5.5. The pH value of soil is the single most important factor that influences the mobility and the bio-availability of Mn. The other factors that play a lesser role in the mobility are

organic matter in the soil and moisture content. Soil with low pH has the most soluble manganese compounds and thus more bio-available Mn [2, 21].

4.2.9.5 Toxicity of manganese

Manganese is essential for biological processes as part of enzyme structures. However, manganese deficiency is not common in the general population. The metal causes irreversible brain damage similar to Parkinson's disease with excessive exposure through ingestion or inhalation. Under acidic conditions the metal is very toxic and it is only aluminium that is more toxic under these conditions. The metal is also known to have teratogenic, mutagenic and carcinogenic properties [4, 6].

4.2.10 Molybdenum (Mo)

4.2.10.1 General characteristics

Molybdenum is part of the transition metal series and is a member of Group VI-B in the periodic table. It also shares some of the chemical characteristics of Cr. Mo is element 42 has an atomic weight of 95.95, a density of 10.2 g/cm³ (at 20°C) and a melting point of 2617°C. Mo is a very hard, silver-white metal and is commonly found in 5 oxidation states. These are +II, +III, +IV, +V and +VI, the most stable of which is +VI. The +IV and +VI oxidation states are the most abundant of the mentioned oxidation states found in nature. The most important compound of Mo is MoO₃, which is used in the production of other Mo compounds and salts. Molybdenum is also resistant to hydrochloric, sulphuric and hydrofluoric acids under a wide range of conditions. Molybdenum is found in water and soils as the

anion MoO_4^{2-} (molybdate) and under very elevated levels as soluble polymolybdate [2, 6].

4.2.10.2 Application and possible pollution contributors

The main use of Mo is in the production of alloys. Molybdenum is considered to be relatively non-toxic to humans and it is increasingly used to substitute for more toxic metals such as (Cr) in the production of alloys. The alloys produced are very resistant to environmental conditions. Other uses are in pigments, catalysts and corrosion inhibitors. The uses of Mo can thus be divided into two groups: Industrial and chemical. The possible sources of Mo pollution are mining activity, as an ingredient of fertilisers, sewage sludge and the burning of fossil fuels [2, 26].

4.2.10.3 Natural occurrence in the environment

In nature, the only important mineral of Mo is molybdenite (MoS_2); however, smaller deposits of powellite and wulfenite do contain Mo to a certain extent. The average concentration of Mo in soil ranges between 1 to 2.3 mg/kg and soils originating from granite and shales show elevated Mo levels. The concentration of Mo in the soil is highly related to the parent rock material and the availability of organic matter in the soil [1, 2 and 21].

4.2.10.4 Factors influencing the mobility of molybdenum in sediments and soil

Molybdenum in nature is much more mobile in alkaline conditions than in acidic conditions. The most important factor that influences the adsorption of Mo in soil is the amount of iron and aluminium oxides present in the soil. This is also closely related to the pH of the soil and it was found that with a decrease of pH the

adsorption of Mo increased substantially. In acidic conditions the soil carries a positive charge and this makes it possible for the molybdate anion (MoO_4^{2-}) to take part in the adsorption reaction. A typical reaction of molybdate in soil is indicated in the following reaction:

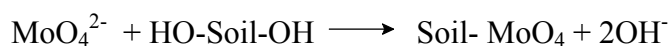

The organic content also plays a role in the adsorption, but does not play a major role [2, 27 and 28].

4.2.10.5 Toxicity of molybdenum

Molybdenum is an essential element in the diet of humans and it plays an important part in a number of enzymatic reactions in the body. Deficiency of molybdenum has not been reported in humans. As previously stated, the element has not been reported to be toxic to humans, but it can be highly toxic to cattle [1,6].

4.2.11 Nickel (Ni)

4.2.11.1 General characteristics

Nickel is element 28 and in part of Group VIII in the periodic table. It has an atomic weight of 58.71, a density of 8.9 g/cm^3 (at 20°C) and a melting point of 1453°C . Nickel is a hard, silver-white, malleable metal with good electrical conductor characteristics. The metal generally occurs in the oxidation states of: 0, +I, +II, +III and +IV. The most common and important oxidation states of nickel found in are the 0 and II states and these are also the most stable of the nickel compounds. Ni also closely resembles the chemical and physical properties of Co. Ni is soluble in

dilute nitric acid and to a small extent in sulphuric and hydrochloric acids. However, it is not soluble in NH_4OH [1, 2, 6].

4.2.11.2 Application and possible pollution contributors

Nickel is used in the manufacture processes of alloys (mainly stainless steel), electroplating, Ni/Cd batteries and electronic components. Nickel is highly corrosion resistant and this gives the alloys produced from nickel the same properties. These alloys are widely used in a number of fields. Nickel is also used in lesser amounts in jewellery, coins, tools and medical equipment. The main sources of possible nickel pollutions are industries refining nickel into alloys, sewage sludge and phosphate fertilisers (Ni content in phosphate rocks) [1, 2].

4.2.11.3 Natural occurrence in the environment

The nickel concentration in the earth's crust is on average 80 mg/kg. The nickel content varies considerably in the different types of rocks. The most important compounds of Ni are: Nickel sulfide (NiS) and nickelarsenate. In nature the mineral containing nickel is laterite, it is a nickel oxide that is generally mined in open-pit mines [2].

4.2.11.4 Factors influencing the mobility of nickel in sediments and soil

In retention studies, it was shown that the retention of Ni increases with the increase of pH (above 7). The mobility of Ni increases when the pH decreases and the pH also contributes to the precipitation of the nickel compounds formed under the different pH conditions. [2, 29].

4.2.11.5 Toxicity of nickel

In studies performed to investigate the toxicity of the metal, it was found that it is toxic to animals, humans and plants. Exposure to nickel has many localised effects and the main studied compound is nickel carbonyl. The main localised effect is dermatitis which can also be caused through ingestion of nickel. Other characteristics of nickel are that it has carcinogenic and teratogenic properties and contact with it must rather be avoided [6].

4.2.12 Lead (Pb)

4.2.12.1 General characteristics

Lead is element 82 and is a member of Group IV-A in the periodic table. The metal has an atomic weight of 207.19, a density of 11.35 g/cm³ (at 20°C) and a melting point of 327.5°C. Pb is a soft malleable metal, which is bluish-white in colour and has a brilliant lustre. It also has poor electrical conductivity. Pb generally occurs in the +II or +IV oxidation states and is slowly soluble in acids. The chloride and bromide salts are not soluble in water and the carbonate (PbCO₃) and hydroxide (Pb(OH)₂) salts are almost insoluble. In contrast, the nitrate (PbNO₃) and acetate forms are very soluble in cold water [2, 6].

4.2.12.2 Application and possible pollution contributors

The main users of lead are in the construction and automotive industries. Other uses of lead are: As a shielding agent for radioactive material, batteries, soldering products and fuel additive. Lead arsenate used to be widely used in pesticides, but it has been banned for this use. Possible pollution contributions will be for industrial

wastes and also in diffuse pollution from the combustion of leaded fuel in automobiles [2, 6].

4.2.12.3 Natural occurrence in the environment

Lead is widely found in the environment and is the most abundant heavy metal with atomic weight of more than 60. The average concentration of lead in the earth's crust is between 13 to 16 mg/kg. There are over 200 minerals that contain Pb, but the most economically important is anglesite (PbSO_4). Lead is present in rocks at varying amounts and it can displace elements from the rock matrix such as calcium, sodium, strontium, barium and potassium through the closely related properties [2, 30 and 31].

4.2.12.4 Factors influencing the mobility of lead in sediments and soil

In mobility studies, it was found that the mobility of lead is closely related to the pH. Under pH conditions of between 5-8.5 lead is present mainly in the carbonate form, between pH 8.5-12.5 it was found that it is in the hydroxide form. With pH values above 12.5 hydroxide complexes are formed which are very soluble in water. The pH also influences the chemical form and stability of Pb. The main factor in adsorption is the clay content in the soil. As discussed in Chapter 3, the amount and type of clay particles affects the adsorption and this was found to be the main contributor for the fixation of lead. Other factors like the CEC and organic matter have a lesser role to play in the adsorption of the metal [2, 32].

4.2.12.5 Toxicity of lead

The most common form of lead poisoning is gastrointestinal colic. It can be the cause of long or short-term exposure to lead. The symptoms are usually: Discolouration of the skin, slow pulse and increase in blood pressure. Under chronic effects it is common to find anaemia with liver, kidney, nervous system, endocrine organ and cardiovascular damage. The carcinogenic, teratogenic and genetic effects are also widely published in the literature [4, 6].

4.2.13 Vanadium (V)

4.2.13.1 General characteristics

Vanadium is element 23 and is part of Group VA in the periodic table. The metal has an atomic weight of 50.94, a density of 6.11 g/cm³ (at 20°C) and a melting point of 1890°C. Vanadium is a soft white metal. This metal mainly occurs in the +II, +III, +IV and +V oxidation states in nature and the trivalent form is the most common. It also shows the ability to form oxyanions and shares this property with Mo, As and phosphorous. Information on vanadium in soil and sediment is sparse [1, 2 and 3].

4.2.13.2 Application and possible pollution contributors

Vanadium is mainly used in the manufacture of tools that need to be resistant to corrosion and must be durable. Vanadium is also used in the production of steel. The metal is a major constituent of titanium alloys. The pentoxide form is used in the ceramic industry and also as a catalyst in the production of certain chemicals [2].

4.2.13.3 Natural occurrence in the environment

Vanadium is abundant in nature and is found in a number of minerals, crude oil and in organic matter. The average concentration of vanadium in soil is 110mg/kg. The vanadium content in soil that has its origin from sandstone is very low, compared with soils formed from clay and shales. Vanadium is commonly in the trivalent state in the parent rock material and other metal ores. In soil and sediment the main form of vanadium is the oxovanadium ion form. It can also substitute Fe in the soils and this is also the reason that there is a close relation between the Fe and V concentrations in soils [2,33].

4.2.13.4 Factors influencing the mobility of vanadium in sediments and soil

The most important ion of vanadium is the vanadate ion (VO_4^{3-}). This ion is in the VO_4^{4-} form under alkaline conditions and as VO^{2+} under acidic conditions. The amount of iron oxide and organic matter also plays a role in the adsorption process. The main factor in the availability of V to plants is the soil type [1,2].

4.2.13.5 Toxicity of vanadium

Generally, vanadium is not well absorbed in the body and thus the effect it has is lessened. In studies performed, it was seen that vanadium could have negative effect on the liver, kidneys, nervous system, lungs and cardiovascular systems. There is, however, no evidence that the metal possesses teratogenic, carcinogenic and mutagenic properties [4, 6].

4.2.14 Zinc (Zn)

4.2.14.1 General characteristics

Zinc is element 30 and a member of Group IIB in the periodic table. The metal is soft and bluish-white in colour. Zn has an atomic weight of 65.37, a density of 7.133 g/cm³ (at 20°C) and a melting point of 419.7°C. The metal occurs mainly in the divalent state (Zn²⁺) in nature and is soluble in acidic and neutral conditions. Under alkaline conditions the Zn precipitates in the hydroxide form. The divalent ion is known to form complexes in water solution, for example, Zn(CN)₄²⁻ and Zn(NH₃)₄²⁺ [2, 34].

4.2.14.2 Application and possible pollution contributors

The metal is mainly used in the electroplating industries where metal that is not corrosion resistant is coated with zinc. This process is known as galvanising and is used on metal that is may be used outdoors. Other uses of zinc include: pigment in paints, a micronutrient in fertilisers, batteries, and hardening agents in concrete and cement. Smaller amounts are also used in the manufacture of disinfectant solutions and cosmetic products. The main contributors to possible pollution are industrial wastes, over fertilisation and sewage sludge [2, 6].

4.2.14.3 Natural occurrence in the environment

Zinc is found in at least 80 minerals in nature, but the most important of these minerals are the sulfides (sphalerite and wurtzite) and their weathering products. Zinc in soil concentration is reported to be about 70 mg/kg and is present in all rock

types. It is also commonly known that this metal can easily be incorporated in the rock structure [2, 6].

4.2.14.4 Factors influencing the mobility of zinc in sediments and soil

Zinc, as previously mentioned, precipitates in alkaline conditions and this makes it less likely to be mobilised. Zinc is very soluble in acidic soil conditions and this solubility also makes it very bio-available for plants. A very small fraction of zinc adsorbed onto the clay particles is not mobilised, but can be dissolved in acid for analytical purposes. In soil with high organic matter, it can help the adsorption process through the formation of organo-metal complexes, which are less soluble in water [1, 2].

4.2.14.5 Toxicity of zinc

Zinc is an essential element in humans and animals and is required in various enzymatic reactions. A deficiency in zinc can easily occur and is well documented. Ingesting large quantities of zinc will cause gastrointestinal disturbances, which in turn promote vomiting and diarrhoea. The toxicity of zinc compared to other metals is very low and can be seen as non-toxic in moderate amounts. Compounds of the carbamate ester, however, are highly toxic and this is in agreement with the characteristics of the compounds. Carcinogenic, mutagenic and teratogenic characteristics are common with high level, long-term exposure. Zinc has a relatively high toxicity to fish and other aquatic life [6].

4.2.15 Zirconium (Zr)

4.2.15.1 General characteristics

Zirconium is element 40 and part of Group IVA in the periodic table. The metal has an atomic weight of 91.22, a density of 6.51 g/cm³ (at 25°C) and a melting point of 1857°C. In nature, the main oxidation states of the metal are +II, +III and +IV. The metal is also highly corrosion and heat resistant. Impurities in the metal such as carbon and/or nitrogen can have an embrittling effect on the metal [3, 4].

4.2.15.2 Application and possible pollution contributors

Zirconium, as previously stated, is highly corrosion and heat resistant and this makes it possible to use it in shielding materials in nuclear reactors and submarines. Its compounds are widely used in the production of paints, light bulbs, tracer bullets and detonators. The chloride and acetate compounds are used as a water repellent in textiles and paper. Zirconium sulfate is often used in the tanning industry. The most likely source of pollution is from industrial wastes from the above-mentioned industries [4].

4.2.15.3 Natural occurrence in the environment

Zirconium's main minerals are zircon (ZrSiO₄) and baddeleyite (ZrO₂) and the largest deposits on earth are in the United States, Brazil and Australia. Zr is at concentrations less than 162 mg/kg on average in the earth's crust. The metal, chemical and physical properties closely resemble that of hafnium [3].

4.2.15.4 Factors influencing the mobility of zirconium in sediments and soil

Zirconium is mobile in soil with pH value of less than 5.5. The pH value of soil is the single most important factor that influences the mobility and the bio-availability of Zr. The other factors that play a lesser role in the mobility are organic matter in the soil and moisture. Soil with low pH has the most soluble zirconium compounds and thus it is more bio available. Very little is known about the effect Zr has on animals and plants [2, 21].

4.2.15.5 Toxicity of zirconium

There are no reported incidents of Zr poisoning and, in general, information on the metabolic and other natural processes is very sparse. However, there is evidence that some people can be allergic to localised exposure, especially from deodorants [4, 35].

4.3 References

1. B. J. Alloway, Heavy Metals in Soils, Second, Blackie Academic & Professional, London (1990), pp 42-56, 105-257, 284-303, 317-322 and 346-351.
2. D. C. Adriano, Trace Elements in the Terrestrial Environment, Springer-Verlag, New York (1986), pp 8-14, 46-69, 106-384, 421-460, 472-474, 475-478, 494-496
3. N. N. Greenwood and A Earnshaw, Chemistry of the elements, Pergamon Press, New York (1984), pp 118-154, 637-646, 1138-1210, 1242-1327, 1365-1422,

4. E. Berman, Toxic metals and their analysis, Heyden & Son Ltd (1980), pp25-47, 82-89 110-135, 141-169, 221-253.
5. K. G. Brown and G. L. Ross, Regulatory Toxicology and Pharmacology, **36** (2002), pp162-174.
6. L. Friberg, G. F. Nordberg and V. B. Vouk, Handbook on the toxicology of metals, Elsevier / North-Holland Biomedical Press (1979), pp293-313, 321-328, 355-420, 435-553, 659-685.
7. J. E. Fergusson, The heavy elements: Chemistry, environmental impact and health effects, Pergamon Press (1990), pp 3-83.
8. J. Morillo, J Usero and I Gracia, Environment International, **28** (2002), pp 263-271.
9. R. J. Bartlett and J. M. Kimble, J Environ Qual, **5** (1976), pp 379-383.
10. W. Mertz, Physio Rev, **49** (1969), pp 163-239.
11. S. Langard and H. A. Waldron, Metals in the environment, Academic Press (1980), pp 111-132.
12. K. B. Krauskopf, Introduction to geochemistry, Second edition, McGraw-Hill, New York (1979), pp 617.
13. M. Astruc and J. N. Lester, Heavy metals in the hydro cycle, Selper Ltd (1988), London, pp 59-66.
14. Z. S. Kaplun, Toxicology of rare metals, Israel Program of Scientific Translations, Jerusalem (1967), pp 110-118.
15. S. F. Sibley, Mineral Yearbook, U.S. Bureau of Mines, Department of the Interior, Washington D.C (1977), pp 485-491.
16. I. K. Iskandar and M. B. Kirkham. Trace elements in Soil, Lewis Publishers, London (2001), pp 21-62.

17. F. A. Cotton and G Wilkinson, *Advanced Inorganic Chemistry*, Interscience (1962), pp 508-512.
18. H. J. M. Bowen, *Environmental chemistry of the elements*, Academic Press, New York (1979), pp 333.
19. D. P. Cox and J. O. Nriagu, *Copper in the environment*, John Wiley and Sons, New York (1979), pp 19-42.
20. S. J. Locascio, *Solutions* (1978), pp 30-42.
21. B. E. Davies, *Applied soil trace elements*, John Wiley and Sons, New York (1980), pp 176-197, 259-286.
22. W. L. Linday and W. A. Norwell, *Soil Sci. Soc. Am. J.*, **42** (1978), pp 421-428.
23. P. R. Hesse, *A textbook of soil chemical analysis*, Chemical Publisher Corp., New York (1962), pp 332-434.
24. A. E. MacKinnon and J. Bancewicz, *Brit Med J.*, **2** (1973), pp 277-279.
25. J. L. Newton, R. Ellis Jr. and G. M. Paulsen, *J. Environ. Qual.*, **5** (3) (1976), pp 251-254.
26. H. N. Lander, W. R. Chappell and K. K. Petersen, *Molybdenum in the environment*, Dekker Inc, New York (1977), pp 773-806.
27. C. M. Johnson, G. A. Pearson and P. R. Stout, *Plant Soil*, **4** (1952), pp 178-196.
28. H. M. Reisenauer, A. A. Tabikh and P. R. Stout, *Soil Sci. Soc. Am Proc*, **26** (1962), pp 23-27.
29. R. D. Harter, *Soil Sci. Soc. Am. J.*, **47** (1983), pp 47-51.
30. D. J. Swaine, *J Royal Soc. New South Wales*, **111** (1978), 41-47.
31. J. O. Nriagu, *Inorg Chem*, **11** (1972), pp2499-2503.

32. R. L. Zimbahl and R. K. Skogerboe, *Environ Sci. Technol*, **11** (1977), pp 1202-1207.
33. K. Norrish, D. J. D. Nicholas and A. R. Egan, *Trace elements in soil-plant-animal systems*, Academic Press, New York (1975), pp 55-81.
34. R. J. Shamberger and F. W. Oehme, *Toxicity of heavy metals in the environment*, Dekker Inc, New York (1979), pp 689-796.
35. D. Kleinhaus and W. Knoth, *Dermatologica*, **152** (1976), pp 161.

Chapter 5

Experimental Procedures

5.1 Sampling procedure

5.1.1 Preparation of sampling equipment

The equipment used in the sampling of river water and sediment was washed using Merck Extran ® MA2 soap (sample bottles and sample tubes). Thereafter it was placed in a solution of 1% (v/v) hydrochloric acid (HCl) for a period of 6 hours. The apparatus was removed from the acid solution and was rinsed with Milli Q® (18 MΩ. cm) quality water. The sample bottles and tubes were dried in a drying oven at a temperature of 60°C. This equipment was stored in a closed cupboard until use.

5.1.2 River sediment sampling

The sediment sampling was done in river flow conditions where the water level was not too deep for sampling. The core sampler and sampling tubes with a length of 500 mm were made of Perspex. This tube was inserted into the sediment, and the rubber stopper placed in the top of the tube. As a consequence of the clay properties and the organic matter present, it was possible to slowly extract a tube of sediment. The bottom rubber stopper was inserted at the moment when the tube was free from the bottom sediment. The sample tubes were thereafter placed in cooler boxes. The

samples, which were not preserved at sampling, were immediately taken to the laboratory where they were kept at 4°C until the sample preparation stage.

5.1.3 River water sampling

The river water samples were taken in 1-litre polyethylene bottles. The samples were taken just under the water surface with the bottle opening facing upstream against the river flow. This prevented accidental contamination from the sampler's hands. This type of water sample is called a sub surface grab sample. The water samples were not preserved at sampling, instead they were transported to the laboratories in cooler boxes and at arrival at the laboratory they were prepared for analysis. Thereafter, the prepared samples were preserved and stored in a cooler room at 4°C until analysis [1].



Photograph 1. Sampling at the Olifants River sampling point

5.2 Sample preparation

5.2.1 River sediment sample preparation

The tube samples were investigated to identify different layers in the sediment. The samples of the Blesbokspruit (Sample 1) and Crocodile River (Sample 2) did not have different layers in the 450 mm sample and the whole sample was used as a single fraction. The Blesbokspruit sample was almost black in colour, with heavy clay content and a significant amount of organic matter. The Crocodile River sediment sample had a dark brown colour and contained clay from top to bottom. The Olifants River sample, however, had a distinct 2-layered sample (Photograph 2). The top layer was light brown in colour and very sandy and comprised about 200 mm of the sample tube's (Olifants sand, sample 3) length. The bottom layer of the Olifants sample consisted of a dark brown clay layer. This comprised about 250-300 mm of the sample (Olifants clay, sample 4) [3].



Photograph 2. Sediment tubes from the Olifants River sampling point

The sediment samples were divided into the different layers (Olifants River sand layer No. 3) and Olifants River clay layer (No. 4). Thereafter the samples were placed in containers and all stones and removable organic matter was removed. The samples were dried in a drying oven at 30°C for a period of 1 day. After the drying stage, the sediment was ground using a mortar and pestle and sieved with a stainless steel sieve (0.2 mm mesh size). The smaller than 0.2 mm fraction (Fraction 1) was collected in the sieve container and placed in another clean wide neck polyethylene bottle. The fraction (Fraction 2) that did not pass through the sieve was also collected and placed in a clean wide neck polyethylene bottle. The last fraction (Fraction 3) used in this investigation was the unsieved fraction, after passing through the mortar and pestle stage, the fraction was collected in a further clean wide neck polyethylene bottle. All the fractions of the different samples were kept at room temperature until final preparation.

The sieved fractions for the different samples were calculated using 100 g of sediment, which underwent the above-mentioned process.

Table 1. Percentage sample representivity of the river sediment samples

Sample	Percentage representivity of the sieve fraction (%)	
	Fraction 1 (< 0.2 mm)	Fraction 2 (> 0.2 mm)
Blesbokspruit (No 1)	51.2	48.8
Crocodile River (No 2)	38.2	61.8
Olifants River (No 3)	11.3	88.7
Olifants River (No 4)	44.2	55.8

5.2.2 River water preparation

Directly after the water samples arrived at the laboratory, the samples were filtered using a vacuum type filtration apparatus. A 0.45 µm membrane filter was used to filter the water samples. The filtration apparatus was cleaned with the same procedure described in section 5.1.1. The 0.45 µm membrane was conditioned before use by filtering 50 mL of Milli Q® water followed by 50 mL 1% nitric acid (HNO₃) (v/v). Both the fractions were discarded and thereafter 100 mL of river water was filtered and preserved using 1 mL of concentrated HNO₃. These samples were then ready for ICP-OES analysis [2].

5.2.3 Extract solutions

The extract reagents used in the investigation were prepared using analytical grade chemicals from Merck (BDH® chemicals) and Milli Q® quality water. The salts were weighted using a calibrated (by a South African National Accreditation System (SANAS) accredited company) 4 decimal analytical balance. The extract solutions were prepared in 5 litre calibrated A grade volumetric flasks. The extract solutions were pH corrected and measured with a Knick® pH Meter 761 Calimatic calibrated with Radiometer Analytical® (pH 4 and 10) buffer solutions. All the chemicals and acids used to adjust the pH were also analytical grade chemicals. River water from the different sample points and Milli Q® water were also used as a mobile phase in the column and shaker procedures [4-10].

Table 2. Preparation of the mobile phases

Mobile phase	Extract Solution
Mobile alkaline phase pH 8	1 mol.dm ⁻³ Ammonium nitrate (NH ₄ NO ₃), pH adjusted to pH 8 with sodium hydroxide (NaOH)
Mobile neutral phase pH 7	1 mol.dm ⁻³ Ammonium acetate (CH ₃ COONH ₄)
Easy reduced phase pH 6	1 mol.dm ⁻³ Ammonium acetate (CH ₃ COONH ₄) and 0.1 mol.dm ⁻³ hydroxyl ammonium chloride (NH ₂ OH.HCl)
Weak acid soluble phase pH 5	1 mol.dm ⁻³ Sodium acetate (CH ₃ COONa), pH adjusted to pH 5 with glacial acetic acid (CH ₃ COOH)
Acid soluble phase pH 3	0.1 mol.dm ⁻³ Hydroxyl ammonium chloride (NH ₂ OH.HCl), pH adjusted to pH 3 with glacial acetic acid (CH ₃ COOH)
Milli Q water ® phase	Water with resistivity of better than 18 MΩ. cm ⁻¹ with measured pH of 6.9
River water phase	River water with measured pH values

5.3 Experimental Procedure

5.3.1 Sediment digestion procedure

The digestion of fractions 1-3 was performed using a mixture 20% (v/v) of HCl and HNO₃ in the ratio 3:1. One gram of the various fractions was weighed on a 4 decimal analytical balance (Mettler®AE 200) and transferred to a 200 mL glass

beaker. The sample mass was recorded for calculation of the concentration ($\mu\text{g/g}$). 100 mL of the digestion mixture was added to the sample in the 200 mL beaker and weighed thereafter. The weight was recorded and the sample was digested in a fume cupboard on a hotplate for a period of 2 hours on medium heat setting ($\pm 100^\circ\text{C}$). After 2 hours the samples were removed from the hotplate and left to cool down to room temperature. These samples were weighed again and the weight difference was adjusted to the original weight using Milli Q® water. The end weight difference was within 0.01g from the original weight. The samples were then filtered into a clean 350 mL polyethylene bottle using an 80 mm funnel fitted with a Whatman® 42 filter paper. This filter paper's filter speed is slow and retention is fine crystalline. The filtrate was stored in a cooler room at below 4°C until analysis. All three fractions of sediment were done in triplicate to minimalise the effects of heterogeneity of the sediment [11, 12].

5.3.2 Column experiment procedure

For the column experiments, 100 g of the three fractions was weighed on a 4 decimal analytical balance and placed in a 50 mm inner diameter glass tube. The glass tube was held in place with the aid of a support stand and clamp and it rested on a 80mm funnel fitted with Whatman® 42 filter paper. The extract solution was added to the sample using a Gilson Minipuls 2® peristaltic pump fitted with tubing with inner diameter of 1.3 mm. The peristaltic pump was set up to produce a flow rate of 1mL per minute and the delivery amount of extract solution was 100 mL. The total addition time of the extract solution was 100 minutes. This set up was used for all the mentioned extract solutions mentioned in Table 2. The tubing was

centred at the top of the glass tube to prevent irregular flow conditions. The filtrate was collected in a clean 350 mL polyethylene bottle and the samples were left to stand for 3 hours after the extract solution was added. Fractions 1 and 2 were done in duplicate and fraction 3 was prepared in quadruplicate to minimise the heterogeneity of the sediments. The filtrate's volume was measured and then stored in a cooler room at less than 4°C until analysis [13].

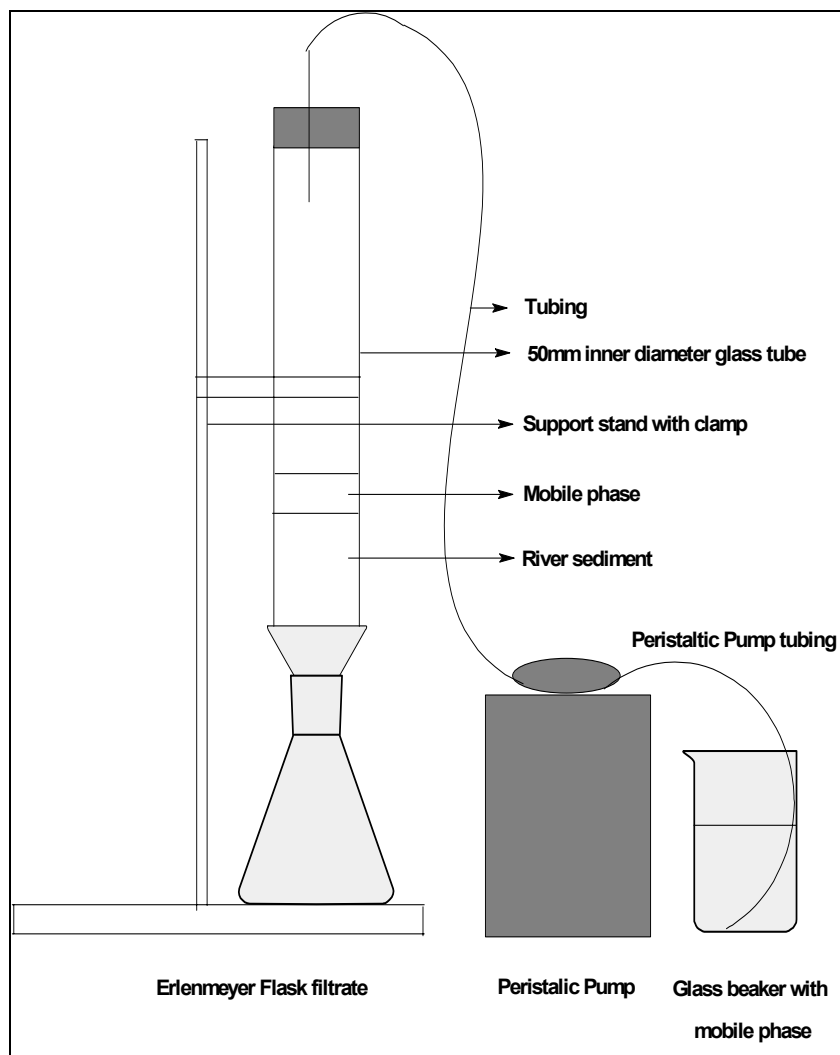

Figure 13. Experimental set up of the column experiment

5.3.3 Shaker experiment procedure

For the shaker test, 5g of sediment was weighed on a 4 decimal analytical balance and placed into a 350 mL polyethylene bottle for all the different fractions.

100 mL of the particular extract solution was added to the 5 g sample. The sample bottles were placed on a Labotec Model 202 shaker at setting 4 for a period of 100 minutes. After the 100 minutes, the samples were taken off the shaker and were filtered through a Whatman® 42 filter paper into a clean 350 mL polyethylene bottle [3].

5.3.4 Trace element spiking procedure

Column experiment.

For this experiment, 100 g of the different fractions were weighed into clean 350 mL polyethylene bottles. 15 mL of Milli Q® water was added to the sample to wet the sediment. Thereafter, 10 mL of each 1000 mg/L single element (Merck ampoule standards (15 elements)) standard was added to the sample (spiking) using an A grade calibrated pipette. This standard addition increased the original sample concentration by 10 mg. The sample was left to air dry at room temperature. After the sample was dry the lumps were crushed using a mortar and pestle to get the fraction as close as possible to the original state (before wetting and spiking).

Shaker experiment

Five gram of the different fractions were weighed into clean 350 mL polyethylene bottles. Five millilitres of Milli Q® water was added to the sample to wet the sediment. Thereafter, 0.5 mL of each 1000 mg/L single element (Merck ampoule

standards (15 elements)) standard was added to the sample using an A grade calibrated pipette. The amount to spike with was decided so as to be in the same ratio as for the column samples. This standard addition increased the original sample concentration by 0.5 mg. The sample was treated exactly the same as the column experiment samples after spiking.

5.3.5 Preparation of dilutions of samples

All the dilutions on over range determinant concentrations were performed using a Microlab® 500 auto diluter. This auto diluter is a double syringe system using Milli Q water for dilutions. The auto diluter has preset programmes for 10, 20, and 40-time dilutions. The dilutions were made directly into the sample cups (final sample amount of 8ml) from the prepared samples in the 350 mL polyethylene bottles [5].

5.4 ICP-OES parameters

5.4.1 Instrument parameters for analysis

Table 3. Instrument set-up and operating parameters

Parameter	Settings
Power	1200 W at 27 MHz
Cooling gas	62 rotameter units Ar
Auxiliary gas	50 rotameter units Ar
Nebulizer type	Cross flow
Nebulizer gas	32 - 34 psi
Spray chamber type	Scott

Parameter	Settings
Torch type	Fixed (radial)
Polychromator	20 channels air (210 – 800 nm).
Monochromator	N ₂ flushed (165 – 460 nm).
Sample introduction rate	2 mL per minute
Sample Replicates	3 integrations
Integration time	200 ms

5.4.2 Wavelength and limit of detection (LOD)

The LOQ was determined by running a method blank 10 times and the 2 mg/L control standard 10 times on the raw intensity mode on the polychromator. The formula used for the determination of the LOD gave better than 99% confidence level.

The formula to calculate the LOD is as follows:

$$\text{LOD} = \frac{3\sigma_{\text{Blank intensity}} \times \text{Standard concentration}}{(\text{Std intensity} - \text{Blank intensity})}$$

The LOD for the scans performed on the monochromator (elements: As, Co, Hg, Zr) were calculated by running the method blank and the 2 mg/L control standard 10 times. The LOD was calculated using the abovementioned formula.

The inter-element corrections were done as explained in Chapter 2 and these factors were incorporated into the calibration programme.

Table 4. Analysis wavelength, LOD and calibration range of the determinants

Determinant	Library Wavelength (nm)	Limit of detection (LOD) in mg/L	Calibration Range (mg/L)
As *	188,979	0.038	0-10
Ba	455,403	0.002	0-50
Cd	226,502	0.006	0-20
Cr	267,716	0.005	0-50
Co *	228,616	0.014	0-10
Cu	324,754	0.009	0-50
Fe	259,940	0.002	0-50
Hg *	184,950	0.015	0-10
Mn	257,610	0.011	0-50
Mo	281,615	0.007	0-20
Ni	231,604	0.046	0-20
Pb	220,353	0.033	0-20
V	311,071	0.006	0-20
Zn	213,856	0.002	0-50
Zr *	339,198	0.020	0-10

All the determinants with (*) were analysed using the monochromator and the rest were analysed with the polychromator.

5.4.3 Quality Assurance

ICP-OES analysis

Calibration and Standardization of the ICP-OES instrument

The ICP-OES instrument was calibrated using ampoule standards of Merck. These ampoule standards were diluted to provide calibration standards over the calibration

range. The calibration range included a calibration blank and a minimum of 4 calibration standards. After the instrument was calibrated, the correlation coefficients were checked to be better than 0.999. This was the accepted criterion of the calibration. After the calibration, a two point standardization was performed using a calibration blank and the highest concentration standard for the particular determinant, The acceptance criteria for the standardization factor was between 0.8 and 1.2. All the standardization factors had to comply with this criterion for the analysis to be accepted [17].

The calibration was verified using a 2 mg/L standard from Sigma-Aldrich. This standard had to give a concentration value of between 1.8 –2.2 mg/L for the calibration to be accepted. The method blanks and extract solutions were analysed and no concentration above the LOD was allowed to be present in order to comply with the quality criteria [17].

Control standard

A control standard with concentration of 2 mg/L (prepared from the calibration standards) was analysed every 10 samples to evaluate the instrument drift. The range that this standard had to comply with was 1.8-2.4 mg/L. After the last sample was analysed, the software calculated the drift corrected results of the samples. The method used for the mathematical calculation was a linear calculation between 2 control standards. If the concentration of the control standard was within 10% no correction was done [15, 17].

Certified Reference Material (CRM)

The digestion efficiency was checked using a certified reference material. This CRM was river sediment spiked with a certified concentration of the analysed elements. The results had to be in the specified range for the particular elements.

Analytical Balance

The Mettler®AE 200 balance was evaluated using a calibrated mass piece (check weight). Before weighing the 100 g samples, the balance was checked with a 100.000g mass piece. The same for procedure was followed for the 1 and 5 g samples, using 1.0000 and 5.0000g mass pieces respectively. The reading on the balance was checked against the certified value of the different mass pieces and it had to comply before it could be used [18].

pH measurements

The Knick® pH Meter 761 Calimatic was calibrated using Radiometer Analytical (pH 4 and 10) buffer solutions. After the calibration, a BDH® pH 7 buffer was used to verify the calibration. The buffer's certificate of analysis has a tolerance, which was used to assess the pH meter performance [19].

5.5 References

1. M. J. Gissera, J. Lacal, P. da Silva, R. Garcia, M. T. Sevilla and J. R. Procopio, *Environmental Pollution* **127** (2004), pp 175-182
2. M. F. Schillack and T. Duma, *Resource Quality Services: Trace metal method manual, SOP 2001 Dissolved metals in water.* (2003), pp 1-3, Department Water Affairs and Forestry, Pretoria

3. M. F. Schillack and T. Duma, Resource Quality Services: Trace metal method manual, SOP 2004 Water extract of solid material. (2003), pp 1-3, Department Water Affairs and Forestry, Pretoria
4. S. Tokalioglu, S. Kartal and L. Elci, *Analytica Chimica Acta* **413** (2000), pp 33-40
5. L. Ngiam and P. Lim, *The Science of the Total Environment* **275** (2001), pp 53-61
6. M. Kaasalainen and M. Yli-Halla, *Environmental Pollution* **126** (2003), pp 225-233
7. C. Dahlin, C. A. Williamson, W. K. Collins and D. C. Dahlin, *Environmental Forensics* **3** (2002), pp 191-201
8. Z. Dang, C. Liu and M. J. Haigh, *Environmental Pollution* **118** (2002), pp 419-426
9. L van der Merwe, P. L. Kempster, H. R. van Vliet and J. F. van Staden, *Water SA* **20(1)** (1994), pp27-34
10. A. J. Fernandez Espinosa, M. T. Rodriguez, F. J. B. de la Rosa, J. C. J. Sanchez, *Atmospheric Environment* **36** (2002), pp 773-780
11. L van der Merwe, Institute for Water Quality Studies: Trace metal method manual, SOP 2003 Microwave digestion of solid samples (1998), pp 1-4, Department Water Affairs and Forestry, Pretoria
12. A. Martin, A. Lopez-Gonzalvez and C. Barbas, *Analytica Chimica Acta* **442** (2001), pp 305-318
13. R. N. Yong, W. Z. W. Yaacob, S. P. Bentley, C. Harris and B. K. Tan, *Engineering Geology* **60** (2001), pp 307-322
14. Hamilton (Ltd) Pty, Microlab® 500 user's manual (1999), pp 1-35.
15. M. F. Schillack and T. Duma, Resource Quality Services: Trace metal method manual, Method 2010 Inductively Coupled Plasma (ICP) method (2003), pp 1-16, Department Water Affairs and Forestry, Pretoria
16. Spectro analytical instruments GmbH Spectro Report, Application Report 66 (1992), pp1-11.

17. M. F. Schillack and T. Duma, Resource Quality Services: Trace metal method manual, SOP 2014 Trace metal laboratory quality control and assurance procedures (2003), pp 1-7, Department Water Affairs and Forestry, Pretoria
18. M. F. Schillack and T. Duma, Resource Quality Services: Trace metal method manual, SOP 1001 Checking of balance and mass pieces (2003), pp 1-7, Department Water Affairs and Forestry, Pretoria
19. M. F. Schillack and T. Duma, Resource Quality Services: Trace metal method manual, SOP 2011 pH Meter: Preparation, calibration and measurement (2003), pp 1-3, Department Water Affairs and Forestry, Pretoria

Chapter 6

Analytical Results and Discussion

6.1 River water analytical result

The river water analytical results are shown in Table 5a and b.

Table 5a. River water analytical results using ICP-OES (Spectroflame Modula)

Determinant	Blesbokspruit water No 1 (mg/L)	Crocodile water No 2(mg/L)	River Olifants water No 3&4(mg/L)
As	0.038	0.051	0.023
Ba	0.050	0.025	0.045
Cd	< LOD	< LOD	< LOD
Co	0.169	< LOD	< LOD
Cr	0.015	0.014	0.011
Cu	0.023	0.027	0.023
Fe	0.612	0.018	0.262
Hg	< LOD	< LOD	< LOD
Mn	3.566	< LOD	0.037
Mo	0.045	0.047	0.044
Ni	0.140	0.035	0.034
Pb	0.085	0.091	0.103
V	0.025	0.030	0.025
Zn	0.115	< LOD	1.378
Zr	0.012	< LOD	< LOD

<LOD shows that the results were lower than the limit of detection of the ICP-OES.

The pH of the river water samples was measured immediately after arrival at the laboratory with a Knick pH meter (calibrated with pH 4 and 10 buffers).

Table 5b. River water pH results using Knick pH meter

Determinant	Blesbokspruit water No 1 (pH units)	Crocodile water No 2 (pH units)	River Olifants water No 3&4 pH units
pH	3.12	7.23	7.39

6.2 Digestion analytical results of the different fractions of the river sediments

6.2.1 Digestion results of Blesbokspruit (No 1)

Table 6a. Results of the different fractions after digestion

Determinant	Fraction 1 < 0.2mm (µg/g)	Fraction 2 > 0.2mm (µg/g)	Fraction 3 Unsieved (µg/g)
As	7.17	5.09	4.68
Ba	23.95	12.37	23.21
Cd	< LOD	< LOD	< LOD
Co	32.82	20.17	18.33
Cr	58.50	52.12	68.74
Cu	16.73	2.94	0.06
Fe	13320	15540	12850
Hg	< LOD	< LOD	< LOD
Mn	31.12	68.69	53.95
Mo	< LOD	< LOD	< LOD
Ni	21.26	26.33	15.12
Pb	12.81	5.18	8.51
V	43.42	34.26	41.92
Zn	53.09	11.91	18.65
Zr	4.12	3.52	3.80

6.2.2 Digestion results of the Crocodile River (No 2)

Table 6b. Results of the different fractions after digestion

Determinant	Fraction 1 < 0.2mm (µg/g)	Fraction 2 > 0.2mm (µg/g)	Fraction 3 Unsieved (µg/g)
As	4.20	6.16	6.80
Ba	123.44	152.99	118.60
Cd	< LOD	< LOD	< LOD
Co	18.39	24.10	20.60
Cr	60.64	99.31	74.36
Cu	48.02	53.64	27.04
Fe	22740	34060	26370
Hg	< LOD	< LOD	< LOD
Mn	1406	1859	1523
Mo	< LOD	< LOD	< LOD
Ni	29.61	40.27	31.87
Pb	90.39	109.96	87.78
V	39.89	56.92	43.71
Zn	346.7	456.5	338.5
Zr	3.27	4.01	3.65

6.2.3 Digestion results of Olifants River sand layer (No 3)**Table 6c.** Results of the different fractions after digestion

Determinant	Fraction 1 < 0.2mm (µg/g)	Fraction 2 > 0.2mm (µg/g)	Fraction 3 Unsieved (µg/g)
As	3.33	1.32	< LOD
Ba	24.27	30.44	25.87
Cd	< LOD	< LOD	< LOD
Co	7.57	8.40	12.56
Cr	38.83	47.24	49.10
Cu	< LOD	< LOD	< LOD
Fe	16090	15940	28120
Hg	< LOD	< LOD	< LOD
Mn	249.1	254.0	285.2
Mo	< LOD	< LOD	< LOD
Ni	10.89	12.98	8.17
Pb	< LOD	< LOD	< LOD
V	47.46	59.75	177.2
Zn	< LOD	< LOD	< LOD
Zr	2.65	2.81	3.30

6.2.4 Digestion results of Olifants clay layer (No 4)**Table 6d.** Results of the different fractions after digestion

Determinant	Fraction 1 < 0.2mm (µg/g)	Fraction 2 > 0.2mm (µg/g)	Fraction 3 Unsieved (µg/g)
As	< LOD	1.86	< LOD
Ba	53.76	45.27	83.08
Cd	< LOD	< LOD	< LOD
Co	17.94	14.80	21.34
Cr	135.22	76.84	134.59
Cu	< LOD	< LOD	< LOD
Fe	43110	26870	40730
Hg	< LOD	< LOD	< LOD
Mn	411.3	337.7	504.8
Mo	< LOD	< LOD	< LOD
Ni	30.22	20.46	37.31
Pb	< LOD	< LOD	< LOD
V	208.8	128.5	159.8
Zn	< LOD	< LOD	< LOD
Zr	2.84	2.37	2.68

6.2.5 Digestion results of the certified reference material NCS DC 73317**Table 6e.** Results of the certified reference material (CRM) NCS DC 73317

Determinant	Digested CRM ($\mu\text{g/g}$)	Certified Values ($\mu\text{g/g}$)	Deviation for Certified Values ($\mu\text{g/g}$)
As	86.57	84.3 \pm 3	-2.57
Ba	689.2	720 \pm 26	30.80
Cd	1.02	1.05 \pm 0.04	0.03
Co	21.55	20.8 \pm 0.8	-0.75
Cr	123.5	122 \pm 3	-1.5
Cu	37.82	38 \pm 0.5	0.18
Fe	46010	Not certified	Not certified
Hg	58.23	53 \pm 9	-5.23
Mn	701.3	690 \pm 12	-11.30
Mo	1.38	1.4 \pm 0.07	0.02
Ni	52.37	53 \pm 2	0.63
Pb	348.9	350 \pm 8	1.10
V	98.52	96 \pm 3	-2.52
Zn	237.3	238 \pm 6	0.7
Zr	157.34	162 \pm 5	4.66

The results of the CRM showed that the digestion procedure produced the desired result and that the results of the digested sediment are reliable.

6.3 Blank sediment column extract and shaker extract test

All the calculated results for the column extract method and shaker extract method are given in the Appendix at the end of this thesis for complete information purposes.

The spike sediment results will be discussed and illustrated through graphs at the end of each sample's results.

6.4 Discussion on the results of the Blesbokspruit samples (No 1)

6.4.1 Results of the Blesbokspruit water sample (Table 5a and b)

The results from the Blesbokspruit water sample showed that 13 out of the 15 trace elements measured were present in varying concentrations. The only trace elements that were not present were Cd and Hg. The main concentration contributions came from: Co, Fe, Mn, Ni and Zn. Their concentrations ranged from 0.115 mg/L (Zn) to 3.566 mg/L (Mn). The pH of the water is also very low for natural water and was measured at 3.12 (pH units). This can definitely play a major role in the elevated levels of trace elements in the river's water. With the pH being this low it will promote the movement of the trace elements in the sediment and they will eventually end up in the ground water source. From the concentrations in the water sample it can be seen that the area around the sampling point is heavily impacted, and the quality of the water is very poor. The main pollution contribution is originating from mining activities as mentioned in Chapter 1.

6.4.2 Blesbokspruit sediment digestion results (Table 6a)

It was clear from the water analysis that very high concentrations were expected. After the digestion of the sediment this was confirmed. These elevated levels were proven through the results obtained and from the 15 elements measured only 3 (Cd, Hg and Mo) were not found at detectable levels. The results for the smaller than 0.2 mm fraction gave a concentration range from the lowest 4.12 µg/g (Zr) to the highest concentration of 13320 µg/g of Fe. The source of the elevated Fe concentration is

probably originating from the pyrites in the sampling area, as previously discussed in Chapter 1. Between the different fractions of sediment that were measured there was not a major difference in concentration and the concentration ranges were within the same order of magnitude. Elements that showed a considerable difference between the fractions were Ba, Cu, Pb and Zn. These elements are closely associated with the clay fraction, which is present in much greater amounts in the smaller than 0.2 mm fraction of the sediment.

6.4.3 Blesbokspruit sediment column leaching tests results (Appendixes 1-3 and Graph 1)

With almost all the trace elements that were investigated, naturally present in the sample, a good understanding of the mobility of the trace elements will be achieved. This will also not rely heavily on the spiking experiment to show the mobility of the trace elements in this particular sediment sample. The trace elements that showed a concentration above their detection limits were Ba, Co, Cr, Cu, Fe, Mn, Ni, V, and Zn.

Ba was present at very low concentration throughout the extract solution series. From the results it is clear that between pH 6–8 are the best conditions for mobility, with the highest concentration being at pH 8 (1.12 µg/g). The behaviour of Ba was consistently displayed in all three fractions of sediment and there were no significant differences in the concentrations achieved.

Co was present in concentrations ranging from 5.99 $\mu\text{g/g}$ (Milli Q water) to 22.98 $\mu\text{g/g}$ at pH 6. The mobility of Co is relatively constant through the extract series and there is not a large difference between pH 3 and pH 6 in the concentrations measured. pH 5 displayed the worst mobility of the pH extract solution series with concentration not much higher than that of Milli Q water. Co was also very mobile in the river water and the calculated value compared well with the other synthetic extract solutions. Co also showed a significant difference between the three fractions of sediment. The smaller than 0.2 mm fraction gave the highest concentration followed by the unsieved and bigger than 0.2 mm fraction. Co concentration of the leachate compared to the digested sample concentration showed that 70% of the available Co was leached under the most favourable conditions. Under river water leaching it was found that the value was still very high (38%) and is of great concern.

Cr displayed mobility from pH 3 through to pH 7. The concentration however, was not high and ranged between 0.44 $\mu\text{g/g}$ (pH 3) to 0.85 $\mu\text{g/g}$ (pH 6). In this experiment it showed that Cr is the most mobile at pH 6 and to a lesser degree at the outer limits of the pH scale. This characteristic was also displayed through the different fractions of the sediment, with no drastic change in the mobility. When comparing the digested sample's concentration to the leachate concentration it is clear that only about 1.5% of the total Cr was leached under the most favourable conditions.

Cu was present at very low levels and the calculated values were between 0.05 $\mu\text{g/g}$ (pH 8) to 0.44 $\mu\text{g/g}$ (pH 3). It also showed a good relation between pH and mobility. The lower the pH the higher the mobility of this trace element. When comparing the calculated values from the digested samples and the leaching test, however the

percentage of Cu mobilised under the best condition was only 1.3%, which shows that the largest fraction of copper is adsorbed onto the sediment particles.

Fe was present in very large amounts and the concentrations ranged between 9.3 $\mu\text{g/g}$ (Milli Q water) and 338.7 $\mu\text{g/g}$ (pH 3). The river water also leached a considerable amount of Fe (132.20 $\mu\text{g/g}$), which showed that under normal river conditions Fe is very mobile and can cause considerable damage to the underground water resource. The result of Fe in fraction 1 was twice that of fraction 2 and 3, but the relationship between the extract series was the same. The amount of Fe leached compared to the total calculated Fe present in the sediment was only 2.5%, but due to the very high concentrations of Fe present it still contributes greatly to the total pollution impact.

Mn, like Fe was also present in high amounts and the concentrations ranged from 76.26 $\mu\text{g/g}$ (pH3) to 14.96 $\mu\text{g/g}$ (pH 7). The river water also showed the ability to mobilise considerable amounts of Mn from the sediment (63.39 $\mu\text{g/g}$). The result of Mn in fraction 1 was twice that of fraction 2 and 3, but the relationship between the extract series was the same. The leachate shows that almost 100% of the Mn present is mobilised and this can also contribute greatly to pollution.

Ni was present at average concentrations and ranged from 12.09 $\mu\text{g/g}$ (pH 3) to 2.45 $\mu\text{g/g}$ (Milli Q water). The river water again showed increased ability to mobilise Ni from the sediment under normal river conditions. The result of Ni in fraction 1 was in the order of twice that of fraction 2 and 3, but the relationship between the extract series was the same. The percentage of Ni mobilised under the most favourable conditions was 57%.

V showed the highest mobility under conditions between pH 3 (0.16 $\mu\text{g/g}$) and pH 6 (0.67 $\mu\text{g/g}$). The calculated concentrations were not high and the percentage V mobilised under the most favourable conditions was a mere 2.9%. The results from the three sediment fractions were closely related and showed the same correlation throughout the extract series. The total contribution of V to possible pollution of the ground water source under normal river conditions is very low. The river water mobilised very small amounts of V and is not seen as a possible pollutant.

Zn was mobile throughout the extract series with concentrations ranging from 3.83 $\mu\text{g/g}$ (Milli Q water) to 24.25 $\mu\text{g/g}$ (pH 6). From the results it could be seen that Zn is the most mobile under pH condition of pH6-8 and to a lesser degree under lower pH conditions. The river water mobilised 14.86 $\mu\text{g/g}$ and this can definitely contribute to pollution of the ground water resource. The result of Zn in fraction 1 was at least two times higher than that of fraction 2 and 3, but the relationship between the extract series was the same. The percentage of Zn mobilised compared to the total Zn available was 46%.

All the abovementioned percentages were calculated using the smaller than 0.2 mm fraction (fraction 1) of the digested samples.

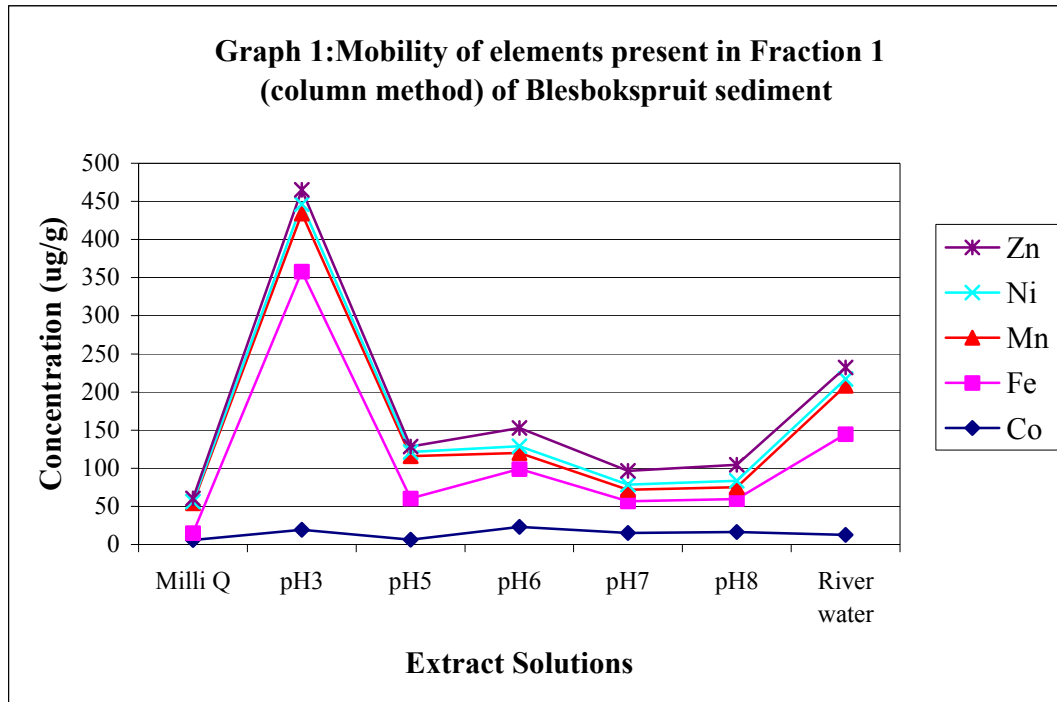

Graph 1. Mobility of the elements present in Fraction 1 (column method) of Blesbokspruit sediment

6.4.4 Blesbokspruit sediment shaker method leaching tests results (Appendixes 4-6 and Graph 2)

The trace elements that showed gave a concentration above their detection limits were Ba, Co, Cr, Cu, Fe, Mn, Ni, V, and Zn. Pb was also detected in the unsieved samples at measurable quantities.

Ba was present at moderate levels throughout the extract solution series. From the results it is clear that pH values of 3 to 6 present the best conditions for mobility, with the higher concentrations being at pH 3 (4.79 µg/g) and pH 6 (4.44 µg/g). Comparing these results with that of the column method it has found that there is much higher

concentrations reported in the shaker method and the pH conditions are slightly different. Calculating the percentage of Ba mobilised with this method gave a value of 20%. This value is considerably higher than that of the column method. The Ba calculated values also consistently displayed the same characteristics throughout the extract series with no significant differences in the concentrations achieved.

Co was present in concentrations ranging from 2.52 $\mu\text{g/g}$ (pH 6) to 12.60 $\mu\text{g/g}$ (pH 3). The mobility of Co is highest at the lower pH, but under the Milli Q water condition the calculated concentration was very close to that at pH 3. This compares well with the column method, which also gave a considerable concentration. The river water shaker sample showed considerable decline in concentration compared with the column method. The differences between the three sediment fractions were not as distinct as for the column methods. Co concentration of the leachate compared to the digested sample concentration, 39% of the available Co was leached under the most favourable conditions.

Cr displayed mobility from pH 3 through to pH 6. The concentration ranged between 4.13 $\mu\text{g/g}$ (pH 3) to 0.93 $\mu\text{g/g}$ (pH 6). In this experiment it showed that Cr is the most mobile at pH 3 and mobility decreases to the upper part of the pH scale. This characteristic was also displayed through the different fractions of the sediment, with drastic decrease in the mobility at higher pH values. The amount of Cr mobilised under normal river conditions was 1.46 $\mu\text{g/g}$, which is high enough to cause concern. When comparing the digested sample's concentration to the leachate concentration it is clear that only about 7.1% of the total Cr was leached under the most favourable conditions.

Cu was only present in three extract solutions e.g. pH 3, 6 and 8. These concentrations ranged from 0.21 $\mu\text{g/g}$ (pH 8) to 16.26 $\mu\text{g/g}$ (pH 3). When comparing the calculated values with that of the column methods it is clear that the concentration with pH 3 extract is considerably higher in the shaker method. The other values compared well with that of the column method. The values obtained between the different fractions shows the same characteristics throughout. Comparing the values from the digested samples and the leaching test, however the amount of Cu mobilised under the best condition gave a percentage of 97%, which contradicts the findings of the column methods. The extract solutions for pH 7 and 8 NH_4 species were available and no mobility of copper was expected due to the complexing properties NH_4 has with copper.

Fe was present in very large amounts and the concentrations ranged between 0.22 $\mu\text{g/g}$ (pH 8) and 378.5 $\mu\text{g/g}$ (pH 3). The river water also leached a considerable amount of Fe (40.42 $\mu\text{g/g}$), which showed that under normal river conditions Fe is very mobile and can cause considerable pollution to the underground water resource. The result of Fe in fraction 1 was higher than in fraction 2 and 3, the relationship between the extract series was the same. The difference in concentration between the fractions was much closer than that of the column method. The amount of Fe leached compared to the total calculated Fe present in the sediment was only 2.8%, but due to the very high concentrations of Fe present it still contributes greatly to the total pollution impact.

Mn was present at moderate levels, which ranged from 2.17 $\mu\text{g/g}$ (river water) to

7.12 $\mu\text{g/g}$ (pH 3). The river water also showed the ability to mobilise Mn, but to a much lesser degree than, which was found in the column method. There were also considerable differences in the different fractions of sediment and the highest concentration was calculated for the larger than 0.2 mm fraction. The leachate shows that 23% of the Mn present is mobilised.

Ni was present at average concentrations and ranged from 7.89 $\mu\text{g/g}$ (pH 3) to 0.63 $\mu\text{g/g}$ (pH 7). It was also observed that with decrease of pH the mobility of Ni increased. The river water again showed the ability to mobilise Ni from the sediment under normal river conditions. The result of Ni in fraction 1 was close to that found in fractions 2 and 3 and the relationship between the extract series was the same. The percentage of Ni mobilised under the most favourable conditions was 37%.

Pb was only present in the unsieved fraction at detectable levels. From the results it can be seen that the mobility of Pb is the highest between pH 6-8. The percentage leachable Pb however is only 15%. The results however of lead were very variable and not consistent.

V showed the highest mobility under conditions between pH 3 (3.51 $\mu\text{g/g}$) and pH 6 (3.23 $\mu\text{g/g}$). The results from the three sediment fractions were closely related and showed the same correlation throughout the extract series. The calculated concentrations were not high and the percentage V mobilised under the most favourable conditions was 8.1%. The total contribution of V to possible pollution of the ground water source under normal river conditions is very low. The river water

mobilised very small amounts of V, which is not seen as an element of major concern in this river.

Zn was mobile throughout the extract series with concentrations ranging from 2.83 µg/g (pH 7) to 21.21 µg/g (pH 3). From the results it could be seen that Zn is the most mobile under lower pH conditions. The river water mobilised 5.63 µg/g and this can definitely contribute to pollution of the ground water resource over a period of time. The result of Zn in fraction 1 was at least two times higher than that of fraction 2 and 3, but the relationship between the extract series was the same. The percentage of Zn mobilised compared to the total Zn available was 40%.

All the abovementioned percentages were calculated using the smaller than 0.2 mm fraction (fraction 1) of the digested samples.

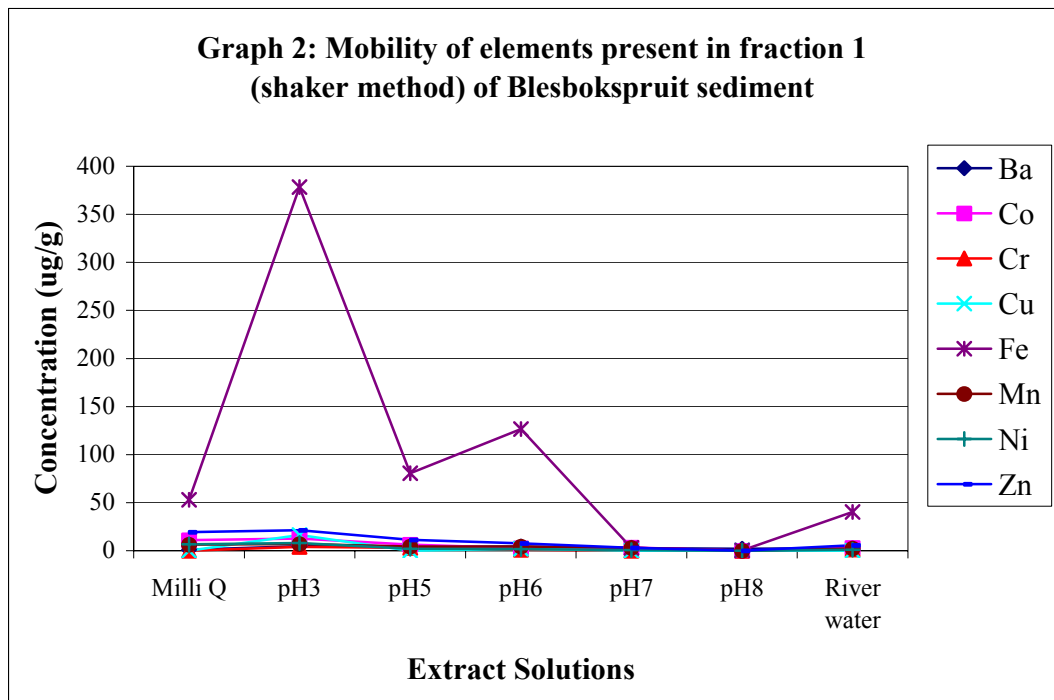

Graph 2. Mobility of the elements present in Fraction 1 (shaker method) of Blesbokspruit sediment

6.4.5 Blesbokspruit sediment spiking results (Graphs 3 & 4)

The results of the spiking exercise for the column method were only reliable for the following elements: Ba, Cd, Co, Ni and Zn. These results are presented in Graphs 3 (column method) and 4 (shaker method). The recovery of Ba varied from 0.86% (Milli Q water) to 11.92% (pH 3). The recovery was not high and this is an indication that the sediment adsorbs the element well. Cd on the other hand was mobile throughout the extract series with recovery ranging from 24.7% (pH 6) to 97.21% (pH 8). These results of the two elements were obtained from the smaller than 0.2 mm fraction.

With the bigger than 0.2 mm fraction Cd exhibited the same type of recoveries throughout the series, but the recoveries were lower in value. Ranging from 16.23% (river water) to 46.52% (pH 3). Co gave results ranging from 0% (pH 8 and river water) to 41.13% (pH 5). Ni showed uniform recoveries from Milli Q water to pH 7, which ranged from 30.51% (Milli Q water) to 10.61% (pH 6). Zn also exhibited the same characteristic as Ni, but the percentages were considerably higher though. The unsieved sample gave the same results on Cd and Co as previously mentioned.

The results of the shaker method gave reliable results for the following elements: Ba, Cd, Ni and V. Ba gave recovery values from 13.04% (pH 8) to 107.37% (pH 3). The values clearly show that the mobility increased with the decrease of pH. Barium's recovery results were much higher than with the column tests. Cd was moderately mobile and gave recoveries ranging from 0% (pH 7&8) to 57.69% (pH 3). V gave recoveries from 0% (pH 8) to 46.58% (river water). These results of the three elements were moderately mobile in the river water extract solutions. This shows that

under normal river conditions these elements can mobilise and move to the underground water source. These results were obtained from the smaller than 0.2 mm fraction.

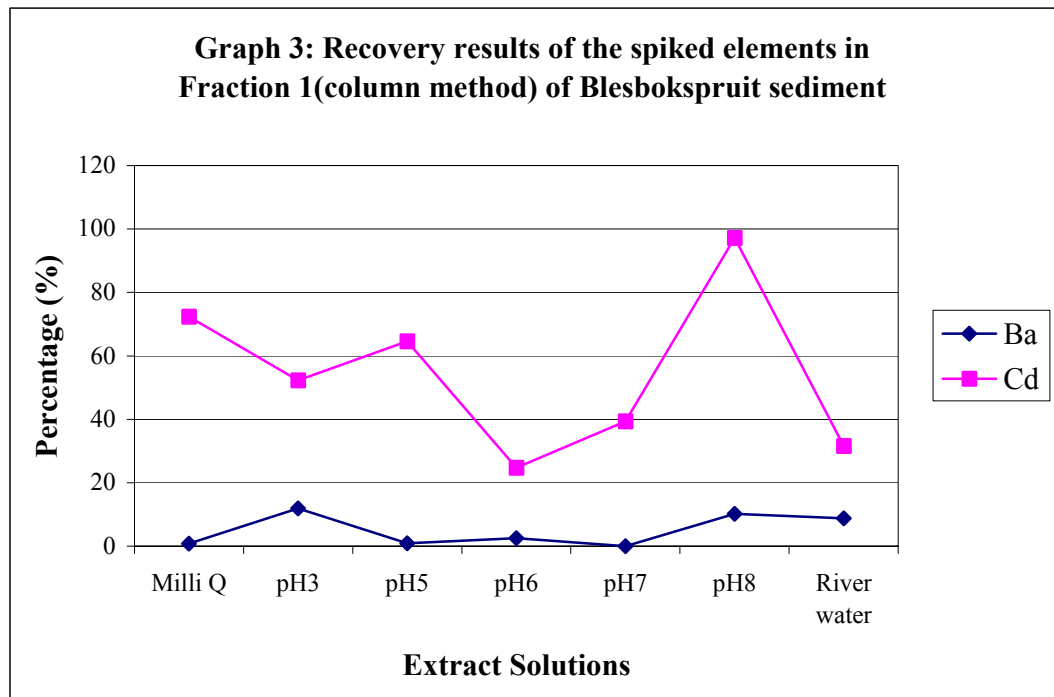

Graph 3. Recovery results of the spiked elements in fraction 1(column method) of Blesbokspruit sediment

With the bigger than 0.2 mm fraction Cd showed the same characteristics as with fraction. The recoveries of Cd ranged from 0% (pH 8) to 71.04% (pH 3). Barium's recovery results were in the same order of magnitude that was obtained from fraction 1. Ni exhibited mobility ranging from 0% (pH 8) to 21.27% (pH 3). The unsieved sample gave the same results on Ba and Cd as previously mentioned.

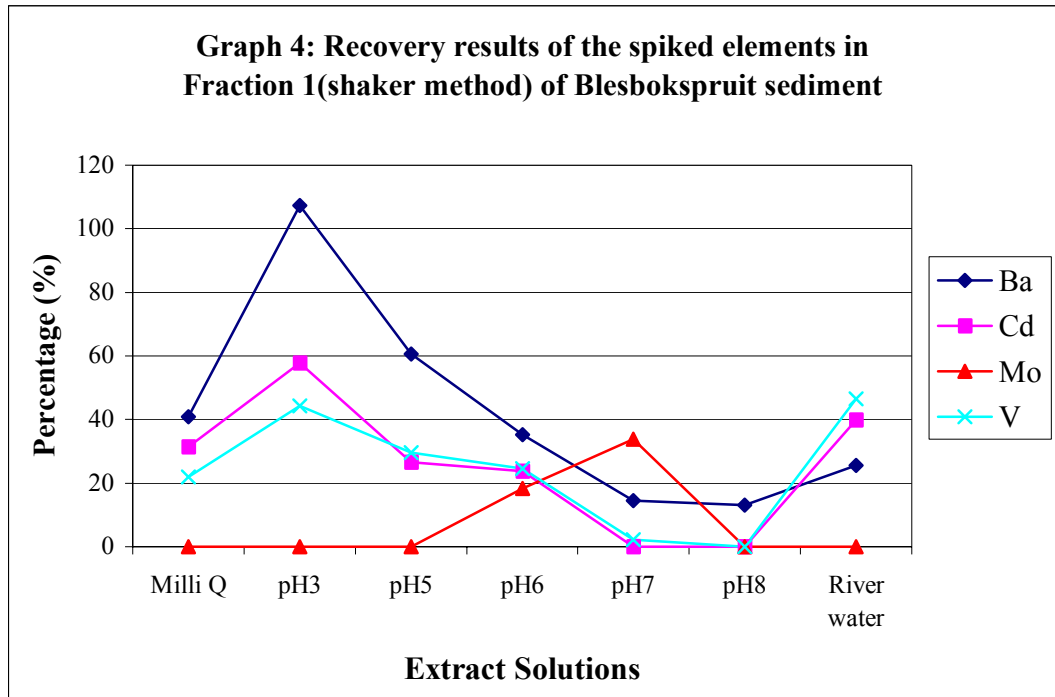

Graph 4. Recovery results of the spiked elements in fraction 1(shaker method) of Blesbokspruit sediment

6.5 Discussion on the results of the Crocodile River samples (No 2)

6.5.1 Results of the Crocodile River water sample (Table 5a and b)

The results from the Crocodile River water sample showed that 9 out of the 15 trace elements measured were present in varying concentrations. The elements that were not present were Cd, Co, Hg, Mn, Zn and Zr. The concentrations of the elements present were much lower than that of the Blesbokspruit and ranged from 0.014 mg/L (Cr) to 0.09 mg/L (Pb). The pH of the water is considered normal for natural water sources and was measured at 7.23 (pH units). The main factor that influences the low concentrations of elements present in the river water is the neutral to slightly alkaline

pH of the water. This is also an indication that little to no acid mine drainage is present in the river water. The main contribution of expected contamination in the Crocodile River is from agricultural processes and to a lesser degree mining as previously mentioned in Chapter 1.

6.5.2 Crocodile River sediment digestion results (Table 6b)

The sediment analysis showed that there were 12 out of the 15 elements measured that were present. The elements that were not present at detectable concentrations were: Cd, Hg and Mo. The results from all the fractions gave correlating results with one another and were in the same order of magnitude. The element with the lowest concentration was Zr with a concentration of 4.12 $\mu\text{g/g}$ and the highest concentration was of 34060 $\mu\text{g/g}$ of Fe. The small difference in the concentrations can be attributed to the low amount of clay present in the sample compared to the Blesbokspruit sediments. The elements are evenly distributed throughout the fractions.

6.5.3 Crocodile River sediment column leaching tests results (Appendixes 7-9 and Graph 5)

The trace elements that showed gave a concentration above their detection limits were Ba, Mn and Zn. Barium was present in rather low concentration ranging from 0.25 $\mu\text{g/g}$ (river water) to 13.34 $\mu\text{g/g}$ (pH 6). This shows that the best mobility of Ba was obtained between pH 5-6. The percentage of leachable Ba was 10.8% under the best mobilisation conditions.

Mn was present at very high concentrations in the digested sediments and was expected to be present in elevated levels in the leachate. The Mn concentrations ranged from 4.72 $\mu\text{g/g}$ (river water) to 478.2 $\mu\text{g/g}$ (pH 6). The percentage of Mn mobilised under the most favourable conditions was 33.9%. Under normal river conditions though, Mn is not easily mobilised and a drastic change in the river water conditions will be necessary.

Zn was present in low to moderate concentrations ranging from 0.71 $\mu\text{g/g}$ (river water) to 24.50 $\mu\text{g/g}$ (pH 5). Again the same applies to Zn as previously mentioned with Mn, very low mobility was seen with the river water. The percentage mobility of the Zn in the sample was calculated as being 7.1%.

Throughout the different fractions of sediment it was seen that the abovementioned elements and characteristics were identical. This is also in line with the findings with the digested sediment fractions. The same explanation as with the digested sediment applies to these fractions. The river water did not contribute to the mobility of the trace elements and will have a small effect on the underground water sources. Comparing this results with the Blesbokspruit results it is clear that the Crocodile River is not nearly as polluted.

All the abovementioned percentages were calculated using the smaller than 0.2 mm fraction (fraction 1) of the digested samples.

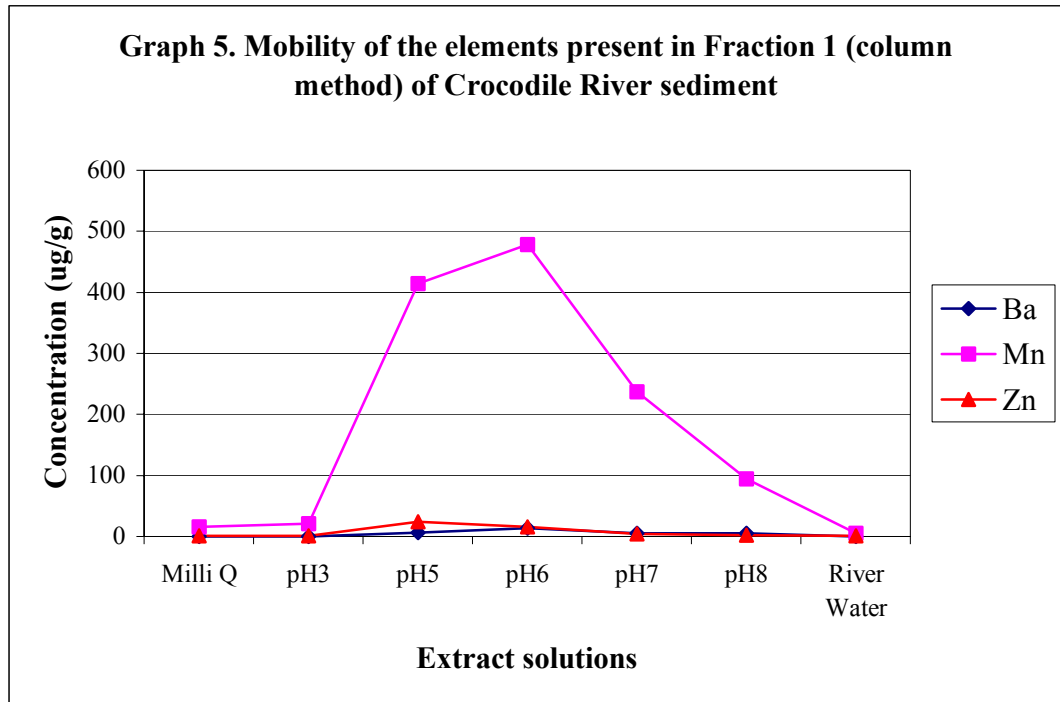

Graph 5. Mobility of the elements present in Fraction 1 (column method) of Crocodile River sediment

6.5.4 Crocodile River sediment shaker method leaching tests results (Appendixes 10-12 and Graph 6)

The same elements that were found to be mobile in the column test were found, in addition to Fe and Ni. All the calculated concentrations were much higher than that of the column method. Ba gave results that ranged from 0.69 $\mu\text{g/g}$ (river water) to 39.15 $\mu\text{g/g}$ (pH 6).

Fe was present in high concentrations ranging from 0.07 $\mu\text{g/g}$ (pH 7) to 620.4 $\mu\text{g/g}$ (pH 3). These results were considerably higher than in the column method. The percentage mobility of Fe under most mobile condition was calculated to be 2.7%.

Under normal river conditions however, the concentration of Fe was very low and slightly mobile. The Ni concentrations were low and showed good relationship of being more mobile under lower pH conditions. The percentage of Ni mobilised was 16%, but under normal river conditions it was only 1.6%.

Mn and Zn, which exhibited considerably higher concentrations, gave the same characteristics as with the column method. The same mobility characteristic was found throughout the extract series of the other sediment fractions and compared well with the column test. This can be attributed to the fact that the amount of clay particles was not present in the same quantities than with the Blesbokspruit samples and the distribution of the elements through the fractions was more uniform.

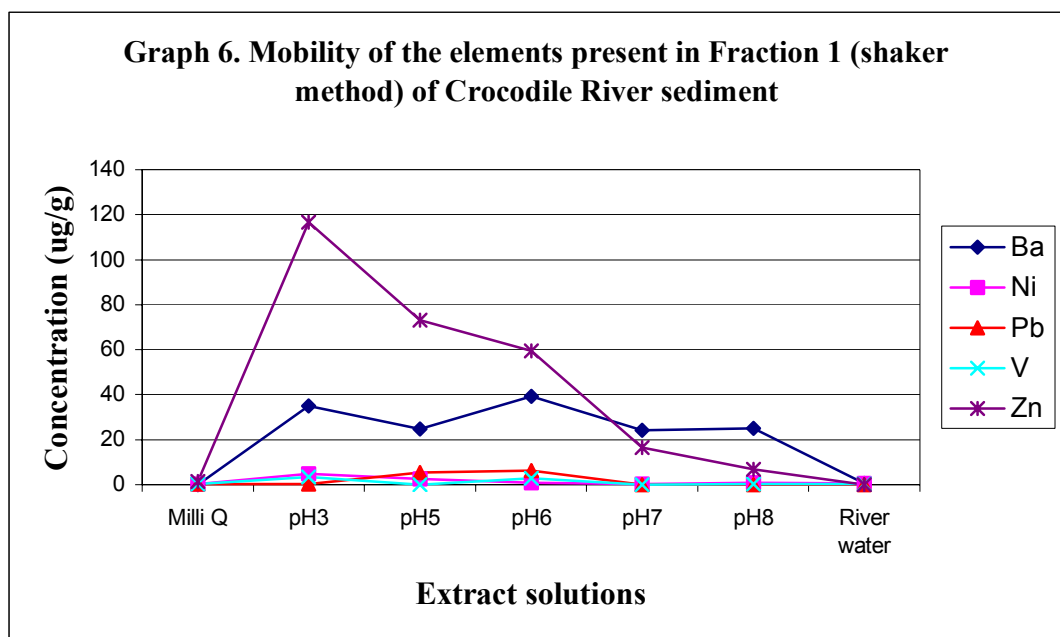

Graph 6. Mobility of the elements present in Fraction 1 (shaker method) of Crocodile River sediment

6.5.5 Crocodile River sediment spiking results (Graphs 7 & 8)

The elements that gave reliable recovery results were Cd, Co, Cr and Ni. The recovery values for Cd, Co and Ni were high and showed a good relationship between the mobility and lower pH levels. Under river conditions it was illustrated that in the event of Cd and Co pollution, it is possible to mobilise these elements. Ni showed that in higher concentration levels it could be mobilised by the river water.

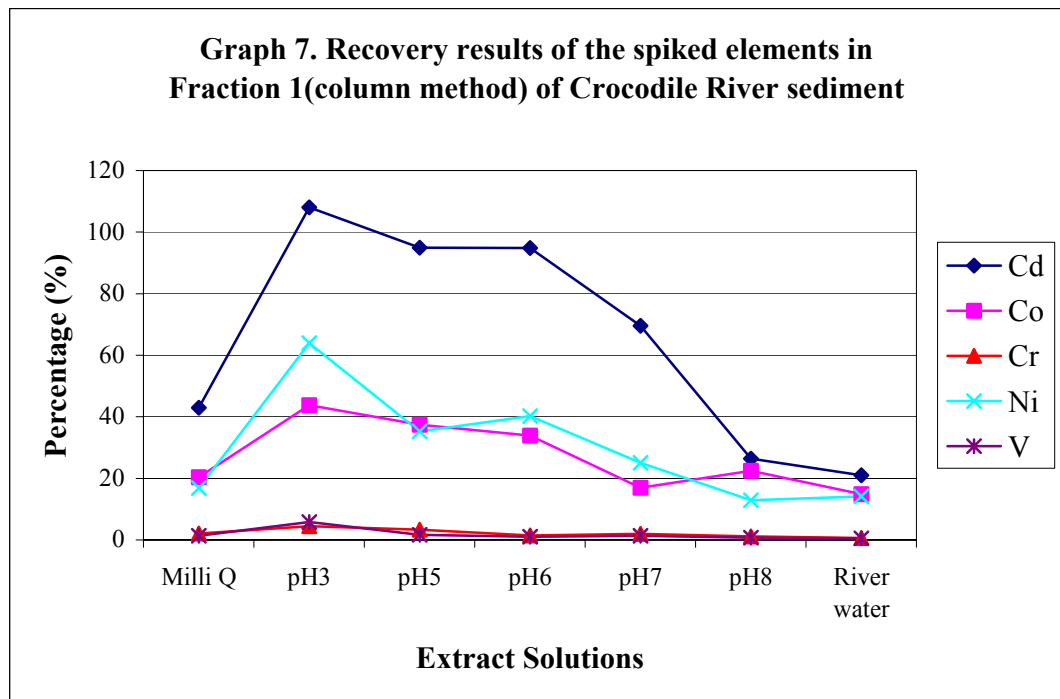

Graph 7. Recovery results of the spiked elements in fraction 1(column method) of Crocodile River sediment

The concentrations from Cd, Co, Cr and Ni gave good correlation with the column method results. The only element that was not present in the column method results was V. In the shaker method vanadium exhibited good mobility throughout the extract series.

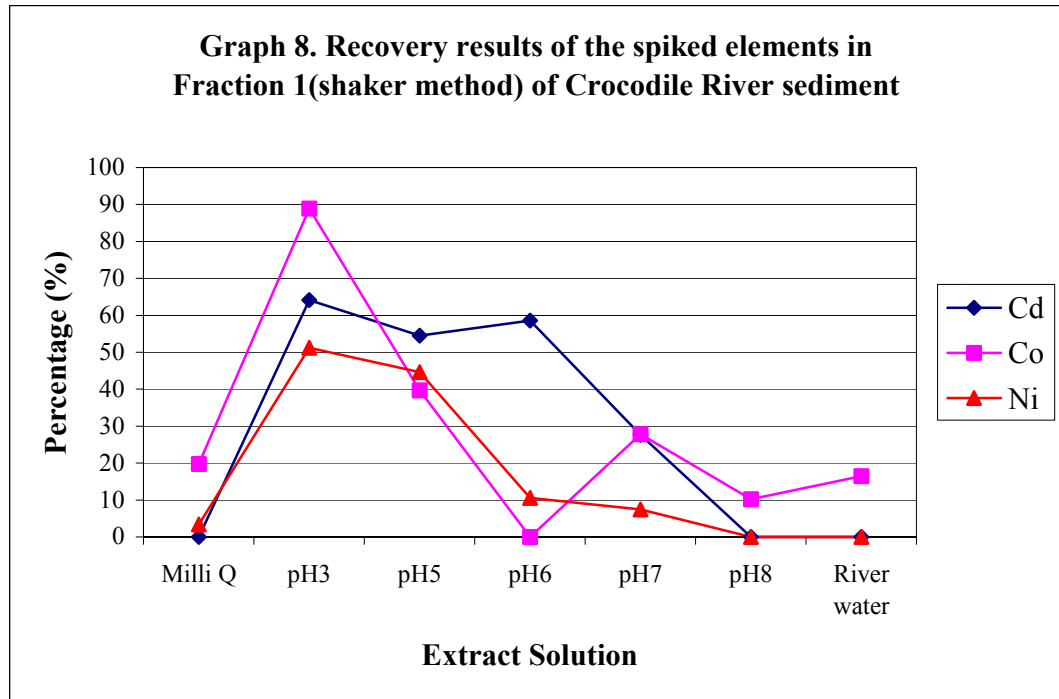

Graph 8. Recovery results of the spiked elements in fraction 1(shaker method) of Crocodile River sediment

6.6 Discussion on the results of the Olifants River sand layer samples (No 3)

6.6.1 Results of the Olifants River water sample (Table 5a and b)

The results from the Olifants River water sample showed that 11 out of the 15 trace elements analysed for were present in varying concentrations. The elements that were not present were Cd, Co, Hg and Zr. The concentrations of the elements present were higher than the Crocodile River and ranged between 0.011 mg/L (Cr) to 1.38 mg/L (Zn). The bulk of the concentrations in the water sample were contributed by: Fe, Pb and Zn. The pH of the water is very much the same as that of the Crocodile River and is considered normal for natural water sources and was measured at 7.39 (pH units).

The main factor that influences the low concentrations of elements present in the river water is the neutral to slight alkaline pH of the water. The main contribution of expected contamination in the Crocodile River is from agricultural processes and to a lesser degree mining as previously mentioned in Chapter 1.

6.6.2 Olifants River sand layer sediment digestion results (Table 6c)

In the digested sediment samples 9 of the analysed elements were present in varying concentrations. The concentration varied from 2.65 µg/g (Zr) to 28120 µg/g (Fe). The bulk contributors to the overall concentration that were measured were: Ba, Cr, Fe, Mn and V. Small differences in concentrations can be attributed to almost complete absence of clay particles present, which usually adsorb more trace elements and contribute more of the trace element measured concentration. The elements were evenly distributed throughout the fractions.

6.6.3 Olifants River sand layer sediment (No 3) column leaching tests results (Appendixes 13-15 and Graph 9)

The concentrations found in the sand fraction of the Olifants River were very low, with the highest contribution being that of Mn. Ba was present at higher concentrations (ranging between 0.05-16.39 µg/g) than in the sand fraction and exhibited the best mobility under pH 6 extract conditions. The percentage Ba mobilised under the best conditions was 68%. Using the river water as extract solution did not mobilise significant amounts of Ba.

Co was present at very low concentrations ranging of between 0.02 $\mu\text{g/g}$ (river water) to 1.43 $\mu\text{g/g}$ (pH 6). It was found that Co was the most mobile under pH 6 conditions and the percentage Co leached was calculated to be 18.9%.

Mn was present at elevated levels in the pH 3 and 6 extract solutions and this agrees with the digested sediment results. The concentration range, however, varied from very low (in the case of pH 8 and river water) to high and under pH 6 the percentage mobility was calculated to be 55%. This percentage is high and the overall concentration too. This can have an influence on the underground water quality, but only under extreme river condition changes.

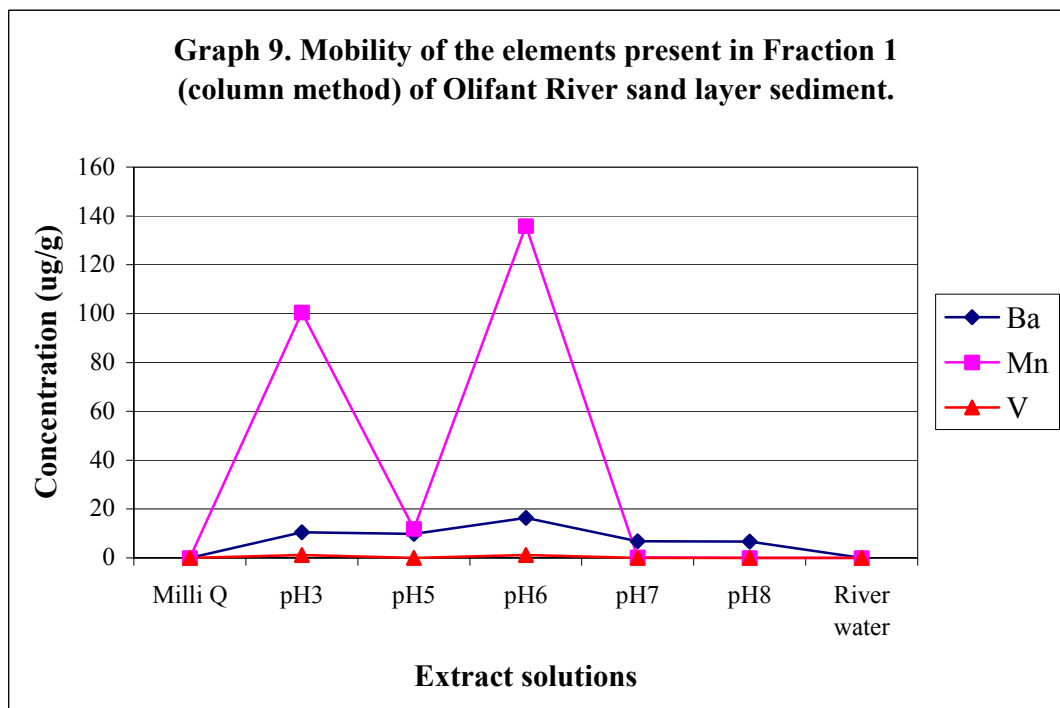

Graph 9. Mobility of the elements present in Fraction 1 (column method) of Olifants River sand layer sediment

Ni and V were present in low concentrations of about 1 µg/g at pH 6. These elements however will not contribute to the deterioration of the water quality at these levels and compared to the digested sample concentration. The concentration characteristics stayed the same throughout the extract series and sediment fractions. None of the elements measured gave substantial concentrations in the river water solution and thus will not pose a serious problem in the immediate future.

6.6.4 Olifants River sand layer sediment (No 3) shaker method leaching tests results (Appendixes 16-18 and Graph 10)

The same elements that were found to be mobile in the column test were found; in addition to Fe and V. Fe and V showed considerably higher concentrations than in the column method.

Fe was present in high concentrations ranging from 0.62 µg/g (pH 8) to 68.46 µg/g (pH 3). The percentage mobility of Fe under the most mobile condition was calculated to be 0.5%. Under normal river conditions however, the concentration of Fe was very low and slightly mobile. The Ni concentrations were low and showed mobility under pH 3 and pH6 conditions, but not under the other extract conditions. The percentage of Ni mobilised was 16.9%, but under normal river conditions no Ni was leached.

V was found at 10.31 µg/g in the pH 6 extract solution and at lower concentrations in pH 3 and pH 8 extract solutions. The mobility of V is high and the percentage leached from the sediment was calculated to be 21.7%. Overall the same mobility

characteristics were found throughout the extract series of the other sediment fractions and compared well with the column test.

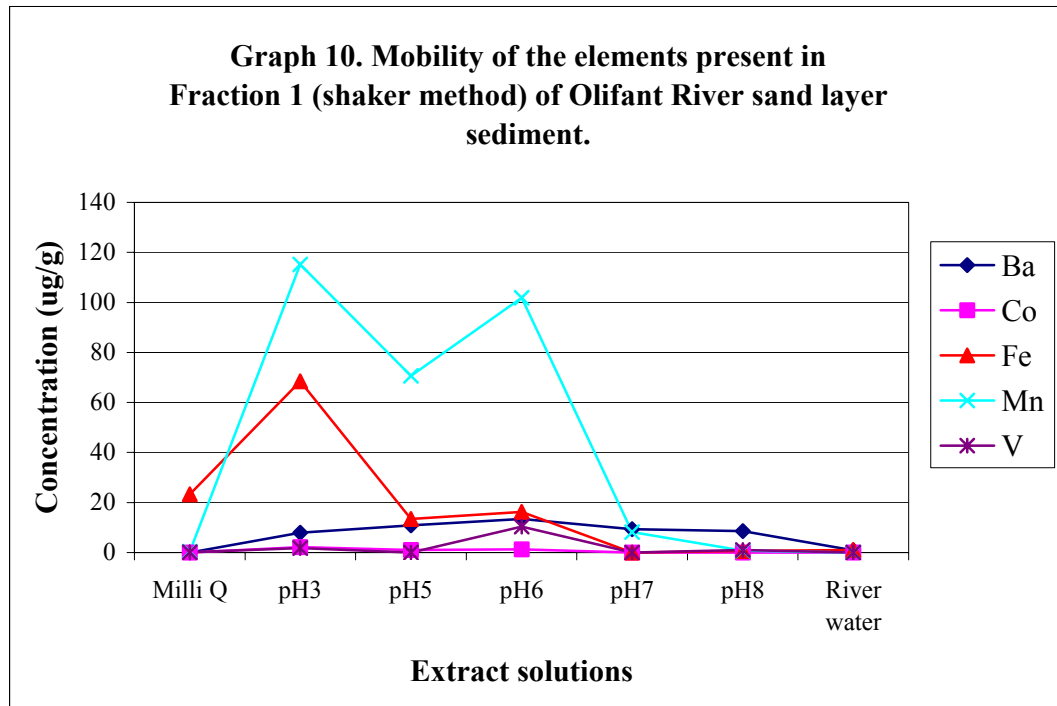

Graph 10. Mobility of the elements present in Fraction 1 (shaker method) of Olifants River sand layer sediment

6.6.5 Olifants River sand layer sediment (No 3) spiking results (Graphs 11 & 12).

The elements that gave reliable recovery results were Cd, Co, Cr, Mo, Ni and V. The recovery values for Cd, Co and Ni were high and showed a good relationship between the mobility and lower pH levels, with the best being between pH 3-6. Under river conditions it was illustrated that in the event of Cd, Co and Ni pollution, it is possible to mobilise these elements. Mo and V shown good mobility under the extract conditions.

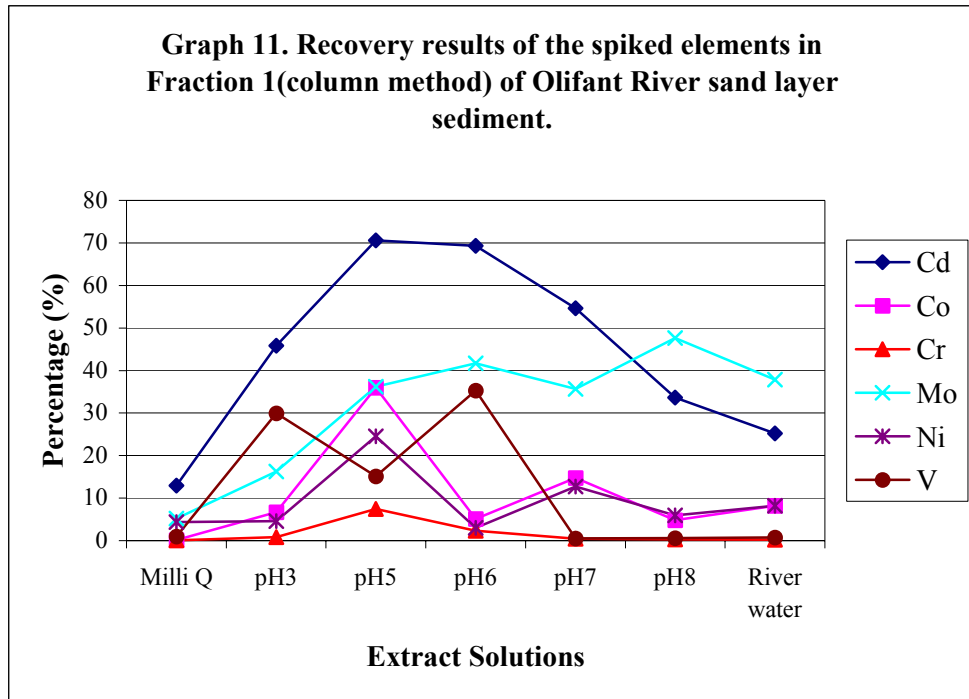

Graph 11. Recovery results of the spiked elements in fraction 1(column method) of Olifants River sand layer sediment

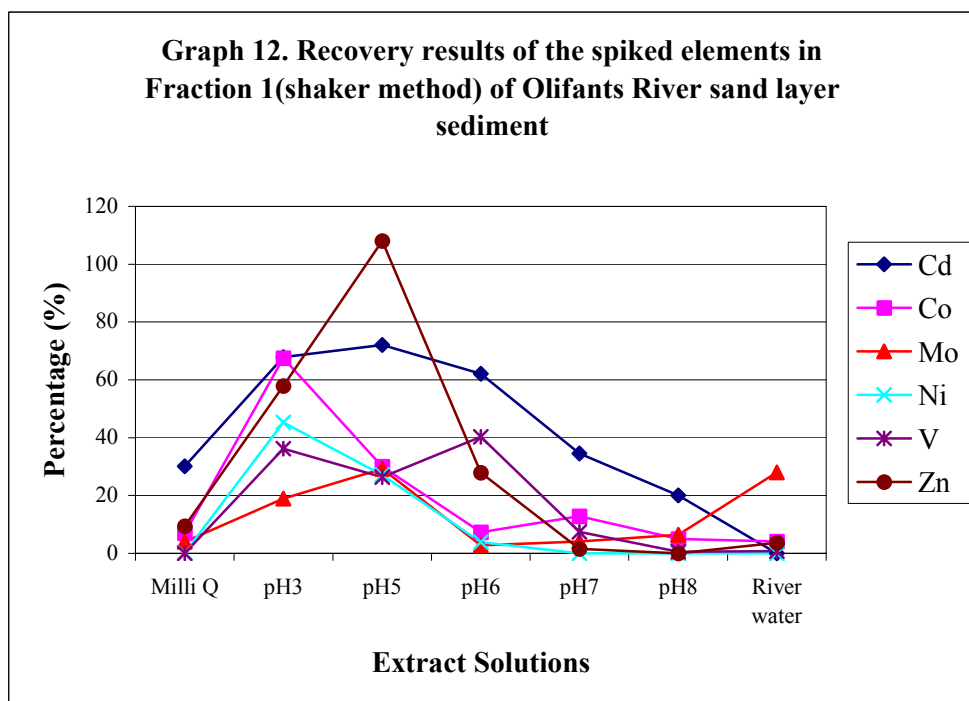

Graph 12. Recovery results of the spiked elements in fraction 1(shaker method) of Olifants River sand layer sediment

The concentrations from Cd, Co, Mo and Ni gave good correlation with the column method results. The only element that was not present in the column method results was Zn. In the shaker method vanadium exhibited good mobility under lower pH conditions.

6.6.6 Olifants River clay layer sediment (No 4) digestion results (Table 6d)

In the digested sediment samples 8 of the analysed elements were present in varying concentrations. The concentration varied from 2.84 µg/g (Zr) to 43110 µg/g (Fe). The bulk contributors to the overall concentration that were measured were: Ba, Cr, Fe, Mn and V. The Cr (135.2 µg/g) and V (208.8 µg/g) concentrations were noticeably higher than the sand layer. The calculated concentrations were overall three times higher than that the sand layer. The concentrations of the different fractions were not far from each other and this again can be attributed to the low amount of clay particles present.

6.6.7 Olifants River clay layer sediment (No 4) column leaching tests results (Appendixes 19-21 and Graph 13)

In the column extract solution 12 out of the 15 elements measured were present. The two main contributions in concentration came from Ba and Mn. The other elements were present in very low concentrations and did not pose a possible pollution risk.

Ba was, as with the sand layer, present in high concentrations between pH 5 and 6. The percentage mobility was calculated to be 55.9% and Mn also exhibited the same

characteristic and percentage mobility was 19.9% under the best mobility conditions. All the other elements that were present were not present in the sand layer, but it is expected that the trace metal content will be higher in sediments with higher clay content.

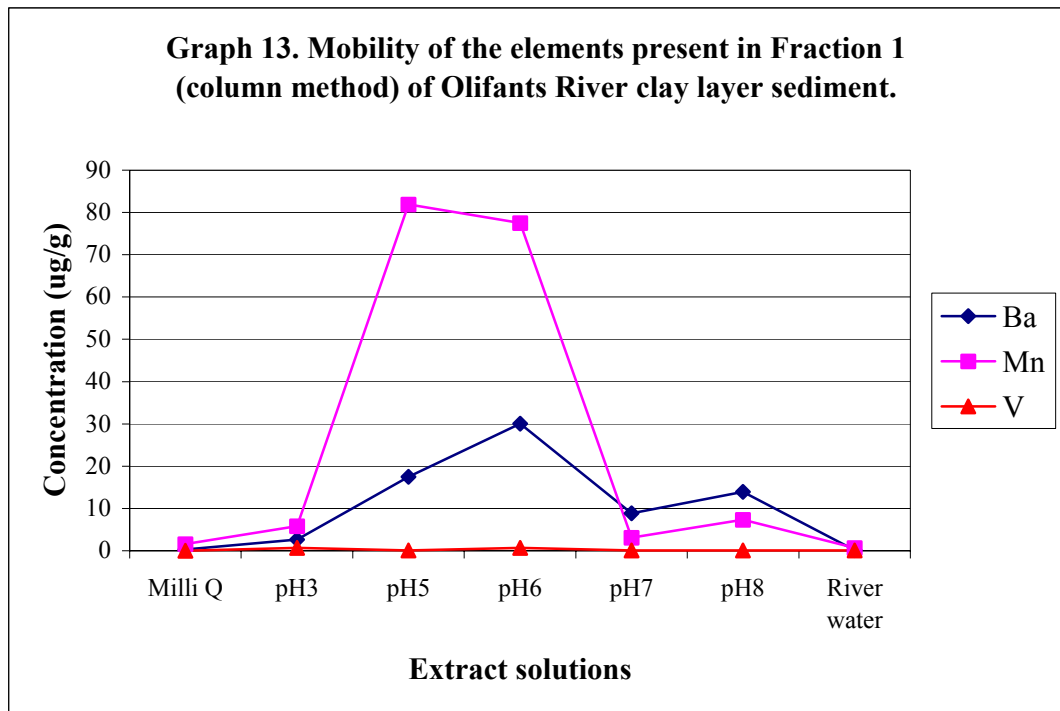

Graph 13. Mobility of the elements present in Fraction 1 (column method) of Olifants River clay layer sediment

6.6.8 Olifants River clay layer sediment (No 4) shaker method leaching tests results (Appendixes 22-24 and Graph 14)

The elements that were found to be mobile were Ba, Fe, Mn, Ni and V. The Ba and the Mn concentrations were in line with what was found in the column method.

Fe was present in high concentrations ranging from 0.58 $\mu\text{g/g}$ (pH 8) to 508.7 $\mu\text{g/g}$ (pH 3). The percentage mobility of Fe under most mobile condition was calculated to be 1.2%. Under normal river conditions however, the concentration of Fe was under the detection limit. The Ni concentrations were low and showed mobility under pH 3 condition, but under the other extract conditions to a lesser extent. The percentage of Ni mobilised was 5.9%, but under normal river conditions small amounts of Ni were leached.

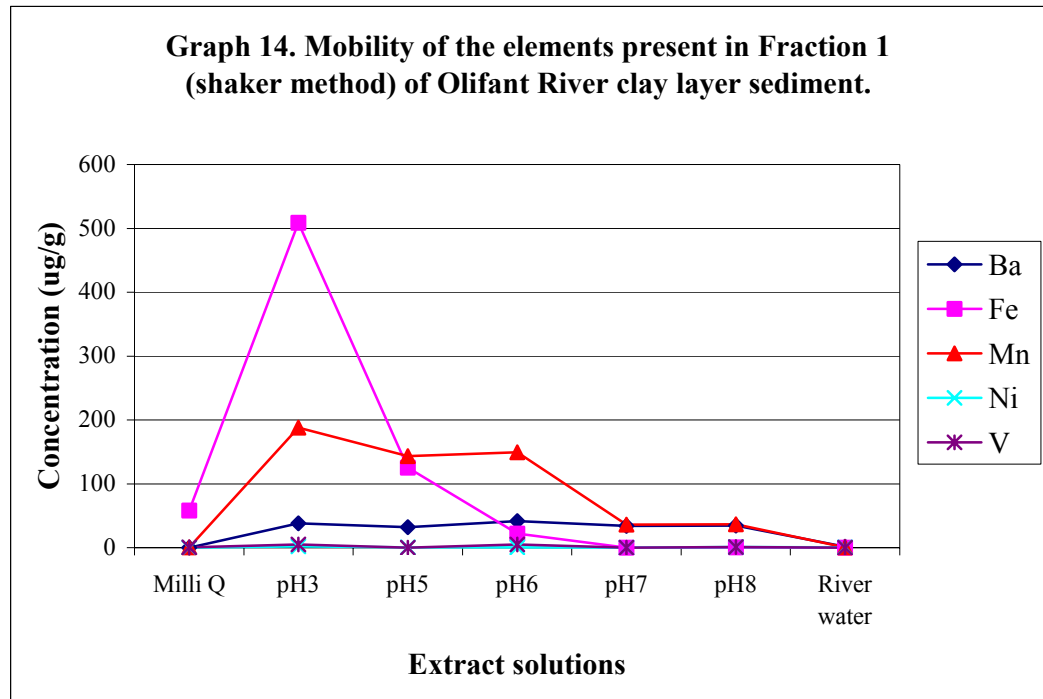

Graph 14. Mobility of the elements present in Fraction 1 (shaker method) of Olifants River clay layer sediment

V was found at 5.19 $\mu\text{g/g}$ in the pH 3 extract solution and at lower concentrations in pH 6 and pH 8 extract solutions. The mobility of V is lower than in the sand layer sediment and the percentage leached from the sediment was calculated to be 2.5%.

Overall the same mobility characteristics were found throughout the extract series of the other sediment fractions and compared well with the column test.

6.6.9 Olifants River clay layer sediment (No 4) spiking results (Graphs 15 & 16)

The elements that gave reliable recovery results were Cd, Co, Hg, Mo, Ni, V and Zn. The recovery values for Cd, Co and Ni were high and showed a good relationship between the mobility and lower pH levels, with the best being between pH 3-6. Under river conditions it was illustrated that in the event of Cd, Co and Ni pollution, it is possible to mobilise these elements. Mo and V shown good mobility under the extract conditions. Zn was also leached at detectable levels.

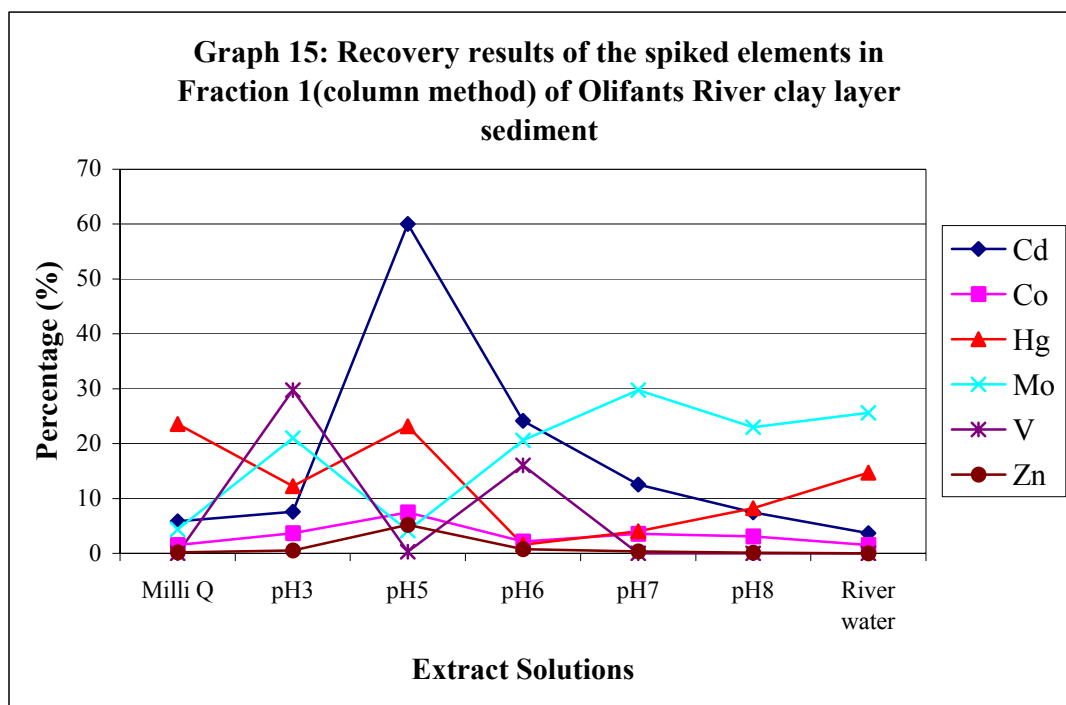

Graph 15. Recovery results of the spiked elements in fraction 1(column method) of Olifants River clay layer sediment

The concentrations from Ba, Cd, Co, Mo, Ni, V, and Zn gave good correlation with the column method results and gave higher recovery percentages. In the shaker method vanadium exhibited good mobility under lower pH conditions.

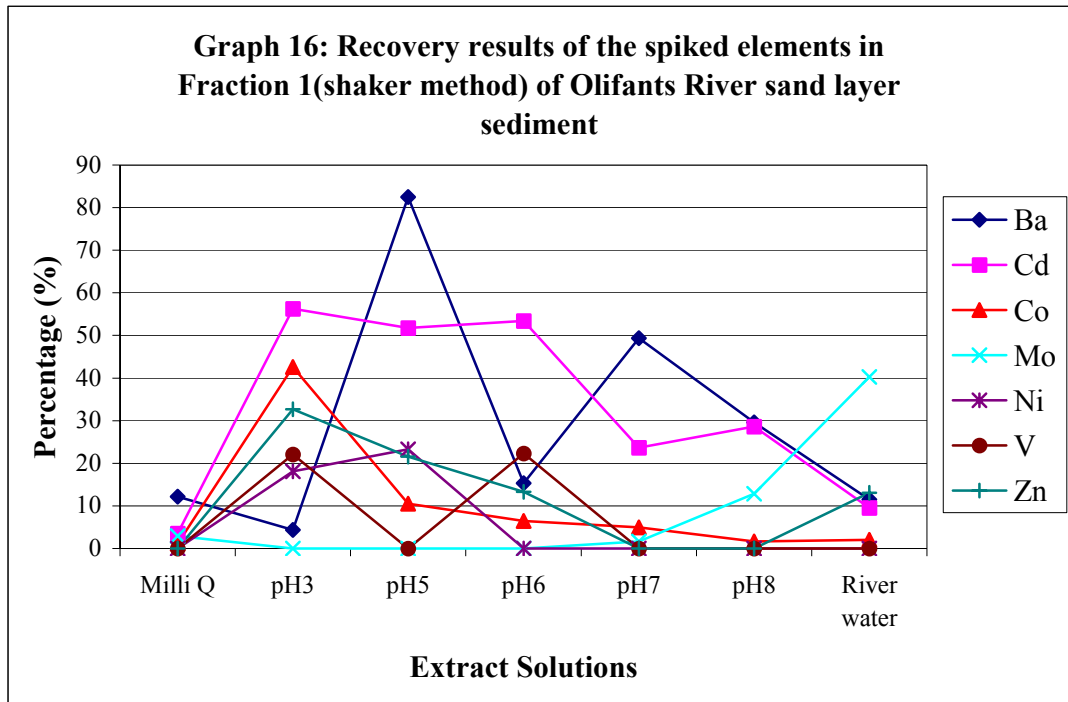

Graph 16. Recovery results of the spiked elements in fraction 1(shaker method) of Olifants River clay layer sediment

Chapter 7

Conclusions and Recommendations

7.1 Conclusion on the results obtained from this study

7.1.1 Blesbokspruit sediment results

The results from the Blesbokspruit showed elevated levels of a number of trace elements present in the sediment. In the leaching experiments, it was seen that the elements were mobile to a high degree, and this was not expected in sediment with high clay content with which to bind the trace elements. Under normal river conditions, it was found that the mobility of the trace elements was very high especially with respect to Co, Fe, Mn, Ni and Zn. This was explained by the very low measured pH and higher than normal trace metal content of the river water. This is a worrying factor because it gives evidence that there need not be a drastic change in the river condition as previously assumed, for the trace elements to be mobilised. The trace elements are already mobile under existing river conditions. From the digested sediment samples, it could be seen that the trace element load of the river sediment is very high and the easily leached trace elements show that the sediment does not have the capacity to strongly bind the trace elements.

The simulated pollution experiment gave good results for Cd that was not present in the original sample, was easily mobilised. This showed that in the event of Cd pollution in the Blesbokspruit, it is possible for it to mobilise and cause possible

deterioration of the groundwater resources. The overall state of the Blesbokspruit is undesirable and drastic action is needed to try and ameliorate the situation.

7.1.2 Crocodile River sediment results

The Crocodile River's main possible polluters are from the agricultural and mining sectors. The trace element content in the river water sample was low, and the pH in the normal range of an unimpacted river. From the leaching methods the results showed that the major part of the leachable trace metal content occurs under pH conditions between five and six. The main contribution in the total concentration using the leach methods was shown to be Mn. Under current river conditions, low concentrations of the trace elements were found, however, there were detectable amounts of Ba, Cu, Fe, Ni and Zn. This indicates that it is possible to mobilise trace elements under the current river conditions. The fact that the best mobility was observed at pH 5 to 6 means that there need not be a drastic change in the river conditions to be able to mobilise trace elements from the river sediments and the acid rain may mobilise trace elements. At this stage, the elements (Cd, Co, Cr and Ni) that clearly showed mobility in the simulated pollution experiment are not present at high concentrations in the sediments. From the results, however, it can be deduced that in the event of possible pollution of the mentioned elements, it is possible to mobilise them from the sediment. Currently, the overall state of the Crocodile River is not heavily impacted upon, but careful monitoring is needed to keep the situation stable.

7.1.3 Olifants River sediment results

The trace element concentrations measured in the Olifants River sand and clay fractions were not extremely high. The main contributions in the sand fraction were from Ba and Mn, with smaller concentrations for Ni and V. The pH of the river water was 7.39 and this is normal for an undisturbed river system of this type. There were not any trace elements that gave significant values in the river water experiment and the main conditions of increased mobility were between pH 3 and 6. On the other hand, in the simulated pollution experiments it was clear that Cd, Co, Cr, Mo, Ni and V were mobile throughout the extract series at high levels. In the event of possible pollution of the abovementioned elements, it is possible to mobilise trace elements under current river conditions. In the clay fraction there were many more different trace elements present, however, they were at low concentrations. The main concentration contributions arose from Ba and Mn. The best mobility conditions were shown to be between pH 5 and 6. Under normal river conditions, a number of elements were mobilised in small quantities, but in the long run they can contribute to the pollution of groundwater resources. The simulated pollution experiment showed the same elements to be mobile as in the sand fraction with the same amount of mobility throughout the extract series. The overall state of the Olifants River at the sampling point was considered to be acceptable.

7.1.4 Sediment fractions

The three sediment fractions from the three rivers investigated in this study gave noticeably different results. This was especially true for the Blesbokspruit sediment. In the Blesbokspruit sediments, it was clear that the main concentration of trace element was present in the smaller than 0.2 mm fraction. This was not surprising due to the high clay content of the sediment and it was, therefore, expected to have the highest concentrations. The unsieved fraction gave good results, being significantly lower than those of the smaller than 0.2 mm fraction. In cases like these, it would be advisable to measure the unsieved and the smaller than 0.2 mm fractions to get a clear picture of the sediment situation. The smaller than 0.2 mm fraction will be helpful in the determination of the worst case scenario where the unsieved fraction will reflect the more the natural concentrations achievable.

In the Crocodile River and Olifants River sediments, it was noticed that the difference between the 3 fractions was not significant. This is mainly due to the type of sediment and the low clay content encountered. The unsieved fraction can be used for determination purpose if the sediment contains low amounts of clay. This will cut down on preparation time without compromising the quality of the results. It will still be safest though to use both the unsieved and smaller than 0.2 mm fractions for the sake of completeness.

7.1.5 Analytical procedures

7.1.5.1 Column method of leaching trace elements

The column method gave very repeatable and reproducible results with a low relative standard deviation between the different replicates. The use of a greater volume of sediment can have negative and positive implications on the analytical procedure. The positive aspects are that with the column method, the leaching process is more natural (simulating natural processes) and that using larger volumes of sediment can lessen the variability observed in the sediment samples. On the other hand, depending on the characteristics of the sediment, it is difficult to know exactly what the end volume of the extract will be once filtered. This means that the amount of extract solution retained in the sediment must first be determined before final decisions on what volume to use can be made. From the results obtained in this study, it can be said that the column method is a reliable way to measure leaching of trace elements if a sufficient volume of sediment is available.

7.1.5.2 Shaker method of leaching trace elements

The shaker method also gave reliable results and compared well with the column method. The relative standard deviation was higher between replications than in the case of the column method. The mechanical process of the method is also not natural and the leaching of elements is predominantly higher than in the column method. The biggest disadvantage of the shaker method is the small amount of sediment used in the sample preparation stage. The variability of the sediment

composition can play a major role in the end concentration measured. This method can be used in the event that only a small amount of sediment is available, but then the results are prone to large variations in resultant concentrations. The advantage compared with the column method is that the end volume of the extract solution is not dependant upon the sediment type. With the results obtained in this study, the shaker method can be used, but the column test gave better results.

7.1.5.3 Digestion of sediment samples

From the results obtained of the digested certified reference material, it is confirmed that the procedure worked adequately for the intended purpose. The procedure can be used in the digestion process, however, if a microwave digestion apparatus is available it is even better. In the event that a microwave digestion apparatus is not available, the open beaker digestion method can be used, but should definitely be used in conjunction with a certified reference material to check the effectiveness of the digestion procedure.

7.1.5.4 ICP-OES and quality control parameters

The parameters of the ICP-OES that were used gave good quality and very reliable results, which were reproducible and repeatable. The wavelengths used gave adequate resolution and detection to measure the analytes required. The quality control parameters were adequate for this study and that was proven through the good quality of the results obtained.

7.2 Recommendations

In South Africa, sedimentation in the river systems is a common occurrence. The general feeling is that sedimentation can provide an inexhaustible source to adsorb trace elements. From this study it is clear that the river sediment has only a limited capacity to adsorb trace elements and if the load on the river sediment increases this capacity can be breached. Under acidic or sometimes normal river conditions, the trace elements may leach and cause problems, for example, with groundwater quality degradation.

It is clear in the case of the Blesbokspruit that the water and sediment quality are hugely affected by anthropogenic activities. This is an example of a system that will take many years to rehabilitate if the process is started immediately. This shows the importance of constantly monitoring a river system's condition. This would then act as an early warning system that will warn the managing authorities before the damage sustained is not reversible.

Appendix 1 Blesbokspruit fraction one (smaller than 0.2 mm) column method blank sediments.

Determinant	Milli Q water. (µg/g)	pH 3 (µg/g)	pH 5 (µg/g)	pH 6 (µg/g)	pH 7 (µg/g)	pH 8 (µg/g)	River water (µg/g)
As	0.04	0.23	0.16	0.23	0.22	0.28	0.13
Ba	0.06	0.16	0.13	0.64	0.45	1.12	0.04
Cd	0.01	0.14	0.06	0.08	0.04	0.04	0.09
Co	5.99	19.22	6.48	22.98	15.29	16.51	12.56
Cr	0.06	0.44	0.47	0.85	0.60	0.24	0.28
Cu	0.18	0.22	0.13	0.16	0.11	0.05	0.12
Fe	9.30	338.7	54.11	76.04	41.58	43.23	132.19
Hg	<LOD	<LOD	<LOD	<LOD	<LOD	<LOD	<LOD
Mn	38.69	76.26	55.48	20.92	14.96	15.21	63.39
Mo	0.01	0.19	0.05	<LOD	<LOD	<LOD	0.12
Ni	2.45	12.09	5.36	8.81	6.47	8.55	9.07
Pb	<LOD	0.03	0.02	0.04	<LOD	0.02	<LOD
V	<LOD	0.16	0.03	0.67	0.49	0.11	0.05
Zn	3.83	18.73	7.07	24.25	18.14	20.89	14.86
Zr	0.05	0.23	0.29	0.41	0.32	0.14	0.13

Appendix 2 Blesbokspruit fraction two (bigger than 0.2 mm) column method blank sediments.

Determinant	Milli Q water. (µg/g)	pH 3 (µg/g)	pH 5 (µg/g)	pH 6 (µg/g)	pH 7 (µg/g)	pH 8 (µg/g)	River water (µg/g)
As	0.02	0.07	0.08	0.09	0.06	0.25	0.05
Ba	0.04	0.15	0.15	0.87	0.70	1.04	0.03
Cd	<LOD	0.04	0.02	0.02	<LOD	0.03	0.03
Co	3.22	6.70	3.22	3.44	2.15	16.67	4.96
Cr	0.03	0.18	0.31	0.51	0.15	0.13	0.12
Cu	0.01	0.08	0.06	0.07	<LOD	0.04	0.04
Fe	9.46	149.5	26.85	26.48	15.89	40.68	38.75
Hg	<LOD	<LOD	<LOD	<LOD	<LOD	<LOD	<LOD
Mn	18.47	28.35	25.68	7.94	4.26	15.23	29.62
Mo	<LOD	0.05	<LOD	<LOD	<LOD	<LOD	0.05
Ni	1.95	4.27	2.62	1.46	0.83	8.63	3.98
Pb	<LOD	0.02	<LOD	0.15	0.10	0.03	<LOD
V	<LOD	0.11	<LOD	0.77	0.12	0.15	0.02
Zn	2.34	7.43	3.23	4.68	1.89	15.85	7.35
Zr	0.03	0.08	0.16	0.22	0.10	0.11	0.06

Appendix 3 Blesbokspruit fraction three (unsieved) column method blank sediments.

Determinant	Milli Q water. (µg/g)	pH 3 (µg/g)	pH 5 (µg/g)	pH 6 (µg/g)	pH 7 (µg/g)	pH 8 (µg/g)	River water (µg/g)
As	0.05	0.06	0.05	0.07	0.07	0.23	0.08
Ba	<LOD	0.14	0.28	1.01	0.65	1.06	0.01
Cd	0.04	0.06	0.04	0.02	<LOD	0.02	0.04
Co	6.97	8.03	2.32	4.05	4.45	13.91	5.26
Cr	0.12	0.18	0.50	0.42	0.22	0.14	0.12
Cu	0.23	0.08	<LOD	0.07	0.02	0.04	0.06
Fe	46.30	159.5	34.18	38.44	29.93	48.43	46.60
Hg	<LOD	<LOD	<LOD	<LOD	<LOD	<LOD	<LOD
Mn	26.98	30.71	11.01	5.68	6.71	15.83	31.49
Mo	0.03	0.08	<LOD	<LOD	<LOD	<LOD	0.07
Ni	4.30	5.22	1.56	1.44	1.62	7.88	4.49
Pb	<LOD	0.03	0.13	0.29	0.11	0.06	0.01
V	0.02	0.10	0.14	0.98	0.14	0.11	0.02
Zn	6.62	8.04	2.97	4.25	3.03	14.02	6.62
Zr	0.07	0.09	0.20	0.21	0.13	0.11	0.07

Appendix 4 Blesbokspruit fraction one (smaller than 0.2 mm) shaker method blank sediments.

Determinant	Milli Q water. (µg/g)	pH 3 (µg/g)	pH 5 (µg/g)	pH 6 (µg/g)	pH 7 (µg/g)	pH 8 (µg/g)	River water (µg/g)
As	<LOD	<LOD	<LOD	<LOD	<LOD	<LOD	<LOD
Ba	1.03	4.79	3.60	4.44	2.62	2.01	2.81
Cd	<LOD	0.30	<LOD	<LOD	<LOD	<LOD	<LOD
Co	11.15	12.60	6.33	2.52	3.49	<LOD	3.16
Cr	<LOD	4.13	2.89	0.93	<LOD	0.04	1.46
Cu	<LOD	16.26	<LOD	1.94	<LOD	0.21	0.10
Fe	52.88	378.5	80.62	126.46	3.03	0.22	40.42
Hg	<LOD	<LOD	<LOD	<LOD	2.11	<LOD	<LOD
Mn	6.30	7.12	4.34	4.43	3.15	<LOD	2.17
Mo	<LOD	0.20	<LOD	<LOD	<LOD	<LOD	<LOD
Ni	6.54	7.89	1.96	1.68	0.63	0.12	1.04
Pb	<LOD	0.56	0.20	0.70	<LOD	<LOD	0.10
V	0.02	3.51	<LOD	3.23	<LOD	0.06	0.03
Zn	19.27	21.21	11.25	7.79	2.83	<LOD	5.63
Zr	<LOD	0.16	0.98	0.52	<LOD	<LOD	0.49

Appendix 5 Blesbokspruit fraction two (bigger than 0.2 mm) shaker method blank sediments.

Determinant	Milli Q water. (µg/g)	pH 3 (µg/g)	pH 5 (µg/g)	pH 6 (µg/g)	pH 7 (µg/g)	pH 8 (µg/g)	River water (µg/g)
As	<LOD	<LOD	<LOD	<LOD	<LOD	<LOD	<LOD
Ba	0.45	3.46	2.50	3.25	1.91	1.29	1.90
Cd	<LOD	0.27	<LOD	<LOD	<LOD	<LOD	<LOD
Co	7.17	9.32	4.67	2.22	2.82	<LOD	13.47
Cr	<LOD	0.50	1.45	0.45	<LOD	0.08	<LOD
Cu	<LOD	3.29	<LOD	0.30	<LOD	0.50	<LOD
Fe	43.96	284.0	58.83	102.6	6.67	0.42	73.66
Hg	<LOD	<LOD	<LOD	<LOD	1.28	<LOD	<LOD
Mn	3.43	13.38	2.74	6.35	2.24	<LOD	68.86
Mo	<LOD	0.39	<LOD	<LOD	<LOD	0.37	<LOD
Ni	4.30	5.79	1.24	1.49	0.55	0.46	6.86
Pb	<LOD	0.69	<LOD	0.40	<LOD	<LOD	<LOD
V	<LOD	3.18	<LOD	2.74	<LOD	0.33	<LOD
Zn	9.20	13.12	7.31	5.74	1.33	<LOD	14.47
Zr	<LOD	0.30	0.70	0.36	<LOD	<LOD	<LOD

Appendix 6 Blesbokspruit fraction three (unsieved) shaker method blank sediments.

Determinant	Milli Q water. (µg/g)	pH 3 (µg/g)	pH 5 (µg/g)	pH 6 (µg/g)	pH 7 (µg/g)	pH 8 (µg/g)	River water (µg/g)
As	<LOD	<LOD	<LOD	<LOD	<LOD	<LOD	<LOD
Ba	0.30	4.14	3.17	3.84	2.14	1.74	1.91
Cd	<LOD	0.26	0.18	<LOD	<LOD	<LOD	<LOD
Co	5.00	7.87	6.7	<LOD	0.41	<LOD	3.34
Cr	<LOD	0.35	0.28	0.27	<LOD	0.36	0.02
Cu	<LOD	1.05	1.45	0.03	<LOD	0.92	<LOD
Fe	22.71	264.5	185.1	16.21	0.45	0.44	9.74
Hg	<LOD	<LOD	0.43	<LOD	1.10	<LOD	<LOD
Mn	3.46	5.01	6.88	0.95	0.42	<LOD	60.16
Mo	<LOD	0.14	0.18	0.04	<LOD	0.90	<LOD
Ni	3.21	5.83	4.05	0.34	0.06	0.73	2.13
Pb	0.41	0.63	0.44	1.03	0.21	1.96	<LOD
V	0.08	4.52	2.57	5.31	0.91	0.72	0.42
Zn	8.13	16.02	10.16	2.38	1.44	<LOD	9.17
Zr	<LOD	0.21	0.17	0.30	<LOD	<LOD	<LOD

Appendix 7 Crocodile River fraction one (smaller than 0.2 mm) column method blank sediments.

Determinant	Milli Q water. (µg/g)	pH 3 (µg/g)	pH 5 (µg/g)	pH 6 (µg/g)	pH 7 (µg/g)	pH 8 (µg/g)	River water (µg/g)
As	0.02	0.02	0.02	0.03	0.02	<LOD	0.01
Ba	0.43	0.48	6.08	13.34	5.07	5.43	0.25
Cd	0.01	<LOD	0.24	0.19	0.09	0.05	<LOD
Co	0.08	0.08	0.37	0.59	0.25	0.13	0.04
Cr	<LOD	<LOD	0.19	0.22	0.08	0.04	<LOD
Cu	0.17	0.19	0.60	0.35	0.33	0.24	0.26
Fe	0.48	0.73	1.70	1.05	0.24	0.14	0.27
Hg	<LOD	<LOD	<LOD	<LOD	<LOD	<LOD	<LOD
Mn	15.53	20.94	414.7	478.2	236.7	94.32	4.72
Mo	0.07	0.08	0.34	0.35	0.31	0.30	0.05
Ni	0.19	0.18	1.05	0.67	0.40	0.22	0.15
Pb	<LOD	<LOD	0.48	0.50	<LOD	<LOD	<LOD
V	<LOD	0.01	0.09	0.25	0.03	0.01	<LOD
Zn	1.02	1.14	24.50	15.71	4.13	2.18	0.71
Zr	0.02	0.11	0.07	0.12	0.01	0.01	0.02

Appendix 8 Crocodile River fraction two (bigger than 0.2 mm) column method blank sediments.

Determinant	Milli Q water. (µg/g)	pH 3 (µg/g)	pH 5 (µg/g)	pH 6 (µg/g)	pH 7 (µg/g)	pH 8 (µg/g)	River water (µg/g)
As	0.02	0.03	0.03	0.02	0.01	<LOD	0.01
Ba	0.69	0.76	6.66	15.60	5.30	6.80	0.35
Cd	0.02	0.01	0.25	0.18	0.08	0.02	<LOD
Co	0.06	0.09	0.39	0.66	0.19	0.08	0.04
Cr	0.01	<LOD	0.17	0.20	0.05	0.01	<LOD
Cu	0.16	0.24	0.61	0.25	0.28	0.24	0.31
Fe	0.29	0.30	1.50	1.12	0.18	0.05	0.14
Hg	<LOD	<LOD	<LOD	<LOD	<LOD	<LOD	<LOD
Mn	31.70	55.85	227.0	474.0	157.0	59.54	4.15
Mo	0.07	0.08	0.37	0.31	0.24	0.19	0.06
Ni	0.15	0.21	1.06	0.62	0.34	0.18	0.17
Pb	<LOD	<LOD	0.49	0.68	<LOD	<LOD	<LOD
V	<LOD	0.01	0.09	0.42	0.01	<LOD	<LOD
Zn	0.91	0.84	23.49	15.86	3.59	1.11	0.26
Zr	0.02	0.04	0.10	0.12	0.03	0.02	0.02

Appendix 9 Crocodile River fraction three (unsieved) column method blank sediments.

Determinant	Milli Q water. (µg/g)	pH 3 (µg/g)	pH 5 (µg/g)	pH 6 (µg/g)	pH 7 (µg/g)	pH 8 (µg/g)	River water (µg/g)
As	0.02	0.01	0.01	0.03	<LOD	0.01	<LOD
Ba	0.15	1.12	4.21	13.83	6.31	9.71	0.21
Cd	<LOD	0.02	0.32	0.14	0.04	0.03	<LOD
Co	0.07	0.09	0.72	0.72	0.13	0.11	0.03
Cr	<LOD	<LOD	0.22	0.16	0.02	0.03	<LOD
Cu	0.21	0.08	0.73	0.06	0.16	0.26	0.17
Fe	0.60	0.10	1.76	1.62	0.13	0.13	0.11
Hg	<LOD	<LOD	<LOD	<LOD	<LOD	<LOD	<LOD
Mn	15.45	73.64	514.9	365.4	95.65	91.98	5.57
Mo	0.01	0.24	0.30	0.22	0.19	0.27	0.09
Ni	0.20	0.21	1.31	0.45	0.20	0.21	0.12
Pb	<LOD	<LOD	0.47	0.76	<LOD	<LOD	<LOD
V	0.01	0.03	0.14	0.43	<LOD	<LOD	<LOD
Zn	0.41	0.63	31.34	16.61	2.01	1.40	0.12
Zr	0.02	0.03	0.03	0.09	0.03	0.01	0.01

Appendix 10 Crocodile River fraction one (smaller than 0.2 mm) shaker method blank sediments.

Determinant	Milli Q water. (µg/g)	pH 3 (µg/g)	pH 5 (µg/g)	pH 6 (µg/g)	pH 7 (µg/g)	pH 8 (µg/g)	River water (µg/g)
As	<LOD	<LOD	<LOD	<LOD	<LOD	<LOD	<LOD
Ba	<LOD	34.88	24.74	39.15	24.33	24.92	0.69
Cd	<LOD	0.11	<LOD	<LOD	<LOD	<LOD	<LOD
Co	<LOD	5.30	3.00	0.10	0.87	<LOD	<LOD
Cr	<LOD	2.72	<LOD	0.10	<LOD	0.30	<LOD
Cu	0.57	0.50	0.72	<LOD	<LOD	2.15	0.39
Fe	28.83	605.7	38.77	76.91	0.07	0.20	5.17
Hg	<LOD	<LOD	<LOD	<LOD	0.82	<LOD	<LOD
Mn	10.11	620.4	387.9	470.1	213.6	39.07	18.01
Mo	<LOD	0.17	<LOD	<LOD	<LOD	0.48	0.36
Ni	0.37	4.74	2.52	0.83	0.24	0.81	0.47
Pb	0.24	0.29	5.51	6.35	<LOD	<LOD	<LOD
V	0.38	3.40	<LOD	2.94	<LOD	0.43	0.43
Zn	1.52	116.8	73.18	59.37	16.63	6.78	0.12
Zr	<LOD	<LOD	0.28	0.22	<LOD	<LOD	<LOD

Appendix 11 Crocodile River fraction two (bigger than 0.2 mm) shaker method blank sediments.

Determinant	Milli Q water. (µg/g)	pH 3 (µg/g)	pH 5 (µg/g)	pH 6 (µg/g)	pH 7 (µg/g)	pH 8 (µg/g)	River water (µg/g)
As	<LOD	<LOD	<LOD	<LOD	<LOD	<LOD	<LOD
Ba	<LOD	37.02	28.63	39.22	0.69	25.35	0.69
Cd	<LOD	<LOD	<LOD	<LOD	<LOD	<LOD	<LOD
Co	<LOD	4.66	3.04	<LOD	<LOD	<LOD	<LOD
Cr	<LOD	0.48	<LOD	0.51	0.06	0.49	0.06
Cu	0.58	0.12	0.91	0.12	0.58	2.72	0.58
Fe	19.29	448.13	33.27	56.33	1.12	0.76	1.12
Hg	<LOD	<LOD	<LOD	<LOD	<LOD	<LOD	<LOD
Mn	8.10	807.4	516.5	592.5	18.01	41.63	18.01
Mo	<LOD	<LOD	<LOD	0.29	0.49	0.95	0.49
Ni	0.48	3.73	2.56	1.15	0.63	1.12	0.63
Pb	<LOD	<LOD	6.31	8.11	<LOD	0.89	<LOD
V	0.40	3.05	<LOD	3.12	0.50	0.70	0.50
Zn	0.41	114.6	83.91	57.93	0.17	6.55	0.17
Zr	<LOD	<LOD	0.34	0.13	<LOD	<LOD	<LOD

Appendix 12 Crocodile River fraction three (unsieved) shaker method blank sediments.

Determinant	Milli Q water. (µg/g)	pH 3 (µg/g)	pH 5 (µg/g)	pH 6 (µg/g)	pH 7 (µg/g)	pH 8 (µg/g)	River water (µg/g)
As	<LOD	<LOD	<LOD	<LOD	<LOD	<LOD	<LOD
Ba	<LOD	33.88	29.22	30.04	22.39	24.02	0.67
Cd	<LOD	0.02	<LOD	<LOD	<LOD	<LOD	<LOD
Co	<LOD	4.99	3.40	<LOD	0.92	<LOD	<LOD
Cr	<LOD	0.43	<LOD	0.21	<LOD	0.89	0.07
Cu	0.57	0.13	1.09	0.03	<LOD	3.32	1.50
Fe	19.39	541.93	76.26	79.30	0.21	0.78	5.14
Hg	<LOD	<LOD	<LOD	<LOD	0.52	<LOD	<LOD
Mn	10.01	674.9	484.6	455.8	263.9	39.30	27.11
Mo	<LOD	<LOD	<LOD	0.08	<LOD	2.00	0.58
Ni	0.45	4.23	3.03	1.01	1.39	1.76	0.64
Pb	<LOD	0.07	7.86	5.68	<LOD	3.19	<LOD
V	0.39	3.10	<LOD	2.61	<LOD	1.23	0.57
Zn	0.58	110.4	87.50	56.91	18.09	6.42	0.99
Zr	<LOD	<LOD	0.32	<LOD	<LOD	<LOD	<LOD

Appendix 13 Olifants River sand layer fraction one (smaller than 0.2 mm) column method blank sediments.

Determinant	Milli Q water. (µg/g)	pH 3 (µg/g)	pH 5 (µg/g)	pH 6 (µg/g)	pH 7 (µg/g)	pH 8 (µg/g)	River water (µg/g)
As	<LOD	<LOD	<LOD	0.01	<LOD	0.01	<LOD
Ba	<LOD	10.42	9.82	16.39	6.76	6.75	0.05
Cd	<LOD	<LOD	0.01	0.01	<LOD	<LOD	<LOD
Co	0.46	0.39	0.02	1.43	<LOD	<LOD	<LOD
Cr	<LOD	<LOD	0.02	0.07	<LOD	<LOD	<LOD
Cu	<LOD	<LOD	<LOD	<LOD	<LOD	<LOD	<LOD
Fe	<LOD	0.39	0.31	1.32	<LOD	<LOD	<LOD
Hg	<LOD	<LOD	<LOD	<LOD	<LOD	<LOD	<LOD
Mn	0.01	100.5	11.93	135.9	0.23	<LOD	<LOD
Mo	<LOD	0.05	0.01	0.14	0.03	0.06	0.01
Ni	0.01	0.49	0.13	1.72	<LOD	<LOD	<LOD
Pb	<LOD	<LOD	<LOD	<LOD	<LOD	<LOD	<LOD
V	0.01	1.18	<LOD	1.14	<LOD	<LOD	<LOD
Zn	<LOD	<LOD	<LOD	0.04	<LOD	<LOD	<LOD
Zr	0.02	0.02	0.03	0.04	0.01	0.02	0.02

Appendix 14 Olifants River sand layer fraction two (bigger than 0.2 mm) column method blank sediments.

Determinant	Milli Q water. (µg/g)	pH 3 (µg/g)	pH 5 (µg/g)	pH 6 (µg/g)	pH 7 (µg/g)	pH 8 (µg/g)	River water (µg/g)
As	<LOD	<LOD	<LOD	0.01	<LOD	0.01	<LOD
Ba	<LOD	9.83	9.80	13.57	5.83	5.09	0.40
Cd	<LOD	<LOD	<LOD	<LOD	<LOD	<LOD	<LOD
Co	0.01	<LOD	0.03	1.43	<LOD	<LOD	<LOD
Cr	<LOD	0.01	<LOD	0.07	<LOD	<LOD	<LOD
Cu	<LOD	<LOD	<LOD	<LOD	<LOD	<LOD	<LOD
Fe	<LOD	0.63	0.48	2.50	<LOD	<LOD	<LOD
Hg	<LOD	<LOD	<LOD	<LOD	<LOD	<LOD	<LOD
Mn	0.12	102.2	11.45	120.6	0.18	<LOD	<LOD
Mo	<LOD	0.11	<LOD	0.11	0.02	0.04	<LOD
Ni	0.01	0.56	0.12	1.44	<LOD	0.01	<LOD
Pb	<LOD	<LOD	<LOD	<LOD	<LOD	<LOD	<LOD
V	0.01	1.00	<LOD	0.82	<LOD	<LOD	<LOD
Zn	<LOD	<LOD	0.26	0.05	<LOD	<LOD	<LOD
Zr	0.01	0.02	0.03	0.04	0.01	0.01	0.01

Appendix 15 Olifants River sand layer fraction three (unsieved) column method blank sediments.

Determinant	Milli Q water. (µg/g)	pH 3 (µg/g)	pH 5 (µg/g)	pH 6 (µg/g)	pH 7 (µg/g)	pH 8 (µg/g)	River water (µg/g)
As	0.01	<LOD	<LOD	<LOD	<LOD	<LOD	<LOD
Ba	<LOD	10.67	8.55	11.85	5.30	6.16	0.05
Cd	<LOD	<LOD	<LOD	0.01	<LOD	<LOD	<LOD
Co	<LOD	0.46	0.03	1.30	<LOD	<LOD	<LOD
Cr	<LOD	0.01	0.01	0.05	<LOD	<LOD	<LOD
Cu	<LOD	<LOD	<LOD	<LOD	<LOD	<LOD	<LOD
Fe	<LOD	0.48	0.45	2.65	<LOD	<LOD	<LOD
Hg	<LOD	<LOD	<LOD	<LOD	<LOD	<LOD	<LOD
Mn	<LOD	99.55	11.40	95.87	0.40	<LOD	<LOD
Mo	<LOD	0.31	0.01	0.10	0.01	0.04	<LOD
Ni	0.01	0.57	0.11	1.02	<LOD	<LOD	<LOD
Pb	<LOD	<LOD	<LOD	<LOD	<LOD	<LOD	<LOD
V	0.01	1.05	<LOD	0.82	<LOD	<LOD	<LOD
Zn	<LOD	<LOD	<LOD	0.04	<LOD	<LOD	<LOD
Zr	0.02	0.02	0.02	0.02	0.01	0.02	0.02

Appendix 16 Olifants River sand layer fraction two (smaller than 0.2 mm) shaker method blank sediments.

Determinant	Milli Q water.	pH 3 (µg/g)	pH 5 (µg/g)	pH 6 (µg/g)	pH 7 (µg/g)	(µg/g)	River water (µg/g)
As	<LOD	<LOD	<LOD	<LOD	<LOD	<LOD	<LOD
Ba	<LOD	7.98	10.91	13.38	9.28	8.62	0.91
Cd	<LOD	<LOD	<LOD	<LOD	<LOD	<LOD	<LOD
Co	<LOD	2.13	1.07	1.34	<LOD	<LOD	<LOD
Cr	<LOD	<LOD	<LOD	0.11	<LOD	0.81	<LOD
Cu	<LOD	<LOD	<LOD	0.25	<LOD	1.85	<LOD
Fe	23.33	68.46	13.50	16.24	<LOD	0.62	0.99
Hg	<LOD	<LOD	<LOD	<LOD	0.91	<LOD	<LOD
Mn	0.39	115.1	70.64	101.9	8.15	0.74	<LOD
Mo	<LOD	<LOD	<LOD	0.37	<LOD	1.81	<LOD
Ni	<LOD	1.76	<LOD	1.84	<LOD	1.23	<LOD
Pb	<LOD	<LOD	<LOD	0.97	5.72	3.52	<LOD
V	0.14	1.78	<LOD	10.31	<LOD	1.04	<LOD
Zn	<LOD	0.08	<LOD	<LOD	<LOD	<LOD	<LOD
Zr	<LOD	<LOD	0.10	0.10	<LOD	<LOD	<LOD

Appendix 17 Olifants River sand layer fraction two (bigger than 0.2 mm) shaker method blank sediments.

Determinant	Milli Q water. (µg/g)	pH 3 (µg/g)	pH 5 (µg/g)	pH 6 (µg/g)	pH 7 (µg/g)	pH 8 (µg/g)	River water (µg/g)
As	<LOD	<LOD	<LOD	<LOD	<LOD	<LOD	<LOD
Ba	<LOD	14.70	9.35	13.47	8.56	7.53	0.98
Cd	<LOD	<LOD	<LOD	<LOD	<LOD	0.24	<LOD
Co	<LOD	1.96	0.74	1.16	<LOD	<LOD	<LOD
Cr	<LOD	0.04	<LOD	0.02	<LOD	0.93	0.13
Cu	<LOD	<LOD	<LOD	<LOD	<LOD	2.00	0.13
Fe	23.66	61.72	8.61	17.96	<LOD	0.68	1.14
Hg	<LOD	<LOD	<LOD	<LOD	0.42	<LOD	<LOD
Mn	0.53	121.3	50.79	105.2	7.25	0.74	<LOD
Mo	<LOD	0.14	<LOD	<LOD	<LOD	1.23	0.61
Ni	<LOD	1.85	<LOD	1.47	<LOD	1.51	0.42
Pb	<LOD	<LOD	<LOD	0.44	<LOD	3.88	<LOD
V	0.10	1.69	<LOD	1.44	<LOD	1.24	0.35
Zn	<LOD	<LOD	<LOD	<LOD	<LOD	<LOD	<LOD
Zr	<LOD	<LOD	0.38	0.10	<LOD	<LOD	<LOD

Appendix 18 Olifants River sand layer fraction three (unsieved) shaker method blank sediments.

Determinant	Milli Q water. (µg/g)	pH 3 (µg/g)	pH 5 (µg/g)	pH 6 (µg/g)	pH 7 (µg/g)	pH 8 (µg/g)	River water (µg/g)
As	<LOD	<LOD	<LOD	<LOD	<LOD	<LOD	<LOD
Ba	<LOD	12.02	7.51	11.32	7.27	6.71	0.66
Cd	<LOD	<LOD	<LOD	<LOD	<LOD	0.29	<LOD
Co	<LOD	1.67	0.68	3.23	<LOD	<LOD	<LOD
Cr	<LOD	0.02	<LOD	<LOD	<LOD	1.08	0.03
Cu	<LOD	<LOD	<LOD	<LOD	<LOD	2.35	0.15
Fe	18.74	57.50	6.08	10.29	<LOD	0.80	1.20
Hg	<LOD	<LOD	<LOD	<LOD	0.51	<LOD	<LOD
Mn	0.24	94.20	45.31	87.34	8.02	1.35	0.16
Mo	<LOD	0.05	<LOD	<LOD	<LOD	2.54	0.88
Ni	<LOD	1.35	<LOD	1.05	<LOD	1.76	0.26
Pb	<LOD	<LOD	<LOD	0.35	<LOD	4.73	0.95
V	0.06	1.51	<LOD	1.20	<LOD	1.44	0.18
Zn	<LOD	0.47	<LOD	<LOD	<LOD	<LOD	3.22
Zr	<LOD	<LOD	0.23	0.07	<LOD	<LOD	<LOD

Appendix 19 Olifants River clay layer fraction one (smaller than 0.2 mm) column method blank sediments.

Determinant	Milli Q water. (µg/g)	pH 3 (µg/g)	pH 5 (µg/g)	pH 6 (µg/g)	pH 7 (µg/g)	pH 8 (µg/g)	River water (µg/g)
As	<LOD	<LOD	0.01	<LOD	0.02	<LOD	0.02
Ba	0.32	2.65	17.49	30.03	8.83	13.92	0.18
Cd	<LOD	0.02	0.05	0.04	0.04	0.04	0.01
Co	0.02	0.02	0.10	0.08	0.01	0.02	0.01
Cr	0.01	0.02	0.10	0.08	0.03	0.05	0.01
Cu	0.06	0.19	0.11	0.04	0.08	0.11	0.12
Fe	0.03	0.20	0.26	0.32	0.05	0.06	0.05
Hg	<LOD	<LOD	<LOD	<LOD	<LOD	<LOD	<LOD
Mn	1.58	5.80	81.89	77.49	3.11	7.38	0.67
Mo	0.16	0.36	0.50	0.57	0.48	0.54	0.18
Ni	0.04	0.32	0.29	0.16	0.08	0.10	0.06
Pb	0.05	0.10	0.12	0.08	0.17	0.17	0.15
V	0.02	0.68	0.06	0.71	0.04	0.05	0.04
Zn	<LOD	<LOD	0.02	0.05	<LOD	<LOD	<LOD
Zr	0.11	0.02	0.04	0.03	0.01	0.02	0.02

Appendix 20 Olifants River clay fraction two (bigger than 0.2 mm) column method blank sediments.

Determinant	Milli Q water. (µg/g)	pH 3 (µg/g)	pH 5 (µg/g)	pH 6 (µg/g)	pH 7 (µg/g)	pH 8 (µg/g)	River water (µg/g)
As	<LOD	<LOD	0.01	<LOD	<LOD	0.01	0.01
Ba	0.71	3.32	17.09	21.11	10.03	12.91	0.42
Cd	<LOD	0.02	0.04	0.04	0.03	0.03	<LOD
Co	0.01	0.02	0.12	0.09	0.01	0.01	<LOD
Cr	<LOD	0.02	0.11	0.08	0.02	0.04	0.01
Cu	0.05	<LOD	0.11	0.03	0.04	0.04	0.07
Fe	0.01	0.04	0.52	0.34	0.18	0.04	0.02
Hg	<LOD	<LOD	<LOD	<LOD	<LOD	<LOD	<LOD
Mn	1.57	9.52	75.83	78.60	2.38	5.09	0.27
Mo	0.15	0.32	0.42	0.45	0.22	0.46	0.15
Ni	0.03	0.05	0.27	0.15	0.07	0.08	0.05
Pb	0.05	0.10	0.10	0.07	0.17	0.16	0.15
V	0.02	0.46	0.09	0.90	0.04	0.05	0.04
Zn	<LOD	<LOD	0.02	0.03	<LOD	<LOD	<LOD
Zr	0.02	0.11	0.06	0.02	0.02	0.01	0.02

Appendix 21 Olifants River clay fraction three (unsieved) column method blank sediments.

Determinant	Milli Q water. (µg/g)	pH 3 (µg/g)	pH 5 (µg/g)	pH 6 (µg/g)	pH 7 (µg/g)	pH 8 (µg/g)	River water (µg/g)
As	<LOD	<LOD	<LOD	0.03	<LOD	<LOD	0.01
Ba	0.31	3.95	13.32	21.93	12.21	12.14	0.13
Cd	<LOD	0.02	0.04	0.04	0.03	0.03	0.01
Co	0.01	0.02	0.13	0.10	0.01	0.02	0.01
Cr	<LOD	0.02	0.13	0.09	0.03	0.04	0.03
Cu	0.05	<LOD	0.11	0.03	0.04	0.04	0.09
Fe	0.01	0.05	0.65	0.43	0.04	0.03	0.02
Hg	<LOD	<LOD	<LOD	<LOD	<LOD	<LOD	<LOD
Mn	0.32	9.90	34.84	80.18	2.40	3.08	0.07
Mo	0.06	0.30	0.44	0.47	0.42	0.42	0.10
Ni	0.02	0.04	0.31	0.15	0.08	0.08	0.07
Pb	0.03	0.09	0.12	0.06	0.20	0.16	0.16
V	0.01	0.59	0.05	0.98	0.05	0.04	0.04
Zn	<LOD	<LOD	0.02	0.03	<LOD	<LOD	<LOD
Zr	0.02	0.03	0.03	0.02	0.02	0.02	0.02

Appendix 22 Olifants River clay layer fraction one (smaller than 0.2 mm) shaker method blank sediments.

Determinant	Milli Q water. (µg/g)	pH 3 (µg/g)	pH 5 (µg/g)	pH 6 (µg/g)	pH 7 (µg/g)	pH 8 (µg/g)	River water (µg/g)
As	<LOD	<LOD	<LOD	<LOD	<LOD	<LOD	<LOD
Ba	0.18	37.91	32.10	41.55	34.21	34.66	1.44
Cd	<LOD	<LOD	<LOD	<LOD	<LOD	<LOD	<LOD
Co	<LOD	2.29	1.89	<LOD	<LOD	<LOD	<LOD
Cr	0.10	0.30	<LOD	0.15	<LOD	0.86	0.08
Cu	0.05	<LOD	<LOD	<LOD	<LOD	1.79	0.19
Fe	58.33	508.7	125.7	21.81	<LOD	0.58	<LOD
Hg	<LOD	<LOD	<LOD	<LOD	<LOD	<LOD	<LOD
Mn	0.68	188.2	143.2	149.3	36.17	36.60	0.55
Mo	<LOD	0.33	<LOD	0.47	<LOD	1.55	0.38
Ni	0.09	1.77	0.52	0.45	<LOD	1.05	0.29
Pb	<LOD	<LOD	<LOD	<LOD	<LOD	2.23	<LOD
V	0.32	5.19	<LOD	4.87	<LOD	1.02	0.24
Zn	<LOD	0.28	<LOD	<LOD	<LOD	<LOD	<LOD
Zr	<LOD	<LOD	0.10	<LOD	<LOD	<LOD	<LOD

Appendix 23 Olifants River clay fraction two (bigger than 0.2 mm) shaker method blank sediments.

Determinant	Milli Q water. (µg/g)	pH 3 (µg/g)	pH 5 (µg/g)	pH 6 (µg/g)	pH 7 (µg/g)	pH 8 (µg/g)	River water (µg/g)
As	<LOD	<LOD	<LOD	<LOD	<LOD	<LOD	<LOD
Ba	0.06	24.45	25.13	31.60	27.25	26.82	1.28
Cd	<LOD	<LOD	<LOD	<LOD	<LOD	<LOD	0.04
Co	<LOD	1.68	1.19	<LOD	<LOD	<LOD	<LOD
Cr	0.24	0.72	<LOD	0.09	<LOD	0.89	<LOD
Cu	0.08	<LOD	<LOD	<LOD	<LOD	1.70	0.18
Fe	66.26	493.4	68.89	23.42	<LOD	0.70	0.71
Hg	<LOD	<LOD	<LOD	<LOD	<LOD	<LOD	<LOD
Mn	1.10	112.0	98.74	101.9	28.84	28.59	0.16
Mo	<LOD	<LOD	<LOD	0.62	<LOD	1.59	0.39
Ni	0.09	1.61	<LOD	0.38	<LOD	1.12	0.28
Pb	<LOD	<LOD	<LOD	<LOD	<LOD	2.55	0.66
V	0.37	3.90	<LOD	3.85	<LOD	1.07	0.23
Zn	<LOD	0.25	<LOD	<LOD	<LOD	<LOD	<LOD
Zr	<LOD	<LOD	0.32	0.14	<LOD	<LOD	<LOD

Appendix 24 Olifants River clay fraction three (unsieved) shaker method blank sediments.

Determinant	Milli Q water. (µg/g)	pH 3 (µg/g)	pH 5 (µg/g)	pH 6 (µg/g)	pH 7 (µg/g)	pH 8 (µg/g)	River water (µg/g)
As	<LOD	<LOD	<LOD	<LOD	<LOD	<LOD	<LOD
Ba	0.16	27.97	30.58	35.58	29.92	29.57	1.49
Cd	<LOD	<LOD	<LOD	<LOD	<LOD	<LOD	<LOD
Co	<LOD	1.54	1.25	<LOD	<LOD	<LOD	<LOD
Cr	0.27	0.56	<LOD	0.17	<LOD	0.99	0.32
Cu	<LOD	0.06	<LOD	0.05	<LOD	1.98	0.61
Fe	86.72	409.7	47.77	18.43	8.79	11.74	4.91
Hg	<LOD	<LOD	<LOD	<LOD	<LOD	<LOD	<LOD
Mn	0.39	124.2	117.0	119.2	32.89	32.35	0.48
Mo	<LOD	0.40	<LOD	0.42	<LOD	1.72	1.04
Ni	0.12	1.50	0.02	0.45	<LOD	1.18	0.79
Pb	<LOD	<LOD	<LOD	0.06	<LOD	2.70	1.86
V	0.41	4.14	<LOD	4.28	<LOD	1.14	0.65
Zn	<LOD	0.15	<LOD	<LOD	<LOD	<LOD	<LOD
Zr	<LOD	<LOD	0.28	0.05	<LOD	<LOD	<LOD

Appendix 25 Blesbokspruit fraction one (smaller than 0.2 mm) recovery column method sediments.

Determinant	Milli Q water. (%)	pH 3 (%)	pH 5 (%)	pH 6 (%)	pH 7 (%)	pH 8 (%)	River water (%)
As	1.47	-1.44	1.55	-1.28	-0.71	0.12	-0.50
Ba	0.86	11.92	0.89	2.55	-0.45	10.20	8.76
Cd	72.35	52.24	64.57	24.70	39.40	97.21	31.59
Co	211.95	-125.81	141.03	-202.33	-5.03	138.18	-76.56
Cr	1.65	-1.32	8.10	0.22	6.17	1.90	-2.49
Cu	-1.42	-2.25	0.05	-1.63	-0.87	0.32	-1.25
Fe	363.07	-3064.22	203.70	-752.70	-266.78	43.06	-1301.46
Hg	0.00	0.00	0.00	0.00	0.00	0.00	0.00
Mn	-164.97	-623.82	-305.47	-153.20	-1.90	80.42	-543.06
Mo	-0.15	-1.42	-0.53	1.15	0.39	1.07	-0.83
Ni	115.56	-88.23	49.04	-76.23	1.32	64.68	-64.52
Pb	0.00	-0.29	5.43	1.57	1.14	5.04	0.00
V	1.66	5.73	6.31	-0.70	-1.98	1.40	1.10
Zn	337.42	-29.06	239.05	-193.47	9.27	216.84	-36.82
Zr	0.89	-1.46	3.67	-2.29	-0.97	1.68	-0.85

Appendix 26 Blesbokspruit fraction two (bigger than 0.2 mm) recovery column method blank sediments

Determinant	Milli Q water. (%)	pH 3 (%)	pH 5 (%)	pH 6 (%)	pH 7 (%)	pH 8 (%)	River water (%)
As	0.38	0.70	0.26	-0.02	0.07	-1.34	-0.08
Ba	0.24	1.51	1.52	-5.20	-4.61	-0.22	3.56
Cd	25.13	46.52	28.67	38.55	21.41	23.10	16.23
Co	36.34	38.81	41.13	1.86	32.42	-80.51	-7.30
Cr	0.21	-0.15	1.24	-1.46	1.50	-0.48	-1.04
Cu	-0.15	-0.72	-0.54	-0.56	0.00	-0.40	-0.43
Fe	90.81	-869.32	8.34	-67.75	-72.68	-260.09	-328.40
Hg	0.00	0.00	0.00	0.00	0.00	0.00	0.00
Mn	-120.20	-209.17	-180.79	-10.11	16.83	-95.00	-238.52
Mo	0.00	-0.23	0.00	3.23	0.00	0.18	-0.54
Ni	30.51	17.22	15.93	10.61	15.20	-37.16	-16.50
Pb	0.00	0.75	6.27	11.78	2.36	1.24	0.00
V	0.48	7.07	2.00	7.44	-0.73	-0.88	0.56
Zn	82.91	88.24	88.25	27.85	36.34	-48.04	-11.18
Zr	0.19	0.04	0.47	-0.10	0.39	-0.37	-0.20

Appendix 27 Blesbokspruit fraction three (unsieved) column method blank sediments

Determinant	Milli Q water. (%)	pH 3 (%)	pH 5 (%)	pH 6 (%)	pH 7 (%)	pH 8 (%)	River water (%)
As	0.37	0.92	1.15	0.54	0.58	-0.96	0.43
Ba	17.88	9.26	3.32	-1.65	0.92	26.01	4.52
Cd	53.08	74.91	58.49	37.59	40.76	59.49	54.30
Co	22.40	61.92	38.86	1.70	7.19	-38.05	126.16
Cr	-0.55	0.17	-1.52	2.46	3.30	0.08	0.77
Cu	-2.29	-0.61	0.05	-0.65	-0.13	-0.24	-0.06
Fe	-393.40	-1100.01	-313.41	-359.32	-269.66	-408.73	-107.68
Hg	0.00	0.00	0.00	0.00	0.00	0.00	0.00
Mn	-106.36	-100.74	30.24	49.85	45.12	11.72	-114.28
Mo	-0.31	0.66	0.20	0.78	1.05	1.18	1.05
Ni	4.55	21.27	13.73	6.73	12.22	-23.30	54.54
Pb	0.00	0.19	-0.48	-2.08	-0.21	0.55	1.20
V	3.60	10.45	5.12	-2.23	4.88	3.41	3.84
Zn	98.25	253.07	89.60	71.27	108.20	127.74	304.64
Zr	-0.09	0.39	0.50	-0.01	0.74	0.19	0.70

Appendix 28 Crocodile River fraction two (smaller than 0.2 mm) recovery column method sediments

Determinant	Milli Q water. (%)	pH 3 (%)	pH 5 (%)	pH 6 (%)	pH 7 (%)	pH 8 (%)	River water (%)
As	-0.15	-0.25	0.16	0.81	0.08	0.00	-0.11
Ba	18.24	34.18	-29.12	-81.04	1.70	23.45	5.82
Cd	42.93	128.04	94.96	94.79	69.61	26.40	20.97
Co	20.38	0.73	37.44	33.85	16.97	22.43	14.84
Cr	2.08	4.45	3.31	1.42	1.94	1.17	0.67
Cu	-0.95	4.50	4.69	3.67	0.84	-0.80	-1.90
Fe	1.51	97.59	79.10	1.15	1.72	2.76	12.75
Hg	0.00	0.00	13.68	7.91	3.14	5.06	2.90
Mn	4022.60	2508.00	3928.58	3399.95	3578.15	2878.27	1871.08
Mo	4.73	3.53	1.98	3.39	4.41	1.45	3.40
Ni	16.83	63.99	35.21	40.24	25.05	12.92	14.15
Pb	0.00	39.91	13.95	-0.51	0.84	0.00	0.00
V	1.34	5.77	1.67	1.05	1.33	0.68	0.51
Zn	180.58	129.81	537.13	188.18	158.04	87.20	70.10
Zr	0.04	-0.72	-0.19	-0.95	0.20	0.13	0.37

Appendix 29 Crocodile River fraction two (bigger than 0.2 mm) recovery column method sediments

Determinant	Milli Q water. (%)	pH 3 (%)	pH 5 (%)	pH 6 (%)	pH 7 (%)	pH 8 (%)	River water (%)
As	-0.21	-0.33	-1.18	-0.20	-0.09	0.00	-0.12
Ba	3.52	9.62	60.97	-98.35	-9.11	17.06	3.85
Cd	8.98	6.29	-26.90	60.89	41.05	20.49	13.65
Co	5.33	5.69	3.57	23.38	27.89	10.85	10.99
Cr	0.69	0.95	2.52	0.96	1.63	1.25	0.54
Cu	-0.35	-1.74	-13.96	3.57	6.88	2.38	-2.31
Fe	1.31	2.53	12.27	4.43	10.59	23.21	14.81
Hg	2.22	1.51	-7.13	7.90	3.11	9.45	1.47
Mn	1083.50	2107.70	10241.99	1913.61	2023.27	2088.38	1458.35
Mo	2.72	2.34	-3.80	5.43	5.76	1.28	1.91
Ni	5.31	2.11	-32.05	21.19	32.52	16.93	10.60
Pb	0.00	0.00	0.00	1.23	5.62	2.52	0.00
V	0.27	0.93	6.59	0.70	1.01	0.51	0.31
Zn	36.21	40.34	41.29	75.65	154.27	90.35	53.60
Zr	-0.01	0.16	1.72	-0.79	-0.04	0.08	0.30

Appendix 30 Crocodile River fraction three (unsieved) recovery column method sediments

Determinant	Milli Q water. (%)	pH 3 (%)	pH 5 (%)	pH 6 (%)	pH 7 (%)	pH 8 (%)	River water (%)
As	0.12	-0.09	0.50	0.05	-0.03	0.21	0.32
Ba	10.81	12.43	1.03	-82.51	-9.55	30.84	9.38
Cd	13.27	27.31	60.68	65.11	47.80	28.71	13.47
Co	13.51	20.17	21.29	32.40	31.26	23.75	9.22
Cr	0.62	1.59	1.89	1.67	2.58	1.62	0.65
Cu	-1.21	-0.08	2.56	4.84	1.10	-0.15	0.83
Fe	-0.75	21.09	95.98	58.32	5.26	52.15	23.05
Hg	0.14	2.23	2.13	7.50	1.72	3.44	1.25
Mn	1296.66	3488.43	1083.11	3279.43	5439.76	3602.23	1749.50
Mo	3.33	0.71	1.55	3.30	3.49	0.28	2.23
Ni	4.44	15.27	25.35	32.92	30.36	23.35	12.89
Pb	0.00	0.00	17.73	3.27	2.52	4.56	0.00
V	0.27	1.57	1.25	4.53	1.92	1.74	0.51
Zn	43.39	129.41	332.63	211.60	230.27	184.62	64.11
Zr	-0.01	0.24	0.24	-0.62	-0.07	0.12	0.24

Appendix 31 Olifants River sand layer fraction one (smaller than 0.2 mm) recovery column method sediments

Determinant	Milli Q water. (%)	pH 3 (%)	pH 5 (%)	pH 6 (%)	pH 7 (%)	pH 8 (%)	River water (%)
As	0.31	0.00	1.67	0.78	0.49	0.99	0.60
Ba	7.92	-64.44	-6.66	-40.48	1.34	34.59	6.29
Cd	12.93	45.82	70.62	69.35	54.65	33.62	25.23
Co	0.15	6.72	35.94	5.09	14.76	4.85	8.17
Cr	0.05	0.82	7.43	2.35	0.48	0.28	0.26
Cu	0.15	0.27	8.39	1.34	2.02	5.58	0.79
Fe	4.49	12.50	30.38	-4.39	0.81	0.29	0.55
Hg	1.78	1.42	4.02	6.76	7.60	1.55	8.62
Mn	90.33	-300.78	1028.34	-422.34	285.10	145.36	127.93
Mo	51.95	16.25	36.23	11.69	35.64	47.60	37.89
Ni	4.38	4.60	24.50	3.05	12.69	5.94	8.22
Pb	0.00	0.27	5.41	4.20	1.37	4.60	1.28
V	1.01	29.92	15.16	35.32	0.53	0.57	0.79
Zn	0.25	5.56	24.84	14.07	4.38	2.21	1.44
Zr	-0.05	0.07	0.49	0.10	0.23	-0.02	0.01

Appendix 32 Olifants River sand layer fraction two (bigger than 0.2 mm) recovery column method sediments

Determinant	Milli Q water. (%)	pH 3 (%)	pH 5	pH 6 (%)	pH 7 (%)	pH 8 (%)	River water (%)
As	1.16	1.18	9.56	0.78	2.03	1.01	0.80
Ba	13.54	-36.22	-23.40	-40.49	11.58	26.90	6.64
Cd	44.48	39.14	67.81	79.18	59.96	48.07	25.15
Co	11.44	22.82	30.89	10.93	7.07	8.59	5.05
Cr	0.23	1.25	7.65	3.01	0.54	0.26	0.29
Cu	0.14	6.89	28.50	7.81	8.38	13.02	0.17
Fe	6.98	75.71	52.84	-10.49	0.30	0.19	2.73
Hg	6.34	9.91	4.57	8.04	10.00	17.40	7.67
Mn	315.40	-244.64	557.62	-401.13	294.96	246.80	164.39
Mo	41.78	3.35	10.80	16.79	40.13	50.08	32.47
Ni	6.96	21.21	28.55	9.38	11.53	13.71	6.23
Pb	0.00	22.47	17.51	12.31	1.61	0.66	0.99
V	7.82	34.32	15.82	37.71	0.74	0.55	1.02
Zn	3.90	32.73	41.63	38.68	13.96	7.33	1.52
Zr	0.03	0.01	0.44	0.02	0.09	0.05	-0.07

Appendix 33 Olifants River sand layer fraction three (unsieved) column method blank sediments

Determinant	Milli Q water. (%)	pH 3 (%)	pH 5 (%)	pH 6 (%)	pH 7 (%)	pH 8 (%)	River water (%)
As	0.63	0.51	3.45	1.88	0.40	0.21	0.22
Ba	6.47	-66.99	-20.41	0.85	15.77	25.27	7.40
Cd	22.14	56.71	70.90	83.32	59.92	21.13	21.49
Co	3.24	11.62	21.92	16.61	8.59	3.47	5.38
Cr	0.09	0.66	6.06	3.27	0.49	0.25	0.26
Cu	0.14	0.66	20.09	11.57	2.44	6.36	0.49
Fe	0.29	45.01	45.56	-14.43	0.39	0.22	0.51
Hg	4.31	1.53	3.51	12.26	11.82	2.55	6.25
Mn	141.42	-314.57	609.57	-186.35	291.84	125.37	133.01
Mo	37.26	3.12	6.96	18.42	36.69	40.76	31.35
Ni	4.87	7.34	24.48	22.78	15.90	7.01	5.84
Pb	0.00	0.30	10.00	10.81	1.51	0.72	1.32
V	0.52	29.34	2.31	42.06	0.49	0.54	0.74
Zn	4.26	15.62	36.19	42.20	5.07	1.22	2.09
Zr	-0.13	0.01	2.65	0.15	0.11	0.00	-0.08

Appendix 34 Olifants River clay layer fraction two (smaller than 0.2 mm) recovery column method sediments

Determinant	Milli Q water. (%)	pH 3 (%)	pH 5 (%)	pH 6 (%)	pH 7 (%)	pH 8 (%)	River water (%)
As	0.28	0.26	0.24	0.37	0.14	0.34	0.15
Ba	2.07	-8.72	-113.50	-234.24	-52.37	-58.28	1.78
Cd	5.84	7.61	60.03	24.13	12.52	7.47	3.67
Co	1.53	3.68	7.48	2.17	3.55	3.08	1.54
Cr	-0.03	0.16	0.89	-0.12	-0.07	-0.15	-0.14
Cu	0.08	-1.90	0.65	-0.19	0.37	0.03	-1.19
Fe	1.97	-1.37	-1.10	-2.51	-0.31	-0.37	-0.46
Hg	23.54	12.22	23.17	1.59	4.04	8.23	14.68
Mn	13.85	90.62	118.81	-356.41	62.94	17.91	18.51
Mo	44.38	20.98	4.16	20.57	29.76	22.96	25.62
Ni	0.32	-1.50	5.76	0.58	1.54	1.08	-0.25
Pb	-0.47	-1.00	-1.20	-0.78	-1.75	-1.65	-1.54
V	0.02	29.76	0.26	16.05	-0.29	-0.23	-0.34
Zn	0.19	0.50	5.18	0.73	0.36	0.11	0.00
Zr	-0.89	0.10	0.09	0.04	0.13	-0.03	-0.03

Appendix 35 Olifants River clay fraction two (bigger than 0.2 mm) column method blank sediments

Determinant	Milli Q water. (%)	pH 3 (%)	pH 5 (%)	pH 6 (%)	pH 7 (%)	pH 8 (%)	River water (%)
As	0.26	0.00	0.86	0.66	0.24	0.40	0.38
Ba	-1.06	-8.79	-116.95	-129.71	-51.88	-51.72	0.59
Cd	4.78	19.67	48.53	51.19	37.91	6.87	8.37
Co	0.68	4.66	12.56	11.31	11.02	1.94	3.26
Cr	0.00	0.16	1.48	0.40	0.06	-0.25	-0.06
Cu	-0.46	0.00	1.16	0.86	1.87	1.15	-0.72
Fe	6.53	1.08	-2.01	-1.19	-1.68	-0.33	0.19
Hg	13.10	1.44	7.31	4.30	24.55	3.91	25.63
Mn	21.91	229.44	63.91	-215.11	134.78	20.00	45.12
Mo	48.47	13.28	11.01	11.80	26.00	32.98	28.43
Ni	-0.04	3.04	10.17	8.70	6.36	1.51	0.92
Pb	-0.51	-0.95	0.99	-0.36	-1.66	-1.55	-1.50
V	0.00	21.29	9.20	26.41	-0.13	-0.31	-0.19
Zn	0.01	0.81	10.69	5.43	2.42	0.08	0.00
Zr	0.00	-0.83	-0.18	0.07	-0.02	-0.06	0.01

Appendix 36 Olifants River clay fraction three (unsieved) recovery column method sediments

Determinant	Milli Q water. (%)	pH 3 (%)	pH 5 (%)	pH 6 (%)	pH 7 (%)	pH 8 (%)	River water (%)
As	0.34	0.16	0.38	-0.10	0.00	0.26	0.07
Ba	0.59	-21.83	-82.74	-138.71	-67.24	-34.06	3.14
Cd	2.55	11.11	51.12	30.82	18.30	3.78	1.27
Co	0.65	4.33	8.33	4.65	5.60	2.45	0.84
Cr	0.00	0.17	1.21	-0.19	-0.03	-0.11	-0.35
Cu	-0.45	0.00	1.81	0.25	0.19	0.25	-0.67
Fe	1.76	0.96	-3.06	-3.35	-0.21	-0.12	0.39
Hg	6.87	5.96	5.59	1.77	13.23	7.14	6.33
Mn	20.51	89.04	314.82	-410.12	117.13	33.04	11.61
Mo	25.38	9.78	3.66	8.95	12.81	18.85	12.96
Ni	0.23	2.36	9.35	2.90	3.24	0.69	-0.40
Pb	-0.29	-0.89	-1.24	-0.59	-2.04	-1.60	-1.61
V	0.14	18.35	0.47	11.75	-0.38	-0.25	-0.20
Zn	0.07	0.49	6.90	1.40	0.61	0.36	0.17
Zr	0.02	-0.03	0.05	0.01	-0.02	0.00	-0.01

Appendix 37 Blesbokspruit fraction two (smaller than 0.2 mm) recovery shaker method sediments

Determinant	Milli Q water. (%)	pH 3 (%)	pH 5 (%)	pH 6 (%)	pH 7 (%)	pH 8 (%)	River water (%)
As	0.00	0.00	0.00	0.0000	0.00	0.00	0.00
Ba	40.81	107.37	60.63	35.1782	14.56	113.04	25.50
Cd	31.48	57.69	26.61	23.7423	0.00	0.00	39.79
Co	-40.48	-51.56	-44.66	-25.2027	-27.51	25.53	64.44
Cr	0.00	-39.19	0.50	-0.7086	0.00	-0.38	-11.90
Cu	0.00	-159.80	0.00	-16.7847	0.00	-2.07	-0.46
Fe	-466.77	-2790.05	-778.70	-1185.7984	-30.27	4.98	403.97
Hg	0.00	0.00	0.00	0.0000	-21.11	0.00	0.00
Mn	38.33	71.29	44.86	39.1415	-1.37	76.16	696.56
Mo	0.00	-1.97	0.00	18.2576	33.80	0.00	0.00
Ni	-25.11	-33.73	-19.60	-12.8012	-6.30	2.73	45.93
Pb	0.00	-5.60	-1.99	5.7059	0.00	0.00	-1.00
V	22.00	44.33	29.55	24.5301	2.29	-0.63	46.58
Zn	-60.23	24.58	-37.43	-44.6067	-21.34	36.26	166.15
Zr	0.00	-1.63	-3.91	-1.2227	5.67	4.03	-0.84

Appendix 38 Blesbokspruit fraction two (bigger than 0.2 mm) shaker method blank sediments

Determinant	Milli Q water. (%)	pH 3 (%)	pH 5 (%)	pH 6 (%)	pH 7 (%)	pH 8 (%)	River water (%)
As	0.00	0.00	0.00	0.00	0.00	0.00	0.00
Ba	11.91	34.81	80.79	46.90	23.14	90.81	3.84
Cd	47.39	71.04	46.59	47.86	13.37	0.00	59.21
Co	181.22	150.02	50.73	27.40	39.30	53.82	131.89
Cr	1.54	5.56	26.96	11.60	0.00	-0.78	32.26
Cu	0.00	-32.88	0.00	-3.04	0.00	-4.99	0.00
Fe	-56.70	2052.02	-49.97	-117.89	-51.28	15.44	1596.56
Hg	0.00	0.00	0.00	0.00	-12.82	0.00	0.00
Mn	96.93	13.70	91.03	57.63	66.76	66.76	110.86
Mo	0.00	-3.90	0.00	9.28	2.51	-3.72	0.00
Ni	73.42	73.96	31.72	18.50	10.01	6.39	92.84
Pb	0.00	-6.88	0.00	24.35	0.00	0.00	0.00
V	0.00	9.02	0.00	8.90	0.00	-3.34	30.08
Zn	191.00	222.17	134.57	80.46	31.47	41.72	247.69
Zr	0.00	-2.96	2.69	1.03	4.84	3.69	6.45

Appendix 39 Blesbokspruit fraction three (unsieved) recovery shaker method sediments

Determinant	Milli Q water. (%)	pH 3 (%)	pH 5 (%)	pH 6 (%)	pH 7 (%)	pH 8 (%)	River water (%)
As	0.37	0.92	1.15	0.54	0.58	-0.96	0.43
Ba	17.88	9.26	3.32	-1.65	0.92	26.01	4.52
Cd	53.08	74.91	58.49	37.59	40.76	59.49	54.30
Co	22.40	61.92	38.86	1.70	7.19	-38.05	126.16
Cr	-0.55	0.17	-1.52	2.46	3.30	0.08	0.77
Cu	-2.29	-0.61	0.05	-0.65	-0.13	-0.24	-0.06
Fe	-393.40	-1100.01	-313.41	-359.32	-269.66	-408.73	-107.68
Hg	0.00	0.00	0.00	0.00	0.00	0.00	0.00
Mn	-106.36	-100.74	30.24	49.85	45.12	11.72	-114.28
Mo	-0.31	0.66	0.20	0.78	1.05	1.18	1.05
Ni	4.55	21.27	13.73	6.73	12.22	-23.30	54.54
Pb	0.00	0.19	-0.48	-2.08	-0.21	0.55	1.20
V	3.60	10.45	5.12	-2.23	4.88	3.41	3.84
Zn	98.25	253.07	89.60	71.27	108.20	127.74	304.64
Zr	-0.09	0.39	0.50	-0.01	0.74	0.19	0.70

Appendix 40 Crocodile River fraction one (smaller than 0.2 mm) recovery shaker method sediments

Determinant	Milli Q water. (%)	pH 3 (%)	pH 5 (%)	pH 6 (%)	pH 7 (%)	pH 8 (%)	River water (%)
As	0.00	0.00	0.00	0.00	0.00	0.00	0.00
Ba	20.96	-48.55	106.97	5.50	33.72	69.85	13.09
Cd	0.00	64.17	54.47	58.55	27.61	0.00	0.00
Co	19.73	88.92	39.72	-1.02	27.84	10.24	16.44
Cr	0.00	-21.60	10.80	5.48	0.00	-3.01	0.00
Cu	-4.73	-5.00	14.70	0.00	3.24	-11.63	0.36
Fe	-281.44	3993.09	80.19	-48.14	-0.67	-2.00	-16.62
Hg	0.00	0.00	0.00	0.00	-8.17	0.00	0.00
Mn	1498.57	1866.31	2618.53	988.55	2072.30	1479.27	1724.30
Mo	9.54	-1.70	0.00	7.56	14.28	27.82	23.59
Ni	3.36	51.23	44.66	10.59	7.41	-8.11	-4.69
Pb	-2.40	-2.90	6.93	-11.68	0.00	0.00	0.00
V	65.05	67.65	119.97	53.88	71.08	78.57	71.41
Zn	-3.62	6.88	0.00	4.10	0.00	-4.27	-4.26
Zr	0.00	0.00	34.04	12.21	0.00	0.00	0.00

Appendix 41 Crocodile River fraction two (bigger than 0.2 mm) recovery shaker method sediments

Determinant	Milli Q water. (%)	pH 3 (%)	pH 5 (%)	pH 6 (%)	pH 7 (%)	pH 8 (%)	River water (%)
As	0.00	0.00	0.00	0.00	0.00	0.00	0.00
Ba	20.70	-100.33	78.47	49.08	284.79	72.96	14.00
Cd	1.07	55.27	54.32	57.53	24.40	0.00	0.00
Co	14.83	92.85	45.22	0.00	31.28	7.71	19.19
Cr	0.15	0.58	11.48	1.78	-0.64	-3.08	-0.64
Cu	-2.47	-1.20	11.91	-1.24	-3.09	-14.38	0.13
Fe	-183.51	3491.09	23.24	12.64	-11.16	-0.99	-2.76
Hg	0.00	0.00	0.00	0.00	0.00	0.00	0.00
Mn	1266.33	644.22	1734.35	925.49	4174.86	1414.94	1573.54
Mo	13.52	0.00	0.00	3.37	11.37	25.56	22.59
Ni	0.99	40.42	44.19	3.76	0.61	-9.91	-6.30
Pb	0.00	0.00	15.51	-26.06	0.00	-8.95	0.00
V	57.98	29.70	83.88	54.45	192.25	59.73	70.39
Zn	-2.91	5.50	0.00	1.95	-4.98	-6.97	-4.98
Zr	0.00	0.00	27.20	10.34	0.00	0.00	0.00

Appendix 42 Crocodile River fraction three (unsieved) recovery shaker method sediments

Determinant	Milli Q water. (%)	pH 3 (%)	pH 5 (%)	pH 6 (%)	pH 7 (%)	pH 8 (%)	River water (%)
As	0.00	0.00	0.00	0.00	0.00	0.00	0.00
Ba	20.83	32.42	115.55	140.08	67.80	119.96	14.98
Cd	1.13	56.74	52.95	54.19	22.12	0.00	0.99
Co	14.34	70.20	33.83	0.00	23.11	8.86	12.01
Cr	0.00	-0.10	9.65	3.48	0.00	-8.87	-0.69
Cu	-2.77	-0.76	11.94	-0.30	17.33	-22.84	-10.39
Fe	-185.45	2149.83	-488.19	-342.40	-1.32	-7.77	-41.65
Hg	0.00	0.00	0.00	0.00	-5.23	0.00	0.00
Mn	1146.64	677.37	1058.03	1115.83	1190.28	1519.26	1261.10
Mo	14.03	0.00	0.00	4.97	13.80	12.34	26.33
Ni	1.08	30.66	30.88	1.42	-8.00	-17.61	-6.42
Pb	0.00	-0.69	10.34	-4.57	0.00	-31.89	0.00
V	55.55	73.65	101.75	108.62	79.27	94.35	70.19
Zn	-3.01	3.99	0.00	4.67	0.00	-12.32	-5.68
Zr	0.00	0.00	22.18	11.58	0.00	0.00	0.00

Appendix 43 Olifants River sand layer fraction one (smaller than 0.2 mm) recovery shaker method sediments

Determinant	Milli Q water. (%)	pH 3 (%)	pH 5 (%)	pH 6 (%)	pH 7 (%)	pH 8 (%)	River water (%)
As	0.31	0.00	1.67	0.78	0.49	0.99	0.60
Ba	7.92	-64.44	-6.66	-40.48	1.34	34.59	6.29
Cd	12.93	45.82	70.62	69.35	54.65	33.62	25.23
Co	0.15	6.72	35.94	5.09	14.76	4.85	8.17
Cr	0.05	0.82	7.43	2.35	0.48	0.28	0.26
Cu	0.15	0.27	8.39	1.34	2.02	5.58	0.79
Fe	4.49	12.50	30.38	-4.39	0.81	0.29	0.55
Hg	1.78	1.42	4.02	6.76	7.60	1.55	8.62
Mn	90.33	-300.78	1028.34	-422.34	285.10	145.36	127.93
Mo	51.95	16.25	36.23	11.69	35.64	47.60	37.89
Ni	4.38	4.60	24.50	3.05	12.69	5.94	8.22
Pb	0.00	0.27	5.41	4.20	1.37	4.60	1.28
V	1.01	29.92	15.16	35.32	0.53	0.57	0.79
Zn	0.25	5.56	24.84	14.07	4.38	2.21	1.44
Zr	-0.05	0.07	0.49	0.10	0.23	-0.02	0.01

Appendix 44 Olifants River sand layer fraction two (bigger than 0.2 mm) recovery shaker method sediments

Determinant	Milli Q water. (%)	pH 3 (%)	pH 5 (%)	pH 6 (%)	pH 7 (%)	pH 8 (%)	River water (%)
As	0.00	0.00	0.00	0.00	0.00	0.00	0.00
Ba	46.43	-73.48	101.16	29.86	82.07	15.68	28.70
Cd	22.26	0.00	57.15	60.38	44.56	26.18	6.57
Co	4.13	-9.80	29.25	25.41	21.67	8.43	7.81
Cr	0.00	-0.20	14.57	7.63	0.00	-9.35	-1.33
Cu	0.00	0.00	28.92	9.74	3.89	-4.75	-1.34
Fe	-236.59	-190.28	27.38	-8.27	2.28	-6.81	-8.66
Hg	0.00	0.00	0.00	0.00	-4.25	0.00	0.00
Mn	159.76	-603.60	165.96	-343.45	386.91	291.89	221.62
Mo	24.95	-0.72	6.54	15.74	11.74	20.08	29.76
Ni	0.00	-9.26	34.09	11.96	3.82	-8.74	-4.21
Pb	0.00	0.00	0.00	6.47	0.00	-38.79	0.00
V	74.51	-44.18	68.14	43.04	63.54	88.52	88.57
Zn	0.94	-7.98	3.58	33.44	0.00	-12.36	-3.49
Zr	0.00	0.00	75.27	48.57	12.67	0.00	0.00

Appendix 45 Olifants River sand layer fraction three (unsieved) recovery shaker method sediments

Determinant	Milli Q water. (%)	pH 3 (%)	pH 5 (%)	pH 6 (%)	pH 7 (%)	pH 8 (%)	River water (%)
As	0.00	0.00	0.00	0.00	0.00	0.00	0.00
Ba	36.31	104.21	123.11	91.54	97.35	88.34	27.21
Cd	23.04	74.99	62.42	70.88	49.43	30.84	9.05
Co	3.63	82.43	28.99	12.13	15.41	5.96	6.28
Cr	0.00	10.31	22.23	12.07	0.00	-10.84	-0.32
Cu	0.00	26.84	36.59	23.28	2.90	-4.73	-0.66
Fe	-177.40	885.38	19.26	66.44	0.00	3.08	-9.16
Hg	0.00	76.36	0.00	0.00	30.31	30.26	0.00
Mn	62.99	173.78	-26.53	39.65	154.20	104.61	88.63
Mo	29.79	-0.52	8.69	23.71	17.50	13.14	39.28
Ni	0.00	51.13	30.13	25.77	0.53	-11.48	-2.56
Pb	0.00	0.00	0.00	7.13	0.00	-47.35	-9.50
V	75.46	81.04	95.56	85.44	87.42	91.00	105.93
Zn	0.11	55.41	0.00	44.17	0.00	-14.44	-1.77
Zr	0.00	31.08	74.46	52.44	8.82	0.00	0.00

Appendix 46 Olifants River clay layer fraction two (smaller than 0.2 mm) recovery shaker method sediments

Determinant	Milli Q water. (%)	pH 3 (%)	pH 5 (%)	pH 6 (%)	pH 7 (%)	pH 8 (%)	River water (%)
As	0.00	0.00	0.00	0.00	0.00	0.00	0.00
Ba	12.16	4.36	132.47	15.35	49.37	29.57	11.47
Cd	3.54	56.25	51.74	53.40	23.63	28.60	9.57
Co	1.15	42.59	10.52	6.45	4.94	1.67	2.05
Cr	-1.04	-1.14	16.34	6.37	0.00	-8.60	-0.78
Cu	-0.46	0.00	1.73	0.00	0.00	-7.07	-0.73
Fe	-583.33	-1248.00	-1183.03	-119.99	0.00	-0.69	34.41
Hg	0.00	0.00	0.00	0.00	0.00	0.00	0.00
Mn	5.99	-171.77	-156.60	-245.32	-25.79	-255.07	22.41
Mo	29.41	-3.33	0.00	-4.68	1.66	12.86	40.29
Ni	-0.86	18.13	23.25	-2.35	0.00	-10.47	-2.91
Pb	0.00	0.00	0.00	0.00	0.00	-22.25	0.00
V	34.36	66.41	117.53	56.38	84.90	26.43	52.50
Zn	-3.17	22.06	0.00	22.32	0.00	-10.22	-2.44
Zr	0.00	0.00	42.43	16.58	0.00	0.00	0.00

Appendix 47 Olifants River clay fraction two (bigger than 0.2 mm) recovery shaker method sediments

Determinant	Milli Q water. (%)	pH 3 (%)	pH 5 (%)	pH 6 (%)	pH 7 (%)	pH 8 (%)	River water (%)
As	0.00	0.00	0.00	0.00	0.00	0.00	0.00
Ba	15.84	109.01	931.67	108.70	28.41	6.81	14.88
Cd	0.00	59.13	591.29	56.33	27.92	13.42	7.31
Co	0.00	54.15	541.51	10.45	5.71	0.00	1.67
Cr	-2.37	-4.83	-24.59	6.67	0.00	-8.86	0.00
Cu	-0.77	0.58	13.43	0.00	0.00	-6.14	-1.76
Fe	-647.97	-1097.36	-4493.84	-49.83	0.00	-2.70	68.88
Hg	0.00	0.00	0.00	0.00	0.00	0.00	0.00
Mn	-3.04	410.77	4138.13	238.84	33.28	-186.55	26.26
Mo	39.78	0.00	-397.77	-3.22	14.28	18.45	47.36
Ni	-0.92	22.40	233.23	2.58	0.00	-11.16	-2.81
Pb	0.00	0.00	0.00	0.00	0.00	-25.52	-6.60
V	35.86	97.47	616.12	93.30	47.90	80.25	53.82
Zn	-3.68	38.99	426.70	34.87	0.00	-10.70	-2.33
Zr	0.00	0.00	0.00	21.39	0.00	0.00	0.00

Appendix 48 Olifants River clay fraction three (unsieved) recovery shaker method sediments

Determinant	Milli Q water. (%)	pH 3 (%)	pH 5 (%)	pH 6 (%)	pH 7 (%)	pH 8 (%)	River water (%)
As	0.00	0.00	0.00	0.00	0.00	0.00	0.00
Ba	12.50	151.01	186.27	83.96	111.20	104.29	12.23
Cd	5.18	45.34	48.94	53.13	11.39	18.27	14.67
Co	0.00	37.84	20.93	5.50	4.22	2.25	2.36
Cr	-2.72	-2.07	13.48	5.17	0.00	-9.88	-3.19
Cu	0.00	-0.58	5.22	-0.52	0.00	-8.94	-2.56
Fe	-826.75	549.90	-195.96	-44.18	-84.76	-116.61	-37.25
Hg	0.00	0.00	0.00	0.00	0.00	0.00	0.00
Mn	15.18	536.94	373.56	54.93	52.64	-204.89	30.89
Mo	36.01	-3.98	0.00	-1.80	7.70	17.99	35.26
Ni	-1.18	14.51	28.40	-1.25	0.00	-11.81	-7.86
Pb	0.00	0.00	13.50	-0.58	0.00	-26.99	-18.58
V	30.30	119.32	127.79	73.75	94.11	58.61	43.70
Zn	-4.12	33.68	0.00	28.76	0.00	-11.37	-6.45
Zr	0.00	0.00	34.05	18.03	0.00	0.00	0.00

Investigation of mobility of trace elements in river sediments using ICP-OES

PJ Botes¹ and JF van Staden^{2*}

¹ Department Water Affairs and Forestry, Directorate Resource Quality Service Private Bag X313
Roodeplaat Dam Pretoria South Africa 0001

² Faculty of Natural and Agricultural Science, Department of Chemistry, University of Pretoria, Hatfield,
Pretoria 0002

Abstract

In this study, the column method was used to determine the leachable trace metals present in selected river sediments. In addition the sediments were investigated using a shaker method and these two methods were compared for reliability. For both these methods extract solutions associated with a sequential extraction method were used. However, the sediments were only subjected to one extract solution and not the whole sequential procedure. The river sediments were also subjected to a digestion procedure to determine the total trace metal contents. Simulated pollution experiments were performed where the sediments were also spiked to give known concentrations of trace metals. These results were very useful especially in cases where certain trace metals were not currently present in river sediment. From the results achieved in this study the general conditions of the sediments can be established. In the case of the less impacted rivers (Crocodile and Olifants Rivers) it was established from the results achieved, that only slight changes in the river conditions are needed to mobilise the trace metals present. From the results of the Blesbokspruit it was seen that urgent attention is needed to prevent further damage to the system.

Keywords: River sediments; pH dependant extraction; trace metal content; acid digestion; column extraction method; shaker extraction method; simulated pollution; experiments.

*Corresponding author.

Tel (012) 420 2515

Email koos.vanstaden@chem.up.ac.za

Introduction

In the past, water quality assessment techniques were the main tool used to assess the impact that humans have on the environment. However, soil and river sediments are also prone to contamination from atmospheric and hydrological sources. In South Africa, this indicator of pollution is not that intensively investigated in comparison to the water resource component. In the last decades, both industrial and urbanisation have led to dramatic increase in the amounts of effluents discharged into the natural environment (Fanguero D et al., 2002).

This study was done to establish ambient concentration values of trace metals in the chosen river sediments. These river sediments originated from the Blesbokspruit (near Witbank in the Mpumalanga Province (25°49'23" S and 29°12'33" E)), Crocodile River (near Hartebeespoort Dam in the Gauteng Province (25°47'47" S and 27°53'42" E)) and Olifants River (near Ohrigstad in the Northern Province (24°22'44" S and 30°39'58" E)). The sediments were investigated to establish their ability to adsorb or retain trace metals. The mobility of the trace metals was also investigated to establish the possibility that trace metals present in the sediments can be mobilised under certain environmental conditions. Two different methods were used to extract the trace metals and these methods were evaluated to determine their suitability. The river sediments were also subjected to a total digestion procedure to determine the total trace metal content. After sample preparation, all of the samples were analysed using an inductively coupled plasma spectrometer.

Two main catchments were identified to investigate the trace metals levels in the sediments and the water components of the selected rivers. The rivers that were chosen for this investigation were the Olifants River (Mpumalanga and Northern Province) and the Crocodile River (Gauteng Province). The sample area covers land use activities ranging from predominantly coal and iron mining to agriculture and forestry (Hill et al., 2001).

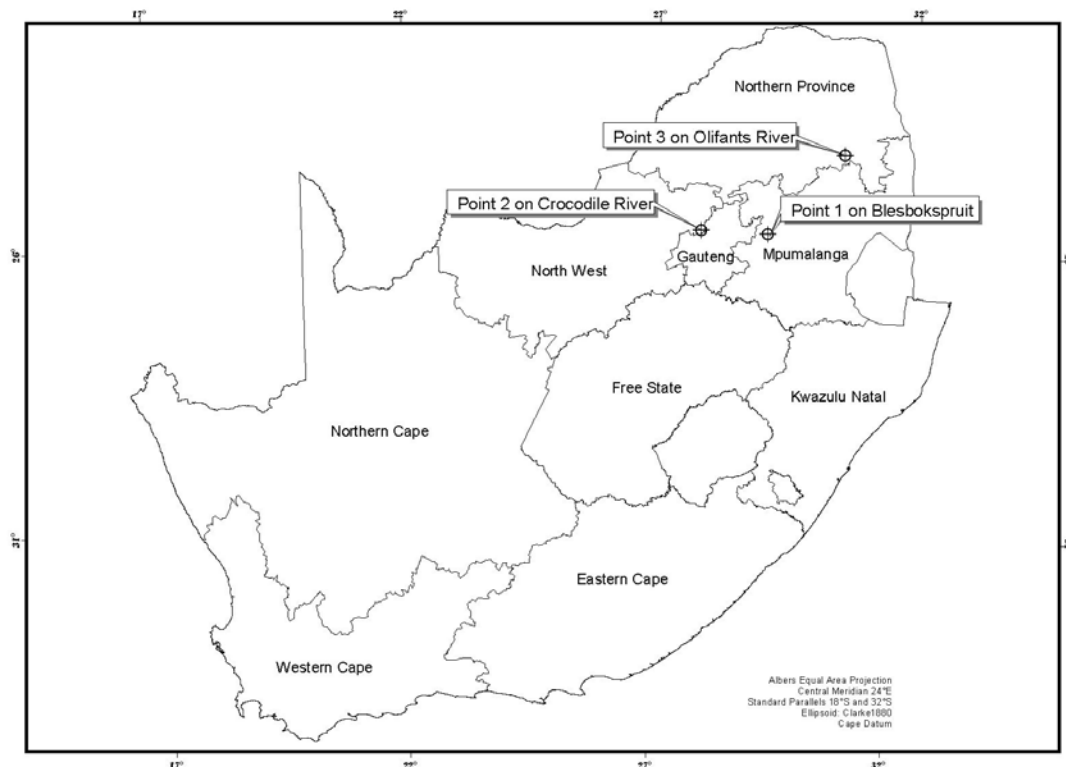

Map showing location of sample points

The Blesbokspruit is a tributary of the Olifants River and is classified as part of the Upper Olifants River catchment. This area is heavily impacted upon by point and non point source discharges. The main land use activities are mining, especially coal and ferro-metal mines. Acid mine drainage problems are found especially in the case of abandoned coalmines. The increased levels of sulphate and nutrients in the water and stimulate aquatic vegetation growth, resulting in encroachment of the water bodies (DWAF

Mpumalanga, 2002). Urban developments including Middelburg, Witbank and Bronkhorstspuit have also a role to play in the overall impact on the environment and the water quality. Large industries and power stations can also have a significant impact on the environment. Farming is not practised extensively in the area (Quibell and Belcher, 1997).

In the Crocodile River catchment the main land use centres mainly on agriculture and forestry. Agriculture is divided into two parts, which consist of dry land and irrigation agriculture. Dry land agriculture produces crops like maize, sub-tropical fruits, citrus and nuts. The most important of the crops cultivated under irrigation are citrus and sugar cane. Both types of agriculture may lead to increased levels of nutrients in the water and soils if fertilisers are used in excess of the crop's requirements and with irrigation return flows. The mining activities in the area consist of chromium, platinum and vanadium mining. Urban development and informal settlements have a detrimental influence on the quality of the environment in this area due to industrial and domestic wastes. Smaller game farming and cattle ranching activities when properly managed have a lesser impact on the state of the catchment, from a water quality perspective (Quibell and Belcher, 1997).

The sample point on the Olifants River was in the mountain to lower catchment. The most important land use activities in the mountain region are small and large scale irrigation farming, afforestation, stock watering and urban developments e.g. Lydenburg, Steelpoort and Burgersfort. In the lower part of the catchment the following land use activities are of importance: Precious and base metal mining, small-scale irrigation farming and urban development e.g. Phalaborwa. The mining activities are mainly concentrated in the Steelpoort River valley and at Phalaborwa (phosphate mining) (Quibell and Belcher, 1997). The Olifants catchment is experiencing an extreme demand for natural resources. This is closely associated with land modification and pollution (Balance et al., 2001).

Materials and methods

Sampling procedure

The equipment used in the sampling of river water and sediment was washed using Merck Extran® MA2 soap (sample bottles and sample tubes). Thereafter it was placed in a solution of 1% (v/v) hydrochloric acid (HCl) for a period of 6 hours. The apparatus was removed from the acid solution and was rinsed with Milli Q® (18 MΩ. cm) quality water.

The sediment sampling was done in river flow conditions where the water level was not too deep for sampling. The core sampler and sampling tubes with a length of 500 mm were made of Perspex. This tube was inserted into the sediment, and the rubber stopper placed in the top of the tube. The tube was slowly removed and the bottom rubber stopper was inserted at the moment when the tube was free from the bottom sediment. The sample tubes were kept at 4°C until the sample preparation stage.

The river water samples were taken in 1-litre polyethylene bottles using the sub surface grab method. The water samples were not preserved at sampling, instead they were transported to the laboratory in cooler

boxes where on arrival they were prepared and preserved. The samples were kept at 4°C until analysis (Gismera et al., 2004).

Sample preparation

The water samples were filtered using a vacuum type filtration apparatus directly after arrival at the laboratory. A conditioned 0.45 µm membrane filter was used to filter the water samples. The 0.45 µm membrane was conditioned before use by filtering 50 mL of Milli Q® water followed by 50 mL 1% nitric acid (HNO₃) (v/v). Both these fractions were discarded and the thereafter 100 mL of river water was filtered and preserved using 1 mL of concentrated HNO₃ (Schillack and Duma (a), 2003).

The sediment samples were divided into the different layers where needed. The samples were dried in a drying oven at 30°C for a period of 1 day. After the drying stage, the sediment was ground using a mortar and pestle and sieved with a stainless steel sieve (0.2 mm mesh size). The smaller than 0.2 mm fraction was collected for further sample preparation (Schillack and Duma (b), 2003).

Extract solutions

The extract reagents used in the investigation were prepared using analytical grade chemicals from Merck (BDH® chemicals) and Milli Q® quality water. The salts were weighted using a 4 decimal analytical balance. The extract solutions were prepared using calibrated A grade volumetric flasks. The extract solutions were pH corrected and measured with a Knick® pH Meter 761 Calimatic calibrated with Radiometer Analytical® (pH 4 and 10) buffer solutions. All the chemicals and acids used to adjust the pH were also analytical grade chemicals. River water from the different sample points and Milli Q® water were also used as a mobile phase in the column and shaker procedures (Tokalioglu et al., 2000; Ngiam and Lim, 2001; Kaasalainen and Yli-Halla, 2003; Dahlin et al., 2002; Dang et al., 2002; Van der Merwe et al., 1994; Fernandez Espinosa et al., 2002).

Table 1. Preparation of the mobile phases

Mobile phase	Extract Solution
Mobile alkaline phase pH 8	1 mol.dm ⁻³ Ammonium nitrate (NH ₄ NO ₃), pH adjusted to pH 8 with sodium hydroxide (NaOH)
Mobile neutral phase pH 7	1 mol.dm ⁻³ Ammonium acetate (CH ₃ COONH ₄)
Easy reduced phase pH 6	1 mol.dm ⁻³ Ammonium acetate (CH ₃ COONH ₄) and 0.1 mol.dm ⁻³ hydroxyl ammonium chloride (NH ₂ OH.HCl)
Weak acid soluble phase pH 5	1 mol.dm ⁻³ Sodium acetate (CH ₃ COONa), pH adjusted to pH 5 with glacial acetic acid (CH ₃ COOH)
Acid soluble phase pH 3	0.1 mol.dm ⁻³ Hydroxyl ammonium chloride (NH ₂ OH.HCl), pH adjusted to pH 3 with glacial acetic acid (CH ₃ COOH)
Milli Q water ® phase	Water with resistivity of better than 18 MΩ. cm ⁻¹ with measured pH of 6.9
River water phase	River water with measured pH values

Experimental procedure

The digestion of the different fractions was performed using a mixture 20% (v/v) of HCl and HNO₃ in the ratio 3:1. One gram of the sediment was weighed on a 4 decimal analytical balance (Mettler®AE 200) and transferred to a 200 mL glass beaker. The sample was then digested using an open beaker digestion technique on a hotplate for 2 hours. The samples were then filtered into a clean 350 mL polyethylene bottle using an 80 mm funnel fitted with a Whatman® 42 filter paper (Van der Merwe, 1998; Martin et al., 2001; Bettinelli et al., 2000; Sastre et al., 2002).

Column experiment procedure

For the column experiments, 100 g of the sieved fraction was weighed on a 4 decimal analytical balance and placed in a 50 mm inner diameter glass tube. The glass tube was held in place with the aid of a support stand and clamp and it rested on a 80mm funnel fitted with Whatman® 42 filter paper. The extract solution was added to the sample using a Gilson Minipuls 2® peristaltic pump fitted with tubing with inner diameter of 1.3 mm. The peristaltic pump was set up to produce a flow rate of 1mL per minute and the delivery amount of extract solution was 100 mL. The total addition time of the extract solution was 100 minutes. This set up was used for all the mentioned extract solutions mentioned in Table 1. The tubing was centred at the top of the glass tube to prevent irregular flow conditions. The filtrate was collected in a clean 350 mL polyethylene bottle and the samples were left to stand for 3 hours after the extract solution was added. The samples were done in duplicate to minimise the heterogeneity of the sediments. The filtrate's volume was measured and then stored in a cooler room at less than 4°C until analysis (Yong et al., 2001).

Shaker experiment procedure

For the shaker test, 5g of sediment was weighed on a 4 decimal analytical balance and placed into a 350 mL polyethylene bottle for all the different fractions. 100 mL of the particular extract solution was added to the 5 g sample. The sample bottles were placed on a Labotec Model 202 shaker at setting 4 for a period of 100 minutes. After the 100 minutes, the samples were taken off the shaker and were filtered through a Whatman® 42 filter paper into a clean 350 mL polyethylene bottle (Schillack and Duma (b), 2003).

Trace element spiking procedure

For the column and shaker tests the sediment wetted with 15 mL of Milli Q® water and then spiked using 1000 mg/L single element (Merck ampoule standards). The ratio of sediment and standard added for the two methods were the same.

Quality Assurance

All the calculations were done with a confidence level of 99% and a certified reference material sample was used to investigate the suitability of the digestion method. All the analysis readings were performed in triplicate and the samples were prepared in duplicate and analysed.

Analytical results of the river water and sediments

The results for the river water samples were as follows.

Table 2. River water analytical results using ICP-OES (Spectroflame Modula)

Determinant	Blesbokspruit water No 1 (mg/L)	Crocodile River water No 2(mg/L)	Olifants River water No 3&4(mg/L)
As	0.038	0.051	0.023
Ba	0.050	0.025	0.045
Cd	< LOD	< LOD	< LOD
Co	0.169	< LOD	< LOD
Cr	0.015	0.014	0.011
Cu	0.023	0.027	0.023
Fe	0.612	0.018	0.262
Hg	< LOD	< LOD	< LOD
Mn	3.566	< LOD	0.037
Mo	0.045	0.047	0.044
Ni	0.140	0.035	0.034
Pb	0.085	0.091	0.103
V	0.025	0.030	0.025
Zn	0.115	< LOD	1.378
Zr	0.012	< LOD	< LOD

<LOD shows that the results were lower than the limit of detection of the ICP-OES

Table 3. River water pH results using a Knick® pH Meter 761 Calimatic

Determinant	Blesbokspruit water No 1 (pH units)	Crocodile River water No 2 (pH units)	Olifants River water No 3&4 pH units
pH	3.12	7.23	7.39

The results for the different river sediment samples were as follows.

Table 4. River sediment digestion results using ICP-OES (Spectroflame Modula)

Determinant	Blesbokspruit <0.2 mm No 1 (µg/g)	Crocodile River <0.2 mm No 2(µg/g)	Olifants River <0.2 mm No 3 (µg/g)	Olifants River <0.2 mm No 4 (µg/g)
As	7.17	4.20	3.33	< LOD
Ba	23.95	123.44	24.27	53.76
Cd	< LOD	< LOD	< LOD	< LOD
Co	32.82	18.39	7.57	17.94
Cr	58.50	60.64	38.83	135.22

Determinant	Blesbokspruit	Crocodile River	Olifants River	Olifants River
	<0.2 mm No 1 (µg/g)	<0.2 mm No 2(µg/g)	<0.2 mm No 3 (µg/g)	<0.2 mm No 4 (µg/g)
Cu	16.73	48.02	< LOD	< LOD
Fe	13320	22740	16090	43110
Hg	< LOD	< LOD	< LOD	< LOD
Mn	31.12	1406	249.1	411.3
Mo	< LOD	< LOD	< LOD	< LOD
Ni	21.26	29.61	10.89	30.22
Pb	12.81	90.39	< LOD	< LOD
V	43.42	39.89	47.46	208.8
Zn	53.09	346.7	< LOD	< LOD
Zr	4.12	3.27	2.65	2.84

Table 5. Blesbokspruit fraction column method blank sediments using ICP-OES (Spectroflame Modula).

Determinant	Milli Q water (µg/g)	pH 3 (µg/g)	pH 5 (µg/g)	pH 6 (µg/g)	pH 7 (µg/g)	pH 8 (µg/g)	River water (µg/g)
As	0.04	0.23	0.16	0.23	0.22	0.28	0.13
Ba	0.06	0.16	0.13	0.64	0.45	1.12	0.04
Cd	0.01	0.14	0.06	0.08	0.04	0.04	0.09
Co	5.99	19.22	6.48	22.98	15.29	16.51	12.56
Cr	0.06	0.44	0.47	0.85	0.60	0.24	0.28
Cu	0.18	0.22	0.13	0.16	0.11	0.05	0.12
Fe	9.30	338.7	54.11	76.04	41.58	43.23	132.19
Hg	<LOD	<LOD	<LOD	<LOD	<LOD	<LOD	<LOD
Mn	38.69	76.26	55.48	20.92	14.96	15.21	63.39
Mo	0.01	0.19	0.05	<LOD	<LOD	<LOD	0.12
Ni	2.45	12.09	5.36	8.81	6.47	8.55	9.07
Pb	<LOD	0.03	0.02	0.04	<LOD	0.02	<LOD
V	<LOD	0.16	0.03	0.67	0.49	0.11	0.05
Zn	3.83	18.73	7.07	24.25	18.14	20.89	14.86
Zr	0.05	0.23	0.29	0.41	0.32	0.14	0.13

Tabel 6. Crocodile River fraction column method blank sediments.

Determinant	Milli Q water (µg/g)	pH 3 (µg/g)	pH 5 (µg/g)	pH 6 (µg/g)	pH 7 (µg/g)	pH 8 (µg/g)	River water (µg/g)
As	0.02	0.02	0.02	0.03	0.02	<LOD	0.01
Ba	0.43	0.48	6.08	13.34	5.07	5.43	0.25
Cd	0.01	<LOD	0.24	0.19	0.09	0.05	<LOD
Co	0.08	0.08	0.37	0.59	0.25	0.13	0.04
Cr	<LOD	<LOD	0.19	0.22	0.08	0.04	<LOD
Cu	0.17	0.19	0.60	0.35	0.33	0.24	0.26
Fe	0.48	0.73	1.70	1.05	0.24	0.14	0.27
Hg	<LOD	<LOD	<LOD	<LOD	<LOD	<LOD	<LOD
Mn	15.53	20.94	414.7	478.2	236.7	94.32	4.72
Mo	0.07	0.08	0.34	0.35	0.31	0.30	0.05
Ni	0.19	0.18	1.05	0.67	0.40	0.22	0.15
Pb	<LOD	<LOD	0.48	0.50	<LOD	<LOD	<LOD
V	<LOD	0.01	0.09	0.25	0.03	0.01	<LOD
Zn	1.02	1.14	24.50	15.71	4.13	2.18	0.71
Zr	0.02	0.11	0.07	0.12	0.01	0.01	0.02

Tabel 7. Olifants River sand layer fraction column method blank sediments.

Determinant	Milli Q water (µg/g)	pH 3 (µg/g)	pH 5 (µg/g)	pH 6 (µg/g)	pH 7 (µg/g)	pH 8 (µg/g)	River water (µg/g)
As	<LOD	<LOD	<LOD	0.01	<LOD	0.01	<LOD
Ba	<LOD	10.42	9.82	16.39	6.76	6.75	0.05
Cd	<LOD	<LOD	0.01	0.01	<LOD	<LOD	<LOD
Co	0.46	0.39	0.02	1.43	<LOD	<LOD	<LOD
Cr	<LOD	<LOD	0.02	0.07	<LOD	<LOD	<LOD
Cu	<LOD	<LOD	<LOD	<LOD	<LOD	<LOD	<LOD
Fe	<LOD	0.39	0.31	1.32	<LOD	<LOD	<LOD
Hg	<LOD	<LOD	<LOD	<LOD	<LOD	<LOD	<LOD
Mn	0.01	100.5	11.93	135.9	0.23	<LOD	<LOD
Mo	<LOD	0.05	0.01	0.14	0.03	0.06	0.01
Ni	0.01	0.49	0.13	1.72	<LOD	<LOD	<LOD
Pb	<LOD	<LOD	<LOD	<LOD	<LOD	<LOD	<LOD
V	0.01	1.18	<LOD	1.14	<LOD	<LOD	<LOD
Zn	<LOD	<LOD	<LOD	0.04	<LOD	<LOD	<LOD
Zr	0.02	0.02	0.03	0.04	0.01	0.02	0.02

Table 8. Olifants River clay layer fraction column method blank sediments.

Determinant	Milli Q water (µg/g)	pH 3 (µg/g)	pH 5 (µg/g)	pH 6 (µg/g)	pH 7 (µg/g)	pH 8 (µg/g)	River water (µg/g)
As	<LOD	<LOD	0.01	<LOD	0.02	<LOD	0.02
Ba	0.32	2.65	17.49	30.03	8.83	13.92	0.18
Cd	<LOD	0.02	0.05	0.04	0.04	0.04	0.01
Co	0.02	0.02	0.10	0.08	0.01	0.02	0.01
Cr	0.01	0.02	0.10	0.08	0.03	0.05	0.01
Cu	0.06	0.19	0.11	0.04	0.08	0.11	0.12
Fe	0.03	0.20	0.26	0.32	0.05	0.06	0.05
Hg	<LOD	<LOD	<LOD	<LOD	<LOD	<LOD	<LOD
Mn	1.58	5.80	81.89	77.49	3.11	7.38	0.67
Mo	0.16	0.36	0.50	0.57	0.48	0.54	0.18
Ni	0.04	0.32	0.29	0.16	0.08	0.10	0.06
Pb	0.05	0.10	0.12	0.08	0.17	0.17	0.15
V	0.02	0.68	0.06	0.71	0.04	0.05	0.04
Zn	<LOD	<LOD	0.02	0.05	<LOD	<LOD	<LOD
Zr	0.11	0.02	0.04	0.03	0.01	0.02	0.02

The recovery results for the spiked sediment samples were as follows.

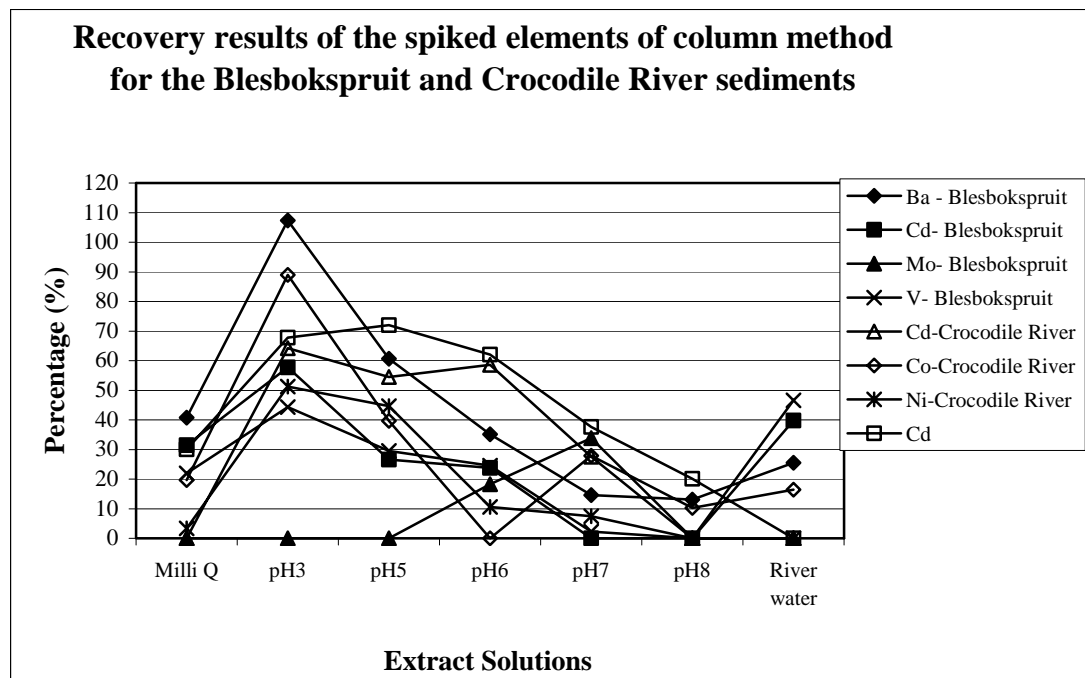

Graph 1. Recovery results of the spiked elements of column method for the Blesbokspuit and Crocodile River sediments

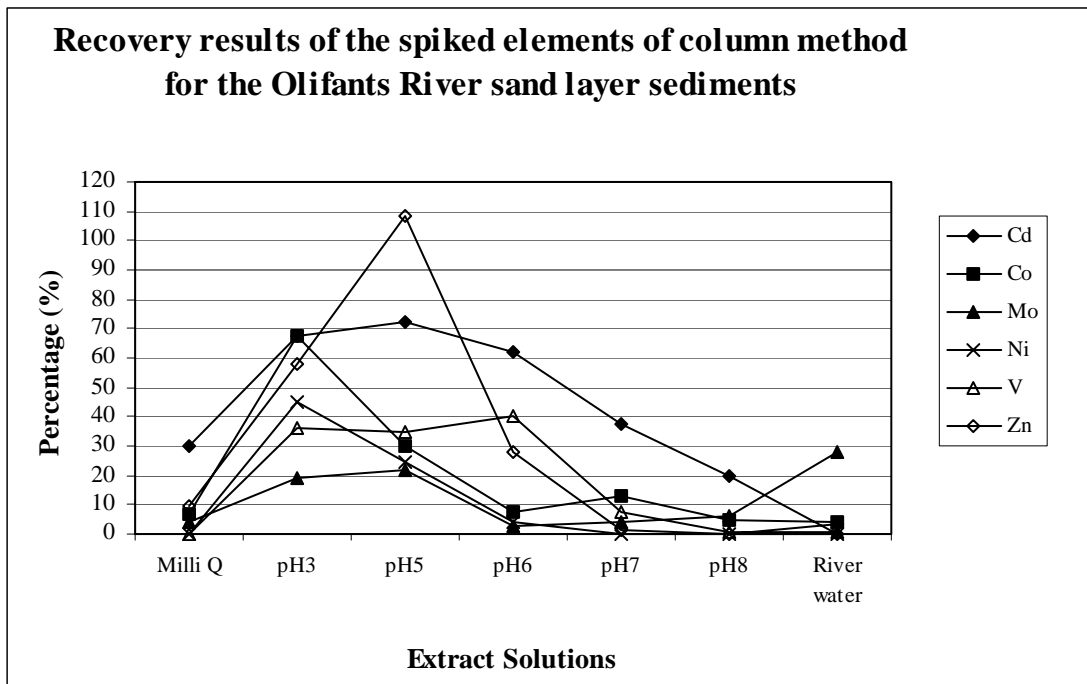

Graph 2. Recovery results of the spiked elements of column method for the Olifants River sand layer sediments.

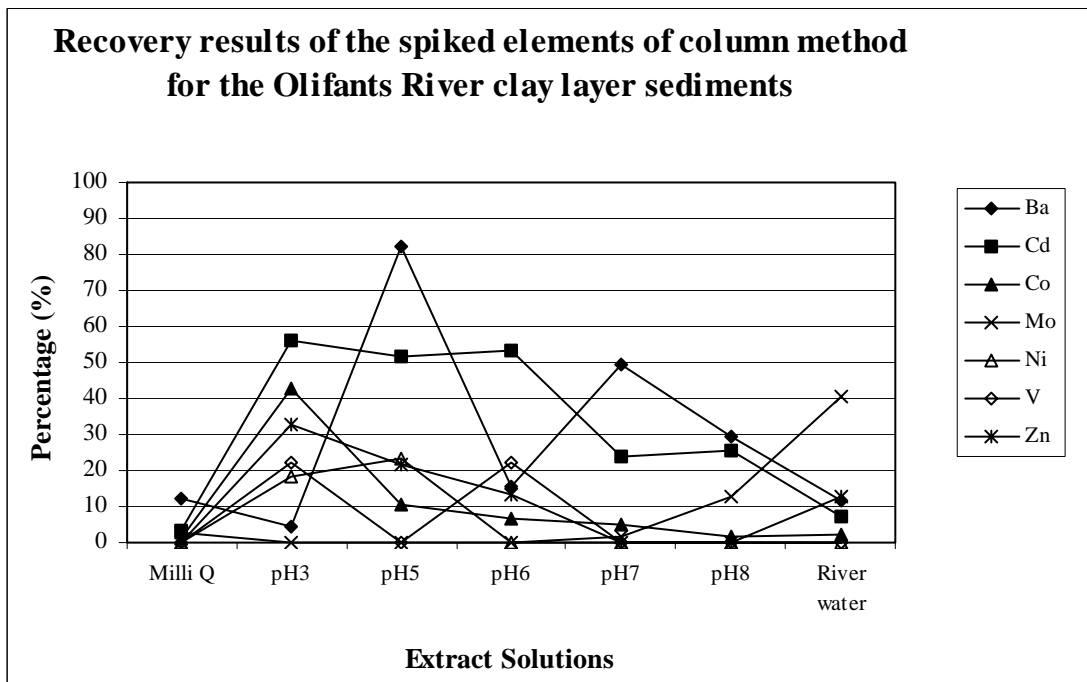

Graph 3. Recovery results of the spiked elements of column method for the Olifants River clay layer sediments.

Discussion on the results of the Blesbokspuit samples

The results from the Blesbokspuit water sample showed that 13 out of the 15 trace elements measured were present in varying concentrations. The main concentration contributions came from: Co, Fe, Mn, Ni

and Zn. The pH of the water is also very low for natural water and was measured at 3.12 (pH units). This can definitely play a major role in the elevated levels of trace elements in the river's water. With the pH being this low it will promote the movement of the trace elements in the sediment and they will eventually end up in the ground water source.

It was clear from the water analysis that very high concentrations were expected. After the digestion of the sediment this was confirmed. These elevated levels were proven through the results obtained.

In the column leach tests the trace elements that showed a concentration above their detection limits were Ba, Co, Cr, Cu, Fe, Mn, Ni, V, and Zn. Ba was present at very low concentration throughout the extract solution series. From the results it is clear that between pH 6–8 are the best conditions for mobility, with the highest concentration being at pH 8 (1.12 µg/g). The mobility of Co is relatively constant through the extract series and there is not a large difference between pH 3 and pH 6 in the concentrations measured. Co was also very mobile in the river water and the calculated value compared well with the other synthetic extract solutions. Cr displayed mobility from pH 3 through to pH 7. The concentration however, was not high and ranged between 0.44 µg/g (pH 3) to 0.85 µg/g (pH 6). Cu was present at very low levels and the calculated values were between 0.05 µg/g (pH 8) to 0.44 µg/g (pH 3). It also showed a good relation between pH and mobility. Fe and Mn were present in very large amounts. The river water also leached considerable amounts, which showed that under normal river conditions Fe and Mn are very mobile. Ni was present at average concentrations and ranged from 12.09 µg/g (pH 3) to 2.45 µg/g (Milli Q water). The river water again showed increased ability to mobilise Ni from the sediment under normal river conditions. V showed the highest mobility under conditions between pH 3 (0.16 µg/g) and pH 6 (0.67 µg/g). From the results it could be seen that Zn is the most mobile under pH condition of pH6-8 and to a lesser degree under lower pH conditions.

In the shaker test the results exhibited the same characteristics. In general, however, the results had much larger deviations between the duplicate samples. This can be attributed to the smaller amounts of sediment used which will be more affected by subtle changes in trace metal content.

The results of the spiking exercise for the column method were only reliable for the following elements: Ba, Cd, Co, Ni and Zn (Graphs 1). The recovery of Ba varied from 0.86% (Milli Q water) to 11.92% (pH 3). The recovery was not high and this is an indication that the sediment adsorbs the element well. Cd on the other hand was mobile throughout the extract series with recovery ranging from 24.7% (pH 6) to 97.21% (pH 8).

Discussion on the results of the Crocodile River samples

The results from the Crocodile River water sample showed that 9 out of the 15 trace elements measured were present in varying concentrations. The pH of the water is considered normal for natural water sources and was measured at 7.23 (pH units). The main factor that influences the low concentrations of

elements present in the river water is the neutral to slightly alkaline pH of the water. This is also an indication that little to no acid mine drainage is present in the river water.

The digested sediment sample analysis showed that there were 12 out of the 15 elements measured that were present. The elements that were not present at detectable concentrations were: Cd, Hg and Mo.

The trace elements that showed gave a concentration above their detection limits were Ba, Mn and Zn. Barium was present in rather low concentration ranging from 0.25 µg/g (river water) to 13.34 µg/g (pH 6). This shows that the best mobility of Ba was obtained between pH 5-6. Mn was present at very high concentrations in the digested sediments and was expected to be present in elevated levels in the leachate. Under normal river conditions though, Mn is not easily mobilised. Zn was present in low to moderate concentrations ranging from 0.71 µg/g (river water) to 24.50 µg/g (pH 5). Again the same applies to Zn as previously mentioned with Mn, very low mobility was seen with the river water. The shaker method gave correlating results with the column method, but Fe and Ni were also detected.

The elements that gave reliable recovery results were Cd, Co, Cr and Ni. The recovery values for Cd, Co and Ni were high and showed a good relationship between the mobility and lower pH levels (Graph 1). Under river conditions it was illustrated that in the event of Cd and Co pollution, it is possible to mobilise these elements. Ni showed that in higher concentration levels it could be mobilised by the river water.

Discussion on the results of the Crocodile River samples

The results from the Olifants River water sample showed that 11 out of the 15 trace elements analysed for were present in varying concentrations. The concentrations of the elements present were higher than the Crocodile River and ranged between 0.011 mg/L (Cr) to 1.38 mg/L (Zn). The bulk of the concentrations in the water sample were contributed by: Fe, Pb and Zn. The pH of the water is very much the same as that of the Crocodile River and is considered normal for natural water sources and was measured at 7.39 (pH units).

Sand layer results

In the digested sediment samples 9 of the analysed elements were present in varying concentrations. The concentration varied from 2.65 µg/g (Zr) to 28120 µg/g (Fe). The bulk contributors to the overall concentration that were measured were: Ba, Cr, Fe, Mn and V. Small differences in concentrations can be attributed to almost complete absence of clay particles present, which usually adsorb more trace elements and contribute more of the trace element measured concentration.

The concentrations found in the sand fraction of the Olifants River were very low, with the highest contribution being that of Mn. Ba was present at higher concentrations (ranging between 0.05-16.39 µg/g) than in the sand fraction and exhibited the best mobility under pH 6 extract conditions. Co was present at very low concentrations ranging of between 0.02 µg/g (river water) to 1.43 µg/g (pH 6). It was found that Co was the most mobile under pH 6 conditions. Mn was present at elevated levels in the pH 3 and 6 extract solutions and this agrees with the digested sediment results.

The same elements that were found to be mobile in the column test were found in the shaker test; in addition to Fe and V. Fe and V showed considerably higher concentrations than in the column method.

The elements that gave reliable recovery results were Cd, Co, Cr, Mo, Ni and V. The recovery values for Cd, Co and Ni were high and showed a good relationship between the mobility and lower pH levels, with the best being between pH 3-6. Under river conditions it was illustrated that in the event of Cd, Co and Ni pollution, it is possible to mobilise these elements. Mo and V shown good mobility under the extract conditions.

Clay layer results

In the digested sediment samples 8 of the analysed elements were present in varying concentrations. The concentration varied from 2.84 µg/g (Zr) to 43110 µg/g (Fe). The bulk contributors to the overall concentration that were measured were: Ba, Cr, Fe, Mn and V. The Cr (135.2 µg/g) and V (208.8 µg/g) concentrations were noticeably higher than the sand layer. The calculated concentrations were overall three times higher than that the sand layer. The concentrations of the different fractions were not far from each other and this again can be attributed to the low amount of clay particles present.

In the column extract solution 12 out of the 15 elements measured were present. The two main contributions in concentration came from Ba and Mn. The other elements were present in very low concentrations and did not pose a possible pollution risk. Ba was, as with the sand layer, present in high concentrations between pH 5 and 6. Mn also exhibited the same characteristic and percentage mobility. All the other elements that were present were not present in the sand layer, but it is expected that the trace metal content will be higher in sediments with higher clay content.

In the shaker test the results exhibited the same characteristics. In general, however, the results had much larger deviations between the duplicate samples. This agrees with what was found with the Blesbokspruit samples.

The elements that gave reliable recovery results were Cd, Co, Hg, Mo, Ni, V and Zn. The recovery values for Cd, Co and Ni were high and showed a good relationship between the mobility and lower pH levels, with the best being between pH 3-6. Under river conditions it was illustrated that in the event of Cd, Co and Ni pollution, it is possible to mobilise these elements. Mo and V shown good mobility under the extract conditions. Zn was also leached at detectable levels.

Conclusions

Blesbokspruit

The results from the Blesbokspruit showed elevated levels of a number of trace elements present in the sediment. In the leaching experiments, it was seen that the elements were mobile to a high degree, and this was not expected in sediment with high clay content with which to bind the trace elements. Under normal river conditions, it was found that the mobility of the trace elements was very high especially with respect to Co, Fe, Mn, Ni and Zn. This was explained by the very low measured pH and higher than normal trace metal content of the river water. This is a worrying factor because it gives evidence that there need not be a drastic change in the river condition as previously assumed, for the trace elements to be mobilised. The trace elements are already mobile under existing river conditions. From the digested sediment samples, it could be seen that the trace element load of the river sediment is very high and the easily leached trace elements show that the sediment does not have the capacity to strongly bind the trace elements.

The simulated pollution experiment gave good results for Cd that was not present in the original sample, was easily mobilised. This showed that in the event of Cd pollution in the Blesbokspruit, it is possible for it to mobilise and cause possible deterioration of the groundwater resources. The overall state of the Blesbokspruit is undesirable and concerted action is needed to try and ameliorate the situation.

Crocodile River

The trace element content in the river water sample was low, and the pH in the normal range of an unimpacted river. From the leaching methods the results showed that the major part of the leachable trace metal content occurs under pH conditions between five and six. The main contribution in the total concentration using the leach methods was shown to be Mn. Under current river conditions, low concentrations of the trace elements were found, however, there were detectable amounts of Ba, Cu, Fe, Ni and Zn. This indicates that it is possible to mobilise trace elements under the current river conditions. The fact that the best mobility was observed at pH 5 to 6 means that there need not be a drastic change in the river conditions to be able to mobilise trace elements from the river sediments and the acid rain may

mobilise trace elements. At this stage, the elements (Cd, Co, Cr and Ni) that clearly showed mobility in the simulated pollution experiment are not present at high concentrations in the sediments. From the results, however, it can be deduced that in the event of possible pollution of the mentioned elements, it is possible to mobilise them from the sediment. Currently, the overall state of the Crocodile River is not heavily impacted upon, but careful monitoring is needed to keep the situation stable.

Olifants River

The trace element concentrations measured in the Olifants River sand and clay fractions were not extremely high. The main contributions in the sand fraction were from Ba and Mn, with smaller concentrations for Ni and V. The pH of the river water was 7.39 and this is normal for an undisturbed river system of this type. There were not any trace elements that gave significant values in the river water experiment and the main conditions of increased mobility were between pH 3 and 6. On the other hand, in the simulated pollution experiments it was clear that Cd, Co, Cr, Mo, Ni and V were mobile throughout the extract series at high levels. In the event of possible pollution of the abovementioned elements, it is possible to mobilise trace elements under current river conditions. In the clay fraction there were many more different trace elements present, however, they were at low concentrations. The main concentration contributions arose from Ba and Mn. The best mobility conditions were shown to be between pH 5 and 6. Under normal river conditions, a number of elements were mobilised in small quantities, but in the long run they can contribute to the pollution of groundwater resources. The simulated pollution experiment showed the same elements to be mobile as in the sand fraction with the same amount of mobility throughout the extract series. The overall state of the Olifants River at the sampling point was considered to be acceptable.

Analytical procedures

Column method of leaching trace elements

The column method gave very repeatable and reproducible results with a low relative standard deviation between the different replicates. The use of a greater volume of sediment can have negative and positive implications on the analytical procedure. The positive aspects are that with the column method, the leaching process is more natural (simulating natural processes) and that using larger volumes of sediment can lessen the variability observed in the sediment samples. On the other hand, depending on the characteristics of the sediment, it is difficult to know exactly what the end volume of the extract will be

once filtered. This means that the amount of extract solution retained in the sediment must first be determined before final decisions on what volume to use can be made. From the results obtained in this study, it can be said that the column method is a reliable way to measure leaching of trace elements if a sufficient volume of sediment is available.

Shaker method of leaching trace elements

The shaker method also gave reliable results and compared well with the column method. The relative standard deviation was higher between replications than in the case of the column method. The mechanical process of the method is also not natural and the leaching of elements is predominantly higher than in the column method. The biggest disadvantage of the shaker method is the small amount of sediment used in the sample preparation stage. The variability of the sediment composition can play a major role in the end concentration measured. This method can be used in the event that only a small amount of sediment is available, but then the results are prone to large variations in resultant concentrations. The advantage compared with the column method is that the end volume of the extract solution is not dependant upon the sediment type. With the results obtained in this study, the shaker method can be used, but the column test gave better results.

Recommendations

In South Africa, sedimentation in the river systems is a common occurrence. The general feeling is that sedimentation can provide an inexhaustible sink to adsorb trace elements. From this study it is clear that the river sediment has only a limited capacity to adsorb trace elements and if the load on the river sediment increases this capacity can be breached. Under acidic or sometimes normal river conditions, the trace elements may leach and cause problems, for example, with groundwater quality degradation.

It is clear in the case of the Blesbokspruit that the water and sediment quality are hugely affected by anthropogenic activities. This is an example of a system that will take many years to rehabilitate if the process is started immediately. This shows the importance of constantly monitoring a river system's condition. This would then act as an early warning system that will warn the managing authorities before the damage sustained is not reversible.

Acknowledgements

The Department of Water Affairs and Forestry of South Africa is thanked for its financial support and the use of their laboratory facilities.

References

- BALANCE A, HILL L, ROUX D, SILBERBAUER M and STRYDOM W (2001) State of the Rivers report Water Research Commission Report no. TT 147/01.
- BETTINELLI M, BEONE GM, SPEZIA S and BAFFI C (2000) Determination of heavy metals in soils and sediments by microwave-assisted digestion and inductively coupled plasma optical emission spectrometry analysis. *Analytica Chimica Acta* **424** 289-296.
- DAHLIN C, WILLIAMSON CA, COLLINS WK and DAHLIN DC (2002) Sequential extraction versus comprehensive characterization of heavy metal species in brownfield soils. *Environmental Forensics* **3** 191-201.
- DANG Z, LIU C and HAIGH MJ (2002) Mobility of heavy metals associated with the natural weathering of coal mine spoils. *Environmental Pollution* **118** 419-426.
- DWAF MPUMALANGA (2002) Proposal for the establishment of a catchment management agency for the Olifants Water Management Area: Appendix C Version 2.2.
- FANGUEIRO D, BERMOND A, SANTOS E, CARAPUCA and DUARTE A (2002) Heavy metal mobility assessment in sediments based on a kinetic approach of the EDTA extraction: search for optimal experimental conditions. *Analytica Chimica Acta* **459** 245-256.
- FERNANDEZ ESPINOSA AJ, RODRIQUEZ MT, DE LA ROSA FJB and SANCHEZ JCJ (2002) *Atmospheric Environment* **36** 773-780.
- GISMERA MJ, LACAL J, DA SILVA P, GARCIA R, SEVILLA MT and PROCOPIO JR (2004) Study of metal fractionation in river sediments. A comparison between kinetic and sequential extraction procedures. *Environmental Pollution* **127** 175-182.
- HILL L, VOS P, MOOLMAN J and SILBERBAUER M (2001) Inventory of the River Health Programme monitoring sites on the Olifants, Sabie and Crocodile Rivers. Water Research Commission Report no. 850/2/01.
- KAASALAINEN M and YLI-HALLA M (2003) Use of sequential extraction to assess metal partitioning in soils. *Environmental Pollution* **126** 225-233.
- MARTIN A, LOPEZ-GONZALVEZ A and BARBAS C (2001) Development and validation of extraction methods for determination of zinc and arsenic speciation in soils using focused ultrasonic application to heavy metal study in mud and soils. *Analytica Chimica Acta* **442** 305-318.
- NGIAM L and LIM P (2001) Speciation patterns of heavy metals in tropical estuarine anoxic and oxidized sediments by different sequential extraction schemes. *The Science of the Total Environment* **275** 53-61.
- QUIBELL G and BELCHER A (1997) Status report: Monitoring the impact of saline mine water from the Grootvlei mine on aspects of the water environmental quality of the Blesbokspruit wetlands system Water Research Commission Report no. N/C210/RMQ/1196.
- SASTRE J, SAHUQUILLO M, VIDAL M and RAURET G (2002) Determination of Cd, Cu, Pb and Zn in environmental samples: microwave assisted total digestion versus aqua regia and nitric acid extraction. *Analytica Chimica Acta* **462** 59-72.

- SCHILLACK MF and DUMA T (a) (2003) Resource Quality Services: Trace metal method manual SOP 2001 Dissolved metals in water Department Water Affairs and Forestry, Pretoria 1-3 pp.
- SCHILLACK MF and DUMA T (b) (2003) Resource Quality Services: Trace metal method manual SOP 2004 Water extract of solid material. Department Water Affairs and Forestry, Pretoria 1-3 pp.
- TOKALIOGLU S, KARTAL S and ELCI L (2000) Determination of heavy metals in their speciation in lake sediments by flame atomic absorption spectrometry after a four-stage sequential extraction procedure. *Analytica Chimica Acta* **413** 33-40.
- VAN DER MERWE L (1998) Institute for Water Quality Studies: Trace metal method manual SOP 2003 Microwave digestion of solid samples Department Water Affairs and Forestry Pretoria 1-4 pp.
- VAN DER MERWE, L., KEMPSTER, P.L., VAN VLIET, H.R., AND VAN STADEN, J.F. (1994) A pH-dependent sequential extraction procedure to determine mobilisation and transport of metals in sediments. *Water SA*, **20** (1) 27-34.
- YONG RN, YAACOB WZW, BENTLEY SP, HARRIS C and TAN BK (2001) Partitioning of heavy metals on soil samples from column tests. *Engineering Geology* **60** 307-322.