



FABI

**Forestry and Agricultural
Biotechnology Institute**

**Biennial Report
2000/2001**

The Forestry and Agricultural Biotechnology Institute (FABI) is located at the University of Pretoria. The primary objectives of the Institute are to:

- Promote the broad field of plant biotechnology through an interdisciplinary approach and with close linkage to a wide range of academic departments
- Undertake research of the highest possible caliber, while at the same time providing short and longer term benefits to the Forestry and Agricultural sectors of South Africa
- Establish partnerships with industries linked to Agriculture and Forestry, both nationally and internationally, to produce new and improved products and thus to promote competitiveness in trading
- Promote the education of South Africans in the fields of Forestry and Agriculture

The association of FABI with the largest University in South Africa provides access to large human and technological resources. Currently, academic staff and postgraduate students from research programmes in the Departments of Biochemistry, Botany, Genetics, Microbiology and Plant Pathology, Zoology and Entomology, Plant Production and Postgraduate School for Agriculture and the Rural Development are associated with the Institute. This affords FABI the opportunity to build future resources in biotechnology which will be crucial to the future of Forestry and Agriculture in South Africa.

FABI is not a new emerging venture, but rather an amalgamation of a tremendous base of expertise in Forestry and Agriculture from different Universities and research organizations in South Africa. The Institute has been operational since April 1998, although it was only officially inaugurated on the 13th of March 1999. This second FABI biennial report covers the period from September 1999 to September 2001.

Forestry and Agricultural Biotechnology Institute (FABI)

University of Pretoria

PRETORIA

0002

Tel. No. +27-12-420 3938

Fax. No. +27-12-420 3960

Email: Mike.Wingfield@fabi.up.ac.za

WWW: <http://www.up.ac.za/academic/fabi>

Compilation, layout and design by T.A. Coutinho

Cover paragraph: Painting in oil entitled "Forests" by H. Timm (1996). This painting depicts the theme of one of FABI's foremost research activities



Forestry and Agricultural
Biotechnology Institute
FUTURE FORESTS and FOOD

CONTENTS

	Page
Director's Report	4
Some Social Highlights in FABI 2000/2001	5
FABI Team Photograph	6
Research Reports	7
Sabbaticals 2000/2001	40
Publications 2000/2001	43
Seminar Presentations	55
FABI Team 2000/2001	57

Director's Report



Almost two years have passed since the publication of the first FABI biennial report. These have signified a period of considerable growth for the Institute and the many research programmes that are associated with it. Some readers will remember our first report, which was compiled approximately one year after FABI was formerly established in April 1998. At that time, we were very much in the throes of consolidating our research activity and expanding our "family" to cover the many areas of interest to us. Now in its fourth year, FABI is well established and is comprised of more than 110 participants including a fantastic group of post graduate students and a smaller team of academic and technical staff. Together with the FABI family, I am proud to share this brief summary of our achievements with you.

There can be no doubt that FABI has lived up to its promise to establish a firm base at the University of Pretoria, to facilitate research in the very broad field of forestry and agricultural biotechnology. This area of science is growing extremely rapidly. Thus, opportunities to form alliances and to establish partnerships to aid farmers and industries in resolving problems and growing new business abound. It is against this background that FABI has grown beyond all expectations. The Institute has also far outgrown the anticipation that it would accommodate the activities of approximately 70 post-graduate researchers and staff.

Unprecedented growth in FABI has brought outstanding research productivity and an impressive output of graduates in the plant sciences, including botany, plant pathology, genetics, biochemistry, microbiology, entomology and others. Together with FABI's growth, space available to accommodate students in this stimulating research environment has rapidly become scarce. I am happy to report that there is strong support for doubling the facilities of FABI during the coming year. I hope to be able to share the excitement of this growth with you in our next biennial report.

One of the most demanding aspects of the rapidly growing biotechnology environment is the constant need for new and sophisticated equipment. In this regard, FABI has been most fortunate in having superb support from the University of Pretoria to ensure the availability of world-class facilities. Just in the last year, one of two automated DNA sequencers has been replaced with a more modern "high throughput" machine, and a DNA microarrayer has been made available to the group. The availability of these facilities has been strongly supported and enhanced via the exciting and nationally relevant strategic alliance between the University of Pretoria and South Africa's major technology provider, the CSIR.

Through the UP/ CSIR alliance, FABI will participate in huge new developments in plant biotechnology. These will come through a close working association with the newly established African Centre for Gene Technologies (ACGT) that will have its headquarters in Pretoria. This is only one of a large number of major developments that will impact on the growth and development of FABI in the coming five year period. Many new programmes and partnerships with agricultural and forestry businesses are in the early stages of establishment. Internationalization of projects through collaborations with organisations and

companies globally are also emerging. Other than resulting in synergy, critical mass and increased research productivity, these partnerships are leading to a rapid increase in students from South Africa but also from many other parts of the world. This strongly enhances a global perspective amongst young Fabians and also fuels exceptional performance in post graduate education.

FABI staff and students participate in research projects across a very broad field, unified only by some link to the "plant" environment. Due to the specific research interests of the founder research team, FABI has a very strong focus on matters pertaining to plant health. While this research field is expanding, there are also rapidly growing programmes in other fields of plant improvement. I expect that we will see continued and unprecedented growth in the next few years and look forward to sharing details with you in our next report. For the present I trust that you will find this summary of our activities interesting and informative. On behalf of all Fabians, I also take this opportunity to thank our collaborators worldwide, as well as the many organisations and industries that support our research effort.

Michael J. Wingfield

Mondi Professor of Forest Pathology and Director of FABI and the TPCP

Some Social Highlights in FABI 2000/2001



Spoof* 2000: Bernard Slippers and Jolanda Roux dressed in accordance with the theme "Middle Ages"



Year end party (2000): left to right: Edzard & Nonnie "Grimbeek", Wilhelm & Sonja de Beer and Bernard & Jana Slippers



Spoof* 2001: Bongani Maseko at his presentation entitled: "African cloning systems"



Spring Day 2001: Prof Johannes vd Walt and Mike Wingfield. This occasion was marked by thanking Johannes for donating his working books to FABI

*Spoof = Society for the Publication of Outrageous Findings

FABI Team



- Front row:** Sonja de Beer, Martin Coetzee, Eduard Venter, Andrew Gallagher, Karen Surridge, Anneke Prins, Raksha Bhoora, Thierry Regnier, Mashudu Silimela, Fhumulani Mashau, Mauricio Marin, Lynelle van Emmenses, Ronelle Koekemoer, Lieschen Bahlmann, Carlos Rodas and Ida Paul
- 2nd row:** Amanda Redmond, Karin Louw, Busisewe Tshabalala, Brenda Buthelezi, Shazia Shaik, Shilo Loots, Anita Steyn, Mike Wingfield, Marveline Molema, Robert Mokgatla, Irene Barnes, Rene Jacobs, Shalati Shiburi, Dirk Swanevelder and Oliver Dickens
- 3rd row:** Karl Kunert, Mesfin Bogale, Leylani Grobler, Sabine Lezar, Wilma van Broekhuizen, Karien van Dyk, Mariette Truter, Amelita Lombard, Wilma Havenga, Eva Muller, James Harrison, Helen Doman, Awelani Mutshembele, Nonnie Geldenhuis, Renate Zipfel, Jolanda Roux, Marieka Venter, Rosemarie Visser, Terry Aveling, Prem Govender, Ntsane Moleleki, Alemu Gezahgne, Deshni Pillay, Leuseged Begashaw, Albé van der Merwe, Brenda Wingfield and Oliver Preisig
- 4th row:** Trish Beart, Chris Visagie, Gerda Vermeulen, Bongani Maseko, Jackie Doyle, Chantal van Niekerk, Christelle Klopper, Anna-maria Oberholster, Jacquie van der Waals, Noëlani van den Berg, Teresa Coutinho, Tessa Bandounas, Gina Swart, Rodrigo Ahumada, Altus Viljoen, Bernard Slippers, Dave Berger and Wilhelm de Beer
- Back row:** Nico Labuschagne, Edzard Grimbeek, Gwen Koning, Schalk van Heerden, Gavin Hunter, Ronald Heath, Juanita de Wet, Lorenzo Lombard, Brett Hurley and Hein van Geuns

RESEARCH REPORTS

Forest Pathology

Research Leader: Prof Mike Wingfield

Research Team: Prof Teresa Coutinho
Dr Jolanda Roux
Dr Oliver Preisig

Objectives of the research programme:

- Development of field monitoring techniques to recognize the appearance of new diseases and to monitor the spread and impact of those already established in South Africa
- Identify new and important tree pathogens and evaluate their genetic structure such that they can be more effectively controlled
- Develop methods to screen trees for tolerance to the most important diseases present in the country
- Establish and evaluate contemporary breeding strategies in order to produce disease tolerant species, clones and hybrids
- Establish an understanding of the biology of tree pathogens such that they might be more effectively controlled
- Study and evaluate novel strategies for disease control

Highlights of research 2000/2001:

In this report, a brief summary of the various research activities of the team members and postgraduate students of the Tree Pathology Co-operative Programme (TPCP) is provided. This is a condensed review and the focus is on highlights and important findings.

Cryphonectria canker

Cryphonectria cubensis is one of the most important *Eucalyptus* pathogens in South Africa. Much progress has been made in reducing the impact of the disease and it is now reasonably rare in plantations. Nonetheless, it is crucial that research on this pathogen continues as it is likely to re-emerge in future years. One key feature will be to ensure that strategies beyond the selection of disease tolerant trees be included in the arsenal of management strategies. In this regard, a biological control approach, based on the deployment

of hypoviruses is being pursued. A key factor here will be permission to release a test biological control agent, which is not a genetically modified organism (GMO), but includes an introduced virus pathogen. An application to make this release has been tendered to the South African Department of Agriculture.

Endothia gyrosa canker

Canker caused by *Endothia gyrosa* was discovered in South Africa in the early 1990's, although the pathogen might have been present in the country for much longer. The pathogen is well known in Australia on *Eucalyptus* and it was thought to be the same as that causing stem cankers on a wide range of trees in the United States. Our view has, however, been that the South African fungus is rather different to the fungus in the United States. After intensive study, we have

concluded that the South African fungus is in fact a species of *Cryphonectria*, which makes it closely related to the Chestnut Blight pathogen. We will refer to the *Eucalyptus* pathogen as *Cryphonectria eucalypti* in the future. This fungus is very different to the American fungus known as *E. gyrosa*, but it remains an important pathogen of *Eucalyptus*, which is now being subjected in intensive pathogenicity tests.

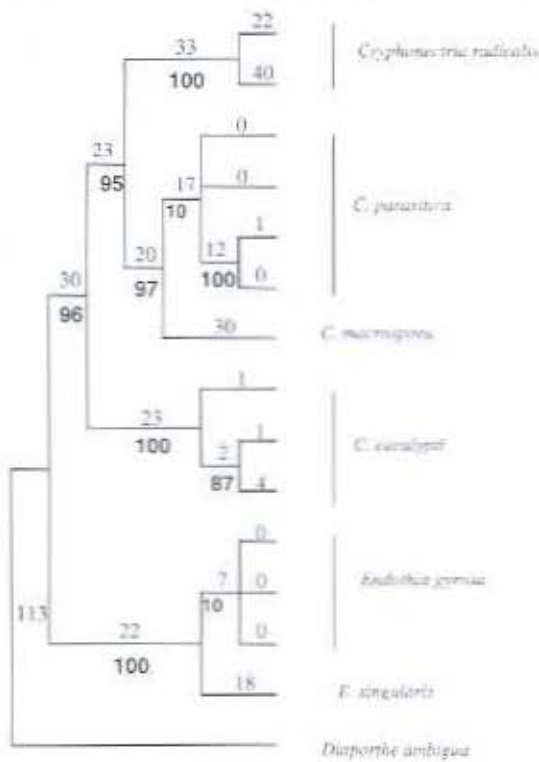

Phylogram based on ITS1/2 sequences of ribosomal operon showing that *C. eucalypti* is separate from *E. gyrosa* (Venter et al., 2001)

Coniothyrium canker

Coniothyrium canker, caused by *C. zuluense*, is without question one of the most serious pathogens of plantation *Eucalyptus* in the world. It was initially only known in South Africa but has more recently been found in Thailand, Argentina, Uruguay and Ethiopia. The disease first appeared in South Africa in 1990 and much effort has been expended to reduce its devastating impact. These efforts have been well rewarded and the disease, although common and damaging, no longer appears to threaten *Eucalyptus* forestry.

Recent studies on *C. zuluense* have shown that there is great variation in the

appearance of isolates of this fungus. This variation is also reflected in significant differences in the pathogenicity of different isolates and in AFLP (Amplified Fragment Length Polymorphisms) banding patterns. This finding is intriguing as we had previously believed that the pathogen had probably been introduced into South Africa. A diverse population would support the alternative hypothesis that the fungus is native to this country. If this is true, it could only have originated on native plants.



Severe coalesced canker on young tissue caused by *C. zuluense*

Sphaeropsis blight and die-back

The canker and stain pathogen, *Sphaeropsis sapinea*, remains one of the most important causes of loss in pine plantations. Findings in recent years have suggested that *S. sapinea* has been introduced into South Africa many hundreds if not thousands of times. Our initial findings on the diversity of *S. sapinea* in South Africa were based on so-called vegetative compatibility tests, which are reasonably reliable. However, what is needed to be certain of these results are molecular markers to allow for population genetic comparisons. We have thus prepared such molecular tools in the form of microsatellite markers. Using these, we will now be able to test our hypothesis regarding the origin of *S. sapinea* in Southern Hemisphere plantations.

A potential strategy to reduce the impact of *S. sapinea* in South Africa is through the deployment of dsRNA viruses that reduce the virulence of this fungus. We have actively pursued this opportunity by testing

isolates for the presence of these viruses. We have found a wide range of dsRNA elements in isolates. These must still be characterised, but none thus far appear to result in obvious hypovirulence.

One source of hypovirulence in fungi is the hypovirus of *Cryphonectria parasitica*. This virus has been characterised by a group of researchers in the United States. We have thus been seeking alternative sources of hypovirulence and believe that we have found such a source in an important canker pathogen of pome and stone fruits, known as *Diaporthe ambigua*. We have recently completed the characterization of the dsRNA virus in *D. ambigua* and work is currently underway to transform this into *S. sapinea* and other pathogens of interest to South African forestry.

Pitch canker

The worldwide concern regarding pitch canker is growing steadily. This is primarily amongst forestry companies growing *Pinus radiata* or *Pinus patula* that are known to be amongst the most susceptible species. South Africa remains in a unique position of having the pathogen well established in the country, but as yet not on mature trees.

Of very significant concern in recent times has been emerging evidence to suggest that the pitch canker fungus has moved to plantations. There is also good evidence to suggest that it has developed an association with insects such as the root feeding bark beetle, *Hylastes*. During the coming years, students will begin to work on this question and this study will be conducted in concert with the industry-established working group on pitch canker. It is hoped that a field forester might also become involved in this project so that field evaluations of losses can be made more effectively.

The taxonomy and population genetics of the pitch canker pathogen has been studied intensively by the TPCP. These studies have emerged chiefly from a need to be able to isolate and identify the fungus with certainty. Various approaches have been used to accomplish this goal. A

recent study using a number of molecular tools has further promoted our ability to rapidly and accurately identify the pitch canker fungus. Beyond South Africa's borders, the research group is providing advice on the identity of suspected pitch canker isolates for groups in other parts of the world.

Armillaria root rot

Armillaria root rot is one of the most important and well-recognised diseases of forest and plantation trees. The causal agent of the disease is one that can form huge colonies represented by single genetic entities. This has led to the discovery that these fungi represent the largest living organisms on earth.

One of the most problematic aspects of dealing with Armillaria root rot has been gaining a meaningful view of the identity of the causal fungi. For many years, these were viewed as a single fungus known as *Armillaria mellea*. This was also true in South Africa where the disease was accepted to be caused by this species. Intensive study at the molecular level has clearly shown that *A. mellea* is a northern hemisphere fungus. Furthermore, studies on South African isolates strongly suggest that the cause of the root disease in pine plantations is *Armillaria fuscipes*. We are currently undertaking population biology studies on this fungus in the hope that we will be able to better understand patterns of spread in plantations.



Shoe string-like rhizomorphs of an *Armillaria* sp. These structures are generally not seen in South Africa

Botryosphaeria canker

Botryosphaeria canker is one of the most common diseases of plantation *Eucalyptus* in South Africa. It is also one of the more intriguing diseases, with the causal agent able to exist in healthy trees without causing disease symptoms. Symptom development appears to be a feature linked to stress. This in turn is also closely linked to susceptibility in trees.



Cankers on the main trunk caused by a species of *Botryosphaeria*

During the course of the past year, we have conclusively shown that two species of *Botryosphaeria* are associated with cankers on *Eucalyptus* in South Africa. For the present, the one fungus retains the name that we have used for many years, i.e. *B. dothidea*. The second fungus will henceforth be known as *B. eucalyptorum*. Recognising these distinct taxa in South Africa will now enable us to evaluate their relative importance and to treat them with the status that will make breeding and selection efforts more logical.

Phytophthora root rot

Until recently, we have believed that *Phytophthora cinnamomi* is the most important species of *Phytophthora* killing young, cold-tolerant *Eucalyptus* in South Africa. An intriguing recent discovery has been that *P. nicotianae*, a known pathogen of *Acacia mearnsii*, appears to be the more important cause of the *Eucalyptus* disease in South Africa. This discovery will have an impact on previous work to select disease tolerant trees. More intensive field work will now be needed to extend our understanding of this interesting situation.

Ceratocystis wilt/canker

Ceratocystis species include some of the most devastating plant pathogens. They affect a wide range of plant species and have a cosmopolitan distribution. In plantation forestry, a number of species have been identified as serious pathogens of trees, as well as the cause of sap stain in wood. The two most important *Ceratocystis* spp. in commercial plantation forestry are *C. albobundus* and *C. fimbriata*.

In South Africa, the most important disease of *Acacia mearnsii* is caused by *C. albobundus*, a fungus thought to be native to this country. Infection by *C. albobundus* may result in death of trees within 6 weeks. During the last two years, *C. albobundus* was also isolated for the first time from wounded and dying trees in Uganda. *C. fimbriata*, a well recognized pathogen of woody plants and a close relative of *C. albobundus*, is a known pathogen of *Eucalyptus* species in tropical areas of Africa and South America. Infection by *C. fimbriata* also results in a rapid wilt and death of trees. The disease has not been found in South Africa, but has a known distribution in Uganda and the Republic of Congo in Africa, as well as several countries in South America.

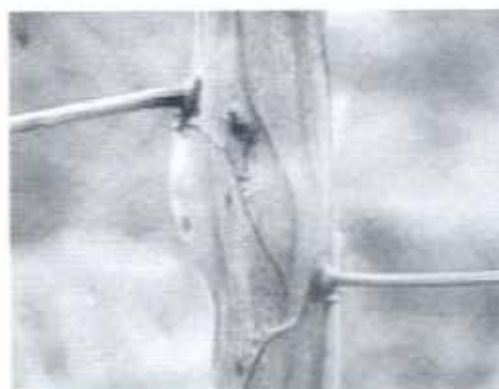

Blister lesions on the stem of a tree after inoculation with *C. albobundus*

Ceratocystis wilt of forestry trees, caused by *C. albobundus* and *C. fimbriata*, is of special concern since infection results in rapid death of trees. *C. albobundus*, a pathogen of *A. mearnsii*, was first described in South Africa ten years ago. Since then, there have been many reports from plantations where 20-50% of the

trees were dead or dying due to infection by this pathogen. The disease of *Eucalyptus* has been reported in the most commonly planted species, *E. grandis*, as well as some *E. grandis* X *E. urophylla* and *E. grandis* X *E. pellita* hybrid clones. Both these important species of *Ceratocystis* are undergoing intensive taxonomic and population biology studies. This is to specifically clarify their often confusing taxonomy and to gain a better perspective of their biology and spread.

Bacterial blight and die-back

In 1998, a severe bacterial disease appeared for the first time in a single nursery in KwaZulu/Natal on ramets of an *E. grandis* x *E. nitens* (GN) hybrid clone. The disease subsequently spread to other nurseries and commercial plantations and was reported from different *Eucalyptus* species, hybrids and clones. The causal agent was identified as *Pantoea ananatis* and this represents the first report of a *Pantoea* sp. infecting *Eucalyptus* spp.

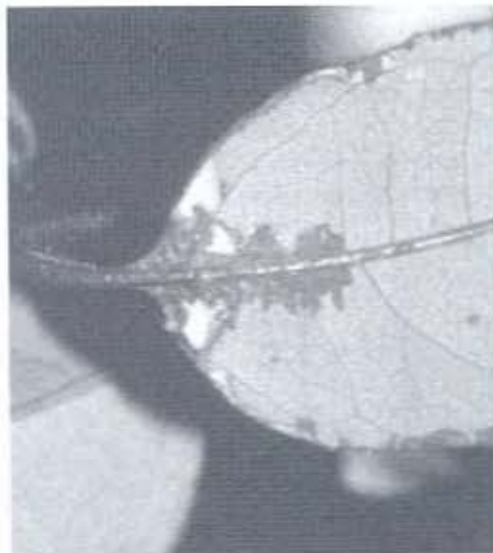

Early symptoms of infection by *P. ananatis* showing water soaking of area adjacent to main vein and point of petiole attachment

Bacterial blight and die-back has become a serious problem in nurseries and young plantations throughout South Africa. This bacterium is not only infecting cuttings but also ramets in nurseries. This severely hinders the ability of forestry companies to produce vegetative material for rooting. There are, however, significant differences

in susceptibility among *E. grandis* clones, and this provides an excellent opportunity for the selection of tolerant material. Development of management strategies to reduce the impact of this disease is now a priority. A rapid screening technique to detect this bacterium is being developed, and commercially important clones will in future be tested to determine their level of tolerance to this bacterial disease.

Insect-related pathogens

The particular focus of past work on insect associated tree pathogens has been on the so-called Ophiostomatoid fungi that include fungi such as the causal agents of Oak Wilt and Dutch Elm Diseases. During the past two years the research team has continued studies on these pathogens. Our studies have included the discovery of a new species on *Eucalyptus* known as *Leptographium eucalyptophilum* and a re-examination of the causal agent of Takamaka disease which is killing trees in the Seychelles. Similarly, the most important pathogen associated with the serious insect pest *Tomicus piniperda* in China has been collected and identified.

Eucalyptus rust

Eucalyptus rust, caused by *Puccinia psidii*, has long been of serious concern to the TPCP. One of the key reasons for this is the fact that some of the initial damage caused by this fungus in Brazil was to *Eucalyptus* raised from South African seed. The pathogen is native to South and Central America and its geographic range appears to be gradually extending. It has, for example, recently been recorded from Argentina, Uruguay and Paraguay for the first time.

The genetic background of *Eucalyptus* in South Africa is such that it is highly susceptible to *P. psidii*. Likewise, the climate is well suited to epidemics of this disease. Of even greater concern is the fact that there is now clear evidence of pathogens moving from South America to South Africa. Thus in terms of risk assessment, it is reasonable to place Eucalyptus rust in the category of "highly threatening pathogens".

During the past five years, the TPCP has worked actively to pursue opportunities to establish a risk abatement programme. Various groups have been solicited for support from national and international forestry groups. These early actions have led to the establishment of a proposal to the Australian Centre for International Agricultural Research (ACIAR) to support a *P. psidii* risk abatement programme. Of particular interest to Australia is the fact that the rust is not present in that country and is likely to cause devastating damage to native vegetation there.

ACIAR has recently established funding for a major eucalypt rust risk abatement programme. The total expenditure for this three year activity will be approximately 1 million AUD. A small portion of the funding will come to the TPCP to enable contact with the project and it is hoped that additional funding will allow for the testing of *Eucalyptus* genotypes from South Africa, in Brazil.

Extension activities

Extension activities continue to be an essential component of the activities of the Tree Pathology Co-operative Programme (TPCP). These include regular visits to plantations, the maintenance of a tree disease clinic and the publication of diagnostic aids and newsletters.

Diagnostic Clinic: The clinic provides a reliable, responsible and reasonably rapid diagnosis of disease and pest problems of forest trees. During 2000/2001 the diagnostic clinic dealt with more than 500 samples that included diseased material from eucalypts, pine, wattle, indigenous trees, water, growth media and seed samples. Data emerging from these diagnoses are not only important to those requesting advice, but also contribute significantly to disease monitoring and the establishment of research priorities.

Field services: Studies in plantations and disease monitoring are a crucially important focus of the TPCP team. Members of the group undertook field work in all forestry areas of the country and on

average spent approximately 550 person days in the field each year.

Newsletters and diagnostic aids: "Tree Protection News", the newsletter of the TPCP, has continued to be an important means of distributing new information to members. The newsletter has recently changed its focus to incorporate forest entomology activities. Experience has shown that the publication of this newsletter results in significant feedback to the TPCP and that it is generally well received and appreciated by members. "Tree Protection News" has been distributed by the Institute for Commercial Forestry Research (ICFR) together with ICFR News for two years and this means of distribution appears to be desirable and effective. Furthermore, news items are regularly launched on the TPCP web site. These can easily be accessed by foresters who require this information.

Three new diagnostic pamphlets were produced during 2000/2001. These illustrate Bacterial Wilt of Eucalypts; Bacterial blight and die-back of Eucalypts; and one provides guidelines on hygiene practices in pine nurseries. The remaining 17 information documents have recently been updated and reprinted.



Wilhelm de Beer and Bernard Slippers examining blue stained logs at Richards Bay harbour

For more information on the activities of the Tree Pathology Co-operative Programme, please visit our web site at:

<http://www.up.ac.za/academic/fabi/tpcp>

Forest Entomology

Research Team: Prof Mike Wingfield
Mr Prem Govender
Mr Brett Hurley
Dr Jolanda Roux

Objectives of the research programme:

- Reduce the impact of insect pests and ensure the future sustainability of plantation forestry in South Africa
- Undertake research to provide integrated pest management solutions for pest problems and generate practical recommendations
- Provide a channel for the reporting of pest problems and offer specialist advice through the Tree Pathology Co-operative Programme (TCP) Diagnostic Clinic and extension visits
- Train future scientists and create capacity in forest entomology

Research Highlights 2000/2001:

The Forest Entomology Support Programme is a collaborative venture between the South African Forestry Industry and the University of Pretoria. This programme was initiated in 1999, to operate alongside the highly successful Tree Pathology Co-operative Programme (TCP), from which it draws synergy and derives impetus. Developments within the programme can be summarised as follows:

Research activities:

Soil pest complex

A complex of soil and above ground pests which include termites, whitegrubs, cutworms, tipulid larvae, false wireworms, grasshoppers, crickets, bark beetles, leaf beetles, weevils, millipedes and nematodes, often cause the failure of wattle, eucalypt and pine seedlings to establish. The impact and status of these pests, especially under different silvicultural regimes, is poorly understood. However, there is a demand for increased productivity of forest products, despite the limited availability of land for the expansion of commercial forestry. The control of these soil pests will result in subsequent increases in survival, better and more uniform growth, a reduction of blanking costs and a reduction in yield loss. This

study is being conducted in representative high and low productivity sites of commercial forestry.

Whitegrubs

Numerous indigenous whitegrub species damage the roots of forestry seedling species. They have a high pest status amongst the soil pests. Many species are undescribed and it is often difficult to separate closely related species using traditional morphological techniques. Molecular genetic tools are now being used to identify the various larval species, without the need for collection of adults. The phenology of these whitegrubs is also being studied, with a view to improving control.

Gonipterus scutellatus

This eucalypt snout beetle was introduced into South Africa from Australia and it seriously defoliates eucalypt trees. An egg parasitoid, *Anaphes nitens*, was consequently successfully introduced as a biological control agent in 1926. However, the efficacy of *A. nitens* has been reported to decrease in low productivity, high altitude sites. A study of parasitism rates of *Gonipterus* eggs by *A. nitens*, along an altitude gradient of sites has been conducted during the past two years. Results show that although there is a

decrease in parasitism during winter, there is an unusually significant decrease in parasitism during mid-summer. Abiotic factors appear to indirectly contribute to this result and current studies are investigating the role that various biotic factors (superparasitism, availability of hosts) play in parasitism rates. This will aid in decisions as to whether to introduce a cold-hardy species of *A. nitens* into South Africa. The susceptibility of alternative species of *Eucalyptus* in tree breeding trials is also being evaluated.



Gonipterus scutellatus Adult

Bark beetles

The relationship of pathogenic fungi, in the genera *Ophiostoma*, *Ceratocystis* and *Leptographium* with bark beetles (*Hylastes angustatus*, *Orthotomicus erosus* and *Hylurgus ligniperda*) on wood and wood products, remains an area of research in the TPCP. These beetles are responsible for considerable damage (tree diseases and sapstain of timber) during the feeding and breeding stages of their life cycles. Virtually nothing is known regarding the fungi that the insects carry. Many Ophiostomatoid species are known and a large number are the associates of pine-infesting bark beetles that have been accidentally introduced into new environments. Further investigations are underway to better understand the composition of fungi associated with bark beetles of relevance to South African forestry, both in their native and exotic situations.

Sirex wood wasp

The *Sirex* wood wasp and its associated fungal symbiont *Amylostereum areolatum* is a relatively recent introduction into South Africa. Although it is not generally

regarded as a primary pest, when populations build up, serious losses occur. Also, when pines are under stress, *Sirex* results in premature death of trees that would otherwise have lived.



Adult female *Sirex noctilio* during oviposition

An important question pertaining to *Sirex* in South Africa concerns its origin. The importance of this question is linked to the likely success of biological control agents and of other efforts to control its spread. During the course of the past few years, we have conducted intensive studies on the fungal symbiont of *Sirex*, in an effort to determine the origin of the insect and the fungus. Results have clearly shown that the insect was introduced into South Africa from South America where it has been known for about a decade. Likewise, these studies have shown that the fungal culture on which the biological control agents have been reared is not the same as that associated with *Sirex* in South Africa, or South America. We believe that this might be the reason why biological control with the parasitic nematode *Deladenus siricidicola* has not been wholly effective in South Africa.

Fungus gnats

Various species of fungus gnat adults and larvae are suspected as being vectors of nursery pathogens. This relationship is currently under investigation, using the pitch canker fungus (*Fusarium circinatum*) on pine seedlings as a model.

Diagnostic Clinic and Extension Services

The scope of services offered by the TPCP Diagnostic Clinic and Extension team have been expanded to include insect pests. Details are reflected under the TPCP programme.

Forest Biotechnology

Research Leader: Prof Anna-Maria Oberholster (née Botha)

Objectives of the research programme:

- Supply the South African Forestry Company Ltd (SAFCOL) with a protocol for somatic embryogenesis using female gametophytes/immature embryos as explants
- Evaluate changes at the genomic level in cell lines in culture/stored for extended periods
- Increase understanding of the development of somatic embryos through a comparative study of somatic and zygotic embryos. This research has focused on similarities and differences between somatic and zygotic embryos in terms of morphology, histology, biochemical and metabolic pathways
- Determine the role of late embryogenic associated proteins in the development of somatic embryos
- Evaluate DNA fingerprints of pine families using microsatellite markers and investigate the parental contribution of *P. elliotii* and *P. caribaea* in the hybrid (gene flow)

Highlights of research 2000/2001:

Research in this programme represents a joint effort between the South African Forestry Company Limited (SAFCOL) and the University of Pretoria. It specifically focuses on the propagation of several pine species of commercial importance, namely *Pinus patula*, *P. elliotii* x *P. caribaea* hybrid and *P. radiata*. The programme has produced somatic embryos in *P. patula*, *P. radiata* and *Picea abies* (model system), while embryonic structures have been obtained in the hybrid species. All relevant cell lines are being stored in cryopreservation for long-term preservation of germplasm. DNA fingerprinting using microsatellite markers

to study gene flow and parental contribution has also been an integral part of this study. We have screened 11 microsatellite markers developed for other *Pinus* species to assess their ability to produce fingerprints in the *Pinus elliotii* x *Pinus caribaea* hybrid. In addition, they have been considered for their ability to reflect gene flow and parental contribution in this hybrid. We found that cross-species amplification is possible with two thirds of the microsatellite markers screened. Furthermore, by pooling information from several microsatellite loci, it was possible to determine gene flow and parental contribution in the hybrid.



Healthy pine callus

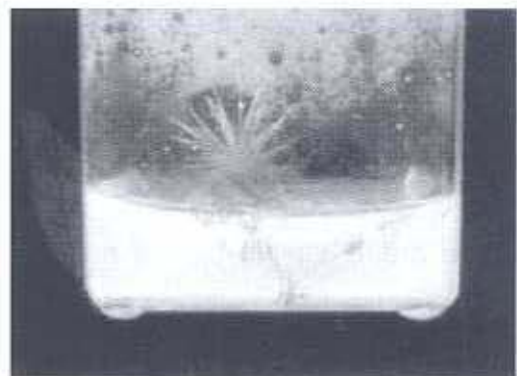

Pine plantlet on tissue culture medium developed in this programme

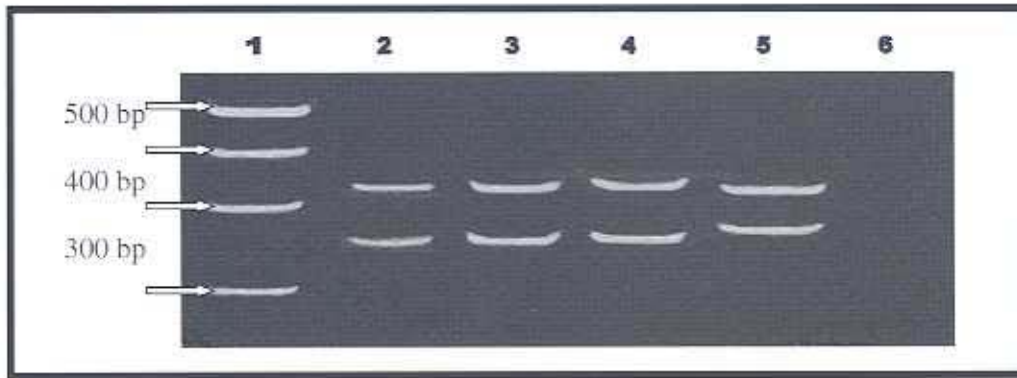

Microsatellite fingerprints of the *P. elliotii* (E 503) x *P. caribaea* (Ach 271) hybrid population. The fingerprints were obtained by PCR amplification with primer RPTest 9. Lane 1 reflects 100 bp DNA ladder, while lanes 2 to 6 show the fingerprints obtained using E 503 megagametophyte DNA, E 503 needle DNA, E 503 x Pch 23 embryo DNA, Ach 271 needle DNA and Ach 271 pollen DNA, respectively

A common problem that occurs in breeding programmes is poor pollination success. This is frequently reflected in the abortion of cones during maturation. To address this problem, a study was initiated to consider factors affecting pollination success and pollen viability. Eighteen different *P. caribaea* pollen types were screened to determine the effect of environmental conditions during storage on germination. Results of this study made it possible to set guidelines for pollen storage. Pollen morphology was also considered and it was found that a correlation exists between *Pinus caribaea* pollen morphology and viability. Scanning electron microscopy was used to investigate the dimensions of the eighteen pollen types. Statistical analysis of the data showed that the eighteen pollen types reside in two groups. Those displaying narrow germ furrows clustered with those displaying wide germ furrows, while those pollen types displaying intermediate germ furrows clustered into a second group. When the clusters were compared with the germination data, it was found that the pollen types displaying highest germination percentages reside in the intermediate cluster. In contrast, the pollen types displaying low to intermediate germination percentages reside in the groups with pollen grains having narrow or wide germ furrows.

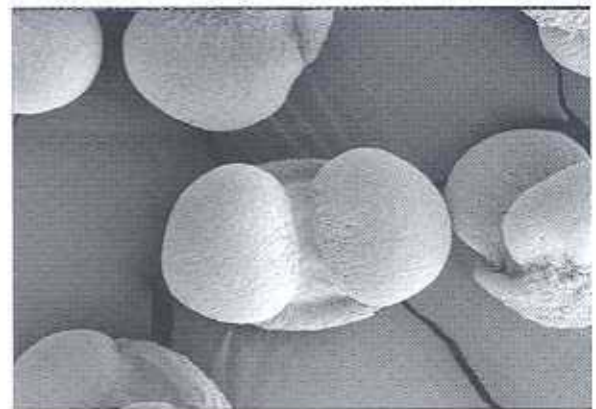

P. caribaea pollen grains with narrow germ furrows

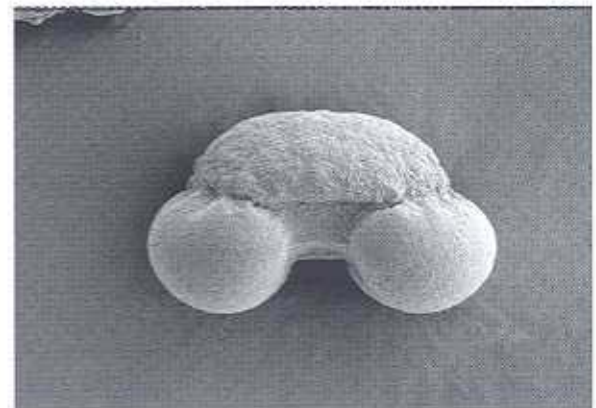

P. caribaea pollen grain with a wide germ furrow

Molecular Systematics of Microorganisms & Forest Molecular Biology Co-operative Programme (FMBC)

Research Leader: Prof Brenda Wingfield

Objectives of the research programme:

- Characterize at the molecular level, economically relevant plant pathogens, especially those on tree crops
- Produce healthy, superior trees for the South African Forestry industry
- Provide forestry companies in South Africa with DNA based techniques to increase the quantity and improve the quality of fibre for pulp, paper and textile production

Highlights of research 2000/2001:

In order to achieve the key objectives of this programme, it is necessary to be continually implementing and using new technologies as well as solving practical problems relevant to South African forestry. The research publications that have appeared during the last 2 years reflect many of the successes that we have had during this period. We have developed the first DNA based phylogenies for a number of key tree pathogens. Concurrently, molecular identification techniques for the fungi that are difficult to identify based solely on morphology have been developed.

During the past two years we have realised the need to develop molecular phylogenies based on more than one gene. Our first molecular phylogenies concentrated on the rRNA genes. More recently other genes such as histone, beta tubulin and alpha elongation factor have been included in these studies. This has resulted in phylogenetic trees with a much greater resolution. In this way we have now also proven that a number of species previously viewed as single entities, are in fact species complexes, encompassing various discrete species. This work has significant implications relating to disease resistance. This is particularly because resistance to one species in a complex does not

necessarily imply resistance to the whole group.



Mushroom like fruiting structures of *Armillaria* sp. thought to be *A. fuscipes*

Species identification is only one aspect of this programme on fungal pathogens. Understanding the population diversity of these pathogens is an essential aspect of our current studies. We have thus developed microsatellite-like markers for the more important groups of fungal pathogens of interest to us. This allows us to study not only the population diversity of these fungi but also to investigate gene flow between populations. This, together with our knowledge on the mating systems of these fungi provides a more lucid view of how rapidly a pathogen population is likely

to overcome resistance genes that have been deployed in plants of interest to the programme.

DNA based identification techniques are equally important for plantation tree species, as they are for the pathogens that affect them. We have thus also developed microsatellite markers for the identification of *Eucalyptus* trees. In addition to our own markers, we have been utilizing microsatellites developed in other

laboratories to study populations of both *Eucalyptus* and *Pinus* species.

Disease resistance and the basic mechanisms dictating this character is in general, poorly understood. Using other plant models we have identified genes known to be important in disease resistance and we have particularly studied these genes in *Eucalyptus*. We have also investigated some fungal genes known to be important in pathogenicity.

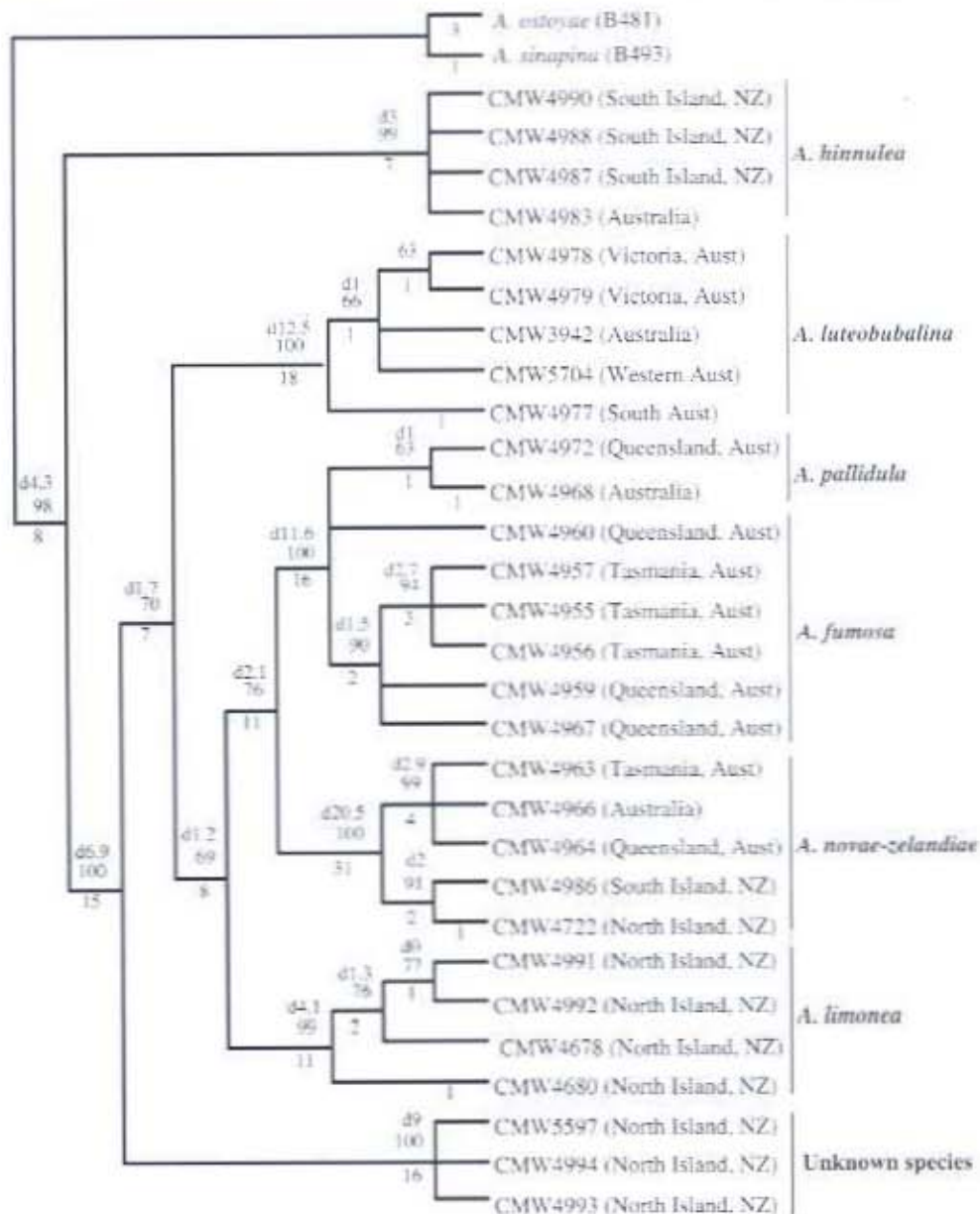

One of the most parsimonious trees generated after a heuristic search from the ITS sequence data with indels coded and gaps treated as missing. Bootstrap (1000 replicates) values and Bremer support indexes for the branching nodes are indicated above the tree branches. Values below the branches are the branch lengths. Number of parsimony informative characters = 113, length of tree = 202, CI = 0.880 and RI = 0.967 (Coetzee *et al.*, 2001)

Wheat Genomics

Research Leader: Prof Anna-Maria Oberholster (née Botha)

Objectives of the research programme:

The ultimate goal of the project is to evaluate useful DNA sequences that confer disease resistance in cereal crops, important to the Southern African region. In the process to achieving this goal, the project has the following short-term objectives:

- Isolate and characterize resistance gene analogs (RGAs) by PCR, Representation Difference Analysis (RDA) and Suppression Subtractive Hybridisation (SSH) from selected wheat cultivars grown in Southern Africa
- Study differential expression of the Expressed Sequence Tags (ESTs) and Defense Response (DR) genes after insect infestation using DNA micro-arrays
- Develop marker systems for mass screening of breeding stock
- Map the relevant sequences using segregating populations

This will eventually enable us to:

- Introduce rare and novel sequences into cereal crops to improve pest resistance through gene transfer technology
- Contribute towards understanding the mechanisms of regulation of plant-insect-pathogen interactions

Highlights of research 2000/2001:

Pathogens and insects constantly challenge agricultural crops. This leads to significant yield reduction resulting in major economic losses. Yield losses of 35 to 65% have been recorded after Russian wheat aphid (RWA, *Diuraphis noxia*) infestations in South Africa. The problem is, to a large extent, addressed by means of chemical application, which is both bio-hazardous and expensive. An alternative to this management approach lies in the development of resistant wheat lines adapted to Southern African conditions. Thus, utilization of host resistance is the most effective and environmentally acceptable means of reducing loss.

Ten genes (*Dn1-DnX*) that confer resistance to the RWA have been mapped through di-/telosomic analysis or other mapping techniques (e.g. SSRs). However, little is known regarding the mechanisms relating to regulation or function of these genes. These genes have also not been fully characterized at the genomic level. What is known from entomological studies,

is that the genes differ in their response to antibiosis, antixenosis or tolerance. To address this problem, we have followed a multi-disciplinary approach applying modern breeding tools, biotechnology and plant genomics. In the project we are studying the mechanisms relating to regulation of genes linked to RWA resistance, through the characterization at the genomic level. Here, we have specifically utilized Expressed Sequence Tags (ESTs) from induced complimentary DNA (cDNA) libraries, a *Triticum aestivum* genomic library and the conserved motifs of the disease superfamilies for the identification and characterization of gene sequences that confer resistance. We are also mapping the gene sequences to establish their position on the chromosome, and their linkage to the trait of interest using Rapid Fragment Length Polymorphisms (RFLPs) and SSRs.

Some recent highlights of this research programme include the isolation of several gene sequences containing nucleotide

binding site (NBS) conserved motifs (part of the disease superfamily of genes). Other highlights include the identification of several SCAR and AFLP markers linked to RWA and leaf rust resistance *Lr41*.

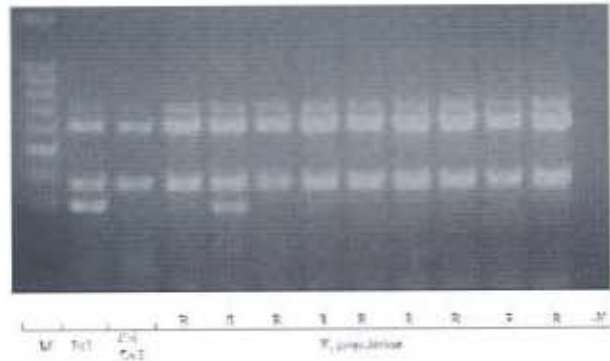

PCR-RFLP analysis of the segregating coupling phase marker OPF14 1083. *Eco*RI restriction analysis of a subset of the segregating F₂ population. Arrow indicates the band able to differentiate between the susceptible (S) and resistant individuals (R). M=100 bp ladder as molecular-weight marker, K=Negative control



A typical wheat field in South Africa

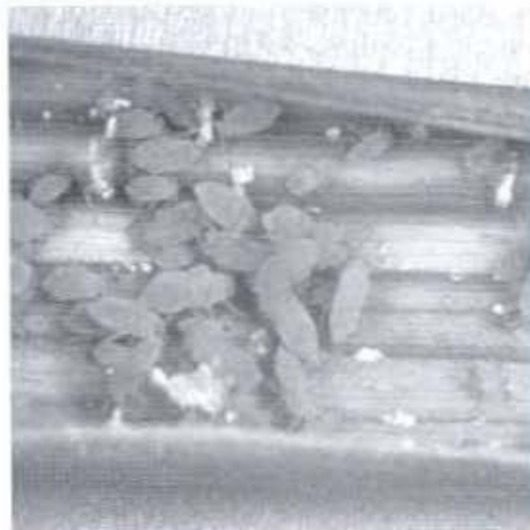

Russian Wheat Aphids

Diseases of Bananas

Research Leader: Dr Altus Viljoen

Fusarium wilt (Panama Disease) is the most important disease of bananas in South Africa. It is caused by the soil-borne fungus *Fusarium oxysporum* f.sp. *cubense* (*Foc*). There is no method available to control the disease, and once the pathogen has been introduced into a field, it is able to survive for decades. This effectively brings an end to banana production in that field. Since the first observation of Fusarium wilt in South Africa during the 1940's, the disease has caused devastating losses in two (Kiepersol and southern KwaZulu-Natal) of South Africa's five banana production regions (the others being Levubu, Tzaneen and Komatipoort). The disease continues to spread, and now threatens to end production of bananas on many farms in Kiepersol. FABI became involved in research on Fusarium wilt of banana in January 1999, and has since built one of the world's most extensive research programmes on this disease.

Objective of the research programme:

- To develop an integrated disease management programme in order to sustain economically feasible banana production in areas where the Fusarium wilt pathogen occurs in South Africa.

Highlights of the research 2000/2001:

Fusarium Wilt of bananas

Analysis of the population structure of Foc in South Africa:

This study focuses on the genetic diversity and mating capabilities of *Foc* in South Africa. Tools used to consider this include those that identify vegetative compatibility groups (VCGs), mating type genes, phylogenies of mitochondrial and nuclear gene regions, and microsatellite markers. In addition, isolates of *Foc* have been transformed with the green fluorescent protein gene for use in host-pathogen interaction investigations.

The only vegetative compatibility group (VCG) of *Foc* occurring in South Africa is VCG 0120. Molecular markers are in the process of being developed for the rapid identification of this VCG from non-symptomatic plant material, soil and water. In a further study, isolates of *F. oxysporum* and *Foc* have been screened for the presence of mycoviruses. Mycoviruses can cause hypovirulence in fungal pathogens, and can easily be transmitted within the

same VCG by means of heterokaryon formation. However, no mycoviruses have as yet been found in either *F. oxysporum* or *Foc* isolates.

The South African population of *Foc* is being investigated based on the biological fitness and virulence of isolates to Cavendish banana plants. The effect of temperature, nutrients, pH, aeration and light on the physiology of the fungus is of particular interest. In addition, the ability of *Foc* to produce toxins and enzymes, is currently being studied.

Studies on the epidemiology and management of Fusarium wilt:

The objective of this study has been to determine the current status of Panama disease in South Africa in particular to identify factors associated with the continued spread of the disease. Furthermore, studies leading to an enhanced understanding of differences in disease severity in Kiepersol and southern KZN, the effect of cultural practices, climate, source of planting material and

Irrigation water, and machinery used, have been undertaken. Our surveys have shown that Panama disease is widely distributed in both regions, but appears to be more severe in Kiepersol. Cultural practices in both regions are similar, but propagules ("bits") from Panama infested fields are still planted in uninfested soils in KZN. Contract machinery is used in both infested and disease-free farms in both regions and this contributes to disease spread.

Of the five banana growing areas in South Africa, Panama disease was, prior to 2000, only found in Kiepersol and southern KZN. By the end of 2000, Panama disease was reported in two new areas: Komatipoort and Tzaneen. Panama disease was apparently introduced into these areas on infected plant material approximately six years ago. Strict quarantine measures have now been implemented in both areas to prevent any further spread of the disease.

Temperature rather than climate in general plays a more important role in the development of Panama disease in countries with subtropical climates. The incidence of Panama disease can exceed 70% after winter and, thereafter, drops to almost 5% in summer. The effect of root and whole plant temperature on disease development is currently being investigated under controlled greenhouse conditions.

In order to determine the role of irrigation water and plants growing near reservoirs, on the epidemiology of *Foc*, the irrigation water of five farms in both Kiepersol and southern KZN is analysed at regular intervals. Several *Fusarium* spp., including *F. oxysporum*, have been isolated, and are now being identified further to *formae speciales* level using molecular techniques.

Studies on host-pathogen interactions:

Several banana cultivars and land races have tolerance/resistance to *Foc*. However, these plants do not always have suitable agronomic or quality characteristics for production in South Africa. A selection of a Cavendish banana plant with high levels of tolerance to *Foc* race 4, and with excellent agronomic and quality characteristics, has recently been produced. Molecular biology

techniques provide us with the tools to identify the genes responsible for resistance/tolerance from this selection to improve susceptible banana cultivars. The aim of this investigation is to identify and isolate genes that are differentially expressed in resistant banana cultivars when they are challenged by *Foc*. This is being achieved by means of suppression subtraction hybridization (SSH).

Systemic fungicides, surface disinfectants, systemically acquired resistance (SAR) compounds and biological control agents provide additional tools to overcome losses due to *Foc*. Various trials are underway to test an array of these compounds, both in the field and in the laboratory.



Internal symptoms of Panama disease

Leaf diseases of banana

FABI became involved in research on leaf diseases of banana in South Africa in August 1999. At that time, a severe outbreak of Yellow Sigatoka (caused by *Mycosphaerella musicola*) occurred in Komatipoort. A major concern was that Black Sigatoka (caused by *M. fijiensis*) had been introduced into the country.

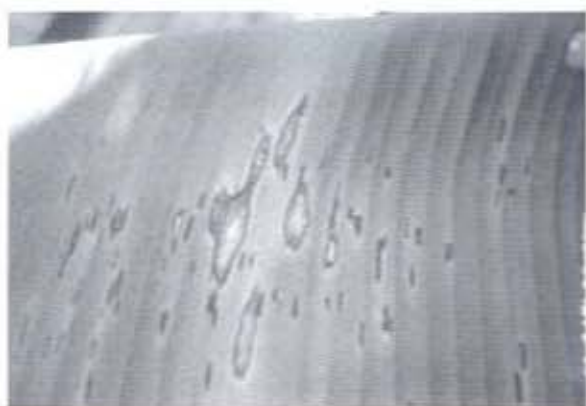

Yellow Sigatoka symptoms on a banana leaf

Objective of the research:

- To undertake regular surveys, and manage banana leaf diseases in South Africa.

Highlights of the research 2000/2001:

- The establishment of a rapid molecular identification method of *M. musicola* and *M. fijiensis*
- The development of a management strategy for Yellow Sigatoka in South Africa
- A survey on banana leaf diseases and fungi associated with leaf symptoms in South Africa, has been concluded

The banana weevil borer

The banana weevil borer (*Casmopolitus sordidus*) is the most important pest of bananas in the world. In South Africa this insect is considered the second most important disease/pest of bananas. Damage caused by the banana weevil is particularly severe in southern KwaZulu-Natal, but the pest is now also becoming important in Tzaneen and Kiepersol. No strategy has been developed to control the banana weevil borer in South Africa.

Although we do not currently have a formal research programme on the weevil borer, preliminary investigations on this pest have been established. These include limited field surveys and a critical evaluation of available information on the management of the banana weevil borer in South Africa.

It is anticipated that two postgraduate students will begin studies on this pest in 2002.

Extension and field services

Regular field trips have been undertaken to all five banana-growing areas of South Africa. In total, the FABI Panama Research Group spent approximately 153 person-days in the field in 2000 and 2001. Apart from attending meetings and the presentation of research results, extension services also included publications in "Banana Talk", evaluations of farmer trials, disease identification and advice on disease management.

Laboratory diagnosis and diagnostic clinic

Samples of Panama infected banana plants and leaf diseases are regularly collected from field sites and presented to the FABI diagnostic clinic. Isolations for pathogens are made and the causal pathogens identified using a wide range of laboratory techniques. The VCG characteristics are routinely determined by means of heterokaryon formation with *nit*-mutants.



Field Day with Banana Growers in Kiepersol

For more information:

<http://www.up.ac.za/academic/fabi/banana>

Plant-Microbe Interactions

Research Leader: Prof Dave Berger

Objectives of the research programme:

- Describe mechanisms whereby plants defend themselves against viral, bacterial and fungal pathogens
- Study plant anti-fungal polygalacturonase-inhibiting proteins (PGIPs)
- Produce genetically modified (GM) plants as a tool to study plant resistance mechanisms
- Use DNA Microarrays as a tool in understanding plant function

Highlights of research 2000/2001:

This research programme has two main research areas. One is focused on the study of antifungal genes, particularly the polygalacturonase inhibitor protein (PGIP) family of plant proteins. Plant transformation will be used as a tool to test combinations of anti-fungal genes for the eventual aim of producing genetically modified crops with improved disease resistance. The research leader is scientific co-ordinator of an European Union funded INCO-DEV project which will run from 2001 to 2003. The project is entitled "Safemaize: Genetic improvement of maize to enhance food safety by introducing resistance to *Fusarium verticillioides*". Conventional selection as well as maize transformation with combinations of antifungal genes will be employed in this project. Partners include the University of Pretoria, Agricultural Research Council (ARC)-Roodeplaat, CSIR-Biochemtek, University of Zambia, Plant Research International (Netherlands) and the University of Rome.

For more information:

<http://fabinet.up.ac.za/personals/dave2.html>

The second area of research in this programme concerns Plant Functional Genomics using Microarray technology to study plant gene expression. During establishment of the Microarray system, genes from the model plant *Arabidopsis* are used to develop the first gene chips, and these will be used in a collaborative project together with a French laboratory to study

the plant response to the bacterial wilt pathogen, *Ralstonia solanacearum*. *Eucalyptus* and cereal microarrays are also being developed.

In addition to the abovementioned projects, several collaborative investigations on the molecular basis of plant-pathogen interactions are underway with other FABI groups, CSIR-Biochemtek, ARC-Roodeplaat Vegetable and Ornamental Plant Institute and the University of Edinburgh.



Arabidopsis plant

Molecular Plant Physiology

Research Leader: Prof Karl Kunert

Objectives of the research programme:

The research focus in this programme is on the physiological characterization of known and novel DNA sequences involved in abiotic stress tolerance. Strategies applied include the characterization of cysteine proteinase inhibitors (cystatins), using genetically enhanced plants. In addition, Representational Difference Analysis (RDA) of environmentally stressed plants is used to search for novel sequences.

Highlights of research 2000/2001:

Cystatins and Abiotic Stress Tolerance

This research programme has produced genetically enhanced tobacco plants expressing a cysteine proteinase inhibitor (cystatin) derived from rice (OC-I). In collaboration with Prof. C. Foyer at IACR-Rothamsted, UK, these plants have been thoroughly evaluated in the last two years investigating a wide range of physiological parameters with the aim to discover both benefits and disadvantages that accrue from cystatin expression in tobacco. Beside protection against chilling injury determined by the measurement of apparent quantum efficiency and CO₂ assimilation, genetically enhanced tobacco plants have a higher protein and chlorophyll content than control plants. A possible protective role of cystatins on the stability of the photosynthetic enzyme ribulose 1,5 biphosphate carboxylase/oxygenase (Rubisco) during low temperature stress is currently being investigated. Different gel-based quantification methods, gene-cloning techniques to direct OC-I expression into the chloroplast, and immuno-detection techniques to study both the chloroplast-encoded large subunit and the nuclear-encoded small subunit of Rubisco during stress, are employed.

Plants expressing an exogenous cystatin surprisingly show a conditional "dwarf" phenotype under low light intensity. In

collaboration with Prof. C. Cullis at Case Western Reserve University in Cleveland, Ohio, USA, conditional "dwarf" plants are currently being genetically characterized using the RDA technique to identify regions in the plant genome, which have been affected by the insertion of the exogenous cystatin gene. This subtractive DNA technique allows a significant fraction of the plant genome to be compared between two closely related plants and to isolate unique DNA differences between two groups of plants. By applying the RDA technique with a methylation sensitive restriction enzyme, we have isolated two difference products, which match part of the DNA of the 18S rRNA and chloroplast genome DNA of a number of different plant species. We hypothesize that foreign gene integration and constitutive expression of the exogenous cystatin has changed the methylation status of DNA. To prove our hypothesis, methylation sensitive sites discovered by the RDA technique and their flanking regions are being characterized in great detail with the help of a genomic DNA library constructed from genetically enhanced tobacco plants. We further expect that identification of genome alterations will also help to address the problem of genomic integrity and bio-safety of genetically enhanced plants.

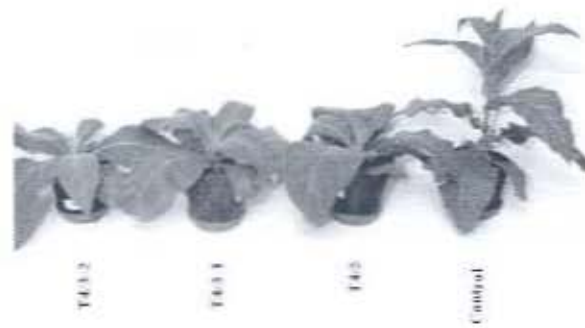

The conditional "dwarf" phenotype of plants of genetically enhanced lines T4/3-2, T4/3-1 and T4/5 expressing an exogenous cystatin gene compared to that of control tobacco plants (control) grown for 7 weeks under a low light intensity (300-350 μmol)

Novel DNA Sequences for Stress Tolerance

Plant subspecies are often morphologically identical despite belonging to completely different biomes. We are using this characteristic together with the RDA technique to identify possible induced DNA variation within a plant species caused by severe environmental conditions. The technique is being applied on the grass species *Monocymbium ceresiforme*. This species, common to several biomes in South Africa, has no obvious detectable difference in its morphological appearance in the various biomes. It does, however, differ greatly in its tolerance to temperature and belongs to two very different biomes. The biomes include a tropical frost-free coastal grassland area in Natal (Savanna biome) and a severe frost

area in the South African Drakensberg (Grassland biome). Thus far, by using the RDA technique we have amplified several unique labile DNA regions from the genome of the grass belonging to the grassland biome. These regions might have changed due to extreme environmental conditions.

We expect that a collection of labile DNA regions may ultimately help to determine how environmental conditions can influence genetic variation. They might also be useful in our efforts to identify the mechanisms which result in variation between species. DNA sequences isolated and identified might also be applicable as DNA markers for temperature tolerance, or might further serve as a pool of unique and rare DNA sequences for plant breeding.

For more information:

<http://www.up.ac.za/academic/fabi/molplantphys/>

Food Safety and Postharvest Technology

Research Leader: Prof Lise Korsten

A major new research focus area has been established that addresses the critical need for establishing a Food Safety Initiative for southern Africa. Global Food Safety concern requires development and implementation of food safety standards in primary agriculture and food technology. This, furthermore, demands that Good Agricultural Practices (GAP) and Hazard Analysis Critical Control Points (HACCP) be implemented within a two-year framework. Due to the critical lack of scientific data on foodborne pathogens on fresh produce, particularly fruit, this programme has embarked on a major initiative to determine the role, impact, presence and detection of human pathogens. We have also established training material for short courses, food safety videos and promotional material for public awareness. We are currently closely involved in developing a legislative framework for South Africa within a governmental forum. In order to enable the group to undertake research in this domain, we have introduced the ISO 17025 management system and will thus be accredited for monitoring foodborne pathogens in agricultural water, on fruit surfaces and in packhouses.

Objectives of the research programme:

- Determine the presence of foodborne pathogens in Southern African fresh produce destined for Europe
- Develop rapid detection techniques to monitor the presence of foodborne pathogens in primary agriculture particularly in agricultural water, packhouses and on fruit surfaces
- Identify critical control points where foodborne pathogens might be introduced into the food chain
- Develop hurdle technologies to eliminate foodborne pathogens that might be introduced into the food chain
- Determine the spectrum of human pathogens that pose a threat to consumer health if fresh produce, minimally processed fruits or vegetables are consumed
- Determine the survival and colonisation potential of foodborne pathogens on fruit and vegetable surfaces
- Determine the economic impact and risk assessments of foodborne pathogens in fresh produce industries in South Africa
- Develop GAP and HACCP systems based on sound scientific data obtained under African conditions
- Develop relevant training materials for workers, managers and students in food safety systems in agriculture

Highlights of research 2000/2001:

The Food Safety research program is the first of its kind in South Africa and focuses primarily on developing Good Agricultural Practices (GAP) and Hazard Analysis Critical Control Points (HACCP) for primary agriculture in South Africa. The presence of foodborne pathogens in agricultural water has been determined and guidelines have been developed to minimise fresh fruit and vegetable contamination of

foodborne pathogens by means of GAP, rapid monitoring and disinfectant products used in a hurdle technology concept. The presence of foodborne pathogens in the postharvest environment has also been monitored. The presence of human pathogens on packing lines, in packing crates, on workers' hands and on fruit surfaces is a major source of concern. If the South African fruit industries want to

remain competitive on the international markets, basic hygiene standards, GAP and HACCP systems will have to be implemented. Studies done by our group over the past five years highlight several points in the food chain where foodborne pathogens can enter the system. Survival and colonisation of fruit surfaces by foodborne pathogens as well as postharvest pathogens and their non-target effect on other epiphytic colonisers have been studied over a three-year period. The more fruit is handled, the greater the chance of colonisation by foodborne pathogens, posing an indirect threat to consumers. An extensive survey undertaken during 2000 showed that worker knowledge is extremely limited in terms of food safety. In contrast, middle and top management have already made the quantum leap to implement new food safety systems. The research program has led to the development of several training models for workers and farmers. Training videos and teaching material that have been developed are currently being distributed throughout Southern Africa.

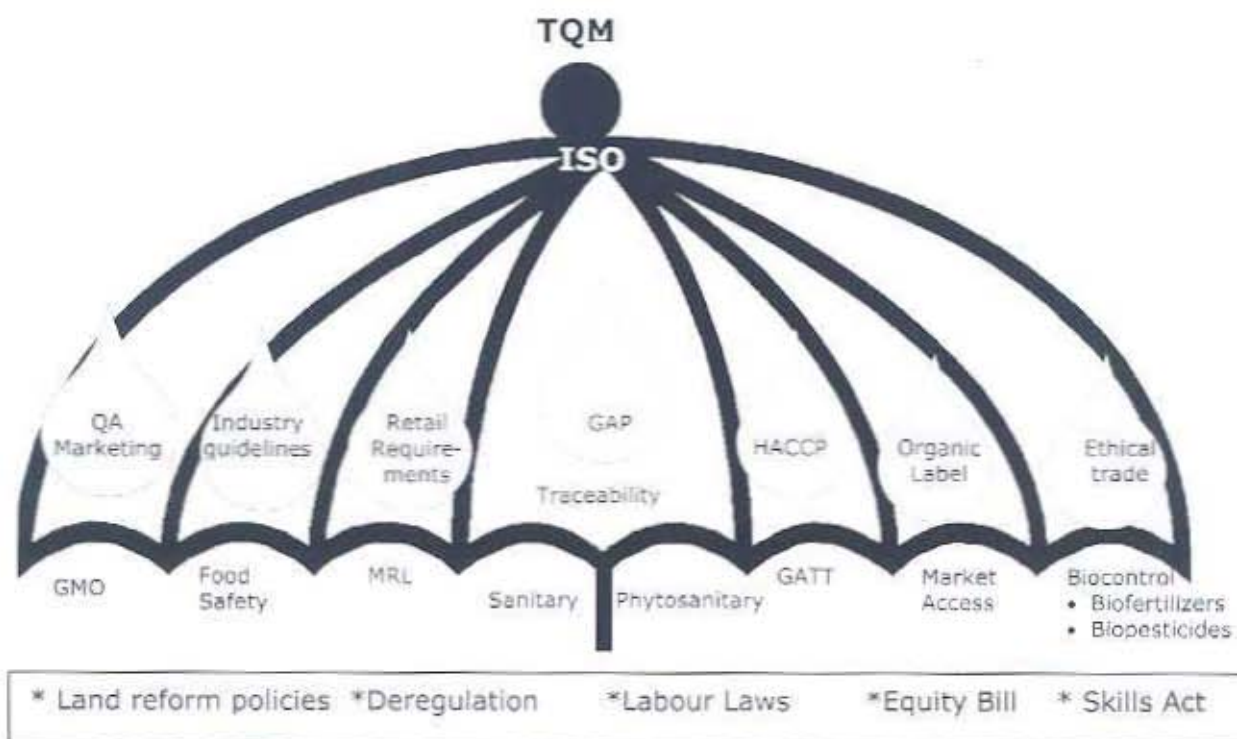

Umbrella of Total Quality Management in Agriculture

Mango and Citrus Pathology (FABI-du Roi Alliance)

Research Leader: Prof Lise Korsten

Research Team: Prof Mike Wingfield
Dr Fanus Swart (Du Roi)
Dr Gina Swart
Dr Linda Meyer
Mr Kobus Serfontein (Du Roi)
Mr Bernard Slippers

Highlights of research 2000/2001:

Mango research

The FABI-Du Roi Alliance is now in its second year and has proved to be of substantial benefit to the South African mango industry. Through this initiative we have addressed the needs of industry with both short and long term research focused on basic and applied aspects. The first successful "Show and Tell" symposium was held in 2000 in order to provide the industry with direct exposure to research findings and to highlight the positive implications of this research.

Major post-harvest problems on mangoes in South Africa include anthracnose, caused by *Colletotrichum gloeosporioides*, and soft brown rot (SBR) caused by *Nattrassia mangiferae*. Pre-harvest fruit diseases include bacterial blackspot caused by *Xanthomonas campestris* pv. *mangiferae-indicae* and anthracnose. Several chemical compounds are registered in South Africa for control of pre- and post-harvest control of anthracnose. Isolates of *C. gloeosporioides* collected during a three-year market survey were used to determine the incidence of resistance to benomyl, thiabendazole (TBZ) and prochloraz (all registered chemicals) using an *in vitro* assay. Isolates of *X. c.* pv. *mangiferae-indicae* were also evaluated *in vitro* for sensitivity to copper. Isolates from certain production areas were more tolerant to benomyl and TBZ. Several *X. c.* pv. *mangiferae-indicae* isolates have shown reduced sensitivity to copper, particularly

those from areas with a history of intensive spray programmes.

Due to the problems with resistance and the international opposition to the use of chemicals, alternative control strategies such as the use of antagonistic microorganisms and sanitizers have been investigated. Trials for these evaluations were performed under commercial and semi-commercial conditions. New disinfectants were tested in packhouses, where they replaced existing disinfectants or wash media, or alternatively, they were used in combination with chemicals in the packhouse. Preliminary results showed that a combination of prochloraz with strobilurins added to wax gave the highest levels of control. The use of disinfectants alone effectively controlled diseases, but prasin with prochloraz was more effective when compared to the commercially used control methods.

A biocontrol agent, *Bacillus licheniformis*, was shown to be effective in reducing pre- and post-harvest diseases. Different formulations of *B. licheniformis* were evaluated on their own or were integrated with copper fungicides to control fruit diseases. An innovative new approach to apply fungicides or biocontrol agents using modified plastic caps was evaluated. Plastic caps with inner wool linings were treated with *B. licheniformis* or copper oxychloride and placed on fruits after initial

fruit drop. The results showed that plastic caps with inner wool linings effectively reduced sunburn. Adding *B. licheniformis* to wooly caps prior to attachment to fruit, significantly reduced antracnose. *B. licheniformis* was also tested in semi-commercial packhouse trials. Commercially available powder and liquid formulations were used individually or in combination with standard packhouse treatments. Preliminary results showed that commercial applications of *B. licheniformis* can increase the total percentage of healthy fruit if used in an integrated program.

Mango trees under stress are more susceptible to a wide spectrum of diseases. One of these diseases is die-back caused by *Nattractia mangiferae*, which can lead to a reduction in yield, since infected inflorescences die and young fruitlets are aborted in early developmental stages. To investigate the causes of die-back, five orchards were chosen at a large mango estate in Mpumalanga on which to conduct the experiments. One of these orchards was salt stressed, two orchards had typical and atypical die-back symptoms respectively, and two control orchards were included. Tree samples consisted of twigs, leaves, bark and fruit and were evaluated for the presence of *N. mangiferae*. *N. mangiferae* was isolated from all orchards chosen for this study with varying degrees of incidence. The highest incidence was found in the orchard in salt stressed conditions, closely followed by the orchard with typical die-back symptoms. This indicates that *N. mangiferae* was more prevalent than was originally thought. It also confirms that *N. mangiferae* is an opportunistic, endophytic pathogen, which attacks trees under stress.

In mango, *Nattractia* spp. cause a variety of pre- and post-harvest disease symptoms. Recent outbreaks of tree die-back in orchards and high export losses due to soft brown rot (SBR) and stem-end rot (SER) has renewed interest in the pathogen. However, there is confusion regarding the taxonomic status of the pathogen. This study was initiated to determine the correct identity of the

pathogen responsible for mango tree die-back, cankers, blossom blight, SBR, and SER on fruit in South Africa. Isolates of the fungus from Tommy Atkins, Keitt, Kent, Heidi and Sensation cultivars were obtained from various farms in the Mpumalanga area. Isolations were made from symptomless and diseased material from various parts of the tree and fruit. Identification of all isolates was done based on spore morphology and sequence data from the internally transcribed spacer (ITS) regions of the rDNA operon. The ITS sequence data strongly suggests that the mango isolates belong to three distinct groups within the genus *Botryosphaeria*. They have tentatively been identified as *Lasiodiplodia theobromae*, *Fusicoccum aesculi* and *Nattractia mangiferae*. Morphological data corresponded with the molecular identification. Recent work on isolates from Australia suggests that *N. mangiferae* belongs to the genus *Fusicoccum*. Our data support this view. All three of these species were isolated from symptomless as well as symptomatic material. *Lasiodiplodia theobromae* was isolated more frequently from fruit rots, while *F. aesculi* and *N. mangiferae* were isolated from both fruit rots and die-back.



Leylani Grobler collecting die-back samples

Highlights of the research:

- Effective natural disease control systems have been developed to control pre- and post-harvest diseases of mango fruit

- The taxonomic status of the endophytic mango pathogen that causes die-back, cankers, SBR and SE has been clarified and shown to represent three species of *Botryosphaeria*

For more information:

<http://www.up.ac.za/academic/agrirural/mango>

Citrus research

Greening is caused by a highly fastidious, Gram negative phloem-limited bacterium. Based on 16S rDNA sequence data, two distinct species have been identified viz. *Liberibacter africanus* and *Liberibacter asiaticus*. Due to dual infections and cultivar differences it is difficult to identify this disease based on symptomology alone. The objectives of this study were to clarify symptomology, use PCR to answer epidemiological questions, and detect *Liberibacter* in alternative hosts. Four hundred and fifty samples of greening infected and healthy citrus from different cultivars and 92 samples from potential alternative hosts (botanical gardens/areas adjacent to greening infected orchards) were collected. A range of previously isolated citrus endophytes were also tested. DNA extractions were done using the Wizard DNA purification kit. Primers directed to the rplKAJL-rpoBC operon, which produced an amplicon of 667 bp (*L. africanus*), and PCR conditions conducted according to previously described protocols were used. Asymptomatic samples from healthy sectors of infected trees tested positive in certain cases. All samples with typical greening symptoms tested positive and all samples from healthy trees tested negative. None of the alternative hosts tested positive except for *Calodendrum capense* from Stellenbosch using new Cal 1 primers (specific to *Liberobacter africanus* subsp. *capensis*). No positive reactions have been obtained from cryopreserved endophytes tested thus far. Mottling followed by yellow vein symptoms was found to be the most reliable indicator of greening. "Green islands", "rabbit ears" and mineral deficiencies were the least reliable indicators of infection. There were differences in the number of positive reactions from different cultivars, with Valencia (most susceptible) having the

most and Satsuma, the least. These results are in accordance with previous findings of varietal susceptibility. There were also different levels of positive reactions from specific areas, with the most from Crocodile Valley followed by Letaba.

The fungus *Guignardia citricarpa*, causes a phytosanitary restrictive disease known as Citrus Black Spot (CBS). It has been suggested that there are two strains responsible for the disease, but they cannot be distinguished on a morphological basis. South African *Guignardia* isolates from different lesion types, as well as from symptomless fruit, were compared by means of ribosomal DNA internal transcribed spacer sequence analysis, proving the existence of two *Guignardia* species on citrus. Restriction enzyme digestion fingerprints of the PCR products using CfoI clearly distinguished the two species providing a rapid, yet reliable identification tool. Growth rate in culture also corresponded with the two species. The first species, *G. citricarpa*, has been confirmed as the causal organism of CBS and is restricted to citrus. This fungus occurs in all major citrus producing areas of South Africa, except the Western Cape. The pathogen can be isolated from hard spots, virulent spots, freckled spots and false melanose lesions from sweet orange, grapefruit, lemon and tangerine. The second species can be isolated from symptomless citrus fruit, but also from avocado, mango, banana, cabbage tree and kumquat, which occur in various geographical areas. The DNA tests devised are able, for the first time, to distinguish the pathogenic from the harmless endophyte of citrus and other plants. Phytosanitary measures may be used to prevent the export of citrus fruit suspected of being infected with CBS, and this research can ensure fair export practice.

Three *Bacillus subtilis* isolates from citrus fruit surface were evaluated for control of green and blue mold of citrus caused by *Penicillium digitatum* and *P. italicum*, respectively. The isolates were evaluated either alone or in combination with sodium bicarbonate and hot water treatment on artificially inoculated valencia and shamouti

orange cultivars stored at 10 ± 1 °C for four weeks. All isolates were significantly better on their own than the control treatment in inhibiting the incidence of both green and blue mould. However, they were not as effective as commercial fungicide treatments. The biological control isolates were generally more effective in inhibiting green than blue mould and isolate F1 inhibited both fungi on both cultivars more effectively than L2 and L2-5. There was a remarkable increase in the biocontrol activity of all isolates when combined with sodium bicarbonate or when applied following hot water treatment. The isolates generally performed better following hot water treatment than when combined with sodium bicarbonate. The treatment using isolate F1 combined with sodium bicarbonate or isolate F1 applied following hot water treatment gave 100 % control of both green and blue mould on both cultivars after four weeks of storage at 10 ± 1 °C. The number of viable cells recovered after antagonist suspension was higher for isolate F1 than L2 and L2-5. This ability of F1 to survive better in sodium bicarbonate solution is a probable explanation for its better performance.



Postharvest citrus research

In preliminary studies, several different antifungal compounds were identified that adversely affect the growth of major post harvest pathogens. Garlic extracts were

tested and showed great promise for control of post harvest diseases. Furthermore, extracts from three promising bulbous plant species in the Amaryllidaceae and Hyacinthaceae families were screened against several important post harvest pathogens. Extraction of bioactive compounds were optimised and extracts were dried and dissolved in water and their efficacy assessed *in vitro*. These extracts also showed great potential for control of post harvest diseases. It was also found that some antagonistic yeasts and *Bacillus* spp. could be used, integrated with certain naturally-occurring antifungal compounds. These results provide the opportunity to enhance the biocontrol activity of antagonists by combining them with naturally-occurring biocides. A variety of naturally-occurring products (chitosan salts, chitin, β -1,3-glucan, chitinase, lysozyme, lyticase, biopreservative organic salts (sorbic; propionic; acetic; benzoic), sodium bicarbonate, medium chain fatty acids; essential oils; plant extracts and volatiles) were screened for their antifungal activity against major post-harvest pathogens and their compatibility with selected microbial antagonists.

Highlights of the research:

- Effective screening of greening infected material was established and this can now be used as a tool to distinguish between symptom types
- A rapid method has been developed to distinguish between pathogenic and non-pathogenic *Guignardia* spp. associated with citrus black spot, which will contribute significantly to effective export
- Several promising biocontrol products have been developed that might be used in the post harvest environment to control disease

For more information:

<http://www.up.ac.za/academic/fabi/citrus>

Potato Diseases

Research Leader: Prof Lise Korsten

Research Team: Prof Dave Berger
Prof Piet Hammes
Dr Gina Swart
Dr Freddie Denner (ARC-Roodeplaat)

Objectives of the research programme:

Three main focus areas, including bacterial soft rot, bacterial wilt and early blight, make up the potato disease research programme. Objectives of these focus areas include:

- Develop a disease forecasting system for potato early blight which is linked to the late blight model currently used by the industry
- Develop a rapid, accurate *Erwinia* and *Ralstonia* detection system
- Determine *Ralstonia* survival levels in the soil

Highlights of research 2000/2001:

Bacterial soft rot

The economic importance of *Erwinia* diseases in South Africa as well as the potato farmer's awareness of the potential impact of the *Erwinia* complex of diseases was determined. Different *Erwinia* isolates were collected from various potato producing areas in SA and compared using physiological, pathological and molecular methods. Several physiological tests were used to compare isolates using a microplate method and testing catalase production, cytochrome oxidase, formation of indole and sugar utilization. Different diagnostic techniques were evaluated for identification of different *Erwinia* spp. The Biolog method was found to be a more rapid and effective method than traditional diagnostic techniques. Standard pathogenicity tests were used to compare virulence of isolates. PCR using primers specific to different repetitive elements and SDS-PAGE were used to compare isolates at a molecular level. Neither PCR nor SDS-PAGE could distinguish isolates based on geographic origin or cultivars, confirming the molecular complexity of this species. The PCR-based method was found to successfully distinguish different species within the group of isolates tested. An ELISA-based technique and specific PCR primers were evaluated for detection and

showed great promise in a commercial screening programme.

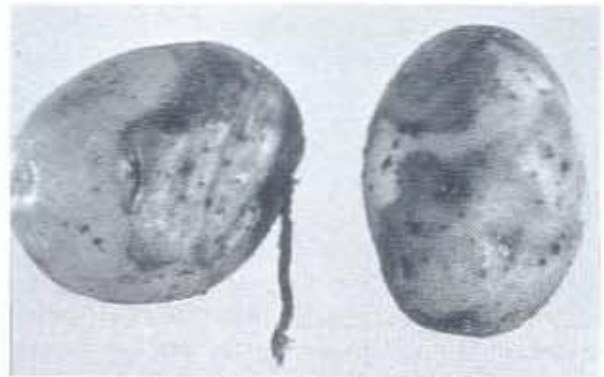

Soft rot symptoms on potatoes

Different cultivars were evaluated for resistance and determination of pathogen threshold values for disease development. Several cultivars including Astrid, Baroc, Buffelspoort, BP1, Bravo, Hertha, Hoelvelder, Late harvest, LT-7, Mnandi, Mondial, Pimpernel, Ronn, Ropedi, Up-to-date and Vanderplank were evaluated. Several control options were also evaluated which included heat treatments and the use of disinfectants. With increasing time-temperature gradients, cell mortality increased. The efficacy of heat treatments at 55°C and 60°C were similar, with 100% mortality, irrespective of exposure time. Results obtained from this study confirm the potential of heat treatments for the control of soft rot and blackleg, both

caused by *E. c.* subsp. *carotovora*. Different concentrations of Ecosanitizer (glutaraldehyde), Sporekill (quaternary ammonium compound) and Oxine (chlorine dioxide) were selected for packhouse evaluations and were tested using 40 kg of tubers. All disinfectants tested showed some measure of control. Chlorine dioxide (Oxine) at a concentration of 0.1% and a contact time of 1 min proved highly effective. Currently, the FDA and USDA approve Oxine for use on food contact surfaces not requiring a water rinse.

Bacterial wilt

Ralstonia solanacearum has been reported on every major continent and islands from the warm temperate to tropical regions of the world. Some of the most important agricultural crops affected by *R. solanacearum* include tomato, potato, pepper, tobacco, eggplant, groundnuts and bananas. In 1996, a strict certification scheme for seed potatoes was introduced in South Africa to control the spread of this disease. The destructiveness of this disease should however not be underestimated and if left unchecked, it could destroy the entire potato industry within a few years.

The primary objective of this study was to develop an alternative method for the detection of *R. solanacearum* in naturally infested soil. This technique should be easy to apply, affordable, fast and sensitive to detect the pathogen below the level that will result in significant economic crop losses. Techniques currently used have various difficulties. Selective media such as those containing tetrazolium chloride (TZC) cannot effectively detect the pathogen where concentrations are lower than 10^3 cfu/ml of soil sample. Although serology tests such as the ELISA can detect much lower concentrations, it is much more expensive and can easily be influenced by other soil microorganisms. Currently, the ELISA technique is used in diagnostic laboratories throughout South Africa and Immunofluorescence in European countries such as Holland. The technique most often used in developing countries is to plant susceptible indicator plants. In this study, a technique was developed based on indicator plant systems using 4-6 week old tissue culture potato

plantlets. Plants were subsequently placed in *Ralstonia* inoculated soil suspensions at various concentrations. Roots were cut to enhance pathogen infection. Plantlets were placed in growth chambers at 20°C until isolation. Thus far the pathogen has been re-isolated from plants one week after inoculation. The technique appears to be promising to distinguish between infected and non-infected soils.

Herbal plants are currently being evaluated to determine whether they have the ability to suppress *R. solanacearum* in the soil and whether they can be used commercially for biofumigation. Currently, various South African *R. solanacearum* isolates are being compared using PCR techniques. A new *Ralstonia* project has also been initiated with Dave Berger who leads the research group mentioned above.

Early blight

Early blight is a common disease of potatoes and tomatoes in most production areas of South Africa and globally. The best control method for this disease remains the use of fungicides. Traditionally, spraying commences when symptoms appear and subsequent sprays are applied every 7-10 days. This provides adequate disease control, but sometimes results in application of fungicides even when the threat of disease outbreak is minimal. Fungicide use can be minimized with the correct implementation of reliable disease warning systems. One such system is PLANT-Plus, originally developed by DaCom Automatisering, Netherlands, for the prediction of late blight in potatoes. The objectives of this study are to confirm the efficiency of the model and to adapt it to South African potato cultivars and growing conditions. Field trials were planted at Roodeplaats Agricultural Research Council (ARC) to determine whether the forecast of spore production and dispersal in the model is accurate. Concentrations of *Alternaria solani* conidia present in the atmosphere were estimated by trapping spores using a volumetric spore trap located close to the edge of the research plot. Preliminary results from these trials show that the model can effectively predict spore release phases. The spore production

and dispersal forecast given by the model correlated well with the spore trap data. However, other modules in the system need to be tested for accuracy. Additional research is underway in order that the model can be commercialised. The ultimate aim of this study is, therefore, to incorporate the late and early blight models into a single system, to provide growers with an integrated control programme for both devastating diseases.

Alternaria solani isolates were collected from various potato growing regions throughout the country. The virulence of isolates was compared using potato tissue culture plants. Plants were incubated at 25°C with a light regime of 12h near-UV and 12h dark for one week. After a week, the plants were analysed and rated for disease development. The lesions were also examined for sporulation of the fungus. These results show that there were few significant differences in virulence of isolates. However, more isolates have since been collected from other potato growing areas and will be included in subsequent virulence assays.

A structured questionnaire was drawn up and distributed to all 14 potato-growing regions of South Africa. The purpose of this survey is to evaluate knowledge, attitudes and spray regimes of potato growers concerning early blight in South Africa. The economic impact of early blight on the local potato industry will also be determined. As yet, questionnaires from only seven regions have completed and returned. From these few responses, it is already evident that growers are aware of the disease and that it can cause severe yield losses if not adequately controlled.

Highlights of the research:

- Population studies have been completed for *Erwinia* spp. isolated from apparently healthy potatoes obtained throughout the Southern African potato growing areas
- Population studies for *Ralstonia solanacearum* have been completed giving us a better understanding of pathogen diversity within the Southern African region

- Development of a disease forecasting model for the two major potato foliar diseases, namely early and late blight



Jacquie van der Waals in her potato research plot where the Plant Plus model is being tested



Symptoms of *A. solani* on potato leaves

Citrus Rootstock Resistance

Research Leader: Dr Nico Labuschagne

Research Team: Dr Zeno Apostolides (Dept of Biochemistry)
Prof Dave Berger

Objectives of the research programme:

- Identify rootstocks with resistance/tolerance against the main fungal root pathogens of citrus
- Develop techniques for rapid screening of rootstocks for resistance
- Elucidation of the mechanisms involved in rootstock resistance

Highlights of research 2000/2001:

In South Africa it is estimated that root diseases of citrus cause an annual loss of R60 - 67 million in foreign currency. This estimation is based on data showing that 10% of citrus trees in Mpumalanga and Northern Province suffer from moisture stress indicative of root disease and that fruit yield of affected trees can be increased threefold by integrated chemical control. These losses can be prevented by the use of tolerant rootstocks.

Resistance to root rot

More than forty different rootstocks were evaluated for their tolerance to *Phytophthora nicotianae*, *Fusarium solani* and a combination of these two fungi in the greenhouse. Plant height and shoot mass were the most reliable parameters, whereas feeder root length was the most unreliable. Australian trifoliolate and Shekwasha mandarin were highly tolerant to *P. nicotianae*, while Natsudaidai, Terra Bella citrange, Jacobsen trifoliolate, Rusk citrange, Shekwasha mandarin and Pomeroy trifoliolate were the most tolerant to *F. solani*. Swingle citrumelo was more tolerant to both fungi than any of the above rootstocks.

Eight citrus rootstocks were evaluated for tolerance or susceptibility to *Phytophthora nicotianae*, *Fusarium solani* and *Tylenchulus semipenetrans* under simulated field conditions. The following rootstocks were found to be tolerant:

Swingle citrumelo and C35-citrange (*Phytophthora* tolerant), Minneola x Trifoliolate hybrid and C35-citrange (*Fusarium* tolerant). Swingle citrumelo was tolerant to the nematode. C32-citrange was tolerant to all three pathogens. Rootstocks that were susceptible were: X639 hybrid, Minneola x Trifoliolate hybrid (susceptible to *Phytophthora*), Carrizo citrange and Benton citrange (susceptible to *Fusarium*). Rough lemon was susceptible to all three pathogens.

The rootstocks which were screened for tolerance against the root pathogens were subsequently evaluated for their ability to regenerate roots. The rootstocks were classified as either vigorous or non-vigorous according to their root growth potential. Pomeroy trifoliolate, Swingle citrumelo, Terra Bella citrange, Cleopatra mandarin, Rusk citrange and 1113 were all vigorous in their growth. Macropylla, C32-citrange, Obovoideae, Shekwasha mandarin, Australian trifoliolate, Japanese citron and Rubidoux trifoliolate were all non-vigorous. No consistent correlation was evident between root regeneration capacity and resistance to root pathogens. Root regeneration rate was, therefore, found not to be a reliable parameter for screening tolerance in citrus rootstocks.

Techniques for the detection of scoparone were evaluated with the aim of using scoparone as an indicator of potential

resistance during the rapid screening of rootstocks. A new Micellar Electrokinetic chromatography (MEKC) method has been developed to determine the amount of the phytoalexin, scoparone, in citrus roots. This method was compared with the fluorescence thin layer chromatography (TLC) method. The detection limit with the MEKC method (2 µg/mL) was better than the TLC method (10 µg/mL), providing a highly sensitive technique for scoparone determination.

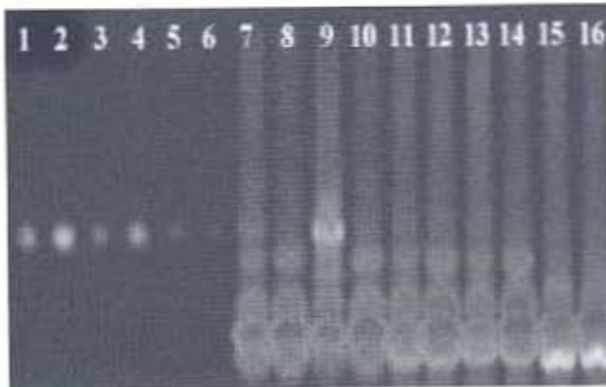

TLC analysis of citrus root extracts:
Lane 1-6, scoparone standards 10-200 µg/ml;
lane 7-8 and lane 10-16, uninduced root extracts;
lane 9, induced citrus root extract showing scoparone production

A novel technique was developed for the detection of fluorescent compounds that are excreted from citrus roots upon infection by *Phytophthora nicotianae*. Zoospore suspensions of *P. nicotianae* were used to inoculate detached root pieces of Rough lemon, Swingle, Troyer, Carrizo, Volkameriana, Sour orange, C35 and Macrophylla rootstocks. Following extraction, TLC revealed up to seven different fluorescent compounds that were excreted. No scoparone was however detected for any of the rootstocks. This technique has great potential as a method for detecting resistance-related compounds such as phytoalexins from citrus roots. It is now evident that scoparone, although important for resistance against *Phytophthora* stem canker, is probably not the primary compound responsible for resistance of the root system.

Citrus blight

Fusarium solani has previously been shown to produce naphthazarin phytotoxins which

are toxic to citrus plants. In this study, it was found that citrus trees in South Africa had varying levels of naphthazarins in their xylem. Significantly higher concentrations of these toxins were detected in trees with blight symptoms, than in symptomless trees.

Citrus seedlings grown in hydroponic culture containing isomarticin showed inhibition of growth, shortening of roots and accumulation of zinc in the trunk wood. A procedural ranking of rootstocks indicated that trees with observed tolerance to blight in the field generally had higher tolerance to isomarticin in hydroponic culture, whereas trees susceptible to blight were more sensitive to the toxin. These findings indicate that *Fusarium*-produced isomarticin is involved in the induction of some of the symptoms associated with the citrus blight syndrome. Furthermore, naphthazarin sensitivity might be used to screen rootstocks for blight susceptibility or tolerance.



**Left = healthy (uninfected) Rough lemon seedling;
Right = Severely wilted seedling stem inoculated with
*Phytophthora citrophthora***

Indigenous Food Crop Pathology

Research Leader: Prof Terry Aveling

Research Team: Dr Nico Labuschagne
Dr Winfred Hammond
Mr Claus Coetzee

Objectives of the research programme:

- Conduct a survey of plant pathogens occurring on indigenous food plants
- Collect, isolate and identify plant pathogens reducing yields of these plants
- Provide a reference collection of plant pathogens on these plants
- Study the biology and seed pathology of these pathogens
- Train and educate black students with relevant expertise to undertake extension work in disadvantaged communities
- Establish a center of excellence of diseases of indigenous food plants for small scale farmers

Highlights of research 2000/2001:

Research during this period focused on the biology and control of *Alternaria cassiae*, a newly discovered pathogen of cowpea. The effect of culture media, temperature, light and wounding on the growth and sporulation of the fungus was studied. Pre-penetration and infection of *A. cassiae* on cowpea leaves was studied with light and scanning electron microscopy. Conidial morphology, types and development of the fungus were studied *in vitro* on different culture media and *in vivo* on cowpea leaves. *A. cassiae* was shown to be seed-borne in cowpea.



Cowpea flower

Six fungicides i.e. Benomyl, bitertanol, captab, mancozeb, propiconazole and triforine were evaluated for their efficacy in reducing *A. cassiae* *in vitro* and *in vivo*. None of the treatments eradicated the pathogen, however, captab at 1.5 times the recommended rate proved to be the best treatment over all.



Ascochyta blight symptoms on cowpea leaves

Various storage fungi were found to be associated with cowpea seeds - *Alternaria*, *Aspergillus* and *Penicillium* spp. were the most dominant even after a three-year cold

storage period at $\pm 5^{\circ}\text{C}$. Some fungi recorded prior to cold storage were not recorded thereafter.

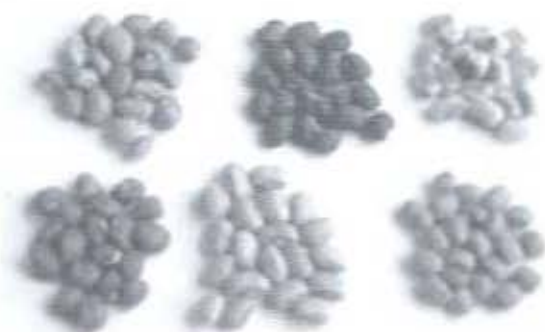

Selection of cowpea seeds

The presence of the fumonisins B1, B2 and B3 was investigated in four cowpea cultivars. All the cultivars were contaminated with fumonisin B1 with levels ranging between 81 - 1002 ng g⁻¹. These toxins have serious health implications and their presence in seed will be studied further. Fumonisin B2 and B3 were not detected in any samples. The efficacy of essential oils (thyme, clove and peppermint) in controlling storage fungi of cowpea seed was tested. Only thyme oil at 1000 ppm reduced fungal growth of naturally infected cowpea seed *in vivo*. The oils did not appear to adversely affect the germination or emergence of cowpea seed. All three oils significantly inhibited the storage fungi on artificially inoculated white cowpea seed, increasing the percentage germination and emergence.



***Alternaria cassiae* conidia**

The ultrastructure of the infection strategy of *Colletotrichum dematium* on cowpea stems was studied. Greenhouse trials on the environmental factors affecting the pathogenicity of *C. dematium* have also been conducted. Characterisation of isolates of *C. dematium* based on cultural morphology and vegetative compatibility groups were determined.

Cowpea seedling damping-off in South Africa was found to be caused by *Pythium ultimum* and *Rhizoctonia solani*. The causal organism of this disease in Benin was found to be *Sclerotium rolfsii*. An epidemiological field study in Benin showed that the disease was favoured by high soil moistures and that the infection rate was higher at the seedling stage. The variability of *S. rolfsii* isolates and their effect on disease incidence and severity was determined.



Septoria leaf spot

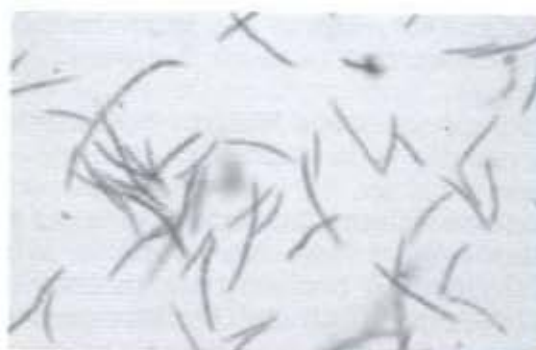

***Septoria* conidia**

Sabbatical Visits 2000/2001

Professor Terry Aveling

Research was done in Dr Alison Powell's laboratories at the University of Aberdeen, Scotland, UK from October 1999 to April 2000 and involved an integration of seed pathology and seed physiology. We looked at the effect of seed coat colour of cowpeas on seed vigour and susceptibility to damping-off. Seed vigour tests included imbibition, tetrazolium and conductivity tests. Percentage germination was also determined in the laboratory according to the International Seed Testing Association and percentage emergence in the greenhouse. The effect of three damping-off pathogens, *Fusarium solani*, *Pythium ultimum* and *Rhizoctonia solani*, on emergence of different coloured seeds was recorded. It was found that light coloured seeds were more susceptible to imbibition damage, had lower vigour and were more susceptible to damping-off than dark coloured seeds. The results of the various experiments have been compiled into two articles that have been submitted for publication in accredited international journals. The results have also been presented at national and international conferences.

Professor Michael Wingfield

During the last six months of 2000, Mike Wingfield had the opportunity to undertake sabbatical leave in Australia. While his initial plan was to spend an uninterrupted six months in Canberra, due to many commitments in South Africa including responsibilities in FABI, this could not be achieved. Ultimately, this sabbatical was honed down to two periods making up approximately three months in total.

Sabbatical leave provides a wonderful opportunity for returning to "bench level" research and to conduct research, not possible under normal circumstances. Sabbaticals also make it possible to think about one's research and interests without interruption and in an environment free of one's normal pressures. It was against this backdrop and philosophy that I joined my colleagues Ken Old, Glen Kile, Mark Dudzinsky and Ruth Gibbs at the Forestry and Forest Products Institute, at Yaralumla, in Canberra. Although the time I had available for research was much more limited than I had hoped, I was able to achieve most of the goals that I had set for myself.

Amongst the many features that attracted me to Canberra was the fact that the city is surrounded by large areas of relatively undisturbed *Eucalyptus* and *Acacia* forest. Species of these trees are the basis of a large part of the South African forestry industry and I had a passionate desire to learn more about their diseases in the Australian environment. More specifically, I was interested to know whether the species of *Botryosphaeria* (*B. eucalyptorum*) that we have recently described from South Africa, might be present on *Eucalyptus* in Australia. Furthermore, I shared an interest with my Australian colleagues in trying to determine whether *Ceratocystis albobundus*, the serious wilt pathogen of *A. mearnsii* (black wattle) might be present and native in Australian forests.

During the time in Canberra, I was able to undertake a number of most interesting and scientifically rewarding field trips. The major objective of these was to meet with colleagues and to collect samples linked to the research questions mentioned earlier. I thus travelled from Canberra to Melbourne, and undertook field trips in areas surrounding Canberra, Sydney, Coff's Harbour and Brisbane. I also established wounding experiments on *Eucalyptus nitens*, *E. globulus* and *E. mearnsii* in Canberra and Orbost. These excursions were hugely interesting and the material collected from them will keep me interested and

excited for at least a year or two more. At this stage, I can already report that we have discovered a new species of *Ceratocystis* on *Eucalyptus* in Australia and our perspective on *Botryosphaeria* spp. occurring on *Eucalyptus* and *Acacia* spp. has been greatly expanded. DNA sequencing work and other laboratory studies are underway to gain a deeper understanding of these various fungi.

In addition to field excursions and laboratory studies, I had the opportunity to enjoy participating in various CSIRO activities. I continued to work with Ken Old on aspects of our joint project on Eucalyptus rust (funded by ACIAR), and also joined a CSIRO team on a trip to Thailand and Vietnam where we shared research experiences with colleagues in those countries. I had the opportunity to participate in various symposia including a local meeting of the Australasian Plant Pathology Society (APPS) at Bungendore, which was hugely enjoyable.

This short report reflects a rather hectic three months of field trips, laboratory work and participation in various training sessions and symposia. What it does not include is the fact that these three months of sabbatical were not only scientifically enriching, but also provided a wonderful opportunity for our family to absorb deeply the many pleasures of a novel environment. Long walks amongst the eucalypts, fascinating birds and the ever-weird kangaroos will be remembered for many years to come. The hospitality and kindness of many Australian friends will also not easily be forgotten.

Professor Brenda Wingfield

Canberra is the capital of Australia and also the site of the CSIRO headquarters and many of the CSIRO central laboratories. This combined with the fact that there are two Universities made Canberra an attractive choice for a sabbatical. It is also a fairly small city that made it doubly attractive from a personal perspective.

My host in Canberra for my sabbatical was Dr. Jeremy Burdon. Jeremy leads a research group in the Plant Industries section of the CSIRO. He has a keen interest in pathogen populations and specifically in a number of rust fungi. It was from this interest in rust fungi that my sabbatical project evolved. This project was rather ambitious; to produce a molecular phylogeny of the rust fungi.

A huge amount of the work for this project was just collecting the rust samples from all over the world. In fact we are still collecting and this phylogeny will never be truly completed. However, by the time I arrived in Canberra a significant collection of samples had been amassed and my job was to develop a DNA isolation technique, do PCR and sequence these PCR products.

Rust fungi are by definition obligate parasites. It is therefore, not possible to culture them on artificial medium, they need live plant tissue. This is extremely costly, time consuming and also risky from a quarantine perspective. My objective was therefore, to isolate DNA from very small samples and to work with this small amount of DNA. This approach has some limitations but I hoped that at least for more conserved gene sequences that I would be able to get sequence without having to resort to cloning.

In many respects the project was far more successful than I could have ever hoped. We had initially decided that a reasonable number of samples to process were around 20. In the end I managed to do DNA isolations from more than 80 fungi, of these I produced PCR products from 60 different samples and I have DNA sequence from parts of the genome for at least 40 samples. These represent around 30 different genera and 13 out of the 14 recognised rust families.

A phylogenetic tree of some of the DNA sequence of the rRNA small subunit gene is given in the Figure below. The small subunit gene was however, not the only area that I was successful in sequencing. I also have a significant amount of rRNA large subunit sequence as well as the ITS regions. We are still collecting rust samples and this project will continue for a number of years. We have a specific interest in a number of South African fungi as well as the guava rust fungus that is potentially a huge threat to the South African forestry industry.

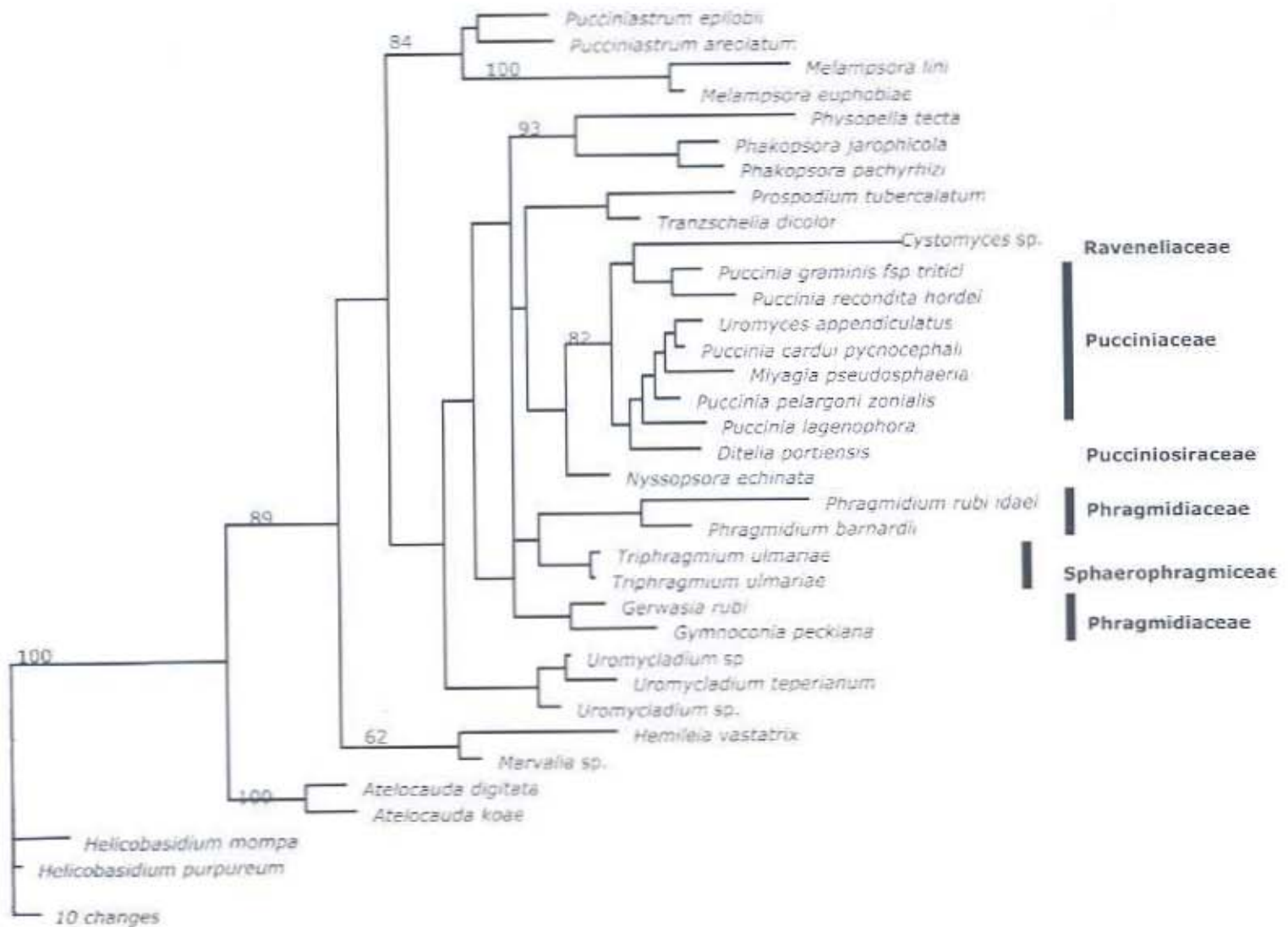

A phylogenetic tree of some of the DNA sequence of the rRNA small subunit gene of selected rust fungi

Publications 2000/2001

In Refereed Journals

- Aucamp, J.P., Kotze, S., Fourie, A., Labuschagne, N. and Apostolides, Z. (2000) Determination of scoparone in citrus roots by Micellar Electro kinetic Capillary Chromatography. *Journal of High Resolution Chromatography* **23**: 519-521.
- Aveling, T.A.S. & Adandonon, A. (2000) First report of pre- and post-emergence damping-off of cowpea caused by *Pythium ultimum* in South Africa. *Plant Disease* **84**: 290.
- Barnes, I., Roux, J., Wingfield, M.J., Coetzee, M.P.A. & Wingfield, B.D. (2001) Characterisation of *Seiridium* spp. associated with cypress canker based on β -tubulin and histone sequences. *Plant Disease* **85**:317-321.
- Botha A-M & Venter, E. (2000) Current status of marker technology linked to pest and pathogen resistance in wheat breeding. *South African Journal of Science* **96**:233-240.
- Burgess, T., Wingfield, M.J. & Wingfield, B.D. (2001) Simple sequence repeat (SSR) markers distinguish between morphotypes of *Sphaeropsis sapinea*. *Applied and Environmental Microbiology* **67**:354-362.
- Chimwamuombe, P.M., Botha, A-M., Wingfield, M.J. & Wingfield, B.D. (2001) Molecular relatedness of the polygalacturonase-inhibiting protein genes in *Eucalyptus* species. *Theoretical and Applied Genetics* **102**:645-650.
- Chimwamuombe, P.M., Wingfield, B.D., Botha A-M. & Wingfield, M.J. (2001) Cloning and sequence analysis of the endopolygalacturonase gene Fcpg from the pitch canker fungus, *Fusarium circinatum*. *Current Microbiology* **42**:350-352.
- Coetzee, C., Wingfield, M.J., Crous, P.W. & Wingfield, B.D. (2000) *Xenochalara*, a new genus of dematiaceous hyphomycetes from *Chalara*-like fungi with apical wall building conidial development. *South African Journal of Botany* **66**:99-103.
- Coetzee, M., Wingfield, B.D., Harrington, T.C., Wingfield, M.J., Coutinho, T.A. & Dalevi, D. (2000) Geographical differentiation of *Armillaria mellea* sensu stricto based on phylogenetic analysis. *Mycologia* **92**:105-113.
- Coetzee, M.P.A., Wingfield, B.D., Coutinho, T.A. & Wingfield, M.J. (2000) Identification of the causal agent of *Armillaria* root rot of *Pinus* species in South Africa. *Mycologia* **92**:777-785.
- Coetzee, M.P.A., Wingfield, B.D., Harrington, T.C., Steimel, J., Coutinho, T.A. & Wingfield, M.J. (2001) The root rot fungus *Armillaria mellea* introduced into South Africa by early Dutch settlers. *Molecular Ecology* **10**:387-396.
- Coetzee, M.P.A., Harrington, T.C., Wingfield, B.D., Wingfield, M.J., Coutinho, T.A. & Dalevi, D. (2000) Geographical diversity of *Armillaria mellea* sensu stricto based on phylogenetic analysis. *Mycologia* **92**:105-113.
- Coutinho, T.A., Wingfield, M.J., Roux, J., Riedel, K-H. & Terblanche, J. (2000) First report of bacterial wilt caused by *Ralstonia solanacearum* on eucalypts in South Africa. *Forest Pathology* **30**: 205-210.
- Crous, P.W., Aptroot, A., Kang, J-C., Braun, U. & Wingfield, M.J. (2000) The genus *Mycosphaerella* and its anamorphs. *Studies in Mycology* **45**:107-121.
- Crous, P.W., Li Hong, B.D. Wingfield, & M.J. Wingfield (2001) ITS rDNA phylogeny of selected *Mycosphaerella* spp. And their anamorphs occurring on Myrtaceae. *Mycologia* **105**:425-431.
- Cullis, C.A. & Kunert, K. (2000) Isolation of tissue culture-induced polymorphisms in bananas by Representational Difference Analysis. *Acta Horticulturae* **530**:421-428.
- De Jager, E.S., Hall, A.N., Wehner, F.C. & Korsten, L. (2001) Microbial ecology of the mango phylloplane. *Microbial Ecology* **42**:201-207.
- De Wet, J., Wingfield, M.J., Coutinho, T. & Wingfield, B.D. (2001) Characterisation of the 'C' morphotype of the pine pathogen *Sphaeropsis sapinea*. *Forest Ecology and Management* **5543**: 1-8.
- De Wet, J., Wingfield, M.J., Coutinho, T.A. & Wingfield, B.D. (2000) Characterization of *Sphaeropsis sapinea* isolates from South Africa, Mexico and Indonesia. *Plant Disease* **84**:151-156.
- Denman, S., Crous, P.W., Taylor, J.E., Kang, J-C., Pascoe, J. & Wingfield, M.J. (2000) An overview of the taxonomic history of *Botryosphaeria*, and a re-evaluation of its anamorphs based on morphology and ITS rDNA phylogeny. *Studies in Mycology* **45**:129-140.
- Gwanama, C., Labuschagne, M.T. & Botha, A-M. (2001) Genetic effects and Heterosis of flowering and fruit characteristics of tropical pumpkin. *Plant Breeding* **120**:271-272.
- Gwanama, C., Labuschagne, M.T. & Botha, A-M. (2000) Analysis of genetic variation in *Curcubita moschata* by random polymorphic DNA (RAPD) markers. *Euphytica* **113**:19-26.
- Jacobs, A.S., Pretorius, Z.A. & Coutinho, T.A. (2000) Quantification of early infections structures of *Puccinia recondita* f.sp. *tritici* in wheat with leaf rust resistance derived from *Triticum monococcum*. *South African Journal of Science* **96**:86-90.
- Jacobs, K., Wingfield, M.J., Uzunovic, A. & Frisullo, S. (2001) Three new species of *Leptographium* from pine. *Mycological Research* **105**: 490-499.

- Jacobs, K., Wingfield, M.J. & Crous, P.W. (2000) *Ophiostoma europoides* and *Ceratocystis pseudoeuropoides*, synonyms of *O. piceaperdum*. *Mycological Research* **104**:238-243.
- Jacobs, K., Wingfield, M.J., Jacobs, A. & Wingfield, B.D. (2001) A taxonomic re-evaluation of *Phialocephala phycomyces*. *Canadian Journal of Botany* **79**:110-117.
- Jacobs, K., Wingfield, M.J., Coetsee, C., Kirisits, T. & Wingfield, B.D. (2001) *Leptographium guttulatum* sp. nov., a new species from spruce and pine in Europe. *Mycologia* **93**:380-388.
- Jacobs, K., Wingfield, M.J., Pashenova, N.V. & Vetrova, V.P. (2000) A new *Leptographium* species from Russia. *Mycological Research* **104**:1524-1529.
- Jacobs, K., Wingfield, M.J. & Bergdahl, D.R. (2000) New *Leptographium* species from Indonesia and Eastern North America. *Mycoscience* **41**:595-606.
- Janse van Rensburg, J.C., Labuschagne, N. & Nemeč, S. (2001) Occurrence of *Fusarium*-produced naphthazarins in citrus trees and sensitivity of rootstocks to isomarin in relation to citrus blight. *Plant Pathology* **50**:258-265.
- Labuschagne, P.M., Eicker, A., Aveling, T.A.S., De Meillon, S. & Smith, M.F. (2000) Influence of wheat cultivars on straw quality and *Pleuratus ostreatus* cultivation. *Bioresource Technology* **71**:71-75.
- Lacock, L. & Botha, A.M. (2000) Genotype variation in regeneration and transformation efficiencies of 11 South African wheat cultivars. *South African Journal of Plant and Soil* **17**:1-5.
- Marais, G.J. & Wingfield, M.J. (2001) *Ophiostoma africanum* sp. nov. and a key to other ophiostomatoid fungi associated with *Protea* infructescences. *Mycological Research* **105**:240-246.
- Masuya, H., Wingfield, M.J., Kaneko, S. & Yamaoka, Y. (2000) *Leptographium pini-densiflorae* from Japanese red pine. *Mycoscience* **41**:425-430.
- Maxwell, A., St. J. Hardy, G.E., Wingfield, M.J. & Dell, B. (2000) First record of *Mycosphaerella lateralis* on *Eucalyptus* in Australia. *Australasian Plant Pathology* **29**:279.
- Meyer, L., Slippers, B., Korsten, L., Kotze, J.M. & Wingfield, M.J. (2001) *Guignardia* species associated with citrus in South Africa. *South African Journal of Science* **97**:191-194.
- Okada, G., Jacobs, K., Kirisits, T., Louis-Seize, G.W., Seifert, K.A., Sugita, T., Takematsu, A. & Wingfield, M.J. (2000) Epitypification of *Graphium penicillodes* Corda, with comments on the phylogeny and taxonomy of *Graphium*-like synnematosus fungi. *Studies in Mycology* **45**:169-188.
- Okole, B., Memela, C., Rademan, S., Kunert, K.J. & M. Brunette, M. (2000) Non-conventional breeding approaches for banana and plantain improvement against fungal diseases at AECI. *Acta Horticulturae* **540**:207-214.
- Preisig, O., Moleleki, N., Smit, W.A., Wingfield, B.D. & Wingfield, M.J. (2000) Characterisation of the hypovirulence-mediating RNA virus of *Diaporthe ambigua*. *Journal of General Virology* **81**:3107-3114.
- Roux, J., Coutinho, T.A., Majuni Byabashaija, D. & Wingfield, M.J. (2000) Diseases of plantation *Eucalyptus* in Uganda. *South African Journal of Science* **97**:16-18.
- Roux, J., Coutinho, T.A., Wingfield, M.J. & Bouillet, J.P. (2000) Diseases of plantation *Eucalyptus* in the Republic of the Congo. *South African Journal of Science* **96**:454-456.
- Roux, J., Dunlop, R. & Wingfield, M.J. (2000) Susceptibility of elite *Acacia mearnsii* families to *Ceratocystis* wilt. *Journal of Forest Research* **4**:187-190.
- Roux, J., Steenkamp, E.T., Marasas, W.F.O., Wingfield, M.J. & Wingfield B.D. (2001) Characterisation of *Fusarium graminearum* from *Acacia* and *Eucalyptus* using β -tubulin and histone gene sequences. *Mycologia* **93**:704-711.
- Roux, J., Wingfield, M.J., Bouillet, J-P., Wingfield, B.D. & Aifenas, A.C. (2000) A serious new wilt disease of *Eucalyptus* caused by *Ceratocystis fimbriata* in Central Africa. *Forest Pathology* **30**:175-184.
- Sanders, G.M., Korsten, L. & Wehner, F.C. (2000) Survey of fungicide sensitivity in *Colletotrichum gloeosporioides* from different avocado and mango production areas in South Africa. *European Journal of Plant Pathology* **106**:745-752.
- Schoch, C.L., Crous, P.W., Wingfield, M.J. & Wingfield, B.D. (2000) Phylogeny of *Calonectria* and selected hypoviralean genera with cylindrical macroconidia. *Studies in Mycology* **45**:45-62.
- Schoch, C.L., Crous, P.W., Witthuhn, R.C., Cronwright, G., El-Gholl, N.E. & Wingfield, B.D. (2000) Recombination in *Cylindrocladium morganii* and phylogeny to other heterothallic small spored *Cylindrocladium* species. *Mycologia* **92**:665-673.
- Slippers, B., Wingfield, M.J., Wingfield, B.D. & Coutinho, T.A. (2001) Population structure and possible origin of *Amylostereum areolatum* in South Africa. *Plant Pathology* **50**:206-210.
- Slippers, B., Wingfield, M.J., Wingfield, B.D. & Coutinho, T.A. (2000) Relationships amongst *Amylostereum* species associated with Siricid woodwasps, inferred from mitochondrial ribosomal DNA sequence. *Mycologia* **92**:955-963.
- Smith, H., Crous, P.W., Wingfield, M.J., Coutinho, T.A. & Wingfield, B.D. (2001) *Botryosphaeria eucalyptorum* sp. nov., a new species in the *B. dothidea*-complex on *Eucalyptus* in South Africa. *Mycologia* **93**:277-285.
- Smith, H., Wingfield, M.J., de Wet, J. & Coutinho, T.A. (2000) Genotypic diversity of *Sphaeropsis sapinea* from South Africa and Northern Sumatera. *Plant Disease* **84**:139-142.

- Smith, J.E., Korsten, L. & Aveling T.A.S. (2000) Evaluation of seed treatments for reducing *Colletotrichum dematium* on cowpea seed. *Seed Science and Technology* **27**:591-598.
- Stauffer, C., Kirisits, T., Nussbaumer, C., Pavlin, R. & Wingfield, M.J. (2001) Phylogenetic relationships between the European and Asian eight spined larch bark Beetle populations (Coleoptera: Scolytidae) inferred from DNA sequences and fungal associates. *European Journal of Entomology* **98**:99-105.
- Steenkamp, E., Britz, H., Coutinho, T., Wingfield, B., Marasas, W. & Wingfield, M. (2000) Molecular characterisation of *Fusarium subglutinans* associated with mango malformation. *Molecular Plant Pathology* **1**:187-193.
- Steenkamp E.T., Wingfield, B.D., Coutinho, T.A., Zeller, K.A., Wingfield, M.J., Marasas, W.F.O. & Leslie, J.F. (2000) PCR-based identification of MAT-1 and MAT-2 in the *Gibberella fujikuroi* species complex. *Applied and Environmental Microbiology* **66**:4378-4382.
- Van Der Nest, M.A., Steenkamp, E., Wingfield, B.D. & Wingfield, M.J. (2000) Development of simple sequence repeats (SSR) markers in *Eucalyptus* from amplified Inter-simple sequence repeats (ISSR). *Plant Breeding* **119**:433-436.
- Van Heerden, S.W. & Wingfield, M. (2001) Genetic diversity of *Cryphonectria cubensis* isolates in South Africa. *Mycological Research* **105**:94-99.
- Venter, M., Wingfield, M.J. & Coutinho, T.A. (2001) Molecular characterization of *Endothia gyrosa* isolates from *Eucalyptus* in South Africa and Australia. *Plant Pathology* **50**: 211-217.
- Venter, E. & Botha, A-M. (2000) Development of markers linked to *Diuraphis noxia* resistance in wheat using a novel PCR-RFLP approach. *Theoretical Applied Genetics* **100**:268-274
- Viljoen, C.D., Wingfield, B.D. & Wingfield, M.J. (2000) Computer aided systematic evaluation of morphological characters of the Ophiostomatoid fungi. *Mycotaxon* **74**:217-240.
- Viljoen, C.D., Wingfield, M.J., Jacobs, K. & Wingfield, B.D. (2000) *Cornuvesica*, a new genus to accommodate *Ceratocystiopsis falcata*. *Mycological Research* **104**:365-367.
- Wikler, K., Gordon, T.R., Clark, S.L., Wingfield, M.J. & Britz, H. (2000) Potential for outcrossing in an apparently asexual population of *Fusarium circinatum*, the causal agent of pitch canker disease. *Mycologia* **92**:1085-1090.
- Wingfield, M.J., Roux, J., Coutinho, T., Govender, P. & Wingfield, B.D. (2001) Plantation disease and pest management in the next century. *South African Forestry Journal* **190**:67-71.
- Wingfield, M.J., van Wyk, P.S. & W. Bryce Kendrick (2001) Analysis of conidogenesis: Helical conidiotaxis in percurrently extending conidiogenous cells. *South African Journal of Science* **96**:580-584.
- Witthuhn, R.C., Harrington, T.C., Wingfield, B.D., Steimel, J.P. & Wingfield, M.J. (2000) Deletion of the MAT-2 mating type gene during uni-directional mating type switching in *Ceratocystis*. *Current Genetics* **38**:48-52.
- Witthuhn, R.C., Harrington, T.C., Steimel, J.P., Wingfield, B.D. & Wingfield, M.J. (2000) Comparison of isozymes, rDNA spacer regions, and MAT-2 DNA sequences as Phylogenetic characters in the analysis of the *Ceratocystis coerulescens* complex. *Mycologia* **92**:447-452.
- Wolfaardt, F., Rabie, C. & Wingfield, M. (2000) Application of fungi and fungal products in biopulping Part 11: biopulping of non-wood fibre. Journal for the Technical Association of the Pulp and Paper Industry of Southern Africa January November 17-19.
- Xu Dong Zhou, Jacobs, K., Morelet, M., Ye, H., Lieutier, F. & Wingfield, M.J. (2000) A new *Leptographium* species associated with *Tomicus piniperda* in South Western China. *Mycoscience* **41**:573-578.

Books

- Jacobs, K. & Wingfield, M.J. (2001) *Leptographium* species: Tree pathogens, insect associates and agents of blue stain. American Phytopathological Society Press, St. Paul, Minnesota, U.S.A.

Chapters in Books and Symposium Proceedings

- Bornman, C.H. & Botha, A-M. (2000) Somatic seed: Balancing expectations against achievements. Forest genetics for the next millennium. Proceedings of the IUFRO Working party 2.08.01. p. 76-79.
- Cullis, C.A. & Kunert, K. (1999) Isolation of tissue culture-induced polymorphisms in bananas by representational difference analysis. In: *Plant Biotechnology and In Vitro Biology in the 21st Century*. Eds. A. Altman, M. Ziv, S. Izhar. Kluwer Academic Publishers, Dordrecht. Pp. 245-249.
- Gedgil, P., Wardlaw, T.J., Ferreira, F.A., Sharma, J.K., Dick, M.A., Wingfield, M.J. & Crous, P.W. (2000) Management of diseases in plantations. In: *Diseases and pathogens of Eucalyptus*. Eds. P.J. Keane, G.A. Kile, F.D. Podger and N. Brown. CSIRO Publishing Australia.
- Garnier, M., Bove, J.M., Cronje, C.P.R., Sanders, G.M., Korsten, L. & le Roux, H.F. (2000) Presence of *Candidatus liberobacter africanum* in the Western Cape Province of South Africa. Fourteenth International Conference on Citrus Virology, Brazil, September, 1998, pp. 369-372.
- Gulya, T.J., Van Wyk, P.S., & Viljoen, A. (2000) Resistance to white rust (*Albugo tragopogonis*) and evidence of multiple genes. Proceedings of the 15th

International Sunflower Conference, Toulouse, France. Pp. 126-130.

Kirisits, T., Fuhrer, E. & Wingfield, M.J. (2000) Pathogenicity of the bark beetle transmitted blue-stain fungi *Ceratocystis polonica* and *Ceratocystis lanicicola* to Norway spruce (*Picea abies* [L.] Karst.) and to European Larch (*Larix decidua* Mill) in central Europe. Proceedings of the International Conference on Forest Ecosystem Restoration. Vienna, Austria, April 2000.

Klopper K.C., Regnier, T. & Botha, A-M. (2000) Inhibition of *in vitro* rooting of *Eucalyptus grandis* in South Africa as a result of phenolic excretion. Polyphenols Communications 2000, Vol 2, p. 631-632.

Klopper K.C., Regnier, T., Wingfield, B.D. & Botha, A-M. (2000) Rooting inhibition as a result of phenolic excretion. Forest genetics for the next millennium. Proceedings of the IUFRO Working party 2.08.01. p. 251.

Korsten, L. & De Jager, E.S. (2000) Status of quality standards in the South African fruit industries. Proceedings of the 19th ASEAN Postharvest Seminar on Quality Assurance in Agricultural Produce. Ho Chi Minh City, Vietnam, November 1999 pp 599-608.

Korsten, L. & Jeffries, P. (2000) Potential for biological control of diseases caused by *Colletotrichum*. In: *Colletotrichum Host Specificity, Pathology and Host-Pathogen Interactions*. Eds. D. Prusky, S. Freeman & M.B. Dickman. APS Press, USA.

Kunert, K.J., Vorster, J., Bey, E. & Cullis, C.A. (2000) Representational difference analysis as a DNA-based quality assurance procedure for date palm micropropagation. Proceedings of the Date Palm International Symposium. Windhoek, Namibia. Pp. 74-80.

Okole, B.N., Memela, C. Chibba, V., Rademan, S., Kunert, K. & Cullis C. (1999) Involvement of biotechnology in commercial plant tissue culture. In: *Plant Biotechnology and In Vitro Biology in the 21st Century*. Eds. A. Altman, M. Ziv, S. Izhar. Kluwer Academic Press, Dordrecht. Pp 725-728.

Park, R.F., Keane, P., Wingfield, M.J. & Crous, P.W. (2000) Fungal leaf diseases of *Eucalyptus*. In: *Diseases and pathogens of Eucalyptus*. Eds. P.J.Keane, G.A. Kile, F.D. Podger and N. Brown. CSIRO Publishing Australia.

Roux, J., Dunlop, R. & Wingfield, M.J. (2000) Development of disease tolerant *Acacia mearnsii*. Proceedings of the IUFRO Symposium on Forest Genetics and Tree Improvement. Durban, October 2000.

Van Heerden S., Wingfield, M.J., Preisig, O. & Wingfield, B.D. (2000) Progress towards reducing the impact of *Cryphonectria* canker in South Africa. Proceedings of the IUFRO Symposium on Forest Genetics and Tree Improvement. Durban, October 2000

Van Heerden, S.W. & Wingfield, M.J. (2000) Strategies line to reducing the impact of *Cryphonectria*

canker in South Africa. Proceedings of the IUFRO World Congress Vol. 2, 293-294. Kuala Lumpur, Malaysia. 7-12 August 2000.

Venter, E., Botha, A-M., Wingfield, B.D. & Wingfield, M.J. (2000) Development of a differential display library from *Pinus patula* upon infection with *Fusarium circinatum*. Forest genetics for the next millennium. Proceedings of the IUFRO Working party 2.08.01. p. 257.

Wingfield, M.J. & Roux, J. (2000) Forest pathogens, forests and society. Proceedings of the IUFRO World Congress Vol. 1, 174-180. Kuala Lumpur, Malaysia. 7-12 August 2000.

Wingfield, M.J., Roux, J., Govender, P., Coutinho, T.A. & Wingfield, B.D. (2000) Plantation disease and pest management in the next century. Proceedings of the IUFRO Symposium on Forest Genetics and Tree Improvement. Durban, October 2000.

Papers/Posters delivered at International Conferences

Adams, G.C. & Wingfield, M.J. (2001) Morphology and molecular phylogenetics of *Cytospora* species on *Eucalyptus*. Annual Meeting of the American Phytopathological Society, Salt Lake City, Utah, USA, 25-29 August 2001. Phytopathology 91, S101.

Adandonon, A., Aveling, T.A.S., Labuschagne, N. & Ahojuendo, B. (2000) Damping-off disease of cowpea in the Ouémé valley, Benin. National Institute of Agricultural Research of Benin Seminar, Cotonou, Benin. May 2000.

Adandonon, A., Aveling, T.A.S., Labuschagne, N. & Ahojuendo, B. (2000) Damping-off disease of cowpea in the Ouémé valley, Benin: Epidemiology, causal agent and mycoparasitism. PEDUNE/RENACO International Conjoint Workshop on integrated protection management of cowpea. IITA, Cotonou, Benin. June, 2000.

Aveling, T.A.S. & Powell, A.A. (2001) Effect of storage potential and seed coat pigmentation on susceptibility of cowpeas to pre-emergence damping-off. 26th Congress of the International Seed Testing Association. Angers, France. 14 - 22 June 2001.

Aveling, T.A.S. & Powell, A.A. (2000) Susceptibility of cowpea cultivars of differing seed coat pigmentation to damping-off. Third World Cowpea Research Conference, International Institute of Tropical Agriculture, Ibadan, Nigeria. 4-7 September 2000.

Aveling, T.A.S. (2000) Microscopy Conference, London, United Kingdom. 27-30 March 2000. Attendance only.

Aveling, T.A.S. (2000) Chairperson of the conference opening plenary session. Third World Cowpea Research Conference, International Institute of Tropical Agriculture, Ibadan, Nigeria. 4-7 September 2000.

Aveling, T.A.S. (2001) The International Society of Plant Pathology-Sponsored Instructional Technology

Symposium 2001. Online <http://www.spp-itsymposium.org.nz>. Participation in discussions.

Barnes J., Roux J., Coetzee M.P.A., B.D. Wingfield, T.A. Coutinho & M.J. Wingfield (2000) Characterization of *Seiridium* isolates associated with cypress canker based on molecular sequence data. Annual Meeting of the American Phytopathological Society, New Orleans, USA, 9 - 16 August 2000. *Phytopathology* 90, S5.

Bester, C., Kunert, K.J. & Cullis, C.A. (2001) Are transgenic plants normal? Plant & Animal Genome IX Conference. 13-17 January, 2001. San Diego, CA.

Bornman C.H., Botha, A-M. & Dickens, O.S.P. (2000) Somatic seed: Balancing expectations against achievements. IUFRO Working party 2.08.01, Durban, South Africa, 8-13 October 2000.

Bornman, CH, Botha, A-M., Steyn, A., van der Merwe, C. & Dickens, O.S.P. (2000) The disadvantaged embryo. 4th International Symposium on *In vitro* culture and Horticultural Breeding, Tampere, Finland, 2 -7 July 2000.

Botha, A-M. & Lottering, J.M. (2000) Linked markers to leaf rust resistance gene Lr41. SAPBA, Harare, Zimbabwe, 13-16 March 2000.

Botha, A-M. & Venter, E. (2000) Development of markers against RWA resistance using novel approaches. SAPBA, Harare, Zimbabwe, 13-16 March 2000.

Botha, A-M, Lacock, L., van Niekerk, C., Loots, S. & du Preez, F.B. (2001) Evaluation of Expressed Sequence Tags (ESTs) from Russian wheat aphid induced wheat cDNA libraries. Annual meeting of the American Society of Plant Biology, Providence, Rhode Island, USA, 21-25 July 2001.

Coetzee, M.P.A., Wingfield, B.D., Bloomer, P. & Wingfield, M.J. (2001) Phylogeny of southern hemisphere *Armillaria* species. Annual Meeting of the American Phytopathological Society, Salt Lake City, Utah, USA, 25 - 29 August 2001. *Phytopathology* 91, S106.

Coutinho, T.A., Oosthuizen, M.C. & Wingfield, M.J. (2000) Bacterial blight and die-back of *Eucalyptus* species, clones and hybrids in South Africa. Annual Meeting of the American Phytopathological Society, New Orleans, USA, 9 - 16 August 2000. *Phytopathology* 90, S16.

Cullis, C.A., Kunert, K. & Okole, B. (2000) Markers for Determining Genomic Integrity: Somaclonal variants in bananas as a model system. October 2000. The 2nd International Symposium on the Molecular and Cellular Biology of Banana, 29-3 October/November, 2000. Byron Bay, Australia.

De Jager, E.S., Hall, A.N., Wehner, F.C. & Korsten, L. (2000) Microbial ecology of the mango phylloplane. 7th International Symposium on the Microbiology of Aerial Plant Surfaces, University of California, Berkeley, USA, 3-8 August 2000.

De Jager, E.S., Hall, A.N., Wehner, F.C. & Korsten, L. (2000) Microbial ecology of the mango antho- and fructoplane. 7th International Symposium on the Microbiology of Aerial Plant Surfaces, University of California, Berkeley, USA, 3-8 August 2000.

De Wet J., Wingfield, M.J., Coutinho, T.A. & Wingfield, B.D. (2000) Characterization of a third morphotype of *Sphaeropsis sapinea*. Annual Meeting of the American Phytopathological Society, New Orleans, USA, 9 - 16 August 2000. *Phytopathology* 90, S18.

De Wet J., Moleleki, N., Preisig, O., Wingfield, M.J. & Wingfield, B.D. (2001) Occurrence of dsRNA elements in isolates of the pine pathogen *Sphaeropsis sapinea* from diverse geographic sources. Annual Meeting of the American Phytopathological Society, Salt Lake City, Utah, U.S.A., August 2001. *Phytopathology* 91, S22.

De Wet J., Wingfield, M.J., Coutinho, T.A., Preisig, O., Roux, J., Smith, H. & Wingfield, B.D. (2000) *Sphaeropsis sapinea*: an important pathogen in exotic pine plantations. Proceedings of the IUFRO World Congress Vol. 3, pp.361-362. Kuala Lumpur, Malaysia. 7-12 August 2000.

Denman, S., Crous, P.W. & Wingfield, M.J. (2001) *Botryosphaeria dothidea* as an endophyte in *Protea magnifica*: A comparison of commercially cultivated and naturally occurring plants. Annual Meeting of the American Phytopathological Society, Salt Lake City, Utah, USA, August 2001. *Phytopathology* 91, S23.

Doyle, J., Botha, A-M. & Wingfield, B.D. (2000) Determination of parental contributions using SSR technology. 4th International Symposium on *In vitro* culture and Horticultural Breeding, Tampere, Finland, 2 -7 July 2000.

Geldenhuis, M.M., Roux, J., Wingfield, B.D., de Beer, Z.W. & Wingfield, M.J. (2001) Ophiostomatoid fungi associated with diseased *Schizolobium parahybum*. Annual Meeting of the American Phytopathological Society, Salt Lake City, Utah, USA, August 2001. *Phytopathology* 91, S31.

Geldenhuis, M.M., Roux, J., Wingfield, B.D. De Beer, Z.W. & Wingfield, M.J. (2001) Ophiostomatoid fungi associated with diseased *Schizolobium parahybum*. APS/SGN/MSA Joint Meeting August 25-29, Salt Lake City, Utah, USA.

Govender, P., Wingfield, M.J., McGeoch, M.A. & Scholtz, C.H. (2000) A national perspective of forest tree pests in South Africa. XXI International Congress of Entomology, XVIII Brazilian Congress of Entomology. Abstracts Book II, p. 883. Foz do Iguassu, Brazil. 20 - 26 August 2000.

Guliyeva, T.J., Van Wyk, P.S., & Viljoen, A. (2000) Resistance to white rust (*Abugo tragapogonis*) and evidence of multiple genes. 15th International Sunflower Conference, Toulouse, France.

Hunter, G.C., Roux, J., Coutinho, T.A., Crous, P.W., Wingfield, B.D. & Wingfield, M.J. (2001) *Mycosphaerella* species causing *Mycosphaerella* leaf blotch on *Eucalyptus* species in South Africa. Annual Meeting of the American Phytopathological Society,

Salt Lake City, Utah, USA, August 2001. *Phytopathology* 91, S41.

Jacobs, K. & Wingfield, M.J. (2001) *Leptographium* species. Tree pathogens, insect associates and agents of blue stain. Annual Meeting of the American Phytopathological Society, Salt Lake City, Utah, U.S.A., 25-29 August 2001. *Phytopathology* 91, S113

Klopper, K.C., Regnier, T. & Botha, A-M. (2000) Inhibition of *in vitro* rooting of *Eucalyptus grandis* in South Africa as a result of phenolic excretion. XXth International Conference on Polyphenols 2000, Freising-Weiherstephan, Germany, September 11-15, 2000.

Klopper, K.C., Regnier, T., Wingfield, B.D. & Botha, A-M. (2000) Rooting inhibition as a result of phenolic excretion. IUFRO Working party 2.08.01, Durban, South Africa, 8-13 October 2000.

Korsten, L. (2000) Status of citrus greening in South Africa. Workshop on citrus greening, Hanoi, Vietnam, 30 March - 3 April 2000. Hosted by ACIAR and CIRAD. Invited Paper.

Korsten, L. (2000) A review of biological control of postharvest diseases of subtropical fruits in South Africa. International Symposium on Tropical and Subtropical fruits. Cairns Australia, 26 November - 1 December 2000.

Korsten, L. (2000) Control measures. Workshop on exotic vectored pathogens of citrus. University of Florida, IFAS Citrus Research and Education Center, Lake Alfred, Florida, USA. 8-9 December 2000. Invited Paper.

Korsten, L. & de Jager, E.S. (1999) Status of quality standards in the fruit industries. 19th ASEAN Postharvest Seminar on Quality Assurance in Agricultural Produce. Ho Chi Minh City, Vietnam, November 1999.

Korsten, L., de Jager, E.S., Paul, I., Obagwu, J. & El-Ghaouth, A. (2000) Alternative control of citrus postharvest diseases. International Society of Citriculture Ninth Congress 2000, Walt Disney World's Coronado Springs Resort - Orlando, Florida, USA. 3-7 December 2000.

Korsten, L., Juckers, E. & Sanders, G.M. (2000) Survey of citrus greening disease in South Africa. International Society of Citriculture Ninth Congress 2000, Walt Disney World's Coronado Springs Resort, Orlando, Florida, USA. 3-7 December 2000.

Kritzing, Q., Aveling, T.A.S. & Marasas, W.F.O. (2001) Contamination of cowpea (*Vigna unguiculata* (L.) Walp) seed by storage fungi and mycotoxins. British Mycological Society International Symposium on Bioactive Fungal Metabolites - Impact and Exploitation. University of Wales, Swansea, Wales. 22-27 April 2001.

Kritzing, Q., Aveling, T.A.S. & Marasas, W.F.O. (2001) Effect of essential plant oils on the growth of storage fungi associated with cowpea seeds. 26th

Congress of the International Seed Testing Association. Angers, France. 14 - 22 June 2001.

Kritzing, Q., Aveling, T.A.S., Marasas, W.F.O., Shephard, G.S. & Leggott, N.L. (2000) Detection of fumonisin B1 in cowpea seeds. World Cowpea Research Conference III, IITA, Ibadan, Nigeria, 4-7 September 2000.

Kunert, K.J., Van der Vyver, C., Cullis, C. & Foyer, C.H. (2001) Evaluation of oryzacystatin I expressing plants for abiotic stress resistance. *Plant Biology* 2001. 21-25 July, 2001. Providence, RI.

Kunert, K.J., Vorster, J. & Cullis, C.A. (2000) DNA microchip technology in the plant tissue culture industry. Spring 2000 ACS National Meeting. 26-30 March, 2000. San Francisco, CA.

La Grange, N., Aveling, T.A.S. & Venter, S.L. (2000) A new disease of cowpea caused by *Alternaria cassiae*. World Cowpea Research Conference III, IITA, Ibadan, Nigeria, 4-7 September 2000.

Loots, A., Botha, A-M., Lottering, J.M. & Tröskle, C. (2000) Comparative study between the genetic analysis of wheat cultivars using RAPDs, AFLPs and microsatellites. SAPBA, Harare, Zimbabwe, 13-16 March 2000.

Moleleki, N., Preisig, O., Wingfield, M.J. & Wingfield, B.D. (2001) Studies of the effects of *Diaporthe ambigua* RNA virus (DaRV) on naturally infected and transfected isolates of *Diaporthe ambigua*. 6th International Symposium on Positive Strand RNA Viruses. May 28- June 2. Institut Pasteur, Paris, France.

Preisig, O., Moleleki, N., Smit, W.A., Wingfield, B.D. & Wingfield, M.J. (2001) A novel RNA virus in the fungus *Diaporthe ambigua* is related to plant Tombusviridae. Sixth International Symposium on Positive Strand RNA Viruses. 28 May - June 2. Institut Pasteur, Paris, France.

Roux, J., Coutinho, T.A., Mujuni Byabashaija, D. & Wingfield, M.J. (2000) Diseases of plantation forest trees in Uganda. Annual Meeting of the American Phytopathological Society, New Orleans, USA, 9 - 16 August 2000. *Phytopathology* 90, S67.

Roux, J., Nkabonge, G., Barnes, I., Wingfield, M.J. & Wingfield, B.D. (2001) *Ceratocystis albofundus*, a wilt pathogen of *Acacia mearnsii* in Africa. Annual Meeting of the American Phytopathological Society, Salt Lake City, Utah, USA, 25-29 August 2001. *Phytopathology* 91, S77.

Roux, J., Heath, R.N., van der Hoef, A. & Wingfield, M.J. (2001) First report of pink disease on *Eucalyptus* and *Podocarpus* in South Africa. Annual Meeting of the American Phytopathological Society, Salt Lake City, Utah, U.S.A., 25-29 August 2001. *Phytopathology* 91, S78.

Sanders, G.M. & Korsten, L. (2000) Use of correlation analysis for the study of anthracnose on avocados and mangoes in South Africa. International Symposium on

Tropical and Subtropical fruits. Cairns Australia, 26 November - 1 December 2000.

Smith, J.E., Korsten, L., Denner, F.D.N. & Raatjes, P. (2000) Adapting PLANT-Plus for early blight of potatoes in South Africa. World Potato Congress 2000. Amsterdam, Netherlands.

Steenkamp, E.T., Coutinho, T.A., Desjardins, A.E., Wingfield, B.D., Marasas, W.F.O. & Wingfield, M.J. (2001) Cryptic speciation in *Giberella fujikuroi* mating population E. Annual Meeting of the American Phytopathological Society, Salt Lake City, Utah, USA, 25-29 August 2001. *Phytopathology* 91, S124.

Troskie, C., Kloppers, F.J. & Botha, A-M. (2000) Molecular markers for resistance gene Lr37 in wheat breeding. SAPBA, Harare, Zimbabwe, 13-16 March 2000.

Van der Waals, J.E., Korsten, L. & Denner, F.D.N. (2001) Accuracy of spore dispersal module in the potato early blight forecaster, Plant-Plus, in South Africa. 8th International Workshop on Plant Disease Epidemiology, 6-11 May 2001, Ouro Preto, Brazil.

Van Heerden, S., Preisig, O., Wingfield, B.D. & Wingfield, M.J. (2001) Characterisation of mitoviruses associated with the fungal pathogen *Cryphonectria cubensis*. 6th International Symposium on Positive Strand RNA viruses. May 28- June 2. Institut Pasteur, Paris, France.

Venter, E., Wingfield, B.D., Wingfield, M.J. & Botha, A-M. (2000) Identification of a resistance response in *Pinus patula*. International Symposium on Durable resistance, Ede-Wageningen, De Reeherst, The Netherlands, 28 November - 1 December 2000.

Venter, M., Wingfield, M.J., Coutinho, T.A. & Wingfield, B.D. (2000) *Endothia gyrosa* from *Eucalyptus* represents a new fungal taxon. Annual Meeting of the American Phytopathological Society, New Orleans, USA, 9 - 16 August 2000. *Phytopathology* 90, S80.

Venter, M., Coutinho, T.A. & Wingfield, M.J. (2000) Pathogenicity of *Endothia gyrosa* on *Eucalyptus* in South Africa. Annual Meeting of the American Phytopathological Society, New Orleans, USA, 9 - 16 August 2000. *Phytopathology* 90, S80.

Venter, E., Botha, A-M., Wingfield, B.D. & Wingfield, M.J. (2000) Development of a differential display library from *Pinus patula* upon infection with *Fusarium circinatum*. IUFRO Working party 2.08.01, Durban, South Africa, 8-13 October 2000.

Venter, M., Myburg, H., Wingfield, M.J. & Wingfield, B.D. (2001) *Cryphonectria cubensis* represents a new genus comprised of three species. Annual Meeting of the American Phytopathological Society, Salt Lake City, Utah, USA, 25-29 August 2001. *Phytopathology* 91, S125.

Viljoen, A. (2000) Research on *Fusarium* wilt of banana in South Africa. *Fusarium* Workgroup Meeting, 2nd Global Meeting on Banana, Bangkok, Thailand.

Wingfield, B.D., Ericson, L. & Burdon, J. (2001) Fungal rust DNA sequences demonstrate new relationships. APS/SOM/MSA Joint Meeting August 25-29, Salt Lake City, Utah, USA.

Wingfield, M.J., Slippers, B., Zhou Xu Dong, De Beer, W., Govender, P. & Wingfield, B.D. (2000) Global spread of insect associated fungi on exotic plantation pines. Proceedings of the IUFRO World Congress Vol. 2, pp. 309-310. Kuala Lumpur, Malaysia. 7-12 August 2000.

Wingfield, M.J., Govender, P., Roux, J. & Wingfield, B.D. (2000) Associations of insects and pathogens resulting in disease and damage to plantation grown *Eucalyptus* in the tropics and southern hemisphere. XXI International Congress of Entomology, XVIII Brazilian Congress of Entomology. Abstracts Book I, pp. 501. Foz do Iguassu, Brazil. 20 - 26 August 2000.

Papers/posters delivered at national conferences

Adandonon, A., Aveling, T.A.S., Labuschagne, N. & Ahojuendo, B. (2001) Epidemiology of the damping-off disease in the Ouémé valley, Benin. 39th South African Society for Plant Pathology, Greenway Woods, Nelspruit.

Aveling, T.A.S. & Powell, A.A. (2000) Surface topography of cowpea seed with different testa colours. 39th Annual Conference Microscopy Society of Southern Africa, Rhodes University, Grahamstown. 6-8 December 2000.

Aveling, T.A.S. & Powell, A.A. (2001) Susceptibility of cowpea seeds with different seed coat colours to damping-off. 39th South African Society for Plant Pathology, Greenway Woods, Nelspruit.

Bahimann, L., Govender, P. & Botha, A-M. (2000) Russian wheat aphid (*Diuraphis noxia*) induced protein alterations in wheat. BioY2K Combined Millennium Meeting, Grahamstown, 23-28 January 2000.

Bahimann, L., Govender, P. & Botha, A-M. (2001) Induction of proteins upon infestation of wheat (*Triticum aestivum* L.) by the Russian wheat aphid (*Diuraphis noxia*). Congress of the Entomological Society of Southern Africa, Pietermaritzburg, July 2001.

Bandounas, T., Aveling, T.A.S. & van der Merwe, C.F. (2000) Stripping method for studying host-pathogen interaction - applications and usefulness. Technical Forum of the Microscopy Society of Southern Africa (MSSA) Conference, Rhodes University, Grahamstown, 6-8 December 2000.

Bandounas, T., Aveling, T.A.S., Viljoen, A., & van der Merwe, C.F. (2000) Colonisation of sunflower cotyledons and leaves by *Albugo tragopogonis*. Microscopy Society of Southern Africa (MSSA) Conference, Rhodes University, Grahamstown, 6-8 December 2000.

- Bandounas, T., Viljoen, A., & Aveling, T.A.S. (2001) Ethograph of *Albugo tragopogonis* on sunflower. 39th South African Society for Plant Pathology, Greenway Woods, Nelspruit.
- Bandounas, T., Viljoen, A. & Aveling, T.A.S. (2000) A novel approach for the inoculation and storage of *Albugo tragopogonis*. BioY2K Combined Millennium Conference, Rhodes University, Grahamstown, 23-25 January 2000.
- Barnes, I., Gaur, A., Roux, J., Burgess, T. & Wingfield M. (2001) Development of microsatellite markers for *Ceratocystis fimbriata*. Proceedings of the Southern African Society for Plant Pathology, Greenway Woods, Nelspruit, South Africa, 21-24 January 2001.
- Bester, C., Whitehead, C. & Kunert, K.J. (2000) Cystatin overexpression and cold tolerance in plants. 26th Annual Conference of the South African Association of Botany. 10-14 January 2000. Potchefstroom, South Africa.
- Bhoora, R., Chimwamurombe, P.M., Wingfield, B.D. & Wingfield, M.J. (2000) Cloning and sequence analysis of the polygalacturonase gene of *Cryphonectria cubensis*, a serious *Eucalyptus* canker pathogen. Proceedings of the South African Society for Biochemistry and Molecular Biology, Grahamstown, 26-27 January 2000.
- Britz, H., Wingfield, M.J., Coutinho, T.A. & Marasas, W.F.O. (2000) Influence of female fertility and mating type distribution on mating population H of *Gibberella fujikuroi* in South Africa. Proceedings of the Southern African Society for Plant Pathology, Grahamstown, 27-28 January 2000. South African Journal of Science 97: (vii).
- Burger, M.C. & Labuschagne, N. (2000) Reaction of citrus rootstocks to *Phytophthora nicotianae*, *Fusarium solani* and *Tylenchulus semipenetrans* infection under field conditions. Citrus Research Conference, July 2000, Nelspruit.
- Burgess, T., de Wet, J., Wingfield, M.J. & Wingfield, B.D. (2000) Identification of *Sphaeropsis sapinea* morphotypes by a microsatellite-based PCR fingerprinting assay. Proceedings of Southern African Society for Plant Pathology, Grahamstown 27-28 January 2000. South African Journal of Science 97: (ix).
- Burgess, T., Wingfield, B.D., StJ. Hardy, G.E. & Wingfield, M.J. (2000) Efficacy of quarantine in restricting the spread of forest tree pathogens. Proceedings of the Southern African Society for Plant Pathology, Grahamstown 27-28 January 2000. South African Journal of Science 97: (x).
- Chimwamurombe, P.M., Wingfield, B.D., Botha, A-M. & Wingfield, M.J. (2000) Isolation and sequence analysis of an endopolygalacturonase gene from the pitch canker fungus *Fusarium circinatum*. Proceedings of the South African Society for Biochemistry and Molecular Biology, Grahamstown, 26-27 January 2000.
- Coetzee, M.P.A., Wingfield, B.D. & Wingfield, M.J. (2000) Clonal diversity of *Armillaria fuscipes* in South African pine plantations. Proceedings of the Southern African Society for Plant Pathology, Grahamstown 27-28 January 2000. South African Journal of Science 97: (xvii).
- Coetzee, M.P.A., Wingfield, B.D. & Wingfield, M.J. (2000) Phylogenetic relationships of the Southern Hemisphere *Armillaria* species. Proceedings of the Southern African Society for Plant Pathology, Grahamstown, 27-28 January 2000. South African Journal of Science 97 (iv).
- Coutinho, T.A., van Zyl, L. & Wingfield, M.J. (2000) A study on the synergistic relationship between *Coniothyrium zuluense* and two *Pantoea* species. Proceedings of the Southern African Society for Plant Pathology, Grahamstown, 27-28 January 2000. South African Journal of Science 97: (xi).
- De Beer, Z.W., Zhou, X.D. & Wingfield, M.J. (2000) Assessment of sapstrain on pine logs in South Africa. Proceedings of the Southern African Society for Plant Pathology, Grahamstown 27-28 January 2000. South African Journal of Science 97: (xi).
- De Beer, W., Zhou, X.D., Crous, P.W. & Wingfield, M.J. (2001) Taxonomic relationships in the *Sporothrix eucalypti* complex. Proceedings of the Southern African Society for Plant Pathology, Greenway Woods, Nelspruit, South Africa, 21-24 January 2001.
- De Jager, E.S. & Korsten, L. (2000) Quality standards in litchi packinghouses. BioY2K Combined Millennium Meeting, Grahamstown, 23-28 January 2000.
- De Meillon, S., Klopper, K.C., van de Venter, A.H. & Botha, A-M. (2000) Water uptake and early metabolism of maize seeds as affected by oxygen. SAAB, Potchefstroom, 10-14 January 2000.
- De Wet, J., Wingfield, M.J., Coutinho, T.A. & Wingfield, B.D. (2000) Characterisation of *Sphaeropsis sapinea* isolates from South Africa, Mexico and Indonesia. Proceedings of the Southern African Society for Plant Pathology, Grahamstown, 27-28 January 2000. South African Journal of Science 97: (xii).
- De Wet, J., Wingfield, M.J., Preisig, O., Coutinho, T.A. & Wingfield, B.D. (2000) Diversity among dsRNA viruses associated with the pine pathogen, *Sphaeropsis sapinea*. Proceedings of the South African Society for Microbiology, Grahamstown, 25-26 January 2000.
- De Wet, J. & Korsten, L. (2001) Evaluering van chemikalieë in die na-oes omgewing vir die beheer van na-oes siektes. South African Mango Research Symposium, 21 June 2001, Tzaneen.
- De Wet, J., Wingfield, M.J., Burgess, T. & Wingfield, B.D. (2001) Characterisation of *Sphaeropsis sapinea* morphotypes. Proceedings of the Southern African Society for Plant Pathology, Greenway Woods, Nelspruit, South Africa, 21-24 January 2001.
- Denman, S., Crous, P.W. & Wingfield, M.J. (2001) Studies on the epidemiology of Botryosphaeria stem canker of *Protea magnifica*. Proceedings of the Southern African Society for Plant Pathology,

Greenway Woods, Nelspruit, South Africa, 21-24 January 2001.

Fourie, A., Aucamp, J.P., Labuschagne, N. & Apostolides, Z. (2000) The role of the phytoalexin scoparone in resistance of citrus rootstocks to root pathogens. Citrus Research Conference, July 2000, Nelspruit.

Fourie, A., Labuschagne, N., Aucamp, J.P. & Apostolides, Z. (2000) Detection of the phytoalexin scoparone in citrus roots and the effect of scoparone and fosetyl-Al on mycelial growth of *Phytophthora nicotianae*. SASPP Congress, January 2000, University of Rhodes, Grahamstown.

Goldenhuis, M.M., Wingfield, M.J., Coutinho, T.A., Wingfield, B.D. & Schoeman, M. (2000) Taxonomy and rapid identification of the guava wilt pathogen in South Africa. Proceedings of the Southern African Society for Plant Pathology, Grahamstown, 27-28 January 2000. South African Journal of Science 97: (xxii).

Goldenhuis, M.M., Wingfield, M.J., Roux, J., Wingfield, B.D. & de Beer, Z.W. (2001) *Graphium* species associated with diseased *Schizolobium parahybum* in Ecuador. Proceedings of the Southern African Society for Plant Pathology, Greenway Woods, Nelspruit, South Africa. 21-24 January 2001.

Govender, P. & Wingfield, M. J. (2001) Effects of slash management on wattle establishment pests in the Natal Midlands. Congress of the Entomological Society of Southern Africa, Pietermaritzburg. July 2001.

Govender, V. & Korsten, L. (2001) Evaluating biological control for mango postharvest diseases control. South African Mango Research Symposium, 21 June 2001, Tzaneen.

Grimbeek, E., Viljoen, A., Prinsloo, J., Wingfield, M.J. & Coutinho, T.A. (2000) Field evaluation of the effect of a nematocide and suppressive soils on the development of Panama disease. Proceedings of the Southern African Society for Plant Pathology, Grahamstown, 27-28 January 2000. South African Journal of Science 97: (xv).

Grimbeek, E.J., Viljoen, A., Coutinho, T.A. & Wingfield, M.J. (2001) The distribution and spread of *Fusarium* wilt of bananas in South Africa. Proceedings of the Southern African Society for Plant Pathology, Greenway Woods, Nelspruit, South Africa. 21-24 January 2001.

Grimbeek, E.J., Viljoen, A., Prinsloo, J., Wingfield, M.J., & Coutinho, T.A. (2000) Field evaluation of the effect of a nematocide and suppressive soils on the development of Panama disease. BioY2K Combined Millennium Conference, Grahamstown.

Grobler, L., Jacobs, R. & Korsten, L. (2001) Die etiologie van terugsterwing op mangobome. South African Mango Research Symposium, 21 June 2001, Tzaneen.

Harrison, J. du G., Govender, P., Wingfield, M.J., Scholtz, C.H. & Wingfield, B.D. (2001) Molecular and

morphological approaches to forest whitegrub (Scarabaeidae) identification. Congress of the Entomological Society of Southern Africa, Pietermaritzburg. July 2001.

Havanga, W., de Jager, E.S. & Korsten, L. (2000) Mode of action of *Bacillus subtilis*. BioY2K Combined Millennium Meeting, Grahamstown, 23-28 January 2000.

Henning, B. J., Snyman, H. G. & Aveling, T.A.S. (2000) Plant-soil interactions of sludge-borne heavy metals and the effect on maize seedling growth. WISA 2000 Biennial conference and exhibition, Sun City, South Africa. May 28- June 1, 2000

Hunter, G.C., Slippers, B., Wingfield, M.J., Coutinho, T.A. & Yamada, T. (2000) A study of symbiotic white rot fungi of *Sirex* and *Urocerus* from the Southern Hemisphere and Japan. Proceedings of the Southern African Society for Plant Pathology, Grahamstown, 27-28 January 2000. South African Journal of Science 97: (xix).

Hunter, G.C., Roux, J., Coutinho, T.A., Wingfield, M.J. & Crous, P.W. (2001) *Mycosphaerella* species causing *Mycosphaerella* leaf blotch on *Eucalyptus* in South Africa. Proceedings of the Southern African Society for Plant Pathology, Greenway Woods, Nelspruit, South Africa. 21-24 January 2001.

Hurley, B.P., Govender, P. & Wingfield, M. J. (2001) Biological control of *Gonipterus scutellatus* (Coleoptera: Curculionidae) by *Anaphes nitens* along an altitude gradient. Congress of the Entomological Society of Southern Africa, Pietermaritzburg. July 2001.

Jacobs, A., Wingfield, M.J., Jacobs, K. & Wingfield, B.D. (2000) The genus *Phialocephala*: a taxonomic re-evaluation. Proceedings of the Southern African Society for Plant Pathology, Grahamstown 27-28 January 2000. South African Journal of Science 97: (xxii).

Jacobs, R., Slippers, B., Wingfield, M. & Korsten, L. (2001) Soft brown rot, tree die-back and other diseases caused by the same pathogen. South African Mango Research Symposium, 21 June 2001, Tzaneen.

Janse van Rensburg, J.C., Labuschagne, N. & Nemeč, S. (2000) Blight-like symptoms caused by isomarticin, a naphthazarin toxin produced by *Fusarium solani* in various citrus rootstocks. Citrus Research Conference, July 2000, Nelspruit.

Klopper, K.C., Doyle, J., Verhoeven, R.L., Bester, C., Methers, J. & Botha, A-M. (2000) The effect of long term storage on the viability of *Pinus carabaea* pollen. SAAB, Potchefstroom, 10-14 January 2000.

Klopper, K.C., Wingfield, B.D. & Botha, A-M. (2000) Genetic analysis of *Eucalyptus*. SAAB, Potchefstroom, 10-14 January 2000.

Korsten, L. (2000) Biological control: Failures of the past, opportunities of the future. "Beneficial organisms and soilborne diseases" 11th Annual interdisciplinary meeting/seminar hosted by the ARC - PPRI, Vredenburg

Research Centre, Stellenbosch, 13-14 September 2000. Invited keynote.

Korsten, L. (2001) Avogreen, the road to commercialisation. Series of presentations for avocado growers at study group meetings in Nelspruit, Hazyview, Tzaneen and Levubu, 15-18 January 2001, Wartburg, 7 February 2001.

Korsten, L. (2001) Challenges and opportunities for subtropical farmers. Guest speaker: Sustainable Agriculture Study Group meeting, 19 April 2001 at Riverside Estate, Malelane.

Korsten, L. (2001) Food safety in primary agriculture. Guest lecture. University of Durban-Westville, Durban. 6 June 2001.

Korsten, L. (2001) Bioproducts and control - Fact or Fiction? "From the Seed to the Plate - Global influences on the fresh produce industry" Conference Midrand 22 - 23 August 2001.

Korsten, L. (2001) Commercialisation aspects of biocontrol products. Series of presentations for avocado growers at study group meetings in Hazyview, Tzaneen and Levubu, 29-31 August 2001.

Korsten, L. (2001) Food Safety, GAP and HACCP. Fresh Produce Management Workshop. Fresh Produce Management Training Initiative. Overberg Conference Centre, Grabouw. 17 August 2001. Invited paper.

Korsten, L. (2001) Food Safety: a practical approach to ensure good quality and safe product. African Women Agribusiness Network Development (AWAND) Workshop. Table Bay Hotel, Cape Town. 16 August 2001. Invited paper.

Korsten, L. (2001) An overview of mango pathological research at University of Pretoria. South African Mango Research Symposium, 21 June 2001, Tzaneen.

Korsten, L. (2001) Food safety and quality. SAMGA Marketing Day, White River. 5 September 2001.

Korsten, L. & De Jager, E.S. (2000) Microbial risk assessment: Promoting a safer environment for litchi. Litchi Research Symposium 4-5 October 2000, Nelspruit.

Korsten, L. & De Jager, E.S. (2000) Quality Assurance: Today's litchi fruit even better tomorrow. Litchi Research Symposium 4-5 October 2000, Nelspruit.

Korsten, L. & De Jager, E.S. (2000) A total quality management system for the litchi industry. BioY2K Combined Millennium Meeting, Grahamstown, 23-28 January 2000.

Korsten, L. & Du Plooy, W. (2001) Total quality management systems for food production in South Africa. 39th Annual Congress of the South African Society for Plant Pathology, Witvriev. 21-24 January 2001.

Korsten, L., Juckers, E. & Swart, G.M. (2000) Survey of citrus greening disease in South Africa. Citrus Research Symposium 19-21 July 2000, Nelspruit.

Korsten, L., Auret, E.E., El-Ghaouth, A., Korf, H. & De Jager, E.S. (2000) Alternative control of citrus post-harvest diseases. Citrus Research Symposium 19-21 July 2000, Nelspruit.

Kritzing, Q., Aveiling, T.A.S., Marasas, W.F.O., Shephard, G.S. & Leggott, N.L. (2001) Mycotoxins associated with cowpea seeds. 39th South African Society for Plant Pathology, Greenway Woods, Nelspruit.

Labuschagne, N., Wehner, F.C., van Heerden, C., Burger, C., Fourie, A., Janse van Rensburg, J.C. & Coutinho, T. (2000) An overview of research on citrus root disease at the University of Pretoria. Citrus Research Conference 19 July 2000, Nelspruit.

Loots, A., Botha, A-M., Lottering, J.M. & Troskie, C. (2000) A comparative analysis of genetic distance in wheat using RAPDs, AFLPs and microsatellites. BioY2K Combined Millennium Meeting, Grahamstown, 23-28 January 2000.

Mabena, L.L., Korsten, L., Swart, G.M., Serfontein, J.J. & Lubbe, E. (2000) Comparison of *Xanthomonas campestris* pv. *vignicola* isolates using SDS-Page, ERIC PCR and plasmid analysis. BioY2K Combined Millennium Meeting, Grahamstown, 23-28 January 2000.

Mansfield, L. R., Govender, P. & MacArthur, D. (2001) Whitegrubs associated with sugarcane and wattle plantations in the Natal Midlands. Congress of the Entomological Society of Southern Africa, Pietermaritzburg. July 2001.

Maseko, B.O.Z., Burgess, T., Coutinho, T.A. & Wingfield, M.J. (2001) First report of *Phytophthora nicotianae* associated with *Eucalyptus* die-back in South Africa. Proceedings of the Southern African Society for Plant Pathology, Greenway Woods, Nelspruit, South Africa, 21-24 January 2001.

Meyer, L. & Korsten, L. (2001) Market access: a classical case study of trade barriers. Mango Show & Tell, University of Pretoria, 3 May 2001.

Meyer, L., Kotzé, J.M., Wingfield, M.J. & Korsten, L. (2000) Taxonomy of *Guignardia citricarpa* in South Africa. Citrus Research Symposium 19-21 July 2000, Nelspruit.

Meyer, L., L. Korsten, B. Slippers & M.J. Wingfield (2001) *Phyllosticta* species on citrus. Proceedings of the Southern African Society for Plant Pathology, Greenway Woods, Nelspruit, South Africa, 21-24 January 2001.

Mokgatla, R.M., Wingfield, M.J., Preisig, O. & Wingfield, B.D. (2000) Isolation and characterisation of mating type genes of *Sphaeropsis sapinea*. Proceedings of the South African Society for Microbiology, Grahamstown, 25-26 January 2000.

Moleleki, N., Preisig, O., Wingfield, M.J. & Wingfield, B.D. (2000) Towards the development of a biological control strategy of *Sphaeropsis sapinea* through hypovirulence mediating dsRNA viruses. Proceedings of the South African Society for Microbiology, Grahamstown, 25-26 January 2000.

- Myburg, H., Wingfield, B.D. & Wingfield, M.J. (2000) Comparison of *Cryphonectria cubensis* isolates based on β -tubulin gene sequence. Proceedings of the South African Society for Microbiology, Grahamstown, 25-26 January 2000.
- Obagwu, J., Korsten, L., Wehner, F.C. & Paul, I. (2001) Inhibitory action of natural epiphytes isolated from citrus fruit surface against *Penicillium digitatum* Sacc. the cause of citrus green mould. 39th Annual Congress of the South African Society for Plant Pathology, Witrivier. 21-24 January 2001.
- Pakela, Y. P., van der Merwe, C. F., Aveling, T. A. S. & Coutinho, T. A. (2000) Formation of acervuli by *Colletotrichum dematium* on cowpea. BioY2K Combined Millennium Conference, Rhodes University, Grahamstown, 23-25 January 2000.
- Pakela, Y.P., Aveling, T.A.S., Koch, S.H., & Coutinho, T.A. (2000) Characterisation of isolates of *Colletotrichum dematium* based on cultural characteristics and vegetative compatibility groups. Microscopy Society of Southern Africa (MSSA) Conference, Rhodes University, Grahamstown, 6-8 December 2000.
- Paul, I., Obagwu, J. & Korsten, L. (2001) Alternative control of green mould caused by *Penicillium digitatum* Sacc. on valencia oranges. 39th Annual Congress of the South African Society for Plant Pathology, Witrivier. 21-24 January 2001.
- Preisig, O., van Heerden, S.W., Moleleki, N., Smit, W.A., de Wet, J., Wingfield, B.D. & Wingfield, M.J. (2000) The mycoviruses: a focus on recent discoveries and opportunities in South Africa. Proceedings of Southern African Society for Plant Pathology, Grahamstown 27-28 January 2000. South African Journal of Science 97: (iii).
- Pretorius, A., Wingfield, B.D., Wingfield, M.J., Roux, J. & Montenegro, F. (2000) Comparison of *Dothistroma septospora* isolates from South Africa and Ecuador. Proceedings of the Southern African Society for Plant Pathology, Grahamstown 27-28 January 2000. South African Journal of Science 97: (xxi).
- Rabie, A., Klopper, K.C. & Botha, A-M. (2000) Utilising liquid cultures to micropropagate *Eucalyptus*. SAAB, Potchefstroom, 10-14 January 2000.
- Roux, J. & Wingfield, M.J. (2001) Ceratocystis wilt of forest trees. Proceedings of the Southern African Society for Plant Pathology, Greenway Woods, Nelspruit, South Africa. 21-24 January 2001.
- Roux, J., Geldenhuis, N., Wingfield, M.J., Montenegro, F. & Wingfield, B.D. (2000) *Ceratocystis* diseases of *Shizobium parahebum* in Ecuador. Southern African Society for Plant Pathology, Grahamstown 27-28 January 2000. South African Journal of Science 97: (xiii).
- Roux, J., Wingfield, M.J. & Marasas, W.F.O. (2000) *Fusarium graminearum*, associated with *Acacia mearnsii* and *Eucalyptus grandis* in South Africa. Proceedings of the Southern African Society for Plant Pathology, Grahamstown 27-28 January 2000. South African Journal of Science 97: (xiv).
- Rutkowska, D.A., Steenkamp, E.T., Wingfield, B.D., Wingfield, M.J., Coutinho, T.A. & Marasas, W.F.O. (2000) A phylogenetic study of *Fusarium* species in the *Gibberella fujikuroi* complex using *MAT-1* DNA sequence. Proceedings of the Southern African Society for Plant Pathology, Grahamstown, 27-28 January 2000. South African Journal of Science 97: (xxiii).
- Sanders, G. & Korsten, L. (2001) Anthracnose on mango - an overview. South African Mango Research Symposium, 21 June 2001, Tzaneen.
- Sanders, G.M. & Korsten, L. (2000) Detection of citrus greening disease from different sources and distinguishing between leaf symptoms using PCR. Citrus Research Symposium 19-21 July 2000, Nelspruit.
- Sanders, G.M. & Korsten, L. (2001) Detection of citrus greening disease from different sources and distinguishing between leaf symptoms using PCR. 39th Annual Congress of the South African Society for Plant Pathology, Witrivier. 21-24 January 2001.
- Sanders, G.M., Korsten, L. & Wehner, F.C. (2000) Comparison of *Colletotrichum gloeosporioides* from avocado and mango. BioY2K Combined Millennium Meeting, Grahamstown, 23-28 January 2000.
- Scherman, R., Slippers, B., Korsten, L. & Wingfield, M.J. (2001) *Botryosphaeria* species from mango. 39th Annual Congress of the South African Society for Plant Pathology, Witrivier. 21-24 January 2001. Best poster award.
- Silimeia, M. & Korsten, L. (2001) Evaluating plastic caps and biocontrol in the pre-harvest environment. South African Mango Research Symposium, 21 June 2001, Tzaneen.
- Sithole, H., Govender, P. & Viljoen, A. (2001) Integrated pest management of the banana weevil, *Cosmopolites sordidus*. Congress of the Entomological Society of Southern Africa, Pietermaritzburg. July 2001.
- Slippers, B., Wingfield, M.J., Coutinho, T.A., Wingfield, B.D. & Smith, H. (2000) The history and influence of *Botryosphaeria* in *Eucalyptus* plantation forestry in South Africa. Proceedings of the Southern African Society for Plant Pathology, Grahamstown, 27-28 January 2000. South African Journal of Science 97: (xiii).
- Slippers, B., Coutinho, T.A., Wingfield, B.D., Crous, P.W. & Wingfield, M.J. (2001) Taxonomy and phylogeny of *Botryosphaeria* species. Proceedings of the Southern African Society for Plant Pathology, Greenway Woods, Nelspruit, South Africa. 21-24 January 2001.
- Smith, J.E., Korsten, L., Denner, F.D.N. & Raarjes, P. (2000) Adapting a disease forecasting model (PLANT-Plus) for early blight of potatoes in South Africa. BioY2K Combined Millennium Meeting, Grahamstown, 23-28 January 2000.

- Steenkamp, E.T., Wingfield, B.D., Coutinho, T.A., Wingfield, M.J. & Marasas, W.F.O. (2000) Histone gene sequence and the taxonomy of *Gibberella fujikuroi*. Proceedings of the South African Society for Microbiology, Grahamstown, 25-26 January 2000.
- Steyn, A.E., Dickens, O.S.P., Maasdorp, K.G., Botha, A-M. & Bornman, C.H. (2000) Somatic embryogenesis of *Picea abies*. SAAB, Potchefstroom, 10-14 January 2000.
- Steyn, T.L., Kruger, K. & Govender, P. (2001) Complex sensory stimuli influence decisiveness in the whitefly *Bemisia tabaci* (Gennadius) (Hemiptera: Aleyrodidae). Congress of the Entomological Society of Southern Africa, Pietermaritzburg, July 2001.
- Swart, G. & Korsten, L. (2001) An investigation into chemical resistance on mango - is it a problem? South African Mango Research Symposium, 21 June 2001. Tzaneen.
- Troskie, C., Kloppers, FR & Botha, A-M. (2000) Molecular markers in aid of *Lr37* resistance breeding in wheat. BioY2K Combined Millennium Meeting, Grahamstown, 23-28 January 2000.
- Uacquete, A., Korsten, L. & Aveling, T.A.S. (2000) Scanning electron microscopy of powdery mildew of cashew. BioY2K Combined Millennium Conference, Rhodes University, Grahamstown, 23-25 January 2000.
- Van den Berg, N. & Aveling, T.A.S. (2001) Evaluation of six fungicides for controlling *Alternaria cassiae* on cowpea seeds. 39th South African Society for Plant Pathology, Greenway Woods, Nelspruit.
- Van den Berg, N., & Aveling, T.A.S. (2000) Infection of cowpea by *Alternaria cassiae*. Microscopy Society of Southern Africa (MSSA) Conference, Rhodes University, Grahamstown, 6-8 December 2000. Wirsam Scientific Prize for best student paper.
- Van der Merwe, N.A., Wingfield, B.D. & Wingfield, M.J. (2000) Diversity in a Colombian population of *Cryphonectria cubensis*. Proceedings of the South African Society for Microbiology, Grahamstown, 25-26 January 2000.
- Van der Nest, M.A., Steenkamp, E.T., Wingfield, B.D. & Wingfield, M.J. (2000) Development of simple sequence repeat (SSR) markers in *Eucalyptus*. BIOY2Kmeeting: joint meeting of the South African Society of Microbiology, South African Society of Biochemistry and Molecular Biology and the Southern African Society of Plant Pathology, Grahamstown.
- Van Heerden, S.W., Preisig, O., Wingfield, M.J. & Wingfield, B.D. (2000) Characterisation of dsRNA elements in a South African isolate of *Cryphonectria cubensis*. Proceedings of the South African Society for Microbiology, Grahamstown, 25-26 January 2000.
- Venter, E. & Botha, A-M. (2000) Development of markers linked to Russian wheat aphid resistance in wheat using a novel PCR-RFLP approach. BioY2K Combined Millennium Meeting, Grahamstown, 23-28 January 2000.
- Venter, M., Wingfield, M.J. & Coutinho, T.A. (2000) Pathogenicity of *Endothia gyrosa* on *Eucalyptus* in South Africa. Proceedings of the Southern African Society for Plant Pathology, Grahamstown, 27-28 January 2000. South African Journal of Science 97: (xxii).
- Venter, M., Wingfield, M.J., Wingfield, B.D., Coutinho, T.A. & Myburg, H. (2000) Taxonomy of the closely related genera *Endothia* and *Cryphonectria*. Proceedings of the South African Society for Microbiology, Grahamstown, 25-26 January 2000.
- Vincent, I., Roux, J., Coetzee, M., Wingfield, B. & Wingfield, M. (2000) Characterisation of *Seiridium* isolates associated with Cypress canker based on beta tubulin sequence. Proceedings of the Southern African Society for Plant Pathology, Grahamstown 27-28 January 2000. South African Journal of Science 97: (iv).
- Vorster, B.J., Cullis, C.A. & Kunert, K.J. (2000) Genetic variation in date palm. 17th Congress of the South African Genetics Society. June 2000. Pretoria, South Africa.
- Vorster, B.J. & Kunert, K.J. (2001) Identification of Genetic "Hotspots" in the Genome of Plants. 27th Annual Conference of the South African Association of Botanists. 14-18 January 2001. Johannesburg, South Africa.
- Wingfield, M.J., Korsten, L., Meyer, L., Carroll, G.W., Wingfield, B.D. & Kotzé, J.M. (2000) The citrus black spot pathogen: Understanding pathogenicity and non-pathogenicity in *Guignardia citricarpa*. Citrus Research Symposium 19-21 July 2000, Nelspruit.
- Witthuhn, R.C., Harrington, T.C., Steimel, J.P., Wingfield, B.D. & Wingfield, M.J. (2000) Comparison of isozymes, rDNA spacer regions and MAT-2 DNA sequences as phylogenetic characters in the analysis of the *Ceratocystis coerulea* complex. Proceedings of the South African Society for Microbiology, Grahamstown, 25-26 January 2000.
- Witthuhn, R.C., Harrington, T.C., Wingfield, B.D., Steimel, J.P. & Wingfield, M.J. (2000) Deletion of the MAT-2 idiomorph during uni-directional mating type switching in *Ceratocystis*. Proceedings of the South African Society for Microbiology, Grahamstown, 25-26 January 2000.
- Zhou, X.D., de Beer, Z.W., Wingfield, M.J. & Wingfield, B.D. (2000) Ophiostomatoid fungi associated with three bark beetles in South Africa. Proceedings of the Southern African Society for Plant Pathology, Grahamstown 27-28 January 2000. South African Journal of Science 97: (vii).

Industry-related publication

Smith, J.E. (2000) Fight early blight with PLANT-Plus. Chips 14:52-54.

Seminar Presentations

All postgraduate students linked to FABI present two seminars each year on a Thursday morning. Special seminars, presented by invited speakers, are occasionally held. Once a postgraduate student has been awarded a degree, he/she will present a prestige seminar.

Special Seminars

Ms Mary Crewe

September 1999

How bad is bad: The AIDS crisis on campus

Dr Francis Thackeray

October 1999

Probabilities of conspecificity: Morphometric approaches of the study of extant and extinct taxa

Prof Steven Chown

March 2000

Biodiversity on Southern Ocean Islands

Mr Colin Harvett

April 2000

Research, Mondi and the Corporate Environment

Prof Pedro Crous

June 2000

Mycosphaerella and *Cylindrocladium* in forestry: Evolving disease complexes and their identification

Ms Sandra Denman

June 2000

Botryosphaeria canker of *Protea magnifica*: Disease development, pathogen taxonomy and disease control

Dr Hester Vismer

July 2000

Sporothrix schenckii is the cause of human sporotrichosis, but is *Ophiostoma stenoceras* the teleomorph of this fungus? A clinical, epidemiological, ecological and molecular approach

Dr Anthony Surridge

August 2000

Energy

Dr Winfred Hammond

October 2000

Developing a sustainable cowpea crop production for Africa

Dr Francois Lieutier

February 2001

Conifer defenses and bark beetle attack strategies

Dr Hugh Glen

June 2001

The "nut" parade

Prof Dr Michael Göttfert

July 2001

Molecular insights into the *Bradyrhizobium japonicum*/soybean symbiosis - an analysis of the bacterial partner

Prof Michael Wingfield

August 2001

Thunder dragon land: a forest pathologist's view of Bhutan

Prestigious Seminars

Lynelle Lacock (MSc)

October 1999
Towards wheat GMOs

Eduard Venter (MSc)

March 2000
The Russian Wheat Aphid: Pestilence or Curable disease

Bongani Maseko (MSc)

July 2000
Oomycetes associated with citrus and *Eucalyptus* root rot in South Africa

Juanita de Wet (MSc cum laude)

September 2000
Studies on the diversity and biology of the pine pathogen *Sphaeropsis sapinea*

Marieka Venter (MSc cum laude)

October 2000
Taxonomy and pathology of a new species of *Cryphonectria* from *Eucalyptus* in South Africa

Karin Jacobs (PhD)

May 2000
Leptographium species: Tree Pathogens, insect associates and agents of blue stain

Gina Swart (PhD)

October 2000
Reflections of post PhD : student adrift in a sea of academia

Emma Steenkamp (PhD)

March 2001
Molecular taxonomic studies of selected species in the *Gibberella fujikuroi* complex

Noëlani van den Berg (MSc cum laude)

April 2001
A new disease of cowpea caused by *Alternaria cassiae*

Adriana Jacobs (MSc)

June 2001
The genus *Phialocephala* – a taxonomic study

Percy Chimwamurombe (PhD)

September 2001
Molecular plant pathogen interactions with special reference to *Eucalyptus grandis* PGIPs, which attack fungal polygalacturonases

FABI TEAM 2000/2001

Full time Academic & Research Staff

Prof. Michael J. Wingfield
Prof. Brenda D. Wingfield
Prof. Karl Kunert
Assoc. Prof. Lise Korsten
Assoc. Prof. Dave Berger
Assoc. Prof. Terry Aveling
Assoc. Prof. Anna-maria Oberholster
Assoc. Prof. Teresa Coutinho
Dr. Altus Viljoen
Dr. Nico Labuschagne
Mr. Prem Govender
Dr. Oliver Preisig
Dr. Jolanda Roux
Dr. Gina Swart

Technical Staff

Ms. Sonja de Beer
Ms. Amelita Lombard
Ms. Shazia Shaik
Ms. Magriet van der Nest (resigned 2001)
Ms. Anita Steyn
Ms. Kerien van Dyk
Ms. Eva Muller
Ms. Martie van Zyl
Ms. Rachel Mchabeleng
Ms. Joyce Jakavula
Mr. Danie Theron
Ms. Amanda Redmond
Ms. Trish Beart

Administrative Staff

Ms. Rose Visser
Ms. Marveline Molema (resigned 2001)
Ms. Helen Doman
Ms. Elizabeth Attinger
Ms. Vivienne Kleynhans
Ms. Deline Muller
Mr. Chris Visser (resigned 2001)
Ms. Magda Engelbrecht

Computer Support

Mr. Chris Visagie

Information Specialist

Ms. Anita Slabbert (resigned April 2001)
Ms. Marie Theron

Honorary Professors

Prof. J.P. van der Walt
Prof. W.F.O. Marasas
Prof. J.M. Kotzé

Past Sabbatical Visitors

Professor Gerry Adams (1999, 2000)
Professor Chris Bornman (1999)

Postdoctoral Fellows

Dr. Gwen Koning
Sphaeropsis sapinea on *Pinus* spp. in South Africa: seed infection, its impact and management
Dr. Linda Meyer
Black spot of citrus
Dr. Marlien van der Merwe
Molecular systematics and phylogenetics of the genera *Eugenia* and *Syzygium* (Myrtaceae) in southern Africa
Dr. Percy Chimwamurombe
Genetic improvement of maize to enhance food safety by introducing resistance to *Fusarium verticillioides*
Dr. Thierry Regnier
Markers for disease resistance in *Eucalyptus*
Dr Treena Burgess
Studies on the population diversity of *Sphaeropsis sapinea*

Past Postdoctoral Fellows

Dr. Oliver Preisig (1997-1999)
Dr. Dennis Wilson (1998-1999)
Dr. Hong Li (1998-1999)
Dr. Jingua Chen (1998-1999)
Dr. Anupama Gaur (1998-1999)

Current Postgraduate Students

PhD students

Bongani Maseko

Phytophthora root rot associated with cold tolerant eucalypts in South Africa

Advisors: TA Coutinho, MJ Wingfield, BD Wingfield & T Burgess

Bernard Slippers

The taxonomy, phylogeny and ecology of Botryosphaericeous fungi on selected woody hosts

Advisors: MJ Wingfield, TA Coutinho, BD Wingfield & PW Crous

Christelle Klopper

Studies on the rooting ability of *Eucalyptus grandis*

Advisors: A-M Oberholster & BD Wingfield

Eduard Venter

Host resistance in South African *Pinus* spp.

Advisors: A-M Oberholster, BD Wingfield & MJ Wingfield

Marius Boshoff

Epidemiology and control of bacterial black spot of mangoes

Advisors: L Korsten & JM Kotze

Henriette Britz

Taxonomic, genetic and molecular studies on *Fusarium* spp. within the *Gibberella fujikuroi* complex

Advisors: MJ Wingfield, TA Coutinho, BD Wingfield & WFO Marasas

Martin Coetzee

Molecular characterization of *Armillaria* (Basidiomycetous Agaricales Tricholomycetaceae)

Advisors: BD Wingfield, MJ Wingfield & P Bloomer

Ntsane Moleleki

Hypovirulence in the pine pathogen, *Sphaeropsis sapinea*

Advisors: MJ Wingfield, O Preisig & BD Wingfield

Robert Mokgatla

Isolation and characterization of mating genes of *Sphaeropsis sapinea* – a paradox

Advisors: BD Wingfield, MJ Wingfield & O Preisig

Schalk van Heerden

Studies on *Cryphonectria cubensis* in South Africa

Advisors: MJ Wingfield, O Preisig & BD Wingfield

XuDong Zhou

Ophiostomatoid fungi with reference to those species associated with three bark beetles in South Africa

Advisors: MJ Wingfield & BD Wingfield

Lynelle Lacock

Sequence Expressed Tags in wheat

Advisor: A-M Oberholster

Cassi Myburg

Molecular studies on *Cryphonectria* canker of eucalypts

Advisors: BD Wingfield & MJ Wingfield

Yolisa Pakela

Interaction between cowpea and *Collectotrichum dematium*

Advisors: TAS Aveling & TA Coutinho

Marinda Visser

Population biology of the banana *Fusarium* wilt pathogen, *Fusarium oxysporum* f.sp. *cubense*

Advisors: A Viljoen, MJ Wingfield, BD Wingfield & T Gordon

Chantel van Niekerk

A genetic study on resistance of wheat to the Russian wheat aphid using Expressed Sequence Tags

Advisor: A-M Oberholster

Esmé van Jaarsveld

Studies on *Phytophthora nicotianae*, the cause of black shank of tobacco

Advisors: MJ Wingfield & BD Wingfield

Jacque van der Waals

Implementing a disease forecasting system for early blight for the South African potato industry

Advisors: L Korsten & TAS Aveling

Noëlani van den Berg

Resistance mechanisms of Cavendish bananas against *Fusarium oxysporum* f.sp. *cubense*

Advisors: A Viljoen, MJ Wingfield & D Berger

Appolinaire Adandonon

Damping-off and stem rot of cowpea in Benin

Advisors: TAS Aveling, N Labuschagne & W Hammond

Christell van der Vyver

Stress induced genomic changes in plants

Advisors: K Kunert & C Cullis

Mesfin Bogale

A survey of *Fusarium* spp. in Ethiopia

Advisors: BD Wingfield & MJ Wingfield

Bridget Campbell

Elucidation of disease resistance in morocotyledous plants through DNA microarray analysis

Advisor: D Berger

Juanita de Wet

Molecular taxonomy and phylogeny of *Sphaeropsis sapinea* and its association with dsRNA elements

Advisors: MJ Wingfield, O Preisig & BD Wingfield

Alemu Gezahgne

Diseases of plantation forest trees in Ethiopia

Advisors: J Roux & MJ Wingfield

James Harrison

Complementary morphological and molecular approaches to plantation white grubs (Scarabaeidae) identification

Advisors: MJ Wingfield, C Scholz, BD Wingfield & P Govender

Riana Jacobs

Interaction between *Pinus radiata* and the fungal pathogens *Fusarium circinatum* and *Sphaeropsis sapinea*

Advisors: TA Coutinho, I Dubery & MJ Wingfield

Quenton Kritzinger

Mycotoxins and medicinal properties of cowpea

Advisors: TAS Aveling & N Lall

Sabine Lezar

Microarray analysis of disease resistance in *Eucalyptus grandis*

Advisors: BD Wingfield, D Berger & MJ Wingfield

Mauricio Marin

Molecular taxonomy of *Ceratocystis polonica sensu lato*

Advisors: MJ Wingfield, O Preisig & BD Wingfield

Sari Mohali

Cylindrocladium spp. in Venezuela

Advisors: MJ Wingfield, TA Coutinho & BD Wingfield

Joseph Obagwu

Studies on the control of citrus postharvest pathogens

Advisor: L Korsten

Ida Paul

Mapping and distribution of citrus greening in South Africa

Advisors: A van Jaarsveld & L Korsten

Albé van der Merwe

Population genetics of *Cryphonectria cubensis*

Advisors: BD Wingfield & MJ Wingfield

Marieka Venter

Revision of the taxonomy of the fungal genera *Endothia* and *Cryphonectria*

Advisors: MJ Wingfield & BD Wingfield

Renate Zipfel

Molecular phylogeny of Ophiostomatoid fungi

Advisors: BD Wingfield & MJ Wingfield

Barnabas Kiule

Increasing GLs resistance in maize hybrids in Tanzania by combining MAS and phenotypic selection indices

Advisors: A-M Oberholster & F Wehner

Michael Luttig

Characterisation of a citrus tristeza closterovirus population which interferes with Huanglongbing infection

Advisor: BD Wingfield

Lesesse Beyene

Genetic diversity in maize inbreds and its association with test cross performances, combining ability and heterosis

Advisors: A-M Oberholster, K Pixely & T Afriyie

Wilma du Plooy

Food safety in fruit crops

Advisors: L Korsten & L Anelich

Elizabeth de Jager

Postharvest quality standards in the South African litchi industry

Advisors: L Korsten & FC Wehner

Prem Govender

Impact assessment of soil pests affecting the establishment of wattle, eucalypts and pine seedlings in South Africa

Advisors: MJ Wingfield & C Scholtz

Dean Oelofse

Molecular approaches towards anthranose resistance in lupins

Advisors: I Dubery & D Berger

Ezanne Swanepoel

Mapping disease resistance in segregating bread wheat populations

Advisors: A-M Oberholster & MT Labuschagne

Current MSc students**Inge Maritz**

A novel strategy for engineering fungal resistance

Advisor: D Berger

Edzard Grimbeek

Management strategies for panama wilt disease of banana in South Africa

Advisors: A Viljoen, TA Coutinho & MJ Wingfield

Nonnie Geldenhuis

Studies on fungi associated with dying *Schizolobium parahybrum* in Ecuador

Advisors: MJ Wingfield & J Roux

Oliver Dickens

Somatic embryogenesis in the *P. Elliottii* x *P. caribae* hybrid

Advisors: A-M Oberholster & C Bornman

Lieschen Bahlmann

Russian wheat aphid (*Diuraphis noxia*) induced gene expression

Advisors: A-M Oberholster & P Govender

Ronelle Koekemoer

Induced gene expression in *Pinus patula* in response to osmotic stress

Advisors: A-M Oberholster & BD Wingfield

Wayne Rathbone

Development and assessment of biotechnology curriculum for high school scholars

Advisors: BD Wingfield & MJ Wingfield

Wilhelm de Beer

The occurrence of Ophiostomatoid fungi on wood and wood products in South Africa

Advisors: MJ Wingfield & BD Wingfield

Anton Jordaan

Molecular manipulation of roses

Advisor: A-M Oberholster

Rodrigo Ahumada

Diseases of commercial plantations in Chile

Advisor: MJ Wingfield

Irene Barnes

Population, taxonomic and phylogenetic studies on *Ceratocystis fimbriata*

Advisors: MJ Wingfield, J Roux & BD Wingfield

Raksha Bhoora

Genetic transformation of *Eucalyptus* clones

Advisors: BD Wingfield & MJ Wingfield

Brenda Buthelezi

Population study on a *Cylindrocium* sp. associated with *Eucalyptus* in South Africa

Advisors: TA Coutinho, O Preisig, MJ Wingfield & PW Crous

Veloshinie Govender

Evaluating biological control systems for mango postharvest disease control

Advisor: L Korsten

Wilma Havenga

Mode of action of *Bacillus subtilis* as biocontrol agent of postharvest diseases of avocado

Advisor: L Korsten

Ronald Heath

Disease of Myrtaceae and Melastomataceae hosts

Advisors: MJ Wingfield & J Roux

Brett Hurley

Species composition, pathogen interactions and management of fungus gnats in forestry nurseries

Advisors: P. Govender, MJ Wingfield & TA Coutinho

Gavin Hunter

Mycosphaerella leaf blotch of *Eucalyptus* in South Africa

Advisors: MJ Wingfield, J Roux, TA Coutinho & PW Crous

Begashaw Leulseged

The potential of rhizosphere microflora in the biocontrol of root rot and growth enhancement of lettuce (*Laetuca sativa*)

Advisors: L Korsten, F Wehner & N Labuschagne

Shilo Loots

Genetic resistance to the Russian wheat aphid in wheat PI 294994.

Advisor: A-M Oberholster

Karin Louw

Antimicrobial activity of South African bulbous plant extracts to control selected pathogens

Advisors: L. Korsten & T Regnier

Lerato Matsaunyane

Isolation and characterization of the apple polygalacturonase inhibiting protein 2 gene (pgip 2) from apple and investigation into the proteins' antifungal activity

Advisors: D Berger & D Oelofse

Awelani Mutshembele

Development of a DNA based identification technique for *Fusarium circinatum*

Advisors: BD Wingfield & MJ Wingfield

Grace Nakabonge

Diseases associated with plantation forestry in Uganda

Advisors: J Roux, TA Coutinho & MJ Wingfield

Marie Onanena

Development of a DNA marker for abiotic stress resistance from grasses

Advisor: K Kunert

Anneke Prins

The role of cystatins in plants in response to abiotic stress

Advisor: K Kunert

Hendrik Sithole

Integrated pest management of the banana weevil, *Cosmopolites sordidus* in South Africa: a critical review of the literature

Advisors: P Govender & A Viljoen

Carlos Rodas

Diseases of plantation forest trees in Colombia

Advisors: MJ Wingfield, J Roux, TA Coutinho & B Slippers

René Jacobs

Characterisation and identification of *Botryosphaeria* spp. from mango in South Africa

Advisors: L Korsten, MJ Wingfield & B Slippers

Stephan Honibal

Biocontrol of False Codling Moth, *Cryptophlebia leucotreta* (Meyr.) (Lepidoptera: Tortricidae)

Advisors: P Govender & A Schoeman

Mashudu Silimela

Alternative methods for preventing pre- and post-harvest diseases and sunburn on mango fruits

Advisor: L Korsten

Franco du Preez

Genetic response upon infestation with the Russian Wheat Aphid

Advisor: A-M Oberholster

Karen Surridge

Banana leaf diseases in South Africa

Advisors: A Viljoen & F Wehner

Dirk Swanevelder

A population study on the genus *Clivia* using microsatellite markers

Advisors: A-M Oberholster & BE van Wyk

Mariette Truter

Epidemiology and control of black scurf and stem canker of potatoes

Advisor: FC Wehner

Busi Tshabalala

Population and pathogenicity studies of *Lasiodiplodia theobromae* in South Africa

Advisors: TA Coutinho, MJ Wingfield & W de Beer

Juan Vorster

Auxin induced DNA methylation changes during somatic embryogenesis

Advisor: K Kunert

Mapula Julia Domola

Survey, indexing and serological detection of sweet potato viruses in South Africa

Advisors: TAS Aveling & G Thompson

Alan Hall

Food safety and quality assurance for hydroponic vegetable production systems and semi-processing plants

Advisor: L Korsten

Tessa Bandounas

Infection studies on white rust of sunflower

Advisors: TAS Aveling & A Viljoen

Americo Uaciquete

Epidemiology, control and germplasm screening for powdery mildew, *Oidium anacardi*, on cashew in Mozambique

Advisors: L Korsten & TAS Aveling

Anton Fourie

Mechanisms of resistance in citrus rootstocks against fungal pathogens

Advisors: N Labuschagne, Z Apostolides & D Berger

L Stander

Cultural practices for the control of bacterial wilt of potato

Advisors: P Hammas & L Korsten

Lara Mansfield

The bioeconomics and control of scarabaeid pests attacking inland sugarcane and forestry in KwaZulu/Natal

Advisor: P Govender

Current MSc Agric/MInstAgrar Students

Wilma van Broekhuizen

Detection and suppression of *Ralstonia solanacearum* causal agent of potato bacterial wilt in naturally infested soil

Advisors: L Korsten & P Hammes

Margareth Schoeman

Comparative studies on *Dathiorella* on avocado

Advisors: L Korsten & G Swart

4th Year and Honours students

Hein van Geuns (2000)

Dirk Swanevelder (2000)

Brett Hurley (2000)

Lerato Matsaunyane (2000)

Karen Surridge (2000)

Juan Vorster (2000)

Wilma van Rensburg (2000)

C Aldous (2000)

Tharina Bird (2000)

Franco du Preez (2000)

Lorenzo Lombard (2001)

Gerda Vermeulen (2001)

Kobus de Wet (2001)

Leylani Grobler (2001)

Susan Groenewald (2001)

Barbara Nel (2001)

Deshni Pillay (2001)
Gladys Ramotshodi (2001)
Besrat Tesfagiorgis (2001)
Andrew Gallahger (2001)
Jenny Smith (2001)
Thuto Maria Matshololo (2001)

Student Assistants

Lorenzo Lombard (2000)
Shalati Shiburi (2000)
Rene van Zyl (2001)

Overseas Visitors

Prof Gerry Adams, Dept of Plant Pathology, Michigan State University, USA
Dr John Taylor, University of California, Berkley, USA
Dr A Elghaanth, USDA, USA
Dr Orlando Petrini, Boeringer Engelheim, Switzerland
Dr Luis Fernando Orsorio, Carton de Colombia, Colombia
Dr Inez Tomerup, CSIRO Division of Forestry and Forest Products, Australia
Dr Ken Old, CSIRO Division of Forestry and Forest Products, Australia
Dr Ruth Frampton, Director Forestry Safety, Ministry of Agricultural and Forestry, New Zealand
Mr Fernando Montenegro, Fundacion Forestal, Equador
Prof James Dale, Director of Research, Queensland University of Technology, Brisbane, Australia
Dr Suzy Bentley, Research Officer, CRC for Tropical Plant Protection, Brisbane, Australia
Dr Julio Hernandez, Project Director, ICIA, Tenerife, Canary Islands
Prof Shin-Chuan Hwang, Director, Taiwan Banana Research Institute, Pingtung, Taiwan
Dr Jean-Vincent Escelant, Coordinator of research of PROMUSA, Montpellier, France
Dr Phillip Prior, INRA, France
Dr Emile Frison, Director-General of INIBAP, Montpellier, France
Dr John Thomas, QDPI, Australia
Prof Daniel Robinson, Director: Hardwood Research Cooperative, North Carolina State University, USA

Recent Graduates

PhD

Karin Jacobs (2000)

A monographic study of the genus *Leptographium*
Advisor: MJ Wingfield
Co-advisors: PW Crous & BD Wingfield

Emma Steenkamp (2001)

Molecular taxonomic studies of selected species in the *Gibberella fujikurii* complex
Advisor: BD Wingfield
Co-advisors: TA Coutinho, MJ Wingfield & WFO Marasas

Cousins Gwanama (2000)

The heterotic patterns of fruit yield and quality of *Cucurbita moschata* using RAPD genetic markers and combing ability estimates
Advisor: A-M Oberholster

Henk Smith (2001)

A comparison of the biology and taxonomy of *Botryosphaeria dothidea* and *Sphaeropsis sapinea* in South Africa
Advisor: MJ Wingfield

Co-advisors: TA Coutinho, PW Crous & BD Wingfield

Percy Chimwamurombe (2001)

Molecular plant-pathogen interactions with special reference to *Eucalyptus grandis* polygalacturonase-inhibiting proteins and fungal polygalacturonases
Advisor: BD Wingfield
Co-advisors: MJ Wingfield & A-M Oberholster

MSc/MSc Agric/MInstAgrar

Riana Jacobs (2001)

The genus *Phialocephala* - a taxonomic study
Advisor: MJ Wingfield
Co-Advisor: K Jacobs

ME Coetzer (2000)

A molecular systematic study of the genus *Encephalartos*
Advisor: JJ Spies
Co-advisors: A-M Oberholster & PJ Vorster

Quenton Kritzing (2001)

Storage fungi and mycotoxins associated with cowpea
Advisor: TAS Aveling
Co-advisor: WFO Marasas

Jo-Mari Lottering (2001)

Identification and characterization of markers linked to the leaf rust resistance gene *Lr41*
Advisor: A-M Oberholster
Co-advisor: J Kloppers

Noëlani van den Berg (2001)

A new disease of cowpea caused by *Alternaria cassiae*
Advisor: TAS Aveling
Co-Advisor: S Venter

Christian Troskie (2001)

Identification and characterization of markers linked to the leaf rust resistance gene *Lr37*
Advisor: A-M Oberholster

Barend Henning (2001)

Agricultural recycling of sewage sludge for maize and oats cultivation
Advisor: HG Snyman

Co-advisor: TAS Aveling

E Botes (2001)

Molecular characterization of toxin-producing and non-toxin producing strains of *Microcystis aeruginosa*

Advisor: JU Grobbelaar

Co-advisor: A-M Oberholster

Albé van der Merwe (2000)

Population diversity studies on the Eucalyptus canker pathogen, *Cryphonectria cubensis*

Advisor: BD Wingfield

Co-Advisor: MJ Wingfield

Jackie Doyle (2001)

Determining gene flow, linkage and parental contribution in *Pinus elliotii* x *Pinus caribaea* hybrids

Advisor: A-M Oberholster

Co-advisor: BD Wingfield

Juanita de Wet (2000)

Population diversity studies on the pine pathogen *Sphaeropsis sapinea*

Advisor: MJ Wingfield

Co-Advisors: TA Coutinho & BD Wingfield

Marieka Venter (2000)

A taxonomic evaluation of the Eucalyptus canker pathogen, *Endothia gyrosa*

Advisor: MJ Wingfield

Co-advisors: TA Coutinho & BD Wingfield

Apollinaire Adandonon (2001)

Damping off of cowpea in Benin and South Africa

Advisor: TAS Aveling

Co-advisor: N Labuschagne

Christi Burger (2001)

Tolerance of citrus rootstocks to root pathogens

Advisor: N Labuschagne

Co-advisor: FC Wehner

Erika Auret (2001)

Integrated control of postharvest diseases of citrus fruit

Advisor: L Korsten

Co-Advisor: FC Wehner

Lise Stander (2001)

Cultural practices for the control of bacterial wilt of potato

Advisor: P Hammes

Co-Advisor: L Korsten

Nomphele Gantsho (2001)

Comparison of *Xanthomonas campestris* pv. *mangiferae-indicae* from mango growing areas in South Africa

Advisor: L Korsten

Co-Advisor: G Swart

Kgabo Matlala (2001)

Epidemiology and detection of *Erwinia* on potatoes

Advisor: L Korsten

Prestigious NRF Bursary Holders

Henriette van Heerden (née Britz)

Martin Coetzee

Eduard Venter

Lynelle van Emmenes (née Lacock)

Marinda Visser

Marieka Venter

Noëlani van den Berg

Aaron Klug Scholarship

Juanita de Wet

Mellon Foundation Grants

Robert Mokgatla

Ntsane Moleleki

Bongani Maseko

Martin Coetzee

Bernard Slippers

Jacque van der Waals (née Smith)

Eduard Venter

Albé van der Merwe

Lynelle van Emmenes (née Lacock)

MANAGEMENT

Management Committee

Professor MJ Wingfield
Professor BD Wingfield
Professor K Kunert
Assoc. Professor L Korsten
Assoc. Professor D Berger
Assoc. Professor A-M Oberholster
Assoc. Professor TAS Aveling
Assoc. Professor TA Coutinho
Dr A Viljoen
Dr N Labuschagne
Dr J Roux
Dr O Preisig
Mr P Govender
Bernard Slippers (Postgraduate student representative 2000)
Eduard Venter (Postgraduate student representative 2001)

Advisory Committee

Professor R Crewe, Dean of the Faculty of Natural and Agricultural Sciences
Professor H Huisman, Head of the Dept of Genetics
Professor TE Cloete, Head of the Dept of Microbiology & Plant Pathology
Professor A Neitz, Head of the Dept of Biochemistry
Assoc. Professor M Meyer, Head of the Dept of Botany
Professor P Hammes, Head of the Dept of Plant Production
Professor C Scholtz, Head of the Dept of Zoology & Entomology
Professor FJC Swanepoel, Head of the Postgraduate School for Agriculture & Rural Development

FABI Management Committee

Board of Control

Ms L Bethlehem, Chief Director, Dept of Forestry and Water Affairs
Dr M Qhobela, Chief Director of Tertiary Education, National Dept of Education
Dr C Seele, Chairman of NCT, Vice-President of the South African Wattle Growers Union, Director of CTC
Mr M Edwards, Executive Director, Forest Owners Association
Prof T Erasmus, Vice-Rector (Research)
Prof R Crewe, Dean of the Faculty of Natural and Agricultural Sciences
Prof MJ Wingfield, Director of FABI

