



**ANALYSIS OF CONTRIBUTIONS
TO THE PM₁₀ CONCENTRATION IN A GOLD MINE
RESIDENTIAL VILLAGE**

by

Dhunraj Ramsuchit (26152224)

A thesis submitted in partial fulfilment of the requirements
for the degree of

**MASTER OF SCIENCE IN APPLIED SCIENCES:
ENVIRONMENTAL TECHNOLOGY**

In the Department of Chemical Engineering
Faculty of Engineering, Built Environment and Information Technology

University of Pretoria

Analysis of contributions to the PM₁₀ concentration in a gold mine residential village

Synopsis

Source apportionment from receptor-based measurements has not been previously conducted at Driefontein Gold Mine. Source apportionment can make a valuable contribution in attempts to reduce air pollution. At a site where particulate matter is the predominant pollutant from a variety of potential sources, the contributions from the individual sources may be difficult to distinguish especially if the sources fall within a single category type with similar pollutant profiles. It would be useful to ascertain the individual contributions so that the effectiveness of existing control measures can be determined and areas where additional controls may be required can be identified. To this effect, potential dust sources at and around a gold mine were identified. Samples of the dust sources were collected and analysed for their elemental compositions and abundances. A receptor point in a mine village was selected and equipped with an E-Sampler PM₁₀ dust monitor as well as an aethalometer, the MicroAeth AE51 (MicroAeth). Monthly receptor samples were collected and analysed for their elemental concentrations. The elemental compositions of the potential sources and the concentrations at the receptor were statistically analysed for 12 periods of a month each to determine the possible contributions to the PM₁₀ concentration at a mine village (West Village, Driefontein Mine, near Carletonville).

Main findings

Although the data did not allow the inclusion of non-identified or “unknown” sources, allocation of the impact at the receptor point to the identified sources proved possible and useful in comparing individual tailings dams contributions. The No. 4 tailings dam has been identified as one of the major contributors to PM₁₀ concentration at West Village. The average PM₁₀ gravimetric concentration recorded at West Village was 18.4 µg/m³ and the concentration with the light scatter method was 15.4 µg/m³. Black carbon has been identified as significant contributor to overall PM₁₀ mass concentrations with up to 34% in the winter season.

Main conclusions

Operational tailings dams can under, certain conditions contribute the major portion of fallout dust and PM₁₀, even more than dormant tailings dams.

Keywords: Particulate matter, dust fall, PM₁₀

Acknowledgements

The kind assistance of Sibanye Gold to use site and data for the research is most appreciated.

The kind assistance of Mark Rowand from S I Analytics to make available the MicroAeth AE51 black carbon aethalometer for research purposes is highly appreciated.

The kind assistance from Jackie Grimbeek and Mike van der Linde of the Statistics Department of the University of Pretoria is acknowledged and appreciated.

The uncompromising support from Ritha and Nikita Ramsuchit is acknowledged.

Contents

Synopsis.....	ii
Main findings.....	ii
Main conclusions.....	iii
Keywords: Particulate matter, dust fall, PM ₁₀	iii
Acknowledgements.....	iii
Nomenclature.....	xii
1. INTRODUCTION.....	1
1.1. Background.....	1
1.2. Problem statement.....	2
1.3. Objective.....	2
1.4. Method and scope of work.....	3
2. THEORY.....	5
2.1. National Environmental Management: Air Quality Act, 2004 (Republic of South Africa (2005)).....	5
2.2. Regional Studies.....	9
2.3. Localised Studies.....	11
2.4. Source apportionment.....	13
3. EXPERIMENTAL.....	14
3.1. Sources and receptor.....	14
3.2. Site Location.....	18
3.3. Particulate Matter E-Sampler.....	19
3.3.1. E-Sampler Overview.....	21
3.3.2. Light scatter (see figures 3.3 and 3.4).....	21
3.3.3. Gravimetric Filter.....	23
3.3.4. k Factor.....	24
3.3.5. Set up.....	24
3.3.6. Self-test.....	24
3.4. Black Carbon Aethalometer.....	25
3.5. Multidirectional Dust fall buckets.....	28

3.6.	Weather Station.....	30
3.7.	Sources	31
3.7.1.	No. 1 and 2 tailings dams.....	32
3.7.2.	No. 3 tailings dam	33
3.7.3.	No. 4 tailings dam	34
3.7.4.	No. 5 tailings dam	35
3.7.5.	Gravel Road	36
3.7.6.	West Village	37
3.7.7.	No. 11 Rock dump	38
3.7.8.	Ploughed Field	39
3.7.9.	Sand Pit	40
4.	RESULTS AND DISCUSSION	42
4.1.	Meteorological data	42
4.2.	Rainfall	42
4.3.	Black Carbon.....	43
4.4.	Particulate Matter (PM ₁₀).....	45
4.5.	Potential sources alpha quartz concentrations	48
4.6.	Period 1: 21 June 2011 to 01 August 2011	48
4.6.1.	Period 1: Meteorological Conditions.....	49
4.6.2.	Period 1: Multidirectional buckets comparison	49
4.6.3.	Period 1: PM ₁₀ Elemental analysis	50
4.6.4.	Period 1: PM ₁₀ Source Apportionment	51
4.7.	Period 2: 05 August 2011 to 01 September 2011	52
4.7.1.	Period 2: Meteorological Conditions.....	52
4.7.2.	Period 2: Multidirectional buckets comparison	53
4.7.3.	Period 2: PM ₁₀ Elemental analysis	54
4.7.4.	Period 2: PM ₁₀ Source Apportionment	55
4.8.	Period 3: 01 September 2011 to 01 October 2011	56
4.8.1.	Period 3: Wind Rose	56
4.8.2.	Period 3: Multidirectional buckets comparison	57
4.8.3.	Period 3: PM ₁₀ Elemental analysis	58

4.8.4.	Period 3: PM ₁₀ Source Apportionment	59
4.9.	Period 4: 01 October 2011 to 01 November 2011	60
4.9.1.	Period 4: Meteorological conditions	60
4.9.2.	Period 4: Multidirectional buckets comparison	61
4.9.3.	Period 4: PM ₁₀ Elemental analysis	62
4.9.4.	Period 4: PM ₁₀ Source Apportionment	63
4.10.	Period 5: 01 November 2011 to 01 December 2011	64
4.10.1.	Period 5: Meteorological conditions	64
4.10.2.	Period 5: Multidirectional buckets comparison	65
4.10.3.	Period 5: PM ₁₀ Chemical analysis.....	66
4.10.4.	Period 5: PM ₁₀ Source Apportionment	67
4.11.	Period 6: 01 December 2011 to 01 January 2012.....	68
4.11.1.	Period 6: Meteorological conditions	68
4.11.2.	Period 6: Multidirectional buckets comparison.....	69
4.11.3.	Period 6: PM ₁₀ Elemental analysis.....	70
4.11.4.	Period 6: PM ₁₀ Source Apportionment.....	71
4.12.	Period 7: 01 January 2012 to 01 February 2012	72
4.12.1.	Period 7: Wind Rose	72
4.12.2.	Period 7: Multidirectional buckets comparison	73
4.12.3.	Period 7: PM ₁₀ Elemental analysis.....	74
4.12.4.	Period 7: PM ₁₀ Source Apportionment.....	75
4.13.	Period 8: 01 February 2012 to 01 March 2012.....	76
4.13.1.	Period 8: Meteorological conditions	76
4.13.2.	Period 8: Multidirectional buckets comparison	77
4.13.3.	Period 8: PM ₁₀ Elemental analysis.....	78
4.13.4.	Period 8: PM ₁₀ Source Apportionment.....	79
4.14.	Period 9: 01 March 2012 to 01 April 2012.....	80
4.14.1.	Period 9: Meteorological conditions	80
4.14.2.	Period 9: Multidirectional buckets comparison	81
4.14.3.	Period 9: Elemental analysis.....	82
4.14.4.	Period 9: PM ₁₀ Source Apportionment.....	83

4.15.	Period 10: 01 April 2012 to 01 May 2012	84
4.15.1.	Period10: Meteorological conditions	84
4.15.2.	Period 10: Multidirectional buckets comparison	85
4.15.3.	Period 10: Elemental analysis.....	86
4.15.4.	Period 10: PM ₁₀ Source Apportionment.....	87
4.16.	Period 11: 01 May 2012 to 01 June 2012	88
4.16.1.	Period 11: Meteorological conditions	88
4.16.2.	Period 11: Multidirectional buckets comparison	89
4.16.3.	Period 11: Elemental analysis.....	90
4.16.4.	Period 11: PM ₁₀ Source Apportionment.....	91
4.17.	Period 12: 01 June 2012 to 01 July 2012.....	92
4.17.1.	Period 12: Meteorological conditions	92
4.17.2.	Period 12: Multidirectional buckets comparison	93
4.17.3.	Period 12: Elemental analysis.....	94
4.17.4.	Period 12: PM ₁₀ Source Apportionment.....	95
4.18.	Dust fall buckets comparison	96
4.19.	Dust fall composite sample period: meteorological conditions	98
4.20.	Dust fall composite sample: Elemental analysis.....	99
4.21.	Dust fall Source Apportionment.....	100
4.21.1.	Source Apportionment: North dust fall bucket.....	100
4.21.2.	Source Apportionment: West dust fall bucket	100
4.21.3.	Source Apportionment: East dust fall bucket	101
4.21.4.	Source Apportionment: South dust fall bucket.....	102
5.	CONCLUSIONS	104
6.	RECOMMENDATIONS	107
7.	REFERENCES	108
8.	APPENDICES.....	112
8.1.	Appendix A: PM ₁₀ Laboratory analysis reports.....	112
8.2.	Appendix B: Dustfall composite sample analysis report.....	112
8.3.	Appendix C: University of Pretoria, Statistics Dept; Analysis methodology and results.....	112

8.4. Appendix D: Sources analysis reports..... 112

List of Tables

Table 2.1: South African Air Quality Standards and Forthcoming Revised Standards (1 January 2015) for PM₁₀..... 6

Table 2.2: South African Air Quality Standards and Forthcoming Revised Standards (1 January 2015) for PM_{2.5} 7

Table 2.3: Draft Dust fall standard..... 7

Table 2.4: SANS 1929 Target, action and alert treshold 8

Table 4.1: Rainfall over sampling periods: 21 June 2011 to 1 July 2012..... 43

Table 4.2: E-Sampler gravimetric analysis results 46

Table 4.3: Elemental Analysis 21 June 2011 – 01 August 2011 51

Table 4.4: Elemental Analysis 05 August 2011 – 01 September 2011..... 55

Table 4.5: Elemental Analysis 01 September 2011 - 01 October 2011 59

Table 4.6: Elemental Analysis 01 October 2011 – 01 November 2011 63

Table 4.7: Elemental Analysis 01 November 2011 – 01 December 2011 67

Table 4.8: Elemental Analysis 01 December 2011 - 01 January 2012..... 71

Table 4.9: Elemental Analysis 01 January 2012 - 01 February 2012 75

Table 4.10: Elemental Analysis 01 February 2012 - 01 March 2012..... 79

Table 4.11: Elemental Analysis 01 March 2012 - 01 April 2012..... 83

Table 4.12: Elemental Analysis 01 April 2012 - 01 May 2012 87

Table 4.13: Elemental Analysis 01 May 2012 to 01 June 2012..... 91

Table 4.14: Elemental Analysis 01 June 2012 - 01 July 2012..... 95

Table 4.15: Dust fall buckets elemental analysis for sampling period: 05 September 2011 to 23 January 2012..... 99

List of Illustrations

Figure 1.1: Driefontein Locality map.....	4
Figure 2.1: Driefontein Mine layout (Source: Airshed, 2008).....	12
Figure 3.1: Potential dust sources locality map	17
Figure 3.2: E-Sampler installation at Driefontein West Village (foreground).....	20
Figure 3.3: E-Sampler Flow system	22
Figure 3.4: Light scatter due to airborne particulate	23
Figure 3.5: Clean air condition for the E-Sampler Nephelometer	25
Figure 3.6: Magee Scientific MicroAeth Model AE51 aethalometer	26
Figure 3.7: Black Carbon aethalometer installation at West Village monitoring station .	27
Figure 3.8: Dustwatch multi-directional buckets at West Village (right hand side)	29
Figure 3.9: Driefontein Weather Station	31
Figure 3.10: No. 1 and 2 Tailings dams.....	33
Figure 3.11: No. 3 Tailings dam	34
Figure 3.12: No. 4 Tailings dam	35
Figure 3.13: No. 5 Tailings dam	36
Figure 3.14: Gravel road	37
Figure 3.15: West Village ground	38
Figure 3.16: No. 11 Rock dump	39
Figure 3.17: Ploughed field	40
Figure 3.18: Sand pit.....	41
Figure 4.1: Black carbon trends	44
Figure 4.2: Black Carbon comparison with cumulative PM ₁₀ concentrations.....	45
Figure 4.3: E-Sampler light scatter and gravimetric concentrations comparison.....	46
Figure 4.4: Sources alpha quartz percentages comparison	48
Figure 4.5: Wind Rose for the period 21 June 2011 to 01 August 2011	49
Figure 4.6: Period 1: Multi-directional dust fall comparison	50
Figure 4.7: Source Apportionment for the period 21 June to 01 Aug 2011.....	51
Figure 4.8: Wind Rose for the period 05 August 2011 to 01 September 2011	53
Figure 4.9: Period 2: Multi-directional dust fall comparison	54
Figure 4.10: Source Apportionment for the period 05 Aug to 01 Sept 2011	55

Figure 4.11: Wind Rose for the period 01 September 2011 to 01 October 2011.....	57
Figure 4.12: Period 3: Multi-directional dust fall comparison	58
Figure 4.13: Source Apportionment for the period 01 Sept to 01 Oct 2011	59
Figure 4.14: Wind Rose for the period 01 October 2011 to 01 November 2011.....	61
Figure 4.15: Period 4: Multi-directional dust fall comparison	62
Figure 4.16: Source Apportionment for the period 01 Oct to 01 Nov 2011.....	63
Figure 4.17: Wind Rose for the period 01 November 2011 to 01 December 2011	65
Figure 4.18: Period 5: Multi-directional dust fall comparison	66
Figure 4.19: Source Apportionment for the period 01 Nov to 01 Dec 2011	67
Figure 4.20: Wind Rose for the period 1 December 2011 to 1 January 2012.....	69
Figure 4.21: Period 6: Multi-directional dust fall comparison	70
Figure 4.22: Source Apportionment for the period 01 December 2011 to 01 January 2012	71
Figure 4.23: Wind Rose for the period 01 January 2012 to 01 February 2012.....	73
Figure 4.24: Period 7: Multi-directional dust fall comparison	74
Figure 4.25: Source Apportionment for the period 01 January to 01 February 2012.....	75
Figure 4.26: Wind Rose for the period 01 February 2012 to 01 March 2012.....	77
Figure 4.27: Period 8: Multi-directional dust fall comparison	78
Figure 4.28: Source Apportionment for the period 01 February to 01 March 2012	79
Figure 4.29: Wind Rose for the period 01 March 2012 to 01 April 2012.....	81
Figure 4.30: Period 9: Multi-directional dust fall comparison	82
Figure 4.31: Source Apportionment for the period 01 March to 01 April 2012.....	83
Figure 4.32: Wind Rose for period 1 April 2012 to 1 May 2012.....	85
Figure 4.33: Period 10: Multi-directional dust fall comparison	86
Figure 4.34: Source Apportionment for the period 01 April to 01 May 2012.....	87
Figure 4.35: Wind Rose for the period 01 May 2012 to 01 June 2012	89
Figure 4.36: Period 11: Multi-directional dust fall comparison	90
Figure 4.37: Source Apportionment for the period 01 May to 01 June 2012	91
Figure 4.38: Wind Rose for the period 01 June 2012 to 01 July 2012.....	93
Figure 4.39: Period 12: Multi-directional dust fall comparison	94
Figure 4.40: Source Apportionment for the period 01 June to 01 July 2012.....	95

Figure 4.41: Dust fall, rainfall and vector wind speed trends at West Village	97
Figure 4.42: Wind Rose for period 05 September 2011 to 23 January 2012.....	98
Figure 4.43: Source Apportionment of dust fall from the North bucket.....	100
Figure 4.44: Source Apportionment of fallout dust from the West bucket.....	101
Figure 4.45: Source Apportionment of fallout dust from the East bucket.....	102
Figure 4.46: Source Apportionment of fallout dust from the South bucket	103

Nomenclature

PM: Particulate matter

PM₁₀: Particulate matter with aerodynamic diameter nominally less than 10 micrometres

PM_{2,5}: Particulate matter with aerodynamic diameter nominally less than 2,5 micrometres

NEM: AQA: National Environmental Management: Air Quality Act

SANS: South African National Standards

TSP: Total Suspended Particulates

WHO: World Health Organisation

US EPA United States Environmental Protection Agency

CMB Chemical mass balance

MicroAeth AE51 aethalometer

1. INTRODUCTION

1.1. Background

Air quality has an impact on human health and the natural environment. This impact is increasingly affected by a growing world population and industrialization. Therefore the need to increase attention to air quality is becoming more important. In order to manage air quality at a specific location, a monitoring and measurement program is required to identify and quantify potential pollution sources. Such a monitoring and measurement program is also required to check on effectiveness of controls and compliance with set standards. In order to assess the status and compliance to air quality standards, two general monitoring approaches can be adopted. These are the top-down or receptor-based source apportionment and bottom-up source-based dispersion modelling. The two approaches can also be used iteratively to complement each other. The receptor-based approach uses the chemical and physical characteristics of gases and particles measured at source and receptor to identify and quantify source contributions to the receptor concentrations (Thomas, 2004). Receptor models are generally contrasted with dispersion models that use pollutant emissions rates, meteorological data and chemical transformation mechanisms to estimate the contribution of each source to receptor concentrations (Thomas, 2004). The two types of models are complementary with each having strengths that compensate for the weaknesses of the other (Thomas, 2004). Photochemical smog, induced by traffic and industrial activities has become the main source of concern for air quality (Molina, 2004). Particulate matter is generally referred to or defined in terms of particle size. Total suspended particulate (TSP) is particulate matter with an aerodynamic diameter $< 30 \mu\text{m}$ (Guttikunda, 2008). PM_{10} is defined as the smaller fraction, particulate matter which passes through a size-selective inlet with a 50% efficiency cut-off at $10 \mu\text{m}$ aerodynamic diameter (SANS 1929, 2005). These particles are deposited in the upper respiratory tract (nasal passages and pharynx). Particles with aerodynamic diameter of $< 2.5 \mu\text{m}$ ($\text{PM}_{2.5}$) deposit in the lower respiratory tract (alveoli within the lungs). Particle size is especially important for its impact on human health, particularly on the respiratory system (Wright and Oosthuizen, 2010). The smaller the particle size, the greater the particles' potential to cause adverse health

effects (Wright and Oosthuizen, 2010). In South Africa ambient air quality standards and guidelines are in place to provide an indication of safe or acceptable airborne concentrations. National standards have been set for the size fractions, PM_{10} and also $PM_{2.5}$. Set standards exist for concentrations averaged over specified periods of 24 hours and 1 year. These standards are listed in section 2.

In applying the standards, it is also important to know where the dust is coming from. There is an acute need for source apportionment analysis in developing countries (ESMAP, 2011). Dispersion models are fairly well developed and have previously been used to predict air quality concentrations at Driefontein Gold Mine, the study site (Kornelius and Bornman, 2008 and Enslin, 2012). Dispersion modelling has some limitations in that site-specific emission factors may not exist and also, its inability to account for unidentified or unexpected sources. Source apportionment, from receptor-based measurements has not been previously conducted at Driefontein Gold Mine. Source apportionment can make a valuable contribution in attempts to reduce air pollution. This report focuses on apportionment of particulate matter, PM_{10} primarily, because of its importance for human health.

1.2. Problem statement

At a site where particulate matter is the predominant pollutant from a variety of potential sources, the contributions from the individual sources may be difficult to distinguish especially if the sources fall within a single category type with similar pollutant profiles. It would be useful to ascertain the individual contributions so that the effectiveness of existing control measures can be determined and areas where additional controls may be required can be identified.

1.3. Objective

The objective is to assess the contributions to PM_{10} concentrations from major sources in and around a gold mine to the measured ambient PM_{10} concentration in a gold mine residential village.

1.4. Method and scope of work

The area for this study has been Driefontein Gold Mine, located approximately 75 km west of Johannesburg and near the town of Carletonville (see locality map in Figure 1.1.). Carletonville town has a population of approximately 182 300 residents. The scope extended to the surface dust generating activities on and around the Mine. The top-down receptor-based source apportionment technique has been followed. Major potential dust sources were identified from existing monitoring programmes and previous studies. These dust sources were sampled and elemental compositions and alpha quartz concentrations were determined by laboratory analysis. The West Village has been selected as the sample receptor on the basis of its central location, accessibility and security. The Village is inhabited by mine employees and their families. Three particulate matter samplers were set up. PM₁₀ levels were measured with an E-Sampler (Met One Scientific Inc.) instrument that was positioned at West Village, the selected receptor point. Black carbon concentrations were measured at the receptor location with a MicroAeth Aethalometer (Magee Scientific Inc.). Dust fall was also measured at West Village (see Figure 1.1) with multidirectional (Dustwatch) buckets. Meteorological contributing factors such as wind direction and wind speed were monitored with a localized weather station, positioned at the Driefontein Office complex. The data on the sources and information collected at the receptor has been used for determining the contributions to the dust concentrations at the selected receptor point. The data was computed by the Statistics Department of the University of Pretoria into their Statistical Analysis System (SAS) software package.

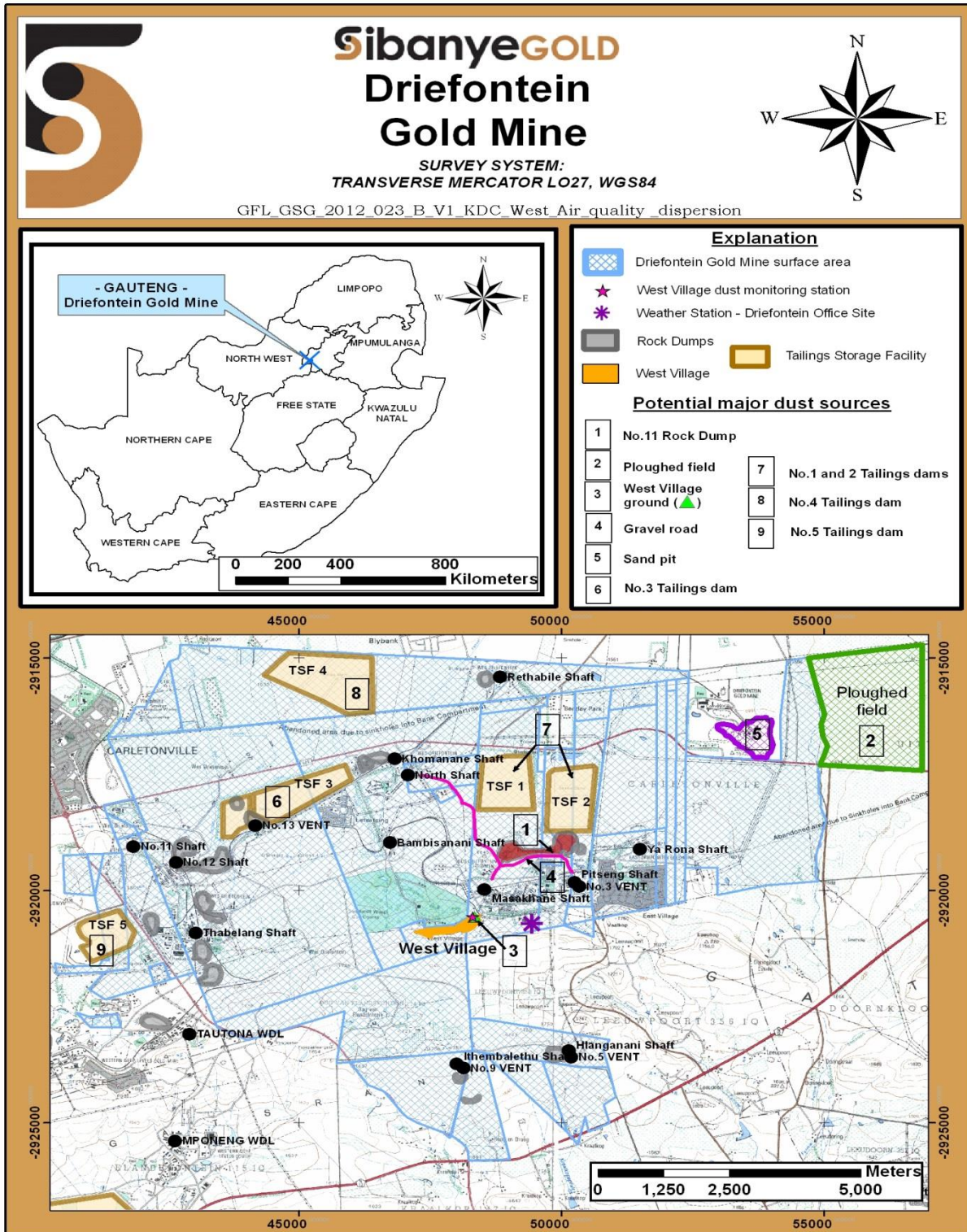

Figure 1.1: Driefontein Locality map

2. THEORY

This chapter provides an overview of the legislative framework, national standards, previous studies and assessment techniques. The Bill of Rights contained in the Constitution of the Republic of South Africa enshrines the right of everyone to an environment that is not harmful to their health or well-being (Republic of South Africa, 1996). In order to give effect to this right, in the context of air quality, it became necessary for the setting of ambient air quality standards. The South African National Standard (SANS) 1929 provides the basis for ambient air quality standards. These national standards have informed legislation, with some already incorporated into regulations under the National Environmental Management: Air Quality Act (NEM: AQA).

2.1. National Environmental Management: Air Quality Act, 2004 (Republic of South Africa (2005))

The NEM: AQA sets out to reform the law regulating air quality in order to protect the environment by providing reasonable measures for the prevention of pollution and ecological degradation. The Act originally set national standards for ambient air quality in one of its Annexures titled, Schedule 2. This was later revised in December 2009 with the addition of compliance timeframes (Republic of South Africa (2009)). The current standards and timeframes for PM_{10} are tabulated below.

Table 2.1: South African Air Quality Standards and Forthcoming Revised Standards (1 January 2015) for PM₁₀

Averaging period	Concentration	Frequency of exceedance	Compliance Date
24 hours	120 µg/m ³	4	December 2009 – 31 December 2014
24 hours	75 µg/m ³	4	1 January 2015
1 year	50 µg/m ³	0	December 2009 – 31 December 2014
1 year	40 µg/m ³	0	1 January 2015

An important point from the table is that current limits will be reduced in the foreseeable future. Current controls should therefore be assessed with a view to manage emissions in accordance with the new limits. The reference method for determination of the PM₁₀ fraction of suspended particulate matter is EN 12341 (Republic of South Africa, 2009). This reference measuring method provides the specifications for PM₁₀ sampling instruments and the gravimetric determination of the PM₁₀ mass collected.

Following on international trends, national ambient air quality standards for PM_{2.5} have been gazetted in June 2012 (Republic of South Africa, 2012a). These are tabulated below.

Table 2.2: South African Air Quality Standards and Forthcoming Revised Standards (1 January 2015) for PM_{2.5}

Averaging period	Concentration	Frequency of exceedance	Compliance Date
24 hours	65 µg/m ³	4	June 2012 – 31 December 2015
24 hours	40 µg/m ³	4	1 January 2016 – 31 December 2029
24 hours	25 µg/m ³	4	1 January 2030
1 year	25 µg/m ³	0	June 2012 – 31 December 2015
1 year	20 µg/m ³	0	1 January 2016 – 31 December 2029
1 year	15 µg/m ³	0	1 January 2030

A phased approach is proposed to achieve the desired concentrations by 2030. Draft regulations for measuring of dust fall lists the ASTM D1739: 1970 or equivalent as the acceptable method (Republic of South Africa, 2012b). The draft dust fall standard is tabulated below.

Table 2.3: Draft Dust fall standard

Restriction Area	Dust fall rate, D (mg/m²/day)	Permitted frequency of exceedance
Residential area	D < 600	Two within a year, not sequential months
Non-residential area	600 < D < 1 200	Two within a year, not sequential months

The standard concentrations are measurable at and beyond the boundary of the premises where dust originates. The latest version of the reference standard is ASTM

D1739 – 98 (2010). The SANS 1929 lists the ASTM D1739 – 98 as the reference method for dust fall. The SANS Standard also states that any other method which can be demonstrated to give equivalent results may be used. The SANS target, action and alert thresholds are tabulated below.

Table 2.4: SANS 1929 Target, action and alert threshold

Level	Dust fall rate, D (mg/m²/day)	Averaging period	Permitted frequency of exceedance
Target	300	Annual	
Action residential	400	30 days	Three within any year, no two sequential months
Action industrial	1200	30 days	Three within any year, no two sequential months.
Alert threshold	2400	30 days	None. First time exceeded, triggers remediation and reporting to authorities.

The ASTM D1739 standard is a crude non-specific test method but is useful in the study of long-term trends (ASTM D1739: 98). For sampling according to the ASTM D1739 method, containers of a standard size and shape are prepared and sealed in a laboratory and then opened and set up at chosen sites so that particulate matter can settle into them for periods of about 30 days. The containers are then closed and returned to the laboratory where the masses of the water-soluble and insoluble components of the collected material are determined. The results are reported as mg/m²/day. The latest version of the standard includes specifications for a wind shield and added criteria for the height of the container and site selection. Driefontein Gold Mine has deployed multi-directional dust fall equipment. This equipment is different to the listed SANS method or draft regulation. The multi-directional dust fall equipment comprises of a set of four buckets with a large lid and single opening. The lid is fitted with a wind vane that rotates the lid with the prevailing wind. Dust is collected separately from each direction, north, east, west and south in the four buckets. This is useful in

determining the direction and potential sources of the dust that is collected. However, demonstration of equivalence to the prescribed standard still needs to be done.

2.2. Regional Studies

The air quality in the industrialised areas of South Africa has been a major concern to the authorities for some time (see for instance Held *et al.* 1996). Following concerns of authorities, industry and residents regarding the poor air quality in the Vaal Triangle, Mintek (Engelbrecht, Reddy & Mostert, 1998) was directed during 1997 to assess the situation to determine:

1. The magnitude of the air pollution problem,
2. How measured pollution levels in the Vaal Triangle compare with international standards,
3. Which polluting processes contribute the ambient air in the region and
4. What proportion is contributed by each of the polluting source-types.

From this study, the gravimetric data clearly illustrated the increased pollution levels with regard to particulate matter during the late autumn to winter periods (Engelbrecht *et al.*, 1998). High gravimetric concentrations showed a corresponding increase in the total carbon content. Carbon concentrations peaked during winter and dropped to their lowest levels during summer, suggesting that carbon sources contribute significantly to the increased gravimetric concentrations. Receptor modelling showed that major contributions stem from domestic coal combustion smoke (25%), secondary ammonium sulphate (21%), fugitive soil dust (20%), iron arc furnace dust (13%) and power station fly-ash (8%). The study recommended that sampling stations be set up in residential areas where the impact of pollution on human health is the greatest. The Department of Environmental Affairs is in the process of expanding their ambient air monitoring networks to get better representation and coverage on a national scale. Driefontein Gold Mine has set up a monitoring station in a residential area and results from the Driefontein Gold Mine, residential monitoring station are analysed further in this report.

A world-wide study of 304 cities (Cohan *et al*, 2004) found the mean ratio of PM₁₀ to Total Suspended Particulate (TSP) to be 0.49. In the same study, analysis of measurements found the PM_{2,5} to PM₁₀ ratio to be typically in the range of 0.5 to 0.8. In areas impacted by more crustal particles such as arid areas or cities with a significant number of unpaved roads or windy days, the ratios are likely to be much lower (Cohan *et al*, 2004). The report (Cohan *et al*, 2004) proposes that future research on exposure should aim to provide better estimates, not only of ambient concentrations of pollutants, but also the characteristics of pollution, including the contribution of the various sources and the size distribution of particulate matter (PM).

The Mintek monitoring station for example, in Randburg, Gauteng, measured PM_{2,5} and PM₁₀ during 1999 and a PM_{2,5} to PM₁₀ ratio of 0.57 was observed (Witi, 2005). The PM₁₀ concentration was 46 µm/m³ and the PM_{2,5} concentration was 26.2 µm/m³.

The City of Johannesburg has conducted an assessment of the diurnal variation in PM₁₀ concentrations from their monitoring stations. Comparatively high concentrations were recorded in the early mornings from 05h00 to 09h00 and in the evenings from 17h00 to 21h00 (City of Johannesburg, 2007). These periods are associated with increased domestic fuel burning. The assessment attributed the higher PM₁₀ concentrations during the winter months to temperature inversions and calm winds which led to the build-up of contaminants. Lower PM₁₀ concentrations during the summer months were attributed to the mixing of air (City of Johannesburg, 2007).

A study was recently conducted on the relationship between aerosol optical depth (AOD) from the Multi-angle Imaging SpectroRadiometer (MISR) instrument on the Terra satellite and ground-based monitored PM mass concentrations measured at the City of Johannesburg monitoring sites (Garland & Sivajumar, 2012). AOD is the vertical integral of the extinction coefficient at a specific wavelength in a column of air from the surface to the top atmosphere. Garland & Sivajumar (2012) found that aerosol particles can have large impacts on human health and the radiative balance of the atmosphere. The PM₁₀ mean and median values, as measured by satellite and ground-based monitoring peaked during May to September. While the maxima and minima values of PM₁₀ varied,

the overall trends on a monthly scale were similar from one month to the next. The satellite and ground-based monitoring suggested that PM₁₀ pollution trends at the ground are driven by regional pollution and not by local emissions near a monitoring site alone. The AOD peaked during September to December. A key consideration in the differences in AOD and PM₁₀ peaks may be the fact that the column of aerosols has different trends and properties than those on the ground.

Quartz is a frequently occurring solid component of most natural mineral dusts (Rice, 2000). Human exposures to quartz occur most often during occupational activities that involve movement of earth, disturbance of silica-containing products or use or manufacture of silica-containing products. Occupational exposure to crystalline alpha quartz has been related to health effects (fibrosis). The lowest observed adverse effect level (human equivalent concentration) is 0,18 mg/m³ (Rice, 2000). Environmental exposure to ambient quartz dust can occur during natural, industrial and agricultural activities. It is for this reason alpha quartz has been included in the study.

Biomass burning can be significant factor in air quality emissions as determined by uMoya-Nilu during the compilation of the 2011 emissions inventory for the West Rand District Municipality (WRDM). In the WRDM, the total burned area for 2011 was 782.6 km², compared to a total estimated area of the WRDM of 4 087 km² (uMoya-Nilu, 2012). A total of 3 651 fires occurred in 2011 (uMoya-Nilu, 2012). The two most significant sources of PM emissions that were identified in the WRDM during the emissions inventory compilation were biomass burning at a 46.0% contribution and tailings dams at a 39.9% contribution. However, no information was available for agriculture and that contribution was excluded from the study.

2.3. Localised Studies

A baseline ambient air assessment was performed at Driefontein during 2008. One of the recommendations emanating from that assessment was that the predicted health impacts be assessed by PM₁₀ monitoring (Kornelius & Bornman, 2008). During the baseline assessment, the short-term and annual average PM₁₀ concentrations were

predicted through dispersion modelling. The ADMS model was used with meteorological data obtained from Johannesburg, Potchefstroom and Vereeniging. The meteorological data was processed with the CALMET pre-processor for the study area. Predicted annual average PM_{10} contributions exceeded the SANS 1929 proposal of $40 \mu\text{g}/\text{m}^3$ mainly along the ore and waste road transport routes. These exceedances were the result of contributions from several sources. Main contributors, as depicted on Figure 2.1 below, were No. 5 tailings dam (point 7), No. 2 tailings dam (point 24), the unpaved roads (green line) and the No. 4 tailings dam (point 20). Crushing, screening and the ventilation shafts provided relatively minor contributions. Predicted annual average PM_{10} contributions at West Village were found to be $35 \mu\text{g}/\text{m}^3$.

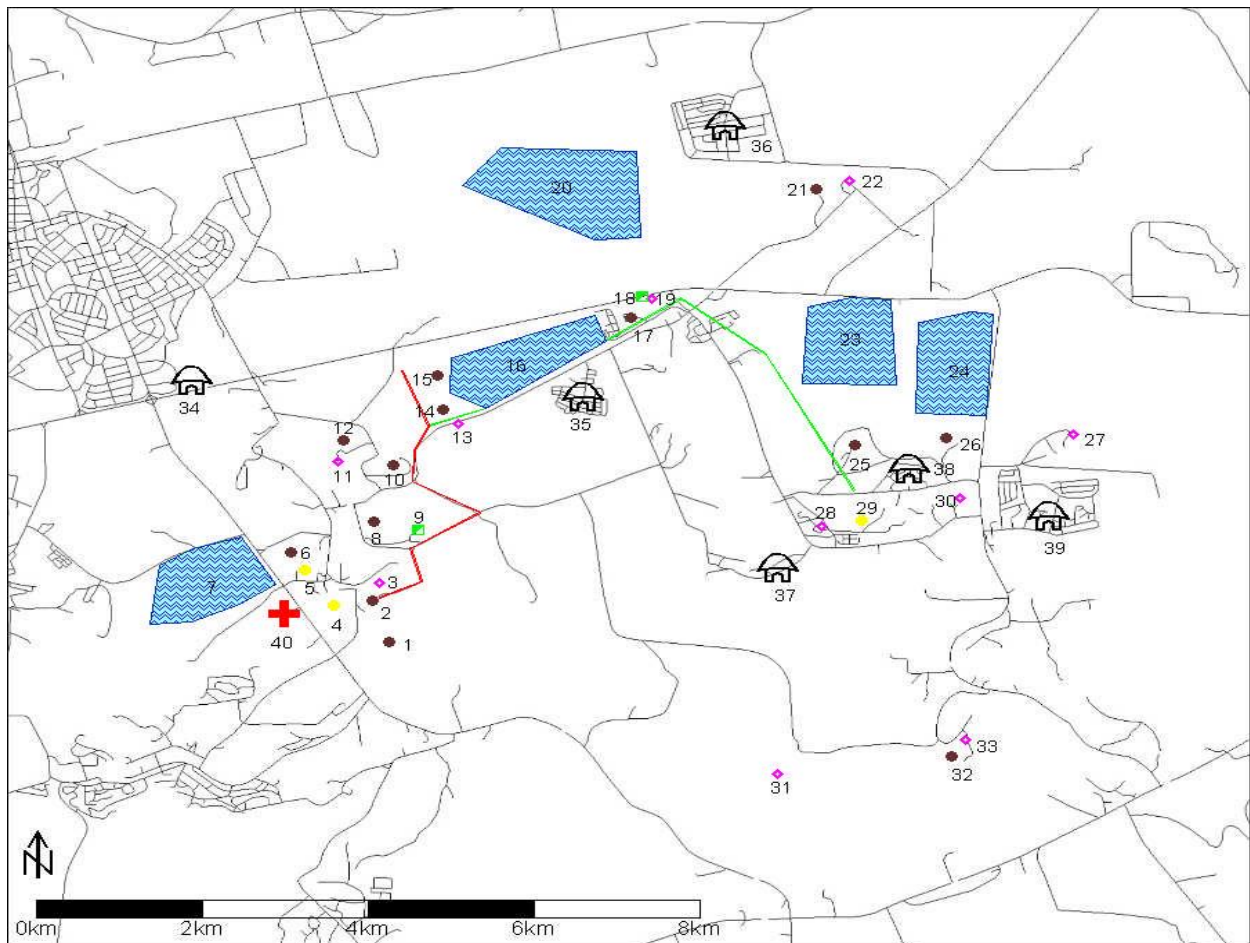

Figure 2.1: Driefontein Mine layout (Source: Airshed, 2008)

A more recent study conducted by Rayten Engineering in 2012, utilised the AERMOD dispersion model (Enslin, 2012). The study found that the unpaved roads and the tailings dams were the main contributors to PM₁₀ dust.

2.4. Source apportionment

Being able to identify different air pollution sources accurately is a key element in an effective air quality management system (Guttikunda, 2009). An air quality management system brings together the scientific activities of determining air pollution emissions, ambient concentrations by pollution type and the resulting health impacts. It is important to note that the health impacts from air pollution are not entirely dependent on the particulate pollution. The health impacts observed or estimated are also dependent on other pollutants such as ozone, hydrocarbons, acidity in the air due to sulphur, nitrogen compounds, carbon monoxide, etc. In developing countries, particulate matter forms the major contributor (Guttikunda, 2009). Source apportionment is part of the top-down approach. The top-down approach begins by sampling at the receptor and inferring contributions to different sources based on their characteristics. The four primary steps entail ambient sampling, source profiling, chemical analysis and receptor apportionment. This process has been utilised in this study. Source apportionment techniques such as the chemical mass balance have been considered. Tests were run on the US EPA CMB 8.2 model. Due to similar source types (tailings dams, rock dumps and soil) under investigation, co-linearity was encountered in the outputs. Co-linearity occurs when the model cannot effectively differentiate between the potential sources (normally encountered when they are similar in nature) (Watson, 2004). For instance, all the tailings dams would have had to be grouped into a single source category. This approach would not have been able to determine contributions from individual tailings dams. Therefore the use of the statistical analysis system (SAS) software package of the University of Pretoria was pursued where the contributions from potential sources could be ascertained.

3. EXPERIMENTAL

3.1. Sources and receptor

From previous studies, the tailings dams and gravel roads were identified as the predominant sources of particulate matter. The tailings dams have varying degree of dust controls from vegetation, water sprays and ridge ploughing. Apart from No. 1 and 2 tailings dams where similar deposition material originated from the No. 1 Gold Plant, the tailings dams would have been characterized by the different types of material processed at different stages in Driefontein mine's operating life. The experiment set out to analyse the constituents of the potential sources so as to differentiate between them and determine the contributions to the PM₁₀ concentration. The No. 1 and 2 tailings dams, which are located adjacent to each other were treated as a combined source.

The experimental process entailed the deployment of the E-Sampler and the MicroAeth black carbon aethalometer instruments to collect data at the receptor point in West Village. The E-Sampler was set to measure PM₁₀ concentrations through the light scatter method at 10 minute intervals. Also, monthly composite gravimetric samples were collected by the same instrument. These samples were analysed for elements, Ag, Al, As, Au, B, Ba, Be, Bi, Ca, Cd, Co, Cr, Cu, Fe, Ir, K, Li, Mg, Mn, Mo, Na, Ni, Os, P, Pb, Pd, Pt, Re, Rh, Ru, S, Sb, Se, Si, Sn, Sr, Ta, Te, Ti, Tl, V, W, Zn and Zr. The alpha quartz concentrations were also analysed. The monthly elemental analysis and alpha quartz analysis reports are attached in Appendix A. A set of 4 multidirectional dust fall buckets was deployed at West Village. A composite analysis of dust fall samples were assessed for its elemental concentrations for Ag, Al, As, Au, B, Ba, Be, Bi, Ca, Cd, Co, Cr, Cu, Fe, Ir, K, Li, Mg, Mn, Mo, Na, Ni, Os, P, Pb, Pd, Pt, Re, Rh, Ru, S, Sb, Se, Si, Sn, Sr, Ta, Te, Ti, Tl, V, W, Zn and Zr using a Bruker FDIR Induction Coupled Plasma – Mass Spectrometry apparatus. The alpha quartz concentrations were also analysed for with an Agilene 7700, using the NIOSH 7602 method. The composite dust fall elemental analysis is attached in Appendix B. Meteorological conditions were recorded with the weather station located at the Driefontein Office Complex. Parameters recorded included wind speed, wind direction, rainfall and temperature.

The data were processed by the Statistics Department of the University of Pretoria with the Statistical Analysis System (SAS) software package. The following is a brief explanation of the methodology followed to apportion and identify the contribution of sources to the receptor concentration. The full exposition and outputs are listed in Appendix C. From each of the nine sources a once-off chemical analysis identifying 44 elements was obtained. The full analysis is attached in Appendix D. From the 44 elements, there were some that were present in concentrations smaller than the detection limit. Missing values for elements were replaced by a “Zero” and used in the analyses so as not to over-estimate the concentrations at the receptor. An investigation of these results indicated that nine elements presented enough observations to justify inclusion in an analysis. The nine elements were selected on the basis of minimum substitution of missing values. The elements included in the final analysis were, in alphabetical order:

Aluminium

Calcium

Iron

Magnesium

Phosphorus

Potassium

Sodium

Titanium and

Zinc.

The nine sources were identified from a physical assessment of activities on and around the mine, review of mining processes and previous studies. The sources investigated were:

No. 11 Rock dump

Ploughed field

West Village ground

Gravel road

Sand pit

No. 3 Tailings dam

No. 1 & 2 Tailings dams

No. 4 Tailings dam and

No. 5 Tailings dam.

These nine sources are depicted in Figure 3.1 below.

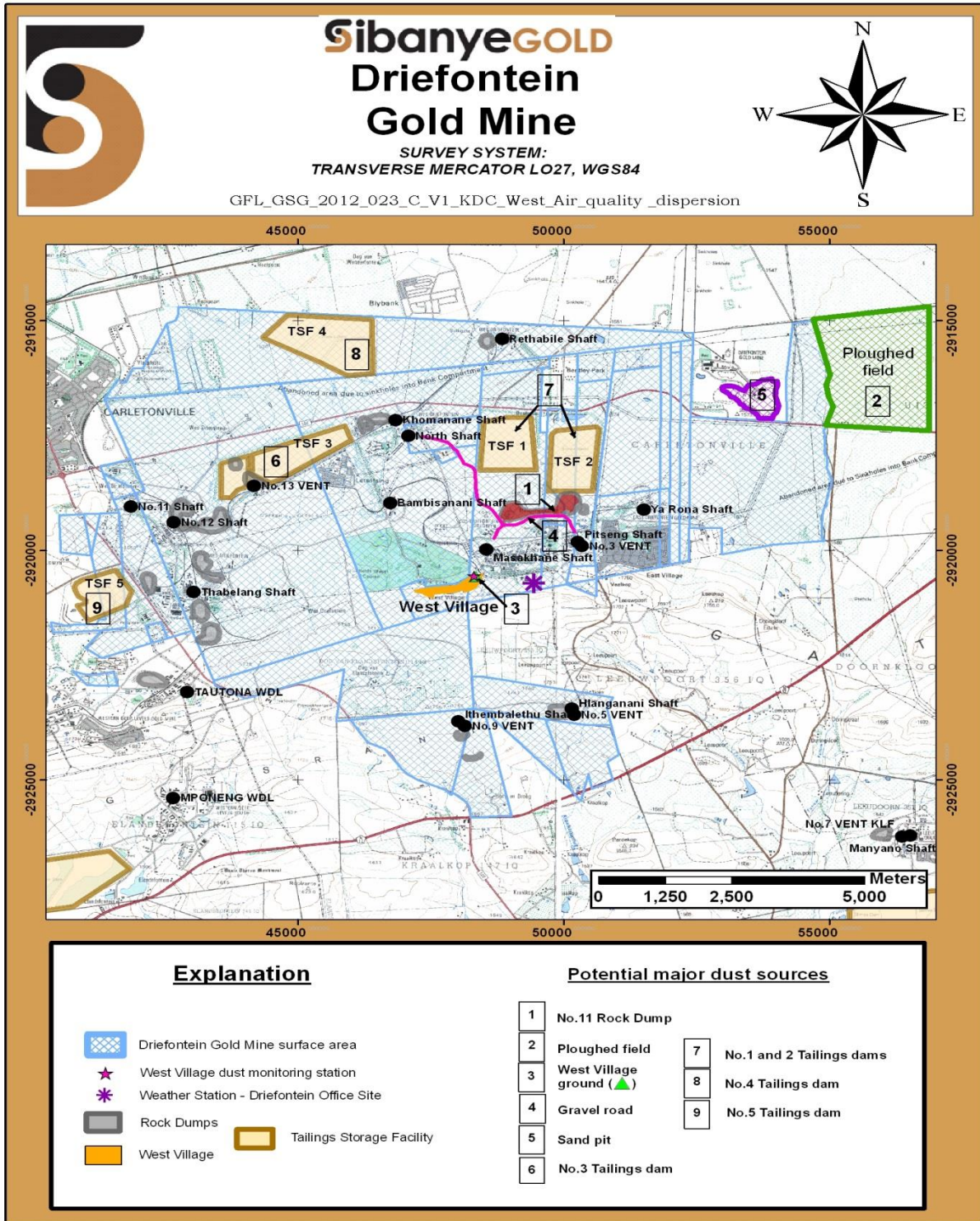

Figure 3.1: Potential dust sources locality map

From the above nine sources and nine elements, nine equations with nine unknowns (contribution from the nine sources) were set up from which a statistical solution has been obtained for the contribution.

The sources had been sampled as a once-off due to its unchanging form from month to month. As such, no regression of sources could be performed. The Jack-knife alike approach was followed to estimate the standard errors for the differences in contributions from the different sources. In order to mitigate the generation of negative contributions from sources to receptor, which is not practically possible, the minimum contribution of source to receptor was rescaled to be zero to provide a statistical solution. This statistical solution did not retain the ratio between elements. It is also acknowledged the dust contributions from unidentified sources may also have been collected at the receptor (such as neighbouring Mines).

3.2. Site Location

The study area, Driefontein Gold Mine is located on the West Wits Line, approximately 75 km west of Johannesburg. Gold mining occurs at depths between 1 000 m and 4 000 m below surface. Mining takes place predominantly within two separate ore bodies, the Carbon Leader Reef (CLR) and the Ventersdorp Contact Reef (VCR). The Middelvei Reef (MR) is a minor contributor to Driefontein's resources. The Mine extends over a surface area of approximately 10 000 ha. The seven operating shaft systems provide access to mine the different ore bodies. There are three gold plants of which, No. 1 Plant processes mainly underground ore, with the remaining No. 2 and 3 Plants processing surface material from historical waste rock dumps. The Mine has a workforce of approximately 15 000 personnel, including contractors. The majority of the workers reside within the mine lease area in high density residences and villages. The activities around the Mine include other mining companies' operations, mealie farm lands, cattle grazing and sand pit excavation for brick making material.

The centrally located West Village has been selected as the receptor test site. West Village is home to some of the mine employees and their families. West Village was

equipped with one of nine multi-directional dust fall monitoring stations. The E-Sampler and black carbon aethalometer were deployed adjacent to the multi-directional dust fall bucket system at West Village.

3.3. Particulate Matter E-Sampler

Particulate matter was monitored with the Met One E-Sampler. The Met One E-Sampler was chosen due to its ability to provide two modes of particulate concentration measurements simultaneously. The E-sampler was setup at West Village, as depicted in Figure 3.2 below. It was equipped with a sharp cut cyclone for inhalable particulate matter (PM₁₀). The PM₁₀ concentrations were measured and analysed for the period June 2011 to June 2012 using both, the light scatter method and gravimetric method.



Figure 3.2: E-Sampler installation at Driefontein West Village (foreground)

3.3.1. E-Sampler Overview

The E-Sampler is a combination of two technologies (Met One Instruments, 2002). Each method can be individually checked and verified for proper operation. It utilizes the light scatter method and also the conventional gravimetric method for determination of airborne particulate. The E-Sampler has a concentration range of 0 to 65 mg/m³

3.3.2. Light scatter (see figures 3.3 and 3.4)

The E-Sampler uses light scatter from suspended particulate to provide a continuous real-time measurement of airborne particulate. An internal visible laser diode is directed through the air sample. This air sample is drawn into the E-Sampler by an internal flow-controlled pump. The flow stream is illustrated in Figure 3.3.

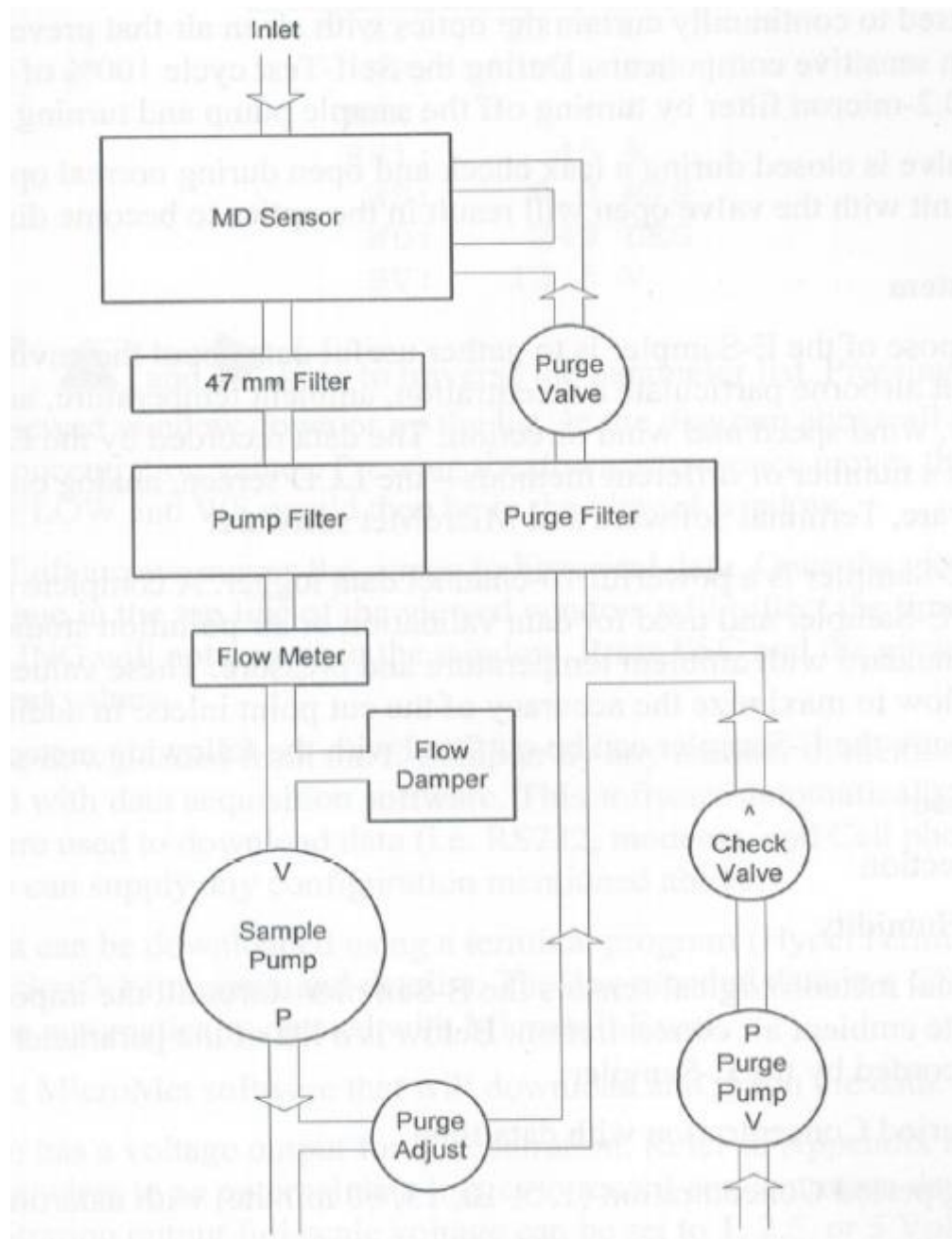

Figure 3.3: E-Sampler Flow system

During normal sampling, the drawn air will contain airborne particulate. When the air sample is drawn through and intersects the laser beam, a portion of the light is scattered by the particulate. This is illustrated in Figure 3.4.

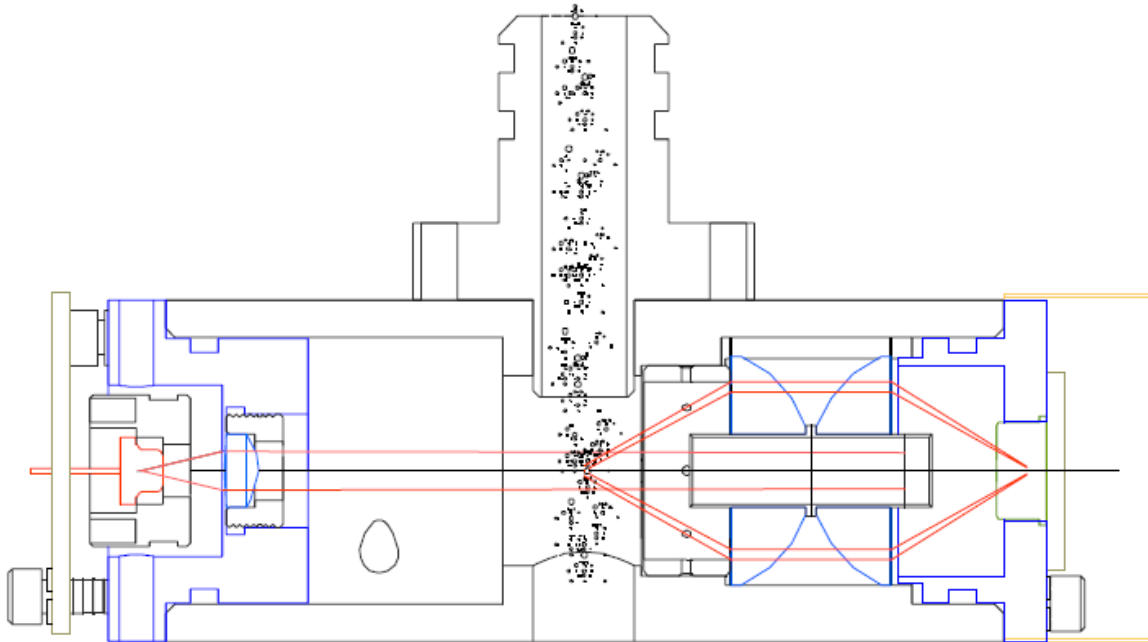

Figure 3.4: Light scatter due to airborne particulate

The scattered portion of the light is collected and focused on a silicon photo diode that converts light to electric signals. The scattered light is proportional to the amount of particulate in the air. Also, the electric signal is proportional to the amount of scattered light. Relative humidity has an influence on the measurement of particulate weight. At relative humidity greater than 50%, such influences become more profound. To counteract this, the E-Sampler controls relative humidity fluctuations with a heated inlet that uses an internal relative humidity sensor. The relative humidity of the incoming air is measured at a set point and the inlet heater is activated to keep the relative humidity from changing the true concentration. This data is then logged on the instrument. The instrument was set to log integrated measurements at 10 minute intervals.

3.3.3. Gravimetric Filter

The E-Sampler uses light scatter from suspended particulate to provide a continuous real-time measurement of airborne particulate. A pre-weighed 47 mm diameter filter is placed in the E-Sampler so that after the dust concentration has been measured by the

light scatter, the dust is deposited onto the filter. The dust concentration can be calculated, as the sample flow is controlled at 2 litres per minute. The filters were deployed over twelve monthly intervals.

3.3.4. k Factor

The light scatter method can produce inherently incorrect measurements due to index of refraction and mean particle diameter. Index of refraction and mean particle diameter can affect the amount of light scattered from the same amount of mass. In order to overcome this, the light scatter concentration for a set period of time is compared with the gravimetric concentration over the same period of time. Through this comparison, the calibration (k) factor can be calculated and applied to correct such deviations. This is used to adjust and correct subsequent light scatter measurements.

3.3.5. Set up

The E-Sampler was set up to measure PM₁₀ at 10 minute averaging intervals. The unit of measure was set to µg/m³. A flow rate of 2 litres per minute was maintained. The E-Sampler was set to carry out daily self-test runs. The mass flow was measured on the exit side of the pump filter. Ambient Temperature and Pressure were measured. A portion of the exhaust air was recirculated through a 0.2 µm purge filter. This is done to continually curtain the optics with clean air that prevents dirt from depositing on sensitive components. During the self-test, 100% of the air is circulated through the 0.2 µm filter by turning off the sample pump and turning on the purge pump (see Figure 3.3).

3.3.6. Self-test

The E-Sampler is capable of conducting a self-test at pre-set intervals. During the self-test, the E-Sampler filters air through a 0.2 µm pore size filter element with 99.99% efficiency before entering the light scatter sensor as depicted in Figure 3.5 below.

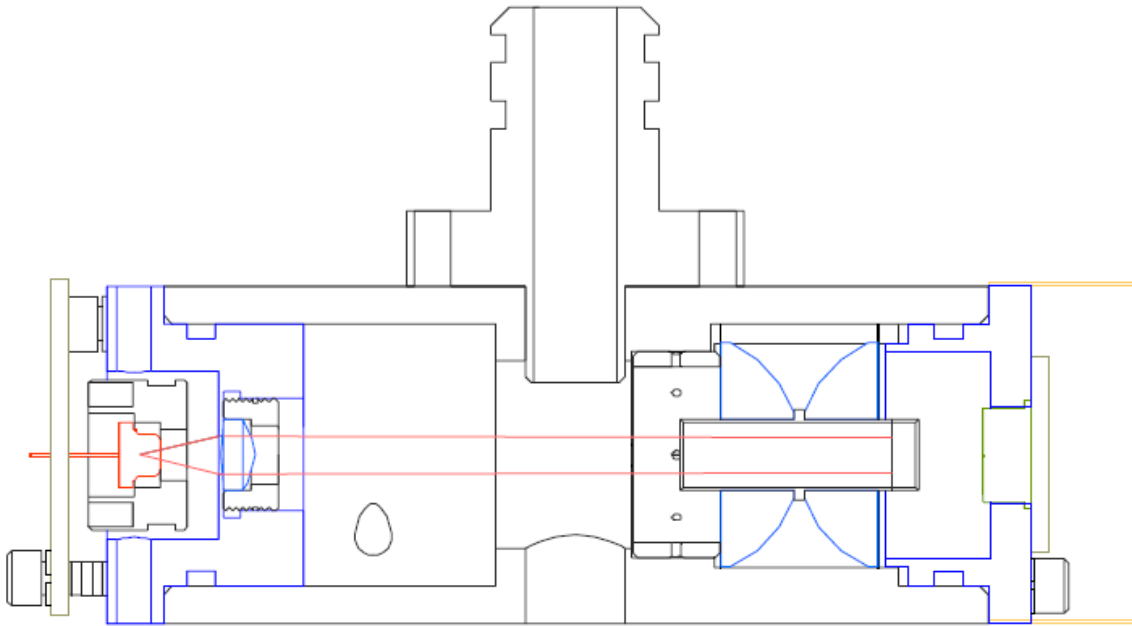

Figure 3.5: Clean air condition for the E-Sampler Nephelometer

When the clean air crosses the path of the laser diode, the laser diode is extinguished in a light trap. The clean air condition without scattered light is the zero condition. The E-Sampler also automatically zeros itself at set periods when the self-test is run. The self-test event is run whenever the unit starts sampling and after that, it runs at the pre-set self-test period. For this exercise, the self-test was set to run once a day.

3.4. Black Carbon Aethalometer

Black carbon is a component of particulate matter that is formed by incomplete combustion. Potential sources include burning of fossil fuels and biomass. Black carbon was assessed with an aethalometer, the MicroAeth Model AE51 (MicroAeth). The MicroAeth is illustrated in Figure 3.6 below.



Figure 3.6: Magee Scientific MicroAeth Model AE51 aethalometer

The MicroAeth is designed specifically for investigation of personal exposure to carbonaceous particles found in ambient air (Magee Scientific, 2009). The instrument is based on aethalometer technology that is widely used for studying indoor or outdoor air quality, and for the mobile mapping of the air quality impacts of localized sources. The instrument provides short time resolved data essential for assessing the real-time concentration of black carbon aerosols in a micro-environment. The MicroAeth draws an air sample at a flow rate of between 50 and 150 ml/min through a 3 mm diameter portion of filter media. Optical transmission through the sensing spot is measured by a stabilized 880 nm LED light source and photo diode detector. The absorbance attenuation of the spot is measured relative to an adjacent reference portion of the filter once per time base period. The gradual accumulation of optically-absorbing particles leads to a gradual increase in attenuation from one period to the next. The air flow rate through the spot is measured by a mass flow sensor which is also used to stabilize the pump. The electronics and microprocessor measure and store the data of each period to determine the increment during each time base. This is then converted to a mass concentration of black carbon expressed in nanograms per cubic meter (ng/m^3) using the known optical absorbance per unit mass of black carbon material. The MicroAeth requires a sample filter ticket to be manually inserted, removed and replaced for each

sampling event. To maintain a leak-free sample path, the filter ticket is clamped between two halves of the spring-loaded sampling head. A release button opens the clamp to allow the ticket to be inserted and removed. A locating pin in the head engages in a matching hole in the ticket holder to ensure correct filter ticket placement. The MicroAeth was placed next to the E-Sampler in a vented cage as illustrated in Figure 3.7. below.



Figure 3.7: Black Carbon aethalometer installation at West Village monitoring station

Black carbon samples were taken from July 2011 to November 2011. The battery of the MicroAeth was charged and placed at the dust monitoring station at West Village. The MicroAeth was started and left to run as long as the battery life allowed. This was about 2 to 3 days at a time. Samples were collected on T60 Teflon-coated borosilicate glass

fiber filters. After each sample run, the unit was re-charged, data downloaded, filter replaced and redeployed at the same location. Samples were collected with the flow rate set at 50 and 150 millilitres per minute. The time base was set at 1 minute and 5 minute intervals. The flow rate was set at 50 millilitres per minute from July until end of October. During November, the flow rate was set to 150 millilitres per minute. The time base was set at 1 minute intervals from 06 July to 13 July. Thereafter, the timebase was set to 5 minute intervals. The longer time base and lower flow were used in the endeavour to prolong the battery life and take samples over longer durations.

3.5. Multidirectional Dust fall buckets

A network of nine multidirectional “Dustwatch” dust fall buckets have been deployed at and around the Driefontein operations. The multidirectional dust fall method differs from the ASTM method in that four buckets are deployed that collect dust from different directions (north, east, west and south) depending on the wind direction. The ASTM method results in dust fall from all directions being deposited in a single bucket. One set of multidirectional buckets has been located in the immediate vicinity of the E-Sampler at West Village as illustrated in Figure 3.8 below. This has been used as a comparison with the PM₁₀ results.



Figure 3.8: Dustwatch multi-directional buckets at West Village (right hand side)

3.6. Weather Station

A weather station is situated at the Driefontein office complex (illustrated on locality map in Figure 3.1). The weather station records on an hourly basis, parameters such as temperature, humidity, wind speed, wind direction and rainfall (see fig 3-9 below).

. One of the more significant findings was the contributions from operational tailings dams, especially at times when deposition rates may be interrupted such as during Christmas Break and strike action. During these episodes, the top surfaces dry out and may liberate more than normal dust. This is important in planning, design and operation of future large tailings facilities for example.



Figure 3.9: Driefontein Weather Station

3.7. Sources

Potential major dust sources identified at and around the operations are illustrated in Figure 3.1.

3.7.1. No. 1 and 2 tailings dams

The No. 1 and 2 tailings dams are located to the north-east of West Village (see figure 3.10 below). These tailings dams are still operational with both receiving deposition tailings material from the No. 1 Gold Plant. The side slopes of the tailings dams are partially vegetated and the top surfaces are partially wet from the on-going tailings slurry deposition. No.1 tailings dam is 48.8 m high and No. 2 tailings dam is 44.3 m high. The No. 1 tailings dam has a footprint of 130 ha and the No. 2 tailings dam covers 141.3 ha. The slurry from the No. 1 Gold Plant is delivered at a density varying from 1,35 to 1,45 tons/m³ at the delivery stations on the top surface of the tailings dams. The slurry delivery system to the tailings dams consists of a perimeter or ring feed pipe and slurry delivery stations at regular intervals around the dams. The deposition points are rotated to ensure a level rate of rise of the dams. The outer wall is built with the tailings residue material and allowed to dry and consolidate before deposition continues. The final wall configuration is designed to ensure that the outer wall is stable within itself and can contain the body of the dam safely. The overall wall slopes of these dams are approximately 23°. As both these tailings dams are located adjacent to one another and also its tailings material comes from the same source, No. 1 Gold Plant, it has been taken as a combined area source.



Figure 3.10: No. 1 and 2 Tailings dams

3.7.2. No. 3 tailings dam

The No. 3 tailings dam is a non-operational dam, located to the north-west of West Village (see fig 3.11 below). The side slopes are partially vegetated. Natural vegetation has also established itself on the top surface. The No. 3 tailings dam has a footprint of 123 ha. The overall wall slope is 25°. A portion of the dam has been removed for gold reclamation. The tailings dam is 42 m high. The northern and western downstream slopes have been buttressed with waste rock to about 8m.



Figure 3.11: No. 3 Tailings dam

3.7.3. No. 4 tailings dam

The No 4. tailings dam is an operational dam, located to the north-west of West Village (see fig 3.12 below). The tailings dam receives tailings deposition from the No. 2 and 3 Gold Plants. The side slopes are partially vegetated and the top surfaces are partially wet from the on-going tailings slurry deposition. The No. 4 tailings dam has a footprint of 211 ha. This is a comparatively large dam consisting of 3 compartments with heights ranging from 20m to 30m. The combined beach area of the 3 compartments is 129 ha. The beach area is where tailings are deposited and its span. This area will be in varying stages of wetness, depending on the time lapse since deposition. The slurry from the No. 2 and 3 Gold Plants is delivered at a density varying from 1,35 to 1,45 t/m³ at the

delivery stations on the top surface of the tailings dams. The overall wall slope of the dam is approximately 23°.



Figure 3.12: No. 4 Tailings dam

3.7.4. No. 5 tailings dam

The No. 5 tailings dam is a non-operational dam, located to the west of West Village (see fig 3.13 below). The side slopes are partially vegetated. Natural vegetation has also established itself on the top surface. The No. 5 tailings dam has a footprint of 103 ha. The overall wall slope is 23°. The height of the dam is 45 m.



Figure 3.13: No. 5 Tailings dam

3.7.5. Gravel Road

Rock is transported via road from the No. 11 rock dump area to the No. 2 and 3 Gold Plants (see fig 3.14 below). Portions of the road surface comprise gravel. Periodic watering down of the roads takes place. The gravel road surface is a source of dust.



Figure 3.14: Gravel road

3.7.6. West Village

The ground at West Village has been identified as a potential source of dust that may be liberated by wind (see fig 3.15 below).



Figure 3.15: West Village ground

3.7.7. No. 11 Rock dump

The rock dump material and its mechanical loading for conveyance to the Gold Plants is a potential dust source (see fig 3.16 below). The rock dump has been formed by trucks hauling material from the shaft and dumping and spreading in terraces. This rock dump has been formed to approximately 57m in height. As part of a program to concurrently rehabilitate disturbed areas, this rock dump is being systematically loaded and transported to the No. 2 and 3 Gold Plants for processing to extract any residual gold content in the process.



Figure 3.16: No. 11 Rock dump

3.7.8. Ploughed Field

A potential source of dust impacting on West Village is the neighbouring farm lands where commercial mealie farming takes place (see fig 3.17 below). This area falls outside of the Mine lease.



Figure 3.17: Ploughed field

3.7.9. Sand Pit

Another area outside of the Mine lease that has been identified as a potential source is the excavation activities from a sand pit located to the north east of West Village (see fig 3.18 below). Material is being excavated from that site. The excavated material is used for the manufacture of bricks.



Figure 3.18: Sand pit

4. RESULTS AND DISCUSSION

The results from the monitoring of the meteorological conditions and ambient particulate matter concentrations are detailed in this chapter.

4.1. Meteorological data

The wind direction and wind speeds from the weather station, located at the Driefontein Office Complex were used to compute wind roses for the various sampling intervals. A wind rose is a graphical representation of the wind speed and wind direction for a specified period for a particular location. There are two graphics on each wind rose. One graphic depicts the average wind speed by wind direction in meters per second. The other graphic represents the frequency percentage of the wind directions. Calms are classified as low (less than 0.5m/s) or no wind periods. This is expressed as a percentage. The resultant vector wind direction is also indicated in degrees from north. The wind roses have been used in identifying potential sources that may be contributing to the recorded dust loadings.

4.2. Rainfall

The rainfall was recorded by the local weather station and is tabulated below.

Table 4.1: Rainfall over sampling periods: 21 June 2011 to 1 July 2012

Sampling Period	Rainfall mm
21 June 2011 - 01 August 2011	1.6
5 August 2011 - 1 September 2011	5.7
1 September 2011 - 1 October 2011	0.1
1 October 2011 - 1 November 2011	56
1 November 2011 - 1 December 2011	119.4
1 Dec 2011 - 1 Jan 2012	90.2
1 Jan 2012 - 1 Feb 2012	106.8
1 Feb 2012 - 1 Mar 2012	114.1
1 Mar 2012 - 1 Apr 2012	54
1 April - 1 May 2012	19.7
1 May 2012 - 1 June 2012	0
1 June 2012 - 1 July 2012	3.1
Total	570.7

The majority of the rainfall was recorded from October to April. The recorded total rainfall of 570 mm over the sampling period is lower than the long term annual average of approximately 650 mm (Baadtjies, 2011).

4.3. Black Carbon

The black carbon measurements have been averaged per month for the sampling period of July to November 2011. The results are graphically illustrated below.

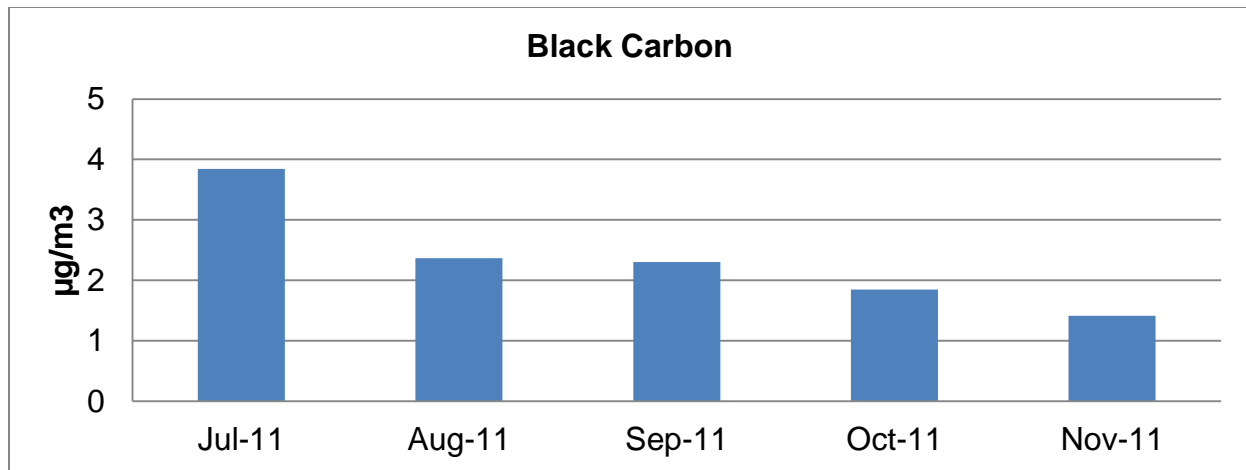

Figure 4.1: Black carbon trends

There is a distinctive decreasing trend from July to November. A possible reason for this could be the reduced use of wood fires in the informal settlements on private land adjacent to the mine with the increasing temperatures moving from winter to summer. Another plausible reason could be the inversion layer forming during the colder periods that has been trapping the black carbon and in the warmer periods, greater dispersion may have occurred as the inversion layer dissipates. There is also the likelihood that both these factors could be contributing as a combination (i.e. increased fire burning and inversion layer). Black carbon formed a significant portion of the total PM₁₀ concentration, especially during the winter period, as illustrated in Figure 4.15 below.

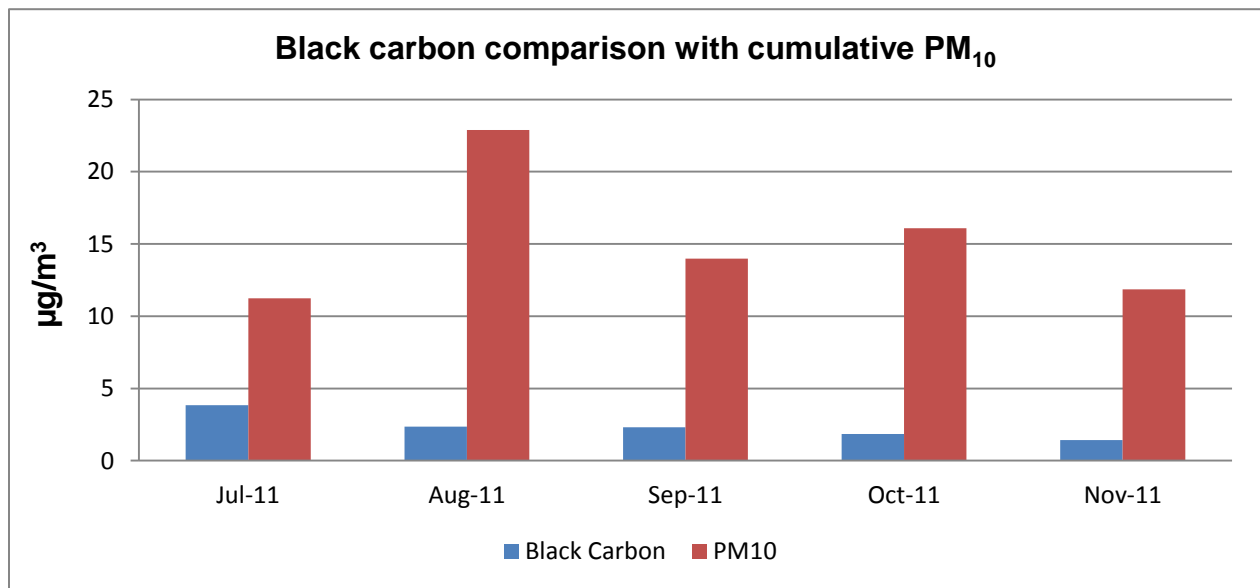

Figure 4.2: Black Carbon comparison with cumulative PM₁₀ concentrations

The black carbon contributions to the total PM₁₀ concentrations ranged from 34% in July to 10% in November.

4.4. Particulate Matter (PM₁₀)

During the first sample period of 21 June 2011 to 1 August 2011, a 0.5 µm nitrocellulose filter was used in the E-Sampler. Thereafter, 0.8 µm nitrocellulose ester filters were used. The 0.8 µm nitrocellulose ester filters were recommended by the analysing laboratory as better suited for the elemental analyses. The results from the pre and post weighs together with the pump running times were used to calculate the dust concentrations. The laboratory analysis reports are attached as Appendix A. The gravimetric dust concentrations are tabulated below.

Table 4.2: E-Sampler gravimetric analysis results

Sampling Period	PM ₁₀ µg/m ³
5 August 2011 - 1 September 2011	22.89
1 Dec 2011 - 1 Jan 2012	10.86
1 Jan 2012 - 1 Feb 2012	16.35
1 Feb 2012 - 1 Mar 2012	25.74
1 Mar 2012 - 1 Apr 2012	14.56
1 April - 1 May 2012	19.68
1 May 2012 - 1 June 2012	18.71
1 June 2012 - 1 July 2012	18.70

The comparative dust concentrations measured by the light scatter method and gravimetric analysis is illustrated below.

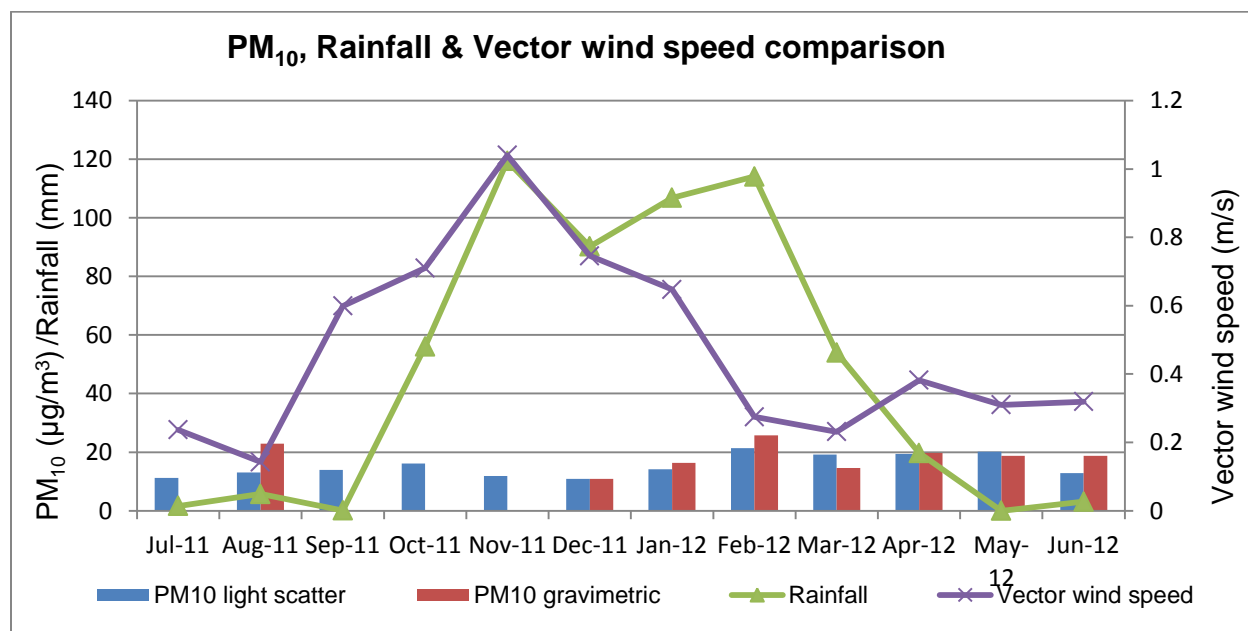

Figure 4.3: E-Sampler light scatter and gravimetric concentrations comparison

The gravimetric analysis of PM₁₀ was not consistently carried out for some of the initial months. The laboratory looked to first analyse for the elemental concentrations which consumed the entire sample on some occasions. Later on, a more consistent approach of halving the filters provided both, elemental analysis and alpha quartz analysis. The average PM₁₀ concentration from the light scatter method is 15.4 µg/m³. The maximum 24 hour concentration is 72.1 µg/m³. The monthly average gravimetric PM₁₀ concentration is 18.4 µg/m³. From this value, the daily and the annual average were extrapolated using the time-averaging equation (Beychok, 2005):

$$C_x C_p' = (t_p t_x')^n$$

Where:

C_x is the known monthly concentration,

C_p is the daily or annual concentration,

t_p is the corresponding daily or annual period,

t_x is the known month period and

n = exponent, function of atmospheric stability class (summarised single-value n , 0.2).

The extrapolated maximum daily average PM₁₀ concentration is 36.3 µg/m³ and the annual average concentration is 11.2 µg/m³. These compare satisfactorily with the current SA daily average limit value of 120 µg/m³ and the annual average limit of 50 µg/m³. The World Health Organisation has proposed a guideline of 50 µg/m³ for the 24 hour mean and 20 µg/m³ for the annual mean (WHO, 2006). Variance in the light scatter measurements and gravimetric results may be related to the time lag from the k-factor inputs. The k-factor was updated at quarterly intervals. The lowest dust concentrations were recorded during November and December. This is also the period of high rainfall which may have provided additional dust suppression. No definitive pattern can be ascertained between the vector wind speed and dust concentrations. The short-term wind speeds and direction may be more influential in dust deposition patterns.

4.5. Potential sources alpha quartz concentrations

The alpha quartz proportions in the samples from the nine potential sources are illustrated in Figure 4.4 below.

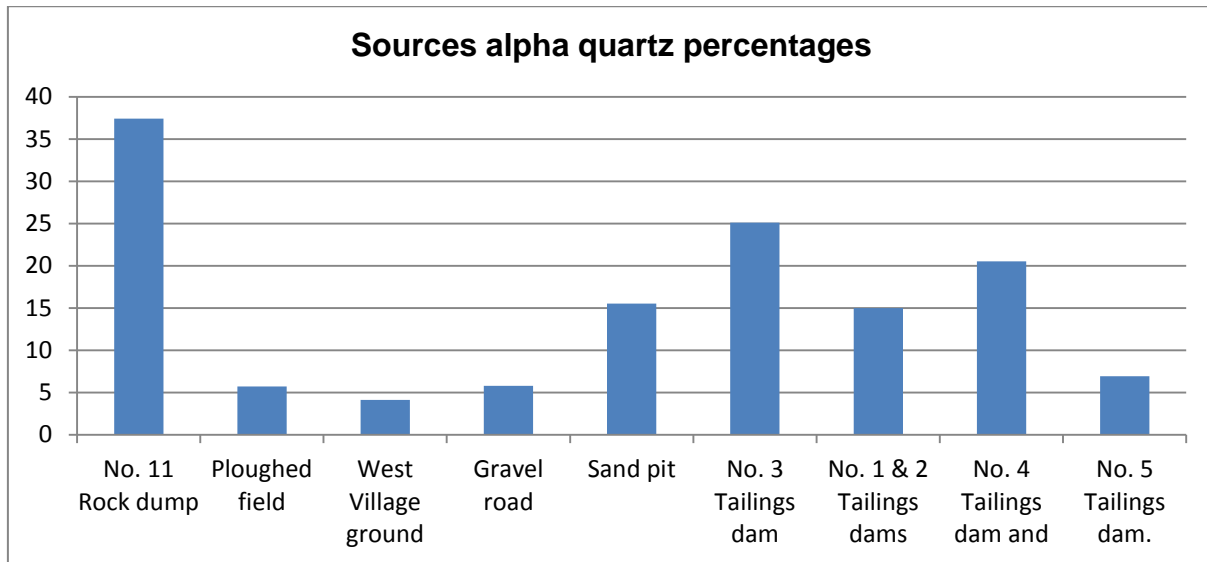

Figure 4.4: Sources alpha quartz percentages comparison

The rock dump exhibits the highest percentage concentration of alpha quartz. This may be attributable to the rock dump composition which is primarily quartzite material. West Village ground had the lowest percentage alpha quartz of 4.1%. The average alpha quartz concentration measured at the receptor point in the PM₁₀ samples was 3.2%. On average, the concentration of alpha quartz to which the general population is exposed is 0.358 µg/m³. There is no defined limit for public exposure to alpha quartz. The exposure level is significantly lower than the workplace exposure limit of 100 µg/m³ (Republic of South Africa, 2006).

4.6. Period 1: 21 June 2011 to 01 August 2011

In the sections that follow, the individual periods are described and analysed. This is followed by an analysis of the combined periods. The meteorological conditions, dust fall comparison, elemental analysis and PM₁₀ source apportionment is detailed below.

4.6.1. Period 1: Meteorological Conditions

The wind rose for period 1 is illustrated in Figure 4.5 below.

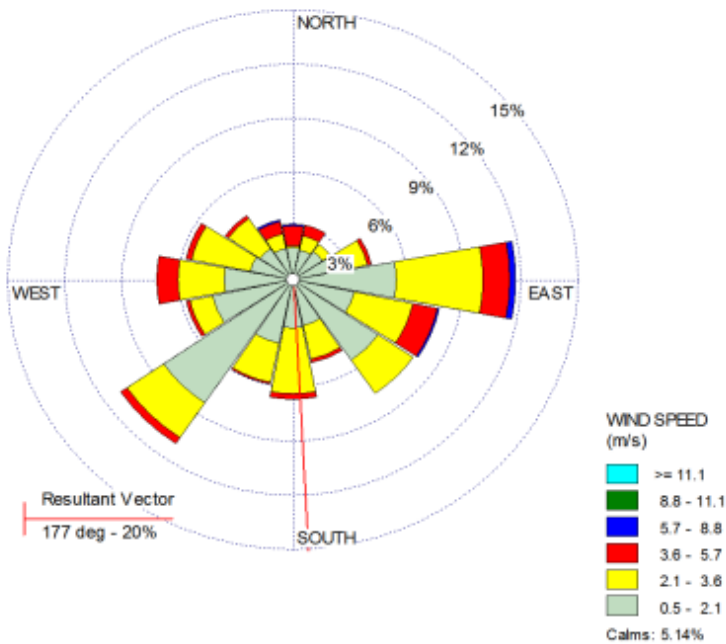

Figure 4.5: Wind Rose for the period 21 June 2011 to 01 August 2011

The resultant vector wind direction is 177 degrees (southerly direction). Easterly winds up to 8.8 m/s were recorded. Less than 2 mm of rainfall was recorded during this period.

4.6.2. Period 1: Multidirectional buckets comparison

Dust fall with the multidirectional buckets were sampled over two-week cycles. The respective two-week samples results were averaged to provide for the period. The multidirectional dust fall buckets concentrations for period 1 are depicted in Figure 4.6 below.

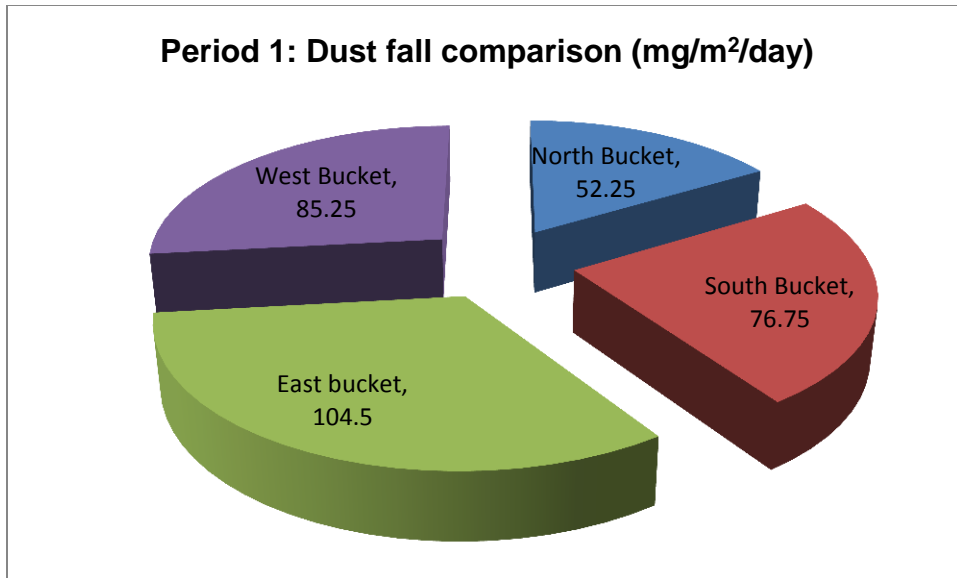

Figure 4.6: Period 1: Multi-directional dust fall comparison

The east bucket has the highest dust loading during this period of 104.5 mg/m²/day. Agricultural dust has been evident in the bucket contents. This could have originated from the ploughed field located on the east side of West Village. This is supported by the wind rose which shows strong easterly winds up to 8.8. m/s recorded during this period.

4.6.3. Period 1: PM₁₀ Elemental analysis

Nine of the most abundant elements were selected and used in the determination of contributions from the nine potential sources. The concentrations of the nine selected elements during period 1 are listed in the table below (the full analyses are attached in Appendix A).

Table 4.3: Elemental Analysis 21 June 2011 – 01 August 2011

Filter constituent	Filter analysis (mg/filter)
Aluminium, Al	0.0081
Calcium, Ca	0.0128
Iron, Fe	0
Magnesium, Mg	0
Phosphorus, P	0.0152
Potassium, K	0
Sodium, Na	0
Titanium, Ti	0
Zinc, Zn	0

4.6.4. Period 1: PM₁₀ Source Apportionment

The contribution from the sources to the PM₁₀ concentration measured at West Village is graphically illustrated below.

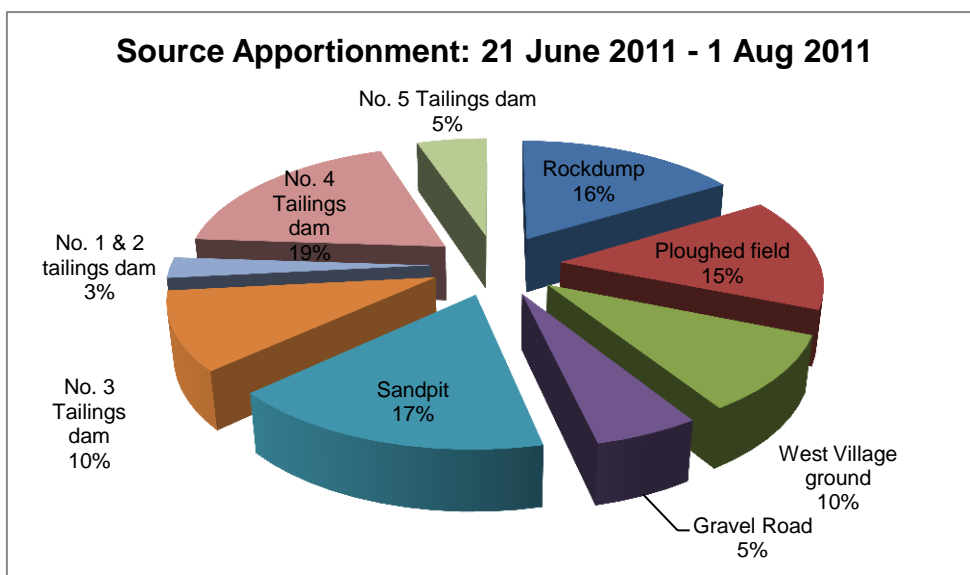

Figure 4.7: Source Apportionment for the period 21 June to 01 Aug 2011

The major contributors are No. 4 tailings dam located to the north-west, the sand pit, located on the north-east, No. 11 rock dump on the north-east and the ploughed field located to the east. High easterly wind speeds between 5.7 and 8.8 m/s were recorded during this period. Of all the tailings dams, the No. 4 tailings dam contributes the greatest portion, followed by No. 3 tailings dam, No. 5 tailings dam and then the No. 1 and 2 tailings dam. The No. 4 tailings dam is the largest of all the dams on the premises. It comprises 3 separate compartments with varying heights. The large top surface area and the spread of the deposition points means that it is relatively more difficult to keep the entire surface area wet at any one time. While the side slopes have vegetation as dust control, the top surfaces may pose as a major source of dust as it dries. The No. 3 tailings dam which is in the same prevailing wind direction as the No. 4 tailings dam contributes less due to natural vegetation that has established on the top surface, acting as dust control. The No. 5 tailings dam, which has lower vegetation growth than the No 3 tailings dam on the upper surface contributes less. This could be attributable to it being located much further away to the west. The No. 1 and 2 tailings dams contributions are the lowest of all the tailings dams. A possible explanation for this is the vegetation establishment on its side slopes and also the top surfaces being kept wet by the on-going tailings deposition.

4.7. Period 2: 05 August 2011 to 01 September 2011

4.7.1. Period 2: Meteorological Conditions

The wind rose for period 2 is illustrated in Figure 4.8 below.

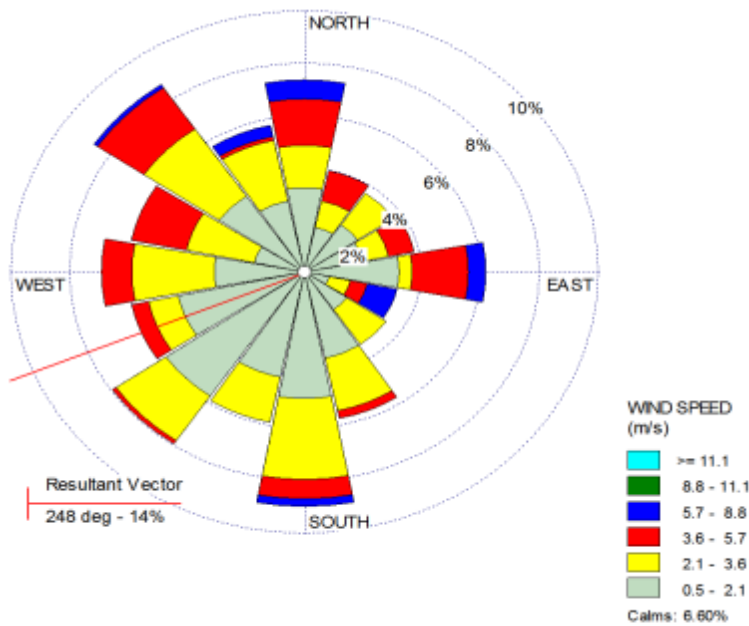

Figure 4.8: Wind Rose for the period 05 August 2011 to 01 September 2011

The resultant vector wind direction is 248 degrees (south-westerly direction). Approximately 6 mm of rainfall was recorded during this period.

4.7.2. Period 2: Multidirectional buckets comparison

The multidirectional dust fall buckets concentrations for period 2 are depicted in Figure 4.9 below.

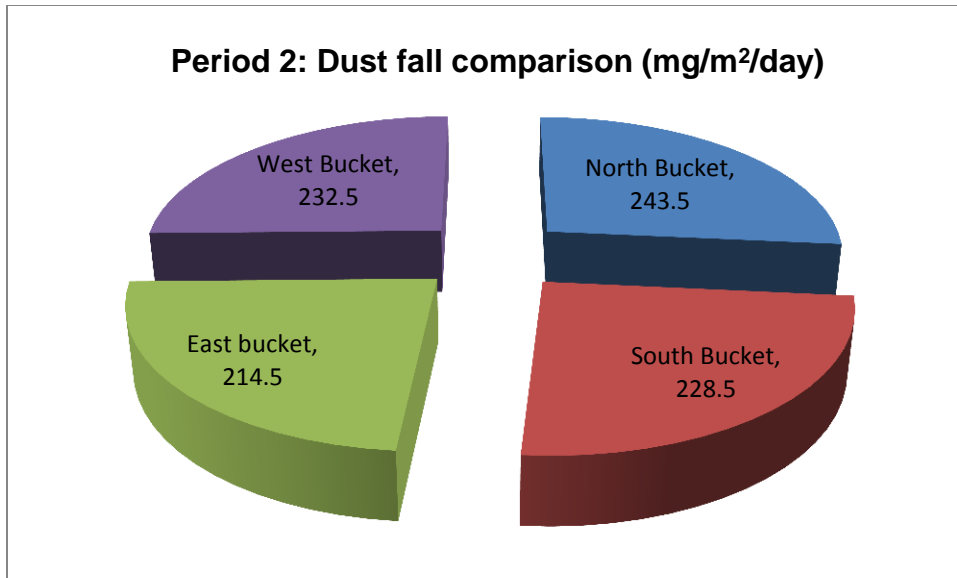

Figure 4.9: Period 2: Multi-directional dust fall comparison

The north bucket has the highest dust loading during this period. All buckets have recorded relatively high dust concentrations during this period. This can be a result of the gusty winds of up to 8.8 m/s from the north, east and southerly directions. The 6 mm of rainfall may not have been sufficient to play a significant role in dust suppression. The east bucket had by far the highest content of vegetation burn. All buckets contained agricultural soil dust, vegetation organic debris and pollen with traces of rock dump or plant tailings quartzites present.

4.7.3. Period 2: PM₁₀ Elemental analysis

The concentrations of the nine selected elements during period 2 are listed in the table below.

Table 4.4: Elemental Analysis 05 August 2011 – 01 September 2011

Filter constituent	Filter analysis (mg/filter)
Aluminium, Al	0.015
Calcium, Ca	0.023
Iron, Fe	0.036
Magnesium, Mg	0.0092
Phosphorus, P	0.0016
Potassium, K	0.017
Sodium, Na	0.031
Titanium, Ti	0.0018
Zinc, Zn	0.0022

4.7.4. Period 2: PM₁₀ Source Apportionment

The contribution from the sources to the PM₁₀ concentration measured at West Village is graphically illustrated below.

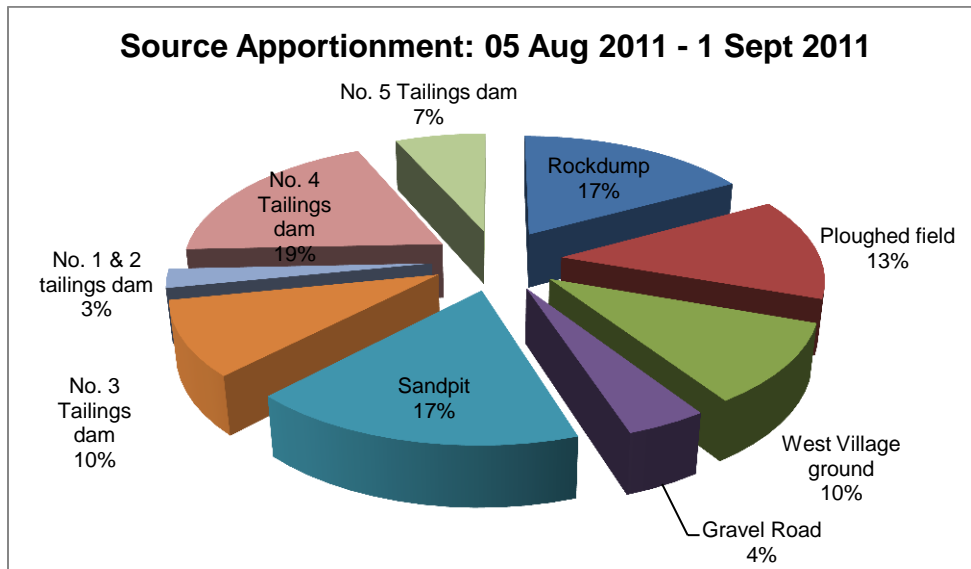

Figure 4.10: Source Apportionment for the period 05 Aug to 01 Sept 2011

The major contributors are No. 4 tailings dam located to the north-west, the sand pit, located on the north-east, No. 11 rock dump on the north-east and the ploughed field

located to the east. High wind speeds between 5.7 and 8.8 m/s were recorded during this period from the south, east and north directions. Of all the tailings dams, the No. 4 tailings dam contributes the greatest portion, followed by No. 3 tailings dam, No. 5 tailings dam and then the No. 1 and 2 tailings dam. The No. 4 tailings dam large exposed surface area may pose as a major source of dust as it dries. The No. 3 tailings dam which is in the same prevailing wind direction as the No. 4 tailings dam contributes less due to natural vegetation that has established on the top surface, acting as dust control. The No. 5 tailings dam, which has lower vegetation growth than the No 3 tailings dam on the upper surface contributes less. This could be attributable to it being located much further away to the west. The No. 1 and 2 tailings dams contributions are the lowest of all the tailings dams. A possible explanation for this is the vegetation establishment on its side slopes and also the top surfaces being kept wet by the on-going tailings deposition.

4.8. Period 3: 01 September 2011 to 01 October 2011

4.8.1. Period 3: Wind Rose

The wind rose for period 3 is illustrated in Figure 4.11 below.

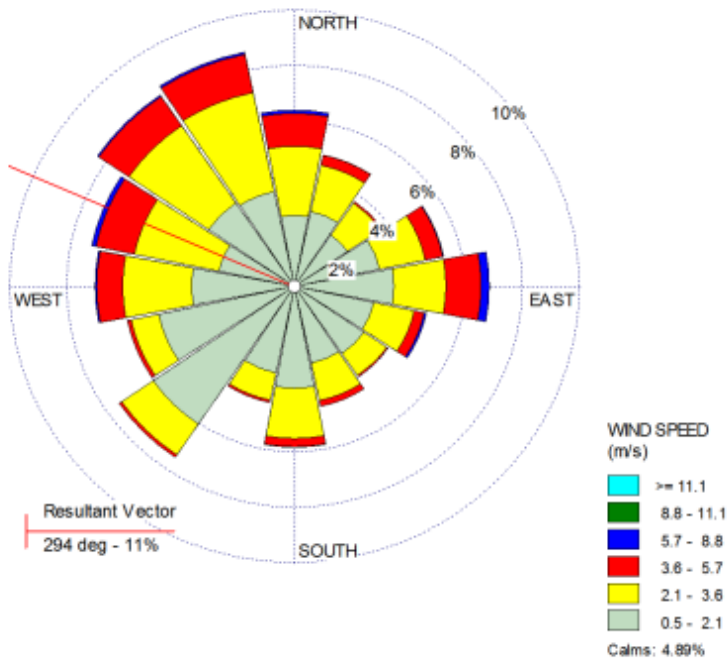

Figure 4.11: Wind Rose for the period 01 September 2011 to 01 October 2011

The resultant vector wind direction is 294 degrees (north-westerly direction). Winds from all directions were prevalent. Less than 1 mm of rainfall was recorded during this period.

4.8.2. Period 3: Multidirectional buckets comparison

The multidirectional dust fall buckets concentrations for period 3 are depicted in Figure 4.12 below.

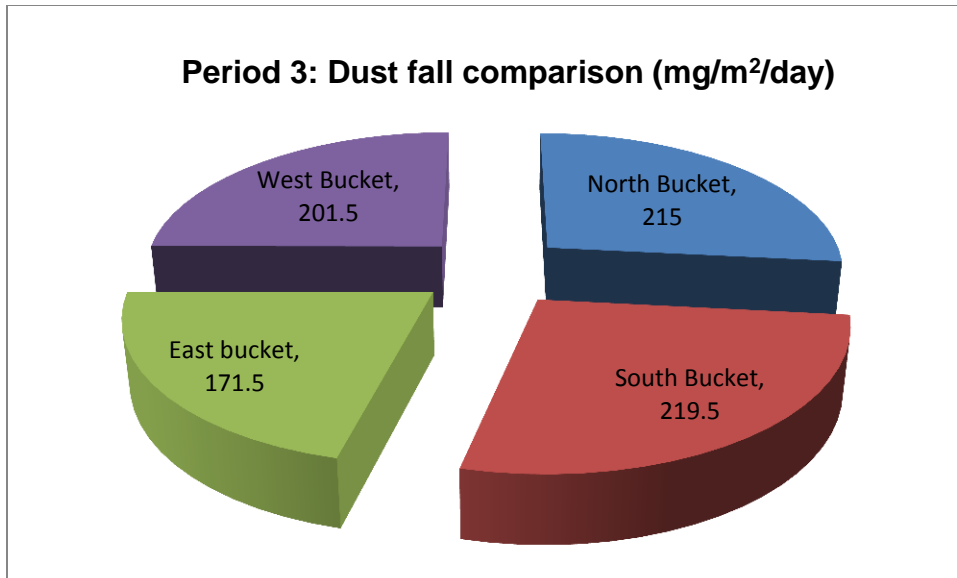

Figure 4.12: Period 3: Multi-directional dust fall comparison

While the north and west buckets have relatively high dust concentrations, consistent with the vector wind direction, the highest dust loading during this period is from the south. The south bucket contained mainly agricultural soil dust. Agricultural soil dust could have originated from the grounds in West Village itself.

4.8.3. Period 3: PM₁₀ Elemental analysis

The concentrations of the nine selected elements during period 3 are listed in the table below.

Table 4.5: Elemental Analysis 01 September 2011 - 01 October 2011

Filter constituent	Filter analysis (mg/filter)
Aluminium, Al	0.028
Calcium, Ca	0.025
Iron, Fe	0.058
Magnesium, Mg	0.014
Phosphorus, P	0.0024
Potassium, K	0.023
Sodium, Na	0.025
Titanium, Ti	0.0015
Zinc, Zn	0.0017

4.8.4. Period 3: PM₁₀ Source Apportionment

The contribution from the sources to the PM₁₀ concentration measured at West Village is graphically illustrated below.

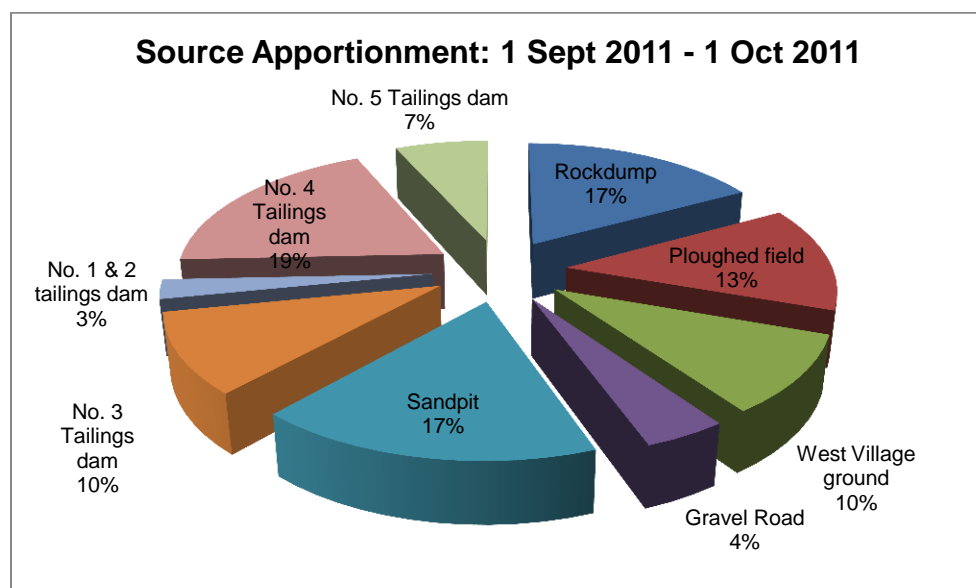

Figure 4.13: Source Apportionment for the period 01 Sept to 01 Oct 2011

The major contributors are No. 4 tailings dam located to the north-west, the sand pit, located on the north-east, No. 11 rock dump on the north-east and the ploughed field located to the east. The prevailing wind has been from the north-west during this period. Of all the tailings dams, the No. 4 tailings dam contributes the greatest portion, followed by No. 3 tailings dam, No. 5 tailings dam and then the No. 1 and 2 tailings dam. The No. 4 tailings dam large exposed surface area may pose as a major source of dust as it dries. The No. 3 tailings dam which is in the same prevailing wind direction as the No. 4 tailings dam contributes less due to natural vegetation that has established on the top surface, acting as dust control. The No. 5 tailings dam, which has lower vegetation growth than the No 3 tailings dam on the upper surface contributes less. This could be attributable to it being located much further away. The No. 1 and 2 tailings dams contributions are the lowest of all the tailings dams. A possible explanation for this is the vegetation establishment on its side slopes and also the top surfaces being kept wet by the on-going tailings deposition.

4.9. Period 4: 01 October 2011 to 01 November 2011

4.9.1. Period 4: Meteorological conditions

The wind rose for period 4 is illustrated in Figure 4.14 below.

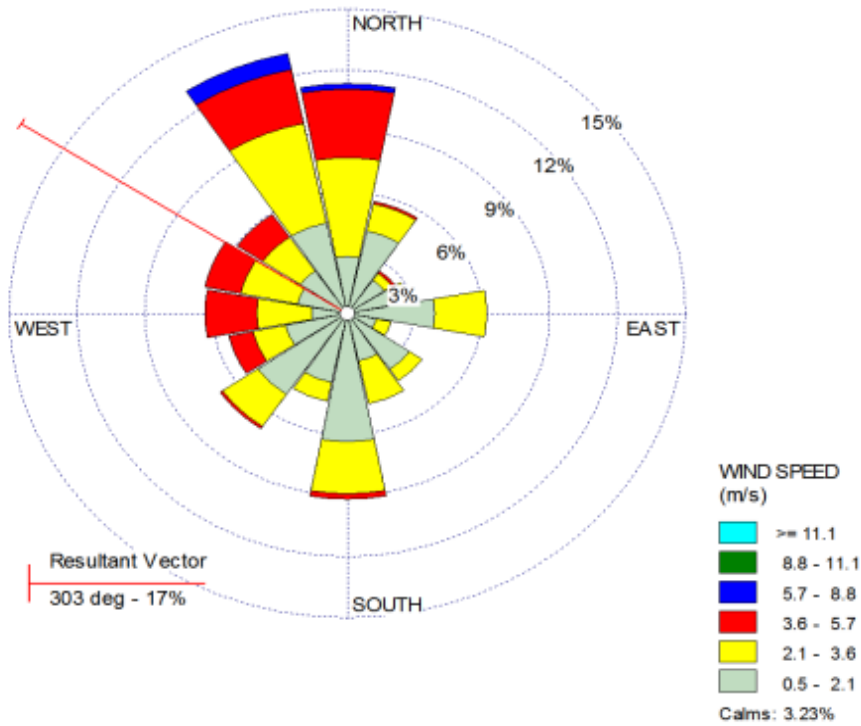

Figure 4.14: Wind Rose for the period 01 October 2011 to 01 November 2011

The resultant vector wind direction is 303 degrees (north-westerly direction). The rainy season started with 56 mm of rainfall recorded during this period.

4.9.2. Period 4: Multidirectional buckets comparison

The multidirectional dust fall buckets concentrations for period 4 are depicted in Figure 4.15 below.

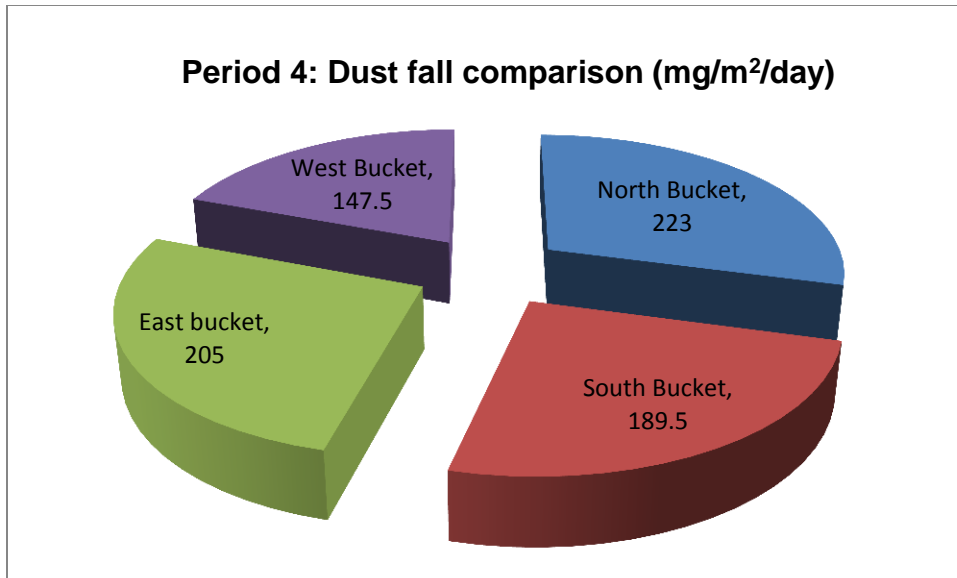

Figure 4.15: Period 4: Multi-directional dust fall comparison

The north bucket has the highest dust loading during this period. This is consistent with the prevailing winds as depicted in the wind rose. The north sample has been characterised by vegetation debris, agricultural soil dust and rounded quartz. The rounded quartz could be milled tailings from the tailings dams. The other buckets had similar compositions of agricultural soil dust and vegetation debris.

4.9.3. Period 4: PM₁₀ Elemental analysis

The concentrations of the nine selected elements during period 4 are listed in the table below.

Table 4.6: Elemental Analysis 01 October 2011 – 01 November 2011

Filter constituent	Filter analysis (mg/filter)
Aluminium, Al	0.034
Calcium, Ca	0.026
Iron, Fe	0.063
Magnesium, Mg	0.014
Phosphorus, P	0.0019
Potassium, K	0.011
Sodium, Na	0.023
Titanium, Ti	0.0014
Zinc, Zn	0

4.9.4. Period 4: PM₁₀ Source Apportionment

The contribution from the sources to the PM₁₀ concentration measured at West Village is graphically illustrated below.

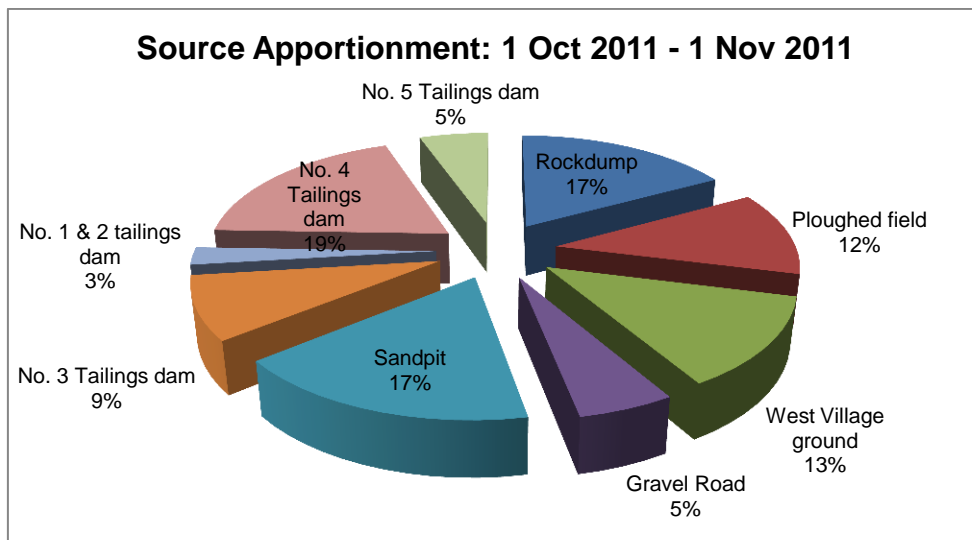

Figure 4.16: Source Apportionment for the period 01 Oct to 01 Nov 2011

The major contributors are No. 4 tailings dam located to the north-west, the sand pit, located on the north-east, No. 11 rock dump on the north-east and West Village ground. The prevailing wind has been from the north-west during this period. Of all the tailings dams, the No. 4 tailings dam contributes the greatest portion, followed by No. 3 tailings dam, No. 5 tailings dam and then the No. 1 and 2 tailings dam. The No. 4 tailings dam large exposed surface area may pose as a major source of dust as it dries. The No. 3 tailings dam which is in the same prevailing wind direction as the No. 4 tailings dam contributes less due to natural vegetation that has established on the top surface, acting as dust control. The No. 5 tailings dam, which has lower vegetation growth than the No. 3 tailings dam on the upper surface contributes less. This could be attributable to it being located much further away to the west. The No. 1 and 2 tailings dams contributions are the lowest of all the tailings dams. A possible explanation for this is the vegetation establishment on its side slopes and also the top surfaces being kept wet by the on-going tailings deposition.

4.10. Period 5: 01 November 2011 to 01 December 2011

4.10.1. Period 5: Meteorological conditions

The wind rose for period 5 is illustrated in Figure 4.17 below.

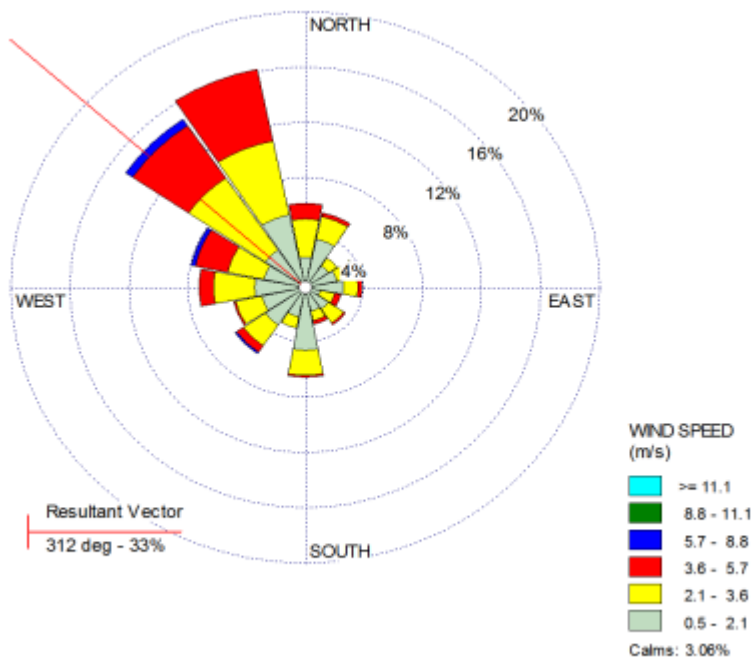

Figure 4.17: Wind Rose for the period 01 November 2011 to 01 December 2011

The resultant vector wind direction is 312 degrees (north-westerly direction). Approximately 119 mm of rainfall was recorded during this period.

4.10.2. Period 5: Multidirectional buckets comparison

The multidirectional dust fall buckets concentrations for period 5 are depicted in Figure 4.18 below.

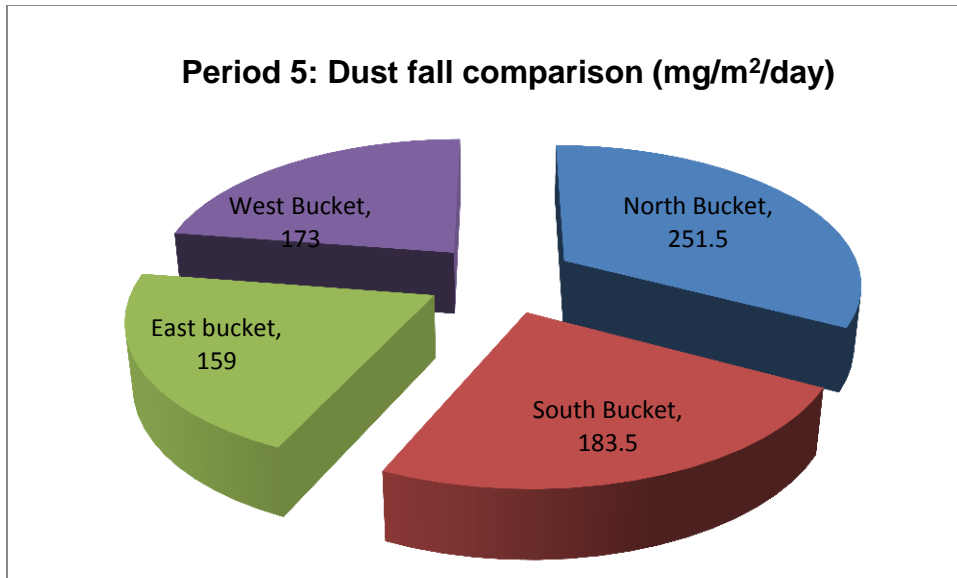

Figure 4.18: Period 5: Multi-directional dust fall comparison

The north bucket has the highest dust loading during this period. This is consistent with the north-west vector wind direction during this period. The north bucket contained agricultural soil dust with some traces of haematite rich topsoils, organic vegetation and fibrous material debris. The east bucket contained mainly agricultural dust. The west and south buckets contained some agricultural dust with traces of both pulverised roadway dust and rounded quartz dust.

4.10.3. Period 5: PM₁₀ Chemical analysis

The concentrations of the nine selected elements during period 5 are listed in the table below.

Table 4.7: Elemental Analysis 01 November 2011 – 01 December 2011

Filter constituent	Filter analysis (mg/filter)
Aluminium, Al	0.025
Calcium, Ca	0.018
Iron, Fe	0.042
Magnesium, Mg	0.0091
Phosphorus, P	0
Potassium, K	0.0088
Sodium, Na	0.14
Titanium, Ti	0.002
Zinc, Zn	0.002

4.10.4. Period 5: PM₁₀ Source Apportionment

The contribution from the sources to the PM₁₀ concentration measured at West Village is graphically illustrated below.

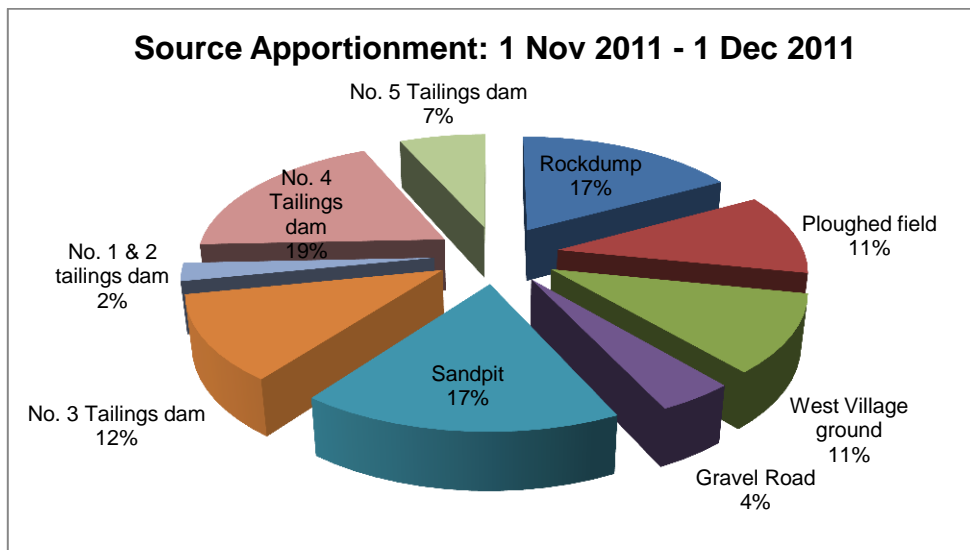

Figure 4.19: Source Apportionment for the period 01 Nov to 01 Dec 2011

The major contributors are No. 4 tailings dam located to the north-west, the sand pit, located on the north-east, No. 11 rock dump on the north-east and No. 3 tailings dam on the west. The prevailing wind has been from the north-west during this period. Of all the tailings dams, the No. 4 tailings dam contributes the greatest portion, followed by No. 3 tailings dam, No. 5 tailings dam and then the No. 1 and 2 tailings dam. The No. 4 tailings dam large exposed surface area may pose as a major source of dust as it dries. The No. 3 tailings dam which is in the same prevailing wind direction as the No. 4 tailings dam contributes less due to natural vegetation that has established on the top surface, acting as dust control. The No. 5 tailings dam, which has lower vegetation growth than the No 3 tailings dam on the upper surface contributes less. This could be attributable to it being located much further away to the west. The No. 1 and 2 tailings dams contributions are the lowest of all the tailings dams. A possible explanation for this is the vegetation establishment on its side slopes and also the top surfaces being kept wet by the on-going tailings deposition.

4.11. Period 6: 01 December 2011 to 01 January 2012

4.11.1. Period 6: Meteorological conditions

The wind rose for period 6 is illustrated in Figure 4.20 below.

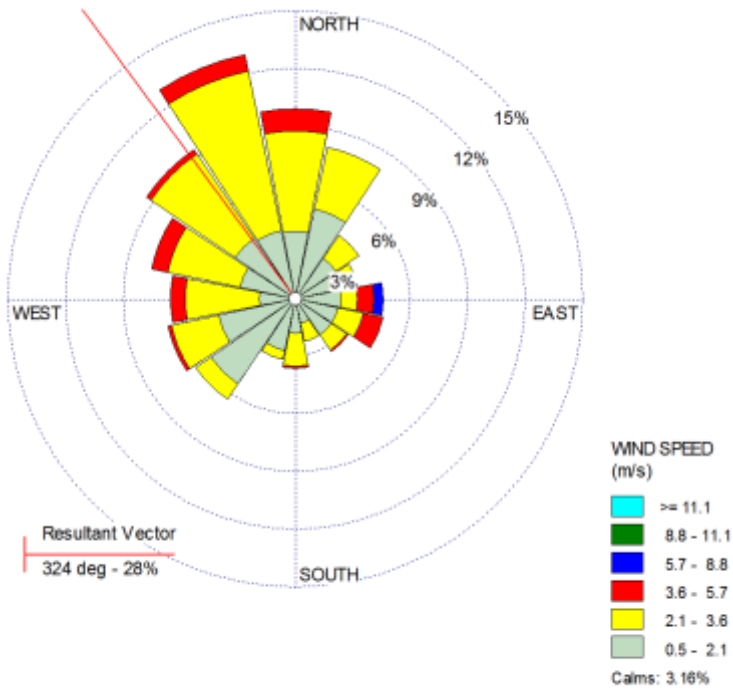

Figure 4.20: Wind Rose for the period 1 December 2011 to 1 January 2012

The resultant vector wind direction is 324 degrees (north-westerly direction). Approximately 90 mm of rainfall was recorded.

4.11.2. Period 6: Multidirectional buckets comparison

The multidirectional dust fall buckets concentrations for period 6 are depicted in Figure 4.21 below.

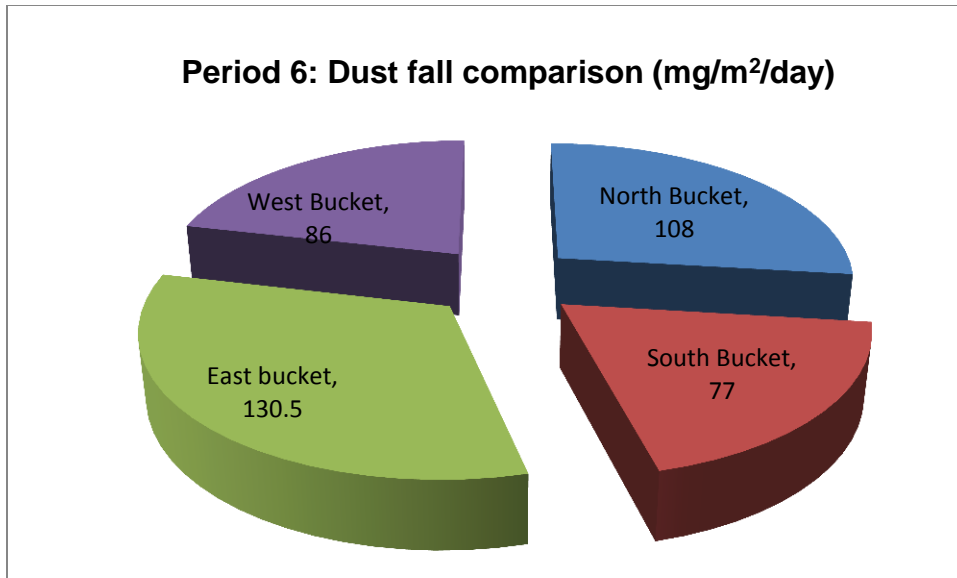

Figure 4.21: Period 6: Multi-directional dust fall comparison

The east bucket has the highest dust loading during this period. While the resultant vector wind direction has been from the north-west, there has been high wind speeds up to 8.8 m/s from the east that could have contributed to the dust loading. The east bucket had mainly agricultural soil dust and topsoil with haematite and loamy material. The north bucket contained some agricultural dust and also high pulverised roadway dust and rounded quartz.

4.11.3. Period 6: PM₁₀ Elemental analysis

The concentrations of the nine selected elements during period 6 are listed in the table below.

Table 4.8: Elemental Analysis 01 December 2011 - 01 January 2012

Filter constituent	Filter analysis (mg/filter)
Aluminium, Al	0.0065
Calcium, Ca	0.0078
Iron, Fe	0.015
Magnesium, Mg	0.0034
Phosphorus, P	0
Potassium, K	0.004
Sodium, Na	0.0036
Titanium, Ti	0.00023
Zinc, Zn	0

4.11.4. Period 6: PM₁₀ Source Apportionment

The contribution from the sources to the PM₁₀ concentration measured at West Village is graphically illustrated below.

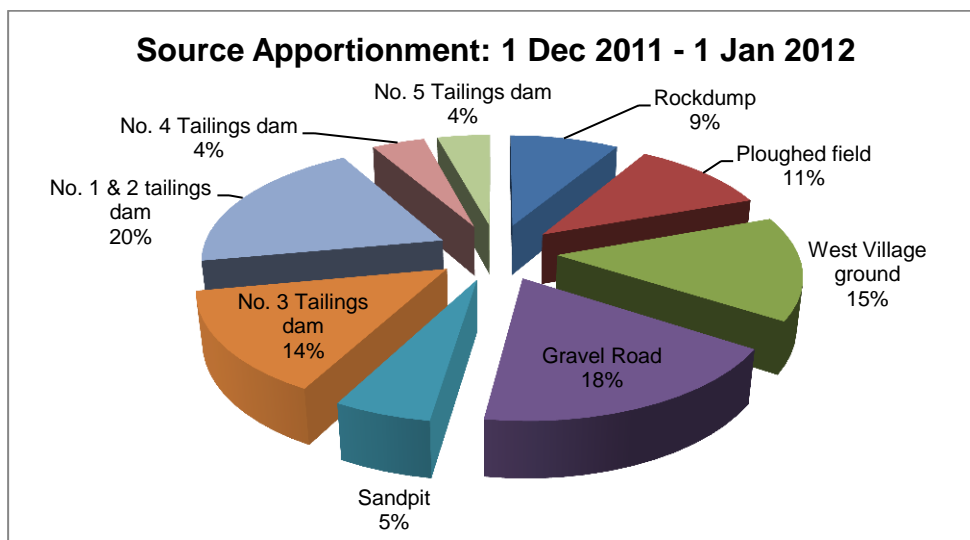

Figure 4.22: Source Apportionment for the period 01 December 2011 to 01 January 2012

The major contributors are No. 1 and 2 tailings dams located to the north-east, the gravel road on the north, West Village ground and No. 3 tailings dam, located on the north-west. The prevailing wind has been from the north-west during this period. Of all the tailings dams, the No. 1 and 2 tailings dam contributes the greatest portion, followed by No. 3 tailings dam and then similar contributions from No. 4 and 5 tailings dams. The No. 1 and 2 tailings dams receives tailings from the No. 1 Gold Plant which processes material from the underground workings while the No. 4 tailings dam receives tailings material from No. 2 and 3 Gold Plants which process the surface rock dumps. During this period, the Mine closed for the Christmas Break on the 23 December and reopened on the 02 January. The No. 1 Gold Plant usually processes 5645 tons per day. The last remaining tonnage processed was 223 tons on 24 December. No milling took place until 02 January. As a result no tailings deposition on the No. 1 and 2 tailings dams took place from 25 December to 01 January. During this period, 14 mm of rain has been recorded. The reduced deposition of tailings on the No. 1 and 2 tailings dams would have resulted in the drier than normal top surface. This could have led to these dams contributing a higher proportion of dust during this period as opposed to the rest of the sampling periods. The transport activities of material from the rock dump to No. 2 and 3 Plants continued during this period as evident in the gravel road being the second highest contributor to the PM₁₀ concentration. The deposition on the No. 4 tailings dam continued as normal during this period.

4.12. Period 7: 01 January 2012 to 01 February 2012

4.12.1. Period 7: Wind Rose

The wind rose for period 7 is illustrated in Figure 4.23 below.

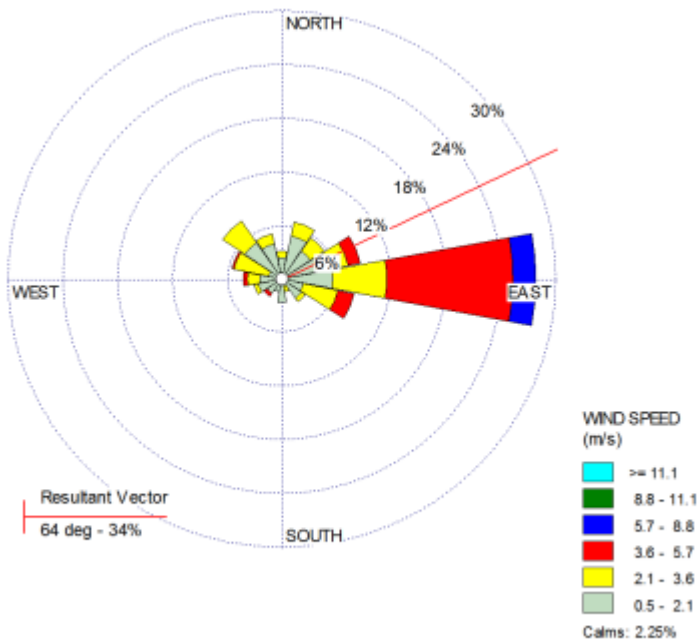

Figure 4.23: Wind Rose for the period 01 January 2012 to 01 February 2012

The resultant vector wind direction is 64 degrees (north-easterly direction). The easterly winds have been dominant with velocities up to 8.8 m/s. Approximately 107 mm of rainfall was recorded.

4.12.2. Period 7: Multidirectional buckets comparison

The multidirectional dust fall buckets concentrations for period 7 are depicted in Figure below.

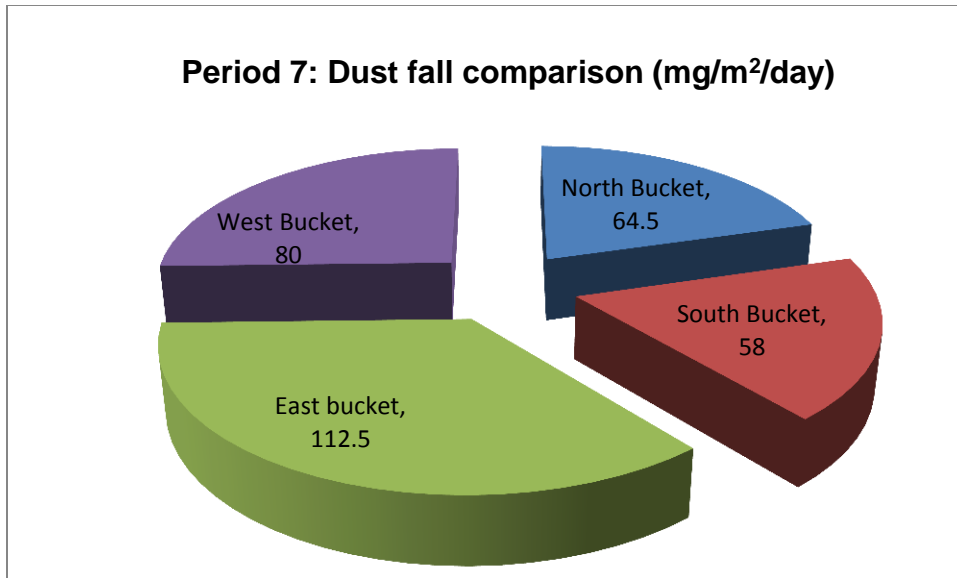

Figure 4.24: Period 7: Multi-directional dust fall comparison

The east bucket has the highest dust loading during this period. The east bucket contained significantly higher dust loading than any of the other buckets. This could be attributable to the pronounced easterly winds. The east bucket contained agricultural soil dust with up to 15% topsoils and traces of clay colloidal material. The ploughed field to the east could be the major source. Also, the sand pit to the north east where clay is being excavated could have contributed.

4.12.3. Period 7: PM₁₀ Elemental analysis

The concentrations of the nine selected elements during period 7 are listed in the table below.

Table 4.9: Elemental Analysis 01 January 2012 - 01 February 2012

Filter constituent	Filter analysis (mg/filter)
Aluminium, Al	0.012
Calcium, Ca	0.0097
Iron, Fe	0.026
Magnesium, Mg	0.005
Phosphorus, P	0.0014
Potassium, K	0.007
Sodium, Na	0.02
Titanium, Ti	0.00096
Zinc, Zn	0

4.12.4. Period 7: PM₁₀ Source Apportionment

The contribution from the sources to the PM₁₀ concentration measured at West Village is graphically illustrated below.

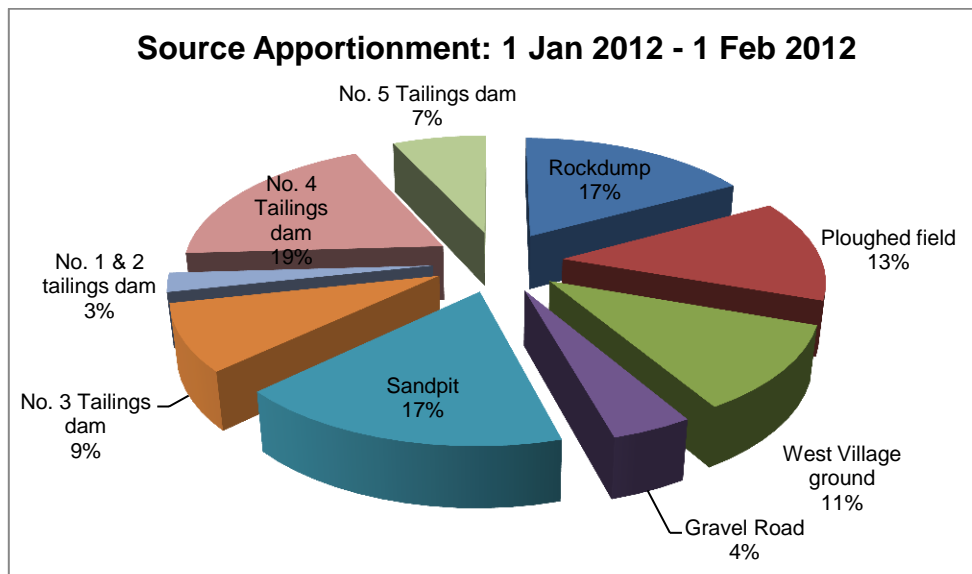

Figure 4.25: Source Apportionment for the period 01 January to 01 February 2012

The major contributors are No. 4 tailings dam located to the north-west, the sand pit, located on the north-east, No. 11 rock dump on the north-east and the ploughed field to the east. The prevailing wind has been from the east during this period. Of all the tailings dams, the No. 4 tailings dam contributes the greatest portion, followed by No. 3 tailings dam, No. 5 tailings dam and then the No. 1 and 2 tailings dam. The No. 4 tailings dam large exposed surface area may pose as a major source of dust as it dries. The No. 3 tailings dam which is in the same prevailing wind direction as the No. 4 tailings dam contributes less due to natural vegetation that has established on the top surface, acting as dust control. The No. 5 tailings dam, which has lower vegetation growth than the No 3 tailings dam on the upper surface contributes less. This could be attributable to it being located much further away to the west. The No. 1 and 2 tailings dams contributions are the lowest of all the tailings dams. A possible explanation for this is the vegetation establishment on its side slopes and also the top surfaces being kept wet by the on-going tailings deposition.

4.13. Period 8: 01 February 2012 to 01 March 2012

4.13.1. Period 8: Meteorological conditions

The wind rose for period 8 is illustrated in Figure 4.26 below.

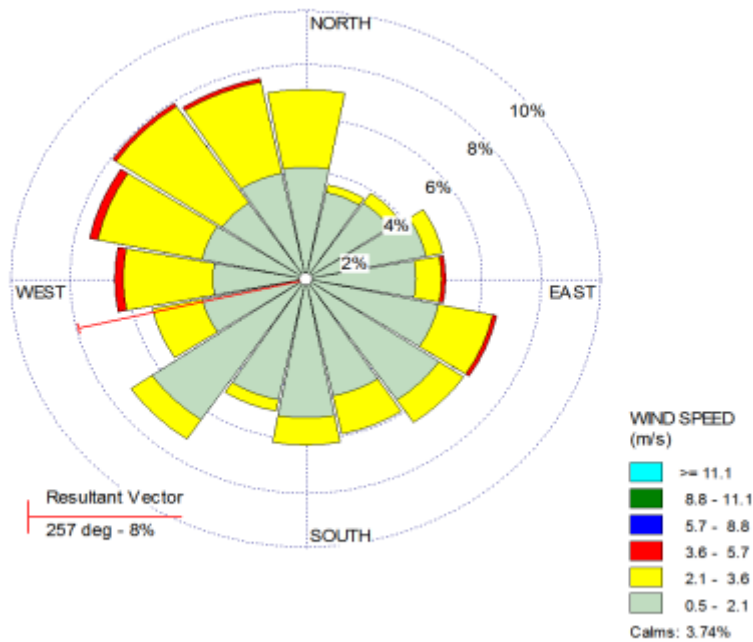

Figure 4.26: Wind Rose for the period 01 February 2012 to 01 March 2012

The resultant vector wind direction is 257 degrees (westerly direction). Approximately 114 mm of rainfall was recorded.

4.13.2. Period 8: Multidirectional buckets comparison

The multidirectional dust fall buckets concentrations for period 8 are depicted in Figure 4.27 below.

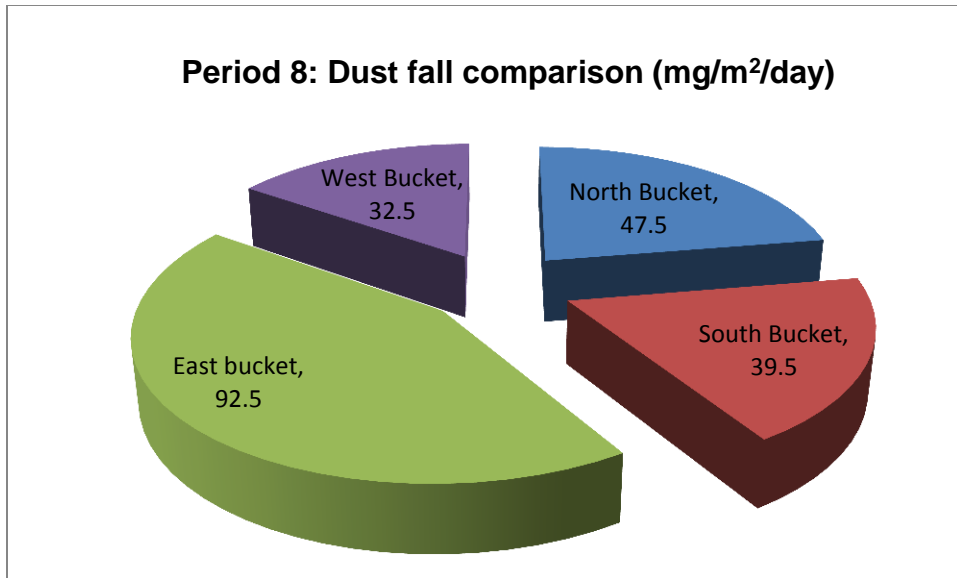

Figure 4.27: Period 8: Multi-directional dust fall comparison

The east bucket has, by a large margin, the highest dust loading during this period. The east bucket contained some (<5%) quartzite material with the rest being agricultural soil dust with some pulverised roadway dust and traces of sandy topsoil. This could be from the ploughed field which also have gravel roads for farm vehicles. Winds during this period has been characterised by low velocity winds from all directions. Also, high rainfall during this period may have contributed to the comparatively low dust fall levels.

4.13.3. Period 8: PM₁₀ Elemental analysis

The concentrations of the nine selected elements during period 1 are listed in the table below.

Table 4.10: Elemental Analysis 01 February 2012 - 01 March 2012

Filter constituent	Filter analysis (mg/filter)
Aluminium, Al	0.02
Calcium, Ca	0.017
Iron, Fe	0.029
Magnesium, Mg	0.0063
Phosphorus, P	0.0025
Potassium, K	0.009
Sodium, Na	0.01
Titanium, Ti	0.0026
Zinc, Zn	0

4.13.4. Period 8: PM₁₀ Source Apportionment

The contribution from the sources to the PM₁₀ concentration measured at West Village is graphically illustrated below.

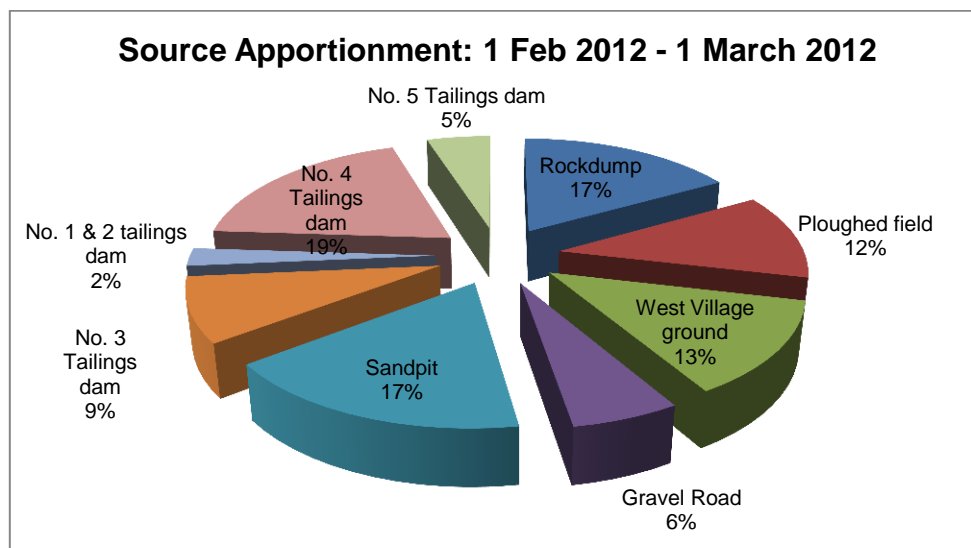

Figure 4.28: Source Apportionment for the period 01 February to 01 March 2012

The major contributors are No. 4 tailings dam located to the north-west, the sand pit, located on the north-east, No. 11 rock dump on the north-east and West Village ground. The prevailing wind has been from the west during this period. Of all the tailings dams, the No. 4 tailings dam contributes the greatest portion, followed by No. 3 tailings dam, No. 5 tailings dam and then the No. 1 and 2 tailings dam. The No. 4 tailings dam large exposed surface area may pose as a major source of dust as it dries. The No. 3 tailings dam which is in the same prevailing wind direction as the No. 4 tailings dam contributes less due to natural vegetation that has established on the top surface, acting as dust control. The No. 5 tailings dam, which has lower vegetation growth than the No 3 tailings dam on the upper surface contributes less. This could be attributable to it being located much further away to the west. The No. 1 and 2 tailings dams contributions are the lowest of all the tailings dams. A possible explanation for this is the vegetation establishment on its side slopes and also the top surfaces being kept wet by the on-going tailings deposition.

4.14. Period 9: 01 March 2012 to 01 April 2012

4.14.1. Period 9: Meteorological conditions

The wind rose for period 9 is illustrated in Figure 4.29 below.

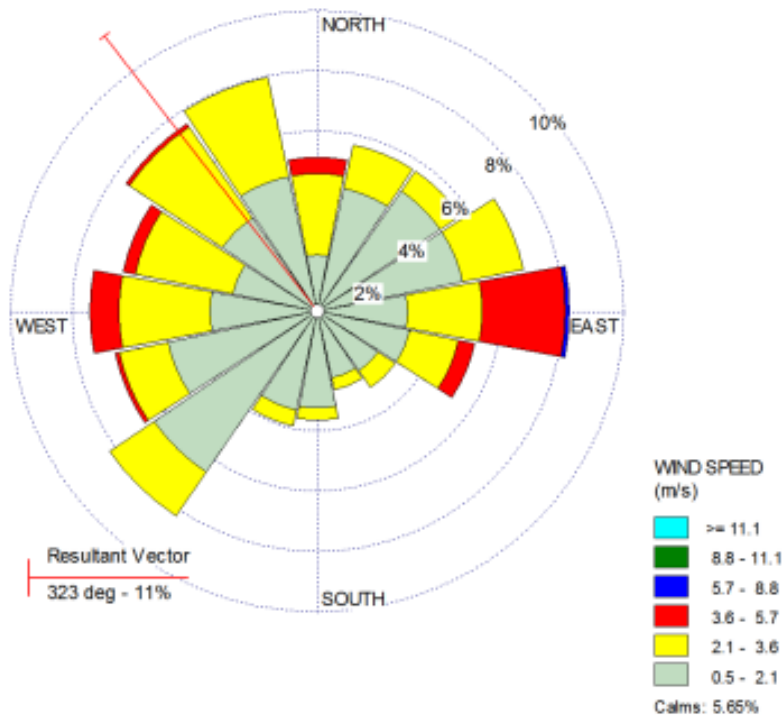

Figure 4.29: Wind Rose for the period 01 March 2012 to 01 April 2012

The resultant vector wind direction is 323 degrees (north-westerly direction). Rainfall of 54 mm was recorded.

4.14.2. Period 9: Multidirectional buckets comparison

The multidirectional dust fall buckets concentrations for period 9 are depicted in Figure 4.30 below.

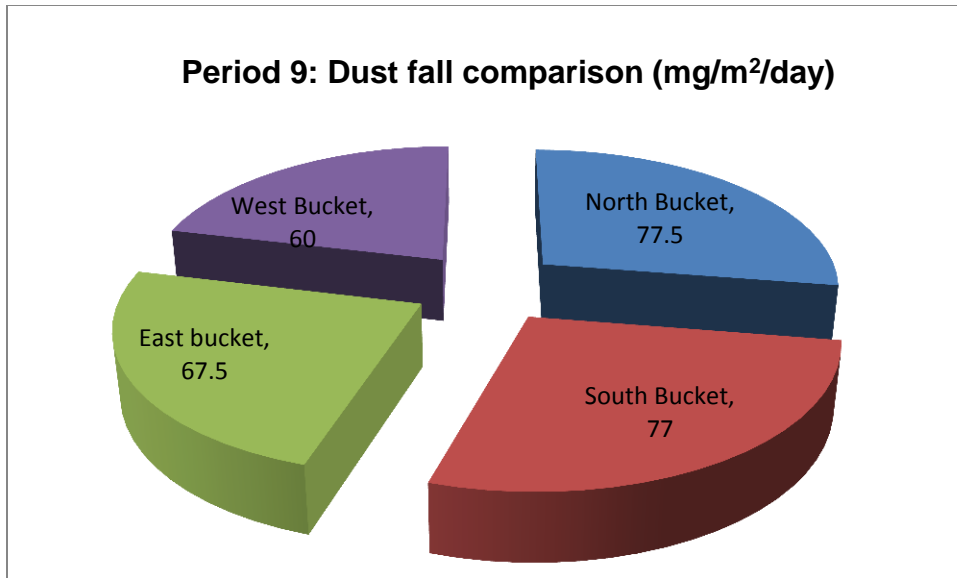

Figure 4.30: Period 9: Multi-directional dust fall comparison

The north bucket has the highest dust loading during this period. This is consistent with the north-west vector direction. All buckets have similar dust loadings. All buckets have similar agricultural dust with organic debris. The organic debris is indicative of originating from veld fires.

4.14.3. Period 9: Elemental analysis

The concentrations of the nine selected elements during period 1 are listed in the table below.

Table 4.11: Elemental Analysis 01 March 2012 - 01 April 2012

Filter constituent	Filter analysis (mg/filter)
Aluminium, Al	0.023
Calcium, Ca	0.018
Iron, Fe	0.034
Magnesium, Mg	0.0081
Phosphorus, P	0
Potassium, K	0.01
Sodium, Na	0.02
Titanium, Ti	0.00086
Zinc, Zn	0.0029

4.14.4. Period 9: PM₁₀ Source Apportionment

The contribution from the sources to the PM₁₀ concentration measured at West Village is graphically illustrated below.

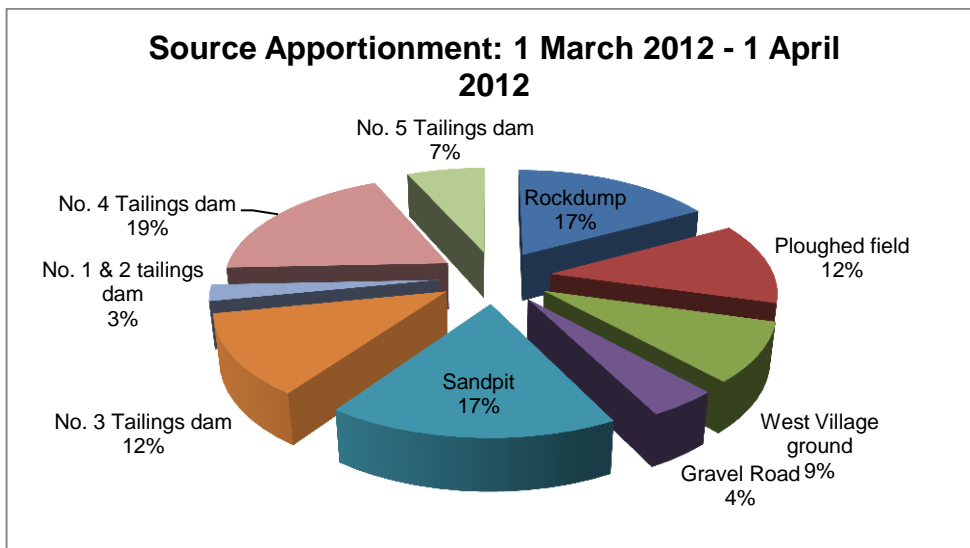

Figure 4.31: Source Apportionment for the period 01 March to 01 April 2012

The major contributors are No. 4 tailings dam located to the north-west, the sand pit, located on the north-east, No. 11 rock dump on the north-east, No. 3 tailings dam on the north-west and the ploughed field on the east. The prevailing wind has been from the north-west during this period. Of all the tailings dams, the No. 4 tailings dam contributes the greatest portion, followed by No. 3 tailings dam, No. 5 tailings dam and then the No. 1 and 2 tailings dam. The No. 4 tailings dam large exposed surface area may pose as a major source of dust as it dries. The No. 3 tailings dam which is in the same prevailing wind direction as the No. 4 tailings dam contributes less due to natural vegetation that has established on the top surface, acting as dust control. The No. 5 tailings dam, which has lower vegetation growth than the No 3 tailings dam on the upper surface contributes less. This could be attributable to it being located much further away to the west. The No. 1 and 2 tailings dams contributions are the lowest of all the tailings dams. A possible explanation for this is the vegetation establishment on its side slopes and also the top surfaces being kept wet by the on-going tailings deposition.

4.15. Period 10: 01 April 2012 to 01 May 2012

4.15.1. Period10: Meteorological conditions

The wind rose for period 10 is illustrated in Figure 4.32 below.

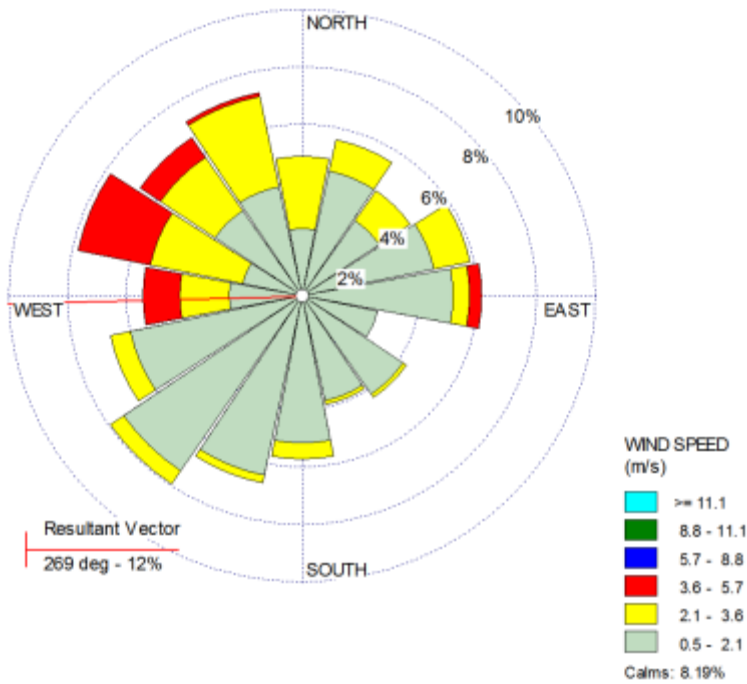

Figure 4.32: Wind Rose for period 1 April 2012 to 1 May 2012

The resultant vector wind direction is 269 degrees (westerly direction). Approximately 20mm of rainfall was recorded.

4.15.2. Period 10: Multidirectional buckets comparison

The multidirectional dust fall buckets concentrations for period 10 are depicted in Figure 4.33 below.

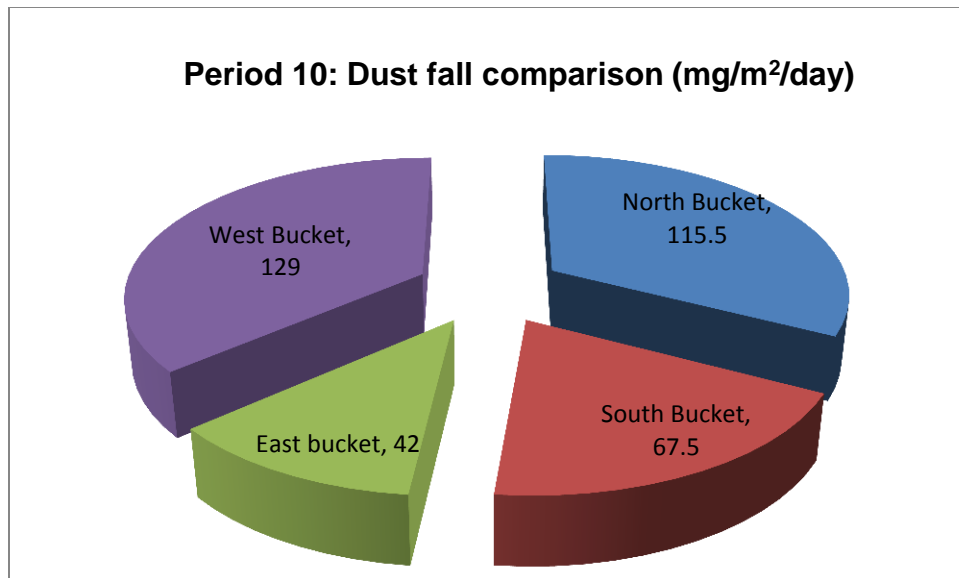

Figure 4.33: Period 10: Multi-directional dust fall comparison

The west bucket has the highest dust loading during this period. This is consistent with the west vector wind direction. The west bucket contained high vegetation burn carbon material. The north bucket had similar high vegetation carbon material possibly due to veldt fires in the north-west area.

4.15.3. Period 10: Elemental analysis

The concentrations of the nine selected elements during period 10 are listed in the table below.

Table 4.12: Elemental Analysis 01 April 2012 - 01 May 2012

Filter constituent	Filter analysis (mg/filter)
Aluminium, Al	0.019
Calcium, Ca	0.017
Iron, Fe	0.033
Magnesium, Mg	0.0075
Phosphorus, P	0.0014
Potassium, K	0.009
Sodium, Na	0.02
Titanium, Ti	0.0028
Zinc, Zn	0

4.15.4. Period 10: PM₁₀ Source Apportionment

The contribution from the sources to the PM₁₀ concentration measured at West Village is graphically illustrated below.

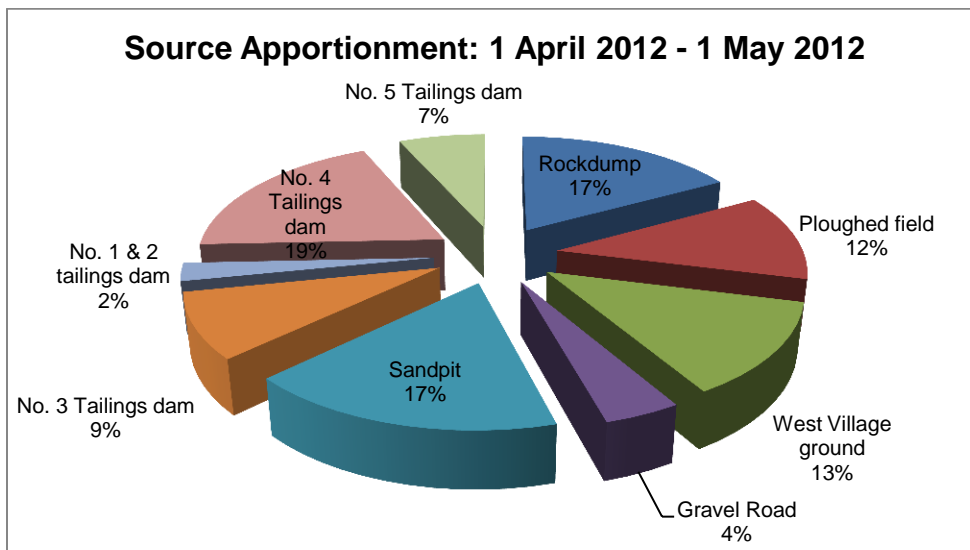

Figure 4.34: Source Apportionment for the period 01 April to 01 May 2012

The major contributors are No. 4 tailings dam located to the north-west, the sand pit, located on the north-east, No. 11 rock dump on the north-east and West Village ground. The prevailing wind has been from the west during this period. Of all the tailings dams, the No. 4 tailings dam contributes the greatest portion, followed by No. 3 tailings dam, No. 5 tailings dam and then the No. 1 and 2 tailings dam. The No. 4 tailings dam large exposed surface area may pose as a major source of dust as it dries. The No. 3 tailings dam which is in the same prevailing wind direction as the No. 4 tailings dam contributes less due to natural vegetation that has established on the top surface, acting as dust control. The No. 5 tailings dam, which has lower vegetation growth than the No 3 tailings dam on the upper surface contributes less. This could be attributable to it being located much further away to the west. The No. 1 and 2 tailings dams contributions are the lowest of all the tailings dams. A possible explanation for this is the vegetation establishment on its side slopes and also the top surfaces being kept wet by the on-going tailings deposition.

4.16. Period 11: 01 May 2012 to 01 June 2012

4.16.1. Period 11: Meteorological conditions

The wind rose for period 11 is illustrated in Figure 4.35 below.

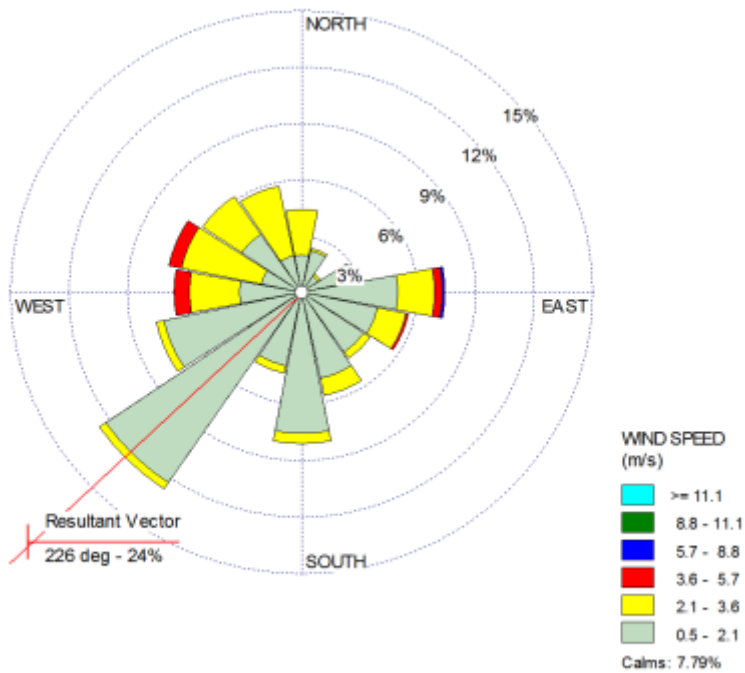

Figure 4.35: Wind Rose for the period 01 May 2012 to 01 June 2012

The resultant vector wind direction is 226 degrees (south westerly direction). No rainfall was evident during this period.

4.16.2. Period 11: Multidirectional buckets comparison

The multidirectional dust fall buckets concentrations for period 11 are depicted in Figure 4.36 below.

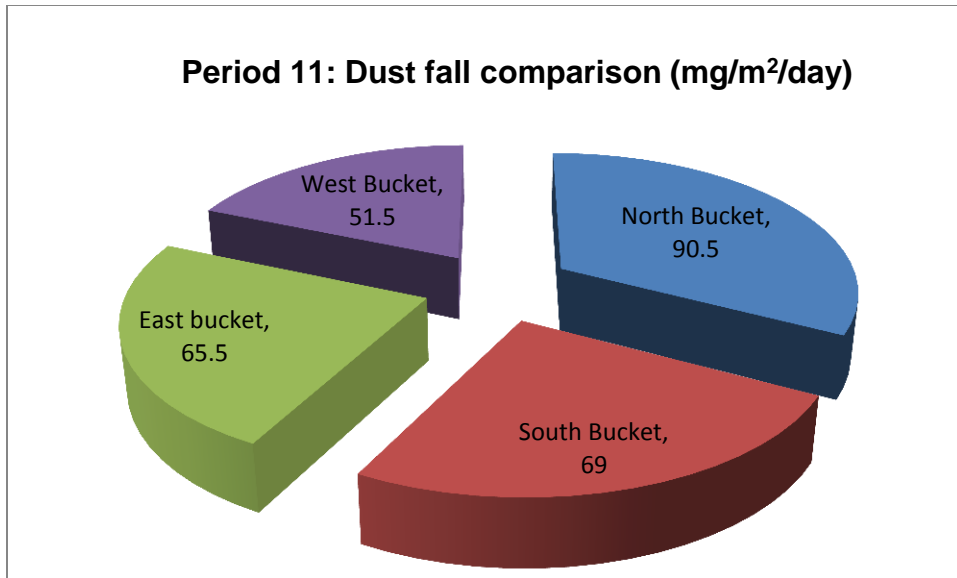

Figure 4.36: Period 11: Multi-directional dust fall comparison

The north bucket has the highest dust loading during this period. The samples contained mainly agricultural soil dust and topsoils. The topsoils were mostly lifted with energy from a veld fire to the north-west. The vector wind direction is from the south-west, this could explain the second highest concentration in the south bucket. The significant sources, though lie to the north and even with the lower wind intensities from that direction may still contribute the majority of the dust loading.

4.16.3. Period 11: Elemental analysis

The concentrations of the nine selected elements during period 11 are listed in the table below.

Table 4.13: Elemental Analysis 01 May 2012 to 01 June 2012

Filter constituent	Filter analysis (mg/filter)
Aluminium, Al	0.019
Calcium, Ca	0.0018
Iron, Fe	0.036
Magnesium, Mg	0.0098
Phosphorus, P	0
Potassium, K	0.01
Sodium, Na	0.024
Titanium, Ti	0.0018
Zinc, Zn	0

4.16.4. Period 11: PM₁₀ Source Apportionment

The contribution from the sources to the PM₁₀ concentration measured at West Village is graphically illustrated below.

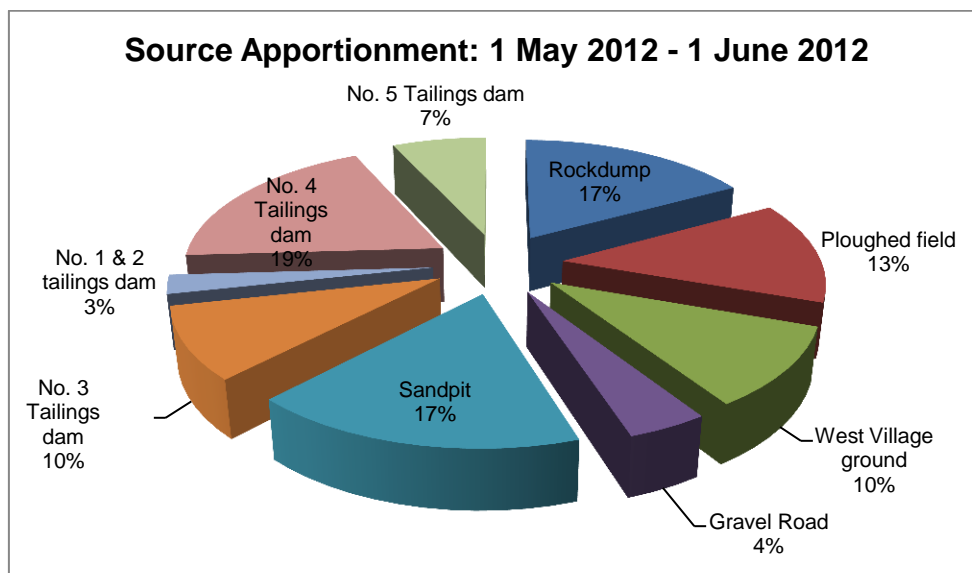

Figure 4.37: Source Apportionment for the period 01 May to 01 June 2012

The major contributors are No. 4 tailings dam located to the north-west, the sand pit, located on the north-east, No. 11 rock dump on the north-east and the ploughed field to the east. The prevailing wind has been from the south-west during this period. Of all the tailings dams, the No. 4 tailings dam contributes the greatest portion, followed by No. 3 tailings dam, No. 5 tailings dam and then the No. 1 and 2 tailings dam. The No. 4 tailings dam large exposed surface area may pose as a major source of dust as it dries. The No. 3 tailings dam which is in the same prevailing wind direction as the No. 4 tailings dam contributes less due to natural vegetation that has established on the top surface, acting as dust control. The No. 5 tailings dam, which has lower vegetation growth than the No 3 tailings dam on the upper surface contributes less. This could be attributable to it being located much further away to the west. The No. 1 and 2 tailings dams contributions are the lowest of all the tailings dams. A possible explanation for this is the vegetation establishment on its side slopes and also the top surfaces being kept wet by the on-going tailings deposition.

4.17. Period 12: 01 June 2012 to 01 July 2012

4.17.1. Period 12: Meteorological conditions

The wind rose for period 12 is illustrated in Figure 4.38 below.

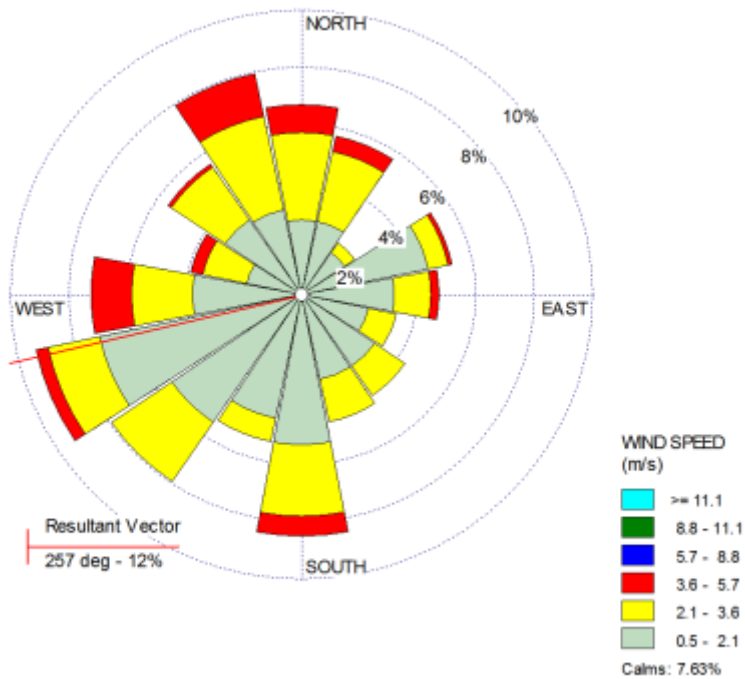

Figure 4.38: Wind Rose for the period 01 June 2012 to 01 July 2012

The resultant vector wind direction is 257 degrees (south westerly direction). Approximately 3 mm of rainfall was recorded.

4.17.2. Period 12: Multidirectional buckets comparison

The multidirectional dust fall buckets concentrations for period 12 are depicted in Figure 4.39 below.

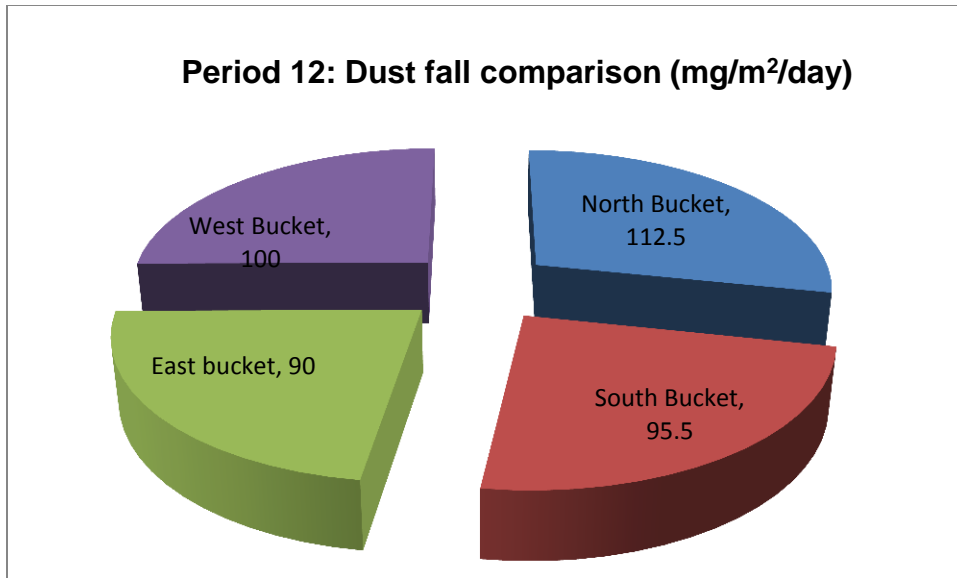

Figure 4.39: Period 12: Multi-directional dust fall comparison

The north bucket has the highest dust loading during this period. The north bucket has been characterised by fine quartzite (<2%) with agricultural soil dust, topsoils and vegetation burn. While the vector wind direction is from the south-west, the veld fires to the north have been the mostly major contributor. Strong northerly winds were also prevalent during this period that could have easily carried fire debris to the receptor.

4.17.3. Period 12: Elemental analysis

The concentrations of the nine selected elements during period 12 are listed in the table below.

Table 4.14: Elemental Analysis 01 June 2012 - 01 July 2012

Filter constituent	Filter analysis (mg/filter)
Aluminium, Al	0.02
Calcium, Ca	0.0022
Iron, Fe	0.038
Magnesium, Mg	0.011
Phosphorus, P	0
Potassium, K	0.034
Sodium, Na	0.027
Titanium, Ti	0.00089
Zinc, Zn	0.0026

4.17.4. Period 12: PM₁₀ Source Apportionment

The contribution from the sources to the PM₁₀ concentration measured at West Village is graphically illustrated below.

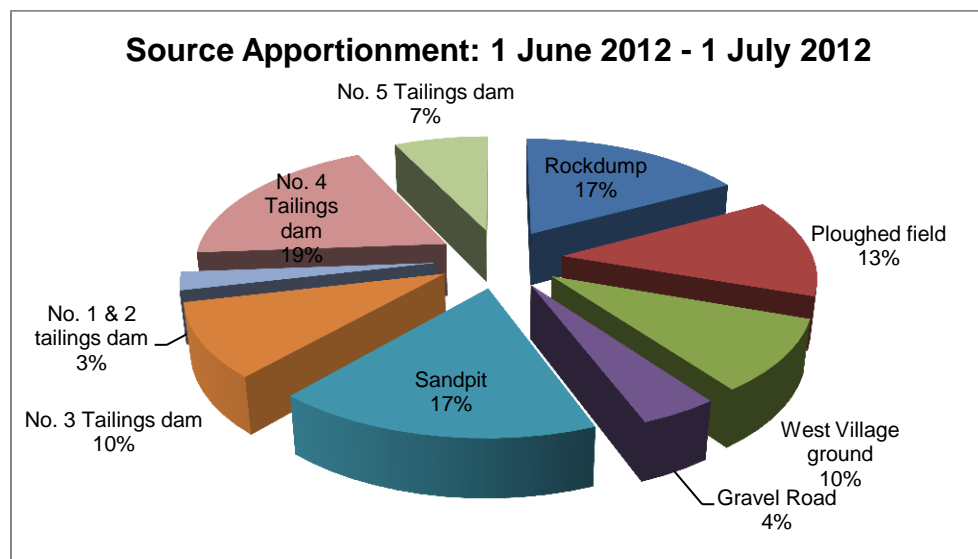

Figure 4.40: Source Apportionment for the period 01 June to 01 July 2012

The major contributors are No. 4 tailings dam located to the north-west, the sand pit, located on the north-east, No. 11 rock dump on the north-east and the ploughed field to the east. The prevailing wind has been from the south-west during this period. Of all the tailings dams, the No. 4 tailings dam contributes the greatest portion, followed by No. 3 tailings dam, No. 5 tailings dam and then the No. 1 and 2 tailings dam. The No. 4 tailings dam large exposed surface area may pose as a major source of dust as it dries. The No. 3 tailings dam which is in the same prevailing wind direction as the No. 4 tailings dam contributes less due to natural vegetation that has established on the top surface, acting as dust control. The No. 5 tailings dam, which has lower vegetation growth than the No 3 tailings dam on the upper surface contributes less. This could be attributable to it being located much further away to the west. The No. 1 and 2 tailings dams contributions are the lowest of all the tailings dams. A possible explanation for this is the vegetation establishment on its side slopes and also the top surfaces being kept wet by the on-going tailings deposition.

4.18. Dust fall buckets comparison

Dust fall was measured with the Dustwatch multidirectional unit at West Village. Rainfall may have had a significant effect on dust loads. The dust fall, rainfall and vector wind speed trends are illustrated below.

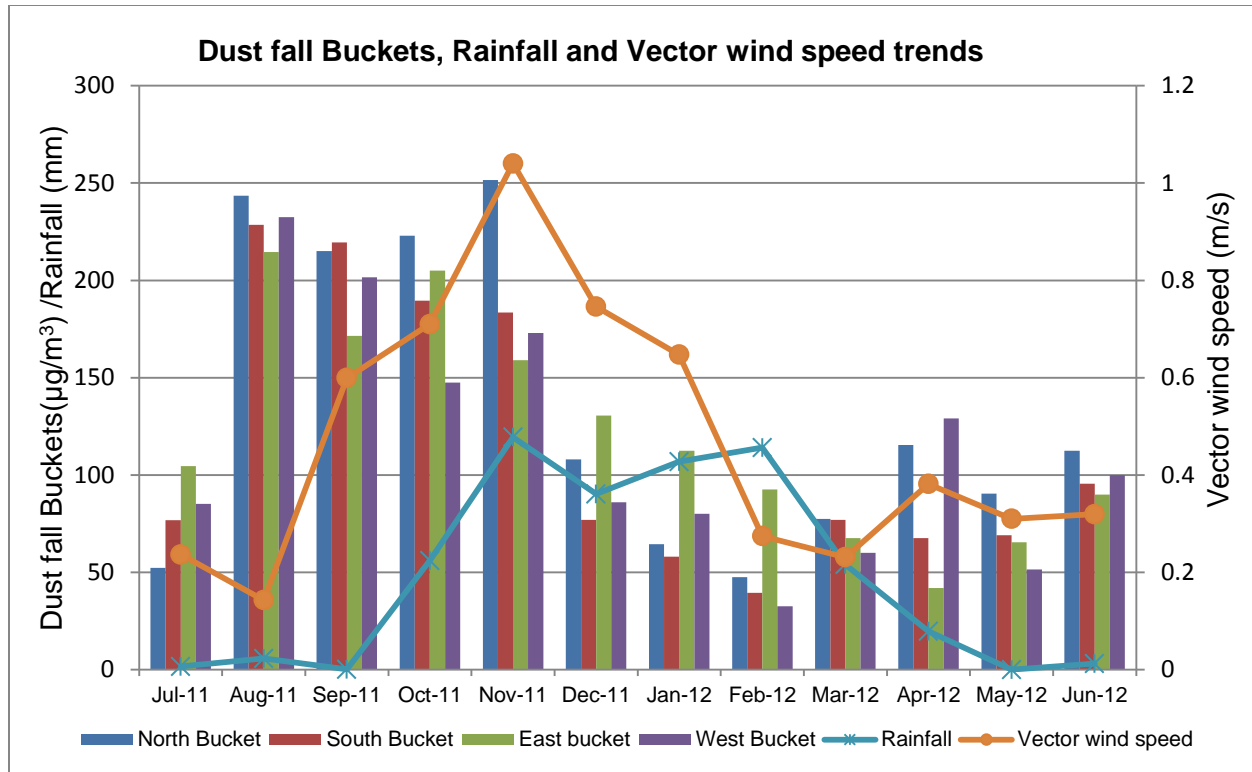

Figure 4.41: Dust fall, rainfall and vector wind speed trends at West Village

The noticeable high dust fall measurements during August to November may be attributable to the gusty winds (also see Figs 4.8, 4.11 and 4.14) experienced in the South African Highveld during spring. Dust fall levels decreased during November. This coincides with the commencement of the rainy season. The vector wind speed peaked in November. During November, the dust loading in the north bucket was the highest recorded from any direction over the entire study term. The rainfall has had an influence on the lower dust loadings during December, January and February. During this period, the east buckets had comparatively higher concentrations. The amount of rainfall decreased from February onwards. As the rains started to reduce from March onwards, the dust loadings seem to track the vector wind speeds with relatively higher dust loading associated with higher vector wind speeds.

4.19. Dust fall composite sample period: meteorological conditions

Composite dust fall samples collected over the period of 05 September 2011 to 23 January 2012. The analysis over this period follows. The integrated wind rose over this sampling period is depicted below.

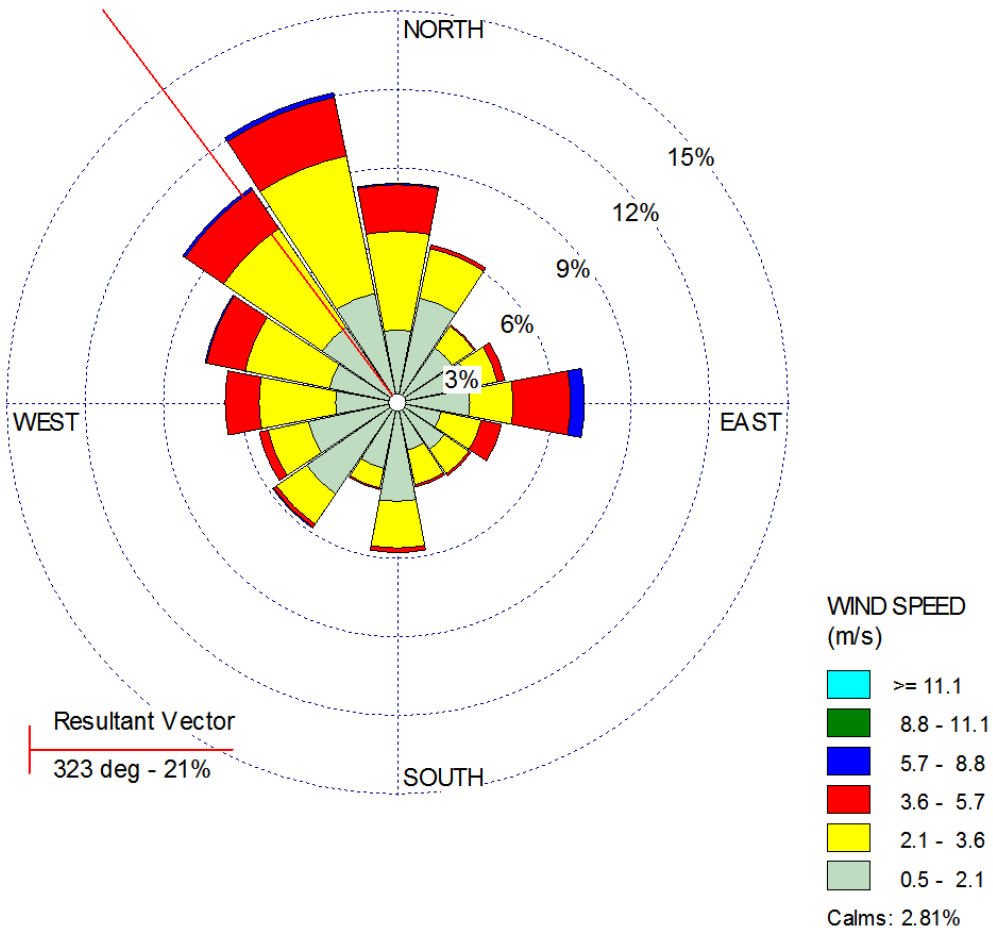

Figure 4.42: Wind Rose for period 05 September 2011 to 23 January 2012

The resultant vector wind direction is 324 degrees (north westerly direction). Strong north westerly and easterly winds prevailed. A total of 378.8 mm of rainfall was recorded.

4.20. Dust fall composite sample: Elemental analysis

Composite dust fall samples collected over the period of 05 September 2011 to 23 January 2012 was analysed for its elemental composition. The compositions of the nine most abundant elements are listed in the table below (the full analyses are attached in Appendix B).

Table 4.15: Dust fall buckets elemental analysis for sampling period: 05 September 2011 to 23 January 2012

Filter constituent	Filter analysis (mg/kg)			
	North bucket	West bucket	South bucket	East bucket
Aluminium, Al	15699.64	16508	14558	13251
Calcium, Ca	208038.27	158354	203396	197114
Iron, Fe	15340.43	21705	19362	12522
Magnesium, Mg	7916.47	9680.9	10968	11737
Phosphorus, P	483.01	687.7	549.92	362.56
Potassium, K	1048.76	1194.3	1038.3	1049
Sodium, Na	6819.44	6266.4	8030.6	7434.5
Titanium, Ti	30.37	77.64	52.41	22.78
Zinc, Zn	2036.07	1366.1	1872.2	1598.3

Calcium is the most abundant, followed by aluminium and iron. Particle size analysis was conducted on the composite sample. The PM₁₀ fraction was 13.4 % and the PM_{2.5} fraction was 3.5 %.

4.21. Dust fall Source Apportionment

The dust samples collected with the multi-directional buckets from West Village during the period of 05 September 2011 to 23 January 2012 were analysed as composite samples of the north, east, south and west buckets.

4.21.1. Source Apportionment: North dust fall bucket

The contribution from the sources to the dust fall concentration measured at West Village, north bucket is graphically illustrated below.

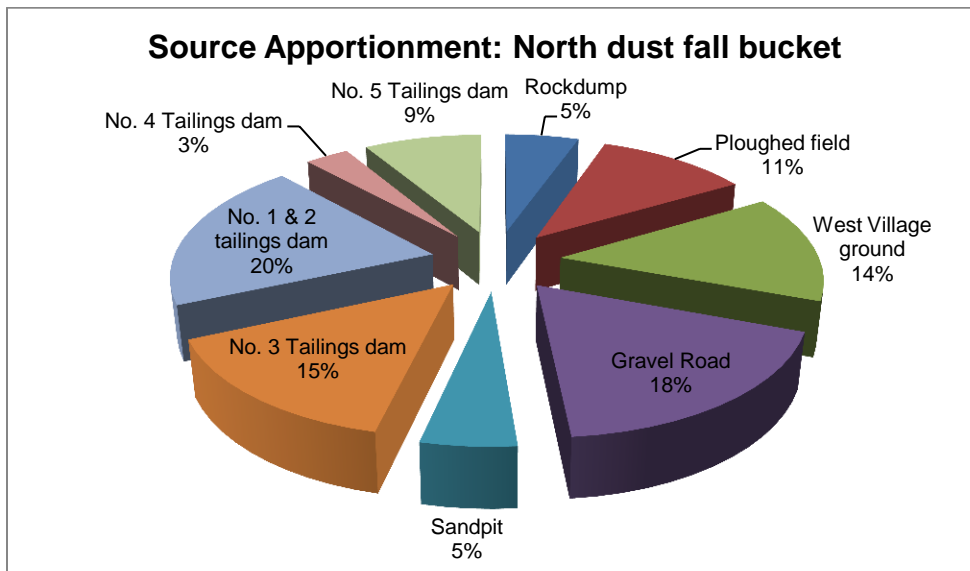

Figure 4.43: Source Apportionment of dust fall from the North bucket

The No. 1 and 2 tailings dam is the highest contributor. Other significant contributors include the gravel road, No. 3 tailings dam and West Village ground. Of note, the No. 4 tailings dam is the lowest contributor. A possible reason for this could be the extended distance the tailings dam is from the receptor point.

4.21.2. Source Apportionment: West dust fall bucket

The contribution from the sources to the dust fall concentration measured at West Village, west bucket is graphically illustrated below.

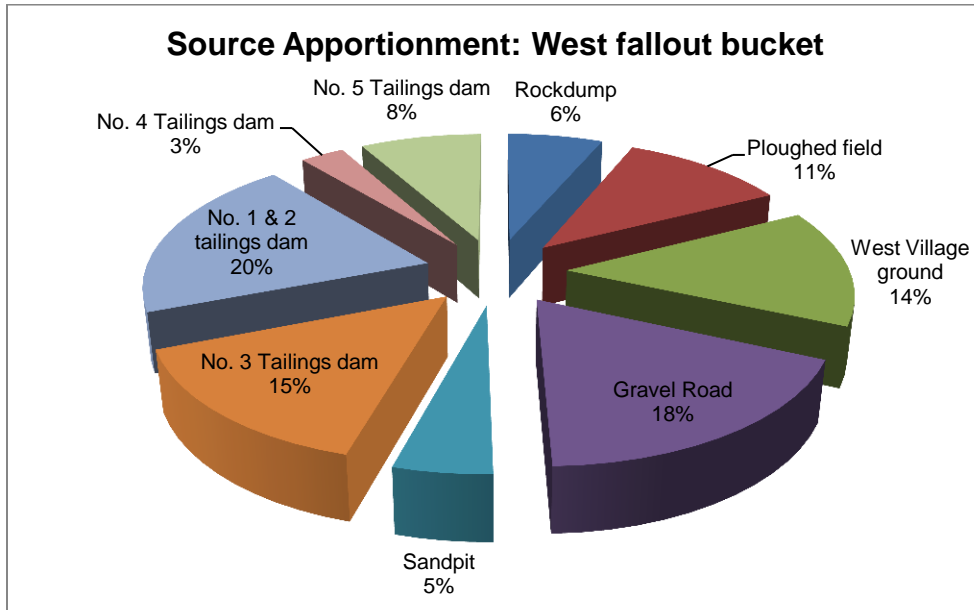

Figure 4.44: Source Apportionment of fallout dust from the West bucket

The distribution is similar to that of the preceding north bucket. The No. 1 and 2 tailings dam is the highest contributor. Other significant contributors include the gravel road, No. 3 tailings dam and West Village ground. Of note, the No. 4 tailings dam is the lowest contributor.

4.21.3. Source Apportionment: East dust fall bucket

The contribution from the sources to the dust fall concentration measured at West Village, east bucket is graphically illustrated below.

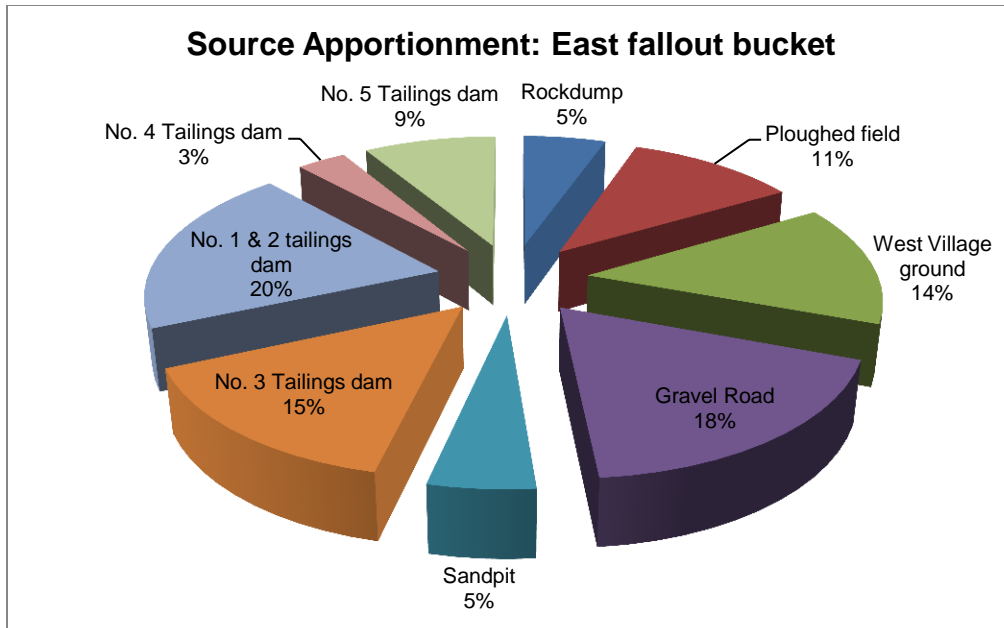

Figure 4.45: Source Apportionment of fallout dust from the East bucket

The distributions are similar to the earlier north and west buckets where No. 1 and 2 tailings dam is the highest contributor. Other significant contributors include the gravel road, No. 3 tailings dam and West Village ground.

4.21.4. Source Apportionment: South dust fall bucket

The contribution from the sources to the dust fall concentration measured at West Village, south bucket is graphically illustrated below.

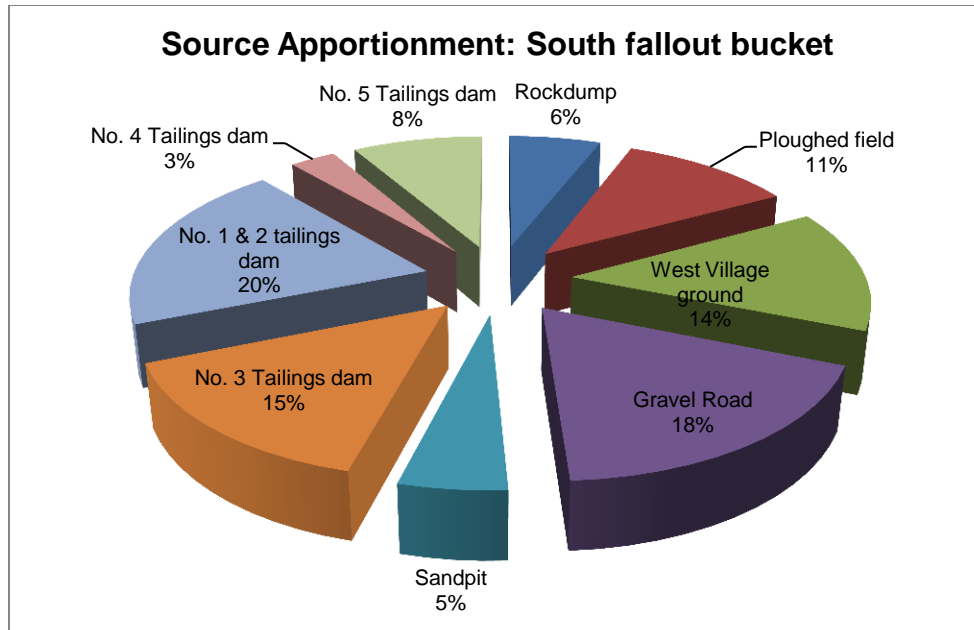

Figure 4.46: Source Apportionment of fallout dust from the South bucket

The compositions, and as such, the apportionment have very similar patterns amongst the 4 buckets. The major contributions of dust fall is from the No. 1 and 2 tailings dams located to the north east, the gravel road to the north, No. 3 tailings dam to the north west and West Village ground. It seems that the closer located sources are the major contributors to the dust fall. A possible explanation for this could be the short distances the heavier particles travel before settling. The sources closer may dominate by contributing the larger size particles. The sources of dust located further away may still contribute in terms of the smaller size fraction while the larger particles settle out before reaching the receptor point at West Village.

5. CONCLUSIONS

1. The different tools used in the assessment of the air quality concentrations have complemented each other. The SAS method had a limitation of not accounting for any unknown sources. It nevertheless was able to provide a ranking of the contributions from the respective known sources. This is useful in confirming effectiveness of dust controls at specific sites and also in determining where additional focus may be required. The weather station data was useful in the interpretation and understanding of the dust loadings, particularly the monthly dust fall results. While the light scatter method is not a reference method for particulate matter, it does provide a useful early indication of prevailing dust concentrations and assessment of the 24 hour concentrations. The gravimetric sampling made possible the multi-elemental assessments for source apportionment and also, the assessment of the alpha quartz concentrations. The multidirectional dust fall buckets assisted in the assessing dust contributions from on-site and off-site sources for the monthly periods.
2. The average monthly gravimetric PM₁₀ concentration was found to be 18.4 µg/m³. The average PM₁₀ concentration as determined by the light scatter method over the study period was 15.4 µg/m³. The extrapolated highest daily PM₁₀ concentration (36.3 µg/m³) and the annual average concentration (11.2 µg/m³) compared satisfactorily with the current SA daily average limit value of 120 µg/m³ and the annual average limit of 50 µg/m³. The concentrations also compare satisfactorily with the World Health Organisation guideline of 50 µg/m³ for the 24 hour mean and 20 µg/m³ for the annual mean.
3. The dominant species found at the receptor point included aluminium, calcium, iron, magnesium, phosphorus, potassium, sodium, titanium and zinc.
4. Black carbon contributions can be a significant contributor to total PM₁₀ concentrations especially in spring when inversion layers form. Black carbon measurements ranged from 10 to 34 % of the PM₁₀ concentration. Black carbon measurements during the sampling period of July to November, showed a distinctive decreasing trend. This could be attributable to the reduced fire burning

activities in informal settlements with the move towards the summer months and also the dissipation of the inversion layer resulting in greater airflow mixing.

5. The multi-directional dust fall buckets recorded comparatively higher concentrations ($\text{mg}/\text{m}^2/\text{day}$) during July to November. This may be attributable to the gusty winds and veld fires experienced in the Highveld over that period.
6. The PM_{10} fraction measured by the E-Sampler however did not track the elevated dust fall closely over this period. Also, the source apportionment of contributions of PM_{10} and that of dust fall out did not show similar correlation. This has been useful though, in that it should be noted that the major source of dust fall may not necessarily be the major source of the smaller inhalable PM_{10} fraction and vice versa.
7. The No. 4 tailings dam has been identified as one of the major contributors to PM_{10} at the receptor point in West Village with the highest contribution over all periods except December. This can change with operational changes such as reduced rate of tailings deposition on another tailings dam. During December, the No. 1 and 2 tailings dams were the major contributor to the PM_{10} concentration. This could be related to the drying of the top surfaces when deposition rates were curtailed. This highlights the significance to consider operational dams as a potential dust source, especially from the top surfaces. Current dust controls at operations have focused mainly on the slide slopes of operational tailings dams.
8. The dust fall compositions, and as such, the apportionment were found to have very similar patterns amongst the 4 directional buckets. The major contribution of dust fall is from the No. 1 and 2 tailings dams. It seems that the closer located sources are the major contributors to the dust fall. A possible explanation for this could be the shorter distances the heavier particles travel before settling. The sources of dust located further away may still contribute in terms of the smaller size fraction while the larger particles settle out before reaching the receptor point.
9. Alpha quartz in the potential sources ranged from 4.1% in the West Village ground to 37.4% in the rock dump. The average alpha quartz in the PM_{10} was 3.2%. On average, the concentration of alpha quartz to which the general

population is exposed is $0.358 \mu\text{g}/\text{m}^3$. There is no defined limit for public exposure to alpha quartz. The exposure level is significantly lower than the workplace exposure limit of $100 \mu\text{g}/\text{m}^3$.

10. Meteorological conditions have influenced both, dust fall and the PM_{10} concentrations. Lower dust fall and PM_{10} were evident during the rainy season.
11. The PM_{10} fraction in the dust fall composite sample was 13.4%.
12. In comparison with Kornelius & Bornman (2008) findings, the tailings dams were confirmed as major dust contributors. A new finding is from the monthly receptor apportionment where the deposition rates have been identified as a condition affecting dust deposition rates.

6. RECOMMENDATIONS

1. Dust control from active tailings dams should also be taken into consideration as it has the propensity to also liberate dust that can, under certain conditions manifest as dust fall or PM_{10} in other instances. It is recommended that contingencies be considered for the planned and unplanned (e.g. strike action) reduction of tailings deposition on operating tailings dams for effective dust control. This should also be considered in the design of any new tailings facilities, especially mega dam projects. The possibility of extending the water supply ring-feed to the top of operational dams should be investigated as an option for the extension and deployment of water spray systems on the dry surfaces (top, side slopes and ramps) of operating dams. These can be switched on at certain intervals or during abnormal conditions for dust control.
2. Maintenance of the effective dust controls at the dormant tailings dams and gravel road and rock dump should continue.
3. The effects of fugitive dust from outside of the Mine boundaries need to be taken into consideration when assessing exposures to communities on the Mine as well.
4. The multidirectional buckets should be assessed to verify conformance with the ASTM method (SANS or legislated reference method).
5. Future monitoring should entail additional sampling and analysis of sources to cater for statistical regression to be performed.

7. REFERENCES

ASTM Standard D1739-98 (2004), 1998: “Standard Test Method for Collection and Measurement of Dustfall (Settleable Particulate Matter)”, (Re-approved 2004), ASTM International: West Conshohocken.

Baadtjies, C (2011) “Driefontein Gold Mine Environmental Management Programme”, EcoPartners report to the Dept of Mineral Resources, Johannesburg.

Beychok, MR (2005) “Fundamentals of stack gas dispersion”, Fourth edition. 1102 Colony Plaza, Newport Beach, California, USA.

City of Johannesburg (2007) “State of the air report”. The Environmental Management Dept. City of Johannesburg.

Cohan, JC, Anderson, HR, Ostro, B, Pandey, KD, Krzyzanowski, M, Künzli, N, Gutschmidt, K, Pope III, CA, Romieu, I, Samet, JM and Smith, KR (2004) “Comparative quantification of health risks” Volume 2, Environmental and occupational risk factors, Chapter 17, Urban air pollution. WHO, Geneva, Switzerland.

ESMAP (2011) “Tools for improving air quality management”. Energy, Trade and Water Department, The World Bank Group, Washington, DC Formal Report 339/11.

Engelbrecht, JP, Reddy, VS, Swanepoel, L. and Mostert, JC (1998) “Aerosol monitoring and source apportionment in the Vaal Triangle”, Mintek, Special Publication No. 17. Randburg.

Enslin, N and Wray, C (2012) “Air Quality Impact Assessment for Gold Fields Driefontein Gold Mine”. Rayten Engineering Solutions cc. Report No. RES-GF-12/1141.

Garland, RM and Sivakumar, V (2012) “Exploring the relationship between monitored ground-based and satellite aerosol measurements over the City of Johannesburg”. South African Society for Atmospheric Sciences Annual Conference, Cape Town, 26-27 September 2012.

Guttikunda, S (2008) "What is particulate matter? Composition & science" SIM-air working paper series 10-2008.

Guttikunda, S (2009) "Urban particulate pollution source apportionment" SIM-air working paper series 16-2009.

Held, G., Gore, B.J., Surridge, A.D., Tosen, G.R., Turner, C.R. and Walmsley R.D. (eds.). *Air pollution and its impacts on the South African Highveld*. Environmental Scientific Association, Cleveland. 144pp.

Kornelius, G and Bornman, R (2008) "Air quality impact assessment for Driefontein Gold Mine near Carletonville", Airshed Planning Professionals (Pty) Ltd. Report No.: APP/08/GMP-00 Rev 0.3. to Gold Fields, Driefontein Mine.

Magee Scientific (2009) "Magee Scientific operating manual aethalometer MicroAeth model AE51", Version S0.000, Magee Scientific Company Berkeley, California.

Met One Instruments, Inc. (2002) "E-Sampler operating manual", Met One Instruments, Grants Pass, Oregon.

Molina, MJ and Molina, LT (2004) "Megacities and atmospheric pollution". *Air Waste Management Assoc.* 54(6):644-680.

Republic of South Africa (1996) "Constitution of the Republic of South Africa Act, No 108 of 1996: , Government Gazette No. 17678, Cape Town, 18 December 1996.

Republic of South Africa (2005) "South African National Standard 1929", Standards South Africa, Pretoria, 0001.

Republic of South Africa (2006) "Mine Health and Safety Act, No 29 of 1996: Amendment to regulations in respect of Occupational Hygiene, Government Notice Regulation No. 989, Government Gazette No. 29276, Cape Town, 05 October 2006.

Republic of South Africa (2009) “National Environmental Management: Air Quality Act, No 39 of 2004: National Ambient Air Quality Standards, Government Gazette Vol. 534 No. 32816, Cape Town, 24 December 2009.

Republic of South Africa (2012a) “National Environmental Management: Air Quality Act, No 39 of 2004: National Ambient Air Quality Standard for particulate matter with aerodynamic diameter less than 2.5 micron metres (PM_{2.5}), Government Gazette Vol. 486 No. 35463, Cape Town, 24 December 2009.

Republic of South Africa (2012b) “National Environmental Management: Air Quality Act, No 39 of 2004: Draft National Dust Control Regulations, Government Gazette No. 35931, Cape Town, 07 December 2012.

Rice, F (2000) “Crystalline silica, quartz,” National Institute of Occupational Safety and Health, Cincinnati, OH, USA.

Thomas, C (2004) “EPA-CMB 8.2 “Users Manual.” US Environmental Protection Agency Office of Air Quality Planning and Standards Emissions, Monitoring & Analysis Division Research Triangle Park, NC 27711.

uMoya-NILU (2012) “Emission Inventory for the West Rand District Municipality”, report for the West Rand District Municipality, uMoya-NILU Consulting (Pty) Ltd, Report No. uMN014-12.

Watson, JG (2004) “Protocol for applying and validating the CMB model for PM_{2.5} VOC”. US Environmental Protection Agency Office of Air Quality Planning and Standards Emissions, Monitoring & Analysis Division Research Triangle Park, NC 27711.

WHO (2006) “Air Quality Guidelines Global Update 2005” World Health Organisation Regional Office, Scherfigsveg – 8, DK2100, Copenhagen, Denmark.

Witi, J (2005) “Report on ambient PM₁₀ and PM_{2.5} estimates from monitoring stations data”. Department of Chemical Engineering, Cape Peninsula University of Technology, Bellville, Cape Town.

Wright, C and Oosthuizen, R (2010) “PM_{2.5} as an emerging priority pollutant in South Africa – impacts on human health”, Department of Environmental Affairs, Directorate: Information Management, Pretoria.

8. APPENDICES

- 8.1. Appendix A: PM₁₀ Laboratory analysis reports**
- 8.2. Appendix B: Dustfall composite sample analysis report**
- 8.3. Appendix C: University of Pretoria, Statistics Dept; Analysis methodology and results**
- 8.4. Appendix D: Sources analysis reports**