

Control of an acid sulphite batch pulp digester based on a fundamental process model

André Kilian

Control of an acid sulphite batch pulp digester based on a fundamental process model

by

André Kilian

A dissertation submitted in partial fulfilment
of the requirements for the degree

Master of Engineering (Control Engineering)

in the

Faculty of Engineering

University of Pretoria

November 1999

Control of an acid sulphite batch pulp digester based on a fundamental process model

Author: André Kilian
Supervisor: Prof. P.L. de Vaal
Department: CHEMICAL ENGINEERING
UNIVERSITY OF PRETORIA
Degree: Master of Engineering (Control Engineering)

Synopsis

The lack of measurements on a batch pulp digester necessitates the use of a model to control the product quality. In the production of dissolving pulps, the degree of polymerisation of the cellulose is the most important control variable. The aim of this study was to develop a model that can be used in a control strategy for the pulp digester. The model should therefore be capable of predicting the final degree of polymerisation of a cook based on the initial conditions.

A modelling strategy was used which combined the techniques of fundamental modelling and empirical modelling. The basic structure of the model was chosen from first principles. Simulation results from the model were compared with both experimental and the actual measured values for a set of cooks and the parameters in the model were adjusted to fit the data.

Excellent results were obtained by using this modelling technique. The accuracy of the model was measured by using the coefficient of variance. The coefficient of variance is calculated as the ratio of the variance between the model predicted values for the final degree of polymerisation and the actual measured values for a set of cook, and the mean of the predicted values. The model was verified against 35 actual cooks and a coefficient of variance of 10,7 was obtained, which can be interpreted as an average of 10% variance between the predicted and measured values. The normal coefficient of variance obtained at SAPPI SAICCOR by using the current model is between 20 and 30, and the results from this study indicate that a significant improvement would be possible if a fundamental model could be used in controlling the product quality.

The correlation coefficient obtained between these two sets of data was 0,77. This high value for the correlation coefficient indicates that the model is able to predict

changes in the final degree of polymerisation. This signifies that the model would be suitable for implementation in a control strategy, since any variations in the process would be predicted and corrected for.

Keywords: acid sulphite pulping, batch modelling, batch control, fundamental model, degree of polymerisation, wood degradation kinetics, empirical modelling, wood constituents.

Beheer van ‘n enkellading suur sulfiet pulpverteerder gebaseer op ‘n fundamentele model

Outeur: André Kilian
Studieleier: Prof. P.L. de Vaal
Departement: CHEMIESE INGENIEURSWESE
UNIVERSITEIT VAN PRETORIA
Graad: Magister in Ingenieurswese (Beheeringeniëurswese)

Sinopsis

Die gebrek aan meting op ‘n enkellading pulpverteerder noodsaak die gebruik van ‘n model in die beheer van produkkwaliteit. Tydens die produksie van oplosbare pulp is die graad van polimerisasie van die sellulose die belangrikste beheerde veranderlike. Die doelwit van hierdie studie was om ‘n model te ontwikkel wat gebruik kan word in ‘n beheerstrategie vir die pulpverteerder. Die model moet daarom die vermoë hê om die finale graad van polimerisasie te voorspel vir ‘n kook, gebaseer op die aanvanklike toestande.

‘n Modellingstrategie is gebruik wat die tegnieke van fundamentele en empiriese modellering kombineer. Die basiese modelstruktuur is gekies uit eerste beginsels. Resultate van simulaties met die model is vergelyk met beide eksperimentele data en werklike aanlegdata en die parameters in die model is verander om aan die data te pas.

Uitstekende resultate is verkry deur van hierdie modelleringstegniek gebruik te maak. Die akkuraatheid van die model is gemeet aan die koëffisiënt van variansie. Die koëffisiënt van variansie word bereken as die verhouding van die variansie tussen die model-voorspelde waardes vir die finale graad van polimerisasie en die werklike gemete waardes vir ‘n stel kook data, en die gemiddeld van die stel voorspelde waardes. Die model is geverifieer teen 35 werklike koke en ‘n koëffisiënt van variansie van 10,7 is verky, wat geïnterpreteer kan word as ‘n gemiddelde afwyking van 10% tussen die voorspelde en werklike waardes. Die normale koëffisiënt van variansie wat deur SAPPI SAICCOR verkry word is tussen 20 en 30 en die resultate van hierdie studie dui aan dat ‘n merkbare verbetering moontlik is indien ‘n fundamentele model gebruik word vir die beheer van die produkkwaliteit.

Die korrelasie koëffisiënt wat verkry is tussen hierdie twee stelle data is 0,77. Hierdie hoë waarde vir die korrelasie koëffisiënt dui aan dat die model die vermoë het om veranderinge in die finale graad van polimerisasie te voorspel. Dit dui daarop dat die model geskik sal wees vir implementering in 'n beheerstrategie, aangesien verandering in die produkkwaliteit voorspel kan word en vroegtydig gekorrigeer kan word.

Sleutelwoorde: suur sulfied verpulping, enkellading modellering, enkellading beheer, fundamentele model, graad van polimerisasie, hout afbraak kinetika, empiriese model, houtkomponente.

Acknowledgements

I would like to thank:

Prof. P.L. de Vaal, for guidance and supervision and for handling the diplomatic issues and negotiations with the different parties involved. I would also like to thank Prof. De Vaal for the effective working environment and computers that he provided that encourages productivity and group work.

SASOL, for giving their permission to work on this project, and for providing the necessary sponsorship and financial support that enabled me to work on this project on a full-time basis.

Mr. Eddie Watson from BeST, for all the experimental data that I used in the verification of the model, as well as valuable input and advice regarding the control of the pulp digesters.

Elmarie, for her love and support and for understanding, especially on many Friday evenings.

My family, for their support and for taking many a burden off my shoulders that enabled me to concentrate on my studies.

The Almighty Father and his son, Jesus Christ, for carrying me through this year and for looking back and seeing only one set of footprints. It remains a privilege to study creation and to learn just how little we know of how big He is and to realise how infinite the love and grace of the Creator must be for people for calling us His sons.

Table of contents

SYNOPSIS.....	II
SINOPSIS.....	IV
ACKNOWLEDGEMENTS	VI
TABLE OF CONTENTS	VII
LIST OF FIGURES.....	X
LIST OF TABLES.....	XII
NOMENCLATURE	XIII
CHAPTER 1: INTRODUCTION.....	1
CHAPTER 2: RAW MATERIALS FOR PULPING	4
2.1. THE BIOLOGICAL COMPOSITION OF WOOD	5
2.2. THE CHEMICAL COMPOSITION OF WOOD	10
2.2.1. Cellulose	11
2.2.2. Hemicellulose.....	15
2.2.3. Lignin.....	18
2.2.4. Association of lignin, hemicellulose and cellulose.....	21
2.3. SUMMARY	23
CHAPTER 3: PULPING PROCESSES	24
3.1. CHEMICAL PULPING.....	27
3.1.1. <i>The sulphite process</i>	28
3.1.1.1. Analysis of sulphite pulping liquors.....	31
3.1.1.2. Bases used in Sulphite pulping.....	33
3.1.1.2.1. Calcium base	34
3.1.1.2.2. Magnesium base	35
3.1.1.3. Sulphite pulping processes	35
3.1.1.3.1. Acid sulphite pulping	35
3.1.1.3.2. Bisulphite pulping	36
3.1.1.3.3. Alkaline sulphite pulping.....	36
3.1.1.3.4. Multistage and high-yield sulphite pulping	36
3.2. SUMMARY	37



CHAPTER 4: THE SAPPI SAICCOR PLANT.....	38
4.1. AN OVERVIEW OF THE PROCESS.....	39
4.2. CONTROL TECHNIQUES CURRENTLY USED BY SAICCOR.....	43
4.2.1. Currently used model for determining the temperature setpoint	48
4.2.2. Why a different strategy was necessary	51
4.3. SUMMARY	52
CHAPTER 5: A PROPOSED SOLUTION.....	53
5.1. SUMMARY	60
CHAPTER 6: IMPORTANT PROPERTIES OF THE ACID SULPHITE PROCESS.....	61
6.1. CHEMICAL REACTIONS IN THE SULPHITE PROCESS.....	61
6.1.1. Lignin sulphonation and dissolution.....	63
6.1.2. Reactions of carbohydrates in sulphite pulping.....	66
6.1.2.1. Cellulose reactions	67
6.1.2.1.1. Degradation reactions.....	68
6.1.2.1.2. Reactions forming addition compounds	69
6.1.2.2. Hemicellulose reactions	70
6.1.3. Other reactions in sulphite pulping.....	71
6.1.4. Composition of the cooking liquor during the sulphite cook	74
6.2. KINETICS OF THE ACID SULPHITE REACTIONS	80
6.2.1. Kinetics of lignin dissolution.....	81
6.2.2. Kinetics of the cellulose hydrolysis reaction.....	85
6.2.3. Kinetics of the hemicellulose hydrolysis	87
6.2.4. Kinetics of strong acids formation	90
6.3. MAIN FACTORS INFLUENCING THE SULPHITE PULPING PROCESS	92
6.3.1. Impregnation of wood with cooking chemical	92
6.3.2. Effect of chip dimensions	93
6.3.3. Effect of temperature.....	94
6.3.4. The effect of pressure	96
6.3.5. Effect of chemical composition	96
6.3.5.1. The pH of sulphite liquor	96
6.3.5.2. Combined Sulfur Dioxide	98
6.3.5.3. Total and free sulfur dioxide	99
6.3.6. Effect of liquor-to-wood ratio	100
6.3.7. The effect of wood species.....	100
6.4. SUMMARY	102
CHAPTER 7: MODELLING TECHNIQUES FOR BATCH PROCESSES.....	104
7.1. MODELLING FROM FIRST PRINCIPLES.....	108
7.2. NEURAL NETWORK MODELLING	114
7.3. EMPIRICAL MODEL	120
7.4. CONCLUSION ON MODELLING TECHNIQUES	121



CHAPTER 8: CONSTRUCTION OF A FUNDAMENTAL MODEL	124
8.1. KINETICS OF THE WOOD CONSTITUENTS	125
8.2. MODELLING OF THE LIQUOR COMPOSITION	129
8.3. MODELLING OF THE CONDITIONS INSIDE THE DIGESTER	133
8.4. SUMMARY	138
CHAPTER 9: THE “DIGEST” SOFTWARE PACKAGE	141
9.1. THE MAIN TITLE SCREEN	142
9.2. PARAMETER ADJUSTMENT.....	143
9.3. DETERMINING THE INFLUENCE OF A SPECIFIC PARAMETER.....	149
9.4. VERIFYING THE CORRECTNESS OF THE MODEL	151
9.5. SIMULATION AND CONTROL OF A COOK.....	153
9.6. SUMMARY	154
CHAPTER 10: EVALUATION OF THE MODEL.....	155
10.1. VERIFICATION OF THE KINETICS AND LIQUOR COMPOSITION	157
10.1.1. <i>The collection of kinetic data (Watson, 1992)</i>	157
10.1.1.1. equipment used.....	157
10.1.1.2. Experimental methodology	158
10.1.1.3. Liquor and pulp sample analysis	160
10.1.1.4. Results.....	161
10.1.1.4.1. pH correction.....	162
10.1.2. <i>Verification using the data</i>	163
10.2. VERIFICATION OF THE CONDITIONS INSIDE THE DIGESTER	167
10.3. VERIFICATION OF THE COMPLETE MODEL.....	167
10.4. APPROACH TAKEN TO OBTAIN THE CORRECT MODEL.....	170
10.5. RESULTS OF THE VERIFICATION.....	172
10.5.1. <i>Verification of the kinetics</i>	173
10.5.2. <i>Verification of modelling the conditions</i>	181
10.5.3. <i>Verification of the complete model</i>	184
10.6. SUMMARY	188
CHAPTER 11: POSSIBLE CONTROL TECHNIQUES.....	189
CHAPTER 12: CONCLUSIONS.....	192
CHAPTER 13: BIBLIOGRAPHY.....	196
APPENDIX A:	A - 1
APPENDIX B.....	B - 1

List of figures

Figure 2.1	Schematic section of four-year-old pine trunk.....	6
Figure 2.2:	Cell-wall architecture, schematically	8
Figure 2.3:	Photograph showing the cell-wall architecture.....	8
Figure 2.4	Distribution of chemical constituents in the cell wall	9
Figure 2.5	The molecular structure of cellulose	12
Figure 2.6:	Orientation of the microfibrils in the cell wall.....	13
Figure 2.7:	Levelling-Off Degree of Polymerisation	14
Figure 2.8:	Monomers in hemicellulose	17
Figure 2.9:	Some monomers in lignin	20
Figure 2.10:	The molecular structure of lignin.....	21
Figure 3.1:	Flow sheet of the sulphite process.....	30
Figure 3.2:	A sulphite pulp mill	31
Figure 3.3:	Composition of sulphite solutions at various pH levels	33
Figure 4.1:	A centre-extraction batch sulphite pulp digester	41
Figure 4.2	Two-way control strategy used at SAICCOR	47
Figure 4.3	Efficiency of temperature control	47
Figure 5.1:	A proposed control strategy	56
Figure 6.1:	Two possible mechanisms of sulphite delignification.....	64
Figure 6.2:	Reactions of lignin at the α - position.....	65
Figure 6.3:	Carbohydrate degradation during sulphite pulping	67
Figure 6.4:	Proposed mechanism for acid hydrolysis of cellulose	69
Figure 6.5:	Formation of thiosulphate and organic excess sulphur during an acid sulphite paper pulp cook.....	74
Figure 6.6:	The relations of hydrogen and bisulphite ion concentrations to combined SO_2	79
Figure 6.7:	Temperature, pressure, and hot and cold pH during a typical acid sulphite cook	97
Figure 6.8:	Effect of combined SO_2 on pulp properties	99
Figure 6.9:	Wood constituents that inhibit sulphite pulping	101
Figure 7.1:	The process of training a neural network.....	115
Figure 7.2:	Simple nodes in a neural network.....	115
Figure 7.3:	A node with a vector in put.....	116
Figure 7.4:	Most commonly used transfer functions	116
Figure 7.5:	A single layer neural network model.....	117
Figure 7.6:	A multi-layer neural network	118
Figure 8.1:	A typical pressure profile.....	134
Figure 8.2:	Modelling of the reactor temperature	136

Figure 8.3: The circulation flowrate during a typical cook	138
Figure 9.1: The main title screen in the “Digest” package.....	142
Figure 9.2: Screen for changing the kinetic parameters of the lignin reactions	145
Figure 9.3: Screen for changing the kinetic parameters of the hemicellulose reactions	145
Figure 9.4: Screen for changing the kinetic parameters of the cellulose reactions	146
Figure 9.5: Screen for changing the kinetic parameters of the strong acid reactions	146
Figure 9.6: Screen for changing the equilibrium parameters	147
Figure 9.7: Operational detail in “Digest” package.....	148
Figure 9.8: The cook details for the individual cooks	149
Figure 9.9: Comparison of different cooks	151
Figure 10.1: A coincidental correct prediction of the degree of polymerisation.....	156
Figure 10.2: A process flow diagram of the satellite mini digester plant	158
Figure 10.3: Screen for parameters adjustment.....	170
Figure 10.4: Verification results for cook 18.....	174
Figure 10.5: Visual display for evaluating the modelling of the conditions.....	181
Figure 10.6: Visual verification of the complete model.....	184
Figure 10.7: Verification of model using 35 cooks	187
Figure 10.8: 45° comparison of verification data.....	187
Figure 11.1: The use of the control option in the “Digest” package	190

List of tables

Table 2.1	Comparison between hardwoods and softwoods	5
Table 2.2:	The chemical composition of wood	11
Table 2.3:	A qualitative comparison of the hemicellulose fractions of softwood and hardwood	18
Table 3.1:	Classification of wood-pulping processes	26
Table 3.2:	Comparison of bases for sulphite pulping	34
Table 6.1:	Side reactions of the sulphite cook	71
Table 6.2:	Temperature dependence of the apparent ionisation constants of sulphurous acid.....	75
Table 6.3:	Lignin dissolution rate parameters at ionic strength 0,5 kmol/m ³	83
Table 6.4:	Lignin dissolution rate parameters found by Watson	84
Table 6.5:	Cellulose dissolution rate parameters	87
Table 6.6:	Hemicellulose dissolution rate parameters	88
Table 6.7:	Hemicellulose dissolution rate parameters	89
Table 6.8:	Parameters for the rate of strong acid formation.....	91
Table 6.9:	Effect of temperature and pressure on the penetration of water into spruce chips.....	93
Table 8.1:	Parameters in kinetic equations for the reaction of the wood constituents	127
Table 8.2:	Values for parameters B and C given by Hagberg and Schön	131
Table 8.3:	Variables in the model.....	140
Table 9.1:	Symbols used in “Digest” package.....	144
Table 10.1	A typical experimental temperature profile.....	159
Table 10.2	Cook times at maximum temperature	159
Table 10.3	A typical set of result from an experimental run	161
Table 10.4:	Correlation coefficients for experimental cooks	177
Table 10.5:	Concordance coefficients for experimental cooks.....	177
Table 10.6:	Mean errors for experimental cooks.....	178
Table 10.7:	Comparison of parameter values obtained by different authors	179
Table 10.8:	Values for parameters B and C in equation (8-5) obtained in this study.....	180
Table 10.9:	Values for parameters B and C given by Hagberg and Schön	180
Table 10.10:	Correlation coefficients for digester conditions	183
Table 12.1:	Parameters in kinetic equations obtained in this study	194
Table 12.2:	Values for parameters B and C in equation (8-5) obtained in this study.....	195

Nomenclature

Symbol	Description	Units of measurement
a	Lignin reaction order in rate equations	
A	Strong acids concentration	mol/l
	Equilibrium to be considered in equation (8-5)	
b	Bisulfite reaction order in strong acid formation	
B	Normalisation factor in Arrhenius equation	
	Constant term in equation (8-5)	
c	Hydrogen reaction order in strong acid formation	
C	Numerator in equation (8-5)	
d	Reaction order of hemicellulose in hemicellulose degradation	
E	Activation energy	K
	Electrode potential	mV
k	Equilibrium constant for a reaction	
	Arrhenius temperature dependency $f(T)$	
k°	Frequency factor in Arrhenius equation	
K_M	Constant in equation (2-4)	
[L]	Residual lignin concentration	%
M	Molecular weight	g/mol
	Concentration of metal ions in sulphite process	mol/l
n	Number of moles	mol
P	Pressure	bar
r	Reaction rate	mol/time
R	Recirculation rate	m^3/hr
t	Time	time
T	Temperature	K
V	Volume	m^3
X	Model predicted value	
Y	Actual or Measured value (see X)	

Greek

α	Reaction order of bisulphite in lignin reactions
β	Reaction order of hydrogen in lignin reactions
δ	Reaction order of hydrogen in cellulose reactions



γ	Hydrogen reaction order in hemicellulose degradation	
μ	Viscosity	cP
v	Liquor-to-wood ratio	
ρ	Density	kg/m ³

Subscripts

a	Constant in Equation (2-4)
C	Concerning cellulose
HC	Concerning hemicellulose
i	Index
L	Concerning lignin
SA	Concerning strong acid
w	Weight
0	Initial

Chapter 1: Introduction

The science of pulping and the use of plant fibres as a building block for synthetic products can be traced back to the early Egyptian civilisations. Yet, the process of pulping is still not completely understood and the control of the pulping process remains a challenge. Various pulping processes have been developed for the separation of the fibres since the Egyptians used papyrus as a source of writing material, based on the accumulated knowledge on pulping materials, the characteristics of the fibres and the component binding the fibres together. These processes have led to a tremendous growth in the pulping industry over the last century and have been refined and improved by using better chemicals, better technology and even recovering and reusing the spent chemicals. However, the ongoing quest for better quality pulp has demanded a better process understanding and improved control systems. The ability to control the pulping process was however always limited by some hampering factors, like the inability to measure the controlled variables.

The acid sulphite process is used at SAPPI SAICCOR to produce dissolving pulps. During this process, dissociated sulphurous acid in the form of bisulphite and hydrogen ions, is used to liberate the fibres by dissolving the binding material. The wood fibres consist mainly of cellulose, which are long, linear polymers. The controlled variable for the production of dissolving pulps, is the length of the cellulose polymer chains, or the so-called degree of polymerisation. The degree of polymerisation cannot be measured directly and it is therefore not possible to monitor the progress of the pulping process directly for control purposes. Some advanced control technique must therefore be used based on a model of the process or an inferred measurement.

A computerised model, called the S-factor model, is currently used at SAICCOR to control the degree of polymerisation. The variance of the product quality obtained by using this model has however become a problem and the need for finding better techniques of controlling the quality has become an increasing priority.

The current control strategy relies heavily on the S-factor model and the limited abilities of this model were identified as the primary reason for the control problems. An investigation done by Watson (1992) into improving the control of the pulping

process indicated that a model with a mechanistic basis offered the best probability for improving the accuracy of the control. It was therefore clear that the development of such a model should form the point of departure in order to improve the control of the pulp digesters.

The purpose of this project was to investigate different means of modelling the pulp digester in a way that can be implemented in a control strategy. Because of the finding of Watson mentioned earlier, as well as all the other advantages offered by a fundamental model, like an improved process understanding, preference was given to the use of a fundamental model. Other modelling techniques were however also considered. The requirements for a model aimed at the control of the process are twofold:

- It must be sufficiently accurate to allow efficient control of the product quality.
- It must be simple enough to allow easy implementation into a control strategy, without unrealistic demands on the control hardware, like the computerised controllers.

A good knowledge of the process would be necessary for the development of a model. This will not only help in the construction of the model, but also in the evaluation of the results of the model. A thorough literature study was therefore done on the composition of the wood used for pulping, as well as the sulphite pulping process used at SAICCOR. Knowledge of the characteristics of the raw material used for pulping would be vital in the understanding of the pulping process, since this would determine the reactions involved during pulping. The extent of the reactions will determine the quality of the pulp and will be the critical part of any model.

Once the model has been developed, it would be essential to verify the correctness of the model. The verification and adjustment of the model to represent the conditions at SAICCOR would constitute a substantial part of the project. Software will have to be developed for the implementation and verification of the model. Some thought will also be given to the implementation of the model in a viable control strategy.

In chapters 2 and 3 the general information regarding pulping is given. This includes the characteristics of the raw material used for pulping, as well as a comparison between some of the different pulping processes. In chapters 4 and 5, the plant and procedure at SAPPI SAICCOR are discussed, as well as the control problems experienced at the plant and the reasons for that. Chapter 6 discusses the acid sulphite process in some detail, since this is the process used at SAPPI SAICCOR and a proper understanding of the process will be essential for the continuation of the project in developing a process model. Chapters 7 and 8 describe the process for



finding a suitable model and also discusses the final model that was developed. In chapters 9 and 10, the implementation and verification of the model are discussed.

Chapters 2, 3 and 6 reflect the extensive literature study mentioned above and can be skipped by readers who are familiar with pulping and the acid sulphite process.

Chapter 2:

Raw materials for pulping

The raw material used for pulping will form the reactants for the chemical reactions that will take place during the pulping process. It is therefore important to know what raw materials are used for pulping and to know what the materials consist of in order to understand the reactions that take place during pulping. A thorough knowledge of these reactions will be important in developing an understanding of the mechanisms of pulping and to be able to construct and evaluate any kind of model for the pulping process.

Fibrous plants, e.g. Papyrus, have been used as a source for writing materials since the earliest Babylonian and Egyptian civilisations. The principal substance in paper pulps is cellulose from plant materials. A wide variety of different plants have been used for pulping since Papyrus was used by the Egyptians, ranging from straw to wood. Cotton and linen rags were once the major source of fibres for paper, but they have been largely replaced by fibres from wood. The most important raw material for the production of pulp nowadays is wood. Only 7-8% of pulp production is based on annual plants, which are mainly employed when wood is not available. In 1995, about 30% of the pulp used in the United States were recycled, while countries in Europe as well as Japan recycled up to 50%. (Bierman, 1996) Until very recently, the South African public wasn't really aware of the recycling of paper and insignificant amounts of pulp are recycled.

In terms of abundance and suitability for pulping, there are two chief botanical classifications of trees: the softwoods or evergreens, which are gymnosperms, and the hardwoods or broad-leaved deciduous trees, which are dicotyledon angiosperms. (Patt and Kardsachia, 1991) The softwoods are generally preferred to the hardwoods for pulping because of their longer fibres. A comparison of hardwood and softwood is given in Table 2.1.

This chapter will focus on the properties and composition of wood as the main source of pulping material. The components of the wood most important to the pulping industry will be discussed as well as the reasons for these components being

important. These components will react differently in different reaction mixtures, or cooking liquors as it is known in pulping, and the possible reactions will be discussed in Chapter 3 where the different pulping processes will be discussed.

	Softwoods	Hardwoods
Wood production	Usually higher productivity	In some cases extremely high productivity; higher stock stability
Wood	More uniform raw material, especially better stem formation, easier to debark, longer fibres, higher yields in acidic cooking	Higher specific weight → lower transport cost → higher digester capacity → higher pulp output Lower lignin content → easier to pulp → less energy and chemical consumption Higher yields in alkaline pulping
Pulp	Better wet web strength, better drainage properties	Requires less beating energy, rapid strength development during beating, better bleachability → fewer bleaching stages → lower chemical demand → less pollution
Paper	High strength properties, especially tear strength, better runability	Better sheet formation, usually smoother surface, higher bulk, higher opacity → better printability

Table 2.1 Comparison between hardwoods and softwoods
(Patt and Kardsachia, 1991)

2.1. The biological composition of wood

The main part of the tree, which is used for pulping, is the trunk. It has three main physiological functions: to carry the crown of the tree aloft, to transport water and mineral salts from the roots to the crown and finally to store some reserve food. The trunk consists mainly of three parts, namely the *xylem* or wood, the *cambium* and the *bark*, as shown schematically in Figure 2.1 (Rydholm, 1965). Cambium is a thin, green layer of growing cells between the bark and the wood. The bark is composed of a white, inner bark, called phloem, and a darker outer bark or cork. As a cambial cell divides, one of the daughter cells remains a cambial cell, whereas the other forms a phloem cell or a xylem cell, depending on which side it was split off.

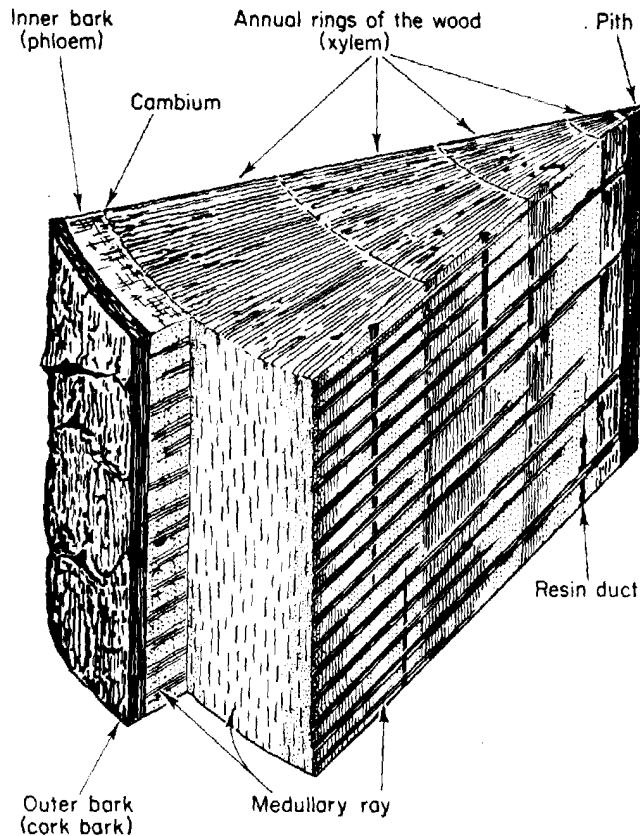

Figure 2.1 Schematic section of four-year-old pine trunk
(Rydholm, 1965)

Several different types of cells, with different functions, are formed from the cambium, which together make it possible for the trunk to fulfil its three above-mentioned main functions. There are four main elements: *parenchyma cells*, *fibres*, *tracheids* and *vessel* elements (Prescott, 1988). The parenchyma cells serve as storage and transport cells for food and water. The fibres are supporting elements, giving rigidity to the wood structure, the tracheids and the vessels function as water conductors and also give mechanical support to the structure. There are several forms of gradations between libriform fibres, which have only mechanical functions, and the tracheids, which have well-developed conductive functions. The intermediate elements are called fibre tracheids. In softwoods the tracheids dominate, with few if any libriform fibres and no vessels, whereas tracheids are scarce in the hardwoods, and the corresponding functions are performed by the more specialised libriform fibres and vessels (Rydholm, 1965). The term “fibre” in its strict botanical sense is confined to cells with mechanical functions only. However, in pulp technology, the word is used for all sorts of structural elements in wood and other pulping raw materials.

According to the modern definition, paper can be described as sheets that have been fabricated from separate fibres of pulp (Rydholm, 1965). From this definition, the primary purpose of pulping can be qualitatively stated as the separation or liberation of

the fibres of some raw material for further usage, such as the manufacturing of paper. Since the “fibres” are seen as the structural elements of the wood, the separate fibres will be used to make the structure of the paper and other synthetic materials. The length and strength of the separate fibres have a strong influence on the pulp quality and the subsequent quality of the paper and it is very important that a suitable source or raw material is selected. The length of the softwood tracheids varies from 1-11 mm and is usually 2-5 mm in the commercially important species (Rydholm, 1965). The hardwood libriform fibres are shorter, about 1-2 mm.

In order to understand the process and reactions involved in pulping, it is important to know the structure of the cells to be able to understand where the different chemical components are in the cells that will influence the pulping process. This is important, since the reactants in the cooking liquor will have to penetrate the wood and the cells in order to reach the necessary reactants within the cells. The chemical composition of wood will be discussed later, but is important to highlight the main components here in order to understand the distribution of these components in the cell. Plant cell walls in wood are composed of cellulose and hemicelluloses bound together by lignin. Most of the chemical constituents of the cell wall are macromolecules, of which only cellulose is entirely linear and possesses a certain stiffness. Consequently, cellulose is the major structural component of plant cell walls. Since it is the lignin that binds the cellulose together, it is important to dissolve or break down the lignin during pulping.

Electron-microscope studies of mature wood cells show that they consist of several layers of cell wall surrounded by an amorphous, intercellular substance (McGinnis and Shafizadeh, 1979). A simplified drawing of the organisation of a typical softwood tracheid or hardwood fibre is shown in Figure 2.2. Between the different cells is a region, called the compound middle lamella, that contains mainly lignin and pectic substances. The primary wall (P), which is only 0,1 to 0,2 μm in thickness, contains a randomly and loosely organised network of cellulose microfibrils embedded in a matrix of amorphous pectins and partially orientated hemicellulose. Immediately below the primary wall is the secondary wall comprising nearly all of the cell wall. The secondary wall is divided into three layers, called S1, S2 and S3. The outer layer of the secondary wall S1 is 0,1 to 0,3 μm thick and has a cross-hatch pattern of microfibrils. It is also called the transition lamella. The S2 layer of the secondary wall is called the main secondary wall, is 1 to 5 μm thick and accounts for the major parts of the cell-wall volume. The microfibrils in this portion of the secondary wall are oriented almost parallel to the fibre axis. In the flat inner secondary wall S3 the microfibrils form a flat helix in the transverse direction about 0,1 μm thick. (McGinnis and Shafizadeh, 1979)

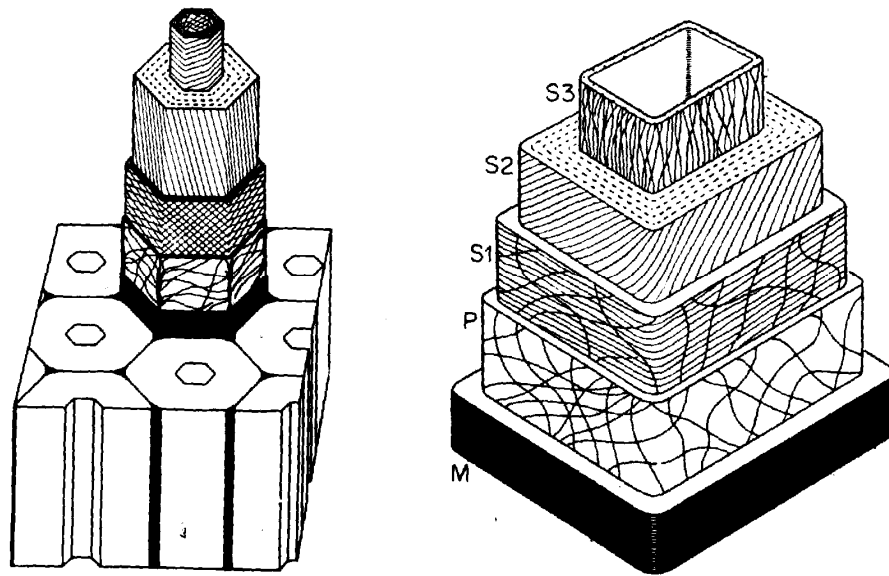

Figure 2.2: Cell-wall architecture, schematically
(Rydholm, 1965)

Kollman and Côté published a dramatic photograph of the adjacent cells of *Celtis occidentalis*, clearly showing the different layers. The photograph is shown in Figure 2.3. This gives a clear perspective of the thickness of the different layers, relative to each other, as well as the function of lignin in binding the different cells together in the middle lamella.

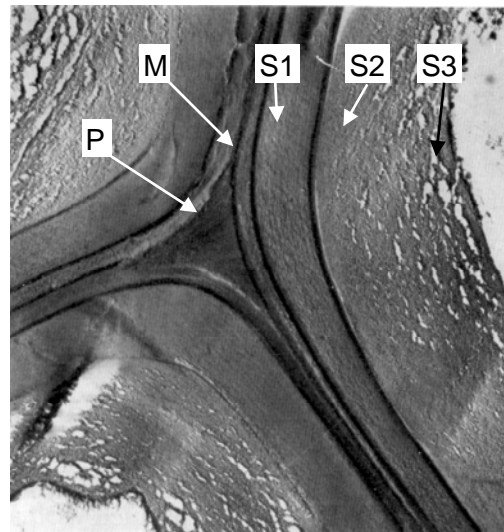

Figure 2.3: Photograph showing the cell-wall architecture
(Kollman and Côté, 1968)

The exact composition and structure of the different layers of the cell wall have been studied extensively and more detail can be found in the literature concerning the biological structure of wood. For the purposes of the pulping industry, and the modelling of the pulping process, it is only necessary to know the distribution of the

most important chemical components in the wood. It is necessary that the pulping reactants get into contact with the lignin to dissolve it. The chemicals will have to be absorbed by the wood chips and penetrate the different parts of the cells to be able to reach the lignin. The typical distribution of the components is shown in Figure 2.4. It is important to note that the majority of the lignin is situated in the middle lamella, and also in the primary wall. Diffusion of the chemicals through the cell wall is therefore not necessary in order to remove most of the lignin. Depending on the quality of the pulp needed, the cooking time may have to be adapted to provide enough time for the penetration of the chemicals through the cell wall. The kinetics of the lignin dissolution will be discussed in paragraph 6.2.1 and it will be shown how it was found that two different reaction rates are applicable for lignin concentration above and below 12,4%. This can easily be explained from the distribution of the lignin in the plant cell, since the rate of removal of lignin from the secondary layer will be much slower compared to the rate of removal of the lignin in the middle lamella.

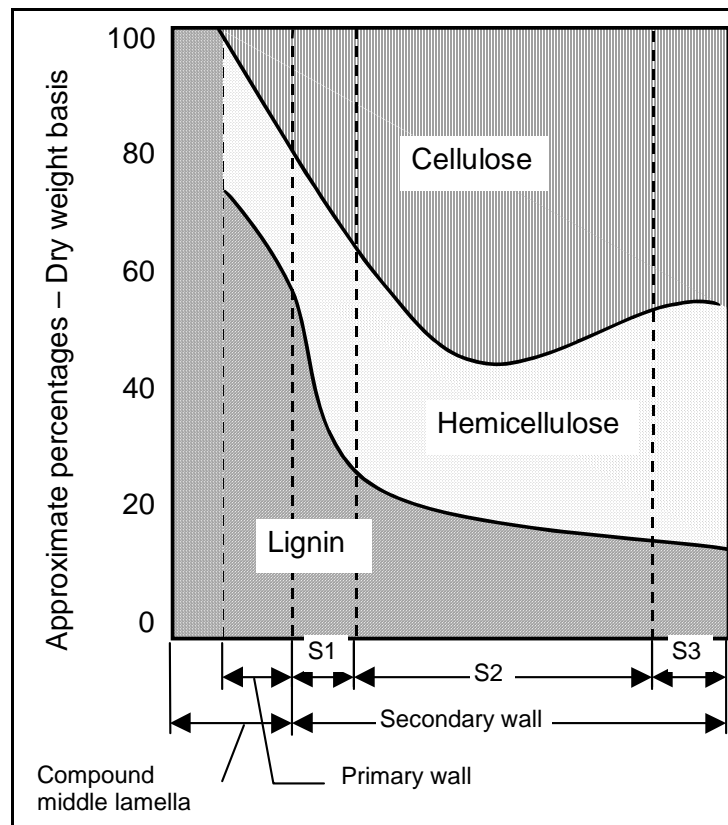

Figure 2.4 Distribution of chemical constituents in the cell wall
(Watson, 1992)

2.2. The chemical composition of wood

Wood consists of carbon, hydrogen and oxygen. Neglecting small amounts of nitrogen, below 0,1% and the ash content, about 3%, the elementary composition of dry wood substances is about 50% carbon, 6% hydrogen and 44% oxygen, with very small variations with species, including both softwoods and hardwoods. However, wood is not a uniform substance, as was already indicated, and consists of many chemical components, varying in quantity with species, within the species, within the tree trunk and within the cell wall. In order to reach some sort of systematic order in describing the composition of wood, the components were classified according to available analytical methods. This was necessary, since the exact nature of the components was not known and in many cases is still not. The definition of the different groups of components has varied over time. The definitions used by Rydholm (1965) will also be used here.

The three most important ingredients of wood, namely cellulose, hemicellulose and lignin, were mentioned in paragraph 2.1. It is important to realise that these refer to a whole range of different molecules, grouped together by some common characteristic. The following general definitions are given by Rydholm for the three components:

- Cellulose are linear polysaccharides, of sufficient chain length to be insoluble in water or dilute alkali and acids at room temperature, containing only anhydroglucose units linked together with 1:4- β -glucosidic bonds and possessing a well-ordered structure.
- Hemicelluloses are the non-cellulosic polysaccharides of wood, including the related substances, such as uronic acids, etc., and their substituents.
- Lignin is the aromatic polymer of wood, consisting of four or more substituted phenylpropane monomers per molecule.

The remaining components are grouped together under the name extractives and the following definitions are given by Rydholm:

- Extractives are the low-molecular compounds of various types, extractable from the wood with water or organic solvents, excluding components which by definition belong to the hemicelluloses or lignin.

The analytical origin of the definitions is evident. It can also be seen that the definitions are very vague and include a very wide range of different molecules. This fact makes the determination of the kinetics of the different reactions very difficult, as well as the accurate modelling of the process.

The content of the different components varies appreciably between the different wood species. The following average values are given by Rydholm (1965):

	Hardwoods	Softwoods
Cellulose	43%	43%
Hemicellulose	35%	28%
Lignin	22%	29%

Table 2.2: The chemical composition of wood
(Rydholm, 1965)

2.2.1. Cellulose

Cellulose was first isolated and recognised as a distinct chemical substance in the 1830's by a French agricultural chemist, Anselme Payen (McGinnis and Shafizadeh, 1979). Payen concluded that that cellulose and starch were isomeric substances and that both were polymers of D-glucose. However, it was nearly 80 years later before the precise empirical formula of cellulose was established as $(C_6H_{10}O_5)_x$, where x is the number of repeating glucose units. This number was called the degree of polymerisation (DP) and is formally defined as the average number of anhydroglucose monomers per molecule (Rydholm, 1965). In experimental studies, cellulose was hydrolysed and over 96% yield of anhydro-D-glucose was obtained. This gave evidence that the only repeating units in the cellulose polymer were anhydro-D-glucose.

Further studies were conducted to determine the exact structure of polymer. It was found that the free hydroxyl groups in cellulose were located at the 2,3 and 6 positions and that the 1,4 and 5 positions were linked by chemical bonds. Finally, the monomers were identified as 4-O-substituted D-glucopyranose (McGinnis and Shafizadeh, 1979). The two-dimensional structure can be seen in Figure 2.5. The final question was to determine whether the linkage between the units were α or β . Structural studies performed settled the problem in favour of the β linkage. The three-dimensional structure can also be seen in Figure 2.5. It was found in 1921 that starch had an α linkage and that the conclusion of Payen 100 years earlier was indeed correct (Rydholm, 1965).

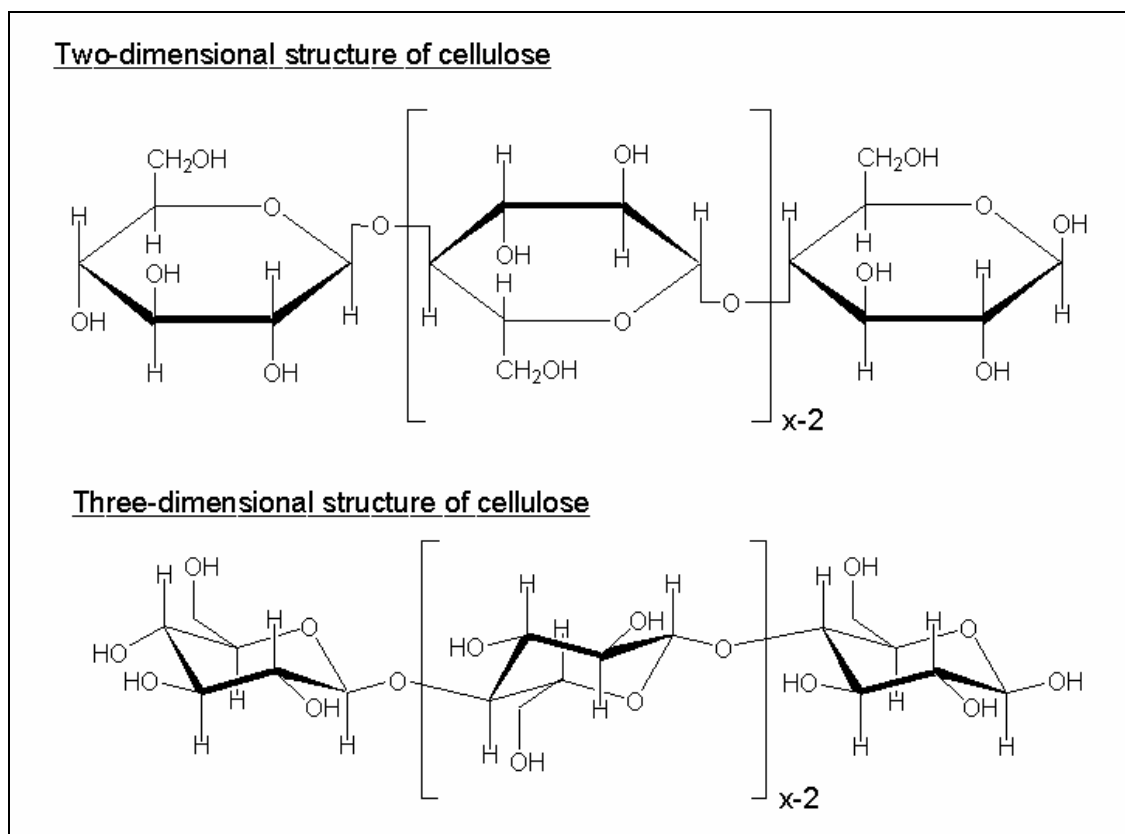

Figure 2.5 The molecular structure of cellulose
(McGinnis and Shafizadeh, 1979)

The average DP value for both hardwoods and softwoods was found to be about 4000 to 5000. (Helm, 1999b)

The β linkage results in a 180° rotation of the plane of the alternate glucose units. This alternation causes the cellulose molecules to form as a straight chain of indefinite length. In the cell wall, the cellulose chains aggregate to form long thin threads called microfibrils. The microfibrils provide the necessary rigidity and stress resistance in the plant. This linear chain structure of cellulose allows the molecules to fit compactly together over long segments, which result in hydrogen bonds forming between the adjacent hydroxyl molecules, giving the cellulose a structure of considerable lateral order, as well as regions of crystallinity. The high degree of orientation of the microfibrils of *Chaetomorpha melangonium* is shown in Figure 2.6.

Studies based on a variety of physical and chemical methods have indicated that the microfibrils are not completely crystalline, but instead contain two distinctly different regions. One region consists of highly ordered cellulose molecules; this is called the crystalline area. Another portion of microfibrils consists of less highly ordered cellulose molecules called the amorphous or para-crystalline region (Kollman and Côté, 1968). Cellulose from various sources and treatments differ noticeably in their degree of crystallinity. The crystalline regions are difficult to penetrate by solvents and

reagents and the hydroxyl and acetal groups are comparatively inaccessible and are consequently more resistant to hydrolysis reactions when compared to the more amorphous regions. Also a very limited fraction of its hydroxyl groups is available for interaction with water and hence remains insoluble in water in spite of its polarity.

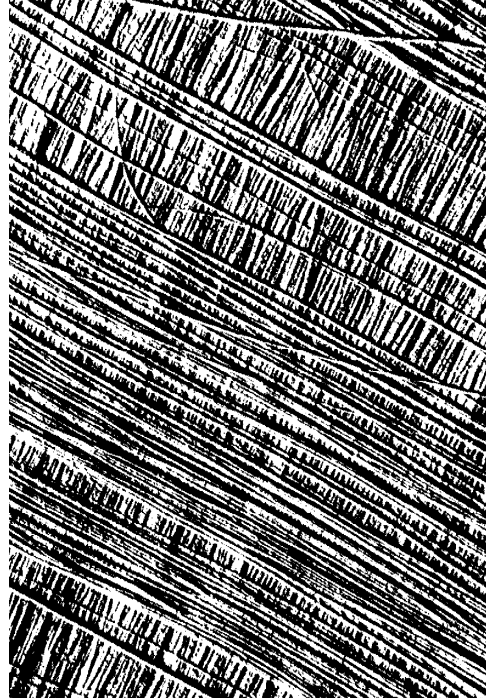

Figure 2.6: Orientation of the microfibrils in the cell wall
(McGinnis and Shafizadeh, 1979)

Helm (1999d) identified the occurrence of a Levelling-Off Degree of Polymerisation (LODP). If the degree of polymerisation of cellulose samples were to be monitored during exposure to acid, a rapid drop followed by a levelling off will be seen as shown in Figure 2.7. This levelling off is independent of acid type or concentration but is source dependent. The degree of polymerisation at the levelling-off point is related to the size of the crystallite. As can be seen from Figure 2.7, rayon has a smaller LODP than cotton or wood cellulose (and hence a smaller crystallite). This occurrence has a definite impact on the pulping industry, since it limits the minimum degree of polymerisation to which the pulp can be broken down.

Aqueous alkalis swell native cellulose, but do not dissolve it. Alkali will degrade cellulose in several ways. At low temperatures and in the presence of oxygen, the glucosidic bonds are broken by a chain reaction involving free radicals. At high temperatures, alkali alone can attack glucosidic bonds. Cellulose dissolves in several strong acids such as 72% sulphuric acid, 41% hydrochloric acid and 85% phosphoric acid. Degradation sets in rapidly, especially in the first two cases. (Kollman and Côtè, 1968)

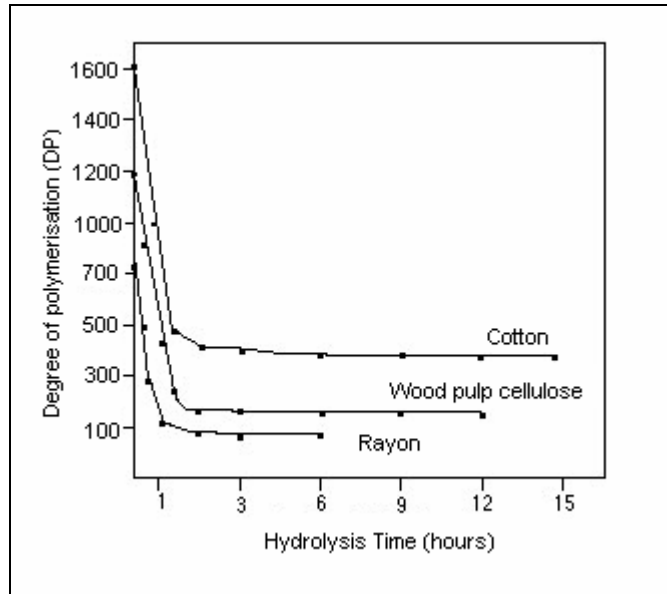

Figure 2.7: Levelling-Off Degree of Polymerisation
(Helm, 1999d)

In the determination of the average molecular weight of cellulose, the usual methods for polymers have been applied, such as end-group determinations, osmometry, light scattering measurements, ultracentrifugation, and above all, the convenient viscometric determinations. The different techniques give different results, for example, the osmometric methods give number average molecular weights:

$$\bar{M}_n = \frac{\sum n_i \cdot M_i}{\sum n_i} \quad (2-1)$$

light scattering methods give the weight average

$$\bar{M}_w = \frac{\sum n_i \cdot M_i^2}{\sum n_i \cdot M_i} \quad (2-2)$$

and the viscometric methods give an average

$$\bar{M}_w = \frac{\sum n_i \cdot M_i^{\alpha+1}}{\sum n_i \cdot M_i} \quad (2-3)$$

which is not far from the weight average, since the constant α has been found to be very close to one. (Rydholm, 1965)

The aldehydic end-group determinations give too low values because of the presence of a few similar groups along the chain (Rydholm, 1965). The next three methods

mentioned require highly specialised equipment and are extremely time-consuming and are usually used for calibration purposes for viscosity measurements (Watson, 1992). In the viscometric methods, the intrinsic viscosity, η , is determined by measuring the specific viscosity of the sample at several, low concentrations and extrapolating to zero concentration. The average molecular weight is calculated according to the equation

$$\bar{M} = K_m \cdot M^a \quad (2-4)$$

where K_m and a are constants obtainable in literature which vary for varying solvents and cellulose derivatives. (Rydholm, 1965) The solvents are powerful swelling agents that disrupts the crystal lattice of the cellulose, forming a gel-type solution with a viscosity which can be related to the average DP value of the cellulose molecules (Watson, 1992). This method is simple and relatively quick and is most commonly used for the estimation of the DP value of the cellulose.

The viscometric method is also used at SAPPI SAICCOR for quality control, with cuprammonium as a solvent. The correlation between the DP value and the measured viscosity was determined by a previous author (Watson, 1992) and were found to be:

$$DP = 285,4\mu^{0,345} \quad (2-5)$$

This correlation is valid over a range of $20 < \mu < 150$.

2.2.2. Hemicellulose

A considerable part of the wood polysaccharides is not cellulose. It was discovered fairly early that there are other carbohydrate monomers than glucose. The borderline cannot however be drawn between glucosidic and non-glucosidic components, as some glucose is chemically combined with other sugars, whereas the major part makes up the cellulose. In the beginning, the definition was based on empirical methods rather than on theoretical grounds. The term hemicellulose was assigned to those carbohydrates that were degraded by acid hydrolysis more rapidly than cellulose. Hemicellulose was also found to be extractable with alkaline solutions to a larger extent than is cellulose. Further studies revealed that some non-glucosidic components were quite resistant to hydrolysis and alkali extraction, which made it evident that a sharp definition could not be made on such grounds. As the heterogeneity of the hemicellulose fraction became evident, the plural term of

hemicelluloses has become increasingly used. The use of this collective term is still practical, in spite of the fact that there are now definite chemical terms for the compounds thus covered. It is, however, becoming increasingly evident that these compounds react differently to the pulping chemicals and have different properties. (Rydholm, 1965)

It is now generally agreed that cellulose as it occurs also in wood is constituted entirely of glucose monomers, linked with 1:4- β -glucosidic bonds. From that ground, the hemicelluloses are defined as all other cell wall polysaccharides, with the exception of substances that occur only occasionally, e.g., during the sapping period or not in close association with cellulose. (Rydholm, 1965)

The location of the hemicellulose within the cell wall is of great interest, as it will influence both the pulping reactions and the final pulp properties. As was discussed earlier, the hemicelluloses are likely to be located throughout the cell wall, as well as in the middle lamella, but predominantly in the outer parts of the cell wall. Pectic substances appear in the primary wall, glucomannan in the secondary wall (S2) and xylan to a large extent in the tertiary wall (S3). (Helm, 1999a) Further, it seems to be established that hemicellulose components may change their location during the pulping processes and become more intimately associated with the cellulose, e.g. glucomannan in some types of sulphite cooking. It seems unlikely that any covalent bonds between cellulose and the hemicelluloses exist, either in the wood or in the pulps. There is however evidence of a chemical combination between lignin and hemicelluloses, especially in softwoods, but only with relatively few and easily hydrolysable bonds. These bonds also seem to link the various types of hemicelluloses together via lignin.

Structurally, the hemicelluloses differ from cellulose in that they are branched and have much lower molecular weights. The hemicelluloses that are found in the stalk or supporting tissue of woody plants are primarily modified xylans, galactoglucomannans, glucomannans and arabinogalactans. All of these polysaccharides are built up from a relatively limited number of sugar residues; the principal ones are D-xylose, D-mannose, D-glucose, D-galactose, L-arabinose and 4-O-methyl-D-glucuronic acid. The molecular structure of these monomers is shown in Figure 2.8.

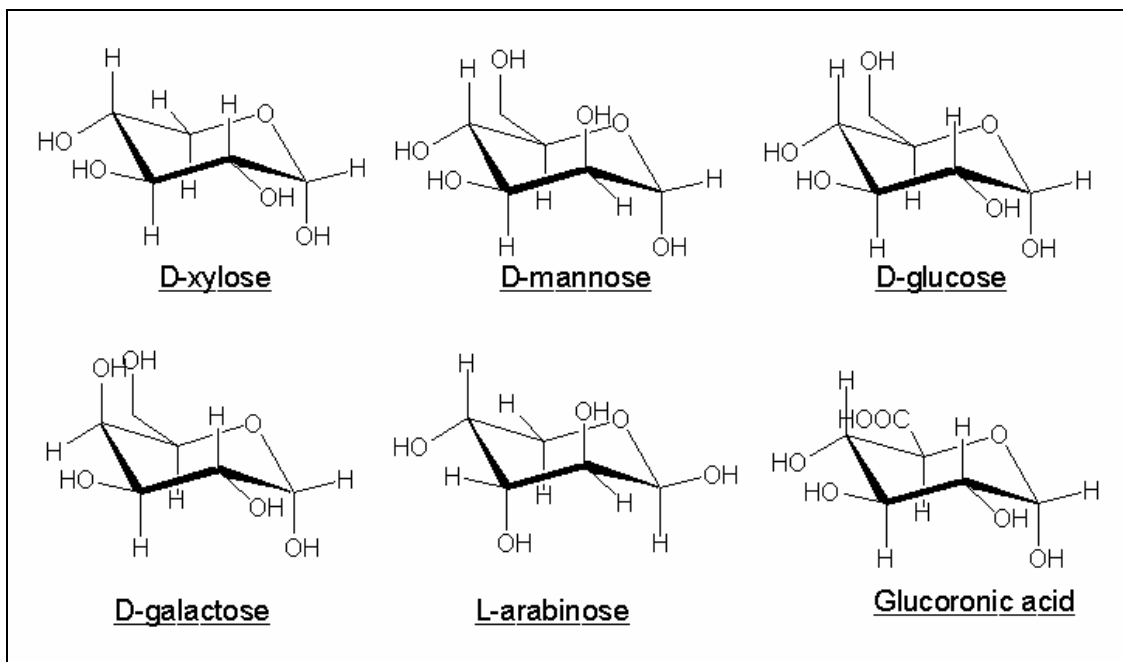

Figure 2.8: Monomers in hemicellulose
(McGinnis and Shafizadeh, 1979)

As is the case with cellulose and lignin, the amounts and proportions of hemicellulose greatly vary with the wood species, and probably also from tree to tree. A qualitative estimation of the hemicellulose content of hardwood and softwood is given in Table 2.3. The table isn't complete, since the trace elements were omitted and only the most common components are shown. The following average composition for hardwood and softwood are given by Rydholm (1965):

Softwood:

- 40-50 % cellulose
- 12-20 % glucomannan and galactoglucomannan acetate
- 10-14 % methylglucuronoarabinoxylan
- 2 % galactan or arabinogalactan
- 29 % lignin

Hardwood:

- 40-50 % cellulose
- 20-35 % methylglucuronoxylan acetate
- 2-5 % glucomannan
- 1-2 % arabinogalactan
- 22 % lignin

Polymer	Hardwood	Softwood
4-O-methylglucuronoxylan acetate	Very large	Small, if present
4-O-methylglucuronoarabinoxylan	Trace	Medium
Glucomannan	Small	Large
Galactoglucomannan	Trace, if present	Small
Arabinogalactans	Trace, if present	Trace to medium

Table 2.3: A qualitative comparison of the hemicellulose fractions of softwood and hardwood
(Rydholm, 1965)

2.2.3. Lignin

To the pulp and papermaker, lignin is the unwanted ingredient of wood that creates the majority of problems encountered during pulping. If it were not for lignin, it would not have been necessary to apply strong alkaline or acidic reagents in the chemical degradation of wood in order to obtain pulp and paper. The primary objective of pulping is the liberation of cellulosic fibres and pulping can be seen as the art of lignin removal from woody plant tissues (Glasser, 1979). Furthermore, lignin undergoes more severe chemical changes during pulping than cellulose. Thus it is apparent that a thorough understanding of the structure of lignin, its purposes, its functions in the tree, its physical and chemical properties, and its reaction behaviour are of the utmost importance for the understanding and a rational control of pulping processes.

Lignin is the major non-carbohydrate fraction of wood and occurs in amounts between 20 and 35% of the wood. It is lignin that is responsible for the stiff woody character of wood. Experimental difficulties associated with the characterisation of lignin as it exists in wood are extensive, because of the variety of bond types and possible condensation or degradation during attempted isolation and purification from the polysaccharides with which lignin is intimately associated. Consequently, detailed knowledge of the structure of lignin *in situ* is not available. A whole array of different tests and analyses has been conducted over the years in order to gain more insight into the exact structure and nature of lignin. Some of the more important and agreed upon information will be given here.

Only carbon, hydrogen and oxygen are present in lignin. The elementary composition determined by analysis of various lignin preparations varies considerably with a carbon content from 63 to 67% and hydrogen between 5 and 6%, showing structural changes

during the isolation, mainly hydration and dehydration. The high carbon content indicates the aromatic nature of the lignin. Hardwood lignin has a somewhat lower carbon content of 59 to 60% and a higher oxygen content of 33-34%. (Glasser, 1979)

The most characteristic functional group in lignin is its methoxyl group. (Rydholm, 1965) Although hemicellulose contains some methoxyl, over 90% of the methoxyl content of wood belong to lignin and this group is often used to trace lignin in various connections. The actual methoxyl content of lignin is around 16% for softwood and 22% for hardwood. Hydroxyl groups are the other major functional group in lignin and amount to about 10% of the total weight for both hardwood and softwood. The hydroxyl groups are varying in nature from phenolic to primary, secondary and tertiary aliphatic hydroxyls in roughly equal amounts. Ether-bound oxygen, aromatic and aliphatic, is also present in considerable amounts. Some other functional groups isolated in lignin are carboxyl and carbonyl groups, as well as aliphatic double bonds and ester groups.

Several degradation methods have been applied to lignin in order to determine the larger fragments and monomers of the lignin structure. A variety of different monomers were isolated and some of the more common structures are shown in Figure 2.9. From this it is apparent that lignin is of predominantly aromatic structure. Further, the fragments of degradation as well as the biogenetical considerations made it likely that the lignin macromolecule is built of monomers of phenylpropane, containing a varying amount of methoxyl groups. The results of the elementary analysis and the determination of the functional groups therefore are calculated on the C₉ basis, excluding all methoxyl carbon. The elementary analyses differ slightly for different wood species. As an example of the general analysis, the analysis for spruce lignin will be given. The following empirical formula was obtained:

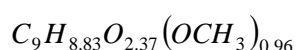

From studies of the functional groups and the elementary analysis, the following general structure for spruce lignin was obtained (Rydholm, 1965):

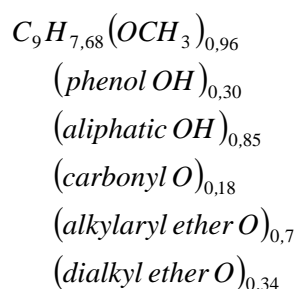

This formula, however, doesn't make the exact structure clearly known and a lot of further studies and reasoning is necessary to obtain the exact structure. There is still not a single model to satisfy all the structural information gathered from all the studies. The model proposed by Adler has been widely accepted as the closest prediction of the structure of lignin currently available. (Glasser, 1979) This structure is shown in Figure 2.10.

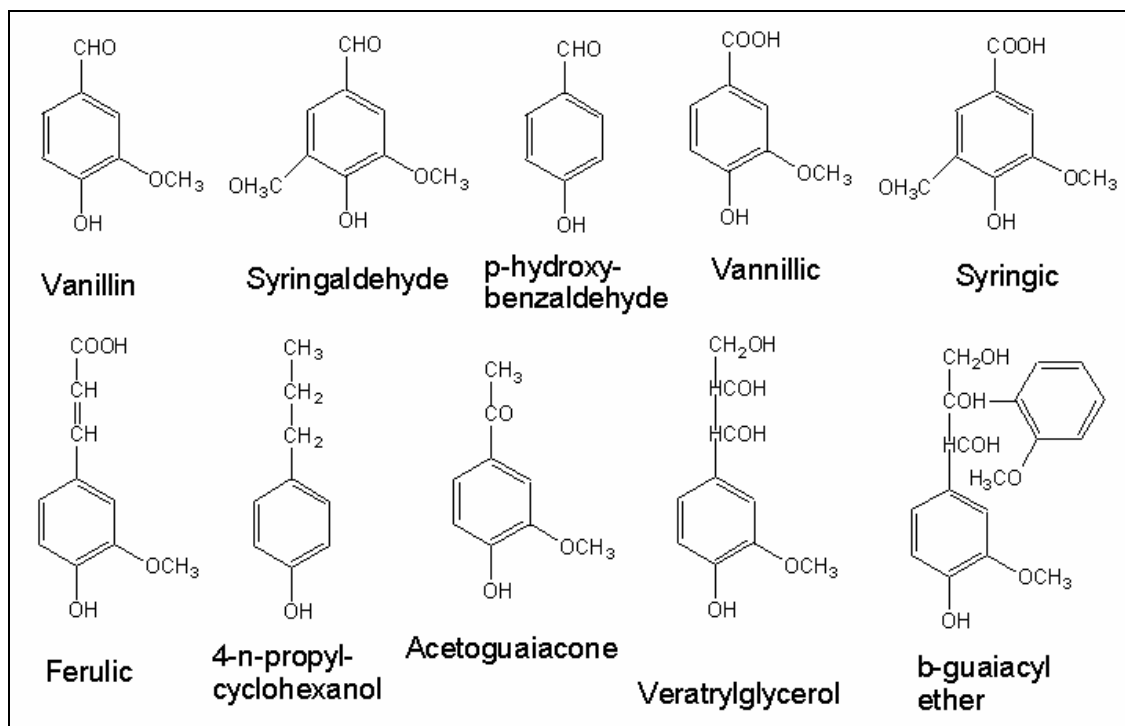

Figure 2.9: Some monomers in lignin
(Rydholm, 1965)

To summarise, lignin is a polymer forming a three-dimensional network. Each polymer molecule contains 5-500, average 60, monomers in softwood lignin and 5-10 in hardwood lignin. Some of the monomer linkages are sensitive to acids and others, which are not, join the monomers together into building blocks of 4-5 monomers. The acid sensitive linkages are dialkyl ether bonds, presumably between α - α and α - γ carbon atoms of adjacent monomers. The non-hydrolysable linkages connecting monomers to the larger building units are alkylaryl ether bonds between the 4- and β -carbon of adjacent monomers as well as carbon-carbon bonds in a number of combinations, mainly involving the 5-, α - and β -carbon atoms. The alkylaryl ether bonds may be opened up with alkali cooking, whereas the carbon-carbon bonds require oxidative treatment. Lignin is insoluble in water but soluble in alkali due to its content of phenolic groups. It can be made water-soluble by the introduction of hydrophilic groups, such as sulphonate groups. Its compact location in the fibre wall, and possible chemical bonds to the carbohydrates, makes it insoluble in alkali *in situ*.

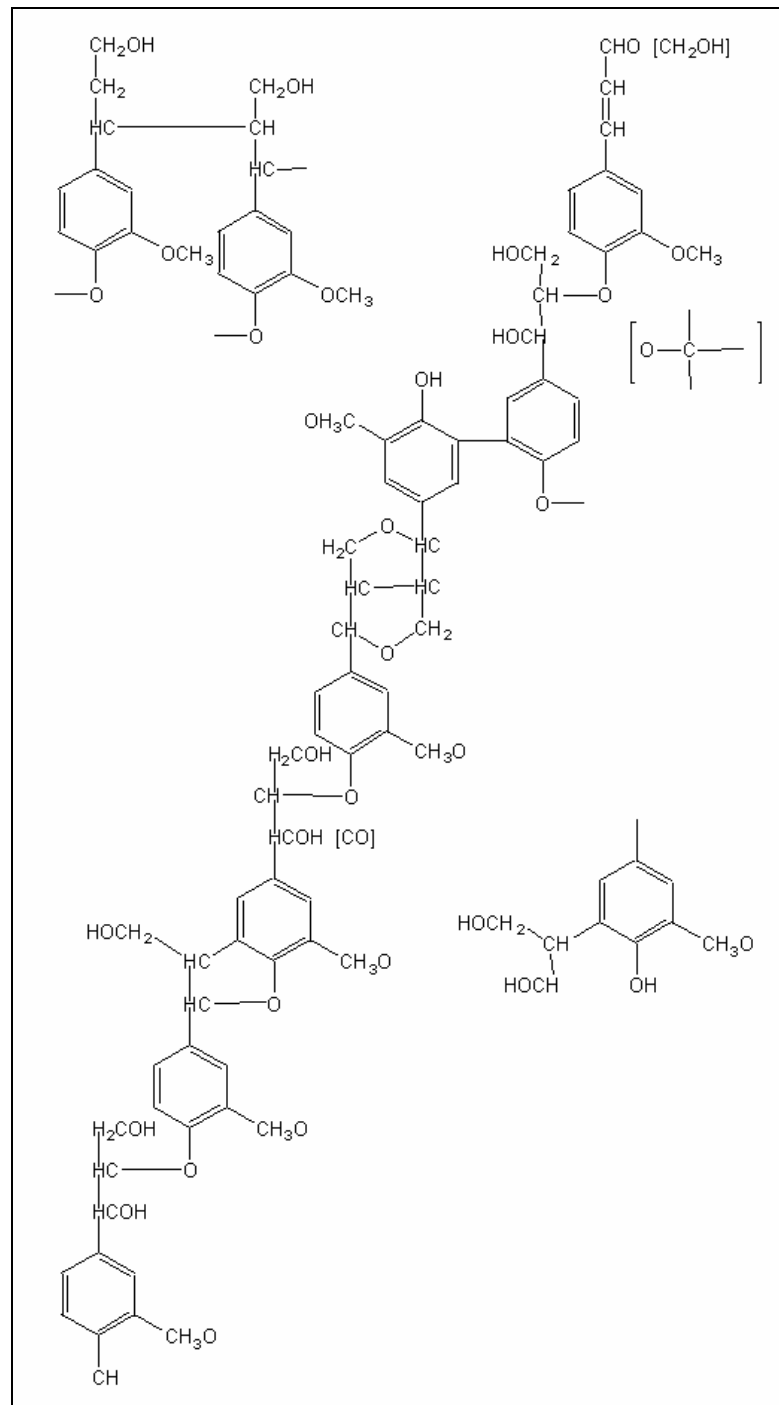

Figure 2.10: The molecular structure of lignin
(Rydholm, 1965)

2.2.4. Association of lignin, hemicellulose and cellulose

The chemical properties of wood fibres are dependent not only on the chemical composition of the fibres, but also on the organisation of their constituents and the

interaction between them. The existence of lignin-carbohydrate complexes has been used to explain the difficulties in extracting the different wood components by solvents in which they are normally soluble as isolated products. Lignin preparations are soluble in alkali or dioxane but cannot be extracted from ordinary wood by these solvents. Carbohydrates are soluble in cuproxam solutions but extraction of the total carbohydrate fraction from the wood with cuproxam solution is possible only if the extraction is repeated several times, with intermediate hydrolytic treatments. (Rydholm, 1965) That wood behaves differently from its constituents is therefore obvious. The question is however whether the reason is mechanical or chemical.

Various authors have shown the existence of both chemical and physical interaction between the different constituents. Karlsson and Westermark (1996) showed that a considerable amount of the residual lignin in kraft pulps was chemically linked to high molecular weight cellulose when pine was used. This is significant since this can limit the amount of delignification that can be accomplished by the normal pulping processes. Salmén and Olsson (1998) suggested that in the fibre wall, xylan is associated with the lignin, while glucomannan is bonded with cellulose.

Associations between the different constituents can have a big influence on the kinetics of the reactions of the individual components. It is therefore important to study the kinetics of the components in their natural form in the wood, as would be the case during pulping.

2.3. Summary

An understanding of the different components of wood is vital in understanding the chemical reactions that take place during the pulping process. This knowledge would be necessary during the development of a model of the process or in the development of a control system.

The purpose of pulping is the liberation of the wood fibres. The fibres form the physical structure of the wood and give rigidity to the tree. When the fibres have been separated, they are again used as structural elements mainly for the production of paper, but also for a variety of different synthetic products like textiles. On their turn, the fibres are mainly formed by cellulose chains. Cellulose are polymers of D-glucose forming long, highly linear chains, called microfibrils. The microfibrils have a high degree of orientation, allowing hydrogen bonds to form between the chains that is responsible for the structural value of the fibres. The degree of polymerisation of cellulose is a measure of the average amount of monomers in the cellulose chains and is often measured through the viscosity of a pulp sample.

The fibres are bonded together by lignin, which is a polymer that forms a three-dimensional network, binding the cellulose chains together. It is lignin that gives the hard, stiff character to wood. Since it is lignin that binds the wanted fibres together, lignin is the unwanted ingredient of wood that necessitates the use of sophisticated pulping techniques to separate the cellulosic fibres.

Chapter 3:

Pulping processes

The pulp consuming industries are based on the use of either the fibres of wood, or their main constituent, cellulose. In both cases a liberation of the fibre is required prior to further treatment, and this is the primary purpose in the preparation of unbleached pulp. The secondary purpose is to give the fibre optimal properties for its ultimate use, to which it may come directly or after further modification in the bleachery. To achieve these two purposes in the most economical way, a large number of pulping processes have been developed, each suited to a special end use.

In principle, there are two ways of fiberising: mechanical and chemical pulping. Chemical pulping has as its purpose the selective removal of the fibre-bonding lignin to a varying degree with a minimum solution of the hemicelluloses and cellulose. This is done by chemically dissolving substances of the middle lamella to an extent that makes fiberising possible without mechanical treatment in more elaborate machinery. The chief drawback of chemical pulping methods is the comparatively high wood consumption, with yields ranging approximately from 35 to 55% of the wood. In mechanical pulping the original chemical constituents of the fibrous material are unchanged, except for removal of water solubles. Mechanical pulping gives nearly quantitative yield but causes rupture of the fibre walls on fiberising and give pulps which contain substances of little value for many purposes. For some uses, however, chemical pulping gives pulps that are unnecessarily high-grade and expensive, whereas mechanical pulps may not fulfil the quality requirements. Therefore, some dissolution of substances are required, but it is found unnecessary to cook as far as the point of fibre liberation, which for most wood species and pulping processes occurs at around 55-60% yield. At higher yields special equipment for mechanical fiberising is necessary, and the processes which involve both chemical and elaborate mechanical treatment have been called semichemical pulping. Over the years, there have been numerous modifications of the chemical, semichemical and mechanical pulping processes. The motivations for this process diversification have been the need for more efficient utilisation of the wood resources and the need for special pulps to meet the diversified requirements of the expanding paper and paperboard markets. The different processes developed are summarised in Table 3.1.

Form of Wood	Common Name	Chemical Treatment	Mechanical Treatment	Pulp Yield (%)
<u>Mechanical</u>				
Bolts	Groundwood, cold and hot	None	Grindstone	93-98
Chips	Refiner mechanical (RMP)	None	Disk refiner	93-98
Chips	Masonite	Steam	Steam expansion	80-90
Chips	Asplund (coarse fibre)	Steam	Disk refiner	80-90
Chips	Thermomechanical (TMP)	Steam	Disk refiner (Pressure)	91-95
<u>Chemimechanical and chemithermomechanical</u>				
Bolts	Steamed groundwood	Steam	Grindstone	80-90
Bolts	Groundwood, Decker process	Acid sulphite (Ca, Na, Mg)	Grindstone	80-90
Bolts	Groundwood, Fish process	Kraft	Grindstone	85-90
Bolts	Chemigroundwood	Neutral sulphite	Grindstone	80-90
Chips	Cold soda	Caustic soda	Disk refiner	80-90
Chips	Alkaline sulphite	Alkaline sulphite	Disk refiner	80-90
Chips	Chemithermomechanical	Steam + chemical	Disk refiner (pressure)	65-85
<u>Semichemical</u>				
Chips	Neutral sulphite (NSSC)	$\text{Na}_2\text{SO}_3 + \text{Na}_2\text{CO}_3, \text{NaHCO}_3$	Disk refiner	65-90
Chips	Kraft	$\text{NaOH} + \text{Na}_2\text{S}$	Disk refiner	75-85
Chips	Green liquor	$\text{Na}_2\text{S} + \text{Na}_2\text{CO}_3$	Disk refiner	65-85
Chips	Soda	Sodium hydroxide	Disk refiner	65-85
Chips	Nonsulphur	$\text{Na}_2\text{CO}_3 + \text{NaOH}$	Disk refiner	65-85

Form of Wood	Common Name	Chemical Treatment	Mechanical Treatment	Pulp Yield (%)
<u>High-yield chemical</u>				
Chips	Kraft (sulphate)	NaOH + Na ₂ S	Disk refiner	55-65
Chips	Sulphite	Acid sulphite (Ca, Na, Mg)	Disk refiner	55-70
Chips	Sulphite	Bisulphite (Na, Mg)	Disk refiner	55-70
<u>Full chemical</u>				
Chips	Kraft (sulphate)	Na ₂ S + NaOH	Mild to none	40-55
Chips	Polysulphite, one stage	(NaOH + Na ₂ S)x	Mild to none	45-60
Chips	Polysulphite, two stage	H ₂ S pre-treatment; kraft	Mild to none	45-60
Chips	Soda	Caustic soda	Mild to none	40-55
Chips	Soda – AQ	NaOH + Anthraquinone	Mild to none	45-55
Chips	Soda-oxygen, two stage	NaOH; oxygen	Disk refiner	45-60
Chips	Acid sulphite	Acid sulphite (Ca, Na, Mg, NH ₃)	Mild to none	45-55
Chips	Bisulphite	Bisulphite (Na, Mg, NH ₃)	Mild to none	45-60
Chips	Magnefite	Magnesium bisulphite	Mild to none	45-60
Chips	Neutral sulphite	Neutral sulphite	-	45-55
Chips	Multistage sulphite			
	Stora	Sulphite-bisulphite; SO ₂	None	45-55
	Sivola	Sulphite; alkaline sulphite	None	45-55
<u>Dissolving</u>				
Chips	Prehydrolysis kraft	Prehydrolysis, kraft	None	35
Chips	Sulphite	Acid sulphite (Ca, Na)	None	35

Table 3.1: Classification of wood-pulping processes
(McGovern, 1979)

Only the sulphite process is relevant to this study, since it is being used at SAPPI SAICCOR. The other pulping process will not be discussed here in any detail and only some of the major differences will be pointed out.

3.1. Chemical pulping

Processing chemical pulps normally involves wood and liquor preparation steps, delignification (pulping), pulp washing, knot removal, screening, cleaning, thickening and, in the case of bleachable grades, residual lignin removal and brightening. Often more than 50% of the mass of the wood is dissolved in chemical pulping. This allows recovery of these solids to generate steam and electrical energy for use in the mill. Spent chemicals are recovered for reuse in the process.

In chemical pulps, sufficient amounts of lignin is dissolved from the middle lamella to allow the fibres to separate, using little, if any, mechanical action. However, a portion of the cell wall lignin is retained in the fibre, and an attempt to remove this during digestion can result in excessive degradation of the pulp. For this reason, about 2 – 3% lignin is normally left in hardwood chemical pulps and 3 – 6 % in softwood chemical pulps. The lignin is subsequently removed by bleaching in separate processing if completely delignified pulps are to be produced.

The most important chemical pulping processes are the sulphate of kraft process, and the acid sulphite process. The kraft process has become increasingly more important and is now the principal pulping process and about 80% of the world pulp production use the kraft process (Rydholm, 1965). In comparison, the importance of the sulphite process has decreased steadily and less than 10% of the current world pulp production are obtained by this method (Bierman, 1996). The main reasons for this are the comparative simplicity and rapidity of the kraft process, its insensitivity to variations in wood conditions and its applicability to all wood species, as well as the valuable properties of the pulp produced.

Kraft pulping is based on the soda process, which employs the use of sodium hydroxide (NaOH). Originally, the soda process couldn't compete with the sulphite process due to the cost associated with NaOH and the need for chemical recovery. The makeup chemical used in the soda process was sodium carbonate (Na₂CO₃). However, in 1879, the makeup chemical was replaced with sodium sulphate (Na₂SO₄) which was much cheaper. Upon heating sodium sulphate forms sodium sulphide

(Na₂S). Mixing sodium sulphide with water provides a mixture of sodium hydroxide (NaOH) and sodium hydrosulphide (NaHS) according to the reaction

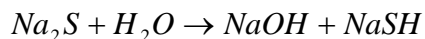

One of the major advantages of the kraft process is that the chemicals can be recovered from the spent liquor and reused. The kraft pulping process is very dependent on its recovery systems, which includes chemical recovery.

No more particulars of the kraft process will be given here, since the sulphite process is used at SAPPI SAICCOR. However, it was felt that some background on the different pulping processes will be useful in understanding the unique characteristics of the sulphite process, and knowing why it is used.

3.1.1. *The sulphite process*

The sulphite process was already developed in the 1880's, and is still, together with the kraft process, the main method of chemical pulp production, although it has lost much ground to the kraft and neutral sulphite methods. In the early years the sulphite method had the advantage of yielding the brightest unbleached and the most easily bleached chemical pulp, and was therefore used for all grades where light colour was of importance. When it was learned in about 1930 how to bleach kraft pulp without any serious loss in strength, the kraft pulps began to gain ground in certain fields because of better paper strength properties. In 1935, the two processes were used about equally, but in 1980 the sulphite process supplied less than 10% of the total paper-grade production in the United States. (Bryce, 1980)

Nevertheless, where suitable conditions exist for the use of the sulphite process, it offers distinct advantages over alkaline pulping processes. The chief reasons for the rapid commercialisation of the sulphite process at the beginning of the century highlight these advantages. The high yield, the low cost of cooking chemicals compared to the alkaline processes, the high brightness of the unbleached pulps that permitted them to be used in many grades without bleaching, and the easy bleachability of the pulps with the relatively simple bleaching agents available at that time, were all factors contributing to its popularity. However, the sulphite process also suffered from some distinct disadvantages. Only a limited number of wood species could be pulped, as mainly softwood can be used, and the pulps were distinctly weaker than those produced by the kraft process. Another serious problem is the

difficulty in recovering the cooking chemicals and utilising the waste products, which corresponds to half of the wood substance.

A flow sheet outlining the main steps in producing low-yield sulphite pulp is shown in Figure 3.1. In the preparation of cooking liquor, or acid, sulphur is burned to yield sulphur dioxide. After cooling, this gas is absorbed in the desired base to form storage acid. This liquor is transferred first to a low-pressure recovery tower and then to a high-pressure accumulator where heat, water vapour and sulphur dioxide (relieved from the previous cook) are absorbed to form the actual cooking liquor. The following reactions take place when sodium hydroxide (for example sodium is used as a base) is added to the aqueous sulphur dioxide. First bisulphite and then sulphite are formed.

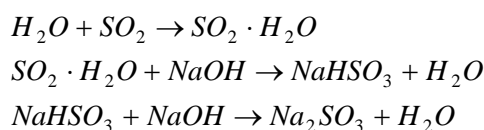

Meanwhile, the digester is filled with chips, presteamed to remove air and then filled with cooking liquor. The digester is heated to cooking temperature, using either direct steam injection or indirect heating. Both natural and forced circulation of liquor in the digester are used, but the latter is the more common method. At any early stage of the cook, a portion of the digester acid, known as side relief, is withdrawn from the digester and returned to the accumulator. After side relief has been removed, digester pressure is controlled by relieving gas (top relief) from the top of the digester, which is also returned to the accumulator. Steaming is continued until the digester reaches the desired temperature. Near the end of the digestion period, blowdown is initiated, that is the digester pressure is reduced by relieving gas at a rapid rate to the accumulator. When the pressure has been substantially reduced, the blow valve at the bottom of the digester is opened and the residual pressure is used to discharge the contents of the digester to a blow pit. (Genco, 1996)

Spent cooking liquor is drained from the blow pits through perforated plates in the bottom. Simultaneously, wash water is added by means of sprays at the top of the blow pit and washing is continued until virtually all the spent liquor is removed. Alternatively, pulp and liquor can be continuously removed from a blow tank and washing performed on a washer, either a drum filter or some other design. If a high-yield pulp is being produced, at least one stage of refining usually takes place before the final washing in order to open up the chip structure for more effective washing. After washing, the pulps are screened and cleaned, and then thickened for storage prior to further processing, such as bleaching, drying or inclusion in a paper-machine furnish. In some cases, the spent liquor is sent for evaporation and incineration or for by-product recovery. (Bryce, 1980) The process is illustrated graphically in Figure 3.2.

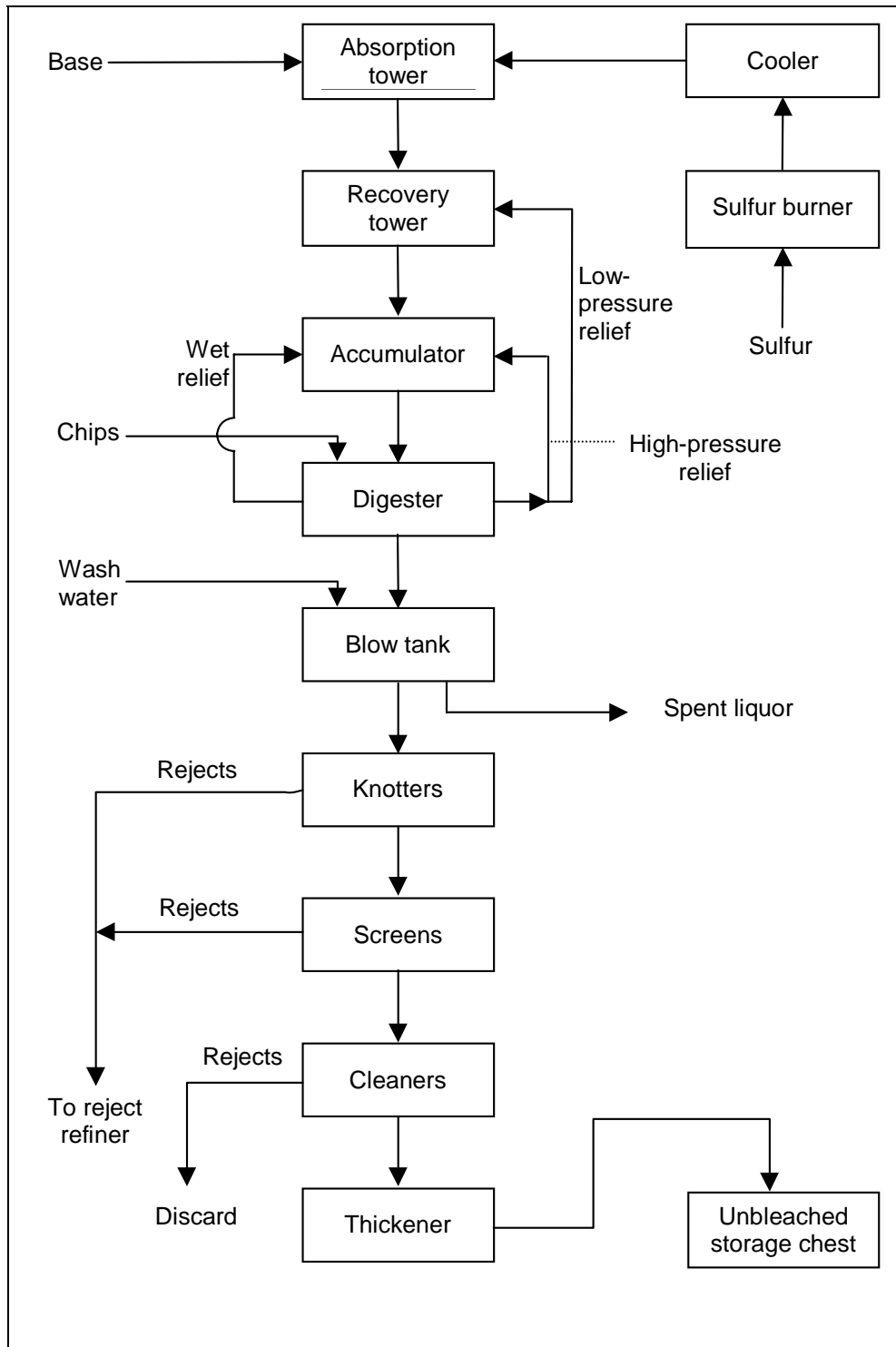

Figure 3.1: Flow sheet of the sulphite process
(Bryce, 1980)

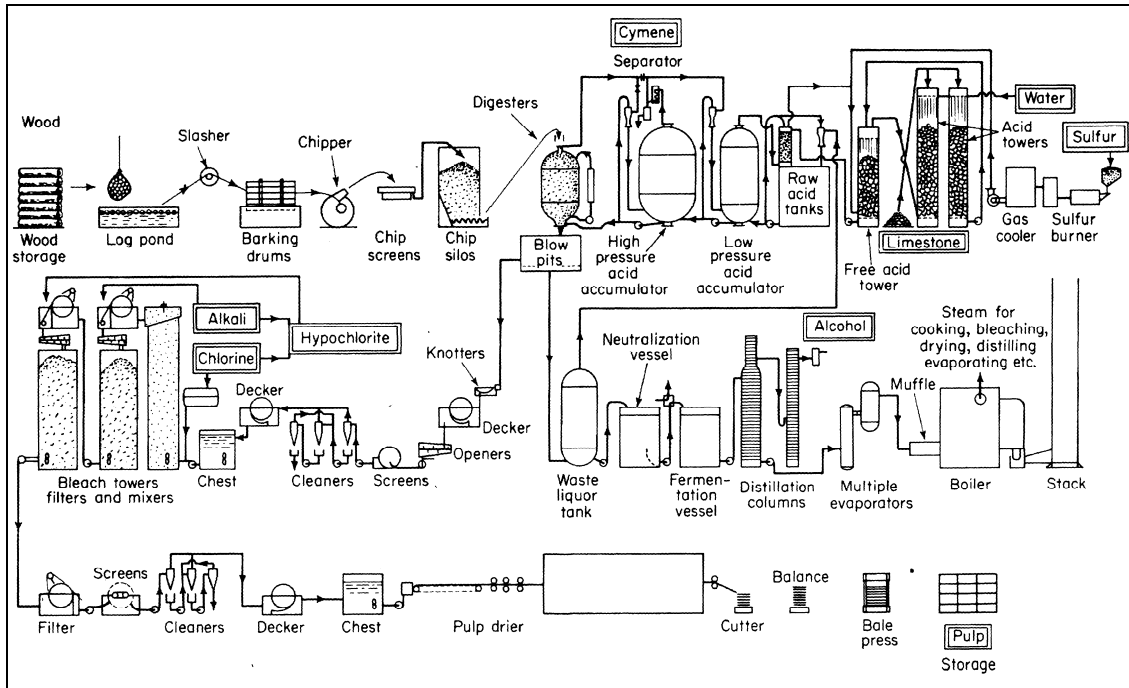

Figure 3.2: A sulphite pulp mill
(Rydholm, 1965)

3.1.1.1. ANALYSIS OF SULPHITE PULPING LIQUORS

Sulphur dioxide in cooking liquor can be present in various chemical forms, depending in the ratio of sulphur dioxide to alkali used in preparing the liquor. The possible forms are: dissolved sulphur dioxide (SO_2) and/or sulphurous acid (H_2SO_3); bisulphite (HSO_3^-); and monosulphite (SO_3^{2-}). The bisulphite can be alone or in combination with either of the other two forms. The conventional way of describing the composition of sulphite cooking liquors is in terms of total, free and combined SO_2 . The total SO_2 is the sum of all three forms listed above; the free SO_2 represents the dissolved SO_2 -sulphurous acid plus one half the SO_2 present as bisulphite; the combined SO_2 represent the SO_2 present as monosulphite plus one-half the SO_2 present as bisulphite. Each form is usually expressed as percent concentration of SO_2 in the liquor (more properly as g SO_2 /100 ml of liquor).

The total, free and combined SO_2 terminology traditionally used in commercial operations does not describe the actual composition of sulphite liquors and can be misleading at times. The composition is described more accurately by giving the content of sulphurous acid, bisulphite and monosulphite. These composition terms can be determined from the total, free and combined SO_2 values. For liquors containing more free than combined SO_2 (no monosulphite present), the sulphurous acid (or "true" free) content is numerically equal to the difference between the free and combined SO_2 . The remainder of the total SO_2 content can be considered to be bisulphite. In liquors containing more combined SO_2 than free SO_2 (no sulphurous

acid present), the difference between the two is equivalent to the monosulphite content and the remainder is bisulphite. A solution having equal free and combined SO_2 contains only bisulphite.

When sulphur dioxide is dissolved in water, a series of equilibria is established.

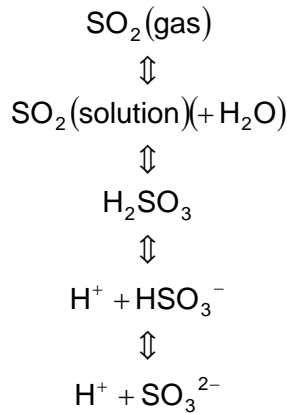

It has been established that in solutions of sulphur dioxide in water relatively little sulphurous acid is formed. This, rather than the limited dissociation of sulphurous acid, is the cause of the low acidity of these solutions. When a base is added to the sulphur dioxide-water system, first bisulphite and then monosulphite is formed. For example, when sodium hydroxide is used, these reactions occur:

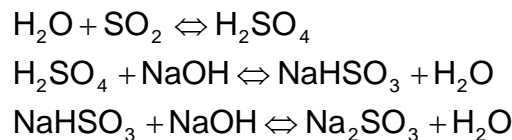

The change in pH at room temperature that occurs during this sequence for a magnesium base is shown in Figure 3.3. It can be seen that the bisulphite inflection occurs at about 4,5 and a pure unbuffered sulphite solution at about pH 9. At these levels, the solutions are unbuffered and relatively small changes in composition cause substantial variations in pH. Since the bisulphite pH range is the one predominantly used for sulphite pulping and acidity (pH) is of major importance in controlling the rate of sulphite pulping, the pH as well as the composition should be specified to describe these liquors adequately.

The effect of the elevated temperature used in sulphite pulping on the above equilibria is also important. Rydholm (1965) found that acidity decreased as temperature increased due mainly to the higher reversion of sulphurous acid into sulphur dioxide and water. It has been confirmed that for solutions of SO_2 in water as well as for solutions containing substantial amounts of bisulphite, the pH increases (acidity decreases) with increasing temperature.

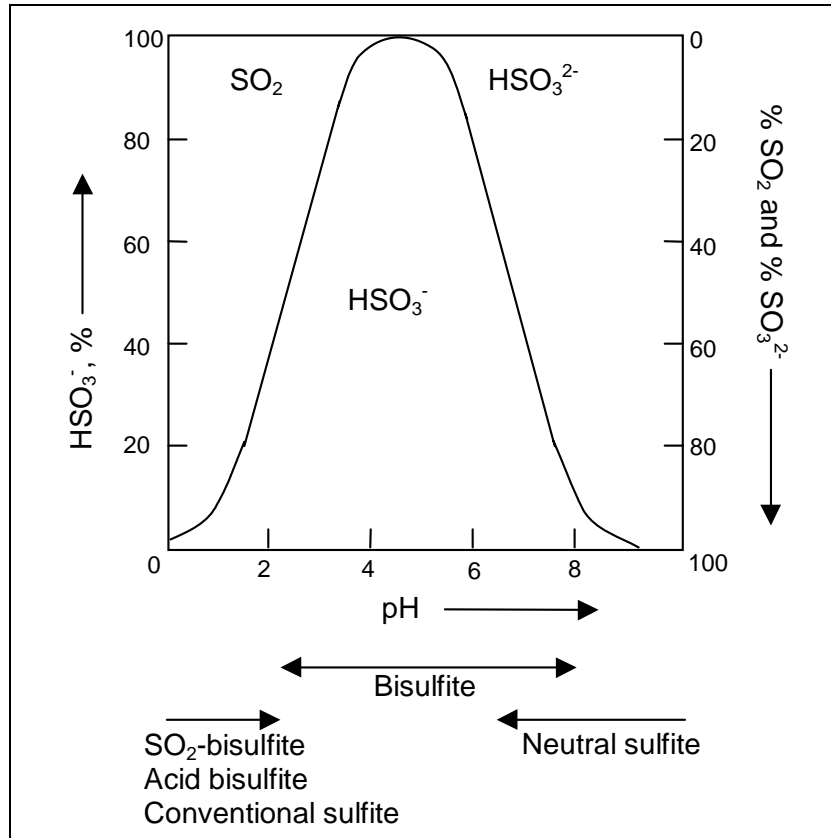

Figure 3.3: Composition of sulphite solutions at various pH levels
(Patt and Kardsachia, 1991)

3.1.1.2. BASES USED IN SULPHITE PULPING

A few different bases are used in the sulphite pulping process. The four most common bases are calcium, magnesium, sodium and ammonium. Two bases are used at SAPPI SAICCOR. The older section of the plant, consisting of 14 digesters, uses calcium as the base, while the new section, consisting of 6 digesters, uses a magnesium base. The reason for the change of the base was that the magnesium can be recovered and recycled, whilst the spent calcium-based liquor is discarded as effluent. Only the two bases used at SAPPI SAICCOR will be discussed here and a comparison of the different bases is given in Table 3.2 for the sake of completeness.

	CALCIUM	MAGNESIUM	SODIUM	AMMONIUM
SO ₂ absorption system	Complex	Relatively simple	Simple	Simple
pH range for digestion	Below 2	Below 5	0 to 14	0 to 14
Rate of pulping	Intermediate	Intermediate	Slowest	Fastest
Level of screening	Moderate	Moderate	Low	Low
Scaling tendency	High	Moderate	Low	Low
Ease of liquor incineration	Difficult, no base or SO ₂ recovery	Simple, base and SO ₂ both recovered	Complex, base and SO ₂ both recovered	Simple, but no base recovery

Table 3.2: Comparison of bases for sulphite pulping (Bryce, 1980)

3.1.1.2.1. Calcium base

From the inception of sulphite pulping in the 1870's until the mid 1950's, calcium was the dominant base used in the process. This was due to the low cost of this base and its wide availability. The most common source of calcium for sulphite liquor preparation is limestone, although calcium hydroxide can also be used.

While calcium was suitable for the conventional acid sulphite process, it suffered from some severe limitations that became impediments to further process development. These include:

1. The relative insolubility of calcium at elevated temperatures, which limits the process to very low pH levels.
2. Severe scaling of the process equipment due to the low solubility of calcium sulphite, sulphate and carbonate.
3. Lack of a suitable recovery system.

Of these restrictions, the limited solubility of calcium sulphite is the most serious. Calcium sulphite exhibits reverse solubility, as it becomes less soluble with increasing temperature. Thus to maintain the required combined SO₂ concentration of 1 to 2% in solution up to the normal cooking temperature of 140°C, a very high SO₂ concentration in the range of 5 to 7% total SO₂ must be maintained. The resultant low pH of the cooking liquor limits the flexibility of the process and reduces the quality of the sulphite pulp.

3.1.1.2.2. Magnesium base

Magnesium base can be used over a wider pH range than calcium because its monosulphite (MgSO_3) is soluble to the extent of about 1% as SO_2 . Combustion of magnesium base liquors produces magnesium oxide and sulphur dioxide as the inorganic products and these can be readily combined to form fresh cooking liquors. Magnesium base is normally obtained in the form of dry or slurried magnesium hydroxide or powdered magnesium oxide.

3.1.1.3. SULPHITE PULPING PROCESSES

The sulphite process is characterised by its high flexibility. In principle, the entire pH range can be used for pulping by changing the dosage and composition of the chemicals. Thus, the use of the sulphite process permits the production of many different types and qualities of pulps for a broad range of applications. Over the years, many different varieties of the sulphite process have been developed. Some of these are the acid sulphite process, the bisulphite process, the alkaline sulphite process, multistage sulphite pulping and the high-yield sulphite process.

3.1.1.3.1. Acid sulphite pulping

The traditional method for sulphite pulping since its inception more than 100 years ago has been the acid sulphite process, which is characterised by a high excess of free sulphur dioxide. The liquor has a pH in the range of 1,2 to 1,5 and contains excess free SO_2 that is not consumed during pulping. The low pH used in acid sulphite pulping offers two main advantage that were the major reasons for the dominance of this method for a long period of time. Firstly, since free sulphur dioxide is added in large excess, there is no need for accurate control of the chemical charge if sufficient combined SO_2 is provided and secondly, because of the acidity, calcium can be used as the base in the form of the readily available and inexpensive limestone.

The high vapour pressure of the excess free sulphur dioxide causes the gas to penetrate the chips faster than the base. If the temperature is elevated under these highly acidic conditions, lignin condensation will occur, producing black, uncooked centres in the chip. The acid sulphite cook is therefore normally started at a relatively low temperature in the range of 70 to 80 °C and heated slowly through the low temperature range so that full penetration of base can take place before the temperature reaches 120 °C. Maximum cooking temperature is usually in the range of 130 to 145 °C. The digester pressure is held substantially above the corresponding steam pressure at all times during the cook to maintain the excess free SO_2 level and avoid calcium precipitation. Relief pressure is normally in the 550 to 700 kPa range. At the end of the period at cooking temperature, pressure must be reduced gradually so that the excess sulphur dioxide can be reclaimed for a subsequent cook.

The acid sulphite process has a number of serious disadvantages. The high free SO_2 content makes it difficult to pulp resinous woods and chips containing bark. Cooking cycles are long because of the long heating and relief periods required. Acid sulphite pulps, although easily refined, are of low strength compared with most other pulps. It continues to be used mainly as pulps for newsprint, tissues, glassine and greaseproof papers.

3.1.1.3.2. Bisulphite pulping

Bisulphite pulping is carried out with liquor having an equal free and combined SO_2 content and having a pH in the range of 3,0 to 5,0. Thus this liquor has the chemical composition of a true bisulphite solution and does not contain the excess free SO_2 that is characteristic of the acid sulphite process. This composition prohibits the use of calcium base because of its low solubility. The main liquor components penetrate the wood simultaneously and thus a higher initial temperature and a more rapid heating cycle can be used than in acid sulphite pulping. The lower acidity of the bisulphite cook necessitates a higher temperature for cooking. In spite of the higher cooking temperature, the total digester pressure can be held at about the same level as with acid sulphite pulping, since there is only a slight SO_2 partial pressure.

Although the SO_2 partial pressure in a bisulphite cook is quite small, it controls the pH of the liquor during the cook. Since, the pH has an important effect on both the rate of the bisulphite cook and the quality of the final pulp, accurate control of the pH and thus the SO_2 partial pressure is necessary. Normally, it is desirable to control the pH on the acid side of the bisulphite point, that is, in the vicinity of a pH of 3,5. The higher pH of the bisulphite cook also permits the use of a wider range of wood species since the competing reactions occur to a much lesser extent at the bisulphite pH. Tolerance to bark is also higher.

3.1.1.3.3. Alkaline sulphite pulping

The alkaline sulphite process uses a combination of sodium sulphite and sodium hydroxide as the pulping chemicals. As a result, it combines features of both kraft and sulphite pulping. The rate of pulping is rapid, there are no species limitations and the pulps have high strength. Yield and brightness are low, but the pulps are easily bleachable.

3.1.1.3.4. Multistage and high-yield sulphite pulping

The use of the soluble bases has not only allowed a wider choice in the pH of the initial pulping liquor, but also has permitted changes to be made in the pH during the

course of the cook. The multistage processes can be classified into two broad categories. The one category are processes in which the first stage is a neutral or alkaline treatment and the second stage is more acidic, either bisulphite or acid sulphite. In the other category are processes in which the first stage is carried out at an acid or bisulphite pH and the second stage is at or near the neutral point.

When bleaching is not required, a substantial yield advantage can be obtained by stopping the sulphite cook before the defibration point and separating the fibres mechanically. The use of high-yield pulps brings about a substantial reduction in the wood, cooking chemicals and the steam usage. High-yield pulping is particularly suited to mills where the sulphite pulp is being used as the reinforcing pulp for newsprint. These techniques will not be discussed further as it is not applicable to this study.

3.2. Summary

There are basically two different ways of liberating the wood fibres; that is by using chemical and mechanical methods. In mechanical pulping, the fibres are literally torn apart by using physical force. Although mechanical pulping gives very high yields, the pulp quality is very poor and pulps with low strength results. Chemical pulping makes use of chemicals to dissolve a sufficient amount of the fibre-binding lignin to separate the fibres. About 80 % of the world's chemical pulps are produced by the alkaline kraft process, using sodium hydroxide as the active chemical. The kraft pulps have a higher tear strength than the products from the other popularly used chemical pulping technique, namely the acidic sulphite process. The other major advantage of the kraft process is that up to 98 % of the chemicals used in the process can be recovered.

The sulphite process has lost much ground to the kraft process, because of the inferior pulp quality, as well the use of chemicals that cannot be recovered as thoroughly as the chemical from the kraft process. However, the reaction that gives a lower pulp quality for the production of paper, namely the acid hydrolysis of the polysaccharides and therefore leads to the breakdown of the cellulose chains and the lowering of the degree of polymerisation, makes the sulphite process the ideal process to use for the production of dissolving pulps. The specification of dissolving pulps requires a pulp with a specific degree of polymerisation and the degradation of the cellulose chains are therefore a requirement during the production of dissolving pulps. The acid sulphite process is used at SAPPI SAICCOR where dissolving pulps are produced.

Chapter 4:

The SAPPI SAICCOR plant

SAPPI (South African Pulp and Paper Industry) SAICCOR (South African Industrial Cellulose Corporation) is currently the world's single largest and lowest cost producer of dissolving pulp and exports almost 100% of its product, mainly to China, India, Japan, the United Kingdom, North America and Europe. The company produces approximately 600 000 tons dissolving pulp per year, which represents a 15% share of the world market. (SAPPI, 1999)

SAICCOR's dissolving pulp is used in the manufacture of a variety of cellulosic products and by-products for the textile, chemical and plastics industries. In the textile industry the dissolving pulp is used in the manufacture of viscose fibre used for woven and non-woven fabrics. Other products produced from SAICCOR pulp include: medical wipes and swaps; tyre cord used inside rubber tyres; cellophane for food and sweet wrappings; yarns for textiles; plastics for steering wheels, telephone bases, knife and screwdriver handles and appliance knobs, toys, signs and pipes; in the manufacture of photographic film; in lacquers, membranes for kidney dialysis and water purification. The product is called dissolving pulps, because in the manufacturing of the different products, the pulp is first dissolved using a number of steps involving the addition of alkali and carbon bisulphite. It is then re-precipitated by passing the solution through microscopic nozzles and simultaneous neutralisation to eventually form the fibre that will be used to manufacture the final products. The important properties of dissolving pulps are the purity (92% Alpha Cellulose) and the degree of polymerisation of the cellulose fibres.

SAPPI SAICCOR uses approximately 1,8 million tons of timber to produce the indicated 600 000 tons of dissolving pulp per annum. Nine different wood species are used at the mill, with the majority of the wood being eucalyptus and wattle. The normal distribution of the wood fed to the digesters are approximately 85% eucalyptus (mostly *Eucalyptus Grandis* and *Eucalyptus Saligna*) and 15% wattle (*Acacia Molissima*). The logs from the plantations are chipped into the required size and then thrown onto a huge pile of chips. Both magnesium and calcium based processes are used at Saiccor. Only eucalyptus is cooked in the calcium base, and consequently all the

wattle is cooked in the magnesium base, although eucalyptus is also cooked in the magnesium base. The pulp from the eucalyptus and wattle cooks are then blended together in an attempt to ensure a uniform product to the next stage of the process.

4.1. An overview of the process

The acid sulphite pulping process is used at SAICCOR. This is done in 23 synchronised batch digesters. A calcium base is used in 15 of the digesters, while a magnesium base is used in the remaining 8 digesters. The calcium digesters are used in the older section of the plant, while the magnesium base is used in the newer section. At the time when the first digesters were built at SAICCOR, calcium was the common base used in the acid sulphite process, for the reasons mentioned in paragraph 3.1.1.2.1. The reason for the switch to the magnesium base is that the magnesium can be recovered and recycled, whilst the spent calcium-based liquor is discarded as effluent.

The operation of a batch sulphite pulping plant was already discussed in paragraph 3.1.1. The process flow diagram of SAPPI SAICCOR is very similar to the one shown in Figure 3.2. The entire process at SAPPI SAICCOR will therefore not be discussed again and since the focus of this project was on the batch pulp digesters, only the detail of an individual cook will be discussed.

The individual digesters make use of common service equipment for the loading and unloading of the wood and the final products, and therefore their operations have to be synchronised to ensure the exclusive use of the service equipment by only one digester at a time. Because of the common service equipment, only one digester can be in each of the following phases at any one time: (the meaning of the different phases will become clear during the rest of this section)

- Wood loading
- Liquor loading
- Pressurising
- Side relief
- High pressure gas release
- Low pressure gas release
- Pulp discharge

Consequently, the cook times of the digesters are fixed according to a scheduling algorithm. Accurate scheduling and control of the cooking process is essential to ensure a steady supply of uniform quality pulp from the cooking process to the rest of the plant, which operates on a continuous basis. This will ensure that the entire plant runs smoothly and produces a uniform and high quality pulp.

Each digester is 16,5 m. high and has a volume of 285 m³. When full, each digester holds about 100 tons of wood chips and 200 m³ of cooking liquor. A circulation line is extracted from the bottom of the digester and passed through an external heat exchanger and returned to the top of the digester. This external heat exchanger uses superheated steam at a temperature of 165 °C and a pressure of 550 kPa to heat the circulating cooking liquor. A schematic diagram of a batch pulp digester is shown in Figure 4.1. It must however be noted that the digester shown in the figure has a centre extraction line and a split circulation flow to the top and bottom of the digester, unlike the digesters used at Saiccor.

There are two temperature sensors on each digester. The temperature at the bottom of the digester is measured in the first section of the circulation line, while the temperature of the liquor in the top of the digester is taken as the temperature of the liquor at the end of the circulation line.

At the start of a new cook, the wood chips are loaded into the digester. The chips are pneumatically conveyed to the top of the digester. Feeders feed the chips into a blower air stream that transports the chips to the cyclone at the top of the digester. The cyclone separates the trapped air from the chips. The chips are then packed into the digester by a Svensson steam packer. The steam packer is connected to the down pipe of the cyclone. The packer fits into the neck of the digester and its steam connection is coupled with the steam line. The Svensson packer blows steam into the chips in such a way that the chips are packed tightly into the digester. While the chips are loaded into the digester, air is extracted from the bottom of the digester by extraction fans. A gamma ray detector measures the height of the chips in the digester and the loading is stopped when the level of the chips is 2 m. from the top of the digester.

On completion of the loading of the wood, the cooking liquor is loaded. The loading of the liquor continues until the liquor level rises above 14,5 m. in the calcium digesters and 13,5 m. in the magnesium digesters. The liquor consists of a calcium or a magnesium base and approximately 6 to 7 % dissolved SO₂ gas and 1,2 % combined SO₂. The combined SO₂ corresponds to the base content of the cooking liquor and is present in the form of bisulphite. As soon as the liquor loading starts, the circulation of liquor through the pump and the heat exchanger starts. The loading of the wood and the liquor takes approximately 20 to 30 minutes each.

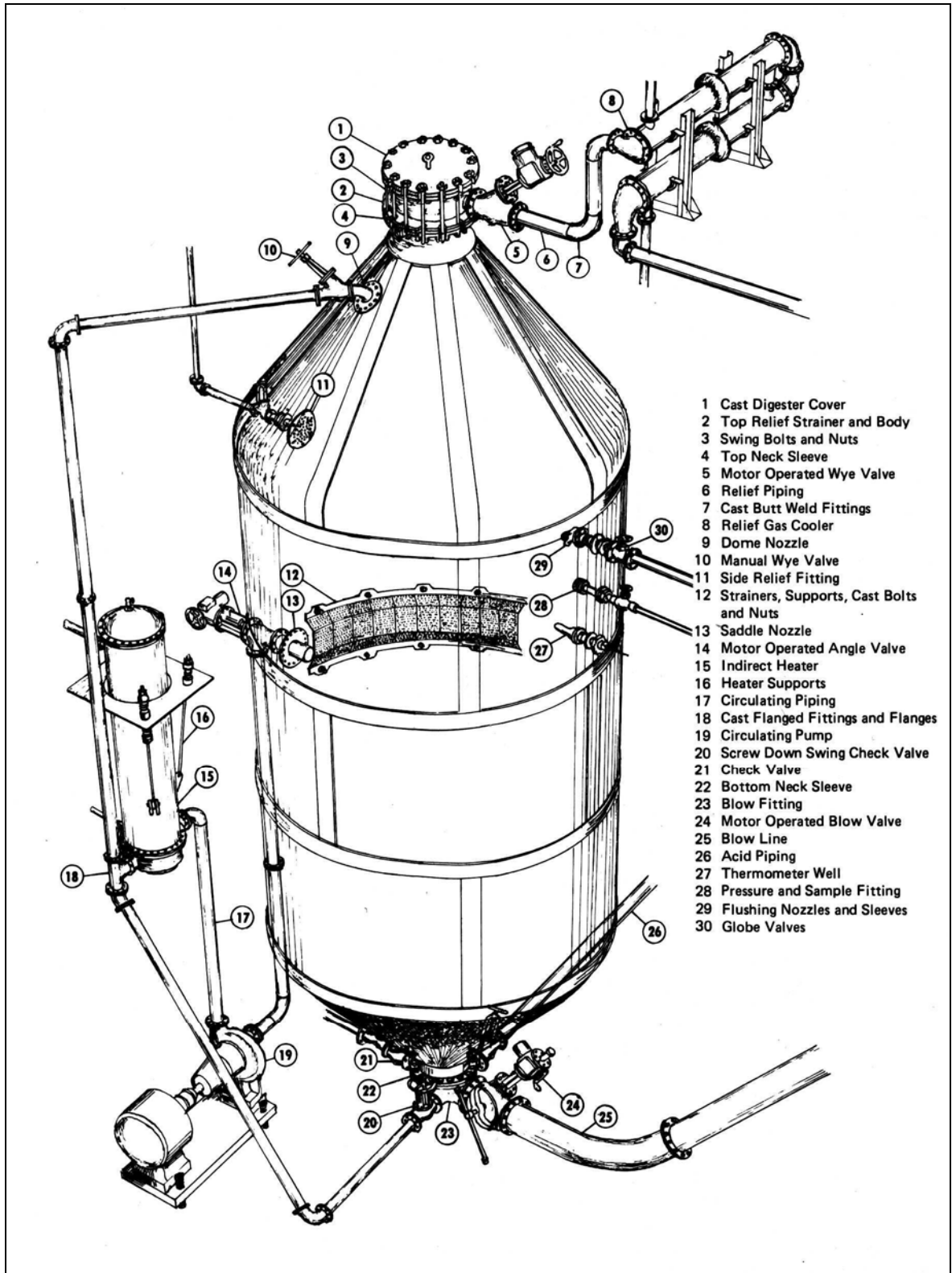

Figure 4.1: A centre-extraction batch sulphite pulp digester
(Bryce, 1980)

Once the loading of the liquor and the wood are completed, the pressurisation of the digester starts, as well as the addition of steam to the heat exchanger. The pressurisation will continue until the pressure is 900 kPa. The pressure will continue

to rise as the temperature of the digester rises and the maximum pressure in the digester is controlled at approximately 1 040 kPa by way of a pressure relief valve.

As was mentioned before, the heating of the liquor in the digester takes place by means of an external heat exchanger. A more or less fixed temperature profile is followed during the heating of the digester up to a temperature of 126 °C. After that, a maximum top temperature is calculated with the control algorithm and the heating of the digester is continued until this top temperature has been reached. Several phases of heating of the digester can be distinguished. These heating phases are as follow:

- A smooth steam ramp: The first 40 minutes of heating is known as the smooth steam ramp. During this time, the steam valve is ramped to a set valve position in a pre-set time, irrespective of the starting cook temperature. This ramp time is 40 minutes on the calcium digesters and 30 minutes in the magnesium digesters. The steam flow during this time is variable, since all of the digesters draw steam from a common steam line. The steam demand of the other digesters will influence the amount of steam available to a specific digester. The steam flow can be up to 15 tons per hour, but is usually closer to 10 tons per hour.
- Rise to 110 °C: The next heating phase heats the liquor to a temperature of 110 °C. A fixed rate for the rise in temperature is calculated from the temperature at the start of the cook and the time allowed for this phase. From the slope of this temperature line, a continuous setpoint temperature can be calculated in order to control the steam supply to the heat exchanger. The control of the temperature is based on the top temperature, measured at the end of the circulation line. Normal feedback control on the rate of steam addition is used, based on the measured top temperature and the calculated setpoint temperature. The following formula is used to calculate the setpoint temperature:

$$\text{Slope } \left(\frac{^{\circ}\text{C}}{\text{s}} \right) = \frac{110 \text{ }^{\circ}\text{C} - \text{Temperature at the start of the phase}}{\text{Pre - set time allowed}}$$

$$T_{\text{Setpoint}} (^{\circ}\text{C}) = T_{\text{Measure}} + \text{Slope} \times \text{Differential time elapsed}$$

The set time for this phase is approximately 90 minutes.

- Rise to 126 °C: As soon as the temperature reaches 110 °C, a new control formula is used for the calculation of the setpoint temperature. This formula is similar to the one used for the 110 °C heating phase, and only the value of the target temperature is changed to be 126 °C.

The set time for this phase is approximately 70 minutes.

- Rise to the maximum temperature: The control algorithm calculated the desired top temperature in order to reach the setpoint value for the degree of

polymerisation. A similar control formula to the one used for the 110 °C temperature rise is used to calculate the setpoint temperature during this phase. Once the desired maximum temperature has been reached, the setpoint temperature is fixed at this maximum temperature for the rest of the cook.

The set time for the temperature rise to the maximum temperature is approximately 110 minutes. When the top temperature has been reached, the cook will continue for approximately another 30 to 40 minutes.

When the temperature of the liquor in the top of the digester has reached 110 °C, some of the liquor in the digester will be let out. This is known as side relief. The side relief will drop the level in the digesters to 10,5 m. for the calcium-based digesters and 8,9 m. for the magnesium-based digesters. This will also cause the pressure to drop significantly. However, the pressure isn't raised to the maximum temperature, but is allowed to climb gradually as temperature increases. Once the pressure has reached its maximum value of 1 040 kPa, it will be controlled again at this value.

When the specified cook time has been reached, the liquor circulation will be stopped. Some of the liquor will be discharged and the pressure will drop to about 800 kPa. When the pressure has reached 800 kPa, the high-pressure gas release will start. During this phase, the pressure in the digester is relieved in a controlled manner by opening the high-pressure gas release valve from fully closed to fully opened in a set time. When the pressure reaches 350 kPa, the low-pressure gas release phase will be started and the pressure will be dropped to atmospheric pressure. The pulp is then discharged and conveyed to the next phase of the total operation.

4.2. Control techniques currently used by SAICCOR

The most important property of the final product that has to be controlled, is the degree of polymerisation of the pulp. This property is therefore the focus of any control strategy. Although the final degree of polymerisation is the most important controlled variable from a quality point of view, some additional variables have to be controlled for safety reasons, but also to make to control of the primary controlled variable possible. For reasons of safety, the maximum pressure must understandably be controlled. An inherent difficulty in the acid sulphite process is that of sulphur dioxide condensation inside the chips and local areas of higher acidity leading to “burned” cooks. This happens when the temperature is raised to quickly and rapid penetration of the SO₂ into the chips occurs. This phenomenon will be discussed in more detail in

paragraph 6.1.1. To prevent the occurrence of burned cooks, the temperature has to be raised slowly to 120 °C to allow full base penetration. The temperature profile must therefore also be controlled in order to be able to achieve the desired final degree of polymerisation. Theoretically, it would be possible to control the cook time in a batch process to allow for accurate control of the final product. This is however not entirely true, since the cook time is calculated according to the scheduling of all the digesters. Small variations are allowed, but ideally, the cook time should remain the same for all the different cooks. The synchronisation of the digester operations has to be controlled to ensure the smooth functioning of the entire plant.

It was shown in paragraph 4.1 that all the reactants in the process are fed into the digesters at the start of the cook, and that no additional reactants are added to control for example the pH of the cooking liquor. Therefore, the only variables that can be manipulated continuously for control purposes are the temperature and the pressure. The pressure is controlled at the maximum allowable pressure to facilitate the penetration of the cooking liquor into the wood chips. Therefore, the logical manipulated variable for this process is the temperature profile. It will however be sufficient to have only the one manipulated variable, since only one controlled variable, the final degree of polymerisation has to be controlled.

Naturally, the starting conditions in the digesters can be controlled as well to yield a different final product. However, the specifications for the final product will seldom change, and therefore optimal initial conditions will be calculated and the feed to the digester will be controlled to try and obtain these conditions. If the feed to the digester can be exactly the same as the calculated values and a fixed process path or sequence can be followed, no control would be necessary. Continuous control is necessary to compensate for any disturbances in these starting conditions. Normal feedback control relies on the ability to continuously measure the value of the controlled variable and to adjust the manipulated variables as soon as abnormalities occur due to disturbances. However, if the disturbances could be measured, feedforward control can be used to compensate for these disturbances and to ensure that the correct product quality is obtained. The use of feedforward control can theoretically eliminate the effect of any disturbance before it can influence the controlled variable. An accurate model of the process is however a further prerequisite for the use of feedforward control.

At SAICCOR, it is easier to measure the disturbances than the value of the controlled variable. No continuous measurement of the degree of degradation of the pulp is possible and studies into the use of inferred measurements, for example the colour of the cooking liquor, haven't been successful yet. However, it is possible to measure the initial liquor strength, the pressure, or the top liquor temperature. All of these values constitute disturbances to the process and some kind of model-based

feedforward control strategy seems to be the only solution to the problem of controlling the final degree of polymerisation. If the disturbances in the process are known, a new possible process path can be calculated from the model in order to be able to still achieve the target degree of polymerisation, in spite of the disturbances. The importance of an accurate process model should be very clear from this discussion.

Various disturbances in the process have been identified that necessitate control of the pulping process. Some of the most common reasons for disturbances at SAICCOR are the following:

- Variations in the wood load: The amount of wood chips loaded into the digester, are monitored with a Gamma-particle source. Wood loading stops when the level in the digester reaches the gamma ray detector at the top of the digester. It can thus be seen that the volume of chips loaded is controlled and not the mass. Historical data collected over a one and a half year period show that the wood load varied between 90 and 120 tons and that the standard deviation of the wood load was 6 tons (Pellow-Jarman, 1997). This is a quite large variation and can influence the cooking process, since the liquor-to-wood ratio will be affected. The following factors can lead to this big variation in the mass of wood loaded:
 - The wood density
 - The chip dimensions: The average chip size is difficult to control, since no continuous measurement of the chip size is possible. Various factors during chipping can lead to varying chip sizes.
 - The packing of the chips and the amount of steam flow to the Svensson packers: The efficiency of the packing of the wood chips will depend largely on the steam pressure and thus the amount of steam flow to the packers. Internal SAICCOR investigations showed that the average steam flow to the calcium based digesters can vary between 6 and 7,5 tons/hr (Beharic, 1994). The steam flow to an individual digester will depend on the steam consumption by other digesters.
- Variations in the liquor load: Internal investigations at SAICCOR showed that the liquor level usually drops from zero to two meters after the loading has been completed (Meneghel, 1998b). The historical data show that the liquor load has varied between 172 m³ and 263 m³. The standard deviation was 10 m³ over this period. This variability is dependent on channelling and air pockets in the digester after wood loading. It was also indicated that the method of measuring the liquor level wasn't very accurate. The reason for this is that the bottom impulse line for the level measurement is situated at the bottom of the digester in the same area as the entry of the liquor loading line (No.26 in Figure 4.1). When liquor loading is started, the impulse line is falsely pressurised and the level indicator gives a level reading that is higher than the actual level. (Meneghel, 1999)

- Starting temperature: The initial temperature of the liquor will depend largely on the ambient temperature. The effect of this will be that a fixed temperature ramp cannot be used, but that the rate of the temperature rise must be variable to obtain a specified temperature at a certain time.
- Liquor strength: Variations in the liquor composition at the start of the cook will influence the pH of the liquor. The variability in the starting liquor composition is apparently largely due to operator error during liquor analysis and a dilution system based on flow and not composition (Meneghel, 1999). The percentage CaO of the liquor loaded into the digester can vary between 0,7 % and 1,28 %. The amount of wood loaded into the digester also depends on the liquor strength. Therefore, the variability of the liquor strength will cause great uncertainty about the initial conditions and will necessitate a model that can be changed to represent the starting conditions.
- Circulation flow: The flowrate of the circulation stream is not controlled and is governed by the resistance to flow in the line. Long-term scaling of the circulation return line, as well as clogging of the extraction line during a cook, cause variances in the flow that are difficult to predict and which cannot be controlled. The temperature profile through the digester is determined by the circulation flow and variances in the flowrate can influence the product quality if it is not compensated for in the control strategy.

A control strategy based on the principles of feedforward control is indeed used at SAICCOR. A predictive model is used to determine the process path, based on the measurement of the initial conditions, that must be followed in order to achieve the desired final specifications of the pulp. The values of the disturbances are measured and the manipulated variables adjusted in order to obtain the desired final degree of polymerisation. It was mentioned that temperature is the most important manipulated variable and it will be temperature that is adjusted by the feedforward controller. Normal feedback control is used for the measurement and control of the temperature, by adjusting the steam flow to the external heat exchanger.

The current control strategy for a single digester can be divided into two separate parts. The first concerns the control of the temperature profile in order to obtain the desired final product. For this, an accurate model of the digester is necessary to relate the final degree of polymerisation to the temperature profile. The second part of the control problem involves the control of the steam flow to the heat exchanger in order to control the temperature profile according to the setpoints calculated by the first part. This control strategy can be presented graphically as in Figure 4.2.

The second part of the control strategy receives its continuous setpoints from the first part, where the temperature profile was calculated. The use of the feedback controller to manipulate the steam flow to the heat exchanger was indicated in Figure 4.2. The

control of the top temperature at the setpoint is quite good. This is illustrated in Figure 4.3, where the measured top- and bottom temperatures for two randomly selected cooks are compared with the setpoint values. It can clearly be seen in this figure how the top temperature follows the setpoint, which indicates that the temperature control is efficient. The different phases in the temperature control can also be distinguished in this figure. It must be noted that the control of the temperature only starts after the smooth steam ramp and ends as soon as the liquor circulation stops. The efficiency of the temperature control was also confirmed by Pellow-Jarman (1997) and Smith (1998). It was clear that the cause of the control problems don't lie in the control of the top digester temperature. The focus of this study was therefore on finding new ways to obtain a reliable way to calculate the temperature setpoint.

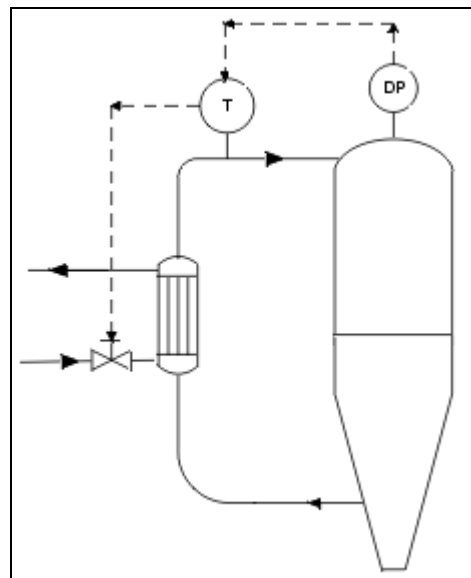

Figure 4.2 Two-way control strategy used at SAICCOR

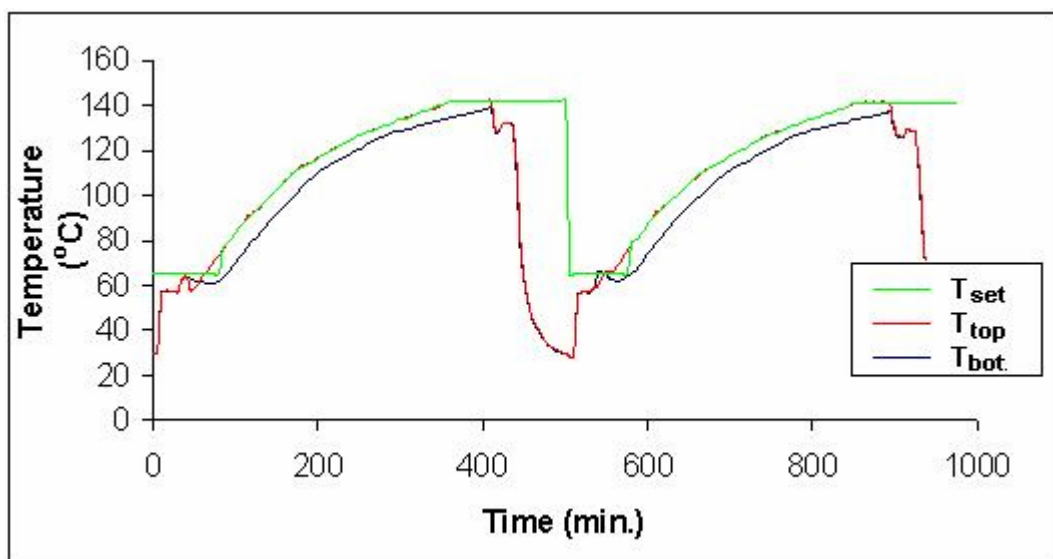

Figure 4.3 Efficiency of temperature control

4.2.1. Currently used model for determining the temperature setpoint

SAICCOR uses the so-called S-factor model to determine the maximum cooking temperature. The S-factor model was originally developed by Yorston and Liebergott (1965) and was based on the assumption that there is a correlation between the lignin content of the solid phase in the reaction and the pulp viscosity. The kinetics of the delignification of wood was better known than the kinetics of the cellulose degradation, since the production of paper pulp was a bigger industry than the dissolving pulp industry. More research was consequently done on developing models for the simulation of the delignification kinetics than models for the simulation of the cellulose degradation. The almost accepted delignification rate equation, in the form also later reported by Hagberg and Schön (1973) in 1973, was used to model delignification and relate the pulp viscosity to that. The following form for the rate equation was used to model the delignification of the pulp:

$$-\frac{d[L]}{dt} = K_L(T) \cdot [L]^a \cdot \left\{ [HSO_3^-] \cdot [H^+] \right\}^n \quad (4-1)$$

The concentration of the lignin, [L], is expressed as the percentage residual lignin in the pulp. Since this equation doesn't give the rate of delignification in terms of easily measurable quantities, a simplified equation based on simple measurements had to be found. Yorston and Liebergott then determined that the product $\left\{ [HSO_3^-] \cdot [H^+] \right\}$ was proportional to the partial pressure of SO₂ and that the power, n, of the product was equal to 0,75. The rate equation then became:

$$-\frac{d[L]}{dt} = K_L(T) \cdot [L]^a \cdot \left\{ P_{SO_2} \right\}^{0,75} \quad (4-2)$$

The temperature and the sulphur dioxide concentration could be measured more readily than the bisulphite and hydrogen ion concentrations in the liquor. In addition, it would also be relatively easy to model the partial pressure of the sulphur dioxide based on the assumption that there will be equilibrium between the dissolved sulphur dioxide and sulphur dioxide in the gas phase. By the time, a few scientists had already confirmed the Arrhenius temperature dependency of the reaction and this was used in the calculation of the factor K_L in equation (4-2). The following form was used for this calculation:

$$K_L(T) = A_0 e^{\left\{ B - \left(\frac{E_0}{RT} \right) \right\}} \quad (4-3)$$

The factor B is known as the normalisation factor that normalises the equation to 100 °C.

The rate equation was then integrated with the assumption that the order of delignification was unity with respect to the residual lignin percentage. This gave the “S-factor” model:

$$SF = -\int_{L_0}^{L_f} \frac{1}{A_0[L]} d[L] = \int_{L_0}^{L_f} e^{\left\{B-\left(\frac{E_0}{RT}\right)\right\}} (P_{SO_2})^{0.75} dt \quad (4-4)$$

Integration of the left-hand side of this equation yields:

$$[L_f] = k_1 e^{\{-A_0 \cdot SF\}} \quad (4-5)$$

From the initial assumption, the residual lignin concentration was taken to be proportional to the cuprammonium viscosity of the pulp. The viscosity was then calculated as follows:

$$\text{Viscosity} = k_2 e^{\{-A_0 \cdot SF\}} \quad (4-6)$$

The parameters k_1 and k_2 are constant parameters.

Equation (4-6) formed the basis of the “S-factor” model. It is apparent that the weakness of the model lies in the assumption that the residual lignin content is proportional to the degree of polymerisation of the cellulose. Individual mills have adapted the S-factor model to their own data and observations in order to improve the control of their respective plants.

SAICCOR came to the conclusion from their own studies that it would be more accurate to use the actual SO_2 concentration of the liquor instead of the partial pressure of the SO_2 (Marr and Bondy, 1986). Equation (4-4) was adapted to the following equation:

$$SF = -\int_{L_0}^{L_f} \frac{1}{A_0[L]} d[L] = \int_{L_0}^{L_f} e^{\left\{B-\left(\frac{E_0}{RT}\right)\right\}} (SO_2^{free})^n dt \quad (4-7)$$

As can be seen from the above equation, the model was initially based on the free SO_2 concentration. However, SO_2 can also be present as combined SO_2 in the form of bisulphite, which complicated the measurements.

The use of the direct measurement of the SO₂ concentration instead of the partial pressure made the S-factor directly dependent on the base concentration in the liquor. The relationship between the base concentration and the target S-factor was determined to be non-linear. This led to the development of the following model, which is currently in use:

$$\text{Target SF} = A \times [\text{SO}_2^{\text{free}}]^2 + B \times [\text{SO}_2^{\text{free}}] + C \times (\% \text{ Base}) + D \quad (4-8)$$

(Smith, 1998)

where A, B and C are all constants determined from plant data and D is a constant which is updated continuously by means of a feedback system. The constants A to C were calculated for different wood species and can be changed when new wood species are used. The feedback system compares the target final degree of polymerisation after each cook with the actual value obtained when the cook was controlled using the S-factor model. Some adjustments are then made to the constant D to try and make the model more accurate.

The following control strategy is used to implement the S-factor model:

1. A target S-factor is calculated from a liquor sample taken one hour after the start of the cook. The target S-factor is calculated by using equation (4-8).
2. From the time that the digester temperature reaches 110 °C, the S-factor values begin to accumulate and are calculated according to the rate equation integrated in equation (4-7). However, investigations resulted in the value of “n” being set to zero and thus effectively removing the dependence of the model on the free SO₂ concentration. The following rate equation resulted:

$$\text{Reaction rate} = e^{\left\{B - \left(\frac{E_0}{RT}\right)\right\}} \quad (4-9)$$

The accumulation was then calculated as:

$$\text{Accumulated S's} = \frac{\text{Reaction rate}}{2} + \text{Previous S} \quad (4-10)$$

The reaction rate was divided by two, since these calculations are done every thirty seconds, and the units of the calculations are in minutes.

3. Another liquor sample is taken after four hours and the target S-factor is adjusted if the SO₂ consumption is considered too high or too low.

4. Once the cook is complete, the resulting viscosity is measured and the average for the last seven cooks is compared with the target viscosity. The difference between the two is then used to adjust the constant D in equation (4-8) in increments of 200. This is done on each individual digester after a minimum of seven cooks, and on all digesters sixty cooks after the last update.

4.2.2. Why a different strategy was necessary

Studies done on historical data show that the performance of the S-factor model is not satisfactory (Meneghel, 1998a). The measure of the accuracy of the control system used at SAICCOR is the coefficient of variance of the viscosity. The coefficient of variance is defined as the ratio of the viscosity standard deviation to the viscosity mean. This is shown in equation (4-11).

$$\text{COV} = \frac{\sqrt{\frac{1}{n-1} \sum_{i=1}^n (\mu_i - \bar{\mu})^2}}{\frac{1}{n} \sum_{i=1}^n (\mu_i)} \times 100 \quad (4-11)$$

Under normal operating conditions, the mean of the viscosities should be equal to the target viscosity. The assumption is however that the actual viscosities obtained are distributed around the target value, with the mean of these values equal to the target viscosity. The coefficient of variance should therefore give an indication of the variation of the real viscosities from the target value. If a constant offset of the mean from the target value occurs over a period of time, the coefficient of variance will not give an accurate indication of the efficiency of the S-factor model, since the coefficient will still be calculated by using the mean of the sample set. The coefficient is however still in use and will also be used in this study to measure the accuracy of the newly developed model, as will be indicated later.

Various studies have shown that the coefficients of variance for the cellulose for monthly periods vary between 20 and 30 (Watson, 1992). The normal target value for the viscosity is around 55. A coefficient of variance of over 20 was considered not to be acceptable. Numerous studies have been done to try and improve the results obtained with the S-factor model. Little improvement was however made through all of these studies. It was decided that a different approach was necessary for the modelling of the viscosity and the determination of a temperature profile.

4.3. Summary

SAPPI SAICCOR produces dissolving pulp for the production of a very wide range of products. Acid sulphite pulping in batch digesters is used to produce the pulp from mainly *Eucalyptus* wood. Since dissolving pulps are produced, the aim of the process is to produce pulp with a certain final degree of polymerisation. The temperature in the digester is used as a manipulated variable in the control of the cellulose degradation, while the steam flow to the external heat exchangers is used to control the top temperature. It was found that the control of the top temperature was very good and that the control problems lie in the difficulty in determining the temperature setpoints for the temperature controller.

A model is necessary to relate the degree of polymerisation to the temperature in the digester in order to be able to calculate the temperature setpoints. The S-factor model is currently used at SAICCOR. This model is based on the assumption that there is a correlation between the lignin content of the pulp and the pulp viscosity. The results obtained by using this model in the control of the digesters are however not satisfactory and new methods for the calculation of the temperature profile have to be developed.

Chapter 5:

A proposed solution

It should be clear from the previous chapter that a model of the pulping process forms the basis of any control strategy for the batch pulp digesters. Poor agreement of this model with reality is then also normally the reason for poor control. The first step in trying to improve the control of the digester should be to confirm the accuracy of the model or to try and develop a more accurate model. Without a good predictive model, no strategy would be able to solve the control problem. The primary reason for this being the lack of measurement to monitor the progress of the cook and to intervene in the event of any disturbances. It was decided that the best solution would be a solution that is as similar to the current strategy as possible, since this would demand the least amount of changes in the current system. The solution should also be as simple as possible. Therefore, the least complicated solution that gives good results would be the best one to use.

The basis for any control strategy would be a model that can relate the degree of polymerisation to the manipulated variable or variables. This will be necessary, since the degree of polymerisation cannot be measured continuously. The digester conditions as well as the degree of polymerisation must therefore be simulated and the control done based on the predictions of this simulation. The possible manipulated variables were discussed in paragraph 4.2 and it was shown that the best variable to use for the control of the final degree of polymerisation will be the temperature profile. That will also be the manipulated variable used in this study. A model is therefore necessary to relate the temperature to the degree of polymerisation.

The prerequisite will however be that temperature control must be efficient. Digester temperature is controlled by steam flow to the external heat exchangers. It was shown in Figure 4.3 that the control of the temperature is effective. The model will therefore only be required to relate the degree of polymerisation to the temperature, and not to the steam flow. The steam supply to the heat exchangers is another service that is shared by all of the individual digesters. The steam pressure will therefore depend heavily on the steam usage of the other units on the plant. The modelling of steam flow to a single digester would demand that the steam requirements of all of the

digester be modelled simultaneously. A model like this will be necessary for the scheduling and optimisation of the operations of the whole plant. It was however decided that a complex model like this will only complicate the model that will be developed and also lead to additional uncertainty in the final results. The extension of the single-digester model to include the entire plant and the use of this model for energy optimisation is a definite opportunity for continued research in future.

The control of any batch-operated plant will consist of two separate parts. The first is concerned with the control of the plant as a whole. This will primarily involve the control of the common services and equipment shared by the individual units in the plant. This will be a scheduling problem. The scheduling algorithm should be used to synchronise the operation of all the digesters. This scheduling algorithm should incorporate limitations like the minimum cooking time to prevent burned cooks, as well as all of the service equipment that are shared between the digesters as was discussed in Chapter 4. The result of the scheduling will be an exact cooking time for each digester, as well as some degree of freedom around this optimum time. The scheduling of a batch process is an extensive field of study in its own and is not addressed in this study. The assumption was therefore made that scheduling had been done already and that the total cooking time for the digesters was fixed and known.

The second part in the overall control strategy of a batch plant would involve the control of the individual units. The units must be controlled to supply the desired quality of products within the operational limitations set by the scheduling. This study focussed on the second area of control only. A strategy was therefore developed for the control of an individual digester, using a fixed cook time.

The difficulties in the control of the individual digester should already be quite apparent. The two major difficulties will be highlighted again.

The first problem in the control of an individual batch digester is that very few measurements can be taken during the process. No continuous measurement of the controlled variable, namely the degree of polymerisation, is at all possible. The progress of the reaction can therefore not be monitored and a model will be necessary to simulate the reactions. This makes feedback control impossible and some kind of feedforward predictor will be necessary in order to achieve a reasonable product quality.

The alternative to direct measurements of the controlled variable will be the use of inferred measurements. For example, if the SO_2 concentration could be measured, it would theoretically be possible to calculate the extent of the reaction from the rate at which the SO_2 is consumed. The rate of reaction can also easily be calculated if pH

measurements were taken by using rate equations that will be discussed in Chapter 8. However, since batch digesters are used, it will be necessary to install a sensor on each of the individual digesters. The plant at SAICCOR consists of 23 digesters as was mentioned in the previous chapter. The equipment needed for this kind of specialised measurement, for example the pH and the concentration of a gas element, is very expensive and the option of installing 23 of these is not economically feasible. Once again a specialised model will be necessary to model the conditions inside the digester, for example pH, since measurement of these values inside a digester is impossible.

The last possibility for taking measurements will be to take pulp and liquor samples during the cook. Two problems hamper this option. The first problem arises from the fact that the digester is a pressure vessel. It is therefore extremely dangerous to take any pulp samples from the digester while it is pressurised. The second problem is caused by the fact that several digesters are run in parallel. If samples were to be taken regularly, the samples would have to be analysed in a laboratory. It would just require too much manpower to do these analyses on all of the digesters simultaneously. Therefore, only two liquor samples are taken for each cook, and only the final pulp product is analysed to determine the final degree of polymerisation.

It should be clear that a total lack of measurements during the cook presents a big problem in the monitoring and control of the digesters. The solution to this problem would obviously be some kind of model that can simulate the conditions inside the digester, as well as the progress of the reactions, based on the initial conditions inside the digester. This solution presents the second major problem in the control of the individual digesters. The pulping process is extremely complicated and is very difficult to model, because of the large number of different chemical components and reactions involved. The development of an accurate model constitutes a major part of the development of a controller for the batch digesters.

The first step in the development of a new control strategy will be the development of a model that can accurately simulate the digester operation, based on only the loading and the initial conditions inside the digester. No further measurements should be necessary in order to be able to predict the outcome of a cook based on the initial conditions. The primary purpose of the model will be the prediction of the final degree of polymerisation. However, the cellulose reactions will definitely depend on the conditions inside the digesters, which have to be modelled as well.

Once the model has been developed and verified, the following strategy based on the currently used strategy is proposed for the control of a digester. This strategy is also represented graphically in Figure 5.1.

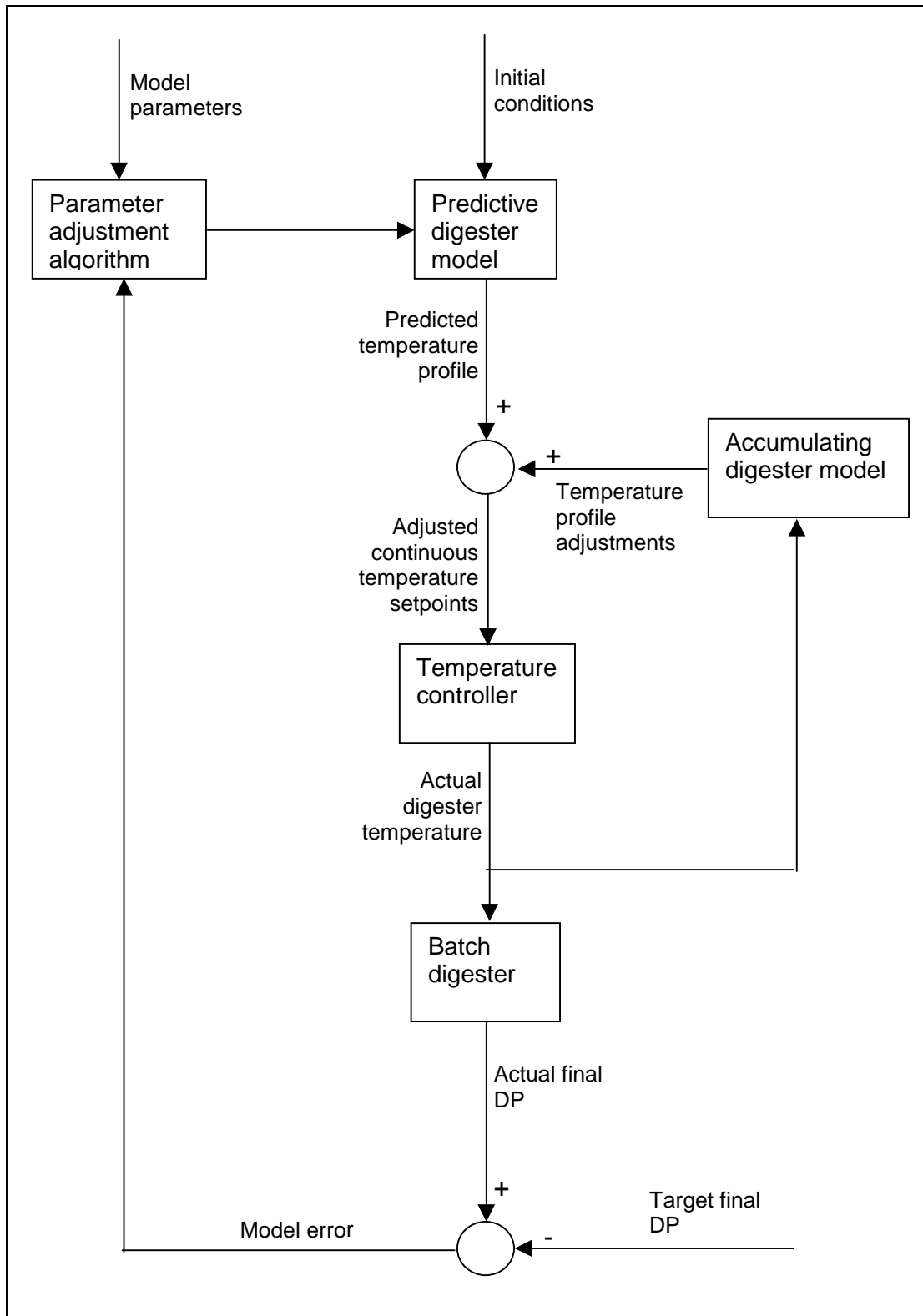

Figure 5.1: A proposed control strategy

- The initial conditions inside the digester must be known or measured to get a starting point for any model. This includes the loading of the digester, i.e. the amount of liquor and wood loaded, as well as the strength of the liquor that was loaded. No prediction of any final values can be made if the initial conditions are not known. The first step of the control strategy would therefore be the measurement of the initial conditions.
- The model of the digester is then used to determine the optimal temperature profile that will give the target final degree of polymerisation. Various techniques are possible to obtain the temperature profile from an accurate model of the digester. The simplest way would be to use a fixed temperature profile up to a certain point and to adjust only the maximum cooking temperature in order to achieve the target degree of polymerisation. The control algorithm can then be a simple iterative method that determines the maximum temperature from a few iterations using different maximum temperatures. The alternative method for determining the temperature profile, would be to use some kind of complicated optimisation algorithm based on, for example the optimal use of energy over the entire plant. This would include the availability of steam during the different phases of cooking, etc. This last method will be very complicated and will demand a lot from the control system. The development of a relatively simple method of calculating an optimal temperature profile is another possibility for future research and improvement on the control strategy.
- After the temperature profile has been calculated at the start of the cook, the cook should progress as planned and the temperature should be controlled at the setpoints that are provided from the continuous temperature profile. Since the top temperature is the controlled variable in the temperature controller, it should be clear that the profile calculated in the previous step needs to be the top temperature profile.
- Continuous measurements of the temperature must be taken during the cook. These measurements must be fed to a copy of the model running in the background while the cook is progressing. The degradation of the cellulose must then be calculated using these actual values of the conditions. At a certain point in the cook that has been determined in advance, the accumulated values from this last model, must be compared with the predictions made by the initial predictor model when the maximum temperature was first calculated. This is just to verify the correctness of the model's predictions of the conditions in the digester, as well as to compensate for temperature control that wasn't perfect. A new maximum temperature must then be calculated based on the difference between the latest accumulated value for the degradation increase and the value predicted by the initial model.

- This procedure can be repeated a few times until the maximum temperature is reached. As soon as the maximum temperature is reached, no additional changes to the temperature should be allowed, since this stage is very critical. Based on the maximum temperature, the degradation increase that will still happen during the high-pressure gas release must be calculated. If this value is added to the target final degree of polymerisation, the degree of polymerisation at which the cook should stop can be calculated. The accumulated value for the degradation should still be calculated using the accumulator that was discussed in the previous paragraph. The actual degree of polymerisation can then still be calculated and compared with the target value before the high-pressure gas release phase starts.
- When the actual degree of polymerisation and the calculated end-of-cook polymerisation agree, the cook should be stopped and the high-pressure gas release phases started. Since the maximum temperature was updated regularly, the end of cook time should be very close to the time calculated by the scheduling algorithm. Some small changes can then still be made to the cooking time just to fine-tune the quality of the final product. The cook time can then be varied a bit, based on the limits determined by the scheduling algorithm.
- Some kind of a feedback system should be installed. This system should compare the actual value of the final degree of polymerisation obtained with the target values. The feedback system should pick up trends in the prediction error and compensate for them by changing the relevant parameters, as will be discussed in Appendix B. In this way, the model can be optimised over time, or long term seasonal trends can be picked up and corrected if necessary, for example seasonal changes in the starting temperature, or the wood composition. If these modifications in the model parameters can be logged, it may be possible to recognise specific trends and to compensate for them even before they have any negative effect on the accuracy of the model. In this way, it may be possible to apply feedforward control on disturbances like changes in the wood species, chip size, moisture content and seasonal variations.

It can be seen that the strategy relies heavily upon the accuracy of the model. The strategy is basically the same as the one currently in use. Not much would therefore be gained from using a better strategy if a substantial improvement in the accuracy of the model isn't made. There are however some subtle differences between the two approaches that can make a big difference.

The first difference between the two approaches is that the new proposed strategy can take all of the initial conditions into consideration, for example the starting liquor load

and the recirculation rate. The S-factor model is based only on the combined sulphur dioxide concentration after one hour. Different liquor-to-wood ratios would therefore not make any difference to the S-factor prediction. Since large variations in the starting conditions can occur from cook to cook as was shown in paragraph 4.2, this can lead to some large errors in the S-factor predictions.

Another difference between the two approaches lies in the reason for using the accumulation model. The new proposed strategy uses the accumulation to compensate for any difference between the conditions used by the prediction model to calculate the maximum temperature, and the actual conditions in the digesters that are measured. Some adjustments can then be made to the values calculated by the prediction model. The S-factor model uses the feedback to determine the end-of-cook time. No adjustments are made to the calculations that have been done by the predictive model. A lot therefore depends on the initial calculation made.

The last significant difference between the two strategies lies in the fact the S-factor model has only one parameter that can be changed. A more general model can be developed for the new strategy with possibly more parameters that can be changed more intuitively. Therefore, a model has to be developed where the parameters can be linked to some actual observation. The feedback model can then be programmed to adjust various parameters according to different variations in the predicted and the measured values.

The most important objective will be to develop an accurate model, since the whole control strategy will be based on the ability of the model to predict a maximum cooking temperature that will result in the target final degree of polymerisation. Different modelling techniques can be investigated to determine the technique that will be the most suitable for the creation of a model. After that, the model must be adapted to be used in the control strategy, both as a predictor and as an accumulator.

A proper understanding of the sulphite pulping process will be necessary for the development of a model, especially in the development of a fundamental model, based on the laws of conservation of mass and energy, as well as chemical engineering principles.

The principles of acid sulphite pulping will be discussed next. These principles will then be used in the development of a predictive model. Software was written for the verification of the model using real data. The software as well as the verification results will be discussed. The use of the model as a predictor in the determination of a maximum cooking temperature was illustrated in a simulated control example. All of these topics will be discussed in subsequent chapters.

5.1. Summary

A new control strategy was proposed that was based on the current system. A new model will however be developed that will form the basis of the new strategy. The new strategy will consist of three separate, but interacting parts.

- A predictor will be used to calculate a temperature profile based on measurement of the initial conditions inside the digester.
- An accumulator will be used to calculate the degradation increase of the cellulose as the cook progresses based on continuous temperature measurements. Adjustments to the predicted maximum temperature will be made to compensate for any differences between the actual temperatures and the predicted temperature values used.
- A feedback system that will compare the actual results of the control with the target values and make some adjustment to the model parameters.

The primary purpose of this study was to develop the new model and to verify its capabilities in predicting a maximum cooking temperature. The last two parts of the control strategy will need direct inputs from the plant and wasn't developed further.

Chapter 6:

Important properties of the acid sulphite process

A proper understanding of the process under investigation is necessary when developing a model of the process. This is not only necessary to develop the equations in the model, but also to evaluate the results and the predictions of the model. In order to implement the suggested control strategy, an accurate model of the acid sulphite pulping process will be necessary. The acid sulphite pulping process will subsequently be examined in some detail.

6.1. Chemical reactions in the sulphite process

The heart of any model of the sulphite pulping process will be the modelling of the chemical reactions taking place inside the digester. The extent of the reactions will determine the amount of residual lignin in the pulp, as well as the degree of polymerisation of the cellulose. Since wood is composed of a large variety of chemical components, a lot of different reactions take place during a sulphite cook. These reactions can be summarised and consist of:

1. Physico-chemical impregnation actions to ensure uniform distribution of chemicals before the main pulping reactions proceed with appreciable velocity;
2. Sulphonation and condensation reactions of lignin preceding its dissolution;
3. Dissolution reactions of both lignin and carbohydrates, probably including both sulphitolysis and hydrolysis;
4. Degradation of carbohydrates in both the pulp and the cooking liquor, including mainly hydrolysis, but also oxidation by bisulphite;



5. Side reaction of the inorganic ions of the cooking liquor with the organic matter dissolved in the liquor as well as interaction of purely inorganic nature.

(McGovern, 1979)

Chemically, the reactions in the sulphite cook can be subdivided into sulphonation, condensation, hydrolysis and redox reactions. Sulphonation mainly concerns lignin, but as a side reaction with carbohydrates also. Condensation mainly concerns lignin and certain extractives, but is not completely excluded for some carbohydrates and their degradation products. Hydrolysis occurs in lignin as well as hemicellulose and cellulose. Redox reactions occur in the inorganic decomposition reactions, but also with carbohydrates and may also be the cause of some colour reactions of lignin. The extent of these reactions depends on time and temperature. Hydrolysis and condensation further depend on the acidity of the reaction medium, which is the cooking liquor or the solid wood phase. The detailed mechanisms of sulphonation and redox reactions are not quite established, but they are likely to depend on acidity and bisulphite ion concentration. In order to understand the course of reactions during the sulphite cook it is therefore important to know the concentration of hydrogen and bisulphite ions in the cooking liquor and the changes of these concentrations during the cook.

In addition to the desired reactions of dissolution of lignin and carbohydrates, and the controlled degradation of the cellulose in the pulp, various side reactions also occur. The intracondensation of lignin has been mentioned. During pulping, the polysaccharides degrade to various sugars, to a large extent monosaccharides. The sugars as well as other carbonyl compounds in the cooking liquor form labile compounds with bisulphite ions, known as α -hydroxysulphonates. They also degrade to aldonic acids or stable sulphonates in little known reactions, in which the α -hydroxysulphonates may play an important role as intermediates. In these reactions, thiosulphate is also formed from bisulphite ions. Thiosulphate accelerates the decomposition of the bisulphite ions leading to increasing quantities of sulphate and thiosulphate. Most of the side reactions affect the acidity and bisulphite ion concentration of the cooking liquor and as those are of great importance for the main reactions of the sulphite cook, the side reactions must not be neglected.

6.1.1. Lignin sulphonation and dissolution

A lot of work and experimental studies have been done by various authors in order to determine the exact reactions taking place during the delignification of wood. The results were not always very clear and in many instances, contradicted each other. As yet, the exact reactions and mechanisms are still not known. Only some of the more agreed upon results, or rather the less disputed ones, will be given here.

The reactions that occur in the dissolution of lignin in the sulphite process have been summarised in three general categories:

1. Sulphonation. This reaction occurs predominantly, if not exclusively, in the α position by a carbonium ion mechanism. All benzyl alcohol, benzyl alkyl ether and benzyl aryl ether structures can be sulphonated in the α position under sulphite pulping conditions.
2. Degradation. Bonds joining lignin units are mainly of the β -aryl ether type; these are quite stable to acidic sulphite conditions. Thus complete separation of two adjacent lignin units does not often occur.
3. Condensation. These reactions compete with the sulphonation reaction for the reactive sites in lignin and counteract any degradation that occurs.

It was found that in order to dissolve lignin with sulphite solutions, the sulphur content of the lignin had to be at least 3,5%, equivalent to one sulphonic acid group per lignin unit of molecular weight 840. (Bryce, 1980)

It has been established that lignin dissolution occurred in two stages: sulphonation of the lignin followed by an acid-catalysed hydrolysis of a covalent linkage. When wood is treated with solutions containing bisulphite and sulphite ions, sulphur is chemically combined with the lignin which under suitable conditions goes into solution as a derivative, which has been found to be a sulphonate and in acid form is called lignosulphonic acid. This reaction is called sulphonation. However, under normal conditions, the lignosulphonic acid is insoluble, since their hydrolysable groups, which form the bonds between the lignin and the carbohydrates, are still intact. The lignin is then made soluble by hydrolysis. However, Rydholm has indicated that not only hydrolysis, but also sulphonation can break the bonds attaching the lignin in the wood. This reaction is called sulphitolysis.

Hydrolysis involves the reactions where a polymer chain is broken by the addition of hydrogen and a substituent group is replaced by hydrogen ions. In lignin chains, hydrolysis is responsible for the scission of benzyl alkyl ether bonds, as well as the breakage of the bonds of the lignin-hemicellulose complex. It can be seen that it is a

reaction that aids the dissolution of lignin in the sulphite process. However, hydrolysis alone is not sufficient, as the lignin units themselves do not have sufficient hydrophilicity to pass into solution but have to be converted to sulphonates.

Either one of these reactions can be the rate determining step, depending on sulphur dioxide content and pH of the pulping liquor. The two mechanisms shown in Figure 6.1 were considered by Rydholm as being possible routes to the sulphite dissolution of lignin.

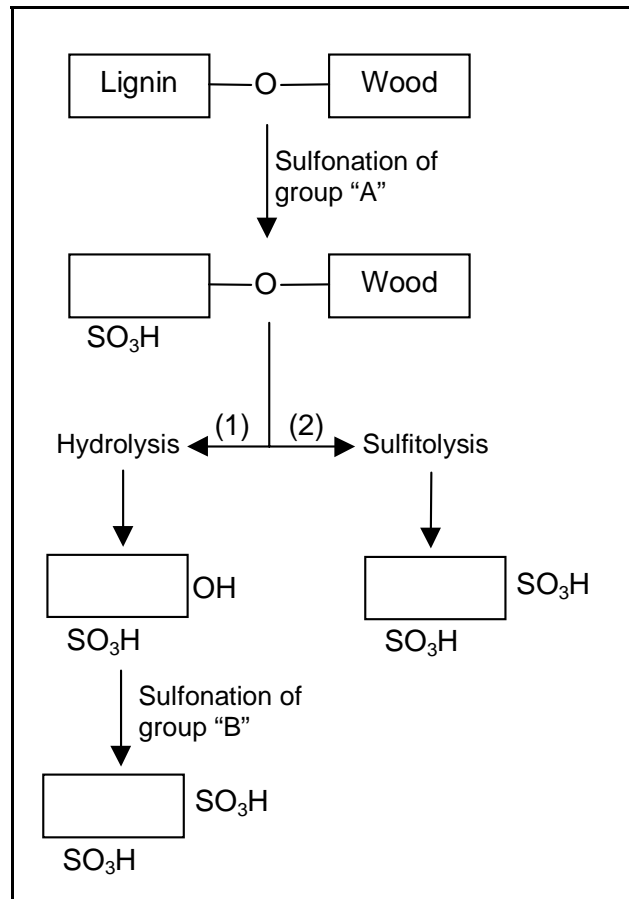

Figure 6.1: Two possible mechanisms of sulphite delignification (Rydholm, 1965)

Considerable work has been done using structural models of lignin functional groupings to determine the nature of the reactions of lignin in the sulphite process. As was shown before, lignin is made up of substituted phenyl propane units. It was evident that the initial reaction takes place at the α -carbon atom of this structure, which is activated by the phenolic grouping in the adjacent benzene ring:

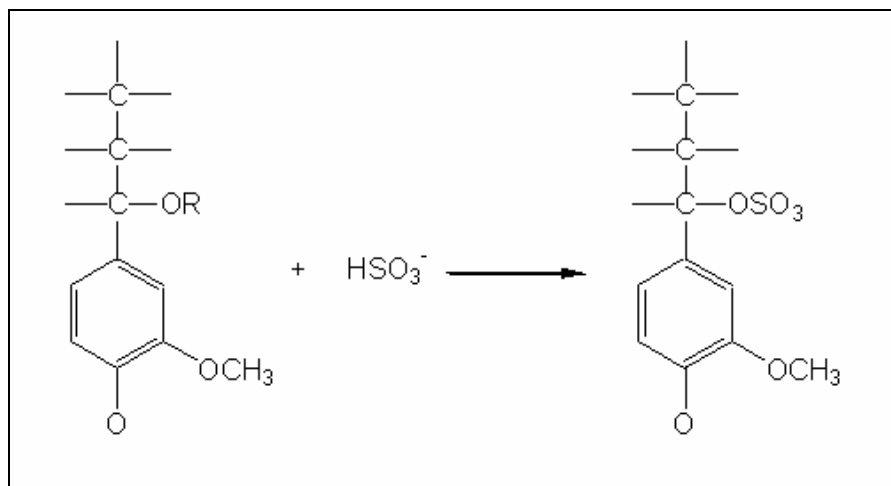

Figure 6.2: Reactions of lignin at the α - position

The R group in the structure can be hydrogen (benzyl alcohol), carbohydrate or another lignin unit (benzyl ethers). Treatment of a wide number of model compounds of this type has indicated that, in all cases, these materials can be sulphonated in the α position.

The main lignin reaction that retards or prevents delignification by sulphite cooking acid is condensation. Acid self-condensation occurs between phenylpropane monomers at moderate to high acidity, especially in the early stages of the sulphite process, when the solid lignosulphonic acids in the wood under unfavourable conditions may give rise to local high acidity. Sulphonation prevents condensation, but the reverse is also true, and excessive condensation of lignin can render lignin insoluble in the sulphite pulping process, since larger molecular complexes are formed which are less easy to dissolve. Lignin condensation also retards the delignification process by blocking the sulphonatable groups.

The rate of the condensation reaction is dependent on the acidity of the solid-liquid interface, and the mechanism of the reaction is similar to the sulphonation reaction. During the early stages of the cook, the bisulphite concentration is high and the rate of lignin condensation is restricted. The rate increases to the end of the cook as the bisulphite concentration drops. However, because of the high vapour pressure of the excess sulphur dioxide in the acid sulphite process, gas can initially penetrate the chip faster than the base, giving rise to local areas of high acidity. For this reason, as was mentioned before, the temperature in the sulphite pulping digester is raised very slowly during the impregnation phase, so that full penetration of the base can take place before the temperature reaches 120 °C. The result of excessive condensation is a pulp with a very dark colour, which is known as a burnt cook. The resulting pulp is unbleachable, because of the large lignin polymers that are resistant to hydrolysis.

The removal of lignin at the fibre level has also been studied. It was found that in the early stages of the cook, lignin is removed preferentially from the cell wall. Later, the middle lamella lignin dissolves rapidly, leaving the residual lignin in the secondary cell wall. (Rydholm, 1965)

6.1.2. Reactions of carbohydrates in sulphite pulping

Three types of polysaccharides enter into the hydrolytic reactions that affect the polysaccharide constituents: cellulose, xylan and glucomannan, the last two being classified as hemicelluloses. (McGinnis and Shafizadeh, 1979) The most important reaction is acid hydrolysis of the glucosidic bonds. This hydrolysis causes a depolymerisation that results in the dissolution of the more accessible and low-molecular parts, mainly hemicellulose, and degradation also of the remaining carbohydrate elements of the fibre, resulting in a weaker paper pulp. The portion dissolved in the cooking liquor undergoes further depolymerisation to monomeric sugars, which are partly destroyed under formation of aldonic acids and sugar sulphonates. Some sugars are also dehydrated under formation of heterocyclic compounds.

The extent of carbohydrate decomposition is largely controlled by three factors, time, temperature and acidity, whereas delignification is also dependent on the bisulphite ion concentration as indicated before. The ratio of delignification to carbohydrate hydrolysis during the cook, according to the following equation:

$$\frac{\text{delignification}}{\text{carbohydrate hydrolysis}} = \frac{k' \cdot [H^+] \cdot [HSO_3^-]}{k'' \cdot [H^+]} = k \cdot [HSO_3^-] \quad (6-1)$$

The ratio should therefore vary largely with bisulphite ion concentration, which decreases during the cook. Consequently, delignification during the sulphite cook proceeds at the same time as and partly somewhat in advance of the carbohydrate removal (in the Kraft process, the delignification lags somewhat behind the dissolution of carbohydrates). The removal of different carbohydrates during the cook is shown in Figure 6.3.

In Figure 6.3 it can be seen that the cellulose DP is reduced right from the start of the cook, and that a dramatic decrease in the DP takes place at yields below 50%. Further reference to this will be made later. It can also be seen from the figure that various carbohydrates of the pulp hydrolyse at different rates. This depends on differences in both reactivity and accessibility.

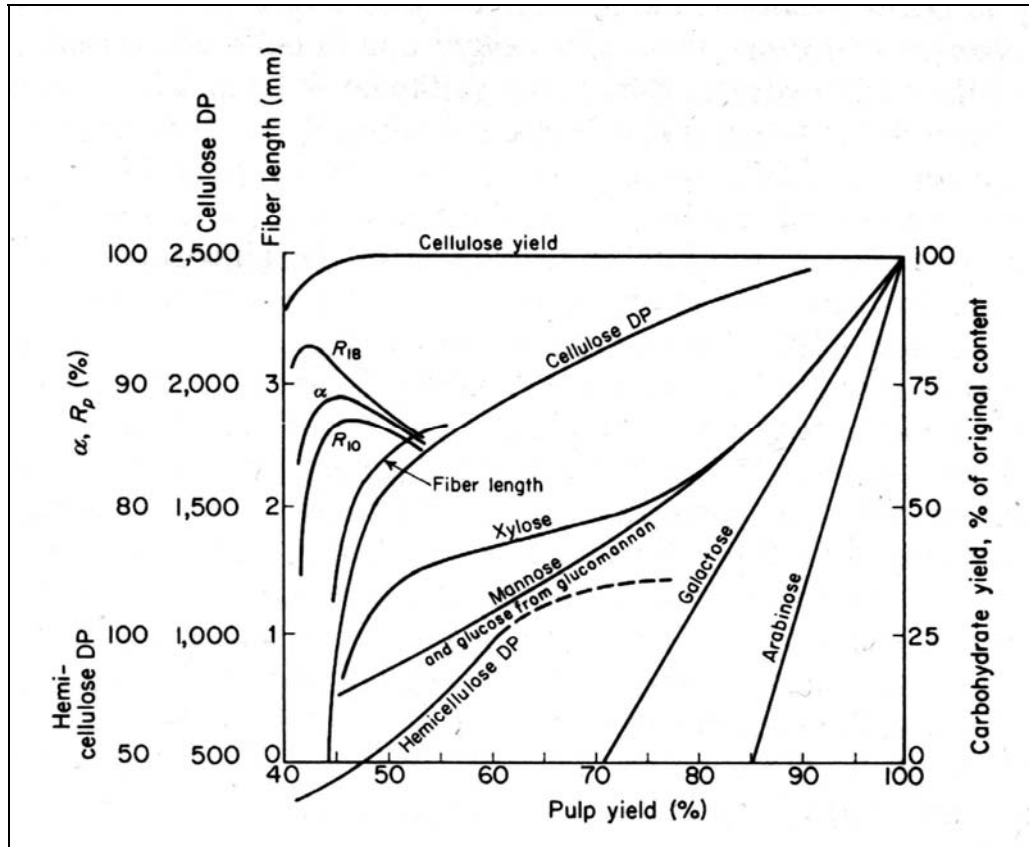

Figure 6.3: Carbohydrate degradation during sulphite pulping (Rydholm, 1965)

6.1.2.1. CELLULOSE REACTIONS

Although the proportion of the original wood cellulose, which is actually dissolved during the cooking process, is relatively small, there is a substantial reduction in its degree of polymerisation. It was shown that the average DP of spruce cellulose is reduced from an original value of 2400 to about 1400 when the normal acid sulphite cook is used. Normally the cellulose in the wood is protected from attack by the presence of lignin and by the highly oriented crystalline structure of the cellulose. However, damage to the wood during chipping exposes additional areas of the cellulose microfibrils to attack by the cooking chemical in the early part of the cook and leads to more extensive loss in viscosity (and therefore also DP) and ultimately, in yield.

The influence of the super-molecular structure on the reactivity of cellulose is profound and has to be considered in all cellulose reactions of heterogeneous type. The amorphous areas of the cellulose structure will be more accessible and are degraded first. For this reason, the DP of the main fraction of cellulose will decrease more rapidly at the start of the cook. However, the various possibilities of cellulose reactions are determined by its molecular constitution. Like all carbohydrates, the cellulose



molecule is capable of reactions at its hydroxyl and acetal groups, as well as at the aldehydic end groups (Bryce, 1980).

The hydroxyl groups react with addition, substitution and oxidation agents and the acetal groups undergo hydrolysis in acid as well as in alkaline medium (Rydholm, 1965). The aldehydic end groups can be reduced to alcohol groups, oxidised to carboxyl groups or rearranged under the influence of alkali to form either alcohol or carboxyl end groups. The redox and rearrangement reactions all influence the ease of hydrolysis of the glucosidic bonds and can be classified together with hydrolysis as degradation reactions. This category of reactions is of importance for the pulping processes, while the addition and substitution reactions are of interest mainly in connection with the use of dissolving pulps.

6.1.2.1.1. Degradation reactions

Hydrolysis of glucosidic bonds occurs in both acid and alkaline medium, although much faster at low pH. Acid hydrolysis is very pH-dependent and its rate becomes appreciable even below 100°C if the acid concentration is high. The mechanism of acid hydrolysis of an acetal bond is considered to be the following: A proton is added to the acetal oxygen, heterolysis results in an intermediate carbonium ion, which finally reacts with water under re-formation of the proton. The mechanism is shown in Figure 6.4.

Hydrolysis reactions are influenced by the supermolecular structure of the cellulose. First of all, the amorphous material, which is most easily accessible, is not only degraded but also dissolved. The dissolved matter amounts to about 10% of wood cellulose, to which should be added 2-5% that seems to crystallise during hydrolysis. The degradation has to proceed to a DP below 10 before solubility in the hydrolysing medium is obtained. The DP of the main fraction decreases more rapidly in the beginning of the hydrolysis and eventually achieves a more or less constant value, around a DP of 100-200 for wood. The initial fast drop in the DP, as well as the relative intermediate resistance are probably caused by heterogeneities in the structure, as well as the protecting influence of non-cellulosic material. However, the limit DP is seldom reached in the technical process and the preceding phases are of more interest. (Rydholm, 1965)

The other type of heterogeneous degradation in pulping processes is the oxidative degradation during bleaching. This reaction is undesirable in the bleaching of paper pulps since it leads to a deterioration of the strength properties and special precautions are taken to avoid degradation. This type of reaction won't be discussed further.

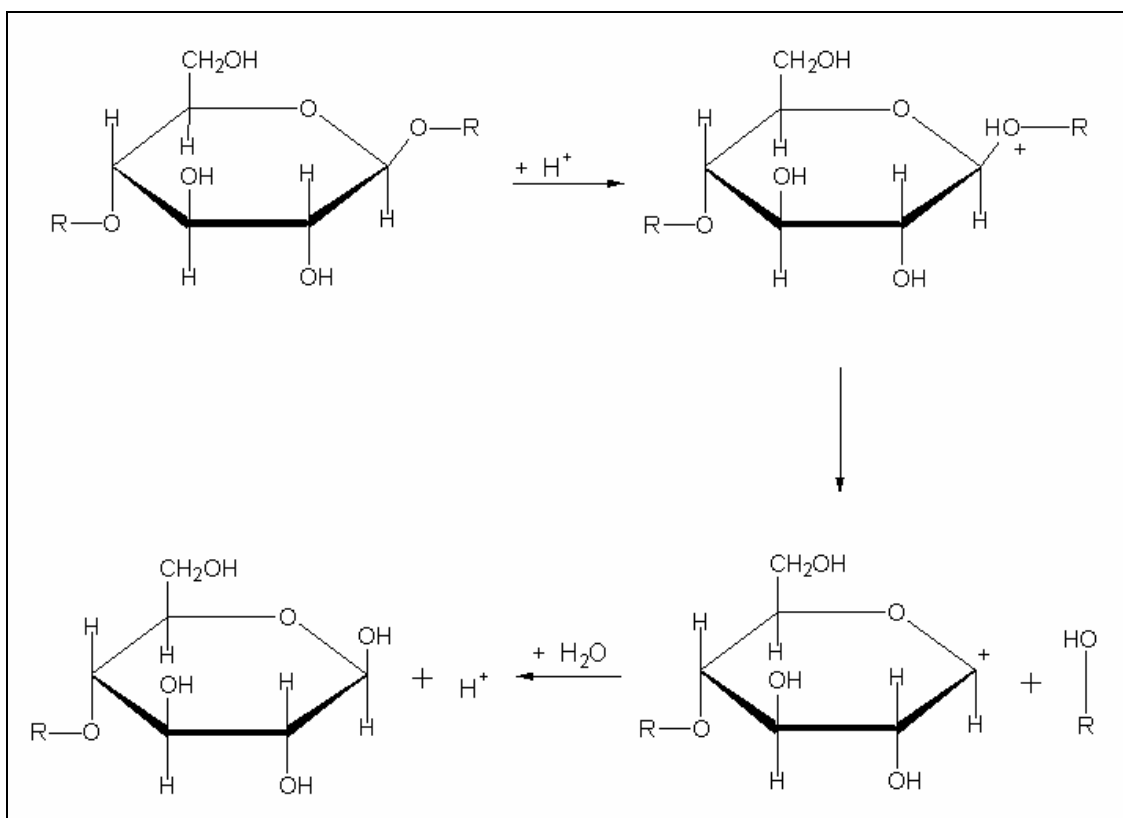

Figure 6.4: Proposed mechanism for acid hydrolysis of cellulose (Rydholm, 1965)

6.1.2.1.2. Reactions forming addition compounds

The preparation of cellulose derivatives forms an important industrial aspect of cellulose chemistry, as several million tons of wood pulp are consumed for this purpose every year. The conversion process involves the substitution of the cellulose hydroxyls to esters or ethers, which are either used as such or further converted to regenerated cellulose by elimination of the substituents. The purpose of the preparation is in all cases to convert the cellulose to a more useful form by dissolving the native fibre structure and extruding the solution to form filaments, sheets, foils, etc., or moulding the derivatives together with a plasticiser to plastics of useful shape, or sometimes as a dissolved ingredient in glues, paints and detergents.

Most of the cellulose hydroxyls are engaged in hydrogen bonding, giving the cellulose chains a dense, ordered structure, which is not easily accessible to the esterifying or etherifying agents. In order to make the hydroxyl accessible to the reagent, cellulose is treated with strongly alkaline or acid solutions, either as a pre-treatment or in the same operation in which the main reaction is performed. These reactions are not of importance during the pulping process and only come into consideration during the further treatment of the dissolving pulps and won't be discussed further.

6.1.2.2. HEMICELLULOSE REACTIONS

As was mentioned before, hemicelluloses are structurally related to cellulose and consequently, their reactions are very similar. Like cellulose, the hemicelluloses form addition compounds at their hydroxyl groups, which also can be substituted to ester and ether groups. Like cellulose, hemicelluloses can also undergo oxidation. However, in acid medium, hydrolytic degradation at the glucosidic bonds is the dominating reaction. Action of the bisulphite or sulphite ions causes formation of polymers containing sulphonate and carboxyl groups, as well as low-molecular aldonic acids.

However, there are important differences in spite of the similar pattern of reaction of cellulose and the hemicelluloses, and on these differences depend not only the methods of modifying the paper pulp properties, but also the principles of dissolving pulp manufacture, where a selective removal of the hemicelluloses is desired to leave a relatively pure and not too degraded cellulose. These differences in reactivity to a large extent have physical causes rather than chemical ones and are better described as differences in accessibility. The hemicelluloses are *in situ* largely amorphous in contrast to cellulose. Most chemical agents therefore reach the hemicelluloses much more easily than the crystalline regions of the cellulose. The oxidation and degradation reactions will thus hit the hemicelluloses more rapidly than the cellulose. There are however indications that xylan as well as glucomannan may undergo secondary crystallisation, probably after losing some substituents.

There are also chemical differences and differences of reactivity in substitution, compared to cellulose, that will not be discussed here. The reactivity of the two most important hemicellulose structures will be discussed briefly.

Xylose occurs in both deciduous and coniferous woods in the form of its polymer, xylan – a series of 1,4-linked xylose units. In softwoods, O-methylglucuronic acid units are attached to one out of every five or ten xylose units. Hardwood xylans are similar in structure, but do not contain arabinose and about seven out of ten xylose units contain an acetyl group. The linkages between the pentose units are particularly susceptible to acid hydrolysis and in sulphite pulping, the arabinose units are eliminated at an early stage. A considerable number of xylose-xylose bonds are also broken as evidenced by the fact that xylose is the predominant sugar in sulphite spent liquors and the degree of polymerisation of the xylan is decreased during sulphite pulping. (Rydholm, 1965)

Glucomannan and galactoglucomannan are the major hemicellulose components of coniferous wood, but do not occur to any significant extent in deciduous species. Glucomannan has a backbone of glucose and mannose units in about a 1:4 ratio with

side units of glucose and galactose. The glucomannans are more stable to acid hydrolysis in sulphite pulping than xylans, but a substantial amount is nevertheless dissolved in both the acid sulphite and bisulphite processes. This fraction of the wood can be stabilised to a large extent by treating the wood under neutral or alkaline conditions at elevated temperatures prior to the main sulphite digestion. (Rydholm, 1965)

6.1.3. Other reactions in sulphite pulping

In addition to all the reactions described above which constitute the main reactions of the sulphite cook, there is also another sequence of reactions that is of importance to the course and result of the cook. These reactions all have in common a consumption of bisulphite ions, which are converted to more or less stable sulphur compounds. The side reactions therefore lead to sulphur consumption in excess of that necessary for delignification. The acidity during the cook are influenced by the consumption of bisulphite ions and the formation of hydrogen ions, which influences the main reactions and the pulp quality. The different possible reactions are summarised in Table 6.1.

Formation of:	Net reaction
Sulphate	$4HSO_3^- \rightarrow 2SO_4^{2-} + HS_2O_3^- + H_2O + H^+$
α -Hydroxysulphonate	$HSO_3^- + RCHO \rightarrow RCH(OH)SO_3^-$
Sugar sulphonates	$nHSO_3^- + RCHO \rightarrow R'(COOH)SO_3^- + HS_2O_3^-$
Aldonic acids	$2HSO_3^- + 2RCHO \rightarrow 2RCOOH + S_2O_3^{2-} + H_2O$
Carbonic acids	$2HSO_3^- + 2HCOOH \rightarrow 2CO_2 + S_2O_3^{2-} + 3H_2O$
<i>p</i> -Cymene	$2HSO_3^- + 2C_{10}H_{16} \rightarrow 2C_{10}H_{14} + S_2O_3^{2-} + 3H_2O$

Table 6.1: Side reactions of the sulphite cook
(Rydholm, 1965)

The first given reaction represents the spontaneous, autocatalytic decomposition of the bisulphite ion and is an entirely, inorganic reaction. The other reactions involve the participation of the organic constituents of the cooking liquor. The formation of α -hydroxysulphonates is an equilibrium reaction and the extent of the reaction will therefore be dependent on the temperature in the digester, as well as the bisulphite ion concentration. Therefore, there will be a decomposition of the α -hydroxysulphonates at the end of the cook when the bisulphite ion concentration is low

and this reaction will not have a significant effect on the cook. The other organic reactions don't seem to occur to a very large extent and are perhaps less important to the overall results.

However, the type of reaction that can materially affect the course of a sulphite cook is the autocatalytic decomposition of bisulphite. Such reactions involve the formation of thiosulphates from bisulphite in the presence of reducing agents. One of the catalysts involved is the thiosulphate that is formed. The net reaction at and above 100 °C is:

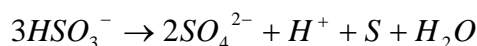

The hydrogen ions formed should act as inhibitors to the decomposition by decomposing the catalysing thiosulphate ions. However, no free sulphur is formed during a normal sulphite cook, and sulphur precipitation only occurs when the product of hydrogen and thiosulphate ion concentrations reaches a certain level. The decomposition prior to that can be expressed by the net reaction:

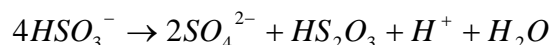

whereby the protons formed could be written as free ions or combined to bisulphate or bithiosulphate. (Bryce, 1980) The actual ionisation of these two latter ions at cooking temperature is unknown.

The reaction is begun with a spontaneous and very slow decomposition, a disproportionation of probably the same form as the net reaction, in any case under formation of thiosulphate of some related sulphur compound. The thiosulphate formed catalyse the reaction, according to the following formulas:

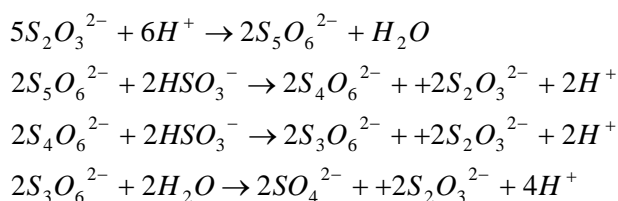

(Bryce, 1980)

These reactions demonstrate that the formation of thiosulphate from bisulphate is autocatalytic and once a certain amount of thiosulphate is formed, the reaction proceeds rapidly and consumes bisulphate that would normally be available for pulping. Once the combined sulphur dioxide is consumed in a sulphite cook, the pH of the liquor drops rapidly, causing the remaining lignin in the pulp to turn very dark and decomposing the thiosulphate to form sulphur:

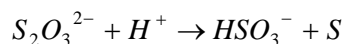

The formation of sulphur in the pulp and the deterioration in pulp properties that accompany this reaction detract seriously from the pulp quality and it is important to ensure that cooking is terminated before reaching this point.

A similar type of reaction involves the oxidation of sugars by bisulphite. It was found that sugars, formed by hydrolysis during cooking, could be oxidised to aldonic acids by bisulphite, forming thiosulphate as the reduction product (McGovern, 1979):

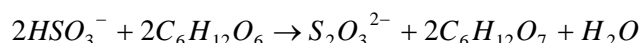

The sugar concentration does not become significant until near the end of the cook, so that these reactions ordinarily consume only minor quantities of bisulphite during a cook. However, it is known that under certain circumstances, sulphite liquors decompose rapidly, producing a burnt or black cook. This phenomenon occurs when, for example, spent liquor is recycled to a subsequent cook, or when the sugars or thiosulphate are present in the cooking liquor at the start of the cook.

It was shown earlier that after the consumption of the combined SO_2 charged to the cook, the bisulphite ion concentration is low and acidity tends to rise sharply. The consumption of combined SO_2 , that is of bisulphite ions, occurs in the main reaction of sulphonation, as well as in the side reactions. Some side reactions increase and others decrease with an increase of the combined SO_2 charged. Thus most of the organic side reactions are favoured by low acidity and a high bisulphite ion content, and sugar destruction and bisulphite consumption are higher in paper pulp cooks of high combined SO_2 than in rayon pulp cooks of low combined SO_2 . On the other hand, the inorganic decomposition reaction under sulphate formation is accelerated by hydrogen ions, and cooks low in combined SO_2 (and high temperature) have the highest sulphate formation. Obviously, the main sulphate formation occurs towards the end of the cook.

The course of the autocatalytic decomposition of bisulphite during the cook is shown in Figure 6.5.

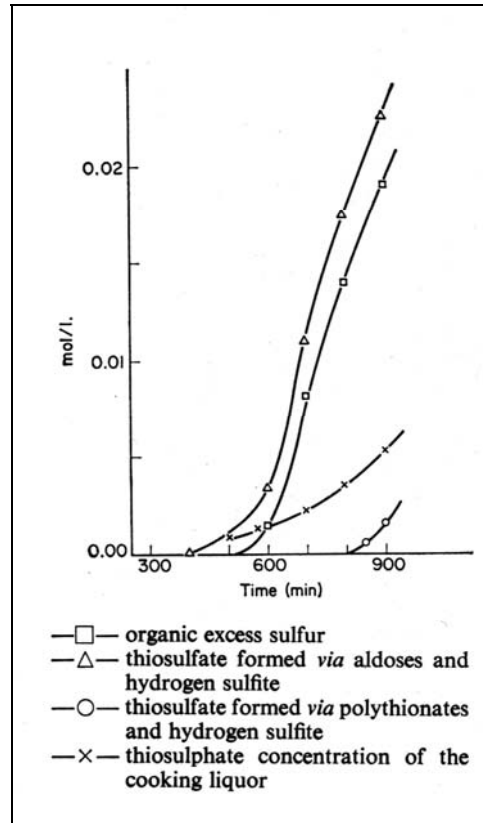

Figure 6.5: Formation of thiosulphate and organic excess sulphur during an acid sulphite paper pulp cook (Rydholm, 1965)

6.1.4. Composition of the cooking liquor during the sulphite cook

The basic initial composition of the cooking liquor for the acid sulphite process was discussed earlier. The composition of the liquor during the cook will be investigated in more detail here.

The important role that the hydrogen ion concentration (the pH) and the bisulphite ions play in the reaction was stressed before and the quantities of these components are obviously very important. The concentrations of the hydrogen and bisulphite ions are related through the dissociation equilibrium of sulphurous acid. Therefore, the systems $\text{H}_2\text{O} - \text{SO}_2$ and $\text{H}_2\text{O} - \text{SO}_2 - \text{M}_2\text{O}$ (where M represents the base used) have been objects of many investigations. Several investigations on the dissociation of sulphurous acid have been performed and dissociation constants have been calculated. The calculated constants over the temperature range applicable in the sulphite cooking process are given in Table 6.2.

Temperature, °C	K _a	pK _a
25	0,0172	1,8
70	0,0046	2,3
100	0,0024	2,6
110	0,0016	2,8
120	0,0011	3,0
130	0,0008	3,1
140	0,0005	3,3
150	0,0003	3,5

Table 6.2: Temperature dependence of the apparent ionisation constants of sulphurous acid (Rydholm, 1965)

Evidently, the dissociation constant of sulphurous acid decreases rapidly with temperature. The constant is defined by the equation

$$k = \frac{[H^+][HSO_3^-]}{[H_2SO_3] + [SO_2]} = \frac{[H^+][HSO_3^-]}{[total\ SO_2] - [HSO_3^-]} \quad (6-2)$$

Because of the analytical difficulty of discriminating between sulphurous acid and dissolved sulphur dioxide, the sum of both is taken to the denominator. Sulphurous acid is in equilibrium with two systems, as described by the equations for dehydration and electrolytic dissociation:



A considerable part of the sulphur dioxide in an aqueous solution is not hydrated to sulphurous acid. On increasing temperature the equilibria are shifted towards dehydration. Assuming that the true dissociation constant, as defined by the equation:

$$k = \frac{[H^+] \cdot [HSO_3^-]}{[H_2SO_3]} \quad (6-4)$$

does not change with temperature, it has been calculated from the change of the apparent dissociation constant with temperature, that the SO₂ fraction hydrated to

sulphurous acid at 90 °C is only about 8% of that at 0 °C (the corresponding figure at 130 °C would be about 2%) (Bryce, 1980). But even at 0 °C the considerable vapour pressure of a sulphur dioxide solution indicates that appreciable amounts of SO₂ exist in a form other than H₂SO₃. Therefore, the real dissociation constant of H₂SO₃ is fairly high, probably even at high temperature, and the concentration of sulphurous acid, especially at cooking temperature, is very small.

With the knowledge of the apparent dissociation constant of sulphurous acid and the content of total and combined SO₂, the acidity and bisulphite ion concentration of a cooking acid at any temperature, e.g. that immediately after acid charging to the digester, can be computed according to the equations

$$\left\{ \begin{array}{l} k = \frac{[H^+] \cdot [HSO_3^-]}{[total\ SO_2] - [HSO_3^-]} \quad (6-5) \\ [M^+] = 2 \cdot [combined\ SO_2] \quad (6-6) \\ [M^+] + [H^+] = [HSO_3^-] \quad (6-7) \end{array} \right.$$

where M again represents the base used.

The hydrogen and bisulphite ion concentrations change during the cook because of two reasons. The increase in temperature lowers the apparent dissociation constant of sulphurous acid and also causes a relief of sulphur dioxide gas. This tends to decrease acidity and bisulphite ion concentration. The reactions during the cook tend to increase acidity and decrease bisulphite concentration.

In discussing the acidity during the sulphite cook, the formation of lignosulphonic, α -hydroxysulphonic, sulphuric, aldonic, formic, acetic and carbonic acids during the cook is usually treated in general terms, without considering the state of dissociation more closely. In a stricter sense it is necessary to distinguish between acids formed, which are more or less undissociated under the conditions of the sulphite cook, and anions formed, corresponding to completely dissociated acids. The various sulphonic acids and sulphuric acid belong to the latter category, whereas aldonic, formic, acetic and carbonic acids are probably dissociated to a very limited extent in the acid sulphite cook, and therefore do not affect the acidity (Rydholm, 1965). Bisulphate ion is one of the few acids formed which may have a changing degree of dissociation during the cook, but its concentration is usually so low, that these changes will not affect the acidity appreciably.

The strong acids formed during the cook do not, however, increase the hydrogen ion concentration to an extent corresponding to their concentration, although they are completely dissociated. Generally, this has been explained by the buffering action of the cooking acid (Bryce, 1980). The base or the combined SO_2 in the cooking acid is said to neutralise the acids formed. Speaking in stricter terms, that should mean that bisulphite ions in the cooking liquor buffer the system by conversion into undissociated sulphurous acid, according to the equations

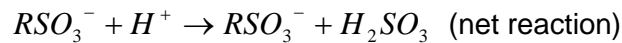
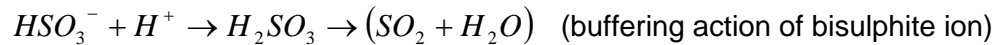
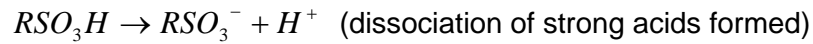

(Bryce, 1980)

However, the strong acids formed in the sulphite cook all seem to originate from reaction in which the bisulphite ions, and not sulphurous acid, takes a part, e.g.

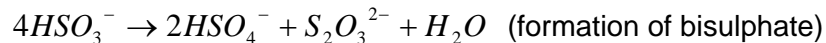
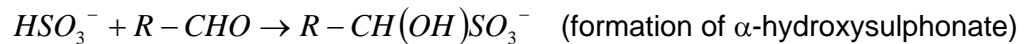
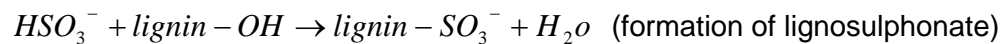

or generally



Therefore, it might be said that there is no formation of strong acids during the sulphite cook, only a formation of their corresponding anions (Bryce, 1980). The role of bisulphite ions with this concept will be a direct participation in the reactions and not a buffering action. The cause of the rapid rise in acidity towards the end of certain cooks therefore will not be that the buffering bisulphite ions are exhausted, allowing the strong acids formed to increase the acidity, but that the reacting bisulphite ions are becoming low in concentration, which causes a formation of new ions from sulphurous acid (sulphur dioxide) according to the dissociation equilibrium



which increases the acidity.

The combined SO_2 is defined as the part of the sulphur dioxide in the cooking acid that corresponds to the base content and could be formulated as M_2SO_3 . The old term available SO_2 during the cook, correctly determined, corresponds to the initial combined SO_2 less the strong acid anions formed, i.e.

$$\begin{aligned} 2 \cdot [\text{combined SO}_2] &= [\text{M}^+] \\ 2 \cdot [\text{available combined SO}_2] &= [\text{M}^+] - [\text{A}^-] \end{aligned} \quad (6-9)$$

from which the following expressions can be derived

$$\begin{aligned} [\text{H}^+] &= \frac{[\text{A}^-] - [\text{M}^+] - k}{2} + \sqrt{\frac{([\text{M}^+] - [\text{A}^-] - k)^2}{4} + k \cdot [\text{total SO}_2]} \\ [\text{HSO}_3^-] &= \frac{[\text{M}^+] - [\text{A}^-] - k}{2} + \sqrt{\frac{([\text{M}^+] - [\text{A}^-] - k)^2}{4} + k \cdot [\text{total SO}_2]} \end{aligned} \quad (6-10)$$

(Rydholm, 1965)

These relations are illustrated graphically in Figure 6.6, where the hydrogen and bisulphite ion concentrations are represented on the Y-axis and the x-axis twice the available combined SO_2 , i.e. $[\text{M}^+] - [\text{A}^-]$, on a decreasing scale, commencing at 0,3 g ions/l, which corresponds to 0,96% combined SO_2 in the cooking acid. The available combined SO_2 then decreases to zero and becomes negative. On the same scale the strong acid anions formed, $[\text{A}^-]$, may be represented on the X-axis, rising from zero to 0,3 g ions/l, at zero available combined SO_2 . As the formation of strong acid anions during the cook proceeds with roughly uniform rate, the x-axis may also be taken roughly to represent cooking time. The different curves represent the following conditions for the cooks:

- Curve 1. 5,12% SO_2 , $k=0,020$ ($T=20^\circ\text{C}$)
- Curve 2. 5,12% SO_2 , $k=0,005$ ($T=70^\circ\text{C}$)
- Curve 3. 5,12% SO_2 , $k=0,002$ ($T=105^\circ\text{C}$)
- Curve 4. 5,12% SO_2 , $k=0,001$ ($T=125^\circ\text{C}$)
- Curve 5. 2,56% SO_2 , $k=0,001$ ($T=125^\circ\text{C}$)
- Curve 6. 2,56% SO_2 , $k=0,0005$ ($T=140^\circ\text{C}$)
- Curve 7. 1,28% SO_2 , $k=0,0005$ ($T=140^\circ\text{C}$)
- Curve 8. 0,64% SO_2 , $k=0,0005$ ($T=140^\circ\text{C}$)

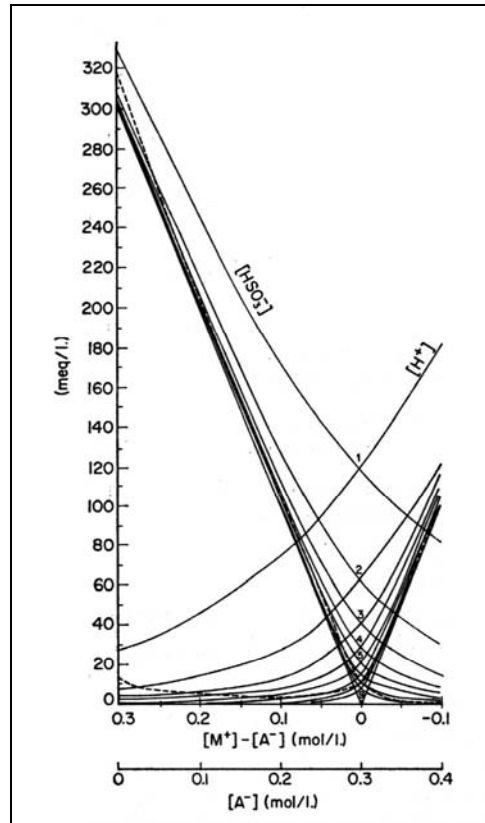

Figure 6.6: The relations of hydrogen and bisulphite ion concentrations to combined SO_2
(Rydholm, 1965)

There is one family of curves for acidity and another for bisulphite ion concentration, the former increasing and the latter decreasing with decreasing combined SO_2 . Each curve relates hydrogen or bisulphite concentration to available combined SO_2 at a constant concentration of total SO_2 and an unchanged ionisation constant k , i.e. constant temperature. However, during the cook, total SO_2 decreases because of gas losses and reaction, and k decreases because of temperature rises. Therefore, to get a correct representation of the changes in hydrogen and bisulphite ion concentrations during the cook, it is necessary to connect those points on the various curves which correspond to the temperature and total SO_2 content of the liquor at a certain content of available combined SO_2 . In this way, curves of the types indicated with dotted lines in the figure are obtained. Different types of cooks, e.g. with varying maximum temperature, varying initial total and combined SO_2 content and varying maximum digester pressure, will of course yield different curves for hydrogen and bisulphite ion concentration. Thus a cook low in initial combined SO_2 and with a relatively high maximum temperature reaches the point of zero concentration of available combined SO_2 sooner. At this point, the bisulphite ion concentration is low and acidity tends to rise sharply. Cooks high in initial combined SO_2 and with low maximum temperature may never reach this point, and thus maintain a fairly low acidity. The former type of cook, especially at higher temperatures, usually causes appreciable degradation of the cellulose, whereas the latter does not. It is, however, evident from the above, that

there is no definite relation between final acidity of the cooking liquor and final viscosity of the pulp.

The bisulphite ion concentration decreases during the cook for three main reasons:

- i. The loss in total SO_2 in gas relief, etc.
- ii. The rise in temperature, accompanied by a lower concentration (or degree of dissociation) of sulphurous acid
- iii. The formation of strong acid anions (decreases in available combined SO_2).

From the curves in Figure 6.6 it is evident that the first two reasons are less important than the last. Thus it is mainly the direct consumption of bisulphite ions in the formation of sulphonates and bisulphite (formerly called the buffering action of the bisulphite ions on the strong acids formed) which causes the decrease in bisulphite ion concentration. The level of the latter is thus almost entirely a function of the available combined SO_2 during the cook, i.e. dependent on the initial base content and the amount of strong acid anions formed.

6.2. Kinetics of the acid sulphite reactions

When discussing the kinetics of pulping processes, it is important to view the process as a heterogeneous process and to take all the different mechanisms involved into account. This will require that both the transport processes and the intrinsic reaction rate be considered. A sequence of steps is involved for converting reactants to products in a heterogeneous system.

1. Transport of reactant from the bulk fluid to the fluid-solid interface (external surface of the solid particle or the piece of wood.)
2. Intraparticle transport of reactants into the particle.
3. Chemical reaction of the reactants inside the particle.
4. Transport of products from the interior sites to the outer surface of the particle.
5. Transport of products from the fluid-solid interface into the bulk-fluid stream.

(Smith, 1981)

Any of the above steps can be the rate-determining step and would therefore dominate the kinetics of the process. Different authors have investigated the kinetics of the acid

sulphite process and included the different steps in their investigations. It was found that once the capillary system of the wood has become completely penetrated, the diffusion paths are very short and thus the influence of diffusion on the overall reaction rates is negligible (Smook, 1994). Kinetic studies using wood pieces and wood pulps also yielded the same results (Kollman and Côté, 1968). The strong temperature dependence of the reaction also indicates that the intrinsic reaction rate is the rate determining step and that diffusion doesn't play a significant role. However, it is important that the wood chips are penetrated completely by the reaction liquor in order to ensure short diffusion paths. To accomplish this, different precautionary measures are taken at the start of the cooking process to ensure complete penetration. This includes:

- Pre-steaming of the chips to remove as much air as possible
- Stringent control of chip quality and dimensions
- A 2-hour pressurisation period at 10,4 Bar at the start of the cook.

With all these measures, complete penetration of the liquid is ensured before the start of the cook. Thus, the only step that has to be taken into account is the intrinsic reaction rate.

6.2.1. Kinetics of lignin dissolution

As was mentioned before, lignin consists of an array of different components and constituents and is also distributed throughout the cells. The lignin situated in the middle lamella will be more easily accessible than the lignin in the cell wall. It should therefore be theoretically possible to distinguish between the different lignin structures, as well as the lignin situated in different locations in the cells. However, most of the kinetic studies have ignored these complexities and the analysis assumed a homogeneous nature. Watson (1992) summarised a few reasons that made this simplifying assumption necessary.

- a) The precise nature of the lignin-carbohydrate structure is still unknown. To incorporate the accessibility of the lignin, an extremely simplified geometry would have to be assumed and this would introduce further inaccuracies. The structure of the wood also changes dramatically during the cooking process.
- b) Since lignin is actually a class of different but related compounds, the different compounds will exhibit a range of reactivities. The delignification process will therefore consist of a large number of independent parallel

reactions and the overall reaction will have to be characterised by a wide range of difficult obtainable rate constants.

- c) The assumption of homogeneous reaction kinetics has yielded adequate results when used for simulation or control purposes in paper pulps, where the residual lignin is an important factor.

A very complex set of differential equations results if all the complexities of the delignification process are to be taken into account, giving an impractical model for simulation and control purposes. Although the theory for such a model has been developed, it has been concluded that use of homogeneous kinetics provides results that are just as accurate and is far more functional (Watson, 1992).

A number of investigations has been aimed at developing kinetics equations that can be used to simulate and optimise the sulphite delignification process. Yorston and Liebergott (1965) studied the kinetics of the pulping process in detail. In acid sulphite pulping the rate of pulping was found to be proportional to the partial pressure of sulphur dioxide.

$$-\frac{d[L]}{dt} = K(P_{\text{SO}_2})^n \quad (6-11)$$

This equation was best satisfied with a value of $n=0,75$. The activation energy was found to be 20,2 kcal. For bisulphite pulping the rate was proportional to the pH and was not substantially influenced by the bisulphite ion concentration. In this case, the activation energy was found to be about 36 kcal (Yorston and Liebergott, 1965).

Hagberg and Schöön (1973) followed a more fundamental approach and studied the different factors that influence the delignification rate. These factors were incorporated into a power type equation. They found the dissolution rate of lignin to be very dependent on both the pH and the content of combined sulphur dioxide at the start of the cook. They also found dissolution to be much higher at a high lignin content than at a low one, and concluded that the dissolution rate is also dependent on the lignin content of the wood phase. A definite temperature dependence was also found and from literature studies, it was concluded that the Arrhenius equation can be assumed. The rate equation was consequently written as follows:

$$r_L = k_L(T)[L]^a [HSO_3^-]^\alpha [H^-]^\beta \quad (6-12)$$

where k_L is the temperature dependent constant of the form:

$$k_L(T) = k_L^0 e^{-E_L/T} \quad (6-13)$$

The factor $[L]$ is the content of lignin in the solid phase, calculated as a fraction of the amount of uncooked wood. The units for r_L are kg lignin/s.100 kg wood. This form of the rate equation has been confirmed by Sloan (1982b).

Different experiments were conducted by Hagberg and Schöön, using spruce wood, in order to determine values for the exponential factors. However, satisfactory results couldn't be obtained by using the single rate equation as stated above. In order to improve the model, a transition point was introduced at a certain lignin content, with different parameter values before and after the transition point. The experiments were conducted at two different ionic strengths: 0,5 kmol/m³ and 1,0 kmol/m³. The values for the ionic strength of 0,5 kmol/m³ are of greater interest from a technical point of view and these values are shown in Table 6.3. A confidence interval for these values is within 95 %. The values obtained were compared to values obtained by other authors and it compared favourably (Hagberg and Schöön, 1973).

	[L] ≥ 12,4 %	[L] < 12,4 %
k_L^0	$(1,346 \pm 0,05) \times 10^{12}$	$(0,407 \pm 0,5) \times 10^{12}$
E_L	12500 ± 260	13400 ± 2500
a	$0,646 \pm 0,03$	$1,621 \pm 0,2$
α	$0,819 \pm 0,03$	$0,765 \pm 0,2$
β	$0,705 \pm 0,01$	$0,779 \pm 0,2$

Table 6.3: Lignin dissolution rate parameters at ionic strength 0,5 kmol/m³
(Hagberg and Schöön, 1973)

The units of time, temperature, lignin content and concentration used in the rate equation to obtain these values are second, Kelvin, % of wood and kmol/m³ respectively.

A comparison of the reaction order a on both sides of the transition point shows that this order is much lower at the high content than at the low content. At high lignin contents the reaction order is $a=0,65$, whereas at low lignin contents $a=1,6$. This significant difference in the reaction order was explained by different reaction steps involving various types of lignin that are rate determining at low and high lignin contents. Hagberg and Schöön also showed that lignin is less soluble at the end of the cooking process than at the beginning of the process. This difference ascribed to a large decrease in the pre-exponential factor k_L^0 . The high value of the reaction order

a at low lignin contents has an increasing effect on the dissolution rate, but the low value of k_L^0 dominates over the effect of the high reaction order.

The difference in lignin solubility was explained by topological reasoning, since the reactivity and accessibility of the lignin in different parts of the wood fibre may vary. For example, the lignin in the secondary wall may be different compared to the lignin in the middle lamella in these respects. (Hagberg and Schön, 1973)

A very important factor that was also investigated by Hagberg and Schön is the influence of hemicellulose on the lignin dissolution, by introducing a factor $[C]^b$ into the rate equation. The value didn't improve the fit and b was estimated to be as low as 0,1 and it was concluded that the influence of hemicellulose on the lignin dissolution is negligible.

Watson (1992) did similar kinetic studies on the wood used at SAICCOR and concluded that the form of the reaction rate equation used by Hagberg and Schön was indeed correct. However, much different values were obtained for the parameters in the equations. Watson also only used one set of parameters for all concentrations of residual lignin. The following values were found by Watson:

k_L^0	$1,5 \times 10^{18}$
E_L	32 704
a	2
α	1
β	1

Table 6.4: Lignin dissolution rate parameters found by Watson
(Watson, 1992)

The relatively large deviations in the activation energy in the Arrhenius temperature dependency were ascribed to the different methods used in estimating the concentrations of the hydrogen and bisulphite ions. The difference in the reaction order of the extent of delignification was attributed to the fact that only very low residual lignin concentrations were covered in Watson's study. This shift in reactivity was thought to be caused by two factors:

- Lignin consists of a heterogeneous mixture of compounds that exhibit different reactivities. During different stages of the delignification, different components will be broken down.

- The accessibility and composition of lignin in various parts of the fibre varies. These observations were also confirmed by the study of Proctor, Yean and Goring on the regional activity of lignin in wood fibres (Proctor *et al.*, 1967).

6.2.2. Kinetics of the cellulose hydrolysis reaction

All the possible cellulose reactions were mentioned above. Of these reactions, the only reaction of importance in acid sulphite cooking is the acid hydrolysis reaction, which reduces the average DP values of the cellulose molecules. The substitution and addition reactions are of importance in the tertiary processing of purified dissolving pulps, while the redox reactions are of importance during the bleaching process. For this reason, only the kinetics of the hydrolysis reaction will be discussed.

Since cellulose was originally defined as the more resistant part of the wood, little interest was shown in doing kinetic studies on the degradation of cellulose, and consequently, not much information is available on this subject. Furthermore, since pulping processes are normally used for the production of paper pulp, it is usually desired to keep the cellulose DP as high as possible and to limit the degradation of cellulose. This resulted in extensive studies on the rate of delignification and hemicellulose dissolution to determine the shortest possible cooking time to remove the unwanted lignin and hemicellulose in order to limit the cellulose degradation. The rate of cellulose degradation, wasn't important to know. However, from the discussion of the mechanism of the hydrolysis reaction, it can be seen that the reaction will be dependent on the hydrogen ion concentration. Rydholm (1965) showed that the reaction is also temperature dependent, according to the Arrhenius equation. A power type equation for the kinetics of cellulose hydrolysis can thus be written in the form:

$$r_c = k_c [H^+]^\delta \quad (6-14)$$

Watson (1992) indicated that the reaction was found to be first order in the hydrogen ion concentration, i.e. $\delta = 1$ in the above equation. Since the reaction is temperature dependent according to the Arrhenius equation, the temperature factor can be written in the following form:

$$k_c = k_c^0 e^{-E_c/RT} \quad (6-15)$$

Based on the research done by Sloan (1982a), Watson further proposed that the reaction rate be expressed as the rate at which cellulose links are broken, according to the following equation:

$$r_c = -\frac{dN}{dt} \quad (6-16)$$

where N represents the number of remaining linkages. However, since the hydrolysis reaction causes random cleavage of the cellulose polymers, these cleavages cannot be used directly in a kinetic model. Watson (1992) used the concept of *degree of degradation* (DD) which allows the DP reduction to be directly related to the number of cleavages and thus to the extent of the reaction. The degree of degradation is defined as the reciprocal of the DP, and this allows the reduction in DP to be related to the number of linkages broken, which is defined as the *degradation increase* (DI). The above relations can be expressed as follows:

$$DI = \frac{1}{DP_f} - \frac{1}{DP_0} = DD_f - DD_0 \quad (6-17)$$

(Watson, 1992)

Since the rate of hydrolysis was defined in terms of the number of remaining linkages, or $N = (1 - DI)$, the hydrolysis reaction rate can be written as:

$$r_c = -\frac{dN}{dt} = \frac{d(1 - DI)}{dt} = \frac{-d(DI)}{dt} \quad (6-18)$$

(Watson, 1992)

It is interesting to note that the number of remaining linkages doesn't play a role in the kinetic equation. However, it was shown in paragraph 6.1.2.1 that the cellulose DP decreases rapidly at the start of the cook, and that it reaches a constant degradation rate, up to a point where the degradation will stop completely, although the DP value hasn't dropped to one. As was discussed in paragraph 6.1.4, the pH normally decreases towards the end of the cook, that is, the hydrogen ion concentration increases. According to the kinetic equation suggested, this will result in the cellulose degradation starting off relatively slowly, and increasing towards the end of the cook. The reason for this will have to be found in the cellulose structure, which causes some of the cellulose to be more easily accessible to the chemical. This will result in the cellulose in the amorphous structure to be degraded first and will give a relatively high degradation rate. Once all of the amorphous cellulose has been degraded, the chemical will have to reach the crystalline cellulose for any further reduction in the DP. This will cause a drop in the degradation rate. The concept of the levelling-off degree

of polymerisation was discussed in paragraph 2.2.1. This observation can be ascribed to the crystalline nature of part of the cellulose that is not susceptible to acid hydrolysis. This implies that the number of remaining linkages must play at least some part in the rate of degradation and it is something that must be looked into.

The other possible cause for a degradation rate that doesn't agree with the proposed rate equation, can be protection of the cellulose by non-cellulosic substances. This will imply that the amount of lignin and hemicellulose left in the wood will also have to be taken into account. All these additional factors will make the model a lot more complicated. It is possible that the cook won't ever progress to the point where a constant degradation rate occurs, i.e. probably the point where the crystalline cellulose is starting to degrade, and that the proposed rate equation will still give good results.

To summarise the results obtained by Watson, the overall reaction rate equation for the degradation of cellulose will be given again.

$$r_c = k_c^0 e^{-E_c/RT} [H^+]^\delta \quad (6-19)$$

The following values were found by Watson for the parameters in the rate equation given above:

k_c^0	$7,68 \times 10^{14}$
E_c	33 867
δ	1

Table 6.5: Cellulose dissolution rate parameters
(Watson, 1992)

6.2.3. Kinetics of the hemicellulose hydrolysis

The problem of hemicellulose being an array of similar compounds is similar to the problems experienced with lignin. Once again, it will be possible to construct a model with detailed kinetics for all the different compounds of hemicellulose, but this will lead to impractically complex models. Therefore, hemicellulose is usually treated as a single homogeneous compound. Reasons for this are given by Watson (Watson, 1992):

- The exact structure of the polymers involved is unknown.
- The methods of analysis for the different polymers in the solid phase are specialised and extremely time-consuming.
- Analysis of the cooking liquor to determine reaction residues is not very instructive, as all the polymers eventually degrade to very similar compounds.

As was discussed in paragraph 6.1.2.2, the mechanisms and reaction of hemicellulose degradation are very similar to cellulose degradation. Kinetic studies showed that the rate of hemicellulose dissolution is independent of the combined sulphur dioxide concentration, i.e. this indicated that hemicellulose degradation is independent of the hydrogen sulphite ion concentration (Hagberg and Schön, 1973). However, the hydrogen ion concentration plays an important role in the dissolution of hemicellulose. It was also shown that the rate of dissolution of hemicellulose is very much dependent on the hemicellulose content in the wood phase, and that the rate is much higher at a high hemicellulose content than at a low one. It was finally shown by Hagberg and Schön that the hemicellulose dissolution also has an Arrhenius dependence on temperature.

All these factors suggested a power equation of the following form:

$$r_{\text{HC}} = k_{\text{HC}}(T)[\text{HC}]^d[\text{H}^+]^\gamma \quad (6-20)$$

with $k_{\text{HC}}(T)$ of the form

$$k_{\text{HC}}(T) = k_{\text{HC}}^0 e^{-E_{\text{HC}}/T} \quad (6-21)$$

This form of the rate equation was also confirmed by Sloan (Sloan, 1982c).

Similar methods to the lignin dissolution were used to determine the values of the parameters in the rate equation. The values found are given in Table 6.6.

k_c^0	$(1,261 \pm 0,67) \times 10^{11}$
E_c	14030 ± 1400
d	$2,542 \pm 0,13$
γ	$0,707 \pm 0,08$

Table 6.6: Hemicellulose dissolution rate parameters
(Hagberg and Schön, 1973)

The units of time, temperature, lignin and hemicellulose content and concentration used in the rate equation are again second, Kelvin, % of wood and kmol/m^3 respectively.

The relatively high reaction order with respect to the hemicellulose content was explained by the fact that the rate equation describes the entire dissolution process, including carbohydrates with quite different properties. At the beginning of the cook the decrease of the hemicellulose content is very high, whereas the decrease is very much lower at the end of the cook. If this process is to be described by one rate equation only, the reaction order of the hemicellulose content will be very high. Attempts were made to describe the dissolution with more than one rate equation, but much higher standard deviations were obtained (Hagberg and Schöön, 1973).

Once again, the influence of lignin on the hemicellulose dissolution was investigated and it was concluded that the lignin has very little influence on the dissolution rate and that the lignin content can be omitted from the hemicellulose rate equation.

The studies done by Watson (1992) confirmed the form of the kinetic equation. However, once again, the values obtained were different from the values reported in the literature. The following values were found by Watson:

k_c^0	$3,7 \times 10^8$
E_c	16 500
d	1
γ	1

Table 6.7: Hemicellulose dissolution rate parameters
(Watson, 1992)

Watson concluded that the values found in his studies weren't very accurate. The reason for this was that the analytical method used to measure the hemicellulose content of the pulp wasn't very accurate, since it was developed for bleached pulps and didn't work very well for unbleached pulp. However, since the hemicellulose content isn't a key variable in the pulping process, little attention was given to this problem.

6.2.4. Kinetics of strong acids formation

Although the formation of strong acids as such isn't of much importance to the cooking process, it is still important to know the rate of formation of the strong acids, since it changes the hydrogen ion and hydrogen sulphite ion concentrations during the cook. The concentrations of these ions are necessary for the modelling of the delignification, as well as the carbohydrate dissolution. The changes in these concentrations are not easily calculated from the rate of lignin dissolution, since there is no simple stoichiometric relationship between the amount of dissolved lignin and the amount of lignin sulphonic acid formed. Furthermore, strong acids are not only formed from lignin. Monosaccharides, especially, react with hydrogen sulphite ions to form α -hydroxysulphonic acids. However, the concentration of these acids and the strong inorganic acids like sulphuric acid and thiosulphuric acid are small in comparison to the strong acids formed from lignin. An additional sulphonation of the dissolved lignin sulphonic acid also occurs during the cook, but this reaction is assumed to be much slower than the primary sulphonation in the solid phase.

To make a calculation of the changes in the concentration of the actual ions during the cook possible, a kinetic investigation of the strong acid formation was carried out by Hagberg and Schöön (Hagberg and Schöön, 1974a), and the results were described with mathematical models.

The results of the experimental studies of Hagberg and Schöön show that temperature and concentrations of hydrogen ions and hydrogen sulphite ions influence the rate of formation of strong acids. It was also found that the formation of strong acids is closely connected to the dissolution of lignin during the first part of the cook and that the formation depends on the cooking conditions in the same way as does the lignin dissolution. During the latter part of the cook, where the delignification rate is low, there is a marked increase in the concentration of strong acids. This increase may be explained by the additional sulphonation of the dissolved lignin and by the formation of strong inorganic acids and other strong acids that do not originate from lignin. (Hagberg and Schöön, 1974a)

Different mathematical models were tried and tested by Hagberg and Schöön. No sufficient mechanistic model could be found; so regression equations were tried. The following equation gave the best results:

$$r_{SA} = \frac{k_{SA}(T)}{v} [SA^-]^n ([L]_0 - [L])^m [HSO_3^-]^b [H^+]^c \quad (6-22)$$

(Hagberg and Schöön, 1974a)

The parameter, v , in the equation is the liquor-to-wood ratio at the start of the cook.

The parameters found for this equation are shown in Table 6.8.

k_{SA}^0	$0,274 \times 10^5$
E_{SA}	10480
n	-0,430
b	0,625
c	0,554
m	1

Table 6.8: Parameters for the rate of strong acid formation
(Hagberg and Schön, 1974a)

This equation gave a standard deviation of $0,015 \text{ kmol/m}^3$ and was considered to be sufficient for modelling purposes. The units of measurement are the same as the units mentioned in the delignification reactions.

6.3. Main factors influencing the sulphite pulping process

There is a large number of variables that affect the sulphite pulping process. These include the wood species, cooking-liquor composition and conditions in the digesters. The most important of these factors are now discussed.

6.3.1. *Impregnation of wood with cooking chemical*

One of the most important requirements in chemical pulping processes is to ensure that the cooking chemical is uniformly distributed throughout the wood. Improper distribution of chemical in the chips leads to uncooked chip centres, high screen rejects, low pulp yield and high dirt count. Penetration is particularly important in sulphite pulping at low pH levels because sulphur dioxide can penetrate gas spaces in the chips ahead of the base and cause lignin condensation as the temperature is increased.

The impregnation of the chemicals into the wood can be considered to take place by two separate processes. The first is the mass flow of liquid and solute into the chips, while the second process is the diffusion of solute through the liquid-saturated chips. These two kinds of movement act under different forces. The movement of liquid into chips is governed by capillary forces and applied pressure, while the diffusion of chemical liquid-filled wood is dependent on the concentration gradient between liquor surrounding the chip and that inside the chip.

The rate of mass penetration of cooking liquor into wood depends on the physical properties of the cooking liquor, the wood species, the pressure differential, the length of the penetration path, the temperature, whether sapwood or heartwood is being penetrated, and the structural direction in the wood. The mass flow of liquid into wood can be accelerated by applying external pressure to the system to augment the natural capillary forces. In a digester this pressure can be applied as hydrostatic pressure by continuing to operate the filling pump after the digester is filled or by adding direct steam to the liquid-filled digester and controlling the pressure through the top relief valve. The rate of penetration of liquids into wood also increases with temperature, as a result of both the reduction of the viscosity of the penetrating liquor and also by the removal of resins and other deposits from the pit membranes, thus allowing freer passage of the liquid. The effect of temperature and pressure on the degree of

penetration of water into spruce chips is shown in Table 6.9. It can be seen that the pressure has a major effect on the water uptake and that temperature has a smaller but significant effect.

Penetration (%)						
Temperature (°C)	At 207 kPa		At 310 kPa		At 414 kPa	
	1 hr	4 hr	1 hr	4 hr	1 hr	4 hr
25	58	72	70	83	81	91
60	72	82	85	90	89	93
90	81	89	89	93	94	96

Table 6.9: Effect of temperature and pressure on the penetration of water into spruce chips
(Bryce, 1980)

The initial penetration will proceed more rapidly if the air is first removed from the chips. Small bubbles of entrapped air will greatly increase the resistance to the flow of liquids through the wood capillaries. Methods to remove air prior to immersing the chips in liquid are therefore frequently employed. The common method is to presteam the chips during the filling of the digester, either as part of the steam-packing operation or by a separate steam addition. It is important that atmospheric-pressure steaming continue until a temperature of 100 °C is reached, an indication that all the air has been displaced from both the chips and the surrounding vapour. At moisture contents of about 30% or higher (the fibre saturation point) there is sufficient water in the chip to displace all the air in the chip when it is vaporised. Chip steaming is more effective at or above this moisture level. If the digester is then filled with liquor at a temperature slightly below the presteaming temperature, water vapour will be condensed and a vacuum created that will draw the cooking liquor into the chip.

6.3.2. Effect of chip dimensions

Chip size has a significant effect on the uniformity of the impregnation of the chips and on the quality of the pulp produced in the sulphite pulping. It has been that penetration and diffusion take place at different rates in the three different directions of the wood structure. (Kollman and Côté, 1968) The mass flowrate is inversely proportional to chip length. Thus both chips thickness and length are of importance, since more rapid penetration will occur with smaller chips. However, the fibres in the wood are damaged during cutting due to both fibre shortening at the point of the cut and to compression damage in the area surrounding it. This fibre damage tends to increase when the chip length is short.

It was however found that the main pulp-quality parameters depend more on the thickness of the chips than the length, due to the more uniform penetration of thin chips (Smook, 1994). However, with conventional chippers it is only possible to control chip length. The chipper knife penetrates the wood until the shear force is great enough to split the wood. As the length setting is increased, more shear is required to bring about this splitting. For this reason, increased length is usually accompanied by increased thickness. However, knots, grain and other gross morphological features, as well as chipper variables have a major effect on these forces, and conventional chips vary widely in thickness.

From the above discussion, it can be seen that the optimum chip size is a compromise between the better penetration and quality obtained by thinner chips, but the resulting loss of strength due to damage to the fibres by the chippers.

6.3.3. Effect of temperature

Temperature mainly affects the sulphite process in three ways:

1. Decrease the hydrogen ion concentration and thus increases the pH.
2. Decreases the solubility of sulphur dioxide thereby increasing the SO₂ pressure above the cooking liquor.
3. Increases the rate of lignin dissolution and cellulose degradation.

Two aspects of temperature will be considered: the rate of rise to maximum temperature and the maximum temperature itself. The rate at which the maximum temperature can be safely approached is dependent on both the effectiveness of chip penetration by the cooking reagent and the nature of the cooking liquor. In acid sulphite pulping, free sulphur dioxide can enter the gas phase and move through the wood structure more rapidly than the base, and produce high local acidity in the centre of the chip, as was discussed earlier. Under these conditions lignin condensation reactions occur at elevated temperatures, and these condensation reactions consume the active sites in the lignin molecule where sulphonation normally occurs. (Bryce, 1980) The condensed lignin can no longer be dissolved by the sulphite liquor and uncooked fragments of wood remain after the completion of the cook. Thus, for acid sulphite pulping a heating cycle must be used that allows for full penetration of the liquor containing the bisulphite and base before the critical temperature for lignin condensation is reached. This critical temperature is generally found to be in the range of 110 to 120 °C. Thus the practice for many years in the sulphite industry was

to use a very slow rise to temperature. This led to long, slow cooking schedules. With modern penetration treatments the heating schedules can be speeded up to permit the cook to be carried out in a much shorter time. With the use of presteaming, pressure impregnation, and forced liquor circulation, heating times of 2 to 3 hr to maximum temperature can be used without lignin condensation (Bryce, 1980). Since the base then permeates all portions of the chip and as elevated temperatures are reached, the sulphonation reaction occurs in preference to the condensation reactions.

The maximum temperature used in acid sulphite pulping is determined by the quality of pulp desired, the digester pressure limitations, and the available digester time. The cooking temperature affects the rate of removal of hemicellulose more than that of the other major components, cellulose and lignin. Thus cooking at low temperature favours hemicellulose retention, while cooking at high temperature favours dissolution. Pulps for use in glassine and greaseproof grades, which require high hemicellulose content to provide a high level of bonding, transparency, and easy beating, are usually cooked in the range of 125 to 135 °C. Pulps for dissolving grades, which must have low hemicellulose content, are cooked at about 150 °C. Acid sulphite paper-grade pulps are normally cooked between these extremes.

Decreased maximum cooking temperature gives higher retention of hemicellulose and reduced degradation of cellulose, and thus results in increased pulp yield. Since yield is an important consideration in the economics of pulping, this indicates that digesters should be operated at quite low temperatures. However, from the standpoint of productivity of the digesters, it is also important that the cooking time should not be extended too long and so both yield and production rate must be considered in choosing the appropriate cooking temperature in a particular situation.

It was shown earlier in this chapter that the kinetics of sulphite delignification obey the Arrhenius equation:

$$\ln k = \ln Z - \frac{E}{RT} \quad (6-23)$$

with k the rate constant of the reaction, E the activation energy and Z a constant. It was found that the rate of the reaction approximately doubles for each 10 °C rise in the maximum cooking temperature (Yorston and Liebergott, 1965).

6.3.4. *The effect of pressure*

The main aspect of operating pressure in the sulphite cooking process is its use to regulate the amount of free sulphur dioxide in the system. This controls the partial pressure of SO₂, which in turn fixes the free SO₂ concentration and pH in the liquor during the cooking period, both of which are important pulping parameters. Digester pressure limitations generally control the maximum pressure that can be used in a particular mill. In the calcium-based systems, high free sulphur dioxide concentrations are necessary in order to prevent calcium sulphite precipitation as the temperature is raised. In order to maintain this high free sulphur dioxide concentration throughout the cook, the pressure must be maintained sufficiently above the steam pressure of the liquor to prevent relieving excessive amounts of sulphur dioxide.

6.3.5. *Effect of chemical composition*

6.3.5.1. THE PH OF SULPHITE LIQUOR

When a base is added to a solution of sulphur dioxide in water, an equilibrium is established between the constituents, as shown below, using sodium as the base:

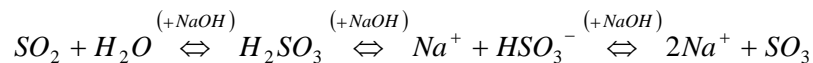

The composition is normally expressed in terms of total, free and combined sulphur dioxide, as defined previously, and pH.

Probably the most important parameter governing the rate of the bisulphite cook is the initial pH. The pH varies during the cooking cycle due to the effects of temperature, SO₂ relief and acid generated during the cooking process. Thus, for a full understanding, it is important to know not only the initial pH of the liquor, but also the changes in the pH as the cook proceeds. For many years, this could be only achieved by withdrawing a series of cooled samples from the digester. Although pH electrodes have been developed, it is still very expensive and is not generally installed on every digester. Bryce (Bryce, 1980) has suggested that the pH could be controlled during a cook by installing a hot pH sensor in the circulating line to regulate the rate of sulphur dioxide relief. The course of pH, measured both cold and hot, during a typical acid sulphite cook, is shown in Figure 6.7. The hot pH values are 1 to 2 units higher than the cold values in this range. The temperature coefficient of pH in acid sulphite

pulping liquors is about 0,011 to 0,012 pH units/°C. The temperature coefficient is dependent on the wood species, type of base and concentration. It is less during wood digestion than when the liquors are heated alone, probably due to the buffering effect of the acids released during cooking.

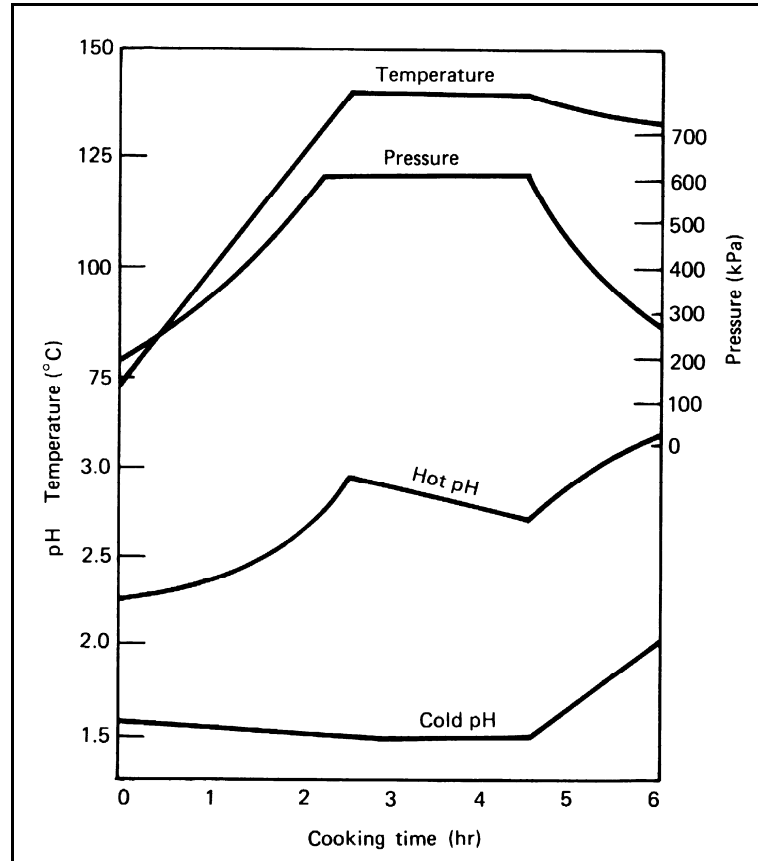

Figure 6.7: Temperature, pressure, and hot and cold pH during a typical acid sulphite cook
(Bryce, 1980)

The quality and yield of the pulp produced is also affected by the pH of the cooking liquor. Pulp yields in the bisulphite pH region are higher than those obtained at lower values because more hemicellulose is retained. The defibration point - that is the yield or Kappa number giving 1% screenings after disintegration by standard defibration treatment - is also higher at the bisulphite pH. This permits the system to be operated at higher Kappa number levels, giving still further gains in yield. Unbleached brightness also reaches a maximum at the bisulphite pH. For a given pH level, the brightness is higher for lower cooking temperatures. For softwoods, pulp-strength properties also reach an optimum when the initial pH of the cooking liquor is about 4. For hardwoods, the strength from bisulphite cooking is higher than that for acid sulphite cooking, but the strength continues to increase as the pH rises to the 5 to 7 range. (Bryce, 1980)

6.3.5.2. COMBINED SULFUR DIOXIDE

The combined sulphur dioxide is important in sulphite pulping in two different ways: its concentration in the initial liquor and its weight ratio to wood. The concentration mainly affects the penetration, which has already been discussed. The charge on wood, on the other hand, mainly affects the course of the cook. It determines the rate at which the concentration is depleted and thus affects the rate of pulping. The more fundamental parameter is the bisulphite ion concentration, which is twice the combined SO_2 level for solutions containing no monosulphite. Increasing the level of combined SO_2 in a bisulphite cook increases the yield at a specific Kappa-number level and increases the brightness of the resultant pulp. The tensile strength of the pulps increases with increasing combined SO_2 but tearing resistance decreases. The effect of combined SO_2 on some of these properties is illustrated in Figure 6.8 which shows that combined SO_2 has a significant effect at the lower levels of charge on wood, but that the effect diminishes at higher charges. This demonstrates the importance of using the optimum charge in pulping operations since the gain from using additional cooking chemical diminishes at the higher addition levels. The use of excessive amounts of combined SO_2 in bisulphite pulping results in substantial chemical costs for systems without recovery, and an overloading of the recovery and liquor regeneration equipment for systems with recovery. In addition, excessive bisulphite enters into autocatalytic decompositions involving thiosulphate, which can deplete the bisulphite concentration and cause burnt or black cooks. The combined SO_2 requirement for pulping varies with wood species and the desired yield level, but for chemical pulps 7 to 10% combined SO_2 on wood is normally the optimum charge. The combined SO_2 requirement would be in the lower part of this range for spruce and aspen, while that for pine and dense hardwoods would be at the upper end. High-yield bisulphite systems require less chemical, although care must be taken not to reduce the level too far because this increases the refining-power requirement for a given yield.

The bisulphite ion plays an active part in lignin sulphonation, and under normal pulping conditions a certain minimum level of bisulphite is required. On the other hand, if the combined SO_2 level is too high, the rate of pulping is retarded, probably because of the lower acidity due to the lower ratio of free to combined SO_2 . In a study of the effect of combined SO_2 on acid sulphite pulping, it was found that for pulps cooked beyond the defibration point, brightness was increased by increasing combined SO_2 level (Bryce, 1980). Other properties were not affected. In high-yield pulping, both brightness and pulp strength improve, and refining-power requirement decreases with increasing charge of base.

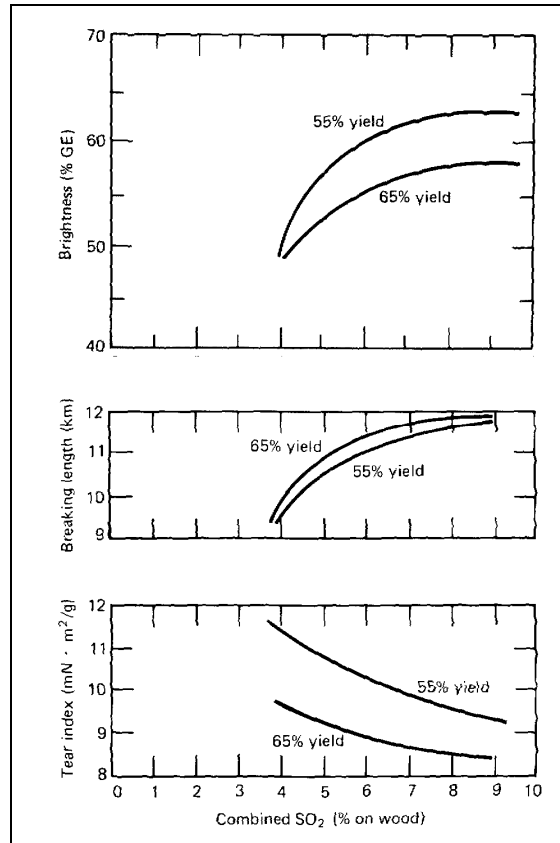

Figure 6.8: Effect of combined SO₂ on pulp properties (Bryce, 1980)

6.3.5.3. TOTAL AND FREE SULFUR DIOXIDE

Of the four composition parameters normally considered in connection with sulphite cooking liquors, namely total SO₂, free SO₂, combined SO₂ and pH, only two need be specified, the other two are then fixed for all practical purposes. In the foregoing discussion on the effect of composition on sulphite pulping, a detailed discussion of the effects of pH and combined SO₂ has been given because they can be related to the hydrogen ion concentration and the bisulphite ion concentration, usually considered to be the most important parameters in sulphite pulping. Only a few further points relating to the total and free SO₂ content are of significance for this discussion.

In acid sulphite pulping, the total SO₂ charge is less important than in bisulphite pulping because the digester is charged with an excess of sulphur dioxide and the unused portion relieved for reuse in subsequent cooks. In acid sulphite pulping, total SO₂ concentration normally varies between 5,5 and 8%. The free SO₂ has been shown to have a significant effect on the rate of acid sulphite pulping, although its influence is probably mainly due to the accompanying increase in hydrogen ion concentration. (McGovern, 1979)

6.3.6. *Effect of liquor-to-wood ratio*

For the calculation of the liquor-to-wood ratio, the weight of all liquid in the digester should be used, including the initial liquor charge, wood moisture, and any steam condensed during either presteaming or direct heating of the digester, less any withdrawal in the form of relief. The liquor-to-wood ratio varies at different point of the cook as direct steam is added and wet relief is withdrawn. In practice, the important value is the net liquor-to-wood ratio after side relief, and an approximate value for this can be obtained by adding the wood moisture to the average of the liquor pumped to the accumulator per cook.

The liquor-to-wood ratio during impregnation must be sufficient to immerse all the chips. The amount of liquor required to do this will depend on the wood density and chip packing, but will usually be about 5 to 1. Once the impregnation has been completed, the ratio can be lowered by side relief so that there is less liquor to be heated to the cooking temperature, thereby reducing the steam requirement. Sufficient liquor must remain in the digester to maintain circulation. The liquor-to-wood ratio after side relief is usually 3,0 or 4,0 to 1 depending mainly on the level of the collection strainers in the digester. For a given chemical charge on wood, the best results can be obtained by filling the digester with a relatively concentrated liquor during the impregnation period and then withdrawing down to a low final liquor ratio. The high liquor concentration during the impregnation stage gives a high driving force for diffusion, resulting in excellent penetration of chemicals and a lower level of screen rejects (McGovern, 1979).

6.3.7. *The effect of wood species*

Spruce, balsam fir, Western hemlock and poplar have traditionally been the preferred species for acid sulphite pulping. The limitations in regard to other species and the intolerance to bark have been mentioned. These limitations apply particularly to those species containing phenolic constituents, which can interfere with the delignification reactions. It was found that two substances in pine heartwood, shown in Figure 6.9, termed pinosylvin and pinosylvin monomethyl ether, inhibited acid sulphite pulping (Rydholm, 1965). When these materials were removed from the heartwood by extraction with alcohol, the wood pulped normally. Conversely, when spruce was impregnated with pinosylvin or other phenols, it could not be pulped. Phenolic materials that are found in other wood species can play a similar role. For example, it has been found that a flavonone present in Douglas fir heartwood is responsible for the resistance of this species to acid sulphite pulping (Bryce, 1980). Similar phenolic

materials, called flavotannins, are found in the bark. Under the acidic conditions of the normal acid sulphite cook, these phenols condense with the lignin in the wood, causing it to become cross-linked and blocking many of the reactive sites normally available for sulphonation. The resultant complex high-molecular-weight polymer is no longer solubilised by the acid sulphite solution.

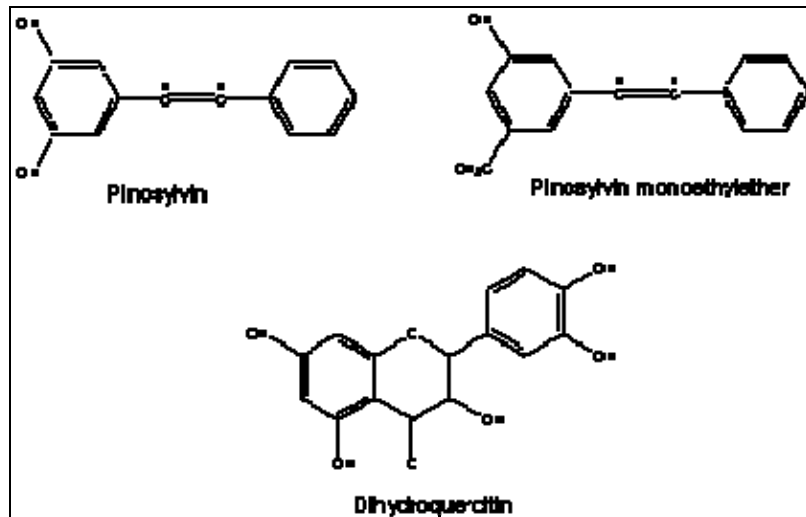

Figure 6.9: Wood constituents that inhibit sulphite pulping
(Bryce, 1980)

Some improvement can be obtained by replacing the calcium base with a soluble base, and using a liquor of higher than normal SO_2 concentration (Rydholm, 1965). Better results can however be obtained with the bisulphite process. At the pH levels used in this pulping process, the condensation occurs much more slowly, while the initial sulphonation reaction is accelerated because of the higher bisulphite concentration. Outer bark is not pulped by any of the sulphite processes and relatively bark-free wood is still a requirement for sulphite pulping.

Dense hardwoods are difficult to pulp with calcium acid sulphite because the density of the wood is very high and the volume available for the liquid within the chip structure is limited. High combined SO_2 concentrations are required in the initial liquor in order to carry out the sulphonation in the early stages. These concentrations are difficult to achieve with calcium. Dense hardwoods are pulped more efficiently using the soluble-base liquors of high combined SO_2 concentration, such as the bisulphite process. Another difficulty in pulping hardwoods is that their defibration point is only reached at a relatively high degree of delignification compared to softwood. This is due to fact that that in hardwoods a higher proportion of the lignin is in the middle lamella, and correspondingly less in the cell wall.

6.4. Summary

It should be clear that the acid sulphite process, just like all the other pulping processes, is a very complicated reaction system. Many different reactions take place simultaneously due to complex nature of the wood constituents. The rate of these reactions will depend on the exact chemical compounds that make up the components simply known as lignin, hemicellulose and cellulose, as well as on the position of the components in the cells. The reaction rate equations were therefore simplified to yield a single rate equation for each of the major components of wood, as well as a rate equation representing the formation of strong acids during the sulphite cooking process. Simplifications like these are vital for the modelling of the reaction system, since it would be virtually impossible to represent all of the different possible chemical components and their possible reactions.

All of the reaction rates depend on the bisulphite and hydrogen ion concentrations in the reacting liquor. The cooking liquor for the acid sulphite process is obtained by dissolving an excess of sulphur dioxide in water. The following equilibrium is established, yielding the hydrogen and bisulphite that is responsible for all of the chemical reactions taking place during the acid sulphite process.

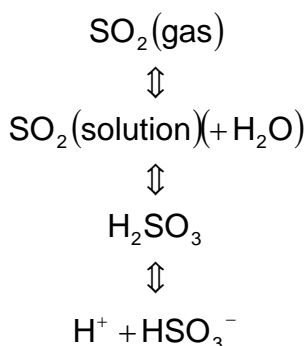

It was found that the dissociation constant for the sulphurous acid is very high, and that the majority of the dissolved sulphur dioxide will be present in the form of bisulphite.

The following four rate equations were given by Hagberg and Schön (1974b) and by Sloan (1982a) to describe the reactions in the sulphite pulping process and these rate equations have been confirmed by several other authors since.



Lignin:
$$-\frac{d[L]}{dt} = k_L^0 e^{-E_L/RT} [L]^a \cdot [\text{HSO}_3^-]^\alpha \cdot [\text{H}^+]^\beta \quad (6-24)$$

Hemicellulose:
$$-\frac{d[HC]}{dt} = k_{HC}^0 e^{-E_{HC}/RT} [HC]^d \cdot [\text{H}^+]^\gamma \quad (6-25)$$

Cellulose:
$$-\frac{d[C]}{dt} = k_C^0 e^{-E_C/RT} [\text{H}^+]^\delta \quad (6-26)$$

Strong Acids:
$$\frac{d[\text{SA}]}{dt} = \frac{k_{SA}(T)}{\nu} [\text{SA}^-]^n ([L]_0 - [L])^m [\text{HSO}_3^-]^p [\text{H}^+] \quad (6-27)$$

Chapter 7:

Modelling techniques for batch processes

The importance of an accurate model for the control of the batch pulp digesters was stressed in previous chapters. Different modelling techniques have to be considered in order to try and find the most appropriate technique for use in the controllers.

At first it would seem as though the modelling of batch reactors wouldn't be that much different from continuous reactors. Like batch processes, models of continuous processes also contain dynamic elements and in the majority of the processes, also some non-linear elements. The biggest difference however between batch processes and continuous processes, is that continuous processes are normally operated at a single steady state. The main purpose of a model of a continuous process will be to make predictions at or in the neighbourhood of the steady conditions under which the plant normally operates, thus more attention can be concentrated on this restricted area. The requirements placed on the model of a batch operation will be somewhat more rigorous, since it will have to describe the behaviour of the system over the whole range of conditions encountered in the batch process. (Rippen, 1983) These may vary widely from the beginning to the end of the batch process.

Furthermore, because continuous processes are operated near some steady state, the model can be linearised around that steady state. Batch processes on the other hand are operated over a much wider range of conditions and the linearisation can't be done at one single state. Most of the batch processes are inherently highly non-linear and it is usually not possible to linearise it at all. However, since the batch processes are always operated in the dynamic range, there are often little sense in attempting to linearise the model.

Other difficulties are also mentioned in the literature. One of the difficulties that is often associated with batch process, but which cannot be generalised, is the difficulty in measuring the values of important variables. This is because batch processes are often used for the production of specialised products, like polymers. Inferred

measurements of the properties in question are often made. However, because no flow takes place, it is often impossible to take any measurements, as is the case in the batch pulp digesters. This makes the verification of any model very difficult.

Because of this, the modelling of batch processes is a field for much study and new techniques of deriving a model directly from process measurements are needed. Frequency analysis from step testing is not possible on batch processes and other similar techniques are needed to easily obtain a model over a batch process. The use of artificial intelligence plays a progressively more important role in batch model development.

A very important field related to batch modelling concerns the modelling of an entire plant that uses batch processes. This is very important for scheduling purposes, where the synchronisation of concurrently running processes must be done. However, the modelling of the entire plant starts at the understanding and modelling of the individual units.

An aspect in the simulation of entire batch plants that gets a lot of attention by the developers of simulation software, is the so-called hybrid nature of batch processes. A batch chemical plant is a typical example of a combined continuous-process and discrete-event system. For example, in many batch-reaction processes human operators still handle the progress of work. They intervene in the current process to maintain the production and time schedule of work. On the other hand, chemical reactions, which depend on both the material and energy balance equations, progress constantly in the chemical reactor. The continuous nature of the chemical process will always be interrupted at the end of the process, when the previous batch is unloaded and a new batch loaded.

For the plant described above, the chemical processes are represented by differential equations with some algebraic equation constraints, and the human intervention is described by the discrete event. The simulation of the continuous process is done to determine the values of the process variables by integrating the state equations. The state equations are represented by a set of differential equations with respect to the state variables such as the concentration of reactants and temperature in the reactor. On the other hand, a discrete event is defined as an instantaneous discrete-state change. A continuing activity has generally both a starting event and ending event. In the discrete event system, only the times at the occurrence of the state changes have meanings. The simulation of the discrete event is done to advance the events along in the time sequence. The events are usually executed according to a schedule table that contains entries with the occurrence time, the event name and other attributes such as the line number of the plant. When the time of the discrete event in the table

coincides with the simulation clock, the corresponding event is taken out from the table and executed. (Akatsuka *et al.*, 1997)

Hanish (1994) identified three levels of discrete control necessary in a batch plant and this gives an indication of the different discrete events in a normal batch plant. The levels are:

- The single control level for the safe operation of the single process unit
- The sequence control level for the control of the sequence of operations in each process unit
- The co-ordination control level for the co-ordination of parallel processes in a batch production plant

Because of the difficulties in modelling a batch process, many batch processes have been operated without mathematical modelling for decades and today it is a combination of physical and empirical modelling that finds growing acceptance in industry. Terwiesch *et al.* (1994) did a survey among process engineering experts who are involved in batch processing and different countries by means of a questionnaire. Almost all of the respondents expressed the view that an exact kinetic model, as assumed to be available for most optimisation methods, is only rarely developed. This is due to economic considerations, as the potential benefit from improved operation of a possible short-lived and small-volume product must be balanced against a prolonged time-to-market and the sometimes excessive cost of model development. The effort for building a useful kinetic model that is still valid only for a limited range of operating conditions often exceeds one man year, which agrees with the observation stated by Juba and Hamer (1986). However, two of the respondents indicated that through the use of modern measurement and modelling tools they had only recently experienced a significant reduction of this effort, making model-based techniques significantly more attractive. Still, as many external influences, such as impurities, are unmeasured, the kinetic model may yield inaccurate results without obvious reason.

Several respondents indicated that even for modelling runs in industrial development laboratories the reproducibility was often not better than 5%, and typically worse on a full-scale production vessel (Terwiesch *et al.*, 1994). Also, the range of model validity may significantly constrain the range over which a model-based optimisation of operating conditions could be performed, especially for temperature optimisation. Models providing physical insight into the process were preferred to black-box models by almost all respondents. After the model building, additional problems can be associated with the scale-up from bench-scale to full-size production vessel, which the respondents said was relatively straightforward only for single-phase liquid homogeneously catalysed reactions, but usually quite involved for others. It should be

noted that many current industrial batch processes are not formally modelled, but are operated using heuristic process understanding. This knowledge is difficult to access, even with rule-based approaches and expert systems, as the operator is often not willing to communicate information that he considers a type of personal job insurance (Terwiesch et al., 1994).

Summarising the above, it can be said that any mathematical model of an industrial batch reactor suitable for finding the best operating strategy contains a large number of simplifications and inaccuracies when compared to the real plant. This means that the outcome of the batch may be subject to inter- or intra-batch variations and disturbances not covered or explained sufficiently by the process model. These variations and disturbances can either be ignored or can be dealt with semi-empirically by treating them as uncertainties described by a suitable model. (Terwiesch *et al.*, 1994) Generally, there is little difference in modelling continuous and batch processes, apart from the omission of some flow terms. The most important differences from a modelling point of view that have been discussed were:

- A batch process doesn't have a steady operating state around which the model can be developed and tested.
- Linearisation of a continuous model is done around the steady operating point, and since a batch process doesn't have such a steady state, linearisation of the batch model is usually not possible.
- The operation of a batch process involves both continuous progress and discrete events. This hybrid nature of the batch process has to be incorporated into the model.
- The individual batch units are usually part of a bigger plant involving similar units run in parallel. These units are operated according to a scheduling algorithm that has to be considered as well during the modelling of the individual units.

Three modelling techniques that can possibly be used in the modelling of the batch pulp digesters, were identified. The techniques are:

- Fundamental modelling from first principles.
- Modelling using neural networks.
- Empirical modelling from experimental data.

The principles of all of these techniques will be investigated, as well as the possibility of using the techniques in the modelling of the batch pulp digester. The most suitable technique will be chosen and will be used in Chapter 8 to develop a model for the digester. The techniques will consequently be discussed quite generally and applied to the digester in Chapter 8.

7.1. Modelling from first principles

In many ways the fundamental modelling techniques for continuous and batch processes are the same. However, because of the nature of the batch process, some of the flow terms will be omitted. Fundamental modelling techniques require a good knowledge of the process and in reactors with very complex reactions and kinetics, it is often not possible to build a fundamental model of the reactor, because of all the uncertainty.

If the conditions of the batch at any instance of time can be regarded as homogeneous, as, for example in an ideally mixed reactor, then the modelling can be expected to be relatively straightforward even if many characteristics of the batch change substantially with time. It will be necessary to model any reaction processes taking place uniformly throughout the batch and any transport processes taking place at the boundaries. A representative state of the batch at any time is defined by point measurements or samples taken anywhere within the batch. This measured state can be used immediately for model development and related to the rate of progress of the reactions or other processes taking place. Of course, difficulties may still be encountered, for example with complex kinetics, particularly when intermediates are postulated which cannot be measured. However, the form in which the behaviour of a uniform batch should be represented is generally clear even if the details of the model may require substantial effort to elucidate. (Rippen, 1983)

A much more difficult situation is encountered when the contents of the batch is not homogeneous since measurements within the batch are then not generally representative. To describe the state of the system at any time some model must be available to characterise the non-homogeneities. These non-homogeneities may range from concentration or temperature gradients in an otherwise uniform phase through systems of fluids containing particles of fixed size to multi-phase systems such as immiscible liquids or crystallisations in which the size distributions of the different phases are changing as the batch progresses. The problems of modelling such systems are clearly much more severe than for homogeneous systems. When only modest departures from uniformity are encountered, such as could, for example, be characterised as incomplete mixing in a single phase system, the methods used to describe such phenomena in continuous systems can often be adapted to the batch case. For example the concept of the residence time distribution is by definition not

applicable to a batch operation in which no material flows in or out. However, extensions of the residence time concept to the two environment models often used to characterise incomplete mixing can also be used to characterise incomplete mixing in batch operations. When large excursions from complete mixing occur even in otherwise homogeneous systems more physically based models, such as those incorporating concepts of turbulent diffusion, may be needed. At the other end of the scale of model complexity called upon to describe non-homogeneous systems are, for example, heterogeneous polymerisation systems in which not only the kinetics, but also the interactions between the phases are very complex. (Rippen, 1983)

The primary objective of the modelling of the process for control purposes is to relate the controlled variables to the disturbances and the manipulated variables. However, during the development of a fundamental model, the most important consideration will be the development of a completely specified model. This requires that every variable in the process has to be accounted for, i.e. there must be some way of calculating or predicting every variable. The main requirement for a complete and usable fundamental model is that the number of variables in the system equals the number of equations in the model. The difference between the number of variables and the number of equations is known as the degrees of freedom of the process. The degrees of freedom can formally be defined as the independent variables that must be specified in order to define the process completely (Stephanopoulos, 1984). This can mathematically be expressed as follows:

$$f = V - E \quad (7-1)$$

In order to have a completely determined process, the number of degrees of freedom of the process should be zero. The possible sources for equations were given in paragraph 7.1. However, if these equations are not sufficient to completely describe the process, there are two sources that provide the additional equations needed to reduce the number of degrees of freedom to zero.

1. The external world, which specifies the values of certain input variables. The external world implies everything outside the process that can determine the value of the input variables, such as:
 - The general surroundings influencing the operating conditions
 - An up-stream unit that feeds the process
 - A down-stream unit when the outflow of the process is a manipulated inflow for the down-stream unit.
2. The control system, which imposes certain relationships between the controlled outputs and the manipulated inputs (feedback) or between the measured disturbances and the manipulated inputs (feedforward). Since a

system shouldn't be overspecified either, a general control principle can be stated as:

The maximum number of independent controlled variables in a processing system is equal to the number of degrees of freedom minus the number of externally specified variables.

(Stephanopoulos, 1984)

The theory of the degrees of freedom of a process determines that every variable in the process has to be accounted for. This can either be done by an equation inferring the value from the values of other variables, by making certain assumptions or by controlling the variable according to a known algorithm.

Luyben (1990) pointed out the danger of developing a model that includes every phenomenon down to microscopic detail, since it will result in a model so complex that it would take a long time to develop and might be impractical to solve. Some simplifying assumptions will always be a part of the modelling process and an engineering compromise between a rigorous description and getting an answer that is good enough is required.

The basis for fundamental models is the fundamental physical and chemical laws, such as the laws of conservation of mass, energy and momentum. These conservation equations are used in their general form with time derivatives included. There are three conservation equations that are usually applied in the modelling of chemical plant, namely the total continuity equation or the mass balance, the component continuity equations or the component balances and the energy equation. The general form of these equations will be given.

➤ Total continuity equation (Mass balance)

$$\left[\begin{array}{c} \text{Mass flow} \\ \text{into system} \end{array} \right] - \left[\begin{array}{c} \text{Mass flow} \\ \text{out of system} \end{array} \right] = \left[\begin{array}{c} \text{time rate of change} \\ \text{of mass inside system} \end{array} \right] \quad (7-2)$$

This is the principle of conservation of mass in a system. For batch processes, the mass balance is seldom of any use, since there is no flow taking place into or out of the system. Although the circulation flow for the batch pulp digester can be modelled with the mass balance, little will be gained, since the flow rate of this stream will be the same into and out of the system, assuming that very little accumulation can take place inside the heat exchanger and circulation line.

➤ Component continuity equations (Component balances)

$$\begin{aligned} & \left[\begin{array}{l} \text{Flow of moles of } j^{\text{th}} \\ \text{component into system} \end{array} \right] - \left[\begin{array}{l} \text{Flow of moles of } j^{\text{th}} \\ \text{component out of system} \end{array} \right] \\ & + \left[\begin{array}{l} \text{Rate of formation of moles of } j^{\text{th}} \\ \text{component from chemical reactions} \end{array} \right] = \left[\begin{array}{l} \text{time rate of change of } j^{\text{th}} \\ \text{component inside system} \end{array} \right] \end{aligned} \quad (7-3)$$

Unlike mass, chemical components are not conserved. Therefore, a reaction term is included in the system, since a chemical reaction will increase or decrease the number of moles of an individual component in the system. For the batch process, the flow terms in the equation will again be omitted. The changes in the concentration of the components in the system will only depend on the reactions taking place. The rate of change of the components due to the reactions taking place will have to be modelled and the kinetics of the reactions must be known for this. The kinetics of the acid sulphite process have been discussed in Chapter 6. It can be seen that the kinetic equations, for example equation (6-12), were given in a form that calculate the rate of change of the components and can be used directly in the component balances.

➤ Energy equation

$$\begin{aligned} & \left[\begin{array}{l} \text{Flow of internal, kinetic and} \\ \text{potential energy into system} \\ \text{by convection or diffusion} \end{array} \right] - \left[\begin{array}{l} \text{Flow of internal, kinetic and} \\ \text{potential energy out of system} \\ \text{by convection or diffusion} \end{array} \right] \\ & + \left[\begin{array}{l} \text{Heat added to system by} \\ \text{conduction, radiation and} \\ \text{reaction} \end{array} \right] - \left[\begin{array}{l} \text{Work done by system on} \\ \text{surroundings (shaft work} \\ \text{and PV work} \end{array} \right] \\ & = \left[\begin{array}{l} \text{Time rate of change of internal, kinetic} \\ \text{and potential energy into system} \end{array} \right] \end{aligned} \quad (7-4)$$

As in the component balances, heat or energy can be consumed or generated by a chemical reaction and therefore a reaction term has to be included. In addition, the system can do some work when the volume changes, leading to a work term in the balance. Since the volume of the digester will not change, the work term in this equation can be omitted. However, for the energy balance, the flow terms cannot be omitted, since the energy of the hot circulation stream flowing into the digester will be higher than the energy of the cold stream flowing out off the digester. The difference in the energy of these two streams will be equal to the heat added to the circulation stream by the steam flow to the heat exchanger. The heat of reaction will depend on the reaction rate and the difference between the specific heats of the products and reactants in the reactions.

From the continuity equations, it may seem as if the system can be completely specified by only these three equations, together with the kinetic equations. However, in order to calculate the reaction rate, it will be necessary to know the concentration of the reagents at the reaction site. In the case of pulping process, the important reactions concerning the degradation of the wood, will take place inside the wood chips. The transport equation will be necessary to model the concentration of the reacting chemicals inside the wood chips. The transport equation will also be used to model the flow of heat in the wood chips, as well as through the digester wall. The two important transport equations will be mass transport or diffusion, as well as heat transport, or conduction. The normal form of the transport equations will be a driving force, divided by some kind of resistance. For the mass transport, Fick's law of diffusion will be used. The equation for the molar flux for a component A will look as follows:

$$N_A = -D_A \frac{dC_A}{dz} = k_L \Delta C_A \quad (7-5)$$

Similarly, Fourier's law for thermal conductivity will be used to model the heat flux through the wall of the reactor. This states that the heat flux, q , through the reactor wall can be calculated as follows:

$$q = -k_T \frac{dT}{dz} = h_T \Delta T \quad (7-6)$$

The transport equation will model the flow of chemicals from the bulk of the liquor into the wood chips. However, the concentration of the chemicals in the liquor phase must also be modelled. The composition of the reaction liquor in the acid sulphite process was discussed in paragraph 6.1.4. The importance of the equilibrium of the dissolved SO_2 between the gas and liquor phases, as well as the equilibrium of the reactions in equation (6-3) can clearly be seen. The reaction mixture is formed by an equilibrium reaction of sulphurous acid dissociating to form bisulphite and hydrogen ions. The sulphurous acid will be formed by sulphur dioxide being dissolved in water. Another equilibrium will exist between dissolved and free sulphur dioxide in the gas phase above the liquor. The equilibria are often expressed in terms of a temperature dependent constant that represents the ratio of the concentration of the component in question between the two phases. As an example, the equilibrium constant for the equilibrium that exists between the concentration of the free sulphur dioxide gas and the dissolved hydrogen and bisulphite ion concentrations according to equation (6-3), is shown below.

$$K_{\text{SO}_2} = \frac{[\text{H}^+][\text{HSO}_3^-]}{[\text{SO}_2]}$$

Various techniques for expressing the temperature dependence of the equilibrium constants are used. The values for the equilibrium constant can for example be given in a table or graph, giving the values of the constant at different temperatures.

It was mentioned at the beginning of this chapter, that batch processes are often modelled as hybrid systems, in other words modelling it as a combination of a continuous and discrete system. Most of the authors that examined the modelling of a batch plant as a hybrid system used fundamental modelling techniques to simulate the continuous state of the plant. (Akatsuka *et al.*, 1997)

From the discussion above, it can be seen that a lot of detail is necessary to define the system completely. This can make the task of fundamental modelling very complicated and it requires physical insight into the process and often a large amount of time and resources. Another difficulty is the availability of the values of the constant parameters in the different equilibrium and kinetic equations, once the reaction mechanisms have been established. The resulting models have the advantage of being valid over a wide range of operating conditions and allow some extrapolation outside of those conditions that were investigated experimentally.

The advantage of being able to extrapolate the model to a range of conditions is extremely important for the modelling of batch processes, since the processes are operated over a wide range of conditions. With a good fundamental model, it will be possible to simulate the batch digesting process from start to finish. This will be very important in the control of the digester. The need for an accumulator in the control strategy was mentioned in Chapter 5 in order to be able to monitor the progress of the reactions. A continuous model will be a necessity for this purpose. The other requirement for the model that was mentioned in Chapter 5, was the ability of the model to predict a final degree of polymerisation, based on the initial conditions inside the digester. The difference between the predictor and the accumulator is that the accumulator receives continuous measurements of the temperature and pressure from the plant, while the predictor has to predict these vectors as well. Since the temperature and pressure are controlled, these vectors can be obtained from the control system.

It is clear that a fundamental model will be able to satisfy the requirements for a model used in the control strategy. However, the biggest disadvantage of a fundamental model is the effort of constructing it. This will be especially difficult for the pulping processes, since there are still a lot of the process that is not understood. The wood consists of a wide variety of different components, conveniently grouped under the

names lignin, cellulose and hemicellulose. However, many different reactions will take place in parallel that will be extremely difficult to model accurately. Furthermore, the system consists of three different phases and the transport of reagents and products between these phases have to be modelled as well. It may also be difficult to obtain values for all the parameters in the equilibrium and kinetic equations that can be used for the specific wood species and conditions at SAPPI SAICCOR.

Despite all the difficulties mentioned above, the basis of a fundamental model for the pulp digesters was developed in the preceding paragraph. Some simplifying assumptions will definitely be necessary, but the development of a fundamental model seems possible and quite realistic. If this can be accomplished, the model will satisfy all the requirement set for the model.

7.2. Neural network modelling

Neural networks and other kinds of artificial intelligence, like fuzzy logic, have grabbed the attention of modelling and control engineers because of the relative ease with which complex systems can be modelled. Historical plant data is used to train the neural network model and to fit a model to the observations. During the process of training, the different variables in the process are identified and the relative importance and effect of each variable is established. An empirical model incorporating all of the variables is then fitted to the data using mathematical algorithms and statistical techniques.

Neural networks are composed of simple interconnected elements, called nodes, operating in parallel. These elements are inspired by the neurons in the biological nervous systems. As in nature, the network function is determined largely by the connections between elements. We can train a neural network to perform a particular function by adjusting the values of the connections (weights) between elements. Commonly neural networks are adjusted, or trained, so that a particular input leads to a specific target output. Such a situation is shown below. There, the network is adjusted, based on a comparison of the output and the target, until the network output matches the target. Typically many such input/target pairs are used, in this supervised learning, to train a network.

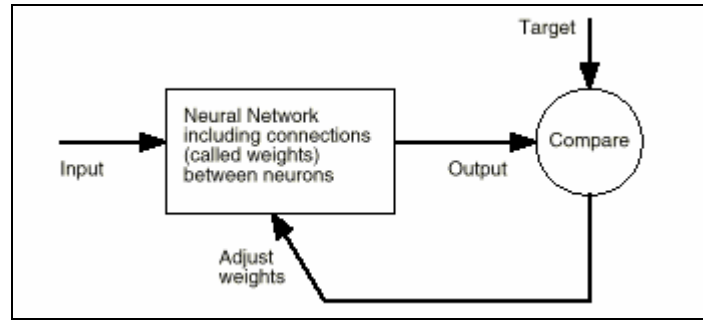

Figure 7.1: The process of training a neural network (Demuth and Beale, 1998)

A neuron with a single scalar input is shown on the left in Figure 7.2. This represents the simplest kind of node in a neural network. The scalar input p is transmitted through a connection that multiplies its strength by the scalar weight w , to form the product wp , again a scalar. Here the weighted input wp is the only argument of the transfer function, which produces the scalar output a .

The neuron on the right in Figure 7.2 also has a scalar bias, b . The bias may be seen as simply being added to the product wp as shown by the summing junction or as shifting the function f to the left by an amount b . The bias is much like a weight, except that it has a constant input of 1. The transfer function net input n , again a scalar, is the sum of the weighted input wp and the bias b . This sum is the argument of the transfer function f . The central idea of neural networks is that such parameters can be adjusted so that the network exhibits some desired or interesting behavior. Thus, the network can be trained to do a particular job by adjusting the weight or bias parameters, or perhaps the network itself will adjust these parameters to achieve some desired end.

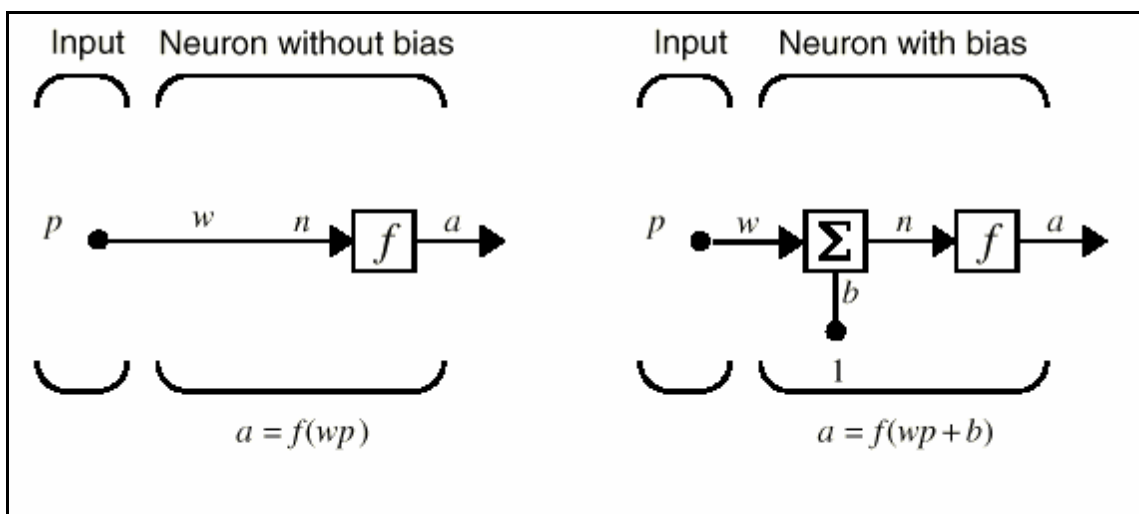

Figure 7.2: Simple nodes in a neural network

A node may also have a vector input. This is shown in Figure 7.3. Each of the inputs is multiplied by a corresponding weight that will be determined during the training of the model. All of these weighted inputs are then summed by the summing function together with the bias. The input n to the transfer function will then be calculated as follows:

$$n = w_1p_1 + w_2p_2 + \dots + w_r p_r + b \tag{7-7}$$

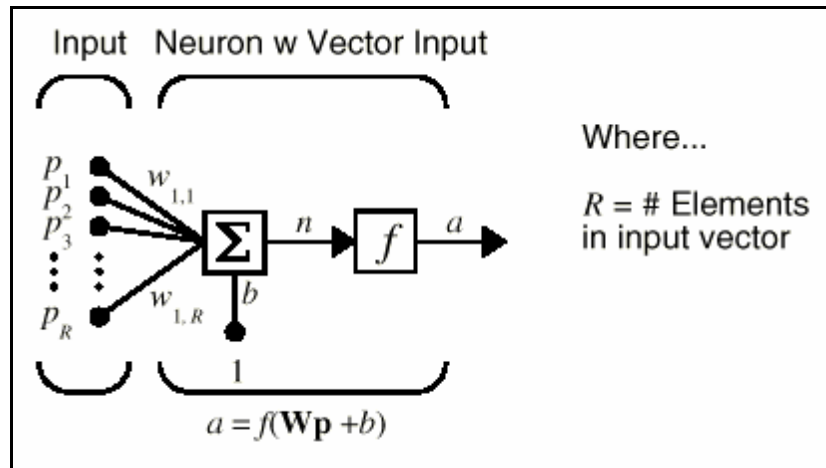

Figure 7.3: A node with a vector in put

The three most commonly used transfer functions are shown in Figure 7.4. The hard limit transfer function shown below limits the output of the neuron to either 0, if the net input argument n is less than 0, or 1, if n is greater than or equal to 0. The sigmoid transfer function shown below takes the input, which may have any value between plus and minus infinity, and weighs the output into the range 0 to 1.

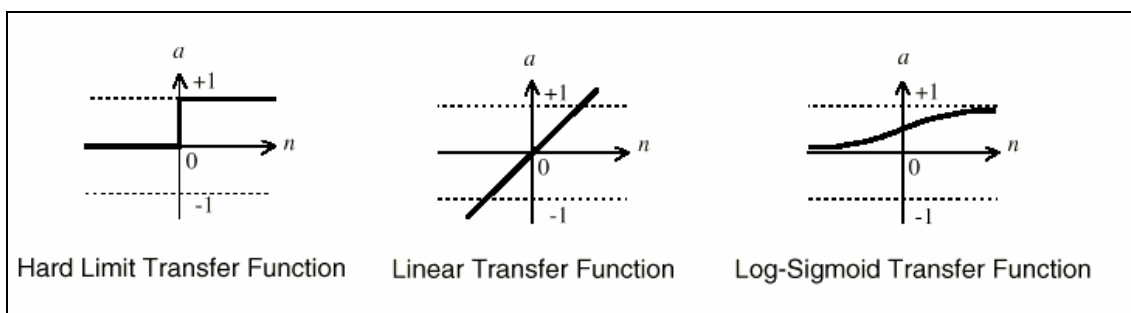

Figure 7.4: Most commonly used transfer functions

Two or more of the neurons shown above may be combined in a layer, and a particular network might contain one or more such layers. A one-layer network with R input elements and S neurons is shown in Figure 7.5. In this network, each element of the input vector p is connected to each neuron input through the weight matrix W . The i^{th} neuron has a summer that gathers its weighted inputs and bias to form its own

scalar output $n(i)$. The various $n(i)$ taken together form an S -element net input vector n . Finally, the neuron layer outputs form a column vector a . The expression for a is shown at the bottom of the figure. A layer is not constrained to have the number of its inputs equal to the number of its neurons. It is common for the number of inputs to a layer to be different from the number of neurons.

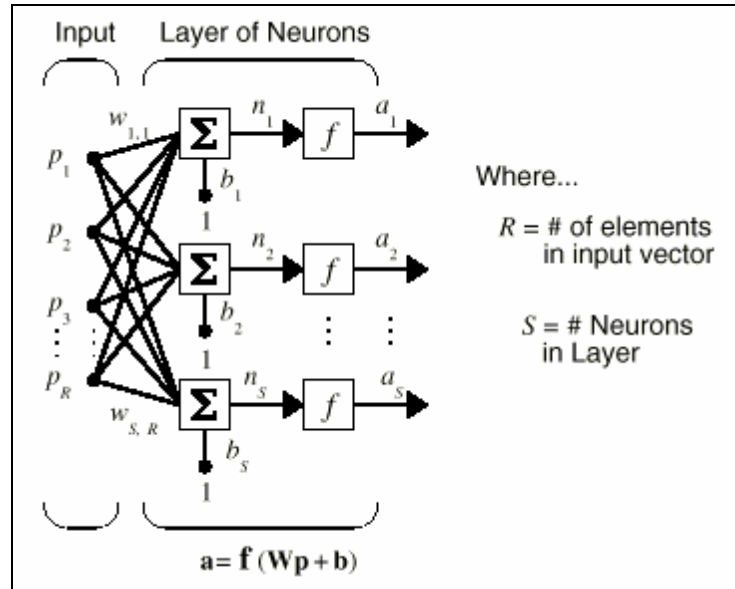

Figure 7.5: A single layer neural network model

A complete neural network can have several layers combined to form one model. Such a network is shown in Figure 7.6. Each layer has a weight matrix W , a bias vector b , and an output vector a . The layers of a multi-layer network play different roles. A layer that produces the network output is called an output layer. All other layers are called hidden layers. The hidden layers are necessary, since they provide multiple paths for data flow and thus allow the network to process information. The three-layer network shown in Figure 7.6 has one output layer and two hidden layers (layer 1 and layer 2). Multiple layer networks are quite powerful. For instance, a network of two layers, where the first layer is sigmoid and the second layer is linear, can be trained to approximate any function (with a finite number of discontinuities) arbitrarily well (Demuth and Beale, 1998).

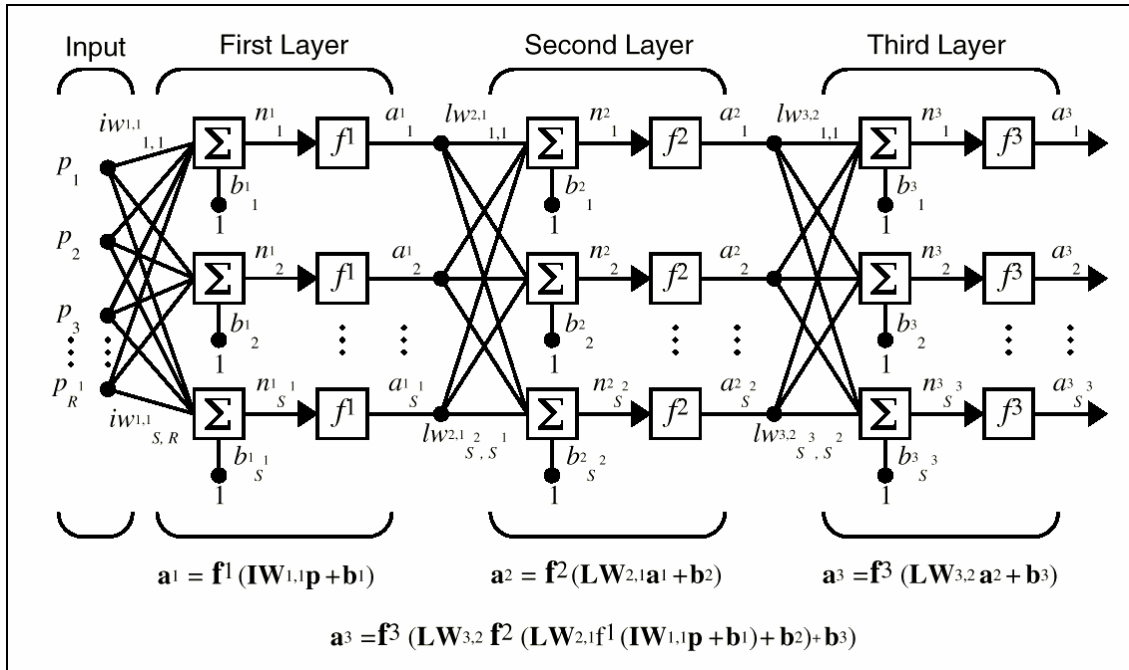

Figure 7.6: A multi-layer neural network

Various training algorithms can be used to fit a model to the historical data. The training algorithm will adjust the various weighting matrices in the neural network so that the outputs of the neural network represent the actual data for the corresponding inputs. During training, the network takes the input values and propagates them forward through the layers of nodes to create output values. These are then compared with the correct historical value for the output. Based on the amount of error, a correction mechanism then starts and propagates in the reverse direction to establish new weighting values. This procedure continues until an error criterion is satisfied. (Fourie, 1999)

The primary advantage of neural networks is the network's ability to identify complex relations between input and output values. Even with limited knowledge of the process, a network model can easily be created for a very complex system by using historical data only. Neural network models are therefore ideally suited for ill-defined systems, or highly non-linear systems.

One of the major disadvantages of the neural network model is that it is still an empirical model. The model will only identify relations between input and output values and will give very little additional insight into the process. The model will also only be valid in the range for which data has been fitted. No extrapolation outside this range is possible.

Various attempts have been made to fit a neural network to the batch digesters at SAPPI SAICCOR with limited success. (Aldrich, 1997) (Pellow-Jarman, 1998) Some of the results that were obtained were very suspicious and didn't correlate with actual

experience and observations. One example of this is the extremely low weighting factor that was obtained for the cooking time at the maximum temperature. This factor had the fifth lowest weight out of 32 variables that were considered. One of the requirements for the training data used for neural networks is that the input data must have a sufficient range of variation (Fourie, 1999). If the variable doesn't vary much during training, it may be assumed that the input doesn't matter and the influence of the variable may be ignored. Since the neural network model was fitted at SAICCOR using historical data that was obtained under controlled conditions, very little variations would have occurred in all of the input variables. It is therefore easy to explain the suspicious weighting factors that were obtained. Since the weighting factors forms the intelligence of the neural network, it was difficult to accept the results of the neural network (Smith, 1998).

In order to fit an accurate neural network model to the digesters, it would be necessary to apply quite large disturbances to the process. The cooking time would have to be tested as well and it would be necessary to vary the cooking time of the test cooks in order to be able to take this factor into account. It would also be necessary to cook the wood to different final degrees of polymerisation in order to obtain data over a sufficient range. There is definitely merit in the investigation into the construction of a neural network model over the digester, but the condition for this will be that data must be available over a sufficient range of final DP values. Because of the dependence of the entire plant on the scheduling of each digester, such an exercise would be very expensive and almost impossible to conduct.

Although the use of neural networks for the modelling of the pulp digester doesn't seem possible, alternative uses for neural networks can be investigated. One possibility is to use neural networks in the process of finding the exact parameters for a fundamental model. A neural network can be trained to optimise the parameters in the model during the feedback control that was suggested in Chapter 5. Not only can complex optimisation algorithms be implemented with neural networks, but it will also be possible to recognise the influence of factors like seasonal changes and wood species on the parameters. The neural network can then be trained to constantly optimise the parameters, while keeping the known trends in mind.

7.3. Empirical model

This approach to modelling is often called the experimental approach (Stephanopoulos, 1984). In this case the physical equipment representing the chemical process is available or has to be built. This equipment is usually very expensive to construct and can make the construction of an empirical model a very expensive exercise. During the creation of an empirical model, the values of various inputs, both disturbances and manipulated variables, are deliberately changed and through appropriate measuring devices, the change of the outputs with time can be observed. Curves are usually fitted to the data and equations are obtained relating the various inputs to the outputs.

Such a procedure is time and effort consuming and is usually quite costly because a large number of experiments must be performed. Every possible disturbance on the process has to be evaluated through a series of experiments. Obviously, only the inputs considered during the experimentation phase can be built into the model. Typical batch process models available for optimisation will only consider a small number of external influences explicitly. All other influences, such as unmeasured impurities, have to be collected under the term 'disturbances'. They may have a significant influence on the outcome of the batch and increase the prediction uncertainty. The limited ability to fit all possible disturbances can lead to very little confidence in the final model, because of the structural model-plant mismatch incurred from fitting a model of limited complexity to a complex process.

Another problem in the construction of an empirical model is that most modelling runs are conducted on the bench-scale. Scale-up problems such as changes in surface to volume ratio, mixing, wall catalysis, or heat balance inaccuracy can appear.

Also, while in most applications the state of the reactor is still known better at the beginning than at any other time, an initial state uncertainty is common particularly for those batch processes located within a chain of operations. It may also happen that the model is built entirely on the measurement of initial conditions and that small errors in these measurements can lead to significant errors to the end of the process.

Another problem that can lead to the uncertainty in the empirical model is that the model is only valid in the range of experimentation. The model can usually not be extrapolated to other conditions. This problem is related to the scale-up problem, since the laboratory equipment can often not handle the same extreme conditions that are found on the plant. Experimentation is then only possible over a limited range.

The result of the experimentation and the fitting of an empirical model, is a so-called “black-box” model. The terms in the model usually have little significance with regards to real meaning in the process. That is, the model does little to explain different occurrences on the plant. It finds the best approximation to the measured input-output data from a user-specified class of functions, but usually does not allow extrapolation.

Very little has been written about the construction of empirical models. It is primarily a statistical approach where equations are fitted to experimental data. The process of experimentation will differ for each unique problem and the person constructing the model will have to find some innovative techniques for testing for each input and for designing the equipment and experiments.

It was mentioned in paragraph 7.1 that a lot of detail is necessary in a fundamental model to define the system completely, which can make the task of fundamental modelling very complicated. Empirical modelling can be a good alternative to fundamental modelling if the necessary equipment is available. It can often be performed more quickly and requires only minimum insight into the process. As both modelling approaches have their obvious drawbacks, they are frequently combined to a certain extent, in order to obtain meaningful models of limited complexity with minimum modelling effort, while still covering the operating regime of interest for the optimisation.

The S-factor model was originally derived from first principles, but with substantial assumptions and simplifications. However, the form given in equation (4-8) is based on observations and experimental studies. The S-factor model can thus be described as an empirical model. The limitations of the S-factor model have been pointed out. It was decided not to try to fit another model to existing data, since a lot of previous work was already done on this and little improvement was made to the original model.

7.4. Conclusion on modelling techniques

From the discussion above, it can be seen that the task of fundamental modelling can be very complicated. It requires physical insight into the process and often a large amount of time and resources. However, the use of a fundamental model offers some distinct advantages over the other modelling techniques. Although it may be very difficult to construct, the advantages gained by having a fundamental model of a process, usually outweighs the time and effort spent in developing the model. The

fundamental modelling technique is the only technique that doesn't give a black-box model. It is usually very difficult to understand the rationale behind a black-box model, since the model only calculates the output from the inputs by using some kind of inferred relations. A fundamental model explains and simulates every step during the course of the process by using differential equations to calculate any changes in the output over a very small time period. Additional disturbances through the course of the process that wasn't incorporated in to the black-box model can then be included into the fundamental model. In this way the process is simulated over the time period and the behaviour of the process during different phases can be obtained. This offers a big advantage over the other approaches, since any problem areas in both the model and the process can be identified.

Since a fundamental model is based on actual observations, the parameters can easily be adjusted in order to obtain a certain desired output. The parameters can intuitively be changed by using previous experience and knowledge of the process. An accurate model can also help to gain insight into the process and simulations can for example be used for training purposes.

Another advantage of a fundamental model is the possibility to extrapolate the model to conditions that wasn't used during the development of the process. Since the model is based on the fundamental principles of the process, any changes in the process should be represented by the model as well. The fundamental model is therefore valid over a very wide range of conditions.

Empirical modelling can often be performed more quickly and requires only minimum insight into the process. A large amount of experimental data is however required and the model is only valid over the range of the experimental data. The empirical modelling techniques are frequently combined to a certain extent with the fundamental techniques, in order to obtain meaningful models of limited complexity and minimum modelling effort, while still covering the operating regime of interest for the optimisation.

Although neural networks are based on complicated theory, the application can be quite simple if the necessary software is available. The neural network approach can therefore be a quite easy-to-use modelling technique. However, since the was already tried by some experts at SAICCOR, it was decided not to repeat the work that has already been done. Little success was achieved in the previous attempts to fit a neural network to historical data.

In an engineering context, the basic model structure will often be chosen from first-principle considerations, while the model parameters are typically computed so that the model predictions best fit the data (Terwiesch et al., 1994). While a full process

model may also contain partial differential equations, these are usually discretised for optimisation purposes, so that models that are finally used for optimisation studies typically consist of a set of first-order ordinary differential equations and possibly some algebraic equations.

The approach taken during this study for the modelling of the digester was to combine the empirical and fundamental modelling techniques. A general fundamental model was constructed from the knowledge of the acid sulphite process and the reactions taking place during the pulping process. This model structure contained the basic reaction mechanisms, as well as the equilibria conditions. However, it was mentioned that one of the biggest problems during fundamental modelling is to obtain accurate parameters for reaction rate equations and the equilibria conditions. The model was therefore created with the ability to easily adjust the parameters. The model was then fitted to experimental and actual plant data and the parameters computed to best fit the real observations. A computer package was written to assist in this process of adjusting the parameters in order to obtain an accurate model. The use of neural networks in the optimisation of the model parameters is another opportunity for further research.

Chapter 8:

Construction of a fundamental model

The strategy proposed by Terwiesch *et al.* (1994) was used for the construction of a model for the batch pulp digesters. First principles were used to obtain the basic model structure. The parameters of this model were then adjusted to actual data collected on the plant. The advantages of both empirical and fundamental modelling are gained by using this approach. A model structure that represents the actual process is used and the model can therefore be used to gain a better understanding of the process. It would however also be very easy to intuitively change the parameters in the model. This is the second part of the strategy proposed by Terwiesch, where the parameters of the model are changed to fit the output of the simulation to real measurements. The advantage of this second step is that a model is obtained that is relevant for the conditions and feed used for the process under investigation.

The digester system was divided into some logical parts in order to be able to create a complete fundamental model. The following three interacting parts were identified:

1. The kinetics of the reactions involving the wood constituents.
2. The liquor composition.
3. The conditions in the digester, like the pressure and the temperature.

The most important function of the model should be to accurately model the reactions involving the wood constituents, and particularly the degradation reactions of the cellulose. However, in order to determine the reaction rate, the concentration of the chemical reagents in the cooking liquor must be known as well. The concentration of these chemical reagents will depend on the equilibrium conditions, which will depend on the conditions in the digester, and especially the temperature and pressure. It can be seen how the different parts are interdependent and that all three parts have to be modelled accurately in order to accurately model the degree of polymerisation.

These three parts will now be considered separately.

8.1. Kinetics of the wood constituents

Kinetic studies are very time consuming. They normally require experimental studies where the influence of every variable possibly affecting the process has to be determined. The degree to which it influences the process has to be determined by changing the value of the variable in the experiments over the relevant range, while keeping all the other variables constant. A requirement for experimental kinetic studies that are aimed at application to an existing process is that the conditions at which the experiments are conducted, like the temperature and the pressure, are in the same region as the real process. Therefore, a reconstruction of the process on a laboratory scale has to be done to get accurate information on the kinetics of the process. This leads to experimental kinetic studies that are not only time consuming, but also very expensive as well.

The results of these studies are a reaction rate equation, giving the rate of each chemical reaction in terms of all the influencing variables. Based on unit volume of reacting fluid, the rate equation can be written as shown in equation (8-1) (Levenspiel, 1972). The rate of change in the number of moles of the component due to the reaction is written as dN_i/dt .

$$r_i = \frac{1}{V} \frac{dN_i}{dt} = f(\text{state of the system}) = \frac{\text{moles } i \text{ formed}}{(\text{Volume fluid})(\text{time})} \quad (8-1)$$

Various authors have studied the kinetics of acid pulping, and it was decided to use the results from one of these studies. The kinetics of the reactions will depend on the details of the process, as well as the wood being used, and therefore it was decided to use the form of the kinetic equations suggested and to adapt the parameters in the equations to represent the process and wood species used at SAICCOR. The kinetics of the acid sulphite process were discussed in paragraph 6.2. The results of Hagberg and Schön (Hagberg and Schön, 1973) were tried first with the intention to try the results of other authors if satisfactory results weren't obtained. However, as will be shown later, the kinetics reported by Hagberg and Schön worked very well and the model was based on their results.

The kinetics considered involve only the degradation of the lignin, hemicellulose and cellulose, as well as the formation of strong acids. Therefore, the majority of the

reactions, with the exception of the formation of the strong acids, take place in the solid phase. As was indicated earlier, the transport of the reactants and products between the liquor and solid phases has to be included in the reaction rate equation. It was however also shown in paragraph 6.2 that the diffusion path is very short once complete penetration of the cooking liquor into the wood chips has occurred. Therefore, the reaction itself will be the rate-determining step and the influence of the transport of reactants and products was considered negligible. Consequently, the concentration of the reactants inside the wood chips was assumed to be the same as the concentration in the bulk liquor.

The kinetics obtained by Hagberg and Schöön were discussed in paragraph 6.2 and will only be summarised again.

The delignification rate was found to depend on the residual lignin in the pulp and the hydrogen and bisulphite ion concentrations. The rate of hemicellulose degradation was a function of the hemicellulose content of the pulp, as well as the hydrogen ion concentration. Watson proved that the degradation increase of the cellulose was a function of only the hydrogen ion concentration, or the pH of the liquor. The kinetics of all of these reactions showed an Arrhenius dependency on the temperature. The reactions of the wood constituents can be summarised as follows:

$$\text{Lignin:} \quad -\frac{d[L]}{dt} = k_L^0 e^{-E_L/RT} [L]^a \cdot [HSO_3^-]^\alpha \cdot [H^+]^\beta \quad (6-24)$$

$$\text{Hemicellulose:} \quad -\frac{d[HC]}{dt} = k_{HC}^0 e^{-E_{HC}/RT} [HC]^d \cdot [H^+]^\gamma \quad (6-25)$$

$$\text{Cellulose:} \quad -\frac{d[C]}{dt} = k_C^0 e^{-E_C/RT} [H^+]^\delta \quad (6-26)$$

It was shown in paragraph 6.1.3 that the lignin monosaccharides will react with the hydrogen and bisulphite ions after lignin degradation to form the so-called strong acids. These strong acids will influence the pH of the cooking liquor and the formation of the strong acids have to be modelled as well. It was pointed out that only information concerning the total concentration of strong acids is necessary and not information about the different strong acids individually. The reaction rate equation proposed by Hagberg and Schöön to calculate the strong acids concentration was given in equation (6-22) and looks as follows:

$$r_{SA} = \frac{k_{SA}(T)}{V} [SA^-]^n ([L]_0 - [L])^m [HSO_3^-]^b [H^+]^c \quad (6-22)$$

The values of the parameters in equations (6-24), (6-25) and (6-22) that was reported by Hagberg and Schöön ((Hagberg and Schöön, 1973) and (Hagberg and Schöön, 1974a)) are given in Table 8.1. Hagberg and Schöön didn't study the kinetics of the cellulose degradation and the values found by Watson (Watson, 1992) are shown in Table 8.1.

Lignin reaction kinetics (Hagberg and Schöön, 1973)		
	[L] > 12,4	[L] < 12,4
K_L^0	$1,346 \times 10^{12}$	$0,407 \times 10^{12}$
E_L	12 500	12 500
a	0,646	1,621
α	0,819	0,765
β	0,705	0,779
Hemicellulose reaction kinetics (Hagberg and Schöön, 1973)		
K_{HC}^0	$1,261 \times 10^{11}$	
E_{HC}	14 030	
d	2,542	
γ	0,707	
Cellulose reaction kinetics (Watson, 1992)		
K_C^0	$2,95 \times 10^{14}$	
E_C	35 000	
δ	1	
Strong Acids reaction kinetics (Hagberg and Schöön, 1974a)		
k_{SA}^0	$0,274 \times 10^5$	
E_{SA}	10480	
n	-0,430	
b	0,625	
c	0,554	
m	1	

Table 8.1: Parameters in kinetic equations for the reaction of the wood constituents

The units of time, temperature, lignin, cellulose and hemicellulose content and concentration used in the rate equations to obtain these values are second, Kelvin, % of wood and kmol/m^3 respectively.

During the implementation of equation (6-22), some problems were encountered due to the dependency of the reaction rate on the strong acid concentration. The power of the strong acid term in the rate equation was found by Hagberg and Schöön to be equal to $-0,430$. Initially, the strong acids concentration is zero. This leads to a reaction rate that is infinitely large at the start of the cook, although no lignin degradation has taken place yet. This is because the power is negative and a division by zero will result. This reaction rate at the start of the cook is clearly not possible, and therefore, another form of the equation also developed by Hagberg and Schöön (Hagberg and Schöön, 1974a) was used. This is shown as equation (8-2).

$$r_{SA} = \left\{ \left(\frac{g}{v} \right) + \left(\frac{2h}{v} \right) ([L]_0 - [L]) \right\} \cdot r_L + \frac{k_{SA}(T)}{v} ([L]_0 - [L])^a [HSO_3^-]^b [H^+]^c \quad (8-2)$$

The results reported by Hagberg and Schöön using equation (8-2) were just as good as the results obtained using equation (6-22). However, the equation in the form of (6-22) was preferred by them, because it is much simpler than the alternative form, and because there are less parameters in the equation. It wasn't clear how the problems encountered in this study were handled by them and personal correspondence with the authors didn't resolve the problem. Equation (8-2) was consequently used in this model and proved to work quite well, as will be shown later.

A few assumptions were necessary to keep the model relatively simple. Luyben stated that some simplifying assumptions will always be a part of the modelling process and an engineering compromise between a rigorous description and getting an answer that is good enough is required (Luyben, 1990). The assumptions that were made, made a big difference to the complexity of the model. The most important assumptions concerning the kinetics of the reactions are:

- It was shown in paragraph 6.1 that a lot of different reactions take place for each different wood constituent, like the lignin and hemicellulose. It was essential that all of these reactions be treated as single degradation reactions. It is virtually impossible to distinguish all of the different reactions and to determine the kinetics of each of these reactions separately. Furthermore, it was indicated that a term like lignin is actually a collective noun for a range of similar chemical components. To model each of the reactions taking place separately would mean that the wood used for pulping would have to be analysed thoroughly before cooking to determine the exact composition. It should be clear that an approach like this would be very unrealistic to implement.
- It was assumed that the concentration of the reactants inside the wood chips is the same as the concentration in the bulk liquor. The diffusion of

chemicals and products into and out of the chips were thus assumed to be negligible. It was shown in paragraph 6.2 that the diffusion path is very short once complete penetration of the cooking liquor into the wood chips has occurred. The reaction rate will therefore be the rate determining step and this assumption will be valid.

- The heat of reactions was not considered in the calculation of the temperature in the digester. Very little was available in literature about the heat of reaction of the degradation reactions. It seemed as if previous authors also considered the influence of the heat of reaction to be small. This would seem reasonable when all the external energy that needs to be added to the digester in order to heat the reaction mixture to cooking temperature is considered. The degradation reactions are exothermic reactions, since the chemical bonds are broken and energy is released. However, this exothermic reaction heat does very little the heat up the digester and the assumption seems to be valid.

Intensive experimental studies would be necessary to determine the heat of reactions of all of the different reactions. It was considered not to be worth the effort to gain the little improvement that would have resulted in the model.

- The concentration of the chemicals in the digester was assumed to be uniform throughout the digester. The mixing of the liquor and distribution of the chemical components were not modelled.

8.2. Modelling of the liquor composition

Although the primary purpose with respect to modelling of the pulp digesters is to model the degree of polymerisation or the cellulose degradation, of the wood, the rate of degradation increase is a function of the hydrogen ion concentration. Therefore, the hydrogen ion concentration has to be modelled as well. It was shown that the hydrogen ion concentration depends on the strong acids concentration, which in turn depends on the extend of delignification. It can thus be seen that it is important to consider all of the variables in the process. The concept of the degrees of freedom can again be mentioned here, since each of these equations helps to reduce the degrees of freedom of the process, and consequently helps to completely specify the process. The kinetics given in paragraph 8.1 depend on the hydrogen and/or bisulphite ion concentrations, and it is therefore very important to model the liquor composition as well.

From a modelling point of view, the most important aspects of the cooking liquor are the acidity and the concentration of bisulphite ions. It was shown in paragraph 3.1.1 that the liquor for the sulphite pulping process is made up by absorbing sulphur dioxide in water and adding a metal base. It was also shown in paragraph 3.1.1.1 that the equilibria shown on the next page are established when sulphur dioxide is absorbed in water:

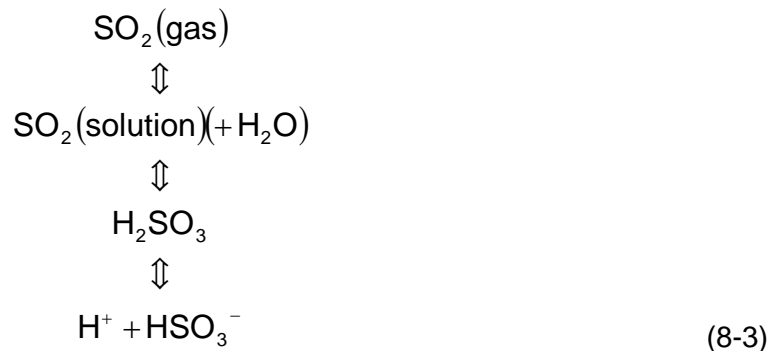

Since the bottom products of the previous dissociation are of interest to the study, the dissociation constant determining the concentration of these ions was developed in paragraph 6.1.4. It was defined as follows:

$$k = \frac{[\text{H}^+][\text{HSO}_3^-]}{[\text{H}_2\text{SO}_3] + [\text{SO}_2]} = \frac{[\text{H}^+][\text{HSO}_3^-]}{[\text{total SO}_2] - [\text{HSO}_3^-]} \quad (6-2)$$

This parameter is temperature dependent and unfortunately, not freely available. Values calculated by Rydholm (1965) over a temperature range were given in Table 6.2. It was however, shown that the dissociation constant for sulphurous acid, H_2SO_3 , is very high and therefore, the concentration of sulphurous acid will be very low, especially at high temperatures. Because of the high dissociation constant for sulphurous acid, the concentration of the sulphurous acid was considered to be negligible. It was decided to use the following definition for the dissociation constant, rather than the one given in equation (6-2):

$$K_{\text{SO}_2} = \frac{[\text{H}^+][\text{HSO}_3^-]}{[\text{SO}_2]} \quad (8-4)$$

The benefit of using this definition is that values for this constant are more readily available. The values are expressed as a mathematical correlation in the form of the Antoine equation to incorporate the temperature dependence of the constant. The form of these equations is shown in equation (8-5).

$$\log_{10} A = B + \frac{C}{T} \quad (8-5)$$

This form of this equation makes it generally applicable to a wide variety of conditions to calculate the temperature dependence. The variable A can be substituted by the value of the condition to be calculated; in this case it is the dissociation constant of sulphur dioxide. The values for the parameters, B and C, that were used by Hagberg and Schön (Hagberg and Schön, 1974b) are given in Table 8.2. Some variations of these values were however obtained by various other authors, which indicates that they are not necessary fixed but can also be changed in order to get better results from the model. However, the values reported give an indication of the magnitude of these parameters.

A	Temperature range (°C)	B	C
K_{SO_2}	20 – 80	-5,077	1 045
	80 – 120	-6,916	1 700
	120 - 150	-7,971	2 133
K_P	20 – 80	-9,430	2 392
	80 – 120	-10,208	2 665
	120 - 150	-10,948	2 960
K_{H_2O}	20 - 150	5,882	-2 198

Table 8.2: Values for parameters B and C given by Hagberg and Schön (Hagberg and Schön, 1974b)

It was shown in paragraph 3.1.1.1 that when a base is added to the sulphur dioxide – water system shown as equation (8-3), first bisulphite and then monosulphite will be formed according to the reactions shown in equation (8-6). This will then represent the reactions in the cooking liquor at the start of the cook.

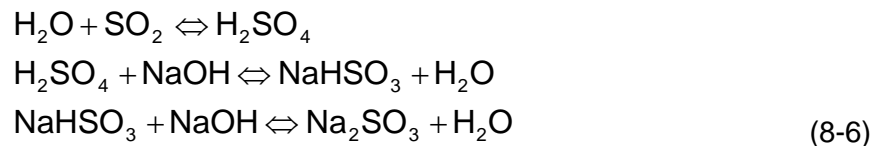

These reactions were used in the construction of equation (6-7), where the two possible products of bisulphite at the start of the cook are used in the electroneutrality condition.



However, as soon as the delignification starts, the lignin monosaccharides will start forming strong acid by reaction with the bisulphite, as shown in (6-8).



These two equations can be combined to form the electroneutrality equation during the cook, that is, after the formation of strong acids has started. The electroneutrality equation can be stated as follows:

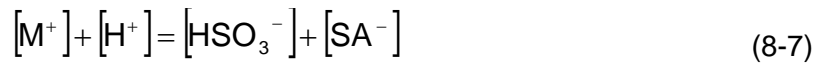

The one property that distinguishes the acid sulphite process from the other sulphite cooking processes, is the large amount of excess sulphur dioxide present in the gas phase. This means that an equilibrium will be established between the dissolved sulphur dioxide and the excess sulphur dioxide in the gas phase. The following equilibrium equation can be used to give the partition of sulphur dioxide between the gas and the liquor phase.

$$K_p = \frac{[H^+][HSO_3^-]}{p_{SO_2}} \quad (8-8)$$

The equilibrium constant can also be calculated from an Antoine type equation similar to the calculation of the sulphur dioxide protolysis constant.

One more equation will be necessary to completely specify the liquor system. It was assumed that the partial pressure of gases other than sulphur dioxide and water was negligible. Therefore, the total pressure will be equal to the sum of these two partial pressures.

$$P = p_{SO_2} + p_{H_2O} \quad (8-9)$$

The vapour pressures of both water vapour and sulphur dioxide above water can easily be calculated and data are freely available. Once again, an Antoine type equation can be used to incorporate the temperature dependency into an easily useable formula.

Equation (8-8) can be substituted into equation (8-7) to obtain an equation similar to equation (6-10), where the dissociation of the sulphurous acid was considered as well.

$$\begin{aligned} [\text{H}^+] &= \frac{[\text{A}^-] - [\text{M}^+]}{2} + \sqrt{\frac{([\text{M}^+] - [\text{A}^-] - k)^2}{4} + K_P \cdot p_{\text{SO}_2}} \\ [\text{HSO}_3^-] &= \frac{[\text{M}^+] - [\text{A}^-]}{2} + \sqrt{\frac{([\text{M}^+] - [\text{A}^-])^2}{4} + K_P \cdot p_{\text{SO}_2}} \end{aligned} \quad (8-10)$$

It can be seen that these equations are very similar and that the effect of the sulphurous dissociation was omitted.

The concentration of the metal ions can be calculated from equation (6-6).

$$[\text{M}^+] = 2 \cdot [\text{combined SO}_2] \quad (6-6)$$

These additional equations are sufficient to calculate the hydrogen and bisulphite concentrations in the liquor phase during any stage of the cook.

8.3. Modelling of the conditions inside the digester

It can be seen from the modelling equations stated thus far, that the only variables that are not accounted for at this stage, are temperature, pressure and time. Since the digester will be modelled over time, time will be a known input to the model, and the only two variables that must be specified in order to reduce the degrees of freedom of the process to zero, are temperature and pressure.

It was mentioned at the start of this chapter, that there are two sources that provide the additional equations needed to reduce the number of degrees of freedom to zero. These were:

1. The external world, which specifies the values of certain input variables, for example, an up-stream unit that feeds the process
2. The control system, which imposes certain relationships between the controlled outputs and the manipulated inputs (feedback).

Both of these sources will be used now to specify the remaining two variables.

The pressure will be modelled according to the control system. A typical pressure profile during a cook is shown in Figure 8.1. The different phases of the cook as described in paragraph 4.1 can be seen clearly and are indicated on the figure. The phases of the cook are controlled according to the control strategy. The control strategy determines the starting and ending time for each phase of the cook, for example the time for side relief and for high and low pressure gas releases. The pressure can then be modelled according to this.

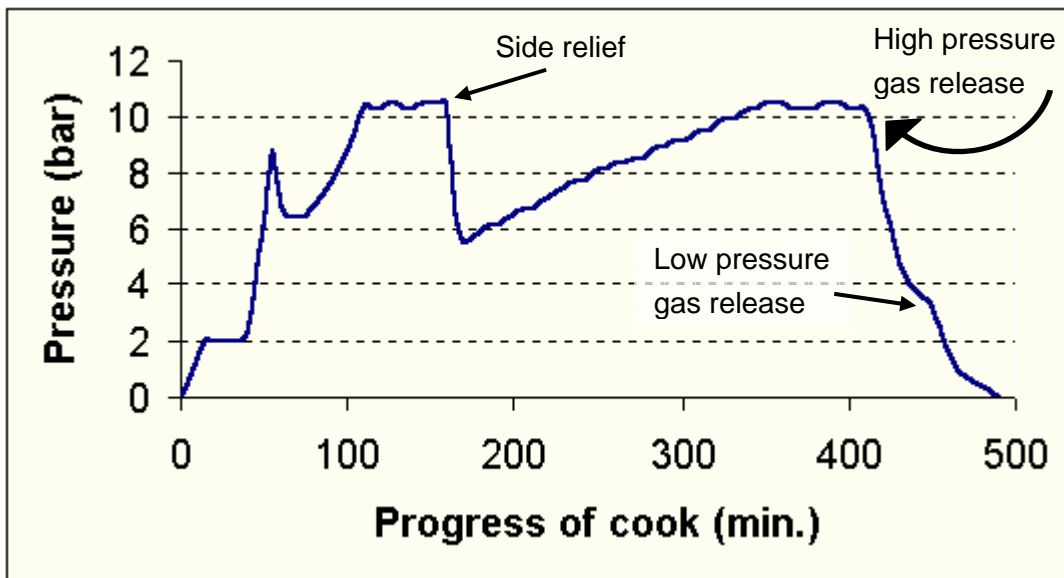

Figure 8.1: A typical pressure profile

A maximum pressure is set according to safety regulations for the digester. This maximum pressure is 10,4 bar. The maximum pressure will therefore be controlled at this value. However, if the pressure is below this maximum pressure, the pressure will be determined by other factors. At the start of the cook, after the liquor has been loaded, a pressurisation phase will start. During this phase, a pump is used to raise the pressure to 9 bar. Once the pressure has reached this value, the controlled pressurisation will stop. It was however found, as can also be seen in Figure 8.1, that a pressure drop of 3 – 4 bar will occur once the pressurisation stops. The pressure during the pressurisation phase is variable and is determined by factors such as channelling and air pockets inside the digester after the wood chips have been loaded. These factors are virtually impossible to model, and it was decided to keep the pressure in the model constant up to side relief. This can easily be justified, since very little reaction takes place during this phase and this assumption will therefore not have a very big influence on the results of the model.

When the temperature reaches 110 °C, side relief will take place, during which the liquor level of the digester will be dropped to a fixed height. This will in turn cause a pressure drop to a certain value that will be constant from one cook to the next. After that, the pressure will steadily rise again due to the rise in temperature to the

maximum pressure. The pressure will be kept at this maximum pressure with a gas release valve, until the high pressure gas release starts. The pressure is dropped at a controlled rate during the high-pressure gas release from the maximum pressure to about 3,5 bar. After that, the uncontrolled low-pressure gas release phase will start. However, it was found that the reaction will stop as soon as the temperature drops to the level at which the low-pressure gas release will start, and the modelling of the digester can therefore be stopped after the high-pressure gas release phase.

Temperature in the digester will be determined by the external world. The liquor in the digester is heated by an external heat exchanger that heats a recirculation stream using steam. The temperature in the digester will therefore be determined by an upstream unit, which is a heat exchanger in this particular case. However, it was shown in Figure 4.3 that the temperature control around the heat exchanger is very efficient and that the temperature of the stream leaving the heat exchanger will be the same as the setpoint temperature. Therefore, temperature in the digester will in effect be determined by the control strategy as well.

After it had been determined that the top temperature control was very good, the modelling of the digester temperature was relatively easy. The set temperature profile during normal operation was used as the top temperature of the recirculation flow to the digester. Different ways were provided in the software to specify setpoints for the temperature profile, that will be discussed in Chapter 8. The first method is used for normal simulation of the digester and for this the entire temperature profile can be set by specifying the time allowed for each heating phase, as well as the maximum temperature. The second method was created to test the ability of the model to be used as a predictor in the control of a cook. For this purpose, the temperature profile up to 126 °C is specified by the user, as well as the cooking time. The predictor is then used to calculate the maximum temperature in order to obtain a target final degree of polymerisation. The final method was used for the verification of the kinetic model against experimental data. The actual temperature profile that was achieved during the experimental cook was extracted from a file containing the continuous measurements on one of the digesters. This profile was then used for the simulation of the experiments and only the results of the kinetic rate equations were compared with the actual measured results. It must be noted that the top temperature was always taken as the controlled variable in the temperature control.

However, there is a big difference between the top temperature and the bottom temperature of the digester, as can be seen in Figure 4.3. A difference of up to 10 °C between the top and the bottom temperature of the digester is not unusual (Meneghel, 1999). The temperature profile through the digester was determined by the difference between the top and the bottom temperatures as well as the recirculation flowrate. The bottom temperature was modelled by dividing the digester volume into ten equal

parts. The separate parts were considered to be well-mixed tanks in series and with a flowrate equal to the recirculation flowrate flowing from the first tank to the last. The temperature of this stream that flows into the first tank was taken to be equal to the top temperature, that was determined according to the set temperature profile, as was discussed in the previous paragraph. The bottom temperature was then taken to be the temperature of the stream leaving the last tank. This approach is illustrated graphically in Figure 8.2.

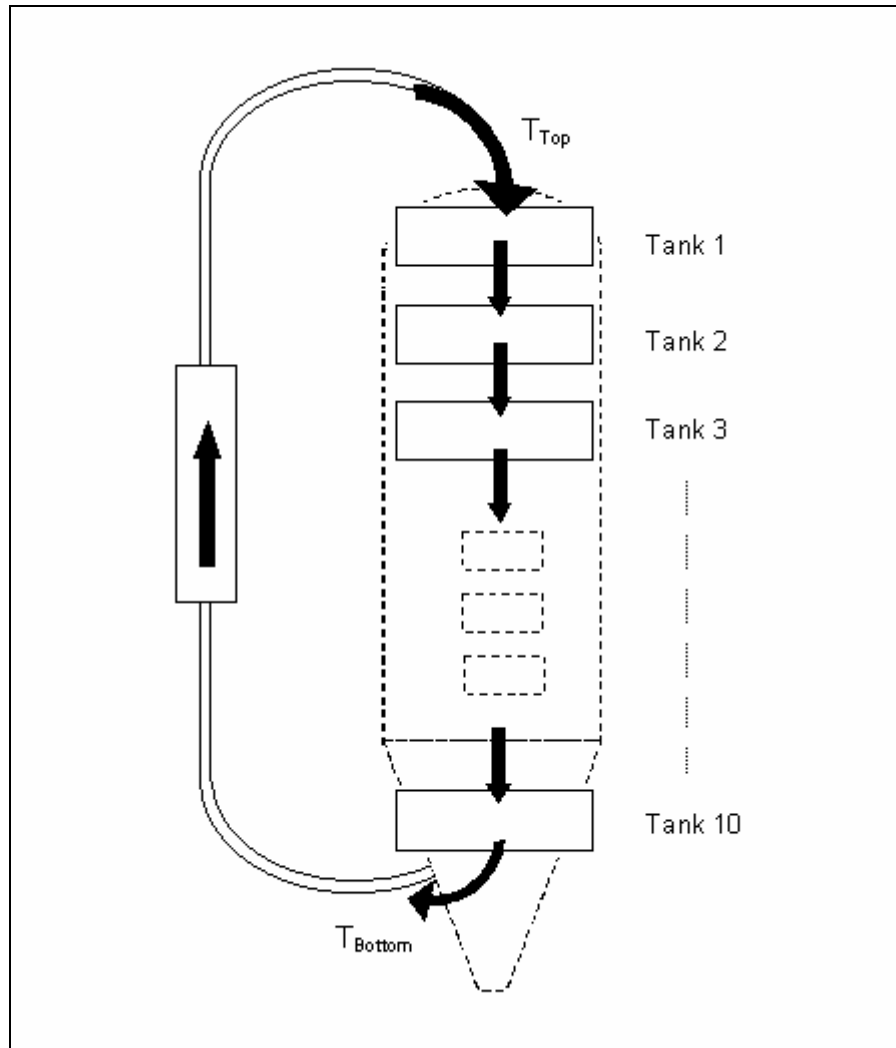

Figure 8.2: Modelling of the reactor temperature

The average digester temperature was used in the kinetic rate equations. The average temperature was calculated as the average temperature of all ten tanks, and not as the average between the top- and bottom temperatures.

The temperatures in each of the tanks were calculated by doing an energy balance similar to equation (7-4) over each of the tanks. The tanks were assumed to be adiabatic and the heat of reaction was assumed to be negligible, as was mentioned in paragraph 8.1. Since the tanks were assumed to be well-mixed, the temperatures of

each of the streams leaving the tanks were assumed to be equal to the temperature of the liquid inside the tank. The following form of the energy balance was then obtained:

$$\rho V C_P \frac{dT_{out}}{dt} = \rho R C_P T_{in} - \rho R C_P T_{out} \quad (8-11)$$

Since the density and the heat capacity of the streams entering and leaving the tanks will be same, equation (8-11) could be simplified to the following equation:

$$\frac{dT_{out}}{dt} = \frac{R}{V} (T_{in} - T_{out}) \quad (8-12)$$

This heat balance was applied over each of the tanks to determine the temperature inside the tanks. The temperature of the stream leaving the tank was then taken as the temperature of the stream flowing into the next tank.

In order to solve the differential equation given in equation (8-12), the recirculation rate has to be known. The recirculation flow rate is not controlled, since the top temperature is controlled only by controlling steam flow to the heat exchanger. The flow rate of the circulation stream depends on the head provided by the circulation pump, as well as the resistance to flow in the circulation line and the heat exchanger. During a cook however, the circulation line tends to be blocked by the pulp that is drawn into the line. The increased resistance caused by this is extremely difficult to model and it is consequently very difficult to model the circulation flow rate from first principles. Empirical modelling techniques were used for this purpose.

By studying the continuous measurements of many different cooks, it was found that the flow rate of the circulation stream has a more or less fixed shape over the duration of the cook. This form is shown in Figure 8.3. It was found that the flow rate is almost constant up to side relief. After that, the flow rate will decrease gradually. A third order polynomial was fitted to the flow rate of a few cooks and the following equation resulted:

$$R = 5,0 \times 10^{-5} t^3 - 4,122 \times 10^{-2} t^2 + 8,71575 t + 41,38612 \quad (8-13)$$

The variable, t , is the time in minutes since the start of the cook.

The strategy used in the modelling of the flow rate was to keep the flow rate constant up to side relief and to use equation (8-13) after that. The initial value of the flow rate seems to be random as well and no way of predicting this initial value was found. It was decided to read this value into the model together with the other initial conditions,

like the liquor strength. The circulation was stopped as soon as the high-pressure gas release phase started.

The modelling of the circulation flow rate was also verified with the “Digest” package and the correlation coefficients for this empirical model determined. This will be discussed in paragraph 10.5.2.

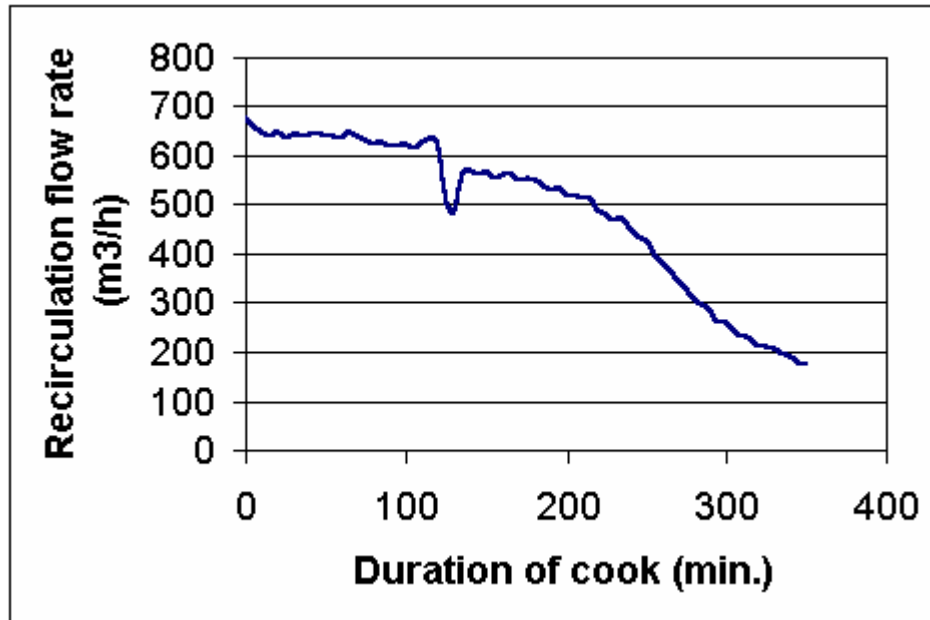

Figure 8.3: The circulation flowrate during a typical cook

The pressure and circulation flow models rely on projections of future values. Since the maximum cooking temperature needs to be determined relatively early in the cook, these projections will always be used in the control strategy to calculate the maximum temperatures, although both the pressure and flowrate are measured.

8.4. Summary

A fundamental model was constructed for the batch pulp digester by dividing the problem into three separate parts, namely:

1. The kinetics of the reactions involving the wood constituents
2. The liquor composition
3. The pressure and the temperature inside the digester.

The fundamental model was constructed as a set of differential equations and algebraic equations. The most important assumptions that had to be made in order to keep the model relatively simple, was that the rate determining step in the reactions was the reaction itself and that diffusion doesn't play a part. The concentration of chemicals in the liquor phase was also assumed to be uniform throughout the digester. The other important assumption was that the heat of reaction was negligible.

The following equations were used to completely specify the process:

- The chemical reactions inside the pulp:

$$\text{Lignin:} \quad -\frac{d[L]}{dt} = k_L^0 e^{-E_L/RT} [L]^a \cdot [\text{HSO}_3^-]^\alpha \cdot [\text{H}^+]^\beta \quad (6-24)$$

$$\text{Hemicellulose:} \quad -\frac{d[HC]}{dt} = k_{HC}^0 e^{-E_{HC}/RT} [HC]^d \cdot [\text{H}^+]^\gamma \quad (6-25)$$

$$\text{Cellulose:} \quad -\frac{d[C]}{dt} = k_C^0 e^{-E_C/RT} [\text{H}^+]^\delta \quad (6-26)$$

$$\text{Strong Acids:} \quad r_{SA} = \left\{ \left(\frac{g}{v} \right) + \left(\frac{2h}{v} \right) ([L]_0 - [L]) \right\} \cdot r_L + \frac{k_{SA}(T)}{v} ([L]_0 - [L])^q [\text{HSO}_3^-]^b [\text{H}^+]^c \quad (8-2)$$

- Liquor composition

$$\text{Chemical equilibrium:} \quad K_{\text{SO}_2} = \frac{[\text{H}^+][\text{HSO}_3^-]}{[\text{SO}_2]} \quad (8-4)$$

$$\text{Electron neutrality:} \quad [\text{M}^+] + [\text{H}^+] = [\text{HSO}_3^-] + [\text{SA}^-] \quad (8-7)$$

$$\text{Vapour-Liquor equilibrium:} \quad K_p = \frac{[\text{H}^+][\text{HSO}_3^-]}{p_{\text{SO}_2}} \quad (8-8)$$

$$\text{Total Pressure:} \quad P = p_{\text{SO}_2} + p_{\text{H}_2\text{O}} \quad (8-9)$$

$$\text{Combined SO}_2: \quad [\text{M}^+] = 2 \cdot [\text{combined SO}_2] \quad (6-6)$$

The following variables can be identified in these equations:

Wood constituents	Individual cook	Equilibria
[L]	Combined [SO ₂]	P _{SO₂}
[HC]	Free [SO ₂]	P _{H₂O}
[C]	[M ⁺]	K _{SO₂}
Liquor composition	v	K _P
[HSO ₃ ⁻]	Digester conditions	
[H ⁺]	T	
[SA ⁻]	P	

Table 8.3: Variables in the model

The constant parameters, like the reaction orders, were not included in table of variables.

Sixteen variables were identified in the model. Nine model equations were given earlier. Three of the equilibrium variables, P_{H₂O}, K_{SO₂} and K_P, can be calculated from the temperature dependent equations in the form of equation (8-5). Twelve of the sixteen variables can be calculated from these model equations. Two additional sources for model equations were given in paragraph 7.1. These were the external world and the control system. The temperature and the pressure were calculated from the control system, as was discussed in paragraph 8.3. If the liquor-to-wood ratio and the combined and the free SO₂ are specified as the starting conditions of a cook, the system is completely specified, with sixteen equations and sixteen variables.

Chapter 9:

The “Digest” software package

After the model was constructed, software needed to be written that could be used to implement and verify the model. A software package called “Digest” was written in Matlab and Simulink for this purpose. It was mentioned that the strategy used in the development of the model was to construct the basis of the model from first principles and to adjust the parameters according to actual plant data. The primary purpose of the “Digest” package was to assist in the development and verification of the digester model.

Various tools were constructed inside the package to fulfil this purpose. The operation of the package revolves around the simulation of the digester using the model that was developed in Chapter 8. *Matlab* together with *Simulink* contain some very powerful simulation tools and were therefore ideally suited for this purpose. The most important functions and the tools available in the “Digest” package will be described here, as well as the main purpose of each tool. The complete help files for the package were printed out and are provided in Appendix A. The help files give complete instructions for the installation and use of the package. It will also highlight some details that won’t be discussed here. More details of the exact principles behind the available tools and in particular the verification tools will be given in subsequent chapters.

Since this was not a programming exercise, the code of the program will not be given or discussed. The purpose of the software was to assist in accomplishing the aim of the study, which was to develop an accurate digester model. Only the use of the package to develop a fundamental model will be discussed.

9.1. The main title screen

When the package is executed, a screen will be displayed which displays all the possible options to the user, as well as the results of simulations that have been run. A user-friendly toolbar contains links to the most commonly used functions, while a menu bar on top of the screen contains the links to all the possible functions and tools.

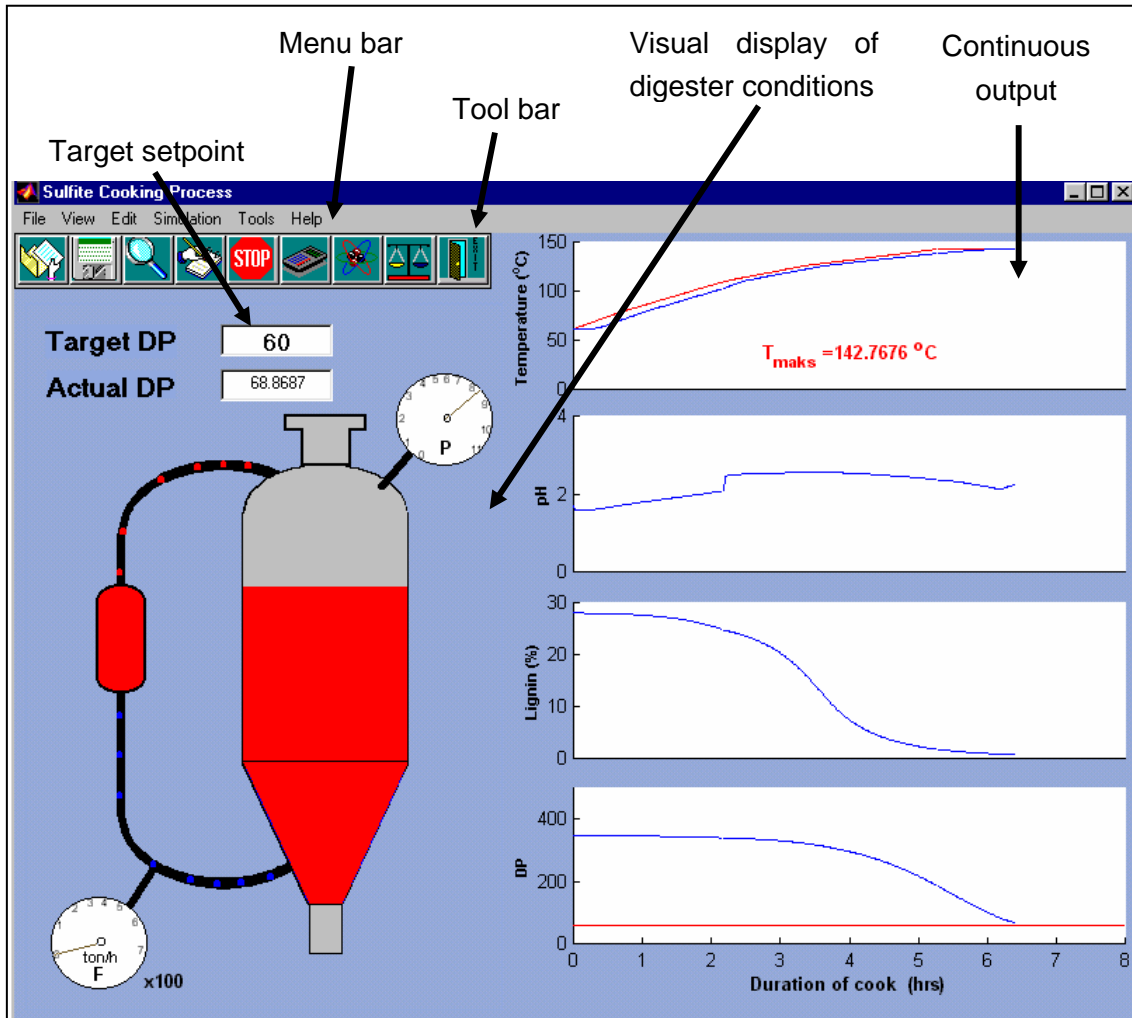

Figure 9.1: The main title screen in the “Digest” package

On the right of the main screen are four axes that will display the values of the four most important variables during a cook as was calculated with a simulation. These values will be displayed continuously during a simulation as the cook progresses and the exact progress of the reactions can be viewed throughout a simulation.

The four variables that were considered to be the most important were:

- The top and bottom temperatures
- The pH of the liquor
- The lignin content of the pulp
- The viscosity of the pulp. This gives an indication of the degree of polymerisation.

On the left hand side of the screen is a representation of the digester with some meters drawn onto it. These meters will indicate the pressure and the recirculation flow rate during the cook. The level of the liquor inside the digester will be indicated on the drawing of the body of the digester. The combination of these various displays gives the user a clear view of the process as it progresses from start to finish.

The ability of the fundamental model to predict a maximum cooking temperature to accomplish a target final degree of polymerisation was also investigated. For this purpose, a target degree of polymerisation can be entered in the space provided in the top left-hand corner of the screen. This target value will also be drawn in as a red line in the axes for the pulp viscosity. The actual accomplished final degree of polymerisation can then easily be compared with the target value.

A screen capture of the main title screen is shown in Figure 9.1. The different parts of the screen are indicated in this figure. The figure shows the title screen while a cook is being simulated. Therefore, the current degree of polymerisation is still much different from the target setpoint. The “Stop” button on the toolbar will be a “simulate” button when the simulation is not running, but will change to the “stop” button once a simulation is started. A simulation can then be stopped at any time.

9.2. Parameter adjustment

Since the primary purpose of the package was to develop an accurate fundamental model of the acid sulphite batch digester process, one of the first requirements of the package was to be able to change the parameters in the model. Based on the results of the comparisons of the simulations with real data, the parameters in the model can be adjusted to represent the actual data. User friendly screens were provided to enable the user to view and change the parameters. A screen capture of one of these screens is shown in Figure 9.2.

All the constant parameters in the fundamental model that was developed in Chapter 8 can be changed in these screens. The screen shown in Figure 9.2 shows all of the parameters in the delignification reaction of equation (6-24). Tabs are provided on top of the screen to page to the reaction parameters of the other reactions, as well as the parameters in the equilibrium equations used to model the liquor composition, as was developed in paragraph 8.2. The constant parameters in the Arrhenius equations are given in both the commonly used British units, as well as SI units. The value can be changed in anyone of these two sets and the value in the other set will be calculated automatically.

The screens for changing the other parameters in the kinetic mode are given in Figure 9.3 to Figure 9.5. The parameters in the equilibrium equations can be changed in Figure 9.6. It wasn't possible to write the Greek symbols in the model in these figure windows. The symbols were changed to normal alphabetic symbols in these screens. Table 9.1 gives an explanation of the symbols used in the program by comparing it to the original symbols used in the digester model as was developed in Chapter 8.

Program symbol	Original symbol in model	Description
a	a	Lignin reaction order in lignin reactions
b	α	Bisulfite reaction order in lignin reactions
c	β	Hydrogen reaction order in lignin reactions
d	d	Hemicellulose reaction order in hemicellulose reactions
e	γ	Hydrogen reaction order in hemicellulose reactions
f	q	Lignin reaction order in strong acid reactions
g	g	Additional parameter in strong acid reactions
h	h	Additional parameter in strong acid reactions
i	b	Bisulfite reaction order in strong acid reactions
j	c	Hydrogen reaction order in strong acid reactions
l	δ	Hydrogen reaction order in cellulose reactions

Table 9.1: Symbols used in “Digest” package

	[L] > 12,4	[L] < 12,4	
Reaction order			
[L] (a)	0.646	1.621	
[HSO ₃ ⁻] (b)	0.819	0.765	
[H ⁺] (c)	0.705	0.779	
Arrhenius parameters			
k _L ⁰	1.346e+012	4.07e+011	cal/gmol
	5.632e+012	1.703e+012	J/gmol
E _L	1.25e+004	1.25e+004	cal/gmol
	5.23e+004	5.23e+004	J/gmol

Figure 9.2: Screen for changing the kinetic parameters of the lignin reactions

	[L] > 12,4	[L] < 12,4	
Reaction order			
[HC] (d)	2.542		
[H ⁺] (c)	0.707		
Arrhenius parameters			
k _{HC} ⁰	1.236e+011		cal/gmol
	5.171e+011		J/gmol
E _{HC}	1.42e+004		cal/gmol
	5.941e+004		J/gmol

Figure 9.3: Screen for changing the kinetic parameters of the hemicellulose reactions

Kinetical Parameters: Cellulose

Cook Details Operational Details

Lignin Hemicellulose **Cellulose** Strong Acids Equilibrium

Reaction order

[C] (k)

[H⁺] (l)

Arrhenius parameters

k _C ⁰	<input type="text" value="7.68e+012"/>	cal/gmol
	<input type="text" value="3.213e+013"/>	J/gmol
E _C	<input type="text" value="1.71e+004"/>	cal/gmol
	<input type="text" value="7.155e+004"/>	J/gmol

Default Cancel Apply OK

Figure 9.4: Screen for changing the kinetic parameters of the cellulose reactions

Kinetical Parameters: Strong acids

Cook Details Operational Details

Lignin Hemicellulose Cellulose **Strong Acids** Equilibrium

Reaction order

[L]₀ - [L] (f)

[HSO₃⁻] (i)

[H⁺] (j)

Additional

g

h

Arrhenius parameters

k _{SA} ⁰	<input type="text" value="1.887e+016"/>	cal/gmol
	<input type="text" value="7.893e+016"/>	J/gmol
E _{SA}	<input type="text" value="1.986e+004"/>	cal/gmol
	<input type="text" value="8.309e+004"/>	J/gmol

Default Cancel Apply OK

Figure 9.5: Screen for changing the kinetic parameters of the strong acid reactions

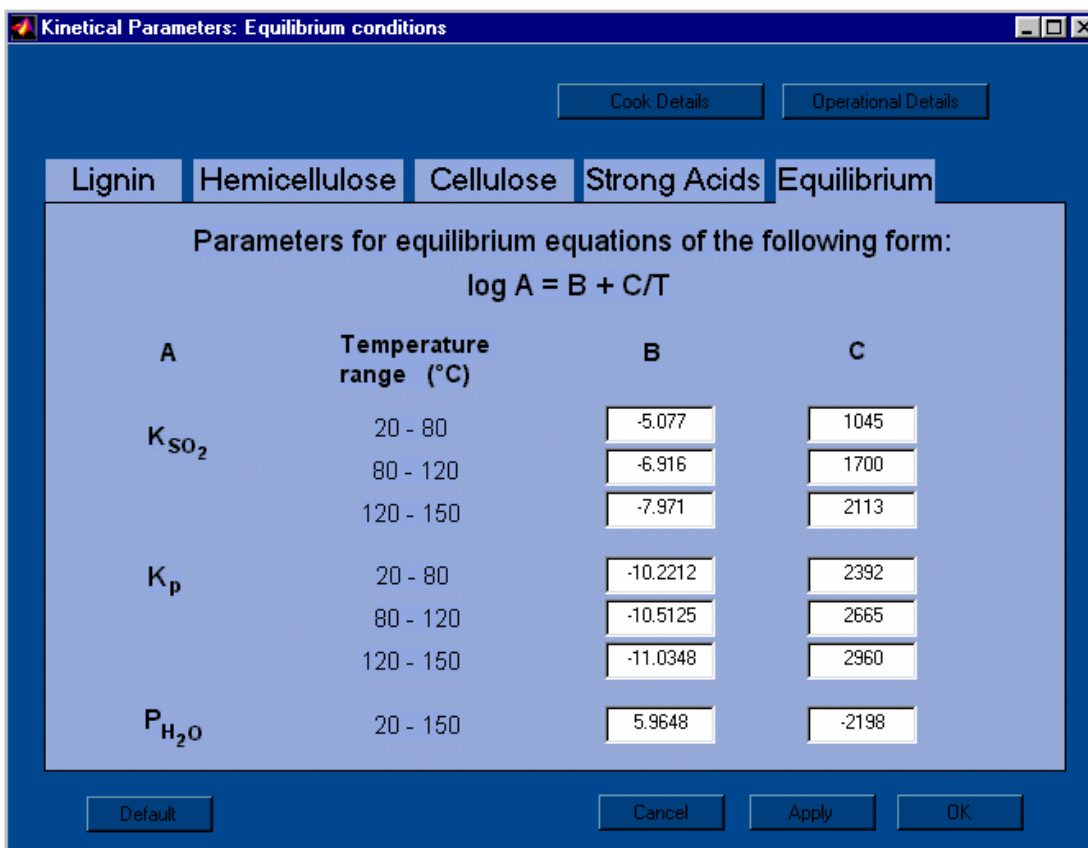

Figure 9.6: Screen for changing the equilibrium parameters

Two other sets of parameters are defined. These are the operational details and the cook details. The operational details define the specifics of the control strategy of the digester that are used to model the conditions inside the digester, as was discussed in paragraph 8.3. The operational details will normally remain the same from one cook to the other and changes will only be made to these parameters if the control strategy changes. It is primarily the temperature profile that is specified here. The screen layout for changing the operational detail is shown in Figure 9.7.

The cook details consist of the specific of an individual cook that will change from one cook to another. This primarily concerns the loading of the digester, that is, the amount of wood and liquor loaded, and the liquor strength. The possibility to change the initial wood properties is also given, although this can't be measured and therefore wouldn't be changed for each cook. However, theoretically the wood properties will be different for almost every cook and therefore it was included at the cook details.

Figure 9.8 shows the screen for changing the details of an individual cook. The target for the final degree of polymerisation and the maximum temperature is also given here. As will be discussed later, the simulation will always continue for the fixed duration as can be set at the operational details. The maximum cooking temperature for the simulation will be the maximum temperature set at this page. The final degree of polymerisation is therefore determined by the cooking time and the maximum

cooking temperature, and not by the target value. The target DP value is used to determine a new maximum temperature if the controlled option for the simulation is selected. In other words, the simulation will not be stopped once the target value is reached. The control is therefore aimed at the realistic situation of a fixed cooking time and where the manipulated variable is the maximum temperature.

The guidelines for changing the parameters are discussed in 10.4.

One of the most important and useful features of the package is the ability to load and save the parameters. The values of all of the parameters that were discussed that can be changed will be saved in a file. The values that will be saved will be the values that are in the Matlab workspace at that moment. The details of a cook can therefore be saved and loaded whenever the cook is repeated. The details and kinetics for a specific wood species can for example be determined, and whenever the kind of wood that is being used is changed, the previously saved parameters can be loaded to accurately represent the new conditions. The saved cooks are also used when determining the influence of a specific parameter on the cook, as will be discussed in paragraph 9.3.

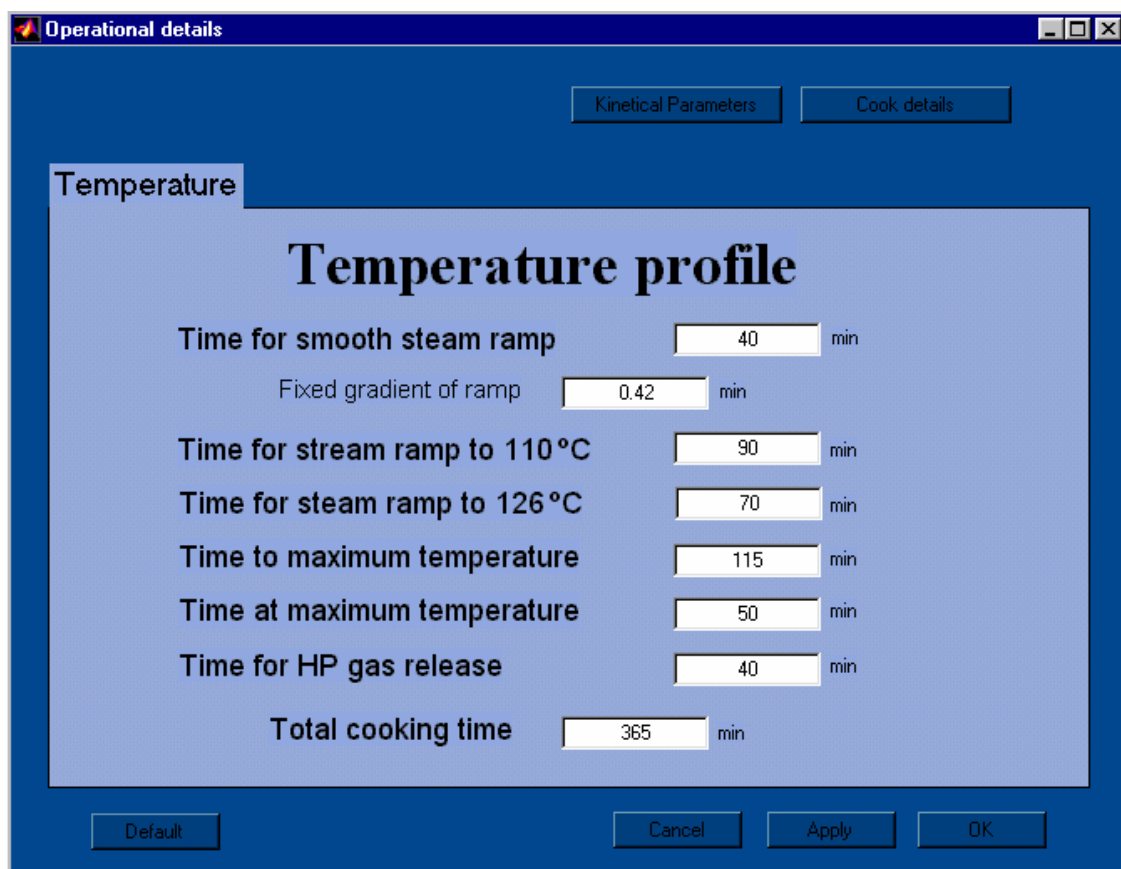
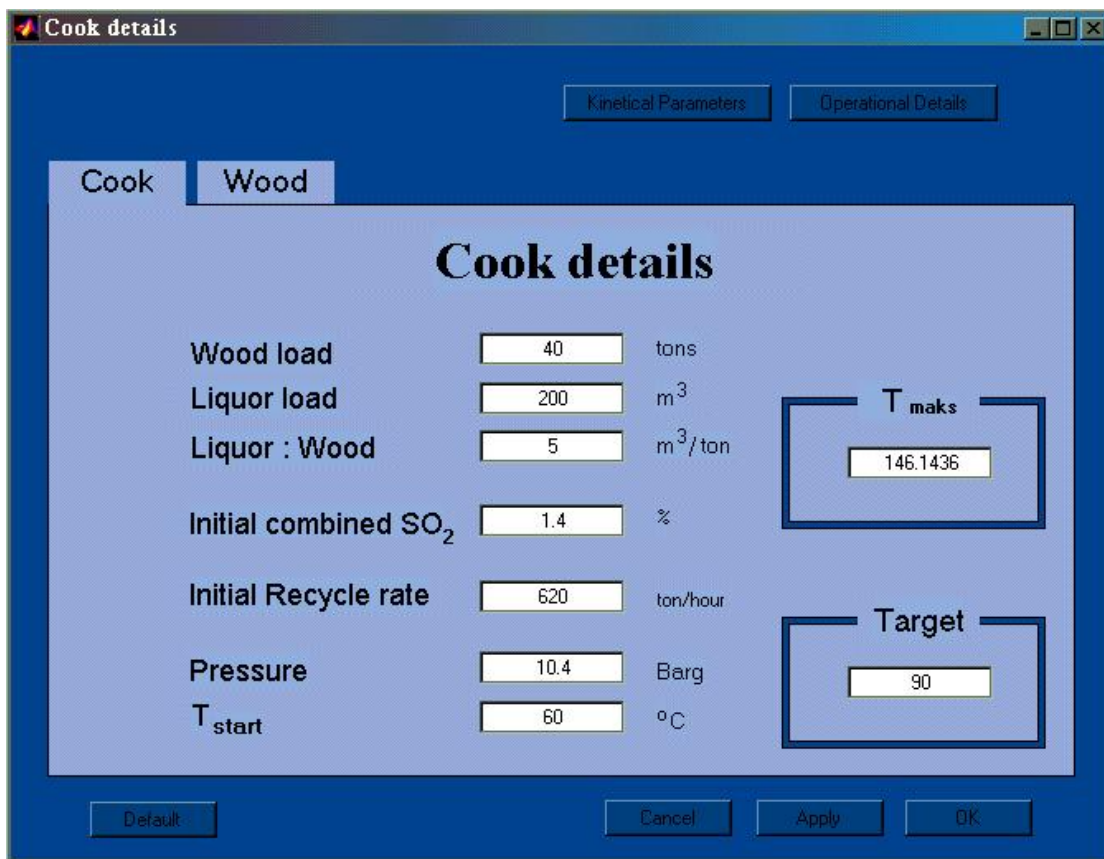

Figure 9.7: Operational detail in “Digest” package



Parameter	Value	Unit
Wood load	40	tons
Liquor load	200	m ³
Liquor : Wood	5	m ³ /ton
Initial combined SO ₂	1.4	%
Initial Recycle rate	620	ton/hour
Pressure	10.4	Barg
T _{start}	60	°C
T _{maks}	146.1436	
Target	90	

Figure 9.8: The cook details for the individual cooks

9.3. Determining the influence of a specific parameter

The model developed in Chapter 8 contains many different parameters that can be changed to change the results of a simulation. Finding the correct parameter to change in order to obtain a desired result can be very difficult, and therefore a tool was created that allows the influence of a specific parameter to be determined. When the influence of all of the parameters on the most important variables have been determined, it will be relatively easy to know which parameter to change.

It must be noted again that a general fundamental model was developed with a lot of changeable parameters. The way to obtain an accurate model to represent the conditions at SAICCOR was to compare the results of the simulations with real measurements and to adjust the parameters in order to obtain the measured results. The advantage of using this method is that much less experimental studies are necessary. Furthermore, the result is not a set of fixed kinetic parameters determined

from experiments that don't necessarily represent the exact actual conditions. Therefore, the model can easily be adapted to suit all conditions in the digester, based on real results.

The primary purpose of this package was to aid in the development of a fundamental model in this way. It was therefore very important to get to know the significance of each parameter in the process.

The influence of a specific parameter can be determined by running simulations with different values for the parameter in question. This can be done with the package by changing only the value of one parameter at a time and saving the cook each time that the parameter was changed. The comparison tool allows for three different cooks to be compared. The influence of a parameter being changed in both directions can therefore be determined by saving three different cooks, with the value of a single parameter being changed for each saved cook. The comparison plots the results of each of the simulations on the same set of axes. The influence of the parameter can then be determined graphically. Whenever a parameter then needs to be changed to obtain a certain result, the correct parameter can easily be determined.

An example of the influence of the “B” – parameter in equation (8-5) for the determination of K_{H_2O} is shown in Figure 9.9. An option is also provided to print these results. The influence of all of the parameters were determined in this way. The results are displayed in Appendix B.

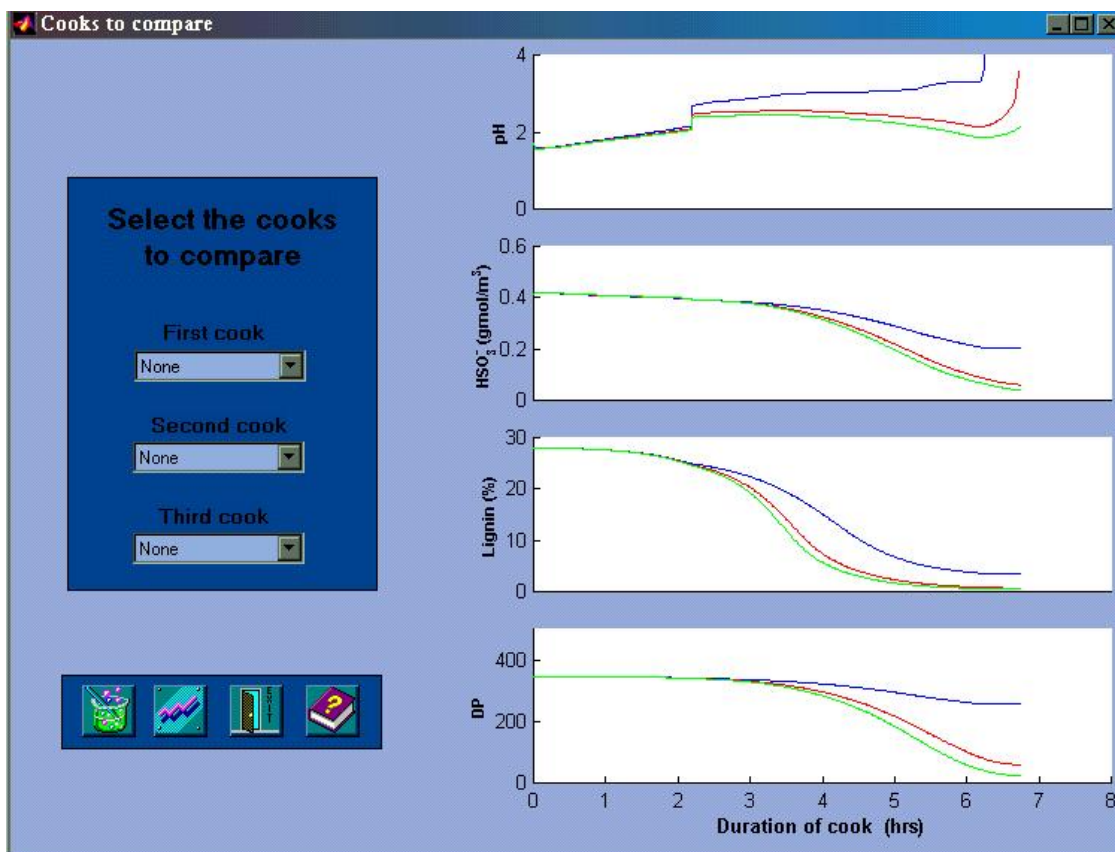

Figure 9.9: Comparison of different cooks

9.4. Verifying the correctness of the model

The most useful tool in the “Digest” package allows for the comparison of the results of simulations with actual measurements. In this way, the correctness of the model can be verified, and if some deviations from the real cook do exist, the simulation will show where the biggest differences are. By using the results obtained when determining the influence of each parameter as was discussed in paragraph 9.3, the parameters can easily be adjusted to try and obtain the correct model.

The details of the verification process will be discussed in Chapter 10. However, the logic of the process will be sketched here. This is necessary to understand the different steps in the verification process.

Two different steps in the process of verifying the model were identified. The first step involves the verification of the correctness of the kinetic model and the modelling of the liquor composition. These variables depend on the conditions inside the digester.

The second step in the verification verifies the correctness of the prediction of the conditions inside the digester. It was reasoned that if the modelling of the kinetics proves to be accurate by using measured conditions in the simulation, and the prediction of the conditions inside the digester are correct, the whole model can be assumed to be correct.

For the verification of the kinetics, experimental values obtained by Watson (1992) were used. The conditions inside the experimental equipment were used in the simulation and were not predicted with the model. Therefore, the modelling of the kinetics was isolated from the modelling of the conditions, and the correctness of the kinetic model could be tested separately. The prediction of the conditions were then tested by comparing the simulation results with actual measurements on one of the digesters at SAPPI SAICCOR.

Two separate comparisons were made for each step in the verification process. The first step compares the simulation results of only one cook with the actual measurement for the corresponding cook. All possible measurements for the cook are compared with the predicted values at the appropriate time. For example, all measurements of the degree of polymerisation taken during the experimental studies are compared with the simulated values.

The second comparison compares only the final degrees of polymerisation. The final degrees of all available cooks are compared with predictions for the final degree of polymerisation obtained by the model. Since this is the actual variable of interest, this is a very important comparison in order to determine the ability of the model to predict the end of cook. This will also determine the possibility of implementing the model in a control strategy.

The measured data are entered into a spreadsheet. This spreadsheet can then be accessed by the package to extract the necessary cooking detail from. Two different types of input to the package are used. The first consists of the cook detail, that is, the starting conditions for the cook and the simulation. This is very important in the simulation of the model. The second set of data involves the measurements taken during the cook. The results of the simulation will ultimately be compared with these values inside the spreadsheet.

The format of the spreadsheets is very important, since the “Digest” package will look for certain data at specific positions in the spreadsheets. The exact format of these spreadsheets is discussed in the help files.

Chapter 10 deals with the verification of the model that was developed in Chapter 8. The verification tools of the “Digest” package was used for this purpose. More details

of the data that were used, as well of screen captures of the verification tools will be given in this chapter.

9.5. Simulation and control of a cook

The verification tools, as well as the function for determining the influence of the individual parameters, are based on simulation of specific cooks. It is however also possible to simulate a cook outside of these functions. This can be done from the main title screen. The values for the parameters currently loaded into the workspace will be used for this simulation. The values can be obtained either from a saved file, by changing the values of the parameters directly, as was discussed in paragraph 9.2, or from the values loaded for an actual cook. In the last instance, the details of the cook that was last simulated during the use of the verification tool, will be kept in the workspace, and the simulation can be repeated from the main title screen.

Two options for the simulation of a cook was created. The first option will simulate the cook, using the maximum temperature that was specified by the user. The cook will progress up to the set end-of-cook time and the high-pressure gas release phase will be started. In the second instance, the target value of the viscosity can be provided by the user. By running a “controlled” cook, a new maximum temperature will be calculated before the simulation is started. The simulation will still continue up to the end-of-cook time and the calculated temperature. It is important to note that a controlled cook will not be stopped once the target viscosity is reached. This was done to illustrate the predictive capabilities of the model.

The results of the simulation will be displayed graphically on the main title screen, as was shown in Figure 9.1. When a simulation is running, the “simulate” button will change to a stop button and the simulation can be stopped at any time.

9.6. Summary

The “Digest” computer package that was developed facilitates the process of constructing an accurate process model over a batch pulp digester. However, the basic model structure has to be in place already before the package can be used to fit the model to actual data. This implies that the package doesn’t apply process identification techniques or artificial intelligence to fit a black-box model to the process. It should be used as a tool to fine-tune the parameters of an already developed model, as well as for the verification of the model. The package is generally applicable to batch pulping processes, and by changing the process model used, could also be used for other batch processes as well.

Chapter 10:

Evaluation of the model

The final but often neglected step in the development of a mathematical model of a process, must always be the verification of the model. That is to prove that the model describes the real-world situation. The best way to do this is obviously to compare the results obtained from the model with data collected from the process. This isn't always possible, since plant data cannot always be obtained. For example, during the design stage of a new process the plant has not yet been build and the collection of data is therefore not possible. Another situation can be that it is not possible to take measurements of the needed variables. Since the lack of measurements in the pulp digester is one of the intrinsic difficulties in the control of the process, obtaining verification data is also difficult.

Two different sets of data were available for the verification of the model. The first set of data consists of actual measurements taken from a single digester. This data contained data like the temperature and pressure throughout the cook, as well as a measurement of the final degree of polymerisation. It was very difficult to use this data to verify the entire model, since only one measurement is taken of the degree of polymerisation. It isn't possible to verify the model's ability to correctly predict the dynamic change of the cellulose degradation during the cook. It may therefore happen that the model can be tuned to coincidentally predict the final degree of polymerisation correctly, but that it will be wrong if the cook time changes for some reason. This situation is shown in Figure 10.1. The predictions made by the model in this figure are clearly wrong. However, it will be possible to adjust the parameters of the model to correctly predict the final degree of polymerisation where the two lines intersect. As soon as anything in the process changes, the predictions made by the model will be erroneous again. It will therefore be necessary to have a few measurements of all the variables in the process to ensure that the model also predicts the right trends to have real confidence in the results of the model. Verification of the model using only the real plant data would give worthless results.

Another set of data was available from the kinetic studies that Watson (1992) did. In order to determine the kinetics of the process, a few measurements of the wood

properties over the duration of the cook were necessary. Some laboratory experiments were done in order to obtain these values. Six measurements of the wood properties near the end of the cook were possible with the equipment available. Although it wasn't possible to exactly represent the actual condition in the digester, the conditions used in the experimental equipment were sufficiently close to the conditions inside a pulp digester to accurately determine the kinetics of the process.

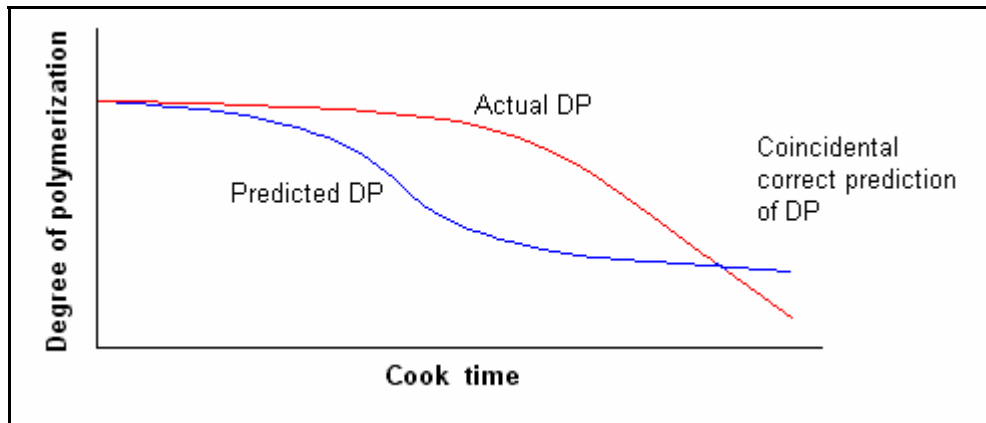

Figure 10.1: A coincidental correct prediction of the degree of polymerisation

In order to combine these two sets of data in the verification process, the model of the digester was divided into two separate parts and the verification was done separately over each part. It was mentioned in Chapter 8 that the process was divided in three parts in order to construct the model. These three parts were:

1. The kinetics of the reactions involving the wood constituents,
2. The liquor composition and
3. The pressure and the temperature inside the digester.

For the verification, the first two parts were considered together and the third part separately. The reaction kinetics and the liquor composition were verified using the data obtained by Watson, since more measurements of the wood and liquor conditions were possible using the laboratory equipment. The modelling of the actual conditions inside the digester was verified with the real plant data. It was reasoned that if the verification of the kinetics, using known conditions for the modelling of the reactions, shows that the kinetic model is correct and the verification of the modelling of the conditions inside the digester give good results, then the entire model can be assumed to be correct. The exact details of the verification of each part will be given in the subsequent paragraphs.

The "Digest" software package was used to do the verification of the model, as well as to simplify the adjustment of the parameters in the model to obtain a model that does represent the real-world situation.

10.1. Verification of the kinetics and liquor composition

It was mentioned that the data obtained by Watson (Watson, 1992) during his studies of the reaction kinetics were used in the verification of the reaction kinetics used in this model and the modelling of the liquor composition during the cook. A short description of the equipment used and the results obtained that was extracted from Watson's thesis will be given here.

10.1.1. The collection of kinetic data (Watson, 1992)

10.1.1.1. EQUIPMENT USED

The requirements of the experimental equipment used were as follows:

- i. Accurate temperature profile control must be possible to allow repeatable temperature profiles for each cook.
- ii. It must be possible to take in-process liquor and pulp samples
- iii. On-line pH measurements must be made
- iv. Continuous collection of temperature, pressure and pH data must be possible.

A satellite mini digester plant was designed to meet the experimental requirements. It consisted of a number of small individual digesters with common liquor distributed through each and enabled isolation and depressurisation of any specific digester at any time during the cook. A process flow diagram of the final plant configuration is shown in Figure 10.2.

The plant was designed to operate at a maximum temperature of 150 °C and a working pressure of 11 Bar and consisted of the following major components:

- i. Liquor circulation system (and water distribution system)
- ii. Six 2-litre digesters
- iii. Liquor sample cooler
- iv. SO₂ absorption column
- v. Electrical panel with hard-wired interlocks for start-up, shut-down and emergency shut-down procedures

- vi. Instrumentation, an instrument panel and communication to a remote computer programmed for data collection.

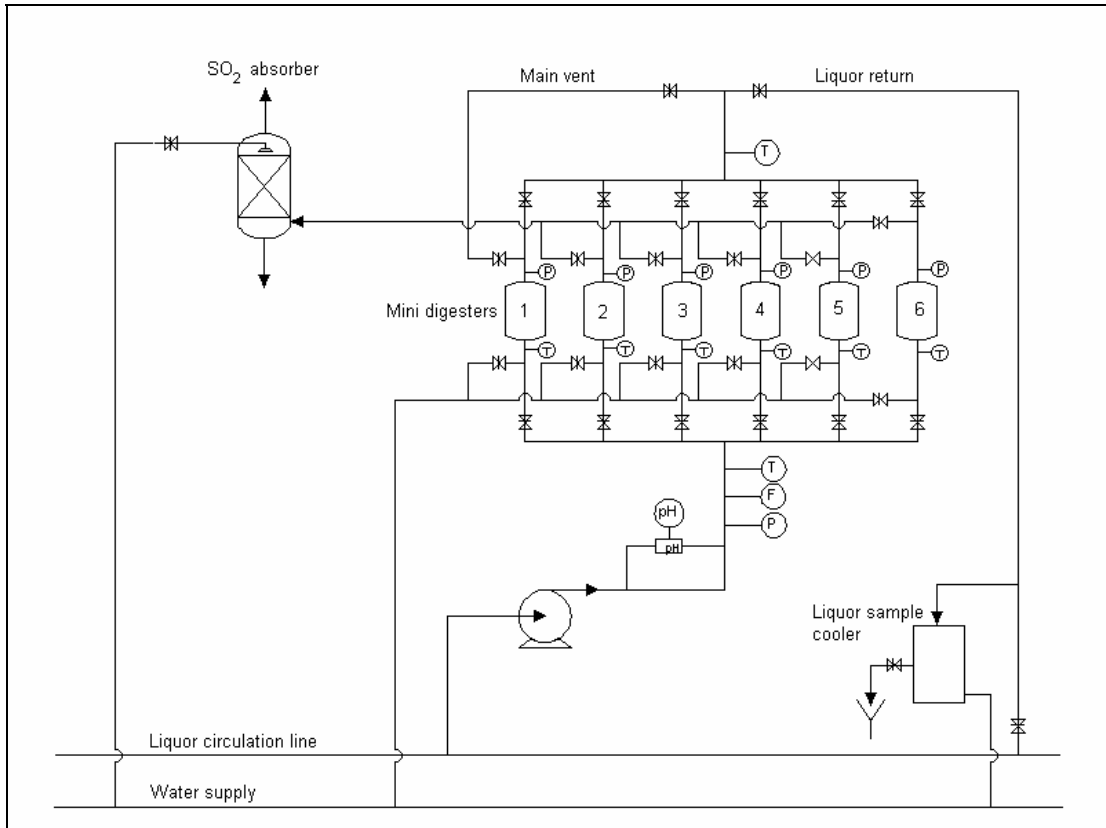

Figure 10.2: A process flow diagram of the satellite mini digester plant (Watson, 1992)

The liquor circulation system consisted of an intake sourced from an external digester and eventually returned to it. The circulation pump was rated to achieve a similar relative liquor flow rate through the chips as occurs in the plant digesters at the start of a cook.

10.1.1.2. EXPERIMENTAL METHODOLOGY

A complete cook cycle in the mini digester plant can be divided into the following phases:

- i. Wood loading: The main laboratory digester was charged with 5,2 kg of chips, and each of the mini digester chip baskets was charged with 0,3 kg of chips and loaded into the mini digesters. The chips were then steamed using a direct 5 bar steam injection. This ensured the removal of trapped air from the chips and had the added benefit of heating the plant up; thus preventing the temperature from lagging behind the set point at the start of the cook when the heat input required was greatest.

- ii. Liquor loading and pressurisation: Raw cooking liquor was withdrawn from the liquor plant. Usually, this liquor had total and combined SO₂ concentrations in the order of 6% and 1,4% respectively. This relatively high concentration of combined SO₂ not only slowed the cooking process down by depressing the acidity of the liquor, but also tended to cause excessive scaling because of the high liquor-to-wood ratio characteristics of the equipment. Liquor concentrations were consequently adjusted to 1,25% combined SO₂ by dilution and then the total SO₂ boosted to 8% using SO₂ gas.
- iii. Cooking: Once the liquor loading was complete, the heating cycle could be started. A typical temperature profile used in the experimental cooks can be found in Table 10.1.

Time (min.)	From (°C)	To (°C)
45	T _{start}	85
45	85	110
60	110	126
60	126	T _{max}

Table 10.1 A typical experimental temperature profile

The estimated time at maximum temperature required to achieve a pulp viscosity of approximately 120 cp. can be found in Table 10.2. The isolation of the first mini digester was based on these estimates. Subsequent mini digesters were isolated and quenched at 15 minute intervals. This procedure resulted in most pulp viscosities falling in the range of interest, namely 120 to 20 cp.

Maximum temperature (°C)	Time at maximum temperature (minutes)*
130	210
140	120
145	90
150	30

Table 10.2 Cook times at maximum temperature

* Time to isolation of first mini digester

10.1.1.3. LIQUOR AND PULP SAMPLE ANALYSIS

Liquor samples were taken throughout the duration of the cook and analysed by using the Palmrose method. Detail of the analysis procedures will not be given here, since the collection of experimental data was not part of this study. Only the measurements taken will be discussed here in order to give an overview of the data used in the verification of the model.

The total, free and combined SO₂ concentrations of the liquor were determined by the Palmrose test. These values could then be used in the calculation of the bisulfite ion concentration in the liquor, as well as the strong acid concentration. Around six to seven liquor samples were usually taken during a cook and this allowed for the calculation of the bisulfite concentration at regular intervals from the start to the end of a cook.

Three variables concerning the composition of the pulp were of importance: the lignin, hemicellulose and cellulose content of the pulp. The important property for the cellulose is the degree of polymerisation. Six pulp samples could be taken from the mini digester plant and these samples were analysed in the laboratory to determine the values of the mentioned variables.

Viscometric methods were used for the determination of the degree of polymerisation of the cellulose. The equation for calculation of the degree of polymerisation from the viscosity was given in paragraph 2.2.1.

$$DP = 285,4\mu^{0,345} \quad (2-5)$$

Watson found the viscosity analysis of the pulp samples to be accurate and reliable. However, a common problem with the viscosity measurement was the interference of lignin, especially if the sample contained an appreciable percentage of lignin. The net effect of the error caused by a high lignin content was a low viscosity measurement. As the cook progressed and the lignin content dropped, the viscosity would increase until sufficient lignin had been removed. For this reason, pulp samples could only be taken near the end of the cook when the lignin content was sufficiently low.

The residual lignin percentage was determined from the so-called K-number that was obtained by a titration of a clean pulp sample and sulphuric acid with potassium permanganate. This measurement was also found to be accurate. The lignin percentage could be calculated from the K-number by using the following correlation:

$$\% \text{lignin} = 0,055 \cdot K^{1,47} \quad (10-1)$$

The last variable to be measured from a pulp sample, was the hemicellulose content. This was done with the so-called S_{18} method. This method consists of measuring the carbohydrate fraction soluble in an 18% caustic solution. The S_{18} measurements were however found to be erratic. The bleaching process resulted in an attack on the carbohydrate fraction that caused a definite source of error. Since the hemicellulose content doesn't play any role in the model for calculating the final degree of polymerisation, this didn't cause much concern and no attempt was made to obtain better measurements.

10.1.1.4. RESULTS

A series of experimental runs were performed at maximum temperatures ranging from 130 °C to 150 °C to gather data for the purpose of determining the kinetic parameters of the various reactions. For every cook, the temperatures, pressures and pH values were recorded over the duration of the cook. Six liquor samples and six pulp samples were also taken at fixed intervals. The total and combined SO_2 contents were determined from each liquor sample, and the lignin, hemicellulose and cellulose content were determined from each pulp sample.

A typical set of results collected from the pulp and liquor samples is shown in Table 10.3. In addition to the results shown, there will also be a table with the temperature, pressure and pH vectors over the duration of the cook.

Cook Number	CK016	Maximum temp.	145 °C			
Wood Load	7,0 kg	Liquor load	46 litre			
Wood moisture	34 %	Total cook time	6h15			
Liquor sample analysis			Pulp sample analysis			
Elapsed time	Total SO_2	Combined SO_2	Elapsed Time	Pulp viscosity	Kappa number	S_{18}
LOAD	7,36 %	1,26 %	5h00	124,7	4,90	5,78
0h00	6,73 %	1,24 %	5h15	91,7	4,08	5,86
1h30	6,41 %	1,16 %	5h30	73,3	3,62	5,44
2h00	6,34 %	1,13 %	5h45	63,0	2,98	5,17
2h35	6,19 %	1,05 %	6h00	54,0	2,77	5,25
3h30	5,92 %	0,82 %	6h15	43,9	2,31	5,13
4h30	5,40 %	0,46 %				

Table 10.3 A typical set of results from an experimental run
(Watson, 1992)

The temperature and pressure measurements were taken on the mini digesters. In addition, the measuring instruments were thoroughly calibrated before the experimentation was started. The measurements can therefore be taken to represent the actual conditions inside the mini digesters. However, the pH values were found to be prone to a constant upward drift, which resulted from the glass electrode ageing. Constant recalibration was found to be impractical, and therefore a manual adjustment to the values were made by calculating the correct pH value at the start of the cook using equation (6-10) and taking the strong acids concentration to be zero. This correction hasn't been made to the data reported by Watson and to be done for this study. The method for doing this was explained by Watson and will be repeated here, since it was also applied in this study.

10.1.1.4.1. pH correction

A pH value is obtained by measuring the electrode potential developed across the measuring and reference electrodes and is based on the following relationship:

$$E_{el} = E_0 - S(pH_a - pH_i) \quad (10-2)$$

Where:

- E_{el} = electrode potential
- E_0 = zero potential
- S = slope (mV per pH unit)
- pH_i = pH value of internal buffer
- pH_a = pH value of measured solution

From this equation, it can be seen that error can occur due to either a change in the slope or a shift in the zero point. Both of these phenomena can be attributed to a reaction with the measuring solution, or the ageing of the electrode.

A shift in the zero can directly be corrected if the pH of the solution is known at one point. However, to compensate for shifts in the slope, two points are needed. Since the pH range over which the measurements were taken was relatively small, small errors in calculating the actual pH can lead to large errors in the calibration. Watson showed that the correction of only the zero drift yielded acceptable results.

A fixed point during the cook must be selected to ensure that the correction is always performed at the same temperature. This is important for the accuracy of the calibration since the temperature influences both the various individual potentials relating to the electrode and the ion activity. Various points were considered by Watson and it was decided to use the combined SO_2 measurement taken ± 20 minutes after side relief. At this stage very little delignification has taken place and therefore

the concentration of strong acids will be virtually zero. Therefore, equation (6-10) can be solved directly for the hydrogen ion concentration and the pH can be calculated from that. The constant pH correction for the cook can then be calculated as the difference of the measured value and the actual value calculated:

$$\text{pH}_{\text{corr}} = \text{pH}_{\text{meas.}} - \text{pH}_{\text{calc.}} \quad (10-3)$$

All the pH measurements can then be corrected by subtracting this constant correction factor:

$$\text{pH} = \text{pH}_{\text{meas.}} - \text{pH}_{\text{corr.}} \quad (10-4)$$

10.1.2. Verification using the data

The way that the collected experimental data was used in this study will be discussed next. The kinetic model developed in paragraph 8.1 was used to simulate the reactions in the mini digester plant. Since the purpose of the first part of the verification process was only to verify the correctness of the kinetic model, as well as the correctness of the modelling of the liquor composition, the conditions inside the mini digesters were taken to be known. The temperature and pressure vectors measured on the mini plant were therefore entered into the model. By doing this, the kinetics of the reactions are isolated, since the conditions are known to be correct. Any errors in the results of the simulation can then be ascribed to errors in either the modelling of the reactions, or the modelling of the liquor composition.

The most important variable in the model for control purposes, is the degree of polymerisation of the cellulose. The primary aim is therefore the accuracy of the simulation of the degradation increase. However, it will also be necessary to verify the correctness of the other parameters. This enables one to locate the source of the largest deviation from the real values. Therefore, if large errors in the degree of polymerisation occur, the variable that is mainly responsible for the errors can be located. The possibility to adapt the model for the variables that give the worst results is then created.

The correctness of the following variables were verified:

- i. Liquor samples
 - Bisulphite ion concentration
 - pH of the liquor
- ii. Pulp samples
 - Lignin content
 - Hemicellulose content
 - Degree of polymerisation of the cellulose

The simulation was done using the software package that was created. After the simulation had been completed, the measurements taken on the mini digesters were compared with the calculated values from the simulation at the corresponding times. A correlation coefficient was then calculated for each variable. Equation (10-5) was used for the calculation of the correlation coefficient. This is the well-known and generally used formula for the calculation of the correlation coefficient.

$$r_{X,Y} = \frac{\text{cov}(X,Y)}{\sigma_X \cdot \sigma_Y}$$

with:

$$\sigma_x^2 = \frac{1}{n} \sum_{i=1}^n (X_i - \bar{X})^2$$

and:

$$\sigma_y^2 = \frac{1}{n} \sum_{i=1}^n (Y_i - \bar{Y})^2 \quad (10-5)$$

The covariance ($\text{cov}(X, Y)$) of the two vectors, is defined as follows:

$$\text{cov}(X, Y) = \frac{1}{n} \sum_{i=1}^n (X_i - \bar{X})(Y_i - \bar{Y}) \quad (10-6)$$

The correlation coefficient is used to determine whether two ranges of data move together - that is, whether large values of one set are associated with large values of the other (positive correlation), whether small values of one set are associated with large values of the other (negative correlation), or whether values in both sets are unrelated (correlation near zero). The best correlation will give a value for the correlation coefficient of one. It must however be noted that the correlation coefficient is only used to compare the trends of the two vectors, and a constant offset between the vectors isn't taken into account. Therefore, two parallel vectors will give excellent correlation coefficient values, although there can be a very large constant error in the prediction.

Various other coefficients can be used to take a constant offset into consideration. The simplest of these is the mean square error. The mean square error is simply calculated as the sum of the squares of the difference between the measured values and the predicted values.

$$\text{MSE} = \frac{1}{n} \sum_{i=1}^n (X_i - Y_i)^2 \quad (10-7)$$

The root of the squared values can also be used. This will give the average error and will have a bit more intuitive value.

$$\text{ME} = \frac{1}{n} \sum_{i=1}^n \sqrt{(X_i - Y_i)^2} \quad (10-8)$$

It doesn't really matter which value is used in the evaluation of the model, since the purpose of the optimisation of the model will be to minimise the mean square error. The mean error has a little more intuitive value, since the value directly gives the mean error of the prediction.

The mean square error coefficient has the obvious disadvantage that it doesn't give any indication of the correctness of the trend. By combining the mean square error and the normal correlation coefficient in the evaluation, the correctness of the model can be evaluated for both a trend and a constant offset.

Another possible coefficient that can be used, is called the concordance correlation coefficient and was developed by Lin (1989). This coefficient takes both the above mentioned factors into account and can therefore be used as a single coefficient to determine the correctness of the model. If the pairs of values of measured and predicted values are again taken to be (X_i, Y_i) , with means μ_1 and μ_2 , the covariance matrix is:

$$\begin{pmatrix} \sigma_1^2 & \sigma_{12} \\ \sigma_{21} & \sigma_2^2 \end{pmatrix}$$

The diagonal elements of the matrix represent the variances for the columns of the column vectors, X and Y. The off-diagonal elements $C(i,j)$ represent the covariances of columns i and j of the column vectors.

The concordance coefficient is then defined as in equation (10-9) on the following page.

$$\rho_c = \frac{2\beta_1\sigma_2^2}{(\sigma_1^2 + \sigma_2^2) + [(\beta_0 - 0) + (\beta_1 - 1)\mu_2]^2}$$

with:

$$\beta_1 = \left(\frac{\sigma_1}{\sigma_2}\right)\rho$$

and

$$\beta_0 = \mu_1 - \beta_1\mu_2 \tag{10-9}$$

with ρ the Pearson correlation coefficient.

The concordance correlation coefficient gives a value between 1 and -1 . A perfect correlation is represented by a 1, for example (1 , 1 ; 2 , 2 ; 3 , 3), and a perfect reversed agreement is represented by a -1 , for example (1 , 3 ; 2 , 2 ; 3 , 1).

For n independent pairs of values, the sample counterparts can be used. The following form for the concordance correlation coefficient was suggested:

$$\hat{\rho}_c = \frac{2S_{12}}{(S_1^2 + S_2^2) + (\bar{Y}_1 - \bar{Y}_2)^2}$$

with:

$$\bar{Y}_j = \frac{1}{n} \sum_{i=1}^n Y_{ij}, S_j^2 = \frac{1}{n} \sum_{i=1}^n (Y_{ij} - \bar{Y}_j)^2 \text{ and } j = 1,2$$

and

$$S_{12} = \frac{1}{n} \sum (Y_{1j} - \bar{Y}_1)(Y_{i2} - \bar{Y}_2) \tag{10-10}$$

Since the concordance coefficient is not yet well known and generally used, it was decided to give preference to the other two coefficients discussed first in the evaluation of the model. One of the important reasons for the verification of the model is to gain acceptance for the model by proving the correctness of the results. It is therefore better to use known coefficients for the expression of the efficiency of the model. It will also be shown later how the coefficient of variance that is currently used at SAICCOR and therefore well known, was used for verify the correctness of the complete model. The concordance coefficient was however also calculated for each verification, because of its potential of being a single coefficient for expressing the correctness of the complete model.

10.2. Verification of the conditions inside the digester

The correctness of the simulated conditions inside the digester was verified by simulating an actual cook and by comparing the predicted conditions to the actual conditions. The conditions inside the digester were simulated according to the control strategy currently used, as was described in paragraph 8.3. The initial conditions of a real cook were entered into the verification tool of the “Digest” package and the conditions for the rest of the cook predicted by the model. Continuous measurements of the top and bottom temperatures, the pressure as well as the recirculation rate were available from one of the digesters at SAICCOR. A pH measurement was also taken, but this was found to be extremely unreliable. Therefore, the pH verification on the data obtained by Watson as was described in paragraph 10.1.2, was taken to be correct.

The verification of the modelling of the conditions was then quite easy, since the predicted values could easily be compared to the actual measurements. The actual cook data were entered into spreadsheets that could be read by the “Digest” package as was discussed in Chapter 9. The actual conditions for the cook can be extracted quite easily and compared with the simulated values. The same correlation coefficients were used as was discussed in paragraph 10.1.2.

10.3. Verification of the complete model

The same data that was used for the verification of the modelling of the conditions inside the digester was used for the verification of the entire model. Actual data for previous cooks were therefore used to verify the ability of the model to predict the final degree of polymerisation. The final degree of polymerisation obtained for each of the cooks was also read into the spreadsheet containing the continuous measurements. The cook was then simulated using the initial conditions supplied in the spreadsheet. The final degree of polymerisation was predicted through the simulation and the results compared with the actual values obtained on the plant. The conditions inside the digester were also modelled and not read from the spreadsheets as has been done for the first part of the verification that was discussed in paragraph 10.2. The result of the verification therefore gives an indication of the ability of the entire model to predict the final degree of polymerisation from the initial conditions.

It must be stressed that this part of the verification only verifies the prediction of the final degree of polymerisation. Consequently, each cook that is used in the verification only gives one single value to compare with the simulated results. From the results obtained from one cook, only the difference between the actual value and the predicted value can be calculated. No statistical correlation coefficient can be calculated on this single value and little indication of the overall ability of the model is given. A tool was created in the “Digest” package to simultaneously compare the results of several cooks. The predicted and actual values of the final degree of polymerisation for each one of the cooks are plotted on the same axes. The ability of the model to constantly predict the actual degree of polymerisation correctly is measured. This tool was discussed in paragraph 9.4.

The coefficient of variance that is currently used at SAPPI SAICCOR to determine the efficiency of the S-factor model was mentioned in paragraph 4.2.2. The coefficient of variance is calculated as the ratio of the standard deviation of the viscosity over a period to the mean of the viscosity values. Some concern about the ability of the coefficient of variance to correctly measure the accuracy of the model was expressed by both Smith (Smith, 1998) and Meneghel (Meneghel, 1998a). The major concern was that the coefficient of variance is an indication of the variance of the viscosity around the mean of the actual values obtained, and not the variance around the target value for the degree of polymerisation. Deviations from the target value will therefore not be considered by the coefficient of variance calculation.

Since the coefficient of variance is a well-known correlation coefficient at SAICCOR for expressing the efficiency of the model, it was decided to use a similar coefficient for the evaluation of the fundamental model. It was mentioned in paragraph 10.1.2 that one of the reasons for the verification of the model is to gain acceptance for the model. It is therefore necessary to use a familiar coefficient to express the efficiency of the mode. By using a similar coefficient to that which is currently used, comparisons between the fundamental model and the S-factor model would also be possible. Some changes were however made to the coefficient to compensate for the criticism against its current form.

The standard deviation can be calculated as follows:

$$s = \sqrt{\frac{1}{n-1} \sum_{i=1}^n (x_i - \bar{x})^2} \quad (10-11)$$

The mean is just calculated as:

$$\bar{x} = \frac{1}{n} \sum_{i=1}^n (x_i) \quad (10-12)$$

It can be seen that the standard deviation is calculated as the square root of the average of the squares of the difference between each value and the mean of the set of values. It is thus a measure of the average deviation from the mean of the set of values. A more accurate calculation of the coefficient of variance for the viscosity would therefore be to use the difference between the target value for the viscosity and the actual values obtained. This would also take any deviations of the mean from the target into account. The value calculated would give a more conservative indication of the efficiency of the model in question.

This adapted coefficient of variance was used in the verification of the fundamental model. However, since the fundamental model was not used in the control of cooks, the model cannot be compared to the target as this would give an incorrect indication of the accuracy of the model. Since the model was compared with the actual cooks, the variation between the predicted values and the actual values was calculated. The mean value in the calculation of the standard deviation was replaced by the actual viscosity of each cook individually. The correlation coefficient used was thus calculated as follows:

$$\text{COV} = \frac{\sqrt{\frac{1}{n-1} \sum_{i=1}^n (x_i - Y_i)^2}}{\frac{1}{n} \sum_{i=1}^n (x_{ii})} \quad (10-13)$$

This would again give a conservative indication of the accuracy of the model compared to the original coefficient of variance. The original form of the coefficient of variance used by SAPPI SAICCOR was shown in equation (4-11). The difference can be clearly seen in the number used for the calculation of the standard deviation.

Since the normal values for the coefficient of variance was always above 20 as was discussed in paragraph 4.2.2, any conservative values lower than 20 should mean that improvements would be possible when the fundamental model is used.

10.4. Approach taken to obtain the correct model

The approach taken in this study was similar to the one mentioned by Terwiesch (Terwiesch et al., 1994), as was discussed in paragraph 7.4. This approach requires that the basic model structure be chosen from first-principles considerations, while the model parameters are typically computed so that the model predictions best fit the data. The software therefore allows for the parameters in the model to be adjusted so that the modelling results best fit the data. An additional interface for adjusting the parameters was created in the “Digest” package. This new interface allows for small controlled changes to be made to the values of the parameters. A scroll bar was provided for each parameter that will change the value displayed in the editbox by 1% each time one of the arrows is pressed. It is however still possible to make the changes directly in the editboxes. An example of the interface is shown in Figure 10.3.

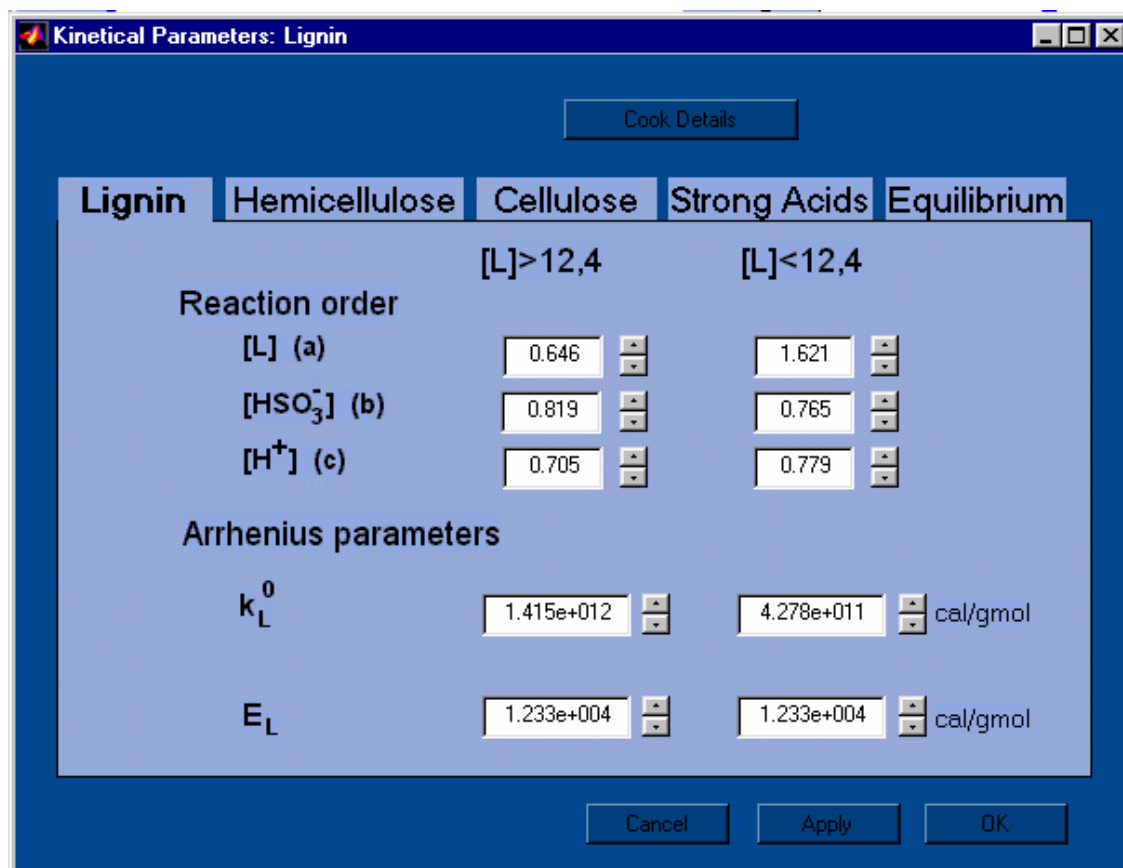

Figure 10.3: Screen for parameters adjustment

Since the verification was done in two steps, the model adjustment can also quite easily be done in a similar way. It is therefore recommended that the kinetic model be adjusted to the data of Watson (Watson, 1992), before the rest of the model is

changed. The assumption can again be made that if the two separate parts of the model are accurate, the complete model will be accurate.

The results of the kinetic verification should be studied carefully and the largest variations between the simulated values and the real values should be identified. It would be ideal if the results of the comparisons of all of the cooks can be studied simultaneously. Any constant deviations and repeating errors can then be easily identified. This can be done by printing the results of each of the verification runs or by saving the results to a file. In this way, the results can easily be viewed again together with the results from other runs. The “Digest” package provides for both of these possibilities by giving the option of viewing and saving the results to a file, or for printing the results. More detail about this can be found in Appendix A.

An example of the results obtained by comparing the model prediction with the experimental data is shown in Figure 10.4. It may for example be found that prediction of the pH value at the end of the cook is too small for all of the experimental cooks. It should then be clear that the model has to be adjusted to correct this erroneous prediction for all of the experimental cooks. By comparing the influence of each of the parameters in the model to the variations between the actual and predicted results, the variables that should be adjusted to obtain the correct results can be identified. The influence of the parameters can be determined by using the comparison tool that was discussed in paragraph 9.3. The results of these comparisons are shown in Appendix B. Since three different cooks are compared in the figures in Appendix B, it is also possible to determine the direction in which the parameters should be adjusted.

It must be stressed again that the package relies heavily upon visual interpretation of the results by the user. This approach seems to be the easiest and most user-friendly one, since the stages and variables that give the worst results can easily be identified and corrected. When the result of a verification run is only a single variable expressing the correctness of the results over the entire cook, little is learned about the area for the biggest concern. On the other hand, if the predictions made by the model and the actual values are visually compared over the entire duration of the cook, it is very easy to see just where the largest errors occurred. A good example of the effectiveness of the approach is shown in Figure 10.4 on page 174. Again the visual interpretation of the influence of certain parameters in certain areas, as was shown in Appendix B, can be used to determine which parameter to adjust. By using only statistical coefficients, this whole process would have been a lot more complicated and probably wouldn't have produced the correct results. The other obvious advantage of this visual approach is that it helps to gain an understanding of the process and the effect of each one of the variables on the outcome of the results.

Different parameters can be changed repeatedly and the results of subsequent simulations again compared to the actual measurements, until an accurate model is obtained. It was found that this is not a very lengthy process and that satisfactory results can be obtained quite quickly.

After the kinetic parameters are adjusted, the same can be done for the modelling of the conditions inside the digester. In this way, the model can be adjusted to represent the actual conditions in the digester quite accurately.

An attempt was made to write an optimisation algorithm to minimise the mean square error and maximise the correlation coefficient by changing all of the parameters. However, it was found that a very complex algorithm that is based on a set of rules for the adjustment of parameters would be necessary. It was concluded that the intuitive changing of parameters yielded much better results. Some kind of optimisation algorithm would however be necessary to optimise the model completely. The purpose of this study was however to construct a fundamental model that can be used in the control of the pulp digester and to prove the accuracy of the model. The results that will be shown in this document were therefore not obtained by a completely optimised model and further improvements would be necessary if such an algorithm could be found.

10.5. Results of the verification

Three sets of verification results were obtained. These were:

1. Verification of the kinetics
2. Verification of the conditions
3. Verification of the entire model

The first two sets of results compared several measurements for each variable for each cook separately. The last set of results compares only the predicted and actual final degrees of polymerisation for several cooks simultaneously.

10.5.1. Verification of the kinetics

The data from nine experimental cooks done by Watson (Watson, 1992) were available for the verification. The experimental cooks were simulated using the “Digest” package and the verification done with the verification tool. It was mentioned in paragraph 10.1 that the conditions of the experimental cooks were read into the simulation and only the reactions and liquor composition were simulated. In this way, the kinetic model was isolated from the modelling of the conditions.

The results obtained by the verification are displayed graphically, together with the correlation coefficients for each variable. An option was created to also display the other coefficients that were discussed in paragraph 10.1. However, these values are then displayed on a separate screen. It was mentioned that the correlation coefficient is primarily a measure of the model’s ability to follow the trend of the data, and not as a measure of a constant offset. However, since the results are displayed graphically, it was decided that the offset can be directly evaluated on the graphical presentation. The mean square error doesn’t have much significance apart from comparing the same set of results after some adjustment has been made to the model. The reason for this is that the value of the mean square error will depend much on the mean value of the series of values. Therefore, a 1% error in a series of values with a mean of 1000 will give a larger mean square error than a set of values with a mean of 1 and an error of 10%. It was decided to calculate the mean square error for optimisation purposes only and not as an indication of the accuracy of the model.

The data for the nine experimental cooks that were available were numbered from cook 16 to cook 24. The visual results for cook 18 are shown in Figure 10.4. The excellent results obtained by the model can clearly be seen here. The simulation of all of the variables was very good, and in particular, the prediction of the viscosity was very good. The same applies to the cooks not shown. The results for all of the cooks will not be displayed visually due to all the space it would require. Only the values of the three coefficients that were discussed in paragraph 10.1.2 are shown in Table 10.4, 10.5 and 10.6.

The correlation coefficients that were obtained for the different variables in each of the nine cooks are shown in Table 10.4. These results should be viewed together with Figure 10.4, since similar visual results were obtained for each of the nine cooks. As was discussed before, the correlation coefficient is a measure of the ability of the model to simulate the trends in the variables as the cook progresses. It can be said that the correlation coefficient is a measure of the correlation between the shape of the graph of the actual data and the predicted results, and no indication is given of any vertical offset between the two sets of data. If the prediction of the pH for example

were too large with a constant factor over the duration of the cook, good correlation coefficients would still be obtained. From the results shown in Table 10.4, the conclusion can be made that the model is able to predict the trends in the variables throughout the cook. Correlation coefficients in the high 0,9's were obtained for almost all of the variables in all of the cooks. Unfortunately, measurements for the variables obtained from pulp samples were only available over the last hour of the cook, and no indication of the accuracy of the model over the first part of the cook can be obtained. It should however be remembered that only the final product quality needs to be controlled and that an accurate model for the last hour of the cook will be sufficient. The prediction of the viscosity of the pulp seems to be very good.

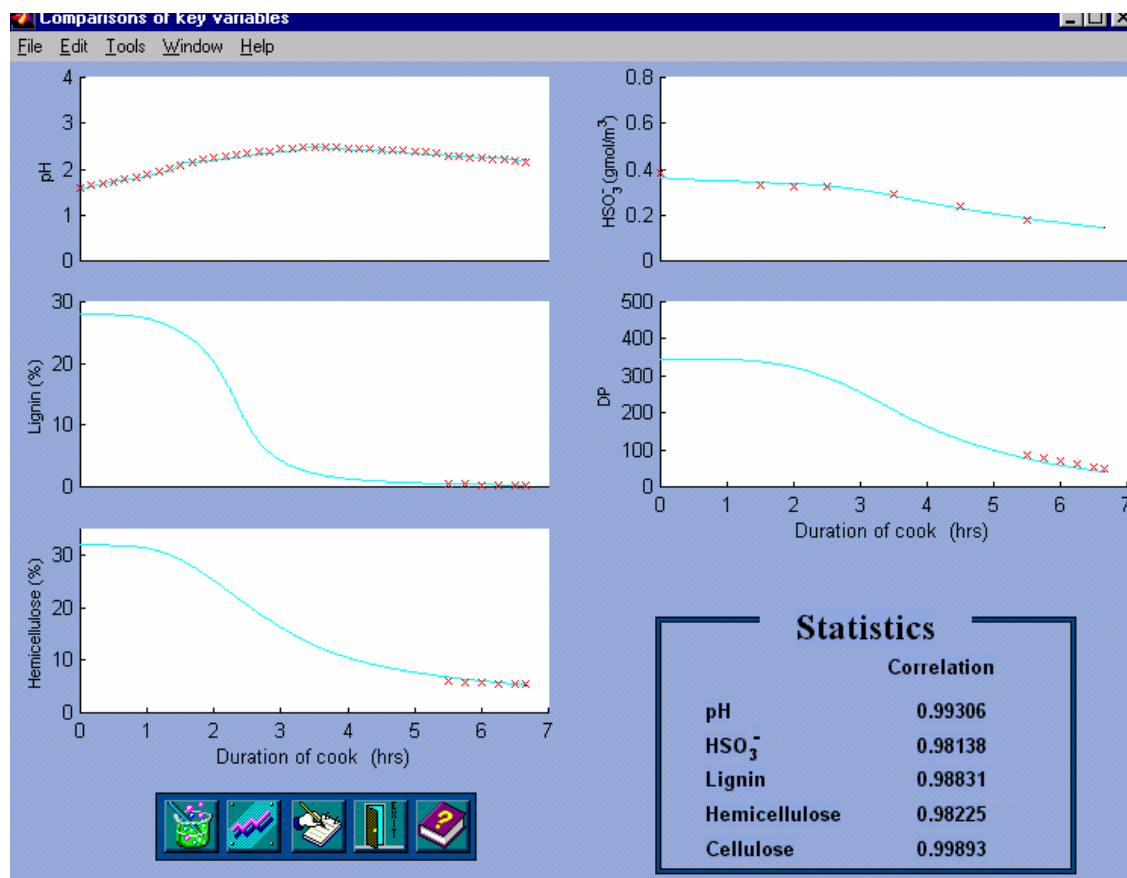

Figure 10.4: Verification results for cook 18

The mean errors in the prediction of the different variables are given in Table 10.6. The shortcomings of this coefficient can clearly be seen from this table. The exact value of the mean error depends very much on the mean of the set of values. The mean errors in the modelling of the pH and the bisulphite concentration are generally very small, while much larger values were obtained in the modelling of the viscosity. The reason for this should be apparent from Figure 10.4. The mean value for the viscosity is much higher than the mean for the concentration of the bisulphite ions. The rational behind the coefficient of variance should be clear from this observation, since the standard deviation is divided by the mean in the calculation of the coefficient

of variance. This is done to normalise the values of the coefficient relative to the mean of the sample set. If this is not done, the mean error should be used in the comparison of the same variable for different experiments or cooks. For example, if changes are made to one of the parameters in the model, the mean error obtained by using the model before and after the changes can be compared. A decision can then be made about the effect of the parameter on the model and whether the changes lead to more accurate results. For this reason, the mean error should be used in the optimisation algorithm.

The mean errors in the calculation of the variables seem to be generally acceptable if the values are compared with the values for the variables in Figure 10.4. The important variable is the viscosity and it can be seen that the mean error is relatively small in comparison to the mean of the viscosity measurements, which should be around 80 over the last hour of the cook, as can be seen in Figure 10.4. It was mentioned that the mean error calculation will be especially valuable in an optimisation algorithm where comparisons are made between the mean errors. No effort was made to calculate the mean value for each of the variables in order to determine the relative error in the prediction. The errors in the prediction of the viscosity should however be seen in perspective by comparing it to the known coefficient, which is the coefficient of variance. An indication of the coefficient of variance that would result if similar prediction results were obtained as in each of the individual cooks, can be obtained by dividing the mean error by the mean value of the viscosities of the six samples for each of the cooks. Two additional columns were inserted into Table 10.6 that show the mean value for the viscosities of the each cook, as well as the indication of the coefficient of variance. It can be seen that values below 10 were obtained for the majority of the cooks. In comparison to the values above 20 currently obtained by SAPPI SAICCOR, these results promise possible improvements over the current model.

The last coefficient that is reported, is the concordance coefficient. Although the concordance coefficient is not yet well known by researchers, it can be very valuable in the calculation of the accuracy of a model. The values obtained for the concordance coefficient are shown in Table 10.5. It was mentioned that a value of 1 indicates a perfect correlation, including the relative value of the variables. The concordance coefficient also considers the vertical offset between the sets of data in Figure 10.4. The power of the concordance coefficient can be seen by comparing the values obtained for the concordance to the values of the correlation coefficient and the mean error. The values for the concordance and correlation coefficients for cook 23 are almost the exactly same. The mean error for this is 2,3 % and it can be seen that this small error caused a slightly smaller concordance coefficient. It can however be concluded that the concordance coefficient is very similar to the correlation coefficient for small mean errors and that it has the ability to measure the accuracy of the model

in modelling trends in the actual data. The concordance coefficients obtained for cooks 17 and 21 differ very much from the corresponding correlation coefficients. From the mean error of the viscosity prediction, it can clearly be seen that the mean error for these two cooks are larger than for the other cooks, and consequently, worse concordance coefficients were obtained.

The ability of the concordance coefficient to consider both the trends and the constant offsets in the data is clear from these results. The concordance coefficient is therefore a single coefficient for expressing the accuracy of a model. The disadvantage of using the concordance coefficient however also lies in the fact that it simultaneously measures both the above mentioned abilities of the model. When a bad concordance coefficient is obtained, no indication is given of where the problem lies in the model. It may happen that a model is able to perfectly simulate the trends in the data, but that bad concordance results are obtained because of a constant offset that could have been corrected easily. A good model can then possibly be discarded because of these confusing results. It can be concluded that the concordance coefficient is an excellent proof of the correctness and accuracy of a model, but that it should not be used while still verifying and adjusting the model to fit data, as has been done in this study. Little attention was therefore given to the concordance coefficient during the rest of the study and it won't be reported for the other verification results.

Some changes were made to the values of the parameters as were given by Hagberg and Schön, based on the results obtained through the simulations and comparison with the experimental results. The values that were obtained for the parameters in the equations given in Chapter 8 are shown in Table 10.7. The values obtained by other authors are also shown in the table and an easy comparison can be made between all the different values. It can be seen that the values from this study are very similar to the values obtained by Hagberg and Schön. Unfortunately, no study on the kinetics of the cellulose degradation was done by Hagberg and Schön. The values for the hemicellulose reaction parameters were used as starting values in this model and these were adjusted according to the experimental cooks.

Correlation coefficients for the following cooks:

Variable	Cook 16	Cook 17	Cook 18	Cook 19	Cook 20	Cook 21	Cook 22	Cook 23	Cook 24
pH	0.9588	0.99593	0.99306	0.89308	0.91279	0.97593	0.85021	0.97286	0.98931
[HSO ₃ ⁻]	0.91755	0.95803	0.98138	0.84572	0.96207	0.9562	0.93358	0.93666	0.96632
Lignin	0.93031	0.9942	0.98831	0.9867	0.98846	0.89487	0.95022	0.94877	0.97686
Hemicellulose	0.91543	0.92334	0.98225	0.99366	0.87641	0.86441	0.87812	0.88314	0.61012
Viscosity	0.98303	0.95735	0.99893	0.99569	0.98246	0.94942	0.96447	0.94631	0.97894

Table 10.4: Correlation coefficients for experimental cooks

Concordance coefficients for the following cooks:

Variable	Cook 16	Cook 17	Cook 18	Cook 19	Cook 20	Cook 21	Cook 22	Cook 23	Cook 24
pH	0.9516	0.9862	0.9897	0.8922	0.9040	0.9707	0.8458	0.96245	0.96152
[HSO ₃ ⁻]	0.8897	0.9466	0.9808	0.8061	0.9017	0.9543	0.7590	0.90387	0.8751
Lignin	0.7274	0.3388	0.7861	0.6721	0.5959	0.6054	0.6500	0.5330	0.9155
Hemicellulose	0.2967	0.4412	0.5282	0.6708	0.4826	0.7318	0.4240	0.5959	0.4910
Viscosity	0.8147	0.2357	0.7771	0.9419	0.9166	0.4802	0.8703	0.9446	0.76144

Table 10.5: Concordance coefficients for experimental cooks

Mean errors for the following cooks:

Variable	Cook 16	Cook 17	Cook 18	Cook 19	Cook 20	Cook 21	Cook 22	Cook 23	Cook 24
pH	0.0149	0.0047	0.0056	0.0268	0.0215	0.0089	0.033	0.089	0.0092
[HSO ₃]	0.0103	0.0068	0.00457	0.00795	0.00958	0.0067	0.016	0.00795	0.0053
Lignin	0.0377	0.0584	0.0246	0.0793	0.0592	0.0426	0.0794	0.0307	0.0095
Hemicellulose	0.3886	0.1878	0.1882	0.3081	0.2918	0.140	0.501	0.1234	0.20361
Viscosity	5.9728	14.3772	4.0679	4.261	3.8397	9.997	5.9192	1.506	5.5846
Mean of Viscosities	75.1	107.5	66.3	68.17	61.5	62.3	66.6	63.332	71.5
% of error (\approx COV)	7.8 %	7.0 %	6.0 %	6.2 %	6.2 %	16 %	8.88 %	2.3 %	7.8 %

Table 10.6: Mean errors for experimental cooks

Previous authors that studied the kinetics						
Parameter	(Hagberg and Schön, 1973), (Hagberg and Schön, 1974a)	Sloan (Sloan, 1982b), (Sloan, 1982c), (Sloan, 1982a)	Watson (Watson, 1992)	This study		
Lignin reaction kinetics						
	[L] > 12,4	[L] < 12,4	$\alpha = 1$	$\alpha = 2$	$\alpha = 1$	$\alpha = 2$
K_L^0	$1,346 \times 10^{12}$	$0,407 \times 10^{12}$	$3,1 \times 10^{15}$	$4,3 \times 10^{20}$	$3,3 \times 10^{17}$	$1,5 \times 10^{18}$
E_L	12 500	12 500	26 800	36 900	30 500	12 330
a	0,646	1,621	1	2	1	2
α	0,819	0,765	1	1	1	1
β	0,705	0,779	1	1	1	1
						[L] > 12,4
						[L] < 12,4
						$4,278 \times 10^{11}$
						12 330
						0,646
						1,621
						0,819
						0,765
						0,705
						0,779
						1,236 $\times 10^{11}$
						14 200
						2,542
						0,707
						1,236 $\times 10^{11}$
						14 200
						2,542
						0,707
						1,236 $\times 10^{11}$
						14 200
						2,542
						0,707
						1,236 $\times 10^{11}$
						14 200
						2,542
						0,707
						1,236 $\times 10^{11}$
						14 200
						2,542
						0,707
						1,236 $\times 10^{11}$
						14 200
						2,542
						0,707
						1,236 $\times 10^{11}$
						14 200
						2,542
						0,707
						1,236 $\times 10^{11}$
						14 200
						2,542
						0,707
						1,236 $\times 10^{11}$
						14 200
						2,542
						0,707
						1,236 $\times 10^{11}$
						14 200
						2,542
						0,707
						1,236 $\times 10^{11}$
						14 200
						2,542
						0,707
						1,236 $\times 10^{11}$
						14 200
						2,542
						0,707
						1,236 $\times 10^{11}$
						14 200
						2,542
						0,707
						1,236 $\times 10^{11}$
						14 200
						2,542
						0,707
						1,236 $\times 10^{11}$
						14 200
						2,542
						0,707
						1,236 $\times 10^{11}$
						14 200
						2,542
						0,707
						1,236 $\times 10^{11}$
						14 200
						2,542
						0,707
						1,236 $\times 10^{11}$
						14 200
						2,542
						0,707
						1,236 $\times 10^{11}$
						14 200
						2,542
						0,707
						1,236 $\times 10^{11}$
						14 200
						2,542
						0,707
						1,236 $\times 10^{11}$
						14 200
						2,542
						0,707
						1,236 $\times 10^{11}$
						14 200
						2,542
						0,707
						1,236 $\times 10^{11}$
						14 200
						2,542
						0,707
						1,236 $\times 10^{11}$
						14 200
						2,542
						0,707
						1,236 $\times 10^{11}$
						14 200
						2,542
						0,707
						1,236 $\times 10^{11}$
						14 200
						2,542
						0,707
						1,236 $\times 10^{11}$
						14 200
						2,542
						0,707
						1,236 $\times 10^{11}$
						14 200
						2,542
						0,707
						1,236 $\times 10^{11}$
						14 200
						2,542
						0,707
						1,236 $\times 10^{11}$
						14 200
						2,542
						0,707
						1,236 $\times 10^{11}$
						14 200
						2,542
						0,707
						1,236 $\times 10^{11}$
						14 200
						2,542
						0,707
						1,236 $\times 10^{11}$
						14 200
						2,542
						0,707
						1,236 $\times 10^{11}$
						14 200
						2,542
						0,707
						1,236 $\times 10^{11}$
						14 200
						2,542
						0,707
						1,236 $\times 10^{11}$
						14 200
						2,542
						0,707
						1,236 $\times 10^{11}$
						14 200
						2,542
						0,707
						1,236 $\times 10^{11}$
						14 200
						2,542
						0,707
						1,236 $\times 10^{11}$
						14 200
						2,542
						0,707
						1,236 $\times 10^{11}$
						14 200
						2,542
						0,707
						1,236 $\times 10^{11}$
						14 200
						2,542
						0,707
						1,236 $\times 10^{11}$
						14 200
						2,542
						0,707
						1,236 $\times 10^{11}$
						14 200
						2,542
						0,707
						1,236 $\times 10^{11}$
						14 200
						2,542
						0,707
						1,236 $\times 10^{11}$
						14 200
						2,542
						0,707
						1,236 $\times 10^{11}$
						14 200
						2,542
						0,707
						1,236 $\times 10^{11}$
						14 200
						2,542
						0,707
						1,236 $\times 10^{11}$
						14 200
						2,542
						0,707
						1,236 $\times 10^{11}$
						14 200
						2,542
						0,707
						1,236 $\times 10^{11}$
						14 200
						2,542
						0,707
						1,236 $\times 10^{11}$
						14 200
						2,542
						0,707
						1,236 $\times 10^{11}$
						14 200
						2,542
						0,707
						1,236 $\times 10^{11}$
						14 200
						2,542
						0,707
						1,236 $\times 10^{11}$

The values for the parameters in the equilibrium equations of the form given in equation (8-5) that were used in the modelling of the liquor composition are given in Table 10.8. These values were also based on the values given by Hagberg and Schön (Hagberg and Schön, 1974b). Some changes were made to the values for the calculation of the equilibrium constant, K_p , for the partition of sulphur dioxide to hydrogen and bisulphite ions.

A	Temperature range (°C)	B	C
K_{SO_2}	20 – 80	-5,077	1 045
	80 – 120	-6,916	1 700
	120 - 150	-7,971	2 133
K_P	20 – 80	-10,2212	2 392
	80 – 120	-10,5125	2 665
	120 - 150	-11,0348	2 960
K_{H_2O}	20 - 150	5,9648	-2 198

Table 10.8: Values for parameters B and C in equation (8-5) obtained in this study

The following values were obtained by Hagberg and Schön:

A	Temperature range (°C)	B	C
K_{SO_2}	20 – 80	-5,077	1 045
	80 – 120	-6,916	1 700
	120 - 150	-7,971	2 133
K_P	20 – 80	-9,430	2 392
	80 – 120	-10,208	2 665
	120 - 150	-10,948	2 960
K_{H_2O}	20 - 150	5,882	-2 198

Table 10.9: Values for parameters B and C given by Hagberg and Schön (Hagberg and Schön, 1974b)

It can be seen that very small changes were made to these values. It must however be said that the exact values given in Table 10.8 for the respective temperature ranges were not used in the model. In order to get a smooth transition between the different ranges, some intermediate ranges were identified and the original values interpolated

for the temperature in the range. This method worked well and good transitions were obtained. However, this method probably caused the differences in the parameters that were found.

10.5.2. Verification of modelling the conditions

Data from ten actual cooks were used to verify modelling of the conditions. The most recently available data were for the period of December 1997 to January 1998. Ten successive cooks were chosen from the set of available data. The set of the ten successive cooks was selected randomly from the set of available data. The validity of using ten successive cooks will be discussed in paragraph 10.5.3.

The verification was again performed with the “Digest” package. Correlation coefficients were again calculated for each variable, while a constant offset was evaluated directly from the visual display. The visual display for the evaluation of the first cook is shown in Figure 10.5. Only the correlation coefficients for the rest of the cooks will again be given. This was done in Table 10.10.

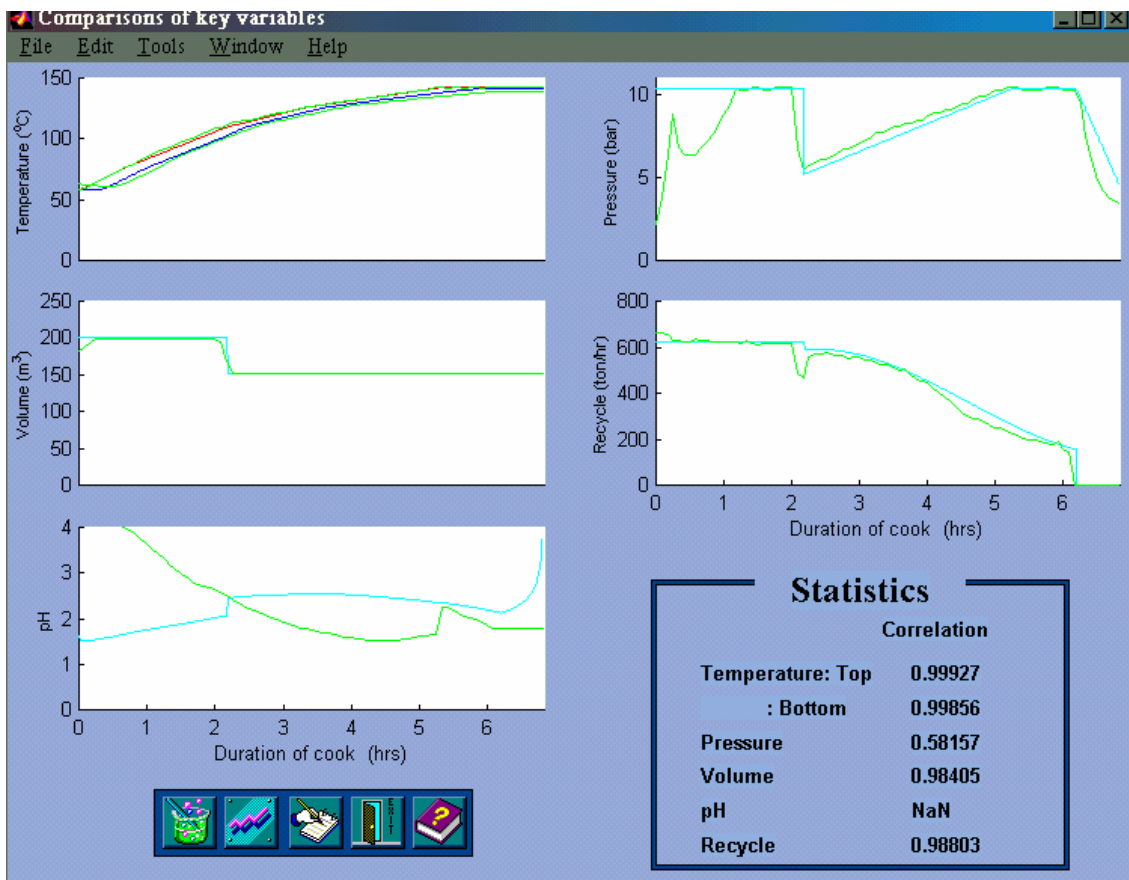

Figure 10.5: Visual display for evaluating the modelling of the conditions

The correlations for the temperatures, volume and recirculation flowrate all look very good. However, the correlation for the pH is non-existent. This was attributed to measurement error, since the pH probes are very fragile and prone to errors if they are not recalibrated often. The data were collected during the normal operation of the plant and no special attention was paid to the accuracy of the pH measurements, since the pH measurements are not used for the control of the plant. The pH probes were installed for investigation purposes and the values are not used during normal operation. Only one of the digesters has a pH probe installed and the pH will not normally be available, even for verification purposes. However, since good correlations were obtained for the values measured by Watson during the experimental cooks, no further attention was paid to these bad correlations.

The other correlations that don't look that good, are the values obtained for the pressure. The reason for the bad correlations can clearly be seen in Figure 10.5. There are a lot of different factors that are difficult to predict that influence the value of the pressure during the first hour, as was discussed in paragraph 8.3. Consequently, no effort was made to model the pressure in the digester during the pressurisation phase, which lasts about the first hour of the cook. After completion of the pressurisation, the pressure is much more predictable and it can be seen from the figure that the modelling of the pressure during these stages were quite good. However, since very little reaction takes place during the first hour of the cook, these bad correlations during the first hour were acceptable. No further attempt was made to model the pressure more accurately.

From the results in Table 10.10 it can be seen that consistently good correlation coefficients are obtained. However, very poor results were obtained for verification of the pressure and the volume for the fourth cook. When the data were investigated, it was seen that no side relief was performed for this specific cook. It is possible for the operators on the plant to prevent side-relief from happening. This is however done through manual intervention from an operator and there is no way that the model can predict this happening. When the model is implemented in a control strategy, the option can very easily be created for preventing side relief from happening in the simulation as well. Better correlation will then be obtained. However, no provision has been made for this occurrence yet and the bad correlation coefficient was therefore no source for great concern. The occurrence of this event highlights the necessity for the use of an accumulator in the control strategy, even after the prediction of the top temperature has been made, as was discussed in Chapter 5. The accumulator will compensate for any of these unforeseen events during the prediction of the progress of the rest of the cook.

Correlation coefficients for the following cooks:										
Variables	Cook 1	Cook 2	Cook 3	Cook 4	Cook 5	Cook 6	Cook 7	Cook 8	Cook 9	Cook 10
T _{Top}	0,99927	0,98291	0,99949	0,99924	0,99906	0,99906	0,999944	0,98694	0,99959	0,999
T _{Bottom}	0,99856	0,98769	0,99747	0,99571	0,99885	0,9945	0,99645	0,99156	0,99816	0,99762
Pressure	0,58157	0,63117	0,44866	0,025064	0,6548	0,48868	0,56511	0,6081	0,5335	0,53459
Volume	0,98405	0,98484	0,97527	-0,24057	0,9896	0,96236	0,99278	0,98579	0,99497	0,96256
Recirculation	0,98803	0,98551	0,98121	0,999035	0,98983	0,99009	0,98391	0,98215	0,97791	0,98507

Table 10.10: Correlation coefficients for digester conditions

10.5.3. Verification of the complete model

It seems as if the model has passed both tests thus far with flying colours. From the assumption made initially, that if both the kinetics and the modelling of the conditions can be proved to be correct, the entire model will be correct, it can now be concluded that the model should indeed be accurate. This will however also be tested by comparing the model's prediction of the final degree of polymerisation of actual cooks with the measured values.

The method for verifying the performance of the complete model has been discussed in paragraph 10.3. This was also implemented by using the "Digest" package. The ten cooks that were mentioned in the previous paragraph were simulated and the results of the simulations compared with the actual measurements. The results of the ten selected cooks can be seen in Figure 10.6. The coefficient of variance that was discussed in paragraph 10.1.2 is displayed in the bottom right hand corner of the screen.

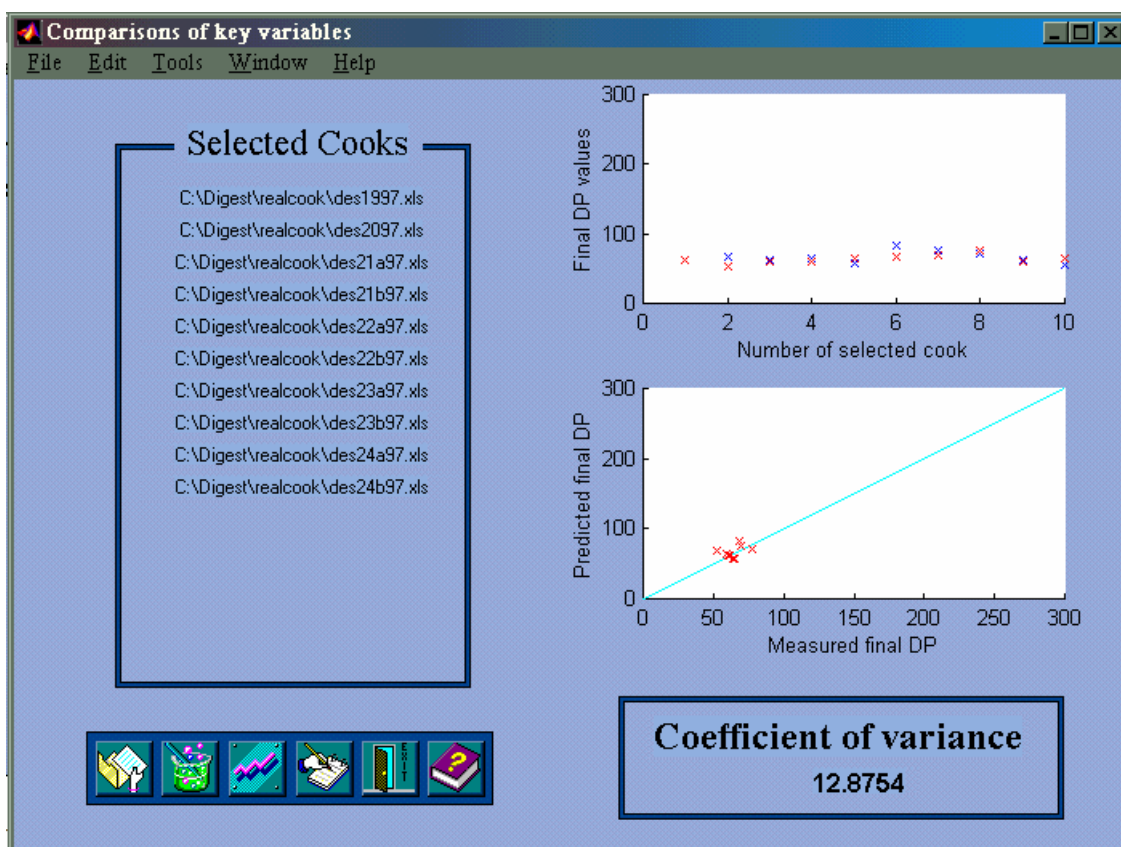

Figure 10.6: Visual verification of the complete model

It was mentioned in paragraph 4.2.2 that the current values for the coefficient of variance were above 20. The value obtained for these 10 cooks were just below 13. This is a very big improvement over the model currently in use. From the top graph on

the right hand side of the figure, it can clearly be seen how the predicted values follow the actual measurement when the degree of polymerisation that was obtained changes. This signifies that the model will be able to predict the degree of polymerisation under changing conditions and that the good results were not obtained coincidentally.

The validity of the results using ten consecutive cooks was mentioned in the previous paragraph. Excellent results were obtained by using these ten consecutive cooks. The same parameters that were obtained by fitting the kinetic model to the experimental data obtained by Watson (1992), as was discussed in paragraph 10.5.1, were used for this part of the verification. No additional adjustments to the kinetic parameters were made to fit the ten actual cooks. Therefore, no special effort was made to obtain an even better fit between the model and the data. This also proves the correctness of the kinetic experimentation done by Watson (Watson, 1992). However, adjustments would have been possible if bad results were obtained. This is precisely the purpose of the feedback model introduced to the control strategy in Chapter 5. During the implementation of the control strategy that was proposed in Chapter 5, it would be most suitable to fit the model to a few consecutive cooks, since this will be the basis for the feedback model. Any constant drift in the prediction of successive cooks can then be corrected by the feedback to ensure that the following cooks are controlled better. It is very important that the model is able to correctly predict the outcome of consecutive cooks, since this will ensure the constant performance of the model and correct pulping products. It is therefore perfectly valid to use data from consecutive cooks in the verification of the complete model.

The verification above was done by using the data from the same cooks that were used in verifying the modelling of the conditions that was discussed in paragraph 10.2. The values of the parameters in the model were also kept the same as was obtained by comparing the cook results to the experimental data, as was discussed in paragraph 10.1.2. The results obtained this far for the comparison of the model predicted final degrees of polymerisation and the actual measured values were therefore obtained by adjusting the model only to the experimental data. Data for 25 additional consecutive cooks were entered into spreadsheets and saved. The same verification was done on these 25 cooks, together with the 10 cooks discussed earlier.

The reason for entering additional cooks, was to have a bigger set of test results with which to work. The advantage of this bigger set is that a few bad predictions, which may have been caused by unfortunate measuring errors during the sample analysis, don't have such a big influence on the results of the verification. An example of this is the sixth cook in Figure 10.6. The other advantage is that a more significant correlation coefficient can be calculated for these sets of values. Once again, the

value of a correlation coefficient will be affected more severely by a bad results in a small data set than in a bigger one.

Some adjustment to the parameters was done for this verification. The results obtained by using the same parameters value obtained before was as follows:

$$\text{COV} = 11,9559$$

$$r^2 = 0,7314$$

It was seen that the prediction of the final degree of polymerisation tended to be a little high. The influence of the parameters on the model results, as given in Appendix B, was investigated and it was seen that by changing the pre-exponential factor, k_C^0 , in the cellulose degradation reaction, the final prediction would be changed. Since the prediction had to be lowered, the value of k_C^0 was increased. The optimal value was found by trail-and-error to be equal to $7,913 \times 10^{12}$. The initial value was $7,68 \times 10^{12}$ as indicated in Table 10.7. Some adjustments to the other parameters were attempted, but no real improvement on the results could be obtained. It was however impossible to try every possible combination of parameter values and the model would certainly not be optimal as it was used here. Some more improvement in the model results is expected if the model can be optimised and this is another opportunity for continued study into this topic. Nevertheless, excellent results were obtained by using the model in its current form. The following values were obtained for the coefficients:

$$\text{COV} = 10,7$$

$$r^2 = 0,77$$

The resulting display window of this verification is shown in Figure 10.7. Some adjustments to the scale of the graphs were made for this figure.

The coefficient of variance is significantly lower than the values obtained by SAPPI SAICCOR by using the S-factor model. The fact that the form of the equation used for the calculation of the coefficient of variance gives conservative results, as was discussed in paragraph 10.3, should also be taken into consideration. The important result is however the correlation coefficient obtained by using the fundamental model. The value of 0,77 indicates that the good coefficient of variance that was obtained is not coincidental. This could easily have been if little variance of the measured values occurred for the cooks that were tested. However, the correlation coefficient indicates that the model can also predict the changes that occurred in the final product quality.

The 45° comparison between the two sets of values, that is the bottom graph in Figure 10.7, was enlarged and is shown in Figure 10.8. This figure gives an indication of the values used for the calculation of the correlation coefficient. The reason for the good

correlation coefficient can be seen clearly, since a definite trend around the 45° line can be observed.

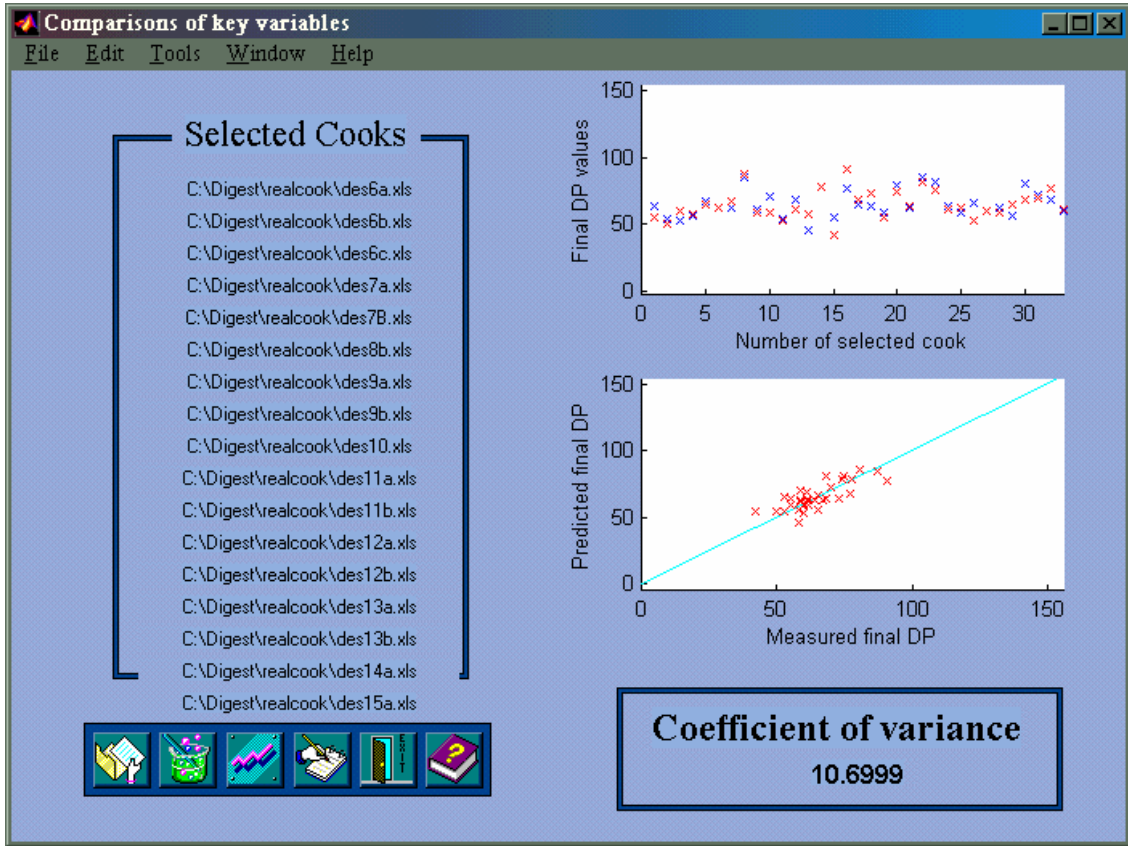

Figure 10.7: Verification of model using 35 cooks

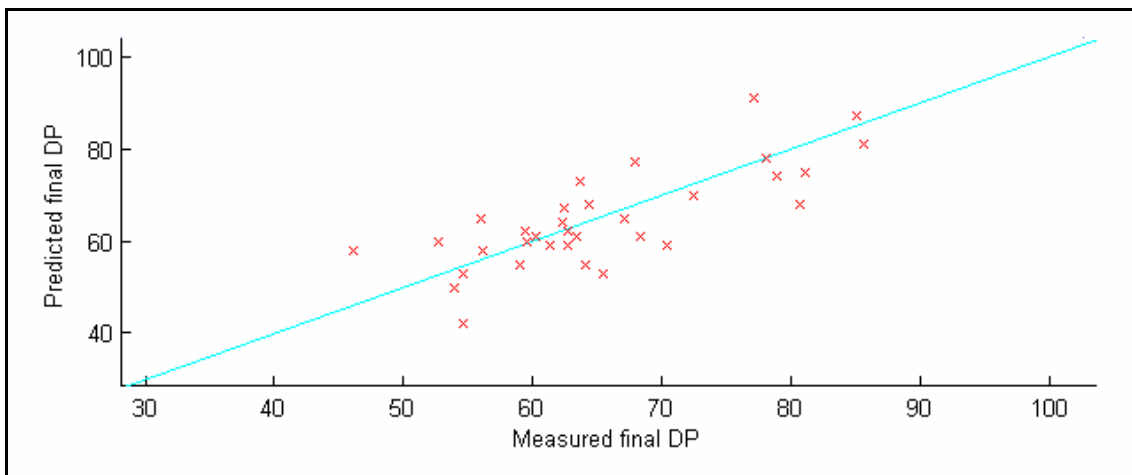

Figure 10.8: 45° comparison of verification data

10.6. Summary

From the results obtained during the verification of the model, the ability of the model to simulate the batch pulping process was clearly proved. Excellent correlation coefficients were obtained for the dynamic simulation of the reactions inside the pulp, as well as for the prediction of the digester conditions. The efficiency of the complete model in predicting the final degree of polymerisation was proved by comparing the predicted results for 35 actual cooks with the real values obtained on the plant. Coefficients of variance of around 10 were obtained that signifies a marked improvement over the S-factor model. An excellent correlation coefficient of 0,77 proves that the good coefficient of variance is not coincidental, that may have been caused by small variance in the set of test data.

The method of modelling proposed by Terwiesch (Terwiesch *et al.*, 1994) was also proved to be effective in fitting an accurate model to a specific process. The model wasn't developed on a purely theoretical basis, but actual plant data was also incorporated to adjust the parameters of the theoretical model to fit the process under investigation. The differences between the theoretical parameters obtained by Hagberg and Schön and the values obtained for this model was shown in Table 10.7. If only the theoretical values were used, the model would probably have been rejected.

Chapter 11:

Possible control techniques

The control of batch processes is very complicated and contains many of the issues common to continuous processes, as well as such concerns as complex sequential control, product variation, dynamic scheduling and lot tracking (Haxthausen, 1995). Therefore, the field of the control of batch systems has been the subject of many studies. Different strategies have been proposed for both the modelling and control of batch processes. These include algorithmic approaches, like advanced PID (Shacham, 1996), adaptive (Pauponis and Krishnagoplan, 1991), predictive (Eaton and Rawlings, 1990) or geometric non-linear control (Wang *et al.*, 1994) as well as approaches based on fuzzy logic (Wilson and Martinez, 1997) and neural networks (Dirion *et al.*, 1996, Willis *et al.*, 1992). State estimation techniques (Terwiesch and Agarwal, 1995) and principal component analysis techniques (Dong and MacAvoy, 1996) have also been suggested.

However, the majority of these techniques are not suitable for application to the batch pulp digesters. Because of the long time delays in the cooking cycle and the difficulties in taking significant measurements, the feedback methods cannot be used. The problems in fitting statistical and artificial intelligence models to the digesters have been discussed. It was therefore concluded that the use of an adaptive predictive fundamental model based on limited plant measurements would be the best technique to use. The proposed strategy was discussed in Chapter 5.

In order to be able to implement the proposed strategy using the fundamental model that was developed, the ability of the model to calculate a maximum temperature to achieve a specific target has to be proved. This was done by using the “Digest” package. A simple control strategy was programmed where a target degree of polymerisation is supplied and a maximum cooking temperature is calculated. An iterative procedure is used with a convergence algorithm. An initial temperature is chosen and the cook is simulated by using this temperature and the fixed cook schedule, including the maximum cooking time. An adjustment is made to the temperature based on the outcome of the simulation and the deviation from the target value.

It was found that this strategy works very well and accurate results for the final degree of polymerisation was obtained during the simulation. An example of a simulation of a controlled cook is shown in Figure 11.1. The target value, as well as the value obtained is shown in the top left-hand side of the screen. On the bottom graph for the viscosity, the target value was shown as a red line. From this graph, it can be seen how the continuing reaction during the high-pressure gas release was taken into account in the calculation of the maximum temperature. The amount of viscosity reduction during this period will also depend on the maximum cooking temperature and the amount of this additional degradation increase has to be adjusted as well during the calculation of the maximum temperature.

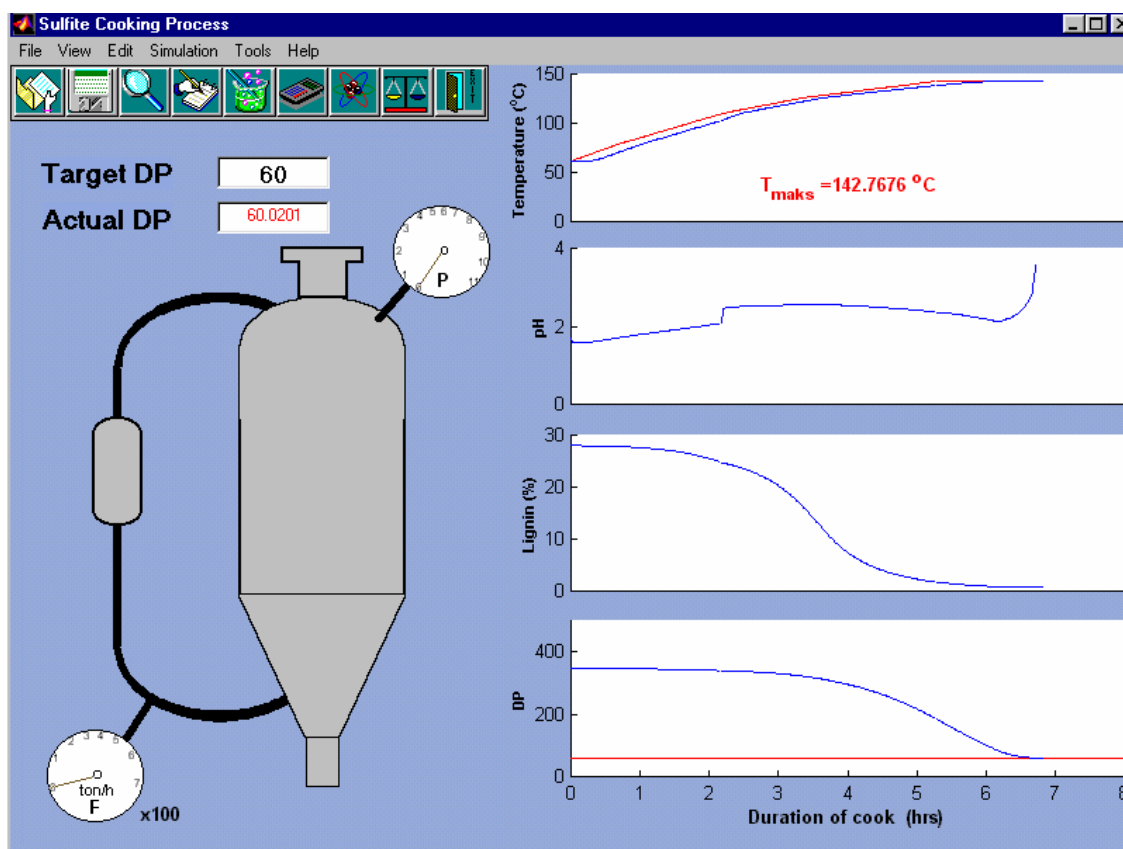

Figure 11.1: The use of the control option in the “Digest” package

Since the simulation is based on the model that is used to calculate the maximum temperature, the good results were to be expected. Perfect control will always be possible when a perfect model is used. This will be the case in simulations of the control strategy. In order to provide for the fact that a perfect model cannot be obtained, some feedback mechanism will be necessary to adjust the manipulated variables of the model that was used. Because the viscosity measurement is only taken after the cook has been completed, the feedback would be too late to make any changes to the manipulated variable. The alternative method of adjusting the model used is therefore recommended. This is the basis for adaptive control.

Adaptive control makes use of some kind of a feedback algorithm to adjust the parameters of the model based on the differences in the values predicted by the model and the actual measurements. The differences used in the feedback algorithm will usually be based on a weighted average of the prediction error of a preceding measurement. No adjustments will therefore be made based on only one measurement that may be erroneous by itself. Any such feedback algorithm will also be based on the model and the parameters to be adjusted will be calculated from a sensitivity analysis of the parameters, as was shown in Appendix B.

Since a feedback algorithm will be very difficult to develop and test without actual results of the control capabilities of the model, no attempt was made during this study to develop such an algorithm. The further development of the complete control strategy based on the fundamental model developed is therefore a definite opportunity for further study.

The potential of the fundamental model to be used as a predictive model in a control strategy was however clearly demonstrated in Figure 11.1. The convergence algorithm got to an answer in a very short time, which makes the model usable in a real control application.

Chapter 12: Conclusions

Various techniques were investigated for modelling the batch acid sulphite pulp digesters at SAPPI SAICCOR. It was concluded that the best approach would be to choose the basic model structure from first-principle considerations, while the model parameters are computed so that the model predictions best fit experimental and real plant data. In this way the empirical and fundamental modelling techniques are combined to obtain an accurate and representative fundamental model. A general fundamental model was constructed from the knowledge of the acid sulphite process and the reactions taking place during the pulping process. This model structure contained the basic reaction mechanisms, as well as the equilibria conditions. The model was created with the ability to easily adjust the parameters. The model was then fitted to experimental and actual plant data and the parameters computed to best fit the real observations.

The following equations were used to completely specify the process:

- The chemical reactions inside the pulp:

$$\text{Lignin:} \quad -\frac{d[L]}{dt} = k_L^0 e^{-E_L/RT} [L]^a \cdot [\text{HSO}_3^-]^\alpha \cdot [\text{H}^+]^\beta \quad (6-24)$$

$$\text{Hemicellulose:} \quad -\frac{d[\text{HC}]}{dt} = k_{\text{HC}}^0 e^{-E_{\text{HC}}/RT} [\text{HC}]^d \cdot [\text{H}^+]^\gamma \quad (6-25)$$

$$\text{Cellulose:} \quad -\frac{d[C]}{dt} = k_C^0 e^{-E_C/RT} [\text{H}^+]^\delta \quad (6-26)$$

$$\text{Strong Acids:} \quad r_{\text{SA}} = \left\{ \left(\frac{g}{v} \right) + \left(\frac{2h}{v} \right) ([L]_0 - [L]) \right\} \cdot r_L + \frac{k_{\text{SA}}(T)}{v} ([L]_0 - [L])^q [\text{HSO}_3^-]^b [\text{H}^+]^c \quad (8-2)$$

- Liquor composition

Chemical equilibrium:
$$K_{SO_2} = \frac{[H^+][HSO_3^-]}{[SO_2]} \quad (8-4)$$

Electron neutrality:
$$[M^+] + [H^+] = [HSO_3^-] + [SA^-] \quad (8-7)$$

Vapour-Liquor equilibrium:
$$K_p = \frac{[H^+][HSO_3^-]}{p_{SO_2}} \quad (8-8)$$

Total Pressure:
$$P = p_{SO_2} + p_{H_2O} \quad (8-9)$$

Combined SO_2 :
$$[M^+] = 2 \cdot [\text{combined } SO_2] \quad (6-6)$$

A computer package was written to assist in this process of finding an accurate model. The package contains several tools for simulating and verifying the model. Experimental and real plant data that were saved in spreadsheets can be read by the package. In this way, the results of the model simulations can be compared with the data. The correctness of the model can be verified or the necessary adjustments made to the model parameters.

Excellent verification results were obtained. The most significant results were obtained by comparing the final degree of polymerisation of a number of actual cooks, to the corresponding model predicted values. Since the primary purpose of the control strategy is to control the final degree of polymerisation, the prediction of these values will be the most important function of the model. The coefficient of variance obtained for a set of 35 consecutive cooks was 10,7. The values reported by SAPPI SAICCOR where the S-factor model was used, were between 20 and 30. A marked improvement was theoretically obtained over the S-factor model. The normal equation for the calculation of the S-factor model was adapted to determine the variance between the predicted values and the measured values, and not the variance relative to the mean of the sample set as usual. It was concluded that conservative values would be obtained by using the adapted equation.

Since this good value was obtained for the coefficient of variance, it was necessary to confirm that the reason for this was not because of small variations in the result of the actual cooks. To determine this, a correlation coefficient was calculated between the actual and predicted values. This would determine the ability of the model to predict changes in the final product quality. A correlation coefficient of 0,77 was obtained,

which is again encouragingly high. It was therefore confirmed that the model can predict these changes.

The final values obtained in this way for the kinetic parameters of the reactions concerning the wood constituents are shown in Table 12.1. The values obtained for the parameters in the equilibrium equations are shown in Table 12.2.

Lignin reaction kinetics		
	[L] > 12,4	[L] < 12,4
K_L^0	$1,346 \times 10^{12}$	$0,407 \times 10^{12}$
E_L	12 500	12 500
a	0,646	1,621
α	0,819	0,765
β	0,705	0,779
Hemicellulose reaction kinetics		
K_{HC}^0	$1,261 \times 10^{11}$	
E_{HC}	14 030	
d	2,542	
γ	0,707	
Cellulose reaction kinetics		
K_C^0	$2,913 \times 10^{14}$	
E_C	35 000	
δ	1	
Strong Acids reaction kinetics		
k_{SA}^0	$0,274 \times 10^5$	
E_{SA}	10480	
n	-0,430	
b	0,625	
c	0,554	
m	1	

Table 12.1: Parameters in kinetic equations obtained in this study

The units of time, temperature, lignin content and concentration used in the rate equation to obtain these values are second, Kelvin, mass % of wood and kmol/m^3 respectively.

A	Temperature range (°C)	B	C
K_{SO_2}	20 – 80	-5,077	1 045
	80 – 120	-6,916	1 700
	120 - 150	-7,971	2 133
K_P	20 – 80	-10,2212	2 392
	80 – 120	-10,5125	2 665
	120 - 150	-11,0348	2 960
K_{H_2O}	20 - 150	5,9648	-2 198

Table 12.2: Values for parameters B and C in equation (8-5) obtained in this study

The values obtained for the parameters in the model are very similar to the values reported in literature.

From the results given the potential for improved control using the fundamental model should be clear. A control strategy is proposed where the fundamental model is used as a predictor to calculate the maximum temperature that will be necessary to obtain the target degree of polymerisation of a cook, once the initial conditions of the cook have been entered into the model. The efficiency of the model to calculate this maximum temperature was also proven. While the cook is progressing, the continuous measurements can be entered directly into the model and the model is then used as an accumulator. Any variation between the initially predicted conditions and the actual measured conditions can then be calculated and the maximum temperature adjusted to compensate for these variations. A feedback strategy can be used to adjust the model when clear trends over a certain period are observed.

The parameters used in the model were not optimised and it is recommended that an optimisation algorithm be developed in order to obtain even further improvements. The use of a neural network techniques to do this optimisation can be investigated. Another possibility for future study is to develop a method for optimising the entire temperature profile for the cook and not only for controlling the maximum temperature for a fixed temperature profile.

Chapter 13: Bibliography

- Aldrich, C. (1997) "Analysis and modeling of pulp viscosity in batch digester 11"
Internal Report: SAPPI SAICCOR, Umkomaas.
- Beharic, S. (1994) "Digesters: Wood chips and cooking liquor loading" Internal report:
SAPPI SAICCOR, Umkomaas.
- Bierman, C. J. (1996) *Handbook of Pulping and Papermaking*, 2nd ed., Academic
Press, California.
- Bryce, J. R. G. (1980) "Sulfite Pulping" In *Pulp and paper: Chemistry and chemical
technology*, Vol. 1 (Ed, Cassey, J. P.) 1st ed., John Wiley and Son, Chichester.
- Demuth, H. and Beale, M. (1998) "Neural network toolbox" The Mathworks, Natick.
- Dirion, J. L., Cabassud, M., Lann, M. V. L. and Casamatta, G. (1996) "Development of
adaptive neural networks for flexible control of batch processes", *The Chemical
Engineering Journal*,(S), **63**, S797 - S802.
- Dong, D. and MacAvoy, T. J. (1996) "Batch tracking via nonlinear principal component
analysis", *AIChE Journal*,(8), **42**, 2199 - 2208.
- Eaton, J. W. and Rawlings, J. B. (1990) "Feedback control of chemical processes
using on-line optimization techniques", *Computers and Chemical Engineering*,
(4),**14**, 469.
- Fourie, S. H. (1999) "An introduction to the application of neural networks in process
control" University of Pretoria, Pretoria.
- Genco, J. M. (1996) "Pulp" In *Kirk-Othmer Encyclopedia of Chemical Technology*, Vol.
20 (Eds, Kroschwitz, J. I. and Howe-Grant, M.) 4th ed., John Wiley and Sons,
Chichester.
- Glasser, W. G. (1979) "Lignin" In *Pulp and Paper: Chemistry and Chemical
Technology*, Vol. 1 (Ed, Casey, J. P.) 3rd ed., John Wiley and Sons, London.
- Hagberg, B. and Schöön, N.-H. (1973) "Kinetic aspects of the acid sulfite cooking
process: Part 1: Rates of dissolution of lignin and hemicellulose", *Svensk
Papperstidning*,(15), **76**, 561-568.
- Hagberg, B. and Schöön, N.-H. (1974a) "Kinetic aspects of the acid sulfite cooking
process. Part 2: Rate of formation of strong acids", *Svensk Papperstidning*,(4),
77, 127-130.
- Hagberg, B. and Schöön, N.-H. (1974b) "Kinetic aspects of the acid sulfite cooking
process. Part 3: Mathematical simulation of cooks", *Svensk
Papperstidning*,(15), **77**, 557 - 562.

- Hanish, H.-M. (1994) "Discrete models of the dynamic behaviour of batch plant", *Computers and Chemical Engineering*,(S), **18**, S403-S407.
- Haxthausen, N. (1995) "The painkillers for batch control headaches", *Chemical Engineering*,(October), 119 - 124.
- Helm, R. (1999a) "Carbohydrates and Polysaccharides", <http://www.chem.vt.edu/chem-dept/helm/3434WOOD/notes1/carbo.html>, Virginia Polytechnic Institute and State University.
- Helm, R. (1999b) "Cellulose", <http://www.chem.vt.edu/chem-dept/helm/3434WOOD/notes1/cellulose.html>, Virginia Polytechnic Institute and State University.
- Helm, R. (1999c) "Kraft pulping", <http://www.chem.vt.edu/chem-dept/helm/3434WOOD/notes1/kraft.html>, Virginia Polytechnic Institute and State University.
- Helm, R. (1999d) "Reactions of polysaccharides", <http://www.chem.vt.edu/chem-dept/helm/3434WOOD/notes1/polyxn.html>, Virginia Polytechnic Institute and State University.
- Juba, M. R. and Hamer, J. W. (1986) "Chemical Process Control - CPCIII" (Eds, Morari, M. and McAvoy, T. J.).
- Karlsson, O. and Westermark, U. (1996) "Evidence of chemical bonds between lignin and cellulose in kraft pulps", *Journal of pulp and paper science*,(10), **22**, J397 - J401.
- Kollman, F. F. P. and Côté, W. A. (1968) *Principles of Wood Science and Technology*, 1 ed., Springer-Verlag New York Inc., New York.
- Levenspiel, O. (1972) *Chemical Reaction Engineering*, 2nd ed., John Wiley and Sons, New York.
- Lin, L. I.-K. (1989) "A concordance correlation coefficient to evaluate reproducibility", *Biometrics*,(March), **45**, 255-268.
- Luyben, W. L. (1990) *Process Modeling, Simulation and Control for Chemical Engineers*, 2nd ed., McGraw-Hill International editions, Singapore.
- Marr, S. Y. and Bondy, W. B. (1986) "Application of viscosity prediction model in sulphite pulping" In *CPPA/TAPPI International Sulphite Conference Quebec*.
- McGinnis, G. D. and Shafizadeh, F. (1979) "Cellulose and hemicellulose" In *Pulp and Paper: Chemistry and Chemical Technology*, Vol. 1 (Ed, Casey, J. P.) 3rd ed., John Wiley & Sons, Chichester.
- McGovern, J. N. (1979) "Pulping" In *Pulp and Paper: Chemistry and Chemical Technology*, Vol. 1 (Ed, Casey, J. P.) 3rd ed., John Wiley and Sons, Chichester.
- Meneghel, C. (1998a) "Historical review of the existing model's capability" Internal report: SAPPI SAICCOR, Umkomaas.
- Meneghel, C. (1998b) "Investigation fo the digester cooking model from an operational point of view" Internal report: SAPPI SAICCOR, Umkomaas.
- Meneghel, C. (1999) "Digester control" Internal report: SAPPI SAICCOR, Umkomaas.

- Patt, R. and Kardsachia, O. (1991) "Pulp" In *Ullmann's Encyclopedia of Industrial Chemistry*, Vol. A18 (Eds, Elvers, B., Hawkins, S. and Shulz, G.) 5th ed., VCH Publishers.
- Pauponis, M. A. and Krishnagoplan, A. (1991) "Adaptive inferential control of kraft batch digesters as based on pulping liquor analysis", *Tappi Journal*,(6), **74**,169 - 175.
- Pellow-Jarman, M. (1997) "Correlations between viscosities at cook end and cooking conditions on Digester 11" Internal report: SAPPI SAICCOR, Umkomaas.
- Pellow-Jarman, M. (1998) "Neural network analysis of digester 11 data including 4 hour liquor strength and 5,25 hour liquor colour" Internal report: SAPPI SAICCOR, Umkomaas.
- Prescott, D. M. (1988) *Cells*, 1st ed., Jonesand Bartlett Publishers.
- Proctor, A. R., Yean, W. Q. and Goring, D. A. (1967) *Pulp and Paper Magazine of Canada*,**68**.
- Rippen, D. W. T. (1983) "Simulation of single- and multiproduct batch chemical plants for optimal design and operation", *Computers and Chemical Engineering*,(3), **7**, 137-156.
- Rydholm, S. A. (1965) *Pulping processes*, 1st ed., Interscience Publications, London.
- Salmén, L. and Olsson, A.-M. (1998) "Interaction between hemicelluloses, lignin and cellulose: Structure - Property relationships", *Journal of pulp and paper*,(3), **24**, 99 - 103.
- SAPPI (1999) <http://www.sappi.co.za/>, 20 September 1999.
- Shacham, M. (1996) "Application of feedback control principles for solving differential-algebraic systems of equations in process control education", *Computers and Chemical Engineering*,(Supplement), **20**, S1329 - S1334.
- Sloan, T. H. (1982a) "Acid Hydrolysis of cellulose in sulfite pulping" Internal Report: ITT Rayonier Incorporated.
- Sloan, T. H. (1982b) "Activation energy for delignification in acid bisulfite pulping" ITT Rayonier Inc.
- Sloan, T. H. (1982c) "Activation energy for hemicellulose dissolution in sulfite pulping" ITT Rayonier Inc.
- Smith, J. M. (1981) *Chemical Engineering Kinetics*, 3rd ed., McGraw-Hill International Editions, Singapore.
- Smith, S. (1998) "Saiccor batch digester model development - Phase 1" Internal report: PiTEC, Randburg.
- Smook, G. A. (1994) *Handbook for Pulp and Paper Technologists*, 2nd ed., Angus Wilde Publications.
- Stephanopoulos, G. (1984) *Chemical Process Control: An Introduction to Theory and Practice*, 1 ed., Prentice Hall International Editions, New Jersey.
- Terwiesch, P. and Agarwal, M. (1995) "A discretized nonlinear state estimator for batch processes", *Computers and Chemical Engineering*,(2), **19**, 238 - 258.

- Terwiesch, P., Agarwal, M. and Rippen, D. W. T. (1994) "Batch unit optimization with imperfect modeling: a survey", *Journal of Process Control*,(4), **4**, 238-258.
- Wang, Z. L., Corriou, J. P. and Pla, F. (1994) "Nonlinear adaptive control of batch polymerisation", *Computers and Chemical Engineering*,, **18**.
- Watson, E. (1992) "Mathematical modeling and experimental study of the kinetics of the acid sulphite pulping of Eucalyptus wood" In *Department of Chemical Engineering* University of Natal, Durban.
- Willis, M. J., Montague, G. A., Massimo, C. d., Tham, M. T. and Morris, A. J. (1992) "Artificial neural networks in process estimation and control", *Automatica*,, **28**.
- Wilson, J. A. and Martinez, E. C. (1997) "Neuro-fuzzy modeling and control of a batch process involving simultaneous reaction and distillation", *Computers and Chemical Engineering*,(Supplement),(S), **21**, S1233 - S1238
- Yorston, F. H. and Liebergott, N. (1965) "Correlation of the rate of sulphite pulping with temperature and pressure", *Pulp and Paper Magazine of Canada*,(May), **66**, T-272.

Appendix A: “Digest” Help pages



Appendix B:

Influence of parameters in fundamental model

The influence of the different parameters in the model was investigated by using the “Digest” package. This was done by changing each of the different parameters individually and then saving the cook data as a separate file. Three different values were saved for each of the parameters and the three different cooks were simulated simultaneously by using the comparison tool in the package, as was discussed in Appendix A.

Different symbols from the ones used in the model were used in the package, since the Greek symbols were difficult to program. A description of the symbols is given in the table below. The model was summarised in Chapter 12 and the meanings of the original symbols can be seen there.

Program symbol	Original symbol in model	Description
a	a	Lignin reaction order in lignin reactions
b	α	Bisulfite reaction order in lignin reactions
c	β	Hydrogen reaction order in lignin reactions
d	d	Hemicellulose reaction order in hemicellulose reactions
e	γ	Hydrogen reaction order in hemicellulose reactions
f	q	Lignin reaction order in strong acid reactions
g	g	Additional parameter in strong acid reactions
h	h	Additional parameter in strong acid reactions
i	b	Bisulfite reaction order in strong acid reactions
j	c	Hydrogen reaction order in strong acid reactions
l	δ	Hydrogen reaction order in cellulose reactions

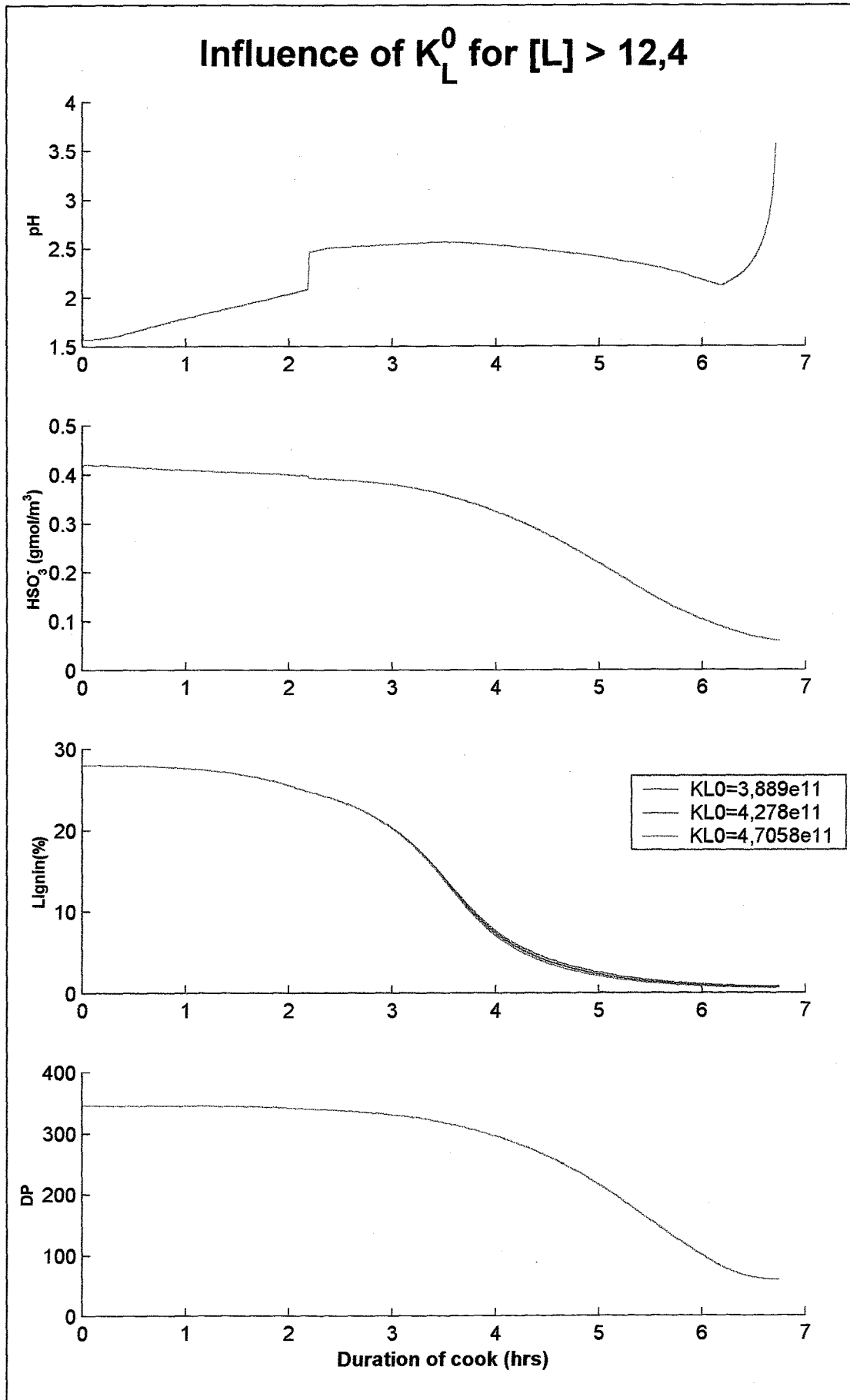

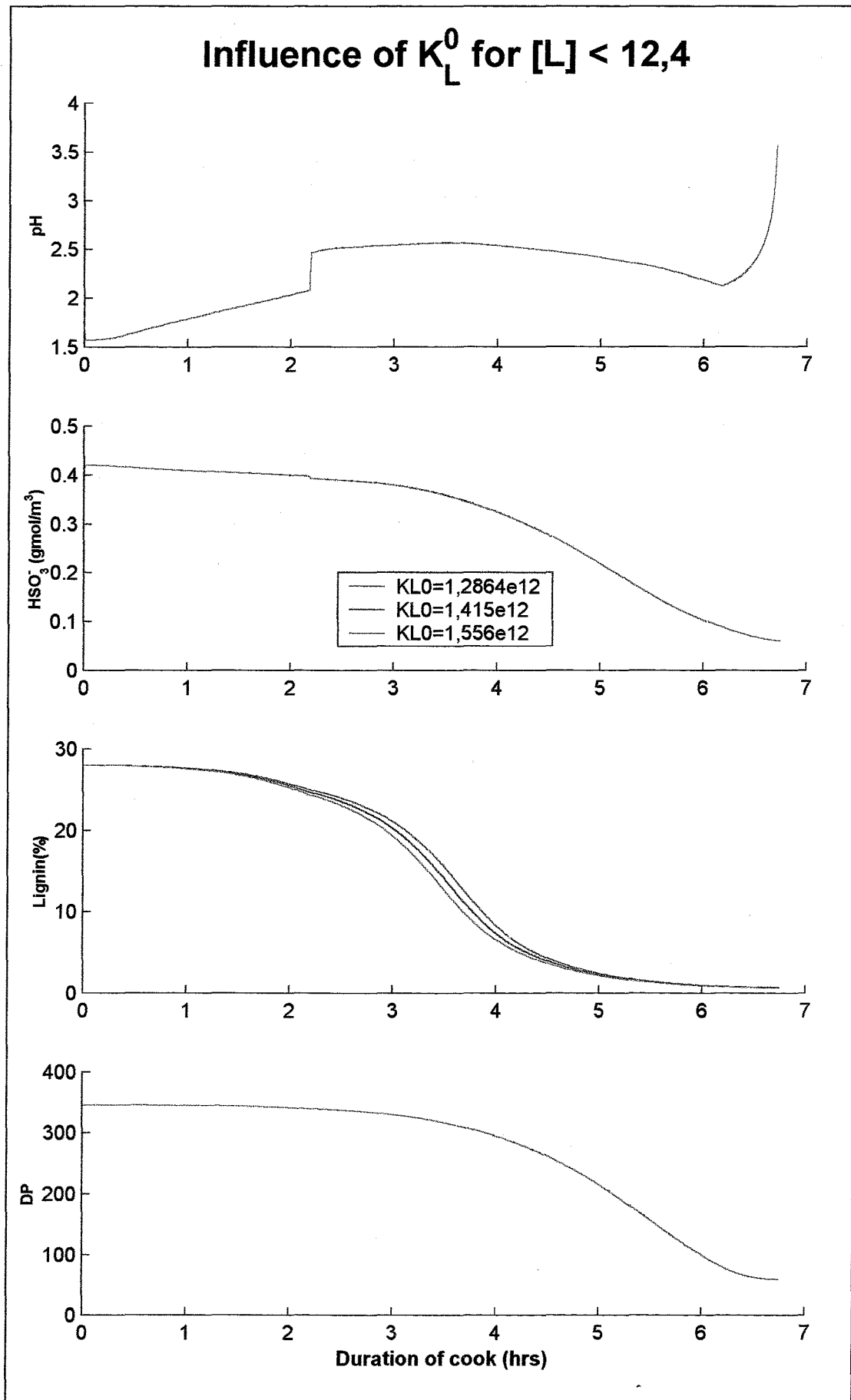

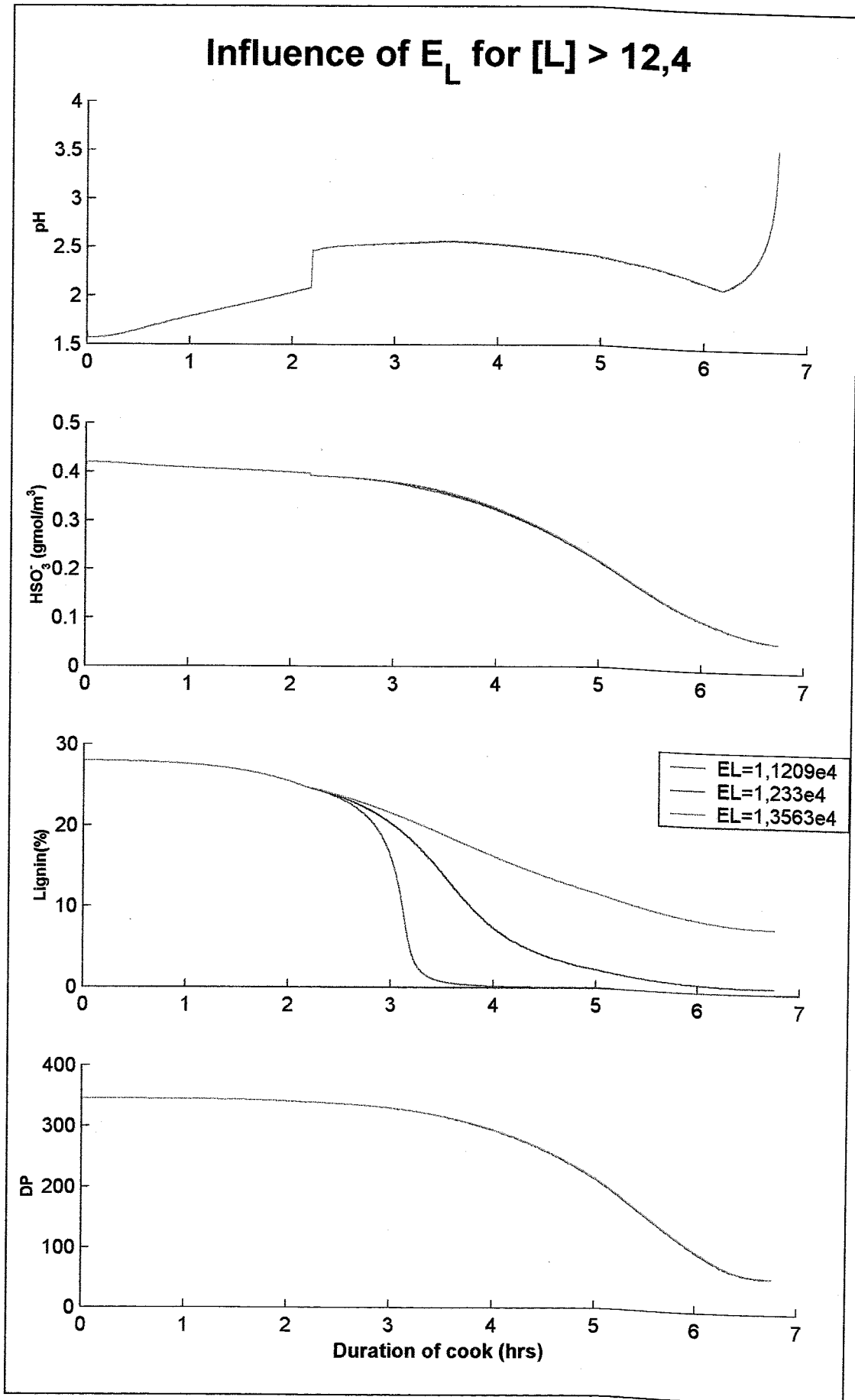

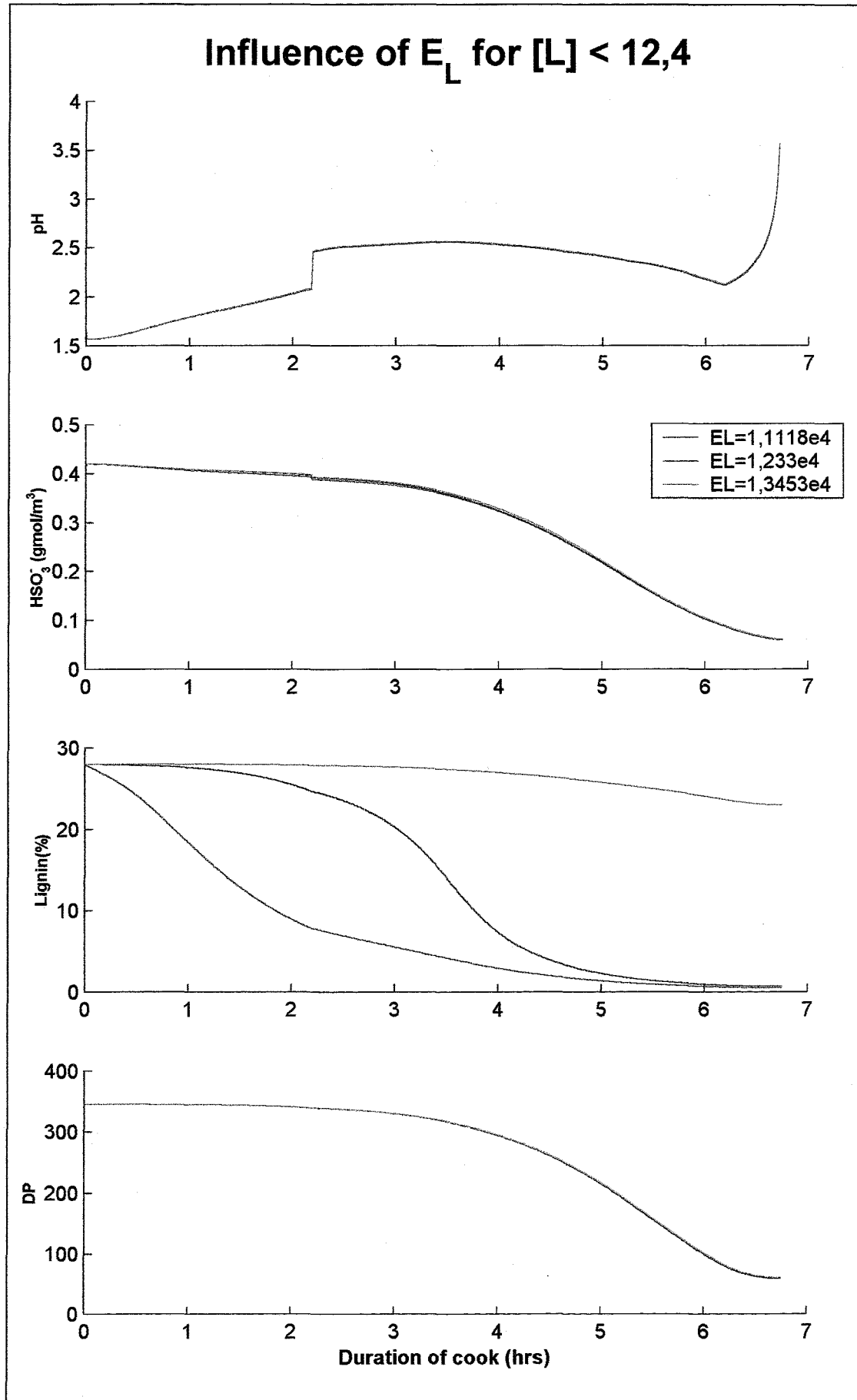

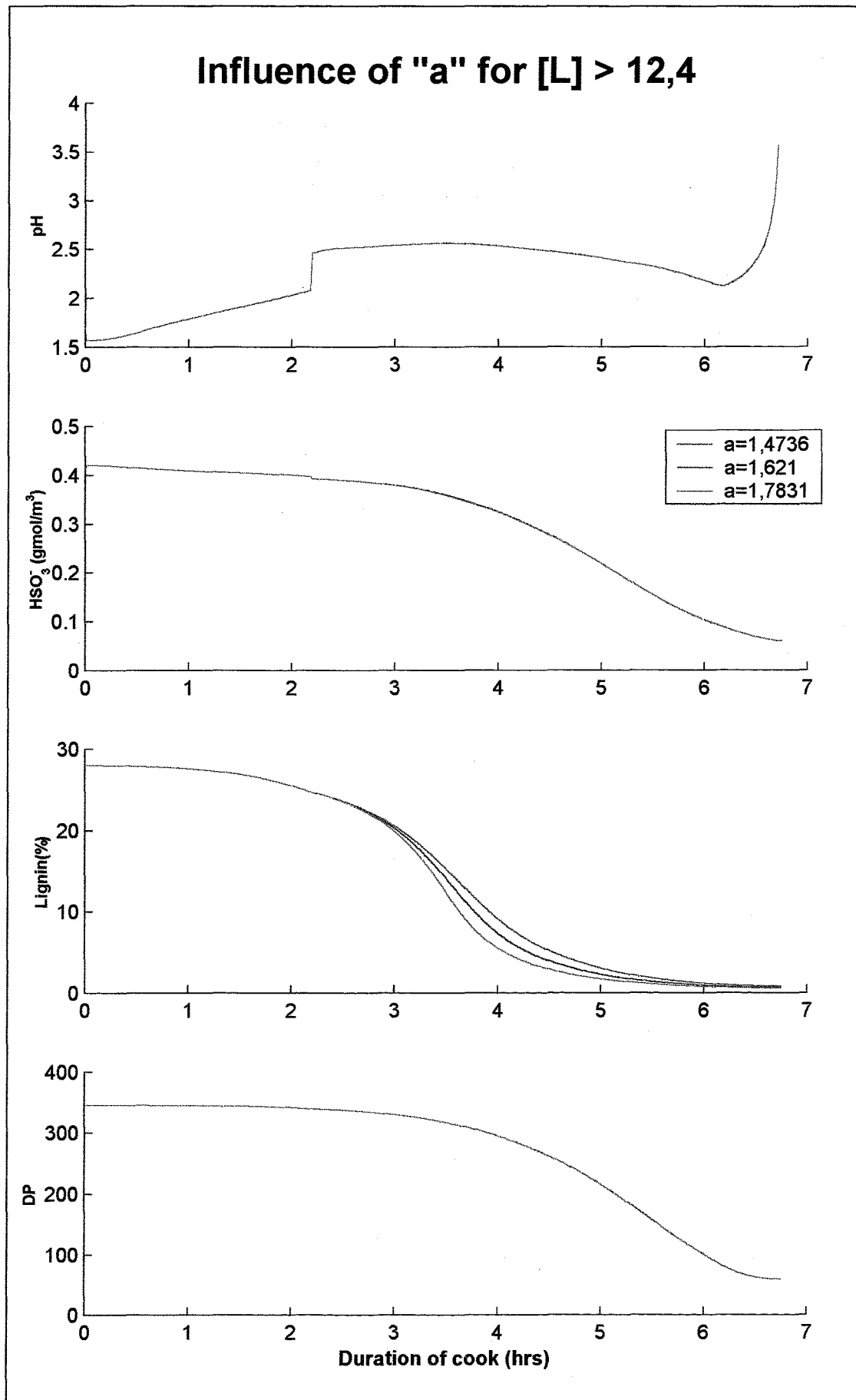

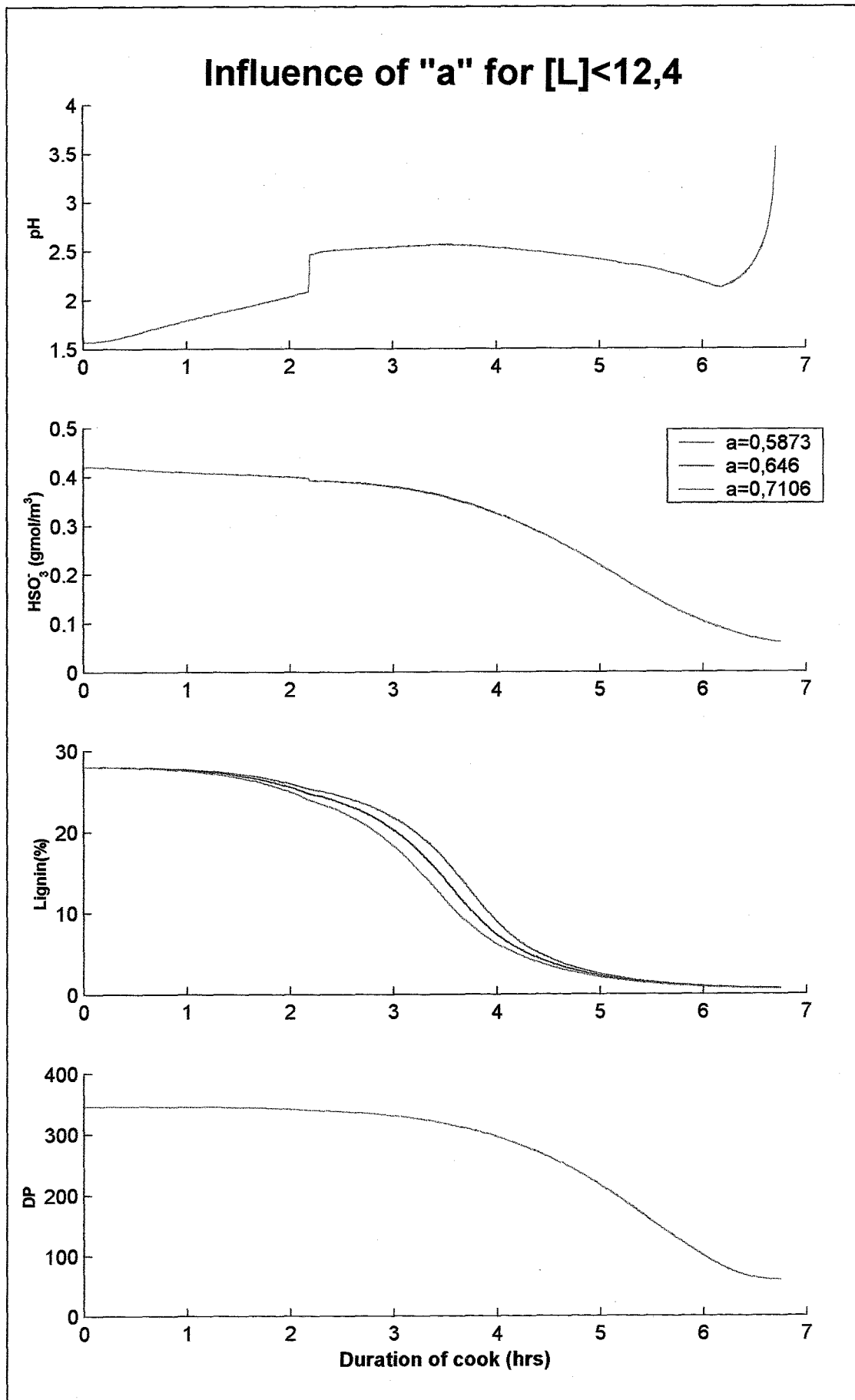

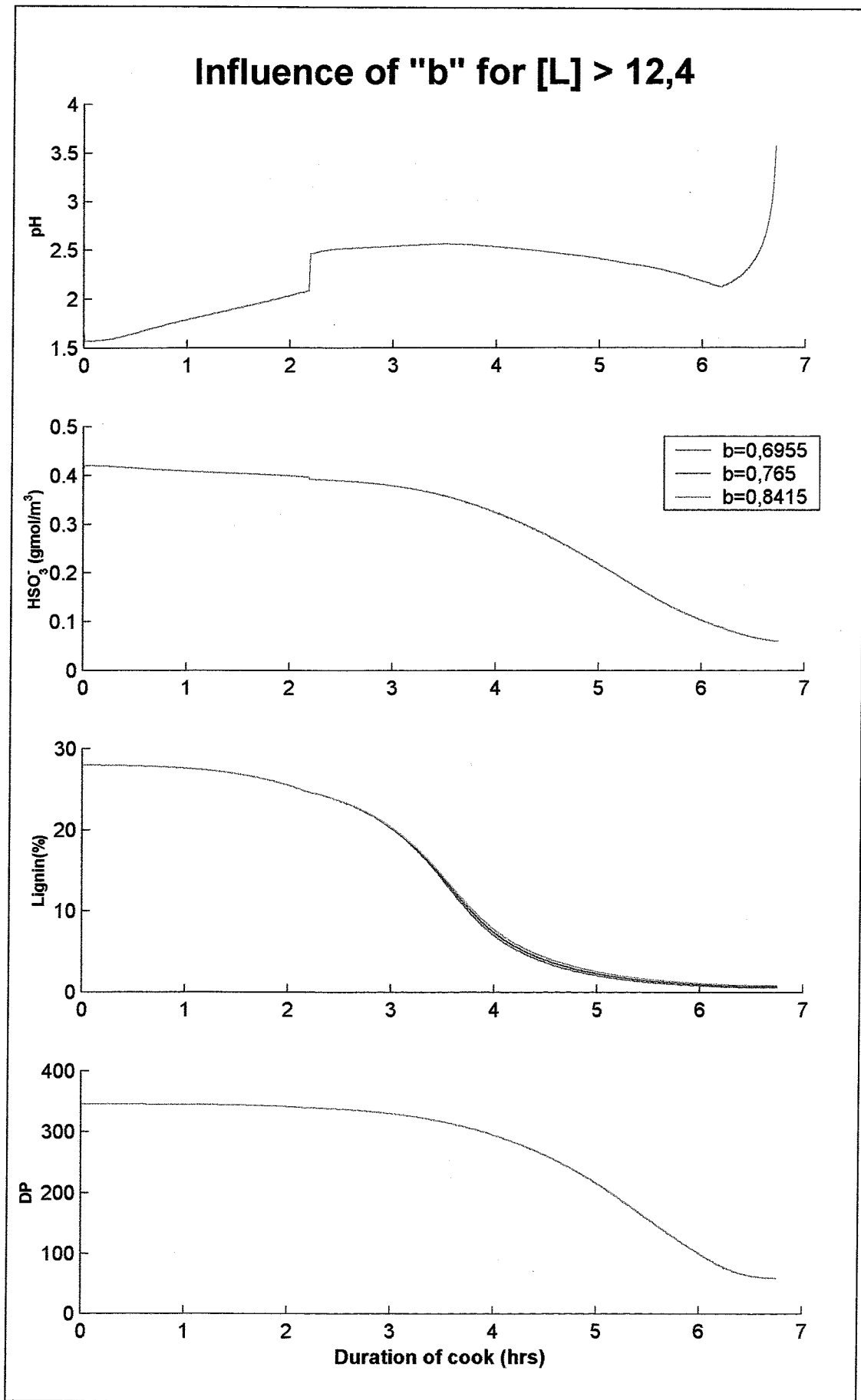

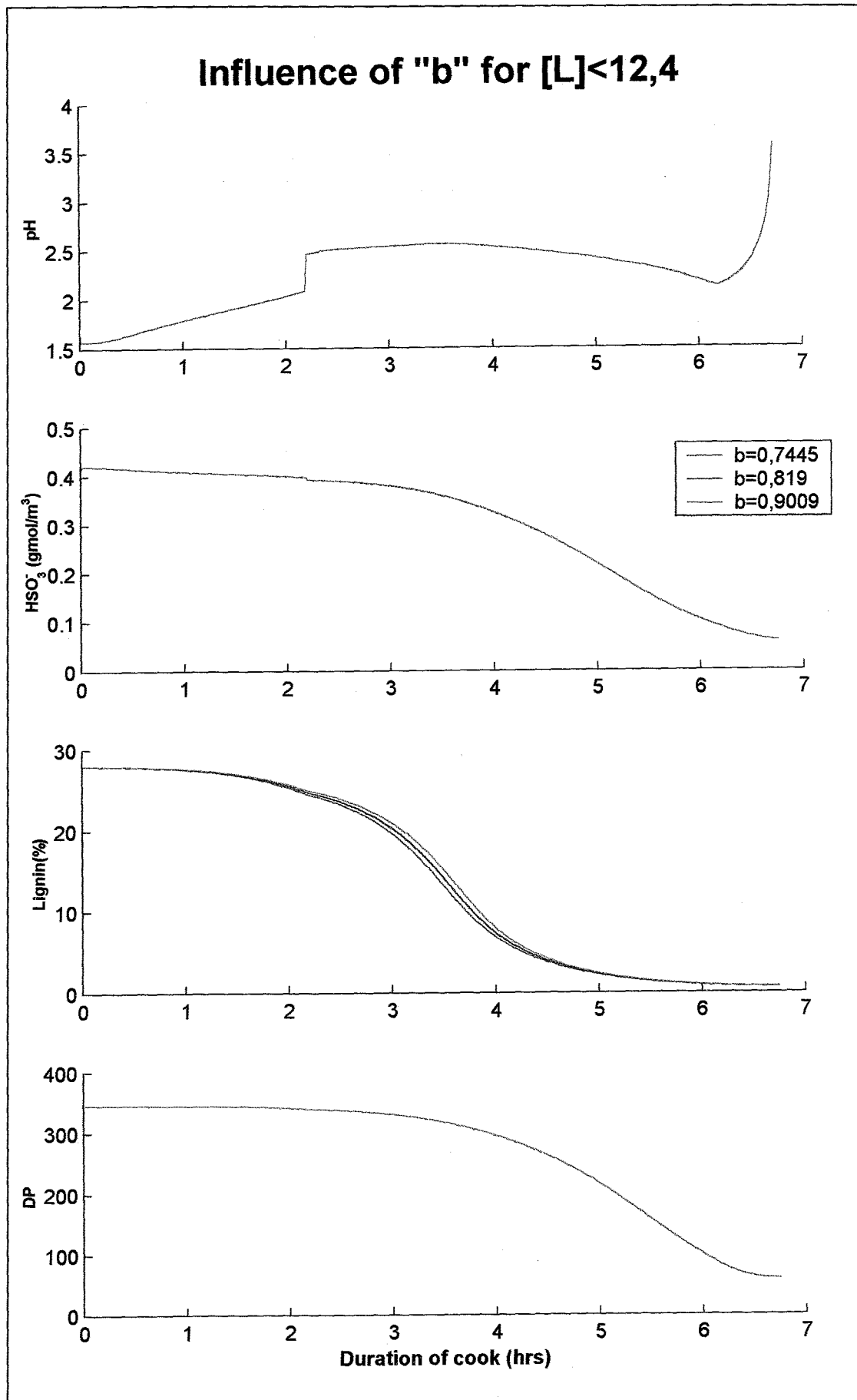

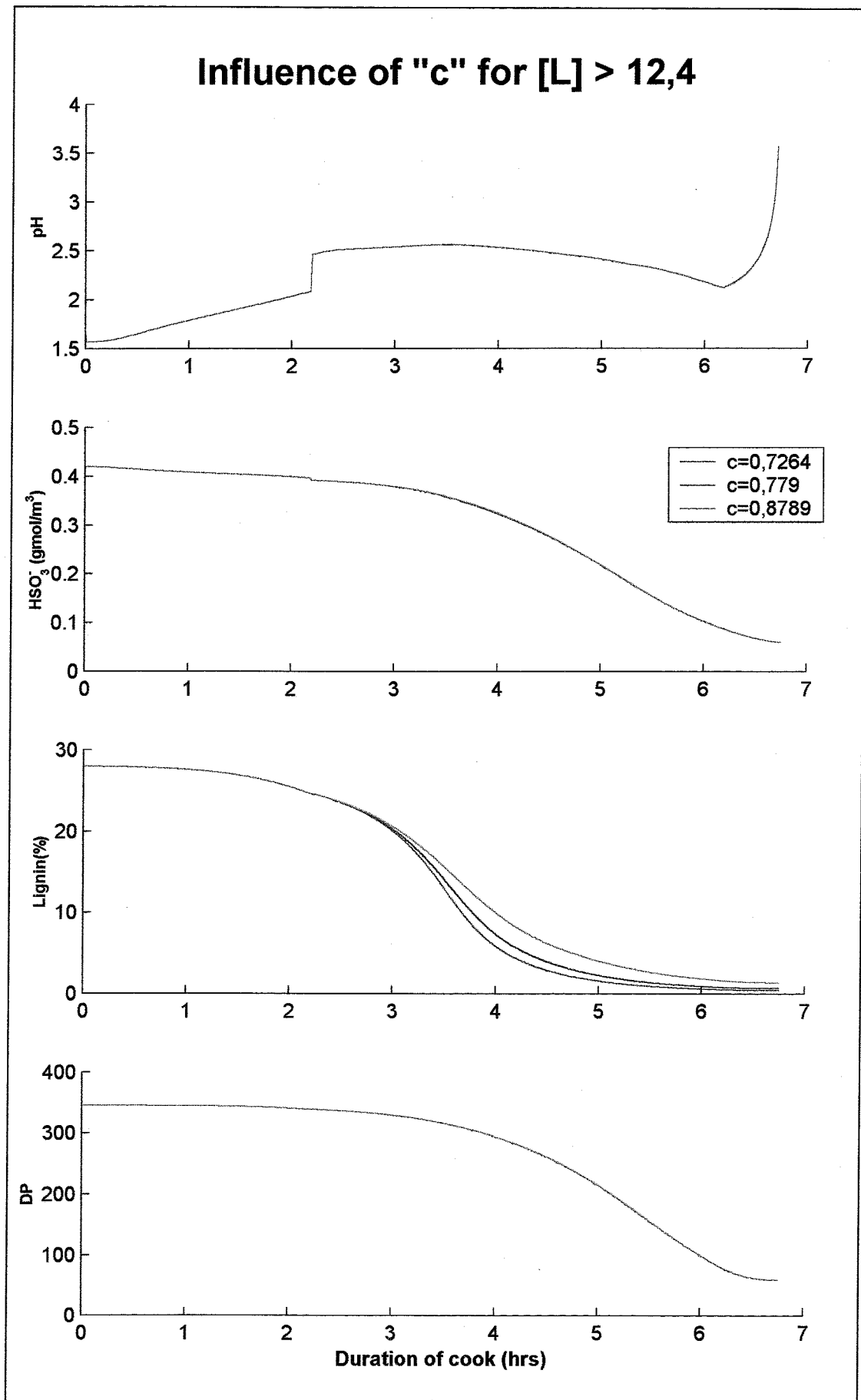

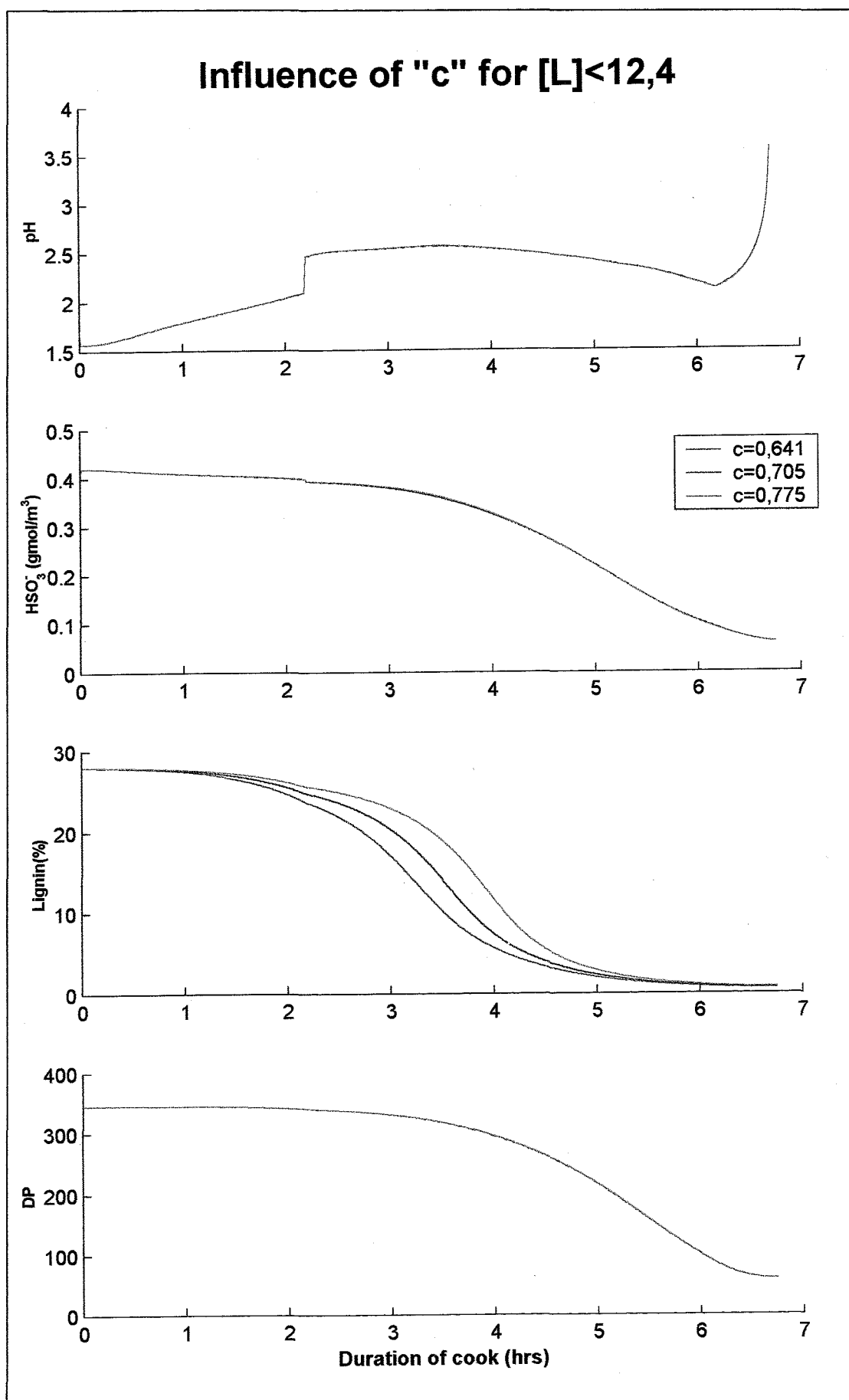

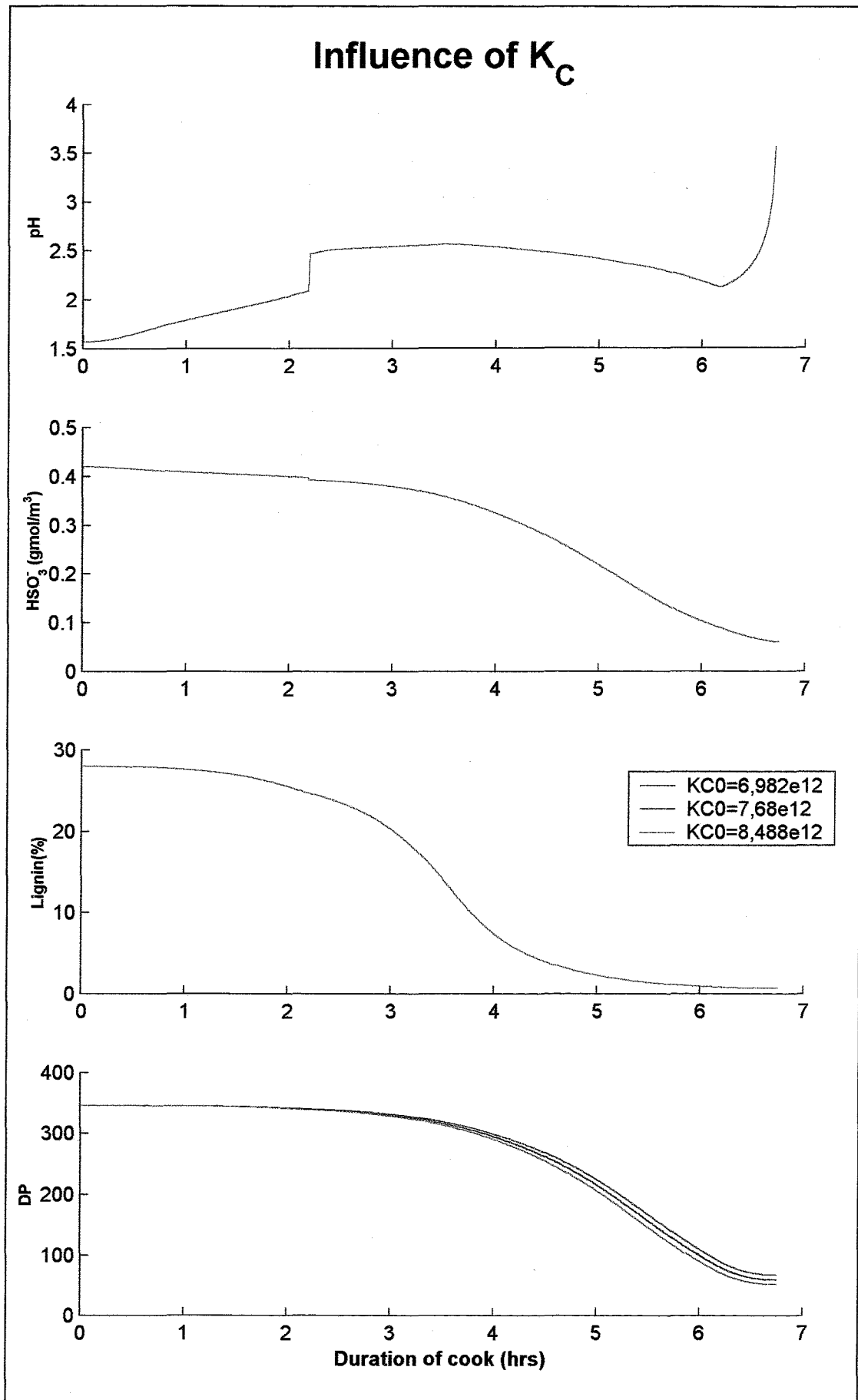

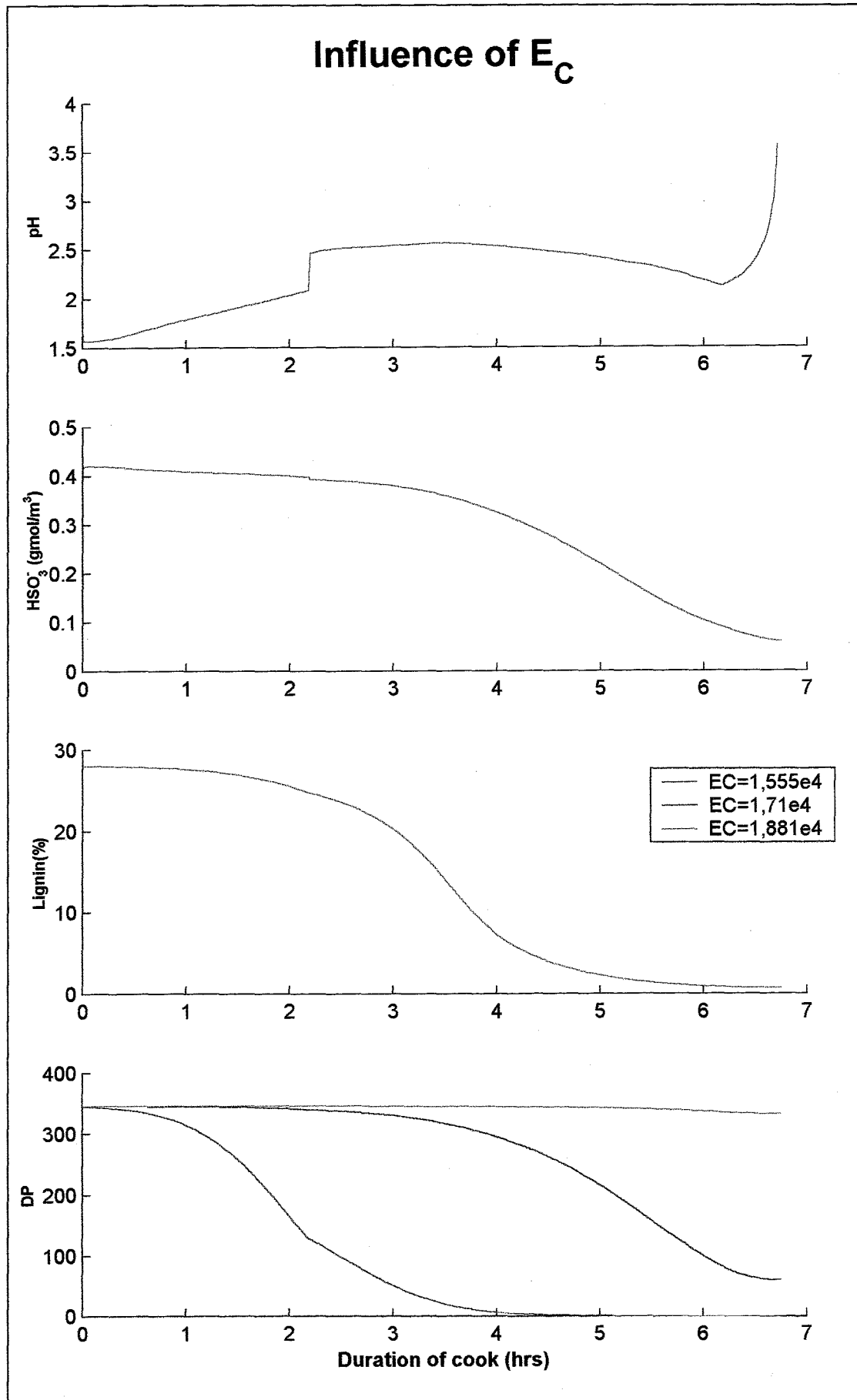

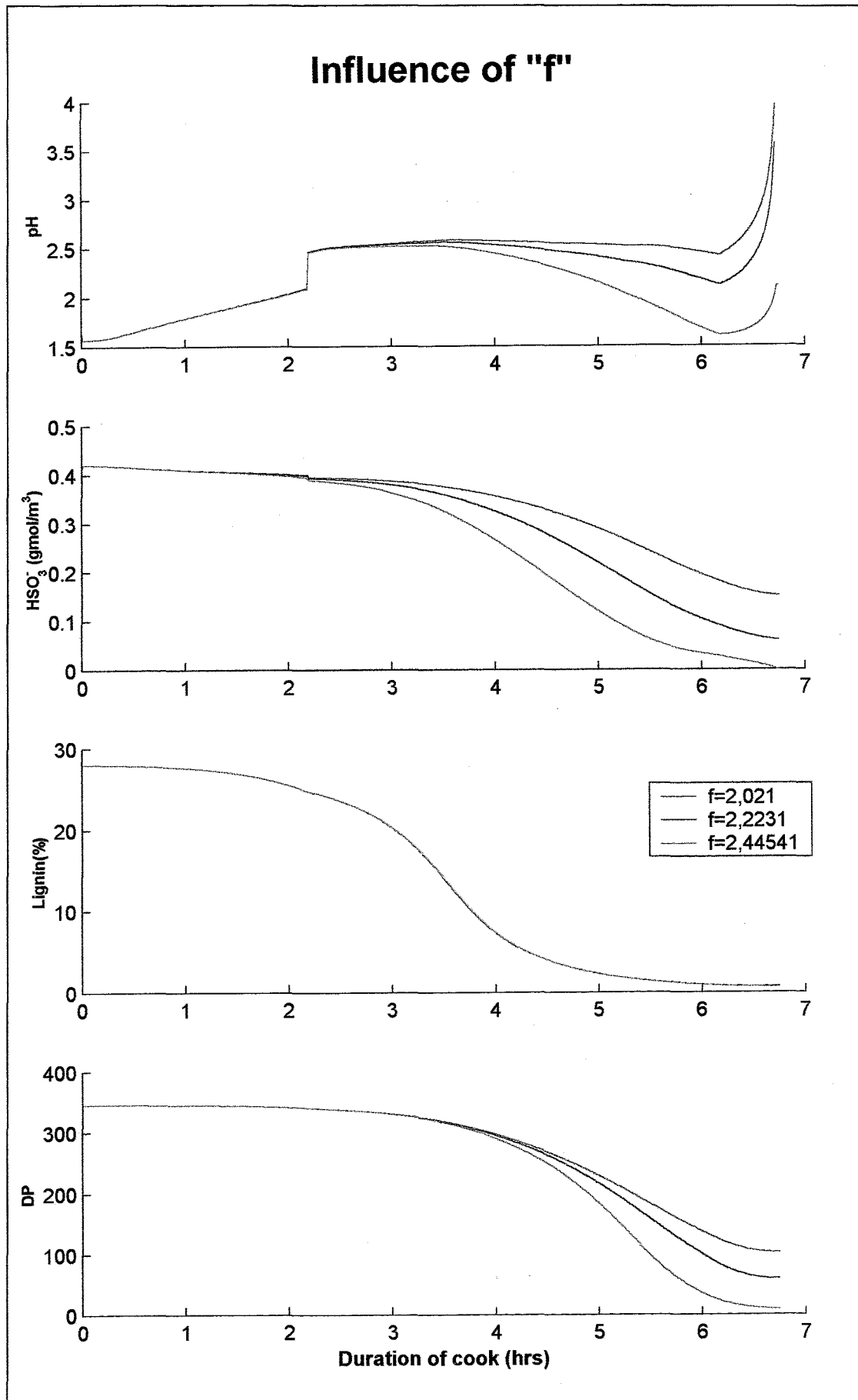

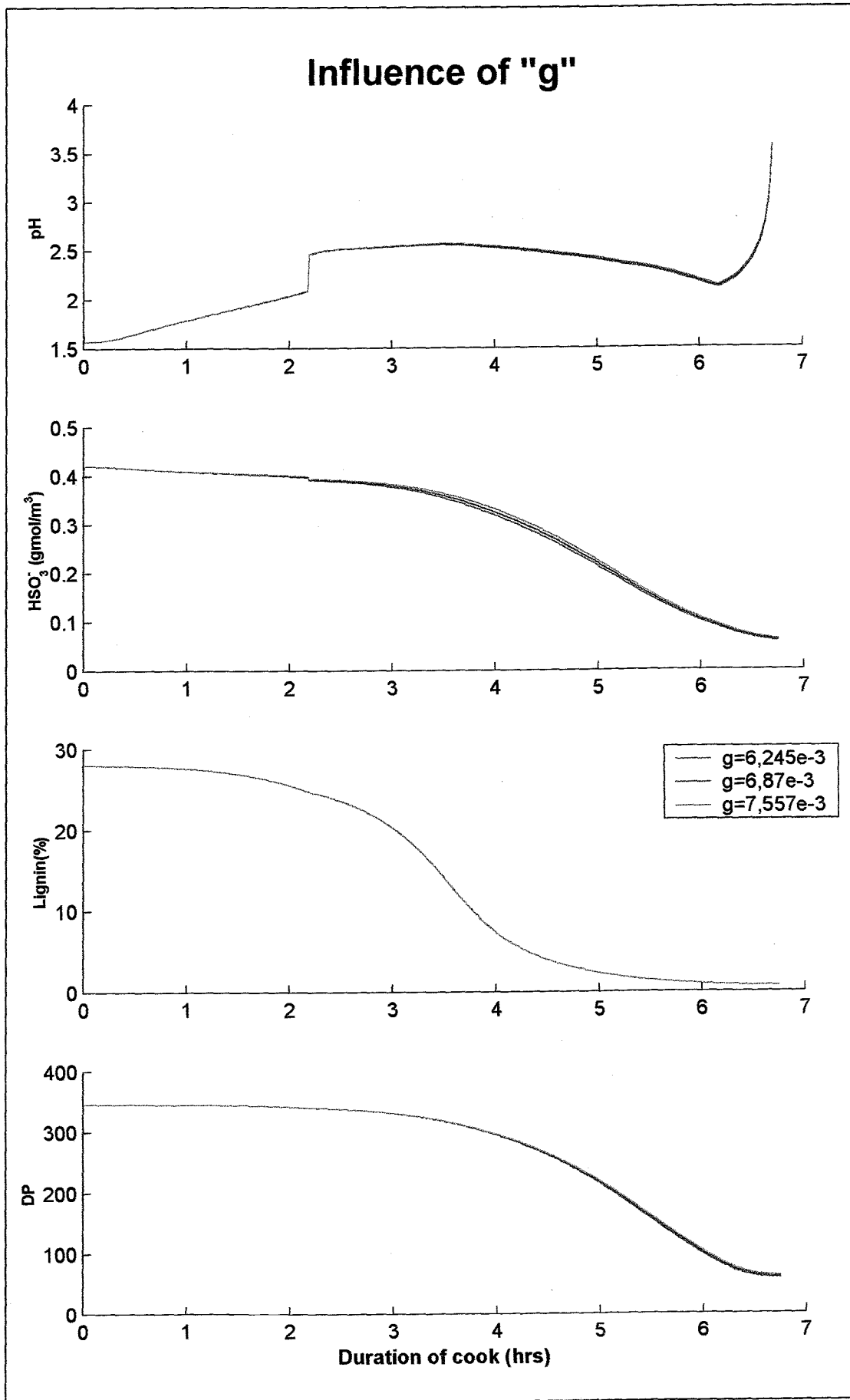

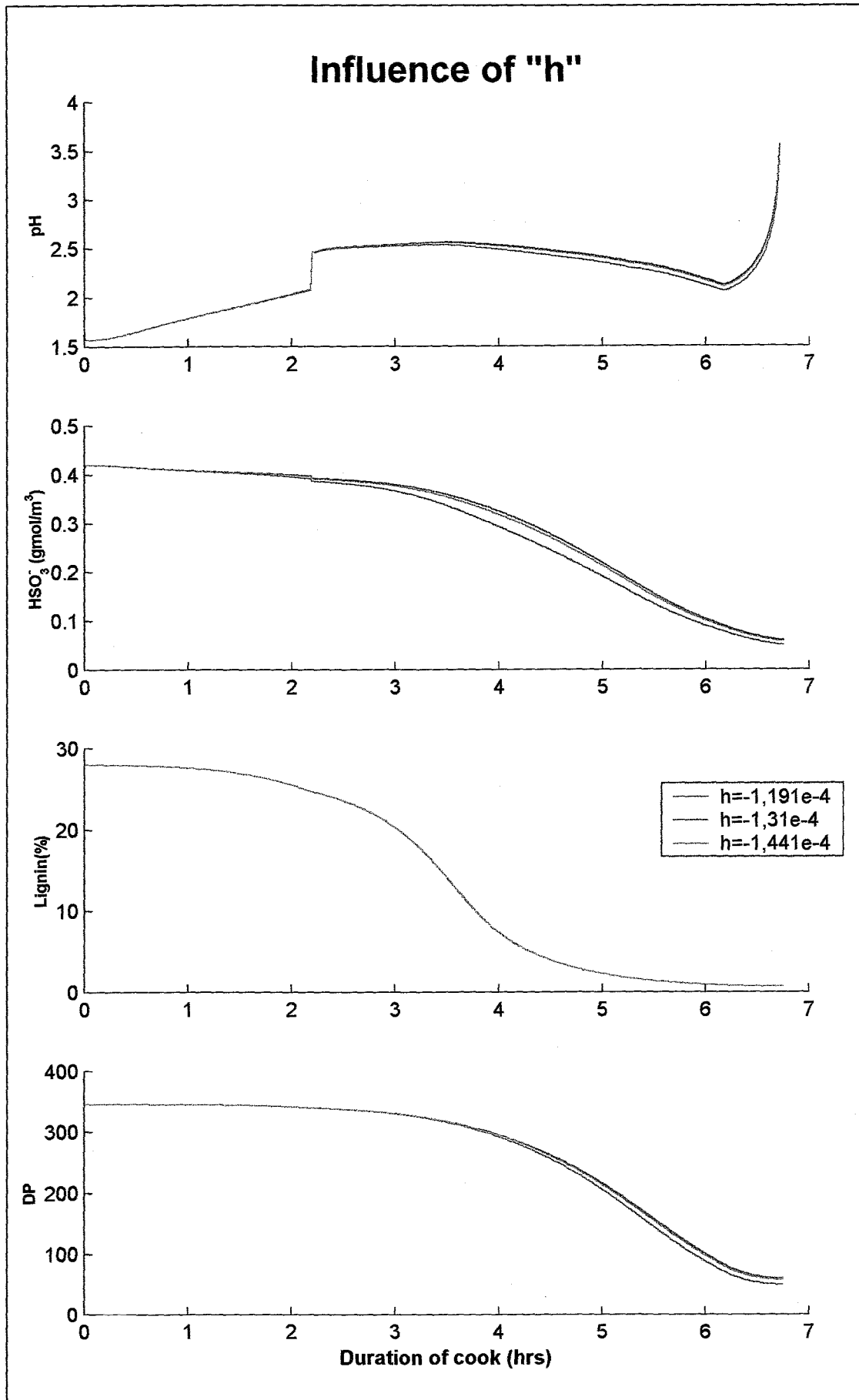

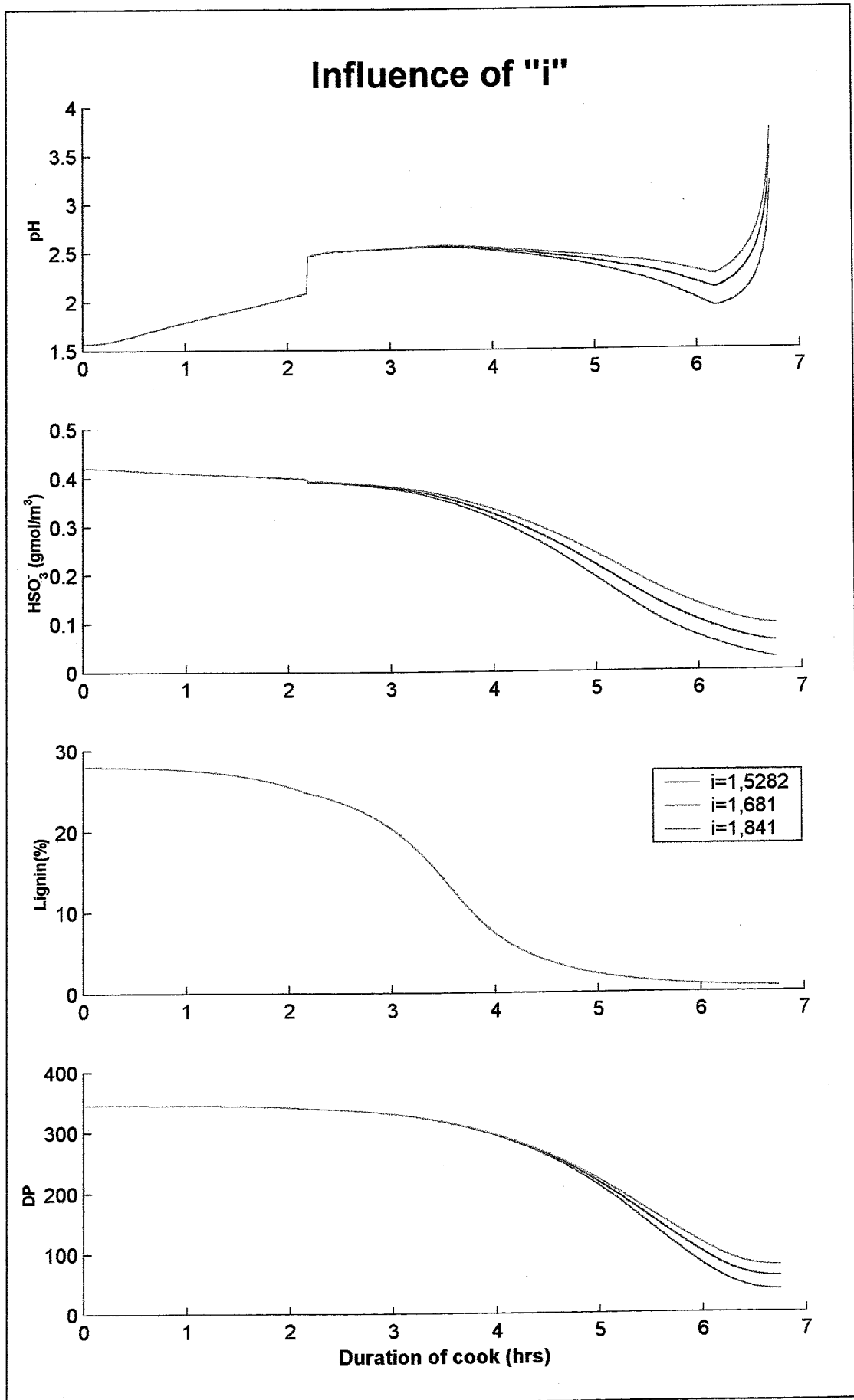

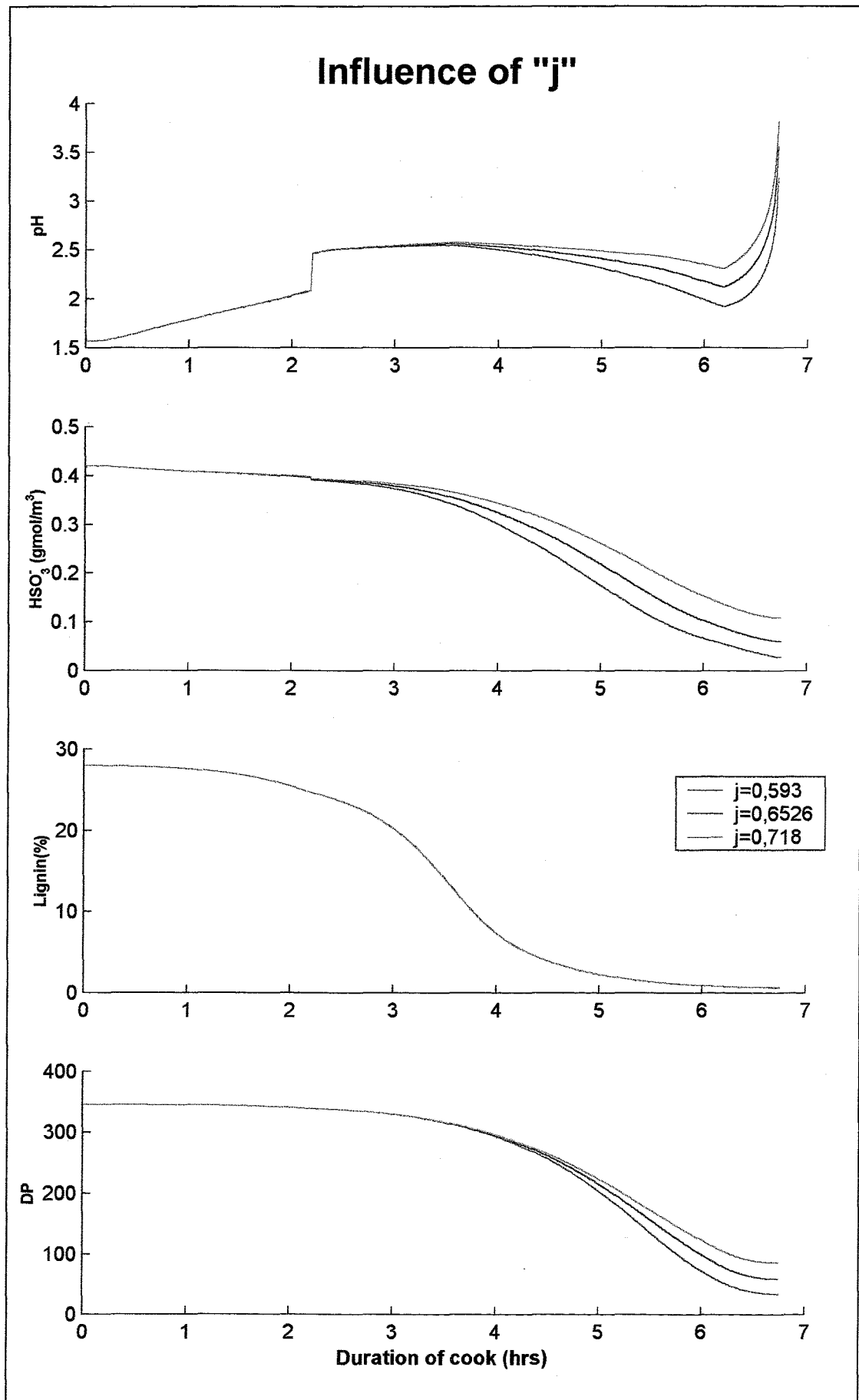



Hydrogen reaction order, "I", in cellulose degradation

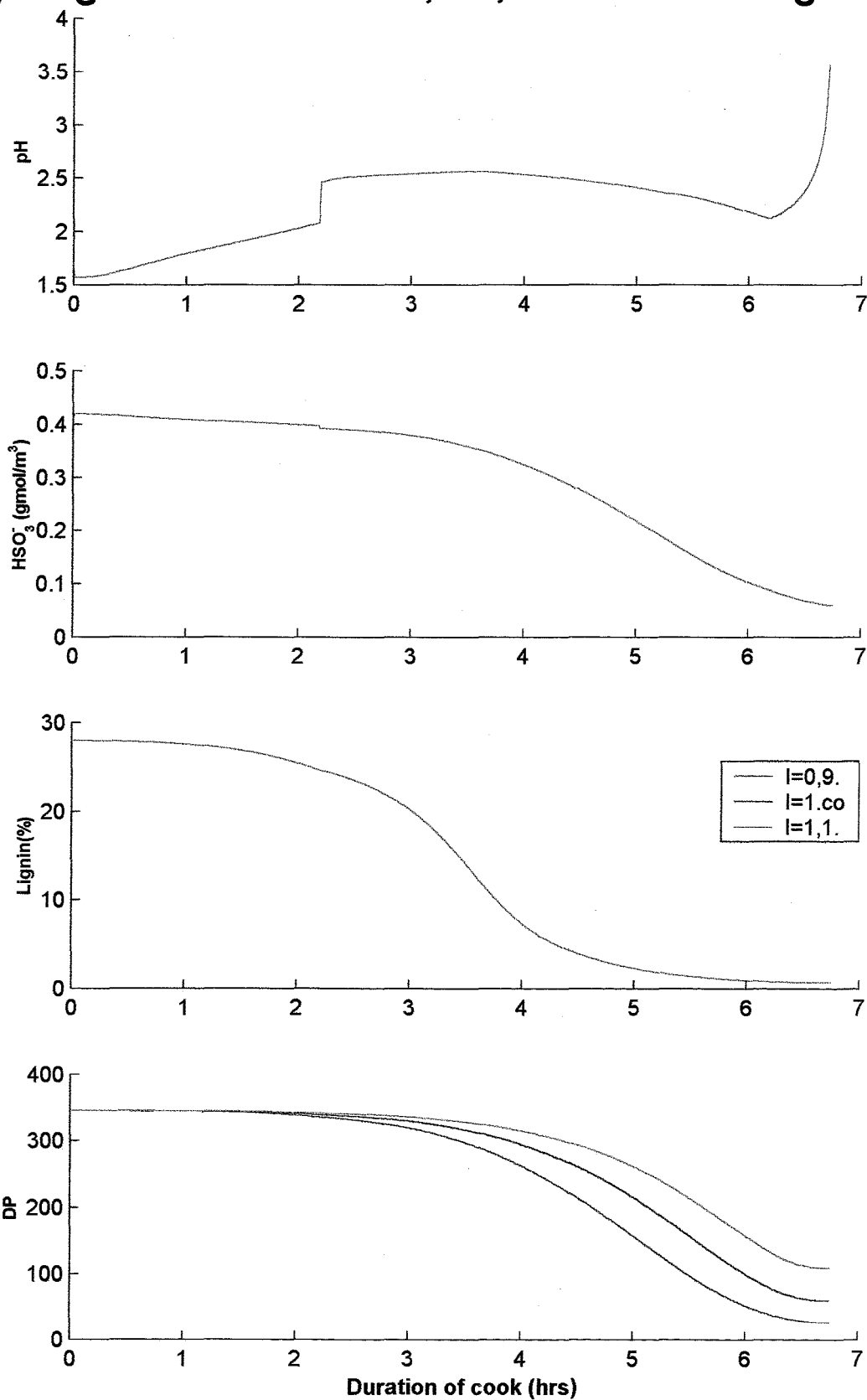

Influence of "B-factor" for K_p for $20 \leq T < 80 \text{ }^\circ\text{C}$

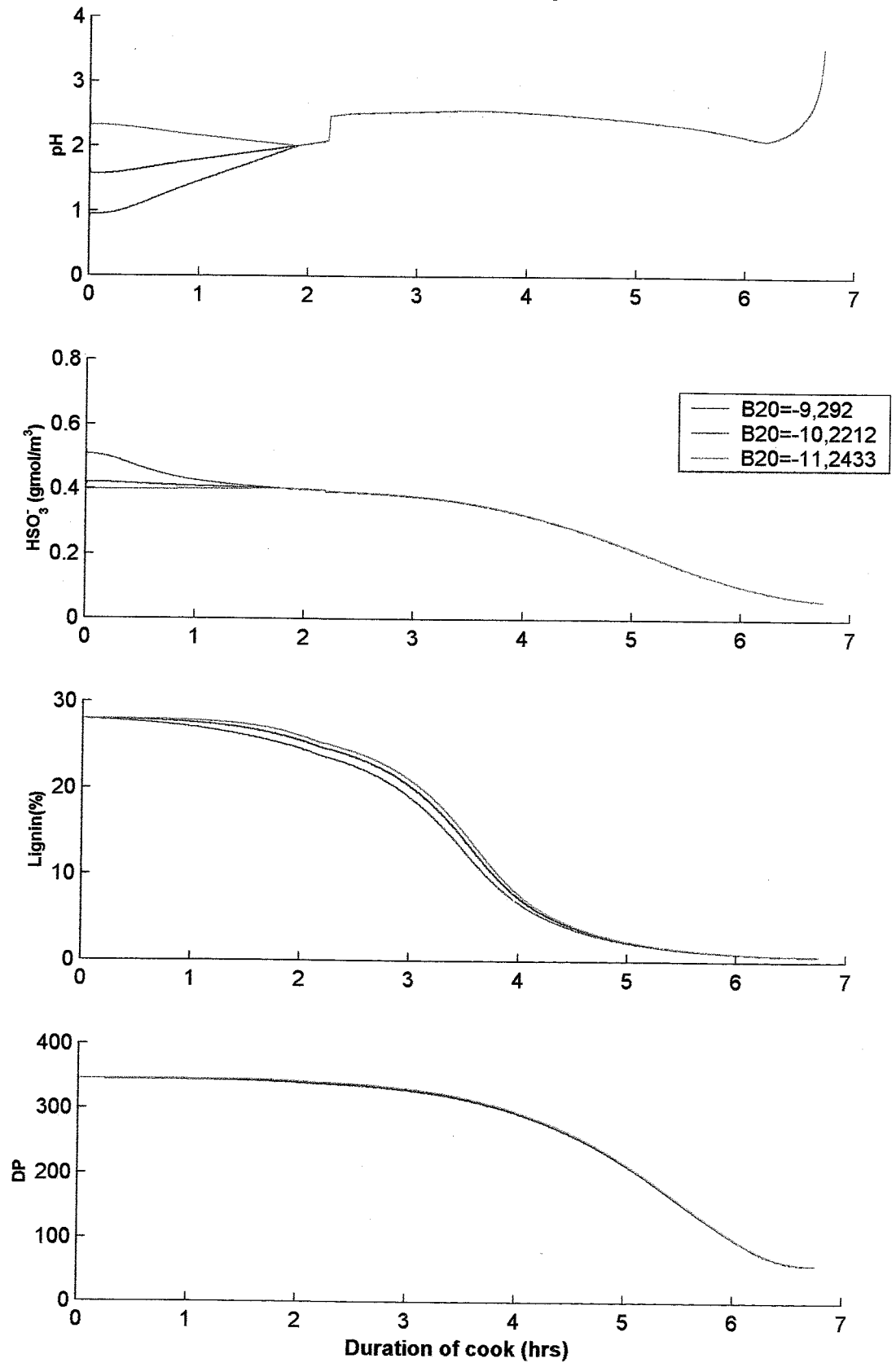



Influence of "C-Factor" for K_p for $20 \leq T < 80 \text{ }^\circ\text{C}$

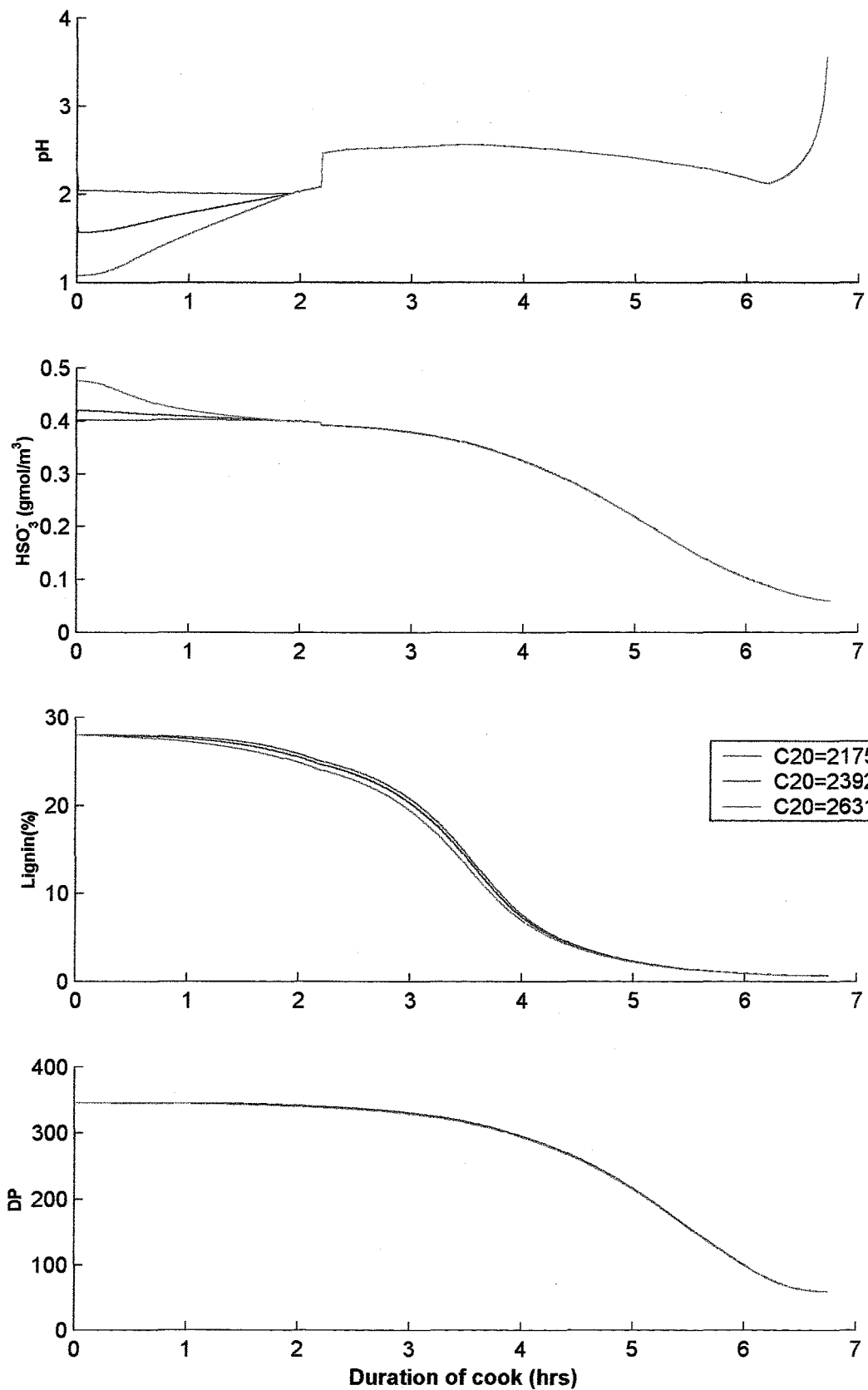



Influence of "B-Factor" for K_p for $80 \leq T < 120 \text{ }^\circ\text{C}$

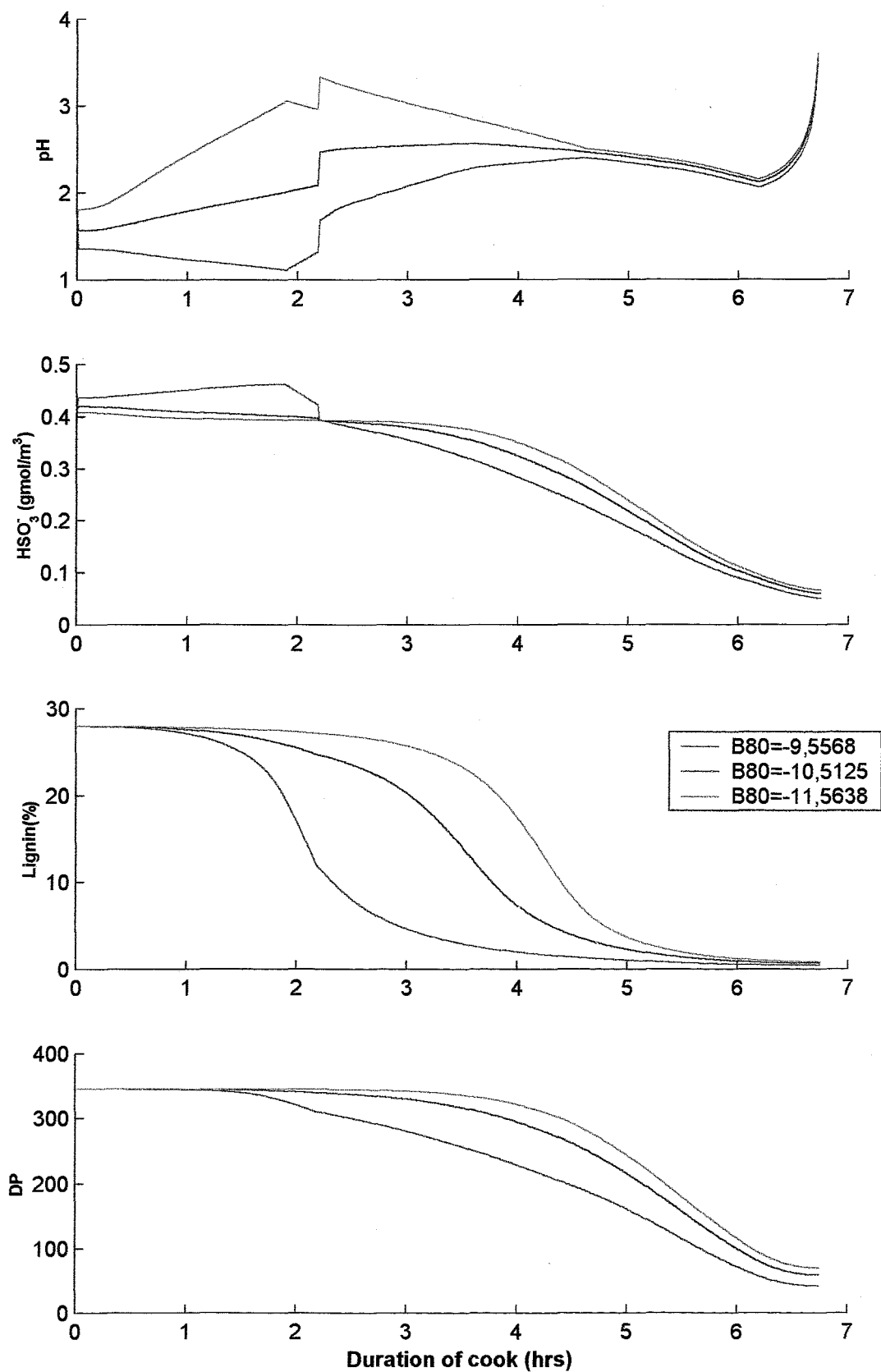



Influence of "C-Factor" for K_p for $80 \leq T < 120 \text{ }^\circ\text{C}$

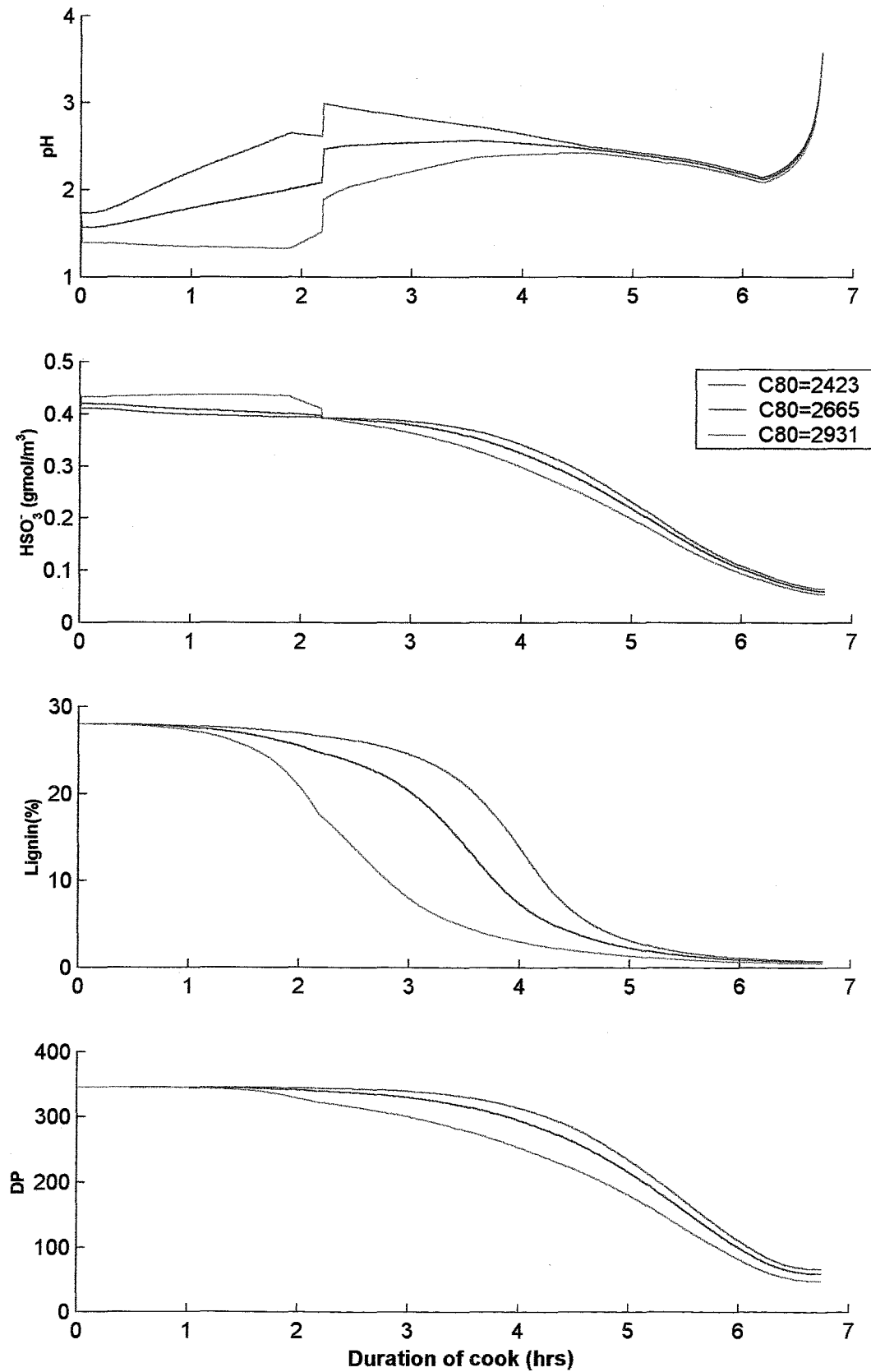



Influence of "B-Factor" for K_p for $120 \leq T < 150 \text{ }^\circ\text{C}$

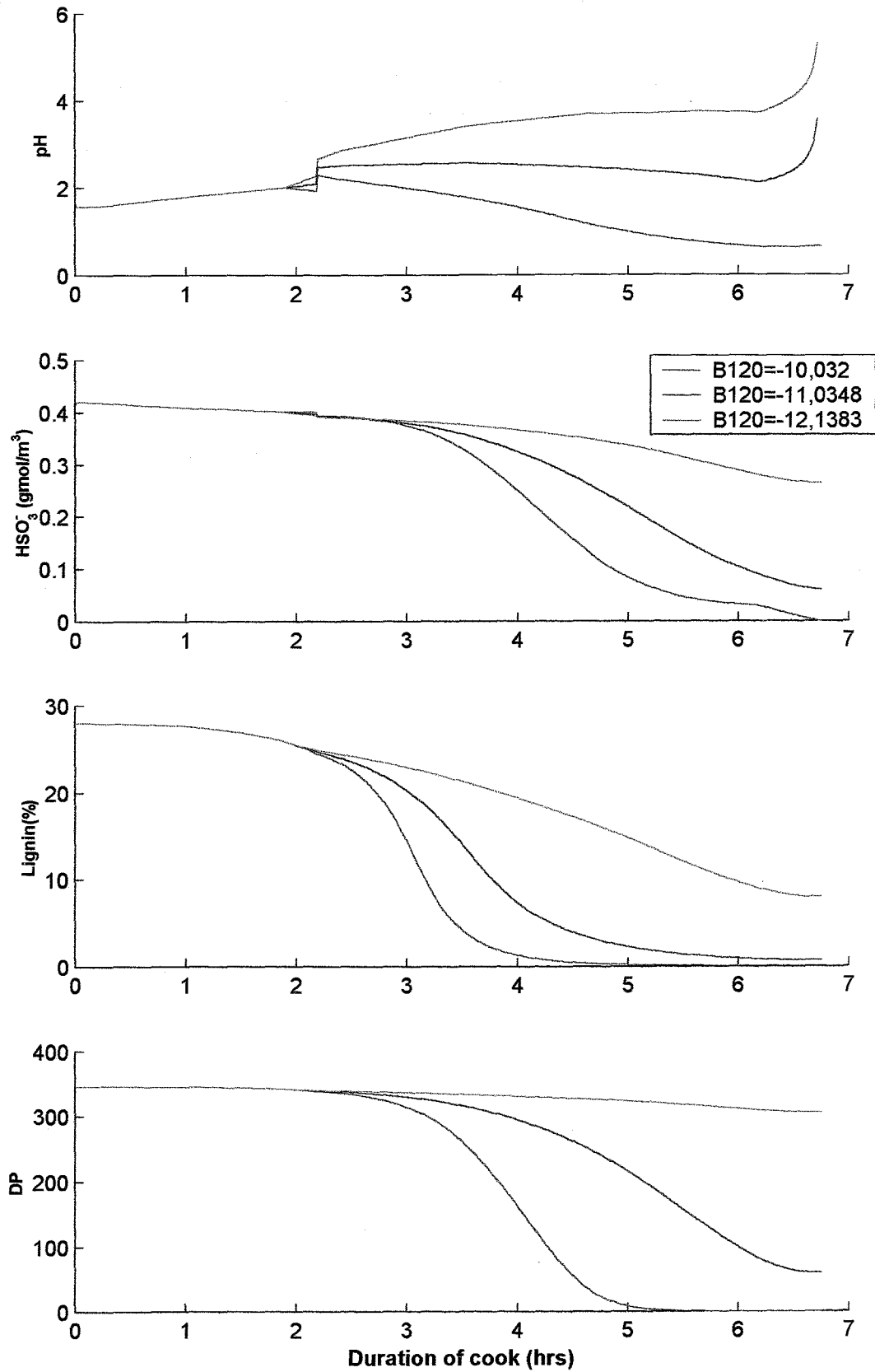



Influence of "C-Factor" for K_p for $120 \leq T < 150 \text{ }^\circ\text{C}$

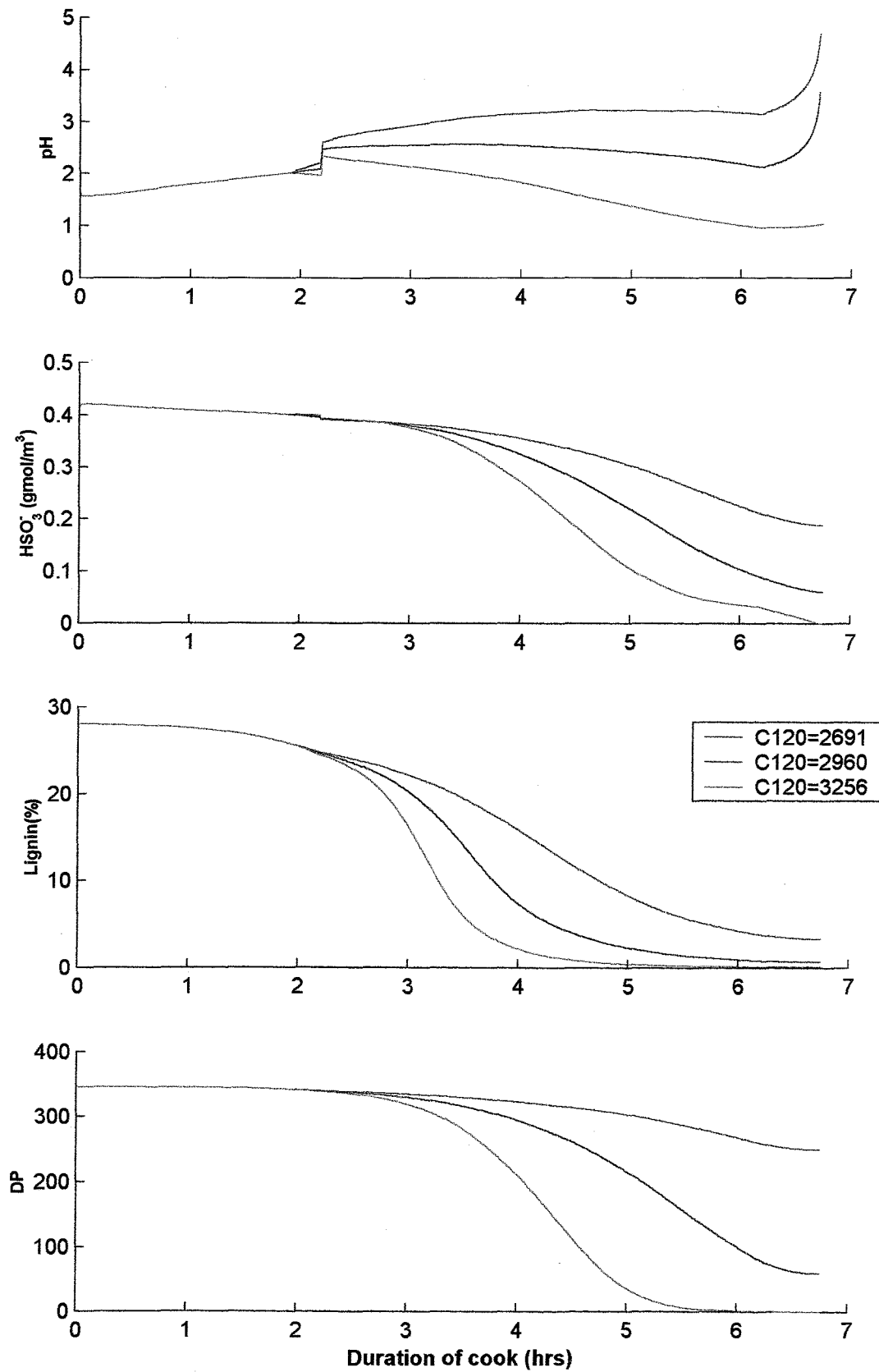



Influence of "B-Factor" for K_{H_2O} for $20 \leq T < 150 \text{ }^\circ\text{C}$

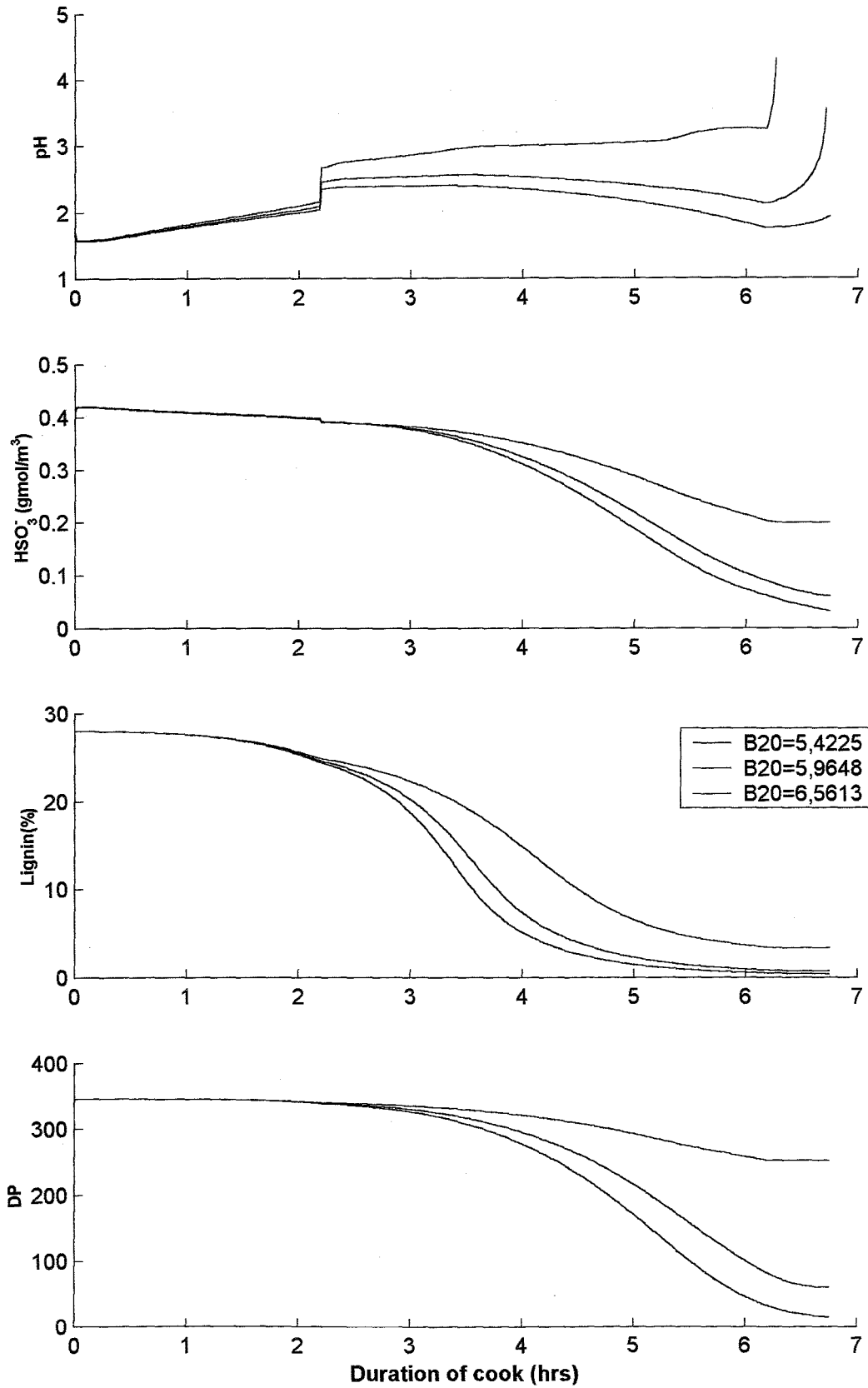

Influence of "C-Factor" for K_{H_2O} for $20 \leq T < 150 \text{ } ^\circ\text{C}$

