



UNIVERSITEIT VAN PRETORIA
UNIVERSITY OF PRETORIA
YUNIBESITHI YA PRETORIA

THE BACKGROUND, ARCHITECTURAL
PHILOSOPHY AND WORK OF
HELLMUT WILHELM ERNST STAUCH

BY

SHELAGH SUZANNE NATION

SUBMITTED IN FULFILMENT OF PART OF
THE REQUIREMENTS FOR THE DEGREE OF
MASTER OF ARCHITECTURE IN THE
FACULTY OF MATHEMATICS AND SCIENCE,
UNIVERSITY OF PRETORIA,
PRETORIA

FEBRUARY 1985



717103
© University of Pretoria



PREFACE

The research for this thesis would have been incomplete and less accurate without the interviews and assistance of those who had been associated with Hellmut Stauch either as family, friends, acquaintances, students, employees, associates or partners. Thanks are due to them for willingly allowing the holding of tape-recorded interviews and subsequently checking the transcripts of these interviews for accuracy.

The names of the persons formally interviewed are listed in the bibliography at the end of this thesis.

The Harvard system of reference was used.



LIST OF CONTENTS

| | |
|---|-----|
| Preface | ii |
| List of contents | iii |
| List of figures | v |
| 1. CHAPTER I – INTRODUCTION | 1 |
| 1.1 Background | 1 |
| 1.2 Present state of knowledge | 1 |
| 1.3 Motivation | 1 |
| 1.4 Statement of problem | 2 |
| 1.5 Delimitations | 2 |
| 1.6 Investigation procedure | 2 |
| 2. CHAPTER II – THE EARLY YEARS | 3 |
| 2.1 Childhood years | 3 |
| 2.2 The basis of Stauch's ambidextrous drawing technique | 4 |
| 2.3 The beginning of his interest in sailing | 4 |
| 2.4 Stauch's interest in the Itten Schule | 6 |
| 3. CHAPTER III – ARCHITECTURAL EDUCATION | 7 |
| 3.1 The Itten Schule and Stauch | 7 |
| 3.2 The Bauhaus system and Johannes Itten | 7 |
| 3.2.1 The Bauhaus | 8 |
| 3.2.2 Johannes Itten | 8 |
| 3.2.3 Conflict | 9 |
| 3.3 The Itten Schule | 10 |
| 3.4 Stauch's probable motives in his statement to the Institute. | 11 |
| 3.5 Stauch's student work | 11 |
| 3.6 The stay at Arosa | 11 |
| 3.7 Financial support ends | 27 |
| 4. CHAPTER IV – THE LAST YEARS IN GERMANY: 1929 TO 1934 | 28 |
| 4.1 Stauch's working circumstance | 28 |
| 4.2 Divorce | 30 |
| 4.3 The Olympia Jolle | 30 |
| 4.4 The decision to leave Germany | 41 |
| 5. CHAPTER V – PRETORIA: 1935 TO 1946 | 44 |
| 5.1 Arrival | 44 |
| 5.2 Aubrey Nunn's practice | 44 |
| 5.3 Projects | 46 |
| 5.4 Contact with his family | 46 |
| 5.5 Sailing in South Africa | 46 |



| | | |
|-----|---|-----|
| 5.6 | Personal life | 55 |
| 5.7 | Application for registration with the Institute of Architects | 56 |
| 5.8 | The beginning of a private practice | 57 |
| 5.9 | Qualification | 60 |
| 6. | CHAPTER VI – PRETORIA: 1946 TO 1952 | 61 |
| 6.1 | The Pretoria School of Architecture | 61 |
| 6.2 | Partnership with F.J. Wepener | 62 |
| 6.3 | The growing practice | 67 |
| 6.4 | The break-up of the Stauch/Wepener partnership | 75 |
| 6.5 | Hakahana | 75 |
| 6.6 | Bauhaus Pretoria | 82 |
| 7. | CHAPTER VII – PRETORIA: 1952 TO 1968 | 83 |
| 7.1 | Competitions: 1952 to 1969 | 83 |
| 7.2 | Further expansion: 1952 to 1960 | 91 |
| 7.3 | The opening of two more offices | 91 |
| 7.4 | Various buildings: 1960 to 1968 | 93 |
| 7.5 | Change in emphasis: 1968 to 1970 | 97 |
| 8. | CHAPTER VIII – THE FINAL YEARS | 98 |
| 9. | CHAPTER IX – ARCHITECTURAL APPROACH AND PHILOSOPHY | 102 |
| 9.1 | Background | 102 |
| 9.2 | Forbat's influence | 103 |
| 9.3 | Peters Bau | 103 |
| 9.4 | Early work in South West Africa | 103 |
| 9.5 | Early years in South Africa | 104 |
| 9.6 | Influence of other architects | 106 |
| 9.7 | The quality of Stauch's design and his influence | 109 |
| | ADDENDUM A : List of projects by Stauch | 110 |
| | ADDENDUM B : The development of standardised building elements | 111 |
| | ADDENDUM C : Unitary furniture design | 126 |
| | SUMMARY | 149 |
| | OPSOMMING | 150 |
| | BIBLIOGRAPHY AND LIST OF REFERENCES | 151 |



LIST OF FIGURES

| | |
|--|----|
| FIG. 1 - Hellmut Stauch | 5 |
| FIG. 2 - Colour chart used for the "Vorkurs" | 12 |
| FIG. 3 - Colour studies by Stauch (1927) | 13 |
| FIG. 4 - Colour study by Stauch, probably as a student | 14 |
| FIG. 5 - Studies in minimum personal requirements | 15 |
| FIG. 6 - Space study of room for two persons | 16 |
| FIG. 7 - Space study of room for parents | 17 |
| FIG. 8 - Design for an exhibition stand | 18 |
| FIG. 9 - Design for an exhibition stand | 19 |
| FIG. 10 - Student designs of houses | 20 |
| FIG. 11 - A design of a house by Stauch as a student | 21 |
| FIG. 12 - Photographic study by a Bauhaus student | 22 |
| FIG. 13 - Photographic study by Stauch as a student | 23 |
| FIG. 14 - Presentation technique used at the Bauhaus | 24 |
| FIG. 15 - Presentation technique of Stauch | 25 |
| FIG. 16 - Sun angle studies | 26 |
| FIG. 17 - Housing at Spandau-Haselhorst | 29 |
| FIG. 18 - Modular housing for Peters Bau, 1934 | 31 |
| FIG. 19 - Structural details for industrialised building type | 32 |
| FIG. 20 - Additional structural details | 33 |
| FIG. 21 - Core housing developed by Stauch in 1932 | 34 |
| FIG. 22 - Room design for Sonsalla | 35 |
| FIG. 23 - Room design for Frau Teichs | 36 |
| FIG. 24 - Furniture designs for construction in cane | 37 |
| FIG. 25 - Furniture designs for a work chair in tubular steel | 38 |
| FIG. 26 - Design for an adjustable table and desk in timber | 39 |
| FIG. 27 - Design for a desk for Dr. Behrendt | 40 |
| FIG. 28 - The Olympia Jolle | 42 |
| FIG. 29 - House by A V Nunn with Hellmut Stauch | 45 |
| FIG. 30 - Hochstetter House | 47 |
| FIG. 31 - Hochstetter House | 48 |
| FIG. 32 - Marchie Mansions stage 1 Axonometric view | 49 |
| FIG. 33 - Marchie Mansions stage 1 Plan and views | 50 |
| FIG. 34 - Marchie Mansions stage 2 Plan and views | 51 |
| FIG. 35 - Marchie Mansions stage 2 Plan and views | 52 |
| FIG. 36 - Marchie Mansions interior perspectives | 53 |
| FIG. 37 - Sketch of Adderley Street | 54 |

| | |
|--|-----|
| FIG. 38 - "Kiepersol" | 58 |
| FIG. 39 - Study of modular furniture | 59 |
| FIG. 40 - House Wooll, Bryanston : Stauch and Wepener | 63 |
| FIG. 41 - House Marriott, Sandton : Stauch and Wepener | 64 |
| FIG. 42 - House for Dr. Glen; site layout | 65 |
| FIG. 43 - House for Dr. Glen; plans, elevation and sections | 66 |
| FIG. 44 - Pietersburg Post Office | 68 |
| FIG. 45 - Meat Board building : plans and elevations | 69 |
| FIG. 46 - Meat Board building : view from street | 70 |
| FIG. 47 - Meat Board building : photograph of model | 71 |
| FIG. 48 - Meat Board building : facade components | 72 |
| FIG. 49 - Meat Board building : structural components | 73 |
| FIG. 50 - Meat Board building : board-room layout | 74 |
| FIG. 51 - Lex Building, Pietersburg : view from street | 76 |
| FIG. 52 - Lex Building, Pietersburg : plans, elevations and interior | 77 |
| FIG. 53 - Hakahana | 79 |
| FIG. 54 - Hakahana | 80 |
| FIG. 55 - Hakahana | 81 |
| FIG. 56 - Windhoek Library, Archives and Musueum | 84 |
| FIG. 57 - Windhoek Library, site plan, plans, section | 85 |
| FIG. 58 - Windhoek Library, plan | 86 |
| FIG. 59 - Native Housing Competition, winning plans | 87 |
| FIG. 60 - Star Model House Competition, winning plans | 88 |
| FIG. 61 - The Virginia House Competition | 89 |
| FIG. 62 - The Virginia House Competition - perspective | 90 |
| FIG. 63 - Netherlands Bank, Johannesburg | 92 |
| FIG. 64 - Zethushof, Pretoria | 95 |
| FIG. 65 - Zethushof : perspective | 96 |
| FIG. 66 - False Bay Reception Centre | 99 |
| FIG. 67 - Caves at Göreme | 100 |
| FIG. 68 - Sun-control | 105 |

SUMMARY

The background, architectural philosophy and work of Hellmut Wilhelm Ernst Stauch

by

Shelagh Suzanne Nation

Supervisor : Prof. A Burger

Department of Architecture

Degree of Master of Architecture

The thesis deals with Stauch's childhood background, his youth and early involvement with sailing, art and architecture in Germany.

The initial belief that he received his architectural training at the Bauhaus was investigated and found to be incorrect. The details of his training at the Ittenschule, his employment by first Forbat and then Peters, and his private practice in Berlin are described.

The circumstances of his move from Berlin to South Africa and his employment by Nunn are discussed. The establishment of his own office in Pretoria, his registration with the Institute of South African Architects and a short-lived partnership with Wepener followed by the establishment of his present practice now known as Stauch Vorster, is described.

Stauch's architectural approach and philosophy are discussed in broad terms.

Illustrations of his work are included chronologically within the text.



OPSOMMING

Die agtergrond, filosofie van argitektuur en werk van Hellmut Wilhelm Ernst Stauch

deur

Shelagh Suzanne Nation

Leier : Prof. A.Burger

Departement Argitektuur

Graad - M.Arg.

Die verhandeling beskryf Stauch se kinderjare, sy belangstelling en deelname in kuns, argitektuur en seil as 'n jongman in Duitsland.

Dit is vasgestel dat die mening dat hy sy argitektoniese opleiding aan die Bauhaus ontvang het, inkorrekt is. Die besonderhede van sy opleiding by the Ittenschule, die jare wat hy eers by Forbat en daarna by Peters werksaam was, en sy eie praktyk in Berlyn word beskryf.

Die omstandighede waaronder hy Duitsland verlaat het en na Suid-Afrika vertrek het en die tydperk wat hy as werknemer by Nunn deurgebring het, word behandel. Die stigting van sy eie praktyk in Pretoria, sy registrasie by die Instituut van Suid-Afrikaanse Argitekte en 'n kort tydperk as vennoot van Wepener, gevolg deur sy eie praktyk, tans bekend as Stauch Vorster, word beskryf.

Stauch se argitektoniese toenadering en filosofie is in breë lyne omskryf.

Illustrasies van sy werk is in tydsorde ingesluit.

CHAPTER I - INTRODUCTION

1.1 Background

When H.W.E. Stauch came to South Africa, towards the end of 1934, architecture in South Africa was undergoing a slow transition towards twentieth century architecture, with most of the quality work at this time still traditional or retrospective, both in public buildings and in domestic architecture. In Pretoria, Stauch made significant contributions to this transition in the following years (Herbert, 1975, pp 73 and 100). In terms of quantity, Stauch was responsible for some 700 projects by 1958, (see Addendum A) and had a tremendous influence on the architectural scene in South Africa, particularly in Pretoria, more even than Martienssen.⁽¹⁾

1.2 Present state of knowledge

Hellmut Stauch was one of South Africa's most prominent architects from 1934 until his death in 1970. He is generally regarded as having made a substantial contribution to architectural development in South Africa. To date, no survey of his work has been carried out; nor have more than a few dozen articles been published concerning the man and his work. He himself was extremely reticent and left almost no written records. The projects with which Stauch was wholly or partly associated have not been identified, listed, collected or recorded.

Generally "known" was that he had done well in sailing, had been trained at the Bauhaus in Dessau and had come to South Africa because of his family connections in South West Africa; and that his father had risen from relative obscurity to the opulent status of a diamond magnate in the then German South West Africa, only to lose everything in the aftermath of over-confident over-investment.

It was also known that Stauch had worked for and with Aubrey Nunn, had for a time been a partner of F.J. Wepener and thereafter practised on his own account.

Motivation

The sources of information about Stauch are decreasing. Those who knew him well and can provide information are ageing. The buildings he designed are being altered or may even run the risk of demolition. And

1. Wepener, J.F., Ex-partner of H.W.E. Stauch, (1984 - interview).

his drawings are deteriorating with age. It was therefore essential for this study to be carried out without further delay and published, to make it generally available to those concerned with the development of architecture in South Africa.

1.4 Statement of the problem

This research programme aims to collect and evaluate all the data obtainable concerning the background of Hellmut Stauch, his training, personal and professional activities, building and other designs and buildings constructed, and any other relevant data; to correlate this and establish an historical chronological sequence of work.

1.5 The Delimitations

This study does not attempt to evaluate his contribution to or influence on architecture in South Africa.

1.6 Investigation procedure

The original intention was to carry out research in phases, first by interviews, then by collection of drawings and location and photography of existing buildings, followed by checking and correlation. It proved more practical, however, to follow leads as they were uncovered, so the process was followed more or less at random although still under the same headings.

Complications in substantiating facts were the imitative drawings of his staff, his love of misleading others, the dearth of any autobiographical facts, and the reticence and introversion of a man who was an apparent extrovert. From this and from the conflicts which arose concerning authorship of buildings and opposing statements, it also became clear that the inclusion of apparently irrelevant facts on Stauch as an individual would be necessary to an understanding of his personal architectural philosophy.

In the course of investigation more information than could be included in this thesis was uncovered so that it was necessary then to winnow and select; and it is this selected information which appears in the following chapters.

CHAPTER II - THE EARLY YEARS

 .1 Childhood years⁽¹⁾

Hellmut Wilhelm Ernst Stauch was born on March 10th 1910 in Eisenach. His brother Hans was then five years old and his sister Marianne four. While Marianne would become his closest friend, confidante and mentor throughout his early life and would mother him in the way of little girls of that age group, Hans would frequently torment and tease him, especially since his mother dressed Stauch in silks and laces, allowing his fair curly hair to hang to his shoulders in the way of a young page-boy.

His first years were spent in luxurious circumstances for his father, August Stauch was a discoverer of diamonds in 1908 in the then South West Africa and had become a multi-millionaire in the years before Stauch's birth. August had developed a number of business interests in South West Africa and spent at least half of each year there attending to these. Christmas and New Year, however, were spent with his beloved family in Germany. Possibly in a move to spend more time in Germany, he invested heavily in other business ventures. Unfortunately these were to lead to later financial disaster, which was to have considerable influence on the course of Stauch's career (Levinson, 1983, pp 125, 126, 127).

His mother Ida was a strong, serene and warm person who endured her husband's frequent absences with a good grace and gave her children emotional security, an immaculate home and a mind - broadening background.

Before Hellmut was a year old, the family moved to Nikolaussee, a suburb of Berlin. Surrounded by lakes and woods, it was a beautiful place. The family would take walks through the woods together, a treat to be looked forward to, where the foundations of a deep and sensitive appreciation of nature were laid.

When he was two years old, the family made their final move in Germany, to Zehlendorf in Berlin. Here, their home was in a hectare of ground, large even for those times, on a lake, where the children had their own rowing boat. There was a special playroom, a well-appointed library and to the joy of the children a large and well-equipped playground. Photographs show a staff of several people and great reception

1. Krafft, Mrs Marianne, Sister of H.W.E. Stauch. Unless otherwise stated, the information contained in this chapter was obtained from Mrs Marianne Krafft in interviews during 1984.

and dining rooms, suitable for the large-scale entertainment which was expected of a millionaire mining magnate.

Hans particularly enjoyed the playground. With the enthusiasm of a child who was particularly able, physically, he would spend much of his time on gymnastic feats while the young Hellmut hero-worshipped from the side-lines, imitating his brother at every possible opportunity. Their father, when he was home, would watch his children with love and pride from the vantage point of the red bench between three birch trees in the middle of the lawn. It was an idyllic childhood. August's keen intellect, warm friendliness, bubbling sense of humour, and intense interest in the world around him had a profound influence on the questioning minds of his children, and each in their own way developed an awareness of colour, form, pattern and order; of touch, taste, smell and physical movement - a feast for the senses.

On his third birthday Hellmut rejected scornfully the new blue silk frock presented by his mother and from that moment followed Hans in every possible way. No longer fastidious and upset by dirt, he entered into the games of boyhood, growing strong and often wild. By this time he had a younger sister, Käthe, but he, in the process of growing up was little concerned with his baby sister; all his attention was on the older two.

He was questioning, inventive, wild, funny and spirited, with a sense of humour matched by that of Hans. Gifted at physical occupations, he was also intensely sensitive, and had an interest in music, playing the cello, and in sailing.

2.2 The basis of Stauch's ambidextrous drawing technique

Stauch was by nature left-handed. Forced by his first school at Zehlendorf to write with his right hand, he produced mirror-writing, but eventually learned to do as the school wished. There was, however, nothing to stop him drawing with his left hand, and throughout his life he was to draw left-handed and write right-handed - often almost simultaneously, (fig. 1) with that abundant, overflowing energy evident in every aspect of his life.⁽²⁾

2.3 The beginning of his interest in sailing

At ten he went sailing for the first time, with his cello teacher.

2. Various interviews (1984, with T.J.R. Scholtz, Mrs Tosca Vorster, R. Vorster, Mrs Pulli Thoms, partners, friends, relations, students)



FIG. 1 Hellmut Stauch; working ambidextrously on plans of the boat initially named "Tagati" with B Lello : this photograph was taken by David Baker in 1962



Typically, he did not wish to expose his lack of knowledge, and spent the entire night beforehand reading up on sailing in a book he had obtained. It was the start of a life-long love-affair with boats. He began building a model boat named the Mariannchen, for his sister, working night and day on its construction and sailing it at a model boat club on one of the nearby lakes. He followed this up with a surprisingly mature article on the boat, published in "Die Jacht" (192-). When he was twelve his father gave him his own boat, which he sailed at the Klein Wannsee yacht club; it was followed within two years by another which he had designed himself. Both these boats were professionally built and Stauch would spend every spare moment watching their progress and construction at the boatbuilders. His later predilection for and understanding of timber as a construction material probably had its roots in this early experience, for his detailing shows a profound sensitivity for its qualities and properties.

2.4

Stauch's interest in the Ittenschule

Stauch's schooling had, until this time, been that of an average German boy in Berlin. When he was 15, Marianne had become one of Johannes Itten's first students at the school which Itten was establishing in Berlin and which would from 1926 onwards be known as the Ittenschule, where her studies took her through the basic course into a specialisation in weaving and painting. Like all of Itten's students she almost idolised him, following his personal philosophy and beliefs on diet and meditation as well as his outstanding approach to the teaching of art. For two years Stauch listened, learned, absorbed and became fascinated with his sister's intense involvement. Eventually he began badgering his father into letting him leave school and join Marianne at the Ittenschule. Reluctantly, his father attended an interview with Itten and discussed the possibility. Itten was greatly impressed with August but it is doubtful whether the feeling was mutual. At that time August's own empire was crumbling; he had over-extended himself in too many directions and his resources were too thinly spread (Levinson, 1983, pp 140, 141). Decisions on the future were difficult to make; there was no knowing what would be the best course for his children to take. Reluctantly, he allowed Stauch to have his own way. In 1926 the sixteen-year-old joined the now formally constituted Ittenschule in Berlin.

CHAPTER III - ARCHITECTURAL EDUCATION

3.1 The Ittenschule and Stauch

The young Stauch was a warm and likeable person, hard-working and capable of intense concentration and sensitive response.⁽¹⁾ He soon became one of Itten's best students and a close life-long friend, visiting Itten several times as a house guest, together with his family, on his visits to Europe.⁽²⁾ The training which he had from Itten was to lay the foundation from which Stauch would develop his architectural approach which would eventually influence the architecture of South Africa.

In respect of his architectural training one question in particular remains unanswered; and that is why it was generally believed that he obtained his training at the Bauhaus in Dessau. The only reference made by him to this training is contained in a letter dated 1942.08.11 to the Institute of South African Architects, in which he states "after completing my education I started my architectural training at the 'Ittenschule', Berlin (branch of the Bauhaus) under Prof. Itten (one of the founders of the Bauhaus in Weimar), Professors Muche, Forbat, Neufert and Koehn, 1926-1929. At the same time I studied at the 'Technische Hochschule Berlin' under Professors Taut and Tessenow." Clearly, he did not conceal the information that he had studied at the Ittenschule; but equally he was misleading in stating that the Ittenschule was a branch of the Bauhaus. In looking for a reason for his misleading of others in this respect, it is necessary briefly to examine the Bauhaus, its reason for existence, function and training. It is also pertinent to examine the role of Johannes Itten in the Bauhaus training, on which he had a profound influence from its inception in 1919 to the date of his departure from it in 1923.⁽³⁾

3.2 The Bauhaus System and Johannes Itten

In the early part of the 20th century, architecture was seen as having largely become weakly sentimental, decorative and ornamental (Gropius, 1959, p 27). A new architecture adapted to the fast moving technologically orientated age was needed, its function clearly recognis-

-
1. Krafft, Mrs Marianne, Sister of H.W.E. Stauch, 1984 - interview.
 2. Vorster, Mrs Tosca, Step-daughter of H.W.E. Stauch, (1984)
 3. Unless specifically otherwise indicated, the general information concerning the Bauhaus and Johannes Itten contained in this chapter is from Wingler (1969), Naylor (1968), Neumann (1970), Gropius (1959).

able in the relationships of its forms. The Bauhaus was developed to meet that need.

3.2.1 The Bauhaus

According to Gropius the Bauhaus did not pretend to be a crafts school. Contact with industry was consciously sought, and a closer approach between craftsmanship and industry.

Johannes Itten joined the Bauhaus at its inception in 1919 on the invitation of Gropius. During the previous year in Vienna he had been teaching according to a system which he had developed and which at the Bauhaus was expanded into the "Vorkurs" - a preliminary course which was to spread and to influence the teaching of art and architecture throughout the world.

The architectural course at the Bauhaus was provided only to those students who had completed this preliminary introductory course and graduated to the workshops for practice and instruction in the study of form. Within the Bauhaus, training consisted of experience in the Research Department as well as with actual buildings under construction, providing students with contact with all the building trades - and with the opportunity of earning a living (Gropius, 1959, p 51).

Since the Bauhaus did not provide advanced courses in engineering, physics, statics, mechanics, heating, plumbing and similar technologies, the students were directed to appropriately selected technical and engineering schools.

3.2.2 Johannes Itten

Itten's total involvement with the Mazdaznan philosophical movement with its headquarters in Herrliberg and his strict application of the Mazdaznan tenets, affected many aspects of life and teaching at the Bauhaus; from the strictly vegetarian and spartan catering to regular periods of meditation and the rejection of conventional dress.

He was a person who evoked strong emotions, whether of love or of hate. His teaching of the Vorkurs gave the students an emotional, spiritual and intellectual understanding of line, form, colour, texture and composition and a depth of involvement that was near to discipleship. He was a strong and influential personality and a teacher in the true sense of the word. A strength of his was the recognition and development of individual tendencies and talents. The group of enthusiastic teachers



and students who surrounded him would not lend themselves to simplification. They were art enthusiasts, and so they would remain (Wingler, 1969, p 51). Marianne Krafft/Stauch, was a pupil of Itten from 1924 to 1929. When she was interviewed in 1984, aged 78, nearly blind and deprived of contact with her beloved painting, she said of him, her face radiant and serene, "in art, Johannes Itten set us free!"

3.2.3 Conflict

But a conflict was coming to a head. Modern technology was developing increasingly fast and contact with industry was becoming more important than Itten's gentle philosophy of a mystic communion with matter. While Gropius urged his students towards reality, Itten's students sought to transcend reality and found themselves in conflict with Gropius' stated aims. In 1922 Gropius sent a circular to the staff in which he highlighted some of the differences between himself and Itten stating "Recently, Master Itten demanded from us a decision either to produce individual pieces of work in complete contrast to the economically oriented outside world or to seek contact with industry. It is here, in this method of formulating the question I believe, that the big unknown that needs to be solved is hidden. Let me at once clarify this: I seek unity in the fusion, not in the separation of these ways of life" and again "Some of our Bauhaus members subscribe to a kind of misunderstood 'return to nature' doctrine of Rosseau's." (Wingler, 1969, p 51).

At this time, in 1921, Theo van Doesburg arrived in Weimar and finding the Bauhaus strongly dominated by Itten, whose approach he disliked intensely, the following year he set up a rival course there. This spurred Gropius on to reorganise some of his courses and to appoint new staff. Rather than dismissing Itten, and in order to retain the highly regarded Vorkurs, he restricted Itten's influence in the workshops by making administrative changes. When Kandinsky was appointed in 1922 he added his weight to that of Klee, and together they tended to counteract Itten's iconoclasm (Naylor, 1968, p 76)

Under these constraints, in the spring of 1923, Itten left the Bauhaus. The circumstances of this parting of the ways are not totally clear. Gerhard Marcks stated curtly "for Itten, Schlemmer and myself, it meant our leaving. Since then I have had nothing more to do with the Bauhaus." (Neumann, 1970, pp 74, 75). Paul Citroen, apparently more subjective in approach; said "After his return from Herrliburg", (Itten

had taken several months leave to become initiated into his doctrine), "Itten never again felt quite at home at the Bauhaus. He felt that what was being done there was not worth the effort, compared with what was taking place at Herrliburg. Only there could he see any chance of growth and spiritual enrichment for himself. And so said farewell and left for Switzerland. The loss to us was great" (Neumann, 1970, p 50).

Werner Graeft writes "... schisms gradually developed among teachers as well as pupils and in 1928 led to an open break between Itten and Gropius and to a new conception of the Bauhaus." (Neumann, 1970, pp 74, 75).

Walter Dexel wrote "Theo van Doesburg fought an almost futile war against the romantic ideas about handicrafts existing at the Bauhaus in its founding years, and against the doctrines of Johannes Itten, ..." (Neuman, 1970, p 105).

Georg Mucbe, more objectively, stated; "Johannes Itten's teaching of creativity went beyond the aims of Gropius. These would have been weakened if neither of them had given in. Itten yielded and left ..." (Neuman, 1970, p 204).

And T. Lux Feiniger with characteristic clarity, gave what may be the most balanced view. He said; "Gropius' plan was based on his expectations of results coming from the total personality of his collaborators rather than from their opinions. In this light it is interesting to note that the most 'trained' and experienced educator on the staff, Itten, was the least able to submit to the collective plan and left the Bauhaus early." (Neumann, 1970, pp 178, 179).

3.3 The Ittenschule

According to Wingler, from 1923 to 1926 Itten was in Zurich, and from 1926 to 1931 he directed his own art school in Berlin (Wingler, 1969, p 253). (According to the Ittenschule records, these dates were 1926 to 1934).

However, Marianne Krafft/Stauch states that she was Johannes Itten's first student, at the outset one of only four, whom he taught in rooms in Berlin in 1924 and 1925 prior to his formally opening the art school in 1927, once he had sufficient students.

While no documentary evidence directly concerning Itten and his school during 1924 and 1925 has yet been found, Mrs Krafft has given sufficient supporting data for this information to be accepted as correct. This casts an interesting sidelight on Itten's motivation and actions after leaving the Bauhaus.



3.4 Stauch's probable motives in his statement to the Institute

It is not unlikely that Itten was, if not embittered or humiliated, at least disappointed by his most recent experiences at the Bauhaus and that this conveyed itself to his students. Under these circumstances his students might well regard Itten's teachings as being closer to the original aims and direction of the Bauhaus than the Bauhaus now was itself. A young graduate, in another country might find it difficult, if not impossible, to explain the circumstances of his training. The Bauhaus was well-known, the Ittenschule was not. And the statement that the Ittenschule was "a branch of the Bauhaus" was in a philosophic sense if not in a legal one true enough and avoided lengthy explanations. (figs. 2 to 16).

3.5 Stauch's Student Work

Marianne was a dedicated and enthusiastic student and has described the Vorkurs used by Itten from 1924 to 1928 which was mandatory, as it had been at the Bauhaus, and which Itten apparently retained with little or no change in character from that which he had developed for use there. ⁽⁴⁾

According to her detailed description, it was a carefully graded introduction to a sensitive appreciation of line, form, colour, texture and rhythm. Analytical studies of the Old Masters were carried out in the same way as they had been in Weimar. And as the school expanded into more specialised fields the students were directed to the appropriate sources of technical training, just as had been the case with the Bauhaus. In the case of the young Stauch, this technical training was obtained at the Technische Hochschule in Berlin. ⁽⁵⁾

Stauch's work bears close comparison with the work of other students at the Bauhaus, published in Wingler's book.

3.6 The stay at Arosa

Marianne and Stauch followed Itten's teachings in every way, including that of a sparse and probably inadequate diet, interspersed with occasional fasts. Towards the end of 1926, both young people developed tuberculosis and were sent to a sanatorium at Arosa for treatment.

The stay at Arosa was not quite a complete holiday; Stauch acquired

4. Krafft, Mrs Marianne, Sister of H.W.E. Stauch, 1984 - interview.

5. Ibid

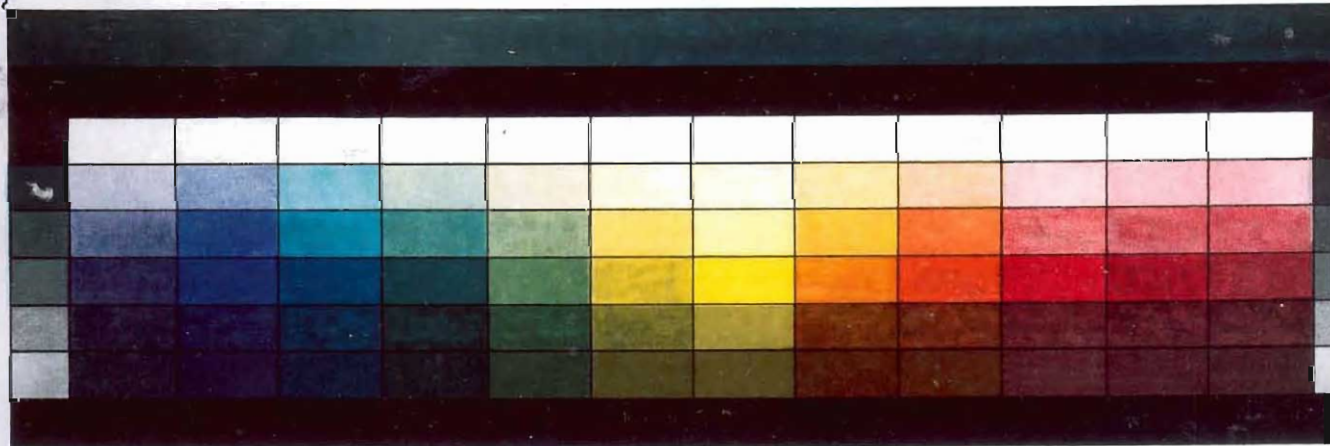

Farbenkugel

in 7 Lichtstufen und 12 Tönen

von
Johannes Itten

FIG. 2 Colour chart used for the "Vorkurs". This chart was developed by Johannes Itten and used in his "Vorkurs" both at the Bauhaus and at the Itten Schule. The original of this print was the full-colour card used by Stauch as a student.

GESETZMÄSSIGE DREI KLÄNGE

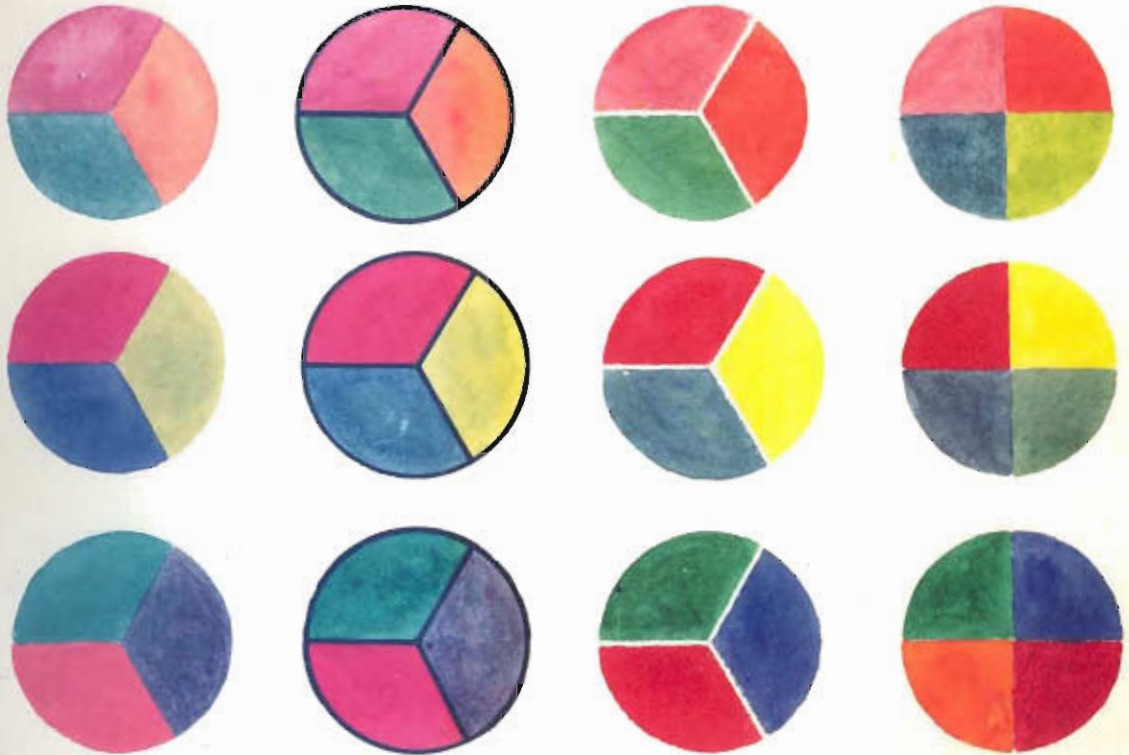

SUBJEKTIVE

DREI KLÄNGE

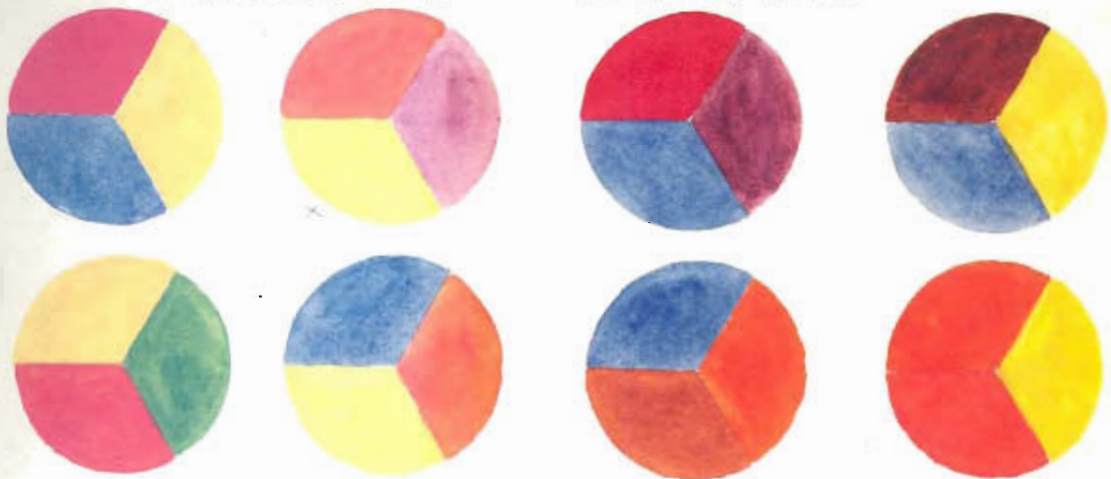

MELIM. STAUCH
1927

FIG. 3 Colour studies by Stauch (1927). These, too, were a standard part of Itten's Vorkurs.

MINDESTBEDARF
FÖR 1 PERSON:

FIG. 5 Studies in minimum personal requirements by Stauch (above) through which he concluded that it was practical to live in a "2x2x2 metre" space - and proceeded to do so for two years, as he stated in his paper at the 1969 Stauch Vorster seminar. Compare with "minimal dwelling", (Gropius (1959) p 109), where a similar concept is expressed in a tongue-in-cheek illustration.

ZIMMER FÜR 2 PERSONEN

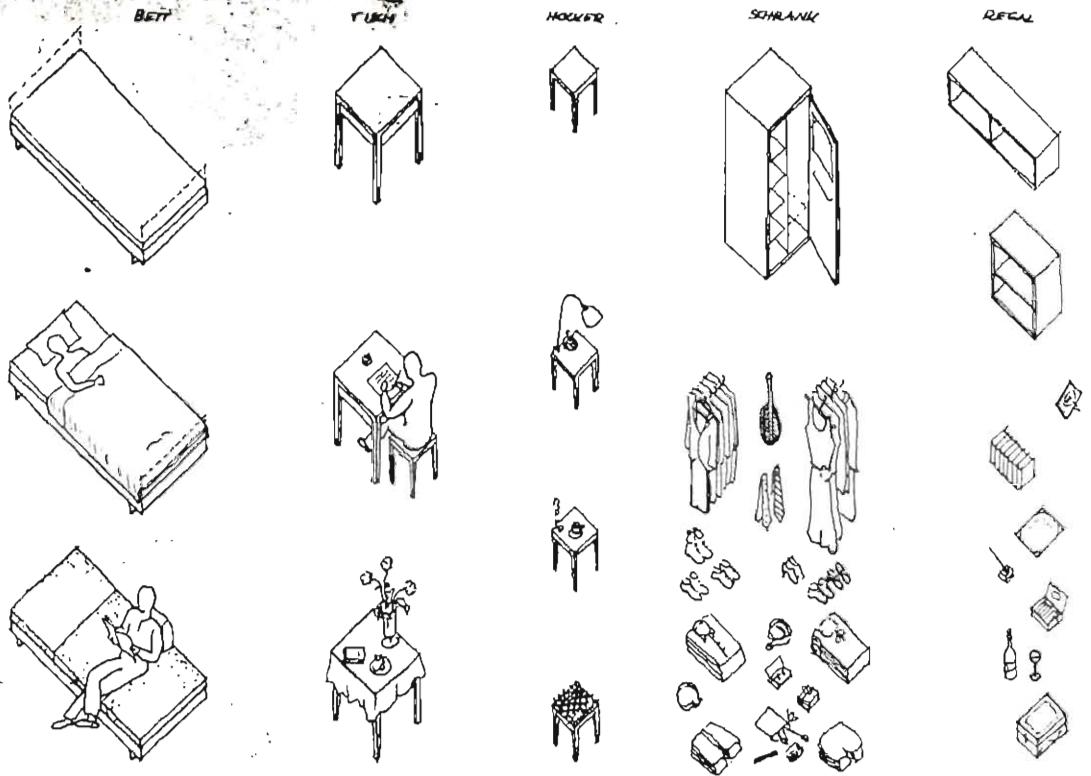
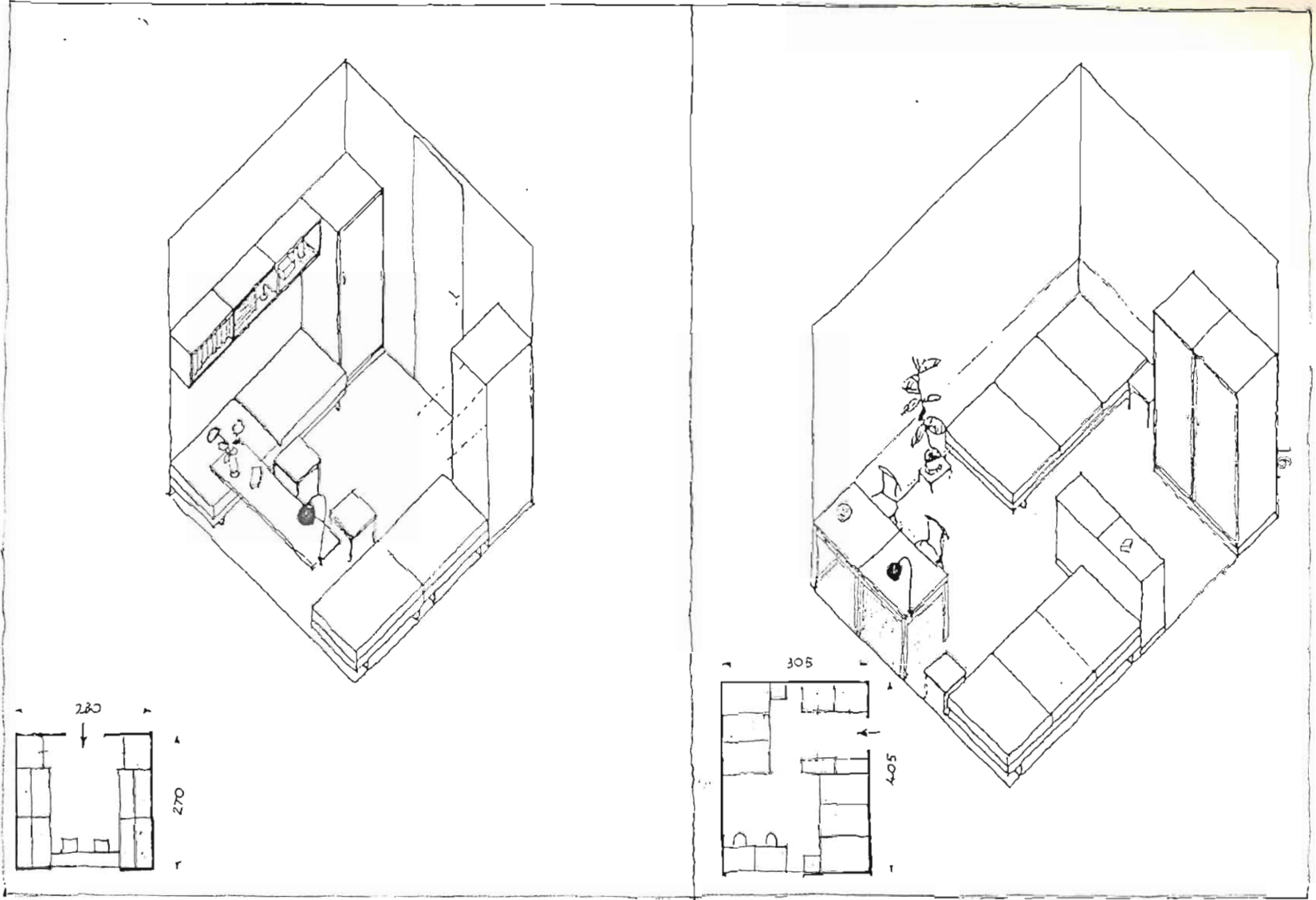

FIG. 6 Space study of room for 2 persons - a development of the "minimal space" concept.

ZIMMER FÜR ELTERN

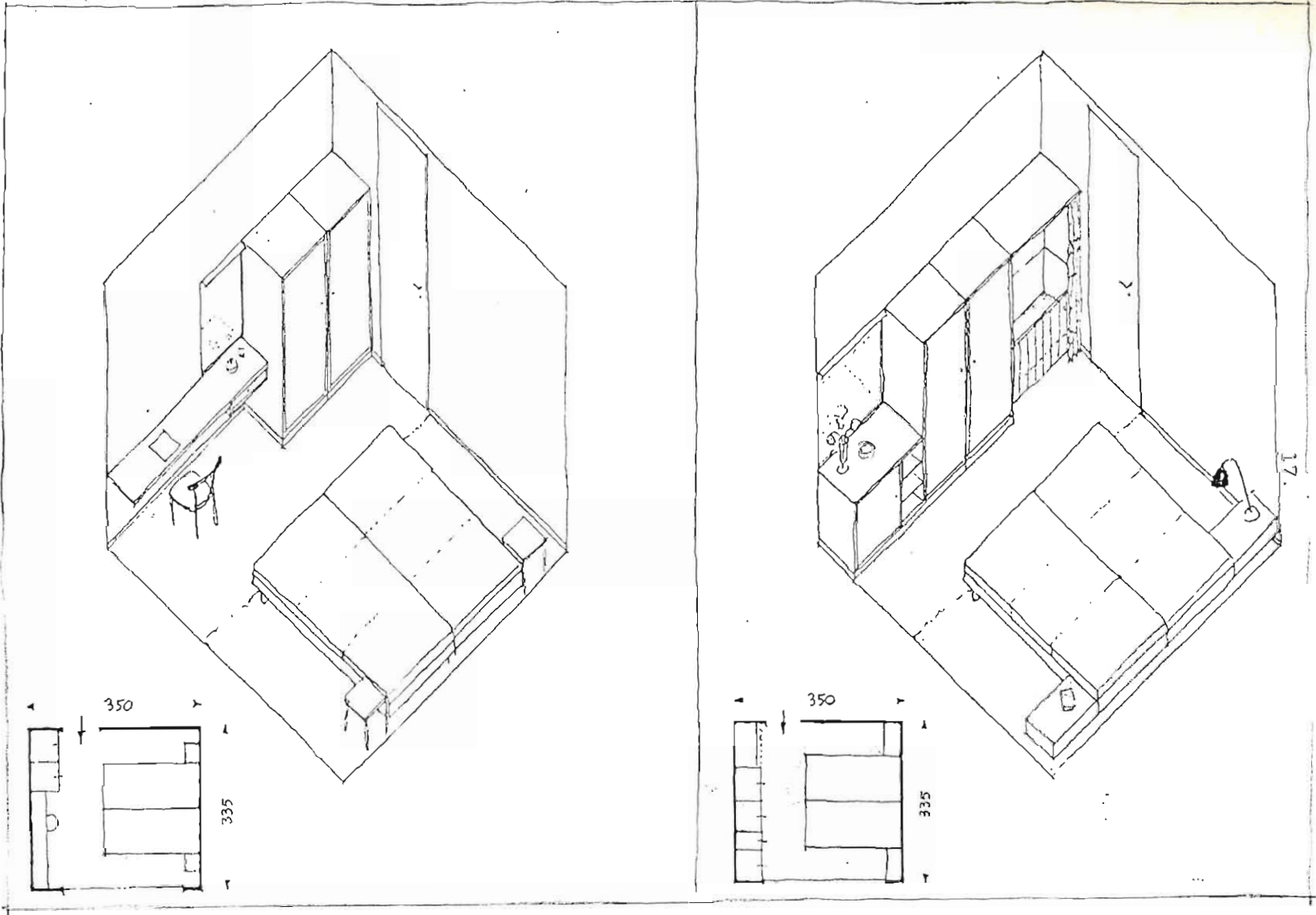

FIG. 7 Space study of room for parents - a similar development of the "minimal space" concept.

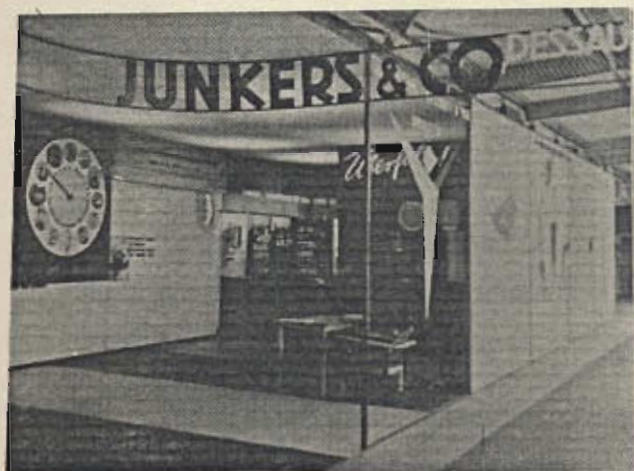
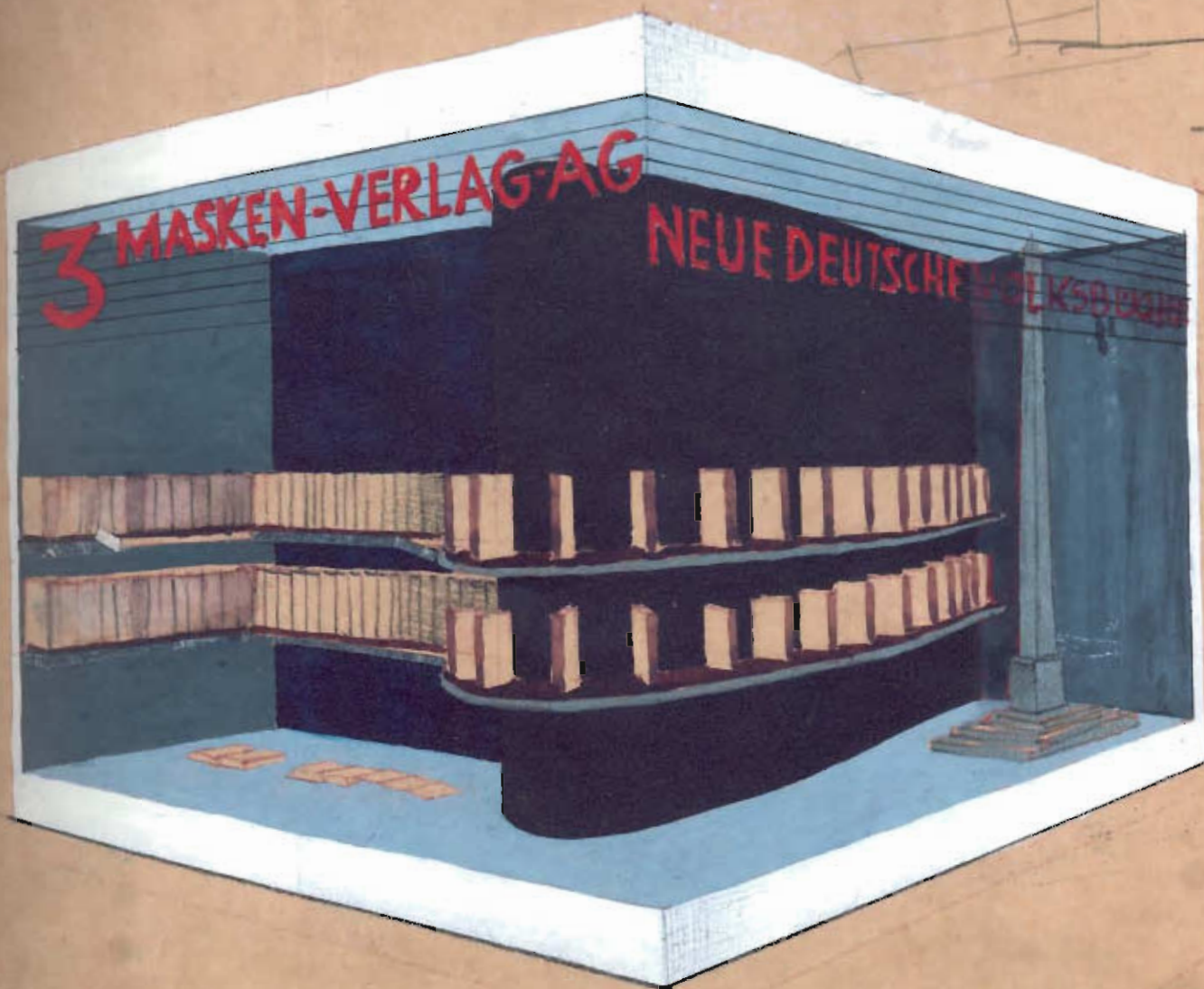

FIG. 8 Design for an exhibition stand. A colour study of an undated project of Stauch (above) and a similar student project carried out at the Bauhaus (Wingler 1969, p 512)

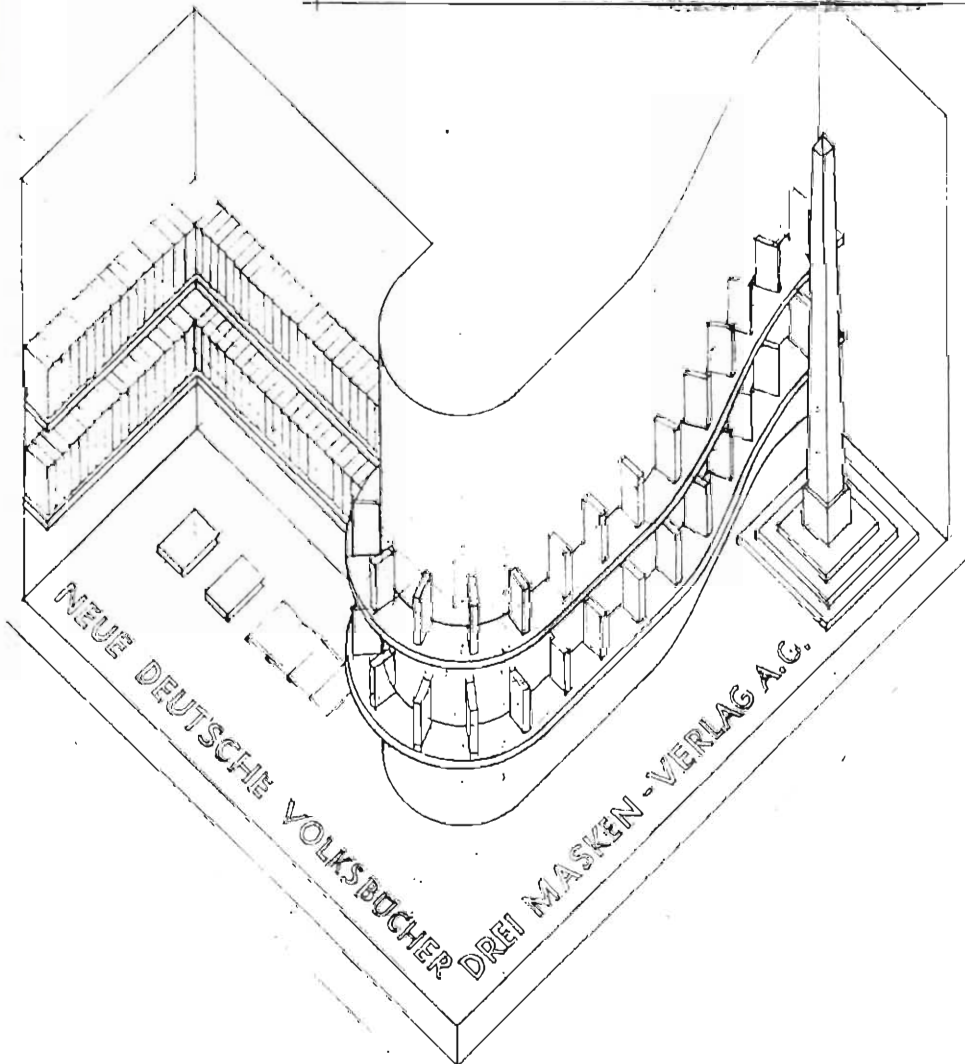
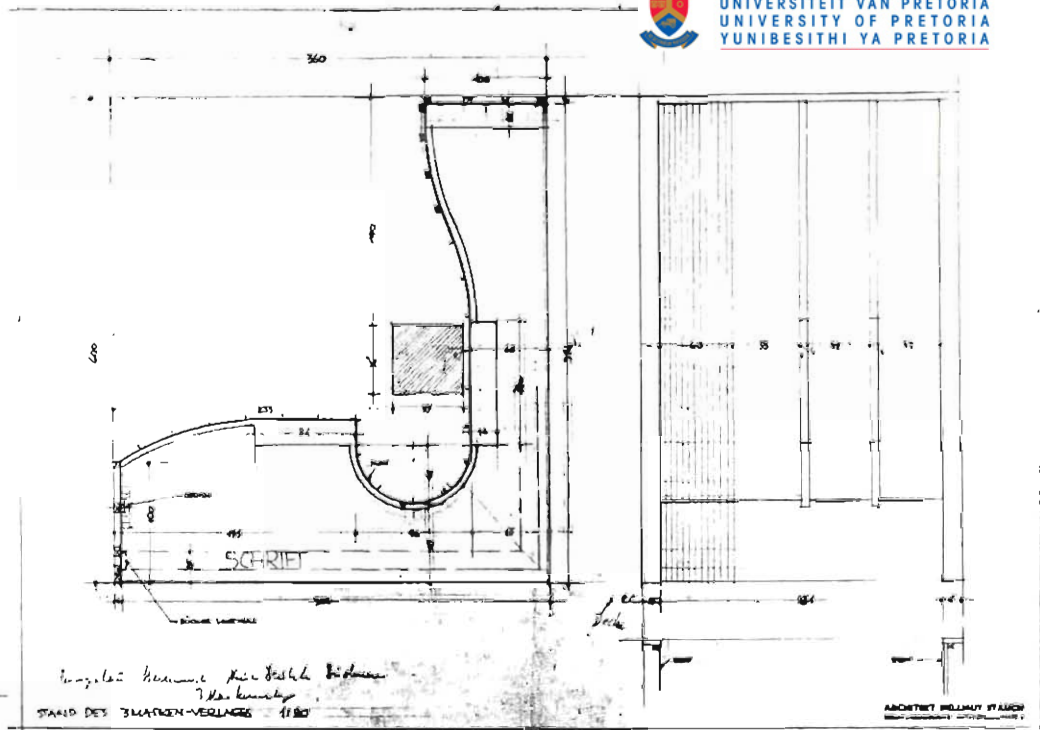

FIG. 9 Design for an exhibition stand. Preparatory line diagram for the colour study shown in fig. 8.

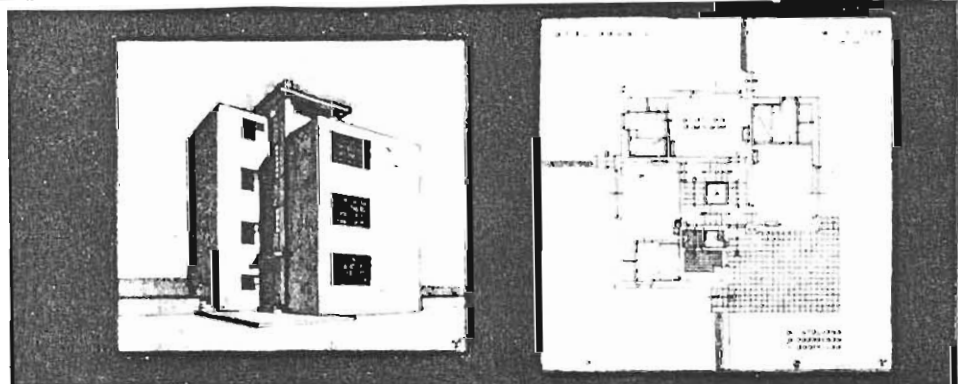
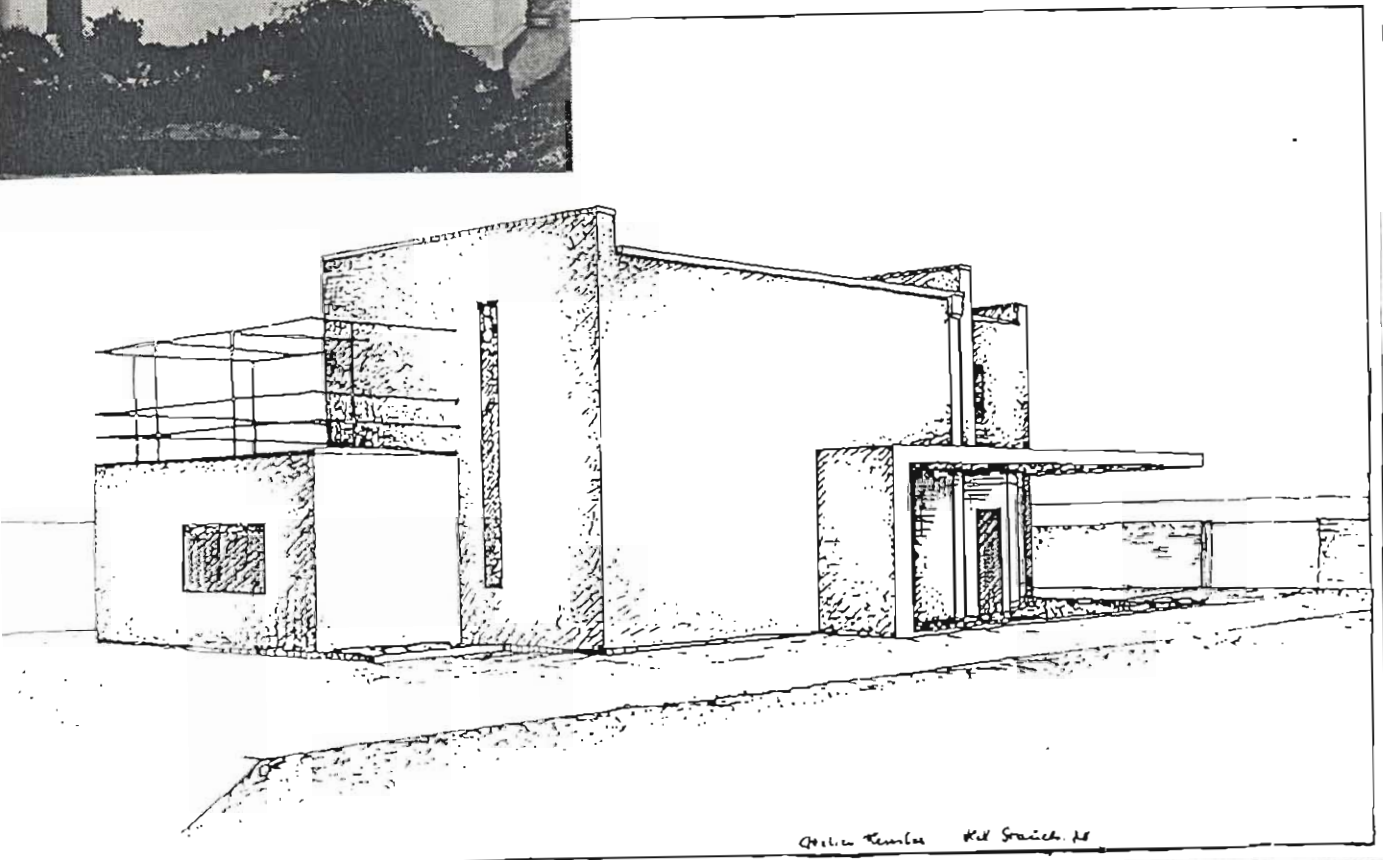

FIG. 10 Student designs of houses. The centre illustration is of his first commission - a studio for a sculptor, A Hensler, at Wiesbaden, designed while Stauch was at Arosa in January, 1928; the other illustrations are of Bauhaus projects Wingler (1969, p 500) and Gropius (1959, p 73).

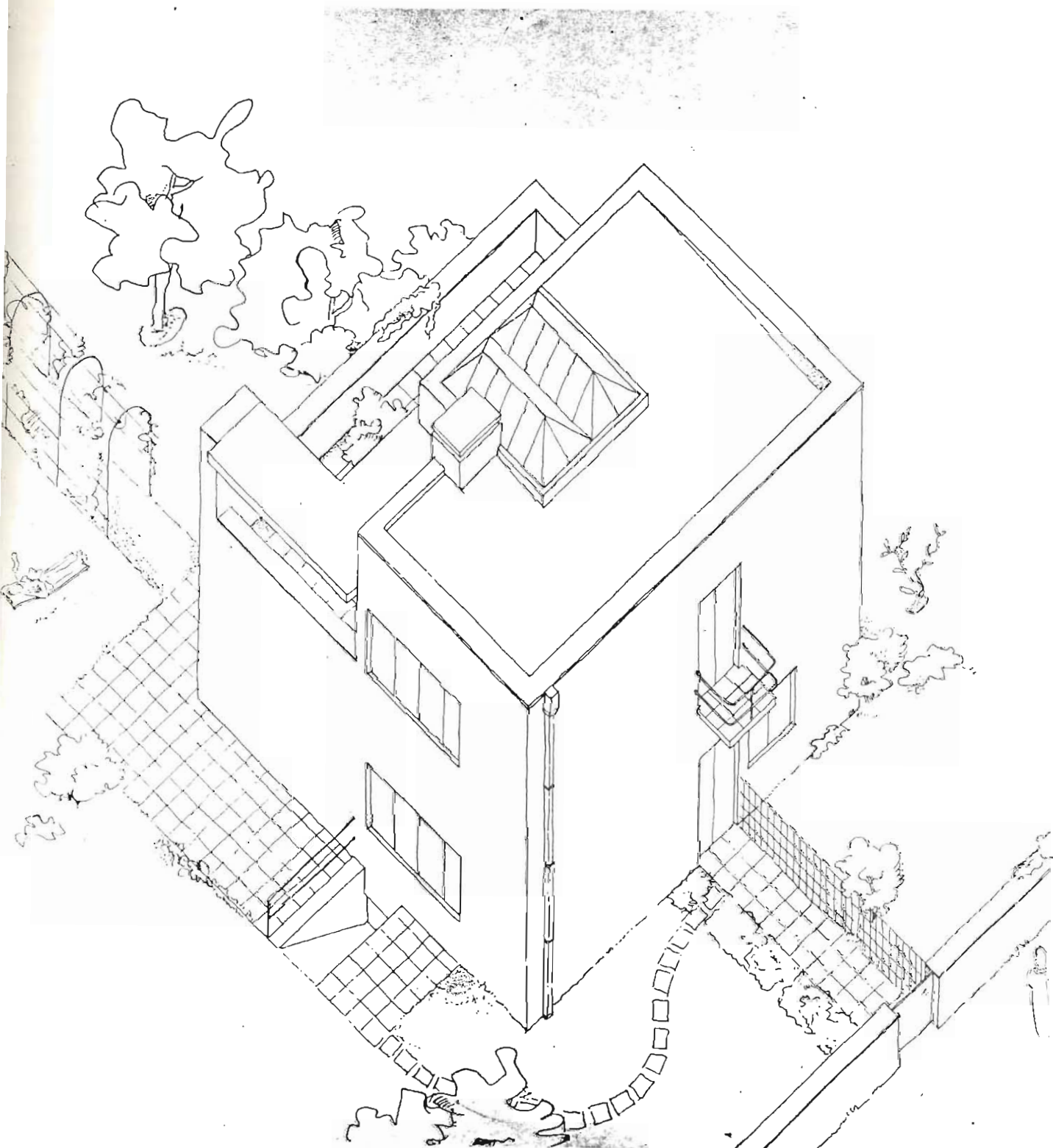

FIG. 11 A design of a house by Stauch as a student. (Compare this also with the illustrations in fig. 10)

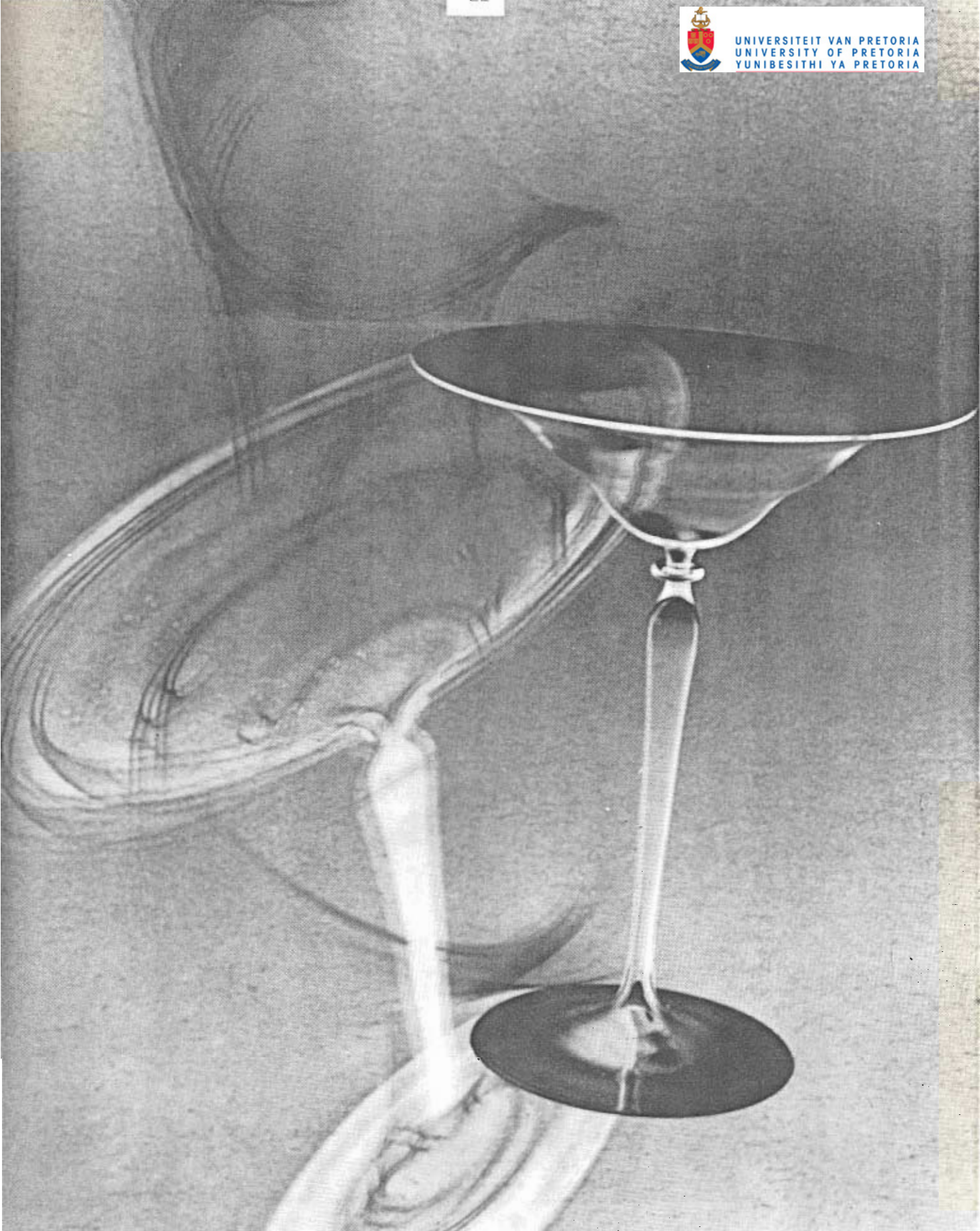

FIG. 12 Photographic study by a Bauhaus student (Wingler 1969, p 499)

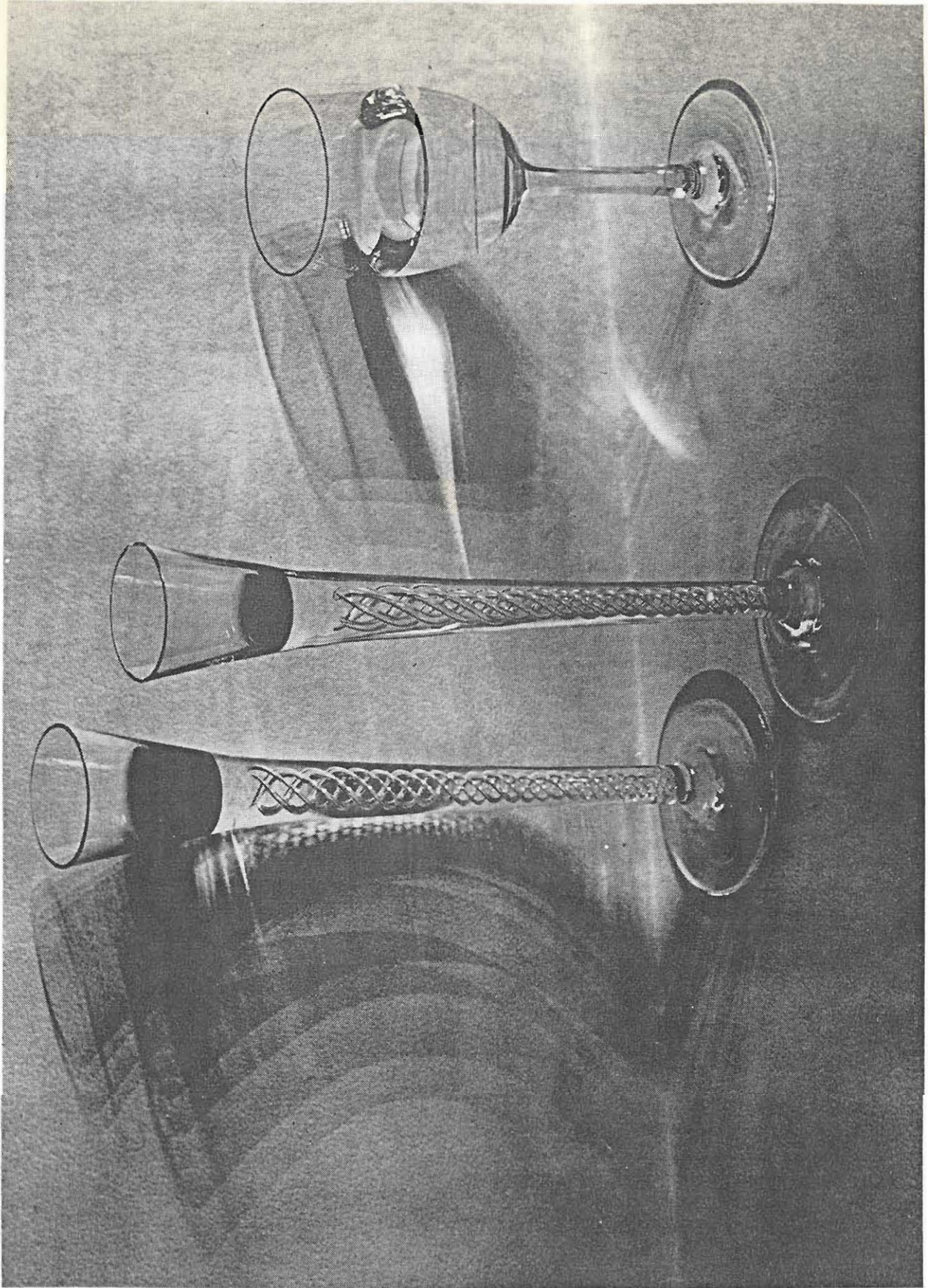

FIG. 13 Photographic study by Stauch as a student. (Compare this with the study in fig. 12)

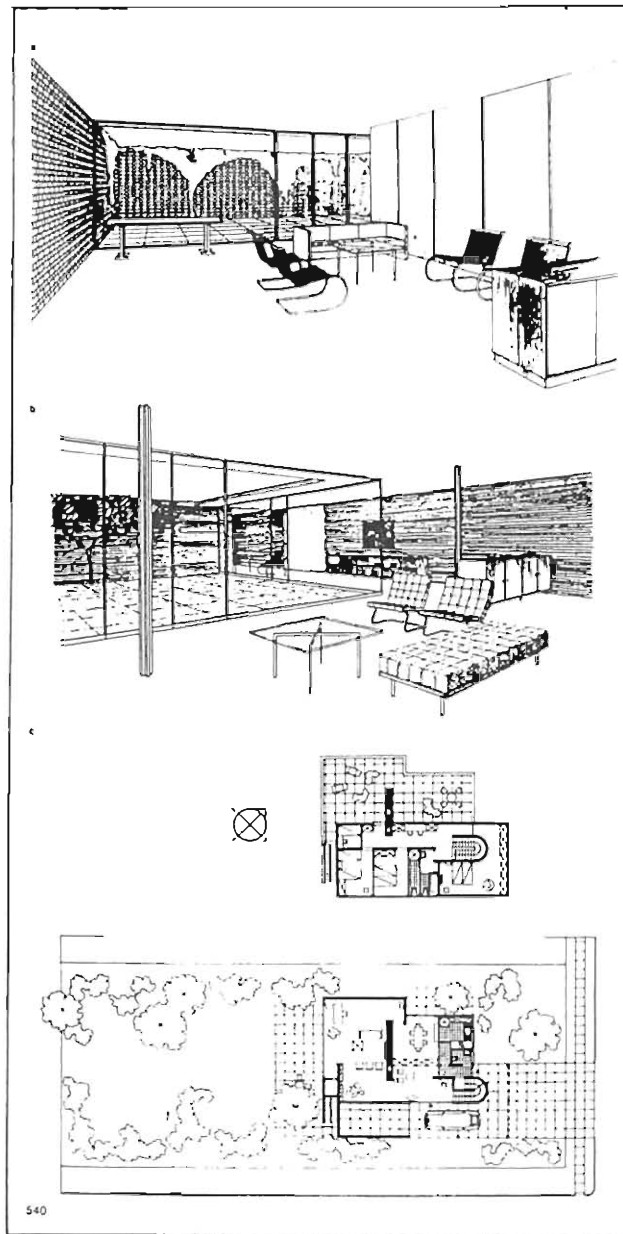
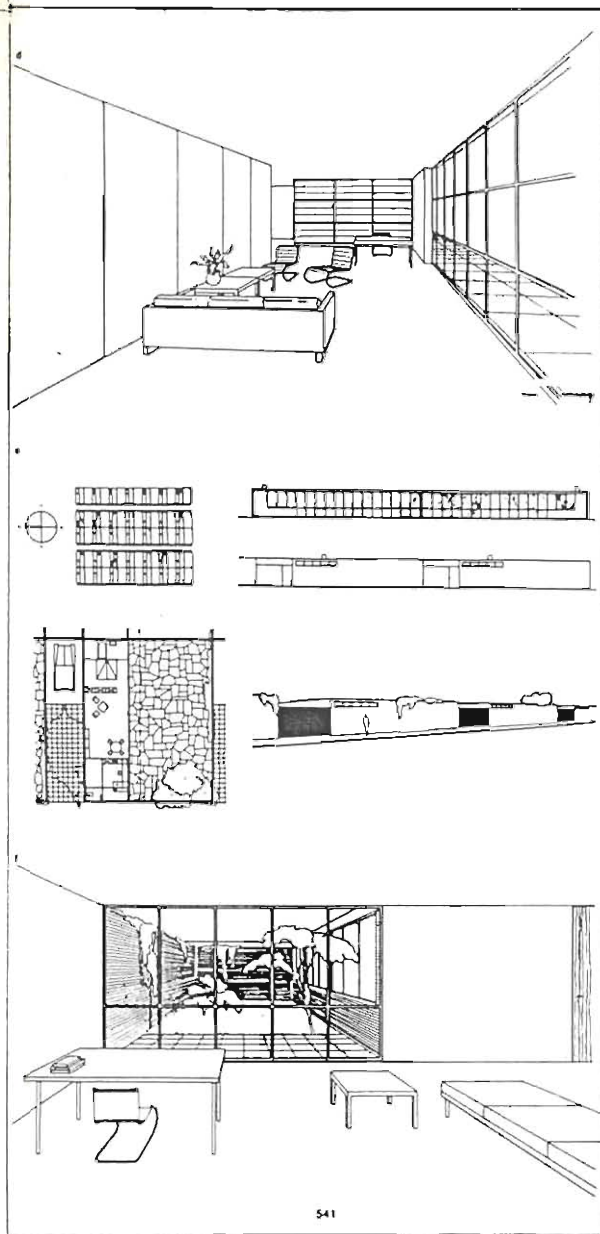

Fig. 14 Presentation technique used at the Bauhaus (Wingler (1969, pp 540, 541))

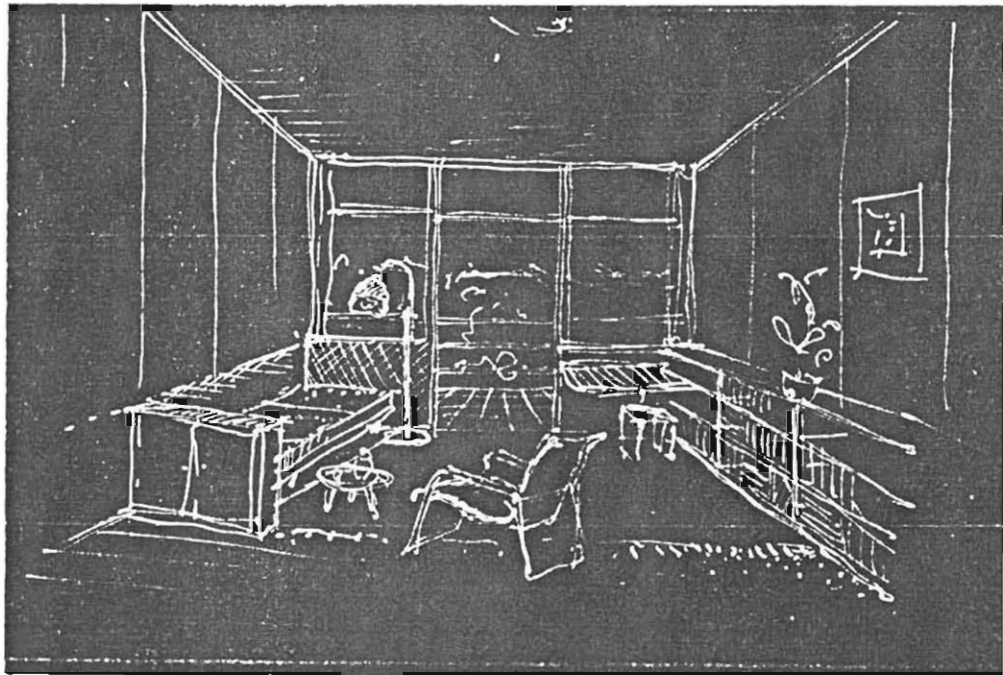
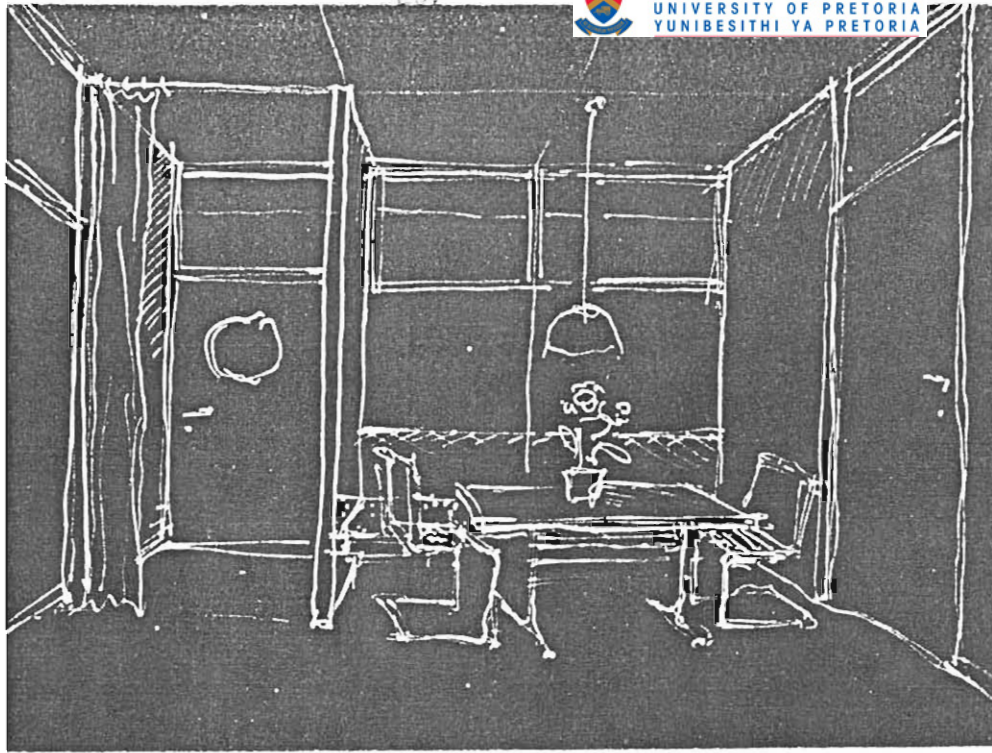

FIG. 15 Presentation technique of Stauch. Although the technique in the blueprint illustrated here is rougher in character it reflects much of the same background technique as that in fig. 14.

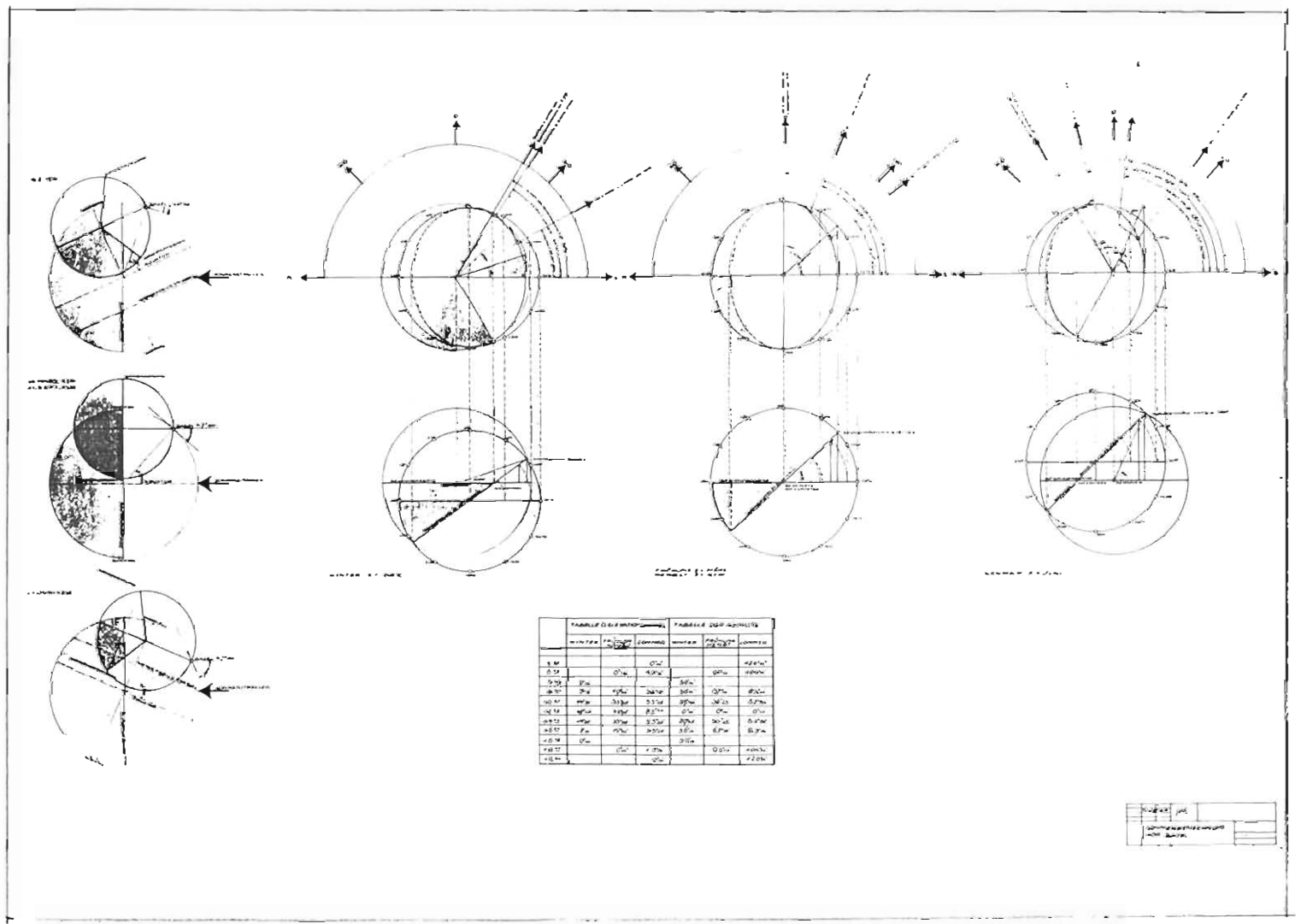

FIG. 16 Sun Angle Studies. Dated November 1929, this was some of the last of his student work.

books and continued his studies there, as the inscriptions in well-thumbed copies of several text-books on building construction, now in library of his step-daughter, Mrs T. Vorster, with dates and notes attests. Marianne, too, was well occupied. She met in Arosa a charming young man, Nikolai Krafft, whom she was later to marry.

August returned to Germany, as was his custom, at the end of the year. He paid a visit to his children at Arosa. He had decided that Ida should move permanently to South West Africa, and that their home at Zehlendorf would have to be sold. Ida reluctantly packed up her personal belongings, the household furniture and silverware was crated to be sent to South West Africa, and a flat was found in Nikolaussee, for the use of Stauch and Marianne (Levinson, 1983, pp 137 and 140). Before returning to her studies, Marianne took a holiday in South West Africa with her parents, returning to Berlin still unaware of her father's precarious financial position as indeed he himself was, while Hellmut continued studying. Fortunately there was no rigid timetable at the Ittenschule and the occasional interruption of studies was not a great handicap.

3.7 Financial support ends

In 1929 their peace was shattered by the unexpected message that there would be "no more pocket money from now on." They were shaken, uncertain as to what had happened, and reluctant to halt their training.⁽⁶⁾ In South West Africa, August's affairs had taken a turn for the worse. His estate was sold up, piecemeal, from 1930 to 1933 with the exception of the farm Dordabis, which he managed to retain with the assistance of a full loan from a leading local bank (Levinson, 1963, p 140). An old friend, Dr. Lübbert, kept Stauch and Marianne supplied with sufficient pocket money to enable them to complete their studies. Ida, with her usual serene self-sufficiency eventually repaid this loan from the proceeds of her small flock of karakul sheep.⁽⁷⁾

The effect of the bankruptcy of their father must have been devastating to the two young people, raised in luxury and never wanting for anything. Marianne had a modicum of her mother's serenity, was engaged to be married and was looking forward to a pleasant change of life-style, so she accepted the blow with relative calm.⁽⁸⁾ But Stauch, judging by his later reactions, may have been deeply and permanently affected, his security shattered and money suddenly becoming something important, perhaps because of its scarcity.

6. Ibid

7. Ibid

8. Ibid

CHAPTER IV - THE LAST YEARS IN GERMANY; 1929 to 1934

4.1 Stauch's working circumstance

In 1929 he had accepted an offer by the SWA Farming and Trust Company (Herbert, 1975, p 150 and Neues Bauen in den Kolonien, 1935) for the design of various farm and office buildings in the Windhoek district and had spent some months on this project. At this time he was still a student, under Forbat, at the Itten Schule. On his return, on December 14th 1929 he married the twenty-year-old Karin Fritz Dolborn,⁽¹⁾ and moved to a new flat nearer the centre of Berlin. Marianne went to live with her future husband's parents until, in 1930, she married and left with her husband to live in South West Africa.⁽²⁾

For Stauch it must have been an anxious time in many ways. To augment his income he took on whatever architectural work he could find. Itten was aware of the predicament of his talented student and would push work his way wherever possible.⁽³⁾

Karin had a strong and dominant personality and Hellmut leaned heavily on her during the early years of their marriage, for she provided him with the security which he needed at that time.⁽⁴⁾ Their daughter, Adi Karin Margot, was born on 19th February 1930, bringing the 19 year-old father yet further responsibility.⁽⁵⁾

Fred Forbat, who had been Stauch's teacher at the Itten Schule, engaged Hellmut in the same month in which Adi was born, and during this time he worked on the plans of garden cities in Berlin-Siemenstadt and Spandau-Haselhorst, as well as on a large scheme for a town hall and on various bungalows and villas.⁽⁶⁾ (fig. 17)

Forbat also was engaged in theoretical studies of housing and his young assistant gained invaluable and comprehensive knowledge in this specialised subject, as well as practical insight gained from the detailing which was expected of him.⁽⁷⁾

-
1. Marriage certificate in Stauch Vorster archives.
 2. Krafft, Mrs Marianne, Sister of H.W.E. Stauch, 1984 - interview.
 3. Ibid
 4. Ibid
 5. Birth certificate in Stauch Vorster archives.
 6. Letter of reference from Fred Forbat (1932.01.19) in Stauch Vorster archives.
 7. Drawings of Stauch from this period, in the possession of Mrs. Tosca Vorster. See also fig. 17.

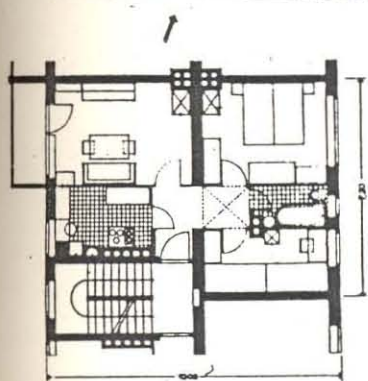
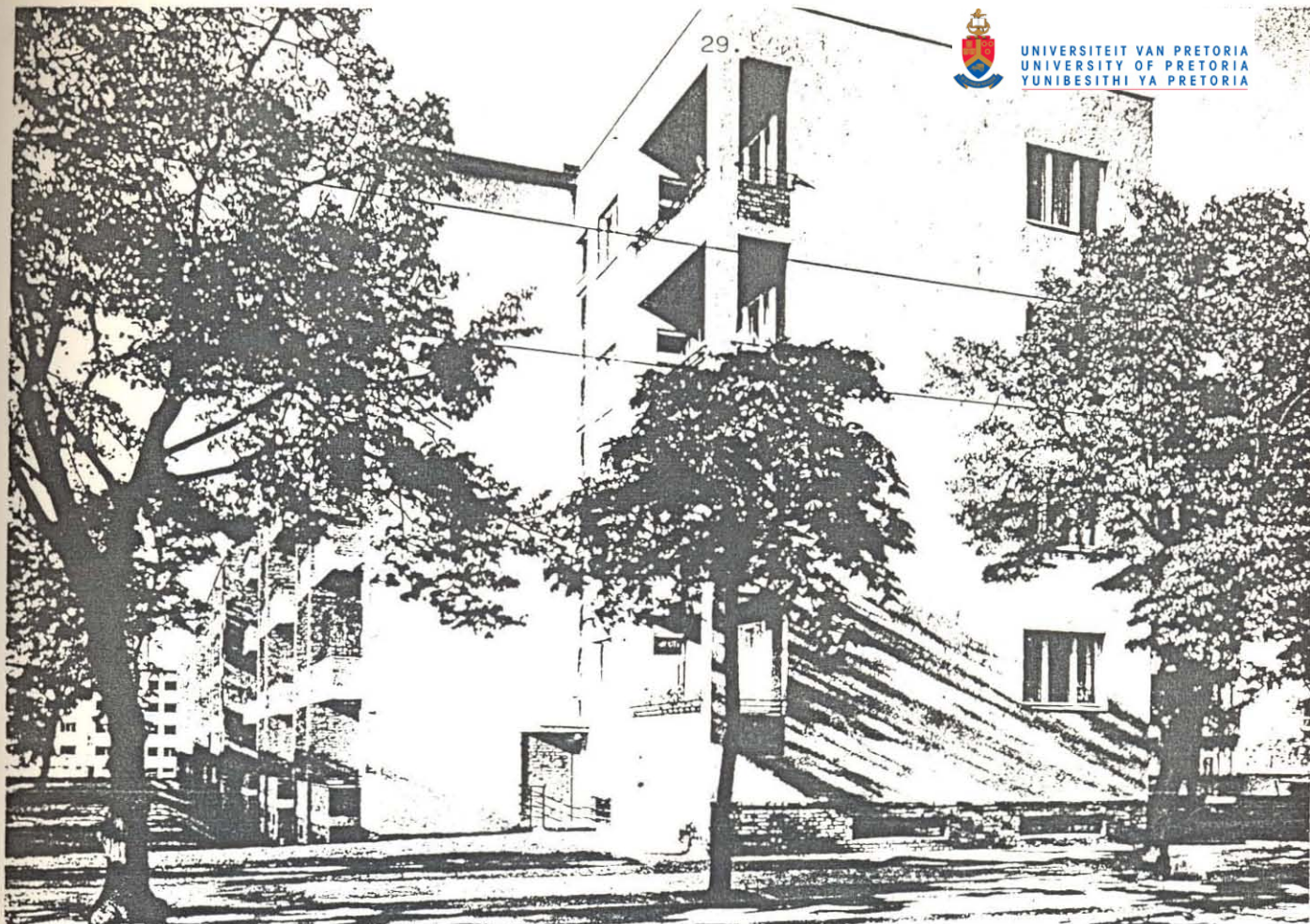

Grundrißtyp mit 57 m² Wohnfläche in den Zellen 2, 4, 6, 8

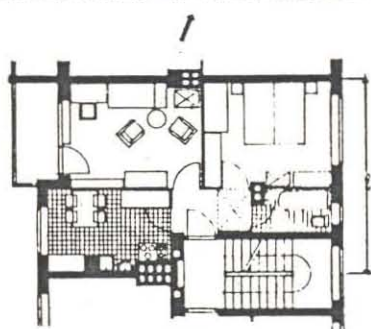

Maßstab 1:250

Grundrißtyp mit rd. 48 m² Wohnfläche in den Zellen 3, 5, 7, 9

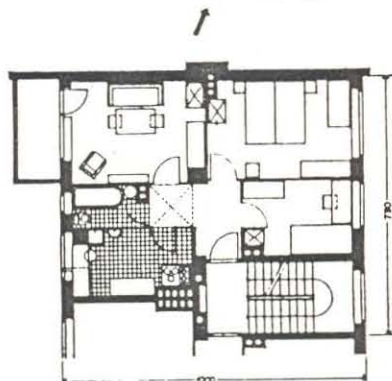

Grundrißtyp mit 68 m² Wohnfläche in den Zellen 3, 5, 7, 9

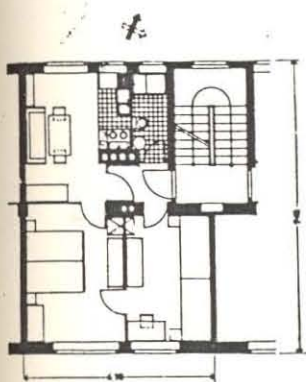

Grundrißtyp mit 45 m² Wohnfläche in den Zellen 11 bis 15

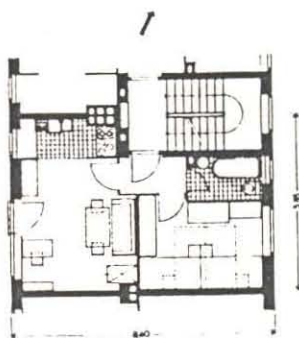

Grundrißtyp mit 37 m² Wohnfläche in den Zellen 16, 17

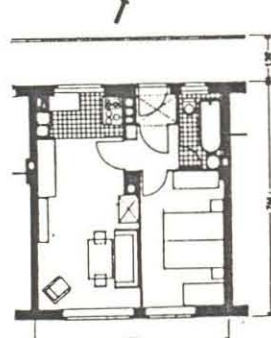

Grundrißtyp mit 40 m² Wohnfläche im Laubenganghaus Zeile 18

FIG. 17 Housing at Spandau Haselhorst - a project on which Stauch worked as an assistant to Forbat. The planning is similar to some of his later work, indicating either Forbat's later influence or an early strong involvement by Stauch.

When Forbat's office closed down in December 1931, he gave Stauch a glowing testimonial emphasizing his systematic and responsible approach and his natural talent for the Arts. These sentiments were exactly and even more enthusiastically echoed by his next employer, Wilhelm Peters, where he worked from February 1932 to January 1934, who added in a letter dated 1934.02.03 that Stauch had gained practical experience as a clerk-of-works during the two years with this firm, where he also carried out further work on industrialised housing systems (Das Ideale Eigenheim, 193-).

During these years he also assisted Walter Gropius and Marcel Breuer with work on some housing schemes.⁽⁸⁾ But he was not content to remain an employee and during 1934 practised as an architect for his own account. He also worked - "in association with professor Gustaf Hassenpflug (subsequently director of Kunstgewerbeschule Hamburg - Lerchenfeld)" but no detail of this association is available.⁽⁹⁾ He was interested in industrialised building and became involved as "consulting architect" for a firm of contractors interested in the prefabrication of economical houses.⁽¹⁰⁾ (figs. 18 to 21). And he carried out a number of furniture studies, both for clients as such and as a basis for design. (figs. 22 to 27).

4.2

Divorce

While he found personal security in his work, the stresses of marriage proved too great and he and Karin were divorced. Karin remarried and she and her new husband, by the name of Zimmerman, together with Adi, left Germany for Brazil, where they settled. Stauch was not to see his daughter until she visited him in Pretoria many years later, a stunning, blue-eyed, fair-haired teenager.⁽¹¹⁾

4.3

The Olympia Jolle

Early in 1933 two major German sailing organisations, the "Segler -

8. Stauch's statement to the Institute of South African Architects (1942.08.11)

9. Credo (April 1971) and as also indicated by the headings of drawings carried out at this time where the title "Architekt Hellmut Stauch" appears.

10. Stauch's letter to the Institute of South African Architects (1942.08.11)

11. Vorster, Mrs Tosca, Step-daughter of H.W.E. Stauch, 1984 - interview.

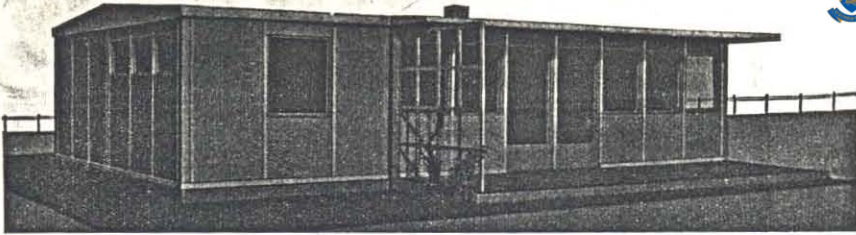

DAS IDEALE EIGENHEIM

ARCHITEKT
HELLMUT STAUCH

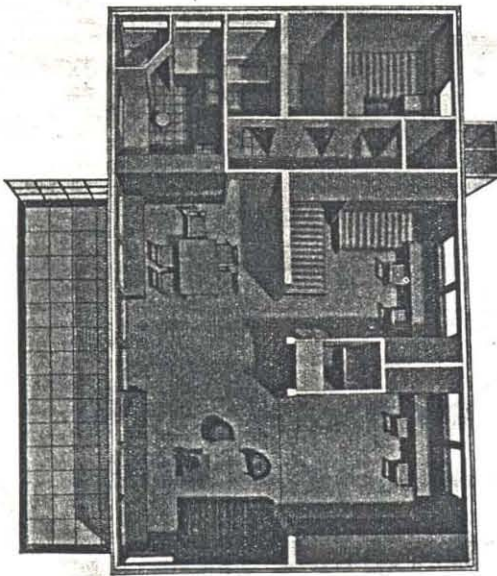

PETERS BAU-G.M.B.H., BLN.-WILME
Rheingau 4814 u. 4

Typ 5/3

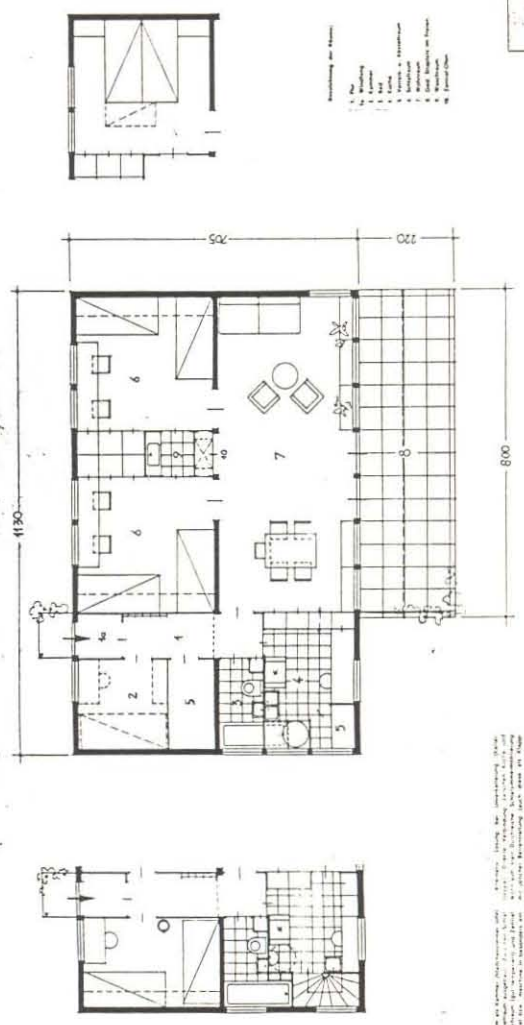

| MATERIALLISTE | |
|---------------|-----------|
| 1. Holz | 2. Zement |
| 3. Eisen | 4. Glas |
| 5. Kacheln | 6. Marmor |
| 7. Stein | 8. Metall |
| 9. ... | 10. ... |

Architekt Hellmut Stauch
Rheinland-Pfalz - 6800 Mainz

Alle Rechte vorbehalten
Verboten ist die Vervielfältigung dieses Werkes
oder die Verbreitung auf irgendeiner Art und Weise
ohne schriftliche Genehmigung des Verlegers
Verlag der Bauverlagsgesellschaft mbH
D-6000 Frankfurt am Main

FIG. 18 Modular housing for Peters Bau, 1933/34. This approach to modular "core" housing probably arose through the economic circumstances of the time. It is an approach which Stauch did not abandon and is today just as valid as when it was designed.

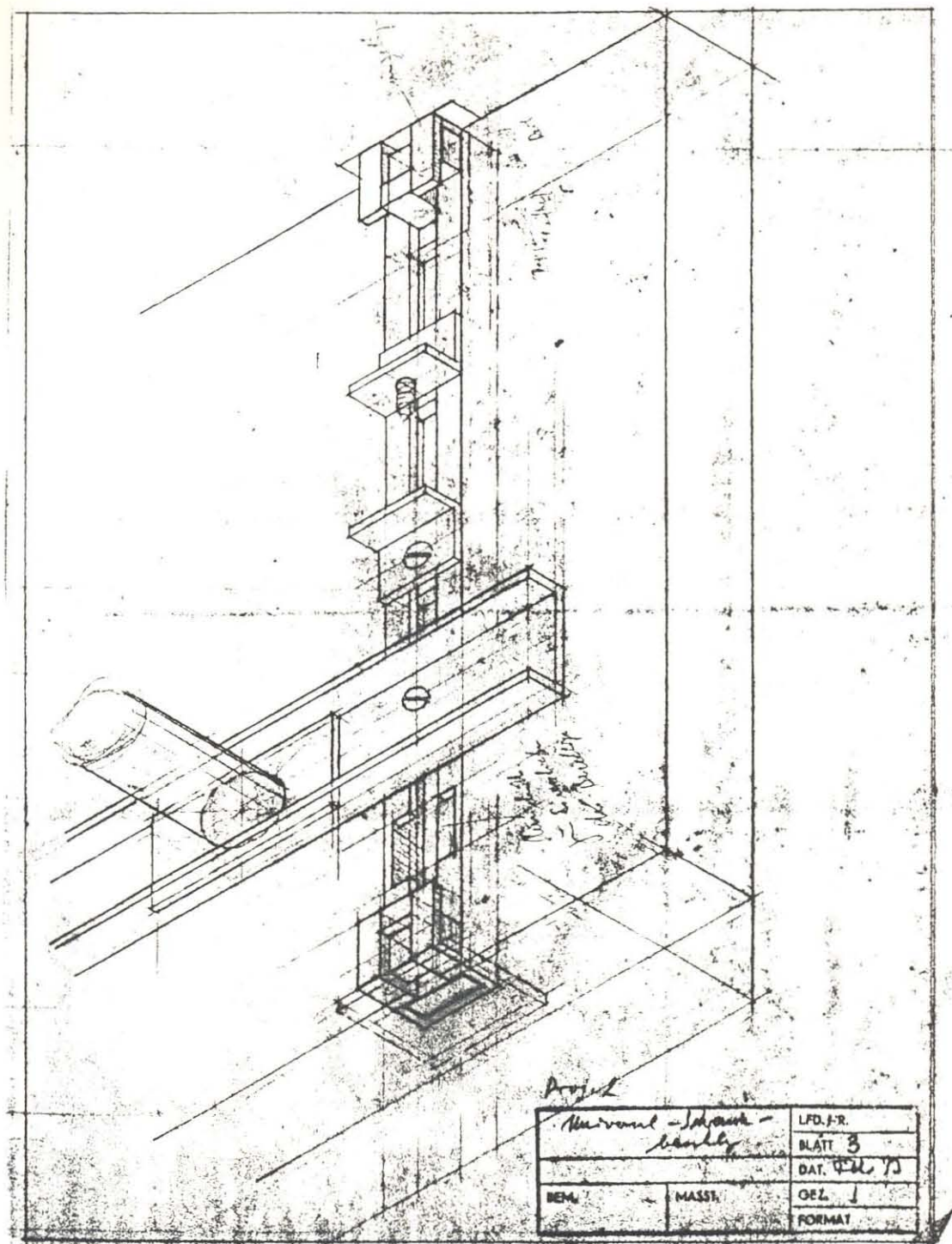

FIG. 19 Structural details for industrialised building type. The provision of what are virtually shop drawings appears to be a consequence of the relatively undeveloped state of this form of building at the time.

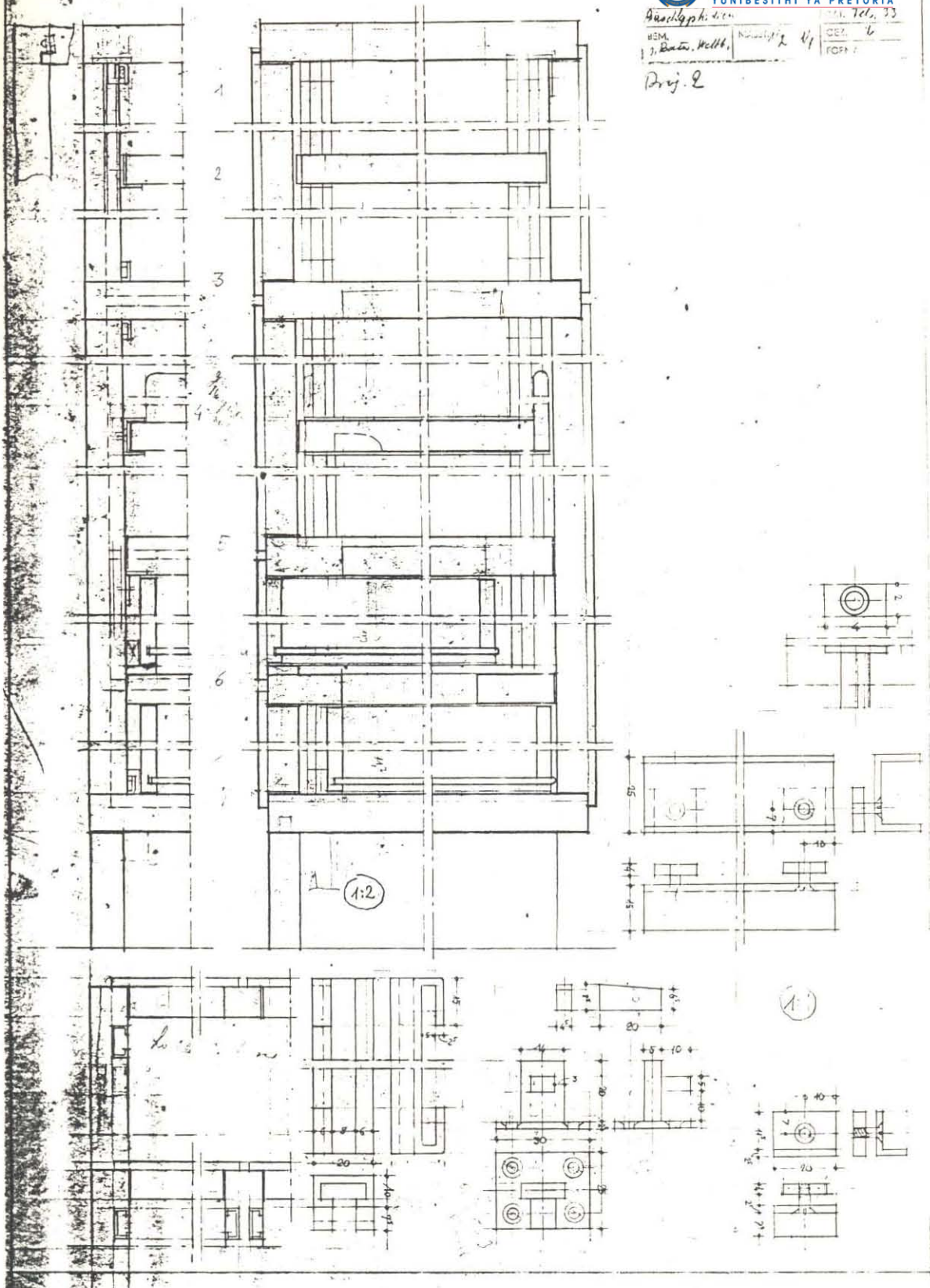
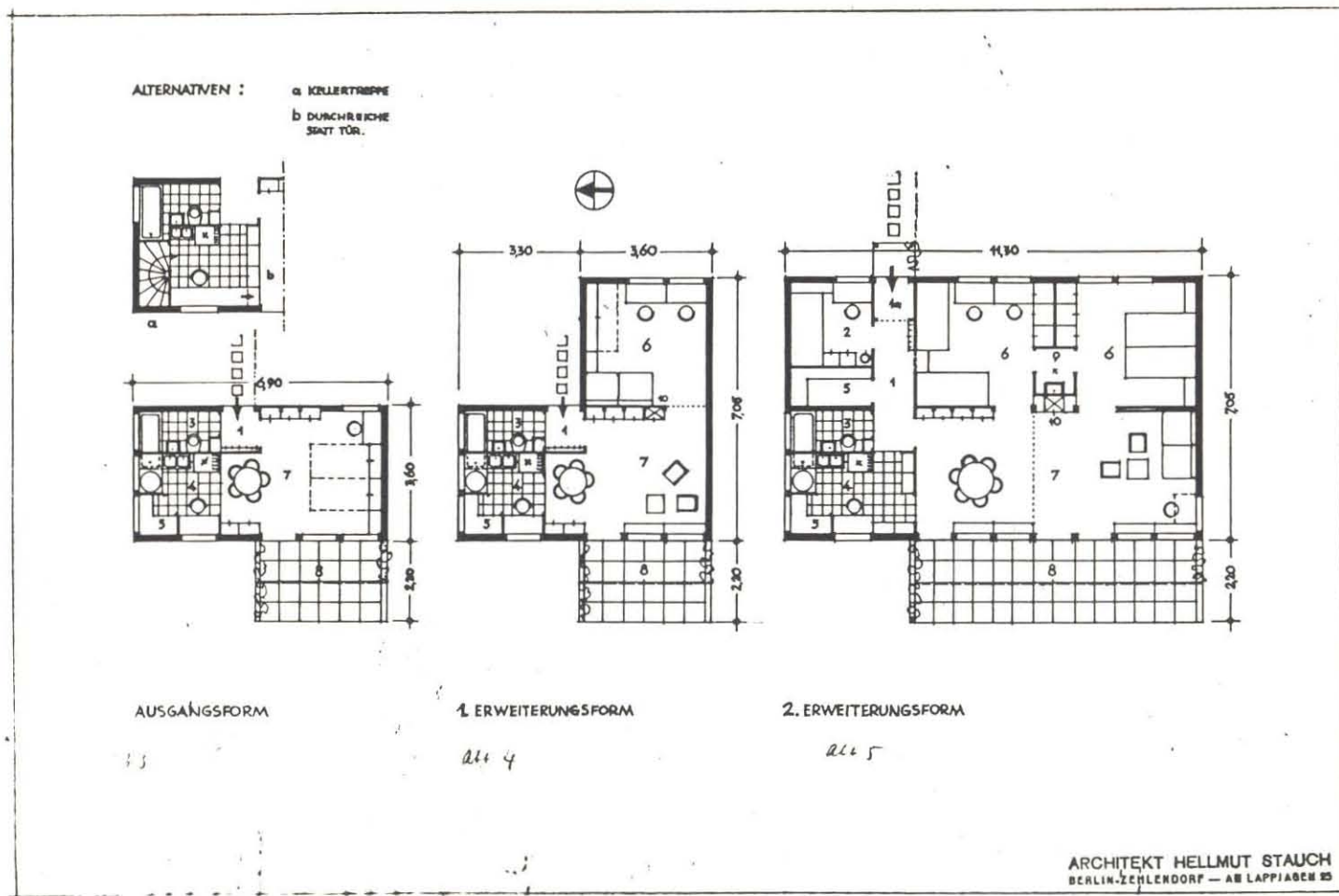

FIG. 20 Additional structural details, apparently for the same project as in fig. 19.

FIG. 21 "Core" housing developed by Stauch in 1932 (see note with fig.18)



| | | |
|---------------------------------------|-----------------|-------------------|
| WACHSENDES HAUS (Reinmannplatz am) | | LFD. NR. |
| GRUNDRISS | | BLATT 47 |
| BEM. 27 Aug. | MASST. 1:100 | DAT. 30.5.32 |
| | | GEZ. <i>Heuck</i> |
| | | FORMAT |

Sonsalla
 Wohnzimmer

 ARCHITEKT
 HELLMUT STAUCH

FIG. 22 Room design for Sonsalla. There is no background giving the circumstance of the room designs done by Stauch, of which there are several, at this time but it might be a result of financial constraints and accommodation shortages prevalent in Germany at the time.

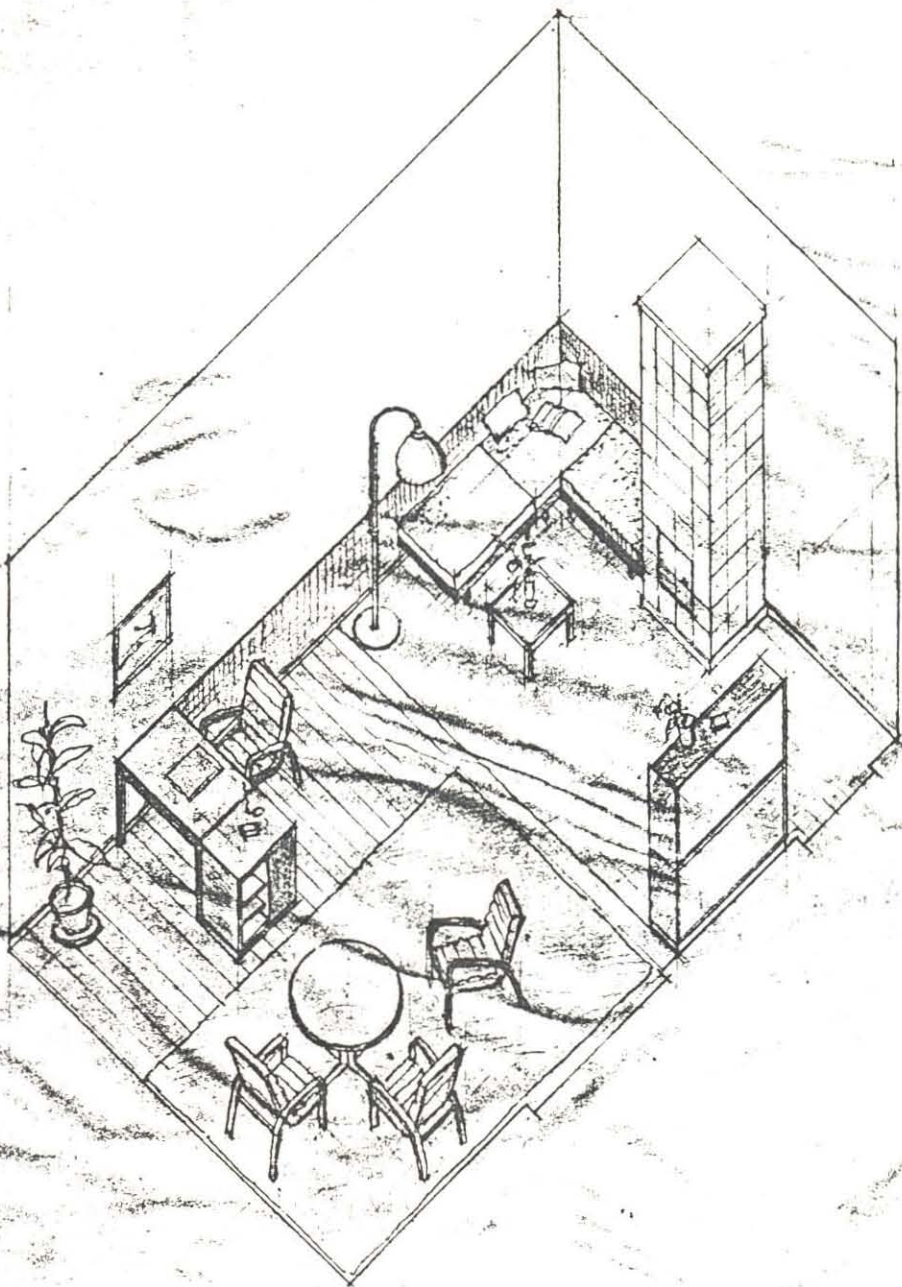

ZIMMER FRAU TEICHS 1:50

Teelwyg

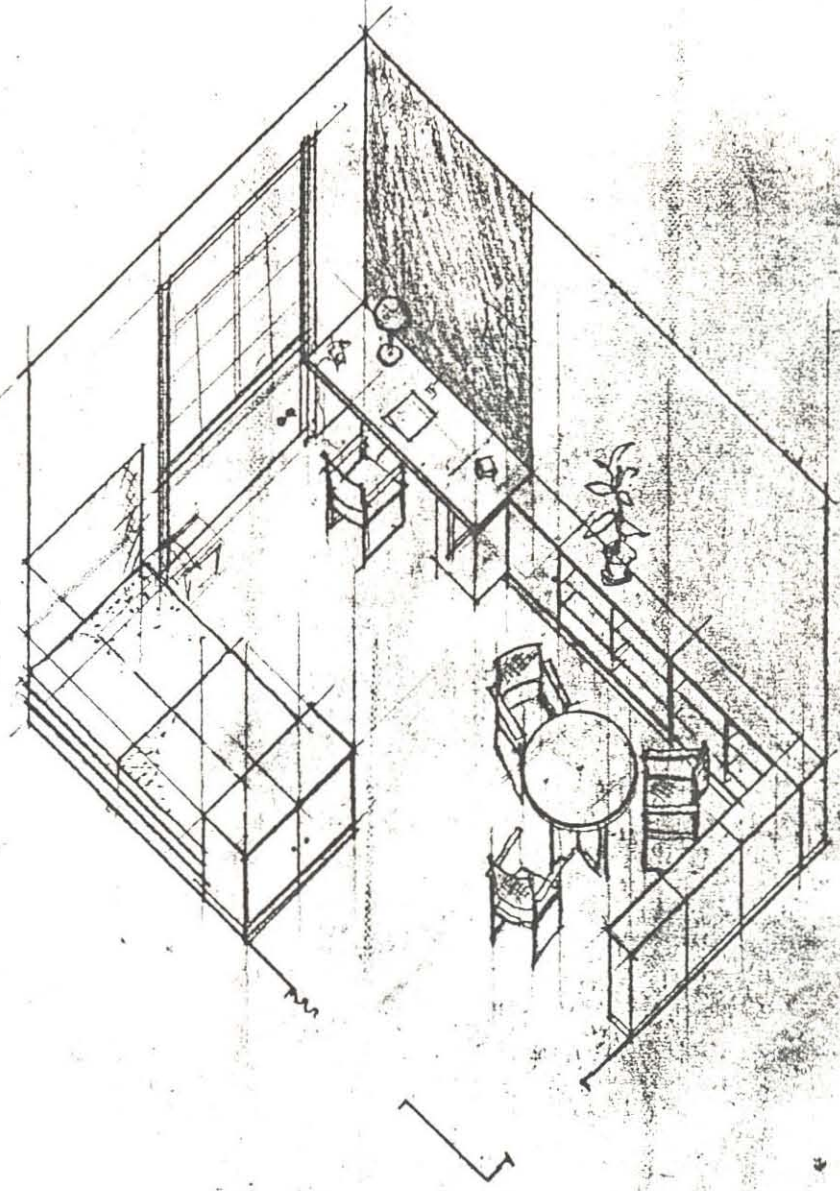
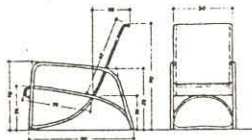
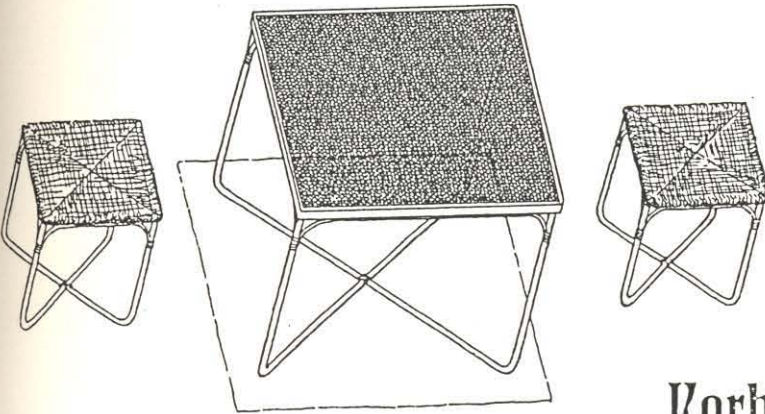
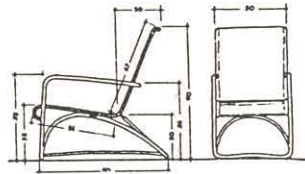
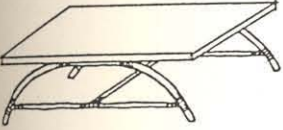
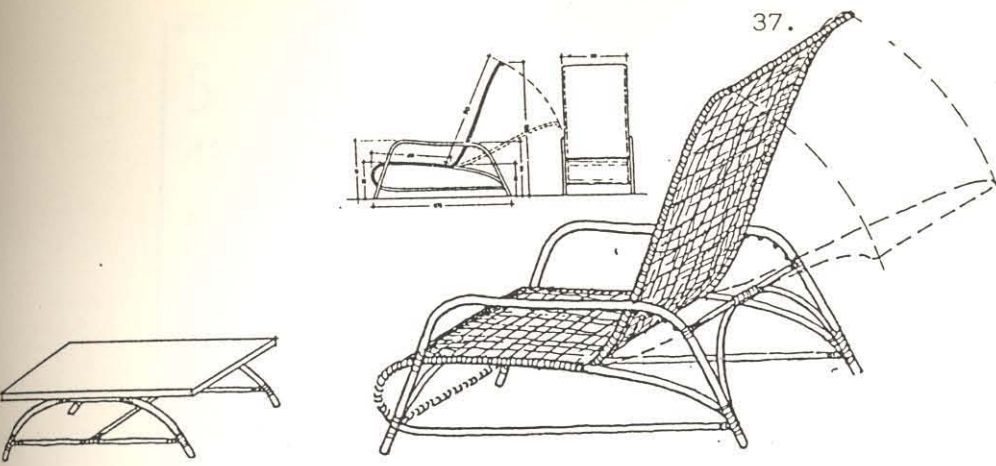

FIG. 23 Room design for Frau Teichs. This is one of the layouts mentioned in the comment on fig. 22.

37.



Korb-Industrie-und Weiden-Zeitung

Offertenblatt für Korb- und Rohrwaren, Korbmöbel, Weidenhandel und Weidenindustrie, für Holz- und Spielwaren sowie Drechslerarbeiten

Größtes Export-Fachblatt der Branche
Zeitung für die Korbwaren-Branche und Hilfindustrien



Offizielles Organ der
Korbmacher-Zwangs-Innungen Meissen und Zwickau

Organ des Vereins deutscher Korbweidenzüchter

Geschäftsstelle: Eberswalde, Schilderstraße 14-24. Fernsprech-Anschluß: Eberswalde Nr. 38, 40, 41. Postcheckkonto Berlin 93396

Bezugspreis für Deutschland: Bei der Post bestellt monatlich RM. 0,40, rückgängig RM. 0,11 Postgebühren, das Ausland zahlt in der Währung des betreffenden Landes. — Anzeigenpreis: 1 mm Höhe einseitig RM. 0,15. 1,00 Mark = 1 Dollar. Umrechnungsbare sämtlicher Berliner Dollarmarkts am Zahlungstage. Umschlagplätze nach besonderem Tarif. Für Platzvorschrift Preiszuschlag. — Stellengeuchte pro 1 mm Höhe RM. 0,05. — Für das Ausland Besuchs- und Anzeigenbedingungen nach Vereinbarung. Erscheinungsweise: 1. und 15. jeden Monats

48. Jahrgang

Eberswalde, 1. Februar 1933

Nr. 3

Architekt Hellmüt Stauch, Berlin

Moderne Korbmöbel

FIG. 24 Furniture designs for construction in cane. These designs were published in successive issues of the above magazine. Stauch's interest in furniture continued for many years, judging by the number of drawings, sketches, models and articles by him virtually throughout his working life.

Schreibtischsessel

1:5

ARCHITEKT
HELLMUT STAUCH

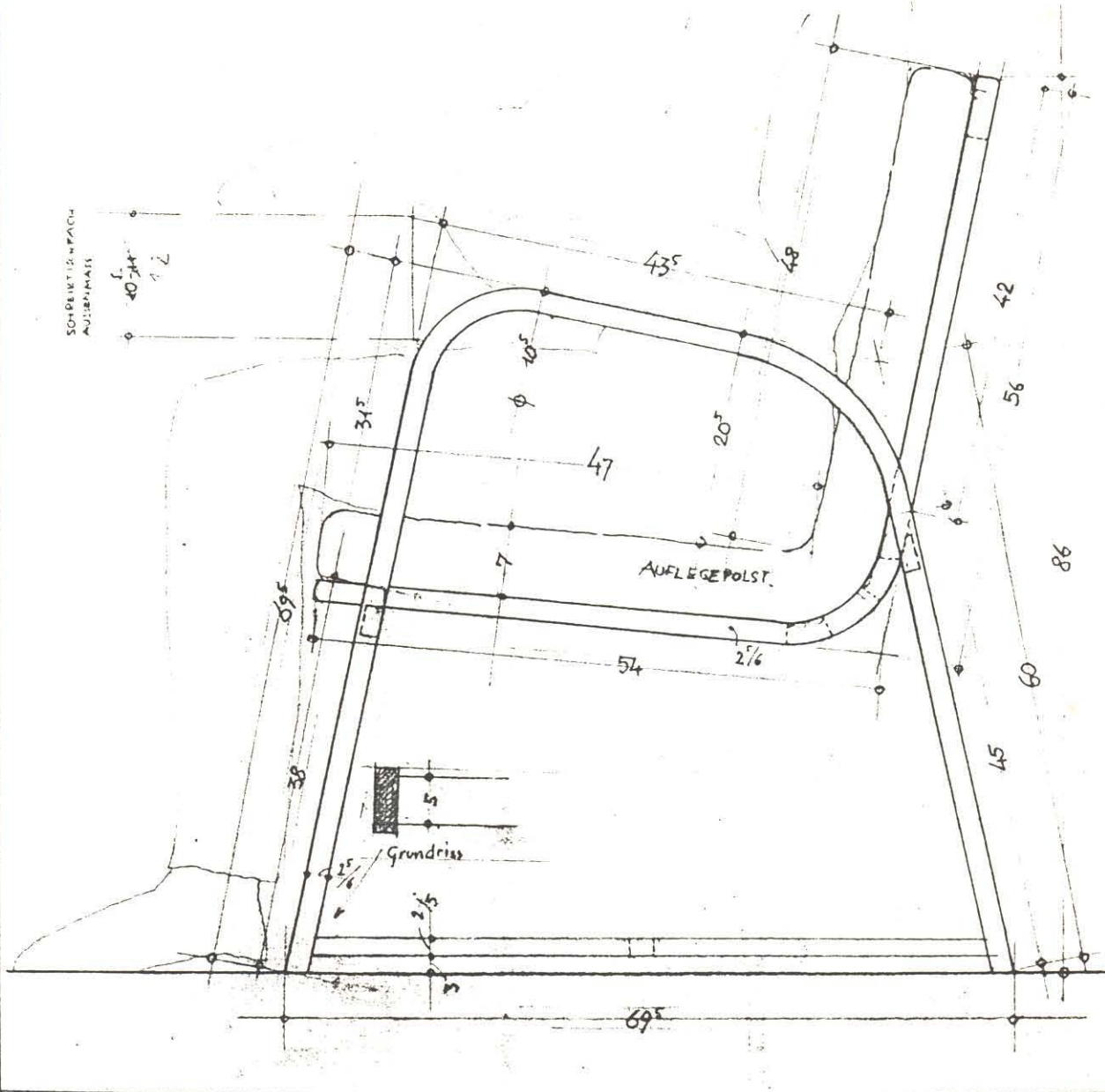

FIG. 25 Furniture design for a work chair in tubular steel construction. Both this and that illustrated in fig. 24 are unusual in their choice of materials, for in most of his later designs Stauch elected to use wood, with or without other materials such as upholstered cushions or leather thonging.

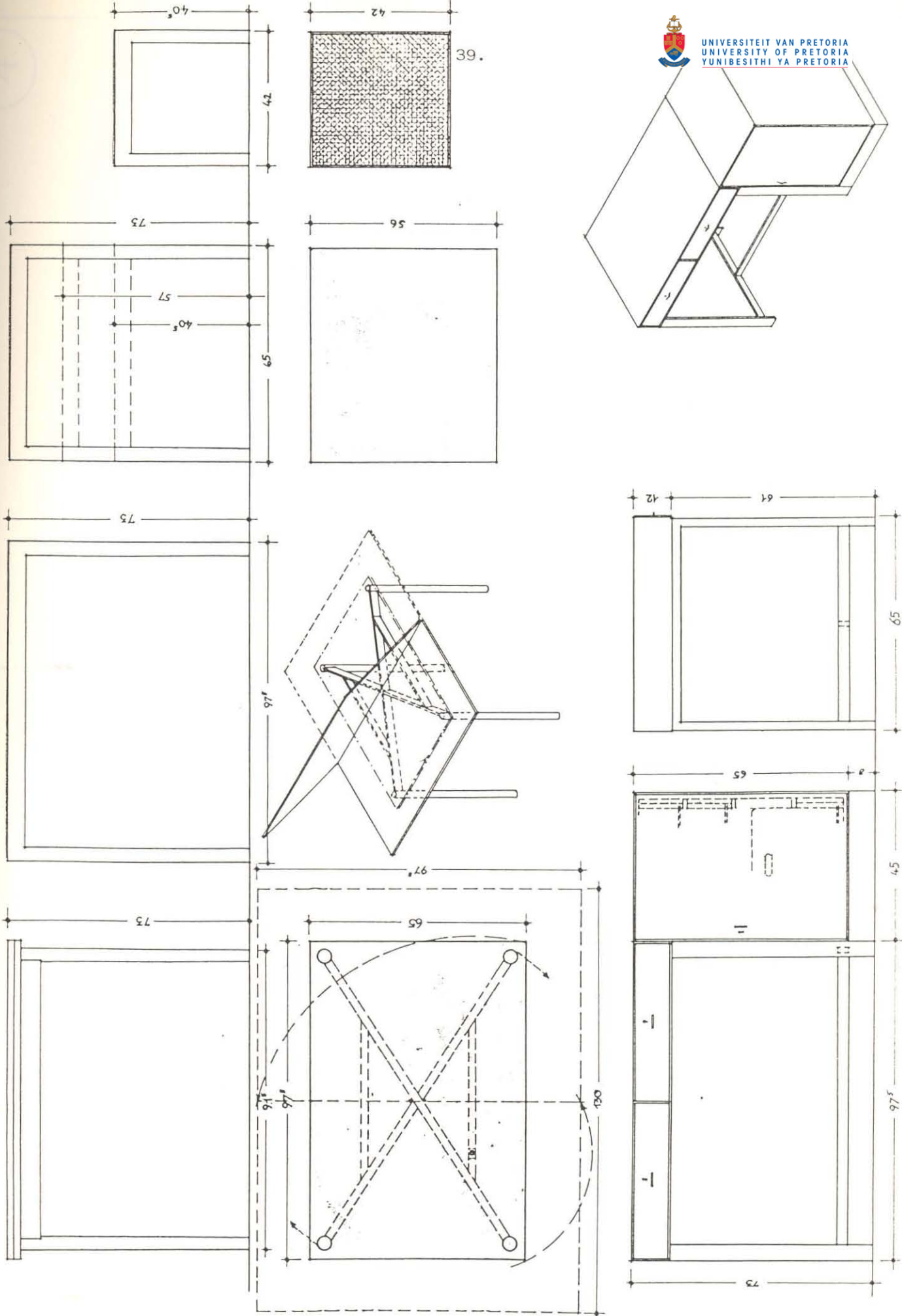
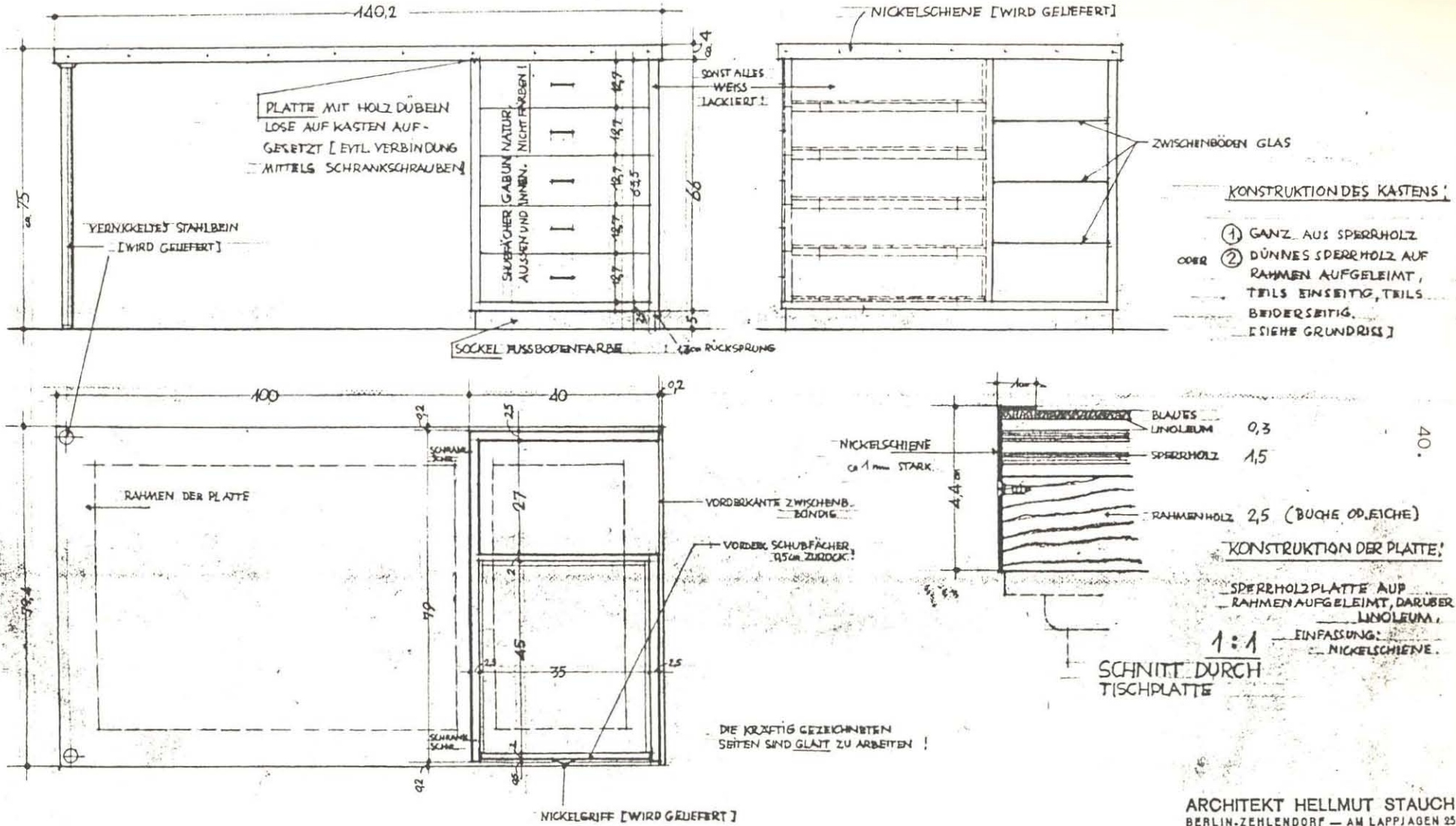

FIG. 26 Design for an adjustable table and desk in timber, as part of a modular series of furniture.

SÄMTLICHE SCHUBKÄSTEN VERSCHLIESSBAR!



- KONSTRUKTION DES KASTENS:**
- ① GANZ AUS SPERRHOLZ
 - ODER ② DÜNNES SPERRHOLZ AUF RAHMEN AUFGELEIMT, TEILS EINSEITIG, TEILS BEIDERSÄITIG. [SIEHE GRUNDRISS]

- KONSTRUKTION DER PLATTE:**
- SPERRHOLZPLATTE AUF RAHMEN AUFGELEIMT, DARÜBER LINOLEUM.
 - 1:1 EINFASSUNG: NICKELSCHIENE.

— DIE GENAUEN MASSE DER FERTIGEN PLATTE SIND SOFORT MITZUTEILEN ZWECHE BESTELLUNG DER SCHIENE!

ARCHITEKT HELLMUT STAUCH
BERLIN-ZEHLENDORF — AM LAPPJAGEN 25

MÖBEL DR. BEHRENDT
SCHREIBTISCH

| | | | |
|------|-------|-------------|------|
| M. | NR 17 | DAT 3.11.34 | GR 4 |
| 1:10 | BL 4 | GR 29/42 | GR 1 |

FIG. 27 Design for desk for Dr. Behrendt, in timber with linoleum writing surface.



Verband" and the "Segler Bund" combined and decided that a new Olympic class single-handed sailing dinghy was needed for use in the 1936 Olympics at Kiel, and that this should be a development based on the single-hander used at Los Angeles in 1932. With his appetite whetted by a brief trial of an Olympic-type boat at Wannsee, Stauch embarked on the design of a suitable boat, in competition with the designs of Brandt, Drewitz and Rutsch. The designs were evaluated and tested and his design accepted and built (Die Jacht, 1984.03.28) (fig. 28).

He was at this time a keen and competitive sailor, and was selected by the "Reichsportführer" as a member of the team of experienced sailors testing and developing the Olympia-jolle (Die Jacht, 1984.03.28). This was a feather in the cap of the young architect; but he had not bargained on the fact that he would be expected to join the Hitler Youth movement and to take part in activities other than sailing. ⁽¹²⁾

4.4

The decision to leave Germany

Stauch was a person of character and determination. He had overcome much of his insecurity and he knew without doubt that while he wanted to sail, he had no desire to march. ⁽¹³⁾ The unease of the early 30's was around him. South Africa beckoned promisingly. He had stayed in touch with his family in South West Africa and was interested in designing for its severe climatic conditions.

(Herbert, 1975, p 151) states that Stauch came to South Africa via Windhoek in 1934, but this does not tally with the facts as stated by his family. ⁽¹⁴⁾ Dr. Gilbert Herbert stated in an interview in 1985 that he used, in the research for his book, the method of tape-recording and transcribing all interviews. He therefore is certain that what Stauch told him was correctly reported, but added that he had found many inaccuracies in facts given by architects about themselves, and felt that it was not impossible that Stauch had made the same type of misstatement. ⁽¹⁵⁾ An article written by him and apparently published in an

12. Ibid

13. Ibid

14. In interviews during 1984, Mrs Marianne Kraftt, Mrs Tosca Vorster, Mr Robin Vorster and Mrs Pulli Thoms state that Stauch consistently spoke of his arrival in Cape Town with "two bob in his pocket", and also of his inability to continue to Windhoek.

15. Herbert, Dr. Gilbert, Prof. of Architecture at the Technion - Israel Institute of Technology; 1985 - interview.

Olympia-Jolle

Länge: 5 m
 Breite: 1,5 m
 Segelfläche:
 10 m²
 Take-
 lungshöhe:
 höchstens
 6,5 m
 geringster
 Freibord:
 mindestens
 0,4 m
 Tiefgang mit
 Schwert:
 höchstens
 1 m
 Gesamtge-
 wicht: 230 kg
 Baumaterial:
 Mahagoni
 Bauweise:
 Rundspant-
 boot, karweel
 gebaut



FIG. 28 The Olympia Jolle. The basic specification of this sailing dinghy, and a photograph of Stauch, taken at the time when he was sailing at Wannsee in preparation for the 1936 Olympic Games. These photographs were published in an article on the current status of the dinghy, in *Die Jacht*, October 1984.

architectural magazine, headed "Neues Bauen in den Kolonien" von Architekt Hellmut Stauch : January 1935 highlights his interest in simple industrial modular "core" housing, which approach was at the time in advance of that of his contemporaries in South Africa.

He weighed up his options, made his decisions, and left Germany. He travelled light, leaving in Germany all his personal papers and property, perhaps because he had no firm intention of staying permanently, or perhaps because of other constraints. The young woman who drove him to the station at the start of his journey spoke of Hellmut riffling through a "pack of playing cards" of passports, selecting a Swiss passport and using that for his exit from Germany.⁽¹⁶⁾

Alternatively, it was possible that he did not wish those with whom he was in contact to know that he might move permanently to South Africa.⁽¹⁷⁾

Typically, he had not contacted nor asked for assistance from his family, but he did intend to join them in Windhoek. This intention was thwarted by lack of money, for he reached Cape Town with completely depleted resources.⁽¹⁸⁾

Staying briefly with friends of his family, who lived there, he met a young visitor who brought news of work available in Pretoria. This was enough to send him northwards in a hurry, where he was to join Aubrey Nunn in practice. He would not see his family in South West Africa until he was once more on his feet and could go to them with a story of success, rather than a request for help.⁽¹⁹⁾

16. Letter from Galerie Gerda Bassenge to Joachim Alexander dated 21 January 1985.

17. Vorster, Mrs Tosca, Step-daughter of H.W.E. Stauch, 1985 - interview.

18. Ibid

19. Ibid and Krafft, Mrs Marianne, Sister of H.W.E. Stauch, 1984 - interview

CHAPTER V - PRETORIA, 1935 TO 1946

5.1 Arrival

Hellmut Stauch arrived in Pretoria on March 24th 1935. The German community there was sociable, friendly and gregarious, and that evening he found himself celebrating with Bram Hoffmann and other members of the German community the birth of Bram's daughter Tosca. It was an auspicious beginning to his stay there. ⁽¹⁾

5.2 Aubrey Nunn's practice

Aubrey Nunn had registered with the ISAA in December 1927 ⁽²⁾ and was in practice in Hamilton Chambers since 1932 (SAAR, October 1932, p 274).

The character of his architecture was charming and romantic in style if workmanlike. He had sufficient commissions to keep the pot gently simmering and needed assistants. ⁽³⁾ The arrival of this new, unknown talent in the shape of an athletic, volatile, unpredictable young architect must have set the practice into a ferment.

Stauch had never meekly conformed to the ideas of others or accepted points of view with which he disagreed. He lived his life intensely, whether related to architecture, sailing or his personal life. ⁽⁴⁾ The houses which he now designed had an unusual individuality and a tremendous appeal to those who lived in them ⁽⁵⁾. His detailing differed from the ordinary; his understanding of materials, form, space and light was superb (Herbert, 1975, p 151). Nunn allowed him a fairly free rein, and although it was not possible to offer him a formal partnership since he had no qualifications recognised by the South African Institute of Architects, he was recognised in other ways and eventually appears to have held the equivalent unofficial status of an associate in the firm; (Herbert, 1975, p 151) an article by Hugh Casson in the Architectural Review of August 1940 (fig 29) crediting four houses and a block of flats to "A V Nunn with Hellmut Stauch", a school and an office building to "A V Nunn and Hellmut Stauch", one house to "Hellmut Stauch" and, surprisingly, one house to "Gordon Macintosh and Hellmut Stauch." In view of Casson's careful differentiation of credits, there seems little doubt

1. Vorster, Mrs Tosca, Step-daughter of H.W.E. Stauch, 1984 - interview.

2. Information from the Institute of South African Architects

3. Vorster, Mrs Tosca, Step-daughter of H.W.E. Stauch, 1984 - interview.

4. Consensus in nearly all interviews

5. Wepener, F.J., Ex-partner of H.W.E. Stauch, 1984 - interview.



4 House by A. V. Nunn with Hellmut Stauch

All the main rooms of this house face north, and receive protection against the sun from generous eaves and the cantilevered balcony, which serves the bedrooms. The sleeping-porch and sleep under are open to the north and east, and their open-air character is further emphasized by the glass screens which protect them from the cold southern winds. The native quarters in this instance are not connected to the house. The house is built of stock bricks, rendered off-white, and roofed with corrugated iron, laid at the minimum pitch.

7, the south (and entrance) front. 8, the garden (north) front.

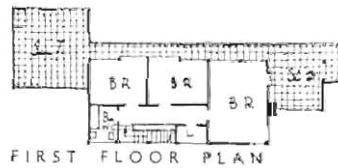

FIRST FLOOR PLAN

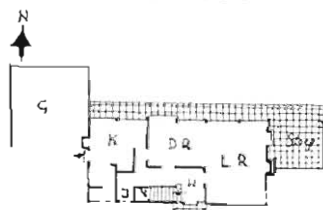

GROUND FLOOR PLAN

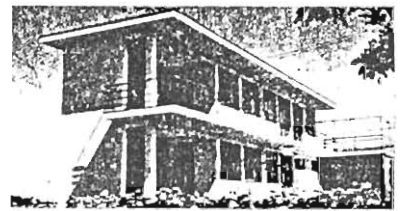

FIG. 29 House by A V Nunn with Hellmut Stauch. Published in an article on Johannesburg and its environs in the *Architectural Review* of August, 1940, this house shows basic similarities to those designed by Stauch while he was still in Germany.

concerning their correctness. In contrast to this, however, four years later the South African Architectural Record published the same block of flats (Marchie Mansions) under the same credit, only to apologise for this in the following issue stating that at the time Stauch had not been Nunn's associate but his assistant (South African Architectural Record November, 1944, pp 279 - 283 and December, 1944)

5.3 Projects

Hochstetter House was unique in that it was probably the first building in Pretoria, if not South Africa, to express totally the concrete frame and infill panel of which it was constructed. It was modular in design, well proportioned and precisely detailed.⁽⁶⁾ Unfortunately, this building was recently demolished and replaced with one of higher bulk. (figs. 30 and 31).

Marchie Mansions was more fortunate; it has survived the wreckers' ball and the passage of time has left it in singularly good condition - largely the result of thoughtful and practical detailing. (figs. 32 to 36).

As well as these two projects his work covered mainly domestic architecture, schools, office buildings and flats (Herbert, 1975, pp 151, 152, 153). And he was interested in projects other than those in the practice, such as the Cape Town Foreshore scheme (fig. 37)

5.4 Contact with his family

For a long time Stauch had stayed out of touch with his family, but now that he was settled he travelled to their farm Dordabis, near Windhoek, to visit them. Typically, he gave them no warning of this visit, but on the way there turned over in his mind ways of surprising his father. Stopping at a garage en route he saw a particularly disreputable hat on one of the attendants, and insisted on buying it from the surprised owner. At Dordabis, he parked his car out of sight and walked up to the farmhouse, his head lowered, with the disgusting hat obscuring his face. August responded predictably, ordering the "stranger" off his farm. Only then was the hat discarded, and the joke enjoyed by father and son.⁽⁷⁾

5.5 Sailing in South Africa

During this time he had by no means confined his interests to

6. Van Wyk, Jan, M.I.A., Ex-student of H.W.E. Stauch, 1984 - interview.

7. Krafft, Mrs Marianne, Sister of H.W.E. Stauch, 1984 - interview.

This block occupies an important frontage in one of the main streets of Pretoria. On the ground floor the whole site is occupied by shops which are planned round an open court. The first floor contains offices, and the remaining floors are planned as one room flats.

The construction consists of a R.C. frame, which is exposed on the main façade, and brick infilling. The floors are of concrete and the eill panels to the front balconies are faced with black terrazzo tiles. The steel windows are painted white and the sunblinds, essential for protection against the afternoon sun, are striped red and white.

27, main elevation to street. 28, looking from courtyard towards street.

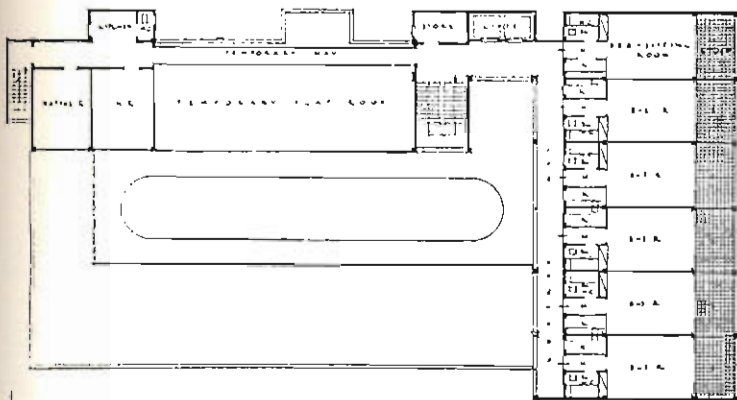

TYPICAL UPPER FLOOR PLAN

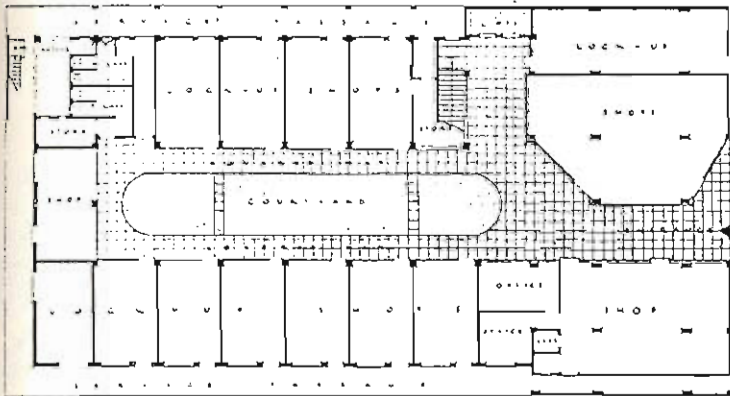

GROUND FLOOR PLAN

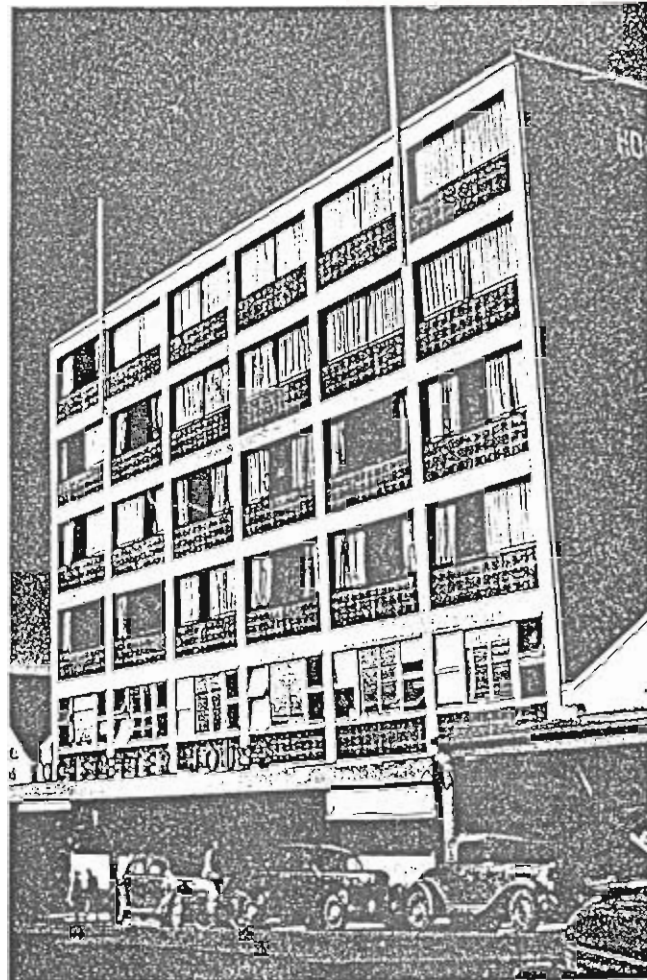

27



28

FIG. 30 Hochstetter House : from an article by Hugh Casson in the Architectural Review of June, 1953. This building's frame-and-panel was unique to Pretoria at the time and served as a model for architectural students, who were referred to it by their lecturers.



HOCHSTETTER HOUSE

The well-known firm of Hochstetter and Dierig (Pty.) Ltd., Estate, Insurance, Finance, Shipping and General Agents, established in 1902, is moving to their new building, Hochstetter House, 280 St. Andries Street, between Pretorius and Schoeman Streets, next to the Graud Theatre, at the end of this month. As will be seen from the architect's sketch, the building consists of six floors. It extends 150 feet to the rear and there will be shops and offices at the back built round a wide courtyard with a pleasant lawn in the centre. The first floor will be occupied as offices and the remaining four floors as flats. The architect is Aubrey V. Nunn and the contractors Messrs.

FIG. 31 Hochstetter House; perspective and view from South-West. Note the differing credits on the newspaper clipping and on the article on the previous page.



ARCHITECT: AUBREY VICTOR NUNN, A.R.I.B.A.

Programme: Eight flats, with garages, to be erected on a narrow, deep site facing north, and with a slight slope from south to north, in the residential area of Pretoria.

On the eastern boundary is an existing brick wall with the neighbour's outbuildings and yard at the back; on the western boundary, the owner's own residence and garden with rooms at the back.

Different schemes have been prepared. The first scheme, featuring one long, south-to-north block, facing east, was not satisfactory in view of the fall of the ground and the not too pleasant eastern aspect. After developing several alternative schemes, the one shown in this publication was decided on, and in practice proves this as being the correct solution. This consists of two separate units, the one placed behind the other, each containing four flats. The native rooms are on top of the garages at the back of the ground. The narrowness of the ground, together with the restrictions of the by-laws regarding the distance from the side boundaries, did not allow the planning of all the rooms on the north side. In view of this the best solution seemed to plan the living section, including balcony and stoep, broadly on the north side, and develop the rest towards the less restricted depth of the ground. The basement of each block contains the boiler. Coal is thrown through a chute from the car drive-in, which is on the east side.

A central staircase leads to the entrance hall of each flat. From here each flat is developed so as to separate the different functional groups. A direct door leads to the living room and, connected with this, the dinette, balcony and stoep. Another direct door leads to the kitchen and allows same to be reached without interfering with the other sections. The kitchen is fitted with electric stove, refrigerator, vegetable cupboard under working table and sink with draining board and plate rack attached.

Between the kitchen and dinette a cupboard is built in. At the height of the working table an opening is provided with sliding doors on each side, forming a smell-proof hatchway. This cupboard is fitted with various sized drawers to hold cutlery as well as smaller groceries. On the dinette side it contains a recess with sliding glass doors, making a special sideboard unnecessary. Shelves with doors opening both to kitchen and dinette make it unnecessary for the servant to leave the kitchen during meals, as the crockery, etc., can be taken out straight from the dinette.

It is felt that one of the biggest disadvantages of flats is the lack of freeness and of space for walking about apart from the space left after the rooms have been furnished. It is a big advantage if a room can be widely opened to the outside, as there is then no feeling of being shut in or cramped. Therefore, an arrangement has been adopted of an open balcony in conjunction with living-room, stoep and dinette. This gives that extra space to the living-room without interfering with stoep or dinette, which, if desired, can be formed into one big unit by a double glass door. A parapet wall on side and back of the stoep gives the necessary privacy, while a glass screen shelters it from wind and rain. Blinds have been provided to separate the stoep from the front balcony. This balcony, running along the full length of the north front, has another advantage: in winter time it allows the sun to shine right into the rooms, giving the necessary warmth, while in summer it affords shade and coolness.

The bedroom section is entered through a lobby containing a built-in cupboard for linen and clothes, with space on top for articles not in use. Bedroom and bathroom are entered from this lobby, which gives the necessary isolation of the bedroom section from the living section. A further deeper cupboard is provided in the entrance hall for storing suitcases, boxes, etc.

The flats on the ground floor have, in addition to the provided balcony space, small gardens in front, which can be reached by means of steps from the balcony. Garden space for use of occupants of the upper flats is provided between the two blocks.

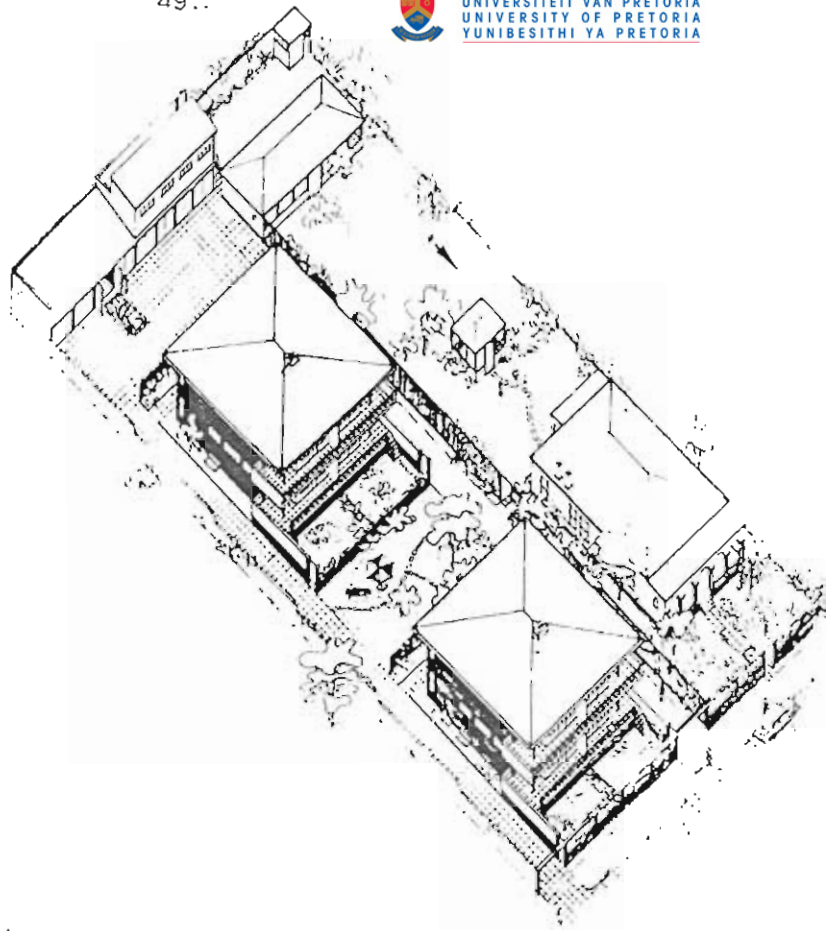

Marchie Mansions Pretoria. Architect Aubrey Nunn

The finish has been chosen with special attention to its durability. The outside walls, including the walls of the staircase, are finished in red face-bricks, the horizontal joints being pronounced. The balconies and eaves are painted white, while the walls under cover of the stoeps and balconies are finished in grey. The windows and external doors are painted white contrasted by the deep blue of the tubular railings and columns of balconies and staircases. The bathroom and kitchen are tiled the full height of the walls. All internal walls are treated in light cream, the ceilings and door frames in broken white, while doors and cupboards are finished in grey. This neutral colour scheme has been chosen so as not to clash with any colour brought in with the furniture of the occupants.

The same principle applies to the sizes and shapes of the rooms, which have been kept as neutral as possible, giving various different possibilities of placing the furniture, according to different individual tastes.

Contractor: W. Stretton (Pty.), Ltd.; reinforced concrete, Hunt, Leuchars and Heppburn, Ltd.; painter, Horak and Gravenstein (materials, Herbert Evans & Co., Ltd.); electric light, Pretoria Electrical Co.; ironwork, A. Wolff.

HELLMUT STAUCH.

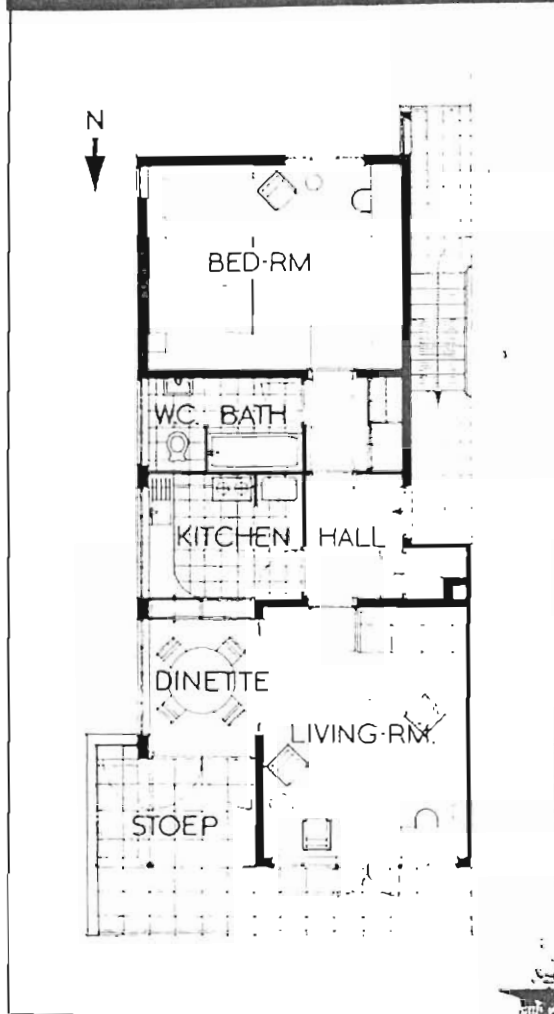

PART PLAN

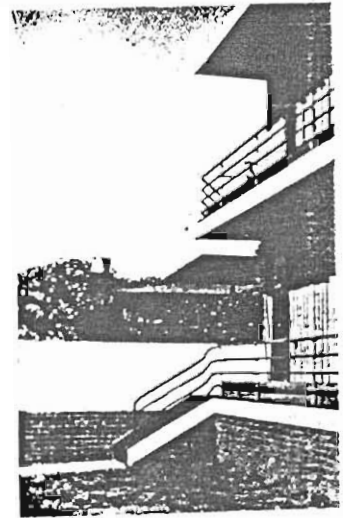

FIG. 33 Marchie Mansions, stage 1; plan of one flat unit and views from Schoeman Street.

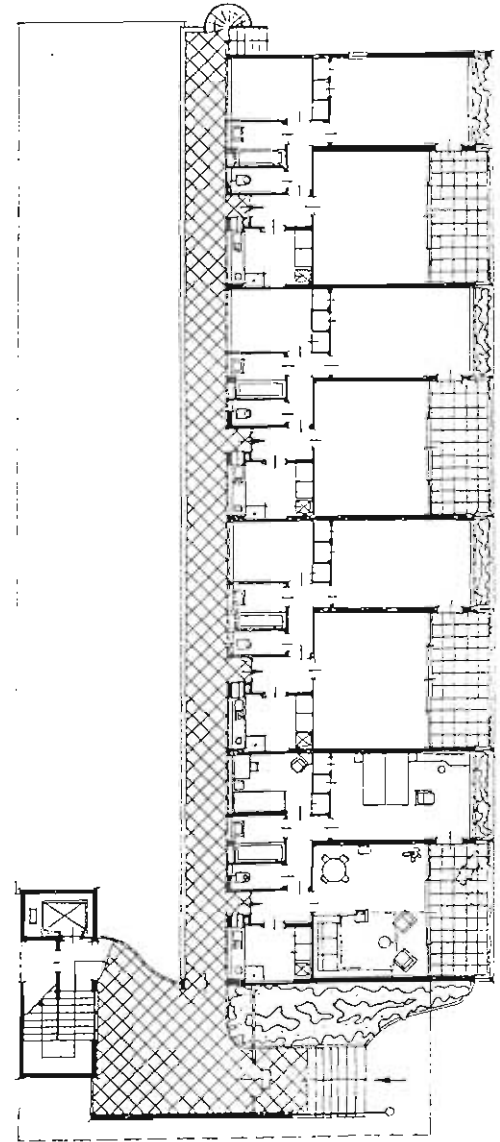
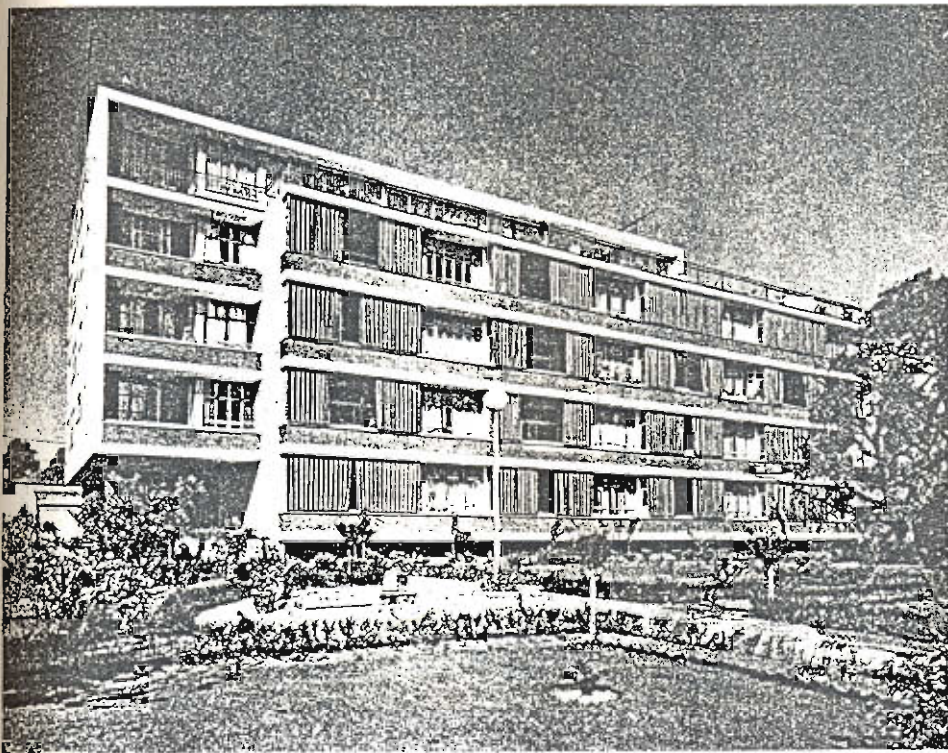

FIG. 34 Marchie Mansions stage 2; ground floor plan and two views of main block from Schoeman Street

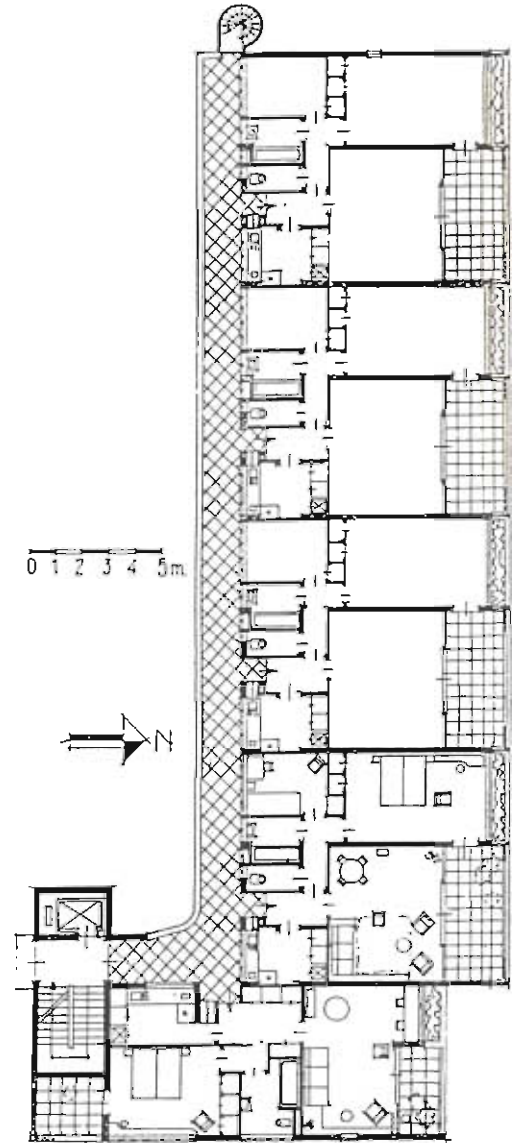
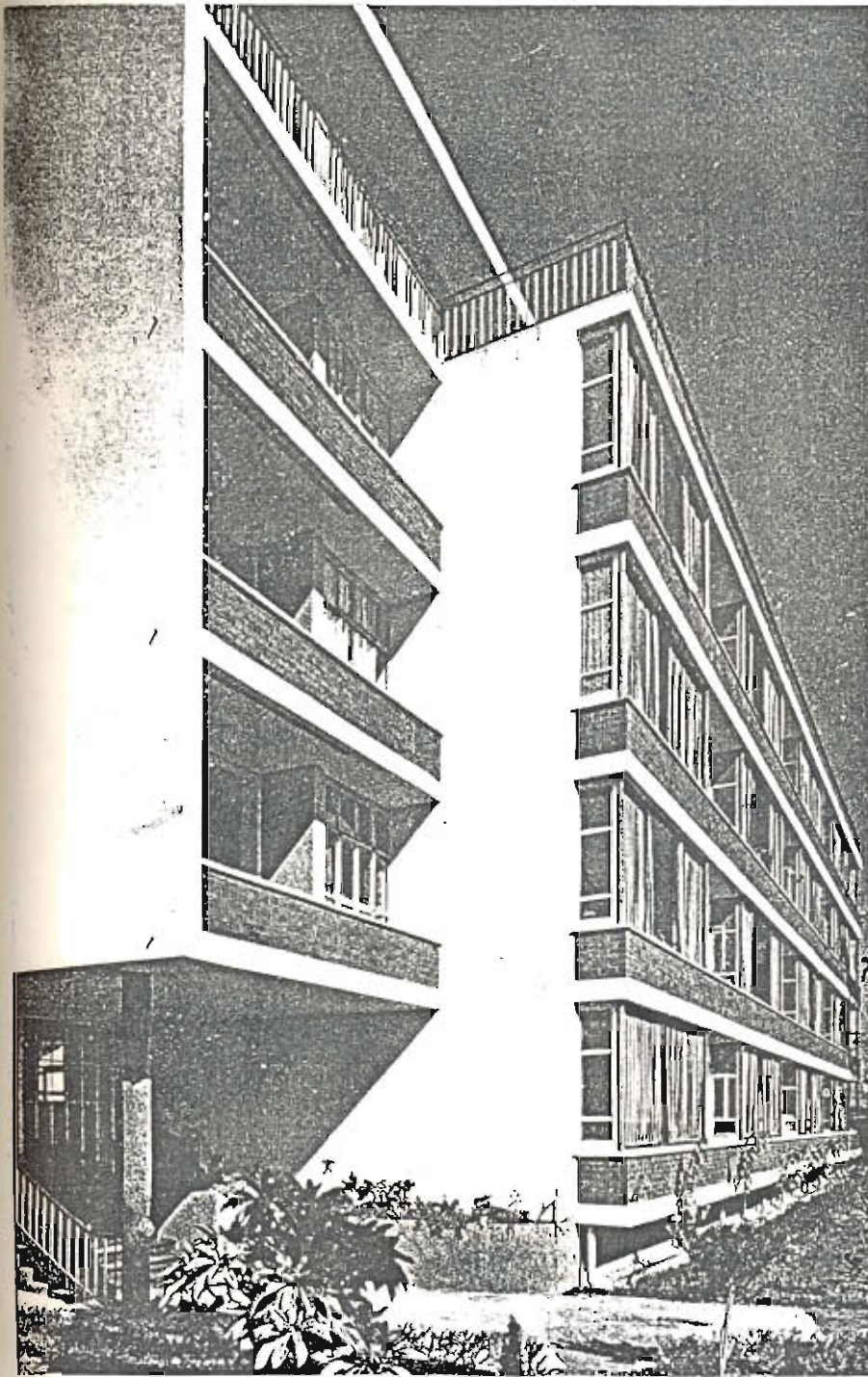
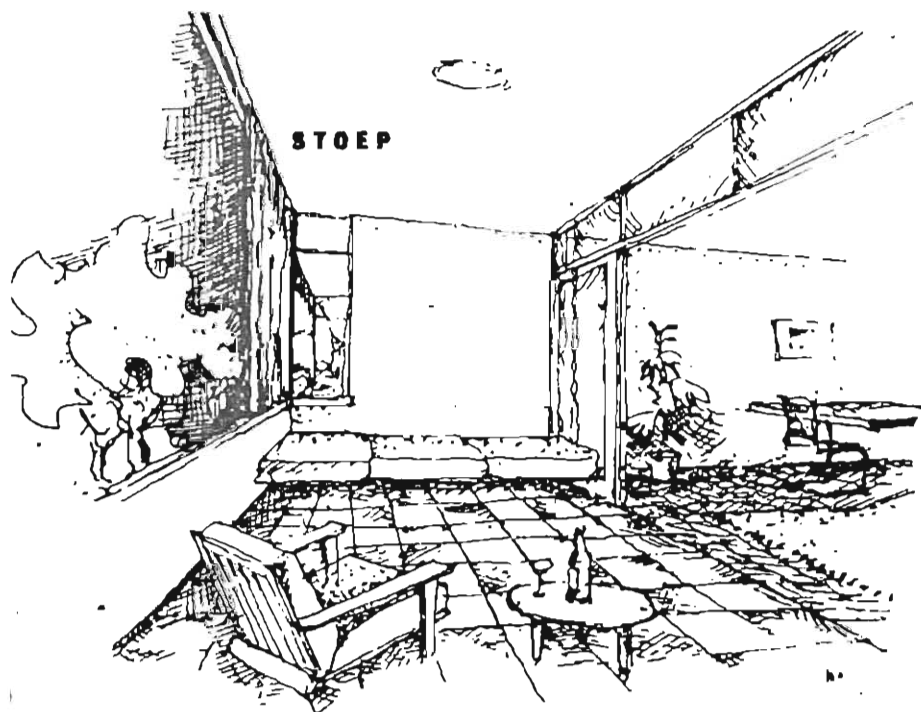
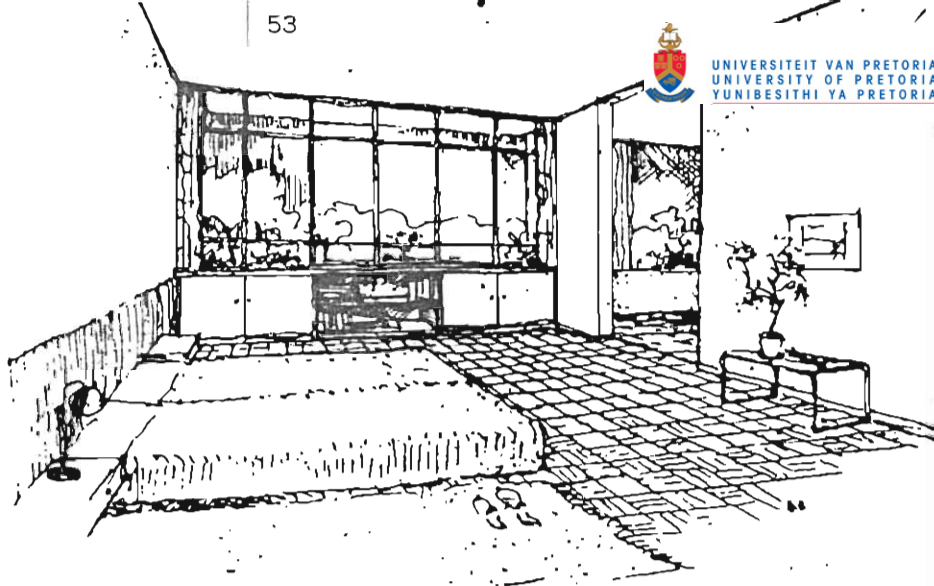

FIG. 35 Marchie Mansions stage 2; first floor plan and a view from the entrance at the North-East of the block.



LIVING ROOM

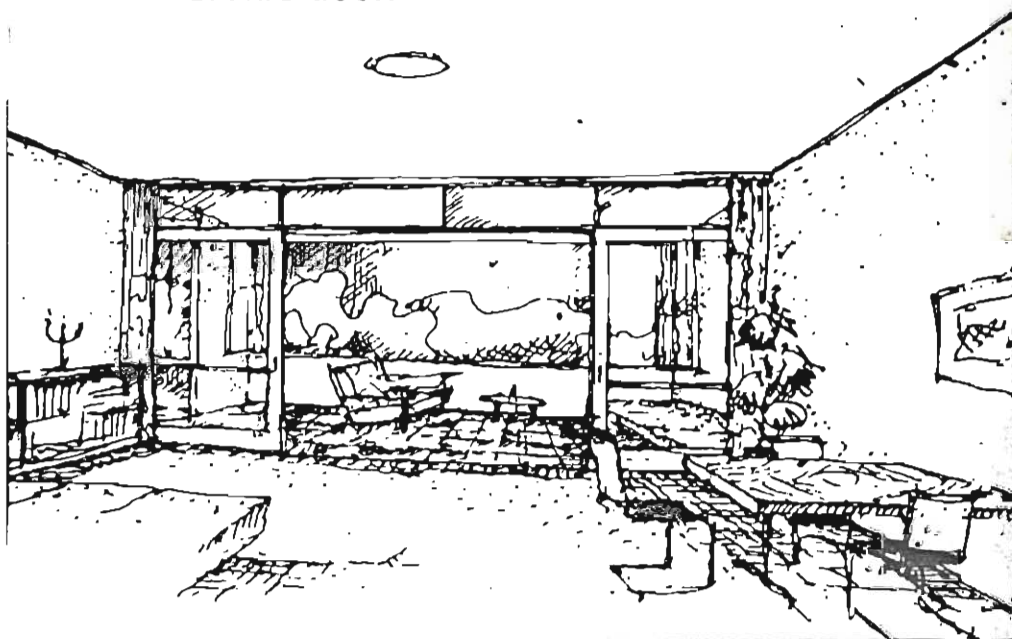
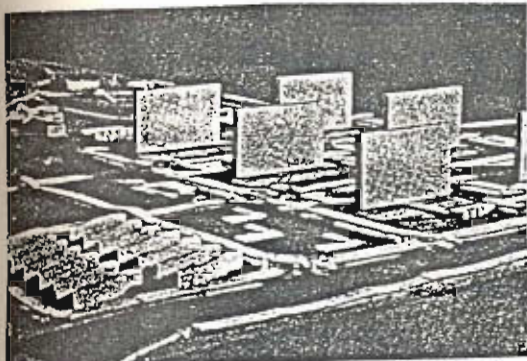
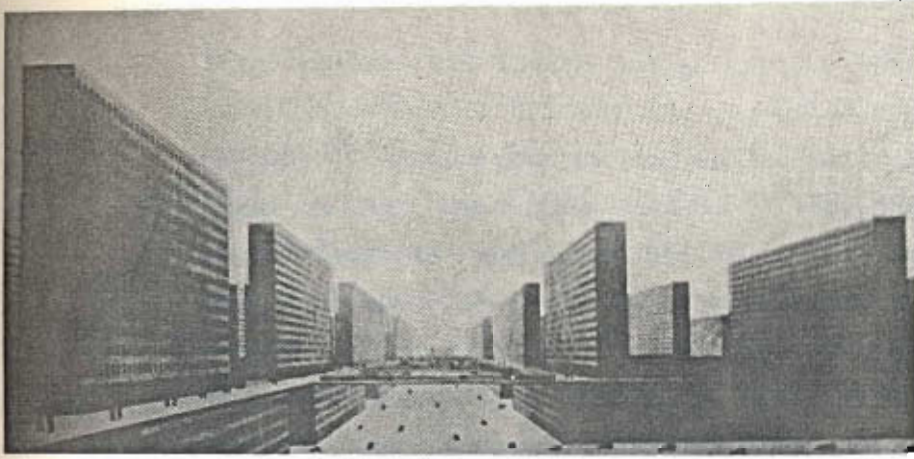
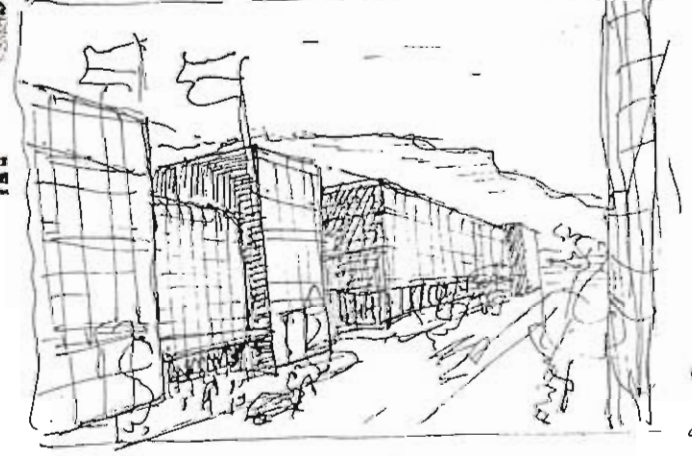
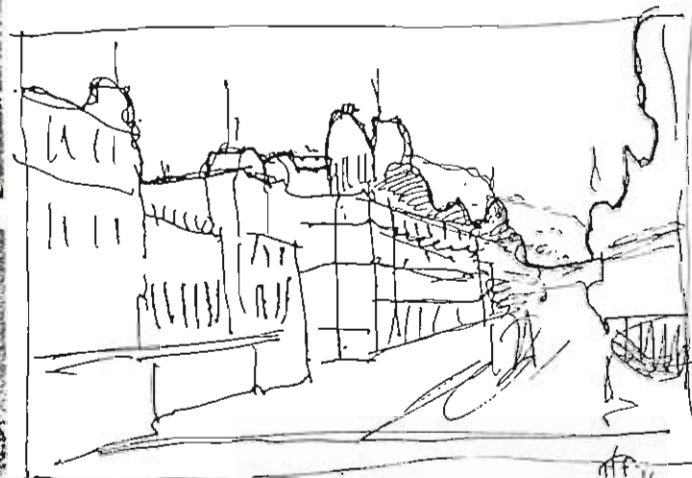
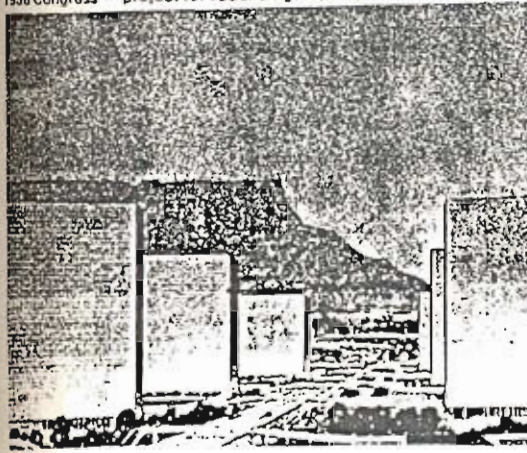

FIG. 36 Marchie Mansions stage 2; interior perspectives. These sketches show Stauch's "modular" approach to both structure and furniture, and the co-ordination of these.



1938 Congress — project for rebuilding Cape Town (SAAR 9/38)



Sollen wir mit-der 15
entwickeln (Wo bleibt
der Tafelberg, er
erd nicht?)

(Vaf 'Pretoria'
Wittley?)

Egerton
Adderley
Street:
(Die Hillside)

(Der Dächer sind
sinnlos auf
dieser Seite
aufgrund i. h. h.
Der st. j. zu h. h.
sind die gleich
von h. h. h.)

Der gleich
Mit ohne
Dächer, mit
den gleich,
etwa von h. h.
von h. h. h.
Der D. h. h.
S. j. j. j.

(Wo man sieht
h. h. h. h. h.
mit h. h. h. h. h.
h. h. h. h. h.
h. h. h. h. h.)

h. h. h. h. h. h. h.

FIG. 37 Sketches of Adderley Street, looking towards Table Mountain. In 1938 there was controversy and discussion on the development of Adderley Street, and an article was published in the journal of the Institute of South African Architects showing a townscape reminiscent of the above Bauhaus-designed cityscape from Wingler (1969). Stauch apparently had similar, Bauhaus-influenced views on Adderley Street, albeit a little less harsh.

architecture. His lively and gregarious character made him the centre of attention wherever he went. He was attractive to women and enjoyed their company.⁽⁸⁾ And he was sailing again, helping to bring the sport which he loved up from the earlier status of "the sport of princes", with all its implications of exclusiveness, to one which was affordable and popular and exciting. The first race he had won was at the age of twelve, on Wannsee, near Berlin.⁽⁹⁾ Now he embarked on what was to be a record-making sailing history in South Africa. Between 1948 and 1970 he was to win National Championships in the Finn, Flying Dutchman, Spearhead-Goodricke, Sprog and Sharpie classes; and Interclub contests in the Flying Dutchman, Sharpie, Spearhead and Twenty-Footer classes (Hocking, 1972, pp 31, 35, 39, 40, 70, 205, 207). It seemed that he could sail anything. An envious competitor, having lost a race to him at Hartebeespoort, was overheard saying "if you gave that man a tennis-shoe with a handkerchief for a sail, he'd win races in it".⁽¹⁰⁾ There was a keen and rapier-like competitiveness about Stauch, together with single-minded concentration and total determination to win, and this was not confined only to his sailing.⁽¹¹⁾ He was to become a Springbok yachtsman, representing SA at the Olympics in Helsinki and Rome and at the Internationals in Cascais. The first of his South African trophies was the Dewar Congella Shield, which he won in 1938 sailing the Twenty-Footer scow, "Rambler", at Hartbeespoort.⁽¹²⁾

5.6

Personal life

In 1941 Stauch, having led the carefree life of a bachelor for some seven or eight years, married again. René van Niekerk was an attractive clerk working as a clerk for a firm of solicitors, and for a time it seemed that Stauch would settle down to greater domesticity, but the following year the marriage ended in divorce and Stauch once more concentrated on working hard, playing hard, and sailing to win.⁽¹³⁾ He had built himself a house on erf 1461, 27th Avenue, Villieria, which was one of 10 erven purchased by him in 1939, (see addendum A) but during his

-
8. Consensus in nearly all interviews.
 9. Statement by Stauch in curriculum vitae (undated) submitted to Architect and Builder to accompany an article.
 10. Overheard by the author at Transvaal Yacht Club.
 11. Consensus in nearly all interviews.
 12. Personal records in Stauch Vorster archives.
 13. Vorster, Mrs Tosca, step-daughter of H.W.E. Stauch and Thoms, Pulli, sister-in-law of H.W.E. Stauch, 1984 - interviews.

marriage he lived in a house in Servaas Street in West End which he owned from 1941 to 1942, while the Villieria house was let.⁽¹⁴⁾ But now there was a major change in his life. At a party with friends, his centre-of-the-stage party games - he would invariably do handstands, play the piano and behave like the born entertainer he was, keeping the other party-goers in fits of laughter - bewitched Carmen Kohly, then married to Bram Hoffmann, who was to become his wife and who was the only woman who could cope with his complex personality and unusual approach to life. Coincidentally, she was the mother of a seven-year-old daughter, Tosca, whose birth Stauch had helped to celebrate on the first day he spent in Pretoria.⁽¹⁵⁾

5.7

Application for Registration with the Institute of Architects

Nunn and he were firm friends as well as associates and spent a fair time together during the eight years up to 1942. During this time, Nunn had urged him to register with the Institute, and eventually in August 1942 he wrote to them, applying for registration, stating that Nunn's firm might close down and adding that through a physical disability he was not eligible for military service and might have to practise on his own.⁽¹⁶⁾ In support of his application he sent copies of published work and stated that several members of the Institute were willing to give their recommendation that the application be accepted. Early in February 1943 he received notification from the Institutes Board of Education that he would be exempted from the First, Second and Third Year examinations, and would be admitted direct to the Final Year examination for the Certificate in Architecture. The Board also suggested that he write this examination at the end of 1944, implying the necessity for a full two-year study period. They also asked him to nominate whether he would write the examination at the University of the Witwatersrand or at the University of Pretoria where the Architectural Faculty had recently been established.⁽¹⁷⁾

Stauch could not have been pleased with this reply to his application which arrived only a few days before he left the employ of Nunn, at the end of February 1943, for he ignored it for a full 14 months.

14. Correspondence with the Receiver of Revenue (1952.12.24).

15. Thoms, Mrs Pulli, Sister-in-Law of H.W.E. Stauch - interview.

16. Letter to Institute of South African Architects (1942.08.13). No further details concerning the date when Nunn ended his practice or Stauch's physical disability were found.

17. Letter from Institute of South African Architects (1943.02.04).

He did not, however, allow this apparent set-back to influence his move. As early as 1938 he had been "moonlighting", earning in that year £22.7.6 for an unnamed number of projects, and now he was committed to the 15 projects which he completed during the 1944 financial year. There is no record of the nature of these projects but from subsequent records and from financial statements it would seem likely that they were almost exclusively residential, some new projects and some alterations or additions.⁽¹⁸⁾

From 1943 to 1951 Stauch lived at Kiepersol, a farm which he had acquired at Kameeldrift, (fig. 38) with Carmen whom he married in 1945, and her daughter Tosca.⁽¹⁹⁾ He also retained his interest in furniture design. (fig. 39), (see addendum B). At the same time as establishing his new practice, he was building a house for himself and one for his manager, sinking boreholes and constructing dams, erecting fencing and building a tennis court, sailing competitively at Hartbeespoort Dam every weekend, and entertaining informally but unstintingly almost every evening. In between this frenetic activity, Carmen taught Stauch to ride, shouting instructions to him as she rode her bicycle next to him. Later, they enjoyed riding together every morning, although Stauch never learned to post but rather bounced his way along the bridle path at a brisk trot, happily maintaining that this was very good for the kidneys.

In this year Tosca was enrolled in Grade I at the Diocesan School for Girls, but after a year of arriving at school at any time up to noon, depending on what Stauch, who had no sense of time whatever, had been doing until then, the school suggested that she become a boarder. This was a great relief to everyone, and her schooling became more conventional, although punctuated by the customary weekends of sailing and entertainment.⁽²⁰⁾

5.8 The beginning of a private practice

He rented offices from the Johannesburg Building Society, at 5 Central Chambers until November 1944 and then moved to RSE Chambers.

The offices in Bureau Lane were unique. It was a down-at-heel two-storied building with open balcony access to the offices. At the end of the first-floor balcony and next to Stauch's office was, reputedly, a

18. Financial records : Stauch Vorster archives.

19. Ibid

20. Vorster, Mrs Tosca, Step-daughter of H.W.E. Stauch, 1984 - interview.

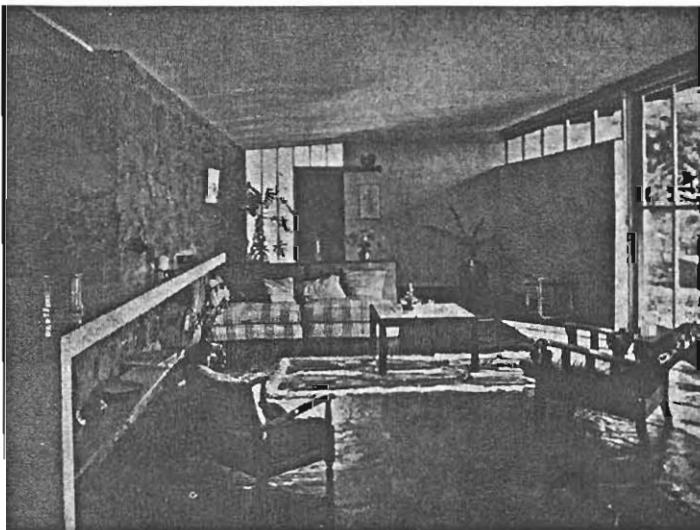
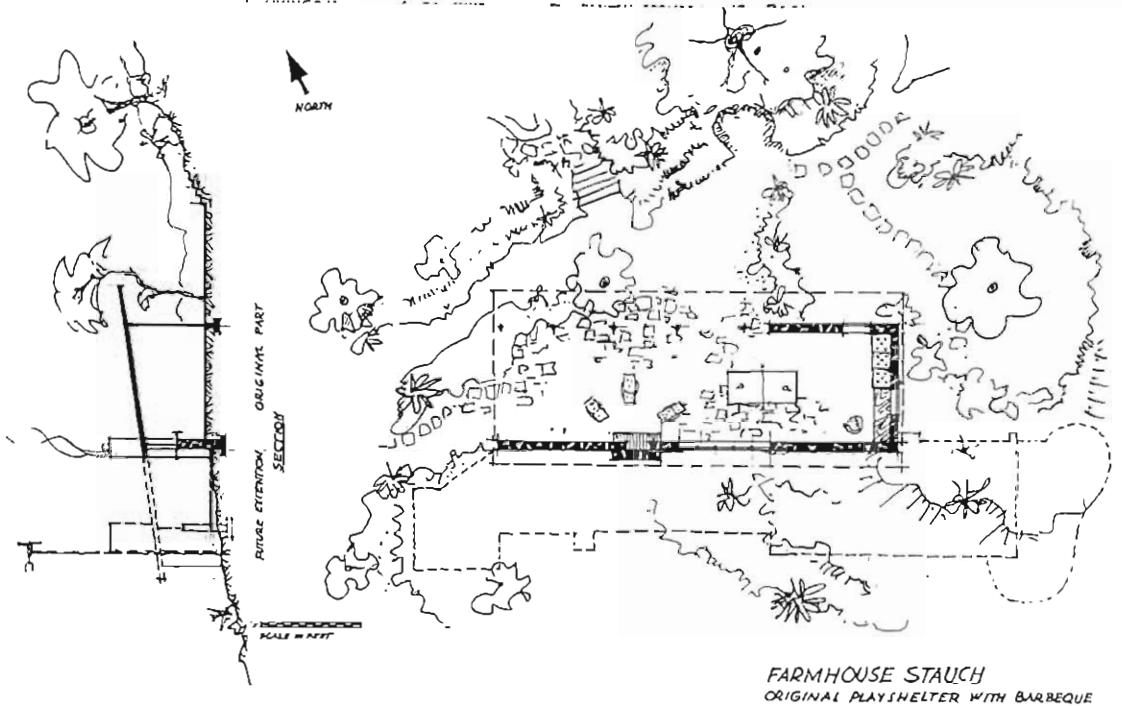
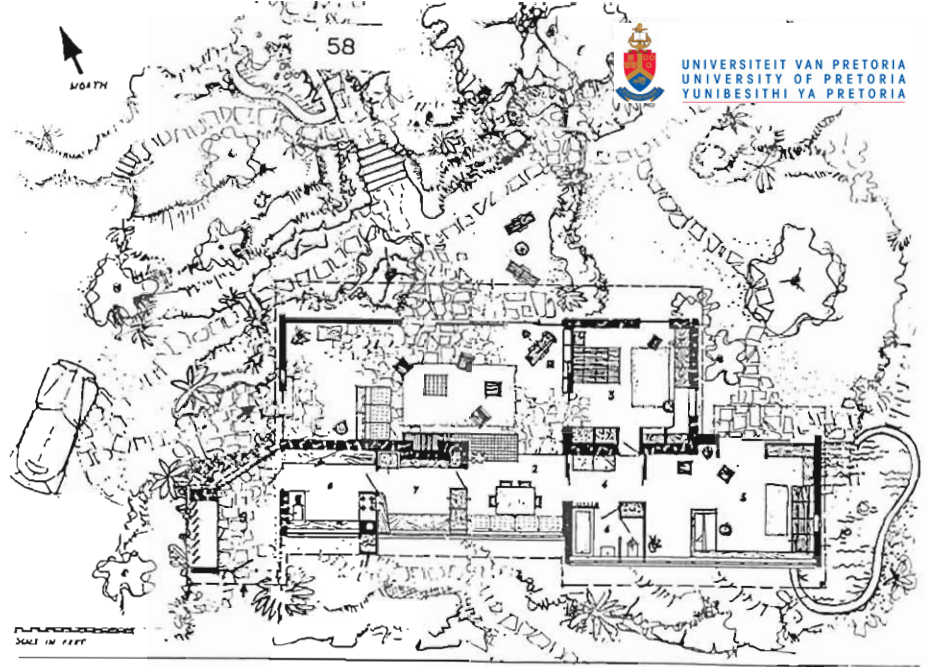

FIG. 38 "Kiepersol" - the farm house which Stauch built for himself at Kameeldrift, East of Pretoria.

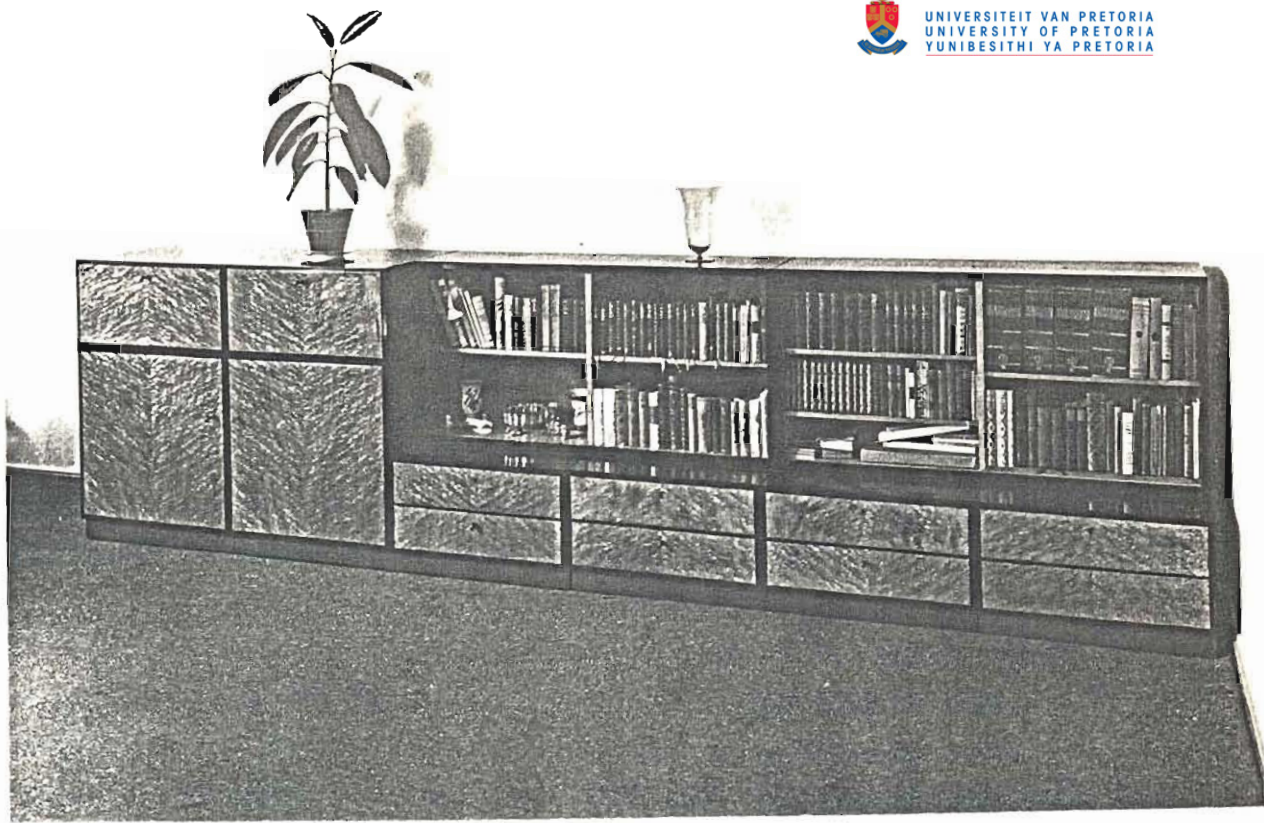

FIG. 39 Study of modular furniture. Stauch's interest in this issue continued and was considered to some extent in each of his projects.

brothel.

Stauch's secretary, Pulli Thoms, was not kept too busy as a secretary so she filled in time doing leatherwork and a little draughting. Because of Stauch's frequent lateness in the mornings - he so enjoyed his farm and the horses and dogs and cows that he did not always get to the office before ten or eleven - she also learned to keep clients happy when they telephoned at such times.

One of Stauch's traits was to make a friend of each client, and these friendships generally endured, even though at times there would be irritable telephone calls about forgotten details.

On one occasion he had reluctantly agreed to design chairs for a client and after having delayed this for a long time he rushed into the office one morning, having apparently made an appointment to give her the drawings, designed the chairs in short order and handed them to her with a flourish when she arrived a few minutes after had had completed the drawings.⁽²¹⁾

5.9

Qualification

After a delay, on 20th April 1944 Stauch again wrote to the Institute of South African Architects. This time he persisted, writing his examination at the Pretoria School of Architecture at the end of 1945 and receiving official notification of acceptance and registration on 1946.01.14.

21. Thoms, Mrs Pulli, Secretary to H.W.E. Stauch - interview.

CHAPTER VI - PRETORIA 1946 TO 1952

6.1 The Pretoria School of Architecture

The Pretoria School of Architecture under Prof. A L Meiring became an independent establishment in 1942. Initially it was staffed by Witwatersrand University graduates, until local staff became available, and Afrikaans became by degrees the language of tuition. The school tended to discard the teaching of le Corbusier in favour of those of Niemeyer, Wright, Stauch and Eaton and inclined towards a "get-down-and-draw" approach with reduced emphasis on design philosophy (South African Architectural Record, 1965, p 45. Article on Personalities of the 30's working today).

Stauch joined the staff of this four-year-old school in 1943 as a lecturer on design for an eight-year period.⁽¹⁾

As a lecturer he tended to approach the teaching of design on a one-to-one basis, coming quietly into the studio and discussing individually with each student the work on his board. It was an encouraging and positive attitude which brought out the best in each, stimulated the imagination and broadened the approach without losing sight of practical considerations. He did not deliver formal lectures to groups of students, as far as anyone can recall.⁽²⁾ He had the ability to see immediately the weak point in a drawing - not just the trained eye, but also the understanding and discipline to recognise the essential and discard the non-essentials⁽³⁾ - and in dealing with his students would in the same way locate the good points of a poor design and encourage them to build on these.⁽⁴⁾

6.2 Partnership with F J Wepener

Before 1948 Stauch had moved his office to Hochstetter House to cope with a growing practice, still mainly in the housing field,⁽⁵⁾ and was looking for a partner to assist him. At the time, Wepener had been senior

-
1. Personal curriculum vitae by H.W.E. Stauch for issue to various magazines, kept with Stauch Vorster staff records.
 2. Interviews - Jan van Wyk, G.T. Fagan, T.J.R. Scholtz, 1984 and personal observation of the author.
 3. Wepener, F.J., Ex-partner of H.W.E. Stauch, 1984 - interview.
 4. Interviews - Jan van Wyk, G.T. Fagan, T.J.R. Scholtz, 1984 and personal observation of the author.
 5. Stauch Vorster project records and archives.

architect in charge of housing for ISCOR at Vanderbijlpark, with Ross Gildenhuis as his assistant. Not liking the job much, he left to work for an architect in practice there. He had met Stauch in 1936 when he was a student, and when Gildenhuis told him of an opening for a partner in Stauch's firm, he got in touch with Stauch, and joined the firm in 1948.⁽⁶⁾

In the three to four years that the partnership between Stauch and Wepener lasted, a number of commissions came its way; the post-war boom combined with a shortage of Afrikaans-speaking architects in Pretoria, a predominantly Afrikaans speaking city, helped to encourage the growth of the firm (South African Architectural Record, 1965, p 45. Article on Personalities of the 30's working today). The partnership produced some good and interesting work, much of which was published, amongst the most well-known of these being the houses for A E Wooll, Dr. Glen, van der Merwe, von Wielligh and D Marriott. (figs. 40 to 43). With the confidence born of consistent success, Stauch would draw out, ready for publication, all the house plans he did.⁽⁷⁾ Three typically compact houses designed during this time were for Anderson in Colbyn, Thom in Waterkloof and L Gillett in Pietersburg. During the period October 1948 to December 1951 no fewer than 90 houses and 20 other projects are listed in the records of Stauch Vorster, varying in scope between small alterations and large (for those times) office blocks, with a few blocks of flats included.

Stauch was good at detail and rational in approach. But, surprisingly to Wepener, he was not completely rational but also had an artistic approach, wilfully doing things just because he wanted to.⁽⁸⁾

He would constantly change the design and detail of his buildings, right up to the time of their completion, searching constantly for perfection in the same way that poets and writers search.⁽⁹⁾

He was not as irrational as Eaton, who was more an artist than an architect, and he was more sure of himself than Fassler and Gordon MacIntosh and even Martienssen. But he did not have their integrity. He accepted no rules, not even his own agreements, and this was a factor leading to the eventual dissolution of the partnership.⁽¹⁰⁾

6. Wepener, F.J., Ex-partner of H.W.E. Stauch, 1984 - interview.

7. Ibid

8. Ibid

9. Ibid

10. Ibid

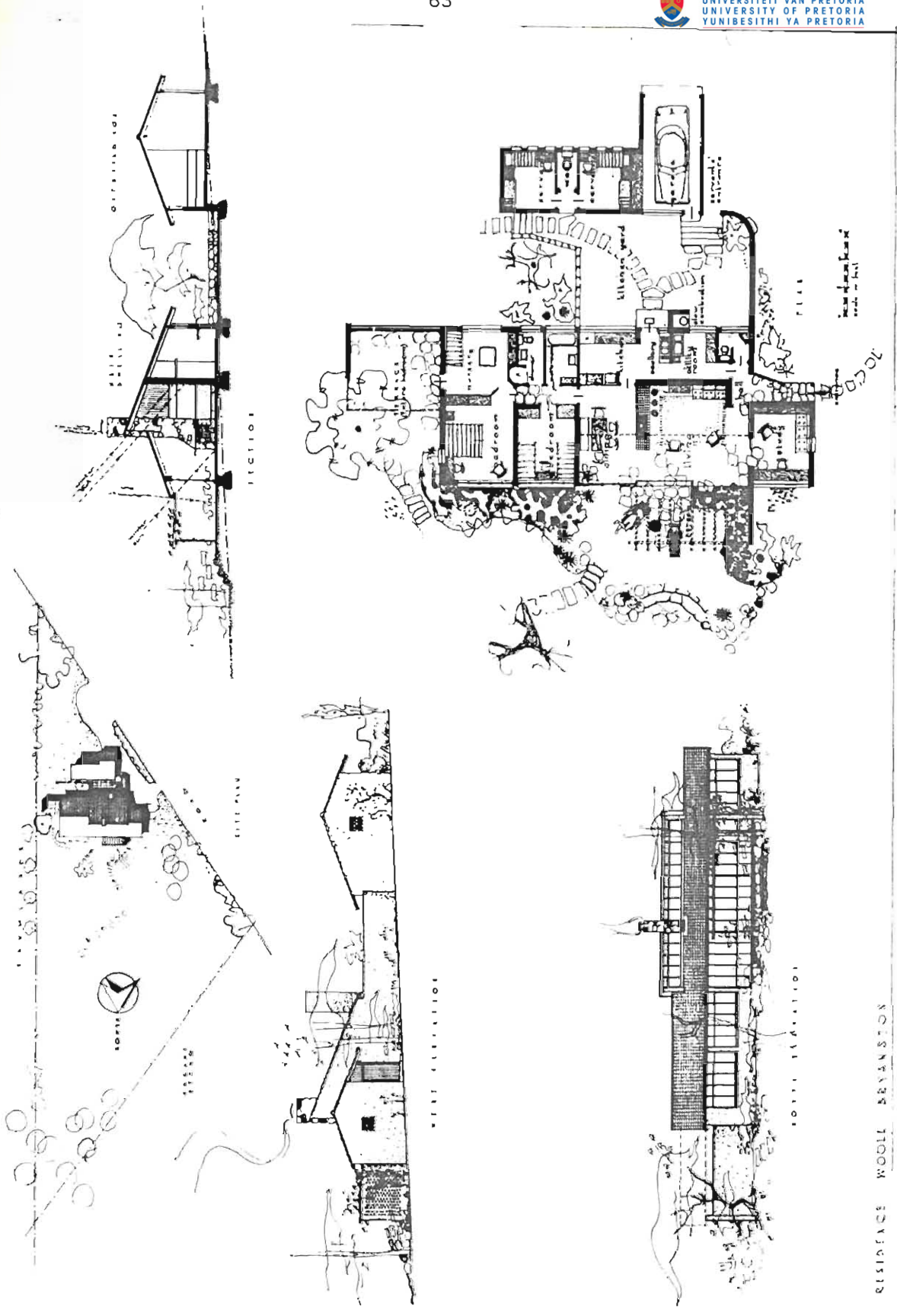

FIG. 40 House Wooll, Bryanston : Stauch and Wepener. This house, together with two other houses, for Marriott in Sandton and van der Merwe in Pretoria, were much published and are good examples of the character of the housing being produced by the partnership.

S T R E E T

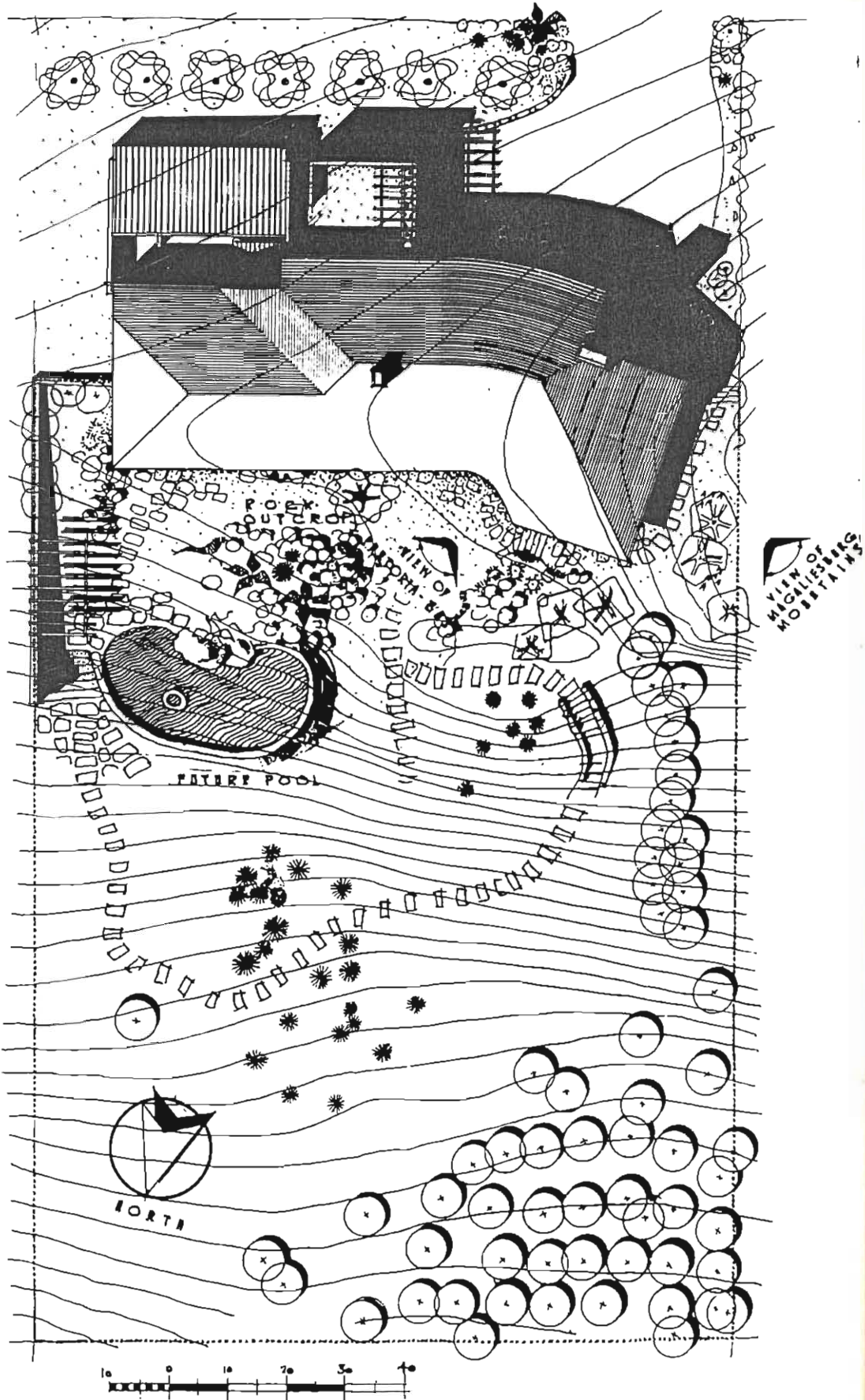

FIG. 42 House for Dr. Glen : site layout. The house plan is angled to enable the sloping site to be used to advantage, and the roof accommodates this with a firm but sweeping line.

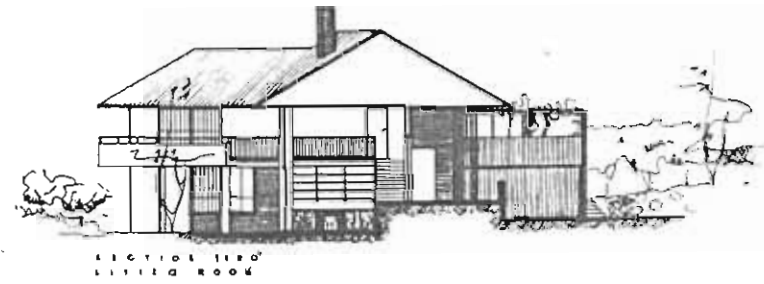
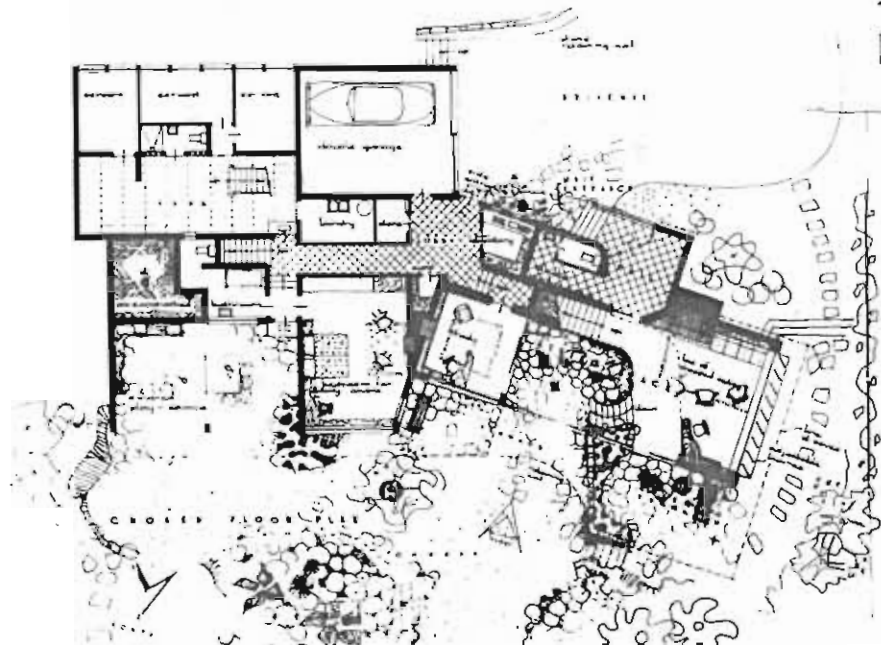
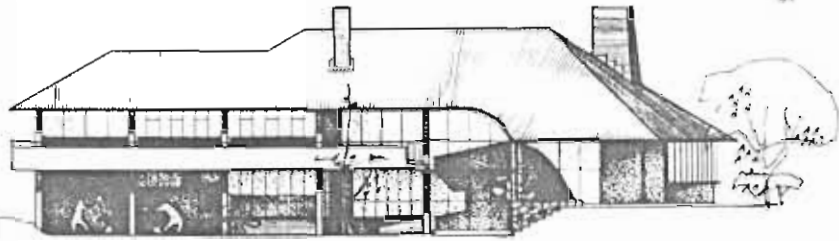
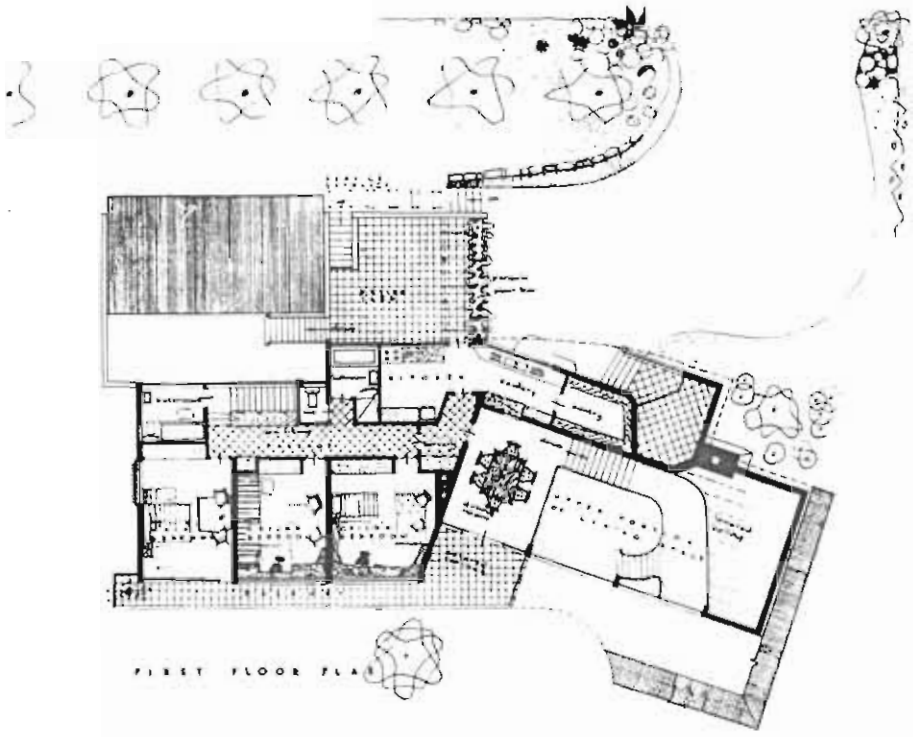

FIG 43 House for Dr Glen : plans, elevations and sections.

About a year after Wepener joined him, he went on a boat trip to Rio de Janeiro with the main intention of meeting Oscar Niemeyer and seeing his work. On this trip he met and became friendly with the then Minister of Posts and Telegraphs, J F (Tom) Naude, and this was to lead to a number of commissions in the Northern Transvaal which was "Oom Tom's" constituency. The most valuable of these was the Pietersburg Post Office, (fig. 44) and he re-opened the Pietersburg branch of his practice to service this project.

His visit to Niemeyer surprised him in many ways. Although he had a deep admiration for the South American architect, Niemeyer's disregard for such practicalities as whether or not the roof leaked came as a shock to Stauch. But Niemeyer's emphasis on aesthetic values appears to have appealed to him strongly; it was to a large extent dominant in his own architectural philosophy.⁽¹¹⁾

When, shortly after his trip, he was commissioned for the Meat Board Building, the Niemeyer influence was clear. His design for this building aroused a great deal of interest. Writing on the architecture of Johannesburg and environs, Nikolaus Pevsner discussed the lagging behind (in architectural character) of public buildings in general and went on to say "As for the public buildings a similar change is perhaps imminent. There is at least one extremely encouraging case. To design the new building for the National Meat Board a private architect H W E Stauch, was commissioned (telegraphic address: Bauhaus, Pretoria), and the result is excellent ..." (The Architectural Review, June, 1953). At least seven leading architectural magazines⁽¹²⁾ published full articles on the building, students in South Africa made a point of visiting it and its impact continued for years. (figs. 45 to 50)

6.3

The growing practice

At this time Stauch recruited a number of assistants including W.P.J. (Porkie) Maartens, whom he sent to Pietersburg to handle the increasing workload there. In spite of having Maartens there as a deputy, he kept in close touch with his clients in the Northern Transvaal, and

11. Stauch's description of his discussions with Niemeyer, Stauch Vorster Seminar record 1969

12. Architect and Builder, September 1952, pp 54 - 61.
Public Works of South Africa, July 1951, REPRINT, pp 1 - 8.
Instituto Technico de la Construccion y del cemento, February 1956.
Bauwelt 25, 1954.06.21, p481 - 487.
Architectural Forum, February, 1953, pp 146 - 149.
Architectural Design, Vol.XXVI, 1956, pp 181 - 197.
The Architectural Review, June 1953
SAAR, September 1952, p 211 - 221

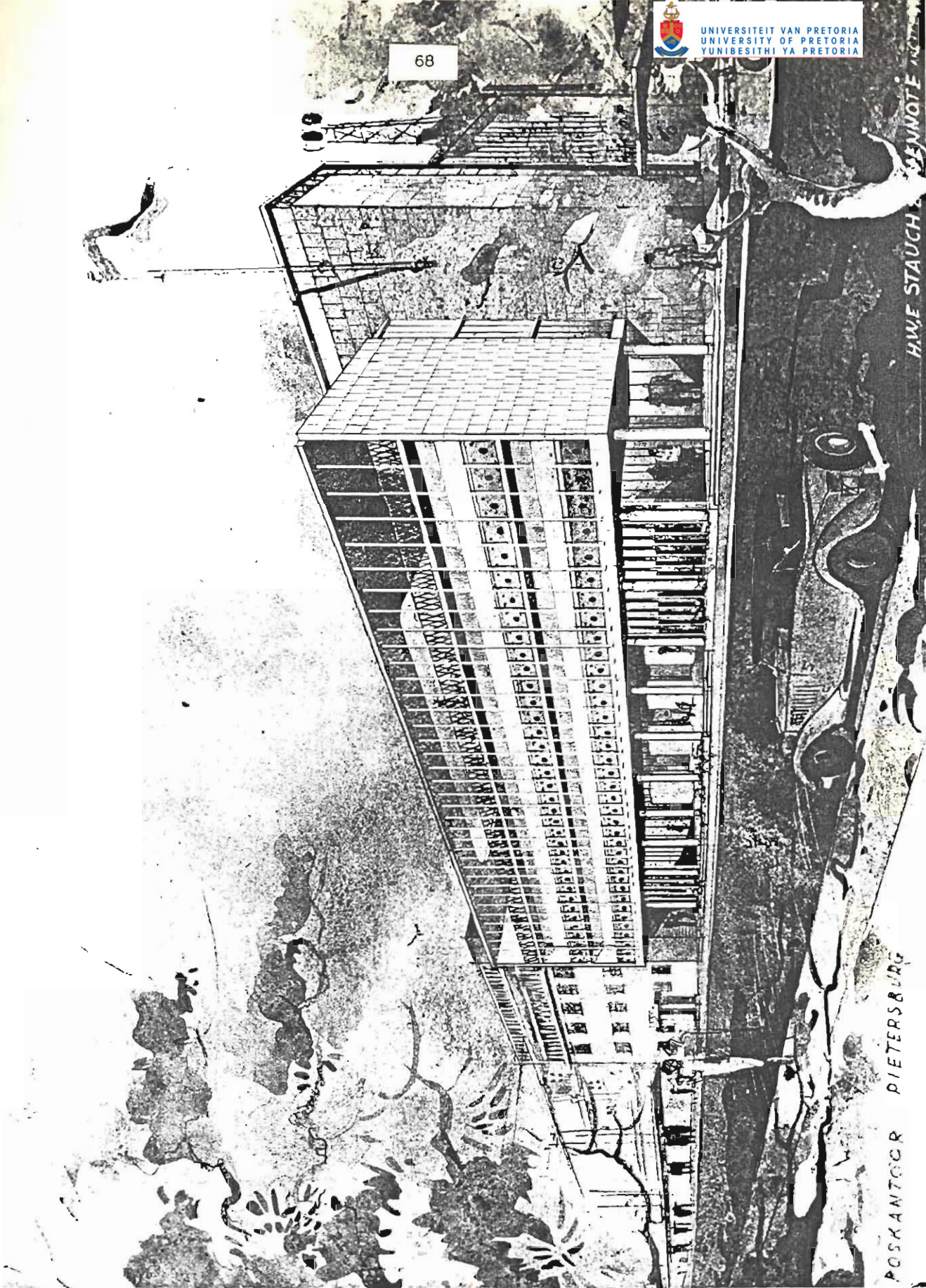
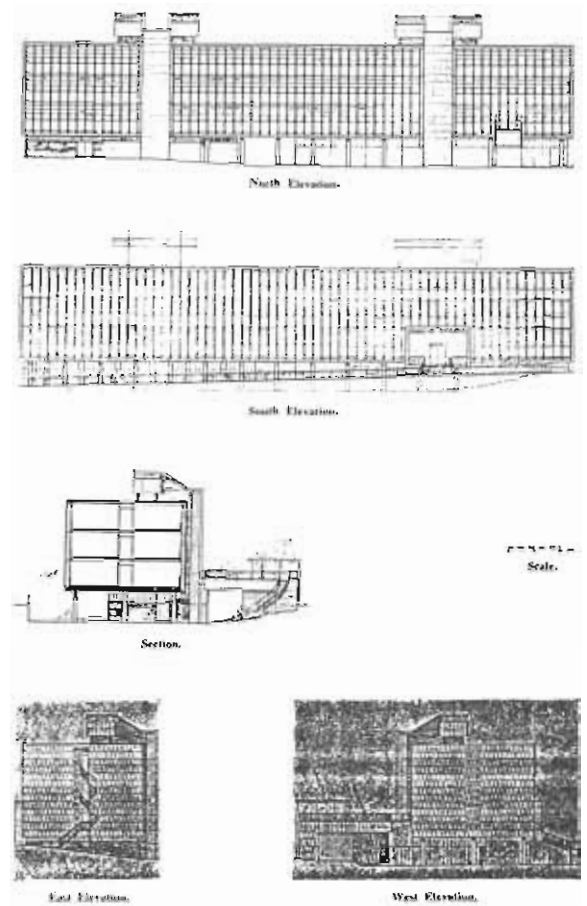
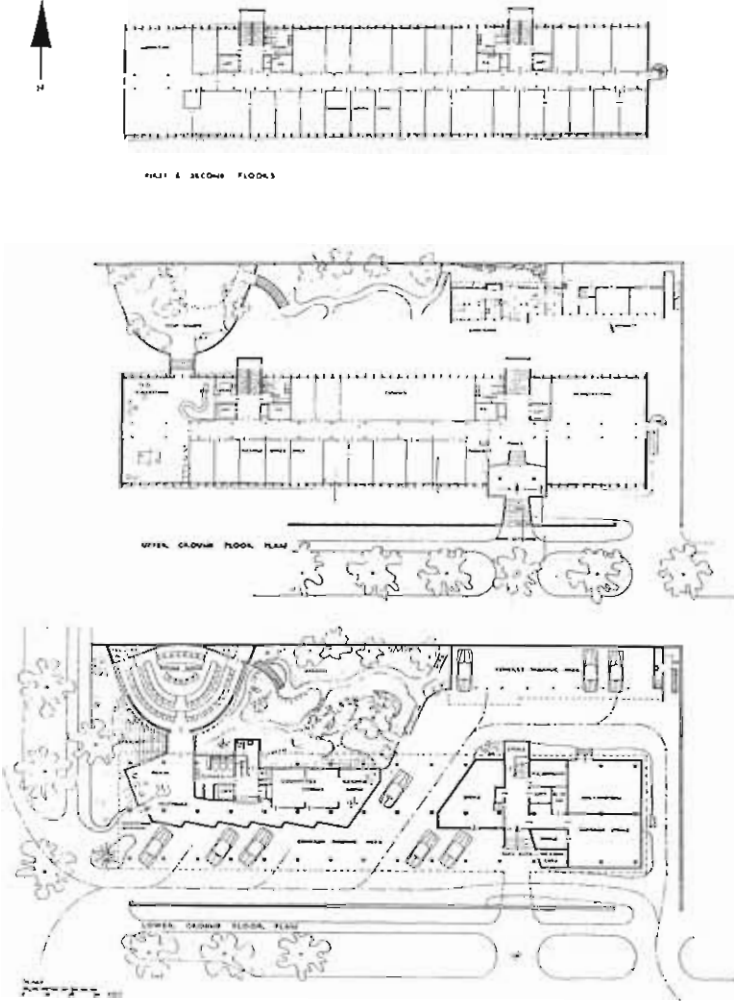
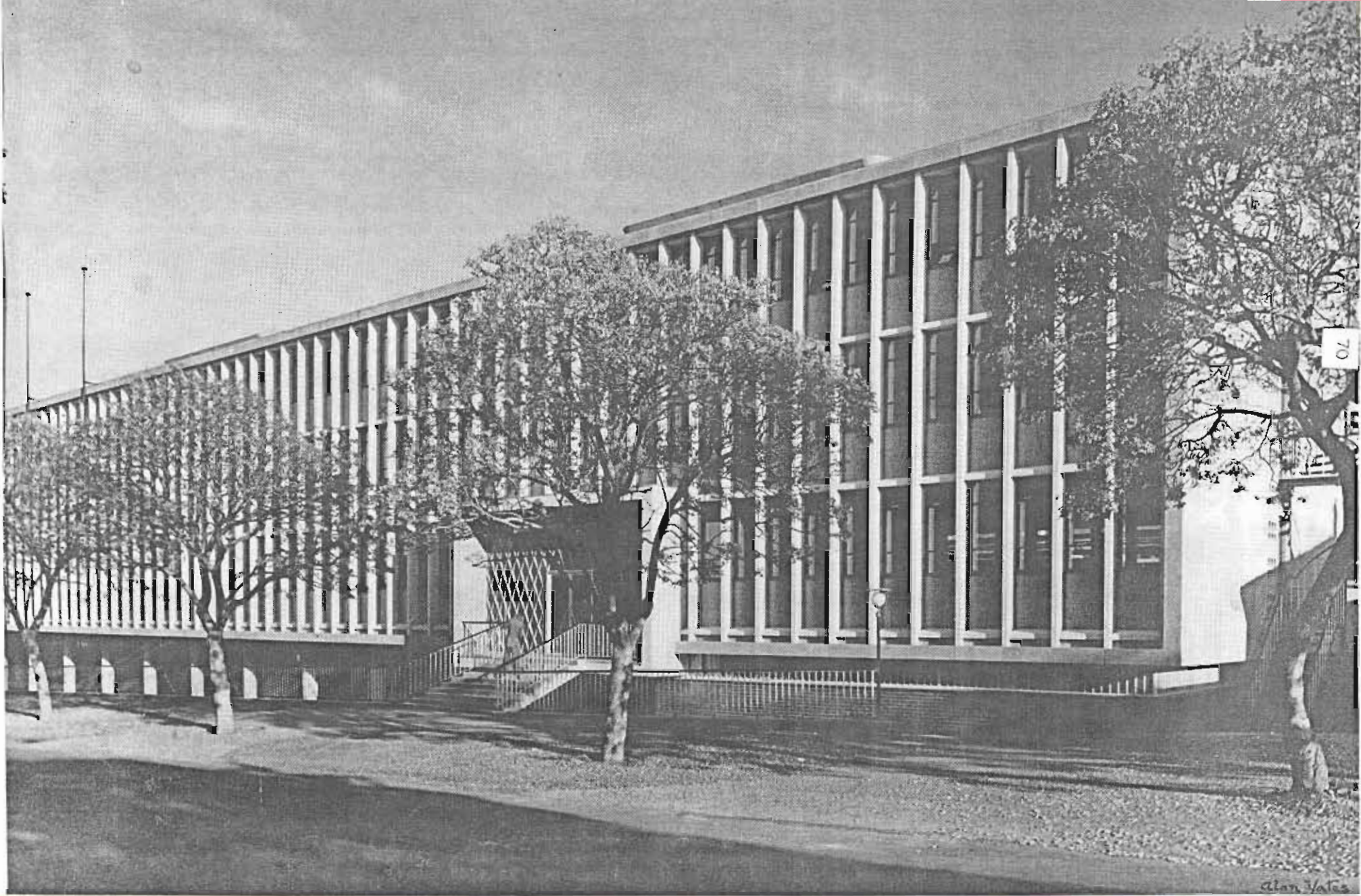

FIG. 44 Pietersburg Post Office. Sun-screening, the free-standing structure with non-structural free facade, and extensive use of mosaic - all new to Pietersburg at the time - are reminiscent of the Meat Board Building.

FIG. 45 Meat Board Building : plans and elevations, (Public Works of South Africa (July, 1951).



MEAT BOARD BUILDING — PRETORIA
Architects: H. W. E. Stauch & Partners



alan yates

FIG. 46 Meat Board building : view from street

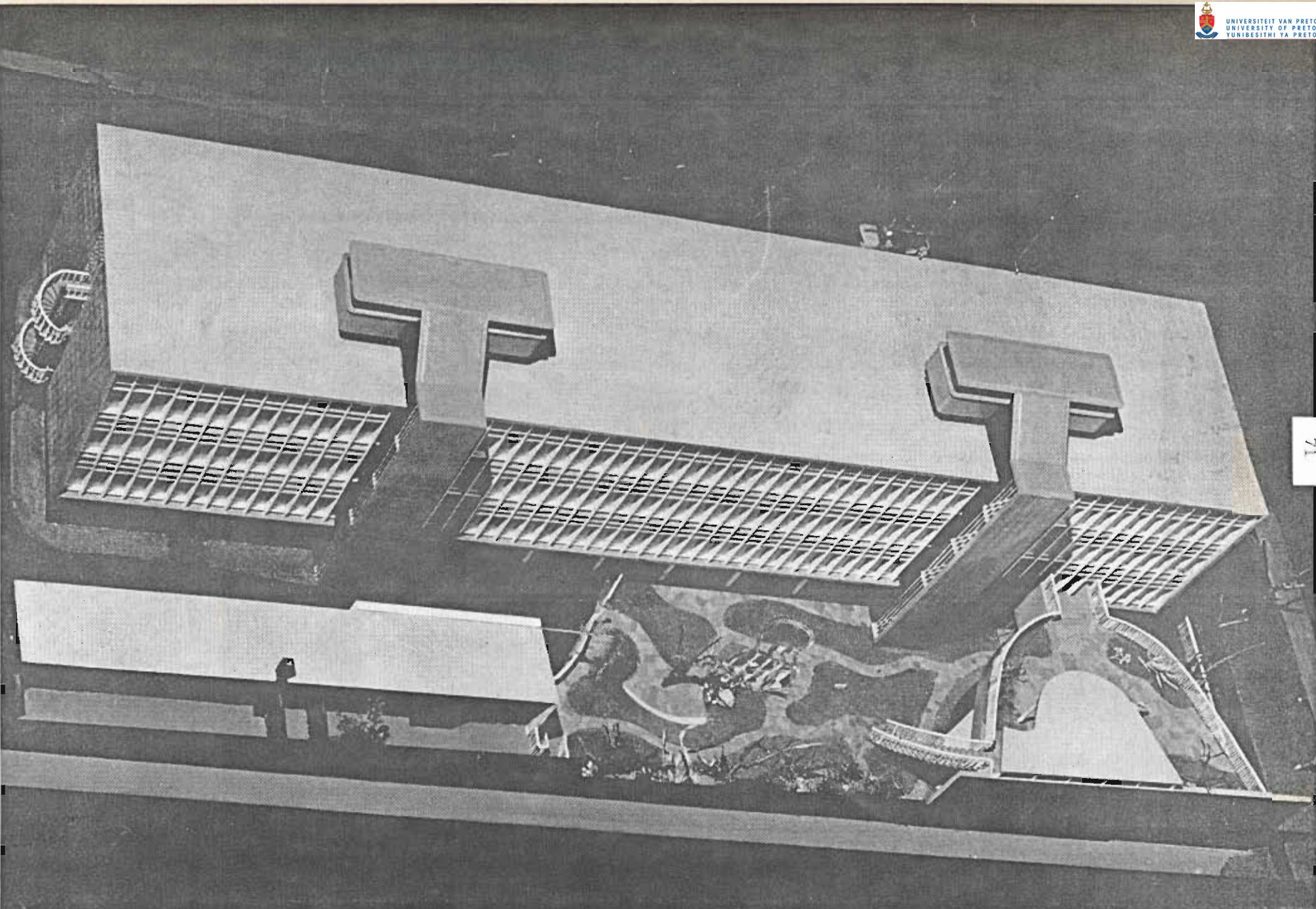

FIG. 47 Meat Board building : photograph of model, showing massing of

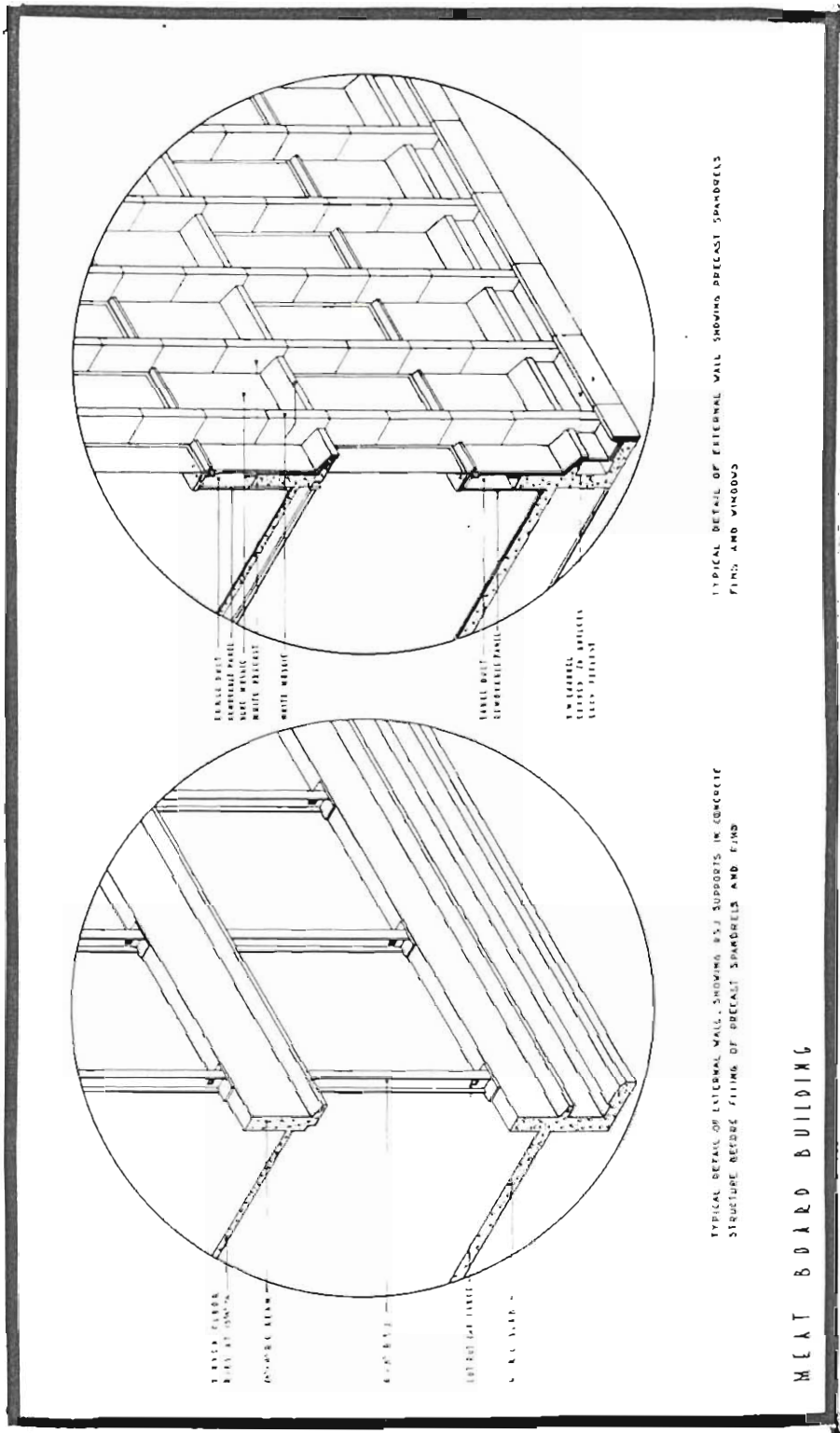

FIG 48 Meat Board building, illustrating the components of the facade and their inter-relationship.

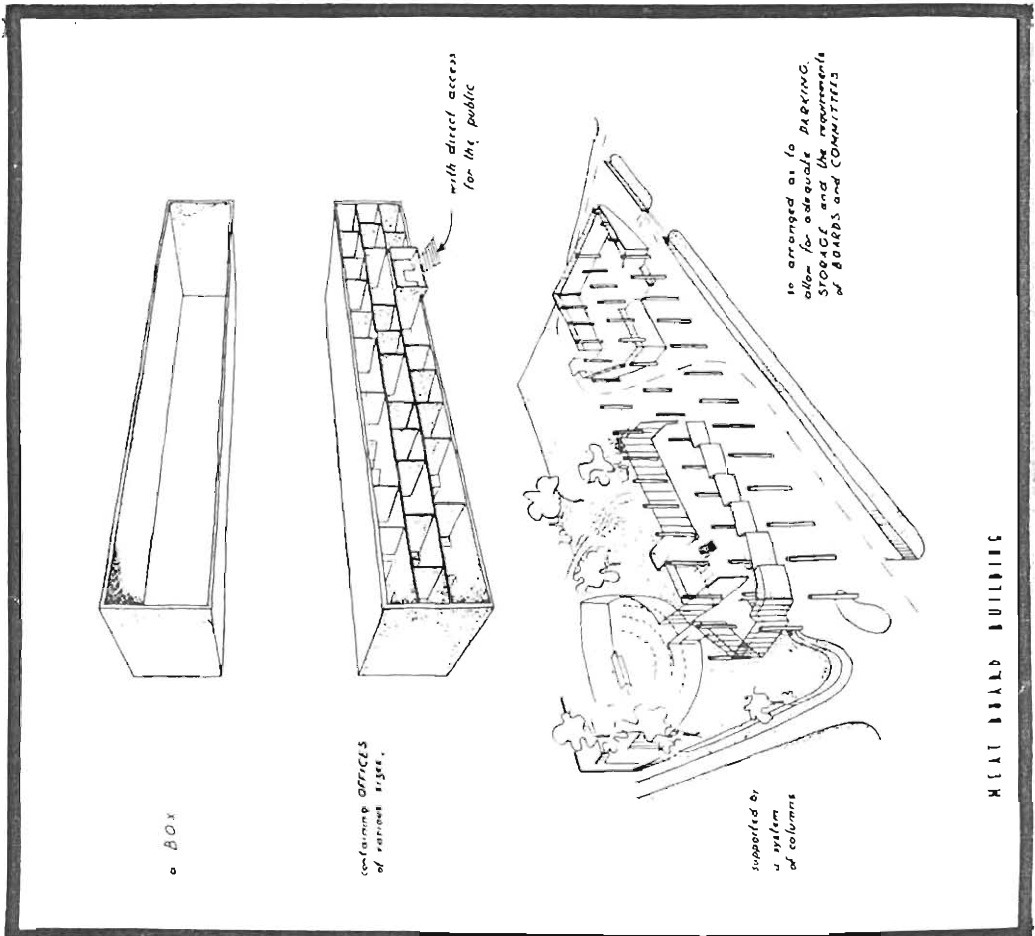

FIG. 49 Meat Board building, illustrating main structural components and their inter-relationship.

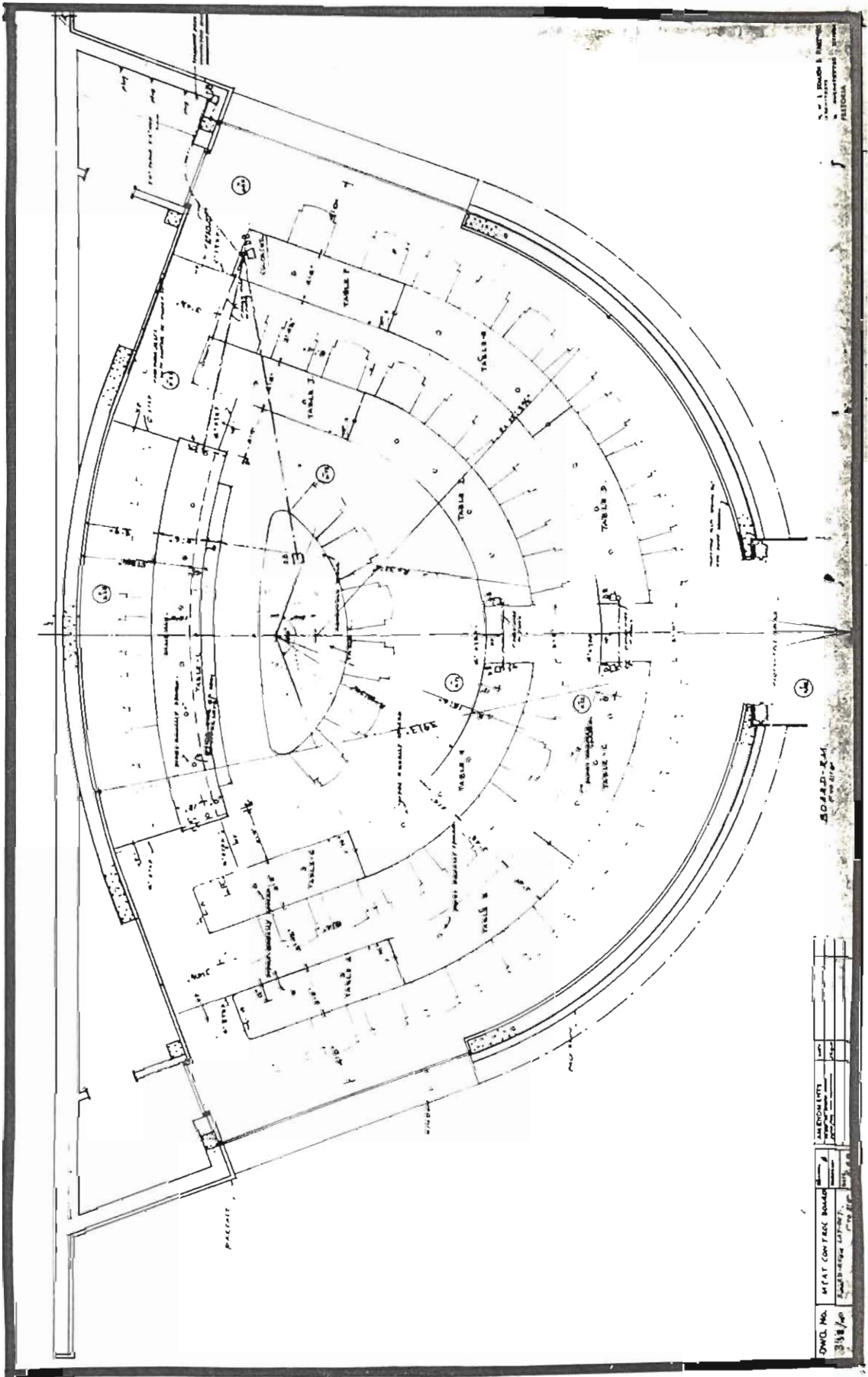

FIG. 50 Meat Board building, board-room layout, showing the close relationship which Stauch perceived between the building and the activities and furniture housed in it.

the office there flourished, although later it was closed between + 1955 and 1958, when Maartens had left and no replacement was readily available. Notable projects in Pietersburg were the Post Office already mentioned (195-), Pietersburg Civic Centre (1958), Lex Building (1948) (figs. 51 and 52), Bakers Garage and Showroom (1950), Shops for B Glass (1950), the Native Affairs Building (1959), Pietersburg Cold Storage Affairs building (1959), Pietersburg Cold Storage Building (195-) and houses for L. Gillett, Dr MacKenzie and several others. Contacts were also being made in Potgietersrus and Tzaneen where clubhouses were designed (+ 1950), which would during the fifties and sixties be followed by a great deal of residential and other projects, in and around the major centres of the Northern Transvaal.⁽¹³⁾

In Pretoria the emphasis of the practice was still on residential buildings although the number of other building types was increasing. Stauch also frequently bought and developed ground, designing and drawing projects in the office, which he considered to be good for publicity, disregarding financial aspects of partnership agreements.⁽¹⁴⁾ The block of flats known as Toscadi, in Troye Street, Pretoria, built in 1951, was one of these.

6.4 The break-up of the Stauch/Wepener partnership

Added to the friction generated by his privately owned building ventures was Stauch's tendency to disappear off to regattas with little or no warning. He had no sense of time and would work under intense pressure for a few days and then vanish for a few days. He had made an agreement with Wepener that they would not be away from the office simultaneously, but Wepener would go on leave and then read in the paper that Stauch was involved in a regatta in the Cape; he was a law unto himself. Eventually the pressures became too great and the partnership broke up at the end of 1951.⁽¹⁵⁾

6.5 Hakahana

About 1951, Stauch exchanged Kiepersol for a property 18 kilometers East of Church Square, and started building his new house. In an interview, published in 1955 (Architect and Builder, May, 1955, pp 34 -

13. Stauch Vorster records.

14. Wepener, F.J., Ex-partner of H.W.E. Stauch, 1984 - interview.

15. Ibid



FIG. 51 Lex Building : view from street. This small and compact building was built to accommodate an attorney's office on the ground floor, with three duplex flats above it. It makes use largely of natural materials - rustic bricks, re-constructed stone, oregon board panels and ceilings and wood-block floors.

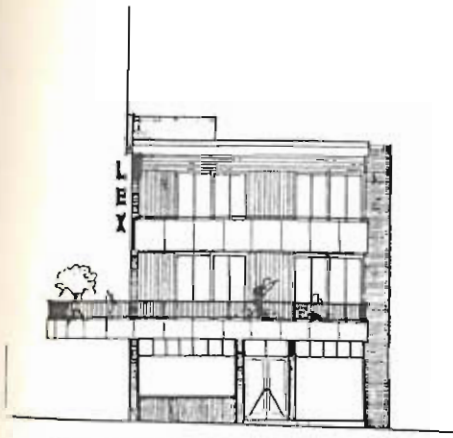

NORTH ELEVATION .

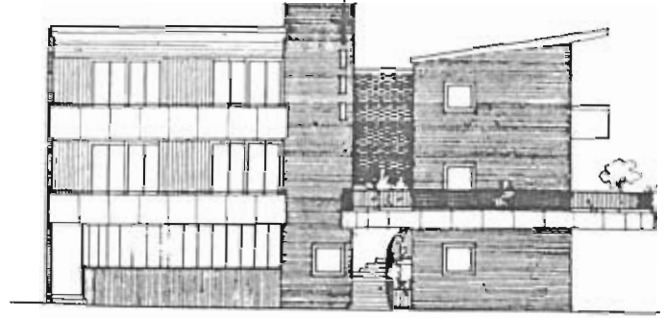

EAST ELEVATION .

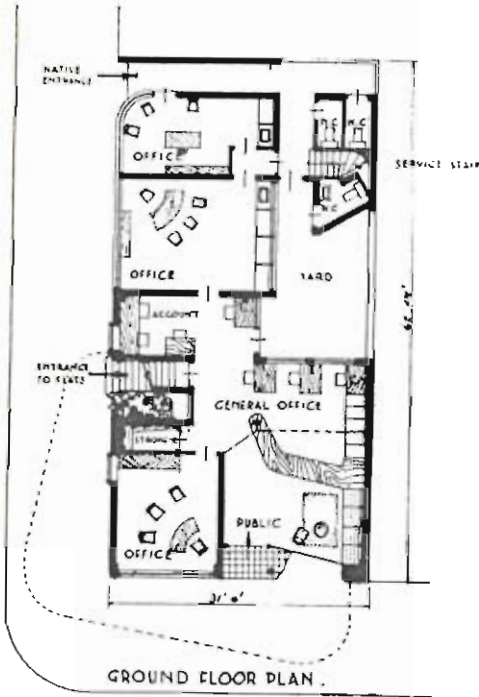

GROUND FLOOR PLAN .

SCALE IN FEET

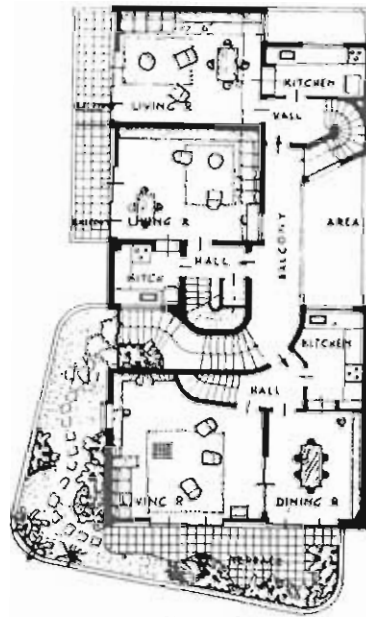

FIRST FLOOR PLAN



SECOND FLOOR PLAN

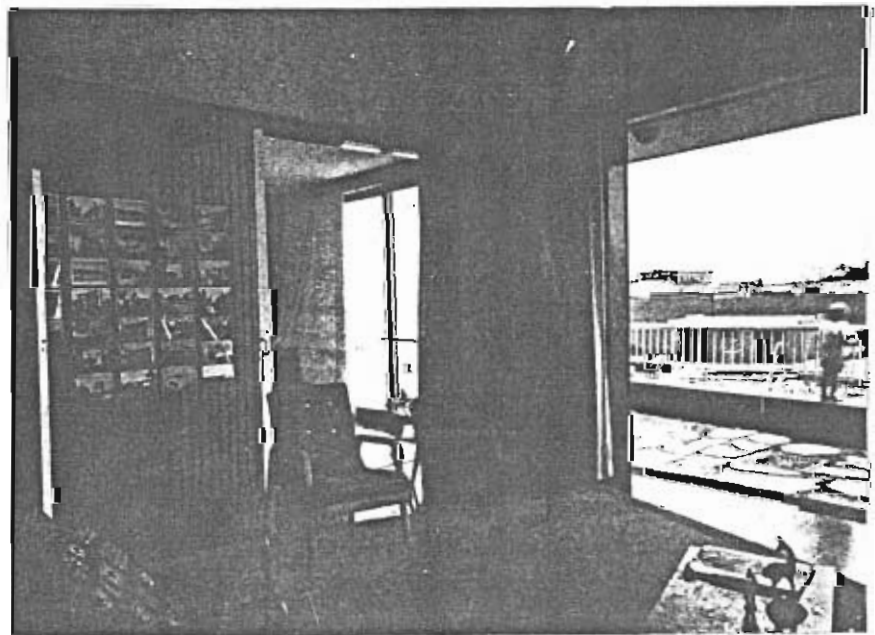

FIG. 52 Lex Building : Plans, elevations and interior.

45) (figs. 53 to 55) he described the brief for Hakahana and because this illustrates clearly his approach to the design of a house, part of the interview is quoted here verbatim:-

"Our requirements:-"

"Bedrooms away from the ground, if possible floating in the air, entirely away from the rest of the house, yet conveniently accessible. They must be airy, sunny in winter, shady and cool in summer. They must not be earthbound - we want to sleep and dream properly, fly away, sever our ties."

"Generous living space for relaxation, entertainment, conversation. This is where we are near the earth and want to feel it. The garden touches this space, comes right into it. The living space must be divisible into small areas, one portion to be 'cave' with low ceiling, warm materials, large fireplace, books, music, comfortable seats. (From this area we want to see the upper pool through the striplight over the seats, the overflow into the lower pool, and the lovely view through the NW picture window. Imagine the cool room with the sound of falling water on a hot summer's day - or an ice cold winter's day, with the water emphasizing the chilly sensation, with a roaring logfire in the fireplace, which warms up the concrete hood and surrounding slate walls!)"

"Diningspace, which is connected with the Living, rather large for entertaining many friends, but reducible in size for intimate parties. For people who like good food and drink, the Diningroom is a most important feature, because pleasant surroundings will stimulate the appetite, and; as everyone knows, good appetite is a basic requirement for an enjoyable meal!"

"A Studio for work and play, attached to workshop and garage to form a large 'hobby' and utility area, with convenient access to the rest of the house, but sufficiently detached for separate activities. This is also the farm office, from which farm wages are paid."

"Guestrooms, with own entrances, sittingroom and bathroom. When our friends stay with us, we want them to be independent, and retain their individual personalities."

"As a contrast to the wide open space, we wanted an enclosed garden court, which could be made 'out of bounds' to the less intimate friends, with a small swimming pool. The pools play an important part, because in South Africa, where water is at a premium, we wanted to fully enjoy the water we have - we wanted to see it all the time, wanted to wrap it

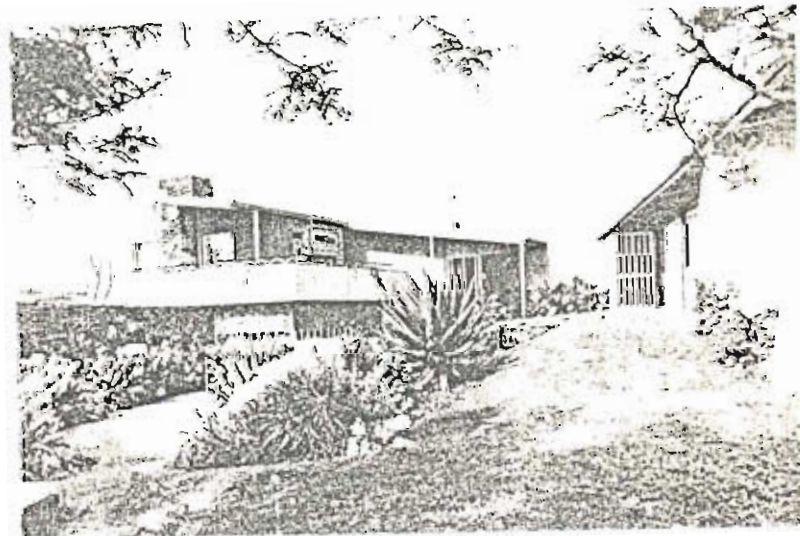
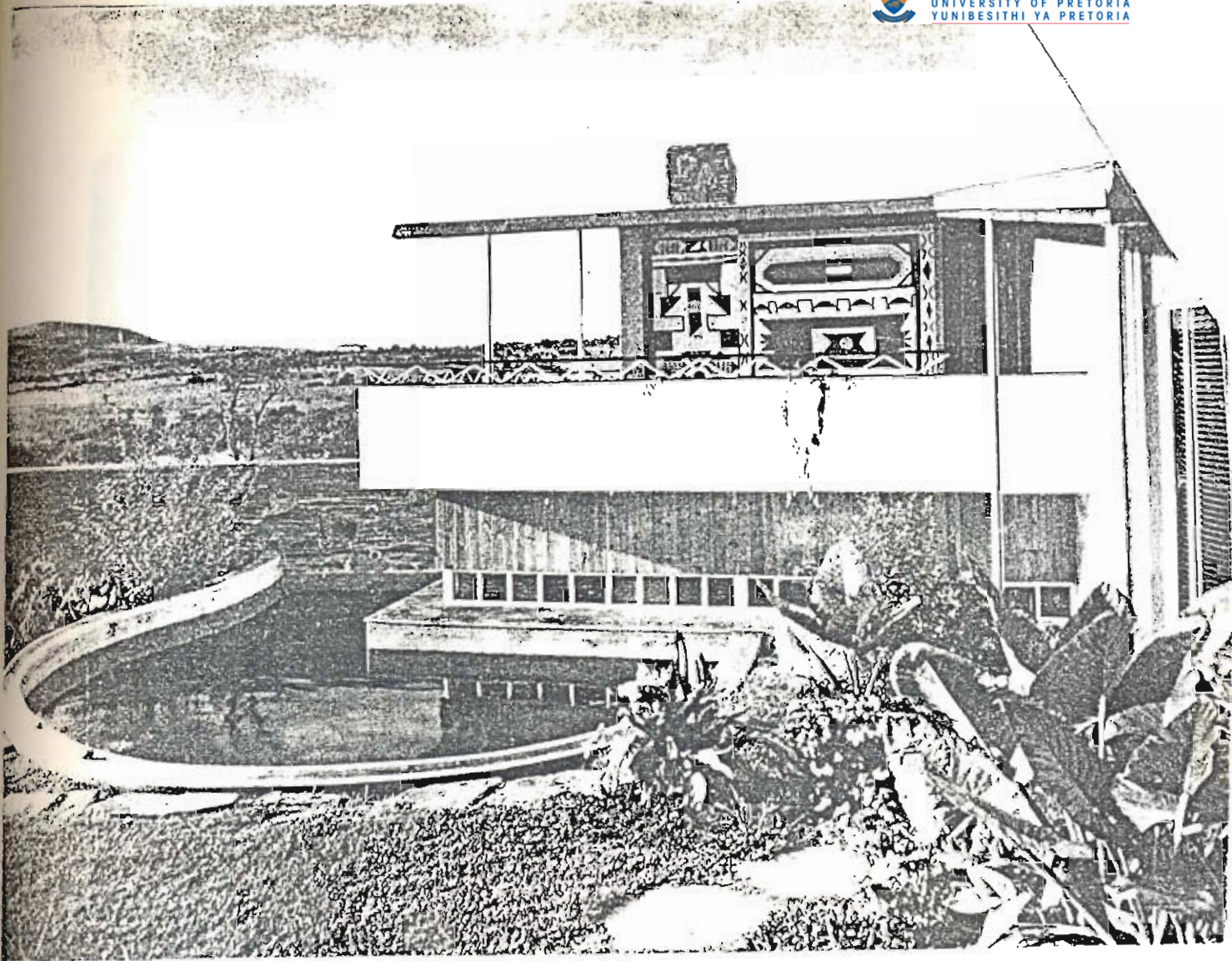

FIG. 53 Hakahana; views from South. The wall painting was carried out by a Mapoch woman who used a toothbrush and oil paint. The cill level of the small high windows at the rear of the lounge is just above the level of the upper pool. (Architect and Builder (May, 1955).

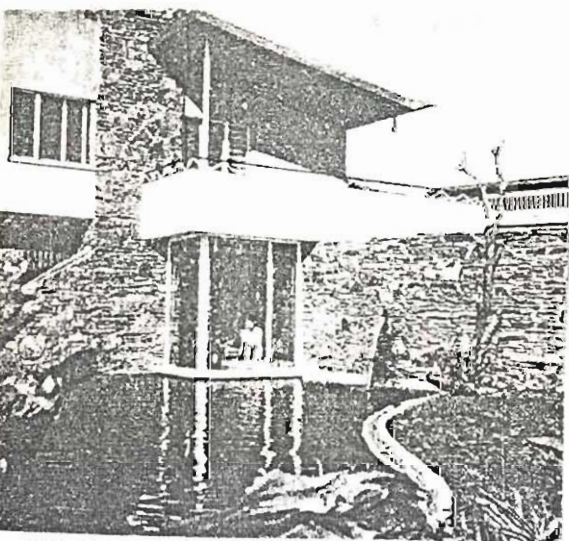
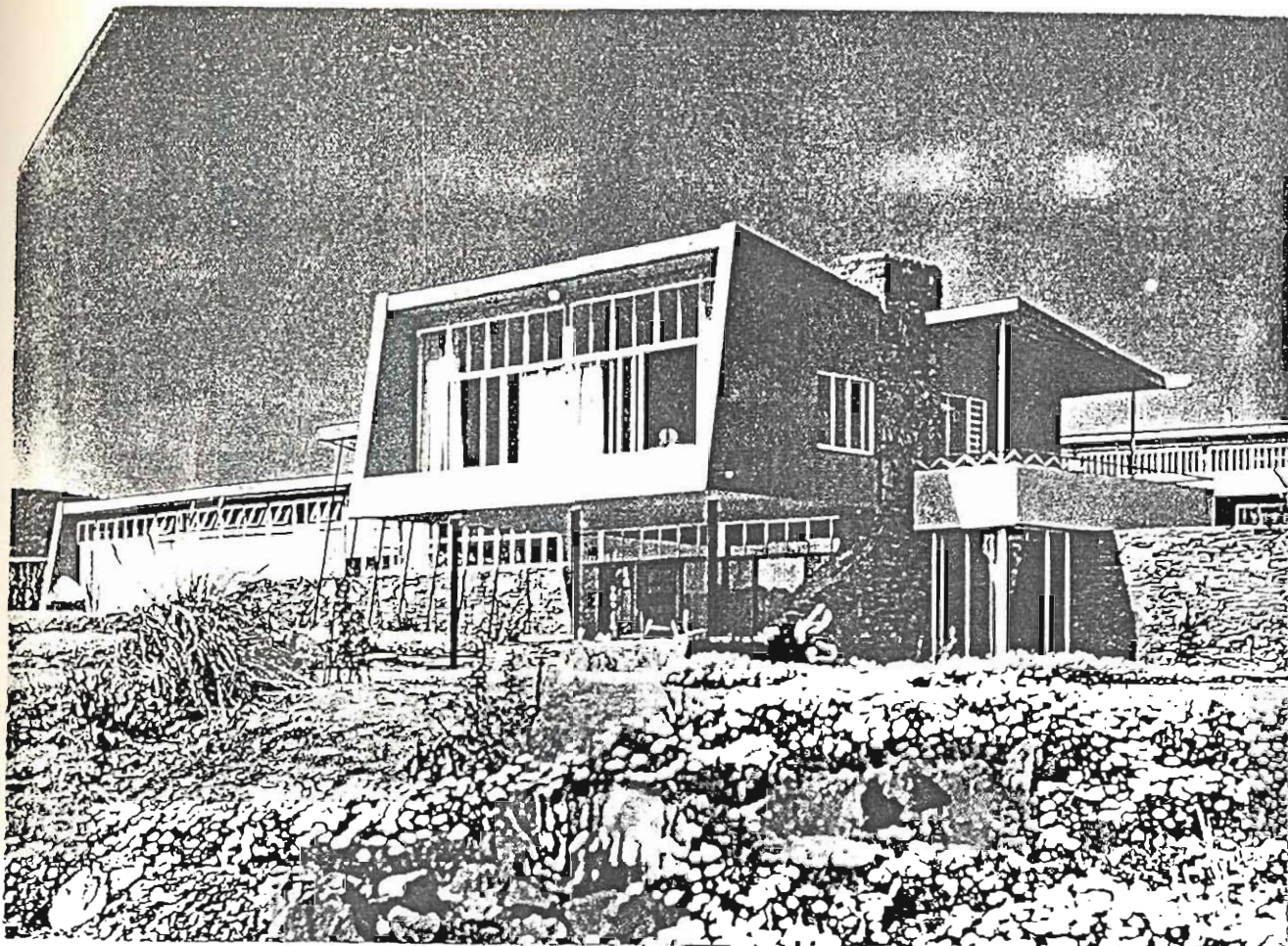
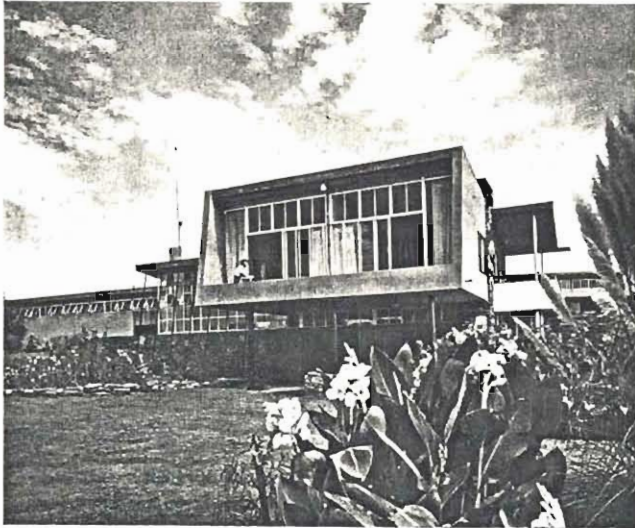

FIG. 54 Hakahana; views from North/West. The garden of succulents and "dry-land" plants is in dramatic contrast with the lower pool, which fringes the living-room windows (Architect and Builder (May, 1955)).

Reprinted from DECORATIVE ART (No. 46) 1956-7



PRETORIA—SOUTH AFRICA

An artesian borehole, a beautiful view over distant hills, indigenous trees, and a river with a series of dams are the setting for this house, situated in a lovely valley about 10½ miles west of Pretoria.

It was built by the architect for his own use and is christened 'Hakahana', meaning 'quick', because he and his wife had to act speedily to get a roof over their heads and to establish a farm. The rear block—a tubular steel structure with non-loadbearing walls—was completed within a month, and was their temporary home: it now houses guestrooms, studio games room, and garage.

In designing the main house, the readily available
(continued below)

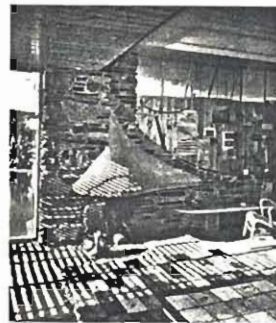
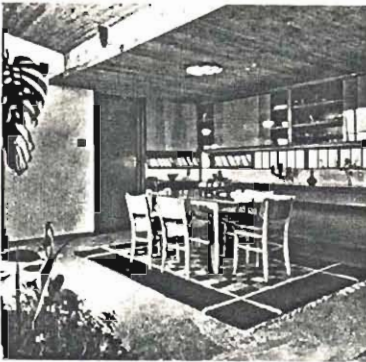
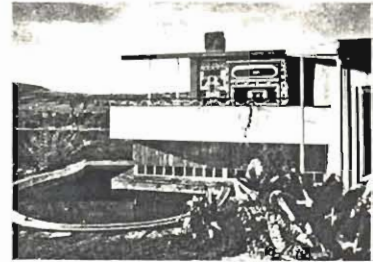

water supply played an important part—'we wanted to see it all the time, to hear it running'. This desire materialised into a swimming pool at two levels abutting directly onto the living room, which has a picture window at water level. This creates a sense of coolness in summer; in winter the concrete-hooded fireplace and slate walls retain the heat and keep the room cosy. Opposite is a bar with steps leading up to the dining room. The bedrooms, raised high above ground level, jut out from the house and command a magnificent view.

Exterior walls are plastered grey; a mural by a native woman of the Mapoch tribe decorates one wall. Architect: H. W. E. Stauch, MIA (SOUTH AFRICA)



Printed in Great Britain by William Clowes and Sons Ltd, London and Beccles

FIG. 55 Hakahana; reprint from Decorative Art (no. 46) 1956-7. This shows the building in occupation for some time. Today it is surrounded by tall trees and its relationship to the landscape has changed, but the building fabric remains unaltered.

around the house, we wanted to hear it running."

"'HAKAHANA' means 'Quick' in Herero language. We had to act quickly to get a roof over our heads, to surround ourselves with lawns and gardens, to establish vegetables and fruit, and the farmyard with stables for cows, horses, pigs, fowls, ducks, etc."

"In order to get a roof over our heads, we designed a structure, which would be adaptable to varying uses in future. It consists of tubular steel columns, to which beams and double rafters are bolted, which carry the roof structure, so that all walls are non-loadbearing and therefore changeable. This we built within a month, and lived there for 2 years. It is the portion at the rear, which now houses guestrooms, studio and garage."

"In the short time at our disposal, we could not design the future house. All we could do was to estimate its probable extent and decide on its rear line, direction, and the levels. We fixed this, which determined the corner in the upper pool. Later we found it rather tricky to actually fit the house into the allocated space with the restriction imposed by the 'corner'. But, perhaps it was just as well to have imposed a restriction in this form, because without that one tends to ramble far afield - it is difficult to discipline imagination sometimes!"

"In designing the house proper, the problem was to integrate the new with the existing so that it would not spoil the setting and the view of the rear block, and could be built whilst the first portion was occupied."

6.6

Bauhaus Pretoria

In January 1951 Stauch commenced work on an office block in which his own office would be incorporated, and named it "Bauhaus", and by the end of the following year he had once more moved his office. (16)

CHAPTER VII - PRETORIA 1952 TO 1968

Competitions: 1952 to 1969

1952, 1953 and 1954 were good years for competitions and these Stauch found rewarding. The tension, excitement and long hours of hard work coupled with the celebrations at the end of it helped to create team spirit and a great sense of involvement.⁽¹⁾ (figs. 56 to 58)

His first success in 1952 was in a competition for architects registered with the SWA Institute for the design of the Windhoek Library, Archives and Museum. For Stauch, this had an ripple effect on his practice; he had for purposes of participating in this competition, and later to handle the erection of the complex, established an office in Windhoek and further commissions helped to keep this office well occupied.⁽²⁾

The second of these competitions was one for low-cost native housing. The plans which Stauch submitted were modular in plan and easily expandable. Stauch was awarded a first and a second place and two honourable mentions.⁽³⁾ (fig. 59)

During 1954 the "Star Housing Competition" gave him a further opportunity to compete; he took third place on the S-oriented site in this.⁽⁴⁾ (fig. 60)

Later, he was to take a second place in the Virginia housing competition (mid 1959) (figs. 61 and 62), a third place in the Pinelands/Bishop Lavis competition (mid 1963) and joint first place overall, with a second on detail design in the Johannesburg Civic Centre competition (mid 1961).⁽⁵⁾

A submission to the Small Homes Bureau of the Institute of South African Architects (1957) was also successful although it is not known to what extent this design was used.⁽⁶⁾

Although he continued to take an interest in competitions, Stauch began to find that the pressure of work inhibited his participation. He drew documents for at least six other local and two international competitions between 1955 and 1968, but made only four unsuccessful submissions - for projects in Welkom (1955), Kimberley (1957), Kiel (1968) and Vereeniging Civic Centre (1969).

-
1. Sternagel, W.H.E., Director, Stauch Vorster, 1984 - interview.
 2. Stauch Vorster archives
 3. Ibid
 4. SAAR, April 1955, p 43
 5. Stauch Vorster archives
 6. Letter from Institute of South African Architects (1957.07.02)

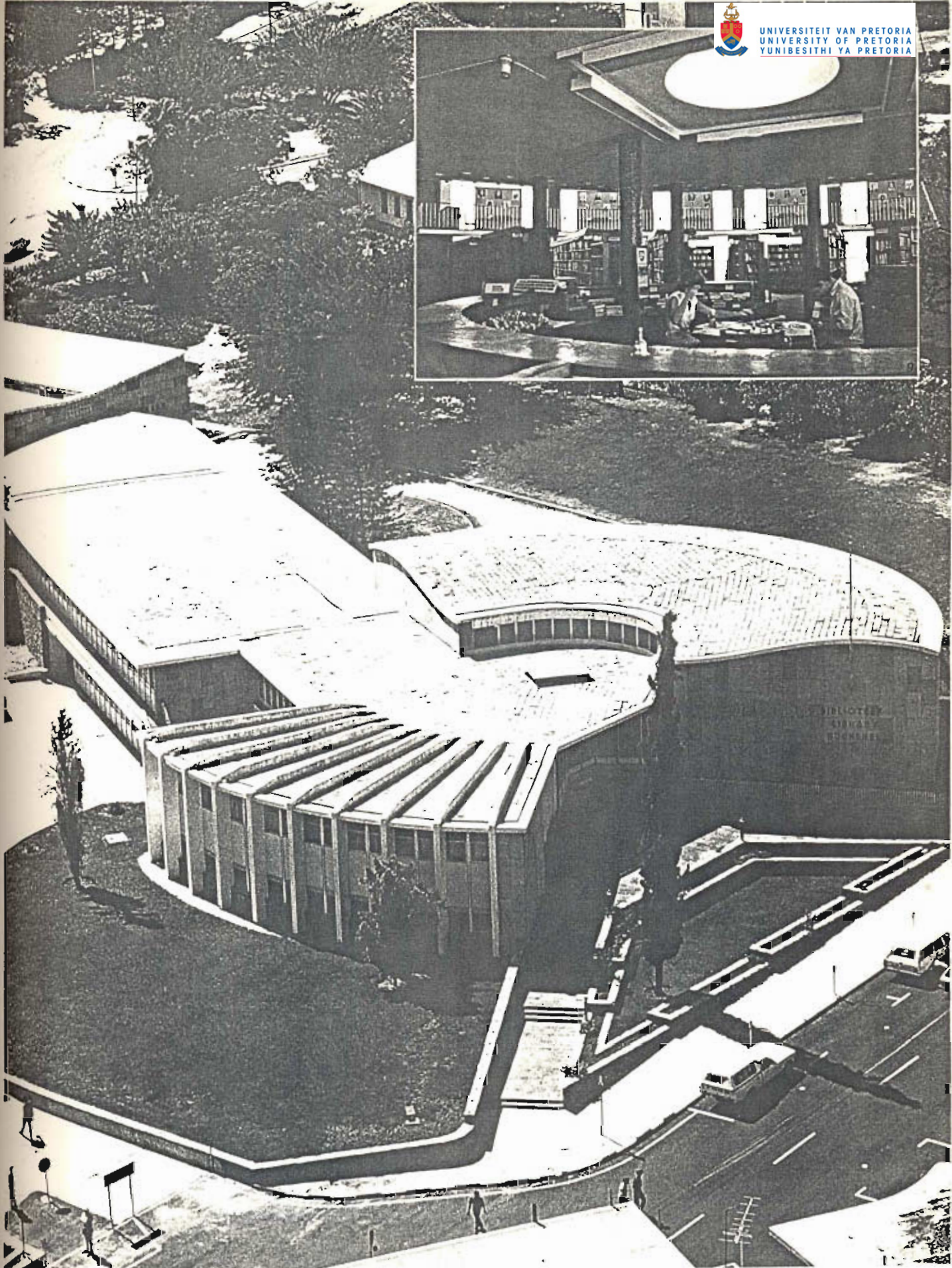

FIG. 56 Windhoek Library, Archives and Museum. Aerial view showing clearly the articulated form of the building, typical of Stauch

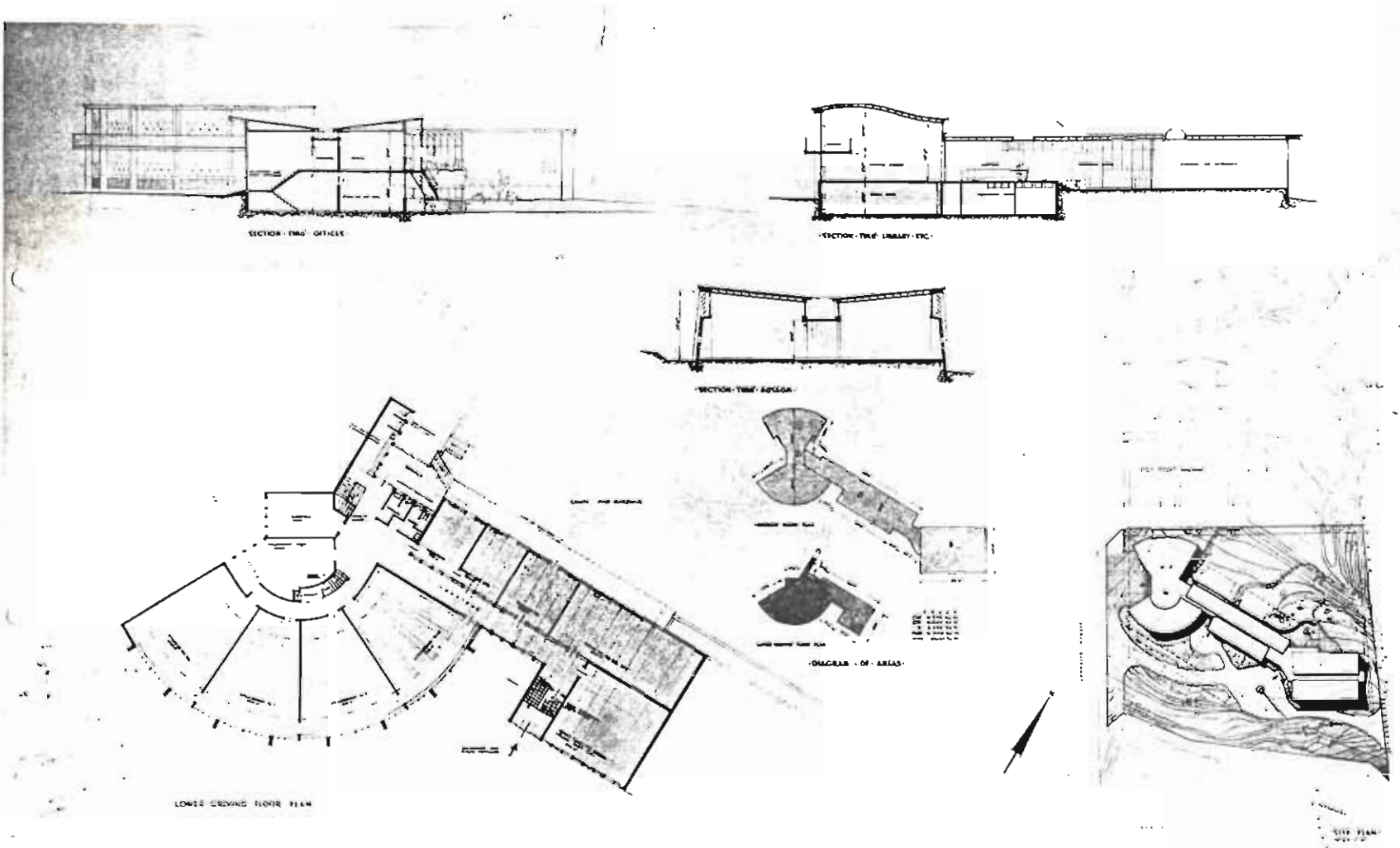

FIG. 57 Windhoek Library, Archives and Museum; site plan, plan, section.

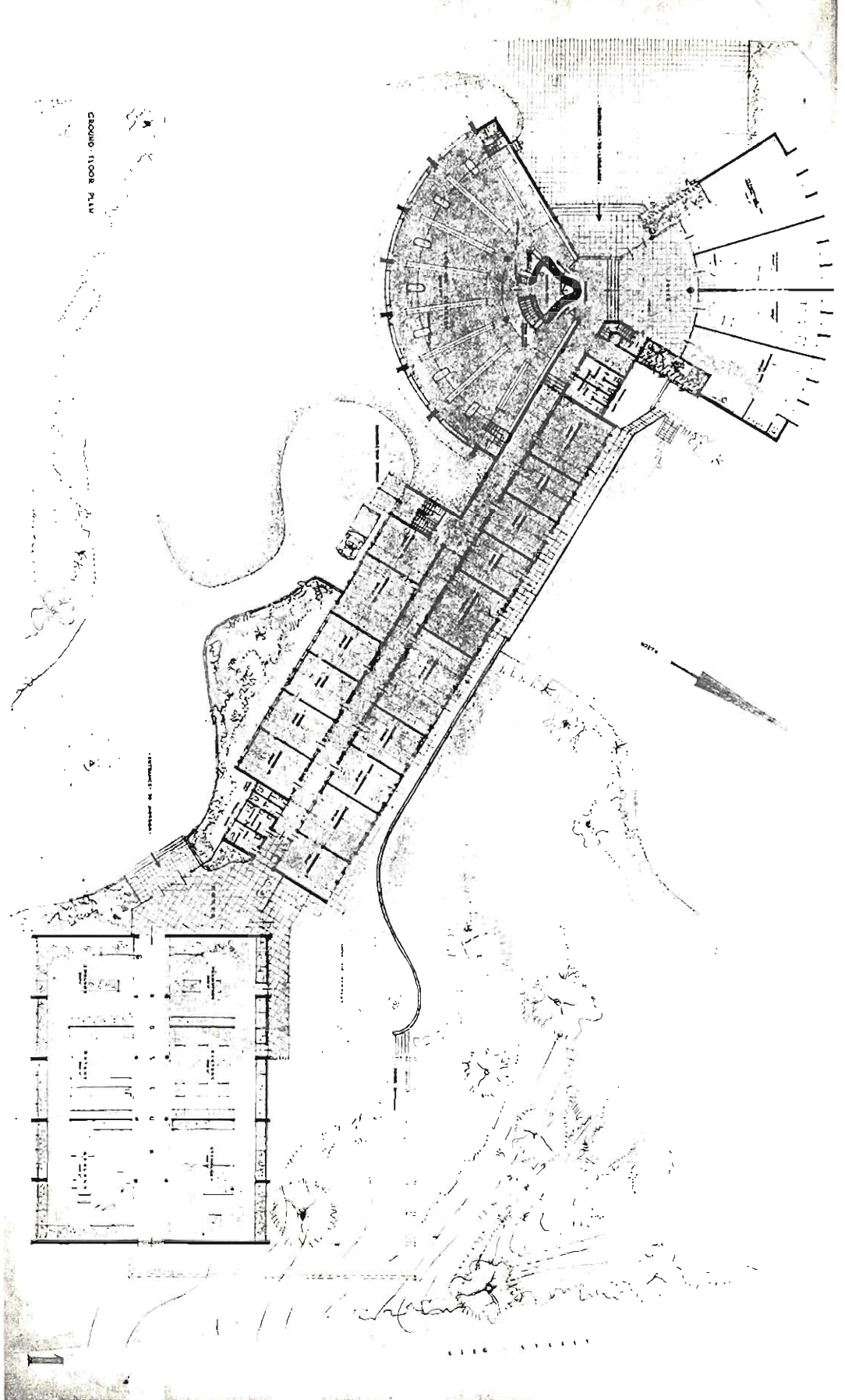

FIG. 58 Windhoek Library, Archives and Museum; plan.

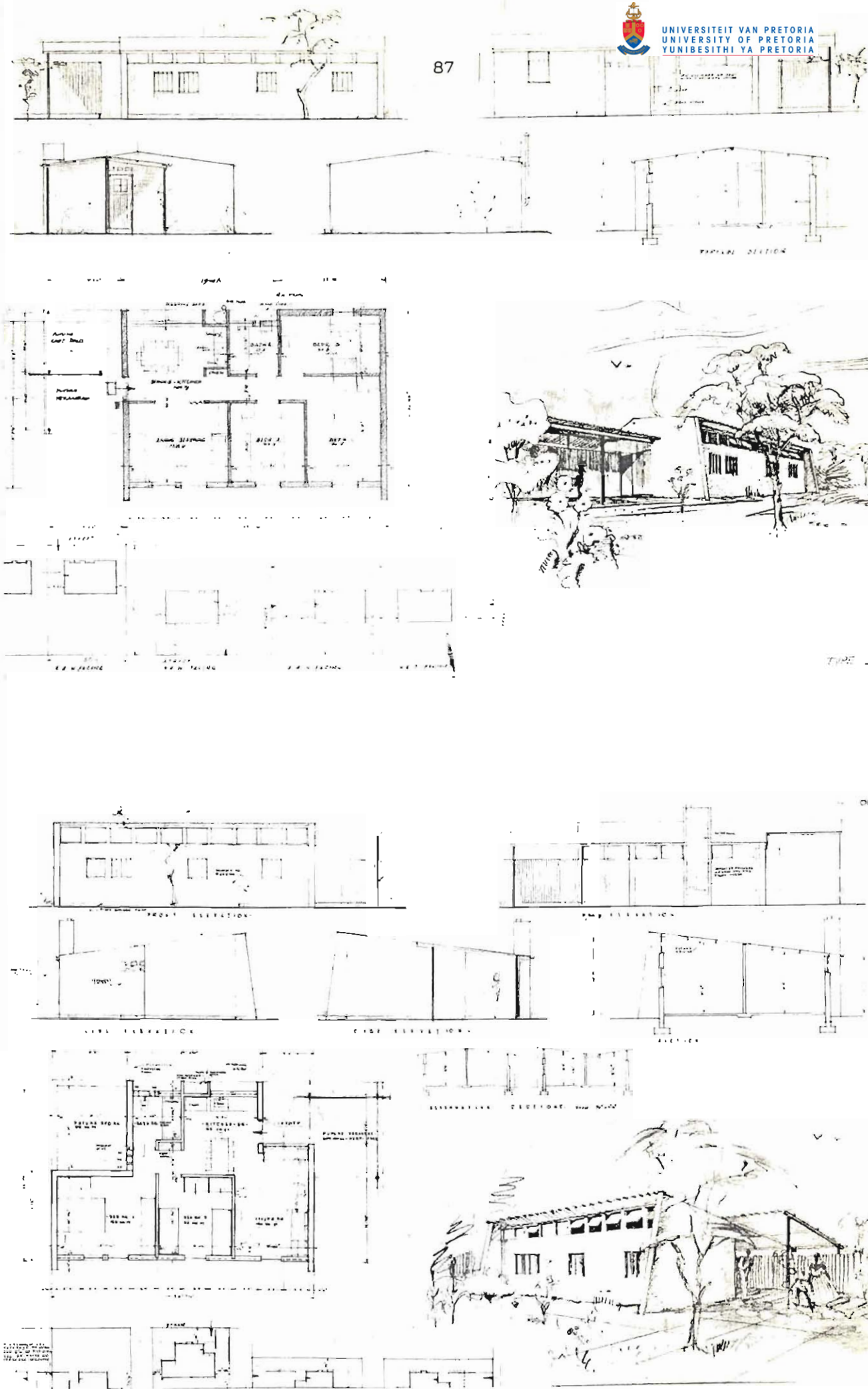
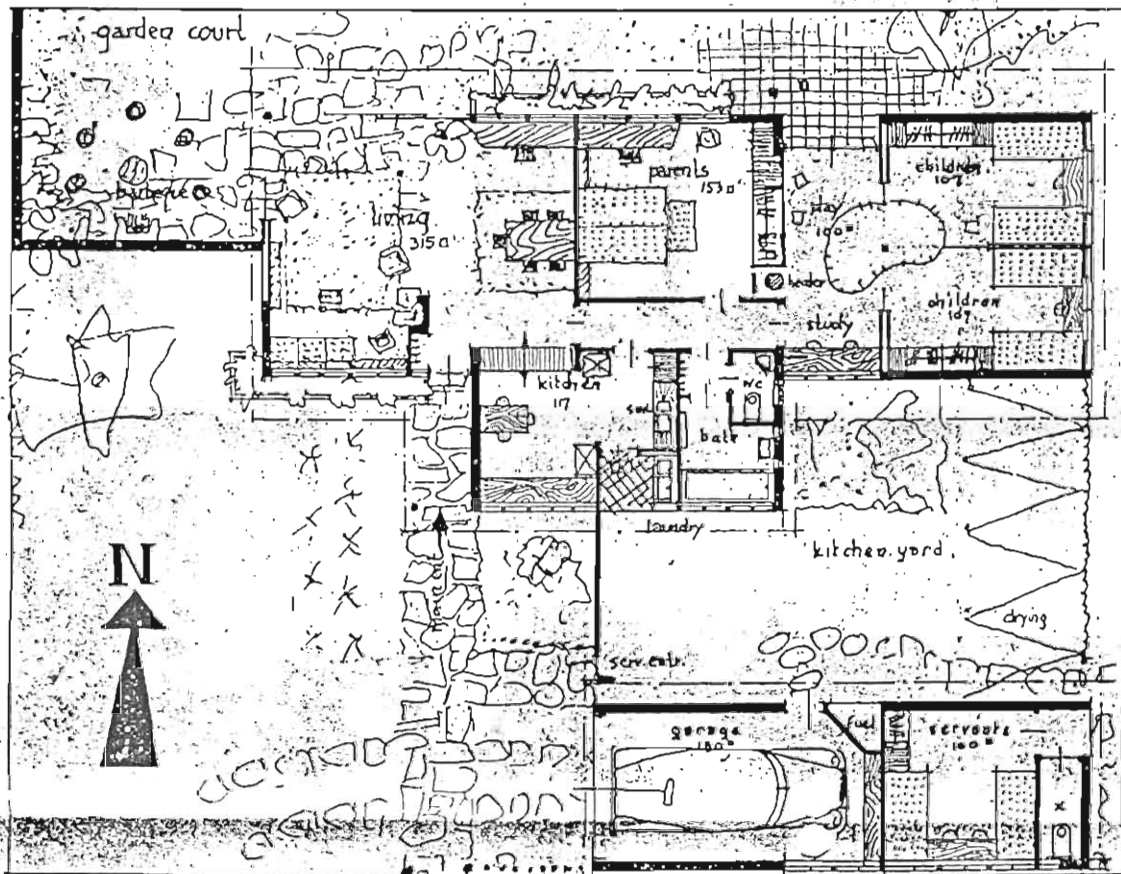
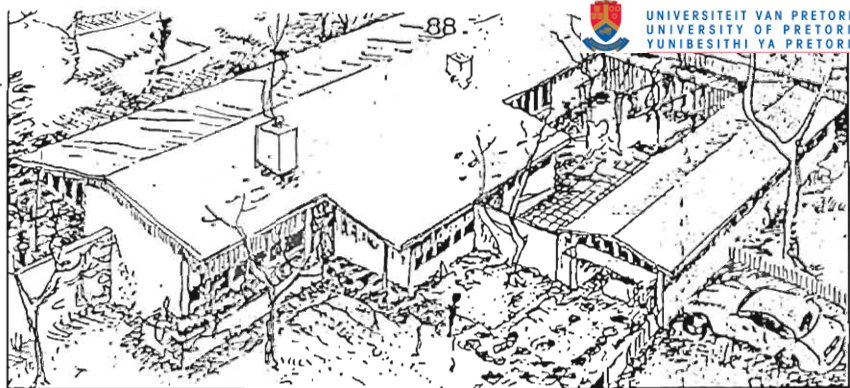
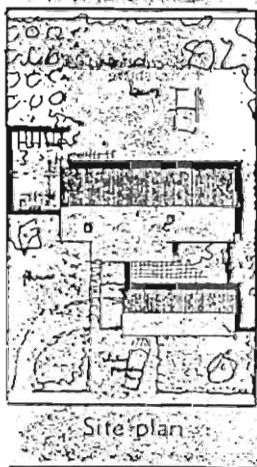

FIG. 59 Native Housing Competition : two of the prize-winning entries.

Star Model House No. 10



Garden Court and Barbecue



THE accompanying design, one of the 16 selected for publication from the 207 entries received in The Star Model House competition, was submitted by Mr. H. W. E. Stauch, M.J.A. of Pretoria.

In his report, Mr. Stauch says that an important feature of the design is the garden court (with barbecue) that adjoins the living area of the house. The court is open to the north-east, and the wall on the western boundary of the property protects it from the late western sun. The same wall reflects the morning sun and tends to keep the garden court warm throughout the day.

A feature of the interior of the house is the extension of the children's bedrooms into a utility area for play and study.

A heating stove (shown on the plan) heats this area as well as the bedrooms. The warm air into the main bedroom can be controlled by adjustable louvres.

PLUMBING

The plumbing is centralized—sinks, laundry, bath and lavatories are in close proximity. Provision is made for an electric geyser, but, if preferred, a slow combustion stove can be installed without trouble.

The walls are of stock bricks with fireface and are finished externally in colour wash. In the living rooms the walls are bagged and colour washed; in the bathroom and kitchen they are plastered and painted.

Floors to the entrance and living and utility areas may be of slate, tiles, bricks on edge or woodblocks. In the bedrooms the floors are of woodblocks. The bathroom and kitchen floors are mastipave with grano skirting.

The estimated cost of the house is £7,663. This includes £25 for slate paving, £20 for the barbecue and £17 for split pole fence.

(Copyright strictly reserved.)

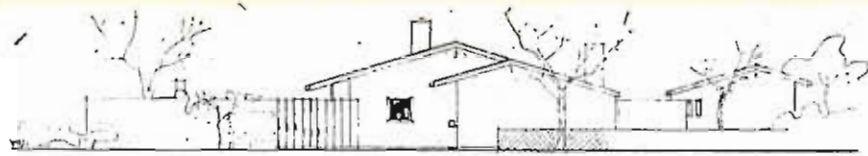

WEST ELEVATION

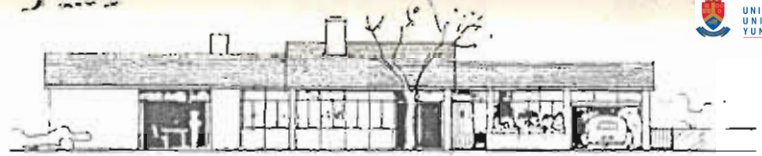

NORTH ELEVATION



SOUTH ELEVATION



EAST ELEVATION

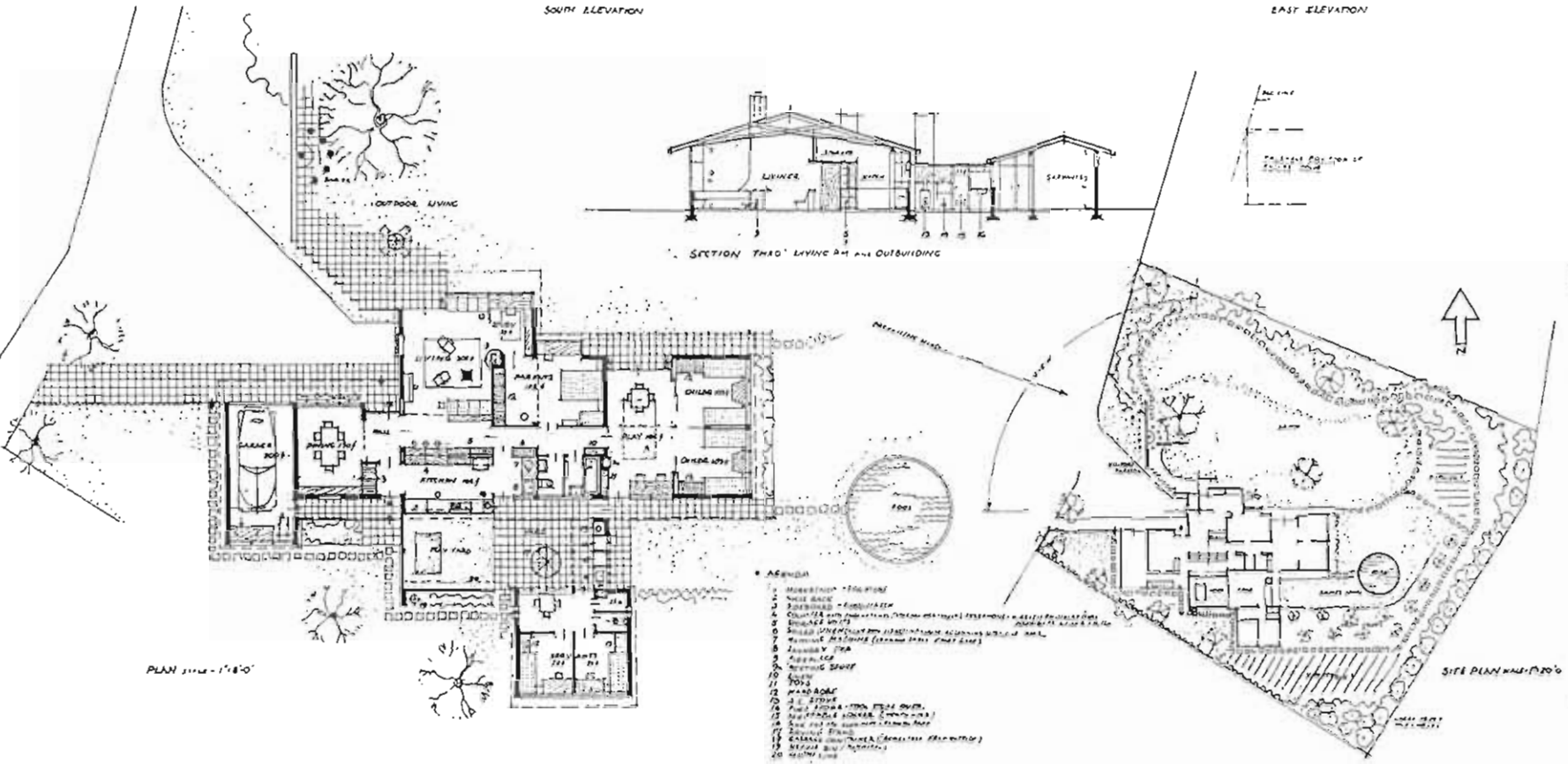

PLAN 1:1/4" = 1'-0"

- ABBREVIATIONS
1. ROOFING - GALVANIZED
 2. WALLS - BRICK
 3. FLOORING - POLISHED
 4. CHIMNEY - BRICK
 5. PORCH - BRICK
 6. DRIVEWAY - ASPHALT
 7. SWIMMING POOL - CONCRETE
 8. GARDEN - GRASS
 9. TREES - PLANTED
 10. FENCE - WOODEN
 11. DRIVE - ASPHALT
 12. WALKWAY - CONCRETE
 13. STAIRS - WOODEN
 14. PAINT - WHITE
 15. GLASS - CLEAR
 16. ROOF - GABLE
 17. CHIMNEY - BRICK
 18. DRIVEWAY - ASPHALT
 19. SWIMMING POOL - CONCRETE
 20. GARDEN - GRASS

FIG. 61 The Virginia House Competition : The second-prize-winning entry.

S.A. ARCHITECTURAL RECORD, NOVEMBER, 1959

DESIGN PLACED SECOND, NO. 80.

H. W. E. STAUCH AND PARTNERS, PRETORIA

DESIGN PLACED
 SECOND, H. W. E. STAUCH
 AND PARTNERS, PRETORIA.

AUTHOR'S PERSPECTIVE

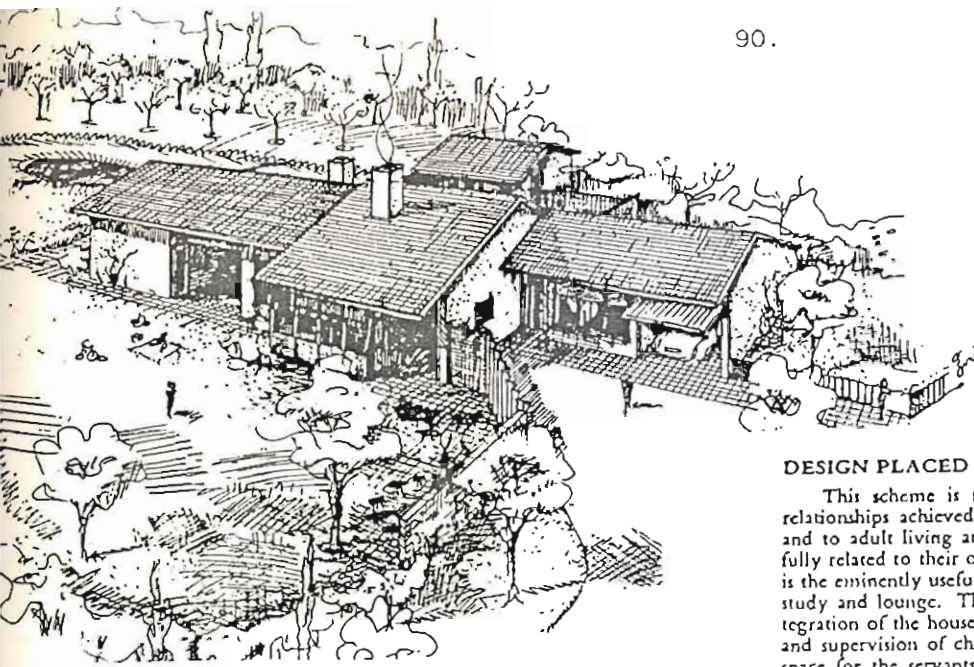

AUTHORS' REPORT

GENERAL

House and outbuildings form a homogeneous architectural whole, built of materials available and manufactured in South Africa. Sitting for maximum benefit of North and East facing and to obtain distance of view. Screen wall with the barbecue shields the outdoor living area from the prevailing North-West wind and a louvred screen can be adjusted according to weather. The living room projection screens the children's section and play area from the prevailing wind. The house is placed well back on the site so that a spacious garden can be developed with maximum privacy.

To facilitate reception of strangers, the points of entry must be concentrated in one section. Visitors enter into the hall, and deliveries are made opposite this position at the servery. There is no need for strangers to enter the enclosed court which serves solely domestic purposes.

The view to North and West is unobstructed from living area and dining room as well as outdoor living area, which cannot be obstructed by future development on the adjoining site either.

PLAN

Hall—as the point of entry, can be shut off in bad weather to act as wind trap. Living area, dining room and kitchen area are directly linked with the hall.

Living Area—serves recreation and entertaining for adults. It is linked with study which is divisible for privacy. For large scale entertaining the living room and study combine with hall and dining room and further with the outdoor living space to form a spacious entertainment area. The fireplace is centrally situated to serve living room, study and also parents bedroom if required. Possibility of incorporation of the *parents bedroom*, which can also double as workroom, into the adult living space by link to study.

The counter between living room and kitchen allows the housewife to participate in conversation and to overlook living area in servantless times. Telephone and wireless are located here for operation from either side.

Dining Room—Separate unit to facilitate the family having meals together. Broad link with living area over Hall. It can be used as guest room or reception room when strangers are not desired in the living area.

DESIGN PLACED SECOND NO. 80.

This scheme is noteworthy for the extremely successful internal relationships achieved within both the zones allocated to the children, and to adult living and entertainment. Both zones are in turn successfully related to their own outdoor spaces. A particularly pleasing feature is the eminently useful if unusual relationship between parents' bedroom, study and lounge. The planning of the kitchen permits a complete integration of the housewife's activities with all functions of living, dining and supervision of children. The introduction of a north-facing dining space for the servants is an interesting innovation. The pedestrian approach past the garage opening and dining room windows is a disadvantage. The provision of visitors' parking and the access to the garage need further consideration to clarify and ease the vehicular access to and egress from the garage and to avoid confusion with visiting cars. The triangular spaces on the southern boundary are wasteful and awkward to develop. The subdivision of the main house into three volumes mitigates against a unified architectural character in a scheme of this somewhat limited extent. The scheme however derives considerable charm from its informality and careful modulation on a basic window unit.

Children's Section—Two bedrooms can be linked with one another and with the playroom by sliding partitions to form a large activity area. Various degrees of privacy can be obtained by adjusting these partitions.

Windows to Bedrooms: broad clerestoreys for general light and ventilations, burglarproofed spotwindows for outlook.

Broad link of Playroom with North lawn; door to outside play area on South.

Roof overhang forms covered link with the service yard and with connecting door open, the games lawn can be overlooked from the kitchen.

Service Section—From the kitchen and its adjuncts any part of the house is readily accessible. Delivery entry through servery. Laundry accessible from bedrooms and next to soiled linen cupboard. Yard doubles as enclosed children's play area under direct supervision.

Servant's Rooms—are directly connected with the service area and have a North facing glassed-in verandah as sitting room.

Garden Layout—Outdoor living space adjoins the Living-area. Heavy planting protects this space against the West winds, as well as screen wall.

Games lawn with swimming pool in convenient relationship to play room and also under supervision from the kitchen. Uninterrupted Lawn to North and East Flower garden, fruit trees and vegetables in convenient proximity to the kitchen. Circular "van Meertan" type pool can be cheaply constructed at a later stage, and if raised, vegetables garden and fruit trees can be irrigated.

FIG. 62 The Virginia House Competition; perspective. This is one of the best examples of Stauch's style of presentation.

In preparing for this last competition he experimented with the use of a team, allowing each person to "go and do his own little bit, his own sketches and his own models and tabling them all and then synthesizing the inputs, which was contrary to Hellmut's way of working. He would have led what everybody was doing and would have worked it up into something that would finally have the stamp of Stauch. This Civic Centre 'thing' became a committee solution. His staff's insistence on discussing, defending, substantiating and explaining why, just tired Hellmut and he turned his back on it. He was involved in it as leader of the practice but not as a design man at all. He merely seemed to accept it and to allow it to go out under his name."⁽⁷⁾ The results of this approach were disappointing to all the partners in the firm, including Stauch; the costs were high in terms of time, money and effort and this was to be the last competition attempted during his lifetime.⁽⁸⁾

7.2 Further Expansion: 1952 - 1960

During this period Stauch's sphere of influence had extended considerably. In Pietersburg he was involved with the design of the Civic Centre and in Windhoek with Carl List House - buildings different in form but having very similar detailing, especially related to sun control. His firm control in these two schemes was apparent.⁽⁹⁾ In addition to these, he designed noteworthy houses in Pretoria for Marquard de Villiers (1953), in Pietersburg for D. Deetlefs (1957) and J.A. Botes (1959), apart from his involvement with virtually all the work on the boards at the time. His staff was again increasing and larger premises were needed. During 1960 drawings were commenced for a building in Park Street where his offices would be housed in combination with a block of flats, under the the name of Atalanta,⁽¹⁰⁾ and the move was made as soon as the building was complete.

7.3 The opening of two more offices

In Johannesburg, the old Commercial Exchange building was being demolished to make way for the new Netherlands Bank Head Office (fig. 63) and the opening of another office in Johannesburg to provide the required

-
7. Scholtz, T.J.R., Director Stauch Vorster, 1984 - interview
 8. Stauch Vorster records
 9. Stauch Vorster records
 10. Ibid



MODEL OF COMPLETE PROJECT. RIGHT HAND PART COMPLETED IN DECEMBER, 1962. LEFT HAND SIDE SCHEDULED FOR COMPLETION 15th MARCH, 1963 (BASEMENTS, GROUND FLOOR AND MEZZANINE, FINAL COMPLETION DECEMBER, 1963.



FIRST SIGNS OF DEMOLITION, CORNER MAIN AND HARRISON STREETS, SITE OF LEGAL AND GENERAL INSURANCE CO. LTD., DEC. 1959.



This Album, containing photographs of what has met the eye from the start until near completion of Phase One of the new premises for the Head Office and the Fox-Simmonds-Main Streets Branch in Johannesburg of the Netherlands Bank of South Africa Limited, is presented to

HELMUTH W.E. STAUCH,

Architect, in memory of the fine collaboration with his firm during the period of the conception and execution of this Project, and with best wishes for its finalisation.
Johannesburg, January, 1962.

F. H. G. van der

W. Koster

H. van der Merwe
G. van der Merwe

Chairman and General Management.

FIG. 63 Netherlands Bank Johannesburg. Letter of appreciation from the client, photograph showing demolition of old building, and photograph of model of completed project.

level of client service was inevitable. In 1965, the commission for the rebuilding of the old Queens Hotel in Sea Point under the proviso that an office was opened in Cape Town, was to expand the office yet further. (11)

In 1958 Robin Vorster had joined the firm which now, as it grew, needed management skills in addition to the available design skills. The need for management arose not only from the volume of work but also from Stauch's tendency to disregard the cost of the constant design changes made during the entire course of the building process, making profitability an affair of chance. In retrospect, and analysing the project records between 1950 and 1970, this probably led to a far greater volume of work than would have been the case without Vorster's active involvement. (12)

The scope and character of the firm were affected by this growth; Stauch worked on the "great man" principle and a pyramid structure, and expected to be intimately in touch with every project on every board. As the office expanded, this became less feasible and the number of buildings with which he was involved reduced accordingly, a circumstance which he did not happily accept. (13) Eventually, the large "pyramid" with Stauch at its head, was supplemented by smaller "pyramids" dealing with the overflow of work beyond his direct control. For some years he had tended to allow others to deal with those projects in which he was less interested (14) and in the same way he now concentrated on those buildings which appealed to him most. Some of these buildings can be more easily identified than others and it is worth examining them.

7.4

Various buildings: 1960 to 1968

In Pietersburg, Stauch designed the Saambou office building (1960) on a narrow East-facing site with a stepped facade and sun-control by means of "eyebrow" slabs on the North and East.

He was closely involved with a few of the more interesting (or occasionally larger) houses, such as those for H. Slabbert, Dendron (1961), C.J.H. Kruger, Bethal (1962), Hildenhagen, Johannesburg (1963), M. Schiess, Pretoria (1963), S. Jansen, Nelspruit (1963), J.P. Lamb, Johannesburg (1964), J.P. Coetzee, Northcliff (1965), Dunston cottage (1966), various house plan types for "Garden and Home" (1968), the Land

11. Ibid

12. Stauch Vorster records

13. Scholtz, T.J.R., Director Stauch Vorster, 1984 - interview.

14. Wepener, F.J., Ex-partner of H.W.E. Stauch, 1984 - interview

and Agricultural Bank, Pietersburg (1958) and B. Rech, Duiwelskloof (195-) as well as the more interesting commissions such as Pietersburg Information Bureau (1968). At this time he was still in touch with most projects on the drawing boards and would discuss these, modifying, commenting, or occasionally even discarding them entirely and starting again. But the structure of the firm was changing, almost imperceptibly, to accommodate a wider spread of designers.

Stauch gave the President Hotel in Johannesburg (1963) a great deal of attention and interest related to the building's mass, finishing and public spaces but he was less interested in the interior decoration, leaving that to the American interior designer, Tom Lee, with whom he clashed in opinion. His attitude towards interior and exterior decoration is clearly defined in an interview with T J R Scholtz who said "... the one thing he would never do was make patterns for the sake of making patterns. The only time he moved in that direction was when he afforded sculptural artists the opportunity to help adorn his buildings and was the only time he would consider art-for-art's-sake or pattern-for-pattern sake whatever. He would give these artists a pretty free rein but in a very controlled section of his work - i.e. he would say 'there is a wall or there is a space, or there is an element with which you can go and do your thing'.⁽¹⁵⁾

Bosman Building and Walter Mansions, (1962) were built on neighbouring sites in Johannesburg.

Zethushof, (1964), a block of flats in Pretoria, was one of the tallest residential blocks Stauch had produced, yet not intimidating as many high-rise flats can be. Size and scale were not problems to Stauch, although he preferred smaller-scaled buildings,⁽¹⁶⁾ but his concept sketches were based on the individual within the building having maximum privacy. (fig. 64 and 65).

Since he was so actively involved with sailing, it was understandable that he was frequently also involved with the built environment of sailing clubs. This included the first club-houses of the Transvaal Yacht Club (1956) and Mountain Yacht Club (1960), both on difficult, steeply sloping, poorly orientated sites; both still in constant use, enlarged by occasionally insensitive additions, but in each case retaining a great deal of character and charm.

15. Scholtz, T.J.R., Director Stauch Vorster, 1984 - interview.

16. Ibid

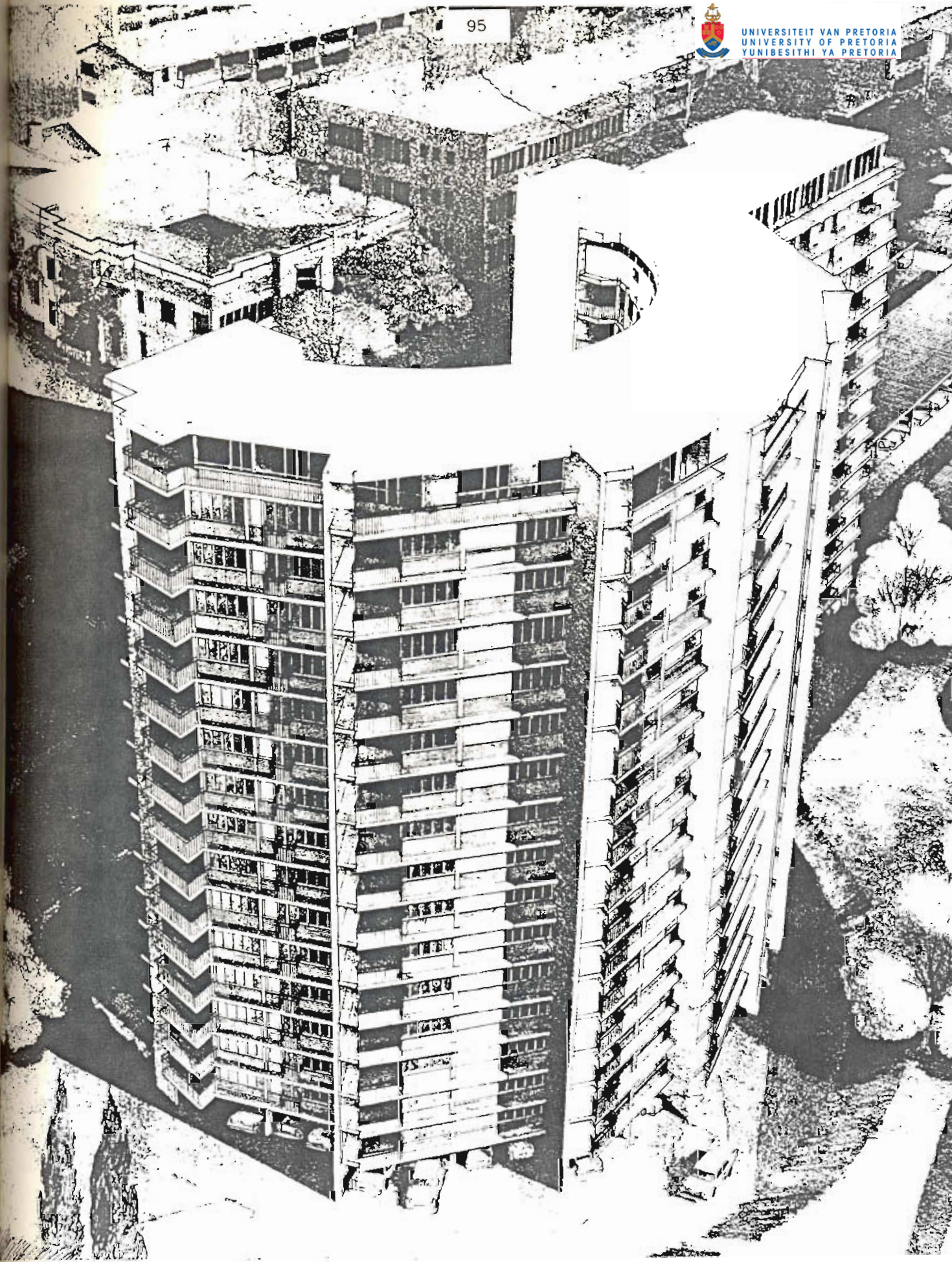

FIG. 64 Zethushof : perspective



FIG. 65 Zethushof, Pretoria. Stauch's design sketch shows the main theme of the building - the outward-turning format for maximum privacy of each unit.

The Mealie Board building, (1964) too had his close and full involvement, as did the President Hotel, Sea Point, (1964). But now he received a commission which appealed to him more deeply than many others, to design for Bruynzeel, prefabricated, aluminium-sheathed timber housing, on the "Lockwood" system (1965). These were in their nature modular, with standard detailing and an industrial approach. So enthusiastic did he become that the amount of care and effort he put into the project absorbed him to the point where communication with the client was neglected and the project ended. Of this project T J R Scholtz said "If you asked him to do something, he did not subject himself to your approval - you asked him to do it and he would do it and he expected you to subject yourself to his approval - it did not work the other way around."⁽¹⁷⁾

7.5

Change in emphasis: 1968 to 1970

The firm as a result of its growth now predominantly handled large buildings, including the mammoth Durban Station (1968), but even here Stauch remained conscious of the reassurance of the people who experienced the building, bringing them into a larger space but relating them to a scale that they understood.⁽¹⁸⁾

17. Ibid

18. Ibid

CHAPTER VIII - THE FINAL YEARS

Towards the end of 1968, a commission to design a Tourist Centre for the National Natal Parks Board led Stauch to design a flowing, thatch-roofed building complex which he enjoyed so much that he did all the sketches himself. Unfortunately the Parks Board did not proceed with this project.⁽¹⁾ (fig. 66)

He had an enthusiasm for smaller projects, challenging sites and unusual concepts.

For Basil Shearer he designed an underwater hotel for a site on the Tzaneen Dam.⁽²⁾

In Majorca, on holiday with Judge H.J. Berker, he drove Berker's parents-in-law to their steep and tricky site, and that evening at dinner he sketched on a serviette with a soft pencil design for their home, which would eventually be built there exactly according to that sketch.⁽³⁾

He designed a series of thatch-roofed-cottages intended primarily for holiday homes, with unusually compact layouts and soft roof lines. There is no record of these having been built although there was much interest in them.⁽⁴⁾

He travelled whenever the opportunity arose, with interest and enthusiasm. On one of these visits, in 1969 he visited Göreme and sketched the cave dwellings there. (fig. 67)

He designed, built and sailed boats wherever and whenever he had or could create the opportunity.

However, expansion of the firm inevitably led to Stauch being out of touch with many of the projects, and this he did not enjoy. He tended to absent himself from the office more frequently and showed signs of greater nervous tension. He appeared to be not up to the challenge of the bigger practice.⁽⁵⁾ At a year-end party, traditionally held at Hakahana, he turned to some of his partners and said with deep feeling "My God, do I really have to feed all those people and their families?"

As has been mentioned, he lived his life intensely and passionately on all levels and he wanted to stay young forever, and resisted the ageing

1. Stauch Vorster records

2. Ibid

3. Berker, Judge H.J., Friend of H.W.E. Stauch, 1984 - interview..

4. Stauch Vorster records

5. Scholtz, T.J.R., Director Stauch Vorster, 1984 - interview.

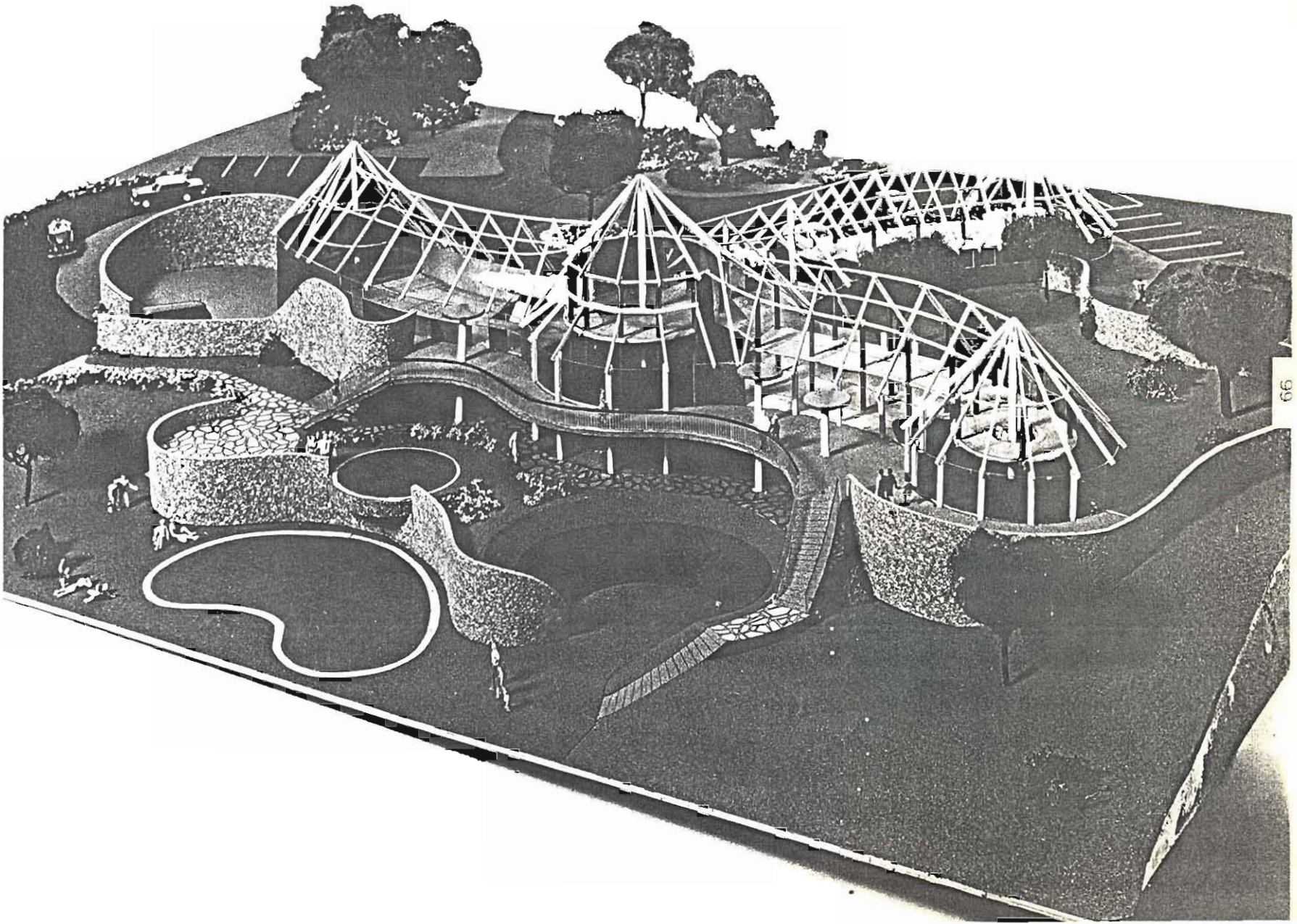

FIG. 66
removed.

False Bay Reception Centre : photograph of model with roof

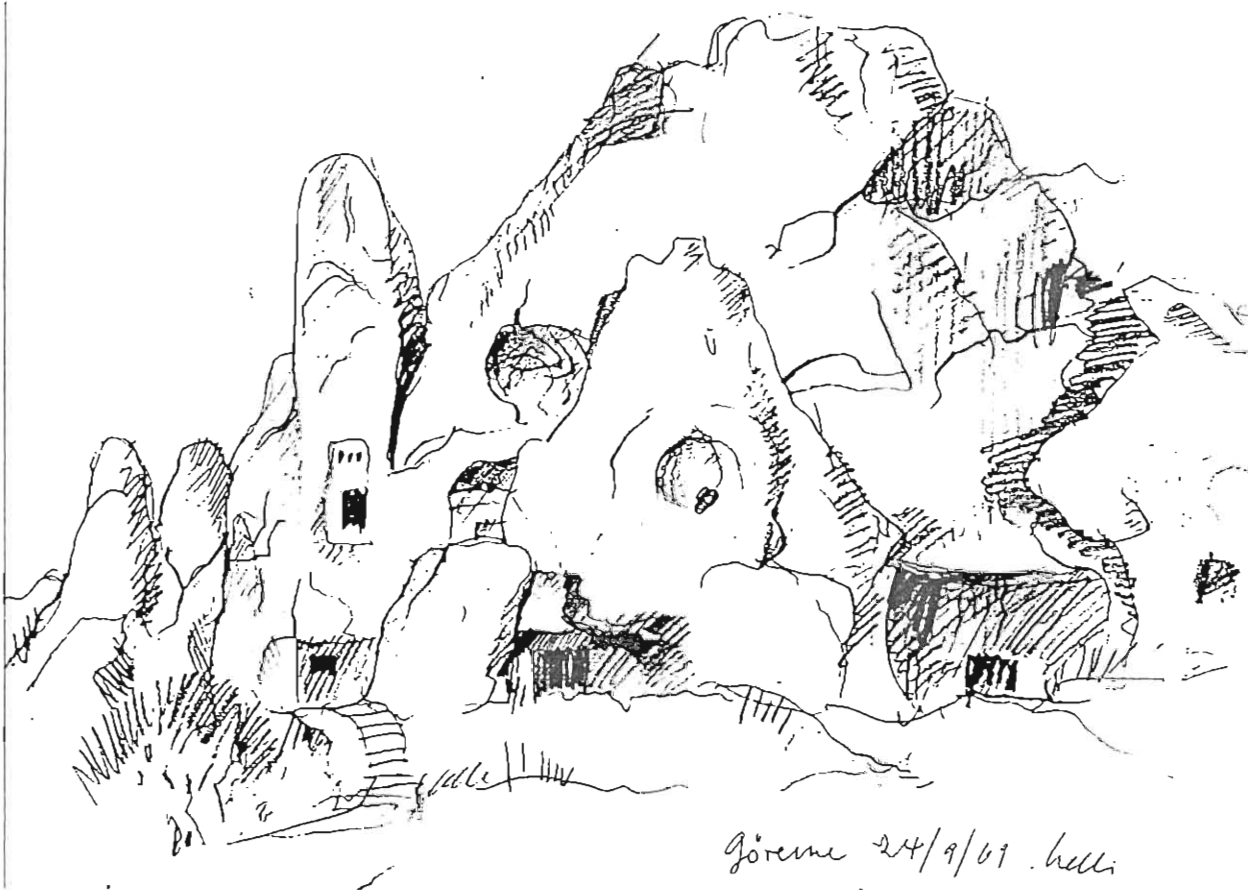

FIG. 67 Stauch's sketch of cave dwellings at Göreme

process, ignoring the possibility that he might one day be old himself.⁽⁶⁾ But the truism that "nothing can make your body as ill as your mind can" may well have been applicable. In the last few years he was beset by ill-health and accidents. In one of these, at Saldanha, his legs were seriously lacerated by the propellor of an outboard motor - but even then, incapacitated in hospital, he insisted that his wife Carmen should race his boat and complete the series on his behalf.⁽⁷⁾ He developed jaundice when he was sailing in Lourenco Marques but even though on the point of collapse insisted on continuing to take part in the regatta; and after the regatta he did not rest, for he wanted to go to the championships in Bavaria.⁽⁸⁾

He continued to drive himself in this way right up to the end, when, after a weeks sailing in the "505" class of dinghy and after taking third place, on July 19th 1970 at Lourenco Marques, he failed to appear for the prize-giving. His body had finally burned itself out, and South Africa had lost one of its finest architects.

-
6. Henkel, Mrs Margot, Friend of H.W.E. Stauch, 1984 - interview
 7. Berker, Judge H.J., of H.W.E. Stauch, 1984 - interview; News clippings in Stauch Vorster records (1968)
 8. Berker, Judge H.J., Friend of H.W.E. Stauch, 1984 - interview.

CHAPTER IX - ARCHITECTURAL APPROACH AND PHILOSOPHY

Background

Hellmut Stauch wrote very little concerning his philosophy or approach. Some of the writings were in his early and formative years while the enthusiasm for expanding his ideas were still strong and his need to carve a niche for himself dominant.⁽¹⁾ During development periods in the middle years he would take a new idea and propound it enthusiastically but this was seldom committed to writing.⁽²⁾ The most comprehensive statement made of his philosophy in writing was in a paper prepared for an in-house seminar for his partners in 1969.⁽³⁾

At the end of the first world war when he was 8 years old, he was developing strongly as an individual. In spite of his wealthy and privileged background, he had been affected by the war. August had been called up and served for a time in Germany, his family visiting him whenever possible (Levinson, 1983). There were shortages and problems; the world was in turmoil. In 1923 inflation was reducing the fortunes of those in Germany and Central Europe. People were losing their assets; insurance was worth nothing at all. Security in any form was non-existent. Both material and spiritual values were affected and this was particularly noticeable in the creative world of art.⁽⁴⁾

For Stauch anything of the past had to be rejected and this made both the Bauhaus and the Itten Schule immensely important for they had based their approach entirely, so they believed, on commonsense without falling back on tradition. Gropius had stated that the new growth should spring not from the branch of the tree but from its roots (Wingler, 1969). Stauch later found it amusing that since everything conventional had to be rejected, even the roof of a house, a primary element, was taboo. A house consisted of a cube which was opened up where light and air was required or where one had to enter it. No roof was visible and the ideal form seemed something which had the same finish all around; walls, roof, the lot. Embellishment or ornamentation were also taboo as was anything curved or not strictly rectangular. The planes were even

-
1. Personal deduction from his early publications, their trend and content (see Addendum listing these).
 2. Student comment, interviews with his employees and partners, personal experience.
 3. Stauch Vorster archives.
 4. H.W.E. Stauch paper : Stauch Vorster Seminar 1969.

surfaces with pure basic colours or, preferably, black and white. To show even the brick texture was considered very daring and not very acceptable. Unfortunately this idealistic example did not last as the buildings weathered dramatically.⁽⁵⁾ Stauch had also joined this band-wagon, as can be seen in some of his earlier and student sketches.

9.2 Forbat's Influence

His time with Forbat had increased his sensitivity to materials and buildings, a commonsense approach to living, the provision of living spaces, and an ordered standardized industrial approach.

One of the projects on which he worked as Forbat's assistant was a riding school "Reithalle der Deutschen Reitschule" near Berlin, a building where timber was used in the form of innovative arched trusses with delicate steel tension members (Bauwelt, Heft. 47, 1931). Another project was a block of flats at Spandau, Haselhorst, an unimaginative but beautifully proportioned series of blocks of flats with careful interior planning which had clearly received a lot of attention in the investigation period, perhaps from Stauch, for the layouts showed the same touch as in much of his subsequent work (Die Baugilde, Heft. 24, 1930.12.25).

Although Forbat's influence may have been strong, Stauch's later work generally had a lighter touch than Forbat's.

9.3 Peters Bau

When Stauch joined Peters Bau in the role of consultant on housing, he developed an appropriate philosophy of "core housing". Those who could, in the strained financial climate of that time, afford to construct anything at all could be assisted by this approach. It utilized an industrial system, was based on a two-directional module of 1 050mm and its plan forms were a great deal more acceptable and liveable than those of many industrialised buildings in production today. The pamphlet which he produced for this firm clearly shows his influence (Das Ideale Eigenheim, Stauch, 193-)

Early work in South West Africa

In 1929 following his visit to SWA where he was commissioned to design farm buildings for the S.W.A. Farming and Trading Co., his designs

and recommendations were published in an (unidentified) German magazine (Neues Bauen in den Kolonien von Architekt Hellmut Stauch, 1935), a reprint of which is in the Stauch Vorster archives. These show his concern for the same issues as those with which he was dealing in Germany, together with great interest in climatic conditions and their control. The assumptions made at the time were in fact faulty for he decided that effective sun-control would be achieved by facing the buildings East to provide cool afternoon living while "controlling" the sun on the western side by means of a large living verandah, as can be seen from the plans in the reprint referred to. Later, he abandoned this approach and concluded that such control would be most effective on a North-facing building.⁽⁶⁾ His development of this, influenced later very strongly by Oscar Niemeyer, was to have a far-reaching effect on South African architectural sun control.⁽⁷⁾ Later forms of sun-control were developed, from a light fretwork of aluminium members fixed across the face of the building on light, brightly coloured grommets on concrete shade slabs and fitted with adjustable horizontal shade louvres, to a heavier form of fixed concrete louvre. (fig. 68). Today, these energy-saving sun-control measures are once more appropriate, and there is probably much to be learned from Stauch's approach.

Early years in South Africa

In 1940 Stauch was about to build his own house and saw the opportunity to put into practise those principles, beliefs and systems which had developed out of his training and circumstances. The primary properties which he stated should be expected from the ideal house and its furniture were according to his own statement: usefulness; suitability; adaptability; movability; universality; value for money; beauty and possibility of enlarging and completing (South African Architectural Record, February, 1941, "Stauch : The Development of Standardised Building Elements").

He sought the attainment of universal values by means of using elementary forms and modes geared to current economic conditions. He felt

6. Compare Marchie Mansions.

7. The sun control louvres on the Meat Board building were apparently the first used in South Africa and had to be purpose-made (Stauch Vorster archives and F J Wepener) The manufacture of standard sun control brise soleils and louvres was in response to subsequent demand.

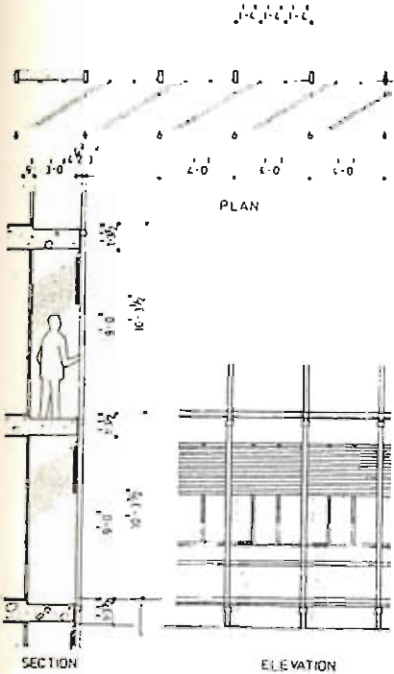

1. 1964. Carl List House.
A typical example of Stauch's earlier approach to facing an office building facade with a simple, elegant, and economical sun screen. He insisted that floor slabs be cantilevered outwards to serve as sun shades over windows and walkways for window cleaners. Yet, to retain his vertical "steel window aesthetic" in the sun screen the RHS aluminium louvre supports are fixed to run continuously in front of the slab edges to correspond with a module of structural MS mullions set into the window wall. Thin horizontal aluminium louvres are fixed to the inside of these supports so as not to break the vertical treatment. Here, the screening is very much an applied metal filligree, elegant and practical in itself but not integrated effectively with the concrete structure. The overall aesthetics of the facade are not very satisfying: one soon tires of the excessive hardware, which is too light and sparse to achieve a vertical effect in a frontal view. There is a duality between the verticality of the screen and the horizontality of the slab edges. These two elements do not integrate visually to form a neutral screen as in Corb's "South American Joe".



4. 1970. J.B.S. Building.
This building is seen only as a street facade. It is a logical development of the firm's changing approach to the external sun screen. Denser shading was required than in the other buildings because of aspects facing East and West. The structural columns (precast) have been moved out to serve as additional shading elements. The available column depth made it possible to fix more effective horizontal louvre trays; adjustable vertical louvres, which would have provided better sun control were not used because of the desire to move away from applied hardware towards a more dignified and long-lasting urban facade. Precast terrazzo face panels thicken the slab edges to produce a definite horizontal effect. The proportional scaling down in thickness of the assembled components is successful. The proportions of the resultant voids are equally harmonious. By contrast, the applied metal sun screen of the Carl List House facade seems weak, unsure and not at all suitable as an urban facade.

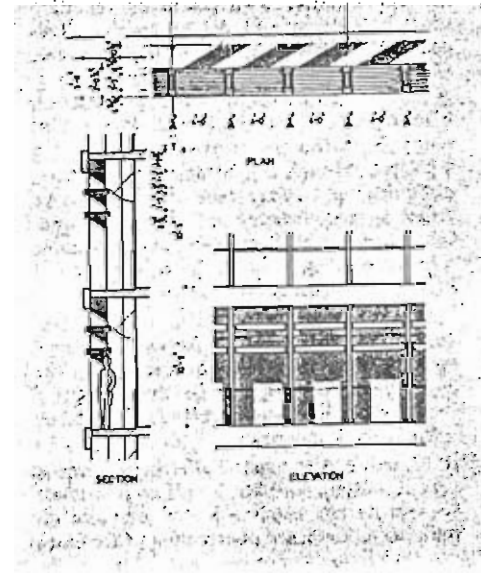

FIG. 68 Sun-control systems. Similar in character, these varied from light to heavy, as shown in these two examples from an article entitled "Facade Aesthetics and the South American Joe" by S M Selfet, in Plan 12 (1972 pp 24 and 25)

that this elementary form would satisfy the craving for harmony and beauty which is common to every human being and that mechanical mass-production could provide this beauty as easily and more economically than could hand-made items. He felt strongly the moral that "a common form ties rich and poor together and quality is no longer the privilege of the wealthy".⁽⁸⁾

As far as the house itself was concerned, he especially held to the concept of a changeable dwelling fitted to current usage. He stated that "Every shape of usage develops into a final perfect shape and this should be the basis for all further development". Home and furniture, he felt, should be able to grow with the income and those things already acquired should not lose any of their value if they matched new acquisitions in form and finish.⁽⁹⁾ Furniture was frequently built-in, carefully designed for harmony and compact living, with the aim of releasing as much free space as possible and not allowing a cluttered room space. He refused to be involved with pretentious interior design.⁽¹⁰⁾ This Spartan philosophy influenced even the detailing of his buildings, each element of which had its rational and simply stated place.

9.6 Influence of other architects

While he was working for Forbat, who was a straight-forward purist. Forbat collaborated with Marcel Breuer on several projects, so giving Stauch the opportunity of working in this interesting circumstance with Breuer. It was to him surprising, in view of his own training, that Breuer would decide on a solution because of its form, the shadow which it cast, the perspective and the impact it gave rather than how practical it was.⁽¹¹⁾ But he must have been influenced by this, for it was similar to his own later approach.

Oscar Niemeyer whom he visited in Brazil struck him as being very similar to Marcel Breuer. Gaudi's buildings he found fascinating. Of Niemeyer he said "He is a very gifted, brilliant artist for whom expression and form is almost everything. We were in Rio de Janeiro in 1948 when this book "Brazil Builds" had just been published and we

8. Ibid

9. Ibid

10. Scholtz, T.J.R., Director Stauch Vorster, 1984 - interview.

11. Unless otherwise identified, the main source of information of section 9.6 is H.W.E. Stauch's paper, delivered at the Stauch Vorster Seminar of 1969.

especially went to look at the various jobs mentioned in this book and when we went to the addresses we could hardly find the buildings because, what in the photograph was a beautiful white, sharp, clean job, now had streaks of grey, rust and brown over it and cracks and creepers were growing and corrugated iron lean-to roofs were attached in front to shade the facade, etc., and this is just one extreme case but there were quite a number of these. We then met Oscar Niemeyer and asked him about his views. He said that it is not very important how buildings looked after ten years, it is important what impact they make initially. A good example is that famous church with a shell roof, covered in mosaic, looking very beautiful in Belo Horizonte and this church is built next to an old wooden structure. When it was completed it was found that it leaked madly and that the congregation could not use this church for services, they had to use the old wooden church for that purpose but the new one was so world famous that it attracted a lot of visitors. When I asked Niemeyer how he would construct this church and do it, now that he has learnt this lesson, he looked at me blankly and said 'Of course, I would do exactly the same'.

"He showed us a very exciting looking printing works, with a most intriguing array of louvres, small, big, all colours of the rainbow - some spaces left without. I thought that a most intricate plan and internal function demanded this variegation, but looking at the plan I found that there were seven quite identical floors housing printing machinery - even the portion without louvres. When I asked him for the reasoning behind the louvre system, his answer was 'Doesn't it look nicer this way?' And visiting in his office, we found that upon opening the front door a terrific draught blew drawings and documents off all 50 boards. But he declared that he'd rather have that than small cubicled offices where he can't talk to his assistants."

Of Gaudi he said "As an old Bauhaus disciple I should be horrified at these seemingly random shapes and forms, but if one allows artistic license, one has to admit that there can be some value in the "more than minimum". Gaudi sculpts everything, pillars, balcony rails, chimney pots and lavatory ventpipes. We must ask our conscience how far to go."

Hannes Meyer, Gropius's successor at the Bauhaus was much admired by Stauch but he appears to have observed the sterility which can arise from Meyer's approach. He said "Hannes Meyer was a Communist and his approach was very straight, honest and logical - that if you build a block of flats, for instance, each flat must be exactly like the other and there

must be no flats slightly better or slightly worse than any of the others. So, if you designed a block of flats consisting of a row of flats on each floor, you were not permitted to take advantage of the fact that the end flats had an additional exposure to the sides and therefore could be improved by additional light and ventilation. But no - the end had to be a blank wall and you were not even allowed to gain the little space which the access passage, for instance, can give you.

In 1952 when Stauch was sailing in the Olympics he met Alvar Aalto, a congenial and warm hearted person. Stauch's comment on his architecture is revealing. "To me the buildings he builds are always terribly ugly looking and yet they have a character which is undeniably fascinating. His detailing is superb, as is his usage of materials and I suppose if you get used to his philosophy you might even learn to like the looks of the buildings. He has an odd sense of beauty but he is a very methodical man with a brilliant gift for planning. He lives and works in a house in the heart of Helsinki and has peacocks walking in the garden - sometimes also on the drawing boards".

Stauch found the most exciting project to be the German Pavilion at the Montreal Expo 1957, by Frei Otto. "... this building was based on the concept of a huge tent with supports at various heights which just covered the whole exhibition area which itself was quite strictly plain and constructed in steel frame and timber, etc. This structure, I might say, is one of the most beautiful things I have seen yet. It was beautifully detailed and the effect of light and space inside this volume was quite fantastic. The new Stadium for the Olympics in 1972 in Munich is based on the same principle, designed by Benisch, and promises to be a most exciting job."

"This building is entirely free form yet it is disciplined because it is based on the structural requirements of cables and tension and skin stretched over this and therefore, although the concept is based on the imagination of the designer and the construction allows for free forms, all forms seem logical and disciplined."

Safdi's "Habitat" he found almost equally as exciting. "The Habitat of pre-fabricated boxes in reinforced concrete, piled on top of one another in many variations so that, I think, with about five or six basic boxes about twenty different types of flats can be created, from bachelor flats to six-bedroom units. By the juxtaposition of these boxes terraces are formed. The whole building looks most exciting with the play of light and shadow and very sculptural forms, and its beautiful finish. It is highly uneconomical (rents from £120 to £400) due to overdimensioning of

structure. Since all boxes are prefabricated uniformly, they are all constructed to carry the full load of seven floors. Surely it would be more economical (and flexible) to erect a carrying framework and insert the living units into this as long ago suggested by Corbusier. You could even think of trading in your old "drawer" unit for a new one."

9.7

The Quality of Stauch's design and his influence

Throughout his life it is apparent that Stauch was open to new concepts, new influences and imaginative answers. He was not an architect who would have stagnated in any way. New trends appeared to set off a "fire-works display" for him and he frequently designed projects without either site or commission. His projects varied from strictly rectangular, logical, rational building to a fluent, thatched, gently curving, almost emotionally planned structure.⁽¹²⁾ Buildings he found equally easy to handle whether they were large or small. Scale did not overwhelm him. He dealt with space with polished assurance.⁽¹³⁾ His domestic work exhibited a light and sensitive interpretation of standardised components, reminiscent of the philosophy of Neutrá (South African Architectural Record, September, 1965, p 45). And, throughout his projects, his mastery of form, scale and light and shade could be observed in every one of the projects he designed or with which he was closely associated.

His contribution to South Africa's architecture was incalculable, and his untimely death was a loss not only to his friends, associates and family, but also to those who would have been influenced by the ever-developing work and constructive criticism of this truly great architect.

12. Stauch Vorster archives.

13. Scholtz, T.J.R., Director Stauch Vorster, 1984 - interview.



ADDENDUM A : LIST OF PROJECTS

 1. Introduction

The projects listed in Stauch Vorster's records both on a card index system and on the subsequently introduced computer system, from the inception of Stauch's practice until his death in July 1970 number one thousand nine hundred and thirty one. As it was impractical within this thesis to catalogue and allocate that number of projects, a summary has been prepared, divided into three sectors and based on the Stauch Vorster list. Estimates of Stauch's participation were based on interviews and discussions with partners, and on the personal experience of the author, (who has for some twenty years been responsible for project records within the firm).

 2. Projects from 1943 to 1958

During this period Stauch was in close touch with virtually all projects, and those in which he had no direct involvement had, at least, his approval. It is estimated that he was directly involved with 90% of these. They varied in size from tiny additions to large commercial or industrial buildings and are:

| | |
|--|------------------|
| . Houses, flats, residential buildings | 659 |
| . Hotels, hostels or similar buildings | 10 |
| . Educational buildings | 6 |
| . Shops, offices, retail/wholesale developments | 19 |
| . Industrial buildings, factories and garages | 29 |
| . Hospitals and research buildings | 8 |
| . Community buildings, clubs, yacht clubs | 16 |
| . Churches/church-related buildings | 6 |
| . Exhibition/tourist buildings, furniture/other projects . | <u>9</u> |
| | TOTAL <u>762</u> |

 3. Projects from 1958 to 1968

At this time the practice was expanding rapidly and records show a reversal of project type. Nine hundred and ninety six projects are listed for this period, predominantly commercial. It is thought that Stauch had direct involvement with approximately 50% of these.

 4. Projects from 1968 to mid-1970

One hundred and seventy two projects are listed for this period, Stauch probably being directly involved with less than half of these.

ADDENDUM B

"The Development of Standardised Building Elements" - an article by Hellmut Stauch, published in an architectural magazine.

This article fully illustrates the use of standardised elements in the actual design and construction of a house - in this case the house which Stauch built in Villieria for his own use.

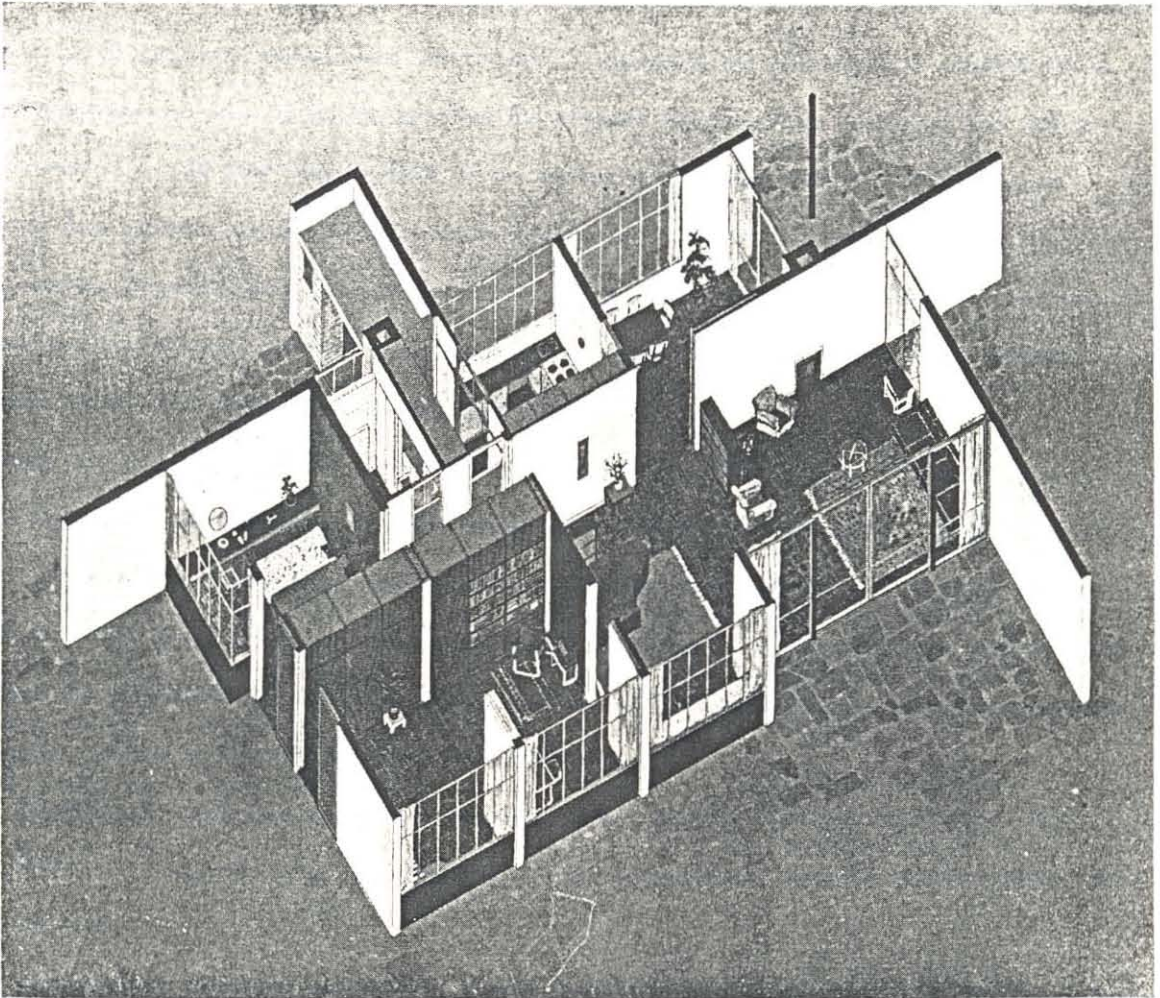

ISOMETRIC VIEW OF A HOUSE IN PRETORIA

THE DEVELOPMENT OF STANDARDISED BUILDING ELEMENTS

by HELLMUT STAUCH

The standard articles available for house building do not seem to be the best and most efficient producible, not so far as quality of material and construction is concerned, but with regard to practical design. The main disadvantage seems to be the fact that the different industries have developed their articles separately, with the result that there is little or no relation in dimensions, materials and appearance. Each one of these articles, such as windows, doors, door-frames, building- and insulation-boards, etc., is based on a certain dimension from which the sizes of its different types have been developed. All these basic dimensions are different, making it difficult, and sometimes impossible, to use these different articles together in the same building harmoniously and economically.

It would be a great advantage if a system could be worked out which develops all these different elements from the same basic dimensions and thus brings them into direct relationship. Such standardisation would make a mass production of building units on a large scale feasible and so make it possible to produce a high grade article at a reasonable price. It seems to be essentially the architect's job to analyse the possibilities of such a development which ought to be carried out in collaboration with the engineer. A few of the most important units would be :—

Window-units which can be opened completely, which provide for night ventilation, which can be fitted at a moment's notice with flyscreens or can be protected by solid shutters against external influences ;

External doors which can open up a large portion of a room to the outside, which also provide for fly-screens and shutters ;

Internal doors, sliding and folding, complete with frames, etc. ;

Internal screens, subdividing rooms partially or wholly, or also allowing them to be opened up into one ;

Cupboards, shelves and other furniture which can be put together in any desired combination and can also be used to subdivide rooms ;

Internal and external wall units ;

Floor, ceiling and roof units.

The idea of relating building elements can be carried further by including all types of movable furniture as well. Quite apart from other advantages this would benefit the inhabitants of houses and flats because they would be certain that their furniture would fit the rooms satisfactorily.

If standardised building units were manufactured and available at reasonable prices, the "growing house" could be made a practicable idea, which would suit many people in this Country. The accompanying diagram could serve as an example : starting with the smallest unit—the cell—(which is not unlike a typical plan for a bachelor flat), all the other types could be built by adding new units onto the cell. This would enable people with small means to build their own house in proportion to their income and to improve it as their income increases, without having to start with cheap or second-hand materials which later might become altogether valueless. For the same money they could use the best articles, not hand-made "any old way," but machine-made to precision, so that for any future addition they would get the same parts to match.

Systems of mass production of house units have been developed on the Continent, and to a larger extent in America. Most of these systems have the disadvantage that their units cannot be used universally because they are designed to suit one particular type of plan or construction. It should be possible to design building units which can be used for all types of human housing.

The arguments against such a development are well known : Boring uniformity, "inartistic" appearance, suppression of individual expression, are a few of the points mentioned frequently. It has even been suggested that it would make the architect superfluous.

These arguments are quite unfounded. After all, we are already working with standardised building units, only they do not quite comply with present day demands. What else than a unit is the stock brick, the standard steel window, the stock door ? The brick, for instance, suits quite ideally the method of work for which it was made. Due to its small size it is adaptable to almost any dimension, but it will never be economical, because it will always demand a slow building process. Incidentally, it is quite a bad sign for the progress of the building industry that the brick is still so popular and still the cheapest means to build a wall.

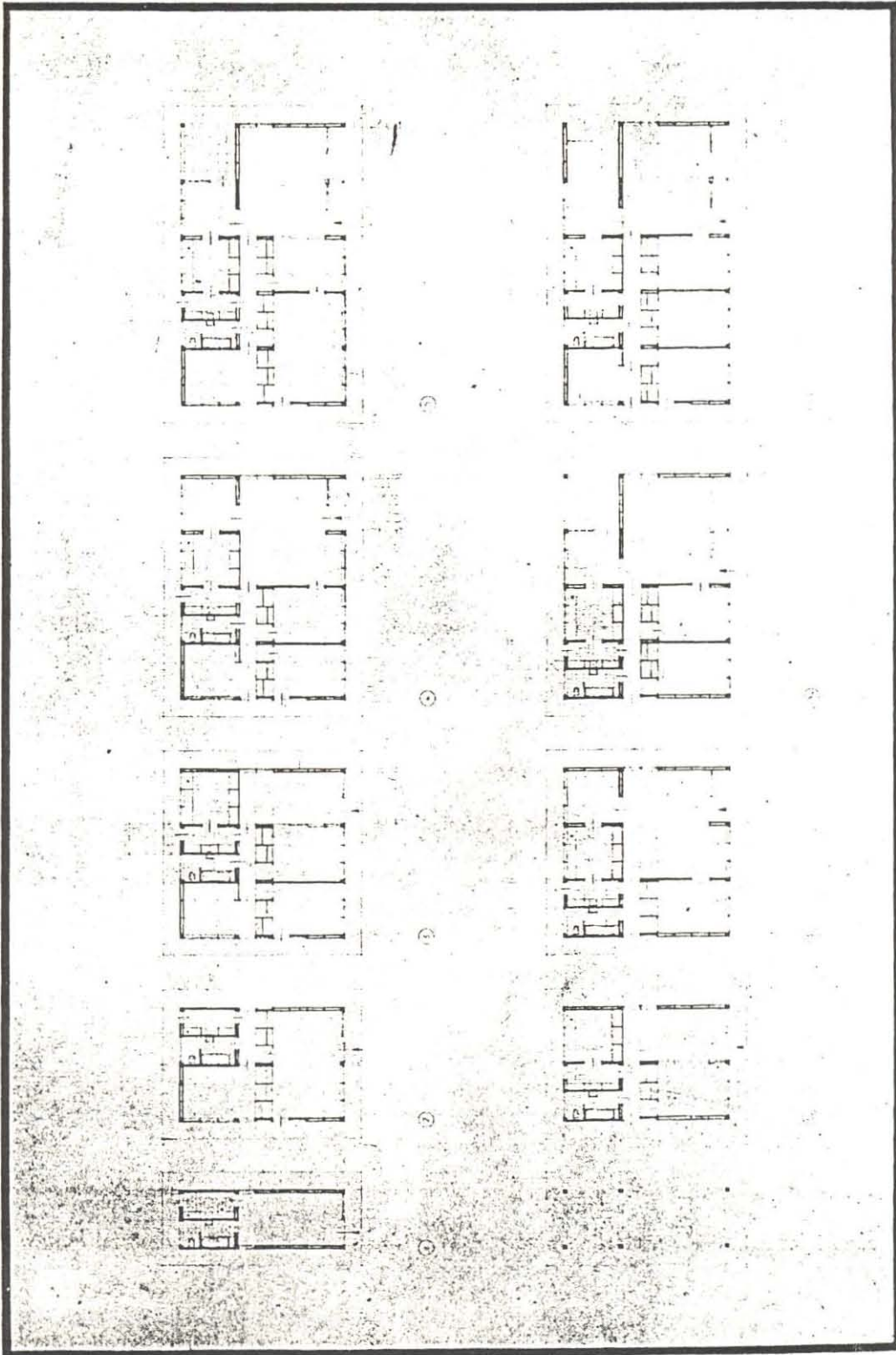

D E V E L O P M E N T O F U N I T P L A N N I N G

However, we have become used to working with brick-sizes, steel-window and -door dimensions, etc., and find it quite natural. It should, therefore, not be so difficult to work with other more efficient units. It seems that if such building elements were designed to satisfy practical demands in the best possible way and were used in the same spirit, then it would rest entirely with the designer and owner to achieve a successful result.

Such a development would not bring any disadvantages but would, on the contrary, have one great advantage: flexibility. Times change and so do people. To give them a chance to adjust their environments according to changed conditions seems a necessity which becomes more and more important as time goes on. This factor is important enough for the individual house but still more so for the flat: it will allow the flat dweller to arrange his quarters as near to ideal as possible and gives the landlord an opportunity to adjust his flats according to the general demand, with the result that his flats will always be let.

The house shown on the following pages was designed to make a general study of the possibilities outlined above. It was based on the same unit as the plans developed in the above shown diagram and is similar to the plan Type 5, except for a different Study arrangement.

Unfortunately many details could not be executed as efficiently as would have been desirable, due to the fact that a high grade article made by hand is very expensive. This house had to be cheap because the means were limited. Only mass production of building units will make it possible to build a house cheaply and yet furnish it with the very best equipment. The principal idea has, however, been adhered to with the aim of making plan and appearance a consequent expression of the system.

SITE:

The ridge of a hill between Meintjieskop and Magaliesberg on the north-eastern outskirts of Pretoria. Approach from the north side by Sixth Street, Villieria, which comes to a dead end at entrance to property. To the north, hill drops steeply to Villieria Valley with Magaliesberg Range further away. On south side, almost level with lower portion of ground, is a Government grass experimental farm which affords a pleasant view on well-kept squares of different varieties of grass. To the north-east one overlooks the flank of the hill with Derdepoort in the background, while the west gives the whole panorama

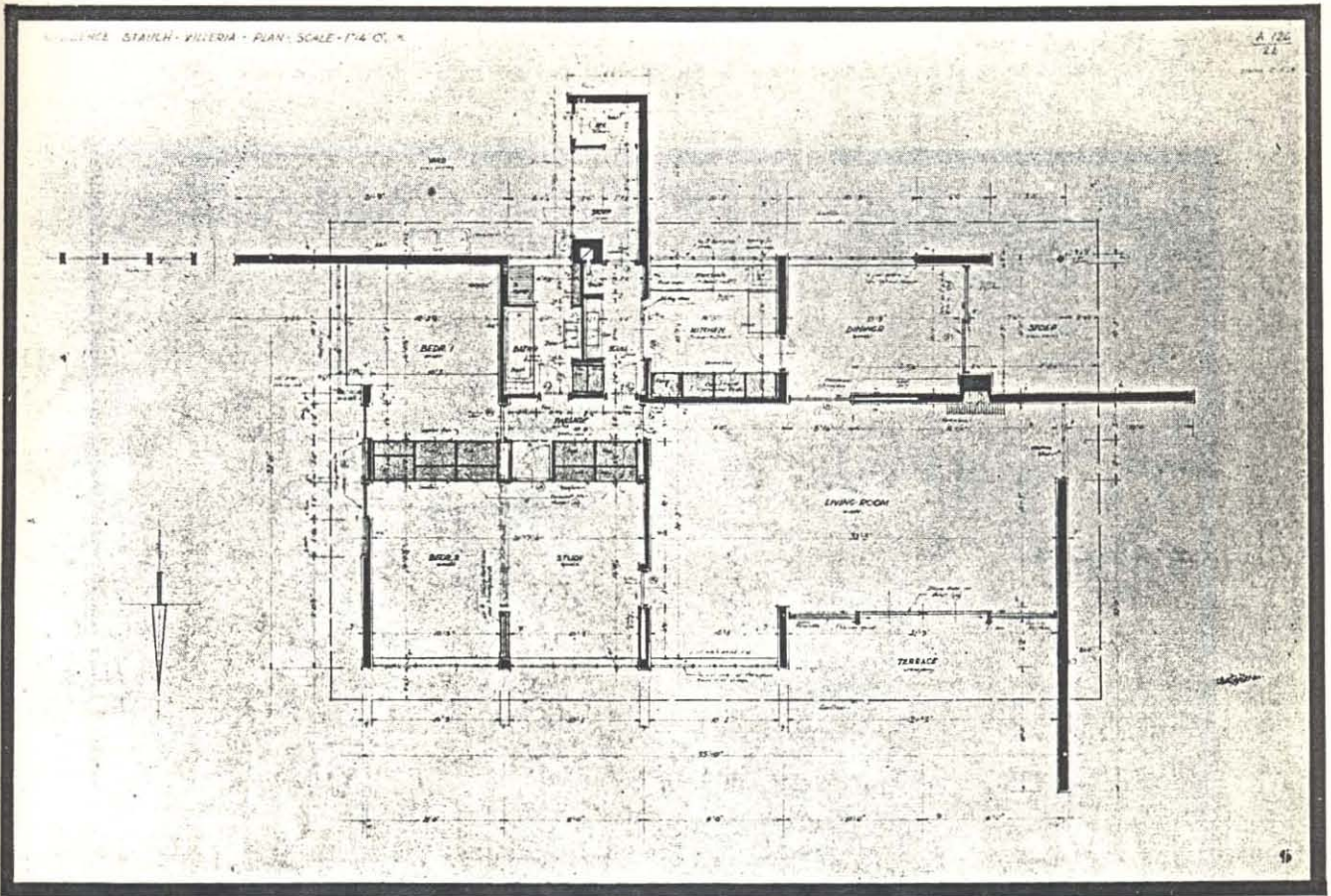

HOUSE IN PRETORIA DESIGNED BY HELLMUT STAUCH
THE PLAN

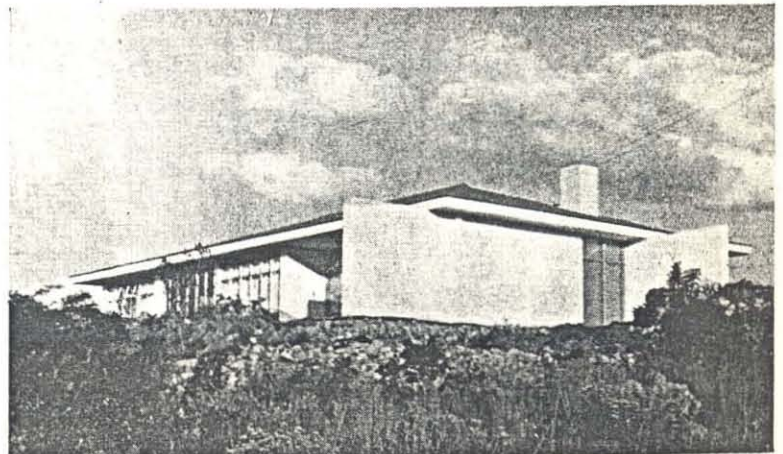

N - W CORNER

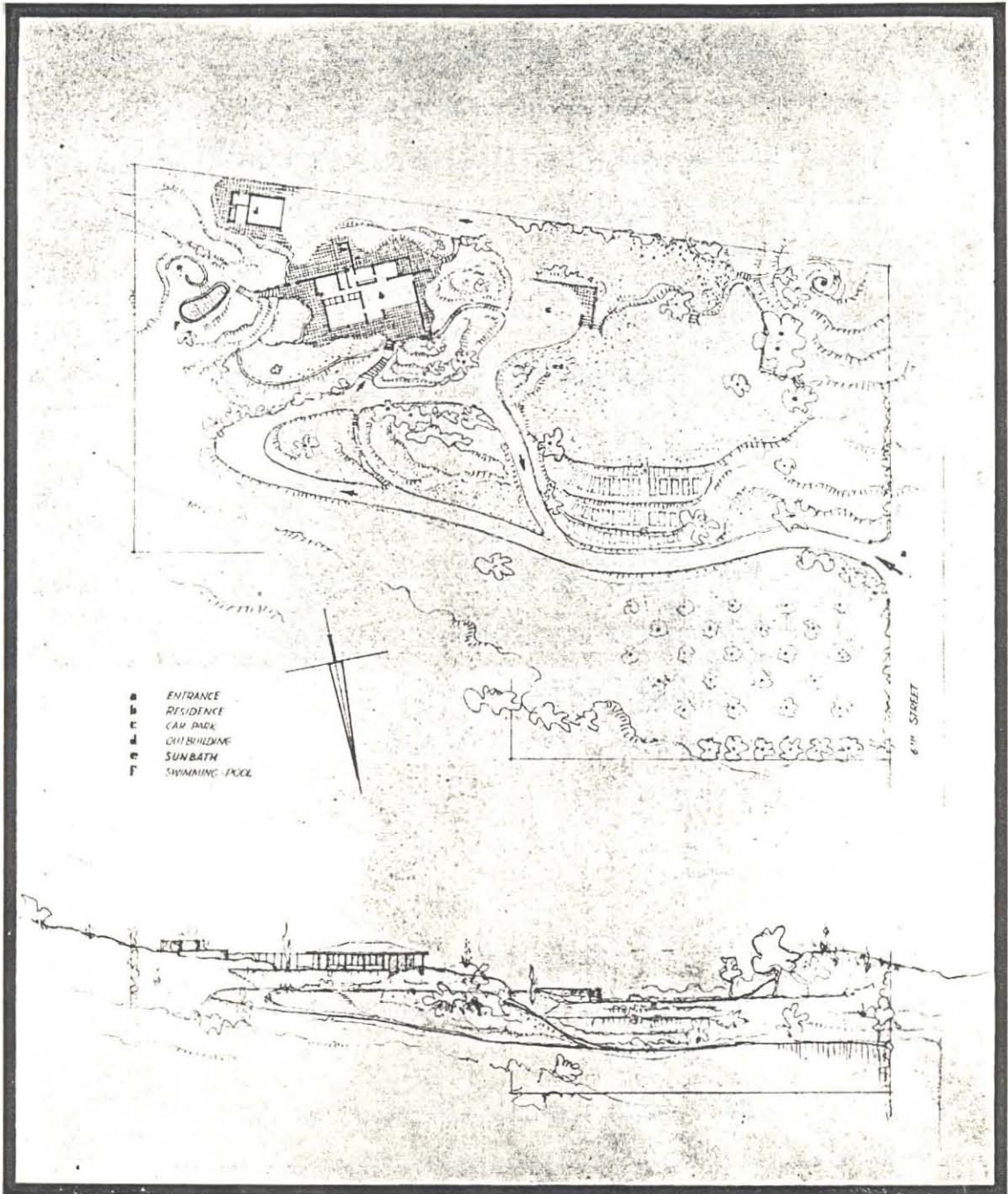

PLAN AND SECTION OF THE SITE



of the centre of Pretoria, the Steelworks and the range of hills continuing the ridge on which the house is built. The south-west is sheltered by the slightly higher continuation of the same ridge.

POSITION AND APPROACH OF HOUSE:

The house is situate on the higher portion of the ground in the south-east corner. The approach leads from the entrance gate on the west boundary to the north of the house where a few steps lead up from the road to the terrace in front of the living room, which is the main entrance to the house. The road continues to the garage, with outbuildings, back yard and back entrance on the south side of the house.

PLAN:

The living room is the centre of the house and leads to all other sections, viz.:—

- (a) Diningroom—kitchen—scullery—back stoep;
- (b) Bedrooms connected by passage with bathroom and back entrance ;
- (c) Study.

All rooms have direct access to outside in form of sliding doors with sliding flyscreens. Utility rooms, such as kitchens, scullery and bathroom, have been kept as small as possible to leave more general living space. The lavatory is placed on back stoep. It was originally planned as an E.C. and has since been converted for waterborne sewerage. A recess in the bathroom, now used as shower, could, alternatively, house the W.C.

CONSTRUCTION:

Floors: form a tray acting as protection against influences from below ; consist of concrete slab with kiasat woodblocks on layer of malthoid in all rooms ; of mastipave with granolithic border in kitchen, bathroom and scullery.

Walls: are solid screens protecting against climatic influences from the sides ; partly extended to the outside to protect against strong winds, and also to act as suntraps or to give shade as required, constructed of brickwork with plaster on both sides.

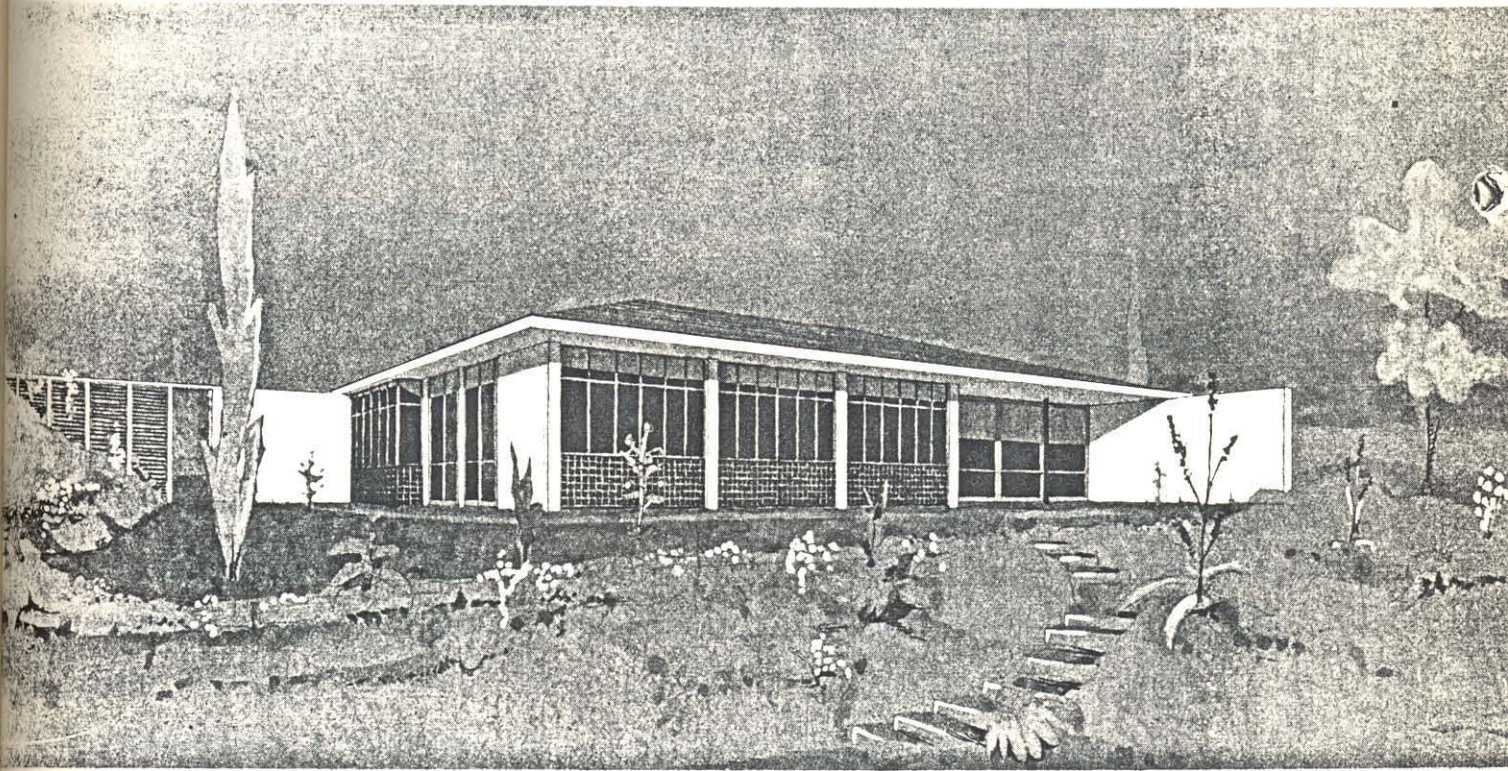

PERSPECTIVE OF THE NORTH FRONT



Windows and External Doors : are transparent screens with a similar function as the walls but, in addition, to give light, ventilation, and, in the case of doors, to act as access to the house. The windows are stock steel windows with plates on top and bottom of mullions to carry the roof structure. The external doors are of plate glass in 4-1/2 x 2 in. wooden frames, sliding on Esavian bottom tracks with ball bearing runners and are fitted with automatic locking spring catches. Every external door is also fitted with horizontally sliding flyscreens of similar construction.

Ceilings, Eaves and Roof : form a unit acting as lid to protect against influences of climate from above ; consist of a wooden structure carrying corrugated iron roof with ceilings of compressed fibre boards cut into small squares to minimise the effects of expansion and contraction, with 1/2 in. match-board eaves forming continuation of ceiling on the same level, finishing against 9 x 1-1/2 in. fascia board with sheet iron gutter behind. Over all openings a wooden beam 6 x 4-1/2 in. supports the roof structure. This beam forms part of the recessed curtain box.

Internal Cupboards : serve to subdivide rooms, and face both ways. Width is divided into three equal parts, each 3 ft. 4 ins. wide, and 2 ft. and 1 ft. deep respectively ; fitted with rods for hanging clothes and shelves. A horizontal division at 7 ft. height leaves storage space 2 ft. high and 3 ft. deep in top section.

In study, the space 2 ft. high from floor is used for sliding drawing-shelves, 3 ft. deep.

Internal Doors : act as movable solid screens and are, where intended to be mostly open, constructed as sliding doors of flush laminated boards to the full height of rooms, sliding on bottom tracks, fitted with hook-bolt, locks and flush handles. Doors which should be kept closed are flush folding doors of usual construction, fitted with fanlights where necessary.

Internal Sliding Screens : have a similar function to doors, and act as partition between study and bathroom, but also as pinning boards for drawings, pictures, photographs, etc. ; constructed of Insul boards in 2 x 2 in. wooden frames, sliding in four panels on bottom tracks across the full width of the room, so that each panel can be placed in any desired position in the room.

Bathroom Fittings : 6 ft. white enamelled bath built in ; dental basin with mirror above, shower, towel cupboard fitted with brass hanging rods and warmed from slow combustion stove in scullery ; cupboard for soiled linen has small receiving hatch and large door for removal of linen, with open glass shelves



INTERIOR VIEWS OF THE
DESIGNED BY HELLMUT



HOUSE IN PRETORIA
STAUCH



N-E CORNER

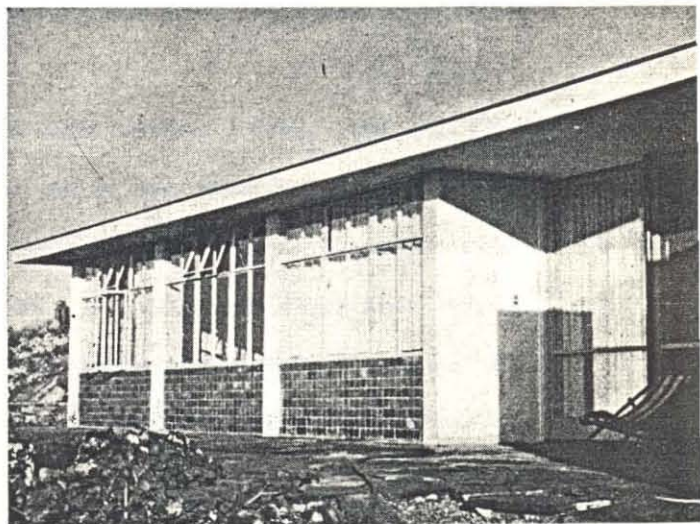

NORTH FRONT



EAST FRONT

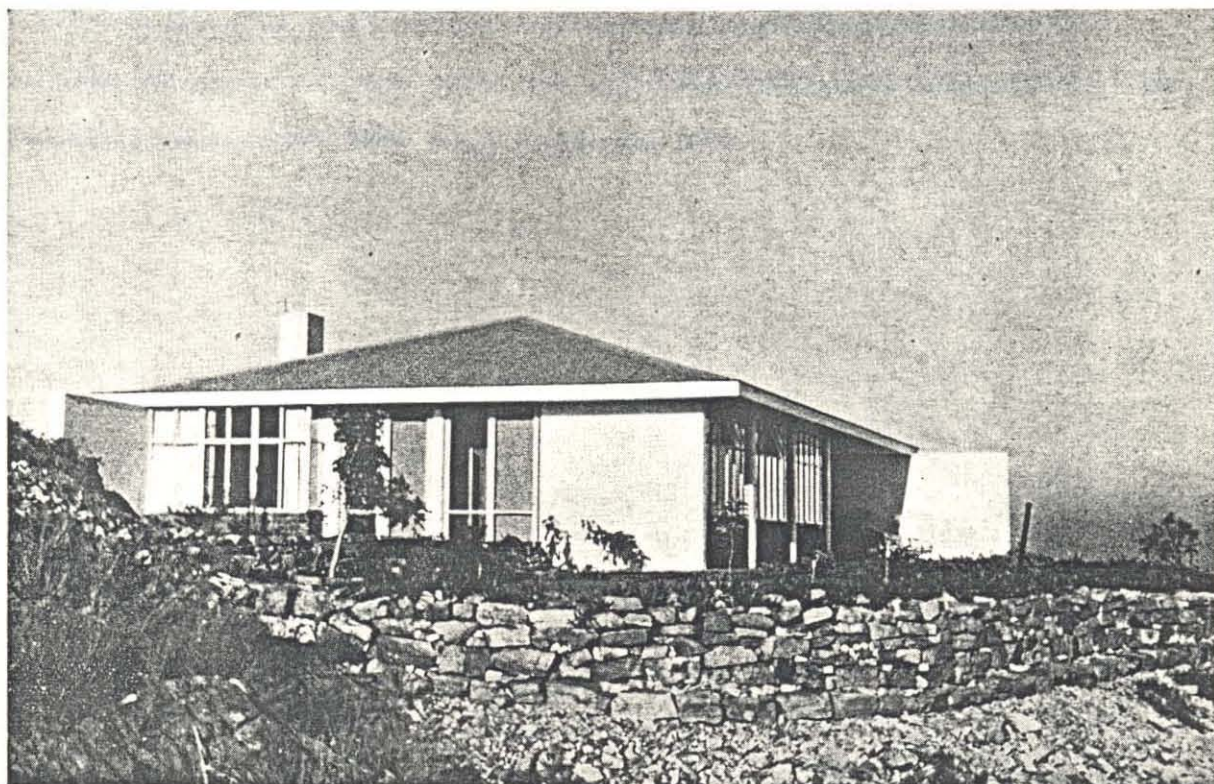

and medicine cupboard above ; walls tiled with 6 x 6 in. white glazed tiles.

Scullery Fittings : Sink table with two enamelled sinks ; plate rack above and storage cupboards fitted with sliding doors beneath. Utility cupboard for brooms on one side, contains also electric meter and switchboard. Facebrick recess on other side contains slow combustion stove. Access to roof through storage cupboard above plate rack. Connection between scullery and kitchen by double sliding doors, allowing both rooms to be used as one spacious unit.

Kitchen Fittings : Work table occupies full length of room under window. Pantry cupboard, fitted with sliding doors and ventilators on external wall, under one half of work table. Other end of table contains rubbish bin, removable from outside, with flap door in table top. The remaining portion is open leaving leg-room. Back wall is formed by built-in cupboard, horizontally divided into three sections : top and bottom sections are fitted with shelves and sliding doors, middle is left open to form serving table. Refrigerator fits into recess on one end of cupboard. Electric four-plate stove adjoins work table next to sitting place.

Colours : Internal wall generally—white, west wall in Bedroom 1—deep blue, in Study—dark maroon ; doors cupboards, etc.—white except cupboard wall in Bedroom 2, and Study, which is in waxed teak.

External walls—white, eaves and fascia—white ; doors and windows—grey ; painted brickwork—grey ; steel columns—red ; parapets—natural klinker colour of stable-floor bricks.



ADDENDUM C

A study by H.W.E. Stauch on modular furniture, indicating by means of diagrams the basic component units and their combinations, together with diagrams and photographs of practical examples of actual composite furniture.

This document is copied from an original draft found in Stauch Vorster archives. The purpose of this is not known, nor is it known whether this has been published.



Practical examples.

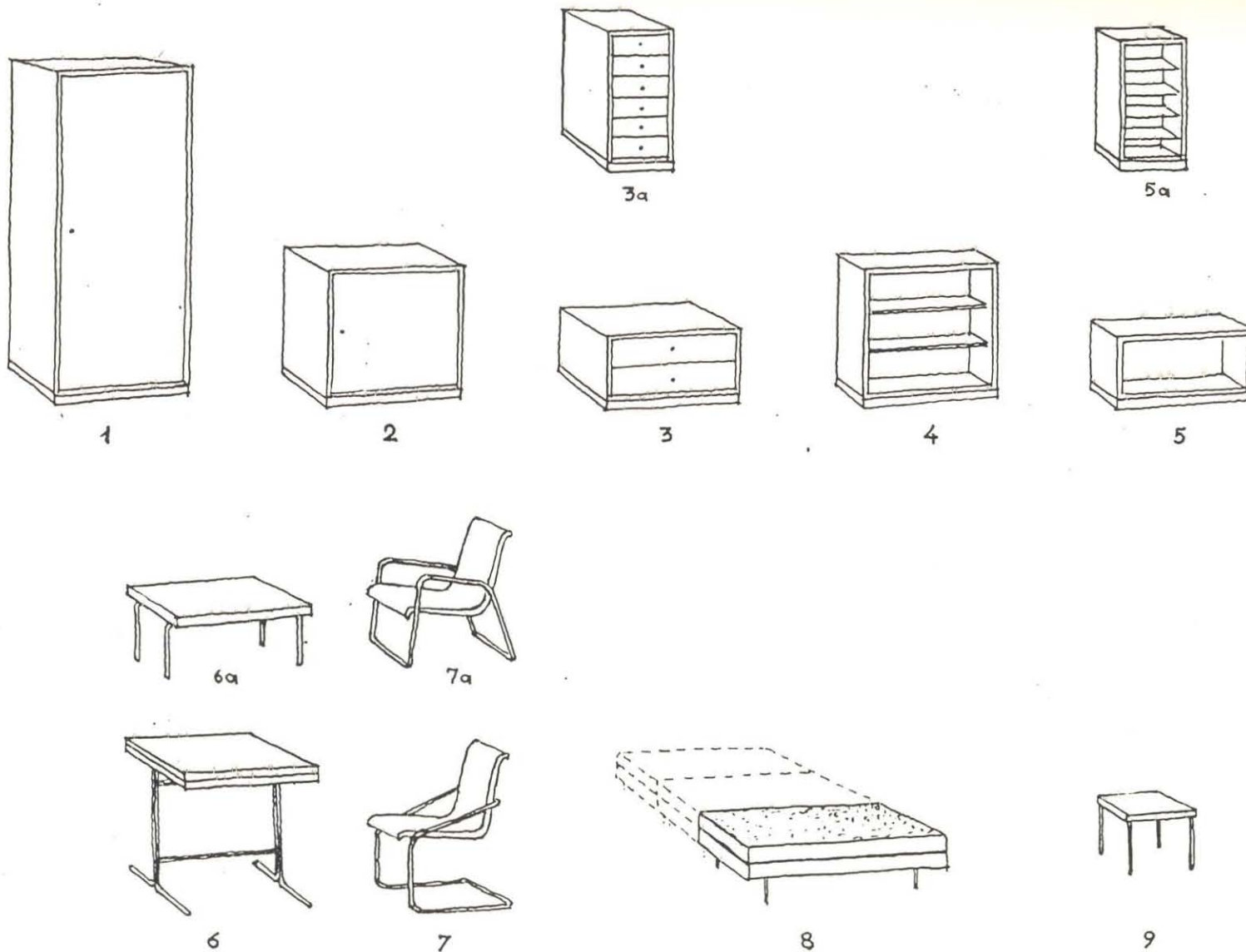

All usual forms of furniture can be composed of these 9 elementary standard-forms

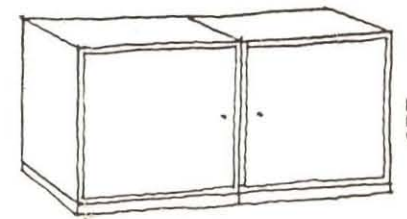
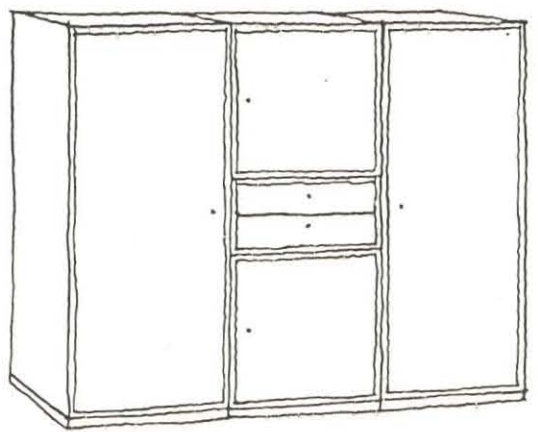
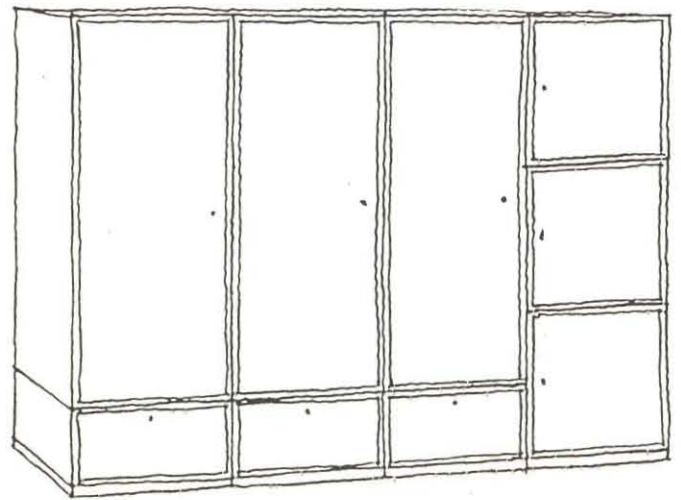
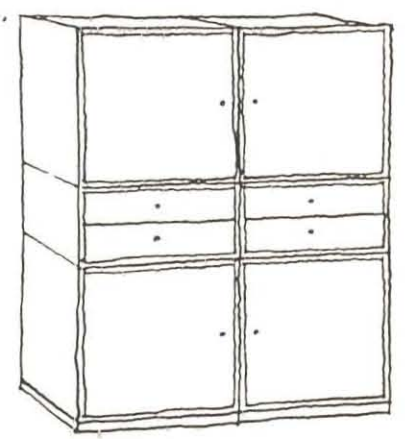
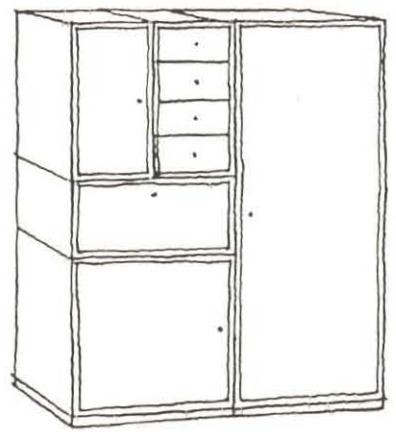
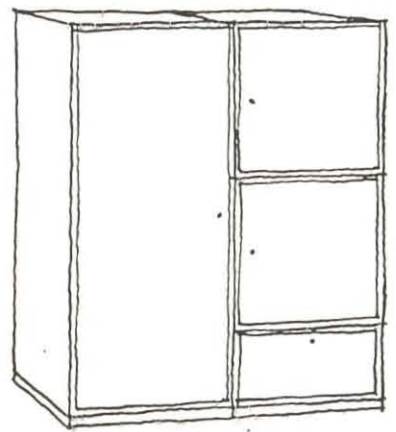
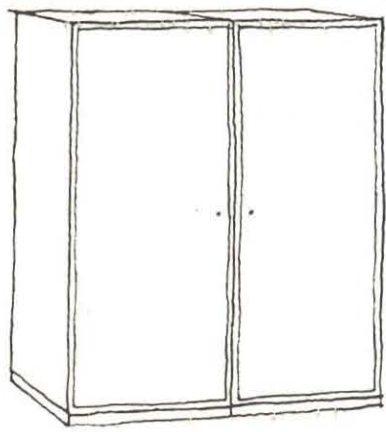

129

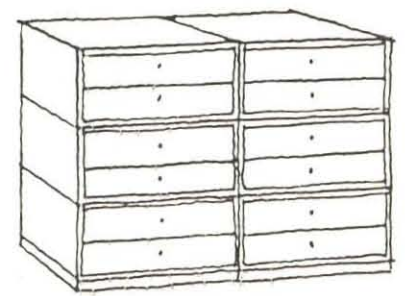

Combinations of form 1,2 and 3

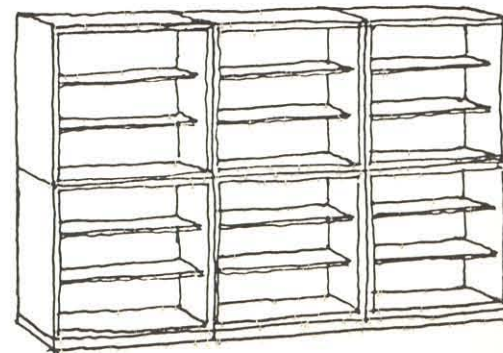
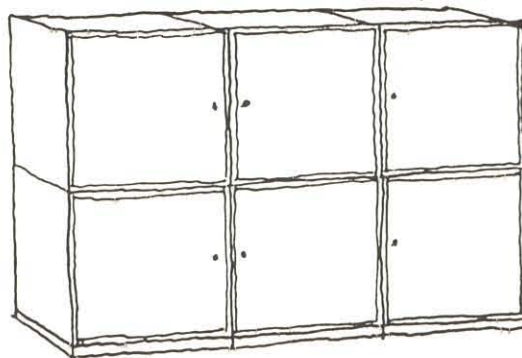
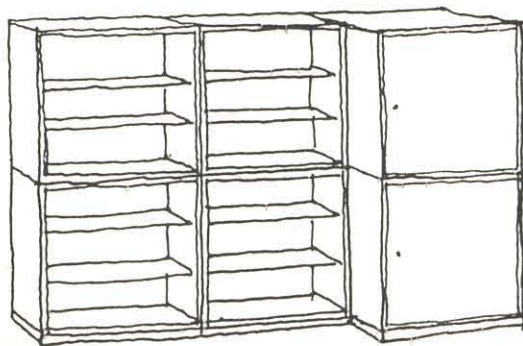
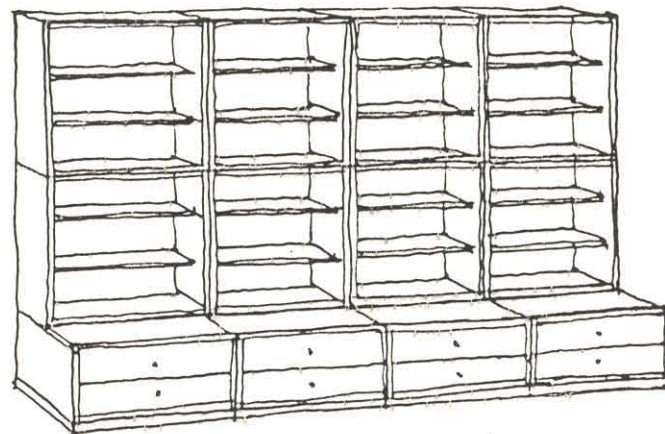
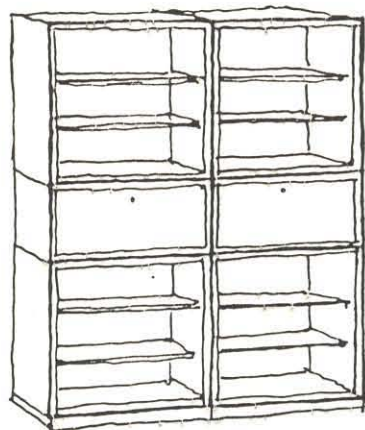
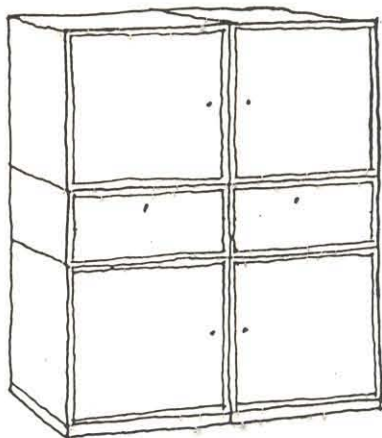
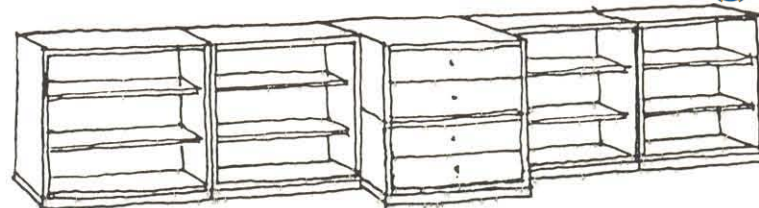
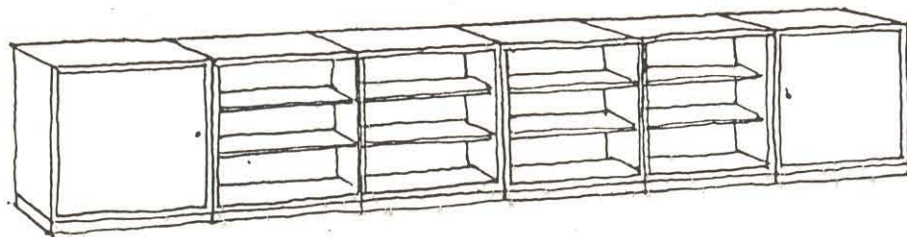

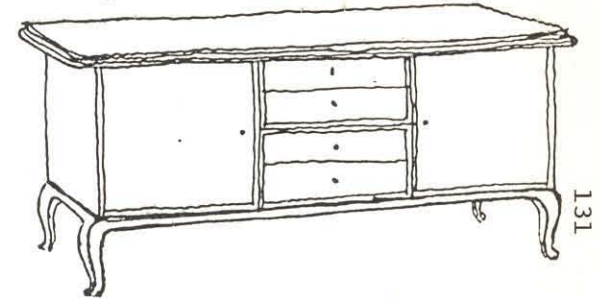
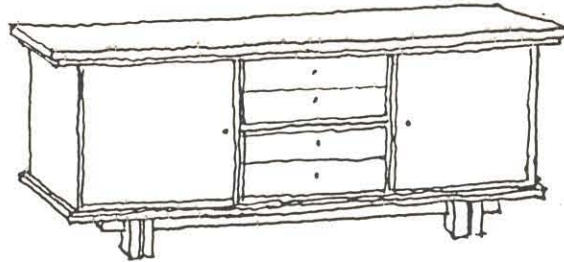
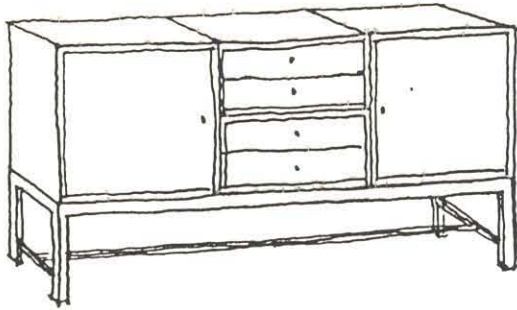
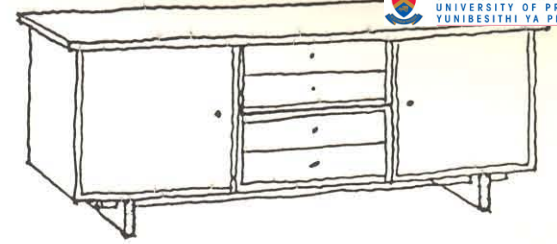
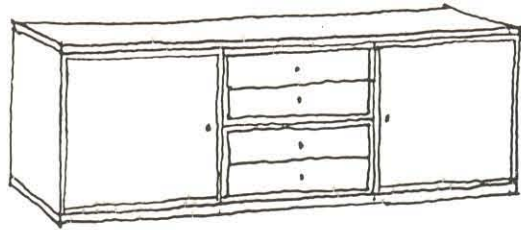
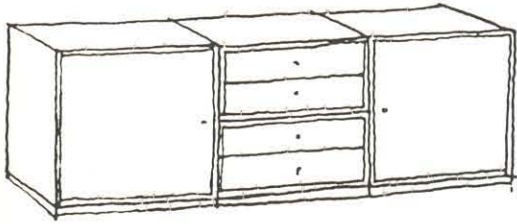

131

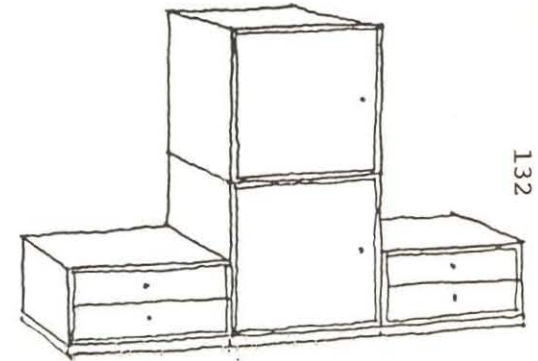
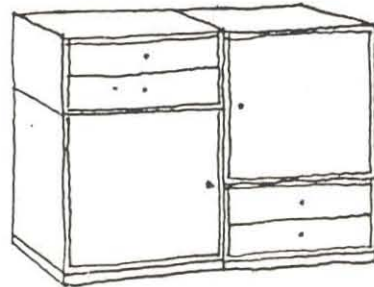
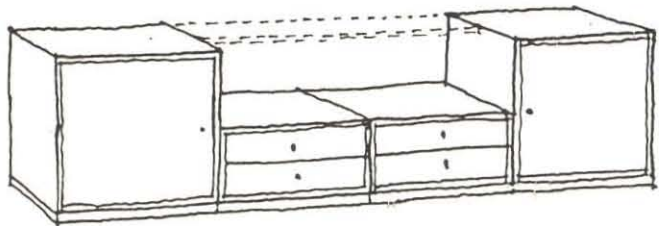
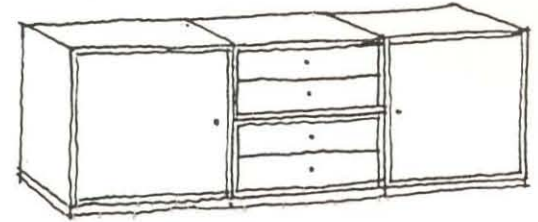
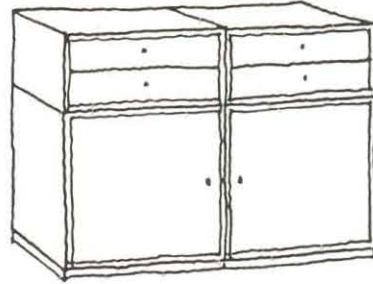
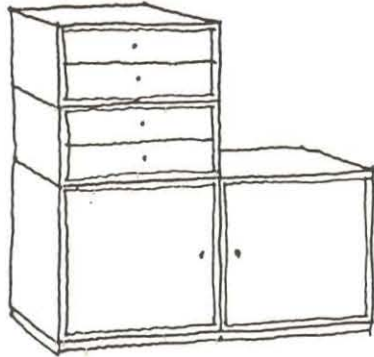
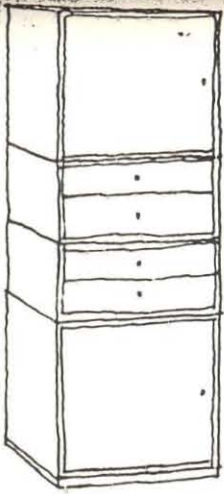

132

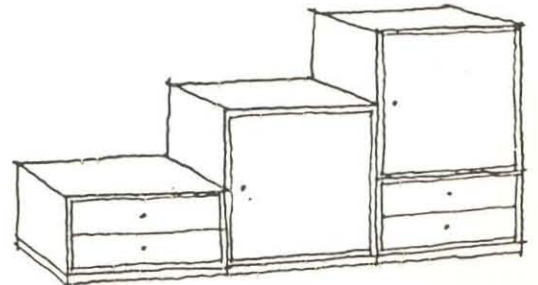
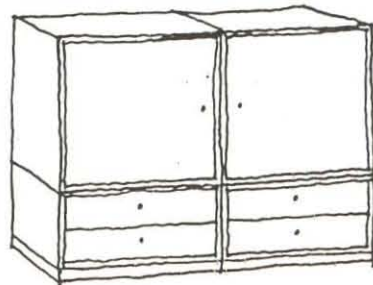
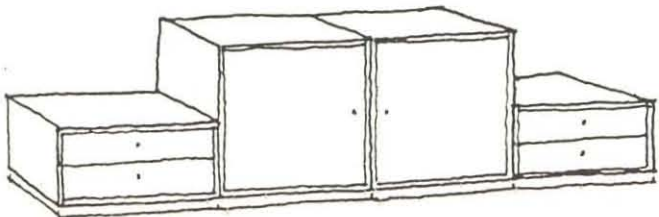

6

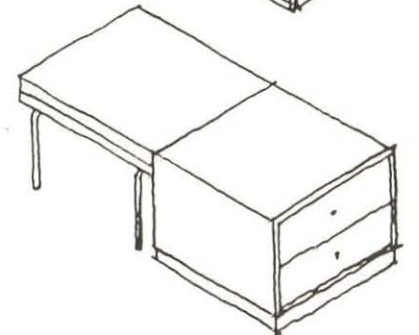
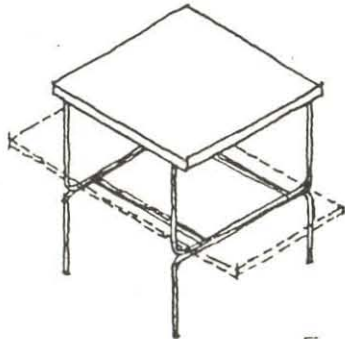
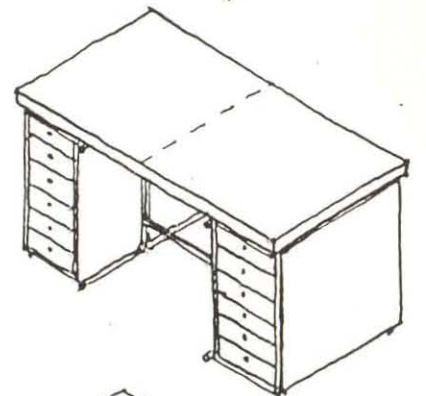
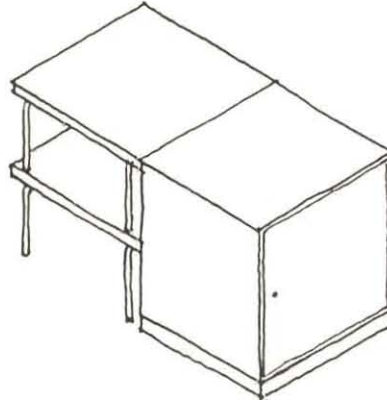
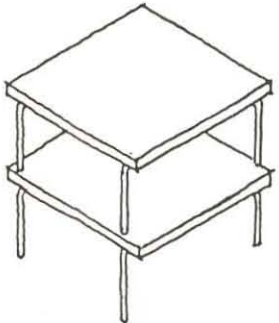
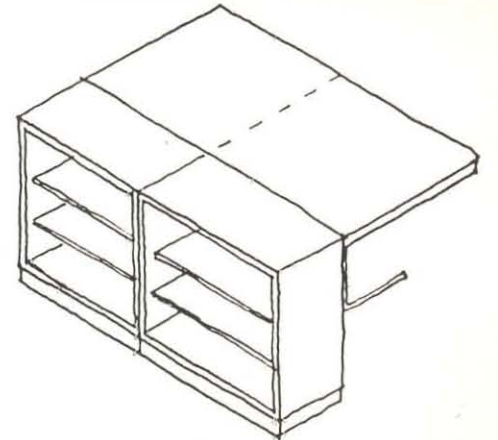
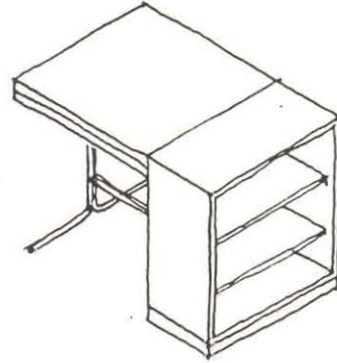
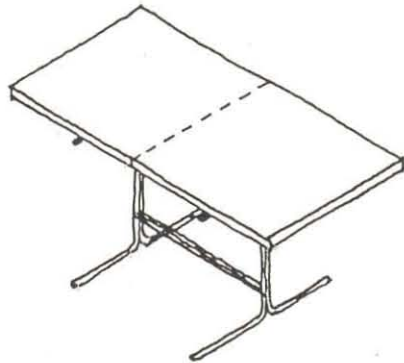

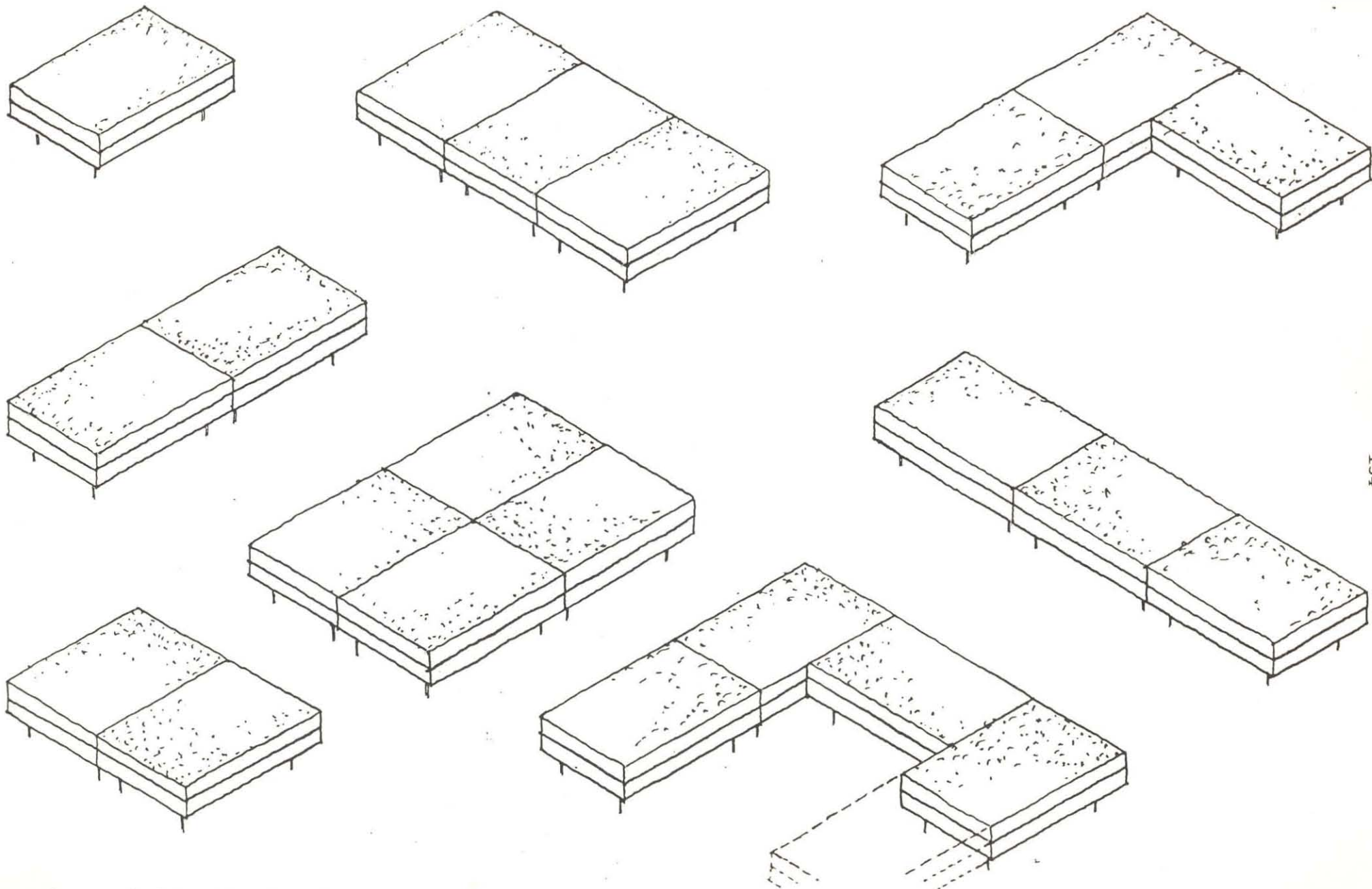

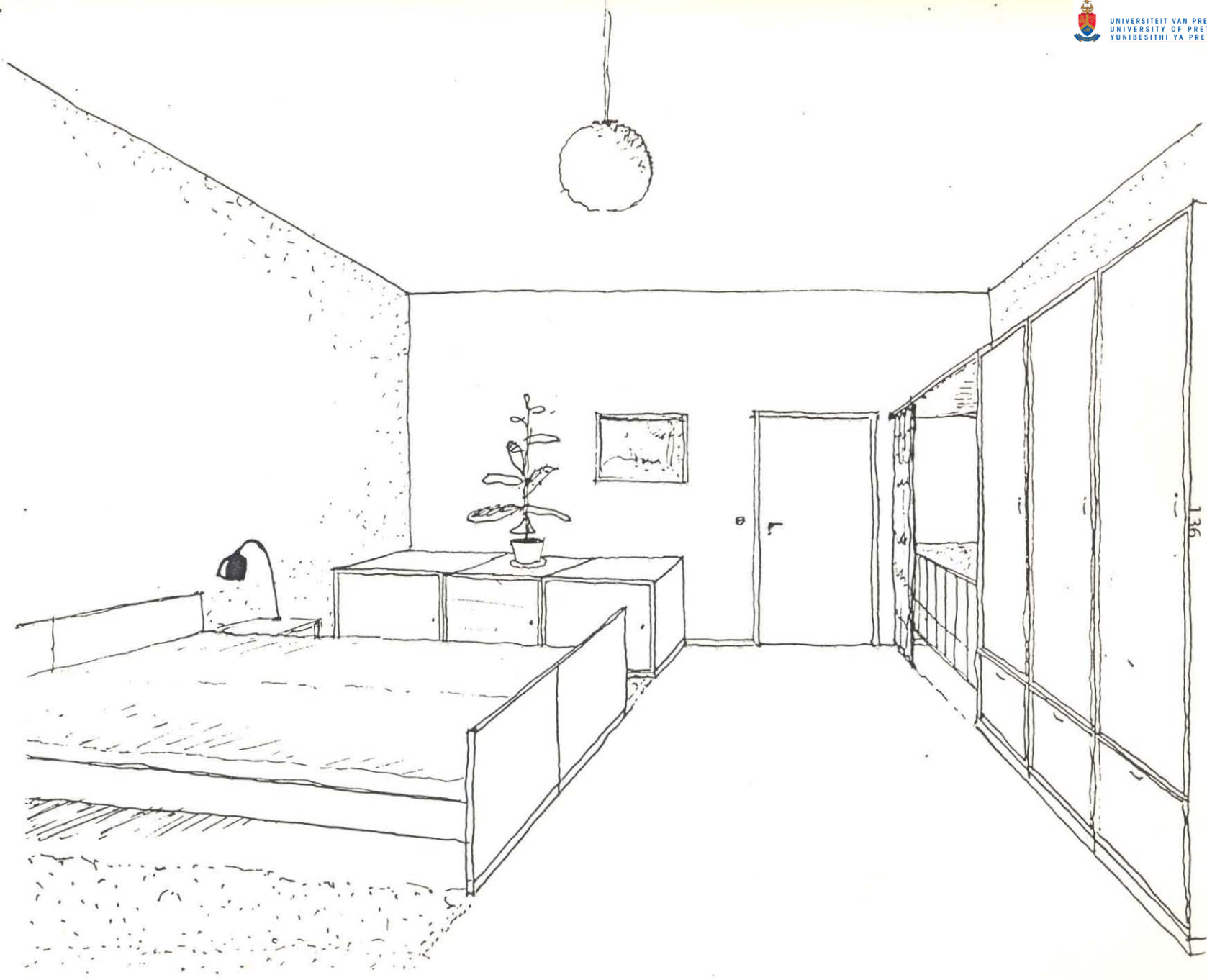
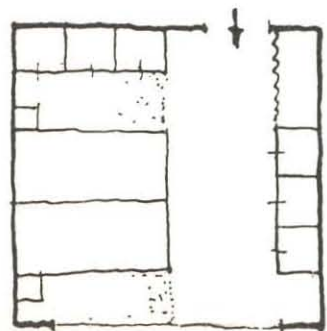

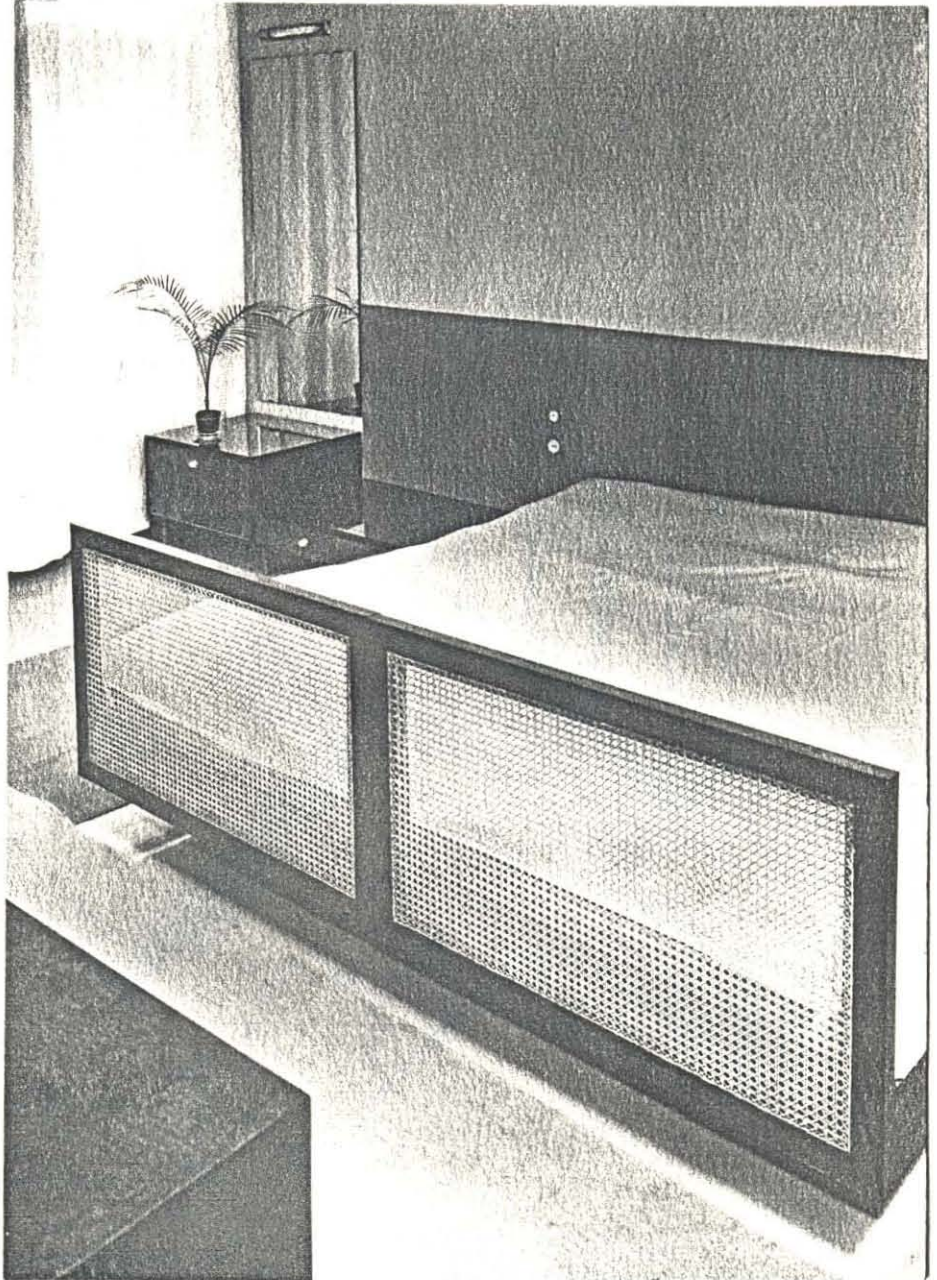

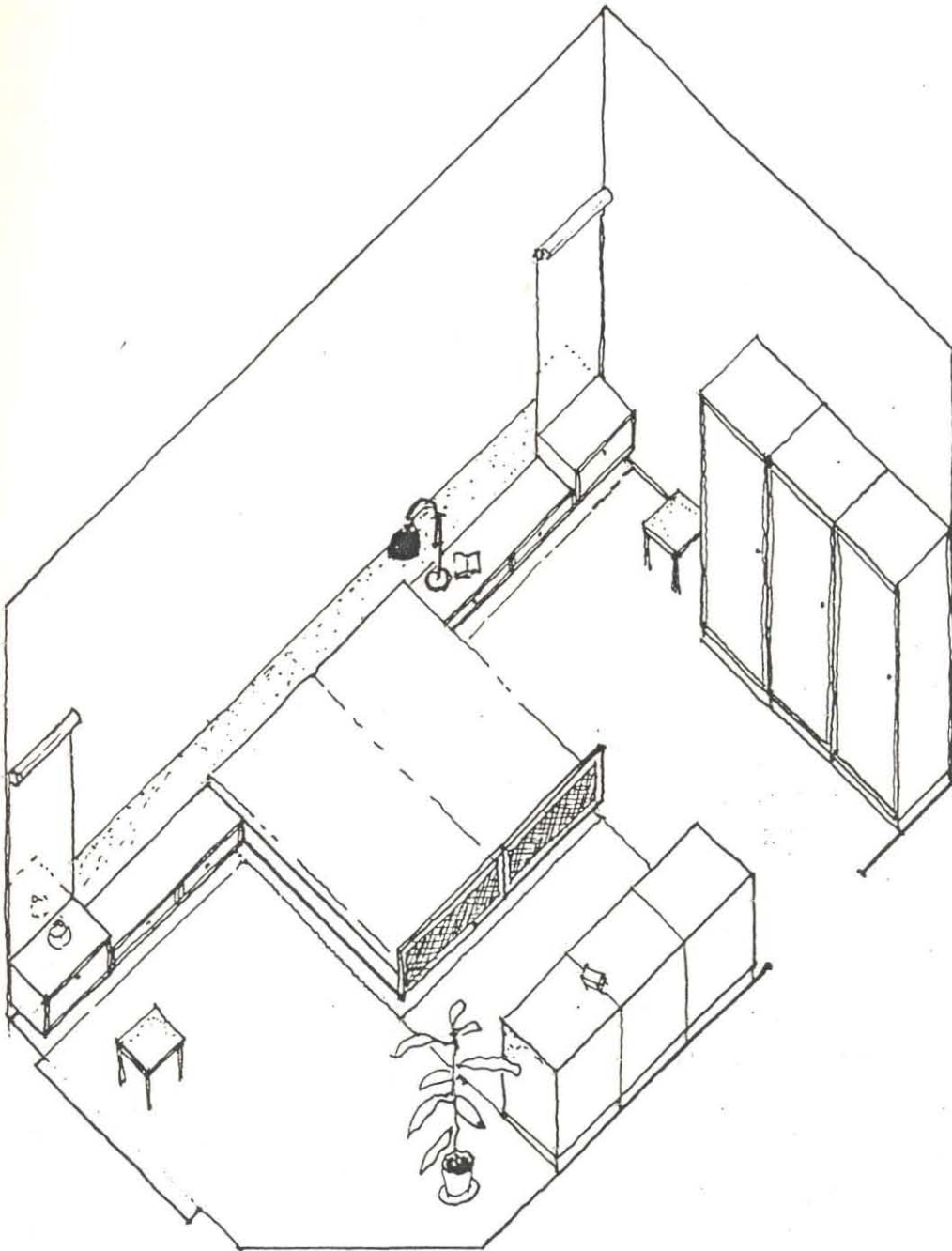

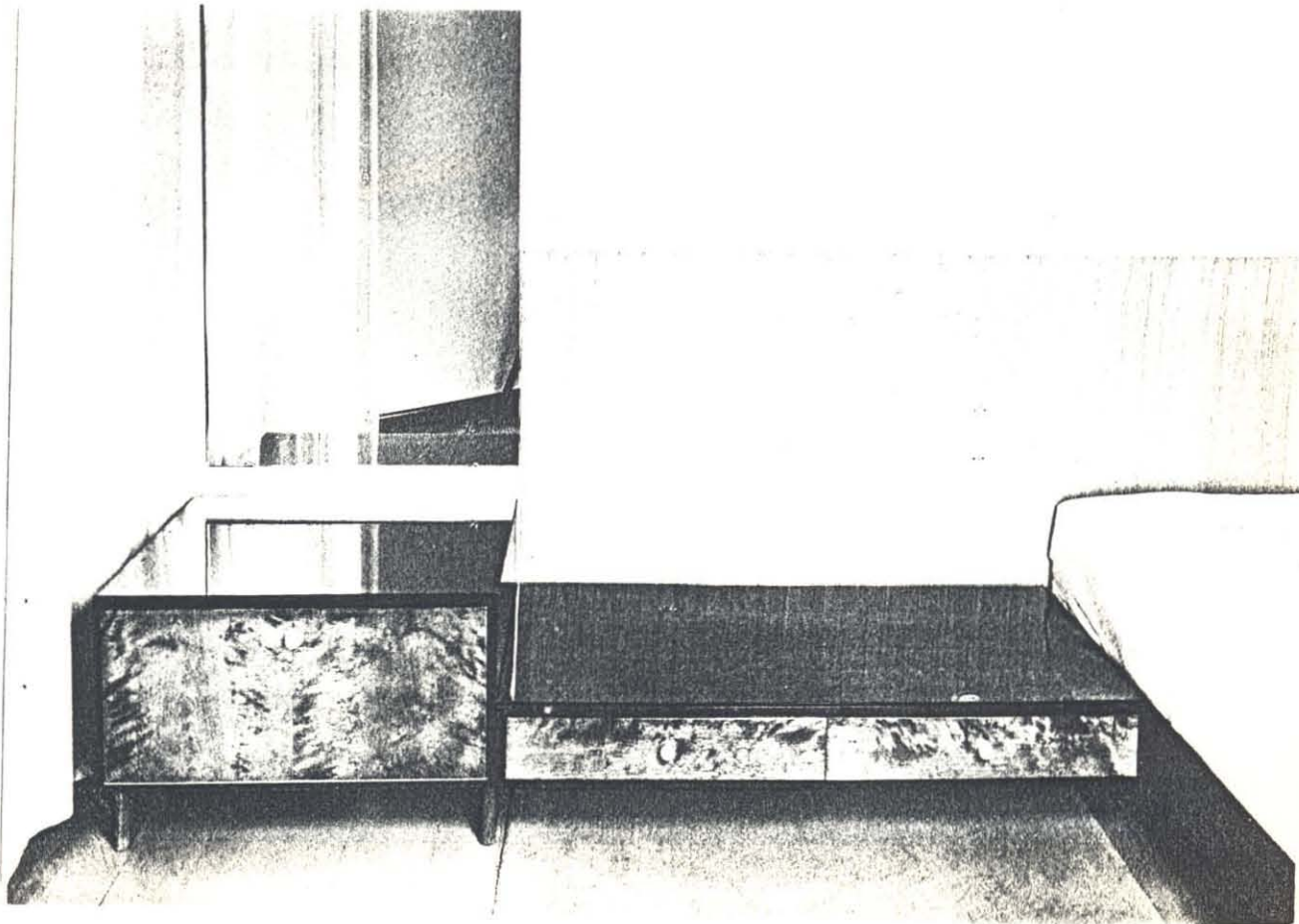
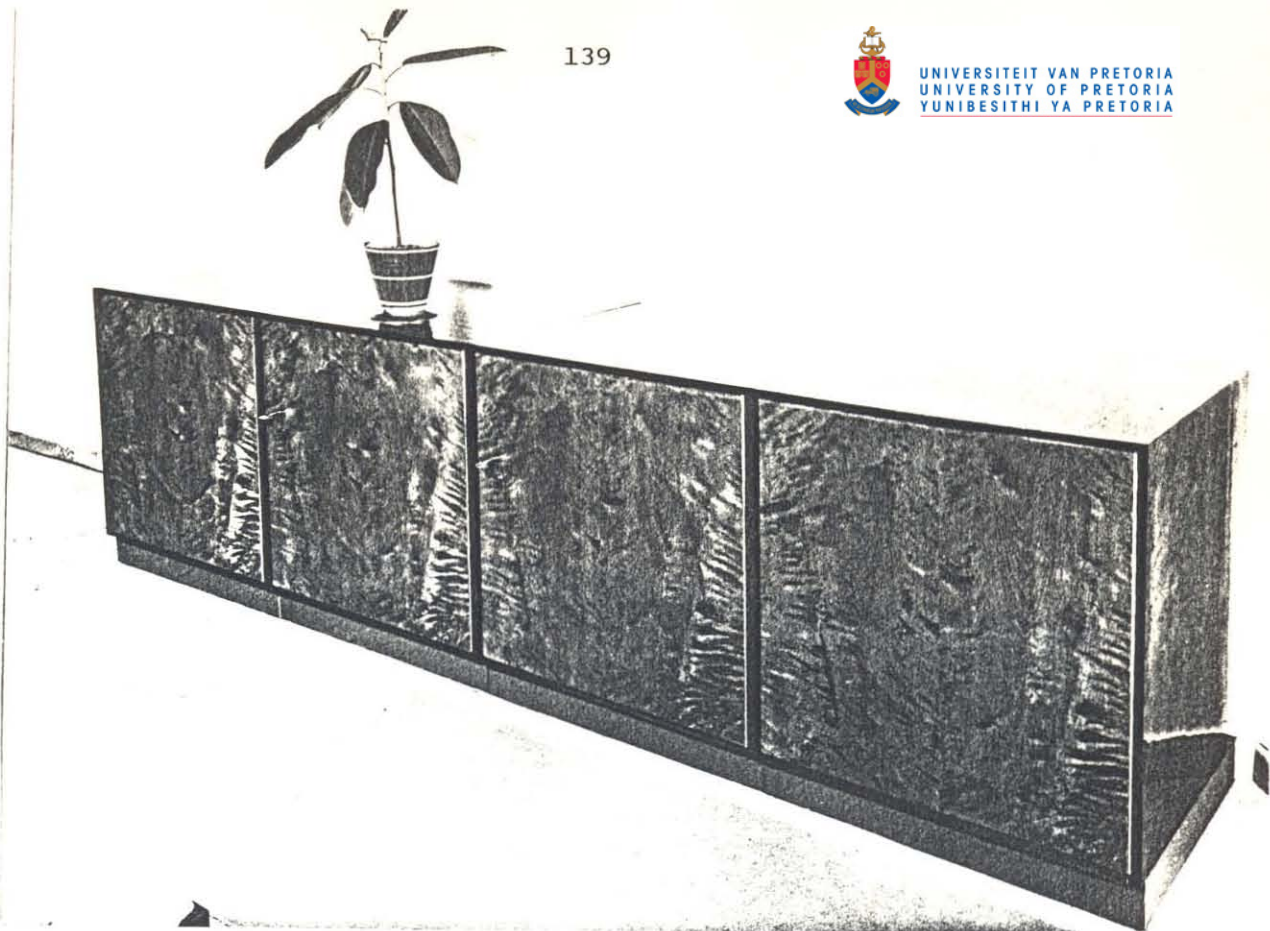

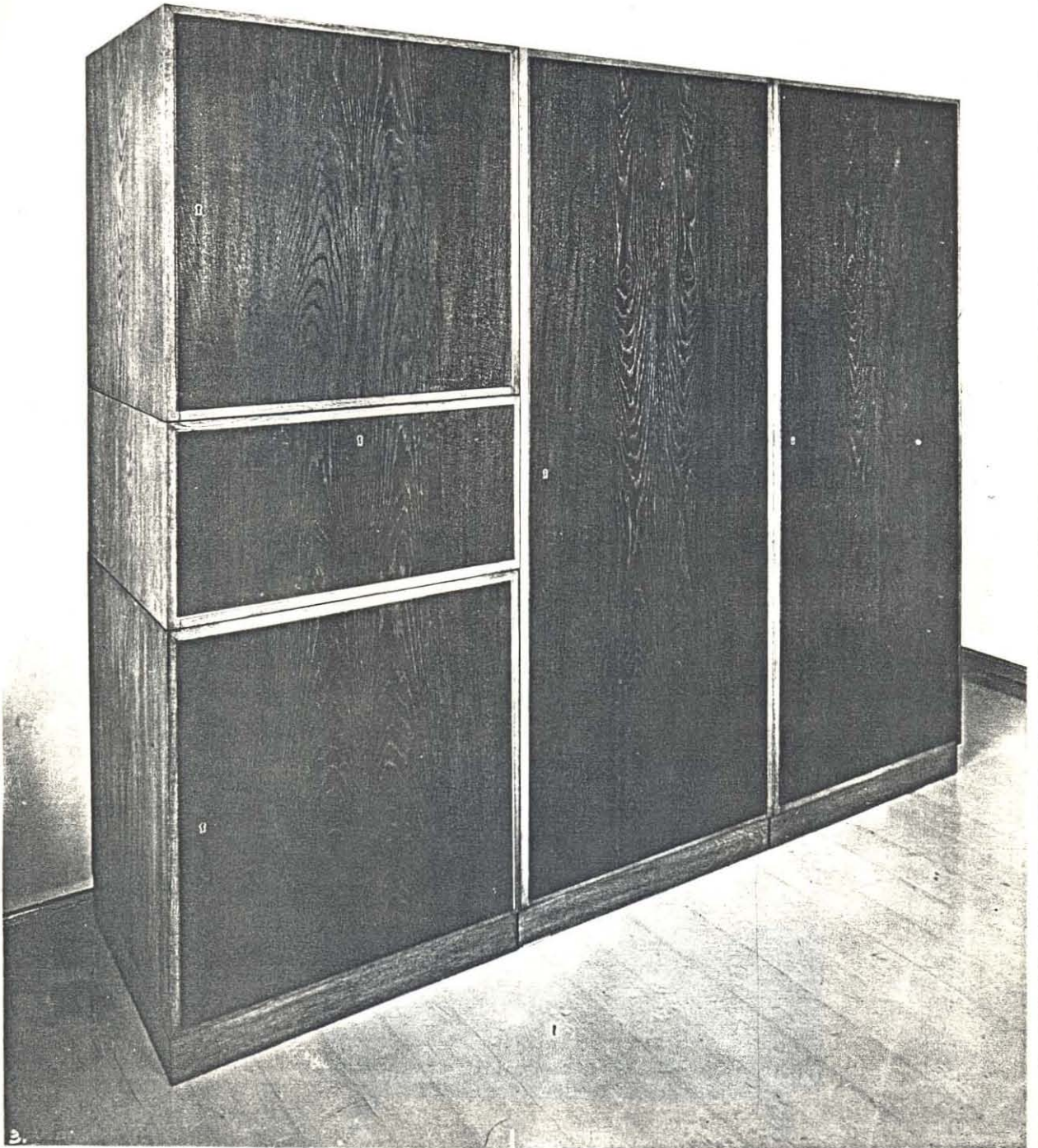



Box unit

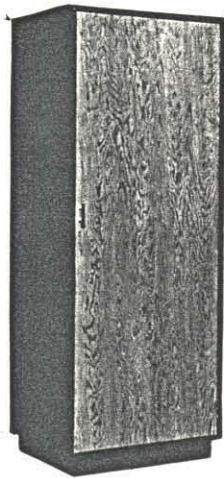

Cabinet unit

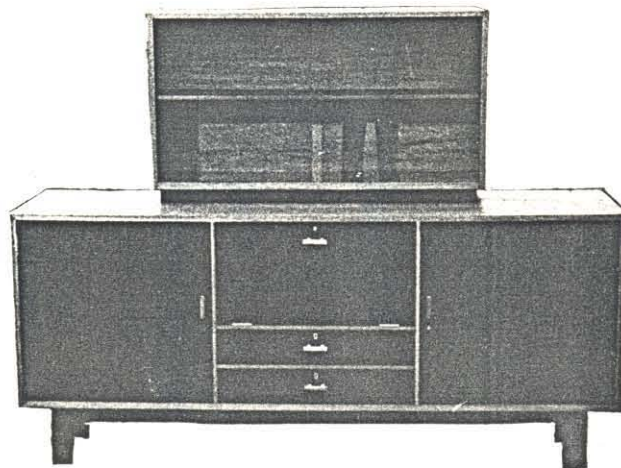

Sideboard



Dressing Table



Dining Chair.

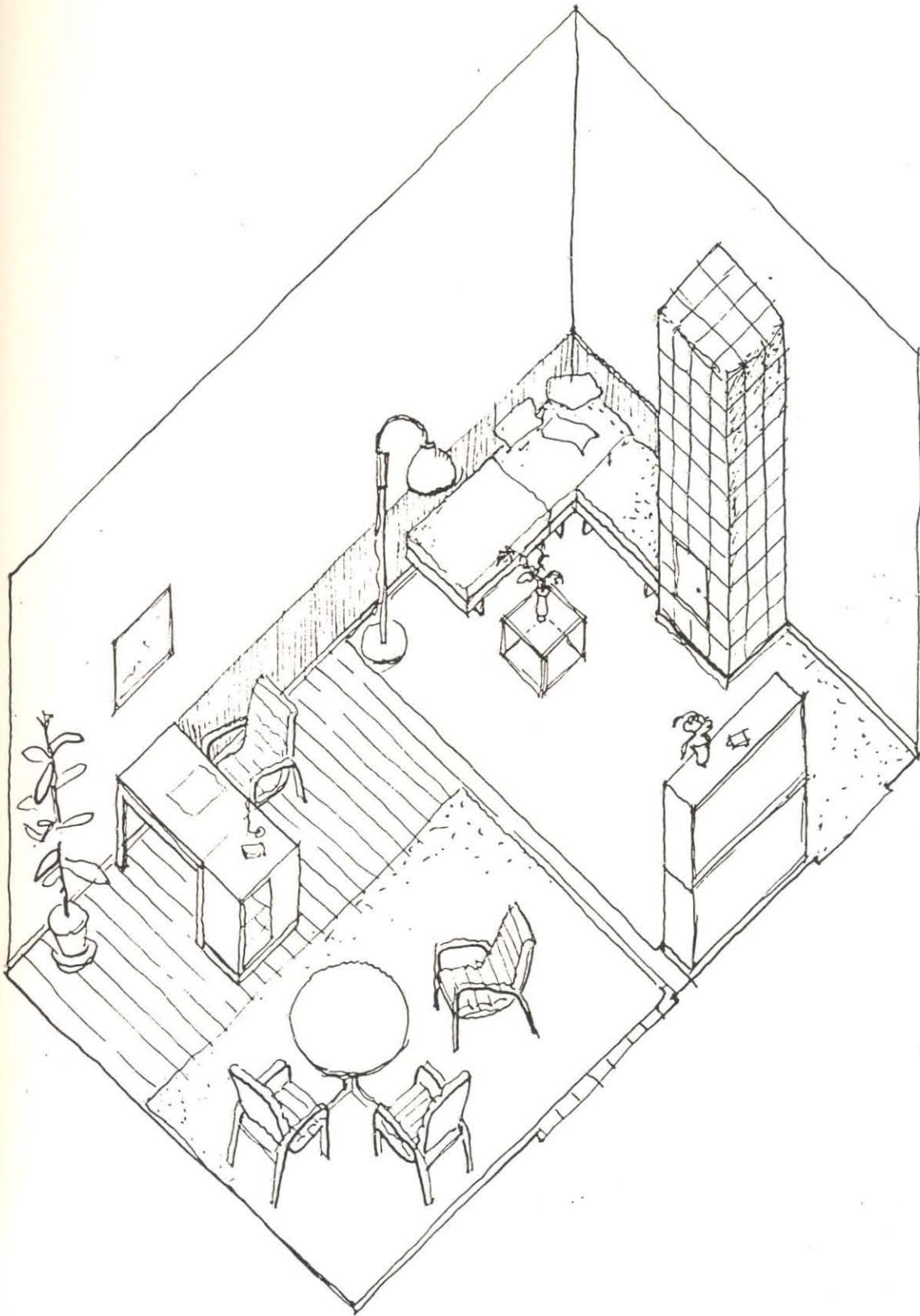

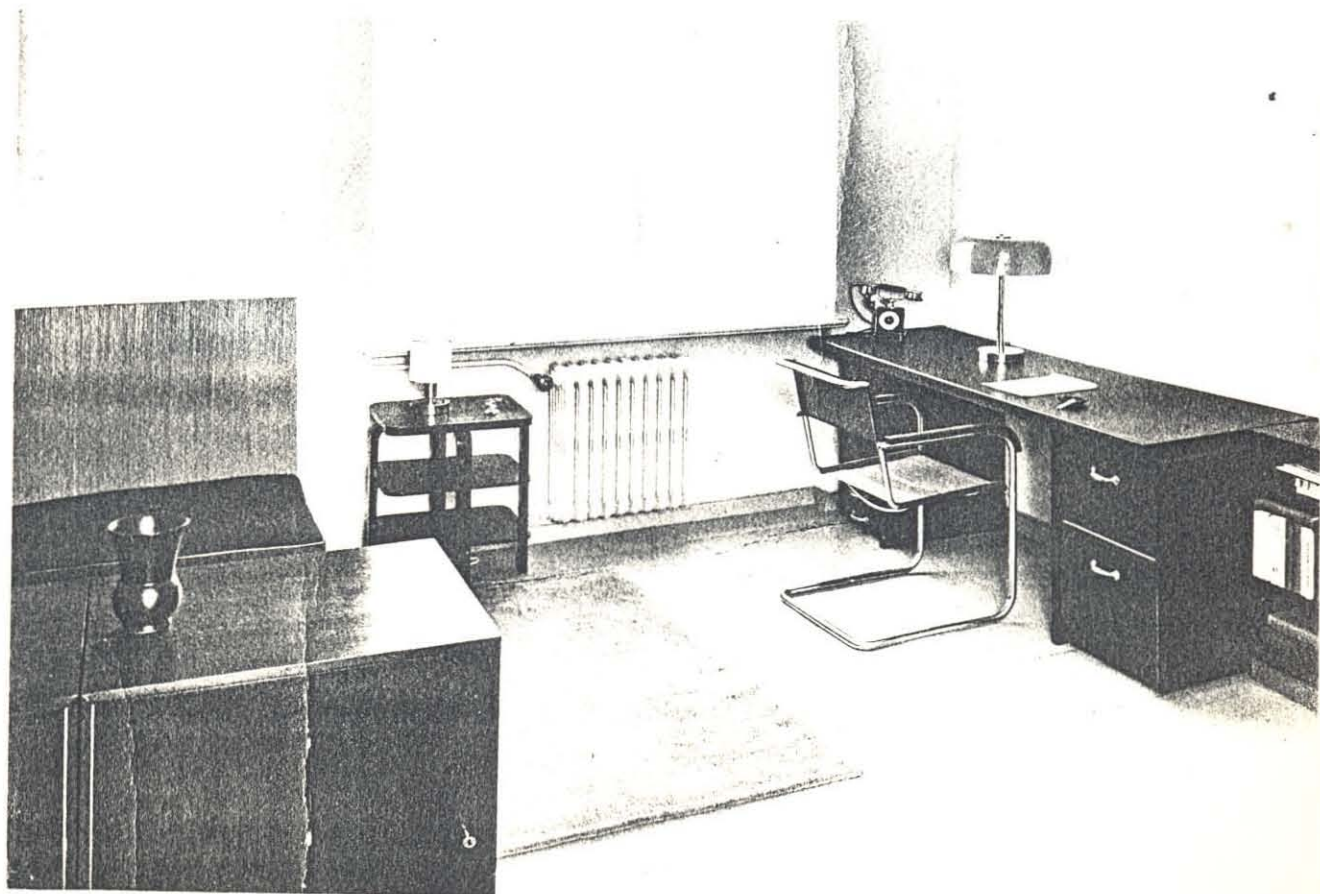





Prookette.

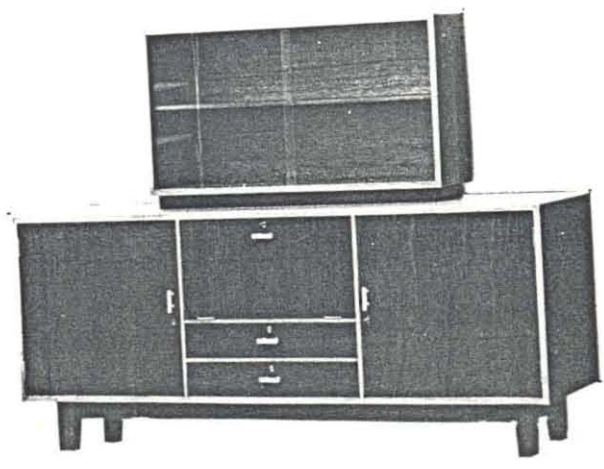
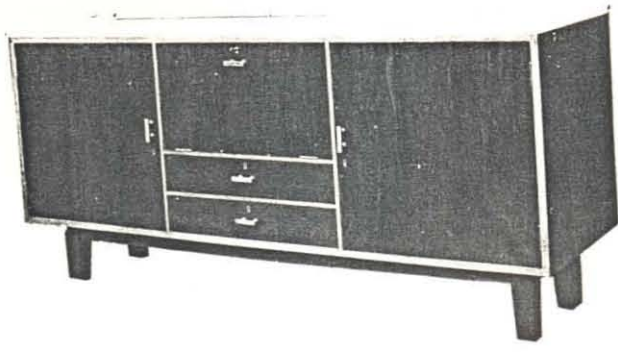

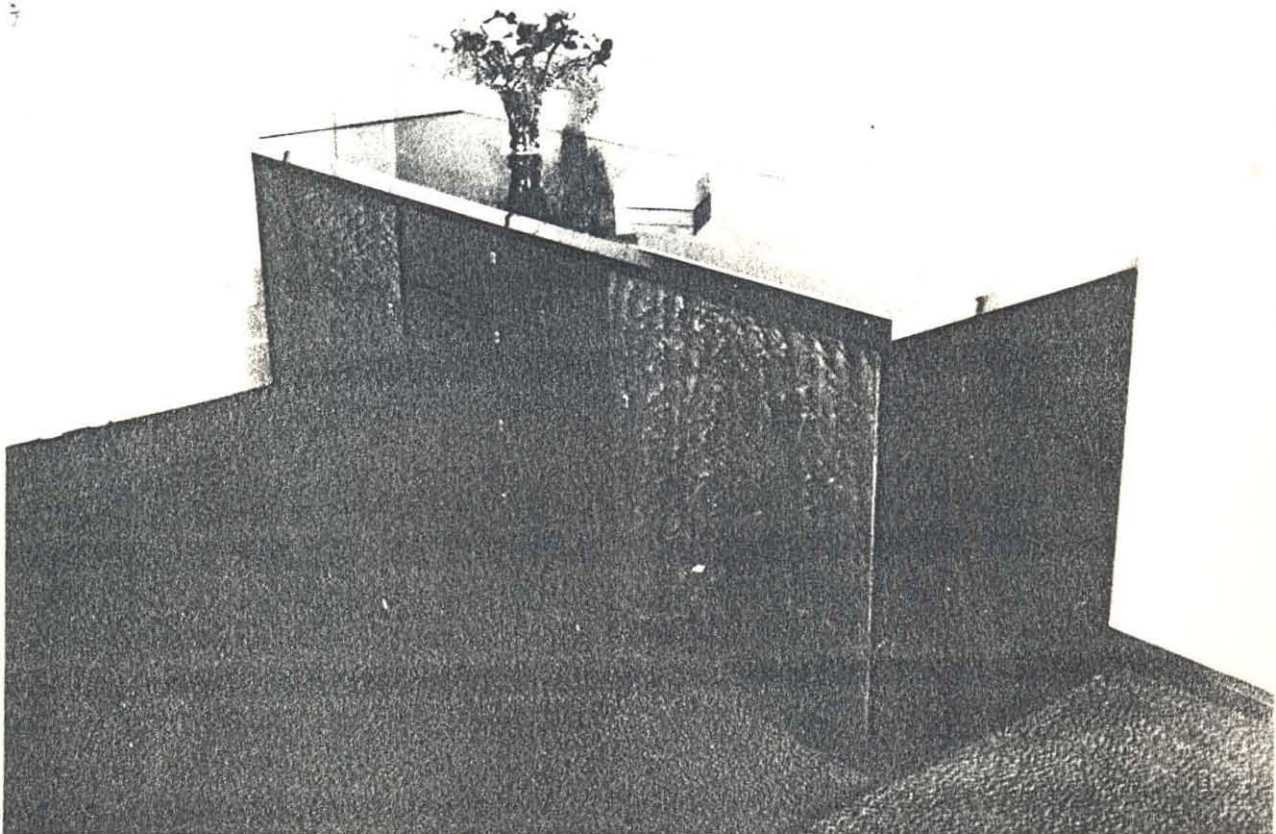
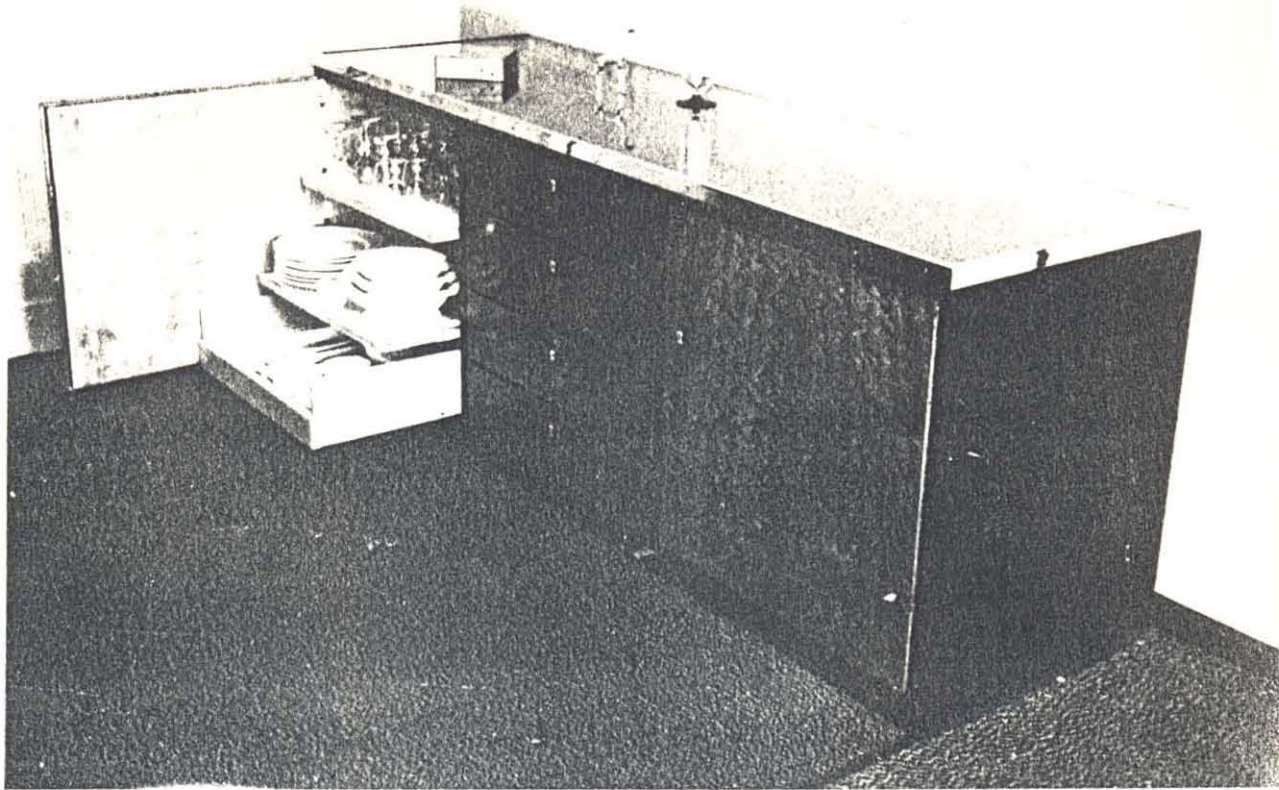



BIBLIOGRAPHY AND SOURCES OF REFERENCE

1. Interviews, tape-recorded and transcribed.

The following persons were interviewed and have been cited in the text:

Mrs Marianne Krafft (nee Stauch). Sister of H.W.E. Stauch.

Mr Robin Vorster. Son-in-law of H.W.E. Stauch, partner and now director of Stauch Vorster.

Mrs Tosca Vorster. Step-daughter of H.W.E. Stauch and wife of Mr Robin Vorster.

Mr F. Wepener. Ex-partner of H.W.E. Stauch.

Mr J.A.N. (Jan) van Wyk. M.I.A., student of H.W.E. Stauch at Pretoria University.

Mr G.T. (Gawie) Fagan. M.I.A., student of H.W.E. Stauch at Pretoria University.

Mr. Wynand Smit. M.I.A., student of H.W.E. Stauch at Pretoria University.

Mr Tielman J.R. Scholtz. M.I.A., partner of H.W.E. Stauch and director of Stauch Vorster.

Mr Hans-Erik Staby. M.I.A., partner of H.W.E. Stauch.

Judge H.J. Berker. Friend of H.W.E. Stauch.

Mrs. (Pulli) Thoms. Secretary to H.W.E. Stauch for the first ten years, approximately, of his practice.

Mr John Nunn. Son of the late Aubrey Nunn. M.I.A.

Mrs Margot Henkel. Widow of artist Irmin Henkel.

Mr Horst W.E. Sternagel. M.I.A., partner of H.W.E. Stauch and director of Stauch Vorster.

Dr. Gilbert Herbert. Professor of Architecture at the Technion - Israel Institute of Technology : author of "Martienssen and the International Style" (1975).

Also interviewed but not directly cited were:

Mr Peter B. Strack. M.I.A., partner of H.W.E. Stauch.

Mr Lauri Wale. Editor of Architect and Builder.

Mr Hosea Masilela. Office assistant to Stauch Vorster since the early fifties.

Mr Mischa Krafft. Son of Mrs. Marianne Krafft, nephew of H.W.E. Stauch.

Mrs Olga Levinson. Author of "Diamonds in the Desert" (see bibliography)

Informal discussions were also held with a number of those who either knew Stauch socially, or had worked with him or against him, in competition and with lecturers at Witwatersrand, Durban and Pretoria Universities who helped to give insight into his work.

2. General references

- 2.1 Stauch Vorster records relating to personal documents, financial and income tax records and confidential records normally retained in security on behalf of each partner/associate.
- 2.2 Stauch Vorster's comprehensive list of projects. Early projects are listed by name only, but after 1948 dates were recorded and after 1960 other data.
- 2.3 Stauch Vorster's library records, including some newspaper cuttings intermittently collected, some published articles, and a large collection of photographs.
- 2.4 Records retained by Mr. and Mrs. R. Vorster, consisting mainly of Stauch's sketches pre 1935, and, Stauch's library, consisting of some 60 books, a few of which have signature, date and annotations.

3. Magazine references

Architect and Builder. September, 1952, May, 1955.
 South African Architectural Record. November, 1944, December, 1944, February, 1949, December, 1951, January, 1958, April, 1958.
 Decorative Art. No. 43, No. 46, 1956-7.
 Architectural Forum. February, 1953.
 Public Works of South Africa. July, 1951.
 Architectural Design. Vol. XXVI June, 1956.
 The Architectural Review. June, 1953.
 Bauwelt. No. 47 - 1931, 1954.06.28, No. 28 - 1957.07.15.
 Die Taalgenoot. July, 1954.
 I.S.A.A. 1965.12.12.
 Property Mail. 1971.01.15.
 S A Garden and Home. May, 1969.
 Milady. October, 1955.
 Instituto Tecnico de la Construccion y del cemento. February, 1956.
 Die Baugilde. 24 : Dezember, 1930.

4. Books

- NEUMANN, Eckhard. 1970. Bauhaus and Bauhaus People. New York: Van Nostrand Reinhold Company. 255 p.
- BAYER, Herbert. 1959. Bauhaus. Boston: Charles, T. Branford Company. - 224 p.
- WINGLER, Hans, M. 1969. The Bauhaus Weimar Dessau Berlin Chicago. English adaption. Massachusetts Institute of Technology. 653 p. (Original publishers Verlag. Gebr. Rasch & Company Cologne. 1962).
- NAYLOR, Gillian. 1968. The Bauhaus. Second edition. London: Studio Vista Limited. 159 p.
- HERBERT, Gilbert. 1975. Martienssen and the International Style. Cape Town, Rotterdam: A.A. Balkema. 283 p.
- HOCKING, Anthony. 1972. Yachting in Southern Africa. South Africa: Purnell & Sons (South Africa) (Proprietary) Limited. 241 p.
- LEVINSON, Olga. 1983. Diamonds in the Desert. Cape Town: Tafelberg Publishers Limited. 172 p.
- STAUCH, H.W.E. Neues Bauen in den Kolonien (unidentified reprint/pamphlet, undated).
- STAUCH, H.W.E. Das Ideale Eigenheim (undated pamphlet - no printers reference).