



ADDENDUM A : LIST OF PROJECTS

1. Introduction

The projects listed in Stauch Vorster's records both on a card index system and on the subsequently introduced computer system, from the inception of Stauch's practice until his death in July 1970 number one thousand nine hundred and thirty one. As it was impractical within this thesis to catalogue and allocate that number of projects, a summary has been prepared, divided into three sectors and based on the Stauch Vorster list. Estimates of Stauch's participation were based on interviews and discussions with partners, and on the personal experience of the author, (who has for some twenty years been responsible for project records within the firm).

2. Projects from 1943 to 1958

During this period Stauch was in close touch with virtually all projects, and those in which he had no direct involvement had, at least, his approval. It is estimated that he was directly involved with 90% of these. They varied in size from tiny additions to large commercial or industrial buildings and are:

. Houses, flats, residential buildings	659
. Hotels, hostels or similar buildings	10
. Educational buildings	6
. Shops, offices, retail/wholesale developments	19
. Industrial buildings, factories and garages	29
. Hospitals and research buildings	8
. Community buildings, clubs, yacht clubs	16
. Churches/church-related buildings	6
. Exhibition/tourist buildings, furniture/other projects .	<u>9</u>
	TOTAL <u>762</u>

3. Projects from 1958 to 1968

At this time the practice was expanding rapidly and records show a reversal of project type. Nine hundred and ninety six projects are listed for this period, predominantly commercial. It is thought that Stauch had direct involvement with approximately 50% of these.

4. Projects from 1968 to mid-1970

One hundred and seventy two projects are listed for this period, Stauch probably being directly involved with less than half of these.

ADDENDUM B

"The Development of Standardised Building Elements" - an article by Hellmut Stauch, published in an architectural magazine.

This article fully illustrates the use of standardised elements in the actual design and construction of a house - in this case the house which Stauch built in Villieria for his own use.

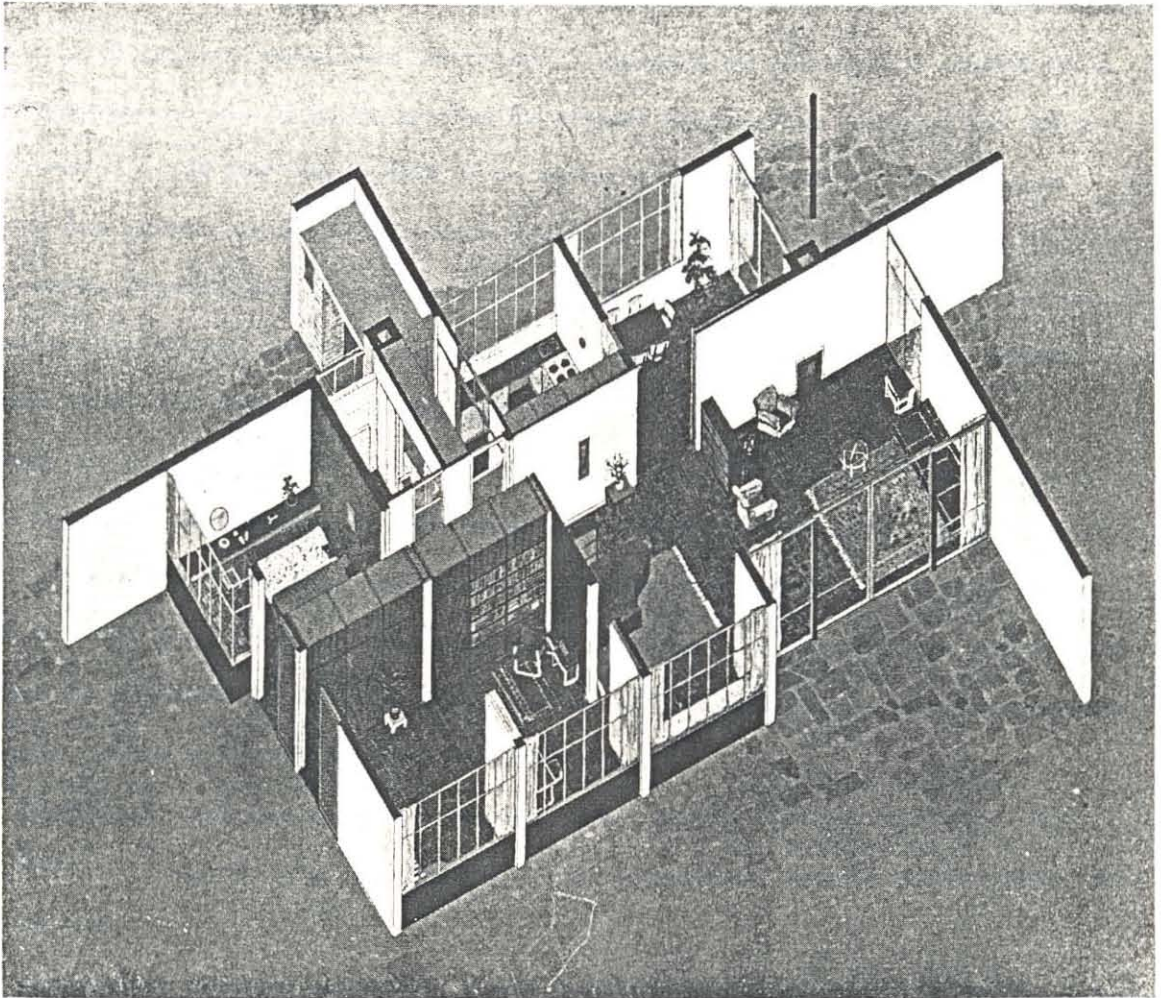

ISOMETRIC VIEW OF A HOUSE IN PRETORIA

THE DEVELOPMENT OF STANDARDISED BUILDING ELEMENTS

by HELLMUT STAUCH

The standard articles available for house building do not seem to be the best and most efficient producible, not so far as quality of material and construction is concerned, but with regard to practical design. The main disadvantage seems to be the fact that the different industries have developed their articles separately, with the result that there is little or no relation in dimensions, materials and appearance. Each one of these articles, such as windows, doors, door-frames, building- and insulation-boards, etc., is based on a certain dimension from which the sizes of its different types have been developed. All these basic dimensions are different, making it difficult, and sometimes impossible, to use these different articles together in the same building harmoniously and economically.

It would be a great advantage if a system could be worked out which develops all these different elements from the same basic dimensions and thus brings them into direct relationship. Such standardisation would make a mass production of building units on a large scale feasible and so make it possible to produce a high grade article at a reasonable price. It seems to be essentially the architect's job to analyse the possibilities of such a development which ought to be carried out in collaboration with the engineer. A few of the most important units would be :—

Window-units which can be opened completely, which provide for night ventilation, which can be fitted at a moment's notice with flyscreens or can be protected by solid shutters against external influences ;

External doors which can open up a large portion of a room to the outside, which also provide for fly-screens and shutters ;

Internal doors, sliding and folding, complete with frames, etc. ;

Internal screens, subdividing rooms partially or wholly, or also allowing them to be opened up into one ;

Cupboards, shelves and other furniture which can be put together in any desired combination and can also be used to subdivide rooms ;

Internal and external wall units ;

Floor, ceiling and roof units.

The idea of relating building elements can be carried further by including all types of movable furniture as well. Quite apart from other advantages this would benefit the inhabitants of houses and flats because they would be certain that their furniture would fit the rooms satisfactorily.

If standardised building units were manufactured and available at reasonable prices, the "growing house" could be made a practicable idea, which would suit many people in this Country. The accompanying diagram could serve as an example : starting with the smallest unit—the cell—(which is not unlike a typical plan for a bachelor flat), all the other types could be built by adding new units onto the cell. This would enable people with small means to build their own house in proportion to their income and to improve it as their income increases, without having to start with cheap or second-hand materials which later might become altogether valueless. For the same money they could use the best articles, not hand-made "any old way," but machine-made to precision, so that for any future addition they would get the same parts to match.

Systems of mass production of house units have been developed on the Continent, and to a larger extent in America. Most of these systems have the disadvantage that their units cannot be used universally because they are designed to suit one particular type of plan or construction. It should be possible to design building units which can be used for all types of human housing.

The arguments against such a development are well known : Boring uniformity, "inartistic" appearance, suppression of individual expression, are a few of the points mentioned frequently. It has even been suggested that it would make the architect superfluous.

These arguments are quite unfounded. After all, we are already working with standardised building units, only they do not quite comply with present day demands. What else than a unit is the stock brick, the standard steel window, the stock door ? The brick, for instance, suits quite ideally the method of work for which it was made. Due to its small size it is adaptable to almost any dimension, but it will never be economical, because it will always demand a slow building process. Incidentally, it is quite a bad sign for the progress of the building industry that the brick is still so popular and still the cheapest means to build a wall.

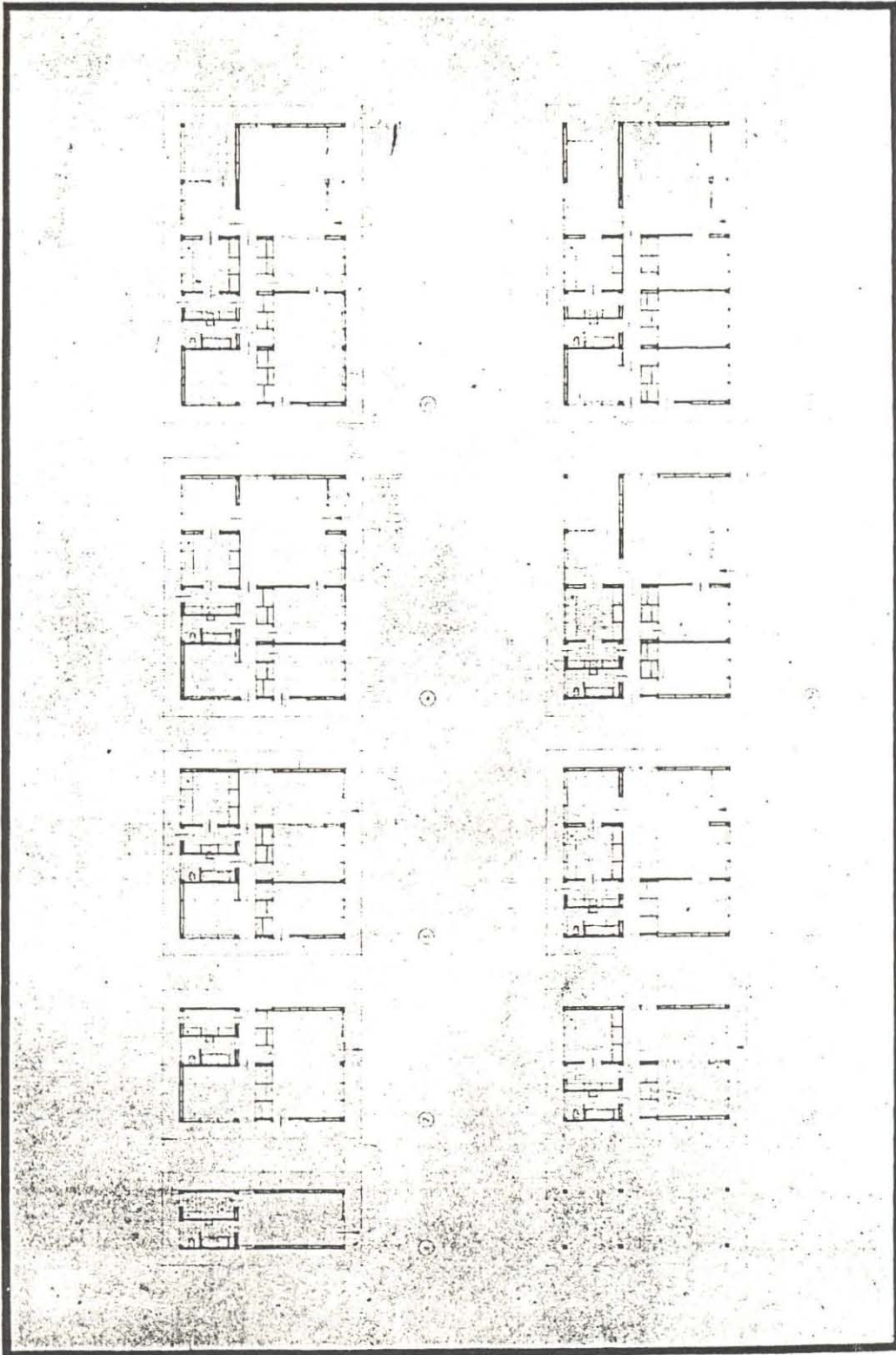

D E V E L O P M E N T O F U N I T P L A N N I N G

However, we have become used to working with brick-sizes, steel-window and -door dimensions, etc., and find it quite natural. It should, therefore, not be so difficult to work with other more efficient units. It seems that if such building elements were designed to satisfy practical demands in the best possible way and were used in the same spirit, then it would rest entirely with the designer and owner to achieve a successful result.

Such a development would not bring any disadvantages but would, on the contrary, have one great advantage: flexibility. Times change and so do people. To give them a chance to adjust their environments according to changed conditions seems a necessity which becomes more and more important as time goes on. This factor is important enough for the individual house but still more so for the flat: it will allow the flat dweller to arrange his quarters as near to ideal as possible and gives the landlord an opportunity to adjust his flats according to the general demand, with the result that his flats will always be let.

The house shown on the following pages was designed to make a general study of the possibilities outlined above. It was based on the same unit as the plans developed in the above shown diagram and is similar to the plan Type 5, except for a different Study arrangement.

Unfortunately many details could not be executed as efficiently as would have been desirable, due to the fact that a high grade article made by hand is very expensive. This house had to be cheap because the means were limited. Only mass production of building units will make it possible to build a house cheaply and yet furnish it with the very best equipment. The principal idea has, however, been adhered to with the aim of making plan and appearance a consequent expression of the system.

SITE:

The ridge of a hill between Meintjieskop and Magaliesberg on the north-eastern outskirts of Pretoria. Approach from the north side by Sixth Street, Villieria, which comes to a dead end at entrance to property. To the north, hill drops steeply to Villieria Valley with Magaliesberg Range further away. On south side, almost level with lower portion of ground, is a Government grass experimental farm which affords a pleasant view on well-kept squares of different varieties of grass. To the north-east one overlooks the flank of the hill with Derdepoort in the background, while the west gives the whole panorama

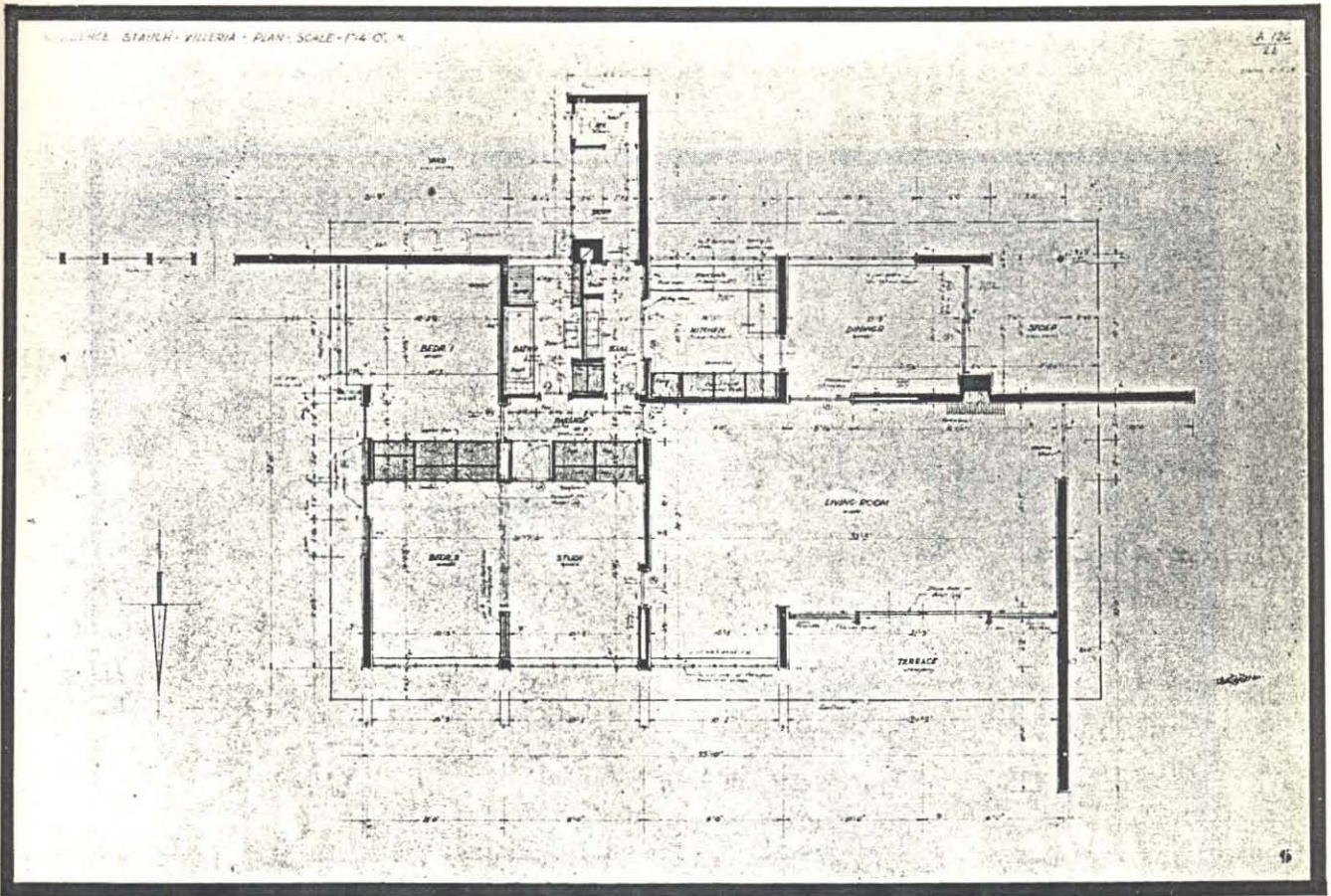

HOUSE IN PRETORIA DESIGNED BY HELLMUT STAUCH
THE PLAN

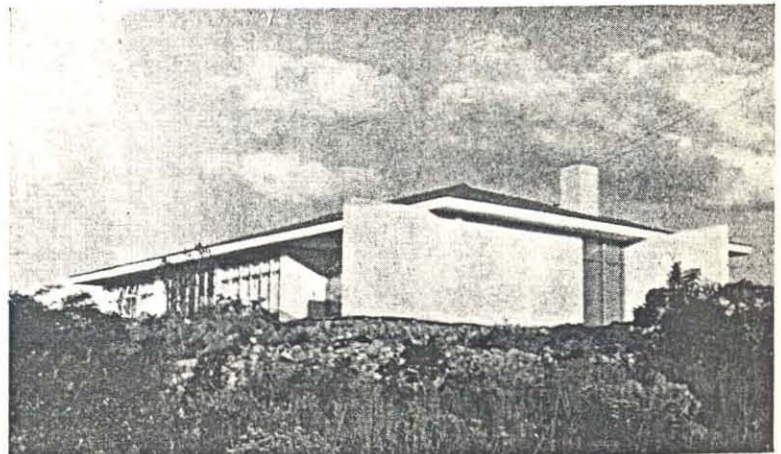

N - W CORNER

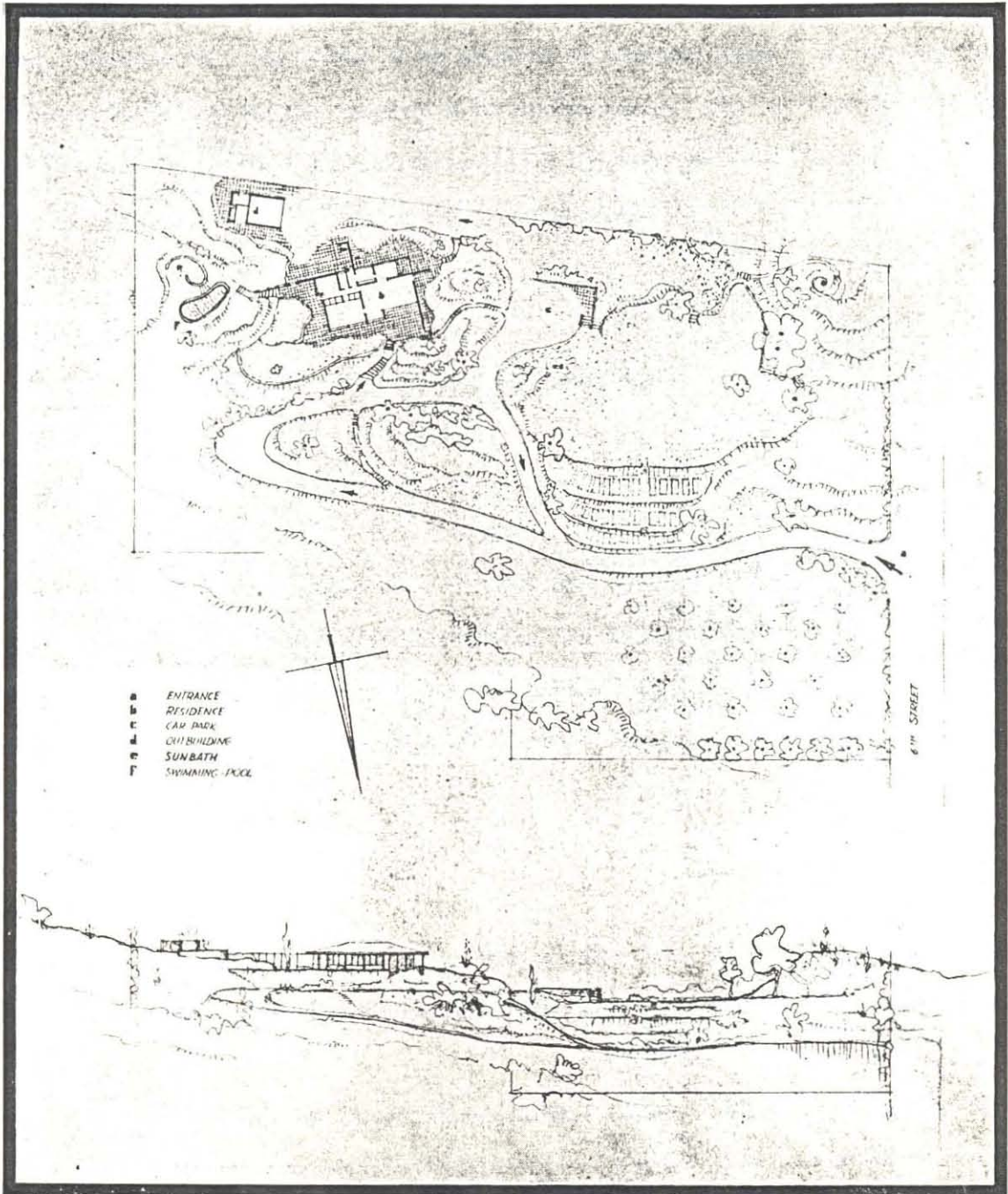

PLAN AND SECTION OF THE SITE



of the centre of Pretoria, the Steelworks and the range of hills continuing the ridge on which the house is built. The south-west is sheltered by the slightly higher continuation of the same ridge.

POSITION AND APPROACH OF HOUSE:

The house is situated on the higher portion of the ground in the south-east corner. The approach leads from the entrance gate on the west boundary to the north of the house where a few steps lead up from the road to the terrace in front of the living room, which is the main entrance to the house. The road continues to the garage, with outbuildings, back yard and back entrance on the south side of the house.

PLAN:

The living room is the centre of the house and leads to all other sections, viz.:—

- (a) Diningroom—kitchen—scullery—back stoep;
- (b) Bedrooms connected by passage with bathroom and back entrance;
- (c) Study.

All rooms have direct access to outside in form of sliding doors with sliding flyscreens. Utility rooms, such as kitchens, scullery and bathroom, have been kept as small as possible to leave more general living space. The lavatory is placed on back stoep. It was originally planned as an E.C. and has since been converted for waterborne sewerage. A recess in the bathroom, now used as shower, could, alternatively, house the W.C.

CONSTRUCTION:

Floors: form a tray acting as protection against influences from below; consist of concrete slab with kiasat woodblocks on layer of malthoid in all rooms; of mastipave with granolithic border in kitchen, bathroom and scullery.

Walls: are solid screens protecting against climatic influences from the sides; partly extended to the outside to protect against strong winds, and also to act as suntraps or to give shade as required, constructed of brickwork with plaster on both sides.

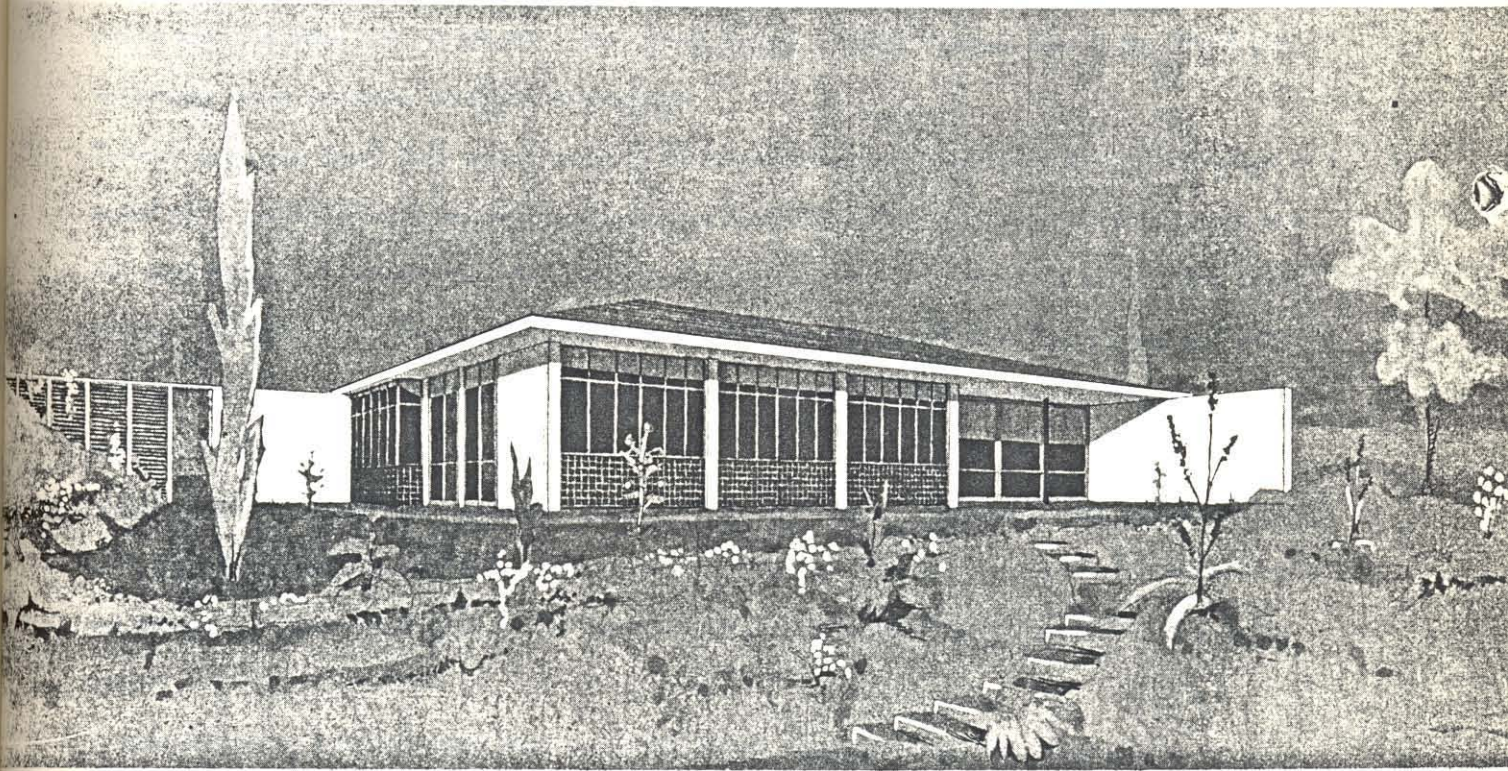

PERSPECTIVE OF THE NORTH FRONT



Windows and External Doors : are transparent screens with a similar function as the walls but, in addition, to give light, ventilation, and, in the case of doors, to act as access to the house. The windows are stock steel windows with plates on top and bottom of mullions to carry the roof structure. The external doors are of plate glass in 4-1/2 x 2 in. wooden frames, sliding on Esavian bottom tracks with ball bearing runners and are fitted with automatic locking spring catches. Every external door is also fitted with horizontally sliding flyscreens of similar construction.

Ceilings, Eaves and Roof : form a unit acting as lid to protect against influences of climate from above ; consist of a wooden structure carrying corrugated iron roof with ceilings of compressed fibre boards cut into small squares to minimise the effects of expansion and contraction, with 1/2 in. match-board eaves forming continuation of ceiling on the same level, finishing against 9 x 1-1/2 in. fascia board with sheet iron gutter behind. Over all openings a wooden beam 6 x 4-1/2 in. supports the roof structure. This beam forms part of the recessed curtain box.

Internal Cupboards : serve to subdivide rooms, and face both ways. Width is divided into three equal parts, each 3 ft. 4 ins. wide, and 2 ft. and 1 ft. deep respectively ; fitted with rods for hanging clothes and shelves. A horizontal division at 7 ft. height leaves storage space 2 ft. high and 3 ft. deep in top section.

In study, the space 2 ft. high from floor is used for sliding drawing-shelves, 3 ft. deep.

Internal Doors : act as movable solid screens and are, where intended to be mostly open, constructed as sliding doors of flush laminated boards to the full height of rooms, sliding on bottom tracks, fitted with hook-bolt, locks and flush handles. Doors which should be kept closed are flush folding doors of usual construction, fitted with fanlights where necessary.

Internal Sliding Screens : have a similar function to doors, and act as partition between study and bathroom, but also as pinning boards for drawings, pictures, photographs, etc. ; constructed of Insul boards in 2 x 2 in. wooden frames, sliding in four panels on bottom tracks across the full width of the room, so that each panel can be placed in any desired position in the room.

Bathroom Fittings : 6 ft. white enamelled bath built in ; dental basin with mirror above, shower, towel cupboard fitted with brass hanging rods and warmed from slow combustion stove in scullery ; cupboard for soiled linen has small receiving hatch and large door for removal of linen, with open glass shelves



INTERIOR VIEWS OF THE
DESIGNED BY HELLMUTH



HOUSE IN PRETORIA
STAUCH



N-E CORNER

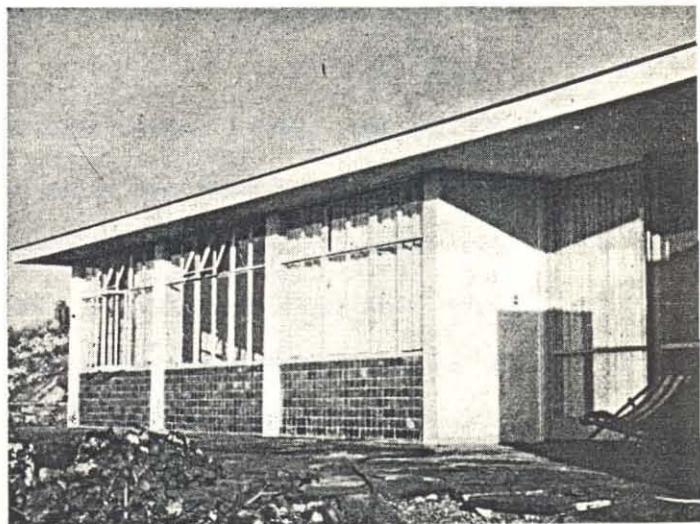
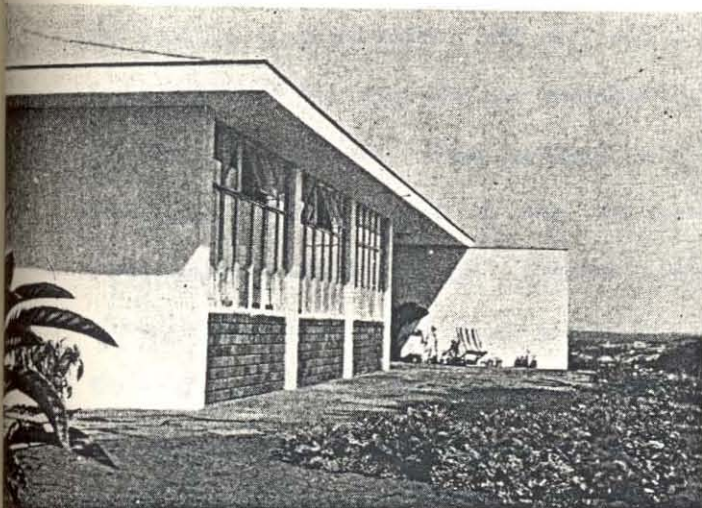

NORTH FRONT



EAST FRONT

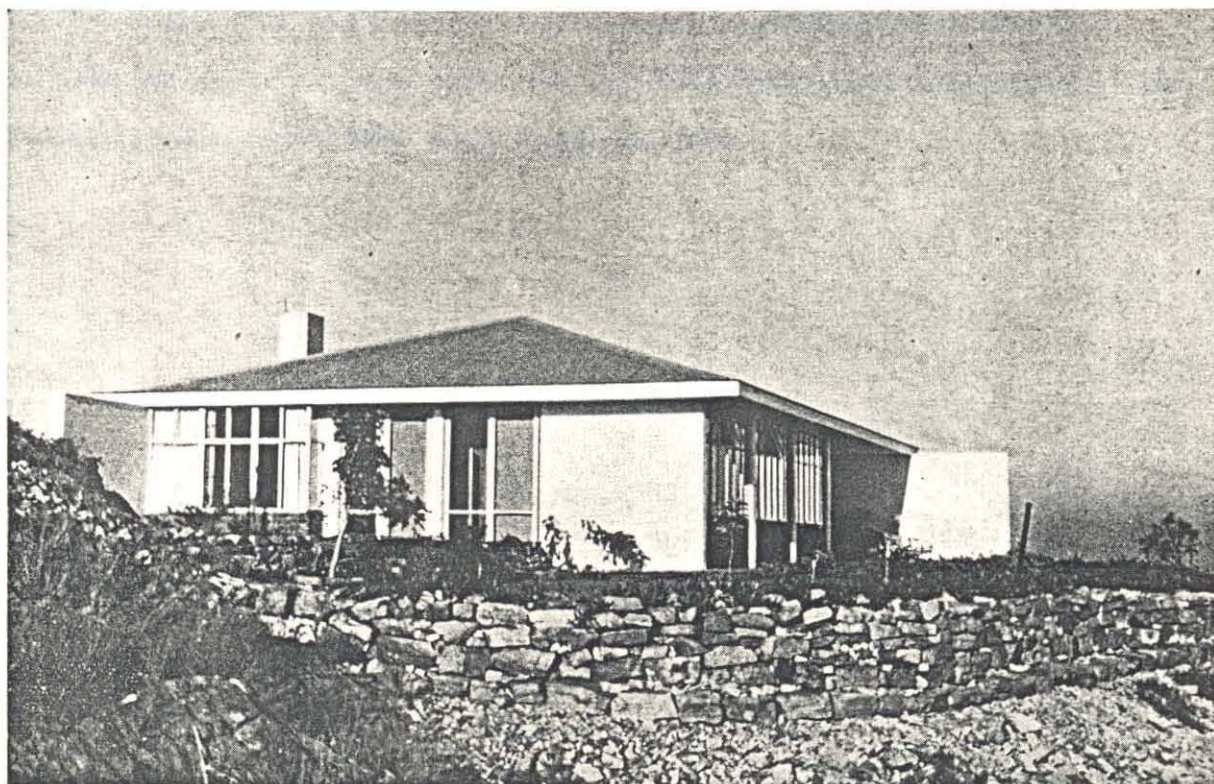

and medicine cupboard above ; walls tiled with 6 x 6 in. white glazed tiles.

Scullery Fittings : Sink table with two enamelled sinks ; plate rack above and storage cupboards fitted with sliding doors beneath. Utility cupboard for brooms on one side, contains also electric meter and switchboard. Facebrick recess on other side contains slow combustion stove. Access to roof through storage cupboard above plate rack. Connection between scullery and kitchen by double sliding doors, allowing both rooms to be used as one spacious unit.

Kitchen Fittings : Work table occupies full length of room under window. Pantry cupboard, fitted with sliding doors and ventilators on external wall, under one half of work table. Other end of table contains rubbish bin, removable from outside, with flap door in table top. The remaining portion is open leaving leg-room. Back wall is formed by built-in cupboard, horizontally divided into three sections : top and bottom sections are fitted with shelves and sliding doors, middle is left open to form serving table. Refrigerator fits into recess on one end of cupboard. Electric four-plate stove adjoins work table next to sitting place.

Colours : Internal wall generally—white, west wall in Bedroom 1—deep blue, in Study—dark maroon ; doors cupboards, etc.—white except cupboard wall in Bedroom 2, and Study, which is in waxed teak.

External walls—white, eaves and fascia—white ; doors and windows—grey ; painted brickwork—grey ; steel columns—red ; parapets—natural klinker colour of stable-floor bricks.



ADDENDUM C

A study by H.W.E. Stauch on modular furniture, indicating by means of diagrams the basic component units and their combinations, together with diagrams and photographs of practical examples of actual composite furniture.

This document is copied from an original draft found in Stauch Vorster archives. The purpose of this is not known, nor is it known whether this has been published.



Practical examples.

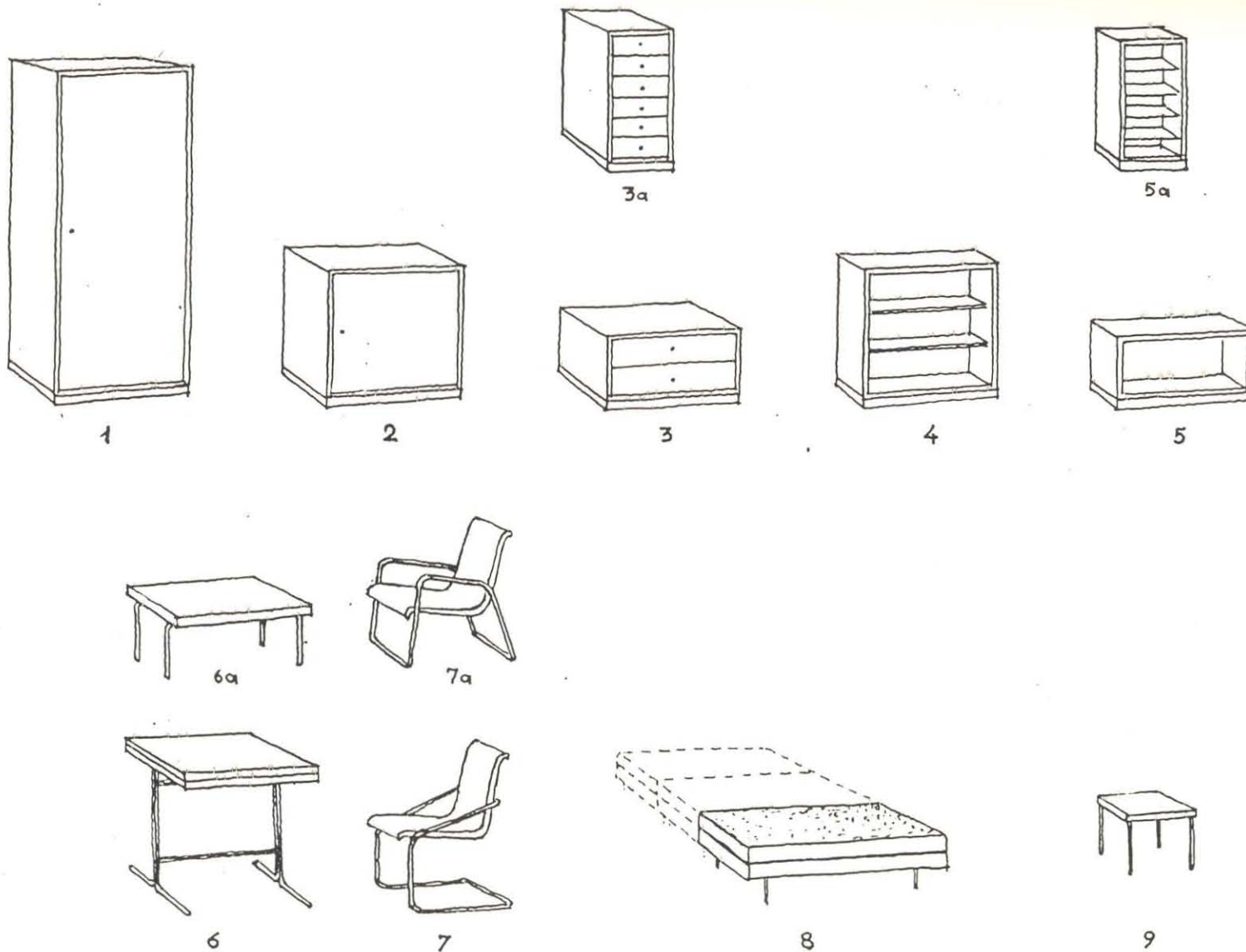

All usual forms of furniture can be composed of these 9 elementary standard-forms

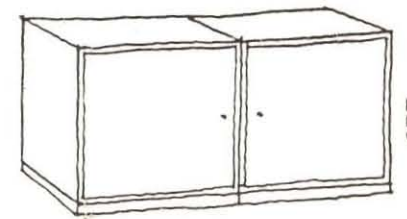
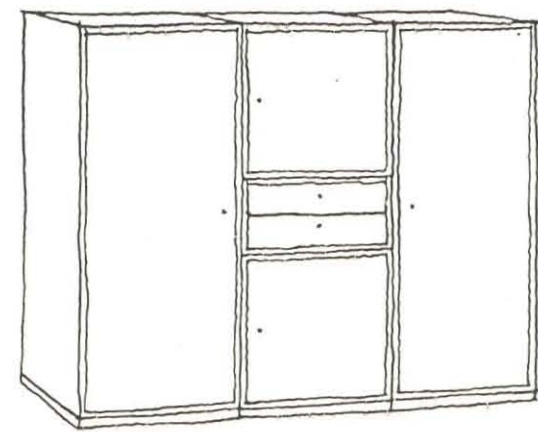
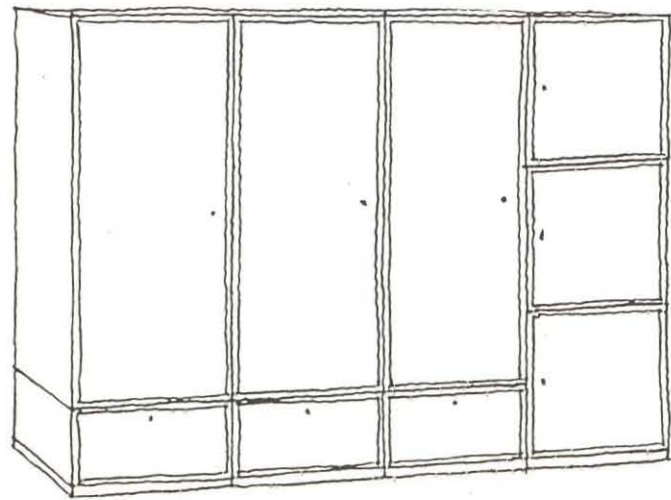
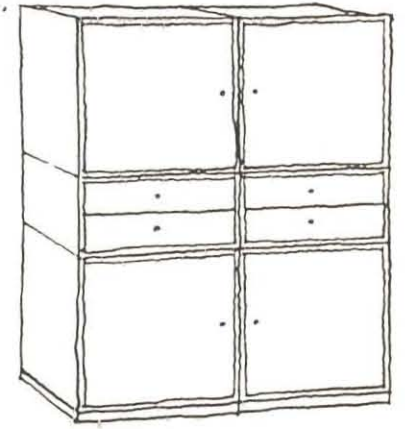
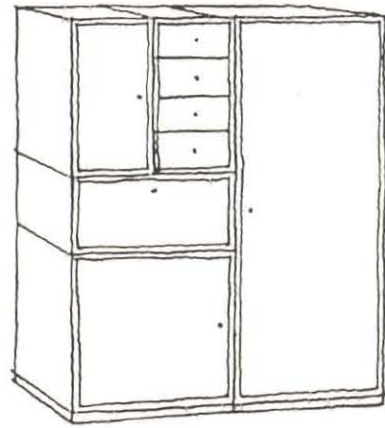
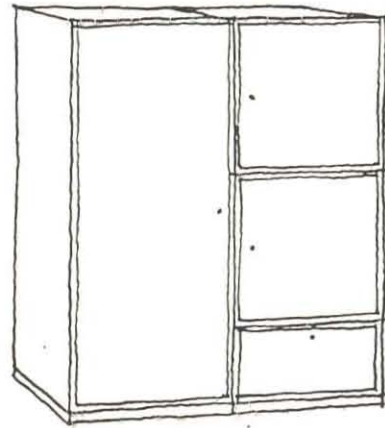
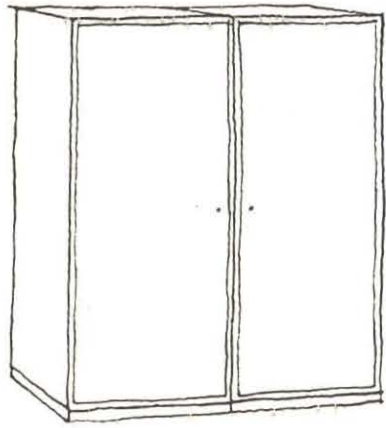

129

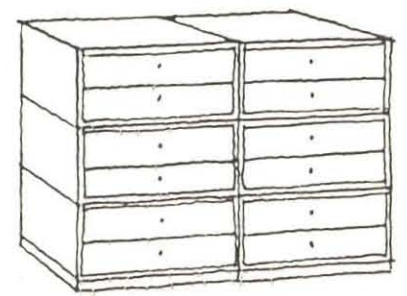

Combinations of form 1,2 and 3

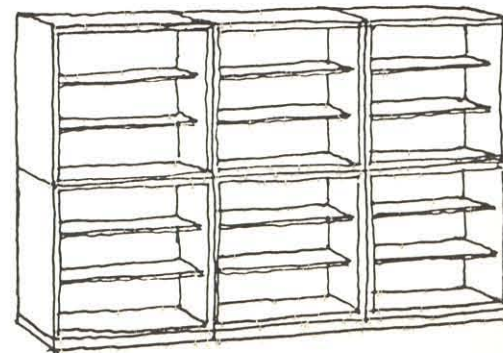
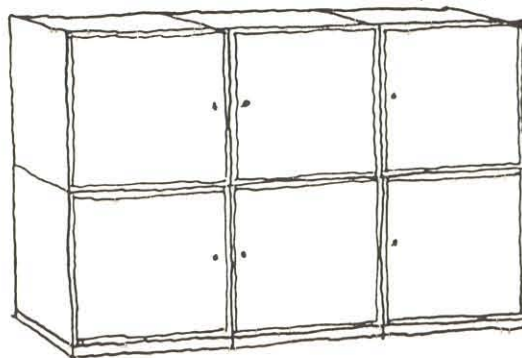
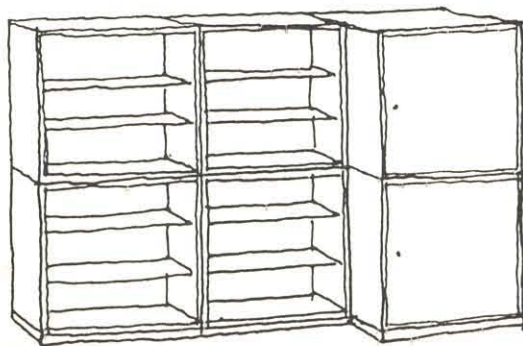
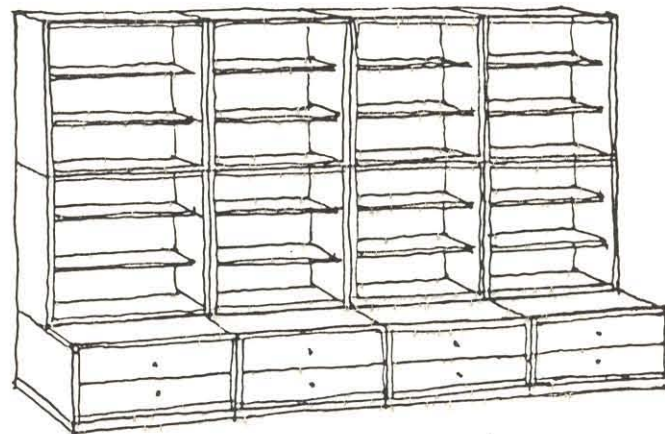
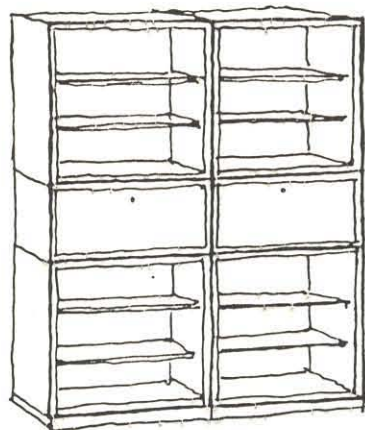
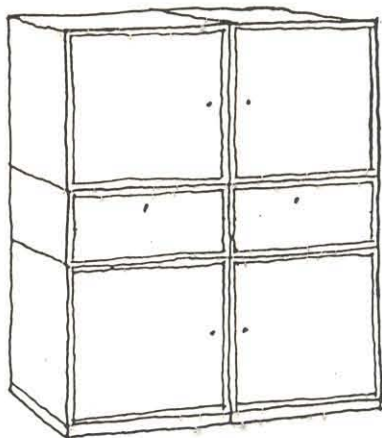
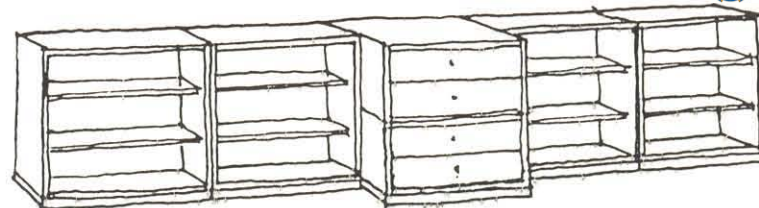
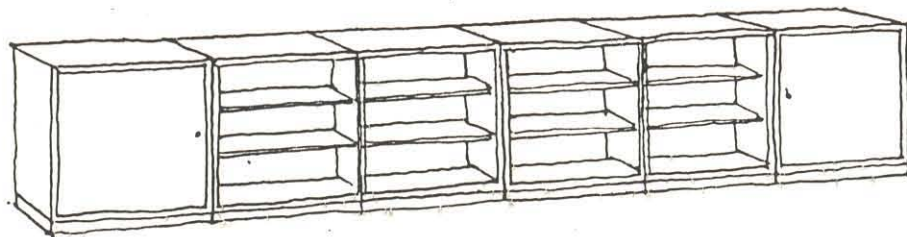

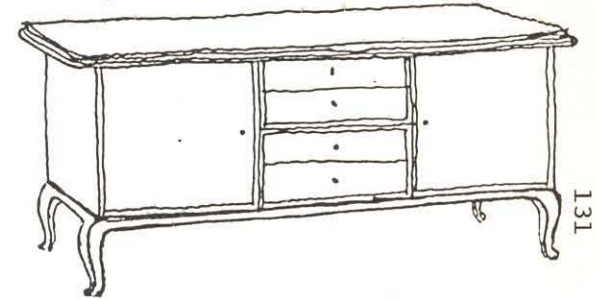
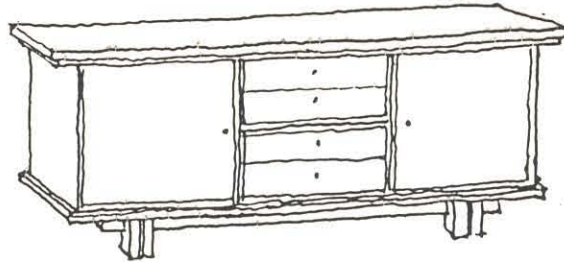
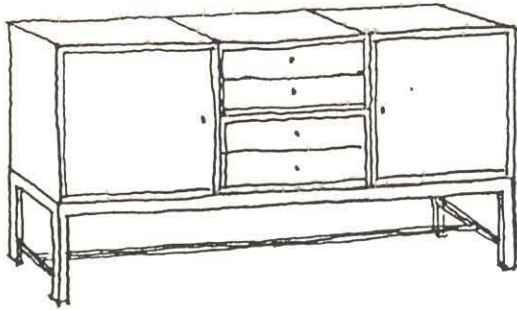
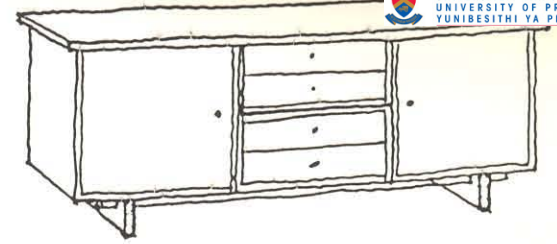
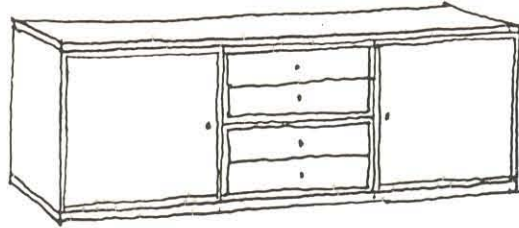
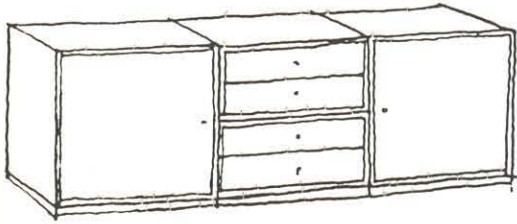

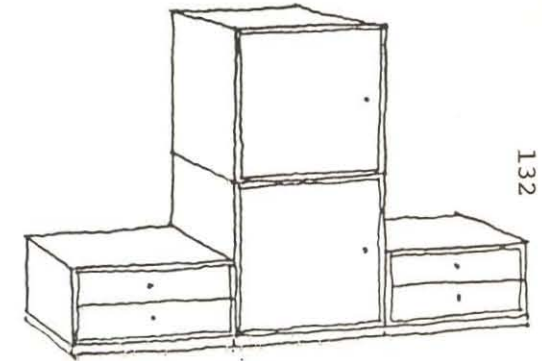
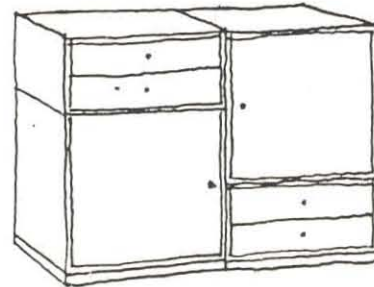
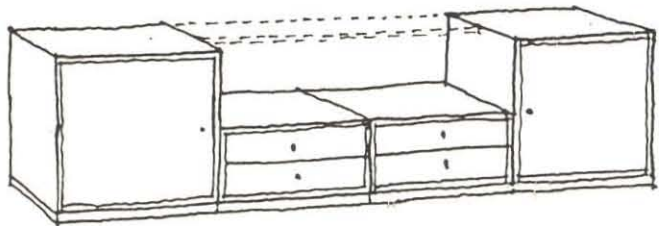
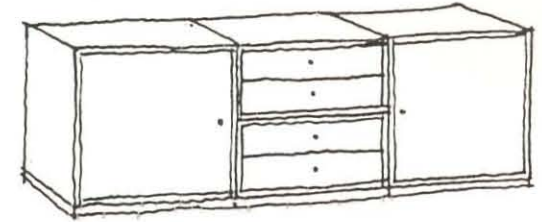
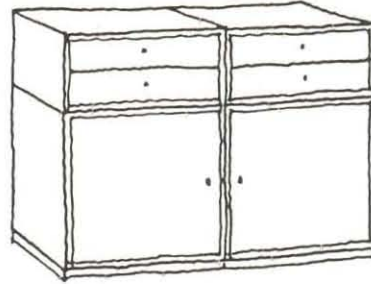
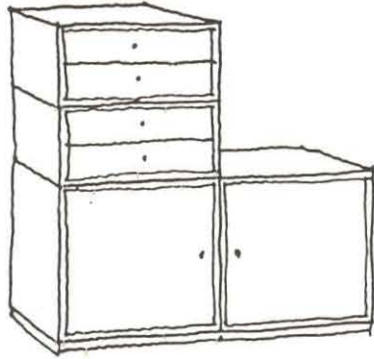
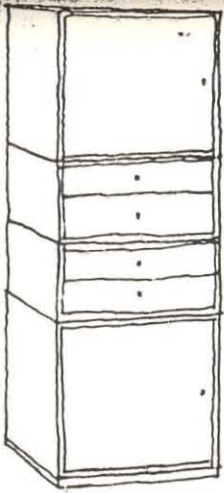

132

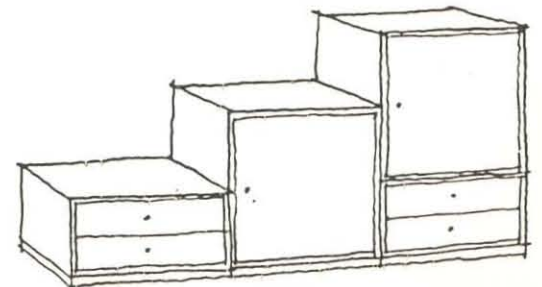
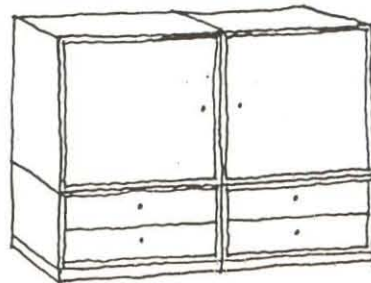
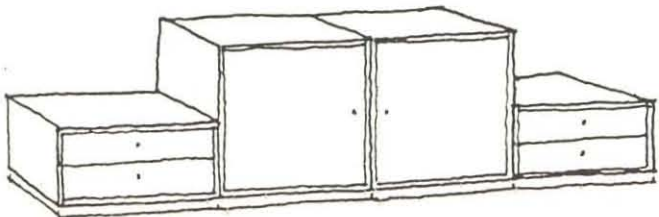

6

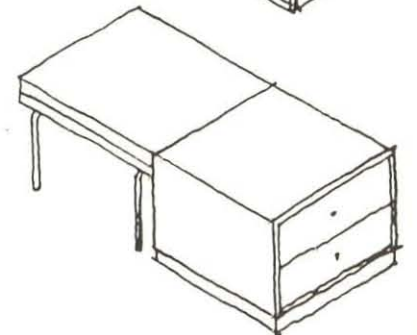
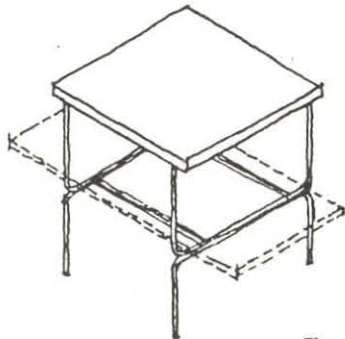
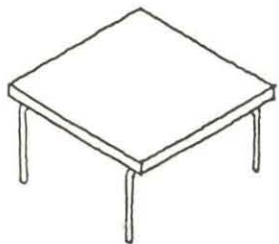
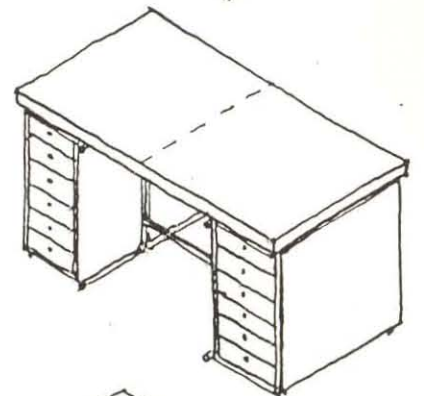
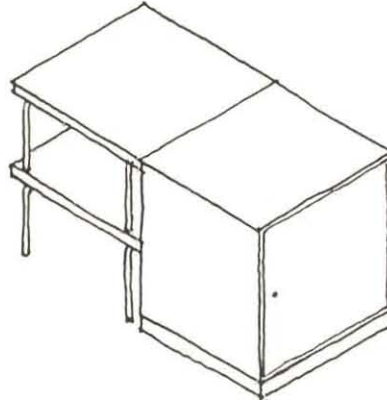
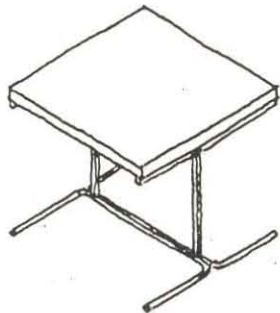
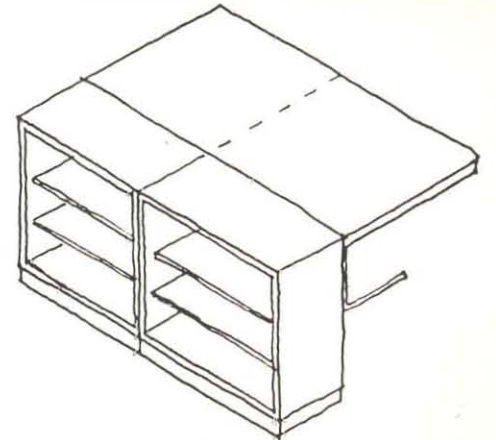
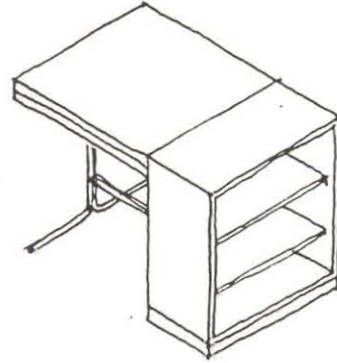
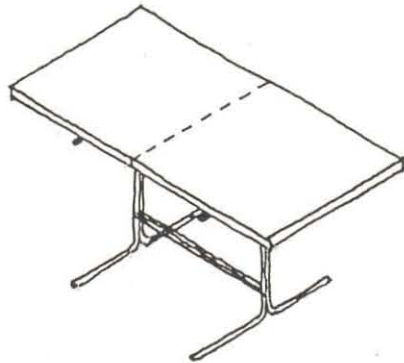
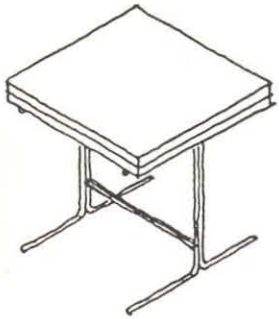

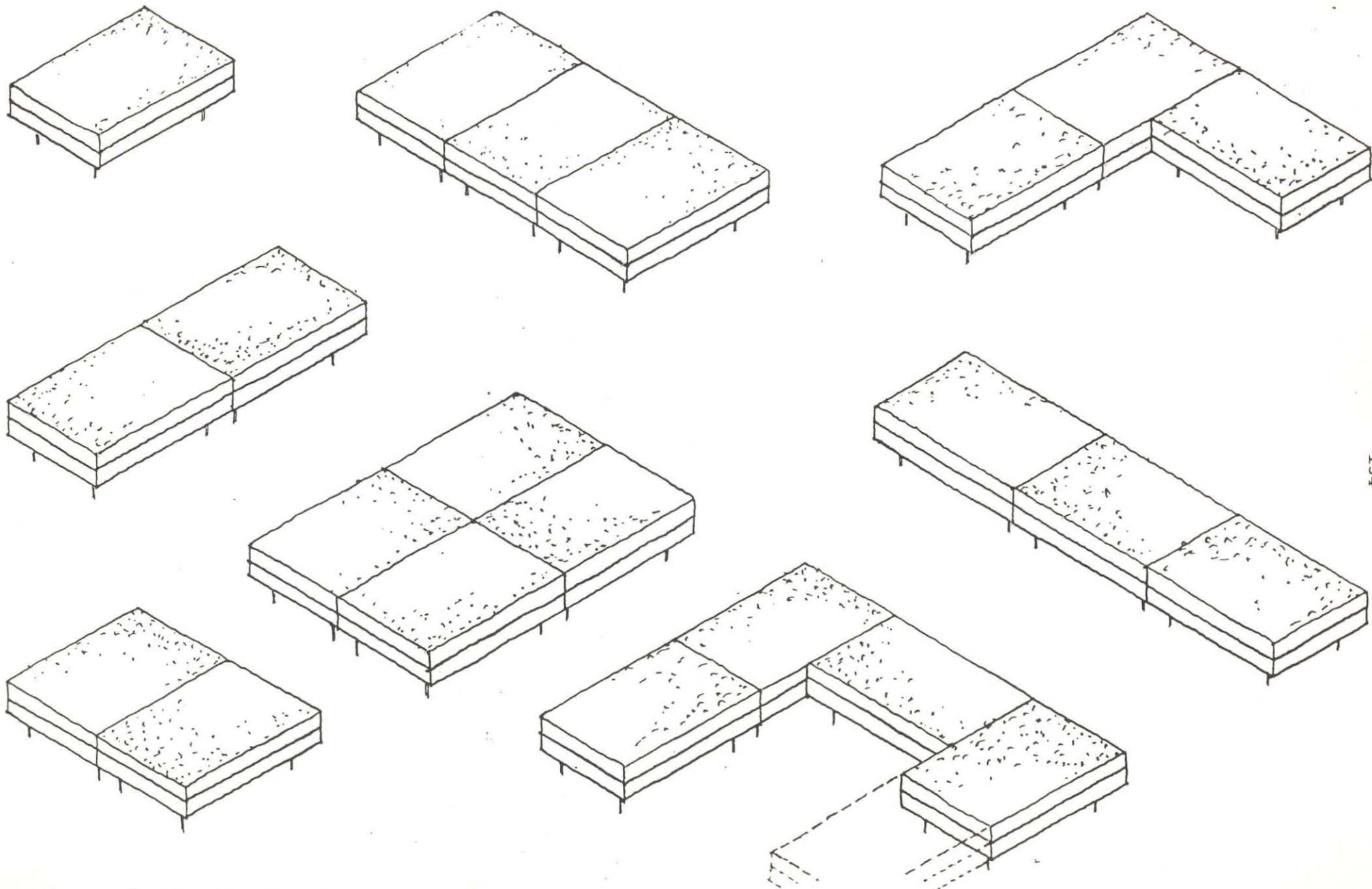

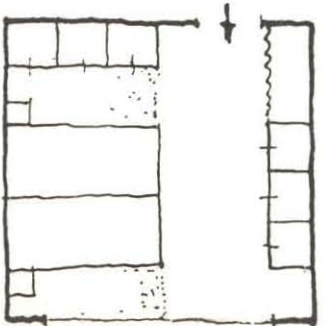
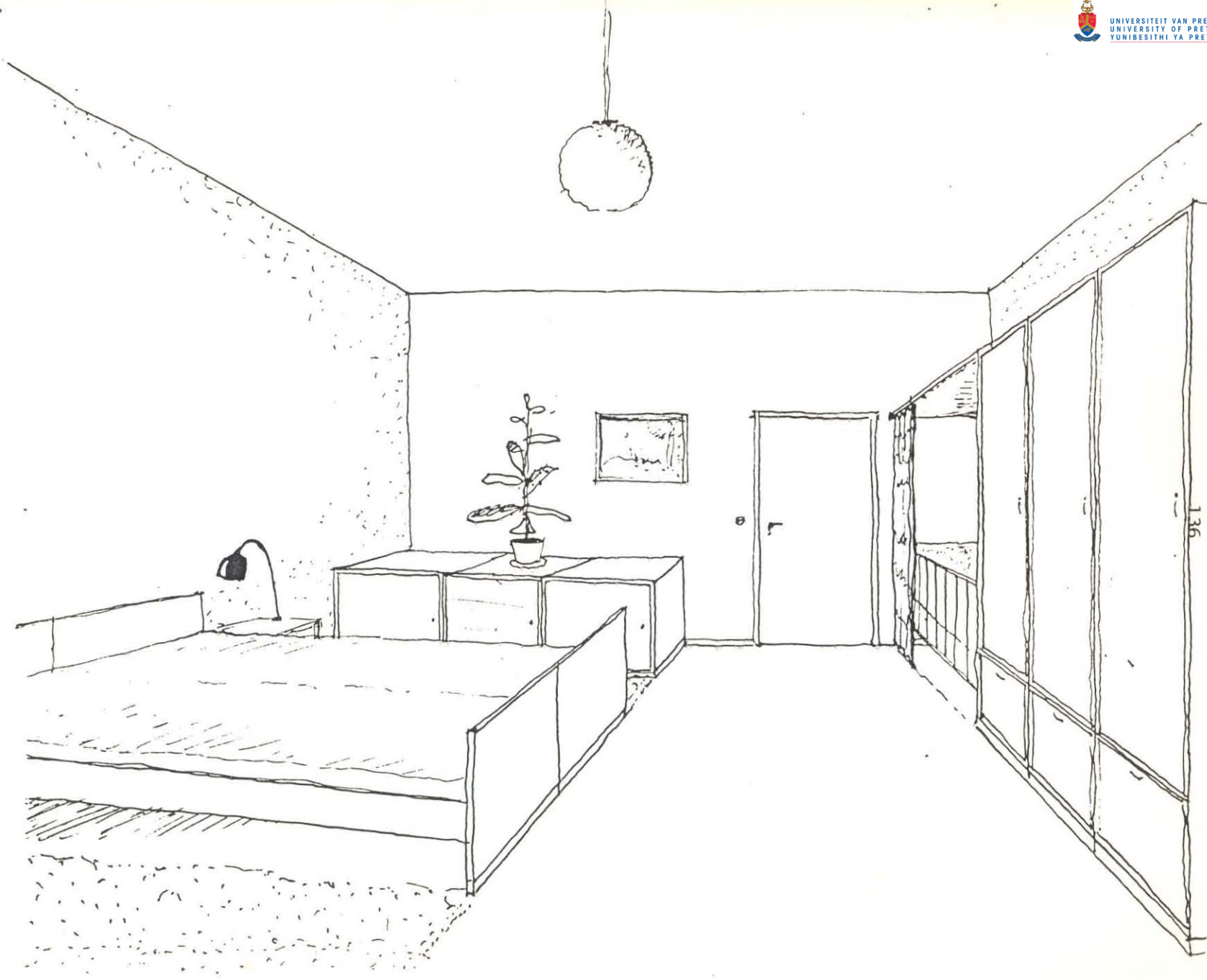

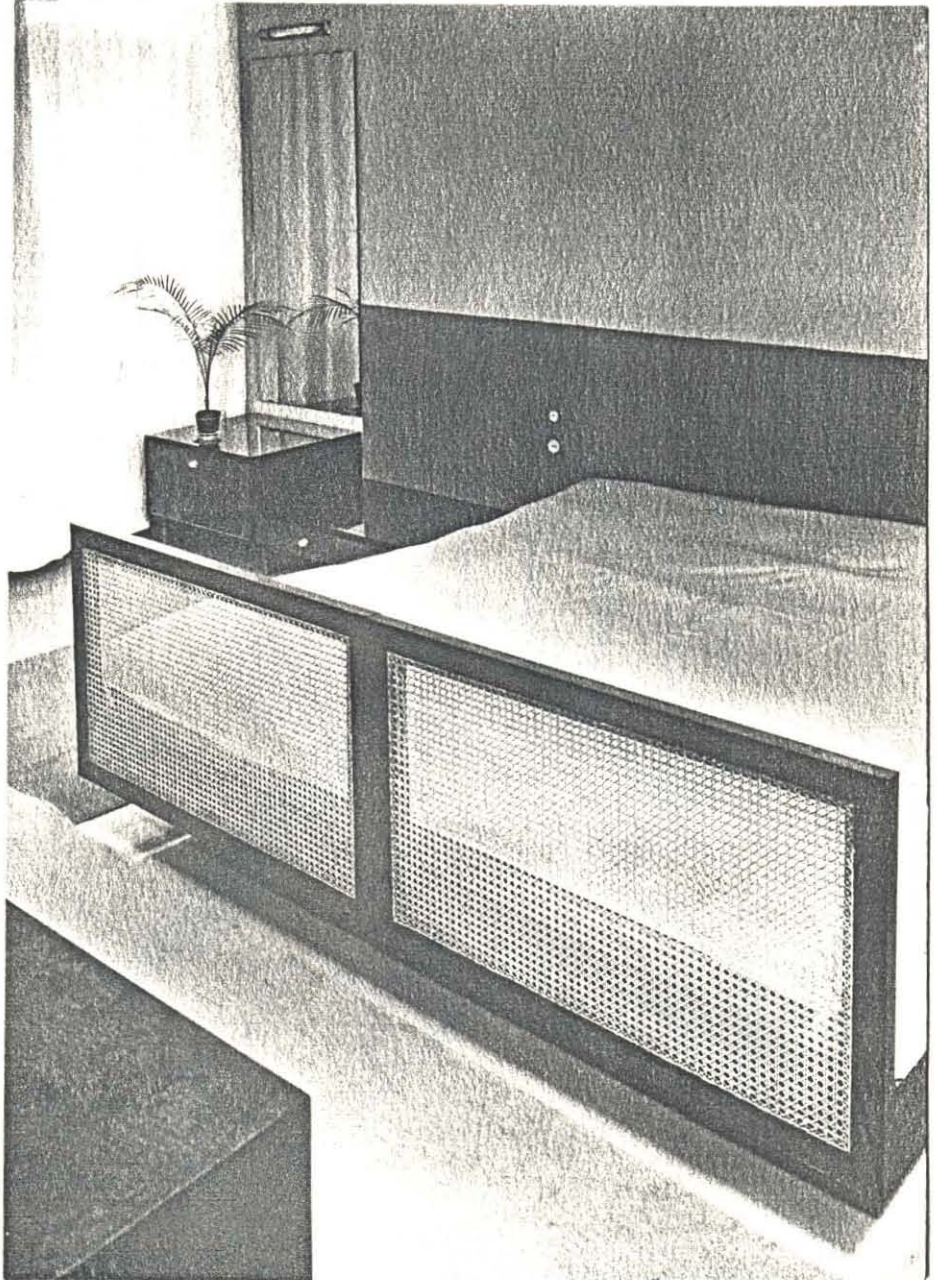

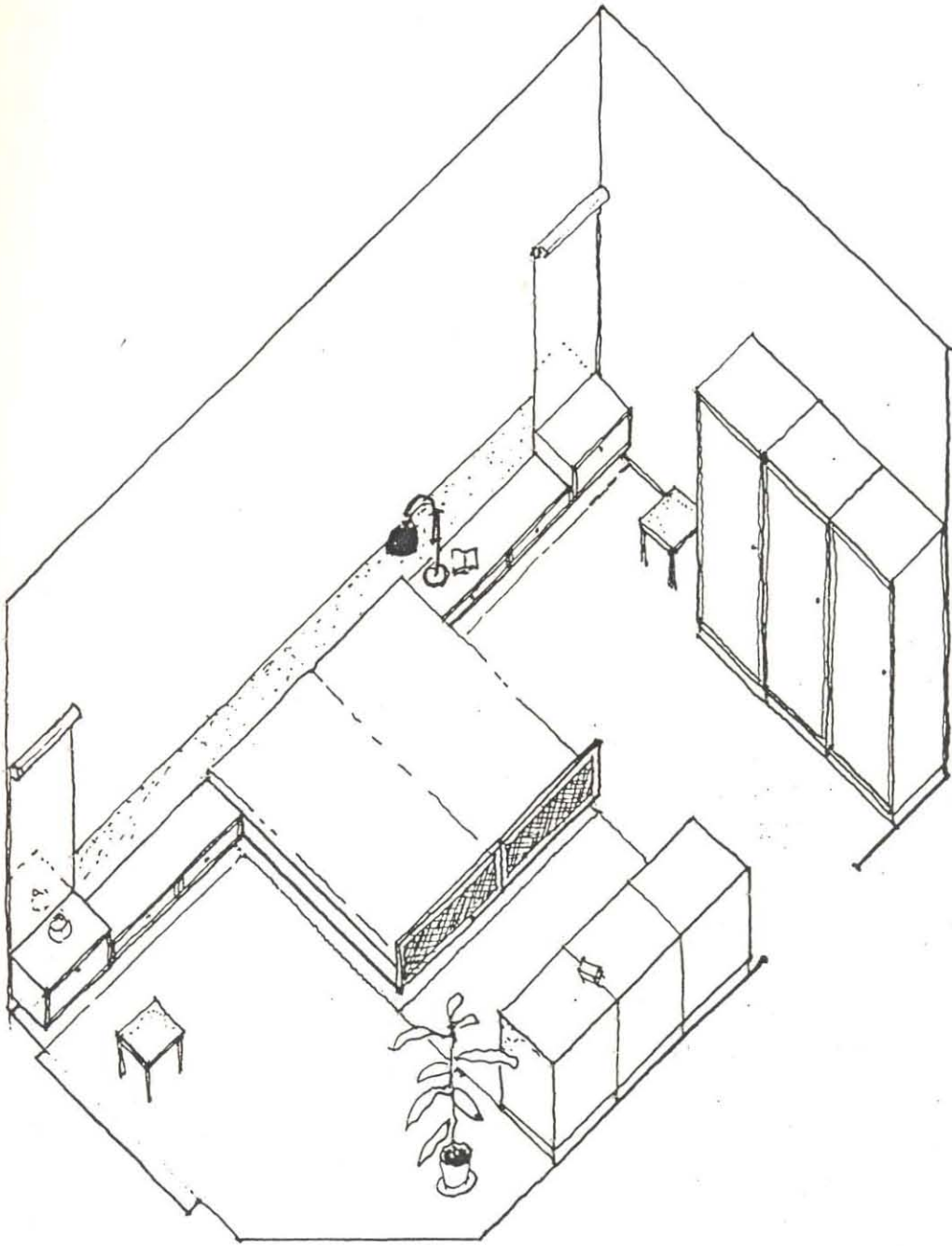

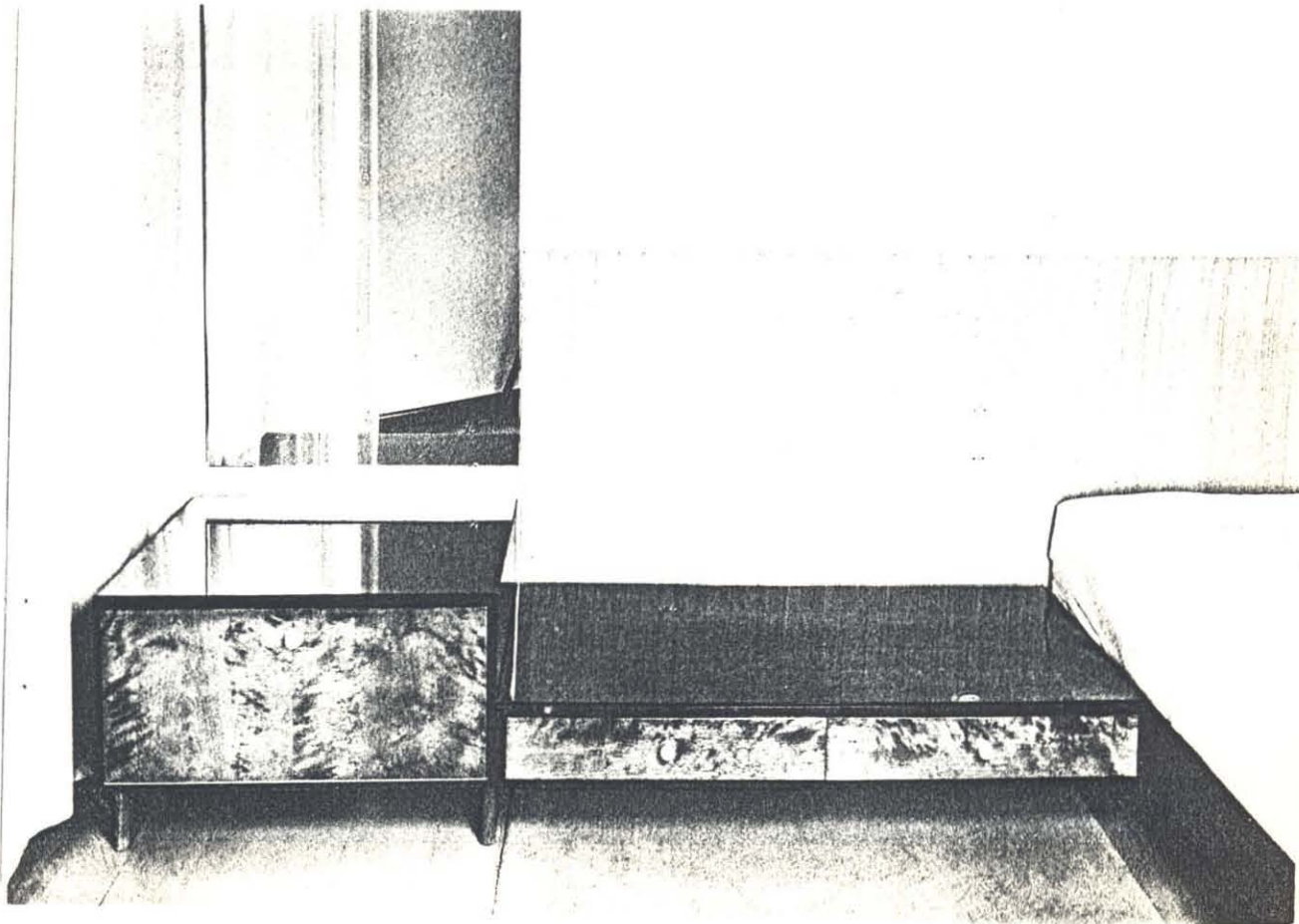
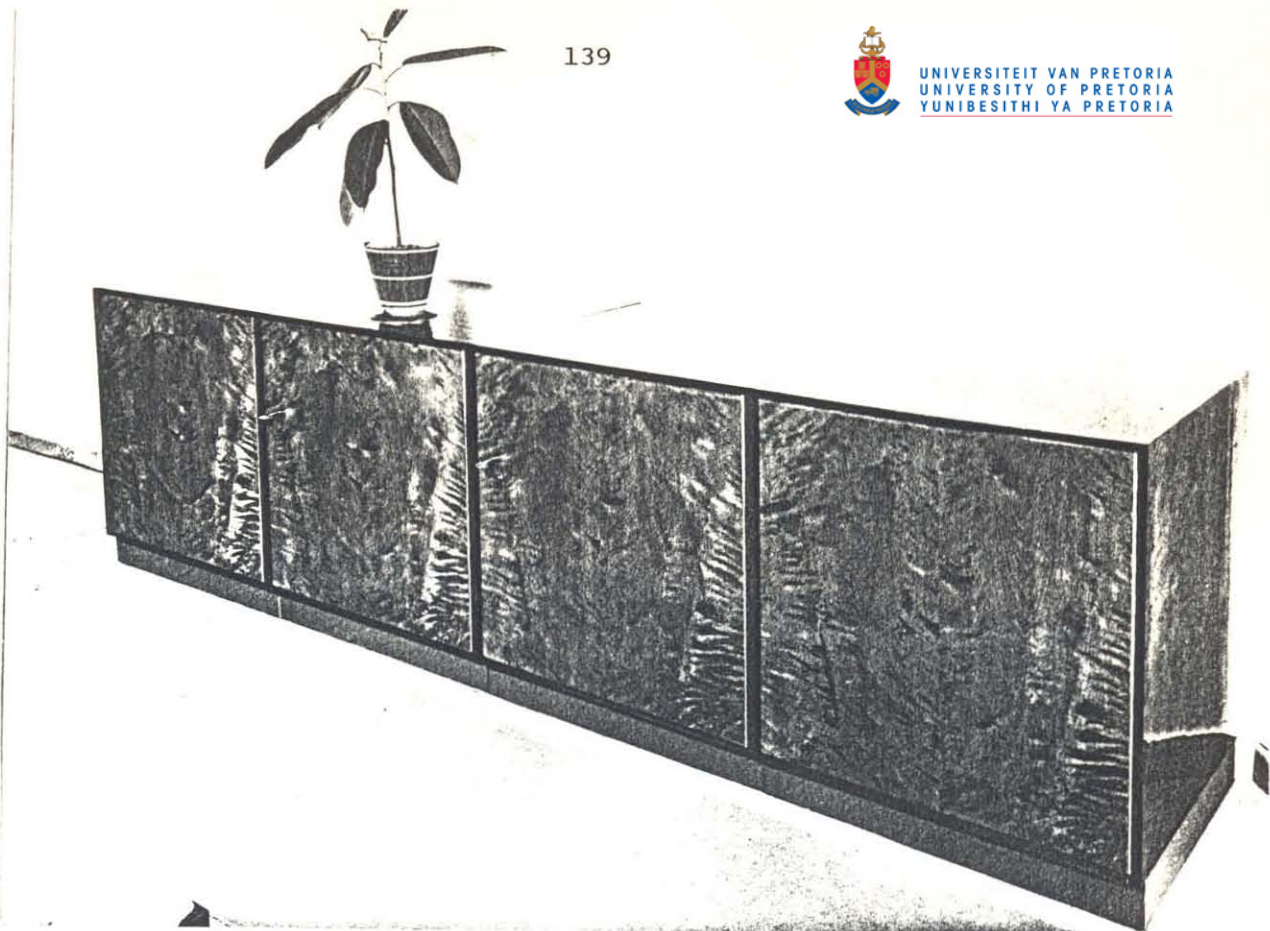

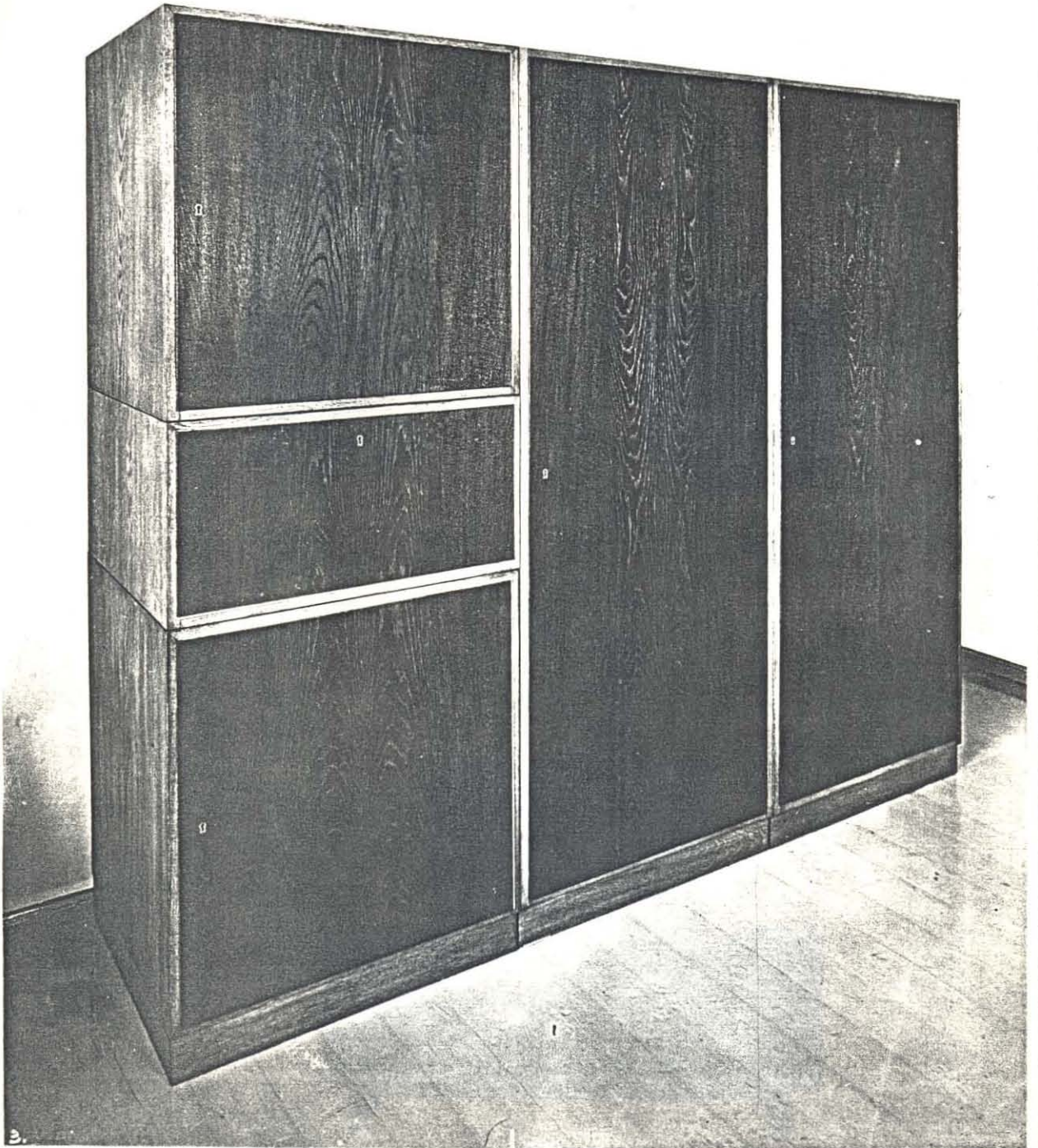



Box unit

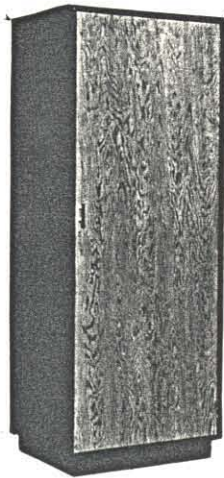

Cabinet unit

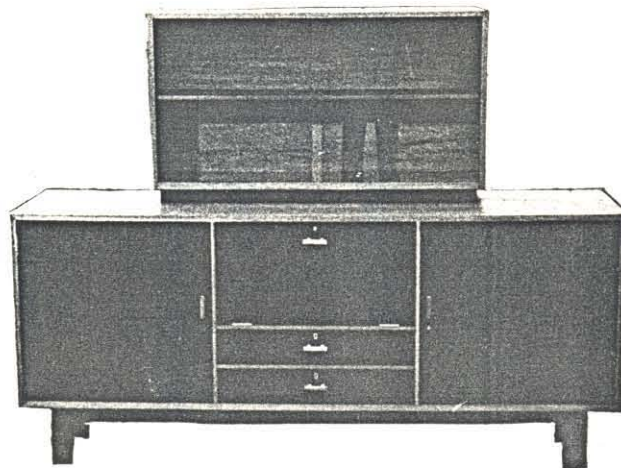

Sideboard



Dressing Table



Dining Chair.

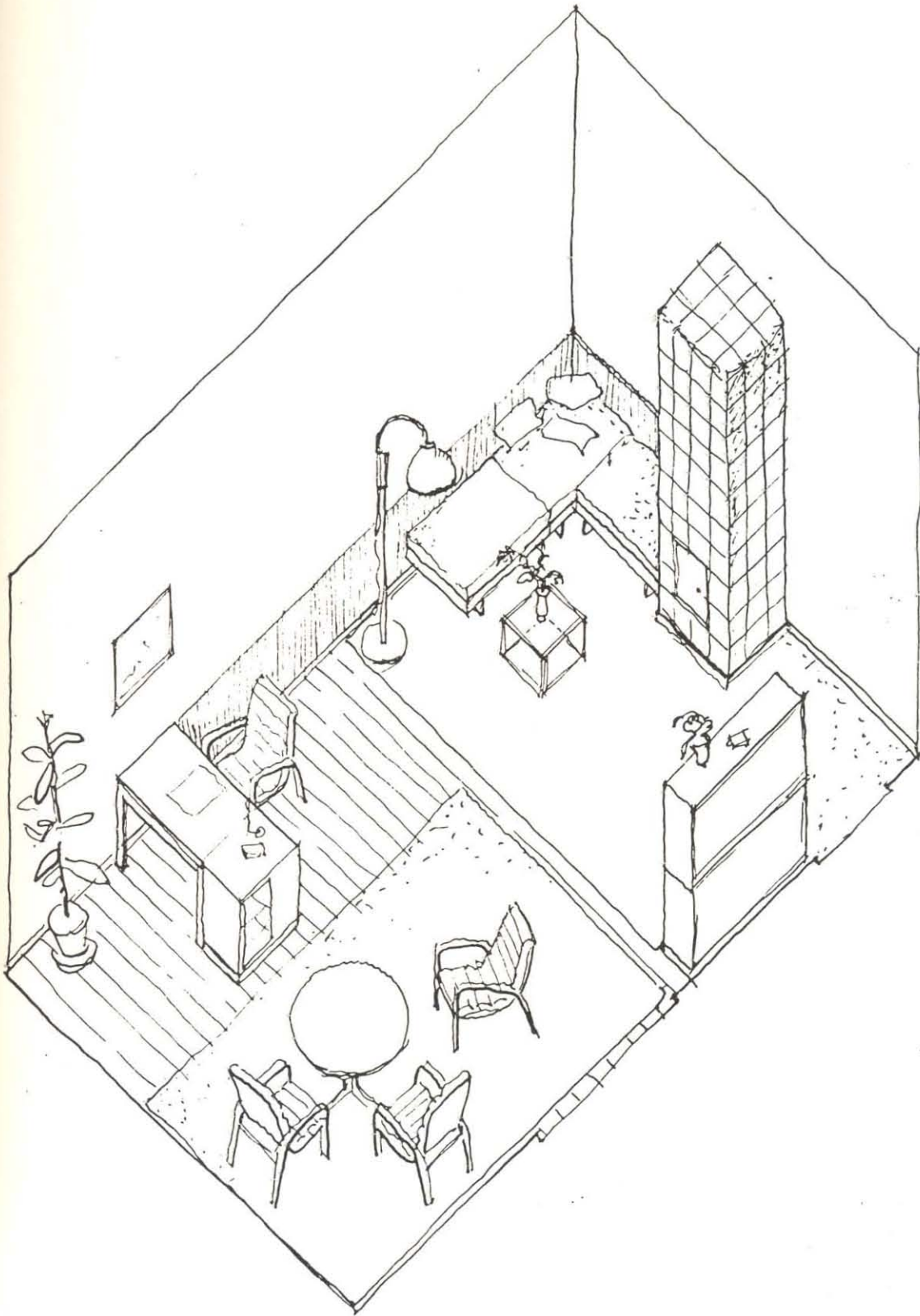

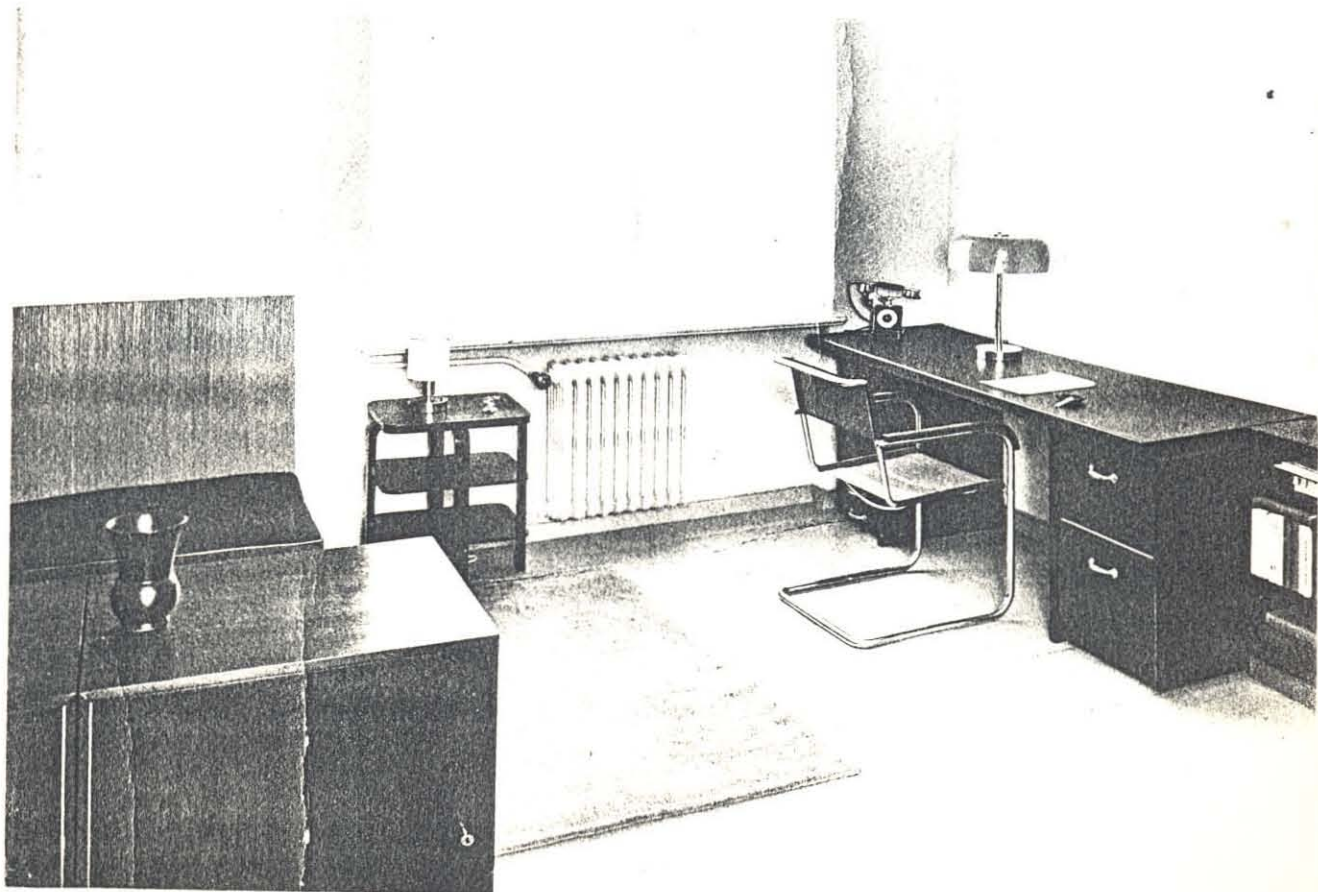





Produk 12

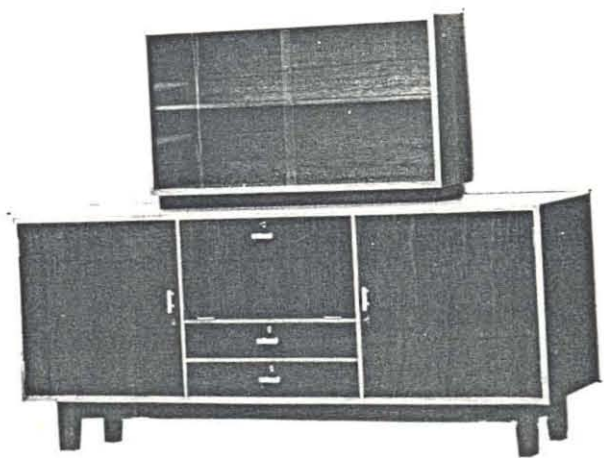
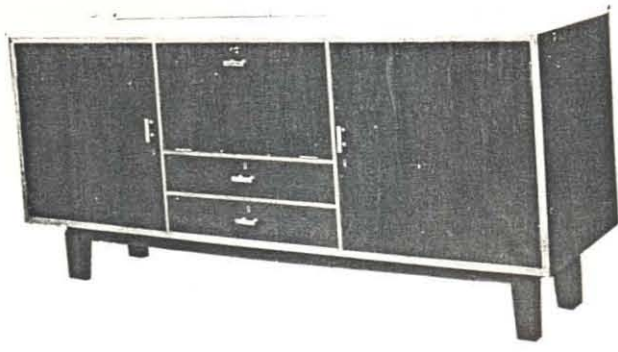

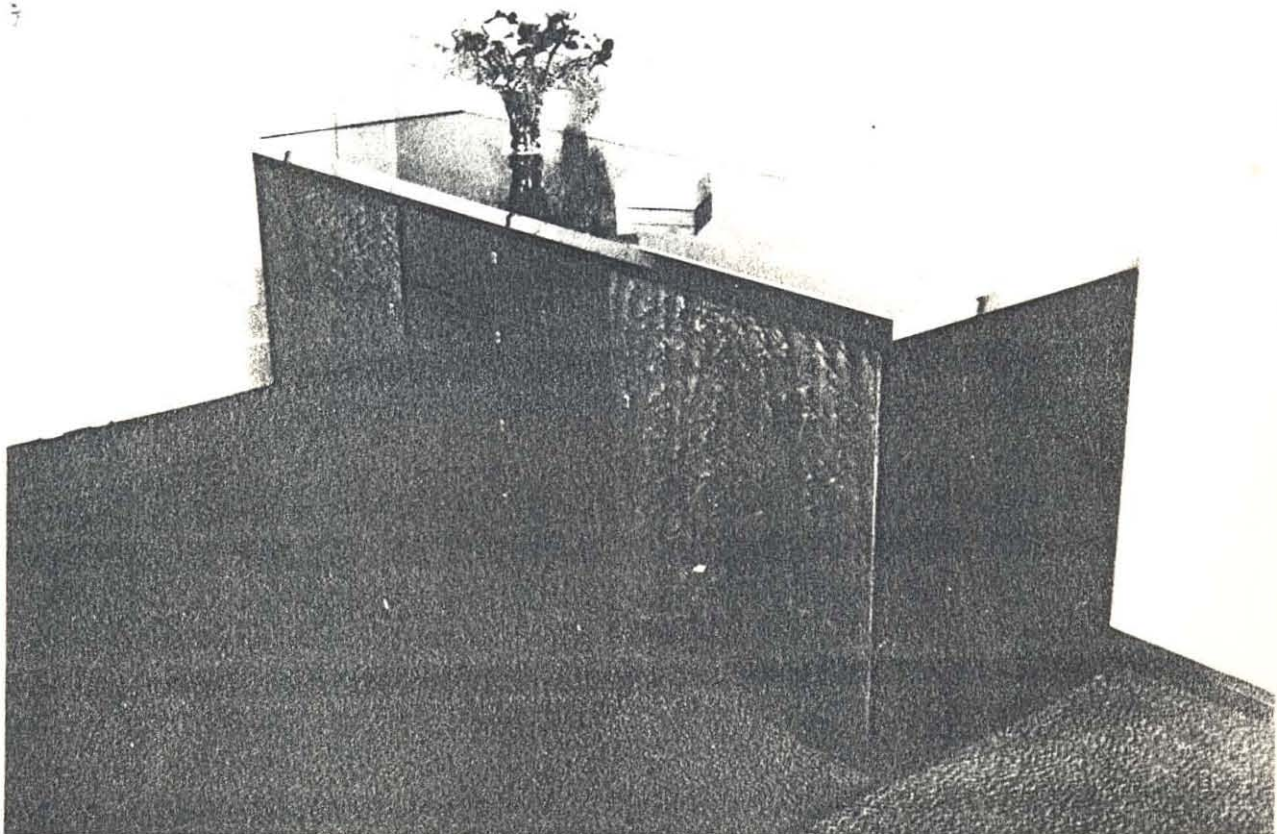
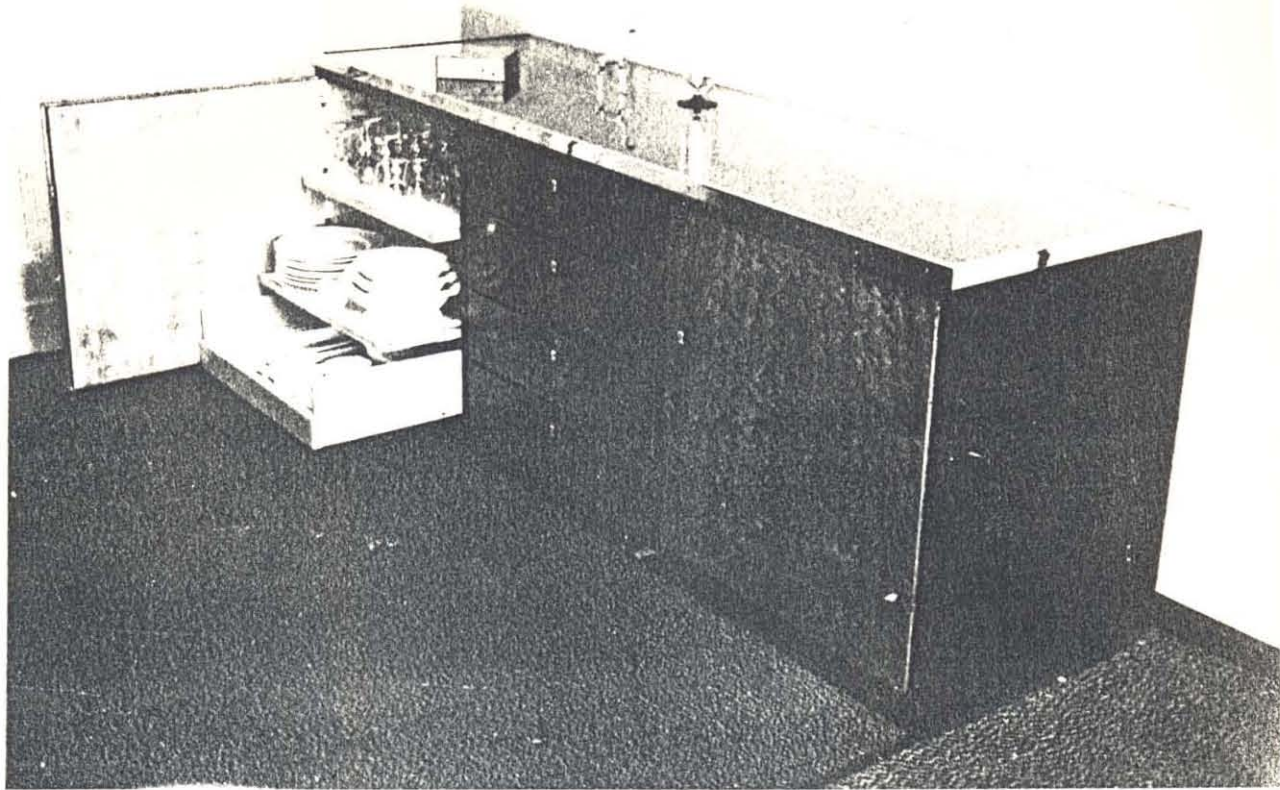



BIBLIOGRAPHY AND SOURCES OF REFERENCE

1. Interviews, tape-recorded and transcribed.

The following persons were interviewed and have been cited in the text:

Mrs Marianne Krafft (nee Stauch). Sister of H.W.E. Stauch.

Mr Robin Vorster. Son-in-law of H.W.E. Stauch, partner and now director of Stauch Vorster.

Mrs Tosca Vorster. Step-daughter of H.W.E. Stauch and wife of Mr Robin Vorster.

Mr F. Wepener. Ex-partner of H.W.E. Stauch.

Mr J.A.N. (Jan) van Wyk. M.I.A., student of H.W.E. Stauch at Pretoria University.

Mr G.T. (Gawie) Fagan. M.I.A., student of H.W.E. Stauch at Pretoria University.

Mr. Wynand Smit. M.I.A., student of H.W.E. Stauch at Pretoria University.

Mr Tielman J.R. Scholtz. M.I.A., partner of H.W.E. Stauch and director of Stauch Vorster.

Mr Hans-Erik Staby. M.I.A., partner of H.W.E. Stauch.

Judge H.J. Berker. Friend of H.W.E. Stauch.

Mrs. (Pulli) Thoms. Secretary to H.W.E. Stauch for the first ten years, approximately, of his practice.

Mr John Nunn. Son of the late Aubrey Nunn. M.I.A.

Mrs Margot Henkel. Widow of artist Irmin Henkel.

Mr Horst W.E. Sternagel. M.I.A., partner of H.W.E. Stauch and director of Stauch Vorster.

Dr. Gilbert Herbert. Professor of Architecture at the Technion - Israel Institute of Technology : author of "Martienssen and the International Style" (1975).

Also interviewed but not directly cited were:

Mr Peter B. Strack. M.I.A., partner of H.W.E. Stauch.

Mr Lauri Wale. Editor of Architect and Builder.

Mr Hosea Masilela. Office assistant to Stauch Vorster since the early fifties.

Mr Mischa Krafft. Son of Mrs. Marianne Krafft, nephew of H.W.E. Stauch.

Mrs Olga Levinson. Author of "Diamonds in the Desert" (see bibliography)

Informal discussions were also held with a number of those who either knew Stauch socially, or had worked with him or against him, in competition and with lecturers at Witwatersrand, Durban and Pretoria Universities who helped to give insight into his work.

2. General references

- 2.1 Stauch Vorster records relating to personal documents, financial and income tax records and confidential records normally retained in security on behalf of each partner/associate.
- 2.2 Stauch Vorster's comprehensive list of projects. Early projects are listed by name only, but after 1948 dates were recorded and after 1960 other data.
- 2.3 Stauch Vorster's library records, including some newspaper cuttings intermittently collected, some published articles, and a large collection of photographs.
- 2.4 Records retained by Mr. and Mrs. R. Vorster, consisting mainly of Stauch's sketches pre 1935, and, Stauch's library, consisting of some 60 books, a few of which have signature, date and annotations.

3. Magazine references

Architect and Builder. September, 1952, May, 1955.

South African Architectural Record. November, 1944, December, 1944, February, 1949, December, 1951, January, 1958, April, 1958.

Decorative Art. No. 43, No. 46, 1956-7.

Architectural Forum. February, 1953.

Public Works of South Africa. July, 1951.

Architectural Design. Vol. XXVI June, 1956.

The Architectural Review. June, 1953.

Bauwelt. No. 47 - 1931, 1954.06.28, No. 28 - 1957.07.15.

Die Taalgenoot. July, 1954.

I.S.A.A. 1965.12.12.

Property Mail. 1971.01.15.

S A Garden and Home. May, 1969.

Milady. October, 1955.

Instituto Tecnico de la Construcccion y del cemento. February, 1956.

Die Baugilde. 24 : Dezember, 1930.

4. Books

- NEUMANN, Eckhard. 1970. Bauhaus and Bauhaus People. New York: Van Nostrand Reinhold Company. 255 p.
- BAYER, Herbert. 1959. Bauhaus. Boston: Charles, T. Branford Company. - 224 p.
- WINGLER, Hans, M. 1969. The Bauhaus Weimar Dessau Berlin Chicago. English adaption. Massachusetts Institute of Technology. 653 p. (Original publishers Verlag. Gebr. Rasch & Company Cologne. 1962).
- NAYLOR, Gillian. 1968. The Bauhaus. Second edition. London: Studio Vista Limited. 159 p.
- HERBERT, Gilbert. 1975. Martienssen and the International Style. Cape Town, Rotterdam: A.A. Balkema. 283 p.
- HOCKING, Anthony. 1972. Yachting in Southern Africa. South Africa: Purnell & Sons (South Africa) (Proprietary) Limited. 241 p.
- LEVINSON, Olga. 1983. Diamonds in the Desert. Cape Town: Tafelberg Publishers Limited. 172 p.
- STAUCH, H.W.E. Neues Bauen in den Kolonien (unidentified reprint/pamphlet, undated).
- STAUCH, H.W.E. Das Ideale Eigenheim (undated pamphlet - no printers reference).