



## DESIGN PRECEDENT STUDIES

CHAPTER **04**  
everyday precedents  
design precedents

## DESIGN PRECEDENT STUDIES

everyday precedents

harnessing the everyday experience

To communicate the everyday experience through a design intervention, the context must be considered. The inspirational, the successful and the well used examples act as precedent for contextual integration and a connection to place, for the moment disregarding the novelty of the new. The 'everyday' also includes impactful precedents which shape the home or work environment and expose people to the unusual. These precedents are inspirational and aim to broaden the scope of what is defined as recurring or commonplace architecture: translating the everyday tasks into meaningful space.

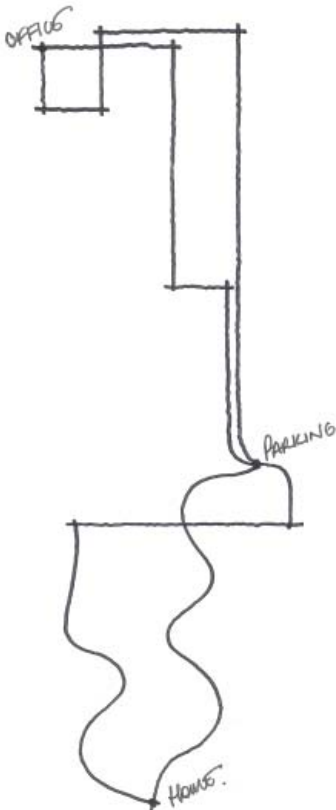

4.01 ABSTRACT OF JULIUS' (CANDIDATE LAWYER) DAILY JOURNEY TO AND FROM WORK



### 01 EVERYDAY INTERACTIONS

City and its people.  
Imagery of the current conditions  
and varied interactions within the  
city.



### 02 ELEMENT OF SURPRISE

Pretoria and street edges.  
Receptive, tracing spaces which  
develop the 'city as possibility'.

### 03 ALLEY INTERACTIONS

Plantation Lane.  
Reshaping the public forum  
through interaction, neglected  
space and transparencies.



### 04 THE CITY WALL

Three facade treatments which  
question the existing overload and  
city boundaries.

### 05 REVEALING IMPORTANCE

Wrapped Reichstag.  
Exposing the meaning of a historic  
resource and continuing the  
narrative.



### 06 EVERYDAY LIFE

Rue de Suisses Apartments.  
Challenging the urban canyon and  
the everyday experience.

### 07 INTERNAL CONECTIONS

Terrence Donnelly Centre.  
Exploring city connections and  
exposure to learning through the  
route taken.



### 08 HISTORIC RE-USE

Hearst Tower.  
Re-using the existing by adapting  
function and preparing for future.

## EVERYDAY INTERACTIONS

church square ; pretorius street ; new york city street intersection

The edge activities which engage the streets of Pretoria prove to strengthen urban conditions. The magnets which shape pedestrian movement patterns should be manipulated to activate the architecture and enliven the everyday experience for pedestrians. The combination and re-use of historic sites with contemporary (temporary) points of activity inspire the routes through the proposed intervention.

## ELEMENT OF SURPRISE

polley's arcade ; koedoe arcade atrium ; guggenheim museum \_frank lloyd wright \_1959

The varied experiences of daily life are influenced through volumes, surface treatments and sidewalk edges. The connection between earth, sky and the surrounding surfaces serve to heighten the element of surprise and connection to place. People will return to specific points of surprise or move along routes of surprise if conditions of repetition are avoided. The New York Guggenheim is an example of reshaping street edges and block patterns.

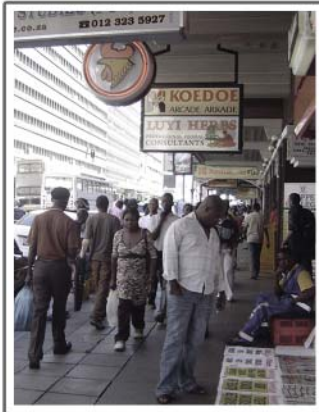

01 4.02 CHURCH SQUARE. PAST AND PRESENT

4.03 PRETORIUS STREET. ACTIVE EDGE

4.04 THE CITY INTERSECTION

02 4.05 POLLEY'S ARCADE. POSSIBILITY

4.06 KOEDOE ARCADE. SURPRISE

4.07 RELATIONSHIP WITH THE STREET



## ALLEY OF INTERACTIONS

plantation lane \_arup associates \_2005

The newly designed pedestrian lane aims to increase pedestrian interaction with the processes of the buildings on its edges by means of varied transparencies and integrating artwork into the path. The sight lines are anchored by Wren's St Margaret Patens Church and the integration of art into the public space heightens the quality of the spaces. Interactions and legibility is encouraged in numerous dimensions.

## THE CITY WALL

puck building\_ wagner ; switch building \_nArchitects ; dior building \_christian de portzamparc

The variation of the city wall marks the intention for the development of a city. This deviation addresses the urban canyon and the repetitive nature of the wall. By means of creating distinctive new work, whilst respecting the existing neighbouring conditions, the quality of the streetscape and the evolving narrative can improve. Form should be influenced by the processes within and the contextual responses to convey appropriate meaning.

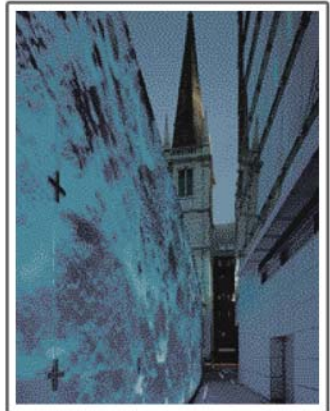
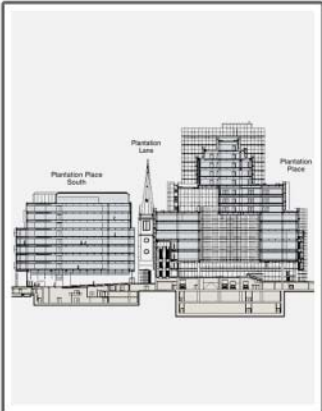

03 4.08 VOLUMETRIC INTERVENTIONS

4.09 PLANTATION LANE (ARUP)

4.10 INTERACTIVE ENVIRONMENT

04 4.11 AD HOC ARCHITECTURE

4.12 SWITCH BUILDING, NEW YORK

4.13 DIOR BUILDING, NEW YORK

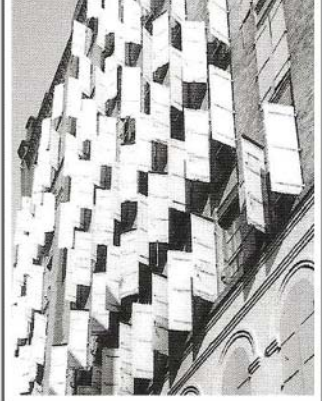

## REVEALING IMPORTANCE

wrapped reichstag \_christo and jeanne-claude \_1995

The German Parliament building has been restored to importance thanks to a series of interventions, beginning with Christo and Jeanne-Claude's Wrapping and culminating in Norman Foster's dome. This form of public sculpture reclaimed the building's importance and evoked the 'city as possibility'. The re-use of this historic building demonstrates the opportunity that lies in perceivably concealed spaces and forms.

## EVERYDAY LIFE

rue de suisses apartments \_herzog and de meuron \_2000

This apartment building shows how 'everyday' adaptation gives a building character as well as displaying its soul. The functional requirements are expressed as 'emotion' on the facade through the shutter system. The city wall responds to the street layout and angles with the turn. By means of singular materials and contextual responses, the building is defined as distinctive new work and considers the architectural overload.

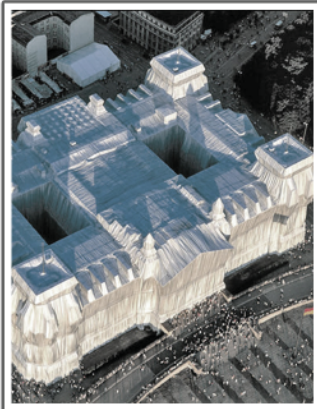

05

4.14 AERIAL WRAPPING

064.16 DISTORTED STREET ELEVATION



NEIGHBOUR  
4.17 CONNECTION



VARIED  
4.18 OPENABILITY



4.15 RENEWED EXPOSURE

4.19 FACADE MICRO MANIPULATIONS

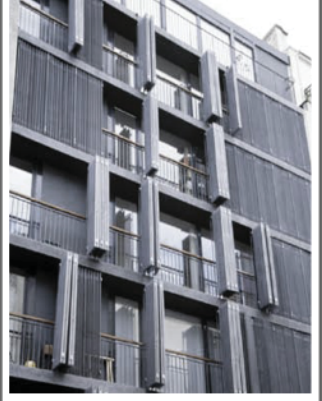

## INTERNAL CONNECTION

terrence donnelly centre for cellular and bio-molecular research \_behnisch architects \_2005

The combination of adaptation and provision of volumetric variance creates an intervention of meaning and harnesses the element of surprise for visitors. The public space and volume within the building improves the working environment and increases legibility by means of a clear section, experienced by the user. The principal external facade uses literal transparency to indicate functional variance and develop a hierarchy, in a noticeboard type expression.

## HISTORIC RE-USE

hearst tower \_foster and partners \_2006

The existing art deco building forms the podium for the skyscraper which emerges from it. The marked distinction between old and new, in terms of aesthetics, technology and sustainable design develops the contextual meaning and narrative for the Hearst Tower. The giant atrium and emphasized circulation paths bisect the original structure, such that the attributes of the original are subsequently emphasized.

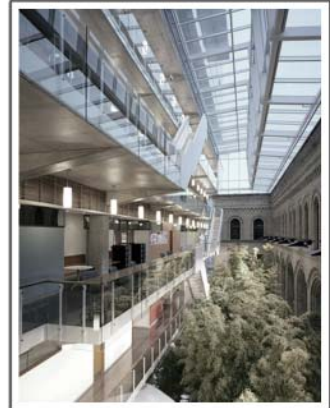

07 4.20 LITERAL TRANSPARENCY

4.21 INTEGRATION OF INTERVENTION

4.22 SECTIONAL LEGIBILITY

08 4.23 HEARST TOWER NEW ATRIUM

4.24 CIRCULATION AND THE EXISTING

4.25 DISTINCTIVE NEW WORK

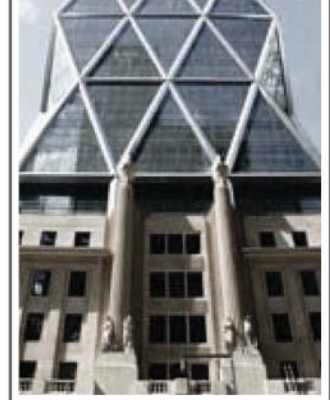



## DESIGN PRECEDENT STUDIES

design precedents

analysing relevant design

The selected design precedents respond to similar urban and programmatic conditions whether in relation to the context and neighbouring buildings or in the investigation of expressing understanding and process. The first two projects are located within dense urban fabric, they respond to the elements of circulation, lighting, view and the urban canyon as well as the connection to place, systems communication and interventions of meaning respectively. Although they are both museums, the selective nature of the programmes have resulted in strong compositional systems. The latter two projects question the role of usable space and the adaptive nature of construction. The introduction of an architecture of opportunity becomes apparent.





**01 MUSEUM OF AMERICAN  
FOLK ART**

tod williams and billie tsien  
2002. New York City. USA.



**02 ALAVA ARCHAEOLOGICAL  
MUSEUM**

francisco mangoda  
2009. Vittorio. Spain.



**03 LLOYD'S REGISTER**

richard rogers partnership  
2000. London. UK.



**04 FUN PALACE**

cedric price  
1962. London. UK.



**05 HIGGINS HALL INSERTION:  
PRATT INSTITUTE**

steven holl  
2005. New York City. USA.



## MUSEUM OF AMERICAN FOLK ART

tod williams and billie tsien

Awarded the prize 'Best Building in the World' for 2001, the Museum of American Folk Art is located in Manhattan, New York City. Built on a narrow, south facing site, the building is surrounded by the Museum of Modern Art and communicates directly with two busy streets. The value of this project is in the space created despite the narrow site and the spatial quality which evokes a different, but functional realm. The principal facade challenges the typical street elevation and is composed of an abstracted hand-like bronze panelled screen. This contorted feature allows for considered glimpses of the external environment and manipulates the lighting conditions within the gallery and atrium spaces. Designed to make a 'strong but quiet statement of independence' (Goldberger, 2003) the facade is sensory and interactive through its materiality and it evokes and communicates the meaning of the inside of the museum. A formal dialogue is achieved whilst editing the public forum and 'the wall' of the urban canyon, making the museum distinctive within its environment.

Williams and Tsien control both the floor and ceiling surfaces and communicate their importance and the role of the walls as supporting elements. The sensuous integration of wall materiality is evoked on two scales (Ryan, 2001: 99). Firstly as a means of intimate experience where the human dimensions are considered and the need for touch. The other wall integration is on an urban scale, where the bronze facade is encountered by the public. The control of natural and artificial lighting renders the design sub-servient to the spaces created. For in spite of the site constrictions, the lighting and connection to sky and skyscrapers is obvious and accordingly combines the ancient (on display) and the contemporary (in architecture and city).

The circulation of the museum is varied as the architects intended the museum to read as a journey. Visitors are taken up to the fifth floor in a view-encompassing elevator and then are allowed to descend by various stairways which pass through the exhibition spaces and encounter the heavily manipulated levels, volumes and their associated functions. The visitor is subtly forced to interact with the displays and the architecture as a result of the circulation. The result encourages surprising encounters and varied viewpoints in the interaction and redundancy of experiential flow. The museum incorporates the element of surprise and the 'city as possibility' in repeated exposure and thus achieves legibility.

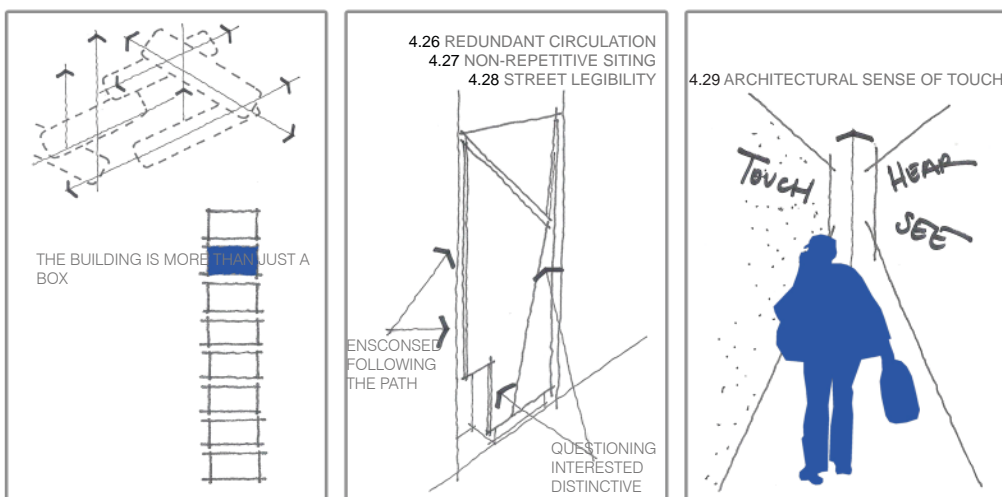

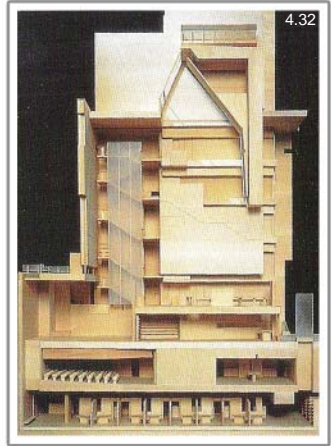

4.30 INTERSECTING VOLUMES /  
CIRCULATION  
4.31 PRINCIPAL STAIRCASE  
4.32 SECTIONAL MODEL  
4.33 INTERIOR VOLUME / MEZZANINE  
4.34 DETAIL. BRONZE ENTRANCE /  
SIGNAGE PANEL  
4.35 53rd STREET ELEVATION  
4.36 STREET PERSPECTIVE



## ALAVA ARCHAEOLOGICAL MUSEUM

francisco mangoda

Situated in Vittorio, Spain the museum is a competition winning project and the result is a stark contemporary intervention within the dense historic core of the town. Physical architectural connection and new and existing movement patterns are sensitive to the surrounding historic buildings in a manner which also exposes the meaning of the existing environment. The museum makes the most of the connections with its neighbours, in order to fully integrate itself within the urban fabric. The region has a wealth of archaeological treasures and the public cognisance and accessibility to these items was an important design influence. The building's architectural languages contrast and the development of new public space has responded to this sense of ownership. The scale of the building responds directly to its context and the museum doesn't compete for landmark status within the historic core.

The manipulation of the building in section is an interesting programmatic and visual consideration. Rectilinear tubes cut through the exhibition levels to act as display stands as well as light wells which strongly contrast the choice of internal wall and floor finish, which is a dark exotic and contrasting timber to focus attention on the exhibits. These tubes allow for a method of self-orientation and control the reveal of artefacts as well as define the route along which visitors should travel. The literal transparency of the museum is effective in communicating these tubes and the composition of the museum and transcribes the temporary and malleable nature of exhibition. The primary staircase is used for legibility between the old and new in spatial isolation and the literal interface of the two from the outsider's perspective. Circulation becomes a journey and the staircase given recognition as a space in itself. These tubes force the user to question the spatial dimensions of the galleries. The user will walk in circles around the tubes to fully understand their presence and use.

The choice of material throughout the intervention responds to the historical nature of the programme. The closed street facades are clad with bronze fins, a material chosen as it was one of the first materials exploited by human craftsman. The deep facades and bronze cladding are seemingly constructed in layers with scattered 'punched' holes to acknowledge the role the museum plays in communicating history. The uniform external expression of this intervention contextualises the museum and considers the future aesthetics of the town.

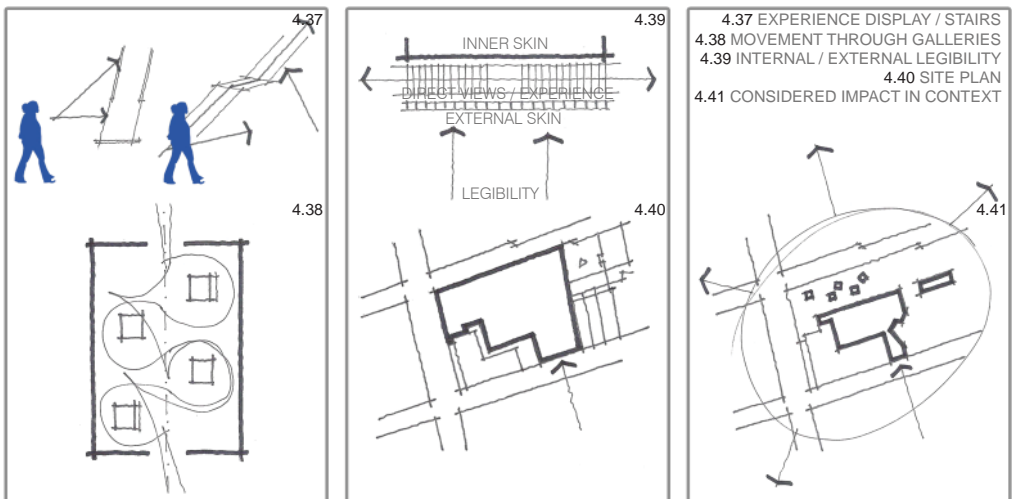



- 4.42 RECTILINEAR TUBES FOR LIGHTING, DISPLAY AND ORIENTATION
- 4.43 PRINCIPAL STAIRCASE
- 4.44 STREET ELEVATIONS
- 4.45 COURTYARD ENTRANCE
- 4.46 INTERVENTION WITHIN HISTORIC CONTEXT
- 4.47 COURTYARD ELEVATION
- 4.48 RELATION TO STREETScape

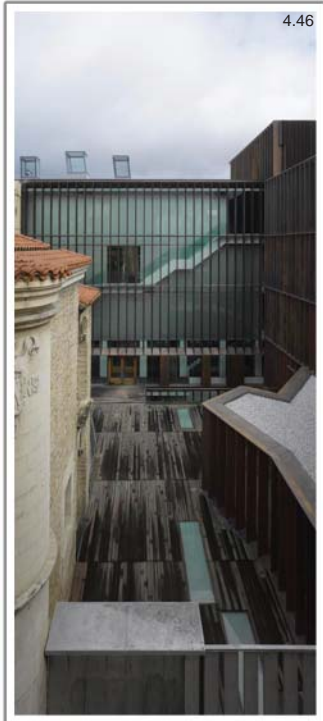

## LLOYD'S REGISTER

richard rogers partnership

The Register Building is part of the redevelopment for Lloyd's Register, combining the original 1901 historic building with a new 14 storey office development and urban regeneration. The opportunity within the block is the integration between the urban public realm, legible new architectural forms and a sub-servient city relationship. The architects describe the building as diserning the:

Clarity of architectural language is the key to this development, where the function of all constituent elements is celebrated, revealing the secrets of their manufacture and operation (RSH-P, 2007: 2).

The associated legibility of the building is in part due to the literal transparency. Large glazed surfaces open to the two atria, such that the processes of office work are easily revealed to the on-looker. Typical of such 'high-tech' architecture, the steelwork and ducting is colour coded for easy reference and the building is animated by circulation patterns. This clarity of circulation develops a hierarchy of forms and is clear in the approach to the building. Although the building is private, corporate office space, the ground floor is part of a public right-of-way and allows through movement. This in turn activates the provision of new urban space. The neglected urban public space of the churchyard is given back to the city and serves as an urban retreat, set with established trees and communicating the narrative of the site and company.

The sub-servient nature of the building is developed through energy efficiency and spatial quality. The two atrium spaces serve as thermal buffers, whilst aiding the legibility of space. The smart double glazing system prevents excessive heat loss and the motorised louvre systems on the east and west facades reduce insolation. The heating of the building uses the thermal mass of the pre-cast concrete frame, whilst the efficient chilled beams cool the office spaces, thus reducing the dependancy on typical air-conditioning. Photo-voltaic panels on the roof power the building as well as the motorised louvres. The success of the building is in the urban integration and appropriate responses to reduce energy requirements and maintain a sense of public ownership within its part of the city. The legibility of historic narrative suggests that in fact we do have the power to affect the way that the story of the city goes forward.

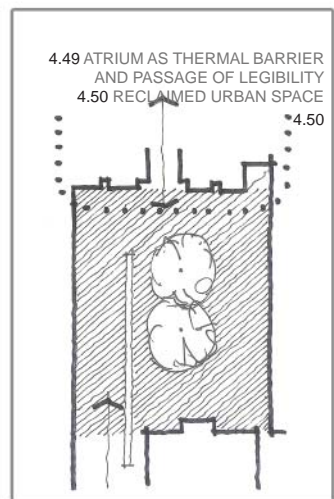
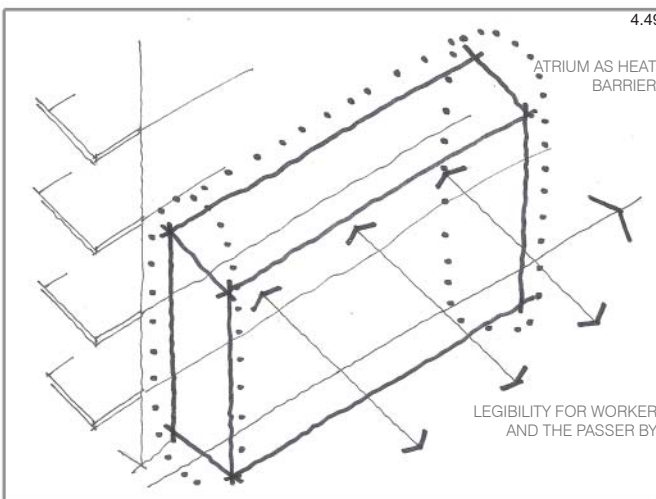



4.51



4.52

- 4.51 OFFICE ENVIRONMENT BETWEEN ATRIA WITH EXPOSED EFFICIENT BEAM SYSTEMS
- 4.52 INTERNAL EDGE
- 4.53 LEGIBILITY OF CIRCULATION
- 4.54 ATRIUM AND MASS WALLING
- 4.55 THE REGISTER'S SKYLINE
- 4.56 RECLAIMED URBAN SPACE
- 4.57 LEGIBILITY IN MATERIAL PARTS



4.53



4.54



4.55

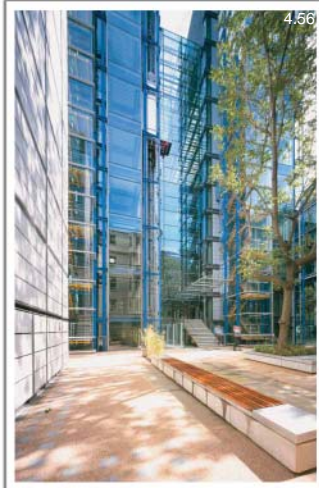

4.56



4.57

## THE FUN PALACE PROJECT

cedric price

In 1962 architect Cedric Price and theatre director Joan Littlewood decided to collaborate on a project that would be more of a social machine than a piece of contemporary architecture. Numerous other professionals including philosophers, architects, artists and computer specialists lent their ideas for this project; however it was never constructed. The aim of the Fun Palace was that the project would be a virtual architecture in which the visitor could emancipate and empower themselves. The scale of the project and contemporary functions and experiments required that the building be highly adaptable and 'acknowledge the inevitability of change, chance and indeterminacy by incorporating uncertainties' (Mathews, 2006: 40) into the experience of the development.

The programme would include performance venues, markets, workshops, rally spaces, rest spaces etc. but would cater for any requirement or desire of the individual. Price described the facilities as contributing to a 'university of the streets' (Riley, 2002: 44) in which a plethora of activities could simultaneously be encountered and engaged with. The project was a response to the perceived mundane and monotonous everyday lifestyle of Britons in the 1960s. Fun Palace would allow for creativity, expression, learning and personal development such that the individual achieved receptiveness. The route through the building would accordingly evoke various scales of legibility. Firstly, visual understanding of the programmes in close proximity and then the temptation of the programmes further along the route. Secondly legibility was possible from the physical engagement between the users and the provided programmes. Thus the route through the Fun Palace would be ever changing and different for every visit and visitor.

The proposed construction of the project would allow for maximum flexibility and adaptation through a pre-fabricated kit of parts system. The site would create a platform of easy access and servicing and the inclusion of computer systems would develop the freedom and organisation to construct and maintain the building. The provision for structural adaptation, the re-arranging and continuous scrapping of systems were aligned with the 'individualised' programme and responded to the circulation and programmes on numerous scales. The revealing and changing nature of the project hoped to re-established the possibilities lost within the city.

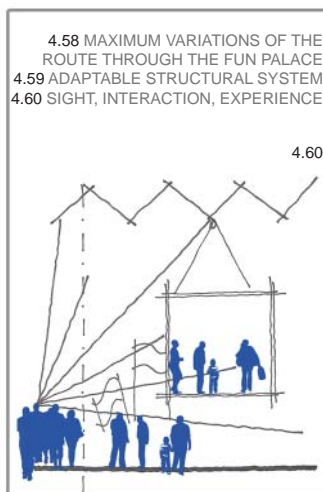
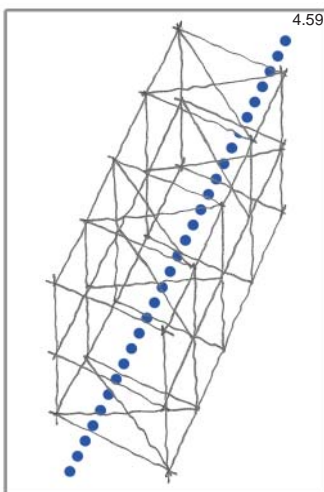
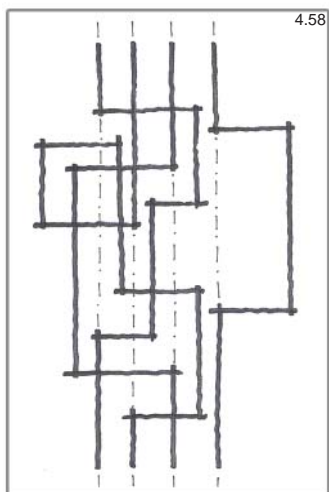

4.58 MAXIMUM VARIATIONS OF THE ROUTE THROUGH THE FUN PALACE  
4.59 ADAPTABLE STRUCTURAL SYSTEM  
4.60 SIGHT, INTERACTION, EXPERIENCE



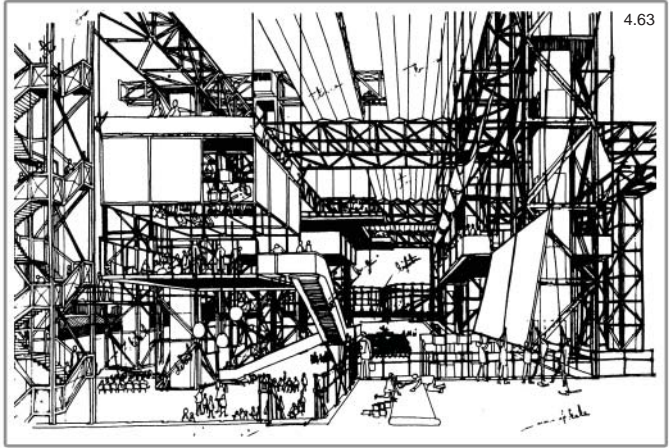
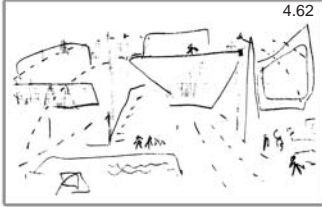
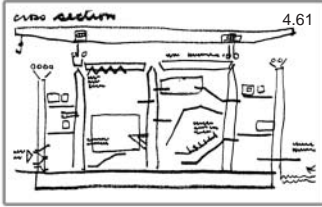

- 4.61 CONCEPTUAL CROSS SECTION
- 4.62 CONCEPTUAL SPATIAL DIAGRAM
- 4.63 PERSPECTIVE OF ADAPTATION, CIRCULATION AND FREEDOM
- 4.64 RELATION TO THE LANDSCAPE
- 4.65 STRUCTURAL SKETCH
- 4.66 AERIAL PERSPECTIVE
- 4.67 'INTERACTION CENTRE' 1976. A DEVELOPMENT OF FUN PALACE

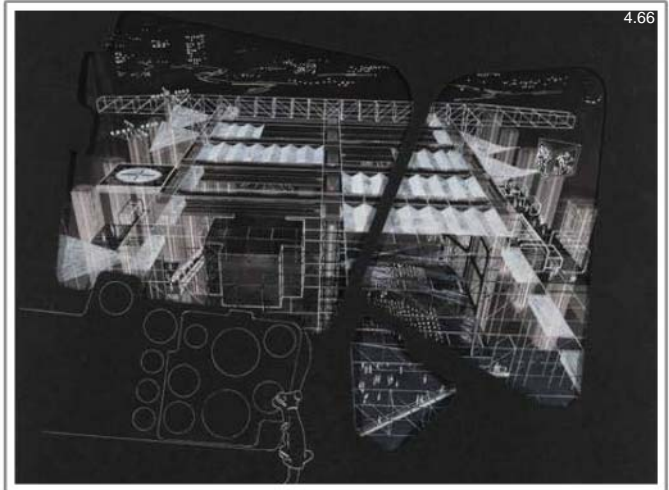
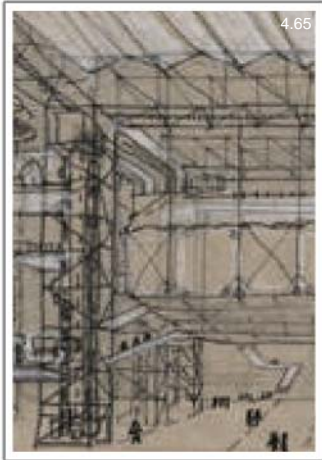
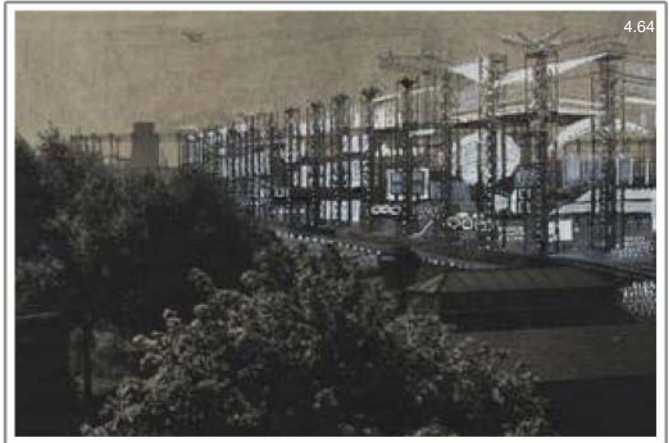

## HIGGINS HALL INSERTION: PRATT INSTITUTE

steven holl

The architectural school's facilities at the Pratt Institute in New York City reconstituted the significance of the institute and the original buildings. The project is respectful to the heritage nature of the site and responds with a new intervention that connects the original buildings literally and visually as well as stands with significance as distinctive new work. The historic, industrial and creative characteristics of the existing are enhanced with the choice of new materials in the tension between the old, new and intersection of the two. The project also addresses the natural and manufactured elements of the site and profiles their significance through circulation and varied degrees of fenestration. The composition and placement of the intervention and the understanding of these aspects are accessible to the users.

The approach to the building ambles past the original buildings, almost enticing a physical connection and the views relate back to the grounds. Internal openings also promote an awareness of the transition between old and new, the significance of the original brick buildings is accordingly restored for the next generation. A clear response to the existing conditions defines the legibility of the design. The recycled nature of facade materials both announces the possibility of the site and programmes within while from the external perspective it marks the distinction and transition of adjoining facades. The legibility of the Institute is in this transition of levels, age, programmes and materials. It is further expressed in the routes within the building. Acting as connecting forces or general circulation, the programmes are exposed as displays of talent and integration of the creative.

In terms of the programmatic exposure of the intervention, the Institute is successful in creating new studio spaces which promote learning and understanding within quality spaces. As the intervention is an insertion between two existing buildings, natural lighting was a combative issue. A two-throated skylight harnesses both north and south light and disperses it throughout the volumes, which are irregular in an effort to filter the light further. The level changes and dissecting circulation also expose the programmes. An integrated, learning environment is encouraged accordingly. The sub-servient consideration of the Institute to the original buildings, responds successfully in the repurposing and rebranding of the context, in addition to the adaptation of environment.

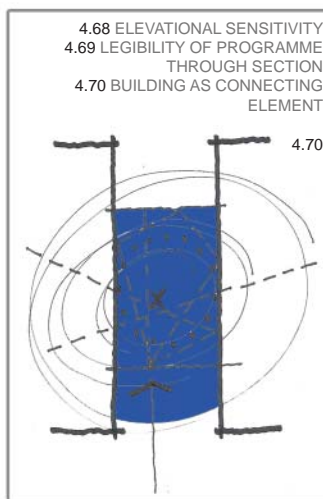
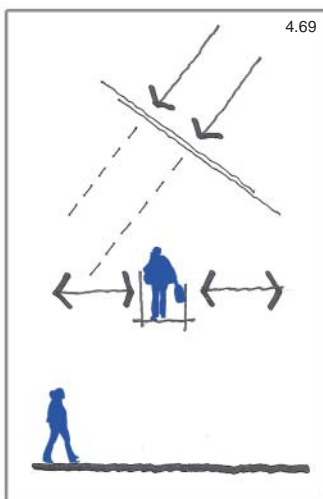
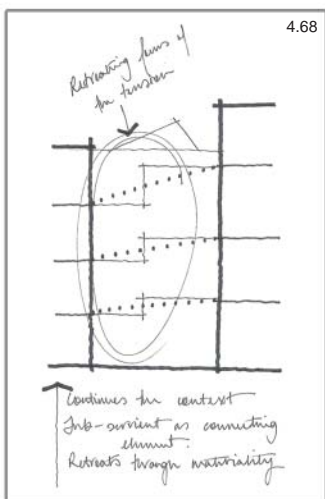



4.71



4.73



4.74



4.72

4.71 ORIGINAL BUILDING  
4.72\_4.73 BRIDGE BETWEEN STUDIOS  
4.74 PROGRAMMATIC EXPOSURE  
4.75 INTERNAL LIGHTING QUALITY  
4.76 FACADE DETAIL  
4.77 FRONT ELEVATION  
4.78 ELEVATION AS CONNECTING  
ELEMENT  
4.79 FACADE\_RECYCLED MATERIALS



4.75



4.76



4.77

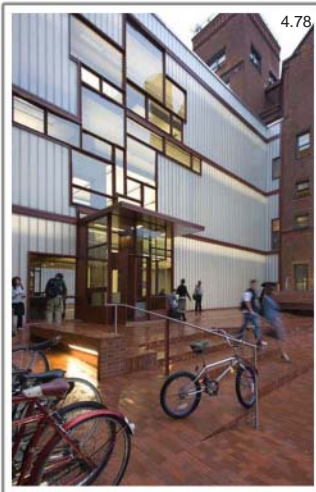

4.78



4.79