



ECOSYSTEMIC SUPPLY CHAIN

a Research and Development Centre for Urban Agriculture



ECOSYSTEMIC SUPPLY CHAIN
a Research and Development Centre for Urban Agriculture

by THOMAS VAN DEVENTER [21017736]

Submitted in partial fulfilment of the requirements for the degree
Master of Architecture (Professional) in the Faculty of Engineering,
Built Environment and Information Technology at the
UNIVERSITY OF PRETORIA [Department of Architecture].

Study leader: Barbara Jekot
Studio Master: Jacques Laubscher
Design Mentor: Arthur Baker

Submission Date: 2011

In accordance with Regulation 4(e) of the General Regulations (G.57) for dissertations and theses, I declare that this thesis, which I hereby submit for the degree Master of Architecture (Professional) at the University of Pretoria, is my own work and has not previously been submitted by me for a degree at this or any other tertiary institution.

I further state that no part of my thesis has already been, or is currently being, submitted for any such degree, diploma or other qualification.

I further declare that this thesis is substantially my own work. Where reference is made to the works of others, the extent to which that work has been used is indicated and fully acknowledged in the text and list of references.

A handwritten signature in black ink, appearing to read 'T. Deventer', written over a horizontal line.

Thomas Van Deventer



ABSTRACT

With our ever increasing global population it will be necessary for dense urban environments to develop methods of farming locally. Not only will urban agriculture be beneficial in aiding in the solution of this growing populations need for food production, but it can help to reconnect us to our food and their processes. This dissertation explores the education and reconnection of the public with the food production cycle through the experience of building integrated agriculture, vermiculture and aquaponic systems (cultivating plants and fish symbiotically).

Pretoria's Apies River is an ideal location for the establishment of a research facility of urban ecosystemic food production. The proposed urban agriculture program will allow for hands on research and development of emerging methods and technologies related to farming in the city environment while providing a platform for public education through interaction & inspiration.



PROJECTS INFORMATION

Function:	URBAN FOOD RESEARCH AND DEVELOPMENT
Site Description:	Site on the edge of the Apies River and along Church street forming gateway into the city from Arcadia.
Client:	Joint venture by Agri SA, CSIR and City of Tshwane.
Users:	Researchers, Urban Farmers, Retailers & Students
Site Location:	Erf 11/1016, Arcadia
Address:	c/o Nelson Mandela Drive & Church Street
GPS Coordinates:	25°44'43.09"S, 28°12'2.76"E
Theoretical Premise:	URBAN FOOD RESEARCH AND DEVELOPMENT
Architectural Approach:	URBAN FOOD RESEARCH AND DEVELOPMENT
Research Field:	ENVIRONMENTAL POTENTIAL

For all the sunny days missed outside and all the rainy days not spent in bed...

A special thanks to friends, family and loved ones for a lifetime of support.

THANKS



CONTENTS

1. INTRODUCTION	14	3. THEORY	44
<i>INTRODUCTION</i>	14	<i>BACKGROUND</i>	44
<i>STUDY OVERVIEW</i>	16	<i>CURRENT THEORY</i>	46
<i>DESIGN OVERVIEW</i>	17	<i>BIOMIMICRY</i>	46
<i>PROPOSAL</i>	18	<i>GENERAL DESIGN STRATEGIES</i>	49
2. RESEARCH	22	4. CONTEXT	52
2.1 FOOD CRISIS	22	<i>CONTEXTUAL PROBLEM</i>	52
<i>REAL WORLD PROBLEM</i>	22	<i>SITE SELECTION</i>	52
<i>THE CAUSES</i>	22	<i>PRETORIA CITY</i>	54
<i>STAPLE FOODS</i>	28	<i>STUDY AREA</i>	55
<i>CONCLUSION</i>	29	<i>THE CITY AND RIVER IN TENSION</i>	60
2.2 FOOD AS A SYSTEM	30	5. FRAMEWORK	64
<i>FOOD WEB</i>	30	5.1 MACRO SCALE	64
<i>ECOSYSTEM</i>	30	<i>REACT & REINTERPRET</i>	64
<i>PLANT GROWTH SYSTEM</i>	31	<i>EXISTING FRAMEWORKS</i>	66
<i>FARMING SYSTEM</i>	32	<i>PUBLIC SPACE NETWORKS</i>	69
<i>NEGATIVE EFFECTS OF FARMING</i>	33	5.2 MESO SCALE	70
<i>PROBLEM STATEMENT</i>	34	<i>APIES RIVER (FOCUS AREA)</i>	70
<i>CONCLUSION</i>	35	<i>CLIMATIC DATA</i>	74
2.3 URBAN AGRICULTURE	36	5.3 MICRO SCALE	76
<i>URBAN FARMING METHODS</i>	36	<i>BUILDING & LAND USE</i>	76
<i>ARCHITECTURE AND FARMING</i>	36	<i>DYSFUNCTIONAL SITES</i>	78
<i>VERTICAL FARMING</i>	37	<i>KEY DEVELOPMENT NODES</i>	79
<i>BENEFITS OF VERTICAL FARMING</i>	38	<i>EDGE CONDITIONS</i>	80
<i>SOILLESS FARMING</i>	38		
<i>FARMING IN A BALANCED SYSTEM</i>	40		



6. PRECEDENTS	84	8. TECHNICAL	118
<i>CASE STUDY</i>	84	8.1 CONSTRUCTION	118
<i>PRECEDENT STUDIES</i>	86	8.2 TECHNOLOGY	124
7. DESIGN DEVELOPMENT	98	8.3 SERVICES	128
<i>CONCEPT: ARCHITECTURE AS MEDIATOR</i>	98	9. DESIGN DOCUMENTATION	130
<i>DESIGN GENERATORS</i>	98	<i>DRAWINGS: PLANS</i>	132
<i>CONNECTING THE EDGES</i>	99	<i>DRAWINGS: SECTIONS</i>	138
<i>SITE DEVELOPMENT</i>	100	<i>PHOTOS: MODEL</i>	142
<i>RIVER CONNECT</i>	102	<i>CGI: INTERIORS</i>	146
<i>ENVIRONMENTAL RESPONSE</i>	104	<i>CGI: EXTERIORS</i>	150
<i>PROGRAM</i>	108		
<i>MASSING STUDY</i>	114	10. APPENDIXES	154



Illustration 02: Hand Holding Plant



List of Figures

FIGURE 01: MAP INDICATING GLOBAL UNDERNOURISHMENT BY CATEGORY	15
(Adapted by Author: March, 2011)	
FIGURE 02: THE INDIVIDUALS DAILY BIRTHRIGHT	22
(Adapted by Author: March, 2011) (DESPOMMIER, Dickson, 2008)	
FIGURE 04: THE GLOBAL URBANIZATION RATE BY DEVELOPED REGIONS	23
(Adapted by Author: March, 2011)	
FIGURE 03: GLOBAL POPULATION GROWTH PROJECTIONS	23
(Adapted by Author: March, 2011)	
FIGURE 05: PERCENTAGE OF AVAILABLE ARABLE LAND CURRENTLY IN USE	25
(Adapted by Author: March, 2011) (DESPOMMIER, Dickson, 2008)	
FIGURE 06: ADDITIONAL LAND MASS REQUIRED FOR PROJECTED POPULATION GROWTH BY 2050	25
(Adapted by Author: March, 2011) (DESPOMMIER, Dickson, 2008)	
FIGURE 07: MAP SHOWING AVAILABLE ARABLE LAND WORLDWIDE	26
(Adapted by Author: March, 2011)	
FIGURE 08: WORLD AVERAGE DIET SHOWN AS PERCENTAGES FROM 1988 - 1990	29
(Adapted by Author: April, 2011)	
FIGURE 09: EXAMPLE OF A FOOD WEB	30
(Unknown Author)	
FIGURE 10: PHOTOSYNTHESIS AND RESPIRATION	31
(Unknown Author)	
FIGURE 11: FARMING SYSTEM DIAGRAM	32
(Adapted by Author: March, 2011)	
FIGURE 13: MODERN AGRICULTURE PROCESS AS A RESOURCE HEAVY AND WASTEFUL PROCESS	34
(Adapted by Author: April, 2011) (DESPOMMIER, Dickson, 2008)	
FIGURE 12: COMPARISON BETWEEN BIOSPHERE AND TECHNO-SPHERE	34
(DESPOMMIER, Dickson, 2008)	
FIGURE 14: ARTISTS IMPRESSION OF THE HANGING GARDENS OF BABYLON	36
(Author Unknown)	
FIGURE 15: "THE LIVING SKYSCRAPER: FARMING THE URBAN SKYLINE" BY BLAKE KURASEK	37
(KURASEK, Blake)	
FIGURE 16: HYDROPONIC FARMING SYSTEM DIAGRAM (INDOOR)	39
(Adapted by Author: March, 2011)	
FIGURE 17: A DIAGRAMATIC EXPLANATION OF AQUAPONICS	41
(DAVIS, Blake, 2010)	
FIGURE 18: A DIAGRAMATIC EXPLANATION OF A "CRADLE TO CRADLE" FARMING SYSTEM	41
(Adapted by Author: March, 2011)	
FIGURE 19: THE GEODESIC DOME BY BUCKMINSTER FULLER	44
(GRUBER, Petra, 2011)	
FIGURE 20: STUDIES IN BIRD FLIGHT BY LEONARDO DA VINCI	45
(GRUBER, Petra, 2011)	
FIGURE 21: BIOMIMICRY AS A DESIGN TOOL	46
(GRUBER, Petra, 2011)	
FIGURE 22: EXAMPLES OF DESIGN INSPIRED BY NATURE	47
(Photo montage by Author: May, 2011)	
FIGURE 23: RESPONSIVE SURFACE STRUCTURES BY STEFFEN REICHERT	48
(HENSEL, Michael and Menges, Achim, 2008)	
FIGURE 24: PRETORIA LOCATION DIAGRAM	52
(By Author: May, 2011)	
FIGURE 26: SITE LOCATION, MACRO SCALE	53
(By Author: March, 2011)	
FIGURE 25: SITE LOCATION DIAGRAM	53
(By Author: May, 2011)	
FIGURE 28: APIES RIVER SYSTEM	55
(Adapted by Author: May, 2011)	
FIGURE 27: PRETORIA CITY ORGANIZING ELEMENTS	55
(By Author: May, 2011)	
FIGURE 29: APIES RIVER WITH MEINTJIES KOP, HENK PIERNEEF	56
(BOLSMAN, E, 2001: 135)	
FIGURE 30: PRETORIA IN 1872, THOMAS BAINES	56
(BOLSMAN, E, 2001: 20)	
FIGURE 31: CANALIZATION OF THE APIES RIVER, PIETER WENNING	56
(BOLSMAN, E, 2001: 134)	
FIGURE 34: FIGURE GROUND OF CURRENT DAY PRETORIA, GRID FORM STILL VISIBLE	57
(By Author: May, 2011)	
FIGURE 32: THE FIRST MAP OF PRETORIA	57
(Allen, V. 1971)	
FIGURE 33: THE ROMAN URBS QUADRATA	57
(Jordaan, G.J. 1989)	
FIGURE 35: PRETORIA ROAD MAP (BEFORE NELSON MANDELA DRIVE)	58
(Boukunde Reading Room)	
FIGURE 36: PHOTO: AUTOMOTIVE DOMINATED CHARACTER OF NELSON MANDELA DRIVE	59
(By Author: May, 2011)	
FIGURE 37: CITY DEVELOPMENT DIAGRAM SHOWING IMPACT ON RIVER THRESHOLD	61
(By Author: June, 2011)	
FIGURE 38: INDIVIDUAL GROUP STUDY AREAS	65
(By Framework group: May, 2011)	
FIGURE 39: OVERLAY OF EXISTING INNER CITY FRAMEWORKS	66
(LOOTS, Annemarie, 2007)	
FIGURE 40: INNER CITY DEVELOPMENT STRATEGY	66
(LOOTS, Annemarie, 2007)	
FIGURE 41: TSHWANE CROSSING	67
(LOOTS, Annemarie, 2007)	
FIGURE 42: RE KGABISA TSHWANE FRAMEWORK	67



FIGURE 43: NELSON MANDELA DEVELOPMENT CORRIDOR	67
(LOOTS, Annemarie, 2007)	
FIGURE 45: TSHWANE INNER CITY LOCAL OPEN SPACE PLAN.....	68
(LOOTS, Annemarie, 2007)	
FIGURE 44: APIES RIVER URBAN DESIGN FRAMEWORK	68
(LOOTS, Annemarie, 2007)	
FIGURE 46: TSHWANE INNER CITY OPEN SPACE NETWORK	69
(By Author: June, 2011)	
FIGURE 47: CHARACTER OF THE CHOSEN STUDY AREA	70
(Adapted by Author: June, 2011)	
FIGURE 48: RIVER AS A URBAN STRIP PARK	72
(By Author: June, 2011)	
FIGURE 49: RIVER AS A THRESHOLD BETWEEN DISTRICTS.....	72
(By Author: June, 2011)	
FIGURE 50: THE RIVER CONNECTING THE OPEN SPACE NETWORK.....	73
(By Author: June, 2011)	
FIGURE 51: SOUTH AFRICA CLIMATIC ZONES AS PER SANS 204.....	74
(SANS 204)	
FIGURE 54: SUN PATH FOR PRETORIA	75
(By Author: July, 2011)	
FIGURE 52: AVERAGE MIDDAY TEMP.....	75
(By Author: July, 2011)	
FIGURE 56: AVERAGE NIGHT TEMP.....	75
(By Author: July, 2011)	
FIGURE 53: AVERAGE RAINFALL.....	75
(By Author: July, 2011)	
FIGURE 55: PRETORIA WIND ROSE.....	75
(By Author: July, 2011)	
FIGURE 57: MACRO SCALE: LAND USAGE	76
(By Author: July, 2011)	
FIGURE 58: BUILDING EDGE CONDITION	77
(By Author: July, 2011)	
FIGURE 59: RIVER ACCESS	77
(By Author: July, 2011)	
FIGURE 60: PEDESTRIAN MOVEMENT.....	77
(By Author: July, 2011)	
FIGURE 61: SITE IDENTIFIED WITH INAPPROPRIATE USAGE OR PROGRAMME.....	78
(By Author: July, 2011)	
FIGURE 62: PROPOSED REDEVELOPMENT OF SITES OR BUILDINGS	78
(By Author: July, 2011)	
FIGURE 64: OPPORTUNITIES FOR ACTIVITY NODES.....	79
(By Author: July, 2011)	
FIGURE 63: POINTS WITH CULTURAL OR HERITAGE VALUE.....	79
(By Author: July, 2011)	
FIGURE 66: APIES RIVER SECTION.....	80
(By Framework group: July, 2011)	
FIGURE 65: STREET SECTION THROUGH CHURCH STR.....	80
(By Framework group: July, 2011)	
FIGURE 67: MAP INDICATING POSITION OF STREET SECTIONS.....	81
(By Framework group: July, 2011)	
FIGURE 68: STREET SECTION THROUGH NELSON MANDELA DRV	81
(By Framework group: July, 2011)	
FIGURE 69: THE GREENHOUSE PROJECT CONSTRUCTION PHOTOS.....	84
(LEBELO, Dorah and Nel, Michelle, 2004)	
FIGURE 70: CONSERVATORY TODAY STANDS EMPTY AND NEGLECTED.....	85
(LEBELO, Dorah and Nel, Michelle, 2004)	
FIGURE 71: THE GREENHOUSE PROJECT: SITE PLAN.....	85
(LEBELO, Dorah and Nel, Michelle, 2004)	
FIGURE 72: GHP OFFICE BUILDING, OLD POTTING SHED.....	85
(LEBELO, Dorah and Nel, Michelle, 2004)	
FIGURE 73: PERSPECTIVE VIEW OF LA TOUR VIVANTE.....	86
(SOA Architects)	
FIGURE 77: LA TOUR VIVANTE: 3D SECTION SHOWING SERVICES.....	87
(SOA Architects)	
FIGURE 74: LA TOUR VIVANTE: SITE PLAN.....	87
(SOA Architects)	
FIGURE 75: LA TOUR VIVANTE: TYPICAL PLANS.....	87
(SOA Architects)	
FIGURE 76: LA TOUR VIVANTE: SECTION SHOWING MIXED USE.....	87
(SOA Architects)	
FIGURE 78: ECO-LABORATORY: BUILDING PERSPECTIVE.....	88
(Weber_Thompson Architects)	
FIGURE 79: ECO-LABORATORY: CONNECTION TO NATURAL RESOURCES.....	88
(Weber_Thompson Architects)	
FIGURE 80: ECO-LABORATORY: COURTYRAD VIEW	88
(Weber_Thompson Architects)	
FIGURE 81: ECO-LABORATORY: FACADE STUDY.....	88
(Weber_Thompson Architects)	
FIGURE 82: ECO-LABORATORY: BUILDING SYSTEM DIAGRAMS.....	89
(Weber_Thompson Architects)	
FIGURE 83: CUA: HABITAT REINTRODUCTION AREA.....	90



<i>FIGURE 84: CUA: WATER COLLECTION AREA.....</i>	90
(Mithun Architects)	
<i>FIGURE 85: CUA: ENERGY COLLECTION AREA.....</i>	90
(Mithun Architects)	
<i>FIGURE 86: CUA: FOOD PRODUCTION AREA.....</i>	90
(Mithun Architects)	
<i>FIGURE 88: CUA: BUILDING PERSPECTIVE SHOWING USE OF UNDER-UTILIZED LAND.....</i>	91
(Mithun Architects)	
<i>FIGURE 87: CUA: BUILDING PERSPECTIVES.....</i>	91
(Mithun Architects)	
<i>FIGURE 89: OSLO OPERA HOUSE: MASSING STUDY.....</i>	92
(Snohetta AS)	
<i>FIGURE 90: OSLO OPERA HOUSE: BUILDING PERSPECTIVE FROM WATER.....</i>	93
(Snohetta AS)	
<i>FIGURE 91: OSLO OPERA HOUSE: ELEVATION VIEWS.....</i>	93
(Snohetta AS)	
<i>FIGURE 95: HONG KONG DESIGN CENTRE: CONCEPT MODELS.....</i>	94
(FAR Frohn & Rojas)	
<i>FIGURE 92: HONG KONG DESIGN CENTRE: SECTIONS.....</i>	94
(FAR Frohn & Rojas)	
<i>FIGURE 93: HONG KONG DESIGN CENTRE: ELEVATIONS.....</i>	94
(FAR Frohn & Rojas)	
<i>FIGURE 94: HONG KONG DESIGN CENTRE: PERSPECTIVES SHOWING BUILDING IN URBAN LANDSCAPE.....</i>	94
(FAR Frohn & Rojas)	
<i>FIGURE 96: HONG KONG DESIGN CENTRE: BUILDING SHAPE RESPONDS TO VIEW.....</i>	95
(FAR Frohn & Rojas)	
<i>FIGURE 97: HONG KONG DESIGN CENTRE: BUILDING SHAPE RESPONDS TO DAYLIGHT.....</i>	95
(FAR Frohn & Rojas)	
<i>FIGURE 98: HONG KONG DESIGN CENTRE: BUILDING SHAPE RESPONDS TO PROGRAM.....</i>	95
(FAR Frohn & Rojas)	
<i>FIGURE 100: ARCHITECTURE AS MEDIATOR.....</i>	98
(By Author: September, 2011)	
<i>FIGURE 99: LIVING BUILDING CONNECTED WITH ECOSYSTEM.....</i>	98
(By Author: September, 2011)	
<i>FIGURE 101: FACTORS USED TO CONNECT URBAN EDGES WITH THE RIVER.....</i>	99
(By Author: September, 2011)	
<i>FIGURE 102: SITE DEVELOPMENT DIAGRAM.....</i>	100
(By Author: September, 2011)	
<i>FIGURE 104: 3D VIEW OF PROPOSED SITE CONDITION.....</i>	101
(By Author: September, 2011)	
<i>FIGURE 103: CURRENT AND PROPOSED SITE EDGE CONDITIONS.....</i>	101
(By Author: September, 2011)	
<i>FIGURE 107: CONCEPT SKETCH SHOWING BUILDING CONNECT TO RIVER EDGE.....</i>	102
(By Author: October, 2011)	
<i>FIGURE 106: SKETCH CONNECTION BETWEEN EDGES AND BUILDING.....</i>	102
(By Author: September, 2011)	
<i>FIGURE 105: SITE EXPLORATION CONCEPT MODELS.....</i>	102
(By Author: August, 2011)	
<i>FIGURE 109: PERSPECTIVE SHOWING BUILDING SHAPE RESPOND TO RIVER EDGE.....</i>	103
(By Author: October, 2011)	
<i>FIGURE 108: PERSPECTIVE SHOWING JUNCTION BETWEEN BUILDING AND RIVER.....</i>	103
(By Author: October, 2011)	
<i>FIGURE 110: STRIP EXTRUSION CONCEPT.....</i>	103
(Adapted by Author: August, 2011) (VYZOVITI, Sophia, 2010)	
<i>FIGURE 111: NATURAL DAYLIGHT AS DESIGN INFORMANT.....</i>	104
(By Author: September, 2011)	
<i>FIGURE 113: BUILDING USE OF EARTH AS FUNCTIONAL SPACE.....</i>	104
(By Author: September, 2011)	
<i>FIGURE 114: DRAFT SECTION INDICATING DIRECT NATURAL DAYLIGHT IN GREENHOUSE AREAS.....</i>	104
(By Author: October, 2011)	
<i>FIGURE 112: NATURAL VENTILATION AS DESIGN INFORMANT.....</i>	104
(By Author: October, 2011)	
<i>FIGURE 115: BUILDING MASS STEPPED AND ANGLED TO ALLOW MAXIMUM DAYLIGHT INTO COURTYARD AND INTERNAL SPACES.....</i>	105
(By Author: October, 2011)	
<i>FIGURE 116: BUILDING MASS STEPPED TO RESPOND TO PROPOSED OPEN GREEN SPACE ON ADJACENT SITE.....</i>	105
(By Author: October, 2011)	
<i>FIGURE 117: VIEW FROM ADJACENT PARK LOCATION.....</i>	105
(By Author: October, 2011)	
<i>FIGURE 119: CONCEPT SECTION SHOWING GROUND FLOOR PROGRAM WITH PUBLIC INTERFACE.....</i>	106
(By Author: September, 2011)	
<i>FIGURE 120: DRAFT PLAN EXPLORING USE OF GROUND FLOOR PROGRAM TO ACTIVE SITE EDGES.....</i>	108
(By Author: October, 2011)	
<i>FIGURE 121: FUNCTIONAL DIAGRAM.....</i>	108
(By Author: September, 2011)	
<i>FIGURE 122: PERSPECTIVE VIEW FROM NELSON MANDELA DRIVE SHOWING PROPOSED RETAIL EDGE.....</i>	109
(By Author: October, 2011)	
<i>FIGURE 123: PERSPECTIVE VIEW FROM CHURCH STREET SHOWING PROPOSED RETAIL EDGE.....</i>	109
(By Author: October, 2011)	
<i>FIGURE 125: DIAGRAM SHOWING POSSIBLE LOCATIONS OF PUBLIC SPACE COMPONENT.....</i>	112
(By Author: September, 2011)	
<i>FIGURE 126: DIAGRAM SHOWING POSSIBLE LOCATIONS OF LANDSCAPE / AGRICULTURE COMPONENT.....</i>	113
(By Author: September, 2011)	
<i>FIGURE 127: DIAGRAM SHOWING DESIGN DEVELOPMENT AS RESPONSE TO DESIGN GENERATORS.....</i>	114



<i>FIGURE 129: BRACED STEEL FRAME WITH PINNED CONNECTIONS</i>	118
(CHING, Francis D K, 2008)	
<i>FIGURE 128: MAIN STRUCTURAL STEEL MEMBERS SPACED AT 6.5M INTERFALS</i>	118
(By Author: October, 2011)	
<i>FIGURE 130: SLAB ON METAL DEICKING</i>	123
(Adapted by Author: September, 2011) (UNKNOWN, Author, 2008)	
<i>FIGURE 131: SLAB ON METAL DEICKING EDGE DETAILS</i>	120
(Adapted by Author: September, 2011) (UNKNOWN, Author, 2008)	
<i>FIGURE 132: EXPLODED VIEW OF GREEN ROOF CONSTRUCTION</i>	120
(Safeguard Europe)	
<i>FIGURE 133: GREEN ROOF EDGE DETAIL</i>	121
(Hydrotech)	
<i>FIGURE 135: CURTAIN WALL GLAZING CONNECTION DETAILS</i>	121
(StructuralGlass)	
<i>FIGURE 134: BASEMENT CONCRETE BEAM AND POST CONSTRUCTION</i>	122
(CHING, Francis D K, 2008)	
<i>FIGURE 136: LIVING WALL ASSEMBLY DRAWING</i>	121
(Adapted by Author: September, 2011) (UNKNOWN, Author, 2008)	
<i>FIGURE 137:LIVING WALL CONSTRUCTION DETAIL</i>	123
(Adapted by Author: September, 2011) (UNKNOWN, Author, 2008)	
<i>FIGURE 138: DEEP WATER CULTURE</i>	124
(Adapted by Author: September, 2011) (UNKNOWN, Author, 2008)	
<i>FIGURE 139: WICK SYSTEM</i>	125
(Adapted by Author: September, 2011) (UNKNOWN, Author, 2008)	
<i>FIGURE 140: EBB & FLOW SYSTEM</i>	125
(Adapted by Author: September, 2011) (UNKNOWN, Author, 2008)	
<i>FIGURE 141: DRIP SYSTEM</i>	126
(Adapted by Author: September, 2011) (UNKNOWN, Author, 2008)	
<i>FIGURE 142: NUTRIENT FILM TECHNIQUE</i>	127
(Adapted by Author: September, 2011) (UNKNOWN, Author, 2008)	
<i>FIGURE 143: AEROPONICS</i>	127
(Adapted by Author: September, 2011) (UNKNOWN, Author, 2008)	
<i>FIGURE 144: FUEL GENERATED BY BIOGAS REACTOR USED FOR POWER, HEATING AND COOLING SYSTEMS</i>	129
(DAVIS, Blake, 2011)	
<i>FIGURE 145: ANAEROBIC DIGESTER AS KEY COMPONENT TO A ZERO-WASTE SYSTEM</i>	129
(Adapted by Author: September, 2011) (DAVIS, Blake, 2011)	

List of Illustrations

<i>ILLUSTRATION 01: COVER PAGE</i>	i
<i>ILLUSTRATION 02: HAND HOLDING PLANT</i>	vii
<i>ILLUSTRATION 03: HUNGER IN THE DEVELOPING WORLD</i>	13
<i>ILLUSTRATION 04: PRETORIA CBD AS AN EXAMPLE OF AFRICAN URBANIZATION</i>	20
<i>ILLUSTRATION 05: THE FUTURE OF THE WORLD IN OUR HANDS</i>	31
<i>ILLUSTRATION 06: SOILLESS FARMING METHODS</i>	35

List of Tables

<i>TABLE 01: RESEARCH METHODOLOGY TABLE</i>	15
(By Author, 2011)	

INTRODUCTION



UNIVERSITEIT VAN PRETORIA
UNIVERSITY OF PRETORIA
YUNIBESITHI YA PRETORIA

01



CHAPTER 1 INTRODUCTION

INTRODUCTION

The neolithic revolution (advent of agriculture) led to a series of events that would change the relationship between man and nature forever. (WILSON, E O, 1992)

The ability to cultivate a reliable food supply resulted in an unprecedented increase in the human population's growth as a species to the point now of domination over the natural world from which we evolved.

Farming catalysed humans transformation from primitive hunter-gatherers to sophisticated urban dwellers in just 10,000 years. The development of traditional farming as a specific vocation practiced in rural areas would eventually lead to the division of labour (producers and consumers), and the division between town and country (areas of production and areas of consumption). (LEFEBVRE, Henri, 1996)

Today, over 800 million hectares or about 38% of the total landmass of the earth is used for traditional soil-based agriculture. This practice has re-arranged the landscape in favour of cultivated fields at the expense of natural ecosystems, reducing most natural areas to fragmented, semi-functional units, while completely eliminating many others.

Despite the obvious advantage of not having to hunt or scavenge for food, farming has led to new health hazards by creating ecotones between the natural world and our cultivated fields. As the result, transmission rates of numerous infectious disease agents have dramatically increased- influenza, rabies, yellow fever, dengue fever, malaria, trypanosomiasis, hookworm, schistosomiasis – and today these agents emerge and re-emerge with devastating regularity at the tropical and sub-tropical agricultural interface.

Modern agriculture employs a multitude of chemical products, and exposure to toxic levels of some classes of agrochemicals (pesticides, fungicides) have created other significant health risks that are only now being addressed by epidemiologists and toxicologists.

However the major concern has to do with available arable land. It is predicted that over the next 50 years, the human population is expected to rise to at least 8.6 billion, requiring an additional 109 hectares (roughly the size of Brazil) to feed them using current technologies. That quantity of additional arable land is simply not available. (DESPOMMIER, Dickson, 2010)

Large parts of the world already suffer from the effects of food shortage, with undernourishment rates being highest in Africa and other parts of the developing world as indicated by Figure 01.

Without an alternative strategy for dealing with just this one problem, social chaos could replace orderly behaviour in even the most developed countries. Novel ways for obtaining an abundant and varied food supply without encroachment into the few remaining functional ecosystems must be seriously entertained.

One solution involves the construction of building integrated agriculture and productive urban landscapes to serve as local food production centres within towns and cities. (DESPOMMIER, Dickson, 2010)

If we could engineer this approach to food production, then no crops would never fail due to severe weather events (floods, droughts, hurricanes, etc.). Produce would be available to city dwellers without the need to transport it thousands of miles from rural farms to city markets. Spoilage would be greatly reduced, since crops would be sold and consumed within moments after harvesting.

If urban farming becomes the norm, then one anticipated long-term benefit would be the gradual repair of many of the world's damaged ecosystems through the systematic abandonment of farmland.

Other benefits of urban farming include the creation of a sustainable urban environment that encourages good health for all who choose to live there; new employment opportunities, fewer abandoned lots and buildings, cleaner air, safe use of municipal liquid waste, and an abundant supply of safe drinking water.

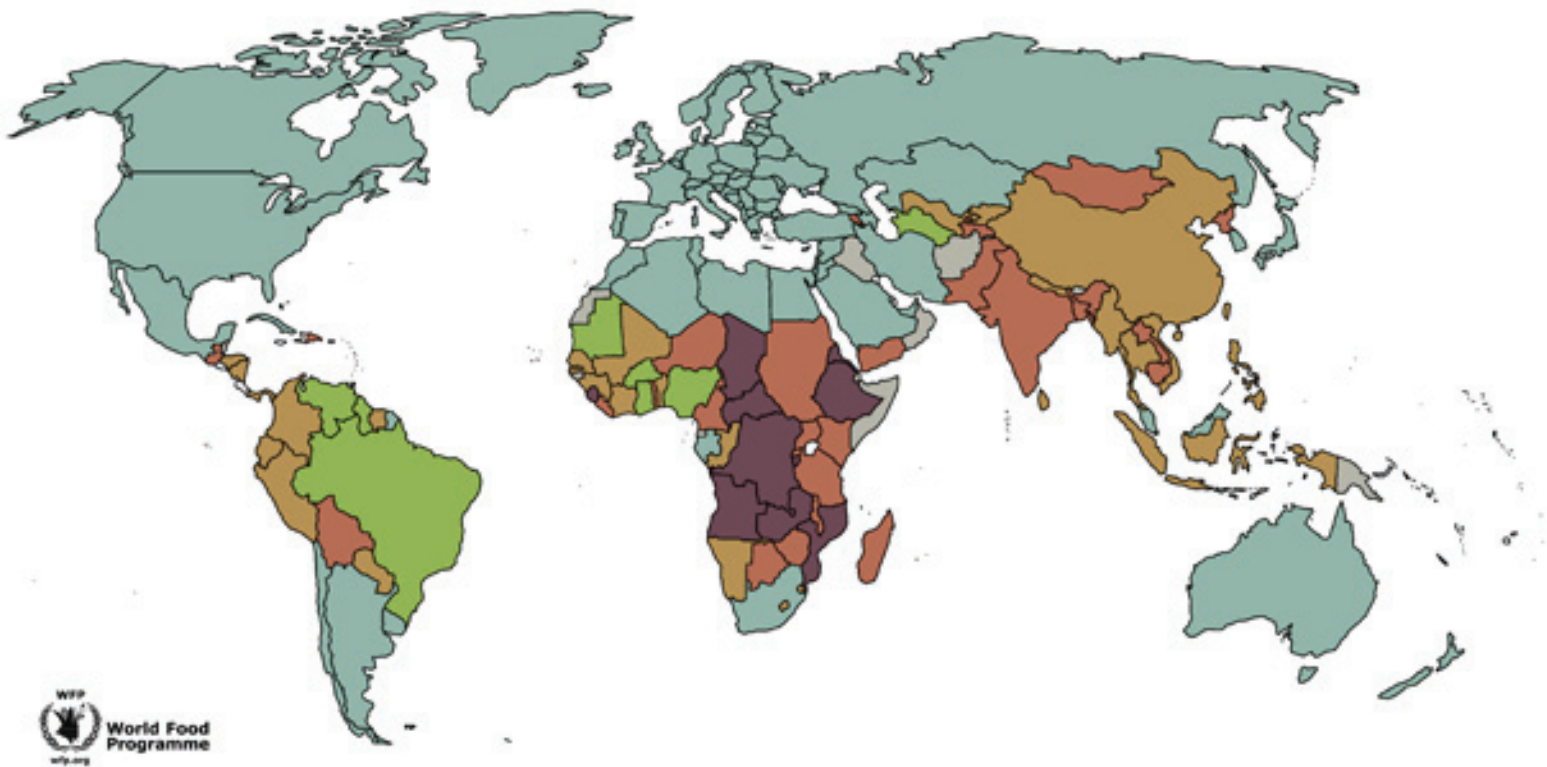

Figure 01: Map indicating global undernourishment by category.

Category	1	2	3	4	5	Incomplete data
Undernourished	<5%	5-9%	10-19%	20-34%	≥35%	
Description	Extremely low	Very low	Moderately low	Moderately high	Very high	

Illustration 03: Hunger in the developing world.





STUDY OVERVIEW

RESEARCH PROBLEM

The general public has become so removed from the process of food production that it has resulted in a wasteful and energy intensive process.

The research will focus on gaining a better understanding of the causes of this problem specifically related to space, proximity, energy and waste.

RESEARCH METHODOLOGY

Table 01 gives a brief overview of the research methodology, sources and expected outcomes found in each of the main study areas.

The research will start with an investigation into current commercial agricultural practice to help identify problems resulting from this.

A closer look at the history of human food production from prehistoric times to current day gives us some clues as to why we have come to this crossroads.

Alternative methods of farming will then be defined to give a understanding of possible solutions that would be appropriate in an urban environment.

Research Area	Methodology	Source	Exp. Outcome
Problem Analysis	Quantitative / Intuitive	Statistical data, Literature (news, journals), Historic Literature.	Research problem and sub-problems.
Theory Study	Qualitative	Theory Literature (books, journal articles)	Applicable theory base and design drivers.
Context Study	Qualitative	Historic Literature (books, newspaper articles), Images (photos, paintings, sketches)	Appropriate site selection.
Site Analysis	Quantitative / Intuitive	Existing Frameworks, Climatic Database, GIS, Maps, Photos	Contextual response and urban objectives.
Precedent Studies	Qualitative	Site Visit, Literature, Photographs, Drawings.	Connect theoretical problem with practical implementaion.

Table 01: Research Methodology used in study.

DESIGN OVERVIEW

DESIGN PROBLEM

To integrate food production into a building and public urban environment.

SUB-PROBLEMS

AVAILABLE LAND

To make urban agriculture feasible the building footprint required to produce crops will need to be reduced beyond that required by normal agriculture or even greenhouse practice.

This can be done by exploring vertical crop production therefore multiplying building footprint by the amount of available ground floor space.

ENERGY

Vertical solutions have practical problems with giving crops enough access to natural sunlight.

High Energy demands are expected for running a “indoor” food production facility: artificial lighting, ventilation, services.

The energy requirements can be reduced by using low energy solutions as well as renewable energy sources.

PROGRAM

Historically production / industrial environments have resulted in negative urban spaces and have been located on the fringe areas within cities.

By introducing ground floor activities that engage with the public realm the negative impact of production can be removed at this level.

GENERAL OBJECTIVES

To promote sustainable food production in urban areas through research, development and training of urban farmers, small food business and community members.

URBAN OBJECTIVES

To reconnect the urban dweller with their natural environment by creating active links between urban form and natural elements.

To identify and activate lost or indeterminate green spaces within the city, thereby increasing the open green space network.

ARCHITECTURAL OBJECTIVES

To use architecture as a mediator between:

- Techno-sphere and biosphere
- Lost space (Apies River) and the city dweller
- Production and Consumption
- Urban scale and pedestrian scale

SOCIO ECONOMIC OBJECTIVES

Empowering local communities by educating them in methods of large and small scale local food production methods that can be applied in their own living and working environments.



PROPOSAL

This dissertation proposes the development of a Urban Food Research and Development Centre with it's main focus on research and education of ecosystemic production process including urban agriculture, urban aquaculture, rainwater harvesting and renewal and local energy production.

Both research and education is implemented with a “working example” approach. Appropriate methods of urban and building integrated farming is programmed into the building and site. This allows researchers to document yields as different crops are rotated through systems, at the same time visitors and students are able to learn through experience.

USERS

PRIMARY USERS:

- Researchers
- Urban Farmers
- Retailers
- Students

SECONDARY USERS:

- Pedestrians
- Restaurant goers
- Shoppers

CLIENT

Joint venture between:

- Agri SA
- CSIR
- City of Tshwane

SITE

Location: c/o Nelson Mandela Dr & Church Str

The chosen site is deemed appropriate for this investigation due to the specific history and qualities of both the site and the surrounding area.

The site is located between a prominent (yet seemingly forgotten) natural element (the Apies river) and the historic city edge, this serves as a appropriate laboratory to explore the tension that exists between techno-sphere and biosphere giving the designer a opportunity to address this problem.

PROGRAM

- Research,
- Education,
- Urban Agriculture,
- Retail



ASSUMPTIONS & EXCLUSIONS

It is assumed that:

Given the conclusions made in the framework proposal that the site will become available for redevelopment.

The possibility of the demolition of existing buildings would be deemed appropriate based on framework requirements.

It is my belief that the design and planning of public open spaces and urban form should be a responsibility that is shared by all design disciplines.

I will not attempt to resolve the urban planning guidelines or landscape design to completion but merely indicate the intent and more importantly show the reciprocal relationship that can exist between other design disciplines and Architecture.

CONSTRAINTS

The agricultural component of the design requires very specific services and indoor environments that will put certain constraints on the design. These constraints will be used as design generators and will be further explored in the design development and technical chapters.



RESEARCH



UNIVERSITEIT VAN PRETORIA
UNIVERSITY OF PRETORIA
YUNIBESITHI YA PRETORIA



02



CHAPTER 2 RESEARCH

Figure 02: The individuals daily birthright.



2.1 Food Crisis

REAL WORLD PROBLEM

It is estimated that 80% of the world's population will be living in urban centres by the year 2050. (United Nations, 2004)

The increase in urban areas combined with global population growth is resulting in a looming resource crisis, soon we will no longer have safe access to food, drinking water and other basic requirements.

Dickson Despommier, a professor at the Department of Environmental Health Sciences from Columbia University estimates that each individual requires approximately 2.3 litres of water and 1500 calories of food per day to sustain a healthy diet. (Despommier, 2010: 1)

The projected increase in global population will therefore put immense strain on our food and water resources.

THE CAUSES

POPULATION EXPLOSION

Figure 04 shows statistics from the United Nations indicating the estimated population growth projected for the future. Current data indicates that global population will increase by approximately 3 billion people by the year 2050.

GLOBAL URBANIZATION

The past few decades has seen a world wide increase in population densities in urban areas. Even though most cities has shown a loss of business from city centres, the steady increase in residential tenants has resulted in a population spike while having a negative effect on the inner city economies. (Pugh, 1997: 49)

Figure 03: Global Population Growth projections.

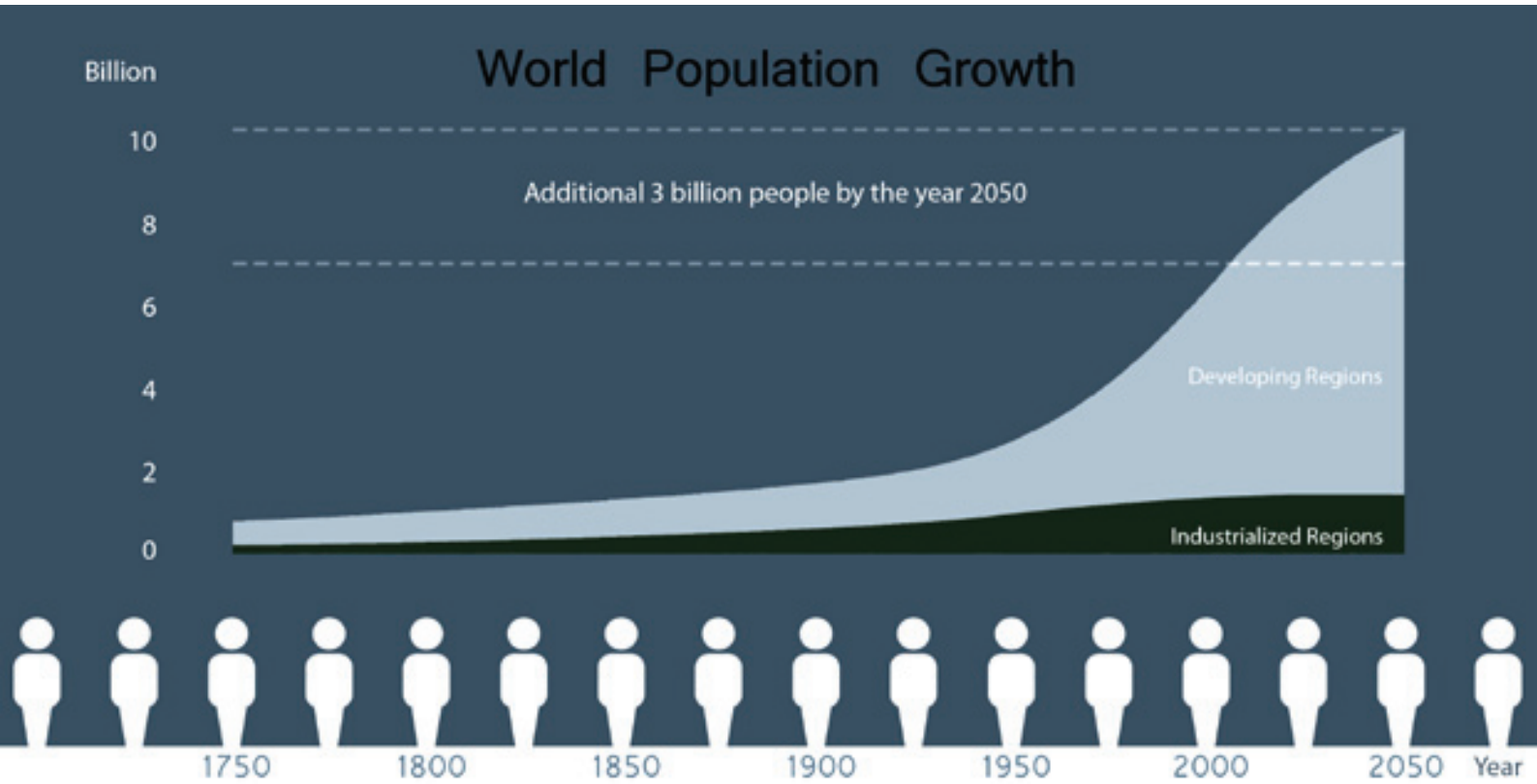

Global Urbanized Population Growth

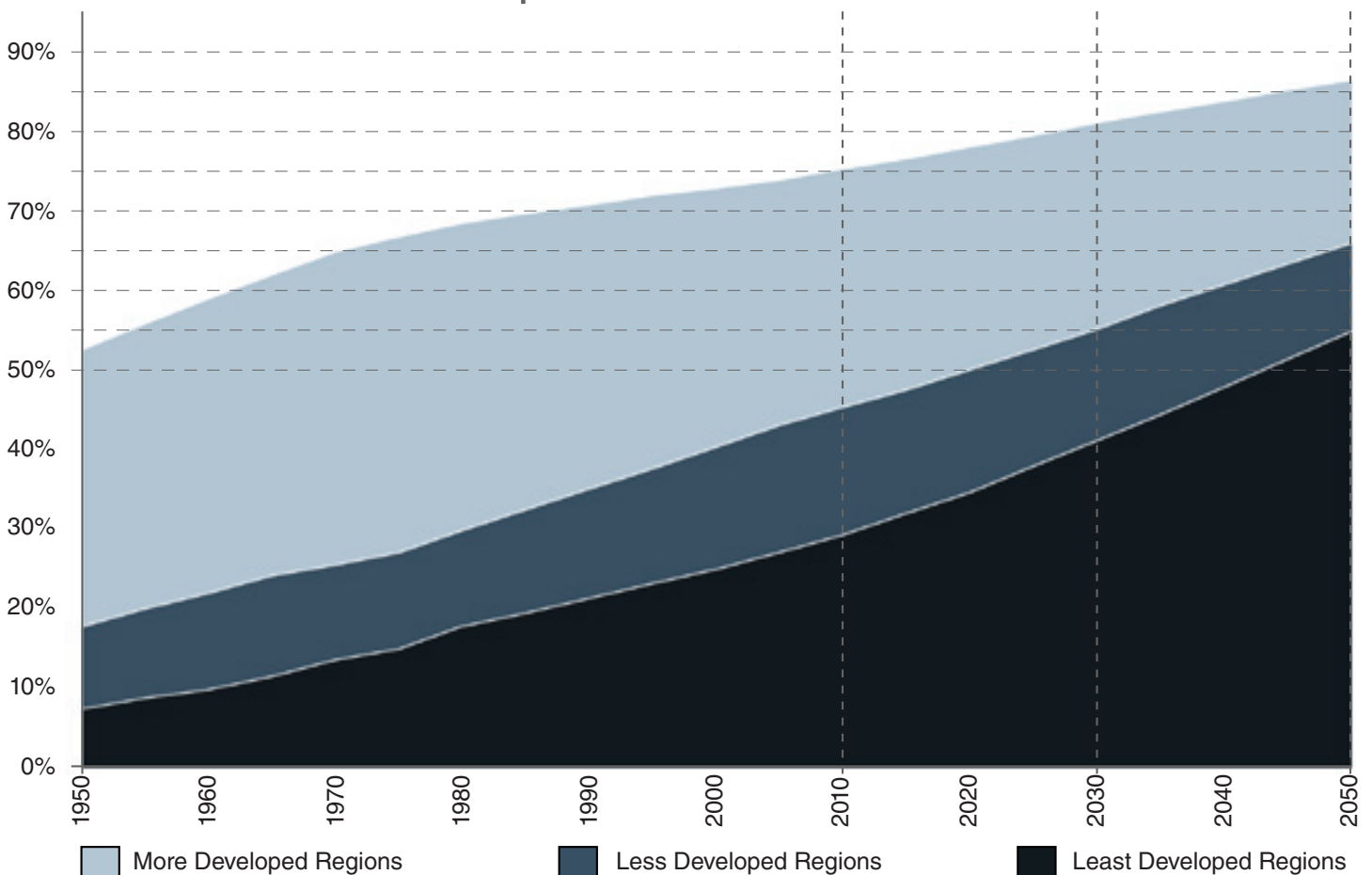

Figure 04: The global urbanization rate by developed regions.



Figure 14 illustrates how in the local context it is estimated that at the current growth rate 60% of Africa's population will be urbanised by the year 2030. (United Nations, 2004)

Statistical data from the South African census indicates an urban population increase from 54% in 1996 to 58% in 2001 (Statistics South Africa: Census, 1996; and Census 2001). This is indicative of the fact that the rate of urbanization in South Africa is currently more rapid than projected for the rest of the world.

PROFILE OF SOUTH AFRICAN URBAN DWELLERS

Most of the urban growth in South Africa is occurring in and around the six major metropolitan areas: Johannesburg-Ekurhuleni, Cape Town, Port Elizabeth, Durban, Pretoria and Vereeniging.

The highest rate of growth is amongst the poorest population typically seeking survival in the informal economic sector. (DEWAR, Dawid, 2003)



By 2050 more than **60%** of Africans will be living in cities or suburbs

GLOBAL ARABLE LAND SHORTAGE

As of 2004, approximately 800 million hectares of land were in use for food production – approximately an area equivalent to Brazil, and allowing for the harvesting of an ample food supply for the majority of a human population approaching 6.3 billion. These land-use estimates include grazing lands (formerly grasslands) for cattle, and represents nearly 85% of all land that can support at least a minimum level of agricultural activity. In addition, farming produces a wide variety of feed grains for many millions of head of cattle and other species of domesticated farm animal. (Despommier & Ellingsen, 2008: 1)



Figure 05: Percentage of available arable land currently in use.

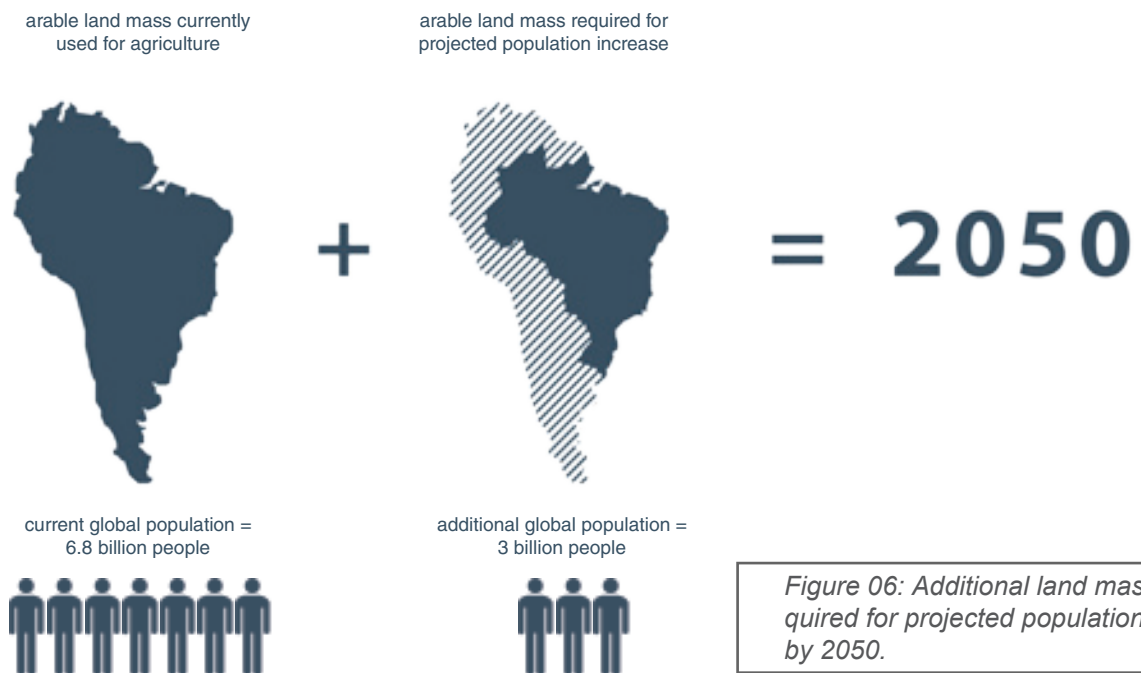

Figure 06: Additional land mass required for projected population growth by 2050.

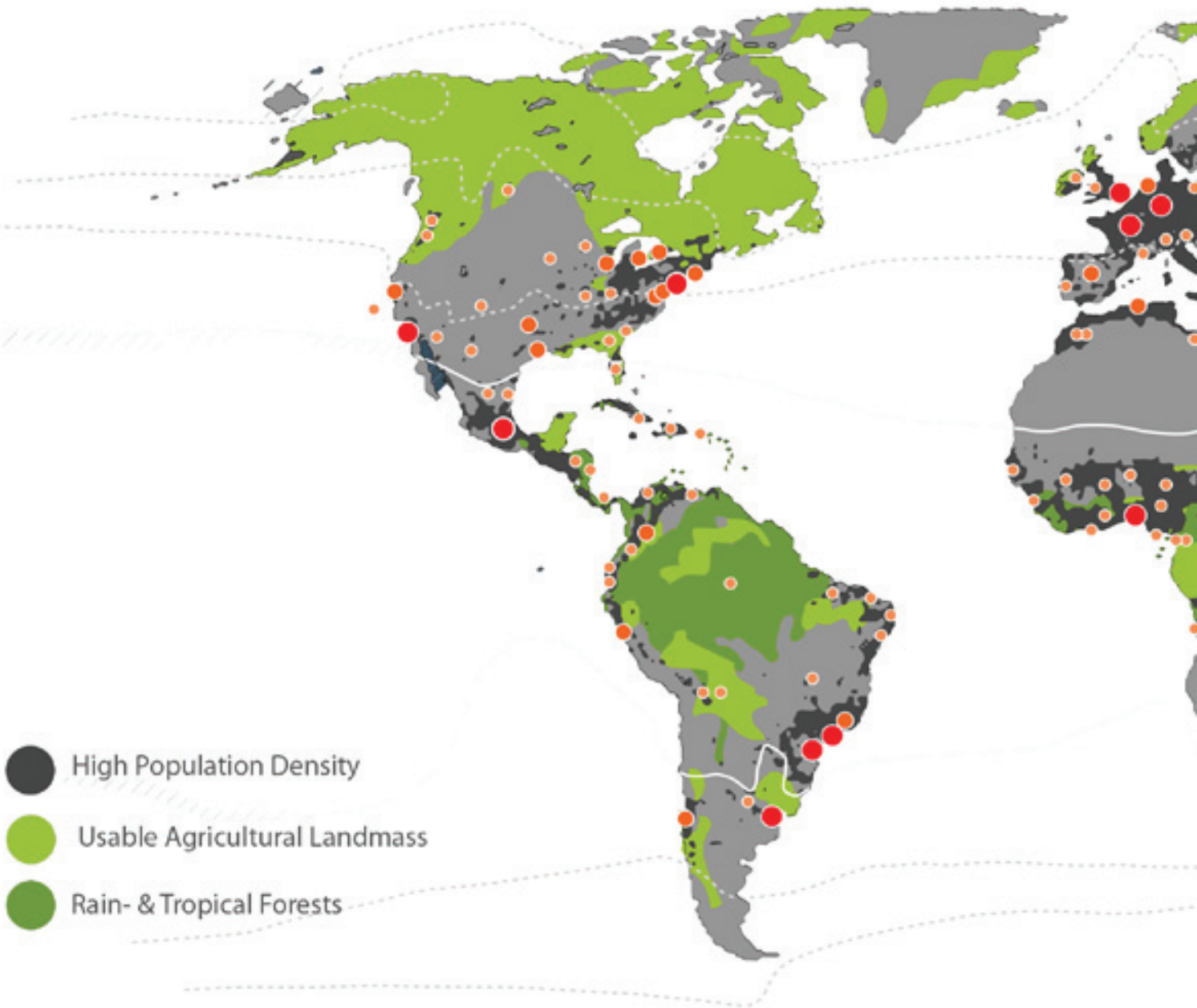
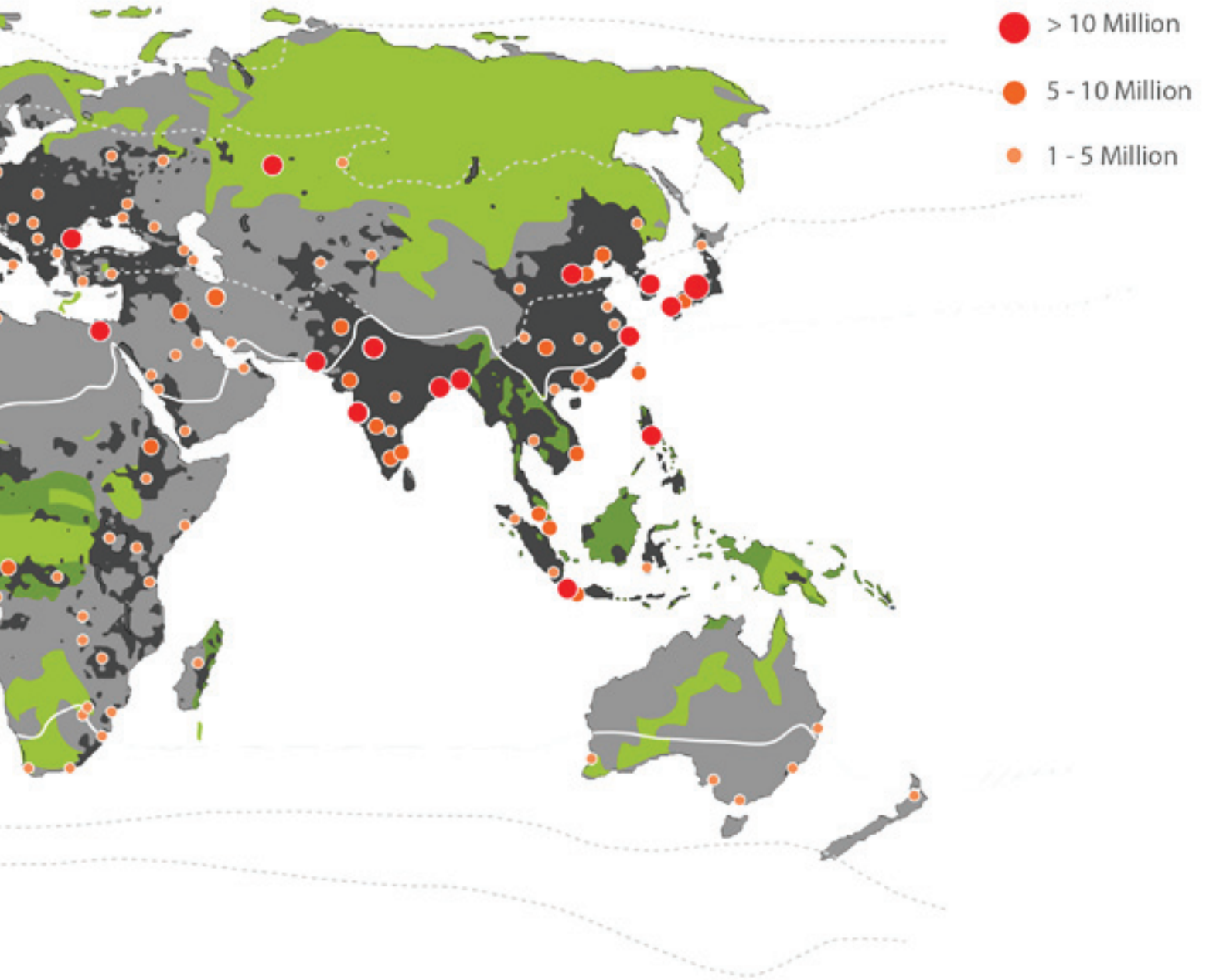

Figure 07: Map showing available arable land worldwide.





STAPLE FOODS

To address the food crisis an analysis of staple foods found in countries throughout the world is required. This will enable the study to focus on food sources and cultivation processes that can make the biggest impact on this global problem.

The Food and Agriculture Organization of the United Nations (FAO) defines a staple food is one that is eaten regularly and in such quantities as to constitute the dominant part of the diet and supply a major proportion of energy and nutrient needs. (DIOUF, Jacques, 1995)

A staple food alone does not meet a population's total nutritional needs, a variety of foods is required. This is particularly the case for children and other nutritionally vulnerable groups.

Typically, staple foods are well adapted to the growth conditions in their source areas. For example, they may be tolerant of drought, pests or soils low in nutrients. Farmers often rely on staple crops to reduce risk and increase the resilience of their agricultural systems. (DIOUF, Jacques, 1995)

An analysis done by the FAO on proportions of food in average diets around the world indicate that most people live on a diet based on one or more of the following staples: rice, wheat, maize (corn), millet, sorghum, roots and tubers (potatoes, cassava, yams and taro), and animal products such as meat, milk, eggs, cheese and fish. (DIOUF, Jacques, 1995)

Of more than 50 000 edible plant species in the world, only a few hundred contribute significantly to food supplies. Of these only 15 crop plants provide 90 percent of the world's food energy intake, with three rice, maize and wheat contributing two-thirds. These three are the staples of over 4 000 million people.

The Gramineae (cereal) family is the largest staple food group as rice feeds almost half of humanity.

Roots and tubers are important staples for over 1 000 million people in the developing world. They account for roughly 40 percent of the food eaten by half the

population of sub-Saharan Africa. They are high in carbohydrates, calcium and vitamin C, but low in protein.

Per caput consumption of roots and tubers has been falling in many countries since the beginning of the 1970s, mainly because urban populations have found it cheaper and easier to buy imported cereals. (DIOUF, Jacques, 1995)

Many countries are experiencing a similar shift away from traditional foods, but there is growing recognition of the importance of traditional food crops in nutrition.

PERCENATGES 1988 -1990

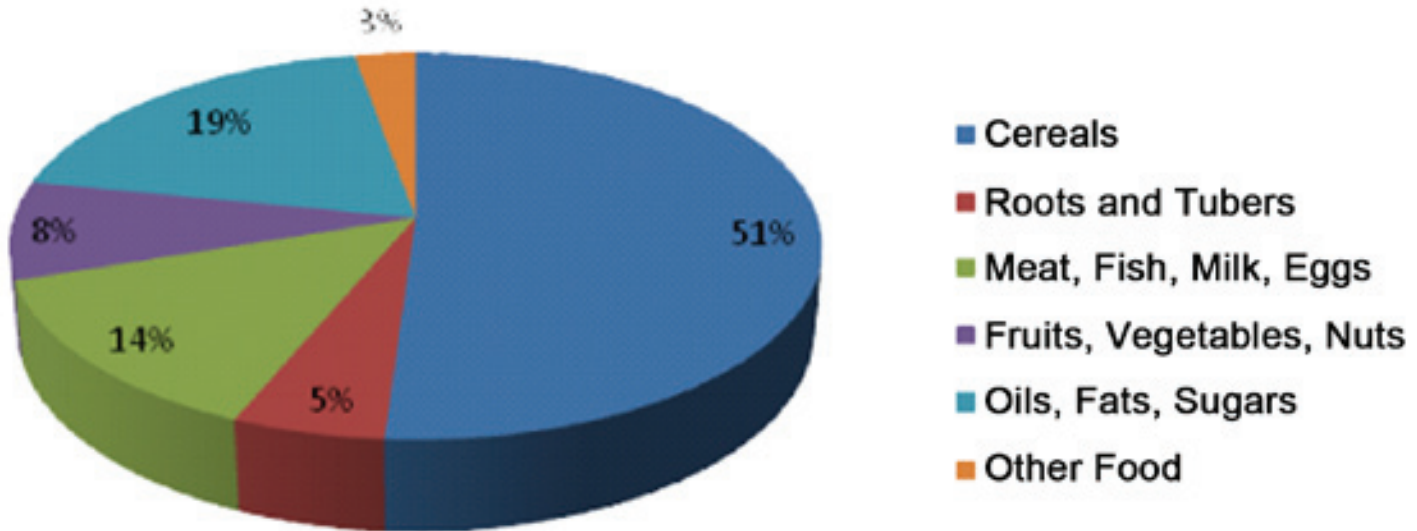

Figure 08: World average diet shown as percentages from 1988 - 1990.

CONCLUSION

Figure 08 shows the average percentages of food sources found in the diets of the global population as per statistical data from the Food and Agriculture Organization of the United Nations (FOA). It is clear from these statistics that edible plant species far outweigh the impact that animal products have on global hunger.

Therefore it seems logical that the focus of the study should be on the cultivation of edible plants as a main area of research or at the very least a departure point.

2.2 Food as a System

FOOD WEB

The concept of food webs or food cycles was pioneered by Charles Elton in his book, *Animal Ecology*. A food web consists of a linear sequence of links (collectively known as a food chain) starting from a trophic species that eats no other species in the web and ends at a trophic species that is eaten by no other species in the web. (ELTON, Charles S, 1927)

Figure 09 gives a simple example food web showing how human beings fit into this system.

ECOSYSTEM

An ecosystem is a biological environment that consists of both living (biotic) and nonliving (abiotic) organisms and components that inhabit a particular area. The abiotic components with which the organisms interact include air, soil, water and sunlight.

(CAMBELL, Neil A, 2008)

By definition then human beings form part of their own particular environments and ecosystem.

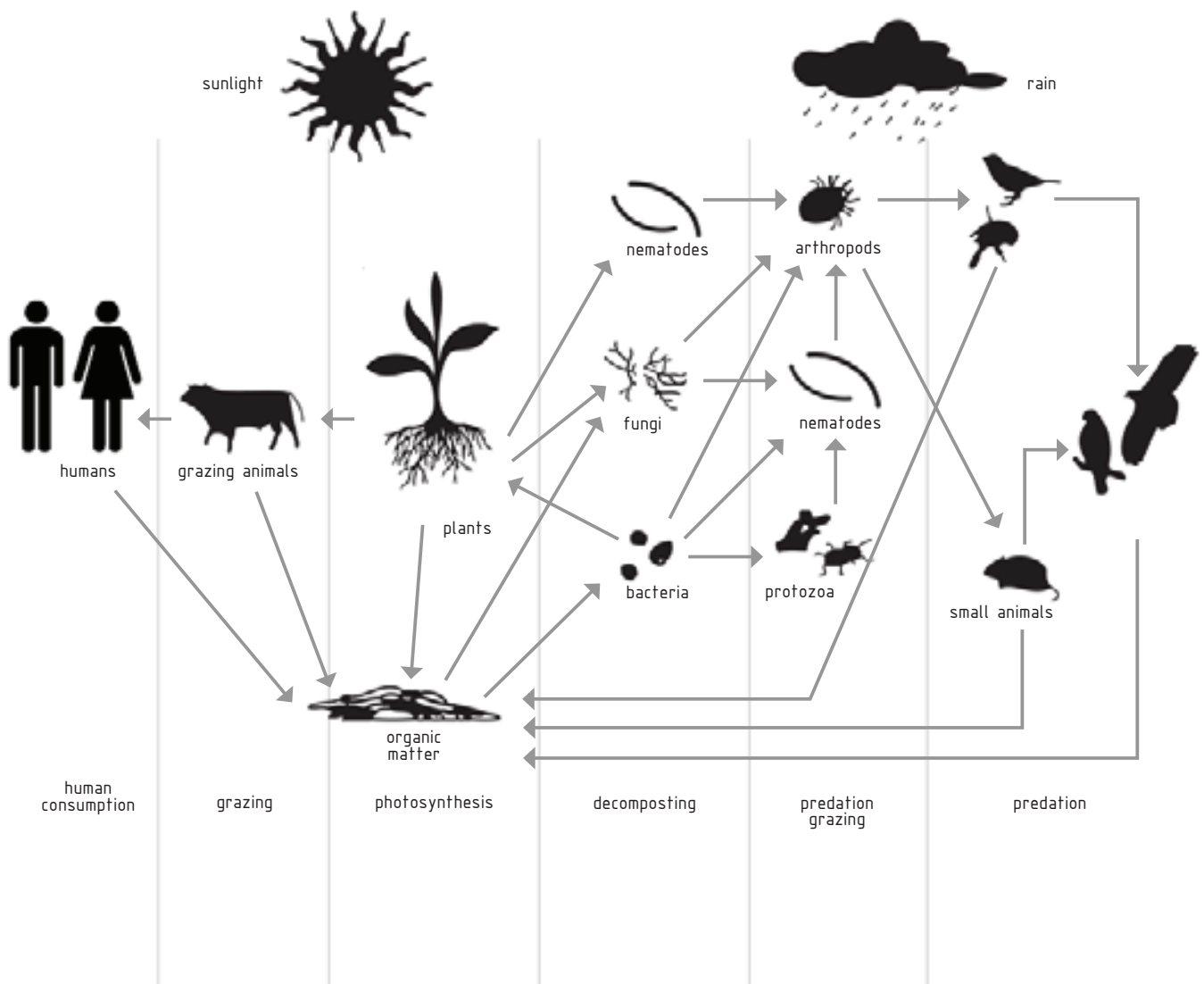

Figure 09: Example of a food web.

PLANT GROWTH SYSTEM

The growing process of plants in their natural environment can be analysed in terms of system design based on inputs, process and outputs:

PHYSICAL INPUTS

- Air (uses CO₂)
- Water (H₂O)
- Plant Nutrients (inorganic mineral salts)
- Energy (Sunlight)
- Anchor (Soil)

PROCESSES

- Osmosis:
Intake of water and minerals via root system
- Photosynthesis and Respiration:
Uses light and air to transform water and minerals into organic matter.

OUTPUTS

Organic Matter: Roots, stems, leaves, fruits and seeds.
Gas: O₂

Note:

All energy (sun) and resources required for the plant growth process comes from renewable resources within the ecosystem.

All outputs are returned to the ecosystem and used by other biotic and abiotic organisms and processes. There is therefore zero waste.

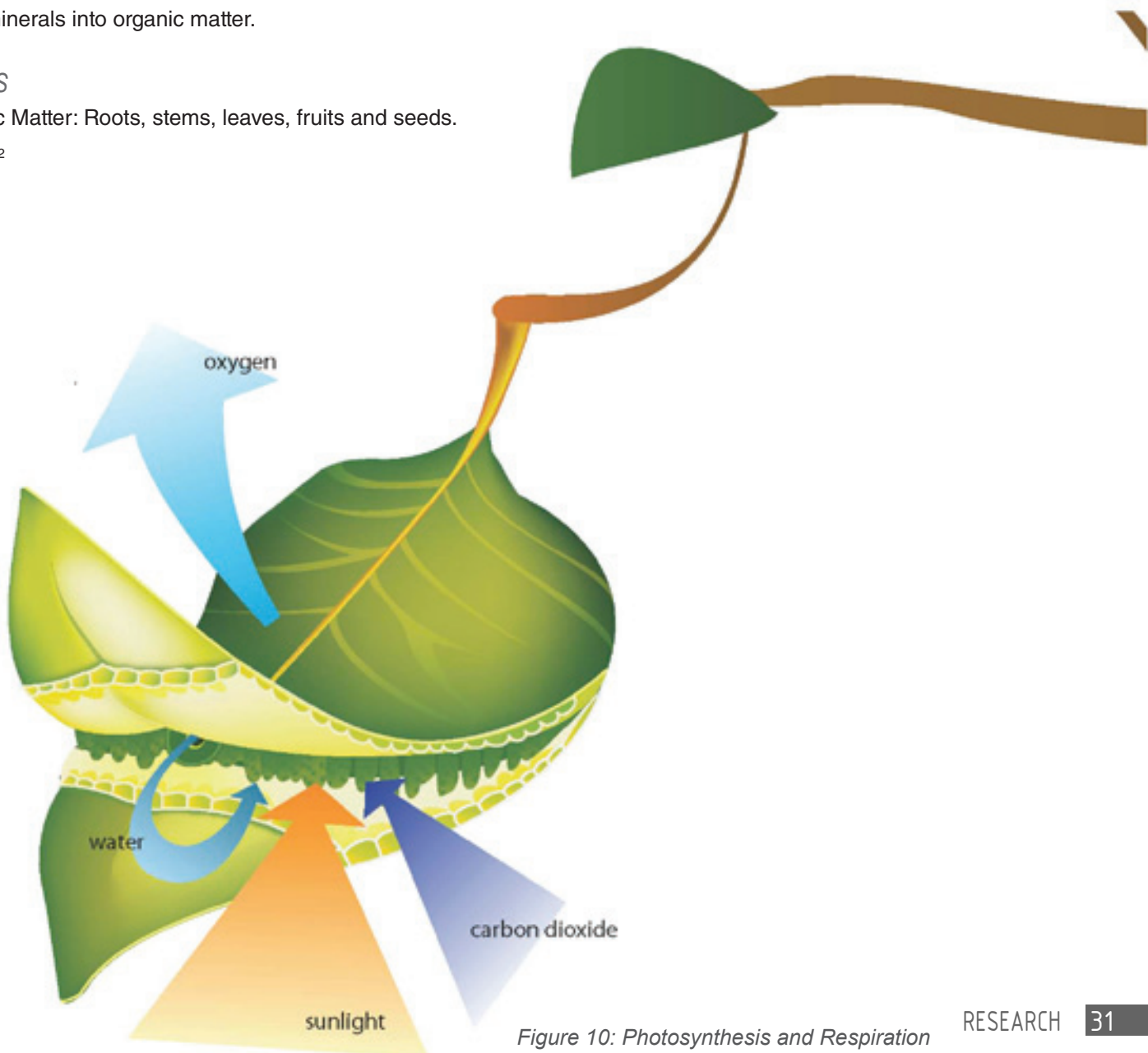

Figure 10: Photosynthesis and Respiration



FARMING SYSTEM

As with the natural plant growth process, farming or cultivation of edible plants can be analysed as a system based on inputs, processes and outputs: (see Figure 11)

PHYSICAL INPUTS:

Climate
Rain
Temperature
Season
Soil

SOCIO-ECONOMIC INPUTS:

Labour
Rent
Transport Cost
Machinery
Fertilisers
Pesticides
Government Control
Seeds
Livestock
Farm Buildings
Energy (electricity, fossil fuel, etc)

PROCESSES

Planting
Irrigation
Harvesting

OUTPUTS

Crops
Feed

Note:

Agriculture uses large quantities of both natural and man-made resources.

Current agricultural process is responsible for large quantities of waste production that results in pollution of the natural environment and large quantities of agricultural run-off.

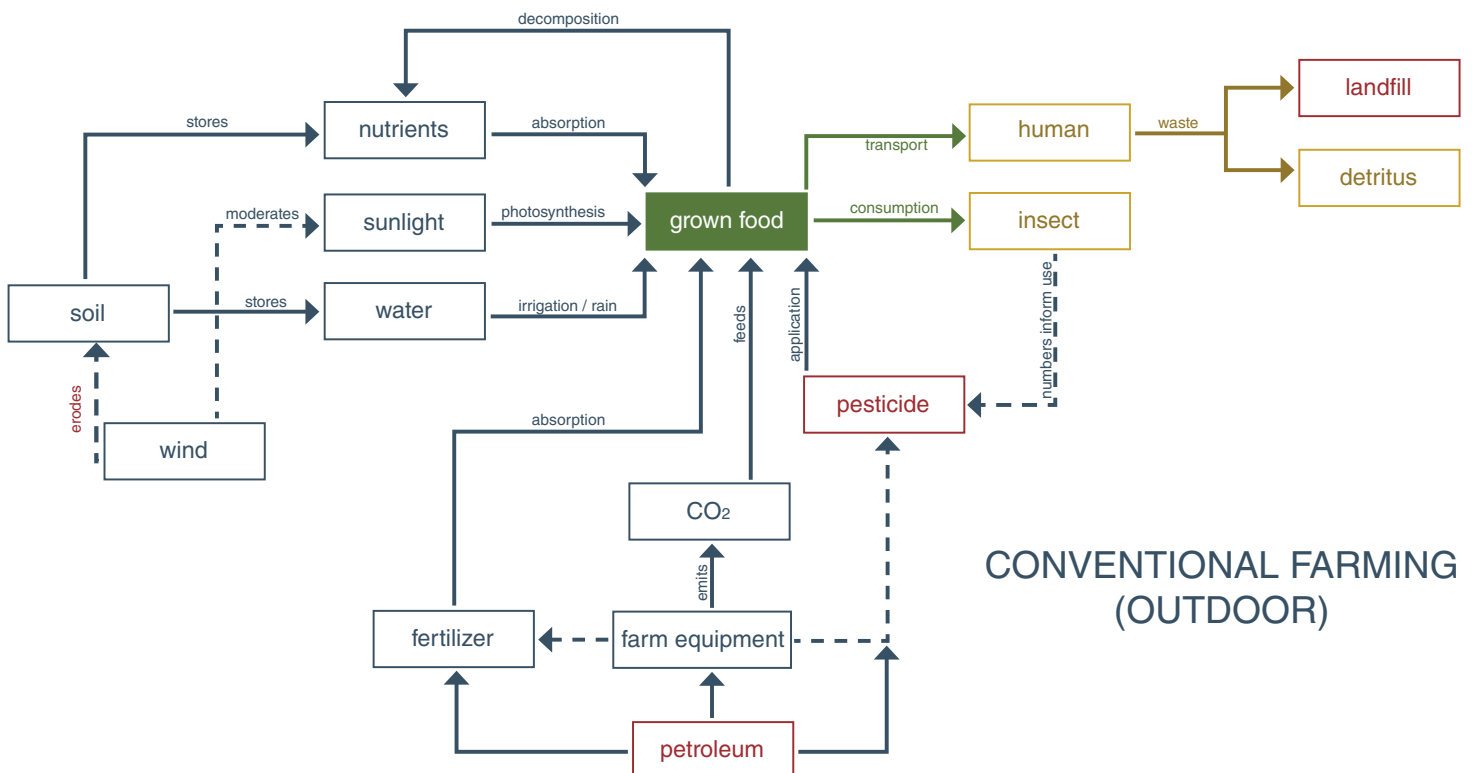

Figure 11: Farming System Diagram

NEGATIVE EFFECTS OF FARMING

Beyond the impact that conventional farming has on resources and waste there are a few more effects that should be mentioned: (BROWN, Katherine H and Carter, Anne, 2003)

EXHAUSTED FARMLAND

The limited reach of current shallow crop rotation practices is woefully underdeveloped and under supported, leaving much of the suitable land available currently for agricultural production infertile or in need of remediation in the years to come.

GEOPOLITICAL POLARIZATION

Developed countries have significantly reduced the areas of land available for their own food supply. These countries are turning to already-strained areas to supplement their own supply. The natural, national resources of a majority of the globe are then stripped away for use by foreign populations, further exacerbating the desperation and conflict in the developing world.

In the long run, this agricultural colonialism is harmful to both the populations it serves, and the populations it exploits. While the developed world loses many of its resources, the industrialized world must pay exorbitantly for shipping costs, and crisis management outside of their legal and sovereign territories. As resources around the world become more scarce, this model of business and international relations will quickly become unsustainable.

SUPPLY CHAIN / PROXIMITY

The proximity of agricultural cultivation to food preparation process and finally to the end user results in high energy demands for processing, storage and transport. These same proximity issues also result in further land loss due to storage requirements.

FLATTENING ECOSYSTEMS

In the developing world, the systematization of the agricultural production has resulted in the homogenization of ecosystems and micro-climates, reducing the overall strength of biodiversity and the resilience of staple food crops.

Modern crops are primarily mono cultured, and not suited to the environment of which they are a part, failing to take advantage of robust local ecologies and their natural systems of irrigation, nutrient cycling, and pest control. This opens the global food supply to vulnerability, making it more susceptible to attack from both existing and yet unknown viruses, fungal infections, and pests.

URBANIZATION / LAND SHORTAGE

For the first time in history, over half of the world's population is living in cities. At the same time, over half of the world is living in poverty. With a severe housing shortage threatening the quality of life and sustainability of rapid urban growth, many communities around the world are turning to the only land left available to them, land which is dangerously unfit for development.

Floodplains and oceanic coastlines are prime targets for informal and illegal settlements. Land here is cheap, and largely deregulated because of the very real threat of impending natural disaster.

PROBLEM STATEMENT

Dickson Despommier compares the biosphere with the techno-sphere and notes the difference between the cyclical nature of the biosphere (cradle to cradle) when compared to the linear nature human processes (cradle to grave).

Ecological observations and studies, beginning with those of J. Teal in Georgia (Teal, 1962) showed how living organisms behave with regards to the sharing of limited energy resources. Tight knit assemblages of plants and animals evolved into trophic relationships that allowed for the seamless flow of energy transfer from one level to the next, regardless of the type of ecosystem in question (Ricklefs, 2000). In fact, this is the defining characteristic of all ecosystems.

In contrast, humans, although participants in all terrestrial ecosystems, have failed to incorporate this same behaviour into their own lives.

Instead of living in harmony with the natural environment, human beings have resorted to systems of control and domination of the biosphere. Smout Allen describes the countryside as “under the influence of nature but under the control of man” He remarks that previously natural landscapes have taken on an artificial patination and a utilitarian topography. (Smout Allen)

Biosphere



“cradle to cradle”

Techno-sphere

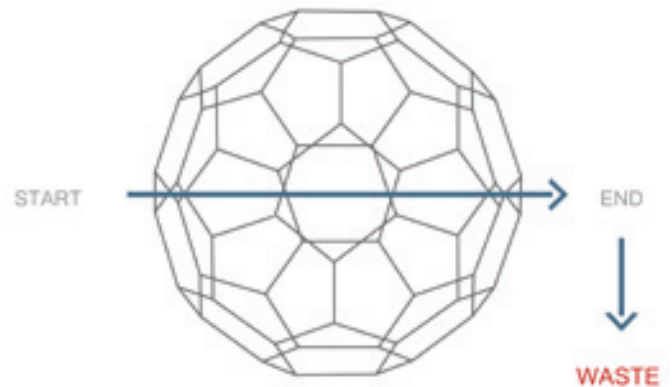

“cradle to grave”

Figure 12: Comparison between biosphere and techno-sphere.

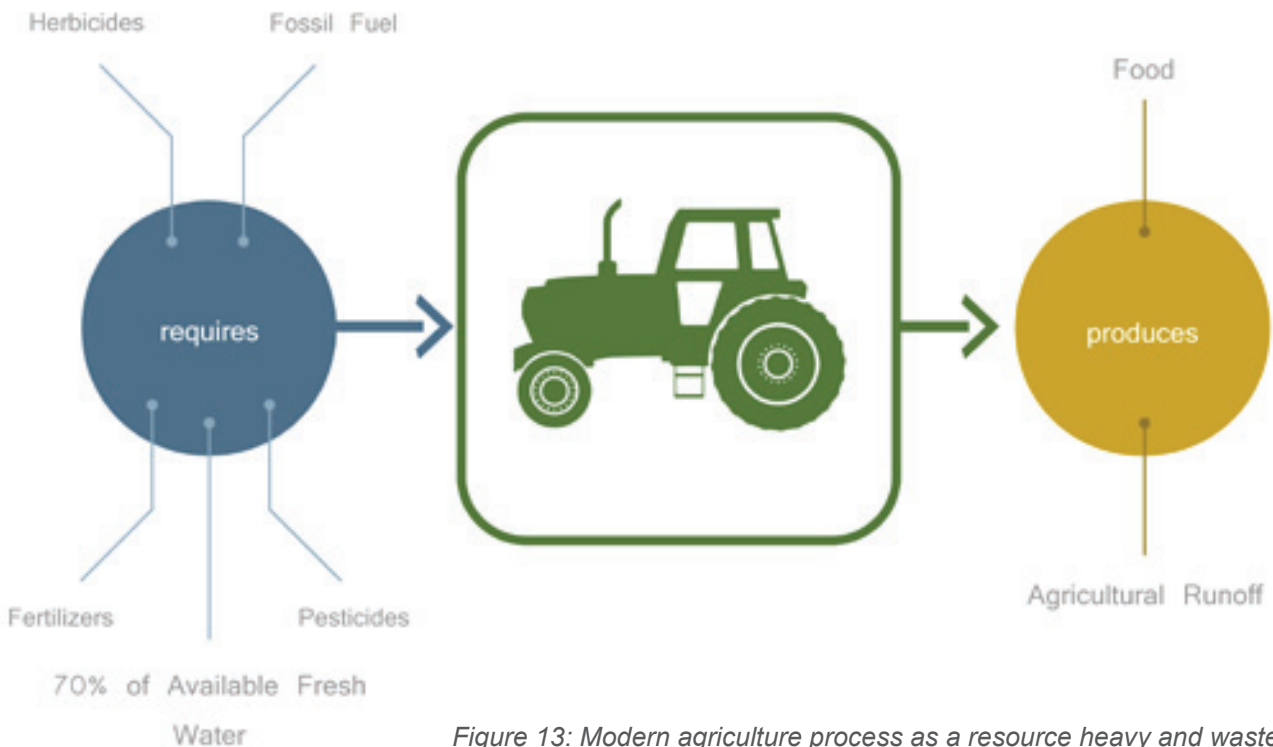

Figure 13: Modern agriculture process as a resource heavy and wasteful process.

CONCLUSION

Two spatial problems can be deduced from the study of the expected food crisis. One of proximity to end user and available arable land.

By exploring the use of urban land for agriculture strain can be taken of the traditional farming sector. This concept of urban farming would reduce the need for arable land and shorten the supply chain between food production and consumption.

Urban farming can be explored both in terms of productive urban landscapes as well as building integrated agriculture.





2.3 Urban Agriculture

URBAN FARMING METHODS

Urban agriculture can be explored in terms of productive urban landscapes and productive architecture or building integrated agriculture: (BROWN, Katherine H and Carter, Anne, 2003)

PRODUCTIVE LANDSCAPES

- Allotments
- Community Gardens
- Urban Garden Agriculture

PRODUCTIVE ARCHITECTURE

- Green Wall
- Green Roof
- Balcony Farming
- Greenhouse
- Vertical Farming

Due to the nature of this study (architecture) the exploration will focus mainly on the relationship between buildings and agriculture however it should be noted that productive landscapes can play a vital role in the integration of farming into an urban setting.

ARCHITECTURE AND FARMING

The concept of cultivated plants being integrated into buildings is not a novel idea, early examples of this practice can be traced as far back as 601 BC to the Hanging Gardens of Babylon.

Today man made structures or greenhouses are used to enclose crops in areas of the globe where climatic conditions are not ideal for their cultivation. Greenhouses rely on maximum light transmittance through a mostly transparent skin making it less ideal for use in an urban setting where overshadowing is common and multistory structures often required to maximize developed area.

Greenhouse systems make use of both soil-based (plants using soil as growth medium) and soil-free (plants roots supported by a substance other than soil) systems. (VON ZABELTITZ, Christian, 2011)

Some ad-hoc methods include greens walls, green roofs and balcony farming. The benefit of these systems is that they can be added to existing buildings or designed into proposed structures as a productive component. Yields from such systems would generally be comparatively low and the care and harvesting of crops can conflict with other building programs.

The most intensive and productive of the methods is the concept of vertical farming, this involves large-scale agricultural production in multistory buildings or any vertically inclined surface.

It is an intensive farming strategy which mainly employs advanced techniques such as hydroponics and aeroponics to produce crops like fruits, vegetables and edible mushrooms continuously. This method has the added benefit of maximizing productive area by multiplying the usable floor space.

(DESPOMMIER, Dickson, 2010)

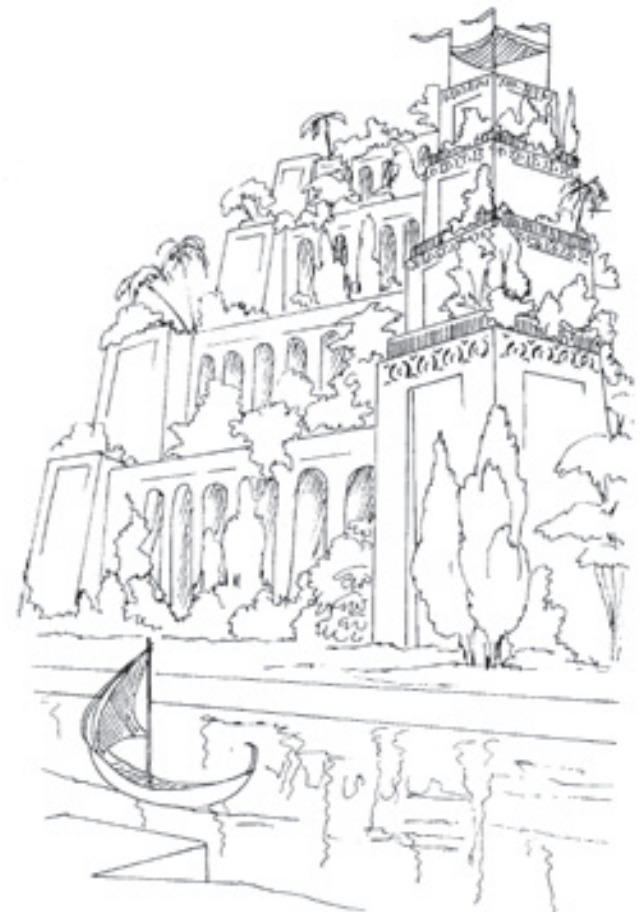

Figure 14: Artists impression of The Hanging Gardens of Babylon

VERTICAL FARMING

As early as 1974 John Hix documented some of the first built examples of vertical farming in his book *The Glass House*.

Koolhaas wrote in his 1978 publication, *Delirious New York*, about “The skyscraper as Utopian device for the production of unlimited numbers of virgin sites on a metropolitan location.” (1994, 82)

Ken Yeang proposes the use of vertical integrated agriculture to serve as decentralized food production units that serves and is linked with groups and communities in a city. His award winning skyscraper *Menara Mesiniaga* (built 1992) serves as an example of the integration food production with living units

In 1999 the American ecologist Dr. Dickson Despommier developed his own concept of the vertical farm focused primarily on the scaling up of soilless cultivation methods like hydroponic and aeroponic farming.

These methods require less space and water than traditional farming and is therefore ideally suited for indoor farming. Due to the limitations of natural light in multistory buildings it can be assumed that most vertical farming proposals will have to make use of artificial grow lights adding to the energy consumption of the process.

Despommier argues that these and other energy demands can be negated by including energy saving techniques, renewable energy sources and by offsetting them with reductions in transport, water and pesticide use. (DESPOMMIER, Dickson, 2008)

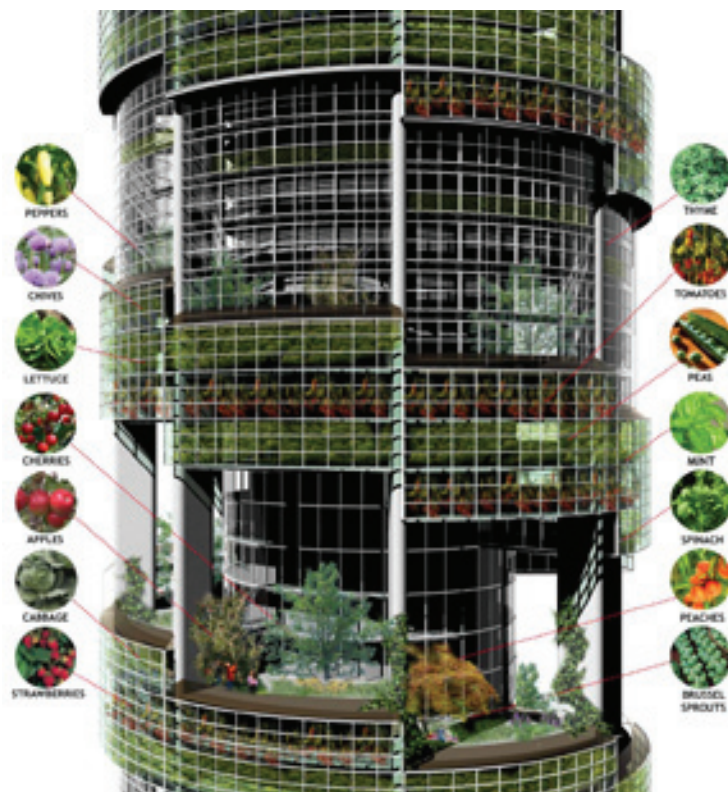

Figure 15: “The Living Skyscraper: Farming the Urban Skyline” by Blake Kurasek



BENEFITS OF VERTICAL FARMING

Despommier and Eric Ellingsen lists the benefits of vertical farming in their 2008 essay *The Vertical Farm: The sky-scraper as vehicle for a sustainable urban agriculture*. (DESPOMMIER, Dickson, 2008)

- Year-round crop production
- Eliminates agricultural runoff
- Significantly reduces use of fossil fuels (farm machines and transport of crops)
- Makes use of abandoned or unused properties
- No weather related crop failures
- Food grown organically employing chemically defined diets specific to each plant and animal species: no herbicides, pesticides, or fertilizers.
- Uses 70% less water.
- Converts black and gray water to drinking water
- Adds energy back to the grid via methane generation
- Creates new urban employment opportunities
- Fresh produce supply for urban dwellers.
- Reduces the risk of infection from agents transmitted at the agricultural interface
- Returns farmland to nature, helping to restore ecosystem functions and services
- Controls vermin by using restaurant waste for methane generation

SOILLESS FARMING

The vertical farming concept promotes the use of soilless farming methods. These include Hydroponics, Aeroponics and Drip Irrigation. (see Illustration 06)

Hydroponic and aeroponic technology has increased yield potential by more than 23 times while decreasing water usage by well over 30 times when compared to traditional farming methods. (KENYON, Stewart, 2002)

Advances in artificial growing light technologies have meant the production of low energy LED's and sulfur-microwave lamps that can now be used as alternative light sources in agricultural environments.

SOILLESS FARMING METHODS

- HYDROPONICS –Nutrient rich water flows through plant roots
- AEROPONICS –Nutrients are sprayed onto roots
- DRIP IRRIGATION - Nutrient rich water is dripped onto growth medium.



Hydroponics

Aeroponics

Drip Irrigation

Illustration 06: Soilless Farming Methods

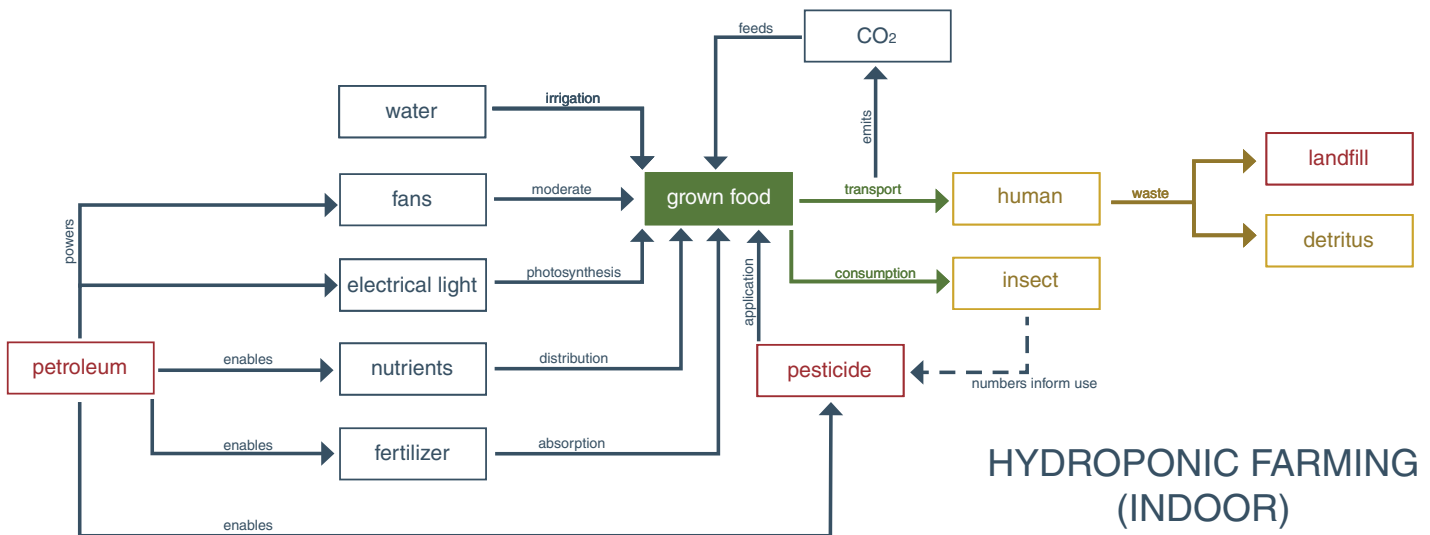

Figure 16: Hydroponic Farming system diagram (indoor).



FARMING IN A BALANCED SYSTEM

Figure 16 illustrates the resources and energy required by a hydroponic system. Even though resource usage has been reduced when compared to traditional farming this is still a linear system (cradle to grave).

By mimicking the principles found in the study of natural ecosystems it is possible to construct a food production system that requires less energy and resources and produces zero waste.

A simple example of this is a system called aquaponics. This refers to a combination of hydroponics and aquaculture (fish farming). (see Figure 17)

More than 50% of the waste produced by fish is in the form of ammonia, secreted through the gills and in the urine. The remainder of the waste is excreted as faecal matter, undergoes a process called mineralization which occurs when Heterotrophic bacteria consumes fish waste, decaying plant matter and uneaten food, converting all three to ammonia and other compounds. In sufficient quantities ammonia is toxic to plant and fish. Nitrifying bacteria, which naturally live in the soil, water and air convert ammonia first to nitrite (*Nitrosomonas* bacteria) and then to nitrate (*Nitrobacter*) which the plants consume. Nitrifying bacteria will thrive in the gravel beds and in the water in the system. The plants readily take up the nitrites and nitrates in the water and, in consuming it, help to keep the water clean and safe for the fish.

The aquaponics system can be expanded to include a vermicomposting component using earthworms. Worm farms have recently become a popular addition to many gardens, balconies and kitchen in South Africa. The attraction being a easy way of disposing of biodegradable waste (food waste) without too much mess or maintenance involved.

(KENYON, Stewart, 2002)

Within the aquaponics systems the worm farm adds the additional benefit of producing feed for the fish in the form of worm larvae because the adult worms can be fed using food waste from local restaurants this system even reduces waste of external systems.

The result is a “near closed” cycle that relies on minimal external input to stay operational.

Power

Biodegradable Waste

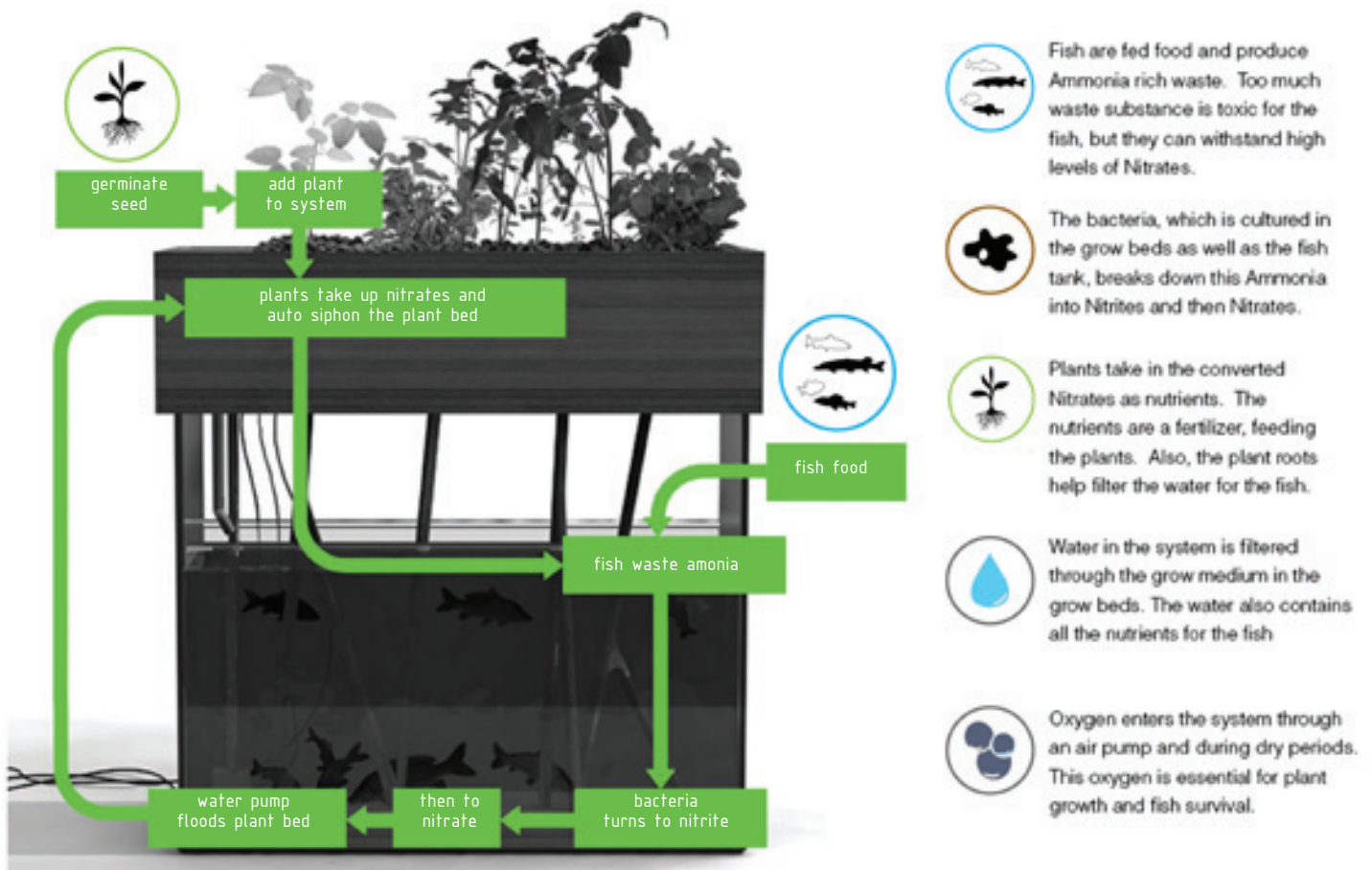

- Fish are fed food and produce Ammonia rich waste. Too much waste substance is toxic for the fish, but they can withstand high levels of Nitrates.
- The bacteria, which is cultured in the grow beds as well as the fish tank, breaks down this Ammonia into Nitrites and then Nitrates.
- Plants take in the converted Nitrates as nutrients. The nutrients are a fertilizer, feeding the plants. Also, the plant roots help filter the water for the fish.
- Water in the system is filtered through the grow medium in the grow beds. The water also contains all the nutrients for the fish
- Oxygen enters the system through an air pump and during dry periods. This oxygen is essential for plant growth and fish survival.

Figure 17: A diagrammatic explanation of aquaponics.

Figure 18: A diagrammatic explanation of a “cradle to cradle” farming system.

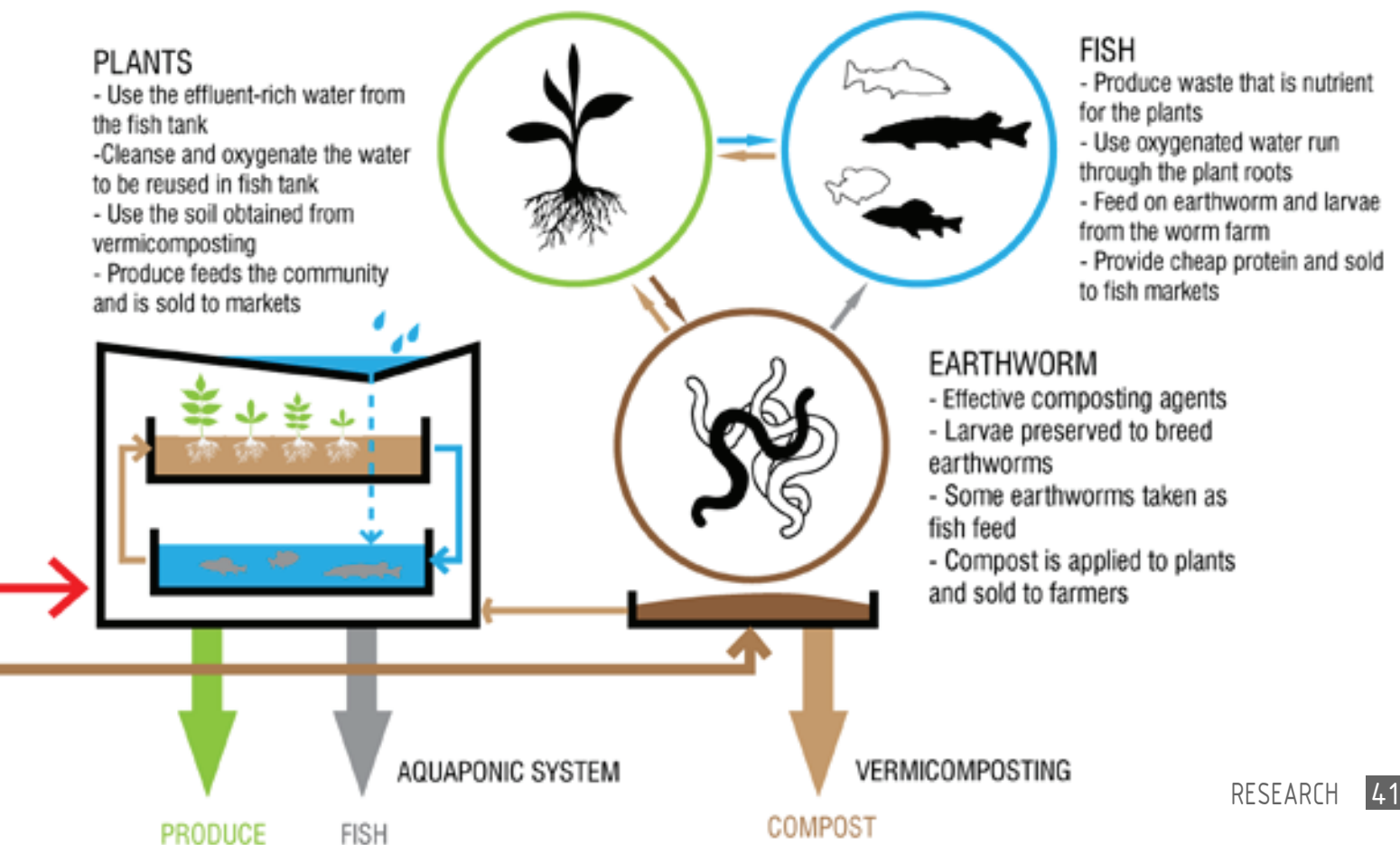

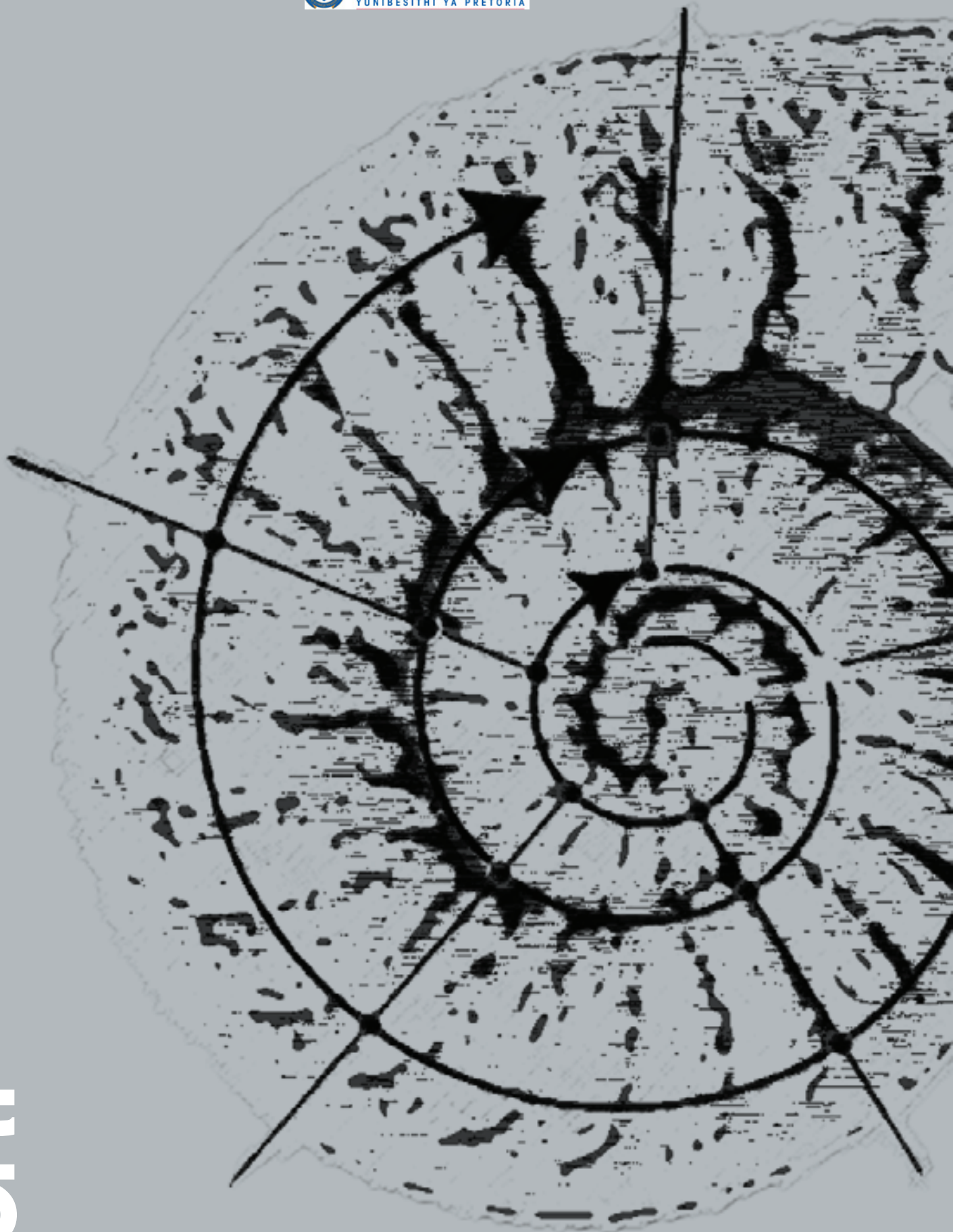

THEORY



03

CHAPTER 3 THEORY

“Human subtlety will never devise an invention more beautiful, more simple or more direct than does nature because in her inventions nothing is lacking, and nothing is superfluous. .”

- Leonardo Da Vinci

BACKGROUND

The use of principles found in nature in research and design is not a new concept, examples of biological role models can be found throughout history.

From the early investigations into the possibility of flight (see Figure 20) to invention of Velcro humans have used the characteristics of natural elements and systems to give them clues for designs.

In the twentieth century, architects and engineers repeatedly underlined the ties and relationships between architecture and nature by resuming ideas that had been known since antiquity.

Antonio Gaudi (1852-1926) developed a unique language of forms inspired by the laws of nature. Twenty years later Buckminster Fuller uses the principles found in nature to develop the intrinsic mathematics behind the geodesic dome. (McLennan 2005, p.27)

Paulo Portogesi compiled a collection of analogies called “Nature and architecture” giving a vast list of examples of overlaps between architecture and nature dating back to classical Greece.

(Porthoghesi, P: Nature and Architecture, 2000, p.10)

“It is my feeling that living things and nonliving things are dichotomous....But I feel that if all living plants and creatures were to disappear, the sun would still shine and the rain still fall. We need Nature, But Nature does not need us.”

Louis Kahn

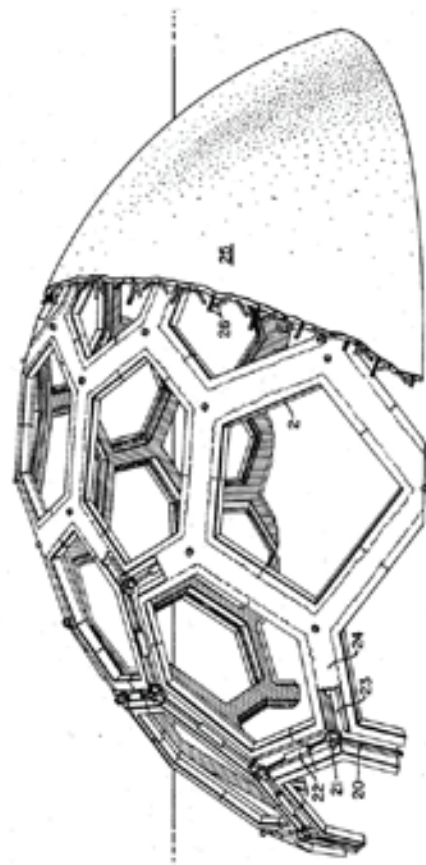

Figure 19: The geodesic dome by Buckminster Fuller

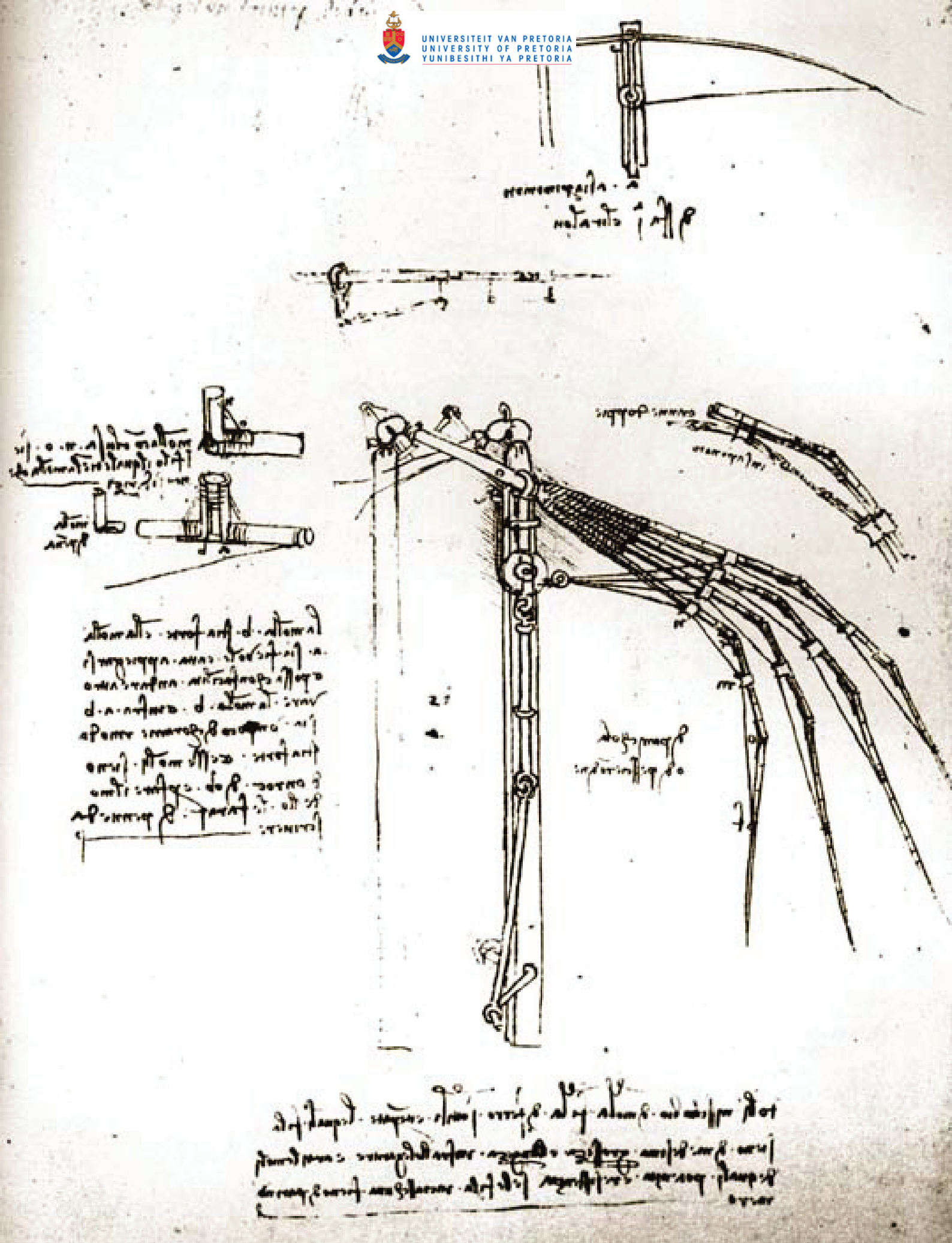

Figure 20: Studies in bird flight by Leonardo Da Vinci

CURRENT THEORY

SIMULTANEITY

Term refers to the idea that the irreconcilable can coexist in a abstract world of surreal reality as was depicted in the work of artist Salvador Dali.

The idea is that urban and natural can coexist within the city in a symbiotic relationship.

(YEANG, Ken, 2008)

BIOMIMICRY

[From the Greek bios, life, and mimesis, imitation]

Biomimicry or biomimetics is the examination of nature, its models, systems, processes, and elements to emulate or take inspiration from in order to solve human problems. (GRUBER, Petra, 2011)

NATURE AS MODEL

Biomimicry is a science that studies nature's models and then imitates or takes inspiration from these designs and processes to solve human problems, e.g. a solar cell inspired by a leaf.

NATURE AS MEASURE

Biomimicry uses an ecological standard to judge the "rightness" of our innovations. After 3.8 million years of evolution, nature has learned: what works. What is appropriate? What lasts?

NATURE AS MENTOR

Biomimicry is a new way of viewing and valuing nature. It introduces an era based not on what we can extract from the natural world, but on what we can learn from it.

As a design tool, biomimicry offers the means to achieving resilience, adaptability, and a sustainable design product. (YEANG, Ken, 2008)

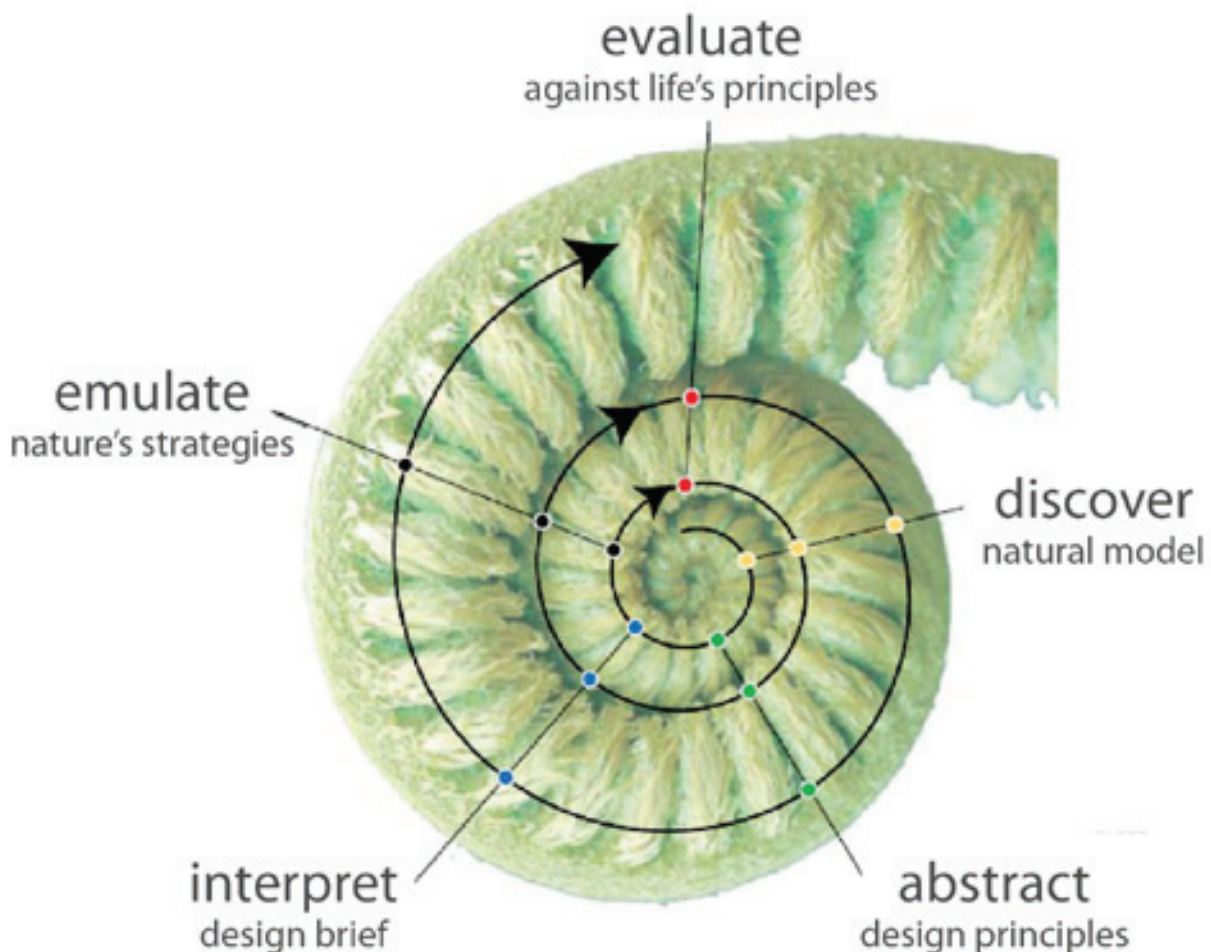

Figure 21: Biomimicry as a design tool



Figure 22: Examples of B. van der Stoep's work

AUGMENTED SPACE AND LANDSCAPES

Architecture can be used as an interactive, dynamic communication device. This engages users and viewers through surveillance, cellspace technology and information display. Robert Venturi proposes that designers use electronic iconography to inform and enrich their design, thereby connecting with modern citizens through current paradigm and media. (Venturi, 1966)

Mark Smout explores this idea of augmentation of both architecture and landscape in his work and writing, showing how buildings can be augmented not only by the addition of modern day technologies but also by being responsive to it's natural environment. (SMOUT, Mark et al., 2007)

RESPONSIVE ARCHITECTURE

The natural environment is not a static system but is constantly subject to change brought on by it's biotic and abiotic components.

The response of a given material to changes in environmental conditions presents interesting opportunities for performance-oriented design. The research, conducted by Steffen Reichert of the Department for Form Generation and Materialisation at the Hochschule für Gestaltung (HfG) in Offenbach, Germany, explores the possibility of utilising the dimensional changes of wood induced by changes in relative humidity in the environment. The project was aimed at developing a surface structure that adapts the porosity of its skin, and related cross-ventilation, in response to relative humidity without the need for any mechanical control devices. Here the response is triggered by the changes in moisture content of the material and actuated through related shape changes in a material element, which affects the structure's degree of porosity.

(HENSEL, Michael and Menges, Achim, 2008)

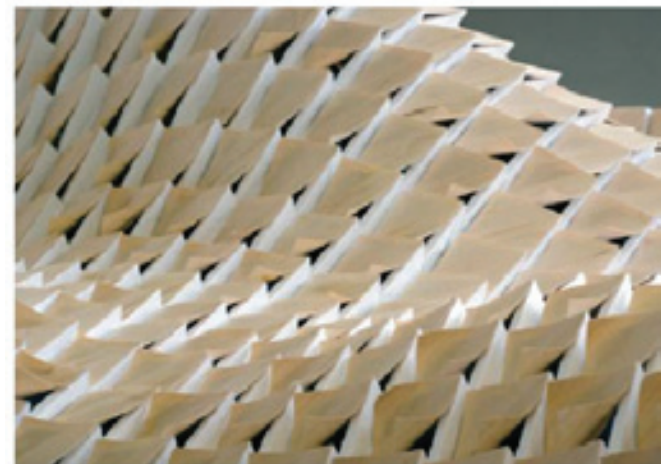
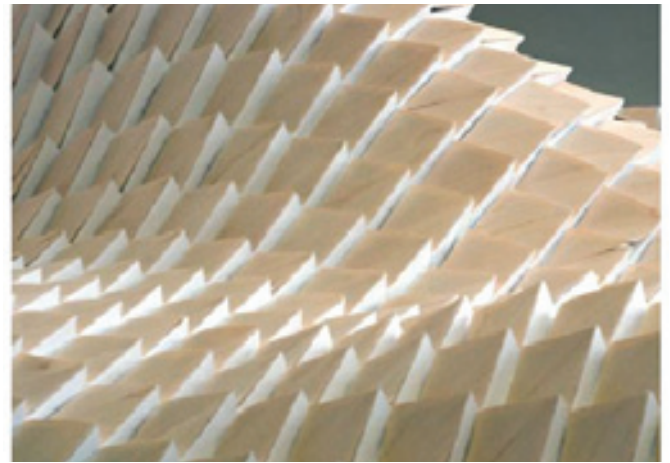

Figure 23: Responsive surface structures by Steffen Reichert

LANDSCAPE AS A METAPHOR

Jorgen Dehs describes the current acknowledgement of the word “landscape” as not simply a geographical term but as a metaphor:

“We have interest in landscape when we feel the need to stretch our eyes. Along with this common understanding - and probably because of it - the term landscape enjoys a comprehensive career as a metaphor... Every chaotic totality is assembled into unity as soon as it is labelled a landscape. The term “urban landscape” sheds a redeeming glow upon even the most dejected neighbourhood; “industrial landscape” transforms any romping ground for the ravages of industry into an object of aesthetic sensibility.”

(Smout et al., 2007: 6)

THE ECONOMY OF CITIES

Jane Jacobs states in her book *The Economy of Cities* that cities are the primary drivers of economic development. Her main argument is that explosive economic growth derives from urban import replacement. Import replacement is when a city begins to locally produce goods which it formerly imported, e.g., Tokyo bicycle factories replacing Tokyo bicycle importers in the 1800s. Jacobs claims that import replacement builds up local infrastructure, skills, and production. Jacobs also claims that the increased produce is exported to other cities, giving those other cities a new opportunity to engage in import replacement, thus producing a positive cycle of growth.

In the second part of the book, Jacobs argues that cities preceded agriculture. She argues that in cities trade in wild animals and grains allowed for the initial division of labour necessary for the discovery of husbandry and agriculture; these discoveries then moved out of the city due to land competition.

GENERAL DESIGN STRATEGIES

ECO-DESIGN PRINCIPLES

Ken Yeang gives the following general premises and clear strategies for achieving sustainable, benign and seamless environmental integration:

- Interrogate Design Premise
- Determine level of environmental integration achievable in design
- Evaluate the ecological history of the site
- Design to integrate inorganic building mass with biomass.
- Design to Improve existing, and create new ecological linkages
- Design to reduce heat-island effect
- Design to reduce transport impact
- Design for improved and appropriate internal comfort levels. (Passive, Mixed-mode and Full- Mode)
- Design for optimal internal integration of biomass.
- Design for water conservation, recycling, harvesting
- Design for Food Production.
- Design for minimal waste during material life cycle.
- Design for Vertical integration.
- Design to reduce light and noise pollution.
- Design energy flow to reduce use of nonrenewable energy.
- Design to reduce pollution and waste.

(YEANG, Ken, 2008)



CONTEXT

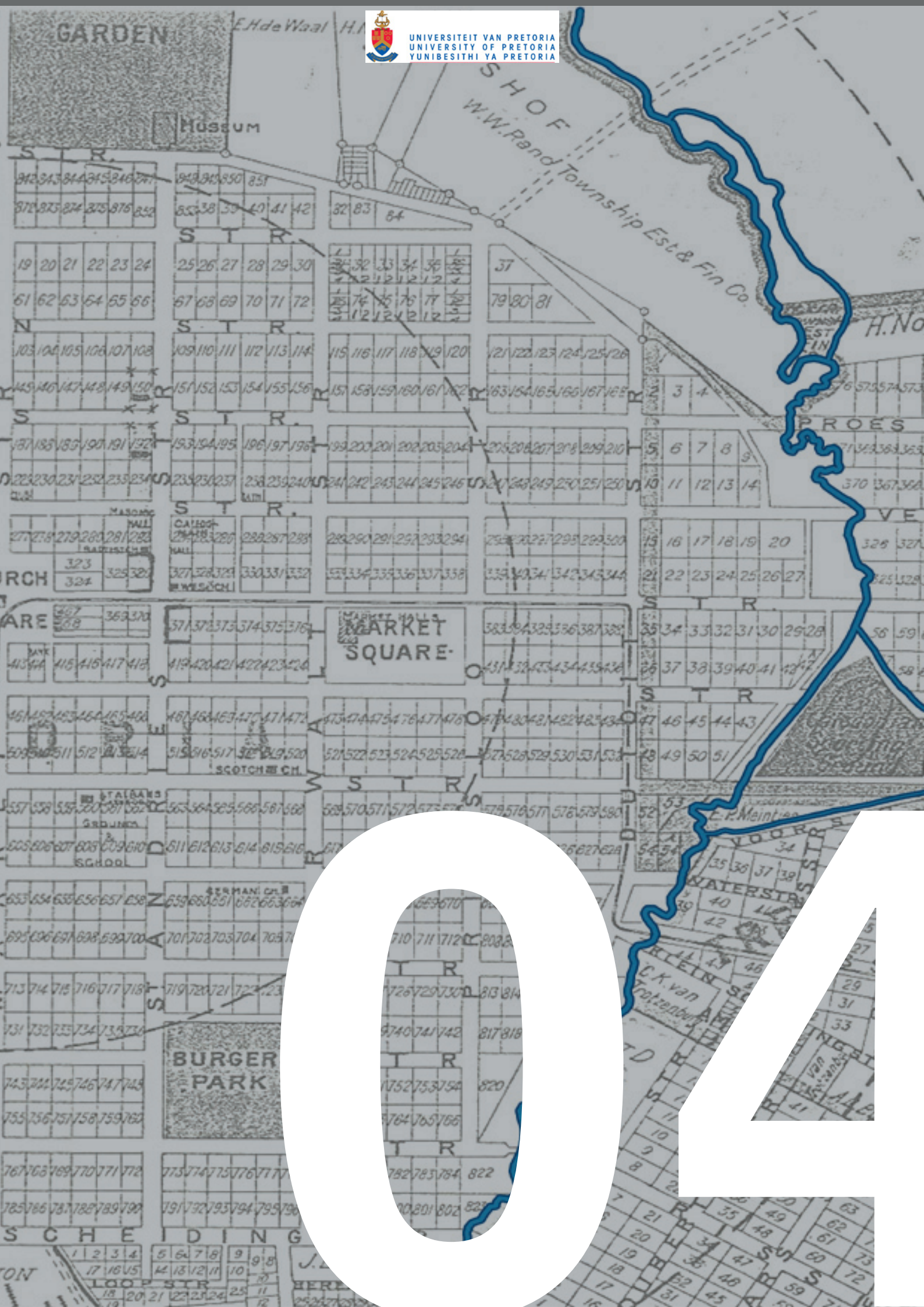

CHAPTER 4 CONTEXT

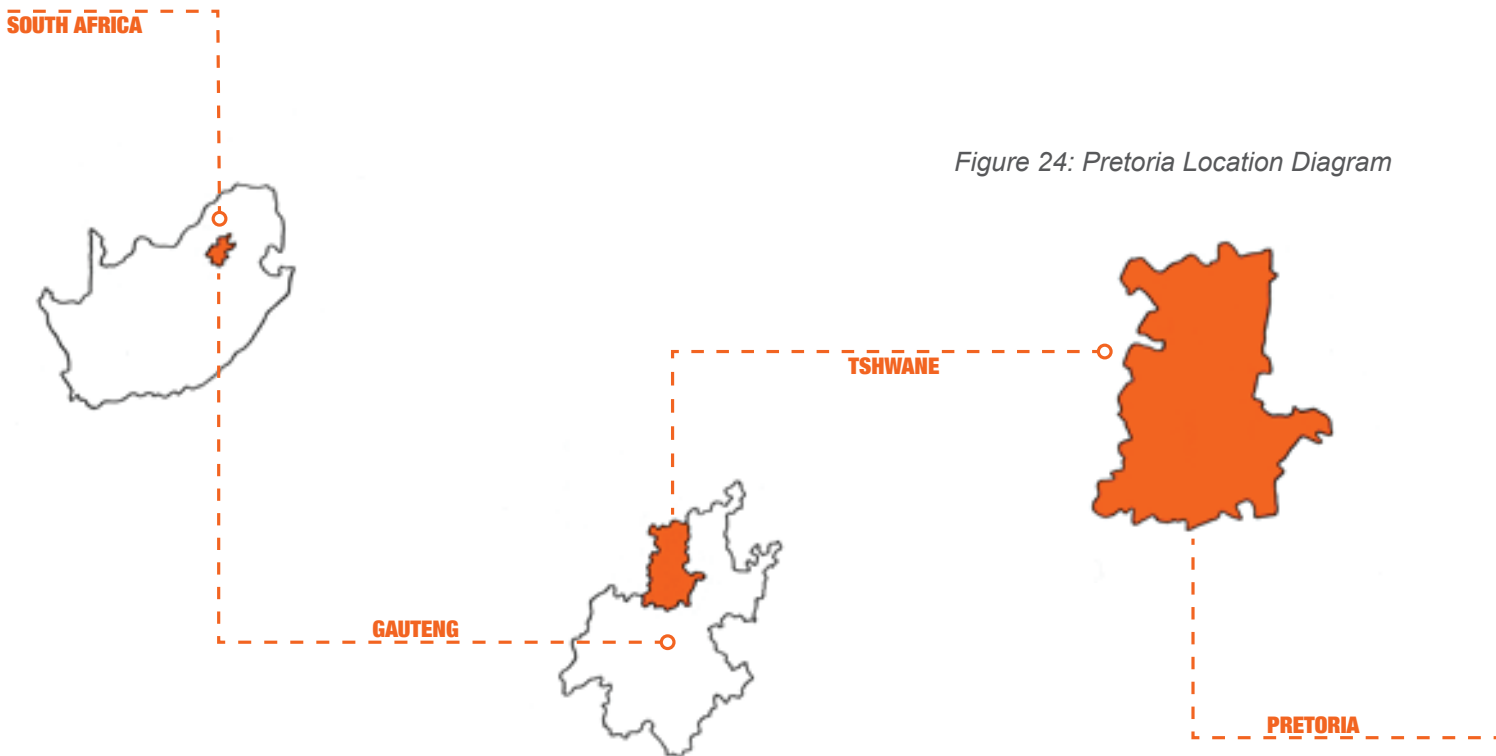

Figure 24: Pretoria Location Diagram

CONTEXTUAL PROBLEM

The site is located on a cross roads between the three main organisational elements of the city. Where these elements meet the “rhythm” of the city is broken and planning of “urban island” created by these intersections become problematic.

“Urban islands” can be defined as sites that have urban form, access and edge condition that makes integration into the greater urban fabric difficult.

The site is one example of such an “urban island”, creating indeterminate spaces (lacking definite function) in its immediate proximity.

The site suffers from poor edge response and access to the natural river edge.

SITE SELECTION

The site is located between a prominent (yet seemingly forgotten) natural element (the Apies river) and the urban core (historic city edge), this serves as an appropriate laboratory to explore the tension that

exists between techno-sphere and biosphere giving the designer an opportunity to address this problem.

Figure 25 indicates the location of the city within the broader context. Our site is located on the crossing of 3 linear routes / systems Church Street, Nelson Mandela Drive & the Apies River. This provides the opportunity to explore 3 strong aspects of Pretoria’s identity:

- Church Street – Historic Identity: linking site with Church Square & Union Buildings
- Nelson Mandela Drive – Modern City Identity – New road system linking site with freedom park development.
- Apies River – Natural Heritage: Opportunity to expose strong natural backbone of the city.

Site is located on a threshold between two spatial systems (identities): CBD & Arcadia providing an opportunity to define transition or a gateway into the city.



Figure 25: Site Location Diagram

INTRODUCTION

THE CITY AND TWO RIVERS

BREAKING WITH RHYTHM

The site and context investigation will focus on the elements in the context that have a direct impact on the contextual problems.

The research and analysis will therefore start with a short discussion of the broader context and history of the Pretoria CBD followed by an analysis of the three organisational elements of the city, the orthogonal grid, ring road and river system.

All three these elements form edges to the chosen site, providing very defined contextual elements to respond to.



Figure 26: Site Location, Macro Scale



PRETORIA CITY

HISTORY

The historic city of Pretoria dates back to the early 1850s when it was established by the ruling Boer community as the capital of their Zuid-Afrikaansche Republiek. The area's historic significance however dates back to many years before to this event. (BRT, 2009, p.32)

Traces of the earliest human settlements have been found in this area. Archaeologists have found stone tools probably used by Homo ergaster during the earlier Stone Age near the zoo that could be as old as a 100 000 years. Iron Age implements have also been discovered dating back to between AD 550 and 700. (BRT, 2009, p.32)

Before the arrival of the Boer trekkers the Pretoria region was occupied by the nguni-speaking Southern Ndebele people who had inhabited these lands for about 300 to 400 years. The area was also briefly occupied by Mzilikazi and his amaKhumalo during the 1820s before eventually migrating to Zimbabwe to establish the Matabele. (WELSH, F., 2000, p.146)

The two great migrations of South Africa: The Great Trek and The Mfecane (or Difeqane) led to the eventual settlement of Boer trekkers in this area and the displacement of the earlier bantu communities. (WELSH, F., 2000, p.147)

The Mfecane forced the original nguni-speaking settlers out of this river valley as Mzilikazi and his raiders moved through the villages forcing them to abandon their homes or be absorbed into his regiments. (WELSH, F., 2000, p.136)

The arrival of the boer settlers (1841) in the area resulted in a series of confrontations between Mzilikazi and the Voortrekkers, who suffered great loss of human life and livestock. General Hendrik Potgieter eventually managed to force Mzilikazi to flee across the Limpopo creating a power vacuum that allowed the Voortrekkers to take control over the area. (GREYLING, P J, 2000)

A later trek under the leadership of Andries Pretorius also settled in the area. Marthinus Wessels Pretorius (son of Andries Pretorius) purchased two farms (Elandpoort and Koedoespoort) and founded a town in 1853 which later became known as Pretoria. The efforts of Pretorius led to the British granting the ZAR independence in 1852. (WELSH, F., 2000, p.221)

Following the discovery of gold in the Witwatersrand (1886) the city (and region) went through a period of British colonial rule leading to the first and second Anglo Boer Wars. This also led to a great increase in population and the transformation of a once rural community into a urban society. (GREYLING, P J, 2000)

The city grew along an orthogonal grid system that emanated from the central square (Church Square) and cross roads where the church could be found. This grid has proven to be one of the most lasting historic features of the city still clearly legible today. (CORTEN, J.P. and van Dun, P., 2009, p.13)

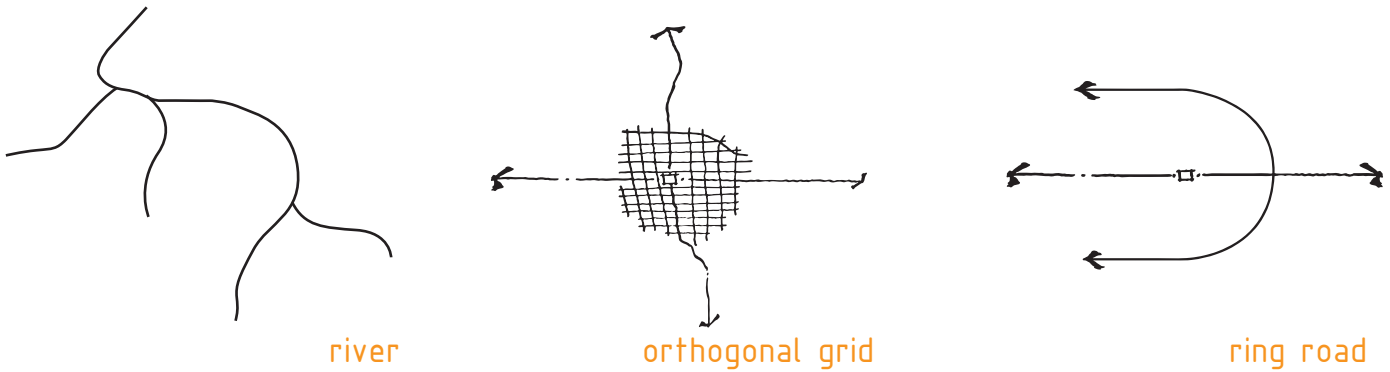

Figure 27: Pretoria city organizing elements

STUDY AREA

NATURAL HERITAGE: APIES RIVER

The Apies River is one of Tshwane's major natural resources, but has been neglected and destroyed over a number of years. (Gerald Garner)

Based on the vision from the city of Tshwane, the Apies River was to be developed as an accessible, safe and pleasant public open space from Fountains Valley to Bon Accord Dam. Even though the framework for this vision has been in place since 1999, very little has been done to re-instate the Apies river as a accessible natural element.

The extent of the Apies river system is far reaching connecting the CBD with the greater metropolitan area. The Apies River begins just south of the quartzite ridges south of Pretoria and flows north to join the Pienaars River, in an area of plains and lowlands, which together flow into the Crocodile River. (Department of Water Affairs, 2011)

Some tributaries join the Apies River from the Wonderboom/Sinoville (east) area (Wonderboom Spruit) and Pretoria North/Akasia/Rosslyn (west) area (Boepens Spruit) at or before entering the Bon Accord Dam. (Department of Water Affairs, 2011)

The Apies River drains the Pretoria CBD, parts of the central-eastern suburbs and most of the western Pretoria industrial and urban areas. Increased high surface water runoff is channelled into the Apies River from these areas. (Department of Water Affairs, 2011)

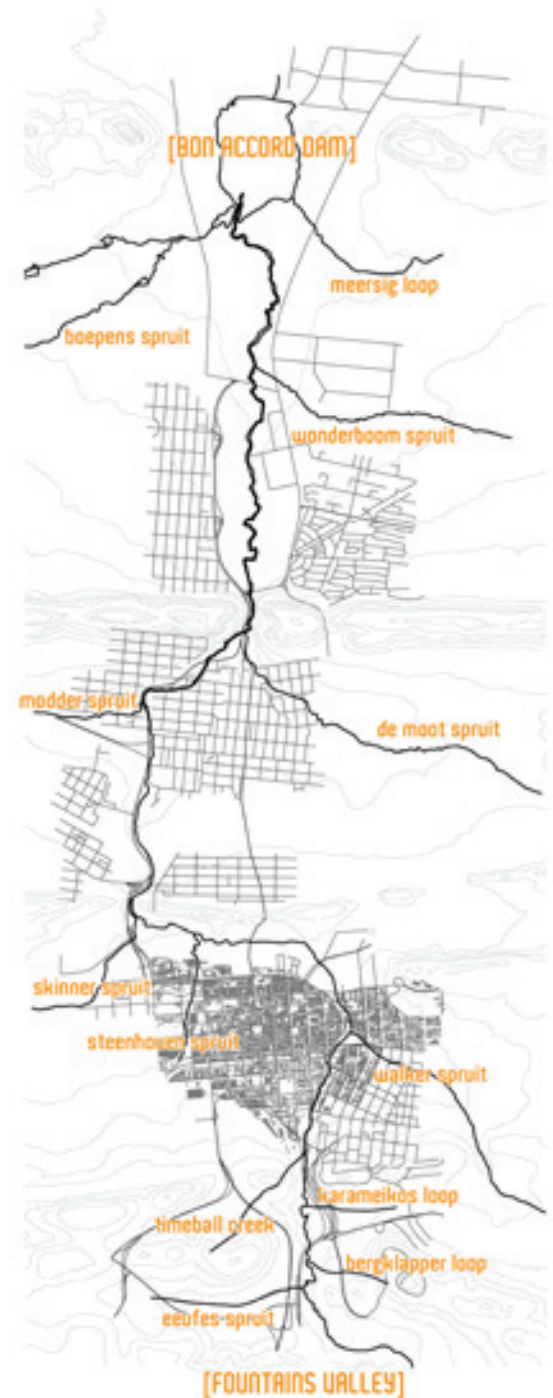

Figure 28: Apies River system

The heritage and cultural importance of the Apies river is as far reaching. The river is also known as the Apiesrivier in Afrikaans (in which “Apies” means “small monkeys”), and is traditionally also called the Tshwane River by the indigenous peoples. Pretoria itself also came to be referred to as Tshwane by the African communities, after the river, and that name is currently the centre of a controversial, politically driven attempt to rename the city itself to Tshwane. (Bolsman, 2001: 170)

Nguni-speaking settlers, who became known as the Ndebele, are thought to have been the first people to recognise the suitability of the Apies River valley as a place to put down roots. They named the river after one of the chiefs, Tshwane (“little ape”), which was later translated into the Afrikaans “Apies.” (Bolsman, 2001: 170)

The Mamelodi township also draws its name from the name of the river, with the full name being “Mamelodi ya Tshwane,” meaning “Whistler of the Apies River”; a nickname given to Paul Kruger.

In 1909 the Apies River is transformed into a raging torrent after a heavy rainstorm resulting in huge damage of property and loss of life.

Work is started on the canalisation of the river beginning at Proes Street and working upwards to the south. Work lasted until the late 1930s. (VAN DER WAAL, G M, 1998)

The process of canalization resulted in an unattractive, dangerous river edge with little resemblance to the natural river reach of the past. (VAN DER WAAL, G M, 1998)



Figure 29: Apies River with Meintjies Kop, Henk Pierneef



Figure 30: Pretoria in 1872, Thomas Baines



Figure 31: Canalization of the Apies River, Pieter Wenning

CULTURAL HERITAGE : ORTHOGONAL GRID

The grid is a city ordering device that was used in the 19th century in South Africa during the settlement of towns, the Roman *urbs quadrata*, where the town is quartered by the intersecting cross of kardo and decumanus, symbolising a stable rational cosmos - an order needed for an effective and controlled settlement. The regular town grid symbolised rational order and republican democracy and was in direct contrast to the natural world which was seen as a threat which had to be tamed - boundaries for civilized human habitation were made.

The urban grid was ordered around the church at the crossing of Church and Paul Kruger Streets and related both to the cosmic order (the universal model of the city as “mandala”) and to the “poorte” in the mountain ranges surrounding Pretoria (repeated at the later Church Square). This rational orthogonal system was combined with the demands of the open furrow water supply system originating at Fountains Valley. (Meiring, A.L. 1955: 151)

Figure 32: The first Map of Pretoria

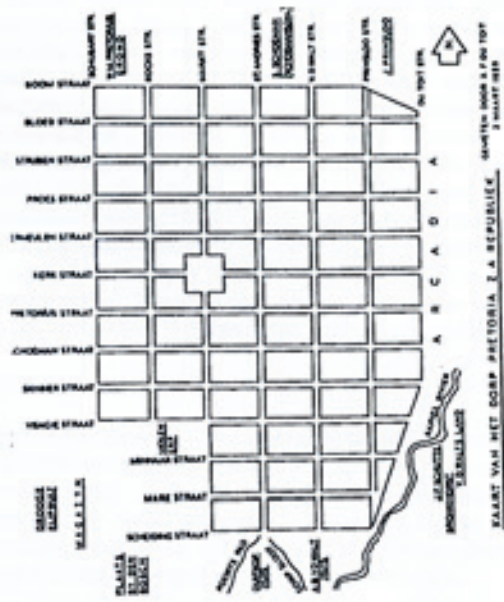

Figure 33: The Roman *urbs quadrata*



Figure 34: Figure ground of current day Pretoria, grid form still visible.

RING ROAD: NELSON MANDELA DRIVE

What is currently known as Nelson Mandela Drive forms part of a larger Ring Road scheme that dates back to 1967. (JORDAAN, Gerrit, 2002)

The road was originally planned from the fountains road system in the South to the Soutpansberg road in the North. The main purpose of this road being to provide additional carrying capacity (additional 6500 cars per hour) in a North-South direction. It was thought that this would help alleviate congestion in Prinsloo, Beatrix, Van Der Walt and Hamilton street. (JORDAAN, Gerrit, 2002)

The plan was for a total of 13 roads to feed into the 2.6km dual carriage road, extending around the city centre in a ring road configuration. The original freeway connections were later changed to “Super Streets” with at-grade intersections. The idea being that this would alleviate traffic congestion by allowing fast moving traffic to move around the cbd on route to destinations North-South or East-west of the city itself.

Part of management scheme included restricting residential developments along the edges of these main routes. The land use along the new road edges was therefore changed to mainly commercial activity. (JORDAAN, Gerrit, 2002)

As can be seen on Figure 29 below the original intended ring road scheme was never fully implemented however some of the main routes including Skinner Street and Nelson Mandela Drive were constructed.

The alignment of the road closely follows that of the Apies river giving it an organic shape. The presence of large numbers of fast moving automobiles along this mobility route does not make for a pedestrian friendly environment. Access to sites directly from Nelson Mandela drive is also made difficult by the speed of traffic that it carries.

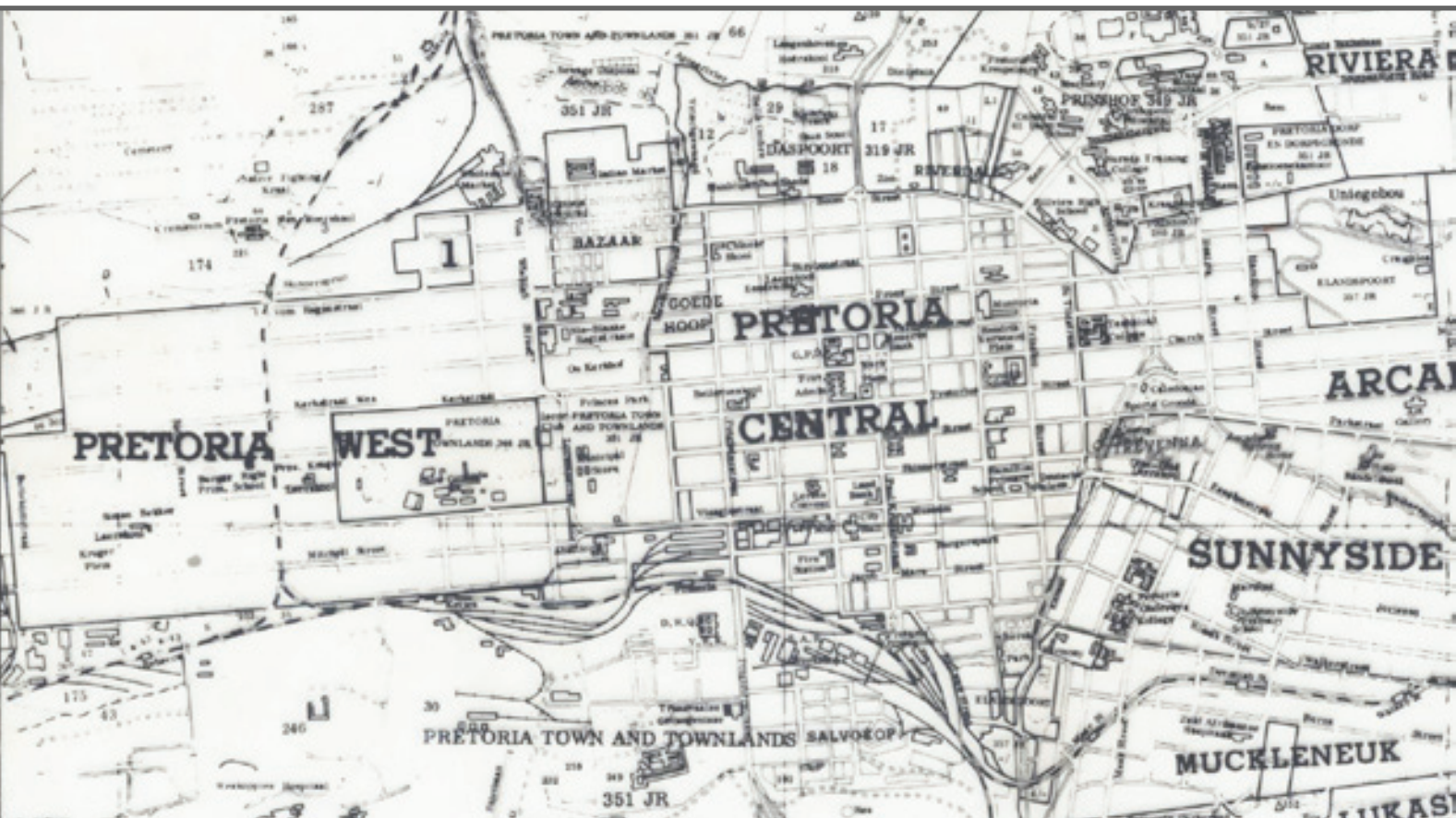
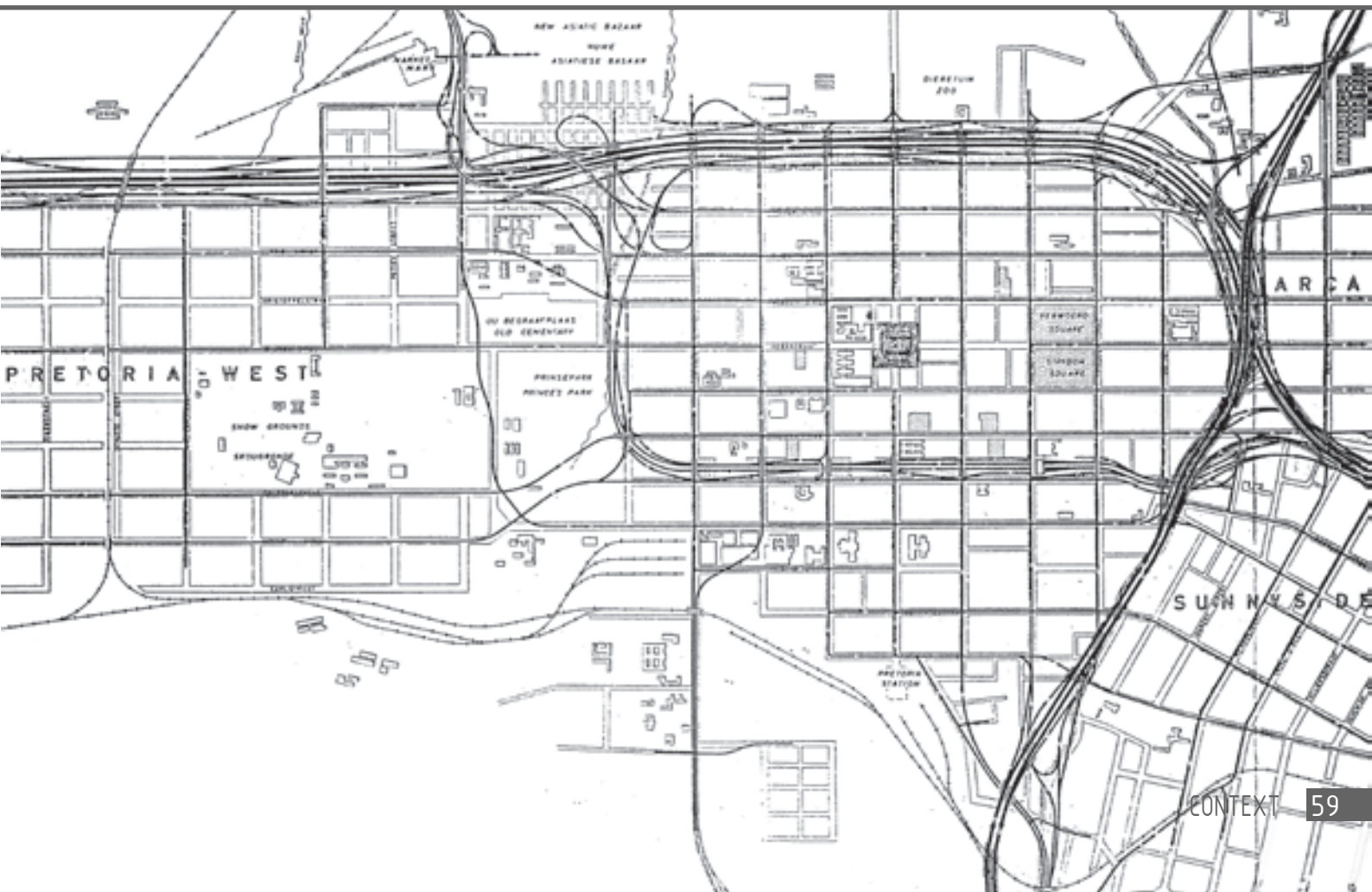

Figure 35: Pretoria Road Map (Before Nelson Mandela Drive)



Figure 36: Photo: Automotive dominated character of Nelson Mandela Drive.



THE CITY AND RIVER IN TENSION

The diagram illustrates how the development of Pretoria from a small settlement into a Modern City impacted on the edge condition of the Apies river resulting in tension between the urban and natural elements.

First Voortrekkers (such as the families of Cornelis and Lukas Bronkhorst and Andries van der Walt) settled along the Apies River. The city begins as a small rural settlement focused mainly on agricultural activities. (VAN DER WAAL, G M, 1998)

As the city expanded it came into contact with its natural boundaries being the ridges to the north and south and the river system (the Apies river and Steenhoven Spruit). In the 1970s the first large plots were established on the banks of the Apies River, east of Du Toit Street and north of Boom Street. (VAN DER WAAL, G M, 1998)

Roads were constructed to follow natural "Poorts" through the ridges and bridges and drifts were used to cross the water ways.

The development pressures and human engineering of the natural river system through bridge construction and canalization eventually changes the river bed from a natural threshold into a dangerous barrier.

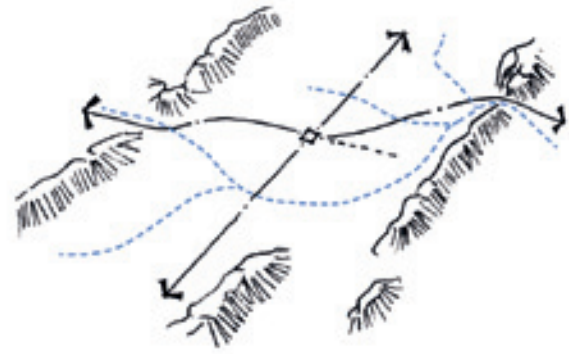

1830 - 1840

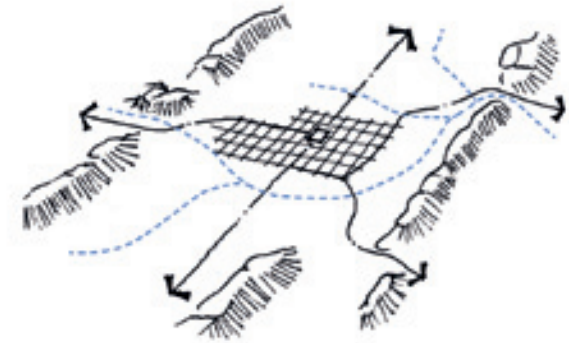

1850s

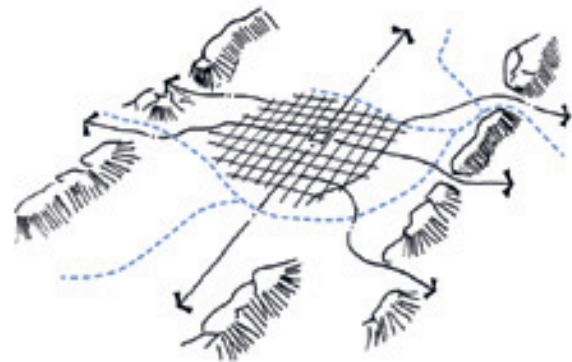

1870-1880's

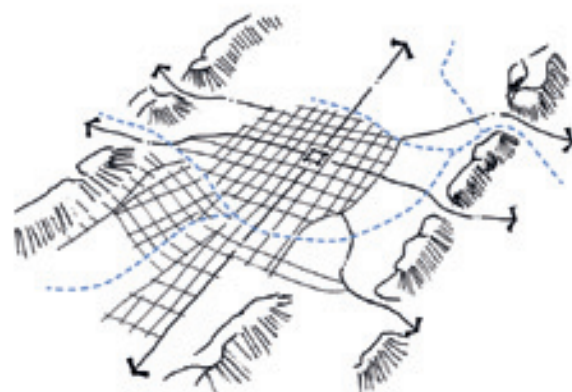

CITY DEVELOPMENT

RIVER THRESHOLD

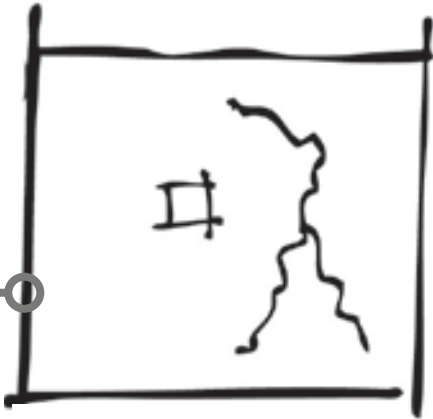

Rural Village:
Settlement in Nature



natural threshold

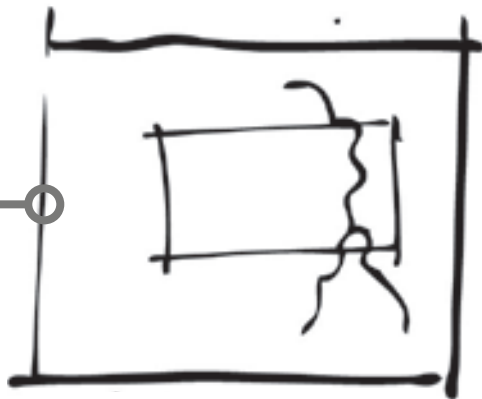

Historic City:
Nature in city limits.



development pressure

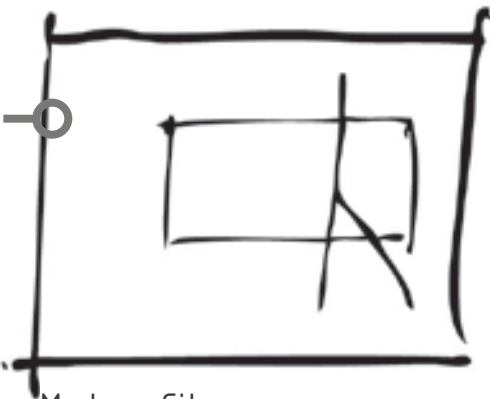

Modern City:
Man engineers nature.



resulting barrier

Figure 37: City Development diagram showing impact on river threshold.



UNIVERSITEIT VAN PRETORIA
UNIVERSITY OF PRETORIA
YUNIBESITHI YA PRETORIA

FRAMEWORK





UNIVERSITEIT VAN PRETORIA
UNIVERSITY OF PRETORIA
YUNIBESITHI YA PRETORIA



05



CHAPTER 5 FRAMEWORK

5.1 MACRO SCALE

An initial study of the broader context was undertaken by the inner city research groups.

This entailed the study of existing frameworks that could impact on both the individual study areas as well as the CBD as a whole.

The 7 precincts outlined in the “Re Kgabisa Tshwane” Framework was used to divide the group into smaller focus areas where a more detailed proposal for each would be undertaken.

A set of broad guidelines called React & Reinterpret (Group Framework) was agreed upon to ensure that each individual focus group would be working towards a single vision for the inner city area.

REACT & REINTERPRET

(GROUP FRAMEWORK)

The proposed group framework is based on the concept of reacting to current urban issues by reinterpreting the existing context.

FRAMEWORK MANIFESTO:

- Superimpose a reactive layer on the city.
- Use the existing city as a canvas for reactive design resolutions.
- Not imposing ideology but rather proposing new possibilities,
- Reacting to contextual issues such as:
 - *In-between Conditions*
 - *Stylistic homogeneity/insularity*
 - *Indeterminate space*
 - *Legibility | Identity (cohesion in the detailing | Subtle ordering of Chaos*
 - *Planning precedents (what came before e.g. “Ceremonial” boulevards)*
 - *Pedestrian hazards*
 - *Vehicle Dominance on Urban Space*

REACTIVE & INTERPRETATIVE VEHICLES:

- **INTERFACES** (soft architecture to address in-between conditions)
- **LEGIBILITY DEVICES** (Subtle detailing of street surface, edges)
- **INHERENT CULTURES** (bridges/underpasses/arcades/raised city floor to address unfriendly side walk conditions)

REACTIVE GUIDELINES:

- Address In-between conditions with Interface Solutions
- Create program mix to improve diversity.
- Address dysfunctional Edges
- Priority on Indeterminate Space
- Legibility | Identity (cohesion in the detailing | Subtle ordering of Chaos
- Strengthen inherent cultures/designs
- Subtle precinct branding/language (tectonic coding, detailing interfaces,)
- Gateway Installations along main corridors

DETAILED REACTIONS:

EDGES (as dysfunctional space)

- Convert Barriers into Interfaces
- Define Edge Continuity

VEHICULAR SPACE (as dysfunctional space)

- Apply opportunistic reprogramming of vehicular space
- Consolidate cars in structures | Free up potential pedestrian space

IN-BETWEEN SPACE

(Can be any, edges fall into this category)

- Address with Interface solution

SERVICE SPACE

Services/unsightly spaces become legibility devices (given a reactive purpose & reacting to unsightly results of negative ideology e.g. bright ORANGE HVAC units.



Figure 38: Individual group study areas.

EXISTING FRAMEWORKS

The inner city currently has a number of plans, frameworks and management schemes in place to help address various aspects of its growth.

The following plans have specifically been selected for study as they impact directly on the chosen study area:

- Inner City Development Strategy
- Nelson Mandela Development Corridor
- “Re Kgabisa Tshwane” Framework
- Tshwane Crossing (Kopanong)
- Apies River Urban Design Framework
- Tshwane Inner City Local Open Space Plan

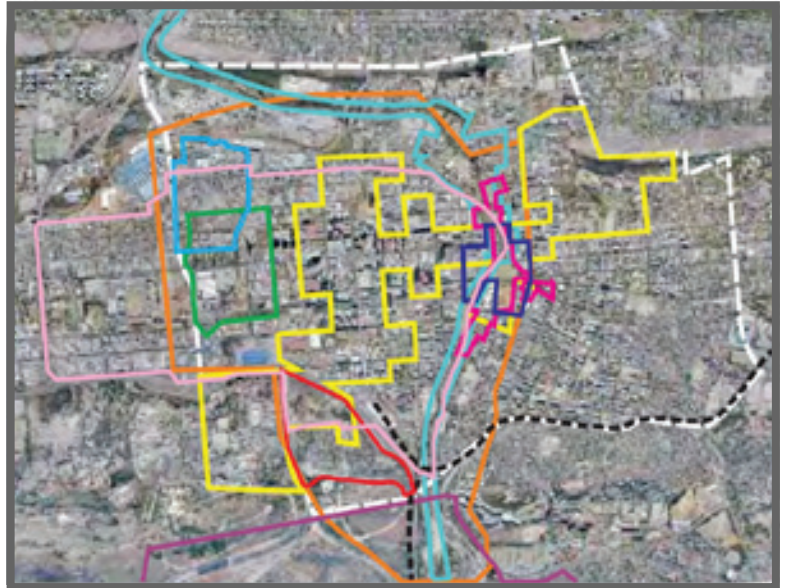

Figure 39: Overlay of existing inner city frameworks.

INNER CITY DEVELOPMENT STRATEGY

(2004)

AIM:

To make proposals for the (re)structuring and (re)positioning of the Inner City within the City of Tshwane.

10 building blocks are proposed with strong relevance to image building. The building blocks include: (1) Announcing the destination; (2) Defining the capital precinct; (3) Pan-African Parliament; (4) Nelson Mandela Corridor; (5) Tshwane Crossing; (6) Apies River Promenade; (7) Tshwane park and residential development; (8) African Spirit; (9) Public transport; and (10) Beautification of the streetscape.

REACTION:

The chosen site is on the crossing between building blocks 1; 4; 5 and 6. This re-affirms the importance of the redevelopment of this site in the inner city context.

The proposed development of a defined gateway is noted and will be incorporated in the design resolution.



Figure 40: Inner city development strategy.

TSHWANE CROSSING (KOPANONG)

(2005)

AIM:

To consider scenarios for the redevelopment of the Apies River - Church Street crossing and the Caledonian Sports Grounds.

Three scenarios are proposed with a soft space at the and (apart from option 3) a hard space at Caledonian.

REACTION:

The change of use of the Caledonian sports fields is seen as a negative element as this facility is currently being used by local communities.

The development of neighbouring sites as public open space is preferred over this proposal.



Figure 41: Tshwane Crossing.

“RE KGABISA TSHWANE” FRAMEWORK

(2005)

AIM:

To make proposals for the development of the Inner City in terms of the Urban Renewal Programme and to enhance the public environment surrounding national departmental offices.

Proposed 7 precincts with a system of hard and soft spaces.

REACTION:

The use of both national and local government as client to fund the improvement of the public environment will be investigated for use in current project.



Figure 42: Re Kgabisa Tshwane Framework.

NELSON MANDELA DEVELOPMENT CORRIDOR

(2005)

AIM:

To propose a framework that could guide development along Nelson Mandela Drive.

Proposed precincts with different characteristics, a system of hard and soft open spaces and pedestrian circulation along the Apies River.

REACTION:

There are concerns about the proposed use of sites along the Apies river specifically in the study area.



Figure 43: Nelson Mandela Development Corridor

APIES RIVER URBAN DESIGN FRAMEWORK

(1999)

AIM:

To make proposals for the development and management of the Apies River (from Fountains to Bon Accord) and adjacent development. Proposed management guidelines in terms of 4 character categories (urban, suburban, cultivated, natural)

REACTION:

The proposal to develop the Apies river edge as an continuous accessible public open space is seen as a vital component of any proposed framework.



Figure 44: Apies River Urban Design Framework

TSHWANE INNER CITY LOCAL OPEN SPACE PLAN

(2007)

AIM:

The Tshwane Inner City Local Open Space Plan (LOSP) is a detailed plan that forms part of the Tshwane Open Space Framework (TOSF). The TOSF is a 3 Volume document compiled in 2006 by the City of Tshwane Environmental Planning section (in association with Holm Jordaan Group and Strategic Environmental Focus).

The aim of the LOSP was to firstly establish an understanding of the need for and value of Open space in cities. Then a plan for the creation of additional open space as well as the management of existing open space was put forth.



Figure 45: Tshwane inner city local open space plan.

REACTION:

The importance of additional public open space in the city is acknowledged and will be supported in the proposed framework.

PUBLIC SPACE NETWORKS

A CASE FOR PUBLIC OPEN SPACE

Open Space is an essential element within cities, for ecological, socio-economic and place-making purposes. It allows natural systems, without which human beings cannot survive, to function: it purifies water, harbours plant and animal life, cleans the air and regulates the urban climate. This life-giving function of Open Spaces is the most threatened by urban development.

(Tshwane, 2006: 35)

Open Spaces are necessary investments if we are to develop and sustain a healthy community.

QUALITY AND QUANTITY OF OPEN SPACES IN TSHWANE

Tshwane has a large variety of Open Space resources from protected areas, ecological and conservation areas to recreational parks, resorts, sporting facilities, as well as cultural historical Open Spaces,

which creates the opportunity and the potential for developing a high quality environment. However, the majority of Open Spaces in Tshwane lag far behind international cities in terms of quality and quantity:

Insufficient Open Space is provided for when compared to international ratios. Across the city a ratio of 0.5ha/1000 people developed recreational Open Space is available as apposed to the required international ratio of 2.4ha/1000.

Open Spaces are not integrated within a network, to facilitate movement easy pedestrian movement between them. (Tshwane, 2006: 35)

The Apies river water margin is identified as an opportunity to develop a continuous “green lung” giving pedestrian safe passage along a “North-South” axis while connecting multiple public open spaces in a wider network.

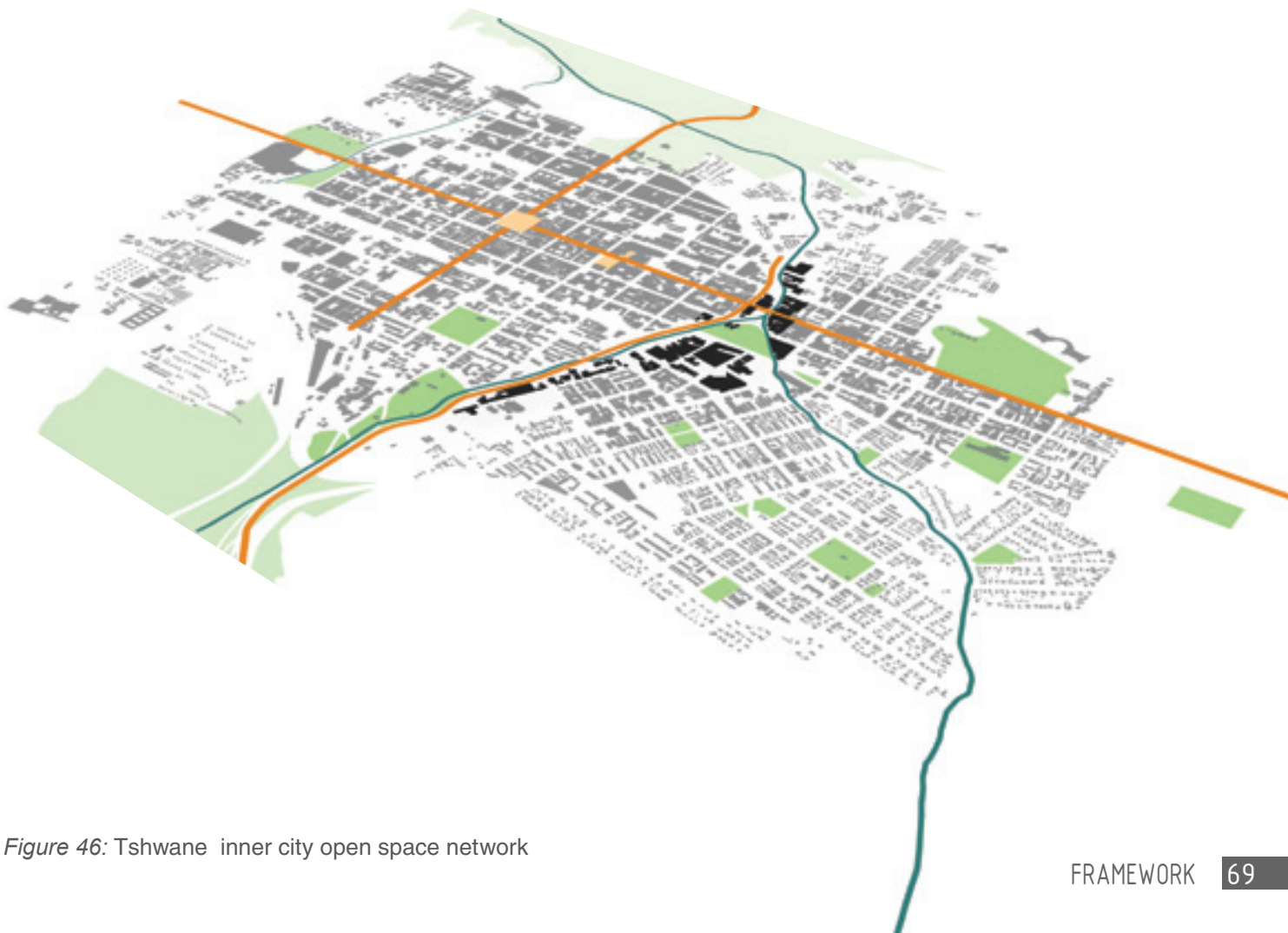

Figure 46: Tshwane inner city open space network

5.2 MESO SCALE

APIES RIVER (FOCUS AREA)

The area of the Apies river that falls within the study area has a high density of urban activity (land use, movement, transport, infrastructure, services and public amenities). (see Figure 47)

The encroachment of such dense urban fabric on the river system provides an ideal study area for the research problem.

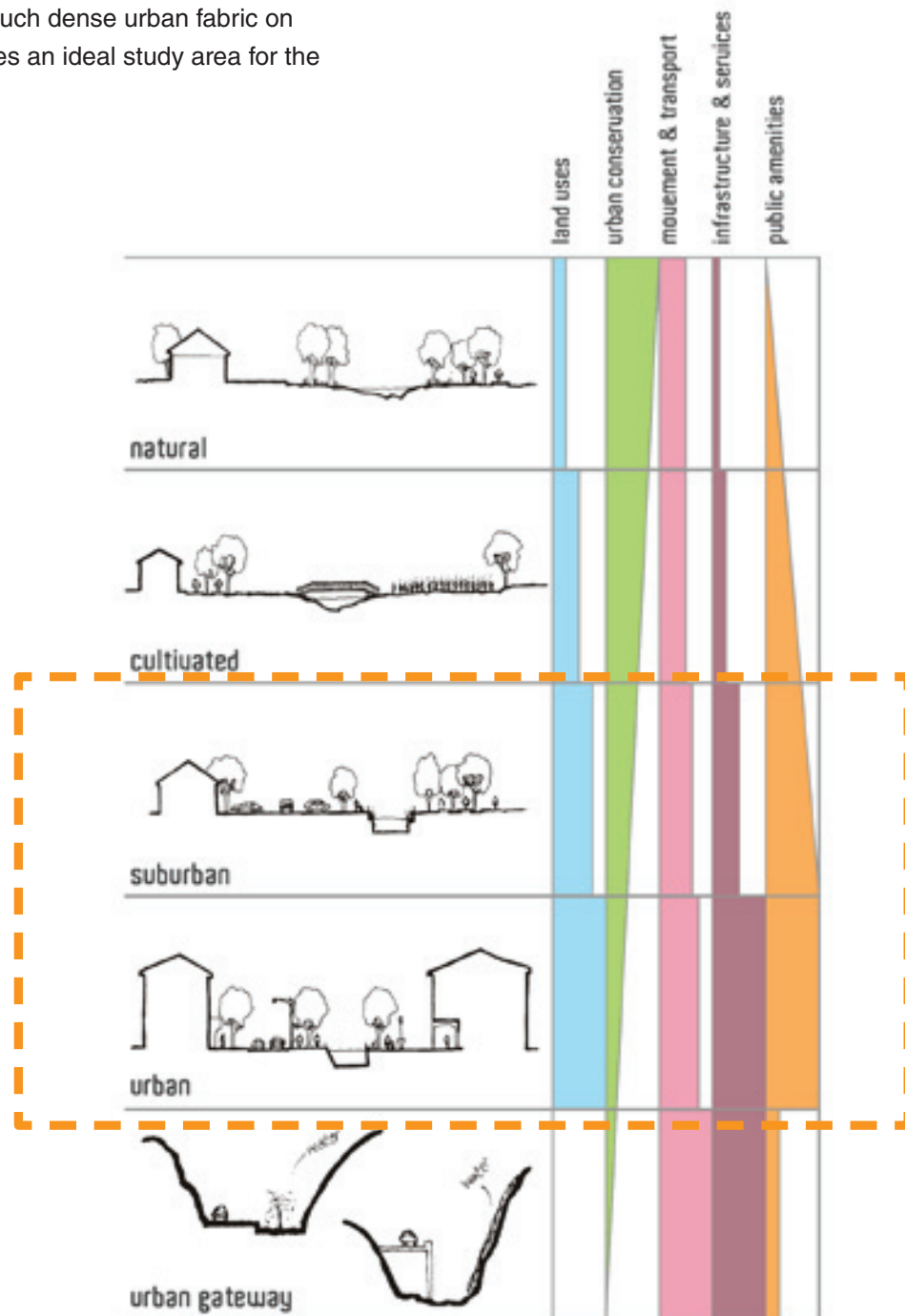

Figure 47: Character of the chosen study area.



URBAN STRIP PARK

The Proposal for the Apies river spine focuses on the development of this edge into a continuous “green lung” or linear park. The changing character of the park will be determined by the predominant usage of the surrounding area.



Figure 48: River as a urban strip park

URBAN THRESHOLD

The Apies river and Walker spruit form a natural boundary between 3 city districts: the CBD, Arcadia and Sunnyside. The redevelopment of the river edge will provide easy to cross thresholds between these areas.



Figure 49: River as a threshold between districts

OPEN SPACE NETWORK

A network of both hard and soft open spaces are identified within then inner city and surrounding area. These areas will be connected to the linear river park via a series of pedestrian routes to create a continuous open space network.



Figure 50: The river connecting the open space network.

HERITAGE NODES

The river system has numerous elements of heritage values, this includes the river itself, the palm trees on the river bank, the Caledonian sports fields and the numerous historic bridges still in use today.

These heritage nodes provide key points for future development due to their cultural significance.



CLIMATIC DATA

LOCALITY

Pretoria is located at 25°44'S; 28°11'E with an altitude of 1330m above sea level.

CLIMATIC DATA

Pretoria falls within the temperate interior climatic zone of South Africa as can be seen on Figure. Midday temperatures range from 27.5°C in summer to 18.3°C during winter.

On average humidity is 59% however it is known to exceed 80% for very short periods during the rainy season. (South African Weather Service 2009)

Pretoria gets an average rainfall of approximately 573mm per year, most of it occurring during summer months. Figure 53 illustrates monthly averages with the maximum 110mm in January and no rain in June.

The predominant wind direction changes from north-east in summer to south west in winter. The year average comes mostly from a North easterly direction however wind speeds in Pretoria are relatively low when compared to other cities in South Africa.

(South African Weather Service 2009)

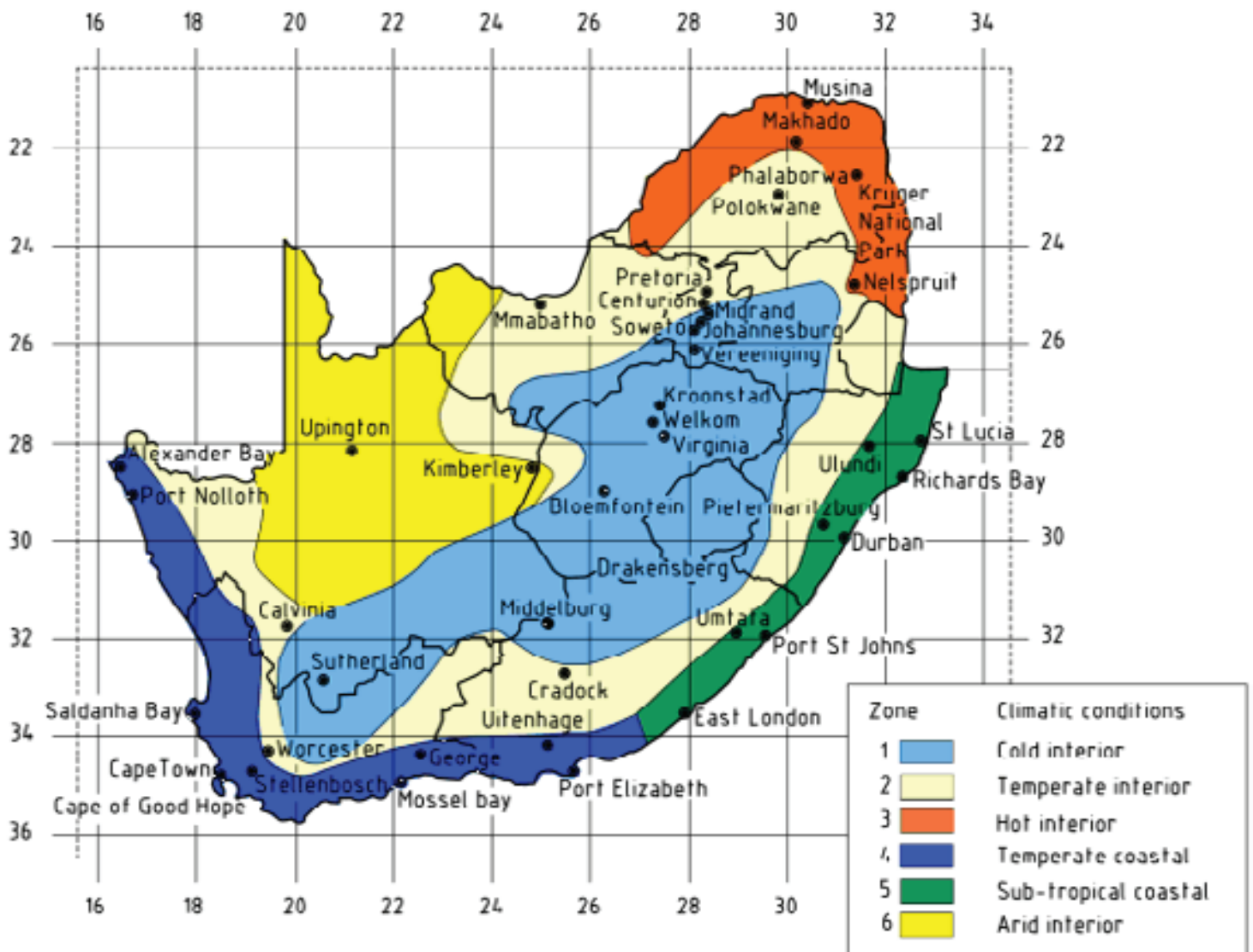

Figure 51: South Africa Climatic Zones as per SANS 204

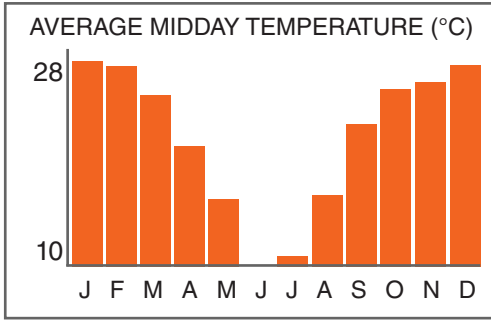

Figure 52: Average Midday Temp.

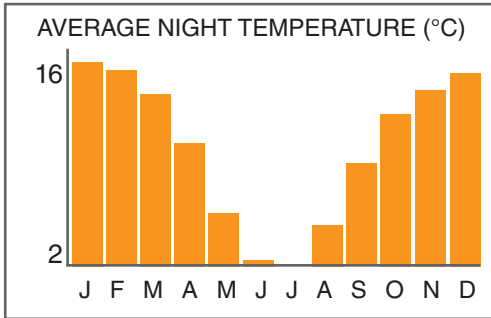

Figure 56: Average Night Temp.

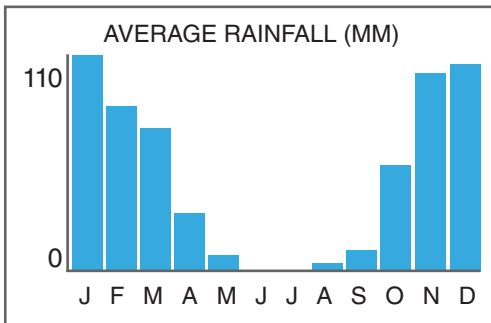

Figure 53: Average Rainfall.

PERIOD 2003 - 2008
TIME 00:00 - 24:00

Wind Speed (km/h)

- 05 - 25
- 25 - 35
- 35 - 56
- 56 - 87
- 87 - 107
- + 107

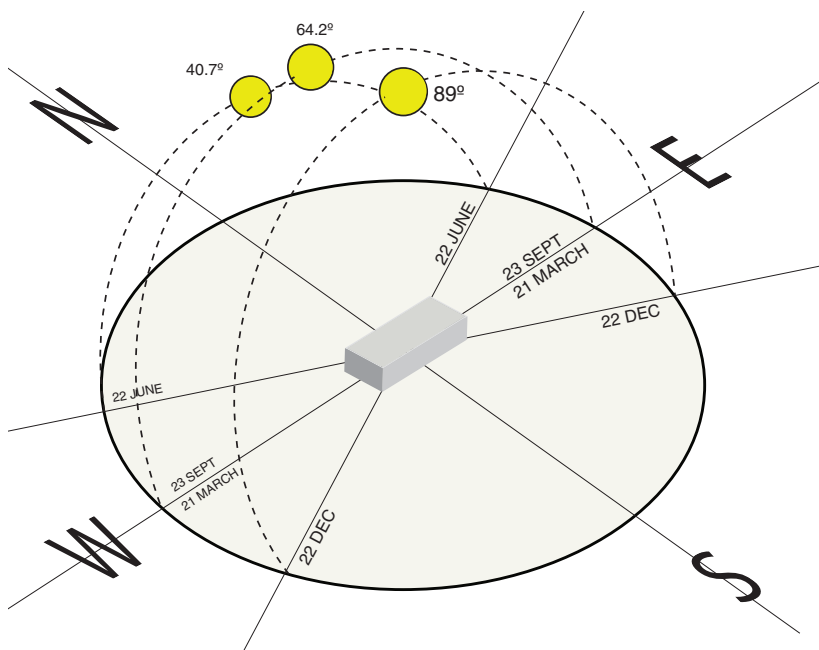
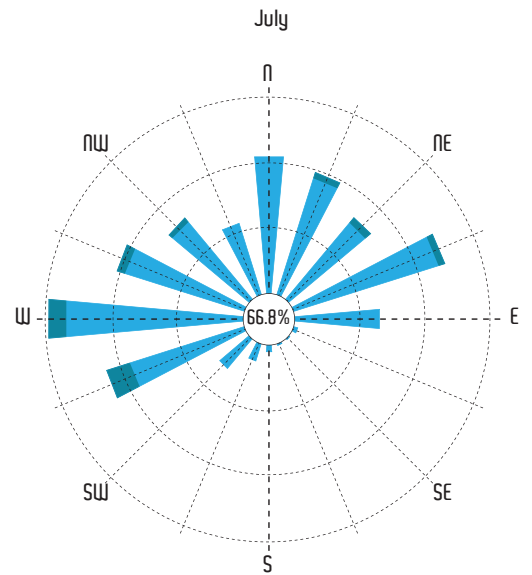
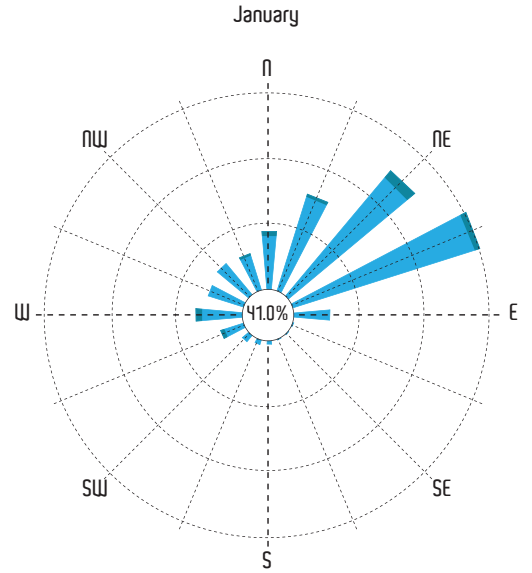

Figure 54: Sun Path for Pretoria

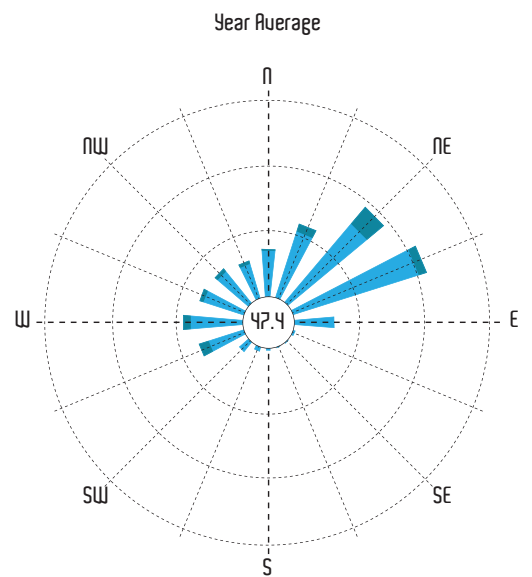

Figure 55: Pretoria Wind Rose

5.3 MICRO SCALE

Figure 57: Macro Scale: Land Usage



BUILDING & LAND USE

Building and land use in the macro context was mapped based on site visit observation of predominant program to identify existing shortcomings. Proposed uses could then be aligned with theory and background studies.

From these observations it is clear that there is a strong civic element in the western quadrant of the study area. These include mostly educational facilities ranging from urban schools to tertiary education.

There is a moderate level of residential program in the area as well as high densities of residential program in the neighbouring zones (Arcadia and Sunnyside). These areas require adequate public open space. The majority of the building (especially around the chosen site) have commercial programs. Almost all the commercial activity immediately surrounding the site is related to motor retail or services.

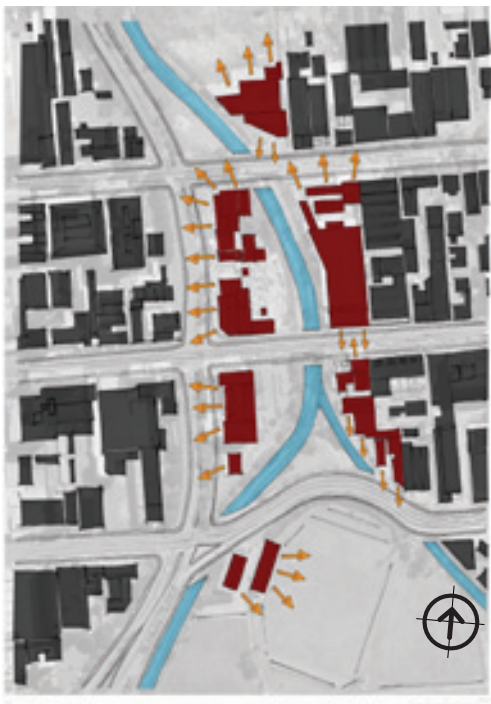

Figure 58: building edge condition



Figure 59: river access



Figure 60: pedestrian movement

BUILDING EDGE CONDITION

The nature of these commercial activities, having base stores, offices and backyards, has a very negative effect on the river focus and edge condition. Base stores, offices and backyards have a very negative effect on the river focus and edge condition.

This is due to the specific programs focusing on street edges and service areas being located on the river side.

PUBLIC RIVER ACCESS

Public access to the river front is very limited.

Sites that have been developed make access to the river difficult edge due to their own security and boundary conditions.

Due to the dangerous edge condition of the storm water channel access is restricted with fencing and locked gates in undeveloped areas.

PEDESTRIAN MOVEMENT

Daytime readings taken from areal photographs show a complete lack of pedestrian activity along the river edge. A combination restricted access to the river as well as security issues in the area could very well be the cause.

The security situation along the river is aggravated by this lack of passive surveillance.

DYSFUNCTIONAL SITES

Following the study of current usage in the area a few sites have been identified as having inappropriate usage or programme. These buildings and sites have a negative impact on the river character, access and security.

The dysfunctional sites indicated on Figure 61 will be redeveloped either by complete demolition or where possible adaptive re-use of existing structures.



Figure 61: Site identified with inappropriate usage or programme.

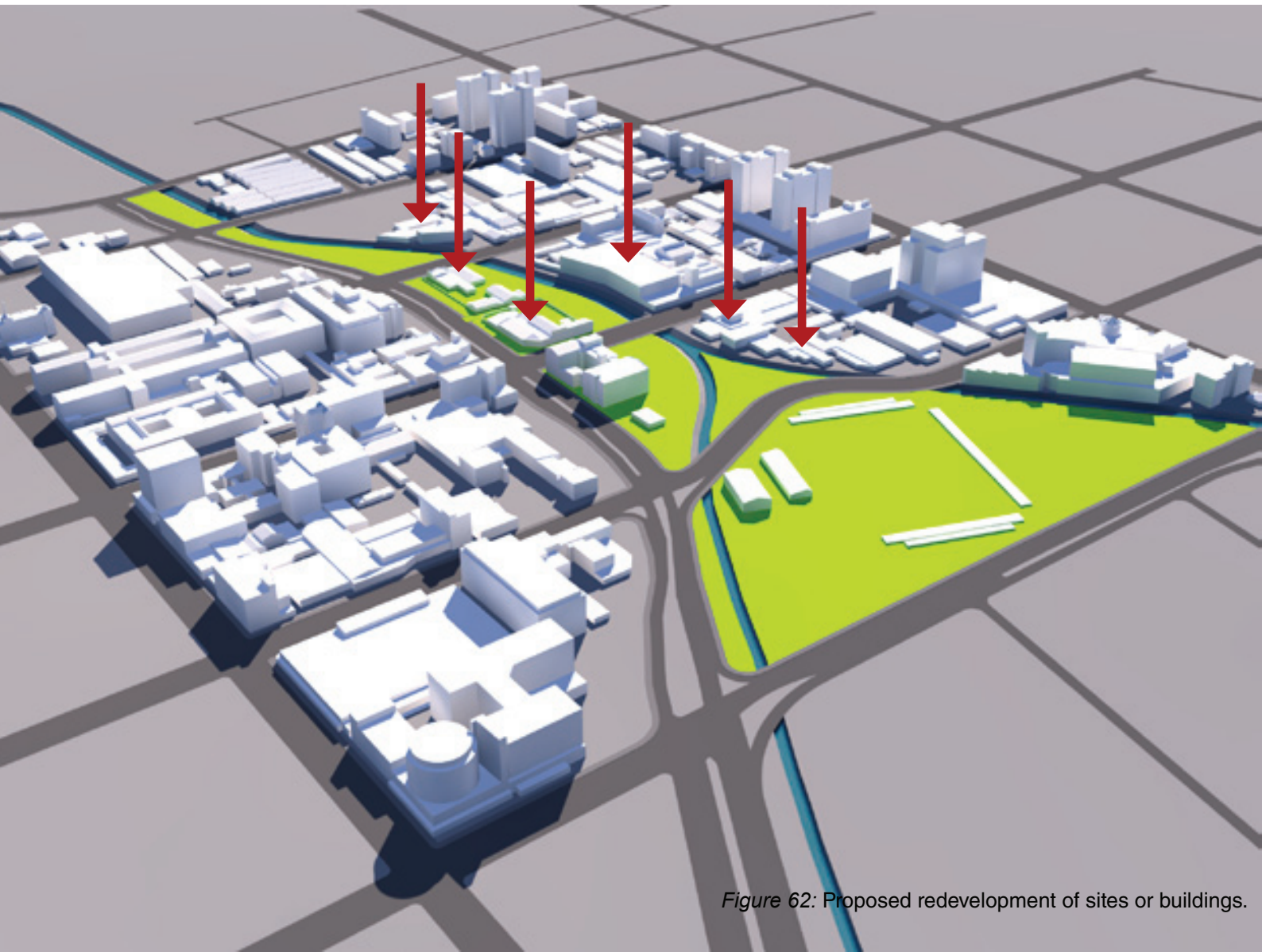

Figure 62: Proposed redevelopment of sites or buildings.

KEY DEVELOPMENT NODES

Figure 63 indicated nodes that exist in the study area with significant cultural or heritage value.

These nodes are ideal points to focus redevelopment on.

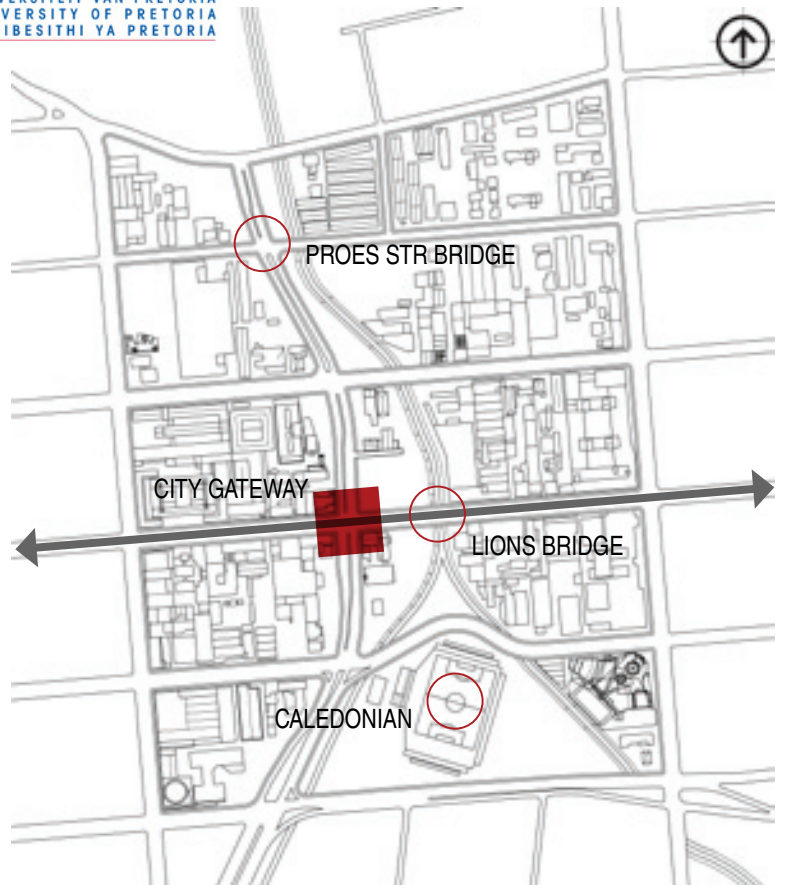

Figure 63: Points with cultural or heritage value.

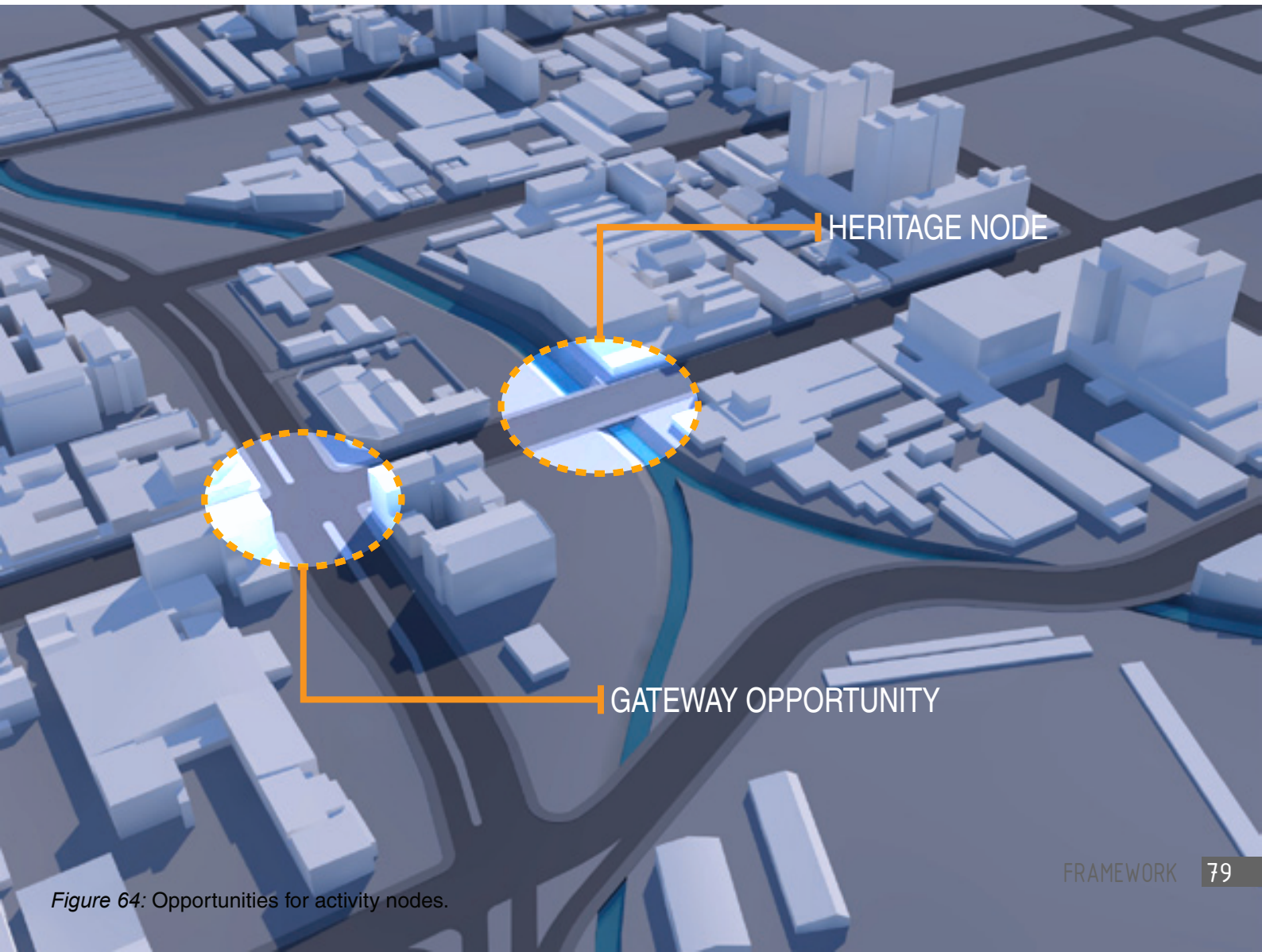

Figure 64: Opportunities for activity nodes.

EDGE CONDITIONS

Proposed street and river sections are indicated for different edge conditions within the study area.

APIES RIVER [1]

This section proposes the redevelopment of the river edge for safer access to the river bed as well as a continuous pedestrian and cycle route along the length of the river.

This proposal would require the introduction of a terraced edge or similar construction in areas where a less steep gradient can be accommodated.

CHURCH STREET [2]

The Church Street section proposes the introduction of dedicated cycle and public transport lanes.

Visible water retention sells in planter beds along the pedestrian walkway will visually connect this street back to the Apies River using the storm water system.

NELSON MANDELA DRIVE [3]

The use of trees, bollards and street furniture to create a continuous visible edge between road and sidewalk could help reduce the negative impact that heavy traffic (carried on Nelson Mandela drive) has on pedestrian activity along this edge.

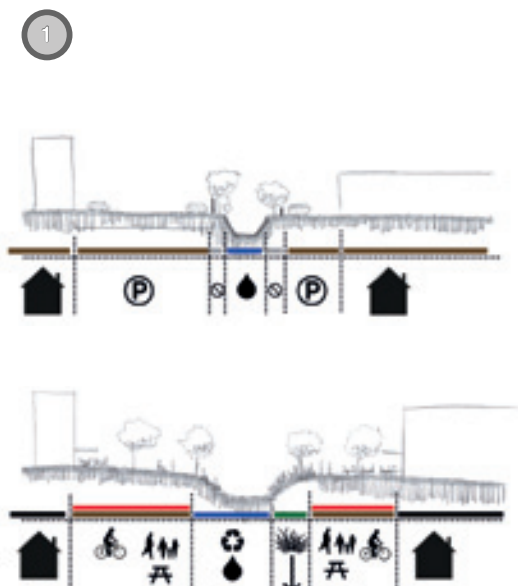

Figure 66: Apies River section.

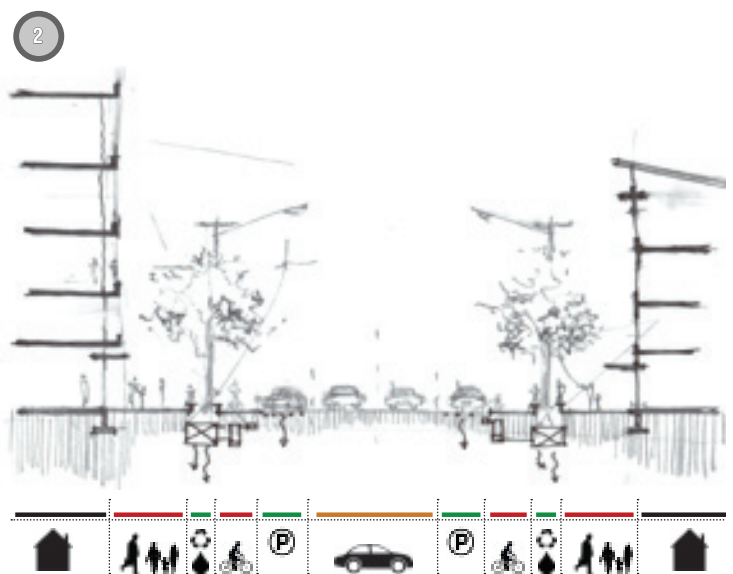

Figure 65: Street section through Church Str.



Figure 67: Map indicating position of street sections.

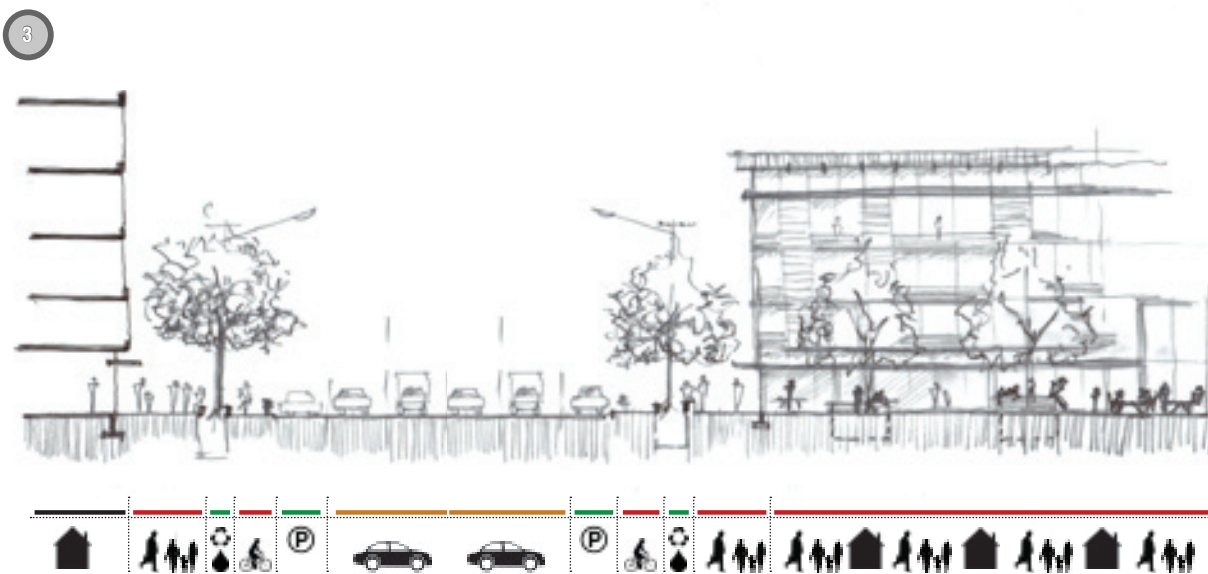

Figure 68: Street section through Nelson Mandela Drv .



PRECEDENTS





UNIVERSITEIT VAN PRETORIA
UNIVERSITY OF PRETORIA
YUNIBESITHI YA PRETORIA

06

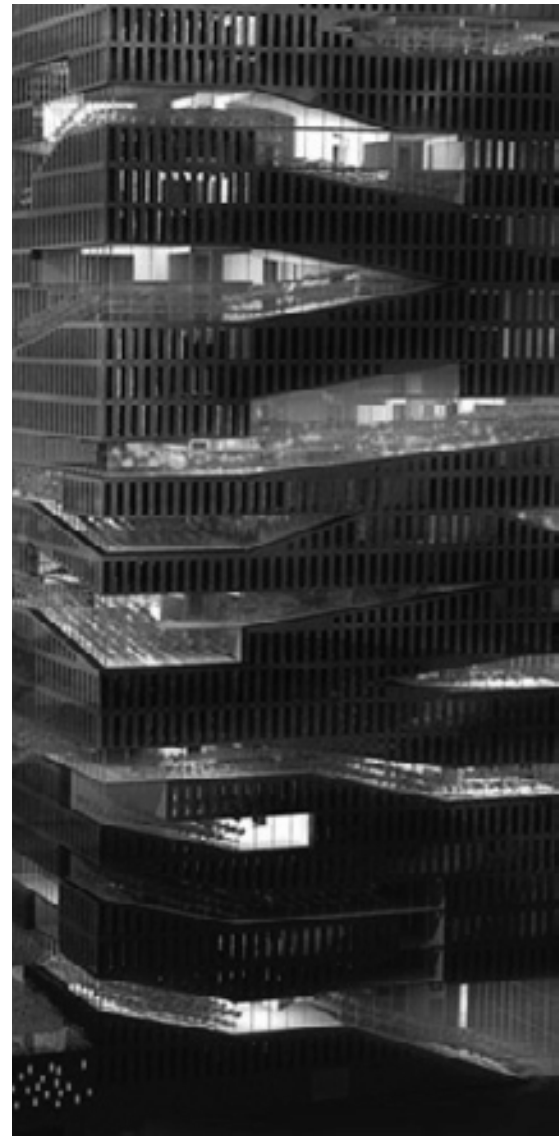
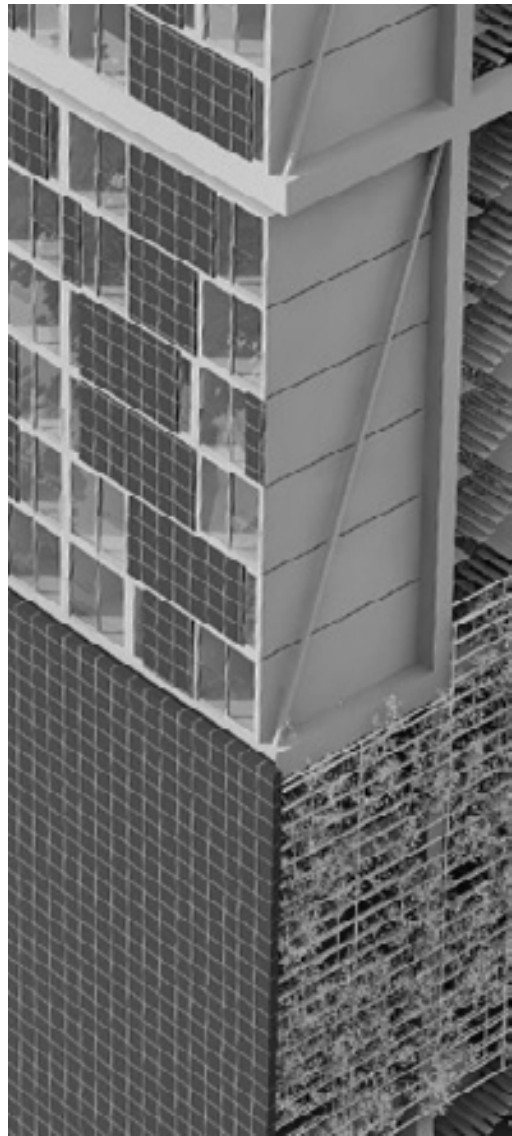

CHAPTER 6 PRECEDENTS

CASE STUDY

BUILDINGS THAT TEACH SUSTAINABILITY

GREENHOUSE PEOPLE'S ENVIRONMENTAL CENTRE

- Design: James Jacobs & Nic Whitcutt (CBS Architects)
- Location: Joubert Park, Johannesburg
- Client: Greenhouse Project (NGO)
- Date: 2002 (Phase 1)
- Project Type: Masterplan

BACKGROUND:

This project was an initiative by the South African NGO the Greenhouse Project (GHP) to address the needs of communities within Johannesburg to access resources and information, and explore more innovative ways of self-help.

The Greenhouse People's Environmental Centre (GHC) is situated in Johannesburg CBD's largest open space, Joubert Park. The centre hopes to empower the local communities to build and re-build their city in economically, socially and ecologically sustainable ways.

MASTERPLAN:

The masterplan for the GHC includes 7 phases that allow different parts of the northwestern corner of Joubert park to be developed still allowing for occupancy and use of the site by GHP throughout the process.

The first phase (to date the only phase completed) focused on establishing a administrative base for GHP by converting an old potting shed into a small office building. This phase also included developing the immediate surrounds, permaculture gardens and a willow wall. Phase 1 is a working example of a "green retrofit" to an existing building.

The upcoming phases will expanding the projects public service face by renovating the historic Victorian-style conservatory in Joubert Park and introducing a local recycling centre.

A working newly built double storey office will replace the potting shed as GHP office space illustrating innovative sustainable building techniques and materials. This in turn frees up the potting shed to become a resource and training centre.

Finally a triple storey office building is built to be rented out to the public. This phase will demonstrate high tech environmental solutions.

FOCUS AREAS:

- Educating local community through working demonstrations of sustainable ways to plan, build, landscape, manage energy, water and material resources.
- Distribution of Information that will help empower individuals in society to improve the quality of life in their community in a sustainable way.
- Supporting organisations that work to improve the urban environment. (focus on community based organisations)



Figure 69: The Greenhouse Project construction photos.

DESIGN APPLICATION

- The use of a working example to educate and uplift a community.
- The use of a working example to educate and uplift a community.



Figure 70: Conservatory today stands empty and neglected.



Figure 72: GHP Office building, old potting shed.



Figure 71: The Greenhouse Project: Site Plan

PRECEDENT STUDIES

URBAN AGRICULTURE

LA TOUR VIVANTE ("THE LIVING TOWER")

- Design: Atelier SOA Architects
- Location: Rennes, France
- Client:
- Date:
- Project Type: Mixed-Use (Housing, Office, Agriculture)

Probably one of the most published vertical farming proposals to date, the Tour Vivante (Living Tower) project by SOA Architects integrates urban agriculture with housing and office space in a mixed-use high-rise building.

DESIGN APPLICATION

- The projects use of multiple programmes to activate the ground floor (street level) edges giving the building a public interface.



Figure 73: Perspective view of La Tour Vivante.



Figure 74: La Tour Vivante: Site Plan.

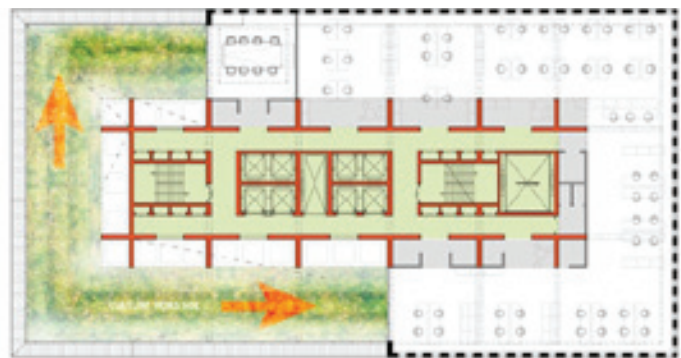
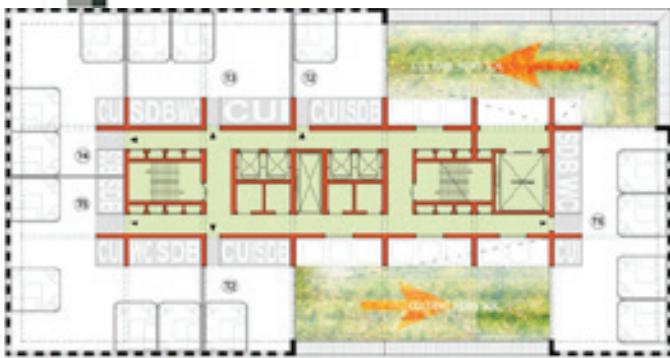

Figure 75: La Tour Vivante: Typical Plans.

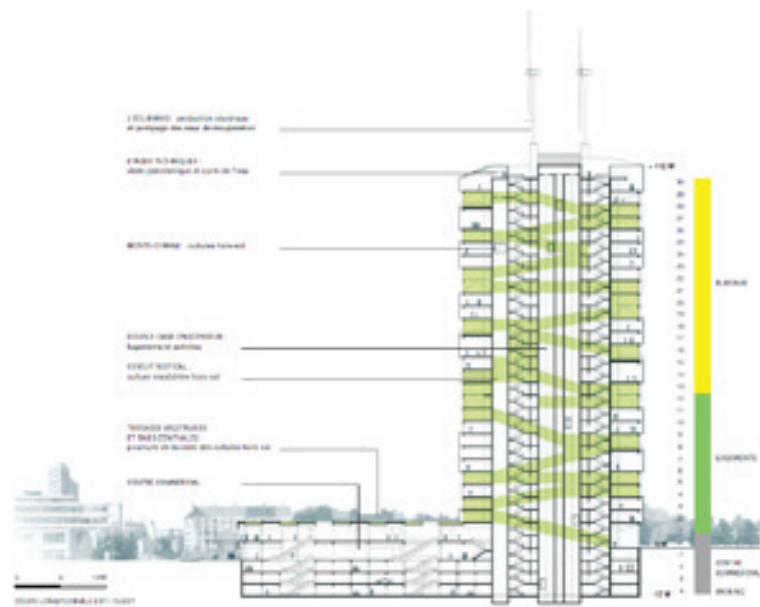
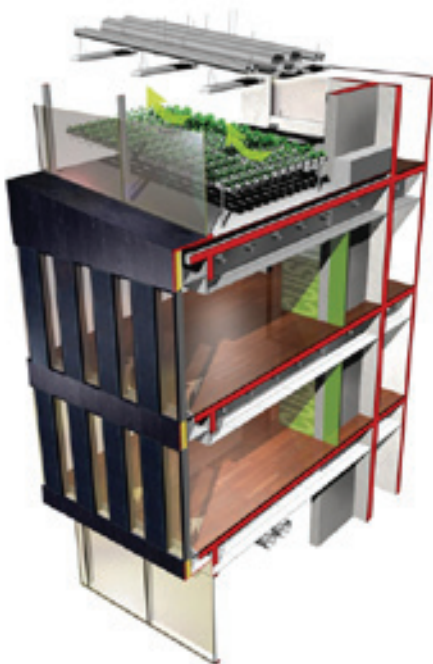

Figure 76: La Tour Vivante: Section showing mixed use.

Figure 77: La Tour Vivante: 3D section showing services.



ECO_LABORATORY

- Design: Weber_Thompson Architects
- Location: Seattle, America
- Client: Living Building Challenge (Competition)
- Date: 2008 (Design Competition Entry)
- Project Type: Mixed-Use (Market, Residential, Education)

Recognizing a living building's dependence on multiple systems, Eco-laboratory is a synergy of economics, culture and environment. It is more than a building; its parts are inspired by a self sustaining, diverse ecological system.

Eco-laboratory merges a neighbourhood market, basic shelter, vocational training facility and public sustainability educational centre into a financially viable downtown residential development.

DESIGN APPLICATION

- The combination of sustainable building systems to create a balanced ecosystem within the building resulting in net-zero energy and water consumption.
- The successful integration of building systems with a living natural system.



Figure 78: Eco-Laboratory: Building perspective.

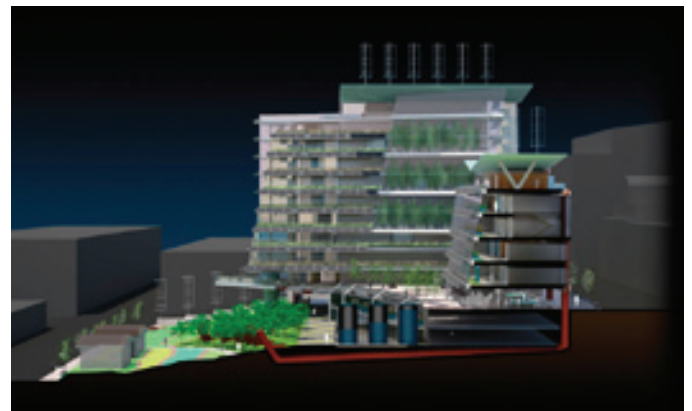

Figure 79: Eco-Laboratory: Connection to natural resources.

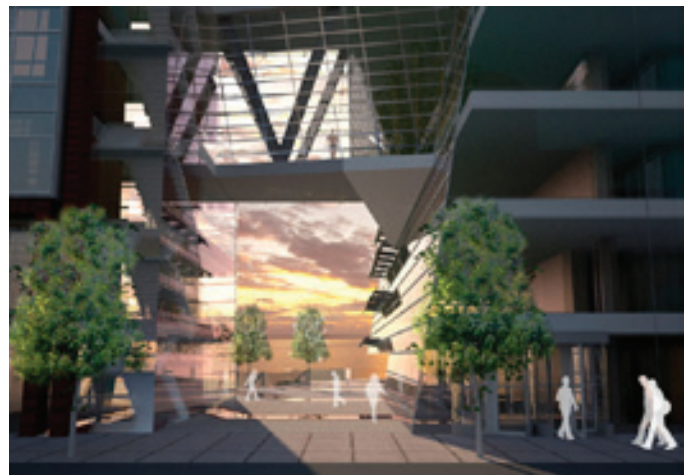
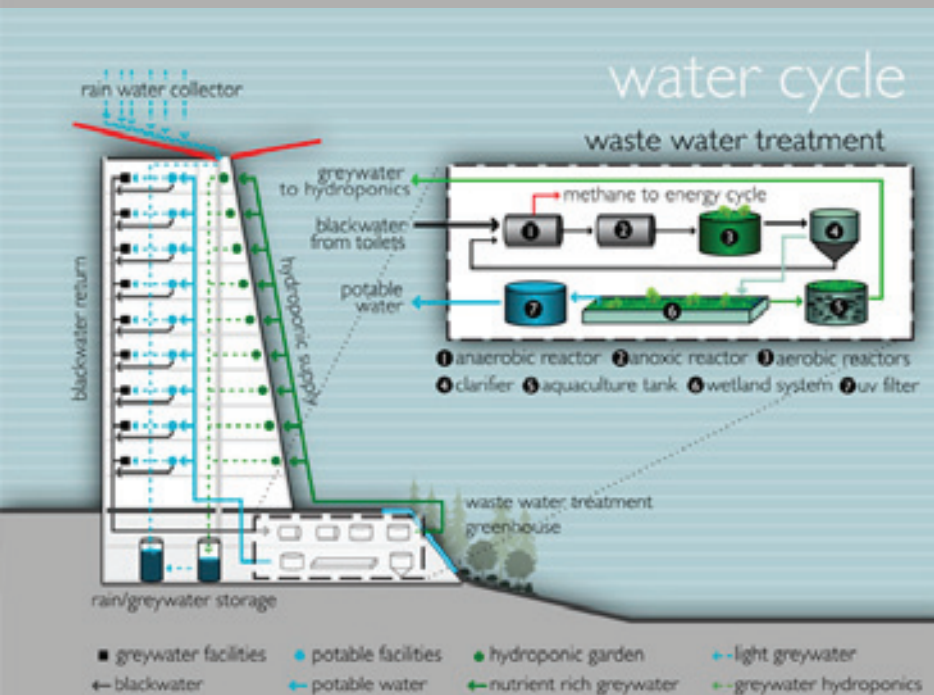
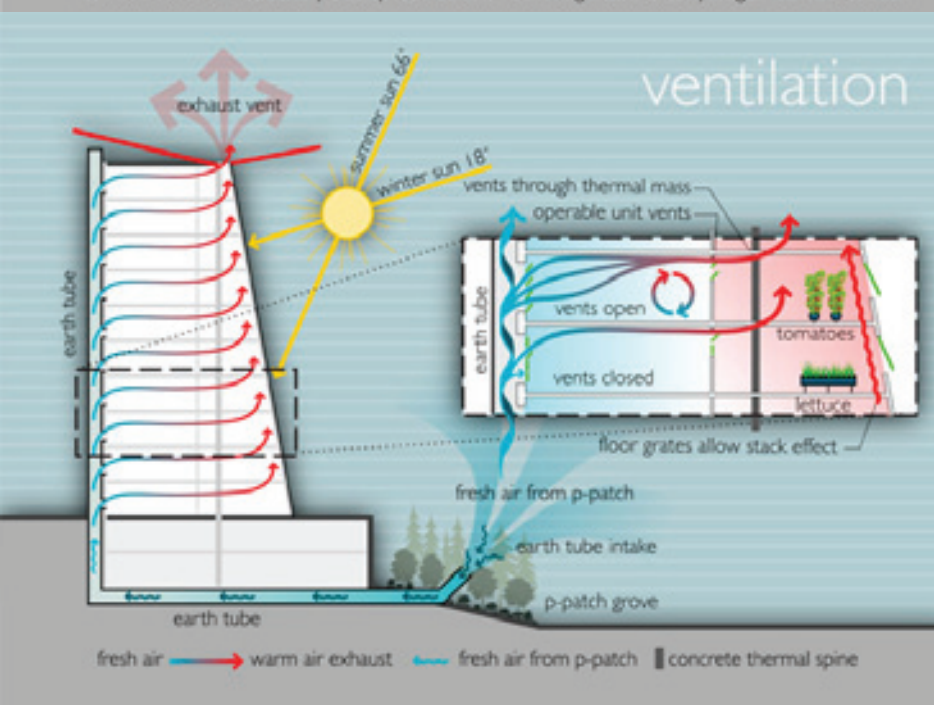
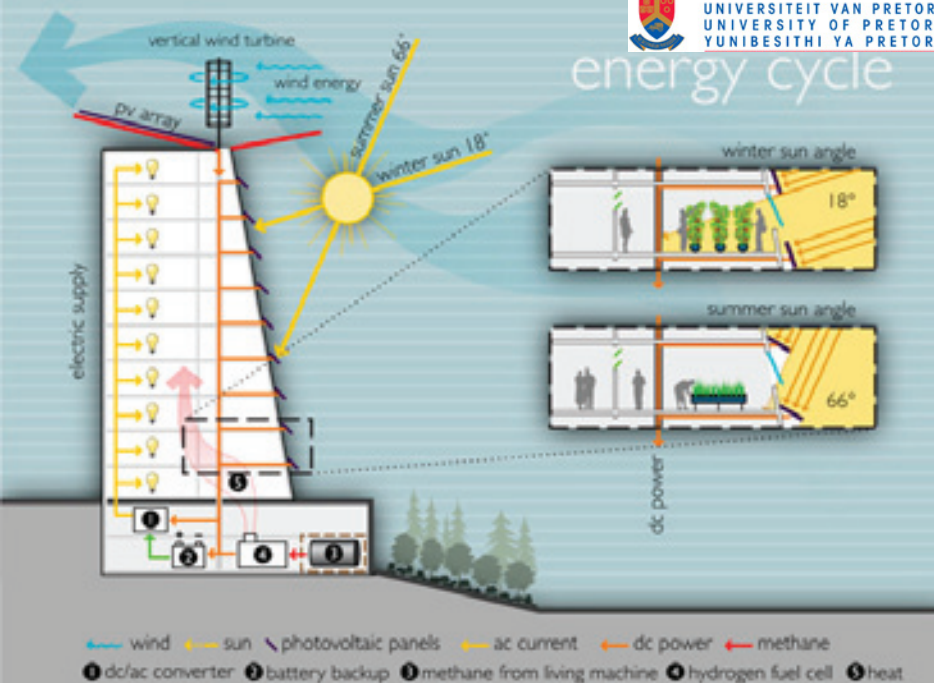

Figure 80: Eco-Laboratory: Courtyard view.



Figure 81: Eco-Laboratory: Facade study.



- ENERGY: on-site generation**
- 5 Wind Turbines
 - 6 Photovoltaics
 - 7 Biofuel
 - 8 Hydrogen Fuel Cell

- INDOOR QUALITY: site driven**
- 9 Ventilation Controls
 - 10 Thermal Spine
 - 11 Double Skinned Facade
 - 12 Earth Tubes

- WATER: collection and enrichment**
- 1 Rain Water Collection
 - 2 Hydroponics
 - 3 Living Machine
 - 4 Greywater Cistern

Figure 82: Eco-Laboratory: Building system diagrams.

CENTRE FOR URBAN AGRICULTURE

- Design: Mithun
- Location: Seattle, America
- Client: Non-Profit
- Date: Start 2007
- Project Type: Mixed-Use

The project is located on two triangular land parcels generated by the intersection of four roads.

Food, water, and energy are the focus of the “Centre for Urban Agriculture” (CUA) design. Agricultural features include fields for growing vegetables and grains, greenhouses, rooftop gardens, and even a chicken farm. Vertical construction allows for the CUA to incorporate more than an acre of native habitat and farmland on the building’s .72 acre site.

With the goal of self-sufficiency, the CUA is designed to be completely independent of city water even providing its own drinking water. Grey water, as well as rain collected via the structure’s 31,000+ sq. ft. rooftop rainwater collection area, would be treated and recycled on site. The filtering and purifying would occur through the use of greenhouses, planters, and biomembrane plants which utilize plants’ ability to remove contaminants from water. 34,000+ sf of photovoltaic cells would collect energy, regulated over the seasons by storage as hydrogen gas in underground tanks.

DESIGN APPLICATION

- The use of under-utilized urban land for food production programme.
- Techniques for rainwater harvesting and re-use.

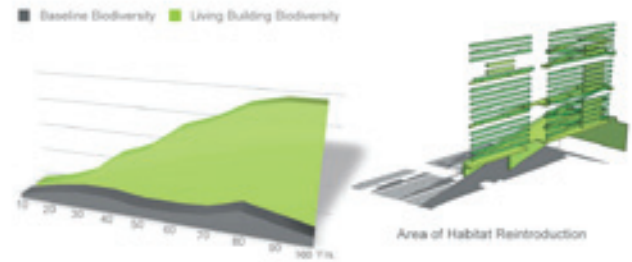

Figure 83: CUA: Habitat reintroduction area.

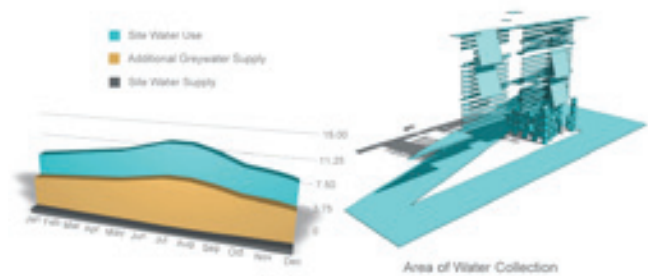

Figure 84: CUA: Water collection area.

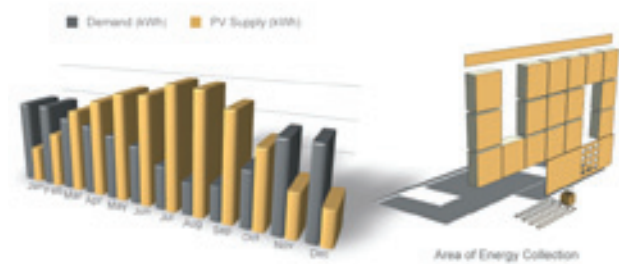

Figure 85: CUA: Energy collection area.

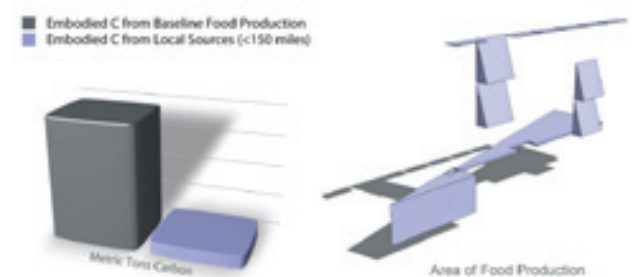

Figure 86: CUA: Food production area.



Figure 87: CUA: Building perspectives.



Figure 88: CUA: Building perspective showing use of under-utilized land.

BLENDING WITH CONTEXT

NEW OSLO OPERA HOUSE

- Design: Snohetta AS
- Location: Bjorvika, Oslo, Norway
- Client: Ministry of Church and Cultural Affairs
- Date: Completed 2007
- Project Type: Arts Complex

The Opera House is located on the Oslo Fjord, so close that it appears to rise out of the water itself and merge both land and water. The building has become the largest public venue to the arts and culture in Norway and thus representative of the political initiative growing in Oslo.

The building consists of 3 design elements, the wave wall, the factory, and the carpet.

The first design element critical to the design intent would be the wave wall. The location of the Opera House serves as a threshold between Norway and the rest of the world. The merging of water and land represents the integration of art into everyday life and everyday life into art.

Another aspect of the design includes incorporating the principle plan of a factory. Each section of the building is intended to promote and serve a separate function. In the end these separate sections merge with one another to serve a united purpose.

The
last

element is known as “the carpet.” The concept of integration, togetherness, joint ownership and connection with all were included in the design details. Monumentally was achieved by focusing on horizontality of the design. The horizontal focus helped connect the Opera House to its surrounding area. Had the building been constructed more vertically, then it would no longer serve its unique purpose of acting as a threshold. The building would be so offset from the rest of the area that it would not blend with the rest of the city or enable art and civilization to interact on a higher level. The carpet defined the horizontality with a design to further enhance the buildings interaction with the previously mentioned principles of design.

DESIGN APPLICATION

- The use of a building as a threshold between nature and city..
- Manipulation of form to integrate architecture into a natural landscape.

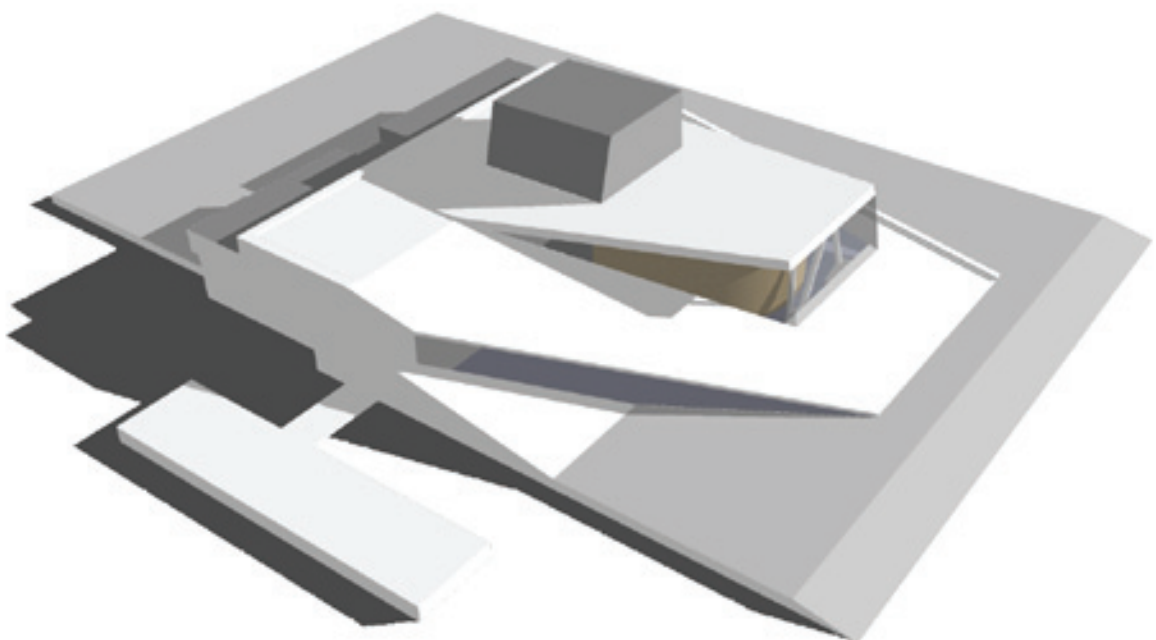

Figure 89: Oslo Opera House:Massing study.



Figure 90: Oslo Opera House:Building perspective from water.

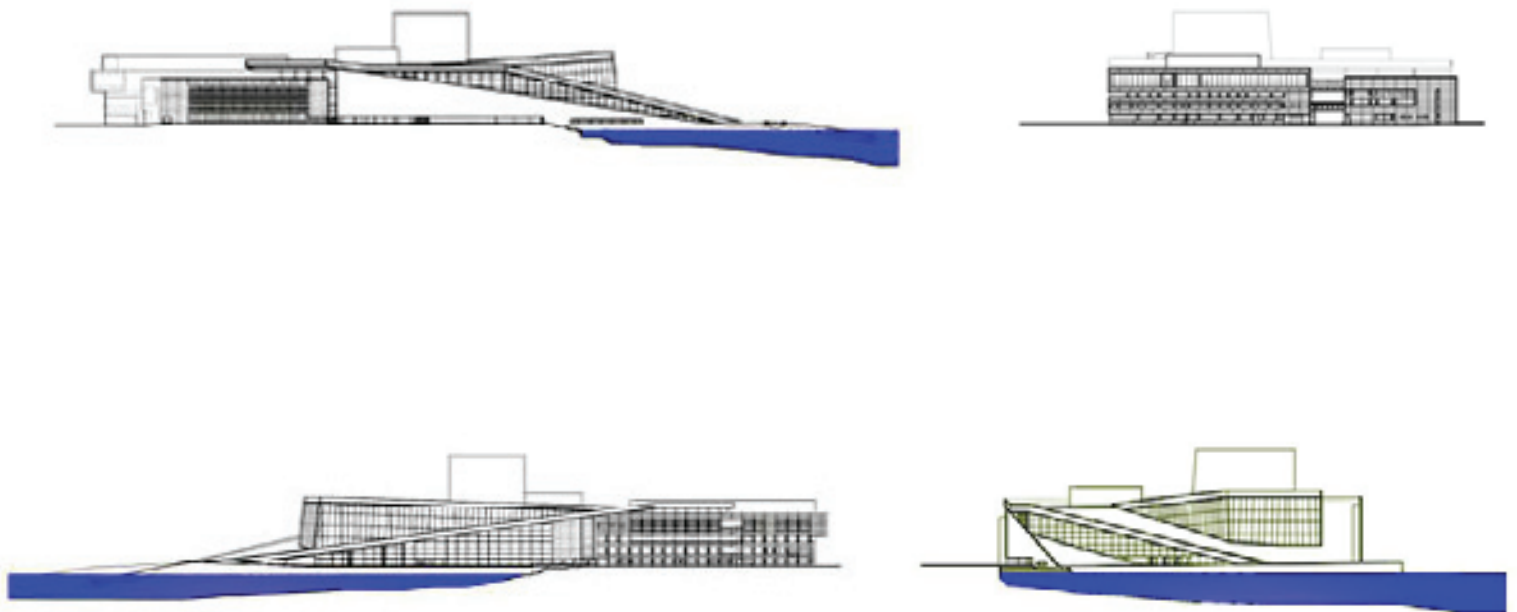

Figure 91: Oslo Opera House:Elevation views.



RESPONDING TO THE ENVIRONMENT

HONG KONG DESIGN CENTRE

- Design: FAR Frohn & Rojas
- Location: Hong Kong (Competition Entry)
- Date: 2006
- Project Type: Competition Entry

Being surrounded by an almost continuous three hundred foot wall of high-rise apartment buildings on three of four sides, the project acts as a grandstand, opening up the view towards the one unobstructed end: Junk Bay .

Cuts within the grandstand form light wells that provide ample and necessary daylight throughout all floors. While the wedge-like shape positions the project on an urban scale, it reflects at the same time an interior organization that aims to create a maximum of cross-synergies between the students of the different disciplines. All studio spaces are located on one stepped level at the top of the structure, while subject-specific shop and support spaces slip underneath this sloping studio floor with direct access to specific studio areas.

DESIGN APPLICATION

- Building form responds to available views.
- Building form stepped to allow for maximum natural light.

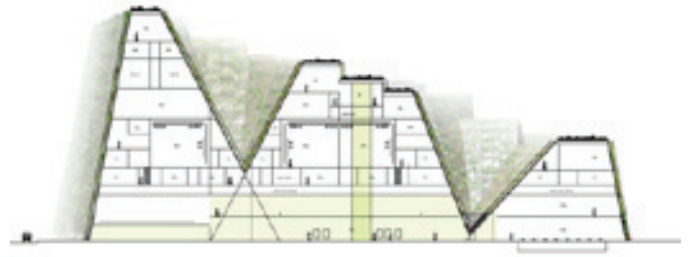

Figure 92: Hong Kong Design Centre: Sections.

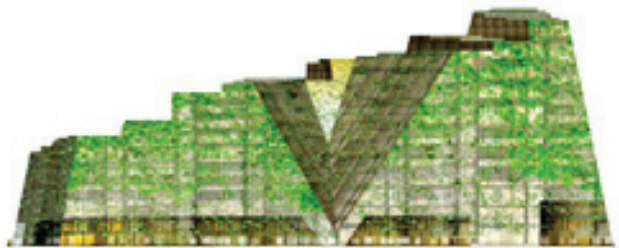
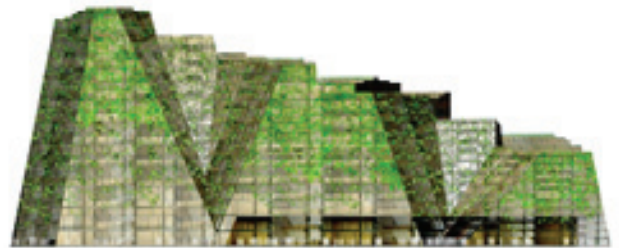
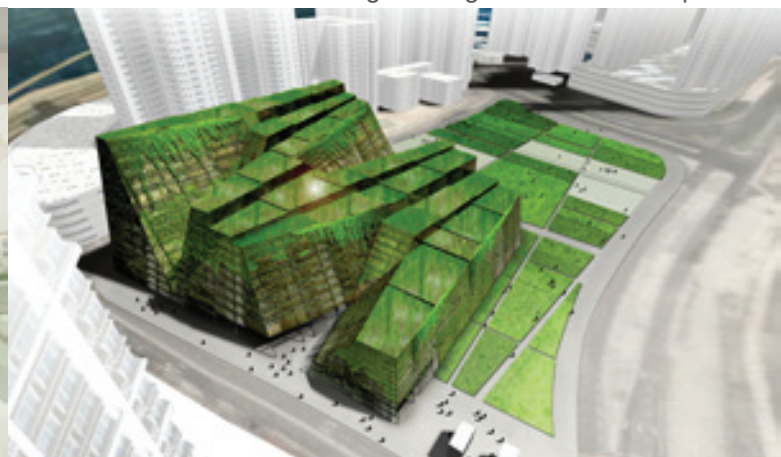

Figure 93: Hong Kong Design Centre: Elevations.

Figure 95: Hong Kong Design Centre: Concept models.



Figure 94: Hong Kong Design Centre: Perspectives showing building in urban landscape.



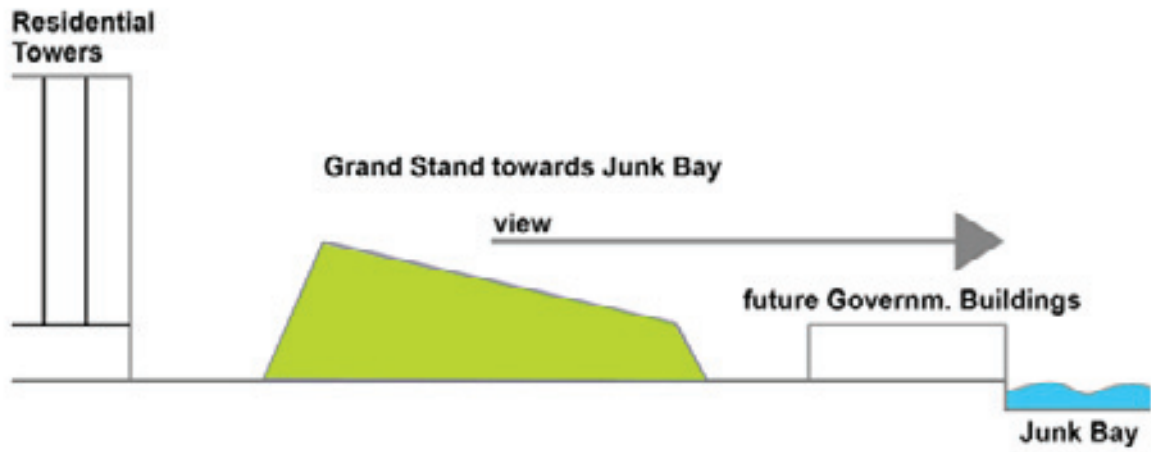

Figure 96: Hong Kong Design Centre: Building shape responds to view.

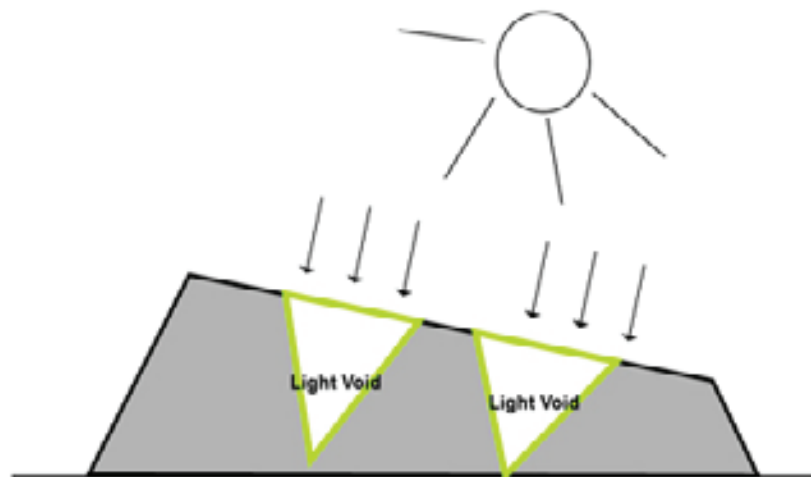

Figure 97: Hong Kong Design Centre: Building shape responds to daylight.

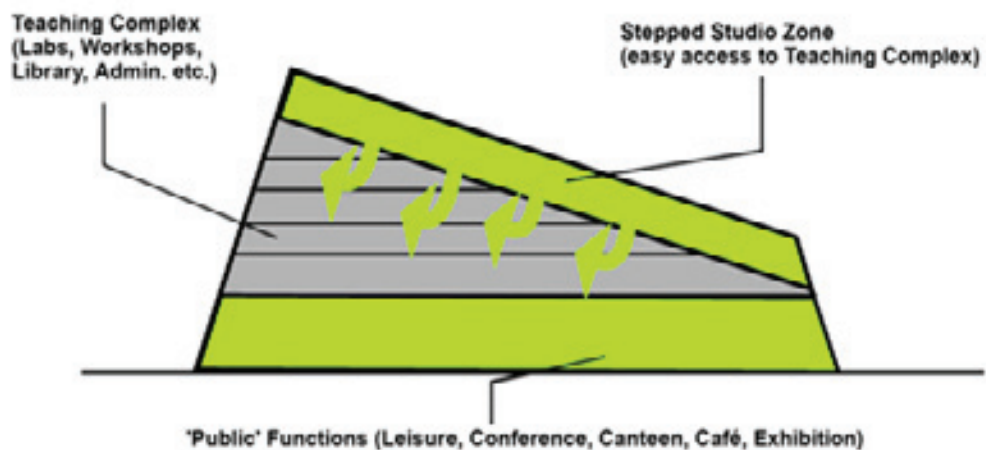

Figure 98: Hong Kong Design Centre: Building shape responds to program.



UNIVERSITEIT VAN PRETORIA
UNIVERSITY OF PRETORIA
YUNIBESITHI YA PRETORIA

DESIGN DEVELOPMENT





UNIVERSITEIT VAN PRETORIA
UNIVERSITY OF PRETORIA
YUNIBESITHI YA PRETORIA

07



CHAPTER 7 DESIGN DEVELOPMENT

CONCEPT: ARCHITECTURE AS MEDIATOR

The concept is based on the idea that architecture can act as a mediator, addressing the disconnection between urban and natural spaces, town and countryside and eventually places of consumption and places of production. To achieve this the design has to engage with both the urban and the natural environment.

Through biomimicry and ecosystemic design the building can function like a living organism or ecosystem, integrating the building systems with available natural resources.

DESIGN GENERATORS

The process is informed by three main design generators:

- Reconnecting the river to the city.
- Responding to environmental context.
- Integration of a mixed use programme.



Figure 100: Architecture as mediator

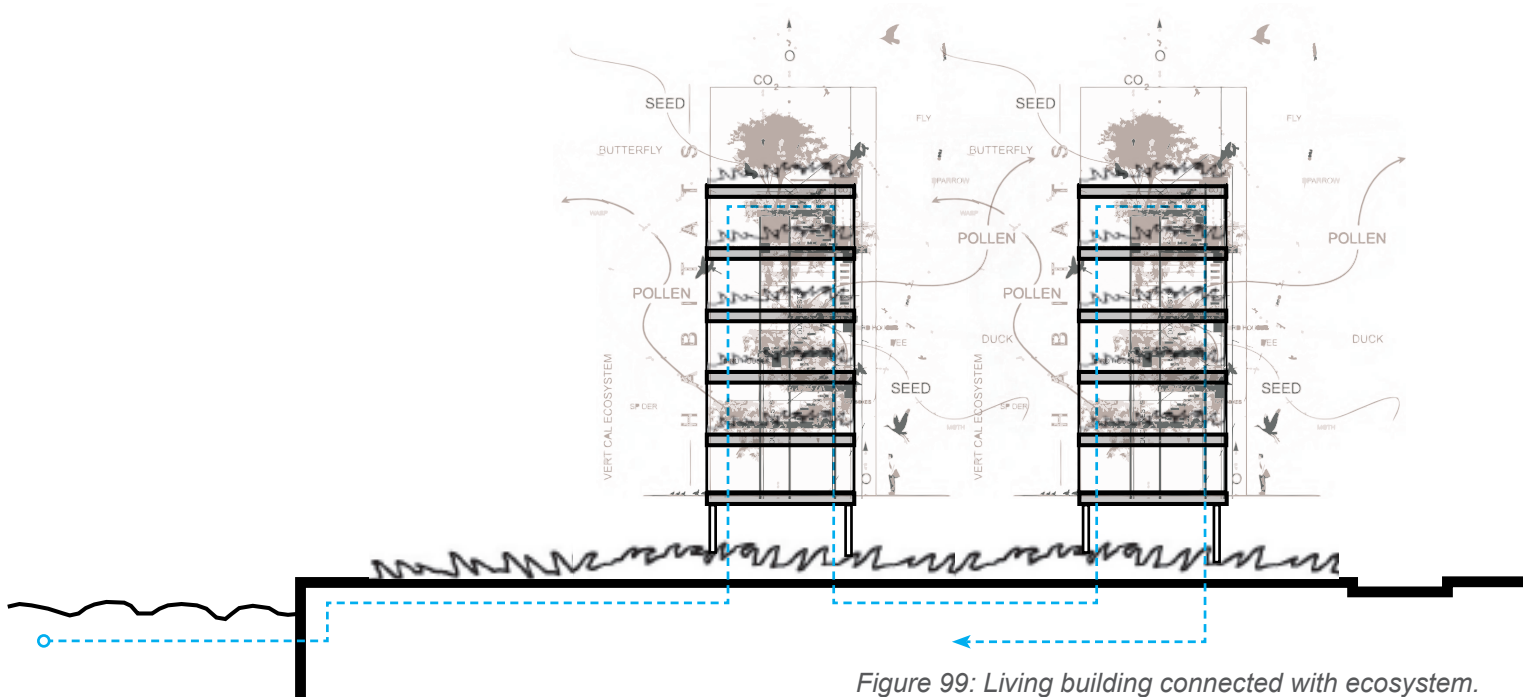

Figure 99: Living building connected with ecosystem.

CONNECTING THE EDGES

To connect the techno-sphere (urban) with the biosphere (nature) the design explores the disjunction between the immediate edges.

Figure 101 indicates the factors that will be used to help connect the urban edges with the natural river reach. This in turn will help to connect the urban dweller with his natural environment.

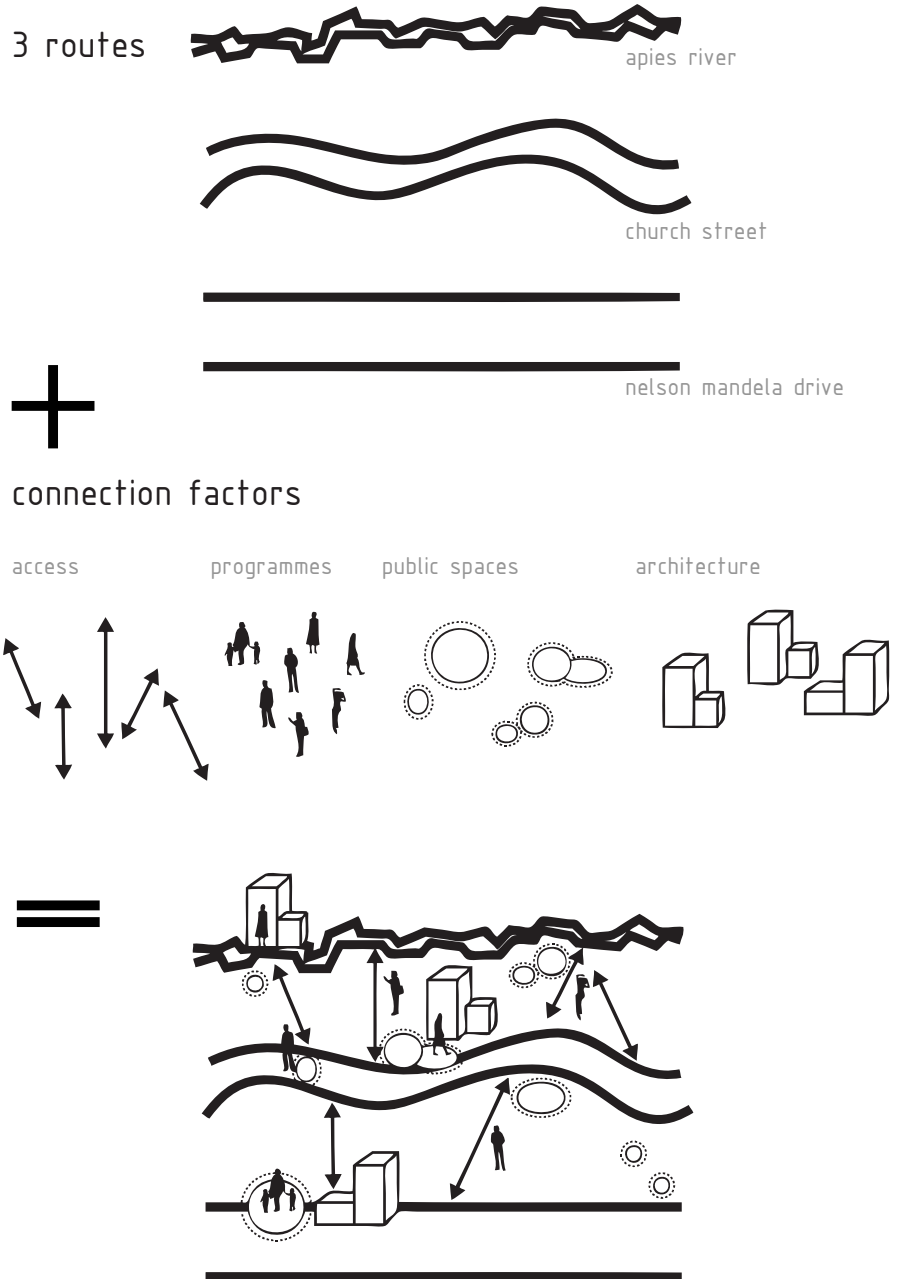

Figure 101: Factors used to connect urban edges with the river.



SITE DEVELOPMENT

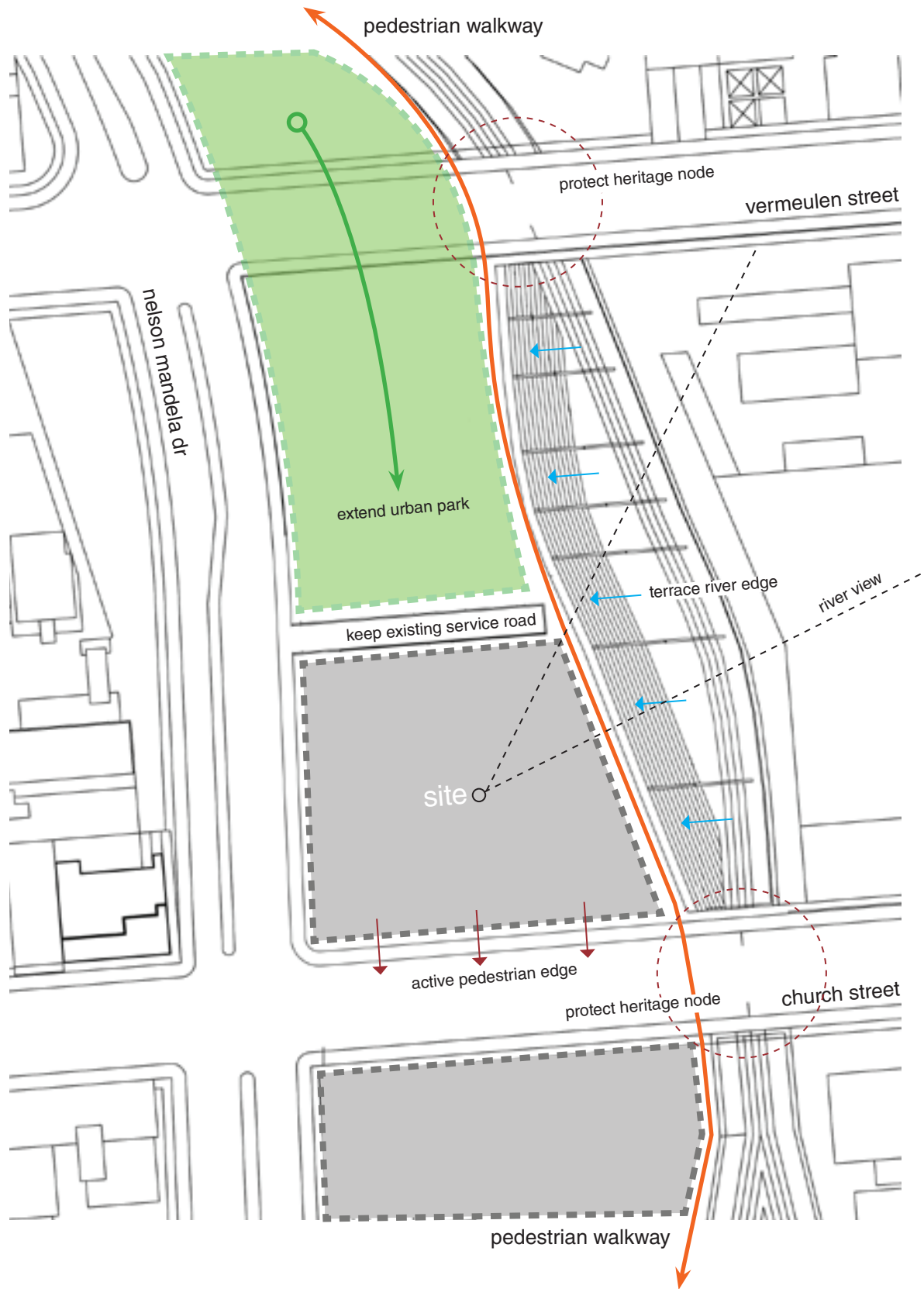

Figure 102: Site development diagram.



Figure 104: 3D View of proposed site condition.

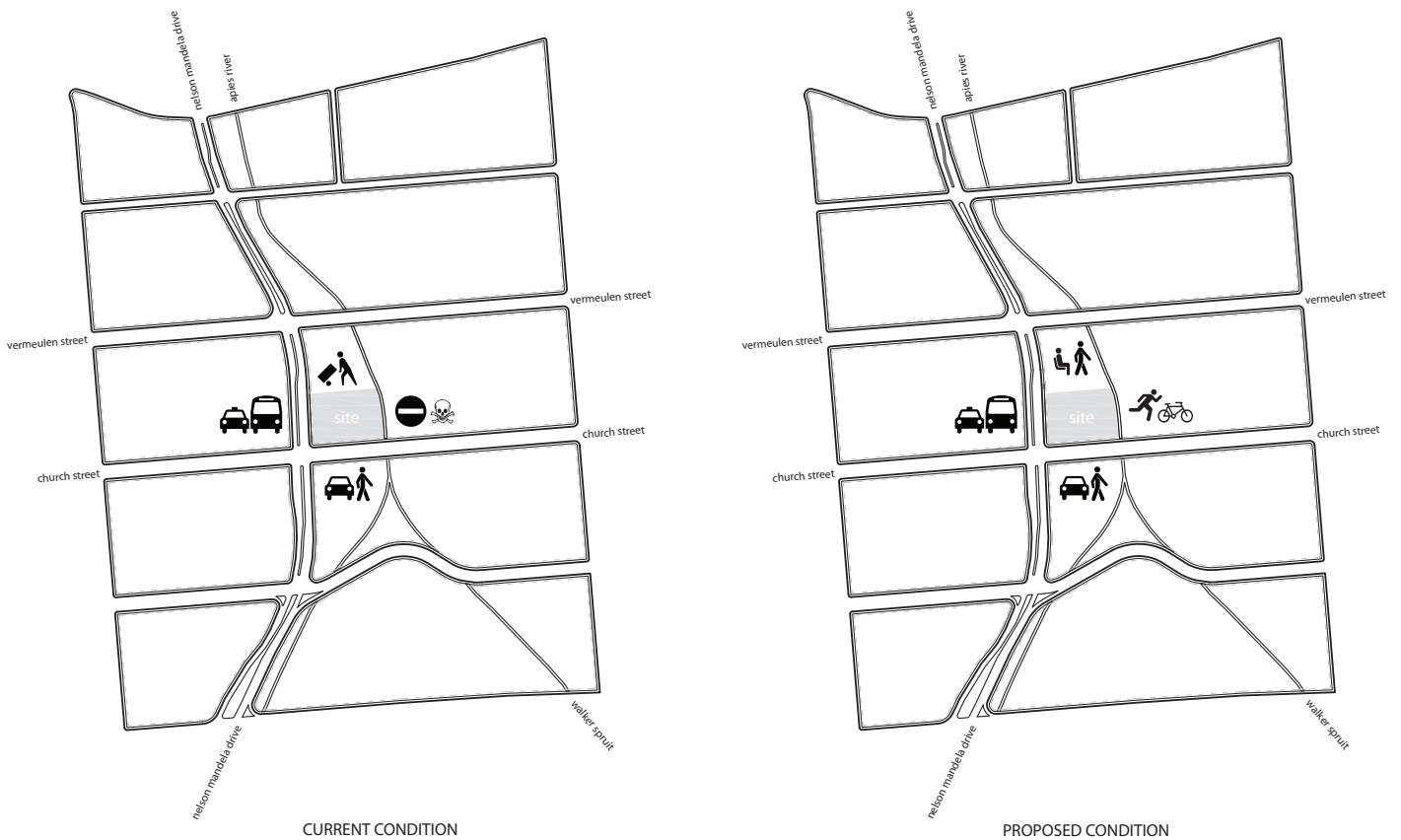

Figure 103: Current and proposed site edge conditions.



RIVER CONNECT

The main contextual problem is the lack of connection between the river and the urban realm. The design therefore has to respond to the problem by providing safe access for all city dwellers. The building form and programme should invite the public in to the river edge.



Figure 107: Concept sketch showing building connect to river edge.

Figure 105: Site exploration concept models.

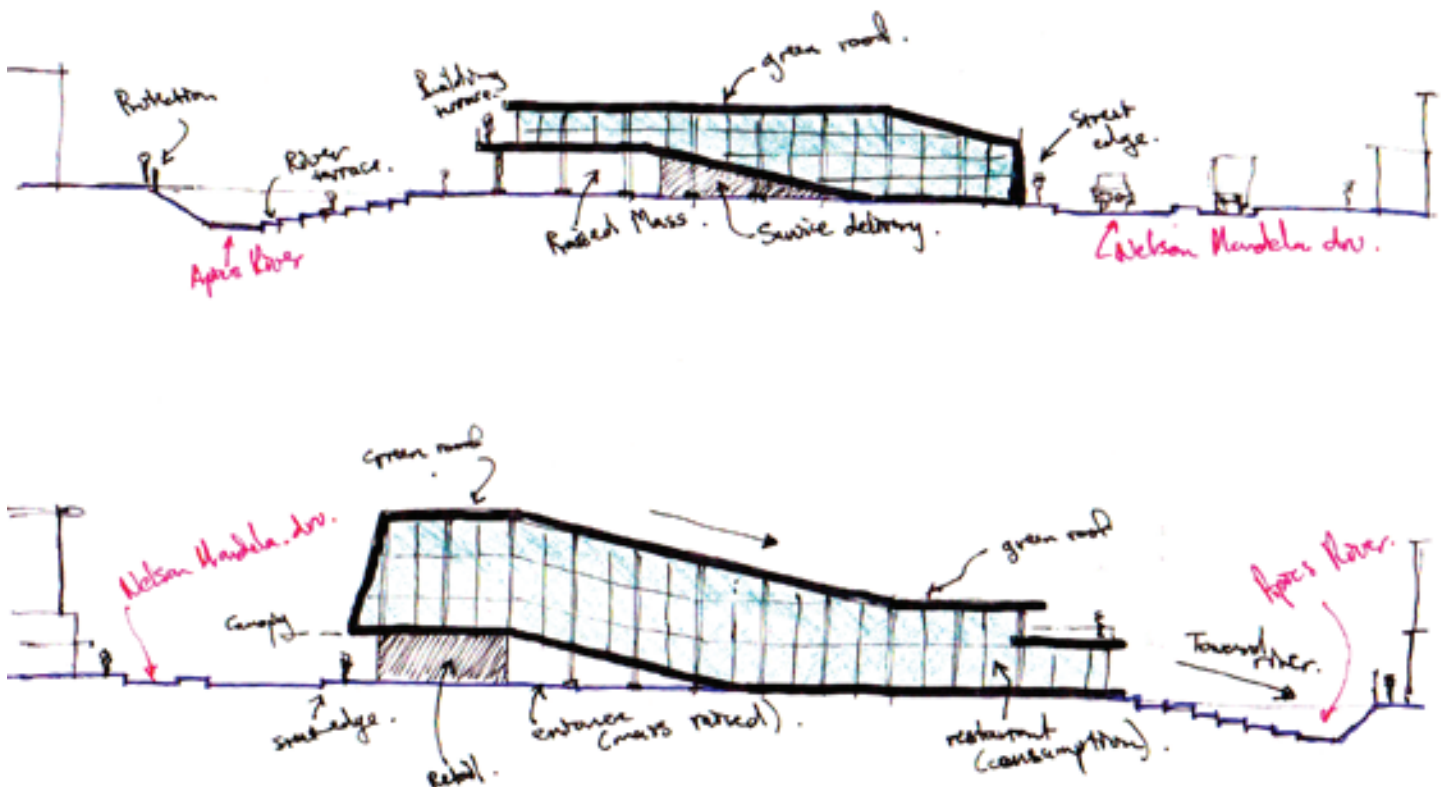

Figure 106: Sketch connection between edges and building.

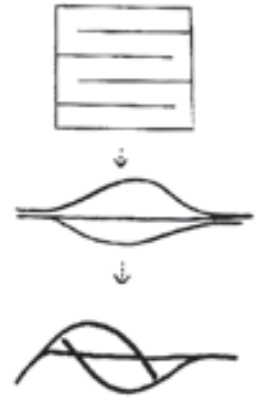
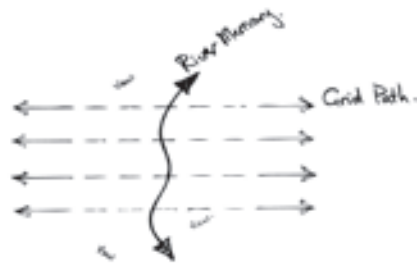

Figure 110: Strip extrusion concept.

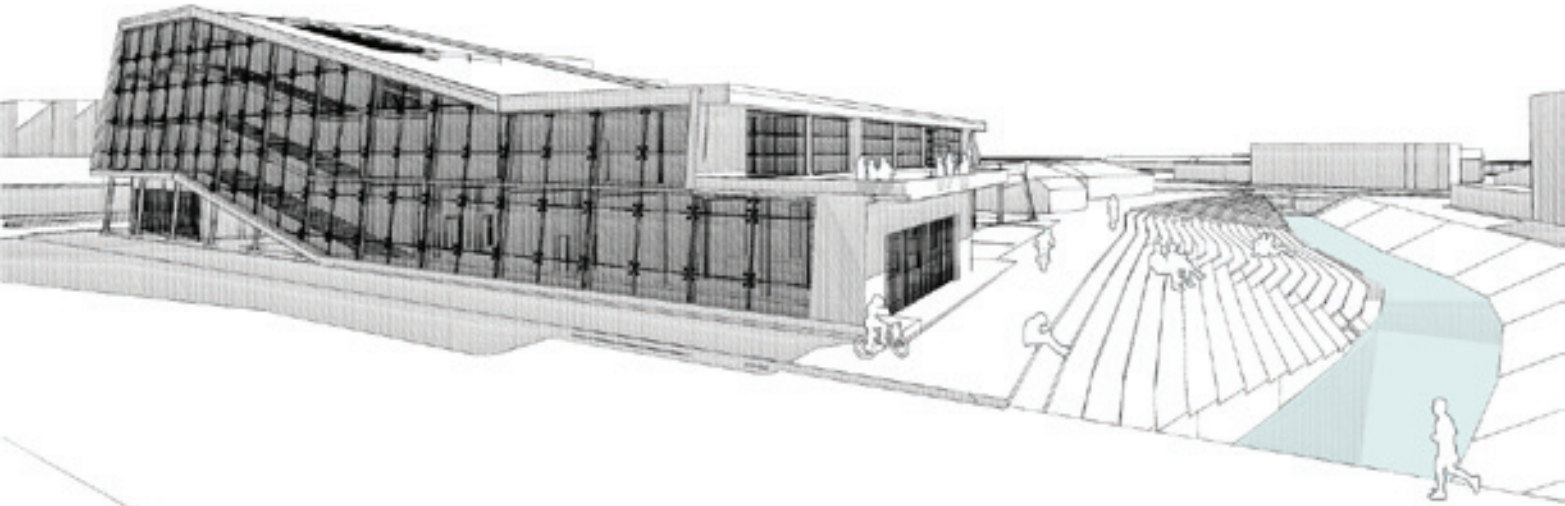

Figure 109: Perspective showing building shape respond to river edge.

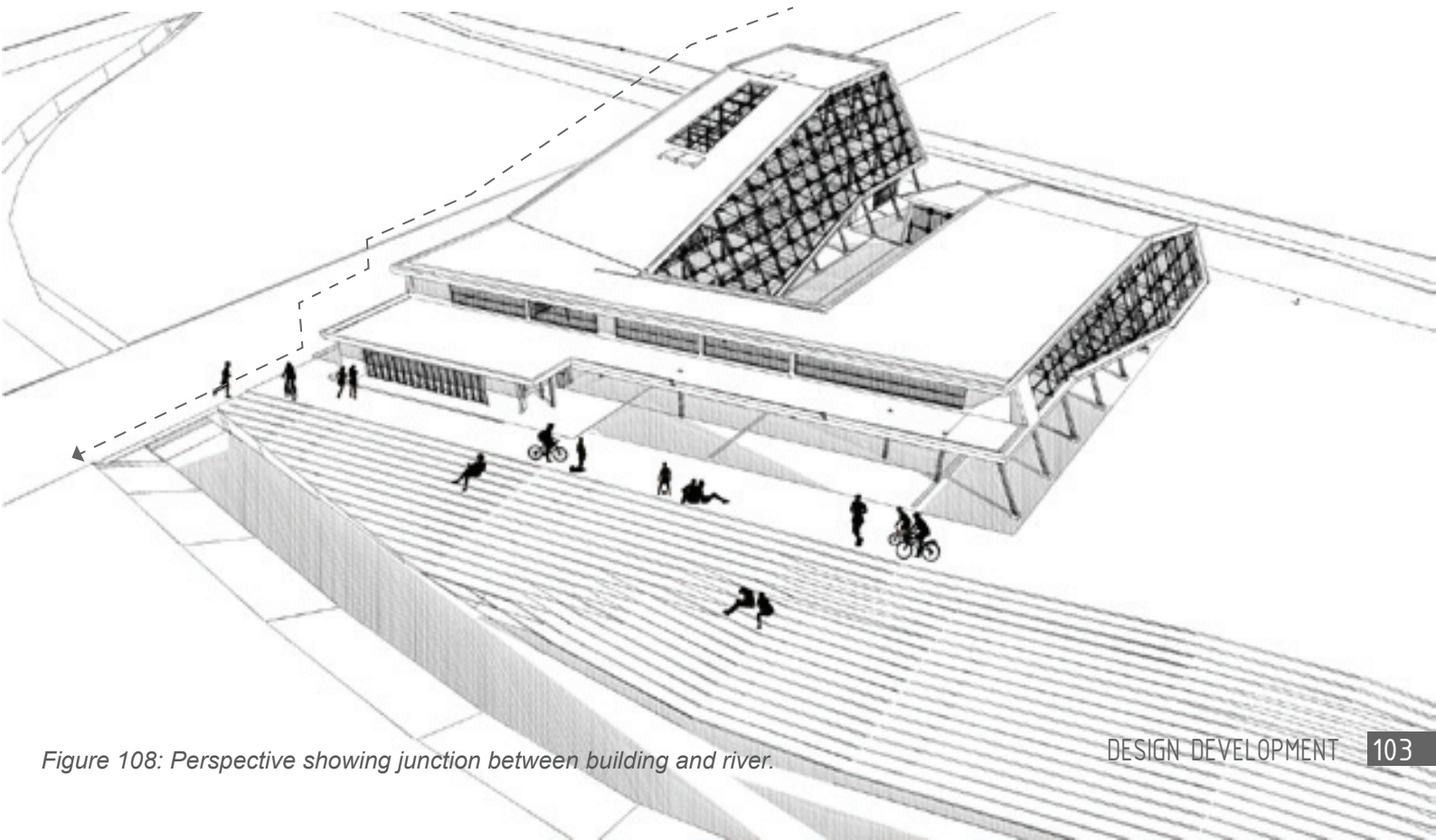

Figure 108: Perspective showing junction between building and river.



ENVIRONMENTAL RESPONSE

The agricultural activities housed within the building requires specific environmental conditions. The building will therefore be shaped and moulded by these climatic and environmental elements

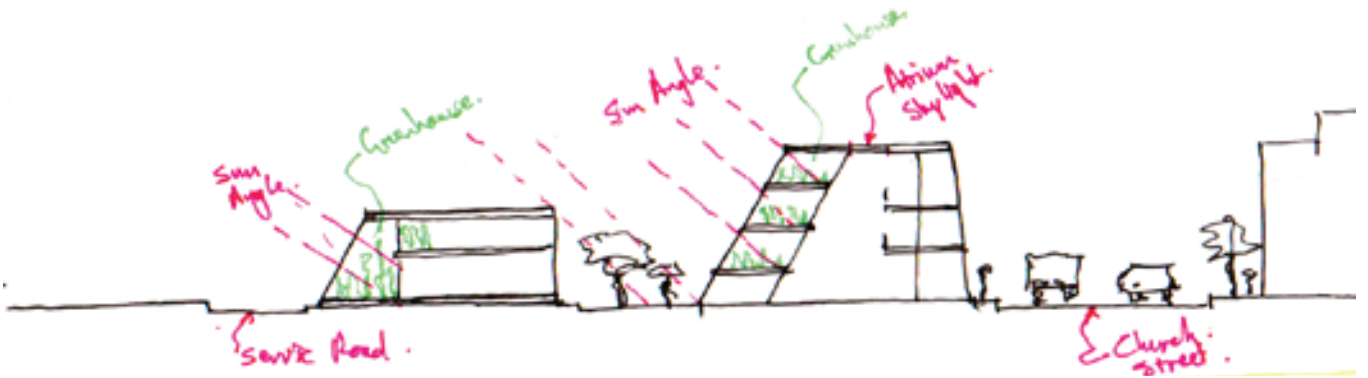

Figure 111: Natural daylight as design informant.

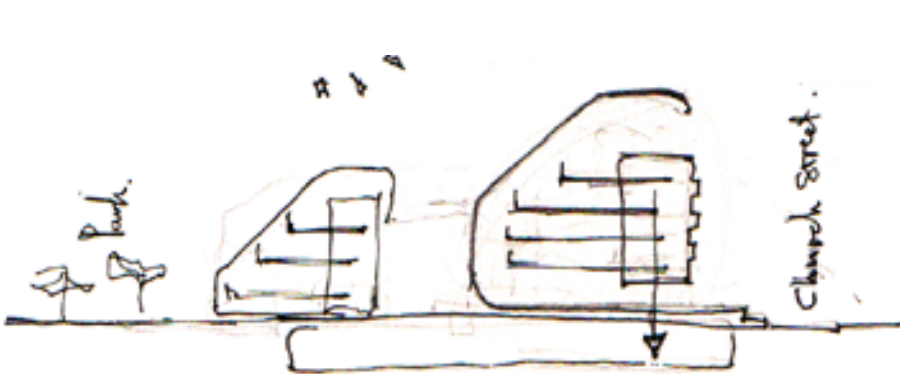

Figure 113: Building use of earth as functional space.



Figure 112: Natural ventilation as design informant

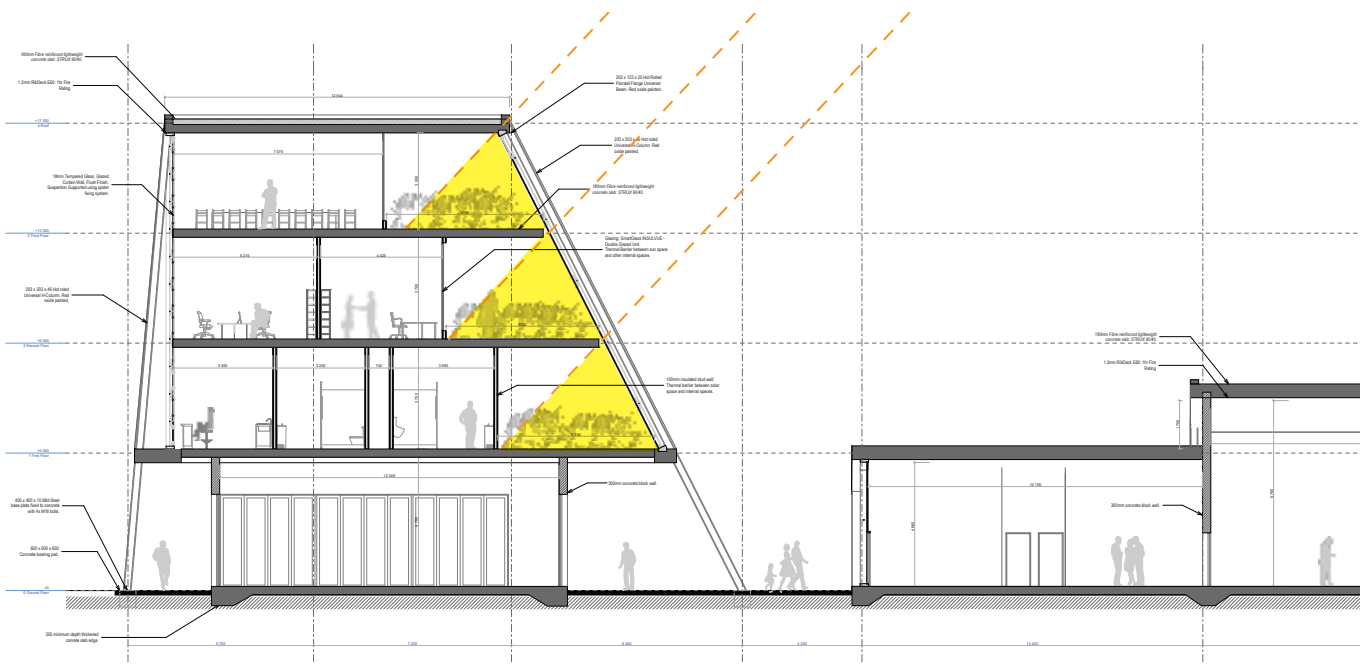

Figure 114: Draft section indicating direct natural daylight in greenhouse areas.

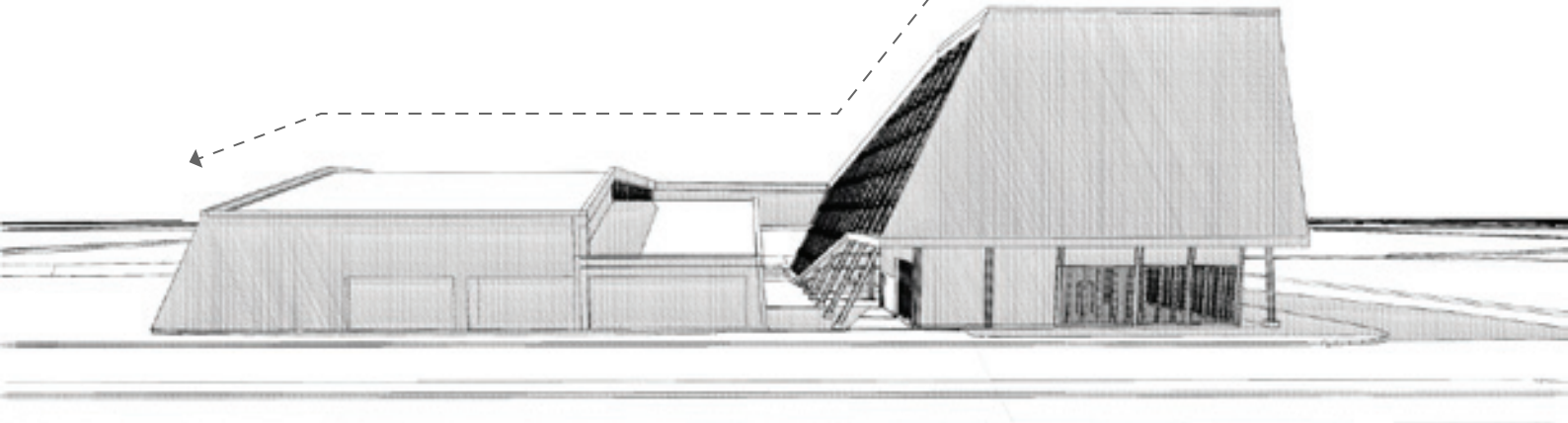

Figure 115: Building mass stepped and angled to allow maximum daylight into courtyard and internal spaces.

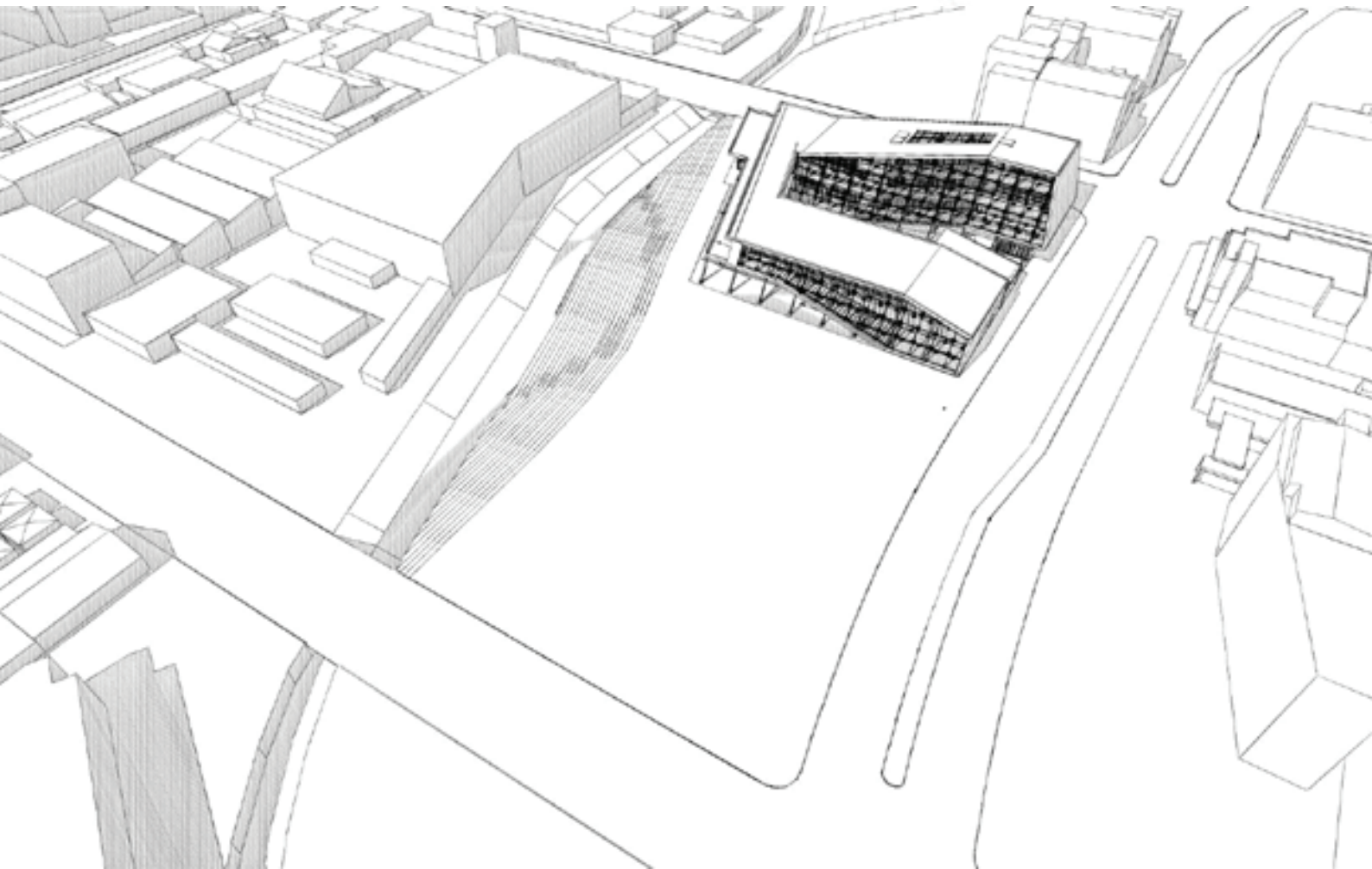

Figure 116: Building mass stepped to respond to proposed open green space on adjacent site.

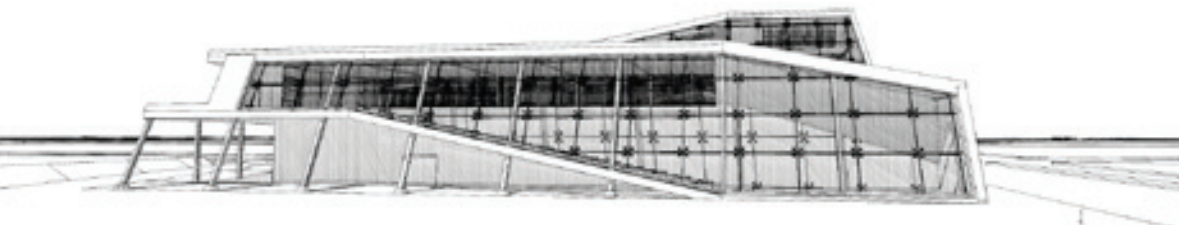
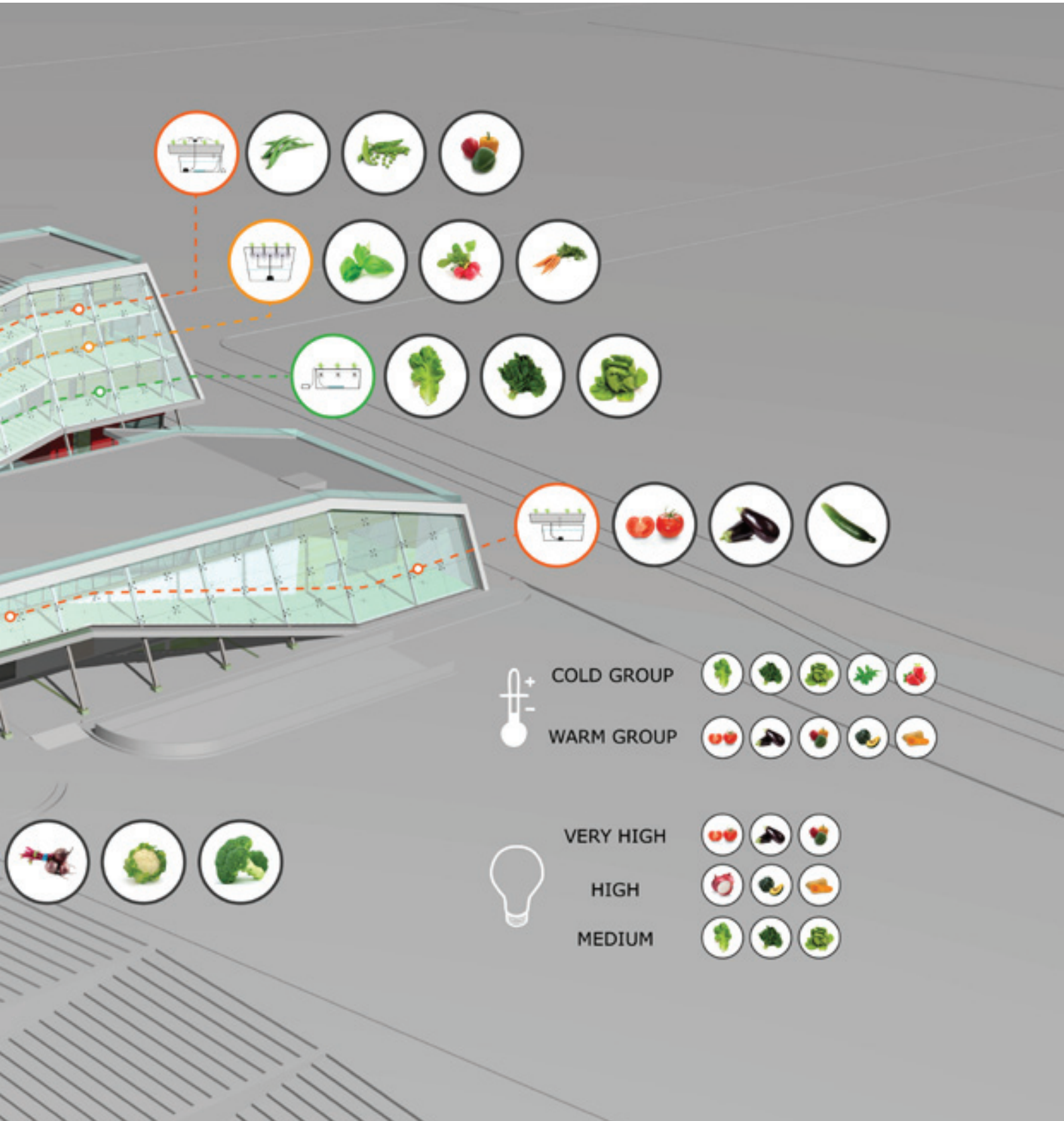

Figure 117: View from adjacent park location.



Figure 118: Diagram showing location of specific crops and hydroponic technologies based on light and heat intensity in specific locations.





PROGRAM

Historically production /industrial environmental have resulted in negative urban spaces and have been located on the fringe areas outside of city centres. By introducing ground floor activities that engage with the public realm, the negative impact of production on the street edge can be negated.



Figure 120: Functional Diagram.

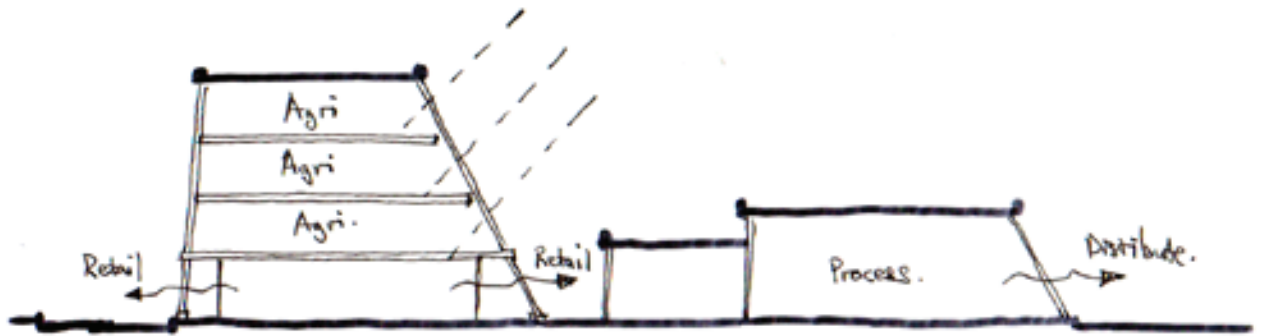

Figure 119: Concept section showing ground floor program with public interface.



With over 50% of the world's population living in cities, it is important for us to think locally and reconnect not only to our food but also its processes and the ability to implement them in our living conditions as an urban bound species

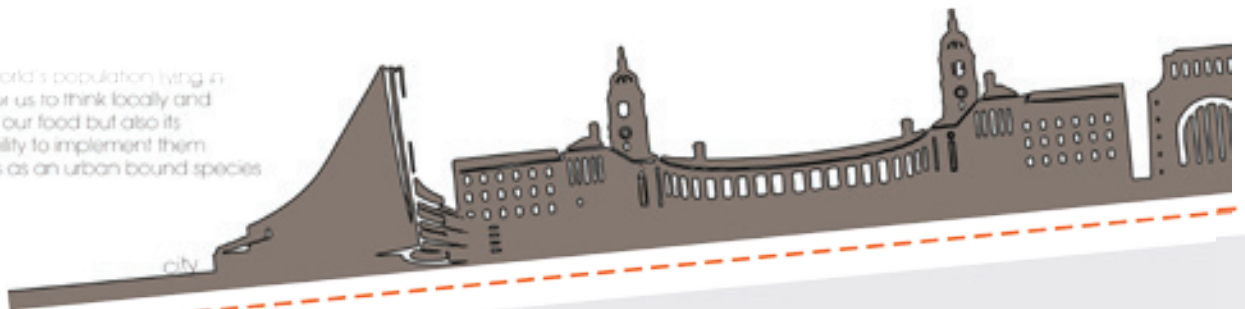

Figure 121: Connecting the city and nature using building program.

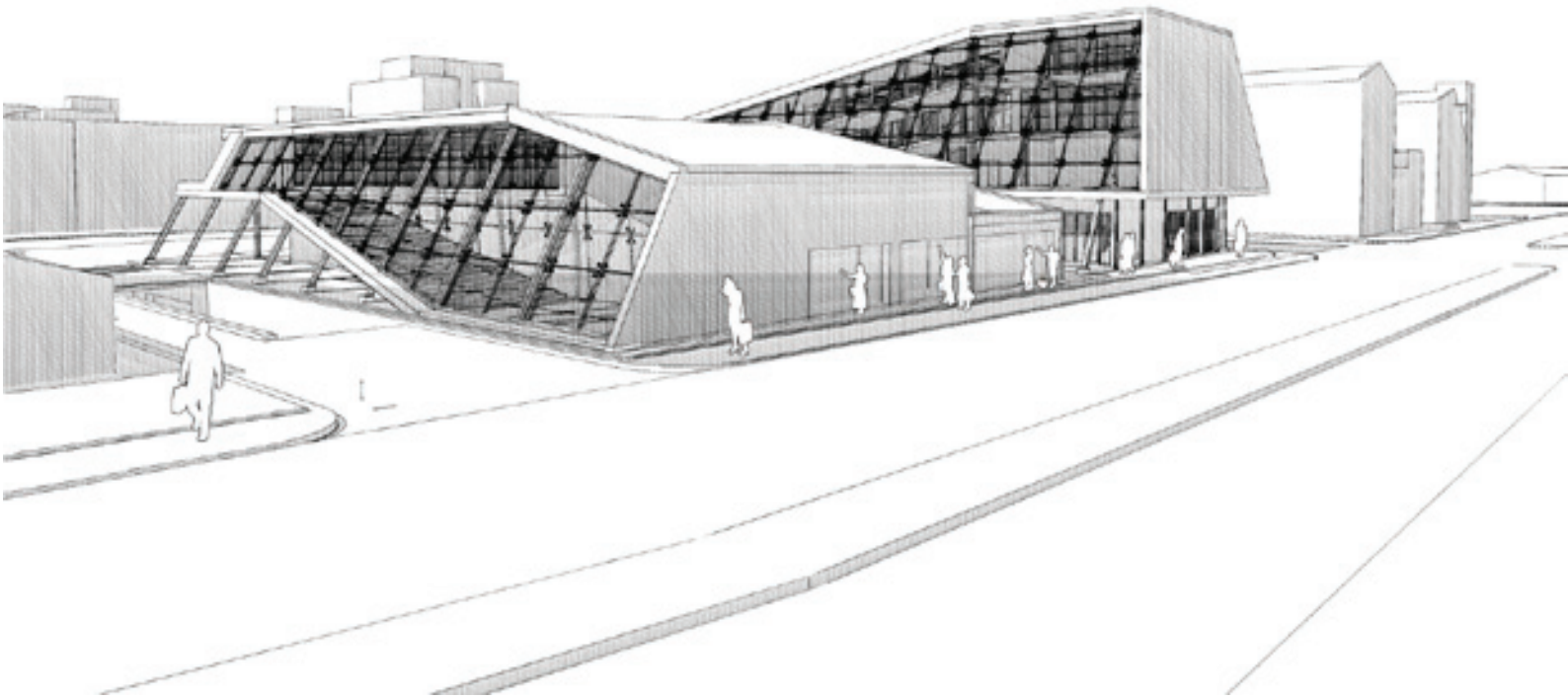

Figure 122: Perspective view from Nelson Mandela drive showing proposed retail edge.

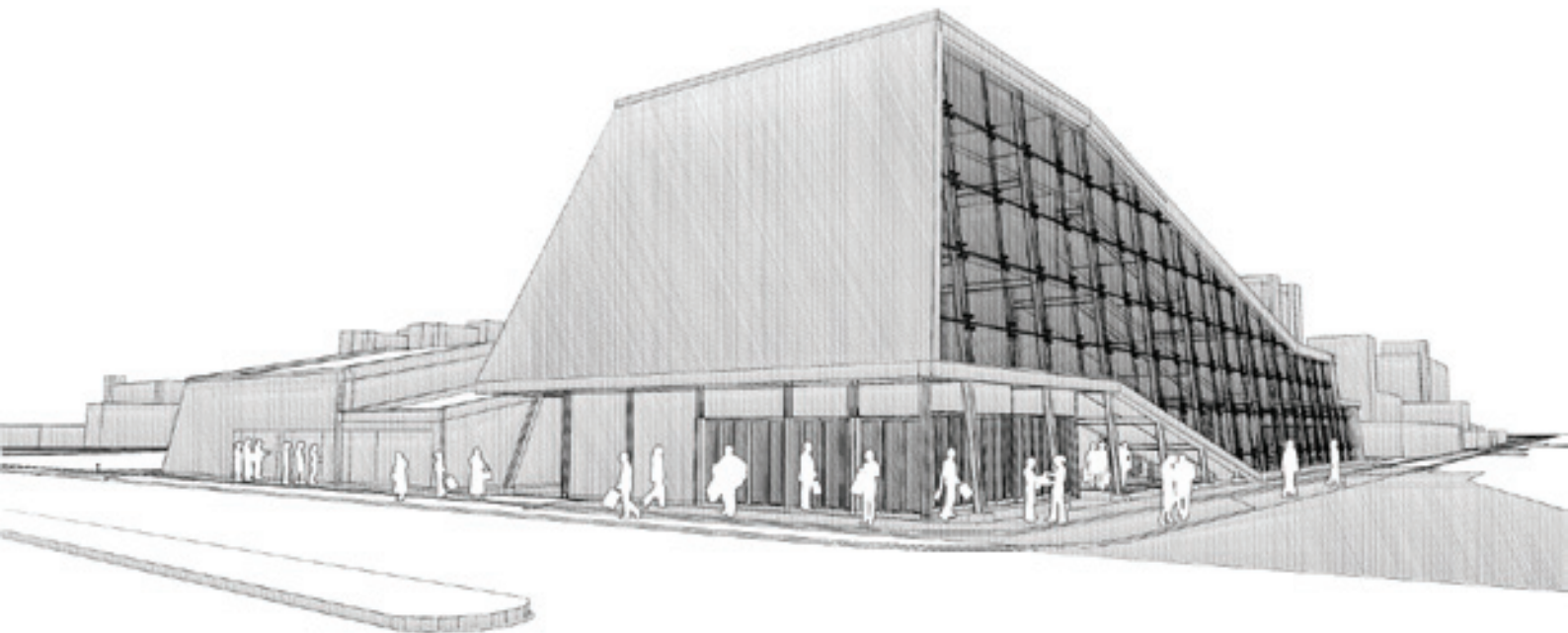

Figure 123: Perspective view from Church Street showing proposed retail edge.

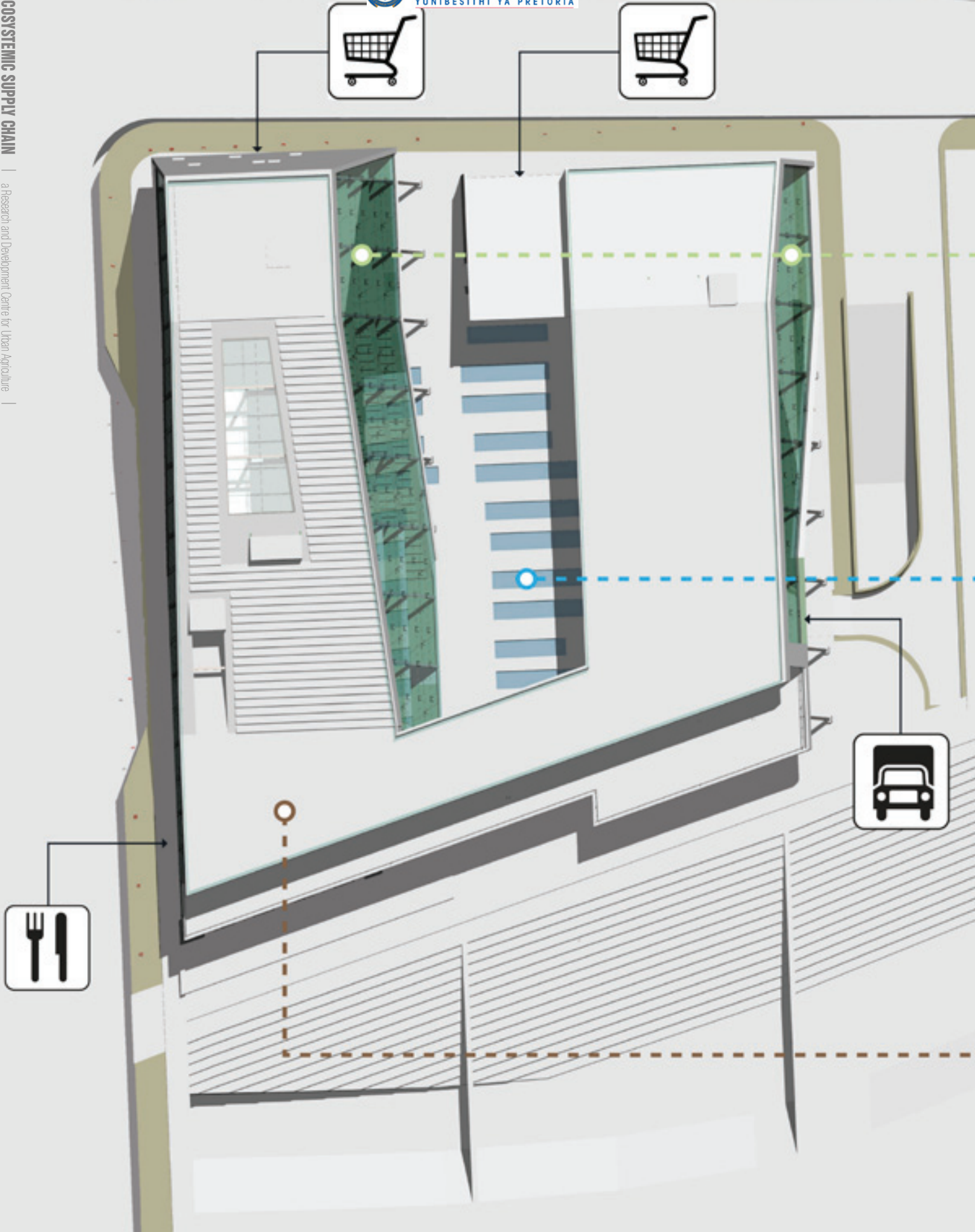
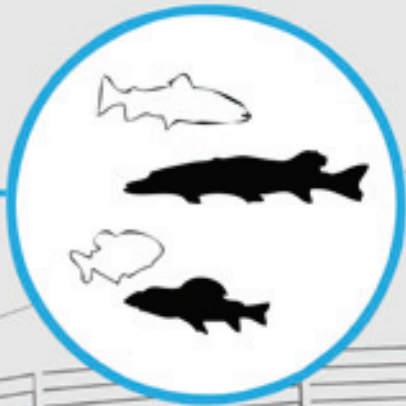
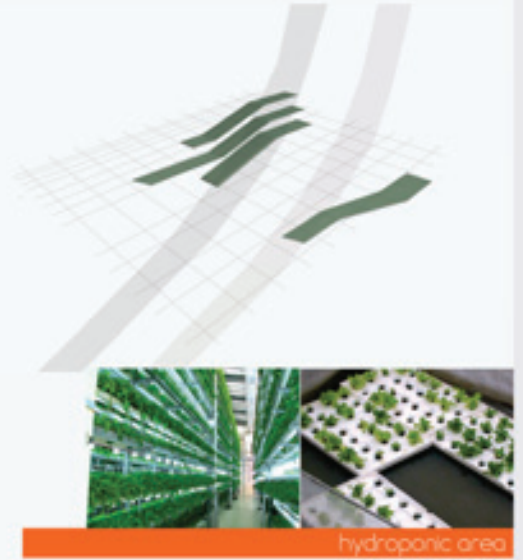

Figure 124: Diagram showing location of production and consumption programs based on climatic and edge conditions.



food production areas





EXPLORATION OF PUBLIC SPACE AND ARCHITECTURE

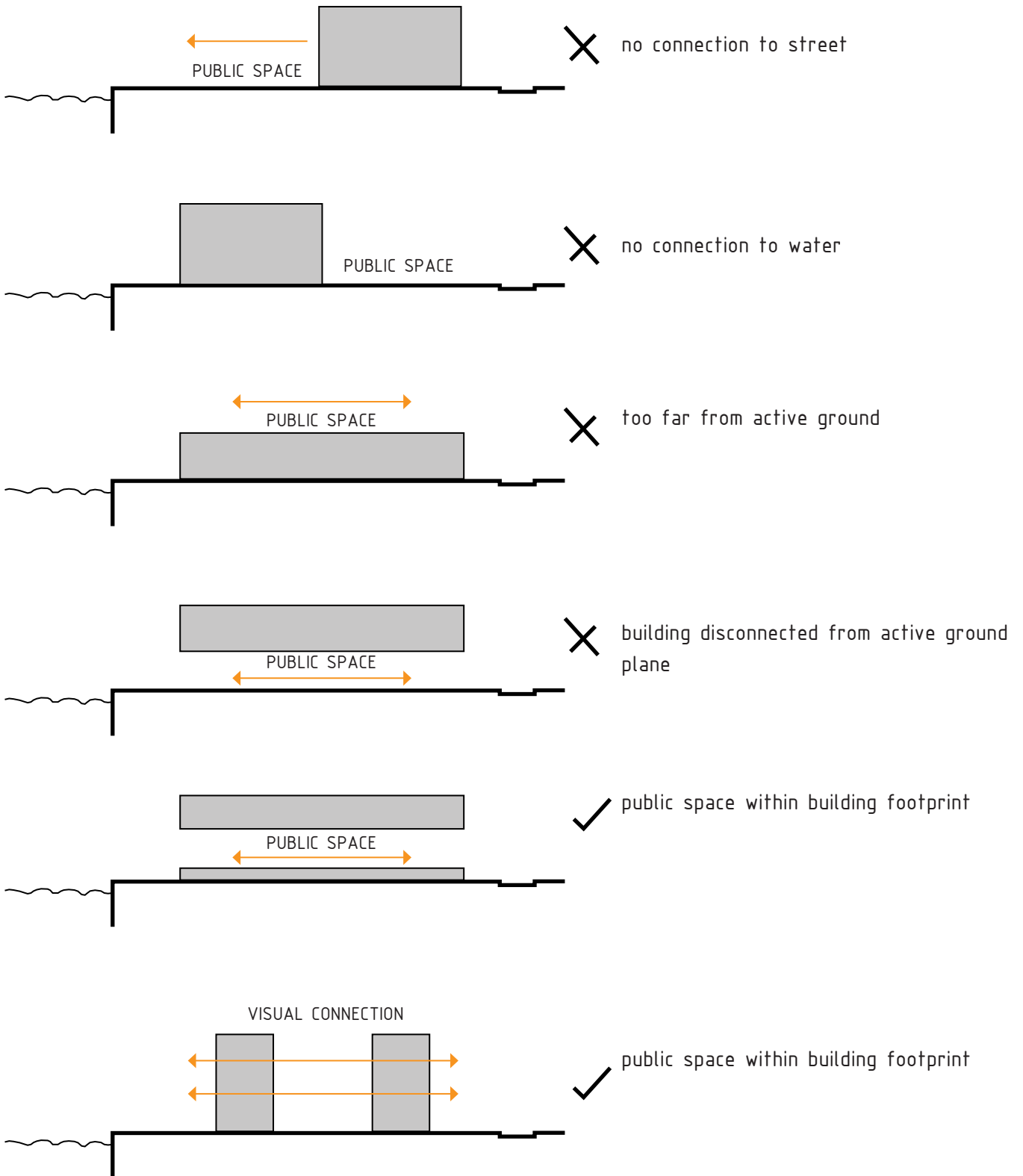

Figure 125: Diagram showing possible locations of public space component.



EXPLORATION OF LANDSCAPE AND ARCHITECTURE

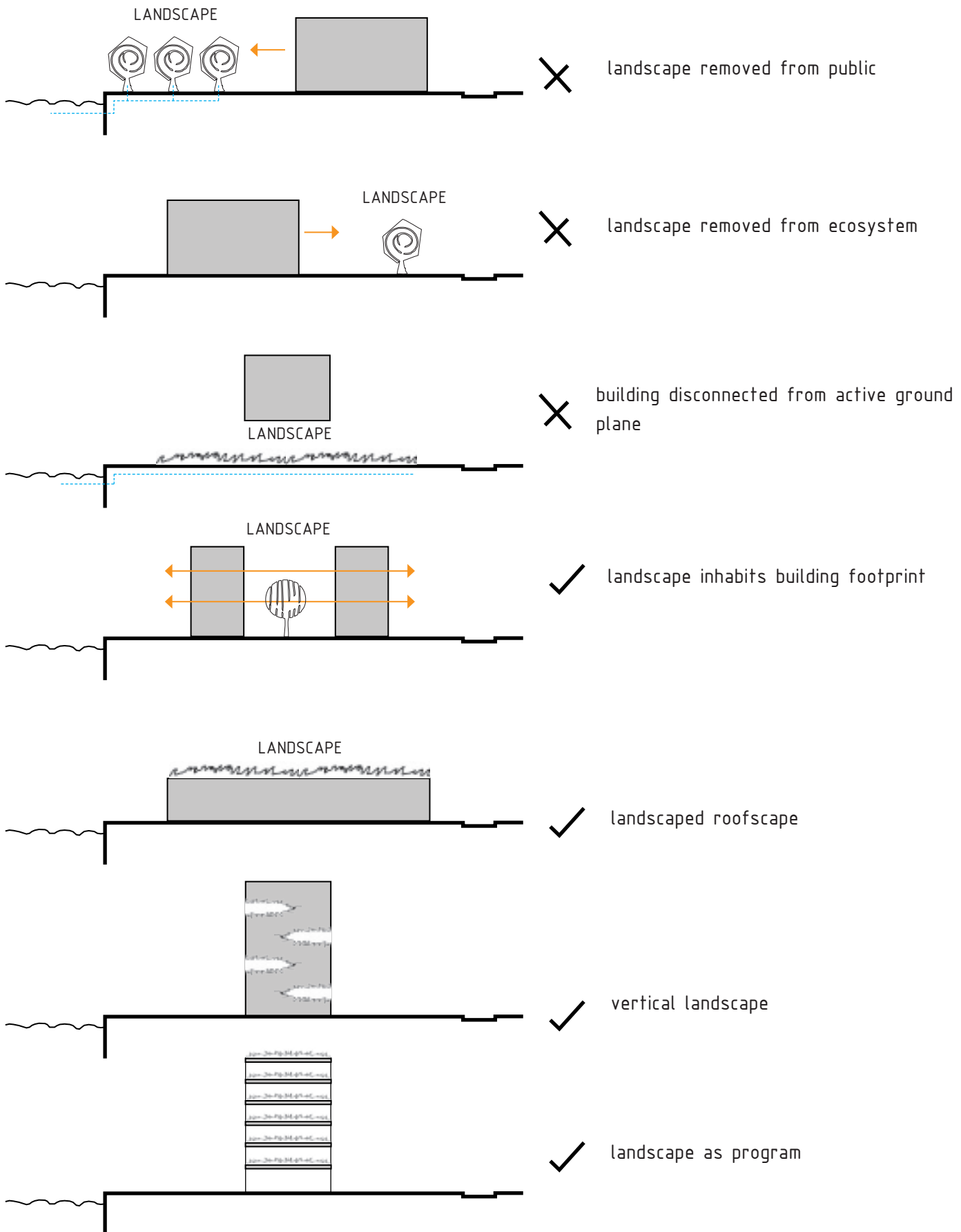

Figure 126: Diagram showing possible locations of landscape / agriculture component.



MASSING STUDY

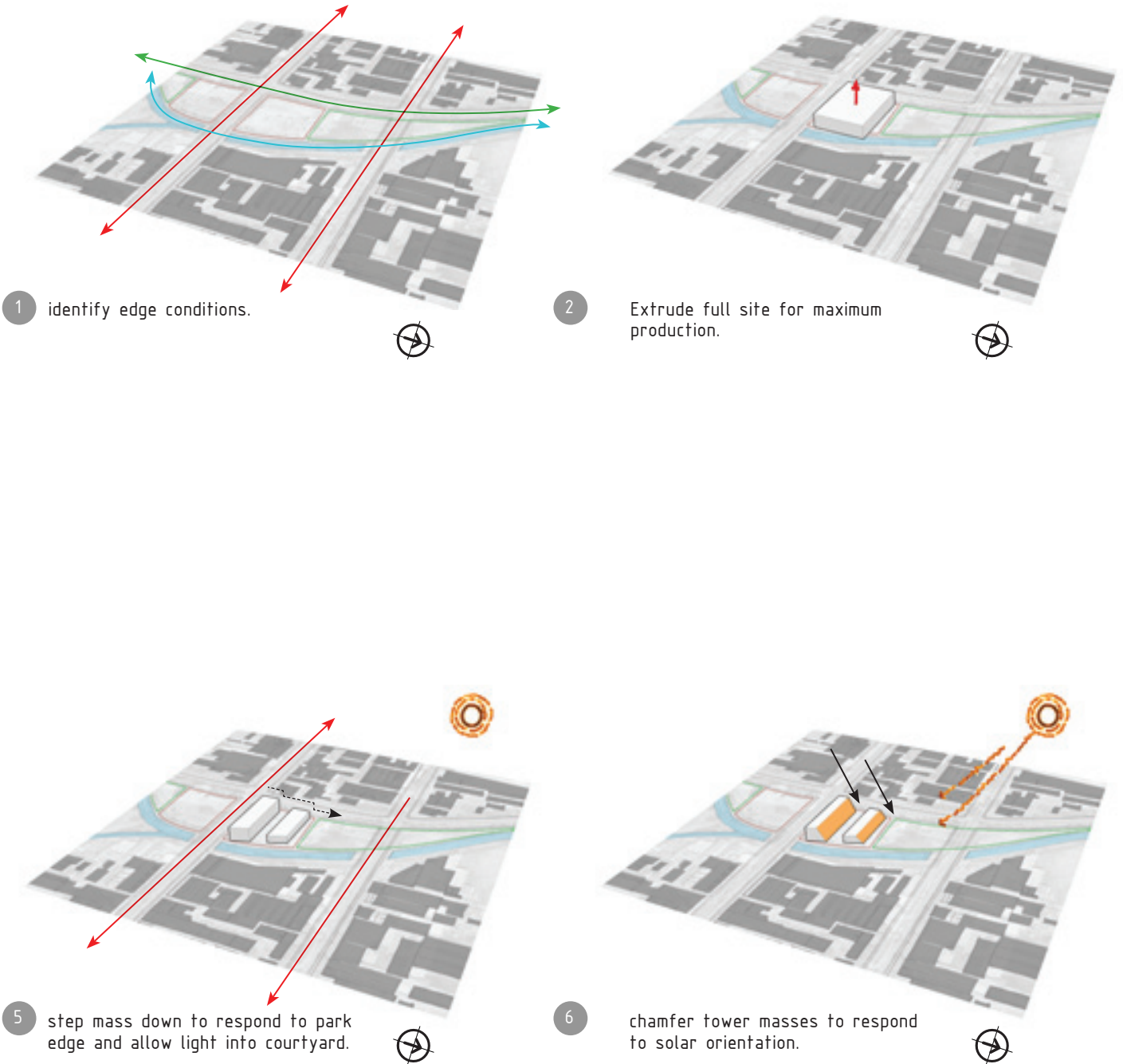

Figure 127: Diagram showing design development as response to design generators.



3 skew mass from street grid to respond to river edge.



4 disjoin mass to allow access to river from city.



7 step mass down to link urban scale to pedestrian scale.

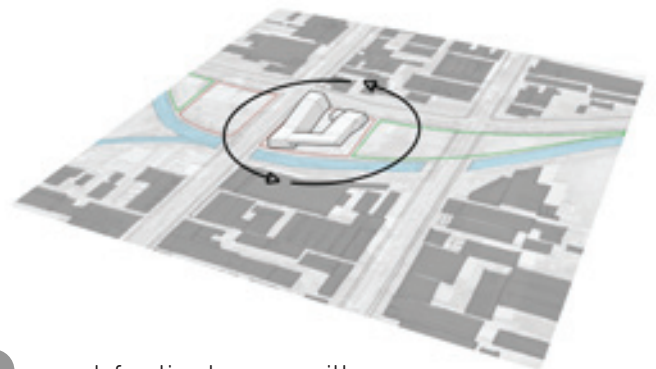

8 connect functional masses with service and circulation space.





UNIVERSITEIT VAN PRETORIA
UNIVERSITY OF PRETORIA
YUNIBESITHI YA PRETORIA

TECHNICAL

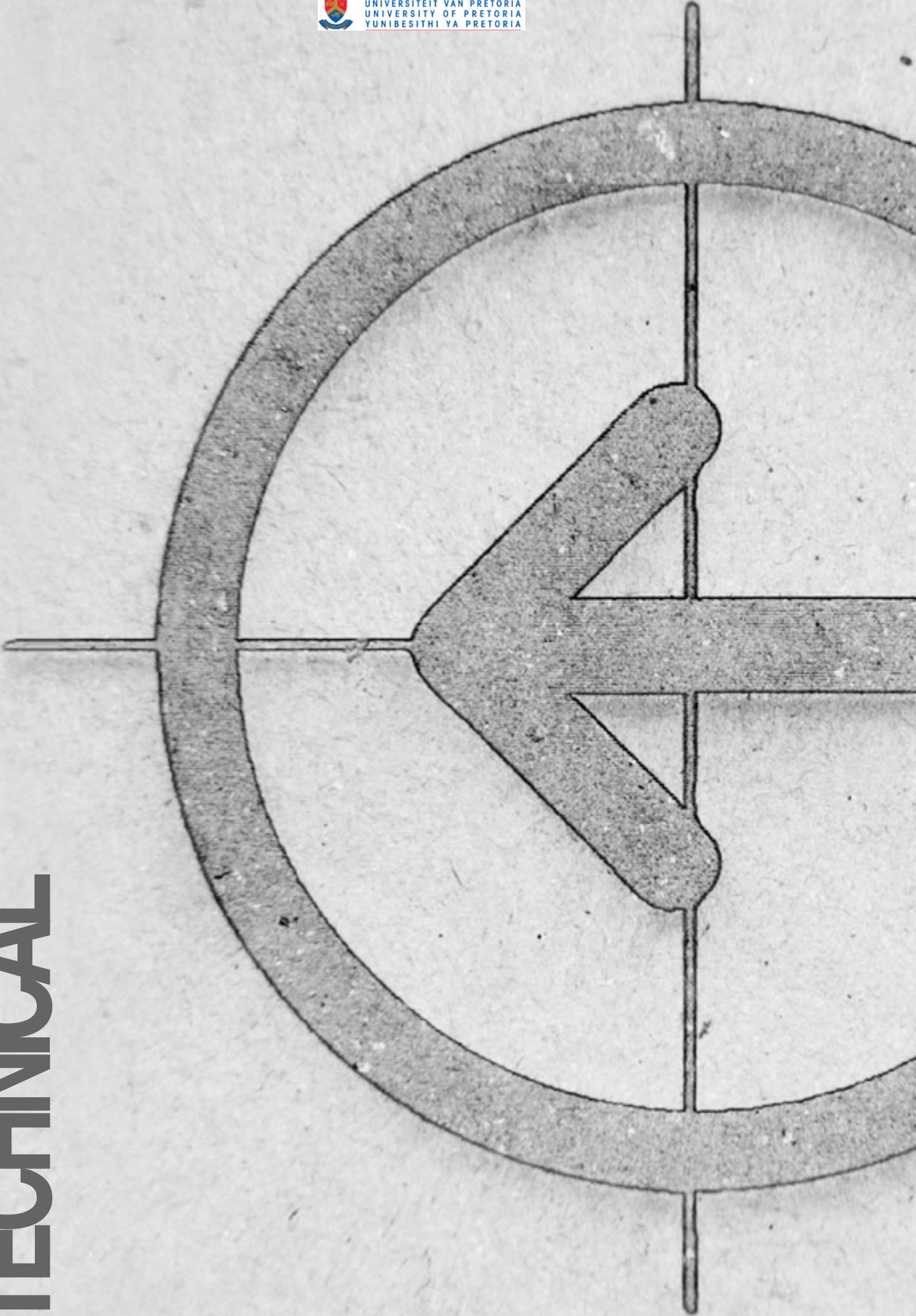



UNIVERSITEIT VAN PRETORIA
UNIVERSITY OF PRETORIA
YUNIBESITHI YA PRETORIA

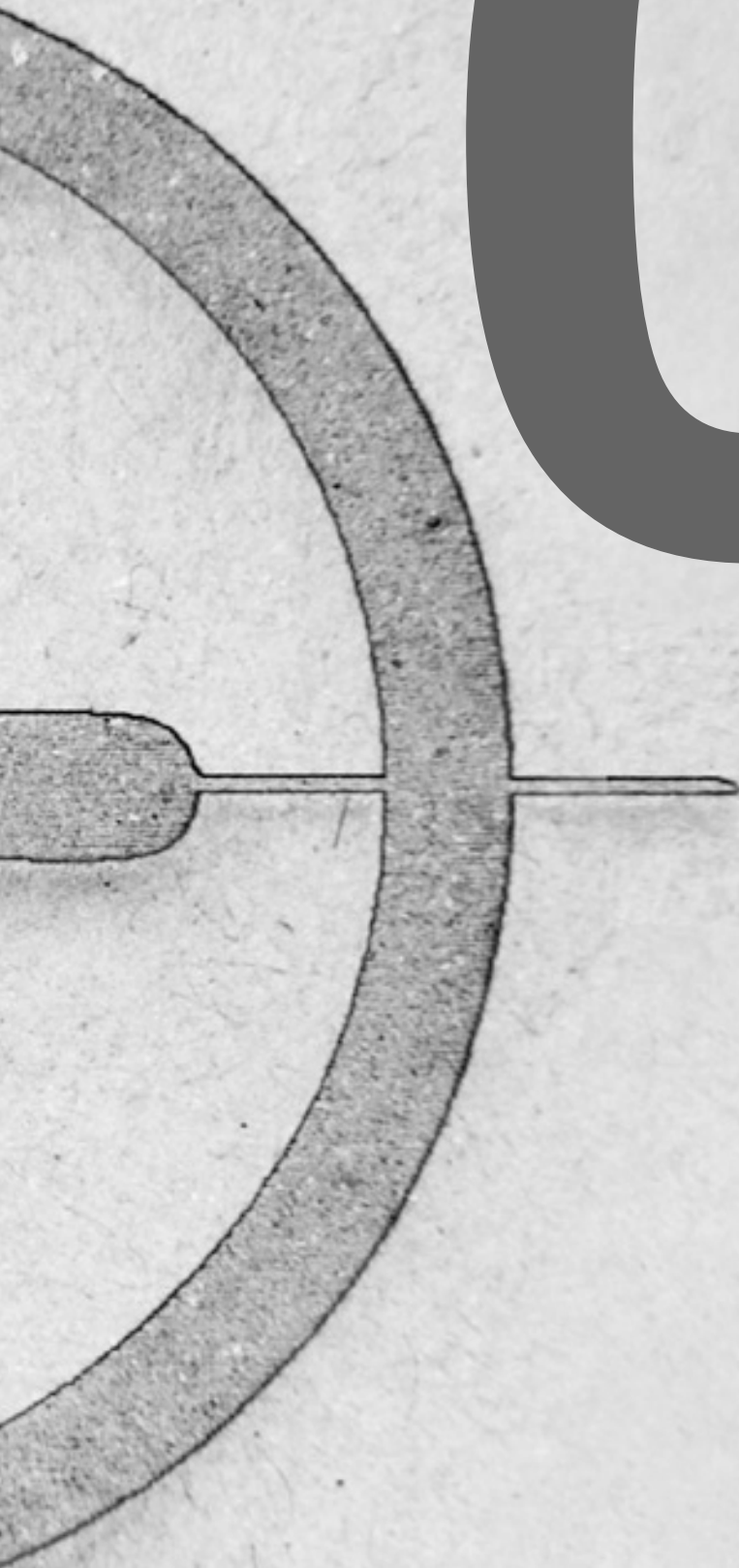

0

9

CHAPTER 8 TECHNICAL

8.1 Construction

STRUCTURE

FRAME

Due to the required height and expected loads that will be imposed on the structure by the indoor agricultural activities the building requires a structure with high compressive strength.

As a large percentage of the building's external envelope is to be glazed (to allow light transmittance) a structural framing system is allowing the flexibility to use non-load bearing glazed infill.

Steel frame is chosen as the primary structure over concrete as this material will allow for easier construction of proposed "angled" facades using prefabricated steel member and that can be assembled on site.

That fact that steel can be recycled whereas concrete can only be re-used also plays a part in the decision.

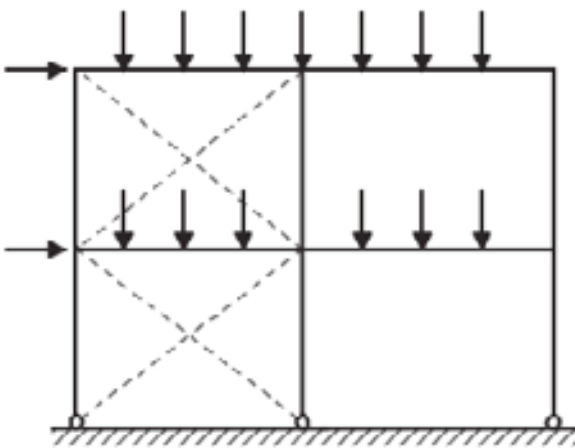

Figure 129: Braced steel frame with pinned connections.

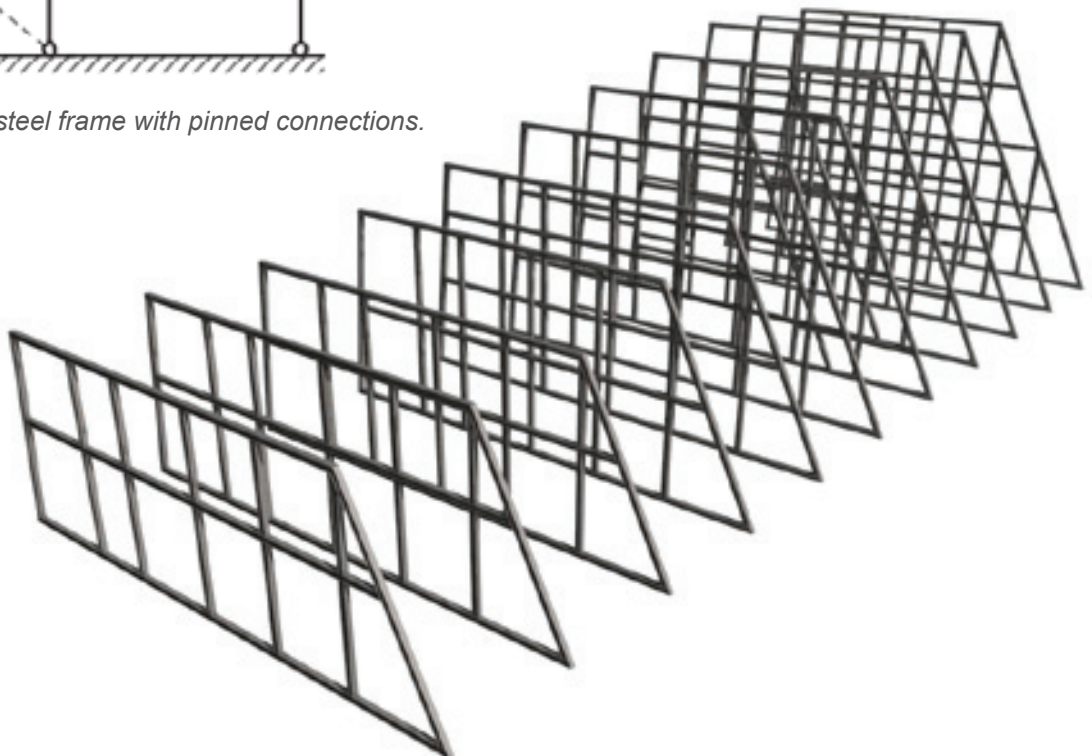

Figure 128: Main structural steel members spaced at 6.5m intervals.

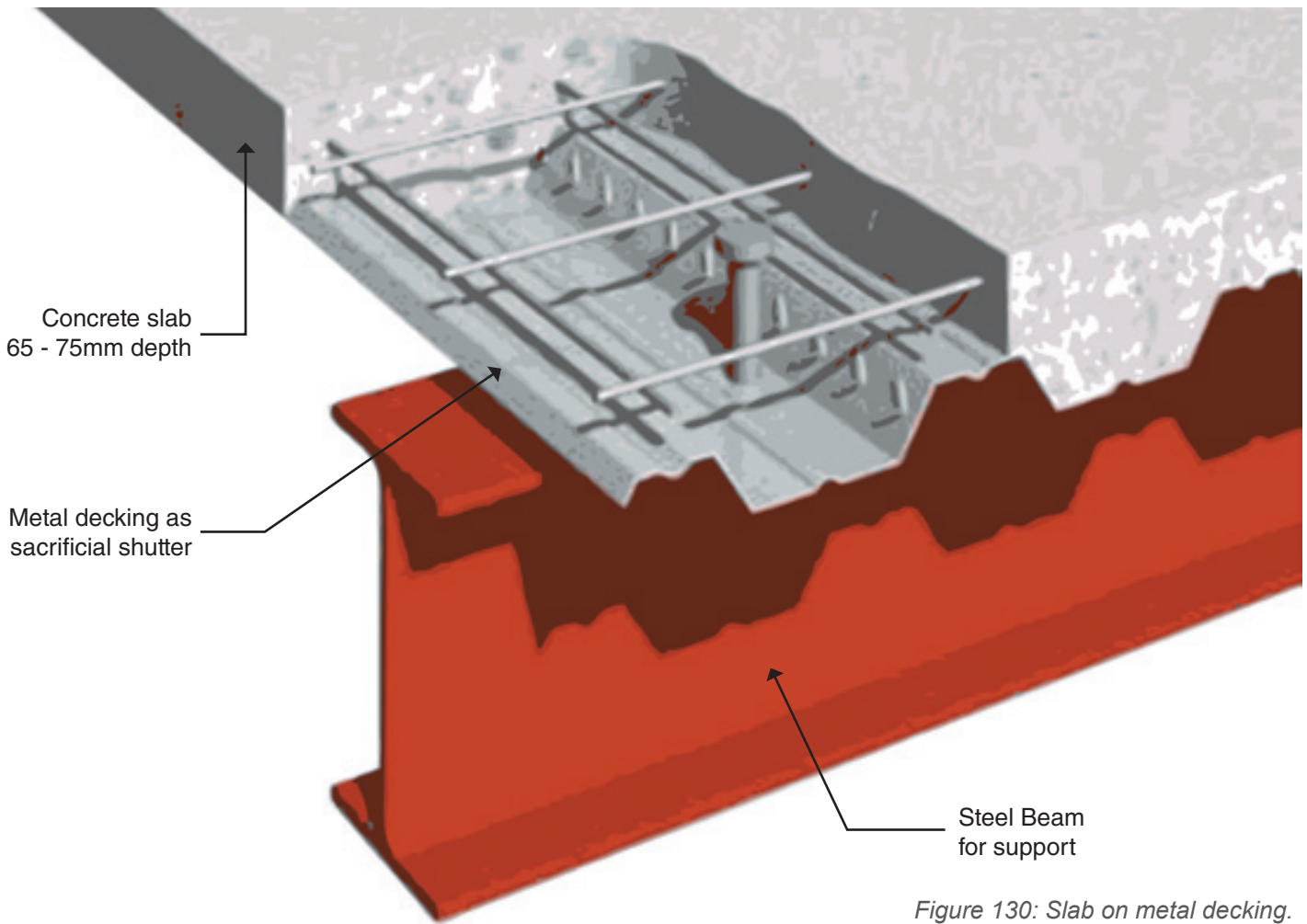
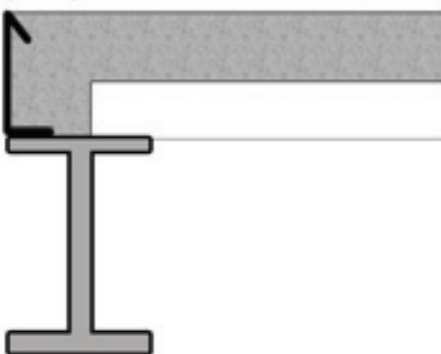

Figure 130: Slab on metal decking.

SLABS

Due to the “ramped” nature of a large percentage of surfaces in the building a cast in-situ slab system is chosen over a pre-fabricated floor or roof construction. Metal decking is used as a sacrificial shutter, thereby making use of the steel frame for support and further reducing the use of concrete.

Edgeform at the perpendicular condition



Edgeform at the parallel condition

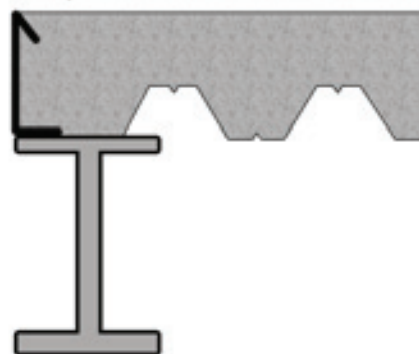

Figure 131: Slab on metal decking edge details.

GREEN ROOF

The roof is required to accommodate a large amount of outdoor agriculture. An intensive green roof construction is proposed to give adequate soil depth for consumable fauna.

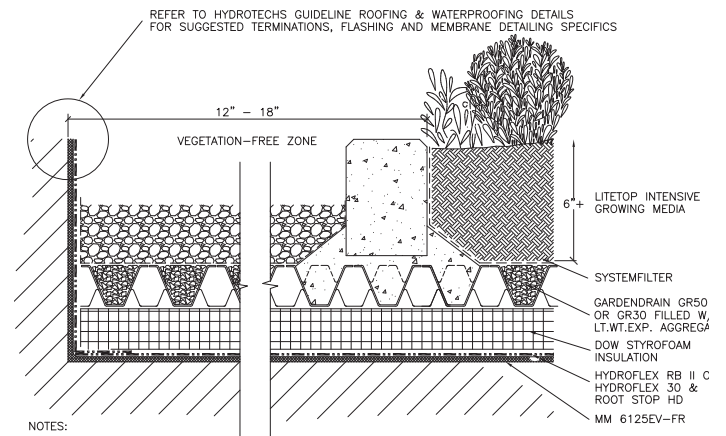

Figure 133: Green roof edge detail.

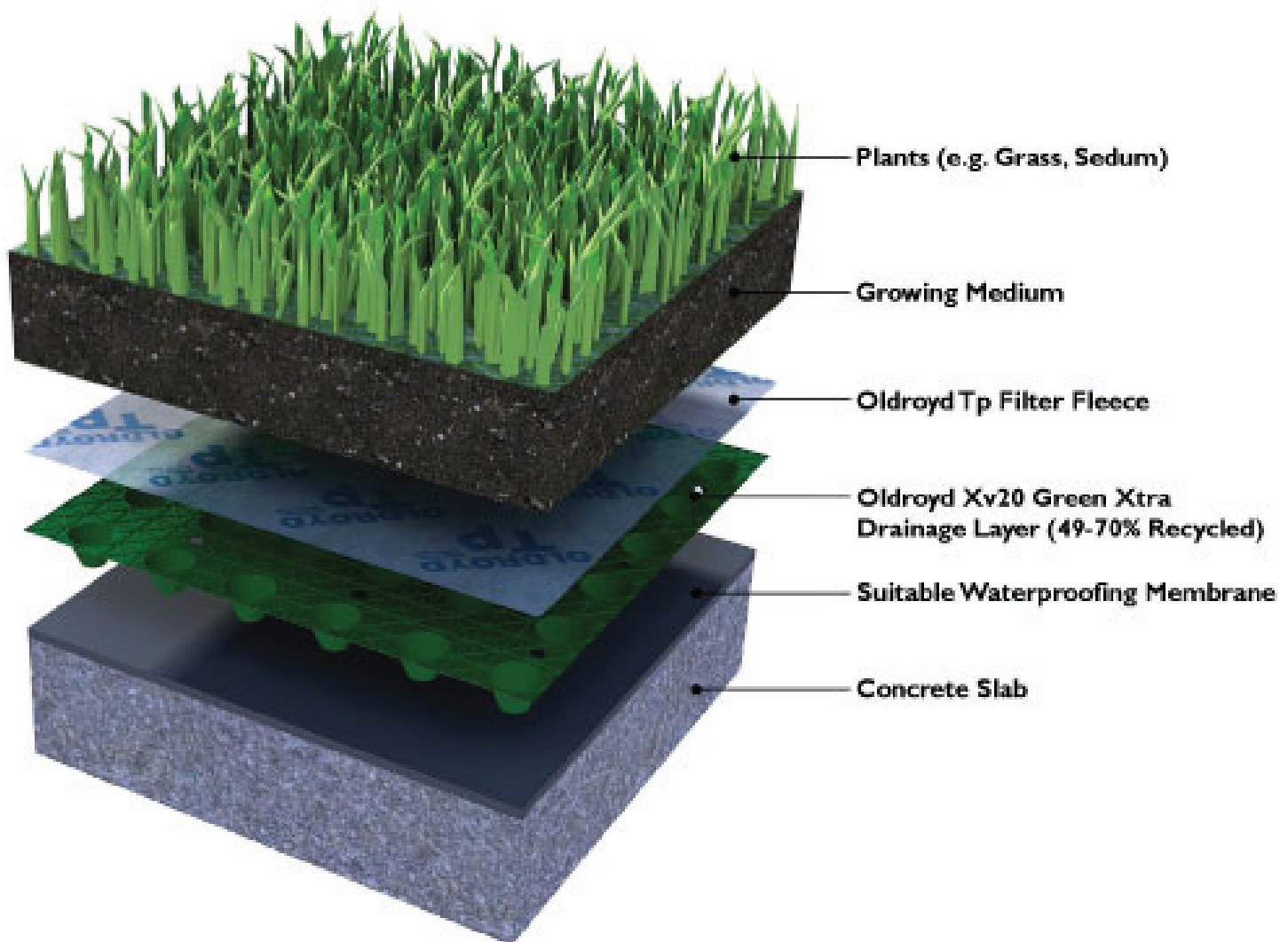

Figure 132: Exploded view of green roof construction.

SUBSTRUCTURE

Due to the expected ground conditions in an area bordering on a river bank a deep foundation system would be preferable for a multistory construction.

Piling was considered to transfer building loads down to a stable soil condition, however it is thought that due to the proposed basement construction adequate depth will be achieved.

The basement is constructed to withstand both the imposed soil pressure and heave caused by water

table.

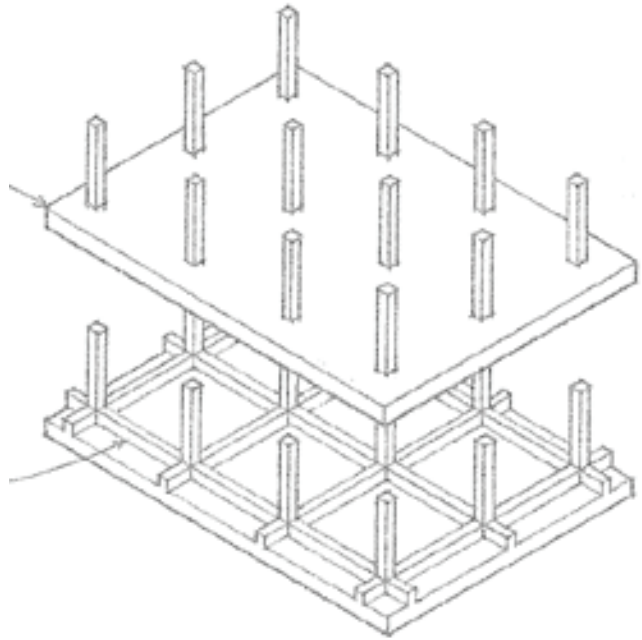

Figure 134: Basement concrete beam and post construction.

ENVELOPE

CURTAIN GLAZING

North and South facing facades are covered with glazed curtain walls to allow for maximum natural light into the growing areas.

These curtain walls can be supported by the proposed steel frame using spider connectors to give a flush glazing finish.

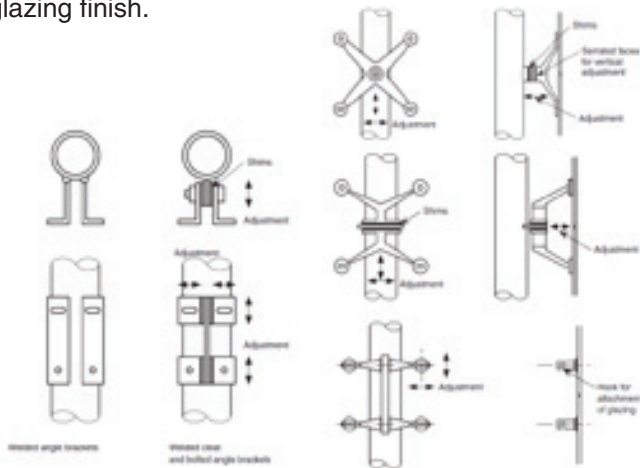
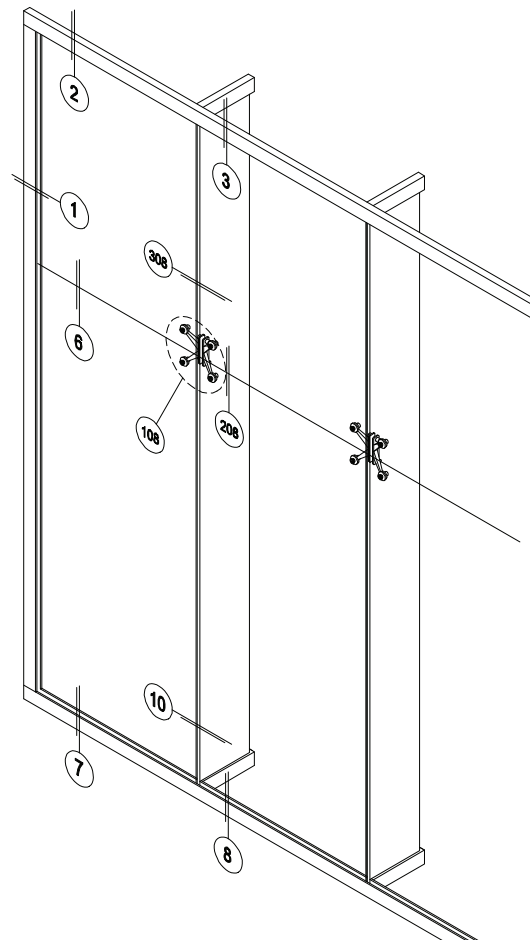

Figure 135: Curtain wall glazing connection details





LIVING WALL

West facing facades are covered with a living green wall system, together with the green roof this system helps to mitigate the heat island effect.

Planting used on this wall will have to be heat tolerant as the western facade is expected to receive high levels of direct late afternoon sun.

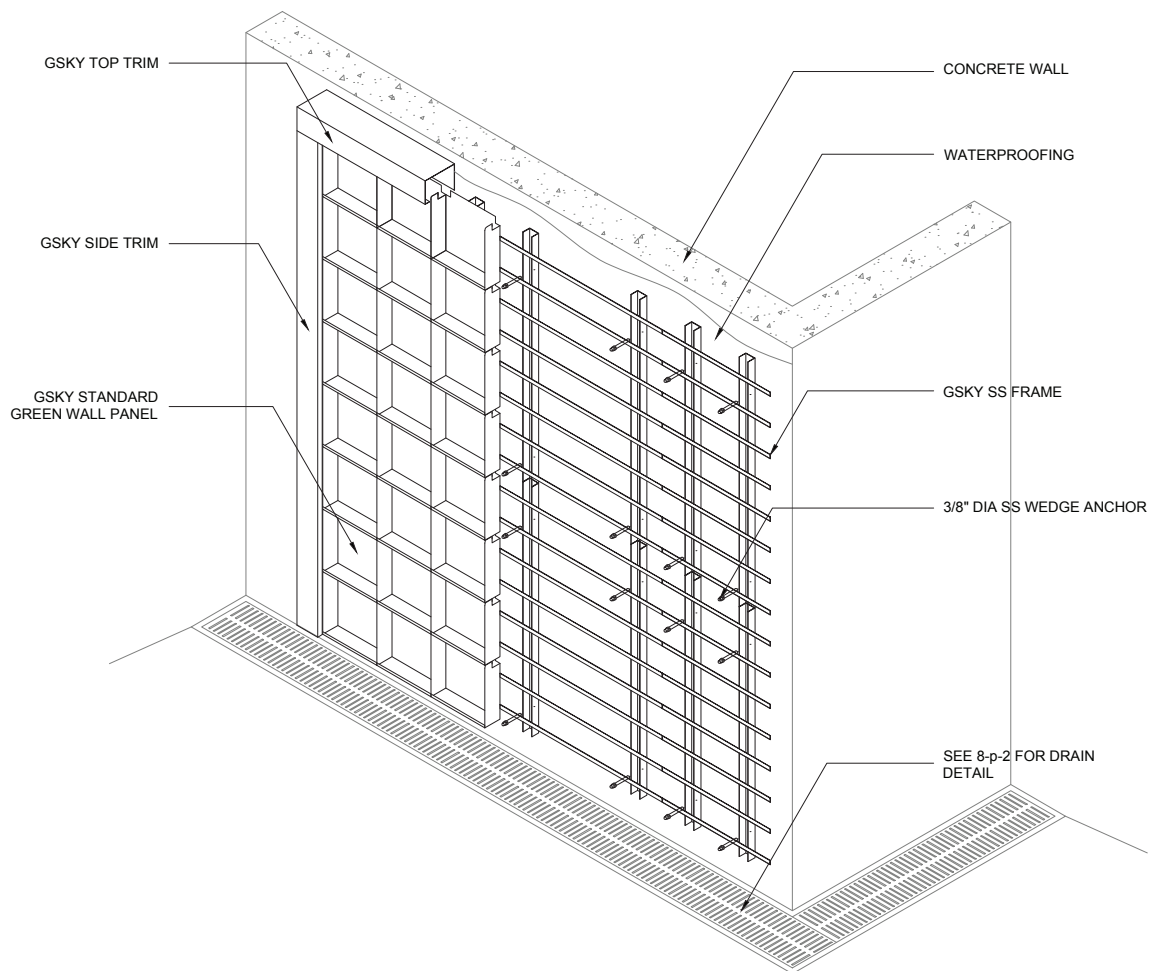

1 3D VIEW / CONCRETE WALL
 SCALE 3/8" - 1'-0" (FILE # 1-p-1)

Figure 136: Living wall assembly drawing.

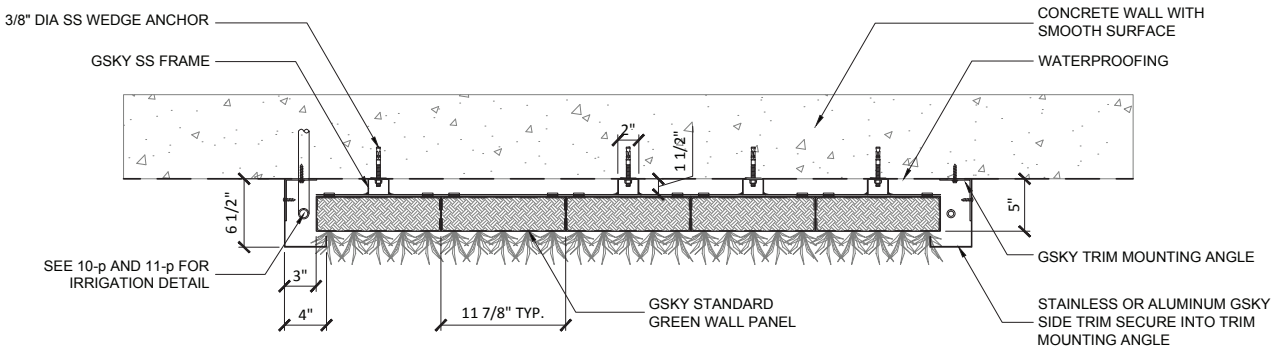

2 PLAN DETAIL / CONCRETE WALL
SCALE 3/4" - 1'-0" (FILE # 1-p-2)

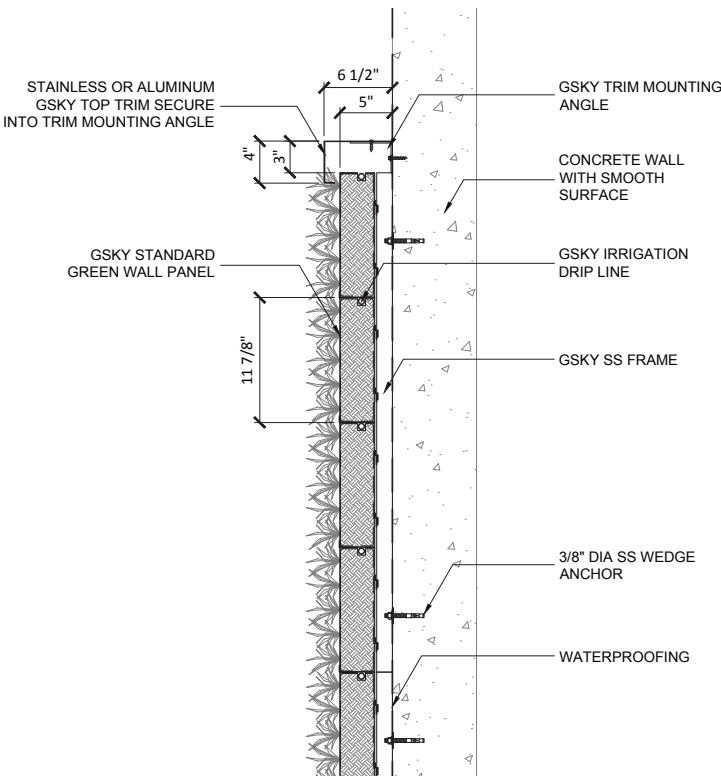

3 SECTION DETAIL / CONCRETE WALL
SCALE 3/4" - 1'-0" (FILE # 1-p-3)

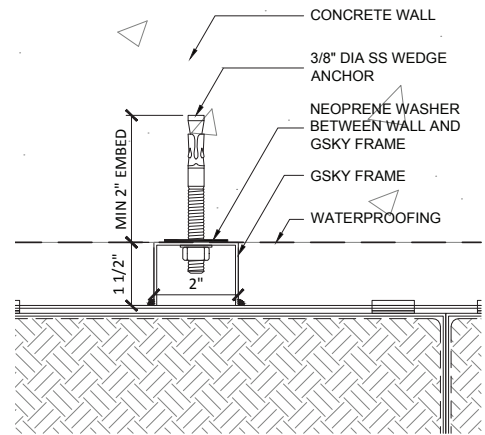

4 FASTENER DETAIL / CONCRETE WALL
SCALE 3" - 1'-0" (FILE # 1-p-4)

Figure 137: Living wall construction details.

8.2 Technology

BASIC HYDROPONIC SYSTEMS

Six basic types of hydroponic systems will be used in the indoor agriculture areas; Wick, Water Culture, Ebb and Flow (Flood & Drain), Drip (recovery or non-recovery), N.F.T. (Nutrient Film Technique) and Aeroponic.

Each one of these systems have specific features that make them ideal for specific crops or climatic conditions. The methods range from fully passive to mechanised systems, the use of all these systems allows for the research of yields given by different levels of natural and artificial resources.

DEEP WATER CULTURE

The water culture system is the simplest of all active hydroponic systems. The platform that holds the plants is usually made of Styrofoam and floats directly on the nutrient solution. An air pump supplies air to the air stone that bubbles the nutrient solution and supplies oxygen to the roots of the plants, keeping the plants roots from drowning. Effort should be made to keep light from getting to the nutrient solution.

Wherever there is light and nutrients, algae will grow. Algae eat the nutrients you are trying to feed to your plants, and when pieces of algae die they attract fungus gnats. Fungus gnats lead to many other problems.

Water culture is the system of choice for growing leaf lettuce, which are fast growing water loving plants, making them an ideal choice for this type of hydroponic system. Very few plants other than lettuce will do well in this type of system.

Since there are no drip or spray emitters to clog, it is also a good choice for organic hydroponics growing systems. This system is well suited for volcanic lava chips media, or else a mixture of one part vermiculite to 5 parts expanded clay pellets.

The biggest draw back of this kind of system is that it doesn't work well with large plants or with long-term plants.

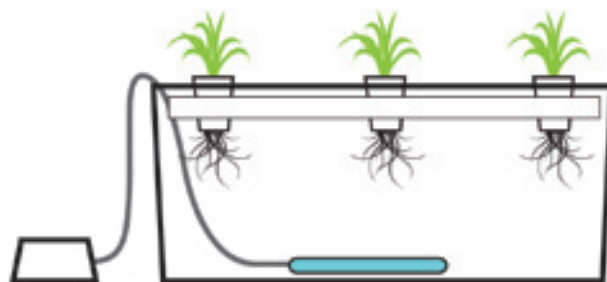

Figure 138: Deep water culture.

EBB & FLOW - (FLOOD AND DRAIN)

In the flood and drain method, the plants sit in their own container separate from the nutrient reservoir. The Ebb and Flow system works by temporarily flooding the grow tray with nutrient solution and then draining the solution back into the reservoir. This action is normally done with a submerged pump that is connected to a timer.

When the timer turns the pump on nutrient solution is pumped into the grow tray. When the timer shuts the pump off the nutrient solution flows back into the reservoir. The Timer is set to come on several times a day, depending on the size and type of plants, temperature and humidity and the type of growing medium used.

The Ebb & Flow is a versatile system that can be used with a variety of growing mediums. The entire grow tray can be filled with Grow Rocks, gravel or granular Rockwool. Individual pots filled with growing medium can be used, this makes it easier to move plants around or even move them in or out of the system.

The main disadvantage of this type of system is that with some types of growing medium (Gravel, Growrocks, Perlite), there is a vulnerability to power outages as well as pump and timer failures. The roots can dry out quickly when the watering cycles are interrupted. This problem can be relieved somewhat by using growing media that retains more water (Rockwool, Vermiculite, coconut fibre or a good soilless mix like Pro-mix or Faffard's).

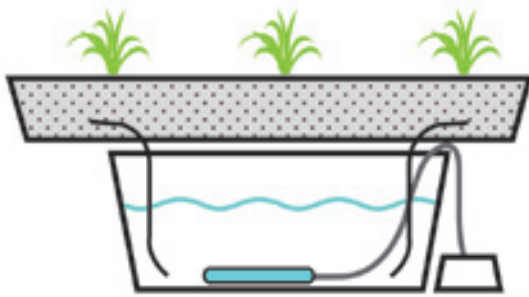

Figure 139: Wick System.

WICK SYSTEM

This is a passive system, which means there are no moving parts. In wick hydroponic growing systems, the plants are again in their own container, separate from the nutrient reservoir. Pieces of absorbent material (usually nylon rope) are buried partially in each plant container. The other end of the rope is allowed to dangle in the nutrient solution. The absorbent material pulls the nutrient solution from the reservoir up into the growing medium.

This system can use a variety of growing medium. Perlite, Vermiculite, Pro-Mix and Coconut Fibre are among the most popular.

The biggest draw back of this system is that plants that are large or use large amounts of water may use up the nutrient solution faster than the wick(s) can supply it.

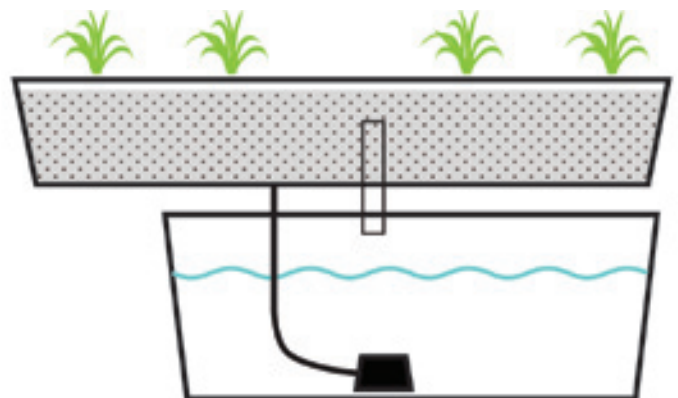

Figure 140: EBB & Flow System.

DRIP SYSTEMS

RECOVERY / NON-RECOVERY

Drip systems are probably the most widely used type of hydroponic system in the world. Operation is simple, a timer controls a submersed pump. The timer turns the pump on and nutrient solution is dripped onto the base of each plant by a small drip line. In a Recovery Drip System the excess nutrient solution that runs off is collected back in the reservoir for re-use. The Non-Recovery System does not collect the runoff.

A recovery system uses nutrient solution a bit more efficiently, as excess solution is reused, this also allows for the use of a more inexpensive timer because a recovery system doesn't require precise control of the watering cycles. The non-recovery system needs to have a more precise timer so that watering cycles can be adjusted to insure that the plants get enough nutrient solution and the runoff is kept to a minimum.

The non-recovery system requires less maintenance due to the fact that the excess nutrient solution isn't recycled back into the reservoir, so the nutrient strength and pH of the reservoir will not vary. This means that you can fill the reservoir with pH adjusted nutrient solution and then forget it until you need to mix more. A recovery system can have large shifts in the pH and nutrient strength levels that require periodic checking and adjusting.

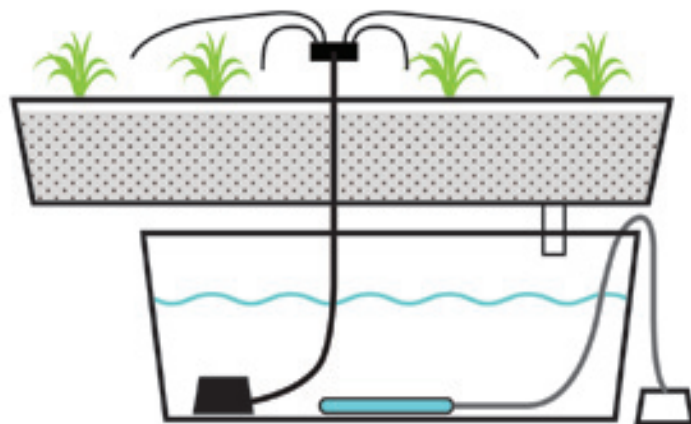

Figure 141: Drip System.

N.F.T.

(NUTRIENT FILM TECHNIQUE)

This is the kind of hydroponic system most people think of when they think about hydroponics. N.F.T. systems have a constant flow of nutrient solution so no timer required for the submersible pump. The nutrient solution is pumped into the growing tray (usually a tube) and flows over the roots of the plants, and then drains back into the reservoir.

There is usually no growing medium used other than air, which saves the expense of replacing the growing medium after every crop. Normally the plant is supported in a small plastic basket with the roots dangling into the nutrient solution.

N.F.T. systems are very susceptible to power outages and pump failures. The roots dry out very rapidly when the flow of nutrient solution is interrupted.

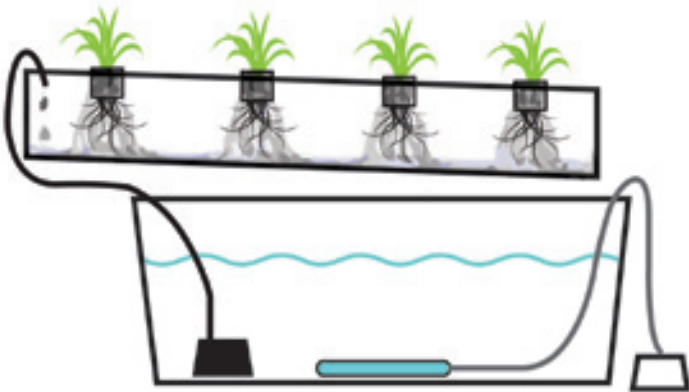

Figure 142: Nutrient Film Technique.

AEROPONIC

As you can see, there really is no growing medium in this method. The plants roots hang down into the container and grow mostly in air, except for the few that grow long enough to make it into the nutrient solution in the bottom.

The pump used is a high-pressure pump, and the spray emitters are made specially to deliver a very fine, highly oxygenated spray.

It is often very hard to assemble individual parts into a well-working system, and the individual parts can be expensive as well. Also, the fine-spray emitters will

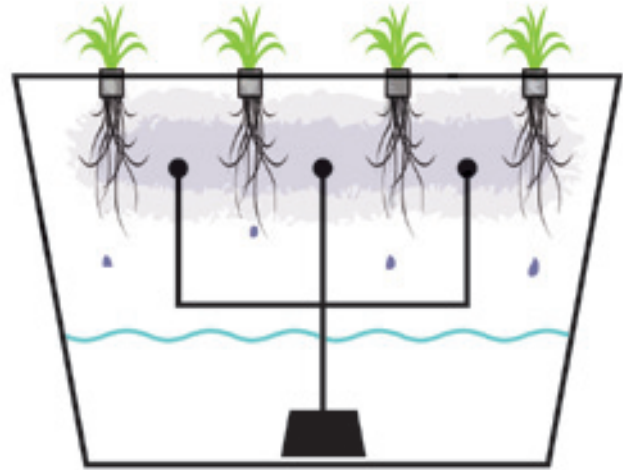

Figure 143: Aeroponics.

instantly clog if you try to use anything except high quality hydroponic fertilizers (no organics).

Of all the hydroponics growing systems, this is the most difficult to master and the most temperamental. Ph changes and nutrient imbalances occur more quickly because of the increased absorption rates and high levels of oxygenation. Furthermore, with no grow media to protect the roots, the plants react negatively to these changes much more quickly.

The aeroponic system is probably the most high-tech type of hydroponic gardening. Like the N.F.T. system above the growing medium is primarily air. The roots hang in the air and are misted with nutrient solution. The mistings are usually done every few minutes. Because the roots are exposed to the air like the N.F.T. system, the roots will dry out rapidly if the misting cycles are interrupted.

A timer controls the nutrient pump much like other types of hydroponic systems, except the aeroponic system needs a short cycle timer that runs the pump for a few seconds every couple of minutes.



8.3 Services

Carbon dioxide (CO₂) and light are essential for plant growth. As the sun rises in the morning to provide light, the plants begin to produce food energy (photosynthesis). The level of CO₂ drops in the greenhouse as it is used by the plants. Ventilation replenishes the CO₂ in the greenhouse. Because CO₂ and light complement each other, electric lighting combined with CO₂ injection are used to increase yields of vegetable and flowering crops. Bottled CO₂, dry ice, and combustion of sulfur-free fuels can be used as CO₂ sources. Commercial greenhouses use such methods.

LIGHTING

Plants utilize certain colour wavelengths of light to manufacture energy through photosynthesis. This energy is then used by the plant as fuel for growth. Major photosynthesis activity takes place when the red and blue wavelengths are present. All plants have different light intensity requirements, ranging from a far corner of a room to brilliant sunshine. Growing hydroponic vegetables indoors requires the use of at least some artificial lights, in order to fruit, vegetables require high light levels to develop vast amounts of energy.

VENTILATION

Air movement by ventilation alone may not be adequate in the middle of the summer; the air temperature may need to be lowered with evaporative cooling. Also, the light intensity may be too great for the plants. During the summer, evaporative cooling, shade cloth, or paint may be necessary. Shade materials include roll-up screens of wood or aluminium, vinyl netting, and paint. Small package evaporative coolers have a fan and evaporative pad in one box to evaporate water, which cools air and increases humidity. Heat is removed from the air to change water from liquid to a vapour. Moist, cooler air enters the greenhouse while heated air passes out through roof vents or exhaust louvres. The evaporative cooler works best when the humidity of the outside air is low. The system can be used without water evaporation to provide the ventilation of

the greenhouse. Size the evaporative cooler capacity at 1.0 to 1.5 times the volume of the greenhouse. An alternative system, used in commercial greenhouses, places the pads on the air inlets at one end of the greenhouse and uses the exhaust fans at the other end of the greenhouse to pull the air through the house.

ENERGY

Growing indoors requires a lot of energy on a continuous basis. Growing lights and water pumps require continual electrical supply and heat and humidity management. A Biogas Reactor can be used to supply a combined heat-and-power system.

WATER

A water supply is essential. Hand watering is acceptable for most greenhouse crops if someone is available when the task needs to be done; however, for commercial use an automated system is preferred. A variety of automatic watering systems is available to help to do the task over short periods of time. Time clocks or mechanical evaporation sensors can be used to control automatic watering systems. Mist sprays can be used to create humidity or to moisten seedlings. Watering kits can be obtained to water plants in flats, benches, or pots.

COMPUTER CONTROL SYSTEMS

The Computer Control System has two main functions with regards to the aquaponics system. The first is to allow efficient control and maintenance of the system which reduces energy use and both simplifies and minimizes the labour involved in the system while providing optimal conditions for the growth of The Plants and fish. The second goal of the Control System is to collect operational data from both automatic sources (sensors/actuators) and manual input sources (growth speeds, complex chemical analysis).

* The final presentation will include a detailed section illustrating the integrated solution of the above services.

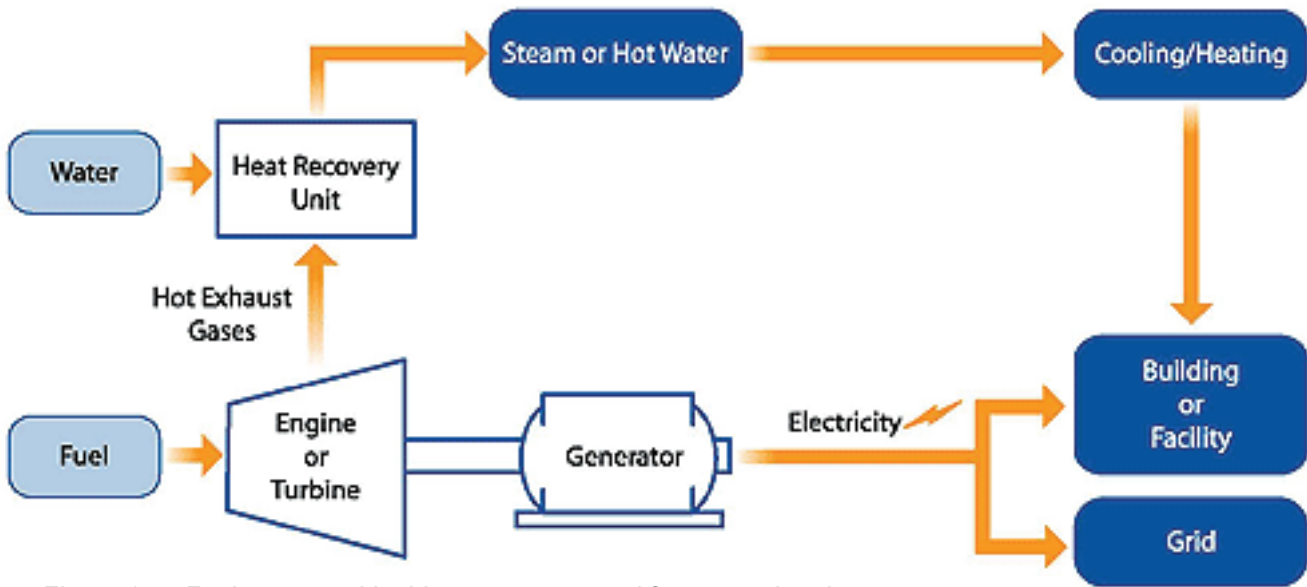

Figure 144: Fuel generated by biogas reactor used for power, heating and cooling systems.

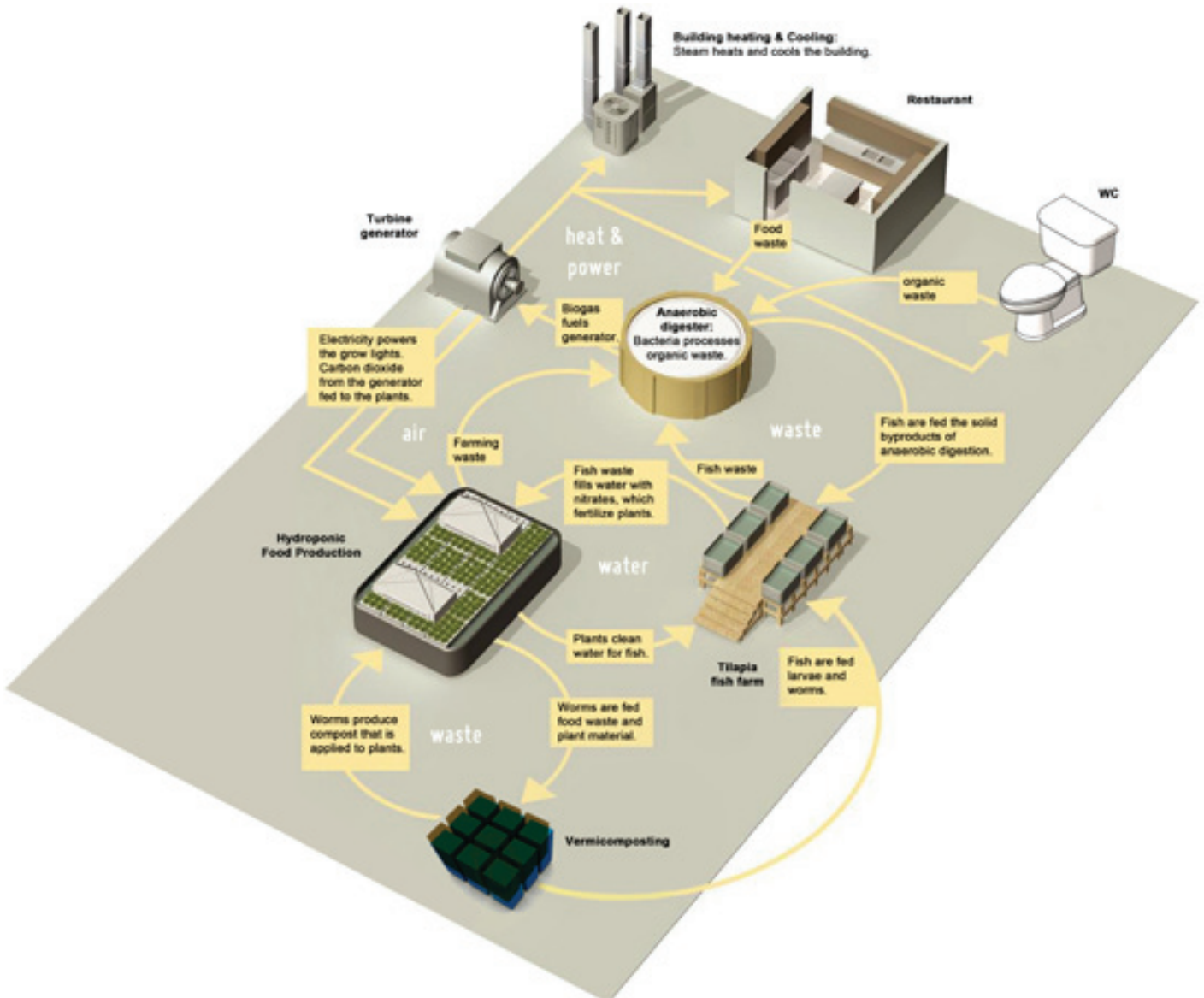

Figure 145: Anaerobic digester as key component to a zero-waste system.



UNIVERSITEIT VAN PRETORIA
UNIVERSITY OF PRETORIA
YUNIBESITHI YA PRETORIA

DESIGN DOCUMENTATION





UNIVERSITEIT VAN PRETORIA
UNIVERSITY OF PRETORIA
YUNIBESITHI YA PRETORIA

09

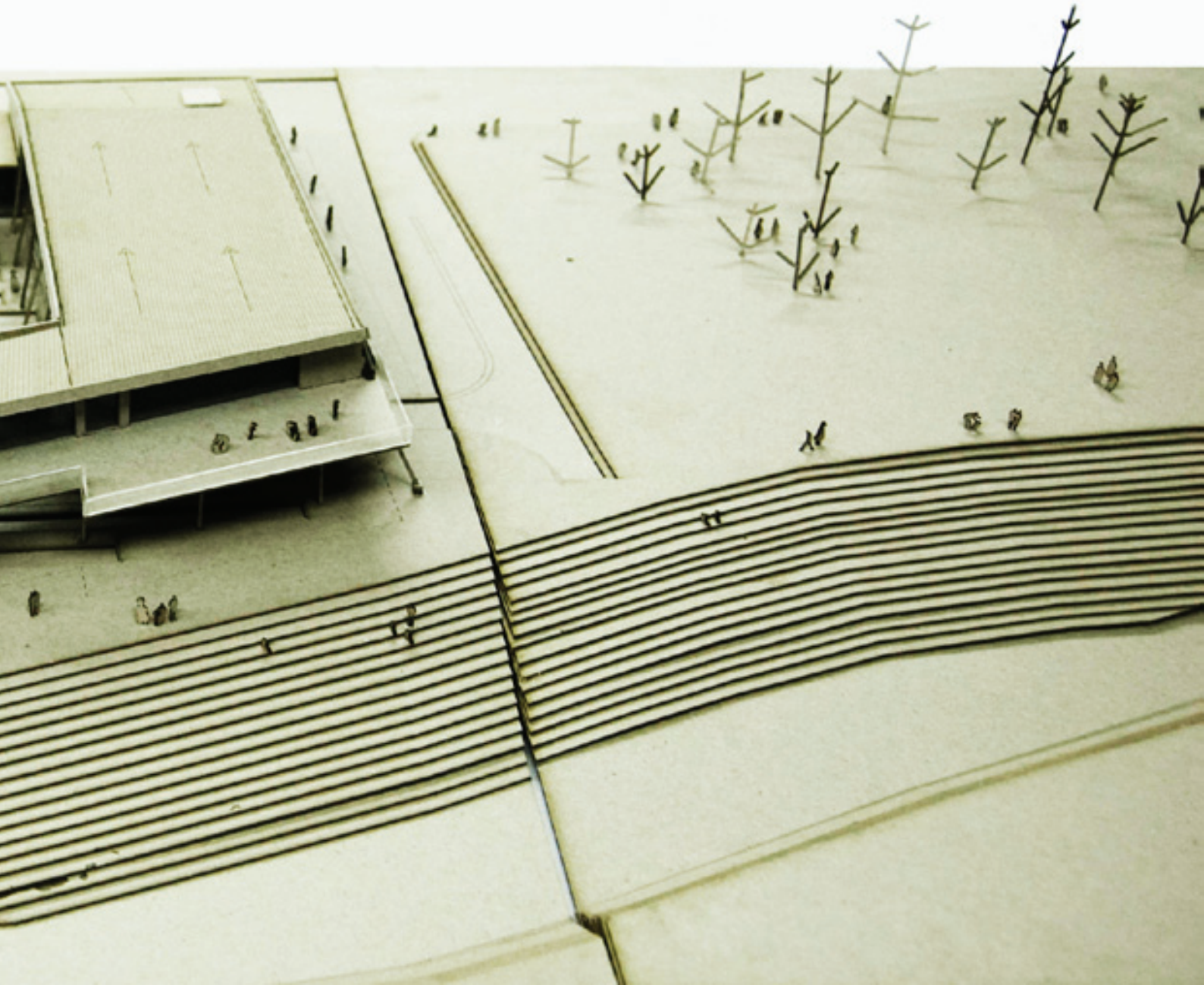

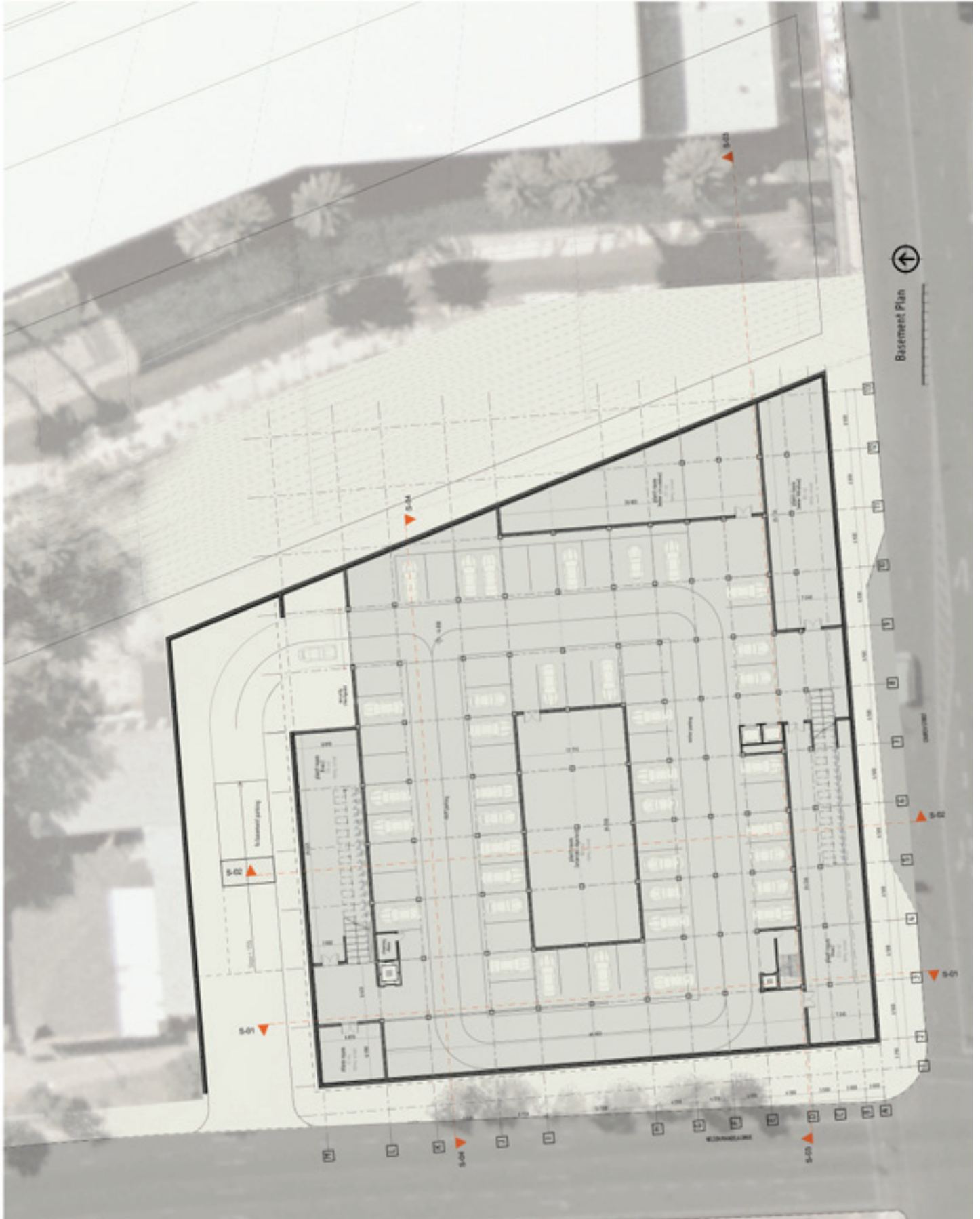





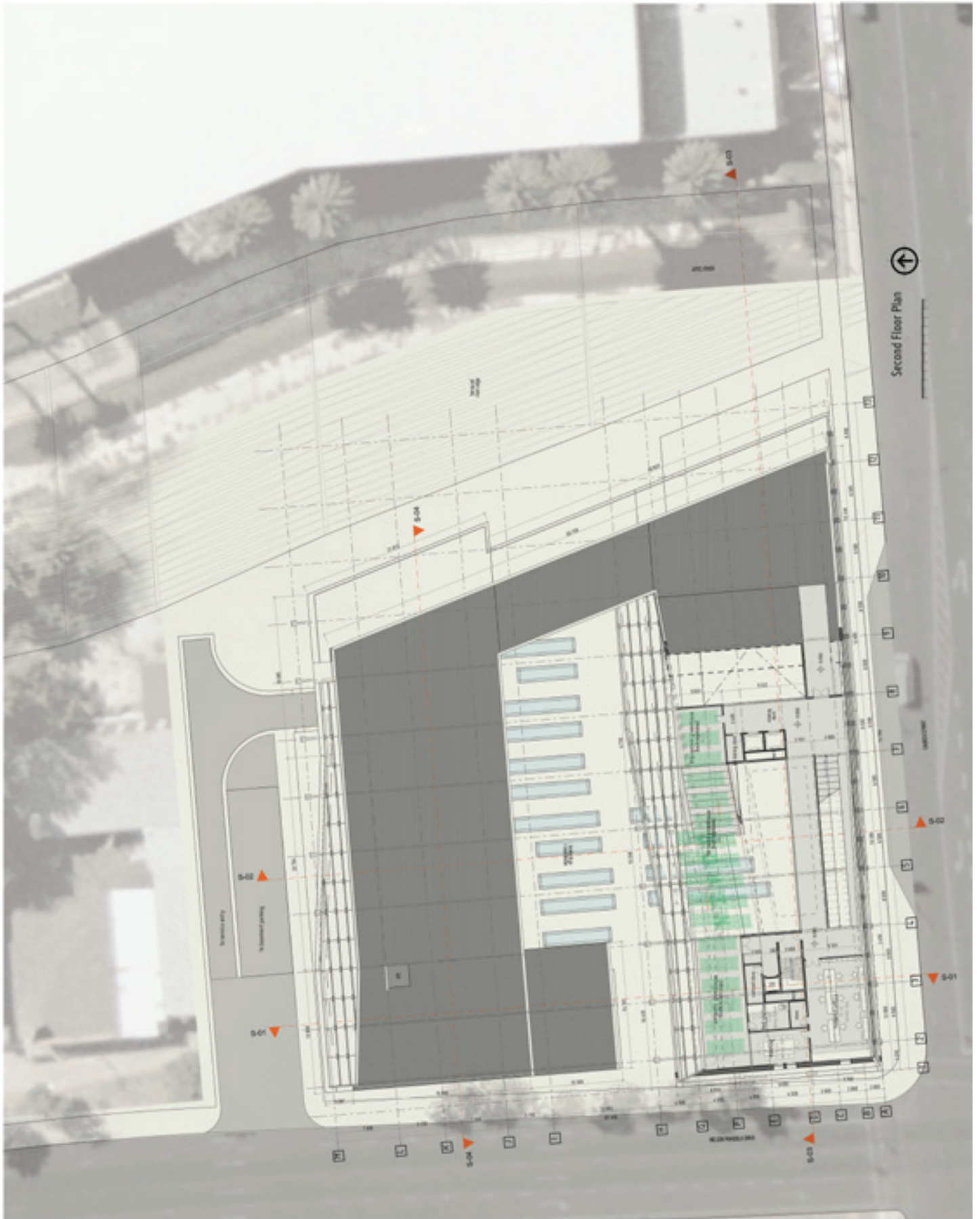

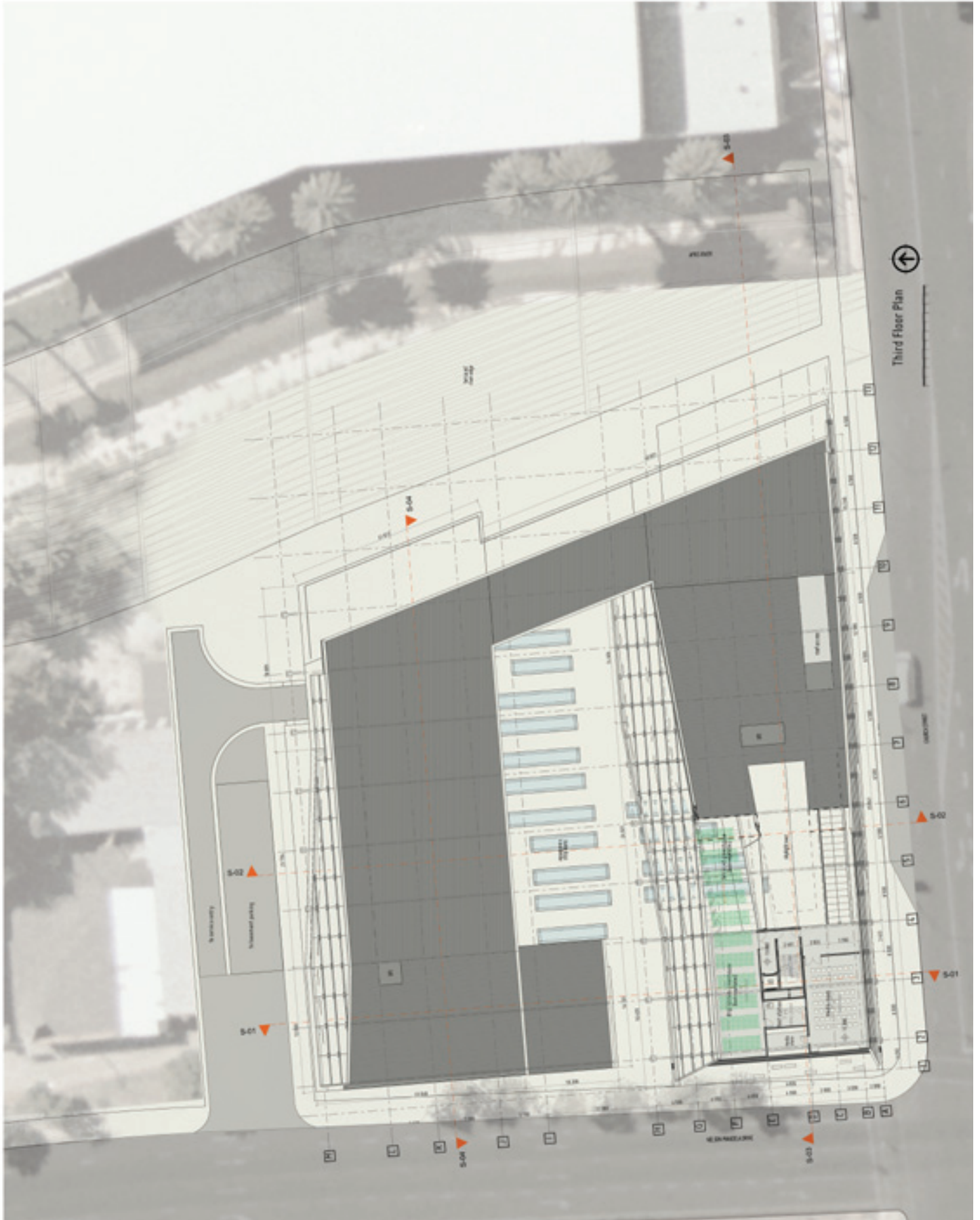

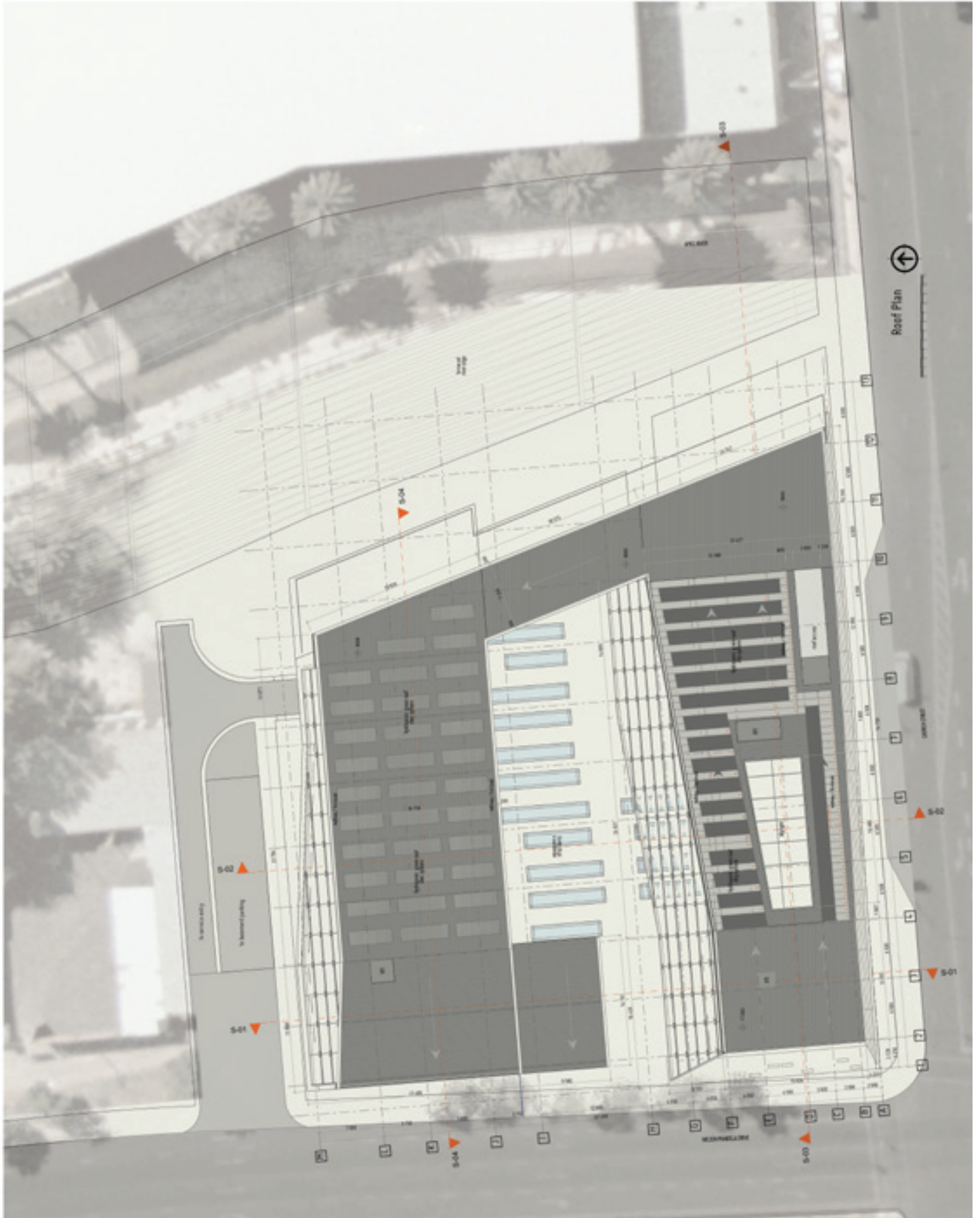

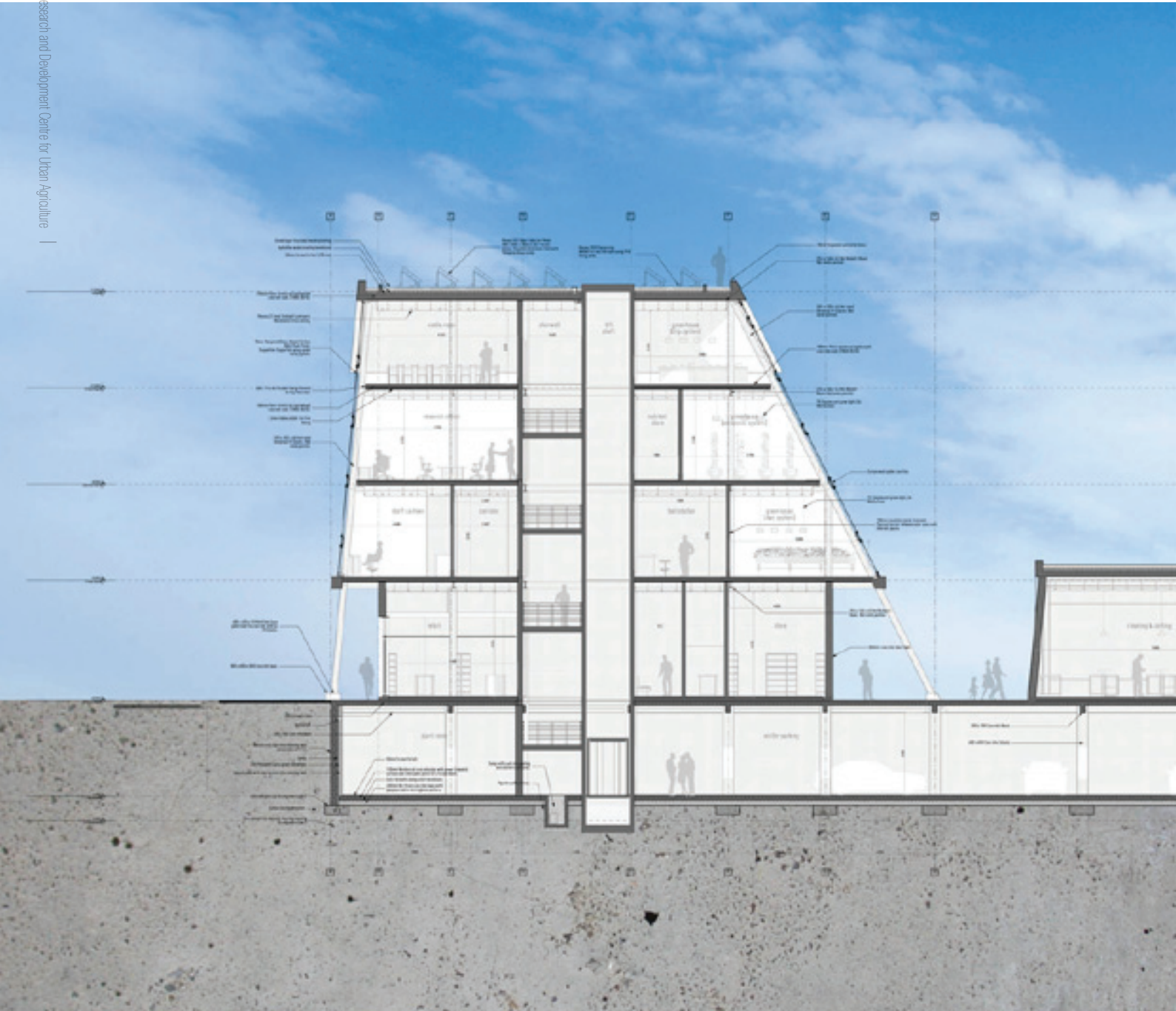

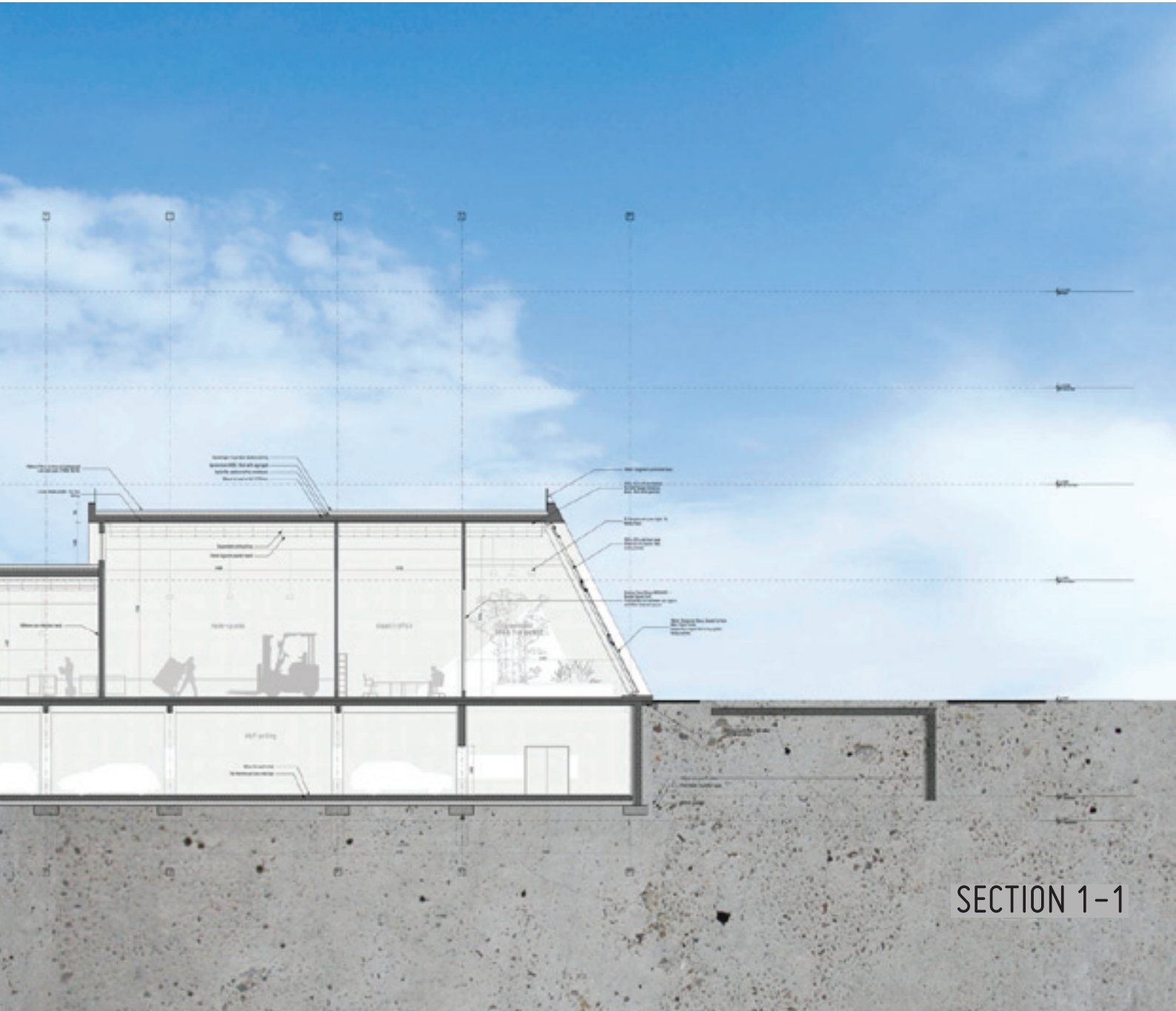

SECTION 1-1

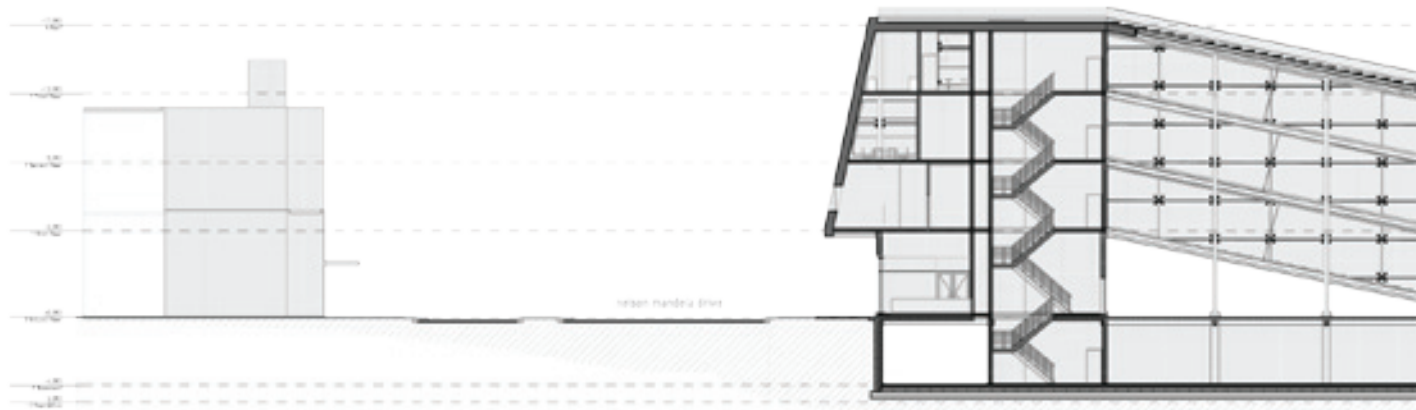
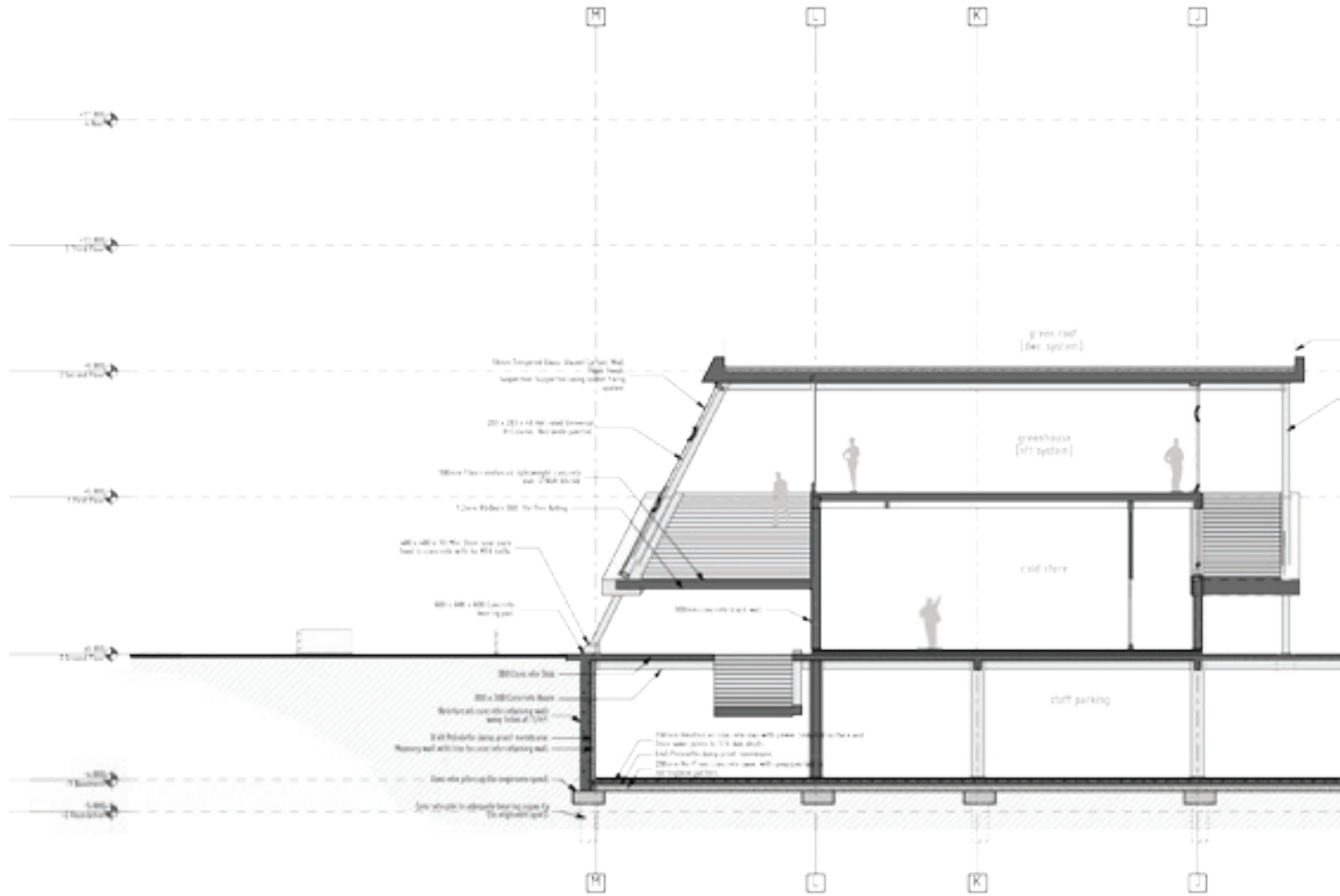

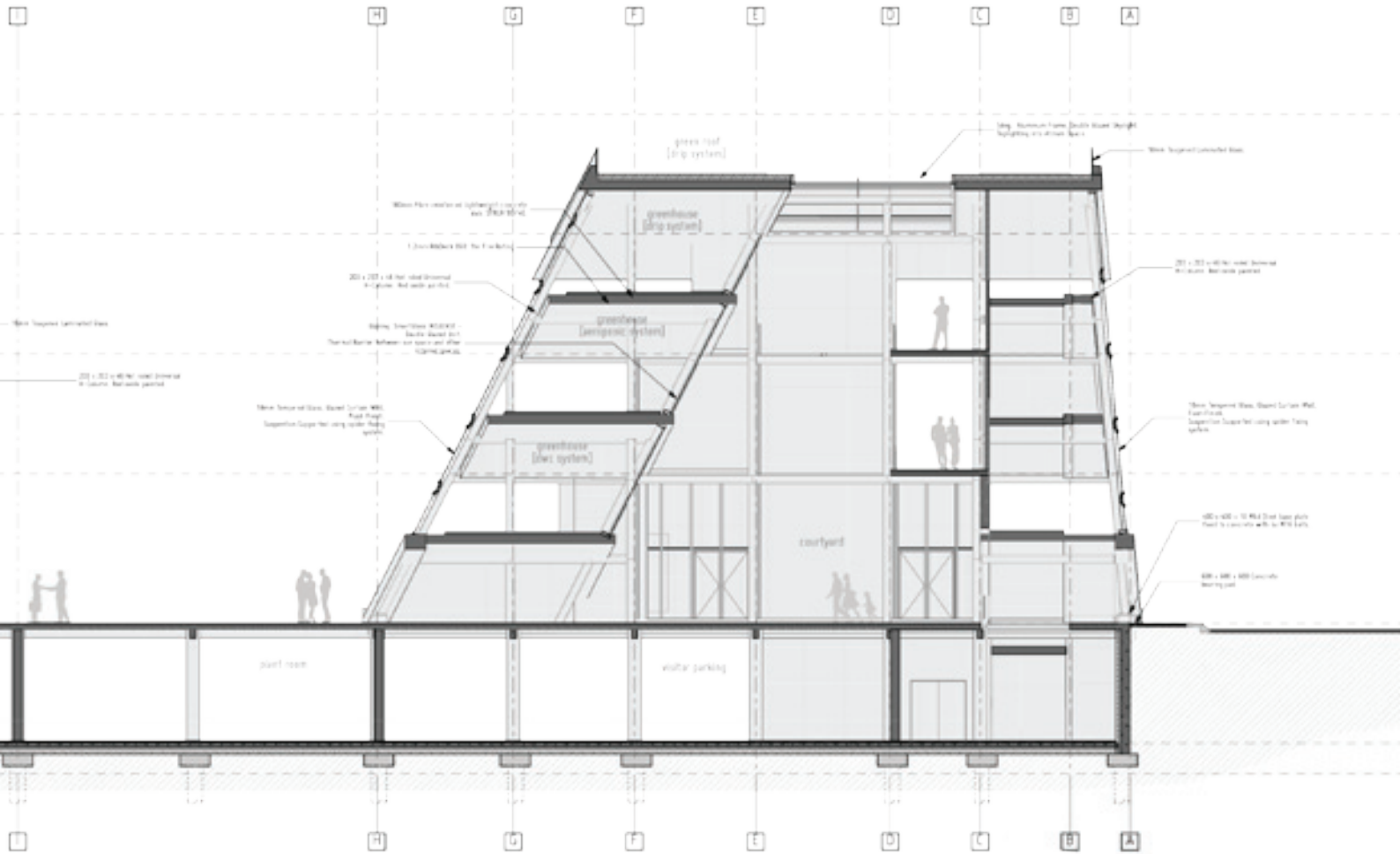

SECTION 2-2

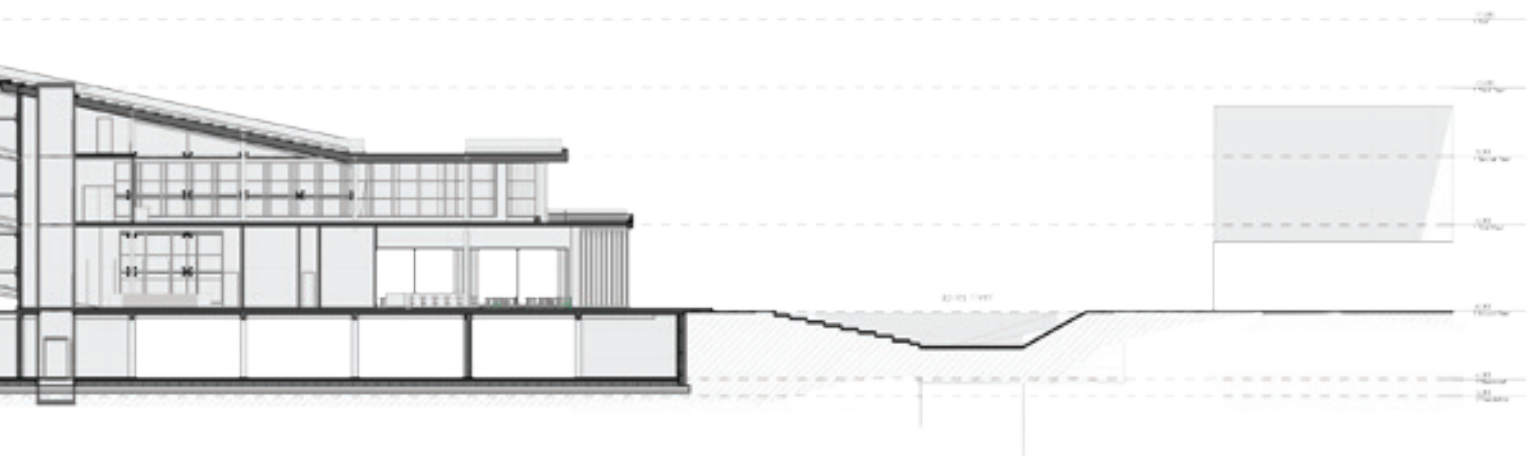

SECTION 3-3

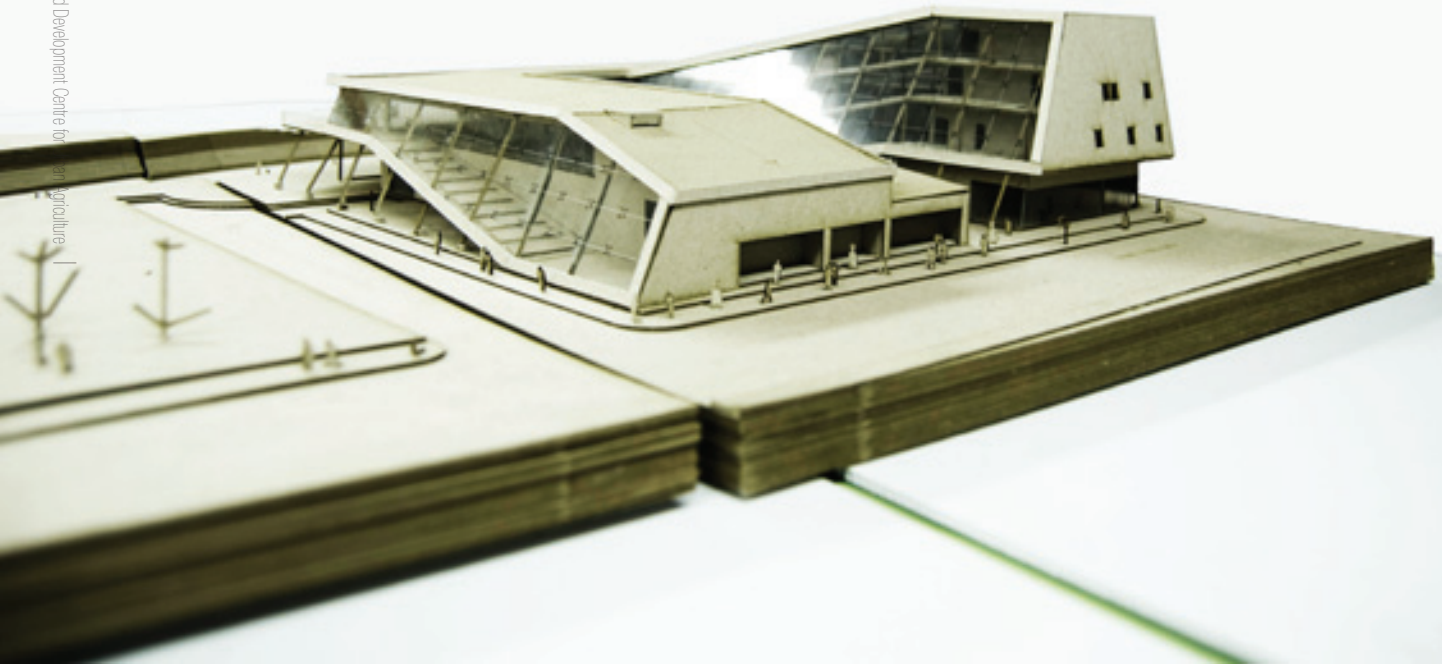

PHOTOS: MODEL

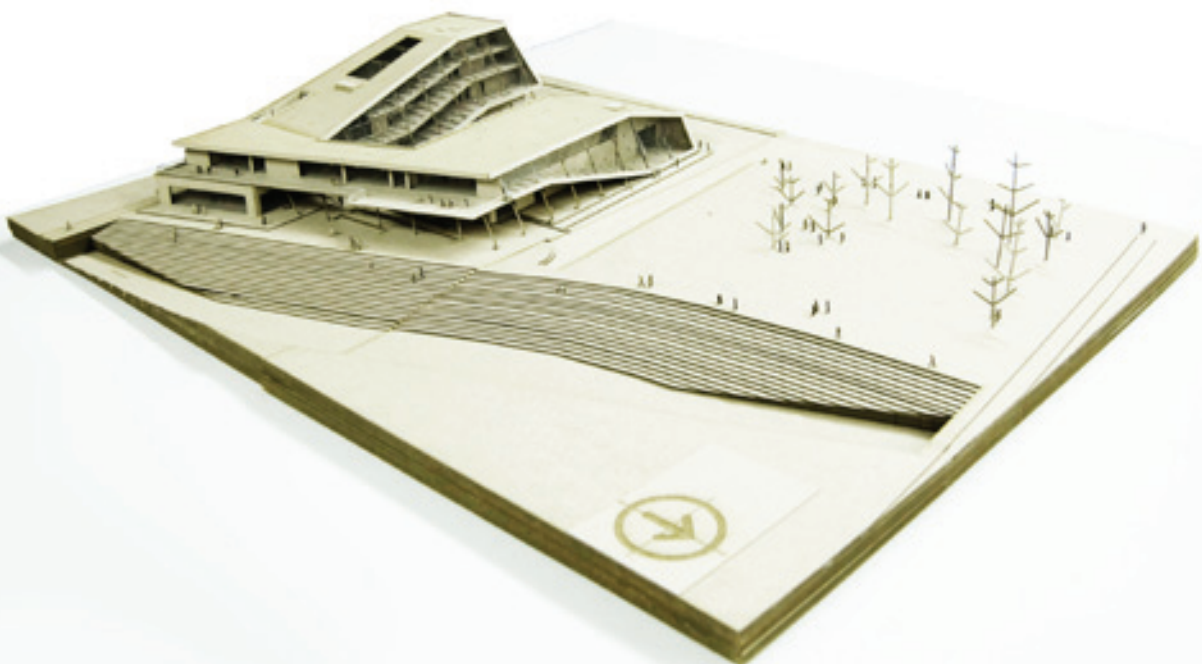

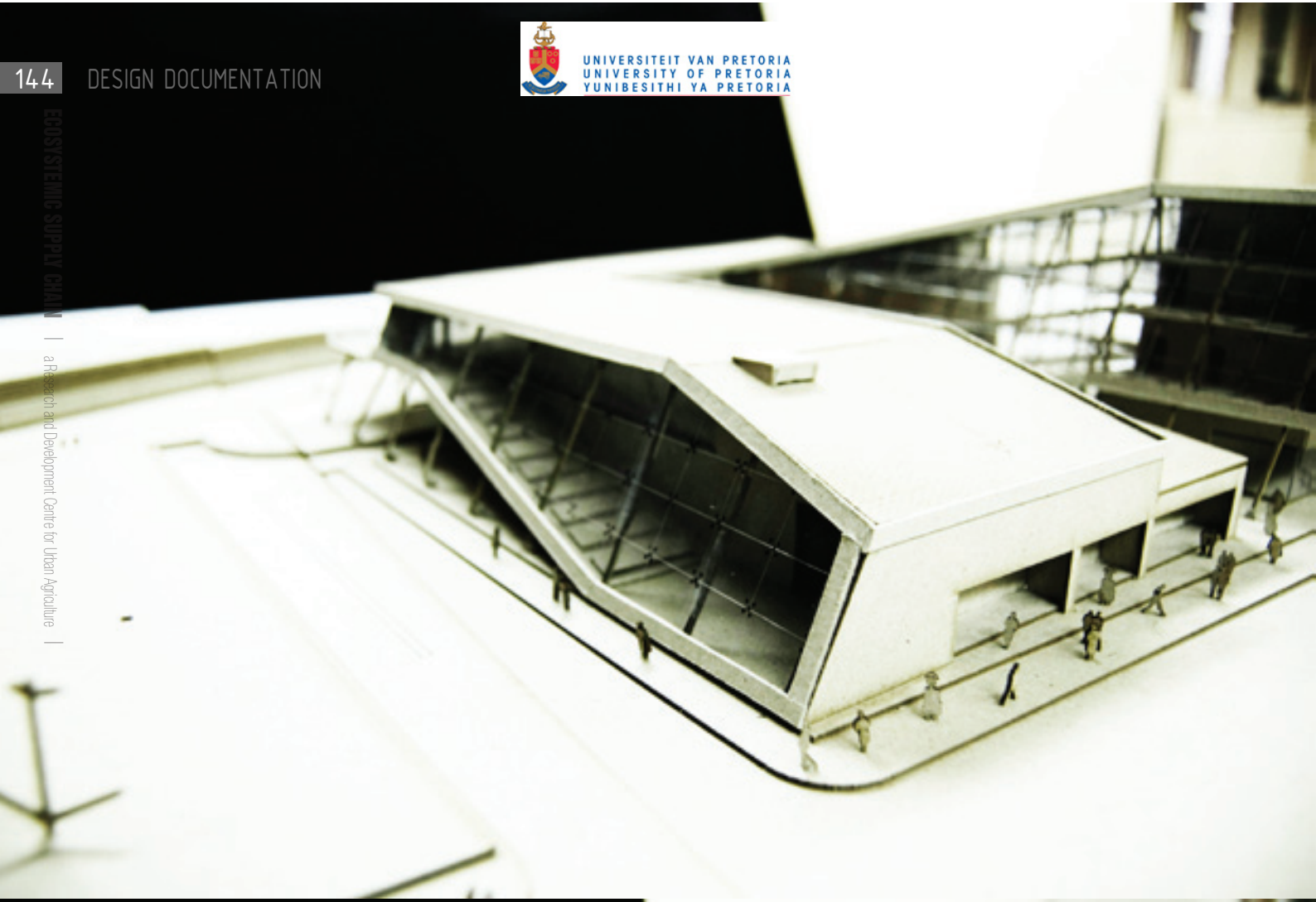

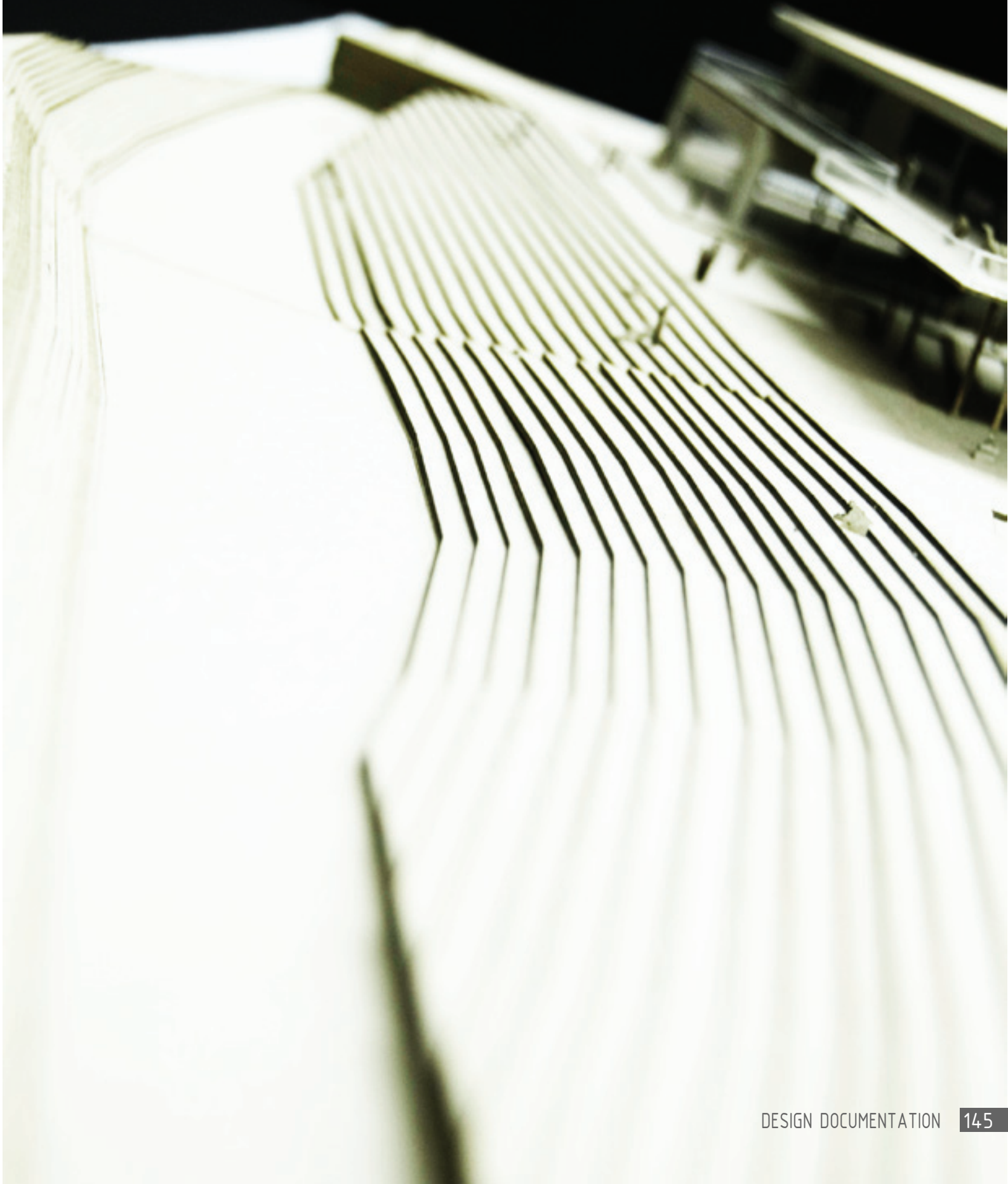



CGI: INTERIORS





ECOSYSTEMIC SUPPLY CHAIN

a Research and Development Centre
Urban Agriculture

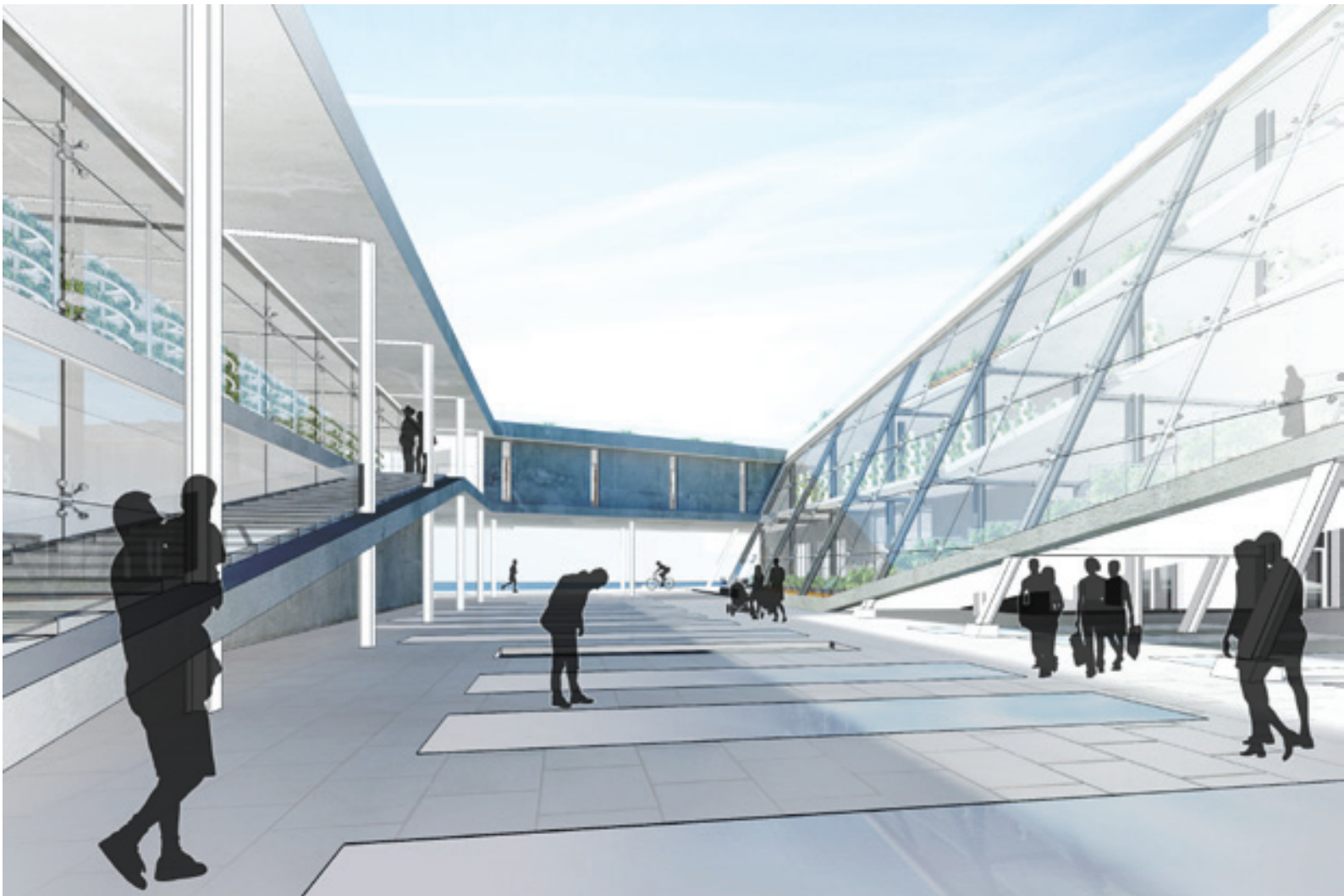



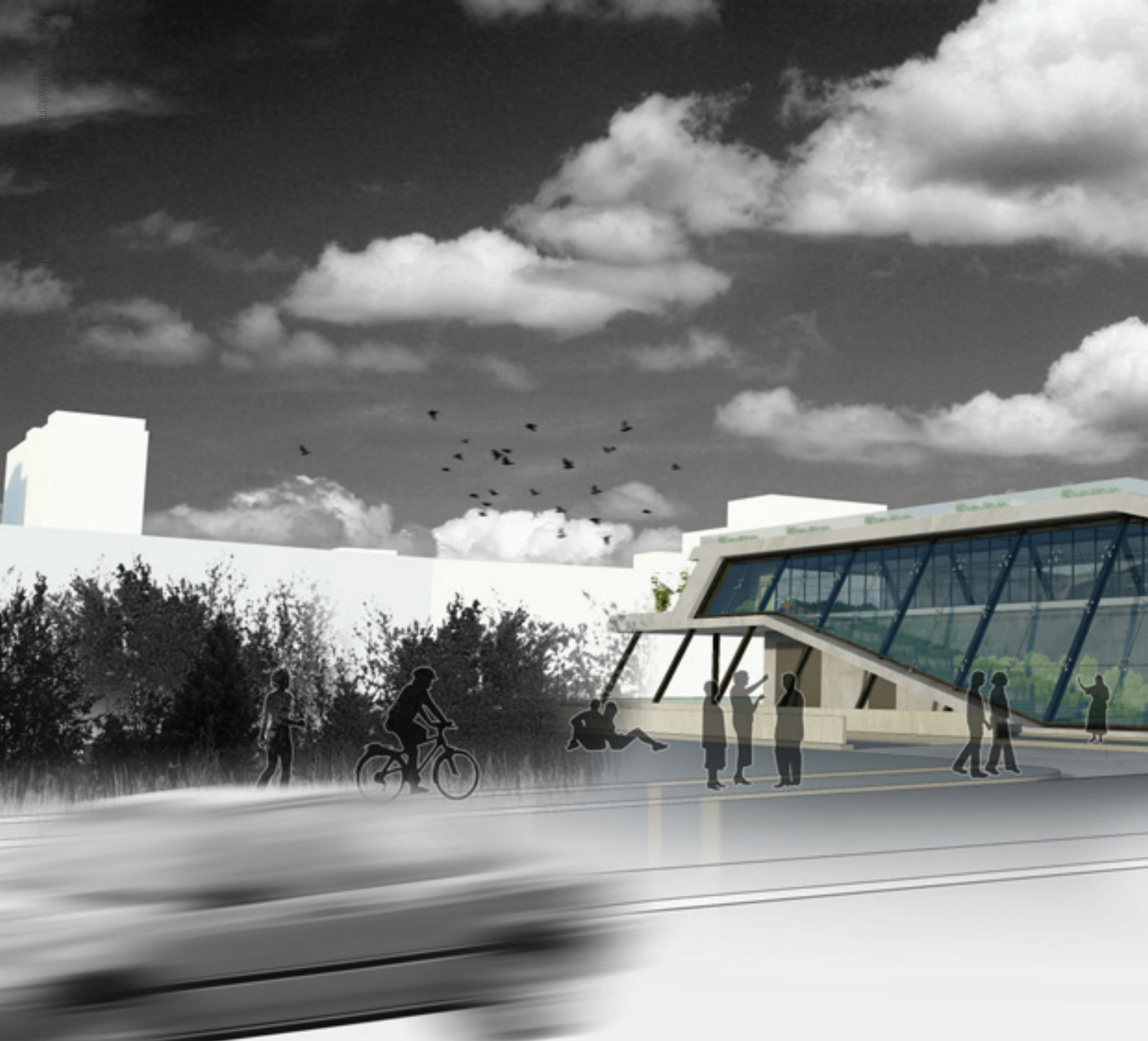





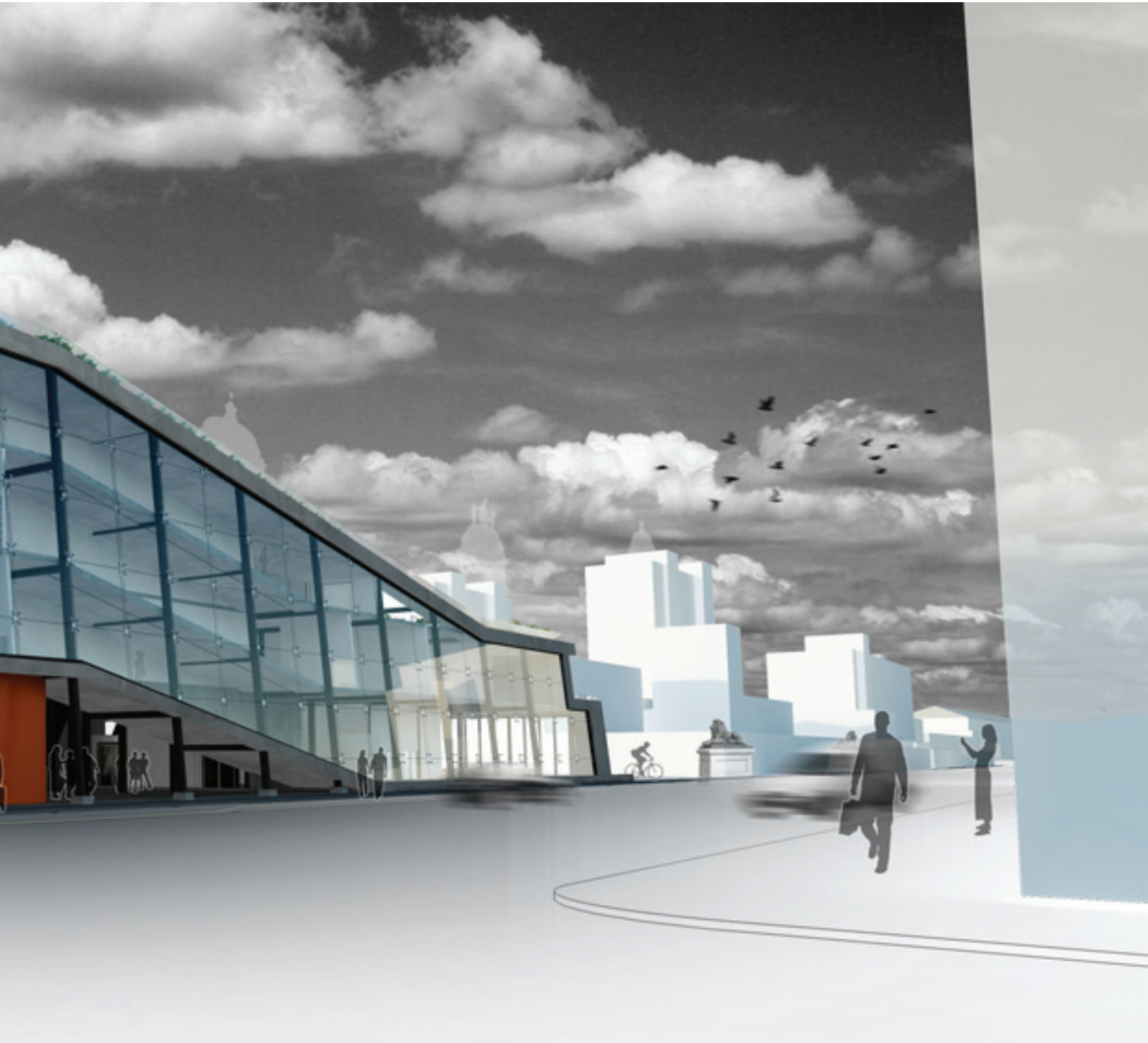



CHAPTER 10 APPENDIXES

CHEMICAL FERTILIZERS

FERTILIZER SALTS	ELEMENTS SUPPLIED
Ammonium phosphate	Nitrogen and Phosphorus
Ammonium sulphate	Nitrogen and Sulphur
Calcium nitrate	Nitrogen and Calcium
Potassium nitrate*	Nitrogen and Potassium
Sodium nitrate	Nitrogen
Potassium sulphate*	Potassium and Sulphur
Superphosphate*	Phosphorus and Calcium
Calcium sulphate*	Calcium and Sulphur
Magnesium sulphate* (Epsom salts)	Magnesium and Sulphur
Ferrous sulphate*	Iron
Manganese chloride	Manganese
Zinc sulphate	Zinc
Copper sulphate	Copper
Boric acid powder*	Boron

FUNCTIONS OF PLANT NUTRIENTS

ELEMENT	FUNCTION
Nitrogen	Necessary for the production of leaves and in stem growth. An essential ingredient in building plant cells.
Phosphorus	Required in the development of flowers and fruits and aids in the growth of healthy roots.
Potassium	Used by plant cells during the assimilation of the energy produced by photosynthesis.
Sulphur	Assists in the production of plant energy and heightens the effectiveness of phosphorus.
Iron	Vital in the production of chlorophyll.
Manganese	Aids in the absorption of nitrogen. An essential component in the energy transference process.
Zinc	An essential component in the energy transference process.
Copper	Needed in the production of chlorophyll.
Boron	Required in minute amounts, but it is not yet known how the plant uses it.
Magnesium	One of the components of chlorophyll, magnesium also is involved in the process of distributing phosphorus throughout the plant.
Calcium	Encourages root growth and helps the plant absorb potassium.
Chlorine	Required for photosynthesis.
Molybdenum	Assists in some chemical reactions.

AVAILABLE GROW LIGHTS

TUBE	COMMENTS
Cool White	The industry standard, and the least expensive — strong blue, medium red.
Warm White	Medium blue, medium red. Strong yellow and orange give it the appearance of red.
Plant Tubes	Strong blue, strong red. Sold under various brand names, such as Gro-Lux and Agro-Lite.
Full Spectrum	A new variety, resulting from research in photobiology. Its spectrum is very close to sunlight, with low-level ultraviolet included. This concept looks promising for the future. Vita-Lite is the most readily available at present.

GROW LIGHTS TECHNICAL INFORMATION

	# of systems	Watts/hour	Coverage (ft ²)	kW/h per ft ²
HPS	1	400	10	0.040
MH	1.363636364	400	10	0.055
Fluorescent T5	10	54	10	0.054
Fluorescent T8 & T12	42	40	10	0.168
Incandescent	84	60	10	0.504



CROP GROWTH CHART

Crop	Growing Season	Max Height/Length (in)	Space Between Plants (in)	Yield (lbs) /sq. ft.	Time to Harvest (days)	Number of Plantings per Year
Chard	Early Spring	18	2 between seeds/18 between rows	0.67	57 - 64	6
Kale	Spring and Fall	36	1 between seeds/18 between rows	0.25	50 - 75	6
Shiitake Mushrooms	All Year	6	Grown on Logs	1.44	180	2
Watercress	Spring to Fall	24	6 to 8	0.47	40 - 70	5
Cucumbers	Summer	24	6 to 8	0.4	50 -60	1
Tomatoes	Summer	36 to 60	18 to 36	2.5	60 - 90	1
Arugula	Early Spring or Late Fall	18 to 24	6	0.47	30 - 40	5
Bell Peppers	Summer	6 to 36	12 to 36	0.53	56 - 95	1
Chives	Spring to Fall	20	12 to 18	0.11	60	4 initially/12 eventually
Button Mushrooms	All Year	6	N/A	1.9	50	12 to 15

FISH GROWTH CHART

Species	Growing Season	Stocking Density (lbs/gallon)	Market Size (lbs)	Water Temperature (°F)	Time to Harvest
Tilapia	All Year	0.25	.88 to 1.1 or 1.54 to 2.4	82 - 86 optimal 68 slow growth 50 death	8 - 10 months or 11 - 14 months
Yellow Perch	All Year	1.5	0.33	70 - 75 optimal 50 - 40 slow growth 32 death	20 months



FISH BREEDING INFORMATION

	Temperature	Food	Breeding	Market Size
Blue Tilapia	47 to 86 Can tolerate up to 106	Algae, duckweed, plant matter as adults	68-72 degrees	In 8 months
Perch	73-77 - optimum Max- 79	Algae, small fish, aquatic insects.	Must be chilled to 45	20 months



APIES RIVER TIMELINE

The Apies River Timeline shows the progression of human domination and engineering of the natural river system over time.

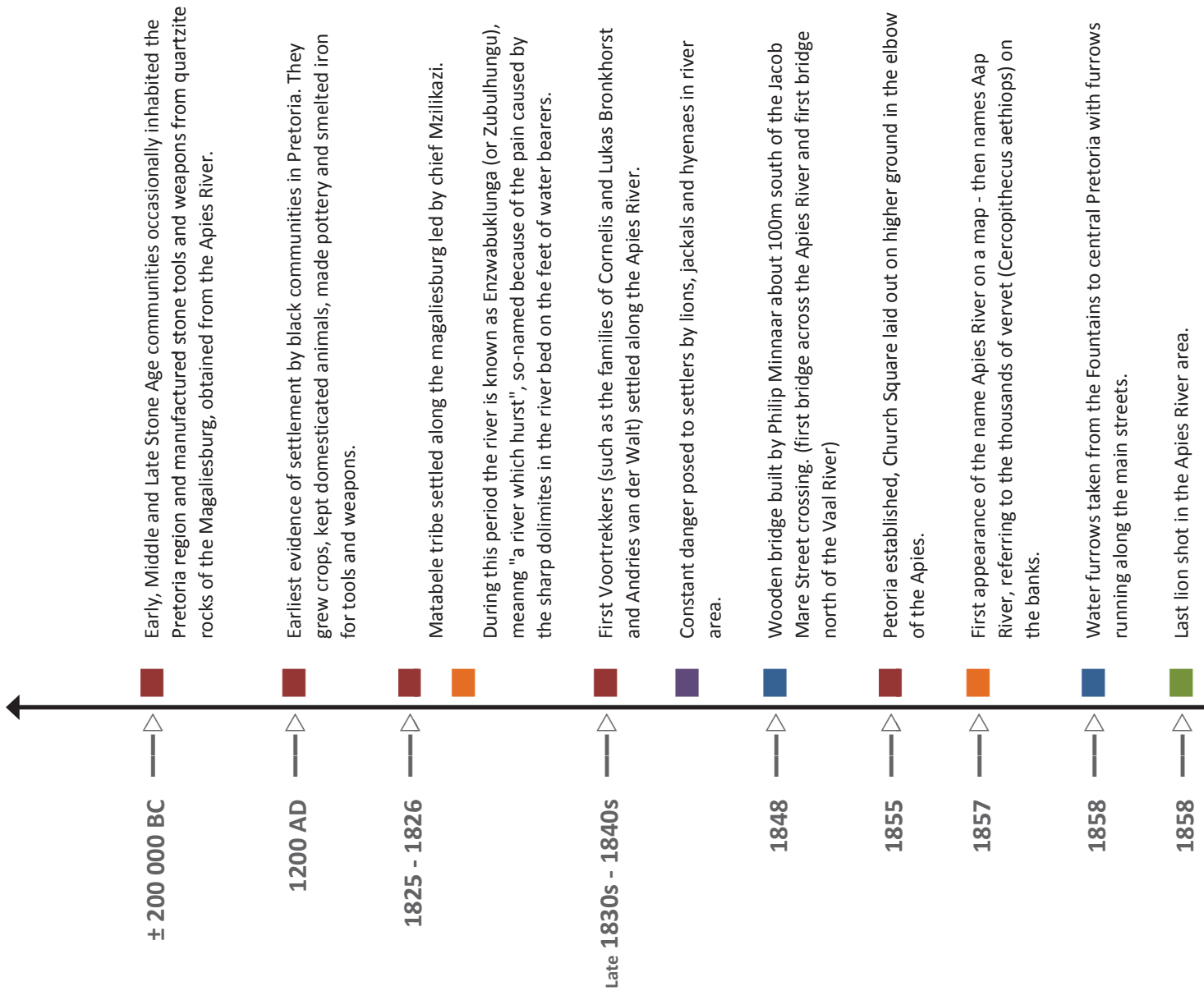

1870s	<p>First large plots established on the banks of the Apies River, east of Du Toit Street and north of Boom Street.</p> <p>Mills erected at Arcadia Drift at Church Street, Dr Savage and at a later stage, also at Daspoort.</p>
1887 - 1888	<p>Victoria Bridge built by JJ Kirkness at Jacob Mare Street.</p> <p>Arcadia Bridge built by JJ Kirkness on Church Street.</p>
1894	<p>Completion of Lion Bridge at Church Street crossing (built by JJ Kirkness)</p> <p>The Netherlands South African Railway Company (NZASM) Bridge built for the Delagoa Bay Railway Line in 1894.</p>
1899	<p>Inclusion of Apies River into the National Zoological Gardens.</p>
1909	<p>Huge damage of property and loss of life when the Apies River is transformed into a raging torrent after a heavy rainstorm in January. Work started on the canalisation of the river beginning at Proes Street and working upwards to the south. Work lasted until the late 1930s.</p>
1909 - 1910	<p>Esselen Street Bridge built in steel for tramway traffic by Tilburg & Engel.</p>
1910	<p>Original Lion Bridge upgraded by Rainey & Thomson (wooden deck replaced by a macadamised surface and sidewalks added).</p>
1911 - 1912	<p>Original Victoria Bridge replaced by a new bridge with single concrete arch, built by Ingram & Co.</p>
1912	<p>Skinner Street Footbridge built by Scribbins & Poole (to replace an older wooden footbridge).</p> <p>Row of date palms planted along the Apies River.</p>
1920 -1921	<p>Proes Street Bridge built by JA Schallies.</p>
1923	<p>Bon Accord Dam completed.</p>

- Human Settlement
- Human Built Environment
- Ownership of Environment
- Human Domination over Nature
- Nature as Hazard to Human life

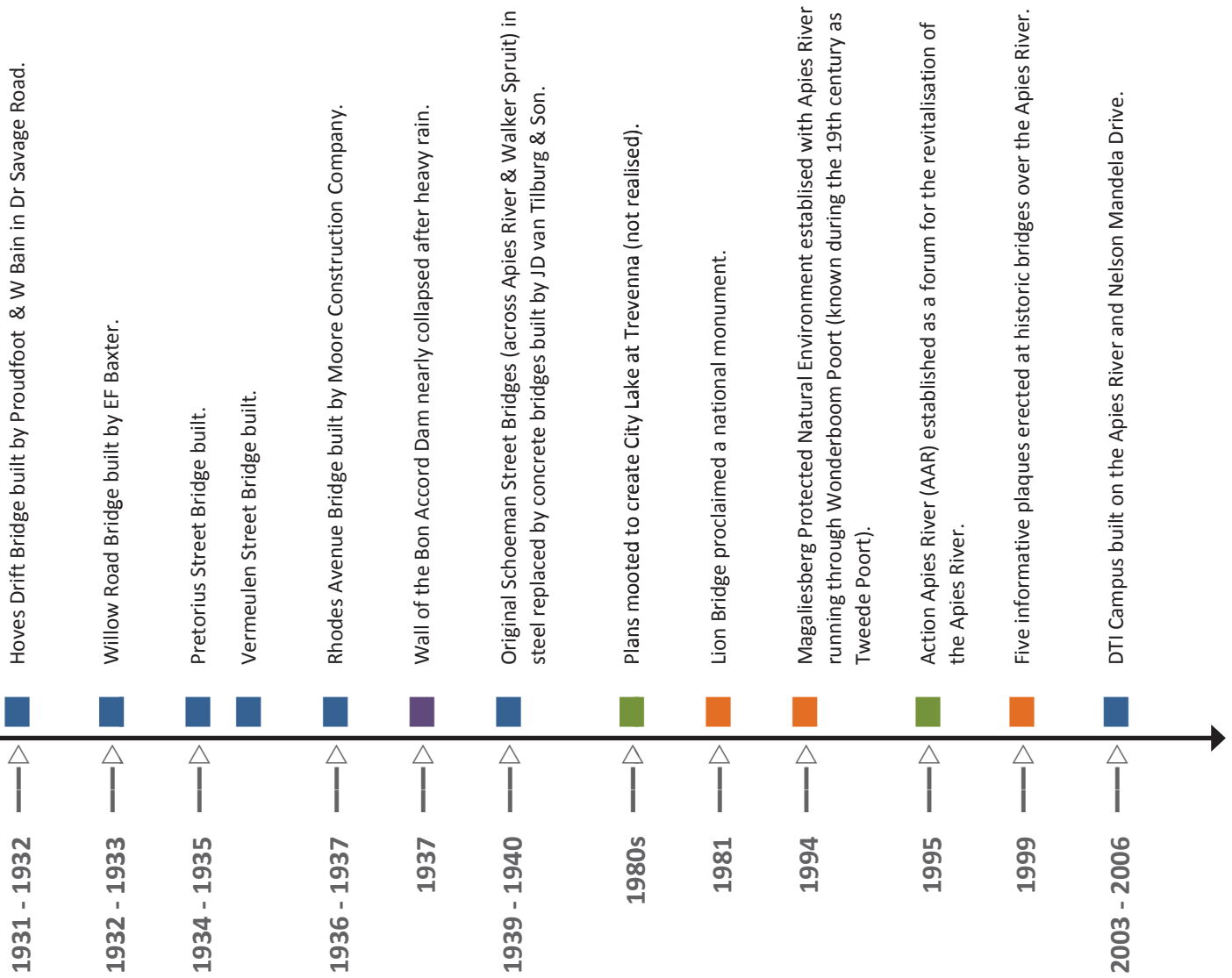





BIBLIOGRAPHY

- AFFAIRS, DEPARTMENT OF WATER. 2011. APIES RIVER: OVERVIEW. [ONLINE]. [ACCESSED 10 JULY 2011]. AVAILABLE FROM WORLD WIDE WEB: <[HTTP://WWW.WATERINFORMATION.CO.ZA/MISC/RIVERGAUAPIESS/PIRESRIVER.HTM](http://www.waterinformation.co.za/misc/rivergauapiess/piresriver.htm)>
- ANDREWS, T E. 1999. TEN WALKING TOURS THROUGH PRETORIA'S HISTORICAL PAST. [ONLINE].
- ARCHITECTS, GAPP. 2005. TSHWANE INNER CITY DEVELOPMENT AND REGENERATION STRATEGY. TSHWANE.
- BOLSMAN, E. 2001. PRETORIA - ARTISTS' IMPRESSIONS 1857 - 2001. PRETORIA: PROTEA BOOK HOUSE.
- BROWN, KATHERINE H AND ANNE CARTER. 2003. URBAN AGRICULTURE AND COMMUNITY FOOD SECURITY IN THE UNITED STATES: FARMING FROM THE CITY CENTER TO THE URBAN FRINGE. CALIFORNIA.
- CAMBELL, NEIL A. 2008. BIOLOGY CONCEPTS & CONNECTIONS. SAN FRANCISCO: BENJAMIN CUMMINGS.
- CHING, FRANCIS D K. 2008. BUILDING CONSTRUCTION ILLUSTRATED. NEW JERSEY: JOHN WILEY AND SONS.
- DAVIS, BLAKE. 2010. THE 21ST CENTURY FARM. CHICAGO.
- DAVIS, BLAKE. 2010. PLANNING THE 21ST CENTURY FARM. CHICAGO.
- DAVIS, BLAKE. 2011. IMPLEMENTING THE PLANT: CHICAGO'S FIRST VERTICAL FARM. CHICAGO.
- DESPOMMIER, DICKSON. 2008. THE VERTICAL FARM: KEYSTONE CONCEPT TO THE SUSTAINABLE ECO-CITY. [ONLINE].
- DESPOMMIER, DICKSON. 2010. THE VERTICAL FARM: REDUCING THE IMPACT OF AGRICULTURE ON ECOSYSTEM FUNCTIONS AND SERVICES. NEW YORK: MAILMAN SCHOOL OF PUBLIC HEALTH.
- DESPOMMIER, DICKSON AND ERIC ELLINGSEN. 2008. THE VERTICAL FARM: THE SKYSCRAPER AS VEHICLE FOR SUSTAINABLE URBAN AGRICULTURE. NEW YORK: MAILMAN SCHOOL OF PUBLIC HEALTH.
- DEWAR, DAWID. 2003. THE APARTHEID CITY AND BEYOND, URBANIZATION AND SOCIAL CHANGE IN SOUTH AFRICA. OXFORD: ROUTLEDGE.
- DIOUF, JACQUES. 1995. DIMENSIONS OF NEED: AN ATLAS OF FOOD AND AGRICULTURE. ROME: FOOD AND AGRICULTURE ORGANIZATION OF THE UNITED NATIONS.
- DOUGLAS, JAMES S. 1975. HYDROPONICS. BOMBAY: OXFORD UP.
- DOWNTON, PAUL F. 2009. ECOPOLIS: ARCHITECTURE AND CITIES FOR A CHANGING CLIMATE. ADELAIDE: SPRINGER.
- ELTON, CHARLES S. 1927. ANIMAL ECOLOGY. CHICAGO: UNIVERSITY CHICAGO PRESS.
- GREYLING, P J. 2000. PRETORIA EN DIE ANGLO-BOERE OORLOG, N GIDS. PRETORIA: PROTEA BOEKHUIS.
- GRONDZIK, WALTER AND ALISON KWOK. 2007. THE GREEN STUDIO HANDBOOK. OXFORD: ELSEVIER.
- GRUBER, PETRA. 2011. BIOMIMETICS IN ARCHITECTURE: ARCHITECTURE OF LIFE AND BUILDINGS. MORLENBACH: SPRINGER.
- HEIMANN, CLINTON ROSSOUW. 2007. AN EXPLORATORY STUDY INTO IMPROVEMENT DISTRICTS IN SOUTH AFRICA. PRETORIA: UP.
- HENSEL, MICHAEL AND ACHIM MENGES. 2008. VERSATILITY AND VICISSITUDE: PERFORMANCE IN MORPHO-ECOLOGICAL DESIGN. ARCHITECTURAL DESIGN. 78(2), PP:34-41.
- JACKOWSKI, NANNETTE AND RICARDO DE OSTOS. 2008. AMBIGUOUS SPACES. NEW YORK: PRINCETON ARCHITECTURAL PRESS.
- JORDAAN, GERRIT. 2002.
- KENYON, STEWART. 2002. HYDROPONICS FOR THE HOME GARDENER. LONDON: KEY PORTER.
- KORMONDY, E J. 1996. CONCEPTS OF ECOLOGY. NEW JERSEY: PRENTICE-HALL.
- LEBELO, DORAH AND MICHELLE NEL. 2004. THE GREENHOUSE PROJECT'S ADVENTURES AND LESSONS IN GREEN BUILDING. JOHANNESBURG: THE GREENHOUSE PROJECT.
- LEFEBVRE, HENRI. 1996. WRITINGS ON CITIES. OXFORD: BLACKWELL PUBLISHERS LTD.
- LOOTS, ANNEMARIE. 2007. TSHWANE INNER CITY LOCAL OPEN SPACE PLAN. PRETORIA.
- MANOVICH, LEV. 2006. THE POETICS OF AUGMENTED SPACE. VISUAL COMMUNICATION. V(2), PP:219-240.
- MARGOLIS, LIAT AND ALEXANDER ROBINSON. 2007. LIVING SYSTEMS. BERLIN: BIRKHAUSER.
- MAYLAM, P. 1995. EXPLAINING THE APARTHEID CITY: 20 YEARS OF SOUTH AFRICAN URBAN HISTORIOGRAPHY. JOURNAL OF SOUTHERN AFRICAN STUDIES. 21(1), PP:19-38.
- OTS, ENN. 2011. DECODING THEORY SPEAK: AN ILLUSTRATED GUIDE TO ARCHITECTURAL THEORY. ABINGTON: ROUTLEDGE.
- SMOUT, MARK, LAURA ALLEN, AND SPILLER NEIL. 2007. AUGMENTED LANDSCAPES. NEW YORK: PRINCETON ARCHITECTURAL PRESS.

- SPENS, MICHAEL. 2007. SITE / NON-SITE: EXTENDING THE PARAMETERS IN CONTEMPORARY LANDSCAPE. IN: HELEN SATLE, (ED). LANDSCAPE ARCHITECTURE: SITE / NON-SITE, OXFORD: JOHN WILEY & SONS LTD, PP.6-11.
- TSHWANE, CITY OF. 2006. TSWANE OPEN SPACE FRAMEWORK. PRETORIA: CITY OF TSHWANE: ENVIRONMENTAL PLANNING SECTION.
- UNKNOWN, AUTHOR. 2008. BASIC HYDROPONIC SYSTEMS AND HOW THEY WORK. [ONLINE]. [ACCESSED 05 OCTOBER 2001]. AVAILABLE FROM WORLD WIDE WEB: <[HTTP://WWW.SIMPLYHYDRO.COM/SYSTEM.HTM](http://www.simplyhydro.com/system.htm)>
- VAN DER WAAL, G M. 1998. APIES RIVER: ENVIRONMENTAL ASSETS. PRETORIA: VAN DER WAAL COLLECTION.
- VAN DER WAAL, G M. 1998. APIES RIVER: HISTORIC BRIDGES. PRETORIA: VAN DER WAAL COLLECTION.
- VAN DER WAAL, G M. 1998. APIES RIVER: TIME LINE. PRETORIA: VAN DER WAAL COLLECTION.
- VAN DER WAAL, G M. 1998. HERITAGE SITES ALONG THE APIES RIVER. PRETORIA: VAN DER WAAL COLLECTION.
- VAN SCHAIK, LEON. 2003. ECOCELLS. LONDON: JOHN WILEY & SONS LTD.
- VENTURI, ROBERT. 1966. COMPLEXITY AND CONTRADICTION IN ARCHITECTURE. NEW YORK: THE MUSEUM OF MODERN ART.
- VIJOEN, ANDRE, KATRIN BOHN, AND JOE HOWE. 2005. CONTINUOUS PRODUCTIVE LANDSCAPES: DESIGNING URBAN AGRICULTURE FOR SUSTAINABLE CITIES. OXFORD: ARCHITECTURAL PRESS.
- VON ZABELTITZ, CHRISTIAN. 2011. INTEGRATED GREENHOUSE SYSTEMS FOR MILD CLIMATES. BERLIN: SPRINGER.
- VYZOVITI, SOPHIA. 2010. FOLDING ARCHITECTURE. AMSTERDAM: BIS.
- YEANG, KEN. 2008. ECODESIGN: A MANUAL FOR ECOLOGICAL DESIGN. LONDON: JOHN WILEY & SONS LTD.
- YEANG, KEN. 2009. ECO MASTER PLANNING. CHICHESTER: JOHN WILEY & SONS LTD.