

precedent\_04



## Women's Jail Precinct, Constitution Hill\_

### PROJECT DETAILS

- **Primary Function** Living Memorial and Commission of Gender Equality Offices
- **Location** Johannesburg, South Africa
- **Climate** Warm, Highveld
- **Architects** Kate Otten Architects
- **Completed in** 2005

### PROJECT DESCRIPTION

The imposing 1909, red bricked wall of the former women's jail forms part of the Constitution Hill precinct located in Braamfontein Johannesburg. Its classical symmetry and elaborate detailing belie its positioning behind the tall impenetrable walls which used to symbolise captivity and pain. In this poignant restoration and addition, the new insertion has been forced to not only maintain many of the historic senses of symmetry and order, but has also broken the strict sense of captivity by allowing the new insertion to form a bridge over the old in an attempt to re-establish connections with the new precinct beyond the walls of the jail. (Joubert (ed), 2009; 120)

The scale and solidity of the existing building has been reinterpreted, with the use of Cor-Ten screens allowing for a high level of lighting flexibility within the office space in contrast to the dimly lit, confining walls of the jail block. In addition the increased

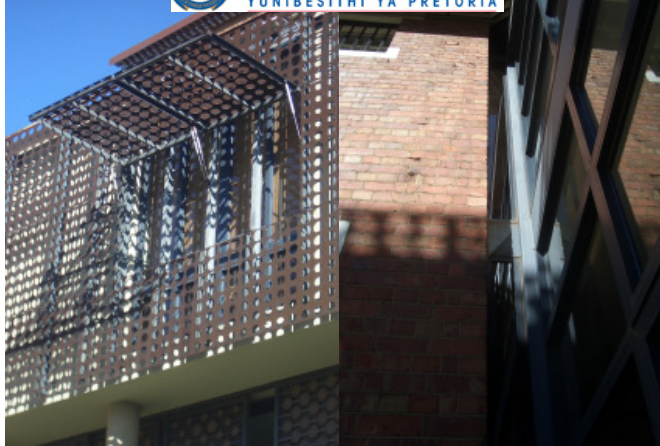

layering afforded by the screen speaks to the layers of confinement and seclusion once experienced by the prisoners within. The new office block, although maintaining the imposing height offered by the prison walls, extends beyond the confines of the wall, with the building being perched over the edge symbolising the new found freedom within the complex (Joubert (ed), 2009; 121).

The connection between the old and the new have been optically separated with the inclusion of a negative space between old and new materials, achieved by recessing the connection from the main plane of the building façade. Connecting corridors, smaller in scale than the office wings, are transparent. This old awaiting trial cell block within the eastern office is juxtaposed with a large balcony space directly above illustrative of its new found freedom.

**ILLUS 73 (OPPOSITE)** Gender Equality Commission Offices (Hart, 2011), **ILLUS 74** Cor-Ten screens (Hart 2011), **ILLUS 75** Negative connectio to existing (Hart,2011), **ILLUS 76** Balcony above awaiting trial block (Joubert (editor), 2009), **ILLUS 77** Section through existing cell block (Joubert (editor), 2009), **ILLUS 78** Section through new offices (Joubert (editor), 2009)

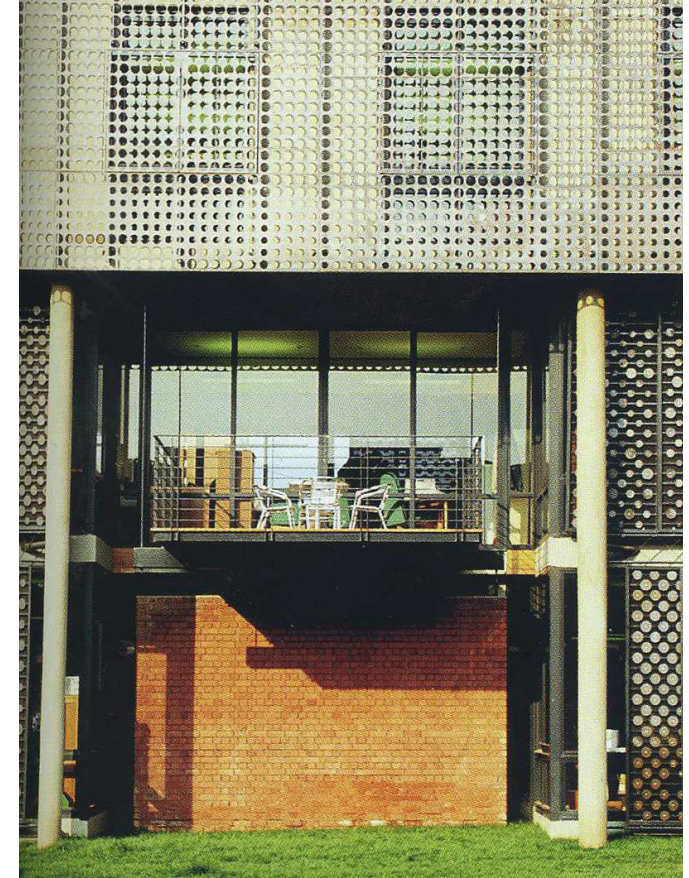

## PROJECT RELEVANCE

The manner in which the symbolism of the old has been reinterpreted and contrasted in the design of the new allows for a layered narrative within the space. The use of design informants such as scale, solidity and emotive response within the addition give both layers added character and meaning. The use of Cor-Ten steel in the screens on the façade adds an additional hapticity to the building, allowing the materials to age and change as the complex itself has changed and will continue to change and re-interpret itself in the future.

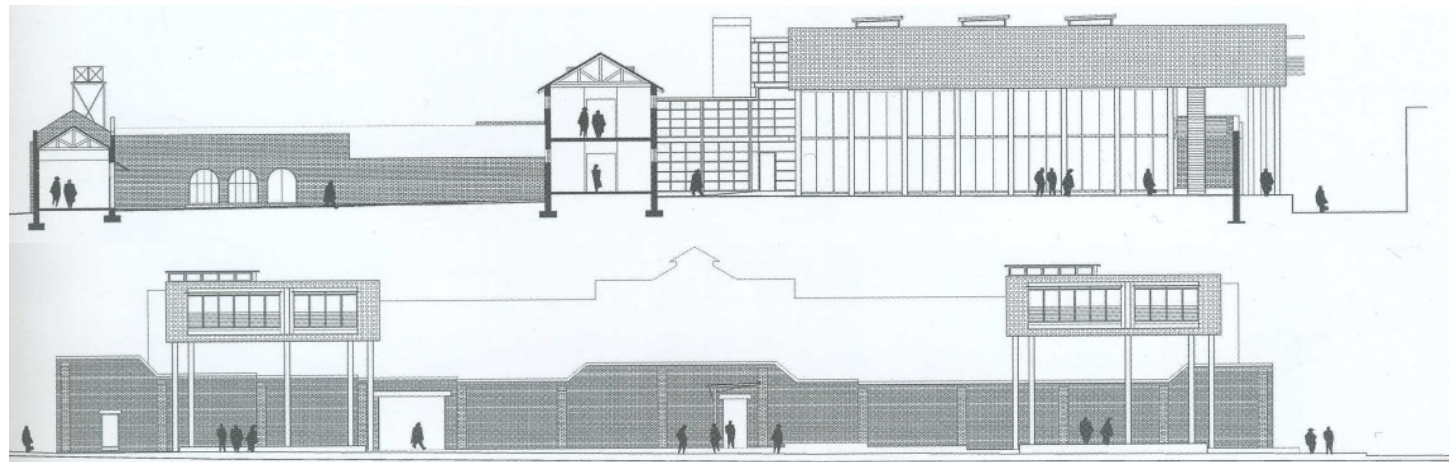



## Turbine Hall and Boiler House\_

### PROJECT DETAILS

- **Primary Function** Event space and head offices for AngloGold Ashanti
- **Location** Newtown Johannesburg
- **Climate** Warm Highveld
- **Architects** TPSP Architects
- **Completed in** 2008

### PROJECT DESCRIPTION

The project is the former home to the Jeppe Street Power Station built in 1927 and one of the three largest steam fired power stations in Newtown, which once supplied power to the city of Johannesburg until it was decommissioned in the 1960's. The building subsequently remained largely vacant with informal housing and vandalism gradually deteriorating the shell of the building and the image of the surrounding environment. Designed in collaboration with the heritage authority of the City of Johannesburg, the restoration of this historically significant site, part of the Newtown development precinct, as the AngloGold Ashanti Head offices and Event space, has generated a welcomed commercial investment into the area. The intentionally modest external expression of the intervention has not been extended into the internal spaces. Here celebrated multi-volume spaces have been created, each with a distinct identity and appeal. Using the principle of building

a “box within a box” (Joubert (ed), 2009; 134), the large 14000m<sup>2</sup> office insertions for the Ashanti head offices comprises of a completely independent inner structural system within the historic shell of the power station. The inserted steel structure within the Boiler house interior borrows its tectonic language from the large raking beams and remnant generator equipment within the shell, allowing layered narrative of past and present functions within the building.

The large volume spaces within the original building allowed for a large scope of possible architectural interventions. The new office insertion maintains the integrity of the existing structure while allowing for a flexibility of uses within the new. As such the use of a steel structure not only marries the new with the old steel structures once housed within the building, but also allows for the intervention to read as a light and temporary addition to the older shell. Interesting spatial qualities have been achieved in the basement levels of the Forum with the provision of break-out seating spaces in the bases which once supported the large brass turbines, as well as the enhancement of the textured concrete walls and complimentary artworks, which add to the dramatic industrial feel within the space.

### PROJECT RELEVANCE

The stratification of architectural elements is one of contrasting materiality. The industrial materiality of the space has been maintained with the use of

exposed concrete and brick work contrasted with highly polished interior finishes, in an attempt to keep the expression of old and new materials honest. For the expression of the inner box within the historic shell, the steel framed insertion has been clearly pulled away from the existing. The poor treatment of threshold space in parts between the two however, has left superfluous voids preventing the old and new from becoming completely integrated. These threshold spaces can become opportunities to manipulate scale and juxtaposition of old and existing tectonics, becoming layering elements to the expressed narrative within the scheme and will be integral to the ultimate success of an adaptive reuse project.

While juxtaposition between old and new has been achieved in parts, the new insertion feels somewhat removed from the existing. The access to the site is completely removed from the pedestrian, with only two vehicular entrance gates serving as the only access points to both buildings and courtyard. While the project has given rise to a revived regeneration of the area, it contributes fairly little to the creation of positive public spaces within the greater Newtown context (Hart, 2011).

**ILLUS 80 (OPPOSITE)** Turbine Hall, east entrance (Hart, 2011), **ILLUS 81** New gallery space within existing structure (Hart 2011), **ILLUS 82** Threshold space between new and existing shell (Hart, 2011), **ILLUS 83** Section through new offices (Louw (editor), 2008; 84), **ILLUS 84** Section through new offices (Joubert (editor), 2009)

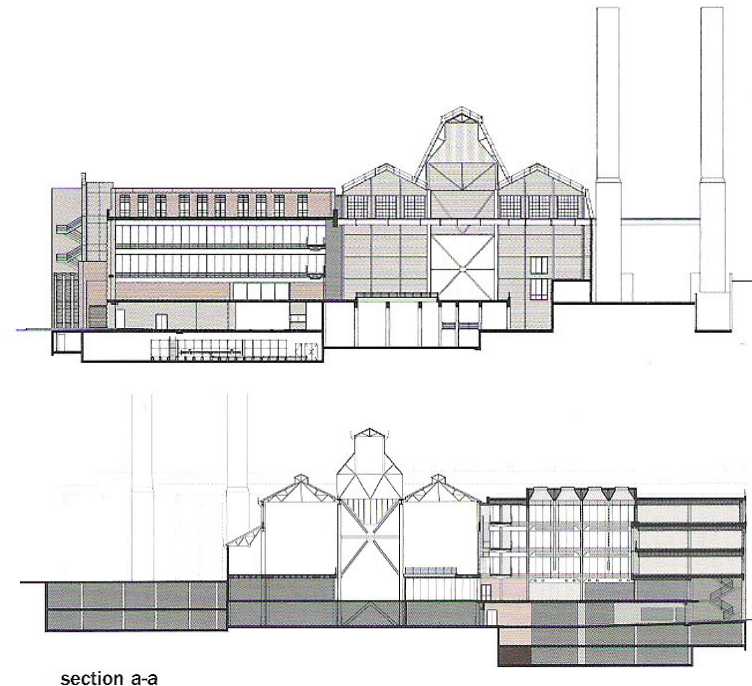



## Selexys Bookstore\_

### PROJECT DETAILS

- Primary Function Retail.
- Location Maastricht, Netherlands
- Climate Cool climate
- Architects Merckx & Girod
- Completed 2007

### PROJECT DESCRIPTION

While the architects have been involved in a number of historic adaptive re-use projects within the Netherlands such as the van Gogh and Rijksmuseum in Amsterdam, the design within the 13th century gothic Dominican church is one of immense elegance and sensitivity. The project scope involves the insertion of a multi-level, black, walk-in steel framed bookcase in the historic town of Maastricht in the Netherlands. The church has housed numerous functions since the Dominican people were driven out by Napoleon in the late 18th century, including a parish, a warehouse and archive as well as a large scale bicycle store, before being turned into the newest in the Selexys bookstore chain. The instalment of the 1200m<sup>2</sup> shopping zone within a space which only allowed for a 750m<sup>2</sup> footprint resulted in the intervention becoming vertical in opposition to the traditional horizontal retail surface. (Pham, 2011)

### PROJECT RELEVANCE

The expression of narrative was achieved by



offsetting the structure from the traditional nave axis of the church, thus allowing the architectural significance of the church to remain unaltered. Café spaces within the apse of the church draw on religious motifs, perhaps somewhat too literally, and the steel materiality of the new insertion speaks to a more industrial function once held within the building.

As expressed within historical guidelines such as the Burra charter, the expression of the insertion is one of a completely separate and removable object within the church. Integrated design elements such as hidden services and recessed lighting panels within the bookshelf structure have been used to create stratified tectonic components repeated throughout the insertion. This stratification of materials has also been used within the furniture design of smaller loose fitting display tables.



**ILLUS 85 (OPPOSITE):** Selexys book store (Pham, 2011), **ILLUS 86** New retail space within existing structure(Pham, 2011), **ILLUS 87** interaction between new and existing shell(Pham, 2011), **ILLUS 88** Cafe space in apse of church (Pham, 2011), **ILLUS 89:** Plan and axonometric of intervention (Pham, 2011)

In addition, the expression of distance between old and new as well as the interplay in floor levels has allowed for unique spaces of interaction with the elaborately vaulted roof space. This facilitates the understanding of the existing structure from a previously un-obtainable perspective by the user. This play on perspective has again been used in combination with a perforated steel structure allowing the insertion to appeal lightweight and unimposing within the heavy stereotomic church structure.

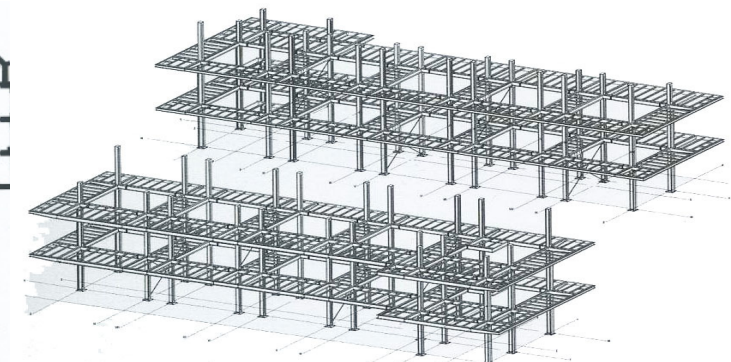
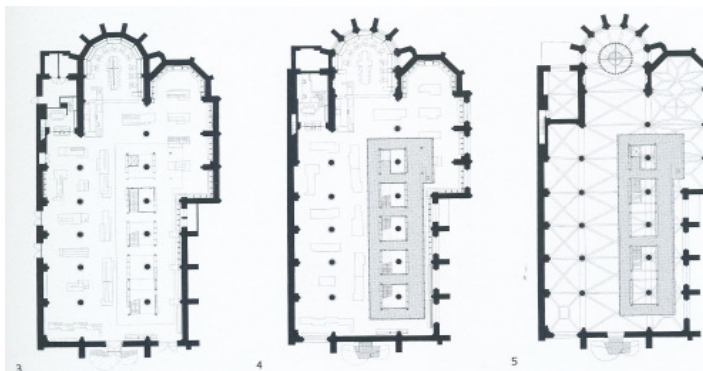



## Castelvecchio\_

### PROJECT DETAILS

- Primary Function Art Gallery
- Location Verona, Italy.
- Climate Cool, Medeteranian
- Architects Carlos Scarpa
- Completed in 1958-64 and 1967-73

### PROJECT DESCRIPTION

There have been four major alterations to the complex since its initial construction in the 12th century as part of the commune town of Verona. The Scala family made additions to the complex between 1354 and 56, with the inclusion of the bridge and commune wall into the complex as a separator between the residential component and the fortress, built to protect against the residents of the city. The building was again expanded by the French who gave it the name Castelvecchio instead of Castello di San Martino after the church which once stood in the inner courtyard before being demolished in 1806 to accommodate the widened entrance road (Schultz, 2010; 78). The addition of military barracks along the northern and eastern walls to house Napoleon's troops, a connecting staircase to the fortress walls, as well as the demolition of five of the original castle towers occurred during this time. In the early 20th century the building underwent a large restoration undertaken by architect Ferdinando Forlatti and museum director Antonia Avena in order to facilitate the housing of the city's painting collection (ibid).



At this time there was a series of additions to the facades of the barracks as well as the reconstruction of the castle towers. Interiors were altered from their basic military furnishings into lavish classical drawing rooms full of embellishment (Coombs, 1992; 5). The central courtyard was landscaped in an Italian Garden style leaving no trace of the former French influence on the complex.

#### ARCHITECTURAL ANALYSIS

Scarpa's interpretation of the historic narrative of the complex as a collection of fragments which had been continuously altered greatly influenced the approach to his architectural intervention. To reinstate the importance of the commune wall, Scarpa removed the Napoleonic staircase as well as a portion of the walls of the barracks (Schultz, 2010; 77). The roof plane is allowed to continue above in a form of memory to its historic volume, but its layers gradually removed to expose its construction and gradually reduce the once heavier physical connection with the wall.

Gothic windows and doors added by Forlatti are undermined with the placement of secondary window frames with contrasting modern mullions (Coombs, 1992; 7). This is a prime example of layering within a component to add to the narrative of the element which has been used by Scarpa in many of his architectural interventions as an expression of two distinct historical layers, being combined into one integral to the structure.

The separation of wall, floor and roof plane, is used to enhance understanding of spatial dimensions and becomes paramount to the successful use of the layered tectonic. Scarpa's visual separation of elements is used throughout the intervention, with the creation of negative seams between the floor and wall planes, reminiscent of the historic moats which would once have surrounded the commune walls. The addition of horizontal and vertical planes allows Scarpa to manipulate the scale and proportions of the building to suit the work to be displayed as well as creating transition spaces between rooms in

ILLUS 90 (OPPOSITE): Castelvecchio gallery space (Schultz, 2010), ILLUS 91 connection to commune wall (Schultz, 2010), ILLUS 92 adaption of gothic windows (Schultz, 2010), ILLUS 93 Stripped back roof element (Schultz, 2010), ILLUS 94 Layering of modular floor finishes (Schultz, 2010)

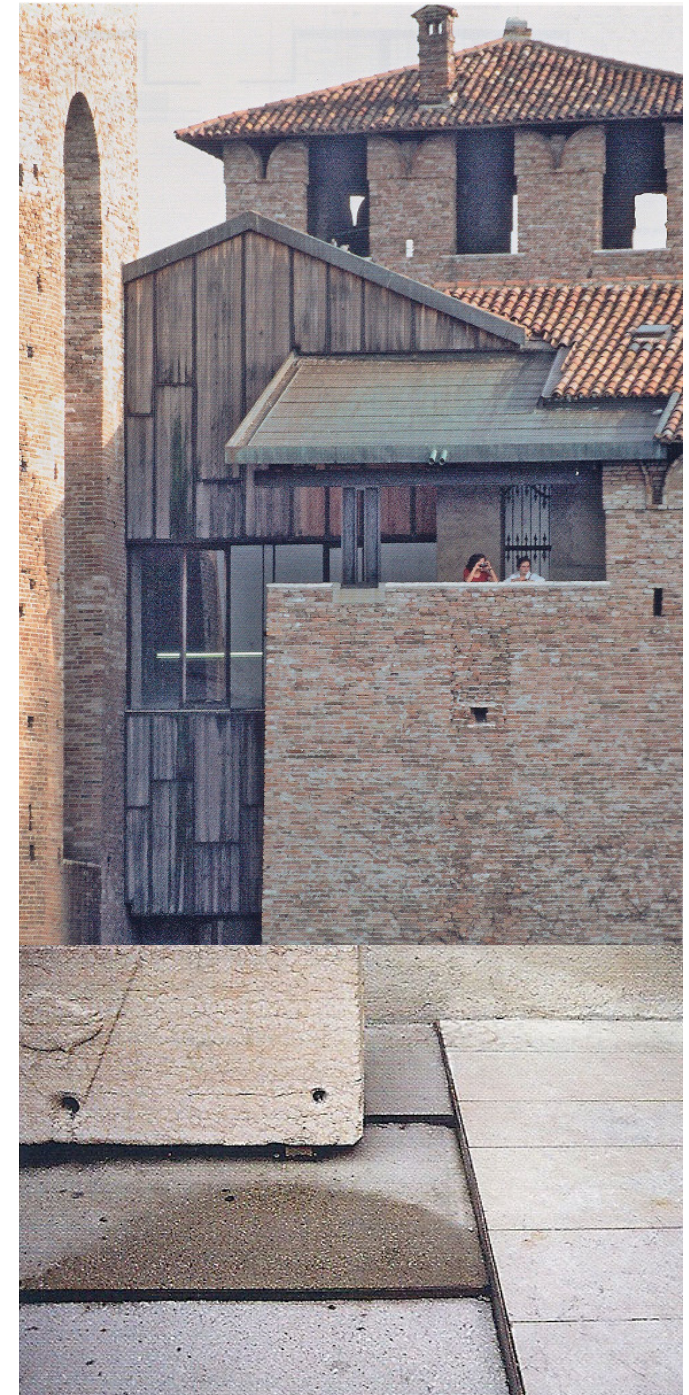
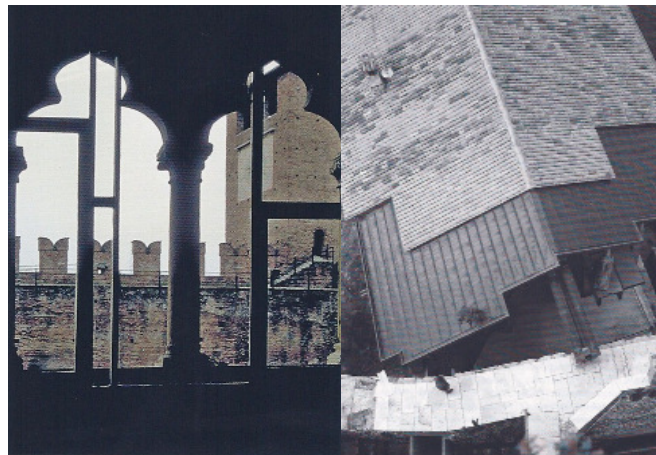

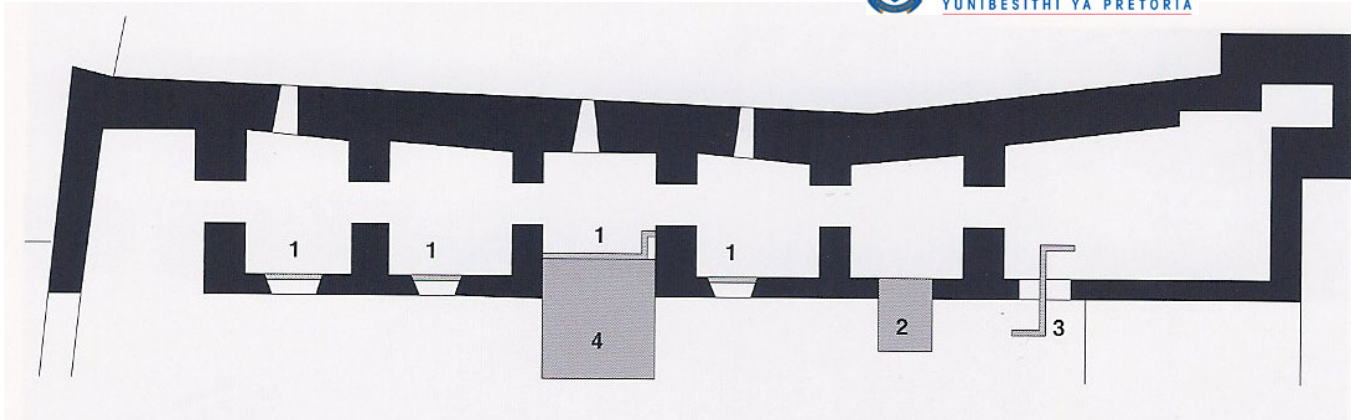

the buildings (*ibid*, 6). A large section of the wall is removed and replaced with wooden panelling, which is reminiscent of the materiality and original configuration once found within the complex.

Scarpa uses the floor surfaces to define spatial zones such as the harder stone flooring as trafficable areas, with display areas having a “carpet consisting of regular terracotta” (Schultz, 2010; 82).

The juxtaposition of old and new is used to express a complex historical narrative of the site and buildings. In contrast to popular historic preservation of the time, this approach to complex factors such as the social and political conversations, to be expressed as a palimpsest upon the built fabric of the building. The conscious separation of planes and materials allows for the abstraction of planes and elements while still allowing for the relationship between the layers to be understood both as an individual part and as a whole.

Scarpa’s use of stratification in architecture is a manner through which he conveys the many layers of meaning and history expressed within a single architectural entity (Hart, 2011). He employs a

multitude of methods to achieve this layering the first being one of straight juxtaposition of differing materials situated adjacent to each other. Secondly, one of distance, which can again be separated into two categories dependant on the size of separation, as one of ‘gap’ (small distances) and another of “threshold” whereby the separation of planes serves to begin to form threshold spaces between each other. Lastly, the use of visual layering, also employed by architects such as Adolf Loos, by which the visual layering of space is achieved through the allowance of visual linkages in a building, such that spaces beyond can be linked, if only visually, on a common axes. The use of the layering in the form of a ‘gap’ or small distance, whether achieved physically or merely visually, can be achieved with the treatment of the two layers as remaining distinct or of one of the creation of a layered component. In the latter, the understanding of the individual draws heavily upon the product of the two elements as a product. To do this Scarpa uses a series of frames and edges which allow for differentiation as well as creating a system of references between the two materials in juxtaposition thus allowing the imposed layer to gain meaning in itself (Schultz, 2010;153)

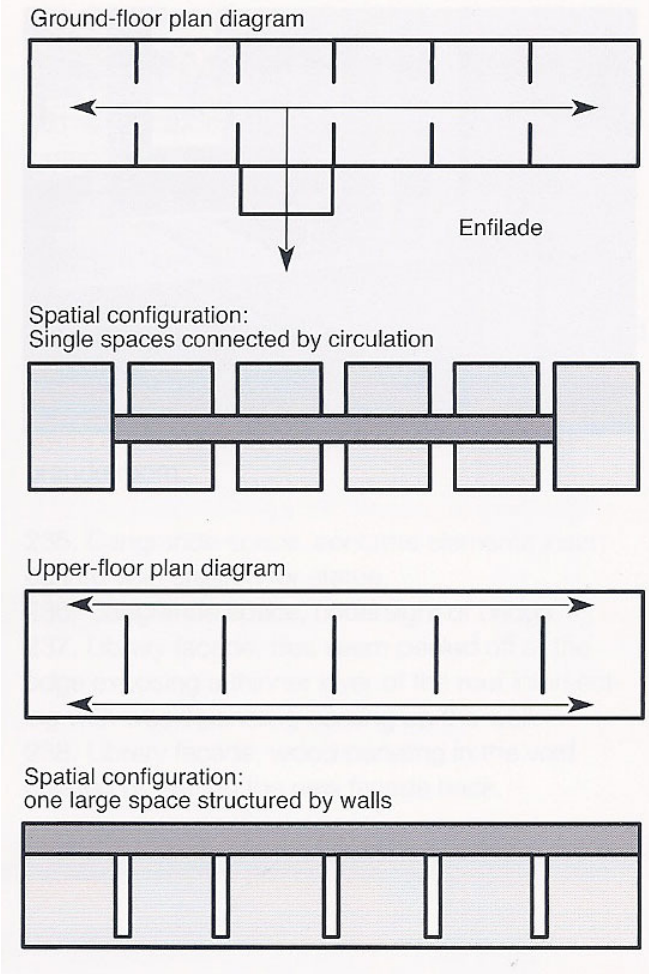

ILLUS 95 stratification of space (Schultz, 2010), ILLUS 96 Movement through gallery (Schultz, 2010), ILLUS 97 (OPPOSITE) layered connections (Hart, 2011), ILLUS 98 Layering of elements expressed in detailing (Schultz, 2010),

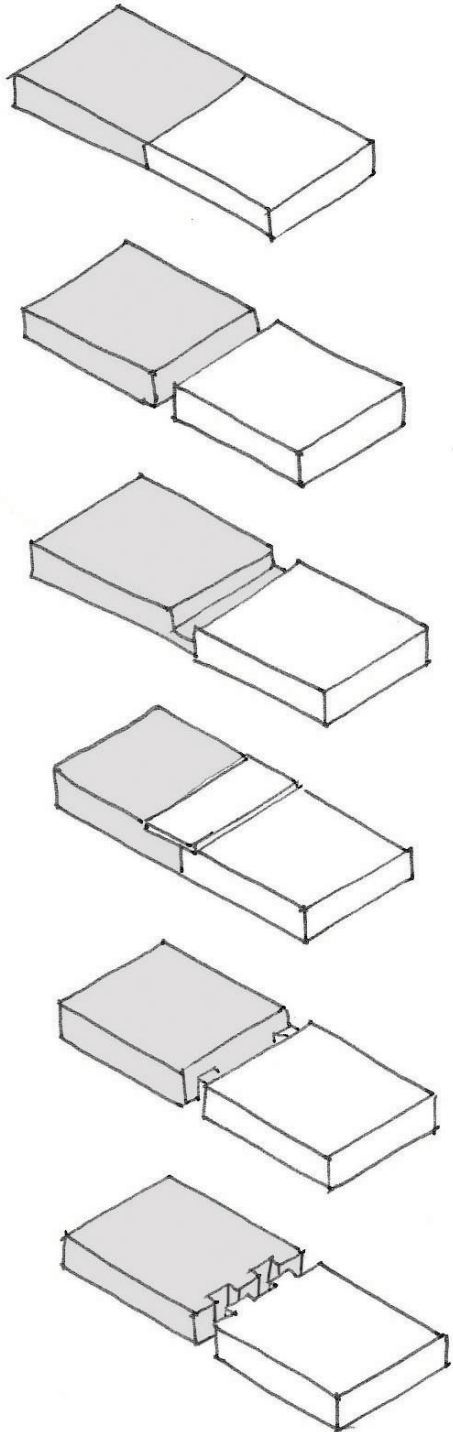

direct connection  
change in material



connection with gap



recessed connection



covered seam



pinned connection



notched connection





## **Banca Popolare: a contemporary interpretation of historical layering**

In order to greater understand the use of layering employed by Scarpa, the brief analysis of his design intervention of the Banca Popolare in Verona, Italy, constructed between 1970 and 1980, and completed by architect, Arrigo Rudi following Scarpa's death in 1978 (Schultz, 2010, 112) will be undertaken.

The completely new intervention adjoining the historic building fabric created by the bank can be seen as a freestanding façade which gains its contemporary architectural expression through an understanding of the layered historic fabric in its immediate context. Reference to the classic “tripartite façade form” (Schultz, 2010; 112) characterised by the distinction of levels into base, middle-part and roof is clearly evident in the architectural language of the intervention.

Scarpa uses cladding techniques on the lower two sections to enhance the stereotomic nature of the building. The base, with its local Botticini marble is intricately detailed with stepped friezework, with the differing wall planes introducing shadows and depth to the applied façade. The middle portion, while treated with a plastered rendering, as typically found on Venetian buildings in the immediate surroundings, has been treated with large projecting box windows or recessed circular voids, which break the plane of the new façade and express the screens' connectivity to a structural system behind.

The change in position of the glass panel facilitates the materials' vastly differing textural qualities, with the transformation from reflective planes, to dark expanses. As seen in Castelvecchio, the glazing system employed does not relate the alignment of mullions and openings, hinting at the applied nature of the layered component.

In addition, the middle plastered portion is pulled down at the connections to the existing neighbouring buildings, extending the upper roof layer downwards as if to capture the applied façade. The roof section or loggia, is formed with steel superimposed column and beam system and a recessed, completely glazed façade. The light and tectonic nature of the structural expression results from the roof planes' suggested linkage to sky.

### ARCHITECTURAL SIGNIFICANCE

The stratification employed by Scarpa, notably in contrast to his work in Castelvecchio, is one of a multi-layered component, as opposed to simple juxtaposition of materials and connections with the stratification of adjacent objects. The creation of the façade is determined by the interplay between the changing planes of materials which afford the user understanding of the structure through the ability to mask or reveal layers beyond itself.

While this project is primarily a new build, the historic setting within the city of Verona requires an intricate play between contemporary architectural techniques and historic styles and textures.

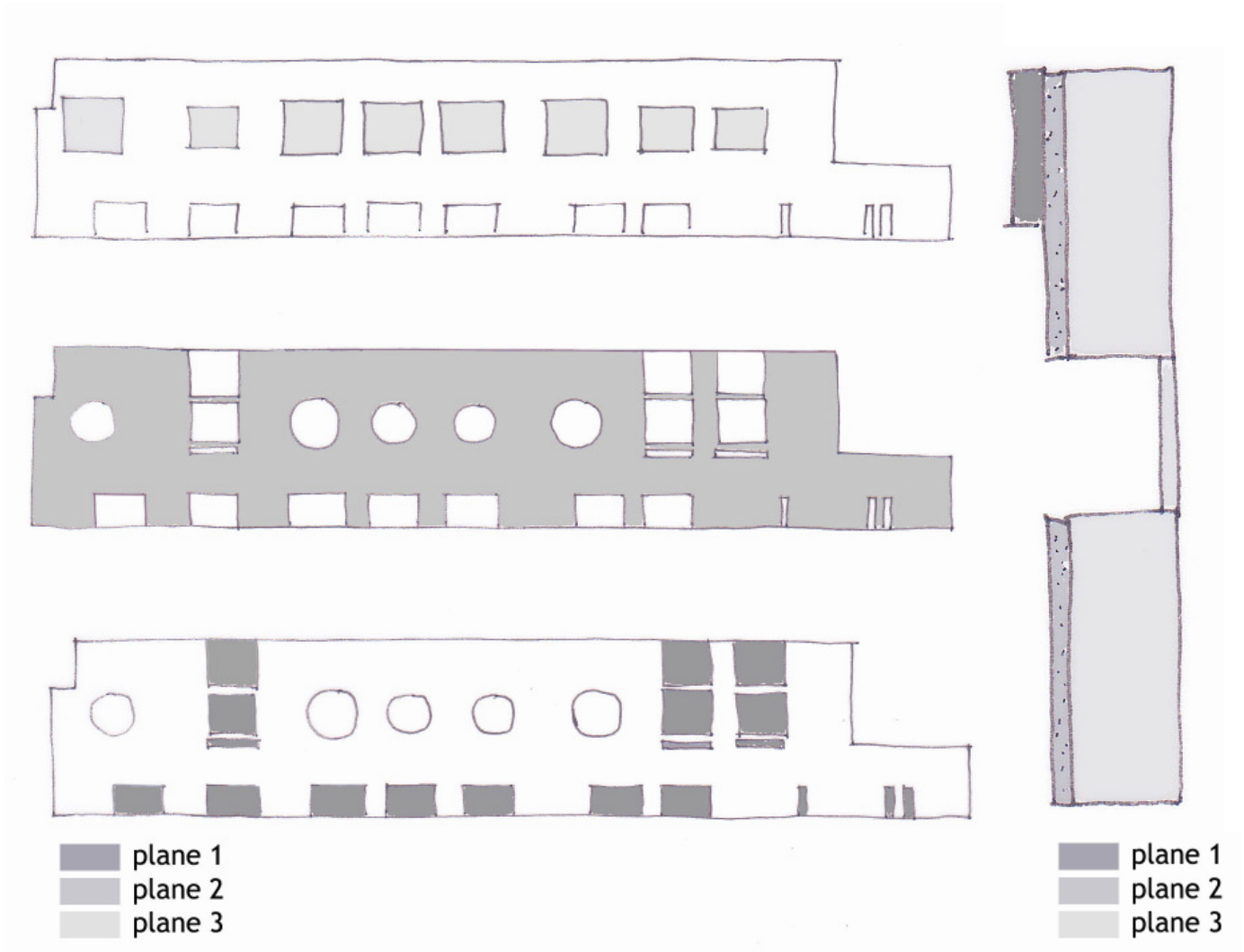

ILLUS 99 (OPPOSITE): Banca Popolare (Schultz, 2010), ILLUS 100 Planar layering of facade elements (adapted from Schultz, 2010)



## Pigsty Showroom\_

### PROJECT DETAILS

- Primary Function Gallery
- Location Pfalz, Germany
- Climate Cool European
- Architects FNP Architekten
- Completed in 2005

### PROJECT DESCRIPTION:

Originally constructed in the 18th century as a pig barn, the building was partially destroyed during the Second World War. Given the crumbling state of the building, FNP Architekten inserted a new, timber frame structure into the historic shell, which is structurally independent from the existing structure. A new roof element and overhang affords the historic walls a level of protection from the elements. In addition, care was taken to align new window openings with existing openings within the historic shell. (Finch, 2005; 46)

### PROJECT RELEVANCE

The sensitive approach to restoration of an historic building, in which the history of the structure and its deterioration is celebrated by being allowed to continue to remain in “ruin” whilst still being able to be reprogrammed into a useable and provocative space, is one that can be of great inspiration to the treatment of the Predio Potts building. Tectonically the layering of materiality of the façade between the romantic shell, and the newer slicker, timber box enhances the contrasting nature of old and new. The historic skin becomes a mask for the new



insertion and allows for the juxtaposition of old and new histories within the building.

A similar style of architectural intervention which was completed in England in 2010 also draws upon this architectural language of insertion. The Dovecoat Studio project by London-based architect studio Hawthorn Tompkins is an addition to a music college set in the Suffolk countryside. Similar to the pigsty showroom project, the intervention takes place in the form of an inserted box within the ruins of a Victorian outhouse. The higher degree of exposure to the elements seen here due in large part to the extension of the studio space above the single story walls of the ruin, informed the use of a completely prefabricated Cor-ten box allowing the inserted building to be water tight. In addition, the materiality of the Cor-ten sheeting allows the new intervention to blend harmoniously with its surroundings as well as to tell a tale of a potential historic narrative of the future as the material gradually deteriorates and shows its age.

In both schemes the relation of old to new is emphasised with distance which is bridged only when openings occur. While in the showroom, the existing openings within the structure informed the placement and size of those in the insertion, there is little attempt for the new opening to be expressed as a stratified narrative upon the existing as can be seen in Scarpa's architecture. Save for the hovering roof-plane above the studio, one might not be aware of the newer inner core. The design approach here is one of mirroring the historic

volume and form. In contrast, the new volume within the studio intervention has been vertically expressed with a volume perhaps more derived from a historic Victorian building typology, as opposed to the original volumetric proportion of the building.

Critically, the treatment of the new plane of intervention in relation with the existing can be seen in contrasting degrees. The Pigsty showroom is one of an intervention that, while separated from the old, relies to a certain degree on the existing to give it meaning. In projecting the roof element above the plane of the existing walls, the new and old shells become spatially connected as a layered component. In addition the protection from the elements provided by the existing to the new shell perhaps somewhat limit the degree to which the continued ruination will be allowed to occur. In contrast, the Dovecoat studio intervention is visually and physically separated from the existing layer. The lack of intersecting planes and visually distinct openings allows the intervention to be read as two separate layers. Thus while one may be seen through the other in a form of visual transparency, it does not rely upon the other to give it meaning or allow understanding of the varying tectonics.

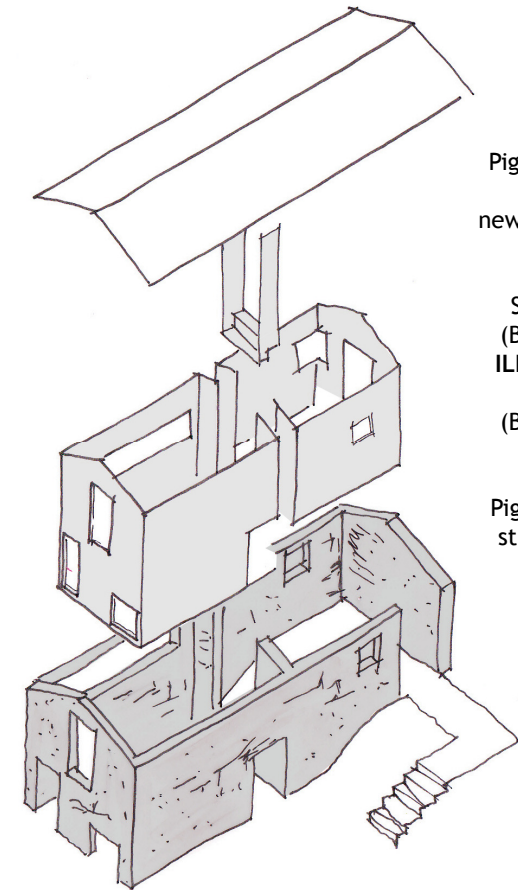

**ILLUS 101 (OPPOSITE):** Pigsty Showroom , insertion of new box (Bennes, 2010), **ILLUS 102** Dovecoat Studio, Suffolk (Bennes, 2010), **ILLUS 103** Pigsty showroom (Bennes, 2010), **ILLUS 104** layering of Pigsty showroom structure (Hart, 2011)



## The Institute of Culinary Arts. (ICA)\_

### PROJECT DETAILS

- Primary Function Culinary School
- Location Bankoek, Stellenbosch. Western Cape

### PROJECT DESCRIPTION

Founded in 1995, the school, set in the Franschhoek valley in the Western Cape in the heart of the winelands, offers a range of comprehensive 1-3 year culinary courses which breathe inspiration and passion into the world of food (ICA, 2011; 1).

The school caters for a maximum of 28 students in each year with a total of 70 students across all degree programs so as to maintain a maximum lecturer to student ratio of 1:10. With a course breakdown which comprises of 60% practical and 40% theory, the school requires cooking workspaces as well as the traditional lecture room spaces. The kitchen spaces are again divided into a patisserie or pastry section and a general section into which the class is split during practical's to allow for smaller groups of 14 at a time. As part of the course curriculum, the students each spend an 8 week rotation working within the "living classroom", The Apprentice Restaurant, situated in the historic Stellenbosch town centre. Owned by the ICA, the restaurant is almost exclusively staffed by students who will be given a chance to interact with all facets of the restaurant industry from food service and menu design to food production and design. This allows the students invaluable work experience as well



as creating a unique eating experience for patrons. The layout of the kitchen allows for two students to work at a workstation, sharing an oven and gas hob and sink. In each kitchen sector there is a display counter from which the initial cooking demonstration is done. This desk has large mirrors above to ensure the students have a good view of the process. All ingredients are stored in either the dry ingredients store or the cold storage rooms. However as much of the fresh produce are brought daily from local farms or grown in the adjacent vegetable garden, the requirement for the cold store is relatively small (Hart, 2011).

There is active waste recycling program within the school, with separation into plastics glass and organic waste. Organic waste is used for composting within the vegetable gardens. There is no grey water recycling within the building as the oils within the waste water make it unsuitable for recycling. Gas is used primarily for the hobs given its instantaneous heat which is suitable for cooking. In contrast the ovens remain electrically powered. Each workstation is fitted with a plug point for auxiliary equipment such as hand mixers etc.

The loose fit of all equipment within the kitchen allows for ease of cleaning after each practical and for the complete removal and sterilisation at the end of every week. This also facilitates the modulation of workspaces allowing for a number of differing furniture layouts.

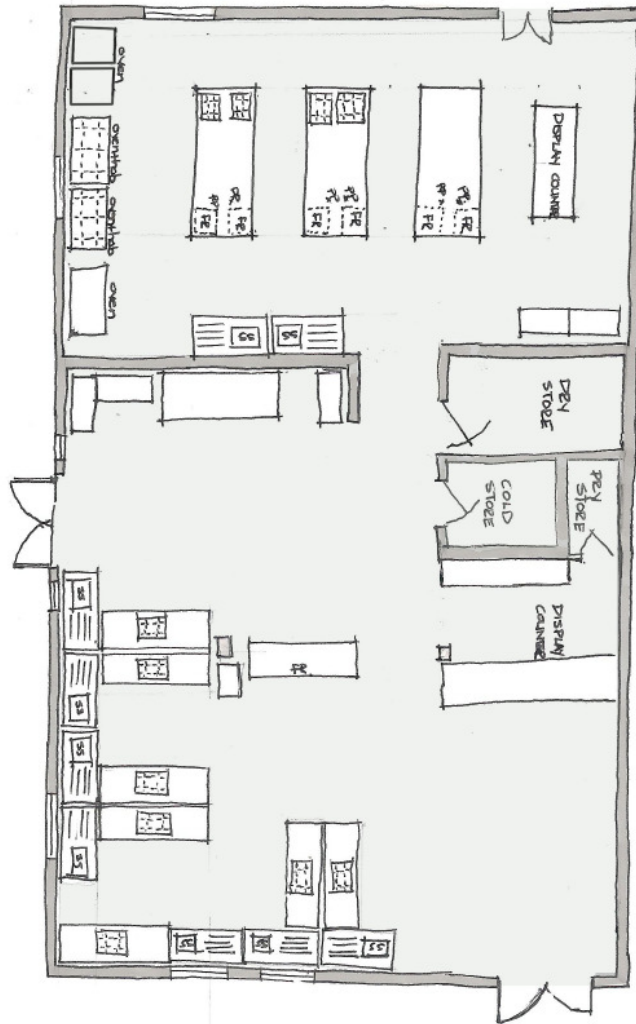

ILLUS.105 (OPPOSITE) ICA cullinary school main building (Hart, 2011), ILLUS 106 Floor plan (Hart , 2011), ILLUS.107 Vegetable garden for fresh produce and herbs (Hart, 2011); ILLUS 108 Modular kitchen furniture (Hart , 2011)