

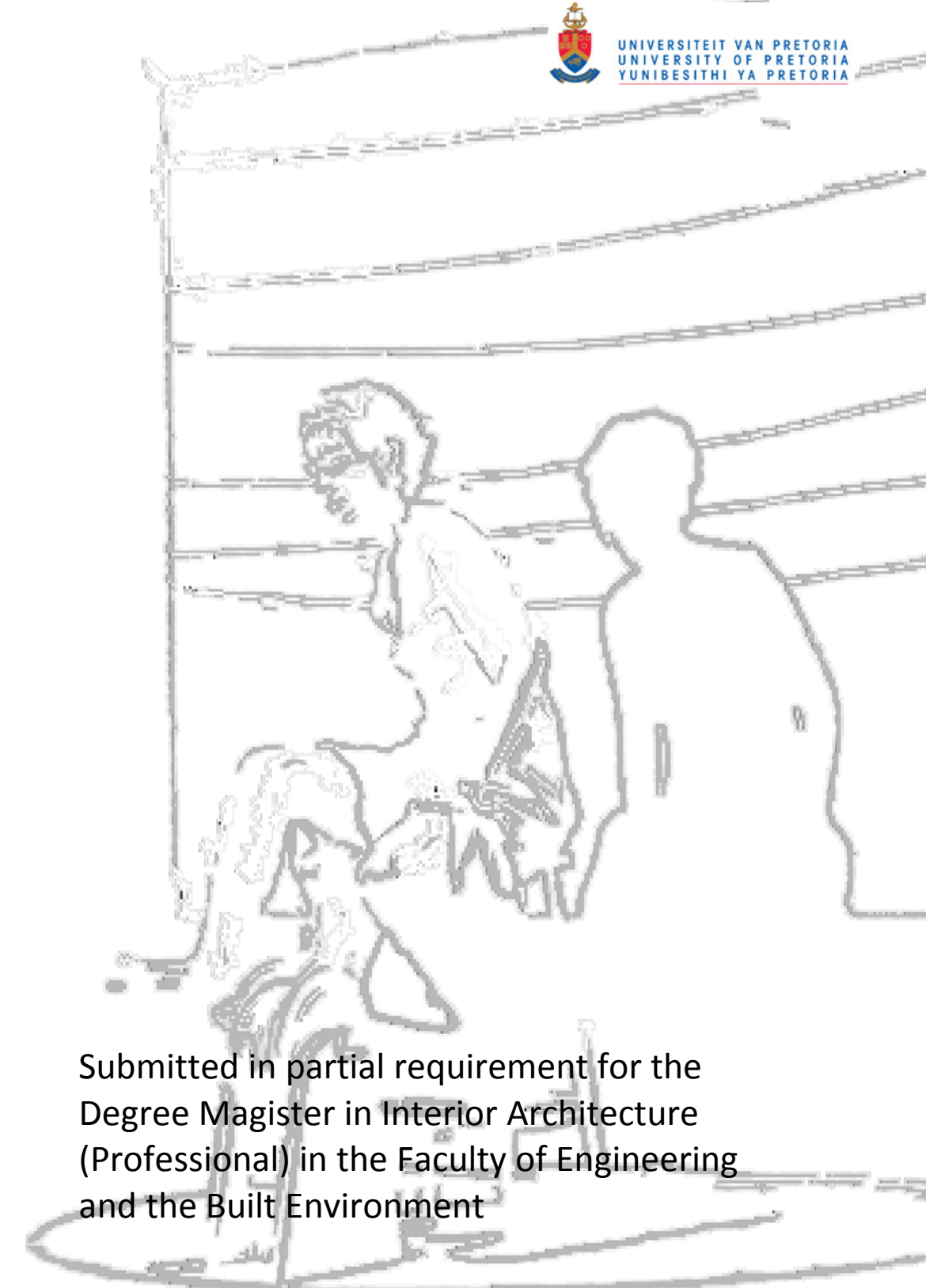


Flexible Education Spaces For Experimentation And
Freedom Of Expression In The Dramatic Arts

By Meera Chita

© University of Pretoria

REINVENTING
THEATRICAL EDUCATION



Submitted in partial requirement for the
Degree Magister in Interior Architecture
(Professional) in the Faculty of Engineering
and the Built Environment

**UNIVERSITY OF PRETORIA | DEPARTMENT
OF ARCHITECTURE
NOVEMBER 2008**

Meera Chita

Study leader: Barbara Jekot

Mentor: Catherine Karusseit

TABLE OF CONTENTS

0X | LIST OF FIGURES

01 INTRODUCTION	1
1.1 CURRENT THEATRE TRENDS	2
1.2 THE REAL WORLD PROBLEM	4
1.3 THE PROBLEM STATEMENT	
1.4 PROJECT BRIEF	5
1.5 PROJECT GOALS	5
02 CONTEXT STUDY	6
2.1 MACRO CONTEXT STUDY	7
2.2 MICRO CONTEXT STUDY	9
2.3 SITE ANALYSIS	11
2.4 BUILDING ANALYSES	13
03 DESIGN APPROACH	17
3.1 THEATRE THEORY	18
3.2 BLACK BOX THEATRES: A VOID SPACE OF MEANINGFUL PRODUCTIONS	23
3.3 SPATIAL THEORY	24
04 PRECEDENT STUDIES	26
CONTENTS	27
4.1 PERFORMANCE ACADEMY, NEWCASTLE COLLEGE	28
4.2 BARKING TOWN SQUARE	29
4.3 MUSEO DI CASTELVECCHIO	31
4.4 YOUNG VIC THEATRE	33

05 DESIGN DISCOURSE	37
5.1 USER GROUP	37
5.2 DESIGN INTERVENTION	37
5.3 PRECINCT DEVELOPMENT	37
5.4 SITE DEVELOPMENT	39
5.5 ARCHITECTURAL LANGUAGE	40
5.6 BUILDING DEVELOPMENT	40
5.7 DESIGN CONCEPT	44
5.8 INTERIOR	48
06 TECHNICAL INVESTIGATION	54
6.1 HVAC, HEATING, VENTILATION AND COOLING	55
6.2 ACOUSTICS	55
6.3 THEATRE RIGGING AND LIGHTING	57
6.4 APPLIED SYSTEM IN DIE MASKER	58
6.5 CONTROL ROOM	58
6.6 LIGHTING IN THE BUILDING	59
6.7 BASELINE CRITERIA	59
6.8 MATERIALS	63
07 TECHNICAL DRAWINGS	64
08 CONCLUSION	81
09 BIBLIOGRAPHY	83
01 APPENDIX 1	87
02 APPENDIX 2	90
ACKNOWLEDGEMENTS	

LIST OF FIGURES

01 INTRODUCTION

- Cover page: Philosopher's stone by Peter R Hall
- Figure 1.1.1: Sophocles's Philoctetes by Heiner, Muller showing the sue of a proscenium thrust stage⁷². Burris Meyer, 1968: 311)
- Figure 1.1.2: Rutherford & Son by Daw, Simon 2005, showing the use of a theatre in the round.
- Figure 1.1.3: *The Secret Love Life of Ophelia* by Simon Holdsworth 2001

02 CONTEXT STUDY

- Figure 2.1.1: GSDP Areas of Large Scale Economic Activity (City of Tshwane Metropolitan Municipality (2007))
- Figure 2.1.2: Metropolitan activity nodes in Tshwane (City of Tshwane Metropolitan Municipality (2007))
- Figure 2.1.3: Above: Diagram showing urban nodes in Pretoria, Hatfield being an urban node. Aerial photo of Hatfield showing vehicle routes in the Hatfield Urban Node.
- Figure 2.1.4: Aerial drawing of the University of Pretoria main campus and South Campus, Hatfield. The orange labels depict the other arts buildings and the circled area depicts the chosen site culminating at the end of the ring road. Author: Chita M
- Figure 2.1.5: Aerial photograph of the existing Drama department building with Die Masker, Die Lier and the Drama Building
- Figure 2.1.6: Panoramic photo of the Drama Building from Lynwood Road. By Misra S, May 2008
- Figure 2.1.7: Photograph of the entranceway into Die Masker. By Misra, S may 2008

- Figure 2.1.8: Photo of Die Lier from the entrance of Die Masker. By Misra, S May 2008
- Figure 2.1.9: Panoramic view of the courtyard to the Drama Building (old CBC), by Misra, S, May 2008
- Figure 2.1.10: Existing Site plan of the Proposed Drama Precinct
- Figure 2.1.11: ground floor plan
- Figure 2.2.12: First floor plan
- Figure 2.1.13: Section A
- Figure 2.1.14: Section B
- Figure 2.1.15: Existing materials and finishes of the Drama Building, Author: Chita M
- Figure 2.1.16: Die Masker, Existing façade, by Misra. S, May 2008
- Figure 2.1.17: Photograph of western façade of Die Masker, by Misra s
- Figure 2.1.18: Photographs of all the facades of Die Masker, By Chita M
- Figure 2.1.19: Interior view of the stairway to the controls level, by Chita M
- Figure 2.1.20: Interior view of the foyer, by Misra S, May 2008
- Figure 2.1.21: Interior view of the theatre. By Misra S
- Figure 2.1.22: Existing Plan Masker Theatre, By Chita, M
- Figure 2.1.23: Longitudinal section B through the theatre
- Figure 2.1.24: Existing Cross section A through the foyer
- Figure 2.1.25: Interior view of the extension used as storage for props and lighting.

- Figure 2.1.26: Stage wings used for storage, by Chita M
- Figure 2.1.27: Interior view of existing dressing rooms, by Chita M
- Figure 2.1.28: Photograph of Die Lier entrance, by, Chita M
- Figure 2.1.29: Interior View of the foyer, by Chita M
- Figure 2.1.30: Interior of Die Lier, by Chita M
- Figure 2.1.31: Interior of Die Bok, by Chita M
- Figure 2.1.32: Photograph of the exterior of Die Bok, by Chita M
- Figure 2.1.33: Section E. By Chita M
- Figure 2.1.34: Section F. By Chita M
- Figure 2.1.35: Plan of Die Lier and Die Bok

03 DESIGN APPROACH

- Figure 3.1.1: *Street theatre* Manchester International (Festival 2007)
- Figure 3.1.2: *Street theatre* Manchester International Festival (2007)
- Figure 3.1.3: Functional spaces within a typical theatre, Chita M
- Figure 3.1.4: Organisation of theatre spaces, Chita M
- Figure 3.1.5: Spatial transition in theatre from public to private, Chita M
- Figure 3.1.6: Sketch of a larger theatre volume and its effects, Chita M
- Figure 3.1.7: Sketch of theatre volume at a more intimate smaller level, Chita M
- Figure 3.1.8: Sketch of end stage, proscenium stage has the same concept. Burris-Meyer, 1964

Figure 3.1.9: Sketch of thrust stage, Burris-Meyer 1964

Figure 3.1.10: sketch of arena stage or theatre in the round, Burris-Meyer, 1964

Figure 3.1.11: interior of the Kwai Tsing Black Box Theatre, http://www.architectsjournal.co.uk/archive/black_box_light_box.html cited: 21 April 2008

04 PRECEDENT STUDIES

4.1 THE PERFORMANCE ACADEMY, Newcastle College 2004:

Figure 4.1.2: Back facade referred to as the black box
Figure 4.1.2: White glowing façade referred to as "light box" (http://www.e-architect.co.uk/newcastle/jpgs/newcastle_coll_ege_rmjm030408_1.jpg, cited 1 August 2008)

Figure 4.1.3: The Polycarbonate light box, (http://www.e-architect.co.uk/newcastle/jpgs/newcastle_coll_ege_rmjm030408_2.jpg, cited 1 August 2008)

Figure 4.1.4: The Light box is used for projections, (http://www.e-architect.co.uk/newcastle/rmjm_newcastle_college.htm, 1 August 2008)

4.2 Barking Town square:

Figure 4.2.1: Aerial diagram of the New Barking Town Square: Author of the image 2008: muf architecture/art ©, cited 25 June 2008

Figure 4.2.2: Aerial plan of the layout of Barking Town Square showing the Pink granite square (a), the end of the pathway with found objects (b), the new checkered arcade leading to the square in front of the Town Hall(c), and the new Secret Garden (d) muf architecture/art © Author of the image 2008). Cited 25 June 2008

Figure 4.2.3: Sketch of the arboretum with forty mature trees of sixteen different species that are lit

up at night with colours that vary according to the time of year. Author of the image 2008: muf architecture/art ©. Cited 1 August 2008

Figure 4.2.4: Pink Granite Slab Square adjoining old Town Hall and new buildings, creating a complete space. Author of the image 2008: muf architecture/art ©. Cited 1 August 2008

Figure 4.2.5: Town Hall Square which accommodates for events. <http://www.cccb.org/en/album?idg=22971>, cited 25 June 2008

Figure 4.2.6: Checkered arcade with golden chandeliers create new pathway into public square.

Figure 4.2.7: Figure 4.2.7: Temporary stage structure with backdrop inserted for an event. Author of the image 2008: muf architecture/art © Cited: 1 August 2008

Figure 4.2.8: Square used for event with the Town Hall as a backdrop. Author of the image 2008: muf architecture/art © Cited 1 August 2008

Figure 4.2.9: Various activities such as festivals and carnivals take place in the square. Author of the image 2008: muf architecture/art ©. Cited 1 august 2008

4.3 Museo di Castelvecchio:

Figure 4.3.3 Drawn plan by Carlo Scarpa of the changes he wanted for the courtyard and building. Author: Murphy 1990

Figure 4.3.2: Image of the Courtyard of Cangrande. Author: Murphy 1990

Figure 4.3.3: Sacello at entrance, new object vs. existing entrance. Author: Murphy 1990

Figure 4.3.5: Image of the timber screen applied over the existing structure. Author: Murphy 1990

Figure 4.3.5 Image of the timber screen applied over the existing structure: Murphy, 1990

Figure 4.3.6: Porticos in exhibition hall showing the new floor tiling and the planes, this creates with spaces between the vertical and horizontal elements: Murphy, 1990

Figure 4.3.7: Scarpa designed plinths for the sculptures to be placed on that lightly touch the existing and where one can see the thinness of the material: Murphy, 1990

Figure 4.3.8: Images of detailed elements that show the truth of their materiality and how they are inserted into the existing fabric: Murphy, 1990

Figure 4.3.9: Statue of Cangrande in the courtyard. <http://www.studiocleo.com/gallerie/scarpa/scarpage.html> Cited 20 October 2008

4.5 Young Vic Theatre:

Figure 4.4.1: Section through foyer and studios, Rob, 2007

Figure 4.4.2: Section through theatre, Rob, 2007

Figure 4.5.3: Ground floor plan, Rob, 2007

Figure 4.5.4: First floor plan, Rob 2007

Figure 4.4.5: Second floor plan, Rob 2007

Figure 4.4.6: Entrance for the theatre showing the 3 spaces joint at with the signage. Author: Philip Vile. Rob 2007

Figure 4.4.7: Photograph showing front façade of eh Young Vic at evening time. Author: Richard Bryant, Rob, 2007

Figure 4.4.8: Interior view showing the combination of new and existing elements. Author Philip Vile, Rob 2007

05 DESIGN DISCOURSE

Figure 4.4.9:	The black box theatre configured in a Catwalk layout (The Young Vic Theatre). Author: Richard Bryant, Rob 2007	Figure 5.1.1:	Spatial analysis with pedestrian paths and building relation analysis.	Figure 5.1.15:	Ground floor plan design for the Drama Building.
Figure 4.4.10:	Black box theatre in Theatre in the Round configuration (The Young Vic Theatre). Author: Richard Bryant, Rob 2007	Figure 5.1.2:	Edge configuration and social space configuration with pathways increasing pedestrian access.	Figure 5.1.16:	First floor plan design for the Drama Building.
Figure 4.4.11:	Interior of foyer showing new and existing elements. Author Phili Vile, Rob 2007	Figure 5.1.3:	Identification of external and internal performance spaces that link interior to the exterior.	Figure 5.1.17:	Sketch diagram of Die Maskers building development.
Figure 4.4.12:	Interior of foyer with inserted timber, glass and steel structure. Author: Richard Bryant, Rob, 2007	Figure 5.1.4:	Sketch of conceptual site development with access paths, service passages, public areas, and building relation.	Figure 5.1.18:	Concept diagram of the spatial configuration for Die Masker.
Figure 4.4.13:	Membrane between service spaces and public spaces. Author Philip Vile, Rob, 2007	Figure 5.1.5:	Concept development of the proposed new building for the Precinct.	Figure 5.1.19:	Photograph of the lighting effect of the entrance canopy during the day. Silhouette created by natural light. Misra, S.
Figure 4.4.14:	Daytime view of the exterior, http://www.haworthtompkins.com/young_vic/index.html , Cited: 23 July 2008	Figure 5.1.6:	Sketch diagram of the proportions of the classical Drama Building.	Figure 5.1.20:	Photograph of the lighting effect of the entrance canopy during at night for performances. Silhouette created by lighting from below light. Misra, S.
Figure 4.5.15:	Night time view of the theatre exterior, http://www.haworthtompkins.com/young_vic/index.html , Cited: 23 July 2008	Figure 5.1.7:	Sketch of outdoor performance in the courtyard.	Figure 5.1.21:	Sketch of the entrance canopy and existing concrete portal wit internal soffit painted red.
Figure 4.5.16:	Photograph showing the detail of the cladding, Author Philip Vile, Rob, 2007	Figure 5.1.8:	Sketch diagram of the Drama Building showing move from public to private spaces.	Figure 5.1.22:	Sketch of existing south façade with new entrance.
Figure 4.5.17:	Exterior of theatre, http://www.haworthtompkins.com/young_vic/index.html , Cited: 23 July 2008	Figure 5.1.9:	Spatial configuration sketch of the ground floor of the Drama Building.	Figure 5.1.23:	Sketch of louvre system on the western façade. With concrete frames painted red to create a focal point.
Figure 4.5.19:	Interior view of entrance and foyer: http://www.haworthtompkins.com/young_vic/index.html , Cited: 23 July 2008	Figure 5.1.10:	Spatial configuration sketch of the first floor of the Drama Building.	Figure 5.1.24:	Sketch perspective of the new addition on the east of the existing Masker Building.
Figure 4.5.20:	Interior view gallery above foyer: http://www.haworthtompkins.com/young_vic/index.html , Cited: 23 July 2008	Figure 5.1.11:	Concept sketch of the convertible classroom used for performance.	Figure 5.1.25:	Sketch interior perspective of the foyer, looking at the new louvered glazing panels and seating area.
		Figure 5.1.12:	Concept sketch of the convertible classroom used for rehearsal.	Figure 5.1.26:	Sketch interior perspective of the foyer, looking towards the staircase and glass lift to the new mezzanine level where the dance studio can be accessed.
		Figure 5.1.13:	Concept sketch of the convertible classroom used for education.	Figure 5.1.27:	Interior perspective of the rehearsal studio.
		Figure 5.1.14:	Site plan for the proposed design of the Drama Building. Chita M	Figure 5.1.28:	Interior perspective of the multi-purpose theatre.

- Figure 5.1.29: Spatial configuration for the backstage and service areas
- Figure 5.1.30: Concept plan of the ablution facilities. M Chita, July 2008.
- Figure 5.1.31: Sketch Interior perspective of the ablution facilities.
- Figure 5.1.32: Concept theatre configurations which aid in the variation of use of the theatre space with regard to education as well as performance. A. thrust stage, B. theatre in the round. Sketch by Chita M, taken from Theatres and auditoriums, Burris Meyer.

06 TECHNICAL INVESTIGATIONS

- Figure 6.1.1: Interior photograph of Di e Masker showing the existing AC duct in roof ridge, Misra, S. May 2008
- Figure 6.1.2: diagram showing reverberation in the existing theatre, Author: Chita, M
- Figure 6.1.3: Reverberation of new design showing absorbent materials and sound reflections, Authoir, Chita M
- Figure 6.1.4: Method of locating theoretical positions of spotlights. (Tutt and Adler 1995:191-192)
- Figure 6.1.5: On thrust and theatre-in-the-round stages virtually all the lighting comes from overhead to avoid glare in the eyes of the audience. (Tutt and Adler 1995:191-192)
- Figure 6.1.6: This system, a 15 x 8m containment Frame, features an integral support structure complete with hangers and lighting grid, and is installed on the first floor of a Georgian villa that is now known as CCA Glasgow. Tension wire grid platforms are woven from stainless or galvanized steel wire rope

Architect: Page & Park
Contractor: Lilley Construction Ltd

- Figure 6.1.7: movable louvre system consists of a range of aluminium elliptical louvers louvres can be motorized to provide maximum control over the amount of daylight passing through the system. www.reynaers.com, cited 12 September 2008
- Figure 6.1.8: Recycled rubber flooring. <http://www.marleyflooring.co.za/> Cited 26 September 2008
- Figure 6.1.9: Envirodeck. www.wpc-decking.co.za/change/main.asp?cbit=7 cited 23 September 2008
- Figure 6.1.10: Screen printed glazing. http://www.smartglass.co.za/performance_data/images.pdf Cited 18 September 2008
- Figure 6.1.11: Stretch ceiling. <http://www.barrisolco.com/technical.php> Cited 4 September 2008
- Figure 6.1.12: Plastic panel. <http://www.greenbuilding.co.za> cited 29 September 2008
- Figure 6.1.13: Multicolor plastic tubes with RGB LED lights. <http://www.ledlighting.co.za> Cited 1 September 2008
- Figure 6.1.14: Modular Concrete block. <http://www.cma.org.za/UploadedMedia/Masonry-Vol-2-Hollow-Units-140-190%5B1%5D.pdf> cited 29 August 2008
- Figure 6.1.15: The Linking Rod System. www.preformedsa.co.za cited 20 September 2008.

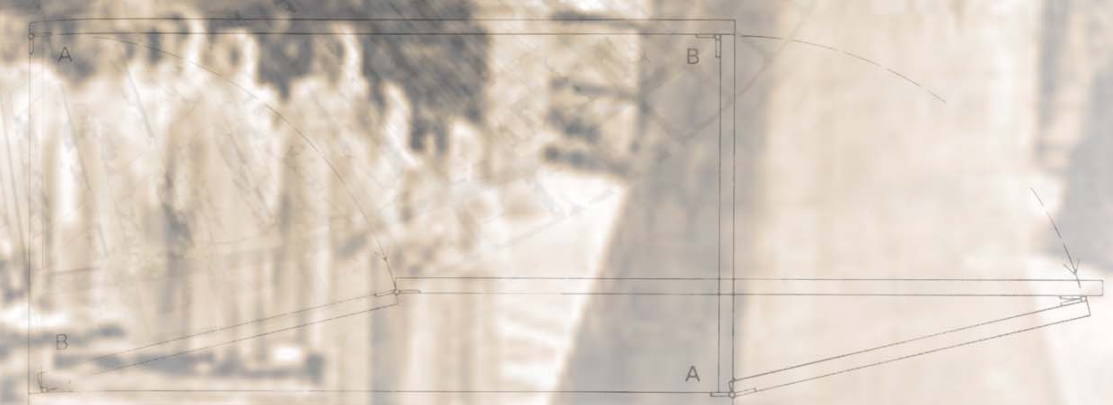
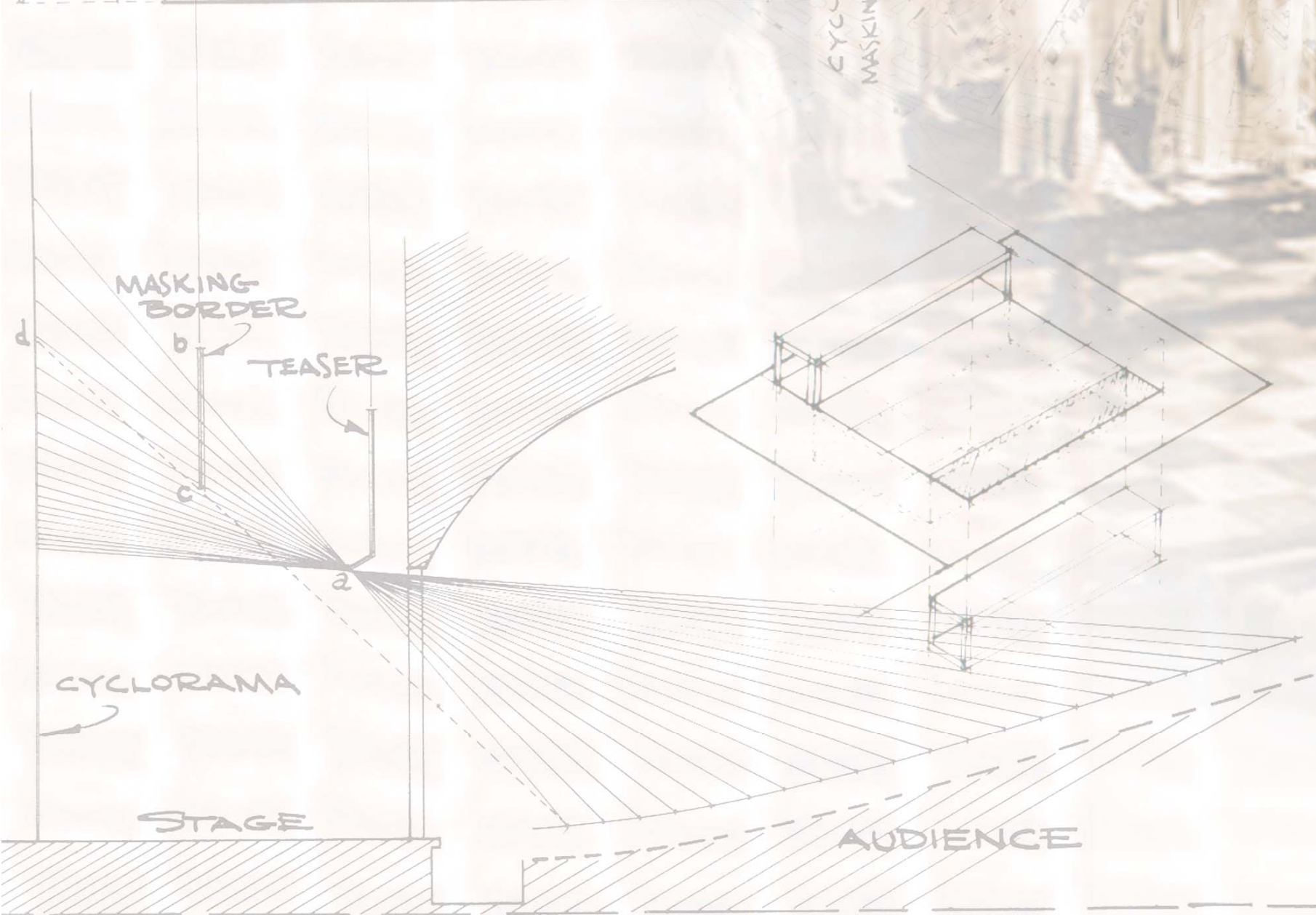
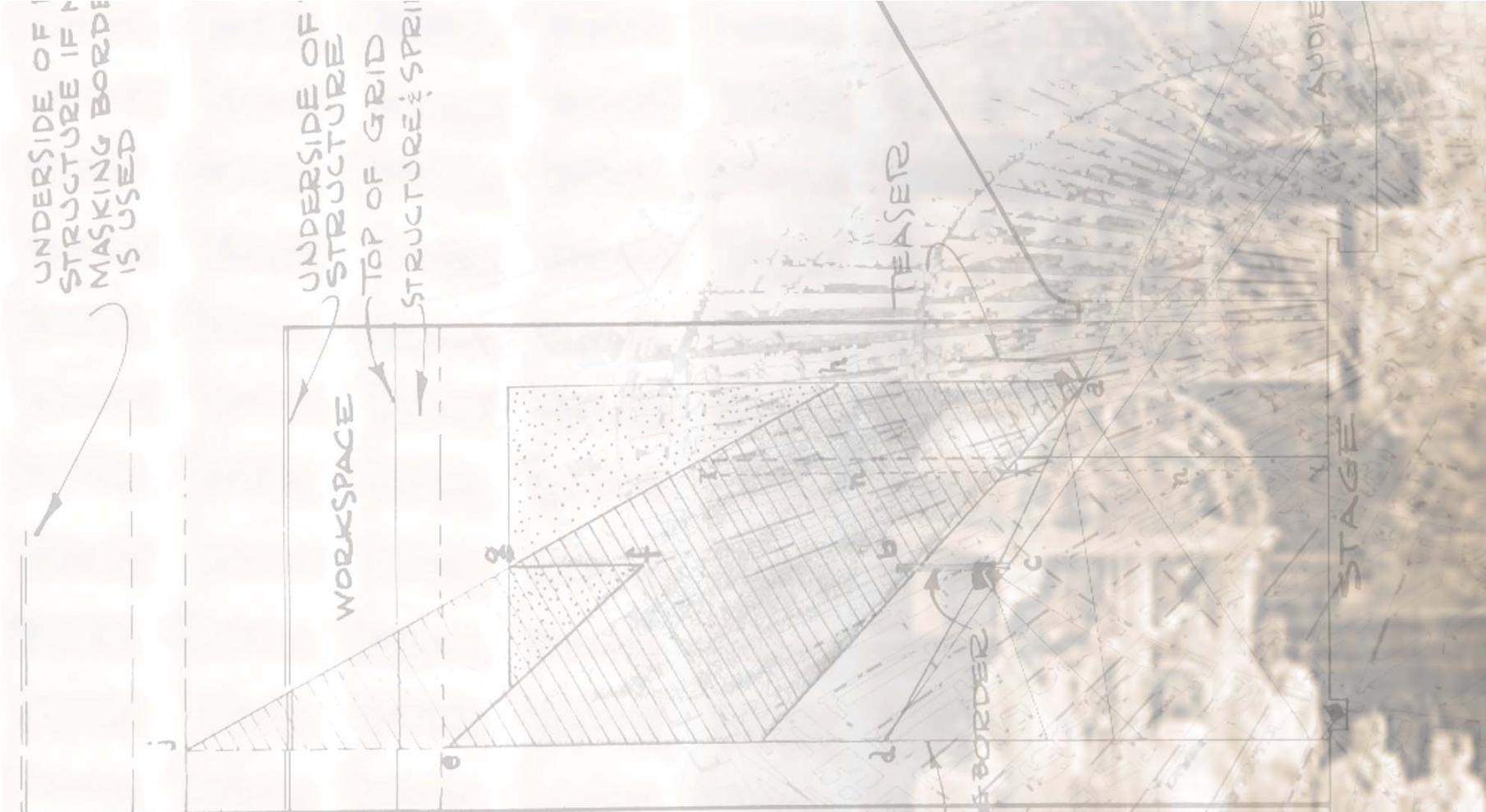
www.thecablenet.net

07 TECHNICAL DRAWINGS

- Figure 7.1: Site plan 1:1000
- Figure 7.2: Demolition Plans, scale 1:300
- Figure 7.3: Ground floor plan, scale 1:150
- Figure 7.4: First Floor plan, scale 1:150
- Figure 7.5: Lighting plan, scale 1:150
- Figure 7.6: Section A, scale 1:150
- Figure 7.7: Section B, scale 1:150
- Figure 7.8: Section C, scale 1:150
- Figure 7.9: South elevation, scale 1:150
- Figure 7.10: West elevation: scale 1:150
- Figure 7.11: Theatre configurations, scale 1:250

APPENDIX 1

- Figure A1: Aerial Photograph of the Grounds of the old CBC, unknown date, Afrikana library. 2008-11-20
- Figure A2: Photo of the courtyard of the old CBC 1928, (www.cbcpretoria.co.za/index.cfm/p/pages.schools-s-history.htm, July 21 2008)



01 | INTRODUCTION

1.1 | CURRENT THEATRE PRACTISE

Current theatre trends follow the ideals of great dramatists such as Samuel Beckett and Eugene Ionesco to name a few (Gronemeyer, 1996). These dramatists were the founders of the “Theatre of the Absurd”, a style of theatre that renounced the realistic character depictions and traditional plots of the theatre before the 1960’s.

It was after the 1960’s that the obscure theories of Antonin Artaud took hold in the theatre world. His ideas were based on the works of a Jerzy Gratowski. Gratowski formulated ideals on moving away from the art of staging as a synthesis of different artistic genres. Instead he was convinced that true performance is depicted through the language of the human body that is used to tell a tale. This theory suggests that performance needs not go to great lengths to imitate the media world with which theatre has had to compete. Theatre should be a subject that focuses on the body in space; no props, costumes, decorations or stage machinery (Gratowski, 1991). This mode of theatre would educate the actor by showing what performance really is; an intense physical and psychological training. Experimental theatre is about breaking down boundaries between the actor, the stage, and the spectator.

Because this movement brought meaning back to theatre, theatre became a way in which one could understand life. It seemed as though life had escaped the human senses and the stage was a space that enabled the invisible to become visible again. The aim of the theatre was to give back to the audience a source of food for thought and an experience to free their minds. Theatre is as dependent on the public for its existence as the public is dependent on the arts that feed the mind.

Contemporary theatre is set in contrast to the immense entertainment industry. The problem with commercializing this experimental theatre trend is that the theatre as entertainment has been overshadowed by the multimedia industry such as T.V. and film. Only commercially-oriented theatre seems to have regained its niche in the public eye as a form of entertainment, i.e. Hairspray, African Footprint, and The Lion King, to name a few. .

Both forms of theatre, experimental and commercial, tend to deal with the idea that through performance, entertainment and art can coincide to produce varying entertaining performances (Gronemeyer, 1996:155). The move from classical theatre is what opened up the possibilities to a freer and a more experimental theatre movement. Theatre practise would seem to be headed in the direction of a combination between the three entertainment genres, which will allow for the creation of new theatre which will exceed its current limitations by use of new technologies. This is where the stage must work against the general degeneration of the power to imagine. Theatrical language must constantly evolve in order to surprise the public and not allow for the theatre to become yet another static routine.

The common point between the various types of theatre is that its proponents redefine theatre as a space of experience. These forms of theatre now place the presentation upon the actor; the interaction between the performers and viewer take centre stage. This is where the viewer is transformed into an active co-operator of the performance. The audience get a sense of freedom and inclusion because they have a chance to choose the way in which they perceive what is going on, and they get to exercise their own imagination in the process.

This clearly shows an evolution of theatre from the classical “removed” styles to a performance method

involving and including the audience. It is through this type of theatre that the engagement of the audience can be gauged in order to gain useful feedback for further performances, and this is how research in the dramatic arts is possible.

Current South African theatre uses this audience-performer relationship to create a sense of communication and understanding. Theatre is used as a language that tells stories with meaning, much like the old tales from the old African tribes.

South African theatre is notable on two fronts: community theatre projects aimed at education, development, and the cohesion of the masses and ethnic groups; and also disciplined, innovative performance styles. South African theatre is known for blending art and social interaction.

Current theatre practises show a move away from the theatre of the Apartheid days and towards performances that convey general life stories in aid of reconstructing the country as a new edifice. Theatre is moving forward with a new vision of portraying the past and present using new theatre methods that give South African history new meaning.

Current national theatre tends to be simple entertainment. This type of theatre is created in conjunction with international performance trends and dramatic styles from the United States, Britain and other Western theatre traditions (Graver, 1995:103-109). Training and performance engenders methods of theatre that is concerned with the advancements in theatrical skill from abroad that can be used within South African culture and history. This will evolve into new forms of performance and take acting to new levels, elevating South Africa’s acclamation to unique theatre on a global level.

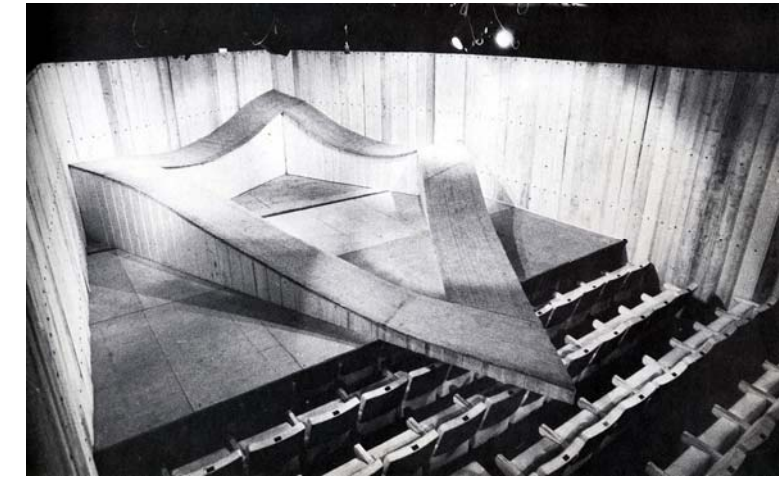


Figure 1.1.1: *Sophocles's Philoctetes* by Heiner, Muller showing the sue of a proscenium thrust stage72. Burris Meyer, 1968: 311)



Figure1.1.2: *Rutherford & Son* by Daw, Simon 2005, showing the use of a theatre in the round.



Figure 1.1.3: *The Secret Love Life of Ophelia* Holdsworth, Simon L 2001

1.2 | THE REAL WORLD PROBLEM

To broaden the scope for global theatrical trends in this country institutions are educating students in ways that will allow them to have the appropriate theatrical knowledge that will adapt to the evolving forms of theatre. To stay ahead of the ever-changing nature of both the national and global theatre, dramatic arts education should incorporate collaborative processes such as workshops for the public as well as workshops from international dramatists and lecturers. The training will enable the student to pursue mastery of various skills, local and international, as well as extend their creative potential to develop work of high artistic and intellectual calibre. This can then be measured against the international dramatic arts trends (Barker & McCaw, 2001:155-169).

There are various tertiary educational institutions around South Africa that offer a Dramatic Arts degree of which the main focus is the fusion between African and European theatre. The general dramatic arts curriculum for most of the South African institutions train students to grasp, and engage with, the dynamics and tensions of theatre in South Africa and develop new approaches to performance by engaging with both new and old theatre trends and explore new methods on a practical level.

The University of Pretoria states that they are keen on internationalizing their Arts Faculty (Haggerman, 2008). This in turn will attract students and lecturers from abroad, which will ultimately strengthen the University's international links. The eventual aims are to make the entire Arts Department nationally relevant, where the Drama Department produces a large number of theatre practitioners who make their mark on the South African scene. They also intend on exploring theatrical studies beyond what is currently available. This will be achieved by creating interest

within its own syllabus and then moving forward in theatrical studies using feedback and further research into the international scene. The Department will adapt their training to the new methods and theatre will take on a more current approach to the dramatic arts training and development (<http://web.up.ac.za>, 12 Aug. 2008).

To achieve a higher level of training the Department requires appropriate facilities. The larger part of the current Drama Department of the University of Pretoria is situated on the north-eastern part of the Hatfield Campus in and around the old Christian Brothers College Residence building. The other facilities, namely the voice and movement halls and the costume department, are located on the South Campus across Lynwood Road. The Faculty is inappropriately disjointed and awkward to use, and therefore cannot be utilised optimally.

Annually there is a ten percent average increase in admissions percent of those who wish to study the dramatic arts. The Department cannot accommodate the intake due to inadequate facilities and venues that are too small for the numbers that are applying for admission and unsuitable for the types of education required (Haggerman, 2008). The Department is small and the focus is on an intimate student to lecturer ratio due to the labour- and attention-intensive methods of teaching required by the performing arts. The facilities available are small and limiting, and the current spaces for teaching and practise does not allow for future growth of the faculty.

Each year The Department of Drama stages around 17 productions. Some of these productions are larger than others and involve all the students from the Department. The smaller productions, such as those performed at the annual Krêkvars Arts Festival, give students the opportunity to stage the performances

they have conceived, written and directed, and are the highlight on the UP calendar. It is also the only interaction that the Department has with the public. The problems arise when the availability of suitable spaces for these productions are limited due to inadequate facilities.

Theatre has a lot to offer a community; it brings people together and creates a culture. It enables freedom of expression and insight into other worlds that are not usually made visible to the public on a daily basis. This opportunity has not been adequately exploited by the university.

1.3 | PROBLEM STATEMENT

The aim of the project is to take the disjointed elements that make up the Drama Department and consolidate them into a **unified space**, turning it into a place based on the appeal and intrigue that performance has on society. This in turn would create a node within the university that becomes the **place for cultural interaction and exploration**: an Arts Precinct for theatrical education and public events, where theatrical training and research can be explored further.

1.4 | PROJECT BRIEF

Drama is a **flexible subject** and therefore requires flexible spaces. The existing facilities are rigid and limit performance, training, and the exploration of the art form.

The design should be focussed around theatrical performance and practise, as well as the **interactive** event spaces that support theatre and theatrical education. The spaces will allow for theatrical events and training to occur **beyond its usual confined borders** in order to facilitate the maximum use of

every space. These would accommodate **teaching, technique, and exploration**, for the actor, student and the average person. All spaces, interior and exterior, become **adaptable for rehearsal, performance and recreation**. The site then becomes a place that allows the dramatic arts training to go **beyond its current limitations**.

The scheme would involve conceptually developing the whole site to create a **unified space** for the performer and the audience. This would link performance into the landscape facilitating site-specific theatre practice and create for random opportunities in theatrical exploration and expression.

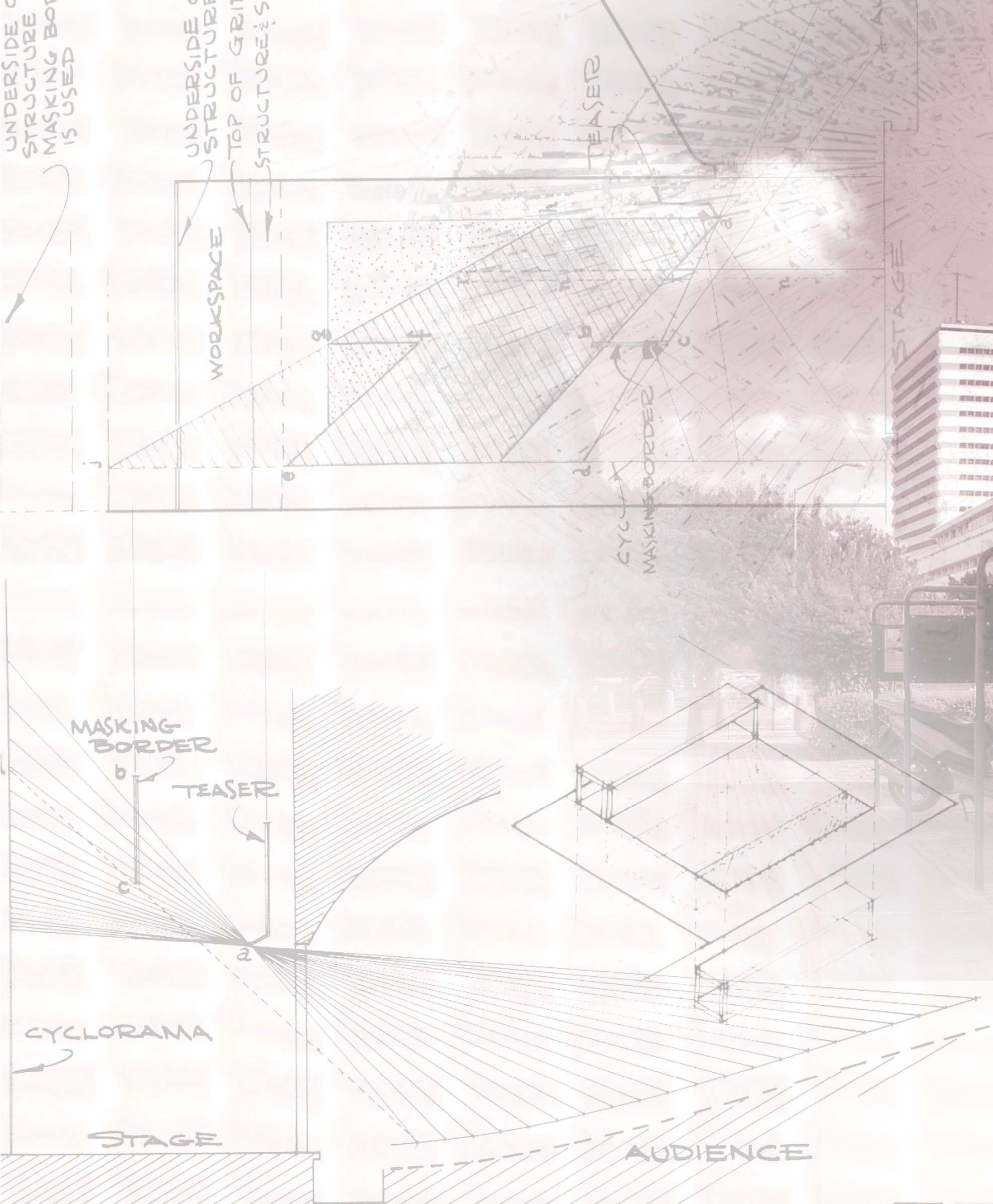
The **Interior intervention of Die Masker** will be based on the **“flexibility”** required for a wide **range of performances to occur in a single space**. This means a design of a theatre that is suitable for multiple performance types as well as theatre training. The design will compare to a new trend in theatre that enables it to **go beyond the proscenium arch** and make the space **multipurpose** and as accessible to the university and the surrounding community as possible.

It should be envisaged as a compliant space that does not imitate traditional theatre, but rather evolves into a space that **explores the relationship between the actor and the audience in unison**. The basic needs for the Department are to create a **dynamic space where students learn: conversational, and interactive**. Contemporary drama has evolved into something that is more **interactive and site-specific**. Drama and theatre now have many other facets. These evolving methods of theatre should be explored and exploited as theatrical research occurs through performing (Haggerman, 2008).

1.5 | PROJECT GOALS

The goals of this project are as follows:

- Due to the extent of the intervention required by the project (interior, architectural and landscape) a basic conceptual scheme for the landscape will be shown based on site analysis and optimal spatial configuration.
- The buildings incorporated within the Precinct that requires architectural intervention will be conceptually designed, suggesting facilities and functions required to complete the square and supply the facilities required. This proposal makes reference to Die Lier and Die Bok.
- The Drama Building (the old CBC) will be designed and shown in plan format. The design will show how the building links to the Precinct as well as the surrounding buildings and the interventions made on the existing structure.
- The focus of the project will be Die Masker theatre.
- Detailed design will show Die Masker with regards to lighting, acoustics, HVAC, finishes and sustainability.
- Product design of elements within the building will be resolved. These are: the light deck in the theatre and foyer, the ticket box in the foyer, and the flexible theatre equipment.



02 | **CONTEXT STUDY**

2.1 | MACRO CONTEXT STUDY

The theatre industry in South Africa has developed consistently since the launch of Johannesburg's innovative Market Theatre in the mid-1970s. Today, South Africa has more than one hundred theatres across the country exhibiting a wide variety of genres (<http://www.southafrica.info/about/arts/drama.htm>, 17 Aug. 2008)

2.1.1 PRETORIA

Tshwane, in the Gauteng Province, is one of three capital cities of South Africa. The inner city has to accommodate capital city functions in terms of achieving exceptional environmental quality, ensuring monumentality and symbolism, and reflecting an entire nation's values and aspirations.

Pretoria has a strong sense of history and culture, with numerous theatres, museums monuments, and places of learning. There are many theatres in and around Pretoria catering for diverse dramatic genres. **The South African State Theatre** is arguably one of the most renowned and prominent theatres in Tshwane. It is situated in the heart of Pretoria's CBD, in the block formed by Church, Prinsloo, Van Der Walt and Pretorius Streets. It is a multi purpose venue that is used for performances, conferences, and a variety of other functions.

The Breytenbach Theatre, situated on Gerhard Moerdyk Street in Sunnyside, belongs to The Technical University of Tshwane (TUT) and therefore often hosts productions from the University of Pretoria, the University of South Africa as well as the TUT's own functions. Additionally, technical training for the Vocal Arts, Drama, Music and Dance Departments from the University of Pretoria are held here (stuku student culture, 2008).

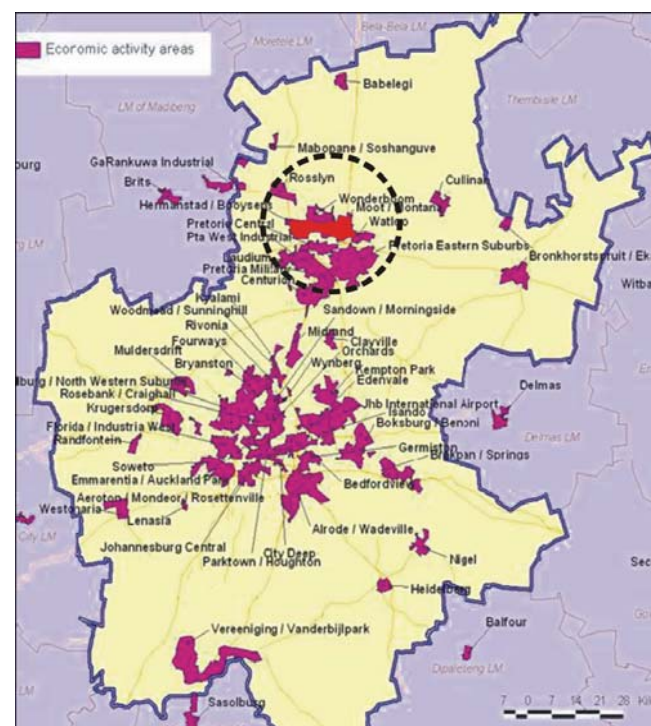


Figure 2.1.1: GDP Areas of Large Scale Economic Activity (City of Tshwane Metropolitan Municipality (2007))

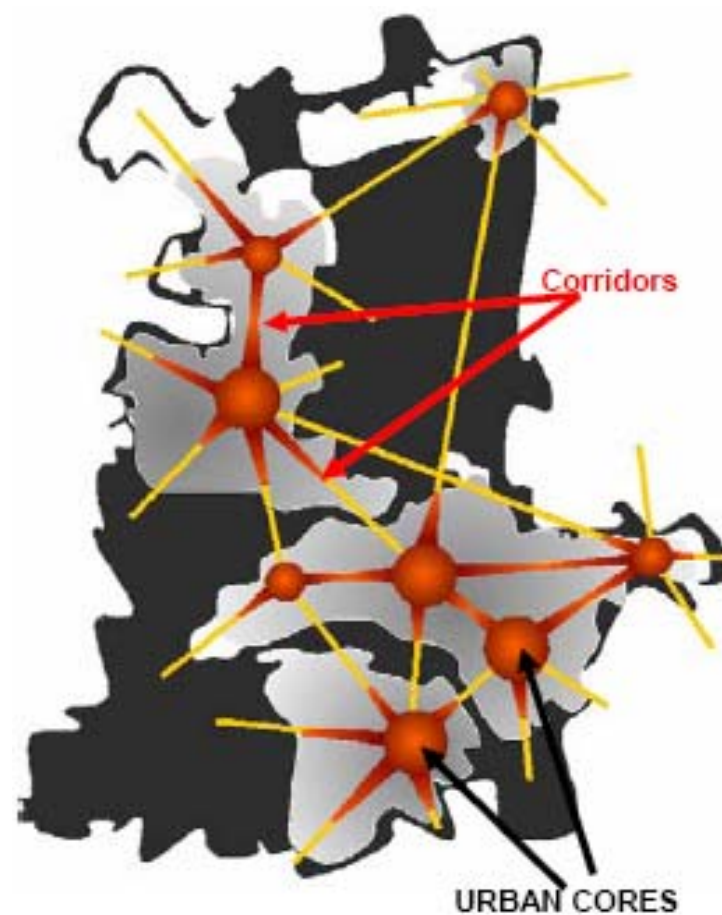


Figure 2.1.2: Metropolitan activity nodes in Tshwane (City of Tshwane Metropolitan Municipality (2007))

2.1.2 SURROUNDING PLANS AND DEVELOPMENT

The City of Tshwane has developed an Urban Framework around the proposed Gautrain stations situated in Hatfield and the CBD. The Gautrain Rapid Link System intends to link Johannesburg, Tshwane and the Oliver Tambo International Airport. It is anticipated that the development will serve as a pivotal stimulus for economic and social development along Gauteng's main north-south transport axis.

The Tshwane Development Framework proposes linking the Gautrain with the Tshwane Rapid Ring Rail System in and around Pretoria CBD. The target market for the Rapid Rail Line is the affluent commuter transport markets that travel between Pretoria and Johannesburg.

This system will connect eleven different settlements in Tshwane and link the economic nodes which will be fostered in each settlement. These settlements will have one or more urban cores which will be integrated with and around major railway stations. These urban centres should therefore focus on high activity levels and should be developed as a dense urban place in terms of residential, commercial, social, and cultural activities (City of Tshwane Metropolitan Municipality, 2007).

2.1.3 METROPOLITAN ACTIVITY

[Fig 2.1.2] The highlighted areas are where public transport facilities and specialised infrastructure are concentrated and where people will enjoy the highest level of accessibility. The Tshwane Metropolitan Framework proposes developing these nodes and therefore making them efficient; such as optimizing accessibility, mobility and additionally providing for sustainable neighbourhoods.

2.1.4 HATFIELD AS A CONTEXT

Hatfield has been identified as one of six metropolitan cores in the Tshwane Metropolitan Spatial Development Framework (City of Tshwane Metropolitan Municipality, 2007). The plan is to densify the area due to the upcoming Gautrain Rapid Rail System. This will cause a market change in the area to commuters. The development of Hatfield will be oriented to a large extent around transit. This means that areas that are mainly suburban and educational will progressively become more urban. A higher quality environment will be needed to counteract the foreseeable increase in population density in Hatfield as well as the University. Hatfield is envisioned to become a vibrant, safe, mixed-use urban area. The consequent development of attractive, interesting and interlinking activities, as well as public spaces for pedestrians and public transport should renew investor confidence.

2.1.5 MAJOR VEHICULAR MOVEMENT ROUTES

These routes link the metropolitan activity nodes as well as the major railway stations and therefore become the most important vehicular transport routes. In order to exploit them to their full potential the routes need to be highly visible and accessible, making them into important activity corridors.

In Hatfield these can be seen along Lynwood Road, Charles Street, Duncan Street, and Atterbury Road, the four main roads that connect Brooklyn, Menlyn and Hatfield. In these nodes, due to high density and convergence points for commuters, public transport and pedestrian walkways become of great importance.



Figure 2.1.3: Above: Diagram showing urban nodes in Pretoria, Hatfield being an urban node. Aerial photo of Hatfield showing vehicle routes in the Hatfield Urban Node.

2.2 | MICRO CONTEXT STUDY

The University of Pretoria is a self contained organism amongst an ever growing and changing urban fabric. It forms part of the educational core of Pretoria along with the Technical University of Tshwane and UNISA. The University of Pretoria is located on Lynwood Road on the border of Hatfield and Brooklyn. It has the ability to be the central node in the area, because many of the activities in and around Hatfield revolve around student life.

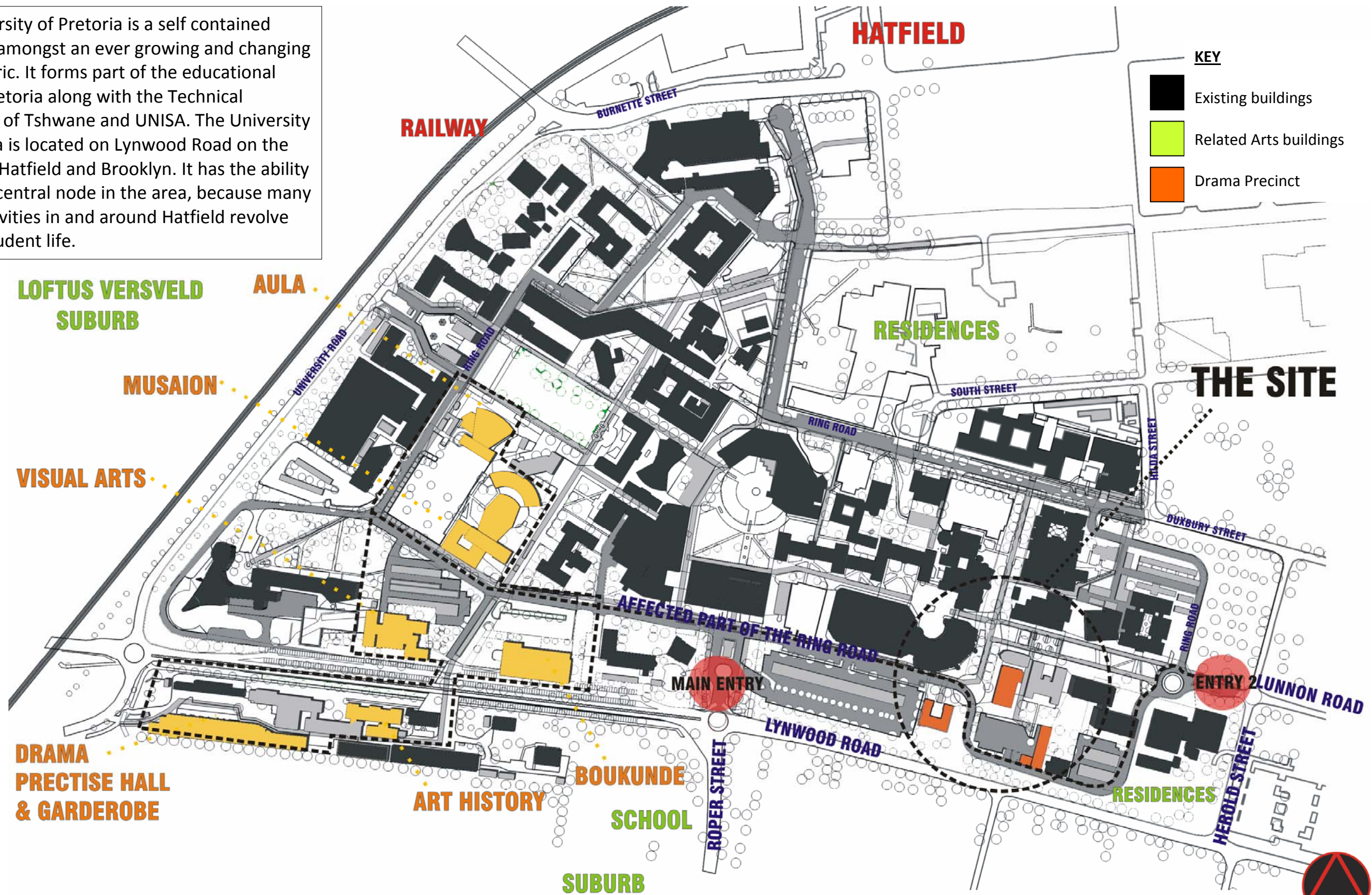


Figure 2.1.4: Aerial drawing of the University of Pretoria main campus and South Campus, Hatfield. The orange labels depict the other arts buildings and the circled area depicts the chosen site culminating at the end of the ring road. Author: Chita M

2.2.1 SITE LOCATION

The site identified for the project is situated on the south-eastern corner of the University's main campus. It sits along the ring road which runs parallel to Lynwood Road. The chosen space is comprised of three buildings that will be the spaces that enclose the square; the fourth boundary would be the road and designed landscape. The basic aim is to draw attention to the fact that arts and culture is an important, even integral element within a community, be it social or economic. The fact that it can actually draw people closer and create a different method of thinking is imperative to the education of people.

The site has an ideal location because the group of buildings sit on the corner of a ring road and is the culmination point where the various arts faculties look to commune. It is located at the opposite side to the administration building on the eastern end of the ring road, which therefore creates the opportunity for the chosen site to be another focal point, or landmark space, for the University near a big intersection (Lynwood Road and Duncan Street.) Completing this arts Precinct would result in a completion of a node and create movement and access along the ring road within the campus just parallel to Lynwood Road.

This kind of a facility will be most important to the university as an improvement to its arts status, but would also add to the enjoyment of the students; a way in which they can experience art as an aspect of education and as a novel, fresh way to gain access to culture. This will produce the greatest positive impact on the image that the Arts Department can have on the university. The site makes up a series of buildings ranging from a heritage building, a converted school hall and a newer school type building with an attached theatre that seat 150 people. It stages performances of exploration as well as private performances.

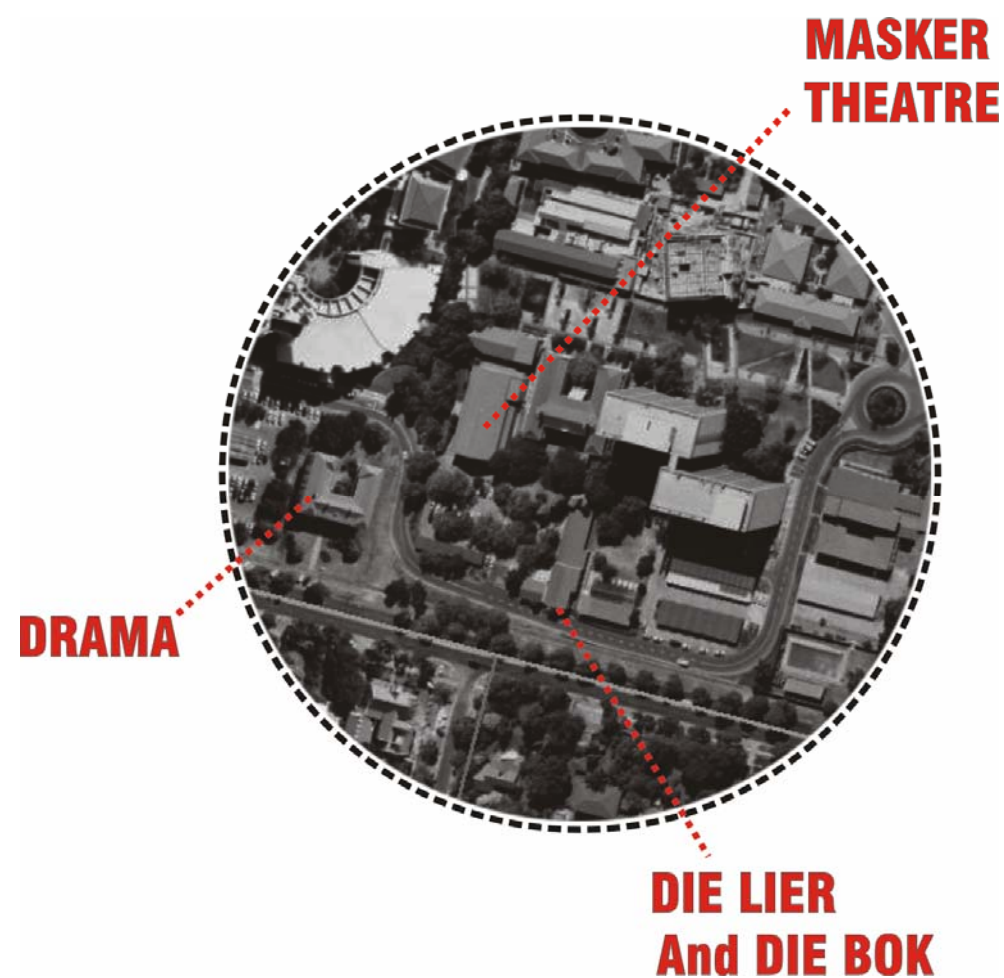


Figure 2.1.5



Figure 2.1.6: Panoramic photo of the Drama Building from Lynwood Road, Misra, S May 2008



Figure 2.1.7: Photograph of the entranceway into Die Masker. By Misra, S may 2008



Figure 2.1.8: Photo of Die Lier from the entrance of Die Masker. By Misra, S May 2008

2.3 | SITE ANALYSIS

2.3.1 HISTORY OF THE C3C

In 1971 Bishop Cox and father Ryan O.M.I., parish priest of Pretoria, wrote to the Superior General offering to secure a site for the school if a staff of brothers could be promised. Consequently the site on Lynwood Road adjoining the University was purchased from Mr Johan Rissik. The brothers themselves were responsible for the erection of the College building and seven years later they completed the building of the Christian Brothers residence. The architects of the residence were Messrs. Cowin, Powers and Ellis and the builders were Clark and Downie (Pty) Ltd. It was not possible to start the College until 1921. In the 1960's the University of Pretoria urgently required the property to expand to the east towards the LC de Villiers sport grounds to consolidate the two properties. In 1965 the University began steps to purchase the property in the east of Roper Street. This included the Christian Brothers College, Loreto Convent and the Roman Catholic Church. The Church only sold its property in 1980. The buildings therefore take on the characteristics of the Old Christian Brothers College and a school hall from the convent (Br Duggan (2008). (refer to appendix 1 for full heritage Report)



Figure 2.1.9: Panoramic view of the courtyard to the Drama Building (old CBC), by Misra, S, May 2008

2.3.2 THE VISUAL CONTEXT

Two of the three buildings on the site are inward facing, i.e. towards the parking area. The buildings do not communicate with one another as they act as separate entities, totally introverted. Dense trees and pathways as well as a central parking lot separates the buildings and their functionality, they have no communication with one another. The Drama building is located across the ring road on the corner and it sits along Lynwood road, the other two building (Die Masker and Lier) are bound in by the Ring road, the parking areas and the pedestrian pathways).

Die Lier and Masker building have the potential to combine with their surrounding buildings, the Visitors Reception Building, of which the drama department use the ground floor facilities for lectures and the agricultural staff uses the top floor; the Theron Hall, also used for lectures; and the Agricultural Sciences Building which, at ten storeys tall, towers over the site.

The oldest buildings in that area of the campus are: the Old Christian Brothers College (the CBC) and the Drama Building which were designed in a Neo-Classical style. The other buildings are designed in a Neo-Brutalist manner (the Education and Law Buildings) and the New Modern style (the Agricultural Sciences Building). The other buildings north of the site are all designed in a brick Post Modern style (University of Pretoria buildings, (2005). South of the chosen site for the arts Precinct is the affluent suburb of Brooklyn that is characterised by new houses on larger residential sites as well as newer student residential complexes, embassies and a Greek Orthodox Church.

2.3.3 ACCESSIBILITY

There are two access points to the University in close proximity to the Drama Precinct; the first is through the main entrance at the intersection of Lynwood Road and Roper Street. The secondary access point is at the Herold Street and Lunnon Road intersection; this entrance is not as prominent and is used primarily by the University's staff. Moreover, it is a highly pedestrian friendly access point from Hatfield. Most student pedestrians access the University from the northern gates in Hatfield off South Street and Festival Road.

Urban design around the Gautrain Station in Hatfield foresees the area becoming an increasingly pedestrian-friendly zone with more focus on various modes of public transport (City of Tshwane Metropolitan Municipality, 2007). Access to the university campus still must be controlled; however, this does not mean that the campus has to be closed off from its surroundings. The aim of the Tshwane Metropolitan Council (2007) is to integrate it with the surroundings and densify the area with multi-purpose zones that allow for a balanced lifestyle and integrate the commuters and students into the plan.

2.3.4 OTHER UNIVERSITY AUDITORIUMS

Aside from Die Masker, Die Lier, Die Bok and the Drama Building located on the chosen site, the following auditoriums are also found on the Hatfield Campus. These are the Aula, the Raytenbach Hall, and the Musaion.

2.3.5 PARKING

The Drama Precinct is situated along the edge of Lynwood Road. There are public parking spaces along the walkways just outside the fence surrounding the University as well as existing parking lots at the main entrance and behind Die Lier Theatre, both of which can be expanded. However, it is undesirable for the Drama Precinct to be swarmed by cars; rather the activity of pedestrians, namely students, staff and the local public, are to be encouraged.

2.3.6 PRETORIA CLIMATE

The following averages in climate for Pretoria are taken from an analysis carried out in November 2007 by the South African Weather Service and relates to the last five years (South African Weather Service, 2008).

Pretoria: Transitional area between the Highveld and the Bushveld. North-east of South Africa (25°43'S and 28°17'E). 1370mm above sea level	
Daylighting	
Jan-Dec: sun rises at ±5am and sets as ±6:30pm	
March and august: sun rises at ±6am and sets at ±5pm	
May-Aug: sun rises at ±6:30 am and sets at ±4:30pm	
Temperatures	
Summer months (Aug-Apr)	Winter months (AprAug)
Highest recorded temperature	
31°-36°C	25°-33°C
Average daily maximum temperature	
25°-29°C	19°-22°C
Average daily minimum temperature	
12°-18°C	5°-12°C
The lowest recorded temperature:	
	-6°C
Rainfall	
Highest rainfall month:	January 136mm
	December 110mm

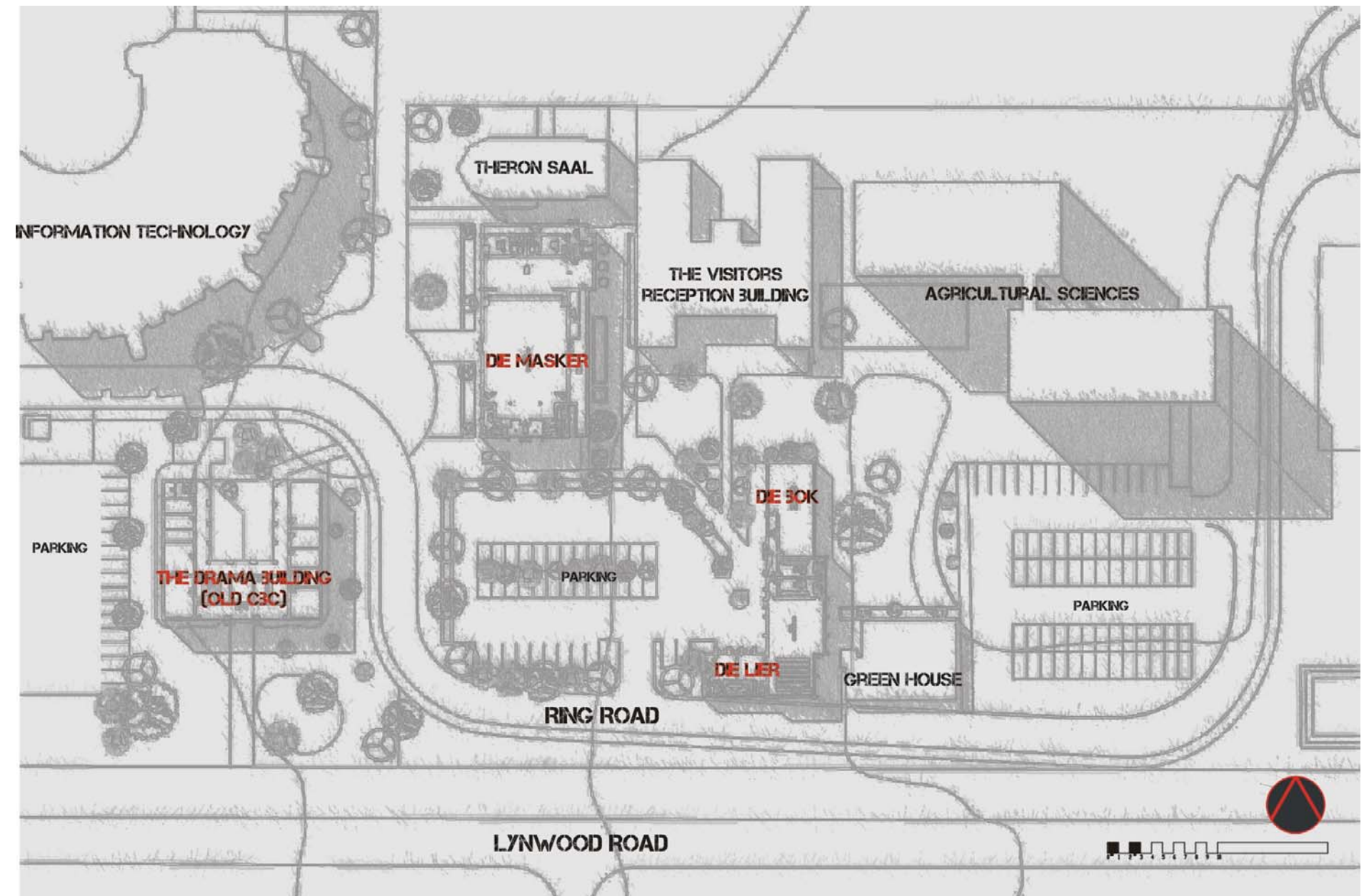


Figure 2.1.10: Existing Site plan of the Proposed Drama Precinct

2.4 | BUILDING ANALYSIS

2.4.1 | DRAMA BUILDING (OLD C3C)

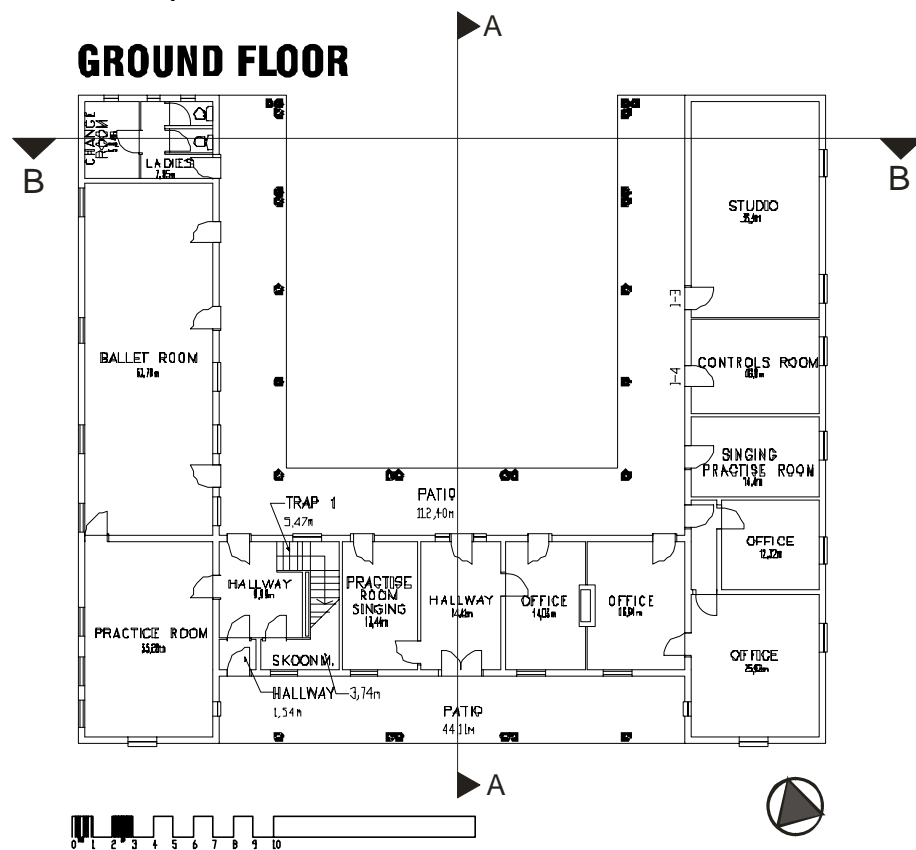


Figure 2.1.11: ground floor plan

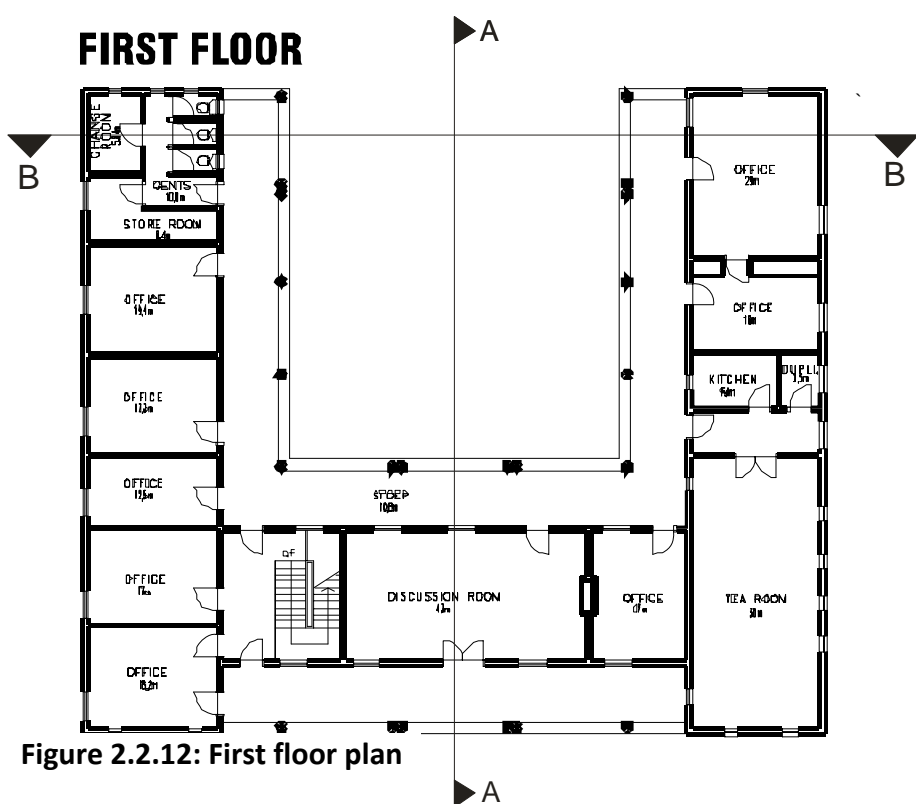


Figure 2.2.12: First floor plan

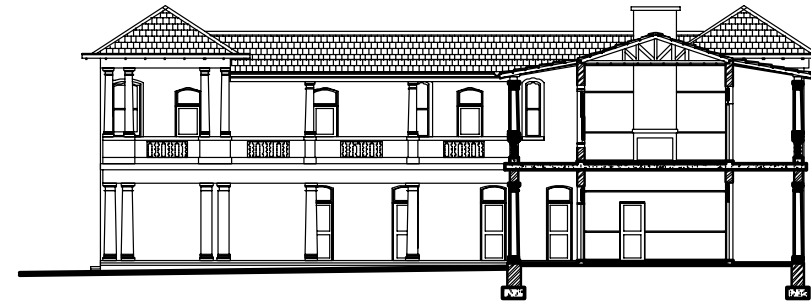


Figure 2.1.13: Section A



Figure 2.1.14: Section B

The Drama Building is structurally sound and relies on a few internal, but mostly external, load bearing walls. The exterior finishes have been well-maintained, the paint work on the walls seem to have been done recently, and the roof tiles are all still intact. There is a problem with birds nesting in the ceilings in the corridors and eaves. The shutters on the western façade windows have degraded from weathering [fig. 2.1.5 g]. The storm water drains through gutters into down pipes and into outlets onto the landscape. The air-conditioning units were added at a later stage to the facades of the building.

The interiors have not been altered much; the floor, doors and windows have all been retained and painted. The interiors need attention as the timber floors are deteriorating with age [fig. 2.1.15 b] and the dado rails leak water [fig. 2.1.15 c]. The floor tiles in the bathroom have worn away [fig. 2.1.15 f]. The floors in the offices are fitted with carpet tiles to keep the offices warmer in winter [fig. 2.1.15 a]. The timber stairwell is well kept; it is the only access to the first floor [fig. 11]. The chapel on the first floor has

undergone minor changes with a new ceiling to improve the acoustics; the space is sometimes used for performance and is rented out. The spaces on the ground floor have been increased in size and turned into studios for dance and rehearsal, and so dance rails and mirrors have been added. Some spaces in the building are unused. The courtyard has good acoustics.

The office windows are all placed in the northern face and are therefore cold. The site is landscaped on the south, east and west sides with trees that are planted by various alumni classes. The previous access to the building was from Lynwood Road but the campus has been fenced off. The building is over 60-years old and is of heritage value, see [appendix 1](#).



Figure 2.1.15

- **MATERIALS AND FINISHES**
- **Arched timber window frames;**
- **Timber flooring [fig. 2.1.12b];**
- **Concrete corridors (painted in maroon enamel);**
- **Concrete ionic columns in the corridor;**
- **Painted timber doors and windows;**
- **Brass ironmongery [fig. 2.1.12h]; and**
- **Stained-glass windows on the eastern façade**

2.4.2 | ANALYSIS OF DIE MASKER BUILDING



Figure 2.1.16: Die Masker, Existing façade, by Misra. S



Figure 2.1.17: Photograph of western façade of Die Masker, by Misra s



Figure 2.1.18: Photographs of all the facades of Die Masker, By Chita M

Die Masker Theatre is an old converted school hall that belonged to the Christian Brothers College, dating from the 1970's. The building is a simple concrete framed building with orange face brick infill panels, the school type windows painted in dark colours to give the internal space the darkness necessary for performance to take place. An additional structure was built along the eastern and northern facades of the original building for services [fig. 2.2.18 b & d]. The roof is corrugated sheeting at a three storey height at its apex. A few panels of wall are fronted by a concrete brise soleil. The services are also on the facades of the building, in the eastern service passage, i.e. the electric meter.

The interior of the building is left exposed to the concrete structure; it is painted in dark colours (black) for performance purposes [fig. 2.1.20]. The theatre is long and narrow and therefore ungainly as a theatre space. The foyer is separated from the theatre by a purple velvet curtain [fig. 2.1.20]. The theatre seating is a series of old rostra that can be altered for various seating purposes. The stage is in a typical school hall position with back stage access from the change rooms and toilet. The stage is at 800mm above ground floor level. The space above the theatre space is equipped with six parallel rigs from the roof at 6m from ground level. Where the theatre separates from the lobby there is a mezzanine level above where the lighting and controls area is situated [fig. 2.1.21].

The outside of the building is brick paved with a few planters, trees and grass on the eastern side along the ring road and pedestrian path [fig. 2.1.18].

There are benches and planters that separate the theatre from the parking area and a series of notice boards that are not used, just along the front façade of the building [fig. 2.1.18].



Figure 2.1.19: Interior view of the stairway to the controls level, by Chita M



Figure 2.1.20 Interior view of the foyer, by Misra S



Figure 2.1.21 Interior view of the theatre. By Misra S

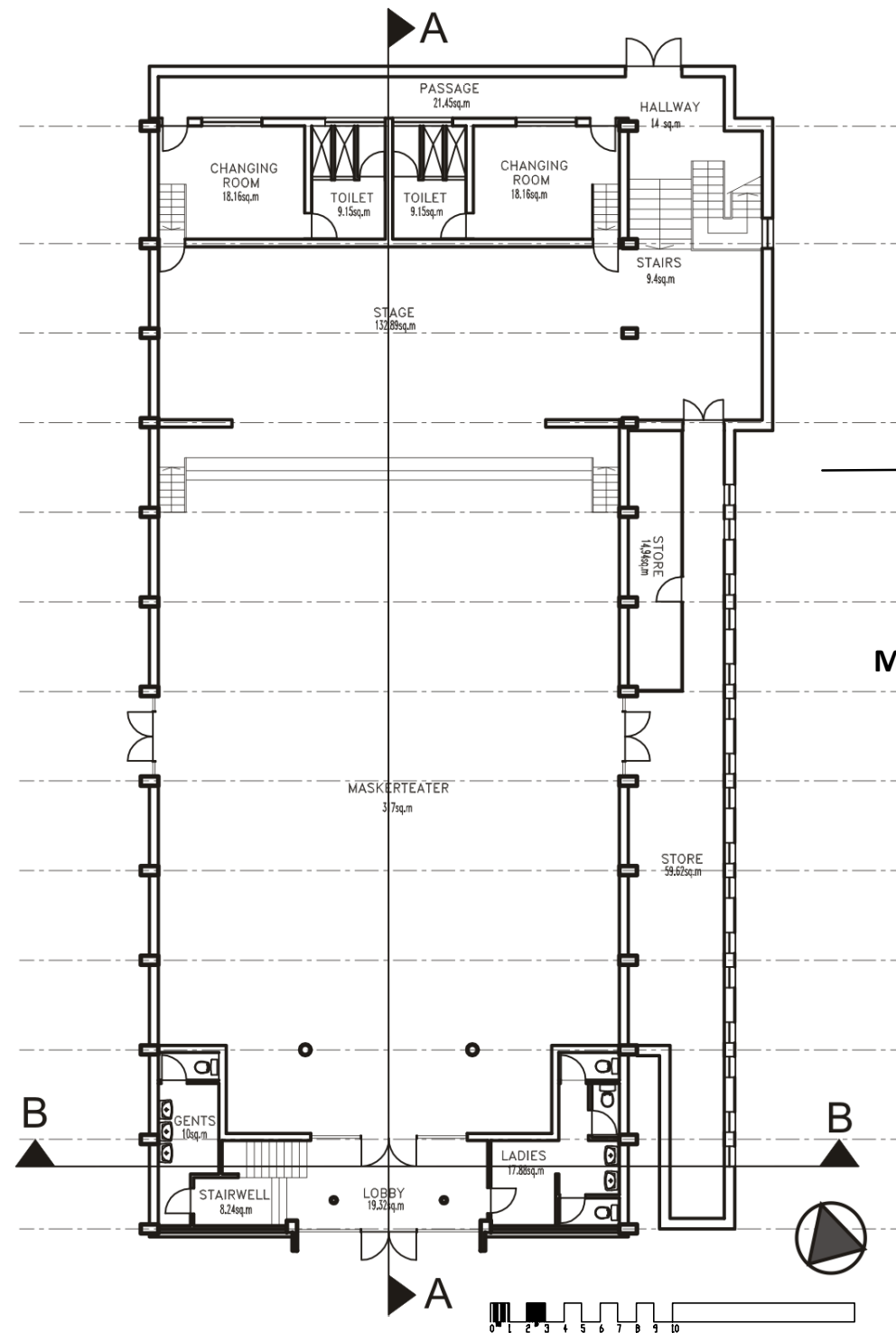


Figure 2.1.22: Existing Plan Masker Theatre, By Chita, M

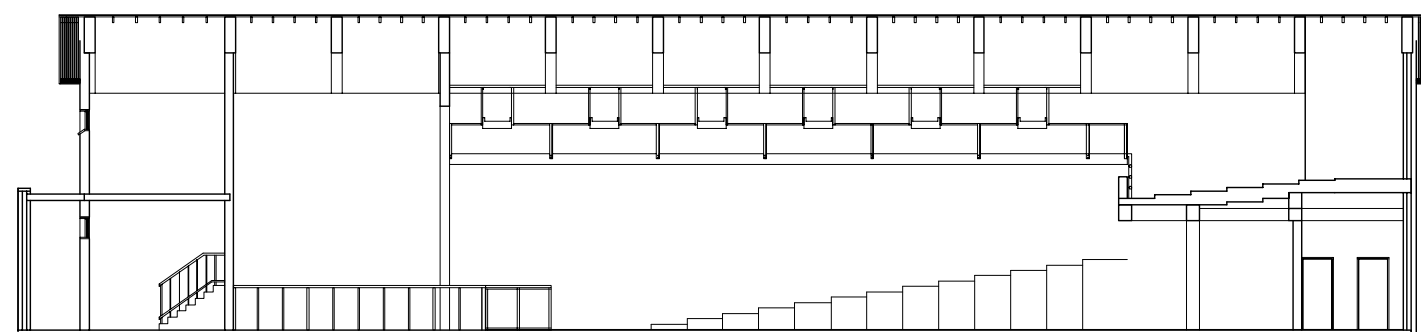


Figure 2.1.23: Longitudinal section B through the theatre

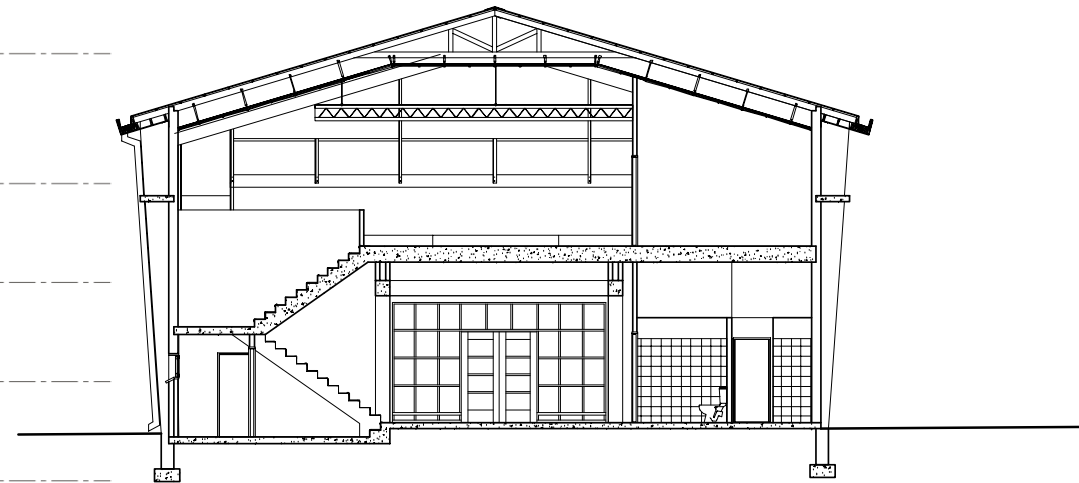


Figure 2.1.24 Existing Cross section A through the foyer

Materials and finishes

- Painted concrete frame structure;
- Corrugated sheeting pitched roof;
- Orange brick infill panels;
- Steel-framed school windows;
- Internal walls of theatre are plastered and painted;
- Floors are tiled with blue vinyl tiles;
- Internal doors are timber;
- The front entrance has a projected concrete frame and a steel door that allows no view into the interior (steel mesh behind the glass);
- Lighting in the lobby is done using live wire and down lighters; and
- Bathrooms are finished with white porcelain tiles with electric green plastered and painted walls.



Figure 2.1.25: Interior view of the extension used as storage for props and lighting



Figure 2.1.26: Stage wings used for storage, by Chita M



Figure 2.1.27: interior view of existing dressing rooms

2.4.3 | BUILDING ANALYSIS OF DIE LIER THEATRE AND DIE BOK THEATRE



Figure 2.1.28: Photograph of Die Lier entrance



Figure 2.1.29: Interior View of the foyer



Figure 2.1.30: Interior of Die Lier



Figure 2.1.31: Interior of Die Bok



Figure 2.1.32: Photograph of the exterior of Die Bok

Die Lier theatre was constructed at a later stage when there was a need for more facilities for the Drama Department. It is a simple orange face brick building with brick piers at 4m intervals. In some sections, the façade has a decorative base that is finished with plaster and paint to a height of 2.5 meters from

finished floor level. It has both timber-framed doors with glazing and solid timber door into Die Lier theatre. The roof is made of painted green steel corrugated roof sheeting.

Behind the dressing rooms is a rehearsal and performance space known as Die Bok. It is a long narrow room with a corridor on the eastern side. There are school type steel windows along the top of the wall on both the east and west façades. Unfortunately, since the ceiling height is only 3.5 meters and the shape of the room is long and narrow, the space tends to echo. Moreover, it cannot be used for dance or performance and although currently it is being used for rehearsal, the space is not optimal. The corridor space is used as storage and is not maintained. At the northern corner of the corridor there is a vinyl tiled niche that acts as a performance space and has a removable curtain so the niche can be also be used as a backstage area.

- Materials and finishes
- Orange face brick walls with piers every 4m;
- Standard FLB timber doors;
- Steel-framed windows;
- Polished concrete foyer floor;
- Vinyl brown tiles; and
- Grey brick pavers with trees and planters and concrete benches along the pathways, separating the building from the parking area that's situated centrally between the three buildings.

The building is not suitable for interior intervention due to its limiting, unusable spaces. It requires architectural intervention in order to make it work to its optimal level as a dramatic arts facility.

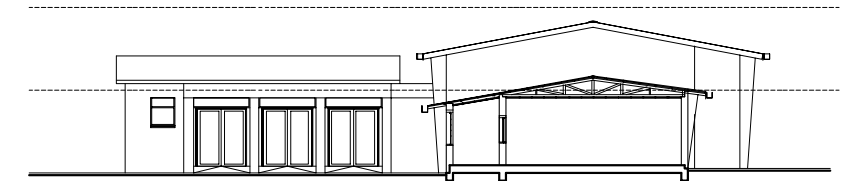


Figure 2.1.33: Section E. By Chita M

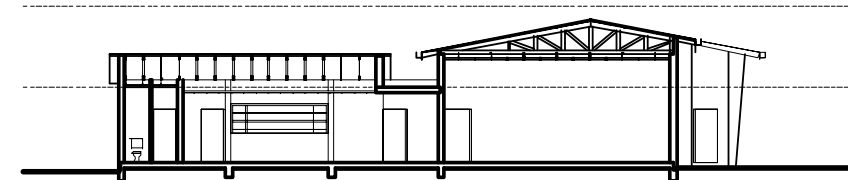


Figure 2.1.34: Section F. By Chita M

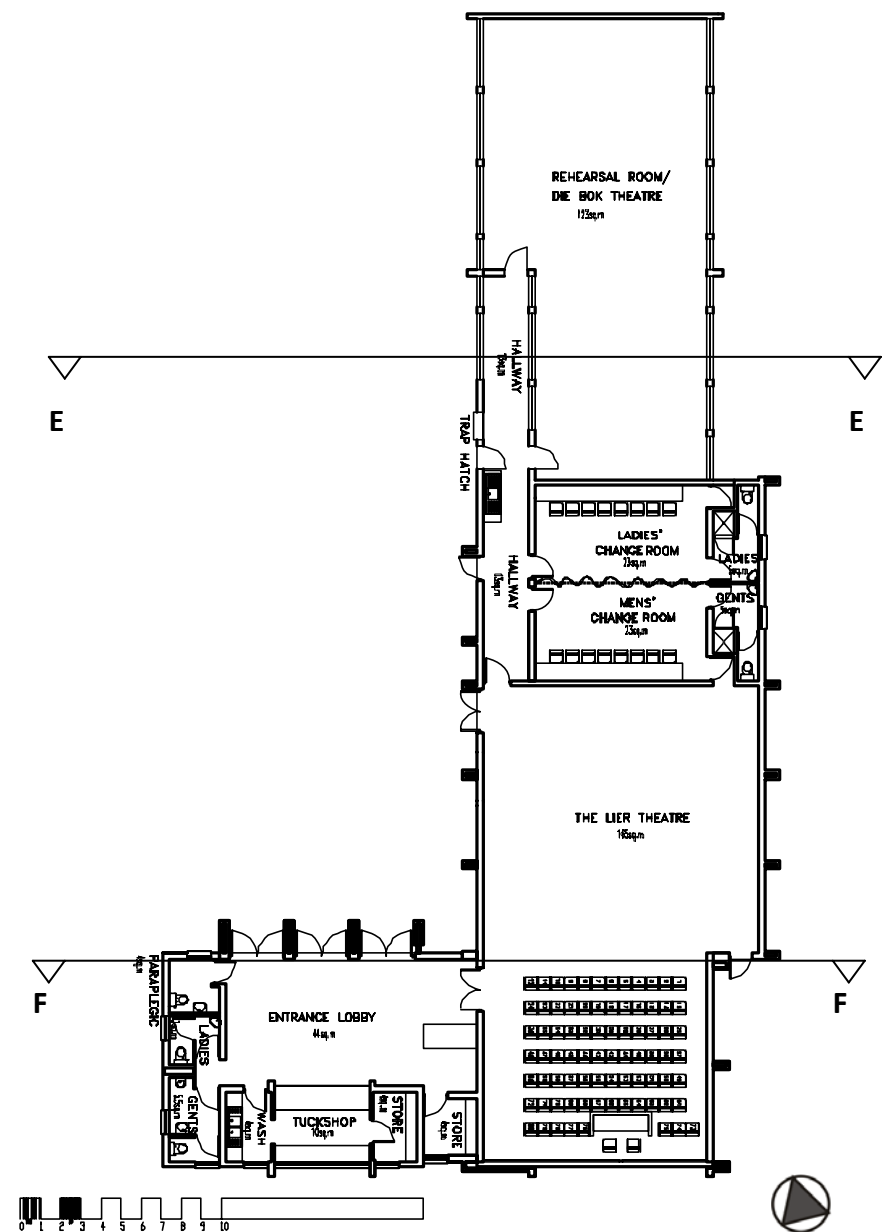
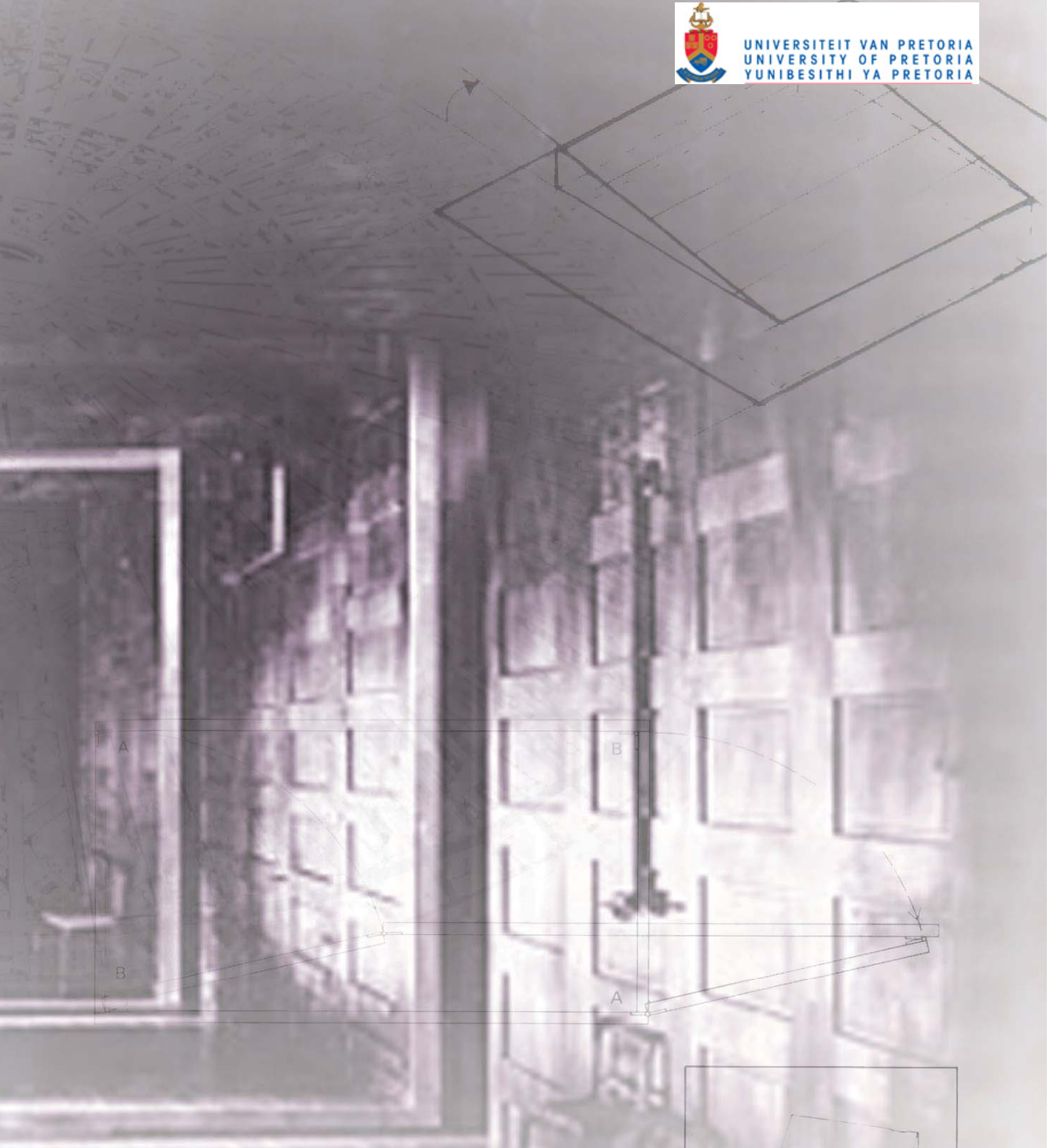
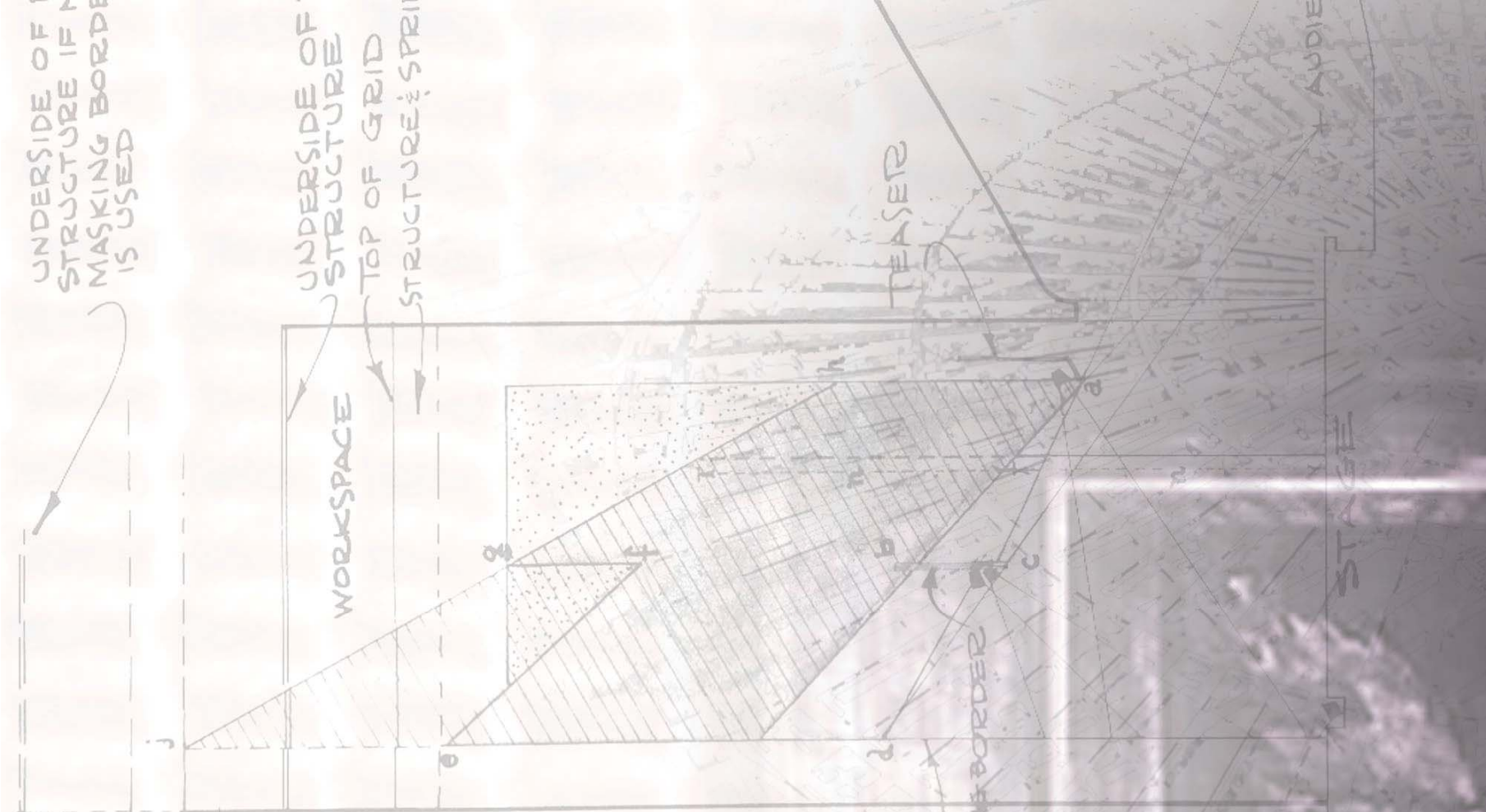


Figure 2.1.35: Plan of Die Lier and Die Bok



03 | DESIGN APPROACH

03 | DESIGN APPROACH

“I can take an empty space and call it a bare stage. A man walks across this empty space whilst someone else is watching him and this is all that is needed for an act of theatre to be engaged” (Brooke, 1968:11).

The aim of this study is to identify the elements that will play a pivotal role in the creation of a fully functional, well-informed dramatic arts Precinct on the University Campus.

The conceptual approach is based on the evaluation of what arts and culture means to society and how it is necessary in the daily lives of the everyday person as well as the student. It will take into account the methods to which optimal theatrical training is achieved and allow for the expandability of the existing curriculum.

This will be combined with the study of how the evolution of a dysfunctional existing space can lead to it being converted into a proactive positive place. This in turn would support the arts (dramatic arts in particular), but also promote social interaction and coherency of spaces.

3.1 | THEATRE THEORY

3.1.1 THE MEANING OF THEATRE

Theatre is not simple and straightforward; it is a series of layers that convey meaning. Performances engender a method of allowing the viewer to see the literal story. Behind that there is an interlacing of phenomenal meaning; where there are values, morals and lessons to be learnt from the hidden meanings, stirring up deeper emotion within the person. Theatrical

performance is about what you see and what you don't see. This is what captures viewers' minds and enables them to generate more meaning from the single experience. Theatre removes the viewer wilfully from the real world into a place different from their own realities, and this allows for the freeing of the mind into a world of free thinking. The ideals behind theatre are to reinvent an event, be it factual or fiction. From this the audience perceives the art form which then generates their own ideas and perceptions based on their own knowledge. Theatre is a medium of exploration of forms, ideals, morals, virtues, history and basic social interaction.

Theatre in essence is a group of “doers” who cultivate a plot, breathe life into it and turn it into another world that is intensified and dense with information and emotion (Brecht, 1960:64).

In order to convey these ideals, a physical role has to be applied with the aid of devices that allow for the reinvention of the events. These devices allow for the creation of realms that remove the actor and spectator into another world of fantasy and illusion, a sort of conscious illusion.

“The essential lies in the transfiguration of the ephemeral quality of the performance into a splinter of life that sinks its roots into their flesh and accompanies them through the years. The toxic secretion penetrates their psychic, mental and intellectual metabolism and becomes memory” (Barba, 1988:22)

3.1.2 THEATRE AND THE AUDIENCE

The effect of the arts on the spectator is important in shaping the expanding mind. Most art forms provide languages that shape and express our understanding of the world around us and allows for the development of the mind to absorb various information which is important to learning.

“Imagination makes empathy possible — to understand another we must be able to understand their lives” (Goodheart, 2000: 5).

Recent theatre has been confined by means of creating a frame around human experience distancing ourselves from the scene so that we gain a different perspective. This affects the viewer's frame of mind to be more focused and perceptive. The aim of the dramatic arts is not only to draw in the audience's attention to an event, but to position them in a precise relationship to it. *How* the audience sees an event is just as important as *what* they see.

Participatory theatre makes the audience crucial to the plot as though they were fellow actors. This allows for them to contribute to and absorb the performance at another level. Here the viewer attains a sense of ownership of the event and has an interest in the outcome. These situations act as devices to allow the audience to explore, deepen, and clarify their understanding of the real world; this is bound to leave a lasting impression on them: “We bracket off a section of human life to enable us to understand it better, often crafting it in narrative or visual terms to see it, approach it differently, more clearly, in other words we make art our experience” (Jackson, 1990:165).

From the early philosophers, artists and mathematicians, it was believed that the arts play an integral role in a person's perception of the world. The mere presence and emotions that the arts awaken in a persons mind causes them to absorb and think about their environments.

3.1.3 | THEATRE AND THE PERFORMER

Up until this point emphasis has been placed on the way in which the dramatic arts influence the spectator. The same aspects affect the performer, in this case the student. Education in the dramatic arts is not a method of training but more a method of education. Teachings are based more on models of drama and composition on an organic rather than on a narrative level. “They are pure forms, a linking together of dynamic elements, without a plot but infused with information which once embodied by the actor, constitutes the essence of the scenic movement” (Meyerhol, 1993:67).

Doing certain actions and exercises allows the intervention of a paradoxical way of thinking. In exercise, daily routines are challenged in various ways, using tension, intensity, rhythm and movement through space.

The aims of rehearsal and exercise:

- The aims of rehearsal and exercise:
- Facilitates the student to think outside of the box
 - (With a global body-mind);
- Allows for thinking through perception and realization through real action (Not necessarily realistic);
- Students start to respect the true beauty of the art form;
- Theatre is not about work on a text, but work on the self;
- Rehearsal and exercise result in self-discipline;
- Exercise is aimed at mental concentrations on a task;
- Exercise helps students think with their bodies, an exercise of individuality and personal growth.

The aim of exercise is to push the student into a stream of physical and mental obstacles and limitations in order to liberate them from the functional and

utilitarian categories of daily life: “Actors breathe life into stereotype patterns of exercise with endless energy” (Barba, 1988:25).

3.1.4 | STREET THEATRE AND INTERNALIZED THEATRE

Performance that takes place in the public realm feeds into the cultural network of city streetscapes, such as the street-mimes or fire acrobats that entice people with their imagination and are an influence on the vibrancy of a place.

Generally outdoor theatre is provided unknowingly; it is a very site-specific form of the dramatic arts that takes many forms of theatre and converts it into an occasion of everyday form, ever-changing due to the constant movement of the external location and spontaneity thereof. It is a form of theatre that is amalgamating with traditional theatre to become known as ENVIRONMENTAL ART (Mason, 1992:205) where elements of political theatre and radical theatre of other groups is taking form in a site-specific manner in order to be seen and create a sense of change in the basic everyday person.

Street theatre is incorporated into the design of the arts Precinct, because site-specific performance and street vibes add to the vibrancies of the space unifying it and creating outside interest. The aim of the design is essentially to be a unified space where theatre rehearsal and performance can take place both indoors and outdoors. This creates different atmospheres in the place at different times. The design will incorporate the idea of creating various backdrops for outdoor performances and will facilitate social interaction at the same time.



Figure 3.1.1: *Street theatre* Manchester International (Festival 2007)



Figure 3.1.2: *Street theatre* Manchester International Festival (2007)

3.1.5 | SPACES FOR PERFORMANCE

Space is a common ground for many encounters. Theatrical space is a place where encounters are practiced and carried out to an audience. A theatrical event can be seen as a dynamic process of communication in which the spectators are implicated. This forms part of a series of interconnected processes of socially situated significance and communication.

- The spaces in theatre that would be considered most important are:
 - The spaces of interaction between the performer and the spectator;
 - The energized space of the stage and off the stage;
 - The organization of on-stage and off-stage; and
 - The fictional places that are represented or evoked in relation to all the above mentioned areas.
- In theatrical planning vitally important aspects to consider are:
 - Occupation of spaces;
 - Entrances;
 - Exits;
 - Movement and gesture (these can only become meaningful when situated in a given space; this would activate the space and make it meaningful);
 - Relationship of movement and gesture between the audience and the performer; and
 - Objects and space [figure 3.1.3].

The classification of spatial functions in a theatrical performance needs to address a few major issues, mostly of the social reality of the theatre experience, the actual theatre building and how it relates to its urban environment as well as either the purpose-made building or the adapted building (McAuley, 1999:18).

Additionally, it is concerned with the relation to the surrounding buildings and the activities associated with them. The space needs to be regarded according to its history, its architectural design, and the kind of access it invites or denies.

For the spectator a theatrical performance is a social event and the reception of the performance plays a role in the theatrical experience. This is constituted as the areas within the theatre space that the spectators have access to. These spaces facilitate or discourage certain types of behaviour. These spaces are:

The access point of the building

- The foyer;
- The stairway;
- The corridors;
- The bar or restaurant;
- The box office; and
- The auditorium

These spaces imply social activity and are just as important as the performance.

The Theatre Worker

The theatre worker owns a different domain within the theatre. His/her access to the theatre is usually through a different door. The system of spaces for the theatre worker is mainly utilitarian and very different to the spaces of the spectator. The theatre practitioner uses spaces such as:

- The stage door access;
- The entire backstage area: dressing rooms, the green room, corridors, and stairways (which are designed according to a hierarchy of comfort), and the production service area; and
- The stage: the acting space that links the actor to the audience. This space is where the actor meets the audience and the experience is created, and can be called the “performance space.” (McAuley, 1999:27) [Figure 3.1.4].

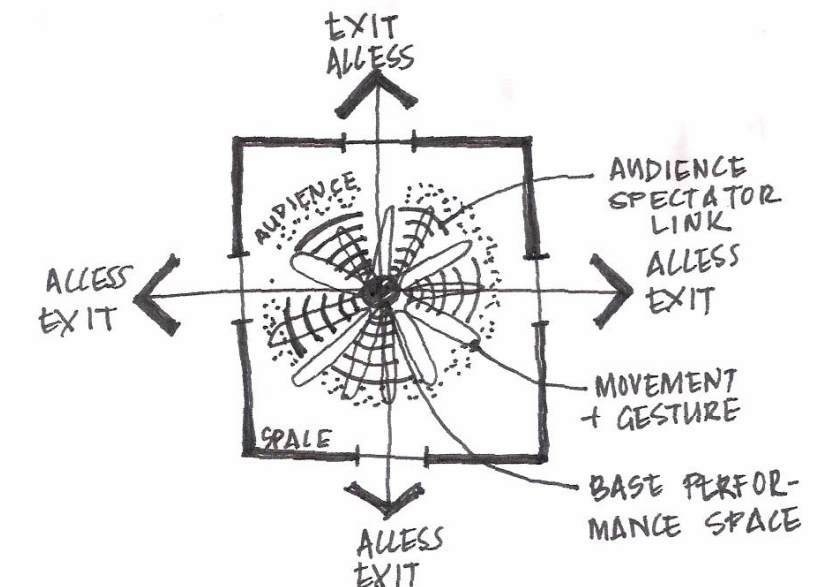


Figure 3.1.3: Functional spaces within a typical theatre, Chita M

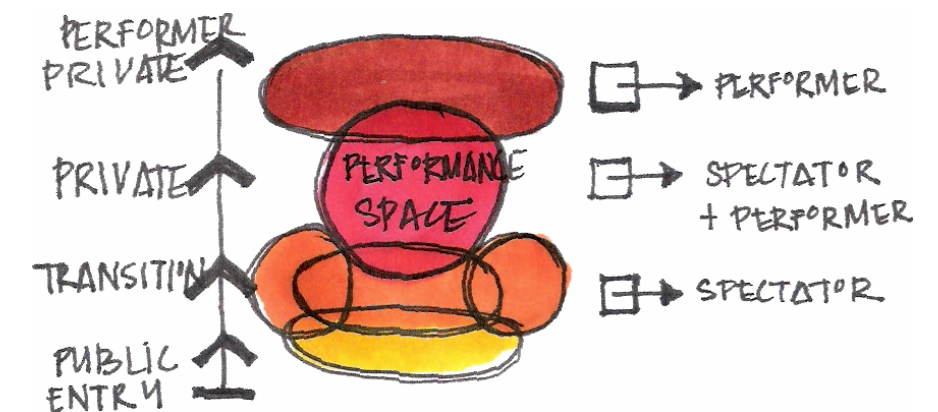


Figure 3.1.4: organisation of theatre spaces, Chita M

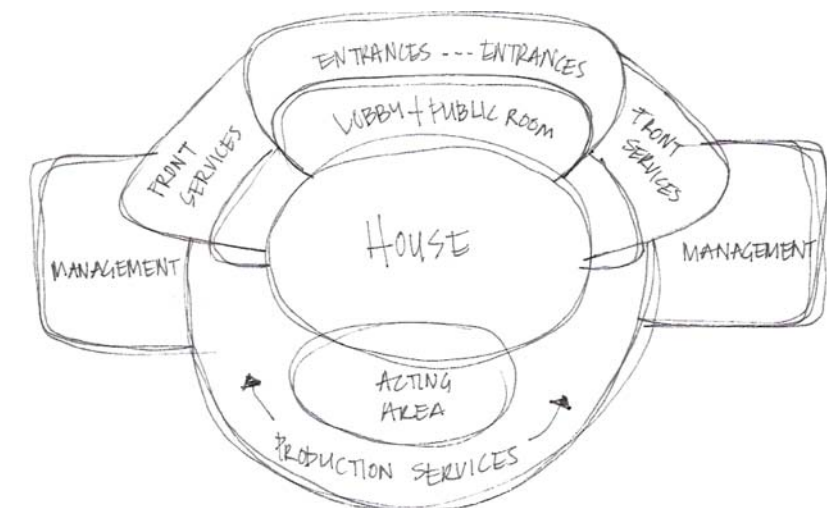


Figure 3.1.5: Spatial transition in theatre from public to private, Chita M

Creating a performance space:

In creating a performance space three aspects need to be considered (McAuley, 1999:20), namely:

The stage space:

- designed to have its own physical characteristics (width and depth);
- The degree of penetration into the audience;
- The number and position of the exits;
- The nature of the back wall; and
- The nature of the division between the onstage and the offstage;

The basic architectural features of the building provide a physical grounding for the performance which plays an important role in the experience it creates.

The Presentational space:

- The occupation of the space by the actors, the set, the props and the spatial demarcations. Presentational space can be considered as perceived space.

The Fictional space:

- This refers to the spaces/places represented or evoked onstage and offstage. This type of space can be considered as conceived space. Fictional place functions according to its location in relation to the physical reality of the performance space.

The theatre building or designated place of performance provides a context for interpretation for the spectator and the performer. There is a certain ritual when visiting the theatre and therefore the exterior is just as important as the interior. The user of the building needs to relate the outside of the building, especially with inward-focused theatres.

Theatres want to encourage the visitor to enter the space. Once they enter they move through a series of

spaces that take them further and further away from reality into a magical area (MacIntosh, 1993:144). The theatre building can be considered as emphasizing a sense of inward progression [figure 3.1.5].

In the architectural design of the theatre building it is important to consider the relation of scale between the human body and the building in order to create a memorable experience (McAuley, 1999:52).

During a performance the spectator is involved in the performance and absorbs the experience through his/her body. Therefore the arrangement of the auditorium design is important. (Bennett, 1990:64) [Figure 3.1.6 & 3.1.7].

Backstage is the where the performance is practiced and put together. This setting is usually kept hidden from the front of house and less attention is paid to it (Burriss-Meyer, 1964:153).

The stage plays an important role by being the plane of interaction between the performer and the spectator. The physical aspects of the stage determine how the performance will be perceived. Examples include:

- The performance scale in comparison to the auditorium;
- The width of the stage opening;
- The degree of penetration into the audience;
- A flat or raked stage;
- The number and position of the doors in the auditorium; and
- The separation of the audience from the performing space by use of lighting or a curtain.

The performer is the one that activates the space by using movement, gesture, and energy that brings life to a space (Barba, 1985:369-382). The spectator experiences the space with all their senses and therefore theatre should be considered in terms of spatial experience rather than just visual experience.

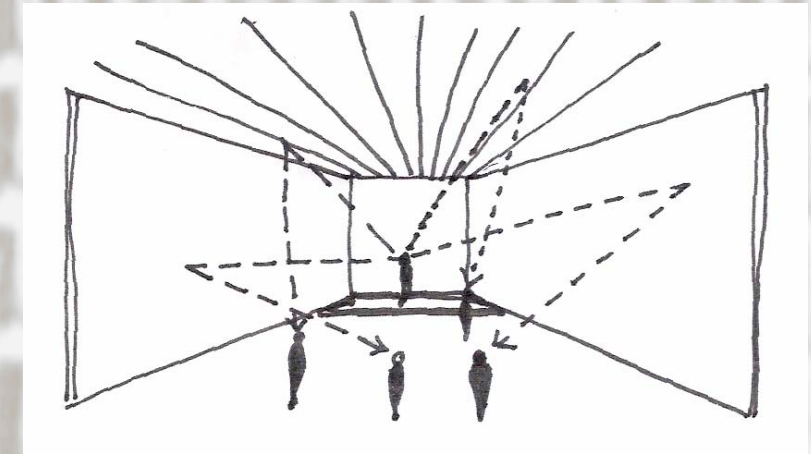


Figure 3.1.6: Sketch of a larger theatre volume and its effects, Chita M

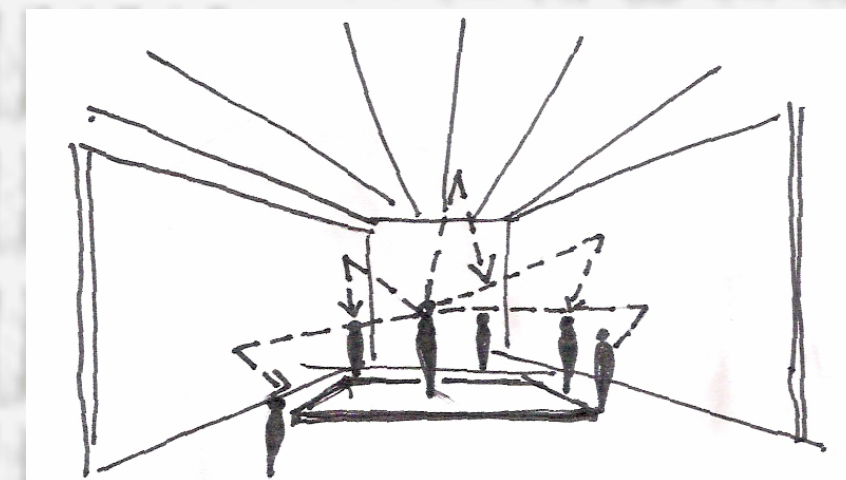


Figure 3.1.7: Sketch of theatre volume at a more intimate smaller level, Chita M

3.1.6 THEATRE CONFIGURATIONS

they can see. Because the proscenium is (or appears to be) an architectural barrier, it creates a sense of distance or separation between the stage and the spectators [Figure 3.1.8].

Thrust Stage

A thrust stage is a platform surrounded on three sides by the audience. A thrust may be backed by a wall or be appended to some sort of end stage. The upstage end (back of the stage, farthest from the audience) may have scenery and provisions for entrances and exits, but the thrust itself is usually bare except for a few scenic elements and props. Because no barrier exists between performers and spectators, the thrust stage generally creates a sense of greater intimacy, as if the performance were occurring in the midst of the auditorium, while still allowing for illusionist effects through the use of the upstage end and adjacent offstage space [Figure 3.1.9].

Arena Stage

The arena stage, or theatre-in-the-round, is a performing space totally surrounded by the auditorium. The necessity of providing equal sight lines for all spectators puts special constraints on the type of scenery used and on the movements of the actors, because at any given time part of the audience will inevitably be viewing a performer's back. Illusion is more difficult to sustain in arena, since in most set-ups, entrances and exits must be made in full view of the audience, eliminating surprise, if nothing else. Nonetheless, arena, when properly used, can create a sense of intimacy not often possible with other stage arrangements [Figure 3.1. 10].

Many earlier forms of theatre were performed in the streets, open spaces, market squares, churches, or rooms or buildings not originally intended for use as theatres. Frequently contemporary experimental theatre rejects the formal constraints of available theatres and seeks more unusual spaces. In all these "found" theatres, the sense of stage and auditorium is created by the actions of the performers and the natural features of the space (<http://pdf.rincondelvago.com/theatre-production.html>, 20 Sep. 2008).

Theatre can also be discussed in terms of the type of space in which it is produced. Stages and auditoriums have had distinctive forms in every era and in different cultures. These all evolved into a series of common theatre types, including:

End Stage

An end stage is a raised platform facing the assembled audience. Frequently, it is placed at one end of a rectangular space. The simplest version of the end stage is the booth or trestle stage, a raised stage with a curtained backdrop and perhaps an awning [Figure 3.1.8].

Proscenium Stage

The proscenium arch is the opening in that wall through which the audience views the performance. A curtain that either rises or opens to the sides may hang in this space. The proscenium developed in response to the desire to mask scenery, hide scene-changing machinery, and create an offstage space for performers' exits and entrances. The result is to enhance illusion by eliminating all that is not part of the scene and to encourage the audience to imagine that what they cannot see is a continuation of what

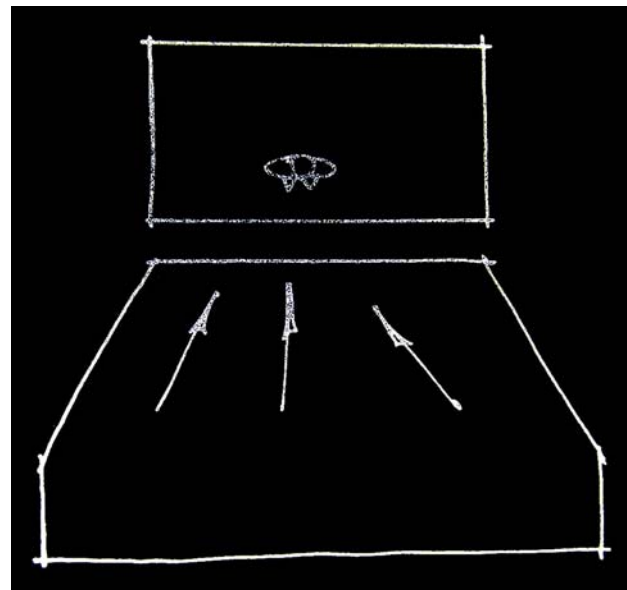


Figure 3.1.8: sketch of end stage, proscenium stage has the same concept

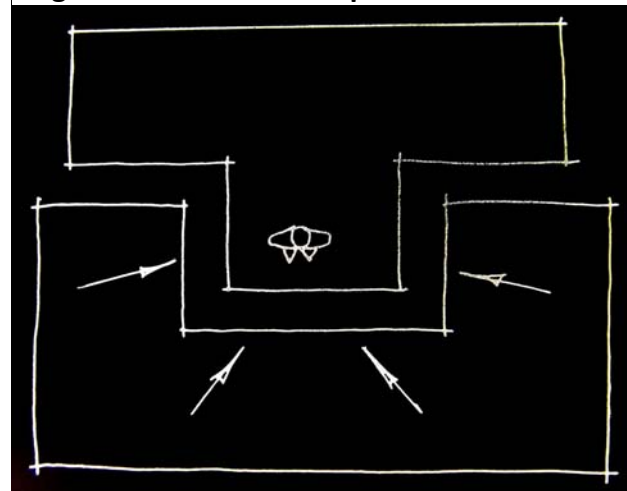


Figure 3.1.9: Sketch of thrust stage

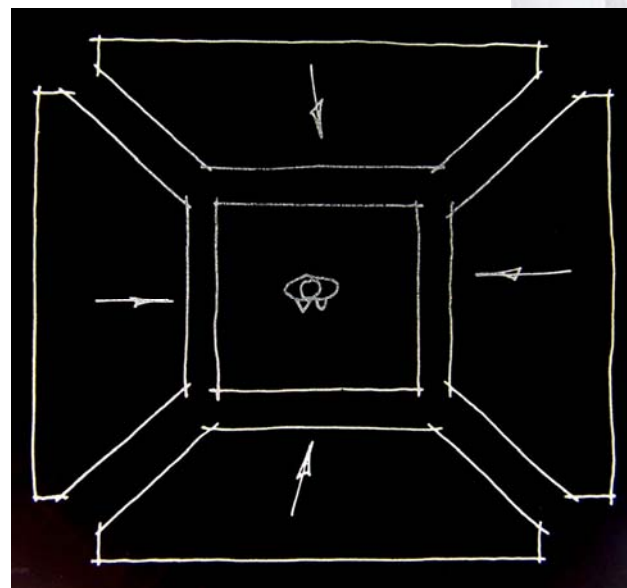
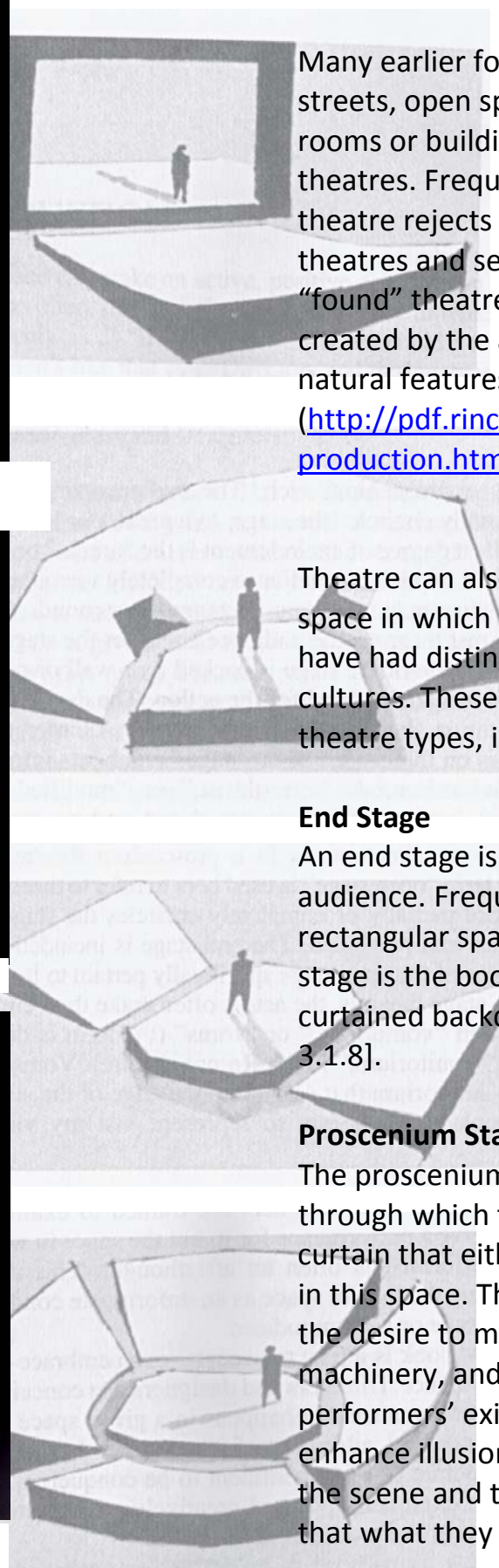


Figure 3.1.10: sketch of arena stage or theatre in the round



3.2 | BLACK BOX THEATRES: A VOID SPACE OF MEANINGFUL PRODUCTIONS



Figure 3.1.11: interior of the Kwai Tsing Black Box Theatre (http://www.architectsjournal.co.uk/archive/black_box_light_box.html cited: 21 April 2008)

Black box theatres show the simplification of the contemporary theatre design. Material space has been fragmented and simplified down to a functional level. This may be considered as a space lacking architectural or interior design, but its true meaning conveys a void-space that embodies a performance-based approach to theatre design and then to the reading of the interior.

An auditorium is a complex room that unites the actor and the audience. It has evolved as an elaborate social instrument that houses performances, heightening the experience and involving the spectator. Modern theatre called for a reworking of the auditorium so that the performance itself could create the identity for the theatre and not the building. This resulted in the eradication of a more architecturally-based theatre design to embody a performance-based design instead.

A black box theatre may represent an absence of material, but through performance and rehearsal it embodies an essence of variable creations. Each production becomes an origin point born out of the darkness that brings life out into the void. This space breaks away from the confines of a conventional theatre and becomes a space where boundaries are broken between the actor and the participant; it becomes an enveloping space that engulfs those implicated within.

The theatre container itself casts shadows on its form where its boundaries are concealed. This suggests a limitlessness within which performances could be endlessly produced. The aim of the black box theatre is to remove the body from any particular space and centre the focus on the actor and the performance.

New century theatre became the means for the recovery of a collective relief of expression (Tafari, 1980:96); it allows an 'entering into' of the space which has no reference to the external environment. This type of theatre creates a focus and allows the absorption of what is happening in the play easily. The breakdown of the theatre is a form that eradicates the limiting proscenium arch and disrupts the boundaries between the actor and the spectator as well as the interior and exterior. This will intensify the experience as an engaging event. This can be achieved by moving away from the typical theatre design, removing all elements, such as the proscenium arch, the box seating, the galleries, the stage, the décor and any other element that depicts a typical theatre. This idea seemed to open up a limitless space for creation which essentially becomes the materiality of the space.

Functional elements and technological systems enhance the space to create the environments needed. They fit into the theatre and act as apparatus for production. The theatre is a dark space within which

machinery is used for the efficiency of its operation. The equipment contained in the space is functional and can be configured for any number of formats, thus making the space a "flexible" one. They act as a "prosthetic" element within the "wall-less" space of the black box, which allows performance to break through from behind the proscenium to be what it is meant to be.

Economically, black box theatres are considered cost-effective because costs are minimised by establishing the various performance layouts in a single space relying on specified equipment and labour. The actual theatre becomes a place where the experimental use of the space is designed by the user (director/designer/actor). They use design systems such as the seating, the staging elements and the lighting. These systems are designed accordingly to extend the relationship between the performer and the space by creating focus and giving the space a purpose. The apparatus used inside aids in creating the environments as well as various identities to what could be considered a stagnant space. The stage is no longer a framed scene into which the audience sees, but rather a platform where they are implicated and involved.

The theatre is named a 'black box' theatre because it is typically a darkened, simple rectangular volume, usually painted black to reduce the containment of the actual space. This suggests an infinite space for possibility. The technologies within define the physical space, and the performances produced therein are what brings life to the space. These productions within are the platforms used to bridge the gap between the audience and actor creating a space of contemplation and participation (Perez-Gomez, 1994:10). There is no distinction between the performer and actor and through participation both memory and imagination are ignited.

3.3 | SPATIAL THEORY

The chosen site is the current location for the Dramatic Arts Department. The provided spaces do not facilitate a meaning of place, because the buildings are very disjointed and self-contained. Other problems experienced by the Department are as follows:

- The space is not lively; meaning that there is a lack of facilities for events and education, but also that the space does not have the aesthetic value to make it a place;
- The space is not accommodating: the site is broken up by a road cutting through the space and the buildings are separated by a parking area;
- The spaces are ill-equipped to work as a school for The Dramatic Arts. The spaces have been adopted, which means that the spaces were not designed for the specific purpose of dramatic arts training; and
- There is very little visibility into the space and it creates no sense of interest in the passer by. This could be because accessibility is also a problem and the site remains quiet and unvisited due to the lack of pedestrian pathways.

The buildings are also self-contained and incoherent; there is no language between the buildings that allows them to work together; to make a place or have a single identity. Circulation within the site prohibits complete movement and accessibility between all three buildings. The aim of the study, therefore, is to take architectural place-making and the specific elements that make theatre place and convert the space into a drama-based node within the university.

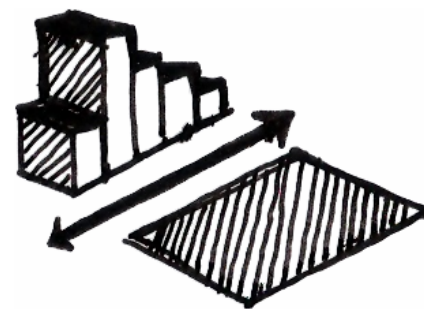
3.3.1 | PLACE MAKING

Place is defined as a term for environment (Norberg-Schulz, 1979: 6), and is evidently an integral part of existence; relational, historical, and concerned with identity; that allows for urban relationships and identities. In order to take the existing site and buildings and create one coherent place with identity, guidelines from the theorist Kevin Lynch were adapted as follows (Lynch, 1962:47-48):



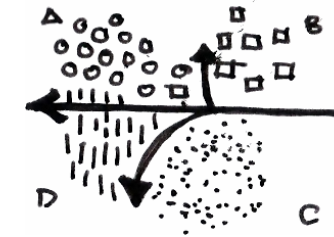
1. Paths

People observe a space while in transition through it. Paths create channels for this movement as well as creating an axis around which other built elements are structured.



2. Edges

Edges are boundaries between two phases or linear breaks in continuity. The boundaries act as barriers or act as a relation point between two places (either separating them visually or physically or joining them). Edges are used to define a space.



3. Districts

A district is a place where people enter into and immediately recognize the place as having a common identifiable character.



4. Nodes

A node is a place where the observer can enter into which is a point of intensive focus, the convergence of paths and a place of meeting; a break in the transportation or movement routes from one structure to another. Nodes are concentrations of one aspect in one place, for example, a street corner or a public square.



5. Landmarks

Landmarks are usually external elements that give a place an identity. A landmark singles out the element from its surroundings and is a point for orientation. (Lynch, 1962:47-49)

How architecture can add to place:

The job of a unifying design is to add to the space what is lacking in a given situation. It must make a site become a place by uncovering meaning potentially present in any environment. To make place, architecture must make a natural structure more precise by enclosing the space, or if any nature shows a direction architectural design must allow for a path. The understanding of nature must be symbolized and the built structure within that place must fit the character of the place.

The job of a unifying design is to add to the space what is lacking in a given situation. It must make a site become a place by uncovering meaning potentially present in any environment. To make place, architecture must make a natural structure more precise by enclosing the space, or if any natural entity shows a direction architectural design must allow for a path. The understanding of nature must be symbolized and the built structure within that place must fit the character of the place. An environment/space becomes meaningful, or a positive space, when a person can orientate and identify themselves in the place. This can be done using physical components and emotion. To make a place, space needs contextual meaning derived from its context. Every place has a story of movement, “a journey and arrival”, through a space.

Three main aspects that enhance a place:

1. Responsive designs:

- contextual content: space is legible to the user;
- varieties of possibilities of use; and
- experience and motivation for using the space

2. Creating richness:

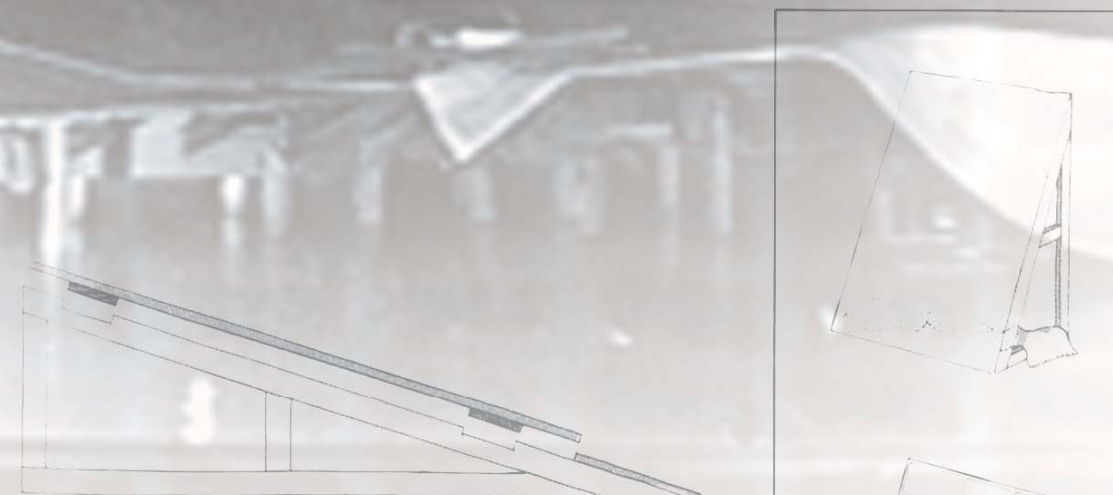
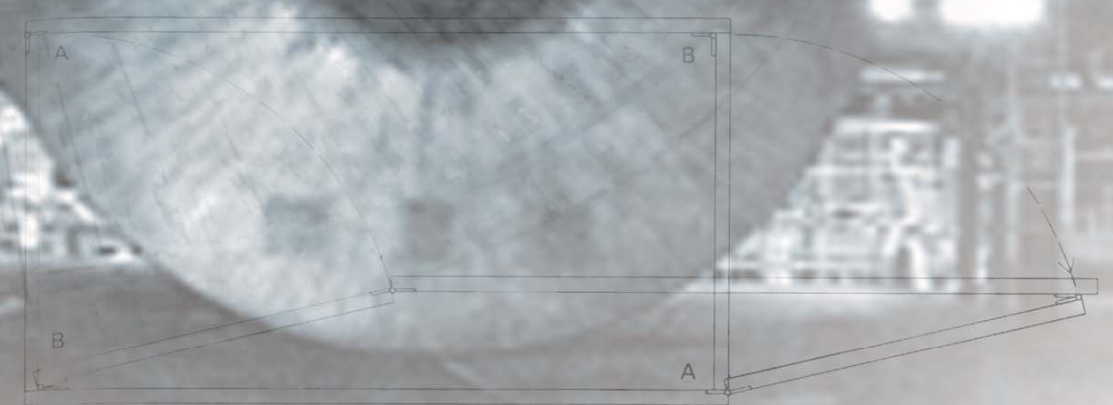
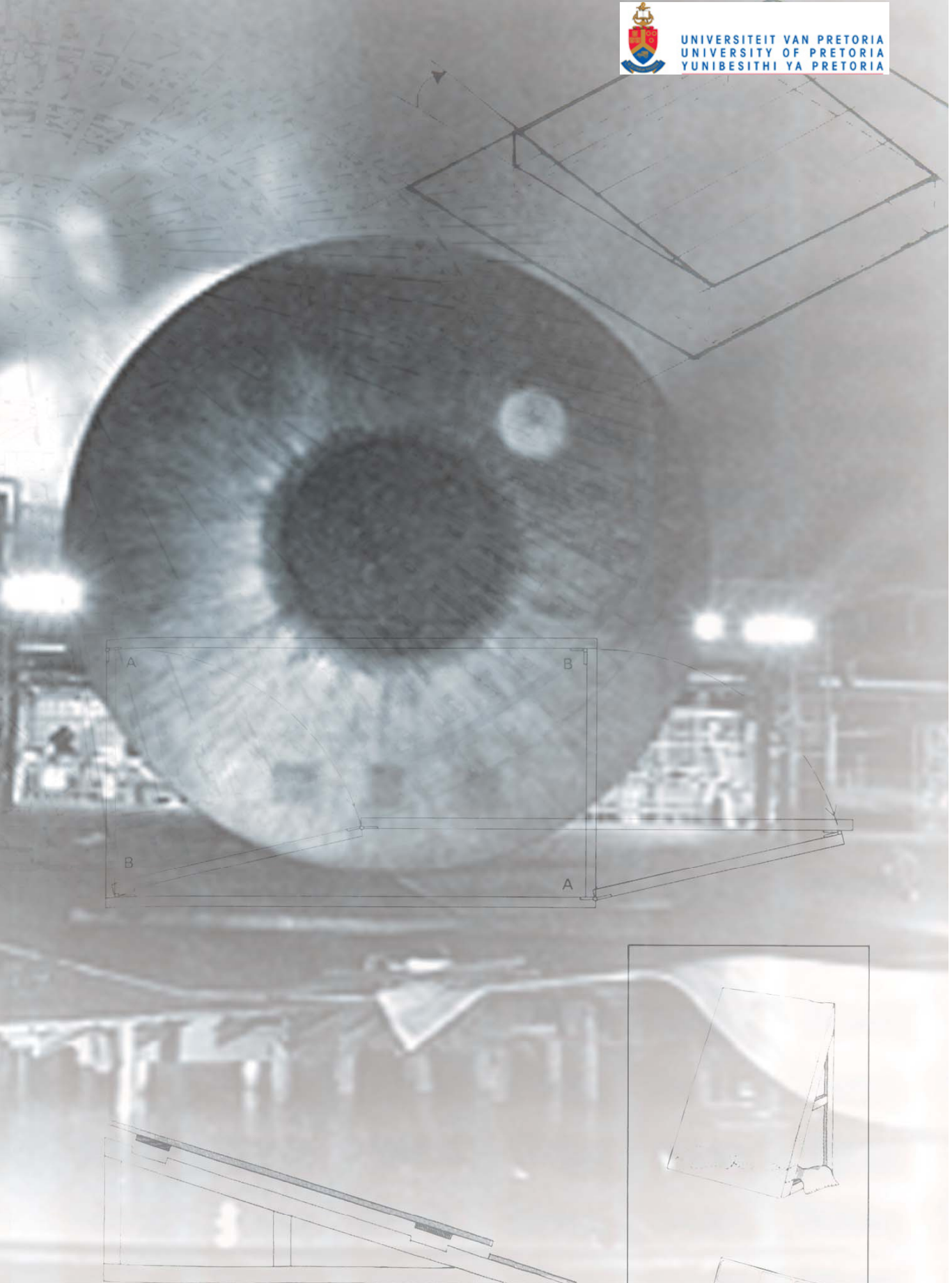
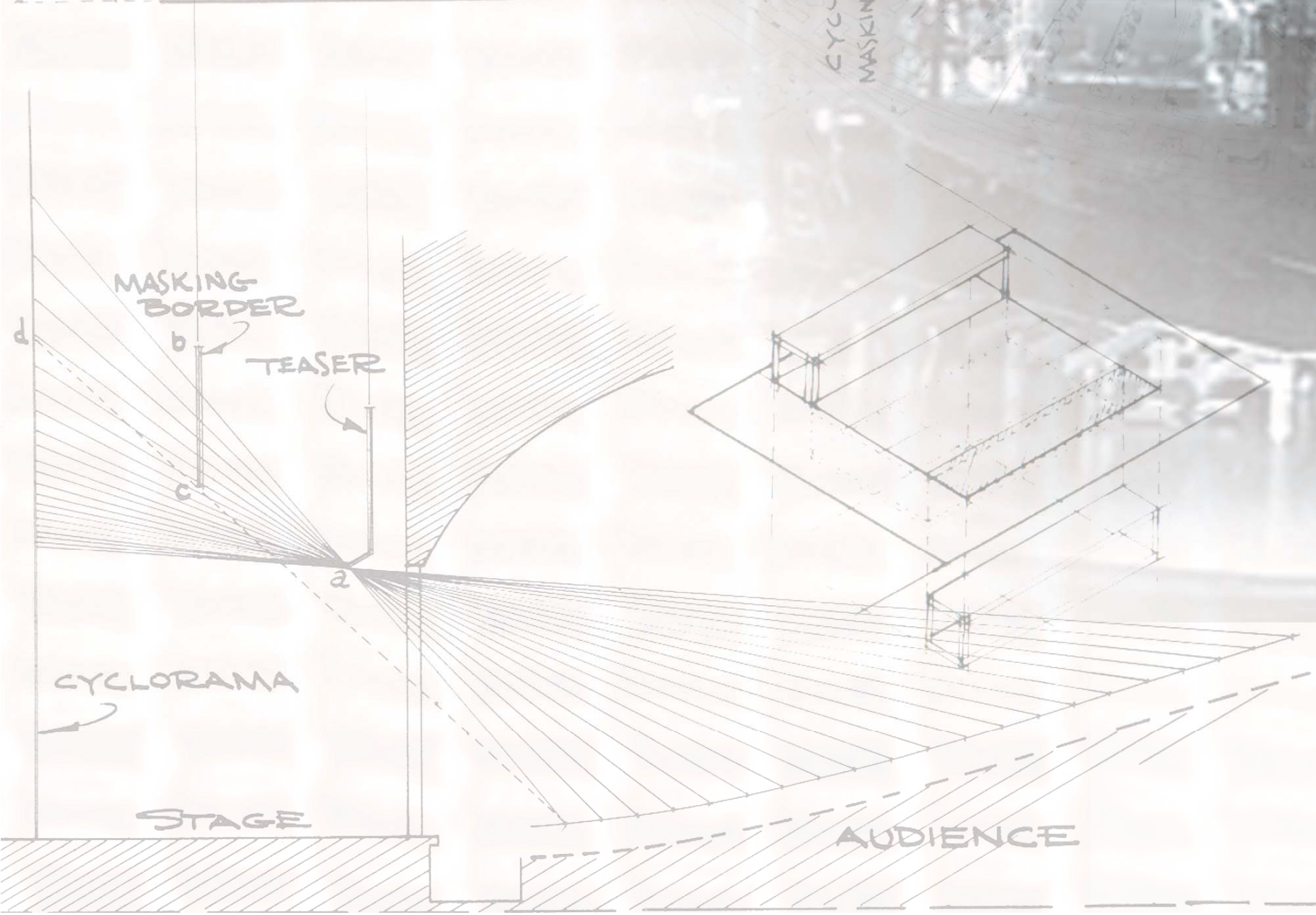
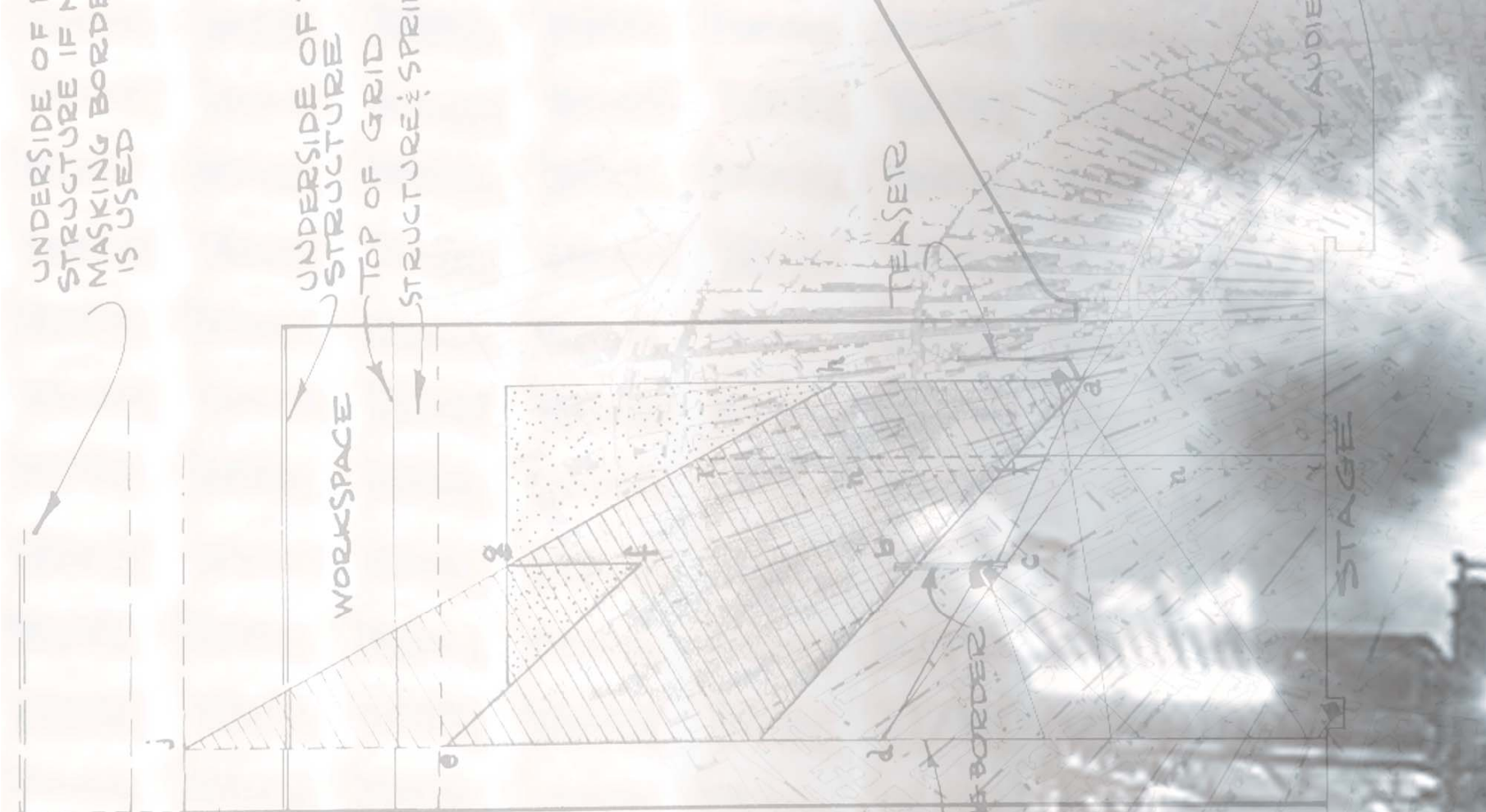
- Use of meaning and sensory applications that enhance experience, emotion and perception.

3. Order

- Structuring the public places in a system of hierarchy (a response to the cultural context); and
- Increasing the legibility of the space using local landscape and the symbolic content of the local community (Trancik, 1986:97).

A place is a space that has distinct character and the task of architecture is to take space and make it meaningful. Character is a description of a space that describes your experience in that space (Norberg-Schulz, 1979: 14).

Richness is added to spatial environments through the senses and the kinetic experiences that the inhabitant perceives. The spaces need to be studied and considered according to what is lacking through the study of the old. Enhancing the space by layering the new spaces above creates an intervention that involves the specific factors of place-making that will give the space meaning and character. This integration can cause synthesis between the spaces to create place.



04 | PRECEDENTS

04 | PRECEDENT STUDIES

4.1 THE PERFORMANCE ACADEMY, NEWCASTLE COLLEGE

The Performance Academy displays the **use of added skeleton structures** that double as a lighting object as well as a projection screen and shows **how a structure can be added** to the façade of the building to give the building both **meaning and function**.

4.2 BARKING TOWN SQUARE:

An analysis of how the various disjointed spaces were **completed with use of public spaces**, new materials and place-making to define a usable social square **integrating old and new buildings giving a space identity**.

4.3 MUSEO DI CASTELVECCHIO

An analysis and **record of a heritage building** that was **restored and given new meaning** by the implementation of basic ideas that **made the spaces rich** and brought out its historical and cultural history.

4.4 YOUNG VIC THEATRE

The young Vic Theatre study shows a relevance to the type of intervention that is possible when incorporating three buildings to create a **single attractive, flexible theatre space** for the people. The building is studied with regards to the **simple changes made to make the space efficient** and it shows the **contrast between the new and the added elements that unite all the spaces**. The Young Vic is also an example on how a **black box theatre** operates with examples of **various theatre configurations**.

4.1 | THE PERFORMANCE ACADEMY, NEWCASTLE COLLEGE 2004

The Performance Academy displays the use of **added skeleton structures** that double as a lighting object as well as a projection screen and shows **how a structure can be added to the façade of the building** to give the building both meaning and function. This can be seen in comparison to my addition of the light box stairwell for Die Masker.

CITY: Newcastle (United Kingdom)
 ARCHITECT: RMJM Architectural Practice

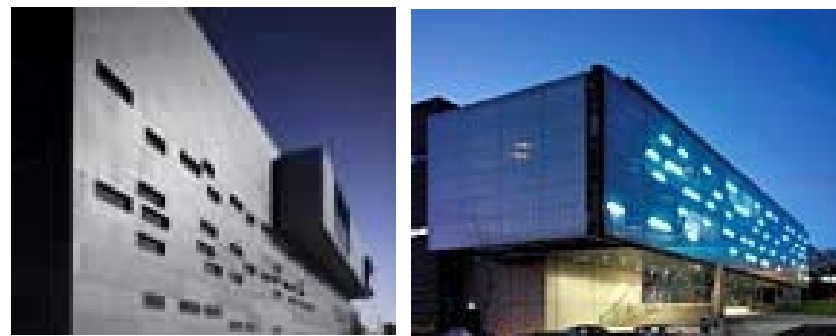


Figure 4.1.1: Back facade referred to as the black box

Figure 4.1.2: White glowing façade referred to as "light box"

(http://www.e-architect.co.uk/newcastle/jpgs/newcastle_college_rmjm030408_1.jpg, cited 1 August 2008)

The building is designed to be the **hub for the students of music, performing arts and media**. It is a first of a series of satellite schools to the Rye Hill Campus and it creates a unique image. The idea behind the College is that it would be seen as a catalyst for further regeneration of the urban development in the surrounding area. It is seen as an iconic building.

The building character was devised by the design team as "a workshop, a robust, stimulating and vibrant place, facilitating experimentation and collaboration, as well as for intense creative energy" (Evan, 2005:21).

The building aesthetic follows that of the local Newcastle aesthetic of the Industrial style. The specific character of the building that **compares the arts with the façade** is detailed by means of a profiled metal box that contains a large-span space located towards the back of the building [fig. 4.1.1]. The front of the building is where the "light box" is situated [fig. 4.1.2], a glazed curtain wall structure containing short span spaces conducive to daylight.

The light box gives the impression that it is floating above the primary social space and entrance of the building. The entrance is a double volume recessed space with a clear pathway, which in turn attracts the visitor into the building [fig. 4.1.3].

The light box is composed of a 75m long exposed steel truss support system that supports the box that bridges over the entrance and creates a column of free space that has a very dramatic appeal. The exoskeleton trusses are clad in an active polycarbonate skin to create a giant media projection screen [fig. 4.1.4].

On the south-east end of the light box the cladding is set up for back projection for drive in or sit out movies [fig. 4.1.4]. **The entire exterior design functions as a metaphor for the arts: the idea of what is seen and what is concealed** (http://www.rmjm.com/index_flash.php, 1 Aug. 2008).



Figure 4.1.3: The Polycarbonate light box, (http://www.e-architect.co.uk/newcastle/jpgs/newcastle_college_rmjm030408_2.jpg, cited 1 August 2008)



Figure 4.1.4: The Light box is used for projections, (http://www.e-architect.co.uk/newcastle/rmjm_newcastle_college.htm, 1 August 2008)

4.2 | BARKING TOWN SQUARE

An analysis of how the various **disjointed spaces were completed with the use of public spaces**, new materials and **place-making** to define a usable social square **integrating old and new buildings giving a space identity.**

CITY: London (United Kingdom)

AUTHORS: muf architecture/art, Allford Hall Monaghan and Morris

PROJECT BEGUN: 2005

START OF WORK: 2007

END OF WORK: 2008

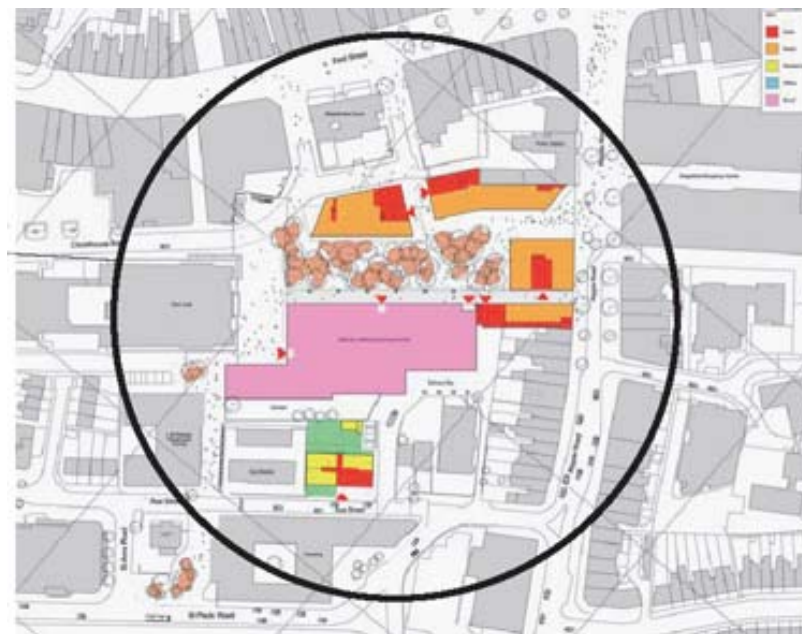


Figure 4.2.1: Aerial diagram of the New Barking Town Square.
Cited: 25 June 2008

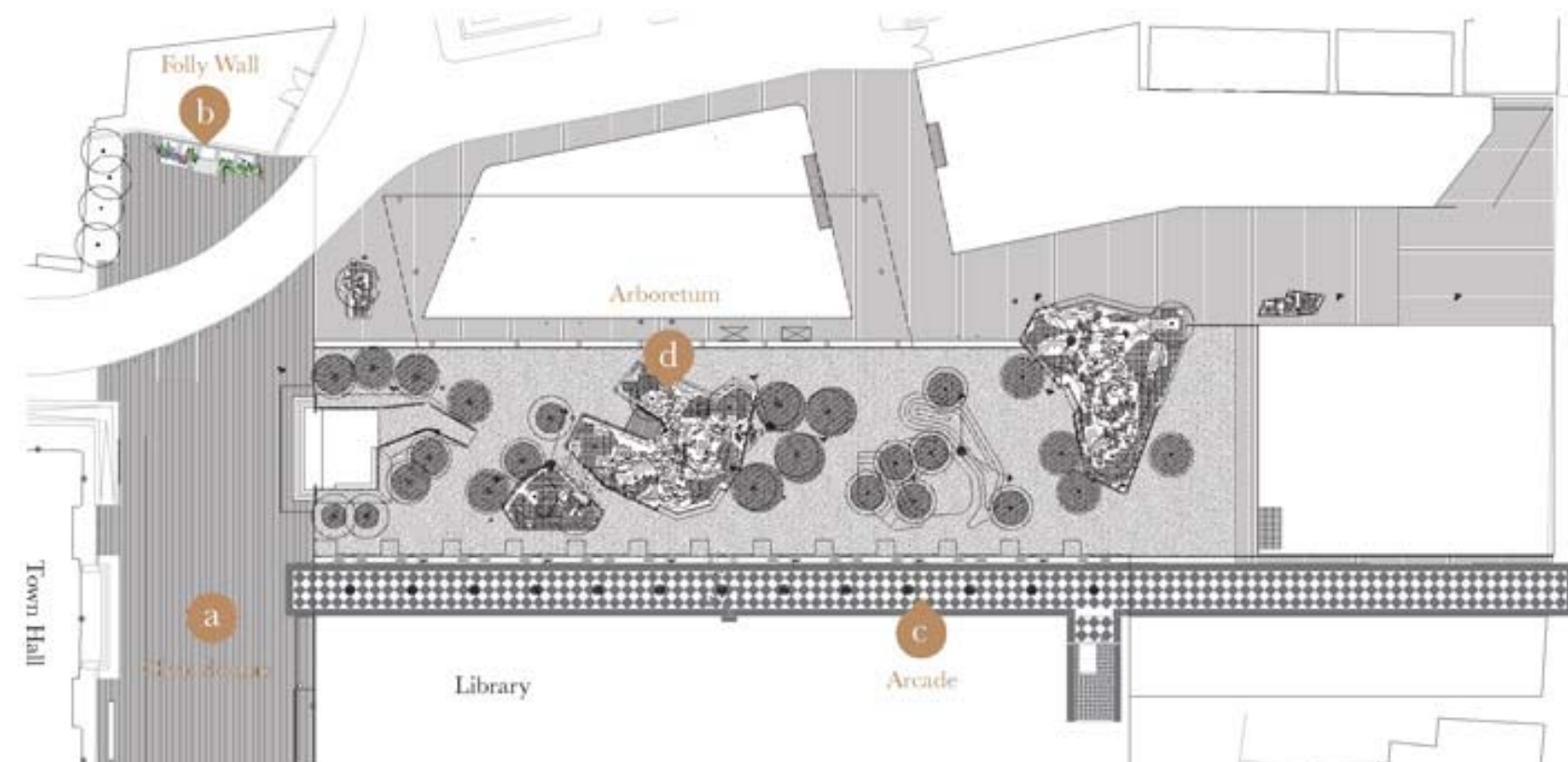


Figure 4.2.2: Aerial plan of the layout of Barking Town Square showing the Pink granite square (a), the end of the pathway with found objects (b), the new checkered arcade leading to the square in front of the Town Hall(c), and the new Secret Garden (d) Cited: 25 June 2008

Barking Town Square is the centre of the new Thames Gateway Development. The completed first phase consists of a large, hard landscape of pink granite slabs (a)[figure 4.2.2] that runs alongside the town hall, a bed of flowers, bricks, and found objects is located at one of its ends (b)[figure 4.2.2].

The second phase is a soft landscape of mounds, woodlands and benches (d) [figure 4.2.2] which will run between a row of flats, shops and the public library adjacent to the arcade (c) [figure 4.2.2].

The **landscape links these two disparate environments.** The architects intended to exploit this by filling one open space with a forest, extending the existing walkway to form an arcade creating a new pedestrian connection, and also marking off an area in front the town hall with a single mature Magnolia Tree.



Figure 4.2.3: Sketch of the arboretum with forty mature trees of sixteen different species that are lit up at night with colours that vary according to the time of year. Cited 1 August 2008

The square provides a new focal point for Barking Town Centre and combines an open public space of pink granite with new furniture including purple benches, bins and new signage [figure 4.2.4].



Figure 4.2.4: Pink Granite Slab Square adjoining old Town Hall and new buildings, creating a complete space. Cited 1 August 2008

The north façade of the AHMM's new building for the square is pulled back at the ground floor level creating an eight meter high arcade. Large scaled candelabra were introduced in the spirit of celebrating municipal provision. The flooring is geometrically tiled with terrazzo, and this marks the route towards the town hall that signifies the historical Edwardian Villas and their front paths [figure 4.2.6].



Figure 4.2.5: Town Hall Square which accommodates for events. Cited: 1 august 2008



Figure 4.2.6: Checkered arcade with golden chandeliers create new pathway into public square. Cited 25 June 2008

A secret garden [figure 4.2.3] has been designed with a seven meter high façade that has been constructed from reclaimed bricks and architectural salvage from surrounding old buildings. It has been developed by bricklayers from the Barking College, **incorporating a public art element into the design of the main square.**

The secret garden is a large-scale public art project commissioned by the London Borough of Barking and Dagenham and is an integral part of the town square. **Trees are positioned to accommodate the desired lines that run diagonally across the site.**

The square in front of the Town Hall is used for **various exhibitions, gatherings and performances where temporary structures and seating can be installed** to suite the event that will take place [figures 4.2.7, 8 & 9] (<http://www.cccb.org/en/>, 25 Jun. 2008).



Figure 4.2.7: Temporary stage structure with backdrop inserted for an event. Cited : 1 August 2008



Figure 4.2.8: Square used for event with the Town Hall as a backdrop. Cited 1 August 2008



Figure 4.2.9: Various activities such as festivals and carnivals take place in the square. Cited 1 august 2008

4.3 | MUSEO DI CASTEL VECCHIO

This building was studied with regards to its **treatment towards its heritage** and the way Scarpa dealt with the **new and the existing** as it is aged at over five hundred years old. The study was also done to look at the significance of the building and how **the truth of the spaces by the use of new materials and elements is revealed** to bring out the essence of the space without destroying the existing structures.

Architect: Carlo Scarpa
 Location: Verona

Attitude towards history:

Scarpa's approach toward the building:

- A) To clean the building of "bogus" decoration; and
 - B) Mount an exhibition according to the "latest ideas on museum design"
- (Murphy, 1990:98).

He went further than just cleaning the building up by attempting to clarify and expose **various layers of history using excavation and creative demolition.**

The aim was to differentiate the various constructions through time so that the **building becomes an exhibition itself**: on the growth and change of nature. Carlo Scarpa was not interested in restoring the existing, but rather in making history visible **through the co-existence of overlaying fragments of construction.**

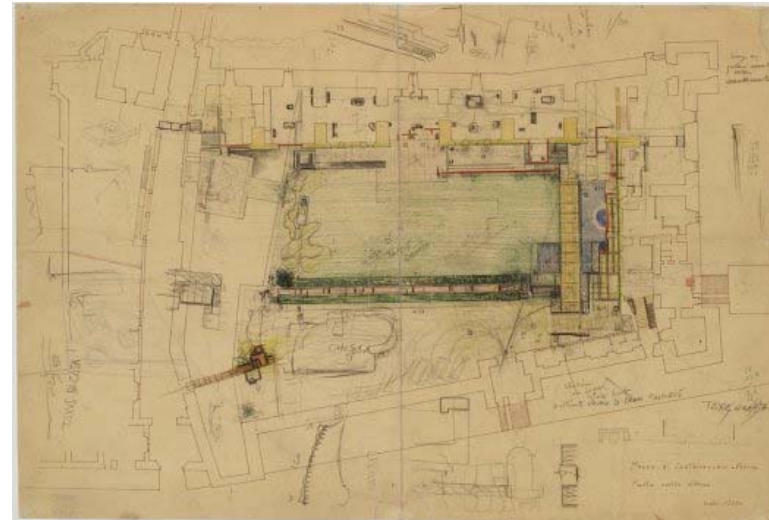


Figure 4.3.1 Drawn plan by Carlo Scarpa of the changes he wanted for the courtyard and building. Murphy 1990



Figure 4.3.2 Image of the Courtyard of Cangrande. Author: Murphy, 1990

Scarpa started the reconstruction by attending to the facades of the courtyard. They could not demolish the facades; therefore Scarpa used devices on the existing surfaces to break it up:

- A violently expressed demolition of the end bay;
- The removal of the entry point from the centre bay, which removed any symmetry from the courtyard;
- Placing a new screen of the museum, which moves independently of the building;
- Making the existing façade look thin and unsubstantial at the reveals; and
- Using active interpenetration of the outside and inside by elements such as the Sacello, entrance screen and paving.

Scarpa's best ideas were to find solutions on site which combine programmatic, historical and formal concerns in one act of creative demolition. The essence of the building shows **how the new and existing are juxtaposed.** For example, in the courtyard of Cangrande where the new concrete pedestal is constructed within the existing freer form space to support the sculpture of the Great Cangrande [fig.4.3.2]. The orthogonal elements are inserted into the old structure wherever possible, leaving a void between the two. These areas show where two eras connect [fig 4.3.3].

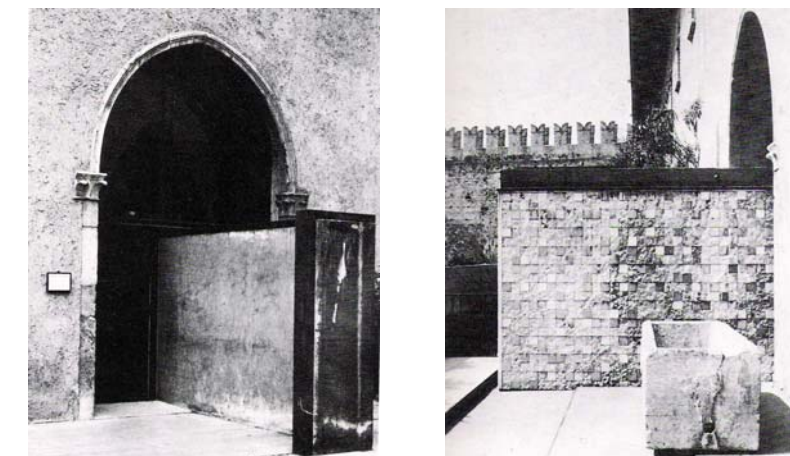


Figure 4.3.3: Sacello at entrance, new object vs. existing entrance. Author: Murphy, 1990

Scarpa believed that if there were any **original parts, they had to be preserved**. Any other intervention had to be designed and thought out in a new way. **Materials had to be used according to necessity and reasoning**. All of the insertions Scarpa made of the new into the existing consisted of the **orthogonal verses the freer forms** of the previous structures. He also used well-finished textures and precisely jointed materials placed adjacently to rougher, homogenous surfaces to **create tension**.

The idea of new **layering** over the walls was used. This shows a comparison between a man-made object, clear and precise, in comparison to the weathered natural object. Scarpa **lightly touches the existing** with a layer of **newer materials** that are **well suited for the function** to give the space meaning and appeal [fig. 4.3.4 & 4.3.5].

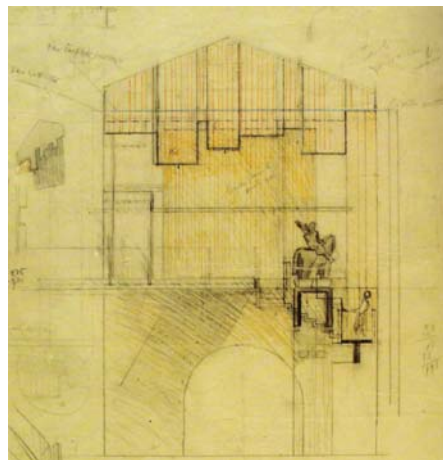


Figure 4.3.4: Drawings by Scarpa showing the layering of materials over the existing. Author: Murphy, 1990



Figure 4.3.5: Image of the timber screen applied over the existing structure. Author: Murphy 1990

Scarpa also used a **composition of planes** where the object's thinness is continually revealed [fig. 4.3.5]. Planes were used that can be deliberately detached from one another at the corners of the spaces. This can be seen where the sculpture plinths meet the ground in the exhibition galleries and where the new tiling

does not coincide with the wall. **Planes are detached** where the horizontal elements meet the vertical elements, **showing where the new meets the old**. At this junction there is a void between the two elements that conceals their real junction (Murphy, 1990:106).

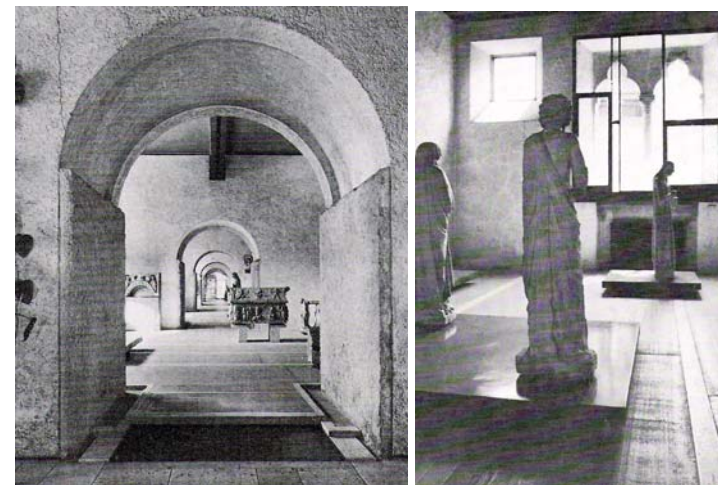


Figure 4.3.6: porticos in exhibition hall showing the new floor tiling and the planes, this creates with spaces between the vertical and horizontal elements.

Figure 4.3.7: Scarpa designed plinths for the sculptures to be placed on that lightly touch the existing and where one can see the thinness of the material. Author: Murphy, 1990

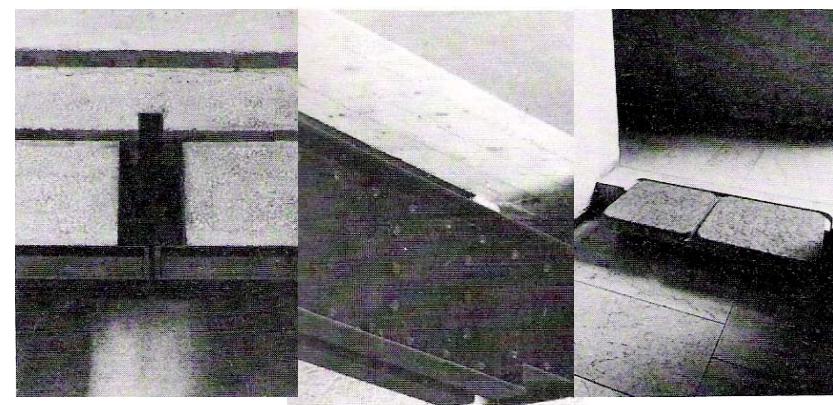


Figure 4.3.8: Images of detailed elements that show the truth of their materiality and how they are inserted into the existing fabric. Author: Murphy, 1990

In the design of the building the truth of the materials are also used intelligently. Scarpa shows this by means of incisions into elements [fig. 4.3.8].

The use of probing materials to reveal their inner realities beneath the surface was used, for example the use of Prun stone in the courtyard as paving. The underlying use of the stone is revealed by the arbitrarily places slabs of hewn stone set below their smoothly finished counterparts.



Figure 4.3.9: Statue of Cangrande in the courtyard. Cited 20 October 2008

Scarpa also creates tension between the materials by using **contrast in texture and colour** to convey the difference, and this can be seen in the Sacello which uses pink Prun stone which is less textured than that of the existing wall, and the separation between the wall and the ground and the existing building by using a darker frame of stone around the wall [fig.4.3.2] (Murphy, 1990:130).

Scarpa uses these principles to make a deliberate and expressive event. He enriches the space by using the interconnectedness between the materials, structure, elements, space and the special event in order to create a single unified space.

4.4 | YOUNG VIC THEATRE

The Young Vic Theatre study shows a relevance to the type of intervention that is possible when **incorporating three buildings to create a single attractive, flexible theatre space** for the people. The building is studied with regards to the simple changes made to make the space efficient and it shows the **contrast between the new and the added elements that unite all the spaces**. The Young Vic is also an example on **how a black box theatre operates** with examples of various theatre configurations.

ORIGINAL ARCHITECT: Bill Howell

REFURBISHMENTS: Haworth Tomkins

LOCATION: The Cut, London Borough of Lambeth.

PRODUCT: a space to produce plays for great audiences, new and in the future.

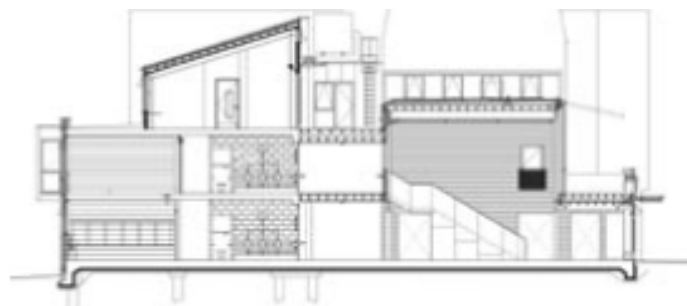


Figure 4.4.1: section through foyer and studios

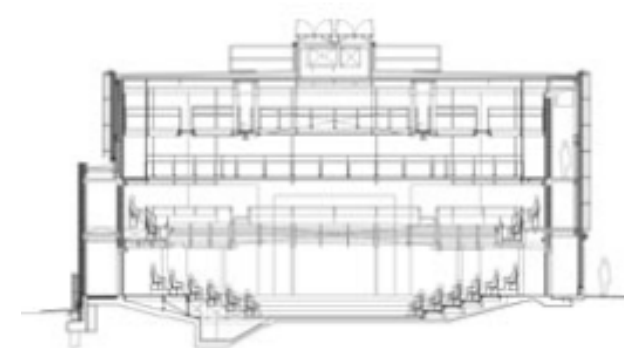


Figure 4.4.2: Section through theatre

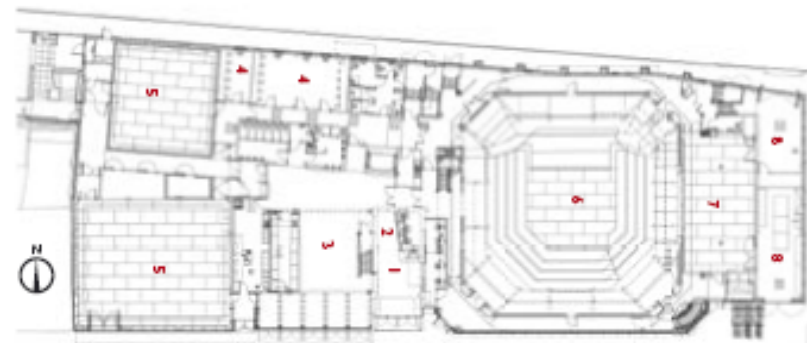


Figure 4.4.3: Ground floor plan

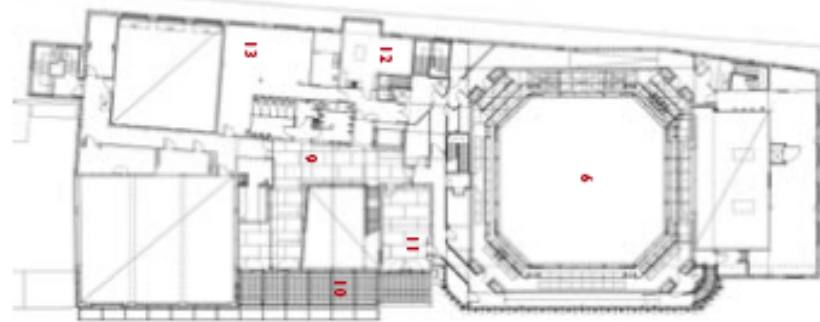


Figure 4.4.4: First floor plan

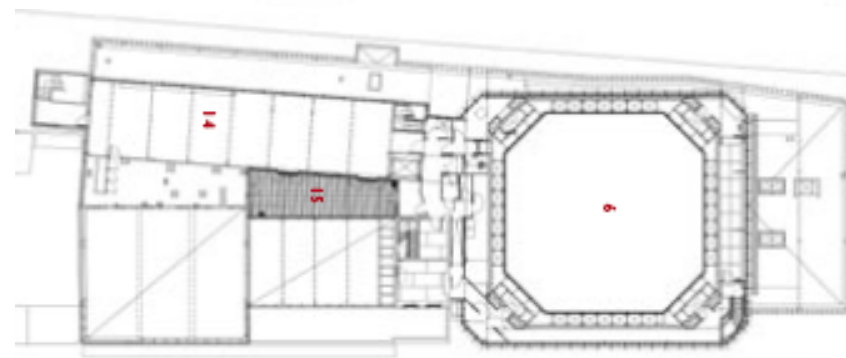


Figure 4.5.5: Second floor plan

1. Entrance
2. Tickets
3. Foyer/bar
4. Dressing rooms
5. Rehearsal studios
6. Auditorium
7. Workshop
8. Loading bay
9. Mezzanine
10. External terrace (public)
11. Event room
12. Green room
13. Wardrobe
14. Offices
15. External terrace (private)



Figure 4.4.6: Entrance for the theatre showing the 3 spaces joint at with the signage. Author: Philip Vile



Figure 4.4.7: Photograph showing front façade of eh Young Vic at evening time. Author: Richard Bryant

The Young Vic Theatre is a spin-off from the nearby Old Vic Theatres. The original theatre was designed by Bill Howell in 1970; he took into consideration the protection of the Old Butcher's shop that survived a bombing just after the war, which he incorporated into the design. The building was then refurbished in the 1990's by John Pawson. He did not see the theatre for what is was and wanted to redesign the theatre again (Rob, 2001:64). Then in 2003 Haworth Tomkins was appointed as architect for the refurbishment. He worked closely with the theatre's director, David Lan, to refurbish the building by 2006. Tomkins took the theatre's history into account in his design.

The **make-shift character of the building** became its defining attribute. Haworth Tomkins tried to **retain this informal atmosphere** in his design. The newest Vic Theatre still gives the impression of an **adhoc collection of existing elements that are held together through the innovation and use of new materials** that maintain the desired character.

The refurbishment was carried out because of the expanding artistic programme and the terminally decaying fabric. The idea behind the design was to remain true to the original ideals of the theatre, but also to **expand the artistic capabilities and to reframe the Young Vic for use by the next generation**. The new design was not to create a new alienating theatre but to **take the existing theatre and turn it into a more functional space**. In this way the character of the building is maintained and the building can retain its original identity (Rob, 2001:64).



Figure 4.4.8: Interior view showing the combination of new and existing elements. Author Philip Vile

Facilities:

- The main house: auditorium with a thrust stage that seats about 500 people depending on the theatre configuration (stage);
- Two smaller theatres, namely:
 - The Maria: seats about 150 people; and
 - The Clare: seats about 70 people.

All three theatres have flexible seating configurations that can be changed to suit the production design. In all the theatres the seating is unreserved and the actors perform in close proximity to the audience.



Figure 4.4.9: The black box theatre configured in a Catwalk layout (The Young Vic Theatre). Author: Richard Bryant

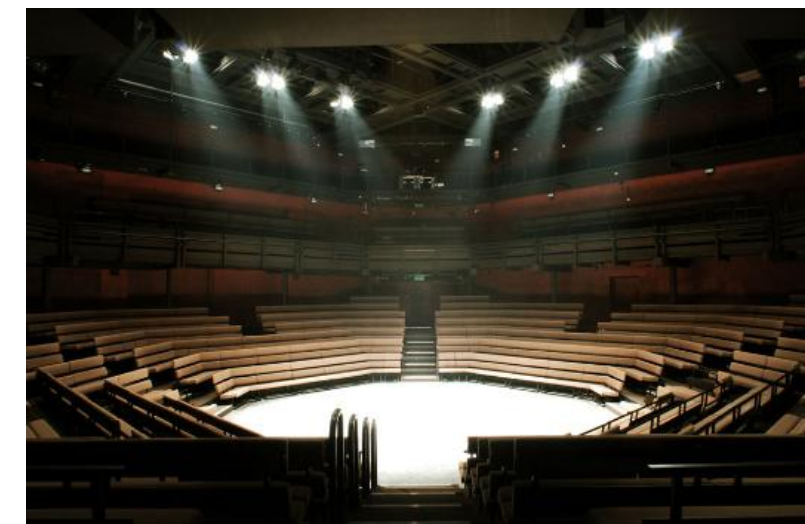


Figure 4.4.10: Black box theatre in Theatre in the Round configuration (The Young Vic Theatre). Author: Richard Brvant

The original auditorium was a great success, but circulation around the auditorium was limited. The theatre was also not of sufficient working height and, because of its rigid shape, the space was restrictive of the idea of transition into surreal.

The adapted auditorium retains much of the old fabric, but **adds a new layer of circulation and entrance, as well as raising the height with a new lighting grid**. The theatre also provides a moveable wall and a

demountable gallery into a large workshop so that a thrust stage can break the linearity of the space.

- The butchers' shop has been retained as the main entrance to the building and the box office; and
- The remainder of the 1970's structure has been rebuilt to house the foyers, dressing rooms, two studio theatres and work spaces.

These support spaces and smaller studios are housed in an enveloping concrete block work skin at the back of the site.

The new public foyer is expressed as an informal, lightweight timber and steel structure that covers the courtyard formed by the principal performance studio and the Butcher's shop. This creates lightness and a double volume in the foyer.



Figure 4.4.11: interior of foyer showing new and existing elements. Author Phili Vile



Figure 4.4.12: Interior of foyer with inserted timber, glass and steel structure. Author: Richard Bryant

There are many potential entrance points into the theatre but, entrances are purposefully made through the foyer. **The materials used on the interior are basic and the detailing is informal to suite the provisional low cost aesthetic. The public and private spaces are made to overlap so as to allow for many patterns of use** (Rob, 2001:65).

This creates a number of different possibilities for arrival, circulation and leave-taking. The membrane between the traditional front-of-house and back-of-house areas is as permeable as possible so that the sense of a working creative environment can be felt in the entire environment [fig. 4.4.13].



Figure 4.4.13: Membrane between service spaces and public spaces. Author Philip Vile

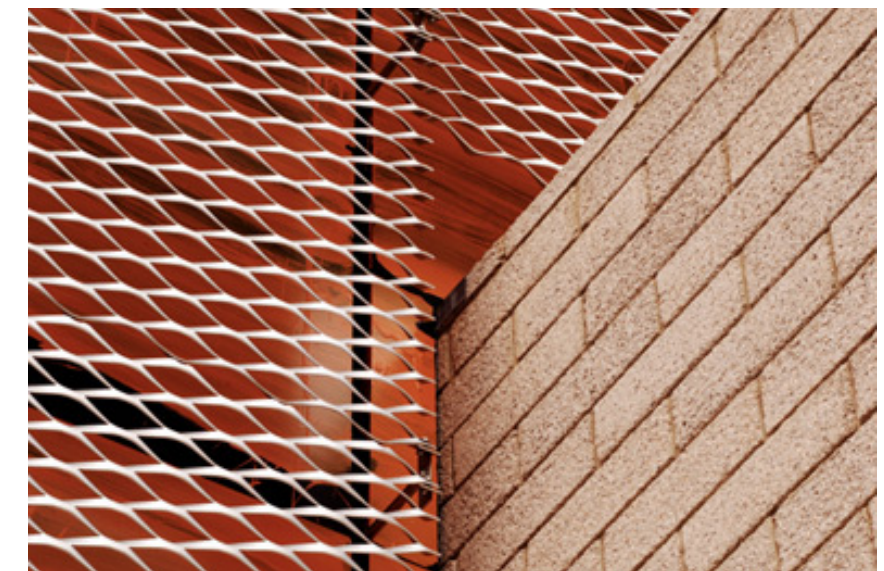


Figure 4.4.14: Daytime view of the exterior

Figure 4.4.15: Evening view of the exterior

Figure 4.4.16: Night time view of the theatre exterior

Figure 4.4.17: Photograph showing the detail of the cladding

The new signboard for the theatre is the cladding of the Auditorium. Hand painted cement-board panels faced by a steel mesh that **appears coppery during the day and is illuminated from the bottom at night** to give the Young Vic an industrial theatricality; this strongly differentiates the daytime at the theatre from the night.

The context of the Young Vic Theatre has changed from urban to high street, but this did not mean that the theatre has had to adopt a new identity; instead it responded appropriately by opening up the facades to the street and signage on the facades making it look more commercial, yet still keeping its personality. The street face has been respectfully treated by salvaging the old Butcher's, but also the tiling and use of signage on the existing auditorium façades that have been re-clad. The new large studio theatre is texturally related to the auditorium by the use of a similarly scaled "weave" of dark profiled brick (Rob, 2001:66).

The architects did not want to create an iconic singular monolith; instead it is a series of buildings.

The form and closeness of these elements work hard to produce an intensity of activity that extends the original theatres character past its boundary. **The Young Vic Theatre uses its symbolism to create a consistency and integrity with the users and the context.**



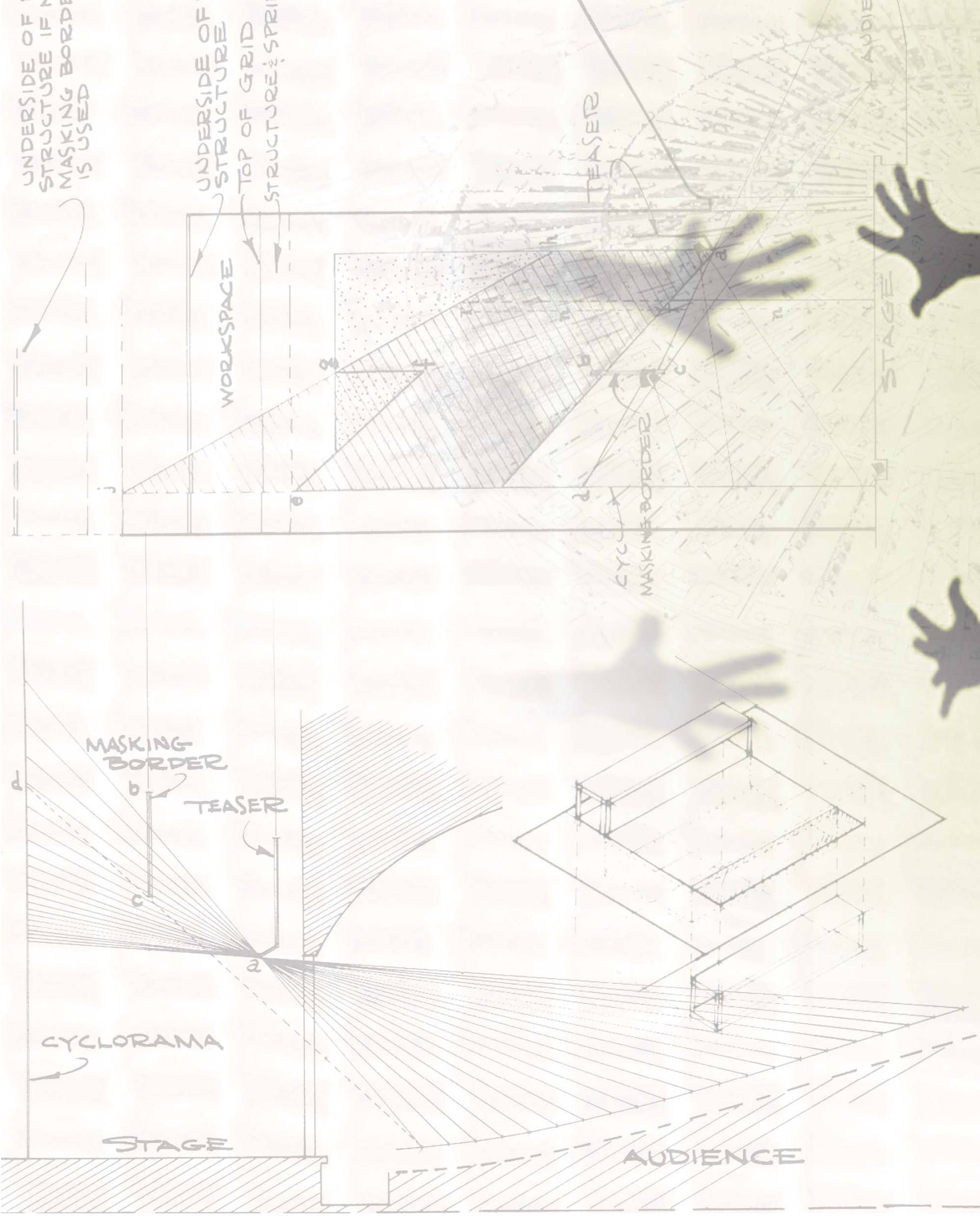
Figure 4.4.18: Exterior of theatre



Figure 4.4.19: interior view of entrance and foyer



Figure 4.4.20: interior view gallery above foyer



05 | DESIGN DISCOURSE

5.1 THE USER GROUP

The viewer

The viewer is the non-arts students who have been invited, or spontaneously come across the Precinct from passing through. Everything they see or hear is an educational experience. What they see is not a foreign object in the landscape, but an integrated entity within the functional space. Not only will they view, but will also participate.

The users are:

- Students from other faculties;
- Invited task-orientated guests;
- Guests/ groups using the venue to view specific performances/talks/ and/or coming in to learn;
- Spaces that are rented; and
- The general public coming for special performances.

The Drama Scholar

Within the Precinct, every space is either a learning, rehearsal (process) or exhibition space for the drama student.

The spaces will allow the student to be educated at an optimum level with regards to facilities. The spaces are designed for utilisation, exploration, education and research through performing. Spaces will be specifically dedicated to the students' education. Rehearsal spaces will be integrated within the buildings and the landscape.

The people using the spaces in this category are:

- Students of the Dramatic Arts Faculty;
- Lecturers; and
- Guests.

(Refer to Appendix 2 for Accommodation Schedule)

5.2 DESIGN INTERVENTION

In order to design a viable Dramatic Arts Precinct the design should consider the needs of both the user and the visitor. In addition to this, the **main criteria used in the design** decision making of the interior space should be **applied to both the landscape and the architectural interventions** in order to make the Precinct a unified space.

The Drama building and Die Masker are to be used as a basis point for further development. Die Bok and Die Lier require major redevelopment, as the proposed changes require greater architectural intervention than interior intervention.

5.3 PRECINCT DEVELOPMENT

As a starting point for creating the Precinct, the design investigation began with an analysis into the existing spaces and routes of circulation. This aids in designing to increase the pedestrian movement over the site [fig 5.1.2]. Furthermore, the relationship between the buildings and their surroundings is enriched. Another design factor explored is how to incorporate the theatrical education into the landscape without it seeming imposing; this involves taking the existing buildings and restructuring them to communicate with the external space and each other.

From this, the preliminary conceptual layout is derived and refined to develop the interior of the chosen building to which the interior intervention would be explored to detail level. The other spaces, the Drama Building and Die Lier are designed to a specific level. Die Lier is conceptually designed to communicate what functions it would house and how it creates a boundary that would act as a pocket for performance for the Precinct, and the basic layout of the Drama Building is designed to proposal level.

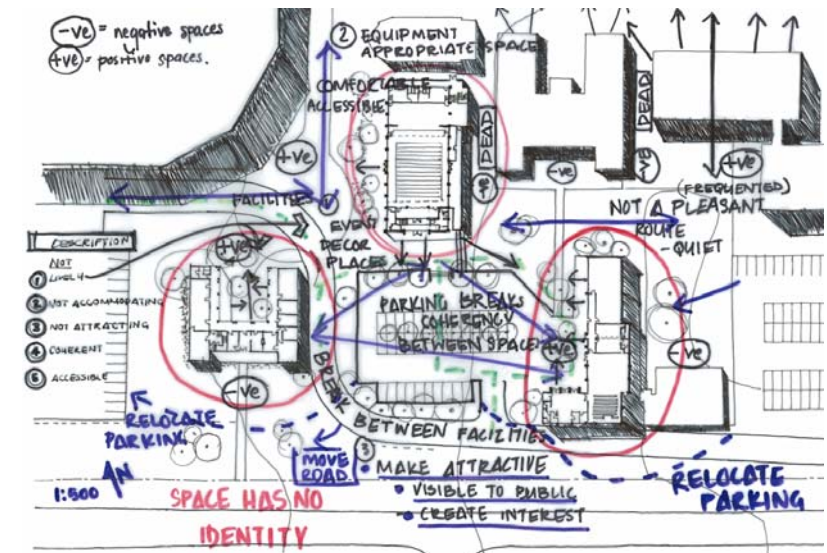


Figure 5.1.1: Spatial analysis with pedestrian paths and building relation analysis.

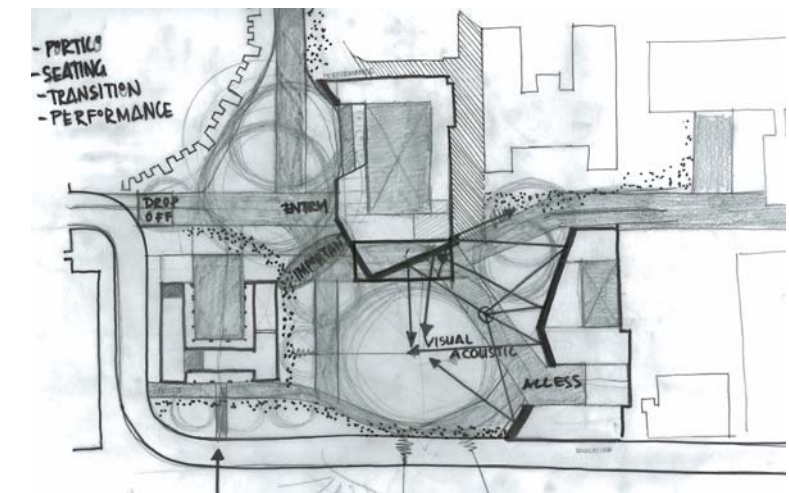


Figure 5.1.2: Edge configuration and social space configuration with pathways increasing pedestrian access.

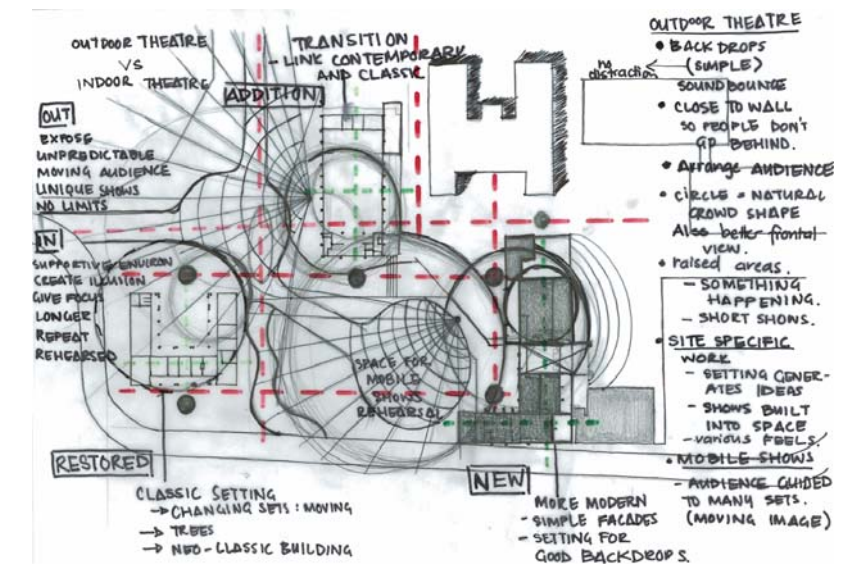


Figure 5.1.3: Identification of external and internal performance spaces that link interior to the exterior.

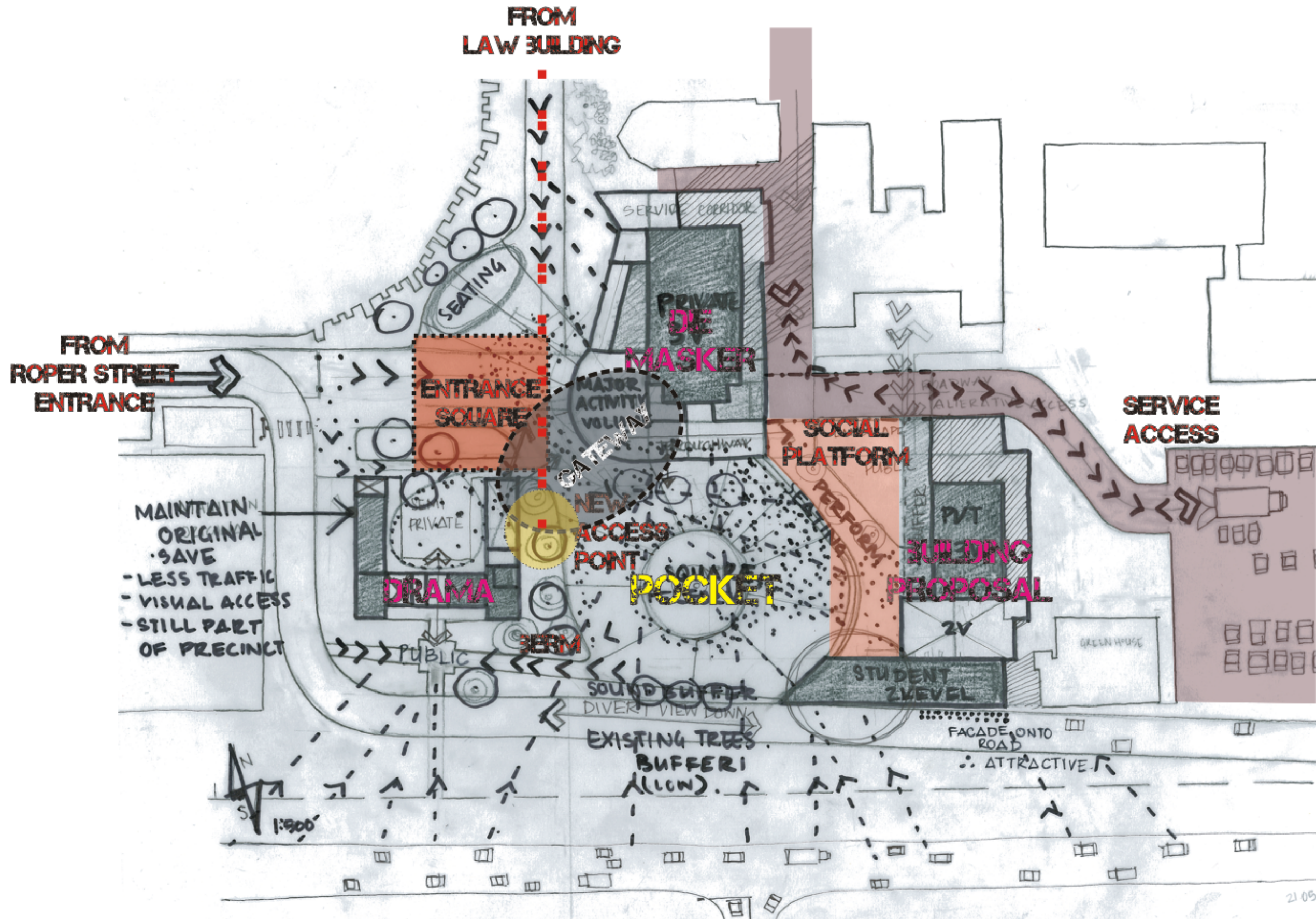


Figure 5.1.4: Sketch of conceptual site development with access paths, service passages, public areas, and building relation.

5.4 SITE DEVELOPMENT

It was decided that the piece of the Ring Road that cuts through the site, separating the Drama Building from the other buildings is proposed to be moved to circulate around the western side of the Drama building. This allows for cohesion of the entire space. The parking from the centre of the site the middle is relocated along the new roadway as well as to the existing adjacent parking areas to supply for sufficient parking for staff and visitors. It is assumed from the proposed framework for the University that these parking spaces are going to be developed to provide a structured parking system.

With these alterations the access of vehicles would be restricted, thereby allowing for an increase of interaction space, a square for performance. It acts as the central point where pedestrian paths from within the campus converge. This space is enveloped by the existing buildings that act as the edges for the space. The buildings would be developed to respond to each other around a common space [fig. 5.1.3].

The fourth edge of the square is a natural boundary that is determined by the row of existing trees that separate the space from the Ring Road. This un-built barrier allows for visual access from the Ring Road as well as from Lynwood Road. It creates the opportunity to design a landscaped square that encourages interest from the public in transit. This layer of existing trees functions as a buffer between the street and the contained space, differentiating the “exterior” space from the “interior” space. The trees also create a sound barrier allowing for the space to be intimate yet still public [Fig. 5.1.4].

The conceptual design of the landscape included the theoretical idea of transition from reality to an abstracted space. This occurs in the transition of the

pedestrian from the public realm into the performance realm. The pedestrian paths all converge at the point where the Ring Road is to be removed, the space between the Drama Building and the western façade of Die Masker. This would be a public entranceway into the main space. This “entrance square” allows for easy circulation into the Drama Building from the Ring Road as well as from the intersection pedestrian paths. The convergence point is located at a focal point seen just off the entry into the University’s main entrance. This space can be seen from the western end of the Ring Road, therefore it lends itself to great possibilities.

From that entry point circulation into the square is aided by means of an unseen gateway. The two buildings; the Drama Building and Die Masker, create the visual access from the entry point by opening up their interior spaces into the landscape. This creates a certain sense of accessibility into each building.

The main square forms a pocket for performance, rehearsal, and social interaction. No specific landscape design is proposed but a conceptual proposal is made with regard to what the design should entail. The square should allow for various performances as well as rehearsals to take place using platform areas and focal points.

In this square the planted areas are to be retained because it creates a buffer between the road and the Precinct as well as supplying protection to the Drama Building by decreasing the pedestrian movement on the south side as well as in the courtyard. The planted area would be retained as a grassed landscape that could act as both a seating area looking into the square, but also as a backdrop to the assemblage of temporary stage set in the square.

Where the landscaped edge intersects the Drama Building is where the new access point into the

building is from the square. This point links the building directly into the square. It is a pivotal point of intersection in the design because this is where the pedestrian path from the Law Building ends, thus creating an end of the north-south axis, between the Law Building and the Drama Precinct [fig. 5.1.4].

Directly across the landscaped area is another focal point embedded in the heart of the performance pocket. It is proposed to be situated where the paths from Die Masker and the new building converge. This gives rise to an opportunity for outdoor performance to take place. The idea is to have a permanent meeting point built between the three buildings in that area, creating a public platform and meeting space. When needed, the platform could be used as a stage, using the new building as a backdrop, and it can be rigged for performances.

Service passages are necessary to feed equipment such as props, scenery and costumes into the precinct. This equipment should be transported with ease from the vehicle to the service spaces. It is made possible by creating a link from the parking behind the new Die Lier building into the site which feeds into the service passage between Die Masker and the Visitor’s Administration building [fig. 5.1.4].

There is no particular detail design for the square, but the conceptual intention is to design the space in such a way that it would facilitate for any configuration of performances: be it an end stage, an arena stage, or even a thrust stage. The landscape should be designed to create spaces of opportunity, where the students can rehearse outdoors. All the spaces become possible site specific stage sets, thus linking performance into the landscape. With this type of vibrancy and interaction the site starts functioning as a unified space.

5.5 THE ARCHITECTURAL LANGUAGE

The proposed Dramatic Arts Precinct is located on the boundary of the University and the suburb of Brooklyn. Around the Drama Precinct, the surrounding buildings form recesses that create areas for social opportunity. The buildings present a range of historical styles. Similarly, the architecture on the chosen site for the Drama Precinct varies in stylistic context. The contemporary architectural language of the re-design of what will be the Drama Precinct is in contrast to the existing context. This is in terms of its materials and form as the intervention seeks to place itself firmly in the present day.

The aim of the Precinct is to expose the Drama Department and its activities to the public by integrating the internal functions into the landscape. The language between the buildings then becomes a crucial matter if they are to make the space perform as a single entity. Each building needs to be approached individually because of its particular significance and history, but the language of the new needs to have commonalities that show that the space works as one.

5.6 BUILDING DEVELOPMENT

DIE LIER:

The idea is to use similar contemporary building language between the three buildings based on materials used and a similar architectural language in the specified interventions. The new building would be used to define the eastern edge of the Precinct. The current building is insufficient in space and volume to suite the required needs for dramatic rehearsal and performance; therefore a new architectural intervention is required to enrich and complete the Precinct. The building is described to envelope the facilities that the current Drama department shares with other faculties, such as rehearsal spaces and studios.

The proposed new building would be designed for high public and student use by supplying spaces such as a new smaller multi-purpose theatre, movement and

rehearsal studios, an exhibition space, a coffee shop and spaces where the drama students can rehearse after hours in safety with access to amenities such as change rooms and a kitchenette.

The building would open up its western facade directly into the square which creates for direct access and movement onto the square. The entrance point would be the link between the buildings due to their proposed location, which would create a visual intersection point in the square between the three buildings. The proposed building volumes are recommended for a design. The platform would link Die Lier and Die Masker by creating for a large purpose made meeting space and stage area. The coffee shop and new entrance lead directly onto this platform which is also the access point for the existing building adjacent to Die Masker, which houses lecture halls currently used by the Drama Department.

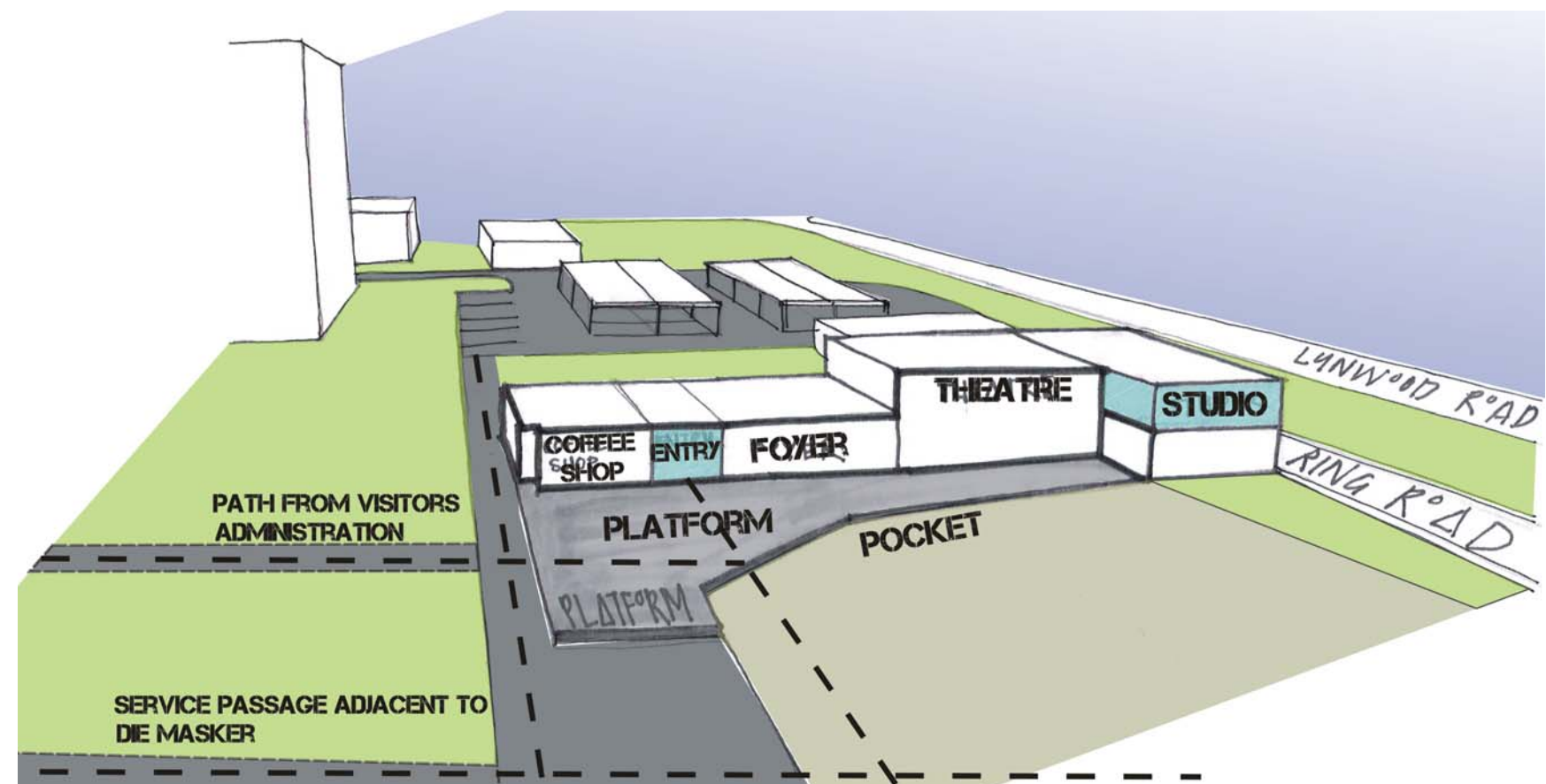


Figure 5.1.5 Concept development of the proposed new building for the Precinct.

DRAMA BUILDING:

The Drama Building is the oldest building in the Precinct; the design developed has to be dealt with in a certain manner in order not to disrupt the integrity of the existing fabric due to its heritage status (see appendix 1). The design proposal for the Drama building, or Old CBC, maintains most of the important original external aesthetic. The southern façade is restored to its original state taking into consideration its proportions.

The building is protected by means of restricting public movement through the spaces. It is designed to house facilities that are mainly staff and drama-student oriented, such as smaller rehearsal areas that double as classrooms, seminar rooms, media facilities, recording studios and staff facilities. The upper level is to be restricted to staff and students utilising the film studios and the voice facilities and offices. Access to the upper level is separated from the main circulation for this reason. In order to accommodate disabled users, as well as the transportation of equipment, a lift is to be installed.

The proposed design is based on the concept that theatre can be both internal and external; therefore the space within the courtyard is designed to accommodate performances *sketch*. This space breaks out from its confined structure into the main square, creating the new access point into the building. This breaks the eastern wing open to the public.

The ground floor is designed for student use with rehearsal rooms and/or classrooms, a recording studio and discussion rooms. These allow for a constant use of the space, creating vibrancy within the building and the landscape. The courtyard and the new entrance are designed with a tensile structure that breaks out from within the courtyard into the main square. The courtyard remains somewhat contained from the

entrance pathway by means of retaining the existing trees *[fig]*. This relates to the building and planted space across the main walkway. The courtyard space still feels intimate and retains its natural acoustic properties. In essence the building becomes lighter and movement through it is easier as it links easily to the surrounding spaces.

The design does not harm the existing building; rather, the new elements are lightly attached to the old structure in a contemporary fashion that breaks away from the rigid form of the existing. Certain internal walls are reconfigured, and the removed wall's memories are retained through retaining the watermark at floor level *[fig]*. Many of the new elements of the interior are inserted and attached to the existing structure, such as the sliding stacking doors and the lighting grid systems in the rehearsal rooms.

These spaces have been designed with the black box theatre in mind. The space is adaptable by the use of moveable elements within the space. The classrooms have been designed to be reconfigured using sliding stacking doors. These panels can be used as separators of space, backdrops, and projection screens. The room is divided into a space with lighting grid structures lightly attached to the existing soffit, this would allow for the space to be separated into various spaces and used for a variety of training and rehearsal activities. There are glass box seminar rooms inserted into the larger open spaces *[fig]*, and facilities such as projection screens and lighting are lightly hung from the existing interior. The finishes are to be simple and light in order to maintain simplicity to the space to maintain a simple austere integrity to that of the Christian Brothers College.

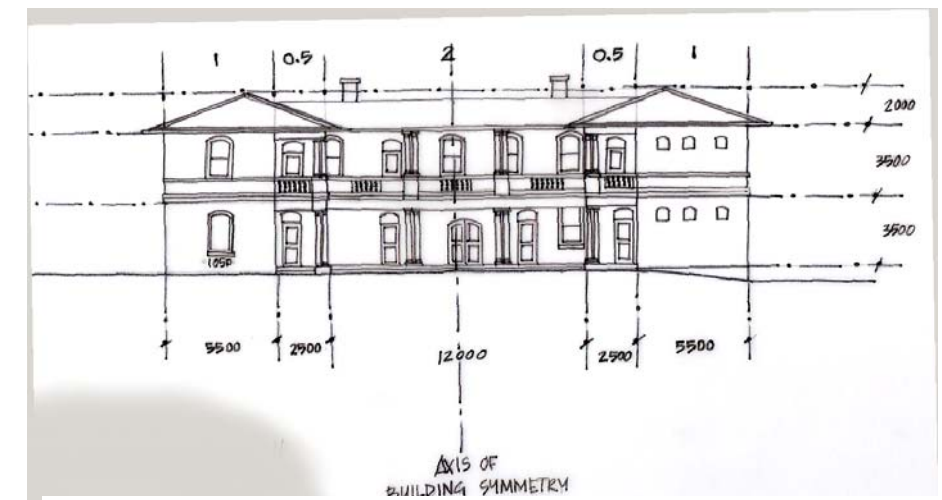


Figure 5.1.6: Sketch diagram of the proportions of the classical Drama Building.

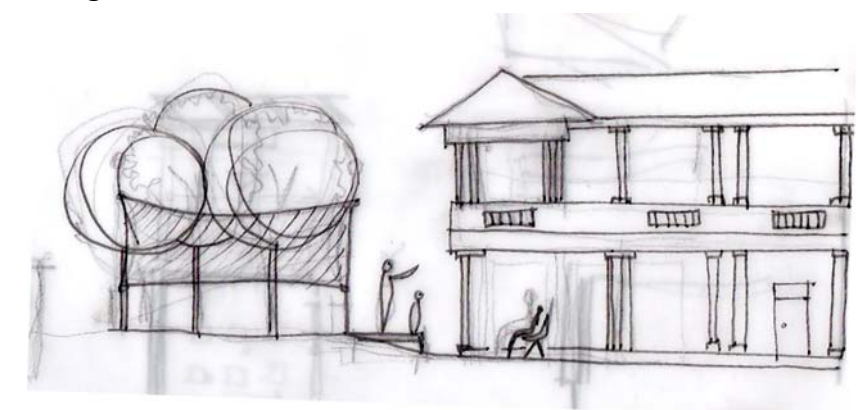


Figure 5.1.7: Sketch of outdoor performance in the courtyard

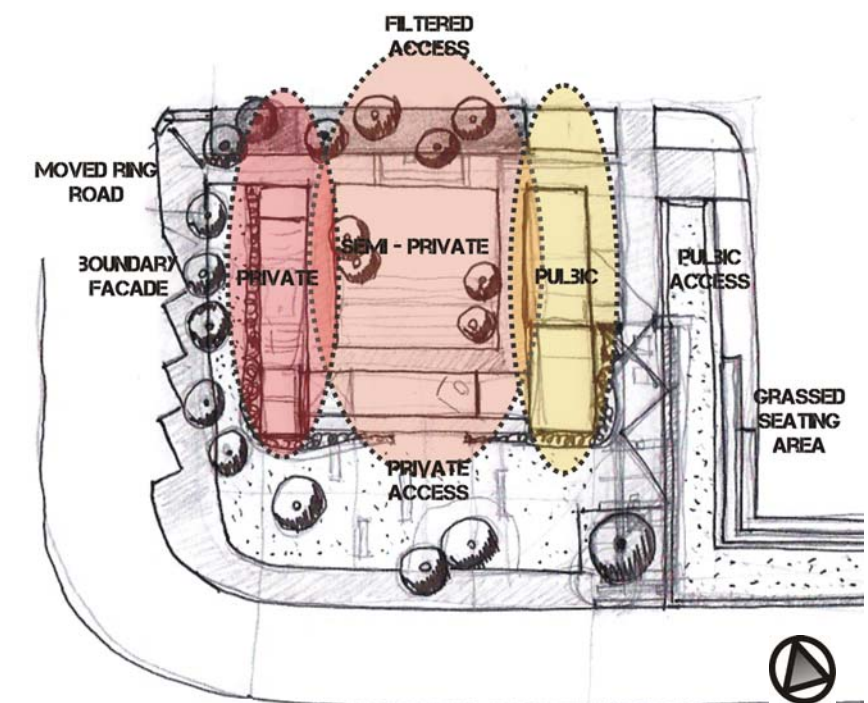


Figure 5.1.8: Sketch diagram of the Drama Building showing move from public to private spaces.

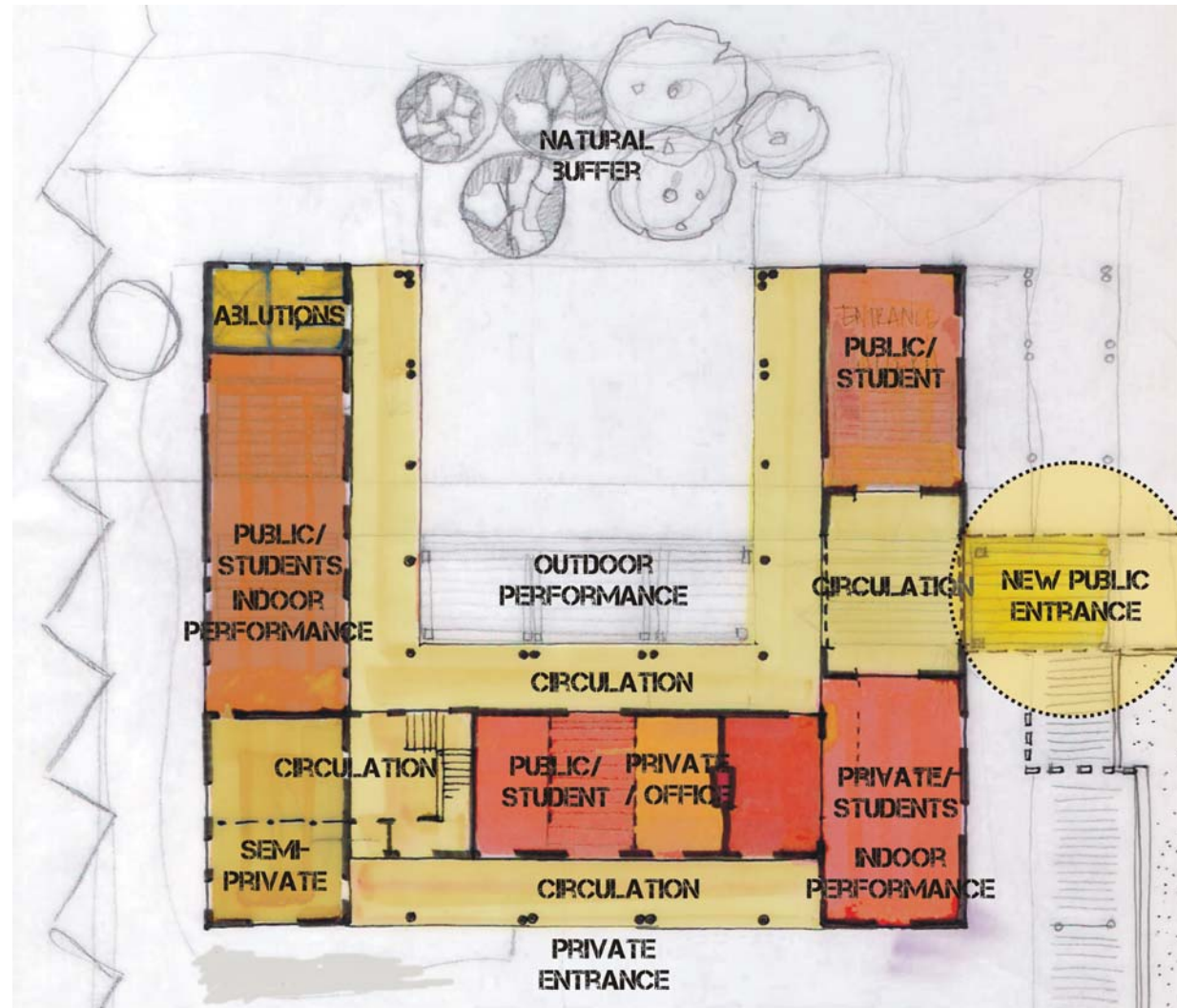


Figure 5.1.9: Spatial configuration sketch of the ground floor of the Drama Building.

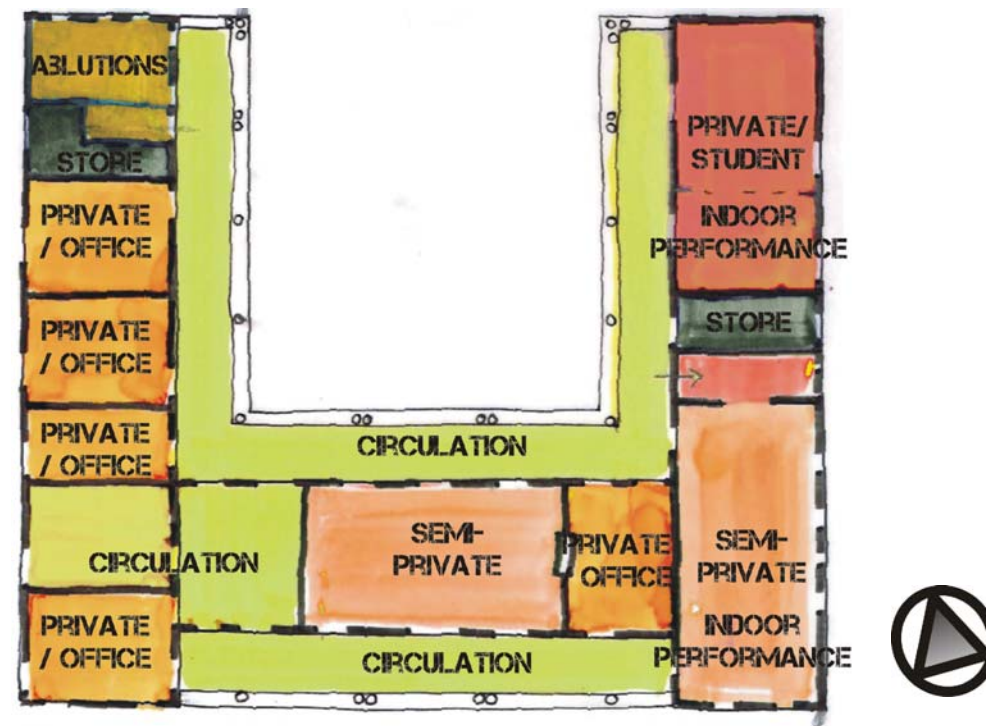


Figure 5.1.10: Spatial configuration sketch of the first floor of the Drama Building.

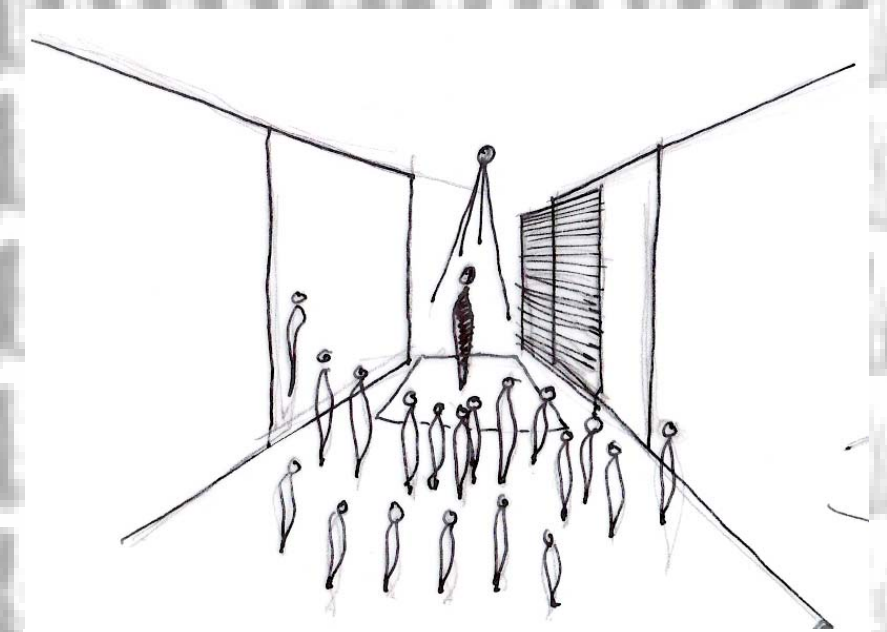


Figure 5.1.11: Concept sketch of the convertible classroom used for performance.

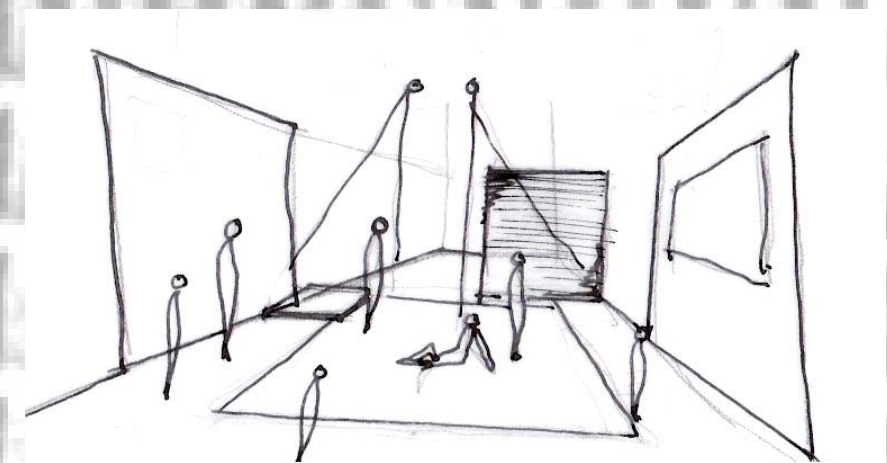


Figure 5.1.12: Concept sketch of the convertible classroom used for rehearsal.

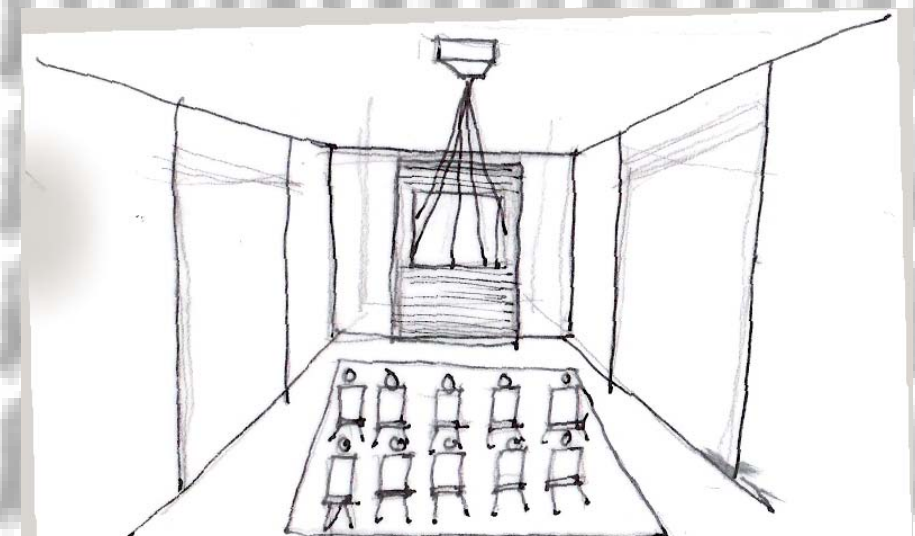


Figure 5.1.13: Concept sketch of the convertible classroom used for education.

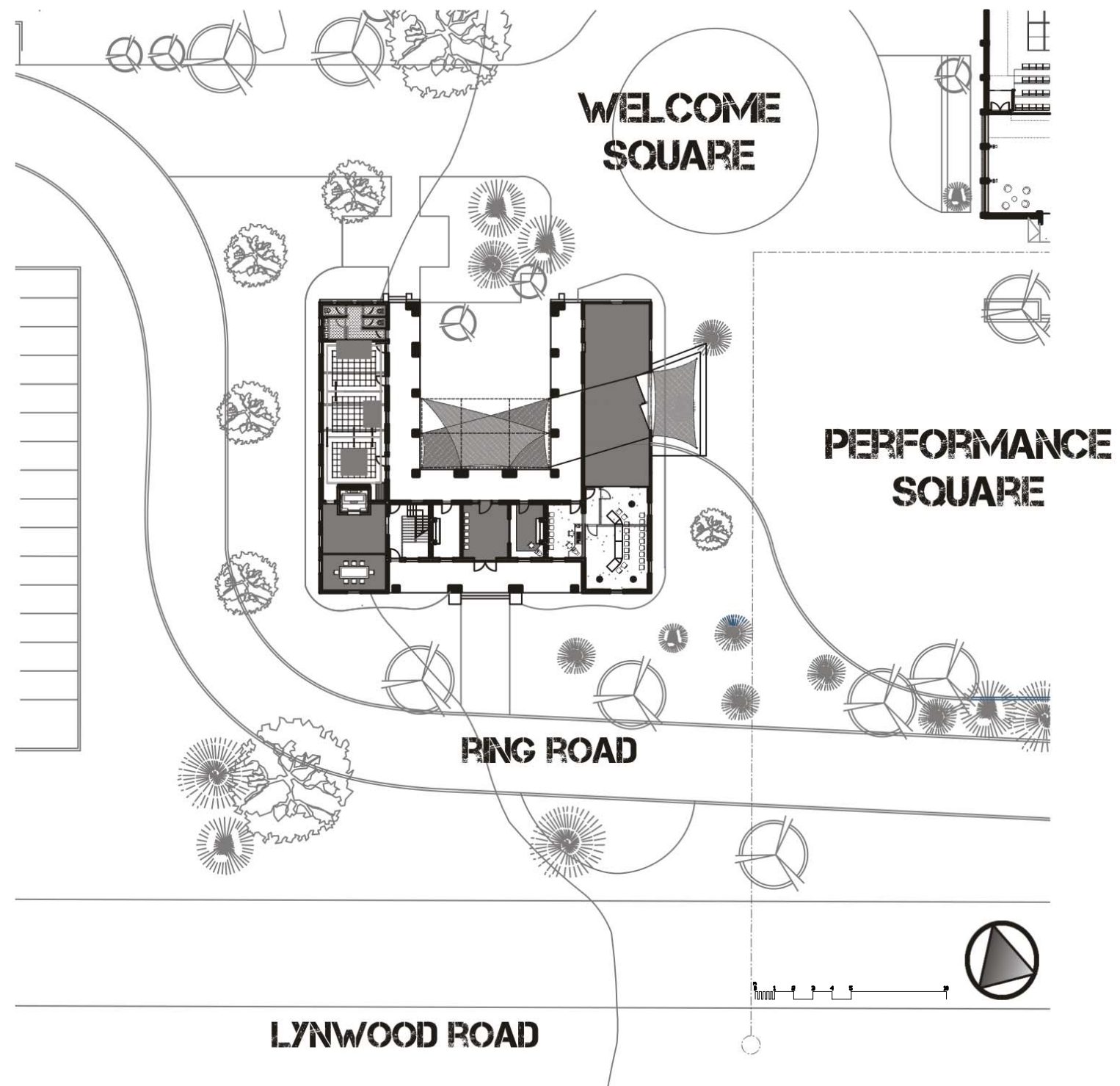


Figure 5.1.14: Site plan for the proposed design of the Drama Building. Chita M

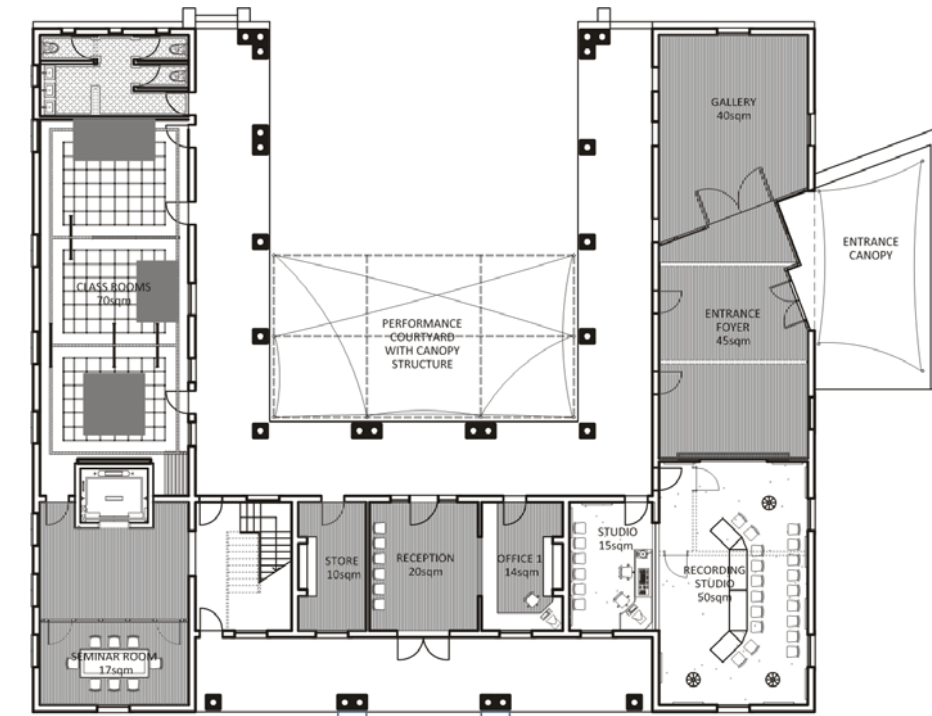


Figure 5.1.15: Ground floor plan design for the Drama Building.

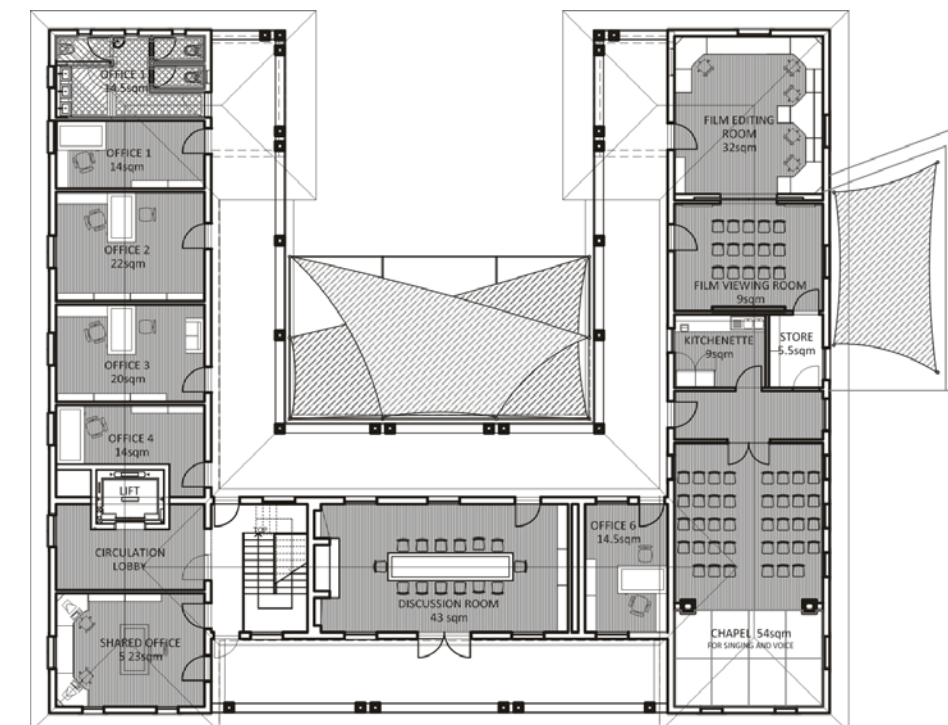


Figure 5.1.16: First floor plan design for the Drama Building.



DIE MASKER:

Die Masker theatre is the focus design intervention of the project. The building has to be treated specifically in order to maintain its existing structure due to its historic background. The idea behind Die Masker is to be a functional iconic building that allows for the education and performance of the many forms of theatre, current and historical. The essence of Die Masker's intervention basically encapsulates the ideas and criteria to which the rest of the Precinct has been designed. It plays the architectural link between the old and the new

Die Masker is a converted school hall (c.f. Context study chapter two). The additions were comprised of a service passage along the east façade, which is to be demolished as it is too small and is subsequently dysfunctional [fig.]. Additionally, internal equipment such as rostra, the light bridges, the lighting rigs and the curtains over the walls in the theatre were installed around the same time (c.f. Technical drawings chapter seven). The concepts investigated in the re-design of Die Masker were determined by a comparison of the theatres and auditoriums available on campus, as well as the form required for the theatre to function efficiently as a tool for drama education.

5.7 DESIGN CONCEPT

Typically theatre design is concerned with both with the performer and the spectator. Traditionally each has had specific spaces demarcated for them during the performance. For the entertainer, it moves from the rehearsal area, to the preparation area and finally to the performance area. From the onset, the spectator is detached from the performer. Even during the performance, they passively view the show from beyond the proscenium.

The approach to the design of a Drama Precinct seeks to challenge traditional notions of performance (c.f. Theory Chapter three). Die Masker's re-design breaks away from the notion of passive performance. Due to its context within an institute of learning, the aim of the re-designed theatre is to create an integrated space that focuses on education as well as performance. It is based on the hypothesis that a transfer of knowledge can be assisted by interaction and invited observation to actions that are normally concealed (c.f. Theory Chapter three). It is for this reason that the format of the proscenium arch has been discarded in the theatre design as the primary stage set.

Furthermore, dramatic arts training and performance is rapidly evolving and to be considered progressive, the theatre should allow for a multitude of training practises and methods (c.f. Theory Chapter three). This allows for maximum exploration and flexibility and therefore produces actors that constantly push the boundaries of the space. The existing spatial configuration and orientation of the building is derived from configurations used regularly in theatres. Die Masker theatre is the second of the three buildings of the Drama Precinct, which form boundaries that frame the central public square

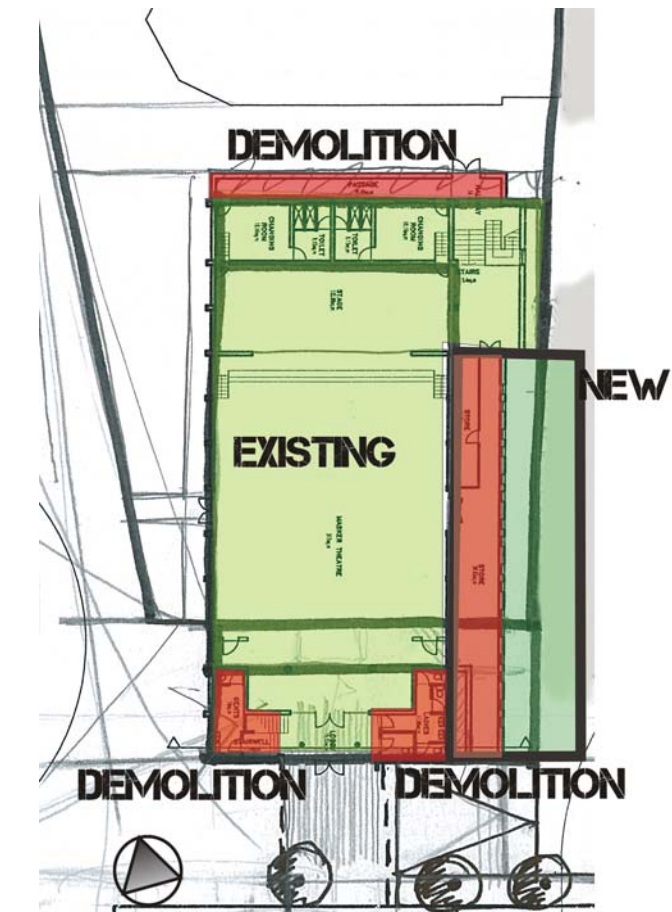


Figure 5.1.17: Sketch diagram of Die Maskers building development

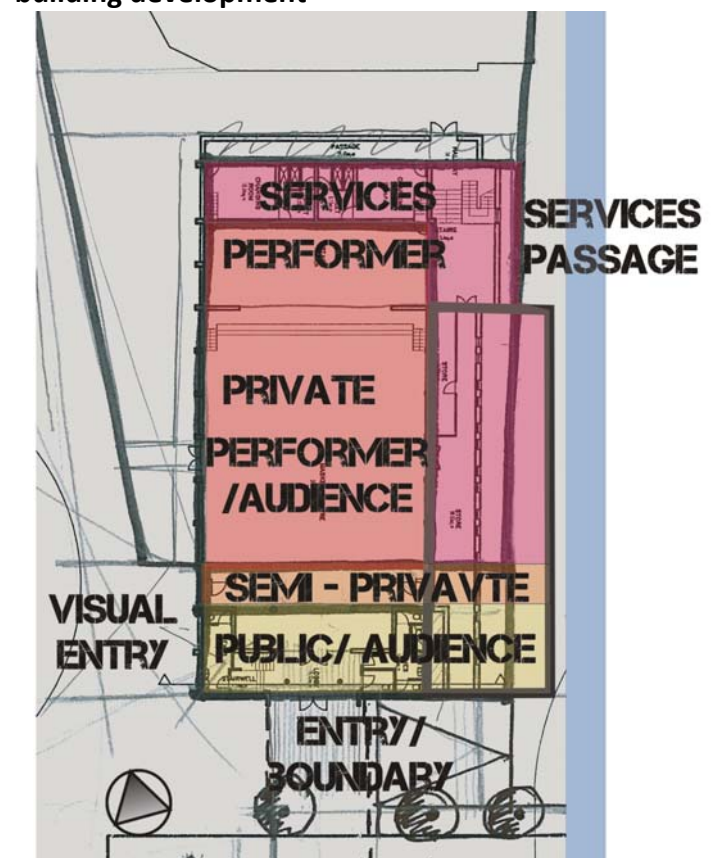


Figure 5.1.18: Concept diagram of the spatial configuration for Die Masker.

of the Drama Precinct. The southern façade of the Die Masker is the most visible of the three from Lynwood Road and the Ring Road; it is a focal point and has the potential to attract the general public. Die Masker is approached from the converging pedestrian paths on the west. It is also seen on entering the campus from Roper Street. Therefore, it plays a pivotal role in creating interest as a visual stimulus. These two façades are the points of focus that link the building to the site and create aesthetic interest, the west and the south facades.

The building is accessed from the south directly off the proposed square. In order to maintain the integrity of the existing building the south façade and the existing concrete portal frame structure are restored and maintained respectively. It is proposed that six brick infill panels (c.f. Demolition plan chapter seven) are removed from the external skin of the building to create a sense of transparency into the space and open up the building to its surroundings. The existing paint on the structure is to be stripped to reveal the natural properties of the concrete underneath. The soffit of the portal frame is to be painted a bright red to differentiate the entrance façade. The floor from within the foyer is extended to create a platform as entrance and a brushed steel canopy structure is fitted over the main entrance doors [fig. 5.1.21].

This canopy will have Die Masker Laser Cut near the long edge. Lighting that will be built into the new entrance platform will light up the canopy from below so that at night the words “Die Masker” will light up the large bricked façade; making the theatre a spectacle at night. During the day the light from above will cast a shadow in the form of “Die Masker” onto the entrance platform. The daytime image of the building is demure and inconspicuous compared to its exciting night-time demeanour and consequently the building develops a dramatic persona [fig. 5.1.19 & 20].



Figure 5.1.19: Photograph of the lighting effect of the entrance canopy during the day. Silhouette created by natural light



Figure 5.1.20: Photograph of the lighting effect of the entrance canopy during at night for performances. Silhouette created by lighting from below light.

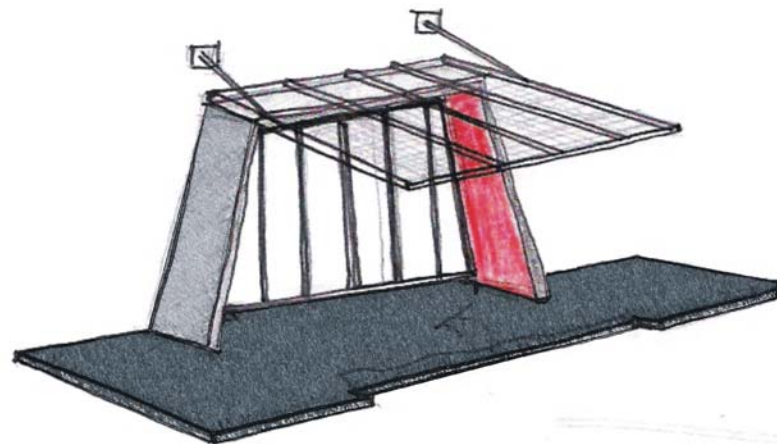


Figure 5.1.21: Sketch of the entrance canopy and existing concrete portal with internal soffit painted red.

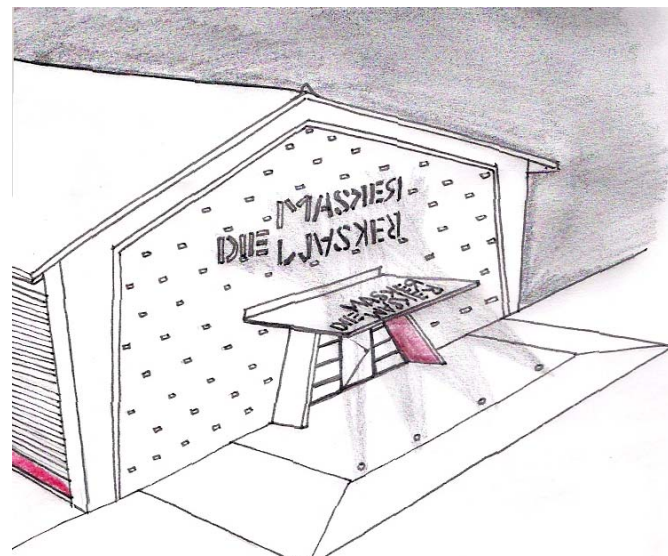


Figure 5.1.22: Sketch of existing south façade with new entrance.

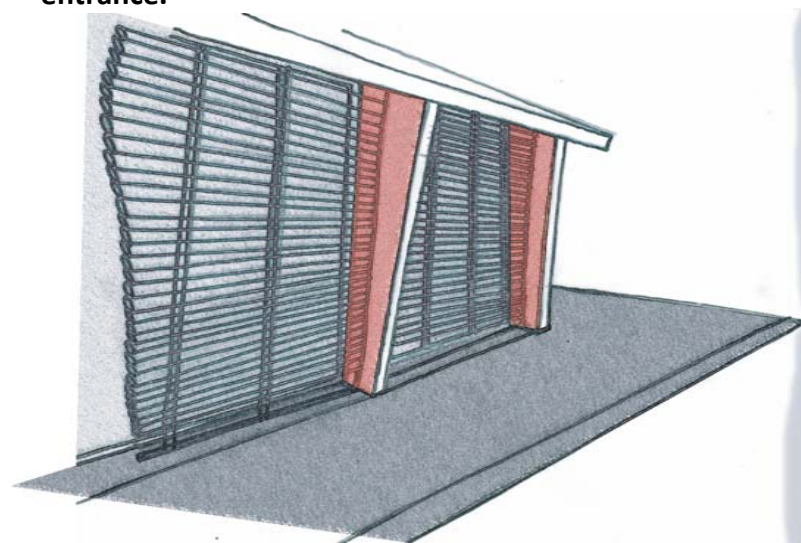


Figure 5.1.23: Sketch of louvre system on the western façade. With concrete frames painted red to create a focal point.

On the west façade, the intervention proposes the removal of the walls and brise soleil that screens the interior where one set of ablutions is currently located. The two brick panels next to that are also removed. These voids will then be fitted with glazing to create a sense of visual access into the building. The concrete portal frames where the glazing has been placed, will be painted the same bright red as the soffit of the entrance portal to differentiate the space and create a focal point showing both physical and visual access. The new glazed portions on the west are to be fitted with an aluminium computer controlled louver system, which reacts to daylight angles and opens and closes accordingly to maintain a comfortable internal environment [fig. 5.1.23]. The louvers are visible from the Roper Street entrance and are to be screen printed with a single image on each panel, so when they are open, the image is unseen, but when they are closed the images are revealed, thereby adding interest to the façade and becoming a focal point on entry into the “welcome square” [c.f. Tech drawings, west elevation west, chapter seven].

The remaining portion of the west façade will be altered by the removal of the window frames. The openings will be bricked up with concrete blocks [c.f. Demolition plans, chapter seven]. These sections of the wall will be fitted with hand-painted cement board panels and faced by a steel mesh that appears metallic during the day and is illuminated from below at night.

The north façade will be restored back to its original state. This will expose the ablution pipes from below, but as the north façade is one of two service passages, it will not be in public view. The removal of the structure will also allow for the windows into the existing change rooms to be exposed, aiding day-lighting and ventilation.

The east façade shows the addition of a new structure that grows out of the existing structure. The addition is a light steel, glass and concrete block extension that houses the two facilities. The extension is extended far enough into the service passage to retain a gap of five meters between itself and the Visitor’s Administration Building. The extension is a steel structure with concrete block walls nearer to the north façade. This is a double volume area that is fitted with a platform and a ramp that leads up to the receiving doors near the stage access. This is because the receiving door has to be at stage height (800mm above finished floor level). There are two service doors that lead onto the interior platform.

The block work facade is bag-washed and painted dark grey. This wall finish continues towards the south and terminates when it collides with the protruding dance studio. The studio space is extruded from above. There is a 3.5m walkway below a red aluminum-clad dance studio.

[Sketch of east façade]

The dance studio has a glazed section that wraps around to the south façade to create visual access into the space from the square and the proposed building. The height of the adjacent existing building casts a shadow onto the east façade and functions as solar control in the mornings. It is therefore unnecessary to have a shading system on this side. For that reason, the design intervention takes the opportunity to create visual stimulus using an extensive glazed system over the entire east side of the rehearsal studio.

An accentuated part of the extension is a light glass box that houses the new staircase and elevator.

[C.f. plans and elevations, chapter seven]

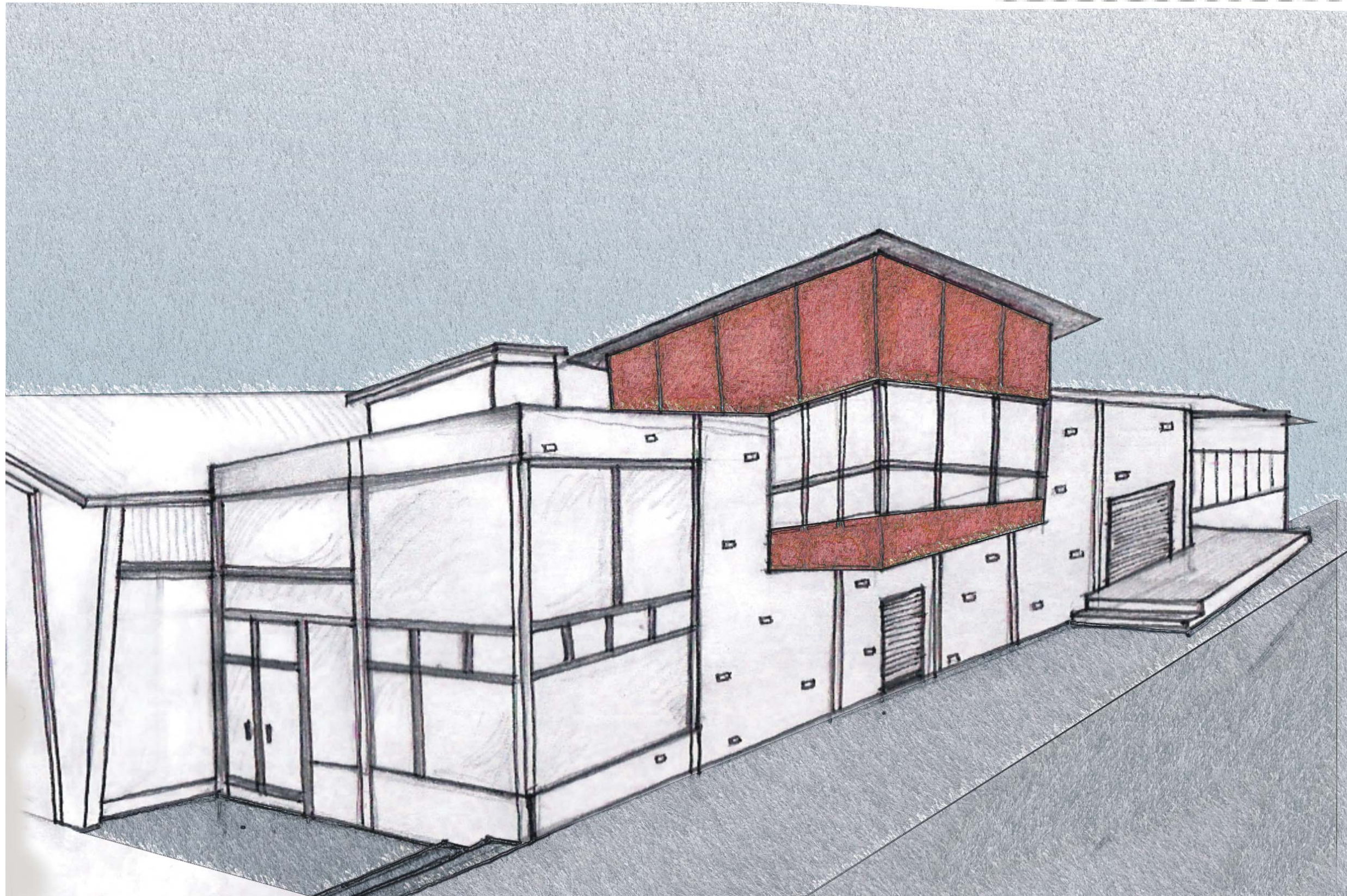


Figure 5.1.24: Sketch perspective of the new addition on the east of the existing Masker Building.

5.8 INTERIOR

Zoning of the spaces:

Hierarchical zones of use have been determined through the building. They relate to the spectator and the performer and move from public, extroverted spaces to private, introverted spaces. The first zone is a public zone where the public move freely through the space. This area includes the entrance, the foyer area and service areas. This is the space that has direct correlation with the external spaces and communicates with the other 2 buildings. This represents the first stage of transition into the building [fig.5.1.18].

In the new proposal, as one enters the building from the covered main entrance, there is a double volume space created by the removal of the slab above. There is a seating area with an obelisk seating element near the new glazing on the west. On the east there is a view to the extension that looks directly onto a glass lift and timber stairwell. The foyer is a large space with a ticket box directly across the entrance. The ticket box is built in under a suspended timber and steel cable bridge that is suspended from I- beams fitted between the portal frame above. The ticket box is a permanent glazed insert with media mesh screen for signage and advertising. The ticket box houses the controls for the louvers as well as the controls for the permanent lighting rig that illuminates the foyer. The ticket box and bridge create a threshold from the public space into a semi-private space.

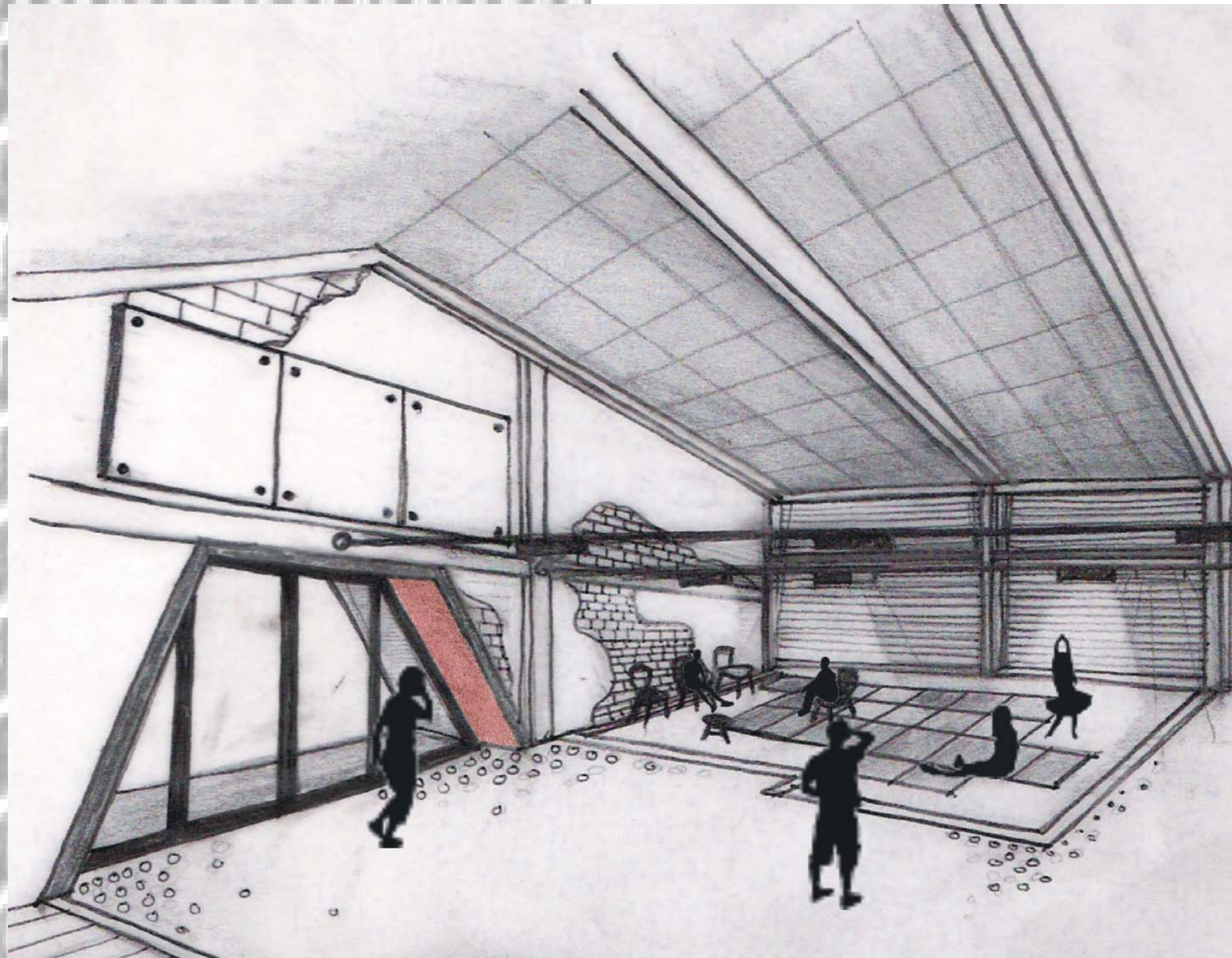
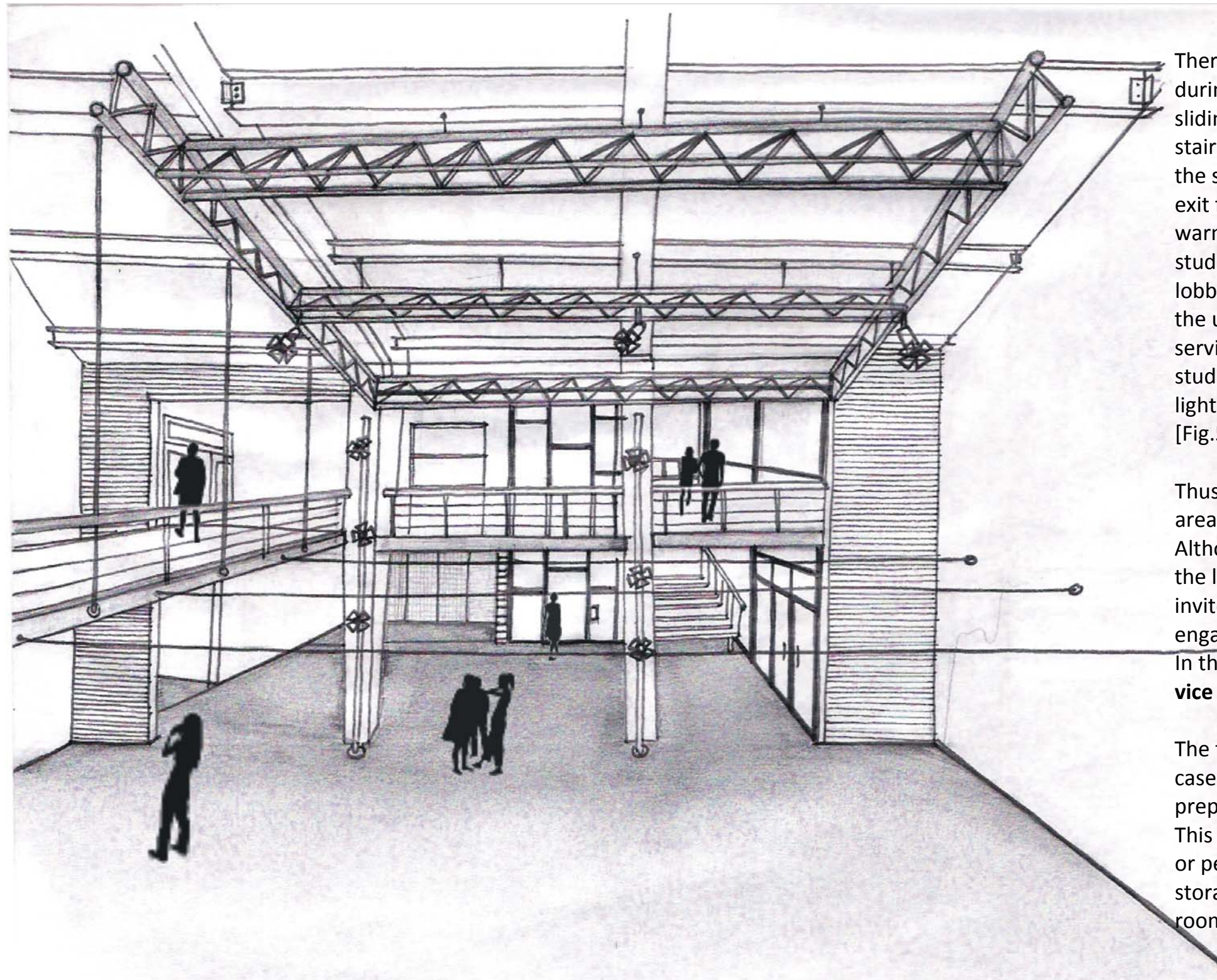


Figure 5.1.25: Sketch interior perspective of the foyer, looking at the new louvered glazing panels and seating area.



There is a small kitchenette that doubles as a tuck-shop during performance hours; this is done by means of sliding stacking doors that reveal a service counter. The stairwell and elevators are used by students going to the studio on the first floor. There is a lobby area on exit from the stairwell and lift, as well as a seating and warm-up space for students before they enter the studio. The light bridge can also be accessed from this lobby. Although it is clearly visible, the bridge is not for the use of the general public, because it leads to the service level within the theatre. It is intended for student and staff to access the control room and lighting rigs in the theatre.

[Fig.5.1.25]

Thus the first floor is considered as semi-public; this area acts as a threshold between students and visitors. Although the space is demarcated for drama students, the lightness and transparency of the construction invites the public and students from other faculties to engage and observe actions that are normally hidden. In this way, **the process becomes the performance and vice versa.**

The fourth and final zone is the private zone; as is the case with theatres, these are the spaces where the preparation and storage areas are; the “backstage”. This zone is the final transitional point for the student or performer. This space consists of dressing rooms, storage and receiving areas, backstage and the control room.

Figure 5.1.26: Sketch interior perspective of the foyer, looking towards the staircase and glass lift to the new mezzanine level where the dance studio can be accessed.



THE THEATRE

The theatre is the focal point of the building. Access is from two sound proof doors on either side of the ticket box in the foyer. The spectator moves through a sound lobby curtained off from the large dark theatre. The theatre has been designed to enable many forms of theatrical configurations. The rostra and existing lighting rigs and equipment have been removed. The theatre floor is level up until the stage at the end. There is a 1.5 meter wide bridge that is built along the lengths of the theatre that is of the same material as the bridge in the foyer. These bridges need to be sound absorbent in order to reduce the noise of footsteps. The bridges in the theatre extend from the new level where the control booth is located and creates access around the periphery of the theatre for maintenance and lighting. The lighting bridges and rigs have been replaced by a suspended tension grid system hung from I-beams fitted between portal frames. This new structure allows for easy access to various lighting fixtures and easy installation of lighting rigs. The tension grid is accessed via ladders from the bridges on either side. The tension grids allow for human access (c.f. refer to Technical Chapter six).

The lighting rig pipes are fixed to the tension grid suspension structure using clamps. These can be changed and moved when needed to allow for flexibility of design. There is also a projection machine fixed from the tension grid, and this can be accessed via panels adjacent to it so that it can be opened for maintenance. The lighting is powered by outlets along the walls of the second level. Speakers are hung from the tension grid above near the balustrades of the bridges. There is one speaker on each side of the stage and at the halfway point, another two. They are all angled at just below 90 degrees towards the theatre entrance to allow for proper sound distribution (Burriss-Meyer & Cole, 1964: 156).

Figure 5.1.27: Interior perspective of the rehearsal studio

THE STUDIO

The studio is located on the first floor. It is accessed via the main entrances. The studio is fitted with sprung-board floors, mirrors and dance rails. There is a store room particularly for the rehearsal studio. The studio is designed to be a projected element from the building that suspends itself within a red box that can be seen from the eastern pathways and the north and south. The idea was to have a space which projects outwards as a place for preparation of the performance contrasting to the closed off box next adjacent, showing what goes into theatre training that is not usually seen. The interior depicts a light almost “exterior” feel with an all around glazing to the south and east and a transparent ceiling that radiates ambient light throughout rehearsal times. Colour changing LED lighting above the translucent ceiling panels were used to radiate atmospheres when

needed for performances. The mirrors reflect the outside and enlarge the space. This space can also adapt itself to being a space for performance as it is viewed from the passer by, hence becoming a focal point of the internal space viewed from the outside.

Since the studio is located adjacent to the theatre, it requires acoustic insulation. The space is acoustically controlled with panels above the mirrors on the northern wall. The wall adjacent to the theatre are clad with the Envirodeck timber wall cladding and a sound absorbent backing to separate and absorb sounds penetrating into the theatre. This studio becomes a pull out from the existing to be a focus which highlights that the dramatic arts training is actually also a visual stimulus for the passer by and it creates the vibrancy within the square through the use and movement within being displayed to the public [fig. 5.1.24].

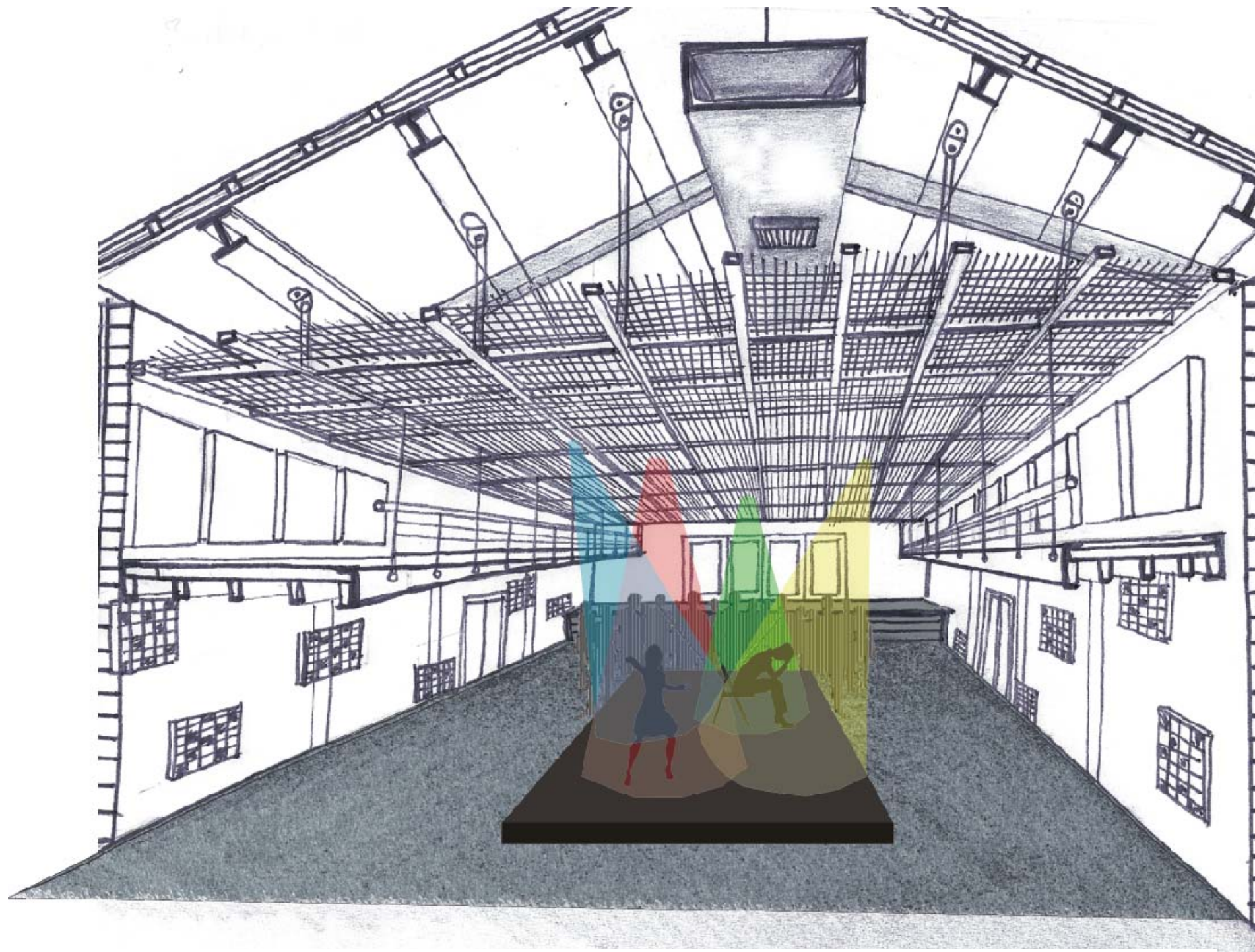


Figure 5.1.28: Interior perspective of the multi-purpose theatre

Most of the spectator access is on the ground level. This space is a level area with retractable seating elements designed to fit under the stage extension and in the recess between the two sound lobbies. These are specially designed retractable seating elements that can be moved to create various theatre configurations and are designed to theatre auditorium specifications, creating correct sight lines and comfort. There is also assembled stage equipment is stored away, and can be wheeled into the theatre and assembled for the various theatre configurations. The stage on the end has been extended with voids beneath that house the retractable seating. The proscenium has been retained, but the curtain system has been removed. This will be replaced by motorized sliding stacking doors that are acoustic barriers for when the backstage is closed off as well as the edge of the theatre when the configurations do not require the space behind.

BACKSTAGE

The backstage area begins where the sliding stacking doors separate the theatre and the service area. The proscenium is retained for the use of the theatre in proscenium configuration. The service areas consist of dressing rooms, storage and receiving spaces, and maintenance and ablution facilities for the performers and staff. The storage, receiving and maintenance spaces are located in the extended part of the building. These spaces are accessed via the external service path where sets, props, equipment and costumes can be brought in and temporarily stored on site in specific storage spaces.

The existing dressing rooms have been reconfigured with access to a single ablution facility between two dressing rooms. The ablution facilities are designed to adapt to the existing water and waste services. This happens on the ground and first floor. The remaining areas are retained for a chair store on the ground level

and a costume store on the first floor, which is accessed via existing steel staircases on each side of the stage. The structure acts as a back wall for the proscenium.

The existing stage space can be activated when the end stage configuration is used. This space is fitted with lighting pipe rigs and a cyclorama.

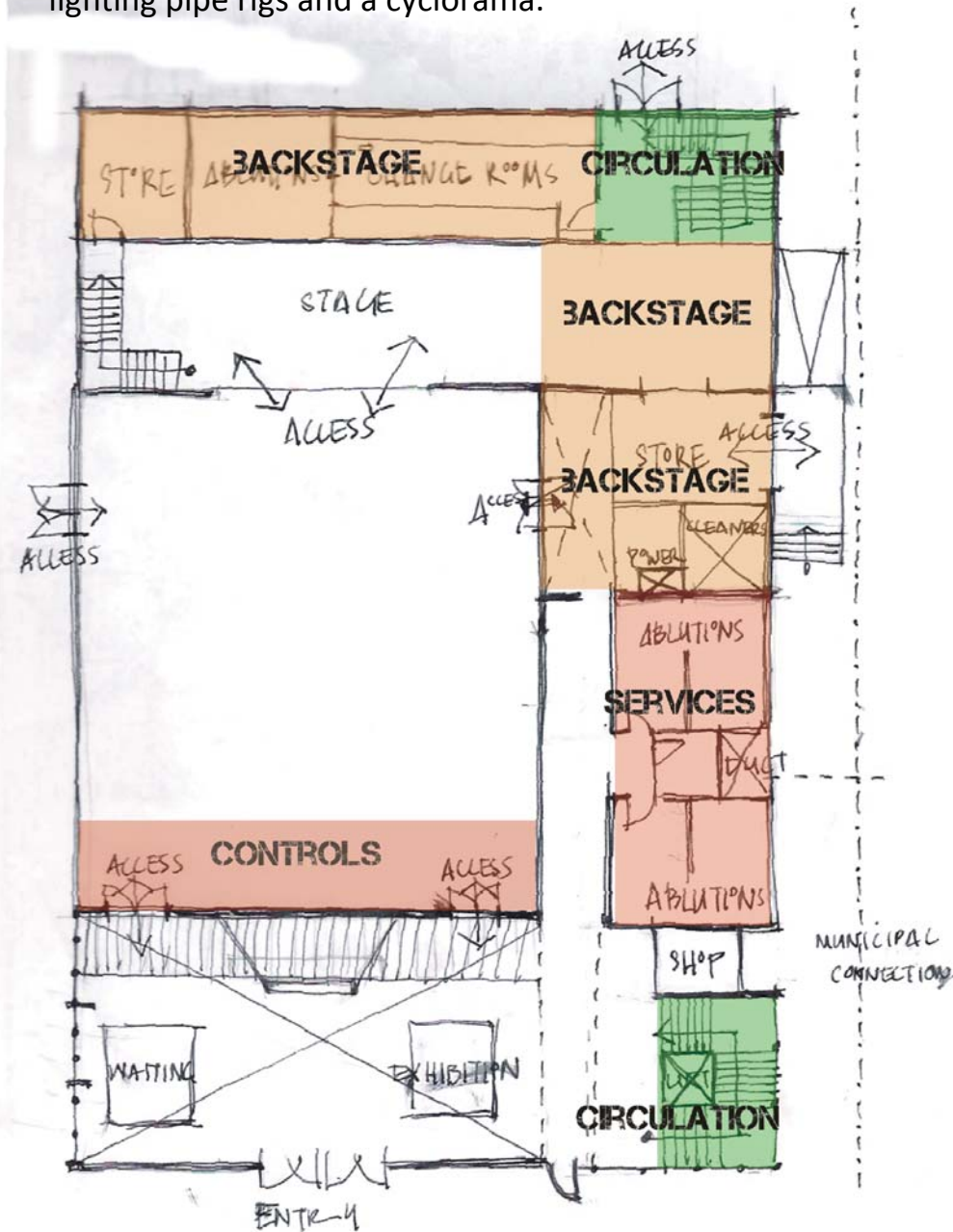


Figure 5.1.29: Spatial configuration for the backstage and service areas

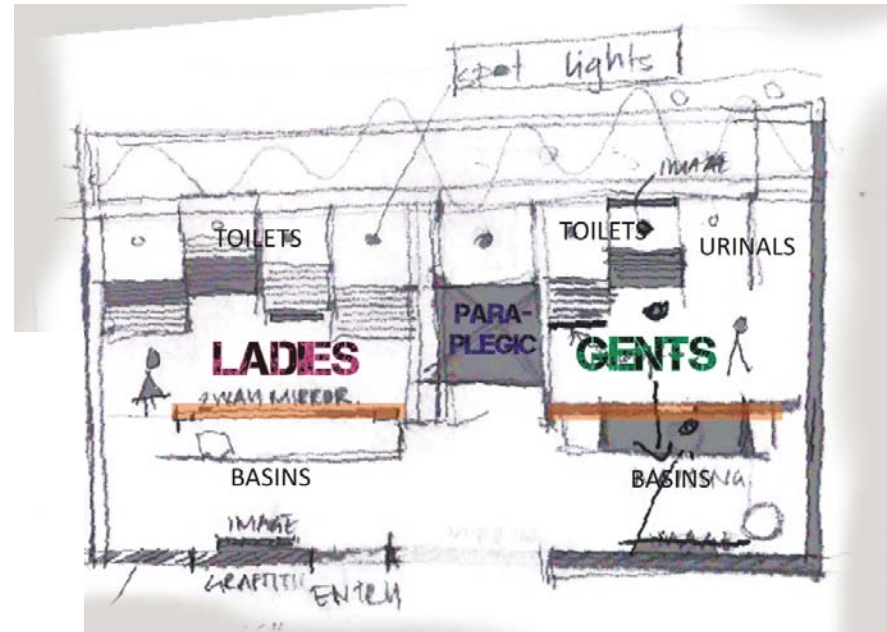


Figure 5.1.30: Concept plan of the abluion facilities.

PUBLIC ABLUTIONS

The public abluions are located in between the store and the kitchenette. With the aid of a two way mirror that separates the basins and passage to the toilet cubicles, making use of the facilities is a tongue in cheek experience that simultaneously pushes human boundaries and plays on the idea of a performance: every act of life can be a performance. The people washing their hands or fixing their make-up at the basins are unaware that they are being watched by others in the room behind the two way mirror. Conversely, the people walking into the cubicles are under the impression that they are being watched when in fact, they are not. To expand the concept, feature walls display rows of toilet paper mounted onto holders in a playful tactic that blurs the boundaries between ordinary life and dramatic art. [Fig.5.1.30 & 31]

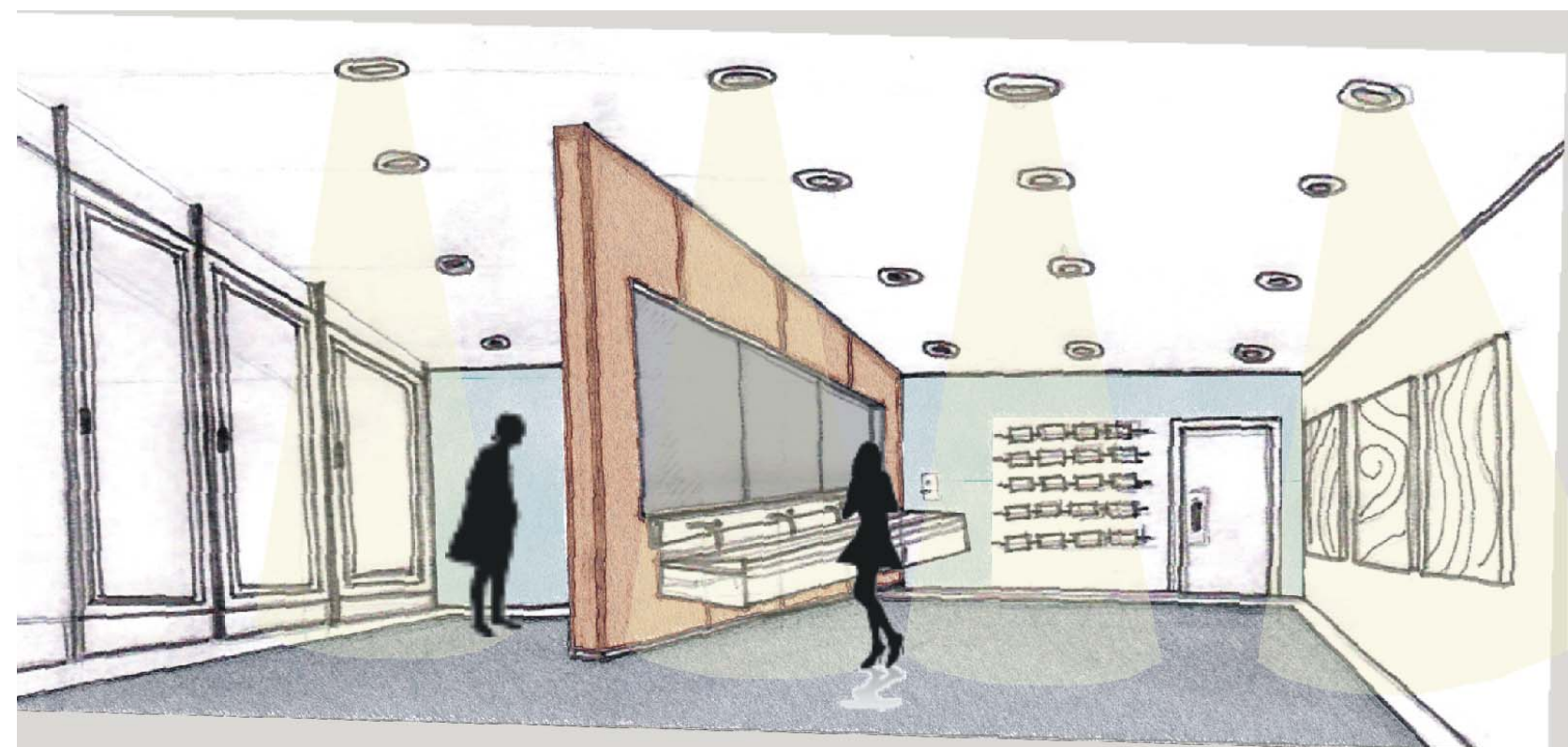
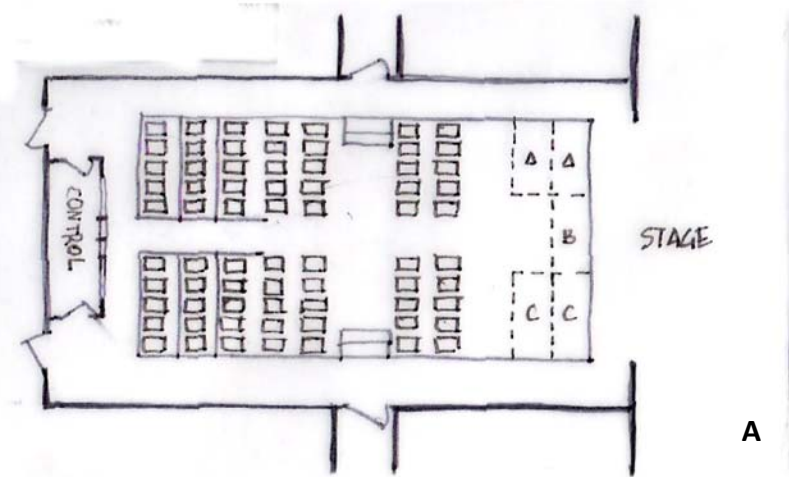
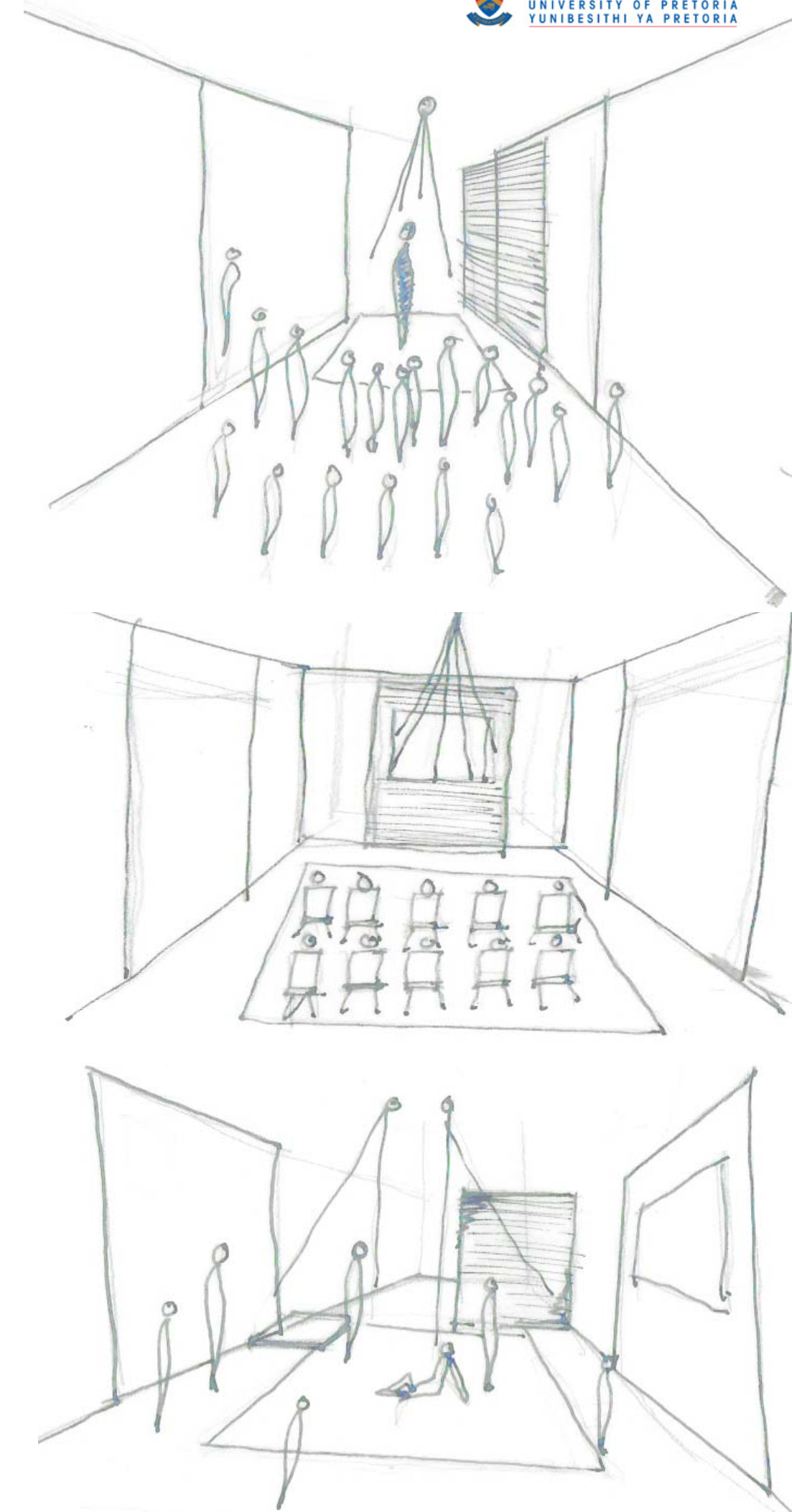
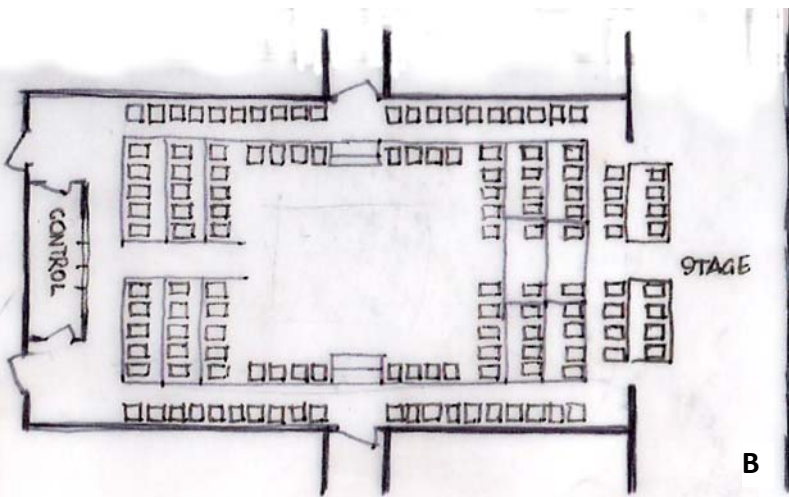


Figure 5.1.31: Sketch Interior perspective of the abluion facilities.



A



B

Figure 5.1.32: Concept theatre configurations which aid in the variation of use of the theatre space with regard to education as well as performance. A. thrust stage, B. theatre in the round.

PERFORMANCE AREAS

All spaces are to be considered as potential performance spaces. They are spaces where one watches and gets watched. Moreover, they have the capacity to be interpreted in a multitude of ways. The foyer area, for example, has retractable ladders that facilitate performance in the foyer space before the audience even enter the seating area. In this way, the audience is transformed from passive spectators into interactive members of the performance.

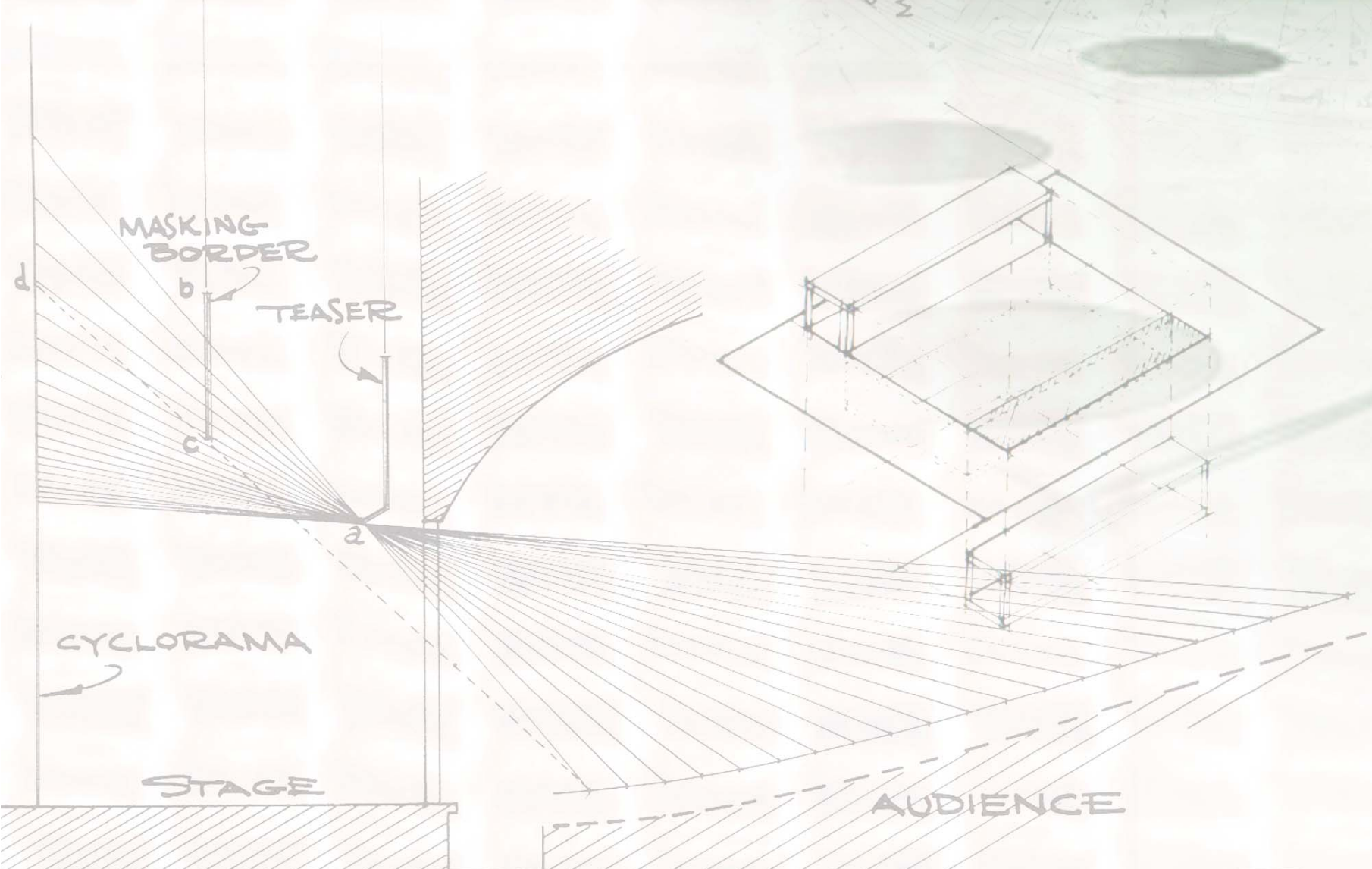
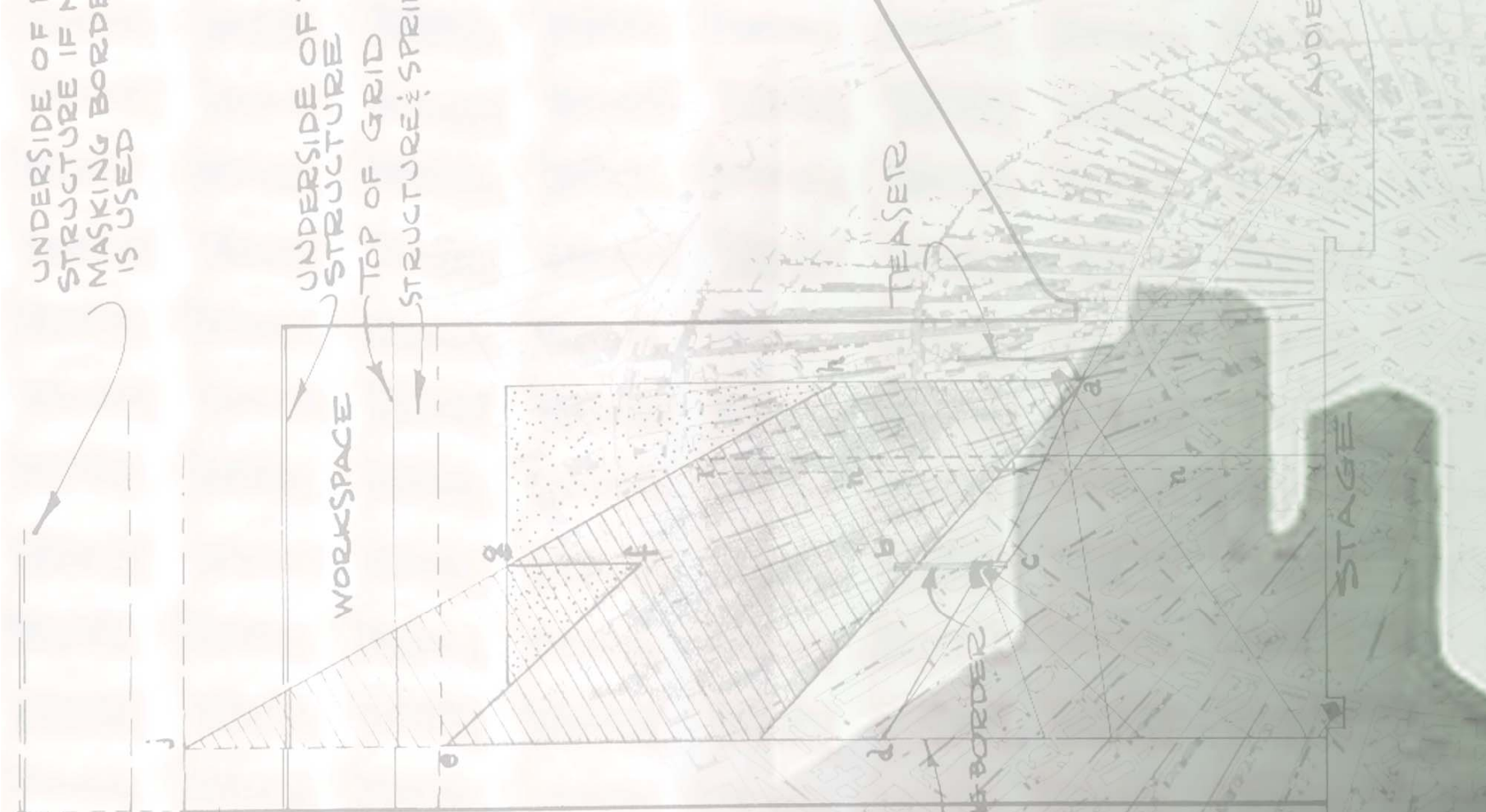
ACOUSTICS AND LIGHTING

The acoustics of the spaces are designed to be textured neutral backdrops in the theatre space. Mounted on the wall, at 3 meters above finished floor level, are a series of absorbent acoustic panels that can be constructed and repaired on site. They are timber-framed panels, sponge-covered and lined with black fabric. Mounted on the wall at floor level are sound diffusing panels. Some have lighting fixtures mounted behind them and serve to diffuse the house lights. The sound diffusing panels are a neutral colour and are therefore not imposing elements during the performance.

The theatre lighting rigs have been provided for and the lighting will be located according to lighting design. Outside of the main theatre ambient lighting is used as well as LED down lighters on live wire.

COLOUR AND TEXTURE

The existing brick and concrete structure is contrasted by the use of steel, glass and timber elements in the new structure. These elements act as attachments to the existing structure, and are either hung or clipped onto it, for example the glass stairwell, the aluminium louvers, and the suspended timber bridge. The idea behind the design is to have a system of exposed structures that can be used and configured for direct view and access as it is a performance education centre. The materials are to be strong and versatile enough to allow for high traffic and concentrated use of every space. The industrial finishes with the lightness of the glass and the use of timber create a space that feels useable. The dark interior colours provide for a neutral backdrop for performance and lighting.



06 | TECHNICAL INVESTIGATION

06 | TECHNICAL INVESTIGATION

6.1 | HVAC, HEATING, VENTILATION AND COOLING



Figure 6.1.1: Interior photograph of Die Masker showing the existing AC duct in roof ridge. By Misra S, May 2008

Mechanical systems should only be used where necessary, because they use a large amount of energy. The building typology requires the use of an HVAC system that will be part of the design, in order to meet the comfort and acoustic requirements of a theatre. The interiors are to be comfortable with temperatures ranging between 20°C and 26°C, which should be maintained for a range of activities (Thomas, 1996:14).

The consideration of the existing HVAC system in Die Masker Theatre was the base of the design for the mechanical systems incorporated. The location and rerouting of ducting for a new system would have been costly and labour-intensive. After consultation with Pieter Joubert, a mechanical engineer, it was clear that the best possible solution was to relocate the air conditioning unit on the roof of the extension. This would reduce the ducting to feed directly into the theatre using the existing ducting, which is located within the ceiling space.

Where required, single serving air-conditioning units would be installed on the roof and routed accordingly to the studio and the service areas. These spaces have been designed to be naturally ventilated and the air conditioning should only be used when necessary.

The system uses only ten percent fresh air, the rest of the air will be filtered and re-circulated. The unit cools the circulating air and then transports it to the specific areas using the existing 1200mm x 600mm ducts. All the existing ducts are located in the ceiling space. The placement of the ducts is appropriate to allow the cold air to be released from above so that when it reaches the ground level it will be warmed, resulting in the hot air rising, being extracted from the ducts above, and being re-circulated. In this way energy can be saved with regards to not having to warm the air in order for it to be recaptured and circulated. Cooling from above also allows for the cooling of the lighting and equipment above, and therefore the location of the ducting at the highest point of the ceiling in the existing building will be left exposed. In the extended spaces cool air will be circulated through vents in the ceilings or directly from the ducts.

In theatre the noise pollution from the air conditioning system must be controlled. Sound filters will be fitted into the duct that leads from the main air conditioning unit. The extraction fans will also be fitted with the sound filters. The air conditioning units on the roof will be fitted on acoustic rubber sheets in order to reduce noise pollution on the outside.

The theatre requires a constant airflow to keep the space from becoming stagnant or allowing dust to collect. In order to do that, air needs to be circulated continuously, and the circulated air will be filtered for dust in the unit. In the winter months the system would be changed to process the air to be warmed and

routed to the specified areas. Thus this system will operate similarly to the cooling system.

6.2 | ACOUSTICS

Acoustic design is an important aspect of theatre design. Theatres for legitimate drama require a good speech intelligibility level with a one second or one and a half second reverberation time (Moore 1983:95). The conditions necessary to obtain good sound reproduction in an auditorium are that the sound should be sufficiently loud in all parts of the auditorium. The original quality of sound should be maintained and the successive sounds in rapid speech and music should be heard clearly and distinctly. External noises should be absent.

Rectangular rooms with parallel walls, floor and ceiling surfaces which are generally long and narrow, tend to have the worst acoustic properties. The flexible theatre space has an acoustic goal which creates an acoustic intimacy around the space where all the performers and audience are situated. This is done by absorbing the sound at the higher levels and sound is diffused at a lower interactive level.

Ideal material characteristics for sound absorption are typically porous soft resilient blankets or panels as well as thicker panels with a porous membrane and absorptive backing material that is located at a distance of not more than a hundred millimetres from the surface. These materials cause delays in the reflection of bass sounds. The mass and rigidity of the material used affect the insulation of sound within spaces. The optimal sound insulation principal to use is that of a higher mass and a lower rigidity.

THEATRE ACOUSTICS: Existing

Room dimensions:	17.7m x 15.5m x 8.5m
Volume:	2332m ³
Wall surface area:	431.11m ²
Floor surface area:	274.35m ²
Ceiling surface area:	286.74m ²

Current acoustics:

Walls:

<u>Materials</u>	<u>Area</u>	<u>S.A.C</u>	<u>Absorption</u>
Brick	431.11 m ²	0.03	12.9m ²

Ceiling:

<u>Materials</u>	<u>Area</u>	<u>S.A.C</u>	<u>Absorption</u>
Suspended Acoustiboard	286.74m ²	0.5	143.37m ²

Floor:

<u>Materials</u>	<u>Area</u>	<u>S.A.C</u>	<u>Absorption</u>
Vinyl tiling on concrete	274.35m ²	0.02	5.487 m ²

Total absorption 161.757 m² (Effective areas)

[S.A.C: Sound Absorption Coefficient for 125Hz]
 (Coefficients taken from: Watson, 1923:25)

Reverberation time (RT60):

$$RT60 = 0.161(V/A)$$

$$RT60 = 0.161(2332m^3 / 161.757m^2)$$

RT60 = 2.32 seconds

The absorption materials in the theatre need to be increased in order to generate the reverberation time of 1.5 seconds in comparison to the existing reverberation time of 2.32 seconds. The time of reverberation that gives optimum results is 1.5 seconds, because in this time sound waves overlap beneficially to increase the loudness of the sound. When this overlapping increases the sound gets

distorted and becomes a blur. The reverberation time in any space should not be more than two seconds.

Critical distance (Dc) is the distance at which the reverberant sound field is equal in level to the direct sound from a sound source. For reverberation times of less than 1.6 seconds, a listener can be up to 3.16 times the critical distance from the sound source. For a reverberation time above 1.6 seconds this value drops to 1 time the distance. This is important in sound system design in reverberant spaces.

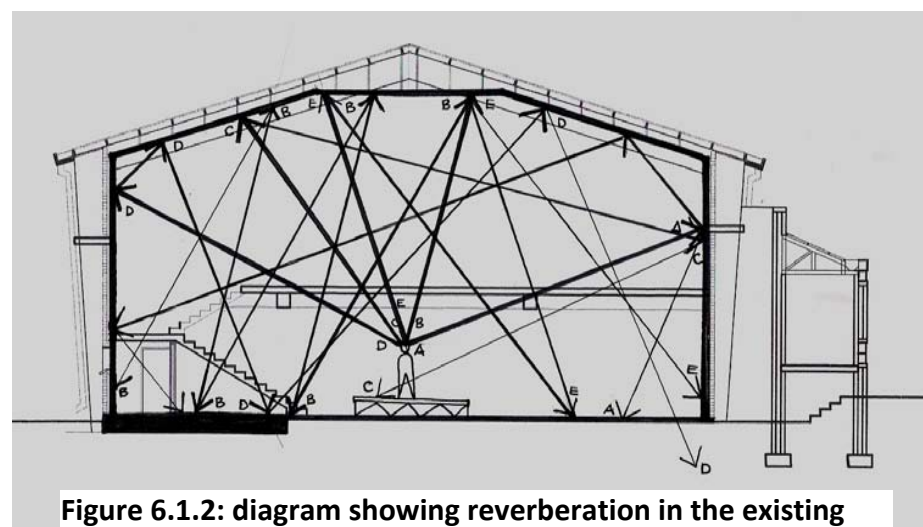


Figure 6.1.2: diagram showing reverberation in the existing theatre

Critical distance (Dc):

$$Dc = 0.057 \cdot \sqrt{V/RT60}$$

$$Dc = 0.057 \cdot \sqrt{2332m^3/2.32}$$

$$Dc = 1.8m$$

The reverberation time is over 1.6 seconds, so the listener can only be 1.8m from the sound source, which is problematic. The audience in the theatre cause the time of reverberation to vary because each audience member absorbs a quantity of sound. It is therefore desirable to have the acoustics designed to the average sized audience in order to have average acoustics as any time, but also to have excellent acoustics at 1 second reverberation time when the theatre is at its maximum capacity (Watson, 1923:25).

The acoustic goals in a Black Box theatre are excellent in regards to speech intelligibility and acoustic intimacy. To achieve these goals the upper half of the theatre (3m and above) needs to absorb most of the sound, but also diffuse a little, while the lower half of the room needs to be reflective and spread sound evenly.

The existing reverberation time proved to be above 1.5 seconds. This had to be rectified by the addition of absorptive elements in the space, which would control the reverberation time between 1-1.5 seconds. The speech delivery to the audience is also to be contained within critical distance range in order to give good speech intelligibility in the auditorium. For this reason the sound reflection has to be absorbed to decrease the amount of sound reflected back into the audience. This will concentrate the speech levels at performance level, where the diffuser elements would be used to refract sound waves in varying directions, but also absorb some sound. The applied acoustic elements improve the acoustics as follows.

THEATRE ACOUSTICS: New

Walls:

<u>Materials</u>	<u>Area</u>	<u>SAC</u>	<u>Absorption</u>
Brick walls painted	323.435 m ²	0.017	5.5 m ²
Acoustic fabric panels (With fibreglass)	71.960 m ²	0.410	29.5 m ²
Diffuser panels	13.680 m ²	0.410	5.61 m ²
Glass screen	3.250 m ²	0.027	0.0875m ²
Acoustic sound			
Lobby curtains	18.780 m ²	0.150	2.817 m ²
Stacking door partitions	33.6 m ²	0.410	13.776 m ²

Ceiling:

<u>Materials</u>	<u>Area</u>	<u>S.A.C</u>	<u>Absorption</u>
Flush plaster ceilings painted black ceilings (With Prolith Thermocoustex fibre insulation)	286.74 m ²	0.73	209.04 m ²

Floor:

Materials	Area	S.A.C	Absorption
Marmoleum floor tiles (Above existing tiling)	274.35 m ²	0.5	8.23 m ²

Total absorption
274.561 m²
(Effective areas)

[S.A.C: Sound Absorption Coefficient for 125Hz]
(Coefficients taken from: Watson 1923:25, and from the various product companies)

Reverberation time (RT60):

$$RT60 = 0.161(V/A)$$

$$RT60 = 0.161(2332m^3 / 274.561m^2)$$

RT60 = 1.367 seconds

Critical distance (Dc):

$$Dc = 0.057 \cdot \sqrt{V/RT60}$$

$$Dc = 0.057 \cdot \sqrt{2332m^3/1.367}$$

Dc = 2.35m

The reverberation time in the theatre will be less than 1.6 seconds. The listener therefore can be located within 3.16 times the critical distance meaning within 7.5m from the source. With the inclusion of the audience and seating elements the reverberation time would be decreased to 1 second, which is the optimal reverberation time for a dramatic arts theatre.

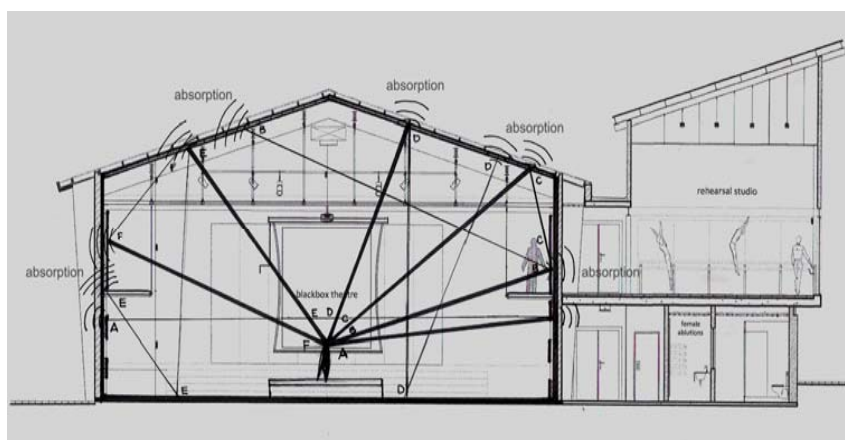


Figure 6.1.3: Reverberation of new design showing absorbent materials and sound reflections

6.3 | THEATRE RIGGING AND LIGHTING

Lighting for Die Masker means lighting design for a wide range of different types of production: dramatic plays, comedies, tragedies, musicals, and reviews. This means that the lighting design would vary in the theatre due to the changing stage set-ups.

The lighting for a production or dramatic text is not easy to determine. Most styles stem from a degree of realism. Many plays are about people, their behaviour and the environments that they are in. The audience will relate more readily to plays where the environment has some sort of relation to reality. This can be created by a designed stage lighting system.

In conjunction with these elements, the lighting design facilitates the creation of the environment in which the actions take place. In order to create these environments lighting designers need a system with which they can work, which usually consists of widespread power supply and rigs for lighting.

Today most stage and entertainment lighting designs use multi-fixture lighting methods as opposed to single source or point source methods. This method allows for lighting designers to have full control over lighting anywhere over the stage [fig 6.1.5].

Multi-fixture lighting methods use a wide range of lighting techniques. Current fixtures use dimmable tungsten-halogen lamp sources. It is also possible to integrate both the conventional lighting fixtures with the newer automated fixtures.

The method for lighting is constructed typically from breaking down the stage space into a number of sections: across the front, across mid-stage, and across upstage. These sections are then illuminated from

above with one or more lighting fixtures. Typically, production lighting is designed to provide a front light, a down light and a back light, depending on the need of a production.

The lighting source for a performance should be directed at the actor where the light is angled at about 45° to generate an adequate visual impression of an actor's facial characteristics. The ranges of horizontal angles to which an actor can be illuminated adequately are between 35° minimum to 55° maximum angle. When the lighting is arranged at either 55°, 45° or 35° respectively, the sources cross and can produce an angle of light that equals the illumination of the 45° lighting (Tutt & Adler, 1995:191-192).

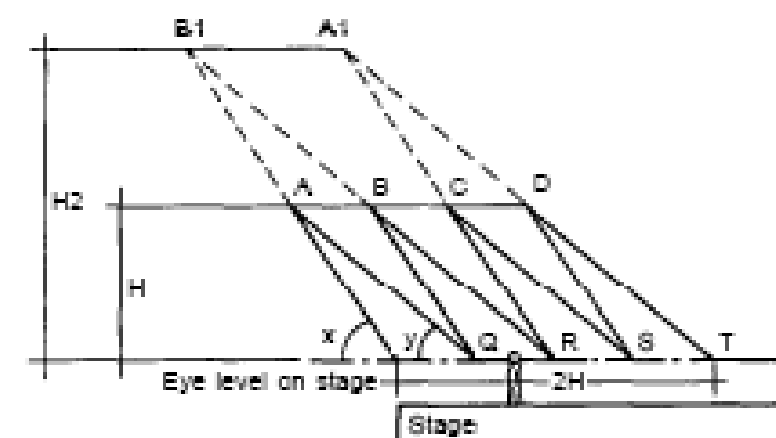


Figure 6.1.4: Method of locating theoretical positions of spotlights. (Tutt and Adler 1995:191-192)

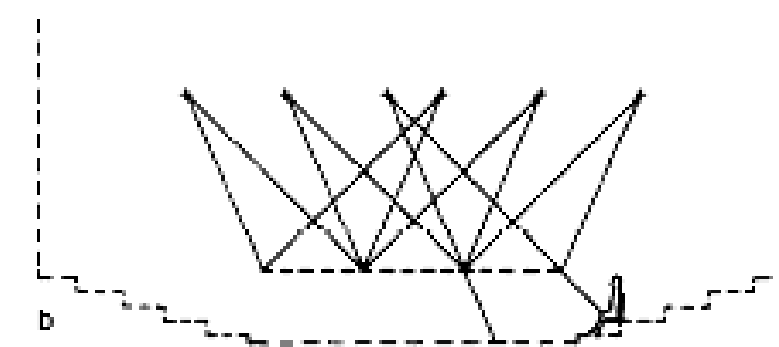


Figure 6.1.5: On thrust and theatre-in-the-round stages virtually all the lighting comes from overhead to avoid glare in the eyes of the audience. (Tutt and Adler 1995:191-192)

6.4 | APPLIED SYSTEM IN DIE MASKER:

In order to create a versatile, flexible lighting rig system for the many configurations, the theatre is to be equipped with a pipe grid configuration overhead that can accommodate the movement and rearrangement of the lighting fixtures. This system has to be accessible to students to learn about lighting, as well as for maintenance and rigging. The solution was to install a system that would act as an invisible ceiling for the theatre and that would allow easy access to most of the ceiling space above.

The tension grid ceiling is an invisible layer above the entire theatre. The structure is suspended from a retrofitted steel beam that is fixed between the existing concrete portal frames. Above the tension grid the pipe rigs are tied to the suspension structure upon which the lighting fixtures can then be hung according to lighting design.

A tension grid is a type of non-standard catwalk that is composed of a tightly stretched grid of steel cables that creates a tough flooring system, which is strong enough for technicians to walk on. There is no need for holes in the tension grid because the light from the fixtures shine through the grid. No shadows are created when the lights are in use.

Tension grid specifications:

The specifications of tension grid are as follows:

- 3mm aircraft cable woven in a 50mm square for a safe walking surface;
- Custom-sized sections;
- The grid is suspended from the overhead structure.
- Maximum economical size is 2440mm x 2440mm panels; and
- Removable or hinged panels can be built in to raise equipment.

The tension grid is suspended from the overhead structure using M48 Ronstan architectural stainless steel rigging rods fixed at 1750mm intervals. 900mm above the tension grid level the lighting bars are fixed to the structural rods using rigging brackets (Reid, 1992:54). They run parallel to the floor level and are located 900mm above tension grid level for ease of maintenance and service.

The lighting is not meant to be a rigid system and therefore the plug sockets are located at a high level to feed the lighting above. For convenience and maintenance, most sockets should be on one of the performance areas near the dimmer system. In order to maintain a maximum lighting flexibility some circuits are looped across to alternative sockets on the other side. The wiring cannot be placed inside the scaffold tubing because that allows for a rigid lighting positioning only. The pipes then have to be located on the outside of the rigging pipes.

Power sockets should also be located around the performance area at low levels for the convenience of feeding power to ground rows and stand equipment. Problems in wiring may occur with various staging layouts because cables are short; therefore a patching system is used. A patching system works like a telephone exchange between dimmers and the large number of socket positions. Patching reduces the amount of temporary wiring required for each production by providing a means of quick and easy central socket location that doesn't require extra cabling because it works like a telephone exchange. The dimmers and patches are then synced to the control room, which is the central point of management for all electrical systems in the theatre.



Figure 6.1.6: This system, a 15 x 8m containment Frame, features an integral support structure complete with hangers and lighting grid, and is installed on the first floor of a Georgian villa that is now known as CCA Glasgow. Tension wire grid platforms are woven from stainless or galvanized steel wire rope

Architect: Page & Park

Contractor: Lilley Construction Ltd

www.thecablenet.net

6.5 | THE CONTROL ROOM

The control room is positioned where the operator has a clear view of the stage areas. The dimmers are controlled remotely from a compact desk by connecting the two with a thin cable. The mechanical systems in the theatre would then be controlled from the control room where the power points would be dispersed for flexible rigging. The actual lighting and controls equipment would be specified by the lighting engineer. The control room units would basically consist of:

- A dimmer channel;
- Power connectors;
- Lighting controls board; and
- A hard patch area where individual lighting fixtures can be connected to a dimmer.

This system has been utilised because it allows for flexibility of lighting for the various performance types. New lighting technologies involve dimmer systems that reduce heat generation, hence reducing the emissions, which require air conditioning. New lighting fixtures are being designed to use LED light technology. LED lamps use less energy and emit less heat.

6.6 | LIGHTING IN THE BUILDING:

The lighting in the other spaces of the building are designed around day lighting because most of the spaces are south facing, which reduces the amount of artificial lighting required during the day. Daylight control on the western façade is controlled by means of an electronic louvre system that can be programmed to react to the solar angles during each season. The louvers provide both adequate lighting control as well as solar balance for internal comfort in the foyer. The louvers have been designed to act as an aesthetic screen as well with screen printed images printed on the steel slats. The images can only be seen when the louvers are closed due to day lighting control or necessity. The system is controlled from within the ticket box and is a computer-aided system.

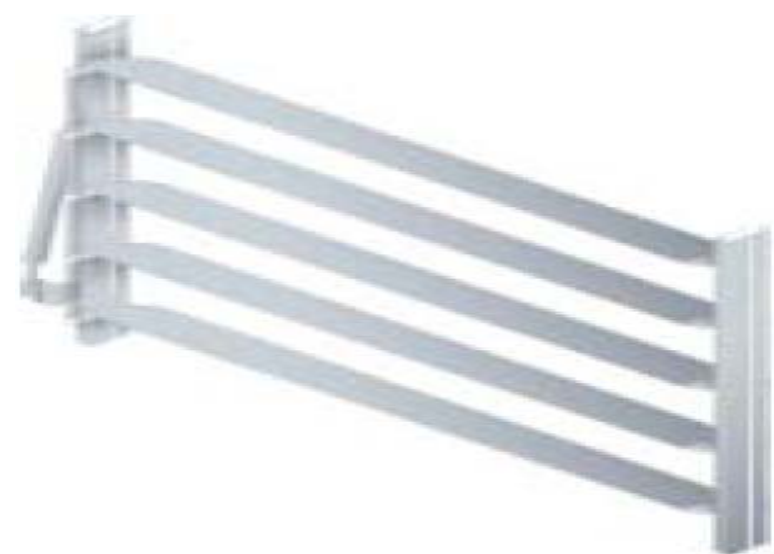


Figure 6.1.7: movable louvre system consists of a range of aluminium elliptical louvers louvres can be motorized to provide maximum control over the amount of daylight passing through the system. (www.reynaers.com)

Lamps are chosen for their power usage and flexibility. Tube LED lighting will be used in the studio where an ambient light is continuously required. These lighting fixtures also have a colour wheel and can be used when the space is being used for other events besides movement and dance, such as exhibitions or small performances. The public spaces are fitted with LED down lighters that are fitted into the ceiling. Service areas (storage, dressing rooms, and passages) are illuminated using single colour LED tube lights concealed behind a steel trough system for lighting and wiring that is fixed to the underside of the soffit.

The foyer is illuminated using theatrical lighting fixtures fixed to a lighting rig truss, which is suspended from the retro-fitted structure above. There are also boom rigs (vertical lighting rigs) fixed to the existing columns in the double volume foyer. Lighting fixtures are hung from these using boom arms. The lighting is controlled from the ticket office situated on the ground floor level. This system is a rigid one with regards to lighting placement, but it can allow for performance to occur in the foyer if needed.

Lighting has been designed most consciously where possible by use of lamps that use less energy (LED lighting systems). Natural lighting has also been utilised to its capacity. These design decisions would counter-balance the energy use of the lighting system used within the theatre.

6.7 | BASELINE CRITERIA

A theatre is not a sustainable responsible entity; this is because of the types of environments required that use a lot of energy. Theatres are enclosed spaces that need to maintain fully internalized spaces in order to create scenarios that are different to the outside world. Therefore mechanical systems for lighting and ventilation have to be used to create comfortable environments within the theatre itself.

SOCIAL CRITERIA:

COMFORT:

Comfort in a building is an important aspect that affects the user, making the building a success or a failure. Lighting and ventilation are important in creating comfort. In theatres however, both lighting and ventilation have to be very controlled systems, because theatres require various atmospheres and moods for performances, created mainly by lighting. Lighting and energy use in a theatre can only become energy efficient by means of changes in technology; advances are already being made in the use of LED lighting for theatrical lighting equipment.

In spaces other than theatres attention is paid to the use of natural lighting and systems of screening and lighting control are used to create optimum internal comfort. The larger glass facades are located on the south façade to inhibit direct sunlight heating the building unnecessarily. The glass façades on the west face are controlled using a solar louvre system that reacts to day lighting and responds accordingly. The eastern glass façade is shaded by the shadow of the neighbouring building and therefore requires no brise soleil.

Buildings should be inclusive and access should not be limited to able-bodied people alone. Where necessary, spaces have been equipped with lifts or ramps at a 1:12

rising angle. Ablution facilities have been provided to accommodate people in wheelchairs. Spaces have been designed simply to create easy articulation through the space. In the theatre a flexible seating system has been used and the space allows for easy access and accommodation for wheelchairs for both performance and education purposes. Wheelchair seating is allocated on ground level near the access points (in compliance with SABS 0400).

Furthermore, there are more toilet facilities for women than for men, because the queues in the women's bathroom tend to take longer during theatre intermission periods. Additionally, movement through the building is undemanding for the elderly and for children.

Air-conditioning systems for the theatre are an essential part of the space. The theatre is an enclosed capsule, which therefore requires the use of a mechanical air-conditioning system to provide for the appropriate comfort levels in the theatre as well as to cool down the equipment. Lighting equipment use energy and in turn produce large amounts of heat in the enclosed space. To decrease the costs of the redesigned building the existing air-conditioning ducts are retained and only the plant is replaced and repositioned on the new concrete roof of the addition, thus decreasing the distance and the usable space that the air conditioning units will take.

The other spaces in the building are controlled by means of natural cross ventilation. However, if needed, the existing air conditioning system does service the existing structure. The existing ducts are to be used in the foyer when necessary. For the studio, it is necessary to install a mechanical system (single units feeding directly into the spaces from the roof) due to the type of activity in that space, but again, provision has been made for natural ventilation and the

mechanical system should only be used when necessary.

EDUCATION, HEALTH, AND SAFETY:

Die Masker Theatre has been redesigned to be used as an educational tool as much as an entertainment venue. The main aim of the design is to create a multi-purpose theatre that is used to aid the education of dramatic arts in the university as well as be used for performances for both the university and the public. The intention with regards to education is to encourage learning through participation and visualisation, and this is conveyed in the way the theatre can morph to suit any configuration required.

The safety of the Precinct is dealt with by means of its location within the university where access is controlled and security is permanently available. Fire safety within the building is also designed to comply with the fire regulations in the SABS 0400. This can be seen in the use of fireproof sliding stacking doors that separate the stage area in the theatre. These acts as a replacement for the typical fire curtain that is used in typical proscenium arch theatres. The theatre must be fitted with a sprinkler system for fire control in the various performances spaces due to the hazards that theatrical lighting might cause. There are three direct exit routes from the theatre; they all are within accessible distance to the exterior. There is also fire escape access directly from the backstage area to the outside. These all comply with National Building Regulations 0400 on fire safety in theatres.

ECONOMIC CRITERIA

Improving on the existing facilities of the Drama Department to be more flexible opens up possibilities to the types of theatre training and performances that are possible. This will break free from the typical theatre restraints and will allow for better use of the spaces. The purpose of the Precinct is to make the

dramatic arts an inclusive subject that involves the public in what happens in the Department and create interest in arts and culture. The Precinct and its spaces will break away from the "behind walls" training and will be more of a "display and participate" type of education.

The function of these spaces would firstly be education and secondly formal performances. The Precinct would promote local student performances as well as performances from visiting acting groups. Even though the theatre is located within the University it could be opened up for use by outside organizations, and companies, but also other faculties on the campus (the fashion school, for instance). This makes the space a multifunctional zone. The location, use, and new aesthetic of the space would enhance the attraction of the Department and the University. By promoting local performance the University would be uplifting the surrounding community and elevating culture within the surrounding society.

Local labour within the area will be contracted to do all the construction on the project, which in turn will have a positive impact on the local economy and will also provide local people with the skills to become more independent. The performance spaces would be kept by the students and university and lighting and other services would either be maintained by students or local contractors from participating organizations that are using the space.

Low-embodied energy materials that are produced locally will be used wherever possible. Building materials such as glass, concrete and standard steel sections will be sourced locally and will be used, because contractor and builders have experience working with them. The use of locally-sourced materials results in the decrease of transportation cost and energy use.

The Precinct is an educational and recreational development space. It is important that the spaces be used efficiently to maximise education as well as culture in the area. The theatre and studios will be used regularly anytime of the day or evening depending on rehearsal times, lecture times and performance times. This will create a high occupancy of the studios as currently there are not enough venues for the students to rehearse and the spaces that are available are scattered all across the University. Negative spaces are now converted into usable service spaces (between the buildings), and the Precinct concentrates the dramatic arts training in a single area. Services and plants are located on the roof of the building to reduce the abuse of usable floor space. The internal spaces have a relationship with the outdoor spaces to allow for the creation of interaction and visual access.

The theatre and studios are designed to be flexible where various theatre configurations can be set up. This allows for use by not only the University, but also by outside groups that can rent the spaces for non-University related training during the times the university is not using the spaces. In this situation the University benefit from the additional income.

BUILDING ADAPTIBILITY AND FLEXIBILITY:

The building required demolition work to remove parasitic structures that had been attached to the structure at a later stage. These structures have become unusable and therefore were not maintained well. The other spaces that have been demolished were the walls that demarcated the entrance from the foyer as well as the staircase, and both the ablution facilities. This was done to improve the quality of a foyer space in order to make it less claustrophobic and easily accessible. This in turn meant that the slab above the foyer level had to be removed to create for a double volume space. Many of the other demolitions

are simple cut through the buildings to link the new to the old. For the whole part the original structure of the building has been retained and allows for restoration if need be.

The magnitude of proposed construction has been kept to a minimum for two reasons: firstly to minimise the superfluous use of construction materials and therefore embodied energy in the renovation and, secondly, to maintain the ability of the space to adapt to the changing needs of the inhabitants. The building's existing structure has been maintained and the important façades (north and west) have been mostly retained. The building has been extended towards the east with a lighter structural steel frame. The existing structure has not been altered much because it has significant value with regards to the Christian Brothers College and the Loreto Convent School. The additions however, have been made by attaching the lighter structure to the existing building, and adapting the interior spaces to suit the spaces required.

Spaces have been left clean and uninterrupted with minimal use of internal walling to create greater open spaces that can be adapted for various uses; this can be seen to extend the lifespan of the building. The interior spaces have been designed minimally to allow for flexible spaces and adaptability. New technology can easily be introduced in the future.

MATERIALITY AND COSTING:

Often, ongoing costs for maintenance in buildings become an issue over time as materials need to be replaced. In the renovation of Die Masker, the Life Cycle Cost of materials has been considered above whimsical novelty and materials that are low maintenance and that are hard-wearing have been favoured throughout the building. For example, the high traffic floors in Die Masker will be finished with recycled rubber resilient floor sheeting that is easy to

clean, decreases echo and is hard wearing. Equipment and systems such as air conditioning and lighting have been left exposed mostly for easy access and placement of lighting fixtures. The location of the plant on the roof of the building means that there will be less interference inside the building due to maintenance.

The design of the interior of Die Masker has been carefully considered by the use of materials that can be recycled or re-used over time. The general breakdown of the base finishes, (floor finishes, wall finishes, and insulation material) have been specified according to their recyclable and sustainable qualities. For example

- Envirodeck processed timber panels used as sound insulation between the studio, foyer and theatre as well as it being used as the flooring for the light bridge;
- Quiet floor acoustic underlay that is fully recyclable;
- Marmoleum flooring in the theatre; and
- Terrazzo recycled countertops in the bathrooms and shop.

Where necessary, arrangements will be made for the safe removal and recycling of harmful materials from the theatre. The building has been altered in such a way that the services need not be rerouted very far from the original positions. The dressing rooms are circulated around ablution facilities that are redesigned around the existing space, making use of the accessibility to existing services. Similarly the new public ablutions of Die Masker follow suit, the existing ablutions were demolished and the new ablution facilities have been located in the extension which runs parallel to the municipal sewerage and waste pipelines, enabling the pipe-work to be minimized. The kitchenette and maintenance areas are also located along this façade. The advantage of this is that the service pipes remain accessible for maintenance and cleaning.

6.8 | MATERIALS

The important finishes within the building allow for ease and freedom of movement for flexible theatre. The spaces are to be public orientate and require strong materials. A series of basic materials have been used to give the theatre that finished yet unadorned theatre feel that is contrasted to other theatres.



Figure 6.1.8: Recycled rubber: For High traffic areas: the highest quality recycled SBR tyre rubber is a single-ply non-laminated surface with high slip resistance, durability, cushioned resilience, stain resistance and consistent color (no wear layer)
 Ambient Noise Reduction, Sabin/ft2 (ASTM C423): 0.10. Material proposed for use in high traffic areas: foyer and passageways.



Figure 6.1.9: Envirodeck: bridge flooring and interior wall cladding: manufactured from polyolefin plastics and natural organic fibre's, through various treatments and processes, creating a revolutionary user-friendly decking material. This highly engineered finishing process allows Envirodeck products to offer you better flexural strengths, load capacities, flexible designs, chemical resistance, water resistance and resistance to insects. For Cladding Applications/Decorative. www.wpc-decking.co.za/change/main.asp?cbit=7. Proposed for use in the light steel and timber bridge as well as wall cladding for sound insulation in the rehearsal studio



Figure 6.1.10: Screen printed glazing: Double glazed screen printed glass in anodized aluminium window frames Laminated safety glass of 4mm with images screen printed. External windows to be double glazed. Maximum sizes: 1500mm x 3000mm. Utilized in the glazed envelope of the extension to Die Masker staircase seen from the square.



Figure 6.1.11: Stretch ceiling is a suspended ceiling system comprising of two basic components aluminium perimeter track and lightweight membrane which stretches and clips into the track. Additionally, the system can be used for wall coverings, light diffusers, floating panels, exhibitions and creative shapes. Stretch ceilings allow incorporation of all types of light fixtures, recessed lighting, vents and sprinklers by use of an appropriate backend support. The material is unique 0.2mm thick titanium based fully recyclable vinyl. The material can be printed or painted for additional effects, it is waterproof, washable, and resistant to vapor, mold and fire rated class "A". utilized in rehearsal studio .

Figure 6.1.12: Plastic panel: used as an interior building material that is made from recycled polyethylene. It takes approximately 8 milk jugs to equal 1 Lb of Origins. The bottle recycling designation is HDPE #2. Polyethylene (PE) is a thermoplastic material that is resistant to chemicals and moisture. This product is ideal for restroom and shower partitions, vanity and counter tops, work surfaces and table tops. Origins will be used as a plastic laminate or a solid surfacing material.



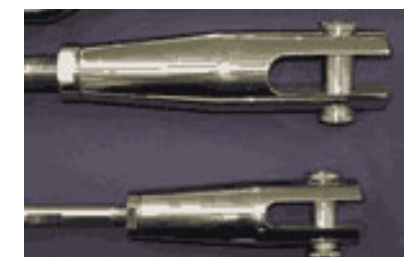
Figure 6.1.13: Multicolor plastic tubes with RGB LED lights fitted inside used. This is used to change the colors of walls, and ceilings. The light has properties that allow it to be used as either a strobe, a chase, or a static lamp. This type of light fitting is controlled with the LED Manager attached to the wall.

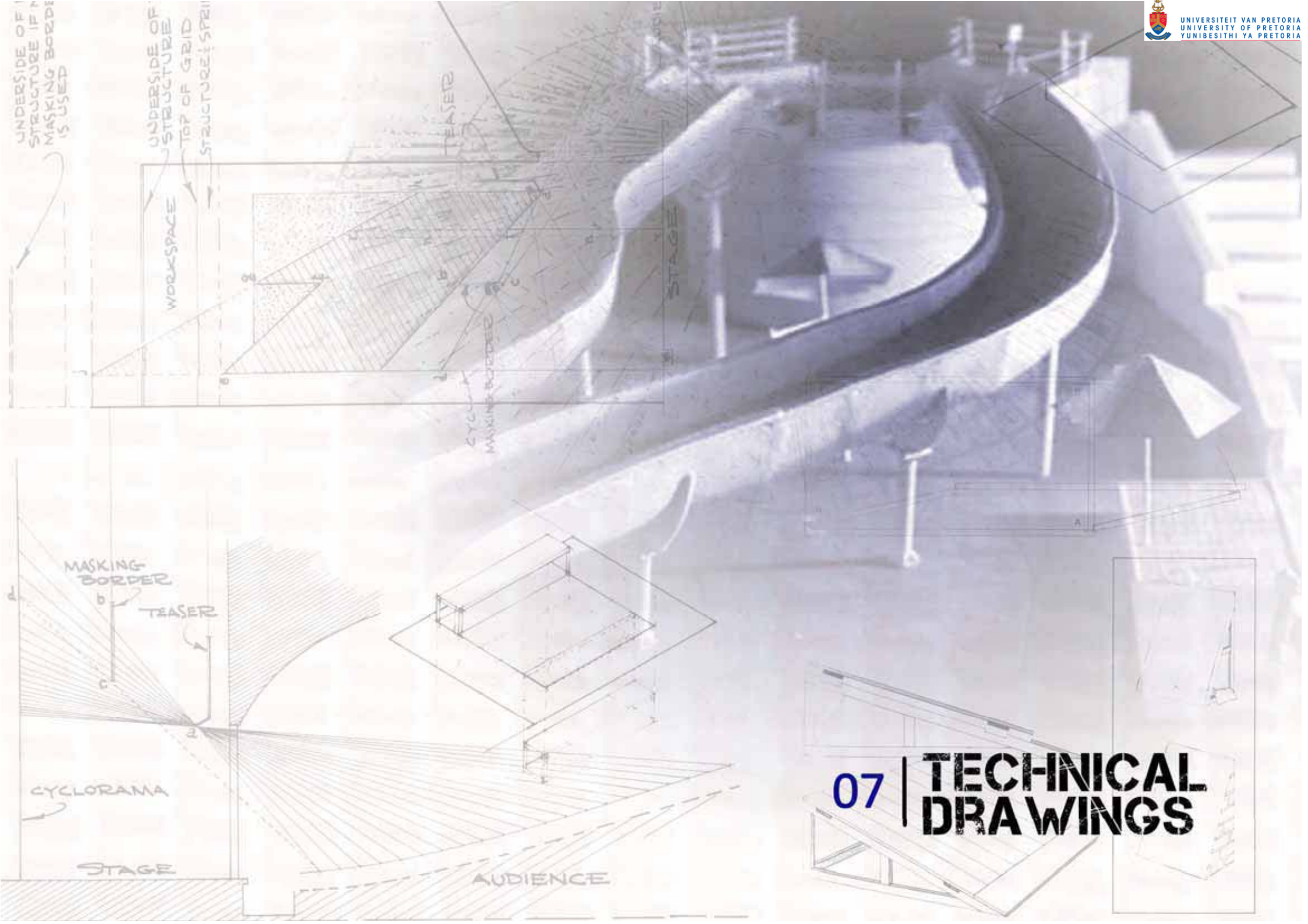


Figure 6.1.14: Modular Concrete block: a co-ordination of building modules with dimensions of 200mm horizontally and 100mm vertically. The Concrete masonry units are: hollow, non-face, grey blocks used in conjunction with the steel extension structure. The modular concrete block walls will be bag-washed and painted a dark grey.



Figure 6.1.15: The Linking Rod System: consists of a range of stainless steel architectural rod assemblies, ideal for many structural and architectural applications. All Guy Linking tendons use high-grade 316 stainless, which ensures a long service life with very little maintenance. Guy Linking stainless rod tendons combine durability with aesthetics, whilst ensuring that loads are safely and efficiently transmitted. Used in conjunction with Envirodeck and sound proofing membrane for the light foot bridge.





UNDERSIDE OF
STRUCTURE IF
MASKING BOARD
IS USED

UNDERSIDE OF
STRUCTURE
TOP OF GRID
STRUCTURE: SPRING

WORKSPACE

TEASER

CYCLORAMA
MASKING BORDER

STAGE

MASKING
BORDER

TEASER

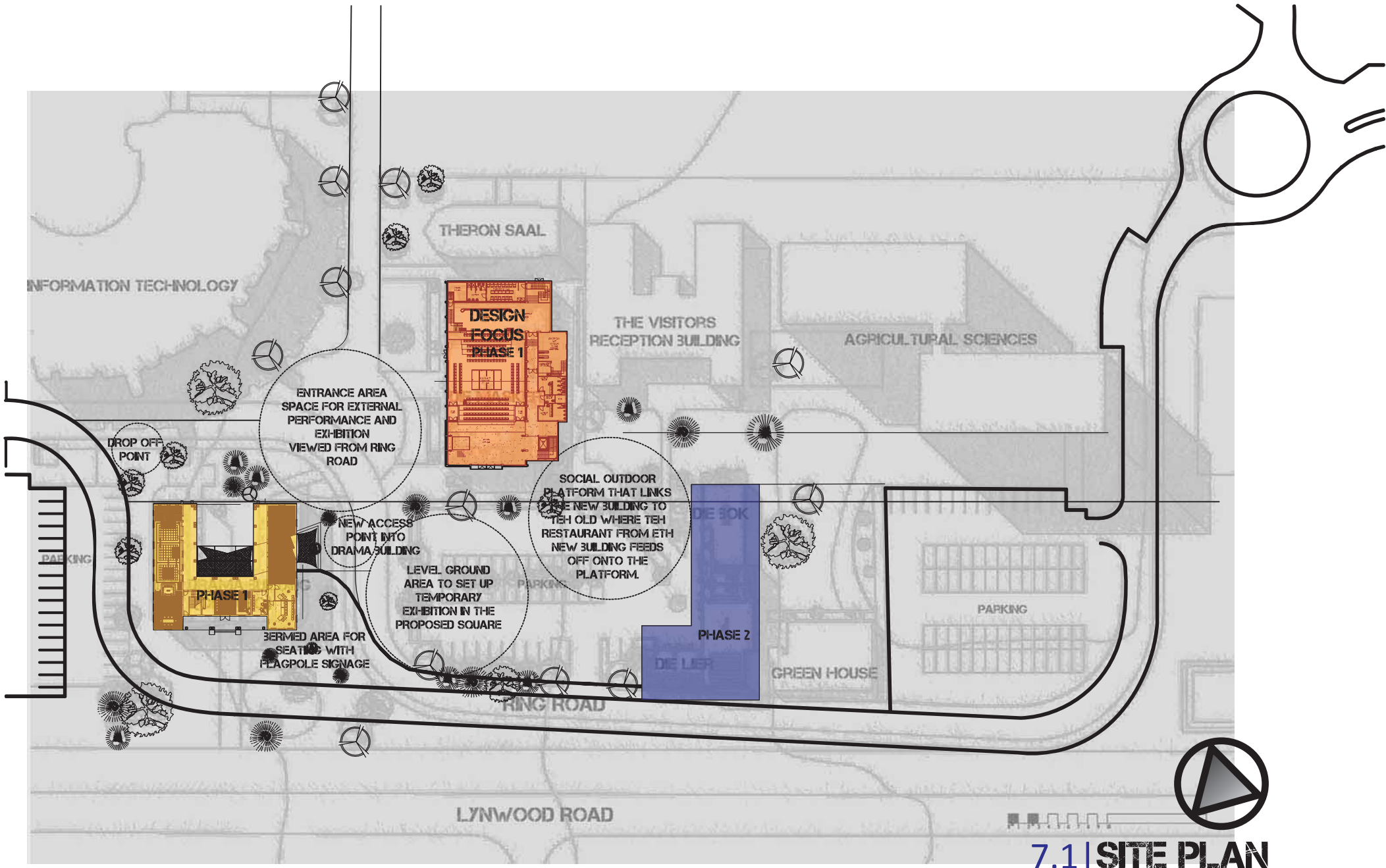
CYCLORAMA

STAGE

AUDIENCE

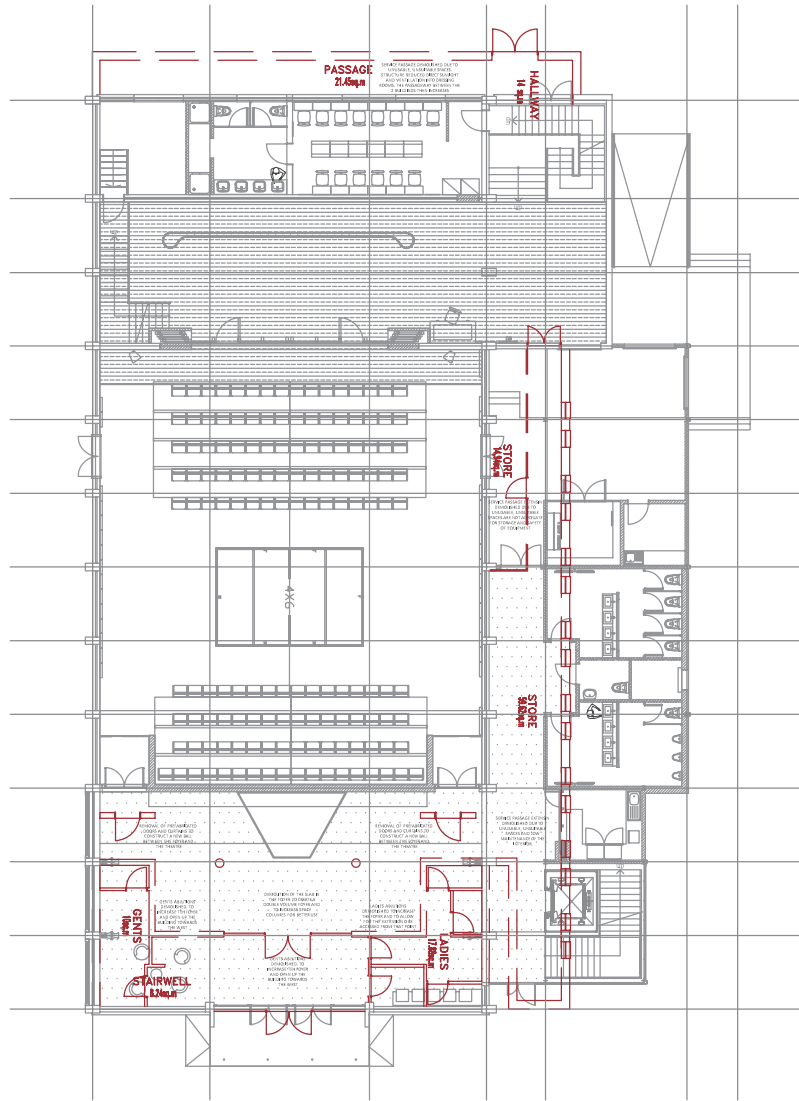
07

TECHNICAL
DRAWINGS

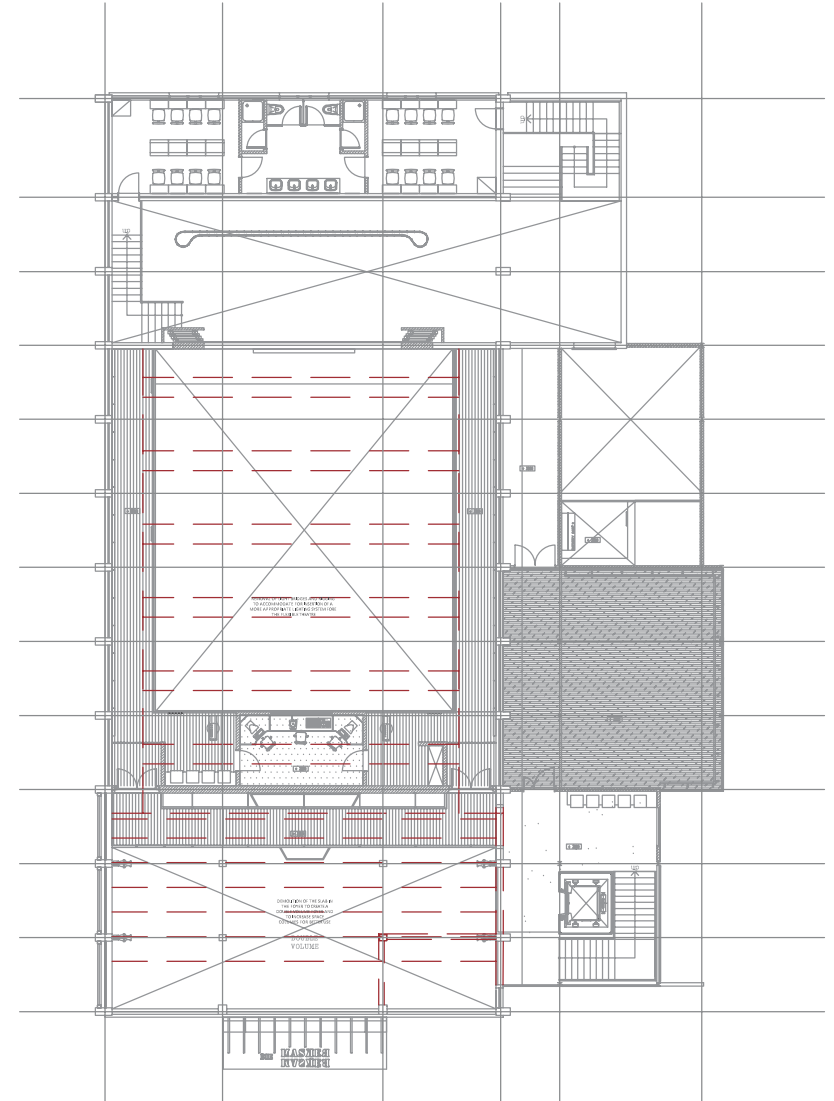


7.1 | SITE PLAN

1 : 1000



7.2.1 GROUND FLOOR

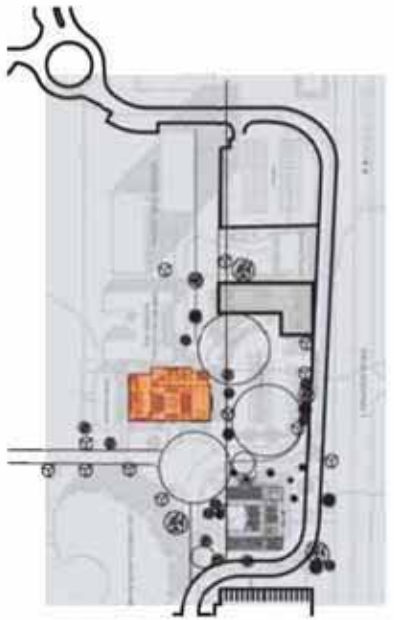
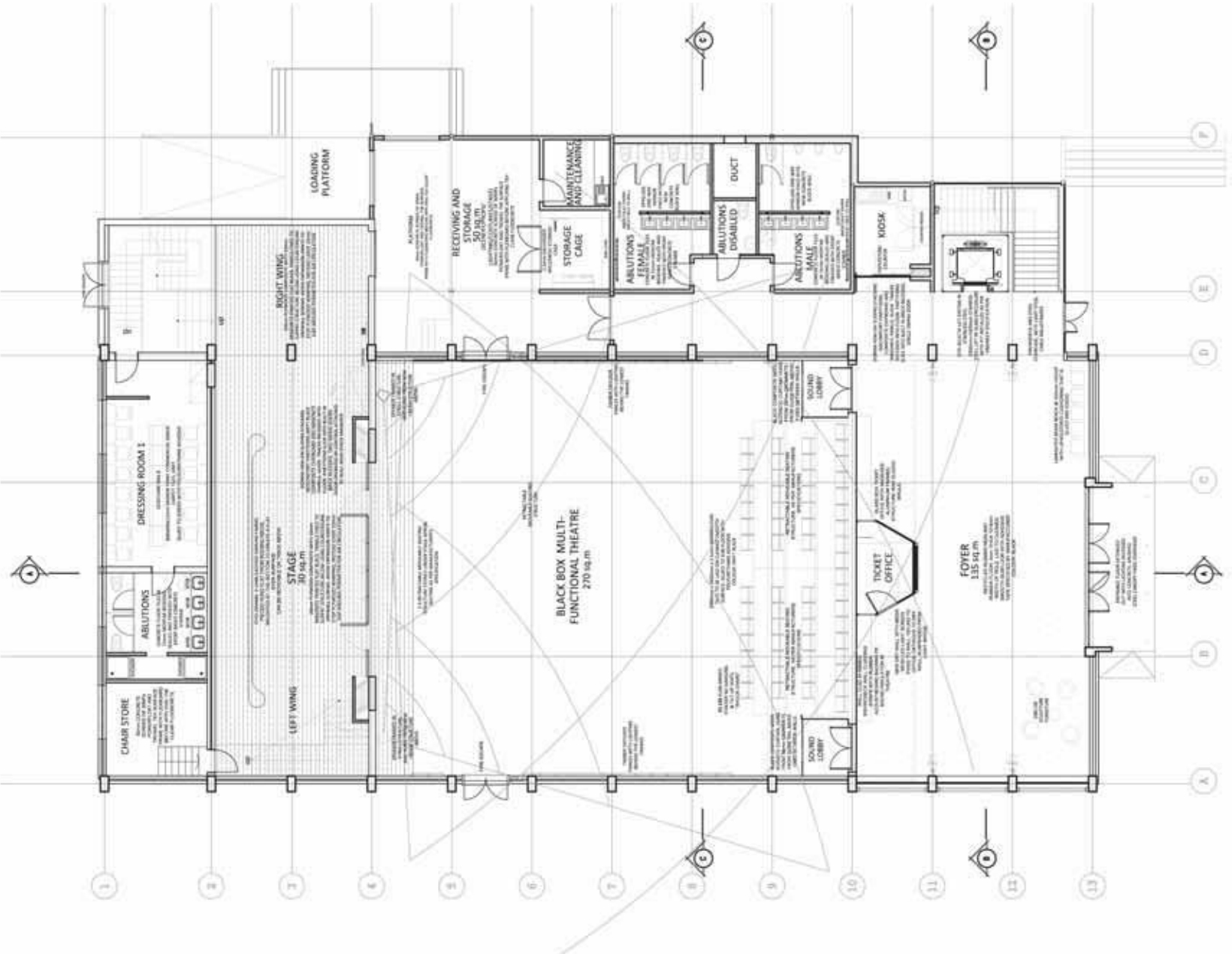


7.2.1 FIRST FLOOR

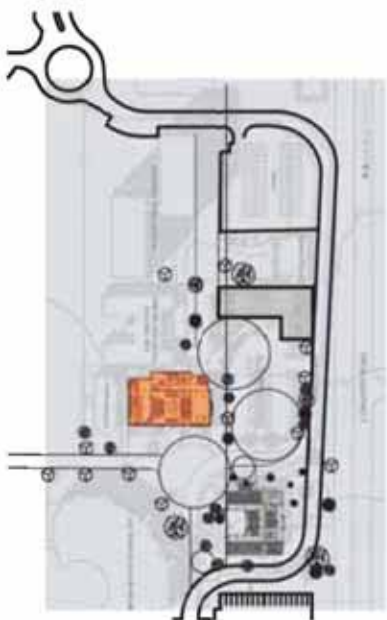
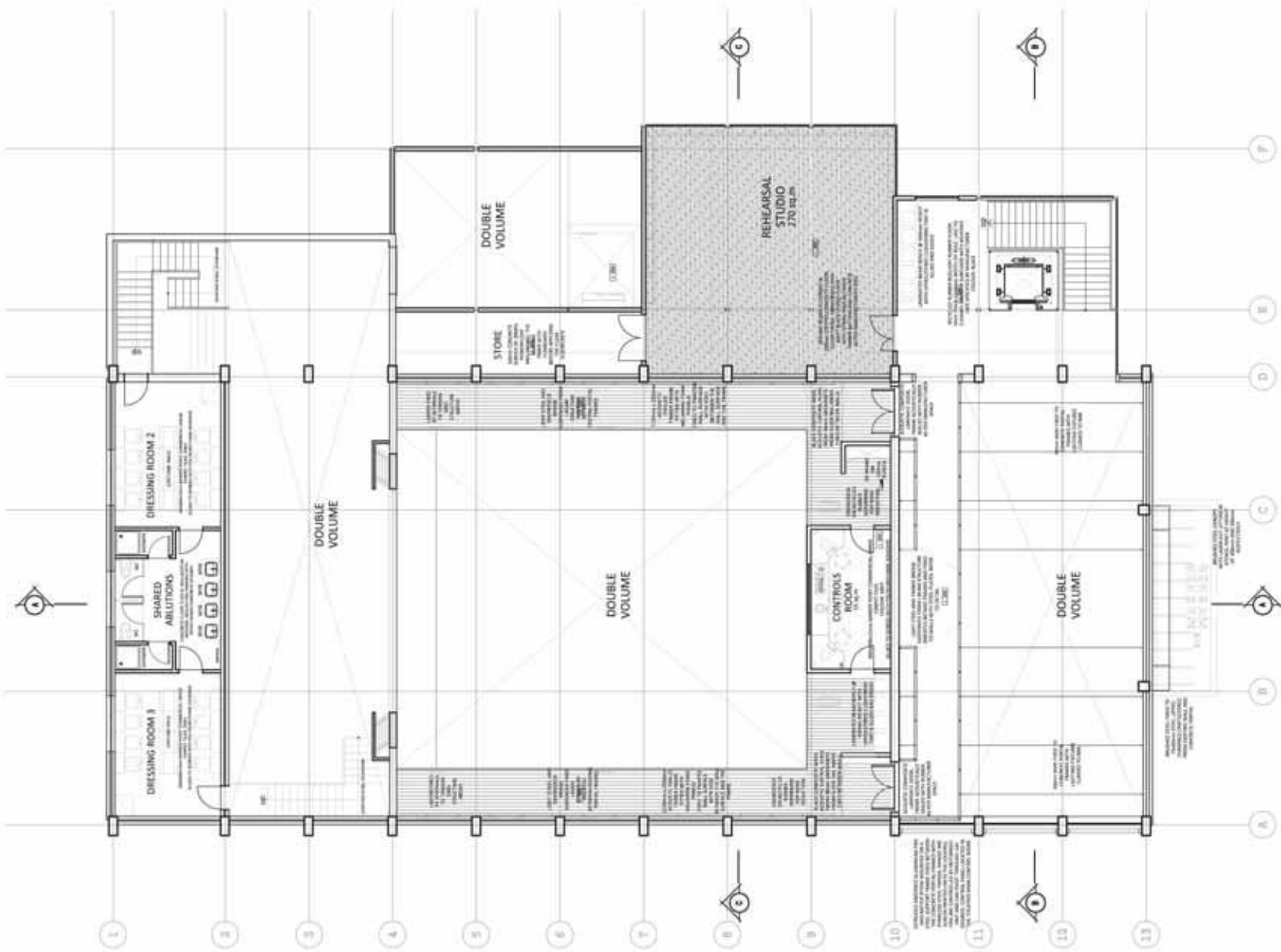


7.2 | GROUND AND FIRST FLOOR
DEMOLITION PLANS

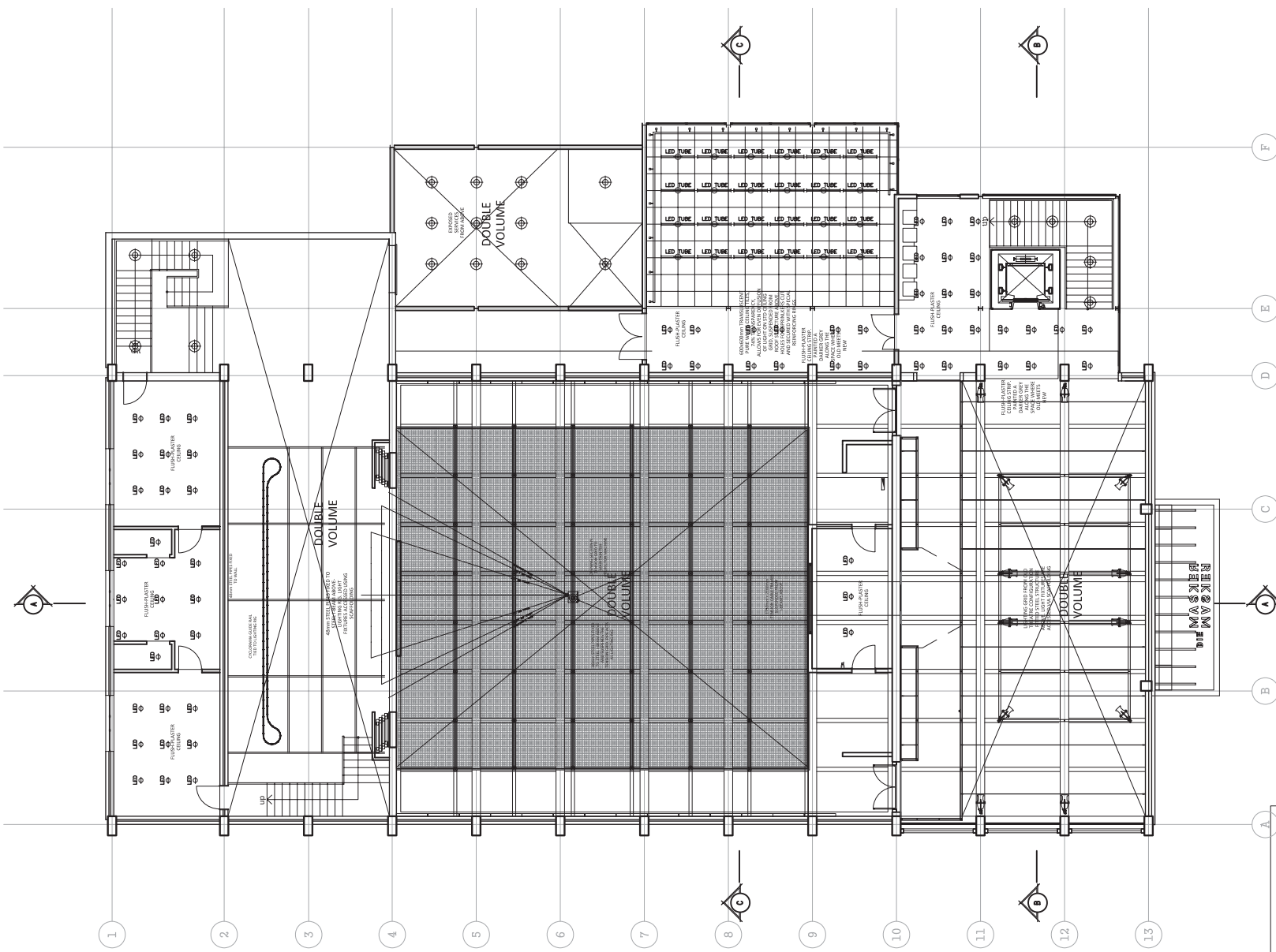
1 : 250



7.3 | GROUND FLOOR PLAN
1 : 150



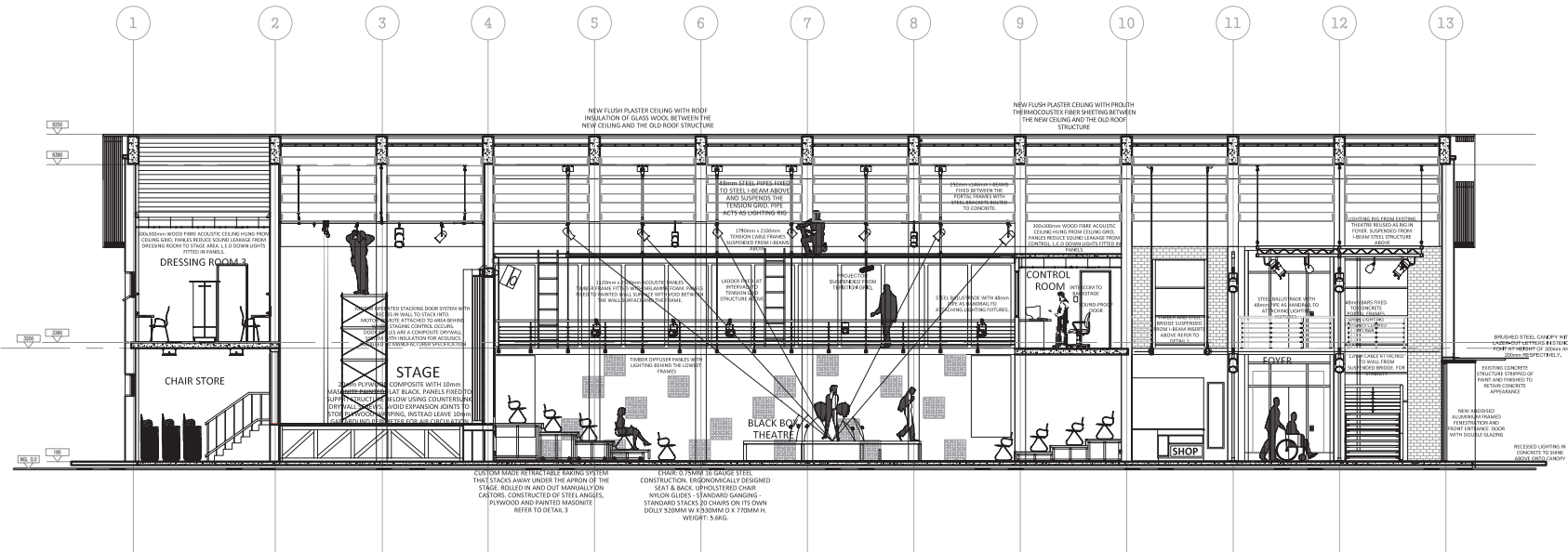
 **7.4 | FIRST FLOOR PLAN**
1 : 150



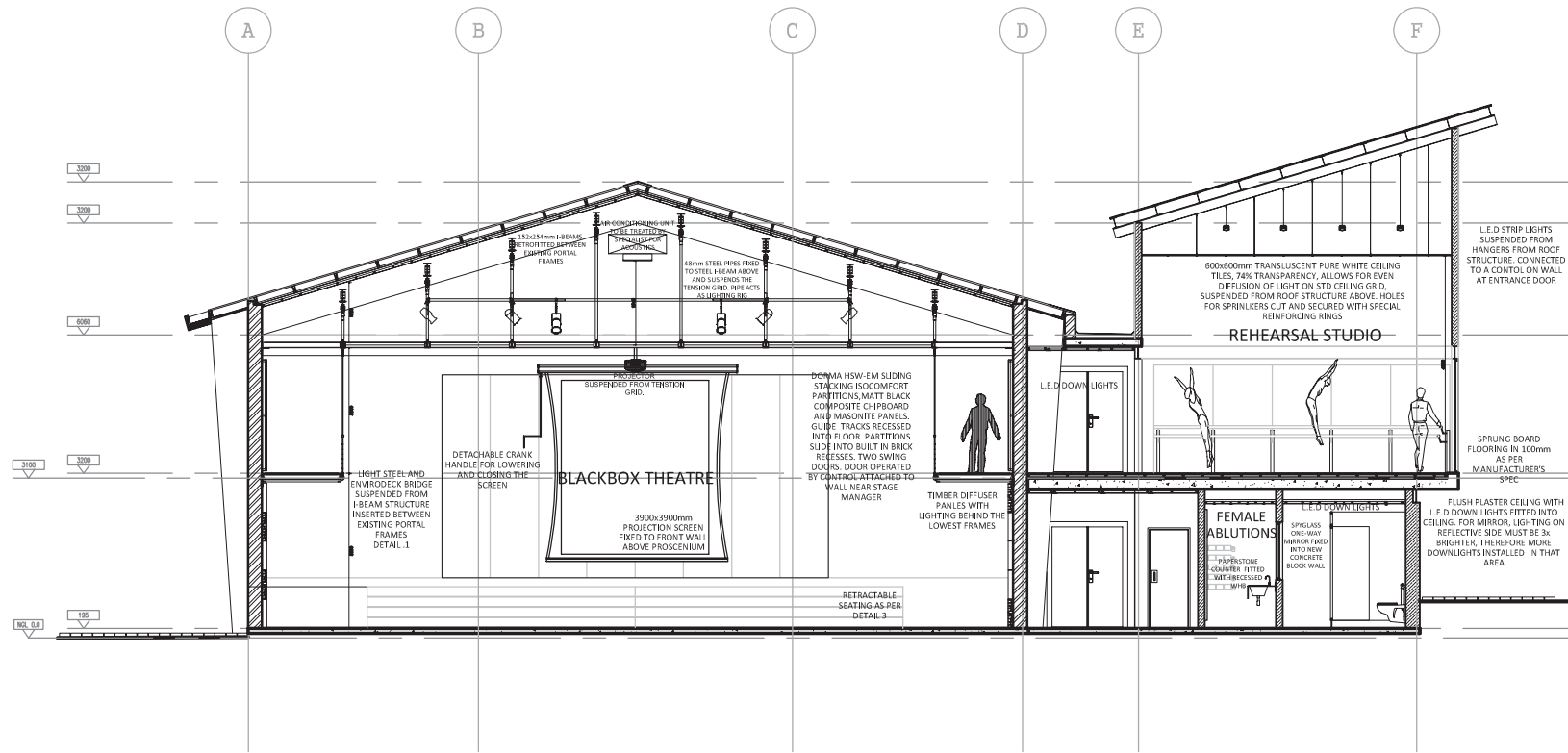
7.5 | PLAN SHOWING TENSION GRID SYSTEM AND LIGHTING IN THE STUDIO

1 : 150

KCT7	LED COLOUR CHANGING TUBE LIGHTS SUSPENDED FROM HANGERS FROM ROOF STRUCTURE. DIMMING IS CONNECTED TO A CONTROL ON WALL.
LED	DIMMABLE LED DOWN LIGHTING FIXTURES. POINT LIGHTING TO HIGHLIGHT AREAS. ENERGY EFFICIENT LIGHTING.
	PARCEN ANS FRESNEL THEATRE LAMPS FOR GENERAL COVER AND HIGHLIGHTING. CONTROLLED FROM CONTROL PANEL LOCATED IN TICKET OFFICE
	GENLUX DECOR HIBBY LIGHTING FOR SERVICE AND CIRCULATION AREAS. BRIGHT ILLUMINATION FOR SERVICE AREAS.

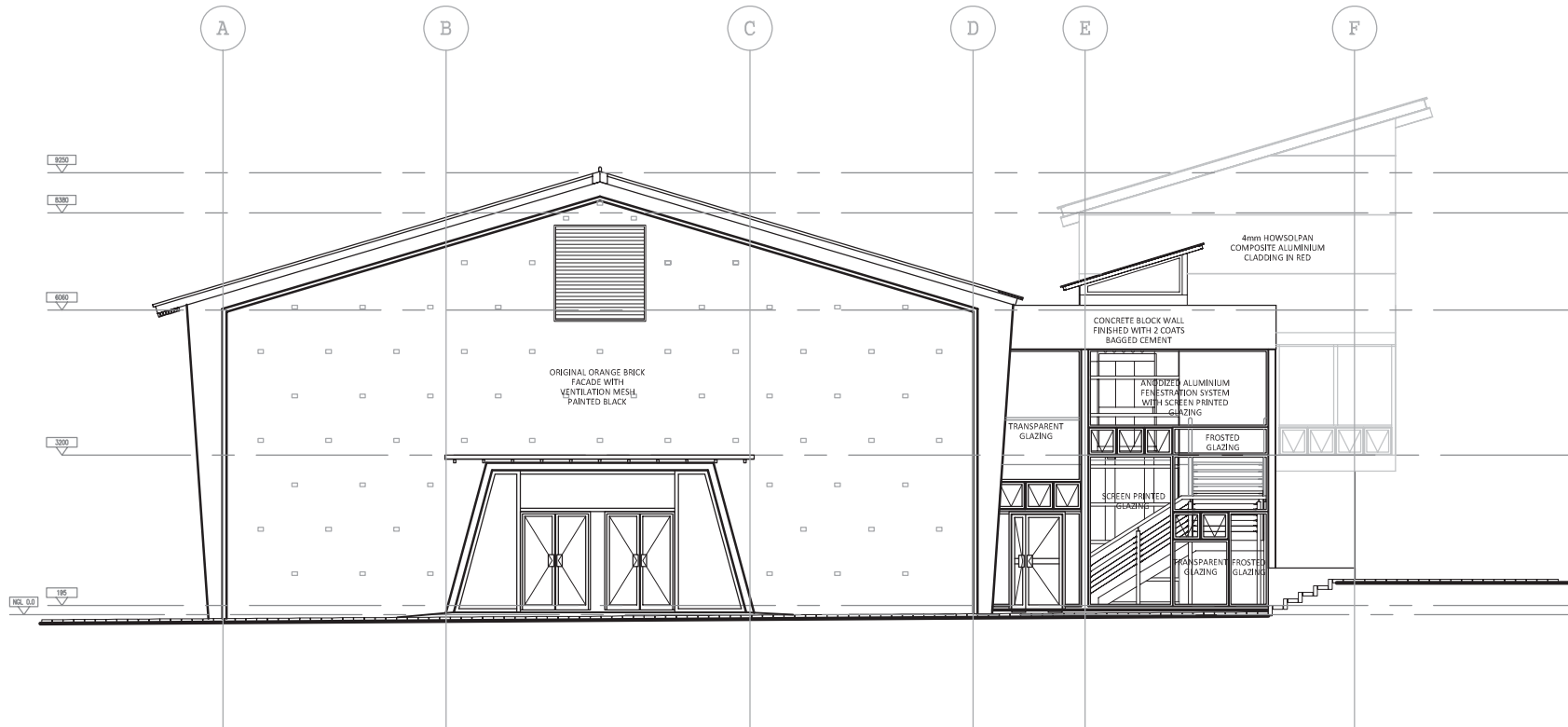


7.6 | SECTION A
1 : 150



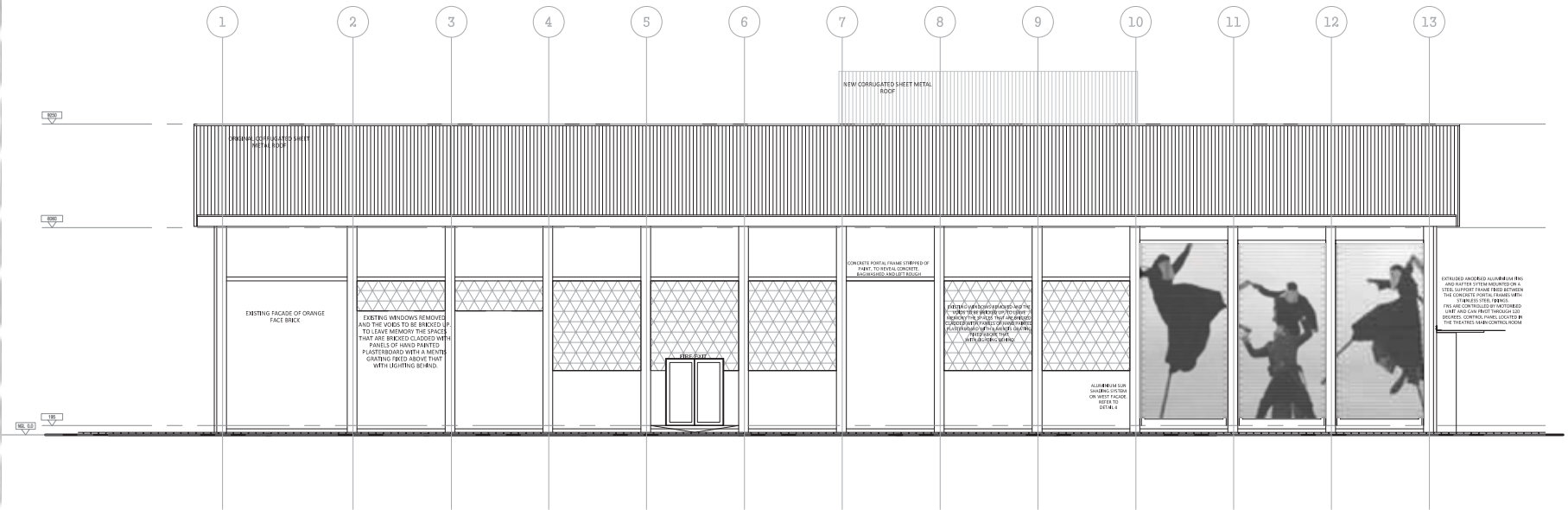
7.8 | SECTION 3

1 : 150



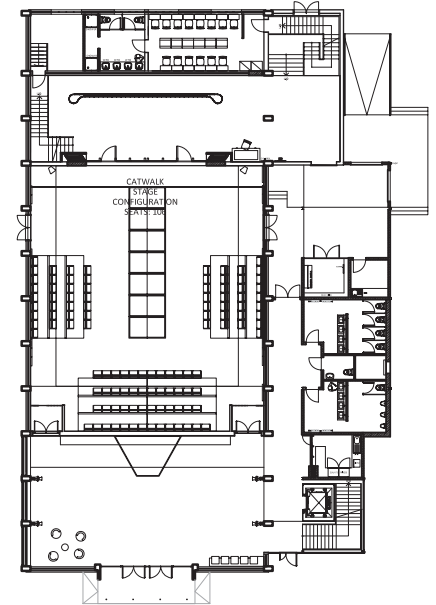
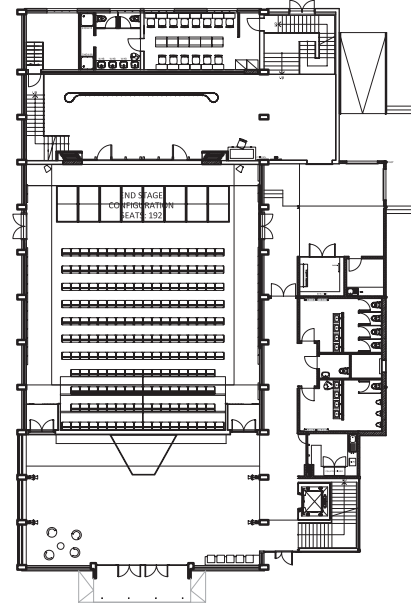
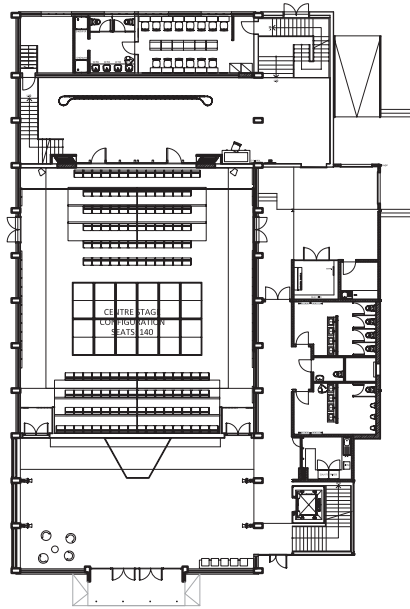
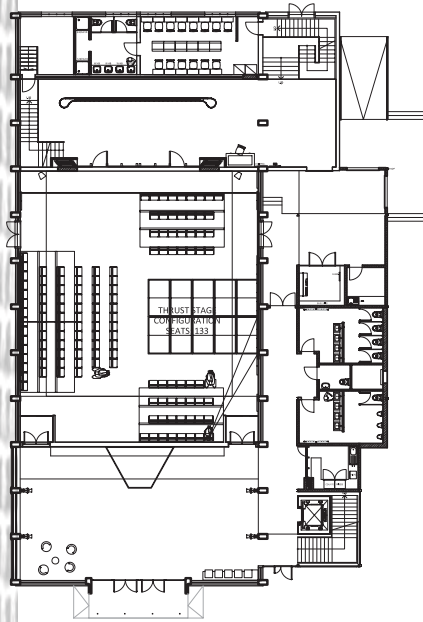
7.9 SOUTH ELEVATION

1 : 150



7.10 WEST ELEVATION

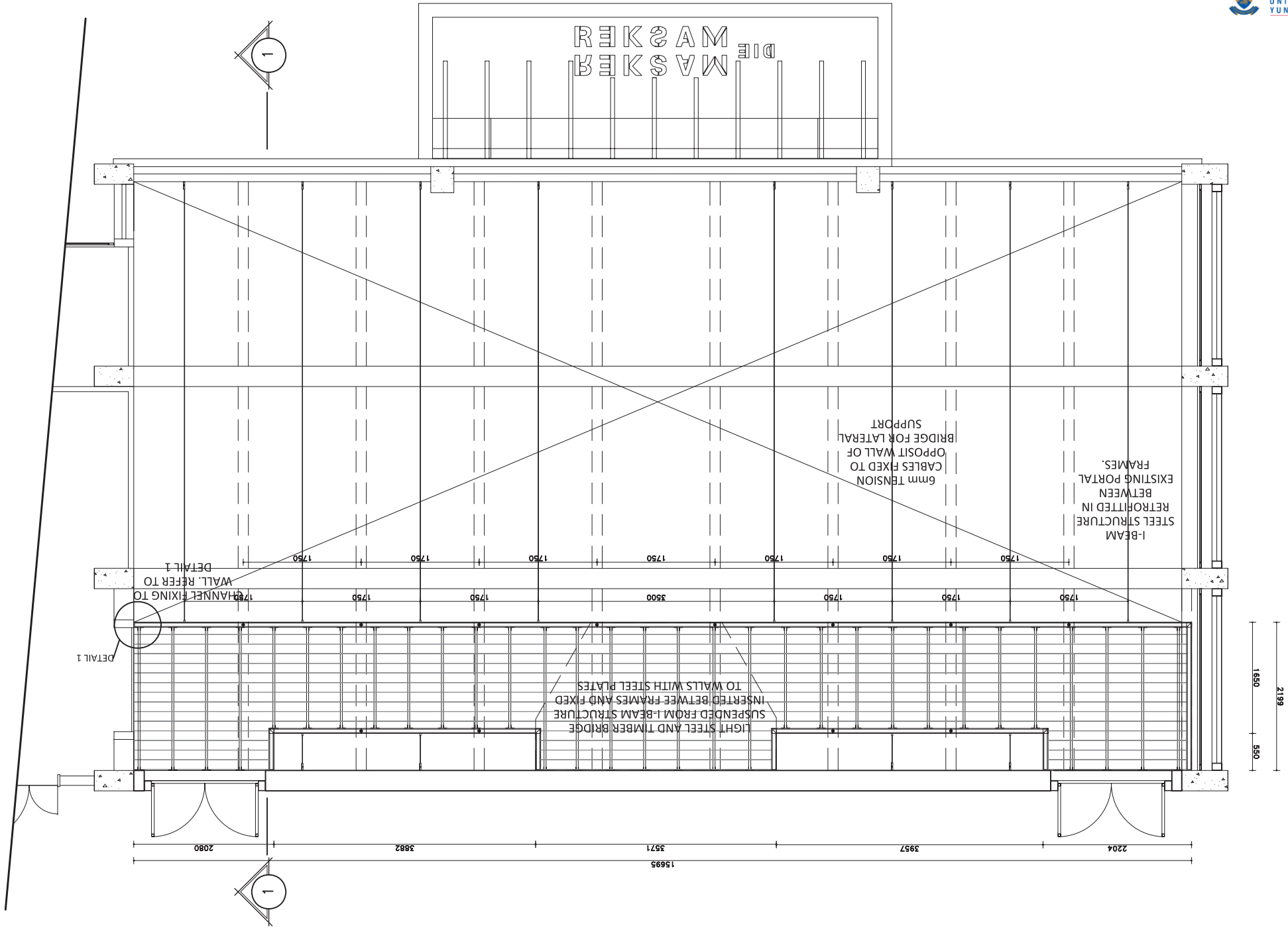
1 : 150



7.11 | THEATRE CONFIGURATIONS

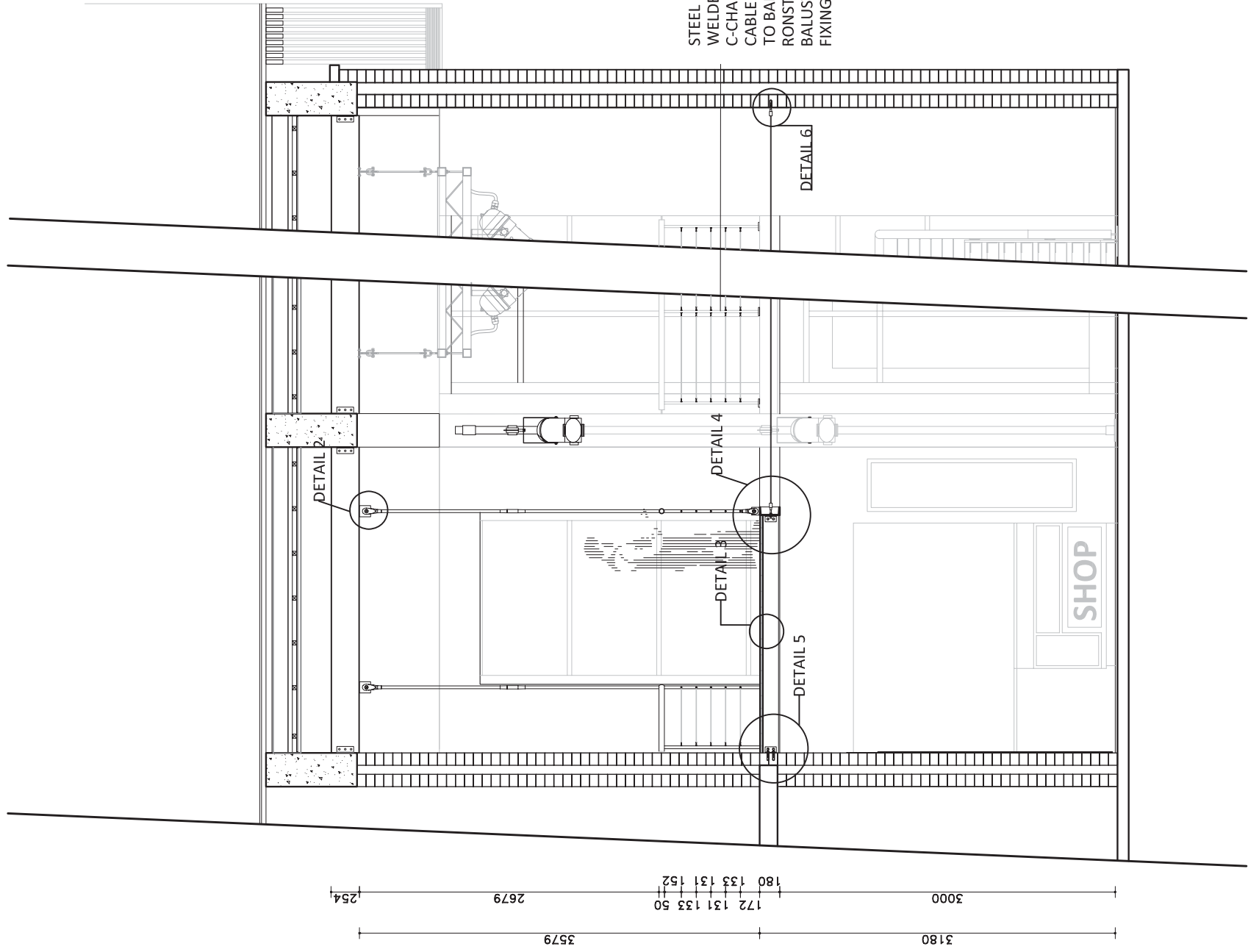
1 : 250

7.12 | BRIDGE PLAN
1:50



7.1.1 BRIDGE SECTION 1

1 : 50



STEEL BALUSTRADES
 WELDED TO THE
 C-CHANNEL. TENSUIN
 CABLE RAILING FIXED
 TO BALUSTRADES WITH
 RONSTAN CABLE
 BALUSTRADING AND
 FIXING

3180
 3579
 3000
 2679
 254
 172 131 133 50
 180 133 131 152

SHOP

DETAIL 2

DETAIL 4

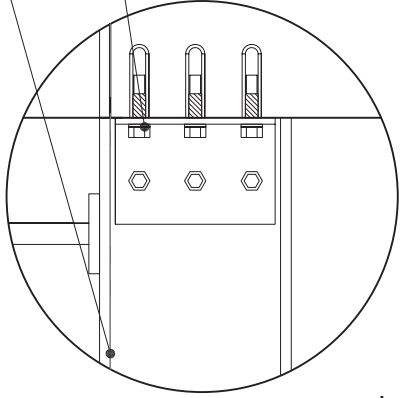
DETAIL 3

DETAIL 5

DETAIL 6

180x89x18mm STEEL CHANNEL FIXED TO
END WALLS AND SUSPENDED FROM ROOF
STRUCTURE ABOVE WITH SUSPENSION RODS

150x100x5mm BOLTED TO CHANNEL
ANGLES ON EITHER SIDE
WITH 3xM12 FRICTION GRIP BOLTS.
ANGLE FIXED INTO WALL WITH 9mm RAWL BOLT



DETAIL 1
1:5

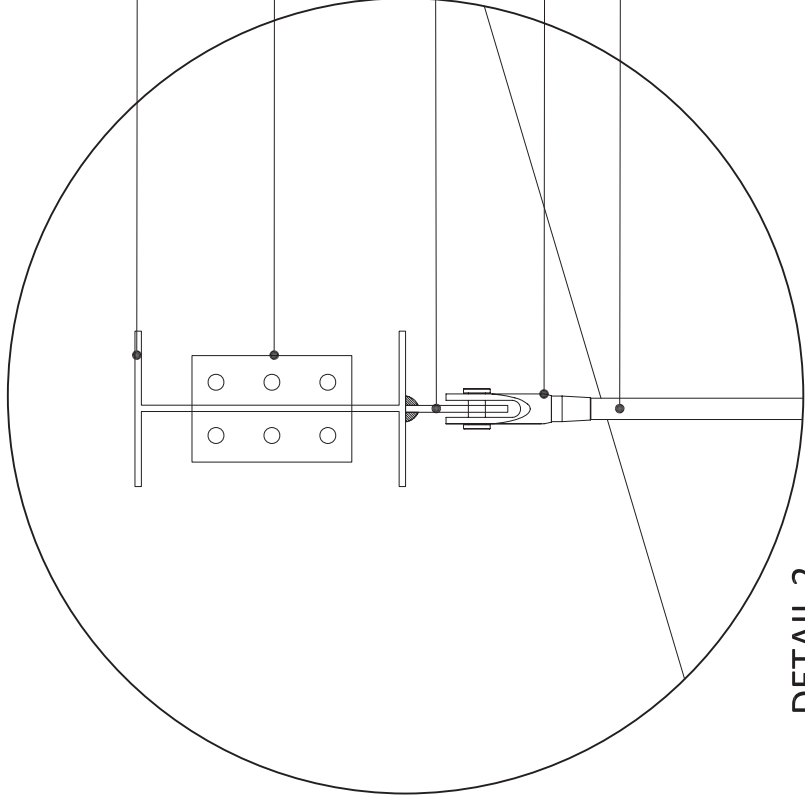
254x146x10mm I-BEAM SECTION
RETROFITTED BETWEEN THE
EXISTING CONCRETE PORTAL
FRAMES.

STEEL PLATE FIXING TO I-BEAM TO
PORTAL FRAME.

60x60x10mm FLATBAR WELDED TO
I-BEAM STRUCTURE FIXED BETWEEN
PORTAL FRAME STRUCTURE

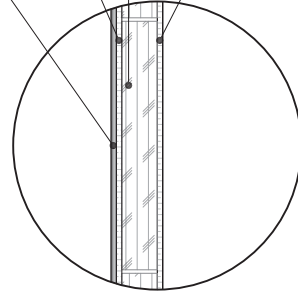
RONSTAN ROD/FORK CLIPPED
TO STEEL FIN

RONASTAN S460 STAINLESS
STEEL ROD OF
25mm DIAMETER

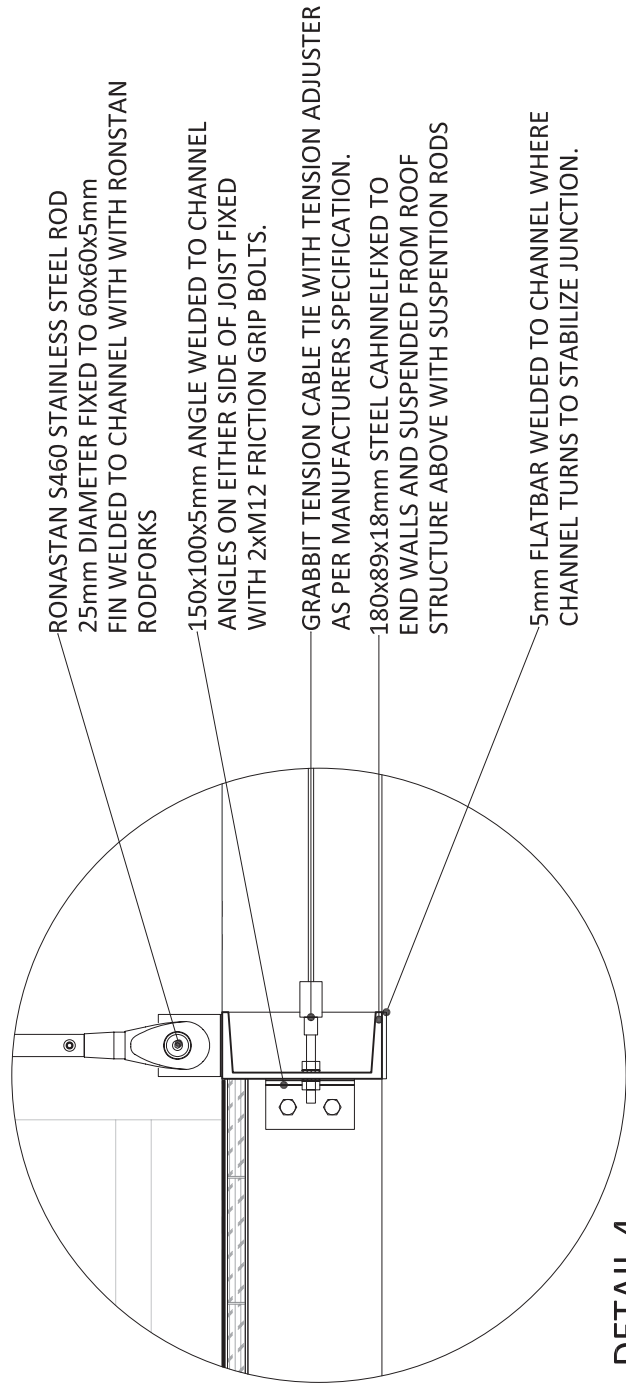


DETAIL 2
1:5

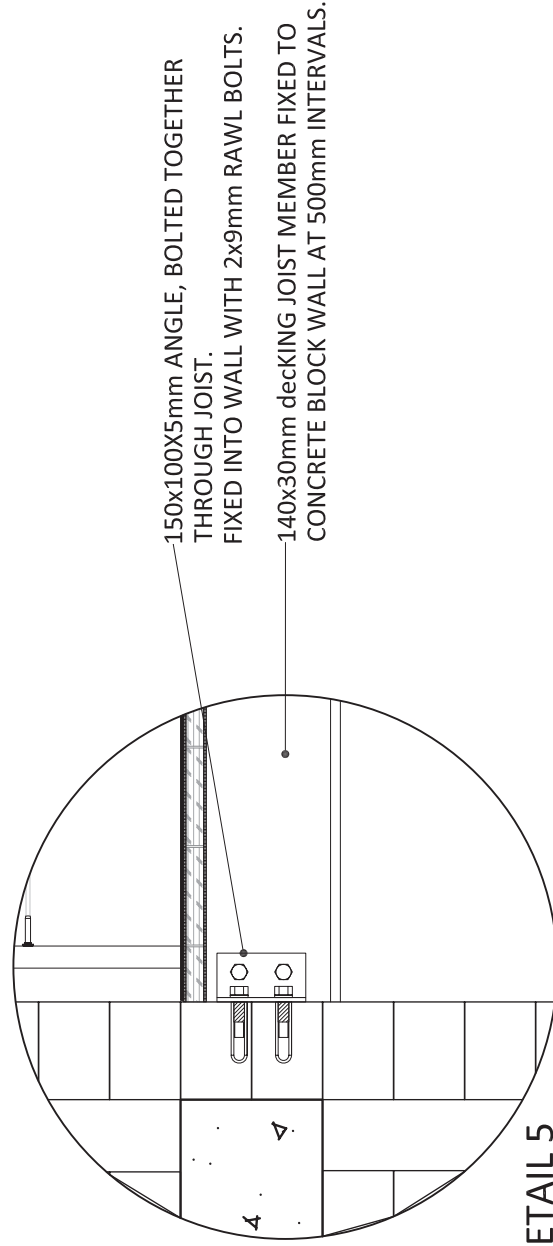
3mm HARLEQUIN STUDIO FLOOR COVERING, BLACK.
COMPLEX VINYL AND FOAM CONSTRUCTION
SOFTENS STEPS AND DECREASES SOUND.



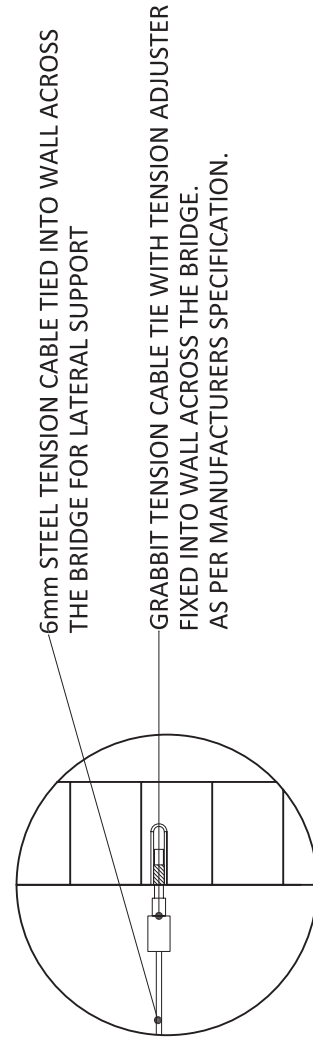
DETAIL 3
1:2



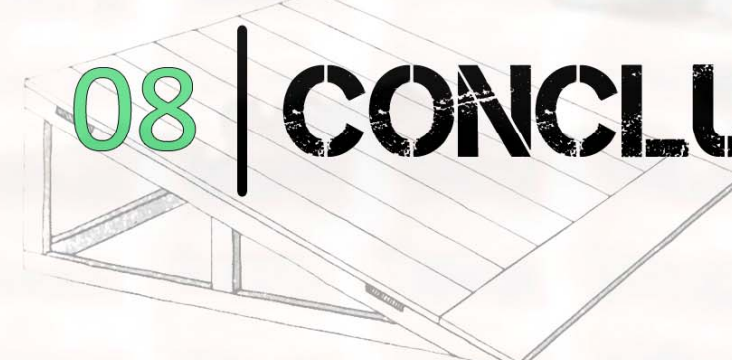
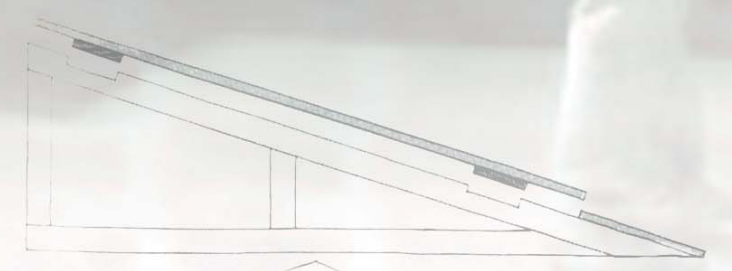
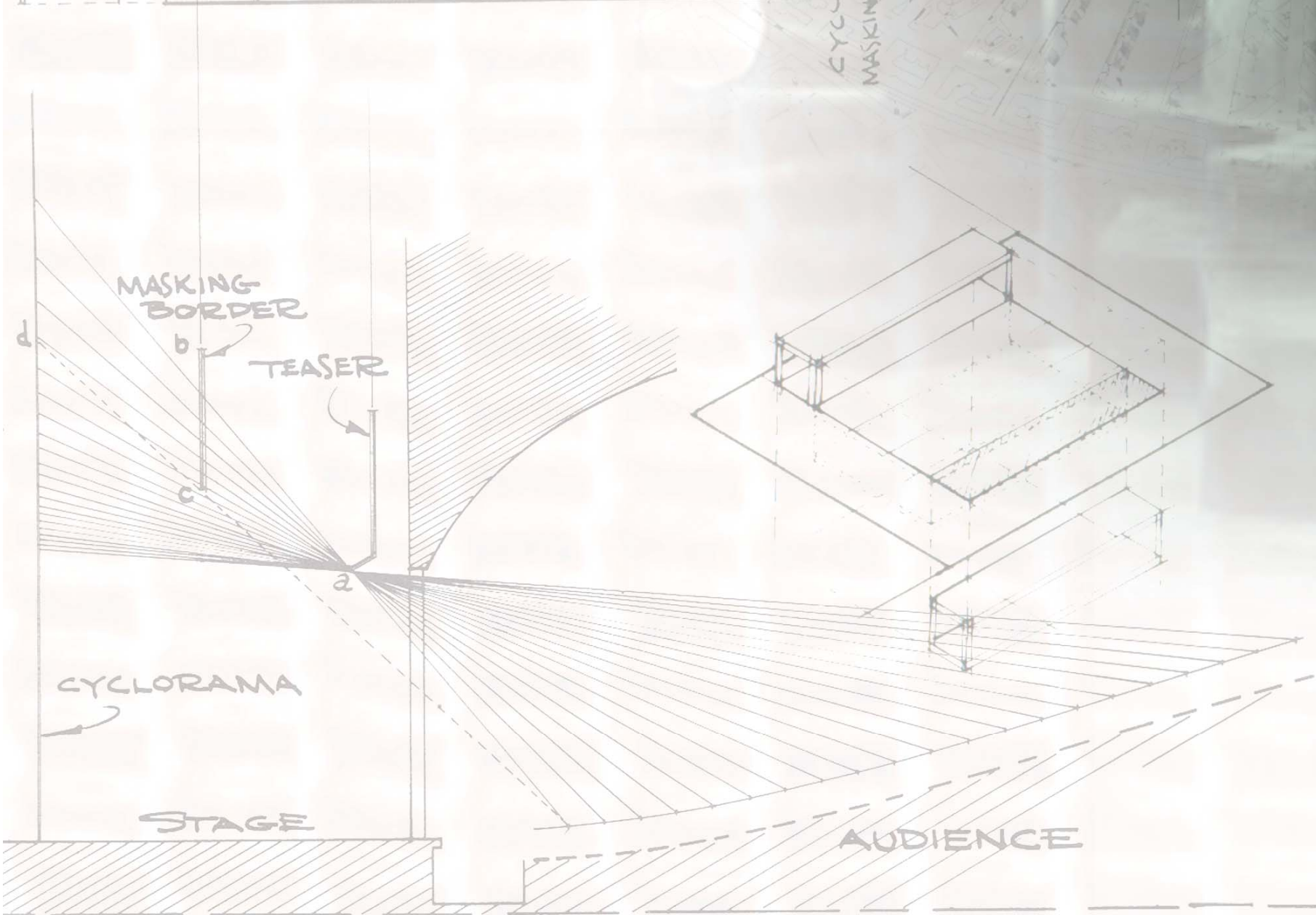
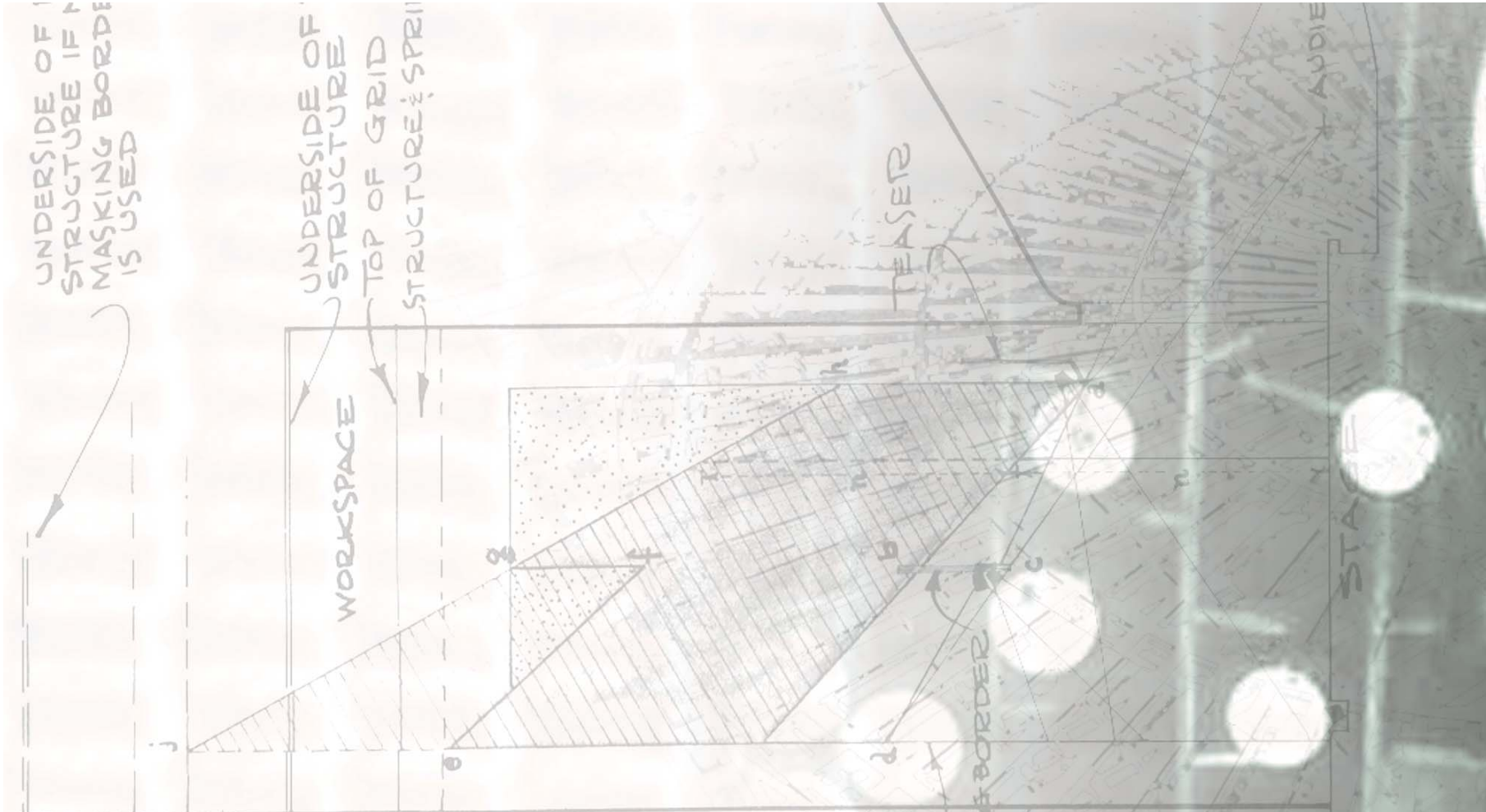
DETAIL 4
1:5



DETAIL 5
1:5



DETAIL 6
1:5

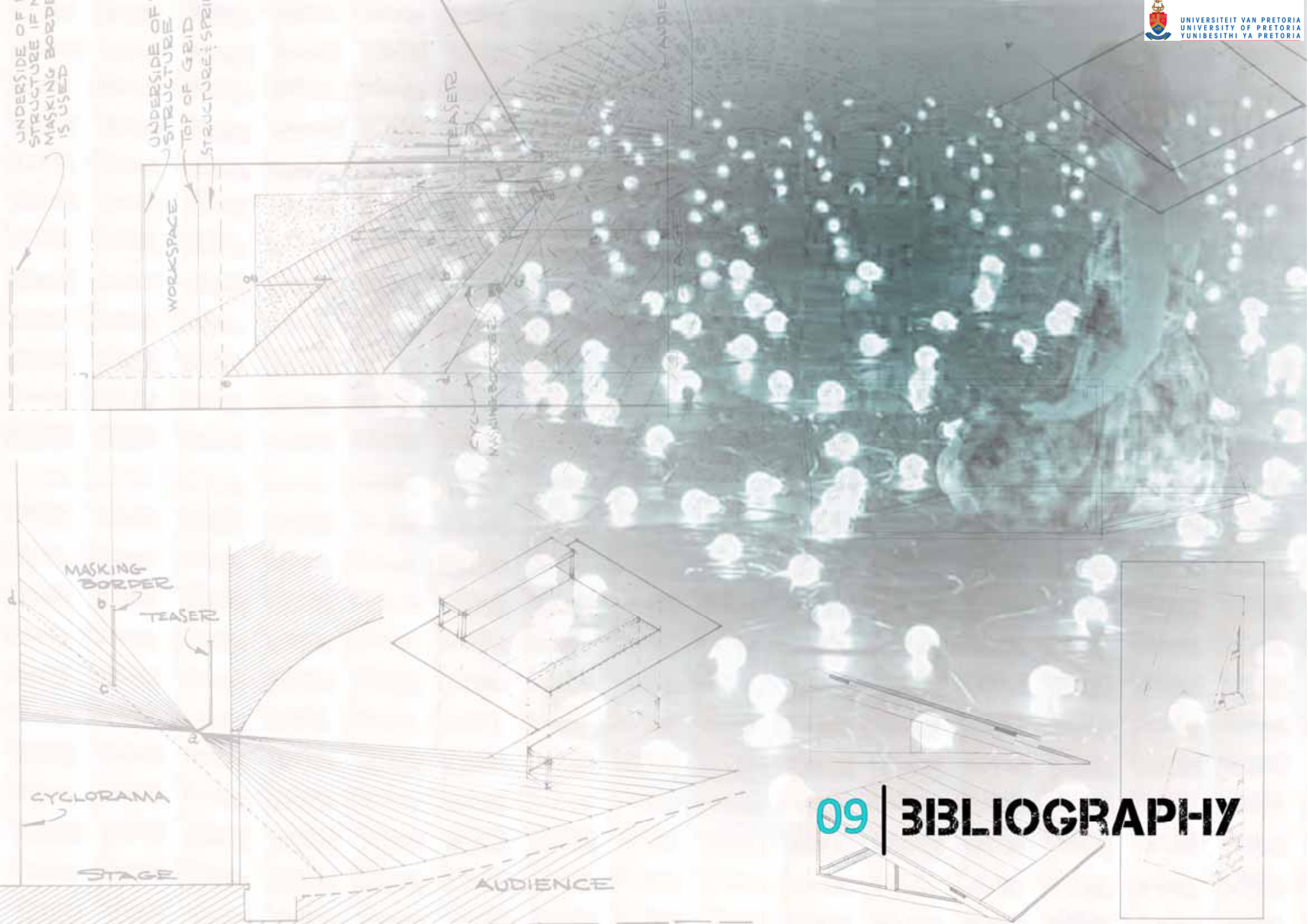


08 | CONCLUSION

08 | CONCLUSION

The project has succeeded in achieving to integrate a sense of culture within the society by integrating the art into the landscape and weaving its essence into the students mind. This is done by:

- **Transforming the spaces** so that the actual art of performance becomes a **natural activity within a society, a node**. This can be the force that brings people together and it can create a **new culture within the society** by means of the public being a part of something, **visually or physically**.
- Implementing elements to dramatic arts education that **functions in various ways for various training and rehearsal**. This allows for dramatic arts research to occur due to the spatial configurations that allow for **any dramatic experience to occur**. This is done by **differentiating the theatre from the many other auditoriums on campus** to be a more student **education and performance orientated space, a flexible theatre space**.
- **Optimising the buildings' spaces** to become functional, if not multi-functional, and allow for a single space or “district” to be used by the Department instead of a variety of spaces in and around the University.
- Enhancing theatre to be user friendly and environmentally safe with regards to the **use of materials and methods that enhance the theatres sustainability**.
- Complying with the planning of the strategy of Tshwane metropolitan municipality to **enhance the social aspects of Hatfield** as it is to become a “Core” within the city of Pretoria.



UNDERSIDE OF
STRUCTURE IF
MASKING BORD
IS USED

UNDERSIDE OF
STRUCTURE
TOP OF GRID
STRUCTURE SPR

WORKSPACE

TEASER

CYCLORAMA

MASKING
BORDER

TEASER

CYCLORAMA

STAGE

AUDIENCE

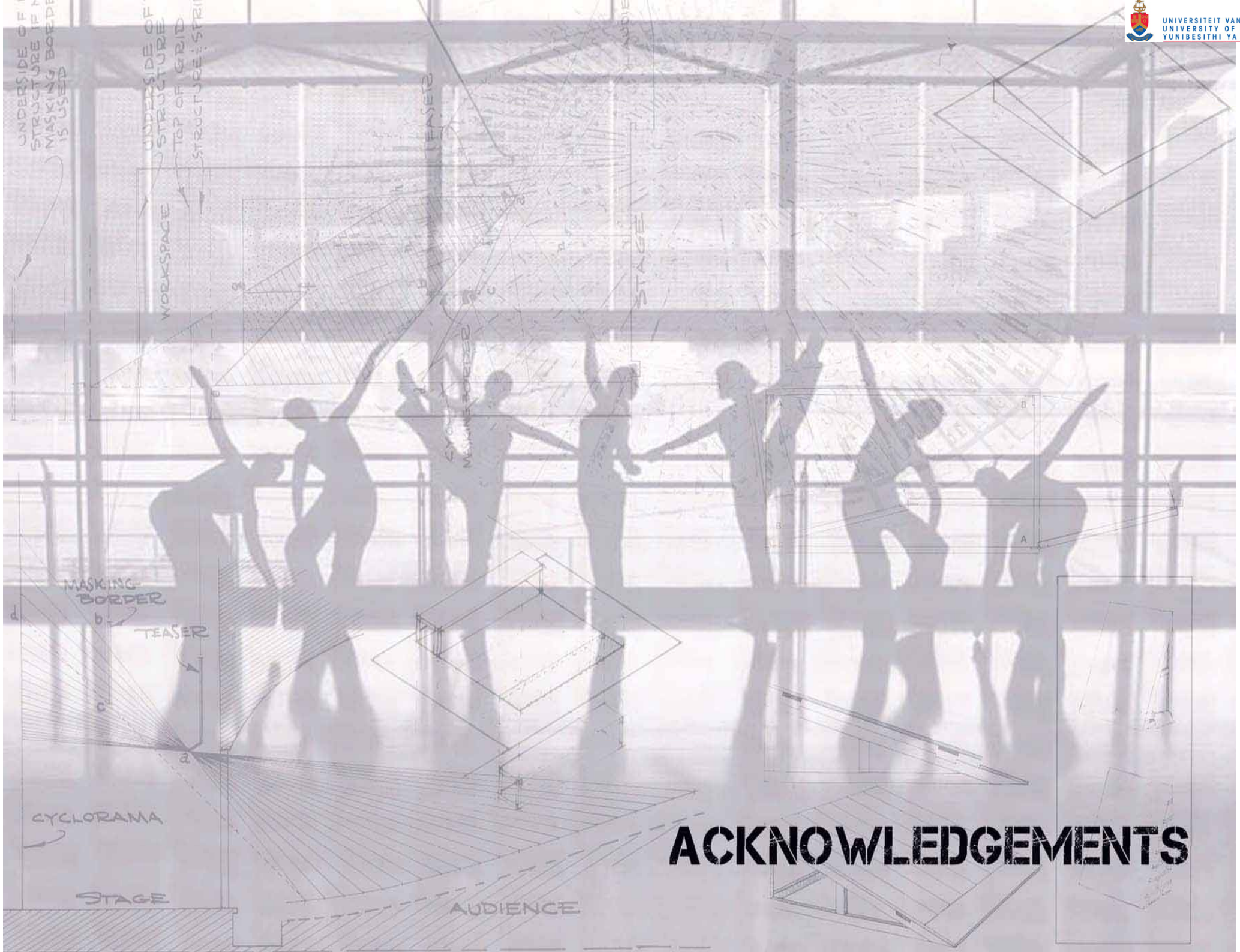
09 | BIBLIOGRAPHY

09 | BIBLIOGRAPHY

1. "Black box theatre". http://en.wikipedia.org/wiki/black_box_theatre (12 Aug. 2008).
2. "Innovation generation: Creating the future, 2007-2011". The strategic plan of the University of Pretoria. <Http://web.up.ac.za/default.asp?ipkcategoryid=2995&subid+2995&ipklookid+z> (1 Feb. 2008).
3. "Stage lighting systems – lighting rig anatomy" <http://www.onstagelighting.co.uk/learn-stage-lighting/stage-lighting-syatemns-lighting-rig/> (12 Aug. 2008).
4. "Tension grid". http://en.wikipedia.org/wiki/tension_grid (12 Aug. 2008).
5. "Tension wire". <http://www.riggingsystems.com/tensionwire.asp> (12 Aug. 2008).
6. Alton Everest, F. 1974. *Acoustic techniques for homes and studio*. Slough Bucks: Foulsham-Tab.
7. Author Unknown. 2005. *Buildings of the UP Campus: Almost a Textbook of 20th Century Architecture*. Pretoria: University of Pretoria.
8. Available from <http://www.jstor.org/stable/1146994> (25 Apr. 2008).
9. Available from <http://www.jstor.org/stable/3245703> (19 Jun. 2008).
10. Available from www.jstor.org/stable/2637075 (21 Aug. 2008).
11. Banham, M. 2004. *A history of theatre in Africa*. Cambridge: Cambridge University Press. Author: Hutchison Yvette (South African theatre).
12. Barba, E. 2002. "The essence of theatre". *TDR* 1988 46(3): 12-30.
13. Barker, C. & McCaw, D. 2001. *Workshops for the world: The international workshop festival*. London: Harwood Academic.
14. Bennet, S. 1990. *Theatre audiences: A theory of production and reception*. London: Routledge.
15. Braun, E. 1979. *The theatre of Meyerhold: Revolution on the modern stage*. London: Eyre Methuen.
16. Brecht, B. 1960. *Brecht on theatre: The development of an aesthetic*. New York: Hill and Wang.
17. Brook, P. 1968. *The empty space*. New York: Atheneum.
18. Burris-Meyer, H. & Cole, E.C. 1964. *Theatres and auditoriums*. New York: Reinhold.
19. Carlson, M. 1989. *Places of performance: The semiotics of theatre architecture*. Ithaca: Cernel University Press.
20. Chita, M. 2008. Photographs of the site
21. City of Tshwane Transport Plan 2004-2009: Chapter 4. City of Tshwane Metropolitan Municipality. <http://www.tshwane.gov.za> (11 Mar. 2008).
22. Climate Data Pretoria. South African Weather Services. Available from <http://www.weathersa.co.za/Climat/Climstats/PretoriaStats.jsp> (11 Mar. 2008).
23. Daw, S. 2005. "Rutherford & Son".
24. Duggan 2008. "Dr Duggan reviews the past". Published in the 1972 Magazine of the Christian Brothers College. Available from www.cbcpretoria.co.za/index.cfm/p/pages.schools-s-history.htm (16 Jun. 2008).
25. Eugenio, B. 2002. "The essence of theatre". *TDR* 46(3): 12-30.
26. Everest, F.A. 1974. *Acoustic techniques for home and studio*. London: Foulsham-Tab.
27. *Filología Inglesa*. "Theatre Production: Functions, Characteristics, Academic Theatre, Auditoriums, Director, Performers and Producer". <http://pdf.rincondelvago.com/theatre-production.html> (15 Oct. 2008).

28. Gardner, L. 2001. The sordid side of Hamlet: The secret life of Ophelia. Published in *The Guardian*, 10 Jul. 2001. <http://www.guardian.co.uk/stage/2001/jul/10/theatre.artsfeatures> (14 Sep. 2008).
29. Goodheart, C. "A case for the arts in education". Published in *New horizons for learning*, 2000.
30. Graver, D. 1995. "Theatres in New South Africa". *Performing arts journal* 17(1): 103-109.
31. Gronemeyer, A. 1995. *Theatre: An illustrated historical overview*. Berlin: Dumont Buch
32. Haggerman, C. 2008. *Interview conducted at the Drama Department*, University of Pretoria, 13 February 2008.
33. Hatfield Metropolitan Core Urban Development framework. 14 Aug. 2007. Metropolitan spatial planning city planning, development and regional services department: City of Tshwane Metropolitan Municipality.
34. http://rpginc.com/commercial/design_assistance/pdfs/black_box_theatre.pdf (12 Aug. 2008).
35. <http://www.jonasarmstrong.net/rutherfordandson.html> (14 Sep. 2008).
36. <http://www.wisegeek.com/what-is-a-black-box-theatre.html> (12 Aug. 2008).
37. Jackson, A. 1993. *Learning through theatre*. London: Routledge.
38. Jones, V. 1980. *Nuefert architect's data*. London: Blackwell Sciences Ltd.
39. Joseph, A. "The value of the arts to the community and education". <http://www.newhorizons.org/strategies/arts/joseph.htm> (12 Aug. 2008).
40. Lynch, K. 1962. *The image of the city*. Cambridge, Massachusetts: The Massachusetts Institute of Technology Press.
41. Mackintosh, L. 1993. *Architect, actor and audience*. London: Routledge.
42. Marquis-Kyle, P. & Walker, M. 2004. *The illustrated Burra Chart: Good practice for heritage places*. Sydney: Burrawood.
43. Mason, B. 1992. *Street theatre and other outdoor performance*. London: Routledge.
44. McAuley, G. 2002. *Space in performance: Making meaning in the theatre*. Ann Arbor, Michigan: University of Michigan Press.
45. Mielziner, J. 1970. *The shapes of our theatre*. New York: Clarkson N. Potter.
46. Misra, S. 2008. Photographs of the site.
47. Moore, J.E. 1983. *Design for good acoustic and noise control*. London: Macmillan.
48. Murphy, R. 1990. *Carlo Scarpa and the Castelvechio*. London: Butterworth-Heinemann.
49. Norberg-Schultz, C. 1979. *Genius loci: Towards a phenomenology of architecture*. New York: Rizolli.
50. Norberg-Schultz, C. 1980. *Genius loci: Toward a phenomenology of architecture, Academy ed*. London: Rizolli.
51. Norberg-Schultz, C. 2000. *Architecture: Presence, language and place*. Milan: Skira.
52. Oddleifson, E. 1990. "A fifty-school arts education demonstration project". *New horizons for learning's on the beam* 4(1): 4-5, 251. Available from <http://www.newhorizons.org/strategies/arts/cabe/oddleifson.html>.
53. Oddleifson, E. 1996. "The necessary role of the arts in education and society: Finding the creative power within us to control our lives and shape out destinies". <http://www.newhorizons.org/strategies/arts/cabe/oddleifson.z.htm> (12 Aug. 2008).
54. Osipovich, D. s.a. *What is a theatrical performance?* New York: Marist College.
55. Perrin, S. 1997. "The arts are nice but..." Published in *New horizons for learning: Centre for arts in the basic curriculum*. Available from: www.newhorizon.org/strategies/arts/cabe/perrin/htm (12 Aug. 2008).
56. Perry, J. 1965. "The enigma of flexible staging". *Educational Theatre Journal* 17(4): 335-340. Available from www.jstor.org/stable/04316329 (18 Aug. 2008).
57. Read, A. 1993. *Theatre and everyday life: An ethics of performance*. London: Routledge.

- 58.Reid, F. 1992. *The stage lighting handbook*, 4th ed. New York: Routledge.
- 59.Reid, F. 1992. *The stage lighting handbook*, 4th ed. New York: Routeledge.
- 60.Rendell, J. 2005. *Art and architecture: A place between*. New York: 1B Tauns.
- 61.Sanford, K. 2001. *Architecture of time: Towards a theory of the events in modernist culture*. Cambridge, Massachusetts: The Massachusetts Institute of Technology Press.
- 62.Steadman, I. 1990. "Towards a popular theatre in South Africa". *Journal of Southern African Studies* 16(2): 208-228.
- 63.Sudjic, D. "Architecture, spectacle, performance". From the catalogue of the Venice architectural Biennale 2002. Posted by John Thackara on 3 Oct. 2002.
- 64.Thomas, R. 1996. *Environmental design*. London: Chapman & Hall.
- 65.Thomas, R. 1996. *Environmental design: An introduction for architects and engineers*. London: E and FN Spon.
- 66.Thompson, J. 2003. *Applied theatre: Bewilderment and beyond*. Bern: Peter Lang.
- 67.Trancik, R. 1986. *Finding lost space: Theories of urban design*. New York: Van Nostrand Reinhold.
- 68.Tutt P & Adler, D. 1995. *New metric handbook*. Oxford: Butterworth.
- 69.Watson, F.R. 1923. *Acoustics of buildings, including acoustics of auditoriums and soundproofing of rooms*. London: Chapman and Hall.
- 70.Watson, F.R. 1923. *Acoustics of buildings, including the acoustics of auditoriums and sound-proofing rooms*. New York: Chapman and Hall.
- 71.Watson, I. 2001. *Performer training: Developments across cultures*. Newark, New Jersey: Rutgers University Press.
- 72.What is black box theatre? "Materiality and the black box theatre as an empty space of reproduction"
http://www.idea_edu.com/Journal/2003/(12 Aug. 2008).
- 73.Wild, L. 2006. *Lighting the arena and thrust stage*. Available from <http://www.northern.edu/wild/litedes/ldarena.htm> (updated 19 Dec. 2006).
- 74.Wiles, D. 2003. *A short history of western performance space*. Cambridge: Cambridge University Press.
- 75.Williams, B. 1999. *Stage lighting design*, 2nd ed. Available from <http://www.mts.net/~william5/sld/sld-700.htm>.
- 76.www.doorsof perception_weblog_architecture_spacacle_performance htm (12 Aug. 2008).
- 77.www.newhorizons.org/strategies/arts/goodheart.html (12 Aug. 2008).



ACKNOWLEDGEMENTS

ACKNOWLEDGEMENTS

This road was long and winding with ups and downs, but with the guidance and support of many my destination was reached.

“Prayer has been the saving of my life.

Without it I should have been a lunatic long ago.” (Mahatma Gandhi, Prayer the food of my soul) God, I know you are there, my guiding force and support system.

Catherine Karusseit, for being my mentor, guiding and supporting me.

Barbara Jekot, thank you.

My family, your support and help are what got me where I am.

Nazly, kept me going...and going and going.

Eloshan, u stayed positive for me, thank you.

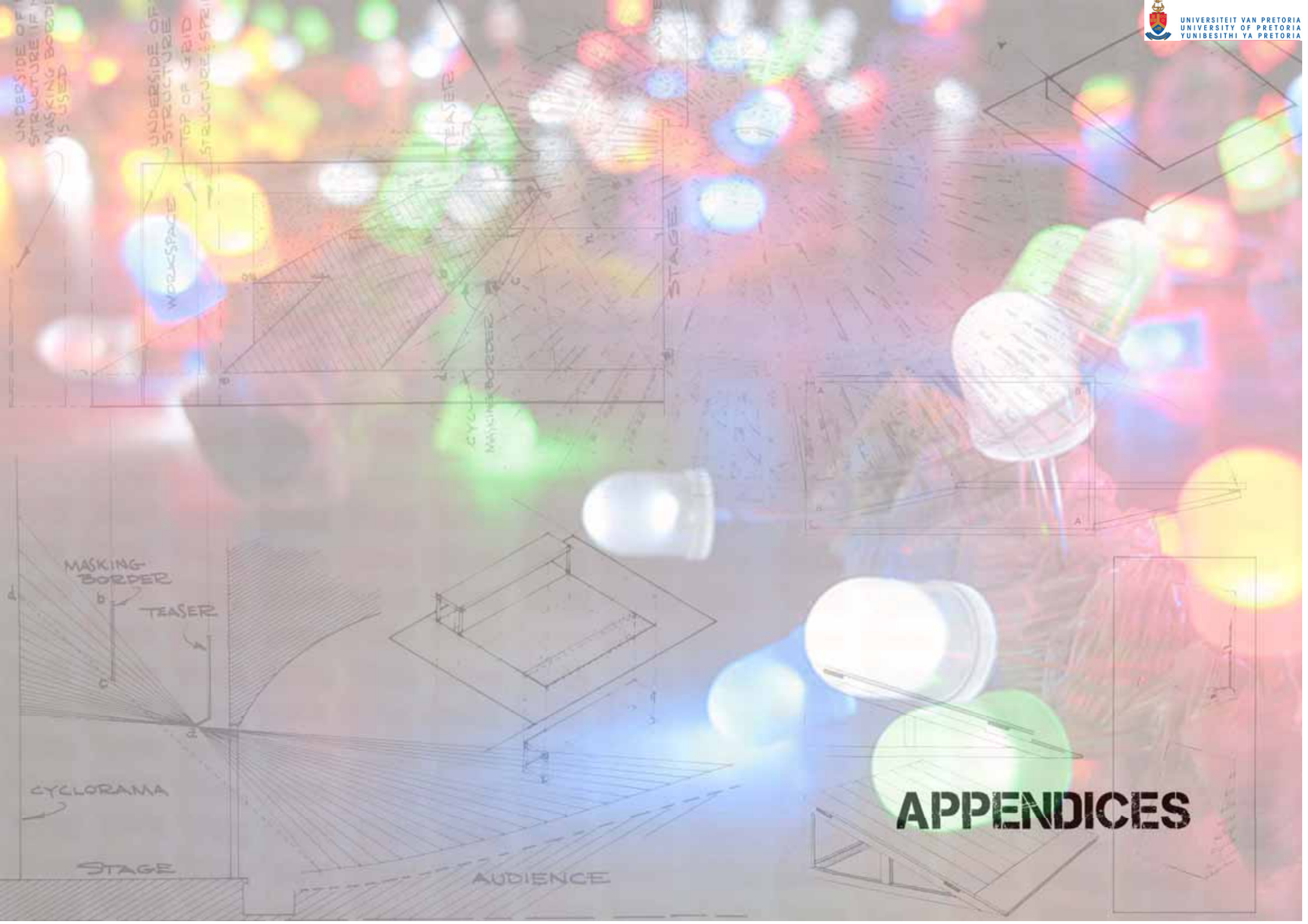
Lianie, Thabo and Marika, together we stressed, worked and made it!

Sudhir, thank you for believing in me.

Vimisha, your wise words calmed me and soothing helping hands made it all better.

Preeti, your “thinking...thinking...thinking” is the only thing that worked.





APPENDICES

APPENDIX 1

THE DRAMA BUILDING: THE OLD CHRISTIAN BROTHERS COLLEGE RESIDENCE



Figure A1: Aerial Photograph of the Grounds of the old CBC, unknown date, Afrikana library



Figure A2: Photo of the courtyard of the old CBC 1928, (www.cbcretoria.co.za/index.cfm/p/pages.schools-s-history.htm, July 21 2008)

Proposed Grade II: Heritage resources which, although forming part of the national estate, can be considered to have special qualities which make them significant within the context of a province or a region.

STATEMENT OF SIGNIFICANCE

The Christian Brothers Residence building for the teaching Brothers (now known as the Drama building for The University of Pretoria) is styled to suite the architecture of early 20th century South Africa. It is a typical courtyard enclosing H-shaped Italian Renaissance building whose style was used all over South Africa according to the basic design principals of the Baker School. It was built in 1929 to house the teaching Brothers of the College when the College was situated in Hatfield next to the University of Pretoria, and was officially opened in 1922. This building is a well-maintained example of the architecture of the time. It was designed by Cowin, Powers and Ellis and the builders were Clark & Downie (Pty) Ltd. Currently the building is being used for educational purposes for the Drama department.

a) Importance in the community, or pattern of South African history:

The community that the building was intended for was a group of Christian Brothers (founded by Edmund Rice in Ireland) who came from abroad to start a school for children less fortunate or disabled in order to educate them regardless of the segregated educational systems prevalent during the Union and the Apartheid regime after 1948.

b) Possession of uncommon, rare or endangered aspects of South Africa's natural or cultural heritage:

1. The building was designed on the Baker School's ideals that suited the then contemporary South African architecture. The buildings are rare in South Africa and

there are only a few that can be recognized in Pretoria: the Agriculture Building, Tuks Chapel (the Old Redemptions Chapel), Tukkiekerf (which was one of the Monastery buildings), and Nerina Hostel, which was part of the Loreto Convent school. The area could have been seen as an educational area for Christian (more particularly Catholic) schools.

c) Potential to yield information that will contribute to an understanding of South Africa's natural or cultural heritage:

1. as a built record of a particular period where an education alternative to that provided by the State was in effect.

d) Importance in demonstrating the principal characteristics of a particular class of South Africa's natural or cultural places or objects:

1. It provides a characteristic example of the type of educational buildings that were being built for religious building typologies of that time, based on principles of Neo-classical architecture from Europe.

e) Importance in exhibiting particular aesthetic characteristics valued by a community or cultural group

1. Aesthetic characteristics: The building was done using the Baker School principals based on the Classic ideal, amongst others using the Orders and proportioning of Vitruvius. It can be classified as built in an Italian Renaissance style.

f) Importance in demonstrating a high degree of creative of technical achievement at a particular period:

1. The building follows the style of the Italian Renaissance with the use of simple construction of brick and the post and lintol system as well as a courtyard. It claims spaces that suited the needs of the brothers as a residence with a chapel and service facilities as well as rooms that led onto corridors.

g) Strong or special association with a particular community or cultural group for social, cultural or spiritual reasons:

1. The building has strong associations with the Christian Brothers College, but also the University of Pretoria.

i) the site on Lynwood Road next to the University was the original site for the first Christian Brothers College that was built; and

ii) When the University took over the buildings from the College they converted it to suit the purposes of a university and with time, due to the existence of other facilities (the Drama building and Die Masker theatre), the building began to be used for the Drama Department and has been used as such since 1967. (Interview: email)

h) Strong or special association with the life or work of a person, group or organization of importance in the history of South Africa:

1. The building can be linked to the life work of the architectural practice of Cowin, Powers and Ellis, a dominant architectural firm that aided in the design of many buildings such as the Old Fire Station in Pretoria, as well as the Physics and Chemistry blocks in the University of Witwatersrand. Their style was typical of the Classical architectural ideals that the Union government was using to construct public buildings.

Recommended Design Response

This is stated as if it were policy:

Accommodation and usage:

- All public and circulation areas should remain intact, and as far as possible, restored to the original.
- Any change in function of areas which are specific to the needs of the new client should be of such a nature as to be easily reversed to the original.
- Any additional accommodation should be added with due regard to preserving the architectural integrity of the whole.

Structure:

Any external structures and additions should have a lightweight appearance and affixed with minimum, preferably no, structural reliance on the original fabric. For example, sunscreens should be affixed by way of loose frameworks adjacent the original building. If, however, it is intended that these be permanent structures, then this should be done within a broader development strategy which should form part of any such proposal.

Where additional provision is to be made for disabled persons, for example ramps, lifts, toilets and similar amenities, these should be located within existing spaces; between and around and preferably separate from existing structures with minimal disturbance of existing fabric, or should clearly be shown as new structure added to the outside of, and separate and clearly distinguishable from, the original.

Materials and Fittings:

All original material should be retained. Doors and windows should be retained. Obsolete openings should be blanked off with the fixtures and fittings intact.

Renovations should be a reversion to original materials where these exist or are currently disguised, and, when previously sacrificed repairs and/or replacement is necessary, material which is sympathetic and complementary to the original should be selected without falsifying the material record through mimicry. Where original material is to be sacrificed for the installation, and/or replacement, and/or upgrading of services, then that material which can readily be replaced should be selected for removal, for example smooth plastered brick rather than tiling or moldings, even if this increases the length and complexity of service runs.

Service areas and services

All should be aesthetically integrated with the whole. Where existing services are replaced due regard should be given to the locating of plant and machinery. Where existing cabling is to be upgraded or additional runs installed this should be done either through existing runs or, if new runs and ducting are to be added, done preferably through exposed channeling or trunking which can be readily reversed, should requirements change.

Fittings and furnishings

The existing fittings and furnishings can be exactly replaced, but where additional light fittings, electrical fixtures, bathroom fittings and fixtures are to be installed they should be of a durable material in neutral contemporary styling.

Stripping and demolition

The building is a palimpsest of many alterations and additions, but most have been done sympathetically and consistently, being neutrally styled. These changes should not be disguised by any projected works.

The building has not been altered much since it had been bought over for the university. Walls had been broken down to create larger rooms and slight changes were made so that the appropriate facilities could be inserted into the existing fabric, such as incisions into the wall in the studio and/or the additions of rails to the ballet rooms. Most changes have been done discreetly and have been neutrally styled. These changes should not be disguised by any projected works.

APPENDIX 02

ACCOMMODATION SCHEDULE

Die Masker		
Foyer	including 8sqm ticket box	195sqm
Kitchenette/shop		10sqm
Ablutions	Ladies: 5xWCs and 4xWHB Gents: 1xWC, 4xUrinals and 4xWHB	30sqm (15sqm each)
Studio for movement and Rehearsal	1.5sqm/person for 65-70 students per class	100sqm
Auditorium for 200 people		225sqm
Acting area		45sqm
Backstage:		
Scenery receiving		20sqm
Props receiving		10sqm
Lighting receiving		10sqm
Wardrobe store	Costume receiving: use props receiving	12sqm
Repair shop		10sqm
Control room		25sqm
Dressing rooms	for 30 people	60sqm
Bathroom:	Ladies: 2xWC, 2xWHB and 2xshowers Gents: 1xWC, 2xUrinals, 2xshowers and 2xWHB	10sqm each dressing room

The Drama Building		
Studios for performance rehearsals	Stage area plus circulation	75sqm
Media spaces:		
Film studio and film editing room	Equipped with 8 functioning computers	2x 12sqm
Film store		4sqm
Recording studio	Studio and control room	20sqm
Media viewing room		15sqm
Singing studio		65sqm
Voice rehearsal spaces		2x 20sqm
8 Offices for staff		15sqm each
staff room		10sqm
Reception		50sqm
Discussion room		30sqm
Student admin office		15sqm
Student lounge and kitchenette	Including smoking area	35sqm

Proposed new building		
Foyer		100sqm
Ablutions	Ladies: 3xWC, 2xWHB Gents: 1xWC, 3xUrinals, 2xWHBs	15sqm
Exhibition gallery		60sqm
Coffee shop	+/- 200 people Kitchen: 150sqm Dining area: 200sqm	350sqm
Auditorium for 125 people		160sqm
Stage		100sqm
Dressing rooms	5-10 people each room	2x 12sqm
Ablutions	Communal: 1xWC 2xWHB and 1xShower. 2xUrinals	15sqm
Studios; for movement and dance	1.5sqm/person for 65-70 students per class	100sqm
Studios for performance rehearsals	+/- 100 students per spaces, Stage area plus circulation	75sqm
Student ablutions	male: 2xWC, 4x urinal, 2xShower, 3xWHB: 25sqm Ladies: 5xWC, 2xShowers, 3XWHB	
Services	HVAC : 15sqm Chair store: 10sqm Rehearsal store: 15sqm	

Information obtained from:

Burris-Meyer, H. & Cole, E.C. 1964. *Theatres and auditoriums*. New York: Reinhold.

Jones, V. 1980. *Nuefert architect's data*. London: Blackwell Sciences Ltd.

Tutt P & Adler, D. 1995. *New metric handbook*. Oxford: Butterworth.