



UNIVERSITEIT VAN PRETORIA
UNIVERSITY OF PRETORIA
YUNIBESITHI YA PRETORIA

**SIMULATION OF *IN SITU* BIOREMEDIATION OF CR(VI) IN
GROUNDWATER AQUIFER ENVIRONMENTS USING A
MICROBIAL CULTURE BARRIER**

PULANE MOLOKWANE



UNIVERSITEIT VAN PRETORIA
UNIVERSITY OF PRETORIA
YUNIBESITHI YA PRETORIA

**SIMULATION OF *IN SITU* BIOREMEDIATION OF CR(VI) IN
GROUNDWATER AQUIFER ENVIRONMENTS USING A
MICROBIAL CULTURE BARRIER**

PULANE ELSIE MOLOKWANE

**Thesis submitted in fulfilment of the requirements of the degree of
DOCTOR OF PHILOSOPHY IN CHEMICAL TECHNOLOGY**

In The

**FACULTY OF ENGINEERING, BUILT ENVIRONMENT AND
INFORMATION TECHNOLOGY**

UNIVERSITY OF PRETORIA

APRIL 2010

**SIMULATION OF IN SITU BIOREMEDIATION OF CR(VI) IN
GROUNDWATER AQUIFER ENVIRONMENTS USING A MICROBIAL
CULTURE BARRIER**

By
Pulane Elsie Molokwane

Supervisor: Evans Martin Nkhalambayausi-Chirwa
Department: Chemical Engineering
Degree: Doctor of Philosophy in Chemical Technology

SYNOPSIS

The feasibility of *in situ* bioremediation of Cr(VI) in groundwater and aquifer media was investigated using microcosm and mesocosm reactors inoculated with indigenous species of bacteria from dry sludge. Microcosm cores were used to simulate contaminant movement in the vadose and aquifer zones of the aquifer system.

Cr(VI) breakthrough analysis through the experimental cores demonstrated successful Cr(VI) immobilisation in simulated barrier systems. Cr(VI) reduction was continuously monitored and microbial culture dynamics were evaluated using 16S rRNA genomic fingerprinting. A culture shift was observed in the microcosm cores with the emerging predominance of known Cr(VI) reducers — *Enterococci* from soil and *Lysinibacilli* from sludge — after operation for 45 days.

The Cr(VI) reduction process in the columns was determined to be enzyme mediated and non-competitively inhibited by Cr(VI). The microbial cultures under micro-aerobic conditions depicted a threshold Cr(VI) concentration (C_r) of approximately

100 mg/L which was much higher than the target operation concentration of 40 mg/L at the proposed remediation sites. Using the Computer Program for the Identification and Simulation of Aquatic Systems (Aquasim), it was possible to predict Cr(VI) removal efficiency and the impact of Cr(VI) toxicity on culture dynamics in the barrier. The study demonstrates the potential of applying selected Cr(VI) reducing bacteria in biological permeable reactive barrier systems in preventing the spread of the pollutant into adjacent water supply aquifers.

The impact of the presence of natural carbon sources was also evaluated by filtering the feed water through a saw dust bed. Reactors without added carbon source removed up to 70% Cr(VI), and no removal was observed in sterile controls. In the packed mesocosm reactor, the areas before the reactive barrier had no chromium reduction whereas most of the areas after the barrier achieved near 100% reduction.

The microbial dynamics were monitored by the 16S rRNA fingerprinting after exposure to Cr(VI). After operating the microcosm reactors under oxygen stressed conditions in the presence of other soil bacteria, a community shift was expected. The soil from inoculated reactors contained a wide range of soil dwelling species of bacteria as well as the newly introduced bacteria from the dried sludge. There was a noted presence of Cr(VI) reducing bacteria, *Microbacterium*, *Acinetobacter*, *Arthrobacter*, *Brevibacterium*, *Rumen bacteria*, and several *Enterococci* in the sludge culture and *Arthrobacter spp.*, *Clostridium spp.*, and *Klebsella spp.* were amongst the evident among identified species.

A non-competitive inhibition model was used for the evaluation of aerobic performances in batch experimental studies, whereas the inhibition threshold term C_0 -

C_r/C_0 , was introduced for the anaerobic model performance for the reduction of chromium in batch studies. In sterile packed soil columns a model for saturated soil column with dispersion was adopted from AQUASIM 2.0. This model was used in combination with the chromium reduction rate adopted from the anaerobic batch modelling for most non sterile reactors in the microcosm performance. The study demonstrates the potential of applying selected Cr(VI) reducing bacteria in biological permeable reactive barrier systems in restraining the spread of the pollutant into adjacent water supply aquifers.

The outcome of this exercise could be useful in the formulation of biological permeable barriers for protection against the spread of the pollutant from hot spots in the area. This serves as a significant step towards a pilot study.



DECLARATION

I Pulane E Molokwane, declare that the thesis which I hereby submit for a Doctor of Philosophy in Chemical Technology degree at the University of Pretoria is my own work and has not been previously submitted by me for any degree at this or other tertiary institution.

Pulane E Molokwane

Date

DEDICATIONS

I dedicate this work to my mother and my siblings

My beloved Mother, Mmita, thanks for giving me life and instilling good principles in me. You did a great job Ma. Here's a "Red gown" you have been waiting for.

My siblings, Omphemetse, Rebaona and Kesaobaka, thanks for being my reason for living. Having you in my life kept me sane, I knew I had to remain abstemious for your sake. Thanks Ba-Mme.

Ausi Phemi, thanks for making me laugh at all times even when things were not rosy, life would not be the same without you in my life.

My step father, Keriri, thanks for being a support to my mother and the kids.

*You all mean the world to me, ausi Pully loves you very much.
May god continue to bless you abundantly.*

ACKNOWLEDGEMENTS

My *Yahweh* has yet again demonstrated the plans He has for me, plans to prosper not to harm me, plans to give me hope and a future-Jeremiah 29:11.

El elyon, I thank you for seeing me through this milestone, Father God I am very grateful for your never changing love and mercy. I give you all the honour and all the glory!

To my study leader Professor Evans Martin Nkhalambayausi-Chirwa, thank you for your guidance, patience and mammoth dedication to my training. Words cannot begin to express how treasured you are. Thank you so much.

To all my colleagues at the Environmental Engineering division, you had become family. Thank you for assisting in so many ways.

Professor Venter at the department of microbiology, Thank you for assisting with the microbiological work.

To all my dear friends I had in the past four years and still are around today, you are true friends. Thanks for being supportive when I was going through trials in my life. I cherish you.

May God Almighty bless you all.

"An investment in knowledge pays the best interest."
- Benjamin Franklin

"Obstacles are those frightful things you see when you take your eyes off your goal."
- Henry Ford

TABLE OF CONTENTS

Synopsis.....	i
Declaration.....	iv
Dedications.....	v
Acknowledgements.....	vi
List of Figures.....	xi
List of Tables.....	xiv
List of Nomenclature.....	xv
CHAPTER 1: INTRODUCTION.....	1
1.1 Background.....	1
1.2 Unique Methods.....	2
1.3 Objectives.....	3
1.4 Main Findings.....	4
CHAPTER 2: LITERATURE STUDY.....	5
2.1 Chromium Sources.....	5
2.2 Chromium Uses and Pollution.....	6
2.3 Environmental and Health Effects.....	8
2.4 Chemical Properties.....	9
2.5 Pollution Remediation Strategies.....	11
2.5.1 Physical-Chemical Treatment Methods.....	11
2.5.2 Chemical Reactive Barriers.....	13
2.5.3 Physical-Chemical Permeable Reactive Barriers (Design Concept).....	15
2.5.4 Biological Permeable Reactive Barriers.....	16
2.6 Physical-Chemical Treatment Methods.....	18
2.6.1 Microbial Resistance to Cr(VI) Toxicity.....	18
2.6.2 Diversity of Chromium Reducing Microorganisms.....	19
2.6.3 Cr(VI) Reduction Pathways.....	22

2.7	Current and Future Biotechnology Solutions.....	25
2.7.1	Suspended Culture Systems.....	25
2.7.2	Attached Growth Systems.....	25
2.7.3	<i>In situ</i> Inoculation.....	26
2.7.4	Bioaugmentation.....	26
2.8	Chapter Summary.....	27

CHAPTER 3: MATERIALS AND METHODS..... 28

3.1	Source of Cr(VI) Reducing Organisms.....	28
3.2	Mineral Media	30
3.3	Culture Isolation.....	30
3.4	Gram Staining.....	31
3.5	Microbial Culture Characterisation.....	31
3.5.1	Aerobic Culture.....	32
3.5.2	Anaerobic Culture.....	35
3.6	Cr(VI) Reduction Experiments.....	38
3.6.1	Aerobic Batch Experiments.....	38
3.6.2	Anaerobic Batch Culture Experiments.....	38
3.6.3	Microcosm Reactor Studies.....	39
3.6.4	Mesocosm Reactor Studies.....	40
3.7	Analytical Methods.....	41
3.7.1	Elemental Analysis.....	41
3.7.2	Cr(VI) and Total Chromium.....	42
3.7.3	Viable Biomass.....	43
3.7.4	Total Biomass (Suspended cells).....	43
3.7.5	Cr(VI) Reduction Activity.....	44

CHAPTER 4: MICROBIAL CR(VI) REDUCTION KINETIC STUDIES..... 45

4.1	Modelling Methodology.....	45
4.2	Mixed Culture Performance.....	45
4.2.1	Biotic versus Abiotic.....	45

4.2.2 Cr(VI) Reduction under Aerobic Conditions.....	46
4.2.3 Cr(VI) Reduction under Anaerobic Conditions.....	48
4.2.4 Decisions from Observed Trends.....	49
4.3 Enzymatic Cr(VI) Reduction Capacity of Cells.....	50
4.4 Cr(VI) Reduction Capacity of Cells.....	53
4.5 Parameter Determination.....	54
4.5.1 Aerobic Batch Kinetics.....	54
4.5.2 Anaerobic Batch Kinetics.....	56
4.6 Sensitivity Analysis.....	59
4.7 Chapter Summary.....	61

**CHAPTER 5 : MICROBIAL CHROMIUM (VI) REDUCTION IN
AQUIFER MEDIA..... 63**

5.1 Microcosm Study Conceptual Basis.....	63
5.2 Performance of Vadose System Microcosm.....	65
5.2.1 Cr(VI) Removal Efficiency.....	65
5.2.2 Cr(VI) Speciation in the Vadose Microcosm Reactors.....	66
5.2.3 Microbial Culture Dynamics in Vadose Systems.....	67
5.3 Performance of the Main Aquifer Microcosm.....	71
5.3.1 Evaluation of the Abiotic Process in the Microcosms.....	72
5.3.2 Cr(VI) Reduction by Inoculated Natural Soil without Carbon Source.....	72
5.3.3 Cr(VI) Reduction by Inoculated Natural Soil with Added Carbon Source.....	73
5.3.4 Cumulative Cr(VI) Reduction in the Microcosm Systems.....	73
5.3.5 Performance Summary.....	76
5.4 Microbial Culture Dynamics in Aquifer Media Microcosm Reactor.....	77
5.4.1 Analysis under Anaerobic Conditions.....	77
5.4.2 Characteristics of Microorganisms in the Microcosm after 45 days.....	78
5.5 Simulation of Cr(VI) Reduction in Microcosm Systems.....	80
5.5.1 Model Description – Advection/Reduction Model.....	80
5.5.2 Simulation of Control Conditions.....	83
5.5.3 Evaluation of the Effect of Carbon Source using the Model.....	85



5.6	Summary of Parameters.....	88
5.7	Chapter Summary.....	89
CHAPTER 6: MESOCOSM STUDIES (BARRIER PERFORMANCE).....		91
6.1	Background.....	91
6.2	Simulation Reactive Barrier: Mesocosm Reactor.....	91
6.3	Barrier Performance evaluation (Quantitative).....	92
6.4	Performance Evaluation (Qualitative).....	97
6.5	Spatial Variation at Discrete Time.....	98
6.6	Chapter Summary.....	102
CHAPTER 7: SUMMARY AND CONCLUSIONS.....		104
LIST OF BIBLIOGRAPHY.....		106
APPENDIX A: AQUASIM 2.0 PROCESS.....		124
APPENDIX B: GRAM-NEGATIVE SPECIES.....		132
APPENDIX C: CONTAMINATED SITE AT BRITS.....		133

LIST OF FIGURES

Figure	Page
2-1	Percentage of ferrochromium and chromite ore produced worldwide..... 7
2-2	A Simplified pourbaix diagram for chromium species dominating in diluted aerated aqueous solutions in the absence of any complexing agents other than H ₂ O or OH..... 10
2-3	Conventional designs of permeable reactive barriers..... 15
2-4	Schematic representation of a two layered biological barriers..... 17
2-5	The two known Cr(VI) reduction pathways..... 23
3-1	Phylogenetic tree of species from Brits dry sludge reflecting microbial diversity under aerobic conditions..... 34
3-2	Phylogenetic tree of species from Brits dry sludge reflecting microbial diversity under anaerobic conditions..... 37
3-3	Experimental setup for gravity fed microcosm..... 40
3-4	Mesocosm reactor setup using the rock media from the Cr(VI) contaminated site in Brits (North West)..... 41
4-1	Evaluation of abiotic Cr(VI) reduction in heat-killed and azide inhibited cells (inoculated with 5×10^4 CFU/ml before incubation)..... 46
4-2	Aerobic culture experiment of Cr(VI) reduction in consortium from dried sludge grown at initial Cr(VI) concentrations ranging from 50 to 600 mg/L (resting cells: $5.2 \pm 2.1 \times 10^9$ CFU/ml)..... 47
4-3	Anaerobic culture experiment of Cr(VI) reduction in consortium from dried sludge grown at initial Cr(VI) concentrations ranging from 50 to 300 mg/L (resting cells: $1.58 \pm 1.8 \times 10^9$ CFU/ml)..... 49
4-4	Aerobic Cr(VI) reduction at different concentration..... 56
4-5	Anaerobic (threshold inhibition) chromium reduction at different concentration (modelled anaerobic plots)..... 59
4-6	Aerobic sensitivity test at 100mg/L(Aerobic)..... 60
4-7	Anaerobic sensitivity test at 100mg/L (Anaerobic)..... 60
5-1	Conceptual basis of the microcosm reactor study with vadose media and aquifer media hydraulic effects..... 64
5-2	Influent and effluent Cr(VI) data in vadose reactors VR2 – sterilised

	column; VR3 – inoculated non-sterile reactor at 0.608 cm ³ /h; and VR6 – inoculated non-sterile reactor at 0.310 cm ³ /h.....	66
5-3	Comparative culture analysis at day 1 (a) and day 17 (b) in the vadose media microcosm experiment showing the disappearance <i>Escherichia coli</i> and appearance of <i>Bacillus drentensis</i> and <i>Lysinibacillus sphaericus</i> at the end of the experiment.....	69
5-4	Main aquifer microcosm columns (HR1-HR8) to simulate the performance of microbial barrier systems in aquifer media.....	71
5-5	Performance of a non-inoculated sterile column showing a characteristic exponential rise in effluent Cr(VI) comparable to the tracer.....	74
5-6	Performance comparison: sludge culture acting alone (HR2), soil culture acting alone (HR3), and the combination of sludge and soil bacteria (HR5).....	74
5-7	Performance of the reactors containing live cultures of sludge bacteria and native soil species (Reactors HR7 and HR8) operated with carbon sources leached from saw dust.....	75
5-8	Cumulative Cr(VI) removal in the aquifer microcosm reactors showing that the reactors had not reached their full capacity.....	76
5-9	Analysis of the consortium culture from the microcosms after 45 days: (a) gram-negative species (b) gram-positive species.....	79
5-10	Model simulation of the sterilized microcosm reactor inoculated with live cultures from sludge (Reactor HR4).....	84
5-11	Model simulation of the live soil culture microcosm inoculated with live cultures from sludge and operated without carbon source (Reactor HR5)...	86
5-12	Model simulation of the live soil culture microcosm inoculated with live cultures from sludge and operated with carbon source (Reactor HR7).....	86
6-1	Schematic representation of mesocosm reactor setup.....	93
6-2	An overview of the reduction at level L(level near the bottom of the reactor).....	94
6-3	Barrier performance at level L.....	95
6-4	Cr(VI) reduction along the length of the mesocosm reactor at specific times showing the improving performance with time(Level M).....	98
6-5	Cr(VI) reduction along the length of the mesocosm reactor at specific times showing the improving performance with time(Level L).....	99
6-6	Cumulative Cr(VI) removal determined through concentration measurements in M-Zone.....	101
6-7	Cumulative Cr(VI) removal determined through concentration	

	measurements in L-Zones.....	102
6-8	Proposed Strategy for the target site.....	103
B-1	Phylogenetic analysis of Gram-negative species of bacteria in the HR7 reactors at day 45. Possible Cr(VI) reducers were detected including Enterobacteriaceae, <i>Escherichia coli</i> , and <i>Citrobacter spp.</i> Bacteria originating from soil was detected including <i>Rhodobacter spp.</i> and <i>Alcalegenes spp.</i>	132

LIST OF TABLES

Table	Page
2-1 Known Cr(VI) reducing bacteria.....	20
3-1 Percentage Cr(VI) reduction in cultures from different sources after 96 hours of incubation at different initial concentrations.....	29
3-2 Partial sequencing of aerobic CRB isolated from Brits dry sludge grown in a solution containing 100mg/L of Cr(VI).....	33
3-3 Characteristics of pure cultures and nearest matches based on the BLAST analysis of 16S rRNA partial sequence.....	36
3-4 Trace metal concentrations.....	42
4-1 Optimisation of kinetic parameters using the cell inactivation only (Equation 4-13) under aerobic conditions.....	54
4-2 Optimisation of the non-competitive inhibition model with cell inactivation (Equation 4-14) under aerobic conditions.....	55
4-3 Optimisation of kinetic parameters under anaerobic conditions using non-competitive model with cell inactivation (Equation 4-14).....	58
4-4 Optimisation of kinetic parameters under anaerobic conditions using the cell inactivation model with threshold inhibition (Equation 4-21).....	58
5-1 Performance of gravity-fed vadose microcosm reactors operated under an influent Cr(VI) concentration of 40 mg/L.....	65
5-2 Summary of microbial culture changes after operation of the microcosms reactors for 15 days under an influent Cr(VI) concentration of 40 mg/L....	70
5-3 Conditions for the aquifer microcosm range of experiments.....	72
5-4 Capability of mixed cultures in reducing Cr(VI) in aquifer microcosms....	77
5-5 Simulation conditions for aquifer microcosm reactors in AQUASIM.....	82
5-6 Final parameter values from the application and optimisation in the microcosm reactors.....	87
6-1 Summary of chromium (VI) reduction performance in the mesocosm reactor.....	96

LIST OF NOMENCLATURES

SYMBOLS

a	Surface area (L^2)
A	Effective cross sectional area (L^2)
a_i	surface area in the segment (L^2)
b	Dimensionless logistic pitch factor for the biomass
C	Cr(VI) concentration (state variable) (ML^{-3})
C	Cr(VI) concentration at a time of incubation t (ML^{-3})
C_{eq}	Equilibrium/saturation concentration (ML^{-3})
C_{eq}	equilibrium concentration at the surface for adsorptive process (ML^{-3})
C_{in}	Influent Cr(VI) concentration (ML^{-3})
C_o	initial Cr(VI) concentration (ML^{-3})
C_s	Cr(VI) concentration at the particle surface (ML^{-3})
D	Coefficient of molecular diffusion (L^2T^{-1})
ΔL	Grid section (L)
ΔL	change in reactor length (L)
ΔV	change in reactor volume (L^3)
F	Input Cr(VI) (MT^{-1})
j_c	mass transport rate ($ML^{-2}T^{-1}$)
k_{ad}	adsorption rate coefficient (T^{-1})
k_d	cell death rate coefficient (T^{-1})
k_L	mass transport rate coefficient (LT^{-1})
k_{ms}	specific substrate utilisation rate coefficient (T^{-1})
N	Grid number
Q	Flow rate (L^3T^{-1})
q_c	adsorption rate ($ML^{-3}T^{-1}$)

q_c	adsorption rate ($ML^{-3}T^{-1}$)
R_c	Cr(VI) reduction capacity (mg Cr(VI) removed /mg cells inactivated)
r_c	Cr(VI) reduction rate ($ML^{-3}T^{-1}$)
r_c	Cr(VI) reduction rate ($ML^{-3}T^{-1}$)
t	time (T)
t_0	logistic interval for biomass (T)
u	interstitial velocity (LT^{-1})
X	viable cell concentration (ML^{-3})
X_0	Initial viable cell concentration/density in the reactor (ML^{-3})
X_{max}	Maximum attainable viable cell concentration (ML^{-3})
X_o	initial viable cell concentration (ML^{-3})
Y	cell yield coefficient ($M \cdot M^{-1}$)

ABBREVIATIONS

AAS	Atomic Adsorption Spectrophotometer
BMM	Basal Mineral Medium
BPRB	Biological permeable Reactive Barriers
CFU	Colony Forming Unit
CRB	Chromium Reducing Bacteria
Cr(III)	Chromium 3
Cr(VI)	Chromium 6/Hexavalent Chromium
CT-PRB	Continuous Trench Permeable Reactive Barrier
DNA	Deoxyribonucleic Acid
EPS	Exo Polysaccharide
FGS	Funnel and Gate System
hrs	Hours
ICP-MS	Induction Coupled Plasma Mass Spectrophotometer
LB	Luria Bettani
MS-PRB	Multi Sequenced Permeable Reactive Barrier
NADH	Nicotinamide Adenine Dinucleotide Phosphate
PC	Plate Count
pH	Potential Hydrogen
PRB	Permeable Reactive Barrier
PVC	Poly Vinyl Chloride
rRNA	Ribosomal Ribonucleic Acid
Rpm	Rotation Per Minute
SA	South Africa
UK	United Kingdom

U.S.EPA

United State of America Environmental Protection Agency

WHO

World Health Organisation

CHAPTER 1

INTRODUCTION

1.1 Background

Hexavalent chromium is one of the toxic heavy metals with high mobility in soil and groundwater which can produce harmful effects on organisms including humans. Hexavalent chromium [Cr(VI)] compounds are used in a wide variety of commercial processes such as chromite ore processing, electroplating, and leather-tanning processes, among others (Chuan and Liu, 1996; Lawson, 1997). The unregulated disposal of chromium containing effluents has led to the contamination of soil, aquatic sediments, and surface and groundwater environments.

Most of the contaminated sites around the world are treated using abiotic processes implemented with pump-and-treat or dig-and-treat methods that require follow up precipitation or immobilisation steps (Cifuentes *et al.*, 1996; Quintana *et al.*, 2001). Among the latest of the findings is the probability of using biological reduction methods for the treatment of hexavalent chromium-containing wastes (Donat and Guruchet, 2003, Rege *et al.*, 1997; Rajwade and Paknikar, 1997; Mel Lytle *et al.*, 1998; Salunkhe *et al.*, 1998).

In situ bioremediation technology using permeable reactive barriers is a relatively a new application, commonly not been implemented much but slowly finding use for the remediation of organic pollutants (Borden *et al.*, 1997); Rasmussen *et al.*, 2002; Wilkin *et al.*, 2003; Carsten *et al.*, 2004). Studies using zero valent iron to reduce and precipitate Cr(VI) have been assessed in both batch and column tests (Blowes & Ptacek, 1992; Powell *et al.*, 1995). However there has been minimum research on

bioremediation of heavy metals including Cr(VI) by means of PRB (permeable reactive barrier) using microorganisms. The process of cleaning up metals is not a straight forward one since metals cannot be destroyed; they are only transformed from one oxidation state to another as it is in the case with hexavalent chromium.

Bioremediation processes are considered a better alternative to physical-chemical treatment technologies since they do not introduce any foreign material into the ecosystem. They also do not involve further transportation of toxic material which may lead to more spillage in transit. Nevertheless, there is still a need for final removal of reduced metal or oxidised states trapped in the media.

The current research evaluates a methodology that could offer an opportunity for on site treatment of the contaminant using chromium reducing bacteria in the form of a permeable reactive barrier. This could minimise the disadvantages and negative impacts experienced with physical-chemical processes. This technology will later be tested at a pilot site around the abandoned refinery found in Brits. The Cr (VI) at the contaminated site estimated at 4,050 kg Cr(VI) will take approximately 30 years to flush out using the currently employed pump-and-treat method.

1.2 Unique Methods

Consortium cultures were characterised using 16S rRNA genomic fingerprinting. In suspended growth batch cultures gram-positive *Bacillus* genera predominated under aerobic conditions with a small composition of the gram-negative *Microbacterium* sp. More biodiversity was observed in anaerobic cultures.

Phylogenetic characterization of cells was also performed on individual colonies of bacteria from cultures grown anaerobically from soil samples extracted from the microcosms at the beginning and end of the experiment. Genomic DNA was extracted

from the pure cultures using a DNeasy tissue kit (QIAGEN Ltd, West Sussex, UK). The 16S rRNA genes of isolates were amplified by reverse transcriptase-polymerase chain reaction (RT-PCR) as described by Coenye *et al.* (1999). Internal primers complimentary to base-pair 519–536 of the 16S gene were used for amplification and sequencing.

The significant part of the current investigation was to establish an *in situ* bioremediation method which could be tried in the pilot study at the site under investigation. This involved operation of a bench-scale mesocosm with a barrier inoculated with a consortium of cultures collected from a local waste water treatment plant. The study demonstrates the potential of *in situ* inoculation as a method of establishing a permeable reactive barrier with minimum engineering work and with no construction required. The laboratory studies were conducted at concentrations of 40 mg/L and 50 mg/L representing aquifer conditions at the target barrier location approximately 200m from the hot spots of contamination.

1.3 Objectives

The main objective of this exercise is to evaluate the prospect of Cr(VI) pollution containment in groundwater aquifers at a site. The proposed methodology could offer a more sustainable alternative to the current pump-and-treat method. Task was undertaken in the in the following order to achieve the main objective:

- Evaluation of the performance of cultures and individual species in the source organism.
- Investigation of microbial culture dynamics during operation of simulated microbial barriers.
- Development and evaluation of a predictive dispersion-reaction for Cr(VI) removal in microbial barrier.

1.4 Main findings

In packed column microcosm reactors, approximately 95% Cr(VI) removal was achieved by live cultures of bacteria from sludge. Experimental results from packed laboratory mesocosm experiment have shown that 50 mg/L of hexavalent chromium was reduced by more than 85% after the feed solution migrated through the microbial barrier. It was also evident that after exposing microorganisms to hexavalent chromium, there was a shift in bacterial composition showing adaptability of the inoculum culture.

CHAPTER 2

LITERATURE STUDY

2.1 Chromium Sources

Chromium (atomic number 24, atomic weight 51.996 g/mole) was discovered by a French chemist Louis Vauquelin in 1797. Vauquelin gave the element the Greek name ‘χρωμα’ (*chroma*) which means colour due to the many different colours found in its compounds (Mohana and Pittman Jr, 2006). The gemstones ‘emerald’ and ‘ruby’ owe their colors to traces of chromium in the matrix. Chromium is the earth's twenty-first most abundant element detected at a concentration of approximately 122 mg per kg of earth's crust. Among the transitional metals, it is the sixth most abundant element. Notably, chromium does not occur in nature in pure elemental form, but is rather bonded in complex mineral forms.

Chromium occurs in nature predominantly in the trivalent form (Cr(III)) mostly as chromite (FeOCr_2O_3) and crocoite (PbCrO_4) in granitic rocks, serpentine rocks, and coal (Hintze, 1930; Merian, 1984). Small amounts of chromium in the hexavalent state (Cr(VI)) occur in silicate rich groundwater associated with Tertiary and Quaternary Alluvium filled basins.

Continuous hydrolysis of silicates in the old alluvial sediments raises the pH of the water causing oxidation of Cr(III) to Cr(VI) (Robertson, 1975). Cr(VI) is also released into the atmosphere from forest fires, burning of coal, volcanic eruptions, automobile exhaust, and combustion of chromium containing materials (Merian, 1984; Xing and Okrent, 1993). The elemental form Cr(0) is also possible although it oxidizes quickly upon exposure to air.

The thin oxide layer so formed is impermeable to oxygen thus protects the rest of the metal against further oxidation. This property is utilized for protection of other metals by electroplating. The other oxidation states of chromium (-2, +4, and +5) only appear transitionally under controlled laboratory conditions.

Chromium is mainly extracted from the earth as one of the many chromium ores. About fifty ores have so far been identified, including the following abundant types:

- Barbertonite: $\text{Mg}_6\text{Cr}_2(\text{CO}_3)(\text{OH})_{16}\cdot 4\text{H}_2\text{O}$
- Brezinaite: Cr_3S_4
- Chromite: $(\text{Mg},\text{Fe}^{2+})(\text{Cr},\text{Al},\text{Fe}^{3+})_2\text{O}_4$
- Chromatite: CaCrO_4
- Nichromite: $(\text{Ni},\text{Co},\text{Fe}^{2+})(\text{Cr},\text{Fe}^{3+},\text{Al})_2\text{O}_4$

The most mined ore is ferric chromite, FeCr_2O_4 , mainly found in South Africa. The chromite ore reserve in South Africa represents approximately 72% of the earth's identified sources. Other countries with exploitable chromium ore reserves include Russia, Zimbabwe, Finland, India, Kazakhistan, the Philippines, and Brazil (Figure 2-1).

2.2 Chromium Uses and Pollution

Chromium has been used extensively in industrial processes such as leather tanning, electroplating, negative and film making, paints and pigments, and wood preservation (Stern, 1982; Beszedits, 1988). Additionally, chromium has been used as a metallurgical additive in alloys (such as stainless steel) and metal ceramics. Chromium plating has been widely used to give steel a polished silvery mirror coating. The radiant metal is now used in metallurgy to impart corrosion resistance. Its ornamental uses include the production of emerald green (glass) and synthetic

rubies. Due to its heat resistant properties chromium is included in brick molds and nuclear reactor vessels (Namasivayam and Yamuna, 1995; Dakiky *et al*, 2002).

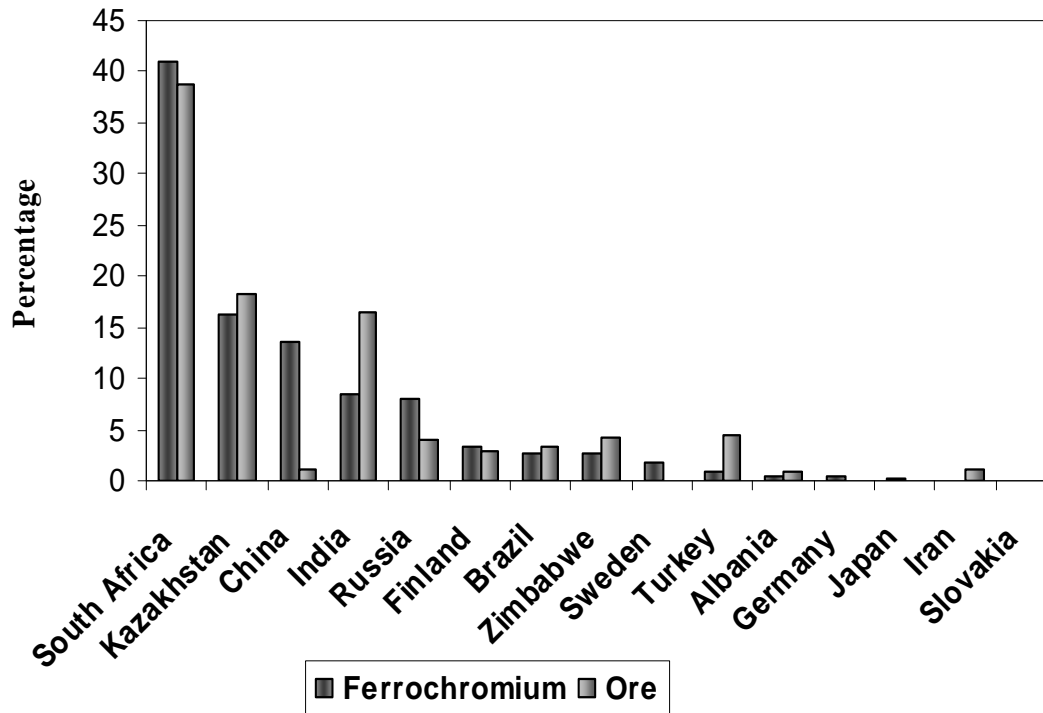

Figure 2-1: Percentage of ferrochromium and chromite ore produced worldwide (Papp, 2006).

Through the above and many other industrial uses, a large amount of chromium (4,500 kg/d) is discharged into the environment making it the most voluminous metallic pollutant on earth (U.S.EPA, 1978). Almost all chromium inputs to the natural systems originate from human activities. Only 0.001% is attributed to natural geologic processes (Merian,1984).

Chromium from the anthropogenic sources is discharged into the environment mainly as hexavalent chromium [Cr(VI)]. Cr(VI) — unlike Cr(III) — is a severe contaminant with high solubility and mobility in aquatic systems. Cr(VI) is a known carcinogen classified by the U.S.EPA as a Group A human carcinogen based on its chronic and

subchronic effects (Federal Register, 2004). It is for this reason that most remediation efforts target the removal of Cr(VI) primarily.

2.3 Environmental and Health Effects

Hexavalent and trivalent chromium compounds differ in their health and environmental effects. Cr(VI) is toxic, carcinogenic and mutagenic to animals as well as humans and is associated with decreased plant growth and changes in plant morphology (Rosko *et al.*, 1977, Silverberg, *et al.*, 1977). The biotoxicity of Cr(VI) is largely due to its high reactivity, its ability to penetrate biological membranes as well as its high oxidizing capabilities (NAS, 1974). The natural intracellular Cr(VI) reduction pathway may involve an acceptance of electrons from organic electron donors such as NAD(P)H resulting in the formation of the transitory Cr(V) state (Horitsu *et al.*, 1990).

In humans and other mammals, acute exposure to Cr(VI) produces several health risks including allergic dermatitis, ulceration of the skin, irritation of the mucous membranes, nasal septum, renal tubular necrosis, and increase risk of respiratory tract infections. Super-active ionisation of water may result in the formation of the free radical (OH^\bullet) which in turn results in excessive DNA damage (Flessel, 1979). Chronic exposure results in carcinogenesis and teratogenesis (abortions and premature still births) in mammals. Due to these and other observed toxic effects, the World Health Organisation (WHO) has set the maximum acceptable concentration of chromium in drinking water to 0.05 mg/L (50 $\mu\text{g/L}$) (Kiilunen, 1994; Lu and Yang, 1995; ACGIH, 2004).

In contrast, trivalent chromium Cr(III) is relatively less toxic, less mobile, and even essential to human glucidic metabolism, contributing to the glucose tolerance factor necessary for insulin-regulated metabolism (Nriagu and Nieboer, 1998; Fendorf *et al.*, 2000; Mertz, 1981). Ingestion of small to moderate amounts of trivalent chromium is thus essential to human metabolism.

2.4 Chemical Properties

Chromium can achieve nine oxidation states ranging from -2 to +6. Two of these, +3 and +6, are the stable forms found in the environment. The tetravalent [Cr(IV)] and pentavalent [Cr(V)] quickly reduces to Cr(III) and oxidizes to Cr(VI), respectively, in the presence of reducing or oxidising agents. Among all the oxidation states, Cr(III) is the most stable, it resides in the lowest energy trough among the oxidation states. The negative standard potential (E°) of the Cr(III)/Cr(II) metal ion couple signifies that Cr(II) is readily oxidized to Cr(III), and Cr(II) species are stable only in the absence of any oxidant (anaerobic conditions) (Kotas and Stasicka, 2000).

In the aquatic environment, the redox potential of the medium affects the oxidation state of chromium where as the pH affects its complexation with anionic forms including the hydroxyl ion (OH⁻) (Figure 2-2). This figure shows the predominance of the insoluble form [Cr(OH)₃(s)] in the pH range 5.5-10.5 under natural redox conditions (E_h ranging from -0.4 +0.6V). This correlates with the area where the majority of biological reactions occur. Figure 2-2 is adapted from Ball and Nordstrom (1998); Richard and Bourg (1991); Nieboer and Jusys (1988) and Rai *et al.* (1987, 1989).

The presence of Cr(III), its concentration and its forms in a given compartment of the environment is dependent on different chemical and physical processes, such as

hydrolysis, complexation, redox reactions and adsorption. In the absence of complexing agents, other than H_2O or OH^- , Cr(III) exists as a hexa-aquachromium(3+) and its hydrolysis products (Figure 2-2) (Rai *et al.*, 1987).

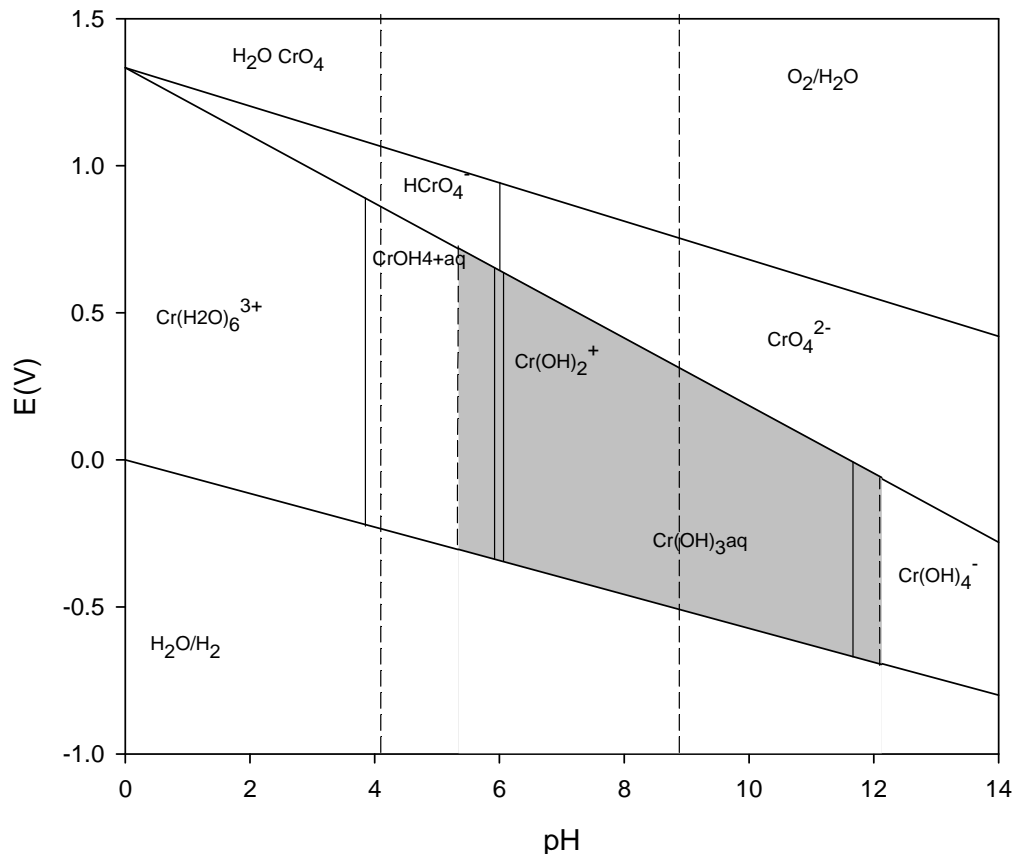
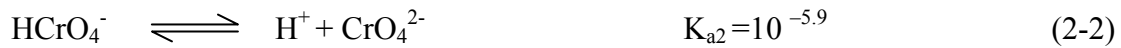

Figure 2-2: A simplified Pourbaix diagram for chromium (Cr) species dominating in diluted aerated aqueous solutions in the absence of any complexing agents, other than H_2O or OH^- (Adapted from Ball and Nordstrom (1998)).

Cr(VI), on the other hand, exists mainly in the oxyanionic forms: chromate (CrO_4^{2-}) and dichromate ($\text{Cr}_2\text{O}_7^{2-}$). Cr(VI) is highly reactive, is a strong oxidising agent, and exists only in oxygenated species. The equilibria of the Cr(VI) oxygenated species favours extremely high solubility and is pH dependent (Nieboer and Jusys, 1988).

Equations 2-1 to 2-3 (below) show the equilibria of the protonated oxyanions of chromate HCrO_4^- and H_2CrO_4 under acidifying conditions, as an example.



H_2CrO_4 is a strong oxidizing agent which is a dominant chromium species at extremely low pH below -0.6 (Cotton and Wilkinson, 1980). Monohydrogen chromate, HCrO_4^- , predominates between the pH values of 1 to 6. CrO_4^{2-} predominates at or above pH 6. The $\text{Cr}_2\text{O}_7^{2-}$ dichromate ion is formed by the dimerization of HCrO_4^- ion in Cr(VI) concentrations above 10^{-2} M (Sharma, 2002).



2.5 Pollution Remediation Strategies

2.5.1 Physical-Chemical Treatment Methods

Cr(VI) is transformed to Cr(III) at low pH through the following reduction-oxidation (redox) reaction:

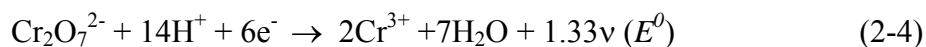

(Garrel and Christ, 1965). Because of the difference in electric potential between the two states, substantial amounts of energy are needed to oxidize Cr(III) to Cr(VI). It is therefore practical to assume that spontaneous oxidation of Cr(III) to Cr(VI) never occurs in natural aquatic systems at ambient pH and temperature.

The redox reaction of Cr(VI) to Cr(III) requires the presence of another redox couple to donate the three necessary electrons. Sets of common Cr(VI) reducing couples in

natural waters include $\text{H}_2\text{O}/\text{O}_2$, $\text{Mn(II)}/\text{Mn(IV)}$, $\text{NO}_2^-/\text{NO}_3^-$, $\text{Fe(II)}/\text{Fe(III)}$, $\text{S}^{2-}/\text{SO}_4^{2-}$, and CH_4/CO_2 (Morel and Hering, 1993; Richard and Bourg, 1991). Once reduced to Cr(III), chromium forms a creamy white precipitate, chromic hydroxide, and other soluble chromic complexes. Chromic hydroxide, $\text{Cr(OH)}_3(\text{s})$, is the predominant reduced chromium species under neutral and alkaline conditions (Ottinger *et al.*, 1973).

Examples of Cr(VI) reducing chemical agents are iron sulfide (FeS) and pyrite (FeS_2). Iron sulfide (FeS) is ubiquitous in reducing environments such as saturated soils, sediments, and sludge zones of secondary clarifiers in sewage treatment plants. Cr(VI) reduction by iron sulfides leaves a complex precipitate in solution:

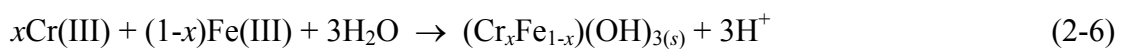
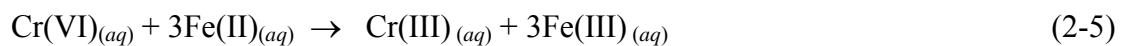

where x may vary from 0 to 1 (Patterson *et al.*, 1997; Eary and Rai, 1988). The precipitate $(\text{Cr}_x\text{Fe}_{1-x})(\text{OH})_3(\text{s})$ is innocuous and unaesthetic, and therefore must be removed from treated water before discharging into the environment. In practice, the removal of byproducts of Cr(VI) reduction such as the Fe-OH complexes may be very difficult and expensive. The final process may require a system operated at low pH ranges (<2.0) for the removal of Fe-OH compounds followed by operation at a much higher pH range (8-9.5) for the removal of the Cr(III) precipitate ($\text{Cr(OH)}_3(\text{s})$) (Eary and Rai, 1988).

Chemical treatment can be performed *ex situ* or *in situ*. However, *in situ* chemical agents must be carefully selected so that they do not further contaminate the treatment area. The primary problem associated with chemical treatment is the nonspecific

nature of the chemical reagents. Oxidizing/reducing agents added to the matrix to treat one metal could transform other metals in the system into mobile and more toxic forms (NAS, 1974). Additionally, the long-term stability of reaction products is of concern since changes in soil and water chemistry might create conditions where the detoxified forms are reversed back to toxic forms.

In the case of groundwater, the conventional chemical reduction–precipitation technique has been extensively used involving a two-step process as described above in Equations 2-5 and 2-6 (Mukhopadhyay *et al*, 2007). Due to the cost of pumping and risk of re-introducing undesirable byproducts during *ex situ* treatment, more effort is directed towards less expensive and less environmentally intrusive *in situ* treatment technologies.

2.5.2 Chemical Reactive Barriers

Several types of treatment walls have been studied to attenuate the movement of metals in groundwater at contaminated sites. Trench materials that have been investigated include zeolite, hydroxyapatite, elemental iron, and limestone (Vidic and Pohland, 1996). Elemental iron has been tested for chromium (VI) reduction and other inorganic contaminants (Powell *et al.*, 1995) and limestone for lead precipitation and adsorption (Evanko and Dzombak, 1997)

Permeable reactive barriers are an emerging alternative to traditional pump-and-treat systems for groundwater remediation. Such barriers are typically constructed from highly impermeable emplacements of materials such as grouts, slurries, or sheet pilings to form a subsurface “wall.” Permeable reactive barriers are created by intercepting a plume of contaminated groundwater with a permeable reactive material.

The properties of the reactive material are selected to promote the attenuation of the contaminant through degradation, precipitation, adsorption or reduction into a sparingly soluble phase. Reactive mixtures for the attenuation of inorganic species are designed to maintain their permeability as secondary precipitates accumulate. The barrier should also be designed in such a way that the contaminant remains immobilized within the aquifer or can be retrieved with the reactive material following treatment.

A wide range of reaction mechanisms can be employed to remove both negatively charged and positively charged contaminants from flowing groundwater. These include adsorption of inorganic anions and cations (Morrison and Spangler, 1993), simple precipitation (McMurty and Elton, 1995), adsorptive precipitation (Baker *et al*, 1997), reductive precipitation (Blowes and Ptacek, 1992), and biologically mediated transformations (Waybrant *et al*, 1995; Robertson and Cherry, 1995; Benner *et al*, 1997).

So far, permeable reactive barriers have been evaluated for the treatment of inorganic contaminants in groundwater, including As, Cd, Cr, Cu, Hg, Fe, Mn, Mo, Ni, Pb, Se, Te, U, V, NO₃, PO₄, and SO₄. Small scale field studies have indicated the potential for treatment of Cd, Cr, Cu, Fe, Ni, Pb, NO₃, PO₄, and SO₄. Permeable reactive barriers have been used in full-scale installations for the treatment of hexavalent chromium and a range of dissolved constituents including nitrate and phosphate (Blowes *et al*, 1998; Blowes and Ptacek, 1992; Powell *et al*, 1995; McRae *et al*, 1997). Specific application for Cr(VI) removal was tested at the US Coast Guard Support Centre (1996) and the Hanford site (1997) where Fe⁰ was used in the reactive barrier material to treat sodium dichromate (US EPA, 2002).

2.5.3 Physical-Chemical Permeable Reactive Barriers: Design Concept

There are two conventional designs of permeable reactive barriers (PRBs), the continuous trench permeable reactive barrier (CT-PRB) and the funnel-and-gate system (FGS) (Figure 2-3 A and B). The continuous trench PRB does not contain any structures, therefore the contaminant plume flows through the treatment zone using the natural hydraulic gradient. This PRB, which is perpendicular to groundwater flow direction, needs to be slightly larger than the cross sectional area of the contaminated

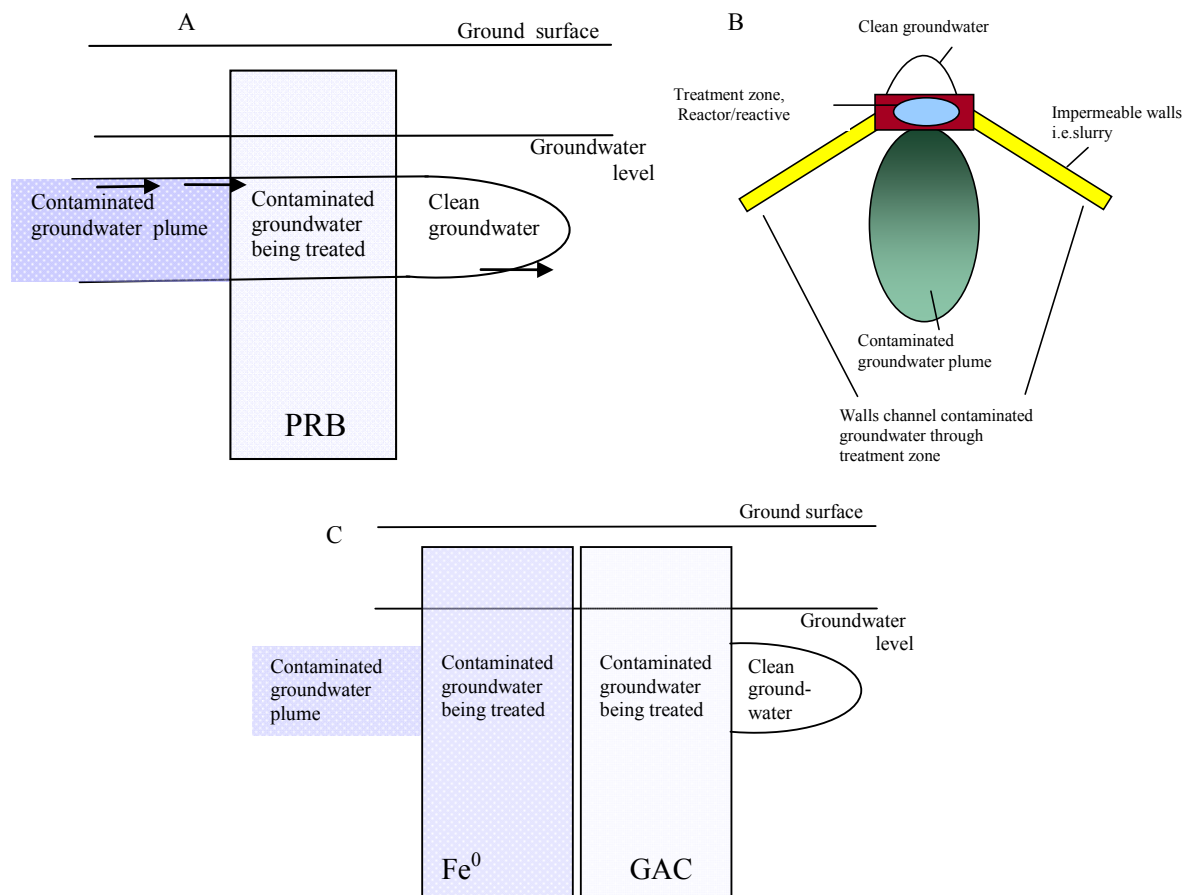

Figure 2-3: Conventional designs of permeable reactive barriers: (A) elevation view of a continuous trench or wall, (B) plan view of a funnel and gate, and (C) elevation view of a multi barrier.

groundwater in order to capture the contaminants in both vertical and horizontal directions (Gavaskar *et al*, 2000). The funnel-and-gate system is composed of impermeable walls and at least one reactive zone. The funnel structure could be sheet piles or slurry walls where the function of the funnel is to intercept the contaminated groundwater and lead it to the treatment zone. Phillips (2009) has elaborated on the designs of different reactive barriers, including mainly involving the thickness of the PRB to provide sufficient residence time for the contaminants within the treatment zone to be completely treated. Other complex designs have been tried including the multi-sequenced permeable reactive barriers (MS-PRBs) for multiple contaminants. MS-PRBs use multiple reactive materials in more than one reactive zone as shown in Figure 2-3C (Dries and Bastiaens, 2005).

2.5.4 Biological Permeable Reactive Barriers (BPRB)

These are PRBs specifically designed to utilise microorganisms in the treatment processes. A typical design comprises of a double-layer with an aeration zone followed by the bioremediation zone. One such system was evaluated against the removal of methyl-tert-butyl-ether (MTBE) contaminated groundwater (Figure 2-4) (Liu *et al*, 2006). The aeration in this case was achieved chemically by the oxidation of calcium peroxide (CaO_2) to release oxygen into the medium. Other growth nutrients were added to encourage the growth of MTBE degrading organisms in the second layer.

Notably, inorganic salts such as potassium dihydrogen phosphate (KH_2PO_4) and ammonium sulphate ($(\text{NH}_4)_2\text{SO}_4$) can act as buffers against pH changes caused by the oxidation of CaO_2 into carbonates (CO_3^{2-}). Thus, nutrients added in the second layer must include the phosphate buffer for the proper functioning of the barrier.

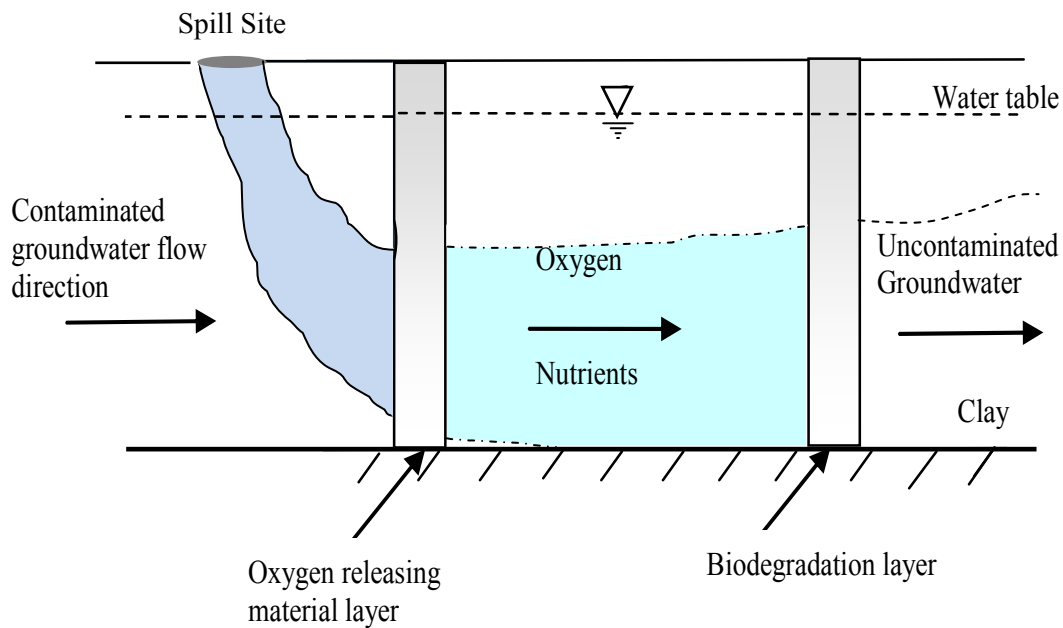

Figure 2-4: Schematic representation of a two layered biological barrier (adopted from Liu *et al*, 2006).

Another documented application is the treatment of petrochemical pollutants (i.e., benzene, toluene, ethylbenzene, xylene and polyaromatic hydrocarbons), heavy metals (i.e., lead, arsenic etc), and cyanide in the system designed by Doherty *et al* (2006) using a modified ash system. The biological permeable reactive barriers (BPRB) system was implemented at an abandoned gas manufacturing plant after 150 years of operation.

Specific application of the biological permeable reactive barrier (BPRB) system for the removal of Cr(VI) in groundwater has not been attempted. This has been both due to the unavailability of microorganisms capable of growing under nutrient deficient conditions and lack of information on the fate of the reduced chromium species in the barrier.

2.6 Microbial Cr(VI) Reduction

2.6.1 Microbial Resistance to Cr(VI) Toxicity

Most micro-organisms are sensitive to Cr(VI), but some microbial species are resistant and can tolerate high levels of chromate. In bacteria, Cr(VI) resistance is mostly plasmid borne. Different resistance strategies have been identified, including:

- modification of sulphate transport (Brown *et al.*, 2006; Hu *et al.*, 2005; Thompson *et al.*, 2007);
- counteracting chromate-induced oxidative stress by activating enzymes involved in ROS scavenging (catalase, superoxide dismutase) (Ackerley *et al.*, 2006);
- specialised repair of DNA damage by SOS response enzymes (RecA, RecG, RuvAB) (Hu *et al.*, 2005; Llagostera *et al.*, 1986; Miranda *et al.*, 2005);
- regulation of iron uptake, which may serve to sequester iron in order to prevent the generation of highly reactive hydroxyl radicals via the Fenton reaction (Brown *et al.*, 2006); and
- extracellular reduction of Cr(VI) to Cr(III), which reacts with lipopolysaccharide ligands (functional groups) on the cell surface (Flemming *et al.*, 1990; McLean *et al.*, 1990; Snyder *et al.*, 1978).

In a few cases, Cr(VI) resistance was associated with the regulation of uptake mechanisms such as the sulphate uptake shuttle system. Because of its structural similarity to sulphate (SO_4^{2-}), CrO_4^{2-} in some species crosses the cell membrane via the sulphate transport system (Cervantes *et al.*, 2001). After crossing the membrane, CrO_4^{2-} is reduced to Cr^{3+} which interferes with DNA transcription resulting in increased mutagenesis. Additionally, Cr^{3+} may alter the structure and activity of enzymes by reacting with their carboxyl and thiol groups (Cervantes *et al.*, 2001).

Among the resistance mechanisms listed above, the extracellular reduction of Cr(VI) may be utilised in environmental engineering. Although the process is facilitated by bacteria for their own survival, this process can be used to lower the concentration of Cr(VI) in a contaminated environment using bacteria.

2.6.2 Diversity of Cr(VI) Reducing Microorganisms

Microbial Cr(VI) reduction was first reported in the late 1970s when Romanenko and Koren’Kov (1977) observed Cr(VI) reduction capability in *Pseudomonas* sp. grown under anaerobic conditions. Since then, several researchers have isolated new microorganisms that catalyse Cr(VI) reduction under varying conditions (Ackerley *et al.*, 2004; Chirwa and Wang, 1997a; Ohtake *et al.* 1990; Ganguli and Tripathi, 2002; Suzuki *et al.*, 1992; Ramírez-Ramírez *et al.*, 2004; Baldi *et al.*, 1990).

Lately, genetic sequences of 16S rDNA have been used to supplement the conventional methods of species identification and characterisation (Blackall *et al.*, 1998; Molokwane *et al.*, 2008; Molokwane and Chirwa, 2009). This allows identification of a wide range of organisms which are unculturable using the conventional solid agar culturing methods. It also helps uncover species that have not been identified before. The cumulative list of known Cr(VI) reducing bacteria and their growth conditions is shown in Table 2-1.

Table 2-1 illustrates a number of known chromium reducing bacteria. Most of the bacterial species were isolated from chromium (VI) contaminated environments (i.e. sediments, wastewater treatment plants, soil etc). Although earlier isolates grew mostly on aliphatic carbon sources, later studies have shown diversity in the preferred carbon sources and electron donors. For example, consortium cultures were shown to grow in the absence of organic carbon sources – utilising only bicarbonate (HCO_3^-) as the carbon source (Molokwane and Chirwa, 2009).

Table 2-1: Known Cr(VI) reducing bacteria.

Name of Species	Isolation Conditions/ C-Sources	References
<i>Achromobacter sp.</i> <i>StrainCh1</i>	Anaerobic / Luria Broth; glucose-lactate	Zhu <i>et al.</i> , 2008
<i>Agrobacterium radiobacter</i> EPS-916	Aerobic-Anaerobic / glucose-mineral salts medium	Llovera <i>et al.</i> , 1993
<i>Alcaligenes eutrophus</i>	Aerobic / sodium gluconate	Nies and Silver, 1989
<i>Bacillus megaterium</i> TKW3	Aerobic / nutrient broth-minimal salt medium-glucose, maltose, and mannitol	Cheung <i>et al.</i> , 2006
<i>Bacillus sp.</i>	Aerobic/ Vogel-Bonner (VB) broth-citric acid; D-glucose	Chirwa and Wang, 1997;
<i>Bacillus sp.</i> ES 29	Aerobic / Luria-Bertani (LB) medium	Camargo <i>et al.</i> , 2003
<i>Bacillus subtilis</i>	Anaerobic / Minimal medium - trisodium citrate and dehydrate glucose	Carlos <i>et al.</i> , 1998
* <i>Bacillus drentesis</i>	Aerobic/Luria Betani Broth	Molokwane and Chirwa, 2009
* <i>Bacillus mycoides</i>	Aerobic/Luria Betani Broth	Molokwane and Chirwa, 2009
* <i>Bacillus thuringiensis</i>	Aerobic/Luria Betani Broth	Molokwane and Chirwa, 2009
<i>Deinococcus radiodurans</i> R1	Anaerobic / Basal Medium-Lactate-Acetate-Pyruvate-Succinate-Ethanol-L-lactate, and D-lactate	Frederickson <i>et al.</i> , 2000
<i>Enterobacter cloacae</i> HO1 strain	Anaerobic / KSC medium-Sodium acetate	Wang <i>et al.</i> , 1989(a)
<i>Escherichia coli</i> ATCC 33456	Aerobic-Anaerobic / Nutrient broth medium; glucose, acetate, propionate, glycerol and glycine	Shen and Wang, 1994b
* <i>Enterobacter sp</i>	Aerobic/Luria Betani Broth	Molokwane and Chirwa, 2009
* <i>Lysinibacillus sphaericus</i>	Aerobic/Luria Betani Broth	Molokwane and Chirwa, 2009
<i>Ochrobactrum sp.</i>	Aerobic / glucose	Zhiguo <i>et al.</i> , 2009
<i>Pantoea agglomerans</i> SP1	Anaerobic / acetate	Francis <i>et al.</i> , 2000
<i>Pseudomonas fluorescens</i>	Aerobic-Anaerobic / Glucose-Acetate-Pyruvate-Lactate-Succinate	Bopp <i>et al.</i> , 1983; Ohtake <i>et al.</i> , 1987
<i>Pseudomonas fluorescens</i> LB300	Aerobic / Vogel-Bonner broth	Bopp and Ehrlich, 1988
<i>Pseudomonas putida</i> MK1	Anaerobic / Luria-Bertani -citric acid-Tris-acetic acid	Park <i>et al.</i> , 2000
<i>Pseudomonas sp</i>	Aerobic / Peptone-glucose; chemostat	Gopalan and Veeramani, 1994
<i>Pseudomonas spp.</i>	Anaerobic / Vogel-Bonner (VB)- D-glucose	Mclean and Beveridge, 2001

Table 2-1: Known Cr(VI) reducing bacteria (Continued....)

Name of Species	Isolation Conditions/ C-Sources	References
<i>Providencia sp.</i>	Aerobic-Anaerobic / Luria broth (tryptone-yeast extract)	Thacker <i>et al.</i> , 2006
<i>Pseudomonas aeruginosa</i>	Aerobic / Nutrient broth or Luria broth	Aguilera <i>et al.</i> , 2004
<i>Shewanella alga</i> (BrYMT) ATCC 55627	Aerobic-Anaerobic / M9 broth- Glucose	Guha <i>et al.</i> , 2001
<i>Shewanella putrefaciens</i> <i>MR-1</i>	Anaerobic / lactate- fumarate	Myers <i>et al.</i> , 2000

*Current study

2.6.3 Cr(VI) Reduction Pathways

Cr(VI) reduction has been demonstrated to be cometabolic (not participating in energy conservation) in certain species of bacteria, but is predominantly dissimilatory/respiratory under anaerobic conditions. In the latter process, Cr(VI) serves as a terminal electron acceptor in the membrane electron-transport respiratory pathway, a process resulting in energy conservation for growth and cell maintenance (Horitsu *et al.*, 1987; Ishibashi *et al.*, 1990; Chirwa, 2005; Lovley and Phillips, 1994). In the dissimilatory/respiratory process, electrons are donated from the electron donor to Cr(VI) via nicotinamide di-hydrogen (NADH) (Suzuki *et al.*, 1990; Chirwa and Wang, 1997a).

The dissimilatory nature of Cr(VI) reduction was demonstrated earlier in whole cell and disrupted cell experiments by Wang *et al.* (1990) in which reduced chromium was predominantly found in the medium and only less than 30% was released from disrupted cells of *Enterobacter cloacae* HO1. In 1993, Shen and Wang (1993) confirmed these results while working with the Cr(VI) reducing *Escherichia coli* ATCC 33456. In the latter experiment, only 10% of the reduced chromium was accumulated inside the cells.

Figure 2.5 illustrates the two common pathways for Cr(VI) reduction, the first one with Cr(VI) reduction involving the formation of the unstable intermediate Cr(V) (Suzuki *et al.*, 1990), and the second depicting direct reduction from Cr(VI) to Cr(III) by a soluble or membrane associated reductase (Chirwa, 2001). The first pathway was observed under anaerobic conditions in *Pseudomonas* species whereas the second is common under aerobic conditions mostly in *Bacilli*.

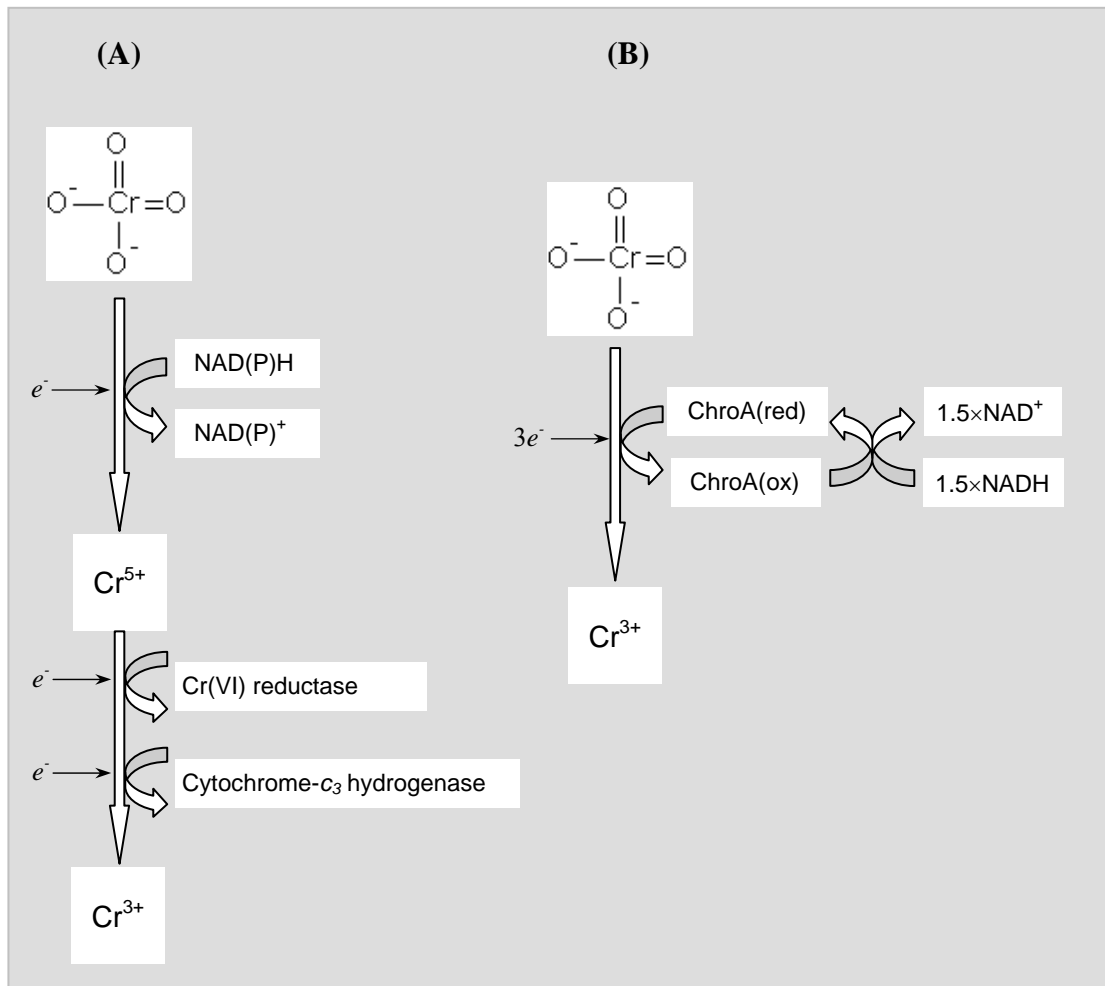
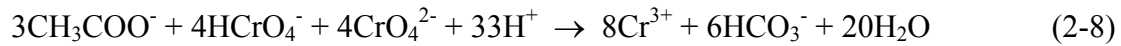
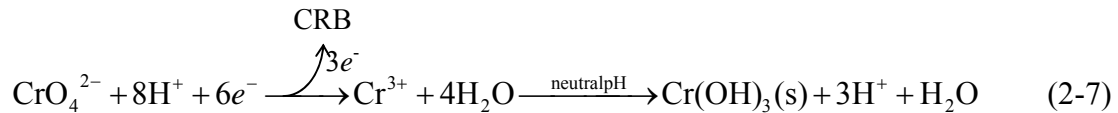

Figure 2-5: The two known Cr(VI) reduction pathways: (A) stepwise reduction via the unstable intermediate (Cr(V)) facilitated by NAD(P)H oxidation (Suzuki *et al*, 1990), and (B) direct reduction by a soluble reductase ChroA facilitated by the oxidation of NADH (Chirwa, 2001).

In the second pathway (B), two electron moles are transferred per mole of NADH oxidised. The reductase ChroA was determined to be encoded by a chromosome borne gene *ChroA* which is activated by Cr(VI) in *Pseudomonas fluorescens* LB300. Cr(VI) reduction by microorganisms often results in consumption of large amounts of proton as reducing equivalents which results in the elevation of the background pH. The increased pH facilitates the precipitation of the reduced chromium as chromium hydroxide, $\text{Cr}(\text{OH})_3(\text{s})$ as shown Equations 2-7 and 2-8 below (Brock and Madigan, 1991; Zakaria *et al.*, 2007).



Equation 2-7 shows a generic Cr(VI) reduction reaction catalysed by Cr(VI) reducing bacteria whereas equation 2-8 shows Cr(VI) reduction with a simple carbon source as an electron donor. Other fatty acid byproducts of hydrolysis can also serve as electron donors for Cr(VI) reduction (Chirwa and Wang, 2000).

In other species, Cr(VI) reduction may occur as a fortuitous reaction in which redox-active biomolecules such as cytochromes transfer electrons to Cr non-specifically (Lovely and Phillips, 1994). Two species of bacteria, *Desulfotomaculum reducens* and *Pantoea agglomerans*, have been shown to obtain energy for growth using Cr(VI) as a respiratory electron acceptor while conserving energy from Cr(VI) reduction coupled to the oxidation of organic acids or H₂ (Francis *et al.*, 2000; Tebo and Obraztsova, 1988). The above observations indicate that the presence of highly degradable substrates such as glucose, peptone, and tryptose is not always necessary to achieve biological Cr(VI) reduction. This indicates that the larger, energy rich molecules may be converted into simpler metabolites that are critical as carbon sources or intermediates for the cell's central metabolic system. This was demonstrated in experiments by Chirwa and Wang (2000) where Cr(VI) reducers (*E. coli* ATCC 33456) utilised organic acid metabolites produced by phenol degraders in an anaerobic consortium of bacteria.

2.7 Current and Future Biotechnology Solutions

2.7.1 Suspended Culture Systems

The first continuous-flow Cr(VI) reducing processes were investigated in suspended culture systems (Mazierski, 1994; Shen and Wang, 1994a; Wang *et al.*, 2000). One common feature in all the above systems was that vigorous mixing was required to keep the systems homogenous. Cells in the suspended culture systems were susceptible to high Cr(VI) concentrations. Additionally the reactors needed to be recharged with new cells after shock loading due to excessive loss of biomass (Wang *et al.*, 2000). During application on actual waste, it is often necessary to dilute the influent stream to lower the incoming toxicity levels to tolerable levels for the microorganisms (Ohtake *et al.*, 1990). This results in large volumes of reactors to treat relatively low concentrations.

2.7.2 Attached Growth Systems

Biofilm systems have been used extensively in treatment processes due to the perceived resilience of microorganisms growing in films. In biological systems, up to 80% of the mass of the biofilm consists of exo-polysaccharide (EPS) matrix which offers mass transport resistance across the biofilm layer (Nelson *et al.*, 1996). As a result, bacteria in the biofilm is exposed to a decreasing concentration profile with increasing depth. Other conditions may also vary resulting in the development of a complex community of microorganisms. For example, Nkhalambayausi-Chirwa and Wang, (2001) observed that spatial and physiological heterogeneity introduced within microbial communities by the formation of biofilm, enhanced Cr(VI) reduction by *E. coli* within the quasi-anaerobic interior of the biofilm while supporting maximum growth of *P. putida* along the more aerobic surface layers. This resulted in a self optimised system in which metabolites formed from phenol degradation in the

aerobic layer supported the growth of the Cr(VI) reducing species in the deeper layers of the biofilm.

2.7.3 *In Situ* Inoculation

Currently applications of *in situ* bioremediation emphasize the construction of a maintainable barrier system where the barrier material is either replaced occasionally or replenished by a reverse reaction. Both systems suffer from high cost and the high probability of producing toxic sludge. *In situ* inoculation as proposed in this study entails injecting an inoculum (mixed) culture of bacteria into the selected barrier zone and allow the microorganisms to grow and optimise in the new environment (Molokwane and Chirwa, 2009). This requires the presence of essential nutrients in the environment or in the waste stream to sustain the culture. The major advantage of this process is its low installation cost. The potential shortcoming is low degree of control with respect to the handling of products (Molokwane and Chirwa, 2010).

2.7.4 Bioaugmentation

The applications of the future will aim at modifying organisms already existing in the environment to treat waste by providing the organisms with the genetic information required to carry out the biotransformation process *in situ*. The genes could be shuttled into the native species through a soup of plasmids or transposons introduced into the environment either directly or through new microbial cultures (Top *et al.*, 2006). Organisms are known to acquire genetic information from the environment when necessary, to deal with adverse conditions (Engo *et al.*, 2002). The advantage is the avoidance of introducing alien species with possible unforeseeable detrimental effects to the native environment. Similarly to biological permeable reactive barriers, *in situ* bioaugmentation processes have only been tested for organic pollutants

(Jianlong *et al*, 2002). Applications on toxic metals including Cr(VI) face the same challenge of removal of the products from the aquifer.

2.8 Chapter Summary

New tools for isolation and characterising bacteria have enabled several research groups to identify a wider array of Cr(VI) reducing organisms recently. In spite of this new worth of knowledge, applications to actual environments and contaminant streams are still limited. One of the areas lagging behind is in the remediation of contaminated environments. Pump-and-treat processes currently applied at the sites have been ineffective and have generated large amounts of toxic sludge requiring further treatment and expensive disposal at landfill sites.

Construction and operation of permeable barriers has been evaluated for physical-chemical processes for treating inorganic pollutants and biological permeable reactive barriers in treating organic pollutants. The latter has not been used for Cr(VI) removal because of the difficulty of removing the reduced metal precipitate from the aquifer. The proposed lower cost inoculated barrier system which forms the basis for the microcosm and mesocosm studies in the following chapters. Although, the problem of dealing with the product (reduced metal precipitate) still exists, this technology could prevent the contamination of surrounding aquifer until the time when a permanent remedy such as a major excavation is achievable.

CHAPTER 3

MATERIALS AND METHODS

3.1 Source of Cr(VI) Reducing Organisms

Four different environments were identified as possible sources of Cr(VI) reducing cultures: (1) soil from a contaminated site, (2) influent to a sewage treatment plant receiving high loadings of Cr(VI), (3) activated sludge from aeration tanks and (4) dried sludge from sand drying beds at the same treatment plant. The measured background Cr(VI) concentration in the influent and mixed liquor from the treatment plant was 2.45 and 2.63 mg/L, respectively, and the Cr(VI) content in dried sludge was 25.44 g/m³ at the time of sampling. Higher values of the reduced form of total Cr were expected in the mixed liquor and dry sludge due to the presence of Cr(VI) reducing bacteria.

The bacteria from the different sources was incubated for 96 hours in LB broth at initial concentrations of 20, 50, 100, 150, 200, 300, 400 and 600 mg Cr(VI)/L under aerobic conditions. The temperature was maintained at an average of $30 \pm 2^\circ\text{C}$ and the pH at 7. The existence of Cr(VI) reducing bacteria in the samples from different sources was indicated by high removal rates observed in the cultures as shown in Table 3-1 (Molokwane *et al*, 2008). All cultures in the screening tests above were incubated for 96 hours.

The cultures from contaminated soil yielded the lowest Cr(VI) removal rate. Soil bacteria reduced Cr(VI) as much as observed in an earlier studies by Chirwa and Wang (1997a, b), however, this performance was much lower compared to the performance of bacteria from dried sludge. Soil cultures were able to reduce 91.5 %

of Cr(VI) at an initial of 20 mg/L, and the Cr(VI) reduction ability significantly decreased with increasing initial concentration.

Cr(VI) reduction ability of cultures obtained from mixed liquor also decreased with increasing initial Cr(VI) concentration in the test batches. The best performance was observed in the cultures from dried sludge with complete Cr(VI) reduction observed at initial Cr(VI) concentrations up to 200 mg/L. At an initial concentration of 300 mg/L the dried sludge culture reduced 99.2 % after incubation for 96 hours.

Table 3-1: Percentage Cr(VI) reduction in cultures from different sources after 96 hours of incubation at different initial Cr(VI) concentration.

Sources of CRB	Initial Cr(VI) concentration (mg/L)						
	20	50	100	150	200	300	600
Dried sludge cultures	100 %	100 %	100 %	100 %	100 %	99.2 %	0 %
Mixed liquor cultures	100 %	100 %	100 %	93.6 %	67.6 %	60.3 %	0 %
Sewage cultures	100 %	100 %	-	74.2 %	-	14.1 %	0 %
Soil cultures	91.5 %	76.0 %	-	29.9 %	-	7.45 %	0 %

- no experiment conducted at this concentration

The high performance in the dried sludge cultures was attributed to the long period of contact between bacteria and Cr(VI) during the wastewater treatment process – from the influent to the final clarifiers. The presence of a wide variety of carbon sources and nutrients in the system was expected to support a wider biodiversity of bacterial species. In all cultures studied, there was no Cr(VI) reduction observed at an initial

concentration of 600 mg/L. Based on those results, bacteria from the sand drying beds was chosen the rest of the studies.

3.2 Mineral Media

The main kinetic experiments were conducted using Basal mineral medium (BMM) prepared by adding (in grams per litre of distilled water): 0.535 NH_4Cl , 10.744 NaHPO_4 , 2.722 KH_2PO_4 , 0.114 Na_2SO_4 , 0.049 MgSO_4 , 0.554 CaCl_2 , 0.695 FeSO_4 , 0.0013 ZnCl_2 , 0.00341 CuCl_2 , 0.00103 NaBr , 0.00121 Na_2MoO_4 , 0.00198 MnCl_2 , 0.00166 KI , 0.00124 H_3BO_3 , 0.00238 CoCl_2 , and 0.00128 NiCl_2 . The medium was then sterilised by autoclaving at 121°C for 15 minutes. The cells were initially cultivated in nutrient broth (NB) and Luria-Bettani (LB) broth. Plate count (PC) agar and Luria-Bettani (LB) agar were used for colony development (Merck, Germany). All broth and media were prepared by dissolving the recommended amounts of media powder in 1 L of distilled water and autoclaved at 121°C for 15 minutes. Agar media were cooled to 45°C before use. All salts unless stated otherwise were obtained from Sigma-Aldrich (St Louis, USA).

3.3 Culture Isolation

Pure cultures were prepared by depositing 1 mL of a serially diluted sample on LB agar followed by incubation at 30°C to develop separate identifiable colonies. Individual colonies were transferred using a heat-sterilised wire loop into 100 mL sterile LB broth spiked with 75 mg Cr(VI)/L . Loop-fulls from individual colonies were used to inoculate fresh media containing 150 mg Cr(VI)/L . The cells were allowed to grow – colonies were grown again for the third time from serially diluted batches grown from individual colonies. Cultures from the third isolation were washed and used in the detailed Cr(VI) reduction rate analysis using BMM as

experimental media. Cr(VI) reducing colonies were selected by observing complete Cr(VI) reduction after incubation for 72 hours. The selected colonies were stored at 4°C in test-tube slant cultures or agar-plate streaks.

3.4 Gram Stain Analysis

Gram stain analysis was conducted following the Hucker Method (APHA, 2005). 1 mL of culture from 24 hour cultivated cells was spread on microscopy slide and dried over a flame. The slide was then immersed in crystal violet then air-dried for 1 minute. The fixed cells on the slide were then washed gently and directly by running water for seconds. The slide was then immersed in iodine mordant for 1 minute, then again gently and directly washed under a tap water stream for 2 seconds. Afterwards, the slide was immersed in Safranin solution for 30 seconds and gently washed under tap water stream for 2 seconds. The slide was then immersed in 95% vol/vol ethanol for 5 seconds, and then gently washed under a stream of tap water for 2 seconds. The slide was then dried with absorbent paper. Finally, the bacteria on the slide were photographed using a ZEISS Axioscop II Microscope (Carl-Zeiss, Oberkochen, Germany) equipped with a 100*/1.30 Oil PLAN-NEOFLUAR Objective. Cells were then differentiated by the colour observed: black-violet for Gram-positive; and red-pink for Gram-negative cells.

3.5 Microbial Culture Characterisation

Phylogenetic characterization of cells was performed on individual colonies of bacteria from the 7th-10th tube in the serial dilution preparation. LB and PC agar was used for colony development. In preparation for the 16S rRNA sequence identification, the colonies were first classified based on morphology. Seven different

morphologies were identified for the aerobic cultures. These were streaked on nutrient agar followed by incubation at 37°C for 18 hours.

Culture purification and 16S rRNA sequencing were performed at the Department of Microbiology, University of Pretoria where the identification was done. At 99% identity match, the results indicated the predominance of four aerobe phenotypes. Genomic DNA was extracted from the pure cultures using a DNeasy tissue kit (QIAGEN Ltd, West Sussex, UK) as per manufacturer's instructions. The 16S rRNA genes of isolates were amplified by reverse transcriptase-polymerase chain reaction (RT-PCR) using primers pA and pH1 (Primer pA corresponds to position 8-27; Primer pH to position 1541-1522 of the 16S gene) (Coenye *et al.*, 1999). An internal primer pD was used for sequencing (corresponding to position 519-536 of the 16S gene). The resulting sequences were matched to genes for known bacteria in the GenBank using a basic BLAST search of the National Centre for Biotechnology Information (NCBI, Bethesda, MD).

3.5.1 Aerobic Culture

Partial sequences of 16S rRNA genes showed the predominance of the *Bacillus* groups – *Bacillus cereus* ATCC 10987, *Bacillus cereus* 213 16S, *Bacillus thuringiensis* serovar finitimus, *Bacillus mycoides* – and two *Microbacterium* species – *Microbacterium foliorum* and *Microbacterium sp.* S15-M4 (Table 3-2).

The observed microbial composition of the startup culture was consistent with microbial culture observed in activated sludge systems with Cr(VI) reducing bacteria (Francisco *et al.*, 2002; Camargo *et al.*, 2003; Faisal and Hasnain, 2006). In the studies by Camargo and others (2003), the Cr(VI) reducing species *Lysinibacillus sp.*, *Bacillus K1*, *Bacillus cereus*, and *Bacillus thirungiensis* were identified as

predominant species in activated sludge cultures. A phylogenetic tree was constructed for the species from purified cultures grown under aerobic conditions based on a basic BLAST search of rRNA sequences in the NCBI database (Figure 3-1).

Table 3-2: Partial sequencing of aerobic CRB isolated from Brits dry sludge grown in solution containing 100 mg/L.

Pure culture	Partial 16S ID ^a	%Identity
X1	<i>Bacillus cereus</i> strain 213 16S, <i>Bacillus thuringiensis</i> 16S	99
X2	<i>Bacillus</i> sp. ZZ2 16s, <i>Bacillus cereus</i> ATCC 10987, <i>B. thuringiensis</i> strain Al Hakam	99
X3	<i>Bacillus</i> sp. 32-661 16s, <i>Bacillus cereus</i> strain 16S	99
X4	<i>Bacillus mycoides</i> strain BGSC 6A13 16S, <i>Bacillus thuringiensis</i> serovar <i>finitimus</i> strain BGSC 4B2 16S	99
X5	<i>B. mycoides</i> strain BGSC 6A13 16S, <i>B. thuringiensis</i> serovar <i>finitimus</i> strain BGSC 4B2 16S	99
X6	<i>B. mycoides</i> strain BGSC 6A13 16S, <i>B. thuringiensis</i> serovar <i>finitimus</i> strain BGSC 4B2 16S	99
X7	<i>Microbacterium</i> sp. S15-M4, <i>Microbacterium foliorum</i>	99

^a S ID¼ 16 Svedburg rRNA Identity of partial sequences (16 Svedburg unit ribosomal Ribo-Nucleic-Acid Identity).

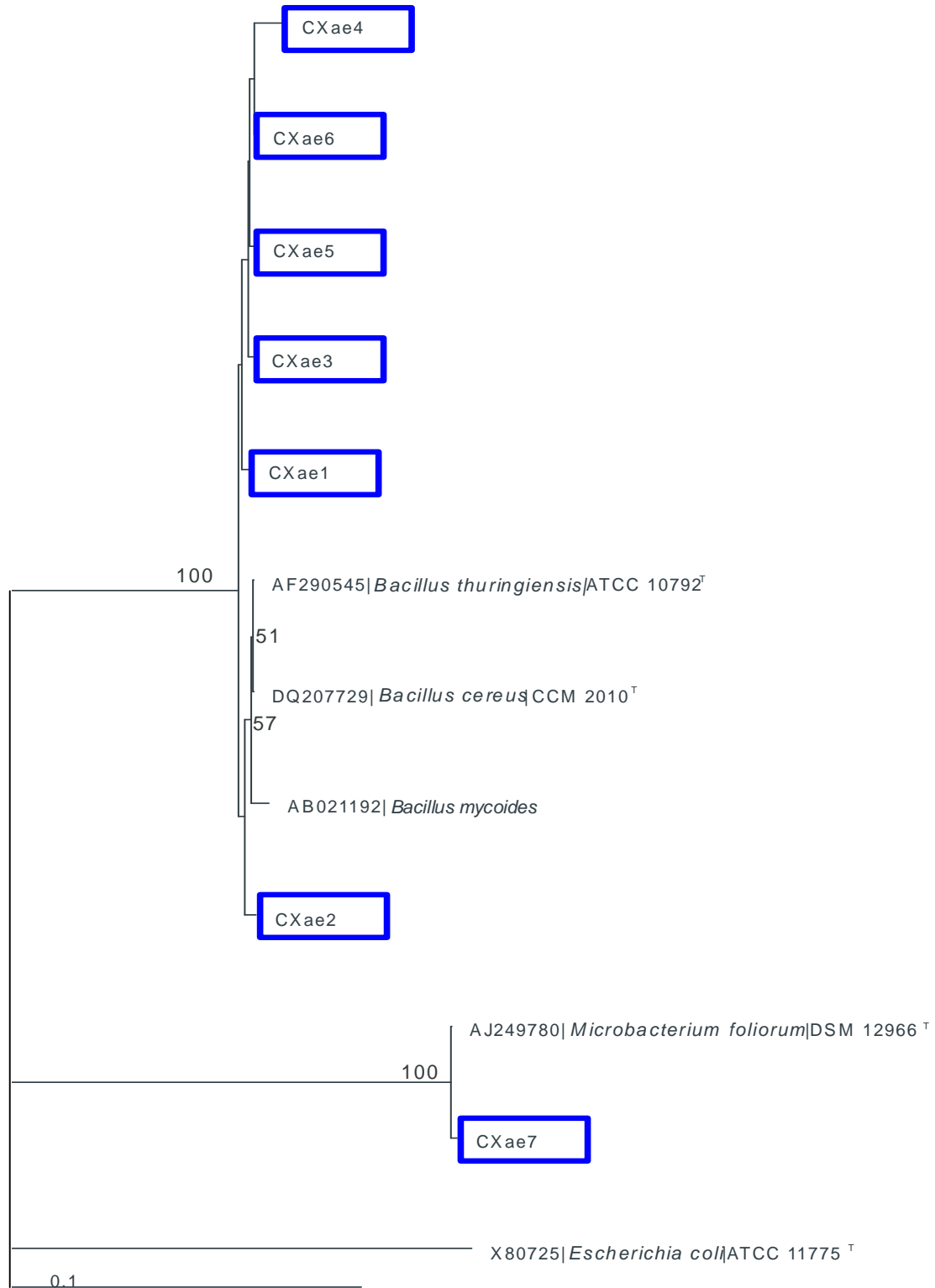

Figure 3-1: Phylogenetic tree of species from Brits dry sludge reflecting microbial diversity under aerobic conditions.

3.5.2 Anaerobic culture

Anaerobic bacteria was isolated from dry sludge following the same procedure described for aerobic cultures, modified by maintaining anaerobic conditions by purging reactors with nitrogen and sealing in serum bottles. All transfers were conducted in an anaerobic glove bag purged with nitrogen. The cultures were isolated under 100, 150 and 200 mg Cr(VI)/L. Eighteen different morphologies were identified from anaerobic cultures (Figure 3-2). Some of the bacteria were unculturable but produced a fingerprint during 16S rRNA analysis. Some were cultured but were marked as unidentified. Only 11 colonies from the anaerobic cultures were partially identified and seven colonies could not be amplified for partial gene sequencing.

Results indicated the predominance of eighteen anaerobic phenotypes ten of which were positively identified as shown in Table (3-3). Partial sequences of 16S rRNA matched the seven *Bacillus* groups:

- Seven phenotypes from the *Bacillus* groups – *Bacillus drentensis*, *Bacillus sp.* BS19, *Bacillus sp.* R21S, *Oceanobacillus sp.* JPLAk1, *Paenibacillus pabuli*, *Paenibacillus xylanilyticus strain XIL14*, *Virgibacillus necropolis*;
- Eight phenotypes from the *Microbacterium* group – *Acinetobacter sp.* ANT9054, *Arthrobacter sp.* AK-1, *Arthrobacter sp.* Sphe3, [*Brevibacterium*] *frigoritolerans*, *Rumen bacterium R4-4*;
- Three phenotypes from the uncultured *Bacterium* group – uncultured *Bacterium clone Y2*, Uncultured soil *Bacterium clone TA12*; and
- Three phenotypes from the *Enterococcus* – *Enterococcus avium*, *Enterococcus faecium strain R0026*, *Enterococcus pseudoavium*.

The genetic relationship between species based on the BLAST search is shown in Figure 3-2. The anaerobic data showed a wider microbial diversity probably due to the partially anaerobic conditions in the aeration tanks at the Wastewater Treatment Plant from which the bacteria were originally collected.

Table 3-3: Characteristics of pure cultures and nearest matches based on the BLAST analysis of 16S rRNA partial sequences.

[Cr(VI) mg/L]	Sample No	Colour	Blast result	% Identity
100	X2	Off-white	<i>Enterococcus avium</i> , <i>Enterococcus pseudoavium</i>	99
	X3	Cream	Uncultured <i>Bacterium</i> clone Y2, <i>Acinetobacter</i> sp. ANT9054	97
	X6a	Yellow	<i>Arthrobacter</i> sp. Sphe3, Uncultured soil <i>Bacterium</i> clone TA12	93,94
150	X6b	Yellow	<i>Arthrobacter</i> sp. AK-1	99
	X7	Cream and yellow rings	<i>Bacillus drentensis</i> , <i>Bacillus drentensis</i>	96,97
	X10	Light brown	<i>Oceanobacillus</i> sp. JPLAK1, <i>Virgibacillus necropolis</i>	99,98
	X11	Off-white	<i>Enterococcus faecium</i> strain R0026, <i>Rumen bacterium</i> R4-4	99
	X12	Coral	<i>Paenibacillus pabuli</i> , <i>Paenibacillus xylanilyticus</i> strain XIL14	99
200	X15	Cream	[<i>Brevibacterium</i>] <i>frigorigerans</i> , <i>Bacillus</i> sp. R21S	99
	X17	Cream	Uncultured <i>bacterium</i> , <i>Bacillus</i> sp. BS19	93

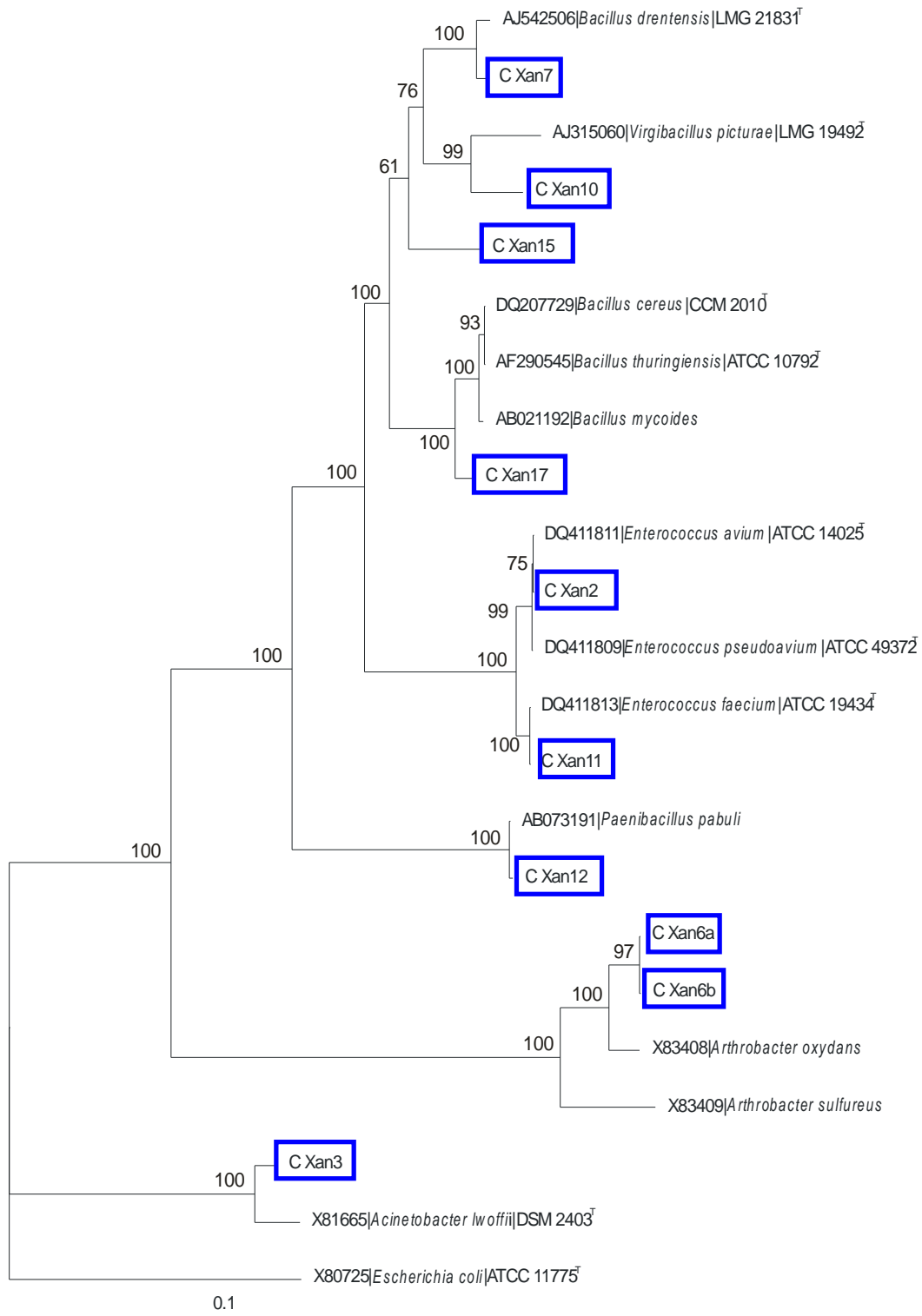

Figure 3-2: Phylogenetic tree of species from Brits dry sludge reflecting microbial diversity under anaerobic conditions.

3.6 Cr (VI) Reduction Experiments

3.6.1 Aerobic Batch Experiments

Aerobic Cr(VI) reduction experiments were conducted in 250 mL Erlenmeyer flasks containing 100 mL sterile BMM, using cells harvested after 24 hours incubation in nutrient broth. The cells were washed twice by centrifugation at 6000 rpm (2817.36 g) for 10 minutes in a Hermle 2323 centrifuge (Hermle Laboratories, Wehingen, Germany). After centrifugation, the cells were re-suspended in a sterile solution of 0.085% NaCl for each wash. The cells were then finally re-suspended in the sterile BMM after the final wash- concentrated by a ratio of 4:1. Cr(VI) of a known concentration was added to the media marking the beginning of the Cr(VI) reduction experiment. The batches were covered with cotton plugs during incubation to allow aeration while filtering away microorganisms from the air.

Cr(VI) concentration in the range of 50 to 400 mg/L was added and the solution was incubated under shaking at $30 \pm 2^\circ\text{C}$. 1 mL samples were withdrawn at time intervals determined by the observed rate of Cr(VI) removal. The samples were centrifuged at 6000 rpm (2817.36 g) for 10 minutes in the Hermle 2323 centrifuge (Hermle Laboratories) to remove suspended cells before analysis.

3.6.2 Anaerobic Batch Culture Experiments

Anaerobic batch experiments were conducted in 100 mL serum bottles using cells harvested after 24 hours incubation under anaerobic conditions. The cells were transferred under an anaerobic glove bag purged with 99.99% N₂ gas. Cells were concentrated to a 4:1 ratio, and washed twice in a sterile solution of 0.085% NaCl before adding Cr(VI) as described earlier for aerobic batches.

The bottles were purged with nitrogen gas (99.99%) for 10 min to expel any residual oxygen before sealing with silicon stoppers and aluminium seals. After sealing, the cultures were incubated at $30\pm 1^\circ\text{C}$ for 7 days. 1 mL samples were withdrawn using a sterile syringe at time intervals determined by the observed rate of Cr(VI) removal. The samples were centrifuged at 6000 rpm (2817.36 g) for 10 minutes in a Hermle 2323 centrifuge (Hermle Laboratories) to remove suspended cells before analysis. Headspace gases were sampled by syringe and analysed by gas chromatography.

3.6.3 Microcosm Reactor Studies

Microcosm cores collected from target environments were set up in the laboratory as packed-bed reactors. The cores were encased in 22-30 cm long and 6 cm diameter polyvinyl chloride (PVC) or Plexiglas[®] (Evonik Röhm GmbH, Essen, Germany) columns and operated under a constant hydraulic head of Cr(VI) contaminated water (Figure 3-3). A peristaltic pump was used to maintain the feed level in the reservoir. Cr(VI) concentration in the range 40-50 mg/L was used in the experiment representing the Cr(VI) concentration at one of the target sites (Brits, North West Province).

Conditions tested in the microcosm studies included the effect of (1) abiotic processes – adsorption and chemical reduction by elements in the soil, (2) natural bacteria from the soil, (3) inoculation with live sludge cultures, and (4) adding a natural carbon source on Cr(VI) reduction. The natural carbon source used was saw dust to simulate the carbon sources leached from the overlying vegetation above the ground.

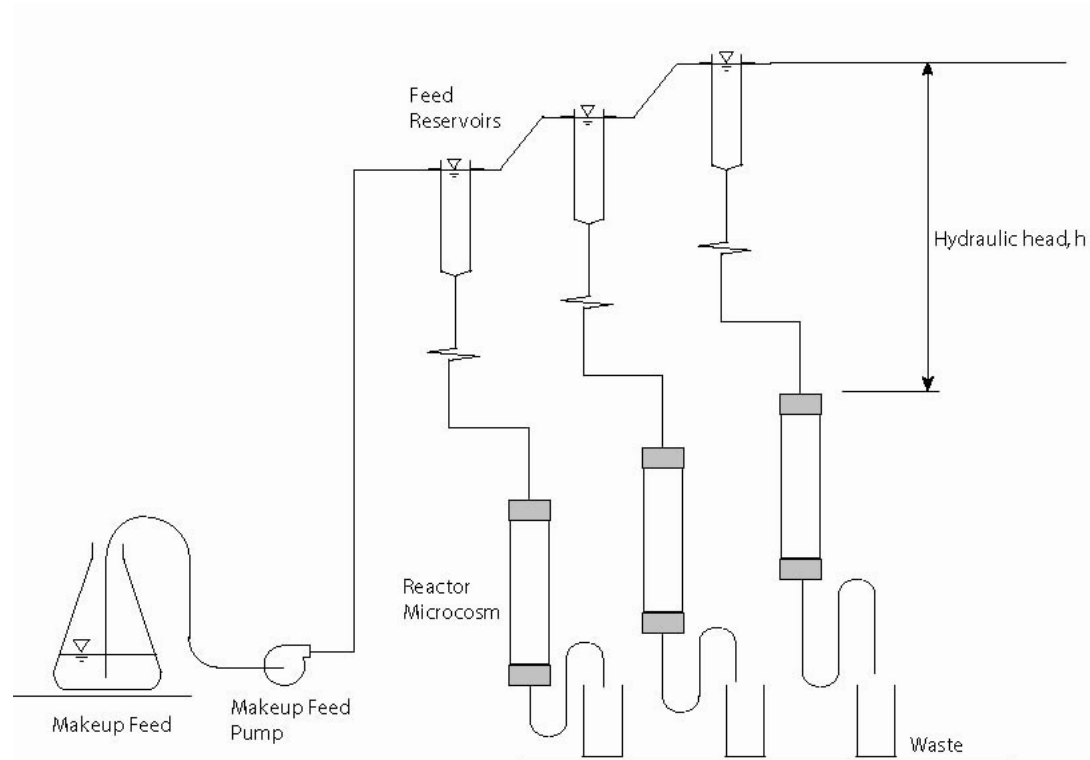

Figure 3-3: Experimental set-up for gravity fed microcosm.

3.6.4 Mesocosm Reactor Studies

An open top tank of (in cm) $123 \times 52 \times 50$ (L×B×H) was constructed from Plexiglas® (Evonik Röhm GmbH, Essen, Germany) reinforced by steel bars as shown in Figure 3-4. The reactor was filled with aquifer medium compacted by hand to a compaction consistent with the ground conditions. Fourteen sample ports of 11 mm diameter and up to 47 cm in length, (M-level being 22cm and L-level 47cm) glass tubing were inserted during placement of the aquifer material. Sample ports were strategically placed to capture the longitudinal and vertical concentration profiles and the concentration drop across the microbial barrier. Two sets of sample ports were placed before the reactive barrier in order to capture the conditions before the chromium had gone through the reactive barrier. The rest of sampling ports were placed after the barrier to evaluate the performance of the barrier. This test was run at a chromium (VI) concentration of 50 mg/L.

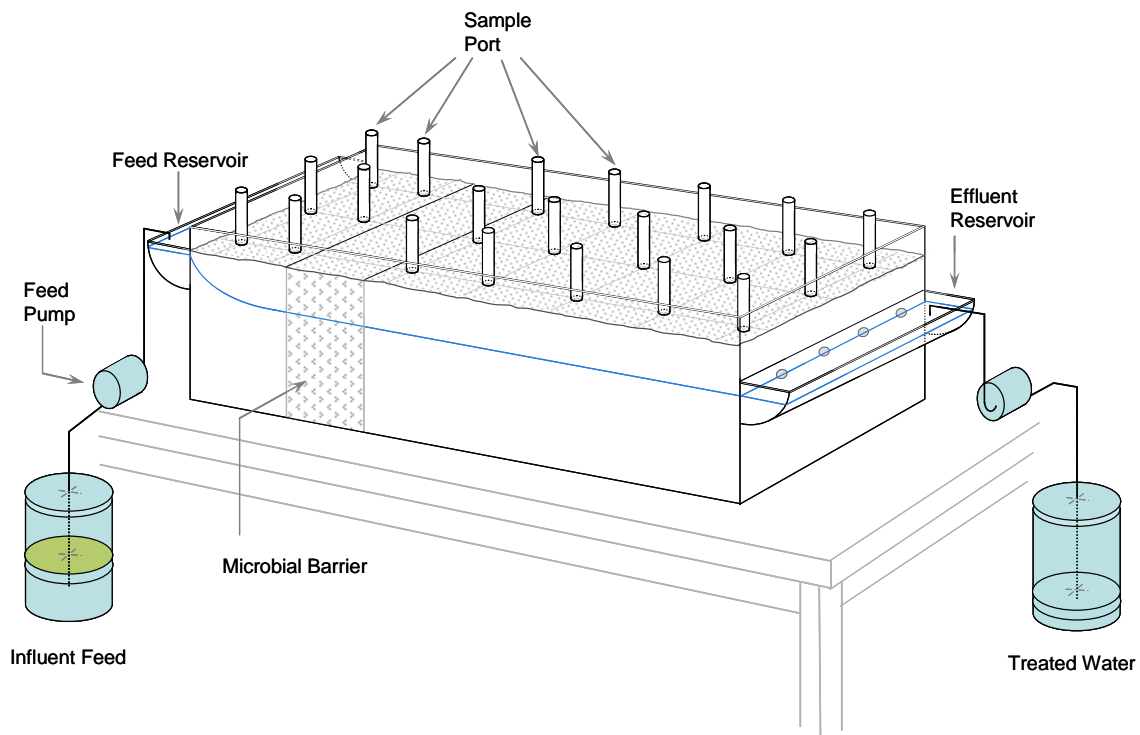

Figure 3-4: Mesocosm reactor setup using the rock media from the Cr(VI) contaminated site in Brits (North West).

3.7 Analytical Methods

3.7.1 Elemental Analysis

Metallic elements in microcosm media were characterised using Induction Coupled Plasma Mass Spectrometry (ICP-MS) in the Soil Sciences Laboratory at the University of Pretoria. This was done to reveal sources of possible interference and levels of background chromium in the samples. Mass concentrations of elements with the most significant presence in the samples are shown in Table 3-4. Of significant note are the concentrations of total iron (Fe), aluminium (Al), and calcium which are expected to produce interference in the UV/Vis spectrophotometric measurements for Cr(VI) (APHA, 2005). However the observed Fe concentration level did not contribute significantly to the coloration of the samples.

Table 3-4 : Trace metal concentrations.

Element	Symbol	Mass concentration, µg/kg
Aluminium	Al	4003
Calcium	Ca	2868
Potassium	K	282
Magnesium	Mg	542
Sodium	Na	248
Phosphorous	P	1046
Manganese	Mn	543
Chromium	Cr	50
Copper	Cu	13
Iron	Fe	15145
Sulphur	S	143
Zinc	Zn	367

3.7.2 Cr(VI) and Total Cr

Cr(VI) Measurement

Cr(VI) was measured using a UV/VIS spectrophotometer (WPA, Light Wave II, Labotech, South Africa). The measurement was carried out at a wavelength of 540 nm (10 mm light path) after acidification of 0.2ml samples with 1N H₂SO₄ and reaction with 1,5-diphenyl carbazide to produce a purple colour (APHA, 2005).

Total Chromium Measurement

Total Cr was measured at a wavelength of 359.9 nm using a Varian AA – 1275 Series Atomic Adsorption Spectrophotometer (AAS) (Varian, Palo Alto, CA (USA)) equipped with a 3 mA chromium hollow cathode lamp. Cr(III) was determined as the difference between total Cr and Cr(VI) concentration.

3.7.3 Viable Biomass Analysis

Viable cells in batch experiments were determined using the pour plate method and colony counts as described in the Standard Methods for the Examination of Water and Wastewater (APHA, 2005), with the colonies grown on Luria Bertani (LB) and Plate Count (PC) agar. Colonies were developed by plating 1 mL samples serially diluted samples (1 mL transferred into 9 mL sterile 0.85% NaCl solution) onto Petri dishes followed by incubation at 30°C for 24 hours. The Petri dishes were inverted during incubation. The number of cells was reported as colony forming units (CFU) per 100 mL of water.

For the mesocosm study (Figure 3-4), soil samples were extracted from barrier section within the mesocosm reactor. Suspended biomass from the soil samples was cultured on LB agar for heterotrophic culture growth. The numbers of colonies counted gave a representation of biomass density in the soil column. Total biomass concentration was estimated using a correlation analysis between viable cells as CFU and total biomass (mg/L) during the log growth phase when over 95% percent of the cells were expected to be viable (Molokwane *et al.*, 2008).

3.7.4 Total Biomass (Suspended Cells)

Five (5) mL of LB broth containing grown cells was withdrawn by sterile pipette after 24 hrs of incubation at 30°C and filtered through a washed dried and weighed sintered glass (tare weight). The sintered glass and wet biomass was dried in the oven at 105°C, cooled in a desiccator and weighed. The drying, cooling and weighing was carried out until a constant dry weight was obtained. The dry weight of the biomass in 5 mL was calculated as the difference in weight between the tare weight of the

sintered glass and the dry weight of sample + sintered glass. The dry weight of the biomass (mg/L) was obtained by multiplying the obtained mass (mg) by a factor of 200. There are 200 samples \times 5 mL samples in 1 litre.

3.7.5 Cr(VI) Reduction Activity

The Cr(VI) reduction capacity of the cells was determined as the amount of Cr(VI) reduced per amount of viable cells inactivated during incubation (Shen and Wang, 1994):

$$R_c = \frac{C_o - C}{X_o - X} \quad (3-1)$$

where R_c = Cr(VI) reduction capacity (mg Cr(VI) removed /mg cells inactivated), C_o = initial Cr(VI) concentration (mg/L), C = Cr(VI) concentration at a time of incubation t , X_o = initial viable cell concentration (mg/L), and X = viable cell concentration (mg/L) at any time t . A viable cell conversion factor of 1.833×10^{-10} mg/cell was used to convert cell count (CFU) to the mass concentration (determined from a standard curve of cell mass versus cell counts performed during the log growth phase). A near linear relationship for the linearised relationship of cell mass versus colony count with the *Pearson's Regression Coefficient*, $R^2 = 0.997$ was obtained.

CHAPTER 4

MICROBIAL Cr(VI) REDUCTION KINETIC STUDIES

4.1 Modelling Methodology

The problem of evaluating fundamental processes in the biologically mediated Cr(VI) reduction in soil media was simplified by studying individual processes first. The reaction rate kinetics in the system is time dependent, thus is best evaluated in batch reactor systems. Time series (batch) experiments were first conducted on the isolated culture from the Cr(VI) contaminated environment. The effect of Cr(VI) on the removal rate was evaluated at different initial Cr(VI) concentrations, 50-400 mg/L, and the results were later used to evaluate the effects of Cr(VI) toxicity on the Cr(VI) reduction rate.

4.2 Mixed Culture Performance (Batch)

4.2.1 Biotic versus Abiotic Cr(VI) Reduction

Abiotic Cr(VI) reduction activity was evaluated by conducting experiments at 100 mg Cr(VI)/L with heat killed and azide inhibited cultures (Figure 4-1). A live cell culture control showed best performance with near complete Cr(VI) removal at 22.5 hours. There was significant decrease in Cr(VI) reduction activity due heat inactivation of the cells.

Only 30% Cr(VI) removal was observed in heat-killed cultures after incubation for 22.5 hours, a much lower removal value than that observed in the live consortium. The 30% removal may be due to Cr(VI) reductase released into the medium from heat-lysed cells and regrowth of cells that escaped destruction by heat. An azide inhibited culture indicated partial inactivation of cells with an observed Cr(VI)

reduction potential of the oxygen stressed culture. Approximately 50% Cr(VI) was removed in the azide inhibited cultures whereas 18% of Cr(VI) was reduced from cell free control experiments.

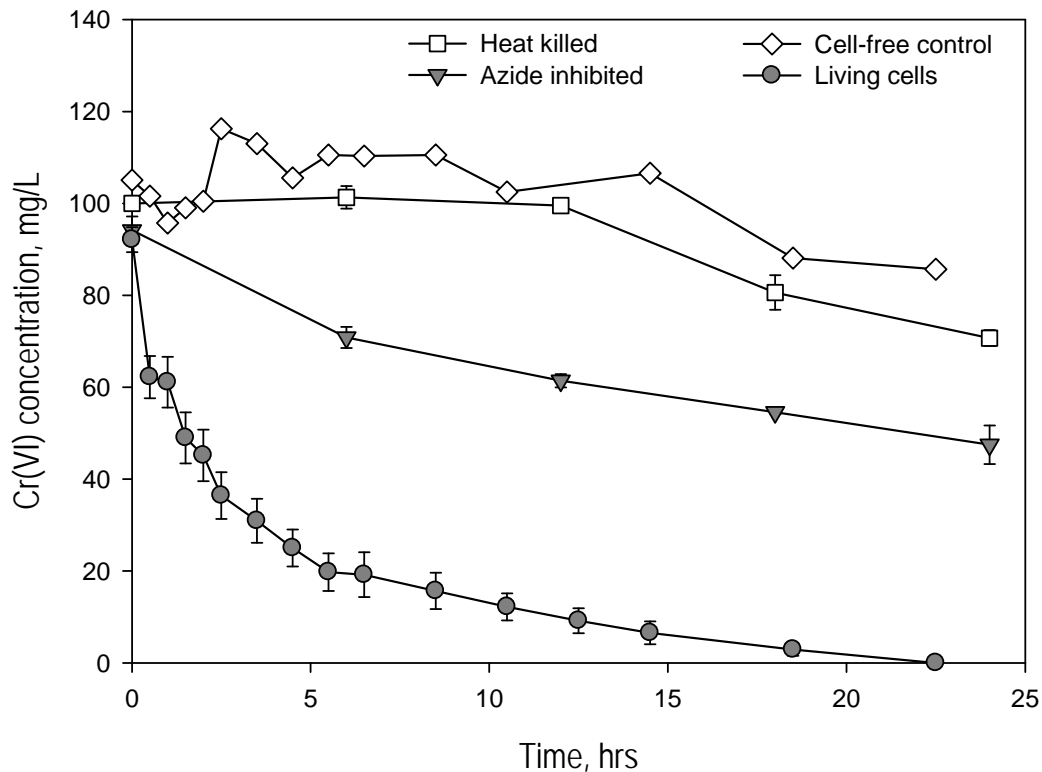

Figure 4-1: Evaluation of abiotic Cr(VI) reduction in heat-killed and azide inhibited cells (inoculated with 5×10^4 CFU/mL before incubation).

4.2.2 Cr(VI) reduction under aerobic conditions

Experimentation under varying initial Cr(VI) concentration of 50-400 mg/L in media with harvested and concentrated cells showed that the culture achieved complete Cr(VI) removal in batches under initial concentration up to 200 mg/L in less than 64.3 hours (2.7 days) (Figure 4-2). Up to 94% of Cr(VI) was removed at the initial concentration of 300 mg/L after incubation for 110 hours.

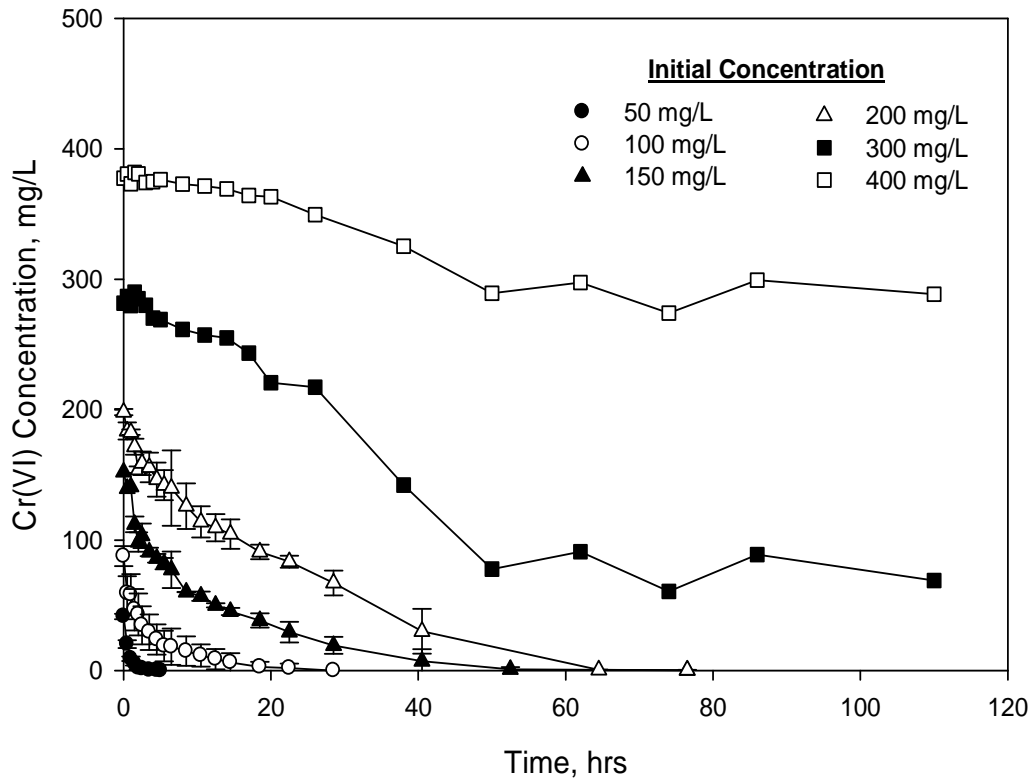

Figure 4-2: Aerobic culture experiment of Cr(VI) reduction in consortium from dried sludge grown at initial Cr(VI) concentrations ranging from 50 to 400 mg/L (resting cells: $5.2 \pm 2.1 \times 10^9$ CFU/mL).

Very little Cr(VI) was reduced at the highest concentration tested (400 mg/L). The loss of the capability to reduce Cr(VI) in cells under very high Cr(VI) loadings was directly correlated to the loss of cell viability. Viable cell concentration in the 400 mg/L batches decreased from $5.2 \pm 2.0 \times 10^9$ to $4.8 \pm 1.5 \times 10^5$ cells/mL after 22.5 hours incubation, a kill rate of 4.1 log, whereas the kill rate at lower concentration of 100 mg/L was only 1.2 log ($6.1 \pm 1.8 \times 10^9$ to $3.81 \pm 1.5 \times 10^8$ cells/mL). The activation of cells was attributed to a combination of toxicity effects and the diversion of reducing equivalents away from metabolism and cell maintenance (Chirwa and Wang, 2000).

Based on the highest concentration completely removed, i.e., 200 mg/L batch, the value of the Cr(VI) reduction capacity coefficient (R_c) of 0.21 mg Cr(VI) reduced/mg

cells deactivated was determined. This value is much higher than the values previously reported in literature (Shen and Wang, 1994a, Nkhalambayausi-Chirwa and Wang, 2005).

4.2.3 Cr(VI) Reduction under Anaerobic Conditions

Cr(VI) reduction under anaerobic conditions has significant engineering implications since most of the environments where *in situ* bioremediation processes could occur are closed systems underneath the ground without any direct contact with the atmosphere. Additionally, anaerobic biological processes tend to be passive in nature without excessive energy input requirements for aeration. Anaerobic processes are the oldest and most versatile of all metabolic processes (Bush, 2003). In the absence of organic carbon sources, a range of autotrophic organisms are capable of utilising inorganic carbon sources such as carbon dioxide and carbonates from the rocks as raw materials for anabolic processes.

To evaluate Cr(VI) reduction under anaerobic conditions, batch experiments were conducted over a lower concentration range (50-300 mg Cr(VI)/L) at a temperature of 30°C and pH of 7 ± 0.2 . Due to observed slower growth in the anaerobic cultures, a lower Cr(VI) reduction capacity of the cells was expected, thus the experiments were conducted under lower initial concentrations than in the aerobic cultures. Complete Cr(VI) reduction occurred in cultures with a lower initial Cr(VI) concentration of 150 mg/L after a longer incubation period (155 hours) than in aerobic cultures (Figure 4-3). Cr(VI) reduction was incomplete at 200 mg/L initial Cr(VI) concentration after incubation for 130 hours (only 50% reduced). This was a much lower performance compared to the observed Cr(VI) reduction under the same concentration in aerobic cultures where 99.7% removal was achieved after 96 hours.

The lower Cr(VI) removal rates observed under anaerobic conditions were accompanied by lower Cr(VI) reduction capacity of the cells ($R_c = 0.011427$ g Cr(VI) reduced/g cells inactivated at 150 mg/L and 0.051697 g Cr(VI) reduced / g cells inactivated at 200 mg/L). The R_c value under anaerobic conditions was thus an order of magnitude lower than the value obtained from aerobically grown cultures from the same source.

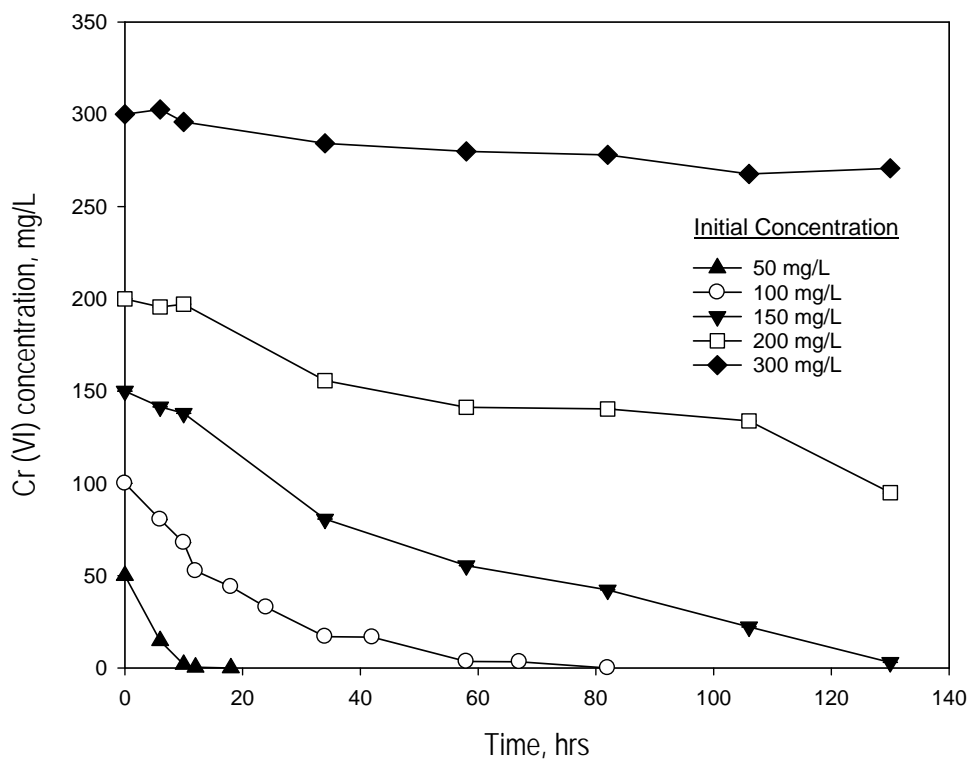

Figure 4-3: Anaerobic culture experiment of Cr(VI) reduction in consortium from dried sludge grown at initial Cr(VI) concentrations ranging from 50 to 300 mg/L (resting cells: $1.58 \pm 1.8 \times 10^9$ CFU/mL).

4.2.4 Decisions from Observed Trends

In the above studies, a clear association was drawn between the Cr(VI) reduction rate and metabolic activity of the cells. Additionally, the experiments clearly show that Cr(VI) reduction facilitated by the cells was inhibited by high concentrations of

Cr(VI) in the medium. These observations are consistent with earlier studies by Shen and Wang (1994a), Wang and Shen (1997), Shen and Wang (1995), and Chirwa and Wang (1997a&b), in which high levels of Cr(VI) inhibited both the growth and Cr(VI) reducing activity in pure and mixed cultures of bacteria. These observations led us to develop the Cr(VI) reduction model based on the enzymatic Cr(VI) reduction kinetics as described in the following section.

4.3 Enzymatic Cr(VI) Reduction

The Cr(VI) reduction rate which forms part of the Cr(VI) removal regime in continuous-flow studies was derived based on the following assumptions:

1. That Cr(VI) reduction is catalysed by a single or dual-site enzyme.
2. That the enzyme is either regulated or induced, i.e., is produced when the cell is exposed to Cr(VI).
3. That the Cr(VI) reduction sites on the enzyme are non-renewable, such that, new enzymes are required to be produced to reduce new load or continue reducing Cr(VI).
4. In the mixed culture, it is assumed that several Cr(VI) reducing species of bacteria exist. However, the Cr(VI) reducing activity of the whole culture may be represented by a common effect – the sum of or the highest of all the activities in all the Cr(VI) reducing species.
5. The sum of or the highest of the activities, ΣE_i , may be represented by one representative enzyme, E .

The representative enzyme (E) is logically proportional to the viable cell concentration X as the only metabolically active component in the culture. Based on Assumption 1, the enzymatic reaction can be represented as:

$$E^* = \frac{C \cdot E}{C + \frac{k_2 + k_3}{k_1}} \quad (4-6)$$

And, the Cr(VI) reduction rate in Equation 4-3 becomes:

$$r = \frac{-d(C)}{dt} = \frac{k_3 \cdot C \cdot E}{C + \frac{k_2 + k_3}{k_1}} \quad (4-7)$$

where k_1 , k_2 and k_3 are constants. The groups of constants in Equation 4-7 can be replaced by symbols from enzyme kinetics as follows: $(k_2 + k_3)/k_1$ can be replaced by the half velocity concentration K_c (ML^{-3}), and k_3 can be replaced by the maximum specific Cr(VI) reduction rate coefficient k_{mc} (T^{-1}) such that:

$$r = \frac{-d(C)}{dt} = \frac{k_{mc} \cdot C \cdot E}{C + K_c} \quad (4-8)$$

For any amount of live cells X , the amount of enzyme produced will be proportional to the viable cell concentration such that the enzyme E can be replaced by the cell biomass term X . This gives a Monod type equation (Shen and Wang, 1994a):

$$r = \frac{-d(C)}{dt} = \frac{k_m \cdot C \cdot X}{C + K_c} \quad (4-9)$$

where C = Cr(VI) concentration at time t (ML^{-3})

k_{mc} = maximum specific Cr(VI) reduction rate coefficient (T^{-1})

K_c = half velocity constant (ML^{-3})

X = concentration of viable cells (ML^{-3}) at any time t (T)

Similar expressions were derived previously by other researchers for Cr(VI) reduction in batch systems (Shen and Wang, 1994a; Mazierski, 1995; Schmieman *et al.*, 1998;

Guha *et al.*, 2001; Li *et al.*, 2006).

4.4 Cr(VI) Reduction Capacity of Cells

The extent of Cr(VI) reduction in batch systems depends on the number of cells in the reactor and the Cr(VI) reduction capacity (R_c) per cell. When batch experiments are conducted using pre-concentrated washed cells, cell growth kinetics may be ignored as the concentration of cells is too high to allow production of new cells. The amount of Cr(VI) reduced under resting cell conditions will thus be proportional to amount of cells inactivated by Cr(VI):

$$C_o - C = R_c (X_o - X) \quad (4-10)$$

where X_o = initial active cell concentration (ML^{-3}),
 X = active cell concentration (ML^{-3}) at time t (T),
 C_o = initial Cr(VI) concentration (ML^{-3}), and
 R_c = finite Cr(VI) reduction capacity (MM^{-1}).

This relationship is expressed in terms of the concentration of viable cells remaining in solution at any time t as follows:

$$X = X_o - \frac{C_o - C}{R_c} \quad (4-11)$$

R_c can be estimated from Cr(VI) reduced and initial cell concentration at high initial Cr(VI) concentration (when $C \neq 0$, and the rate of change, $dC/dt \cong 0$, at $t \rightarrow T_\infty$, where T_∞ represents a very long time of incubation) for the last highest batch in which Cr(VI) is completely removed:

$$R_c = \frac{C_o - C}{X_o} \quad (4-12)$$

Since the concentration of Cr(VI)-reductase (E_t) in whole cell cultures is proportional to viable cell concentration at time t , E_t in Equation 4-8 can be replaced with the term for active cell concentration (X) as represented in Equation 4-10 (Shen and Wang,1994a), such that:

$$-\frac{dC}{dt} = \frac{k_{mc}C}{K_c + C} \left(X_o - \frac{C_o - C}{R_c} \right) \quad (4-13)$$

4.5 Parameter Determination

4.5.1 Aerobic batch kinetics

Equation 4-13 was simulated initially using guessed values using the Computer Program for the Identification and Simulation of Aquatic Systems (AQUASIM 2.01) (Reichert, 1998). The results showed that the maximum reaction rate coefficient (k_{mc}) and half velocity concentration (K_c) was not constant over different Cr(VI) concentration ranges (Table 4-1). The results suggested non- competitive inhibition rate kinetics affected directly by the increase in initial Cr(VI) concentration. The amended kinetic model (Equation 4-14) produced near constant kinetic parameters at 95% confidence (Table 4-2).

Table 4-1: Optimisation of kinetic parameters using the cell inactivation only (Equation 4-13) under aerobic conditions.

Initial [Cr(VI)] (mg/L)	k_{mc} (1/hr)	K_c (mg/L)	R_c (mg/mg)	X_o (mg/L)
50	1.0797	835	0.0402	4500
100	0.3924	785	0.0776	4500
150	0.3909	2773	0.1435	3480
200	0.0046	3.549	0.1856	2000
300	0.2827	21432	10270.2	1460
400	0.0387	24677	0.0543	1250

$$-\frac{dC}{dt} = \left(\frac{k_m}{(1 + C_o/K_I)} \right) \left(\frac{C}{K_c + C} \right) \left(X_o - \frac{C_o - C}{R_c} \right) \quad (4-14)$$

Table 4-2 shows the optimum parameters generated for each initial Cr(VI) loading condition using the non-competitive inhibition model. The parameter values determined using the revised model are reasonably constant thus this mechanisms was accepted under the aerobic conditions. The parameters optimized simultaneously using the 100 mg/L and 150 mg/L data were used to simulate the Cr(VI) concentration through the entire range of data and the results were plotted against measured data as shown in Figure 4-4. The model captured well the trend of data under all experimental conditions. Slight difficulty of fit was observed for the 400 mg/L data set mainly due to excessive loss of biomass not captured by the initial model. The highest range of uncertainty was observed in the data for the 300 mg/L mainly due to the instability in the measured values near time zero.

Table 4-2: Optimisation of the non-competitive inhibition model with cell inactivation (Equation 4-14) under aerobic conditions.

Initial [Cr(VI)] (mg/L)	k_{mc} (1/hr)	K_c (mg/L)	R_c (mg/mg)	K_I (mg/L)	X_o (mg/L)	Chi^2
50	0.0404	403.3	0.0665	145.1	4500	0.87965
100	0.0404	403.3	0.0665	145.1	4500	139.4847
150	0.0404	403.3	0.0665	145.1	3480	880.0954
200	0.0404	403.3	0.1730	145.1	2000	2082.352
300	0.0404	403.3	0.1730	145.1	1460	7646.5751
400	0.0113	551.9	0.1306	151.0	1250	2537.7485

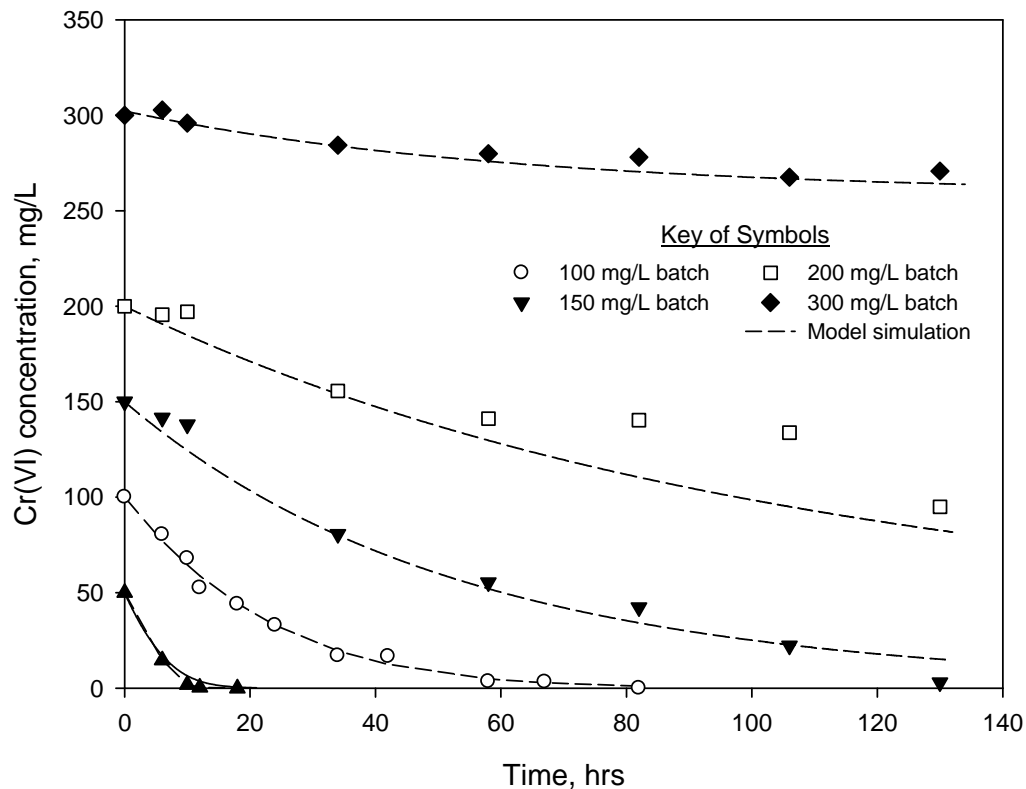

Figure 4-4: Aerobic Cr(VI) reduction at different concentration (modelled aerobic plots).

4.5.2 Anaerobic Batch Kinetics

Although chromate reduction ($\text{CrO}_4^{2-} \rightarrow \text{Cr}^{3+}$) is thermodynamically favourable, Cr(VI) reduction to Cr(III) may be limited by reaction kinetics under physiological conditions (Glaze, 1990). On the other hand, the kinetics of Cr(VI) reduction may be improved by coupling Cr(VI) reduction to other energy yielding reactions such as the catabolism of organic compounds and intermediates (Chirwa and Wang, 1997a, Shen and Wang, 1995a; Ishibashi *et al.*, 1990). Anaerobic Cr(VI) reduction can be carried out through energy yielding dissimilatory respiratory process in which Cr(VI) serves as a terminal electron sink (Lovley and Phillips, 1994).

In this study, Cr(VI) reduction under low initial Cr(VI) concentrations appeared to benefit from the presence of Cr(VI). In such a case, a toxicity threshold concentration

has to be reached before Cr(VI) inhibition becomes effective. The data in Table 4-3 shows that the equation derived for anaerobic conditions (Equation 4-14) could not describe the kinetics for Cr(VI) reduction under anaerobic conditions.

The model did not converge with respect to the inhibition parameter K_I under all tested conditions. Alternatively, a threshold of inhibition C_r was applied with a non-competitive inhibition model as shown in Equation 4-15a and b (below):

$$-\frac{dC}{dt} = \frac{k_m \cdot K^{-(C_0-C_r)/C_0} \cdot C}{(K_c + C)} \left(X_0 - \frac{C_0 - C}{R_c} \right) \quad (4-15a)$$

For numerical formulation, the form presented below was used:

$$-\frac{dC}{dt} = \frac{k_m \cdot C}{K^{1-C_r/C_0} \cdot (K_c + C)} \left(X_0 - \frac{C_0 - C}{R_c} \right) \quad (4-15b)$$

Table 4-3 shows that the parameters evaluated from different initial Cr(VI) concentration batches converged at decreasing values generally. This response shows that the non-competitive inhibition model is ill suited under these conditions. After introducing the threshold inhibition term, the maximum Cr(VI) reduction rate coefficient is stabilised. The model fits other data sets universally as shown by near constant values in Table 4-4. The target biomass concentration in the anaerobic cultures was 1800 mg/L. The optimum inhibition threshold concentration was determined to be between 95-105 mg/L.

Table 4-3: Optimisation of kinetic parameters under anaerobic conditions using non-competitive model with cell inactivation (Equation 4-14).

Initial [Cr(VI)] (mg/L)	k_{mc} (1/hr)	K_c (mg/L)	R_c (mg/mg)	K_I (mg/L)	X_o (mg/L)
50	0.0025	167.2	0.1804	1×10^9	--
100	0.0025	167.2	0.1804	1×10^9	4459.50
150	0.0025	167.2	0.2062	1×10^9	2098.64
200	0.0023	121.6	0.2318	1×10^9	883.65
300	0.0025	114.5	0.1473	1×10^9	281.56

Table 4-4: Optimisation of kinetic parameters under anaerobic conditions using the cell inactivation model with threshold inhibition (Equation 4-15b).

Initial [Cr(VI)] (mg/L)	k_{mc} (1/hr)	K_c (mg/L)	R_c (mg/mg)	K (mg/L)	X_o (mg/L)	Chi^2
50	0.0025	167.2	0.1027	9.964	4459	1.9387
100	0.0025	167.2	0.1027	9.964	4460	88.8598
150	0.0025	167.2	0.1027	9.964	2100	460.823
200	0.0025	167.2	0.1027	9.964	1000	685.1592
300	0.0025	167.2	0.0391	9.964	260	54.0873

The model based on model parameters optimised in the 100 mg/L batch fitted well the rest of the experimental data as shown in Figure 4-5. The data obeyed the proposed model at different concentrations except for the concentrations at lower levels, e.g., 50 mg/L, since the threshold was determined at 100 mg/L hence the 50 mg/L parameters are not shown. The more the bacteria were exposed to higher doses of chromium the more the population of the bacterial species decreased.

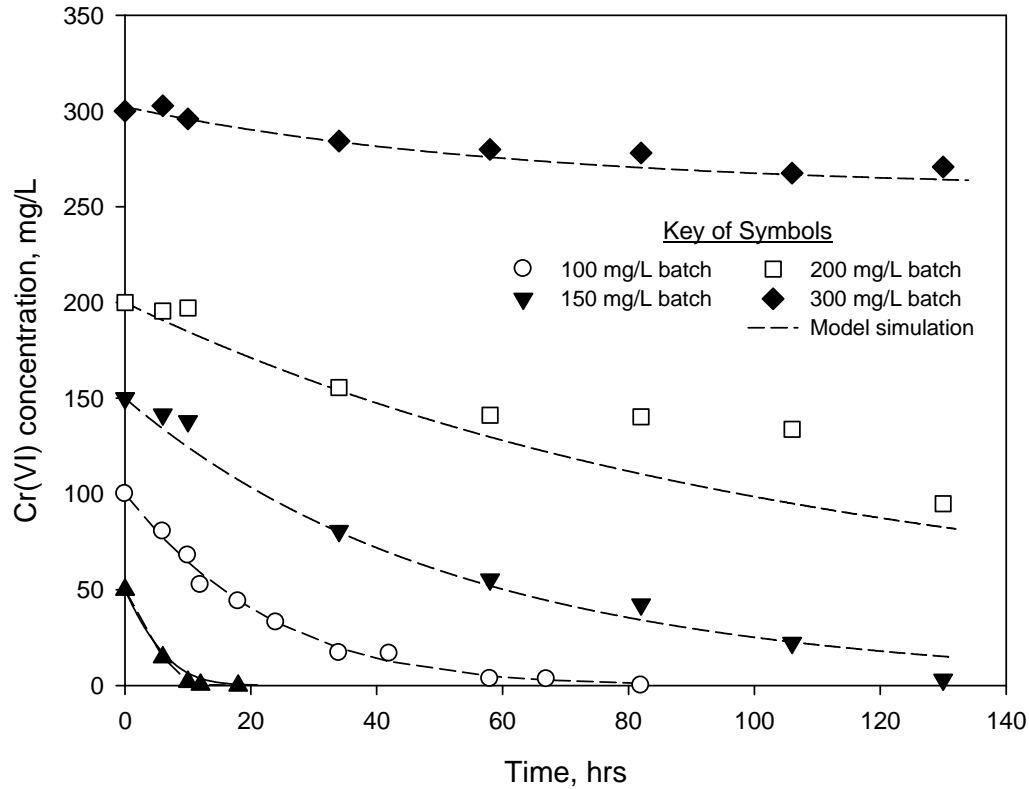

Figure 4-5: Anaerobic (threshold inhibition) chromium (VI) reduction at different concentration (modelled anaerobic plots).

4.6 Sensitivity Analysis

Sensitivity is a function used to compare the effect of different parameters on a common variable (Peter Reichert, 1998). Figures 4-6 and 4-7 illustrate the time dependence of the sensitivity response curves computed over a 1.0% variability of each kinetic parameter in the object function. For the aerobic culture, parameter sensitivity was conducted for the parameters k_{mc} , K_c , R_c , and K_I (Figure 4-6). The parameters k_{mc} , R_c , K_c and K were evaluated for the anaerobic culture. The parameter C_r was assigned and was expected to be strictly culture dependent.

The results show that the aerobic model was highly sensitive to minor adjustments in k_{mc} , K_c , and K_I in the first 20 hours of incubation. The response was highest at approximately 5 hours which indicates the period of highest activity. These results

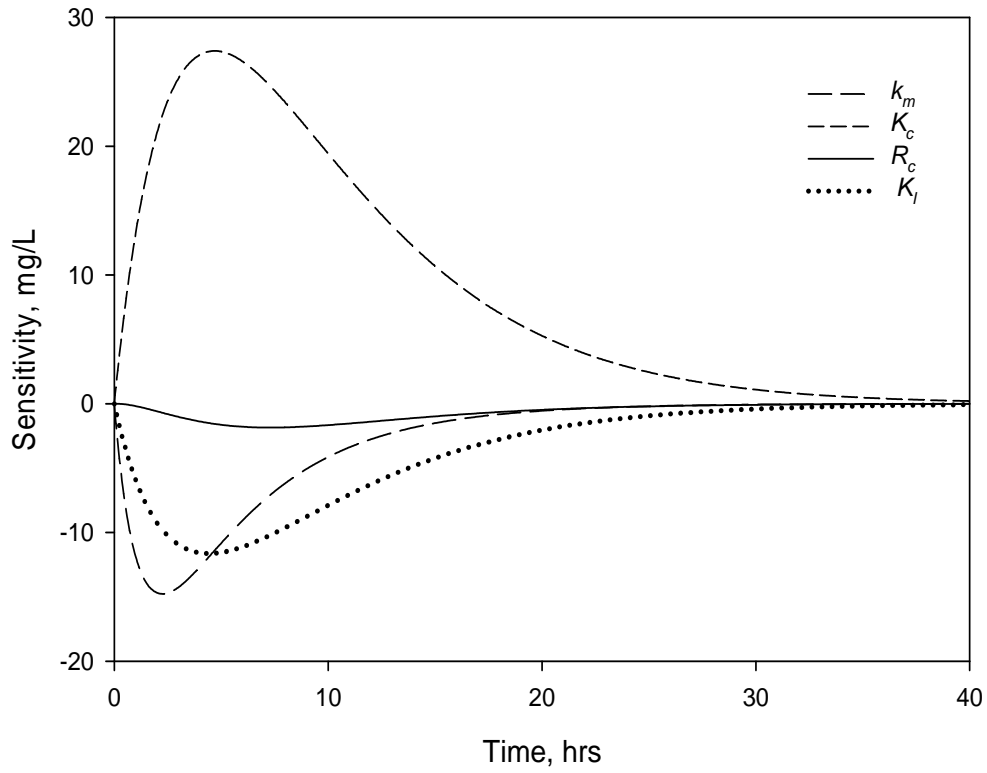

Figure 4-6: Aerobic sensitivity test at 100 mg/L.

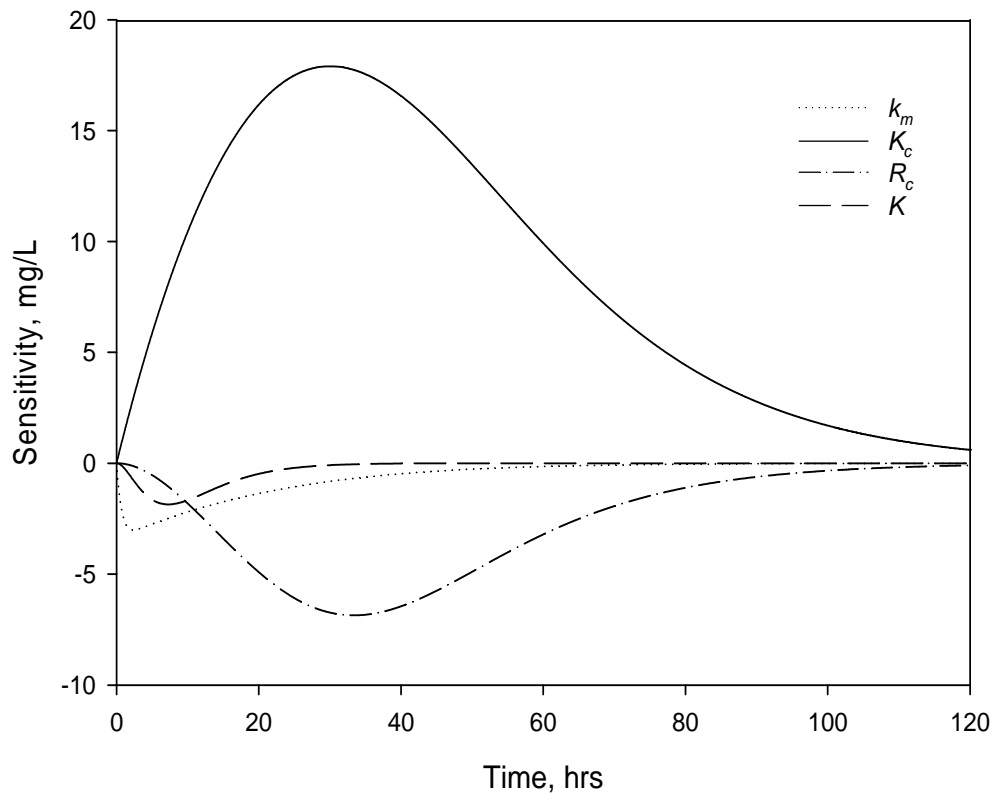

Figure 4-7: Anaerobic sensitivity test at 100 mg/L.

show that the kinetic parameters k_{mc} , K_c , and the inhibition parameter K_I will be very important in the scale up of the reactor.

Similarly, the anaerobic model was highly sensitive to the reaction rate coefficient k_{mc} and half velocity concentration K_c . Due to the low Cr(VI) reduction capacity in the anaerobic culture and higher sensitivity to toxicity, the Cr(VI) reduction capacity coefficient R_c is also significantly sensitive (Figure 4-7). The impact of the non-competitive parameter K was mild at 100 mg/L since this was just at the threshold when the presence of Cr(VI) is no longer beneficial to the metabolic process. The Sensitivity analysis highlights the fundamental difference between Cr(VI) reduction under anaerobic conditions at high metabolic rate and the Cr(VI) reduction under anaerobic conditions at slower metabolic rate. The complex interrelationship between the toxicity effects and Cr(VI) reduction capacity is illustrated by the behaviour of the R_c , K_I and K values under the two growth conditions.

4.7 Chapter Summary

The results showed that the performance of the bacteria fitted best the non-competitive inhibition model with cell inactivation under aerobic conditions. This suggests that the fast cell metabolism under aerobic conditions compensated for the competition for sites between the two available electron sinks – O_2 and Cr (VI). Under anaerobic conditions, the kinetic process was complex due to the high biodiversity of species and the slow growing culture that was more sensitive to toxic loading. Cr(VI) reduction under these conditions was competitively inhibited with cell inactivation. The competitive inhibition was effective above a threshold concentration of approximately 100 mg/L following a mechanism observed earlier by (Shen and Wang, 1995b). The threshold Cr(VI) toxicity level in this study was much higher than

reported by Wang and Shen (1995b) because non-toxic carbon sources similar to those found in the environment (mainly from decaying vegetation) were used.

CHAPTER 5

MICROBIAL CHROMIUM (VI) REDUCTION IN AQUIFER MEDIA

5.1 Microcosm Study Conceptual Basis

Microbial barrier studies were conducted to simulate the movement of the pollutant across the soil strata into the open aquifer system below the contaminated site. The study takes into consideration the difference in pore structure and organic substrate content in the two layers. The top layer (vadose zone) is characterised by low pore volume and high content of organics from decaying roots and vegetation. The movement of water in the vadose zone is facilitated by weight displacement. If no water enters the vadose zone from above, water will enter this zone from below through capillary action. On the other hand, the aquifer zone has higher pore volume and the water flows under the influence of the hydraulic gradient. The two layers are illustrated in Figure 5-1.

Microcosm samples were collected for the vadose and aquifer microcosm studies at the depths of 1 m and 3 m, respectively. The microcosms were installed in the laboratory as packed-column continuous flow bioreactor systems as described below. Performance of each microcosm was evaluated by comparing the influent and effluent Cr(VI) concentration under sustained hydraulic loading. The shift in microbial community was also monitored by withdrawing soil samples at intervals and analysing the 16S rRNA and 16S rDNA gene sequence for the microbial culture. This was done to determine the presence or absence of Cr(VI) reducers previously identified in the inoculum sludge culture.

The performance of the culture in aquifer media was validated through an *in situ* mesocosm barrier study. The same inoculum culture was used in the barrier system for a laboratory scale mesocosm. Performance in the mesocosm study was evaluated in three dimensional space (along the length, width and depth of the mesocosm). In the following sections, comprehensive results are presented and discussed and a *dispersion-reaction* model is used to determine kinetic and dynamic parameters for the microbial barrier system.

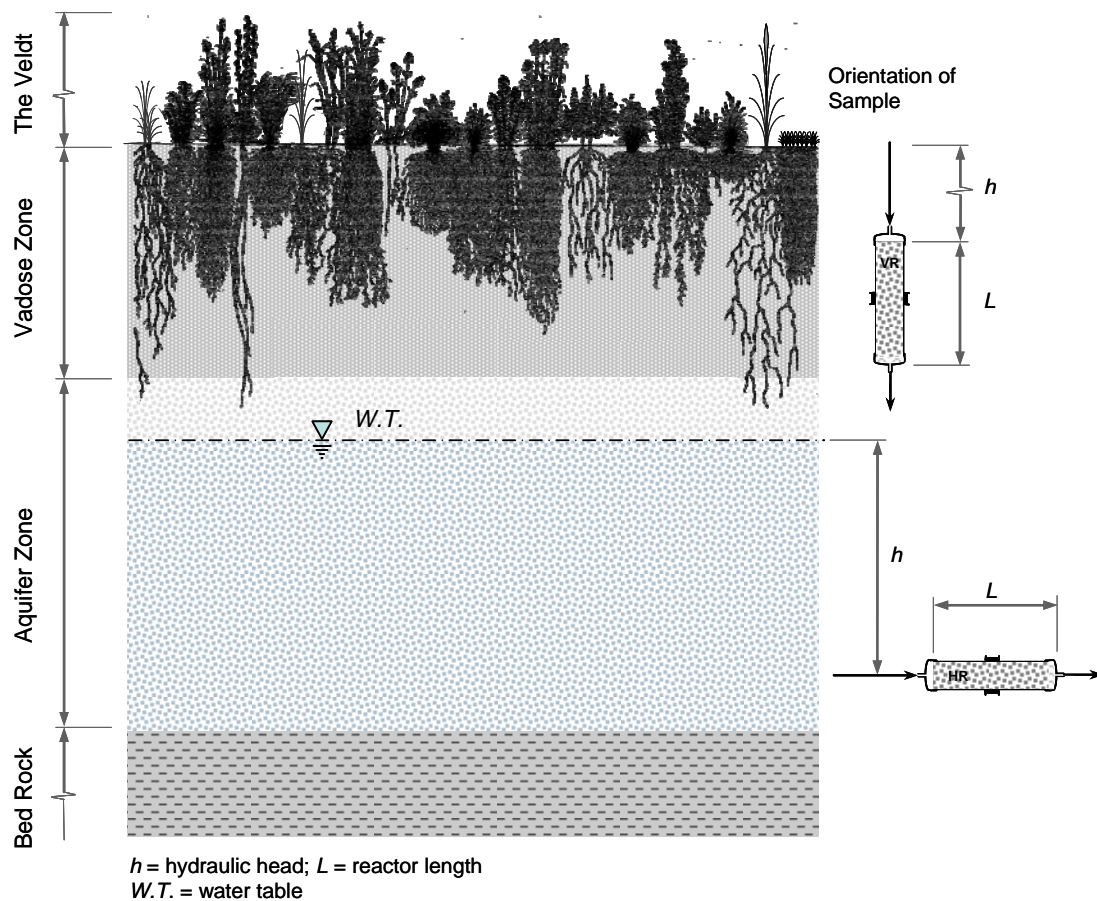

Figure 5-1: Conceptual basis of the microcosm reactor study with vadose media and aquifer media hydraulic effects.

5.2 Performance of Vadose System Microcosm

5.2.1 Cr(VI) Removal Efficiency

These results were obtained for a six-column study (VR1-VR6) using the vadose zone media. All columns were operated under the same hydraulic head. Flow characteristics varied mainly due to slight differences in packing. The operation of Reactors 4 and 5 was discontinued as they experienced severe short circuiting.

From the compiled time series data for the four reactors, it is shown that the reactor inoculated with Cr(VI) reducing bacteria (VR6) achieved near complete removal of Cr(VI) after operation for 16.7 days under a slow feed (flow rate, $Q = 0.310 \text{ cm}^3/\text{hr}$). Up to 95% Cr(VI) removal was observed in this reactor. However, operation of VR3 at almost twice the flow rate of VR6 resulted in decreased efficiency in the Cr(VI) reduction process. The removal rate in VR3, which was also inoculated with live sludge bacteria, but operated at a high flow rate of $0.608 \text{ cm}^3/\text{h}$, was approximately 80%, much lower than the Cr(VI) removal rate in VR6. The time series data for the four reactors including the control are shown in Figure 5-2. No Cr (VI) removal was observed in the sterilised, non-inoculated control (VR2). The operation conditions and final performance of the reactors is summarized in Table 5-1.

Table 5-1: Performance of gravity-fed vadose microcosm reactors operated under an influent Cr(VI) concentration of 40 mg/L.

Reactor (Column No.)	Flow Rate cm^3/h	Effluent Cr(VI) mg/L	Effluent Cr(III) mg/L	Cr(VI) Removal %
Native-soil (VR1)	0.614	39.0 ± 2.0	0.0 ± 0.0	0.0 ± 0.0
Non inoculated (VR2)	0.310	37.8 ± 1.5	0.0 ± 0.0	0.0 ± 0.0
Inoculated (VR3)	0.608	6.7 ± 0.8	1.5 ± 0.4	80 ± 3.6
Inoculated (VR6)	0.310	1.9 ± 0.3	3.2 ± 1.1	95.3 ± 1.4

In the sterile reactor (VR2), effluent Cr(VI) concentration increased to the influent level and remained there until the experiment was concluded after 400 hours (16.7 days). The two data points at 84 and 96 hours showed removal up to 49% (Figure 5-2), but this was later attributed to system error on the spectrometric measurement. Based on this data, a theoretical hydraulic retention time (HRT) was estimated at 8.67 hours for the control reactor which was later used in a tracer analysis.

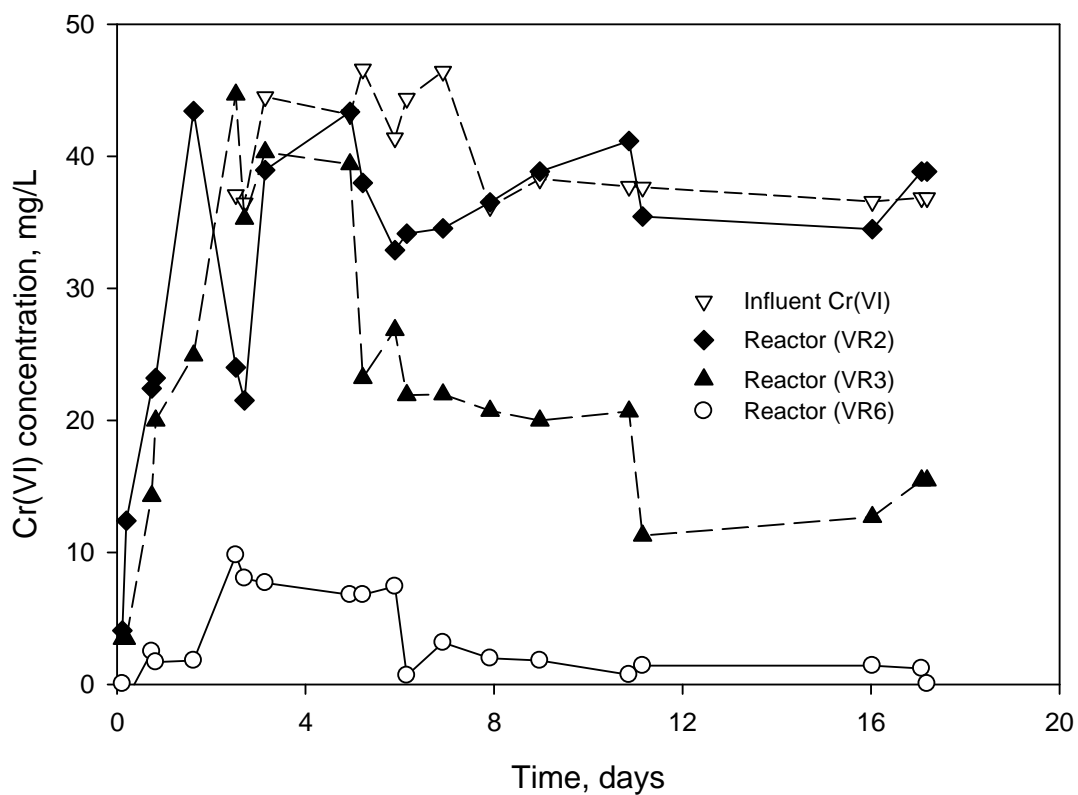

Figure 5-2: Influent and effluent Cr(VI) data in vadose reactors VR2 – sterilised column; VR3 – inoculated non-sterile reactor at $0.608 \text{ cm}^3/\text{h}$; and VR6 – inoculated non-sterile reactor at $0.310 \text{ cm}^3/\text{h}$.

5.2.2 Cr(VI) Speciation in the Vadose Microcosm Reactors

Studies in batch systems showed that Cr(VI) was reduced to Cr(III) using the dried sludge consortium cultures. In the batch studies, all Cr(VI) reduced was accounted for

as Cr(III) (Molokwane *et al.*, 2008). Cr(III) is known to readily precipitate as chromium hydroxide ($\text{Cr}(\text{OH})_3(\text{aq})$) at pH above 6.5 (Morel and Herring, 1986).

In this study, measurement of total Cr in the effluent from the inoculated microcosms correlated with the measurements of Cr(VI) in the effluent suggesting that most of the Cr(III) produced was trapped in the columns as amorphous $\text{Cr}(\text{OH})_3(\text{aq})$ (Table 5-1). Longer-term studies showed a characteristic decrease in flow indicating reduction of pore space for the free flow of water due to continuous Cr(III) precipitation. Additionally, a characteristic change in colour – to dark-green – was observed in the reactors with high Cr(VI) reduction (VR3 and VR6) showing accumulation of Cr(III) in the pores of the aquifer media. The other factor that contributed to decrease in flow is the growth of bacteria most of which remained trapped in the reactors.

5.2.3 Microbial (culture) dynamics in Vadose Systems

Characteristics of Initial Consortium

The dry sludge culture used to inoculate the vadose zone reactors was grown under aerobic to microaerobic conditions. The operation of the area for 15 days was determined to be not long enough to completely eliminate facultative bacteria in the reactors. This was evidenced by the presence of significant amounts of *Bacillus* species from the original inoculum. Partial sequences of 16S rRNA matched the *Bacillus* groups – *Bacillus cereus* ATCC 10987, *Bacillus cereus* 213 16S, *Bacillus thuringiensis* (serovar finitimus), *Bacillus mycoides* – and two *Microbacterium* species – *Microbacterium foliorum* and *Microbacterium sp.* S15-M4. A phylogenetic tree was constructed for the species from purified cultures grown under aerobic conditions based on results from a basic BLAST search of rRNA sequences in the NCBI database (Figure 5-3a).

Characterisation of Microcosm Bacteria (After 15 days)

After operating the reactors under oxygen stressed conditions in the presence of other soil bacteria, a community shift was expected. In reactors VR3 and VR6, the soil contained a wide range of soil dwelling species of bacteria as well as the newly introduced bacteria from the dried sludge. The microbial dynamics monitored by the 16S rRNA fingerprinting showed a decrease in culturable species after exposure to Cr(VI) as shown in Tables 5-2. Only the *Bacillus cereus* and *Bacillus thuringiensis* serotypes persisted either due to resilience against toxicity or adaptation to the changing conditions in the reactor. The *Lysinibacillus* group is also a well known sludge bacteria. Both *Bacilli* (*Bacillus cereus* and *Bacillus thuringiensis*) and the *Lysinibacillus* species contain well known Cr(VI) reducing serotypes such as *Bacillus* K1 (Shen *et al.*, 1996), *Bacillus cereus*, *Bacillus thuringiensis* (Francisco *et al.*, 2002; Camargo *et al.*, 2003; Faisal and Hasnain, 2006), and *Lysinibacillus sphaericus* AND 303 (Pal *et al.*, 2005).

The microbial community shift is indicated by the appearance of the *Lysinibacillus* *sp.* and *B. drentensis* which were not detectable in the original soil and sludge cultures (Table 5-2). The *B. drentensis* and *L. sphaericus* probably originated from the sludge used for inoculation. Among these two new species, *L. sphaericus* is known to produce a Cr(VI) reductase – an enzyme responsible for Cr(VI) reduction utilising a mechanism independent from the membrane respiratory pathway (Pal *et al.*, 2005). When cultured under anaerobic conditions, more Gram-negative species emerged that were not observed under aerobic and microaerobic conditions.

Performance of Native Species

Cr(VI) reduction by native species in soil acting alone was insignificant. The predominant species from the soil include *Rhizobium spp.*, *Pseudomonas spp.*, and

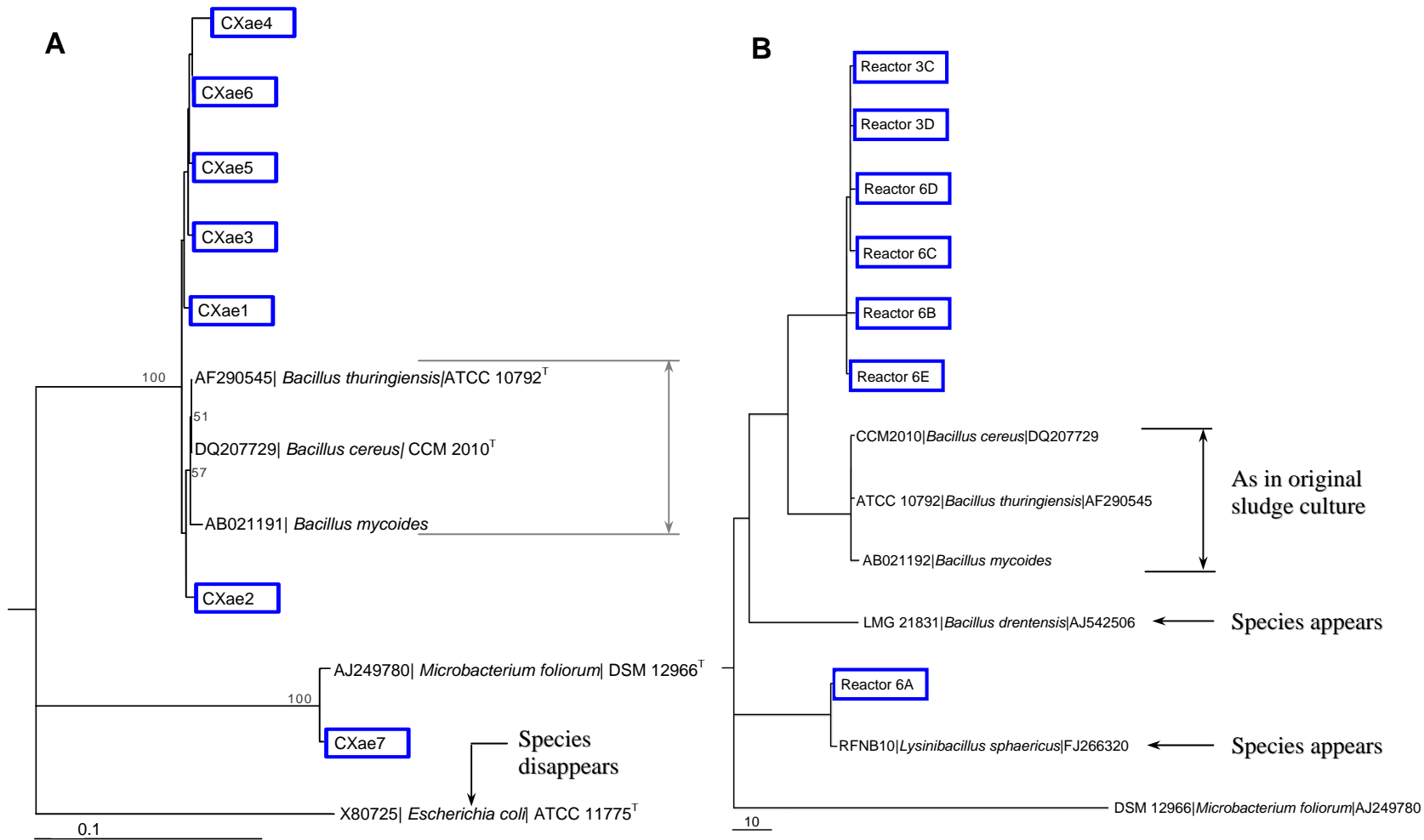

Figure 5-3: Comparative culture analysis at day 1 (a) and day 15 (b) in the vadose media microcosm experiment showing the disappearance of *Escherichia coli* and appearance of *Bacillus drentensis* and *Lysinibacillus sphaericus* at the end of the experiment.

Klebsiellae and many others. Most of the bacteria from the soil could not be cultured. However, the cultures detected are the ones that were resistant to Cr(VI). No significant Cr(VI) reduction was observed in the reactor that contained only bacteria from the soil (VR1). The performance did not improve after long term exposure and reloading the reactor with the 40 mg/L feed.

Table 5-2: Summary of microbial culture changes after operation of the microcosms reactors for 15 days under an influent Cr(VI) concentration of 40 mg/L.

Inoculation culture Consortium		Culture in Reactor 3 and 6 at end of experiment	
Type	Predominant species	Type	Predominant species
X1	<i>Bacillus cereus</i> 213 16S, <i>Bacillus thuringiensis</i> 16S	A	<i>Pantoea</i> or <i>Enterobacter</i> sp.
X2	<i>Bacillus cereus</i> ATCC 10987, <i>Bacillus thuringiensis</i> str. Al Hakam	B	<i>Bacillus</i> sp. possibly <i>Bacillus thuringiensis/ cereus</i> group
X3	<i>Bacillus cereus</i> ATCC 10987, <i>Bacillus thuringiensis</i> str. Al Hakam	C	<i>Pantoea</i> or <i>Enterobacter</i> sp.
X4	<i>Bacillus mycoides</i> BGSC 6A13 16S. <i>Bacillus thuringiensis</i> serovar <i>finitimus</i> BGSC 4B2 16S	D	<i>Lysinibacillus sphaericus</i> strain BG-B111, <i>Bacillus</i> sp. G1DM-64, <i>Bacillus sphaericus</i>
X5	<i>Bacillus mycoides</i> BGSC 6A13 16S. <i>Bacillus thuringiensis</i> serovar <i>finitimus</i> BGSC 4B2 16S	E	<i>Bacillus</i> sp. possibly <i>Bacillus thuringiensis/ cereus</i> group
X6	<i>Bacillus mycoides</i> BGSC 6A13 16S. <i>Bacillus thuringiensis</i> serovar <i>finitimus</i> BGSC 4B2 16S	F	<i>Bacillus</i> sp. possibly <i>Bacillus thuringiensis/ cereus</i> group
X7	<i>Bacillus mycoide</i> BGSC 6A13 16S. <i>Bacillus thuringiensis</i> serovar <i>finitimus</i> BGSC 4B2 16S	G	<i>Bacillus cereus</i> strain ZB

5.3 Performance of the Main Aquifer Microcosm

Soil columns extracted from the aquifer (below the water table) were installed in a continuous dose experiment as shown in Figure 5-4. Eight microcosm columns were installed with the first acting as the control, Reactor HR2 evaluates the sludge bacteria acting alone, and Reactors HR3 and HR4 evaluate the native soil bacteria acting alone (in duplicate). The main experiments comprised (in duplicate) HR5 and HR6 with both sludge bacteria and native soil bacteria but operated without carbon source, and HR7 and HR8 with soil bacteria and sludge bacteria operated with added carbon source. The carbon source in HR7 and HR8 consisted of a natural matrix of organics leached from saw dust. This was intended to simulate humic organics leaching from stems of dead plants in the Veldt. The experimental plan for the detailed evaluation of the performance of aquifer microcosm reactors is summarised in Table 5-3.

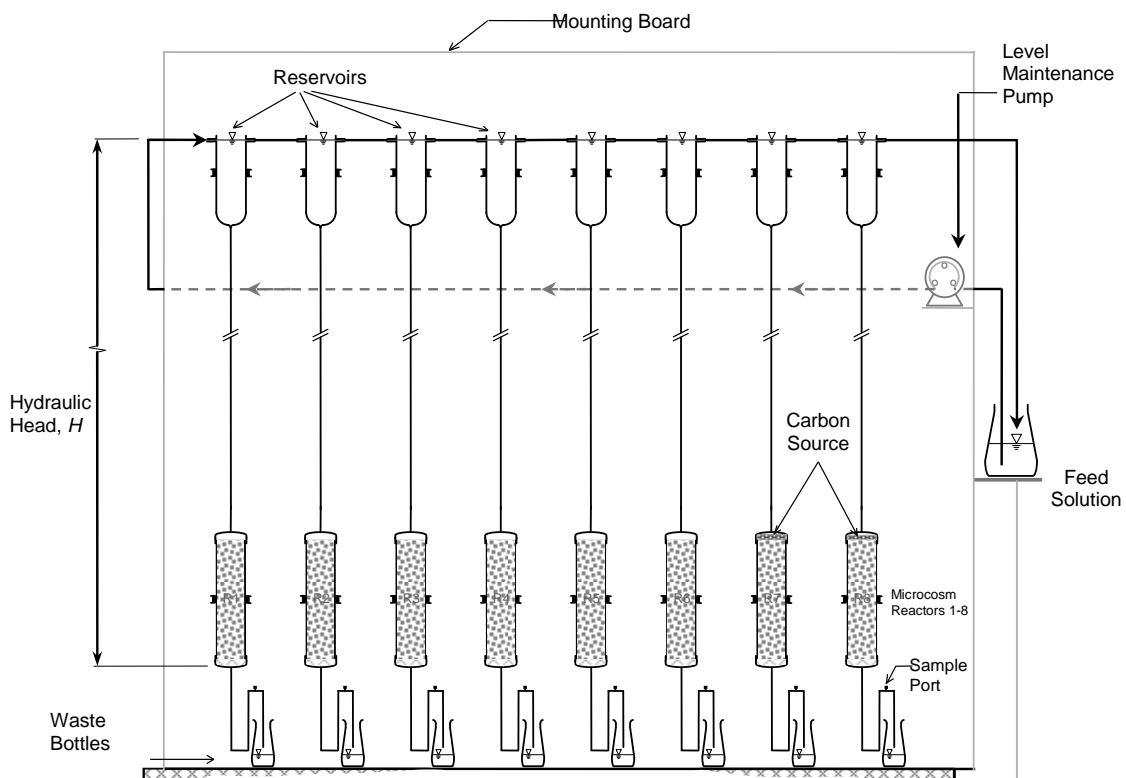

Figure 5-4: Main aquifer microcosm columns (HR1-HR8) to simulate the performance of microbial barrier systems in aquifer media.

Table 5-3: Conditions for the aquifer microcosm range of experiments.

Reactor(s)	Experiment
Reactor HR1	Sterilised (killed native bacteria) + no inoculation
Reactor HR2	Sterilised (killed native bacteria) + inoculated (sludge bacteria)
Reactors HR3 and HR4	Live native soil bacteria (non-sterile) + no inoculation
Reactors HR5 and HR6	Live native soil bacteria (non-sterile) + inoculated (sludge bacteria)
Reactors HR7 and HR8	Live native soil bacteria (non-sterile) +inoculated + carbon source

5.3.1 Evaluation of the Abiotic Process in the Microcosms

The operation of the sterilised reactor without added biomass showed a characteristic rise following the effluent tracer line for the clean-bed reactor system (Figure 5-5). The characteristic exponential rise suggests that adsorption processes were insignificant, i.e., the column reached equilibrium with respect to adsorption during the 45 days of operation. The extended controls Reactors HR2, HR3 and HR4 show that soil bacteria and activated sludge bacteria acting alone in these conditions did not reduce Cr(VI). The reason why the soil bacteria could not reduce Cr(VI) is most certainly because there were no Cr(VI) reducing bacterial species in the soil. However, it is not known why the sludge bacteria did not reduce Cr(VI) after inoculating a sterile column. One suggestion is that the Cr(VI) bacteria from the sludge required some biochemical metabolites or cofactors produced by the soil bacteria.

5.3.2 Cr(VI) Reduction by Inoculated Natural Soil without Carbon Source

The first indication of significant Cr(VI) reduction was observed in the reactors containing live cultures of both soil bacteria and dried sludge bacteria (Reactors HR5 and HR6) (Figure 5-6). The operation of Reactor HR6 was later discontinued due to

severe short circuiting. Cr(VI) reduction in the reactors HR5 and HR6 was achieved in absence of any carbon source. It is suggested that Cr(VI) reducing bacteria from the sludge required certain cofactors or metabolites from the native bacteria in the soil. Up to 66% Cr(VI) removal was achieved by the mixed culture growing without a carbon source (Figure 5-6). The bacteria in these reactors were expected to be predominantly anaerobic due to the longer period of operation in the absence of oxygen. It was therefore expected that some of the bacteria could utilise inorganic carbon sources such as bicarbonate (HCO_3^-) for cell synthesis and sulphides and nitrates in the soil as electron donors and energy sources.

5.3.3 Cr(VI) Reduction by Inoculated Natural Soil with added Carbon Source

The best performance was observed in reactors with live native soil bacteria (non-sterile soil column) inoculated with sludge bacteria in the presence of the carbon source (saw dust) (Reactors HR7 and HR8, Figure 5-7). Cr(VI) removal under a lower hydraulic loading of $304 \text{ cm}^3/\text{d}$ was 93% after 45 days. The Cr(VI) removal under a higher hydraulic loading of $433 \text{ cm}^3/\text{d}$ was 78%. These results show that the Cr(VI) reducing culture derived more energy from an organic carbon source than from the inorganic sources. This finding is consistent with previous conclusions by other researchers where it was determined that Cr(VI) reduction is an energy intensive process drawing energy resources from the cellular housekeeping processes (Chirwa and Wang, 2000; Ishibash *et al.*, 1990).

5.3.4 Cumulative Cr(VI) Reduction in the Microcosm Systems

From the determination of cumulative Cr(VI) reduction in the microcosms over time (Figure 5-8), it was shown that the highest Cr(VI) reduction rate ($5.69 \text{ g Cr(VI)}/\text{m}^3/\text{d}$); was achieved in the Reactor HR7 operated under a low hydraulic loading $0.403 \text{ cm}^3/\text{d}$ with carbon sources introduced through a layer of saw dust and reactor HR8 at a

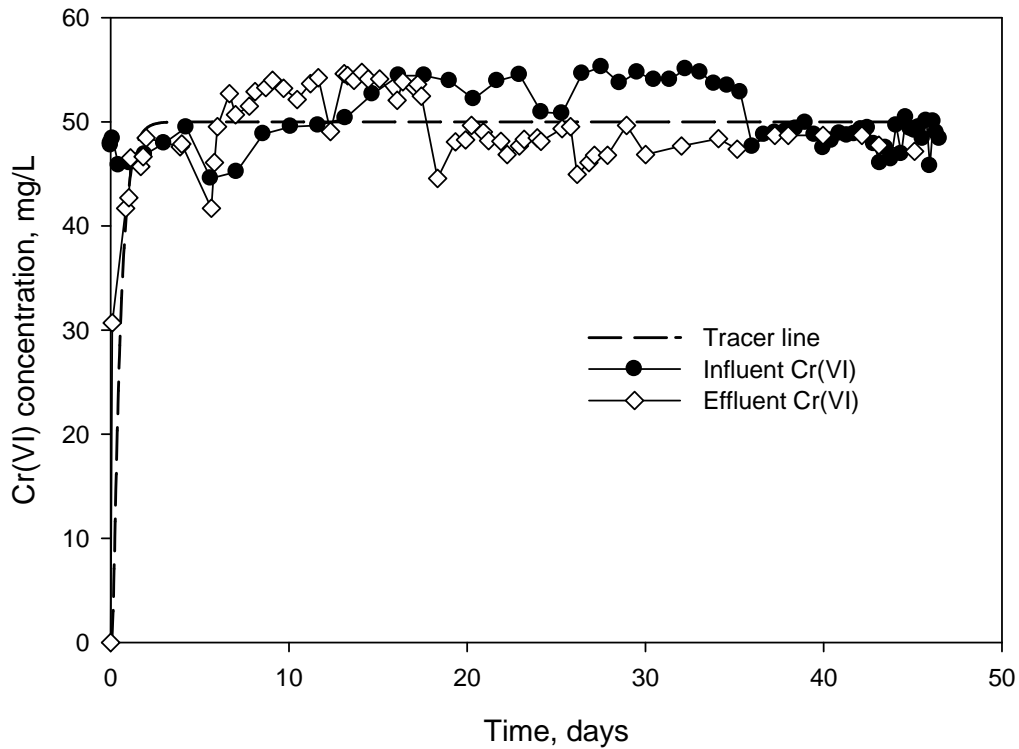

Figure 5-5: Performance of a non-inoculated sterile column showing a characteristic exponential rise in effluent Cr(VI) comparable to the tracer.

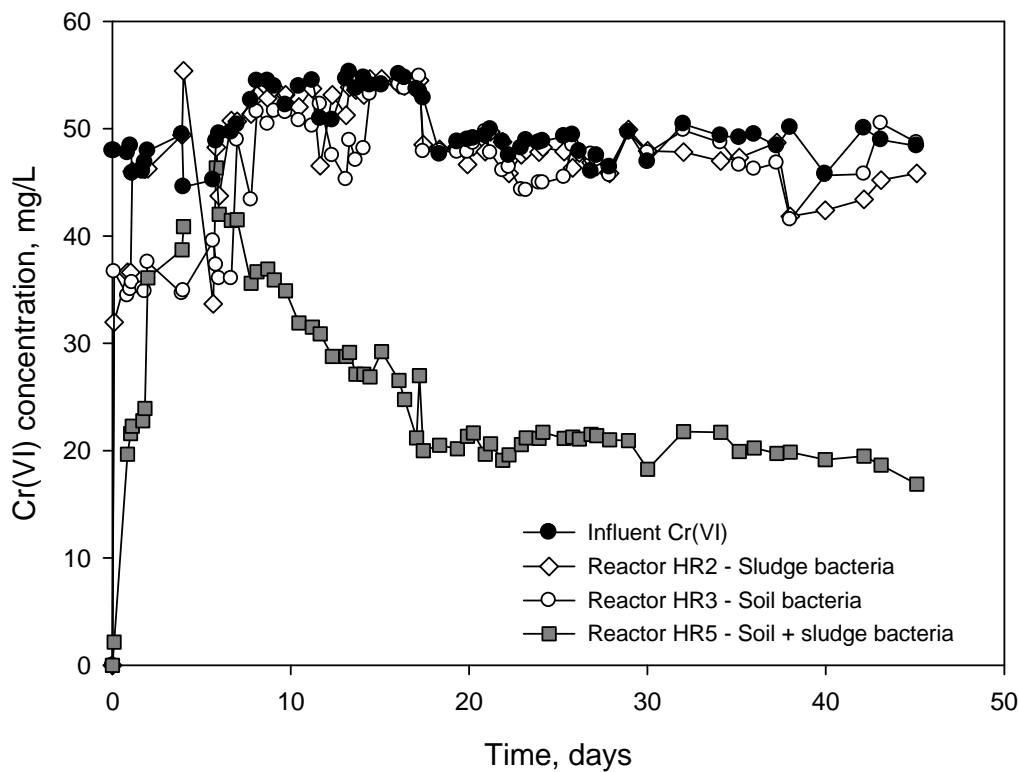

Figure 5-6: Performance comparison: sludge culture acting alone (HR2), soil culture acting alone (HR3), and the combination of sludge and soil bacteria (HR5).

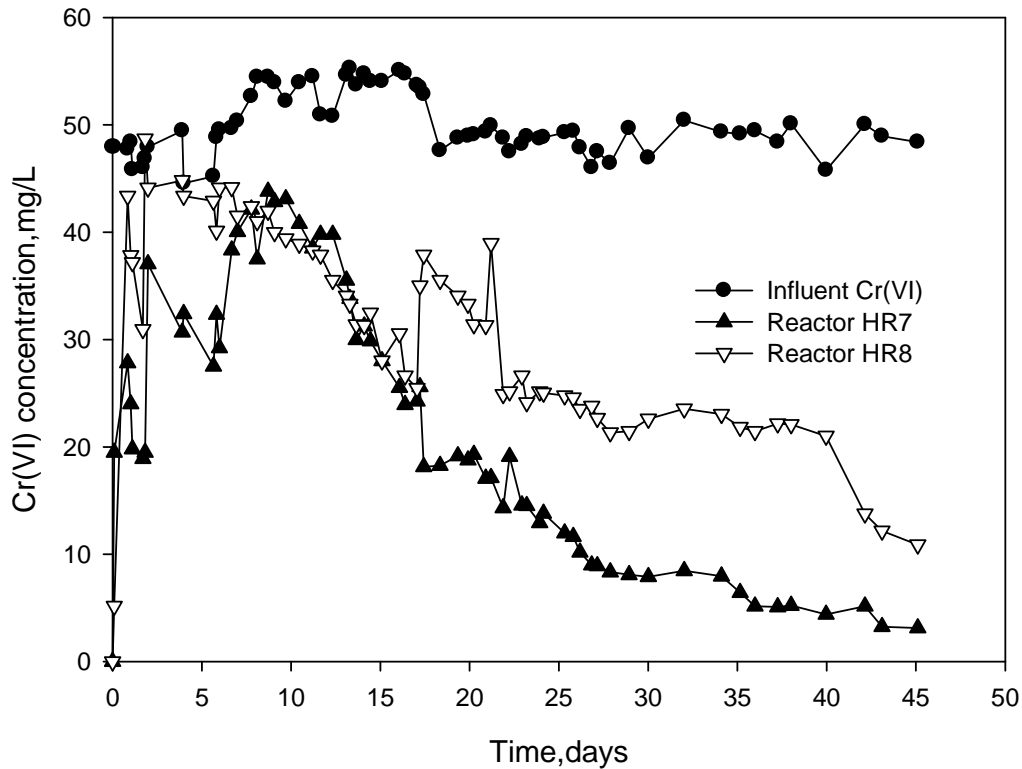

Figure 5-7: Performance of the reactors containing live cultures of sludge bacteria and native soil species (Reactors HR7 and HR8) operated with carbon sources leached from saw dust.

slightly higher hydraulic loading $0.433 \text{ cm}^3/\text{d}$ with carbon sources introduced by the presence of saw dust ($4.54 \text{ g Cr(VI)}/\text{m}^3/\text{d}$) (Figure 5-8). The reactor with no carbon source but with both sludge and soil bacteria in the starter culture (Reactor HR5) achieved the next highest performance ($3.08 \text{ g Cr(VI)}/\text{m}^3/\text{d}$). The reactors HR5, HR7 and HR8 did not reach their Cr(VI) reduction capacity as demonstrated by the continuing increase in the cumulative Cr(VI) removal slope. It is however expected that at one point, Cr(VI) reduction capacity could be lost mainly due to blocking of pores with Cr(III) precipitate.

Insignificant cumulative Cr(VI) removal was observed in the sterile reactor control (HR1) and the reactors with soil bacteria and sludge bacteria acting alone HR3 (Figure 5-8).

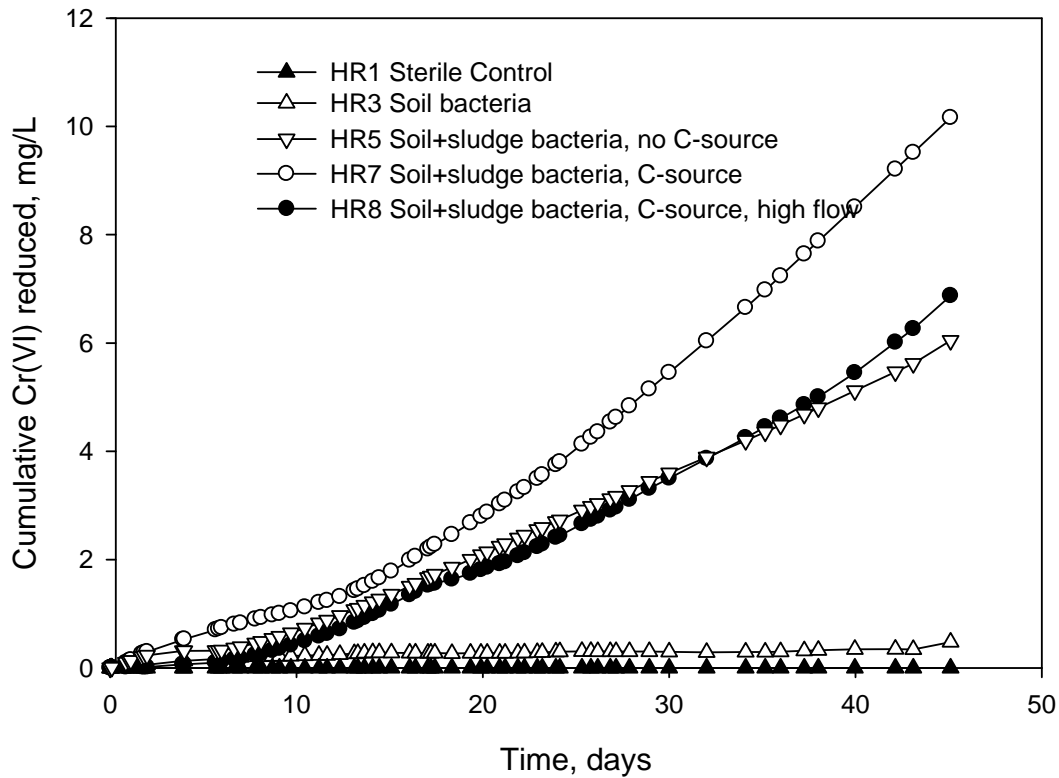

Figure 5-8: Cumulative Cr(VI) removal in the aquifer microcosm reactors showing that the reactors had not reached their full capacity.

5.3.5 Performance Summary

Overall performance of different reactors is summarised in Table 5-4. The results show that the presence of the carbon source had a significant impact on the Cr(VI) reduction rate in the microcosms. Up to 93% removal is achieved in HR7 with carbon source after operation for 45 days. Reactor HR5 without carbon source achieved approximately 66%. The high performance in reactors with live bacteria from both the soil and sludge is demonstrated by the maximum Cr(VI) removal rates (Table 5-4, last column).

Table 5-4: Capability of mixed cultures in reducing Cr(VI) in aquifer microcosms at day 45.

Reactor No.	Flow rate (Q) cm ³ /h	Measured Cr(VI) (Effluent) mg/L	Total Removal % (at day 45)	Removal Rate g Cr(VI)/m ³ /d
HR1	0.660	47.2	0	0
HR2	0.259	45.8	4.5	0.07
HR3	0.714	48.7	0	0.37
HR4	0.290	48.8	0	0.56
HR5	0.228	16.9	66.3	3.08
HR6	0.430	13.5	73.0	--
HR7	0.304	3.1	93.0	5.69
HR8	0.433	10.9	78.2	4.54

5.4 Microbial Culture Dynamics in Aquifer Media Microcosm Reactor

5.4.1 Analysis under Anaerobic Conditions

Due to the oxygen deprivation conditions of the deeper microcosm and operation for a longer period, consideration was given for the anaerobic microbial composition of the start-up culture. Both the sludge bacteria and soil bacteria favouring anaerobic conditions were analysed and the results obtained were presented in phylogenetic tree diagrams (shown in Appendix 2).

The results showed the predominance of *Microbacterium*, *Acinetobacter*, *Arthrobacter*, *Brevibacterium*, *Rumen bacteria*, and several *Enterococci* in the sludge culture and *Arthrobacter spp.*, *Clostridium spp.*, and *Klebsella spp.* and several unidentified unculturable species in the soil cultures. None of the identified soil bacteria were recognised from literature as Cr(VI) reducing species. However, several species from the sludge culture tested positive in their capability to catalyse the reduction of Cr(VI) to Cr(III).

5.4.2 Characteristics of Microorganisms in the Microcosm after 45 days

The cultures were analysed again after 45 days to determine the microbial shift and microorganisms responsible for the observed Cr(VI) reduction especially in the Reactors HR5, HR7 and HR8. The results were once again presented in phylogenetic tree diagrams for ease of comparison between the different cultures under the different Cr(VI) exposure conditions (Figure 5-9). The results showed a wider biodiversity in the gram-negative species. Most of the G-negative species are predicted to be anaerobic thus are capable of growing on a variety of carbon sources including inorganic carbon sources. The long-term operation conditions in the aquifer microcosm experiments favoured these species.

Cr(VI) reduction in anaerobic cultures of bacteria was previously determined to be slower than the reduction in aerobic cultures (Shen and Wang, 1993). This is attributed to the faster metabolic rate in the aerobic cultures. The Cr(VI) removal in the vadose microcosm (VR) systems was much faster than in the deeper microcosm (HR) systems. The slower Cr(VI) removal rate in the aquifer microcosms (HR system) was mainly due to the proliferation of obligate anaerobes and higher sensitivity to Cr(VI) toxicity in these organisms.

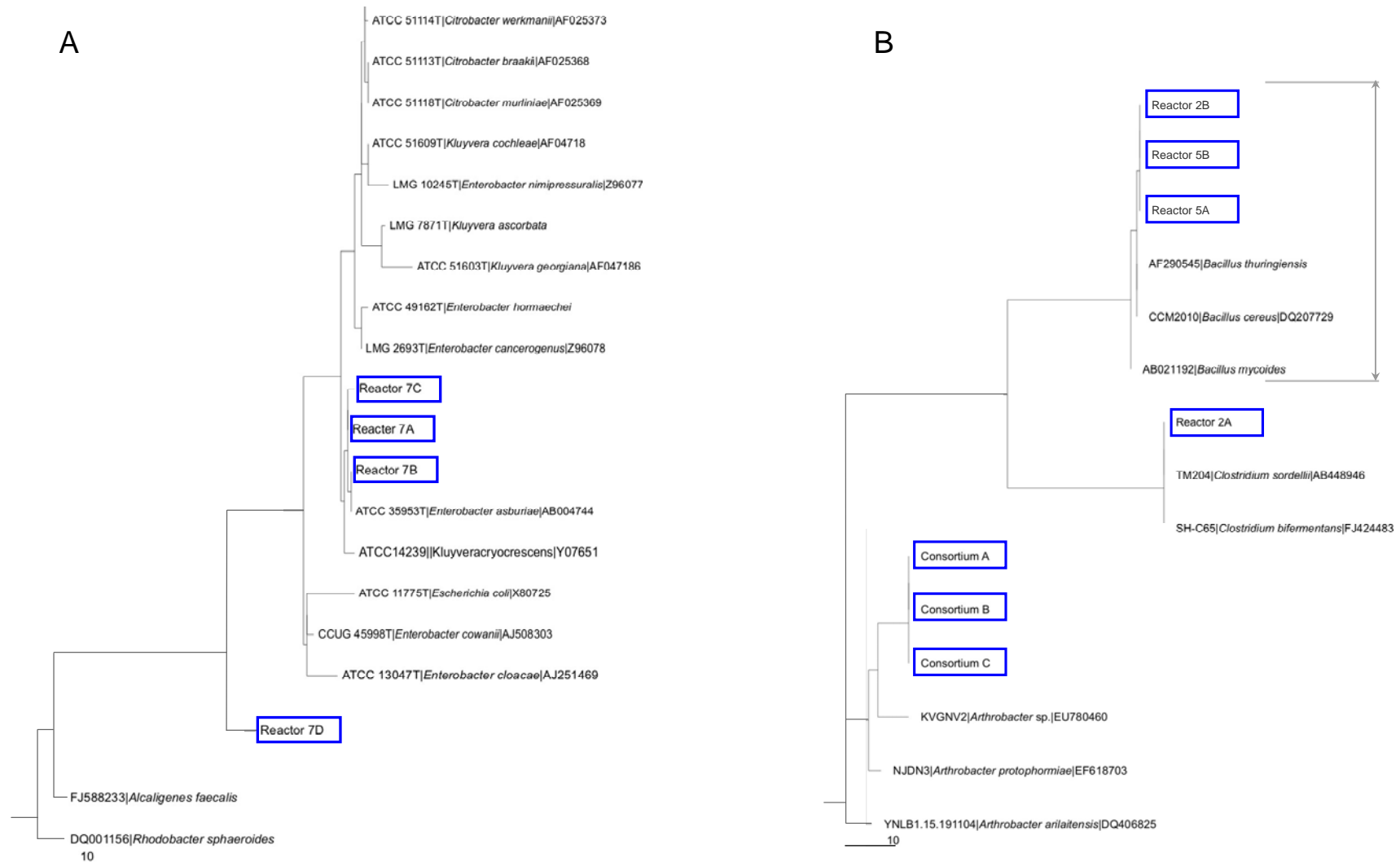

79 **Figure 5-9:** Analysis of the consortium culture from the microcosms after 45 days: (a) gram-negative species (b) gram-positive species.

5.5 Simulation of Cr(VI) Reduction in Microcosm Systems

5.5.1 Model Description – Advection/Reduction Model

The microcosm reactors were modelled as plug flow reactors with the Cr(VI) removal influenced by the following internal processes: (1) advection influenced by the interparticle velocity u (LT^{-1}), (2) mass transport into media particles governed by mass transport rate coefficient k_L (LT^{-1}), (3) adsorption rate governed by mass transport and surface reaction, (4) Cr(VI) reduction governed by the kinetics described in Chapter 4, and (5) cell replacement rate with the cells acting as the catalyst in the Cr(VI) reduction process. The above fundamental processes in the reactor during transient state operation can be represented by the Equations 5-1 to 5-5 below:

$$\frac{dV}{dt} = u \cdot A \quad (5-1)$$

$$\frac{dC}{dt} = -k_L a (C - C_s) = -j_c \quad (5-2)$$

$$\frac{dC}{dt} = -k_{ad} (C_{eq} - C) = -q_c \quad (5-3)$$

$$\frac{dC}{dt} = -\frac{k_m \cdot C}{K^{1-Cr/C_0} \cdot (K_c + C)} \left(X_0 - \frac{C_0 - C}{R_c} \right) = -r_c \quad (5-4)$$

$$\frac{dX}{dt} = Y \left(\frac{k_{ms} S}{K_s - S} \right) - k_d X \quad (5-5)$$

where C_s = Cr(VI) concentration at the particle surface (ML^{-3}), C_{eq} = equilibrium concentration at the surface for the adsorptive process (ML^{-3}), the coefficient k_L = mass transport rate coefficient (LT^{-1}), a = total surface area in the reactor (L^2), k_{ad} = adsorption rate coefficient (T^{-1}), Y = cell yield coefficient ($M \cdot M^{-1}$), k_{ms} = specific

substrate utilisation rate coefficient (T^{-1}) and k_d = cell death rate coefficient (T^{-1}). The interstitial space A in the microcosm was estimated as the volume of the mobile phase (bulk liquid) minus entrained water determined as the difference between the weight of the wet non-flowing reactor and a dry reactor. The process terms: j_c = mass transport rate ($ML^{-2}T^{-1}$), q_c = adsorption rate ($ML^{-3}T^{-1}$), and r_c = Cr(VI) reduction rate ($ML^{-3}T^{-1}$). Since the aquifer reactors were operated under predominantly anaerobic conditions, Cr(VI) reduction with toxicity threshold inhibition (Equation 4-15) was chosen during the simulation. Equation 4-15 is rearranged for the AQUASIM format as shown in Equation 5-4. The reaction rate and inhibition coefficients as determined from batch experiments were maintained in the continuous flow systems with minor adjustments permitted due to different culture sensitivity as the microbial community shifted to more gram-negative anaerobic species.

Due to space limitations in the reactor, cells could only grow to a certain maximum concentration. The time at which the cells reached the maximum allowable concentration was dependent on initial cells, Cr(VI) toxicity and hydraulic loading rate. These conditions caused the cells to obey a logistic function as shown in Equation 5-6 below:

$$X = X_0 + \frac{X_{\max}}{1 + \left(\frac{t}{t_0}\right)^b} \quad (5-6)$$

where X = viable cell concentration (ML^{-3}) at any time t (T), X_{\max} = maximum attainable viable cell concentration (ML^{-3}) in the microcosm, t_0 = logistic interval (T), and b = pitch (dimensionless). The impact of the adsorptive process was determined to be minimal based on an earlier tracer study (Figure 5-5). In the adsorptive process, equilibrium was reached within hours of operation, but the experiment was extended

to 45 days. The predominant processes in the reactor are thus limited to advection, reduction, mass transport and cell growth. These processes were used in the mass balance for Cr(VI) removal across the bulk liquid phase in the microcosm reactor:

$$\frac{d(C \cdot V)}{dt} = A \sum_{l=0}^{l=L_i} u(C_{in} - C) + j_c \cdot a_i + (q_c + r_c) \cdot \Delta V \quad (5-7)$$

where, for each segment of reactor of length ΔL (L), ΔV = change in reactor volume (L^3), the interstitial velocity u (LT^{-1}) is assumed to be constant throughout the entire reactor, a_i = surface area in the segment (L^2). The adsorption rate, q_c ($ML^{-3}T^{-1}$) Approaches zero in the order of 6 to 10 hours. The Cr(VI) reduction rate, r_c ($ML^{-3}T^{-1}$), is a function of viable biomass in the reactor. Table 5-5 shows the description of parameters used. Time series data was simulated in the Software for Simulation of Aquatic Systems (AQUASIM 2.0) software shown in Appendix C.

Table 5-5: Definition of parameters used.

Parameter	Description	Value/Units
Q	Flow rate	m^3/d
C_{in}	Influent Cr(VI) concentration	mg/L
C	Cr(VI) concentration (state variable)	mg/L
a	Surface area	m^2
A	Effective cross sectional area	$4.6 \times 10^{-4} m^2$
F	Input Cr(VI), $Q \cdot C_{in}$	mg/d
D	Coefficient of molecular diffusion	$98.4 m^2/d$
ΔL	Grid section	m
N	Grid number	52
C_{eq}	Equilibrium/saturation concentration	mg/L
X_0	Initial viable cell concentration/density in the reactor	$23.5-4.5 g/m^3$
X_{max}	Maximum attainable viable cell concentration	$3.5-65.3 g/m^3$
t_0	Logistic interval for biomass	10.4-20.4 d
b	Logistic pitch for the biomass	dimensionless
t	Time (programme variable)	d

5.5.2 Simulation of Control Conditions

The performance of the reactor in the absence of viable biomass X is shown previously in Figure 5-5. Application of the mass balance model (Equation 5-7) to the operation of the sterile reactor results in the characteristic exponential curve showing saturation of physical processes in the system within the first 3 days.

The accuracy of simulation of performance of media reactors depends on the accurate prediction of viable biomass in the reactor. Since the majority of the microbial species were unculturable using conventional methods, direct measurement of viable cell concentration was impossible. However, the activity of viable biomass in the reactors could be predicted based on the activity of known values from batch studies. In this study, the simulated performance of the microcosm reactors is plotted together with the simulated biomass activity as shown in Figures 5-10, 5-11 and 5-12 for the Reactors HR4, HR5 and HR7. Therefore the continuous flow systems provided an opportunity for the analysis of the biomass growth parameters and physical characteristics of the media.

The first system to be evaluated in detail was the reactor inoculated with live cultures from sludge but which was initially ridden of native soil biomass (Reactor HR4). The performance of this reactor shows the growth of Cr(VI) reducing species in the inoculum from sludge in the reactor devoid of other species could not be sustained in the absence of the native species. The simulation of Cr(VI) reduction shows initial removal probably from the delay in culture response as the Cr(VI) spread through the reactor. But after operation for 6.5 days, the toxicity in the reactor was probably too high for the culture. The culture started to die off in day 7 (Figure 5-10). In this simulation the biomass values of $X_{in} = 23.5 \text{ g/m}^3$, an X_{max} in the opposite direction =

3.5 g/m³, the logistic interval $t_0 = 10.4$ days, and pitch b of 5.03 were determined. The interstitial velocity u of 6.24×10^{-4} m/d was determined from measured values and the surface area in the reactor, a (L²), was estimated through parameter optimisation in AQUASIM. The model accurately predicted the trend of effluent Cr(VI) concentration in the reactor as shown by the dotted line against the effluent symbols in Figure 5-10.

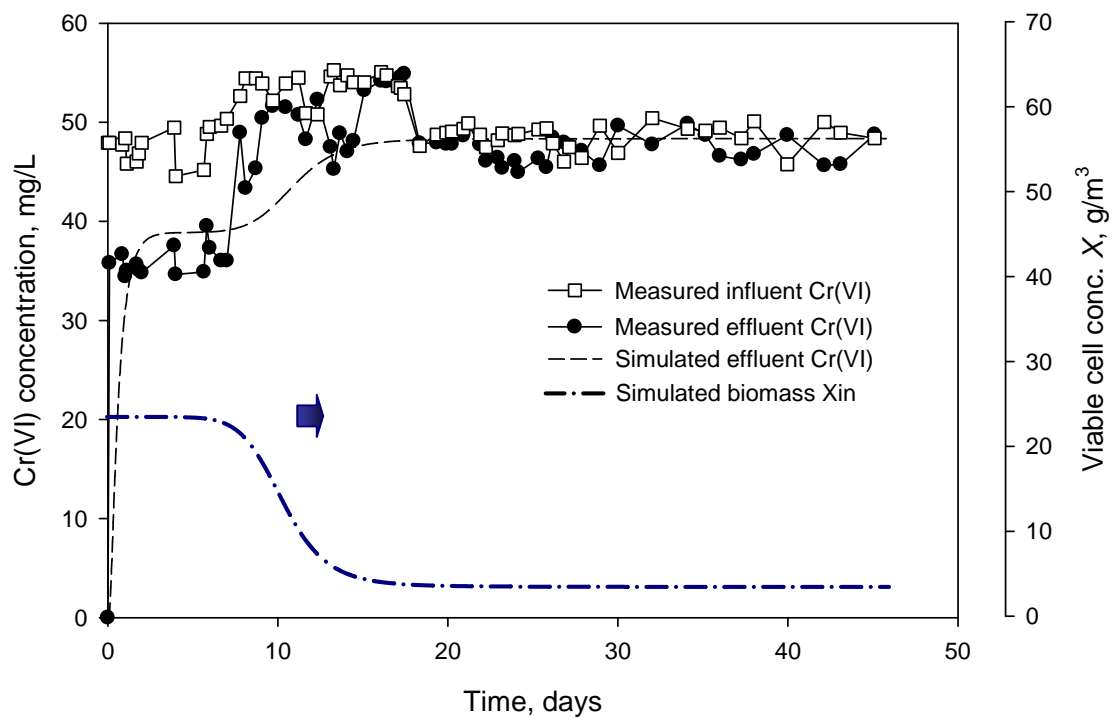

Figure 5-10: Model simulation of the sterilized microcosm reactor inoculated with live cultures from sludge (Reactor HR4).

5.5.3 Evaluation of the effect of carbon source using the model

In the second and third system, the performance of live cultures from both sources (soil and sludge) working together was evaluated. Reactor HR5 represents the operation on only inorganic carbon sources. Simulation of the system showed growth of biomass from a low inoculation value of approximately 8.5 g/m^3 to a maximum value of approximately 45.5 g/m^3 . The cell viability was reflected in the increased Cr(VI) reduction removal rate after 6 bed volumes (day 6). The characteristic flattening of the curve suggests an approach to the maximum cell growth and Cr(VI) reduction capacity of the reactor.

The best performance was observed in Reactor HR7 operated under carbon source. In this reactor, the simulated effluent continually increased with time and this was reflected in the ever increasing Cr(VI) reduction rate until the termination of the experiment at day 45. The continuing increase in the reduction rate is in agreement with the performance depicted by the cumulative Cr(VI) reduction (Figure 5-8). The trend in biomass from day 6 to 45 shows that the reactor supplied with carbon source had capacity for further Cr(VI) removal at the end of the experiment.

In this simulation, the system performed well regardless of having started with the lowest initial biomass value, $X_{in} = 4.5 \text{ g/m}^3$. The biomass in the reactor increased to approximately 65.5 g/m^3 a value more than 1.5 times higher than the maximum achievable cell concentration under no carbon source (Reactor HR5). The logistic time constant t_0 almost doubled to 10.4 days as X continued to increase. The pitch factor and interstitial velocity remained the same as under the other simulations conditions at 5.03 and $6.24 \times 10^{-4} \text{ m/d}$, respectively. The model simulation results helped validate the parameters previously determined in batch and made possible the

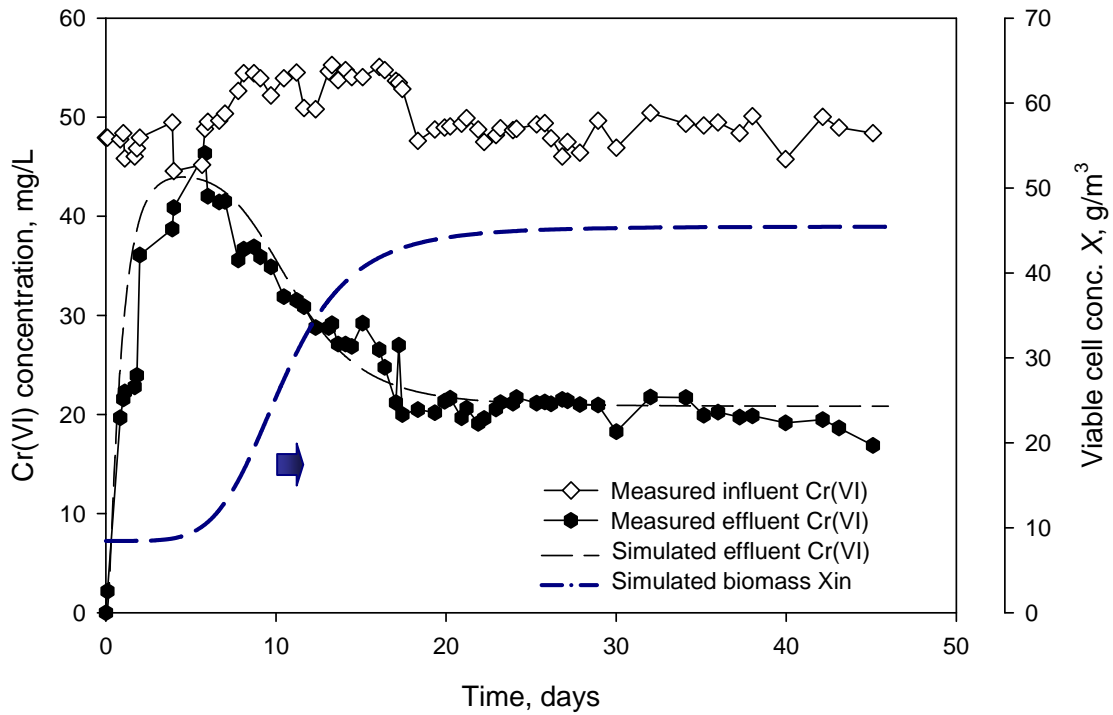

Figure 5-11: Model simulation of the live soil culture microcosm inoculated with live cultures from sludge and operated without carbon source (Reactor HR5).

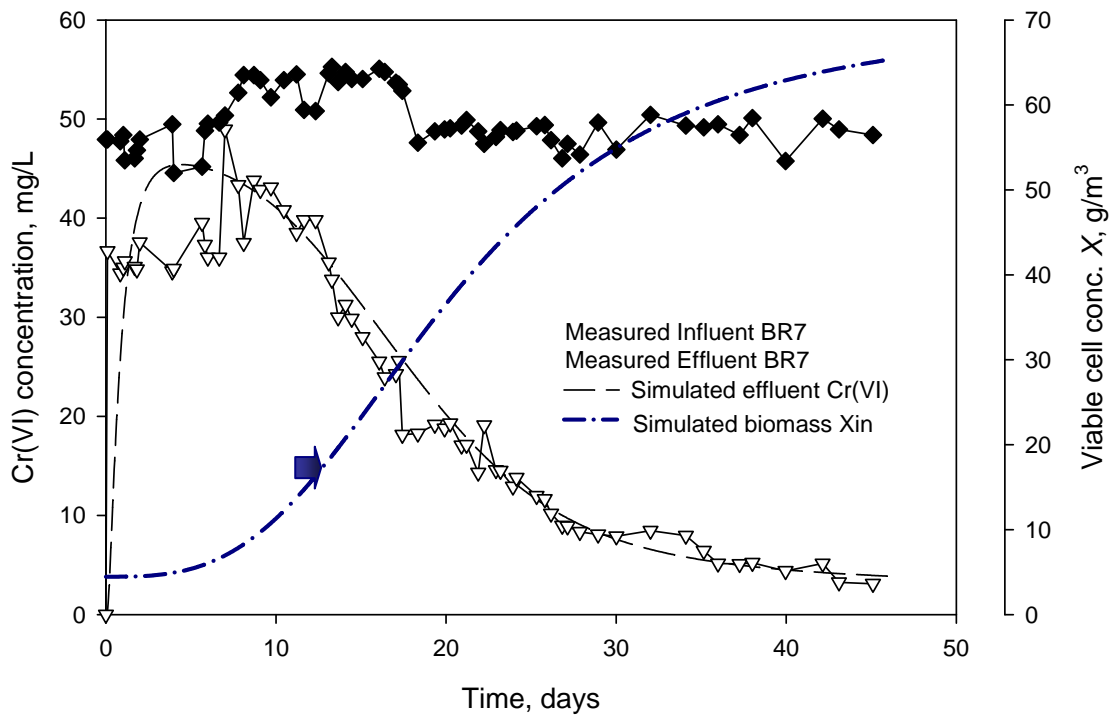

Figure 5-12: Model simulation of the live soil culture microcosm inoculated with live cultures from sludge and operated with carbon source (Reactor HR7).

evaluation of the viable biomass component which is difficult to measure directly in a heterogeneous media environment. All parameters used in the simulation of the microcosm reactor operation are summarised in Table 5-6.

Table 5-6: Final parameter values from the application and optimisation in the microcosm reactors.

Parameters Symbols	Associated Process	Optimum Value	Units
k_{mc}	Cr(VI) reduction rate	1.385	1/d
K_c	Cr(VI) reduction rate	2.450	mg/L
R_c	Cr(VI) reduction rate	0.533	mg/mg
K	Cr(VI) reduction rate	0.50	mg/L
C_r	Cr(VI) reduction rate	99	mg/L
b	Cell growth	3.0-8.0	--
t_o	Cell growth	10.4-20.4	d
X_0	Cell growth	4.5-23.5 (HR7-HR4)	g/m ³
X_{max}	Cell growth	3.5-65.3 (HR4-HR7)	g/m ³
C_s	Surface adsorption	1x10 ⁶	mg/kg
C_{crit}	Surface adsorption	0.01	mg/m ³
C_{smax}	Surface adsorption	0.00029	mg/kg
$alpha$	Surface adsorption ^a	0.5	--
$theta$	Surface adsorption ^a	0.4	--
rho_s	Surface adsorption ^a	2300	kg/m ³
C_{in}	Cr(VI) loading	50	mg/L
Q_{in}	Cr(VI) loading	0.001	m ³ /h
D	Column properties	98.4	m ² /h
A	Column properties	3.65-4.65 × 10 ⁻⁴	m ²
a	Column properties	variable	m ²

^a Stoichiometric coefficient for surface adsorption

5.6 Summary of Parameters

The model for the saturated soil column with dispersion which was adopted from AQUASIM 2.0 for the simulation of soil columns successfully simulated the operation of the microcosms used in this study. The breakthrough characteristics of the columns are typical of packed-media reactors with moderate dispersion depicting an exponential rise to a maximum followed by reduction in effluent as the Cr(VI) culture becomes more established.

The parameters for reaction rate processes were optimised in batch and were applied directly into the continuous flow process. Minor adjustments were applied to inhibition parameters due to the low levels of biomass in the continuous flow reactor systems compared to the batch systems. Different biomass values simulated in the reactor systems were attributed to different culture adaptability to high Cr(VI) loading. The culture grown under a carbon source showed a higher Cr(VI) reduction capacity than the cultures grown on organic sources from the soil.

Although, the model tracked successfully the trend in effluent Cr(VI) concentration in all the reactors tested, modifications would be required to take into consideration the loss of working volume and decreasing flow rate due to the growth of biomass in the reactors. The increase in biomass limits the working volume with time.

Some of the biomass related coefficients (i.e., X_o , X_{max} and t_0) converged at different values during optimisation since the biomass in the reactor varies as a function of available carbon source. Physical and chemical parameters were assumed constant within the applied experimental period.

5.7 Chapter Summary

Cr(VI) reduction capability was evaluated in this study in vadose reactors (VR) and unconfined aquifer reactors (HR) to simulate the behaviour of the pollutant and microcosms in aquifers. Results in vadose reactors showed the capability of Cr(VI) reducing species to reduce Cr(VI) and prevent the migration of Cr species across an inoculated barrier. The Cr(VI) reduction in the vadose reactors was achieved without any added carbon sources. The success of the inoculated reactors was mainly because the culture reconfigured into an optimal adapted culture for the reactor environment. This was demonstrated by analysing microbial culture composition in the reactor using 16S rRNA fingerprinting of the conserved 16S rRNA gene sequence.

The impact of a carbon source on Cr(VI) reduction and removal in an aquifer was evaluated using the HR system. It is expected that the water in the deep aquifer environment may be extremely low in organic carbon sources. The presence of an organic carbon source greatly enhanced the performance of the reactor. This was demonstrated by the high performance in reactors HR7 and HR8 which achieved up to 93% removal while operating in an oxygen deprived environment. Reactor HR5 and HR6 without carbon source achieved only about $66\pm 2\%$ and $73\pm 2\%$ removal, respectively. The reactor with native bacteria showed no chromium removal as an indication that the sludge bacteria were actively responsible for the reduction of chromium.

An advection-reaction model was used to successfully simulate effluent conditions. Reaction rate kinetic parameters optimised using batch data were used directly into the continuous flow reactor simulation. Most of the Physical-chemical parameters, apart from the media surface area a (L^2), were determined from known literature

values from similar systems. Only the mass transport parameters and adsorption parameters were estimated from the continuous flow reactor data.

CHAPTER 6

MESOCOSM STUDIES (BARRIER PERFORMANCE)

6.1 Background

This chapter reports on the performance prediction for a reactive barrier based on results from a laboratory mesocosm using aquifer media from a Cr(VI) contaminated site in South Africa. The mesocosm study was the second step towards the possible development of an *in situ* bioremediation process for field testing at a target contaminated site. The culture used in the mesocosm study was the same dried sludge culture tested in batch systems (Chapter 4) and in microcosm reactors (Chapter 5). The culture was originally isolated from sand drying beds from the Brits Wastewater Treatment Plant (Brits, North West Province). The mesocosm reactor was operated without any bioaugmentation – i.e., no additional nutrients or external carbon sources were introduced.

6.2 Simulation of Reactive Barrier: Mesocosm Reactor

An open top tank of (in cm) $123 \times 52 \times 50$ (L×B×H) was constructed from Plexiglas[®] (Evonik Röhm GmbH, Essen, Germany) reinforced by steel bars as shown earlier in Chapter 3 (Figure 3-4). The reactor was filled with aquifer medium compacted by hand to a compaction consistent with the ground conditions. Fourteen sample ports of 11 mm diameter glass tubing were inserted during placement of the aquifer material. Sample ports were strategically placed to capture the longitudinal and vertical concentration profiles and the concentration drop across the 19 cm wide microbial barrier (about the size of microcosm columns). Monitoring was conducted in the vertical direction at two depths of mesocosm: the deeper zone was monitored using

ports L1 to L7 and the shallower (medium) zone was monitored using the ports M1 to M7. Sampling the horizontal direction was conducted at positions 1 to 7 (P1 to P7). The data is presented two dimensions longitudinal (P1 to P7) and vertical (M and L)

6.3 Barrier Performance Evaluation (Qualitative)

From the 50th day the reactor started showing some yellow precipitate on top, this precipitate was observed on the whole top surface of the mesocosm reactor except the 19 cm biological permeable reactive barrier. The liquid which remained inside the mesocosm reactor turned greenish from the original hexavalent chromium yellowish colour. Studies done by Prat and colleagues (1997) for the reduction and precipitation of chromium using zero valent iron, have shown through X-ray Photoelectron Spectroscopy (XPS), that the chromium found within the precipitate is exclusively in the Cr(III) oxidation state, and that Fe present in the precipitate is in the Fe(III) oxidation state (Pratt et al., 1997). The AA was used to determine total chromium and an average of 90% of the chromium could be accounted for at the end of the experiment. This indicated that less than 10% may be adsorbed or retained onto soil particles during the cause of the experiment.

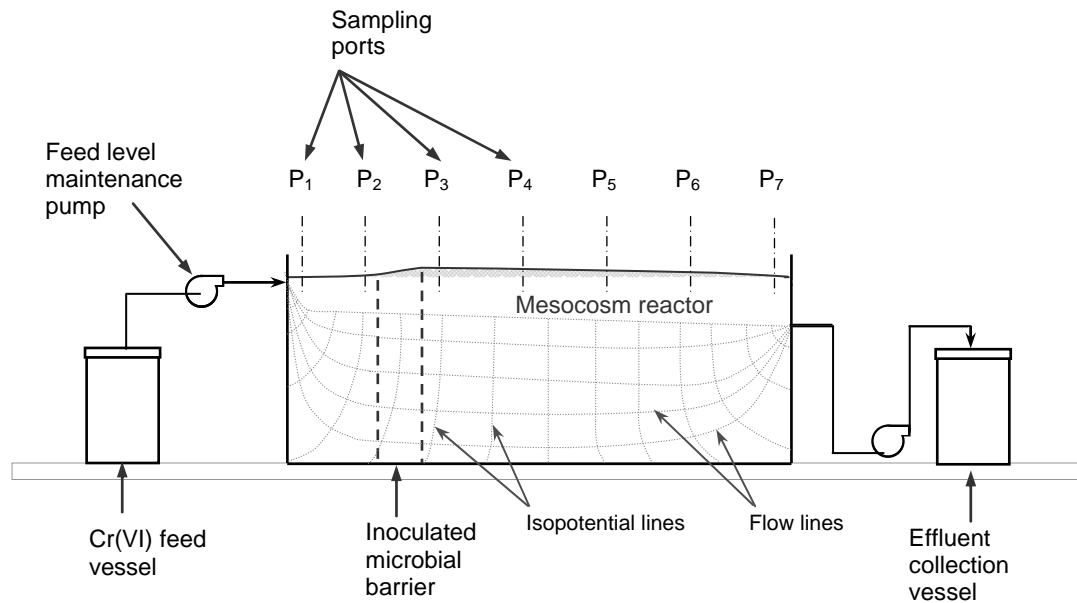

Figure 6-1: Schematic Representation of Mesocosm Reactor setup.

6.4 Barrier Performance Evaluation (Quantitative)

The results indicated that all the zones before the reactive barrier Zones 1M, 1L, 2M, 2L experienced no chromium reduction whereas most of the other zones after the reactive barrier experienced near total reduction after operation for more than 60 days. The set up of the ports in the reactor was in the following order; Zone 1 being the zone just before the feed area, Zone 2 the one just before the barrier, Zone 3 the zone just after the barrier followed by Zones 5 and 6 and finally Zone 7 the furthest away from the barrier but closer to the waste outlet. Figure 6-2 shows the reduction of chromium (VI) at different zones at level M (mid-depth of the reactor tank). The graph shows that there was visible reduction observed before the end of the first 30 days.

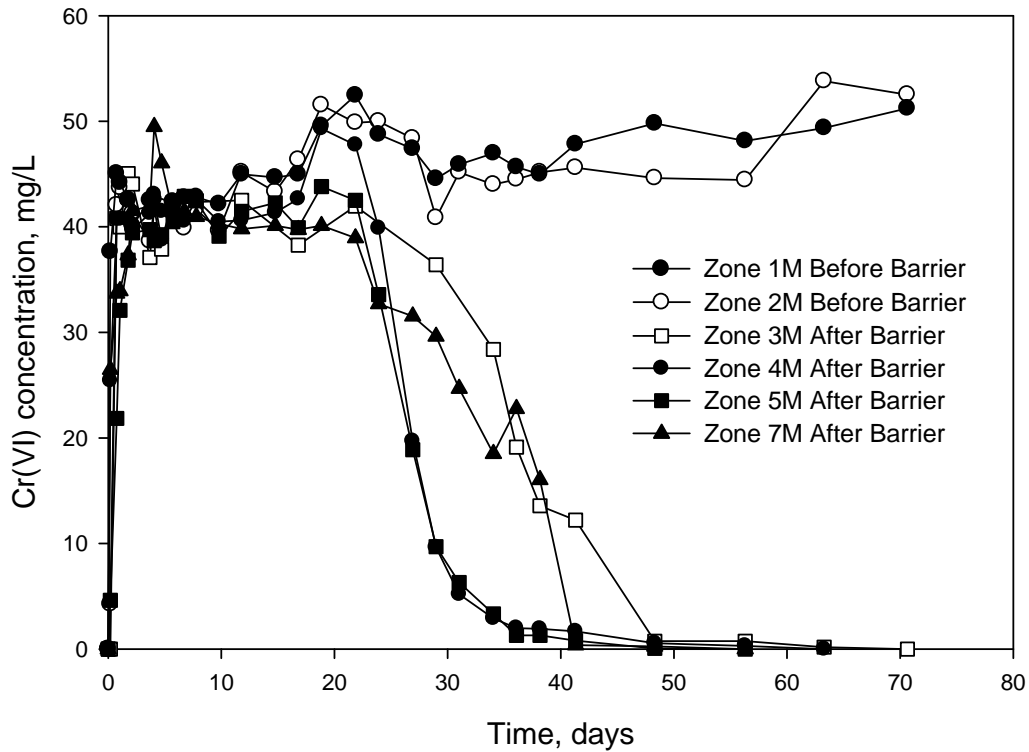

Figure 6-2: An overview of the reduction at level M (mid-depth of reactor).

In Figure 6-3, Zones 3L, 4L and 6L showed evidence of reduction after operation for approximately 21 days. Zone 4L and 6L reached near complete Cr(VI) removal before most of the zones at Level L. Samples from Zone 6L and 5L were the slowest performing of all zones. This could be a result of short circuiting or could have been caused by the presence of rocky material in the zone that interfered with flow nets in the vicinity. The problem of irregular flow resulted in slower dilution of the deeper zones during operation. This could be remedied by having a longer reactor to avoid rising flow lines towards the effluent ports which were at a height of approximately 25 cm from the bottom of the reactor. For the Level L, only the ports immediately after the barrier 3L and 4L reached 100% after day 40. This is because of more efficient dilution with the clean water coming through the microbial barrier. If the reactor operated under laminar flow conditions, the flow lines will be deepest in the region of Ports 3 and 4.

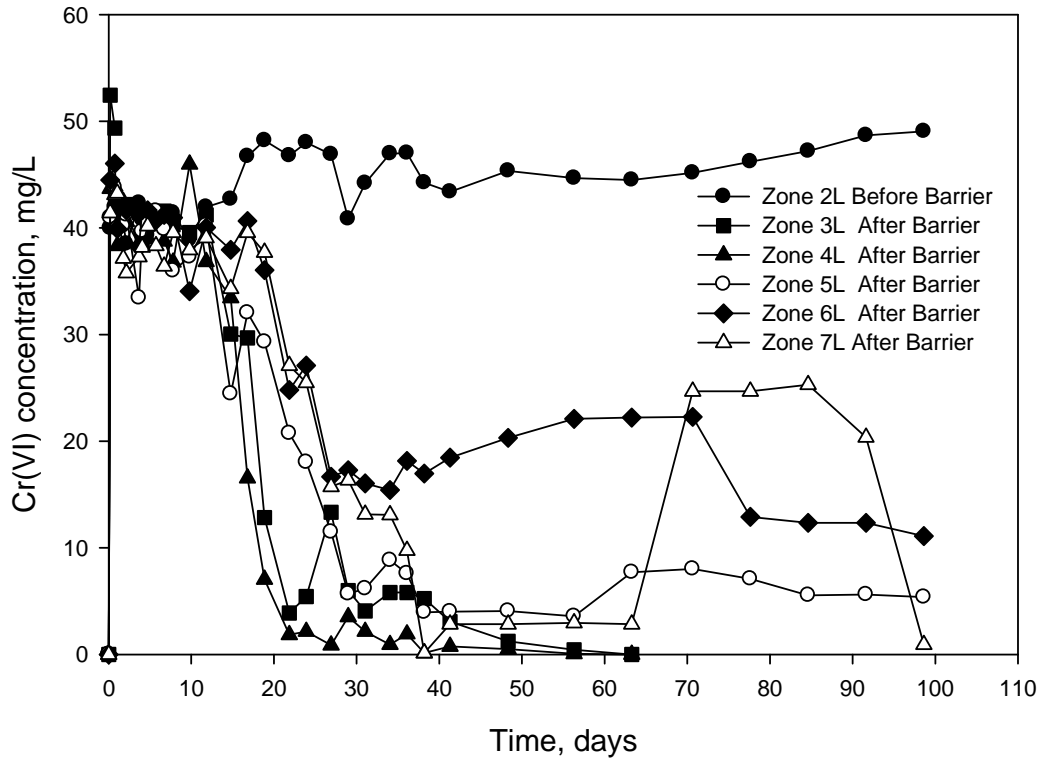

Figure 6-3: Barrier performance at level L (level near the bottom of the reactor).

The performance of the mesocosm reactor as monitored by bulk liquid concentration in samples drawn at the various ports is summarised in Table 6-1. The summary in this table clearly shows complete removal in barriers immediately after the barrier and some residual Cr(VI) concentration in the deeper zones of Ports 5 to 7.

Table 6-1: Summary of chromium (VI) reduction performance in the mesocosm reactor.

Zones	Remaining Cr(VI) Concentration After 13 Weeks ± 2 (mg/L)	Cr Removal %
2M(Pre barrier)	50	0
3M(Post barrier)	0	100
5M(Post barrier)	0	100
6M(Post barrier)	1.42	97
2L(Pre barrier)	49.5	5
3L(Post barrier)	0	0
5L(Post barrier)	5.3682	89
7L(Post barrier)	0.925	98

6.5 Spatial Variation at Discrete Time

The spatial Cr(VI) concentration profiles (snap shot profiles) in the mesocosm were calculated for specific time points – day 9.8, 26.9, 36.1, 48.3, and 63.3 as shown in Figure 6-4 for the mid-depth zone (M). Figure 6-4 illustrated the rate of Cr(VI) reduction in each specific port as time elapsed. It is clearly shown through Ports 3-7 that Cr(VI) was indeed continuously removed in the barrier and the rest of the ports (Ports 3-7) were cleaned up with time by dilution. It is also indicated that Port 7 was the slowest to clean probably due to rising flow lines at the end of the reactor which left a dead zone below Port 7.

Similar results were obtained in the deeper zone sampled by the long tubes (L). The samples for the Level L were analysed for a longer period – day 9.8, 26.9, 36.1, 48.3, 63.3, 84.6 and 98.6. Results from Figure 6-5 show that Ports 3 and 4 were cleaned up fast, receiving clean water from the barrier. The Ports downstream of Port 4 were the hardest to clean for the same reason as stated for Level M (above), that the flow lines were deepest in the region of Ports 3 and 4. It can therefore be concluded that, the closer the port to the barrier, the quicker the chromium is cleaned from the zone.

In spite of the difficulty of cleaning up 6L and 7L, it was demonstrated that these ports could be cleaned eventually as indicated by the low concentrations at day 98.6. At this point, Cr(VI) in zones 3 and 4 was completely removed.

The foregoing evaluation shows a two dimensional view of the spatial variability of Cr(VI) concentration in discrete time. This shows that studies at the mesocosm level will yield better representation of the three dimensional space and that spatial distribution parameters such as dispersion coefficient (D, L^2T^{-1}) and flow pattern as described by the Reynolds number could be important.

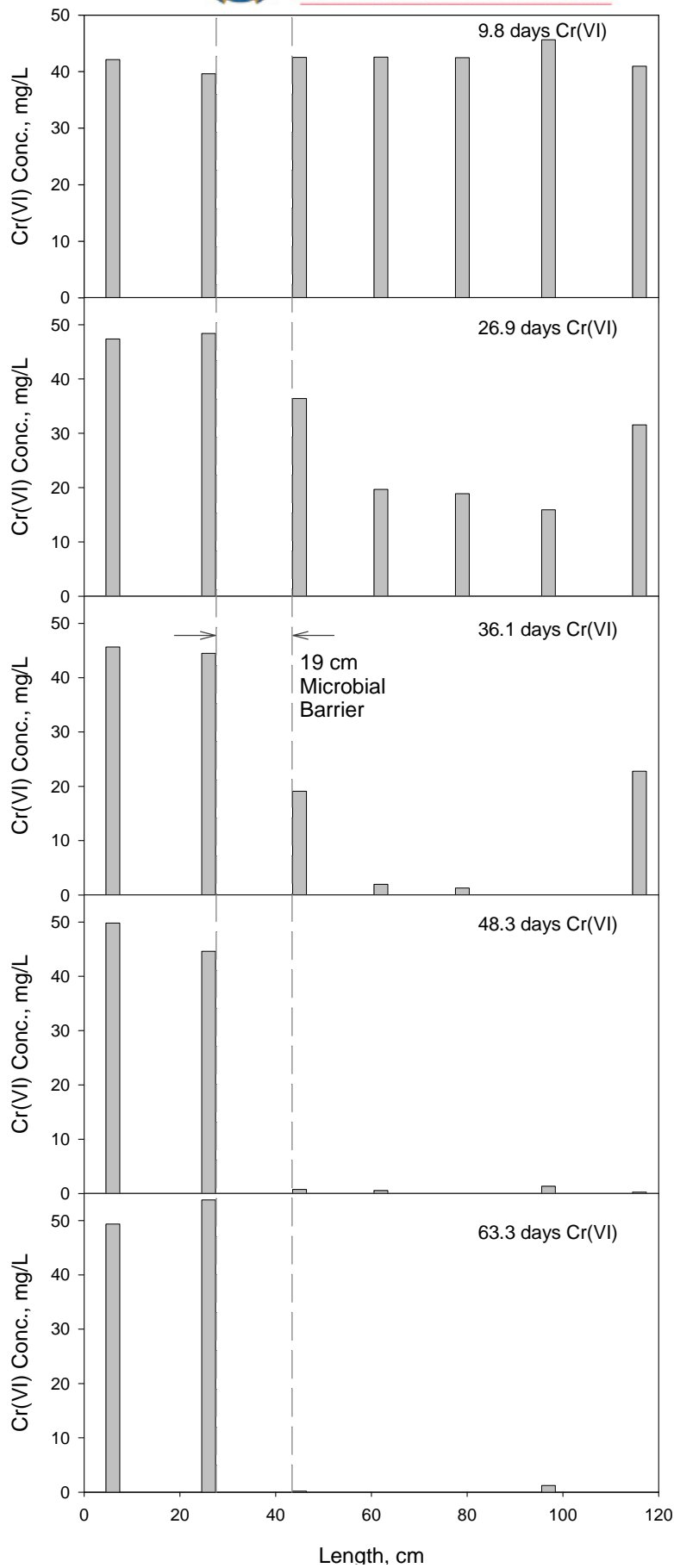

Figure 6-4: Cr(VI) reduction along the length of the mesocosm reactor at specific times showing the improving performance with time(Level M).

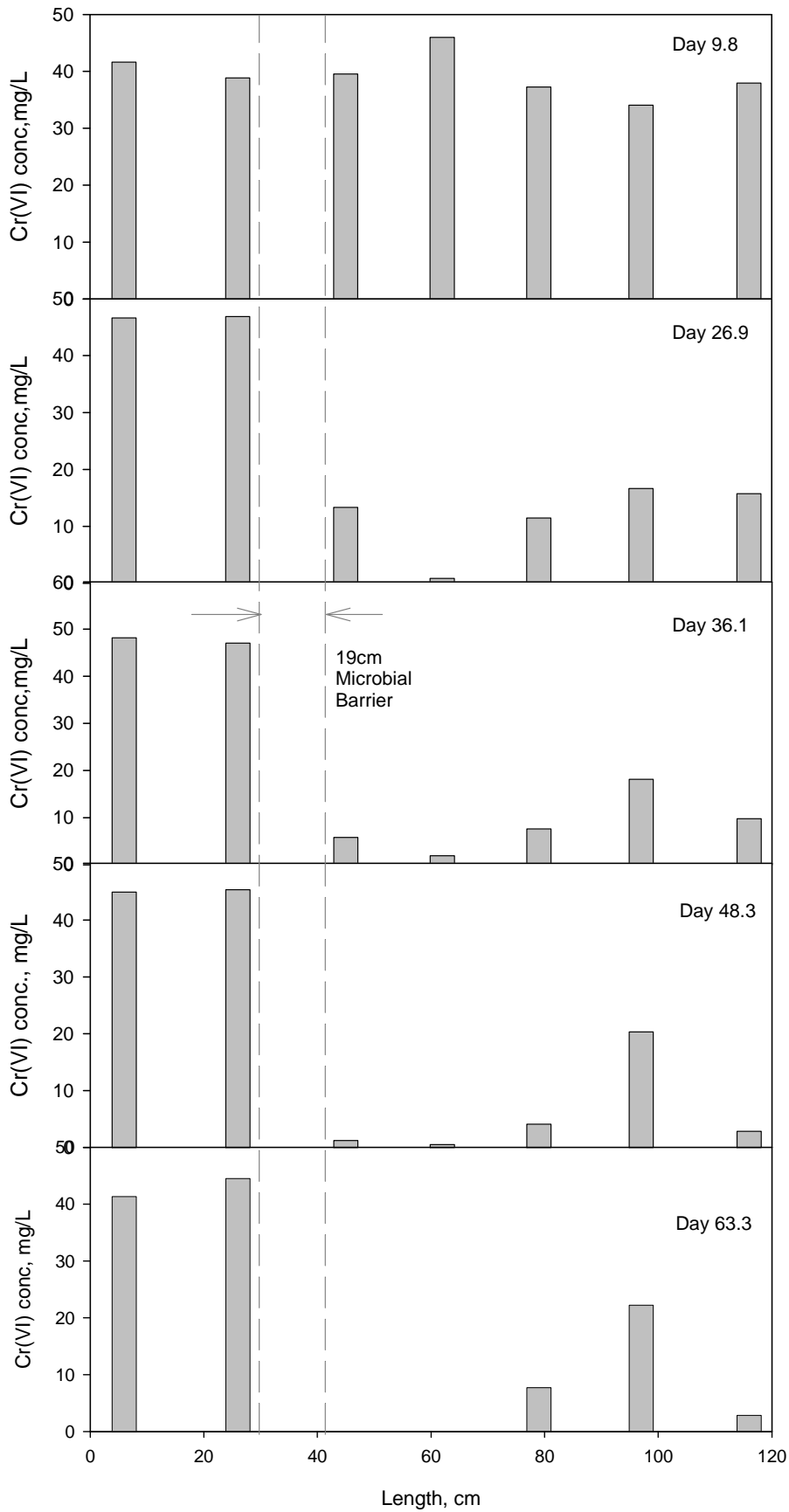

Figure 6-5: Cr(VI) reduction along the length of the mesocosm reactor at specific times showing the improving performance with time(Level L). (Continues/..).

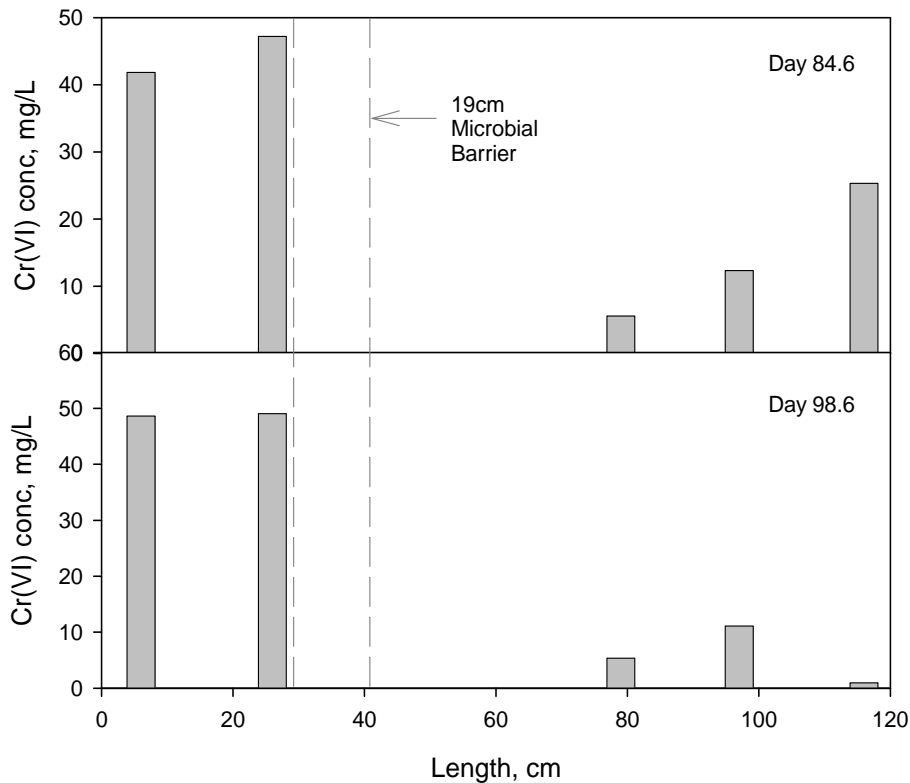

Figure 6-5: Cr(VI) reduction along the length of the mesocosm reactor at specific times showing the improving performance with time(Level L) (.../continued).

The cumulative reduction analysis was also assessed in the mesocosm studies in order to establish whether the microorganisms had reached their maximum performance ability. Figures 6-6 and 6-7 show that the reactor had not reached system failure yet for the larger part of the mesocosm reactor.

In Figures 6-6 and 6-7, zones 1M and 1 L were used as controls, respectively, since they were placed before the barrier presumably no Cr(VI) reduction was observed in these zones. The same scenario applied for the ports/zones 2M and 2L which showed minimal/zero chromium reduction. Based on the cumulative Cr(VI) reduction plot in Figures 6-6 and 6-7, the section of the reactor remained around the zero level in terms of culture capability since there was mostly no bacterial activity hence there was no Cr(VI) reduction.

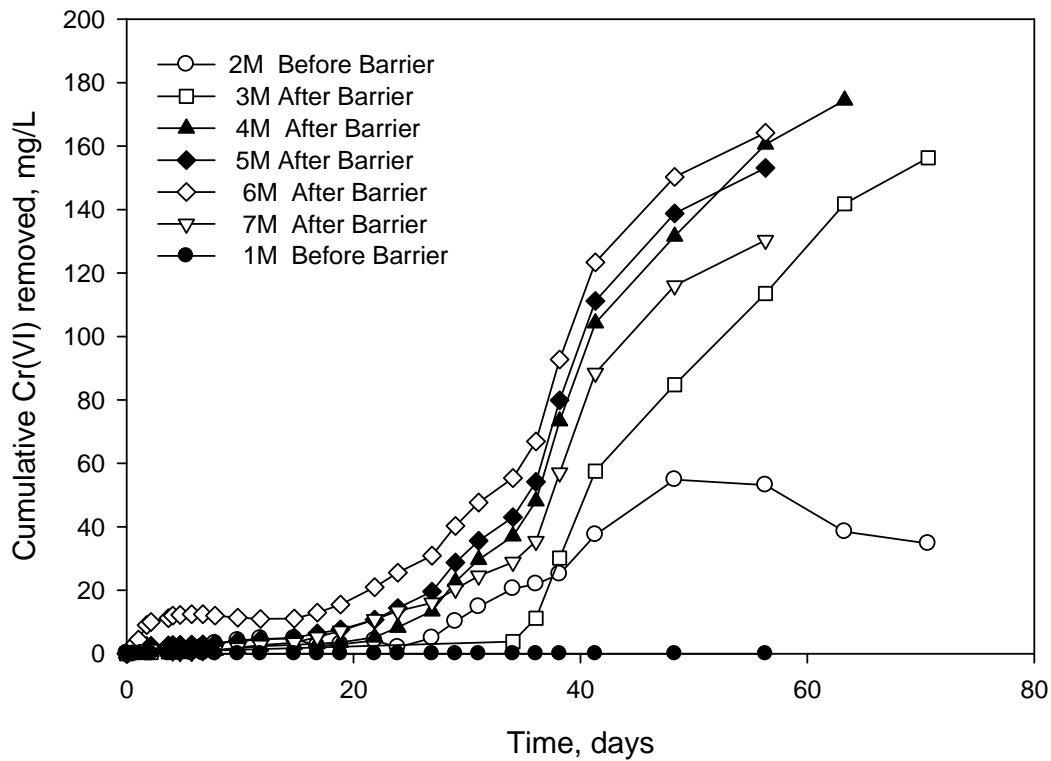

Figure 6-6: Cumulative Cr(VI) removal determined through concentration measurements in M-Zones.

Zone 2M showed a slight increase in performance from around day 29 of the experiment. The assumption is that microorganisms had started migrating towards the 2 zones therefore beginning to reduce chromium. The microbial activity then started to slow down after some time but there was still some activity until the experiment was terminated.

Similar analysis was conducted for the deep zones of the mesocosm reactor using samples collected from Level L. Ports 1L and 2L reflected near zero cumulative Cr(VI) removal suggesting no bacterial activity during the course of the experiment in the zone before the barrier, whereas all the samples after the barrier showed cumulative removal (Figure 6-7).

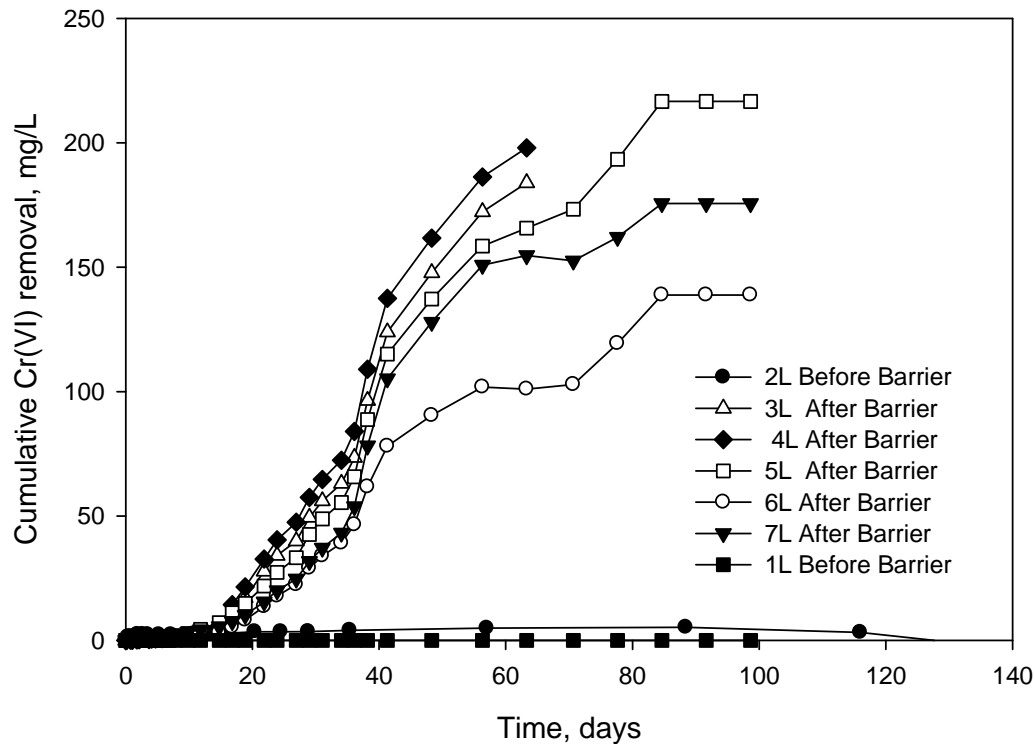

Figure 6-7: Cumulative Cr(VI) removal determined through concentration measurements in L-Zones.

6.6 Chapter Summary

The results from this study successfully demonstrated the ability of a permeable reactive microbial barrier to curb the spread of Cr(VI) pollution. This further highlights the potential of Cr(VI) reducing bacteria from activated sludge to both attenuate the spread of Cr(VI) pollution and the reduction of Cr(VI) in aquifer material. This could be a good starting point in the formulation of a pilot study on biological permeable barriers for protection against the spread of the Cr(VI) contaminant from hot spots in the area. Figure 6-8 shows a proposed barrier concept around the hotspots.

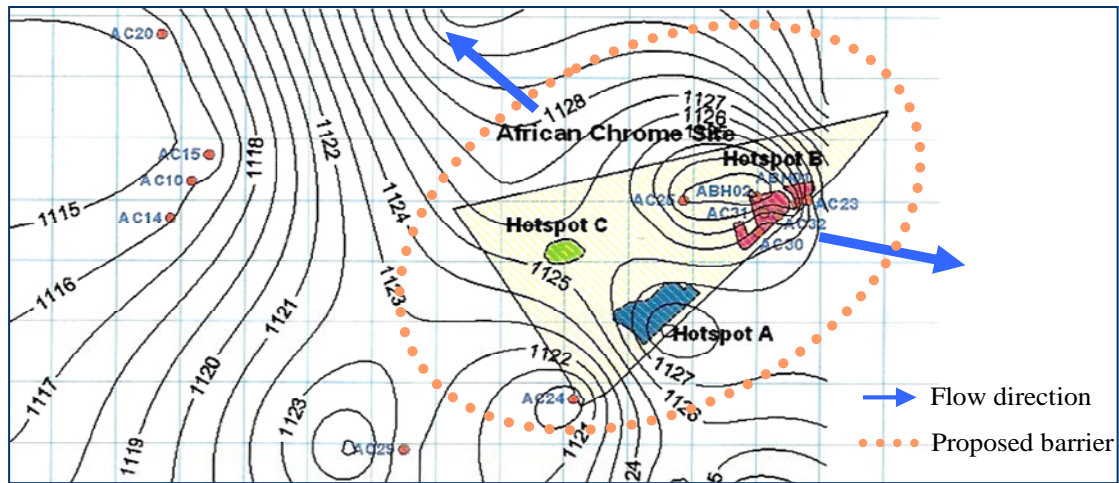

Figure 6-8: Proposed strategic positioning of the biological permeable reactive barrier at the target bioremediation site in Brits.

The cumulative results showed that the microbial activity in the mesocosm reactor system was still high at the time the experiment was terminated, which means the microorganisms could still be able to reduce hexavalent chromium at a higher loading than applied in this study. This on its own is a positive milestone since the annual average concentration at the proposed distance to the barrier at the target site has been reported to be approximately 40 mg/L, 20% lower than the applied 50 mg/L in this study.

CHAPTER 7

SUMMARY AND CONCLUSIONS

Batch experiments under varying initial Cr(VI) concentration of 50-400 mg/L in media with harvested and concentrated cells showed that the indigenous culture achieved complete Cr(VI) removal under initial concentration up to 200 mg/L in less than 64.3 hours (2.7 days). Up to 94% of Cr(VI) was removed at the initial concentration of 300 mg/L after incubation for 110 hours whereas tests under anaerobic conditions were conducted over a lower concentration range of 50 mg/L to 300 mg/L. The rate of Cr(VI) reduction was generally slower in the anaerobic cultures. Near total Cr(VI) reduction occurred in cultures with a lower initial Cr(VI) concentration of 150 mg/L after a longer incubation period of 155 hours compared with aerobic cultures.

The feasibility of using Cr(VI) reducing microorganisms in vadoze zone material was demonstrated by better performance of microcosm reactors inoculated with a locally isolated consortium of Cr(VI) reducing organisms than sterilized controls. The inoculated reactor achieved near complete removal of Cr(VI) (95.3 %) while operating under a low hydraulic loading after 17 days at 40 mg/L. The inhibitory effect of Cr(VI) on the Cr(VI) reducing microorganisms was demonstrated by the decrease in Cr(VI) reduction rate in reactor VR3 which operated at twice the hydraulic loading rate of reactor VR6.

Microcosm reactors with saw dust performed better than the ones with no carbon source, the best performing reactor after about 45 days of operation at 50 mg/L of chromium was 93%. Microbial culture conditions in the best performing microcosms from the microaerobic vadose zone favoured the Cr(VI) reducing species, *Bacillus*

cereus/thirungiensis and *Lysinibacillus sphaericus*, probably originating from the sludge. Microbial culture composition in anaerobic deep aquifer microcosms was predominated by anaerobic Gram-negative species.

The batch modelling results showed that the performance of the bacteria fitted best the non-competitive inhibition model with cell inactivation under aerobic conditions, whereas the competitive inhibition was effective above a threshold concentration of about 100 mg/L under anaerobic conditions. The model used for aquifer zone simulation (HR) was adopted from AQUASIM 2.0. The model simulated the operation of a soil column with dispersion and a plug flow regime. Most of the reaction rate kinetic parameters optimised using batch data were used directly in the continuous flow reactor simulation. Reaction rate kinetics predominated during operation without carbon source due to low biomass activity.

Experimental results from Mesocosm experiments showed that 50 mg/L of hexavalent chromium was completely reduced after operation for approximately 9 weeks as measured in the ports just after the barrier. The ports before the barrier showed no chromium reduction. The outcome of this study is a good basis for testing the concept in a pilot study on site.

The microbial reactive barrier has performed well in this study with significant reduction in all zones and an average of approximately 90% in the final effluent. The outcome of the mesocosm results could be useful in the formulation of biological permeable barriers for protection against the spread of the pollutant from hot spots in the area.

BIBLIOGRAPHY

LIST OF REFERENCES

1. ACGIH (American Conference of Governmental Industrial Hygienists), 2004, Threshold limit values for chemical substances and physical agents and biological exposure indices. ACGIH, Cincinnati, OH, USA.
2. Ackerley, D.F., Gonzalez, C.F., Keyhan, M., Blake, R., and Matin, A., 2004, Mechanism of chromate reduction by the *Escherichia coli* protein, NfsA, and the role of different chromate reductases in minimizing oxidative stress during chromate reduction. *Environmental Microbiology*, 6 (8), 851-860.
3. Ackerley, D.F., Barak, Y., Lynch, S.V., Curtin, J. & Matin, A., 2006, Effect of chromate stress on *Escherichia coli* K-12. *Journal of Bacteriology*, 188, 3371–338
4. Amann, R.I., Ludwig, W., Schleifer, K.-H., 1995, Phylogenetic identification and in situ detection of individual microbial cells without cultivation. *Microbiology Reviews*, 59, 143– 169.
5. APHA, 2005, *Standard Methods for the Examination of Water and Wastewater*. 21st Edition (Centennial Edition). By Eaton, A.D., Clesceri, L.S., Rice, E.W., Greenberg, A.E., Franson, M.A.H., (Eds.). American Public Health Association, American Water Works Association, Water Environment Federation, USA.
6. Baker, M.J., Blowes, D.W., and Ptacek, C.J., 1997, Phosphorous adsorption and precipitation in a permeable reactive wall: applications for wastewater disposal systems. *Land Containment Reclamation*, 5, 189-193.
7. Baldi, F., Vaughan A.M., Olson, G.J., 1990, Chromium (VI)-resistant yeast isolated from a sewage treatment plant receiving tannery wastes. *Applied and Environmental Microbiology*, 56 (4), 913-918.
8. Baral, A., and Engelken, R.D., 2002, Chromium-based regulations and greening in metal finishing industries in the USA. *Environmental Science and Policy*, 5 (2), 121–133.

9. Beceiro-Gonzalez, E., Barciela-Garcia, J., Bermejo-Barrera, P., Bermejo-Barrera, A, Fresenius, J., 1992. *Journal of Analytical Chemistry*, 344, p. 301.
10. Benner, S.G., Blowes, D.W., and Ptacek, C.J., 1997, A full-scale porous reactive wall for prevention of acid mine drainage. *Groundwater Monitoring Retention*, 17 (4), 99-107
11. Beszedits, S. ,1988, "Chromium removal from industrial wastewaters," p. 232-263, in O. Nriagu and E. Nieboer (eds.), *Chromium in the Natural and Human Environments*, John Wiley, New York.
12. Blackall, L.L., Burrell, P.C., Bradford, H.D., Bond, P.L., and Hugenholtz, P., 1998, The use of 16S rDNA clone libraries to describe the microbial diversity of activated sludge communities. *Water Science and Technology*, 37 (4-5), 451-454.
13. Blowes, D.W. and Ptacek, C.J., 1992, Geochemical remediation of groundwater by permeable reactive walls: Removal of chromate by reaction with iron-bearing solids. In: *Proc. Subsurface Restoration Conference (3rd Int. Conference on groundwater Quality research*, Dallas, Texas, June 1992), 214- 216.
14. Blowes, D.W., Ptacek, C.J.S., Benner, G.C., Mcra, W.T., 1998, Treatment of dissolved metals using permeable reactive barriers, Remediation and Protection. *Proceedings of the GQ'98 Conference* held at 4g3, Tubingen, Germany, IAHS Publ. no. 250.
15. Blowes, D.W., Ptacek, C.J., Waybrant, K.R., Bain, J.D., and Robertson W.D., 1995, In situ treatment of mine drainage water using porous reactive walls. *Proceedings of Ontario Environment and Energy Conference - The new Economy*". Green needs and opportunities, Toronto, Ontario.
16. Borden, R.C., Goin, R.T., Kao, C.M., 1997, Control of BTEX migration using a biologically enhanced permeable barrier. *Ground Water Monitoring and Remediation*, 17, 70-80.
17. Brown, S.D., Thompson, M.R., Verberkmoes, N.C., Chourey, K., Shah, M., Zhou, J.Z., Hettich, R.L. and Thompson, D.K., 2006, Molecular dynamics of the *Shewanella oneidensis* response to chromate stress. *Molecular Cell Proteomics*, 5, 1054-1071.

18. Brock, T.D., and Madigan, M.T., 1991, *Biology of Microorganisms*. 6th Edition. Prentice Hall, New Jersey.
19. Bush, M.B., 2003, *Ecology of a Changing Planet*, 3rd Edition, Prentice Hall, New Jersey, USA.
20. Carsten, V., Albin, A., Helmut, L., Doreen, H., Lothar, W., and Wolfgang, B., 2004, Bioremediation of chlorobenzene-contaminated ground water in an in situ reactor mediated by hydrogen peroxide. *Journal of Contaminant Hydrology*, 68, 121–141.
21. Camargo F.A.O., Bento F.M., Okeke B.C. and Frankenberger W.T., 2003, Chromate Reduction by Chromium-Resistant Bacteria Isolated from Soils Contaminated with Dichromate. *Journal of Environmental Quality*, 32, 1228-1233.
22. Cervantes, C., Campos-Garcia, J., Devars, S., Gutierrez-Corona, F., Loza-Tavera, H., Torres-Guzman, J.C., Moreno-Sanchez, R., 2001, Interactions of chromium with microorganisms and plants. *FEMS Microbiology Review*, 25(3), 335-47.
23. Chirwa, E.M.N., and Wang, Y.T., 1997a, Hexavalent chromium reduction by *Bacillus sp.* in a packed-bed bioreactor. *Environmental Science and Technology*, 31 (5), 1446-1451.
24. Chirwa, E.M.N., 2001, Modelling Chromium (VI) Reduction in Pure and Coculture Biofilm Reactors. Doctoral Thesis, Department of Civil Engineering, University of Kentucky, Lexington, Kentucky, USA.
25. Chirwa, E.M.N., 2005, Uncoupling Cr(VI) reduction in a dual species bacterial culture system electron flow pathway analysis. *Chemical Engineering Transactions*, vol 7, AIDIC, Proc 8th Processing and Control Conference, 14-18 May 2005, Gardini di Naxos, Sicily, Italy.
26. Chirwa, E.M.N., and Wang, Y.T., 1997a, Hexavalent chromium reduction by *Bacillus sp.* in a packed-bed bioreactor. *Environmental Science and Technology*, 31 (5), 1446–1451.
27. Chirwa, E.M.N., and Wang, Y.T., 1997b, Chromium(VI) reduction by *Pseudomonas fluorescens* LB300 in fixed-film bioreactor. *Journal of*

- Environmental Engineering*, 123 (8), 760–766.
28. Chuan, M. and Liu, J., 1996, Release Behavior of Chromium from Tannery Sludge. *Water Research*, 30, 932.
 29. Cifuentes, F., Lindemann, W., Barton, L., 1996, Chromium Sorption and Reduction in Soil with Implications to Bioremediation. *Soil Science*, 161, 233.
 30. Coenye, T., Falsen, E., Vancanneyt, M., Hoste, B., Govan, J.R.W., Kersters, K., Vandamme, P., 1999, Classification of *Alcaligenes faecalis*-like isolates from the environment and human clinical samples as *Ralstonia gilardii* sp. nov. *International Journal of Systematic Bacteriology*, 49, 405–413.
 31. Cooke, V. M.; Hughes, M. N.; Poole, R. K., 1995, Reduction of chromate by bacteria isolated from the cooling water of electricity generating station. *Journal of Industrial Microbiology*, 14, 323–328.
 32. Cotton, F.A., and Wilkinson, G., 1980, *Advanced Inorganic Chemistry*, A Comprehensive Textt. John Wiley & Sons, New York.
 33. Dakiky, M., Khamis, M., Manassra, A., and Mer'eb, M., 2002, Selective adsorption of Cr(VI) in industrial waste water using low-cost abundantly available adsorbents, *Advances in Environmental Research*, 6, 533–540.
 34. De Flora, S., 2000, Threshold mechanisms and site specificity in chromium (VI) carcinogenesis. *Carcinogenesis*, 21, 533–541.
 35. De Flora, S., Bagnasco, M., Serra, D., and Znacchi, P., 1990, Genotoxicity of chromium compounds. A review. *Mutation Research*, 238, 99-172.
 36. Doherty, R., Phillips, D.H., McGeough, K.L., Walsh, K.P., and Kalin R.M., 2006, Development of modified flyash as a permeable reactive barrier medium for a former manufactured gas plant site, Northern Ireland. *Environmental Geology*, 50, 37–46.
 37. Donat, E., Oliver, C., Guruchet, G., 2003, Jan./Mar, Reduction of chromium (VI) by the indirect action of *Thiobacillus thioparus*. *Brazilian Journal of Chemical Engineering*, 20 (1), São Paulo, doi: 10.1590/S0104-66322003000100013.
 38. Dries Bastiaens, L., Vos, J., Simons, Q., De Smet, M., and Diels, L., 2004, Comparison of different multi-barrier concepts designed for treatment of

- groundwater containing mixed pollutants, in: A. Boshoff, B. Bone, eds., Permeable Reactive Barriers. *International Symposium on Permeable Reactive Barriers*, March 14, 2004, Queens University Belfast Northern Ireland, 298 (2005), 45-51.
39. DWAF, 2005, December 23, Pollution of chrome-6 in the Crocodile River between Brits and the Roodekopjies Dam. Press Release by the Department of Water Affairs and Forestry, Pretoria, South Africa.
 40. Eary, L.E., and Rai, D., 1988, Chromate removal from aqueous wastes by reduction with ferrous ion. *Environmental Science and Technology*, 22(8), 972-977.
 41. Ehrlich, H.L., 1996, *GeoMicrobiology*, 3rd ed.; Marcel Dekker: Inc.: New York, USA.
 42. EC-Official Journal of the European Communities, L330/32, 1998, December 12.
 43. Endo, G., Narita, M., Huang, C.-C., and Sliver, S., 2002, Microbial heavy metal resistance transposons and plasmids: potential use for environmental biotechnology. *Journal of Environmental Biotechnology*, 2 (2), 71-82.
 44. Ercolini, D., 2004, PCR-DGGE fingerprinting: novel strategies for detection of microbes in food. *Journal of Microbiological Methods*, 314 56 , 297–314.
 45. Ehrlich, H. L., 1996, *GeoMicrobiology*, 3rd ed.; Marcel Dekker: Inc.: New York.
 46. Evanko, C.R., and Dzombak, D.A., 1997, Remediation of Metals-Contaminated Soils and Groundwater Carnegie, Mellon University Department of Civil and Environmental Engineering Pittsburgh, PA.
 47. Faisal, M., and Hasnain, S., 2006, Detoxification of Cr(VI) by *Bacillus cereus*. *Research Journal of Microbiology*, 1 (1), 45-50.
 48. Federal Register, 2004, Occupational Safety and Health Administration. Occupational Exposure to Hexavalent Chromium. *69 Federal Register 59404*. October 4, 2004.
 49. Fendorf, S.; Wielinga, B. W.; Hansel, C. M., 2000, Chromium transformations in natural environments: the role of biological and abiological processes in

- chromium (VI) reduction. *International Journal of Geology Reviews*, 42, 691–701.
50. Ferris M.J., Muyzer G., Ward D.M., 1996, Denaturing gradient gel electrophoresis profiles of 16S rRNA-defined populations inhabiting a hot spring microbial community. *Applied and Environmental Microbiology*, 62, 340-346.
 51. Fisher, S.G., Lerman, L.S., 1983, DNA fragments differing by single base pair substitutions are separated in denaturing gradient gels: correspondence with melting theory. *Proceedings of the National Academy of Science, U.S.A*, 80, 1579-1583.
 52. Flemming, C.A., Ferris, F.G., Beveridge, T.J., and Bailey, G.W., 1990, Remobilization of toxic heavy-metals adsorbed to bacterial wall-clay composites. *Applied Environmental Microbiology*, 56, 3191–3203
 53. Flessel, C.P., 1979, *Trace Metals in Health and Disease*. Pp. 109-122, Raven Press, New York.
 54. Flores, A., Pérez, J.M., 1999, Cytotoxicity, apoptosis, and in vitro DNA damage induced by potassium chromate. *Toxicology and Applied Pharmacology*, 161, 75-81.
 55. Francis, C.A., Obraztsova, A.Y., and Tebo, B.M., 2000, Dissimilatory metal reduction by the facultative anaerobe *Pantoea agglomerans* SP1. *Applied and Environmental Microbiology*, 66, 543–548.
 56. Francisco, R., Alpoim, M.C., and Morais, P.V., 2002, Diversity of chromium-resistant and -reducing bacteria in a chromium-contaminated activated sludge. *Journal of Applied Microbiology*, 92, 837–843 .
 57. Fredrickso, J.K., Kostandarithes H. M., Li S.W., Plymale, A.E., Daly M.J., 2000, Reduction of Fe(III), Cr(VI), U(VI), and Tc(VII) by *Deinococcus radiodurans* R1. *Applied and Environmental Microbiology*, 66, 2006–2011.
 58. Garrels, R.M. and Christ, C.L., 1965, In *Solutions, Minerals and Equilibria*, pp. 403-435. Harper and Row Publishers, New York.

59. Ganguli, A. and Tripathi, A.K., 2002, Bioremediation of toxic chromium from electroplating effluent by chromate-reducing *Pseudomonas aeruginosa* A2 Chr in two bioreactors. *Applied Microbiology and Biotechnology*, 58, 416-420
60. Garbisu, C., Alkorta, I., Llama, M.J., and Serra, J.L., 1998, Aerobic chromate reduction by *Bacillus subtilis*. *Biodegradation*, 9, 133-141.
61. Gavaskar, A., Gupta, N., Sass, B., Janosy, R., and Hicks, J., 2000, Design Guidelines for Applications of Permeable Reactive Barriers for Groundwater Remediation, Battelle, Columbus, OH, Report No. AFRL-ML-WP-TR-2000-4546, NTIS: ADA380005, pp. 399.
62. Glaze, W.H., 1990, Chemical precipitation. In *Water Quality and Treatment*, ed. Pontius, F. W., pp. 747-779. McGraw-Hill, Inc., NY.
63. Hintze, C., 1930, In *Handbook of Mineralogy*, vol. 1 III/2, p. 4012-4030, Berlin, Leipzig, DeGryter, Germany.
64. Giovannoni S.J., Britschgi T.B., Moyer C.L., Field K.G., 1990, Genetic diversity in Sargasso Sea bacterioplankton. *Nature (London)* 345, 60– 63.
65. Golder Associates, 2006, Contamination Assessment at Envirochrome – *Brits*. Golder Associates Report to the Industrial Development Corporation. Sandton, South Africa.
66. Hao O.J., Huang, L Chen, J.M., and Buglass R.L., 1994, Effects of metal additions on sulfate reduction activity in wastewaters. *Toxicological and Environmental Chemistry*, 46(2), 197.
67. Head, I.M., Saunders, J.R., and Pickup, R.W., 1998, Microbial evolution, diversity, and ecology: a decade of ribosomal analysis of uncultivated microorganisms. *Microbial Ecology*, 35, 1– 21.
68. Heuer, H., Krsek, M., Baker, P., Smalla, K., and Wellington, E.M.H., 1997, Analysis of actinomycete communities by specific amplification of genes encoding 16S rRNA and gel electrophoretic separation in denaturing gradients. *Applied and Environmental Microbiology*, 63, 3233-3241.
69. Horitsu, H., Futo, S., Miyazawa, Y., Ogai, S., and Kawai, K., 1987, Enzymatic reduction of hexavalent chromium by hexavalent tolerant *Pseudomonas ambigua* G-1. *Agricultural and Biological Chemistry*, 51 (9), 2417-2420.

70. Hu, P., Brodie, E. L., Suzuki, Y., McAdams, H.H., and Andersen, G. L. ,2005,. Whole-genome transcriptional analysis of heavy metal stresses in *Caulobacter crescentus*. *Journal of Bacteriology*, 187, 8437–8449.
71. Imai, A., and Gloyna, E.F., 1990, Effects of pH and oxidation state of chromium on the behavior of chromium in the activated sludge process. *Water Research*, 24, 1143-1150.
72. Ishibashi, Y., Cervantes, C., and Silver, S., 1990, Chromium reduction in *Pseudomonas putida*. *Applied and Environmental Microbiology*, 56, 2268-2270.
73. International Agency for Research on Cancer and World Health Organization, 1990, Chromium, nickel and welding. Lyon: International Agency for Research on Cancer: distributed for the International Agency for Research on Cancer by the Secretariat of the World Health Organization; p. 677.
74. Jianlong, W., Xiangchun, Q., Libo, W., Yi, Q., and Hegemann, W., 2002 December 31, Bioaugmentation as a tool to enhance the removal of refractory compound in coke plant wastewater. *Process Biochemistry*, 38 (5), 777-781.
75. Kotas, Â.J., Stasicka, Z., 2000, Chromium occurrence in the environment and methods of its speciation. *Environmental Pollution*, 107 (2000), 263-283.
76. Kashefi, K., and Lovley, D.R., 2000, Reduction of Fe(III), Mn(IV), and toxic metals at 100 °C by *Pyrobaculum islandicum*. *Applied and Environmental Microbiology*, 66, 1050-1056.
77. Kieft, T.L., Fredrickson, J.K., Onstott, T.C., Gorby, Y.A., Kostandarithes, H.M., Bailey, T.J., Kennedy, D.W., Li, S. W., Plymale, A.E., Spadoni, C.M., and Gray, M.S., 1999, Dissimilatory reduction of Fe(III) and other electron acceptors by a *Thermus* isolate. *Applied and Environmental Microbiology*, 65, 1214-1221.
78. Kiilunen, M., 1994, Occupational exposure to chromium and nickel in Finland and its estimation by biological monitoring. Doctoral thesis, Kuopio University Publications C, Natural and Environmental Sciences, 17.
79. Krishna, K.R and Philip, L., 2005, Bioremediation of Cr(VI) in contaminated soils. *Journal of Hazardous Materials B*, 121, 109-117.

80. Langand, S., 1983, The carcinogenicity of chromium compounds in man and mammals. In D. Burrows (ed.), *Metabolism and Toxicity*, pp. 13-30. CRC Press, Inc., Boca Rotan, FL .
81. Llagostera, M., Gariddo, S., Guerrero, R., and Barbé, J.,1986,. Induction of SOS genes of *Escherichia coli* by chromium compounds. *Environmental Mutagenesis*, 8, 571-577.
82. Llovera, S., Bonet, R., Simon-Pujol, M. D., and Congregado, F., 1993, Chromate reduction by resting cells of *Agrobacterium radiobacter* EPS-916. *Applied and Environmental Microbiology*, 59, 3516-3518.
83. Lovley, D.R., Giovannoni, S.J., White, D.C., Champine, J.E., Phillips, E.J.P., Gorby, Y. A., and Goodwin, S., 1993, *Geobacter metal lireducens* gen. nov. sp. nov., a microorganism capable of coupling the complete oxidation of organic compounds to the reduction of iron and other metals. *Archives of Microbiology*, 159, 336-344.
84. Lovley, D.R., and Phillips, E.J., 1994, Reduction of chromate by *Desulfovibrio vulgaris* and its *c₃* cytochrome. *Applied and Environmental Microbiology*, 60, 726-728.
85. Lu, Y.L., and Yang, J.L., 1995, Long-term exposure to chromium (VI) oxide leads to defects in sulfate transport system in *Chinese hamster ovary* cells. *Journal of Cellular Biochemistry*, 57, 655-665.
86. Ludwig, W., Schleifer, K.H., 1994, Bacterial phylogeny based on 16S and 23S rRNA sequence analysis. *FEMS Microbiology Reviews*, 15, 155-173.
87. Mazierski, J., 1994, Effect of chromium (VI) on the growth of denitrifying bacteria. *Water Research*, 28(9), 1981-1985.
88. Mel Lytle, C., Lytle, F., Yang, N., Qian, J.-H., Hansen, D., Zayed, A., and Terry, N., 1998, Reduction of Cr(VI) to Cr(III) by Wetland Plants: Potential for in situ Heavy Metal Detoxification. *Environmental Science and Technology*, 32, 3087.
89. Merian, E., 1984, Introduction on environmental chemistry and global cycles of arsenic, beryllium, cadmium, chromium, cobalt, nickel, selenium, and their derivatives. *Toxicological and Environmental Chemistry*, 8, 9-38.

90. McLean, R.J.C., Beauchemin, D., Clapham, L. and Beveridge, T.J., 1990, Metal-binding characteristics of the gamma-glutamyl capsular polymer of *Bacillus licheniformis* ATCC 9945. *Applied and Environmental Microbiology*, 56, 3671-3677
91. McRae C.W., Blowes, D.W. and Ptacek, C.J., 1997, Laboratory-scale investigation of remediation of As and Se using iron oxides. *Proc. Sixth Symposium and Exhibition on Groundwater and Soil Remediation*, March 18-21, Montreal, Quebec, 167-168.
92. McMurty, D., and Elton, R.O., 1985, New approach to *in situ* treatment of contaminated groundwaters. *Environmental Progress*, 4, 168-170.
93. Miranda, A.T., Gonzalez, M.V., Gonzalez, G., Vargas, E., Campos-Garcia, J. and Cervantes, C., 2005, Involvement of DNA helicases in chromate resistance by *Pseudomonas aeruginosa* PAO1. *Mutation Research*, 578, 202-209.
94. Mohan, D. and Pittman, C.U., Jr., 2006, Activated carbons and low cost adsorbents for remediation of tri- and hexavalent chromium from water. *Journal of Hazardous Materials*, B137, 762-811.
95. Morel, F.M.M, and Hering, J.G., 1993. *Principles and Applications of Aquatic Chemistry*. John Wiley & Sons, Inc., New York, NY, USA.
96. Morrison, S.J, Metzler, D.R, and Carpenter, C.E, 2001, Uranium Precipitation in a Permeable Reactive Barrier by Progressive Irreversible Dissolution of Zerovalent Iron. *Environmental Science and Technology*, 35 (2), 385-390.
97. Myers, C.R.; Carstens, B.P.; Antholine, W. E.; and Myers, J. M., 2000, Chromium(VI) reductase activity is associated with the cytoplasmic membrane of anaerobically grown *Shewanella putrefaciens* MR-1. *Journal of Applied Microbiology*, 88, 98-106.
98. Mertz W., 1981, The essential trace elements. *Science*, 213, 1332–1338.
99. Metfies K. and Medlin L., 2005, Ribosomal RNA Probes and Microarrays: Their Potential Use in Assessing Microbial Biodiversity. *Methods in Enzymology*, 395, 258-278.
100. Molokwane, P.E., and Chirwa, E.M.N., 2008, Bioremediation of a Cr(VI) contaminated site: a conceptual and feasibility study for a site in Brits. *Proc.*

- 11th Conference on Process Integration, Modelling and Optimisation for Energy Saving and Pollution Reduction, 2008 PRES, 24-28 August 2008, Prague, Czech Republic.
101. Molokwane, P.E., Meli, C.K. and Chirwa, E.M.N., 2008, Chromium (VI) reduction in activated sludge bacteria exposed to high chromium loading. *Water Science and Technology*, 58 (2), 399-405.
 102. Molokwane, P.E., Meli, K.C., and Nkhalambayausi-Chirwa, E.M., 2008, Chromium (VI) reduction in activated sludge bacteria exposed to high chromium loading: Brits culture (South Africa). *Water Research*, 42 (17), 4538-4548.
 103. Molokwane, P.E., and Chirwa, E.M.N., 2009, Microbial culture dynamics and chromium (VI) removal in packed-column microcosm reactors. *Water Science and Technology*, 60 (2), 381-388.
 104. Morel, F. M. M., and Hering, J. G., 1993, In *Principles and Applications of Aquatic Chemistry*, chap. 6, Wiley & Sons, Inc., New York.
 105. Mukhopadhyay, B., Sundquist, J., and Schmidt, J.R., 2007, Removal of Cr(VI) from Cr-contaminated groundwater through electrochemical addition of Fe(II). *Journal of Environmental Management*, 82 (1), 66-76.
 106. Muyzer, G., de Waal, E.C., Uitterlinden, A.G., 1993, Profiling of complex microbial populations by denaturing gradient gel electrophoresis analysis of polymerase chain reaction-amplified genes coding for 16S rRNA. *Applied and Environmental Microbiology*, 59:695-700.
 107. Muyzer, G., Smalla, K., 1995, Application of denaturing gradient gel electrophoresis (DGGE) and temperature gradient gel electrophoresis (TGGE) in microbial ecology. *Antonie van Leeuwenhoek*, 73, 127-141, 1998.
 108. Namasivayam, C. and Yamuna, R.T., 1995, Adsorption of chromium (VI) by a low-cost adsorbent: biogas residual slurry, *Chemospher*, 30, 561-578.
 109. NAS, (National Academy of Science), 1974, In Chromium, National Research Council, Committee on Biological Effects of Atmospheric Pollutants. National Academy of Sciences, Washington, DC. page 155.

110. Nelson, Y. M., Lion, L. W., Shuler, M. L., and Ghiorse, W. C., 1996, "Modeling oligotrophic biofilm formation and lead adsorption to biofilm components." *Environmental Science and Technology*, 30, (6), 2027-2035.
111. Nieboer, E., Jusys, A.A., 1988, Biologic chemistry of chromium in the Natural and Human Environments. Nriagu, F.O. Nieboer, E., Eds., John Wiley, New York, 21.
112. Nkhalambayausi-Chirwa, E.M., Wang, Y.T., 2001, Simultaneous chromium(VI) reduction and phenol degradation in a fixed-film coculture bioreactor: reactor performance. *Water Research*, 35(8), 1921-1932.
113. Nriagu, J. O.; Nieboer, E., Eds. 1998, *Chromium in the Natural and Human Environments*; John Wiley and Sons: New York, .
114. Nriagu, J.O., Robins, T., Gary, L., Liggans, G., Davila, R., Supuwood, K., Harvey, C., Jinabhai, C.C., and Naidoo, R., 1999, Prevalence of asthma and respiratory symptoms in south-central Durban, South Africa, *European Journal of Epidemiology*, 15: 747-755.
115. Nies, D.H., 1995, Microbial heavy-metal resistance. *Applied Microbiology and Biotechnology*, 51, 730–750.
116. Øvreås, L., Forney, L., Daae, F.L., and Torsvik, V., 1997, Distribution of bacterioplankton in meromictic Lake Saelenvannet, as determined by denaturing gradient gel electrophoresis of PCR-amplified gene fragments coding for 16S rRNA. *Applied Environmental Microbiology*, 63, 3367-3373.
117. Ohtake, H., Fujii, E., and Toda, K., 1990, Reduction of toxic Cr(VI) in an industrial effluent by use of a Cr(VI)-reducing strain *Enterobacter cloacae* HO1. *Environmental Technology Letters*, 11, 663-668.
118. Pal, A., Sumana Dutta, S., and Paul, A.K., 2005, Reduction of hexavalent chromium by cell-free extract of *Bacillus sphaericus* AND 303 Isolated from serpentine soil. *Current Microbiology*, 51 (5), 327-330.
119. Papp, J.F., 2006, Chromium. U.S. Geological Survey Minerals Year Book. <http://minerals.usgs.gov/minerals/pubs/commodity/chromium/myb1-2006-chrom.xls> 2006/10/14.

120. Park, C. H., Keyhan, M., Wielinga, B., Fendorf, S., Matin, 2000, Purification to homogeneity and characterization of a novel *Pseudomonas putida* chromate reductase. *Applied Environmental Microbiology*, 66, 1788-1795.
121. Patterson, R.R., Fendorf, S., and Fendorf, M., 1997, Reduction of hexavalent chromium by amorphous iron sulphide. *Environmental Science and Technology*, 3 (7), 2039-2044.
122. Reichert P, 1998, Swiss Federal Institute for Environmental Science and Technology (EAWAG), Switzerland, ISBN: 3-906484-16-5.
123. Petrilli, F.L., and De Flora, S., 1977, Toxicity and mutagenicity of hexavalent chromium compounds in *Salmonella typhimurium*. *Applied Environmental Microbiology*, 33, 805-809.
124. Phillips, D.H., 2009, Permeable reactive barriers: A sustainable technology for cleaning contaminated groundwater in developing countries. *Desalination*, 248, 352-359.
125. Powell, R.M., Puls, R.W., Hightower, S.K., and Sabatini, D.A., 1995, Coupled iron corrosion and chromate reduction: Mechanisms for subsurface remediation. *Environmental Science and Technology*, 29, 1913.
126. Prat, AR, Blowes, D., W, and Ptacek, C.J., 1997, Products of chromate reduction on proposed remediations material. *Environmental Science and Technology*, 31, 2492-2498.
127. Quintana, M., Curutchet, G., and Donati, E., 2001, Factors Affecting the Chromium(VI) Reduction by *Thiobacillus ferrooxidans*. *Biochemical Engineering Journal*, 9, 11.
128. Rajwade, J. M., Paknikar, K. M., 1997, Microbiological Detoxification of Chromate from Chrome-plating Effluents. *In Proceedings of International Biohydrometallurgy Symposium*. Sydney, Australia, pp. 221.
129. Rasmussen, G., Fremmersvik, G., Olsen, R.A., 2002, Treatment of creosote-contaminated groundwater in a peat/sand permeable barrier—a column study. *Journal of Hazardous Materials*, B 93, 285-306.

130. Rege, M. A., Petersen, J. N., Johnstone, D. L., Turick, C. E., Yonge, D. R., Apel, W. A., 1997, Bacterial Reduction of Hexavalent Chromium by *Enterobacter cloacae* Strain HO1 Grown on Sucrose. *Biotechnology Letters*, 19, 691.
131. Ramirez-Diaz, M.I., Diaz-Perez, C., Vargas, E., Riveros-Rosas, H., Campos-Garcia, J., and Cervantes, C., 2008, Mechanisms of bacterial resistance to chromium compounds. *Biometals*, 21, 321-332.
132. Ramírez-Ramírez, R., Calvo-Méndez, C., Ávila-Rodríguez, M., Lappe, P., Ulloa, M., Vázquez-Juárez, R., Gutiérrez-Corona, J.F., 2004, Cr(VI) reduction in a chromate-resistant strain of *Candida maltosa* isolated from the leather industry. *Journal Antonie van Leeuwenhoek*, 85 (1), 63-68
133. Reichert, P., Swiss Federal Institute for Environmental Science and Technology (EAWAG) CH Dubendorf, Switzerland, September 1998, ISBN 3906484-16-5
134. Reid, V.M., Wyatt, K.W., and Horn, J.A., 1994, A new angle on groundwater remediation. *Civil Engineering*, 64 (4), 56-58.
135. Richard, F.C., and Bourg, A.C. M., 1991, Aqueous geochemistry of chromium: A review, *Water Research*, 25(7): 807-816.
136. Robertson, R.D. & Cherry, J.A., 1995, *In situ* denitrification of septic system nitrate using reactive porous medium barriers: field trials. *Ground Water*, 33, 99-111.
137. Robertson, F.N., 1975, Hexavalent chromium in the ground water in Paradise Valley, Arizona, *Ground Water*, 13(6): 516-527.
138. Romanenko, V.I., and Koren'kov, V.N., 1977, A pure culture of bacteria utilizing chromate and dichromate as hydrogen acceptors in growth under anaerobic conditions. *Mikrobiologiya*, 46, 414-417.
139. Rosko, J.J., Rachlin, J.W., 1977, Effect of cadmium, copper, mercury, zinc and lead on cell- division, growth, and chlorophyll-a content of *chlorophyte Chlorella vulgaris*. *Bulletin of the Torrey Botanical Club*, 104, 226-233.
140. Salunkhe, P.B., Dhakephalkar, P.K., and Paknikar, K. M., 1998, Bioremediation of hexavalent chromium in soil microcosms. *Biotechnology Letters*, 20, 749.
141. Sani, R. K.; Peyton, B. M.; Smith, W. A.; Apel, W. A.; Petersen, J. N., 2002, Dissimilatory reduction of Cr(VI), Fe(III), and U(VI) by *Cellulomonas* isolates.

- Applied Microbiology and Biotechnology*, 60, 192-199.
142. Stearns, D.M., Kennedy, L.J., Courtney, K.D., Giangrande, P.H., Phieffer, L.S., and Wetterhahn, K.E., 1995, Reduction of chromium (VI) by ascorbate leads to chromium-DNA binding and DNA strandbreaks *in vitro*. *Biochemistry*, 34, 910-919
 143. Shen, H., Pritchard, P.H., and Sewell, G.W., 1996. Kinetics of chromate reduction during naphthalene degradation in a mixed culture. *Biotechnology and Bioengineering*, 52 (3), 357-363.
 144. Shen H., and Wang, Y.T., 1993, Characterization of enzymatic reduction of hexavalent chromium by *Escherichia coli* ATCC 33456. *Applied Environmental Microbiology*, 59 (11), 3771-3777.
 145. Shen, H., and Wang Y T., 1994a, Modeling hexavalent chromium reduction in *Escherichia coli* ATCC 33456. *Biotechnology and Bioengineering*, 43 (4), 293-300.
 146. Shen, H., and Wang, Y.T., 1994b, Biological reduction of chromium by *E. coli*. *Journal of Environmental Engineering*, 120, 60-572.
 147. Shen H. and Wang Y.T., 1995, Simultaneous Chromium Reduction and Phenol Degradation in a Coculture of *Escherichia coli* ATCC 33456 and *Pseudomonas putida* DMP-1. *Applied Environmental Microbiology*, 61 (7), 2754–2758.
 148. Shi, X.L., and Dalal, N.S., 1990, Evidence for a Fenton-type mechanism for the generation of $\cdot\text{OH}$ radicals in the reduction of Cr(VI) in cellular media. *Archives of Biochemistry and Biophysics*, 281, 90-95.
 149. Silverberg, B.A., Wong, P.T.S., and Chau, Y.K., 1977, Effect of tetramethyl lead on freshwater green-algae. *Archives of Environmental Contamination and Toxicology*, 5, 305-313.
 150. Stern, R.M., 1982, Chromium compounds: production and occupational exposure,” p. 5-47. In S. Langard (ed.), *Biological and Environmental Aspects of Chromium*, Elsevier Publishers, Amsterdam, New York, Oxford.
 151. Snyder, S.L., Walker, R.I., MacVittie, T.J., and Sheil, J.M., 1978, Biologic properties of bacterial lipopolysaccharides treated with chromium chloride. *Canadian Journal of Microbiology*, 24, 495–501.

152. Suzuki, T., Miyata, N., Horitsu, H., Kawai, K., Takamizawa, K., Tai, Y., and Okazaki, M., 1992, NAD(P)H-dependent chromium (VI) reductase of *Pseudomonas ambigua* G-1: a Cr(V) intermediate is formed during the reduction of Cr(VI) to Cr(III). *Journal of Bacteriology*, 174(16), 5340-5345.
153. Tebo, B.M., Obraztsova, A., Y., 1998, Sulfate-reducing bacterium grows with Cr(VI), U(VI), Mn(IV), and Fe(III) as electron acceptors. *FEMS Microbiology Letters*, 162, 193-198.
154. Teske, A., Wawer, C., Muyzer, G., Ramsing, N.B., 1996, Distribution of sulfate-reducing bacteria in a stratified fjord (Mariager Fjord, Denmark) as evaluated by most-probable-number counts and denaturing gradient gel electrophoresis of PCR-amplified ribosomal DNA fragments. *Applied Environmental Microbiology*, 62, 1405-1415.
155. Thompson, M.R., Verberkmoes, N.C., Chourey, K., Shah, M., Thompson, D.K., and Hettich, R.L., 2007, Dosage-dependent proteome response of *Shewanella oneidensis* MR-1 to acute chromate challenge. *Journal of Proteome Research*, 6, 1745-1757.
156. Top, E.M., Springael, D., and Boon, N., 2006, Catabolic mobile genetic elements and their potential use in bioaugmentation of polluted soils and waters. *Microbiology Ecology*, 42 (2), 199-208.
157. U.S.EPA, 1978, Reviews of the environmental effects of pollutants - III. Chromium, EPA 600/1-78-023, Washington, District of Columbia.
158. U.S. EPA, 1997, Permeable Reactive Subsurface Barriers for the Interception and Remediation of Chlorinated Hydrocarbon and Chromium (VI) Plumes in Ground Water, EPA/600/F-97/008, Ada, OK.
159. U.S. EPA, 2001, Chromite ore from the Transvaal Region of South Africa; toxic chemical release reporting; community right-to-know, 40 CFR Part 372.
160. Vidic, R.D. and Pohland, F.G., 1996, "Treatment Walls," Technology Evaluation Report TE-96-01, Ground-Water Remediation Technologies Analysis Center, Pittsburgh, PA.
161. Viti, C., Pace, A., and Giovannetti, L., 2003, Characterization of Cr(VI)-resistant bacteria isolated from chromium-contaminated soil by tannery activity. *Current*

- Microbiology*, 46, 1-5.
162. Viti, C., and Giovannetti, L., 2007, Bioremediation of soils polluted with hexavalent chromium using bacteria – the challenge. In *Environmental Bioremediation Technologies*, pp. 57-76. Edited by S. N. Singh & R. D. Tripathi. Berlin: Springer.
 163. Wang, P., T. Mori, K. Toda, and H. Ohtake.,1990, Membrane associated chromate reductase activity from *Enterobacter cloacae*. *Journal of Bacteriology*, 172, 1670-1672.
 164. Ward, D.M., Weller, R., and Bateson, M.M., 1990, 16S rRNA sequences reveal numerous uncultured microorganisms in a natural community. *Nature*, 345, 63–65.
 165. Wang, M., Chen, J.K., and Li, B., 2007, Characterization of bacterial community structure and diversity in rhizosphere soils of three plants in rapidly changing salt marshes using 16S rDNA. *Pedosphere*, 17 (5), 545-556.
 166. Wang, Y.T., and Shen, H., 1995, Bacterial reduction of hexavalent chromium. *Journal of Industrial Microbiology*. 14, 159-163.
 167. Wang, Y.T., and Shen, H., 1997, Modelling Cr(VI) reduction by pure bacterial cultures. *Water Research*, 41 (4), 727-732.
 168. Wang, Y.-T., Chirwa E.N., and Shen H., 2000, Cr(VI) reduction in a continuous-flow coculture reactor. *Journal of Environmental Engineering*. 126, (4), 300-306.
 169. Wang, Y.-T., Chirwa, E.N., and Shen H., 2000, Cr(VI) reduction in a continuous-flow coculture reactor. *Journal of Environmental Engineering*. 126, (4), 300-306.
 170. Wetterhahn, K.E., Hamilton, J.W., Aiyar, J., Borges, K.M., and Floyd, R., 1989, Mechanism of chromium(VI) carcinogenesis. Reactive intermediates and effect on gene expression. *Biological Trace Element Research*, 21, 405-411.
 171. Wilkin, R.T., Puls, R.W., and Sewell, G.W., 2003, Long-term performance of permeable reactive barriers using zero-valent iron: geochemical and microbiological effects. *Ground Water*, 41 (4), 493–503.

172. Williams, J.W., and S. Silver., 1984, Bacterial resistance and detoxification of heavy metals. *Enzyme Microbial Technology*, 6, 530-537.
173. Wybrant, R.D., and Cherry, J.A., 1995, *In situ* denitrification of septic system nitrate using reactive porous medium barriers: field trials. *Ground Water*, 33, 99-111.
174. Xing, L. and Okrent., D., 1993, Future risk from a hypothesized RCRA site disposing of carcinogenic metals should a loss of societal memory loss occur. *Journal of Hazardous Materials*, 38, 363-384.
175. Zayed, A.M., and Terry N., 2003, Chromium in the environment: factors affecting biological remediation, *Plant Soil*, 259, 139-156.
176. Zhao, M. and Duncan, J.R., 1997, Batch removal of hexavalent chromium by *Azolla filiculoides*. *Biotechnology and Applied Biochemistry*, 26,179-182.
177. Zakaria, Z.A., Zakaria, Z., Surif, S., and Ahmad, W.A., 2007, Biological detoxification of Cr(VI) using wood-husk immobilized *Acinetobacter haemolyticus*. *Journal of Hazardous Materials*, 148 (1-2), 164-171.



APPENDIX A

AQUASIM 2.0

Variables

A:	Description:	Cross-sectional area
	Type:	Constant Variable
	Unit:	m ²
	Value:	0.00046495435
	Standard Deviation:	1
	Minimum:	0
	Maximum:	1000
	Sensitivity Analysis:	active
	Parameter Estimation:	inactive

a:	Description:	
	Type:	Constant Variable
	Unit:	
	Value:	-66
	Standard Deviation:	1
	Minimum:	-100
	Maximum:	10000
	Sensitivity Analysis:	active
	Parameter Estimation:	inactive

alpha:	Description:	
	Type:	Formula Variable
	Unit:	
	Expression:	0.5

b:	Description:	
	Type:	Constant Variable
	Unit:	days
	Value:	3.030879
	Standard Deviation:	1
	Minimum:	0
	Maximum:	1000
	Sensitivity Analysis:	active
	Parameter Estimation:	inactive

C:	Description:	Dissolved concentration
	Type:	Dyn. Volume State Var.
	Unit:	mg/m ³
	Relative Accuracy:	1e-006
	Absolute Accuracy:	1e-006

C5:	Description:	
	Type:	Constant Variable



Unit: mg/L
Value: 4.02255
Standard Deviation: 1
Minimum: 0
Maximum: 55
Sensitivity Analysis: active
Parameter Estimation: inactive

calcnm: Description:
Type: Program Variable
Unit:
Reference to: Calculation Number

Cmeas: Description:
Type: Real List Variable
Unit: mg/L
Argument: t
Standard Deviations: global
Rel. Stand. Deviat.: 0
Abs. Stand. Deviat.: 1
Minimum: 0
Maximum: 1e+009
Interpolation Method: linear interpolation
Sensitivity Analysis: inactive
Real Data Pairs (65 pairs):
0 0
0.0938 36.6697
0.8438 34.4415
1.0208 35.0144
1.1146 35.651
38.0063 5.2203
39.9646 4.3927
42.1417 5.1567
43.1 3.2468
45.1 3.1195

Co: Description: Initial added added chromium
Type: Formula Variable
Unit:
Expression: 50

C_crit: Description:
Type: Formula Variable
Unit: mg/m³
Expression: 0.01

C_in: Description:
Type: Formula Variable
Unit: mg/L
Expression: 50



C_in_meas: Description:

Type: Real List Variable
 Unit: mg/L
 Argument: t
 Standard Deviations: global
 Rel. Stand. Deviat.: 0
 Abs. Stand. Deviat.: 1
 Minimum: 0
 Maximum: 1e+009
 Interpolation Method: linear interpolation
 Sensitivity Analysis: inactive

Real Data Pairs (65 pairs):

0	47.937929
0.09375	47.937929
0.84375	47.746941
1.0208333	48.383567
1.1145833	45.837064
38.00625	50.102457
39.964583	45.773401
42.141667	50.038794
43.1	48.95653
45.1	48.383567

D: Description: Dispersion coefficient
 Type: Constant Variable
 Unit: m²/h
 Value: 4.0990701
 Standard Deviation: 1
 Minimum: 0
 Maximum: 10
 Sensitivity Analysis: active
 Parameter Estimation: inactive

K: Description:
 Type: Formula Variable
 Unit: mg/m³
 Expression: 0.5

k: Description: Relaxation rate constant for sorption of B
 Type: Formula Variable
 Unit: 1/h
 Expression: 10000

Kc: Description: half velocity
 Type: Constant Variable
 Unit:
 Value: 2.452503
 Standard Deviation: 1
 Minimum: 0.0005



Maximum: 1e+009
Sensitivity Analysis: inactive
Parameter Estimation: inactive

Kd: Description: cell death coefficient
Type: Constant Variable
Unit: m³/kg
Value: 0.00058
Standard Deviation: 1
Minimum: 0
Maximum: 10000
Sensitivity Analysis: active
Parameter Estimation: inactive

KF: Description:
Type: Formula Variable
Unit:
Expression: 0.00025

kmc: Description: Maximum specific Cr(VI) reduction rate coefficient
Type: Constant Variable
Unit:
Value: 1.53
Standard Deviation: 1
Minimum: 0
Maximum: 100000
Sensitivity Analysis: active
Parameter Estimation: active

Qin: Description:
Type: Formula Variable
Unit: m³/h
Expression: 0.001

Rc: Description: Inactivation capacity
Type: Constant Variable
Unit: mg/mg
Value: 0.533764
Standard Deviation: 1
Minimum: 0
Maximum: 100
Sensitivity Analysis: active
Parameter Estimation: inactive

rho_s: Description: Density of solid material
Type: Formula Variable
Unit: kg/m³
Expression: 2300



S:	Description:	Adsorbed concentration
	Type:	Dyn. Surface State Var.
	Unit:	mg/kg
	Relative Accuracy:	1e-006
	Absolute Accuracy:	1e-009

Smax:	Description:	
	Type:	Formula Variable
	Unit:	mg/kg
	Expression:	0.00029

S_eq:	Description:	Isotherm
	Type:	Variable List Variable
	Unit:	mg/kg
	Argument:	calcnium
	Interpolation Method:	linear interpolation
	Real-Variable Data Pairs (1 pairs):	
	0	S_eq_0

S_eq_0:	Description:	Isotherm for no sorption
	Type:	Formula Variable
	Unit:	mg/kg
	Expression:	Kd*C

S_eq_Freundlich:	Description:	Freundlich isotherm
	Type:	Formula Variable
	Unit:	mg/kg
	Expression:	if C>C_crit then KF*C^alpha else K F*C_crit^alpha*C/C_crit endif

S_eq_Langmuir:	Description:	Langmuir isotherm
	Type:	Formula Variable
	Unit:	mg/kg
	Expression:	Smax*C/(K+C)

S_eq_lin:	Description:	Linear isotherm
	Type:	Formula Variable
	Unit:	mg/kg
	Expression:	Kd*C

t:	Description:	Time
	Type:	Program Variable
	Unit:	d
	Reference to:	Time

theta:	Description:	Porosity
	Type:	Formula Variable
	Unit:	



	Expression:	0.4

to:	Description:	initial time
	Type:	Constant Variable
	Unit:	days
	Value:	20.356
	Standard Deviation:	1
	Minimum:	0
	Maximum:	1000
	Sensitivity Analysis:	active
	Parameter Estimation:	inactive

X:	Description:	Biomass
	Type:	Formula Variable
	Unit:	mg/L
	Expression:	$X_0 + a / (1 + (t/t_0)^b)$

Xo:	Description:	Concentration of viable cells at time t
	Type:	Constant Variable
	Unit:	mg/L
	Value:	70.456994
	Standard Deviation:	1
	Minimum:	0
	Maximum:	100000
	Sensitivity Analysis:	inactive
	Parameter Estimation:	inactive

Processes

Reduction:	Description:	Chromium(VI) Reduction
	Type:	Dynamic Process
	Rate:	$(K^{-1} * (C_0 - C_5) / C_0) * k_{mc} * C * (X) / (K_c + C)$
	Stoichiometry:	
	Variable :	Stoichiometric Coefficient
	C :	-1

Sorption:	Description:	
	Type:	Dynamic Process
	Rate:	$k * (S_{eq} - S)$
	Stoichiometry:	
	Variable :	Stoichiometric Coefficient
	C :	$-rho_s * (1 - theta) / theta$
	S :	1

Compartments

column:	Description:	
	Type:	Soil Column Compartment



Compartment Index:	0
Active Variables:	C, S
Active Processes:	Sorption, Reduction
Initial Conditions:	
Variable(Zone) :	Initial Condition
C(Advective Zone) :	0
Inflow:	Q _{in}
Loadings:	
Variable :	Loading
C :	Q _{in} *C _{in}
Lateral Inflow:	0
Start Coordinate:	0
End Coordinate:	1
Cross Section:	A
Adv. Vol. Fract.:	theta
Dispersion:	D
Parallel Zones:	
Num. of Grid Pts:	52 (high resolution)
Accuracies:	
Rel. Acc. Q:	0.0001
Abs. Acc. Q:	1e-006
Rel. Acc. D:	1e-006
Abs. Acc. D:	1e-006

Definitions of Calculations

calc_0:	Description:	
	Calculation Number:	0
	Initial Time:	0
	Initial State:	given, made consistent
	Step Size:	0.02
	Num. Steps:	2300
	Status:	active for simulation inactive for sensitivity analysis

Definitions of Parameter Estimation Calculations

fit1:	Description:	
	Calculation Number:	0
	Initial Time:	0
	Initial State:	given, made consistent
	Status:	active
	Fit Targets:	
	Data :	Variable
		(Compartment,Zone,Time/Space)
	C _{meas} :	C (column,Advective Zone,0)

Plot Definitions



plot: Description:
 Abscissa: Time
 Title: Break through curves
 Abscissa Label: t [d]
 Ordinate Label: C [mg/L]
 Curves:
 Type : Variable
 [CalcNum,Comp.,Zone,Time/Space]
 Value : C [0,column,Advection Zone,1]
 Value : Cmeas [0,column,Advection Zone,0]
 Value : C_in_meas [0,column,Advection Zone,0]

 X: Description:
 Abscissa: Time
 Title: Biomass
 Abscissa Label:
 Ordinate Label:
 Curves:
 Type : Variable
 [CalcNum,Comp.,Zone,Time/Space]
 Value : X [0,column,Advection Zone,0]

Calculation Parameters

Numerical Parameters: Maximum Int. Step Size: 1
 Maximum Integrat. Order: 5
 Number of Codiagonals: 8
 Maximum Number of Steps: 1000

 Fit Method: simplex
 Max. Number of Iterat.: 100

Calculated States

Calc. Num.	Num. States	Comments
0	2301	Range of Times: 0 - 46

APPENDIX B

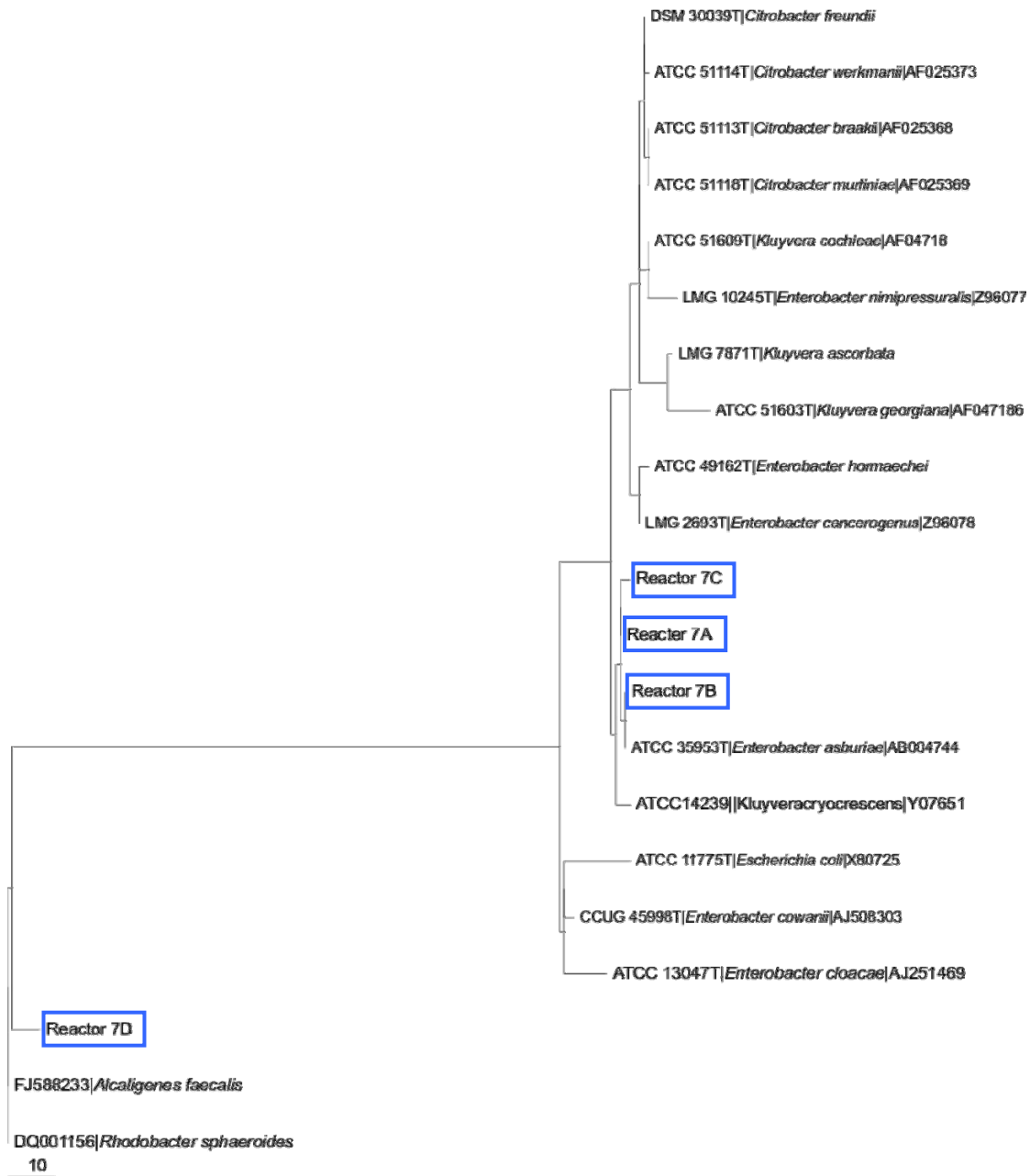

Figure B-1: Phylogenetic analysis of Gram-negative species of bacteria in the HR7 reactors at day 45. Possible Cr(VI) reducers were detected including Enterobacteriaceae, *Escherichia coli*, and *Citrobacter spp.* Bacteria originating from soil was detected including *Rhodobacter spp.* and *Alcaligenes spp.*



TARGET SITE AT THE DEFUNCT CHROME REFINERY, BRITS, NORTHWEST PROVINCE

