

Tribological evaluation of joint fluid and the development of a synthetic lubricant for use in hip joint simulators.

by

Tertius Opperman

Submitted in fulfilment of part of the requirements for the degree of Master's in Engineering (Mechanical Engineering) in the Faculty of Engineering, Building Environment and Information Technology,
University of Pretoria,
Pretoria

09 November 2004

Table of Contents

TABLE OF CONTENTS	I
LIST OF FIGURES	IV
LIST OF TABLES.....	IX
ABSTRACT	X
SAMEVATTING.....	XII
GLOSSARY.....	XIV
CHAPTER I - INTRODUCTION.....	1
CHAPTER II – SURVEY OF LITERATURE	4
2.1 Synovial fluid.....	4
2.2 Chemical composition of synovial fluid.....	6
2.2.1 Hyaluronic Acid.....	6
2.2.2 Lubricating Glycoproteins	8
2.2.3 Hyaluronic acid, glycoproteins and lubricity.....	10
2.3 Viscous behaviour of synovial fluid	13
CHAPTER III – LUBRICITY TESTING	17
3.1 Apparatus used.....	17
3.2 Test Method	18
3.3 Test Outcome	20
3.4 Lubricity properties of Primary Patients.....	22
3.4.1 Discussion.....	24
3.5 Lubricity properties of Revision Patients	26
3.5.1 Discussion.....	28
3.6. Combining the lubricity properties	29
3.6.1 Discussion.....	30

CHAPTER IV – VISCOSITY TESTING.....	32
4.1 Apparatus used.....	33
4.2 Test Method	35
4.3 Test Outcome	36
4.4 Test Results	37
4.5. Discussion.....	43
CHAPTER V – DEVELOPING A SYNTHETIC LUBRICANT	47
5.1 Design parameters.....	47
5.2 Chemicals used	48
5.2.1 Poloxamer 188	49
5.2.2 Xanthan Gum	51
5.2.3 Lube-booster [®] II	52
5.3 Combining the chemicals.....	53
CHAPTER VI – SIMULATOR VERIFICATION.....	57
6.1 Method	57
6.2 Apparatus used.....	57
6.3 Test method.....	61
6.3.1 Simulator testing	61
6.3.2 Bovine Serum.....	62
6.3.3 Isolating the wear debris from the patients’ scar tissue	62
6.3.4 Examining the filter paper	63
6.4 Test Observations.....	63
6.4.1 Femoral-head breakage in simulator.....	63
6.4.2 Using Saline as a test medium	65
6.4.3 Bovine serum station after 500 000 cycles	66
6.4.4 Findings during the 500 000 cycle intervals	68
6.4.5 Stripping the bovine serum stations after 4 500 000 cycles.....	70
6.4.6 Stripping the synthetic lubricant stations.....	71
6.5 Test results	72
6.6 Discussion	75

CHAPTER VII – CONCLUSION	77
CHAPTER VIII – REFERENCES.....	79
APPENDIX A – BILATERAL PATIENT	82
APPENDIX B – POLOXAMER 188.....	83
APPENDIX C – LUBE-BOOSTER II	90

List of Figures

Figure 1.1 – A summary of the reasons as to why patients receive more than one hip replacement as published in the Swedish (Malchau <i>et al.</i> 2002, p.4) and Australian (Graves <i>et al.</i> 2002, p.18) Hip Registers.....	1
Figure 2.1 – A schematic drawing of the human hip joint as presented by Rowett (1973, p.30).....	4
Figure 2.2 – A schematic presentation of areolar tissue by Rowett (1973, p.32).....	5
Figure 2.3 – The structure of hyaluronic acid (Laurent and Fraser 1992).....	7
Figure 2.4 – Results published by O’Kelley <i>et al.</i> (1978, p.77) using synovial fluid, retrieved from a patient with rheumatoid arthritis, in a pendulum test apparatus	11
Figure 2.5 – Results published by O’Kelley <i>et al.</i> (1978, p.77) using bovine synovial fluid in a pendulum test apparatus.....	12
Figure 2.6 – A schematic drawing of typical viscosity measurement equipment. ..	13
Figure 2.7 – The relationship between the shear rate versus the shear stress is shown for a Newtonian fluid and a pseudoplastic fluid.....	14
Figure 2.8 – The relationship between the shear rate and viscosity of both a Newtonian and a pseudoplastic fluid.	14
Figure 2.9 – The differences between the viscosities of joint fluid retrieved from healthy joints versus the viscosities of fluid retrieved from joints with various joint related diseases.	15
Figure 2.10 – Summary of the work done by Mazzucco <i>et al.</i> (2002, p.1157) on joint fluid retrieved during total knee arthroplasty.	16
Figure 3.1 - A schematic representation of the working of a Linear-Oscillation Test Machine (SRV Machine)	17
Figure 3.2 - Synovial fluid normally has a yellowish colour. Blood contamination and/or the presence of haemoglobin in the solution cause the redness.....	18
Figure 3.3 - An example of a typical lubricity test result. The loads at failure at each temperature are indicated in the graph.....	21
Figure 3.4 - A typical wear scar present on the ball and disk is presented here.	22

Figure 3.5 - Histograms of the primary patients' data that were found during the lubricity testing	23
Figure 3.6 - Combining the coefficient of friction data with the load at failure values for the primary patients.....	24
Figure 3.7 – One of the best samples recorded showed loads at failures as high as 1050N at 50°C.....	25
Figure 3.8 – One of the worst samples recorded showed loads at failures as low as 400N at both 38°C and 50°C.....	25
Figure 3.9 - Histograms of the revision patients' data that were found during the lubricity testing	27
Figure 3.10 - Combining the coefficient of friction data with the load at failure values for the revision patients	28
Figure 3.11 - Histograms of the combined data of the primary and revision patients	29
Figure 3.12 - The spread of the combined primary and revision patients' data.	30
Figure 3.13 – A histogram of the load at failure for both the primary and revision patients groups.	31
Figure 4.1 – A schematic drawing of typical viscosity measurement equipment. ..	32
Figure 4.2 – A conical shaped spindle was designed and built by Böhmer (2002) to determine the viscous behaviour of small samples.....	33
Figure 4.3 – A schematic drawing of the cone shape spindle integrated with the small reservoir used in determining the viscous behaviour of synovial fluid..	35
Figure 4.4 – A typical viscosity test outcome.....	37
Figure 4.5 – The distribution of the viscosity test results at 38°C.....	38
Figure 4.6 – The distribution of the viscosity test results at 50°C.....	38
Figure 4.7 – The distribution of the viscosity test results at 60°C.....	39
Figure 4.8 – The average viscosity with a 95% confidence interval at 38°C	41
Figure 4.9 – The average viscosity with a 95% confidence interval at 50°C	41
Figure 4.10 – The average viscosity with a 95% confidence interval at 60°C	42
Figure 4.11 – An increase in the viscosity relative, to that found for 38°C, can be seen for an increase in test temperature.	42
Figure 4.12 – The average viscosity can be seen to be a function of test temperature.	43

Figure 4.13 – The results of the viscosity testing of both sides of a patient under going a bilateral hip replacement surgery.....	44
Figure 4.14 – The denatured proteins group together to form a “seal”. This then prevents fresh lubricant from reaching the contact area.	45
Figure 5.1 – The average viscosity can be seen to be a function of the test temperate.....	47
Figure 5.2 – A histogram of the load at failures for both the primary and revision patients groups.	48
Figure 5.3 – The general formula of Poloxamer 188.....	49
Figure 5.4 – The viscosity of an aqueous solution of Lutrol [®] F68 (Poloxamer 188) as a function of the concentration used and the temperature of the solution. (BASF 2002, p.4).....	50
Figure 5.5 – The effect of temperature on the behaviour of Xanthan Gum as published by Davidson (ca. 1995, p.24-2).	52
Figure 5.6 – The stability of the synthetic lubricant as a function of time at a temperature of 38°C.	54
Figure 5.7 – The stability of the synthetic lubricant as a function of time at a temperature of 50°C.	54
Figure 5.8 – The stability of the synthetic lubricant as a function of time at a temperature of 60°C.	55
Figure 5.9 – The lubrication abilities of the synthetic lubricant over a period of eight weeks.....	56
Figure 6.1 – The five-post simulator developed and built by Burger.....	57
Figure 6.2 – A schematic drawing of a station on the five-post simulator.	58
Figure 6.3 – Strain gauges were used to monitor the load applied to each station..	59
Figure 6.4 – A typical recorded load profile on the simulator.....	59
Figure 6.5 – A typical recorded load profile on the simulator during a typical run-in phase after a stoppage.	60
Figure 6.6 – Every station was mounted on a spring configuration to supply the required load profile.....	60
Figure 6.7 – Typical wear debris at 60x magnification.	63
Figure 6.8 – The same wear debris as shown in Figure 6.7, at 200x magnification.	63

Figure 6.9 – The broken femoral head as found in the simulator.	64
Figure 6.10 – The femoral head had broken into several pieces.	64
Figure 6.11 – The damage to the acetabular cup caused by the stem as the femoral head broke.	64
Figure 6.12 – A burr located on the femoral side of the stem was found to be the cause of the broken femoral head.	64
Figure 6.13 – The acetabular cup retrieved from the saline station after 500 000 cycles. Note the flakes that formed on the metal surface surrounding the cup.	65
Figure 6.14 – The whole cup was filled with cracks and flakes that peeled from the cup.	65
Figure 6.15 – The drained bovine serum station after 500 000 cycles.	66
Figure 6.16 – A fibrous deposit was found inside the bovine serum station after 500 000 cycles.	66
Figure 6.17 – The acetabular cup of the bovine serum station was severely cracked and brittle.	67
Figure 6.18 – The visibility of the cracks was enhanced with the use of die penetrate.	67
Figure 6.19 – A black deposit was found on the femoral head after 500 000 cycles.	67
Figure 6.20 – An enlargement of the black area shown in Figure 6.16.	67
Figure 6.21 – The result of a point analysis of the black deposit as conducted by the Department of Microscopy and Micro-analysis at the University of Pretoria.	67
Figure 6.22 – The “seal” in station 4 after 4 000 000 cycles.	69
Figure 6.23 – A close-up of the removed “seal” shown in Figure 6.20.	69
Figure 6.24 – The “seal” in station 4 after 5 000 000 cycles.	69
Figure 6.25 – A close-up of the removed “seal” shown in Figure 6.22.	69
Figure 6.26 – The “seal” in station 5 after 4 000 000 cycles.	69
Figure 6.27 – The “seal” in station 5 after 4 500 000 cycles.	69
Figure 6.28 – A black deposit was found on the femoral head of the bovine serum station after 4 500 000 cycles. The station used an aluminium post.	70
Figure 6.29 – The black deposit found on the femoral head of the station using a preserved steel post and bovine serum as test medium. The station completed 4 500 000 cycles.	70

Figure 6.30 – The acetabular cup of station 4 showed a light yellowish colour after 4 500 000 cycles.....	70
Figure 6.31 – The acetabular cup of station 5 showed a darker yellowish colour than seen in Figure 6.30 after the same amount of cycles.	70
Figure 6.32 – No deposit was present on the balls retrieved from the stations using the synthetic lubricant as test medium.	71
Figure 6.33 – No deposit was found in either of the two stations using the synthetic lubricant.	71
Figure 6.34 – The wear pattern as found in the first station using the synthetic lubricant.	71
Figure 6.35 – The retrieved cup from the second station using the synthetic lubricant clearly shows the wear pattern.....	71
Figure 6.36 – Samples of the flake-like type of wear debris	73
Figure 6.37 – Samples of the whisker-like type of wear debris.....	74
Figure A.1 – The lubricity test results for the left side of the bilateral patient. The loads at failures found were 650N, 550N and 750N for 38°C, 50°C and 60°C respectively.	82
Figure A.2 – The lubricity test results for the right side of the bilateral patient. The loads at failures found were 1200N, 800N and 850N for 38°C, 50°C and 60°C respectively.	82

List of Tables

Table 2.1 – Concentrations of hyaluronic acid in different tissues or fluids (Laurent and Fraser 1992).	7
Table 2.2 – Classification of proteins (Suttie 1972).	8
Table 3.1 - The table contains a summary of the lubricity test used to determine the lubricity properties of the fluid.	20
Table 3.2 - Statistical analysis of the primary patients' data.....	23
Table 3.3 – The load at failure values of the left and right sides of a patient that underwent a primary bilateral hip replacement	26
Table 3.4 - Statistical analysis of the revision patients' data.....	27
Table 3.5 - The average values with a 95% confidence level (calculated by the Department of Statistics at the University of Pretoria).....	30
Table 4.1 – The correlation between the spindle speeds and the shear rate	34
Table 4.2 – The calibration factors of the new spindle.....	34
Table 4.3– A statistic analysis of the test data as calculated by the Department of Statistics of the University of Pretoria	40
Table 5.1 – The chemical composition of the synthetic lubricant	53
Table 6.1 – The statistical analysis of the flake-like wear debris found in the scar tissue retrieved from patients and from the simulator using different lubricants.	72
Table 6.2 – The statistical analysis of the whisker like wear debris found in the scar tissues retrieved from patients and from the simulator using different lubricants.....	72

Abstract

Title: Tribological evaluation of joint fluid and the development of a synthetic lubricant for use in hip joint simulators.

By: Tertius Opperman

Study leader: N.D.L. Burger

Department: Faculty of Engineering, Building Environment and Information Technology.

Degree: Master's in Engineering (Mechanical Engineering).

Key words: Hip, simulator, synovial fluid, joint fluid, viscosity, lubricity, lubricant, non-Newtonian, wear debris, wear

Over the years, different lubricants have been used to operate hip simulators. The current applicable ISO standard (ISO 14242-1:2002) recommends the use of 25% calf serum diluted with deionised water. The standard further recommends that the fluid be changed and the acetabular cup be weighed every 500 000 cycles. This procedure results in a loss of both the third body wear particles and the wear pattern. The purpose of this study was to develop a synthetic lubricant that would map the viscosity and lubricity properties of joint fluid ("synovial fluid") over the whole duration of a simulator test, which is typically five million cycles.

The first objective of this study was to find the effect of temperature increase on the viscous and lubricative properties of joint fluid retrieved from both primary and revision patients prior to surgery.

The lubricity tests were done on a Linear-Oscillation Test Machine (SRV machine). Three test temperatures were used namely 38°C, 50°C and 60°C. The load at failure and the average coefficient of friction were parameters measured during these tests. A decrease in the load at failure was found for an increase in test temperature, while the coefficient of friction stayed relatively stable.

The viscosity tests were done using a Brookfield Viscometer. The three test temperatures mentioned above, were copied. The joint fluid tested showed pseudoplastic flow behaviour. An increase in the viscosity as a function of test temperature increase and a magnitude of shear rate was observed.

The second objective of this study was to develop a synthetic lubricant that had the same average properties than that found for the retrieved joint fluid. A mixture of three different chemicals, namely Poloxamer 188, Xanthan Gum and Lube Booster[®] II was used to map the viscous and lubricative properties of the joint fluid.

A comparative test using the synthetic lubricant and bovine serum was performed in a custom-built simulator. Wear debris was sampled at 500 000 cycle intervals up to 4 500 000 cycles. During these intervals the bovine serum stations were drained and washed with deionised water, but not stripped and weighed as specified in the ISO standard. This was done intentionally to preserve the wear pattern during the entire test. The synthetic lubricant stations were not stripped or drained during these intervals. This ensured that the wear pattern was maintained and that the effect of accumulative wear could be investigated throughout the duration of the test. The wear debris from the test was then compared to wear debris retrieved from scar tissue of revision patients.

The wear debris that was found in the scar tissue retrieved from patients was similar in shape and size to that which was found in the simulator using bovine serum and the synthetic lubricant. It can thus be concluded that an acceptable lubricant had been developed to replace the current test medium in the simulators.

Samevatting

Titel:	Tribological evaluation of joint fluid and the development of a synthetic lubricant for use in hip joint simulators.
Deur:	Tertius Opperman
Studie Leier:	N.D.L. Burger
Departement:	Fakulteit Ingenieurswese, Bou-omgewing en Inligtingtegnologie.
Graadbenaming:	Meesters in Ingenieurswese (Meganiese Ingenieurswese).
Sleutel terme:	Heup, simulator, sinoviale vloeistof, gewrigsvloeistof, viskositeit, smeervermoë, smeermiddel, nie-Newtoniese, slytasiepartikels, slytasie

Verskillende smeermiddels is oor die jare heen gebruik as toetsmediums in heupsimulators. Die huidige internasionale standaard (ISO 14242-1:2002) beveel aan dat 'n mengsel van 25% kalfserum en gedeïoniseerde water as toetsmedium gebruik moet word. 'n Verdere aanbeveling is dat die toetsmedium elke 500 000 siklusse vervang moet word en dat die gewrigsholte geweeë moet word. Gevolglik gaan die derde liggaam partikels asook die slytasiepatroon verlore. Die doelwit van hierdie studie was om 'n sintetiese smeermiddel te ontwikkel wat dieselfde viskeuse- en smeereienskappe as gewrigsvloeistof (sinoviale vloeistof) het. 'n Verdere vereiste van die sintetiese smeermiddel was dat dit chemies stabiel moet bly oor 'n tydperk soortgelyk aan die duur van 'n simulatortoets, wat tipies 5 000 000 siklusse duur.

Die eerste doelwit van hierdie studie was om vas te stel wat die effek van 'n temperatuurstyging op die viskeuse en smeereienskappe van gewrigsvloeistof is. Die gewrigsvloeistof was afkomstig van pasiënte wat primêre en reësie chirurgie ondergaan het.

'n Lineêr-ossillerende toetsmasjien (SRV masjien) was gebruik om die smeertoetsing te doen. Drie toetstemperature naamlik 38°C, 50°C en 60°C was gebruik. Gedurende die smeertoetsing is twee parameters, naamlik die wrywingskoeffisiënt en lasdravermoë gemeet.

'n Afname in die lasdravermoë was gevind vir 'n styging in temperatuur, terwyl die wrywingskoëffisiënt redelik stabiel gebly het.

Die viskositeitstoetsings was gedoen deur gebruik te maak van 'n Brookfield Viskosimeter. Dieselfde drie toetstemperature, naamlik 38°C, 50°C en 60°C was gebruik. Die gewrigsvloeistof het pseudoplastiese vloei-eienskappe getoon. 'n Styging in die viskositeit van gewrigsvloeistof as funksies van toetstemperatuur styging en skuifkrag was waargeneem.

Die tweede doelwit van hierdie studie was om 'n sintetiese smeermiddel te ontwikkel wat dieselfde eienskappe toon as die gemiddelde viskeuse en smeereienskappe van gewrigsvloeistof afkomstig van pasiënte. 'n Mengsel van drie chemikalieë naamlik Poloxamer 188, Xanthan Gum en Lube Booster[®] II was gebruik om die smeermiddel te meng.

'n Vergelykende toets tussen die sintetiese smeermiddel en kalfserum is gedoen op 'n simulator. Gedurende die toetsperiode van 4 500 000 siklusse is daar na elke 500 000 siklusse monsters geneem. Die slytasiepartikels is dan herwin uit die monsters uit. Gedurende die intervale is die kalfserum stasies dan ook gedreineer, uitgewas met gedeïoniseerde water en hervul met nuwe kalfserum, maar nie uitmekaar gehaal en geweeg soos vereis in die internasionale standaard nie. Dit was opsetlik gedoen om te verseker dat die slytasiepatroon nie verlore sal gaan gedurende die toetstydperk nie. Die simulator stasies wat die sintetiese smeermiddel gebruik het was nooit uitmekaar gehaal of gedreineer nie, dus het die slytasiepatroon behoue gebly asook die slytasiepartikels en kon die effek daarvan ondersoek word oor die hele tydperk van die simulatortoets. Die slytasiepartikels herwin vanuit die simulator stasies was dan vergelyk met die slytasiepartikels herwin vanuit die bindweefsel van pasiënte.

Die slytasiepartikels wat in die bindweefsel gevind is, het dieselfde vorm en grootte gehad as die slytasiepartikels wat gevind is in die simulatortoetsing. Die gevolgtrekking kan dus gemaak word dat 'n aanvaarbare sintetiese smeermiddel ontwikkel is vir die gebruik in heupsimulators.

Glossary

Coefficient of friction	The ratio between the tangential force (F) needed to move a body and the weight (W) applied to that body. Formulated by: $F=\mu W$
Joint Fluid	Fluids retrieved, from synovial joints, for both primary and revision patients groups.
Load at failure	The load obtained from the Linear-Oscillation Test Machine (SRV machine) as being the load at which the lubricant cannot support lubrication anymore.
Lubricity	The ability of a fluid to support lubrication.
Lymph	A liquid similar to blood plasma, but has less proteins and food materials and more waste materials than blood plasma.
Lymphatic	Is similar to veins but carries only lymph.
Newtonian	A linear relationship displayed between the shear rate and the shear stress, see Figures 2.7 and 2.8.
Non-Newtonian	A non-linear relationship is found between the shear rate and the shear stress, see Figures 2.7 and 2.8.
Osteolysis	Foreign body reaction caused by the wear debris in and around the joint.
Polysaccharide	Group of carbohydrates whose molecules consist of long chains of monosaccharides, also known as gums.
Primary patient	A patient receiving his or her first replacement surgery due to the failure of the natural joint.
Pseudoplastic	Also known as shear-thinning fluids are fluids of which the viscosity would decrease as the shear rate is increased.
Revision patient	A person whose prosthetic joint has failed and is thus due to receive a replacement.
Synovial fluid	The fluid found in a healthy synovial joint, like hip and shoulder joints
Viscosity	Quantity measuring the force needed to overcome internal friction.

Chapter I - Introduction

Hip Replacement Surgery is a multi-million dollar industry in the world. Several million dollars are annually spent on the research and development of new and improved materials to be used in the manufacturing of these prostheses. Unfortunately the testing methods used to evaluate these newly developed prostheses are somewhat lacking.

A lifetime in the excess of 30 years is expected if one is to believe the current wear rate obtained in simulator testing. These tests involve a ceramic ball running on an ultra high molecular weight polyethylene (UHMWPE) acetabular cup. Unfortunately the current actual expected lifespan of modern day hip replacement parts are in the order of between 12 and 15 years (Jacobson 2003, p.32). From this it is clear that the wear rate obtained from simulator testing is not the governing parameter in the expected lifespan of the prostheses.

In order to try and better understand why revision surgery is needed, one needs to look at what causes a patient to receive revision surgery. In Figure 1.1 a summary of the data obtained from the Swedish (Malchau *et al.* 2002, p.4) and Australian (Graves *et al.* 2002, p.18) Hip Registers are shown.

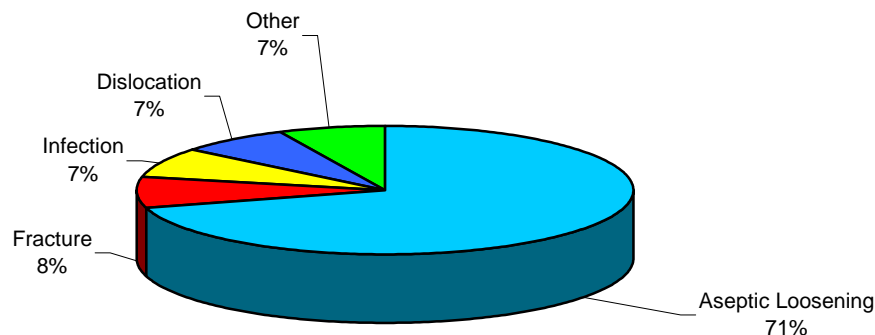

Figure 1.1 – A summary of the reasons as to why patients receive more than one hip replacement as published in the Swedish (Malchau *et al.* 2002, p.4) and Australian (Graves *et al.* 2002, p.18) Hip Registers.

The primary cause for aseptic loosening is indicated in literature (Haraguchi *et al.* 2001, p.29, Tipper *et al.* 2001, p.120 & Saikko *et al.* 2001, p.1507) as being a foreign body reaction (osteolysis) to the wear debris accumulating in and around the joint. Size and volume of the wear particles in the joint can be linked to the amount of osteolysis in the joint, according to the above scientists. If the size and volume of wear particles produced by the joint can be controlled, one can be sure to increase the expected lifespan of the prosthesis.

It was only recently that an international standard for the testing of hip implants (ISO 14242-1:2002) was proposed and accepted. This standard tackled one of the most debated issues, namely the load profile used during the testing. Prior to this standard two load profiles were commonly used namely the Paul (1967, p.53) and the Bergman (1992, p.969) profiles. The load profile proposed by the international standard is similar in shape to that proposed by Paul.

The fluid test medium proposed in the standard is a 25 ± 2 % Calf Serum solution with a minimum protein mass of 17g/l. This test medium was shown by Mazzucco *et al.* (2002, p.1157) to have Newtonian flow properties, while synovial fluid retrieved from patients showed non-Newtonian flow properties. It is also recommended that an anti-microbial reagent be used to minimise the microbial contamination in the fluid. The standard further proposed the fluid test medium to be changed every 500 000 cycles.

Two problems can be seen in the proposed procedure. The first was that every time the fluid test medium was replaced, the accumulative wear debris was removed and thus the third body abrasive wear was reduced. This resulted in a longer life expectancy. The second problem was that the standard proposed that the test had to be stopped every 500 000 cycles and that the wear had to be measured. This process involved the disassembling and assembling of the test prosthesis. The net result of this was that the likelihood of picking up the exact wear pattern in the test pieces was reduced dramatically. Basically with every restart, a new test began, with new fluid and on a "new" bearing surface.

The main aim of this research project is to develop a fluid that could replace the Calf Serum as the fluid test medium. The following methodology was used:

- Joint fluid from a range of patients, including primary and revision patients, were retrieved and characterised, in terms of its lubricity and viscosity, over a temperature range of between 38°C and 60°C
- A synthetic lubricant was then developed to have similar lubricity and viscosity characteristics to that of the joint fluid tested.
- This newly developed synthetic lubricant was then used in a simulator test. During this test the size and shape of the wear debris in the simulator were monitored and compared to wear debris retrieved from the scar tissues of revision patients.

Chapter II – Survey of Literature

2.1 Synovial fluid

A brief description of where synovial fluid is found and its chemical composition will be given in this section.

Synovial fluid is found in a healthy natural synovial joint. Typical synovial joints are the hip, shoulder and knee. All of these joints differ in shape but the lubrication mechanism stays the same. The basic lay-out of the synovial joint can be described as follows:

The ends of the bones are covered with articular cartilages. The whole joint is closed up in a capsule called the *fibrous capsule*. This capsule is lined with the synovial membrane called the *synovial capsule*. The capsule is filled with a fluid called synovial fluid or synovia, meaning “*like egg white*” (Basmajian 1937, p.20). Synovial fluid appears yellowish in colour.

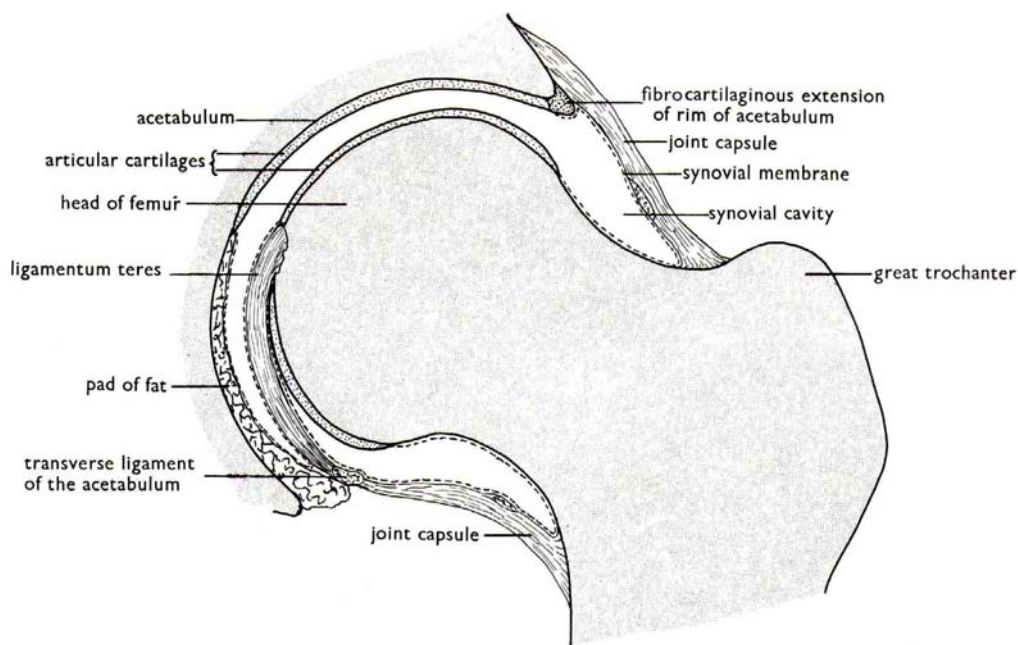

Figure 2.1 – A schematic drawing of the human hip joint as presented by Rowett (1973, p.30).

The synovial membrane is a thin sheet of areolar tissue, see Figure 2.2. The areolar tissue is known for its richness in blood vessels and lymphatics. The synovial membrane has the ability to change the plasma into synovial fluid. By using this ability the level and concentration of the synovial fluid can be monitored.

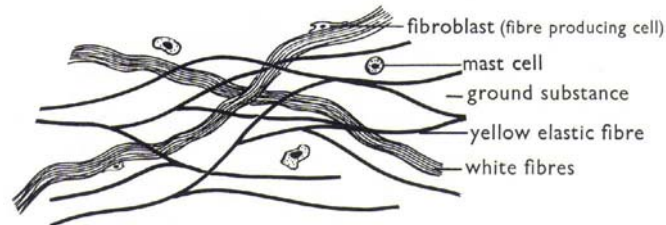

Figure 2.2 – A schematic presentation of areolar tissue by Rowett (1973, p.32).

Synovial fluid has two main functions. The first function is the nutrition of the joint. This is necessary because articular cartilages have neither blood vessels nor lymphatics. The cartilage receives all its nourishment via the diffusion of fluids into the cartilage. Sokoloff (1978, p.407) reported that cartilages not only live in synovial fluid, but can also grow in it.

The second function is the lubrication of the joint. This is one of the principle interests for this research. More will be said later on this subject.

From this discussion one can see that to have synovial fluid in a joint, a healthy, fully functional synovial membrane is needed to manufacture the synovial fluid. During hip replacement surgery the synovial membrane needs to be cut to get to the acetabulum. Some surgeons even remove the synovial membrane. It is not widely known (no references in literature) whether the synovial membrane can function properly after surgery and this raises the question whether or not the fluid present in the joint after arthroplasty really is synovial fluid. During the course of this research, the fluid inside the joint, whether retrieved from primary or revision patients', will be referred to as joint fluid.

2.2 Chemical composition of synovial fluid

The exact constituents of synovial fluid are not known and it can vary from patient to patient or even from synovial joint to synovial joint. This will be shown in Chapter 3.4.1. The condition of the joint and other joint abnormalities can also play a role in the composition of synovial fluid (Sokoloff 1978, p.448). However, some components are known.

Hyaluronic acid (HA) and proteins are the main components of synovial fluid. Sokoloff (1978, p.409) stated that all the proteins in the synovial fluid could be derived from plasma. There are also other high molecular weight plasma, such as macroglobulins and lipoproteins, present in small concentrations (Sokoloff 1978, p.409).

2.2.1 Hyaluronic Acid

Hyaluronic Acid (HA, hyaluron) is a linear nonsulfated polysaccharide composed largely of 2-acetamido-2-deoxy-3-O- β -D-glucopyranosyluronic acid-D-glucose linked by 1.4 β -glycosidic linkages (Sokoloff 1978, p.412), see Figure 2.3. From literature it was shown that the structure of hyaluron stays the same for other tissues, see Table 2.1 (Laurent and Fraser 1992). Hyaluronic acid is produced by the peripheral tissues and is transported via the lymphatic system. It can be found in almost every part of the human body.

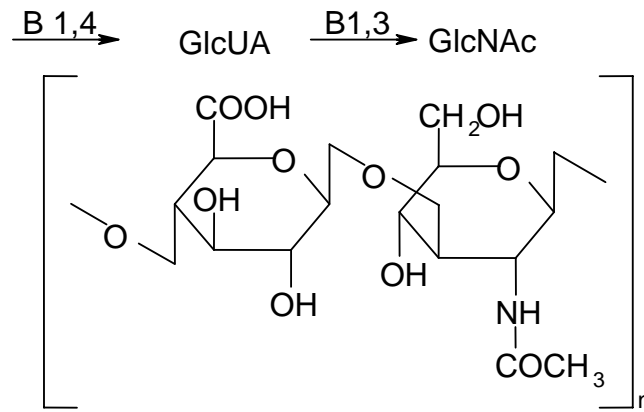

Figure 2.3 – The structure of hyaluronic acid (Laurent and Fraser 1992).

Table 2.1 – Concentrations of hyaluronic acid in different tissues or fluids (Laurent and Fraser 1992).

Tissue or fluid	Concentration [mg/l]
Rooster Comb	7500
Human Umbilical cord	4100
Human Synovial fluid	1420-3600
Bovine Nasal Cartilage	1200
Human Vitreous Body	140-338
Human Dermis	200
Human Thoracic Lymph	8.5-18
Human Urine	0.1-0.5
Human Serum	0.01-0.1

According to Laurent and Fraser (1992), hyaluron has only a half-life of a few minutes before it is taken up by the liver and broken down to carbon dioxide and water. The process of braking down hyaluronic acid takes about 20 minutes. The half-life of the polymer in the skin and joints is about 12 hours (Laurent and Fraser 1992).

It is believed that the viscous behaviour of synovial fluid is a result of this high-molecular-mass polysaccharide (Sokoloff 1978, p.415).

2.2.2 Lubricating Glycoproteins

Proteins are molecules that have high molecular weight ranging from a few thousand to a million or more. Proteins are built up from mixed polymers of amino acids. Proteins will therefore contain carbon, hydrogen, oxygen and nitrogen. Some proteins also contain sulphur, phosphorus and even mineral elements (Conn and Stumpf 1972). Table 2.2 gives the general classification of conjugated proteins based on their non-protein (prosthetic) portions.

Table 2.2 – Classification of proteins (Suttie 1972).

Protein	Contents
Nucleoproteins	Contain nucleic acid, usually bound to a basic protein
Glycoproteins	Contain carbohydrate groups
Phosphoproteins	Yields H ₃ PO ₄ upon hydrolysis (not nucleic acid or phospholipid)
Lipoproteins	Combination protein and lipid (usually, but not always phospholipid)
Chromoproteins	Contain colored prosthetic groups such as heme groups or flavins

The hypothesis proposed is that the proteins interact with the surface of the articular cartilage and that this then acts as the boundary lubricant in the joint. The following is known about glycoproteins and its lubrication ability on the articular cartilage:

According to Sokoloff (1978, p.416), Linn and Radin added trypsin to synovial fluid and found that the lubricity decreased. Trypsin is known to break down proteins (O’Kelly *et al.* 1978, p.75). An increase in the trypsin concentration would result in a decrease in the protein concentration.

During the same study they also added hyaluronidase to the synovial fluid and found that the lubricity remained the same. Hyaluronidase is a serum that breaks the hyaluronic acid chains (O'Kelly *et al.* 1978, p.75).

The same researchers also assumed that the hyaluronic acid played a role in the lubrication of the joint. This led them to conclude that the protein component of the hyaluronic acid was responsible for the lubrication and further that the lubrication was independent of the chain length of the polysaccharide.

Sokoloff (1978, p.416-430) gives a detailed description of all the experiments that was done to isolate the different proteins in the synovial fluid. The following paragraphs are just a summary of the findings of the different scientists involved in the research. The reader is referred to the original research material for the respective references used in the following paragraphs.

In 1970 Radin showed that lubricating activity was found in the protein fraction of bovine synovial fluid. This could indicate that the proteins gave the lubricity of the fluid and that hyaluron wasn't necessary for the lubrication.

Swann and Radin continued the research and showed in 1972 that the active ingredients responsible for lubrication were high molecular weight or asymmetric constituents. Attempts were then made to isolate this active ingredient that was responsible for the lubricating ability by various scientists. The following three components were isolated: LGP-1 (Lubricin), LGP-2 and a small amount of proteins similar to γ -globulin.

Analysis of purified, pooled LGP-1 showed that it was composed of amino acid and carbohydrate constituents. It had a molecular weight of 227,500. Swann and Bloch have shown that LGP-1 is absent in serum. It has also not been found in the articular cartilage. The only explanation given to its existence is that it is produced by the synovial membrane and is only found in synovial fluid.

Purified LGP-1 at a concentration of 0.5mg/ml had half the lubricity ability of normal synovial fluid. A more purified LGP-1 isn't yet available to see if the same lubricating ability can be found at higher concentrations than that of synovial fluid. There might also be a loss of ingredients during the purification process and this might also influence the lubricating ability.

LGP-2 had been found in small quantities in the articular cartilage. It has a molecular weight of 70,000. The identity and relationship of LGP-2 isn't known at this stage.

2.2.3 Hyaluronic acid, glycoproteins and lubricity

O'Kelly *et al.* (1978, p.75) conducted an interesting study on this subject by using a pendulum apparatus fitted with articular cartilage retrieved during autopsies.

Different fluids were used during their comparison study, namely bovine synovial fluid retrieved from animal joints immediately after death, synovial fluid retrieved from a patient with rheumatoid arthritis and water with added hyaluronic acid to increase the viscosity. The fluids of interest in this study were the synovial fluids.

Hyaluronic acid was added to the synovial fluid retrieved from the patient to increase the viscosity of the fluid, as the viscosity was much lower than that of the bovine synovial fluid.

Both the bovine and patient synovial fluids were divided into different sub-volumes. The first of these sub-volumes was then treated with trypsin to decrease the protein concentration in the fluid. This was designated (t). The second sub-volume was treated with hyaluronidase to break down the hyaluronic acid in the synovial fluid (h), while the third sub-volume was left untreated (u). The results from this study can be seen in Figure 2.4 for the human synovial fluid and Figure 2.5 for the bovine synovial fluid.

The effects of trypsin and hyaluronidase on the lubrication ability of synovial fluid retrieved from a patient with rheumatoid arthritis

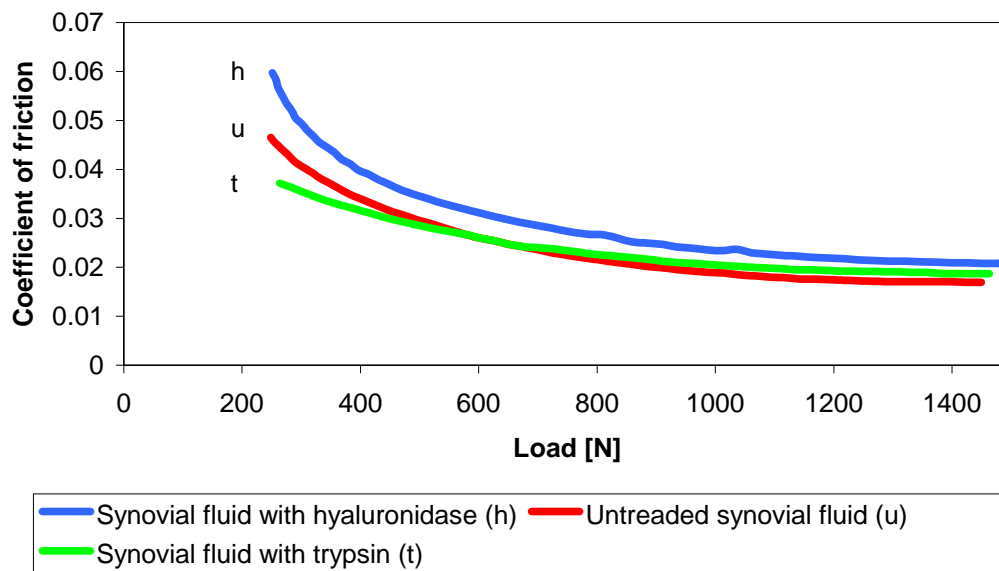

Figure 2.4 – Results published by O’Kelley *et al.* (1978, p.77) using synovial fluid, retrieved from a patient with rheumatoid arthritis, in a pendulum test apparatus

The effects of trypsin and hyaluronidase on the lubrication ability of bovine synovial fluid

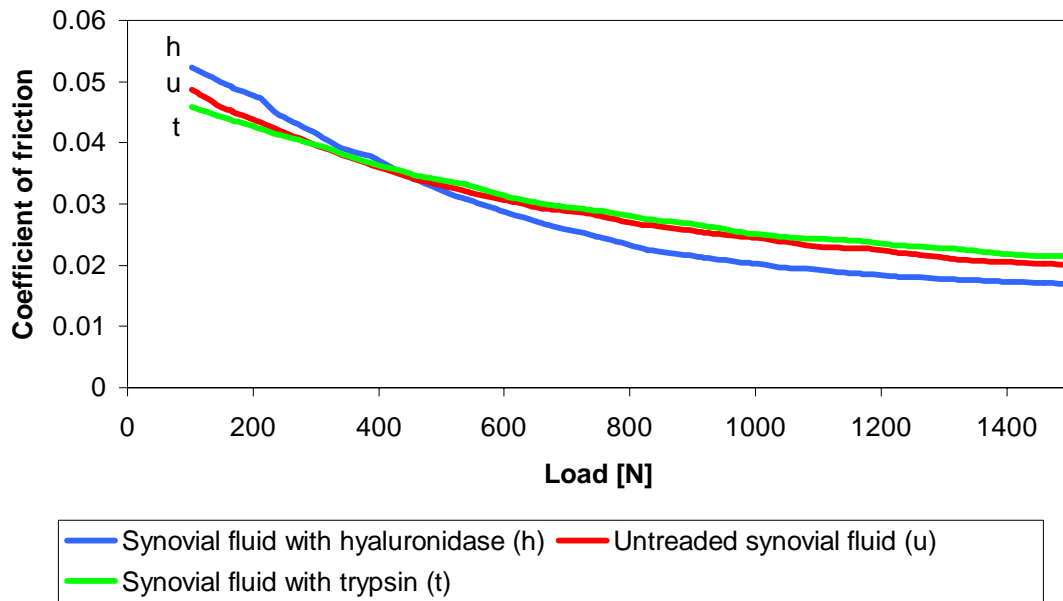

Figure 2.5 – Results published by O’Kelley *et al.* (1978, p.77) using bovine synovial fluid in a pendulum test apparatus

From Figures 2.4 and 2.5 it can be seen that decreasing the protein concentration by adding trypsin to the synovial fluid, resulted in a decrease in the coefficient of friction. An increase in the coefficient of friction was found when adding hyaluronidase to the synovial fluid thus decreasing the concentration of hyaluronic acid. Although the amount of change to the coefficient of friction differs between the bovine and human synovial fluid, the general tendency was the same.

It is important to note that the above study did not compensate for any viscosity changes to the fluid. The results of their study can unfortunately not be generalised to all patients, due to the small sample size of human synovial fluids (only one patient was used in the study). It is, however, interesting to see the effect that protein and hyaluronic acid concentrations have on the lubrication abilities of synovial fluid.

The results of previous studies were contradictory to the results found by O’Kelly *et al.* For instance Sokoloff (1978, p.417) reports that the lubricating ability of synovial fluid was destroyed when trypsin was added to the fluid, resulting in a decrease in the protein concentration.

2.3 Viscous behaviour of synovial fluid

Viscosity is one of the most important parameters of a lubricant and can be defined as the measure of resistance of a fluid to shearing flow (Hutchings 1999, p.56). A more technical definition for viscosity is that it is the ratio between the shear rate and the shear stress. The ratio between shear rate and the shear stress can be found by doing a simple experiment as explained in Hutchings (1999, p56):

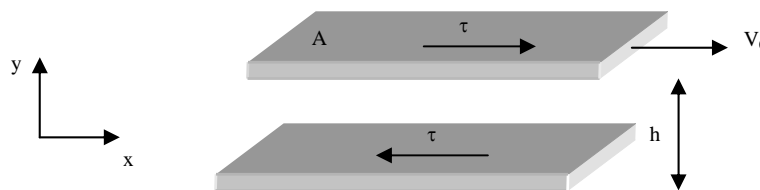

Figure 2.6 – A schematic drawing of typical viscosity measurement equipment.

Two plates are placed submerged in a fluid. One plate is then moved relatively to the other while measuring the shear force required. The velocity gradient in the fluid is assumed to be constant and uniform between the two plates. The following calculation can be made from the results of such a test:

$$\tau = \eta \frac{dv}{dy}$$

where τ = shear stress acting on the planes
 η = viscosity
 dv/dy = velocity gradient or shear rate

Figures 2.7 and 2.8 shows the differences between the different types of ratios found between shear rate and shear stress. Fluids with a linear ratio between the shear rate and shear stress are called Newtonian fluids. A non-Newtonian fluid is a fluid where a non-linear ratio is found between the shear rate and the shear stress. Shear thinning or pseudoplastic behaviour is a term used to describe the shear thinning effect of a non-Newtonian fluid, as the shear rate is increased.

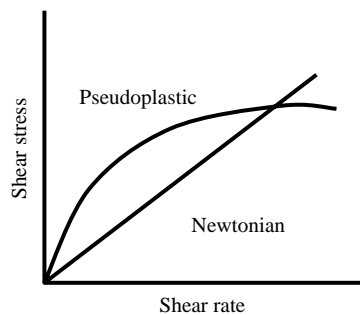

Figure 2.7 – The relationship between the shear rate versus the shear stress is shown for a Newtonian fluid and a pseudoplastic fluid.

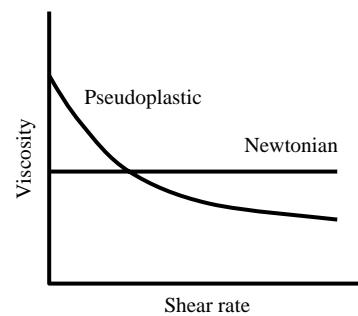

Figure 2.8 – The relationship between the shear rate and viscosity of both a Newtonian and a pseudoplastic fluid.

Previous studies have proved that synovial fluid is a non-Newtonian fluid that exhibits pseudoplastic behaviour (Cooke *et al.* 1978, p.66, Mazzucco *et al.* 2002, p.1157 & Sokoloff 1978, p.448).

The viscosity of synovial fluid in the temperature range of 20°C to 38°C has been extensively researched (Cooke *et al.* 1978, p.66, Mazzucco *et al.* 2002, p.1157 & Sokoloff 1978, p.448), but information at higher temperatures is not freely available. This leaves a serious gap in understanding the lubrication mechanism of the prosthetic hip joint where local hot spots can reach temperatures higher than the temperatures mentioned previously (Lu and McKellop 1997, p.101).

Lu and McKellop (1997 p.101) did an experiment where they measured the temperature in a zirconium femoral head running in an ultra-high molecular weight polyethylene (UHMWPE) acetabular cup. A finite element model was then used to extrapolate the measured temperatures to estimated surface temperatures. A maximum temperature of 99°C was calculated.

Cooke, Dowson and Wright (1976 p.66) also investigated the effects of different joint related diseases on the flow properties of synovial fluid. Figure 2.9 shows a summary of their results obtained at 21°C. Their results indicate a decrease in the viscous behaviour of the joint fluid retrieved from joints with joint related diseases.

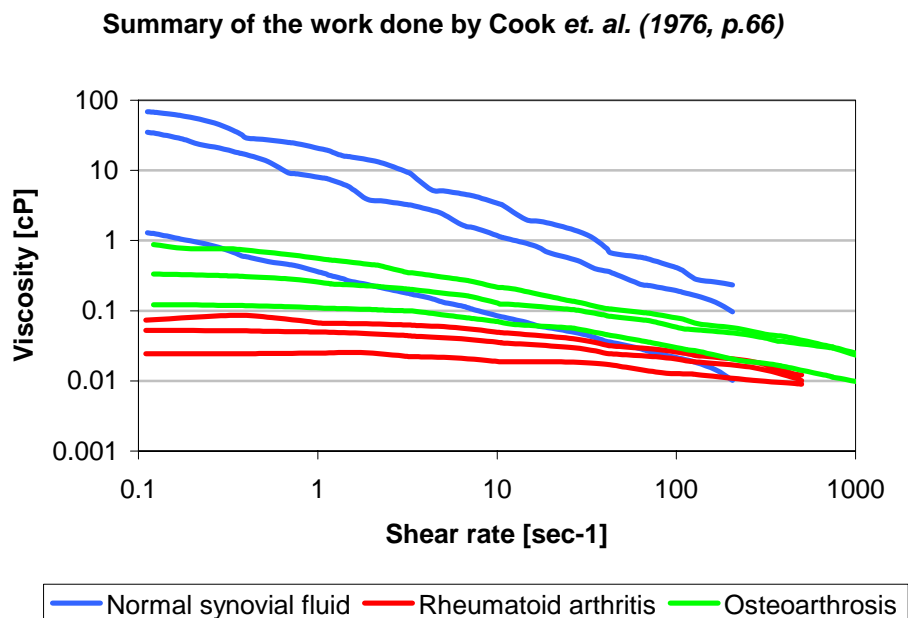

Figure 2.9 – The differences between the viscosities of joint fluid retrieved from healthy joints versus the viscosities of fluid retrieved from joints with various joint related diseases.

Mazzucco, McKinley, Scott and Spector (2002, p.1157), see Figure 2.10, investigated the difference in the viscosity of joint fluid retrieved from patients undergoing total knee arthroplasty (TKA). A total of three primary and three revision patients were evaluated in this study.

Two of the primary patients' fluids were more viscous than the revision patients, while one primary patient's fluid showed to have the same viscous behaviour than the revision patients.

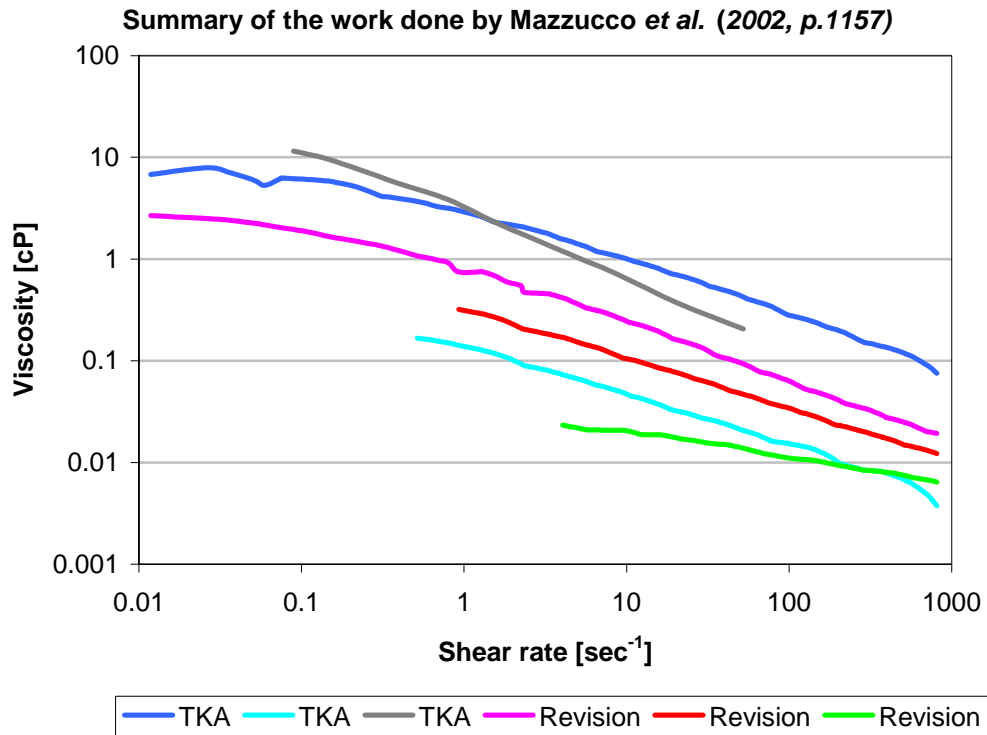

Figure 2.10 – Summary of the work done by Mazzucco *et al.* (2002, p.1157) on joint fluid retrieved during total knee arthroplasty.

It is necessary to note that the viscous behaviour of the results published by Cooke *et al.* (1976 p.66) differ as much as four orders for the same shear rate, while the difference in the viscous behaviour of the results published by Mazzucco *et al.* (2002, p.1157) differ by three orders for the same shear rate.

From the above research, one can derive that: The effect of a temperature increase on the viscous behaviour of joint fluid is not well defined and that the results of the small number of patients cannot be generalised to the entire population of patients. It is thus required that an extensive amount of viscosity tests be done to define an average viscous behaviour as well as to predict the possible effect of a temperature change on the viscosity of synovial fluids of a representative population of patients

Chapter III – Lubricity Testing

Lubricity is defined as the ability of a lubricant to support lubrication. Two parameters were used to quantify lubricity, namely load at failure and coefficient of friction. The effects of an increasing temperature were also investigated in the temperature range of 38°C to 60°C.

The joint fluids of 24 primary and 17 revision patients were tested. One primary patient undergoing a bilateral hip replacement was also investigated in this study. A total of 42 hip joints were thus included into this study.

3.1 Apparatus used

Lubricity testing was conducted on a Linear-Oscillation Test Machine, also known as the SRV machine (ASTM D5706-97). The outcome of a lubricity test was the load (in Newton) at which breakthrough of the lubricating film occurred, as well as the average coefficient of friction measured. A schematic drawing of the Linear-Oscillation Test Machine is shown in Figure 3.1.

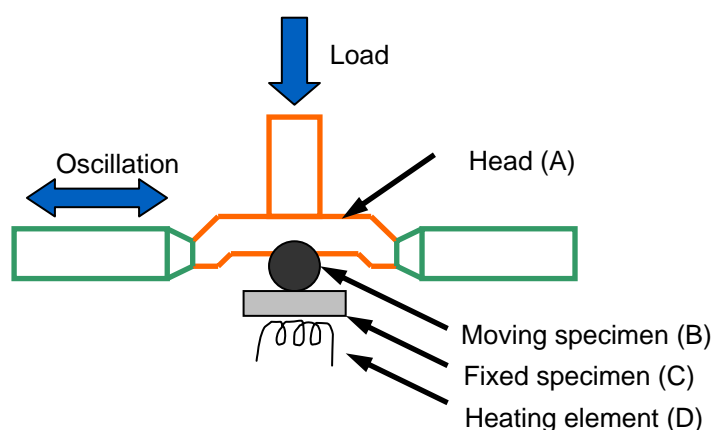

Figure 3.1 - A schematic representation of the working of a Linear-Oscillation Test Machine (SRV Machine)

The working of the machine is as follows: A specimen, known as the moving specimen (B), was clamped into the head of the machine (A) - this prevented the moving specimen from rotating relative to the fixed specimen, ensuring only a relative sliding motion. The fixed specimen (C) was placed on a heating element (D) to regulate the temperature of the test sample. An oscillating motion was generated with an actuator. The frequency and stroke length of this motion could be controlled via settings in the hardware of the test machine.

3.2 Test Method

The joint fluid used in this research was retrieved mainly from the hip joints of patients that underwent hip surgery. An orthopaedic surgeon did the retrieval of the joint fluid prior to the implant procedure. The fluid was then stored in a freezer at -2°C until collection. Once collected, the fluid was slowly defrosted at room temperature. Normal synovial fluid is yellowish in colour - see A in Figure 3.2. The joint fluid was then visually screened to identify the samples contaminated with blood - see C and D in Figure 3.2. These samples were then excluded from the study. The retrieved fluid was then centrifuged for five minutes at low velocity ($\pm 1\ 000\ \text{g}$) to separate any wear particles from the retrieved fluid.

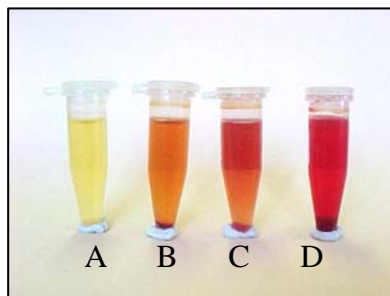

Figure 3.2 - Synovial fluid normally has a yellowish colour. Blood contamination and/or the presence of haemoglobin in the solution cause the redness.

Volumes of between one and five millilitres were the norm for the retrieved samples. The first millilitre of fluid was used to do the lubricity testing, while the rest was used to measure the viscosity of the sample at different test temperatures. Unfortunately there wasn't always enough joint fluid to complete all three the viscosity tests at different temperatures. In these cases at least one viscosity test would be done at the lowest test temperature (38°C – body temperature) to form a base line between the samples.

The retrieved fluids were not pooled but tested individually. If fluids are pooled the patients' data must be omitted and in our case it was unsure whether or not the patients data could play a role or not. The result of the decision not to pool the fluids, was that the ability to repeat tests was lost. It was then required to work as accurately as possible to try and maximise the amount of tests done on the small amount of fluid retrieved.

Three temperatures were chosen namely 38°C (body temperature), 50°C (temperature in the middle) and 60°C (based upon temperatures measured in simulator testing by Lu and McKellop (1997, p.101). A lubricity test was done at every temperature for almost every sample included in this research.

It was decided to design a test based on the ASTM D5607-97 standard for testing the film strength of lubricating fluids. Table 3.1 shows the test parameters used during the lubricity testing of the retrieved fluid.

Table 3.1 - The table contains a summary of the lubricity test used to determine the lubricity properties of the fluid.

Fixed Specimen (Disk)	Size: ϕ 24 x 7.85 mm Material: AISI E 52100 Hardness: Rockwell C 60 \pm 2 Surface Finish: $R_z = 0.1 - 0.15 \mu\text{m}$
Moving Specimen (Ball)	Size: ϕ 10 mm Material: AISI E 52100 Hardness: Rockwell C 60 \pm 2
Load	A run-in load of 50N, where after the load is increased by 50N per minute.
Temperature	38°C, 50°C and 60°C
Oscillation	Frequency: 50 Hz Stroke: 1 mm
Feeding Mechanism	A drop of fluid was placed between the moving and fixed specimen prior to the test commissioning.

3.3 Test Outcome

Different test set-ups on this machine can give different test outcomes. In the test specification as given in Table 3.1, the most important factor is to determine the load at failure. According to the ASTM D5606-97 standard the load at failure is defined as the load where the coefficient of friction rises with more than 0.2 over the steady state coefficient of friction or where total seizures occur.

The average coefficient of friction was worked out by taking the average of the coefficients from an applied load of 200N to just before the sudden increase in coefficient of friction as failure occurred. The coefficient of friction normally reached a steady state value at loads exceeding 200N.

A typical test result of a lubricity test is shown in Figure 3.3.

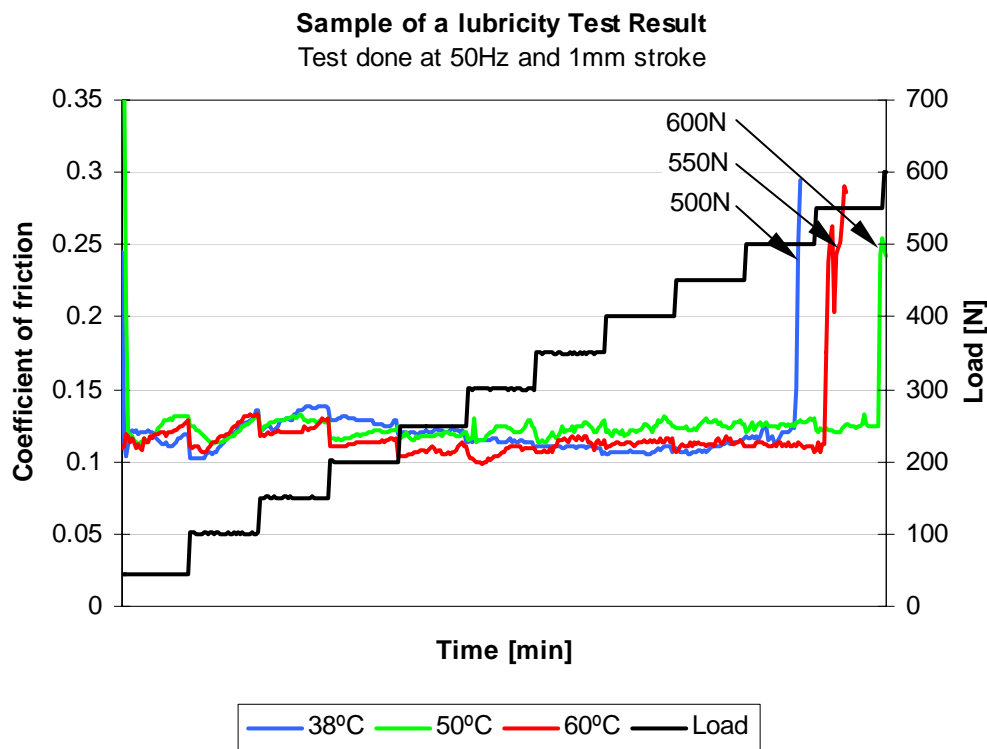

Figure 3.3 - An example of a typical lubricity test result. The loads at failure at each temperature are indicated in the graph.

It can be seen from the graph in Figure 3.3 that the load at failure for the 38°C, 50°C and the 60°C lubricity test were 500N, 550N and 600N respectively. Also note that the average coefficients of friction for the three tests were almost the same.

In Figure 3.4 a typical wear scar on a ball and disk are presented. What is interesting about this figure is the visible imprint of the ball (A) on the disk as it was cold welded to the surface and then, when disassembled, tore away. The vertical scratch (B) on the disk was caused during disassembling and had no influence on the lubricity of the fluid. The size of the wear scar is a function of the load at which the lubricant failed. A larger diameter wear scar on the ball is obtained at larger loads, while a longer and thicker wear scar will be seen on the disk.

A typical wear scar size on the ball for a load at failure of 550N is 0.697 mm in the direction of sliding motion and 0.713 mm across the direction of the sliding motion. A typical wear scar size on the disk for the same load at failure was found to be in the region of 1.733 mm in the direction of the sliding motion and 0.72 mm across the direction of the sliding motion.

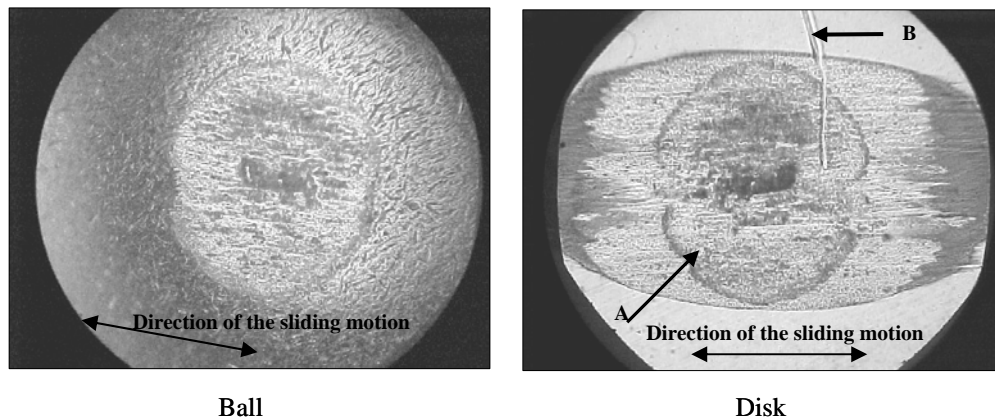

Figure 3.4 - A typical wear scar present on the ball and disk is presented here.

3.4 Lubricity properties of Primary Patients

A primary patient will receive a hip replacement once the natural hip has ceased to perform its normal function pain free. This failure can be caused by a joint disease like osteoarthritis, which is the most common, or can be due to mechanical failures, such as fractures (Malchau *et al.* 2002, p.4 and Graves *et al.* 2002, p.18).

Researchers have found (Cooke *et al.* 1978, p.66 and Sokoloff 1978, p. 448) that the nature of the joint fluid in a diseased joint changes and, due to this, the viscous property of the fluid also changes. What the alteration to the fluid's chemical composition is can differ from patient to patient and is most likely a function of the reason for the hip replacement.

The joint fluids retrieved from a total of 24 primary patients were tested. The results of these tests are shown in Table 3.2 and Figures 3.5 and 3.6.

Table 3.2 - Statistical analysis of the primary patients' data

	Load at failure [N]			Average coefficient of friction		
	38 °C	50 °C	60 °C	38 °C	50 °C	60 °C
Minimum	400	400	450	0.105	0.0973	0.0989
Maximum	1100	1050	850	0.132	0.135	0.139
Average	622.92	619.57	614.587	0.11827	0.11869	0.12306

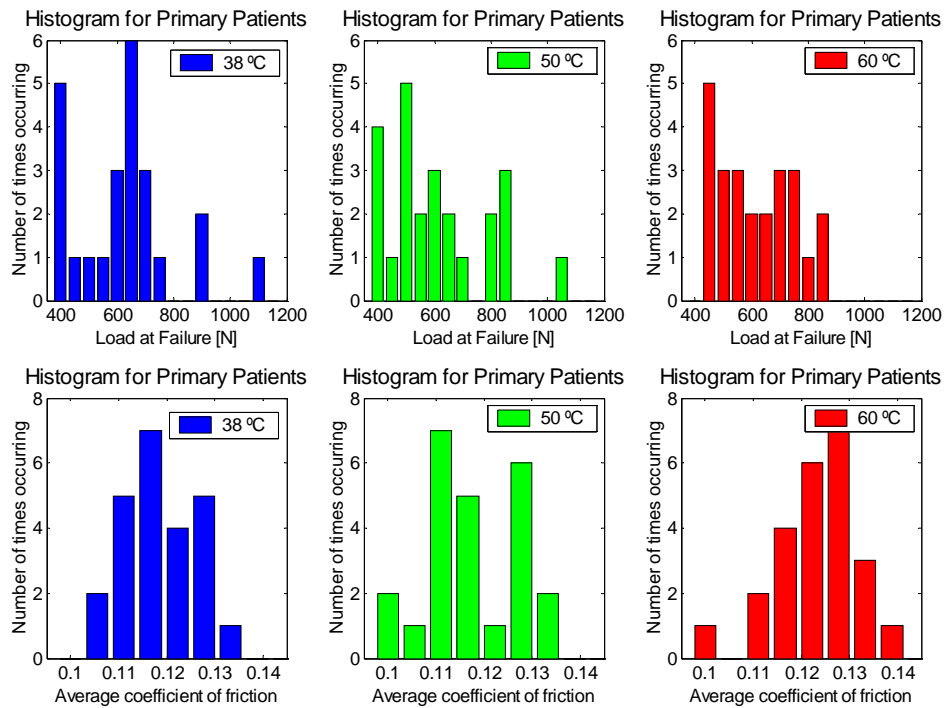

Figure 3.5 - Histograms of the primary patients' data that were found during the lubricity testing

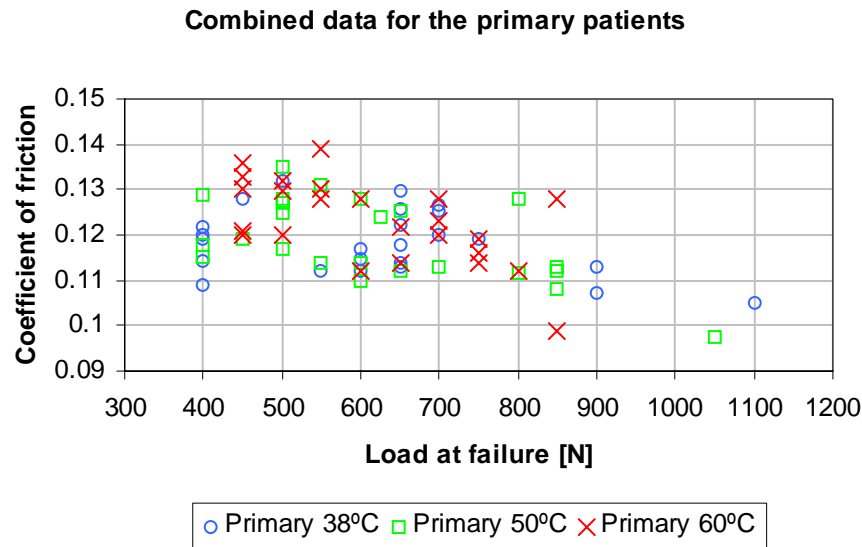

Figure 3.6 - Combining the coefficient of friction data with the load at failure values for the primary patients.

3.4.1 Discussion

The average coefficients of friction as tested do not differ a great deal between the three temperatures used for the lubricity testing. A small decrease can be seen in the average load at failure, but if one takes into account that the tests were done in 50 N increments, one realises that the difference can be neglected and can be described to experimental error.

One of the most impressive test results was retrieved from a 94-year-old male patient who was diagnosed with a fractured dislocation. The load at failures recorded for the fluid retrieved were 900, 1050 and 850 N for the 38°C, 50°C and the 60°C tests respectively (see Figure 3.7).

The worst lubrication fluid retrieved belongs to a 55-year-old female patient. The results of the lubricating tests for this sample were 400, 400 and 450N for the 38°C, 50°C and the 60°C lubricity tests (see Figure 3.8).

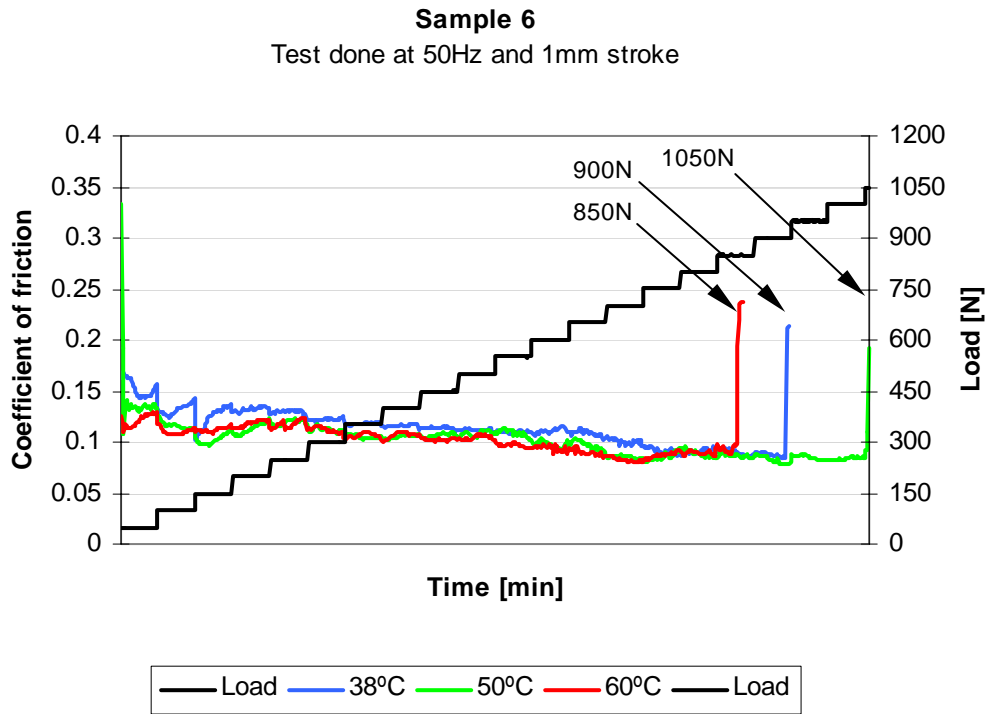

Figure 3.7 – One of the best samples recorded showed loads at failures as high as 1050N at 50°C.

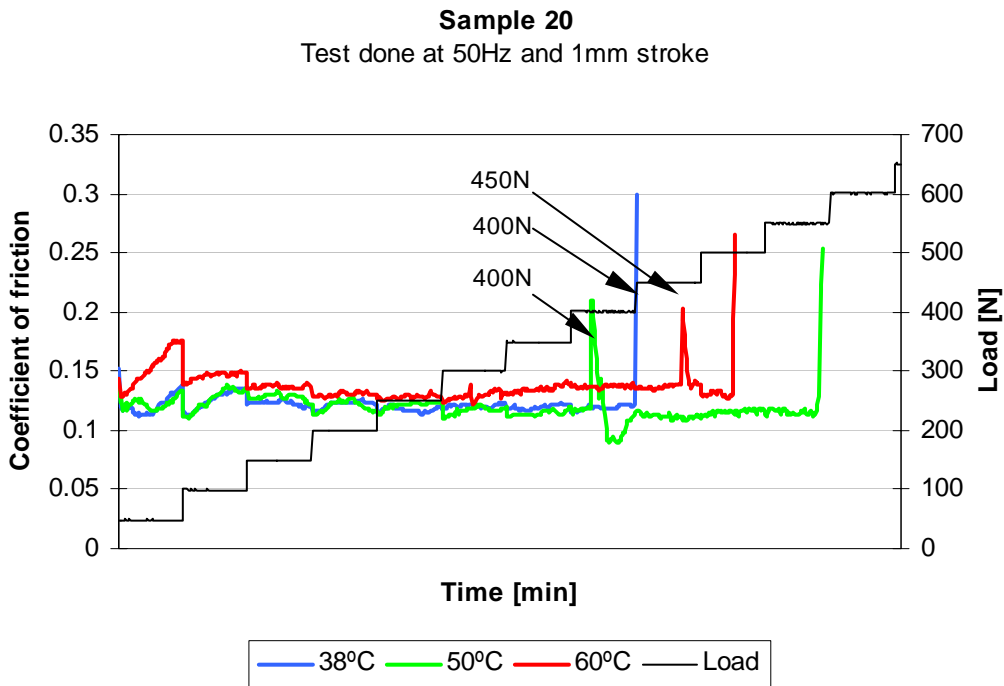

Figure 3.8 – One of the worst samples recorded showed loads at failures as low as 400N at both 38°C and 50°C.

In both cases mentioned above the fluid was retrieved from primary patients, yet a difference can be seen in their load-carrying capability. Possible reasons for this phenomenon is that the chemical contents of the fluid differ from patient to patient and that there might even be a relationship between the lubricating abilities and the clinical reason for the hip joint replacement. This can even be highlighted by the difference in the lubricating abilities of the fluid retrieved from the left and right sides of a 54 years old female patient that had undergone a bilateral hip replacement. Table 3.3 gives the summary of the results obtained from lubricity testing. The full results of these tests can be seen in Appendix A. The joint fluid retrieved from the right side of this bilateral patient showed better load-carrying capabilities than the left side.

Table 3.3 – The load at failure values of the left and right sides of a patient that underwent a primary bilateral hip replacement

Temperature	Load at failure [N]	
	Left side	Right side
38°C	650	1200
50°C	550	800
60°C	750	850

3.5 Lubricity properties of Revision Patients

When a hip implantation failed to fulfil its normal function without pain, this implant must be replaced and this is called a revision procedure. If a patient had a hip prosthesis and went for another operation on the same joint, he or she is defined as a revision patient. Revision operations take place for various reasons. The most common reason, according to the Australian (Graves *et al.* 2002, p.18) and Swedish (Malchau *et al.* 2002, p.4) Hip Registers for revision surgery, is aseptic loosening of the cup or stem due to osteolysis.

The joint fluids retrieved from a total of 17 revision patients were tested. The summary of these test results can be seen in Table 3.4 and the graphic presentation in Figures 3.9 and 3.10.

Table 3.4 - Statistical analysis of the revision patients' data

	Load at failure [N]			Average coefficient of friction		
	38 °C	50 °C	60 °C	38 °C	50 °C	60 °C
Minimum	500	350	400	0.085	0.11045	0.1042
Maximum	1100	1050	800	0.1307	0.1357	0.1346
Average	679.41	639.71	555.88	0.1161	0.1199	0.1219

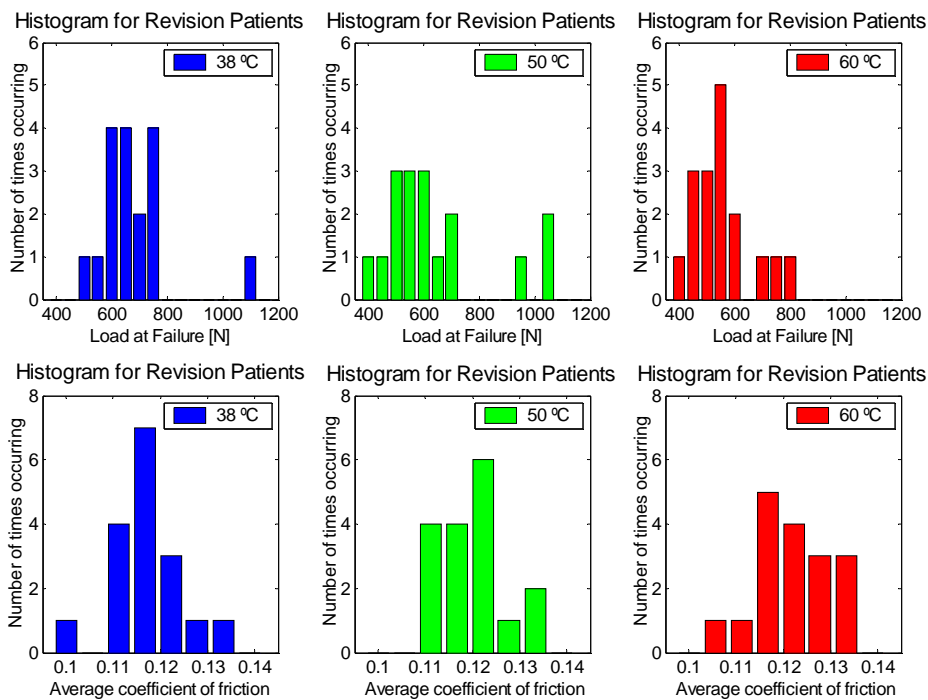

Figure 3.9 - Histograms of the revision patients' data that were found during the lubricity testing

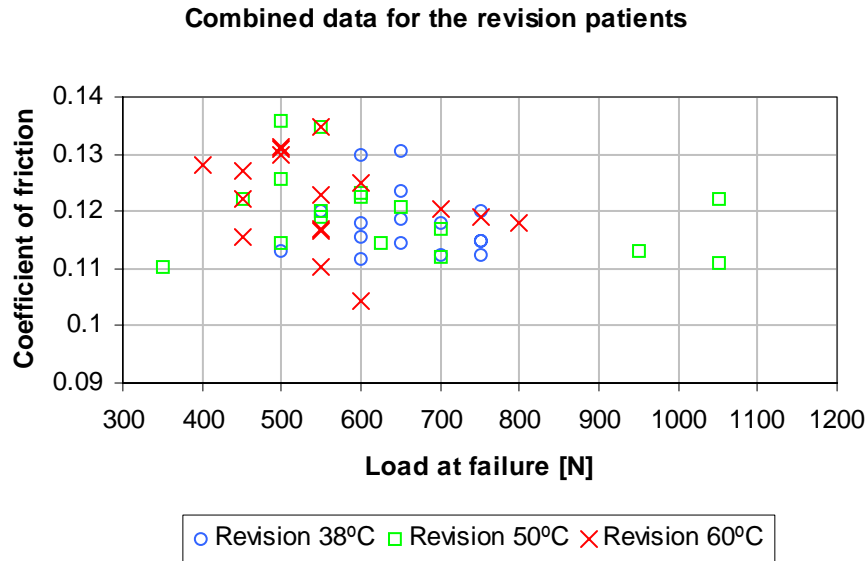

Figure 3.10 - Combining the coefficient of friction data with the load at failure values for the revision patients

3.5.1 Discussion

The results obtained for the revision patients were similar to those obtained for primary patients. One of the differences was that the decrease in the load-carrying capability could no longer be neglected. A decrease of 40 N was found with an increase in temperature from 38°C to 50°C. This is a decrease of 5.8%. A further decrease of 84 N was found as the temperature increased from 50°C to 60°C, translating to a decrease of 18.2% to the original lubricity at 38°C.

3.6. Combining the lubricity properties

The results of the primary and revision patients were combined to increase the number of samples. The data was analysed by the Department of Statistics at the University of Pretoria and 95% confidence levels determined. The combined results for all temperatures are also shown in Figures 3.11 to 3.12. The data was also analysed by the Department of Statistics at the University of Pretoria and 95% confidence levels were determined - see Table 3.5).

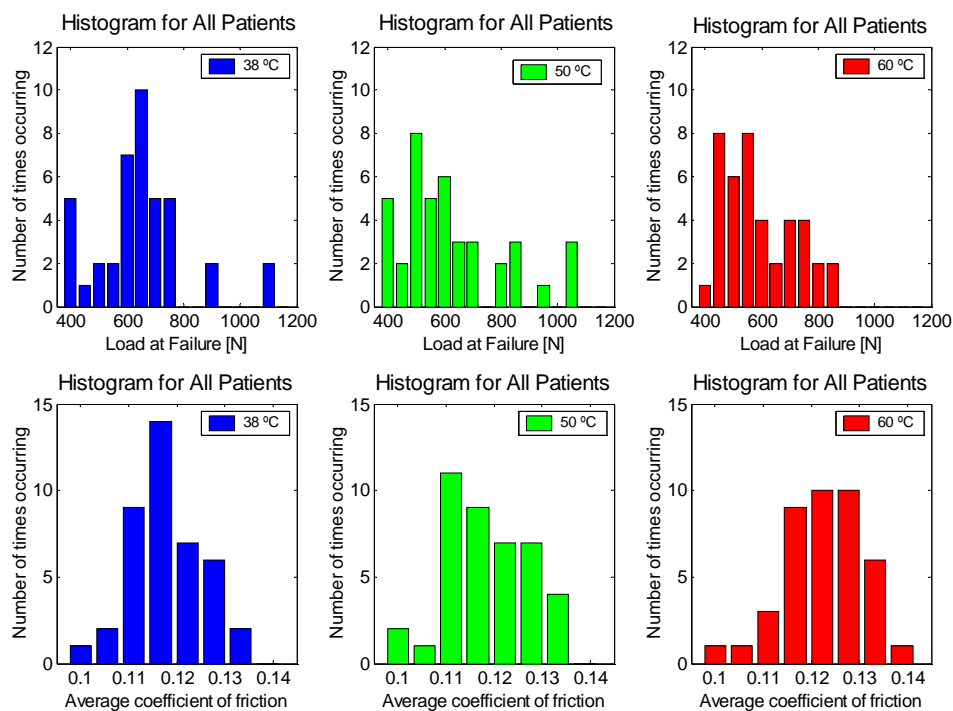

Figure 3.11 - Histograms of the combined data of the primary and revision patients

Combined data for both the primary and revision patients

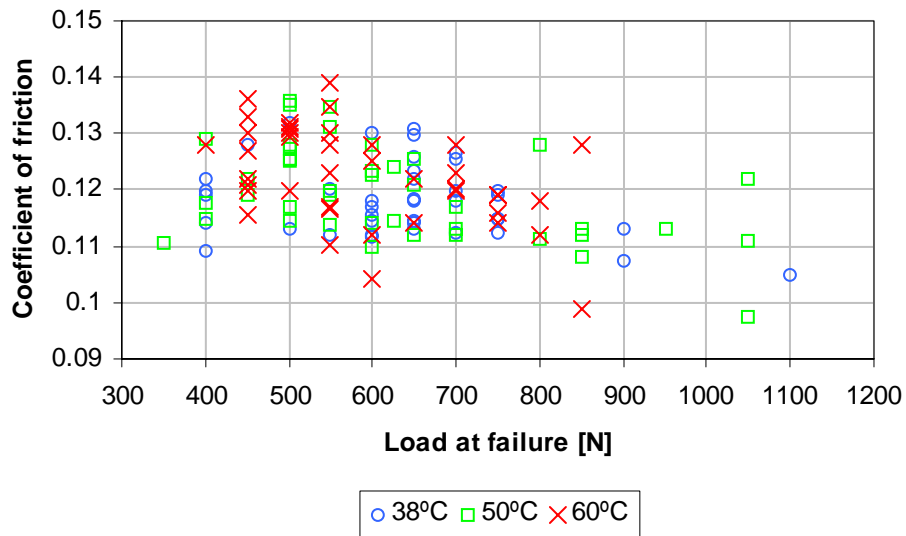

Figure 3.12 - The spread of the combined primary and revision patients' data.

Table 3.5 - The average values with a 95% confidence level (calculated by the Department of Statistics at the University of Pretoria)

	Load at failure [N]			Average coefficient of friction		
	38 °C	50 °C	60 °C	38 °C	50 °C	60 °C
Average	648.96	617.71	584.38	0.117	0.119	0.122
Min 95% Confidence Level	603.99	567.04	549.17	0.115	0.117	0.120
Max 95% Confidence Level	693.93	668.38	619.58	0.119	0.121	0.125

3.6.1 Discussion

Combining the primary and the revision patients' data increased the pool of samples. This allowed the load at failure bandwidth to become smaller for the same confidence levels - see Table 3.5.

A decrease in the load-carrying capabilities was found with an increase in temperature (see Table 3.5). A decrease of 25 N was found as temperatures increased from 38°C to 50°C. This is a decrease of 3.7%. A further decrease of 49 N was found as the temperature increased from 50°C to 60°C, translating to a decrease of 10.7% to the original load-carrying capability at 38°C.

Figure 3.13 shows the histogram of the load at failures for all the different test temperatures. From this figure it can be seen that all samples, with the exception of one, had a load-carrying capability of more than or equal to 400 N. The significance of this is that a synthetic lubricant that is to be developed, needs to have a load-carrying capability of less than 400 N at all test temperatures to be able to simulate the worst-case scenario, with regards to lubrication.

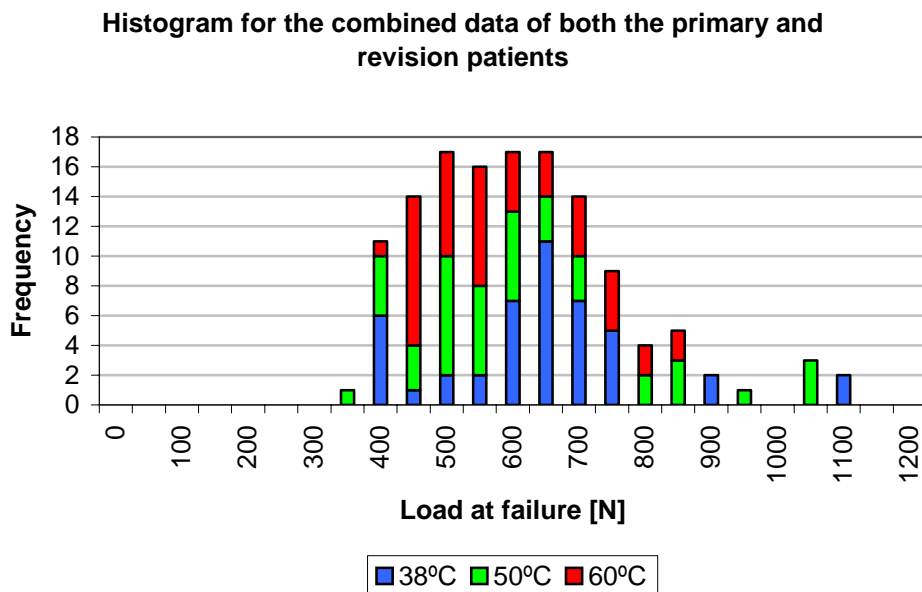

Figure 3.13 – A histogram of the load at failure for both the primary and revision patients groups.

Chapter IV – Viscosity testing

Hutchings (1999, p.56) defines viscosity as follows:

“Viscosity provides a measure of the resistance of a fluid to shearing flow, and may be defined as the shear stress on a plane within the fluid, per unit velocity gradient normal to that plane.”

The implementation of the definition is shown in the Figure 4.1 and Equations 4.1 and 4.2.

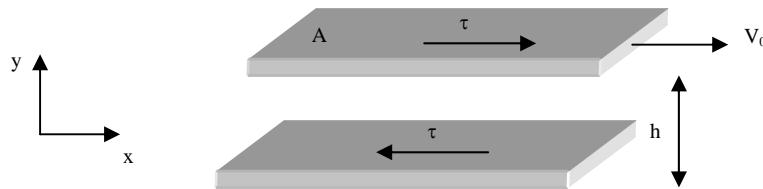

Figure 4.1 – A schematic drawing of typical viscosity measurement equipment.

The velocity gradient (dv/dy) in the fluid between the two plates is assumed to be constant and uniform. See Equation 4.1.

$$\frac{dv}{dy} = \frac{V_0}{h} \quad \text{Equation 4.1}$$

Equation 4.2 gives the shear stress (τ) as a function of the velocity gradient and the viscosity (η).

$$\tau = \eta \frac{V_0}{h} \quad \text{Equation 4.2}$$

The viscosity defined in the above method is deemed dynamic viscosity and has dimensions of [Pa s], commonly referred to as centipoise [cP]. The relationship between [Pa s] and centipoise is as follows: $1 \text{ cP} = 10^{-3} \text{ Pa s}$

This chapter deals with the development of a technique to measure the viscosity of small amounts of samples (1 ml). The samples tested with this technique were retrieved, stored and centrifuged in the same way as described for the lubricity testing samples - see Section 3.2.

4.1 Apparatus used

The viscosity testing was done using a Brookfield Viscometer. The Brookfield Viscometer is a rotating type viscous meter measuring the dynamic viscosity [cP] of fluids. A custom spindle (see Figure 4.2) was designed and built by Böhmer (2002) to allow testing of small amounts of fluid (1 ml in this case).

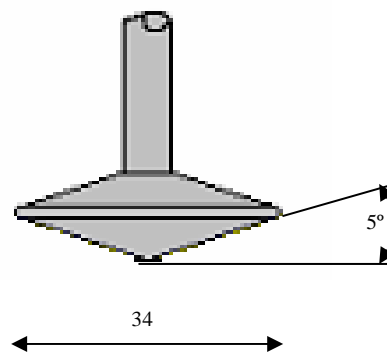

Figure 4.2 – A conical shaped spindle was designed and built by Böhmer (2002) to determine the viscous behaviour of small samples.

A conical shaped spindle was selected to ensure a uniform shear rate over the whole surface. Five spindle speed increments, namely: 3, 6, 12, 30 and 60 rpm, were selected in such a way as to cover the complete range offered by the specific spindle-viscometer combination. Different spindle speeds can be related to different shear rates (S') by using the formula proposed by Brookfield Engineering Labs (no date, p.19), see Equation 4.3.

The shear rates for all spindle speeds are tabulated in Table 4.1.

$$S' = \frac{\omega}{\sin \theta}$$

$$S' = \frac{(3) \left(\frac{2\pi}{60} \right)}{\sin(5^\circ)}$$

$$S' = 3.6 \text{ sec}^{-1}$$

Equation 4.3

Table 4.1 – The correlation between the spindle speeds and the shear rate

Spindle speed [rpm]	3	6	12	30	60
Shear rate [sec ⁻¹]	3.57	7.15	14.30	35.74	71.49

The new spindle was calibrated using CANNON viscosity standard oil RT100 (lot number 03201). See Table 4.2 for the calibration factors.

Table 4.2 – The calibration factors of the new spindle.

Spindle speed [rpm]	3	6	12	30	60
Calibration Factor	14	7	3.5	1.4	0.7
Viscosity = Calibration Factor x Measured Value					

The spindle rotated in a bucket that was mounted on top of a small reservoir (see Figure 4.3). Water from a larger reservoir was circulated through the small reservoir. The water temperature in the big reservoir could be controlled via a heater/pump unit, ensuring that the same controlled temperature could be measured in the small reservoir. Three temperatures were chosen namely 38°C, 50°C and 60°C. These were also the temperatures used in the testing of the lubricity properties.

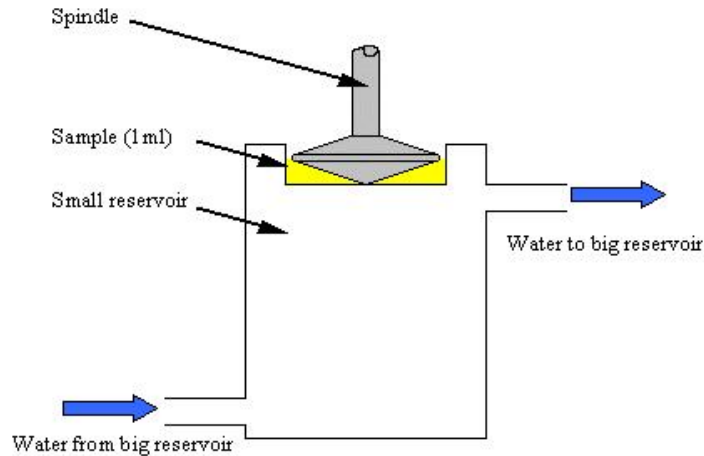

Figure 4.3 – A schematic drawing of the cone shape spindle integrated with the small reservoir used in determining the viscous behaviour of synovial fluid.

4.2 Test Method

The required test temperature was set on the temperature controller of the big reservoir. The centrifugal pump was switched on to circulate water between the big and small reservoirs. It is important to remove all the air from the small reservoir to ensure the bucket's uniform temperature.

The test sample was added into the test bucket as soon as the temperature in the big reservoir stabilised at the required temperature. The volume of test sample injected into the bucket was one milliliter. The spindle was lowered into position. Five minutes were allowed so that the test sample's temperature could stabilize at the required test temperature.

From a practical point of view it was found that the best results were obtained when the viscous measurement was started at the highest spindle speed and worked downwards to the lowest spindle speed. An average of three measurements was taken at every spindle speed. This process was repeated three times for every test temperature setting. Between temperature changes the joint fluid was replaced to minimize any shear effects on the fluid. Three temperatures were used to characterise the joint fluid, namely 38°C, 50°C and 60°C.

4.3 Test Outcome

A joint fluid sample was characterized at a temperature by an average of three measurements at every spindle speed. To characterise the fluid retrieved from a patient one would need to characterise the fluid at the three temperatures and for every temperature one would need a millimeter of fluid. It can now be seen that to be able to characterise the fluid retrieved, one would need more than four millimeters of fluid if one takes the fluid lost in the centrifuge into account.

Sometimes it happened that only enough fluid for two tests was left after the centrifugal process and the lubricity testing. The first viscosity test was then done at 38°C to ensure that a comparison could be made between the different fluids. The second viscosity test was done, as required to build a database, at either 50°C or 60°C.

No duplication tests could be performed, as the amount of fluid retrieved per patient was very limited. The repeatability of the Brookfield Viscometer with the newly designed spindle was however tested, by using a different known fluid and it was found to be within the experimental error margin set for the Brookfield Viscometer.

Power curves, defined as: $y = ax^{\beta}$, were fitted to the different viscosity curves obtained at the different test temperatures. The result of this curve fitting was that the non-Newtonian behaviour of the retrieved joint fluid could be quantified by a power and a coefficient.

A test sample was excluded from the research if a correlation factor of smaller than 0.95 was found. This criterion was set to eliminate experimental errors from the database. A typical test sample, with the fitted power curves, is shown in Figure 4.4.

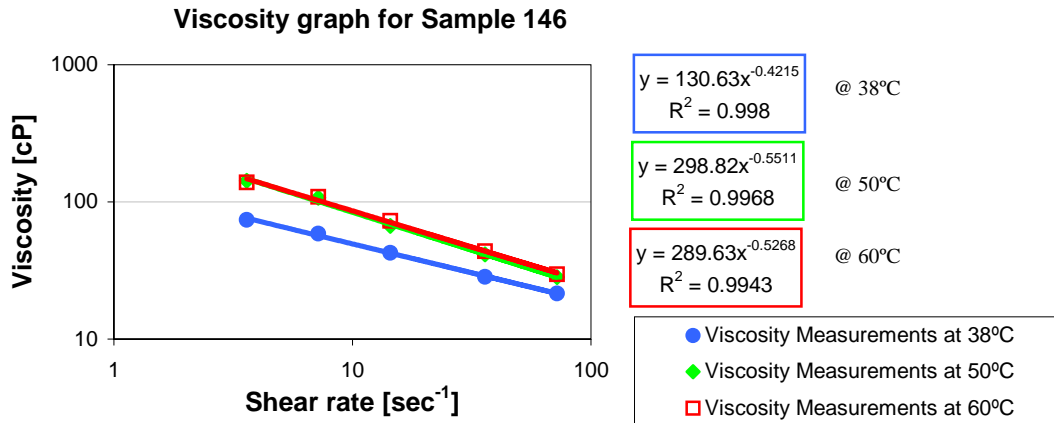

Figure 4.4 – A typical viscosity test outcome.

4.4 Test Results

From the literature survey it was seen that previous researchers showed that the viscous properties of fluids retrieved from normal patients and those with joint related diseases can differ (Cooke *et Al.* 1978, p.66 and Mazzucco *et al.* 2002, p.1157). The fluids tested in this study were retrieved from both primary patients with joint related diseases and revision patients. Both these two groups of patients fall into the joint related diseases group as set out in the literature study. In Figures 4.5 to 4.7 the tests performed at every test temperature are plotted for both the primary and revision patient groups. Note that the results for the primary and revision patients' groups are distributed over the same range of viscous values. This is an indication that the viscous properties of the fluids retrieved from the patients are indeed very similar. It was thus decided to group the results obtained from the primary and revision patients groups in order to find a better average and smaller intervals of the 95% confidence levels.

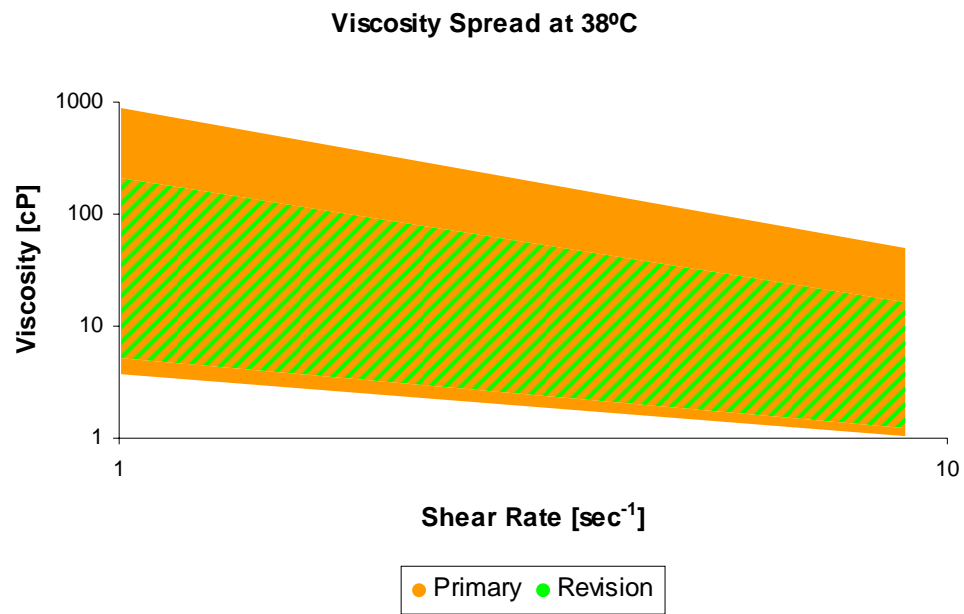

Figure 4.5 – The distribution of the viscosity test results at 38°C.

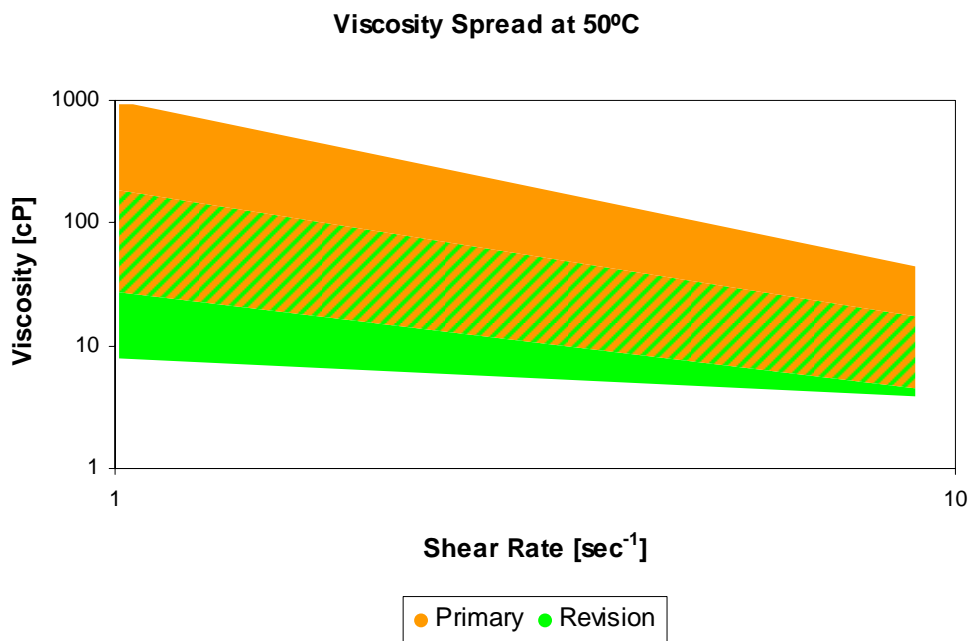

Figure 4.6 – The distribution of the viscosity test results at 50°C.

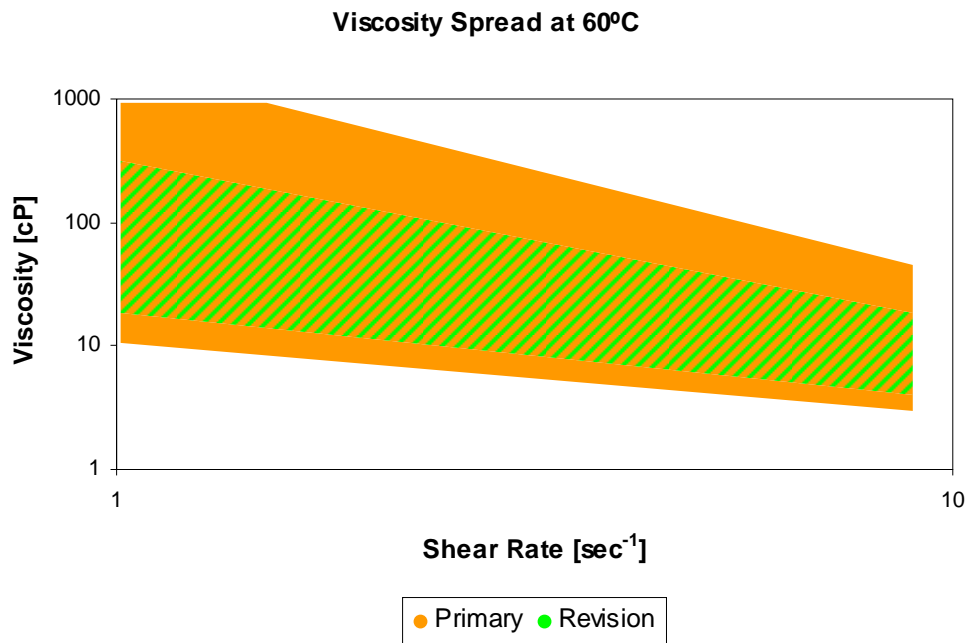

Figure 4.7 – The distribution of the viscosity test results at 60°C.

An increase in viscosity was seen as the test temperature increased. In some test samples this increase was so big at 60°C, that the viscosity measurements fell outside the range of the spindle used on the Brookfield Viscometer. In cases like this, the 60°C test was not used in finding the average viscosity.

Table 4.3 shows the statistic analysis, conducted by the Department of Statistics at the University of Pretoria, with the average and 95% confidence intervals for the coefficient (α) and power variables (β) as was used in the following equation: $y = \alpha x^\beta$. The same data is also presented graphically in Figures 4.8 to 4.10.

Table 4.3– A statistic analysis of the test data as calculated by the Department of Statistics of the University of Pretoria

Test temperature	38°C	
Number of samples	23	
	Coefficient (α)	Power (β)
	[cP]	[]
Mean	175.465	-0.435
Lower 95% Confidence level	77.651	-0.480
Upper 95% Confidence level	273.280	-0.391
Test temperature	50°C	
Number of samples	17	
	Coefficient (α)	Power (β)
	[cP]	[]
Mean	255.066	-0.472
Lower 95% Confidence level	123.909	-0.524
Upper 95% Confidence level	386.23	-0.421
Test temperature	60°C	
Number of samples	15	
	Coefficient (α)	Power (β)
	[cP]	[]
Mean	351.179	-0.511
Lower 95% Confidence level	101.905	-0.576
Upper 95% Confidence level	600.453	-0.447

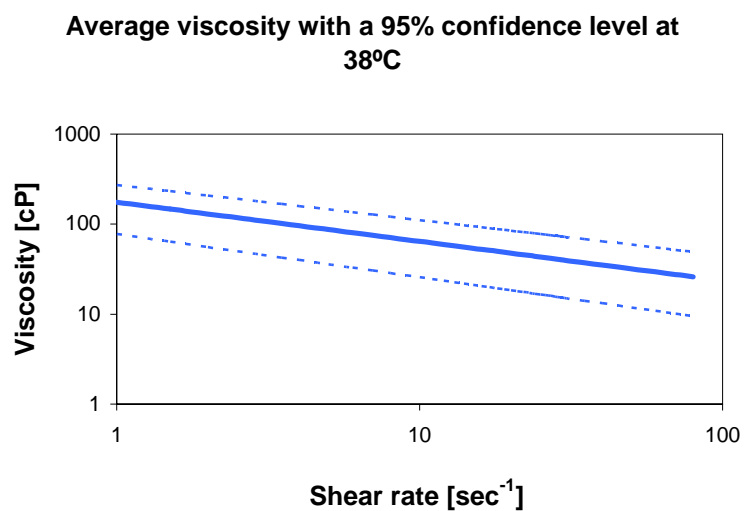

Figure 4.8 – The average viscosity with a 95% confidence interval at 38°C

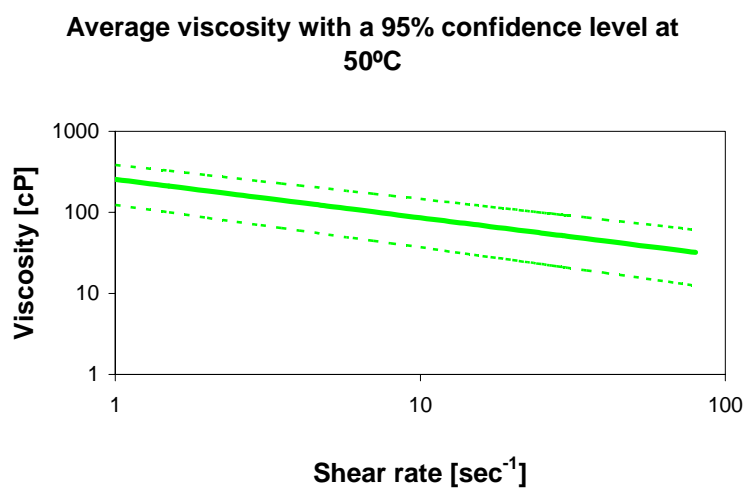

Figure 4.9 – The average viscosity with a 95% confidence interval at 50°C

Average viscosity with a 95% confidence level at 60°C

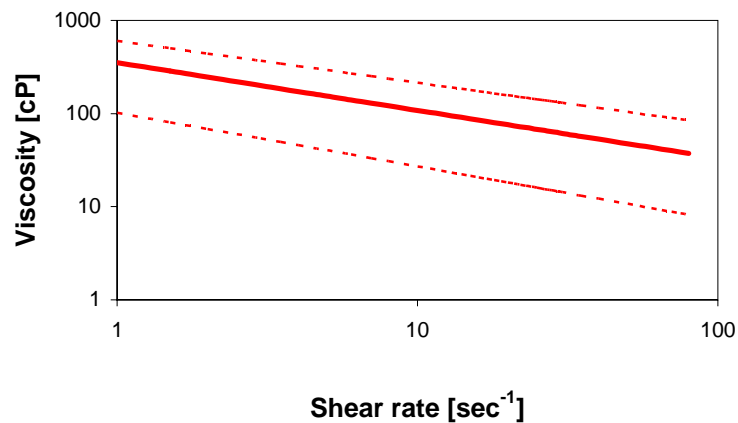

Figure 4.10 – The average viscosity with a 95% confidence interval at 60°C

An interesting result from the viscosity testing was to compare the viscosity increase of the 50°C and the 60°C tests to that of the 38°C test - see Figure 4.11.

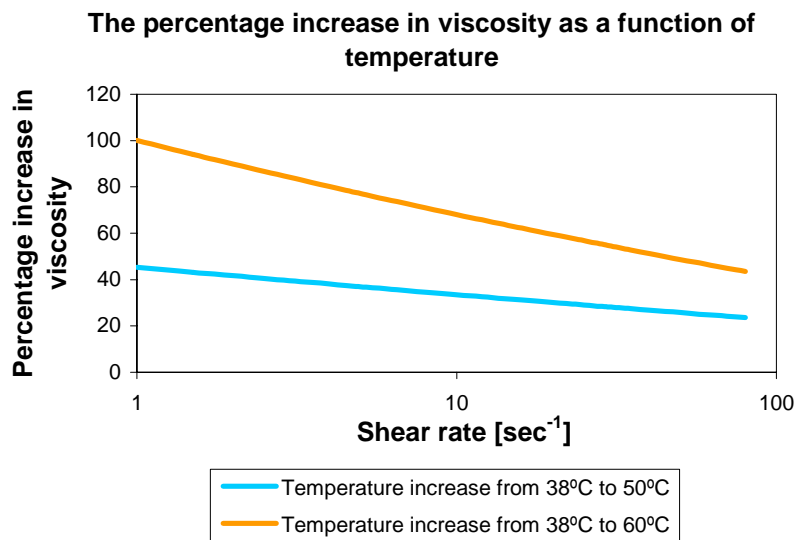

Figure 4.11 – An increase in the viscosity relative, to that found for 38°C, can be seen for an increase in test temperature.

The average viscosity values at every test temperature are shown in Figure 4.12.

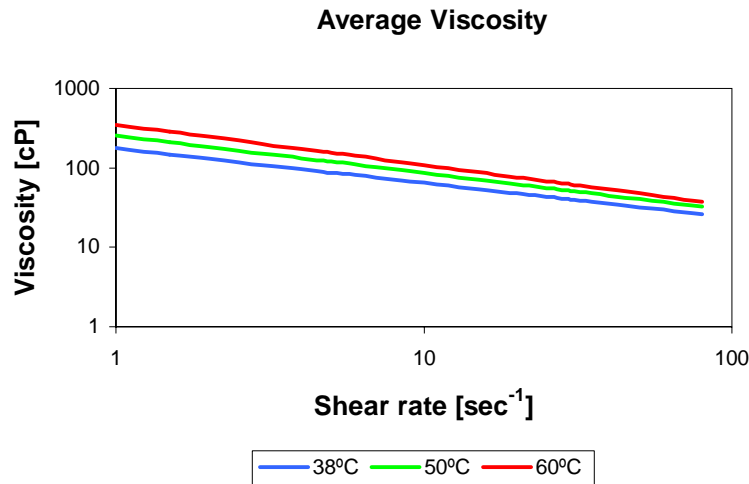

Figure 4.12 – The average viscosity can be seen to be a function of test temperature.

4.5. Discussion

The joint fluids retrieved from the patients showed pseudoplastic (shear thinning) flow behaviour. This is in line with other scientific studies (see Figures 2.9 and 2.10). Most lubricants used in the engineering industry would show a decrease in viscosity with an increase in temperature, but this was not the case for the retrieved joint fluid (ENGEN Product Handbook 2001 and SKF General Catalogue 1994) The joint fluid tested showed an increase in the viscosity for an increase in test temperature (see Figures 4.12). It was also found that the increase was a function of the shear rate. At low shear rates the increase was bigger than at high shear rates (see Figure 4.11).

The extent of the increase in viscosity for an increase in the test temperature was found to differ between patients and even between joints of the same patient as shown in Figure 4.13. This phenomenon led to an increase in the bandwidth of the 95% confidence interval as the test temperature was increased.

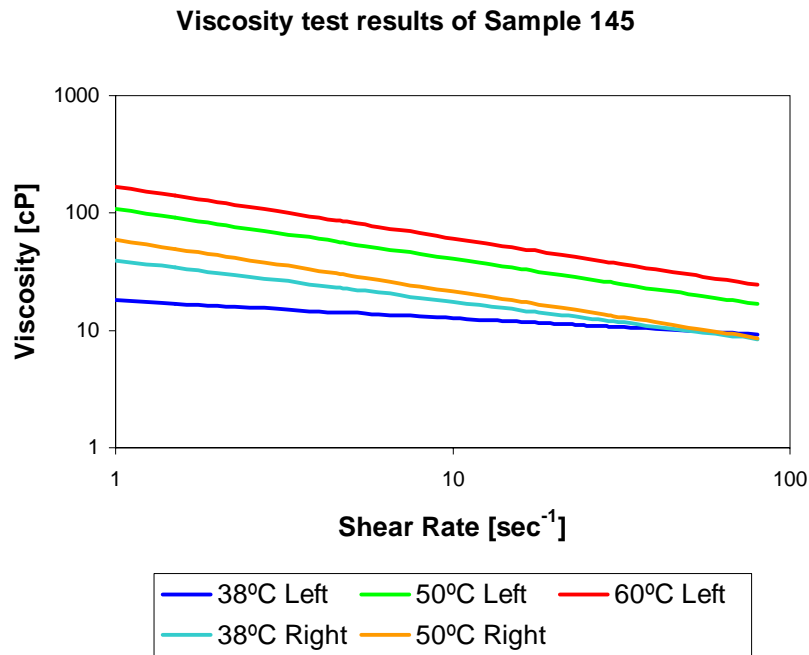

Figure 4.13 – The results of the viscosity testing of both sides of a patient under going a bilateral hip replacement surgery.

The differences between the left and right hip joints of a patient undergoing a bilateral hip replacement surgery are shown in Figure 4.13. Joint fluid retrieved from the left side hip joint showed almost a characteristic Newtonian flow property at 38°C, while the fluid retrieved from the right was thicker and showed more shear thinning properties. At 50°C the roles were reversed and the fluid retrieved from the left side hip joint showed thicker properties than that retrieved from the right side. The amount of viscosity increase for the same test temperature increase was greater for the fluid retrieved from the left side hip joint. It was also interesting to note that the slopes of all the tests shown in Figure 4.13, except for the 38°C tests, are inherently the same.

From the discussion above it is clear that the joint fluid retrieved from different patients are unique to its host and that even inside the body the fluid can, and most likely does, differ from joint to joint. The reason as to why the fluids differ falls outside the scope of this research but is most likely caused by the difference in the chemical composition of the fluid.

The general tendency was an increased viscous behaviour for an increase in test temperature. It is also known that at some high temperatures the proteins in the fluid would denaturate causing the fluid to become gel-like.

It is generally accepted (Unsworth 1995, p.487) that the fluid in the hip joint does get into contact with the highly loaded areas of the joint. These highly loaded areas are also the areas where the maximum temperatures are expected. The amount of fluid present at the contact surfaces is small relatively to the amount of fluid present in the joint. These small amounts of fluid are exposed to the high contact temperatures inside the joint and viscous behaviour of the joint fluid will change and thicken up. It is then more difficult to get the thick fluid out of the joint and new cool fresh fluid into the joint. When no new fluid enters the joint, the joint will then heat up even more due to the heat build up and at some stage the temperature inside the joint can reach the denaturation temperature. This would then cause the one-way transition from the fluid phase to a gel-like phase.

The joint is now building a “seal” preventing the flow of new cool lubricant into the joint. It is important to note that the amount of wear debris generated inside the joint will increase as the temperature increases. Figure 4.14 shows a typical “seal” found in simulator testing.

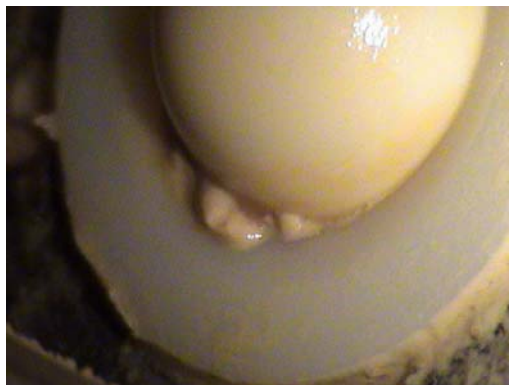

Figure 4.14 – The denatured proteins group together to form a “seal”. This then prevents fresh lubricant from reaching the contact area.

From the previous discussion it is apparent that the correct viscous behaviour is needed for the test medium in the hip simulator. Using a fluid that does not simulate the increase in viscosity for an increase in temperature will cause the joint inside the simulator to run at a lower temperature resulting in less generated wear debris, thus not imitating the true nature of the hip joint and its lubricating fluid.

Chapter V – Developing a synthetic lubricant

This chapter deals with the development of a synthetic lubricant that will have the same lubricative and viscous characteristics than that of the joint fluid previously tested. The viscosity and lubricity of this lubricant must also stay constant over a time similar to that of a simulator test period (5 000 000 cycles). Cooke *et al.*(1978, p.66) introduced the concept of using water-based polymers in trying to map the viscosity behaviour of synovial fluid.. Unfortunately they only mapped the viscosity at one temperature.

5.1 Design parameters

Figure 5.1 depicts that the retrieved joint fluid that was tested, showed an increasing viscous behaviour with an increase in the test temperature. This study, therefore, attempted to design a lubricant that will show the same tendencies to that of the average viscous behaviour of the joint fluid.

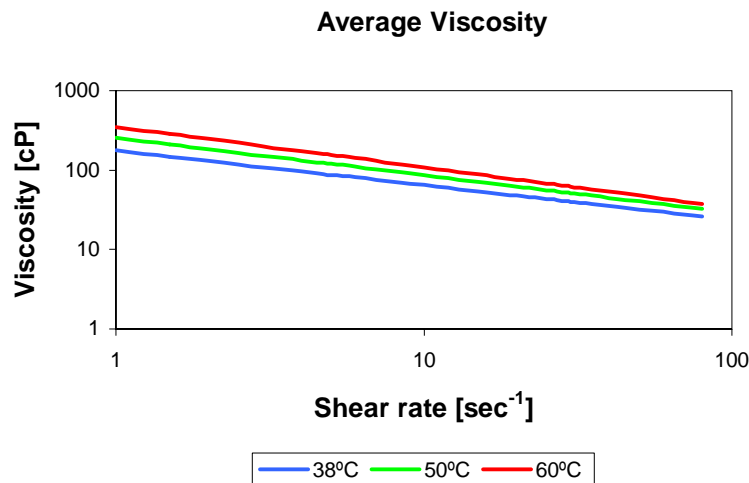

Figure 5.1 – The average viscosity can be seen to be a function of the test temperate.

From Figure 5.2 it can be seen that only one sample had a load at failure less than 400 N. It was therefore decided to use 400 N as the required load at failure for the synthetic lubricant.

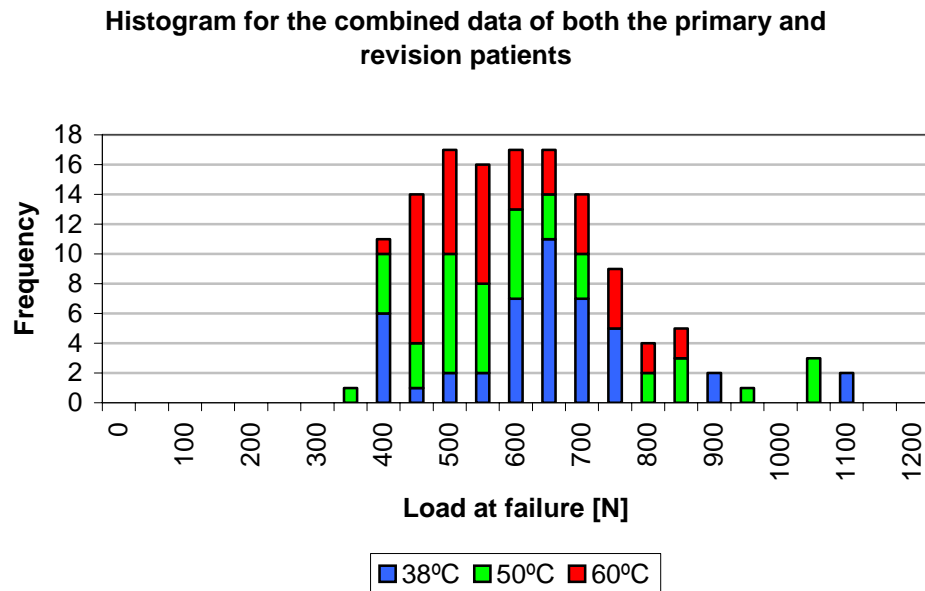

Figure 5.2 – A histogram of the load at failures for both the primary and revision patients groups.

5.2 Chemicals used

Different bases were considered to be used in the development of a synthetic lubricant. They included bases like esters, mineral oils and water. For both the first two bases a viscosity decrease would most likely be found for a temperature increase. Thus they necessitated the prerequisite that the additive package should not only reduce the decrease in viscosity, but should also show an increase in viscosity with an increase in temperature.

On the other hand, unlike the first two proposed bases, water is not a lubricant but it does have a more stable viscous behaviour with an increase in temperature. It was thus decided to use a water based polymer solution as a synthetic lubricant.

An extensive search of all the water-soluble polymers showed that no polymer had the ability to conform to all the requirements on its own and thus a combination of polymers was proposed. A combination of two polymers and one additive package to increase the lubricity properties was used to find the optimum solution. A brief summary of the essential chemical properties of the chemicals used will now be presented.

5.2.1 Poloxamer 188

The information of Poloxamer 188 supplied in this section is a summary of the technical specifications on Lutrol[®] F68 as supplied by BASF (2002).

Poloxamer 188, or Lutrol[®] F68, the tradename used by BASF, is a commonly used chemical in the pharmaceutical industry. The uses of Poloxamer 188 stretch over a wide range of applications from being an emulsifier, solubilizer or even a dispersing and wetting agent. It is freely soluble in water and insoluble in diethyl ether, paraffin and fatty oils.

Poloxamer 188 is a polyoxyethylene-polyoxypropylene copolymer with a general formula as shown in Figure 5.3.

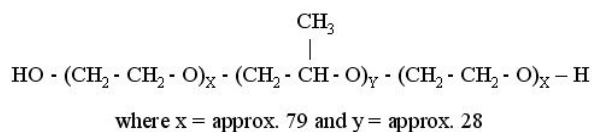

Figure 5.3 – The general formula of Poloxamer 188

Poloxamer 188 is also known to be thermo reversible, meaning that its viscosity would increase with an increase in temperature, see Figure 5.4. This increase in viscosity is totally reversible and even after repeated heating and cooling, the viscosity would stay the same.

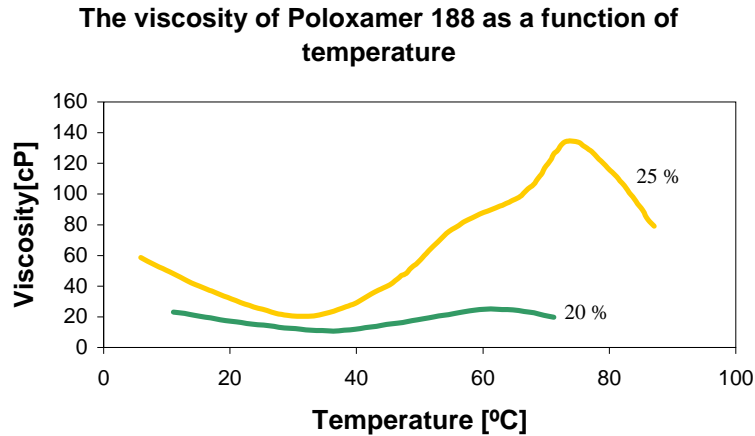

Figure 5.4 – The viscosity of an aqueous solution of Lutrol[®] F68 (Poloxamer 188) as a function of the concentration used and the temperature of the solution. (BASF 2002, p.4).

Normally Poloxamer 188 would have a minimum viscosity between 30°C and 40°C and a maximum between 60°C and 70°C (Figure 5.4). These minimum and maximum points can be manipulated with the addition of other substances. For example, the addition of sodium chloride reduces the gel forming temperature, while the addition of ethanol would increase the gel forming temperature. The gel forming temperature is defined as the temperature where the solution would start to gel. This then increases the viscous behaviour of the lubricant.

Poloxamer 188 is a Newtonian fluid, which changes to a non-Newtonian fluid above concentrations of 60%. The down-side of using this polymer is that it is not known for its lubricating capabilities.

5.2.2 Xanthan Gum

Xanthan gum is one of the most widely used microbial polysaccharides used in our daily living. The ADI (acceptable daily intake) value for Xanthan gum is set as "not specified", meaning that any amount of gum can be congested daily without any side effects (Katzbauer 1998, p.81). Xanthan gum is extensively used in low-fat products to increase the viscosity of the product as less oil is being used in these products. It is also non-digestible in humans and thus helps to lower the calorific value of the food that it is used in. The non-Newtonian behaviour of xanthan gum makes it ideal to be used in salad dressings, sauces and even toothpaste.

Xanthan gum is also stable over a wide range of pH levels and is therefore also used in the cleaning industry. It is also used in the oil-drilling industry because of its lubricating capabilities.

The chemical structure of Xanthan gum is unique giving the gum some interesting chemical and physical properties. The property of interest in this study is the stability at elevated temperatures. A salt-free solution of Xanthan gum in deionised water shows a slight decrease in viscosity at first, after which an increase is seen with an increase in temperature. The addition of salt to the solution helps to moderate the effects of temperature on the viscosity for temperatures below 90°C, see Figure 5.5. The viscosity is fully recoverable when the solution is cooled down (Davidson ca. 1995, p.24-2).

Xanthan gum is compatible with a lot of other chemicals including acids, bases and preservatives. Xanthan gum was primarily chosen for this study because of its strong non-Newtonian behaviour, even at small concentrations. The stability during temperature changes and the tolerances to other chemicals were added bonuses.

The product used in this study was KELTROL TF from Cp-Kelco.

The viscous behaviour of a 1% Xanthan Gum aqueous solution with 0.1% NaCl

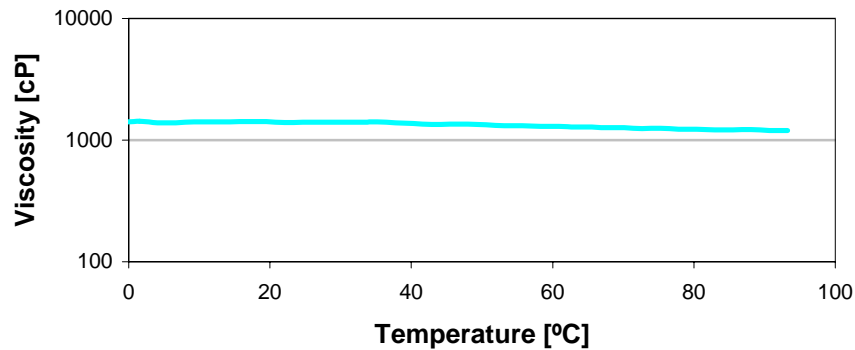

Figure 5.5 – The effect of temperature on the behaviour of Xanthan Gum as published by Davidson (ca. 1995, p.24-2).

5.2.3 Lube-booster[®] II

Lube-booster[®] II is an additive package marketed by FERRO Petroleum Additives. FERRO Petroleum Additives published the following in their technical specification about Lube-booster[®] (no date, p.1):

"Lube-booster[®] II is a water-soluble, polymer based lubricity additive for formulating synthetic and semi-synthetic fluids for ferrous and non-ferrous applications."

Lube-booster[®] II is free from any nitrate, chlorine, sulphur, phosphorous heavy metals and petroleum oils.

A solution made up of 13% Lube-booster[®] II and 63% deionised water on a volume-volume base showed that the additive had Newtonian flow behaviours and had a load at failure of 450 N.

5.3 Combining the chemicals

The three chemicals discussed previously in this report were experimentally mixed in different ratios. A mixture with more Poloxamer 188 led to a solution with a greater viscosity increase for the same temperature increase. The non-Newtonian behaviour was manipulated with the Xanthan gum, while the lubricity behaviour was the result of the concentration Lube-booster[®] II used. Methyl Paraben was used as a preservative. The final mixture is shown in Table 5.1.

Table 5.1 – The chemical composition of the synthetic lubricant

Chemical	Amount	Supplier and Lot number
Lutrol [®] F68	45g	BASF (S_2K3486V)
Keltrol T	0.7g	CP-Kelco (01029301)
Lube-booster [®] II	100ml	FERRO (M2086)
Methyl Paraben	1.8g	
Deionised water	750g	

Some polymers can take a lot of time to completely dissolve into a chemical mixture to give a uniform mixture. In this case the synthetic lubricant is best when left to dissolve for a minimum of 48 hours.

Figures 5.6 to 5.9 show the chemical stability of the lubricant over a period of eight weeks. This is longer than the expected simulator time required to complete 5 000 000 cycles.

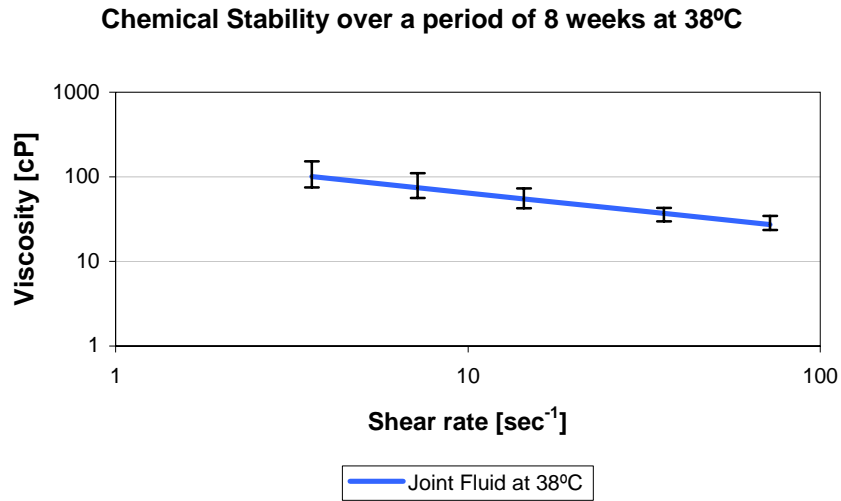

Figure 5.6 – The stability of the synthetic lubricant as a function of time at a temperature of 38°C.

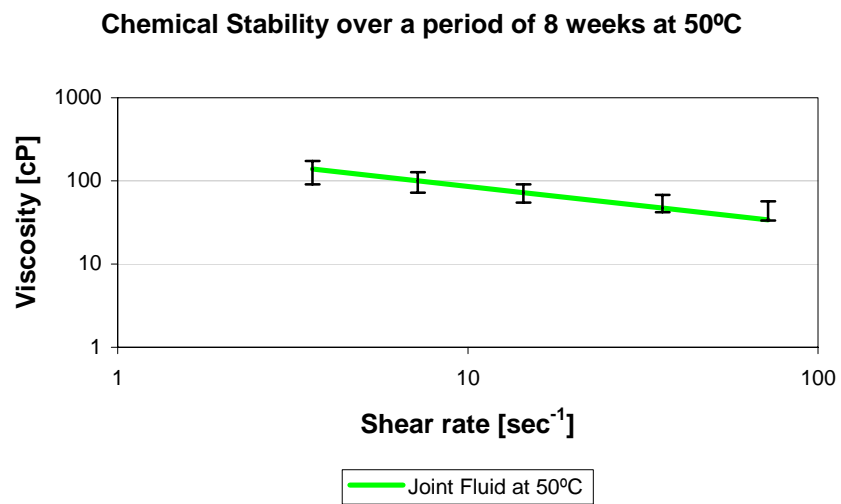

Figure 5.7 – The stability of the synthetic lubricant as a function of time at a temperature of 50°C.

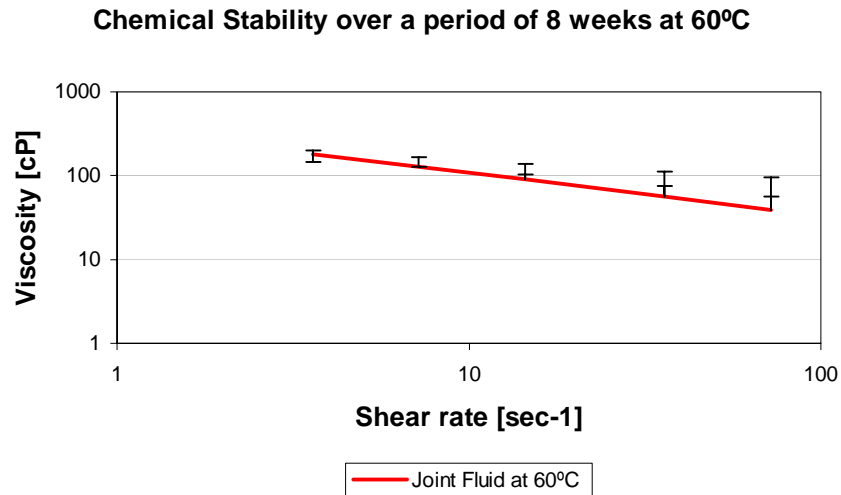

Figure 5.8 – The stability of the synthetic lubricant as a function of time at a temperature of 60°C.

The load at failure of the synthetic lubricant was found to be in the region of 350 N after mixing. Figure 5.9 shows the lubricity of the lubricant over a period of eight weeks. A decrease was noted towards the end of the eight-week period. This decrease in the lubricative abilities of the lubricant is not ideal, but it was decided to keep on using the lubricant in the simulator testing, as a different compromise between viscosity and lubricity could not be found.

The mixture shown in this report was the best compromise between mixing a fluid that would reproduce the viscous and lubricative behaviour of the retrieved joint fluids, see Chapters 3 and 4.

Chemical Stability over a period of 8 weeks

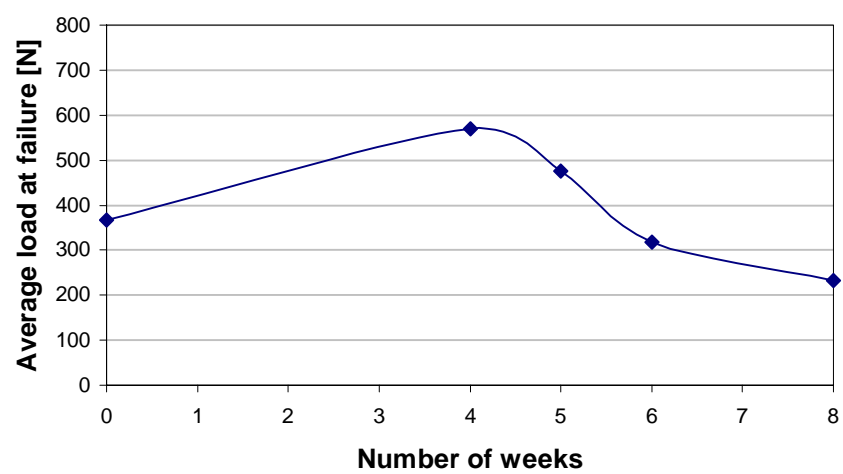

Figure 5.9 – The lubrication abilities of the synthetic lubricant over a period of eight weeks.

(Note: the data for the different temperatures were combined in this graph.)

Chapter VI – Simulator Verification

6.1 Method

The newly developed synthetic lubricant was used in a simulator test where small samples of the test medium were drawn from each station at regular intervals. These samples were filtered and examined under an optical microscope. The wear debris found on the filter paper were classified and measured. Comparisons were made between the wear debris found during the simulator testing and those found in the scar tissue retrieved during revision surgery. A lubricant that could cause similar size and shapes of wear debris in the simulator to those found in the scar tissue of patients, would be ideal.

6.2 Apparatus used

The five-post simulator (Figure 6.1) used in the verification of the synthetic lubricant was a simulator developed and built by Burger. A short description of the working of the simulator follows in the rest of this section. A schematic drawing of a station on the simulator can be seen in Figure 6.2.

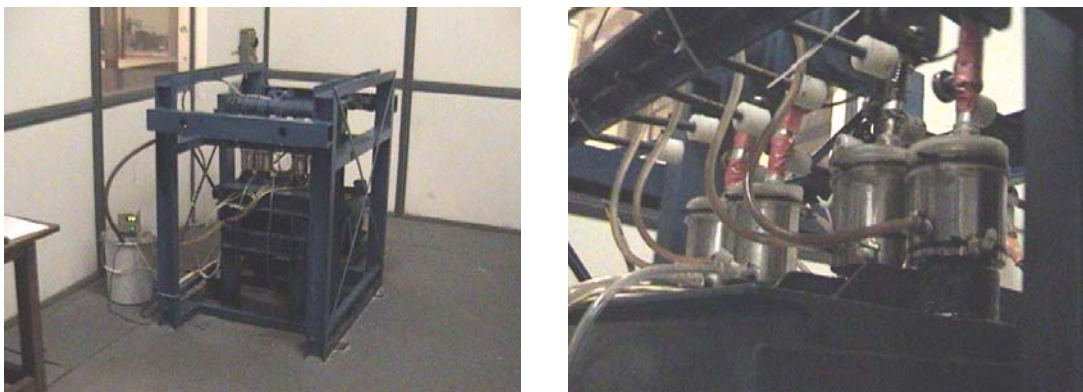

Figure 6.1 – The five-post simulator developed and built by Burger.

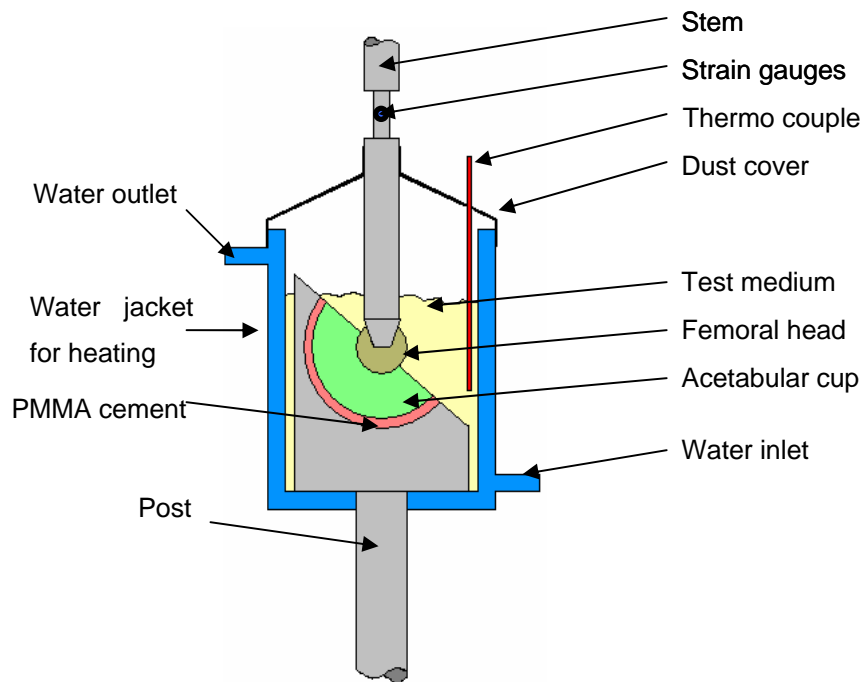

Figure 6.2 – A schematic drawing of a station on the five-post simulator.

The acetabular cups were cemented into the aluminium or preserved steel posts using bone cement (PMMA). The posts were then individually mounted into their own containers. Water, from a reservoir with a set temperature of 37.5°C, was then circulated through the sides of these containers to maintain a test medium temperature of 37.5°C, simulating the *in-vivo* temperature.

Strain gauges (see Figure 6.3) were mounted onto the stem to monitor the load between the cup and head. A load profile similar to that which was determined by Bergman (1993, p.969) for a person walking at 6km/h, was used in the simulator testing. This load profile (Figure 6.4) required a maximum load of 400 kg at top dead centre, a minimum load of 200 kg on the one side and 250 kg on the other side. Provision for 5° adduction and abduction rotation was made at the minimum loads.

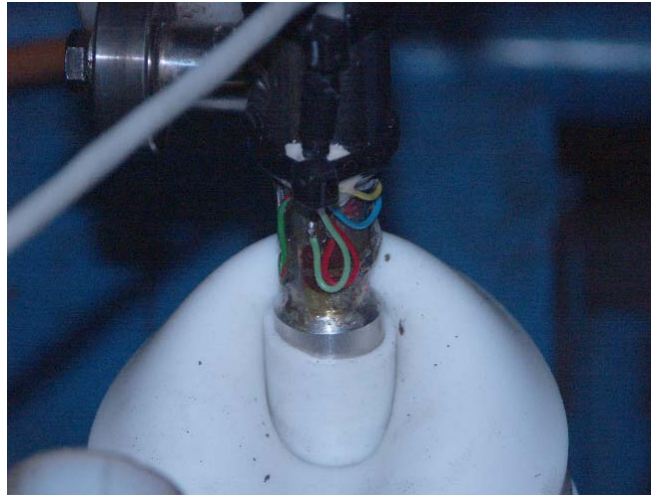

Figure 6.3 – Strain gauges were used to monitor the load applied to each station.

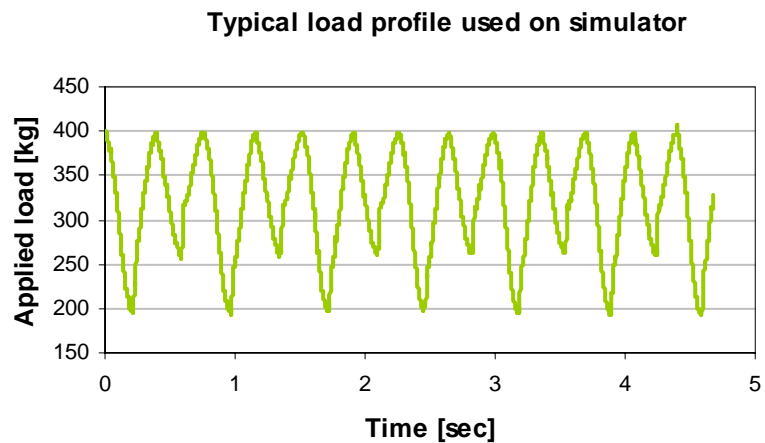

Figure 6.4 – A typical recorded load profile on the simulator

A computer program was then written to monitor and control the simulator. The program stopped the simulator when a station's maximum load differed by 12.5% from the expected maximum value of 400 kg.

This high load difference was needed to allow the simulator to start up every time it was stopped. During these stoppages the loading system in the simulator would “cool down” resulting in a loss of applied load. When the simulator was then restarted, an increase in the applied load was seen till the loading system stabilizes at the working temperature.

The water used to heat the individual stations did not preheat the loading system. The reason for this phenomenon is not known but is believed to be related to the spring set-up used for the load application - see Figure 6.6.

A typical run-in phase on one of the simulator stations

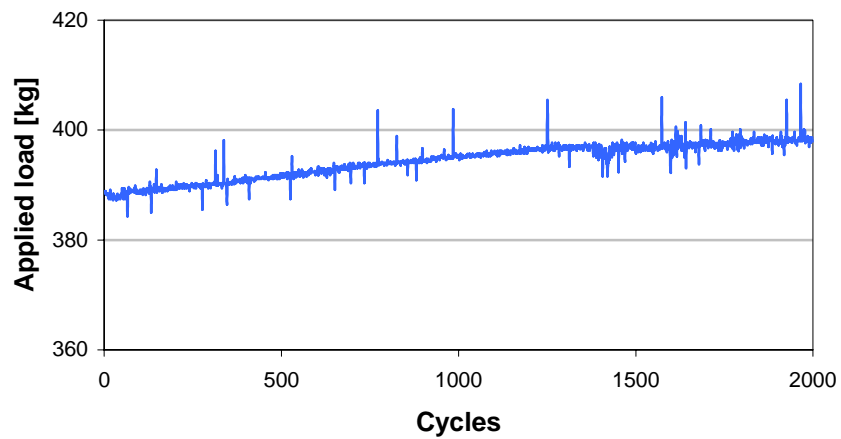

Figure 6.5 – A typical recorded load profile on the simulator during a typical run-in phase after a stoppage.



Figure 6.6 – Every station was mounted on a spring configuration to supply the required load profile.

6.3 Test method

6.3.1 Simulator testing

Four of the five stations were used in the testing of the synthetic lubricant (Station 3 was not allocated). All the stations were fitted with 28 mm alumina femoral heads. The cups used in the simulator were manufactured from ultra high molecular weight polyethylene (Trade name: Chirulen[®] Lot number: B15331081), which were not sterilised.

The cups were not sterilised due to the fact that free radicals would be introduced into the system (McKellop *et al.* 2000, p.1708 and Oonishi *et al.* 1997, p.11). The effects that free radicals have on the wear rate in simulator testing falls outside the scope of this study.

Two of the stations used bovine serum as test medium, while the other two stations used the new synthetic lubricant as their test medium.

Simulator testing was stopped every 500 000 cycles until it reached 4 500 000 cycles. Typical standing time of less than an hour was the norm. During these stoppages 5 ml of fluid was retrieved from the top layer of fluid present in each station. These fluids were then filtered through a 0.45 µm filter after which each filter paper was tagged and left to dry.

During these intervals the bovine serum stations were drained, washed with deionised water and refilled with new bovine serum (see Paragraph 6.3.2), but not stripped and weighed as specified in the ISO standard (ISO 14242-1:2002). This ensured that the wear pattern stayed the same during the whole test. Lubricant from the same batch as at the beginning was used to top-up the two synthetic lubricant stations.

The lubricant level was checked and topped up twice a day with deionised water.

6.3.2 Bovine Serum

The bovine serum used in two of the simulator stations was prepared as follows: Blood from young cattle was collected from a local abattoir and left to stall. The serum was separated from the blood by filtering the stalled blood mixture through some cheesecloth.

The serum was placed in a centrifuge for half an hour at 15 000g to remove any red blood cells still in the solution. An optical microscope was used to ensure that no red blood cells were still present in the serum solution. None was found.

A diluted bovine serum mixture was made by diluting the serum with 75% deionised water (v/v). Sodium azide was added to prevent the growth of bacteria in the diluted serum mixture. This diluted serum mixture was then filtered through a 2.5 μm filter and frozen until required for testing. The protein mass concentration of the diluted bovine serum mixture was found to be 17 g/l.

6.3.3 Isolating the wear debris from the patients' scar tissue

During revision operations some scar tissue surrounding the prosthesis was retrieved. The scar tissue was dissolved in a caustic soda mixture and filtered through a 0.45 μm filter after which the filter paper was tagged and left to dry.

6.3.4 Examining the filter paper

The filter papers were coloured with a liquid penetrant, Ardrex® 996P, which improved visibility of the transparent wear debris on the filter paper by colouring the paper red. A microscope with a 60x optical magnification was used to scan the filter paper for any wear debris. Once found, the wear debris was photographed at 60x and 200x magnification. These photographs were used to classify and measure the size of the wear debris. See Figure 6.7 and Figure 6.8 for an example of the same wear debris at 60x and 200x magnification.

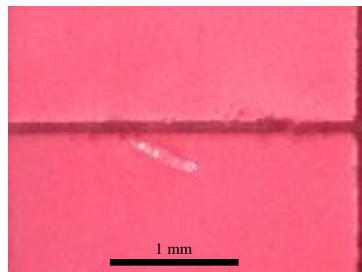

Figure 6.7 – Typical wear debris at 60x magnification.

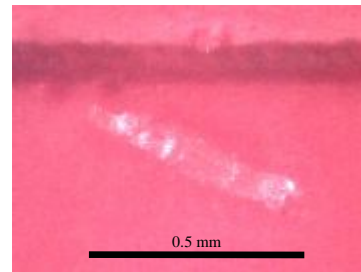

Figure 6.8 – The same wear debris as shown in Figure 6.7, at 200x magnification.

6.4 Test Observations

6.4.1 Femoral-head breakage in simulator

The computer that continuously monitored the simulator stopped the simulator after 450 cycles due to a load failure on station 1. An investigation into the reason as to why the load was lost revealed a broken femoral head (see Figures 6.9 and 6.10).

The reason for the broken femoral head was found to be a burr located on the taper side of the stem, see Figure 6.12. This burr interfered with the tight fitment between the femoral head and the stem, causing a stress concentration inside the head, which led to the breakage of the head. The burr was removed using a file.

The whole station was stripped, washed and refitted with another femoral head and acetabular cup, as the stem also damaged the acetabular cup when the head broke (Figure 6.11).



Figure 6.9 – The broken femoral head as found in the simulator.



Figure 6.10 – The femoral head had broken into several pieces.



Figure 6.11 – The damage to the acetabular cup caused by the stem as the femoral head broke.

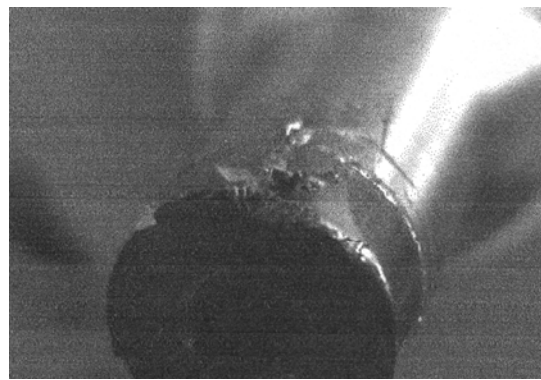

Figure 6.12 – A burr located on the femoral side of the stem was found to be the cause of the broken femoral head.

6.4.2 Using Saline as a test medium

The use of saline as a test medium in simulator testing was investigated in the hope to find an acceptable cheap test medium. Unfortunately the use of saline was found to be lacking due to salty deposits that formed in the test station, as can be seen in Figures 6.13. These salty deposits could then induce extra wear due to the addition of extra third body particles.

The acetabular cup that was being used was found to be very brittle and full of cracks (see Figure 6.14). This brittleness was not caused by the saline test medium but rather induced by the age of the acetabular cup. The cup was 10 years old and was previously sterilized.

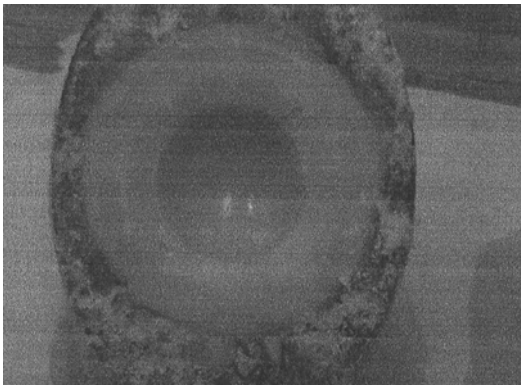

Figure 6.13 – The acetabular cup retrieved from the saline station after 500 000 cycles. Note the flakes that formed on the metal surface surrounding the cup.

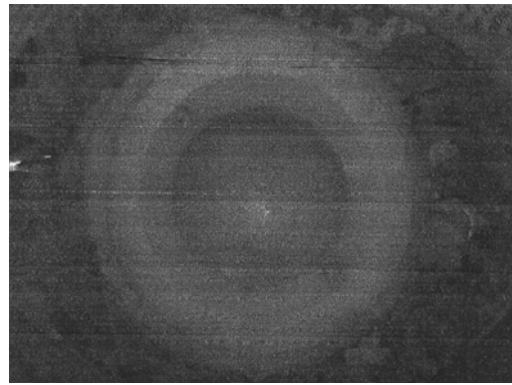

Figure 6.14 – The whole cup was filled with cracks and flakes that peeled from the cup.

The conclusion to this test had to be that saline was not a suitable test medium due to the salty deposits that formed inside the station that could enhance the wear rate of the acetabular cup. This test was stopped at the start of the crystal formation.

6.4.3 Bovine serum station after 500 000 cycles

The first bovine serum test was stopped after 500 000 cycles. During the draining of the station it became apparent that something was wrong. A fibrous deposit was found around the femoral head in the station (Figures 6.15 and 6.16). The station was then stripped to investigate the situation.

The acetabular cup was found to be very brittle and filled with cracks on and off the load carrying part (Figure 6.17 and 6.18). A black deposit was also found on the load carrying part of the femoral head (Figure 6.19). The femoral head was then sent to the Department of Microscopy and Micro-analysis at the University of Pretoria for further analysis. Figure 6.20 shows an enlargement of the black deposit found on the surface, while Figure 6.21 shows the result of a point analysis at the same point.

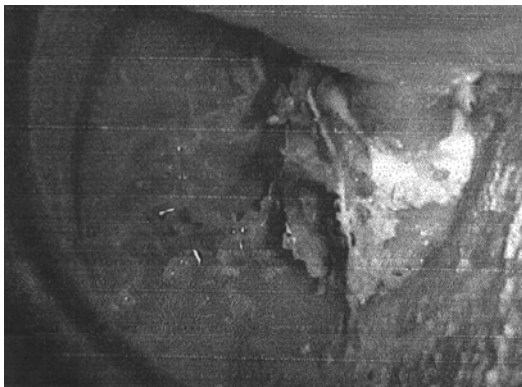

Figure 6.15 – The drained bovine serum station after 500 000 cycles.

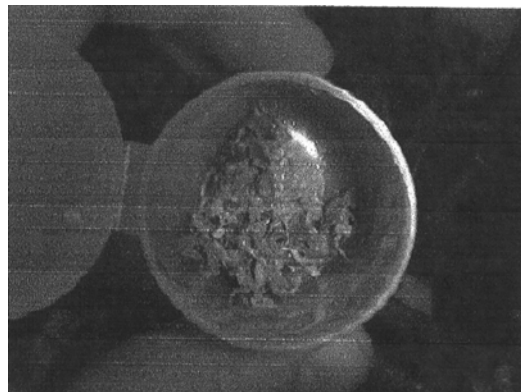

Figure 6.16 – A fibrous deposit was found inside the bovine serum station after 500 000 cycles.

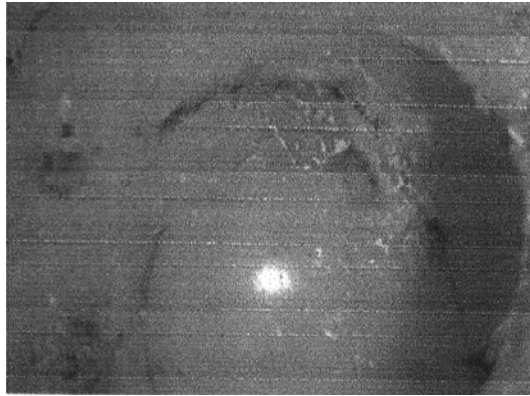

Figure 6.17 – The acetabular cup of the bovine serum station was severely cracked and brittle.

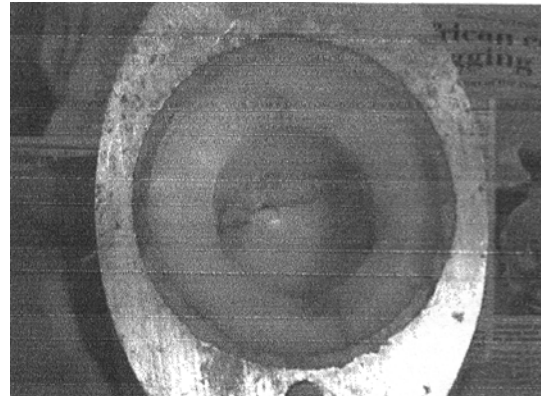

Figure 6.18 – The visibility of the cracks was enhanced with the use of die penetrant.

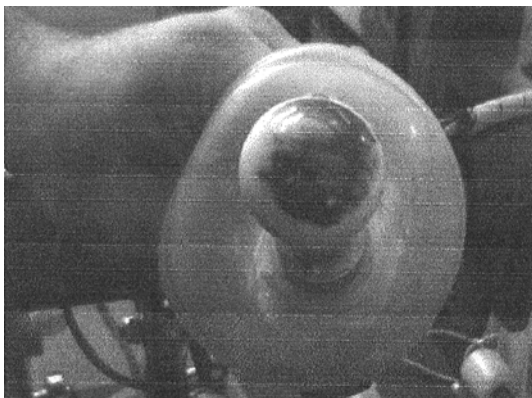

Figure 6.19 – A black deposit was found on the femoral head after 500 000 cycles.

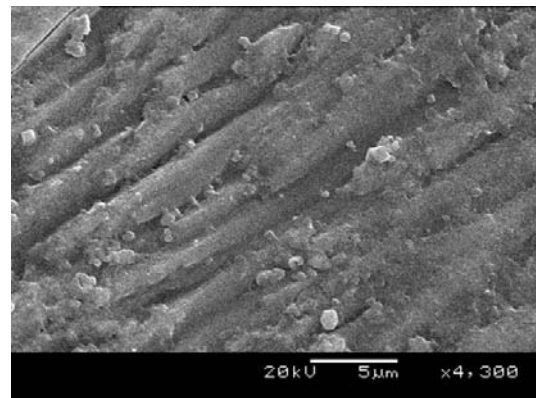

Figure 6.20 – An enlargement of the black area shown in Figure 6.16.

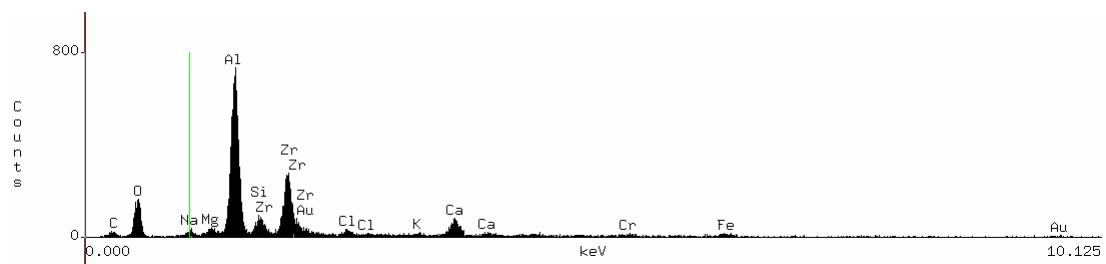

Figure 6.21 – The result of a point analysis of the black deposit as conducted by the Department of Microscopy and Micro-analysis at the University of Pretoria.

The first hypothesis about the black deposit was that it is denatured proteins. This hypothesis was however, proven wrong. The structure of the deposit, see Figure 6.20, did not correlate to known protein structures. The point analysis of the black deposit showed a high value of aluminium on the femoral head (Figure 6.21). Aluminium was only used in the post of the station (Figure 6.2) and nowhere else in the station assembly.

The conclusion of this investigation was that the acetabular cup was brittle due to its age (10 years) and that the black deposit found on the femoral head was the result of some chemical reaction between the aluminium post and the bovine serum being used as a test medium. In order to avoid chemical interactions between the different materials used in simulator test stations it is important that the newly developed synthetic lubricant would not cause reactions between the different materials used in the simulator test stations.

6.4.4 Findings during the 500 000 cycle intervals

During most of the draining intervals, denatured proteins were found to form a "seal" between the femoral head and the acetabular cup (Figures 6.22 to 6.27). Proteins are known to denature because of extreme loading or temperatures above 62°C, and in this case, the loading wasn't that high. High temperatures must therefore be the cause of the denaturation of the proteins. Lu and McKellop (1997, p.101) calculated a surface temperature of 99°C between a zirconia ball and a UHMWPE cup.



Figure 6.22 – The “seal” in station 4 after 4 000 000 cycles.



Figure 6.23 – A close-up of the removed “seal” shown in Figure 6.20.



Figure 6.24 – The “seal” in station 4 after 5 000 000 cycles.



Figure 6.25 – A close-up of the removed “seal” shown in Figure 6.22.

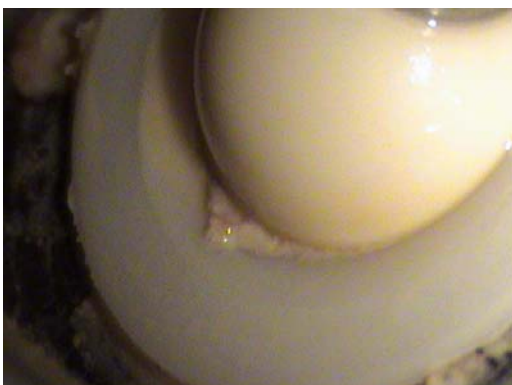

Figure 6.26 – The “seal” in station 5 after 4 000 000 cycles.

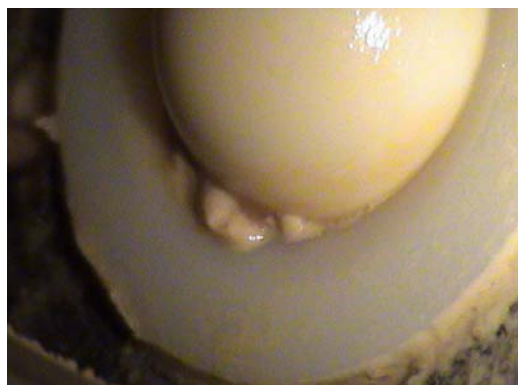

Figure 6.27 – The “seal” in station 5 after 4 500 000 cycles.

6.4.5 Stripping the bovine serum stations after 4 500 000 cycles

The same black deposit, see Paragraph 6.4.3, was found in the two bovine serum stations that completed the 4 500 000 cycle test (see Figures 6.28 and 6.29). In these cases the one post was aluminium and the other one preserved steel. It was thus apparent that the bovine serum showed reactions with both the preserved steel and aluminium posts.

The bovine serum acetabular cups both showed a yellowish discolouration (see Figures 6.30 and 6.31).



Figure 6.28 – A black deposit was found on the femoral head of the bovine serum station after 4 500 000 cycles. The station used an aluminium post.



Figure 6.29 – The black deposit found on the femoral head of the station using a preserved steel post and bovine serum as test medium. The station completed 4 500 000 cycles.



Figure 6.30 – The acetabular cup of station 4 showed a light yellowish colour after 4 500 000 cycles.

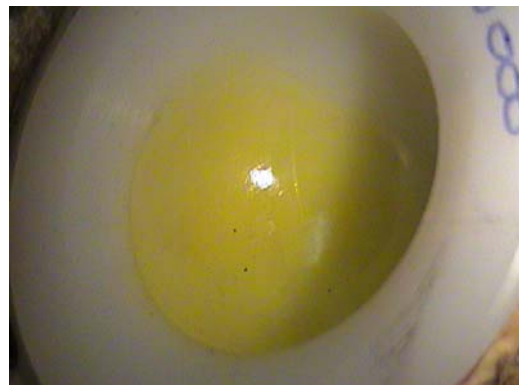

Figure 6.31 – The acetabular cup of station 5 showed a darker yellowish colour than seen in Figure 6.30 after the same amount of cycles.

6.4.6 Stripping the synthetic lubricant stations

No deposit was found in either of the two simulator stations using the synthetic lubricant as test medium (see Figures 6.32 and 6.33). The preserved wear pattern was also clearly visible in both stations after the tests (see Figures 6.34 and 6.35). There was no discolouring of the cups present as in the case of the stations using the bovine serum as test medium.



Figure 6.32 – No deposit was present on the balls retrieved from the stations using the synthetic lubricant as test medium.

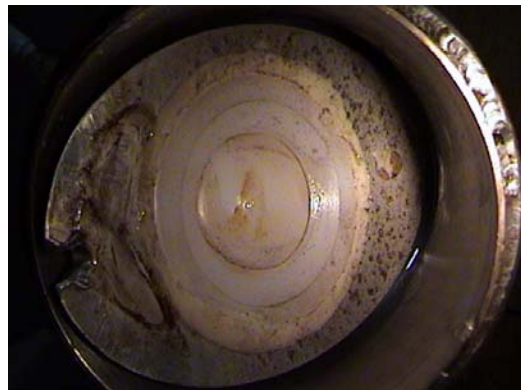

Figure 6.33 – No deposit was found in either of the two stations using the synthetic lubricant.

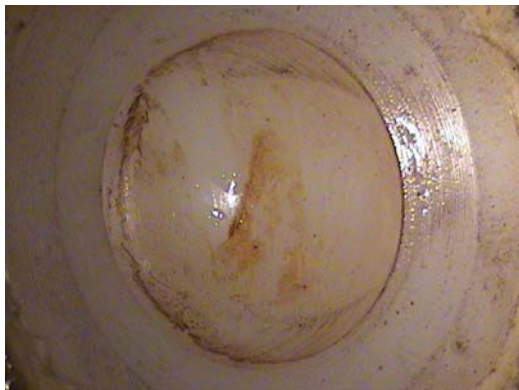

Figure 6.34 – The wear pattern as found in the first station using the synthetic lubricant.



Figure 6.35 – The retrieved cup from the second station using the synthetic lubricant clearly shows the wear pattern.

6.5 Test results

The wear debris found, from both the patients and the simulator, was divided into two main groups, namely round or flake-like and whisker or fibrous. The statistical analysis of the wear debris found during this study is shown in Table 6.1 and Table 6.2. Figures 6.36 and 6.37 shows the comparison between the different wear debris found in the simulator versus the wear debris retrieved from patients.

Table 6.1 – The statistical analysis of the flake-like wear debris found in the scar tissue retrieved from patients and from the simulator using different lubricants.

	Lubricant	Avg. diameter	Min. diameter	Max. diameter	Standard deviation
		[μm]	[μm]	[μm]	[μm]
Patients	Natural Hip Fluid	92.45	49	231	39.01
Station 1	Synthetic Lubricant	89.83	23	244	48.12
Station 2	Synthetic Lubricant	107.69	27	244	55.03
Station 3	Bovine Serum*	122.94	38	211	42.11
Station 4	Bovine Serum*	102.18	17	243	57.73

Table 6.2 – The statistical analysis of the whisker like wear debris found in the scar tissues retrieved from patients and from the simulator using different lubricants.

	Lubricant	Ave. length	Min. length	Max. length	Standard deviation
		[μm]	[μm]	[μm]	[μm]
Patients	Natural Hip Fluid	792.513	310.230	2122.100	471.898
Station 1	Synthetic Lubricant	826.269	153.710	3855.000	622.054
Station 2	Synthetic Lubricant	774.604	168.070	2677.500	507.507
Station 3	Bovine Serum*	825.485	151.100	2692.200	571.685
Station 4	Bovine Serum*	776.449	104.400	2279.500	530.831

* It must be noted that the assembly was not stripped, in order to ensure the preservation of the wear pattern in the station. This is however not according to the current ISO standard.

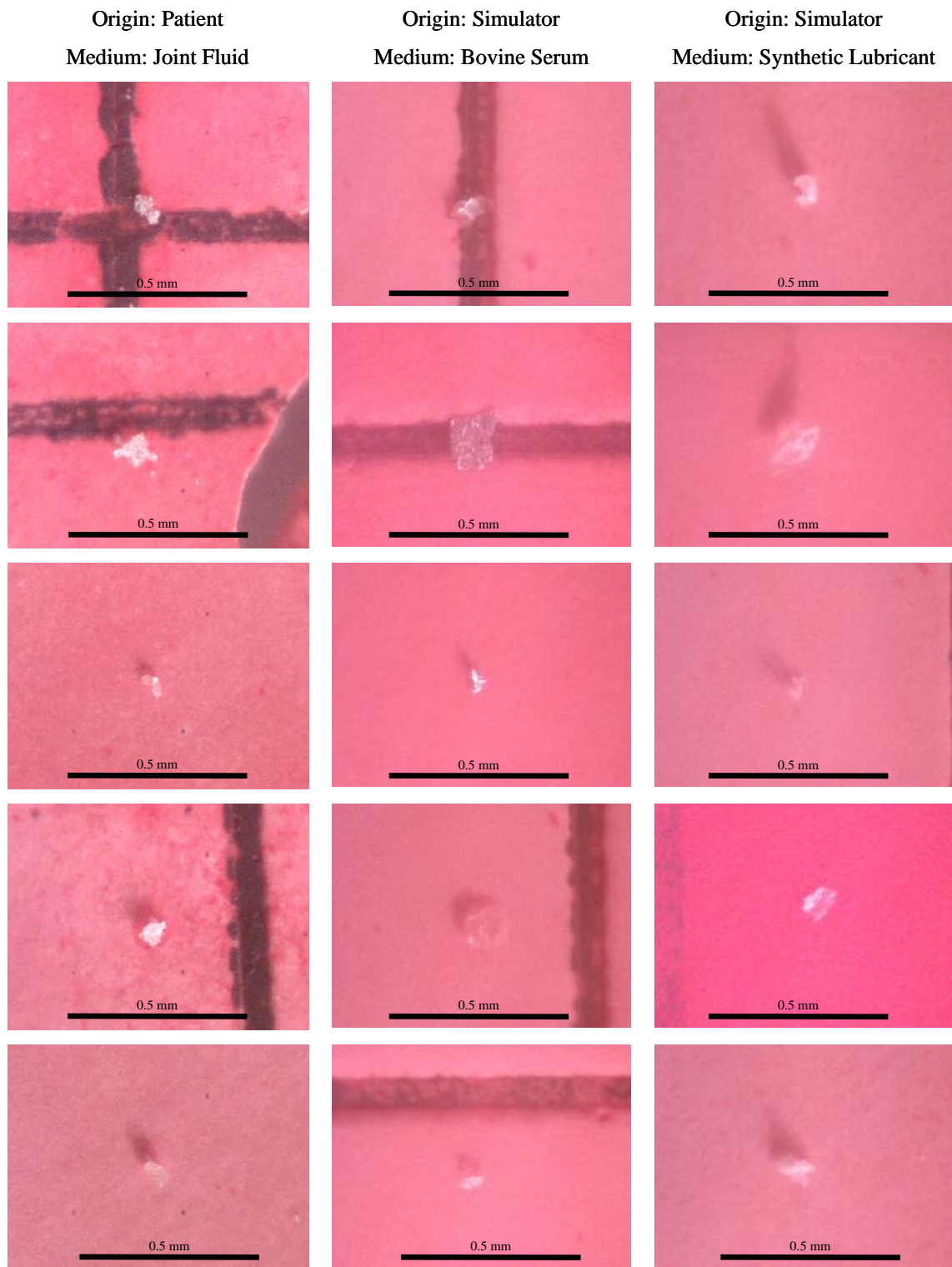

Figure 6.36 – Samples of the flake-like type of wear debris

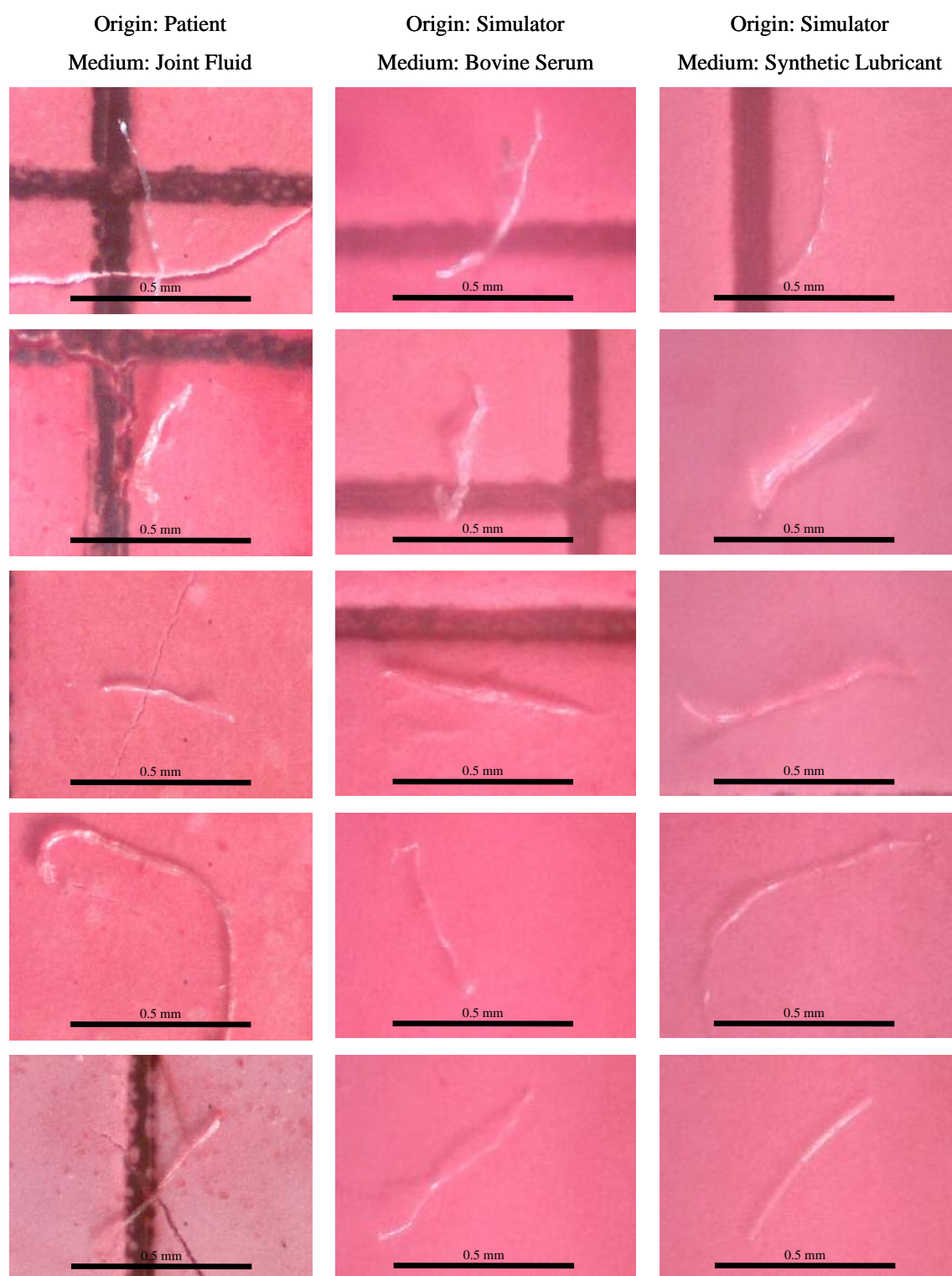

Figure 6.37 – Samples of the whisker-like type of wear debris

6.6 Discussion

Previous scientific studies showed the size of the general expected wear debris to be smaller than 0.3 μm . (Tipper *et al.* 2001, p.120, Saikko *et al.* 2001, p.1507 and Wang *et al.* 1995, p.865). Tipper *et al.* (2001, p.120) showed flake-like UHMWPE wear debris of maximum 50 μm . The average value obtained from this study was almost twice this value. The size of the whisker like wear debris found in this study was almost hundred times bigger than previously recorded. This is the case for both the wear debris retrieved from the scar tissues of patients and the wear debris generated during simulator testing.

A possible cause for this might be the magnification used in searching for the wear debris. In some of these studies, magnifications of up to 20 000x were used, while the maximum magnification used in this study was 200x. If a big magnification is used to search for wear debris, one might not be able to see the wear debris due to the fact that the wear debris fills the whole screen.

The wear debris that was found in the scar tissue retrieved from patients was similar in shape and size to that which was found in the simulator using bovine serum and the synthetic lubricant. It has to be noted that the bovine serum stations were not stripped and weighed as specified in the ISO standard (ISO 14242-1:2002).

The advantage of using the synthetic lubricant is that it does not need to be replaced every 500 000 cycles due to the following reasons:

- Excellent chemical stability over a time period similar to a typical simulator test session.
- No deposits were formed inside the stations.

This means that one does not have to throw away the third body particles when changing the fluid. More third body particles may lead to more wear in the cups.

Chapter VII – Conclusion

A synthetic lubricant was developed for the purpose of this study to replace the bovine serum currently being used in simulator testing. This is needed because the bovine serum is currently being replaced every 500 000 cycles. The new synthetic lubricant does not need to be replaced, thus leaving the third body particles in the fluid, which may lead to an increase in wear rate of the acetabular cups.

The development of the synthetic lubricant was started by characterising joint fluid retrieved prior to corrective surgery. This was necessitated since the viscosity and lubricity response of the joint fluids has not been specifically studied when temperature fluctuates, as is the case in the human body. An increase in the viscosity was observed in response to increase in test temperature, while the lubricity showed a decrease for an increase in test temperature. It was thus decided to design a synthetic lubricant that would map the viscous behaviour of joint fluid while achieving a minimum lubricity value.

A solution of two chemicals and one additive package delivered the required results. A preservative was also added to the mixture to prevent any bacterial growth in the mixture. This new lubricant was then tested over a period of eight weeks to ensure chemical stability, resulting in constant viscous and lubricative behaviour over this period of time.

A simulator test was run with the new synthetic lubricant and bovine serum as the test mediums. During this test, samples of the test mediums were taken at 500 000 cycles intervals until 4 500 000 cycles. These samples were then filtered through a 0.45 μm filter. The bovine serum stations were also drained, washed and refilled with new fluid at these intervals, but not stripped and weighed as required in the ISO standard (ISO 14242-1:2002).

The size and shape of the wear debris found in the simulator were then compared to the size and shape of the wear debris found in the scar tissue of revision patients.

The wear debris retrieved from the scar tissue was similar in size and shape to that which was found in the simulator using bovine serum and the synthetic lubricant. The advantage of using the synthetic lubricant is that it does not need to be replaced every 500 000 cycles as it showed stable viscous and lubricative behaviour over a time period similar to that of a simulator test.

It can thus be concluded that an acceptable lubricant for use in hip simulators had been developed.

Chapter VIII – References

- 1 AMERICAN SOCIETY FOR TESTING OF MATERIALS. 1997. *Standard Test Method for Determining Extreme Pressure Properties of Lubricating Grease Using A High-Frequency, Linear-Oscillation (SRV) Test Machine.* (ASTM D5706-97). Annual Book of ASTM Standards.
- 2 ANONYMOUS. 1994. *SKF International. SKF General Catalogue (4000 /IV E).* Gerber & Bruckmann.
- 3 ANONYMOUS. 2001. *ENGEN Product Handbook.* ENGEN South Africa.
- 4 ANONYMOUS. 2002. *Lutrol[®] F68 Technical specifications.* Ludwigshafen: BASF.
- 5 ANONYMOUS. [S.a.]. *Lube-Booster[®] II Technical specifications.* FERRO Petroleum Additives.
- 6 ANONYMOUS. [S.a.]. *More solutions to sticky problems.* Brookfield Engineering Labs. Inc .
- 7 BERGMANN, G., GRAICHEN, F. & ROHLMANN, A. 1993. Hip joint loading during walking and running. Measured in two patients. *Journal of Biomechanics*, vol.26, no.3, p.969-990.
- 8 BÖHMER, V. 2002. *Viscosity Meter.* B(Eng.) Mech. Thesis, University of Pretoria.
- 9 CONN, E.E. & STUMPF, E.L. 1972. *Outlines of Biochemistry*, Third Edition. John Wiley & Sons Inc.
- 10 COOKE, A.F., DOWSON, D. & WRIGHT, V. 1978. The rheology of synovial fluid and some potential synthetic lubricants for degenerate synovial joints. *Engineering in Medicine*, vol.7, no.2, p.66-72.
- 11 DAVIDSON, R.L. *Handbook of Water-Soluble Gums and Resins.* McGraw-Hill Book Company.
- 12 GRAVES, S., DAVIDSON, D. & INGERSON, L. 2002. *Australian Orthopaedic Association National Joint Replacement Registry.* Annual Report 2002. Adelaide:AOA.
- 13 GREGORY, D.J., HABERSTROH, K. & CHA, C.J. 1998. Comparison of the boundary-lubricating ability of bovine synovial fluid, lubricin and Healon. *Biomed Mater Res*, vol.40, p.414-418.

- 14 HARAGUCHI, K., SUGANO, N., NISHII, T., SAKAI, T., YOSHIKAWA, H. & OHZONO, K. 2001. Influence of polyethylene and femoral head surface quality on wear: A retrieval study. *International Orthopaedics*, vol.25, p.29-34.
- 15 HUTCHINGS, I.M. 1999. *Tribology: Friction and wear of engineering materials*, Fifth impression, London: Edward Arnold.
- 16 INTERNATIONAL STANDARD, 2002. *Implants for surgery – Wear of total hip-joint prostheses Part1: Loading and displacement parameters for wear-testing machines and corresponding environmental conditions for test*. (ISO 14242-1:2002).
- 17 JACOBSON, A. 2003. Biotribology: The tribology of living tissues. *Tribology & Lubrication Technology*, vol.59, no.12, p.32-38.
- 18 KATZBAUER, B. 1998. Properties and applications of Xanthan gum. *Polymer Degradation and Stability*, vol.59, p.81-84.
- 19 KESTERIS, U., HARDINGE, K., ILCHMANN, T. & WINGSTRAND, H. 2003. Polyethylene wear in prosthetic hips with loose components. *The Journal of Arthroplasty*, vol.18, no.1, p.10-15.
- 20 LAURENT, T.C. & FRASER, J.R.E. 1992. Hyaluronan. *The FASEB Journal*, vol. 6.
- 21 LU, Z. & MCKELLOP, H. 1997. Frictional heating of bearing materials tested in a hip joint wear simulator. *Proc Instn Mech Engrs*, vol.211, no.H, p.101-107.
- 22 MALCHAU, H., HERBERTS, P., GARELLICK, G., SÖDERMAN, P. & EISLER, T. 2002. *Prognosis of Total Hip Replacement*. Scientific exhibition presented at the 69th annual meeting of the American Academy of Orthopaedic Surgeons, February 13-17, 2002, Dallas, USA.
- 23 MAZZUCCO, D., MCKINLEY, G., SCOTT, R.D. & SPECTOR, M. 2002. Rheology of joint fluid in total knee arthroplasty patients. *Journal of Orthopaedic Research*, vol.20, p.1157-1163.
- 24 MCKELLOP, H., SHEN, F., LU, B., CAMPBELL, P. & SALOVEY, R. 2000. Effect of sterilization Method and Other Modifications on the Wear Resistance of Acetabular Cups Made of Ultra-High Molecular Weight Polyethylene: A Hip-Simulator Study. *The Journal of Bone and Joint surgery*, vol.82, no.A12, p.1708-1725.

- 25 O'KELLY, J., UNSWORTH, A., DOWSON, D., HALL, D.A. & WRIGHT, V. 1978. A study of the role of synovial fluid and its constituents in the friction and lubrication of human hip joints. *Engineering in Medicine*, vol.7, no.2, p.73-83.
- 26 OONISHI, H., KUNO, M., TSUJI, E. & FUJISAWA, A. 1997. The optimum dose of gamma radiation-heavy doses to low wear polyethylene in total hip prostheses. *Journal of Material Science: Materials in Medicine*, vol.8, p.11-18.
- 27 PAUL, J.P. 1976. Loading on normal hip and knee joints and on joint replacement. *Engineering in Medicine*, vol.2, p.53-70.
- 26 ROWETT, H.G.Q. 1973. *Basic anatomy and physiology*. Second edition. Norwich: Jarrold & Sons Ltd.
- 27 SAIKKO, V., AHLROOS, T., CALONIUS, O. & KERÄNEN, J. 2001. Wear simulation of total hip prostheses with polyethylene against CoCr, alumina and diamond-like carbon. *Biomaterials*, vol.22, p.1507-1514.
- 28 SOKOLOFF L. 1978. *The joints and synovial fluid Volume I*. Academic Press Inc. ISBN 0 12 655101 4.
- 29 SUTTIE, J.W. 1972. *Introduction to Biochemistry*. Holt Rinehart and Winston Inc.
- 30 TIPPER, J.L., FIRKINS, P.J., BESONG, A.A., BARBOUR, P.S.M., NEVELOS, J., STONE, M.H., INGHAM, E. & FISHER, J. 2001. Characterisation of wear debris from UHMWPE on zirconia ceramic, metal-on-metal and alumina ceramic-on-ceramic hip prostheses generated in a physiological anatomical hip joint simulator. *Wear*, vol.250, p.120-128.
- 31 UNSWORTH A. 1995. Recent developments in the tribology of artificial joints. *Tribology International* , vol.28, no.7, p.485-495.
- 32 WANG, A., ESSNER, A., STARK, C. & DUMBLETON, J.H. 1995. Comparison of the size and morphology of UHMWPE wear debris produced by a hip joint simulator under serum and water lubricated conditions. *Biomaterials*, vol.17, p.865-871.

Appendix A – Bilateral Patient

The lubricity test results shown in this section of the report are for a 54-year-old patient that had undergone a bilateral hip replacement.

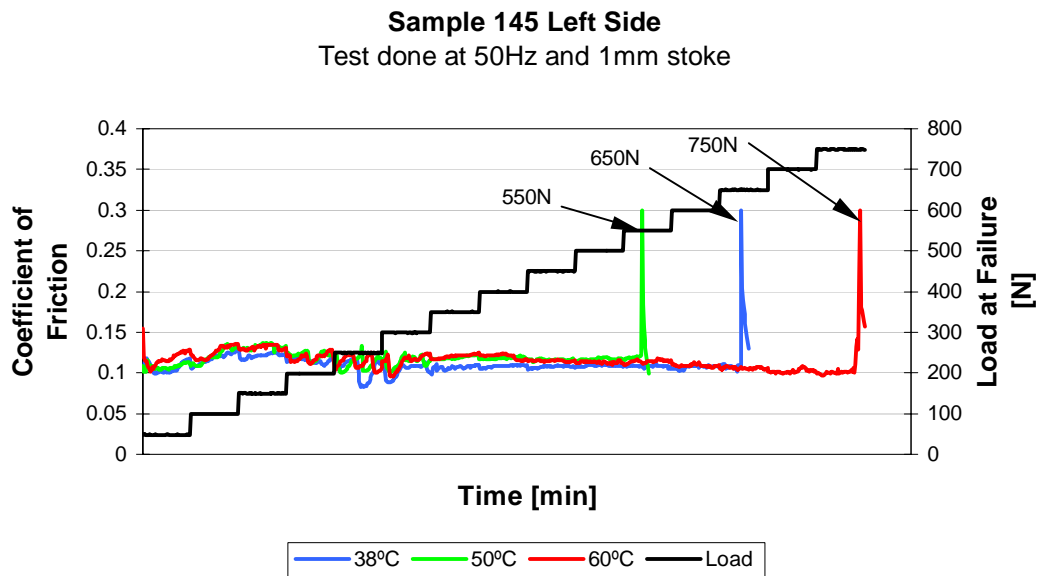

Figure A.1 – The lubricity test results for the left side of the bilateral patient. The loads at failures found were 650N, 550N and 750N for 38°C, 50°C and 60°C respectively.

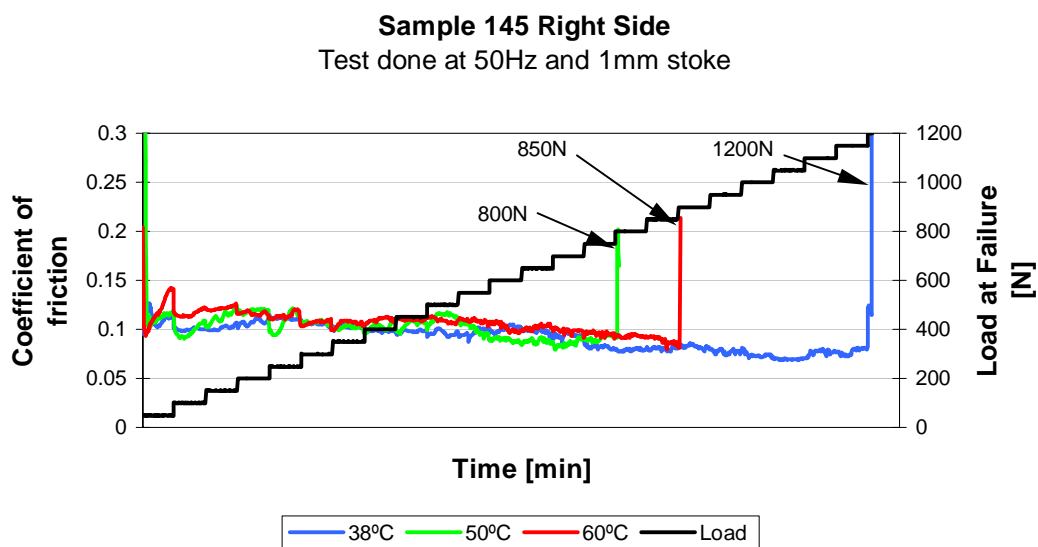

Figure A.2 – The lubricity test results for the right side of the bilateral patient. The loads at failures found were 1200N, 800N and 850N for 38°C, 50°C and 60°C respectively.

Appendix B – Poloxamer 188

BASF South Africa (Pty.) Ltd.

Reg. No. 1964/0326/07

BASF

Head Office: P.O. Box 2801, Halfway House 1685. Telephone: (011) 254-2400 Fax: (011) 254-2431
852 Sixteenth Road, Midrand.

BRANCHES:
Cape Town
Durban
Port Elizabeth

Despatch Note/Packing Slip

Nº 19220

CONSIGNEE <i>Tersius Opperman</i> <i>University of Pretoria</i> <i>084 744 0911</i>		MAIL: Air <input type="checkbox"/> Sea <input type="checkbox"/>	DATE OF DESPATCH	
		FREIGHT: Air <input type="checkbox"/> Sea <input type="checkbox"/>	<i>20-05-03</i>	
		RAIL: Goods <input type="checkbox"/> Express <input type="checkbox"/>	METHOD OF TRANSPORT	
		OTHER:	<i>Collection</i>	
		PAID <input type="checkbox"/>	FREIGHT/POSTAGE	
TO PAY <input type="checkbox"/>				
REMARKS FOR LABLES OR DOCUMENTS				
No. & TYPE OF PACKAGES	CONTENTS & VALUE	MARKS No.	WEIGHT	
			NETT	GROSS
<i>1x white plastic bottle</i>	<i>Lutrol F68</i>	<i>lot 090001</i>		<i>500g</i>
ORDERED BY:	DATE	DEPT.	DANGEROUS CODES	
<i>R Mascher</i>	<i>20/5</i>	<i>M.E.</i>		
SIGNATURE				
<i>Roz Mascher</i>				
DATE:	PACKED BY:	RECEIPT No:	COSTS:	
	<i>T. OPPERMAN</i>	<i>UP</i>	<i>EM</i>	

BASF Aktiengesellschaft

BASF

Safety data sheet

according to 91/155/EEC

Page 1 of 3

BASF Safety data sheet
Date / revised: 23.03.2001
Product: LUTROL* F 68

ME 00387 (D/E)
version 3 01

(Print date: 26.09.2002)

1. Substance/preparation and company name

LUTROL* F 68

Company:

BASF Aktiengesellschaft
Unternehmensbereich Feinchemie
67056 Ludwigshafen
Telephone: 0621-60-46077
Telefax number: 0621-60-8607434

Emergency information:

BASF works fire brigade BASF Ludwigshafen
Telephone: 0621-60-43333
Telefax number: 0621-60-92664

2. Composition/information on ingredients

Chemical nature

Block copolymer, based on: polyoxyethylene, polyoxypropylene

CAS-No. 9003-11-6

EINECS-No. - | Polymer; starting
materials listed in: EINECS |

INCI-name: Poloxamer 188

3. Possible hazards

Advice on critical hazards to man and the environment: none

4. First aid measures

No special measures necessary.

5. Fire fighting measures

Suitable extinguishing media: water, dry extinguishing media, foam,
carbon dioxide (CO₂)

Special protective equipment: In case of fire, wear a self contained
breathing apparatus.

Further information: Dispose of fire debris and contaminated
extinguishing water in accordance with local regulations.

6. Accidental release measures

Personal precautions: No special measures necessary.

Methods for cleaning up: Sweep/shovel up.

7. Handling and storage

Handling

Protection against fire and explosion: Handle in accordance with good
industrial hygiene and safety practice.

BASF Safety data sheet
Date / revised: 23.03.2001
Product: LUTROL* F 68

ME 00387 (D/E)
version 3.01

Storage

Keep tightly closed in a dry and cool place.

8. Exposure controls and personal protection

Additional information on the lay-out of technical plant
(see 7)

Components with workplace control parameters
none

Personal protective equipment

Not necessary.

General safety and hygiene measures: The usual precautions for the handling of chemicals must be observed.

9. Physical and chemical properties

Form: beads, wax-like
Colour: white
Odour: faint specific odour

Change in physical state
Melting point/melting range: 52 'C

Flash point: 260 'C

Bulk density: 1055 kg/m3 (approx.)

Solubility in water: > 100 g/l

pH value: 5-7.5 (at 10 g/l H2O)

10. Stability and reactivity

Hazardous reactions: None provided product is correctly processed.

Hazardous decomposition products: None provided product is correctly processed.

11. Toxicological information

Acute toxicity

LD50/oral/rat: > 15000 mg/kg
LD50/dermal/rabbit: > 20000 mg/kg

Primary skin irritation/rabbit/OECD test: non-irritant
Primary mucous membrane irritation/rabbits' eyes/OECD test:
non-irritant

Other information

Ames-test: no mutagenic effect

12. Ecological information

BASF Safety data sheet
Date / revised: 23.03.2001
Product: LUTROL* F 68

ME 00387 (D/E)
version 3.01

Elimination information

Test method: adsorption test on activated sludge (BASF test)
Method of analysis: DOC reduction
Degree of elimination: 3% (DOC reduction)
Evaluation: hard to eliminate

Behaviour and environmental fate

Inhibition of degradation activity in activated sludge is not to be anticipated during correct introduction of low concentrations.

Ecotoxic effects

Toxicity to fish (acute):
Test method: OECD 203/ ISO 7346/ EEC 84/449/V, C.1
LC50/Brachydanio rerio/: >10000 mg/l/96h
LC0 (48 h): 10000mg/l

Toxicity to bacteria: Pseudomonas putida
Test method: DIN 38412 Part 8
EC10 (16 h): >10000mg/l
EC50 (16 h): >10000mg/l
EC90 (16 h): >10000mg/l

Further ecological information

No negative ecological effects are expected according to the present state of knowledge.

13. Disposal considerations

Product: Must be dumped or incinerated in accordance with local regulations.

14. Transport information

Not classified as hazardous under transport regulations.

15. Regulatory information

Labelling according to EEC Directives

Not subject to labelling.

National legislation/regulations

Water hazard class: 1 VwWwS (Germany) of 17.5.1999, Annex 3

16. Other information

A backslash in the left hand margin indicates an amendment from the previous version.

The information contained herein is based on the present state of our knowledge and does not therefore guarantee certain properties. Recipients of our product must take responsibility for observing existing laws and regulations.

BASF Aktiengesellschaft

BASF**Certificate of Analysis**

05/20/2003 10:21:52

BASF South Africa (PTY) Ltd

FAX NO 002727112542602

P.O. BOX 2801

2002-02-05
GKA/M320
Dr. Leyendecker
0621-60-45308
CERTIFICATE NO 1773
PAGE 1 OF 31685 MIDRAND
South Africa**INSPECTION CERTIFICATE 3.1 B ACCORDING TO EN 10204**

LUTROL F 68	ARTICLE NO	50001260
0,50kg PE-Bottle	PRODUCT NO	010293 01
Purchase Order/Customer Product#	COLLI NO	321 2372
50001260	LOT/NO	09000101
	LOT/QTY	1.000 KGE
	TOTAL	1.000 KGE

Schwermetalle / Heavy Metals	max. 20 mg/kg
Propylenoxid / Propylene Oxide (CGC)	<5 mg/kg
pH-Wert / pH-value 100g/l in Wasser / in water Ph.Eur.	7.0
Aussehen der Loesung/Appearance of solution 100g/l in water Ph.Eur.	Entspricht / conforms
1,4-Dioxan / 1,4-Dioxane (CGC)	<5 mg/kg
Ethylenoxid / Ethylene Oxide (CGC)	<1 mg/kg
APHA-Farbzahl / Color APHA (50/50 in CH3OH)	17 APHA
Identitaet / Identification (IR)	Entspricht / conforms
Identitaet / Identification (Hydroxylzahl / hydroxyl value)	Entspricht / conforms
Restloesemittel / residual solvents (Trocknungsverlust / loss on drying) Ph.Eur., class 3	0.2 g/100g
Ungesaetzigtheit / Unsaturation (Hg-acetat-Meth.)	0.028 meq/g
Molekulargewicht / Average Molecular weight	9048 g/mol

BASF Aktiengesellschaft

BASF**Certificate of Analysis**

05/20/2003 10:21:52

BASF South Africa (PTY) Ltd

FAX NO 002727112542602

P.O.BOX 2801

2002-02-05

1685 MIDRAND
South AfricaGKA/M320
Dr.Leyendecker
0621-60-45308
CERTIFICATE NO 1773
PAGE 2 OF 3**INSPECTION CERTIFICATE 3.1 B ACCORDING TO EN 10204**

LUTROL F 68	ARTICLE NO	50001260
0,50kg PE-Bottle	PRODUCT NO	010293 01
Purchase Order/Customer Product#	COLLI NO	321 2372
50001260	LOT/NO	09000101
	LOT/QTY	1.000 KGE
	TOTAL	1.000 KGE

pH-Wert / pH-value	6.7
25 g/l in Wasser / in water	
Wasser / Water	0.18 g/100g
(Karl- Fischer- Titration)	
Trübungspunkt / Cloud point	>100 Grad Celcius
100g/l in Wasser/ in water	
Butylhydroxytoluol /	110 mg/kg
Butylhydroxitoluene	
Polyoxyethylen-Gehalt /	82.0 g/100g
Weight percent oxyethylene	
Asche / total ash	0.1 g/100g
Restloesemittel / Residual solvents	<50 mg/kg
(Ethylenglykol / Ethyleneglycol)	
Ph.Eur., Class 2	

Andere im USP/NF genannte fluechtige organische Verunreinigungen (Benzol, Chloroform, Methylenchlorid, Trichlorethylen) sind synthesebedingt nicht enthalten.
Nur die Restloesemittel Ethylenglykol und 1,4-Dioxan der Klasse 2 und Restloesemittel der Klasse 3 des Ph.Eur. 3.Ed Supplem.2000 koennen enthalten sein. Die Konzentrationen der Klasse 2 liegen unterhalb der im Ph.Eur., Kapitel 5.4 genannten Grenzwerte und der Gehalt an Klasse 3 liegt unterhalb 0,5 %.

Other organic volatile impurities cited in USP/NF (Benzene, Chloroform, Methylene Chloride, Trichloroethylene) are not present due

BASF Aktiengesellschaft

BASF**Certificate of Analysis**

05/20/2003 10:21:52

BASF South Africa (PTY) Ltd

FAX NO 002727112542602

P.O.BOX 2801

2002-02-05
GKA/M320
Dr.Leyendecker

.../qzform.py?Vorgangsart=CoA-Show&Registriernummer=2002020501773&Formular- 20/05/2003

1685 MIDRAND
South Africa

0621-60-45308
CERTIFICATE NO 1773
PAGE 3 OF 3

INSPECTION CERTIFICATE 3.1 B ACCORDING TO EN 10204

LUTROL F 68	ARTICLE NO	50001260
0,50kg PE-Bottle	PRODUCT NO	010293 01
Purchase Order/Customer Product#	COLLI NO	321 2372
50001260	LOT/NO	09000101
	LOT/QTY	1.000 KGE
	TOTAL	1.000 KGE

to synthesis.
Only class 2 solvents ethylene glycol and 1,4-dioxane and class 3 solvents of EP 3.Ed Supplem.2000 are likely to be present. The concentrations of class 2 solvents are below the limits given in EP, chapter 5.4. and class 3 solvents are below 0,5 %.

Das Produkt erfuehlt die Anforderungen der Monographie Poloxamer des NF 19 und EP 3.Ed.
The product meets the requirements of the monograph poloxamer of NF 19 and EP 3.Ed.

QS-Referenz-Nr. / QC-Reference-No.	01C05577
Analysiert am / Analyzed on	27.07.2001
Mindestens haltbar bis / Best before	07.2003

BASF Aktiengesellschaft

GKA Analytik

Qualitaetskontrolle / Quality Control

gez. / sig. H.Fischer

Dieses Abnahmepruefzeugnis wurde maschinell erstellt und ist ohne Unterschrift gueltig.

This Certificate of Analysis has been produced electronically and is valid without signature.

Appendix C – Lube-Booster II



LUBE-BOOSTER® II

I. PRODUCT DESCRIPTION

LUBE-BOOSTER® II is a water soluble, polymer based lubricity additive for formulating synthetic and semi-synthetic fluids for ferrous and non-ferrous applications. It is used in diversified operations including general purpose machining, multi-metal machining, and especially in combination with EM-706 in drawing, stamping and machining of aluminum alloys.

II. TYPICAL PROPERTIES

PROPERTY	TYPICAL VALUE
Active, %	95
Water, %	5
Appearance, 77°F (25°C)	Clear
Appearance, 36°F (2°C)	Opaque
Viscosity, SUS @ 100°F (37.8°C)	2,300
Color, ASTM	4
Specific Gravity, 77°F (25°C)	1.00
Flash Point, COC, °F (°C)	>375 (>191)
Acid Number, mg KOH/g	65
Base Number, mg KOH/g eq.	76
pH, 2.5% (Buffer 7.0)	8.1
Temperature Stability (36°F, 130°F)	Reconstitutes itself @ R.T.
Refractive Index, 77°F (25°C)	1.4734

Ferro Corporation - Petroleum Additives, 3000 Sheffield Avenue, Hammond, Indiana 46327 (219) 931-2630 • FAX (219) 931-0895

The technical information set forth above and any product description thereon being delivered subject to the following terms and conditions: 1. The technical information set forth above is presented in good faith to assist you in evaluating the product. It is intended for use by persons having technical skill at their own discretion and risk and is furnished with the express condition that you will make your own tests to determine the suitability of the product for your particular use. No warranty is knowingly expressed or implied is given by Ferro Corporation with respect to such technical information NOR IS ANY GUARANTEE OR WARRANTY EXPRESSED OR IMPLIED, INCLUDING ANY IMPLIED WARRANTIES OR CONDITIONS OF MERCHANTABILITY OR FITNESS FOR A PARTICULAR PURPOSE, GIVEN BY FERRO CORPORATION WITH RESPECT TO THE PRODUCT OR ITS USE. 2. This technical information is not intended as a method to operate under, or a recommendation to attempt, any patent covering the product, any process incorporated in the product or use of the product. 3. Where the product is described in experimental or quality specifications they will not be fully determined by your analysis of materials and cannot be held as evidence of such product. A mandatory and Ferro Corporation shall not be held responsible or liable for these specific hazards resulting from the handling or use of the product, and (1) Ferro Corporation, in its sole discretion reserves the right to change specifications at any time and/or the original production with respect to the product. 4. The terms and conditions set forth herein shall govern and control any terms or conditions set forth in any other literature, including Ferro Corporation's conditions of sale and your order. Any sale or delivery of the product described in the technical information set forth above is expressly conditioned upon your assent to these terms and conditions. This written document has been assented to these terms and conditions unless you notify Ferro Corporation in writing of your objection within five (5) days of your receipt of this issue.



III. PERFORMANCE PROPERTIES

FOAMING

LUBE-BOOSTER® II at 1% in tap water (8 grains/gallon) exhibits low foaming properties; foam formed after shaking in a glass cylinder is unstable and breaks within 5 seconds.

COMPATIBILITY WITH VARIOUS METALS¹

Cold rolled steel ² SAE 100	Pass
Aluminum 2024T4	Pass
1 1/2 side galvanized steel ³	Stain ⁴
Copper	Stain ⁴

¹ 1% **LUBE-BOOSTER® II** in tap water (8 grains/gal), 24 hrs @ 100°F

² Q-Panel Co

³ 1 1/2 hot dip galvanized G 60/AOI Chrysler Control & Audit Panel, Advanced Coating Technology Co.

⁴ Likely to be caused by free amine present in the product; suitable inhibitor should be included in formulations intended for galvanized steel and copper applications.

RESIDUE

LUBE-BOOSTER® II, after 16 hours at 130°F (54.4°C), remains a smooth, flowable liquid.

HARD WATER STABILITY

LUBE-BOOSTER® II has moderate hard water stability.

Ferro Corporation - Petroleum Additives, 3000 Sheffield Avenue, Hammond, Indiana 46327 (219) 931-2630 - FAX (219) 931-0895

The technical information set forth above and any product described herein are being delivered subject to the following terms and conditions: 1. The technical information set forth above is presented as good faith to assist you in evaluating the product. It is intended for use by persons having technical skill at their own discretion and risk and is furnished with the express condition that you will make your own tests to determine the suitability of the product for your particular use. No liability or warranty is given by Ferro Corporation with respect to such technical information, NOR IS ANY GUARANTEE OR WARRANTY EXPRESSED OR IMPLIED, INCLUDING ANY IMPLIED WARRANTY OF MERCHANTABILITY OR FITNESS FOR A PARTICULAR PURPOSE GIVEN BY FERRO CORPORATION WITH RESPECT TO THE PRODUCT OR ITS USE. 2. This technical information is not intended as a basis for operation unless of a recommendation to change any patent covering the product, any material incorporated in the product or use of the product. 3. Where the product is described as being new, its quality specifications may not be fully determined. If your analysis of material and condition of handling and use of such product is mandatory and Ferro Corporation does not guarantee or warrant that there are no hazards relating to the handling or use of the product, and/or Ferro Corporation in its sole discretion reserves the right to change specifications and/or discontinue production with respect to the product. 4. The terms and conditions set forth herein shall govern and control any terms or conditions set forth in any other documents, including Ferro Corporation's Customer Notice and your order. Any sale or delivery of the product described in the technical information set forth above is expressly conditional upon your agreement to these terms and conditions. You will be deemed to have assented to these terms and conditions, unless you notify Ferro Corporation in writing of your objection within five (5) days of your receipt of the data.



ENVIRONMENTAL DATA

Effluent Concentration at:

	0.1%	1.0%
BOD (5 day, mg/l)	827	9,800
COD (mg/l)	2,030	20,500
Ratio BOD:COD	1:3*	1:2*
TOC (mg/l)	360	1,270
Freon Extractables (mg/l)	250	1,270

- Biodegradable

ECOLOGICAL PROFILE

LUBE-BOOSTER® II utilizes straight-chain chemistry in order to preserve a biodegradable profile. BOD:COD ratios of less than 1:3 are generally preferred to achieve biodegradability. Use of double and triple bonded chemistries are minimal to nil in order to accommodate degradation. TOC values show a low organic load which minimizes impact on the industrial effluent and improves the likelihood of compatibility with traditional waste-treatment schemes currently in place. **LUBE-BOOSTER® II** is compatible with most publicly owned waste treatment (POWT) systems. Freon extractables indicate low values at typical effluent concentrations. **LUBE-BOOSTER® II** does not contain nitrite, chlorine, sulfur, phosphorous, heavy metals or petroleum oil.

IV. APPLICATION INFORMATION

IN FORMULATING PRODUCT

Lubricity additive for formulating machining fluids on ferrous and non-ferrous metals (4-8%); lubricity additive for synthetic drawing compounds on ferrous and non-ferrous metals (6-12%).

TANK-SIDE ADDITION

In heavy-duty applications, where high lubricity and excellent surface finish are required, **LUBE-BOOSTER® II** can be added directly to the machine tank, "tank side." The required amount should be determined experimentally.

Ferro Corporation - Petroleum Additives, 3000 Sheffield Avenue, Hammond, Indiana 46327 (219) 931-2630 • FAX (219) 931-0885

The technical information set forth above and any product described herein are being delivered subject to the following terms and conditions: 1. The technical information set forth above is unclassified or good faith to assist you in evaluating the product. It is intended for use by persons having technical skill at their own discretion and risk and is furnished with the express condition that you will make your own tests to determine the suitability of the product for your particular use. No warranty or warranty expressed or implied is given by Ferro Corporation, with respect to such technical information, NOR IS ANY GUARANTEE OR WARRANTY EXPRESSED OR IMPLIED, INCLUDING ANY IMPLIED WARRANTY OF MERCHANTABILITY OR FITNESS FOR A PARTICULAR PURPOSE, GIVEN BY FERRO CORPORATION WITH RESPECT TO THE PRODUCT OR ITS USE. 2. This technical information is not intended as a license to operate under, or a recommendation to infringe, any patent covering the product, any process incorporated in the product or use of the product. 3. Where the product is described as experimental, its quality specifications may not be fully determined. 4. Your analysis of hazards and caution in handling and use of such product is mandatory and Ferro Corporation does not guarantee or warrant that there are no hazards relating to the handling or use of the product, and; (c) Ferro Corporation in its sole discretion reserves the right to change specifications and/or production with respect to the product. 4. The terms and conditions set forth herein shall govern and control any terms or conditions set forth in any other document, including Ferro Corporation's customary invoice and your order. Any sale or delivery of the product described in the technical information set forth above is expressly conditioned upon your agree to these terms and conditions. You will be deemed to have assented to these terms and conditions unless you notify Ferro Corporation in writing of your objection within ten (10) days of your receipt of this form.



V. HANDLING AND STORAGE

Store in closed, original container at 40°-100°F. Exposure to temperatures in excess of 150°F can cause darkening of the product.

VI. PACKAGING INFORMATION

Available in 440 lb (200 kg) net new, lined steel drums, bulk rail and truck quantities.

10/96

Ferro Corporation - Petroleum Additives, 3000 Sheffield Avenue, Hammond, Indiana 46327 (219) 931-2630 • FAX (219) 931-0895

The technical information set forth above and any product described therein are being delivered subject to the following terms and conditions: 1. The technical information set forth above is presented in good faith to assist you in evaluating the product. It is intended for use by persons having technical skill at their own discretion and risk and is furnished with the express condition that you will make your own tests to determine the suitability of the product for your particular use. No quantity or warranty expressed or implied is given by Ferro Corporation with respect to such technical information. **THIS IS ANY GUARANTEE OR WARRANTY EXPRESS OR IMPLIED, INCLUDING ANY IMPLIED WARRANTY OF MERCHANTABILITY OR FITNESS FOR A PARTICULAR PURPOSE GIVEN BY FERRO CORPORATION WITH RESPECT TO THE PRODUCT OR ITS USE.** 2. This technical information is not intended as a license to operate under, or a recommendation to, or a right, any patent covering the product, any material incorporated in the product or use of the product. 3. Where the product is described as experimental, all quality specifications may not be fully observed. 4) your analysis of hazards and caution in handling and use of such product is mandatory and Ferro Corporation does not guarantee or warrant that there are no hazards relating to the handling or use of the product, and c) Ferro Corporation in its sole discretion reserves the right to change specifications and/or discontinue production with respect to the product. 4. The terms and conditions set forth herein shall govern and control any terms or conditions set forth in any other document, including Ferro Corporation's customary invoice and your order. Any sale or delivery of the product, described in the technical information set forth above is expressly conditioned upon your assent to these terms and conditions. You will be deemed to have assented to these terms and conditions unless you notify Ferro Corporation in writing of your objection within five (5) days of your receipt of this form.